

The wide-field telescopes for NEO surveillance of the GAL Hassin astronomical center

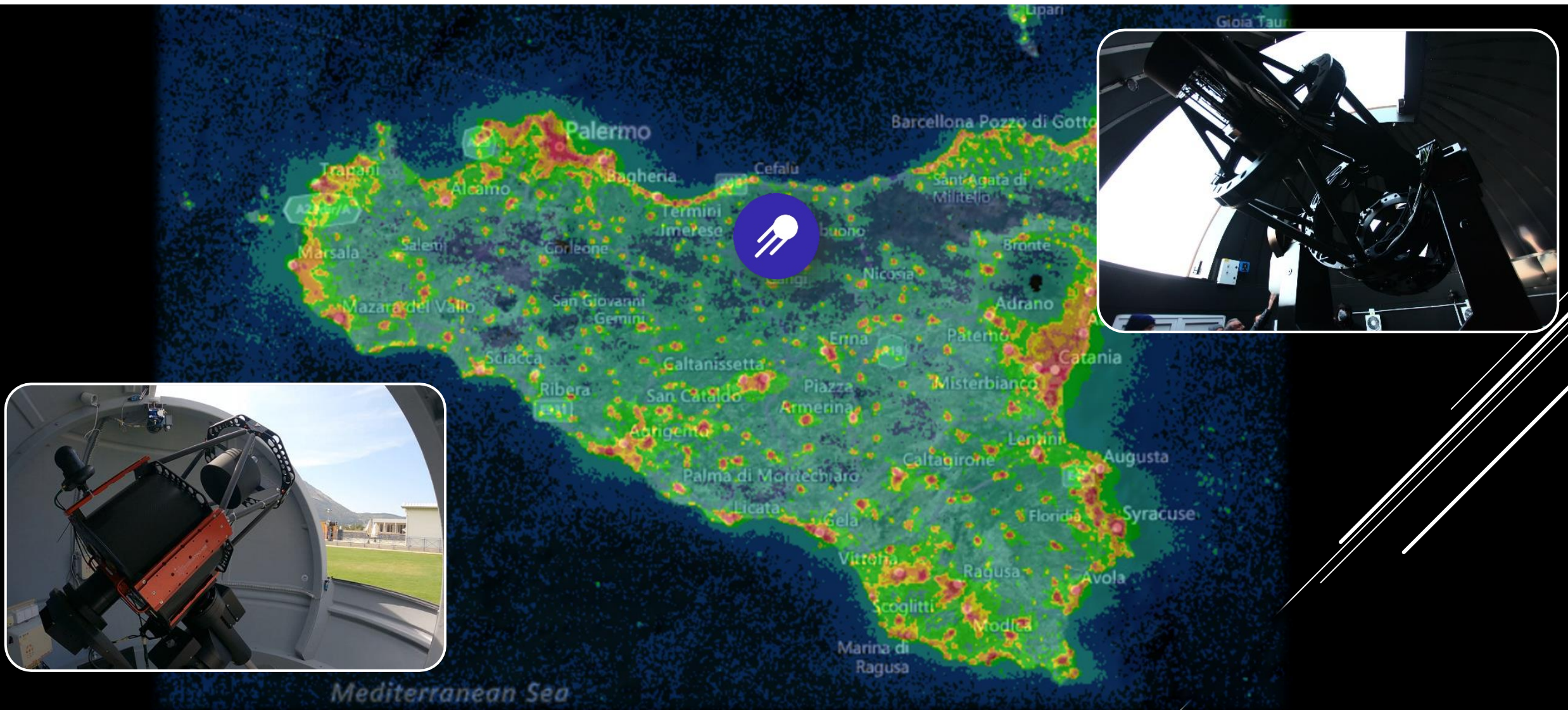

The GAL Hassin facilities for NEO monitoring

- Excellent night sky conditions (median annual seeing **~1.5 arcsec**).
- Very low **light pollution**.
- **>200 clear nights/year** (~60%).
- Low **latitude** (~38°).

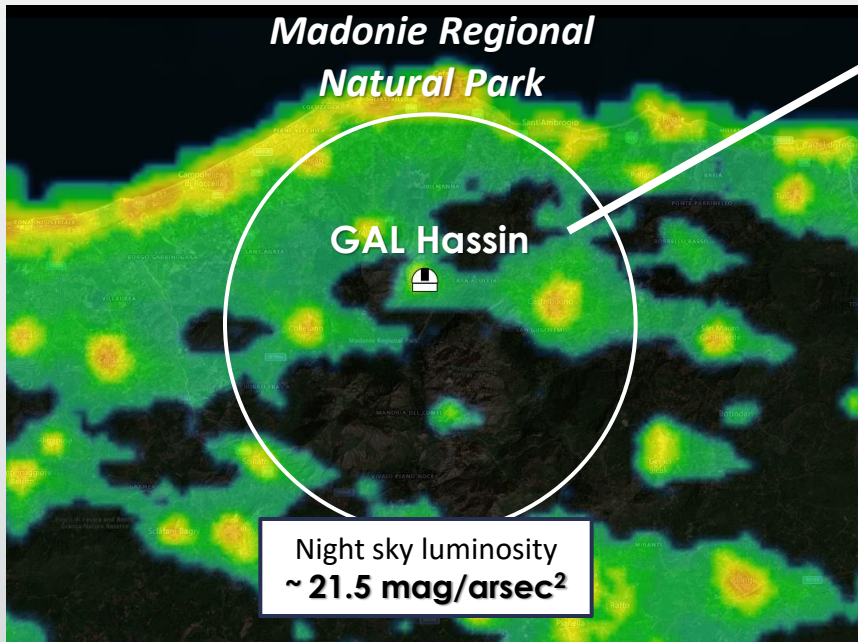

Sicily light pollution map (2023)
Source: <https://www.lightpollutionmap.info>



The GAL Hassin facilities for NEO monitoring

- Excellent night sky conditions (median annual seeing ~**1.5 arcsec**).
- Very low **light pollution**.
- **>200 clear nights/year** (~60%).
- Low **latitude** (~38°).

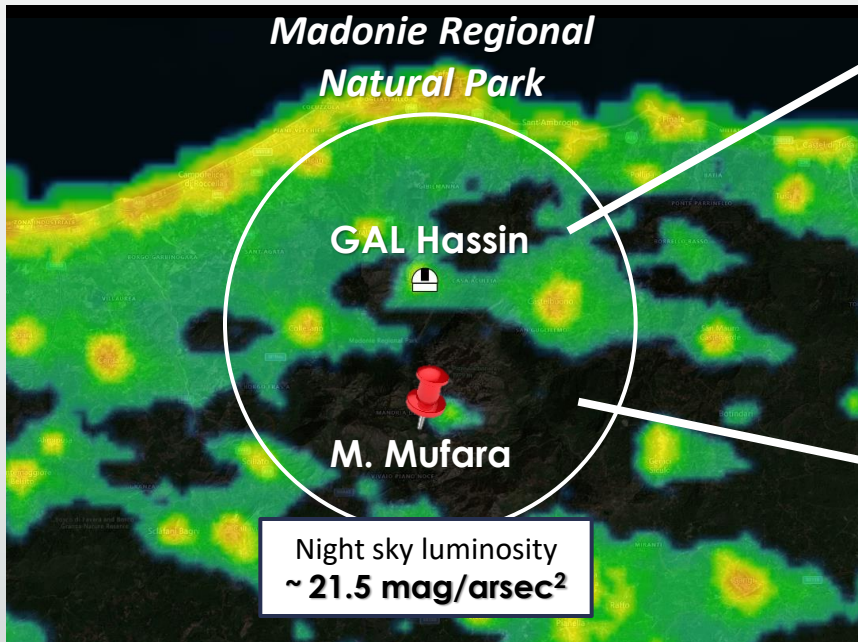

Sicily light pollution map (2023)
Source: <https://www.lightpollutionmap.info>

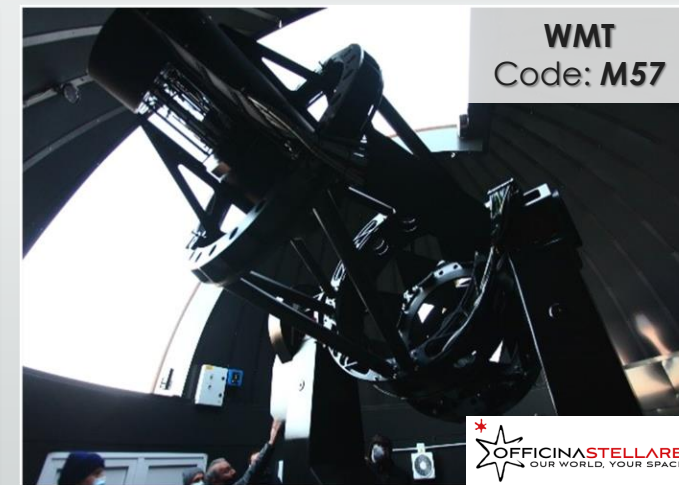

The GAL Hassin facilities for NEO monitoring – Galhassin Robotic Telescope (GRT – L34)

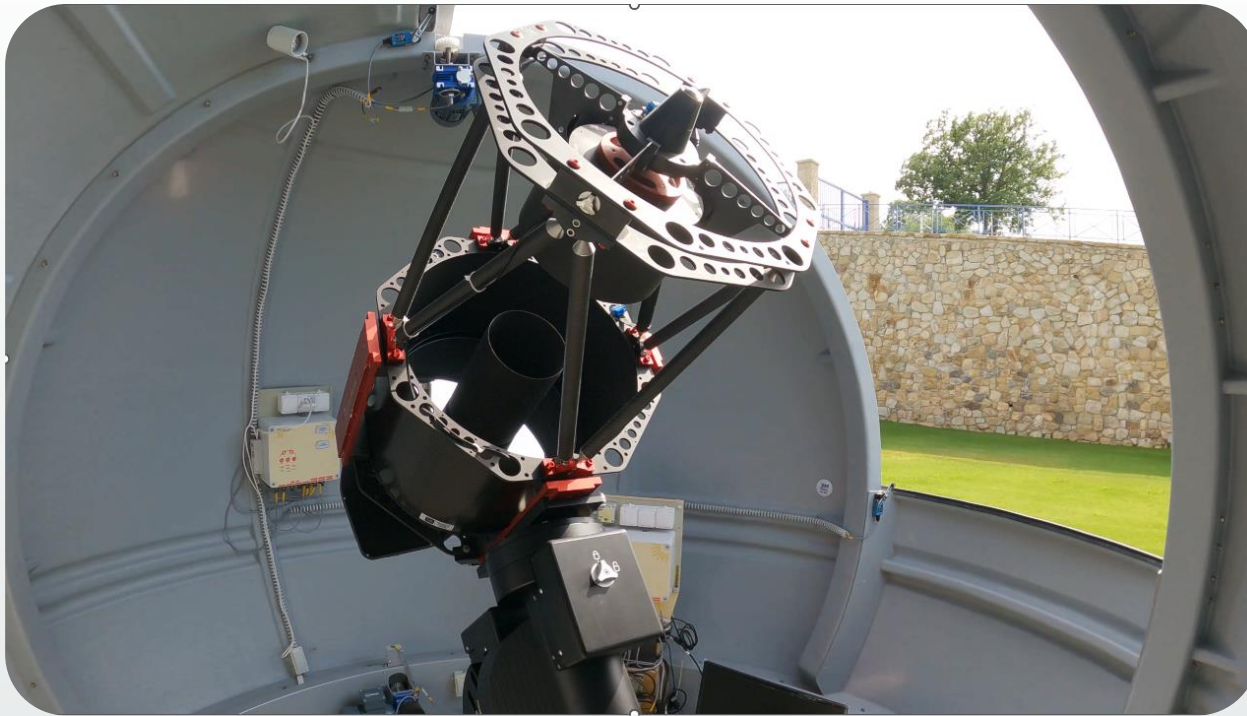

- **Officina Stellare RC telescope, 40 cm aperture, $f/D=3.8$.**
- **Camera sCMOS Moravian C4-16000, 4k x 4k pixels (2024).**
- **Wide field of view (1.5 deg^2).**
- **Fast equatorial mount 10 micron 3000 HPS.**
- **GPS time synchronization system (accuracy $\sim 0.1 \text{ sec}$).**
- **Fully remotely controlled.**

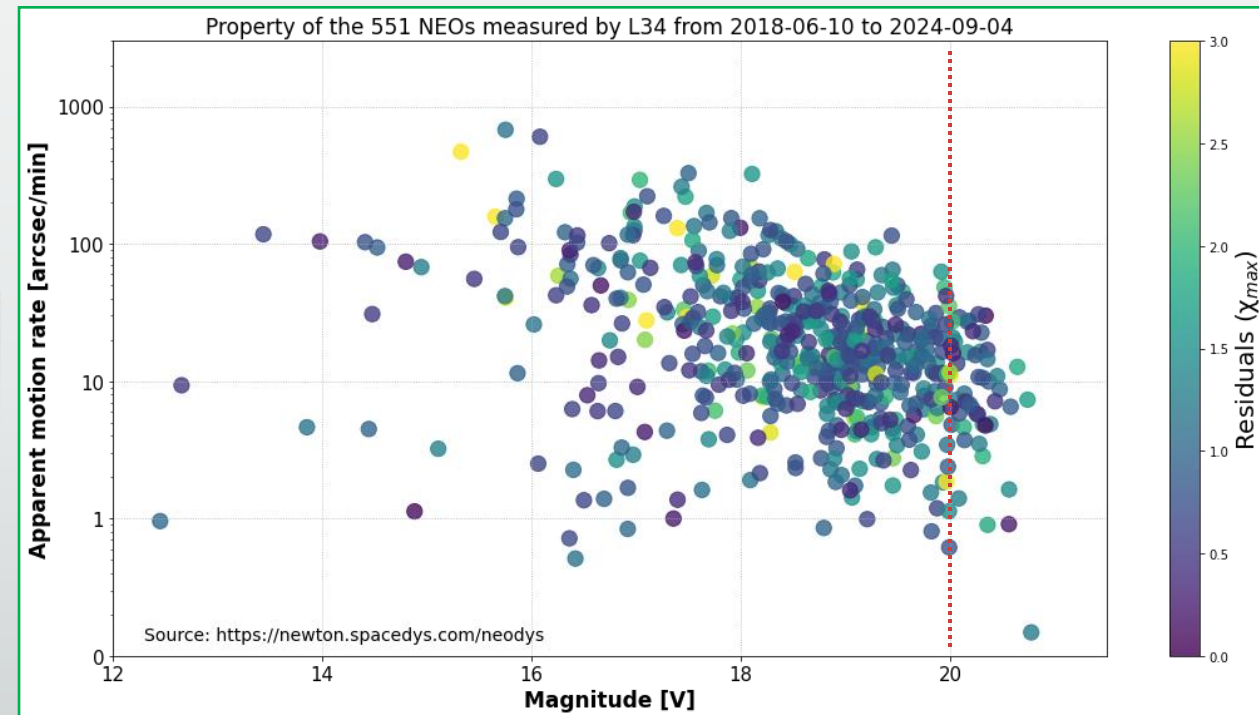

The GAL Hassin facilities for NEO monitoring – Galhassin Robotic Telescope (GRT – L34)

Number of NEO and NEOCPs observed by L34

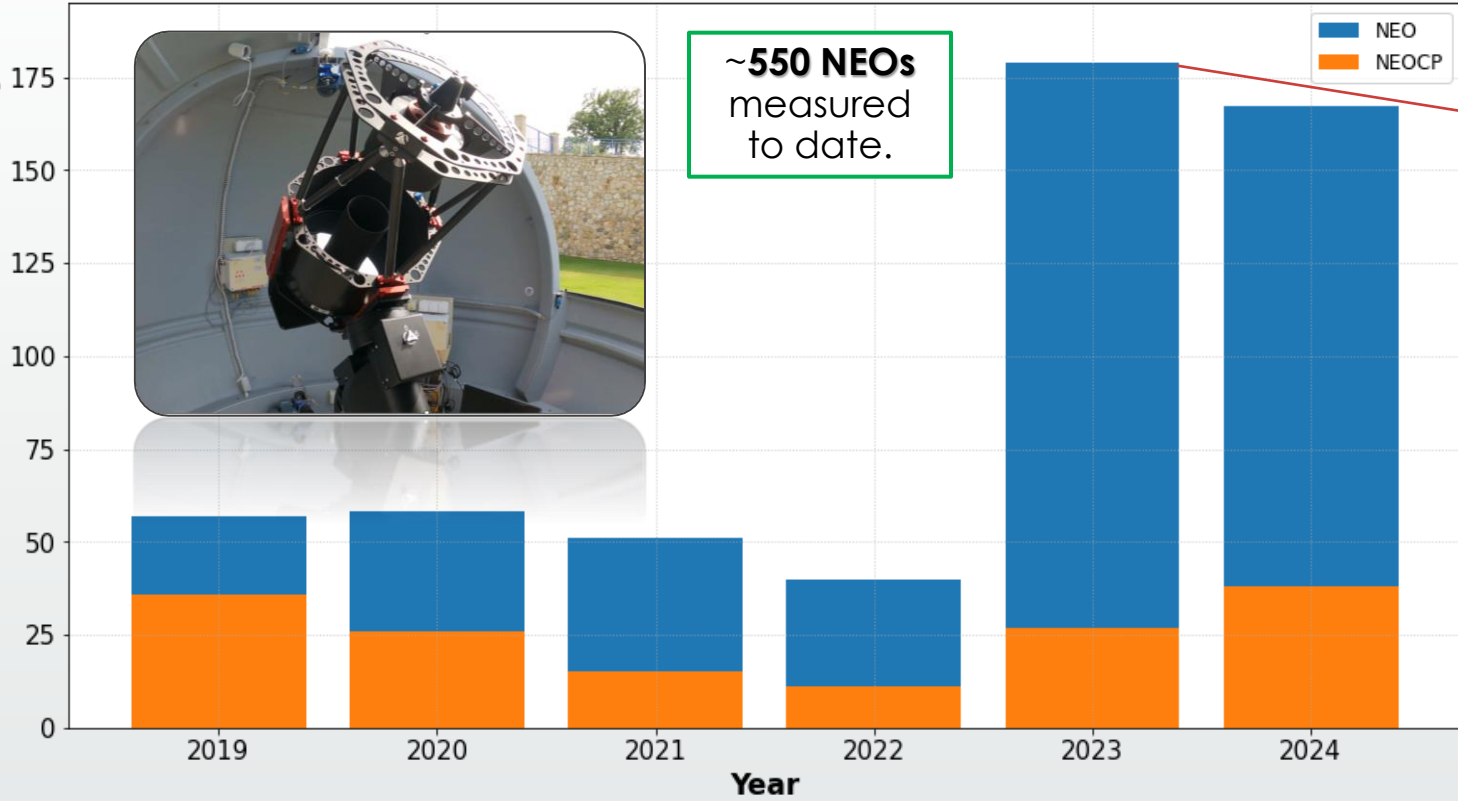

2023: the GRT gets 100% automated.

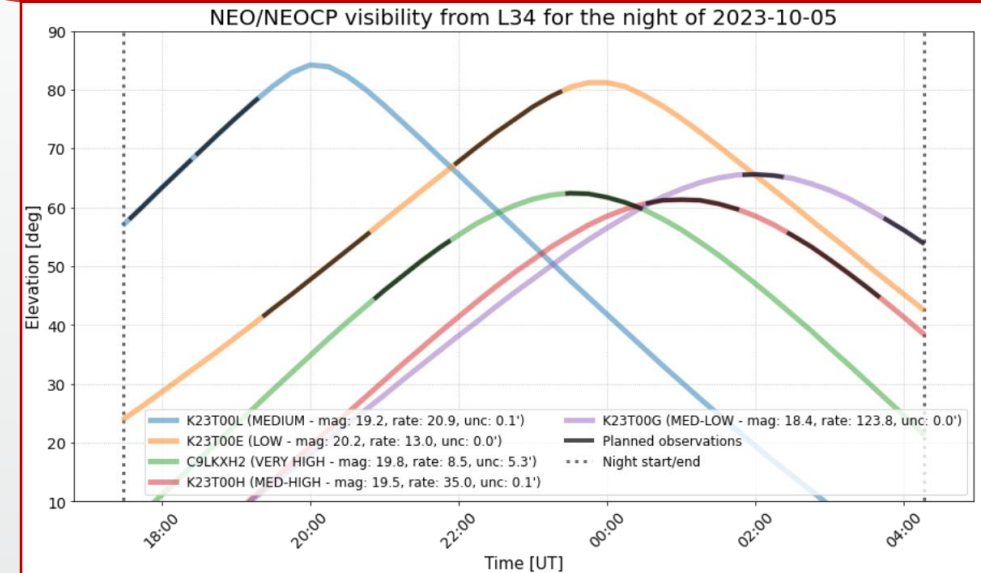

```
[16:31:07] Connecting camera.
[16:31:08] Set BINNING = 2x2
[16:31:16] Connecting TheSkyX - Scope.
[16:31:17] Unparking mount.
[16:31:17] Observing target K24A02E - set1 at 2024-01-16 17:15:00 ...
[16:31:17] Start cooling camera (T:-30°C) at 2024-01-16 17:10:00 (start in 2322 sec) ...
[17:10:01] Cooling camera at T:-30°C.
[17:10:06] Connecting Dome - Scope.
[17:10:06] Slewing to target
Slewing to RA(J2000)=02:56:00.28, DEC(J2000)=+38:24:55.50 ...
[17:10:15] Waiting 293 sec to start observing ...
[17:15:11] NEOfixer report status 'observing' for target K24A02E sent.
[17:15:11] Taking 247 x 13sec frames: 100% ██████████ 247/247 [1:16:21<00:00, 18.55s/it]
[18:31:33] NEOfixer report status 'observed' for target K24A02E sent.
[18:31:33] Moving FITS files into folder: C:/Users/control_GRT/Desktop/GRT_images/gennaio_16_2024/K24A02E/set1
[18:31:35] Observing target K24A02E - set2 at 2024-01-16 18:35:00 ...
[18:31:35] Slewing to target
Slewing to RA(J2000)=02:55:55.70, DEC(J2000)=+38:39:34.35 ...
[18:31:35] Waiting 204 sec to start observing ...
[18:35:02] NEOfixer report status 'observing' for target K24A02E sent.
[18:35:02] Taking 247 x 13sec frames: 100% ██████████ 247/247 [1:16:19<00:00, 18.54s/it]
[19:51:22] NEOfixer report status 'observed' for target K24A02E sent.
```

NEODyS-2

NEOfixer



The GAL Hassin facilities for NEO monitoring – **Wide-field Mufara Telescope (WMT – M57)**

- **Prime-focus** telescope.
- **1 meter** aperture.
- Low focal ratio **$f/D = 2.1$** .
- Field of view: **2.5 x 2.5 deg**, corrected with five lenses.
- **$V_{lim} \sim 21$ in 60 sec** (Clear filter).

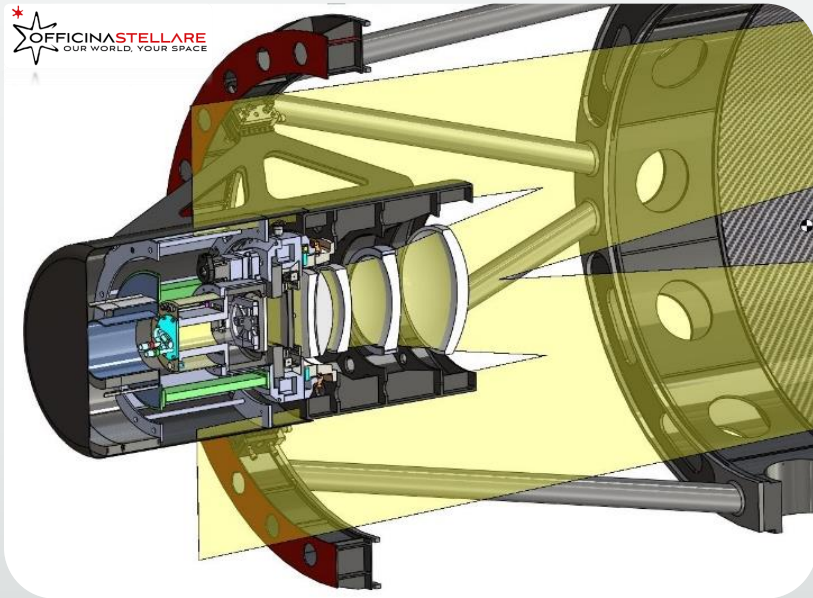

9k x 9k 10 μ m pixels,
cryocooled, >90% QE
CCD camera (scale: **1''/px**).

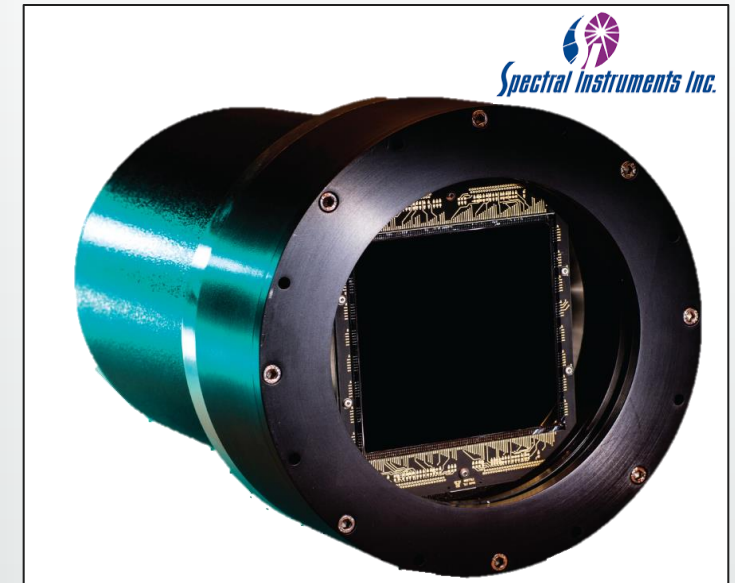

The GAL Hassin facilities for NEO monitoring – **Wide-field Mufara Telescope (WMT – M57)**

- **Prime-focus** telescope.
- **1 meter** aperture.
- Low focal ratio **$f/D = 2.1$** .
- Field of view: **2.5×2.5 deg**, corrected with five lenses.
- **$V_{lim} \sim 21$ in 60 sec** (Clear filter).

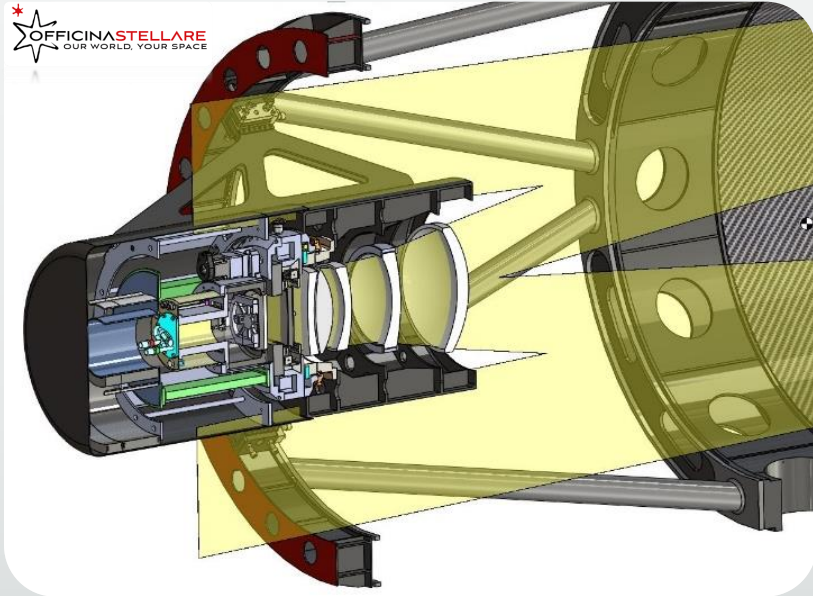

9k x 9k 10 μ m pixels,
cryocooled, >90% QE
CCD camera (scale: **1''/px**).

Equipped with **Sloan**
(**g' , r' , i' , z'**) and Clear **filters**.

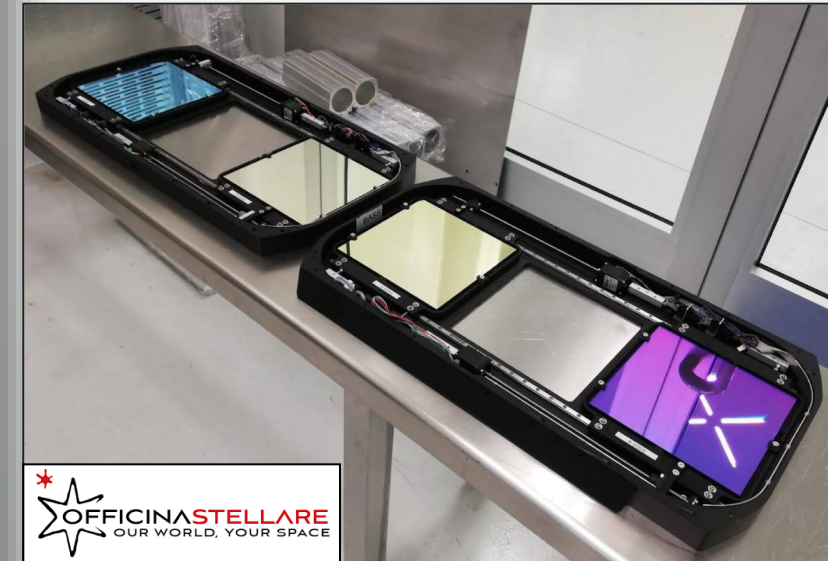

The GAL Hassin facilities for NEO monitoring – **Wide-field Mufara Telescope (WMT – M57)**

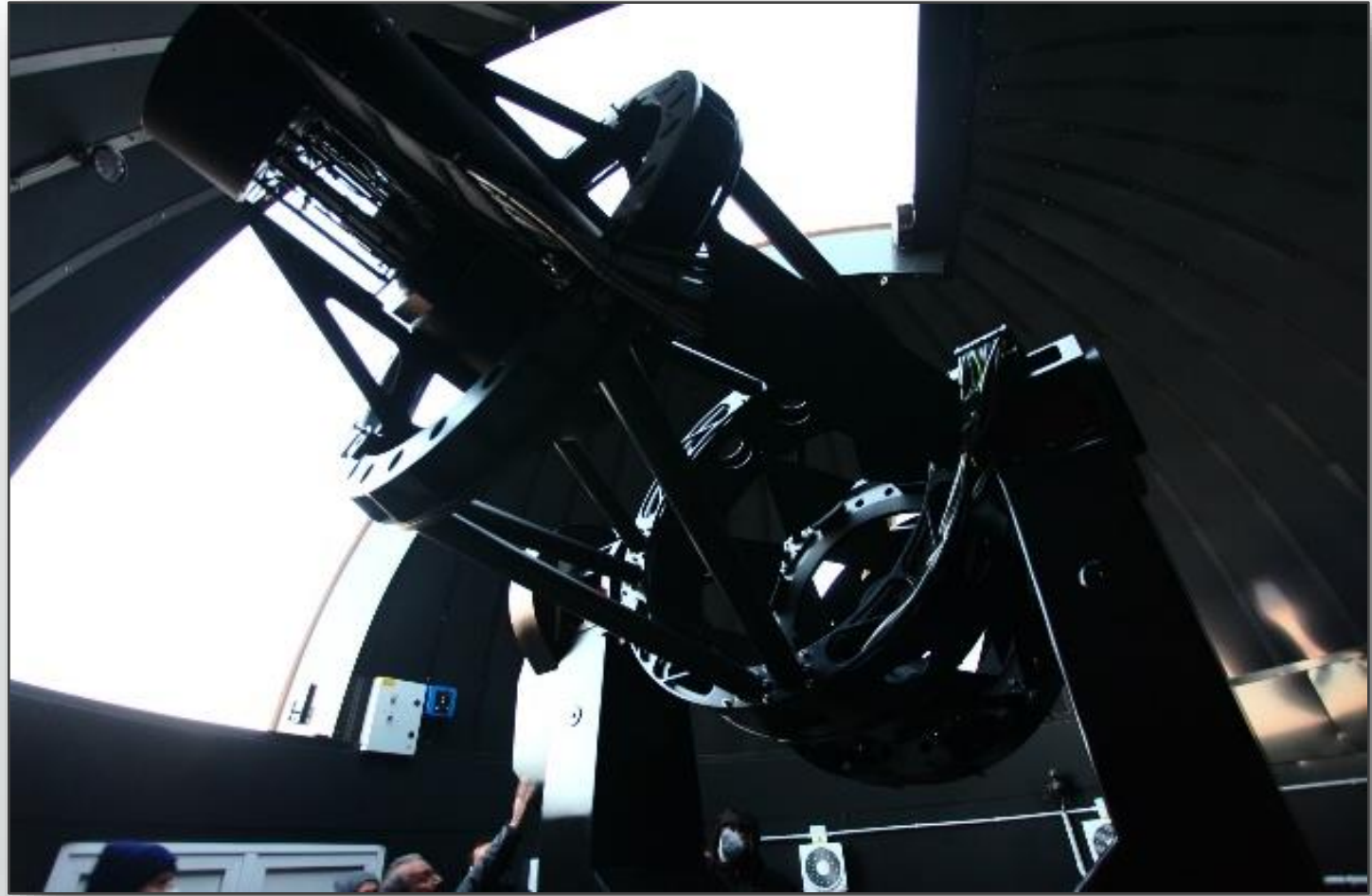

- Installed on **M. Mufara** (1865 m altitude)
- Commissioning phase **completed** in June 2023.
- IAU observatory code: **M57** (Aug. 2023).
- **Remotely controlled** since July **2024**.

The GAL Hassin facilities for NEO monitoring – **Wide-field Mufara Telescope (WMT – M57)**



Min. declination: **-40 deg**
Min. solar elongation: **~ 30 deg**



The GAL Hassin facilities for NEO monitoring – Wide-field Mufara Telescope (WMT – M57)

PermID: 58641
 ProvID: 1997 WX20
 TrkSub:
 Speed: 0.981"/min
 PA: 119.2 deg

Main belt asteroid (58641)
 Magnitude V ~ 20.4
 Solar elongation: **29.6 deg**
 Elevation: 12.6 deg
 Observed with SNR ~ 5

Date: 2024 08 08.813278
 RA: 11 00 52.41
 Dec: +33 33 51.9
 Mag: 20.1 G
 Exp: 7.333m (22x20s)

PermID: 58641
 ProvID: 1997 WX20
 TrkSub:
 Speed: 0.982"/min
 PA: 119.2 deg

Date: 2024 08 08.819611
 RA: 11 00 53.00
 Dec: +33 33 47.4
 Mag: 20.6 G
 Exp: 7.333m (22x20s)

Elong: 29.6 deg
 Phase: 9.8 deg
 Alt: 12.6 deg
 Az: 302.7 deg
 Earth: 3.778 AU
 Sun: 2.939 AU
 PABL: 155.9 deg
 PABB: 29.0 deg
 Speed: 0.98"/min
 PA: 119.2 deg

Elong: 29.6 deg
 Phase: 9.8 deg
 Alt: 12.6 deg
 Az: 302.7 deg
 Earth: 3.778 AU
 Sun: 2.939 AU
 PABL: 155.9 deg
 PABB: 29.0 deg
 Speed: 0.98"/min
 PA: 119.2 deg

Obs: A. Nastasi
 Stn: M57
 Tel: 1.00-m f/2.1 reflector
 PSc: 1.96"/px
 Cam: 149.7 x 149.9 arcmin



Obs: A. Nastasi
 Stn: M57
 Tel: 1.00-m f/2.1 reflector
 PSc: 1.96"/px
 Cam: 149.7 x 149.9 arcmin



The GAL Hassin facilities for NEO monitoring – Wide-field Mufara Telescope (WMT – M57)

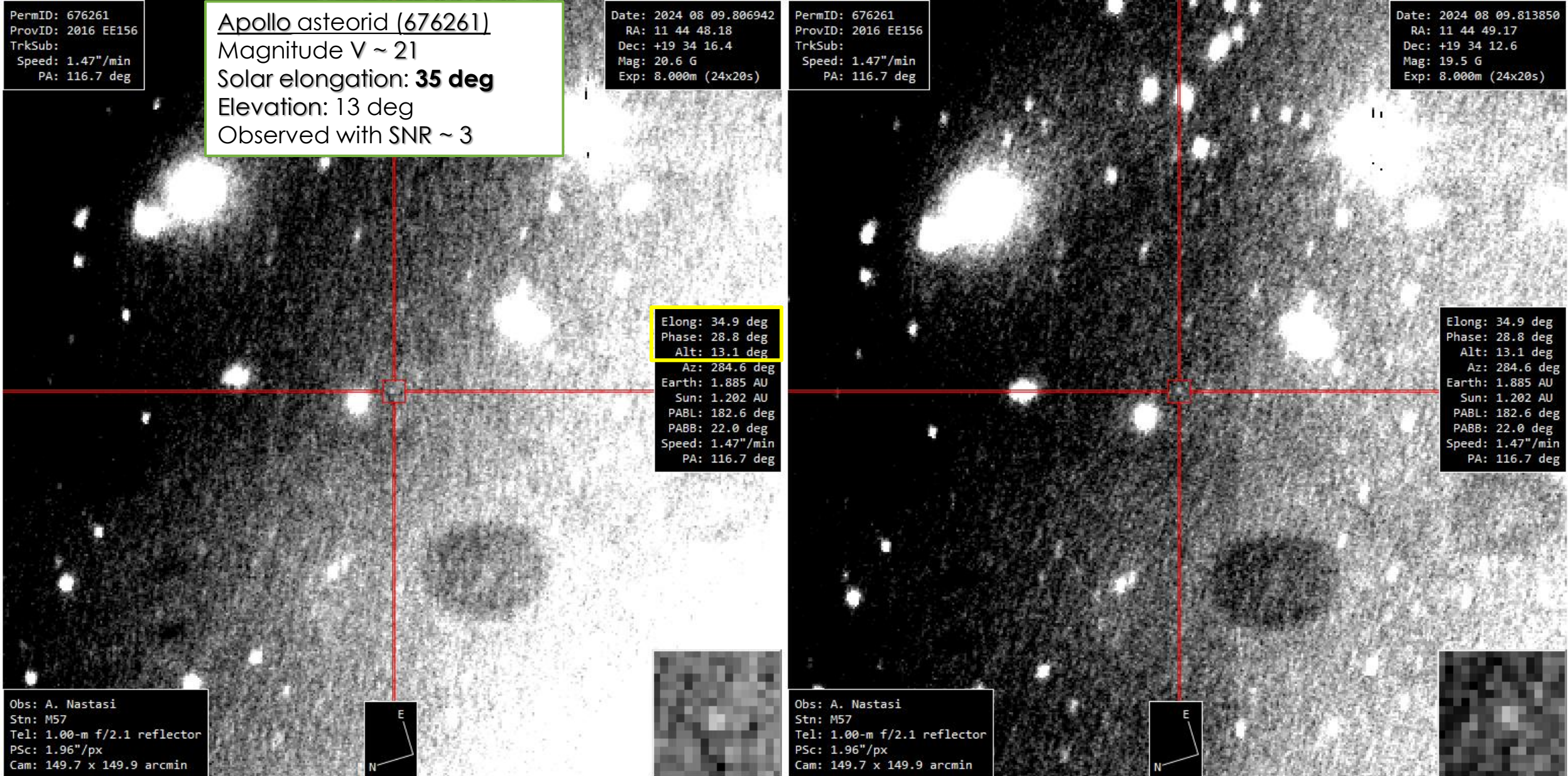

A **network** of wide field telescopes soon active in Sicily...

WMT & ESA NEOSTEL “Flyeye” may work in **synergy** as **complementary** facilities:

- **Simultaneous runs**, having the same weather conditions.
- WMT will offer prompt **confirmation** and **photometric characterization** of targets discovered by the **ESA Flyeye**.
- A unique network of telescopes in the **Mediterranean area**.

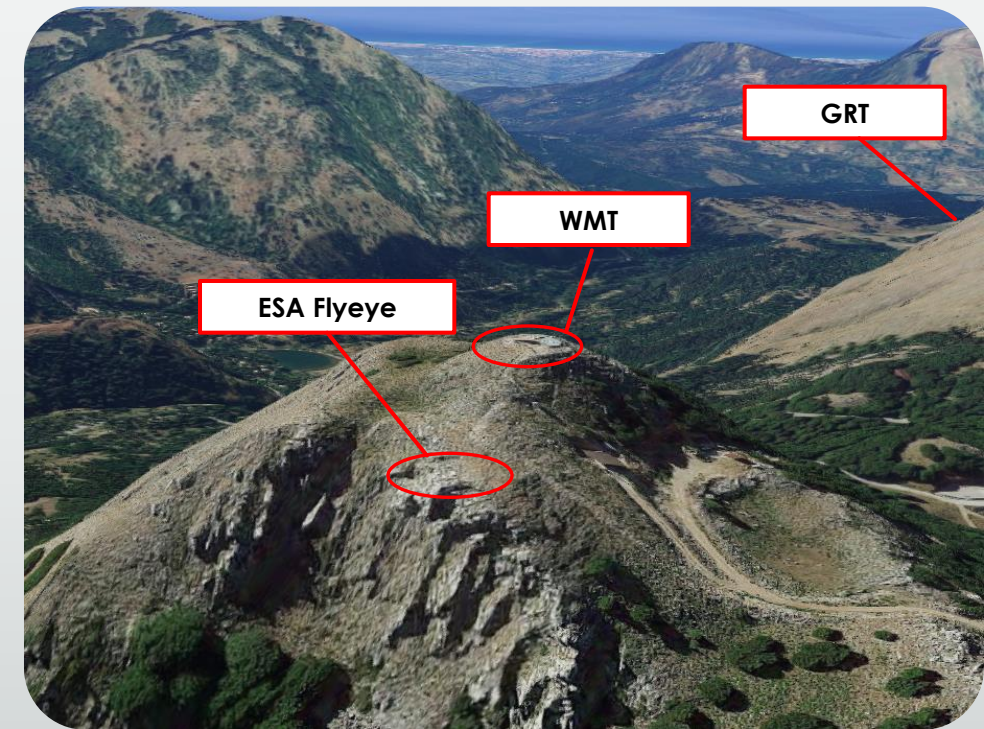
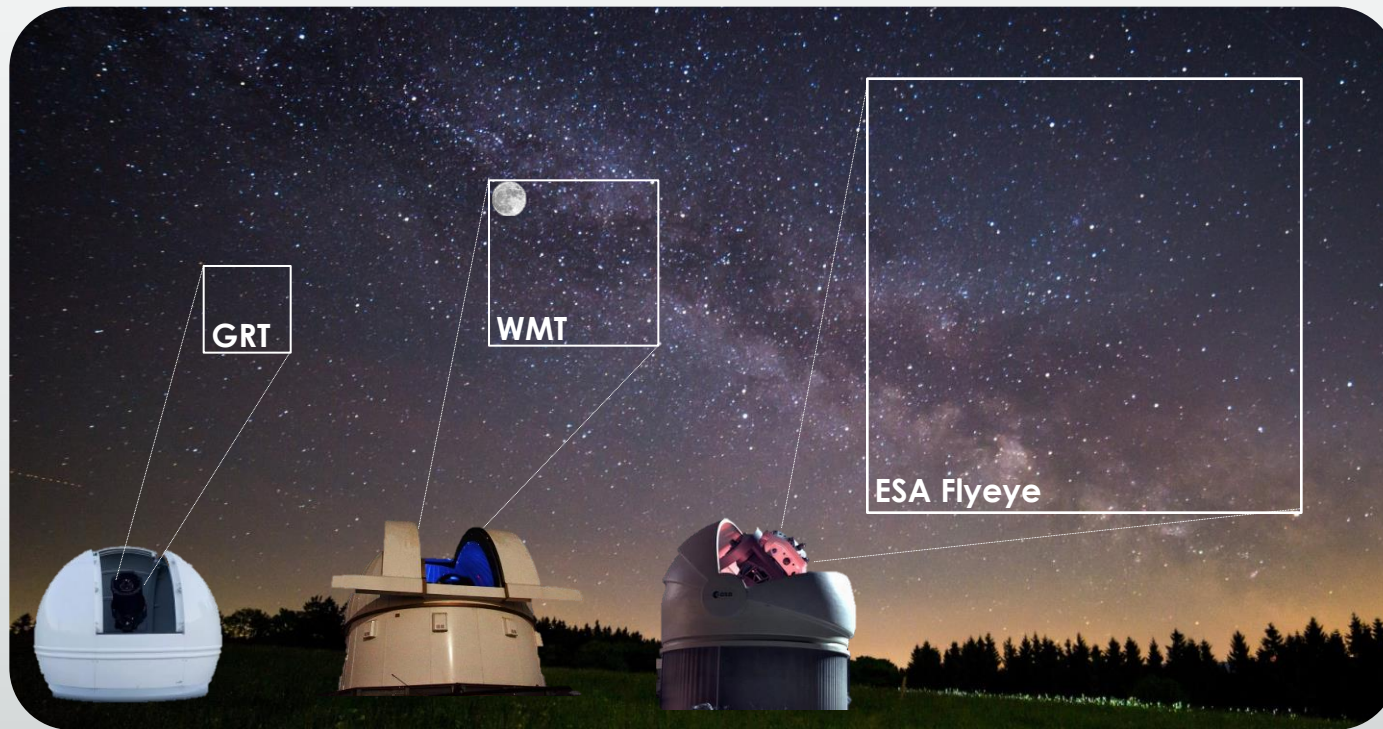

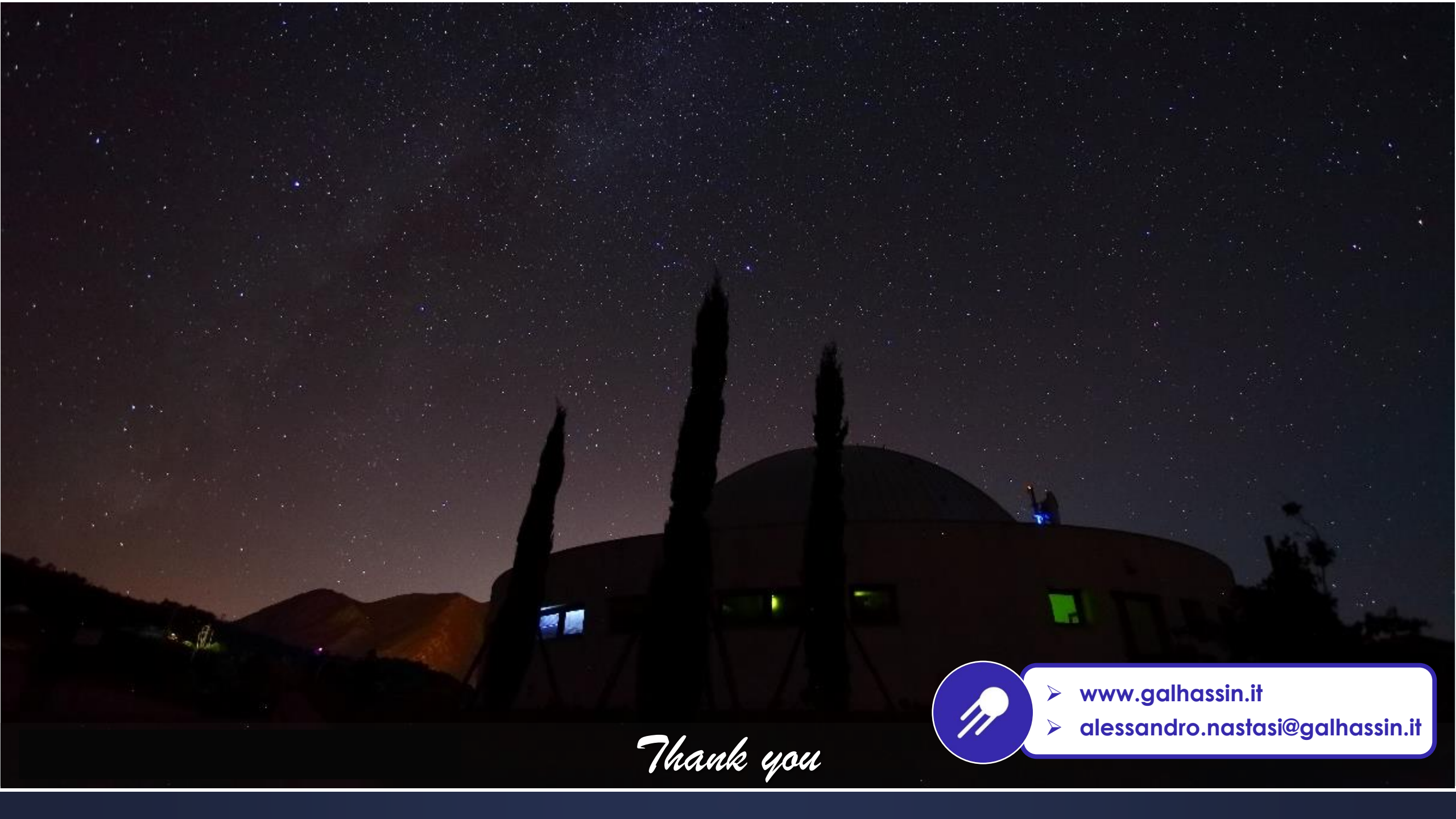

Thank you



- www.galhassin.it
- alessandro.nastasi@galhassin.it

Additional information

The Madonie park in Sicily: an excellent area for astronomical research

- Excellent night sky conditions (median annual seeing **~1.5 arcsec**).
- Very low **light pollution**.
- **>200 clear nights/year** (~60%)*.
- Low **latitude** (~38°).

(*) A. Di Cecco, E. Perozzi, C. Marzo, et al. (2019) - *Analysis of Italian sites for NEO and space debris observations with the ESA Fly-Eye telescope.* ESA 1st NEO and Debris Detection Conference.

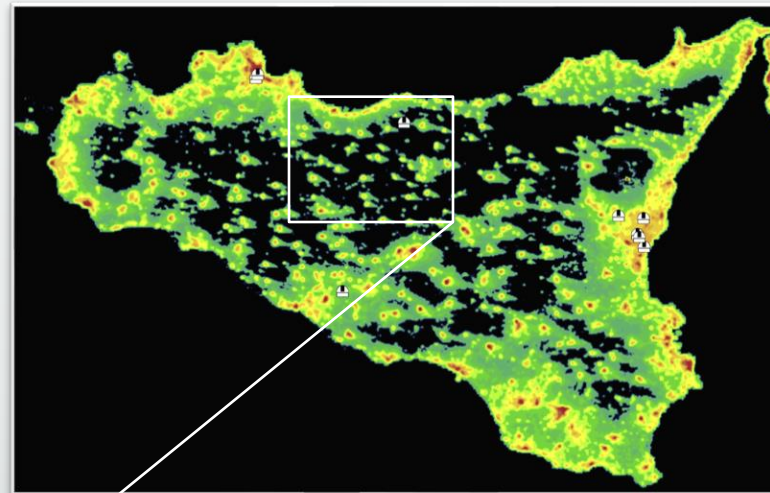
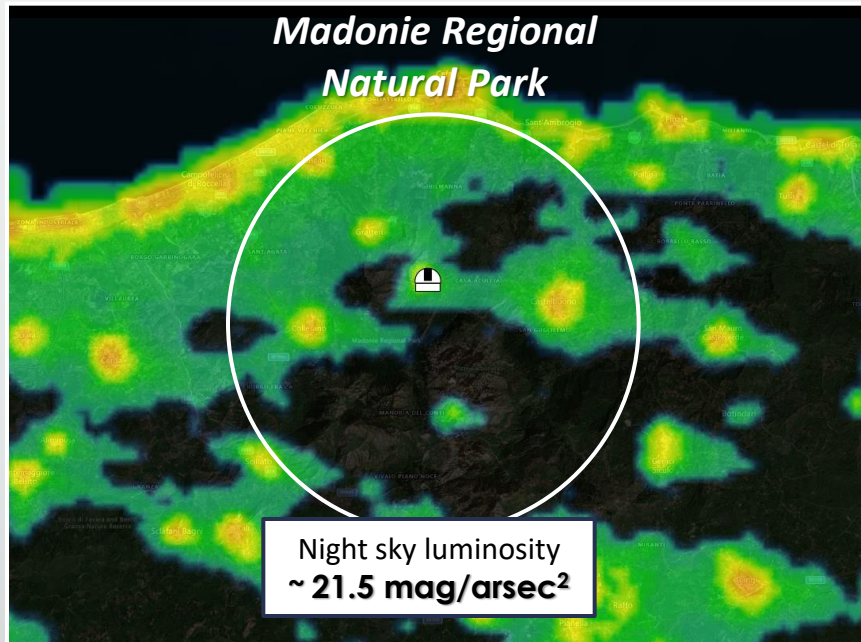

Source:
Visible Infrared Imaging Radiometer Suite (VIIRS) 2023
<https://www.lightpollutionmap.info>

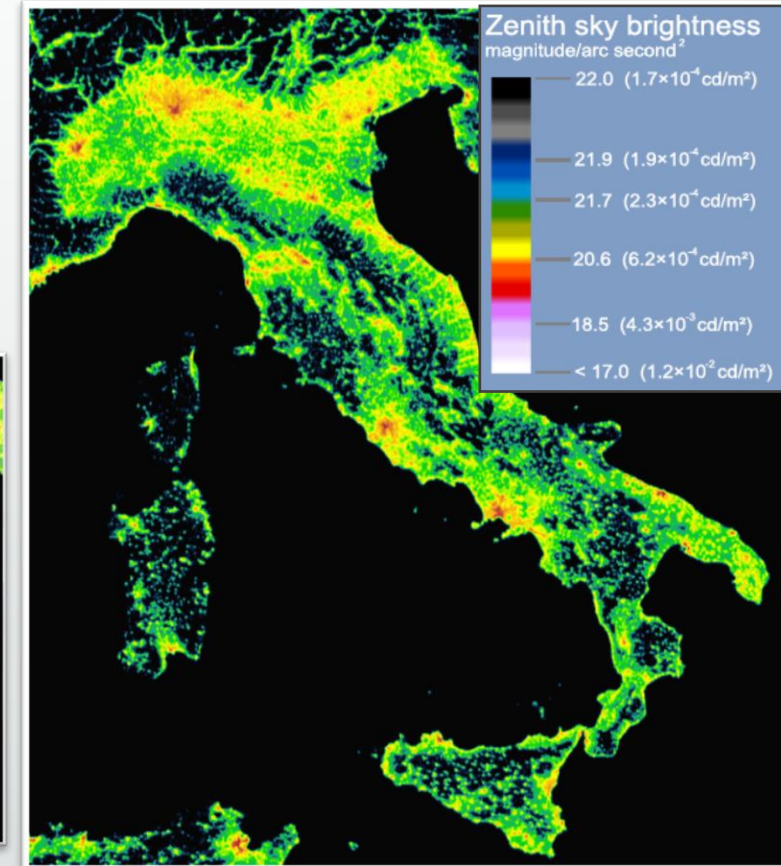

The GAL Hassin facilities for NEO monitoring – Galhassin Robotic Telescope (GRT – L34)

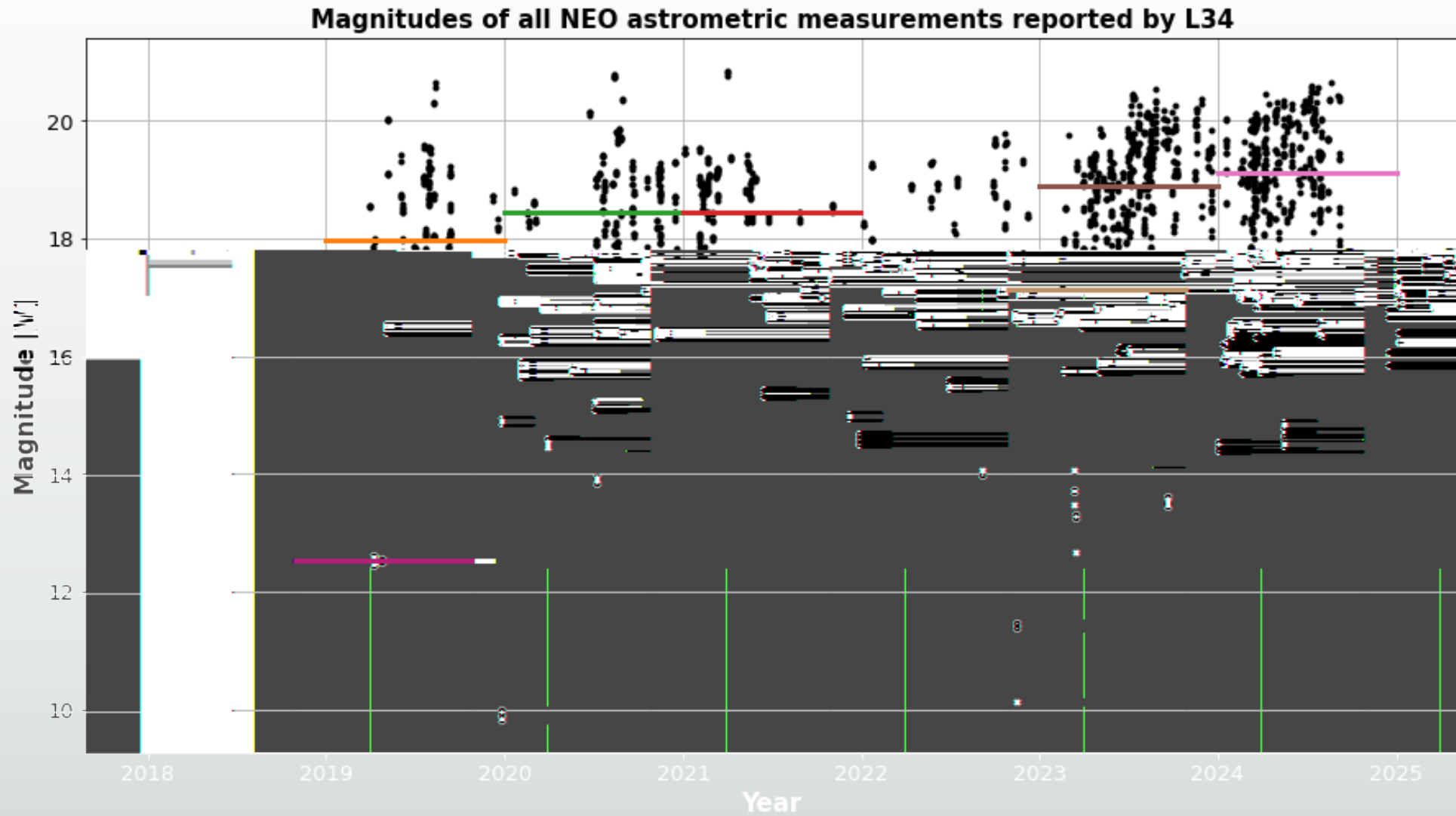

The GAL Hassin facilities for NEO monitoring – Wide-field Mufara Telescope (WMT – M57)

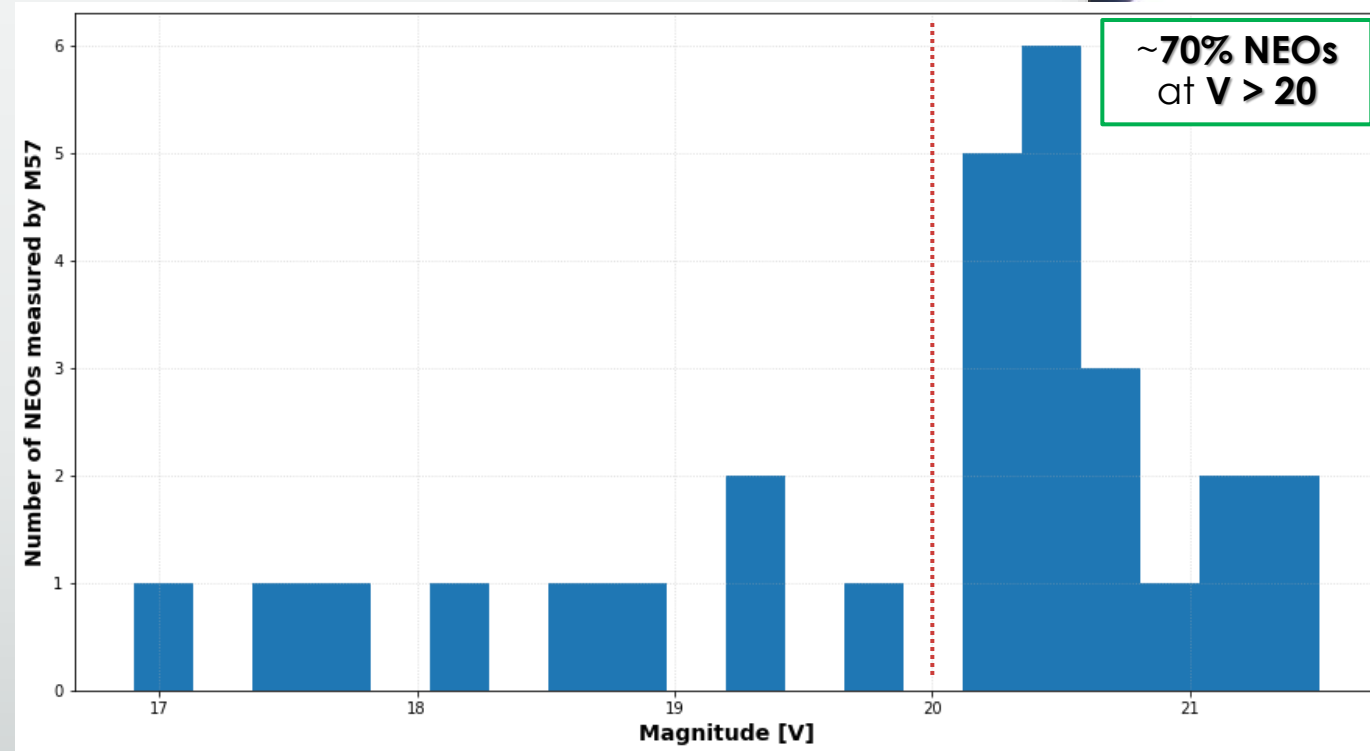
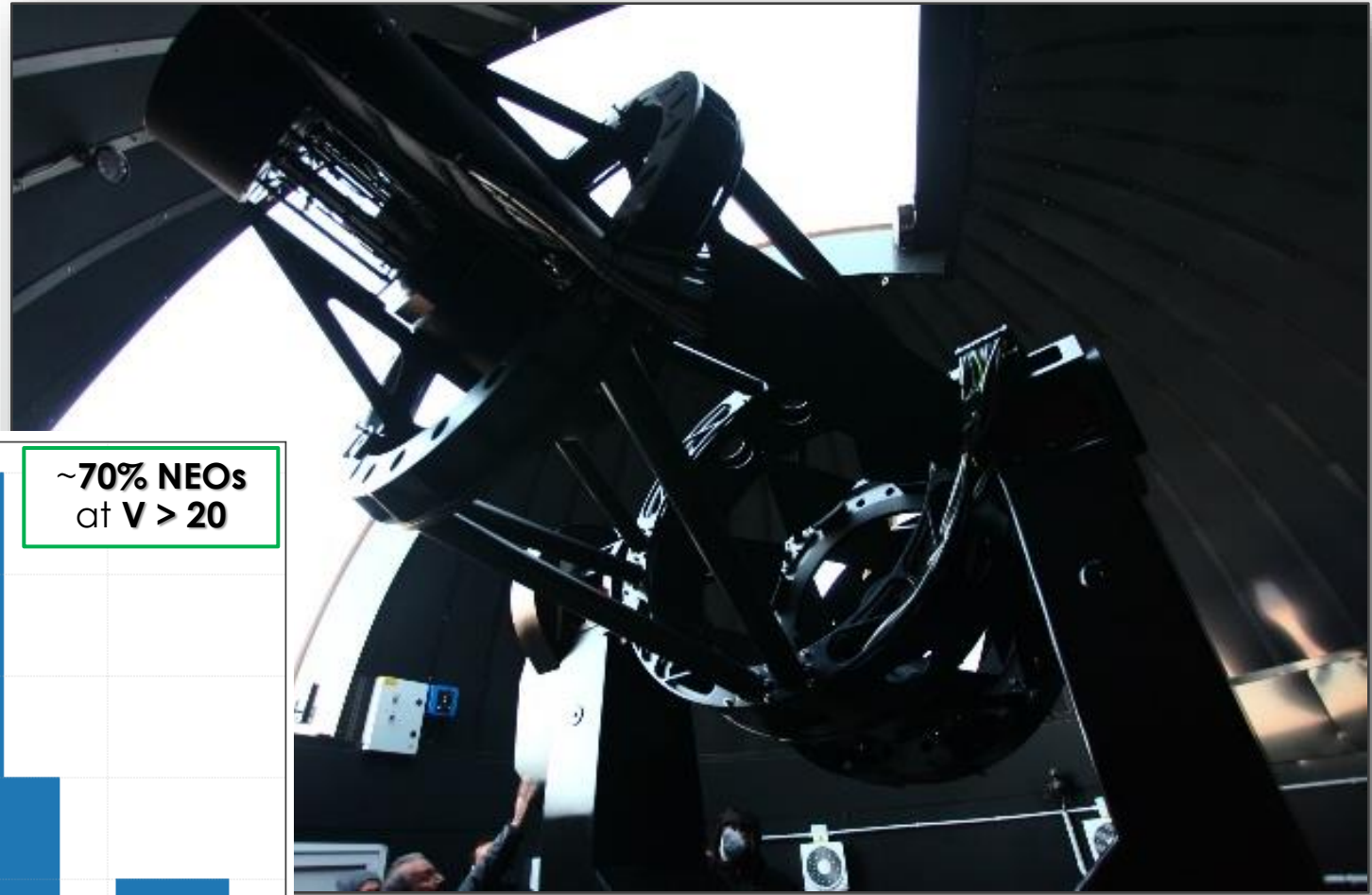

The GAL Hassin facilities for NEO monitoring – **Wide-field Mufara Telescope (WMT – M57)**

Night sky conditions on M. Mufara (as measured in 2017):

- 1/3 of photometric nights, with **seeing of ~1 arcsec** for more than 6 hrs per night;
- 1/3 of quasi-photometric nights;
- 1/3 not clear nights.

