

PICES Press



Newsletter of the North Pacific Marine Science Organization (Published semi-annually)



Beyond El Niño Conference

Since the creation of PICES, scientists from member countries have actively debated the influence of climate variability on the productivity of the North Pacific. Following the extraordinary 1998 El Niño, it was first resolved to review the physical and ecosystem consequences of that event. A broader perspective soon led to the planning of a meeting which would go beyond the concern with El Niño to encompass a broad spectrum of changes over longer time scales (decadal oscillations, regime shifts...), both in the physical environment and within the biological realm. Given the wide interest in these issues among other organizations, PICES sought partners in planning and organizing the meeting. The support and participation of the Inter-American Tropical Tuna Commission, the International Pacific Halibut Commission, the Interim Scientific Committee for Tuna and Tuna-like Species, the North Pacific Anadromous Fish Commission and the Scientific Committee for Oceanic Research, was a significant contribution to the flavour and success of the conference.

While the meeting, convened on the campus of the University of California at San Diego, attempted in vain to restrict itself to the North Pacific, it acknowledged few other constraints. The discussions progressed through four themes, starting with presentations on the *Evidence for Variability* (convenors: Richard J. Beamish, Richard D. Brodeur and Kimio Hanawa), following with papers on *Ecosystem Consequences of Variability* (convenors: Anne B. Hollowed, Daniel Lluch-Belda and Yasunori Sakurai), continuing with discussions of

Mechanisms of Interaction with Ecosystems (convened by Ann Gargett, Michio J. Kishi, Jeffrey J. Polovina), and concluding with the more practical *Implications for Fisheries Management* (convenors: Steven R. Hare, David W. Welch and Chang-Ik Zhang). A total of 142 presentations were scheduled, 79 as posters. It is impossible to do justice to each paper in this short review but I have tried to capture the essence of the oral presentations, although generally not in the order in which they were presented. For brevity, only the name of the presenter is given in multi-author papers. Full abstracts are to be found on the PICES web site: <http://pices.ios.bc.ca>.

The Chairman of PICES, Dr. Hyung-Tack Huh, opened the conference, followed by brief opening remarks by the Co-Chairmen of the Scientific Steering Committee, Paul H. LeBlond and Warren S. Wooster. L. Scott Parsons, President of the International Council for the Exploration of the Sea, presented a summary of ocean climate change from an Atlantic perspective.

The evidence for interannual and decadal scale variability in all aspects of the North Pacific ecosystem is overwhelming. Presentations first focused on El Niño. Todd Mitchell's review of the instrumental record of ENSO over the past 150 years revealed the surprising variability of the equatorial characteristics of the phenomenon. El Niño's impact on the local physical environment off Alaska (Thomas C. Royer) and Oregon (Robert L. Smith) brought up the question of the

(cont. on page 13)



- | | |
|---|---|
| 1 Beyond El Niño Conference | 10 Report of the ICES Zooplankton Ecology Working Group/PICES meeting |
| 2 The status of the Bering Sea: June – December, 1999 | 16 Shark abundance increases in the Gulf of Alaska |
| 4 The state of the western North Pacific in the second half of 1999 | 18 PICES Lower Trophic Level Modeling Workshop, Nemuro |
| 7 The state of the eastern North Pacific since autumn 1999 | 23 On the third meeting of the LMR-GOOS Panel |
| 9 Project Argo | 25 Ocean Ecology of Juvenile Salmonids along the North American Coast |

The status of the Bering Sea: June – December, 1999

Phyllis J. Stabeno
Pacific Marine Environmental Laboratory
National Oceanic and Atmospheric Administration
7600 Sand Point Way NE,
Seattle, WA 98115, U.S.A.
E-mail: stabeno@pmel.noaa.gov



Dr. Phyllis J. Stabeno, a physical oceanographer at the Pacific Marine Environmental Laboratory (PMEL) of NOAA, conducts research focused on understanding the dynamics of circulation of the North Pacific, Bering Sea and their adjoining shelves. She is the PMEL Director of NOAA Fishery Oceanography Coordinated Investigations (FOCI), and by applying her knowledge of physical processes to fisheries oceanography, she plays a vital role in its success. FOCI research focuses on building sustainable fishery resources in the Gulf of Alaska and Bering Sea while maintaining a healthy ecosystem. Phyllis is also a Principal Investigator on several research elements for other programs, including: Southeast Bering Sea Carrying Capacity (Coastal Ocean Program), the Bering Sea Green Belt: processes and ecosystem production (Arctic Research Initiative) and Prolonged Production and Trophic Transfer to Predators: processes at the inner front of the southeast Bering Sea (National Science Foundation). This research seeks to improve our understanding of ecosystems through the integration of physical and biological phenomena.

Physical observations of the eastern Bering Sea shelf in 1999 contrasted sharply with those of the previous two years. From June to December of 1997 and 1998, warm water persisted over the southeastern shelf. In 1999, colder surface and depth-averaged sea temperatures existed until the end of the year. Observations collected at Site 2 (Fig. 1) are representative of conditions over the southeastern middle shelf. When ice was advected over the mooring the water column quickly cooled (black; Fig. 2) and salinity was reduced. In March 1999, strong winds quickly mixed the water column, cooling it uniformly to $\sim 1.7^{\circ}\text{C}$. In contrast, weaker winds in May only provided energy to mix the upper 20-m of the water column. In addition to cooling the upper water column via ice melt, ice in May delayed the seasonal warming that typically begins in April.

The presence of sea ice is a defining characteristic of the continental shelf of the Bering Sea. The greatest variability in the amount and persistence of ice cover occurs over the southeastern shelf. As part of the ongoing Southeastern Bering Sea Carrying Capacity (Coastal Ocean Program/NOAA), we developed an index of sea ice extent and persistence for the southeastern Bering Sea. This index consists of the percentage of ice coverage in a 1° band (57°N - 58°N ; see Fig. 1) across the shelf. The index was determined from Alaska Regional Ice Charts (NOAA) since 1994, and from the Joint Navy/NOAA charts before 1994. The maximum ice coverage did not differ greatly between 1997 and 1999, although in 1998 it was lower. The arrival date of sea ice does not appear to be important in establishing conditions the following summer,

but the departure date is important. Sea ice conditions were similar in 1997 and 1999, however, ice persisted into May of 1999. This contributed to the cold depth-averaged temperatures throughout the remainder of the year over the shelf.

A major feature of the surface atmospheric conditions over the North Pacific and Bering Sea is the frequent passage of low-pressure centers along the Aleutian Island chain. This results in the feature known as the Aleutian Low, which varies on multi-decadal time scales (10 to 70 years). The Aleutian Low, in turn, is affected by both oceanic and atmospheric phenomena. No single tropospheric teleconnection pattern accounts for the variance of the Aleutian Low. Both the variability in SST patterns (the Pacific Decadal Oscillation, PDO) and the pattern of atmospheric pressure variability (Arctic Oscillation, AO) affect conditions in the Bering Sea. Analyses of numerous physical and biological time series indicate that a regime shift occurred in 1977. This is associated with the PDO shifting from a strongly positive to a negative mode. A second weaker regime shift occurred in 1989 related to changes in the AO.

Using the time of the suggested regime shifts, we divided the ice coverage observations into three regimes: the cold period of 1971-1976; the warm period of 1977-1989; and the moderate period of 1990-1999 (Fig. 3). There was little difference in the arrival date of ice among these periods, however during the cold period, ice persisted through the

Maximum Ice Extent

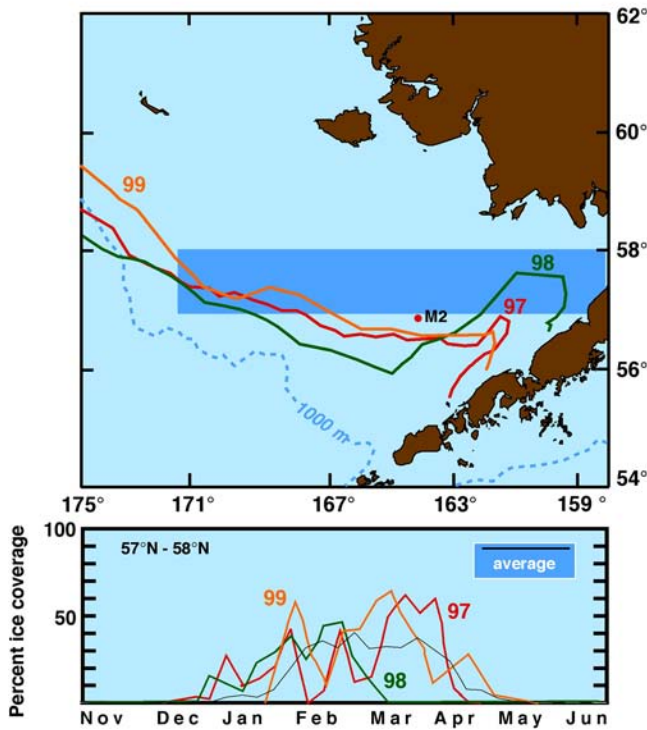

Fig. 1 (a) The southeast Bering Sea shelf. Site 2 (M2: 56.9°N, 164°W) is located on the 70m isobath of the middle shelf. The maximum ice extent for 1997-99 is indicated. The blue band is the region used to calculate average ice coverage. (b) The percent ice coverage in the blue band (map) for 1997-99. The dark line is the average ice coverage during the 1990-1999 period.

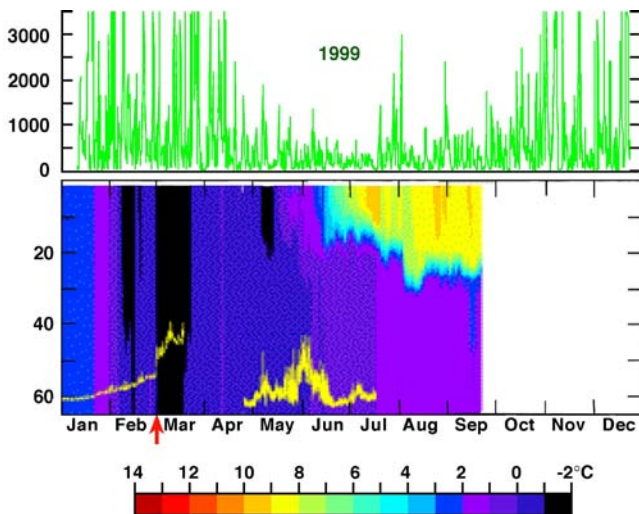

Fig. 2 (a) Wind speed cubed at Site 2 (M2 in Fig. 1). (b) Contour of temperatures measured at M2. The yellow line is fluorescence from a depth of 11 m. Note an increase in fluorescence in March associated with the presence of ice, while the increase during May/June may be associated with both ice and the beginning of stratification.

winter and departed late. During the warm period, ice extent was less on average and ice departed earlier. In the moderate period, timing was the same as the warm period, but more extensive. In the fall/winter of 1999, ice first appeared in November, and by the end of December ice covered ~20% of the 1° band. This early arrival and relatively extensive coverage is more typical of cold period years. If this persists into 2000, it will lend support for a regime shift.

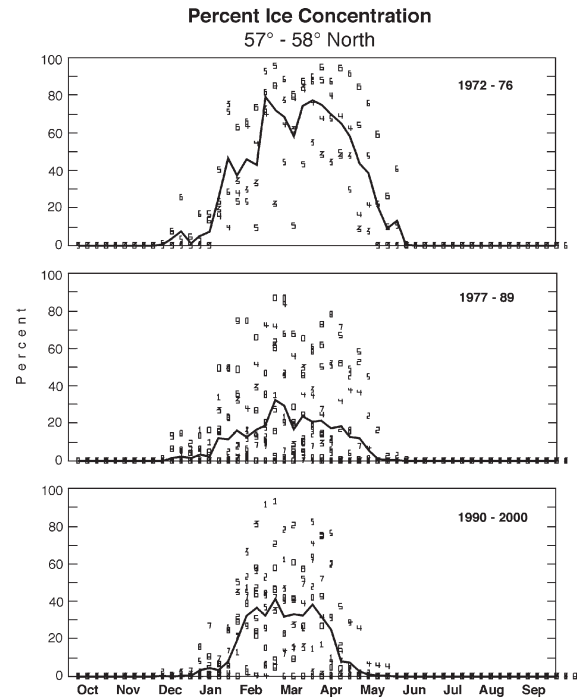

Fig. 3 Percent ice concentration during three regimes in the one degree band (57°-58°N, see Fig. 1).

A coccolithophore bloom that was first observed in SeaWiFS images in 1997 recurred for the third year. Coccolithophores are small cells covered by calcareous plates (liths), from which light reflects giving the water its distinctive milky white color. In 1999, the bloom was first observed in February from both satellite and ships. By August, it covered a significant portion of the eastern Bering Sea shelf. Surprisingly, cooler SSTs did not appear to restrict its location.

These observations were collected as part of the Southeast Bering Sea Carrying Capacity and the Inner Front Program (an NSF program). One fundamental result is that our understanding of the importance of sea ice, in terms of its timing and duration, over the southeastern Bering Sea shelf, has increased markedly. This also has implications for biota. For example, the median biomass of large medusae over the southeastern shelf increased tenfold between the warm and moderate periods found in the sea ice index. Increasing our knowledge of the germane physical processes is allowing examination of pathways that potentially transfer physical changes to biota, shedding new light on how this vibrant ecosystem functions.

The state of the western North Pacific in the second half of 1999

Satoshi Sugimoto
Oceanographical Division, Climate and Marine Department
Japan Meteorological Agency
1-3-4 Otemachi, Chiyoda-ku,
Tokyo 100-8122, Japan
E-mail: s_sugimoto@met.kishou.go.jp

Mr. Satoshi Sugimoto is Scientific Officer of the Oceanographical Division of the Climate and Marine Department at the Japan Meteorological Agency (JMA). He is working as a member of a group in charge of monitoring and forecasting sea surface temperature and sea surface current in the western North Pacific. Based on in situ and satellite data, this group provides various oceanographical products. One of the main products is the "Monthly Ocean Report", which is published and distributed by JMA every month. Mr. Sugimoto is now involved in developing a new analysis system for sea surface and subsurface temperature to improve sea surface temperature forecasts in the western North Pacific.



Sea Surface Temperature

Figure 1 shows monthly mean sea surface temperature (SST) anomalies in the western North Pacific from July to December 1999, computed with respect to JMA's 1961-90 climatology. Satellite-derived SSTs (NOAA/AVHRR) and *in situ* observations are used for the area between 20°N and 50°N from 120°E to 160°E, and only *in situ* observations are used in the other region.

It is noteworthy that positive SST anomalies prevailed zonally between 30°N and 40°N throughout the second half of the year, and those exceeding +3°C were found east of Japan in August (Fig. 1). The large, positive SST anomalies in the northern part of the Japan Sea and east of Japan in August were comparable to those recorded in August 1994, as shown

in the time series of the regional ten-day mean SST anomaly for regions 1, 2, and 4 (Fig. 3).

South of 20°N, positive anomalies prevailed around the Philippines and negative anomalies prevailed near the date line throughout the period.

Kuroshio

In Figure 2, a small meander of the Kuroshio became noticeable near 135°E in the last 10 days of September, and the Kuroshio largely meandered south of Japan in November. The southernmost positions of the meander were 32°N, 137°E in the last 10 days of October and 31°N, 139.5°E in the last 10 days of November, gradually shifting eastward. The northward flow of the meander was along 139°E in the first 10-day of November, along 140°E in the second and last 10 days of November, and east of 140°E in December.

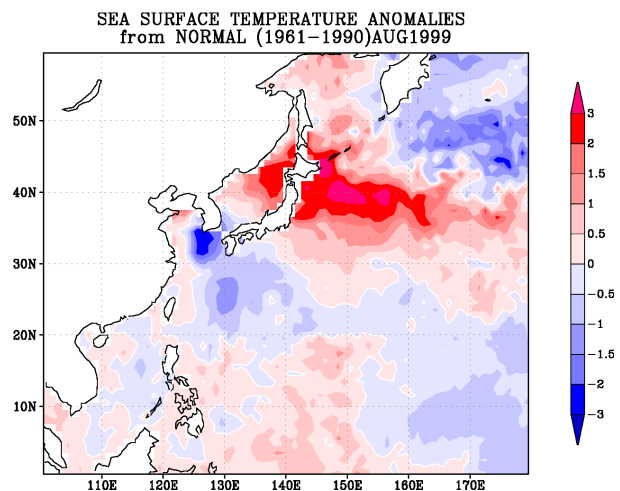
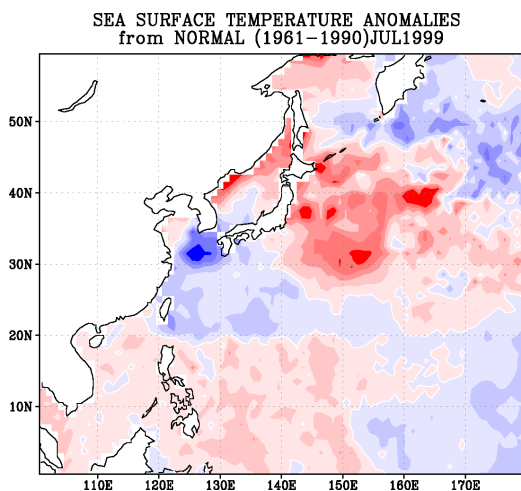

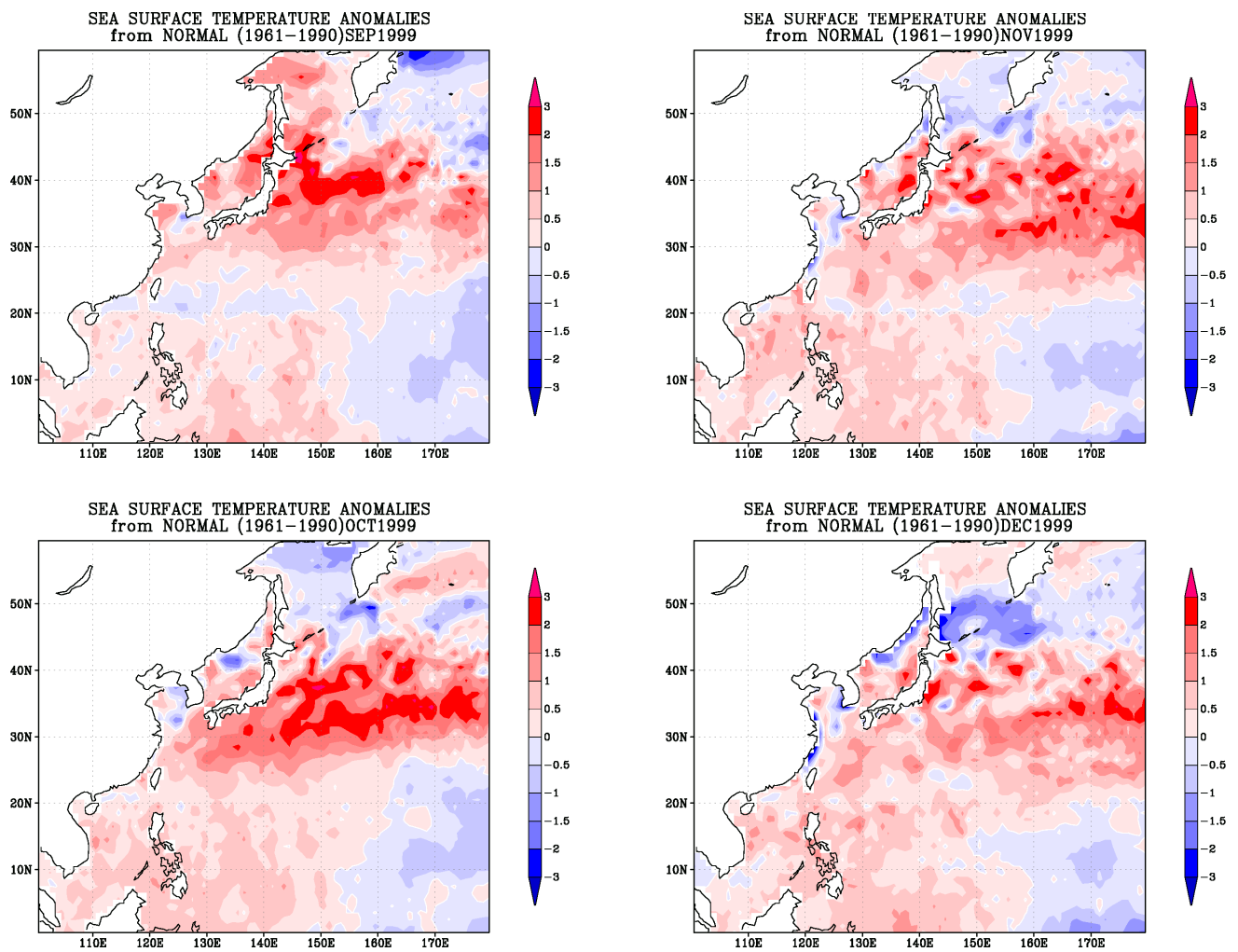

Fig. 1 Monthly mean sea surface temperature anomalies ($^{\circ}\text{C}$). Anomalies are departures from JMA's 1961-1990 climatology.

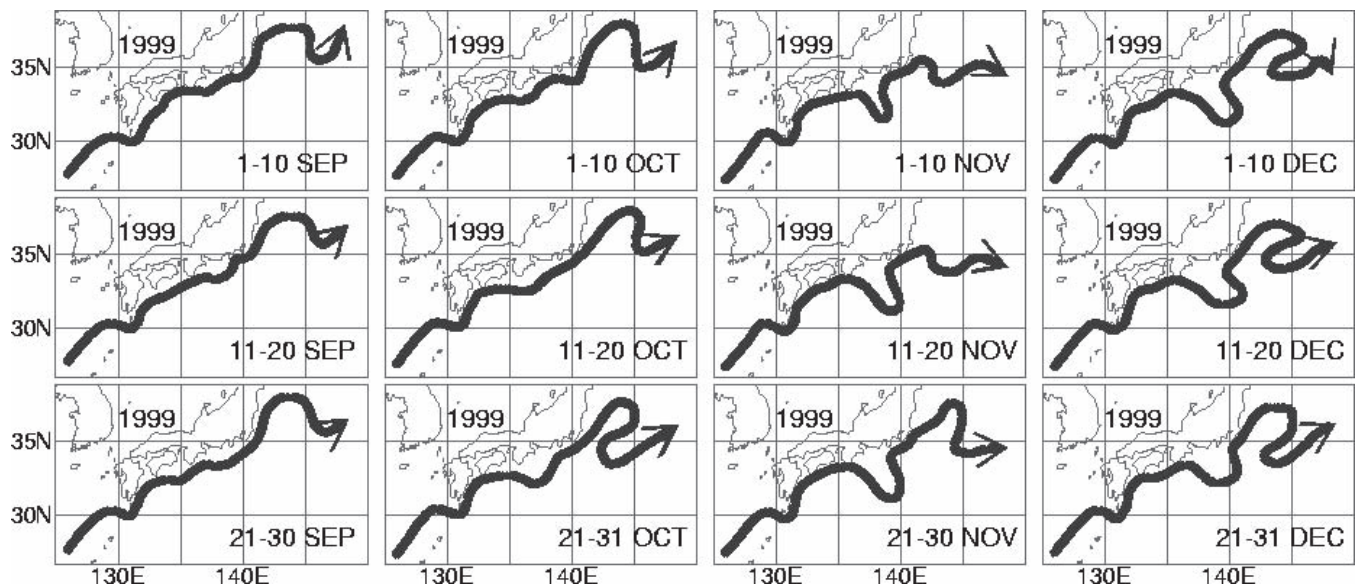

Fig. 2 Location of the Kuroshio axis from September to December 1999.

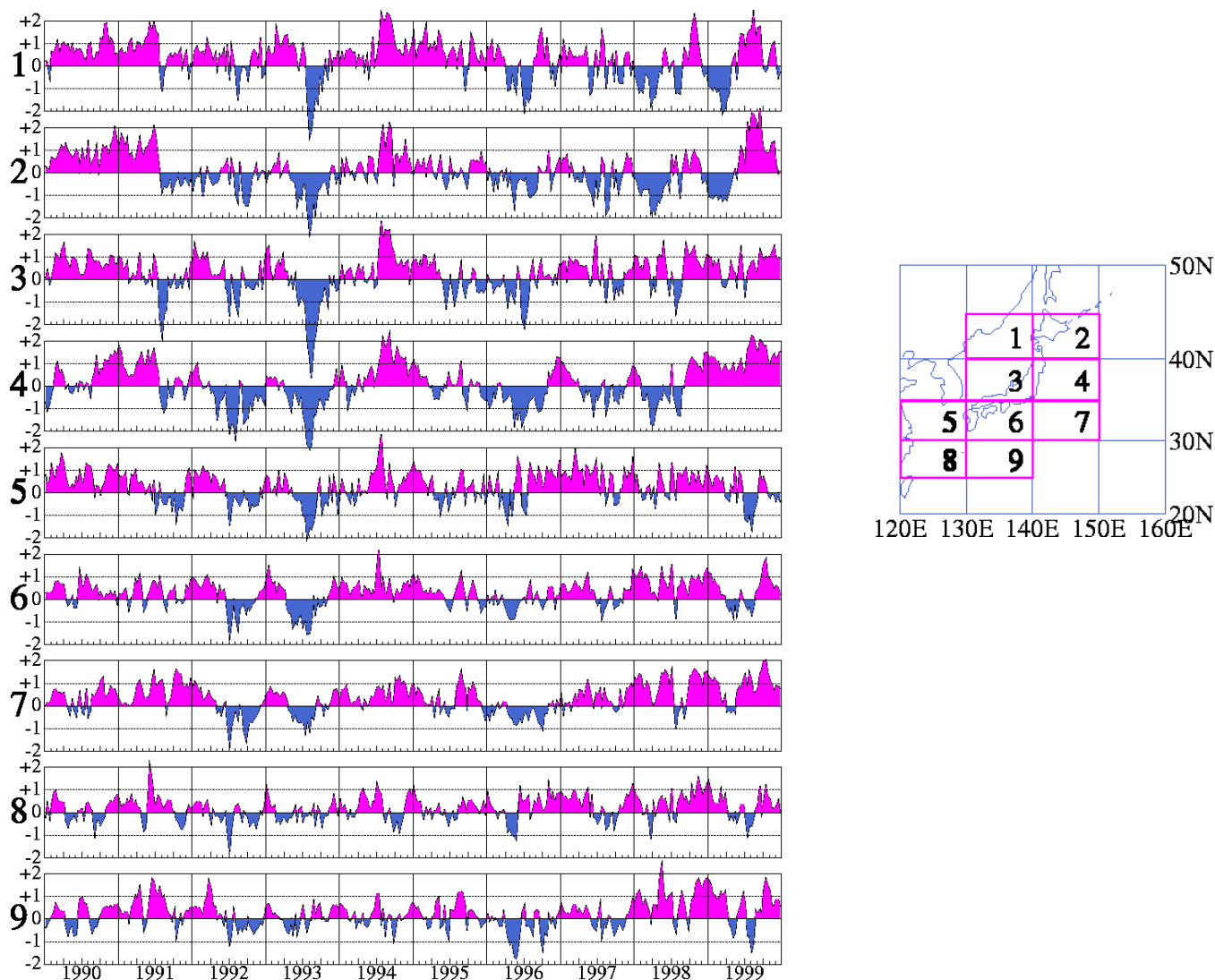
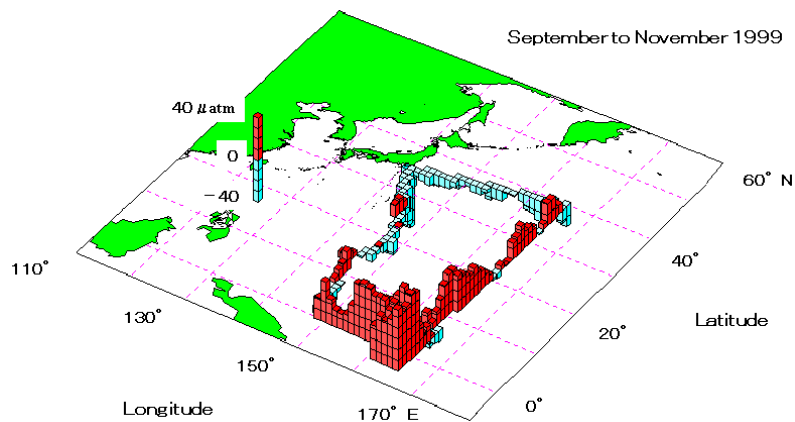

Fig. 3 Time series of the ten-day mean sea surface temperature anomalies ($^{\circ}\text{C}$), computed from JMA's 1961-1990 climatology for the areas shown in the side panel.

Carbon Dioxide

JMA observed the distribution of carbon dioxide concentration (partial pressure, pCO_2) in the western North Pacific on board the R/V *Ryofu Maru* from September to November 1999. Figure 4 shows the distribution of the difference (DpCO_2) in pCO_2 between the surface water and the overlying atmosphere. One of the most remarkable features of this observation is that large DpCO_2 values of 45-65 μatm were observed in the equatorial region (155-165 $^{\circ}\text{E}$), similar to those in October 1998. It is interesting that both periods were under La Niña conditions. Such a large DpCO_2 value could be attributed to a strong upwelling of CO_2 -rich water during a La Niña event.

Fig. 4 Difference in pCO_2 between the surface water and the atmosphere in September-November 1999. Red upward pillars indicate the emission of CO_2 from the ocean and blue downward pillars indicate atmospheric CO_2 absorption by the ocean.



The state of the eastern North Pacific since autumn 1999

Howard Freeland
Ocean Science & Productivity Division
Institute of Ocean Sciences
P.O. Box 6000, Sidney, B.C.,
CANADA V8L 4B2
E-mail: freelandhj@pac.dfo-mpo.gc.ca



Dr. Howard Freeland is a research scientist in the Ocean Science and Productivity Division at the Institute of Ocean Sciences (Fisheries and Oceans Canada). His research interests include the climatic state of the ocean and low frequency variability. Presently he has interests in the maintenance of Line P, a line of CTD stations that has been monitored for over 45 years between the mouth of the Juan de Fuca Strait and Ocean Station Papa at 50°N and 145°W. Howard is also on the international science team for project Argo which aims to deploy a global array of profiling ALACE floats to monitor the evolving state of the ocean. He is involved in various PICES activities as a member of the Physical Oceanography and Climate Committee and Chairman of the Publications Committee.



As is well known, climatic conditions in the eastern North Pacific are heavily determined by conditions in the equatorial Pacific. Figure 1 shows a plot of the daily values of the southern oscillation index from January 1, 1997, through to April 3, 2000. This is one of the indicators used to describe the tendency towards or away from El Niño or La Niña conditions. The red line is the 31-day running mean of the daily values. The El Niño event of 1997-98 is evident in the long period of negative values that started in the spring of 1997. In the spring of 1998 there was an abrupt transition to distinctly positive values, and we entered the La Niña phase. As is fairly evident in the recent observations, we passed through a period of apparent normalcy in the summer to autumn of 1999, and seem to be in a period since that time when the index appears somewhat unstable. A more interesting indicator is the distribution of subsurface temperature along the equator. Through the period of apparent normalcy in 1999, as suggested by Figure 1, it was also evident that though surface temperatures in the equatorial Pacific were close to normal, there was in fact a large pool of cool water rather close to the surface. The latest forecasts from the Climate Prediction Center (NOAA) do suggest a steady return towards normal conditions. Thus we should not expect any large climate anomalies during 2000.

Through the fall to winter to spring of 1999-2000 sea surface temperatures in the eastern North Pacific have been systematically below normal, though not greatly so, as shown by the sequence of maps comprising Figure 2.

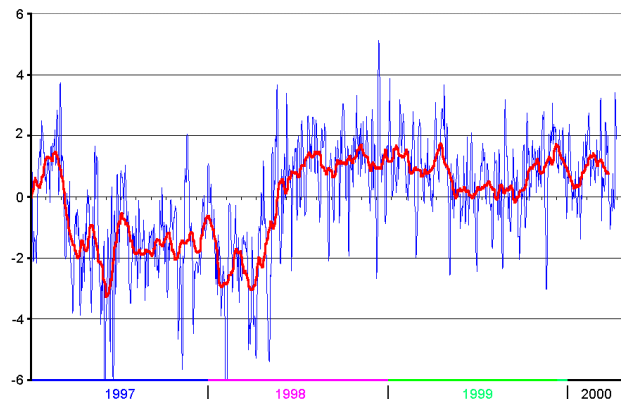

Fig. 1 The Southern Oscillation Index from January 1997 to present.

Unfortunately, we were unable to execute the usual winter survey along Line-P during February 2000, so for the first time I am unable to include any comments about ocean conditions along Line-P. However, 3 years ago a profiling Alace float (Webb Research P-Alace float, serial number 578) was launched at Ocean Station Papa. [See the **Project Argo** article following immediately after this article.] After three years it remains close to Line-P (Fig. 3). The three warm periods shown represent the summers of 1997, 1998 and 1999.

The drift diagram is shown to demonstrate the continued proximity to Line-P. Despite the fact that the float has remained in a climatologically homogeneous region, i.e. no

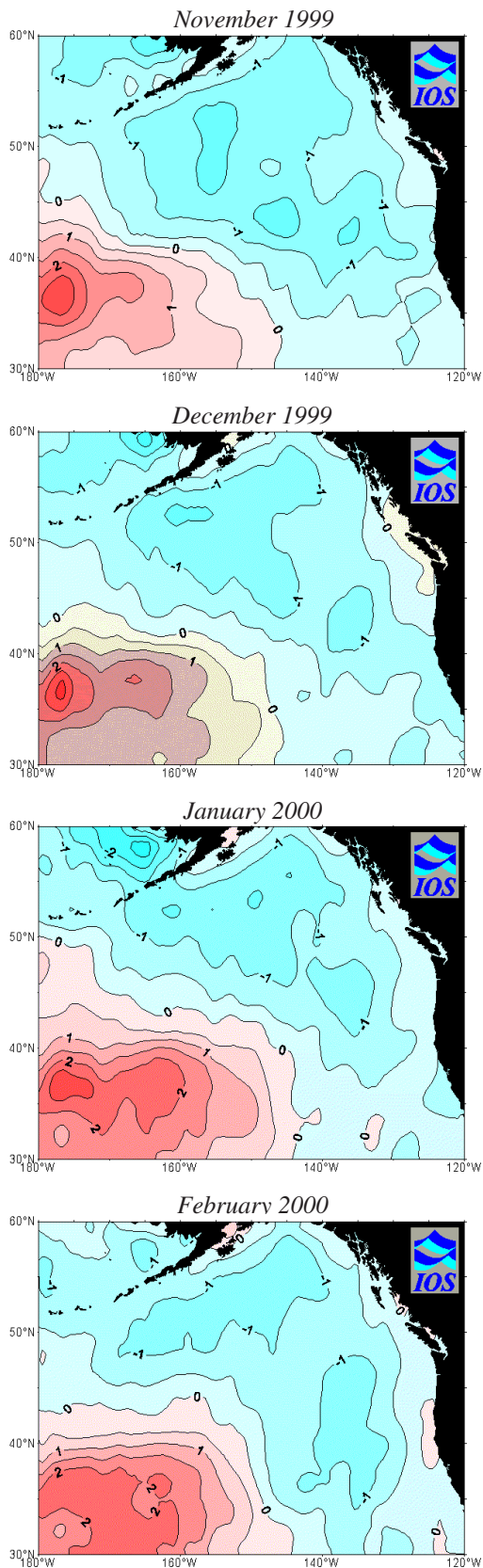

Fig. 2 Maps of sea-surface temperature anomaly in the eastern North Pacific for November 1999 through February 2000.

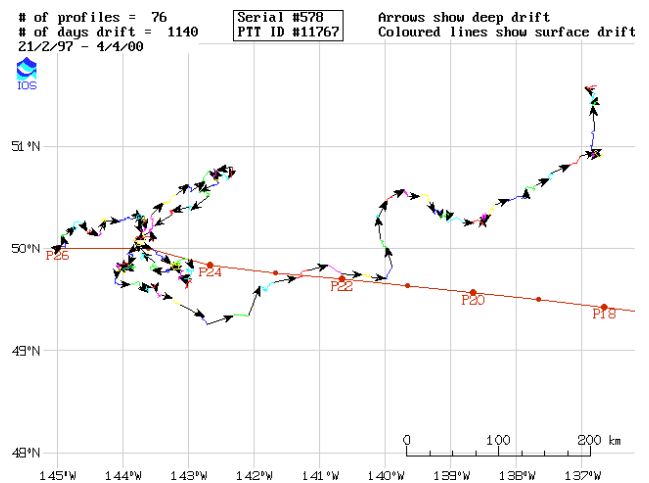
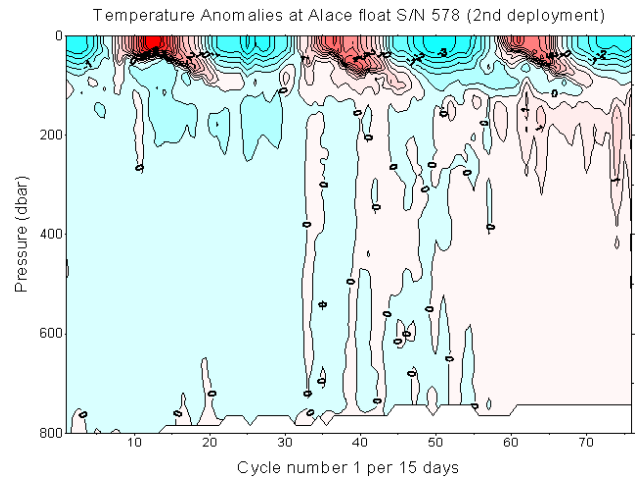
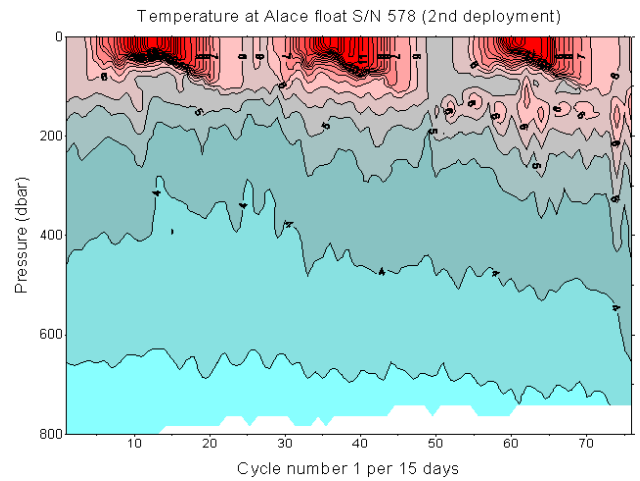

Fig. 3 Temperature and temperature anomaly distributions and drift of P-Alace float S/N 578 near Station Papa.

large temperature gradients are expected, a warm anomaly shows up in the temperature and its anomaly plots starting in the fall of 1998 centered near a depth of 200 dbar but also penetrating into deep water. This is presumably an advective feature and represents an influx of more southerly water masses into the N.E. Pacific. I would be interested in talking to anyone who can speculate on the origin of this water mass. More information about this float can be found on the web site:

<http://www-sci.pac.dfo-mpo.gc.ca/osap/projects/alace/578b.htm>

Project Argo

Howard Freeland
Ocean Science & Productivity Division
Institute of Ocean Sciences
P.O. Box 6000, Sidney, B.C.
CANADA V8L 4B2
E-mail: freelandhj@pac.dfo-mpo.gc.ca



In March 2000, several members of the PICES Physical Oceanography and Climate Committee (Drs. Howard J. Freeland (Canada), Stephen C. Riser (U.S.A.) and Kuh Kim (Korea)) attended the second meeting of the International Argo Science Team (IAST-2) at the Southampton Oceanography Centre, UK. At that meeting, Dr. Kuh Kim became a member of the International Argo Science Team (Drs. Freeland and Riser were appointed in this capacity earlier). In April, we and the PICES Chairman, Dr. Hyung-Tack Huh, attended the International Implementation Planning Meeting for Argo Floats in the Pacific Ocean and Adjacent Regions in Tokyo. Argo is moving steadily towards the deployment phase, and the purpose of this article is to report my views on the progress of Argo program.

The first important change is visible in the title of this article, the spelling of “Argo” with only a capital first letter. We decided to cease considering the project name as an acronym. It is a partner project with Jason so we should regard Argo as just a proper name. For those not familiar with these names, Jason-1 is the satellite that is due to be launched in September of this year as a successor to the very successful Topex-Poseidon satellite. Jason-2 should be launched in about 5 years as a successor to Jason-1. In Greek mythology Jason sailed in a ship called Argo with his crew (the Argonauts) in search of the Golden Fleece.

Argo is intended to deploy 3000 robotic floats in a global array. These are the profiling Alace floats that have been described previously in PICES Press. Dean Roemmich from the Scripps Institution of Oceanography deployed 3000 floats in a $3^\circ \times 3^\circ$ array in a computer model, allowed them to drift for a while and then produced the schematic diagram opposite (Fig. 1). The floats will drift at a target pressure of about 2000 dbars. Periodically they will adjust their buoyancy, float to the surface, observe a profile of temperature and salinity on the way up and transmit that to a satellite. Thence, the data will be reported to the owner of the float who will process the data in real time and transmit profiles on the Global Telecommunication System (GTS), which is accessible to all members of the World Meteorological Organization, and post data on the WWW. The complete Argo archives will be available free of charge to any and all users in near-real-time. Each float has sufficient energy for about 200 profiles. Thus any float could potentially supply data for 5 to 6 years.

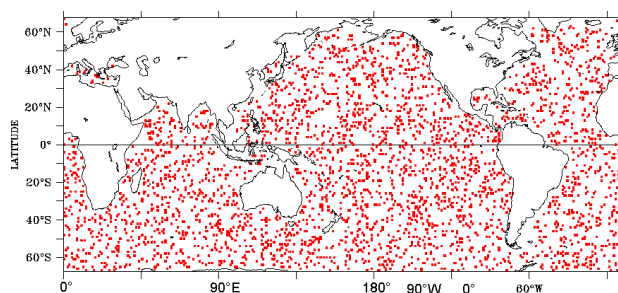

Fig. 1 Highly schematic map showing a possible distribution of 3000 floats.

The countries and entities planning to deploy floats in support of Argo presently are: Australia, Canada, the European Union, France, Germany, Japan, Korea and the United States. There may be small contributions from some other countries, possible contributors include New Zealand, India and Brazil.

Argo is expected to supply data on the internal dynamics of the ocean every 10 days. Jason will provide global sea-level data. These two projects will supply data to GODAE, the Global Ocean Data Assimilation Experiment, that is the object of the whole exercise, to demonstrate the feasibility of seasonal climate forecasts up to 1 year in advance.

So where is Argo now? Of the float-deploying nations, two, U.S.A. and Japan (the two largest contributors), have secure funding and are moving ahead rapidly. Canada has a commitment to supply 10 floats to Argo, but has a rough target number much greater. For all of the other nations including the European Union, funding remains somewhat uncertain. Summing all of the national targets, we still remain a little short of the 3000 floats required, but the discrepancy is small and might be accommodated by contributions from smaller participants. Deployment in large numbers is likely to begin in 2001.

The really exciting development involves demonstration of the ability to launch one type of profiling float (the APEX float manufactured by Webb Research) by air. This float is now certified for launch from C-130 aircraft. This makes the rather daunting task of deploying floats in remote corners of the Earth considerably easier. So far seven floats have been air launched. Of these six are reporting data, and the

(cont. on page 27)

Report on the ICES Zooplankton Ecology Working Group/PICES meeting

Tsutomu Ikeda
Biological Oceanography Laboratory
Faculty of Fisheries
Hokkaido University
1-1 Minato-cho, 3-chome,
Hakodate, Hokkaido,
JAPAN 041-5541
E-mail: tom@pop.fish.hokudai.ac.jp

Dr. Ikeda completed his M.S. and Ph.D degrees at the Graduate School of Hokkaido University, and got postdoctoral experience at the University of Miami. He worked at the Australian Institute of Marine Science, Australian Antarctic Division, and three Japanese National Institutes of Fisheries Science. Since 1996, he has been appointed Professor in Biological Oceanography of Hokkaido University. His major research interests include metabolism, growth and nutrition, and experiment-oriented life history study of marine zooplankton. To pursue his research interest, Dr. Ikeda has participated in many research cruises from the Arctic to the Antarctic. The current emphasis of his research is on the evaluation of life cycle of major zooplankton species in the western subarctic Pacific. Dr. Ikeda has been serving as a regional editor for the Journal of Marine Biology since 1991. He is the present Chairman of the PICES Biological Oceanography Committee and has been a Committee member since 1993. He has also been a member of the Scientific Steering Committee for GLOBEC International since 1996.



Introduction

Large *Neocalanus* spp. copepods predominate the mesozooplankton biomass in the subarctic North Pacific Ocean, in contrast to the predominance of the smaller copepod *Calanus finmarchicus* in the North Atlantic. In addition to the difference in the dominant copepod species, these two oceans also differ in nutrient conditions and occurrence of phytoplankton blooms. In recent years, our understanding of the life cycle characteristics of *Neocalanus* in the North Pacific and *Calanus* in the North Atlantic have rapidly advanced. It is felt that a better understanding of the adaptive significance of copepods' life histories and their roles in pelagic ecosystems may be gained by the comparison of *Neocalanus* in the North Pacific and *Calanus* in the North Atlantic, and the outcome would contribute to our on-going activities of ecosystem modeling, ocean carrying capacity, trophodynamics etc., within PICES. As the first opportunity to discuss and compare the ecology of the two oceans, PICES received an invitation from the ICES Working Group on Zooplankton Ecology (WGZE), to participate in the WGZE meeting held in Hawaii, April 17-19 of this year. ICES WGZE members who participated in the meeting were Luis Valdés (Spain, WGZE Chairman), Roger Harris (UK, International GLOBEC SSC Chairman), Xabier Irigoien (UK), Peter Wiebe (U.S.A.), Jeff Runge (U.S.A.), Doug Sameoto (Canada), Lutz Postel (Germany), and Astthor Gislason (Iceland). PICES

participants were Tsutomu Ikeda (Japan), Song Sun (P.R. China), Jeffrey Napp (U.S.A.), Charlie Miller (U.S.A.), and Mark Huntley (U.S.A.) was the local organizer. PICES participants contributed to the discussion in several sessions.

Zooplankton ecology of the North Atlantic and North Pacific

Charlie Miller reviewed the life cycle of *Calanus finmarchicus* in the North Atlantic, most of which was summarized from recent results of the Trans-Atlantic Study of Calanus (TASK) program. *C. finmarchicus* (stage 5 copepodites) sink to the deep layer and enter diapause for overwintering. They ascend to the surface layer for reproduction in the following year. The cues which trigger diapause and wake up are still not known. The number of generations per year regionally varies, and some populations repeat generations in shallow water during summer (i.e. 1-3 generations/year). He then reviewed up-to-date information about the life cycle of *Neocalanus* (*N. cristatus*, *N. plumchrus*, *N. flemingeri*) and *Eucalanus* (*E. bungi*) copepods at Station P in the eastern subarctic Pacific, noting that the ontogenetic migration patterns are similar to that of *C. finmarchicus*. The generation lengths of the Pacific species (1-2 years) are longer than that of *C. finmarchicus* (<1 year). These species achieve rapid development in the surface layer in summer, and perhaps avoid interspecific competition through small-scale separation in depth. Interannual variations

in the body size of *N. plumchurus* and *N. flemingeri* have been observed, and the magnitude of new production may be a possible cause for these variations (water temperature and salinity are not important). In addition to body size, interannual variations in development timing to C5 stage of *N. plumchurus* have been documented at Station P (Mackas et al. 1998).

Jeffrey Napp reviewed data from Brodeur and Ware (1992) which showed that zooplankton biomass in eastern subarctic Pacific was low in the period 1956-1962, and then increased in 1980-1989 together with biomass of pelagic fishes and squids in the eastern subarctic Pacific. He also discussed the role of *Neocalanus* spp. in the coastal areas of the North Pacific and compared it with the smaller copepods. It was noted that in the North Atlantic, *Calanus*, which dominates the mesozooplankton biomass, is an important consumer of phytoplankton carbon and produces prey (nauplii) that are available to larval fish. In the coastal North Pacific Ocean, *Neocalanus* is a dominant biomass and is responsible for removing a significant fraction of primary production. However the nauplii of *Neocalanus* are not available as prey for larval fish. The genera *Calanus*, *Pseudocalanus*, *Metridia* and *Acartia* play this role in the coastal North Pacific Ocean.

Tsutomu Ikeda presented recent results of these *Neocalanus* and *Eucalanus* copepods at Site H in the Oyashio current (western subarctic Pacific). Unlike Station P, Site H has a conspicuous diatom bloom in the spring (no diatom blooms at Station P) and a greater annual temperature range to which these copepods are exposed (2-15°C vs. 3-14°C at Station P). Remarkably, general life cycle timing of all these copepods at Site H is well synchronized to those at Station P. However, there are some differences between these sites, i.e. *N. cristatus* is the most dominant copepod at Site H (*N. plumchurus* at Station P), two size forms are seen in *N. flemingeri* at Site H (it is not the case at Station P), and life cycle of major population of *E. bungi* is annual at Site H (biennial at Station P). A 20-year monitoring of abundance and body size of all these copepods on longitudinal monitoring stations in the central subarctic Pacific shows clear interannual variations in both abundance and body size. Environmental variables including Northern Hemisphere Zonal Index (NHZI), Northern Pacific Index (NPI), Sea Surface Temperature (SST), water column stability, abundance of phytoplankton, total zooplankton, salps and chaetognaths, and salmon catches do not explain the interannual variations in abundance and body size of *Neocalanus* copepods well enough.

Thus, the presentations of Miller, Napp and Ikeda provided to ICES colleagues a broad picture of the current status of the study on life cycle and abundance of major copepods and interannual variations in its abundance over the subarctic Pacific.

Presentations of ICES colleagues were mostly about monitoring programs of each country. The general theme was a search for indices (physical and biological) that could be used to document the health and future productivity of ecosystems.

Doug Sameoto presented recent results from the Continuous Plankton Recorder (CPR) monitoring program in the western Northwest Atlantic on *C. finmarchicus*, total copepods, euphausiids, dinoflagellates, and phytoplankton (the last was determined from the color index). It is shown that dinoflagellates increased markedly in 1990 while copepods concomitantly decreased.

Xabier Irigoien provided long-term monitoring data on egg production and egg hatchability of *Calanus helgolandicus* and discussed its correlations with abundance of diatoms, *Phaeocystis*, ciliates, dinoflagellates, and flagellates simultaneously.

Luis Valdés presented ongoing time-series data from off northern Spain, including hydrography, phytoplankton, zooplankton and fishes. His data show a marked change during the past decade (1992-1998): SST and phytoplankton biomass increased while zooplankton biomass and its diversity decreased. Northern limits of distribution of some fishes extended further north.

Astthor Gislasón reported time-series biological data around Iceland. He noted that interannual trends of the biomass of *Calanus finmarchicus*, the most dominant zooplankton component, were similar to those of the CPR data sets in the North Atlantic. *C. finmarchicus* is predated heavily upon by Iceland capelin, and biomass of the former was correlated with body weight of the latter (but not with its biomass).

Lutz Postel presented time series data in the Baltic Sea, and suggested the possible importance of galactic cosmic rays which affect cloud cover and insolation, and eventually zooplankton and fish via primary production.

Development of technology and methodology for zooplankton monitoring

Jeffrey Napp as part of his terms of reference on sampling technology and monitoring, presented some data showing recent changes in plankton fauna and flora in the eastern Bering Sea: an outbreak of coccolithophores (*Emiliania huxleyi*) and the gradual increase of medusae. He also reported on the recently launched CPR program in the eastern subarctic Pacific by David Welch (Canada) and Sonia Batten (UK). This two-year project, funded by the North Pacific Marine Research Program (NPMR), will sample five north-south lines (from Alaska to California), and one east-west line (from Vancouver Island to the Bering Sea) per year. The project is using ships of opportunity (oil tankers and cargo ships) and successfully conducted a trial transect in 1999. The project completed the first year 2000 north-south transect in March, and the silk has been returned to the Sir Alister Hardy Foundation for Ocean Sciences (SAHFOS) for processing. Taxonomists at SAHFOS have prepared themselves to identify North Pacific Ocean zooplankton. One north-south transect this year is scheduled to coincide with a Canada GLOBEC cruise to Ocean Station P. The project will use identical equipment to that used in the Atlantic Ocean. ICES has

formed an Advisory Panel to provide scientific advice and encouragement. The next major task of the project is to secure long-term funding. The principal investigators and Advisory Panel are also considering adopting new sampling technologies into the monitoring protocol.

Song Sun reported on ongoing China GLOBEC activities in the Yellow Sea and East China Sea, where the major zooplankton components are identified as *Calanus sinicus* and *Euphausia pacifica*, and major micronektonic component as anchovy. Preliminary results show that a large biomass of *C. sinicus* is located in the deep, low temperature zone along the continental slope.

The discussion of the Terms of Reference on sampling technology and monitoring was very lively with contribution from all countries. Although there was a consensus on the need for inexpensive, reliable sensors for zooplankton, there was no agreement on how to proceed or to facilitate development of such sensors. The ICES WGZE decided to continue this discussion as a minor part of their discussions on monitoring and environmental indices. This decision was based on the limited number of recommendations they can make to ICES in any one year, and the limited number of TOR that can be discussed at an annual meeting. Since the WGZE is holding a joint meeting with the Working Group on Phytoplankton Ecology next year and usual annual meetings will be replaced by joint meetings of all working groups in two years, the WGZE members did not feel they could continue these discussion as a major theme.

Plan for a major ICES/PICES/GLOBEC symposium on comparative zooplankton ecology

Prior to the meeting, PICES prepared a proposal for a joint ICES/PICES/GLOBEC symposium on comparative zooplankton ecology (many thanks to William Peterson for his efforts). This proposal was distributed at the meeting, and Tsutomu Ikeda made a short presentation to emphasize the need of North Pacific-North Atlantic comparison for various aspects of zooplankton ecology to deepen our understanding of the role and functions of zooplankton in the marine ecosystem under global climate change.

Definitions and Scope: In our proposal, the term “zooplankton” includes all sizes and functional types of heterotrophic and mixotrophic plankton that contribute to secondary and higher level production.

Themes/Sessions: (i) Physical variability and zooplankton population dynamics; (ii) Role of zooplankton in biogeochemical cycles; (iii) Climate influences — what are long-term data sets telling us? (iv) Comparative life histories/ life cycles of zooplanktonic populations within and between North Atlantic and North Pacific; (v) Progress in molecular biology of zooplankton; (vi) Role of microzooplankton in marine ecosystems.

Scientific Steering Committee: We propose that the Scientific Steering Committee (SSC) be led by up to two members from

the ICES community, two from the PICES community and two from the International GLOBEC community. These people should be selected by their respective bodies. The SSC could then work with a Local Organizing Committee on meeting logistics. May 2002, and Barcelona, Spain were suggested as an appropriate time and place.

Products: It is expected that the meeting will result in the publication of the best papers in a special issue of an international journal. A journal should be selected soon so that a publication date of the symposium volume can be scheduled by the editors.

Diversity of zooplankton topics discussed: Most of the papers presented at the previous Plymouth meeting in 1994 dealt with different aspects of the ecology of copepods. The proposed symposium should consider the value of bringing together a more diverse group of contributions that treat not only copepods, but microzooplankton, euphausiids, and other meso- and macrozooplankton groups (such as pelagic mollusks, chaetognaths, amphipods, etc).

ICES colleagues expressed their general support for this proposal, except the date and place for the symposium. They suggested the year of 2003, instead of 2002, and some places other than Barcelona to be considered as several large meetings are already scheduled in Barcelona and the proposal did not identify a local host. Roger Harris (International GLOBEC SSC Chairman) expressed his support for this proposal, and will bring it to the attention of the GLOBEC SSC members at their meeting scheduled in May 2000. At the end of the discussion, Luis Valdés concluded that the WGZE’s recommendation to support the proposal will be discussed at the ICES Annual Meeting in September 2000. Any ICES decision concerning support for the proposal should be known to the PICES Science Board for review and discussion at the PICES Annual Meeting in Hakodate in October 2000.

During the 3-day meeting, under the pleasant tropical climate, I felt that both ICES and PICES zooplanktologists have many common problems on which we could work together. During the meeting, a question was raised by ICES colleagues: whether it is possible to establish a PICES Working Group on Zooplankton Ecology (equivalent to ICES WGZE) with an unlimited life span. Under the present structure and rules of PICES, this is difficult but may be worth considering in the future. Exchange of views, ideas and data by zooplanktologists of these two organizations will indisputably facilitate development of zooplankton ecology. From this point of view, a proposed ICES/PICES/GLOBEC Zooplankton Symposium would be a good start for collaboration between ICES and PICES, and provide some substance to the ICES/PICES MOU on scientific cooperation.

(cont. from page 1)

propagation of the influence by Kelvin waves from the equator, which P. Ted Strub examined through tantalizing TOPEX altimetry data. Richard A. Feely explained the important role played by El Niño in modulating the global air-sea flux of CO₂, while Takashige Sugimoto (invited speaker) addressed the influence of El Niño and the Asian monsoon on ocean conditions and living marine resources in the western Pacific. On a broader time scale, Kimio Hanawa presented an analysis of variability of sea-surface temperatures based on the 100-year Kobe Collection of ship observations, identifying modes of variability and regime shifts as transitions between them, each shift endowed with its own individual characteristics. Steven R. Hare gathered together 100 time series of physical and biological variables to re-examine the 1976 shift and a somewhat similar event in 1989. George L. Hunt (invited speaker) presented a comprehensive regional overview of changes in the Bering Sea over the past three decades, ranging from physical variables to the highest trophic levels (birds and sea mammals). In the same area, Grace E. Abromaitis reported on a stable-isotope analysis of bird tissues as an indication of a possible decline in marine productivity. Daniel Lluch-Belda discussed variability in the California current, while Atsamon Limsakul described links between atmospheric forcing and primary productivity south of Japan. Tim R. Baumgartner (invited speaker) documented very long-term variability using 1,500 years of sedimentary record of sardine scales off Southern California and British Columbia, finding a significant spectral peak at a period of 65 years. Gordon A. McFarlane reviewed the history of the BC sardine, from its disappearance in 1947, attributed at the time to overfishing, to its spontaneous recovery after 1992. Finally, Jürgen Alheit and Andrey S. Krovnin presented results on the variability of North Atlantic fish stocks which they held as examples of similar variations in the North Pacific, encouraging a more global perspective in relating environmental change to fish fluctuations.

The second day, focusing on ecosystem consequences of variability, started with an invited review by Jake Rice of the practical impact of the presence of ecosystem variability at a multiplicity of time scales. He advocated a re-examination of classical ecological principles, discarding ideas based on equilibrium systems, stressing the need for basic understanding of transition periods and for extreme caution in managing resources through times of change. Starting at the bottom of the productivity ladder, Joaquim I. Goes described a method of estimating primary production from satellite measurements of temperature and chlorophyll-*a*, finding that in contrast to what happens in the eastern North Pacific, El Niño brings significant increases in productivity in western North Pacific waters. Michael M. Mullin found that larger phytoplankton cells were more abundant off southern California during El Niño years, especially during periods of low grazing pressure. William T. Peterson examined zooplankton assemblages during cold and warm

PDO (Pacific Decadal Oscillation) years on the Oregon coast, finding a replacement of cold by warm water species (and vice versa) consistent with a shift in the latitude of the coastal transition between temperate and sub-polar waters. Further north, on the coast of Vancouver Island, Ronald W. Tanasichuk (paper presented by Richard D. Brodeur) found a significant interannual variability in euphausiid species, the main food item of many pelagic fishes, in response to changing ocean conditions. In California waters, Paul E. Smith described shifts in the areas inhabited by four assemblages of fish larvae in response to large-scale ocean variations. Mitsuyuki Hirai (invited speaker) reported on sea-surface temperature variations in the Japan Sea and their marked effects on sardine and squid spawning areas. Across the ocean, Salvador Lluch-Cota presented a simple but successful model of atmospheric forcing of sardine biomass in the Gulf of California. Francisco Chavez discussed the influence of upwelling fluctuations and the PDO index on the Peruvian anchovy stocks, arguing applicability to the California coast by symmetry across the equator. Kerim Y. Aydin presented an analysis of the transmission of variability through trophic levels in models forced at different frequencies at the phytoplankton level. He found, in applications to Bering Sea pollock as well as to east-Pacific tuna, that the response was highest for zooplankton and lowest for the higher trophic levels (marine mammals). Nancy D. Davis reported on studies of temperature dependence on the food habits of salmon in the eastern North Pacific and the Bering Sea. Anne B. Hollowed brought together a whole series of environmental and fish abundance indices in a comparative approach to the study of variability. Ruben Rodriguez-Sanchez found that tuna catches dropped in the eastern tropical North Pacific during El Niño, accompanied by shifts in population distributions. Studies of birds in British Columbia (Doug F. Bertram) and in the CALCOFI domain (K. David Hyrenbach) showed that they are very sensitive to changes in water properties, especially food availability. Whales, on the other hand, appear rather insensitive to climatic variability, at least in the Bering Sea (Cynthia T. Tynan).

After two days of emphasis on the characterization of long-term variability, it was good to be reminded by David W. Pierce (invited speaker) of the intrinsic variability of an ocean forced by an equally variable atmosphere. He insisted that the null hypothesis for most ocean variability is simply “red” noise, increasingly energetic at low frequencies, a point he illustrated by showing four synthetic randomly generated series nearly indistinguishable from the Pacific Decadal Oscillation. The day focused on the exploration of mechanisms linking physical and ecosystem variability. Considerable progress has been made, as illustrated by many of the presentations. Ocean-scale models of the tropical Pacific successfully accounted for nutrient and phytoplankton (Fei Chai, James R. Christian) and tuna (Patrick Lehodey, invited speaker) variations during ENSO events. Robert J. Olson presented an ECOPATH-ECOSIM analysis of the response of the eastern tropical North Pacific ecosystem to

ENSO, examining the response to amplitude, frequency and cadence of the events, with results similar to those presented by Kerim Y. Aydin on the previous day. Michio J. Kishi reported on the accomplishments of the January 2000 Nemuro modeling workshop, which yielded two versions (tuned respectively to an offshore Hokkaido station and to Station P in the Gulf of Alaska) of an 11-box upper layer model. Further presentations focused on mechanisms effective in specific areas: Vladimir I. Radchenko discussed Bering Sea variability; Konstantin A. Rogachev described the influence of modulations of tidal mixing in the Okhotsk Sea; Ann Gargett tested the applicability of the optimal stability window hypothesis to variations in the North American salmon stocks; Richard J. Beamish speculated on the presence of “growth-based” mortality in British Columbia salmon; Elizabeth A. Lugerwell presented a bio-energetic model demonstrating the importance of offshore mesoscale eddies for the production of California sardines; Jeffrey J. Polovina illustrated the role of the convergent Tropical Zone Chlorophyll Front in albacore tuna and sea-turtle concentrations; Kerim Y. Aydin studied the effect of temperature and food availability on salmon growth in the Gulf of Alaska, finding a good correlation between Fraser River sockeye body weight and the size of the area where 2 year old and older fish can feed on squid; Michael G. Hinton described the links between El Niño and the habitat of the blue marlin. Invited speaker Andrew Bakun encouraged us to reconsider some fundamental aspects of the population dynamics of schooling fish, suggesting that the influence of remembered affinities of individual fish on schooling behaviour might perpetuate and amplify evolutionary useful options and help understand responses to varying conditions.

Sunday, the last day of the conference, was devoted to discussions of the implications of climate variability on stock assessment and exploitation and other aspects of fisheries management. Lead speaker Alec D. MacCall showed examples of periodic climate shifts on single and multiple species systems, concluding that long-term interspecific interactions and climate change effects are very difficult to distinguish without a sufficient understanding of the workings of the ecosystem. Many speakers presented case studies of climate change impact on specific stocks. Jae-Bong Lee described how to arrive at an Acceptable Biological Catch level in the Korean horse mackerel fishery; Jacquelynn R. King showed how an environmental “report card” could provide a useful summary of ecosystem information for managing the British Columbia sablefish stocks; Mark N. Maunder explained how the impact of environmental dependence of growth parameters could be tested and used in snapper population models; Daniel B. Lluch-Cota presented a study of the impact of temperature changes on the Gulf of California brown shrimp fishery; Eleuterio R. Yañez described the impact of El Niño on the pelagic fisheries of northern Chile, illustrating the alternation of anchovies and sardines; Miguel N. Carranza extended the discussion to the Peruvian fisheries to the immediate north; Dagoberto F. Arcos showed

that El Niño also affected the more southerly stocks of jack mackerel, through temperature impacts on their more northerly nursery area. David W. Welch argued that the growth rate of coastal salmon stocks of southern British Columbia had been severely limited in recent years by lack of food in nearshore areas. Katherine W. Myers reviewed information pertaining to oceanic influence on Bristol Bay salmon stocks, finding it insufficient. Ernesto A. Chavez showed the importance of temperature effects on the growth rate and longevity of Californian anchovies, arguing for a management regime that would recognize the differences between different parts of the population. Franklin B. Schwing suggested, with illustrations, that patterns of long-term change might have sufficient similarities with those of ENSO that the latter might be used as a guide to understand the former. Tsuyoshi Kawasaki (invited speaker) drew on the global synchrony of some fish stock variations to suggest a 65-70 year cycle driven by fluctuations in the formation rate of the North Atlantic Deep Water. Might this correspond to the periodicity found by Baumgartner in the sedimentary record? An archaeological report by Yukimasa Ishida revealed the presence of salmon remains in 5,000 year old middens, associated with warmer water shells, an indication of former warm climates and possible shifts in the zoogeographical limits of salmon species.

The many posters were of a generally superb quality, informative and supportive of the oral presentations. Overall, the 200 conference participants gained an intensive perspective of the interdisciplinary issues of ocean climate variations and of the significant advances made in recent years.

Paul H. LeBlond
Co-Chairman
Beyond El Niño Steering Committee
Galiano Island, B.C., Canada



Highlights of the Beyond El Niño Conference

Beyond El Niño Conference co-sponsors from left to right: Vladimir Fedorenko (NPAFC), Alexander Bychkov (PICES), Hyung-Tack Huh (PICES Chairman), Robin Allen (IATTC), Vera Alexander (PICES Vice-Chairman), Michael Tillman (ISC), Warren Wooster and Paul LeBlond (Steering Committee Co-Chairmen), and Bruce Leaman (IPHC).



Dr. Alec D. MacCall giving a presentation on fish management and low frequency climate variability.



Dr. Kimio Hanawa giving his presentation on climate changes in the North Pacific during recent 100 years.



PICES and NPAFC Secretariats collaboration: Ms. Christina Chiu and Ms. Christie McAlister from PICES (left & right), and Mrs. Wakako Morris of NPAFC (center).



Lt. Governor Fran Ulmer (NPAFC President) behind Dr. Al Hermann, checking out his state-of-the-art visual presentation techniques.



Dr. L. Scott Parsons (ICES President) giving his opening speech on ocean climate change from an Atlantic perspective.



The dynamic 'beer & wine' poster session.



Shark abundance increases in the Gulf of Alaska

Bruce A. Wright
National Marine Fisheries
Service
11305 Glacier Highway,
Juneau, AK 99081, U.S.A.
E-mail: Bruce.Wright@noaa.gov

Lee Hulbert
National Marine Fisheries
Service
11305 Glacier Highway,
Juneau, AK 99081, U.S.A.
E-mail: Lee.Hulbert@noaa.gov



Bruce Wright and Lee Hulbert started the Alaska Shark Assessment Program in 1998, as part of the Alaska Predator Ecosystem Experiment (APEX) Project. They were interested in the ecological implications of increasing shark abundance in their study area. Several sources of information identified the increasing role of sharks in the northeast Pacific. Mr. Wright is now the Chief of the Office of Oil Spill Damage Assessment and Restoration, and the Chairman of the Jay Hammond Bald Eagle Research Institute. He graduated from San Diego State University in 1977 with a M.S. degree in ecology. Mr. Hulbert is the principal investigator of the Alaska Shark Assessment Project and is co-principal investigator of the APEX Forage Fish Assessment project. He graduated from the Humboldt State University in 1991 with a B.S. in fisheries biology.

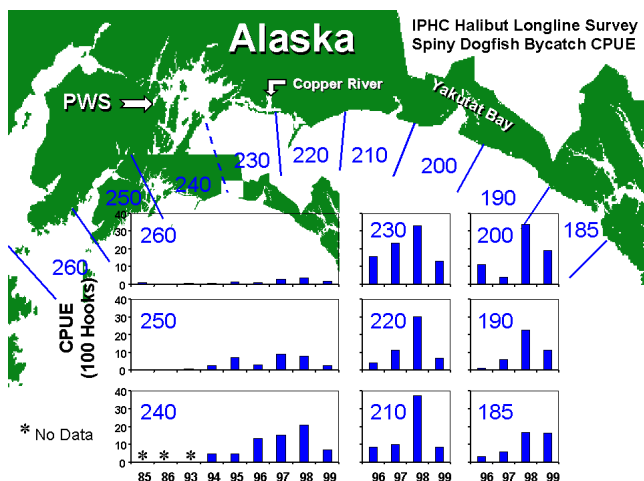

Fig. 1 Bycatch of spiny dogfish (*Squalus acanthias*) in the IPHC survey data in the Gulf of Alaska.

Shark abundance increases in the Gulf of Alaska (GOA) have been apparent to fishermen throughout the 1990s. The predominant shark species in nearshore Alaska waters, spiny dogfish sharks (*Squalus acanthias*), Pacific sleeper sharks (*Somniosus pacificus*), and salmon shark (*Lamna ditropis*), have dramatically increased in abundance in the eastern GOA and Prince William Sound (PWS). Spiny dogfish are commonly taken as bycatch in commercial fishing gear in Alaska. They are well represented in the pelagic trawl pollock fishery and in longline fisheries for sablefish, halibut, Greenland turbot, and Pacific cod.

International Pacific Halibut Commission (IPHC) longline survey data are the only available long-term source of spiny dogfish bycatch records. IPHC grid surveys were expanded in 1996 to include statistical areas east of area 240. The survey data indicate an increasing trend in relative abundance of dogfish along the eastern and central gulf coast of Alaska in the 1990s (Fig. 1).

Dogfish bycatch has presented a formidable problem for IPHC statistical analyses of halibut abundance in recent years (Dan Randolph 1999 pers. comm.). The increasing trend of dogfish abundance is supported by data from Paul Anderson with the National Marine Fisheries Service (NMFS) lab in Kodiak who conducts standardized small mesh trawl surveys in the Kodiak Island region (Fig. 2). The downturn in this trend in 1999 corresponds to a virtual absence of eulachon (*Thaleichthys pacificus*) in the Copper River, although fishermen in the Yakutat area continued to have problems with dogfish swamping salmon gillnets.

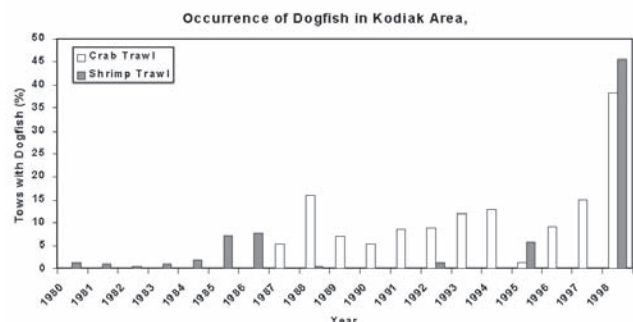

Fig. 2 Occurrence of spiny dogfish (*Squalus acanthias*) in the Kodiak Island region.

Another shark species that has increased in abundance in recent years is the Pacific sleeper shark (Figs. 3 and 4). Sleeper sharks are one of the few sharks found in polar waters year-round. They are a large demersal species generally inhabiting deep water, although they occasionally come to the surface at high latitudes. NMFS and IPHC researchers in Alaska have caught specimens in the six meter range although they average 1.8-2.4 meters in length in PWS sablefish surveys. Sleeper sharks are opportunistic predators whose diet consists primarily of groundfish, squid, and salmon. They are also known to prey on marine mammals, including harbor seals and southern right whale dolphins.

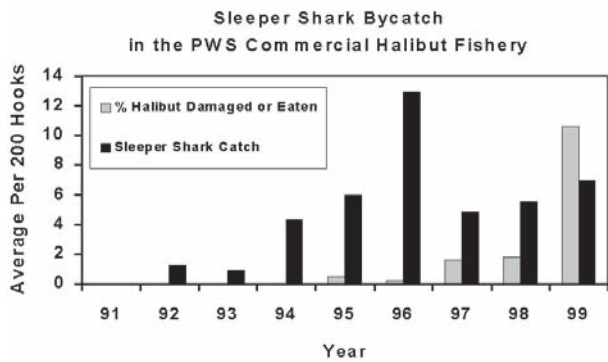

Fig. 3 Bycatch of Pacific sleeper shark (*Somniosus pacificus*) in the PWS commercial halibut fishery.

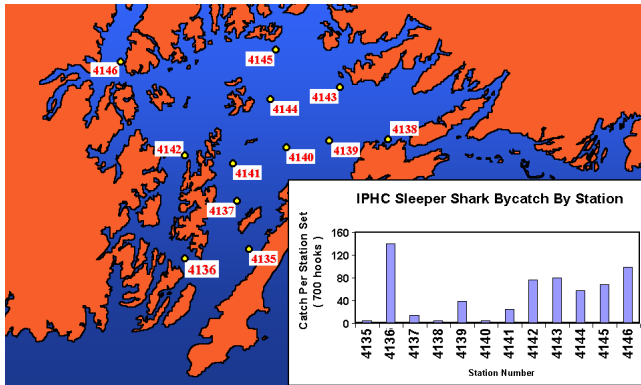

Fig. 4 Bycatch of Pacific sleeper shark (*Somniosus pacificus*) in the 1998 IHPC survey.



Fig. 5 Halibut damage.

Sleeper sharks are suspected of attacking halibut that has been caught on fishing gear (Fig. 5). Alaska Department of Fish and Game sablefish survey data also indicate an increasing trend in sleeper shark abundance since the survey began in 1996. While finding empirical data for relative trends in sleeper shark and dogfish bycatch in Alaska is difficult, it is particularly hard for salmon sharks.

Salmon sharks are rarely caught in commercial gear and information on trends in abundance is largely anecdotal. However, salmon sharks appear to be the predominant large predatory pelagic fish in the coastal GOA (Fig. 6). A member of the family Lamnidae, they are the Pacific congener of the porbeagle shark in the Atlantic and are closely related to white and mako sharks. Throughout the 1990s, salmon shark abundance in the northern GOA increased dramatically.

The vast majority of salmon sharks aggregating in surface waters of the GOA are adult females. They have been reported to reach 3m in length, although normal size range appears to



Fig. 6 Salmon shark (*Lamna ditropis*).

be between 1.8 and 2.4m. Salmon sharks maintain an elevated body temperature and studies have shown that they may have the highest body temperature of any shark, as much as 13.6°C above ambient water temperatures. Because of this, they likely possess a relatively high metabolic rate and daily ration. Their diet consists primarily of salmon, squid, and groundfish.

As part of the Alaska Predator Ecosystem Experiment (APEX) project (See PICES Press July 1999, pages 35-36), the NMFS Auke Bay Laboratory conducted a pilot salmon shark study in 1999, the first sampling effort ever directed at salmon sharks in the eastern Pacific. We collected non-lethal stomach contents, tissue samples for fatty acids, stable isotope, and population genetics analyses. The sharks were tagged with Floy tags, and three were released with “pop-up” archival satellite tags. Although large surface aggregations of salmon sharks have become common during summer months in PWS in recent years, data collected from the satellite tags, hydroacoustics, and underwater video indicate that the majority of the sharks present are below the surface at any given time. The pop-up archival satellite tag data from late July to late September indicates that the sharks spend the majority of their time between 10 and 50 meters depth. The sharks did not have clear diel patterns of depth preference. The hydroacoustics, and underwater video data support this finding.

What caused the increase in abundance of sharks in coastal GOA?

An ocean climate regime shift occurred in the winter of 1976/77. One of the major findings from the evaluation of historic data is that there has been a dramatic shift in the biotic communities in the GOA in the past two decades. A biota dominated by crustaceans and capelin in the early 1970s and before, shifted to a biota dominated by gadids and flatfish by the late 1980s (See PICES Press July 1999 pages 35-36). This shift coincides with a shift in temperatures (sea surface

(cont. on page 22)

PICES Lower Trophic Level Modeling Workshop, Nemuro

Bernard A. Megrey
National Marine Fisheries Service
Alaska Fisheries Science Center
7600 Sand Point Way NE,
Seattle, WA 98115-0070, U.S.A.
E-mail: bern.megrey@noaa.gov

Makoto Kashiwai
Fisheries Oceanography Division
Hokkaido National Fisheries Research Inst.
Kushiro, Hokkaido 085-0802, Japan
E-mail: kashiwai@hnf.affrc.go.jp

David L. Eslinger
NOAA Coastal Services Center
2234 South Hobson Avenue,
Charleston, SC 29407, U.S.A.
E-mail: dave.eslinger@noaa.gov

Michio J. Kishi
Faculty of Fisheries
Hokkaido University
Hokkaido, Hokodate 041, Japan
E-mail: kishi@salmon.fish.hokudai.ac.jp

Daniel M. Ware
Pacific Biological Station
3190 Hammond Bay Road,
Nanaimo, B.C. V9R 5K6, Canada
E-mail: wared@pac.dfo-mpo.gc.ca

Francisco E. Werner
Marine Sciences Department
University of North Carolina
Chapel Hill, NC 27599-3300, U.S.A.
E-mail: cisco@marine.unc.edu



Fig. 1 NEMURO Workshop participants. Left to right -Bottom row: Tomonori Azumaya, Yukimasa Ishida, Kosei Komatsu, Makoto Kashiwai, Michio J. Kishi, Yuri I. Zuenko, Daji Huang, Hiroaki Saito, Katsumi Yokouchi. Top row: Hyun-chul Kim, Hitoshi Iizumi, Gennady A. Kantakov, Francisco E. Werner, Sukyung Kang, Vadim V. Navrotsky, Atsushi Tsuda, Dan Ware, Bernard A. Megrey, David L. Eslinger, Vladimir I. Zvalinsky, Jing Zhang, Naoki Yoshie, Yasuhiro Yamanaka, Masahiko Fujii, Maki Noguchi, Lan S. Smith.

Introduction

The PICES Climate Change and Carrying Capacity (CCCC) MODEL Task Team is encouraging, facilitating and coordinating modeling activities within PICES member nations as they relate to the goals and objectives of the CCCC Program. Toward this end, the MODEL Task Team convened a workshop in Nemuro, Japan, to develop a prototype lower trophic level marine ecosystem model. The goals of the workshop were to:

- select a lower trophic level model of the marine ecosystem as a PICES prototype;
- select a suite of model comparison protocols to examine differences and similarities in model dynamics;
- demonstrate the applicability of the prototype model by comparing lower trophic ecosystem dynamics among different regional study sites in the CCCC Program;
- compare the prototype model with other models;
- identify information gaps and the necessary process studies and monitoring activities to fill the gaps; and
- to discuss how to best link lower and upper trophic level marine ecosystem models and regional circulation models.

Participants, organizers, sponsors and venue

Twenty-nine scientists from Canada, China, Japan, Korea, Russia and the United States (Fig. 1) met in Nemuro, Japan, between January 30–February 4, 2000. Fifteen of these arrived with their own laptop computers, ready to: (1) build a numerical NPZ (Nutrients, Phytoplankton, Zooplankton) model, (2) estimate model parameters, (3) select a suite of model comparison protocols, (4) compare the model to validation data sets, and (5) perform regional comparisons. Participants included plankton biologists and modelers, individuals who knew about or brought key data sets, and individuals knowledgeable about lower trophic level modeling in each region.

The meeting was organized by Drs. Michio J. Kishi, Makoto Kashiwai, Bernard A. Megrey and Daniel M. Ware. Dr. Megrey served as workshop chairman. The Japan International Science and Technology Exchange Center (JISTEC), PICES, and the city of Nemuro provided financial support and access to an excellent venue. The Nemuro Supporting Committee supplied local logistical support. The venue was the Multi-Purpose Hall, a large octagonal room in the Nemuro City Cultural Center.

Workshop activity

Five different but related models were examined at the workshop.

- The PICES CCCC prototype lower trophic level marine ecosystem model named “*NEMURO*” (see below): a conceptual model representing the minimum trophic structure and biological relationships between and among all the marine ecosystem components thought to be essential in describing ecosystem dynamics in the North Pacific (Fig. 2).
- The “*NEMURO*/FORTRAN Box” Model: A FORTRAN computer program to solve the coupled set of differential equations making up *NEMURO* and the graphing software needed to examine model output.
- The “*NEMURO*/1-D Kishi” Model: The *NEMURO* model coupled with a 1-D ocean physics model. The physical model runs prior to *NEMURO*, and provides the necessary physical forcing required by *NEMURO*.
- The “*NEMURO*/1-D Yamanaka” Model: Similar to the 1-D Kishi model except that the ocean physics model and *NEMURO* are calculated simultaneously in one FORTRAN computer program.
- The “*NEMURO*/MATLAB Box” Model: A MATLAB® version of *NEMURO*.

A friendly competition among meeting participants resulted in the naming of the prototype model as *NEMURO* (North Pacific Ecosystem Model for Understanding Regional Oceanography). The winning name was a joint effort with contributions from Dr. Vadim V. Navrotsky (Russia), Dr. Lan S. Smith (Japan), and Dr. Bernard A. Megrey (U.S.A.).

Three days of the workshop were spent in various activities. The morning of the first day consisted of informal presentations to provide a general introduction to the activities of the PICES CCCC MODEL Task Team (Dr. Megrey), a presentation on model comparison protocols (Dr. Kashiwai), and a presentation on logistical, practical, and theoretical issues related to linking lower trophic marine ecosystem models to higher trophic level models (Dr. Francisco Werner). Dr. Megrey finished the morning by leading a discussion on what models, data sets, parameters, and validation data were brought to the meeting by participants.

The afternoon session focused primarily on a presentation by Dr. Kishi and the status of his prototype model. The state variables, process equations representing system fluxes, parameter needs and outputs were discussed in detail. After considerable discussion, the model was modified slightly and the group of 29 scientists collectively accepted *NEMURO* as the PICES prototype lower trophic level marine ecosystem model (Fig. 2).

This significant occasion was followed by a presentation on the importance of including a microbial food web in the marine ecosystem lower trophic level model (Dr. Ware). The afternoon ended with a selection of model comparison locations. Regions selected for comparison included station A7 on the A-line off the east side of Hokkaido Island (41.5°N,

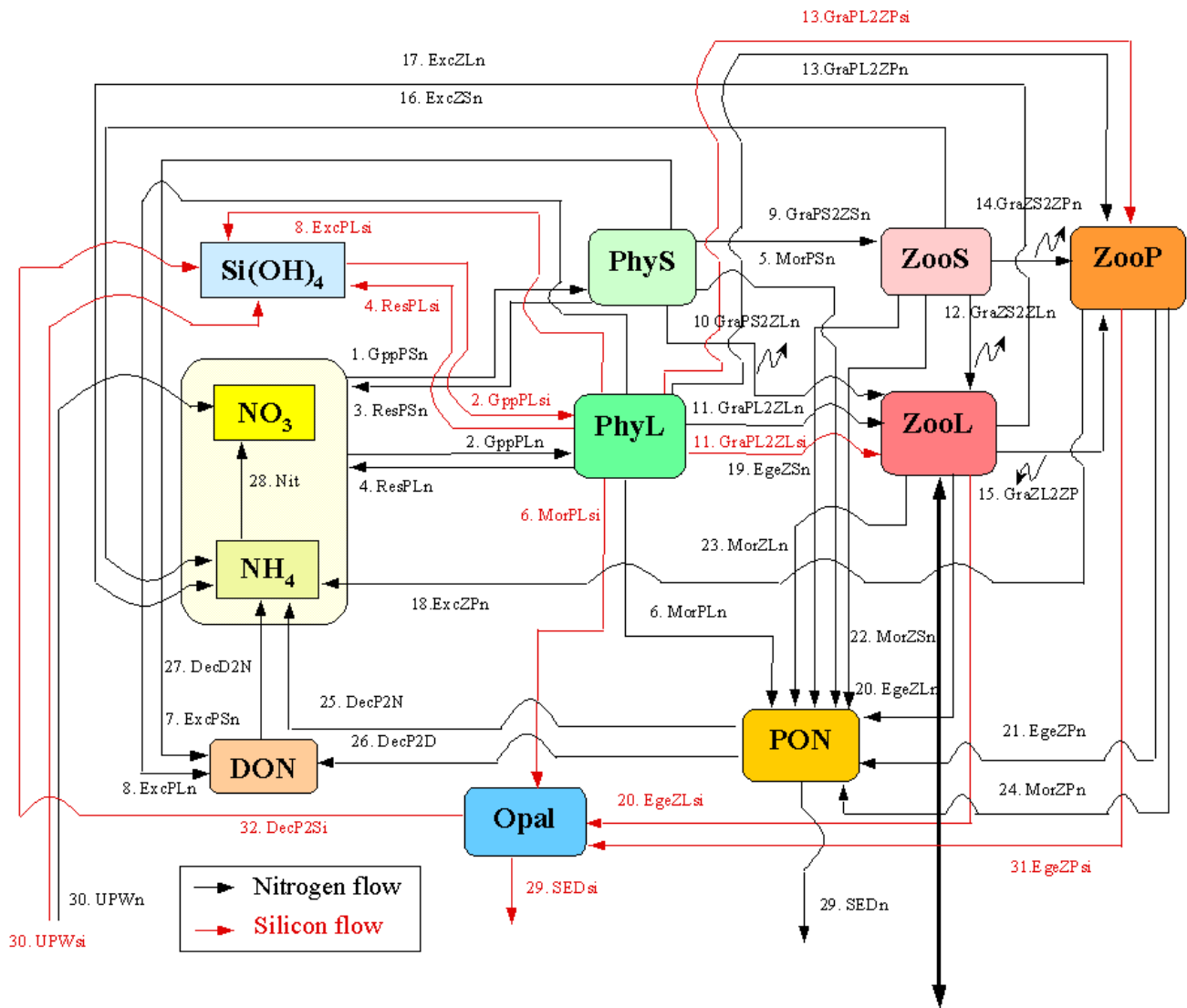

Fig. 2 NEMURO/FORTRAN Box Model output showing the time-dependent dynamics of the state variables for two locations, station A7 (top panel) and Station P (lower panel).

145.5°E), Ocean Station P (50°N, 145°W), and the Eastern Bering Sea (57.5°N, 175°W).

On the second day, the participants broke into four working groups. The first group prepared the forcing files for the three sites as well as coding the test models. The second group reviewed the appropriateness of all biological process equations and the suitability of individual parameter values. They generated a list of parameter values for each geographic location, where possible, and provided a reference and plausible limits. The third group prepared software for post-processing the model output (reformatting of output data files and defining standard figures for graphing model output). The third group, mainly through the efforts of Dr. Werner and subsequently with the assistance of Dr. David Eslinger,

programmed the prototype model using MATLAB® software. The fourth working group concerned themselves with formulating a microbial food web extension to NEMURO and developing a strategy to incorporate the microbial food web sub-model into the existing prototype.

On the afternoon of the second day, there was a presentation by Dr. Yasuhiro Yamanaka on the structure of the NEMURO/1-D Yamanaka model, and by Mr. Naoki Yoshie and Mr. Masahiko Fujii on the status of the NEMURO/FORTRAN Box Model. Also on the afternoon of the second day, preparation of the forcing files for stations A7, Station P and Bering Sea was reviewed and Dr. Vladimir Zvalinsky gave a presentation on alternative formulations for modeling the marine primary production process.

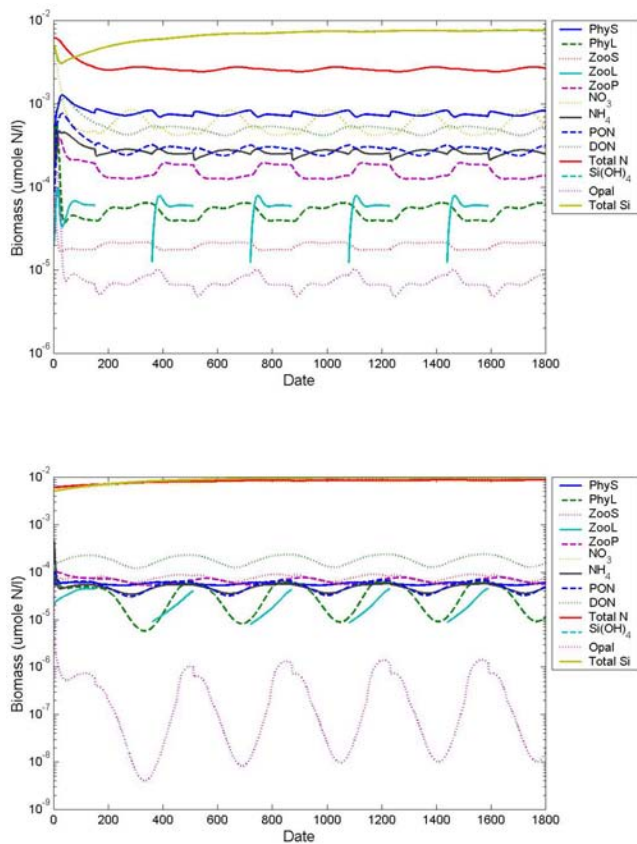

Fig. 3 *NEMURO/FORTRAN* Box Model output showing the time-dependent dynamics of the state variables for two locations, station A7 (top panel) and Station P (lower panel).

Model description - the NEMURO Model

The *NEMURO* NPZD marine ecosystem model consists of the conceptual model, a set of coupled differential equations and process equations, and a table of parameter values and initial starting conditions. *NEMURO* is made up of 11 state variables each represented by a box compartment shown schematically in Figure 2. The state variables (and state variable names) are Nitrate (NO_3), Ammonium (NH_4), Small Phytoplankton Biomass (PhyS), Large Phytoplankton Biomass (PhyL), Small Zooplankton Biomass (ZooS), Large Zooplankton Biomass (ZooL), Predatory Zooplankton Biomass (ZooP), Particulate Organic Nitrogen (PON), Dissolved Organic Nitrogen (DON), Particulate Organic Silicate (Opal), and Silicate Concentration ($\text{Si}(\text{OH})_4$). Fluxes between and among the state variables (represented in Fig. 2 with arrows) represent the fluxes between the model compartments in both nitrogen (black arrows) and silicon (red arrows) units.

The formulation of the fluxes between the model compartments is given by a set of 14 coupled ordinary

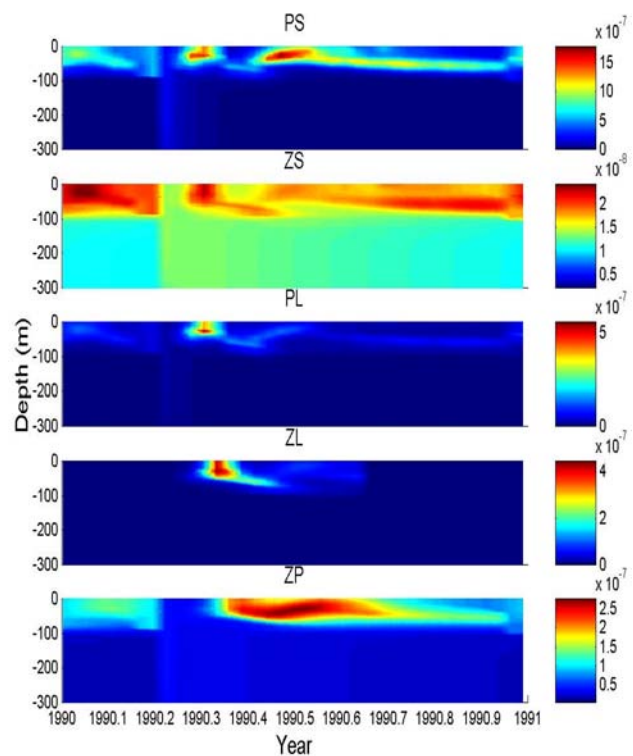

Fig. 4 *Biological state variables* output from applying the *NEMURO/1-D Yamanaka Model* to station A7 using daily physical forcing data files and plotted against time and depth. Shown are (small phytoplankton (PS), small zooplankton (ZS), large phytoplankton (PL), large zooplankton (ZL), and predatory zooplankton (ZP). All biological state variables are plotted as biomass concentrations expressed in nitrogen units ($\mu\text{molN/l}$).

differential equations. Process equations, which describe individual submodel processes (i.e. photosynthesis, grazing), supply the detail needed by the differential equations. Parameter values and initial conditions supply the specific information needs of the process and differential equations. Details regarding these items as well as details of the *NEMURO/1-D Yamanaka* model, the *NEMURO/1-D Kishi* model, and the *NEMURO/MATLAB* Box Model will be published later this year in PICES Scientific Report No. 15.

Preliminary model results

In Figure 3, the time-dependent features of the *NEMURO/FORTRAN* Box model are shown.

The top and bottom panels show model dynamics for stations A7 and Station P respectively. Figure 4 shows selected output from the *NEMURO/1-D Yamanaka* model for station A7.

A “base” twenty-year run of the *NEMURO/MATLAB* Box model using the Station P parameters, for years 4 through 6, is shown in Figure 5.

Model experiments and comparisons

The MODEL Task Team plans to vary three factors: the model, the geographical location and corresponding sets of biological parameters, and physical forcing scenarios. The model comparison protocols will be used as a basis of comparison.

Recommendations for future work

- Perform a sensitivity/stability analysis on *NEMURO*.
- Test the sensitivity of production of small and large zooplankton, P/B ratio, and ecological efficiency to inclusion of the microbial food web.
- Develop a way to measure when a change in model output is “significant”. The metric should consider time, space, and some absolute values of parameters.
- Future work should be coordinated by the MODEL Task Team Co-Chairmen, and participants encouraged to present their results at the next Annual Meeting of PICES. Cooperation and coordination with other CCCC Task Teams are very important.
- Issues related to model management need to be addressed to control the increasing number of different versions of model, including process equations, parameter files, physical forcing data files, and post processing programs. We propose to examine the ICES/GLOBEC experience to obtain guidance as to how best to proceed.
- Develop a *NEMURO*/Stella Box Model using the Stella software package.
- Make progress on making an executable version of the prototype model available on the WWW.
- Develop a means of staying in contact to continue unfinished work.
- Develop a project home page.

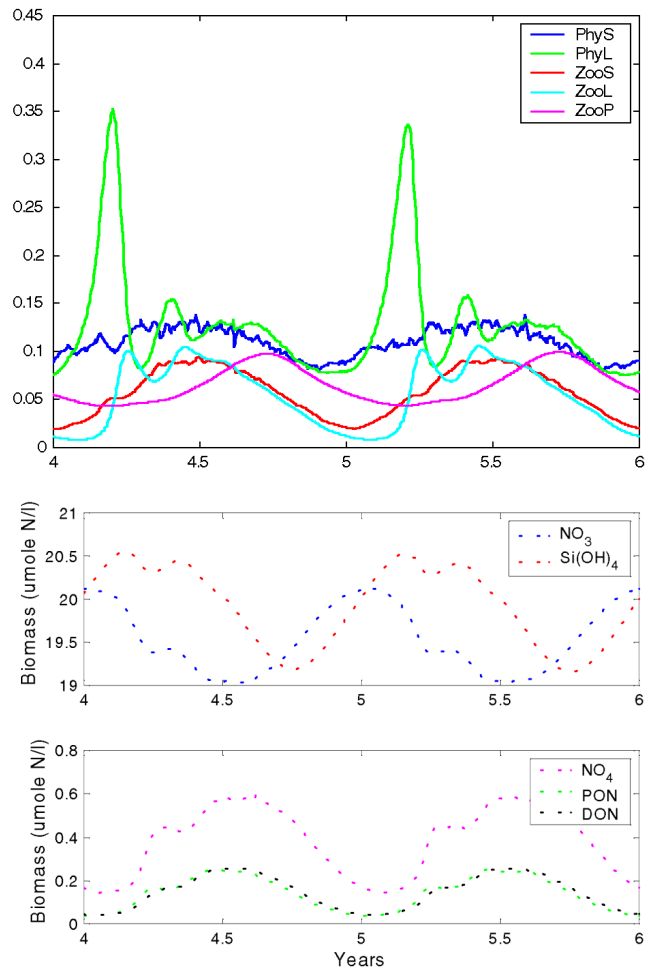

Fig. 5 Details of plankton fields for years 4 through 6 of the *NEMURO*/MATLAB Box model 20-year base run for Station P.

(Shark abundance – cont. from page 17)

temperature, air temperature, and ocean temperature at 250 meters depth) from cooler to warmer. Forage species began a rapid decline between 1977 and 1980 and high trophic level groundfish increased 250% in biomass by the 1990s. By the late 1980s the GOA saw dramatic declines in abundance indices of sea lions, fur seals, and harbor seals.

The forage base responds quickly to changes in climate regimes and is further impacted by predation as groundfish biomass increases. It may be that shark succession in trophic community structure is a natural response to the regime shift, but delayed due to low intrinsic rates of population increase. Has enough time elapsed following the trophic regime shift to justify an explanation of the trend to an increase in shark numbers? Little is known of salmon shark and sleeper shark life history parameters and dogfish age at maturity appears to vary greatly with region and environmental stressors. Considering low intrinsic rates of population increase for sharks in general, it may seem unlikely that the trend follows an increase in numbers. However, changes in reproductive

potential due to favorable conditions is a factor that should not be ruled out. Until demographic parameters of these sharks in the GOA are described, the answer is highly speculative. Other reasons for the increase in shark abundance in the northeast Pacific may be due to increased salmon production, both hatchery and wild salmon, reduced mortality from high seas gillnetting, or a shift in the shark populations in reaction to changes in water temperatures.

In conclusion, we believe that a combination of factors has resulted in the increased shark abundance in the northeast Pacific and they are now one of the predominant apex predators in the region. The cause and consequences of this trend are unclear. Monitoring shark population trends through better shark bycatch data records and directed surveys, combined with research describing the sharks' spatial and temporal movements, diet, and demographics, will contribute greatly to the understanding of the role of sharks as indicators of, and their effects on, trophic community structure in the GOA.

On the third meeting of the LMR-GOOS Panel

Warren S. Wooster
University of Washington
School of Marine Affairs
3707 Brooklyn Avenue NE,
Seattle, WA 98105-6715, U.S.A.
E-mail: wooster@u.washington.edu

Dr. Warren S. Wooster is an oceanographer who studies interactions between climate variations and marine ecosystems. He is a professor emeritus at the School of Marine Affairs, University of Washington, in Seattle, and Co-Chairman of the Living Marine Resource Panel of the Global Ocean Observing System. His earlier academic appointments were at the Scripps Institution of Oceanography (1947-1973) and the University of Miami, and he has been at the University of Washington since 1976. Dr. Wooster was Secretary of the Intergovernmental Oceanographic Commission (1961-1963), President of the Scientific Committee on Oceanic Research (1968-1972) and of the International Council for the Exploration of the Sea (1982-1985), and the first Chairman of PICES (1992-1996). He continues to be involved in PICES as the Chairman of the Advisory Panel on Continuous Plankton Recorder survey in the North Pacific, member of the MONITOR Task Team and the National representative for the CCCC Implementation Panel. A detailed biography of Dr. Wooster can be found in PICES Press Vol.5, No.1 (January 1997).



The Living Marine Resource Panel of the Global Ocean Observing System (LMR-GOOS) held its third meeting in Talcahuano, Chile, on December 8-11, 1999. (Reports on the first and second meetings can be found in PICES Press, Vol. 6(2), 7(1) and 7(2).) GOOS, a global international program led by UNESCO's Intergovernmental Oceanographic Commission, is planning the monitoring of the world ocean with a view to provide useful now-casts (descriptions) and forecasts of ocean conditions of value to users of the ocean and its resources. The climate module is most advanced, followed by panels concerned with the coastal ocean and the health of the ocean. Planning of the living marine resource component has been slow to develop, largely because apart from sampling related to fish stock assessment, there are few routine observing programs of biological variables.

This LMR meeting was the first to be held in the southern hemisphere, by chance (!) during the austral summer. The first days were devoted to a review of relevant activities, including those of the PICES MONITOR Task Team, and of progress on initiatives taken at earlier meetings. Several ongoing programs were proposed for inclusion in the GOOS Initial Observing System. In the North Pacific, these included the monitoring aspects of the California Cooperative Oceanic Fisheries Investigations, observations on Station P and Line P west of British Columbia, and the Japanese and Korean LMR monitoring programs. Two programs under development in the PICES region were identified as LMR-GOOS pilot projects. The first is a Continuous Plankton Recorder survey recommended by the MONITOR Task Team

of the PICES CCCC Program. This will start in March 2000, with five lines per year from Alaska to California, and one from Vancouver Island to the Bering Sea. The second project was proposed by Mexican colleagues who have initiated a study of Biological Action Centers (BACs), highly productive coastal regions along the west coast of North America. Successful implementation of LMR-GOOS will require use of existing databases, and the Panel initiated a review of those for selected ecosystem components - marine mammals, sea turtles, sea birds, zooplankton - not well covered in fishery databases such as those compiled by the Food and Agriculture Organization (FAO). Steps were proposed to promote the development of meta-databases for these components, and the help of PICES in this venture will be welcome.

The following comments on the general problem of monitoring related to living marine resources are taken from the draft report of the Talcahuano meeting. The output of a practicable monitoring system might include routine information on the time and space variability of the surface layer physical conditions (e.g., T, S, wind forcing, circulation), primary production (derived from remotely-observed surface color), and community structure of larger zooplankton (from CPR), plus irregular information on the abundance and distribution of higher trophic levels (from observers and from fishery data). Using this output, a centralized mechanism for data compilation and analysis should be able to provide useful now-casting. Monitoring systems for the open ocean, the coastal ocean, and inshore will differ significantly in the frequency of observations in time and space and to some extent

in the variables observed. These differences will reflect the nature of the time and space gradients of these properties as well as the uses to which the data will be put. In order to obtain a useful description of the variability, sampling frequency will normally increase in passing from the open ocean to the inshore. While the physical variables of interest will be much the same offshore and inshore, the numbers and types of necessary biological observations will also increase towards inshore. The demand for products, and hence the funding, of monitoring systems can also be expected to be greatest inshore. Therefore, it seems appropriate to speak in general terms of three nested monitoring systems.

The open ocean system extends shoreward to where presence of the coastal boundary is felt, generally to the edge of the continental shelf. The coastal ocean system then extends from there to the inshore system where terrestrial influences tend to dominate. These boundaries fall roughly at about 200 miles and about 3 miles from the land-sea boundary. Note that continuity in space between observations can be provided in two dimensions by remote sensing and in one dimension by underway recording or by towed devices. At fixed locations, continuity in time can be provided by recording devices.

In all monitoring systems for LMR purposes, there is a need for information on the atmospheric forcing, ocean velocity field, and distributions of temperature and salinity at the surface and in the surface layer. Such information is also required for monitoring of ocean climate and health of the ocean. In addition, biological studies also utilize information on the distributions of dissolved oxygen and of nutrient substances such as inorganic compounds of nitrogen, phosphorus, silicon, and iron. For assessment of living marine resources, a case might be made for quantitative sampling at all trophic levels from bacteria to whales. The problem is to select from these possibilities the most cost-effective suite of observations that will yield information of direct value to users of living marine resources. An ocean basin would be overflowed by satellites measuring sea surface height, winds, temperature, and ocean color. Surface weather would be reported by voluntary observing ships reporting to the World Meteorological Organization (WMO) network. On transects selected to cross major features of circulation or of changes in properties (e.g., ocean fronts), selected merchant and research ships would tow plankton recorders and drop expendable BTs at appropriate intervals (e.g., hourly). In a minimal system, other ecosystem components and conditions, from top predators and commercial finfish down to phytoplankton and nutrient chemistry, would be observed opportunistically at irregular intervals.

A composite picture at quarterly intervals could be built on the framework provided by the satellite data and transect observations, with the irregular biological data inserted where applicable. This analysis, which would provide the basis for elaboration of useful products, would be made at appropriate basin-scale regional analysis centers.

Part of the problem is to transform data resulting from feasible monitoring schemes into useful products, now-casts and forecasts of the state of marine ecosystems of interest and their living marine resources. Methods for this transformation largely remain to be developed. To produce forecasts will require the use of models relating knowledge of the present state of the ecosystem, including the history of its development and rate of change, with the production (including recruitment and growth) of species of interest. Development of such models is a necessary ingredient of research (e.g., GLOBEC) that supports the development of GOOS. As in the case of now-casting, data compilation and analysis is a necessary function of regional analysis centers. The analysis of data resulting from the LMR components of GOOS will require bringing them together with relevant data from other sources in a description of the changing regional ecosystem of concern and of the processes causing the changes. The compilation and interpretation of data in a holistic analysis of an ecosystem is an essential element of a monitoring system.

It is proposed that such analyses be made in regional analysis centers, where scientists of appropriate disciplines from participating countries would undertake the work. Work in these centers could also serve a central role in capacity building. Such an analysis center would receive climate, oceanographic, and fisheries data from national and international sources, and on a regular basis would prepare descriptions of the current state of the ecosystem and recent and longer term changes therein, including climate forcing, ocean physical conditions and circulation, and abundance and distribution of various biological components of the system. To the extent that available data and understanding of the system permitted, forecasts would be made of probable future conditions of these same ecosystem components. The products of the now-casting and forecasting analyses would be regularly provided to participating countries and organizations and would be made widely available on the web. Results of the analyses would also be used for improving the observational system. As a first step in the development of regional analysis centers, it was proposed to request several organizations, including PICES, to initiate discussions of design and possible implementation of such centers in their regions of interest. These discussions should include assessment of present exchange arrangements for climate, oceanographic, and fisheries data relating to those regions.

The LMR Panel will have its fourth meeting in Honolulu in early May 2000. It is anticipated that before the end of 2000, this panel will be amalgamated with panels on the coastal ocean and on the health of the ocean, and planning for this merger will take place in mid-May. It will be a challenge for the LMR Panel to ensure that the needs for monitoring living marine resources are preserved in the planning of the unified panel.

Ocean Ecology of Juvenile Salmonids along the North American Coast



William T. Peterson
Hatfield Marine Science Center
National Marine Fisheries Service
2030 South Marine Science Dr.,
Newport, Oregon 97365, U.S.A.

Dr. William Peterson is an oceanographer with NOAA-Fisheries at the Hatfield Marine Science Center in Newport, Oregon. He served as Program Manager for the U.S. GLOBEC program at NOAA-Fisheries Headquarters in Washington D.C. for three years and previous scientific posts included 2 years in Monterey with NOAA, 2 years in Cape Town, South Africa with the Sea Fisheries Research Institute, and 8 years at Stony Brook, NY. His field of research is zooplankton ecology with a focus on the ecology of euphausiids off the coast of Oregon. Bill is a member of the U.S. GLOBEC SSC and serves on the U.S. GLOBEC Northeast Pacific Program Coordination Committee; he is a Co-Chairman of the PICES/REX Task Team and serves on the PICES/CCCC Implementation Panel.

Scientists from the United States National Marine Fisheries Service (NOAA) hosted the second annual workshop on *Ocean Ecology of Juvenile Salmonids* on February 14-15, 2000, at the Northwest Fisheries Science Center in Seattle. The first workshop was held in January 1999, in Newport, Oregon. The idea for these workshops arose from the realization that the early ocean life of juvenile salmonids is being investigated by at least six different research teams located at government labs and universities along the North America coast and that most of the work was being conducted without frequent exchange of information or results. Thus, the consensus was that an annual regional workshop might be useful to facilitate coordination, collaboration, and cooperation among North American investigators. The overall objective of the 2000 workshop was to compare and contrast the response of juvenile salmonid distribution, abundance and growth to the dramatic coastal ocean ecosystem changes that occurred during the transition from the 1997/98 El Niño to the 1999/00 La Niña. For example, the mean sea surface temperatures at Kains Island (northwest Vancouver Island, B.C.) had not been so cold since before the 1976/77 regime shift (Fig. 1).



Stewart M. (Skip) McKinnell
North Pacific Marine Science Organization
c/o Institute of Ocean Sciences
P.O. Box 6000,
Sidney, B.C., CANADA V8L 4B2

Dr. Skip McKinnell is a research scientist on leave from Fisheries and Oceans Canada as Assistant Executive Secretary of PICES. He spent 20 years at the Pacific Biological Station working on scientific data analysis and computing, driftnet fisheries, and wild/farmed salmon issues. Skip has participated in various scientific and advisory roles in PICES, NPAFC (and the former INPFC), ICES (WGBAST) and PSARC. His research interests currently include salmon ecology and aquaculture and he occasionally tries to make sense of climate/ecosystem interactions. He is an Adjunct Professor at the Department of Aquaculture, Swedish University of Agricultural Sciences, where he works on Baltic salmon and sea trout.

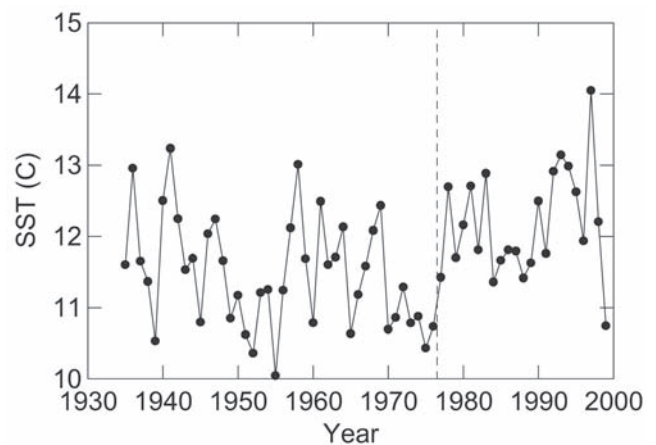

Fig. 1 Average sea surface temperature in June at Kains Island lighthouse on northwest Vancouver Island, BC. June 1999 was the coldest observed since before the 1976/77 regime shift (source: Institute of Ocean Sciences).

A total of 55 persons from Alaska, British Columbia, Washington, Oregon and California attended the meeting; 18 presentations were given followed by several hours of open discussion. Mike Schiwe (NMFS/Seattle) officially opened the meeting and gave a brief overview of the status of endangered and threatened salmonid stocks in the Pacific Northwest. The workshop began with four climate-related talks: Nate Mantua (UW/IISAO) reviewed how ENSO and PDO interact to modify ocean conditions in the Gulf of Alaska and California Current. He showed that the PDO had been positive from 1992 to 1998 but went negative in fall 1998. Frank Schwing (NMFS/Monterey) discussed ways that climate can directly influence salmonids and presented a new climate index, the Northern Oscillation Index. He noted that the Bakun upwelling index for the summer of 1999 off northern California was the highest ever recorded, and that sea surface temperature off central California were among the lowest ever measured. Bill Peterson and Bob Emmett (NMFS/Newport) reviewed changes in zooplankton and pelagic fish communities observed in the northern California Current. In 1999 there was a dramatic shift in zooplankton species composition from a community that has been dominated by a mixture of warm water and boreal coastal species (over a seven year period from 1992-1998) to a community that now contains only species that are subarctic in origin. The pelagic fish community also changed in 1992, becoming dominated by warm water species such as mackerel and sardines; but unlike the zooplankton, a change in the pelagic fish community composition did not occur in 1999. Bob Emmett speculated that if upwelling was again strong in 2000, the pelagic fish community might change from one dominated by sardines to one in which anchovy are once again conspicuous.

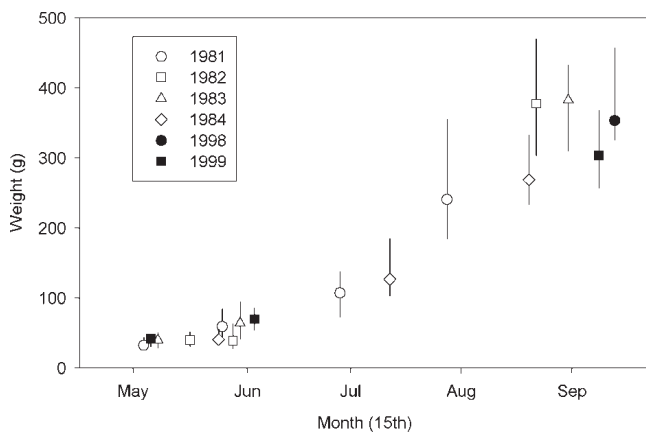

Fig. 2 Median weight (and quartiles) of juvenile coho salmon caught along the Oregon coast versus date of capture. Note that the weights of fish caught in September of the El Niño years (1983, 1998) are similar to those observed in other years.

Regional juvenile salmon sampling programs were reviewed, beginning from north to south. Jack Helle (NMFS/Auke Bay) discussed the Ocean Carrying Capacity Program. He also showed that adult chum salmon in Auke Creek have been larger in the past two years. Jack also presented results of the Southwest Alaska program on behalf of Joe Orsi (NMFS/Auke Bay) who was unable to attend. The Auke Bay group has completed three years of sampling hydrography, zooplankton and juvenile salmonids at monthly intervals (May-September) in coastal waters. Catch rates are highest in June/July; most juvenile salmon were captured within 25 km of shore. Lou Haldorsen (Univ. Alaska) presented some results from his GLOBEC-funded work in shelf waters of the Gulf of Alaska near Seward, reporting that euphausiids were far more important in juvenile salmon diets in 1999 compared to 1998. Chrys Neville (DFO/Nanaimo) discussed results of the Strait of Georgia coho and chinook work and David Welch (DFO/Nanaimo) reviewed his research on nutrients and changes in salmon survival off the west coast of Vancouver Island. Work off Washington/Oregon was presented by Ed Casillas (NMFS/Seattle) who reported an increase in low salinity water and that salmon distribution in May tends to reflect the Columbia River plume. He indicated a 10-fold increase in coded-wire tag recoveries in 1999. Bruce McFarlane (NMFS, Tiburon & Santa Cruz) summarized work on juvenile salmon in the San Francisco Bay estuary in California, showing that fish captured offshore near the Farallon Islands were larger compared to fish of the same age collected in San Francisco Bay, suggesting better feeding conditions in coastal waters.

Modelling and focused biological studies were presented on the second day. Cathy Rhodes (UC/Davis) discussed modelling of size and time of ocean entry as determinates of survival of jack salmon. Tom Wainwright (NMFS/Newport) reviewed recent trends in salmon escapement and noted the tremendous declines in coho survival that have occurred since 1992. Also, the jack-to-adult ratio is very low now suggesting higher adult mortality. Joe Fisher (OSU/Corvallis) showed that growth of coho in 1998 and 1999 was not different from growth in the 1980s (Fig. 2). Results of feeding studies were presented by Ron Tanasichuk (DFO/Nanaimo) and Ric Brodeur (NMFS/Newport). Both demonstrated the importance of crab larvae, euphausiids, amphipods and juvenile fishes in the diets of juvenile coho. Ron also showed that recruitment of the euphausiid *Thysanoessa spinifera*, an important salmonid prey item, has been virtually nil since 1992 in Berkeley Sound. Kym Jacobsen (NMFS/Newport) found that the varying load of diseases and parasites in young salmonids could explain much of the high mortality observed for fishes in their first few months at sea. Skip McKinnell reported on the survival of sockeye, coho, and chinook salmon that went to sea during the extreme ocean conditions of the summer of 1997. The final talks were on the use of a mercury mass balance model to measure salmon energy budgets (Marc Trudel, DFO/Nanaimo), relationships between climate cycles and coho survival (Pete Lawson, NMFS/Newport), and the

role of ocean conditions as a factor influencing decisions concerning the removal of hydroelectric dams on the Columbia River (Phil Levin, NMFS/Seattle).

Much of the final discussion was led by David Welch and was directed at better coordination of sampling, in terms of where and when sampling is done, and the importance of using standard methods. The workshop identified increases in upwelling strength, nutrients, phytoplankton, zooplankton and salmonid numbers in 1999, but we should not lose sight of the fact that this may have been only a brief response to a strong La Niña. On the other hand, 1999 could mark the onset of another regime shift (or at least a minor climate shift).

Whichever case turns out to be correct, the most interesting lesson that we have learned from field work in 1999 is that the ocean conditions can change quickly and coho salmon can respond almost as quickly. The third annual workshop will be organized in early 2001, in Nanaimo, B.C., Canada. Those interested in attending and/or keeping abreast of climate and oceanographic issues affecting juvenile salmonid distribution, abundance, growth and survival, should contact Bill Peterson (bpeterso@sable.nwfsc-hc.noaa.gov). For more details on the results of the Seattle workshop, feel free to contact Bill and he will put you in contact with the appropriate person(s).

(Project Argo – cont. from page 9)

nature of the failure in the seventh case is well understood and will not recur. Though this will greatly simplify the process of deployment, there do remain parts of the world that cannot be reached easily with C-130 aircraft. In those cases deployment from surface vessels will remain the only (and likely expensive) option. Assistance from other countries to assist with the deployment of floats during their routine research missions may be needed.

At both meetings we discussed the handling of data in detail. All countries participating in Argo have agreed to the free exchange and transmission of data in near-real-time (usually interpreted as <12 hours) and absolutely no protection of data by scientists. Thus, all scientists with an interest in ocean circulation will have free and easy access to the global Argo database. Anyone using the data should make an effort to understand the processing of data that will take place. There will be a fast check on the data. This process will be automated to check the data to see if they are rational. For example, we may choose to compare data with a climatology and flag data that are >3 standard deviations away from the climatology. Other standard checks will take place, such as a speed check on the position data, to ensure that there is a reasonable chance that the data are of good quality. These data will be made available on the WWW. Later, there will be a visual examination of each profile acquired in a delayed-mode quality check. This may involve recalibration of the data based on new information on sensor drifts, for example. These data will be made available separately and identified as a delayed-mode product. Generally, float data will be processed at data centres in the countries that own the specific floats. However, arrangements will be made to exchange data on a daily basis between centres. Thus, the Canadian processing centre at MEDS in Ottawa will process data derived from Canadian-deployed floats and post those data. They will exchange data with other agencies, so that, for example, the US, Japanese and Korean data centres will own the Canadian data within a day of it being received by Canada, and vice versa. Thus, Korean users of float data will be able to acquire the global

data sets from a source within Korea, Japanese users can use a Japanese source, etc.

Communication remains a major outstanding issue. At the present time all floats are communicating through *Système Argos*, because it is there, and it works, and it is reliable. However, the data transmission rate is extremely low. Experiments are being undertaken on the potential use of *Orbcomm*, a system designed to allow the tracking of commercial freight, such as containers, around the world. There are problems to resolve, and the data transmission rate on *Orbcomm* is not as great as we would like, but the results so far are quite positive.

Floats deployed in the open ocean will drift into the EEZs of countries that are not members of the Argo organisation. The Law of the Sea requires that coastal states be notified if a float is about to enter the EEZ of another country. This process will be handled for Argo by UNESCO. They will monitor launches and positions of all floats and issue notifications as required.

I would like to finish with some personal comments. The profiling float concept was developed exclusively by teams of physical oceanographers. During this process I suspect that some important opportunities might have been missed. I would rather have seen the development of a more generic platform that adjusts its buoyancy and has ports for fairly generic sensors. Perhaps we could create a float that observes profiles of chlorophyll or zooplankton or dissolved oxygen. Perhaps we could install computation capability to compute Thorpe scales. There are many possibilities, and I would encourage scientists to think about innovative sensor systems that might be installed on a profiling float.

There are now many web sites where information about the profiling floats, Projects Argo, Jason and GODAE can be found. I would suggest the following as a good starting point, which will quickly lead to the University of Washington, the Argo web site and many other places:
http://www-sci.pac.dfo-mpo.gc.ca/osap/projects/alace/hjf_argo.htm



PICES Ninth Annual Meeting

October 20-28, 2000
Hakodate, Hokkaido, Japan

Subarctic Gyre processes and their interaction with coastal and transition zones: physical and biological relationships and ecosystem impacts. (Science Board Symposium)

Prey consumption by higher trophic level predators in PICES regions: implications for ecosystem studies. (BIO Session)

Recent progress in zooplankton ecology in PICES regions. (BIO/CCCC Session)

Short life-span squid and fish as keystone species in North Pacific marine ecosystems. (FIS Session)

Large-scale circulation in the North Pacific. (POC Session)

North Pacific carbon cycling and ecosystem dynamics. (POC/BIO Session, co-sponsored by JGOFS)

Recent findings and comparisons of GLOBEC and GLOBEC-like programs in the North Pacific. (CCCC Session, co-sponsored by GLOBEC)

Environmental assessment of Vancouver Harbour: results of an International Workshop. (MEQ Session)

Science and technology for environmentally sustainable mariculture in coastal areas. (MEQ Session)

Progress in monitoring the North Pacific. (MONITOR Workshop)

Trends in herring populations and trophodynamics. (REX Workshop)

Strategies for coupling higher and lower trophic level marine ecosystem models. (MODEL Workshop)

Development of a conceptual model of the Subarctic Pacific Basin Ecosystem(s). (BASS Workshop)

The basis for estimating the abundance of marine birds and mammals, and the impact of their predation on other organisms. (BIO/MBMAP Workshop)

North Pacific CO₂ data synthesis. (Symposium/Workshop) (Oct. 18-21, 2000, Tsukuba, co-sponsored by PICES and JST/CREST)

Designing the iron fertilization experiment in the Subarctic Pacific. (IFEP Workshop) (Oct. 19-20, 2000, Tsukuba, co-sponsored by PICES and CRIEPI)



PICES Publications in 1999 and 2000

Dynamics of the Bering Sea: A summary of the physical, chemical, and biological characteristics, and a synopsis of research on the Bering Sea (Eds. Loughlin, T. R. and Ohtani, K.) Alaska Sea Grant, AK-SG-99-03, Fairbanks, 1999, 838 pp.

Ecosystem Dynamics in the Eastern and Western Gyres of the Subarctic Pacific (Guest eds. Beamish, R. J., Kim, S., Terazaki, M., and Wooster, W. S.). Progress in Oceanography, 1999, 43:(2-4).

PICES Scientific Report No. 10. Proceedings of the 1998 Science Board Symposium on the Impacts of the 1997/98 El Niño Event on the North Pacific Ocean and its Marginal Seas, 1999, 131 pp.

PICES Scientific Report No. 11. PICES-GLOBEC International Program on Climate Change and Carrying Capacity: Summary of the 1998 MODEL, MONITOR and REX Workshops and Task Team Reports, 1999, 88 pp.

PICES Scientific Report No. 12. Proceedings of the Second PICES Workshop on the Okhotsk Sea and Adjacent Areas, 1999, 203 pp.

PICES Scientific Report No. 13. Bibliography of the Oceanography of the Japan / East Sea, 2000, 108 pp.

The Nature and Impacts of North Pacific Climate Regime Shifts (Guest eds. Hare, S.R., Minobe, S., Wooster, W.S.). Progress in Oceanography, 2000 (to be published before PICES IX).

PICES Scientific Report No. 14. Report of the Working Group 11 on the Consumption of Marine Resources by Marine Birds and Mammals in the PICES Region, 2000 (to be published before PICES IX).

PICES Scientific Report No. 15. PICES-GLOBEC International Program on Climate Change and Carrying Capacity: Summary of the 1999 MONITOR and REX Workshops, 2000 MODEL Workshop, and Task Team Reports, 2000 (to be published before PICES IX).

PICES PRESS

Published and produced by PICES Secretariat
c/o Institute of Ocean Sciences,
P.O. Box 6000, Sidney, B.C.,
Canada. V8L 4B2
Tel.: (1-250) 363-6366
Fax: (1-250) 363-6827
E-mail: pices@ios.bc.ca
<http://pices.ios.bc.ca>
ISSN 1195-2512