

Keystone Wall

DESCRIPTION



Permacon's Keystone retaining wall, made of textured concrete, is approved by the *Ministère des Transports et de la Mobilité durable* in the Province of Quebec. Designed to meet your needs for large retaining walls, our modular system makes it possible to build strong walls up to 32 ft. (10 m) high. For designing walls with a geogrid reinforcement, please contact your Permacon sales representative.

Design and installation may vary according to project and site. Please consult your Permacon representative.

CORNER UNIT

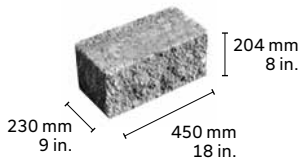

COMPACT UNIT

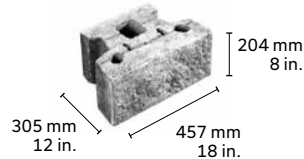

STRAIGHT CAPPING UNIT

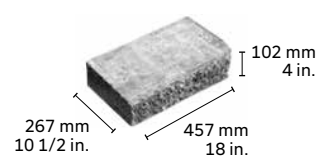

All units are packaged separately. Compact units include fibreglass pins.

LAYING PATTERN

RUNNING BOND PATTERN

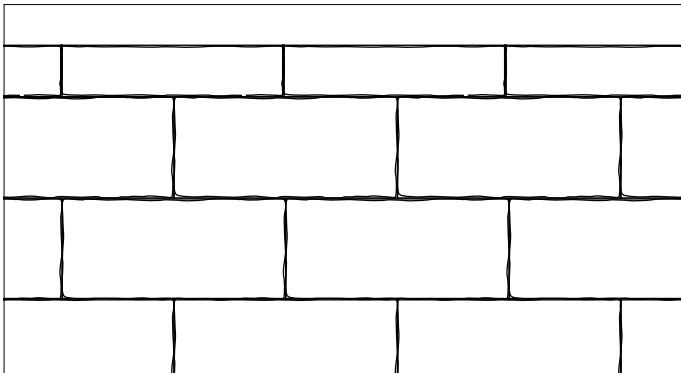

The information contained in these technical documents is supplied for information purposes only. Any application of the information is the sole responsibility of the installer. The installer must ensure that the installation and use of retaining wall projects comply with local regulations and code requirements. A qualified engineer must be consulted for final design for construction purposes. Oldcastle Building Products Canada, Inc. and its affiliates cannot be held responsible for the improper use of information contained in these technical documents.

KEYSTONE WALL - INSTALLATION

BASIC INSTALLATION

If you have any questions about installation, please contact your Permacon representative.

BURYING AND LAYING BED

- 1 - Excavate a space large and deep enough to create the laying bed and install the Keystone wall units to be buried
 - The laying bed must be at least the width of one unit plus 6 inches on each side, as shown in the diagram below
 - Depending on the type of installation, the minimum height of the wall to be buried is either 200 mm - 8 in., or the total height of the wall divided by 10 (whichever is greater)
- 2 - Fill the laying bed with 0 to 20 mm - 0 to 3/4 in. compacted stone
Refer to Step 3 in the Wall Installation section of the Installation Guide

COMPACTED GRANULAR FOUNDATION

INSTALLING FIRST ROW

- 1 - Lay the compact Keystone wall units side by side on the laying bed
- 2 - Ensure that all compact units are installed against each other and level to one another. There should be no holes at the sides or bottom of the units.
 - Using a mallet, **gently** tap the ends of the compact units so that they are straight with the ground and the other wall units

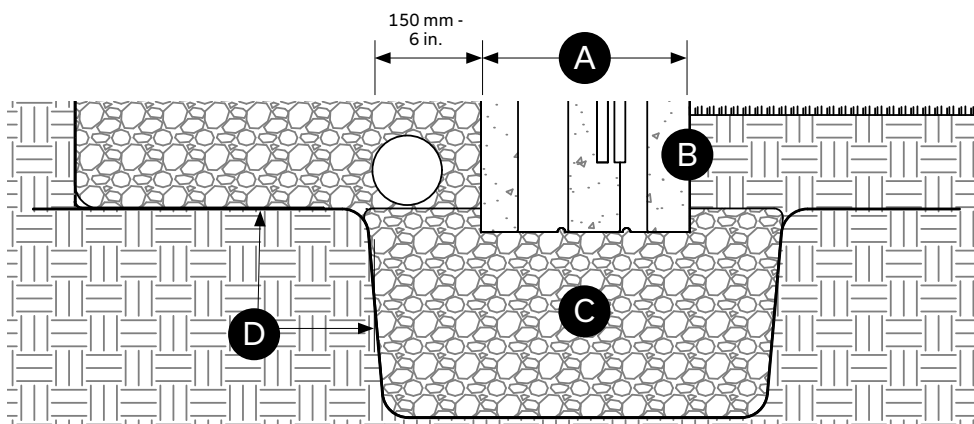

- A Wall dimensions
- B Front face
- C Compacted granular foundation:
Depth: 150 mm - 6 in.
Width: 610 mm - 24 in.
- D Excavation limits

Buried depth recommendation: For small Keystone gravity walls, a minimum of 6 inches embedment is required.

FIBREGLASS PINS

WALL AND PIN INSTALLATION

Insert the fibreglass pins of the compact unit into the two appropriate holes.

- Depending on the required setback, place the pins in the front pin cores closest to the unit textured face (1° setback) or in the back pin cores closest to the inner cavity (9° setback). If the holes in which the pins are inserted are interchanged from row to row, the wall will have a 4° setback.

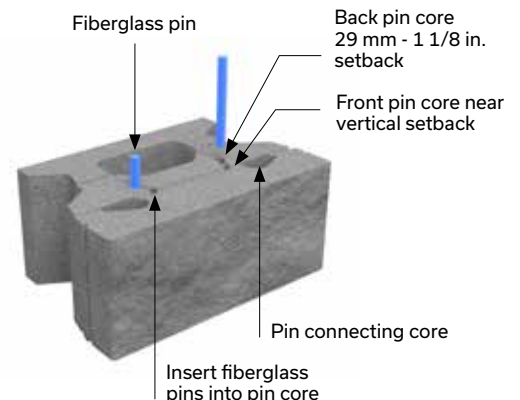

KEYSTONE WALL - INSTALLATION

ANCHOR PIN SYSTEM

KEYSTONE UNIT

Straight face compact - View from above

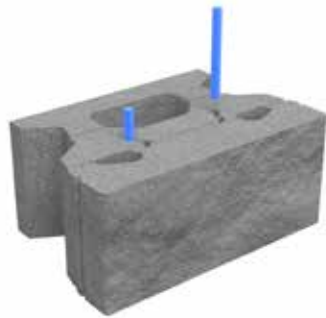
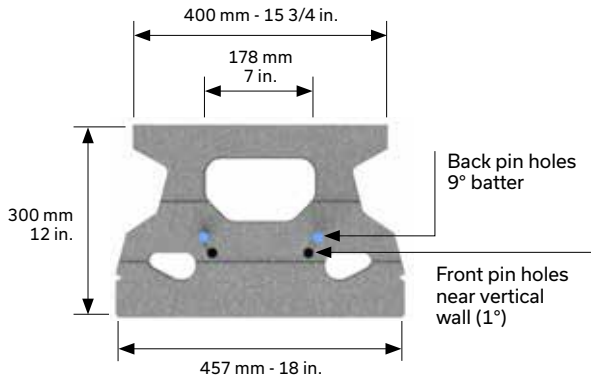

Insert connecting pin into pin holes

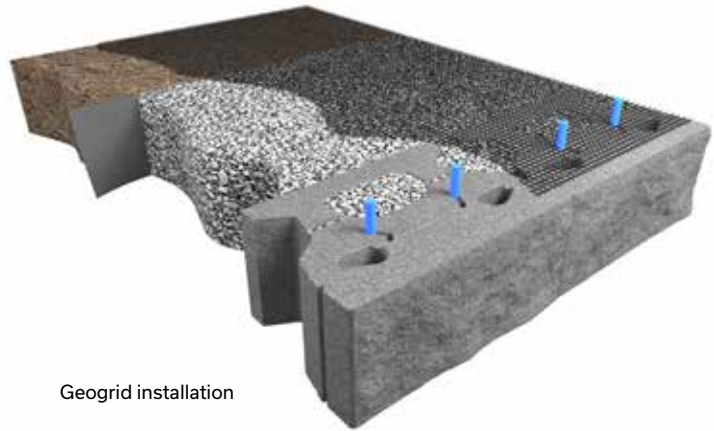

Geogrid installation

SETBACK OPTIONS

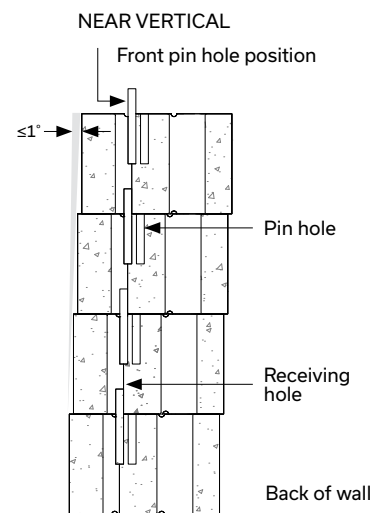
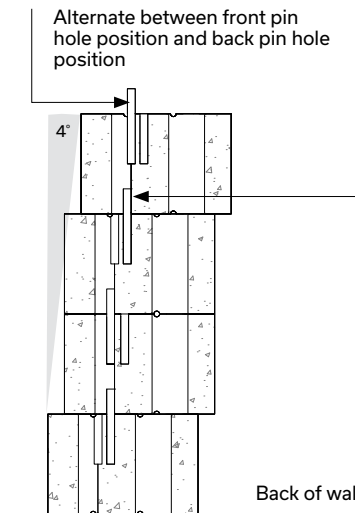
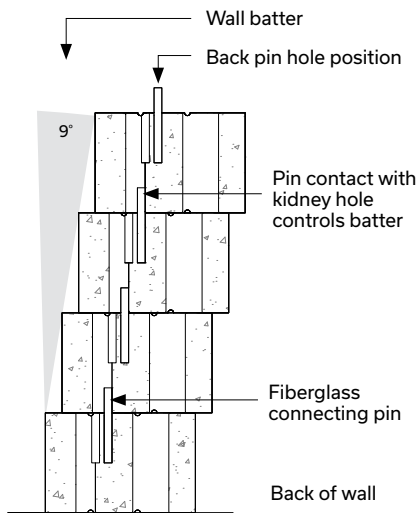

KEYSTONE WALL - INSTALLATION

DRAINAGE PIPE DETAILS

To ensure proper drainage and durability over the years, it is critical to install a drain behind the wall.

- 1 - Install the drainage pipe behind the first row of Keystone wall units
- 2 - Fill this area with 20 mm - 3/4 in. crushed drainage stone at least 300 mm - 12 in. wide while covering the drainage pipe

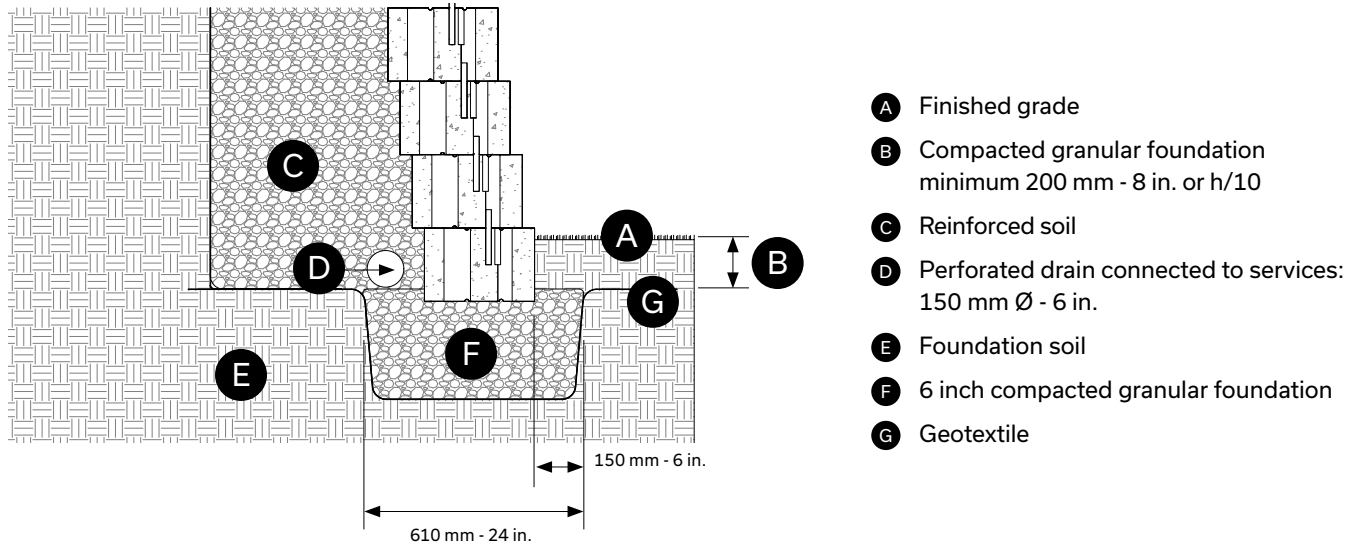

UNIT INSTALLATION

TOP ROWS

Once the first row has been laid on the compacted granular foundation and the drainage system installed, the remaining rows of Keystone units can be installed.

- 1 - Align the pin cores of the compact units above the fiberglass pins of the first row
- 2 - Lay the units, making sure that the pins of the lower row are in the cores of the upper unit
- 3 - Repeat steps #1 and 2 for all units in the row
- 4 - Make sure all units are installed against each other and level to one another. There should be no space in the sides or bottom of the units.
 - Using a mallet, **gently** tap the ends of the units so that they are straight with the ground and the other wall units
- 5 - Repeat steps #1 to 4 for all rows of the wall, inserting geogrids where indicated

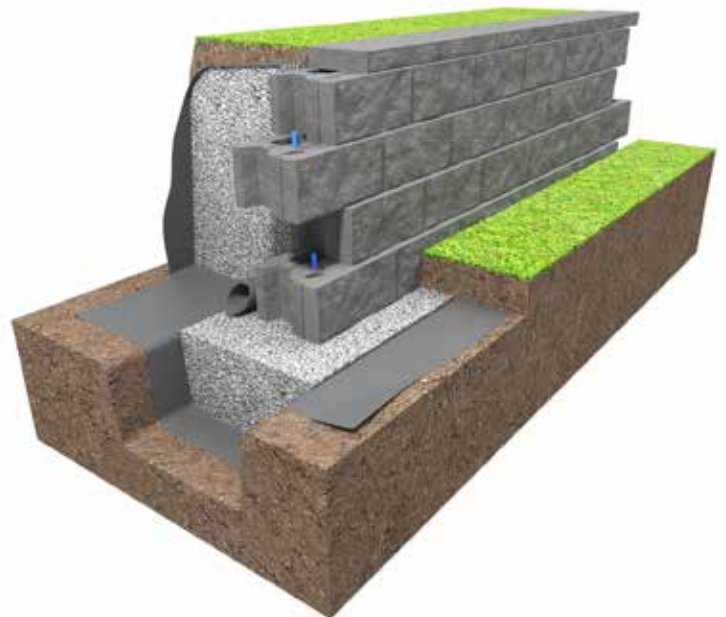

UNIT CONNECTION - CONT'D

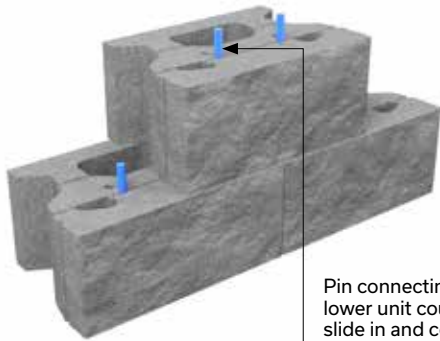

Pin connecting of upper unit course to lower unit course. Core allowing pin to slide in and complete unit connection.
Note: Place two Keystone fiberglass pins in each unit

PIN CONNECTION - near vertical setback section

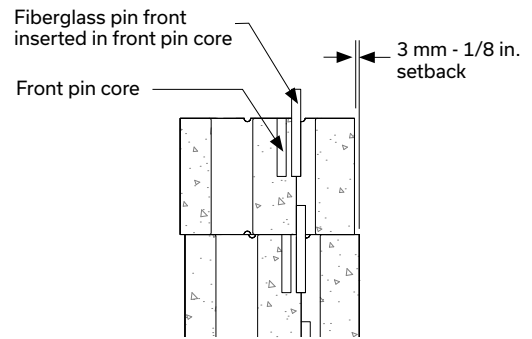

WALL UNIT TO WALL UNIT CONNECTION

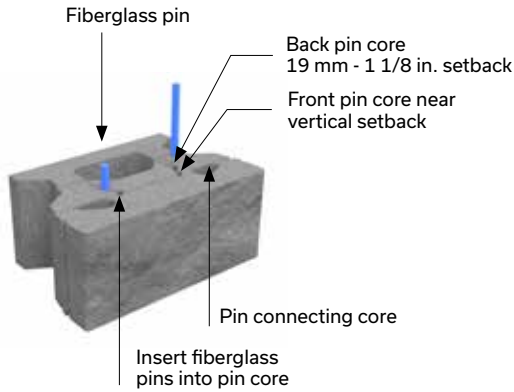

PIN CONNECTION

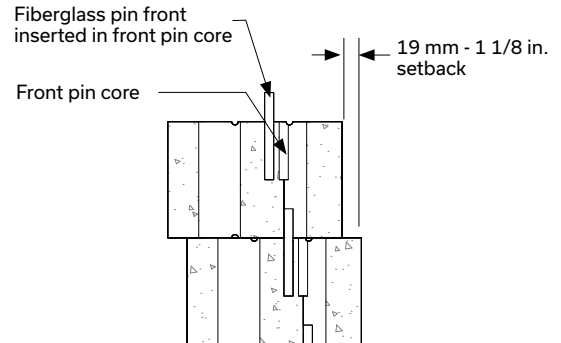

KEYSTONE WALL - INSTALLATION

CAPPING

SECURING THE CAPPING UNITS

Once the wall has been installed to the desired height, the capping units must be installed.

- 1 - Using Techniseal® concrete adhesive, glue the clean, dry Keystone capping units to the last row of Keystone compact units, still in running bond pattern
- 2 - Make sure all capping units are level with no gap between units

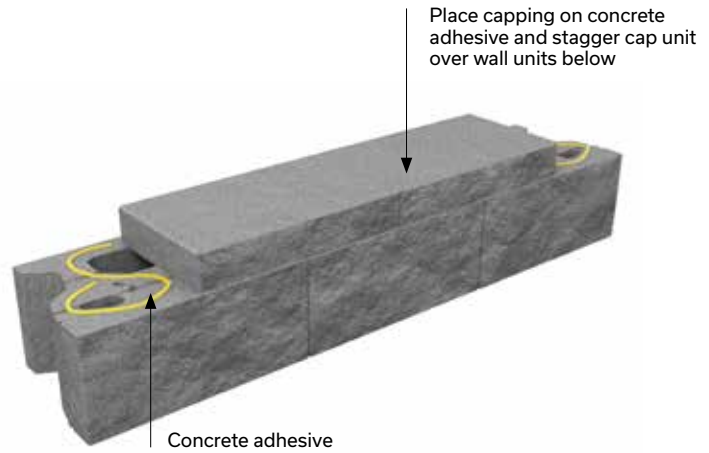

CROSS-SECTIONS

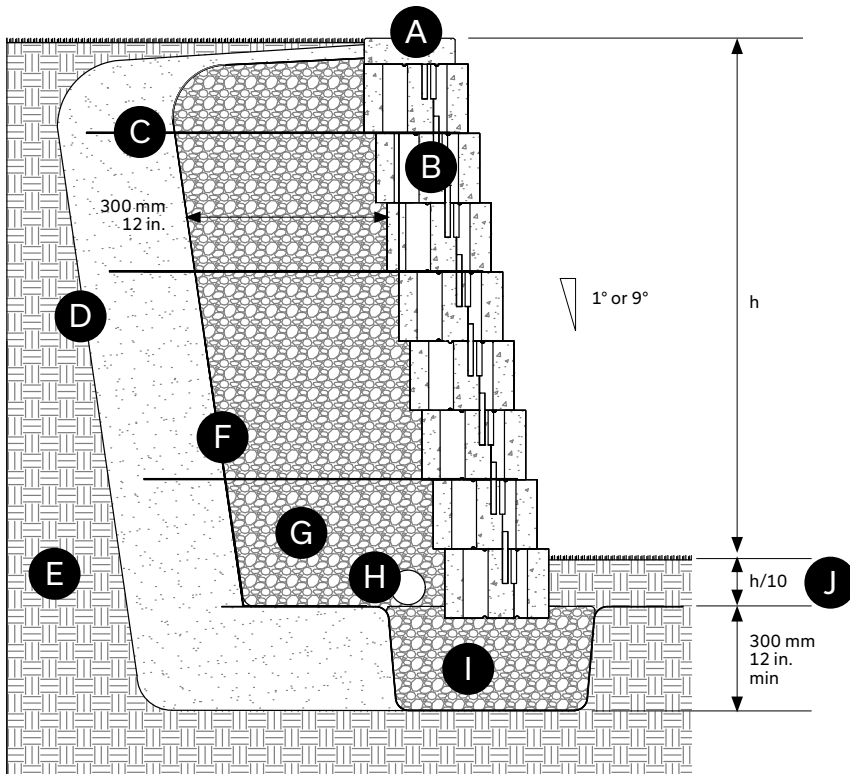

- Ⓐ 102 mm - 4 in. capping unit
- Ⓑ 200 mm - 8 in. Keystone unit
- Ⓒ Typical geogrid (for engineering, contact your Permacon sales representative)
- Ⓓ Excavation slope
- Ⓔ Existing soil
- Ⓕ Geotextile
- Ⓖ Clean stone 20 mm - 3/4 po
- Ⓗ Perforated drain connected to services: 150 mm Ø - 6 in.
- Ⓘ Compacted granular foundation 0 to 20 mm - 0 to 3/4 in.
- Ⓙ Minimum buried depth largest 200 mm - 8 in. or h/10

KEYSTONE WALL - INSTALLATION

CROSS-SECTION - 9° SETBACK WALL - NO SURCHARGE, NO SLOPE

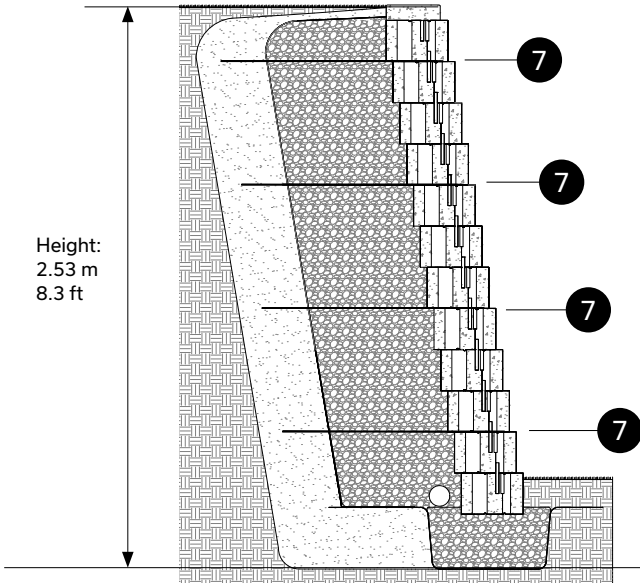

Length of the geogrid: 2.13 m - 7 ft

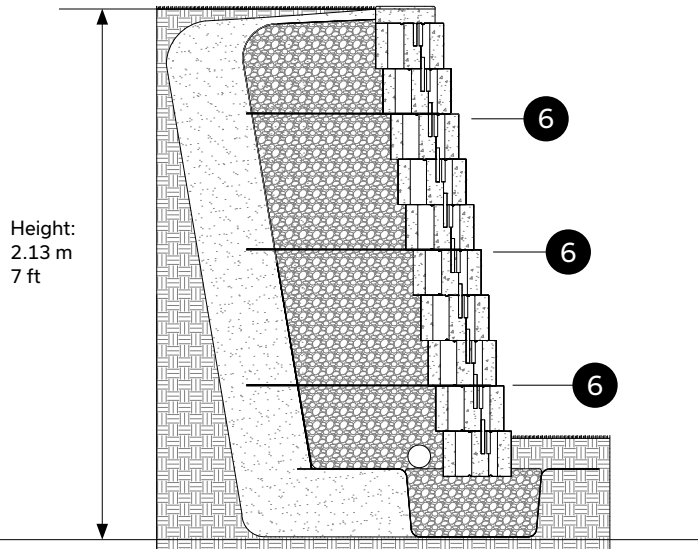

Length of the geogrid: 1.83 m - 6 ft

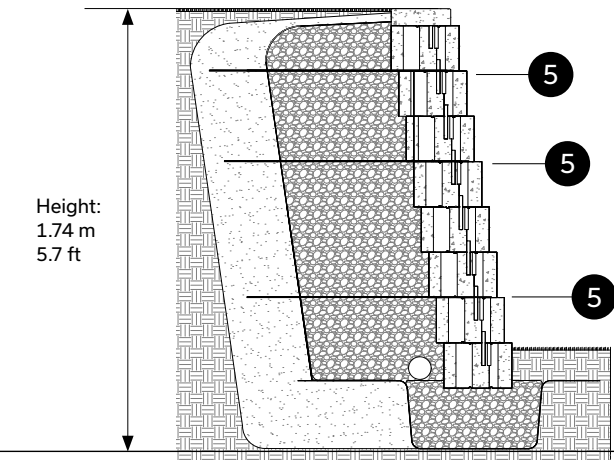

Length of the geogrid: 1.52 m - 5 ft

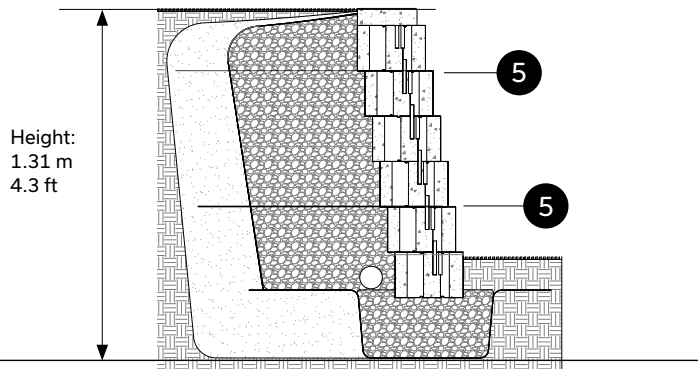

Length of the geogrid: 1.52 m - 5 ft

Maximum wall heights assume there is no surcharge behind the wall and no slope, and that the wall retains sand or gravel ($\phi = 30$ degrees, $\gamma = 22$ kN/m³).

KEYSTONE WALL - INSTALLATION

CROSS-SECTION - 1° SETBACK WALL - NO SURCHARGE, NO SLOPE

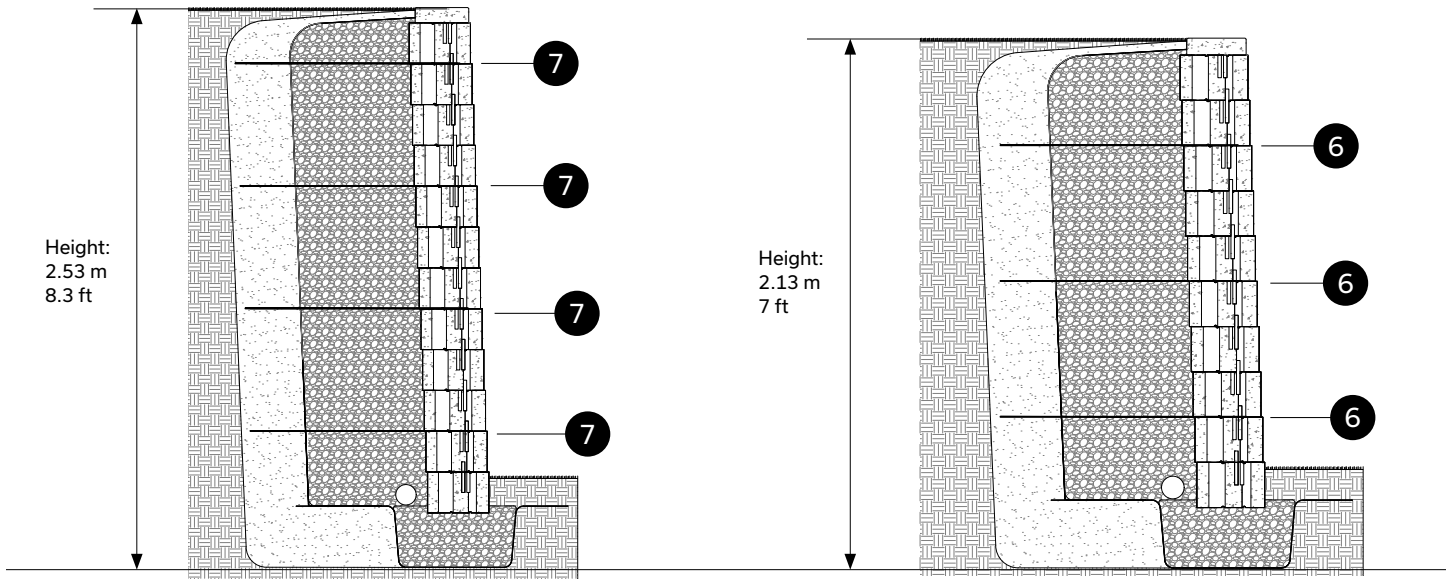

Length of the geogrid: 2.13 m - 7 ft

Length of the geogrid: 1.83 m - 6 ft

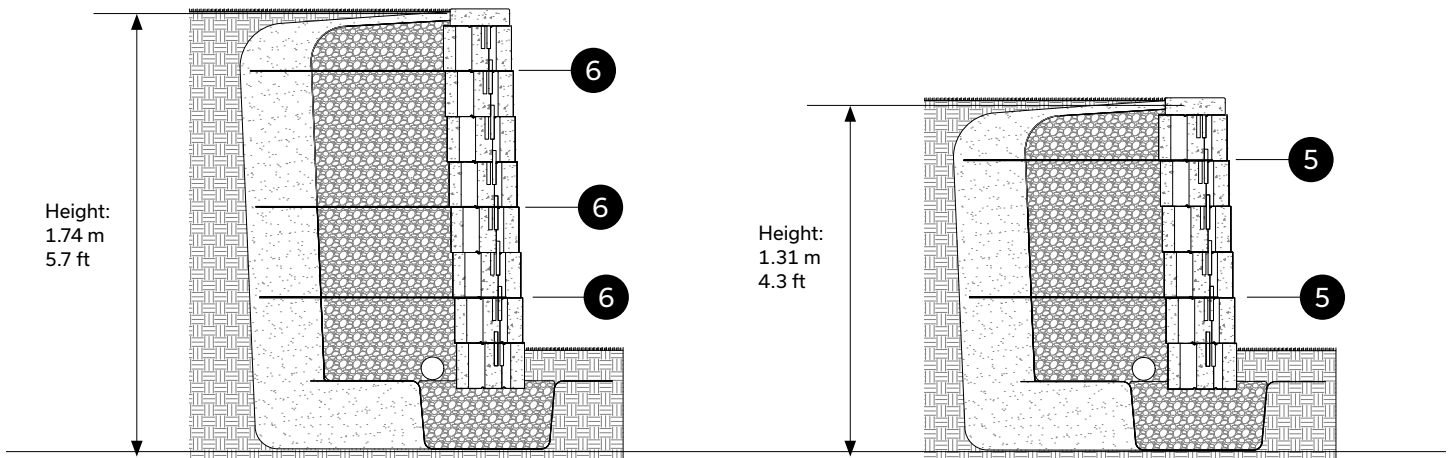

Length of the geogrid: 1.52 m - 5 ft

Length of the geogrid: 1.52 m - 5 ft

Maximum wall heights assume there is no surcharge behind the wall and no slope, and that the wall retains sand or gravel ($\phi = 30$ degrees, $\gamma = 22$ kN/m³).

KEYSTONE WALL - INSTALLATION

CROSS-SECTION - 1° SETBACK WALL - NO SURCHARGE, NO SLOPE

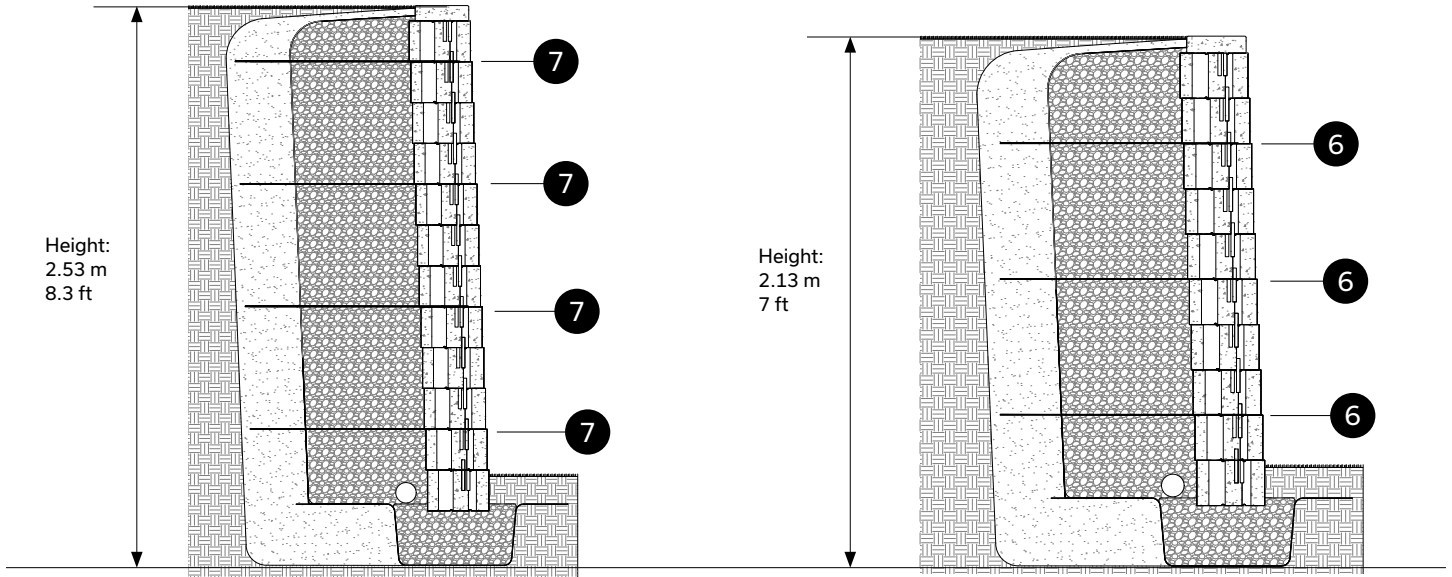

Length of the geogrid: 2.13 m - 7 ft

Length of the geogrid: 1.83 m - 6 ft

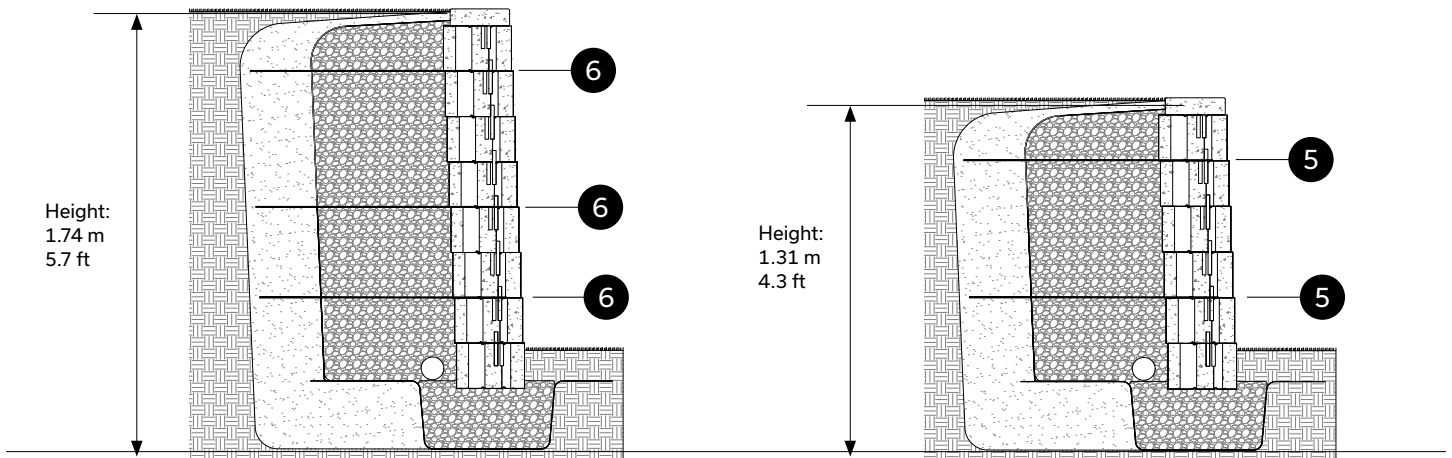

Length of the geogrid: 1.52 m - 5 ft

Length of the geogrid: 1.52 m - 5 ft

Maximum wall heights assume there is no surcharge behind the wall and no slope, and that the wall retains sand or gravel ($\phi = 30$ degrees, $\gamma = 22$ kN/m³).