

Vertex Operators and Metaplectic Whittaker Functions (arXiv:1806.07776)

Ben Brubaker

Valentin Buciumas
Henrik Gustafsson

Daniel Bump

June 26, 2018

<http://sporadic.stanford.edu/Zurich.pdf>

Origins in Number Theory

Metaplectic Whittaker functions and the related field of Weyl Group Multiple Dirichlet series have origins in analytic number theory.

- Patterson and Heath-Brown: Kummer problem on cubic Gauss sums (1979)
- Goldfeld and Hoffstein: Moments of quadratic L-series (1985)
- Bump, Friedberg and Hoffstein: nonvanishing of derivatives of L-functions with applications to elliptic curves and number theory (1990)

We will follow a thread leading into the theory of quantum groups.

Milestones

- Kazhdan and Patterson (1984).
- Bump, Friedberg and Hoffstein (BAMS, 1996).

This paper advocated a method requiring more combinatorics (+ convexity from complex analysis). This led to key insights.

- Brubaker, Bump, Friedberg and Hoffstein (2007).
- Chinta and Gunnells (2010).
- Brubaker, Bump, Chinta, Friedberg and Gunnells (2012).
- Brubaker, Buciumas, Bump (2016); +Friedberg, +Gray
- Brubaker, Buciumas, Bump, Gustafsson (2018).

Others: J. Beineke, A. Bucur, A. Diaconu, S. Frechette, H. Friedlander, D. Ivanov, K.-H. Lee, M. Nakasuji, M. Patnaik, A. Puskas, A. Schultz, I. Whitehead, L. Zhang.

Origins in Mathematical Physics

Quantum groups are deformations of Lie groups. They arose from the **Yang-Baxter equation**, a tool from physics.

Affine Lie algebras arose in string theory. They act on **Fock spaces**, which come in two flavors: **bosonic** and **fermionic**.

Vertex operators are operators on Fock spaces that arose independently in string theory and soliton theory.

Our goal is to explain new connections between metaplectic Whittaker functions, quantum groups and vertex operators.

Metaplectic group

- F : a number field (e.g. \mathbb{Q}).
- \mathbb{A} : its adèle ring.
- μ_n : group of n -th roots of unity.
- v : a place (prime) of F .
- ψ : character of \mathbb{A}/F .

Then $\mathrm{GL}(r, \mathbb{A})$ (for definiteness) admits a central extension

$$1 \longrightarrow \mu_n \longrightarrow \widetilde{\mathrm{GL}}(r, \mathbb{A}) \longrightarrow \mathrm{GL}(r, \mathbb{A}) \longrightarrow 1 .$$

This is the **metaplectic group** (Weil, Kubota, Matsumoto).

Metaplectic Whittaker Functions

- Let $\mathbf{s} = (s_1, \dots, s_r)$ be complex numbers,
- $\mathbf{M} = (M_1, \dots, M_{r-1}) \in \mathfrak{o}_F^{r-1}$

We have an Eisenstein series $E_{\mathbf{s}}$ on $\widetilde{\mathrm{GL}}(r, \mathbb{A})$. The **Whittaker coefficient** is ($r = 3$)

$$D(s_1, s_2; M_1, M_2) = \int_{(\mathbb{A}/F)^3} E_{\mathbf{s}} \begin{pmatrix} 1 & x_1 & x_3 \\ & 1 & x_2 \\ & & 1 \end{pmatrix} \psi(M_1 x_1 + M_2 x_2) dx_1 dx_2 dx_3.$$

This is a **multiple Dirichlet series** with analytic continuation and functional equations. It has twisted multiplicativity hence is not an Euler product but is determined by its **p -parts**.

Heuristic form

Combinatorial descriptions of metaplectic Whittaker functions as multiple Dirichlet series were urgently needed by 1996.

Let D be a Dynkin diagram. With each vertex we associate a variable d_j .

- Let $r(i, j)$ be the number of bonds between i and j in D .
- $g(m, d) =$ Gauss sum.
- $(\cdot) = n$ -th power residue symbol.

Heuristically consider:

$$\sum_{d_1, \dots, d_r} \left[\prod_{i, j \text{ adjacent}} \left(\frac{d_i}{d_j} \right)^{-r(i, j)} \right] \left[g(M_i, d_i) |d_i|^{-2s_i} \right].$$

The p -parts

The heuristic form is suggestive but not realistic as it does not describe the coefficient of $\prod |d_i|^{-2s_i}$ if the d_i are not coprime.

Due to the twisted multiplicativity, the multiple Dirichlet series reduces to its p -part.

Example: $r = 3$. Assume $M_1 = p^{m_1}$ and $M_2 = p^{m_2}$.

We need to understand the p -part combinatorially:

$$D_p(\mathbf{s}; p^{\mathbf{m}}, \mathbf{a}) =$$

$$D_p(s_1, s_2; p^{m_1}, p^{m_2}; \mathbf{a}) = W_p \begin{pmatrix} p^{m_1+m_2+m_3} & & \\ & p^{m_2+m_3} & \\ & & p^{m_3} \end{pmatrix}.$$

Here W is a *spherical metaplectic Whittaker function*. If $n > 1$ it is **not unique**, but lies in an n^r -dimensional vector space.

Index it by “charges” $\mathbf{a} = (a_1, \dots, a_r) \in (\mathbb{Z}/n\mathbb{Z})^r$.

Enter quantum groups

The function $D_\rho(\mathbf{s}, p^{\mathbf{m}}, \mathbf{a})$ can be connected with the theory of quantum groups in at least three ways.

- $D_\rho(\mathbf{s}, p^{\mathbf{m}}, \mathbf{a})$ may be expressed as a sum over a **crystal**.
Tools: Schützenberger involution + hard work.
(We will not discuss this today.)
This was the first signpost towards quantum groups.
- Express D_ρ as the partition function of a **solvable lattice model**. Tool: Yang-Baxter equation. Now the quantum group $U_q(\widehat{\mathfrak{gl}}(n|1))$ enters the picture. This is the quantized enveloping algebra of the affine Lie superalgebra $\widehat{\mathfrak{gl}}(n|1)$.
- **(New!)** Relate D_ρ to **vertex operators**.

Solvable lattice models

Solvable Lattice models are statistical mechanical systems that can be solved exactly (Onsager, Lee-Yang, Lieb, **Baxter**, ...).

Brubaker, Bump, Friedberg, Chinta and Gunnells proposed that Whittaker functions are partition functions of such models.

Brubaker, Buciumas, Bump overcame difficulties to give two such models, **Gamma Ice** and **Delta Ice**. With Gray, they proved that these two different models have the same partition function, equalling $\sum_{\mathbf{a}} D_{\rho}(\mathbf{s}, p^{\mathbf{m}}, \mathbf{a})$. With Friedberg, they studied representations of the affine Hecke algebra in which the generators T_i act on Whittaker coinvariants via R-matrices.

Delta ice

We begin with a rectangular grid. In our system \mathfrak{S}_Δ a **state** assigns a **spin** \pm to each edge and additionally to each horizontal edge we assign a **charge** which is an integer mod n .

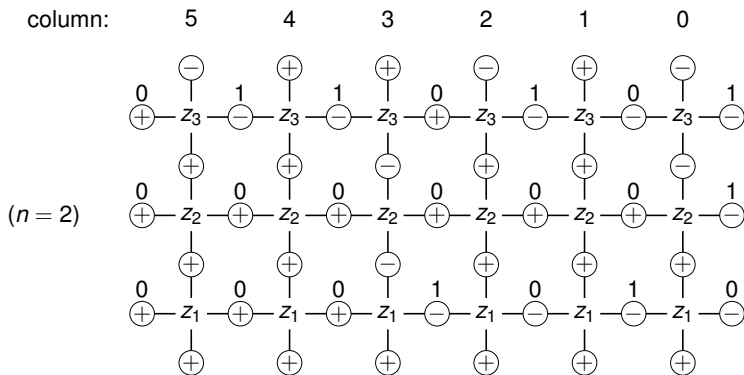

Delta ice

We impose the following conditions for Δ -ice. If a horizontal edge has a $+$ spin then its charge must be 0 (mod n). Let $v^{-1} = |o/p|$ and for i -th row $z_i = |p|^{-s_i}$. (ϖ =prime element, etc.)

Gauss sum:
$$g(a) = \frac{1}{v^{-1}} \sum_{t \in o/p} (t, \varpi) \psi \left(\frac{at}{\varpi} \right).$$

a_1	a_2	b_1	b_2	c_1	c_2
1	$g(a)z_i$	1	z_i	$(1 - v)z_i$	z_i

Here are the **Boltzmann weights** at a vertex. Use z_i in the i -th row from bottom. Weight is 0 if not in table. The **Boltzmann weight** of the state is the product over all vertices.

Boundary Conditions

We prescribe certain **boundary conditions** encoding \mathbf{m} and \mathbf{a} .

Spins along the top edge encode $\mathbf{m} + \rho$

Charges on the right edge encode \mathbf{a} . Example:

$\mathbf{m} = (3, 1, 0)$, $\mathbf{m} + \rho = (5, 2, 0)$, $\mathbf{a} = (0, 1, 1)$

Boltzmann weight of this state = $(1 - \nu)g(0)z_1^4 z_2^5 z_3^5$

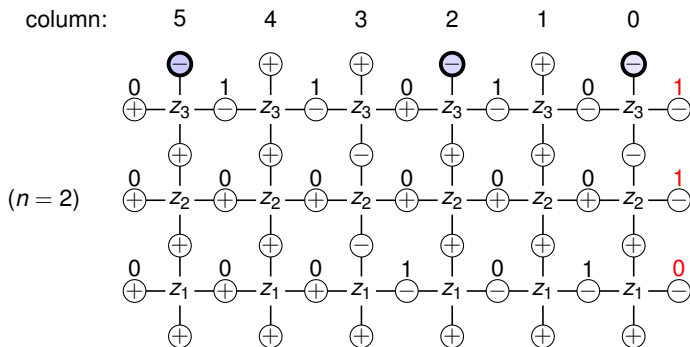

The partition function

The sum over states of the Boltzmann weights with boundary spins and charges fixed is the **partition function** $Z(\mathfrak{G}_\Delta, \mathbf{z}, \mathbf{m}, \mathbf{a})$.

Theorem

(Brubaker, Buciumas, Bump, Gray)

$$D_p(\mathbf{s}, p^{\mathbf{m}}, \mathbf{a}) = Z(\mathfrak{G}_\Delta, \mathbf{z}, \mathbf{m}, \mathbf{a}).$$

(Remember $z_i = p^{-s_i}$ encodes the Langlands parameters.)

Thus the p -adic Whittaker functions may be expressed as the partition function of the Delta model.

What makes this model solvable?

The R-matrix

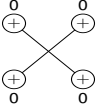
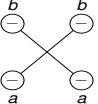
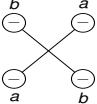
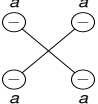
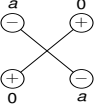
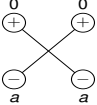
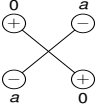
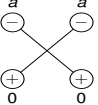
<p>Another type of vertex, the R-matrix R_{z_1, z_2}.</p> <p>$1 \triangleleft a \triangleleft b \triangleleft n$ $c \equiv a - b \pmod n$.</p>	 <p>$z_1^n - v z_2^n$</p>	 <p>$(1 - v) z_1^{n-c} z_2^c$</p>
 <p>$g(a - b)(z_1^n - z_2^n)$</p>	 <p>$z_2^n - v z_1^n$</p>	 <p>$v(z_1^n - z_2^n)$</p>
 <p>$(1 - v) z_1^{n-a+1} - z_2^{a-1}$</p>	 <p>$(1 - v) z_1^a z_2^{n-a}$</p>	 <p>$(1 - v) z_1^{n-a} z_2^a$</p>

The First Yang-Baxter Equation

Theorem

The following partition functions are equal.

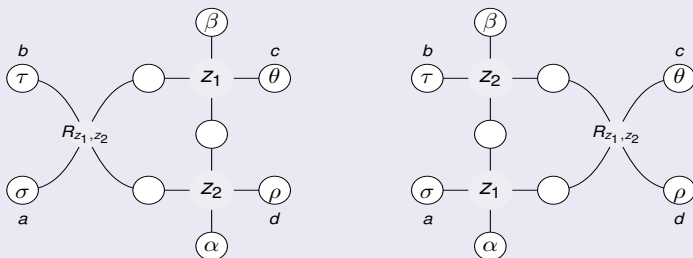

(As usual, the interior edge spins are summed.)

Useful but mysterious.

Another Yang-Baxter equation

Theorem

Fix z_1, z_2 and z_3 and (decorated) boundary spins. The following partition functions are equal:

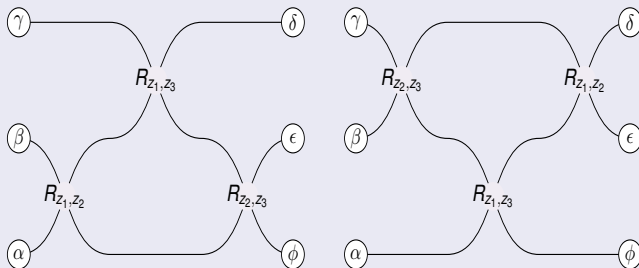

Less mysterious, this YBE reveals $U_q(\widehat{\mathfrak{gl}}(n|1))$.

Yang-Baxter equation as a categorical braiding

If V and W are (finite-dimensional) modules for a (quasitriangular) quantum group H there is an H -module homomorphism $c = c_{V,W} : V \otimes W \rightarrow W \otimes V$.

The category of modules is **braided**. This implies that if V and W are H -modules then the following diagram commutes:

$$\begin{array}{ccccc}
 & & V \otimes U \otimes W & \xrightarrow{1_V \otimes c_{U,W}} & V \otimes W \otimes U & & \\
 & \nearrow^{c_{U,V} \otimes 1_W} & & & & \searrow^{c_{V,W} \otimes 1_U} & \\
 U \otimes V \otimes W & & & & & & W \otimes V \otimes U \\
 & \searrow_{1_U \otimes c_{V,W}} & & & & \nearrow_{1_W \otimes c_{U,V}} & \\
 & & U \otimes W \otimes V & \xrightarrow{c_{U,W} \otimes 1_V} & W \otimes U \otimes V & &
 \end{array}$$

The Second YBE reflects braiding

Associate an object in the module category with every edge.
Categorical braiding is equivalent to second YBE.

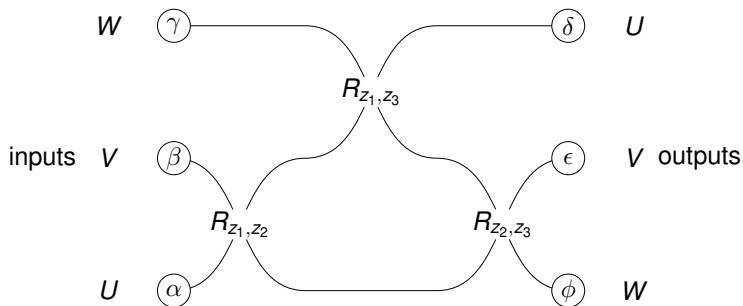

Depending on a parameter z , the $n + 1$ dimensional vector space spanned by $+a, -0$ is an object in a braided category. This diagram encodes a morphism $U \otimes V \otimes W \rightarrow W \otimes V \otimes U$. The other diagram encodes the other morphism.

Consequences

- The R-matrix and first YBE implies model is **solvable**.
- The R-matrix may be identified with the R-matrix of a supersymmetric quantum group, (twisted) $U_q(\widehat{\mathfrak{gl}}(n|1))$.
- Twisting introduces Gauss sums into the R-matrix.
- The $n + 1$ states of the horizontal edges ($-a$ and $+0$) are basis vectors of its module $\mathbb{C}_{z_i}^{n|1}$. This is a $\mathbb{Z}/2\mathbb{Z}$ -graded “super” vector space.
- The theory of quantum groups gives a framework for understanding solutions to the Yang-Baxter equation.
- The second YBE (involving only edges of horizontal type) fits into that framework.
- **The first does not because the vertical edges do not correspond to a module of $U_q(\widehat{\mathfrak{gl}}(n|1))$.**

Reminder: First YBE

Theorem

The following partition functions are equal.

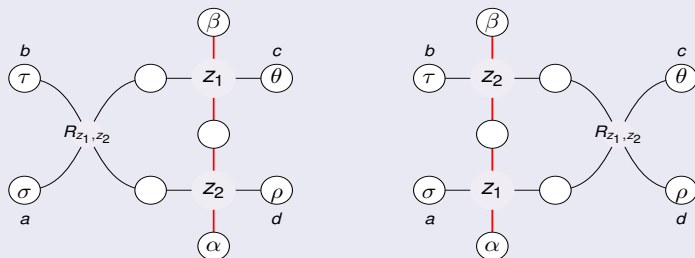

Mysterious: quantum group interpretation is incomplete.

Vertical edges have no interpretation as $U_q(\widehat{\mathfrak{gl}}(n|1))$ -modules.

Reminder: Second YBE

Theorem

Fix z_1, z_2 and z_3 and (decorated) boundary spins. The following partition functions are equal:

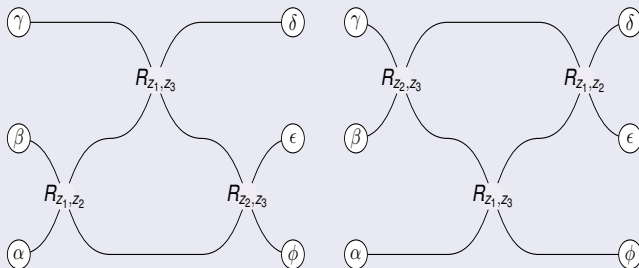

This YBE reveals the connection with quantum groups.

Bosons and Fermions

In quantum mechanics, the interchange of two identical particles can either change the sign of the wave function describing the universe, or not.

In the first case, the particle is called a **fermion** (examples: quarks and electrons).

In the second case the particle is called a **boson** (examples: photons, gravitons and the Higgs boson).

We can model a system of n bosons by the symmetric algebra on an n -dimensional vector space: $\text{Sym}(\mathbb{C}^n)$.

We can model a system of n fermions by the exterior algebra on an n -dimensional vector space: $\wedge(\mathbb{C}^n)$.

They are not isomorphic if $n < \infty$. But if $n = \infty$, we can try to relate bosons and fermions ...

The Dirac sea (Fermionic Fock space)

The Dirac equation is a differential equation describing the states of an electron. The energy levels are quantized. Let u_i be a solution with energy i ($i \in \mathbb{Z}$). The energy can be arbitrarily negative, which is problematic.

Dirac proposed that all sufficiently negative states u_i are occupied, and all sufficiently positive states are unoccupied.

A state of the electron system in which energy levels i_m are occupied is a wedge:

$$u_{i_m} \wedge u_{i_{m-1}} \wedge u_{i_{m-2}} \wedge \cdots$$

where $u_k = k$ when k is sufficiently negative. These wedges span the charge m part \mathfrak{F}_m of the Fermionic Fock space

$$\mathfrak{F} = \bigoplus_m \mathfrak{F}_m.$$

States correspond to partitions

With m fixed, a basis element

$$u_{i_m} \wedge u_{i_{m-1}} \wedge u_{i_{m-2}} \wedge \cdots$$

of \mathfrak{F}_m can be indexed by a **partition**

$$\lambda = (\lambda_1, \lambda_2, \cdots).$$

$$\lambda_1 > \lambda_2 > \cdots, \quad \lambda_i = 0 \quad \text{eventually}$$

$$i_k = k + \lambda_{k+1-m}.$$

There is a state of lowest energy in \mathfrak{F}_m :

$$u_m \wedge u_{m-1} \wedge \cdots = |\emptyset\rangle$$

This is the **vacuum**, also denoted $|m\rangle$.

Heisenberg action

A Heisenberg Lie algebra has basis elements J_k ($k \in \mathbb{Z}$) and $\mathbf{1}$.

$$[J_k, J_l] = \begin{cases} k \cdot \mathbf{1} & \text{if } k = -l, \\ 0 & \text{otherwise.} \end{cases}$$

The action of J_k ($k \neq 0$) on $\tilde{\mathfrak{F}}_m$:

$$J_k(u_{i_m} \wedge u_{i_{m-1}} \wedge u_{i_{m-2}} \wedge \cdots) = \sum_{r \in m} u_{i_m} \wedge u_{i_{m-1}} \wedge u_{i_{m-2}} \wedge \cdots \wedge u_{i_r - k} \wedge \cdots$$

Making sense of the latter (essentially finite) sum requires reordering the vectors using the rule

$$u_a \wedge u_b = -u_b \wedge u_a.$$

Vertex operators

The J_k with $k > 0$ mutually commute, and the J_k with $k < 0$ also mutually commute.

Thus if a_k and b_k are constants ($k > 0$) we consider

$$T_+^a = \exp\left(\sum_{k=1}^{\infty} a_k J_k\right), \quad T_-^b = \exp\left(\sum_{k=1}^{\infty} b_k J_{-k}\right).$$

We will call such expressions **half-vertex operators**.

Although in the Heisenberg Lie algebra J_k and J_{-k} do not commute they **almost** commute since their commutator is in the center. Thus T_a and T_b also do not commute, but they commute up to a scalar (phase) and expressions such as $T_a^+ T_b^-$ come up in practice. Today we need mainly half-vertex operators.

The $n = 1$ case

We will use the Fermionic Fock space to study the solvable lattice models related to metaplectic Whittaker functions.

If $n = 1$, Whittaker functions are unique. Their values are Schur functions (Casselman-Shalika).

- This case was studied by Brubaker and Schultz.
- The vertex operators are related to ones known from soliton theory (Sato, Date, Jimbo, Miwa).

Parallel to the appearance of the $\widehat{\mathfrak{gl}}(n|1)$ R-matrix in Brubaker, Buciumas and Bump,

Brubaker and Schultz found $\widehat{\mathfrak{gl}}(1|1)$ indications here, too.

Kashiwara, Miwa and Stern

Central to our construction is a modification of the Fermionic Fock space due to Kashiwara, Miwa and Stern.

The KMS Fock space is a module for $U_q(\widehat{\mathfrak{sl}}_n)$.

We can modify KMS by **Drinfeld twisting**, modifying $U_q(\widehat{\mathfrak{sl}}_n)$ to introduce Gauss sums.

If $l < m$ then $u_l \wedge u_m$ equals

$$\begin{array}{ll} -u_m \wedge u_l & \text{if } l \equiv m \pmod n, \\ g(l-m)u_m \wedge u_l + \text{correction terms} & \text{otherwise.} \end{array}$$

Now J_k shifts by nk instead of k :

$$J_k(u_{i_m} \wedge u_{i_{m-1}} \wedge u_{i_{m-2}} \wedge \cdots) = \sum_{r \leq m} u_{i_m} \wedge u_{i_{m-1}} \wedge u_{i_{m-2}} \wedge \cdots \wedge u_{i_{r-nk}} \wedge \cdots .$$

The J_k are twisted $U_q(\widehat{\mathfrak{sl}}_n)$ -module homomorphisms.

Delta Ice: Fock space interpretation

Modify the grid for Delta ice to be infinite in both directions.

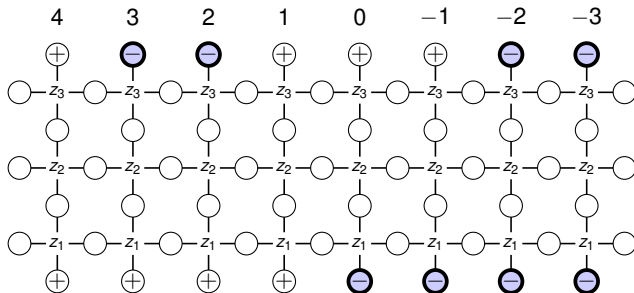

Interpret the top and bottom rows as \mathfrak{F}_0 states:

$$\begin{array}{ll} \text{top :} & u_3 \wedge u_2 \wedge u_{-2} \wedge u_{-3} \wedge \cdots = |(3, 3)\rangle \\ \text{bottom :} & u_0 \wedge u_{-1} \wedge u_{-2} \wedge u_{-3} \wedge \cdots = |0\rangle. \end{array}$$

Row Transfer matrix

Consider a system with just one row (example: $n = 3$)

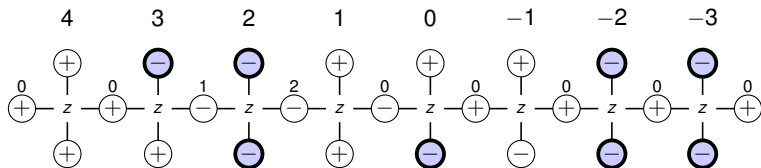

Interpret the top and bottom rows as \mathfrak{F}_0 states:

$$\begin{aligned} \text{top :} & \quad u_3 \wedge u_2 \wedge u_{-2} \wedge u_{-3} \wedge \cdots = |(3, 3)\rangle \\ \text{bottom :} & \quad u_0 \wedge u_{-1} \wedge u_{-2} \wedge u_{-3} \wedge \cdots = |(2, 1)\rangle \end{aligned}$$

Define an operator $T_{\Delta}(z) : \mathfrak{F}_m \rightarrow \mathfrak{F}_m$ such that the coefficient of $|\mu\rangle$ in $T_{\Delta}(z)|\lambda\rangle$ is the partition function of this system.

This is the **row transfer matrix**.

Compose the transfer matrices

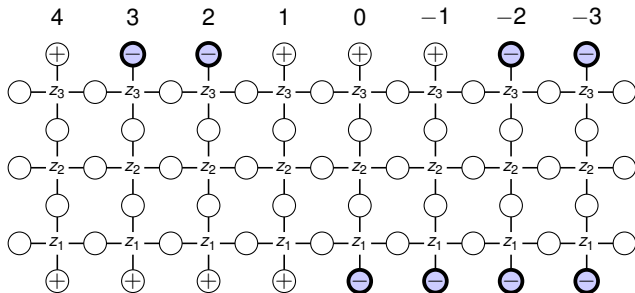

With λ and μ the partitions indexing the top and bottom rows, the partition function is the inner product:

$$\langle \mu | T_{\Delta}(z_1) T_{\Delta}(z_2) T_{\Delta}(z_3) | \lambda \rangle.$$

The Main Theorem

The main theorem expresses the transfer matrix as a half-vertex operator involving right moving modes.

Theorem (Brubaker, Buciumas, Bump, Gustafsson)

We have

$$T_{\Delta}(z) = \exp \left(\sum_{k=1}^{\infty} \frac{1}{k} z^{nk} (1 - v^k) J_k \right).$$

Thus T_{Δ} is a (twisted) $U_q(\widehat{\mathfrak{sl}}_n)$ module homomorphism.

Thus T_{Δ} is expanded in right-moving modes. Gamma ice (which often plays with Delta ice) will be expanded in left-moving modes. (Not proved yet:)

$$T_{\Gamma}(z) = \exp \left(\sum_{k=1}^{\infty} \frac{1}{k} z^{-nk} (1 - v^k) J_{-k} \right).$$

Metaplectic symmetric functions

The Main Theorem implies

$$\langle \mu | T_{\Delta}(z_1) \cdots T_{\Delta}(z_r) | \lambda \rangle = \left\langle \mu \left| \exp \left(\sum_{k=1}^{\infty} \frac{1}{k} (1 - v^k) p_{nk}(\mathbf{z}) J_k \right) \right| \lambda \right\rangle.$$

Here $p_{nk}(\mathbf{z}) = \sum_i z_i^{nk}$ is the power-sum symmetric function.

These partition functions of infinite grids are no longer metaplectic Whittaker functions.

They are (new) [metaplectic symmetric functions](#).

Metaplectic Whittaker functions are not symmetric but have functional equations when Langlands parameters z_i are permuted.

Recovering metaplectic Whittaker functions

We can express Whittaker functions in terms of from the metaplectic symmetric functions.

Fix $\xi = u_{i_{-r}} \wedge u_{i_{-r-1}} \wedge \cdots \in \mathfrak{F}_{-r}$.

Theorem

Assume $0 > i_{-r} > i_{-r-1} > i_{-r-2} > \dots$. Then there exist constants $c(\xi, \mathbf{a})$ such that if $\lambda = (\lambda_1, \dots, \lambda_r)$ is a partition then

$$\langle 0 | T_{\mathbf{z}} | u_{\lambda_1+r-1} \wedge u_{\lambda_2+r-2} \wedge \cdots \wedge u_{\lambda_r} \wedge \xi \rangle \quad (1)$$

equals

$$\sum_{\mathbf{a} \in (\mathbb{Z}/n\mathbb{Z})^r} c(\xi, \mathbf{a}) D_p(\mathbf{s}; p^{\mathbf{m}}, \mathbf{a}). \quad (2)$$

Here $m_i = \lambda_i - \lambda_{i+1}$. *This is a Whittaker function.*

LLT symmetric functions

The KMS Fermionic Fock space is also fundamental in the theory of **ribbon symmetric functions** (LLT polynomials) discovered by Lascoux, Leclerc and Thibon (1997).

n -ribbon symmetric functions are q -deformations of products of n Schur functions.

They are a reflection of the plethysm with power-sum symmetric functions (Adams operations).

They are related to algorithms in the (modular) representation theory of symmetric groups.

They have reappeared in other contexts such as Schur positivity and affine Schubert calculus.

n -Ribbon Tableaux

An n -ribbon is a connected skew shape (Young diagram) containing no 2×2 block. A horizontal ribbon n -strip is a skew shape λ/μ that is a union of n -ribbons, each of whose northeast corner touches μ (or the upper quadrant). The spin of the ribbon is its height, minus 1.

A n -ribbon tableau is a tableau such that if λ_i is the set of boxes labeled with integers $\leq i$, then λ_i/λ_{i-1} is a horizontal ribbon n -strip. This 3-ribbon tableau has spin 5 and weight $(3,9,6)$.

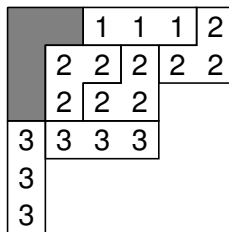

LLT polynomials

We may now define the LLT polynomial

$$\mathcal{G}_{\lambda,\mu}^n(\mathbf{z}) = \sum_T q^{s(T)} \mathbf{z}^{\text{wt}(T)},$$

where the sum is over n -ribbon tableaux T and $\mathbf{z} = (z_1, \dots, z_r)$.

Theorem (Lascoux, Leclerc, Thibon)

The polynomial $\mathcal{G}_{\lambda,\mu}^n$ is symmetric.

We may prove

$$\mathcal{G}_{\lambda,\mu}^n(\mathbf{z}) = \left\langle \mu \left| \exp \left(\sum_{k=1}^{\infty} \frac{1}{k} z^{nk} J_k \right) \right| \lambda \right\rangle.$$

LLT versus metaplectic symmetric functions

We could generalize LLT polynomials by Drinfeld twisting to introduce Gauss sums, or eliminate the Gauss sums from the metaplectic Whittaker functions by not twisting.

LLT:
$$\left\langle \mu \left| \exp \left(\sum_{k=1}^{\infty} \frac{1}{k} z^k J_k \right) \right| \lambda \right\rangle$$

super LLT (Lam):
$$\left\langle \mu \left| \exp \left(\sum_{k=1}^{\infty} \frac{1}{k} (z^k - w^k) J_k \right) \right| \lambda \right\rangle$$

metaplectic:
$$\left\langle \mu \left| \exp \left(\sum_{k=1}^{\infty} \frac{1}{k} (1 - v^k) z^{nk} J_k \right) \right| \lambda \right\rangle.$$

Different systems can have the same partition function (common in physics). There are **two** lattice models for Whittaker functions.

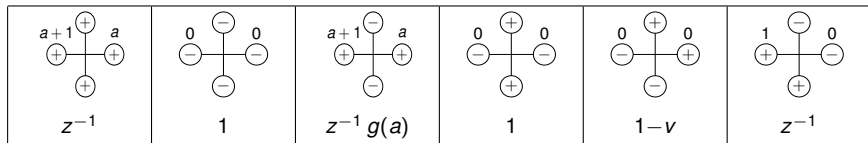

Gamma ice

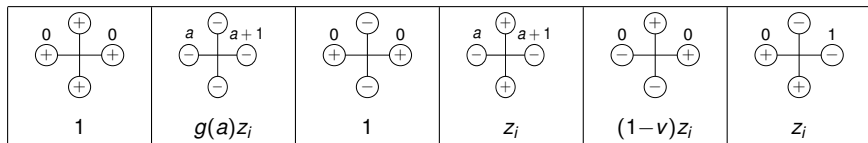

Delta ice

The two types Gamma ice and Delta ice were introduced by Brubaker, Bump and Friedberg to solve the problem of analytic continuation of $D(\mathbf{s})$.

Defined combinatorially as $D(\mathbf{s}) = D_{\Delta}(\mathbf{s})$, collecting coefficients we can write (inductively)

$$D_{\Delta}(\mathbf{s}) = \sum_m D_{\Delta}(s_1, \dots, s_{r-1}; m) |m|^{-s_r}$$

giving all but one needed functional equation.

$$D_{\Gamma}(\mathbf{s}) = \sum_m D_{\Gamma}(s_2, \dots, s_r; m) |m|^{-s_1}$$

has the missing functional equation.

So we need to prove $D_{\Delta} = D_{\Gamma}$.

Gamma ice and Delta ice also appear together in symplectic Whittaker functions. (Ivanov; Brubaker, Bump, Chinta and Gunnells; Nathan Gray).

Theorem

$$D_{\Delta} = D_{\Gamma}.$$

First proof (Brubaker, Bump, Friedberg):

Schützenberger involution, intricate combinatorics.

Second proof (BBB+Gray):

Yang-Baxter equation.

So far we have emphasized half-vertex operators (expansions in right moving currents, only). To develop a deeper theory, we may combine the Gamma ice and Delta ice half-vertex operators.

$$T_{\Delta}(z) = \exp\left(\sum_{k=1}^{\infty} z^{nk}(1 - v^k)J_k\right)$$

$$T_{\Gamma}(z) = \exp\left(\sum_{k=1}^{\infty} z^{-nk}(1 - v^k)J_{-k}\right)$$

(Second identity unproved at this moment.) Since J_k and J_{-k} do not commute, T_{Δ} (expansion in right moving currents) and T_{Γ} (left moving currents) do not commute. Nevertheless they play together nicely.

Global speculations

This line of thought started with multiple Dirichlet series having functional equations. How to return to that topic?

To encode the Gauss sums needed for the Kubota Dirichlet series that underlies the functional equations, we have to make a Drinfeld twist. At a place p , we modify \mathfrak{F}_0 using

$$g_p(a) = \frac{1}{|p|} \sum_{t \in \mathfrak{o}/\mathfrak{p}} \left(\frac{t}{\varpi} \right) \psi \left(\frac{at}{\varpi} \right).$$

Let us call the resulting quantum group and Fock space

$$U_{\sqrt{|p|}}(\widehat{\mathfrak{sl}}_n)^{g_p} \text{ and } \mathfrak{F}_0(g_p).$$

We hope $\bigotimes_p \mathfrak{F}_0(g_p)$ is a module for $\bigotimes_p U_{\sqrt{|p|}}(\widehat{\mathfrak{sl}}_n)^{g_p}$ this will lead back to the automorphic theory.

Happy Birthday Sol!

Happy Birthday Sol!