

Whittaker Functions and Quantum Groups

by Daniel Bump

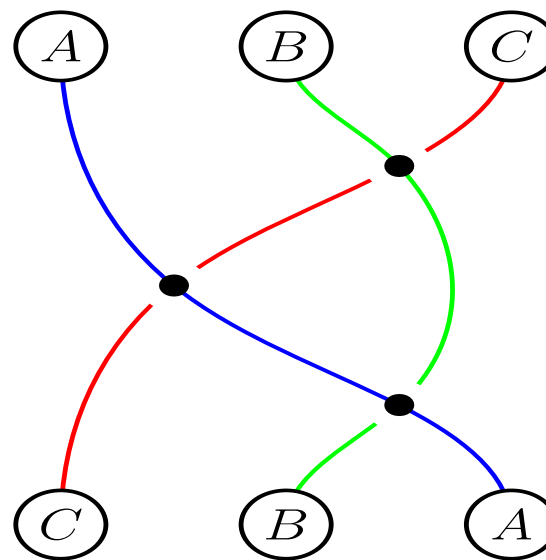
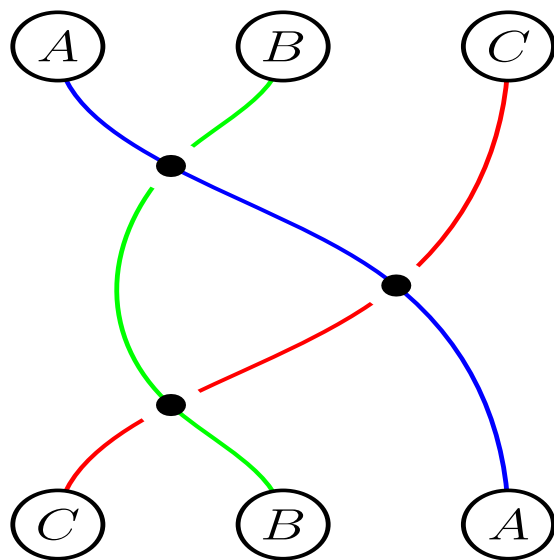

Supported in part by NSF grant 1001079

Whittaker Functions

Let $F = \mathbb{R}, \mathbb{C}, \mathbb{Q}_p$ or \mathbb{F}_q . Let $G = \mathrm{GL}(n, F)$ or more generally a split reductive group. Let U be the maximal unipotent subgroup. Let ψ be a **nondegenerate** character of F . If $G = \mathrm{GL}(3)$ we may use

$$\psi \begin{pmatrix} 1 & x & y \\ & 1 & z \\ & & 1 \end{pmatrix} = \psi_0(x + z)$$

where $\psi_0: F \rightarrow \mathbb{C}^\times$ is an additive character, e.g. $\psi_0(x) = e^{2\pi i x}$ if $F = \mathbb{R}$.

Theorem 1. (Gelfand-Graev, Piatetski-Shapiro, Shalika, Rodier) *If (π, V) is an irreducible representation of G there admits at most one linear functional $\Omega: V \rightarrow \mathbb{C}$ such that $\Omega(\pi(u)v) = \psi(u)\Omega(v)$ for all $v \in V$ and $u \in U$.*

If $v \in V$ then $W(g) = \Omega(\pi(g)v)$ is called a **Whittaker function**. Usually we are interested in particular v , e.g. the **unique** (up to scalar) K -fixed vector where

$$K = \begin{cases} O(n) & \text{if } F = \mathbb{R} \\ U(n) & \text{if } F = \mathbb{C} \\ \mathrm{GL}(n, \mathbb{Z}_p) & \text{if } F = \mathbb{Q}_p \end{cases} .$$

For this choice, W is called the **spherical Whittaker function**.

It may be defined by an integral hence has a natural normalization.

The Archimedean Case

If $F = \mathbb{R}$, Kazhdan and Kostant observed that the differential equations satisfied by the spherical Whittaker function are observables (Hamiltonians) for the **Quantum Toda Lattice**. This has led to many developments of which we mention the work of **Gerasimov, Lebedev and Oblezin (GLO)**.

The Nonarchimedean Case

This talk will mainly be about the nonarchimedean case.

Interpolation

One intriguing aspect of **GLO** is that they are able to interpolate between the archimedean and nonarchimedean cases. This is perhaps similar to the case with Macdonald polynomials which interpolate between the spherical functions for the archimedean case (“Zonal functions”) and the nonarchimedean case (“Hall-Littlewood polynomials”).

This Talk

Without further ado we turn to the question of how nonarchimedean Whittaker functions relate to quantum groups.

The Weyl Character Formula

Let $\hat{G}(\mathbb{C})$ be a complex reductive Lie group, realized as an affine algebraic group. Let \hat{T} be a maximal split torus, and $\mathbf{z} \in \hat{T}(\mathbb{C})$. Let $P = X^*(\hat{T})$ be the weight lattice. Let λ be a dominant weight and let χ_λ be the irreducible character of $\hat{G}(\mathbb{C})$ with highest weight λ . By the **Weyl character formula**

$$\prod_{\alpha \in \Phi} (1 - \mathbf{z}^\alpha) \chi_\lambda(\mathbf{z}) = \sum_{w \in W} (-1)^{l(w)} \mathbf{z}^{w(\lambda + \rho) + \rho} \quad \left(\rho = \frac{1}{2} \sum_{\alpha \in \Phi^+} \alpha \right)$$

The Casselman-Shalika Formula

Let F be a nonarchimedean local field and \mathfrak{o} its ring of integers.

Let G be the split reductive group in duality with \hat{G} . This means if T is the maximal split torus of G then the weight lattice P of \hat{G} may be identified with the cocharacter group $X_*(T)$ of G , and with $T(F)/T(\mathfrak{o})$. If $\lambda \in P$ let t_λ be a representative in $T(F)$. The **Casselman-Shalika formula** shows that for the **spherical Whittaker function W**

$$W(t_\lambda) = \begin{cases} (*) \prod_{\alpha \in \Phi} (1 - q^{-1} \mathbf{z}^\alpha) \chi_\lambda(\mathbf{z}) & \text{if } \lambda \text{ is dominant,} \\ 0 & \text{otherwise.} \end{cases}$$

Here q is the residue field size. The unimportant constant $(*)$ is a power of q . **The expression is a deformation of the Weyl character formula.**

Example

We will soon enter territory where each Cartan type must be handled individually, and although results are available for other Cartan types we will restrict ourselves to Type A, that is, $\mathrm{GL}(n)$. Here is the Casselman-Shalika formula for $\mathrm{GL}(n)$. (It was proved earlier by Shintani for this case.)

If $G = \mathrm{GL}(n)$ then the Langlands dual $\hat{G} = \mathrm{GL}(n)$ also. We may identify the weight lattice P with \mathbb{Z}^n . If $\lambda = (\lambda_1, \dots, \lambda_n) \in P$ then λ is **dominant** if and only if $\lambda_1 \geq \lambda_2 \geq \dots \geq \lambda_n$.

$$t^\lambda = \begin{pmatrix} \varpi^{\lambda_1} & & \\ & \ddots & \\ & & \varpi^{\lambda_n} \end{pmatrix}, \quad \varpi = \text{a generator of the maximal ideal } \mathfrak{p} \text{ of } \mathfrak{o}.$$

The Casselman-Shalika formula asserts

$$W(t_\lambda) = \delta^{1/2}(t_\lambda) \prod_{i < j} (1 - q^{-1} z_i z_j^{-1}) s_\lambda(z_1, \dots, z_n)$$

where

$$\mathbf{z} = \begin{pmatrix} z_1 & & \\ & \ddots & \\ & & z_n \end{pmatrix} \in \hat{T}(\mathbb{C}) \quad \text{is the Satake or Langlands parameter.}$$

The character $\chi_\lambda(\mathbf{z}) = s_\lambda(z_1, \dots, z_n)$ is a **Schur polynomial**.

Tokuyama's deformation of the WCF

The Weyl character formula has a deformation ([Tokuyama, 1988](#)) that may be exactly matched with the Casselman-Shalika formula. It produces, with t a parameter

$$\prod_{\alpha \in \Phi^+} (1 - tz^\alpha) \chi_\lambda(z).$$

Tokuyama expressed this as a sum over strict Gelfand-Tsetlin patterns with shape $\lambda + \rho$. There are different ways of expressing his result.

- As a sum over the Kashiwara crystal $\mathcal{B}_{\lambda+\rho}$.
- As the partition function of a solvable lattice model.

At first glance it seems a stretch to lay too much significance on this as a formula for the spherical Whittaker function. However, we affirm that this is important on the following evidence: the identity of Tokuyama's formula with the Casselman-Shalika formula may be extended to a formula for the far more subtle Whittaker functions on metaplectic groups.

Tokuyama's Formula: Crystal Version

Tokuyama's formula may be expressed as a sum over Kashiwara's crystal with highest weight $\lambda + \rho$:

$$\prod_{\alpha \in \Phi^+} (1 - tz^\alpha) \chi_\lambda(z) = \sum_{v \in \mathcal{B}_{\lambda+\rho}} G(v) z^{\text{wt}(v) - w_0 \rho}.$$

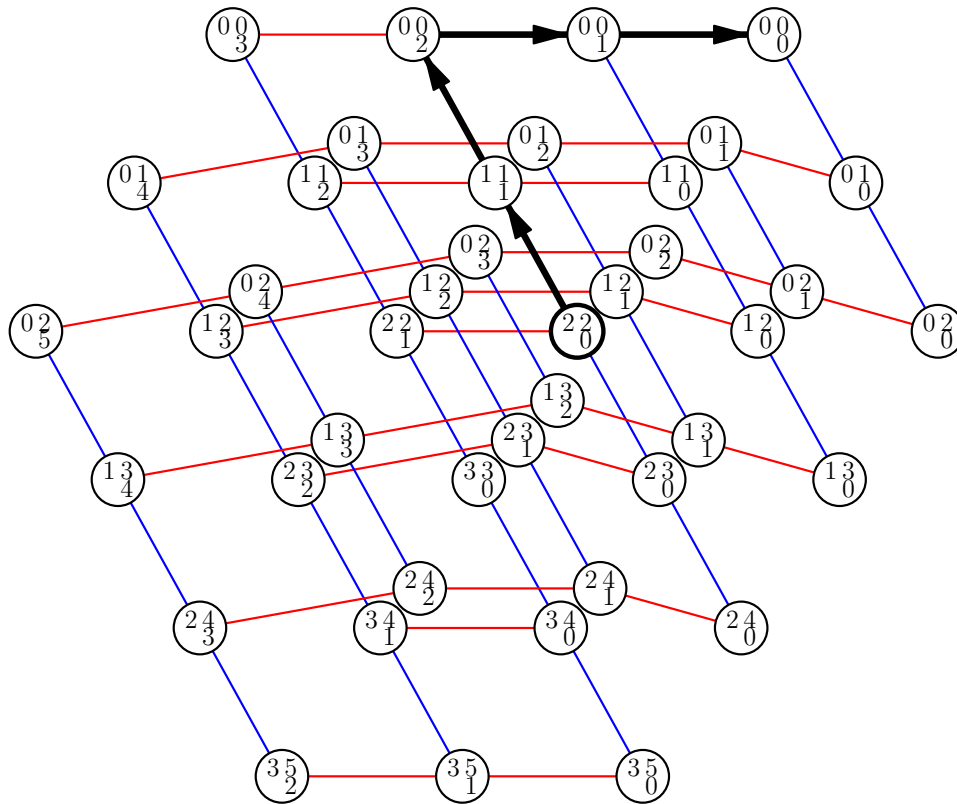

The data defining $G(v)$ are the lengths of segments in a path through the crystal from v to the highest weight vector.

For the marked vertex the segments have lengths 2,2,0.

These are the lengths of the paths in the red-blue-red directions ...

Tokuyama's Formula: Crystal Version

Tokuyama's formula may be expressed as a sum over Kashiwara's crystal with highest weight $\lambda + \rho$:

$$\prod_{\alpha \in \Phi^+} (1 - tz^\alpha) \chi_\lambda(z) = \sum_{v \in \mathcal{B}_{\lambda+\rho}} G(v) z^{\text{wt}(v) - w_0 \rho}.$$

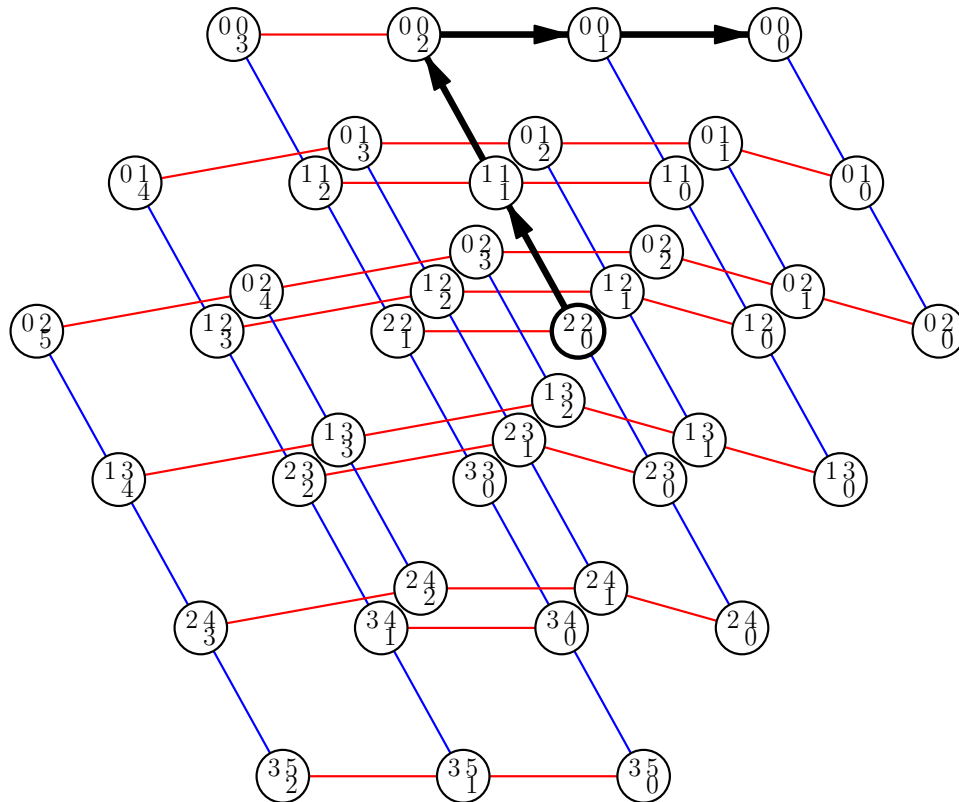

$$G(v) = \begin{cases} g(b_i) & \text{sometimes} \\ h(b_i) & \text{ditto} \\ q^{-b_i} \\ 0 \end{cases}$$

where b_i runs through the path lengths (0,2,2 for the marked v) and:

$$g(b) = -t^{1-b}$$

$$h(b) = (t^{-1} - 1)t^{1-b}$$

In this case:

$$G(v) = 1 \cdot g(2) \cdot h(2).$$

Change g and h to **Gauss sums** to get metaplectic Whittakers.

Tokuyama's Formula: Six Vertex Model

There is another way of writing Tokuyama's formula that was first found by Hamel and King. This represents

$$\prod_{\alpha \in \Phi^+} (1 - tz^\alpha) \chi_\lambda(z)$$

as the **partition function** of a statistical mechanical system. This uses the **six-vertex model**, an example that was studied extensively prior to the discovery of quantum groups. Begin with a grid, usually (but not always) rectangular:

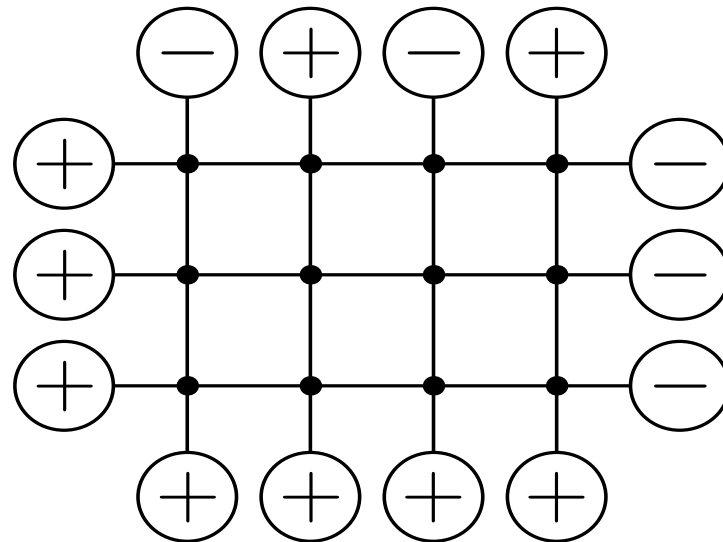

Each exterior edge is assigned a fixed **spin** + or -. The inner edges are also assigned spins but these will vary.

Six Vertex Model

A **state** of the model is an assignment of spins to the inner edges. (The outer edges have preassigned spins. Every vertex is assigned a set of **Boltzmann weights**. These depend on the spins of the four adjacent edges. For the six-vertex model there are only six nonzero Boltzmann weights:

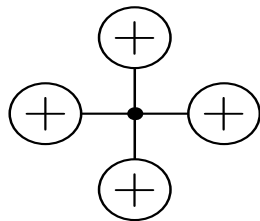

a_1

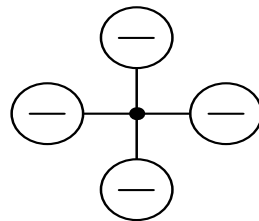

a_2

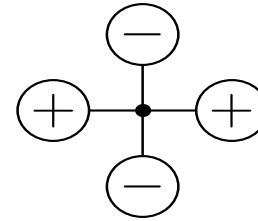

b_1

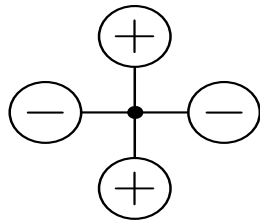

b_2

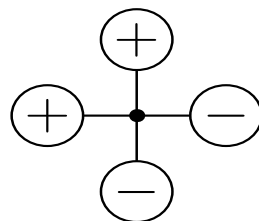

c_1

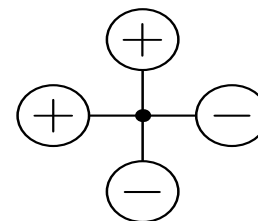

c_2

The **Boltzmann weight** of the state is the product of the weights at the vertices. The **partition function** is the sum over the states of the system.

The Partition Function

The Boltzmann weights are called **field-free** if $a_1 = a_2$, $b_1 = b_2$ and $c_1 = c_2$. They are called **free-fermionic** if $a_1a_2 + b_1b_2 - c_1c_2 = 0$.

Theorem 2. (Lieb, Sutherland, Baxter, Korepin-Izergin) *If every vertex has the same field-free Boltzmann weights then the partition function can be evaluated.*

- Kuperberg used this to prove the ASM conjecture.

One method of proof is Baxter's and uses the **Yang-Baxter equation**. After Onsager's work on Ising model this gave a second example of a **solvable lattice model**.

Theorem 3. (Hamel and King's reformulation of Tokuyama) *For certain free-fermionic Boltzmann weights the partition function can be evaluated and equals*

$$\prod_{\alpha \in \Phi^+} (1 - tz^\alpha) \chi_\lambda(z).$$

- The set of states injects into the $\mathcal{B}_{\lambda+\rho}$ crystal using Gelfand-Tsetlin patterns.
- **Hamel and King** gave a novel proof using **jeu de taquin**.
- **Brubaker, Bump and Friedberg** used instead the **Yang-Baxter equation**.
- The version of the **Yang-Baxter equation** they use was first found by **Korepin**.
- Brubaker, Bump, Chinta, Friedberg and Gunnells gave a variant that produces **metaplectic** Whittaker functions.

Ice

Consider the following Boltzmann weights:

$R(z):$						
	a_1	a_2	b_1	b_2	c_1	c_2
	1	z	t	z	$z(t+1)$	1

This is in the **free-fermionic** regime: $a_1 a_2 + b_1 b_2 = c_1 c_2$. Consider a system:

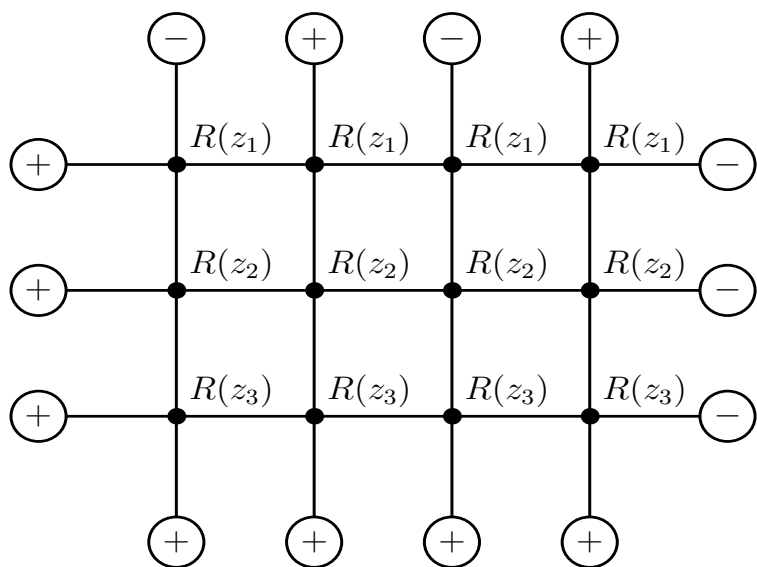

The boundary conditions: + on left and bottom edges, - on right and signs on top edge are determined by the partition λ by some rule. Use $R(z_i)$ in i -th row: z_i eigenvalues of \mathbf{z} .

Tokuyama, Hamel-King and Brubaker-Bump-Friedberg proved the partition function equals

$$\prod_{\alpha \in \Phi^+} (1 - t z^\alpha) \chi_\lambda(\mathbf{z}).$$

Baxter

In the field-free case let S be Boltzmann weights for some vertex with $a = a_1 = a_2$ and $b = b_1 = b_2$ and $c = c_1 = c_2$. Following Lieb and Baxter let

$$\Delta_S = \frac{a^2 + b^2 - c^2}{2ac}.$$

Given one row of “ice” with Boltzmann weights S at each vertex:

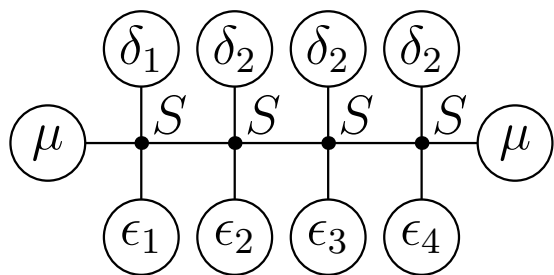

Toroidal boundary conditions:
Equal spins at left and right edges,
so sum over $\mu = +$ and $-$. Effectively
 μ is an interior edge. Non-toroidal BC
can be handled by a variant of this method.

Let $\delta = (\delta_1, \delta_2, \dots)$ and $\varepsilon = (\varepsilon_1, \varepsilon_2, \dots)$ be the states of the top and bottom rows. The partition function then is a **row transfer matrix** $\Theta_S(\delta, \varepsilon)$. The partition function with several rows is the product of the row transfer matrices.

Theorem 4. (Baxter) *If $\Delta_S = \Delta_T$ then Θ_S and Θ_T commute.*

Though we will not explain this point, the commutativity of transfer matrices yields, among other things, the solvability of the model. The proof uses the **Yang-Baxter equation** and the ideas here are key for us.

The Yang-Baxter equation

Theorem 5. (Baxter) *Let S and T be vertices with field-free Boltzmann weights. If $\Delta_S = \Delta_T$ then there exists a third R with $\Delta_R = \Delta_S = \Delta_T$ such that the two systems have the same partition function for any spins $\delta_1, \delta_2, \delta_3, \epsilon_1, \epsilon_2, \epsilon_3$.*

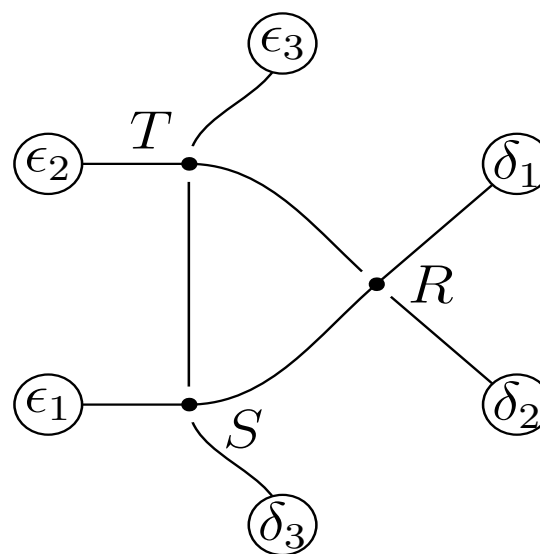
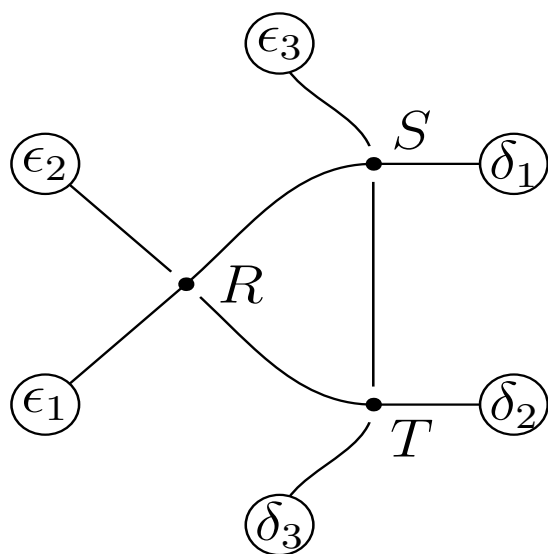

Commutativity of Transfer Matrices

This is used to prove the commutativity of the transfer matrices as follows. Consider the following system, whose partition function is the product of transfer matrices

$$\Theta_S \Theta_T(\phi, \delta) = \sum_{\varepsilon} \Theta_S(\phi, \varepsilon) \Theta_T(\varepsilon, \delta):$$

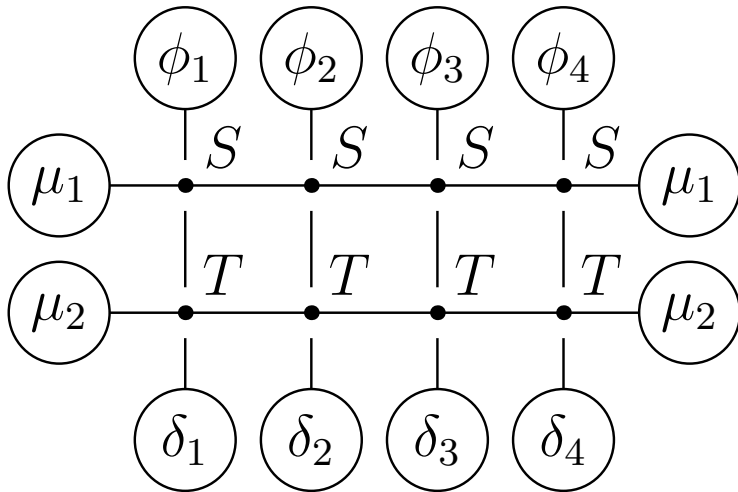

Toroidal Boundary Conditions:
 μ_1, μ_2 are interior edges and so we
 sum over μ_1, μ_2 .

Insert R and another vertex R^{-1}
 that undoes its effect:

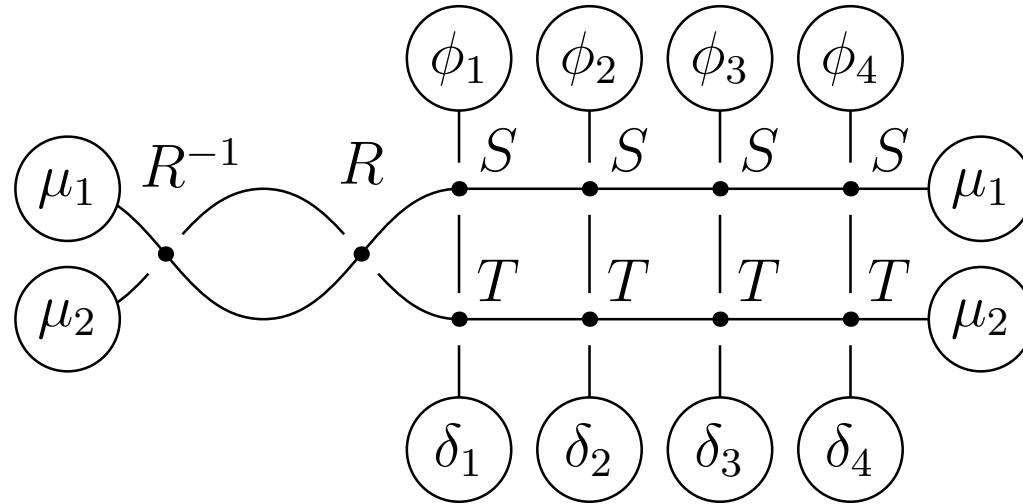

Now use YBE repeatedly:

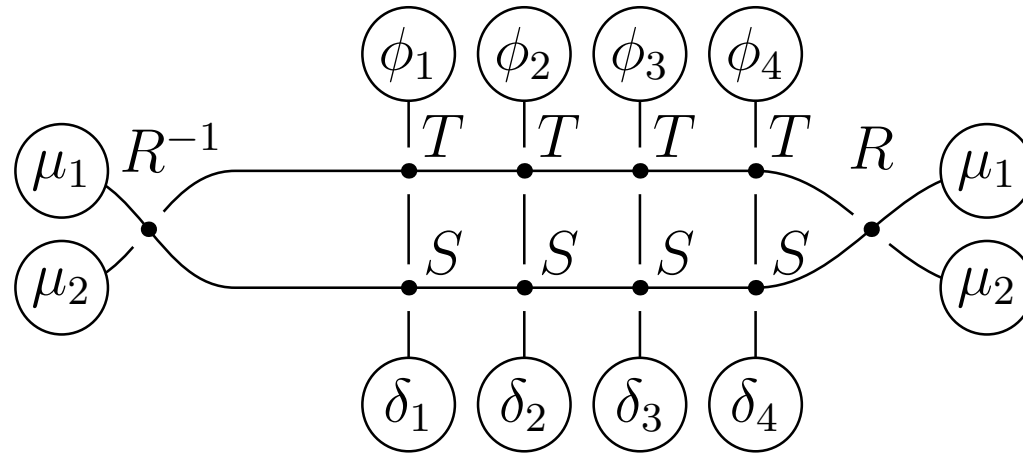

Due to toroidal BC now R, R^{-1} are adjacent again and they cancel. The transfer matrices have been shown to commute.

Algebraic Formulation

The investigation of the Yang-Baxter equation by mathematical physicists in Russia and Japan (descended from Faddeev and Sato) in the 1980s led in an algebraic direction culminating in the discovery of quantum groups (quasitriangular or co-quasitriangular Hopf algebras) by Drinfeld and Jimbo. Now we understand things as follows. The Yang-Baxter equation, which we considered previously as the identity of the partition functions of

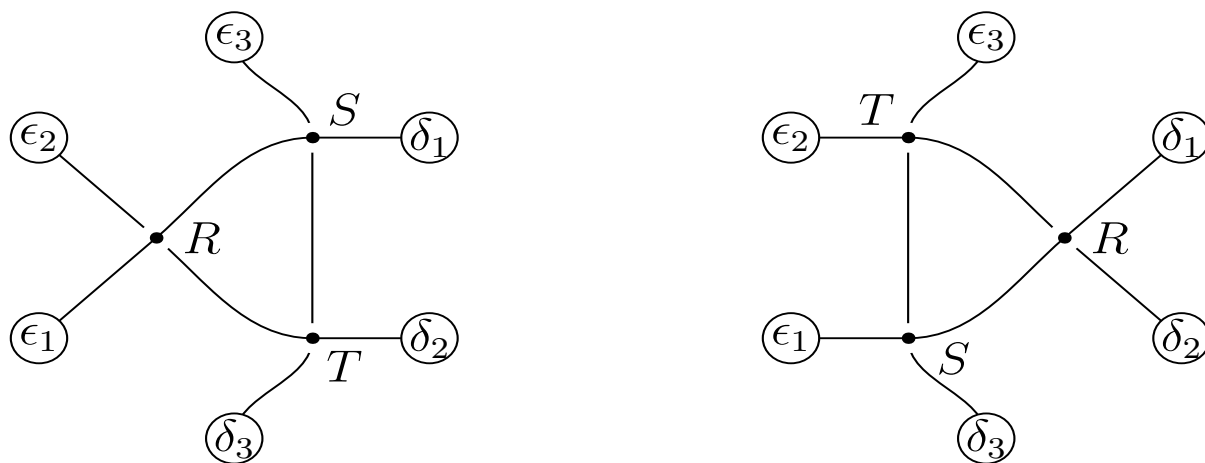

can be interpreted as follows. Let V be a two-dimensional free vector space on the spins $+$ and $-$. Then R , S and T may be interpreted as elements of $\text{End}(V \otimes V)$ and the Yang-Baxter equation is an identity in $\text{End}(V \otimes V \otimes V)$. It is written

$$\boxed{R_{12}S_{13}T_{23} = T_{23}S_{13}R_{12}}$$

where if $A \in \text{End}(V \otimes V)$ then A_{ij} is $A \otimes I$ with A acting on the i, j components of a tensor in $V \otimes V \otimes V$ and I acting on the third component.

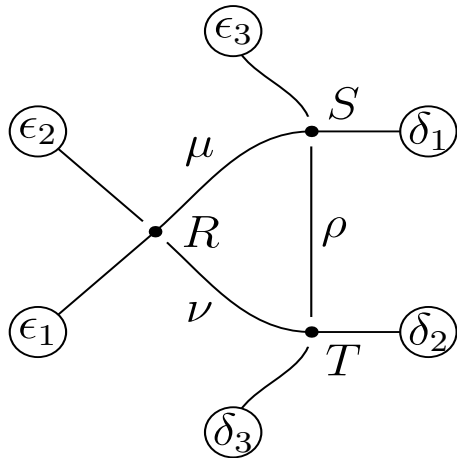

Remember that we sum over interior edge spins. Let us label these μ, ν, ρ for the purpose of the following discussion.

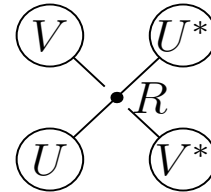

R-Matrices

We imagine the spins $\varepsilon_1, \varepsilon_2$ and μ, ν as specifying vectors each in a two-dimensional vector space. It will help us later if we take two vector spaces U and V with $\varepsilon_1 \in U$, $\varepsilon_2 \in V$, $\mu \in U^*$ and $\nu \in V^*$. The four spins together specify a vector in $U \otimes V \otimes U^* \otimes V^* = \text{End}(U \otimes V)$.

This **endomorphism** of $U \otimes V$ is called an **R-matrix**.

Braid Picture

Deform the picture above.

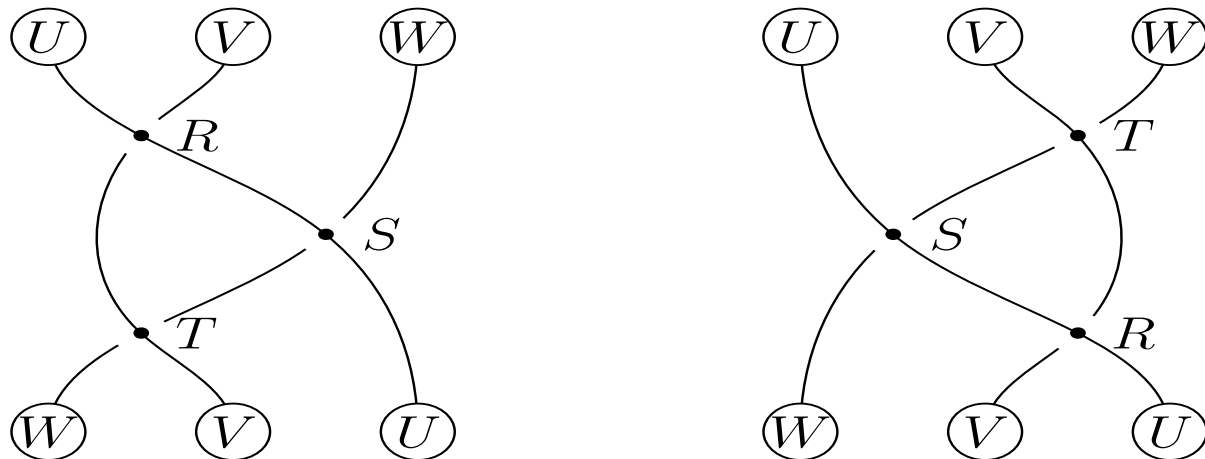

We interpret R as being an endomorphism of $U \otimes V$, where U and V are vector spaces. Similarly $S \in \text{End}(U \otimes W)$ and $T \in \text{End}(V \otimes W)$. The Yang-Baxter equation is still written $R_{12}S_{13}T_{23} = T_{23}S_{13}R_{12}$. It is not important whether $U = V = W$.

Since R and the cancelling R^{-1} are distinct, we draw the vertex as an over-and-under crossing. This will help us keep track of things and also introduces the Artin braid group.

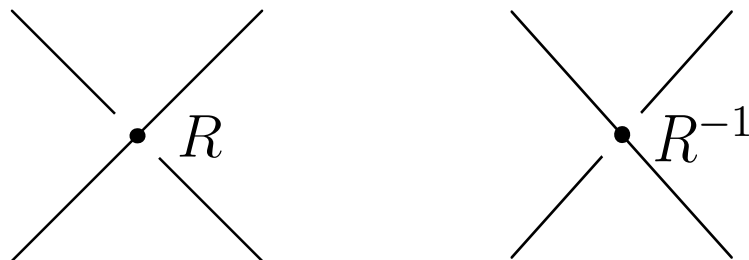

Monoidal Categories

A **monoidal** or **tensor category** is a category with an associative composition law \otimes with **natural** isomorphisms $A \otimes (B \otimes C) \longrightarrow (A \otimes B) \otimes C$. It is assumed that there is a unit I with natural isomorphisms $A \otimes I \longrightarrow A$ and $I \otimes A \longrightarrow A$.

Coherence: Any two ways of getting from one parenthesization of $A_1 \otimes A_2 \otimes \dots$ to another give the same result. (**MacLane**)

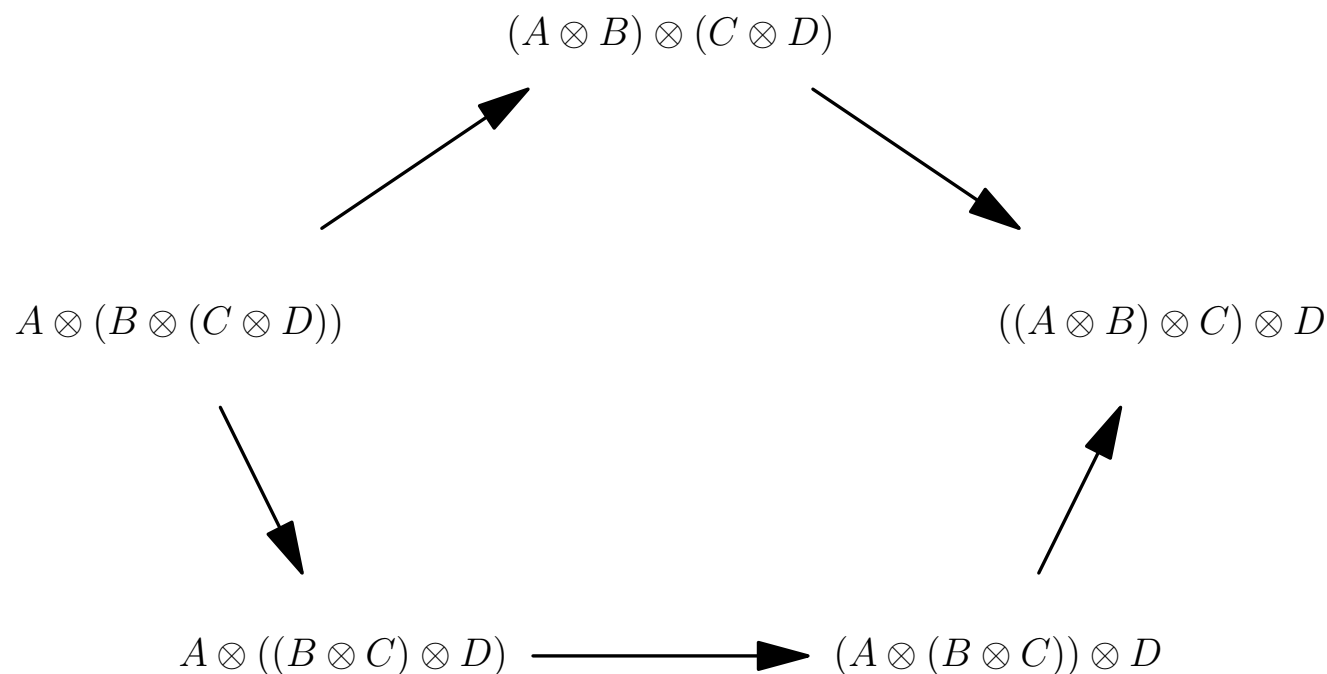

Symmetric vs Braided Monoidal Categories

A **symmetric monoidal category** (**Maclane**) adds natural isomorphisms $\tau_{A,B}: A \otimes B \longrightarrow B \otimes A$.

Coherence: any two ways of going from one **permutation** of $A_1 \otimes A_2 \otimes \dots$ to another give the same result.

$$\begin{array}{ccc} A \otimes B \otimes C & \xrightarrow{\tau_{A \otimes B, C}} & C \otimes A \otimes B \\ & \searrow 1_A \otimes \tau_{B, C} & \nearrow \tau_{A, C} \otimes 1_B \\ & A \otimes C \otimes B & \end{array}$$

Important generalization!

Maclane assumed that $\tau_{A,B}: A \longrightarrow B$ and $\tau_{B,A}: B \longrightarrow A$ are **inverses**. But ...

Joyal and Street proposed omitting this assumption. This leads to the important notion of a **braided monoidal category**.

Coherence in a Braided Monoidal Category

In a symmetric monoidal category $\tau_{A,B}: A \otimes B \rightarrow B \otimes A$ and $\tau_{B,A}^{-1}: A \otimes B \rightarrow B \otimes A$ are the same but in a braided monoidal category they may not be. We may distinguish them by using crossings:

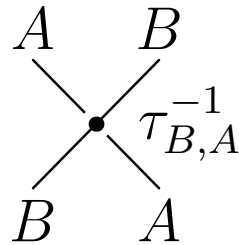
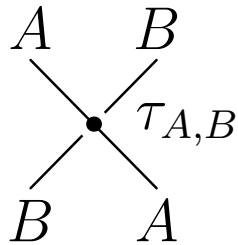

The top row is $A \otimes B$

The bottom row is $B \otimes A$

Coherence: Any two ways of going from $A_1 \otimes A_2 \otimes \dots$ to itself gives the same identity **provided** the two ways are the same in the Artin braid group. **For example:**

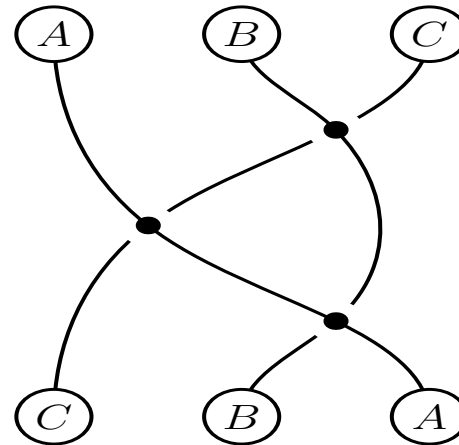
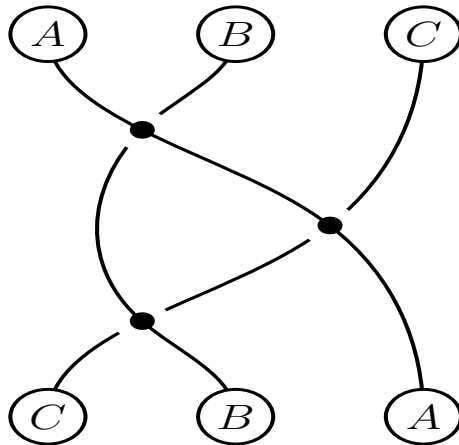

These diagrams describe two morphisms $A \otimes B \otimes C \rightarrow C \otimes B \otimes A$.

Quantum Groups

Hopf algebras are convenient substitutes – essentially generalizations – of the notion of a group. The category of modules or comodules of a Hopf algebra is a **monoidal category**. (A **module** over H has a multiplication $H \otimes V \rightarrow V$ so dually a **comodule** has a **comultiplication** $V \rightarrow H \otimes V$.)

The group G has morphisms $\mu: G \times G \rightarrow G$ and $\Delta: G \rightarrow G \times G$, namely the multiplication and diagonal map. These become the multiplication and the comultiplication in the Hopf algebra.

The modules over a group form a **symmetric monoidal** category. There are two types of Hopf algebras with an analogous property.

- In a cocommutative Hopf algebra, the **modules** form a **symmetric monoidal category**.
- In a **commutative** Hopf algebra, the **comodules** form a **symmetric monoidal category**.

Roughly a **quantum group** is a Hopf algebra whose modules or comodules form a **braided monoidal category**.

Groups as Hopf Algebras.

If G is a Lie group, its enveloping algebra $U(\mathfrak{g})$ is the convolution ring of distributions at the identity. Modules of G correspond to **modules** of $U(\mathfrak{g})$. They form a **symmetric monoidal category**.

Dually, consider the coordinate ring $\mathcal{O}(G)$ of an **affine algebraic group**. Since the functor $X \rightarrow \mathcal{O}(X)$ from affine schemes to commutative rings is contravariant, the **multiplication** in G corresponds to the **comultiplication** in $\mathcal{O}(G)$. The **comodules** of $\mathcal{O}(G)$ correspond to **modules** of G and they form a **symmetric monoidal category**.

Quantum Groups

If \mathfrak{g} is a complex Lie algebra, Drinfeld and Jimbo defined a quantized enveloping algebra $U_q(\mathfrak{g})$. The **modules** form a **braided monoidal category**.

The group $\mathcal{O}(G)$ may also be deformed. The **comodules** form a **braided monoidal category**.

Parametrized Yang-Baxter Equation

Let us assume that we have a collection of possible **vertices**, R, S, T, \dots each representing a set of **Boltzmann weights**. We call them **R-matrices**. Assume for every pair S and T of vertices that there exists a vertex ST such that the Yang-Baxter equation is true in the sense that the following two partition functions are equal:

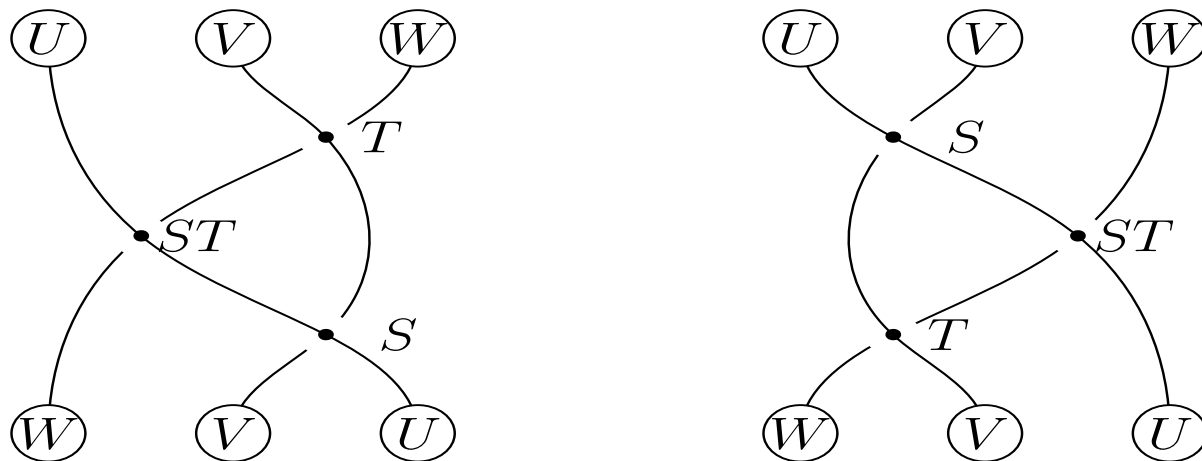

It is to be imagined that U, V, W are all copies of the same vector space which will eventually become modules in some category. We may think of $(S, T) \longrightarrow ST$ as a kind of “multiplication” on the set Γ of **R-matrices**.

- Given S, T the condition on ST is **overdetermine** so ST (if it exists) is **undoubtedly unique** up to scalar multiple.
- The composition tends to be **associative**. If $U = V = W = \dots$ this may give a **group** or **monoid** structure on a subset of $\mathbb{P}(\text{End}(V \otimes V))$

Associativity of composition of R-matrices

Consider the following setup.

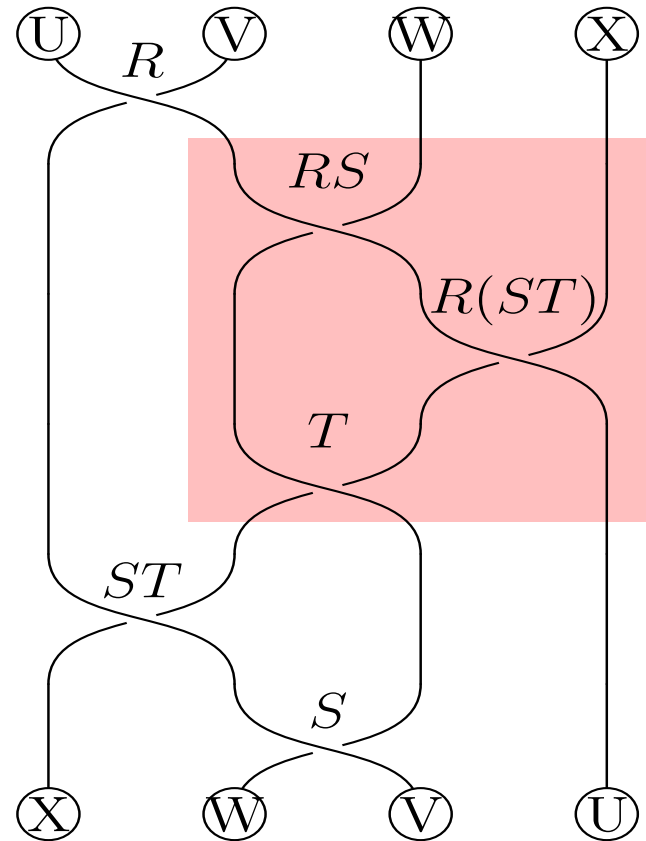
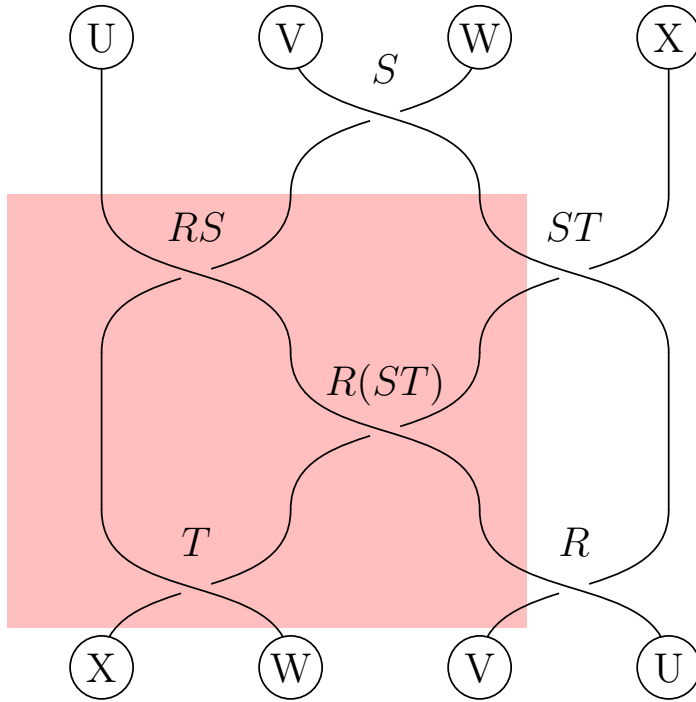

We'll prove these are equal.

Here goes:

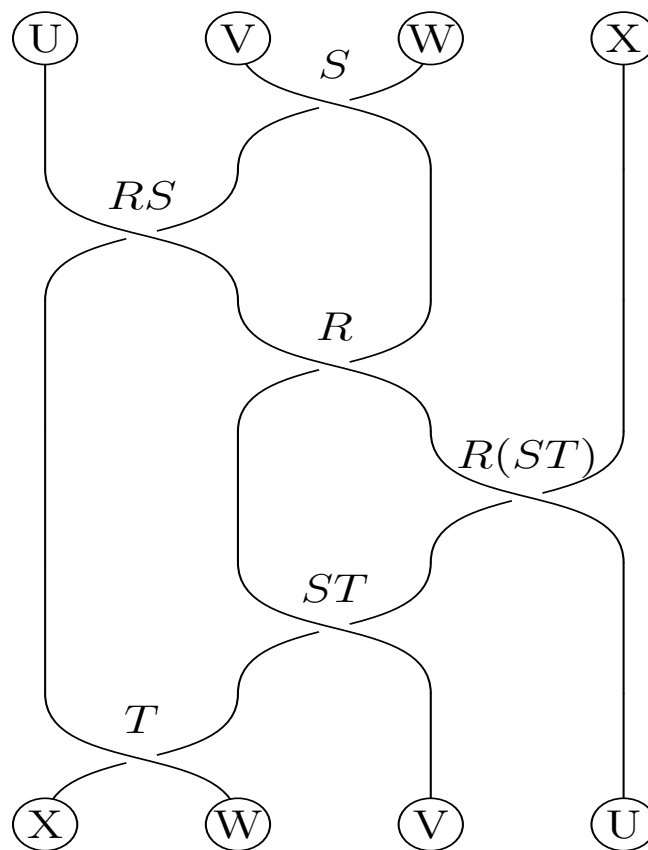
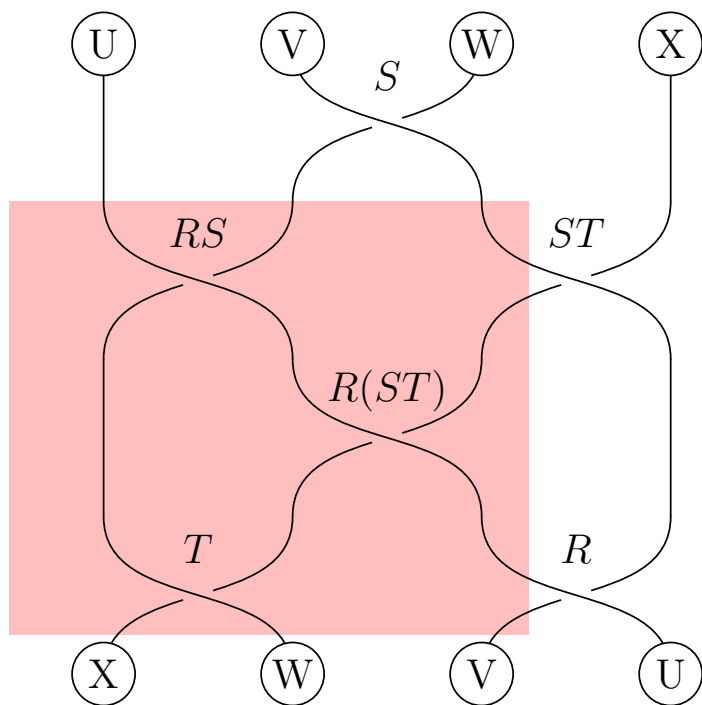

Use **YBE** on the **right hand side**.

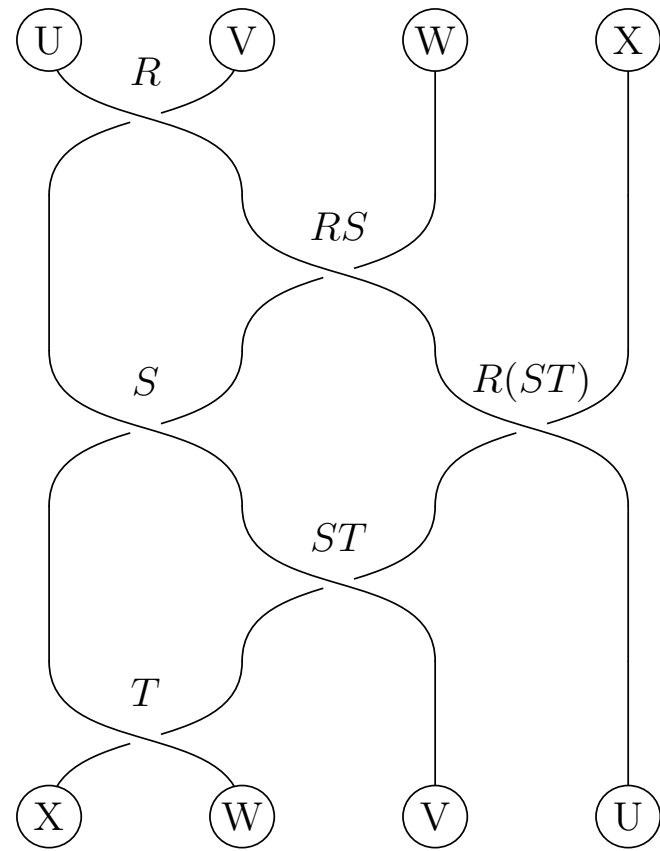
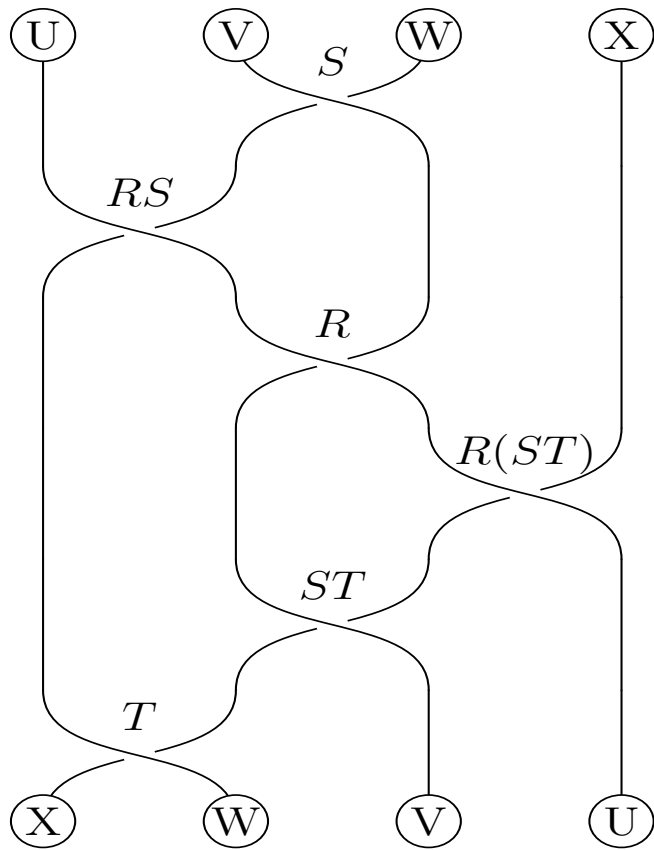

YBE on the **upper left side**.

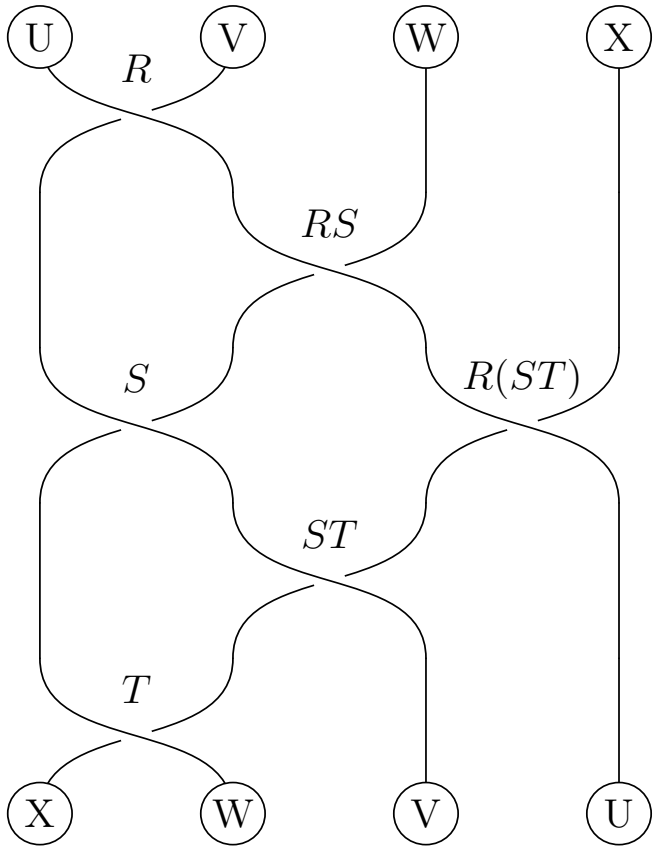

Next on the lower left.

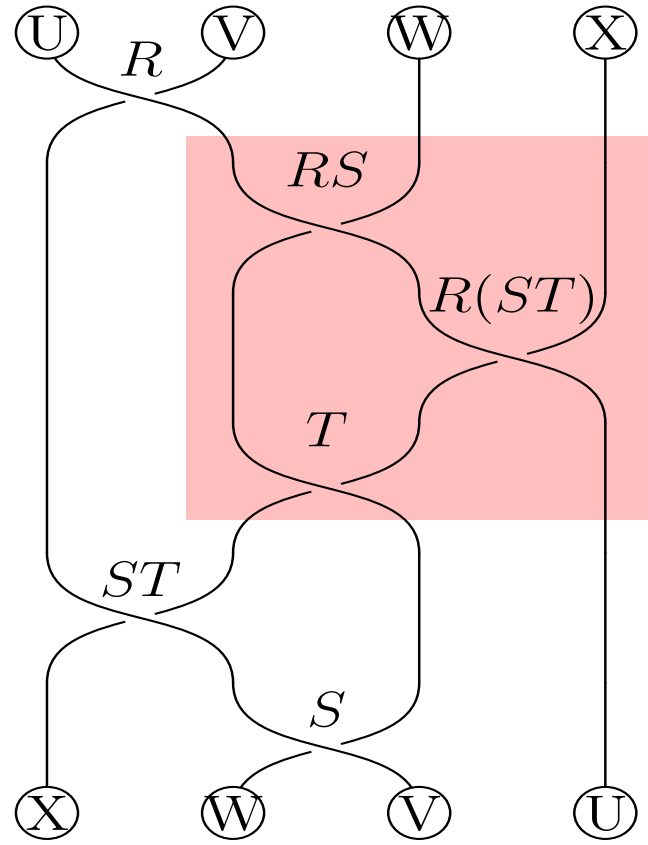

Done.

Similarly ...

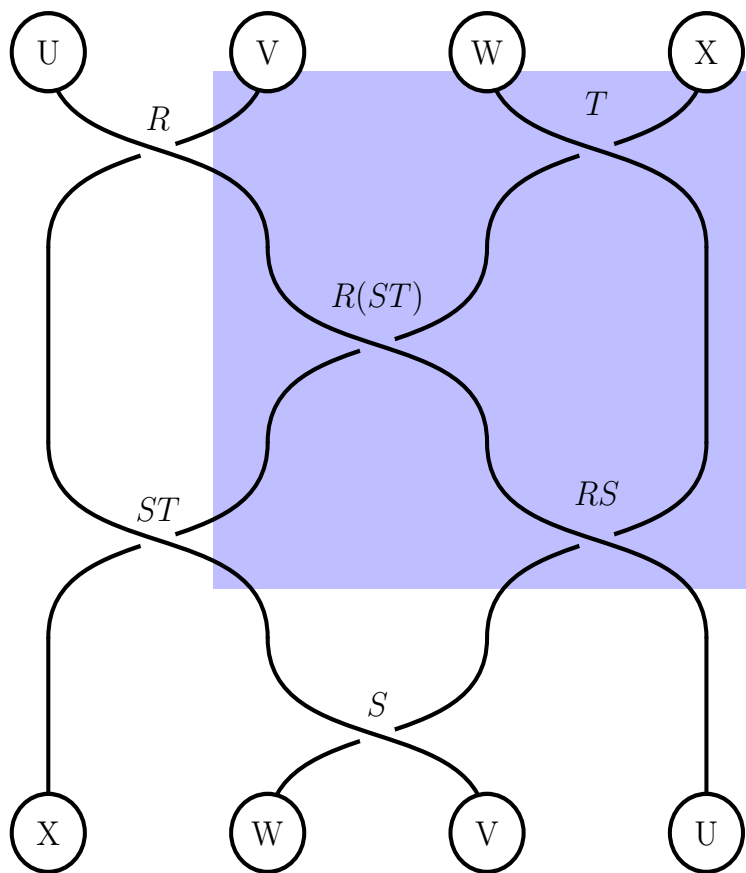
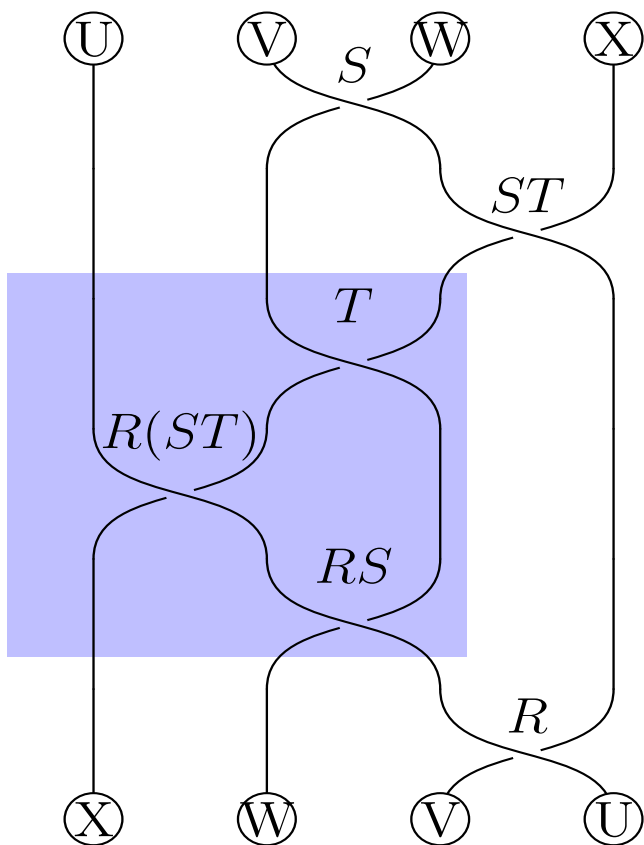

These two partition functions are also equal. (Similar proof.)

Comparison

We've exhibited **two endomorphisms** of $U \otimes W \otimes X$ (represented as **greenies** below) such that for **either** endomorphism the two partition functions are equal:

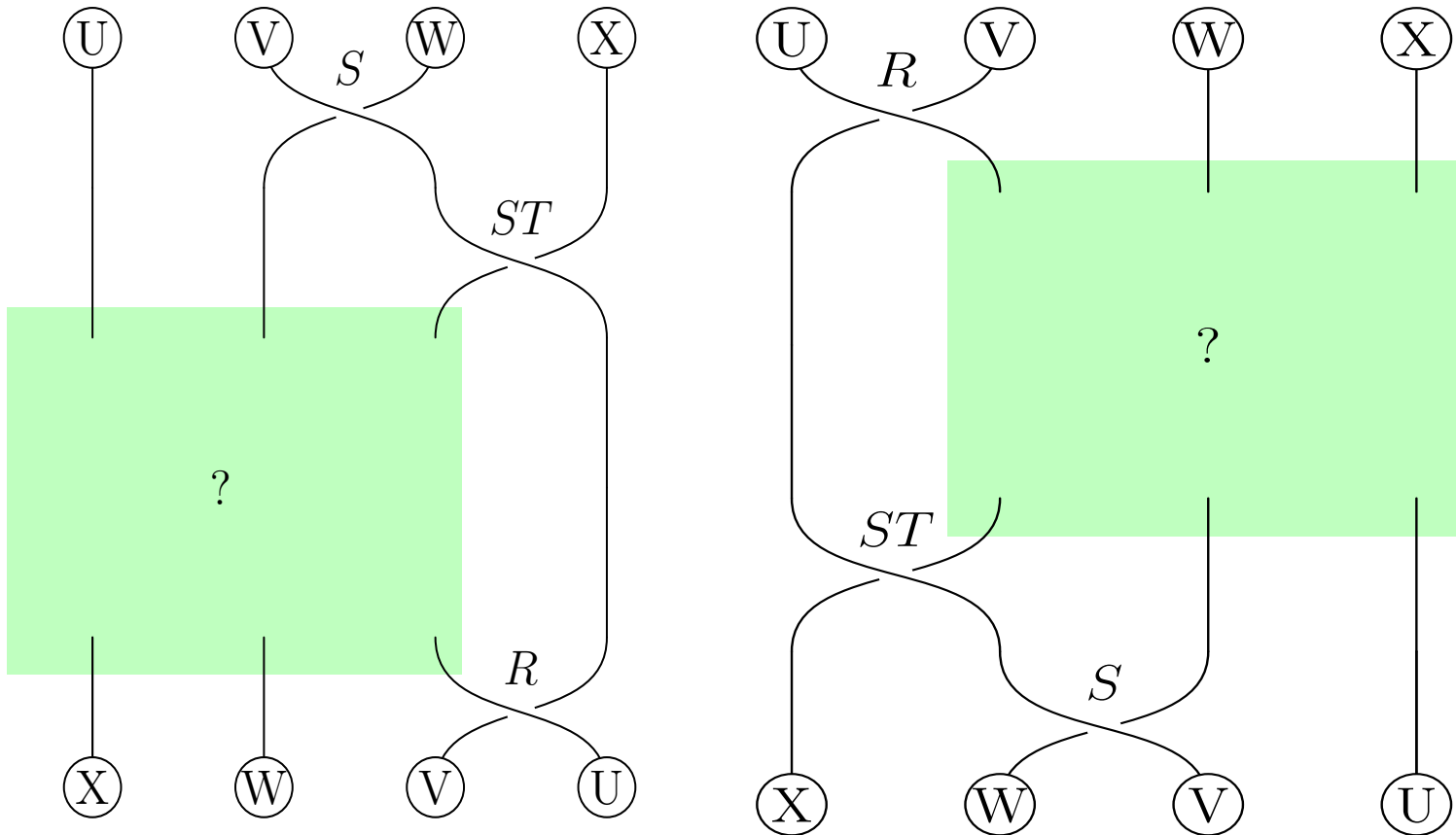

This is an **overdetermined** system of equations on the **endomorphism** of $U \otimes W \otimes X$.

Overdetermined system should have only one solution

... so the two different endomorphisms are equal. Thus

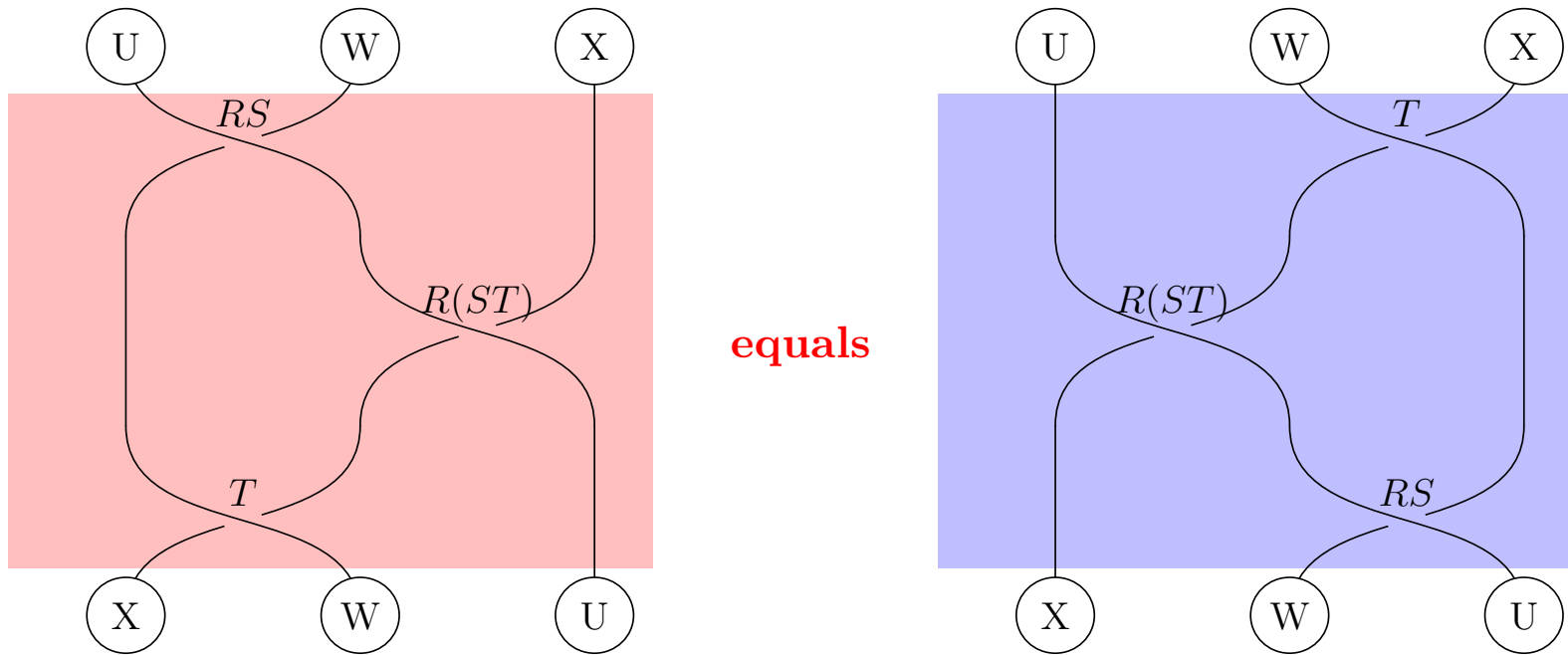

That means that $R(ST)$ has the property **characterizing** $(RS)T$ so

$$R(ST) = (RS)T.$$

Parametrized Yang-Baxter Equation

Fix a vector space.

Suppose $ST \in \text{End}(V \otimes V)$ is defined (as above) for all S and T in some collection of endomorphisms of $V \otimes V$. This means $R = ST$ satisfies $R_{12}S_{13}T_{23} = T_{23}S_{13}R_{12}$, or in pictures

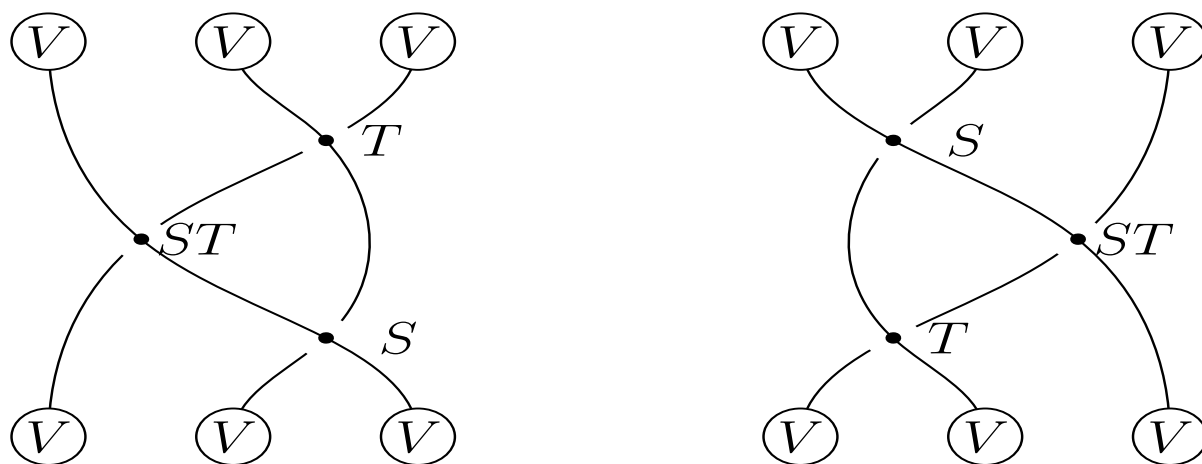

Beginning with Baxter's field-free example, one often draws R , S , T from a collection of matrices parametrized by a **group** Γ . More generally Γ can be a **monoid**.

Make a Category

We may think of having one copy V_γ of a fixed vector space for every $\gamma \in \Gamma$ and the equation becomes

$$R_{12}(\xi/\eta)R_{13}(\xi/\zeta)R_{23}(\eta/\zeta) = R_{23}(\eta/\zeta)R_{13}(\xi/\zeta)R_{12}(\xi/\eta)$$

where now $R(\xi.\eta) \in \text{End}(V_\xi \otimes V_\eta)$.

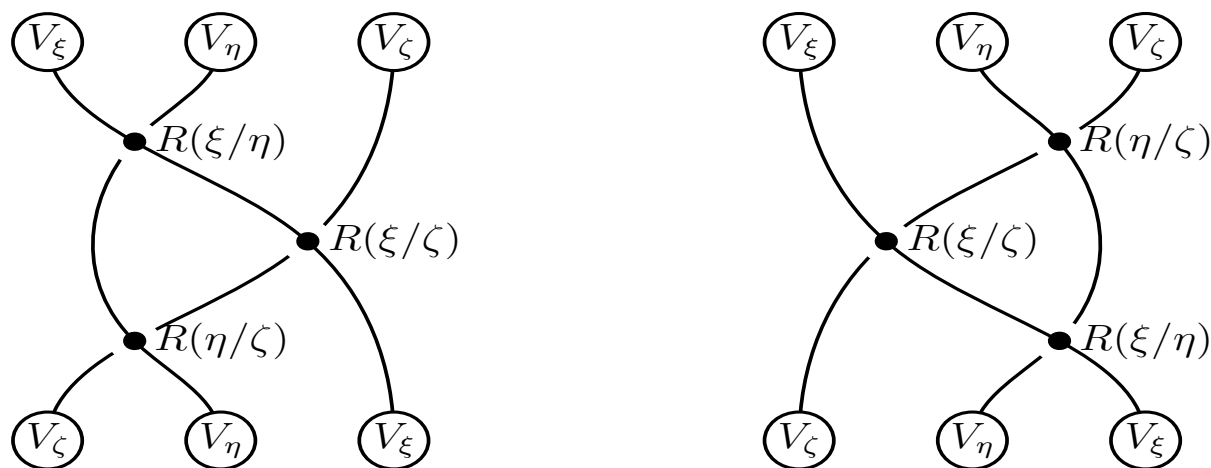

We might adjoin kernels and cokernels (Karoubi completion) to get an abelian category out of the V_γ and hope it's a **braided monoidal category**.

We might then hope it's the category of modules over a **QTHA** (we'll explain later)

Example: parametrized YBE: Baxter

First, in Baxter's field free case, we recall that

$$\Delta = \frac{a^2 + b^2 - c^2}{2ab} \quad \text{or} \quad \frac{a^2 + b^2 - c_1 c_2}{2ab}$$

- It is **OK to allow** $c_1 \neq c_2$ as long as $a_1 = a_2$ and $b_1 = b_2$.

Find q such that $\Delta = \frac{1}{2}(q + q^{-1})$. The parameter **group** Γ will be \mathbb{C}^\times . Solve:

$$a = z - q^2, \quad b = q(z - 1), \quad c_1 = (1 - q^2), \quad c_2 = z(1 - q^2).$$

The R -matrix is (for suitable basis

$$R(z) = \begin{pmatrix} a & & & & \\ & b & c_2 & & \\ & c_1 & b & & \\ & & & & a \end{pmatrix} = \begin{pmatrix} q^2 - z & & & & \\ & q(1 - z) & z(q^2 - 1) & & \\ & (q^2 - 1) & q(1 - z) & & \\ & & & & \\ & & & & q^2 - z \end{pmatrix}$$

in $\text{End}(V_\xi \otimes V_\eta)$ where $z = \xi/\eta$.

Or the parameter **monoid** Γ can be \mathbb{C} : if $z = 0$ this gives us a solution

$$\begin{pmatrix} q^2 & & & \\ & q & & \\ & q^2 & q & \\ & & & q^2 \end{pmatrix}$$

Example: parametrized YBE: Eight-vertex model

Baxter realized that the eight vertex model led to parametrized YBE with parameter group an **elliptic curve**. In the field free case the R-matrices look like:

$$\begin{pmatrix} a & & & d \\ & b & c & \\ & c & b & \\ d & & & a \end{pmatrix}.$$

Example: parametrized YBE: Free-Fermionic Case

The set of Boltzmann weights with $a_1 a_2 + b_1 b_2 = c_1 c_2$ forms a parametrized YBE with R-matrices

$$\begin{pmatrix} a_1 & & & & \\ & b_1 & c_2 & & \\ & c_1 & b_2 & & \\ & & & & a_2 \end{pmatrix}.$$

Thus if $\Delta = 0$ we can **drop the field free hypothesis**. The subset of this **monoid** with $c_1 c_2 \neq 0$ forms a **group parametrized YBE** with **nonabelian parameter group**

$$\Gamma = \text{GL}_2 \times \text{GL}_1.$$

Quasitriangular Hopf algebras

Drinfeld defined the notion of a **quasitriangular Hopf algebra (QTHA)**. If H is a QTHA then its category of modules forms a **braided monoidal category**.

The exact definition is **not important for our discussion** and we omit it.

Similarly there are **dual QTHA**'s with the property that its **comodules** form a **braided monoidal category**.

Triangular = Symmetric

If the QTHA or dual QTHA is **triangular** the category of modules is a **symmetric monoidal category** meaning the commutativity constraint $\theta_{A,B}: A \otimes B \rightarrow B \otimes A$ satisfies $\theta_{A,B} = \theta_{B,A}^{-1}$. This is **less interesting**. For example, the applications of quantum groups to **knot theory** depend on being able to distinguish

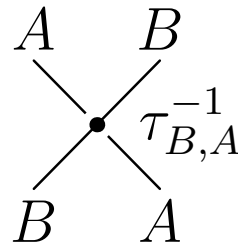
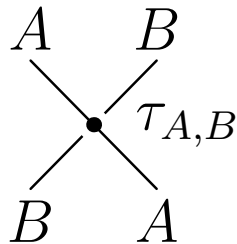

Tannakian problem

Saavedra-Rivano proved given a **symmetric monoidal category** satisfying certain axioms (rigidity, fiber functor) there exists a **commutative Hopf algebra** having the category as comodule category.

Given a suitable **braided monoidal category**, can we find a QTHA (or dual QTHA) having an equivalent category of modules (or comodules)? (Joyal and Street, Majid.)

More modestly, given a solution to YBE or parametrized YBE, construct a QTHA (or dual QTHA) having that vector space or family of vector spaces as a module (or comodule).

Two main methods:

- **Drinfeld double** glues two dual Hopf algebra to make a QTHA.
- **Faddeev, Reshetikhin and Takhtajan (FRT)**. This method first produces a dual QTHA, and a QTHA may be obtained by duality.
- **FRT** method was extended to parametrized case by **Cotta-Ramusino, Lambe and Rinaldi**.
- **Buciumas** reconsiders the **FRT** method in the parametrized case more functorially with an eye on the Free-Fermionic YBE.

Duality (classical case, i.e. $q = 1$)

Let G be an affine algebraic group over \mathbb{C} . Its coordinate ring $\mathcal{O}(G)$ is a Hopf algebra: the comultiplication corresponds to the multiplication in G .

Let \mathfrak{g} be its Lie algebra. The universal enveloping algebra $U(\mathfrak{g})$ is a Hopf algebra: the multiplication in \mathfrak{g} corresponds to convolution. That is, $U(\mathfrak{g})$ may be identified with the convolution ring of distributions on G concentrated at the identity.

Applying a distribution to a function gives a dual pairing $U(\mathfrak{g}) \times \mathcal{O}(G) \longrightarrow \mathbb{C}$. We have

$$\langle \Delta\xi, f_1 \otimes f_2 \rangle = \langle \xi, f_1 f_2 \rangle, \quad \langle \xi \otimes \eta, \Delta f \rangle = \langle \xi \eta, f \rangle$$

where Δ is comultiplication. If V is a module of \mathfrak{g} then V^* is a comodule of G .

- The modules/comodules form a **symmetric monoidal category**.

Deformation

Let q be a parameter. Let $U_q(\mathfrak{g})$ be the quantized enveloping algebra and $\mathcal{O}_q(G)$ the “quantum” G . Both are Hopf algebras, in duality. $U_q(\mathfrak{g})$ is a **QTHA** and $\mathcal{O}_q(G)$ is a **dual QTHA**. The above case is $q = 1$.

- The modules/comodules form a **braided monoidal category**.

Faddeev, Reshetikhin and Takhtajan (FRT)

Problem: beginning with a solution of (unparametrized) **YBE** $R \in \text{End}(V \otimes V)$ where V is a vector space, produce a bialgebra with V as a comodule. Then τR should be a comodule endomorphism. ($\tau(x \otimes y) = y \otimes x$.) Categorically, it corresponds to the commutativity constraint.

Solution: Let T be a matrix of noncommuting variables equal in number to $\dim(V)^2$. These variables are subject to the condition

$$RT_1T_2 = T_2T_1R \quad (T_1 = T \otimes I, \quad T_2 = I \otimes T). \quad (1)$$

Then A_R is the algebra generated by these variables.

Perspective 1: For **FRT**, the motivation is from inverse scattering theory. Here T plays the role of the Lax operator which satisfy the Fundamental Commutation Relation (1).

Perspective 2: Assuming that V is a comodule for an algebra A , the comultiplication $V \rightarrow A \otimes V$ may be expressed as $v_i \mapsto \sum_j t_{ij} \otimes v_j$. Now consider the algebraic consequences of the **requirement** that $\tau R: V \otimes V \rightarrow V \otimes V$ is a coalgebra homomorphism, where $\tau(x \otimes y) = (y \otimes x)$. **This requirement leads to the identity (1).**

Cotta-Ramusino, Lambe, Rinaldi, Bucimuas:

This works in the parametrized case with one set of variables $T(z)$ for each $z \in \Gamma$.

Dual Affinization

If \mathfrak{g} is a complex semisimple Lie algebra let $\hat{\mathfrak{g}}$ be the derived Lie algebra of the Kac-Moody affinization. It is

$$0 \longrightarrow \mathbb{C} \cdot c \longrightarrow \hat{\mathfrak{g}} \longrightarrow \mathfrak{g} \otimes \mathbb{C}[t, t^{-1}] \longrightarrow 0.$$

Dual to the enlargement $U_q(\mathfrak{g})$ to $U_q(\hat{\mathfrak{g}})$:

Special case: $\Gamma = \mathbb{C}^\times$. Suppose we already have a Hopf algebra A with V as a comodule.

The $\mathcal{O}(\Gamma) = \mathbb{C}[t, t^{-1}]$ is a Laurent polynomial ring. This is a Hopf algebra.

$$A'_\Gamma = \text{Hom}(\mathcal{O}(\Gamma), A)$$

is a Hopf algebra.

Proposition 6. A'_Γ has a comodule V_z for every $z \in \Gamma$.

Proof. If $z \in \Gamma$, then comultiplication $\Delta_z: V \longrightarrow A'_\Gamma \otimes V$ may be defined making V an A'_Γ comodule V_z . If $\Delta: V \longrightarrow A \otimes V$ is the comultiplication, $\Delta v = \sum a_i \otimes v_i$ then $\Delta_z v = \sum \phi_i \otimes v_i$ where $\phi_i \in A_\Gamma$ sends $f \in \mathcal{O}(\Gamma)$ to $f(z)a_i$.

Suppose $\Gamma = \mathbb{C}^\times$ inside the **multiplicative monoid** \mathbb{C} . (Call this algebraic monoid $\hat{\Gamma}$.) The algebra A can be obtained by taking the R -matrix at 0, which satisfies

$$R_{12}R_{13}R_{23} = R_{23}R_{13}R_{12}$$

then applying the FRT construction.

Triangularity

In order for a braided monoidal category to be symmetric we need the commutativity constraint $\theta_{A,B}: A \otimes B \longrightarrow B \otimes A$ satisfy $\theta_{B,A} = \theta_{A,B}^{-1}$. Given a parametrized YBE

$$R: \Gamma \longrightarrow \text{End}(V \otimes V)$$

We have one copy V_z for each $z \in \Gamma$ and $\theta_{V_z, V_w} = \tau R(z, w^{-1})$. This means we need

$$\boxed{\tau R(z) \tau R(z^{-1}) = I.}$$

In the Baxter case we may check that this is true, after adjusting $R(z)$ by a scalar:

$$R(z) = \begin{pmatrix} a & & & & \\ & b & c_2 & & \\ & c_1 & b & & \\ & & & & a \end{pmatrix} = \left(\frac{1}{zq^{-1} - q} \right) \begin{pmatrix} qz - q^{-1} & & & & \\ & z - 1 & z(q - q^{-1}) & & \\ & q - q^{-1} & z - 1 & & \\ & & & & \\ & & & & qz - q^{-1} \end{pmatrix}$$

in $\text{End}(V_\xi \otimes V_\eta)$ where $z = \xi/\eta$. Hence this Yang-Baxter equation is triangular and the resulting monoidal category is **symmetric**.

Limiting Case is not triangular

The parameter **group** in this example can be enlarged to the multiplicative monoid \mathbb{C} which contains two idempotents, $z = 1$ (the unit) and $z = 0$. Taking $z = 0$ gives $R = R(0)$ satisfying

$$R_{12}R_{13}R_{23} = R_{23}R_{13}R_{12}$$

and the FRT construction gives $GL_q(2)$ which is **quasitriangular** but not **triangular** since $\tau R \tau R = I$ is **not true**.

What about the Free-Fermionic Case?

A Hopf algebra exists with two-dimensional comodules in bijection with the parameter group $\Gamma = GL(2) \times GL(1)$.

- Is it $\text{Hom}(\mathcal{O}(\Gamma), \text{SL}_{\sqrt{-1}}(2))$ with dual QTHA structure?
- Is it dual to some enlargement of $U_{\sqrt{-1}}(\widehat{\mathfrak{sl}}_2)$?
- What about limiting cases?
- What about the eight vertex model?
- What about the metaplectic case?