

NOAA Technical Memorandum NWS WR-181



QUANTITATIVE AND SPACIAL DISTRIBUTION OF WINTER
PRECIPITATION ALONG UTAH'S WASATCH FRONT

Salt Lake City, Utah
August 1983

**U.S. DEPARTMENT OF
COMMERCE**

National Oceanic and
Atmospheric Administration

National Weather
Service



NOAA TECHNICAL MEMORANDA
National Weather Service, Western Region Subseries

The National Weather Service (NWS) Western Region (WR) Subseries provides an informal medium for the documentation and quick dissemination of results not appropriate, or not yet ready, for formal publication. The series is used to report on work in progress, to describe technical procedures and practices, or to relate progress to a limited audience. These Technical Memoranda will report on investigations devoted primarily to regional and local problems of interest mainly to personnel, and hence will not be widely distributed.

Papers 1 to 25 are in the former series, ESSA Technical Memoranda, Western Region Technical Memoranda (WRTM); papers 24 to 59 are in the former series, ESSA Technical Memoranda, Weather Bureau Technical Memoranda (WBTM). Beginning with 60, the papers are part of the series, NOAA Technical Memoranda NWS. Out-of-print memoranda are not listed.

Papers 2 to 22, except for 5 (revised edition), are available from the National Weather Service Western Region, Scientific Services Division, P. O. Box 11188, Federal Building, 125 South State Street, Salt Lake City, Utah 84147. Paper 5 (revised edition), and all others beginning with 25 are available from the National Technical Information Service, U. S. Department of Commerce, Sills Building, 5285 Port Royal Road, Springfield, Virginia 22151. Prices vary for all paper copy; \$3.50 microfiche. Order by accession number shown in parentheses at end of each entry.

ESSA Technical Memoranda (WRTM)

- 2 Climatological Precipitation Probabilities. Compiled by Lucianne Miller, December 1965.
- 3 Western Region Pre- and Post-FP-3 Program, December 1, 1965, to February 20, 1966. Edward D. Diemer, March 1966.
- 5 Station Descriptions of Local Effects on Synoptic Weather Patterns. Philip Williams, Jr., April 1966 (revised November 1967, October 1969). (PB-17800)
- 8 Interpreting the RAREP. Herbert P. Benner, May 1966 (revised January 1967).
- 11 Some Electrical Processes in the Atmosphere. J. Latham, June 1966.
- 17 A Digitalized Summary of Radar Echoes within 100 Miles of Sacramento, California. J. A. Youngberg and L. B. Overaas, December 1966.
- 21 An Objective Aid for Forecasting the End of East Winds in the Columbia Gorge, July through October. D. John Coparanis, April 1967.
- 22 Derivation of Radar Horizons in Mountainous Terrain. Roger G. Pappas, April 1967.

ESSA Technical Memoranda, Weather Bureau Technical Memoranda (WBTM)

- 25 Verification of Operational Probability of Precipitation Forecasts, April 1966-March 1967. W. W. Dickey, October 1967. (PB-176240)
- 26 A Study of Winds in the Lake Mead Recreation Area. R. P. Augulis, January 1968. (PB-177830)
- 28 Weather Extremes. R. J. Schmidli, April 1968 (revised February 1981).
- 29 Small-Scale Analysis and Prediction. Philip Williams, Jr., May 1968. (PB-178425)
- 30 Numerical Weather Prediction and Synoptic Meteorology. Capt. Thomas D. Murphy, U.S.A.F., May 1968. (AD-673365)
- 31 Precipitation Detection Probabilities by Salt Lake ARTC Radars. Robert K. Belesky, July 1968. (PB-179084)
- 32 Probability Forecasting--A Problem Analysis with Reference to the Portland Fire Weather District. Harold S. Ayer, July 1968. (PB-179289)
- 35 Joint ESSA/FAA ARTC Radar Weather Surveillance Program. Herbert P. Benner and DeVon B. Smith, December 1968 (revised June 1970). AD-681857)
- 36 Temperature Trends in Sacramento--Another Heat Island. Anthony D. Lentini, February 1969. (PB-183055)
- 37 Disposal of Logging Residues without Damage to Air Quality. Owen P. Cramer, March 1969. (PB-183057)
- 39 Upper-Air Lows over Northwestern United States. A. L. Jacobson, April 1969. (PB-184296)
- 40 The Man-Machine Mix in Applied Weather Forecasting in the 1970's. L. W. Snellman, August 1969. (PB-185068)
- 42 Analysis of the Southern California Santa Ana of January 15-17, 1966. Barry B. Aronovitch, August 1969. (PB-185670)
- 43 Forecasting Maximum Temperatures at Helena, Montana. David E. Olsen, October 1969. (PB-185762)
- 44 Estimated Return Periods for Short-Duration Precipitation in Arizona. Paul C. Kangieser, October 1969. (PB-187763)
- 46 Applications of the Wet Radiometer to Short-Range Fog and Stratus Forecasting at Eugene, Oregon. L. Yee and E. Bates, December 1969. (PB-190476)
- 47 Statistical Analysis as a Flood Routing Tool. Robert J. C. Burnash, December 1969. (PB-188744)
- 48 Tsunami. Richard P. Augulis, February 1970. (PB-190157)
- 49 Predicting Precipitation Type. Robert J. C. Burnash and Floyd E. Hug, March 1970. (PB-190962)
- 50 Statistical Report on Aeroallergens (Pollens and Molds) Fort Huachuca, Arizona, 1969. Wayne S. Johnson, April 1970. (PB-191743)
- 51 Western Region Sea State and Surf Forecaster's Manual. Gordon C. Shields and Gerald B. Burdwell, July 1970. (PB-193102)
- 52 Sacramento Weather Radar Climatology. R. G. Pappas and C. M. Veliquette, July 1970. (PB-193347)
- 54 A Refinement of the Vorticity Field to Delineate Areas of Significant Precipitation. Barry B. Aronovitch, August 1970.
- 55 Application of the SSARR Model to a Basin without Discharge Record. Vail Schermerhorn and Donald W. Kuehl, August 1970. (PB-194394)
- 56 Areal Coverage of Precipitation in Northwestern Utah. Philip Williams, Jr., and Werner J. Heck, September 1970. (PB-194389)
- 57 Preliminary Report on Agricultural Field Burning vs. Atmospheric Visibility in the Willamette Valley of Oregon. Earl M. Bates and David O. Chilcote, September 1970. (PB-194710)
- 58 Air Pollution by Jet Aircraft at Seattle-Tacoma Airport. Wallace R. Donaldson, October 1970. (COM-71-00017)
- 59 Application of PE Model Forecast Parameters to Local-Area Forecasting. Leonard W. Snellman, October 1970. (COM-71-00016)

NOAA Technical Memoranda (NWS WR)

- 60 An Aid for Forecasting the Minimum Temperature at Medford, Oregon. Arthur W. Fritz, October 1970. (COM-71-00120)
- 63 700-mb Warm Air Advection as a Forecasting Tool for Montana and Northern Idaho. Norris E. Woerner, February 1971. (COM-71-00349)
- 64 Wind and Weather Regimes at Great Falls, Montana. Warren B. Price, March 1971.
- 66 A Preliminary Report on Correlation of ARTCC Radar Echoes and Precipitation. Wilbur K. Hall, June 1971. (COM-71-00829)
- 69 National Weather Service Support to Soaring Activities. Ellis Burton, August 1971. (COM-71-00956)
- 71 Western Region Synoptic Analysis-Problems and Methods. Philip Williams, Jr., February 1972. (COM-72-10433)
- 74 Thunderstorms and Hail Jax Probabilities in Nevada. Clarence M. Sakamoto, April 1972. (COM-72-10554)
- 75 A Study of the Low Level Jet Stream of the San Joaquin Valley. Ronald A. Willis and Philip Williams, Jr., May 1972. (COM-72-10707)
- 76 Monthly Climatological Charts of the Behavior of Fog and Low Stratus at Los Angeles International Airport. Donald M. Gates, July 1972. (COM-72-11140)
- 77 A Study of Radar Echo Distribution in Arizona During July and August. John E. Hales, Jr., July 1972. (COM-72-11136)
- 78 Forecasting Precipitation at Bakersfield, California, Using Pressure Gradient Vectors. Earl T. Riddiough, July 1972. (COM-72-11146)
- 79 Climate of Stockton, California. Robert C. Nelson, July 1972. (COM-72-10920)
- 80 Estimation of Number of Days Above or Below Selected Temperatures. Clarence M. Sakamoto, October 1972. (COM-72-10021)
- 81 An Aid for Forecasting Summer Maximum Temperatures at Seattle, Washington. Edgar G. Johnson, November 1972. (COM-73-10150)
- 82 Flash Flood Forecasting and Warning Program in the Western Region. Philip Williams, Jr., Chester L. Glenn, and Roland L. Raetz, December 1972, (revised March 1978). (COM-73-10251)
- 83 A Comparison of Manual and Semiautomatic Methods of Digitizing Analog Wind Records. Glenn E. Rasch, March 1973. (COM-73-10669)
- 86 Conditional Probabilities for Sequences of Wet Days at Phoenix, Arizona. Paul C. Kangieser, June 1973. (COM-73-11264)
- 87 A Refinement of the Use of K-Values in Forecasting Thunderstorms in Washington and Oregon. Robert Y. G. Lee, June 1973. (COM-73-11276)
- 89 Objective Forecast Precipitation over the Western Region of the United States. Julia N. Paegle and Larry P. Kierulff, Sept. 1973. (COM-73-11946/3AS)
- 91 Arizona "Eddy" Tornadoes. Robert S. Ingram, October 1973. (COM-73-10465)
- 92 Smoke Management in the Willamette Valley. Earl M. Bates, May 1974. (COM-74-11277/AS)
- 93 An Operational Evaluation of 500-mb Type Regression Equations. Alexander E. MacDonald, June 1974. (COM-74-11407/AS)
- 94 Conditional Probability of Visibility Less than One-Half Mile in Radiation Fog at Fresno, California. John D. Thomas, August 1974. (COM-74-11555/AS)
- 96 Map Type Precipitation Probabilities for the Western Region. Glenn E. Rasch and Alexander E. MacDonald, February 1975. (COM-75-10428/AS)
- 97 Eastern Pacific Cut-Off Low of April 21-28, 1974. William J. Alder and George R. Miller, January 1976. (PB-250-711/AS)
- 98 Study on a Significant Precipitation Episode in Western United States. Ira S. Brenner, April 1976. (COM-75-10719/AS)
- 99 A Study of Flash Flood Susceptibility--A Basin in Southern Arizona. Gerald Williams, August 1975. (COM-75-11360/AS)
- 102 A Set of Rules for Forecasting Temperatures in Napa and Sonoma Counties. Wesley L. Tuft, October 1975. (PB-246-902/AS)
- 103 Application of the National Weather Service Flash-Flood Program in the Western Region. Gerald Williams, January 1976. (PB-253-053/AS)
- 104 Objective Aids for Forecasting Minimum Temperatures at Reno, Nevada, During the Summer Months. Christopher D. Hill, January 1976. (PB-252-866/AS)
- 105 Forecasting the Mono Wind. Charles P. Ruscha, Jr., February 1976. (PB-254-650)
- 106 Use of MOS Forecast Parameters in Temperature Forecasting. John C. Plankinton, Jr., March 1976. (PB-254-649)
- 107 Map Types as Aids in Using MOS Pops in Western United States. Ira S. Brenner, August 1976. (PB-259-594)
- 108 Other Kinds of Wind Shear. Christopher D. Hill, August 1976. (PB-260-437/AS)
- 109 Forecasting North Winds in the Upper Sacramento Valley and Adjoining Forests. Christopher E. Fontana, September 1976. (PB-273-677/AS)
- 110 Cool Inflow as a Weakening Influence on Eastern Pacific Tropical Cyclones. William J. Denney, November 1976. (PB-264-655/AS)
- 112 The MAN/MOS Program. Alexander E. MacDonald, February 1977. (PB-265-941/AS)
- 113 Winter Season Minimum Temperature Formula for Bakersfield, California, Using Multiple Regression. Michael J. Oard, February 1977. (PB-273-694/AS)
- 114 Tropical Cyclone Kathleen. James R. Fors, February 1977. (PB-273-676/AS)
- 116 A Study of Wind Gusts on Lake Mead. Bradley Colman, April 1977. (PB-268-847)
- 117 The Relative Frequency of Cumulonimbus Clouds at the Nevada Test Site as a Function of K-Value. R. F. Quiring, April 1977. (PB-272-831)
- 118 Moisture Distribution Modification by Upward Vertical Motion. Ira S. Brenner, April 1977. (PB-268-740)
- 119 Relative Frequency of Occurrence of Warm Season Echo Activity as a Function of Stability Indices Computed from the Yucca Flat, Nevada, Rawinsonde. Darryl Randerson, June 1977. (PB-271-290/AS)

NOAA Technical Memorandum NWS WR-181

QUANTITATIVE AND SPACIAL DISTRIBUTION OF WINTER
PRECIPITATION ALONG UTAH'S WASATCH FRONT

Lawrence B. Dunn

Scientific Services Division
National Weather Service Western Region
Salt Lake City, Utah
August 1983

UNITED STATES
DEPARTMENT OF COMMERCE
Malcolm Baldrige, Secretary

National Oceanic and
Atmospheric Administration
John V. Byrne, Administrator

National Weather
Service
Richard E. Hallgren, Director

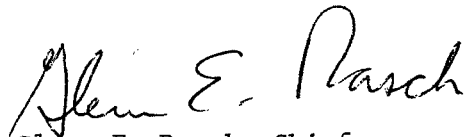

This publication has been reviewed
and is approved for publication by
Scientific Services Division,
Western Region.

A handwritten signature in cursive script that reads "Glenn E. Rasch".

Glenn E. Rasch, Chief
Scientific Services Division
Western Region Headquarters
Salt Lake City, Utah

TABLE OF CONTENTS

	<u>Page</u>
I. Introduction	1
II. Data Base	3
III. Wind Analysis.....	7
IV. Correlation of Rawinsonde Parameters to Precipitation	34
V. Raob Profiles of Various Precipitation Patterns	46
VI. Closed Lows and Cold Frontal Effects on Precipitation Distribution.....	54
VII. Conclusions	68
VIII. References	72

LIST OF FIGURES

<u>Number</u>		<u>Page</u>
1	Area Map.....	4
2	Alta Wind vs. Precipitation.....	8
3	Alta Wind vs. Precipitation.....	9
4	Alta Wind vs. Precipitation.....	10
5	Alta Wind Speed.....	11
6	Alta Wind Rose.....	13
7	Alta Wind Rose Heavy Cases.....	14
8	Ogden 700 Wind vs. Precipitation.....	15
9	S.L.C. 700 Wind vs. Precipitation.....	16
10	Cottonwood 700 Wind vs. Precipitation.....	17
11	Park City 700 Wind vs. Precipitation.....	18
12	Pineview 700 Wind vs. Precipitation.....	19
13	Mountain Dell 700 Wind vs. Precipitation.....	20
14	Alta 700 Wind vs. Precipitation.....	21
15	Alpine 700 Wind vs. Precipitation.....	22
16	Brighton 700 Wind vs. Precipitation.....	23
17	Ogden 850 Wind vs. Precipitation.....	25
18	S.L.C. 850 Wind vs. Precipitation.....	26
19	Cottonwood 850 Wind vs. Precipitation.....	27
20	Park City 850 Wind vs. Precipitation.....	28
21	Pineview 850 Wind vs. Precipitation.....	29
22	Mountain Dell 850 Wind vs. Precipitation.....	30
23	Alta 850 Wind vs. Precipitation.....	31
24	Alpine 850 Wind vs. Precipitation.....	32
25	Brighton 850 Wind vs. Precipitation.....	33
26	February 12, 1978 Storm.....	50
27	March 27, 1975 Storm.....	59
28	March 14, 1978 Storm.....	64
29	December 13, 1972 Storm.....	66
30	Alta and Brighton Canyons.....	70

LIST OF TABLES

<u>Number</u>		<u>Page</u>
1	Site Elevation and Observation Time	6
2	Parameters of Correlation Analysis	35
3	Alta Linear Correlation	37
4	Alta Linear Correlation	39
5	Linear Correlation Coefficients.....	40
6	Alta Multicorrelation	42
7	Multicorrelation Coefficients	43
8	Average Precipitation at All Sites	44
9	S.L.C. vs. Alta Raob Profile	48
10	Precipitation February 13 Storm	49
11	Precipitation Ratios Closed Lows	56
12	Precipitation Ratios Nonlows	56
13	Precipitation Ratios Raob Lows.....	58
14	Precipitation March 25-27 Storm	58
15	Average Precipitation Frontal and Nonfrontal	61
16	Precipitation Ratios Frontal and Nonfrontal	62
17	Precipitation March 14, 15 Storm	63
18	Precipitation December 13 Storm	65

I. INTRODUCTION

This Technical Memorandum is the result of work performed as a graduate student at the University of Washington. This study presents an analysis of winter precipitation events along the Wasatch Front region of northern Utah. Accurate mountain precipitation forecasts are necessary for estimating avalanche hazard in the heavily used Wasatch Mountain backcountry, and to facilitate avalanche control measures taken by the developed ski areas and the Utah State Highway Department.

The emphasis is on relationships between meteorological parameters observed in rawinsondes taken at the Salt Lake City airport and spacial and quantitative distribution of precipitation among mountain and valley locations. Precipitation amounts are extremely variable in this small geographic area. The variance is not only between the valleys and the high mountains, but also among closely spaced mountain locations.

The correlations of meteorological variables in various combinations and under varying synoptic regimes may prove useful in determining the effectiveness of weather modification aimed at enhancing precipitation. Additionally, the ratios of observed precipitation between mountain and valley locations in different synoptic regimes may provide a further basis for analysis of weather modification efforts and mountain precipitation forecasting.

A number of studies of winter orographic precipitation have been done. The National Weather Service Forecast Office in Salt Lake City is currently using a semi-objective method for forecasting snowfall rates and accumulations for the Wasatch Mountains (Nielson, 1965). Rhea (1976) has developed a 10km grid orographic precipitation model which is used in Colorado. In Canada the Alberta Weather Office (1976) developed a numerical technique using 500-mb map types as a diagnostic tool in quantitative precipitation forecasting.

This study examines winter precipitation in the Wasatch Front region using a single station's rawinsonde data. The purpose is twofold, namely to define the precipitation climatology based on rawinsonde observations and secondly to determine the prognostic value of the Salt Lake City rawinsonde data in winter quantitative precipitation forecasting.

Chapters III through VI represent four distinct experiments with the Salt Lake City rawinsonde data that address the above two objectives. In Chapter III the relationship between wind and precipitation at each site establishes a climatological data base not previously available. The ability of any single rawinsonde parameter or combination of parameters to explain the variance in precipitation amounts is studied in Chapter IV. The linear and multiple linear correlation coefficients determined provide a measure of the prognostic value of individual rawinsonde parameters. Chapter V examines the prognostic value of the rawinsonde data by determining rawinsonde profiles for unusual precipitation patterns and comparing these to profiles of more typical precipitation patterns. Unusual patterns are those in which very heavy precipitation takes place or when the distribution of precipitation is anomalous as in cases when valley locations receive more than the mountain sites. The final chapter looks at the variability of site to site precipitation ratios due to closed 700-mb low circulations and surface fronts. This is climatological information that may aid forecsters in making quantitative precipitation forecasts for remote areas based on precipitation in the more populated areas. A method for identifying synoptic scale closed lows from a single site's rawinsonde data is also presented.

II. DATA BASE

The region considered in this study is the Wasatch Front of northern Utah. Nine stations were used to ascertain observed precipitation amounts. One location was used for rawinsonde observations, namely the Salt Lake City airport. All meteorological parameters were taken from the sounding data. The surface and upper-air observation data cover the winter seasons (November 1st through April 30th) of 1969 to 1978, and November and December of 1978. Rawinsonde data were obtained through the National Center for Atmospheric Research. This data consisted of height, pressure, temperature, relative humidity, wind direction, and wind speed at 50-mb increments. Surface observations were obtained from two sources. Alta data were obtained from the U.S. Forest Service in Fort Collins, Colorado. The data for the other eight sites were obtained from the Utah State Climatologist's office in Logan, Utah. The only significant difference between the two types of surface observations was that in addition to 24-hour precipitation totals, the Alta data also included six-hour precipitation intensities (i.e., light, moderate, heavy). A tape consisting of data from frontal passages through Salt Lake City was obtained from the University of Utah Meteorology Department.

The Wasatch Front region consists of a long valley at approximately 4,200 feet above sea level bounded to the east by the Wasatch Mountains which rise to over 11,000 feet above sea level. The Great Salt Lake is to the west of the valley in the north. The southern portion of the valley is bounded in the west by the Oquirrh Mountains which are generally below 10,000 feet above sea level. The Wasatch Mountains provide a very abrupt barrier, rising from the valley floor to the highest peaks in less than five miles. There are essentially no foothills.

The surface observation locations used in this study are all within thirty-five miles of the Salt Lake City airport rawinsonde site as shown in Figure 1. This close proximity eliminates any time lag considerations since the air mass measured by the sounding will nearly always be representative of the other locations within the hour. The nine sites can be considered in two separate groups. The Salt Lake City airport, Cottonwood Wier, Alpine, and Ogden Power House can be considered valley stations. Alta, Silver Lake Brighton, Park City ski area summit house, Mountain Dell, and Pineview Reservoir are considered mountain sites. The highest

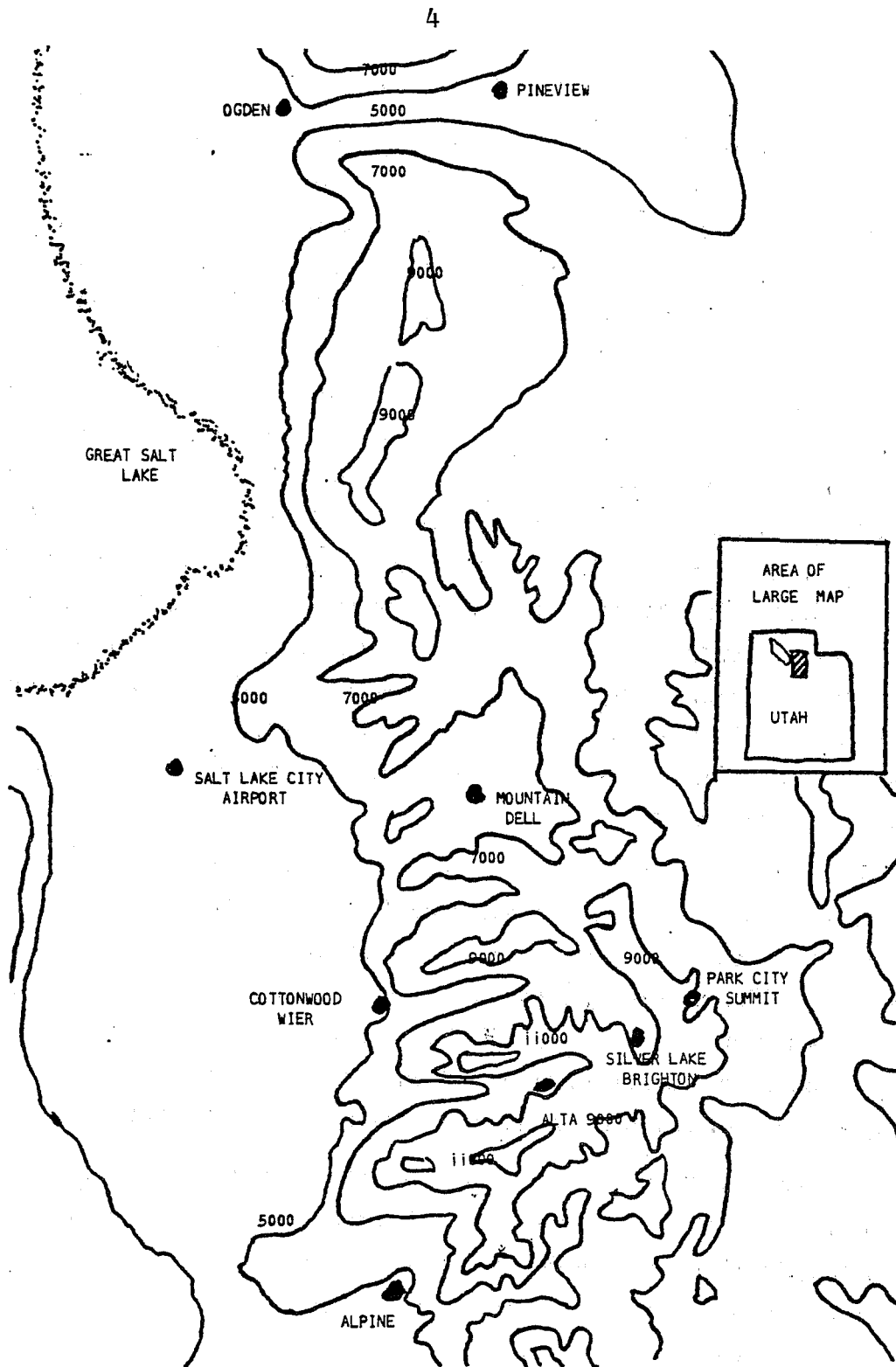

Figure 1. A contour map of the area considered in this study. The data sites are indicated.

site is Park City Summit, at 9,270 feet above sea level; the lowest site is the Salt Lake City airport at 4,222 feet above sea level. A listing of the stations with their elevation and the time of day at which the 24-hour precipitation measurement is taken is given in Table I.

<u>STATION</u>	<u>24-HOUR PRECIPITATION OBSERVATION TIME</u>	<u>SITE ELEVATION (FEET)</u>
Silver Lake Brighton	10 a.m.	8740
Alpine	Sunset	4920
Park City Summit	Sunset	9270
Cottonwood Wier	3 p.m.	4950
Salt Lake City Airport	Midnight	4222
Odgen Power House	Midnight	4350
Mountain Dell	5 p.m.	5420
Pineview	8 a.m.	4940
Alta	8 a.m.	8760

Table 1. The elevation and the time of the 24-hour precipitation measurement for each site.

III. WIND ANALYSIS

In this chapter the relationship between the 700-mb and 850-mb winds and precipitation is examined. The 850-mb wind is representative of the low level flow in this region since the Salt Lake City airport is generally near the 870-mb level during the winter. The 700-mb level is approximately the height of the Wasatch Mountains. Thus, this near-ridge-top wind is very much affected by orography, but still high enough to depict upper level synoptic disturbances. The results that follow present the different climatological wind vs. precipitation relationships that exist in northern Utah.

The observations at Alta offer a more detailed look at the time variation of wind and precipitation observations. The Forest Service record from Alta consists of 24-hour precipitation measurements taken early each morning. This is the same situation as exists at the other eight observing sites. Additionally, Alta records contain four separate 6-hour precipitation intensity observations. Due to these additional observations a more detailed analysis of the wind and precipitation events was done at Alta.

A plot of the percentage of precipitation events at Alta versus the 700-mb wind direction at ten degree increments was done three different ways in order to determine if any differences result in the distribution when surface observations are taken prior to or following the rawinsonde observation. The different ways of measuring this relationship are presented in Figures 2-4.

The similarity of all the plots indicates that from a large sample the result will be the same regardless of the observations taken. In other words, since the rawinsonde observations are taken independent of the prevailing synoptic situation, the observations will, over a large sample, have equal chance of occurring before or after a frontal or trough axis passage. The significance of this is that a single representative frequency plot of wind versus precipitation can be obtained by comparing the 00 GMT and 12 GMT observations separately to the precipitation record, normalizing the number of cases by converting to percentages and then averaging the two results at all stations.

In addition to wind direction at 700 mb, the wind speed was examined in relation to Alta precipitation. In Figure 5 it is clear that the precipitation plot is

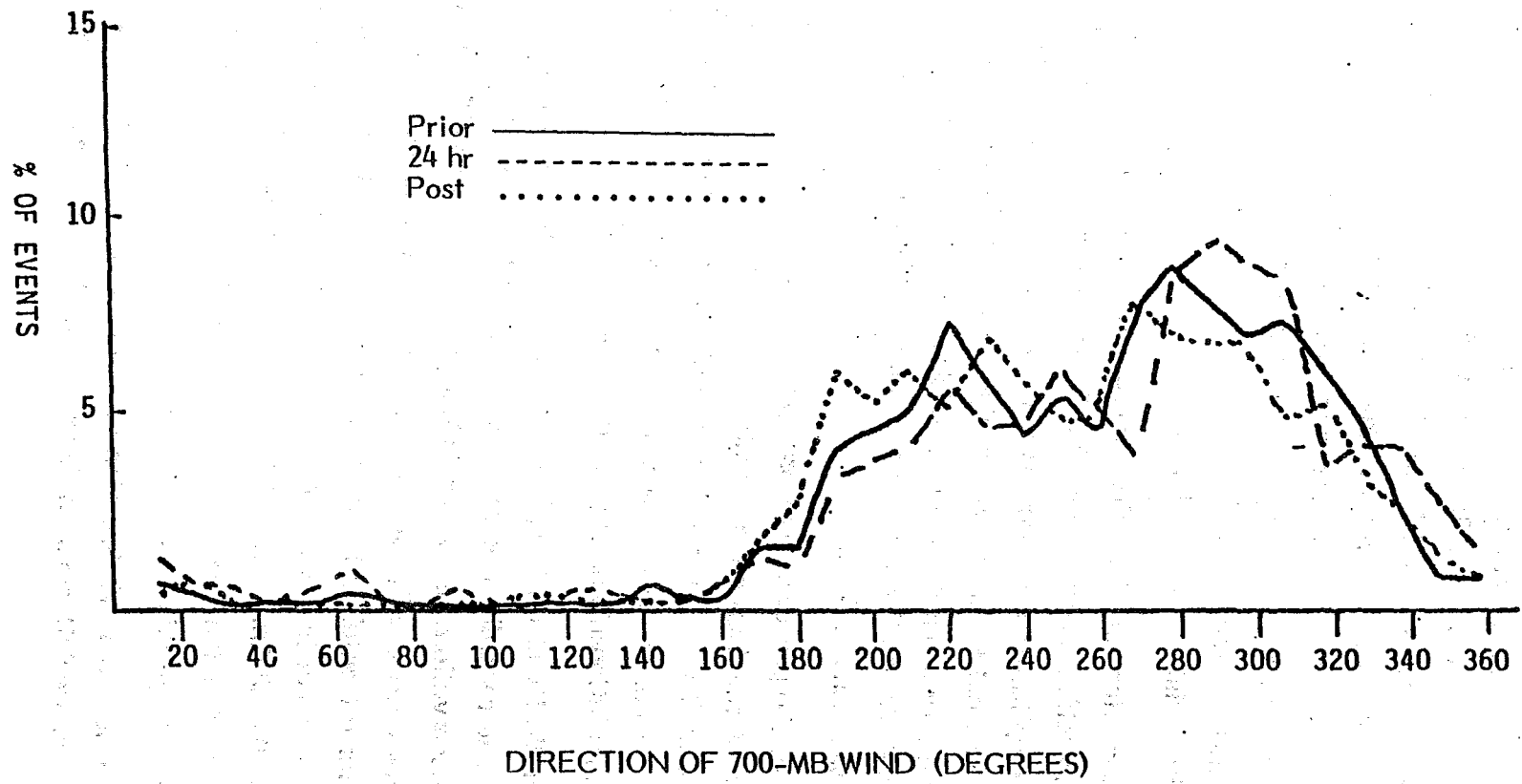

Figure 2. The percentage of all precipitation events at Alta is plotted three ways with respect to the 700-mb wind direction at 00Z. One line is from checking only intensity observations prior to 00Z. A second line is checking only observations after (post) 00Z. The third line is based on the 24 hour precipitation measurement taken at 8am.

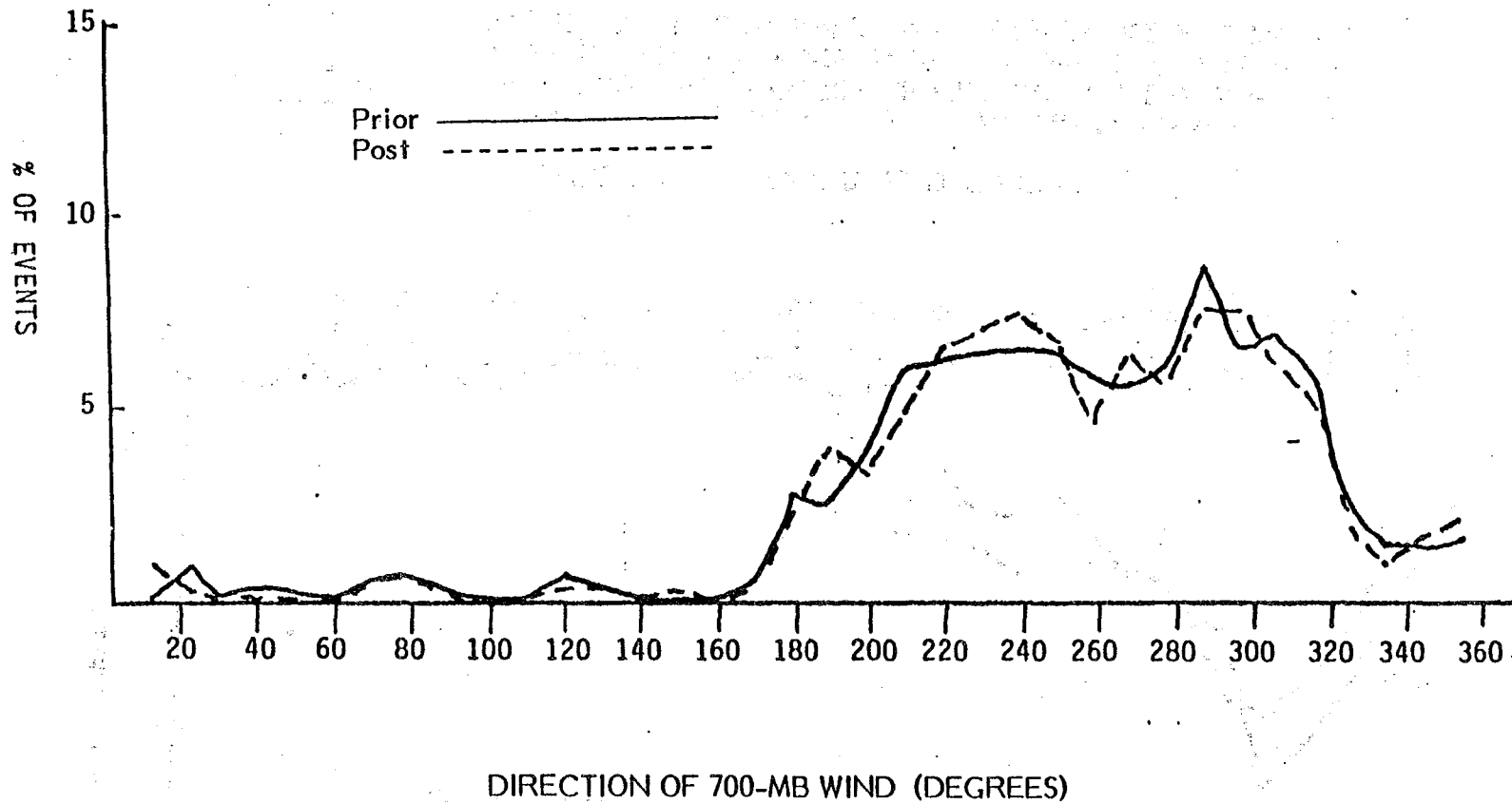

Figure 3. The percentage of all precipitation events at Alta is plotted two ways with respect to the 700-mb wind direction at 12Z. One line is from checking only intensity observations prior to 12Z and the other is from only intensity observations after (post) 12Z.

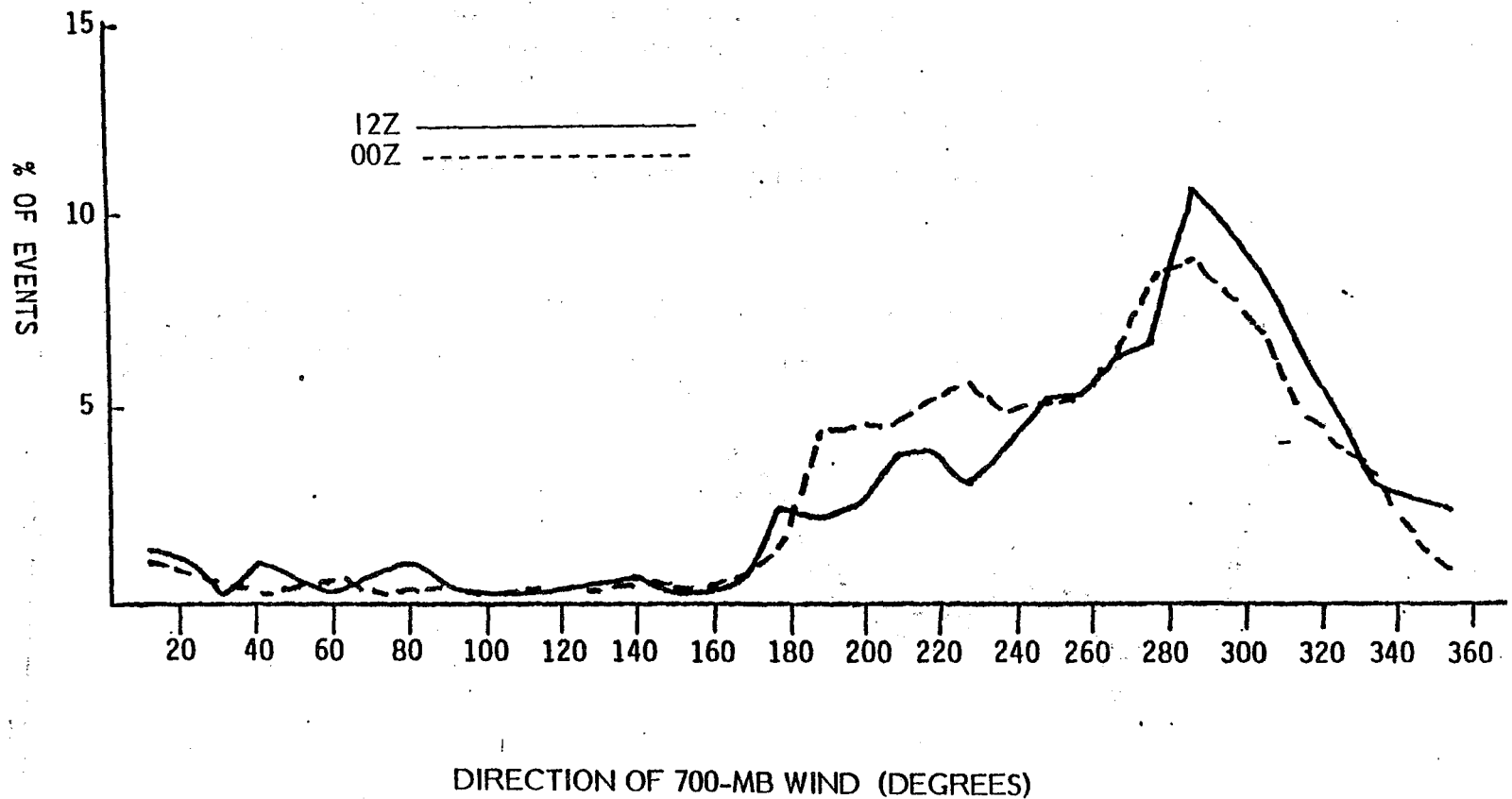

Figure 4. The percentage of all precipitation events at Alta is plotted two ways with respect to the 700-mb wind direction. Both plots are based on the 24 hour precipitation measurement. One line is for the 12Z wind direction and the other is for the 00Z wind direction.

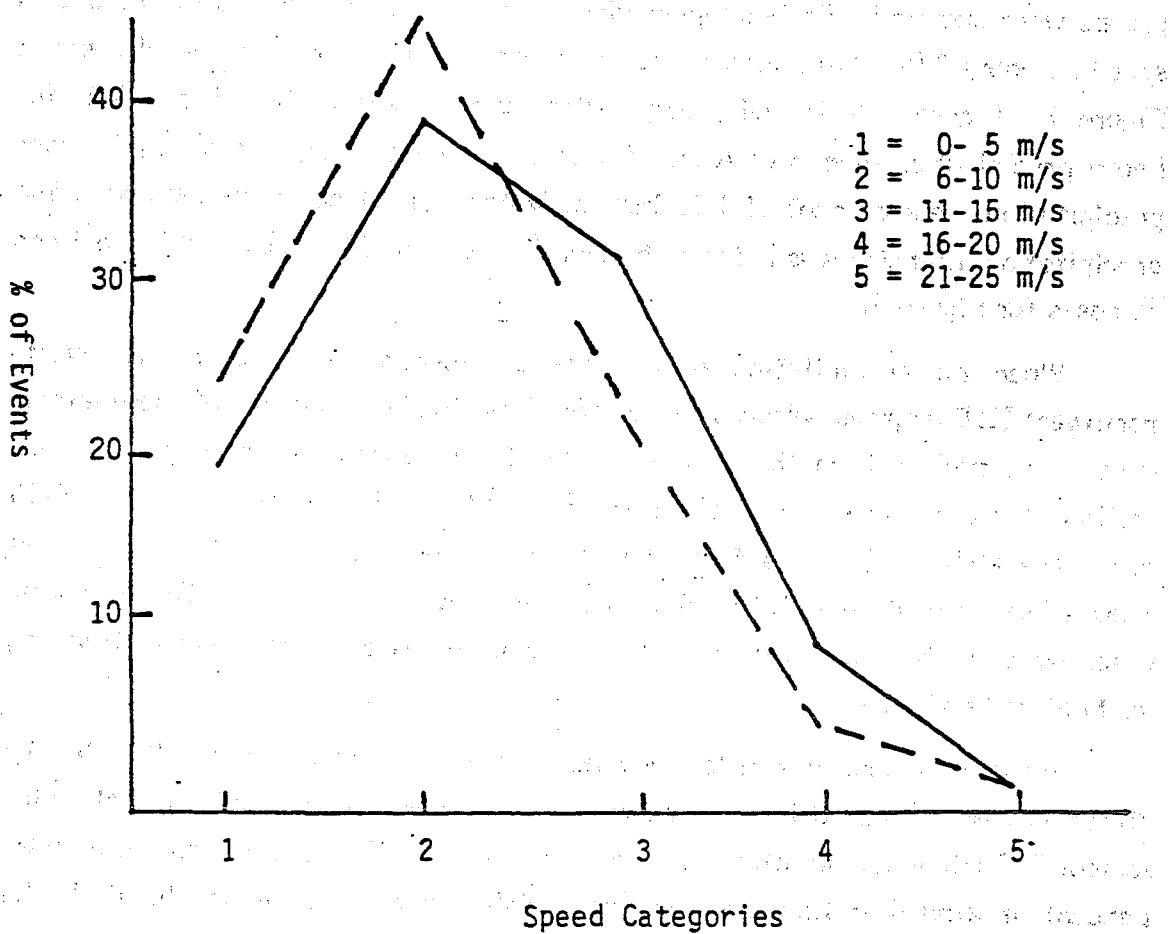

Figure 5. The percentage of all precipitation events at Alta was plotted (solid line) with respect to five categories of 700-mb wind speed. The dashed line is the 700-mb wind speed for all days.

very similar to the climatology, with a slight precipitation bias with wind speeds between 11 and 20 meters per second. The highest speed category accounted for less than 1% of all cases both in the climatology and in the precipitation. Thus, wind speed does not seem to have a strong relationship to precipitation.

An analysis of the 700-mb wind speed and direction together was done to produce Figures 6 and 7. In both figures the number of cases with a given speed and direction were found at 10 degree intervals and 5 meter per second categories. The number of cases was normalized to percentages and then 40-50 degree groups were summed. For example, wind directions of 290, 300, 310, and 320 in speed category 2 (6-10 m/s) accounted for approximately 15 percent of all cases in Figure 7. Figure 6 is for all precipitation cases at Alta, while Figure 7 is for heavy precipitation events at Alta. A heavy event was classified as any 24-hour precipitation measurement of 1.00 inch of water equivalent or greater, or if the precipitation intensity was noted as heavy. There were 500 cases for Figure 6 and 78 cases for Figure 7.

When all precipitation events are considered, most occur with west-northwest (290 degrees) winds of 6-10 m/s. Less than one percent of these events were associated with southerly or easterly 700-mb winds. There was a concentration of the heavy events with northwesterly (310-320 degrees) winds at 10-15 m/s. The high wind speeds from the northwest associated with the heavy cases show a bias to post 700-mb trough axis precipitation at Alta. The southerly wind cases were likely associated with slow moving waves or closed lows with strong vertical motion fields.

Frequency diagrams of 'all' and 'heavy' precipitation events by 700-mb wind direction were prepared for all nine observation sites. Additionally, the climatological 700-mb wind direction profile was plotted. If precipitation were independent of wind direction the plots would follow the climatological line. If the plot is above climatology the direction would be a favored one for precipitation and vice versa. Figures 8-16 show the results of the 700-mb analysis. The climatological peak is at 290 degrees with few winds having easterly components. The classification for heavy precipitation was 24-hour amounts.

Alta Wind Rose
ALL

Figure 6. Isopleths of the percentage of all precipitation events at Alta are plotted on a 700-mb wind rose. The isopleths are at two percent intervals starting at one percent of events. The concentric circles represent wind speed.

Alta Wind Rose
HEAVY

Figure 7. The same as Figure 6 except only cases in which 24-hour precipitation at Alta exceeded 1.00 inch were considered.

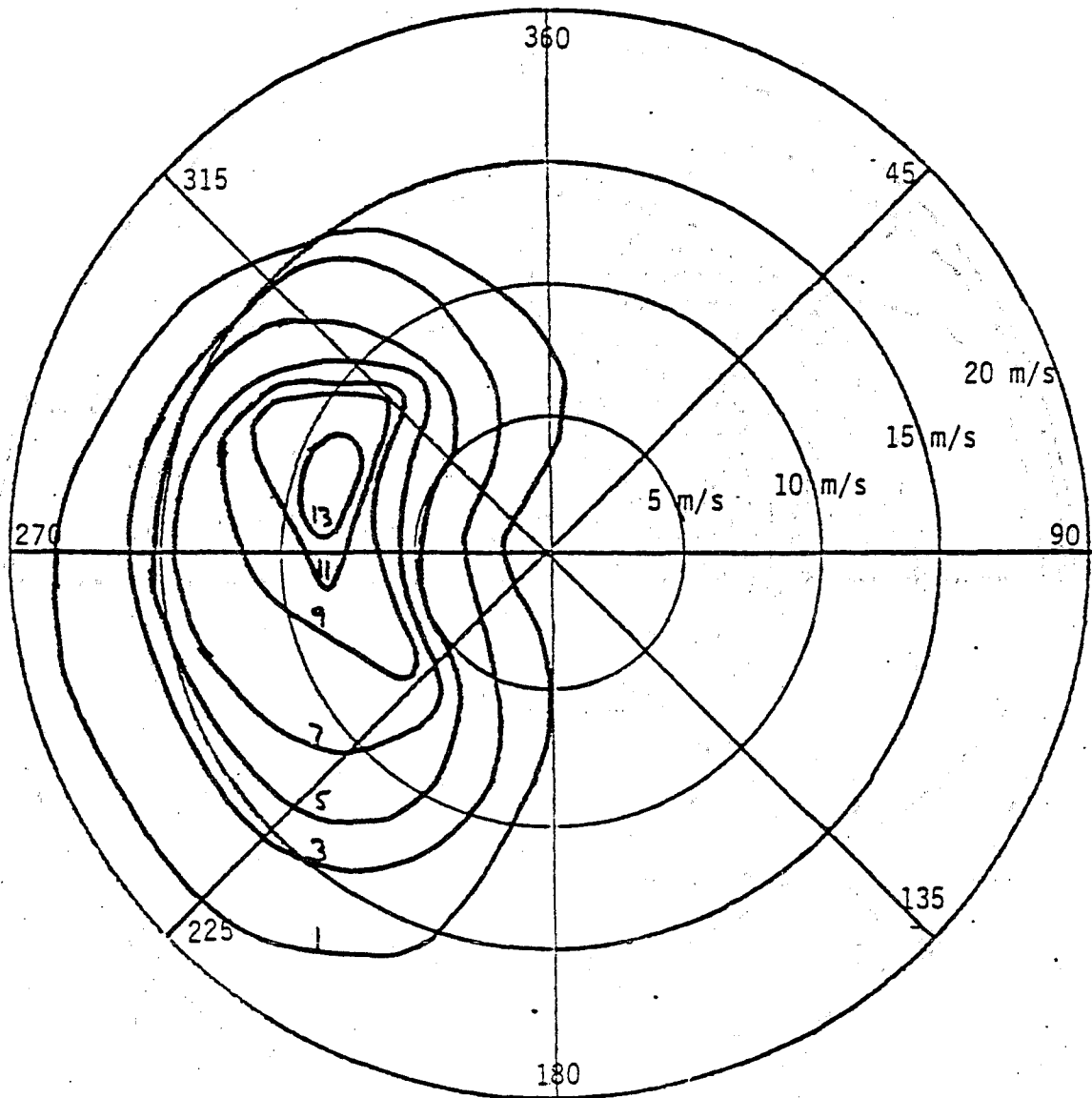

Figures 8-16.

The percentage of all and heavy precipitation events with respect to the 700-mb wind direction was plotted for each site. Additionally, the 700-mb wind direction climatology was plotted. The solid line is for all precipitation events. The dashed line is for only heavy precipitation events. The dotted line is the climatology (both wet and dry days). The site location and the number of precipitation events is noted on the figure.

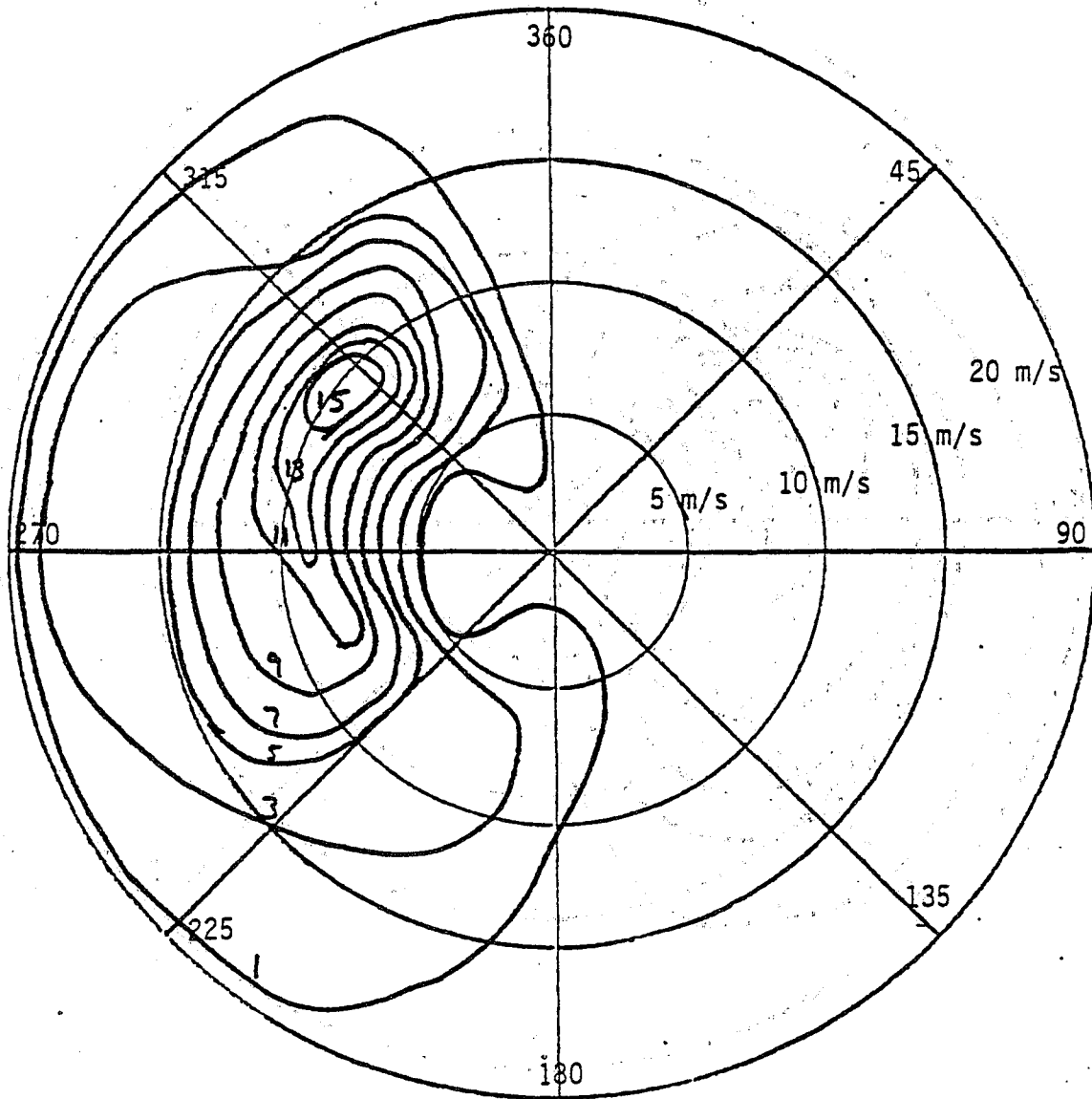
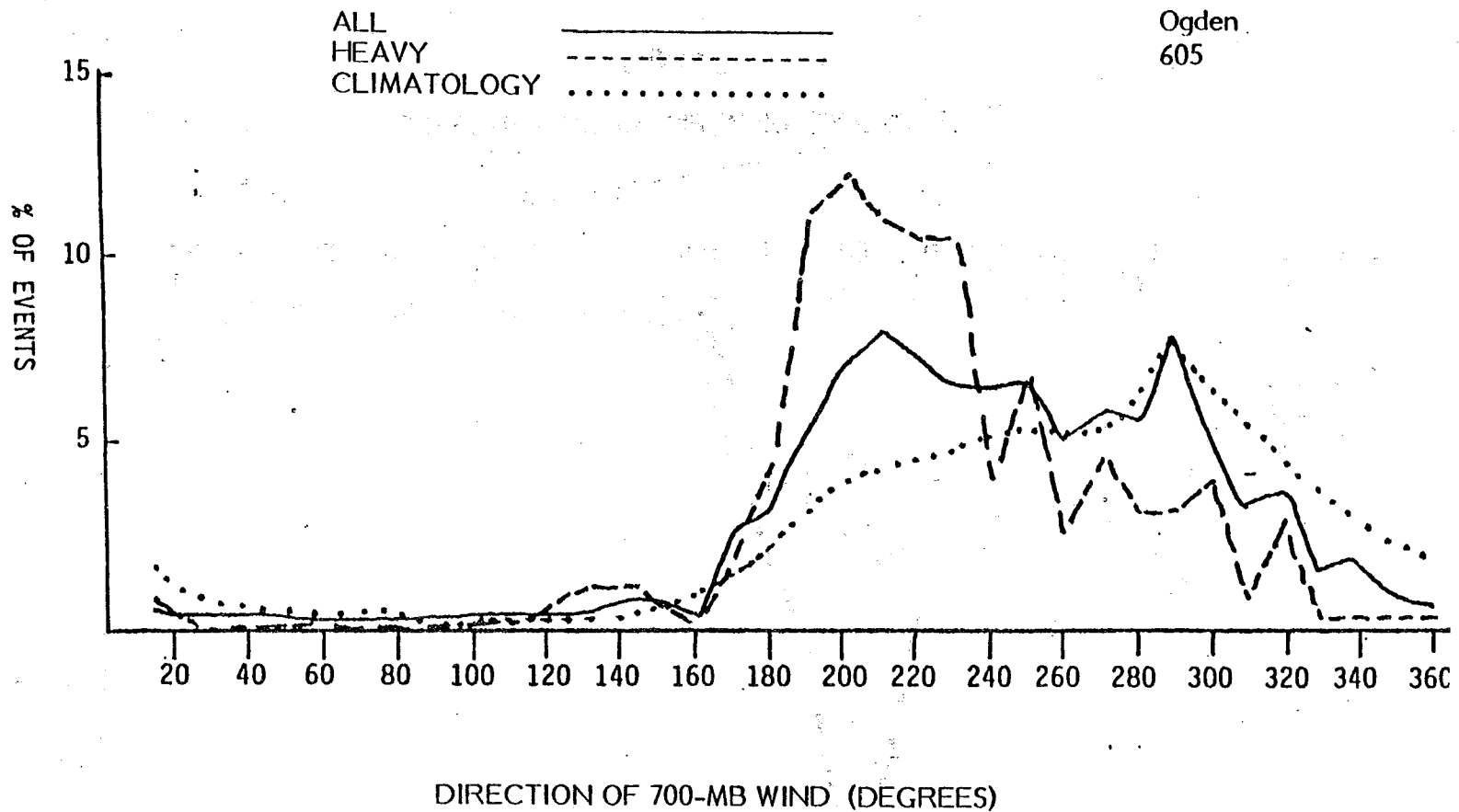
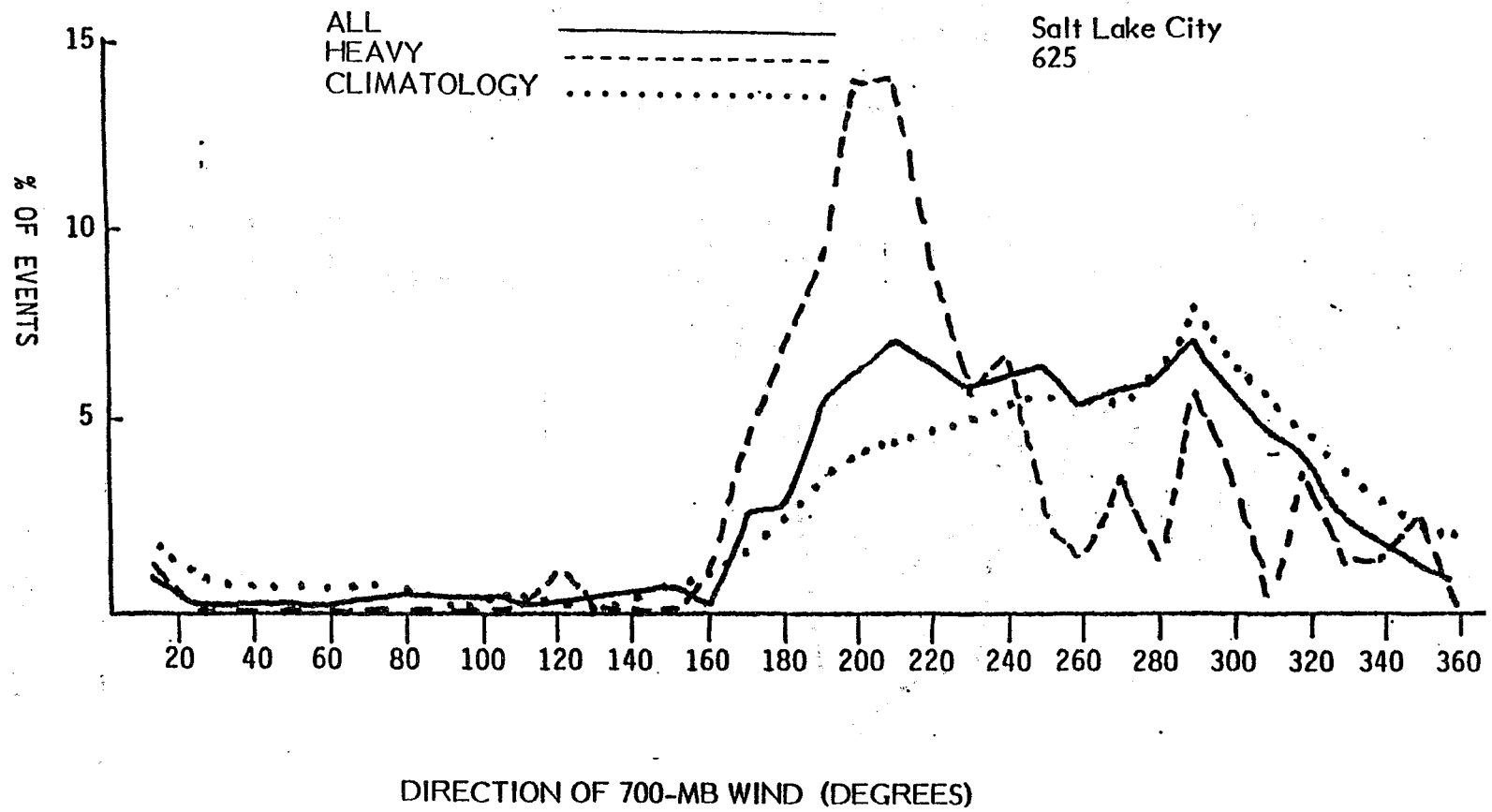

Figure 9

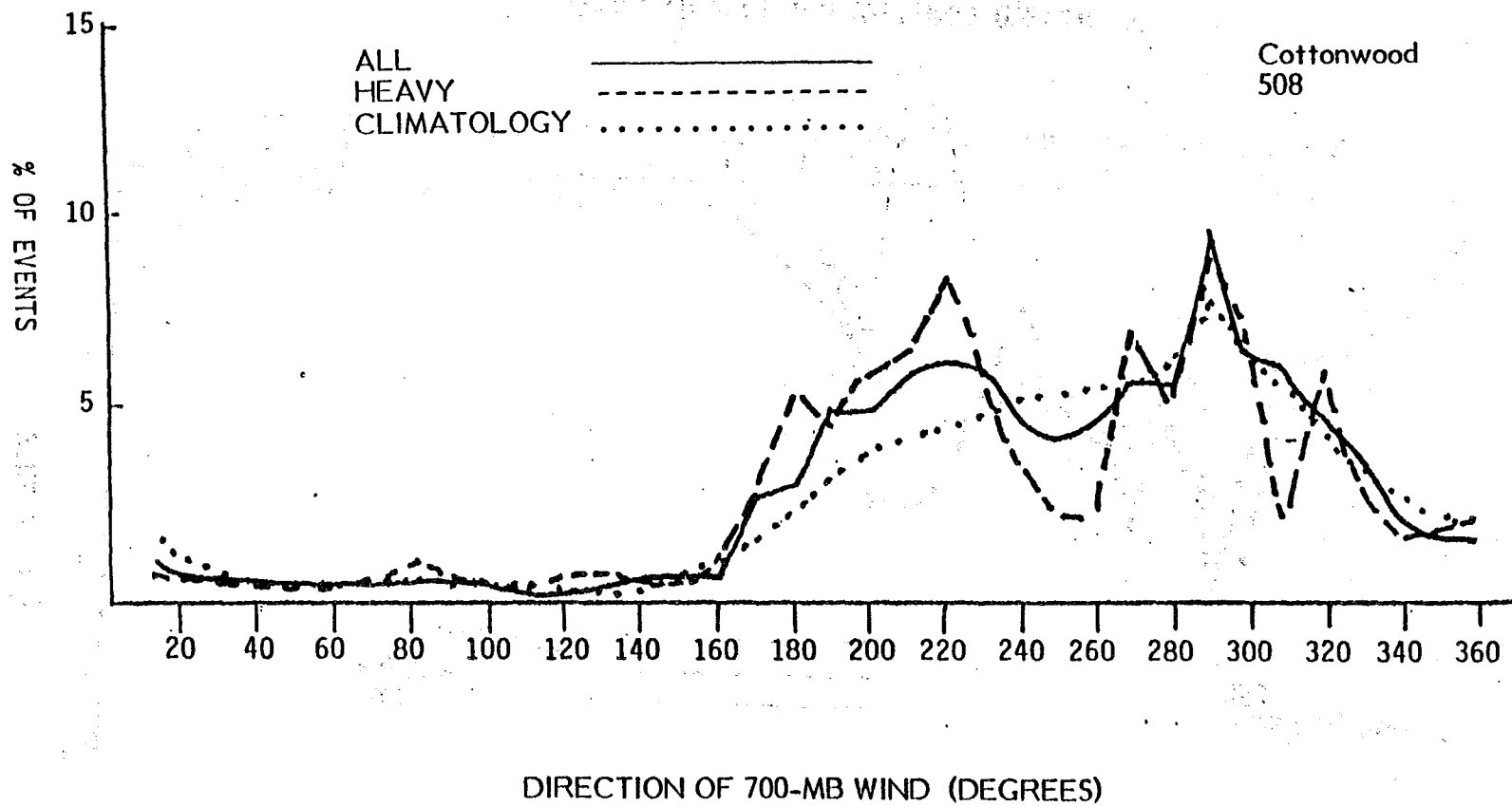

Figure 10

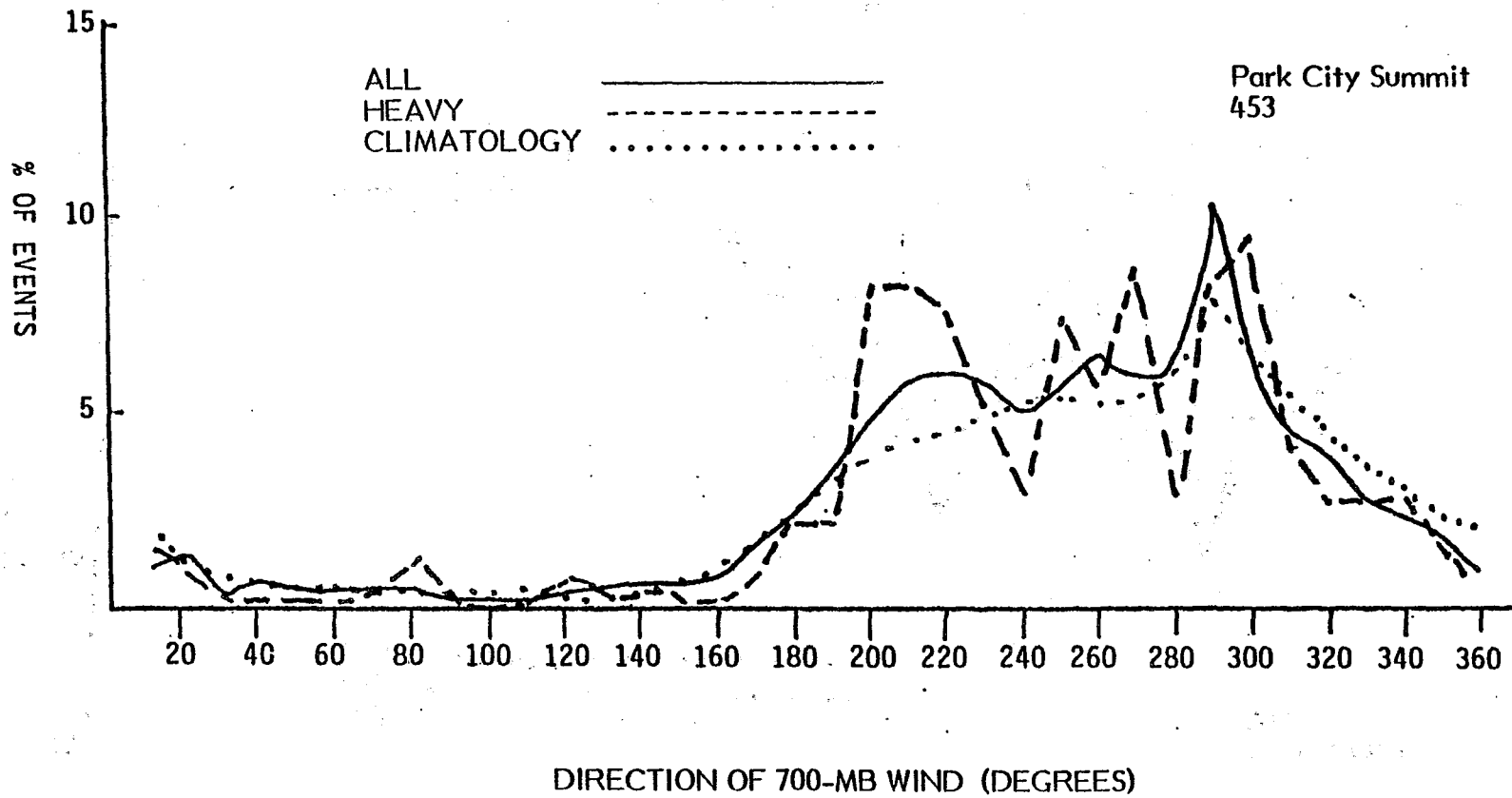
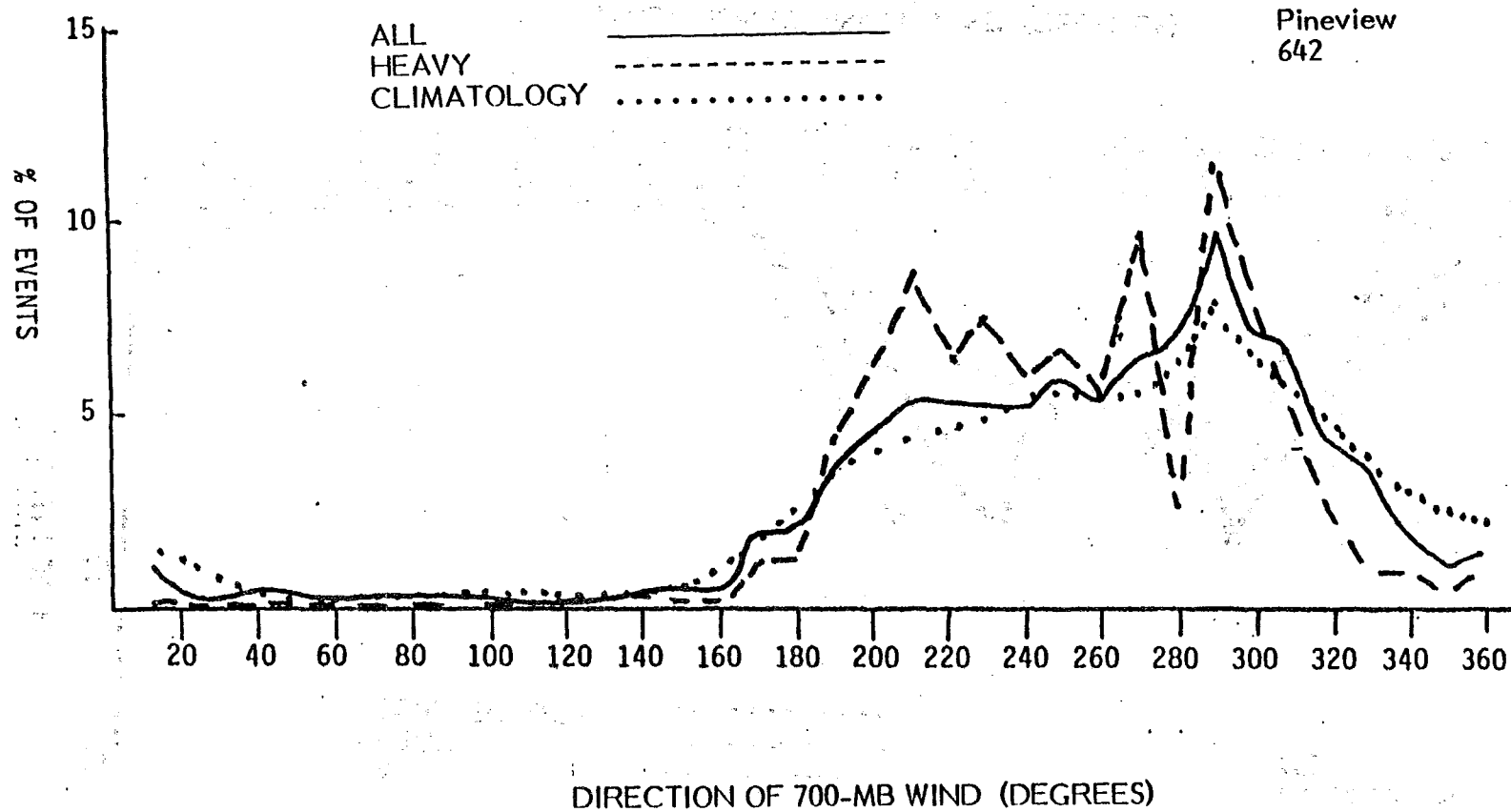

Figure 11



Pineview
642

Figure 12

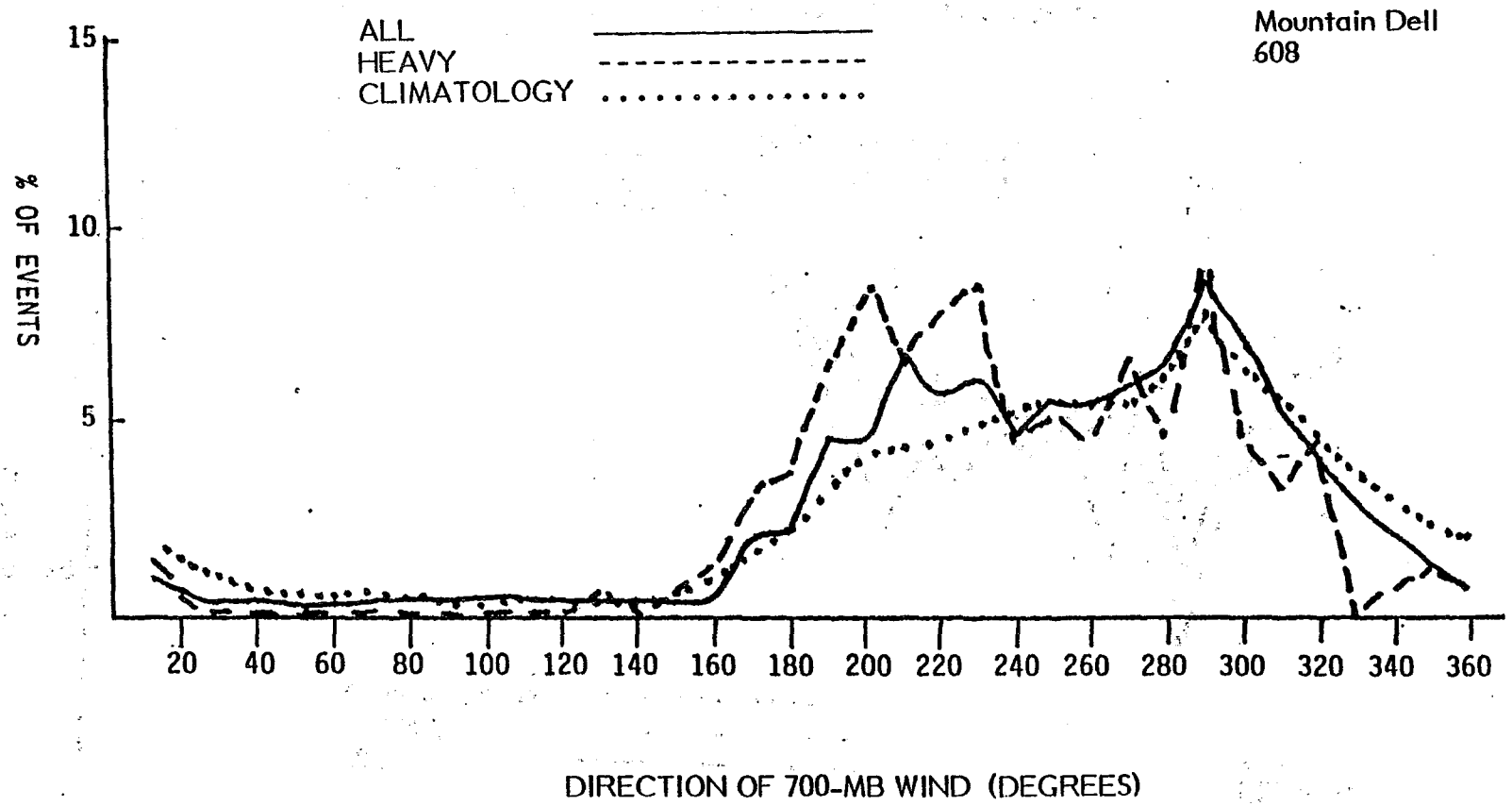

Figure 13

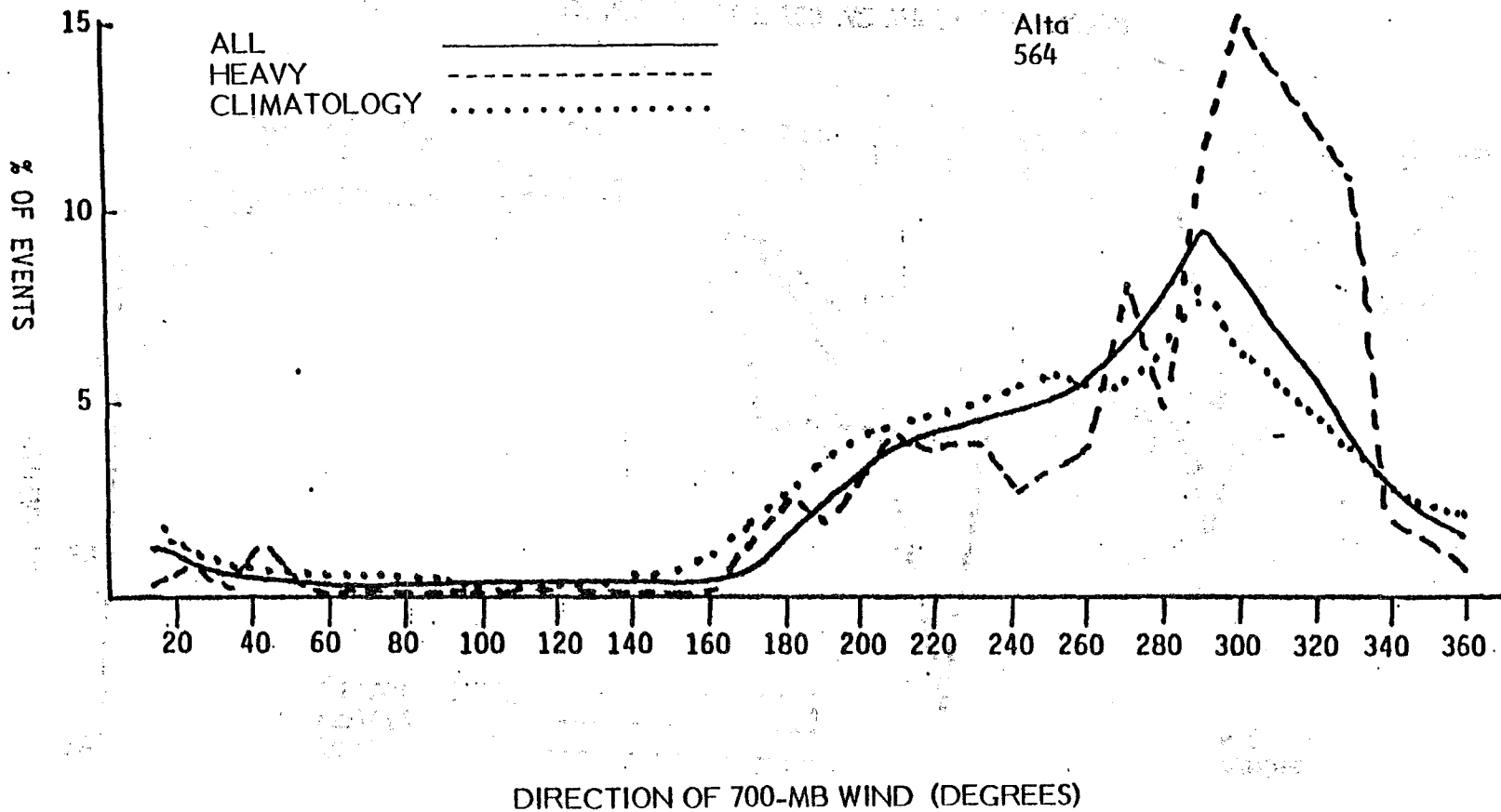

Figure 14

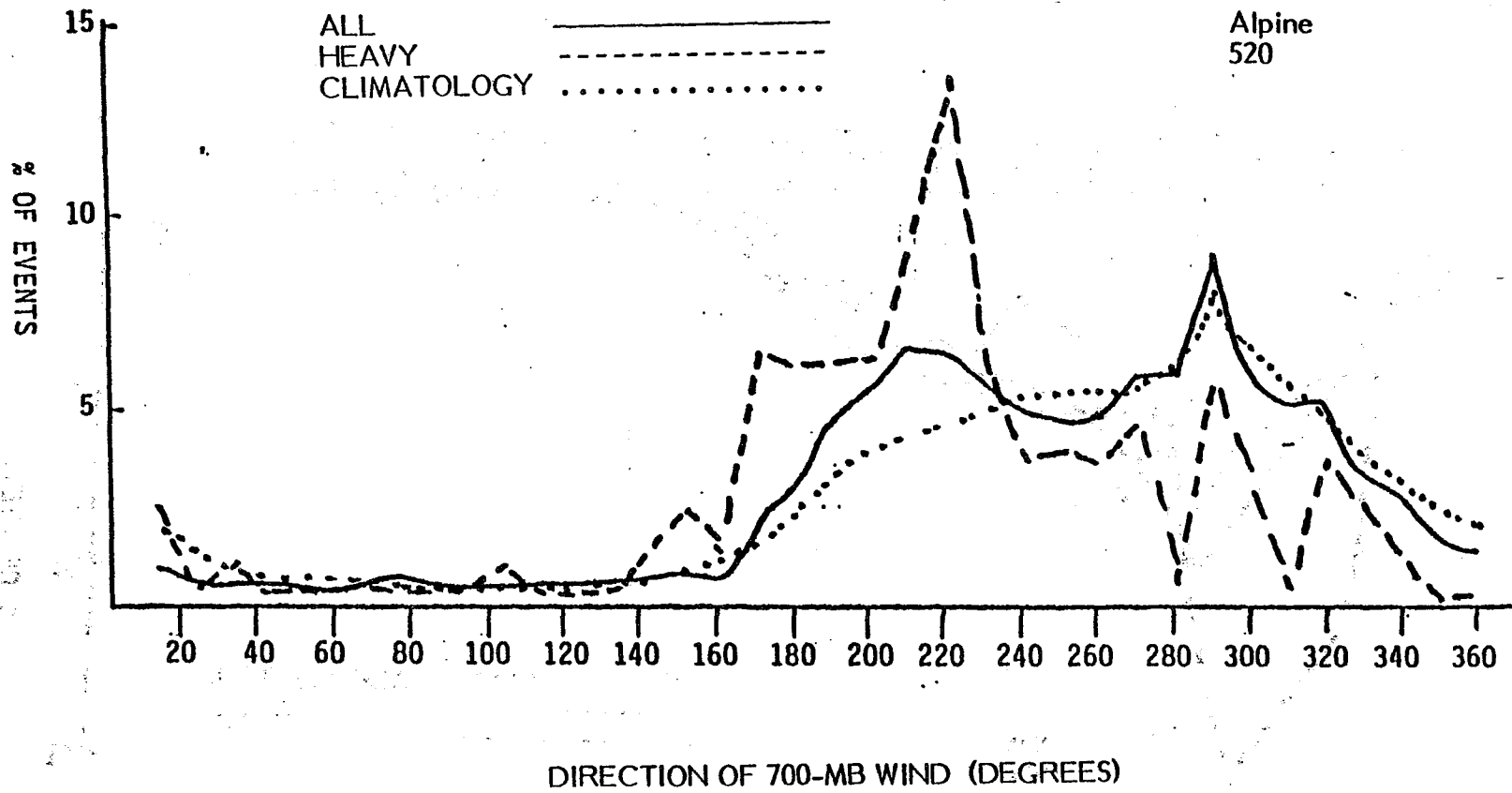

Figure 15

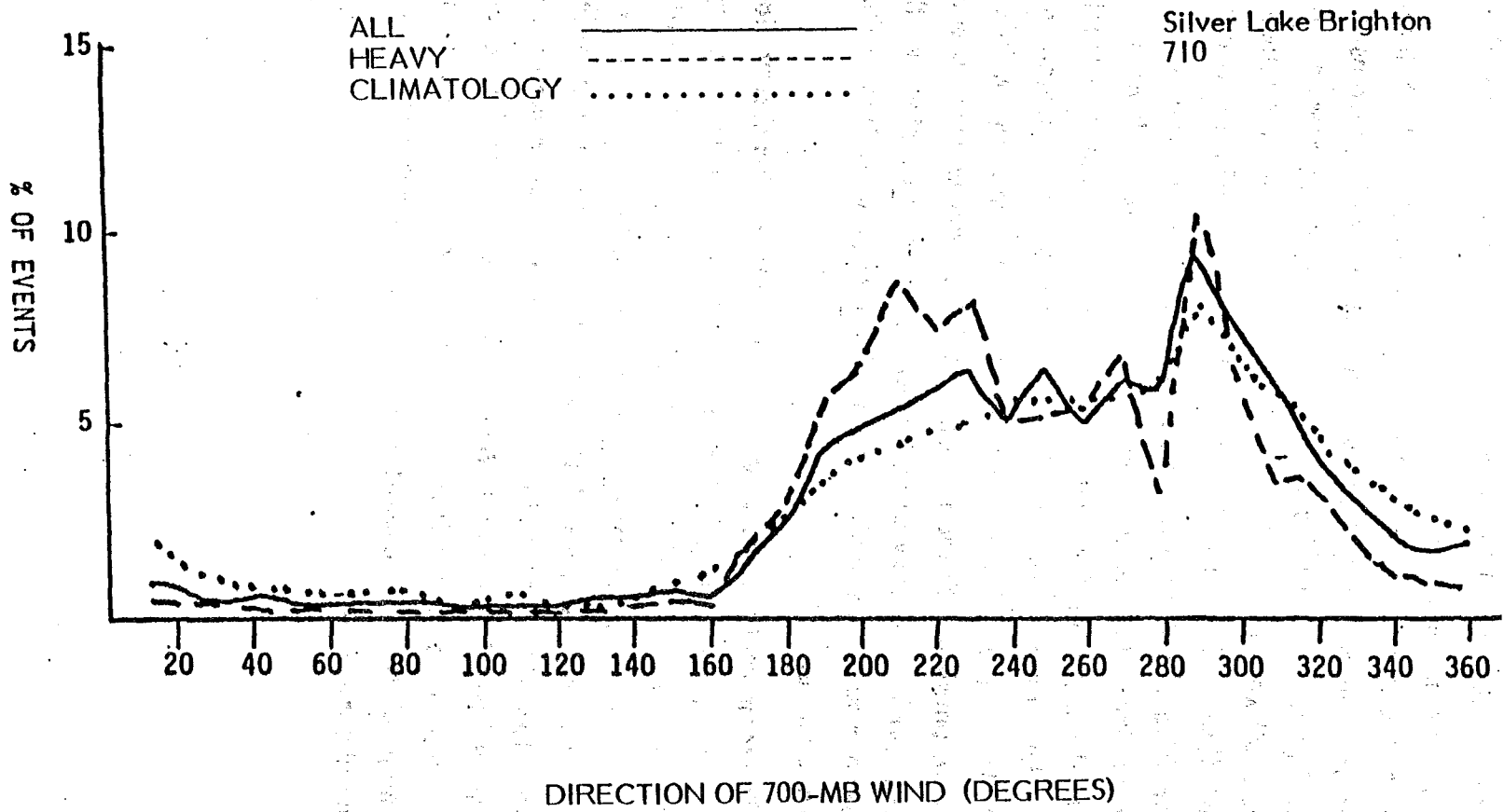

Figure 16

equaling or exceeding .5 inches of water equivalent except at Alta where the threshold was 1.00 inch. The number of cases is indicated by the number beneath the site location on the figures.

With the exception of Alta, all the sites showed at least a relative maximum for 'all' and 'heavy' precipitation events with southwest flow (190-230 degrees). The three valley sites, Salt Lake City airport, Ogden, and Alpine peaked with this southwest flow and generally were below the climatological curve for northwest flow. The other sites showed another maximum with northwesterly flow with Alta exhibiting the greatest maximum at 300 degrees. Although the Cottonwood Wier site is located in the Salt Lake Valley, it is at the mouth of Big Cottonwood Canyon at the foot of the mountains. Thus, the location probably explains the similarity of its 700-mb profile to the mountain sites. Heavy precipitation at the valley locations was strongly related to south-southwest flow while the mountains, with the exception of Alta, received heavy precipitation with either south-southwest flow or northwest flow. This indicates that the passage of the 700-mb trough axis marks the end of heavy precipitation in the valleys, but not the mountains.

The same analysis was done with the low level wind observations (850 mb). Again, frequency distributions of all precipitation events and heavy events were plotted by wind direction along with the 850-mb climatological profile (Figures 17-25). All sites showed maxima above climatology for south-southwest flow and northwesterly flow. Alta and Cottonwood Wier maxima were most pronounced in northwest flow while Ogden, Pineview, and Apline maxima were most pronounced in southerly flow. The southerly flow is associated with prefrontal overrunning. Moist prefrontal conditions favor heavy valley precipitation, but most heavy mountain precipitation is associated with low level northwesterly flow in postfrontal conditions.

Figure 17

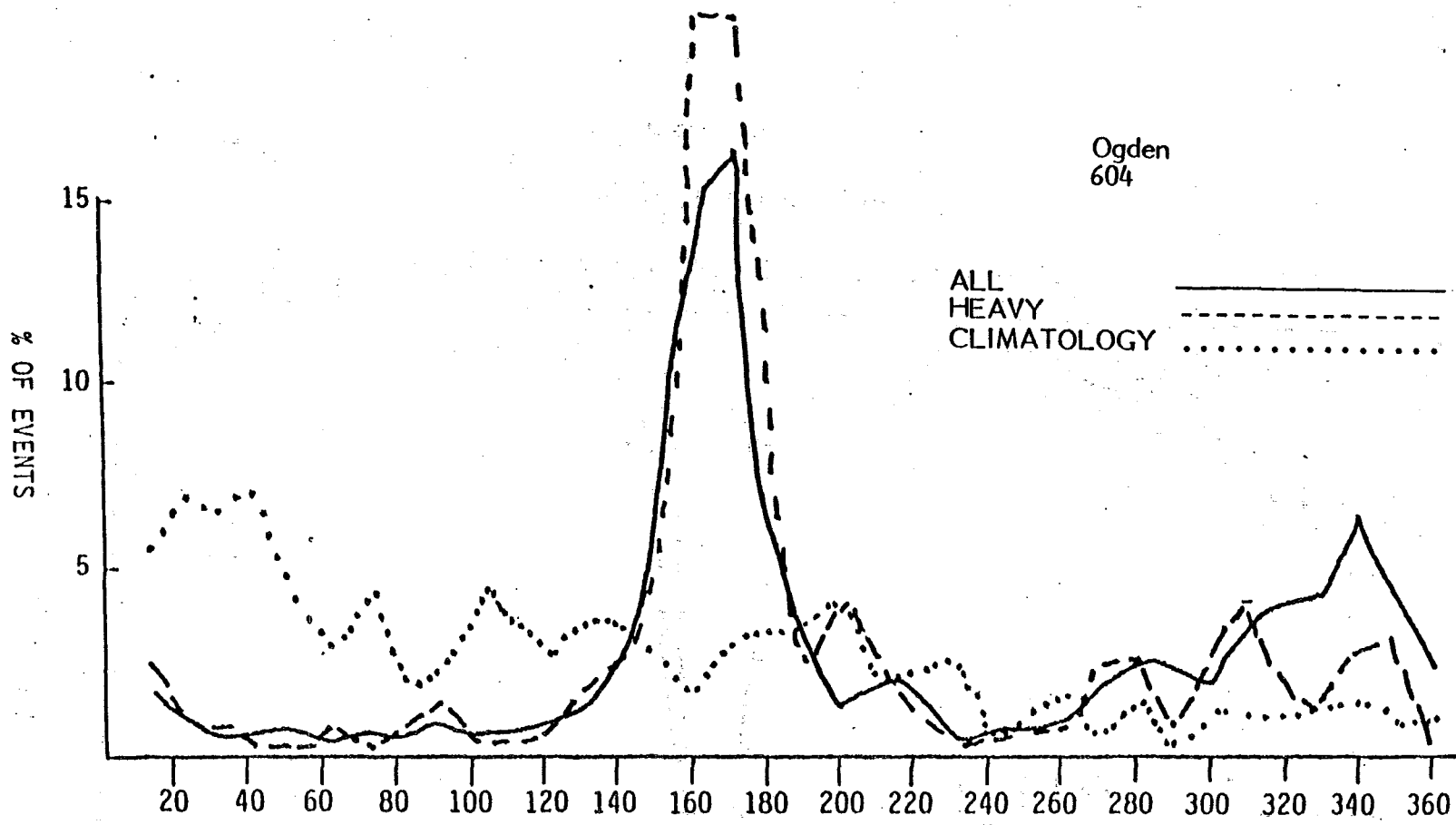

Figures 17-25.

The same as Figures 8-16 except it is for the 850-mb wind.

DIRECTION OF 850-MB WIND (DEGREES)

Figure 17

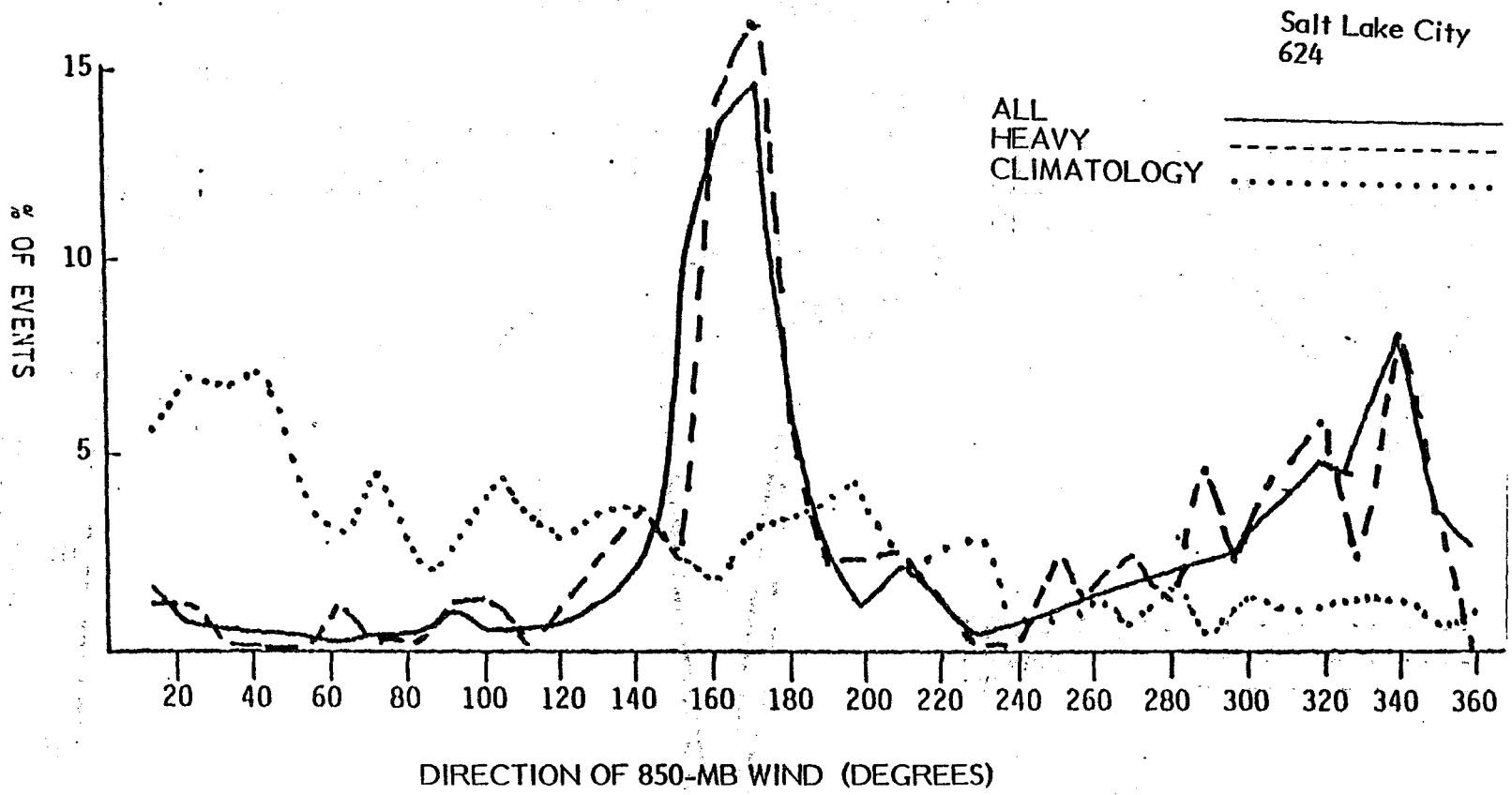

Figure 18

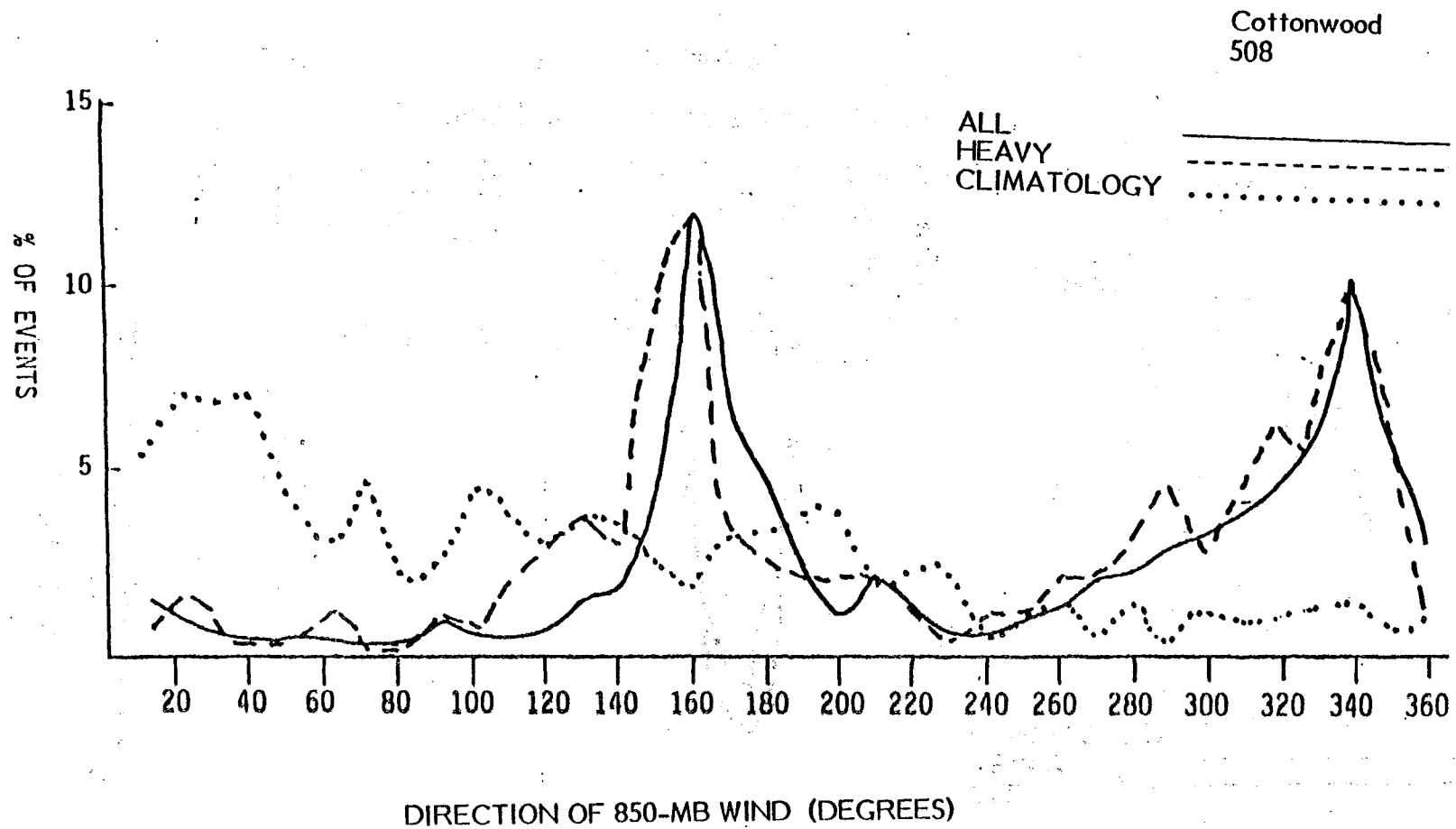

Figure 19

Park City Summit
454

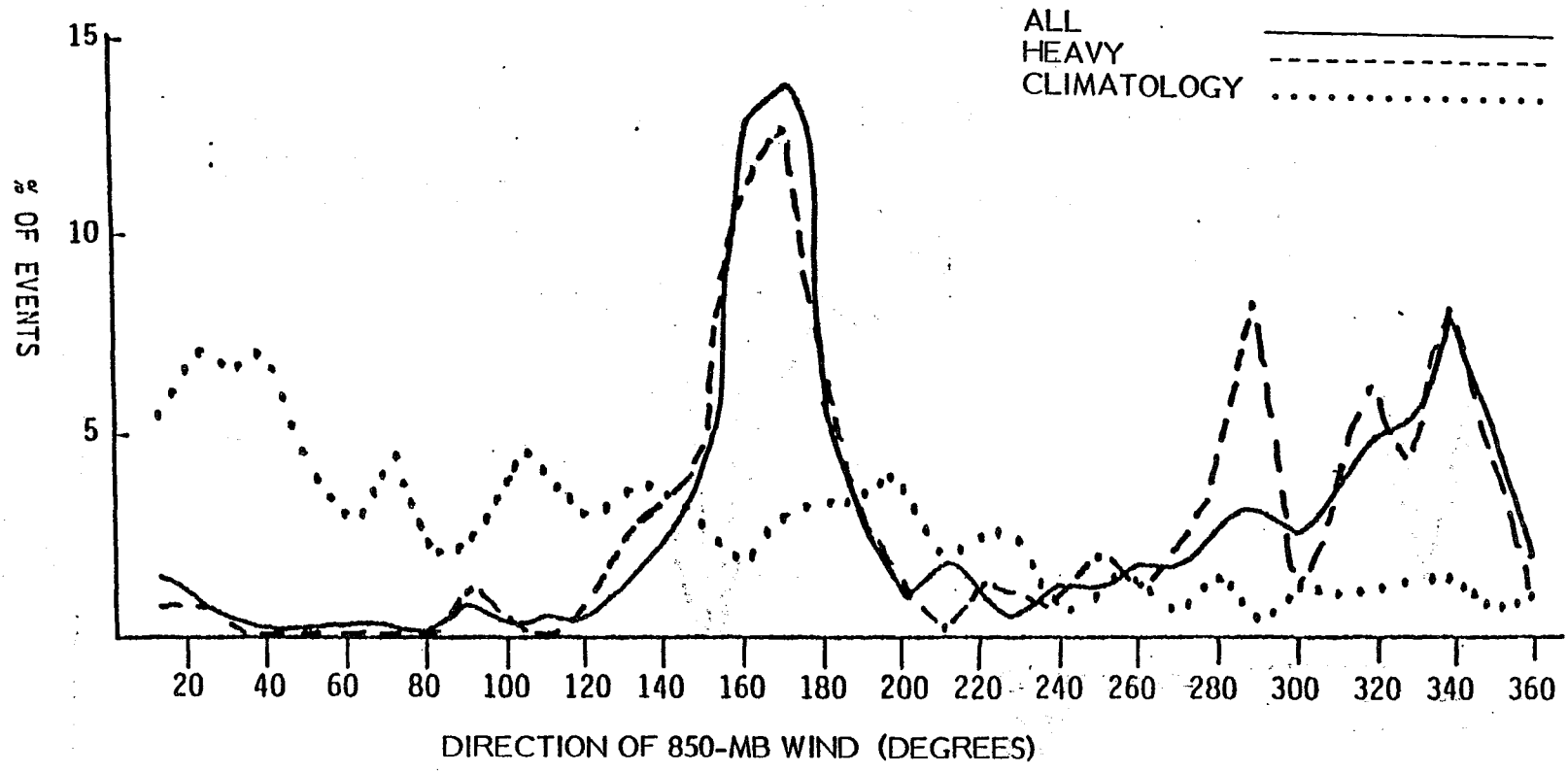

Figure 20

Pineview
542

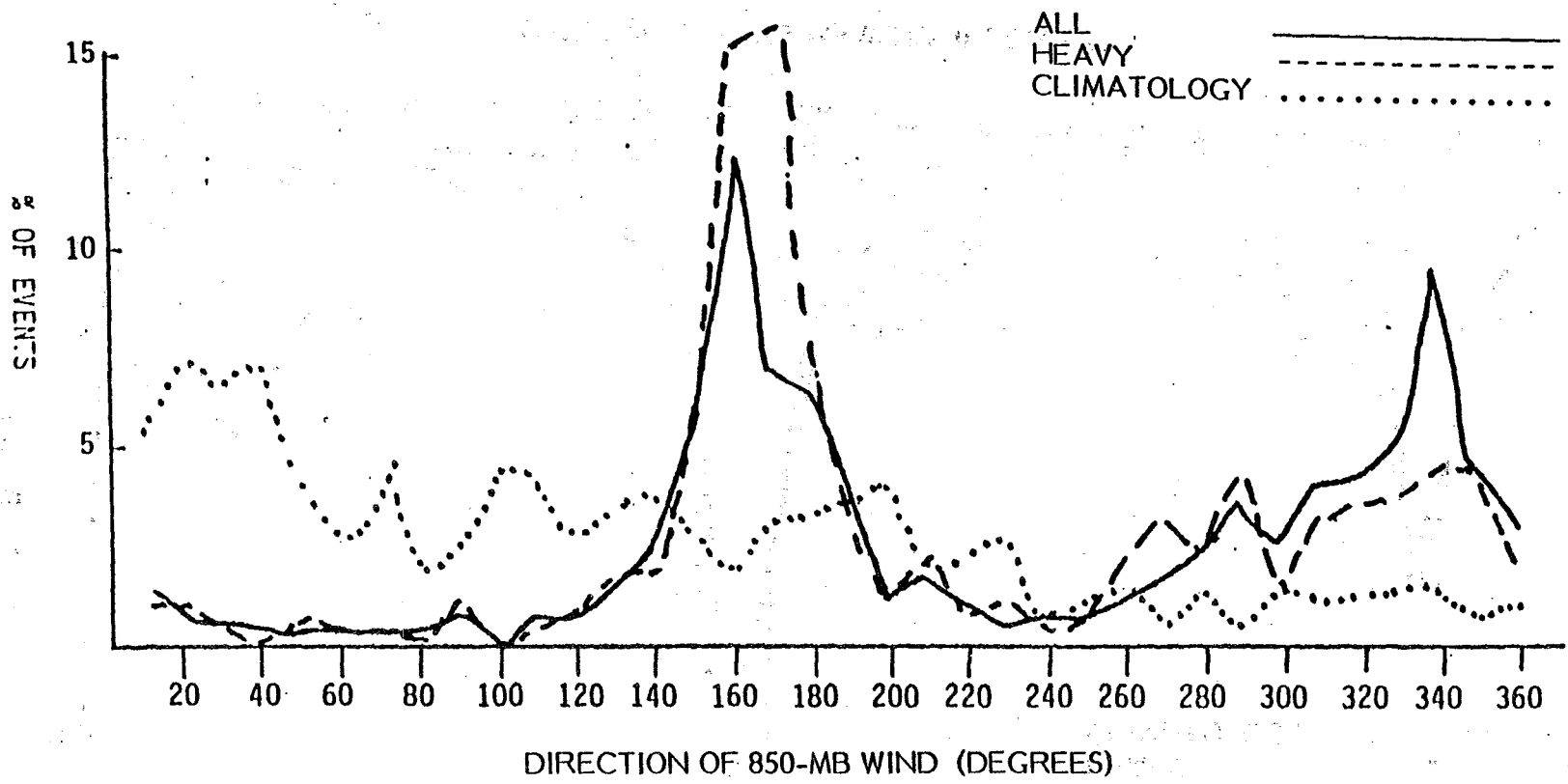

Figure 21

Mountain Dell
608

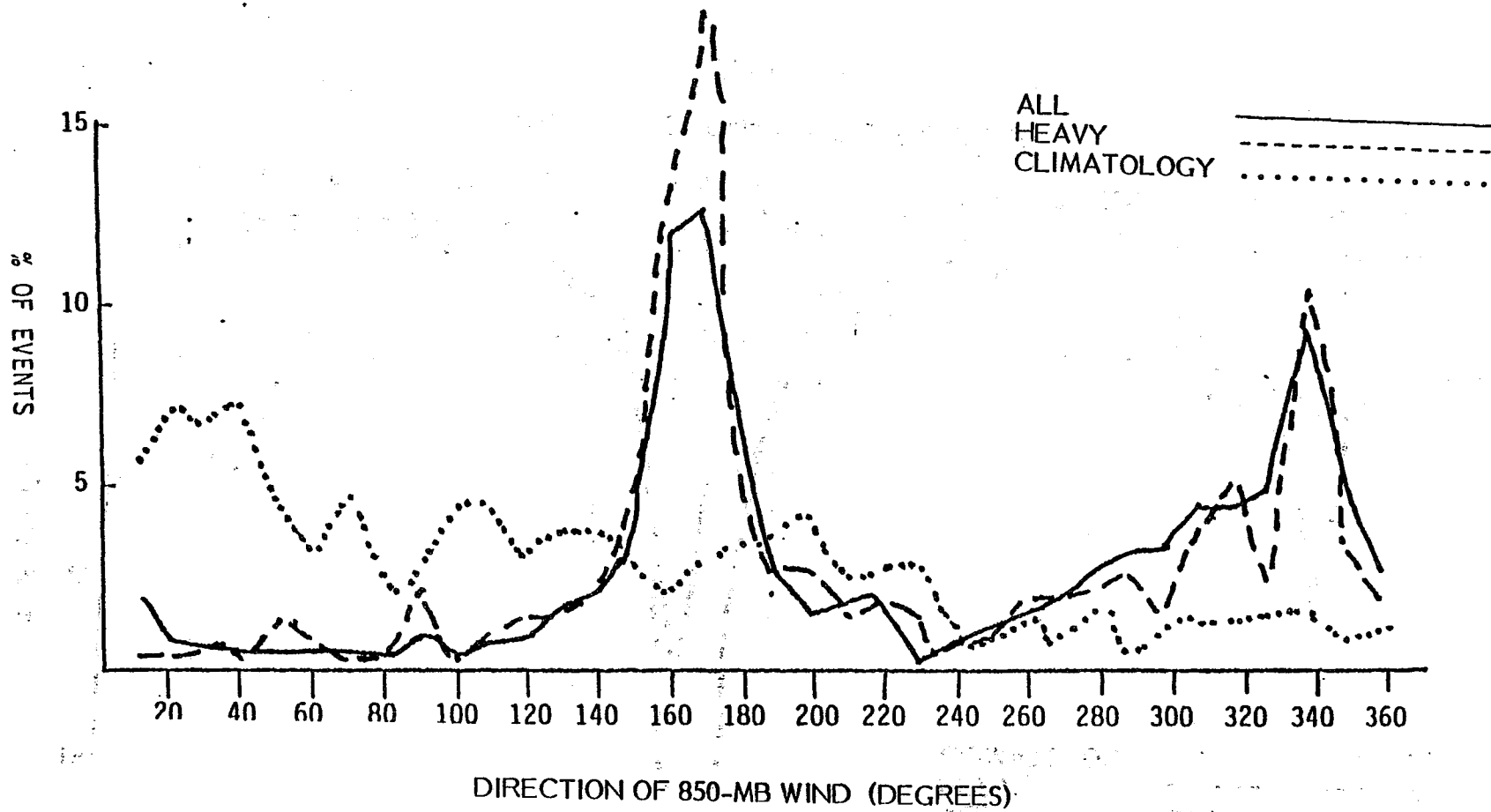

Figure 22

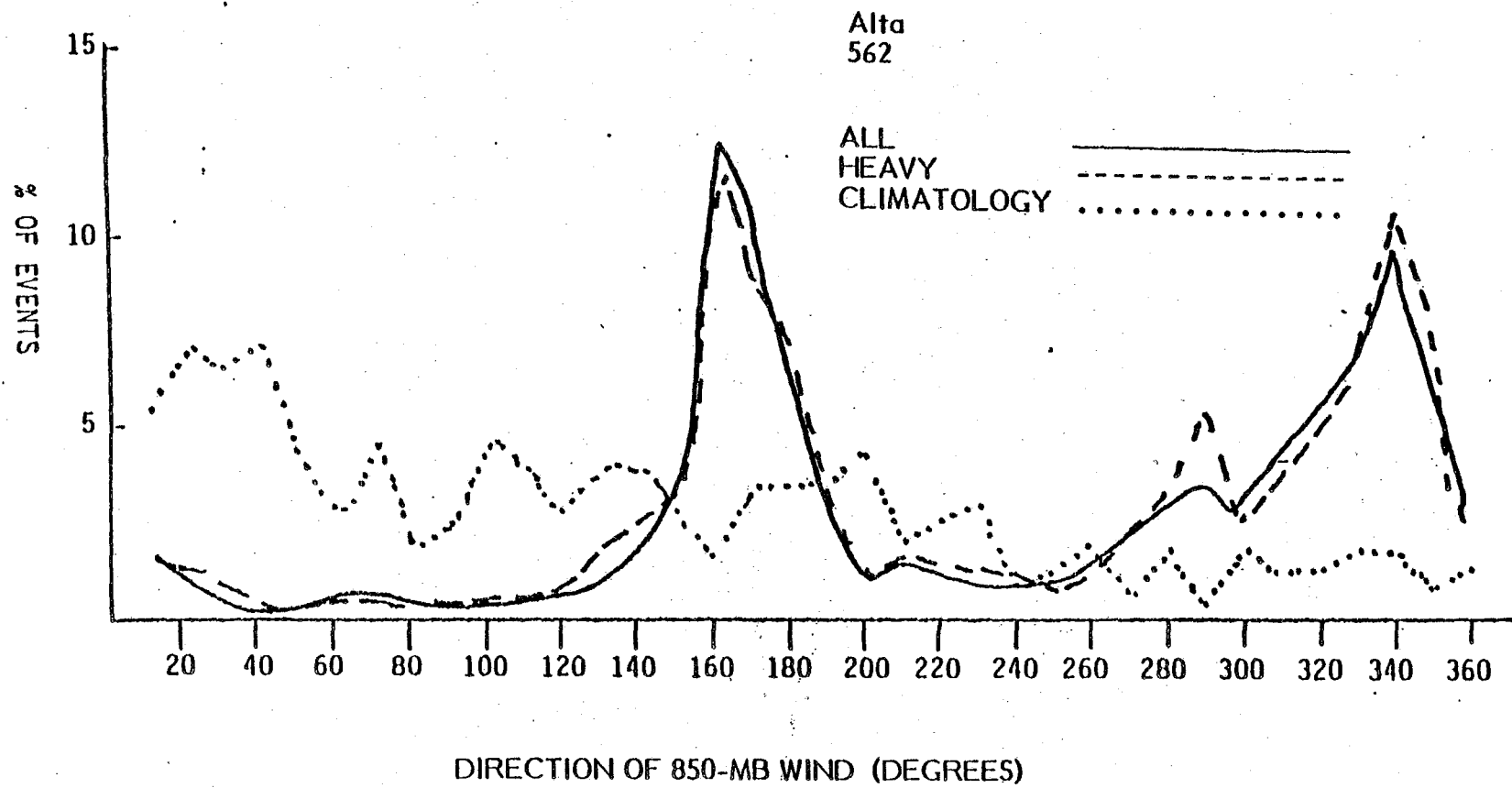

Figure 23

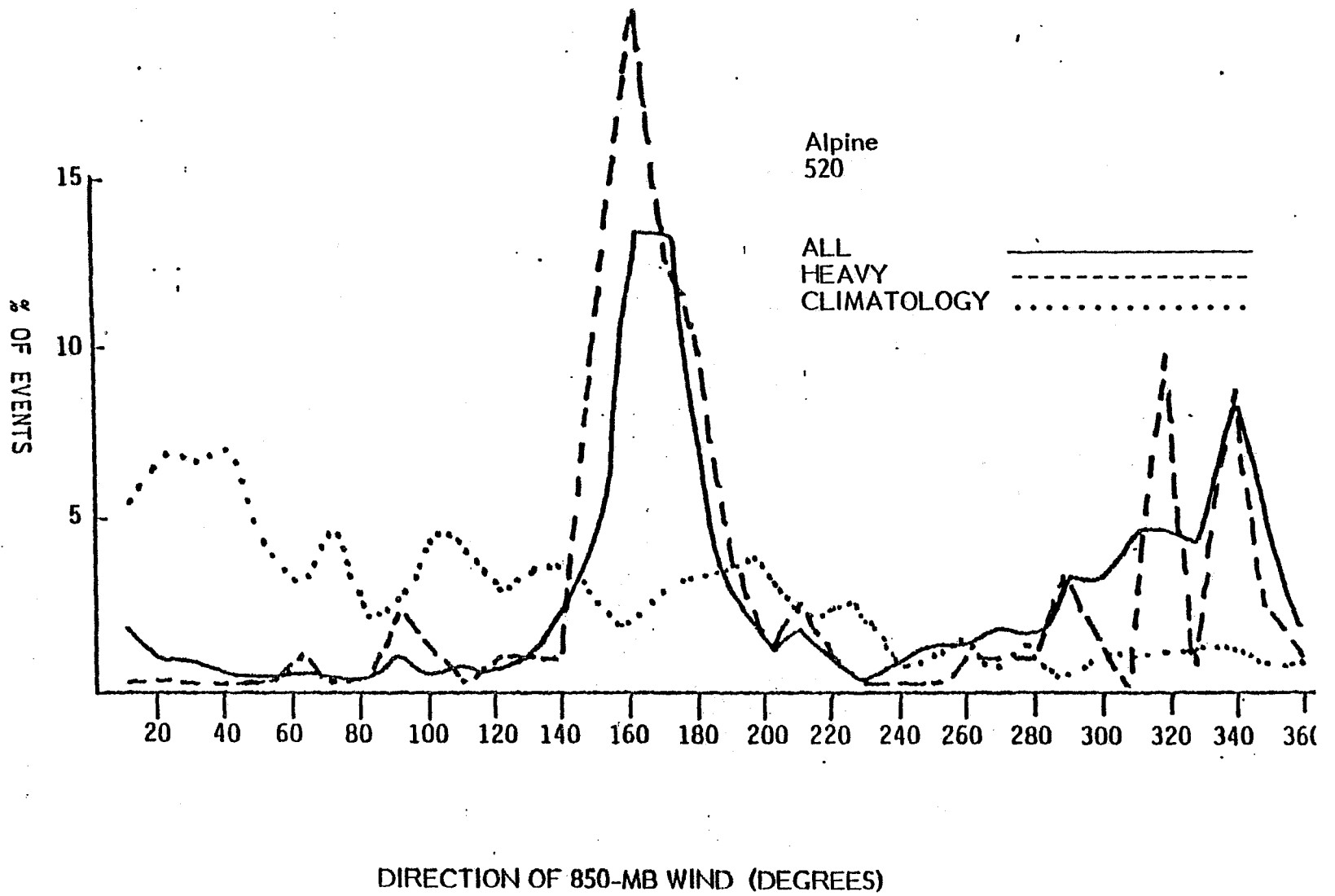

Figure 24

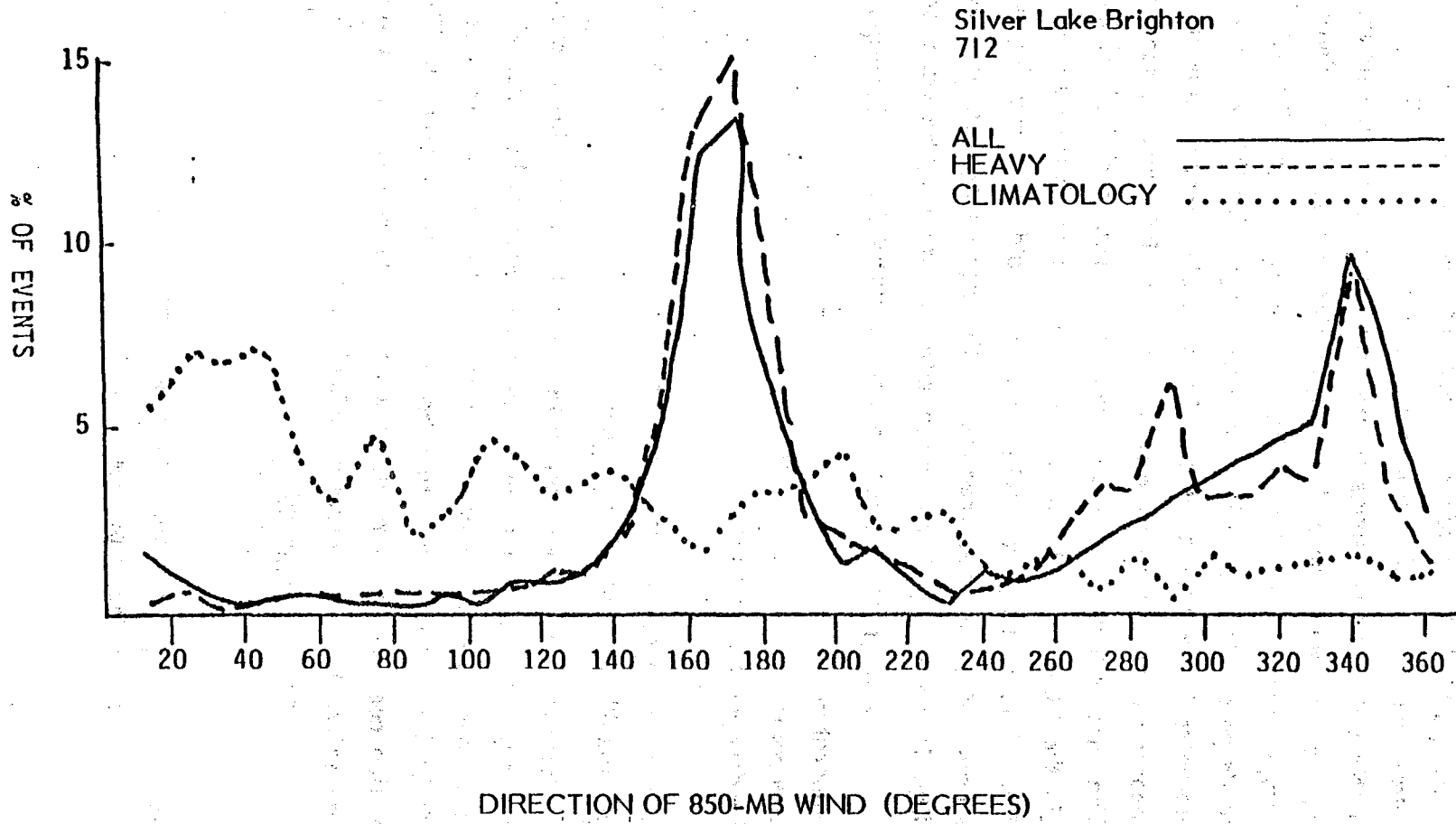

Figure 25

IV. CORRELATION OF RAWINSONDE PARAMETERS TO PRECIPITATION

This part of the study examined the relationship between rawinsonde parameters and precipitation amounts at the various sites. The strength of the relationship between rawinsonde parameters and precipitation serves to identify the usefulness of these observations to quantitative precipitation forecasting. The first analysis consisted of finding the linear correlation coefficient for different rawinsonde parameters. The 18 parameters chosen for this are listed in Table 2. The geo-potential height values and the associated temperatures at these levels were departures from monthly means. This took into account seasonal variability. The relative humidity values were based on readings at 50 mb increments as given in the NCAR data tape. The k index is a rough measure of atmospheric stability. This index is generally used as an aid in forecasting warm season convection. It is a good measure of the lapse rate and low level relative humidity. It is also very simple to compute. It is given by the equation:

$$k = T(850) - T(500) + Td(850) - TDEP(700) \quad (\text{George, 1960}) \quad (1)$$

T = temperature

Td = dew point

TDEP = dew point depression

A temperature advection parameter was approximated by the turning of the wind between the 800-mb and 500-mb levels.

There is a difficulty in determining exactly what value a parameter has on a given day. Two soundings were taken for each 24-hour period precipitation amount. Thus, depending upon when in the day the measurement was taken, either the 00 GMT or 12 GMT data may be prefrontal or postfrontal. Therefore, the correlation coefficients were determined for the two sets of rawinsonde times independently. The linear correlation is given by:

$$r = \frac{\sum (x_i - \bar{x})(y_i - \bar{y})}{(\sum (x_i - \bar{x})^2 \sum (y_i - \bar{y})^2)^{1/2}}$$

where: x_i, y_i = parameter and precipitation amount
 \bar{x}, \bar{y} = the respective means

PARAMETERS EXAMINED IN CORRELATION ANALYSES

<u>PARAMETER</u>	<u>ABBREVIATION</u>
1. 850-mb height	850H
2. 700-mb height	700H
3. 500-mb height	500H
4. 850-mb temp	850T
5. 700-mb temp	700T
6. 500-mb temp	500T
7. Surface to 800-mb relative humidity	SFC-800RH
8. 600-mb to 800-mb relative humidity	600-800RH
9. 900-mb to 600-mb relative humidity	400-600RH
10. Surface to 400-mb relative humidity	SFC-400RH
11. Surface pressure	SFC Pr
12. k index	k
13. 850-mb wind speed	850ws
14. 700-mb wind speed	700ws
15. 600-mb wind speed	600ws
16. 500-mb wind speed	500ws
17. Temperature advection	Temp Adv
18. Precipitable water	Prec Wat

Table 2. This is a list of the eighteen parameters examined in the correlation analysis. A number and abbreviation for each parameter is given.

Both wet and dry days were considered together. Then days for which the 24-hour precipitation amount was greater than .01 inches were analyzed separately.

The five most highly correlated parameters for Alta for all days are given in Table 3. The 00 GMT results are generally higher than the 12 GMT. This may be because at Alta the 00 GMT sounding occurs at approximately the midpoint of the 24-hour measurement period whereas the 12 GMT sounding is near the end of the period. Thus, the conditions recorded at 12 GMT may be associated with precipitation that was not recorded until the next day. Three of the five parameters show correlations at both times. However, surface to 400-mb relative humidity and 600-mb to 800-mb relative humidity are likely to be highly correlated to each other. This will be examined in the section on multiple correlation. It is interesting to note that the 700-mb height is in both the 12 GMT and 00 GMT results. Thus, the intensity of the mid-level trough may be one of the best indicators of precipitation for Alta.

Tests for significance and confidence intervals were done. Using Fisher's Z transformation (Daniel, 1977), 99 percent confidence intervals were constructed. The total number of cases was 1,345. This yielded intervals of .59 to .49 for the 00 GMT surface to 400-mb relative humidity. If only every third set of paired observations is used, the events may be considered independent of each other. This is essentially taking rawinsondes from 48-hour intervals as independent. This assumption is probably valid in nearly all synoptic regimes. In this case the 99 percent confidence interval is .62 to .45. Thus, the most highly correlated parameters account for 15 to 35 percent of the variance in precipitation amounts at Alta. Using a 't' test and either 1,345 or 448 cases leads to rejecting the null hypothesis (no relationship) at the .001 significance level.

The heights, temperatures, and pressures were negatively correlated with precipitation amounts, the other parameters were positively correlated. The absolute value is presented in the tables.

When only wet cases (precipitation greater than .01 inch) were considered the correlation coefficients of the most highly correlated parameters were lower. The three most highly correlated parameters are presented in Table 4. There were 569 wet cases. After constructing a 99 percent confidence interval it

LINEAR CORRELATION COEFFICIENTS

<u>00Z</u>	<u>r</u>	<u>12Z</u>	<u>r</u>
SFC-400RH	.539	600-800RH	.450
600-800RH	.501	500H	.426
700H	.449	SFC-400RH	.413
850H	.431	700H	.387
400-600-RH	.405	500T	.380

Table 3. The five parameters with the highest linear correlations at Alta are given for 00Z and 12Z separately. Both wet and dry days were considered.

is found that the 00 GMT surface to 400-mb relative humidity accounts for from 4 to 25 percent of the variance in Alta precipitation amounts. Any correlation coefficients below .2 were not significant at the .001 percent level. Thus, very little of the Alta precipitation variance is accounted for by any one parameter once the condition of measurable precipitation is imposed.

Linear correlation coefficients were also determined for the other eight sites. The two highest coefficients found at each site are given in Table 5. The parameters were generally the same as at Alta except for the surface pressure. Surface pressure was among the most highly correlated parameters even at Silver Lake Brighton, and Park City Summit which are at or above the elevation at Alta. Thus, Alta's precipitation may be less dependent on the intensity of the low level synoptic features than the other mountain locations.

Precipitable water was one of the most highly correlated parameters at all but the three highest sites, Alta, Brighton, and Park City Summit. It was a particularly significant parameter at Salt Lake City and Ogden. Low level moisture seems to be important for the low elevation sites but not for the ski areas.

The highest coefficients when the condition of measurable precipitation was imposed were generally near .37. This is approximately the same result as at Alta. The statistical significance at the other sites was approximately the same as at Alta, thus, no single parameter could explain more than about one third of the variance in precipitation amounts.

Therefore, any scheme of weather modification evaluation that depends on an established ratio between precipitation and one of these parameters is of questionable value.

A multicorrelation analysis was done to find the combination of rawinsonde parameters that were most significant to heavy precipitation events. This was done for all cases, and again for cases in which measurable precipitation was recorded. Similar analyses were then done with a precondition of a certain mid-level flow orientation. In each case the average value of the rawinsonde parameters were found. The multicorrelation analysis resulted in choosing the six parameters that resulted in the highest coefficient.

LINEAR CORRELATION COEFFICIENTS

<u>00Z</u>	<u>r</u>	<u>12Z</u>	<u>r</u>
SFC-400RH	.379	500H	.204
600-800RH	.344	700H	.196
Prec Wat	.311	600-800RH	.193

Table 4. The three parameters with the highest linear correlations at Alta are given for 00Z and 12Z separately. Only wet days were considered.

LINEAR CORRELATION COEFFICIENTS

<u>SITE</u>	<u>2 HIGHEST PARAMETERS</u>	<u>r</u>
Brighton	850H	.489
	SFC Pr	.459
Alpine	SFC-400RH	.495
	600-800RH	.449
Park City Summit	850H	.415
	SFC-400RH	.403
Cottonwood	SFC-400RH	.457
	600-800RH	.428
Salt Lake City	850H	.440
	SFC Pr	.427
Ogden	SFC-400RH	.434
	Prec Wat	.419
Mountain Dell	SFC-400RH	.448
	600-800RH	.409
Pineview	SFC-400RH	.475
	Prec Wat	.446

Table 5. The two parameters with the highest linear correlations at the eight sites listed are given. Both wet and dry days were considered.

At Alta approximately 36 percent of the variance was accounted for by just three parameters with additional parameters adding little information in the case where all days were considered. When only wet days were considered the parameters were essentially the same as when all days were examined, but the coefficient obtained was lower, accounting for only 23 percent of the variance in precipitation. The parameters chosen are given in Table 6. Atmospheric stability seems to be an important criteria in determining the potential for heavy snow. The average value of the k index rose from 7.5 when all days were considered to 14 when only wet days at Alta were examined.

The same analysis was done for the other eight sites in the study. The parameters chosen and the resulting coefficients are given in Table 7. Generally most of the variance in precipitation amount was accounted for by the first two parameters chosen with additional parameters yielding little new information. Again, the coefficients determined for only wet days were lower than when all days were considered. Nearly every site had either the 850-mb height or the surface pressure as a top parameter. Precipitable water and either surface to 400-mb or 800-mb to 600-mb relative humidities also were among the top parameters at most sites. The highest sites, Alta, Brighton, and Park City Summit, did not show precipitable water to be a highly correlated parameter.

The direction of the 700-mb wind was imposed as a precondition on the data before doing a multicorrelation analysis again. The average precipitation amount per event for the various flow direction is given in Table 8. The 700-mb wind speed was a highly correlated parameter at all the mountain sites in north-west flow. In contrast, precipitable water was highly correlated at the valley sites but not the mountain sites. Northwest flow at 700 mb of 270-360 degrees produces the highest average precipitation amount at Alta of any of the flow directions, heavy valley precipitation in northwesterly flow seems to be dependent on the amount of moisture available.

A precondition of a 700-mb wind direction of 170-269 degrees was imposed and the multicorrelation analysis was done again. Every site except Alta had a higher average precipitation amount per event in this flow than in north-northwest flow. Precipitation in southwest flow was strongly influenced by the amount of moisture present as measured by the precipitable water. Also notable was the

MULTICORRELATION COEFFICIENTS AT ALTAALL DAYS

<u>PARAMETERS CHOSEN IN ORDER</u>	<u>r</u>
SFC-400RH	.539
SFC Pr	.589
k index	.594
400-600RH	.602
700ws	.606
850T	.607

WET DAYS

<u>PARAMETERS CHOSEN IN ORDER</u>	<u>r</u>
SFC-400RH	.379
SFC Pr	.429
700ws	.456
k index	.467
Prec Wat	.474
700T	.486

Table 6. The six parameters chosen by multicorrelation analysis for both wet and dry days together and just wet days at Alta are given. The r value is the multicorrelation coefficient after each new parameter is added.

MULTICORRELATION COEFFICIENTSALL DAYS

<u>SITE</u>	<u>6 PARAMETERS IN ORDER CHOSEN</u>	<u>r AFTER 3 PARAMETERS</u>	<u>r AFTER 6 PARAMETERS</u>
Brighton	10,1,9,12,4,6	.570	.586
Alpine	10,1,7,18,12,11	.548	.563
Park City Summit	1,10,14,18,17,15	.492	.501
Cottonwood	10,1,7,17,11,14	.521	.527
Salt Lake City	11,18,7,12,9,4	.526	.549
Ogden	10,11,18,12,17,7	.524	.557
Mountain Dell	10,11,18,7,16,3	.491	.504
Pineview	10,11,18,12,7,17	.562	.588

WET DAYS

<u>SITE</u>	<u>6 PARAMETERS IN ORDER CHOSEN</u>	<u>r AFTER 3 PARAMETERS</u>	<u>r AFTER 6 PARAMETERS</u>
Brighton	11,18,14,17,15,9	.489	.508
Alpine	10,11,18,7,13,2	.479	.507
Park City Summit	18,2,14,17,12,15	.441	.472
Cottonwood	1,8,17,7,12,18	.438	.455
Salt Lake City	11,18,9,4,12,13	.462	.472
Ogden	18,11,17,10,12,1	.482	.504
Mountain Dell	18,7,2,17,16,4	.378	.392
Pineview	18,11,13,17,3,12	.463	.497

Table 7. The six parameters chosen by the multicorrelation analysis for both all days and just wet days at eight sites are listed. The parameters are listed by the number assigned in Table 2.

AVERAGE PRECIPITATION PER EVENT (24 HOUR)

700-mb FLOW ORIENTATION

<u>SITE</u>	<u>ALL</u>	<u>WNW</u>	<u>SSW</u>	<u>WEST</u>	<u>WEAK</u>
Alta	.59	.69	.57	.63	.38
Brighton	.37	.37	.44		.25
Alpine	.19	.17	.22		.18
Park City Summit	.33	.34	.36		.27
Cottonwood	.26	.27	.30		.29
Salt Lake City	.17	.14	.21		.17
Ogden	.22	.18	.30		.24
Mountain Dell	.21	.22	.28		.17
Pineview	.31	.34	.37		.21

Table 8. The average 24 hour precipitation in inches at each site according to 700-mb flow direction is given.

fact that 700-mb wind speed was more highly correlated at Park City in southwest flow than any other directions. Strong 700-mb winds could pose measurement problems at the high elevation sites. Thus, the relationship between 700-mb wind speed and mountain precipitation may be stronger than these results indicate.

Thus, moist south-southwest flow is favorable for precipitation at all sites except Alta. The amount of moisture is a critical factor in south-southwest flow for all sites, whereas it is not in north-northwest flow for the mountain sites.

A condition of 700-mb wind speed being less than 5 meters per second was imposed and the multicorrelation analysis was done again. The average heights at 500 mb and 700 mb were much lower than the other wind regimes. This is an indication that the weak flow is the result of closed lows aloft or very weak short wave troughs. The precipitation at the mountain sites was less in weak flow than the other wind regimes, while the valley locations were about the same in weak flow as other flows. The parameters that were most highly correlated were essentially the same as found previously; relative humidity and the low level pressure field at all sites with precipitable water a factor at the valley sites. The lack of flow is most significant in the mountains where the orographic effects are greatest.

Both the linear correlations and multiple regression analysis failed to explain more than about one third of the variance in precipitation amounts. This was true even when events were divided by wind regimes. Thus, the prognostic value of these parameters for forecasting precipitation amounts is very low.

However, some qualitative information is clear. Most notable is that northwesterly flow is particularly favorable for heavy precipitation at Alta, but not as much so for the other mountain locations. Also of note is the significance of the low-level pressure field and the amount of precipitable water to valley precipitation.

V. RAOB PROFILES RELATED TO VARIOUS PRECIPITATION PATTERNS

An attempt was made to determine what conditions observed in rawinsonde data might point to anomalous precipitation patterns. Frequency distributions of six atmospheric parameters were constructed in order to find unusual precipitation patterns such as the valleys receiving more precipitation than the mountains, or one valley site getting much heavier precipitation than another.

The six parameters chosen for this analysis were the 700-mb and 500-mb wind directions, 700-mb wind speed, precipitable water, k index, and surface pressure. Each parameter was divided into categories and the percentage of all cases that fell in each category was determined. The categories of each parameter are as follows:

k index 0-5, 6-10, 11-15, 16-20, GT 20

700-mb wind speed (m/s) . . . LT 3, 3-6, 7-9, 10-12, GT 12

precipitable water (inches) . 0-.33, .34-.66, .67-1.00, 1.01-1.33

surface pressure (mb) LT 860, 860-864, 865-868, GT 868

500- and 700- wind direction (degrees) . 120-180, 180-240, 240-300, 300-360

GT = Greater Than

LT = Less Than

Precipitation events rarely occur in northern Utah with east or northeasterly winds aloft at 500 or 700 mb; thus, a category for these wind directions was not created.

A mountain to valley site comparison was between Alta and the Salt Lake City airport. Alta has the highest average precipitation and the airport has one of the lowest averages. The days were separated into three categories. Days in which the difference between Alta and Salt Lake City precipitation was less than .10 inches were classified as equal days. When Salt Lake City precipitation exceeded Alta precipitation by more than .10 inches the day was classified as greater. Days when Alta precipitation exceeded Salt Lake City precipitation by more than .10 inches were classified as normal. There were 41 greater days, 40 equal days, and 484 normal days. Days with less than .10 inches of precipitation at both sites were disregarded.

A problem arises in this comparison since Alta reports 24-hour precipitation at 7 a.m. and Salt Lake City reports 24 hour precipitation at midnight. Although the two stations are not exactly comparable, the present analysis has used the data as reported. It is thought that the precipitation patterns reported here are representative, although the distribution of categories reported in each case obviously will not exactly reflect reality.

The first analysis considered all days. An example of the tabulated data is given in Table 9, but the full tabulation will be omitted for the subsequent analyses in this Chapter. Equal and greater days were found to have high percentages of the events with higher precipitable water, somewhat higher k index values and lower surface pressures than normal cases. Additionally, the 700-mb wind tended to be from 180-240 degrees for equal and greater days while it was northwesterly for normal days. The same was true for the 500-mb wind. These results are in agreement with those described in Chapters III and V for cutoff lows and in the multiple correlation analysis, particularly the significance of low surface pressure to valley precipitation.

The 500-mb and surface chart for February 12, 1978 as well as the observed precipitation for the storm, are presented in Table 10 and Figure 26 as an example of an event in which valley and mountain precipitation were approximately equal. The upper level flow in northern Utah is quite weak with a closed low circulation centered over Idaho. The surface pattern shows relatively low pressures and no building surface high over the region. This combination resulted in similar precipitation amounts in both the mountains and the valleys. It is of particular note that the upper level flow is southwesterly. This flow direction is not favorable for heavy precipitation at Alta.

To look for the presence of a lake effect due to the proximity of the Great Salt Lake to the city, only cases in which the 700-mb wind direction was greater than 270 degrees but less than 360 degrees were considered. The postfrontal lake convection occasionally will produce locally heavy precipitation within a few miles of the shoreline and in the mountains directly downwind, but very little if any precipitation at other mountain locations. This situation is relatively rare and only 23 of 400 cases were found in which the airport received more precipitation than Alta in northwesterly flow. The most notable difference between greater

SALT LAKE CITY VS ALTA PRECIPITATION - ALL WIND DIRECTIONS

<u>k INDEX</u>						
<u>0-5</u>	<u>6-10</u>	<u>11-15</u>	<u>16-20</u>	<u>21-25</u>		
<u>11%</u>	<u>6%</u>	<u>17%</u>	<u>26%</u>	<u>38%</u>		Equal
9	5	14	27	43		Greater
23	11	15	20	27		Normal
<u>700-mb WIND SPEED (m/s)</u>						
<u>3</u>	<u>3-6</u>	<u>6-9</u>	<u>9-12</u>	<u>12</u>		
<u>5</u>	<u>22</u>	<u>31</u>	<u>17</u>	<u>22</u>		Equal
3	16	25	22	31		Greater
3	13	26	23	31		Normal
<u>PRECIPITABLE WATER (in)</u>						
<u>0-.33</u>	<u>.34-.66</u>	<u>.67-1.00</u>	<u>1.01-1.33</u>			
<u>32</u>	<u>67</u>	<u>0</u>	<u>0</u>			Equal
31	63	5	0			Greater
57	42	0	0			Normal
<u>SURFACE PRESSURE (mb)</u>						
<u>860</u>	<u>860-864</u>	<u>865-868</u>	<u>868</u>			
<u>7</u>	<u>19</u>	<u>34</u>	<u>38</u>			Equal
23	12	36	25			Greater
7	16	22	53			Normal
<u>700-mb WIND DIRECTION (deg)</u>						
<u>120-180</u>	<u>180-240</u>	<u>240-300</u>	<u>300-360</u>			
<u>3</u>	<u>35</u>	<u>36</u>	<u>23</u>			Equal
7	42	31	17			Greater
2	33	41	23			Normal
<u>500-mb WIND DIRECTION (deg)</u>						
<u>120-180</u>	<u>180-240</u>	<u>240-300</u>	<u>300-360</u>			
<u>2</u>	<u>33</u>	<u>50</u>	<u>12</u>			Equal
3	49	36	9			Greater
2	25	49	23			Normal

Table 9. The percentage of all cases that fell into each category of a given parameter when Salt Lake City and Alta precipitation were equal, when Salt Lake City precipitation was greater than Alta, and the normal case of Alta precipitation being greater than Salt Lake City precipitation are given. Events were considered regardless of wind direction.

SALT LAKE CITY VS ALTA STORM — FEBRUARY 13, 1978

<u>STATION</u>	<u>PRECIPITATION (inches)</u>
Brighton	.12
Alpine	.29
Park City Summit	.00
Cottonwood Wier	.52
Salt Lake City	.24
Ogden	.34
Mountain Dell	.35
Pineview	.30
Alta	.20

Table 10. Precipitation resulting from storm in which Salt Lake City precipitation exceeded Alta precipitation.

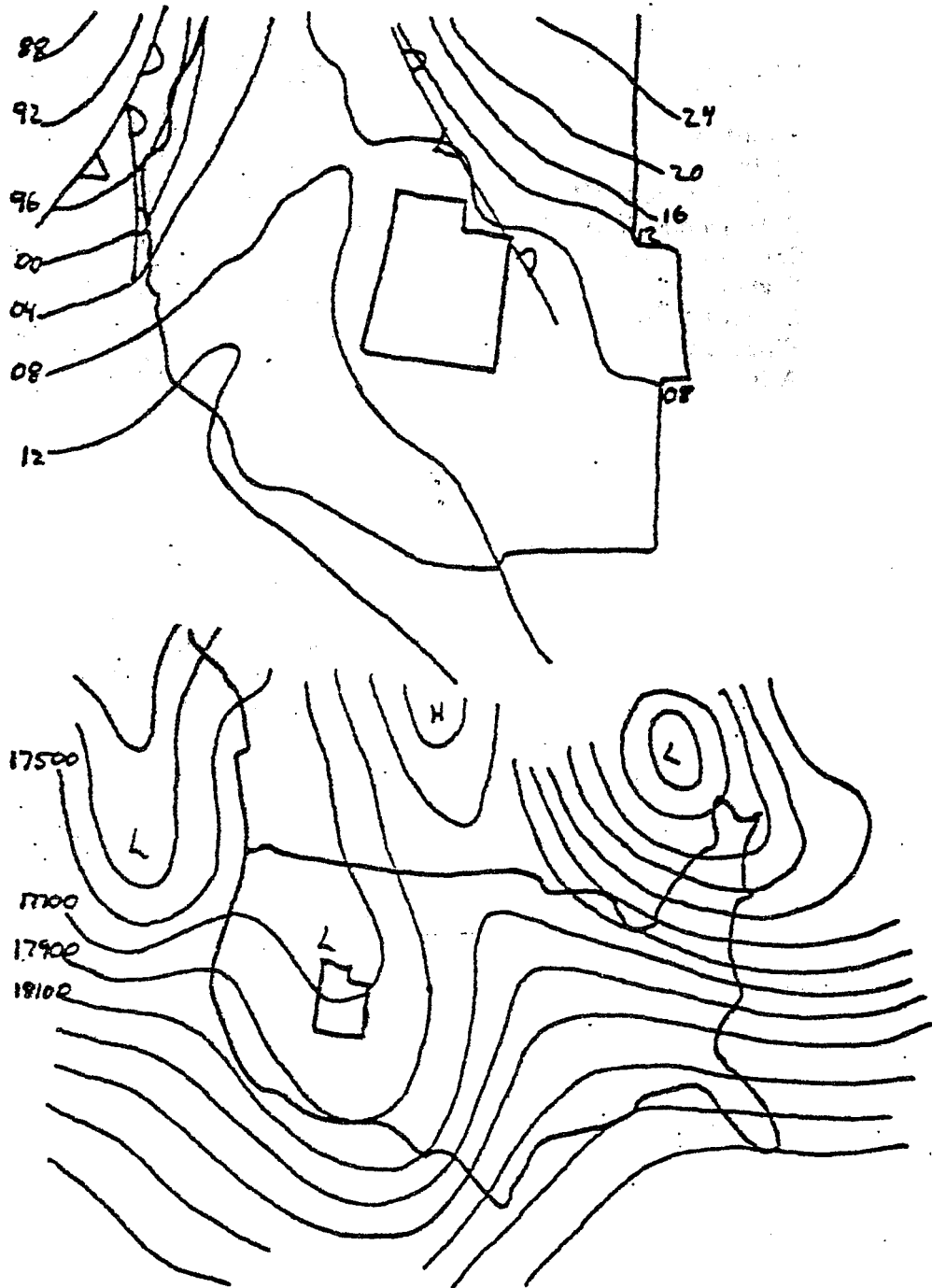

Figure 26. Surface and 500 mb charts for SLC greater than Alta storm February 12, 1978. Height (feet) Pressure (mb).

and normal days is the clustering of k index values in the higher classifications and the lack of high surface pressures in the greater days as opposed to normal days.

A comparison of precipitation at two valley sites was done using Salt Lake City and Ogden. Both sites are at approximately the same elevation with Ogden slightly closer to the mountains. Ogden is exposed to the lake in westerly flow but not northerly flow. Salt Lake City is exposed to the lake in northerly and northwesterly flow. In this analysis the two sites were considered to have received equal precipitation if the 24 hour amounts differed by .15 inches or less. There was not a time sampling problem with these sites.

The Salt Lake vs. Ogden analysis was done with the precondition that the 700-mb wind direction be greater than 270 degrees but less than 360 degrees. This attempted to look to postfrontal conditions and possible differences in the effects of the Great Salt Lake. Significant differences in the raob profiles were seen in the surface pressure and wind directions. Ogden days have much higher surface pressures than Salt Lake City days. This is similar to the equal days. Thus, low surface pressure is more important to Salt Lake City precipitation than Ogden precipitation. This was also the case in the comparison between Salt Lake City and Alta. The 500-mb wind direction shows a very strong tendency towards southwesterly directions on Salt Lake City days while Ogden days are spread out among various directions at 500 mb. Thus, the passage of the 500-mb trough axis and accompanying wind shifts limits likelihood of significantly more precipitation falling at Salt Lake City than Ogden. Northerly 700-mb flow seems to eliminate the possibility of Ogden receiving more precipitation than Salt Lake City. This difference seems to point out the different position relative to the lake of the two sites. As mentioned previously, northerly flow may be unfavorable orographically for Ogden.

Abnormally heavy precipitation events at the individual sites were examined to look for tendencies in the raob profiles. The criteria for a heavy event at Salt Lake City was 24 hour precipitation of .5 inches or more. When all wind directions were considered there were 44 heavy days and 589 light days. High precipitable water, low surface pressures and southwesterly flow are conditions that characterize heavy precipitation at Salt Lake City.

Analysis of heavy and light precipitation days at Silver Lake Brighton was done in a similar manner as for Salt Lake City. The analysis was done twice, once with a threshold for heavy precipitation of .75 inches and again for 1.25 inches of precipitation in 24 hours. There were 89 days greater than .75 inches of precipitation and 25 days with 1.25 inches or more. Strong 700-mb winds, high precipitable water, and low surface pressures were characteristic of heavy regimes. Instability as indicated by high k index values was also a factor in heavy days. The very heavy cases at Brighton showed very high percentages in these categories indicating that the exceptional precipitation events do have a definite signature.

In all the other results Alta had somewhat different atmospheric conditions associated with its precipitation than the other mountain sites. Most notable was the bias to northwesterly flow to the exclusion of other directions for heavy precipitation. The Alta analysis was done twice, once with a precipitation threshold of 1.00 inch with all wind directions, and with a precipitation threshold of 1.50 inches and only 700-mb wind directions greater than 270 degrees. Heavy precipitation days at Alta accompany a raob profile with high instability, high 700-mb wind speeds and low surface pressures. In contrast to the other mountain sites Alta did not show much difference in the precipitable water between heavy and light days. The presence of low surface pressure seemed to favor heavier precipitation, but the contrast in surface pressure between heavy and light days was not as strong as at the other sites. Thus, as was indicated in the correlation analysis, Alta precipitation seems to depend less on available moisture and surface pressure than the other sites, and more on the direction and speed of the mid level flow.

These analyses of rawinsonde data point out that definite, characteristic atmospheric conditions favor certain precipitation distributions. To summarize:

- 1) High precipitable water, southwest flow, low surface pressure, and extra instability favor Salt Lake City precipitation over Alta.

- 2) Equal Salt Lake City and Alta precipitation is favored by weak south-westerly upper-level flow with a closed low over Idaho, low surface pressure, and no surface high building over the region.
- 3) Post-frontal conditions with high instability but no rapid building of a surface high can favor lake effect precipitation at Salt Lake City.
- 4) Precipitation distribution between Salt Lake City and Ogden is governed by position of the 500-mb trough axis and orientation of the 700-mb flow.
- 5) Heavy precipitation at Salt Lake City tends to occur with high precipitable moisture, low surface pressures, and southwest flow.
- 6) Strong 700-mb winds, high precipitable moisture, low surface pressure, and a high k-index characterize heavy precipitation at Silver Lake Brighton.
- 7) Heavy precipitation at Alta occurs with high 700-mb winds, high instability, and low surface pressures. Direction and speed of mid-level flows are dominant parameters with northwest winds aloft the key indicator.

VI. CLOSED LOWS AND COLD FRONTAL EFFECTS ON PRECIPITATION DISTRIBUTION

Different synoptic patterns produce precipitation patterns in northern Utah that are marked departures from normal. Certain patterns might be expected to bring significantly more precipitation to the mountains than the valleys and vice versa. A study of mountain and valley precipitation in southern California was done by Elliot and Schaffer (1962). This section examines the quantitative distribution of precipitation in cases of upper level closed lows and surface cold fronts. The aim of this experiment is to identify precipitation patterns associated with these features to aid quantitative precipitation forecasting in these situations.

An examination of precipitation distribution under various synoptic regimes was done using both rawinsonde data and National Meteorological Center (NMC) surface analyses. A study at the University of Utah produced a list of dates on which a surface cold front was analyzed by NMC to have passed through the Salt Lake City area. This list served as a means of classifying a precipitation event as either frontal or nonfrontal. The rawinsonde data were used to identify instances of closed low centers or weak flow systems at 700 mb. This section attempts to characterize the different precipitation patterns associated with these different synoptic features.

To determine 700 mb closed low systems solely from rawinsonde data a definite procedure was followed.

Four successive rawinsondes were examined to be referred to as 1, 2, 3, 4 with 1 being the first and 4 being the last rawinsonde in the series. The following criteria defined a closed low or weak flow case:

1. 700-mb wind speed decreases from 1 to 2 and increases from 3 to 4.
2. temperature decreases from 1 to 2 and rises from 3 to 4.
3. height of the 700-mb level falls from 1 to 2 and rises from 3 to 4.
4. directional shear of the 700-mb and 500-mb wind in either sounding 2 or 3 is less than 35 degrees.

These four criteria are very likely to identify either a closed low or weak flow trough at 700 mb. The falling and then rising temperature and height in a 48-hour period would indicate the passage of synoptic scale trough. The fall and rise of the wind speed would likely eliminate troughs embedded in a strong flow. The condition of a minimum wind shear between 700 mb and 500 mb during the middle two soundings would help identify troughs with little vertical tilt and thus, likely candidates to be closed circulations. This procedure resulted in a list of two or three day periods in which either a closed low or a baroclinic wave with weak flow existed at the 700-mb level. There were 73 cases in the period examined. A random sample of ten of these cases was compared to the synoptic charts. Each case proved to have a closed low or weak flow trough present.

In order to compare closed low precipitation distribution to cases in which no closed low was present, a list of storm dates based on Alta precipitation was compiled. Alta was chosen since it had the most complete observation record and because even if only one site received precipitation in a given event it would most likely be Alta. This produced a list of storms ranging in length from 1 to 15 days. This list was compared with the list of days determined from the raob low analysis and if a date was common to both lists the storm was categorized as a 'low' storm, otherwise it was classified as a 'nonlow' storm. There were a few problems with this classification scheme. Some raob low dates did not exist in the Alta storm data and were thus left out of further analysis. Occasionally two raob low storms would fall into a single very long Alta storm. Some Alta storms were quite long and the days on which a closed low was identified might be preceded and followed by days with significant mid-level flow. Thus, a long storm may be classified as a low storm when in fact most of the precipitation fell under high flow conditions. A raob low storm consisted of only the 48-72 hour period in which the weak flow was present, while a low storm consisted of the entire storm period.

The ratio of mountain to valley precipitation in low and nonlow cases was examined. The ratios of each station to the other stations in the two regimes is presented in Tables 11 and 12. The ratios from the raob low cases are given in Table 13. The Silver Lake Brighton to Salt Lake City ratios of 2.56 and 3.57 for low and nonlow respectively correspond quite well with the results from a

PRECIPITATION RATIOS IN CLOSED LOWS

	<u>ALTA</u>	<u>BRIG</u>	<u>ALPI</u>	<u>PCS</u>	<u>COTW</u>	<u>SLC</u>	<u>OGDN</u>	<u>MTD</u>	<u>PINE</u>
Alta	--	1.94	5.04	3.18	3.13	4.93	3.26	3.41	2.60
Brighton	.52	--	2.60	1.64	1.62	2.56	1.69	1.76	1.35
Alpine	.20	.38	--	.63	.62	.97	.64	.67	.52
Park City Summit	.31	.61	1.59	--	.99	1.55	1.04	1.07	.82
Cottonwood	.31	.62	1.61	1.01	--	1.57	1.04	1.08	.83
Salt Lake City	.20	.39	1.02	.64	.63	--	.66	.69	.52
Ogden	.30	.59	1.54	.97	.96	1.49	--	1.03	.79
Mountain Dell	.29	.56	1.49	.93	.92	1.43	.96	--	.77
Pineview	.38	.74	1.95	1.22	1.20	1.87	.126	1.30	--

Table 11. Ratios of precipitation per event between sites under conditions of a 700-mb low are given.

PRECIPITATION RATIOS IN NONLOWS

	<u>ALTA</u>	<u>BRIG</u>	<u>ALPI</u>	<u>PCS</u>	<u>COTW</u>	<u>SLC</u>	<u>OGDN</u>	<u>MTD</u>	<u>PINE</u>
Alta	--	1.97	6.00	3.21	4.75	7.00	5.75	4.76	2.71
Brighton	.51	--	3.04	1.63	2.41	3.57	2.92	2.41	1.37
Alpine	.17	.33	--	.53	.79	1.15	.96	.79	.45
Park City Summit	.31	.61	1.87	--	1.48	2.15	1.79	1.48	.84
Cottonwood	.21	.41	1.26	.67	--	1.45	1.21	1.00	.57
Salt Lake City	.15	.29	.87	.46	.69	--	.83	.69	.39
Ogden	.17	.41	1.04	.56	.83	1.20	--	.83	.47
Mountain Dell	.21	.41	1.26	.67	1.00	1.45	1.21	--	.57
Pineview	.37	.73	2.21	1.18	1.75	2.55	2.12	1.76	--

Table 12. Ratios of precipitation per event between sites for events with no 700-mb low are given.

(Williams and Peck, 1962) study of 500-mb lows which were 2.45 and 3.75 respectively. The Alta to Salt Lake City ratio goes from 7.00 in nonlow conditions to 4.93 in low conditions and to 3.96 in the raob low cases. The ratios between two mountain sites and between two valley sites are approximately the same in both closed low or nonlow conditions.

The ratio of mountain to valley precipitation decreases under closed low conditions, with the lowest ratios during the period when the low center is closest to Salt Lake City. The absence of flow to produce orographic lifting is most pronounced when the 700-mb center is directly over northern Utah. Closed low storms do produce the highest average precipitation due to their slow movement and strong vertical motion fields.

An example of a closed low storm taken from the time period of this study is an event that took place March 25 through March 27, 1975. The precipitation for the entire storm at each site is presented in Table 14. The surface and 500-mb charts valid at 1200 GMT, March 27, 1975, are presented in Figure 27. The synoptic pattern at 500 mb is typical of a major closed low storm in the intermountain region. There is a complete lack of flow over northern Utah at this map time. The surface pressure is still relatively low, but the lowest pressure and frontal development is typically to the south and east of Utah at the time of the weakest flow aloft. The precipitation observed shows a major precipitation event, but the mountain to valley ratios are significantly smaller than in nonlow cases.

A study (Jorgensen, et al, 1966) of the spacial and quantitative distribution of precipitation in the intermountain west from closed lows at 700 mb found that the area of heavy precipitation in relation to the low center was determined by the intensity of the low as measured by the departure from normal of the central pressure. The heavier precipitation was associated with the more intense lows. The area of heavy precipitation was found to be to the east of the low in intense lows with the area shifting to the low center and southwest of the center with the least intense lows. Lows of moderate intensity had the heaviest precipitation to the south and southeast of the low center.

The frontal and nonfrontal classification also served as a means of comparing mountain to valley precipitation relationships. There were 127 frontal storms and 110 nonfrontal storms as defined by the University of Utah data. Non-

PRECIPITATION RATIOS IN RAOB LOWS

	<u>ALTA</u>	<u>BRIG</u>	<u>ALPI</u>	<u>PCS</u>	<u>COTW</u>	<u>SLC</u>	<u>OGDN</u>	<u>MTD</u>	<u>PINE</u>
Alta	--	1.64	4.14	2.90	2.90	3.96	2.90	3.34	2.56
Brighton	.61	--	2.52	1.77	1.77	2.41	1.77	2.04	1.56
Alpine	.24	.40	--	.70	.70	.95	.70	.81	.62
Park City Summit	.34	.57	1.43	--	1.00	1.36	1.00	1.15	.88
Cottonwood	.34	.57	1.43	1.00	--	1.36	1.00	1.15	.88
Salt Lake City	.25	.42	1.04	.73	.73	--	.73	.84	.65
Ogden	.34	.57	1.43	1.00	1.00	1.36	--	1.15	.88
Mountain Dell	.30	.49	1.24	.87	.87	1.18	.87	--	.76
Pineview	.39	.64	1.62	1.13	1.13	1.54	1.31	1.31	--

Table 13. Ratios of precipitation per event between sites during the 48-72 hour period of the storm in which the 700-mb low was closest to Salt Lake City are given.

CLOSED LOW STORM -- MARCH 25-27, 1975

<u>STATION</u>	<u>PRECIPITATION (inches)</u>
Brighton	2.17
Alpine	.00
Park City Summit	.60
Cottonwood Wier	1.03
Salt Lake City	.79
Ogden	1.91
Mountain Dell	.77
Pineview	1.81
Alta	3.53

Table 14. Precipitation resulting from storm with a closed low a 700 mb.

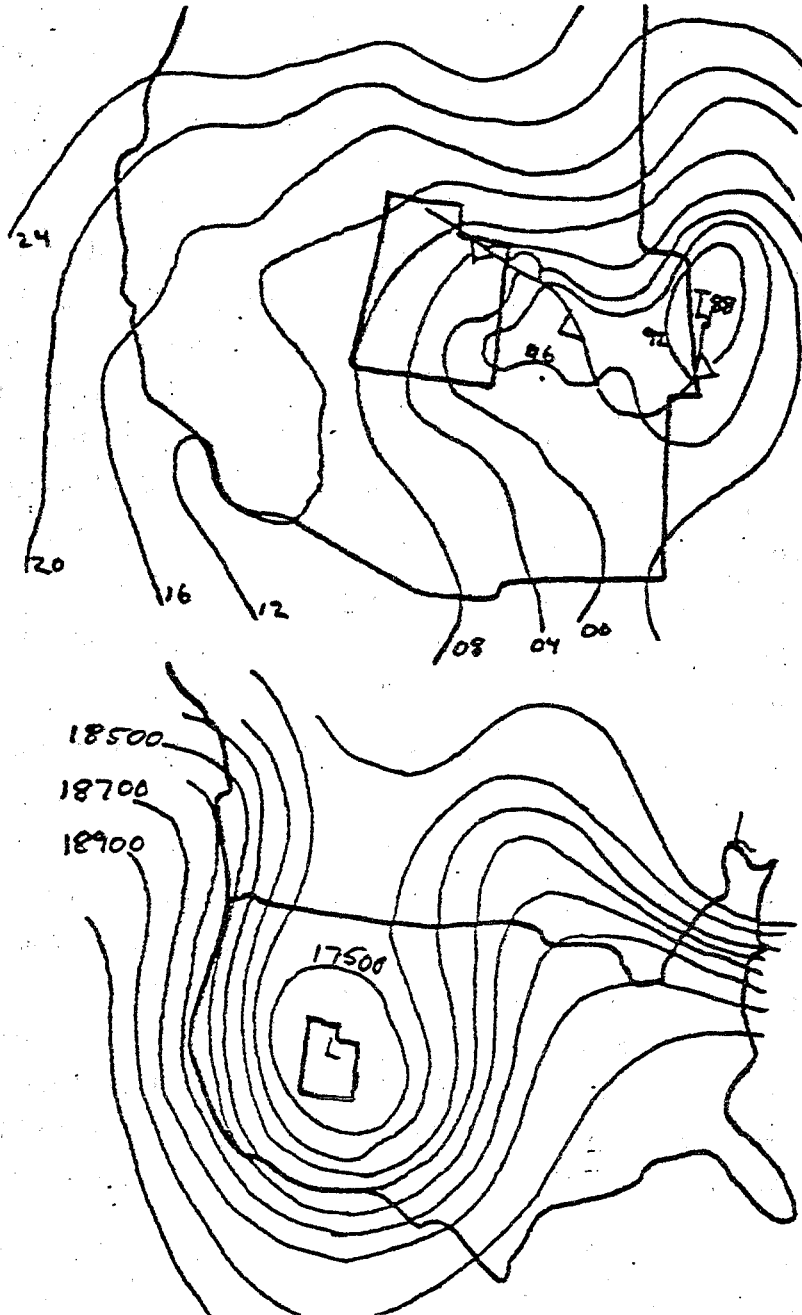

Figure 27. Surface and 500-mb Charts for closed low storm March 27, 1975.
Height (feet) Pressure (mb)

frontal storms were precipitation events in which no surface front was shown to pass through Salt Lake City on N.M.C. analyses. The average precipitation for each site was computed by summing the 24 hour precipitation for each day of a storm and dividing by the number of storms. The average precipitation in frontal and nonfrontal cases is given as well as the frontal to nonfrontal ratio in Table 15. All stations had higher average precipitation values in frontal cases with the valley sites showing the greatest difference between frontal and nonfrontal conditions. Cottonwood Wier was an anomaly in that the average precipitation did not go up significantly in frontal cases. The station to station ratios in frontal and nonfrontal conditions are given in Table 16. The ratios between two mountain sites and two valley sites are approximately equal under either condition. The ratio between Alta and Salt Lake City goes from 5.89 in frontal situations to 7.80 in nonfrontal cases. Thus, valley sites are more affected by the presence of a surface front than mountain locations. The presence of a front provides additional lifting that has the most pronounced result in the valley. The front may become quite disorganized as it passes through the Wasatch Mountain range which is a considerably higher and more extensive barrier than any upstream mountain range east of the Sierras and Cascades.

Two storms are given as examples of a frontal and nonfrontal event. The 500 mb and surface chart for 1200 GMT March 14, 1978 and observed precipitation from a frontal case on March 14 and 15, 1978, are presented in Table 17 and Figure 28. The same information is presented for a nonfrontal event on December 13, 1972 in Table 18 and Figure 29. The 500-mb charts both depict a west to northwest flow with shortwave troughs embedded in the flow. The surface maps differ in that the nonfrontal event has relatively high pressure over the region. Thus, the upper level trough in the 1972 case has no low level feature associated with it. The mountain to valley precipitation ratios are higher in this nonfrontal case than in the 1978 case which had an organized surface frontal structure.

Very definite differences in mountain to valley precipitation patterns exist depending on the type of synoptic conditions present. These ratios provide a means of estimating precipitation in remote areas based on observed precipitation at only a few sites. The difficulty arises in correctly classifying the type of regime present. Any scheme of weather modification based on site to site

AVERAGE PRECIPITATION IN FRONTAL AND NONFRONTAL CASES

<u>SITE</u>	<u>FRONTAL</u>	<u>NONFRONTAL</u>	<u>RATIO FNT/NONFNT</u>
Alta	2.24	.78	2.87
Brighton	1.17	.40	2.96
Alpine	.41	.13	3.17
Park City Summit	.71	.24	2.97
Cottonwood	.51	.19	2.72
Salt Lake City	.38	.10	3.73
Ogden	.50	.14	3.43
Mountain Dell	.56	.15	3.75
Pineview	.83	.32	2.64

Table 15. The average precipitation in inches for each site in frontal and nonfrontal storms is given. The ratio of frontal to nonfrontal precipitation is calculated.

PRECIPITATION RATIOS IN FRONTAL AND NONFRONTAL CASESNONFRONTAL

	<u>ALTA</u>	<u>BRIG</u>	<u>ALPI</u>	<u>PCS</u>	<u>COTW</u>	<u>SLC</u>	<u>OGDN</u>	<u>MTD</u>	<u>PINE</u>
Alta	--	1.95	6.00	3.25	4.10	7.80	5.57	5.20	2.44
Brighton	.51	--	3.08	1.67	2.10	4.00	2.86	2.67	1.25
Alpine	.17	.32	--	.54	.68	1.30	.93	.87	.41
Park City Summit	.31	.60	1.85	--	1.26	2.40	1.71	1.60	.75
Cottonwood	.24	.48	1.46	.79	--	1.90	1.36	1.27	.59
Salt Lake City	.13	.25	.77	.42	.53	--	.71	.67	.31
Ogden	.18	.35	1.07	.58	.74	1.40	--	.93	.44
Mountain Dell	.19	.38	1.15	.62	.79	1.50	1.07	--	.47
Pineview	.41	.80	2.46	1.33	1.68	3.20	2.29	2.13	--

FRONTAL

	<u>ALTA</u>	<u>BRIG</u>	<u>ALPI</u>	<u>PCS</u>	<u>COTW</u>	<u>SLC</u>	<u>OGDN</u>	<u>MTD</u>	<u>PINE</u>
Alta	--	1.91	5.46	3.15	4.39	5.89	4.98	4.00	2.70
Brighton	.52	--	2.85	1.65	2.29	3.07	2.34	2.09	1.41
Alpine	.18	.35	--	.58	.80	1.09	.82	.73	.49
Park City Summit	.32	.61	1.73	--	1.39	1.87	1.42	1.27	.86
Cottonwood	.23	.43	1.24	.72	--	1.34	.102	.91	.61
Salt Lake City	.17	.33	.93	.53	.74	--	.76	.68	.46
Ogden	.22	.43	1.22	.70	.98	1.32	--	.89	.60
Mountain Dell	.25	.47	1.37	.79	1.10	1.47	1.12	--	.67
Pineview	.37	.71	2.02	1.17	1.63	2.18	1.66	1.48	--

Table 16. Ratios of precipitation per event between sites in frontal and nonfrontal storms are given.

FRONTAL STORM -- MARCH 14, 15, 1978

<u>STATION</u>	<u>PRECIPITATION (inches)</u>
Brighton	.69
Alpine	.01
Park City Summit	.00
Cottonwood Wier	.49
Salt Lake City	.23
Ogden	.10
Mountain Dell	.26
Pineview	.33
Alta	1.29

Table 17. Precipitation resulting from a storm with a cold front.

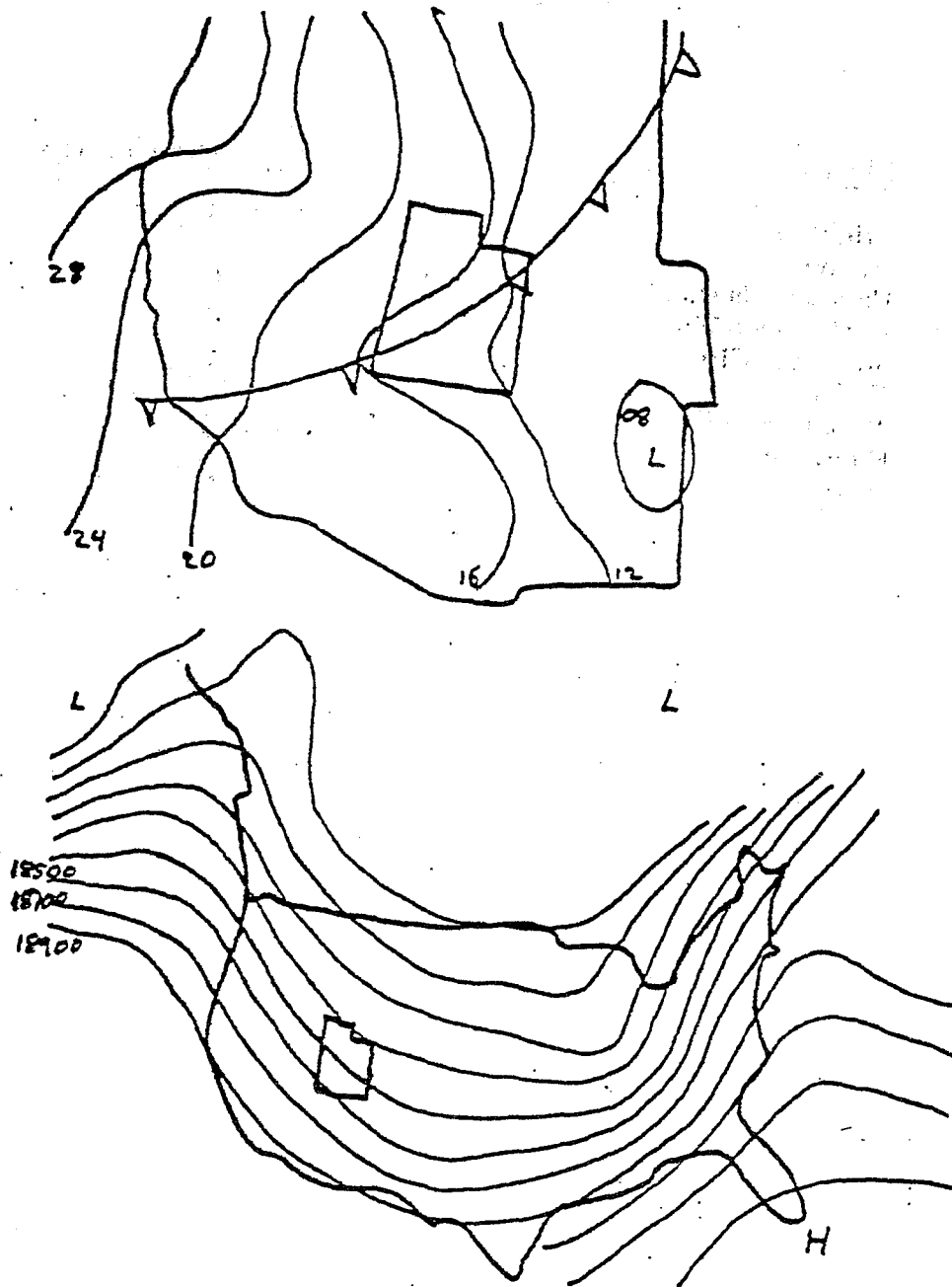

Figure 28. Surface and 500-mb charts for frontal storm March 14, 1978.
Height (feet) Pressure (mb)

NONFRONTAL STORM -- DECEMBER 13, 1972

<u>STATION</u>	<u>PRECIPITATION (inches)</u>
Brighton	.04
Alpine	.32
Park City Summit	.19
Cottonwood Wier	.00
Salt Lake City	.06
Ogden	.02
Mountain Dell	.00
Pineview	.15
Alta	.47

Table 18. Precipitation resulting from a storm with no cold front.

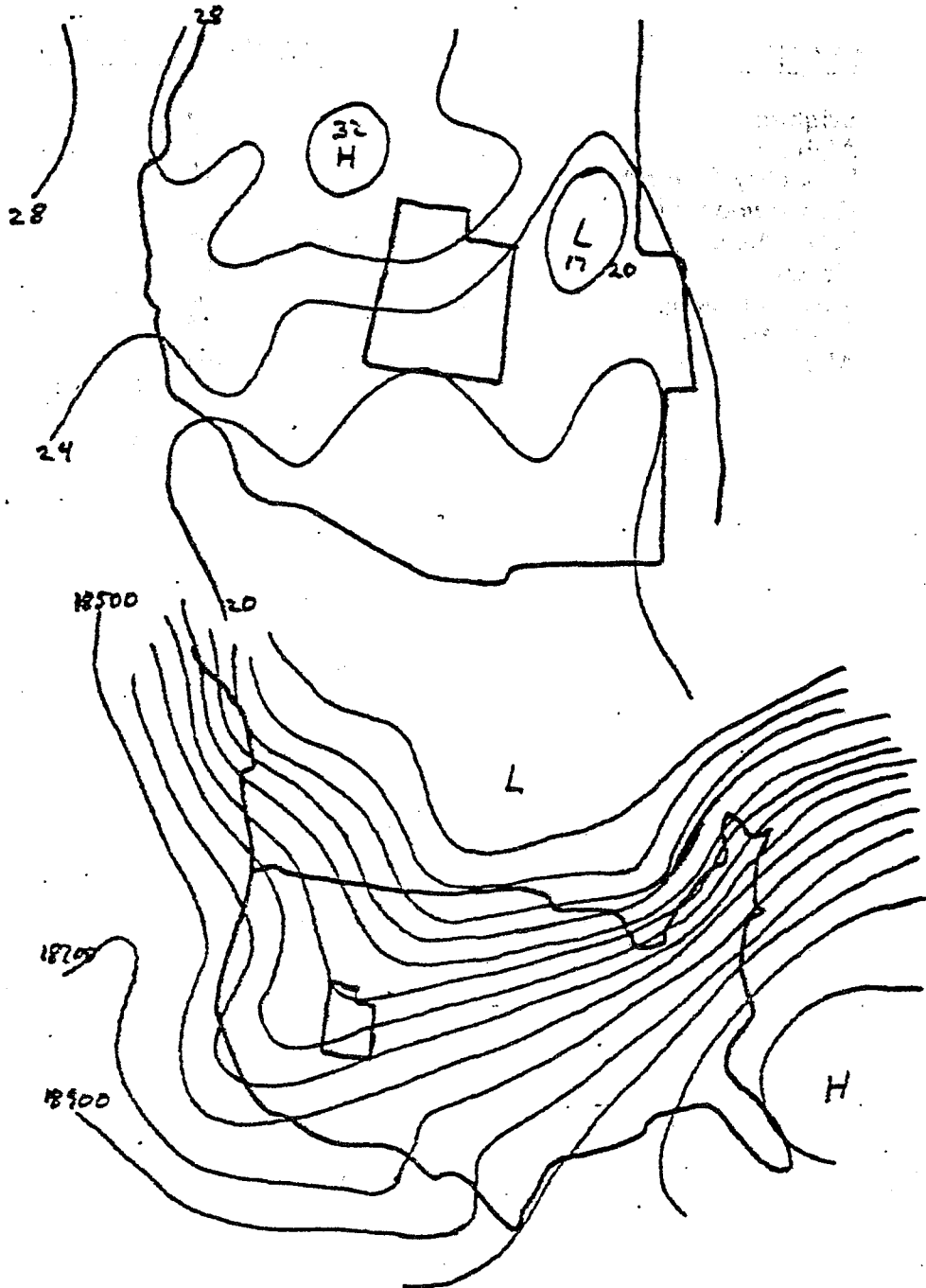

Figure 29. Surface and 500-mb charts for nonfrontal storm December 13, 1972.
Height (feet) Pressure (mb)

precipitation ratios must take into account the type of synoptic regime present if the results are to have any meaning at all.

VII. CONCLUSIONS

Winter precipitation in northern Utah occurs under rather variable synoptic conditions. The ability of the correlation analyses to explain only one-third of the variance in precipitation amounts is indicative of different types of storms producing the same results. Thus, atmospheric conditions that produce significant precipitation in northern Utah vary a great deal.

The ratio of mountain to valley precipitation is very much influenced by the synoptic pattern present. The ratio of mountain to valley precipitation is much less with a closed upper level low than with an open wave. This is due to the lack of flow to produce orographic lifting while the low is over northern Utah. These closed low storms are often preceded by strong moist southerly flow which produces extensive precipitation at all sites except Alta. The lifting associated with a well defined cold front has a greater impact on valley precipitation than in the mountains. Thus, systems without defined cold fronts result in high mountain to valley precipitation ratios.

Unstable northwesterly flow with the absence of a building surface high favors heavy precipitation at Alta as well as localized 'Lake Effect' convection.

Stations which are less than five miles apart exhibit very different responses to wind direction. This is particularly true of Alta precipitation which is very biased to northwest flow, whereas the other mountain sites exhibit maxima in southwesterly and northwesterly flow.

In the wind direction frequency diagrams Alta was alone in not exhibiting a maximum in southwesterly flow. Alta's precipitation data also stood out in that it was significantly higher than either Silver Lake Brighton or Park City Summit which are both at similar elevations and located within a few miles of Alta. Alta's anomalous precipitation seems to be due to the shape of the nearby terrain. In comparing the terrain near Brighton and Alta there are two big differences. In northwesterly flow the high mountains between Big and Little Cottonwood Canyons act as a barrier which the flow likely goes around rather than over. Also, the formation at the southeast end of the Salt Lake Valley sticks out against a northwest flow (Figure 30). These two large and very high (over 11,000 feet) barriers may serve to channel northwesterly flow into the canyon towards Alta.

Thus, a zone of low level convergence is likely to result in northwesterly flow. The Alta Canyon is a much shorter and more open canyon to low level flow than Big Cottonwood Canyon. Thus, while Brighton and Alta are very closely located the terrain configuration favors low level convergence for Alta in unstable northwesterly flow. Brighton precipitation more likely results from pure orographic lifting, thus the dual maxima in northwesterly and southwesterly flow. Alta and Brighton get similar precipitation in southwesterly flow, since the terrain is not favorable for low level channeling in this regime.

The presence of strong low level convergence in northwesterly flow has dramatic consequences in Alta Canyon. The postfrontal northwesterly flow that creates this convergence is typically very stable at low levels, but quite unstable aloft. Thus, lifting of the lower air can bring on deep convection under these conditions. The general orographic lift provided by the Wasatch is not always sufficient to start this convection. In combination with strong low level convergence, the orographic lift produces enough lift to bring postfrontal convection to Alta more often and more intensely than other nearby mountain sites. Thus, the much higher precipitation observed at Alta is due to its favorable position in postfrontal northwesterly flow conditions.

A detailed study of the local wind field near and in the canyons during precipitation would be necessary to verify these conclusions. To define the convergence field would require accurate wind observations along the sides and center of Big and Little Cottonwood Canyons. Additional wind observations would be needed in the southeastern portion of the Salt Lake Valley and especially along the east bench area between the canyons. Hourly precipitation intensity observations are already being taken at Alta and Snowbird ski areas. Similar observations in Big Cottonwood Canyon would help verify not only the different convergence fields, but also the different character of precipitation in each canyon as the 700-mb trough axis passes.

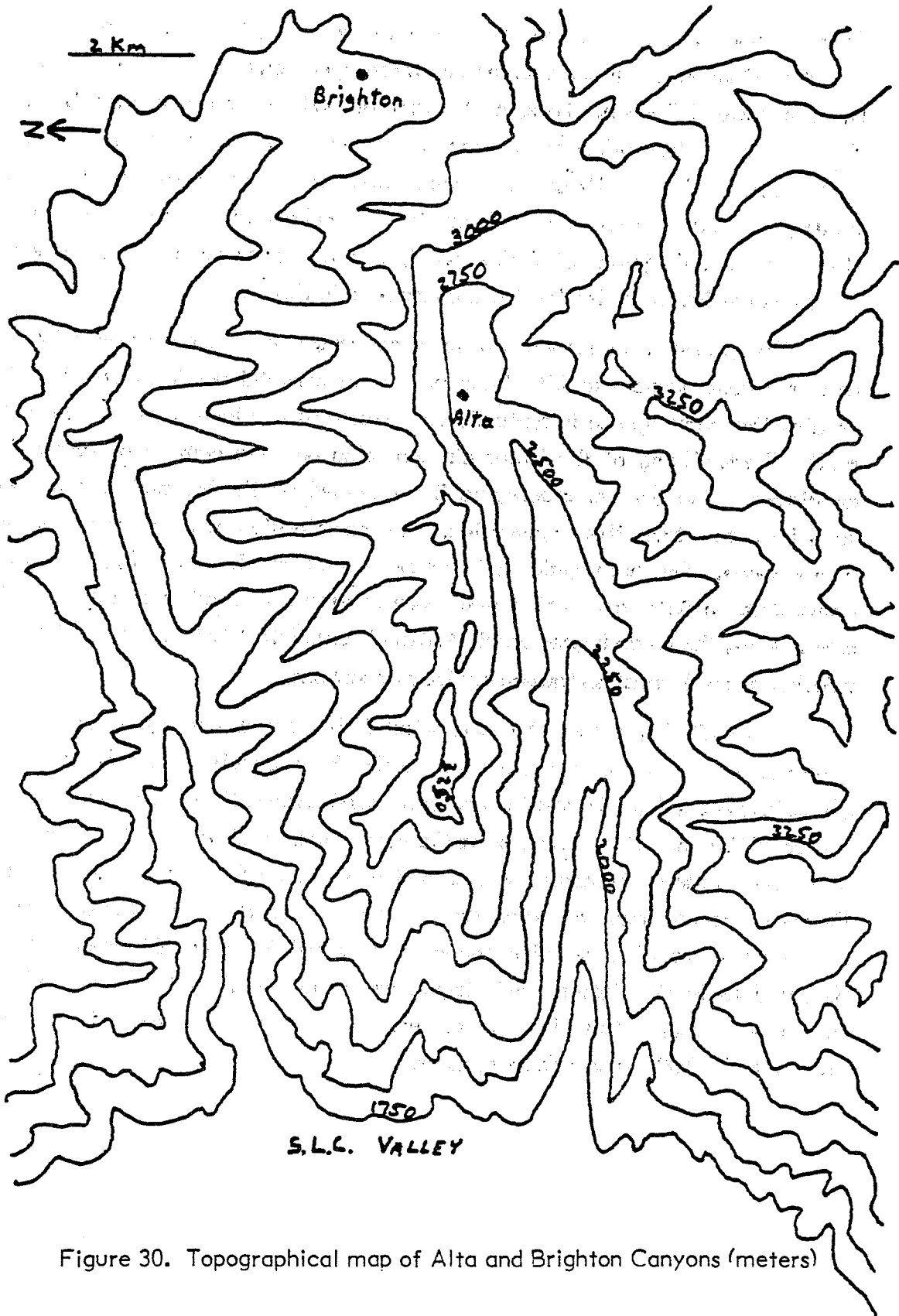

Figure 30. Topographical map of Alta and Brighton Canyons (meters)

Valley locations also show a bias to certain flow directions. This is due to the position of the Great Salt Lake to Ogden and Salt Lake City and the position relative to the mountains of Cottonwood Wier, Alpine, and Ogden. The effects of the Great Salt Lake on precipitation seem to be very localized and relatively rare. The data in this study support the idea of a 'Lake Effect,' but are not conclusive.

Precipitation in northern Utah may be summarized as follows. The stabilization of the low levels brings about the end of valley precipitation. Thus, the lack of rapidly rising surface pressures indicates the potential for heavy valley precipitation. This condition occurs with a slow moving, closed, upper low or with a strong flow with closely spaced embedded 500-mb short waves. Southerly pre-frontal flow will bring heavy precipitation only if there is abundant moisture which is observable in precipitable water values. This is not the case for postfrontal northwest flow which depends mostly on the atmospheric stability as to whether or not heavy precipitation will result. The passage of the 700-mb trough axis marks the onset of the heavy precipitation at Alta. The passage of the 500-mb trough axis marks the end of valley precipitation.

The ability to extrapolate precipitation amounts from a few sites to remote areas is very valuable in both avalanche hazard forecasting and weather modification verification. The results of this paper point out the need to define the type of atmospheric conditions present before a legitimate attempt to predict quantitative precipitation at remote sites can be made.

VIII. REFERENCES

- [1] Daly, K. W., Winter Precipitation Forecasting for Sunshine Village, Banff National Park, Alberta Weather Office, 1976.
- [2] Daniel, Wayne W., Introductory Statistics With Applications, pp. 319-321, 1977.
- [3] Elliot, Robert D. and Schaffer, Russell W., "The Development of Quantitative Relationships between Orographic Precipitation and Air-mass Parameters for Use in Forecasting and Cloud Seeding Evaluation," Journal of Applied Meteorology, 1, pp. 218-228, 1962.
- [4] Jorgensen, Donald L.; Klein, William H.; Forte, August F., "A Synoptic Climatology of Winter Precipitation from 700-mb Lows for Intermountain Areas of the West," Weather Bureau Technical Notes, Technical Note 45-TDL-4, 1966.
- [5] Nielson, Barry C., "A Technique for Forecasting the Rate of Snowfall at Alta, Utah, 1965.
- [6] Rhea, J. Owen and Grant, Lewis O., "Topographic Influences on Snowfall Patterns in Mountainous Terrain," Inter-Disciplinary Symposium on Advanced Concepts and Techniques in the Study of Snow and Ice Resources, Monterey, California, 1973.
- [7] Rhea, J. Owen, "Winter Quantitative Mountain Precipitation Forecasting Using an Orographic Precipitation Model as an Objective Aid," American Meteorological Society Meeting, Tuscon, Arizona, 1976.
- [8] Williams, Phillip Jr. and Peck, Eugene L., "Terrain Influences on Precipitation in the Intermountain West as Related to Synoptic Situations," Journal of Applied Meteorology, 1, pp. 343-352, 1962.

- 121 Climatological Prediction of Cumulonimbus Clouds in the Vicinity of the Yucca Flat Weather Station. R. F. Quiring, June 1977. (PB-271-704/AS)
- 122 A Method for Transforming Temperature Distribution to Normality. Morris S. Webb, Jr., June 1977. (PB-271-742/AS)
- 124 Statistical Guidance for Prediction of Eastern North Pacific Tropical Cyclone Motion - Part I. Charles J. Neumann and Preston W. Leftwich, August 1977. (PB-272-661)
- 125 Statistical Guidance on the Prediction of Eastern North Pacific Tropical Cyclone Motion - Part II. Preston W. Leftwich and Charles J. Neumann, August 1977. (PB-273-155/AS)
- 127 Development of a Probability Equation for Winter-Type Precipitation Patterns in Great Falls, Montana. Kenneth B. Mielke, February 1978. (PB-281-387/AS)
- 128 Hand Calculator Program to Compute Parcel Thermal Dynamics. Dan Gudge, April 1978. (PB-283-080/AS)
- 129 Fire Whirls. David W. Goens, May 1978. (PB-283-866/AS)
- 130 Flash-Flood Procedure. Ralph C. Hatch and Gerald Williams, May 1978. (PB-286-014/AS)
- 131 Automated Fire-Weather Forecasts. Mark A. Mollner and David E. Olsen, September 1978. (PB-289-916/AS)
- 132 Estimates of the Effects of Terrain Blocking on the Los Angeles WSR-74C Weather Radar. R. G. Pappas, R. Y. Lee, B. W. Finke, October 1978. (PB289767/AS)
- 133 Spectral Techniques in Ocean Wave Forecasting. John A. Jannuzzi, October 1978. (PB291317/AS)
- 134 Solar Radiation. John A. Jannuzzi, November 1978. (PB291195/AS)
- 135 Application of a Spectrum Analyzer in Forecasting Ocean Swell in Southern California Coastal Waters. Lawrence P. Kierulff, January 1979. (PB292716/AS)
- 136 Basic Hydrologic Principles. Thomas L. Dietrich, January 1979. (PB292247/AS)
- 137 LFM 24-Hour Prediction of Eastern Pacific Cyclones Refined by Satellite Images. John R. Zimmerman and Charles P. Ruscha, Jr., Jan. 1979. (PB294324/AS)
- 138 A Simple Analysis/Diagnosis System for Real Time Evaluation of Vertical Motion. Scott Heflick and James R. Fors, February 1979. (PB294216/AS)
- 139 Aids for Forecasting Minimum Temperature in the Wenatchee Frost District. Robert S. Robinson, April 1979. (PB298339/AS)
- 140 Influence of Cloudiness on Summertime Temperatures in the Eastern Washington Fire Weather District. James Holcomb, April 1979. (PB298674/AS)
- 141 Comparison of LFM and MFM Precipitation Guidance for Nevada During Doreen. Christopher Hill, April 1979. (PB298613/AS)
- 142 The Usefulness of Data from Mountaintop Fire Lookout Stations in Determining Atmospheric Stability. Jonathan W. Corey, April 1979. (PB298899/AS)
- 143 The Depth of the Marine Layer at San Diego as Related to Subsequent Cool Season Precipitation Episodes in Arizona. Ira S. Brenner, May 1979. (PB298817/AS)
- 144 Arizona Cool Season Climatological Surface Wind and Pressure Gradient Study. Ira S. Brenner, May 1979. (PB298900/AS)
- 145 On the Use of Solar Radiation and Temperature Models to Estimate the Snap Bean Maturity Date in the Willamette Valley. Earl M. Bates, August 1979. (PB80-160971)
- 146 The BART Experiment. Morris S. Webb, October 1979. (PB80-155112)
- 147 Occurrence and Distribution of Flash Floods in the Western Region. Thomas L. Dietrich, December 1979. (PB80-160344)
- 149 Misinterpretations of Precipitation Probability Forecasts. Allan H. Murphy, Sarah Lichtenstein, Baruch Fischhoff, and Robert L. Winkler, February 1980. (PB80-174576)
- 150 Annual Data and Verification Tabulation - Eastern and Central North Pacific Tropical Storms and Hurricanes 1979. Emil B. Gunther and Staff, EPHC, April 1980. (PB80-220486)
- 151 NMC Model Performance in the Northeast Pacific. James E. Overland, PMEL-ERL, April 1980. (PB80-196033)
- 152 Climate of Salt Lake City, Utah. Wilbur E. Figgins, June 1980. (PB80-225493) (Out of print.)
- 153 An Automatic Lightning Detection System in Northern California. James E. Rea and Chris E. Fontana, June 1980. (PB80-225592)
- 154 Regression Equation for the Peak Wind Gust 6 to 12 Hours in Advance at Great Falls During Strong Downslope Wind Storms. Michael J. Oard, July 1980. (PB81-108367)
- 155 A Raininess Index for the Arizona Monsoon. John H. TenHarkel, July 1980. (PB81-106494)
- 156 The Effects of Terrain Distribution on Summer Thunderstorm Activity at Reno, Nevada. Christopher Dean Hill, July 1980. (PB81-102501)
- 157 An Operational Evaluation of the Scofield/Oliver Technique for Estimating Precipitation Rates from Satellite Imagery. Richard Ochoa, August 1980. (PB81-108227)
- 158 Hydrology Practicum. Thomas Dietrich, September 1980. (PB81-134033)
- 159 Tropical Cyclone Effects on California. Arnold Court, October 1980. (PB81-133779)
- 160 Eastern North Pacific Tropical Cyclone Occurrences During Intraseasonal Periods. Preston W. Leftwich and Gail M. Brown, February 1981. (PB81-205494)
- 161 Solar Radiation as a Sole Source of Energy for Photovoltaics in Las Vegas, Nevada, for July and December. Darryl Randerson, April 1981. (PB81-224503)
- 162 A Systems Approach to Real-Time Runoff Analysis with a Deterministic Rainfall-Runoff Model. Robert J. C. Burnash and R. Larry Ferral, April 1981. (PB81-224495)
- 163 A Comparison of Two Methods for Forecasting Thunderstorms at Luke Air Force Base, Arizona. Lt. Colonel Keith R. Cooley, April 1981. (PB81-225393)
- 164 An Objective Aid for Forecasting Afternoon Relative Humidity Along the Washington Cascade East Slopes. Robert S. Robinson, April 1981. (PB81-23078)
- 165 Annual Data and Verification Tabulation, Eastern North Pacific Tropical Storms and Hurricanes 1980. Emil B. Gunther and Staff, May 1981. (PB82-230336)
- 166 Preliminary Estimates of Wind Power Potential at the Nevada Test Site. Howard G. Booth, June 1981. (PB82-127036)
- 167 ARAP User's Guide. Mark Mathewson, July 1981. (revised September 1981). (PB82-196783)
- 168 Forecasting the Onset of Coastal Gales Off Washington-Oregon. John R. Zimmerman and William D. Burton, August 1981. (PB82-127051)
- 169 A Statistical-Dynamical Model for Prediction of Tropical Cyclone Motion in the Eastern North Pacific Ocean. Preston W. Leftwich, Jr., October 1981.
- 170 An Enhanced Plotter for Surface Airways Observations. Andrew J. Spry and Jeffrey L. Anderson, October 1981. (PB82-153883)
- 171 Verification of 72-Hour 500-mb Map-Type Predictions. R. F. Quiring, November 1981. (PB82-158098)
- 172 Forecasting Heavy Snow at Wenatchee, Washington. James W. Holcomb, December 1981. (PB82-177783)
- 173 Central San Joaquin Valley Type Maps. Thomas R. Crossan, December 1981. (PB82-196064)
- 174 ARAP Test Results. Mark A. Mathewson, December 1981. (PB82-193103)
- 175 Annual Data and Verification Tabulation Eastern North Pacific Tropical Storms and Hurricanes 1981. Emil B. Gunther and Staff, June 1982. (PB82-252420)
- 176 Approximations to the Peak Surface Wind Gusts from Desert Thunderstorms. Darryl Randerson, June 1982. (PB82-253089)
- 177 Climate of Phoenix, Arizona. Robert J. Schmidl, April 1969 (revised March 1983).
- 178 Annual Data and Verification Tabulation, Eastern North Pacific Tropical Storms and Hurricanes 1982. E. B. Gunther, June 1983.
- 179 Stratified Maximum Temperature Relationships Between Sixteen Zone Stations in Arizona and Respective Key Stations. Ira S. Brenner, June 1983.
- 180 Standard Hydrologic Exchange Format (SHEF) Version I. Phillip A. Pasteris, Vernon C. Bissel, David G. Bennett, August, 1983.

NOAA SCIENTIFIC AND TECHNICAL PUBLICATIONS

The National Oceanic and Atmospheric Administration was established as part of the Department of Commerce on October 3, 1970. The mission responsibilities of NOAA are to assess the socioeconomic impact of natural and technological changes in the environment and to monitor and predict the state of the solid Earth, the oceans and their living resources, the atmosphere, and the space environment of the Earth.

The major components of NOAA regularly produce various types of scientific and technical information in the following kinds of publications:

PROFESSIONAL PAPERS — Important definitive research results, major techniques, and special investigations.

CONTRACT AND GRANT REPORTS — Reports prepared by contractors or grantees under NOAA sponsorship.

ATLAS — Presentation of analyzed data generally in the form of maps showing distribution of rainfall, chemical and physical conditions of oceans and atmosphere, distribution of fishes and marine mammals, ionospheric conditions, etc.

TECHNICAL SERVICE PUBLICATIONS — Reports containing data, observations, instructions, etc. A partial listing includes data serials; prediction and outlook periodicals; technical manuals, training papers, planning reports, and information serials; and miscellaneous technical publications.

TECHNICAL REPORTS — Journal quality with extensive details, mathematical developments, or data listings.

TECHNICAL MEMORANDUMS — Reports of preliminary, partial, or negative research or technology results, interim instructions, and the like.



Information on availability of NOAA publications can be obtained from:

**ENVIRONMENTAL SCIENCE INFORMATION CENTER (D822)
ENVIRONMENTAL DATA AND INFORMATION SERVICE
NATIONAL OCEANIC AND ATMOSPHERIC ADMINISTRATION
U.S. DEPARTMENT OF COMMERCE**

**6009 Executive Boulevard
Rockville, MD 20852**