



Seized At Sea: *Iranian Weapons Smuggled to the Houthis*



Seized At Sea: Iranian Weapons Smuggled to the Houthis

This product provides a visual comparison of Iranian weapons and weapon components interdicted in transit to the Houthis in Yemen on 11 and 28 January 2024. Photographs of missiles displayed by the Iranians—as well as debris acquired from previous Houthi attacks, compared with those of the interdicted materiel—strongly indicate their Iranian origin. Between 2015 and 2024, the United States and its partners have interdicted at least 20 Iranian smuggling vessels, seizing ballistic, cruise, and surface-to-air missile (SAM) components, antitank guided missiles (ATGMs), unmanned aerial vehicles (UAVs), and thousands of assault rifles, rocket components, and other illicit weapons destined for the Houthis. The Houthis probably have used Iran-supplied weapons to conduct more than 100 attacks against land-based targets in Israel, Saudi Arabia, the United Arab Emirates, and Yemen and dozens of attacks targeting ships in the Red Sea and Gulf of Aden.^{1,2}



For more information about the Defense Intelligence Agency and to view this report, visit DIA's website at www.dia.mil

For media and public inquiries about this report, contact DIA Public Affairs at DIA-PAO@dodis.mil

Information cutoff date: 30 April, 2024

Cover images: USCENTCOM Intercepts Iranian Weapons Shipment Intended for Houthis

Image sources: USCENTCOM, Youtube, Tasnim News, Fars News, US Institute for Peace, The Drive

DIA_F_255LQ_A

This report contains copyrighted material. Copying and disseminating the contents are prohibited without the permission of the copyright owners. Images and other previously published material featured or referenced in this publication are attributed to their source.



Iranian Smuggling Enables Houthi Attack Campaign

Since 2015, Iran's Islamic Revolutionary Guard Corps-Qods Force (IRGC-QF) has been smuggling weapons and weapon components to the Houthis, which has enabled the advancement of the Houthis' military capabilities. As of 30 April 2024, the Houthis have used Iran-supplied ballistic and cruise missiles to conduct at least 100 attacks against land-based targets in Israel, Saudi Arabia, the United Arab Emirates, and Yemen and at least 56 attacks targeting ships in the Red Sea and Gulf of Aden. Between 2015 and 2024, the United States and its partners have interdicted at least 20 Iranian smuggling vessels, seizing ballistic, cruise, SAM missile components, ATGMs, UAVs, and thousands of assault rifles, rocket components, and other illicit weapons destined for the Houthis. This graphic is focused on Iran's provision of missiles and missile components to the Houthis because they represent the most technically sophisticated weapons Iran is providing the Houthis.^{3 4 5 6 7 8 9 10 11 12 13 14 15 16 17 18}

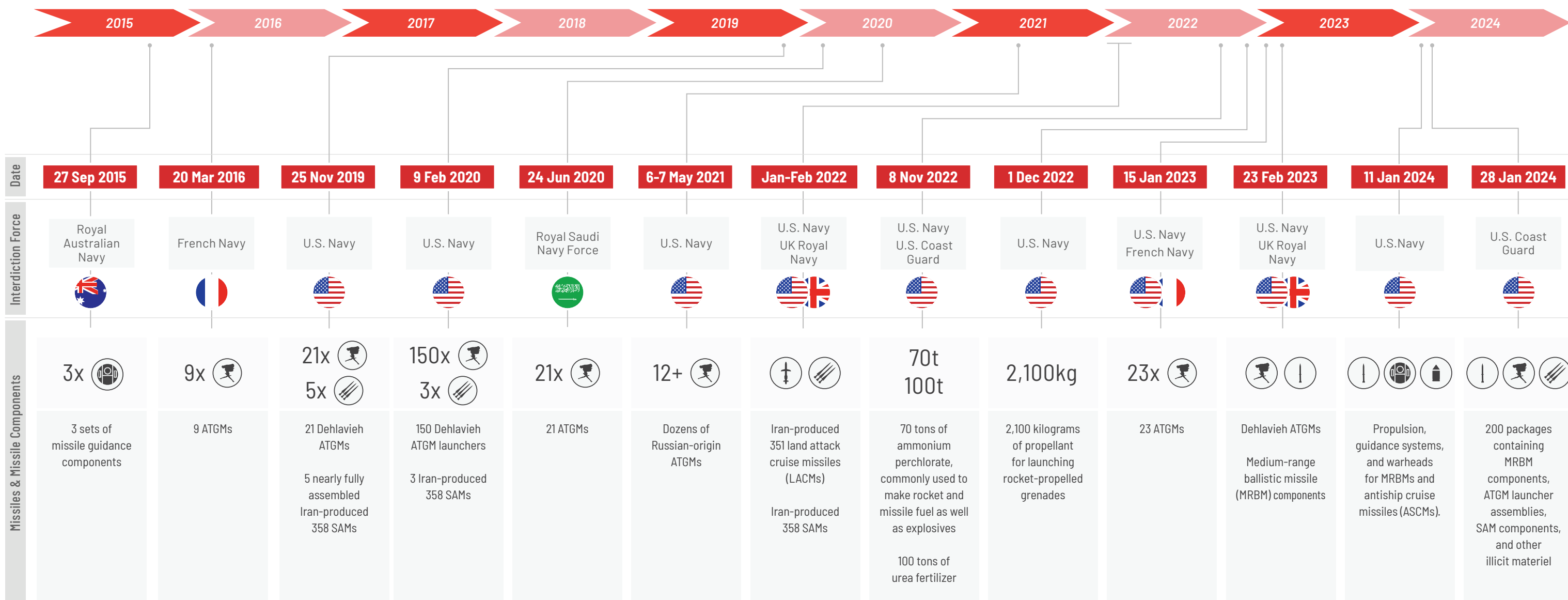

Legend: ATGM, Guidance System, LACM, MRBM, SAM, Warhead



11 and 28 January Interdictions of Iranian Weapons

In January, U.S. forces conducted two operations to impede Iranian smuggling of lethal aid from Iran to the Houthis. On 11 January, the U.S. Navy conducted a nighttime raid of an Iranian dhow traveling near the coast of Somalia, resulting in the seizure of various components for ballistic and cruise missiles. On 28 January, a forward-deployed U.S. Coast Guard vessel interdicted a dhow operating in the Arabian Sea, again seizing components for Iranian-origin ballistic and antitank guided missiles.^{19 20}

11 January Interdiction

Components seized during the 11 January interdiction are used in the Houthis' ballistic and cruise missile systems and air defense systems, shown below
Photos: USCENTCOM

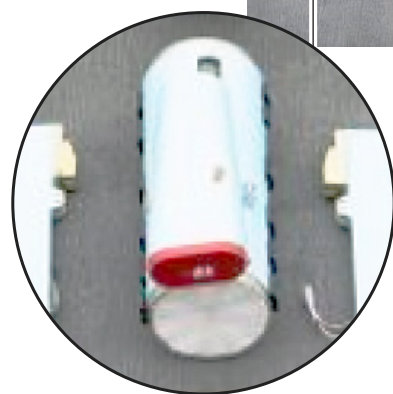
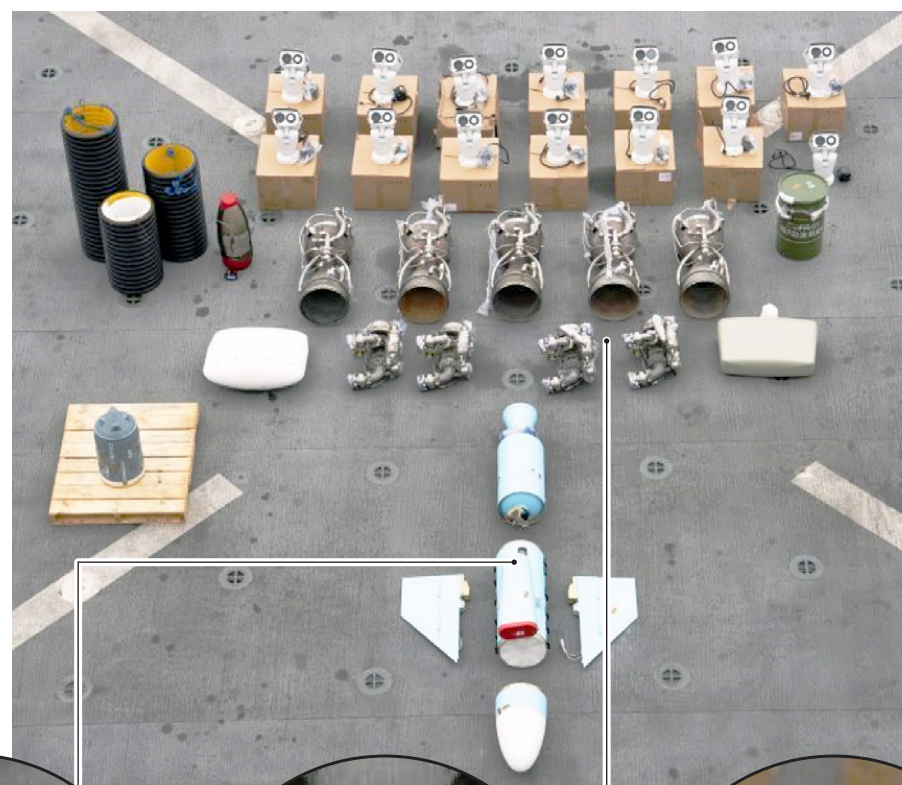

Antiship Cruise Missile Air-Intake

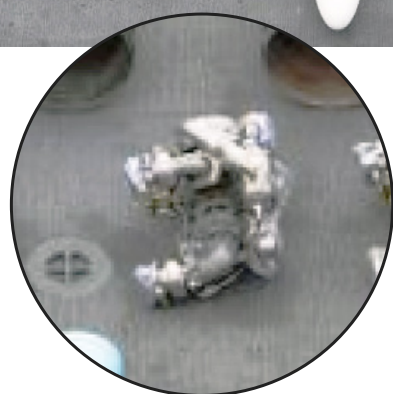

Ballistic Missile Engines



28 January Interdiction

Components seized during the 28 January interdiction are used in the Houthis' ballistic missiles, antitank guided missiles, and other weapons systems
Photos: USCENTCOM



Antitank Guided Missile System



Air Defense Navigation Systems



Iran and Houthi Antiship Cruise Missile Comparison

The interdicted materiel shares key identifiable features with Iranian antiship cruise missiles, including the **stabilizer fin (1)**, **rocket booster (2)**, **air-intake cabin (3)**, and **nose cone (4)**.

The Iranian Tolu-4 turbojet engine, used in the Noor ASCM, has unique features—including the **compressor stage (5)** and **stator (6)**—that are consistent with engine debris recovered from the 11 December 2023 Houthi attack on the M/T Strinda.^{21 22 23 24}

IRANIAN SYSTEM

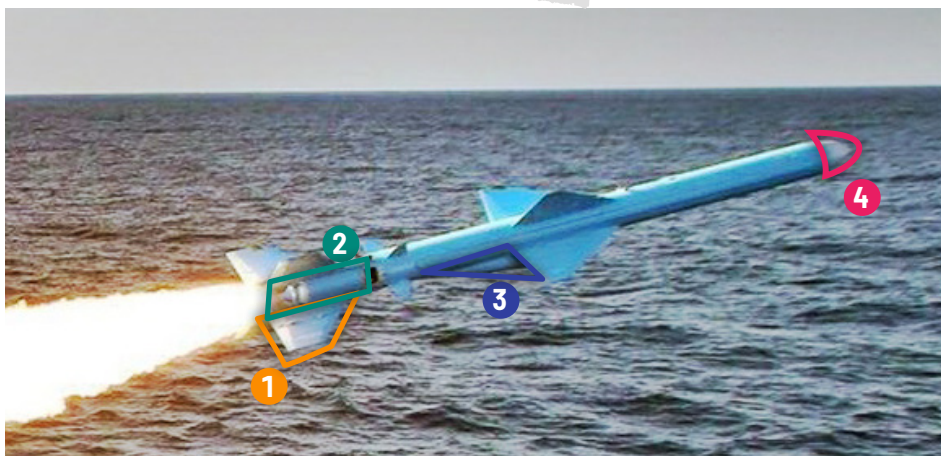

Iran has developed the Noor family of antiship cruise missiles

Photos: Tasnim News



The Noor family of missiles uses the Tolu-4 engine, which Iran displayed at the International Air and Space Show in Russia in 2017

Photos: Fars News

INTERDICTED SYSTEM

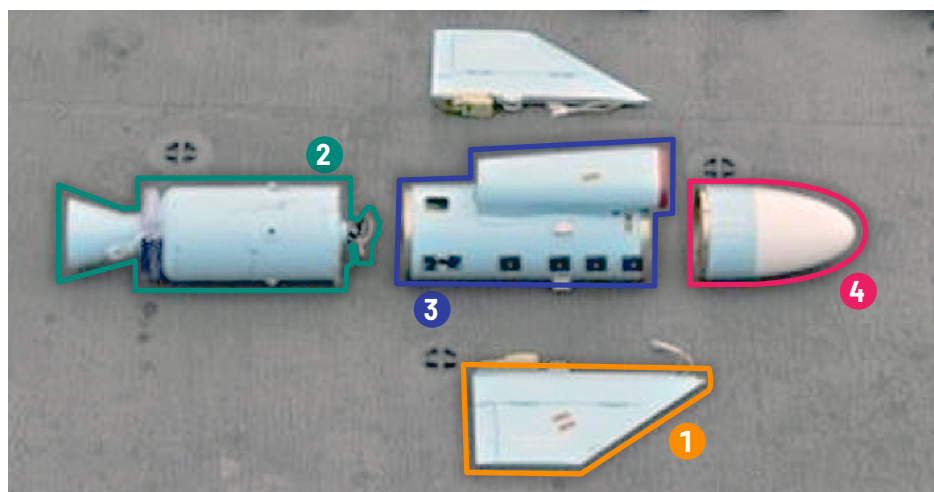

Cruise missile parts interdicted on 11 January en route from Iran to the Houthis match those of the Noor family of missiles

Photos: USCENTCOM

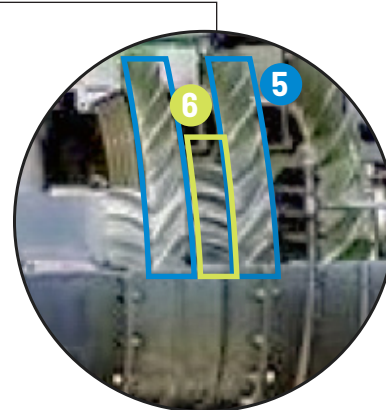

HOUTHILAUNCHED SYSTEM

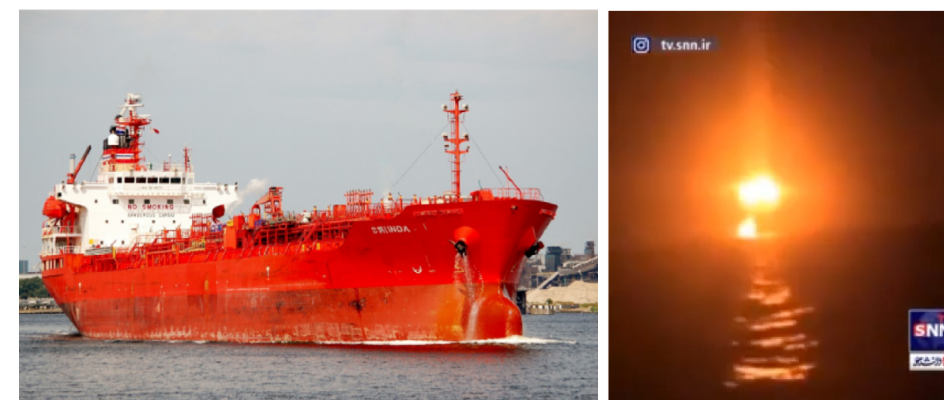

On 11 December 2023 the Norwegian-flagged M/T Strinda (left) was attacked by a Houthi cruise missile (right)

Photos: Youtube



The turbojet engine debris recovered from the M/V Strinda are consistent with the Iranian Tolu-4 from the Noor ASCM

Photos: USCENTCOM



Qiam/Burkan Ballistic Missile Comparison

Since 2017, the Houthis have used Burkan missiles, the Houthi name for the Iranian Qiam. The Houthis have launched the Burkan-3 missile against several countries in the region. Burkan debris recovered following a 2017 Houthi strike in Saudi Arabia features **markings (1)** and **fuel ports (2)** that are consistent with an Iranian Qiam variant. ²⁵

IRANIAN SYSTEM

HOUTHIS SYSTEM

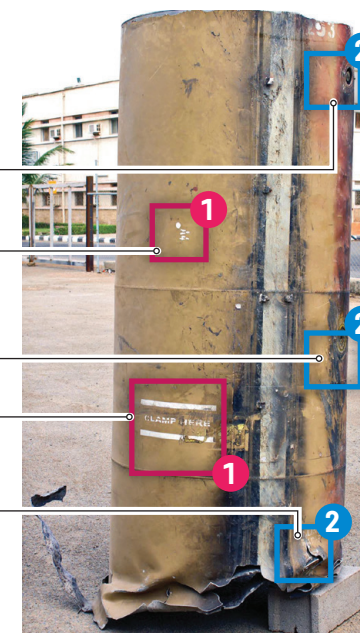
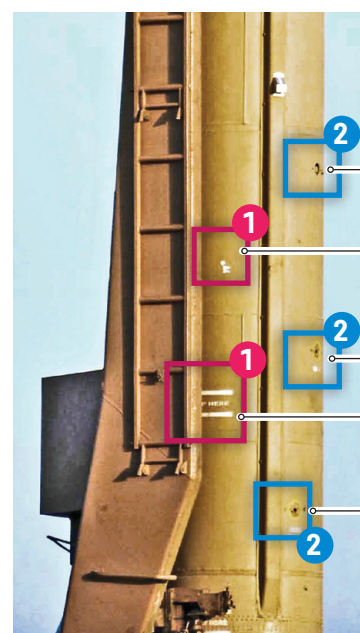

Fuel Port

Markings

Fuel Port

Markings

Fuel Port

An Iranian Qiam variant ballistic missile displayed in Iran, May 2011
Photos: Fars News

Comparison of markings and fuel ports on Houthi Burkan debris recovered in Saudi Arabia (right) and Iranian Qiam ballistic missile (left)
Photos: U.S. Government



Qiam/Burkan-Ballistic Missile Engine Comparision

Iranian Qiam engines seized from an Iranian smuggler on 11 January near the coast of Somalia are consistent with Houthi Burkan-2H engines recovered from a 2017 Houthi attack in Saudi Arabia. The **combustion chamber (1)**, **nozzle (2)**, and **turbopumps (3)** of the engines interdicted in January 2024 match the physical characteristics shown with the engine recovered in Saudi Arabia. ^{26 27}

IRANIAN SYSTEM

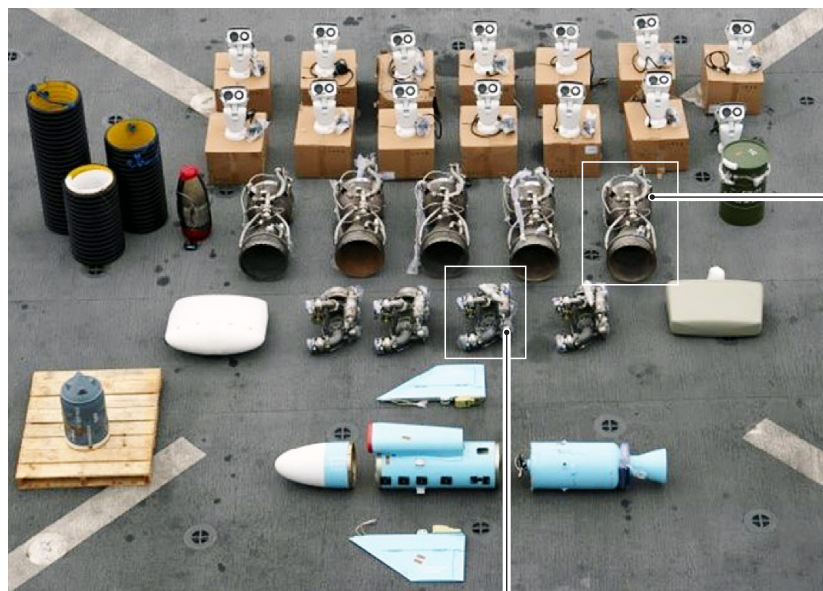

Qiam engine from 11 January 2024 interdiction
Photos: USCENTCOM & U.S. Government

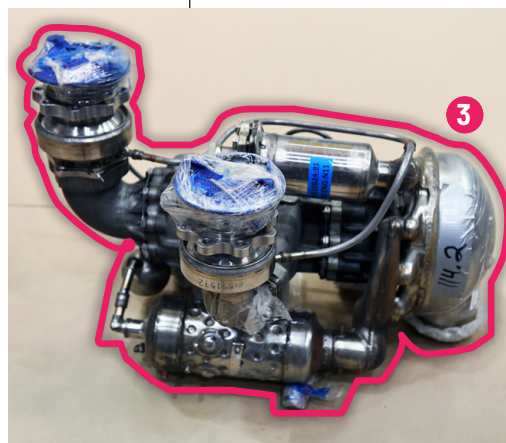

HOUTHIS SYSTEM

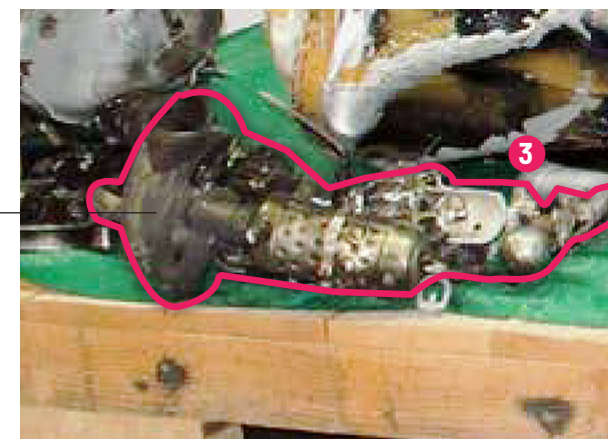

Burkan/Qiam engine debris recovered after a 4 November 2017 Houthi attack against King Khalid International Airport in Saudi Arabia
Photos: DVIDS



358 (Saqr) Surface-to-Air Missile Comparison

The Houthis' Saqr surface-to-air missile (SAM) exhibits nearly identical features to a missile interdicted on a dhow headed to Yemen in 2020 as the Iranian 358 SAM displayed for Russian officials in Tehran in September 2023. The Saqr and 358 both have distinctive features, which include **front-mounted fins (1)** and **rear-mounted fins (2)** in an X-shaped orientation and the **engine (3)**.

The Houthis have used the Saqr to attack U.S. UAVs in Yemen. In addition to the Houthis, Iran proliferated the 358 to partners and proxies in Iraq and Lebanon.²⁸

IRANIAN SYSTEM

INTERDICTED SYSTEM

HOUTHIS SYSTEM



An Iranian 358 missile interdicted from a dhow headed to Yemen, 2020
Photos: U.S. Institute of Peace

The Houthis display the Saqr during a military parade in Sanaa, September 2023
Photo: YouTube

An Iranian display of the 358 SAM to Russian officials in Tehran, September 2023
Photo: Reuters

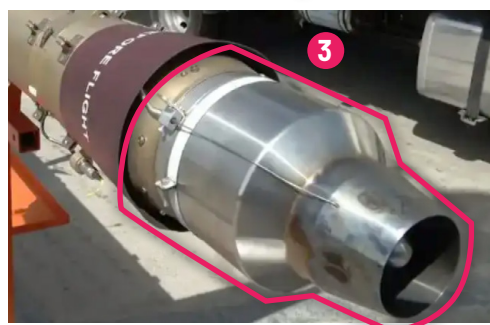

An Iranian display of a 358 SAM in Tehran, September 2023
Photo: The Drive

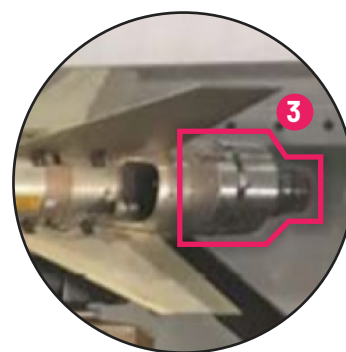

The engine of the 358 SAM interdicted en route to Yemen
Photos: U.S. Institute of Peace



Interdicted Components of the Iranian 358 Surface-to-Air Missile

A large number of inertial navigation systems and air data computers interdicted on January 2024 have the **label 358 (1)**, which is associated with the Iranian 358 surface-to-air defense missile system.²⁹

INTERDICTED SYSTEM



An Iranian missile interdicted from a dhow headed to Yemen, 2020
Photos: U.S. Institute of Peace



Inertial navigation systems with Iranian labels interdicted on 28 January 2024
Photos: USCENTCOM

Air data computers with Iranian labels interdicted on 28 January 2024
Photos: U.S. Government

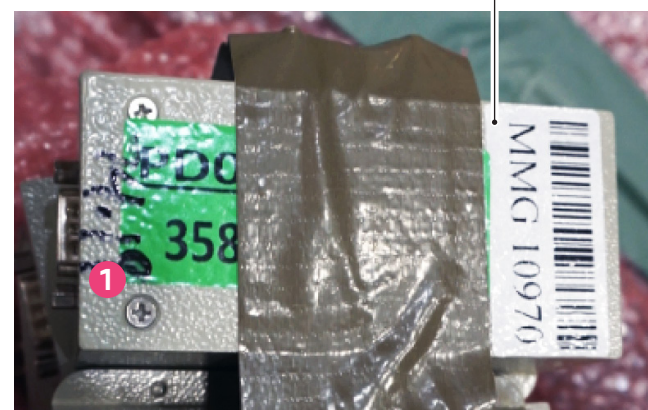



Dehlavieh Antitank Guided Missile Comparison

The Dehlavieh-2 is an Iranian-developed copy of the Russian Kornet-EM antitank guided missile (ATGM). The system has an extended range of 8 kilometers and an improved warhead capability. The interdiction on 28 January captured, for the first time, the Dehlavieh and Dehlavieh-2 launchers. The characteristics of these captured launchers—including the **missile rail (1)**, **sight head (2)**, **traversing unit (3)**, **joining fixture (4)**, and **tripod legs (5)**—are consistent with the Dehlavieh ATGM system displayed in Iran.

IRANIAN SYSTEM

HOUTHIS SYSTEM

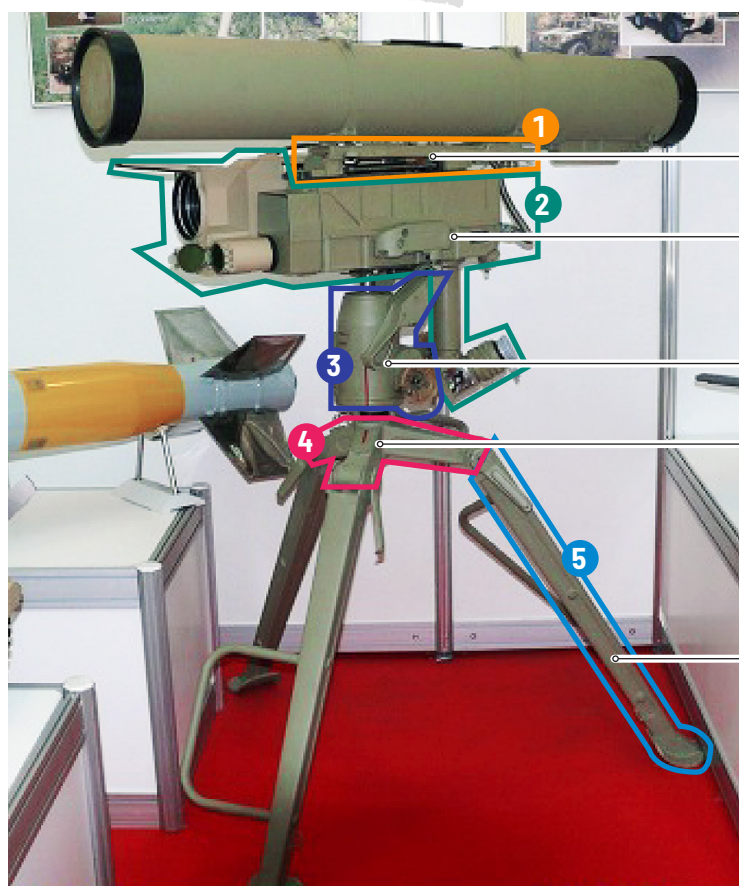

Photos: Mashregnews.ir

Similar components:

Missile Rail

Sight Head

Traversing Unit

Joining Fixture

Tripod Legs

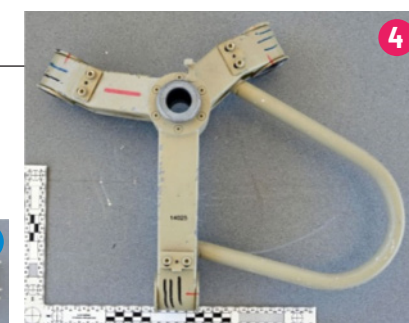
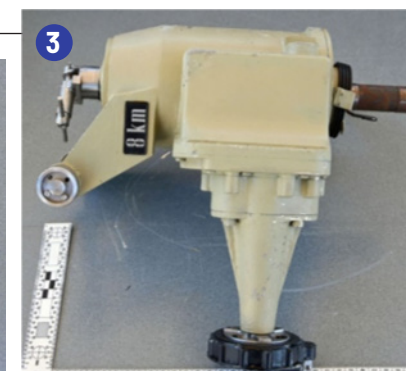

Photos: USCENTCOM

English markings, commonly used by Iran on the Dehlavieh, interdicted being smuggled from Iran to Yemen

Photos: USCENTCOM



The Iranian Dehlavieh has English markings compared to the Russian Kornet-EM, which has Cyrillic markings

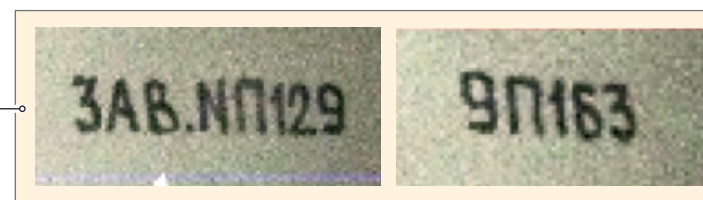

Cyrillic markings on Russian Kornet-E launcher

Photos: U.S. Government



DEFENSE INTELLIGENCE AGENCY

Seized At Sea: *Iranian Weapons Smuggled to the Houthis*

Sources

- 1 USCENTCOM; 15 FEB 24; CENTCOM INTERCEPTS IRANIAN WEAPONS SHIPMENT INTENDED FOR HOUTHIS; [HTTPS://WWW.CENTCOM.MIL/](https://www.centcom.mil/)
- 2 WASHINGTON INSTITUTE; ACCESSED 18 APR 24; TRACKING MARITIME ATTACKS MIDDLE EAST 2019; [HTTPS://WWW.WASHINGTONINSTITUTE.ORG/POLICY-ANALYSIS/TRACKING-MARITIME-ATTACKS-MIDDLE-EAST-2019](https://www.washingtoninstitute.org/policy-analysis/tracking-maritime-attacks-middle-east-2019)
- 3 CENTER FOR STRATEGIC AND INTERNATIONAL STUDIES; JUN 20; THE MISSILE WAR IN YEMEN.
- 4 WASHINGTON INSTITUTE; TRACKING MARITIME ATTACKS MIDDLE EAST 2019; [HTTPS://WWW.WASHINGTONINSTITUTE.ORG/POLICY-ANALYSIS/TRACKING-MARITIME-ATTACKS-MIDDLE-EAST-2019](https://www.washingtoninstitute.org/policy-analysis/tracking-maritime-attacks-middle-east-2019)
- 5 CENTER FOR STRATEGIC AND INTERNATIONAL STUDIES; JUN 20; THE MISSILE WAR IN YEMEN.
- 6 USCENTCOM; 15 FEB 24; CENTCOM INTERCEPTS IRANIAN WEAPONS SHIPMENT INTENDED FOR HOUTHIS; [HTTPS://WWW.CENTCOM.MIL/](https://www.centcom.mil/)
- 7 USCENTCOM; 16 JAN 24; USCENTCOM SEIZES IRANIAN ADVANCED CONVENTIONAL WEAPONS BOUND FOR HOUTHIS; [HTTPS://WWW.CENTCOM.MIL/](https://www.centcom.mil/)
- 8 USCENTCOM; 06 SEP 18; JASON DUNHAM COUNTS 2,521 AK-47S; [HTTPS://WWW.CUSNC.NAVY.MIL/MEDIA/NEWS/DISPLAY/ARTICLE/1621512](https://www.cusnc.navy.mil/media/news/display/article/1621512)
- 9 DOJ; 07 DEC 21; UNITED STATES PREVAILS IN ACTIONS TO SEIZE AND FORFEIT IRANIAN TERROR GROUP'S MISSILES AND PETROLEUM; [HTTPS://WWW.JUSTICE.GOV/OPA/PR/UNITED-STATES-PREVAILS-ACTIONS-SEIZE-AND-FOREFIT-IRANIAN-TERROR-GROUPS-MISSILES-AND-PETROLEUM](https://www.justice.gov/opa/pr/united-states-prevails-actions-seize-and-forefit-iranian-terror-groups-missiles-and-petroleum)
- 10 NAVY.MIL; 08 MAY 21; USS MONTEREY SEIZES ILLICIT WEAPONS IN THE NORTH ARABIAN SEA; [HTTPS://WWW.NAVY.MIL/PRESS-OFFICE/NEWS-STORIES/ARTICLE/2600834](https://www.navy.mil/press-office/news-stories/article/2600834)
- 11 NAVY.MIL; 07 JUL 22; NAVY DESTROYER SUPPORTS UK SEIZURE OF IRANIAN MISSILES IN GULF OF OMAN; [HTTPS://NAVY.MIL/PRESS-OFFICE/NEWS-STORIES/ARTICLE/3085311](https://navy.mil/press-office/news-stories/article/3085311)
- 12 USCENTCOM; 15 NOV 22; U.S. NAVAL FORCES INTERCEPTED EXPLOSIVE MATERIAL BOUND FOR YEMEN; [HTTPS://WWW.CUSNC.NAVY.MIL/MEDIA/NEWS/DISPLAY/ARTICLE/3218261](https://www.cusnc.navy.mil/media/news/display/article/3218261)
- 13 NAVY.MIL; 03 DEC 22; U.S. SEIZES 1.1 MILLION ROUNDS OF AMMUNITION, OTHER ILLEGAL WEAPONS IN GULF OF OMAN; [HTTPS://WWW.NAVY.MIL/PRESS-OFFICE/NEWS-STORIES-3235314](https://www.navy.mil/press-office/news-stories-3235314)
- 14 USCENTCOM; 01 FEB 23; U.S. CENTRAL COMMAND SUPPORTS PARTNER FORCES IN MAJOR IRANIAN WEAPONS SEIZURE; [HTTPS://WWW.CENTCOM.MIL/](https://www.centcom.mil/)
- 15 WALL STREET JOURNAL; 01 FEB 23; FRENCH FORCES SEIZE IRANIAN-SUPPLIED WEAPONS BOUND FOR YEMEN; [HTTPS://WWW.WSJ.COM/ARTICLES/FRENCH-FORCES-SEIZE-IRANIAN-SUPPLIED-WEAPONS-BOUND-FOR-YEMEN-11675242819](https://www.wsj.com/articles/french-forces-seize-iranian-supplied-weapons-bound-for-yemen-11675242819)
- 16 DVIDS; 02 MAR 23; U.S. FORCES ASSIST UK SEIZURE OF MISSILES SHIPPED FROM IRAN; [HTTPS://WWW.DVIDSHUB.NET/NEWS/439538/US-FORCES-ASSIST-UK-SEIZURE-MISSILES-SHIPPED-IRAN](https://www.dvidshub.net/news/439538/us-forces-assist-uk-seizure-missiles-shipped-iran)
- 17 USCENTCOM; 16 JAN 24; (U) USCENTCOM SEIZES IRANIAN ADVANCED CONVENTIONAL WEAPONS BOUND FOR HOUTHIS | CITED PORTION CLASSIFIED U | OVERALL DOCUMENT CLASSIFIED U | (U) OFFICIAL WEBSITE OF THE UNITED STATES GOVERNMENT, [HTTPS://WWW.CENTCOM.MIL/](https://www.centcom.mil/)
- 18 USCENTCOM; 15 FEB 24; CENTCOM INTERCEPTS IRANIAN WEAPONS SHIPMENT INTENDED FOR HOUTHIS; [HTTPS://WWW.CENTCOM.MIL/](https://www.centcom.mil/)
- 19 USCENTCOM; 15 FEB 24; CENTCOM INTERCEPTS IRANIAN WEAPONS SHIPMENT INTENDED FOR HOUTHIS; [HTTPS://WWW.CENTCOM.MIL/](https://www.centcom.mil/)
- 19 (U) CENTCOM | 20240116-01 | (U) USCENTCOM SEIZES IRANIAN ADVANCED CONVENTIONAL WEAPONS BOUND FOR HOUTHIS | 16 JAN 24 | CITED PORTION CLASSIFIED U | OVERALL DOCUMENT CLASSIFIED U | (U) OFFICIAL WEBSITE OF THE UNITED STATES GOVERNMENT, [HTTPS://WWW.CENTCOM.MIL/](https://www.centcom.mil/)
- 20 TASNIM; 19 JUNE 2018; TASNIM REPORTS ON THE ISLAMIC REPUBLIC OF IRAN'S 300-KILOMETER-RANGE GHADIR CRUISE MISSILE; [HTTPS://WWW.TASNIMNEWS.COM/FA/NEWS/1397/03/21/1746519](https://www.tasnimnews.com/fa/news/1397/03/21/1746519)
- 21 (U) CENTCOM | 20240116-01 | (U) USCENTCOM SEIZES IRANIAN ADVANCED CONVENTIONAL WEAPONS BOUND FOR HOUTHIS | 16 JAN 24 | CITED PORTION CLASSIFIED U | OVERALL DOCUMENT CLASSIFIED U | (U) OFFICIAL WEBSITE OF THE UNITED STATES GOVERNMENT, [HTTPS://WWW.CENTCOM.MIL/](https://www.centcom.mil/)
- 22 IRAN DEFENSE MINISTRY; 17 AUGUST 2017; IRAN: DEFENSE MINISTRY, AEROSPACE COMPANIES PRESENT 'ACHIEVEMENTS' AT MAKS EXHIBITION IN RUSSIA; [HTTP://WWW.FARSNEWS.COM](http://www.farsnews.com)
- 23 THE ROYAL UNITED SERVICES INSTITUTE FOR DEFENCE AND SECURITY STUDIES (RUSIA); 10 JAN 2024; SECURING THE RED SEA: HOW CAN HOUTHİ MARİTİME STRİKES BE COUNTERED?; [HTTPS://WWW.RUSI.ORG/EXPLORE-OUR-RESEARCH/PUBLICATIONS/COMMENTARY/SECURING-RED-SEA-HOW-CAN-HOUTHİ-MARİTİME-STRİKES-BE-COUNTERED](https://www.rusi.org/explore-our-research/publications/commentary/securing-red-sea-how-can-houthi-maritime-strikes-be-counterred)
- 24 THE INTERNATIONAL INSTITUTE FOR STRATEGIC STUDIES (IISS); 08 JAN 2024; HOUTHİ ANTI-SHIP MISSİLE SYSTEMS: GETTING BETTER ALL THE TIME; [HTTPS://WWW.IISS.ORG/ONLINE-ANALYSIS/MILİTARY-BALANCE/2024/01/HOUTHİ-ANTI-SHIP-MISSİLE-SYSTEMS-GETTING-BETTER-ALL-THE-TIME/](https://www.iiiss.org/online-analysis/military-balance/2024/01/houthi-anti-ship-missile-systems-getting-better-all-the-time/)
- 25 DIA; FEBRUARY 2024; IRAN ENABLING HOUTHİ ATTACKS ACROSS THE MİDĐLE EAST; [HTTPS://WWW.DIA.﻿MIL/NEWS-FEATURES/ARTICLES/ARTICLE-VIEW/ARTICLE/3662325/DIA-REPORT-CONFIRMS-THE-HOUTHIS-USE-OF-IRANIAN-MISSILES-AND-UNMANNED-AERIAL-VEH/](https://www.dia.mil/news-features/articles/article-view/article/3662325/dia-report-confirms-the-houthis-use-of-iranian-missiles-and-unmanned-aerial-veh/)
- 26 TWITTER; U.S. CENTRAL COMMAND SEIZES IRANIAN ADVANCED CONVENTIONAL WEAPONS BOUND FOR HOUTHIS; 11 JAN 2024.
- 27 (U) USG INSPECTION PHOTOS; 10 APR 2024; QİAM ENGINE AND TURBOPUMP EQUIPMENT ACQUIRED DURING JANUARY 2024 USG INTERDICTION, WITH PHOTOS TAKEN DURING USG INSPECTION.
- 28 DIA; FEBRUARY 2024; IRAN ENABLING HOUTHİ ATTACKS ACROSS THE MİDĐLE EAST; [HTTPS://WWW.DIA.﻿MIL/NEWS-FEATURES/ARTICLES/ARTICLE-VIEW/ARTICLE/3662325/DIA-REPORT-CONFIRMS-THE-HOUTHIS-USE-OF-IRANIAN-MISSILES-AND-UNMANNED-AERIAL-VEH/](https://www.dia.mil/news-features/articles/article-view/article/3662325/dia-report-confirms-the-houthis-use-of-iranian-missiles-and-unmanned-aerial-veh/)
- 29 USG INTERDICTION PHOTOS; U.S. CENTRAL COMMAND; 8 MAR 2024.



www.dia.mil