



Iranian UAVs in Ukraine: A Visual Comparison

AUGUST 2023 UPDATE

This product provides a visual comparison of UAVs used by Russian forces in Ukraine and Iranian UAVs used to attack U.S. and partner interests in the Middle East. Photos of UAV debris and components from Ukraine are consistent with systems showcased at military expos and other venues in the Middle East. This analysis confirms Russia's use of various Iranian lethal UAVs in its war in Ukraine.



For more information about the Defense Intelligence Agency and to view this report, visit DIA's website at www.dia.mil

For media and public inquiries about this report, contact DIA Public Affairs at DIA-PAO@dodiiis.mil

Information cutoff date: 10 August 2023

Cover Image: An Iranian-origin UAV is seen flying over Kyiv, Ukraine, during an attack on 17 October 2022

Image Source: EPA Images

DIA_F_24L1L_G

This report contains copyrighted material. Copying and disseminating the contents are prohibited without the permission of the copyright owners. Images and other previously published material featured or referenced in this publication are attributed to their source.



DEFENSE INTELLIGENCE AGENCY

Iranian UAVs in Ukraine: A Visual Comparison–August 2023 Update

The Story So Far

In mid-2022, Iran provided Russia with unmanned aerial vehicles (UAVs) to sustain Moscow’s ability to attack Ukraine after severely depleting its own stores of precision-guided munitions in the war’s opening months. Since then, Iran has provided Russia with hundreds of one-way attack UAVs for its war in Ukraine. Ample evidence of such transfers has been provided to the public, but Iran continues to deny these UAVs were Iranian in origin. The U.S. Defense Intelligence Agency (DIA) has collected actual debris from attacks in Ukraine and the Middle East that we have presented in the following pages to clearly prove Iran’s support to Russia.

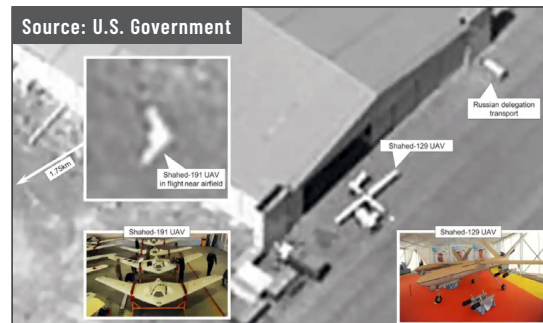

JUL 2022
Russian delegation visits Iran to examine Iranian UAVs



SEP 2022
First use of Iranian UAVs by Russian military forces to attack Ukraine



MAY 2023
National Security Council highlights deepening Iran-Russia military cooperation



JUN 2023
White House announces Iran is helping Russia establish a UAV production facility

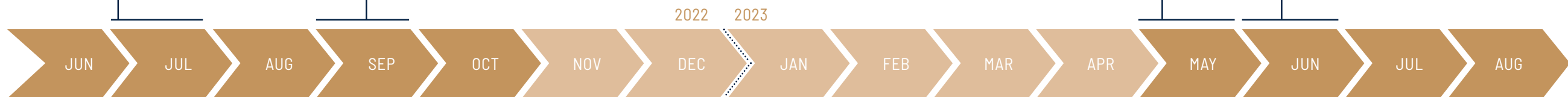

JUL 2022
White House says Iran is preparing to transfer UAVs to Russia

OCT 2022
Iran’s Foreign Minister denies providing Russia with UAVs to use against Ukraine

MAY/JUN 2023
The United Kingdom submits report to UN providing evidence of Iranian support to Russia

JUN/JUL 2023
The United States, Albania, France, the United Kingdom, and Ukraine urge the UN Security Council to investigate Russia’s use of Iranian UAVs in Ukraine

AUG 2023
Recovered UAVs are displayed at DIA to offer undeniable proof that UAVs found in the Middle East and Ukraine share a common point of origin: Iran

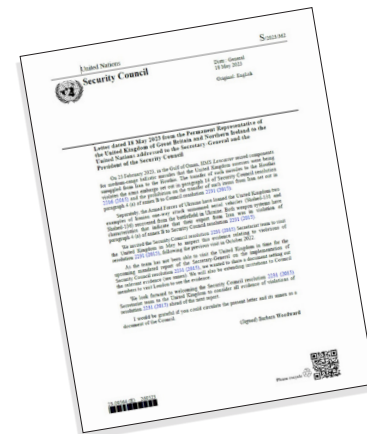



Shahed-131 (Geran-1) One-Way Attack UAV Comparison

The Iranian-origin Shahed-131, renamed Geran-1 by the Russians, has a delta-wing body shape similar to the Shahed-136 (Geran-2), but the vertical stabilizers extend only above the body. Recovered components in Ukraine and the Middle East appear to be very similar; some components even fractured in the same manner after impact.¹²

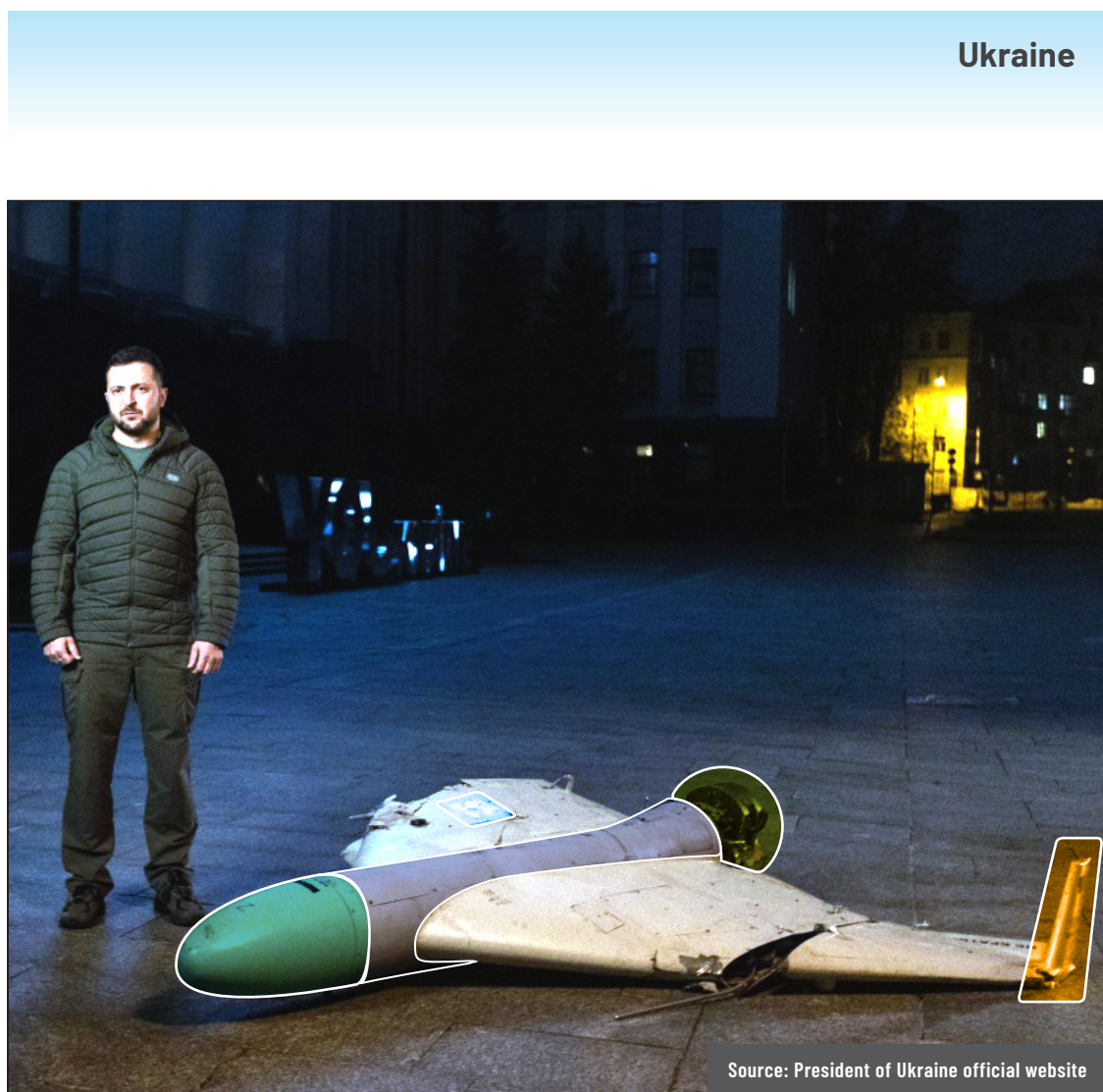

Source: President of Ukraine official website

Ukrainian President Volodymyr Zelenskyy showcased a Shahed-131 (Geran-1) recovered in Ukraine, 27 October 2022



Shahed-131 recovered in the Middle East, 2021

Source: U.S. Government

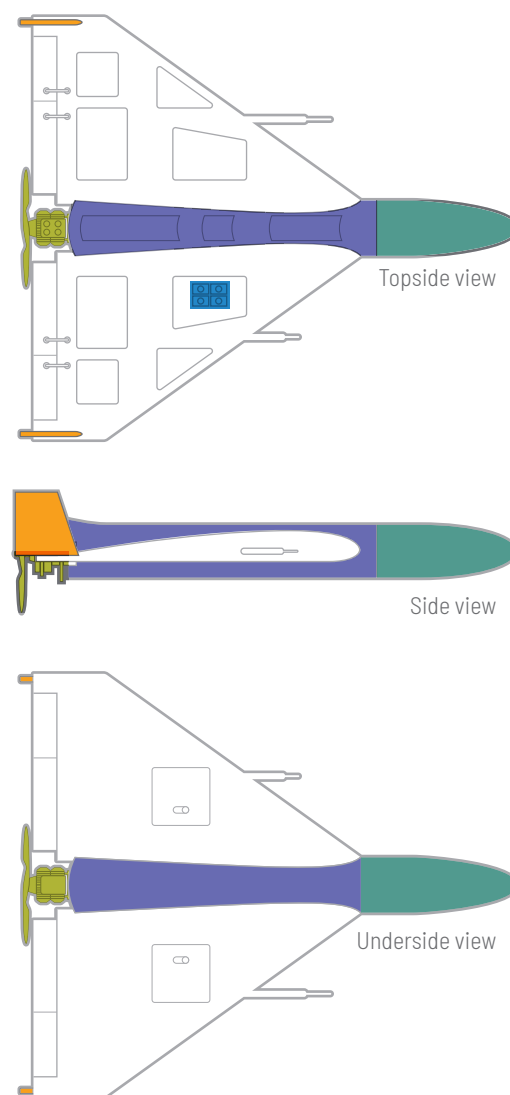

Selected points of comparison:

Engine Wing stabilizer Fuselage Nose cone Antenna array



Side by Side–The Geran-1 and the Shahed-131

In August 2023, DIA publicly displayed debris from the Shahed-131s (Geran-1s) used in Ukraine in fall 2022 side by side with a Shahed-131 recovered in Iraq in 2021. The systems are the same size and shape and were built using similar materials and subcomponents. The Shahed-131s (Geran-1s) from Ukraine and the Shahed-131 from Iraq also share the same honeycomb-like structure within the airframe.

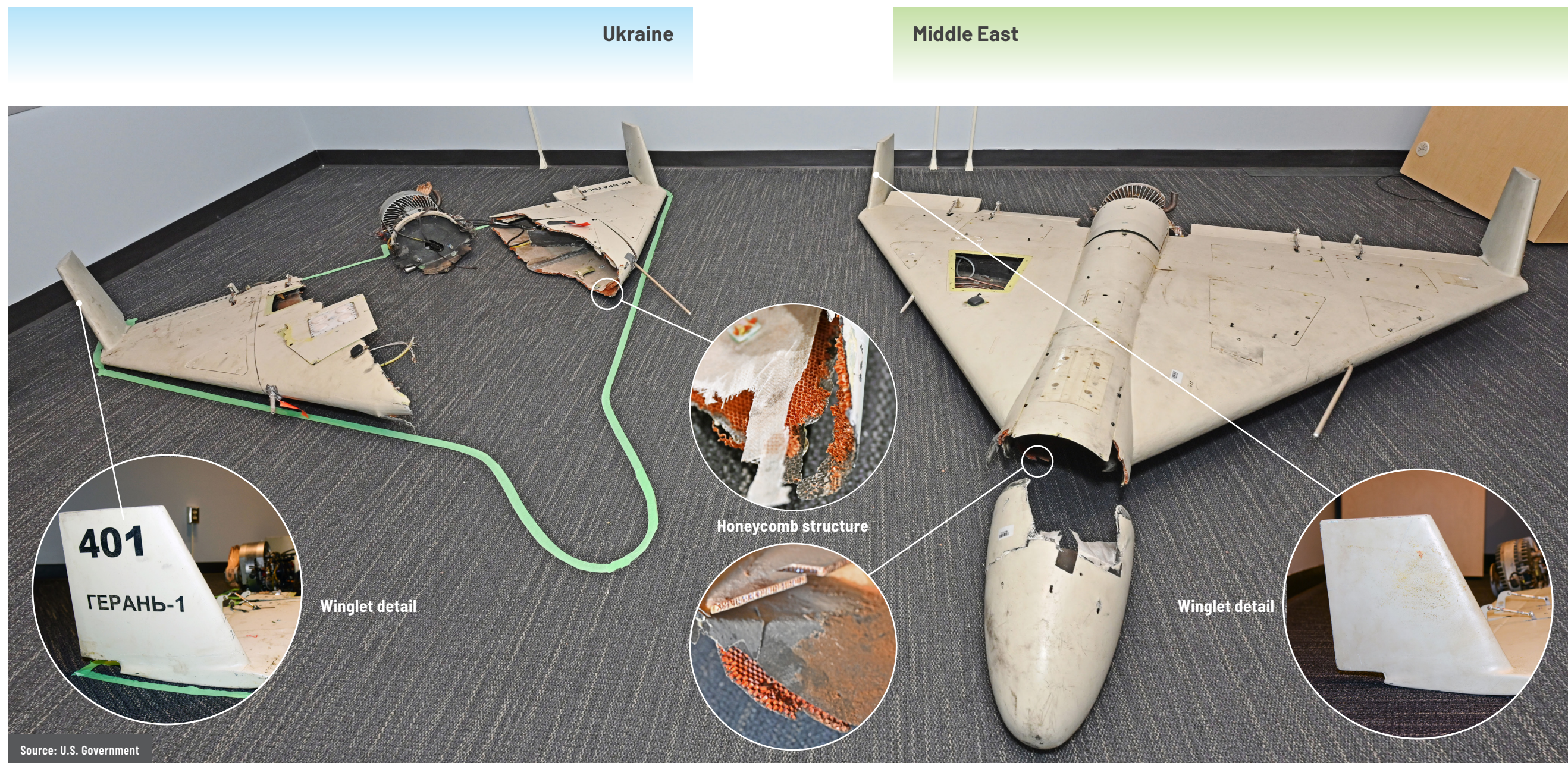



A Clear Iranian Connection

On 28 September 2022, Iran conducted and then publicly claimed a missile and UAV attack against the Kurds in northern Iraq, enabling DIA to remove doubt about the origin of the UAVs recovered from the strike. The UAVs recovered from Iraq were Shahed-131s, which match Shahed-131s (Geran-1s) recovered in Ukraine in fall 2022. Nearly identical UAV components appearing at the same time in two separate conflicts thousands of miles apart, with Iran publicly claiming responsibility for one of the UAVs, leads to the conclusion that both of these systems are Iranian in origin.

Kyiv after a Russian attack using Iranian UAVs, October 2022



Iran conducted a missile and UAV attack in northern Iraq, September 2022

Ukrainian President Zelenskyy showcased a Shahed-131 (Geran-1) used by Russian forces to attack Ukraine, October 2022



Iran publicly claimed responsibility for the attack, September 2022

Components recovered in Ukraine, October 2022



Components recovered in Iraq, September 2022





Shahed-131 Wing Stabilizers

The wing stabilizers on the Shahed-131 (Geran-1) recovered in Ukraine are consistent with the wing stabilizers on the Shahed-131 recovered from an Iranian-claimed attack in Iraq. Notably, both wing stabilizers have the nearly identical material resembling a honeycomb on the inside of the stabilizer.

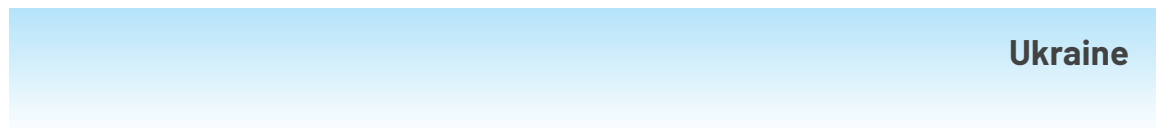

Shahed-131 (Geran-1) wing stabilizer recovered in Ukraine, Fall 2022



Shahed-131 wing stabilizer recovered from a 2022 attack in Iraq that Iran claimed



Underside of the Shahed-131 (Geran-1) recovered in Ukraine showing distinctive honeycomb design

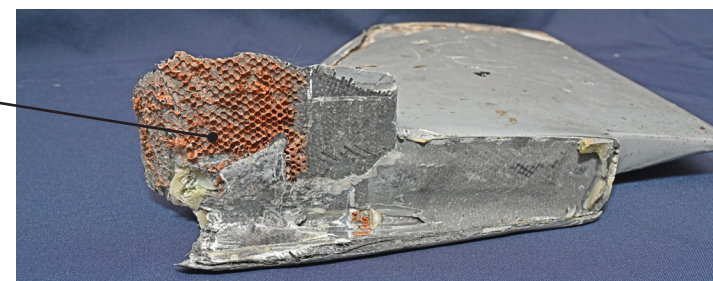
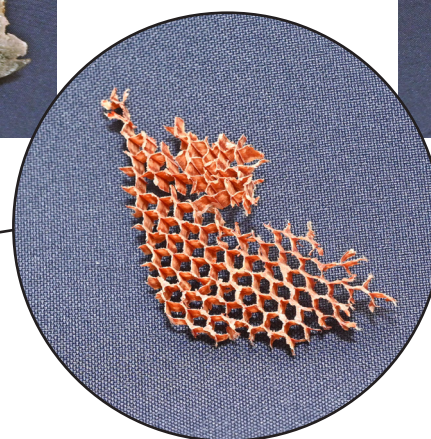

Shahed-131 wing stabilizer from Iranian-claimed attack in Iraq showing distinctive honeycomb design



Recovered Shahed-131 (Geran-1) Engine

The Shahed-131 (Geran-1) engines recovered in Ukraine are nearly identical to engines recovered from the September 2022 Iranian-claimed attack in Iraq.

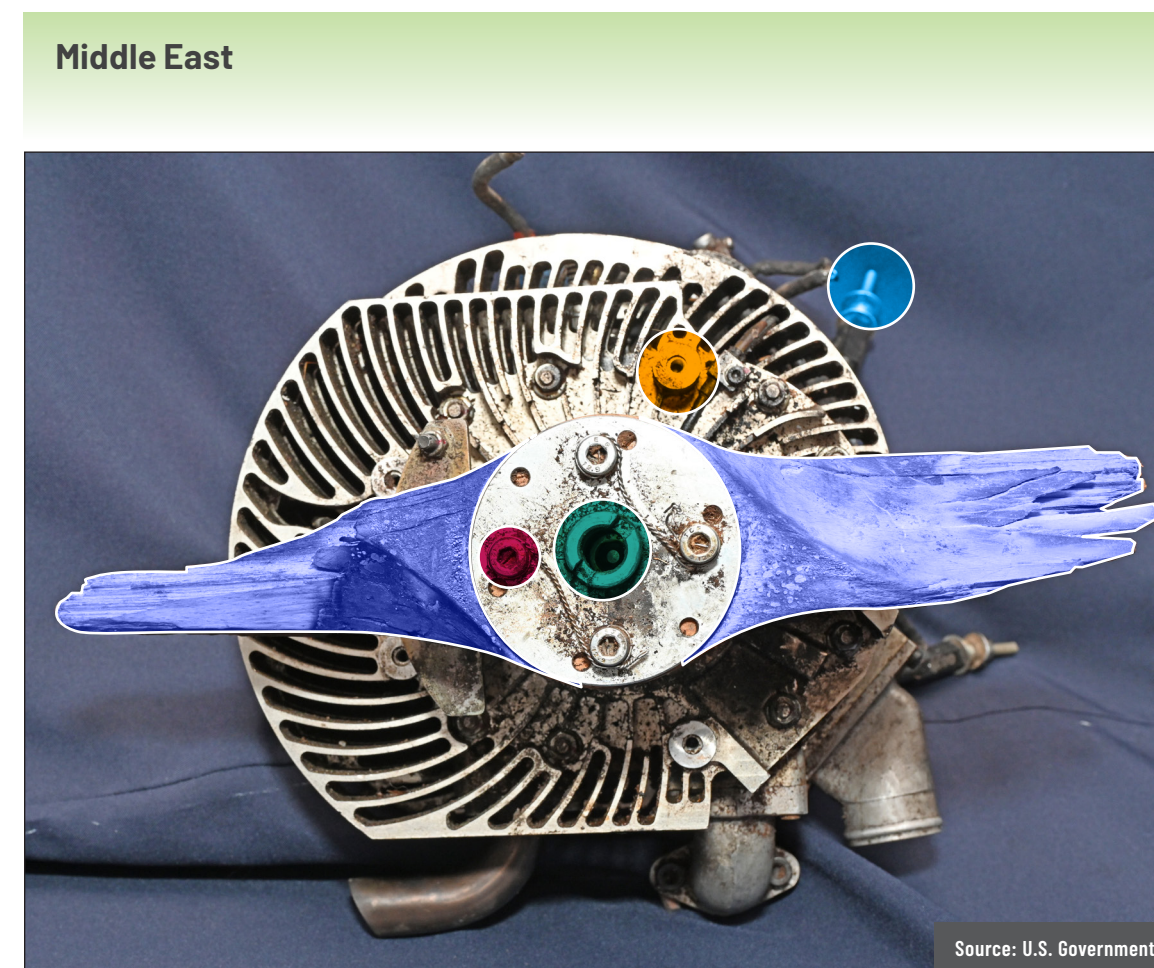
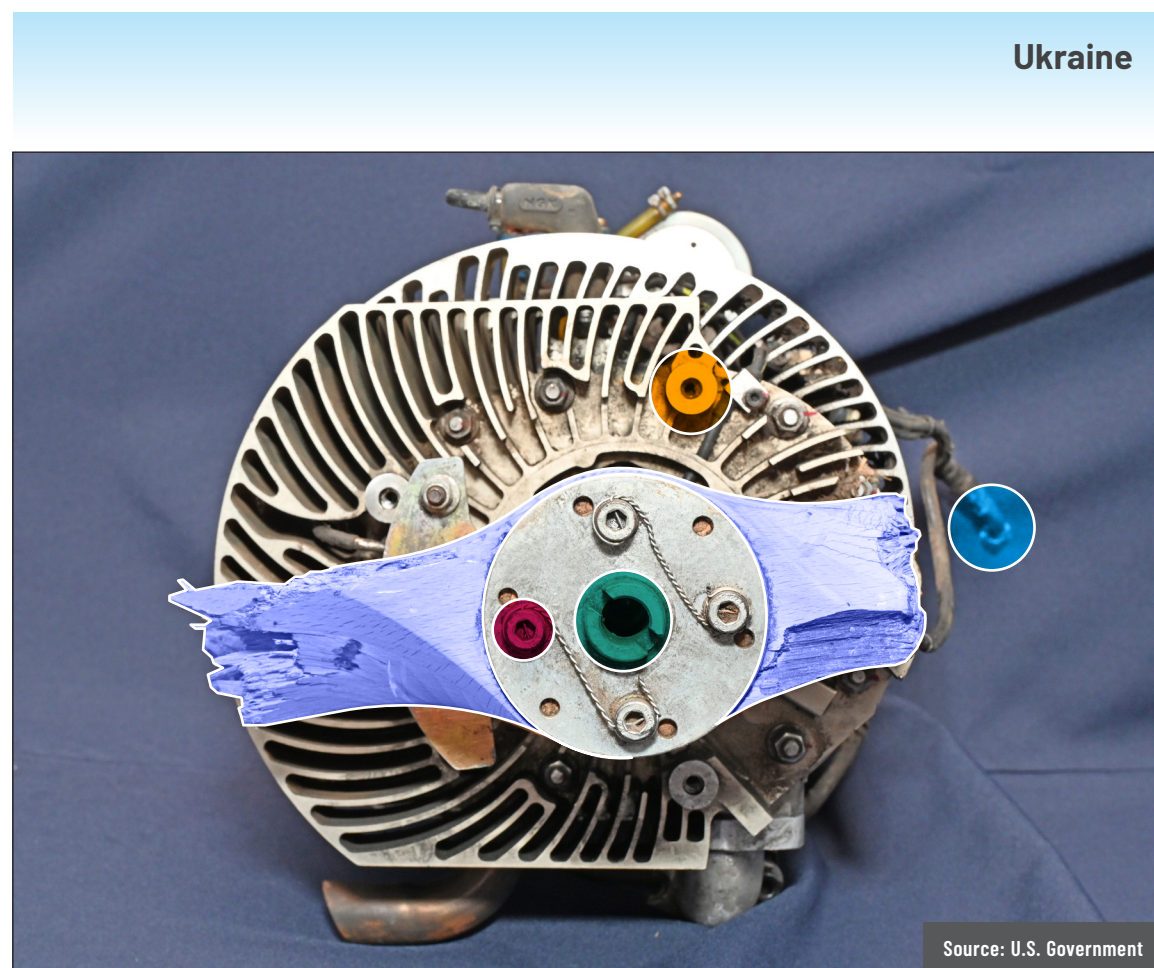

Selected points of comparison:



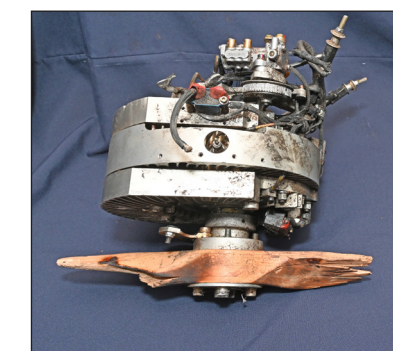
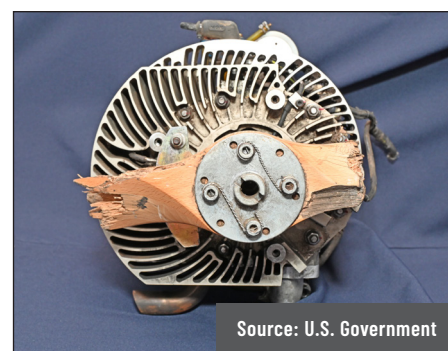
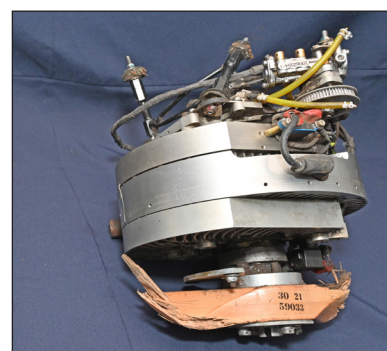





- Wooden propeller
- Crank shaft
- Hex screw
- Distinctive housing feature
- Engine mount



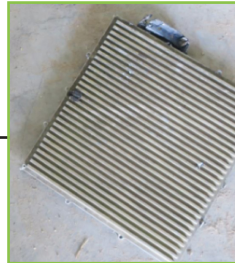

Recovered Shahed-131 (Geran-1) Components

Shahed-131 (Geran-1) UAV components recovered from debris in Ukraine are consistent with Shahed-131 components recovered from the September 2022 Iranian-claimed attack in Iraq.³

Ukraine	Middle East
Similar components:	
	
	
	
	
	
	
	
<p style="text-align: right; font-size: small;">Source: Ukrainian War Crimes Prosecutors</p>	 <p style="text-align: right; font-size: small;">Source: U.S. Government</p>

Recovered in Kyiv, Ukraine, October 2022

Recovered after Iranian-claimed attack in Iraq, September 2022



Shahed-136 (Geran-2) One-Way Attack UAV Comparison

The Iranian-origin Shahed-136, renamed Geran-2 by the Russians, has a distinctive shape, with a delta-wing body and vertical stabilizers extending above and below the body, as displayed in Iranian press and military expos. Iran used Shahed-136 UAVs in the 2021 attack against the merchant vessel *Mercer Street* and has also transferred this system to the Huthis in Yemen. The Huthis have not used this system in an attack to date but have displayed it publicly. The images circulating in open press of UAVs in Ukraine clearly show the features of the Shahed-136’s delta-wing body and vertical stabilizers.⁴⁵⁶



Underside of a Shahed-136 (Geran-2) spotted over Kyiv, Ukraine, October 2022

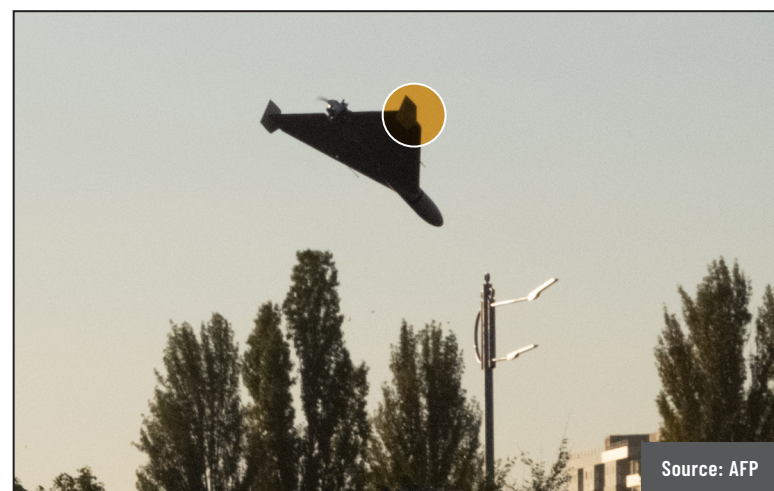

Shahed-136 (Geran-2) spotted over Kyiv, Ukraine, moments before impact, October 2022

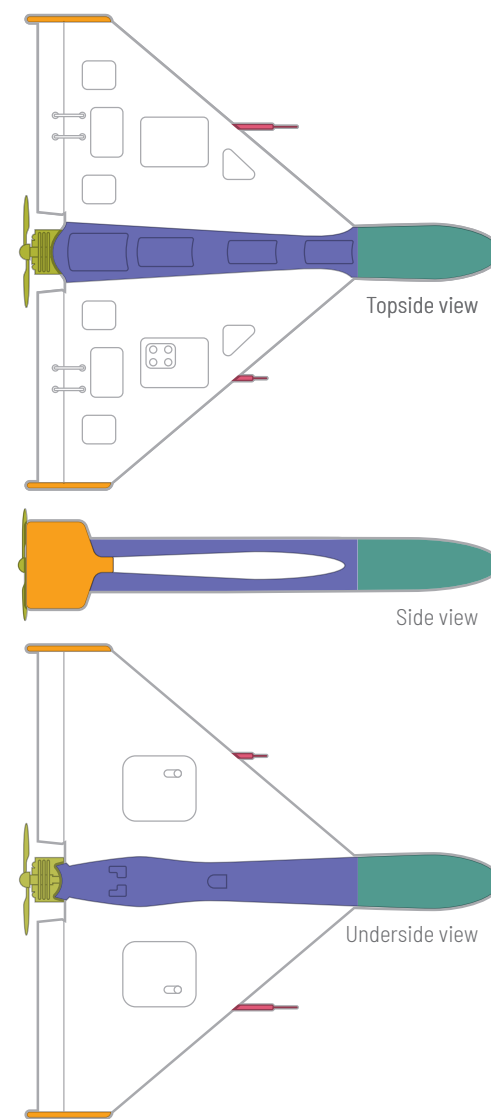

Selected points of comparison:

Engine Wing stabilizer Air data collection Fuselage Nose cone

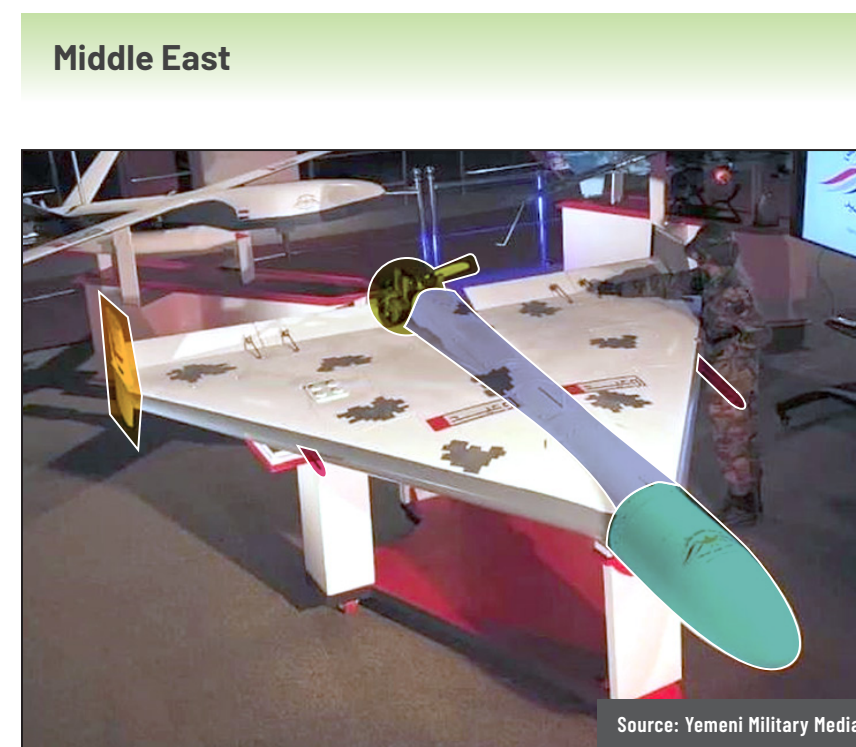

Shahed-136 displayed by the Huthis in Yemen

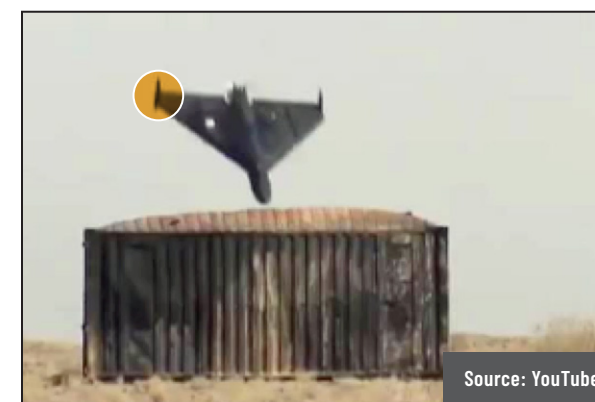

Shahed-136 from an Iranian video of military exercises in Iran, April 2021



Shahed-136 (Geran-2) Wing Stabilizer

Shahed-136 (Geran-2) wing stabilizers recovered in Ukraine are consistent with the size, shape, and markings of the Shahed-136 wing stabilizers observed or recovered in the Middle East.⁷⁸

Ukraine



Shahed-136 (Geran-2) wing stabilizer recovered in Ukraine, October 2022

Middle East



Shahed-136 UAVs preparing for launch from truck platform during IRGC Aerospace Force exercise in Iran, December 2021

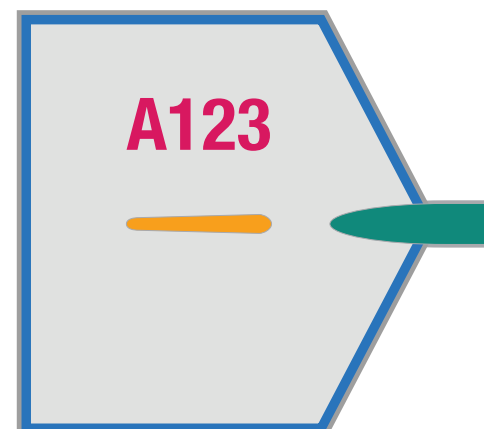

Selected points of comparison:

Stabilizer shape

Serial number

Winglet

Edge of delta wing



Shahed-136 (Geran-2) wing stabilizer recovered in Ukraine, September 2022

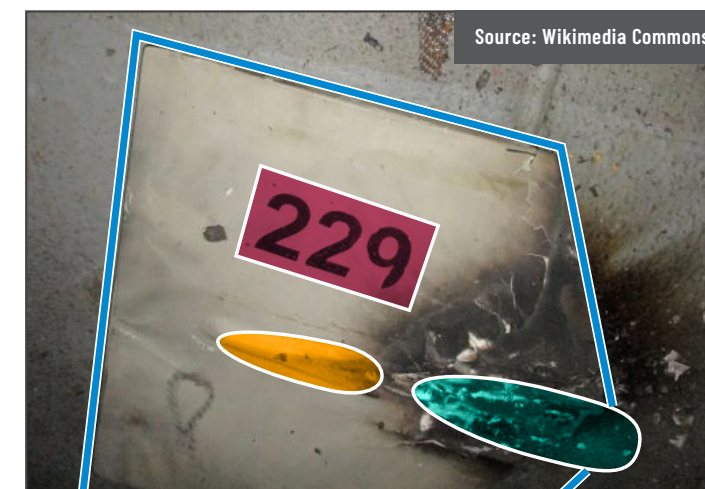

Shahed-136 wing stabilizer recovered from the attack on the merchant vessel Pacific Zircon, November 2022



Shahed-136 (Geran-2) Engine

Shahed-136 (Geran-2) engines recovered in Ukraine appear to be Iranian-produced MAD0-550 engines, the same engine model used in the Shahed-136.⁹

Ukraine



Shahed-136 (Geran-2) engine recovered in Ukraine, October 2022

Middle East

**Selected points
of comparison:**

- Ring gear
- Starter
- Exhaust
- Heat sink and
ignition components



MAD0-550 engine displayed at the Iranian National Aerospace Exhibition, October 2014



Mohajer 6 Multirole UAV Comparison

The Iranian-origin Mohajer 6 has been displayed publicly in Iran and Iraq, and it can be easily identified by its distinctive tail, as well as by the attached surveillance equipment and guided munitions. In October, Ukraine captured a mostly intact Mohajer 6 from the Black Sea, and it appears to be indistinguishable from the Mohajer 6 systems photographed in Iran and Iraq. Components recovered from the wreckage display very similar markings to those observed in Iran.^{10 11 12}

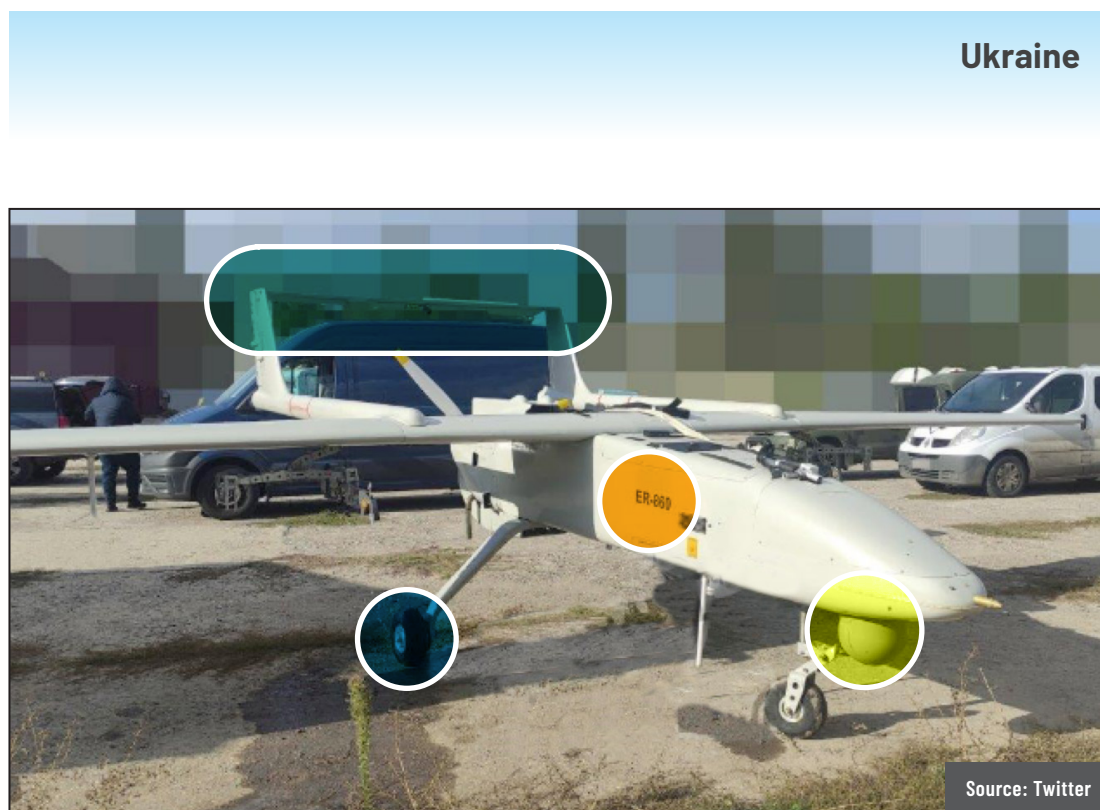

Mohajer 6 recovered from the Black Sea, October 2022



Mohajer 6 displayed in Iran, February 2018

Selected points of comparison:
 Horizontal stabilizer
 Serial number
 Landing gear wheel
 Surveillance equipment

Guided munition recovered from Mohajer 6, October 2022



Source: Twitter



Source: Twitter



Source: Wikimedia Commons

Iranian guided munition displayed at a military expo, August 2022



DEFENSE INTELLIGENCE AGENCY

Iranian UAVs in Ukraine: A Visual Comparison–August 2023 Update

Source Endnotes

¹ PRESS RELEASE, UKRAINIAN GOVERNMENT; 27 OCT 2022; TODAY WE REMEMBER THE EXPULSION OF THE NAZIS, APPROACHING THE EXPULSION OF THE RASHISTS – ADDRESS BY THE PRESIDENT OF UKRAINE; URL: [HTTPS://WWW.PRESIDENT.GOV.UA/EN/NEWS/SOGODNI-MI-ZGADUYEMO-VIGNNNYA-NACISTIV-NABLIZHAYUCHI-VIGNAN-78753](https://www.president.gov.ua/en/news/sogodni-mi-zgaduyemo-viginnya-nacistiv-nablizhayuchi-vignan-78753).

² PRESS RELEASE, UKRAINIAN GOVERNMENT; 13 OCT 2022; PROSECUTORS, TOGETHER WITH REPRESENTATIVES OF THE INTERNATIONAL CRIMINAL COURT, RECORD ANOTHER CRIME OF THE RUSSIAN MILITARY – AN ATTACK ON THE ENERGY INFRASTRUCTURE OF THE KYIV REGION; URL: [HTTPS://GP.GOV.﻿UA/UA/POSTS/PROKURORI-SPILNO-Z-PREDSTAVNIKAMI-MKS-FIKSUYUT-CERGOVII-ZLOCIN-VIISKOVIX-RF-ATAKU-NA-ENERGETIC-NU-INFRASTRUKTURU-KIYIVSHHINI](https://gp.gov.ua/ua/posts/prokurori-spilno-z-predstavnikami-mks-fiksuyut-cergovii-zlocin-viiskovix-rf-ataku-na-energetic-nu-infrastrukturu-kiyivshhini).

³ PRESS RELEASE, UKRAINIAN GOVERNMENT; 13 OCT 2022; (U) PROSECUTORS, TOGETHER WITH REPRESENTATIVES OF THE INTERNATIONAL CRIMINAL COURT, RECORD ANOTHER CRIME OF THE RUSSIAN MILITARY – AN ATTACK ON THE ENERGY INFRASTRUCTURE OF THE KYIV REGION; URL: [HTTPS://GP.GOV.﻿UA/UA/POSTS/PROKURORI-SPILNO-Z-PREDSTAVNIKAMI-MKS-FIKSUYUT-CERGOVII-ZLOCIN-VIISKOVIX-RF-ATAKU-NA-ENERGETIC-NU-INFRASTRUKTURU-KIYIVSHHINI](https://gp.gov.ua/ua/posts/prokurori-spilno-z-predstavnikami-mks-fiksuyut-cergovii-zlocin-viiskovix-rf-ataku-na-energetic-nu-infrastrukturu-kiyivshhini).

⁴ ARTICLE, THE DRIVE; THOMAS NEWDICK, TYLER ROGOWAY; 13 SEP 2022; RUSSIA HAS BEGUN USING IRANIAN KAMIKAZE DRONES ON UKRAINE; [HTTPS://WWW.THEDRIVE.COM/THE-WAR-ZONE/RUSSIA-HAS-BEGUN-USING-IRANIAN-KAMIKAZE-DRONES-ON-UKRAINE](https://www.thedrive.com/the-war-zone/russia-has-begun-using-iranian-kamikaze-drones-on-ukraine).

⁵ ARTICLE, ORYX; MAR 2021; HOUSHI REBELS UNVEIL HOST OF WEAPONRY; URL: [HTTPS://WWW.ORYXSPIOENKOP.COM/2021/03/HOUSHI-REBELS-UNVEIL-HOST-OF-WEAPONRY.HTML](https://www.oryxspioenkop.com/2021/03/houthi-rebels-unveil-host-of-weaponry.html).

⁶ UNITED STATES INSTITUTE OF PEACE – THE IRAN PRIMER; 06 AUG 2021; CENTCOM: IRAN BEHIND DRONE ATTACK ON TANKER; URL: [HTTPS://IRANPRIMER.USIP.ORG/BLOG/2021/AUG/10/CENTCOM-IRAN-BEHIND-DRONE-ATTACK-TANKER](https://iranprimer.usip.org/blog/2021/aug/10/centcom-iran-behind-drone-attack-tanker).

⁷ ARTICLE, MEHR NEWS; APR 2022; TITLE UNKNOWN.

⁸ UNITED STATES INSTITUTE OF PEACE – THE IRAN PRIMER; 06 AUG 2021; CENTCOM: IRAN BEHIND DRONE ATTACK ON TANKER; URL: [HTTPS://IRANPRIMER.USIP.ORG/BLOG/2021/AUG/10/CENTCOM-IRAN-BEHIND-DRONE-ATTACK-TANKER](https://iranprimer.usip.org/blog/2021/aug/10/centcom-iran-behind-drone-attack-tanker).

⁹ ARTICLE, USKOWI ON IRAN; 25 NOV 2014; TAKEAWAYS FROM IRANIAN NATIONAL AEROSPACE EXHIBITION 2014; URL: [HTTPS://WWW.USKOWIONIRAN.COM/2014/11/TAKEAWAYS-FROM-IRANIAN-NATIONAL.﻿HTML](https://www.uskowioniran.com/2014/11/takeaways-from-iranian-national-65279.html).

¹⁰ ARTICLE, JANES DEFENCE WEEKLY; JEREMY BINNIE; 13 JUL 2022; CUT-PRICE CAPABILITY: THE PROLIFERATION OF IRANIAN ATTACK UAVS.

¹¹ ARTICLE, MEHR NEWS AGENCY; 05 FEB 2018; IRAN STARTS MASS PRODUCTION OF ADVANCED DRONE MOHAJER-6; URL: [HTTPS://EN.MEHRNEWS.COM/PHOTO/131926/IRAN-STARTS-MASS-PRODUCTION-OF-ADVANCED-DRONE-MOHAJER-6](https://en.mehrnews.com/photo/131926/iran-starts-mass-production-of-advanced-drone-mohajer-6).

¹² ARTICLE, PAKISTAN DEFENCE; FEB 2018; IRAN STARTS MASS PRODUCTION OF MOHAJER 6 UCAV, QAEM SMART GUIDED BOMB [PIC]; URL: [HTTPS://DEFENCE.PK/PDF/THREADS/IRAN-STARTS-MASS-PRODUCTION-OF-MOHAJER-6-UCAV-QAEM-SMART-GUIDED-BOMB-PIC.542732/](https://defence.pk/pdf/threads/iran-starts-mass-production-of-mohajer-6-uca-qaem-smart-guided-bomb-pic.542732/).



www.dia.mil