

Bridge Scour and Stream Instability Countermeasures: Experience, Selection, and Design Guidance-Third Edition

Volume 2

1. Report No. FHWA NHI HEC-23	2. Government Accession No.	3. Recipient's Catalog No.	
4. Title and Subtitle BRIDGE SCOUR AND STREAM INSTABILITY COUNTERMEASURES Experience, Selection and Design Guidance Volumes 1 and 2 Third Edition		5. Report Date September 2009	
7. Author(s) P.F. Lagasse, P.E. Clopper, J.E. Pagán-Ortiz, L.W. Zevenbergen, L.A. Arneson, J.D. Schall, L.G. Girard		6. Performing Organization Code	
9. Performing Organization Name and Address Ayres Associates 3665 JFK Parkway Building 2, Suite 200 Fort Collins, Colorado 80525		8. Performing Organization Report No.	
12. Sponsoring Agency Name and Address Office of Bridge Technology National Highway Institute FHWA, HIBT-20 4600 North Fairfax Dr., Suite 800 1200 New Jersey Ave., SE Arlington, Virginia 22203 Washington, D.C. 20590		10. Work Unit No. (TRAVIS)	
15. Supplementary Notes Project Managers: Dr. Larry A. Arneson and Mr. Jorge E. Pagán-Ortiz, FHWA Technical Assistants: Scott Anderson, Kornel Kerenyi, Joe Krolak, Barry Siel, FHWA; S. Mishra, Ayres Associates; B. Hunt, STV Inc.		11. Contract or Grant No. DTFH61-06-D-00010/T-06-001	
16. This document identifies and provides design guidelines for bridge scour and stream instability countermeasures that have been implemented by various State departments of transportation (DOTs) in the United States. Countermeasure experience, selection, and design guidance are consolidated from other FHWA publications in this document to support a comprehensive analysis of scour and stream instability problems and provide a range of solutions to those problems. Selected innovative countermeasure concepts and guidance derived from practice outside the United States are introduced. Management strategies and guidance for developing a Plan of Action for scour critical bridges are outlined, and guidance is provided for scour monitoring using portable and fixed instrumentation. The results of recently completed National Cooperative Highway Research Program (NCHRP) projects are incorporated in the design guidance, including: countermeasures to protect bridge piers and abutments from scour; riprap design criteria, specifications, and quality control; and environmentally sensitive channel and bank protection measures. This additional material required expanding HEC-23 to two volumes. Volume 1 now contains a complete chapter on riprap design, specifications, and quality control as well as an expanded chapter on biotechnical countermeasures. The guidance on scour monitoring instrumentation has been updated and now includes additional installation case studies. Volume 2 contains 19 detailed design guidelines grouped into six categories, including countermeasures for: (1) stream instability (2) streambank and roadway embankment protection, (3) bridge pier protection, (4) abutment protection, (5) filter design, and (6) special applications.		13. Type of Report and Period Covered	
17. Key Words stream stability, scour, countermeasures, plan of action, bendway weirs, soil cement, wire enclosed riprap, articulating concrete block systems, concrete armor units, gabion mattresses, grout filled mattresses, grout bags, rock riprap, partially grouted riprap, spurs, guide banks, check dams, revetments, scour monitoring instrumentation		14. Sponsoring Agency Code 18. Distribution Statement This document is available to the public through the National Technical Information Service, Springfield, VA 22161 (703) 487-4650	
19. Security Classif. (of this report) Unclassified	20. Security Classif. (of this page) Unclassified	21. No. of Pages 376	22. Price

Hydraulic Engineering Circular Number 23, Volume II
Bridge Scour and Stream Instability

Countermeasures:

Experience, Selection, and Design Guidance-Third Edition

September 2009

Publication No. FHWA-NHI-09-112

Errata Sheet

September 3, 2019 – version 1.0

#	Page	Object	Description
1	DG17.13	Vertical Height of riprap Equation found in C. Layout Specification, Step 2.	<i>Remove (Wave Height) from equation. Corrected equation should be:</i> Vertical height = (Still Water Depth) + (Runup) + (Freeboard) = (13 ft) + (6.6 ft) + (2 ft) = 21.6 ft (6.6 m)

Notes:

- Webpage document will be updated:
<https://www.fhwa.dot.gov/engineering/hydraulics/pubs/09111/09112.pdf> (accessed 9/3/2019)
- FHWA does not have any printed copies of this document.

Bridge Scour and Stream Instability Countermeasures
Experience, Selection, and Design Guidance
Third Edition
Volume 1

TABLE OF CONTENTS

LIST OF FIGURES.....	vii
LIST OF TABLES.....	xi
DESIGN GUIDELINES (Volume 2).....	xiii
ACKNOWLEDGMENTS AND DISCLAIMER.....	xv
GLOSSARY.....	xvii
CHAPTER 1. INTRODUCTION.....	1.1
1.1 PURPOSE.....	1.1
1.2 BACKGROUND.....	1.1
1.3 MANUAL ORGANIZATION.....	1.2
1.4 COMPREHENSIVE ANALYSIS.....	1.3
1.5 PLAN OF ACTION.....	1.5
1.6 DUAL SYSTEM OF UNITS.....	1.6
CHAPTER 2. PLAN OF ACTION AND THE COUNTERMEASURES MATRIX.....	2.1
2.1 STRATEGIES FOR PROTECTING SCOUR CRITICAL BRIDGES.....	2.1
2.1.1 Technical Advisories.....	2.1
2.1.2 Additional Guidance and Requirements.....	2.2
2.1.3 Management Strategies for a Plan of Action.....	2.2
2.1.4 Inspection Strategies in a Plan of Action.....	2.3
2.1.5 Closure Instructions.....	2.4
2.1.6 Countermeasure Alternatives and Schedule.....	2.5
2.1.7 Other Information Necessary in a Plan of Action.....	2.5
2.1.8 Development and Implementation of a POA.....	2.5
2.2 STANDARD TEMPLATE FOR A PLAN OF ACTION.....	2.6
2.2.1 Overview.....	2.6
2.2.2 Executive Summary.....	2.7
2.3 THE COUNTERMEASURE MATRIX.....	2.7
2.4 COUNTERMEASURE GROUPS.....	2.8
2.4.1 Group 1. Hydraulic Countermeasures.....	2.8
2.4.2 Group 2. Structural Countermeasures.....	2.13
2.4.3 Group 3. Biotechnical Countermeasures.....	2.13
2.4.4 Group 4. Monitoring.....	2.14

2.5	COUNTERMEASURE CHARACTERISTICS.....	2.15
2.5.1	Functional Applications.....	2.15
2.5.2	Suitable River Environment	2.16
2.5.3	Maintenance.....	2.16
2.5.4	Installation/Experience by State Departments of Transportation	2.17
2.5.5	Design Guideline Reference.....	2.17
2.5.6	Summary.....	2.17
CHAPTER 3. CONSIDERATIONS FOR SELECTING COUNTERMEASURES.....		3.1
3.1	INTRODUCTION.....	3.1
3.2	CRITERIA FOR THE SELECTION OF COUNTERMEASURES.....	3.2
3.2.1	Erosion Mechanism	3.2
3.2.2	Stream Characteristics	3.2
3.2.3	Construction and Maintenance Requirements	3.4
3.2.4	Vandalism	3.4
3.2.5	Countermeasure Selection Based on Cost.....	3.4
3.2.6	Countermeasure Selection Based on Risk	3.8
3.3	COUNTERMEASURES FOR MEANDER MIGRATION.....	3.9
3.4	COUNTERMEASURES FOR CHANNEL BRAIDING AND ANABRANCHING.....	3.11
3.5	COUNTERMEASURES FOR DEGRADATION AND AGGRADATION.....	3.12
3.5.1	Countermeasures to Control Degradation	3.12
3.5.2	Countermeasures to Control Aggradation	3.13
3.6	SELECTION OF COUNTERMEASURES FOR SCOUR AT BRIDGES	3.14
3.6.1	Countermeasures for Contraction Scour	3.15
3.6.2	Countermeasures for Local Scour	3.16
3.6.3	Monitoring	3.18
CHAPTER 4. COUNTERMEASURE DESIGN CONCEPTS.....		4.1
4.1	COUNTERMEASURE DESIGN APPROACH.....	4.1
4.1.1	Investment in Countermeasures.....	4.1
4.1.2	Service Life and Safety.....	4.1
4.1.3	Design Approach.....	4.2
4.2	ENVIRONMENTAL PERMITTING.....	4.3
4.3	HYDRAULIC ANALYSIS	4.4
4.3.1	Overview	4.4
4.3.2	Physical Models.....	4.4
4.3.3	Scour at Transverse Structures	4.6
4.3.4	Scour at Longitudinal Structures.....	4.7
4.3.5	Scour at Protected Bendways	4.10
4.3.6	Hydraulic Stress on a Bendway	4.11

CHAPTER 5. RIPRAP DESIGN, FILTERS, FAILURE MODES, AND ALTERNATIVES	5.1
5.1 OVERVIEW	5.1
5.2 RIPRAP DESIGN	5.2
5.2.1 Introduction	5.2
5.2.2 Riprap Revetment	5.2
5.2.3 Riprap for Bridge Piers	5.3
5.2.4 Riprap for Bridge Abutments	5.4
5.2.5 Riprap Protection for Countermeasures	5.4
5.2.6 Riprap for Special Applications	5.4
5.2.7 Termination Details	5.5
5.2.8 Riprap Size, Shape, and Gradation	5.5
5.3 FILTER REQUIREMENTS	5.7
5.3.1 Overview	5.7
5.3.2 Placing Geotextiles Under Water	5.8
5.4 RIPRAP FAILURE MODES	5.10
5.4.1 Riprap Revetment Failure Modes	5.12
5.4.2 Pier Riprap Failure Modes	5.17
5.4.3 Pier Riprap Failure Modes – Schoharie Creek Case Study	5.18
5.5 RIPRAP INSPECTION GUIDANCE.....	5.21
5.5.1 General	5.21
5.5.2 Guidance for Recording Riprap Condition	5.22
5.5.3 Performance Evaluation	5.22
5.6 GROUTED AND PARTIALLY GROUTED RIPRAP	5.22
5.7 CONCRETE ARMOR UNITS	5.25
CHAPTER 6. BIOTECHNICAL ENGINEERING	6.1
6.1 OVERVIEW	6.1
6.2 CURRENT PRACTICE.....	6.1
6.3 GENERAL CONCEPTS	6.2
6.4 ADVANTAGES AND LIMITATIONS OF BIOTECHNICAL ENGINEERING	6.3
6.5 DESIGN CONSIDERATIONS FOR BIOTECHNICAL COUNTERMEASURES.....	6.4
6.6 COMMONLY USED VEGETATIVE METHODS.....	6.6
6.7 ENVIRONMENTAL CONSIDERATIONS AND BENEFITS	6.6
6.8 APPLICATION GUIDANCE FOR BIOTECHNICAL COUNTERMEASURES	6.10
6.8.1 Streambank Zones	6.10
6.8.2 Biotechnical Engineering Treatments	6.11
6.9 SUMMARY	6.13

CHAPTER 7. COUNTERMEASURE DESIGN GUIDELINES	7.1
7.1 INTRODUCTION.....	7.1
7.2 DESIGN GUIDELINES.....	7.2
7.2.1 Countermeasures for Stream Instability.....	7.2
7.2.2 Countermeasures for Streambank and Roadway Embankment Protection	7.2
7.2.3 Countermeasures for Bridge Pier Protection	7.3
7.2.4 Countermeasures for Abutment Protection.....	7.4
7.2.5 Filter Design	7.4
7.2.6 Special Applications	7.4
CHAPTER 8. OTHER COUNTERMEASURES AND CASE HISTORIES OF PERFORMANCE	8.1
8.1 INTRODUCTION.....	8.1
8.2 HARDPOINTS.....	8.1
8.3 RETARDER STRUCTURES	8.1
8.3.1 Jacks and Tetrahedrons.....	8.2
8.3.2 Fence Retarder Structures	8.4
8.3.3 Timber Pile	8.4
8.3.4 Wood Fence.....	8.4
8.4 LONGITUDINAL DIKES	8.5
8.4.1 Earth or Rock Embankments.....	8.5
8.4.2 Rock Toe-Dikes.....	8.7
8.4.3 Crib Dikes.....	8.8
8.4.4 Bulkheads	8.8
8.5 CHANNEL RELOCATION	8.11
8.6 CASE HISTORIES OF COUNTERMEASURE PERFORMANCE	8.13
8.6.1 Flexible Revetment.....	8.13
8.6.2 Rigid Revetments	8.15
8.6.3 Bulkheads	8.16
8.6.4 Spurs.....	8.16
8.6.5 Retardance Structures.....	8.17
8.6.6 Dikes	8.17
8.6.7 Guide Banks.....	8.17
8.6.8 Check Dams.....	8.18
8.6.9 Jack or Tetrahedron Fields.....	8.19
8.6.10 Special Devices for Protection of Piers.....	8.19
8.6.11 Channel Alterations	8.20
8.6.12 Modification of Bridge Length and Relief Structures	8.20
8.6.13 Investment in Countermeasures.....	8.20
CHAPTER 9. SCOUR MONITORING AND INSTRUMENTATION.....	9.1
9.1 INTRODUCTION.....	9.1
9.2 PORTABLE INSTRUMENTATION	9.2

9.2.1	Components of a Portable Instrument System	9.2
9.2.2	Instrument for Making the Measurement	9.2
9.2.3	System for Deploying the Instrument.....	9.7
9.2.4	Positioning Information.....	9.10
9.2.5	Data Storage Devices.....	9.11
9.3	FIXED INSTRUMENTATION.....	9.11
9.3.1	NCHRP Project 21-3	9.11
9.3.2	Scour Measurement	9.12
9.3.3	Summary of NCHRP Project 21-3 Results	9.13
9.3.4	Operational Fixed Instrument Systems.....	9.14
9.3.5	NCHRP Project 20-5	9.22
9.3.6	Application Guidelines	9.23
9.4	SELECTING INSTRUMENTATION	9.24
9.4.1	Portable Instruments	9.25
9.4.2	Fixed Instruments.....	9.26
9.5	FIXED INSTRUMENT CASE HISTORIES.....	9.30
9.5.1	Introduction	9.30
9.5.2	Typical Field Installations.....	9.30
CHAPTER 10.	REFERENCES.....	10.1
APPENDIX A –	Metric System, Conversion Factors, and Water Properties	A.1
APPENDIX B –	Standard Template for a Plan of Action.....	B.1
APPENDIX C –	Pier Scour Countermeasure Selection Methodology	C.1
APPENDIX D –	Riprap Inspection Recording Guidance.....	D.1

(page intentionally left blank)

Bridge Scour and Stream Instability Countermeasures
Experience, Selection, and Design Guidance
Third Edition

Volume 2

DESIGN GUIDELINES

INTRODUCTION..... 1
DESIGN GUIDELINES..... 2

SECTION 1 - COUNTERMEASURES FOR STREAM INSTABILITY

Design Guideline 1 – Bendway Weirs/Stream Barbs..... DG1.1
Design Guideline 2 – Spurs..... DG2.1
Design Guideline 3 – Check Dams/Drop Structures..... DG3.1

**SECTION 2 - COUNTERMEASURES FOR STREAMBANK AND ROADWAY
EMBANKMENT PROTECTION**

Design Guideline 4 – Riprap Revetment..... DG4.1
Design Guideline 5 – Riprap Design for Embankment Overtopping DG5.1
Design Guideline 6 – Wire Enclosed Riprap Mattress DG6.1
Design Guideline 7 – Soil Cement..... DG7.1
Design Guideline 8 – Articulating Concrete Block Systems DG8.1
Design Guideline 9 – Grout-Filled Mattresses DG9.1
Design Guideline 10 – Gabion Mattresses DG10.1

SECTION 3 - COUNTERMEASURES FOR BRIDGE PIER PROTECTION

Design Guideline 8 – Articulating Concrete Block Systems at Bridge Piers..... DG8.21
Design Guideline 9 – Grout-Filled Mattresses at Bridge Piers DG9.14
Design Guideline 10 – Gabion Mattresses at Bridge Piers DG10.13
Design Guideline 11 – Rock Riprap at Bridge Piers DG11.1
Design Guideline 12 – Partially Grouted Riprap at Bridge Piers DG12.1

SECTION 4 - COUNTERMEASURES FOR ABUTMENT PROTECTION

Design Guideline 13 – Grout/Cement Filled Bags DG13.1
Design Guideline 14 – Rock Riprap at Bridge Abutments DG14.1
Design Guideline 15 – Guide Banks..... DG15.1

SECTION 5 - FILTER DESIGN

Design Guideline 16 – Filter Design DG16.1

SECTION 6 – SPECIAL APPLICATIONS

Design Guideline 17 – Riprap Design for Wave Attack DG17.1
Design Guideline 18 – Riprap Protection for Bottomless Culverts DG18.1
Design Guideline 19 – Concrete Armor Units..... DG19.1

(page intentionally left blank)

ACKNOWLEDGMENTS

This manual is a major revision of the second edition of HEC-23 which was published in 2001. The writers wish to acknowledge the contributions made by Morgan S. Byars (formerly Ayres Associates) as a co-author of the first edition (1997). Technical assistance for the second edition was provided by J. Sterling Jones (FHWA) and A. Firenzi, J.L. Morris, E.V. Richardson, W.J. Spitz, and A. Waddoups (Ayres Associates).

DISCLAIMER

Mention of a manufacturer, registered or trade name does not constitute a guarantee or warranty of the product by the U.S. Department of Transportation or the Federal Highway Administration and does not imply their approval and/or endorsement to the exclusion of other products and/or manufacturers that may also be suitable.

(page intentionally left blank)

VOLUME 2

COUNTERMEASURE DESIGN GUIDELINES

INTRODUCTION

In this volume design guidelines are provided for a variety of stream instability and bridge scour countermeasures. Most of these countermeasures have been applied successfully on a state or regional basis, but, in several cases, only limited design references are available in published handbooks, manuals, or reports. No attempt has been made to include in this document design guidelines for all the countermeasures listed or referenced in Volume 1.

Countermeasure design guidelines formerly presented in HEC-20 (spurs, guide banks, drop structures) and in HEC-18 (riprap at abutments and piers) are now consolidated in this document. Since many bridge scour and stream instability countermeasures require riprap revetment as an integral component of the countermeasure, riprap revetment design guidance is summarized in Design Guideline 4. An appropriate granular or geotextile filter is essential for any countermeasure requiring a protective armor layer (e.g., riprap, articulating concrete blocks, etc.). Filter design guidance is provided in Design Guideline 16.

Design Guideline 8 – Articulating Concrete Block Systems, Design Guideline 9 – Grout-Filled Mattresses, and Design Guideline 10 – Gabion Mattresses each contain two countermeasure applications: (1) bankline revetment or bed armor, and (2) pier scour protection. Consequently, these three design guidelines appear in Section 2, but are referenced in Section 3 with a page citation to the pier protection application.

A number of highway agencies provided specifications, procedures, or design guidelines for bridge scour and stream instability countermeasures that have been used successfully locally, but for which only limited design guidance is available outside the agency. Several of these are presented as design guidelines for the consideration of and possible adaptation to the needs of other highway agencies (see for example, Design Guideline 6, Wire Enclosed Riprap Mattress, and Design Guideline 13, Grout/Cement Filled Bags). These specifications, procedures, or guidelines have not been evaluated, tested, or endorsed by the authors of this document or by the FHWA. They are presented here in the interests of information transfer on countermeasures that **may** have application in another state or region.

Since publication of the Second Edition of HEC-23 in 2001, both the Transportation Research Board through the NCHRP Program and FHWA have sponsored a number of research projects to improve the state of practice in bridge scour and stream instability countermeasure technology and provide definitive guidance to bridge owners in countermeasure design. Among the projects that represent advances in countermeasure technology that have been incorporated into the Design Guidelines are:

- NCHRP Report 544 - Environmentally Sensitive Channel and Bank Protection Measures
- NCHRP Report 568 - Riprap Design Criteria, Specifications, and Quality Control
- NCHRP Report 587 - Countermeasures to Protect Bridge Abutments from Scour
- NCHRP Report 593 - Countermeasures to Protect Bridge Piers from Scour

DESIGN GUIDELINES

The following specifications, procedures, or design guidelines are included in this volume. The application of the countermeasure and the contributing source(s) of information are also indicated below.

SECTION 1 - COUNTERMEASURES FOR STREAM INSTABILITY

Design Guideline 1

- **Bendway Weirs/Stream Barbs**
 - **Source(s):** Colorado Department of Transportation
Washington State Department of Transportation
Tennessee Department of Transportation
Soil Conservation Service (now Natural Resources Conservation Service)
U.S. Army Corps of Engineers
 - **Application:** Bankline protection and flow alignment in meandering channel bends

Design Guideline 2

- **Spurs**
 - **Source(s):** HEC-20 Stream Stability at Highway Structures (Second Edition)
NCHRP Report 568
 - **Application:** Bankline stabilization and flow alignment

Design Guideline 3

- **Check Dams/Drop Structures**
 - **Source(s):** HEC-20 Stream Stability at Highway Structures (Second Edition)
HEC-14 Hydraulic Design of Energy Dissipators for Culverts and Channels
 - **Application:** Correcting or preventing channel degradation

SECTION 2 - COUNTERMEASURES FOR STREAMBANK AND ROADWAY EMBANKMENT PROTECTION

Design Guideline 4

- **Riprap Revetment**
 - **Source(s):** NCHRP Report 568
 - **Application:** Bankline/abutment protection and riprap component of many other countermeasures

Design Guideline 5

- **Riprap Design for Embankment Overtopping**
 - **Source(s):** NCHRP Report 568
 - **Application:** Protection for roadway approach embankments and flow control countermeasures

Design Guideline 6

- **Wire Enclosed Riprap Mattress**
 - **Source(s):** New Mexico State Highway and Transportation Department
 - **Application:** Revetment for banklines, guide banks, and sloping abutments

Design Guideline 7

- **Soil Cement**
 - **Source(s):** Portland Cement Association
Pima County Arizona
Maricopa County Arizona
 - **Application:** Revetment for banklines and sloping abutments, drop structures, and bed armor

Design Guideline 8

- **Articulating Concrete Block Systems for Bank Protection or Bed Armor**
 - **Source(s):** Harris County Flood Control District (2001)
Federal Highway Administration
Maine Department of Transportation
Minnesota Department of Transportation
 - **Application 1:** Bankline revetment and bed armor

Design Guideline 9

- **Grout-Filled Mattresses for Bank Protection or Bed Armor**
 - **Source(s):** Federal Highway Administration
Oregon Department of Transportation
Arizona Department of Transportation
 - **Application 1:** Bankline revetment and bed armor

Design Guideline 10

- **Gabion Mattresses for Bank Protection or Bed Armor**
 - **Source(s):** Federal Highway Administration
 - **Application 1:** Bankline revetment and bed armor

SECTION 3 - COUNTERMEASURES FOR BRIDGE PIER PROTECTION

Design Guideline 8

- **Articulating Concrete Block Systems at Bridge Piers**
 - **Source(s):** NCHRP Report 593
 - **Application 2:** Pier scour protection

Design Guideline 9

- **Grout-Filled Mattresses at Bridge Piers**
 - **Source(s):** NCHRP Report 593
 - **Application 2:** Pier scour protection

Design Guideline 10

- **Gabion Mattresses at Bridge Piers**
 - **Source(s):** NCHRP Report 593
 - **Application 2:** Pier scour protection

Design Guideline 11

- **Rock Riprap at Bridge Piers**
 - **Source(s):** HEC-18 Scour at Bridges (Third Edition)
NCHRP Report 593
NCHRP Report 568
 - **Application:** Pier scour protection

Design Guideline 12

- **Partially Grouted Riprap at Bridge Piers**
 - **Source(s):** NCHRP Report 593
 - **Application:** Pier Scour Protection

SECTION 4 - COUNTERMEASURES FOR ABUTMENT PROTECTION

Design Guideline 13

- **Grout/Cement Filled Bags**
 - **Source(s):** Maryland State Highway Administration
Maine Department of Transportation
 - **Application:** Protection of undermined areas at piers and abutments, and bed armor

Design Guideline 14

- **Rock Riprap at Bridge Abutments**
 - **Source(s):** NCHRP Report 568
NCHRP Report 587
 - **Application:** Abutment scour protection

Design Guideline 15

- **Guide Banks**
 - **Source(s):** HEC-20 Stream Stability at Highway Structures (Second Edition)
NCHRP Report 568
 - **Application:** Abutment scour protection

SECTION 5 - FILTER DESIGN

Design Guideline 16

- **Filter Design**
 - **Source(s):** NCHRP Report 568
NCHRP Report 593
 - **Application:** Filter for revetment or countermeasure armor

SECTION 6 – SPECIAL APPLICATIONS

Design Guideline 17

- **Riprap Design for Wave Attack**
 - **Source(s):** HEC-25 (1st and 2nd Editions)
 - **Application:** Protection for coastal roadway embankments

Design Guideline 18

- **Riprap Protection for Bottomless Culverts**
 - **Source(s):** FHWA Reports FHWA-RD-02-078 and FHWA-HRT-07-026
 - **Application:** Scour protection at bottomless culverts

Design Guideline 19

- **Concrete Armor Units (Toskanes and A-Jacks®)**
 - **Source(s):** Testing at Colorado State University
 - **Application:** Pier scour protection



SECTION 1 – COUNTERMEASURES FOR STREAM INSTABILITY

Design Guideline 1 – Bendway Weirs/Stream Barbs

Design Guideline 2 – Spurs

Design Guideline 3 – Check Dams/Drop Structures

DESIGN GUIDELINE 1
BENDWAY WEIRS/STREAM BARBS

(page intentionally left blank)

DESIGN GUIDELINE 1

BENDWAY WEIRS/STREAM BARBS

1.1 INTRODUCTION

Bendway weirs, also referred to as stream barbs, bank barbs, and reverse sills, are low elevation stone sills used to improve lateral stream stability and flow alignment problems at river bends and highway crossings. Bendway weirs are used for improving inadequate navigation channel width at bends on large navigable rivers. They are used more often for bankline protection on streams and smaller rivers. The stream barb concept was first introduced in the Soil Conservation Service (now the Natural Resource Conservation Service, NRCS) by Reichmuth (1993) who has applied these rock structures in many streams in the western United States. The NRCS has recently published design guidance for streambarbs in their National Engineering Handbook (NRCS 2007).

The U.S. Army Corps of Engineers Waterways Experiment Station (WES) developed a physical model to investigate the bendway weir concept in 1988 (USACE 1988, Watson et al. 1996). Since then WES has conducted 11 physical model studies on the use of bendway weirs to improve deep and shallow-draft navigation, align currents through highway bridges, divert sediment, and protect docking facilities. WES has installed bendway weirs to protect eroding banklines on bends of Harland Creek near Tchula, Mississippi. The U.S. Army Corps of Engineers, Omaha District, has used bendway weirs on the Missouri River in eastern Montana. The Missouri River Division (MRD) Mead Hydraulic Laboratory has also conducted significant research and testing of underwater sills. Bendway weirs are a relatively new river training structure and research is providing useful information on their use and effectiveness.

1.2 DESIGN CONCEPT

Bendway weirs are similar in appearance to stone spurs, but have significant functional differences. Spurs are typically visible above the flow line and are designed so that flow is either diverted **around** the structure, or flow along the bank line is reduced as it passes **through** the structure. Bendway weirs are normally not visible, especially at stages above low water, and are intended to redirect flow by utilizing weir hydraulics **over** the structure. Flow passing over the bendway weir is redirected such that it flows perpendicular to the axis of the weir and is directed towards the channel centerline. Similar to stone spurs, bendway weirs reduce near bank velocities, reduce the concentration of currents on the outer bank, and can produce a better alignment of flow through the bend and downstream crossing. **Experience with bendway weirs has indicated that the structures do not perform well in degrading or sediment deficient reaches.**

Bendway weirs have been constructed from stone, tree trunks, and grout filled bags and tubes. Design guidance for bendway weirs has been provided by the U.S. Army Corps of Engineers, Omaha District, WES, and the NRCS. The following geometric design guidelines for stone bendway weirs reflect guidance provided by NRCS (2007), LaGrone (1996), Saele (1994), and Derrick (1994, 1996). The formulas provided by LaGrone were developed to consolidate many of the "rules of thumb" that currently exist in the field. The formulas are not based on exhaustive research, but appear to match well to current practices. Installation examples were provided by Colorado Department of Transportation (CDOT), Washington State Department of Transportation (WSDOT), and Tennessee Department of Transportation (TDOT).

1.3 DESIGN GUIDELINES

1. HEIGHT - The height of the weirs, H , is determined by analyzing various depths of flow at the project site (Refer to Figures 1.1 and 1.2). The bendway weir height should be between 30 to 50% of the depth at the mean annual high water level. The height of the structure should also be below the normal or seasonal mean water level and should be equal to or above the mean low water level. The weir must be of adequate height to intercept a large enough percentage of the flow to produce the desired results. For applications relating to improved navigation width, the weir must be at an elevation low enough to allow normal river traffic to pass over the weir unimpeded.

2. ANGLE - The angle of projection, θ , between the bendway weir axis and the upstream bankline tangent typically ranges from 60 to 80 degrees. Experience has indicated that it is easier to measure this angle from the chord between two weirs in the field rather than using the bankline tangent. The chord is drawn from the points of intersection with the weirs and the bankline (Figure 1.1). The angle of projection is determined by the location of the weir in the bend and the angle at which the flow lines approach the structure. Ideally, the angle should be such that the high-flow streamline angle of attack is not greater than 30 degrees and the low-flow streamline angle of attack is not less than 15 degrees to the normal of the weir centerline of the first several weirs. If the angle of flow approaching the upstream weirs is close to head-on, then the weir will be ineffective and act as a flow divider and bank scalloping can result. If the angle of flow approaching the upstream weirs is too large then the weir will not be able to effectively redirect the flow to the desired flow path. Ideally, the angle should be such that the perpendicular line from the midpoint of an upstream weir points to the midpoint of the following downstream weir. All other factors being equal, smaller projection angles, θ , would need to be applied to bends with smaller radii of curvature to meet this criteria and vice versa. Experiments by Derrick (1994) resulted in a weir angle, θ , of 60 degrees being the most effective for the desired results in a physical model of a reach on the Mississippi River. Observations by LaGrone (1996), indicate that the angle, θ , of the upstream face of the structure is most important in redirecting flows. The upstream face should be a well defined straight line at a consistent angle.

3. CROSS SECTION - The transverse slope along the centerline of the weir is intended to be flat or nearly flat and should be no steeper than 1V:5H. The flat weir section normally transitions into the bank on a slope of 1V:1.5H to 1V:2H. The structure height at the bankline should equal the height of the maximum design high water. This level is designed using sound engineering judgment. The key must be high enough to prevent flow from flanking the structure. The bendway weir should also be keyed into the stream bed a minimum depth approximately equal to the D_{100} size, but also below the anticipated long-term degradation and contraction scour depth.

4. LENGTH - The bendway weir length (L) should be long enough to cross the stream thalweg; however, should not exceed $1/3$ the mean channel width (W). A weir length greater than $1/3$ of the width of the channel can alter the channel patterns which can impact the opposite bankline. Weirs designed for bank protection need not exceed $1/4$ the channel width. A length of 1.5 to 2 times the distance from the bank to the thalweg has proven satisfactory on some bank stabilization projects. The length of the weir will affect the spacing between the weirs.

$$\text{Maximum Length } L = W/3 \quad (\text{typically: } W/10 < L < W/4) \quad (1.1)$$

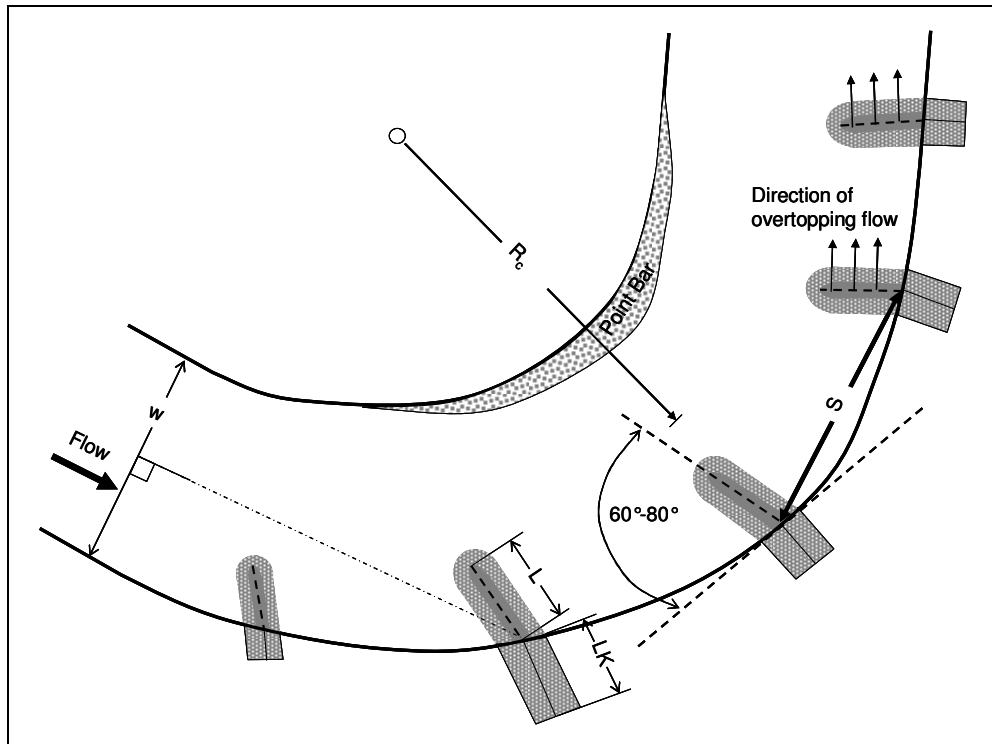

Figure 1.1. Bendway weir typical plan view.

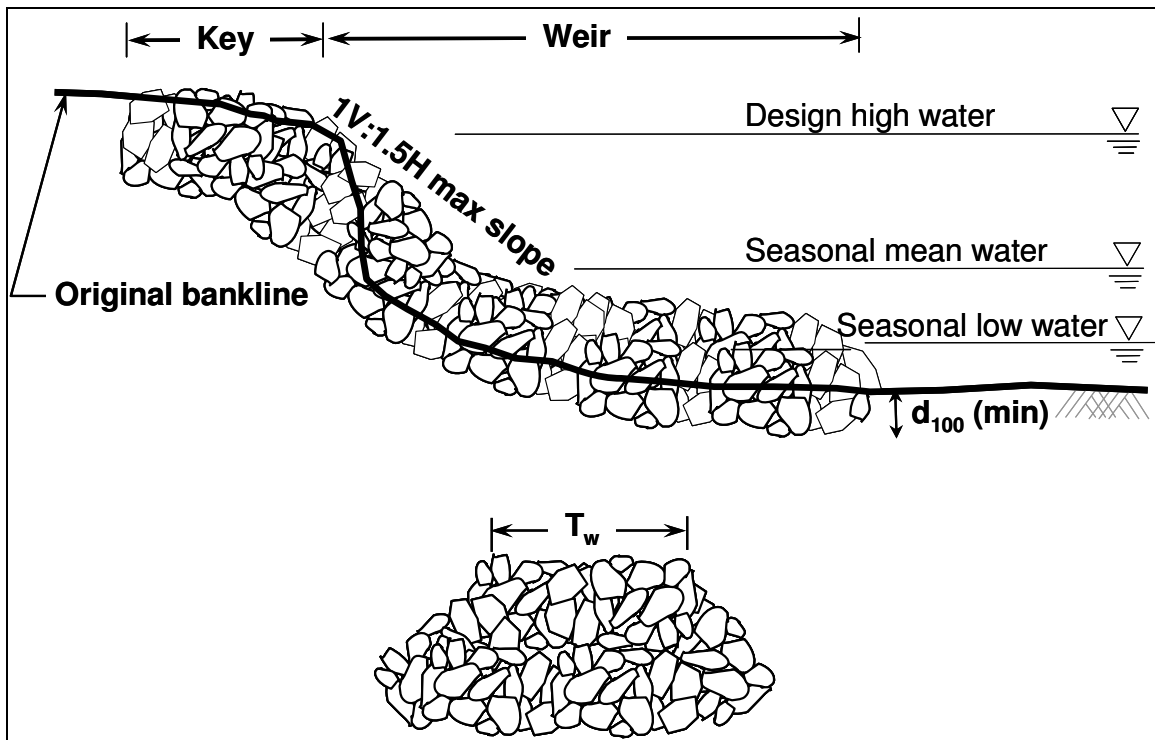

Figure 1.2. Bendway weir typical cross section.

5. LOCATION - Ideally, a short weir should be placed a distance (S) upstream from the location where the midstream tangent flow line (midstream flow line located at the start of the curve) intersects the bankline (PI). Additional bendway weirs are then located based on the site conditions and sound engineering judgment. Typically, the weirs are evenly spaced a distance (S) apart (Figure 1.1).

6. SPACING - Bendway weir spacing is influenced by several site conditions. The following guidance formulas are based on a cursory review of the tests completed by WES on bendway weirs and on tests completed by MRD on underwater sills. Based on the review, bendway weirs should be spaced similarly to hardpoints and spurs. Weir spacing is dependent on the streamflow leaving the weir and its intersection with the downstream structure or bank. Weir spacing (S) is influenced by the length of the weir (L), and the ratios of weir length to channel width (W) and channel radius of curvature (R) to channel width. Spacing can be computed based on the following guidance formulas (USACE 1988, LaGrone 1996):

$$S = 1.5L \left(\frac{R}{W} \right)^{0.8} \left(\frac{L}{W} \right)^{0.3} \quad (1.2)$$

$$S = (4 \text{ to } 5)L \quad (1.3)$$

The spacing selected should fall within the range established by Equations 1.2 and 1.3, depending on bendway geometry and flow alignment. The spacing should not exceed the maximum established by Equation 1.4. Maximum Spacing (S_{max}) is based on the intersection of the tangent flow line with the bankline assuming a simple curve. The maximum spacing is not recommended, but is a reference for designers. In situations where some erosion between weirs can be tolerated, the spacing may be set between the recommended and the maximum.⁽⁴⁾

$$S_{max} = R \left(1 - \left(1 - \frac{L}{R} \right)^2 \right)^{0.5} \quad (1.4)$$

Results from the spacing formulas should be investigated to determine if the weir spacing, length, and angle would redirect the flow to the desired location. Streamlines entering and exiting the weirs should be analyzed and drawn in planform.

7. LENGTH OF KEY - Bendway weirs like all bankline protection structures should be keyed into the bankline to prevent flanking by the flow. Typically the key length (LK) is about half the length of the short weirs and about one fifth the length of the long weirs. Tests conducted by MRD found that lateral erosion between spurs on nearly straight reaches could be estimated by using a 20 degree angle of expansion (Figure 1.3). The following guidance formulas for LK were therefore developed. **These formulas compute minimum LK which should be extended in critical locations.** The need for a filter between the weir key and the bank material should also be determined. Guidelines for the selection, design, and specification of filter materials can be found in Holtz et al. (1995) and Design Guideline 16.

When the channel radius of curvature is large ($R > 5W$) and $S > L/\tan(20^\circ)$

$$LK = S \tan(20^\circ) - L \quad (1.5)$$

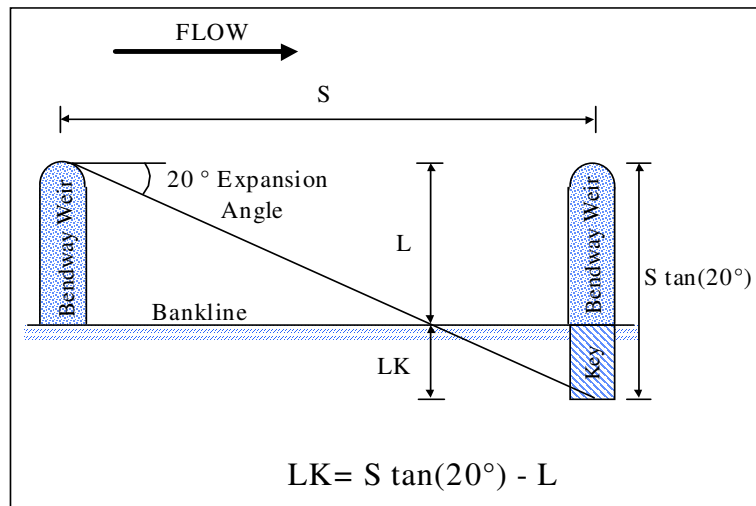

Figure 1.3. Length of key for mild bends.

When the channel radius of curvature is small $R < 5W$ and $S < L/\tan(20^\circ)$

$$LK = \frac{L}{2} \left(\frac{W}{L} \right)^{0.3} \left(\frac{S}{R} \right)^{0.5} \quad (1.6)$$

NOTE: LK should not be less than 1.5 times the total bank height.

The NRCS guideline for length of key (LK) for short weirs or barbs (NRCS 2007, Saele 1994) is to key the barb into the bank a minimum distance of 8 ft (2.4 m) or not less than 1.5 times the bank height, which ever is greater.

8. TOP WIDTH - The top width of the weir may vary between 3 and 12 ft (1 m and 4 m), but should be no less than $(2 \text{ to } 3) \cdot D_{100}$. Weirs over 30 ft (9 m) in length will have to be built either from a barge or by driving equipment out on the structure during low flows. Structures built by driving equipment on the weir will need to be at least 10 to 15 ft (3 to 5 m) wide. Side slopes of the weirs can be set at the natural angle of repose of the construction material (1V:1.5H) or flatter.

9. NUMBER OF WEIRS - The smallest number of weirs necessary to accomplish the project purpose should be constructed. The length of the weirs and the spacing can be adjusted to meet this requirement. Typically, not less than three weirs are used together on unrevetted banks.

10. CONSTRUCTION - Construction of the bendway weirs are typically conducted during low flow periods for the affected river. Construction methods will vary depending on the size of the river. Construction on larger rivers may be conducted using a barge which would allow the rock to be placed without disturbing the bankline. For rivers where a barge is not available and where the bendway weir is longer than 30 ft (9 m), access will need to be made from the bank and equipment may need to be driven out on the weir as it is being constructed.

Supplemental information on the use of bendway weirs on tight bends (small radius of curvature) and complex meanders can be found in LaGrone (1996).

1.4 MATERIAL SPECIFICATIONS

1. Stone should be angular, and not more than 30% of the stone should have a length exceeding 2.5 its thickness.
2. No stone should be longer than 3.5 times its thickness.
3. Stone should be well graded but with only a limited amount of material less than half the median stone size. Since the stone will most often be placed in moving water, the smaller stone will be subject to displacement by the flow during installation.
4. Construction material should be quarry run stone or broken, clean concrete. High quality material is recommended for long-term performance.
5. Material sizing should be based on standard riprap sizing formulas for turbulent flow. Typically the size should be approximately 20% greater than that computed from nonturbulent riprap sizing formulas. The riprap D_{50} typically ranges between 1 and 3 ft (300 mm and 910 mm) and should be in the 100 to 1,000 lb (45 kg to 450 kg) range. The D_{100} rock size should be at least 3 times the calculated D_{50} size. The minimum rock size should not be less than the D_{100} of the streambed material.
6. Guidelines for the selection, design, and specification of filter materials can be found in Holtz et al. (1995) and Design Guideline 16.

1.5 BENDWAY WEIR DESIGN EXAMPLE

The following example illustrates the preliminary layout of bendway weirs for use in bank protection at a stream bend. The design uses guidelines provided in the previous sections.

Given:

The stream width is 100 ft (30 m). The radius of the bend is 500 ft (152 m). The bank height is 10 ft (3 m), which is the mean annual high water level.

Develop a preliminary layout for bendway weir placement for bank protection at the stream bend. The preliminary layout should include weir height, weir length, key length, and weir spacing. Assume the stone size will be established in the final design of the system.

Step 1: Determine the weir height.

$H = 0.3$ to 0.5 of mean annual high water depth (use 0.3 for this problem)

$H = 0.3 (10 \text{ ft}) = 3 \text{ ft} (0.9 \text{ m})$

Step 2: Determine the weir length.

$L = W/3$ for flow redirection

$L = W/4$ for bank protection

$L = 100 \text{ ft}/4 = 25 \text{ ft} (7.5 \text{ m})$

Step 3: Determine the weir spacing.

$$S = 1.5L \left[\frac{R}{W} \right]^{0.8} \left[\frac{L}{W} \right]^{0.3}$$

$$S = 1.5(25) \left[\frac{500}{100} \right]^{0.8} \left[\frac{25}{100} \right]^{0.3} = 90 \text{ ft (27.2m)}$$

Check against $S = 4(L) = 4(25 \text{ ft}) = 100 \text{ ft (30 m)}$. Based on site conditions, use 100 ft (30 m).

Check against the maximum spacing, given by:

$$S_{\max} = R \left[1 - \left[1 - \frac{L}{R} \right]^2 \right]^{0.5}$$

$$S_{\max} = 500 \left[1 - \left[1 - \frac{25}{500} \right]^2 \right]^{0.5} = 156 \text{ ft (47.2m)}$$

$S_{\max} > S$, continue:

Step 4: Determine the key length.

Check for $R > 5W$ and $S > L/\tan(20^\circ)$

$R = 500 \text{ ft (152 m)}$ and $W = 100 \text{ ft (30 m)}$, therefore $R > 5(W) = 500 \text{ ft (152 m)}$

$S = 100 \text{ ft (30 m)}$ and $L = 25 \text{ ft (7.5 m)}$, therefore $S > L/\tan(20^\circ) = 68.7 \text{ ft (20.6 m)}$

$$LK = S \tan(20^\circ) - L$$

$$LK = 100 \tan(20^\circ) - 25 = 11.4 \text{ ft (3.4 m)}$$

Check against $LK \geq 1.5(\text{Bank Height}) = 1.5(10) = 15 \text{ ft (4.5 m)}$

LK must be set to 15 ft (4.5 m) because this value is greater than the value computed first.

Step 5: Preliminary Layout.

The preliminary layout for this stream bend as follows:

Height	$H = 3 \text{ ft (0.9 m)}$
Length	$L = 25 \text{ ft (7.5 m)}$
Spacing	$S = 100 \text{ ft (30 m)}$
Length of key	$LK = 15 \text{ ft (4.5 m)}$

1.6 INSTALLATION EXAMPLES

Some illustrations of bendway weirs in use are shown in Figures 1.4 - 1.7. Figures 1.4 and 1.5 show short bendway weirs shortly after installation by CDOT on the Blue River near Silverthorne, Colorado in February 1997. These weirs were designed with weir lengths of 11.5 – 20 ft (3.5 - 6 m) at θ angles of 75° to the bankline tangent. The CDOT engineer indicated that adjustments in the field are equally as important and necessary as original design plans. It can be observed that the bendway weirs are being constructed at low flow conditions as discussed previously.

Figures 1.6 and 1.7 show bendway weirs installed by WSDOT on the Yakima River, Washington in 1994. Figure 1.6 shows the weirs at low flow conditions and Figure 1.7 shows the submerged weirs at normal to high flow conditions. Surface disturbances as flow passes over the weirs can be observed in Figure 1.7. These weirs were designed at θ angles of 50° to the bankline tangent to direct flow away from a critical pier at a bridge just downstream of this bend.

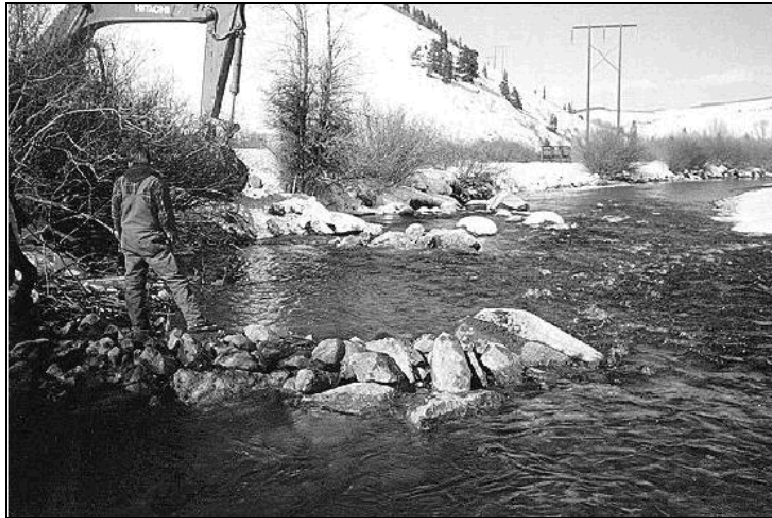

Figure 1.4. Bendway weirs installed on the Blue River near Silverthorne, Colorado (CDOT).

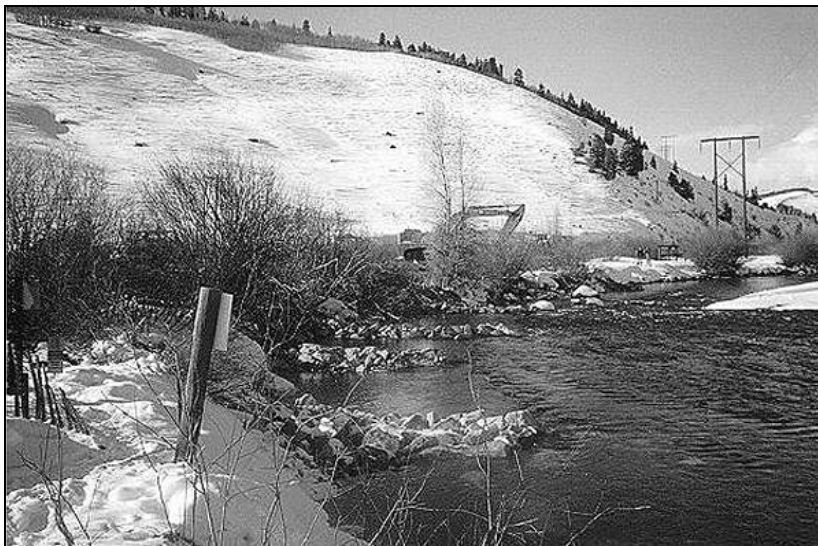

Figure 1.5. Bendway weirs installed on the Blue River near Silverthorne, Colorado (CDOT).

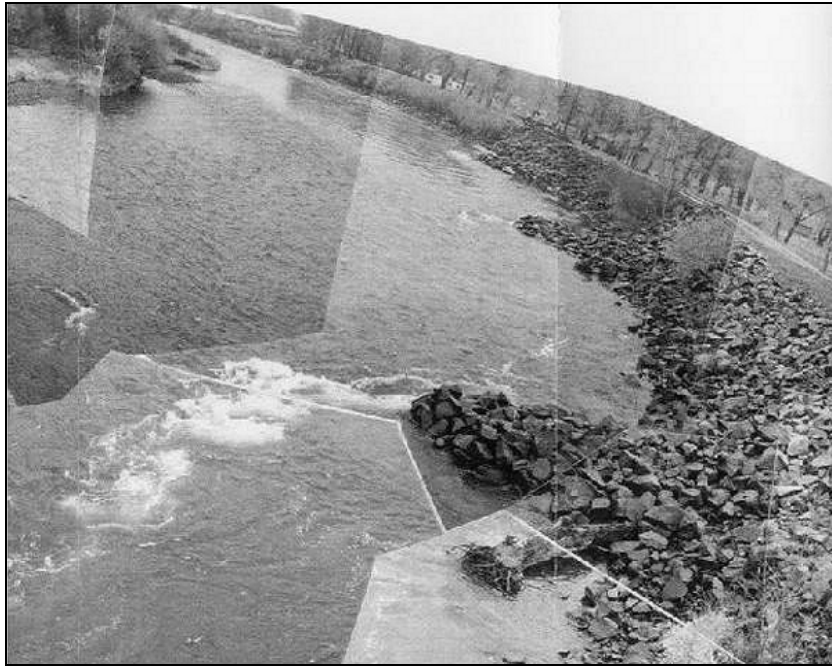

Figure 1.6. Bendway weirs on the Yakima River, Washington at low flow (WSDOT).

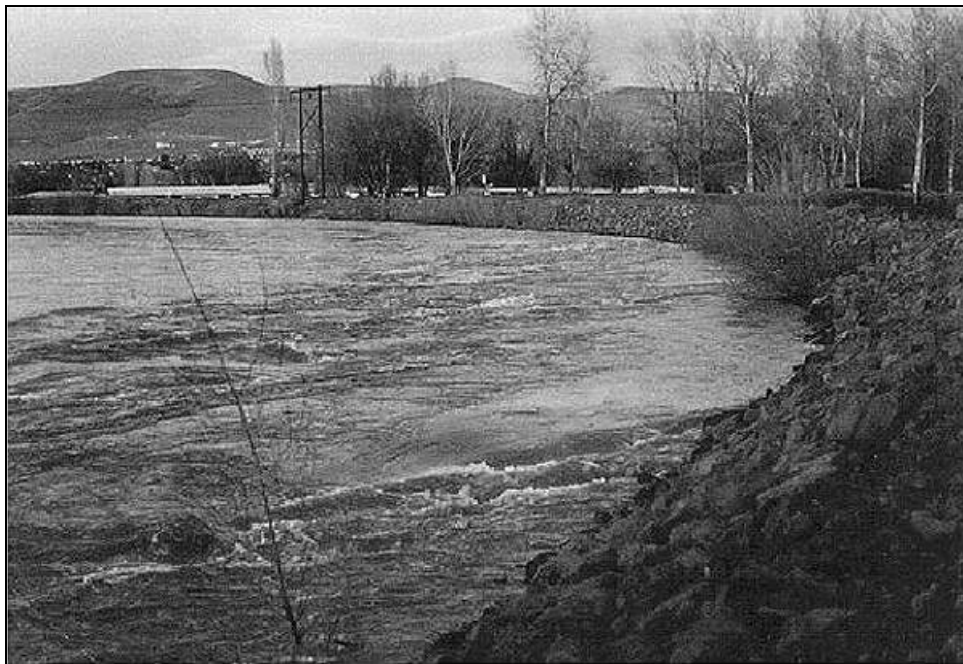

Figure 1.7. Submerged bendway weirs on the Yakima River, Washington at high flow (WSDOT).

1.7 CASE STUDY - BENDWAY WEIRS ON THE HATCHIE RIVER, TENNESSEE

On April 1, 1989 the north-bound bridge of U.S. Route 51 over the Hatchie River near Covington, Tennessee collapsed with the loss of eight lives. The flow was 8,620 cfs (244 m³/s) with a 2-year return period. However, the U.S. Geological Survey estimated that this 1989 flow was in the top 10 for overbank flow duration and the longest overbank flow duration since 1974 (Bryan 1989).

The foundation of the bridge consisted of pile bents on the floodplain and piers in the channel. The bents were supported on 20 ft (6.1 m) long timber piles embedded 1 ft (0.3 m) into concrete pile caps. The bottom of the pile caps for the floodplain bents was at an elevation 13 to 14 ft (4 to 4.3 m) higher than for the piers (Figure 1.8). The floodplain and river channel were erodible silt, sand, and clay. The north bound bridge was built in 1936 and spanned 4,000 ft (1,219 m) of the floodplain on 143 simple spans. The south bound bridge was built in 1974 and narrowed the bridge opening to 1,000 ft (305 m) on 13 spans.

The bridges spanned the Hatchie River on a meander bend. Bend migration to the north was well documented. From 1931 to 1975 the migration rate averaged 0.8 ft (0.24 m) per year; 1975 to 1981 (after the south bound bridge was built) was 4.5 ft (1.37 m) per year; and 1981 to 1989 was 1.9 ft (0.58 m) per year (Figure 1.8). The migration was such that in 1989 bent 70 was exposed to the flow. The combination of channel migration and local pier scour caused the bent to fail.

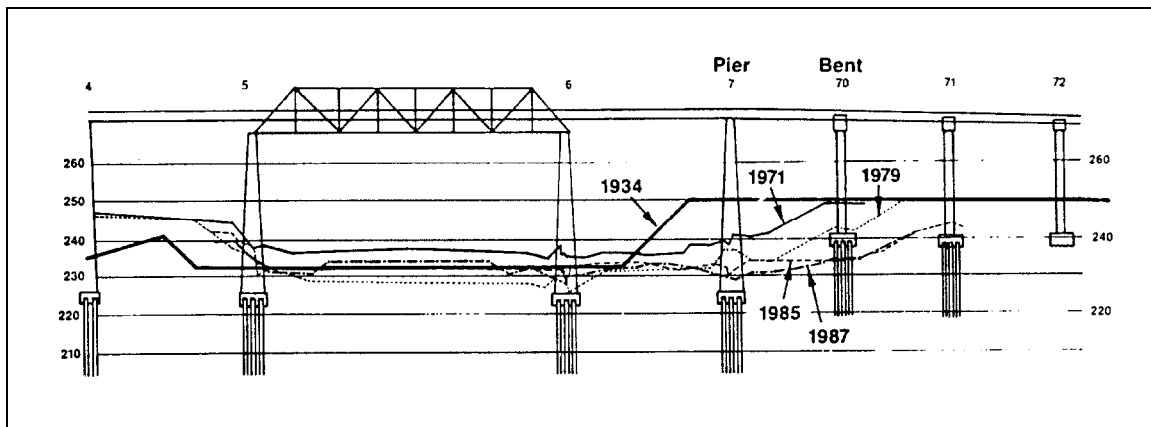

Figure 1.8. Documented channel migration of the Hatchie River, Tennessee.

The National Transportation Safety Board (NTSB 1990) investigated the failure and gave as probable cause "...the northward migration of the main river channel which the Tennessee Department of Transportation failed to evaluate and correct. Contributing to the severity of the accident was the lack of redundancy in the design of the bridge spans."

After the failure of the Hatchie River bridge, TDOT experienced additional instability on the north bank of the river, upstream from the replacement bridge. The solution was to design and install bendway weirs along the north bank (Peck 1999). A field of five bendway weirs was designed to halt the bank erosion. Design parameters were estimated using guidance from HEC-23 (First Edition). As part of the design process, a 2-dimensional hydraulic model was utilized. The model provided flow field data to refine and verify the bendway weir design. Construction was initiated and completed in the Fall of 1999. Figures 1.9 and 1.10 show the installed countermeasures at low flow.



Figure 1.9. Bendway weirs on northbank of Hatchie River looking upstream (TDOT).



Figure 1.10. Close up bendway weir on Hatchie River (TDOT).

1.8 REFERENCES

- Bryan, B.S., 1989, "Channel Evolution of the Hatchie River near the U.S. Highway 51 Crossing in Lauderdale and Tipton Counties, West Tennessee," USGS Open-File Report 89-598, Nashville, TN.
- Derrick, D.L., 1994, "Design and Development of Bendway Weirs for the Dogtooth Bend Reach, Mississippi River, Hydraulic Model Investigation," Technical Report HL-94-10, WES, Vicksburg, MS.
- Derrick, D.L., 1996, "The Bendway Weir: An Instream Erosion Control and Habitat Improvement Structure for the 1990's," Proceedings of Conference XXVII, International Erosion Control Association, 2/27/1996 - 3/1/1996, Seattle, WA.
- Derrick, D.L., "Bendway Weirs Redirect Flow to Protect Highway Bridge Abutments," U.S. Army Corps of Engineers Waterways Experiment Station, Vicksburg, MS, undated document.
- Holtz, D.H., Christopher, B.R., and Berg, R.R., 1995, "Geosynthetic Design and Construction Guidelines," National Highway Institute, Publication No. FHWA HI-95-038, Federal Highway Administration, Washington D.C., May.
- LaGrone, D.L., 1996, "Bendway Weir General Guidance Memorandum," U.S. Army Corps of Engineers, Omaha District, Omaha, NE, revised from 1995.
- NTSB, 1990, "Collapse of the Northbound U.S. Route 51 Bridge Spans over the Hatchie River near Covington, Tennessee," April 1, 1989, NTSB/HAR-90/01, National Transportation Safety Board, Washington, D.C.
- National Resources Conservation Service, 2007, "NRCS National Engineering Handbook, Part 654 – Stream Restoration Design," 210-VI-NEH, Washington, D.C.
- Peck, W.W., 1999, "Two-Dimensional Analysis of Bendway Weirs at US-51 Over the Hatchie River," Proceedings, ASCE International Water Resource Engineering Conference, Session BS-2, August 8-12, Seattle, WA.
- Reichmuth, D.R., 1993, "Living with Fluvial Systems," Workshop notes February 23 - 25, 1993, Portland, OR.
- Saele, L.M., 1994, "Guidelines for the Design of Stream Barbs," Stream bank Protection & Restoration Conference, 9/22/1994 - 24/1994, SCS-WNTC, Portland, OR.
- U.S. Army Corps Engineers, 1988, "Bendway Weir Theory, Development, and Design," USACE Waterways Experiment Station Fact Sheet, Vicksburg, MS.
- Watson, C.C., Gessler, D., Abt, S.R., Thornton, C.I., and Kozinski, P., 1996, "Demonstration Erosion Control Monitoring Sites, 1995 Evaluation," Annual Report DACW39-92-K-0003, Colorado State University, Fort Collins, CO.

DESIGN GUIDELINE 2

SPURS

(page intentionally left blank)

DESIGN GUIDELINE 2

SPURS

2.1 BACKGROUND

A spur can be a pervious or impervious structure projecting from the streambank into the channel. Spurs are used to deflect flowing water away from, or to reduce flow velocities in critical zones near the streambank, to prevent erosion of the bank, and to establish a more desirable channel alignment or width. The main function of spurs is to reduce flow velocities near the bank, which in turn, encourages sediment deposition due to these reduced velocities. Increased protection of banks can be achieved over time, as more sediment is deposited behind the spurs. Because of this, spurs may protect a streambank more effectively and at less cost than revetments. Furthermore, by moving the location of any scour away from the bank, partial failure of the spur can often be repaired before damage is done to structures along and across the stream.

Spurs are generally used to halt meander migration at a bend. They are also used to channelize wide, poorly defined streams into well-defined channels. The use of spurs to establish and maintain a well-defined channel location, cross section, and alignment in braided streams can decrease the required bridge lengths, thus decreasing the cost of bridge construction and maintenance.

Spur types are classified based upon their permeability as retarder spurs, retarder/deflector spurs, and deflector spurs. The permeability of spurs is defined simply as the percentage of the spur surface area facing the streamflow that is open. Deflector spurs are impermeable spurs which function by diverting the primary flow currents away from the bank. Retarder/deflector spurs are more permeable and function by retarding flow velocities at the bank and diverting flow away from the bank. Retarder spurs are highly permeable and function by retarding flow velocities near the bank.

Table 2.1 can be used as an aid in the selection of an appropriate spur type for a given situation (Brown 1985). The primary factors influencing the selection of a specific spur type are listed across the top, and primary spur types are evaluated in terms of those selection criteria. A scale from 1 to 5 is used to indicate the applicability of a specific spur for a given condition. A value of 1 indicates a disadvantage in using that spur type for given condition, and a value of 5 indicates a definite advantage. The table can be used by summing values horizontally for given site conditions to select the best spur type for the specific site. It should be recognized however, that adherence to the results of such a procedure assigns equal weight to each of the factors listed across the top of the table and places undue reliance on the accuracy and relative merit of values given in the rating table. It is recommended that values given in the table be used only for a qualitative evaluation of expected performance. Spur type selection should be based on the results of this evaluation as well as estimated costs, availability of materials, construction and maintenance requirements, and experience with the stream in which the spur installation is to be placed.

Table 2.1. Spur Type Performance (Brown 1985).																						
Spur Type	Function			Erosion Mechanism				Sediment Environment		Flow Environment			Bend Radius			Ice/Debris Environment						
	Project Ext. Bank	Re-est. Prev. Align	Flow Construction	Transport	Shear Stress - Toe	Shear Stress - Upper Bank	Abrasion	Regime/Low Threshold	Medium Threshold	High	Low	Medium	High	Large	Medium	Small	Minimal	Light Debris	Large Debris/Ice			
																				Velocity	Stage	
Retarder																						
Fence Type	3	2	2	3	3*	1	1	4	3	2	3	3	2	3	2	1	3	2	3	2		
Jack/Tetrahedron	3	3	1	3	3	1	1	4	3	1	3	2	1	3	2	2	3	2	1	2	4	1
Retarder/Deflector																						
Light Fence	3	3	3	3	3	2	2	3	3	2	3	3	2	3	3	2	3	3	2	3	4	2
Heavy Diverter	3	4	4	3	3	4	3	2	3	3	3	2	2	3	3	4	3	3	2	3	4	3
Deflector																						
Hardpoint	3	4	4	3	3	3	4	2	3	4	3	3	4	3	3	2	3	4	4	3	3	5
Transverse Dike	3	4	4	3	3	3	4	2	3	4	3	3	4	3	3	2	3	4	3	3	3	5

*Henson spur jetties are rated a 4 for this condition.

1. Definite disadvantage to the use of this type structure.
2. Some disadvantage to the use of this type structure.
3. Adequate for condition.
4. Some advantage to the use of this type structure.
5. Significant advantage to the use of this type structure.

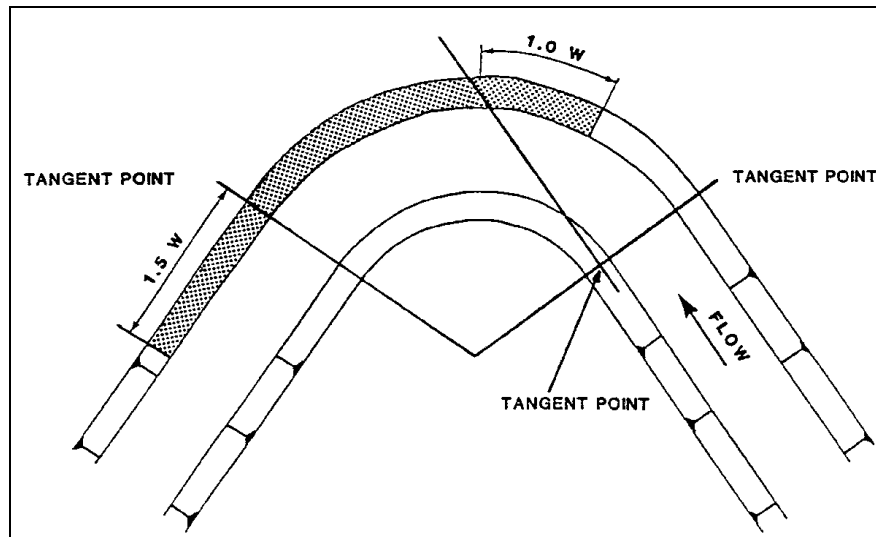

Figure 2.1. Extent of protection required at a channel bend (after USACE 1991).

2.2 DESIGN CONSIDERATIONS

Spur design includes setting the limits of bank protection required; selection of the spur type to be used; and design of the spur installation including spur length, orientation, permeability, height, profile, and spacing.

2.2.1 Longitudinal Extent of Spur Field

The longitudinal extent of channel bank requiring protection is discussed in Brown (1985, 1989). Figure 2.1 was developed from USACE studies of the extent of protection required at meander bends (USACE 1991). The minimum extent of bank protection determined from Figure 2.1 should be adjusted according to field inspections to determine the limits of active scour, channel surveys at low flow, and aerial photography and field investigations at high flow. Investigators of field installations of bank protection have found that protection commonly extends farther upstream than necessary and not far enough downstream. However, such protection may have been necessary at the time of installation. The lack of a sufficient length of protection downstream is generally more serious, and the downstream movement of meander bends should be considered in establishing the downstream extent of protection.

2.2.2 Spur Length

Spur length is taken here as the projected length of spur normal to the main flow direction or from the bank. Where the bank is irregular, spur lengths must be adjusted to provide for an even curvature of the thalweg. The length of both permeable and impermeable spurs relative to channel width affects local scour depth at the spur tip and the length of bank protected. Laboratory tests indicate that diminishing returns are realized from spur lengths greater than 20% of channel width. The length of bank protected measured in terms of projected spur length is essentially constant up to spur lengths of 20% of channel width for permeable and impermeable spurs. Field installations of spurs have been successful with lengths from 3 to 30% of channel width. Impermeable spurs are usually installed with lengths of less than 20% while permeable spurs have been successful with lengths up to 25% of channel width. However, only the most permeable spurs were effective at greater lengths.

The above discussion assumes that stabilization of the bend is the only objective when spur lengths are selected. It also assumes that the opposite bank will not erode. Where flow constriction or changing the flow path is also an objective, spur lengths will depend on the degree of constriction required or the length of spur required to achieve the desired change in flow path. At some locations, channel excavation on the inside of the bend may be required where spurs would constrict the flow excessively. However, it may be acceptable to allow the stream to do its own excavation if it is located in uniformly graded sand

2.2.3 Spur Orientation

Spur orientation refers to spur alignment with respect to the direction of the main flow current in a channel. Figure 2.2 defines the spur angle such that an acute spur angle means that the spur is angled in an downstream direction and an angle greater than 90° indicates that the spur is oriented in an upstream direction.

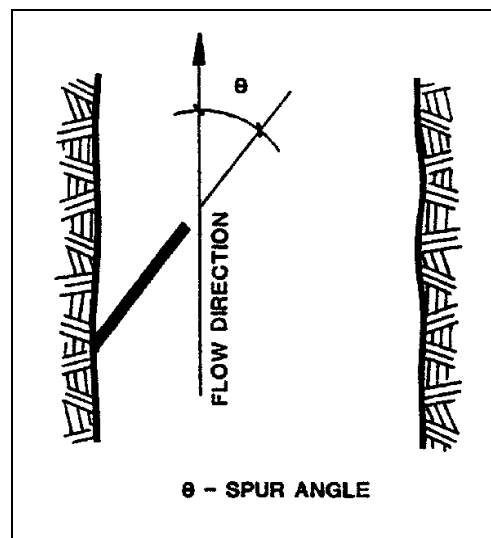

Figure 2.2. Definition sketch for spur angle (after Karaki 1959).

Permeable retarder spurs are usually designed to provide flow retardance near the streambank, and they perform this function equally as well without respect to the spur angle. Since spurs oriented normal to the bank and projecting a given length into the channel are shorter than those at any other orientation, all retarder spurs should be constructed at 90° with the bank for reasons of economy.

No consensus exists regarding the orientation of permeable retarder/deflector spurs and impermeable deflector spurs. There is some agreement that spurs oriented in an upstream direction do not protect as great a length of channel bank downstream of the spur tip, result in greater scour depth at the tip, and have a greater tendency to accumulate debris and ice.

Spur orientation at approximately 90° has the effect of forcing the main flow current (thalweg) farther from the concave bank than spurs oriented in an upstream or downstream direction. Therefore, more positive flow control is achieved with spurs oriented approximately normal to the channel bank. Spurs oriented in an upstream direction cause greater scour than if oriented normal to the bank, and spurs oriented in a downstream direction cause less scour.

It is recommended that the spur furthest upstream be angled downstream to provide a smoother transition of the flow lines near the bank and to minimize scour at the nose of the leading spur. Subsequent spurs downstream should all be set normal to the bank line to minimize construction costs.

Figure 2.3 can be used to adjust scour depth for orientation. It should be noted that permeability also affects scour depth. A method to adjust scour depth for permeability is presented in the following section.

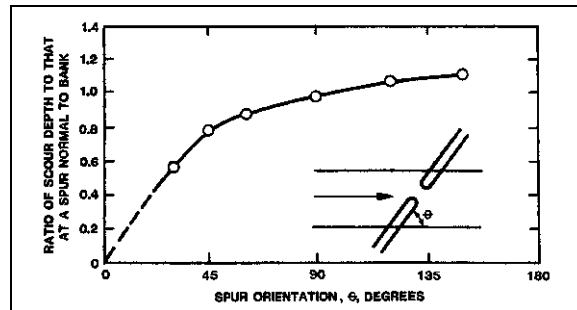

Figure 2.3. Scour adjustment for spur orientation (modified from Richardson et al. 2001).

The lateral extent of scour can be determined from the depth of scour and the natural angle of repose of the bed material [see HEC-18 (Richardson and Davis 2001)].

The expansion angle downstream of a spur, i.e., the angle of flow expansion downstream of the contraction at the spur is about 17° for impermeable spurs for all spur angles. The implication is that spur orientation affects the length of bank protected only because of the projected length of the spur along the channel bank.

2.2.4 Spur Permeability

The permeability of the spur depends on stream characteristics, the degree of flow retardance and velocity reduction required, and the severity of the channel bend. Impermeable spurs can be used on sharp bends to divert flow away from the outer bank. Where bends are mild and only small reductions in velocity are necessary, highly permeable retarder spurs can be used successfully. However, highly permeable spurs can also provide required bank protection under more severe conditions where vegetation and debris will reduce the permeability of the spur without destroying the spur. This is acceptable provided the bed load transport is high.

Scour along the streambank and at the spur tip are also influenced by the permeability of the spur. Impermeable spurs, in particular, can create erosion of the streambank at the spur root. This can occur if the crest of impermeable spurs are lower than the height of the bank. Under submerged conditions, flow passes over the crest of the spur generally perpendicular to the spur as illustrated in Figure 2.4. Laboratory studies of spurs with permeability greater than about 70% were observed to cause very little bank erosion, while spurs with permeability of 35% or less caused bank erosion similar to the effect of impermeable spurs (Richardson et al. 2001).

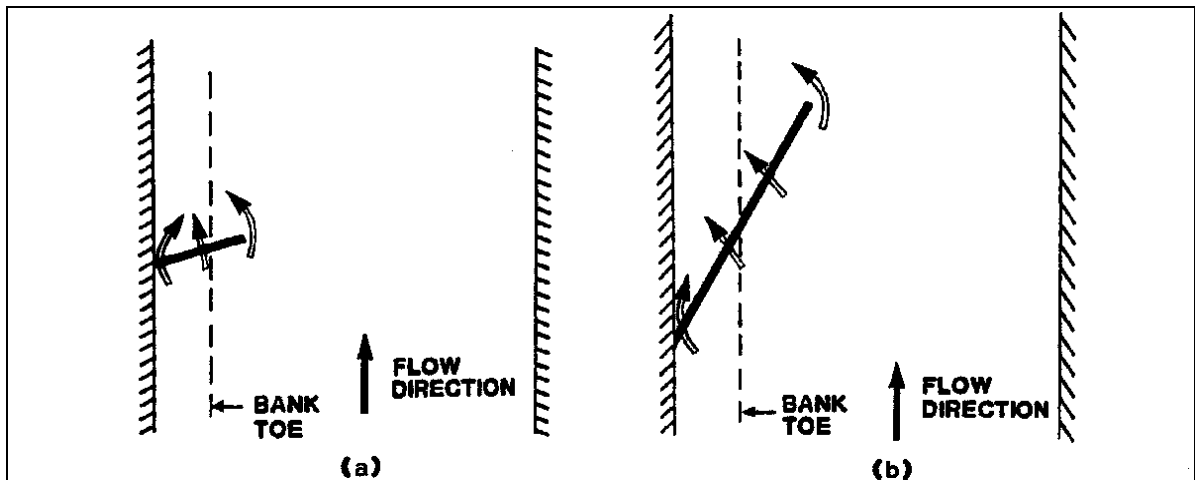

Figure 2.4. Flow components in the vicinity of spurs when the crest is submerged (after Brown 1985).

Permeability up to about 35% does not affect the length of channel bank protected by the spur. Above a permeability of 35%, the length of bank protected decreases with increasing permeability. Figure 2.5 shows the results of laboratory tests of the effects of permeability and orientation on the expansion angle of flow downstream of spurs. For this figure, spur lengths were 20% of the channel width projected normal to the bank (Brown 1985).

From the above discussion, it is apparent that spurs of varying permeability will provide protection against meander migration. Impermeable spurs provide more positive flow control but cause more scour at the toe of the spur and, when submerged, cause erosion of the streambank. High permeability spurs are suitable for use where only small reductions in flow velocities are necessary as on mild bends but can be used for more positive flow control where it can be assumed that clogging with small debris will occur and bed load transport is large. Spurs with permeability up to about 35% can be used in severe conditions but permeable spurs may be susceptible to damage from large debris and ice.

2.2.5 Spur Height and Crest Profile

Impermeable spurs are generally designed not to exceed the bank height because erosion at the end of the spur in the overbank area could increase the probability of outflanking at high stream stages. Where stream stages are greater than or equal to the bank height, impermeable spurs should be equal to the bank height. If flood stages are lower than the bank height, impermeable spurs should be designed so that overtopping will not occur at the bank.

The crest of impermeable spurs should slope downward away from the bank line, because it is difficult to construct and maintain a level spur of rock or gabions. Use of a sloping crest will avoid the possibility of overtopping at a low point in the spur profile, which could cause damage by particle erosion or damage to the streambank.

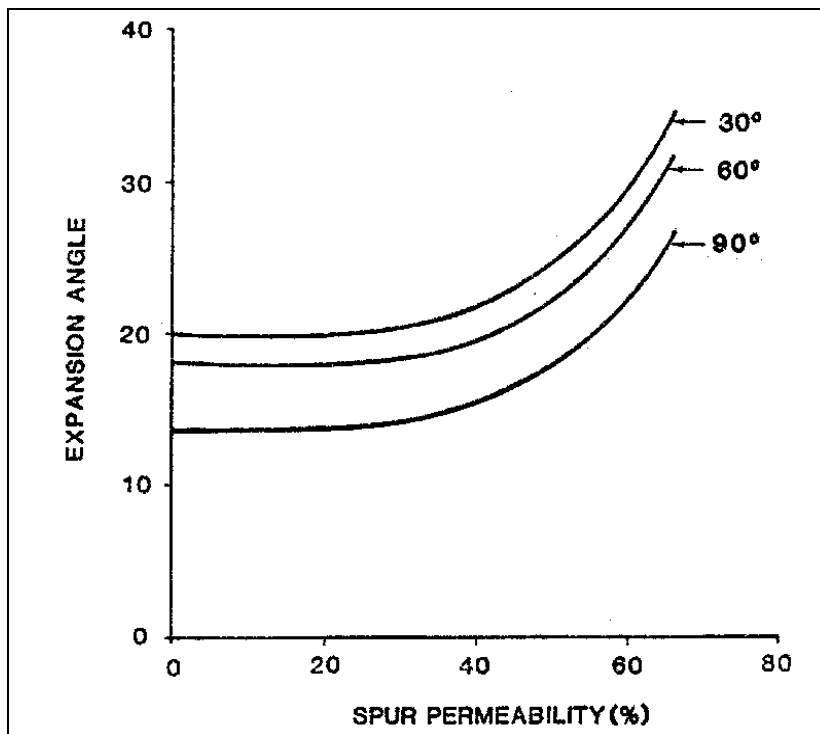

Figure 2.5. Spur permeability and spur orientation vs. expansion angle (after Brown 1985).

Permeable spurs, and in particular those constructed of light wire fence, should be designed to a height that will allow heavy debris to pass over the top. However, highly permeable spurs consisting of jacks or tetrahedrons are dependent on light debris collecting on the spur to make them less permeable. The crest profile of permeable spurs is generally level except where bank height requires the use of a sloping profile.

2.2.6 Bed and Bank Contact

The most common causes of spur failure are undermining and outflanking by the stream. These problems occur primarily in alluvial streams that experience wide fluctuations in the channel bed. Impermeable rock riprap spurs and gabion spurs can be designed to counter erosion at the toe by providing excess material on the streambed as illustrated in Figures 2.6 and 2.7. As scour occurs, excess material is launched into the scour hole, thus protecting the end of the spur. Gabion spurs are not as flexible as riprap spurs and may fail in very dynamic alluvial streams.

Permeable spurs can be similarly protected as illustrated in Figure 2.8. The necessity for using riprap on the full length of the spur or any riprap at all is dependent on the erodibility of the streambed, the distance between the slats and the streambed, and the depth to which the piling are driven. The measure illustrated would also be appropriate as a retrofit measure at a spur that has been severely undermined, and as a design for locations at which severe erosion of the toe of the streambank is occurring.

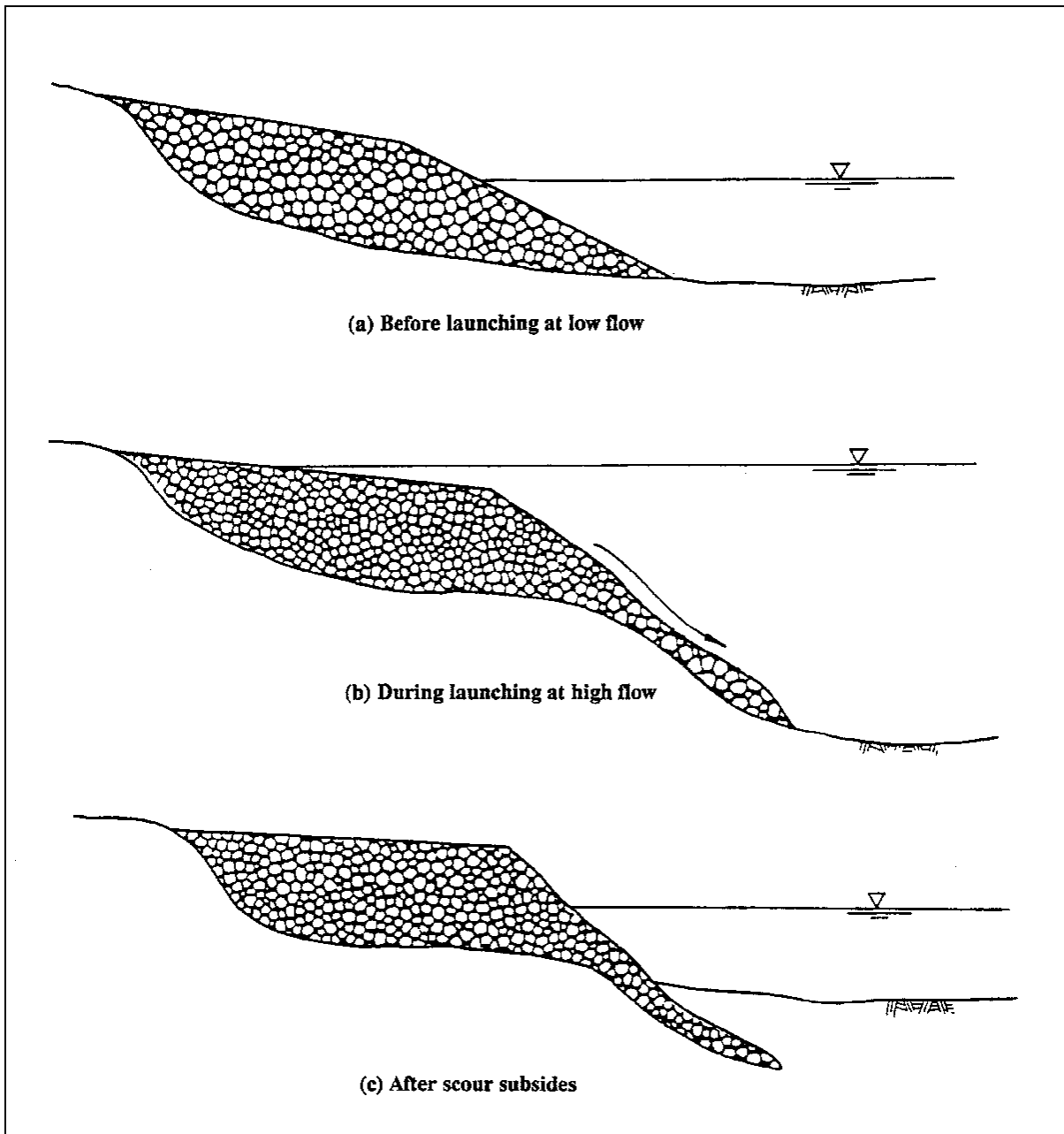

Figure 2.6. Launching of stone toe protection on a riprap spur: (a) before launching at low flow, (b) during launching at high flow, and (c) after scour subsides (after Brown 1985).

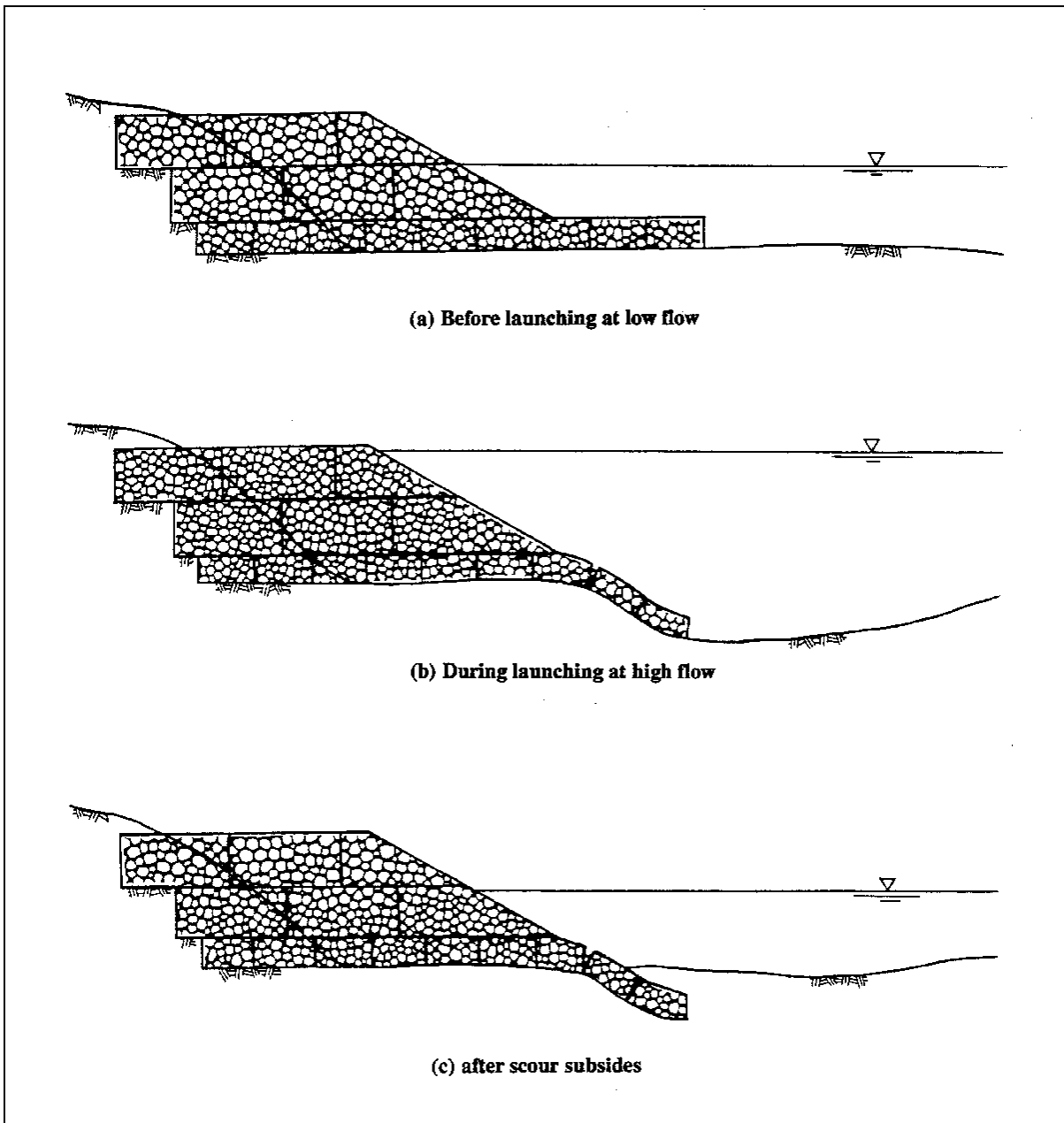

Figure 2.7. Gabion spur illustrating flexible mat tip protection: (a) before launching at low flow, (b) during launching at high flow, and (c) after scour subsides (after Brown 1985).

Piles supporting permeable structures can also be protected against undermining by driving piling to depths below the estimated scour. Round piling are recommended because they minimize scour at their base.

Extending the facing material of permeable spurs below the streambed also significantly reduces scour. If the retarder spur or retarder/deflector spur performs as designed, retardance and diversion of the flow within the length of the structure may make it unnecessary to extend the facing material the full depth of anticipated scour except at the nose.

A patented Henson spur, as illustrated in Figure 2.9, maintains contact with the streambed by vertical wood slats mounted on pipes which are driven to depths secure from scour. The units slide down the pipes where undermining occurs. Additional units can be added on top as necessary.

2.2.7 Spur Spacing

Spur spacing is a function of spur length, spur angle, permeability, and the degree of curvature of the bend. The flow expansion angle, or the angle at which flow expands toward the bank downstream of a spur, is a function of spur permeability and the ratio of spur length to channel width. This ratio is susceptible to alteration by excavation on the inside of the bend or by scour caused by the spur installation. Figure 2.10 indicates that the expansion angle for impermeable spurs is an almost constant 17° . Spurs with 35% permeability have almost the same expansion angle except where the spur length is greater than about 18% of the channel width.

As permeability increases, the expansion angle increases, and as the length of spurs relative to channel width increases, the expansion angle increases exponentially. The expansion angle varies with the spur angle, but not significantly.

Spur spacing in a bend can be established by first drawing an arc representing the desired flow alignment (Figure 2.11). This arc will represent the desired extreme location of the thalweg nearest the outside bank in the bend. The desired flow alignment may differ from existing conditions or represent no change in conditions, depending on whether there is a need to arrest erosion of the concave bank or reverse erosion that has already occurred. If the need is to arrest erosion, permeable retarder spurs or retarder structures may be appropriate. If the flow alignment must be altered in order to reverse erosion of the bank or to alter the flow alignment significantly, deflector spurs or retarder/deflector spurs are appropriate. The arc representing the desired flow alignment may be a compound circular curve or any curve which forms a smooth transition in flow directions.

Next, draw an arc representing the desired bankline. This may approximately describe the existing concave bank or a new theoretical bankline which protects the existing bank from further erosion. Also, draw an arc connecting the nose (tip) of spurs in the installation. The distance from this arc to the arc describing the desired bank line, along with the expansion angle, fixes the spacing between spurs. The arc describing the ends of spurs projecting into the channel will be essentially concentric with the arc describing the desired flow alignment.

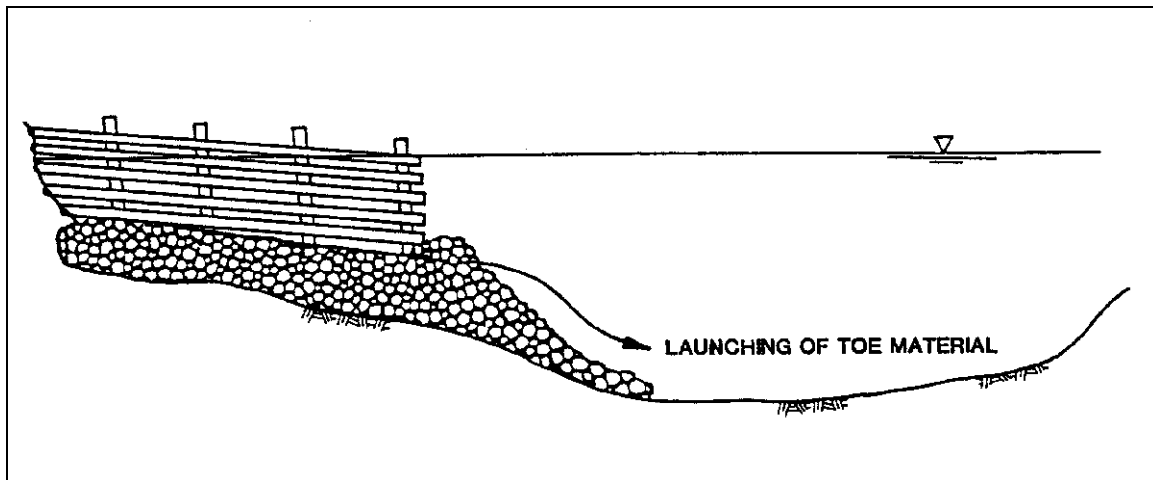

Figure 2.8. Permeable wood-slat fence spur showing launching of stone toe material (after Brown 1985).

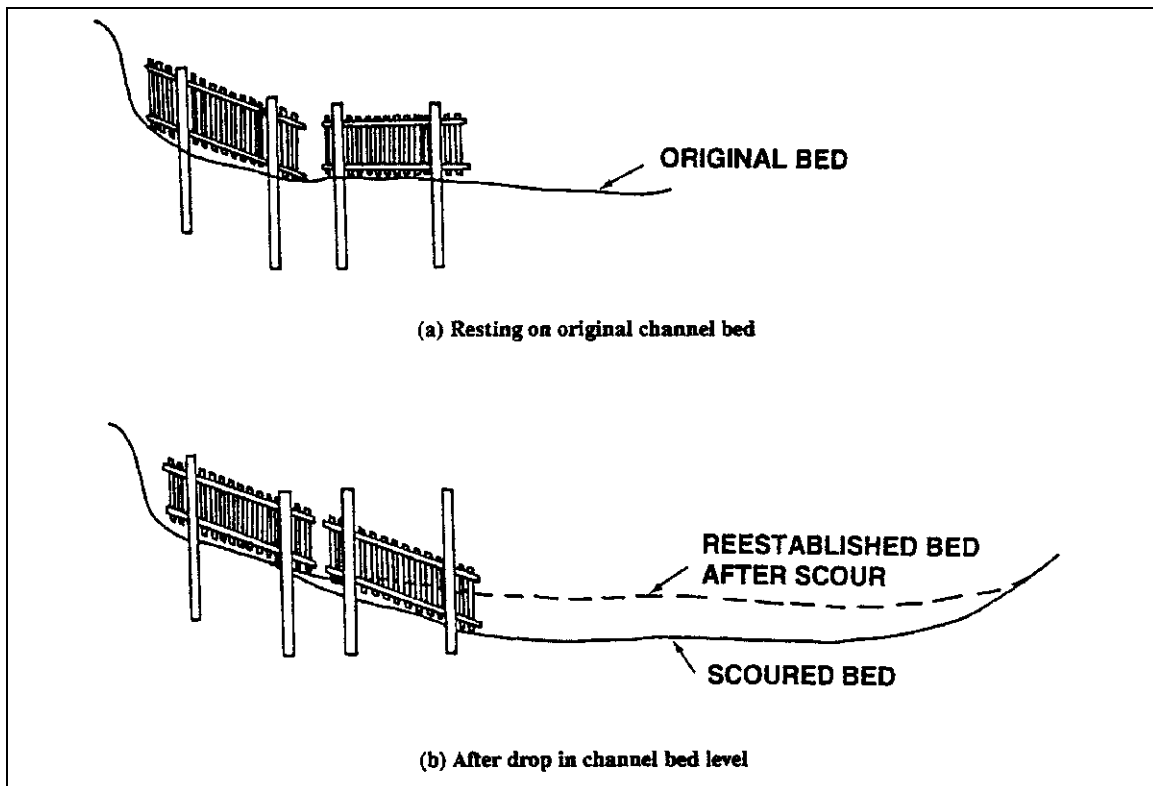

Figure 2.9. Henson spurs (a) resting on original channel bed, and (b) after drop in channel bed level (after Brown 1985).

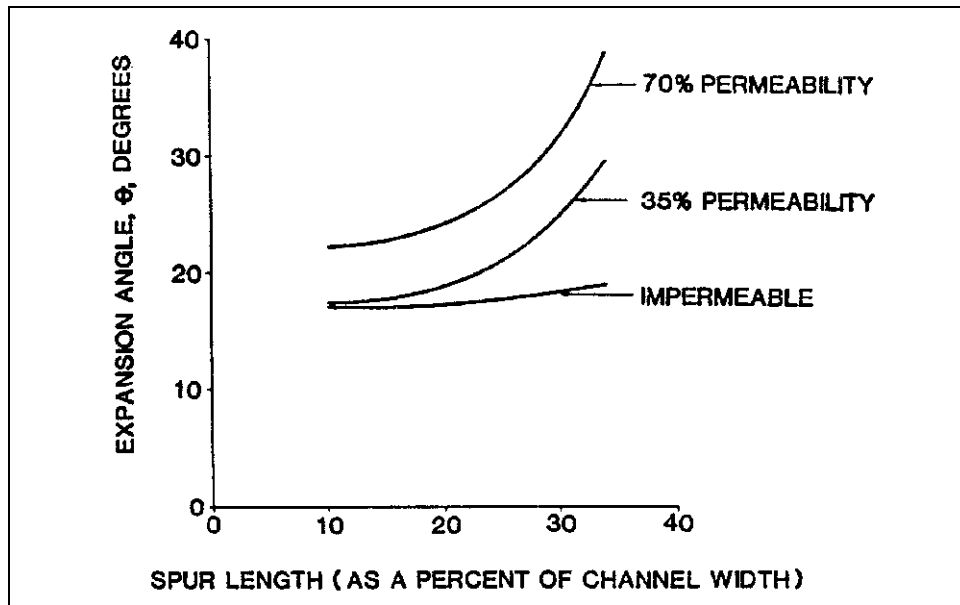

Figure 2.10. Relationship between spur length and expansion angle for several spur permeabilities (after Brown 1985).

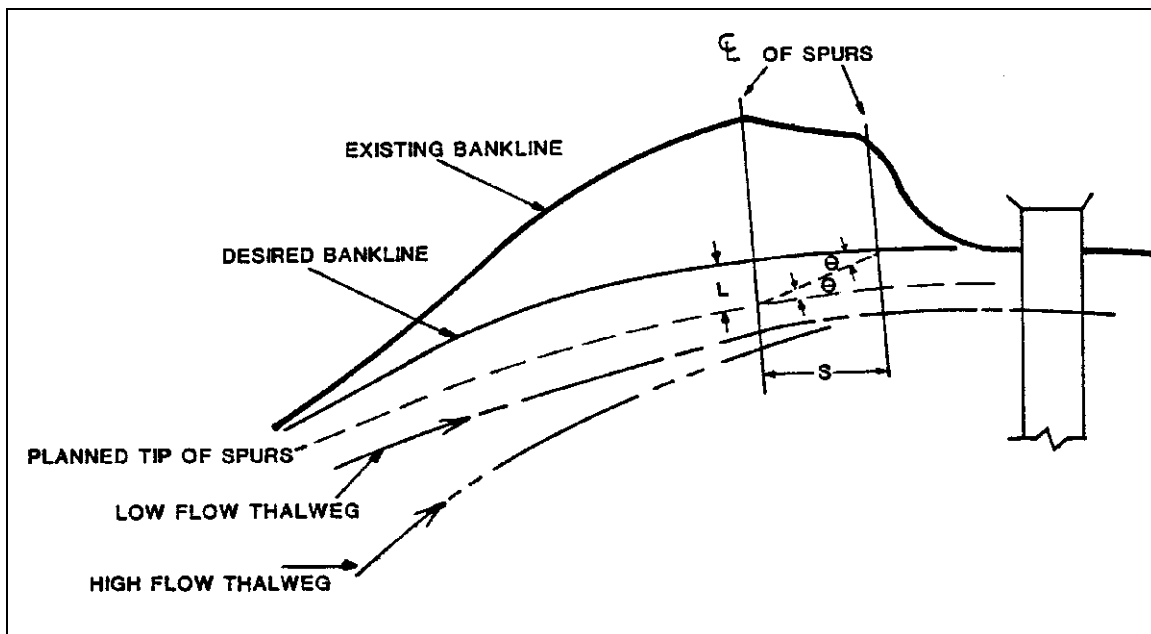

Figure 2.11. Spur spacing in a meander bend (after Brown 1985).

Now, establish the location of the spur at the downstream end of the installation. For a highway application, this is normally the protected abutment or guide bank at the bridge. Finally, establish the spacing between each of the remaining spurs in the installation (Figure 2.11). The distance between spurs, S , is the length of spur, L , between the arc describing the desired bank line and the nose of the spur multiplied by the cotangent of the flow expansion angle, θ . This length is the distance between the nose of spurs measured along a chord of the arc describing spur nose location. Remaining spurs in the installation will be at the same spacing if the arcs are concentric. The procedure is illustrated by Figure 2.11 and expressed in Equation 2.1.

$$S = L \cot \theta \quad (2.1)$$

where:

- S = spacing between spurs at the nose, ft (m)
- L = effective length of spur, or the distance between arcs describing the toe of spurs and the desired bank line, ft (m)
- θ = expansion angle downstream of spur nose, degrees

At less than bankfull flow rates, flow currents may approach the concave bank at angles greater than those estimated from Figure 2.10. Therefore, spurs should be well-anchored into the existing bank, especially the spur at the upstream end of the installation, to prevent outflanking.

2.2.8 Shape and Size of Spurs

In general, straight spurs should be used for most bank protection. Straight spurs are more easily installed and maintained and require less material. For permeable spurs, the width depends on the type of permeable spur being used. Less permeable retarder/deflector spurs which consist of a soil or sand embankment should be straight with a round nose as shown in Figure 2.12.

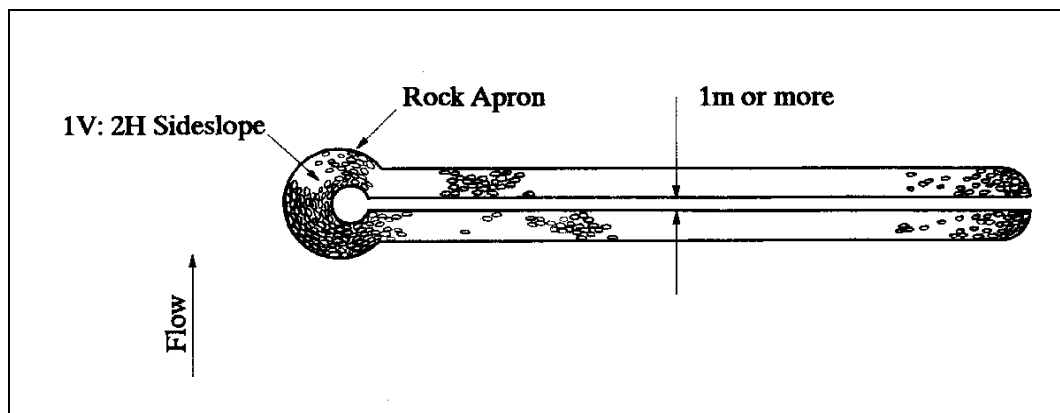

Figure 2.12. Typical straight, round nose spur.

The top width of embankment spurs should be a minimum of 3 ft (1 m). However, in many cases the top width will be dictated by the width of any earth moving equipment used to construct the spur. In general a top width equal to the width of a dump truck can be used. The side slopes of the spur should be 1V:2H or flatter.

2.2.9 Riprap

Rock riprap should be placed on the upstream and downstream faces as well as on the nose of the spur to inhibit erosion of the spur. Depending on the embankment material being used, a gravel, sand, or geotextile filter may be required. The designer is referred to Design Guideline 4 on revetment riprap design for procedures for sizing riprap at spurs. If a revetment equation is used for sizing spur riprap, then either the factor of safety should be increased or a higher velocity (than the channel average) should be used in the design. To accomplish this, the EM 1601 equation can be used to size riprap at spurs by selecting a C_v value of 1.25 (see Design Guideline 4).

It is recommended that riprap be extended below the bed elevation to a depth as recommended in Design Guideline 4 (to the combined long-term degradation and contraction scour depth). Riprap should also extend to the crest of the spur, in cases where the spur would be submerged at design flow, or to 2 ft (0.6 m) above the design flow, if the spur crest is higher than the design flow depth. Additional riprap should be placed around the nose of the spur (Figure 2.12), so that spur will be protected from scour. Figure 2.13 shows an example of an impermeable spur field and a close-up of a typical round nose spur installation.

2.3 DESIGN EXAMPLE OF SPUR INSTALLATION

Figure 2.14 illustrates a location at which a migrating bend threatens an existing bridge (existing conditions are shown with a solid line). Ultimately, based upon the following design example, seven spurs will be required. Although the number of spurs is not known in advance, the spurs (and other design steps) are shown as dashed lines on Figure 2.14 as they will be specified after completing the following design example. Assume that the width of the river from the desired (north) bankline to the existing (south) bankline is 164 ft (50 m).

For this example, it is desirable to establish a different flow alignment and to reverse erosion of the concave (outside) bank. The spur installation has two objectives: (1) to stop migration of the meander before it damages the highway stream crossing, and (2) to reduce scour at the bridge abutment and piers by aligning flow in the channel with the bridge opening. Impermeable deflector spurs are suitable to accomplish these objectives and the stream regime is favorable for the use of this type of countermeasure. The expansion angle for this spur type is approximately 17° for a spur length of about 20% of the desired channel width, as indicated in Figure 2.10.

Step 1. Sketch Desired Thalweg

The first step is to sketch the desired thalweg location (flow alignment) with a smooth transition from the upstream flow direction through the curve to an approach straight through the bridge waterway (Figure 2.14). Visualize both the high-flow and low-flow thalwegs. For an actual location, it would be necessary to examine a greater length of stream to establish the most desirable flow alignment. Then draw an arc representing the desired bankline in relation to thalweg locations. The theoretical or desired left bank line is established as a continuation of the bridge abutment (and left bank downstream) through the curve, smoothly joining the left bank at the upstream extremity of eroded bank.



Figure 2.13. Impermeable spur field in top photograph with close-up shot of one spur in the lower photograph, vicinity of the Richardson Highway, Delta River, Alaska.

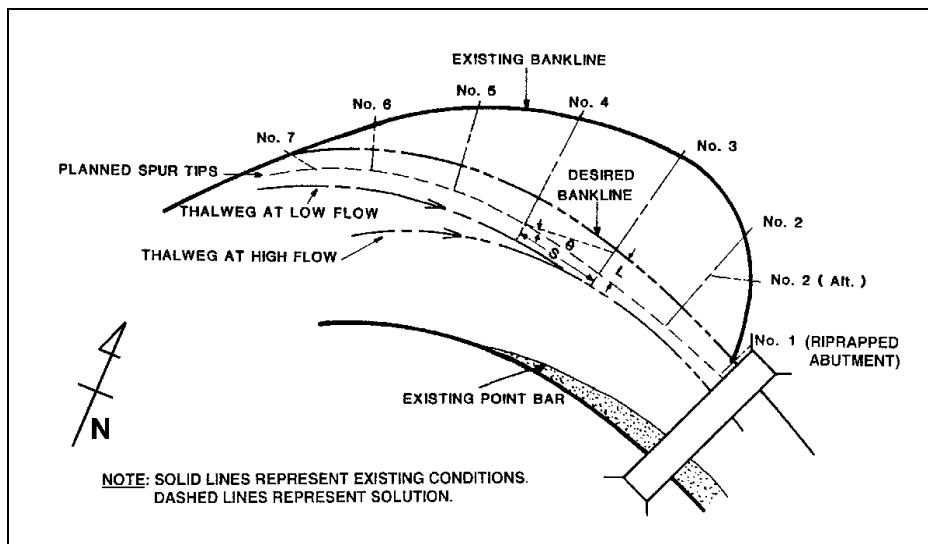

Figure 2.14. Example of spur design.

Step 2. Sketch Alignment of Spur Tips

The second step is to sketch a smooth curve through the nose (tip) locations of the spurs, concentric with the desired bankline alignment. Using a guideline of 20% of the desired channel width for impermeable spurs (see Section 2.2.2) the distance, L , from the desired bankline to the spur tips (Figure 2.14) would be:

$$L = 0.20 (164 \text{ ft}) = 33 \text{ ft (English)}$$

$$L = 0.20 (50\text{m}) = 10\text{m (SI)}$$

Step 3. Locate First Spur

Step number three is to locate spur number 1 so that flow expansion from the nose of the spur will intersect the streambank downstream of the abutment. This is accomplished by projecting an angle of 17° from the abutment alignment to an intersection with the arc describing the nose of spurs in the installation or by use of Equation 2.1. Spurs are set at 90° to a tangent with the arc for economy of construction. Alternatively, the first spur could be considered to be either the upstream end of the abutment or guide bank if the spur field is being installed upstream of a bridge. Thus, the spur spacing, S , would be:

$$S = L \cot \theta = (33 \text{ ft}) \cot 17^\circ = 108 \text{ ft (English)}$$

$$S = L \cot \theta = (10 \text{ m}) \cot 17^\circ = 33 \text{ m (SI)}$$

It may be desirable to place riprap on the streambank at the abutment. Furthermore, the size of the scour hole at the spur directly upstream of the bridge should be estimated using the procedures described in Chapter 4. If the extent of scour at this spur overlaps local scour at the pier, total scour depth at the pier may be increased. This can be determined by extending the maximum scour depth at the spur tip, up to the existing bed elevation at the pier at the angle of repose.

Step 4. Locate Remaining Spurs

Spurs upstream of spur number 1 are then located by use of Equation 2.1, using dimensions as illustrated in Figure 2.11 (i.e., the spacing, S , determined in Step 3). Using this spur spacing, deposition will be encouraged between the desired bank line and the existing eroded bank.

The seventh and last spur upstream is shown oriented in a downstream direction to provide a smooth transition of the flow approaching the spur field. This spur could have been oriented normal to the existing bank, and been shorter and more economical, but might have caused excessive local scour. Orienting the furthest upstream spur at an angle in the downstream direction provides a smoother transition into the spur field, and decreases scour at the nose of the spur. As an alternative, a hard point could be installed where the bank is beginning to erode. Hard points are discussed in Chapter 8. In this case the hard point can be considered as a very short spur which is located at the intersection of the actual and planned bank lines. In either case, spurs or hard points should be anchored well into the bank to prevent outflanking.

2.4 REFERENCES

Brown, S.A., 1985, "Streambank Stabilization Measures for Highway Stream Crossings—Executive Summary," FHWA/RD-84/099, Federal Highway Administration, Washington, D.C.

Brown, S.A., 1985, "Streambank Stabilization Measures for Highway Engineers," FHWA/RD-84. 100, Federal Highway Administration, McLean, VA.

Brown, S.A., 1985, "Design of Spur-Type Streambank Stabilization Structures, Final Report," FHWA/RD-84-101, Federal Highway Administration, Washington, D.C.

Brown, S.A. and Clyde, E.S., 1989, "Design of Riprap Revetment," Hydraulic Engineering Circular No.11, FHWA-IP-89-016, prepared for the Federal Highway Administration, Washington, D.C.

Karaki, S.S., 1959, "Hydraulic Model Study of Spur Dikes for Highway Bridge Openings," Colorado State University, Civil Engineering Section, Report CER59SSK36, September, 47 pp.

Lagasse, P.F., Clopper, P.E., Zevenbergen, L.W., and Ruff, J.F., 2006, "Riprap Design Criteria, Recommended Specifications, and Quality Control," NCHRP Report 568, Transportation Research Board, National Academies of Science, Washington, D.C.

Richardson, E.V., Simons, D.B., and Lagasse, P.F., 2001, "River Engineering for Highway Encroachments - Highways in the River Environment," Report No. FHWA NHI 01-004, Hydraulic Design Series No. 6, Federal Highway Administration, Washington, D.C.

Richardson, E.V. and Davis, S.R., 2001, "Evaluating Scour at Bridges," Hydraulic Engineering Circular No. 18, Fourth Edition, FHWA NHI 01-001, Federal Highway Administration, U.S. Department of Transportation, Washington, D.C.

U.S. Army Corps of Engineers, 1981, "The Streambank Erosion Control Evaluation and Demonstration Act of 1974," Final Report to Congress, Executive Summary and Conclusions.

(page intentionally left blank)

DESIGN GUIDELINE 3
CHECK DAMS/DROP STRUCTURES

(page intentionally left blank)

DESIGN GUIDELINE 3

CHECK DAMS/DROP STRUCTURES

3.1 BACKGROUND

Check dams or channel drop structures are used downstream of highway crossings to arrest head cutting and maintain a stable streambed elevation in the vicinity of the bridge. Check dams are usually built of rock riprap, concrete, sheet piles, gabions, or treated timber piles. The material used to construct the structure depends on the availability of materials, the height of drop required, and the width of the channel. Rock riprap and timber pile construction have been most successful on channels having small drops and widths less than 100 ft (30 m). Sheet piles, gabions, and concrete structures are generally used for larger drops on channels with widths ranging up to 300 ft (100 m). Check dam location with respect to the bridge depends on the hydraulics of the bridge reach and the amount of headcutting or degradation anticipated.

Check dams can initiate erosion of banks and the channel bed downstream of the structure as a result of energy dissipation and turbulence at the drop. This local scour can undermine the check dam and cause failure. The use of energy dissipators downstream of check dams can reduce the energy available to erode the channel bed and banks. **In some cases it may be better to construct several consecutive drops of shorter height to minimize erosion.** Concrete lined basins as discussed later may also be used.

Lateral erosion of channel banks just downstream of drop structures is another adverse result of check dams and is caused by turbulence produced by energy dissipation at the drop, bank slumping from local channel bed erosion, or eddy action at the banks. Bank erosion downstream of check dams can lead to erosion of bridge approach embankments and abutment foundations if lateral bank erosion causes the formation of flow channels around the ends of check dams. The usual solution to these problems is to place riprap revetment on the streambank adjacent to the check dam. The design of riprap revetment is given in Design Guideline 4.

Erosion of the streambed can also be reduced by placing rock riprap in a preformed scour hole downstream of the drop structure. A row of sheet piling with top set at or below streambed elevation can keep the riprap from moving downstream. Because of the problems associated with check dams, the design of these countermeasures requires designing the check dams to resist scour by providing for dissipation of excess energy and protection of areas of the bed and the bank which are susceptible to erosive forces.

3.2 BED SCOUR FOR VERTICAL DROP STRUCTURES

3.2.1 Estimating Bed Scour

The most conservative estimate of scour downstream of channel drop structures is for vertical drops with unsubmerged flow conditions. For the purposes of design the maximum expected scour can be assumed to be equal to the scour for a vertical, unsubmerged drop, regardless of whether the drop is actually sloped or is submerged.

A sketch of a typical vertical drop structure with a free overfall is shown in Figure 3.1. An equation developed by the Bureau of Reclamation (Pemberton and Lara 1984) is recommended to estimate the depth of scour downstream of a vertical drop:

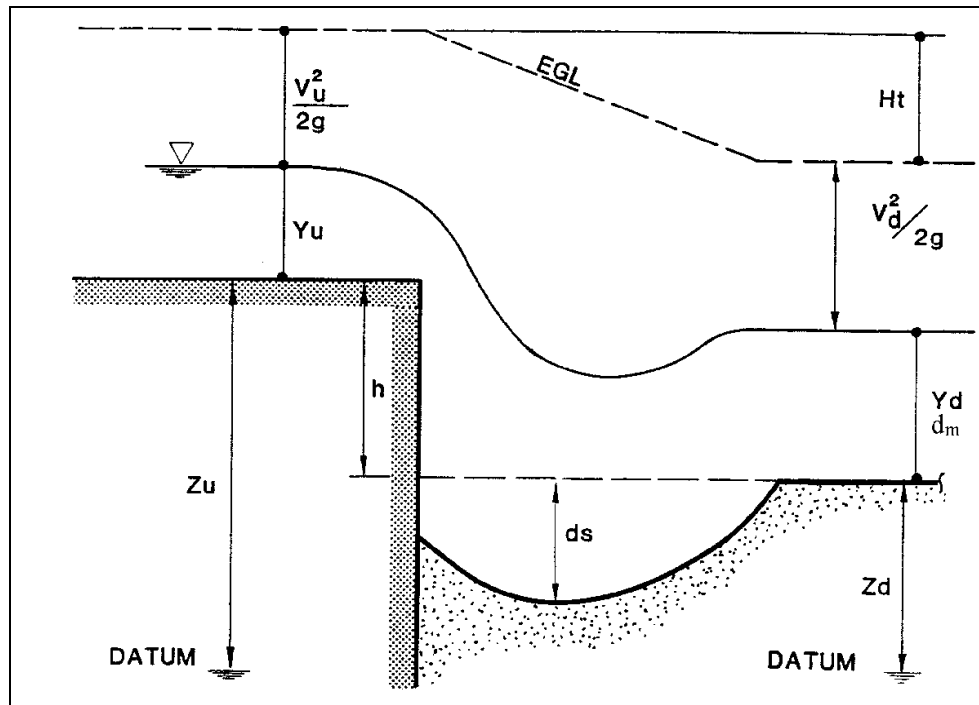

Figure 3.1. Schematic of a vertical drop caused by a check dam.

$$d_s = K_u H_t^{0.225} q^{0.54} - d_m \quad (3.1)$$

where:

- d_s = local scour depth for a free overfall, measured from the streambed downstream of the drop, ft (m)
- q = discharge per unit width, cfs/ft ($m^3/s/m$)
- H_t = total drop in head, measured from the upstream to the downstream energy grade line, ft (m)
- d_m, Y_d = tailwater depth, ft (m)
- K_u = 1.32 (English)
- K_u = 1.90 (SI)

It should be noted that H_t is the difference in the total head from upstream to downstream. This can be computed using the energy equation for steady uniform flow:

$$H_t = \left(Y_u + \frac{V_u^2}{2g} + Z_u \right) - \left(Y_d + \frac{V_d^2}{2g} + Z_d \right) \quad (3.2)$$

where:

Y	=	depth, ft (m)
V	=	velocity, ft/s (m/s)
Z	=	bed elevation referenced to a common datum, ft (m)
g	=	acceleration due to gravity 32.2 ft/s ² (9.81 m/s ²)

The subscripts *u* and *d* refer to up- and downstream of the channel drop, respectively.

The depth of scour as estimated by the above equation is independent of the grain size of the bed material. This concept acknowledges that the bed will scour regardless of the type of material composing the bed, but the rate of scour depends on the composition of the bed. In some cases, with large or resistant material, it may take years or decades to develop the maximum scour hole. In these cases, the design life of the bridge may need to be considered when designing the check dam.

The check dam must be designed structurally to withstand the forces of water and soil assuming that the scour hole is as deep as estimated using the equation above. Therefore, the designer should consult geotechnical and structural engineers so that the drop structure will be stable under the full scour condition. In some cases, a series of drops may be employed to minimize drop height and construction costs of foundations. Riprap or energy dissipation could be provided to limit depth of scour (see, for example, Peterka 1964 and FHWA 1983).

3.2.2 Check Dam Design Example

The following design example is based upon a comparison of scour equations presented by the USBR (Peterka and Lara 1984).

Given:

Channel degradation is threatening bridge foundations. Increasing the bed elevation 4.6 ft (1.4 m) will stabilize the channel at the original bed level. A drop structure will raise the channel bed and reduce upstream channel slopes, resulting in greater flow depths and reduced velocity upstream of the structure. For this example, as illustrated by Figure 3.2, the following hydraulic parameters are used:

Design Discharge	Q	=	5,900 ft ³ /s	(167 m ³ /s)
Channel Width	B	=	105 ft	(32 m)
Upstream Water Depth	Y _u	=	10.6 ft	(3.22 m)
Tail Water Depth	d _m , Y _d	=	9.5 ft	(2.9 m)
Unit Discharge	q	=	56.2 ft ³ /s/ft	(5.22 m ³ /s/m)
Upstream Mean Velocity	V _u	=	5.3 ft/s	(1.62 m/s)
Downstream Mean Velocity	V _d	=	5.9 ft/s	(1.80 m/s)
Drop Height	h	=	4.6 ft	(1.4 m)

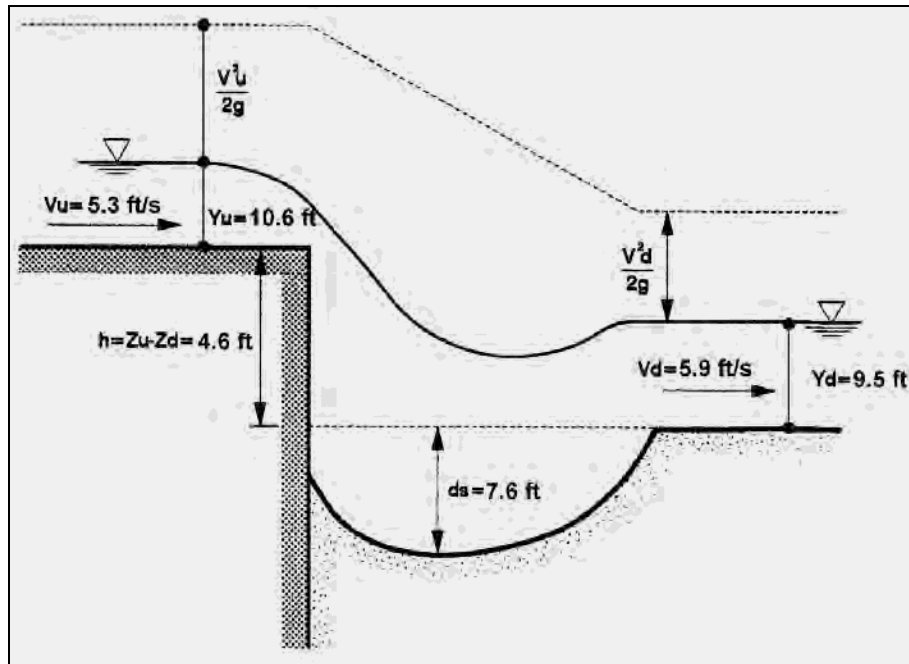

Figure 3.2. Design example of scour downstream of a drop structure.

H_t is calculated from the energy equation. Using the downstream bed as the elevation datum gives:

$$H_t = \left(10.6 + \frac{(5.3)^2}{(2)32.2} + 4.6 \right) - \left(9.5 + \frac{5.9^2}{(2)32.2} + 0 \right) = 5.6 \text{ ft (1.69m)} \quad (3.3)$$

Using Equation (3.1), the estimated depth of scour below the downstream bed level is:

$$d_s = K_u H_t^{0.225} q^{0.54} - d_m$$

$$d_s = 1.32 (5.6)^{0.225} (56.2)^{0.54} - 9.5$$

$$d_s = 7.6 \text{ ft (2.3 m)}$$

In this case, the unsupported height of the structure is $(h + d_s)$ or 12.2 ft (3.7 m). If, for structural reasons, this height is unacceptable, then either riprap to limit scour depth or a series of check dams could be constructed. It should be noted that if a series of drops are required, adequate distance between each drop must be maintained (Peterka 1964).

3.2.3 Lateral Scour Downstream of Check Dams

As was mentioned, lateral scour of the banks of a stream downstream of check dams can cause the streamflow to divert around the check dam. If this occurs, a head cut may move upstream and endanger the highway crossing. To prevent this the banks of the stream must be adequately protected using riprap or other revetments. Riprap should be sized and placed in a similar fashion as for spurs and guide banks. The designer is referred to Design Guide 4 for proper sizing, and placement of riprap on the banks.

3.3 STILLING BASINS FOR DROP STRUCTURES

This section on stilling basins for drop structures is taken from the FHWA Hydraulic Engineering Circular Number 14, "Hydraulic Design of Energy Dissipators for Culverts and Channels" (FHWA 1983).

A general design for a stilling basin at the toe of a drop structure was developed by the St. Anthony Falls Hydraulic Laboratory, University of Minnesota (Donnelly and Blaisdell 1954). The basin consists of a horizontal apron with blocks and sills to dissipate energy. Tailwater also influences the amount of energy dissipated. The stilling basin length computed for the minimum tailwater level required for good performance may be inadequate at high tailwater levels. Dangerous scour of the downstream channel may occur if the nappe is supported sufficiently by high tailwater so that it lands beyond the end of the stilling basin. A method for computing the stilling basin length for all tailwater levels is presented.

The design is applicable to relative heights of fall ranging from $1.0(h_o/y_c)$ to $15(h_o/y_c)$ and to crest lengths greater than $1.5y_c$. Here h_o is the vertical distance between the crest and the stilling basin floor, and y_c is the critical depth of flow at the crest (Figure 3.3). The straight drop structure is effective if the drop does not exceed 15 ft (4.6 m) and if there is sufficient tailwater.

There are several elements which must be considered in the design of this stilling basin. These include the length of basin, the position and size of floor blocks, the position and height of end sill, the position of the wingwalls, and the approach channel geometry. Figure 3.3 illustrates a straight drop structure which provides protection from scour in the downstream channel.

3.3.1 Design Procedures

1. Calculate the specific head in approach channel.

$$H = y_0 + \frac{V_0^2}{2g} \quad (3.4)$$

where:

$$\begin{aligned} y_0 &= \text{normal depth in the approach channel} \\ V_0 &= \text{velocity associated with normal depth in the approach channel} \end{aligned}$$

2. Calculate critical depth.

$$y_c = \frac{2}{3}H \quad (3.5)$$

3. Calculate the minimum height for tailwater surface above the floor of the basin.

$$y_3 = 2.15 y_c \quad (3.6)$$

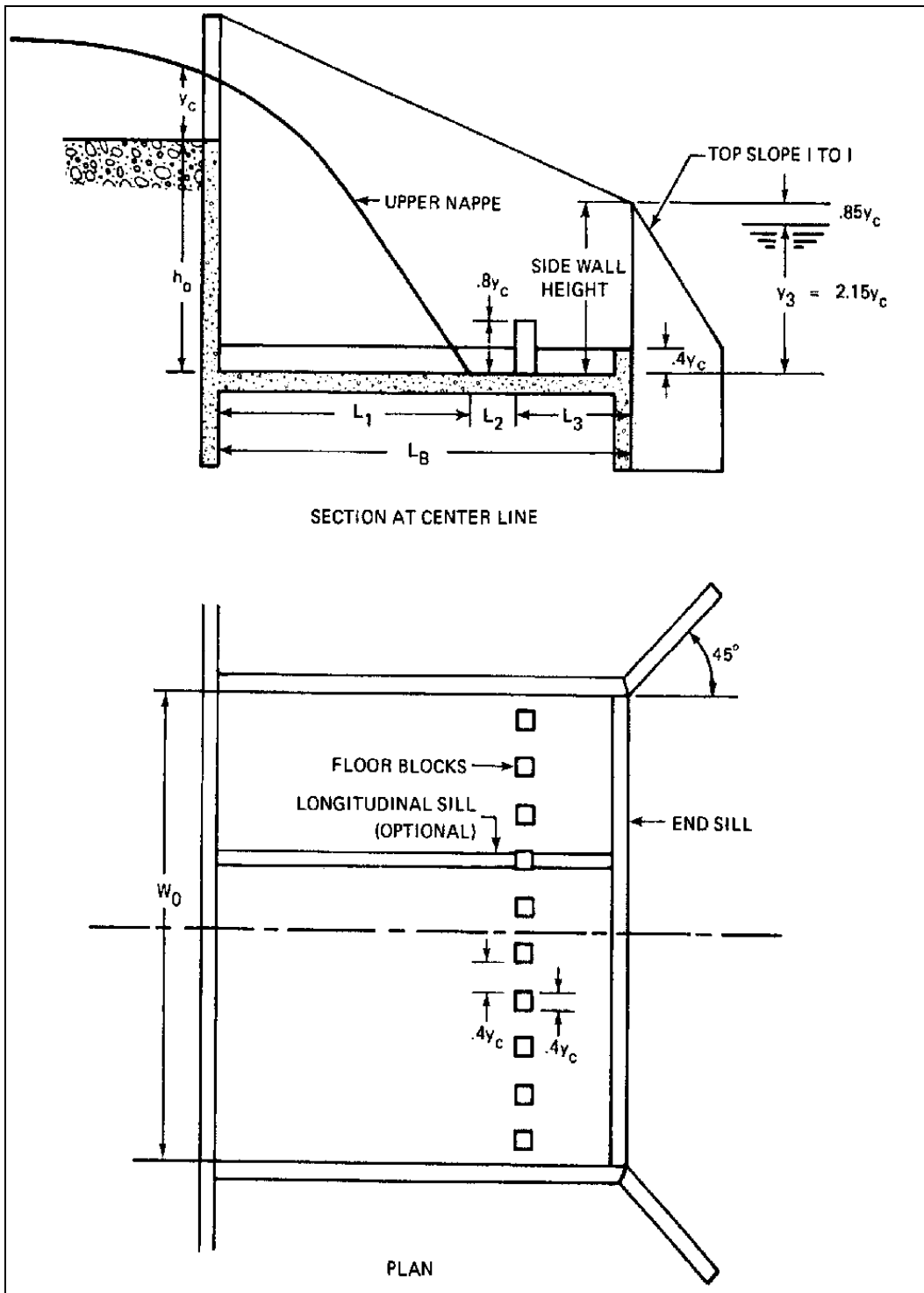

Figure 3.3. Straight drop structure stilling basin.

4. Calculate the vertical distance of tailwater below the crest. This will generally be a negative value since the crest is used as a reference point.

$$h_2 = -(h - y_o) \quad (3.7)$$

where:

"h" = total drop from the crest of the drop to the flow line of the outlet channel and y_o is the normal depth in the outlet channel

5. Determine the location of the stilling basin floor relative to the crest.

$$h_o = h_2 - y_3 \quad (3.8)$$

6. Determine the minimum length of the stilling basin, L_B , using:

$$L_B = L_1 + L_2 + L_3 = L_1 + 2.25 y_c \quad (3.9)$$

where:

L_1 is the distance from the headwall to the point where the surface of the upper nappe strikes the stilling basin floor. This is given by:

$$L_1 = (L_f + L_s) / 2 \quad (3.10)$$

where:

$$L_f = y_c \left\{ -0.406 + \sqrt{3.195 - \frac{4.368 h_o}{y_c}} \right\} \quad (3.11)$$

$$L_t = \left\{ -0.406 + \sqrt{3.195 - \frac{4.368 h_2}{y_c}} \right\} y_c \quad (3.12)$$

$$L_s = \frac{\left[0.691 + 0.228 \left(\frac{L_t}{y_c} \right)^2 - \left(\frac{h_o}{y_c} \right) \right] y_c}{\left[0.185 + 0.456 \left(\frac{L_t}{y_c} \right) \right]} \quad (3.13)$$

or L_1 can be found graphically from Figure 3.4

L_2 is the distance from the point at which the surface of the upper nappe strikes the stilling basin floor to the upstream face of the floor blocks, Figure 3.3. This distance can be determined by:

$$L_2 = 0.8 (y_c) \quad (3.14)$$

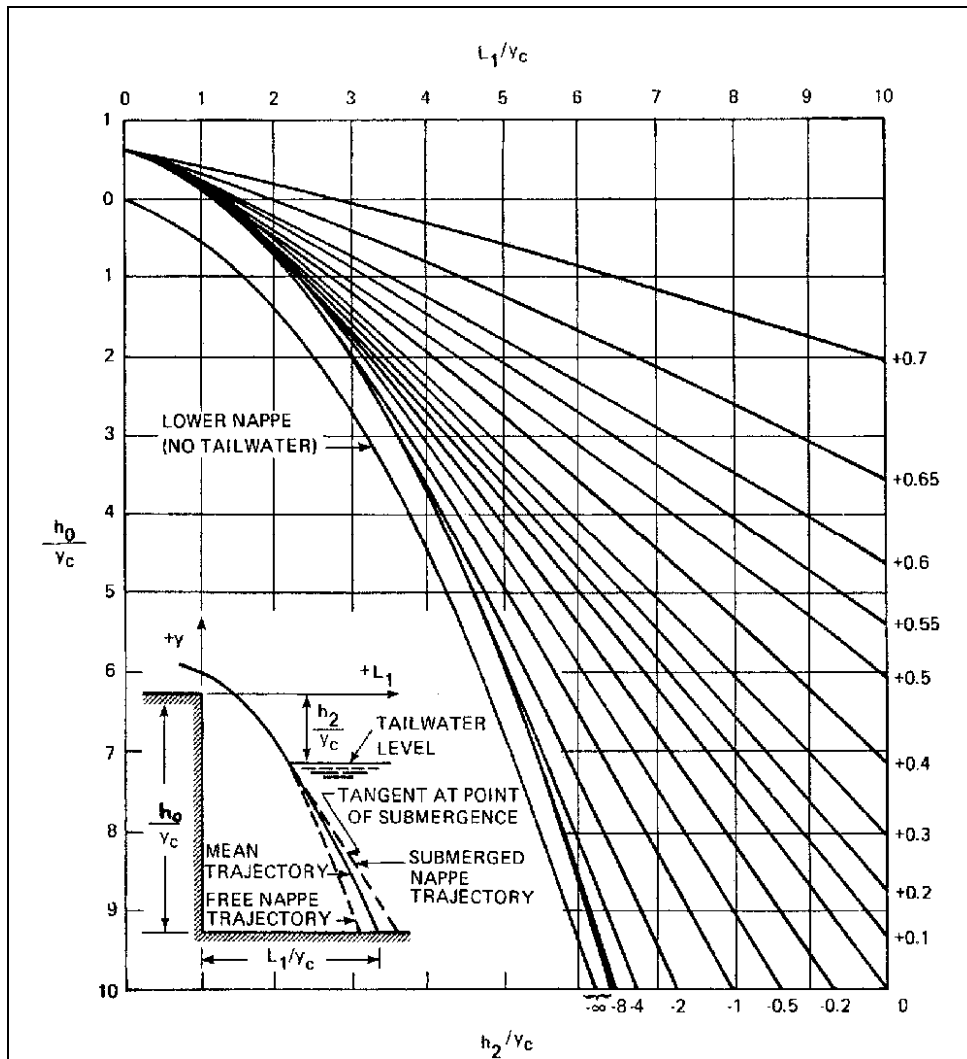

Figure 3.4. Design chart for determination of L_1 .

L_3 is the distance between the upstream face of the floor blocks and the end of the stilling basin. This distance can be determined from:

$$L_3 > 1.75 y_c \quad (3.15)$$

7. Proportion the floor blocks as follows:

- a. Height is $0.8 y_c$,
- b. Width and spacing should be $0.4 y_c$, with a variation of $\pm 0.15 y_c$, permitted,
- c. Blocks should be square in plan, and
- d. Blocks should occupy between 50 and 60% of the stilling basin width.

8. Calculate the end sill height, $(0.4 y_c)$.
9. Longitudinal sills, if used, should pass through, not between, the floor blocks. These sills are for structural purposes and are neither beneficial nor harmful hydraulically.
10. Calculate the sidewall height above the tailwater level, $(0.85 y_c)$.
11. Wingwalls should be located at an angle of 45° with the outlet centerline and have a top slope of 1 to 1.
12. Modify the approach channel as follows:
 - a. Crest of spillway should be at same elevation as approach channel,
 - b. Bottom width should be equal to the spillway notch length, W_o at the headwall, and
 - c. Protect with riprap or paving for a distance upstream from the headwall equal to three times the critical depth, y_c ,
13. No special provision of aeration of the space beneath the nappe is required if the approach channel geometry is as recommended in step 12.

The geometry of the undisturbed flow should be taken into consideration in the design of a straight drop stilling basin. If the overfall crest length is less than the width of the approach channel, it is important that a transition be properly designed by shaping the approach channel to reduce the effect of end contractions. Otherwise the contraction at the ends of the spillway notch may be so pronounced that the jet will land beyond the stilling-basin and the concentration of high velocities at the center of the outlet may cause additional scour in the downstream channel.

3.3.2 Stilling Basin Design Example

Using the same problem as was used to estimate scour at the check dam (Section 3.2.2), establish the size of a stilling basin.

Given:

Channel degradation is threatening bridge foundations. Increasing the bed elevation 4.6 ft (1.4 m) will stabilize the channel at the original bed level. A drop structure will raise the channel bed and reduce upstream channel slopes, resulting in greater flow depths and reduced velocity upstream of the structure. For this example, as illustrated by Figure 3.2, the following hydraulic parameters are used:

Design Discharge	Q	= 5,900 ft ³ /s	(167 m ³ /s)
Channel Width	B	= 105 ft	(32 m)
Upstream Water Depth	Y _u	= 10.6 ft	(3.22 m)
Tail Water Depth	d _m , Y _d	= 9.5 ft	(2.9 m)
Unit Discharge	q	= 56.2 ft ³ /s/ft	(5.22 m ³ /s)

Upstream Mean Velocity	V_u	= 5.3 ft/s	(1.62 m/s)
Downstream Mean Velocity	V_d	= 5.9 ft/s	(1.80 m/s)
Drop Height	h	= 4.6 ft	(1.4 m)

Find: Dimensions for the stilling basin as shown in Figure 3.3.

Solution:

Step 1. Calculate the Specific Head in Approach Channel

$$H = y_0 + \frac{V_0^2}{2g} = 10.6 + \frac{(53)^2}{2(32.2)} = 11.0 \text{ ft (3.35m)}$$

Step 2. Calculate Critical Depth

$$y_c = \frac{2}{3} H = \frac{2}{3} (11.0) = 7.3 \text{ ft (2.23m)}$$

Step 3. Calculate the Minimum Height for Tailwater Surface Above the Floor of the Basin

$$y_3 = 2.15 y_c = 2.15 (7.3) = 15.7 \text{ ft (4.8 m)}$$

Step 4. Calculate the Vertical Distance of Tailwater Below the Crest

This will generally be a negative value since the crest is used as a reference point.

$$h_2 = -(h - y_0) = -(4.6 - 9.5) = +4.9 \text{ ft (+1.5 m)}$$

where:

"h" = total drop from the crest of the drop to the flow line of the outlet channel
and y_0 is the normal depth in the outlet channel

Step 5. Determine the Location of the Stilling Basin Floor Relative to the Crest

$$h_0 = h_2 - y_3 = 4.9 - 15.7 = -10.8 \text{ ft (-3.3 m)}$$

Step 6. Determine the Minimum Length of the Stilling Basin

$$L_B = L_1 + L_2 + L_3 = L_1 + 2.55 y_c$$

where:

L_1 is the distance from the headwall to the point where the surface of the upper nappe strikes the stilling basin floor. This is given by:

$$L_1 = (L_f + L_s) / 2$$

where:

$$L_f = y_c \left\{ -0.406 + \sqrt{3.195 - \frac{4.368h_0}{y_c}} \right\} = 7.3 \left\{ -0.406 + \sqrt{3.195 - \frac{4.368(-10.8)}{7.3}} \right\}$$

$$L_f = 19.7 \text{ ft (6.02 m)}$$

$$L_s = \frac{\left[0.691 + 0.228 \left(\frac{L_t}{y_c} \right)^2 - \left(\frac{h_0}{y_c} \right) \right] y_c}{\left[0.185 + 0.456 \left(\frac{L_t}{y_c} \right) \right]} = \frac{\left[0.691 + 0.228 \left(\frac{0.78}{7.3} \right)^2 - \left(\frac{-10.8}{7.3} \right) \right] 7.3}{\left[0.185 + 0.456 \left(\frac{0.78}{7.3} \right) \right]}$$

$$L_t = \left\{ -0.406 + \sqrt{3.195 - \frac{4.368h_2}{y_c}} \right\} y_c = \left\{ -0.406 + \sqrt{3.195 - \frac{4.368(4.9)}{7.3}} \right\} 7.3$$

$$L_t = 0.78 \text{ ft (0.25 m)}$$

$$L_s = 67.9 \text{ ft (20.53 m)}$$

$$\text{Then, } L_1 = (19.7 + 67.9) / 2 = 43.8 \text{ ft (13.38 m)}$$

or L_1 can be found graphically from Figure 3.4

L_2 is the distance from the point at which the surface of the upper nappe strikes the stilling basin floor to the upstream face of the floor blocks, Figure 3.3. This distance can be determined by:

$$L_2 = 0.8 (y_c) = 0.8 (7.3) = 5.8 \text{ ft (1.78 m)}$$

L_3 is the distance between the upstream face of the floor blocks and the end of the stilling basin. This distance can be determined from:

$$L_3 > 1.75 y_c = 1.75 (7.3) = 12.8 \text{ ft (3.9 m)}$$

Step 7. Proportion the Floor Blocks

- Height is $0.8 y_c$, $0.8 (7.3) = 5.8 \text{ ft (1.78 m)}$
- Width and spacing should be $0.4 y_c$, with a variation of $\pm 0.15 y_c$, permitted,
- Blocks should be square in plan, and
- Blocks should occupy between 50 and 60% of the stilling basin width.

Step 8. Calculate the End Sill Height

$$(0.4 y_c) = 0.4 (7.3) = 2.9 \text{ ft (0.89 m)}$$

Step 9. Longitudinal Sills

If used, should pass through, not between, the floor blocks. These sills are for structural purposes and are neither beneficial nor harmful hydraulically.

Step 10. Calculate the Sidewall Height Above the Tailwater Level

$$(0.85 y_c) = 0.85 (7.3) = 6.2 \text{ ft (1.9 m)}$$

Step 11. Wingwalls

Should be located at an angle of 45° with the outlet centerline and have a top slope of 1 to 1.

Step 12. Modify the Approach Channel

- a. crest of spillway should be at same elevation as approach channel,
- b. bottom width should be equal to the spillway notch length, W_o at the headwall, and
- c. protect with riprap or paving for a distance upstream from the headwall equal to three times the critical depth, y_c ,

Step 13. Aeration of the Nappe

No special provision of aeration of the space beneath the nappe is required if the approach channel geometry is as recommended in Step 12.

3.4 REFERENCES

Donnelly, C.A., and Blaisdell, F.W., 1954, "Straight Drop Spillway Stilling Basin," University of Minnesota, St. Anthony Falls Hydraulic Laboratory, Technical Paper 15, Series B, November.

Federal Highway Administration, 1983, "Hydraulic Design of Energy Dissipators for Culverts and Channels," Hydraulic Engineering Circular Number 14, U.S. Department of Transportation, Washington, D.C.

Pemberton, E.L. and Lara, J.M., 1984, "Computing Degradation and Local Scour," Technical Guidelines for Bureau of Reclamation, Engineering Research Center, Denver, CO, January.

Peterka, A.J., 1964, "Hydraulic Design of Stilling Basins and Energy Dissipators," Engineering Monograph No. 25, Bureau of Reclamation, Division of Research, Denver, CO.

**SECTION 2 – COUNTERMEASURES FOR STREAMBANK AND
ROADWAY EMBANKMENT PROTECTION**

Design Guideline 4 – Riprap Revetment

Design Guideline 5 – Riprap Design for Embankment Overtopping

Design Guideline 6 – Wire Enclosed Riprap Mattress

Design Guideline 7 – Soil Cement

**Design Guideline 8 – Articulating Concrete Block Systems
(Bank Revetment and Bed Armor)**

**Design Guideline 9 – Grout-Filled Mattresses
(Bank Revetment and Bed Armor)**

**Design Guideline 10 – Gabion Mattresses
(Bank Revetment and Bed Armor)**

DESIGN GUIDELINE 4

RIPRAP REVETMENT

(page intentionally left blank)

DESIGN GUIDELINE 4

RIPRAP REVETMENT

4.1 INTRODUCTION

Revetments are used to provide protection for embankments, streambanks, and streambeds. They may be flexible or rigid, and can be used to counter virtually all erosion mechanisms. They do not significantly constrict channels or alter flow patterns. However, revetments do not provide resistance against geotechnical instability, such as slumping failure in saturated streambanks and embankments. In addition, they are relatively unsuccessful in stabilizing streambanks and streambeds in degrading streams. **Special precautions must be observed in the design of revetments for degrading channels.** This design guideline provides recommendations for the design and installation of rock riprap as an armoring-type bank protection against erosion.

4.2 FLEXIBLE REVETMENTS

Flexible revetments include rock riprap, partially grouted rock riprap, rock-and-wire mattresses, gabions, pre-cast articulating concrete blocks, rock-filled trenches, windrow revetments, used tire revetments, and vegetation. Because rock riprap is almost always installed in a layer that is multiple particles thick, it adjusts to distortions and local displacement of materials without complete failure of the revetment installation. This aspect of rock riprap behavior is often referred to as a "self-healing" characteristic. In contrast, flexible rock-and-wire mattresses, gabions, articulating concrete blocks, used-tire systems, and grout-filled mats may sometimes span over voids in the underlying soil, but usually can adjust to gradual distortions. Discussion of design guidelines for flexible revetments other than rock riprap can be found separately in the following section.

4.2.1 Flexible Revetments Other Than Rock Riprap

Design guidelines, installation recommendations, and suggested specifications for flexible revetments other than rock riprap are provided in this document, as follows:

- Wire Enclosed Riprap Mattresses: Design Guideline 6
- Articulating Concrete Blocks: Design Guideline 8
- Grout-Filled Mattresses: Design Guideline 9
- Gabion Mattresses: Design Guideline 10
- Partially Grouted Riprap: Design Guideline 12

4.2.2 Design Guidelines for Revetment Riprap

NCHRP Report 568, "Riprap Design Criteria, Recommended Specifications, and Quality Control" (Lagasse et al. 2006) provides design guidance for sizing the rock for dumped riprap used for bank protection. That NCHRP study evaluated numerous procedures for sizing revetment riprap, and recommends using the method developed by Maynard (1989, 1990) and published by the U.S. Army Corps of Engineers (USACE) as Engineering Manual No. 1110-2-1601 (EM-1601) (USACE 1991). The procedure uses both velocity and depth as its primary design parameters.

The EM-1601 equation can be used with uniform or gradually varying flow. Coefficients are included to account for the desired safety factor for design, specific gravity of the riprap stone, bank slope, and bendway character. The EM-1601 equation is:

$$d_{30} = y(S_f C_S C_V C_T) \left[\frac{(V_{des})}{\sqrt{K_1(S_g - 1)gy}} \right]^{2.5} \quad (4.1)$$

- where:
- d_{30} = Particle size for which 30% is finer by weight, ft (m)
 - y = Local depth of flow, ft (m)
 - S_f = Safety factor (must be > 1.0)
 - C_S = Stability coefficient (for blanket thickness = d_{100} or $1.5d_{50}$, whichever is greater, and uniformity ratio $d_{85}/d_{15} = 1.7$ to 5.2)
 - = 0.30 for angular rock
 - = 0.375 for rounded rock
 - C_V = Velocity distribution coefficient
 - = 1.0 for straight channels or the inside of bends
 - = $1.283 - 0.2\log(R_c/W)$ for the outside of bends (1.0 for $R_c/W > 26$)
 - = 1.25 downstream from concrete channels
 - = 1.25 at the end of dikes
 - C_T = Blanket thickness coefficient given as a function of the uniformity ratio d_{85}/d_{15} . $C_T = 1.0$ is recommended because it is based on very limited data.
 - V_{des} = Characteristic velocity for design, defined as the depth-averaged velocity at a point 20% upslope from the toe of the revetment, ft/s (m/s)
 - For natural channels, $V_{des} = V_{avg}(1.74 - 0.52\log(R_c/W))$
 $V_{des} = V_{avg}$ for $R_c/W > 26$
 - For trapezoidal channels, $V_{des} = V_{avg}(1.71 - 0.78\log(R_c/W))$
 $V_{des} = V_{avg}$ for $R_c/W > 8$
 - V_{avg} = Channel cross-sectional average velocity, ft/s (m/s)
 - K_1 = Side slope correction factor

$$K_1 = \sqrt{1 - \left(\frac{\sin(\theta - 14^\circ)}{\sin(32^\circ)} \right)^{1.6}}$$
 - where: θ is the bank angle in degrees
 - R_c = Centerline radius of curvature of channel bend, ft (m)
 - W = Width of water surface at upstream end of channel bend, ft (m)
 - S_g = Specific gravity of riprap (usually taken as 2.65)
 - g = Acceleration due to gravity, 32.2 ft/s^2 (9.81 m/s^2)

The values of the coefficients used in the EM-1601 equation are provided in the variable definitions as given above. They can also be determined graphically from charts provided in Appendix B of EM 1601 (USACE 1991). The EM-1601 document can be downloaded from USACE websites if additional guidance is desired.

Using the recommended riprap gradations from NCHRP Report 568, the d_{30} size of the riprap is related to the recommended median (d_{50}) size by:

$$d_{50} = 1.20 d_{30} \quad (4.2)$$

The flow depth "y" used in Equation 4.1 is defined as the local flow depth. The flow depth at the toe of slope is typically used for bank revetment applications; alternatively, the average channel depth can be used. The smaller of these values will result in a slightly larger computed d_{30} size, since riprap size is inversely proportional to $(y^{0.25})$.

The blanket thickness coefficient (C_T) is 1.0 for standard riprap applications where the thickness is equal to $1.5d_{50}$ or d_{100} , whichever is greater. Because only limited data is available for selecting lower values of C_T when greater thicknesses of riprap are used, a value of 1.0 is reasonable for all applications.

The recommended Safety Factor S_f is 1.1 for bank revetment. Greater values should be considered where there is significant potential for ice or impact from large debris, freeze-thaw degradation that would significantly decrease particle size, or large uncertainty in the design variables, especially velocity.

A limitation to Equation 4.1 is that the longitudinal slope of the channel should not be steeper than 2.0% (0.02 ft/ft). For steeper channels, the riprap sizing approach for overtopping flows should be considered and the results compared with Equation 4.1 (see Design Guide 5).

Once a design size is established, a standard size class can be selected, if design criteria and economic considerations permit. Using standard sizes the appropriate gradation can be achieved by selecting the next larger size class, thereby creating a slightly over-designed structure, but economically a less expensive one. Recommended size classes and gradation characteristics are derived from NCHRP Report 568, and are provided in Section 4.2.4 of this design guide.

4.2.3 Thickness of Riprap

All stones should be contained reasonably well within the riprap layer thickness, with little or no oversize stones protruding above the surface of the riprap matrix. The following criteria are recommended in NCHRP Report 568 for revetment riprap:

1. Layer thickness should not be less than the spherical diameter of the D_{100} stone nor less than 1.5 times the spherical diameter of the D_{50} stone, whichever results in the greater thickness.
2. Layer thickness should not be less than 1 ft (0.30 m) for practical placement.
3. Layer thickness determined either by criterion 1 or 2 should be increased by 50% when the riprap is placed underwater to compensate for uncertainties associated with this placement condition.

4.2.4 Riprap Shape and Gradation

Riprap design methods typically yield a required size of stone that will result in stable performance under the design loadings. Because stone is produced and delivered in a range of sizes and shapes, the required size of stone is often stated in terms of a minimum allowable representative size. For example, the designer may specify a minimum d_{50} or d_{30} for the rock comprising the riprap, thus indicating the size for which 50 or 30% (by weight) of the particles are smaller. Stone sizes can also be specified in terms of weight (e.g., W_{50} or W_{30}) using an accepted relationship between size and volume, and the known (or assumed) density of the particle.

Shape: The shape of a stone can be generally described by designating three axes of measurement: Major, intermediate, and minor, also known as the "A, B, and C" axes, as shown in Figure 4.1.

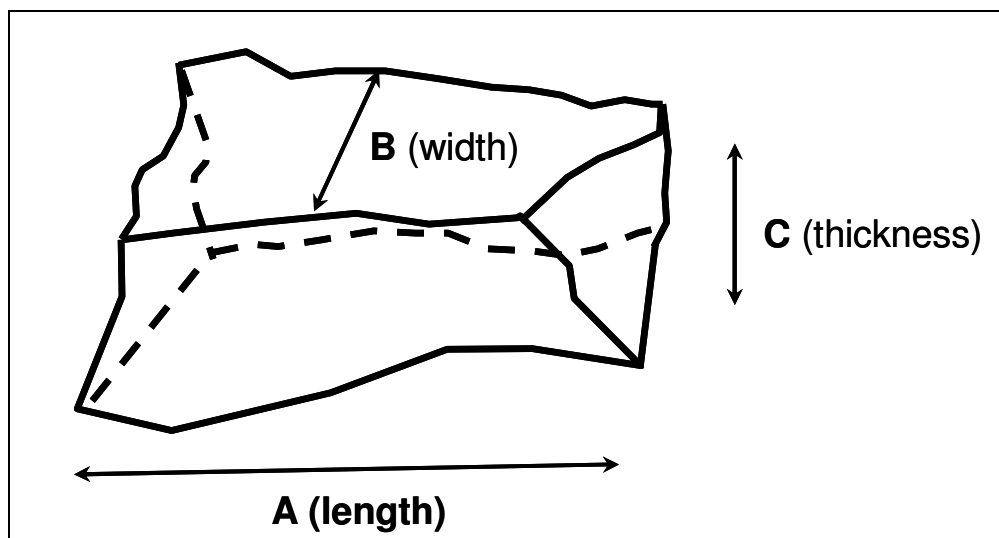

Figure 4.1. Riprap shape described by three axes.

Riprap stones should not be thin and platy, nor should they be long and needle-like. Therefore, specifying a maximum allowable value for the ratio A/C , also known as the shape factor, provides a suitable measure of particle shape, since the B axis is intermediate between the two extremes of length A and thickness C. A maximum allowable value of 3.0 is recommended:

$$\frac{A}{C} \leq 3.0 \quad (4.3)$$

For riprap applications, stones tending toward subangular to angular are preferred, due to the higher degree of interlocking, hence greater stability, compared to rounded particles of the same weight.

Density: A measure of density of natural rock is the specific gravity S_g , which is the ratio of the density of a single (solid) rock particle γ_s to the density of water γ_w :

$$S_g = \frac{\gamma_s}{\gamma_w} \quad (4.4)$$

Typically, a minimum allowable specific gravity of 2.5 is required for riprap applications. Where quarry sources uniformly produce rock with a specific gravity significantly greater than 2.5 (such as dolomite, $S_g = 2.7$ to 2.8), the equivalent stone size can be substantially reduced and still achieve the same particle weight gradation.

Size and weight: Based on field studies, the recommended relationship between size and weight is given by:

$$W = 0.85(\gamma_s d^3) \quad (4.5)$$

where:

- W = Weight of stone, lb (kg)
- γ_s = Density of stone, lb/ft³ (kg/m³)
- d = Size of intermediate ("B") axis, ft (m)

Table 4.1 provides recommended gradations for ten standard classes of riprap based on the median particle diameter d_{50} as determined by the dimension of the intermediate ("B") axis. These gradations conform to those recommended in NCHRP Report 568 (Lagasse et al. 2006). The proposed gradation criteria are based on a nominal or "target" d_{50} and a uniformity ratio d_{85}/d_{15} that results in riprap that is well graded. The target uniformity ratio d_{85}/d_{15} is 2.0 and the allowable range is from 1.5 to 2.5.

Nominal Riprap Class by Median Particle Diameter		d_{15}		d_{50}		d_{85}		d_{100}
Class	Size	Min	Max	Min	Max	Min	Max	Max
I	6 in	3.7	5.2	5.7	6.9	7.8	9.2	12.0
II	9 in	5.5	7.8	8.5	10.5	11.5	14.0	18.0
III	12 in	7.3	10.5	11.5	14.0	15.5	18.5	24.0
IV	15 in	9.2	13.0	14.5	17.5	19.5	23.0	30.0
V	18 in	11.0	15.5	17.0	20.5	23.5	27.5	36.0
VI	21 in	13.0	18.5	20.0	24.0	27.5	32.5	42.0
VII	24 in	14.5	21.0	23.0	27.5	31.0	37.0	48.0
VIII	30 in	18.5	26.0	28.5	34.5	39.0	46.0	60.0
IX	36 in	22.0	31.5	34.0	41.5	47.0	55.5	72.0
X	42 in	25.5	36.5	40.0	48.5	54.5	64.5	84.0

Note: Particle size d corresponds to the intermediate ("B") axis of the particle.

Based on Equation 4.5, which assumes the volume of the stone is 85% of a cube, Table 4.2 provides the equivalent particle weights for the same ten classes, using a specific gravity of 2.65 for the particle density.

Nominal Riprap Class by Median Particle Weight		W ₁₅		W ₅₀		W ₈₅		W ₁₀₀
Class	Weight	Min	Max	Min	Max	Min	Max	Max
I	20 lb	4	12	15	27	39	64	140
II	60 lb	13	39	51	90	130	220	470
III	150 lb	32	93	120	210	310	510	1100
IV	300 lb	62	180	240	420	600	1,000	2,200
V	1/4 ton	110	310	410	720	1,050	1,750	3,800
VI	3/8 ton	170	500	650	1,150	1,650	2,800	6,000
VII	1/2 ton	260	740	950	1,700	2,500	4,100	9,000
VIII	1 ton	500	1,450	1,900	3,300	4,800	8,000	1,7600
IX	2 ton	860	2,500	3,300	5,800	8,300	13,900	30,400
X	3 ton	1,350	4,000	5,200	9,200	13,200	22,000	48,200

Note: Weight limits for each class are estimated from particle size by: $W = 0.85(\gamma_s d^3)$ where d corresponds to the intermediate ("B") axis of the particle, and particle specific gravity is taken as 2.65.

4.2.5 Recommended Tests for Rock Quality

Standard test methods relating to material type, characteristics, and testing of rock and aggregates typically associated with riprap installations (e.g., filter stone and bedding layers) are provided in this section and are recommended for specifying the quality of the riprap stone. In general, the test methods recommended in this section are intended to ensure that the stone is dense and durable, and will not degrade significantly over time.

Rocks used for riprap should only break with difficulty, have no earthy odor, no closely spaced discontinuities (joints or bedding planes), and should not absorb water easily. Rocks comprised of appreciable amounts of clay, such as shales, mudstones, and claystones, are **never** acceptable for use as fill for gabion mattresses. Table 4.3 summarizes the recommended tests and allowable values for rock and aggregate.

4.2.6 Filter Requirements

The importance of the filter component of revetment riprap installation should not be underestimated. Geotextile filters and granular filters may be used in conjunction with riprap bank protection. When using a granular stone filter, the layer should have a minimum thickness of 4 times the d_{50} of the filter stone or 6 inches, whichever is greater. When placing a granular filter under water, its thickness should be increased by 50%.

The filter must retain the coarser particles of the subgrade while remaining permeable enough to allow infiltration and exfiltration to occur freely. It is not necessary to retain all the particle sizes in the subgrade; in fact, it is beneficial to allow the smaller particles to pass through the filter, leaving a coarser substrate behind. Detailed aspects of filter design are presented in Design Guideline 16 of this document.

Some situations call for a composite filter consisting of both a granular layer and a geotextile. The specific characteristics of the base soil determine the need for, and design considerations of the filter layer. ***In cases where dune-type bedforms may be present at the toe of a bank slope protected with riprap, and where adequate toe down extent cannot be ensured, it is strongly recommended that only a geotextile filter be considered.***

Table 4.3. Recommended Tests for Riprap Quality.

Test Designation	Property	Allowable value		Frequency ⁽¹⁾	Comments
AASHTO TP 61	Percentage of Fracture	< 5%		1 per 20,000 tons	Percentage of pieces that have fewer than 50% fractured surfaces
AASHTO T 85	Specific Gravity and Water Absorption	Average of 10 pieces: $S_g > 2.5$ Absorption < 1.0%		1 per year	If any individual piece exhibits an S_g less than 2.3 or water absorption greater than 3.0%, an additional 10 pieces shall be tested. If the second series of tests also exhibits pieces that do not pass, the riprap shall be rejected.
AASHTO T 103	Soundness by Freezing and Thawing	Maximum of 10 pieces after 25 cycles: < 0.5%		1 per 2 years	Recommended only if water absorption is greater than 0.5% and the freeze-thaw severity index is greater than 15 per ASTM D 5312.
AASHTO T 104	Soundness by Use of Sodium Sulfate or Magnesium Sulfate	Average of 10 pieces: < 17.5%		1 per year	If any individual piece exhibits a value greater than 25%, an additional 10 pieces shall be tested. If the second series of tests also exhibits pieces that do not pass, the riprap shall be rejected.
AASHTO TP 58	Durability Index Using the Micro-Deval Apparatus	<u>Value</u> > 90 > 80 > 70	<u>Application</u> Severe Moderate Mild	1 per year	Severity of application per Section 5.4, CEN (2002). Most riverine applications are considered mild or moderate.
ASTM D 3967	Splitting Tensile Strength of Intact Rock Core Specimens	Average of 10 pieces: > 6 MPa		1 per year	If any individual piece exhibits a value less than 4MPa, an additional 10 pieces shall be tested. If the second series of tests also exhibits pieces that do not pass, the riprap shall be rejected.
ASTM D 5873	Rock Hardness by Rebound Hammer	See Note (2)		1 per 20,000 tons	See Note (2)
Shape	Length to Thickness Ratio A/C	< 10%, $d_{50} < 24$ inch < 5%, $d_{50} > 24$ inch		1 per 20,000 tons	Percentage of pieces that exhibit A/C ratio greater than 3.0 using the Wolman Count method (Lagasse et al. 2006)
ASTM D 5519	Particle Size Analysis of Natural and Man-Made Riprap Materials			1 per year	See Note (3)
Gradation	Particle Size Distribution Curve			1 per 20,000 tons	Determined by the Wolman Count method (Lagasse et al. 2006), where particle size "d" is based on the intermediate ("B") axis
<p>(1) Testing frequency for acceptance of riprap from certified quarries, unless otherwise noted. Project-specific tests exceeding quarry certification requirements, either in performance value or frequency of testing, must be specified by the Engineer.</p> <p>(2) Test results from D 5873 should be calibrated to D 3967 results before specifying quarry-specific minimum allowable values.</p> <p>(3) Test results from D 5519 should be calibrated to Wolman Count (Lagasse et al. 2006) results before developing quarry-specific relationships between size and weight; otherwise, assume $W = 85\%$ that of a cube of dimension "d" having a specific gravity of S_g</p>					

4.2.7 Edge Treatment and Termination Details

Riprap revetment should be toed down below the toe of the bank slope to a depth at least as great as the depth of anticipated long-term bed degradation plus toe scour (see Volume 1, Section 4.3.5). Installations in the vicinity of bridges must also consider the potential for contraction scour.

Recommended freeboard allowance calls for the riprap to be placed on the bank to an elevation at least 2.0 feet greater than the design high water level. Upstream and downstream terminations should utilize a key trench that is dimensioned in relation to the d_{50} size of the riprap. Where the design water level is near or above the top of bank, the riprap should be carried to the top of the bank. Figures 4.2, 4.3, and 4.4 are schematic diagrams that summarize these recommendations. If toe down cannot be placed below the anticipated contraction scour and degradation depth (Figure 4.2), a mounded toe approach (Figure 4.3) is suggested.

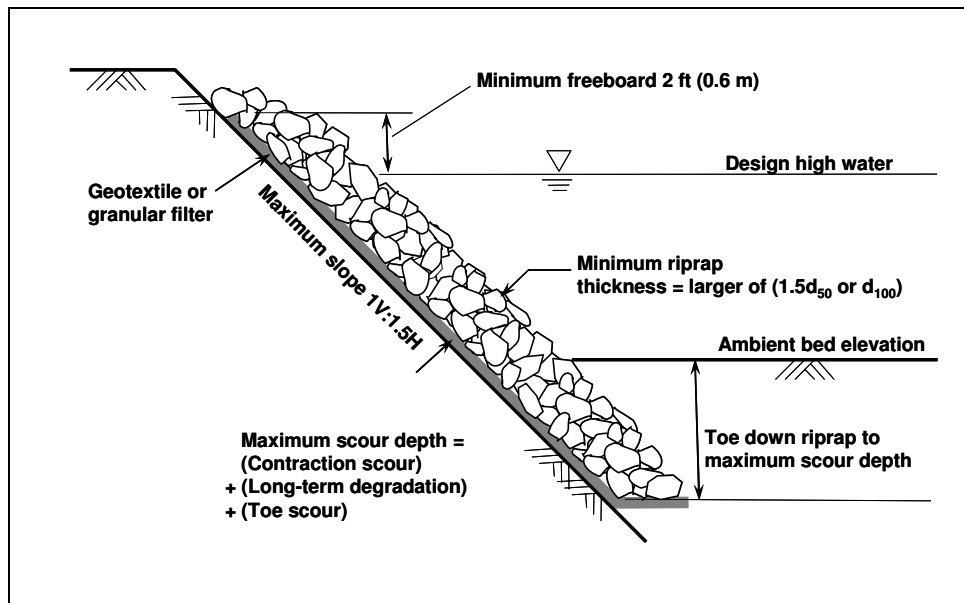

Figure 4.2. Riprap revetment with buried toe.

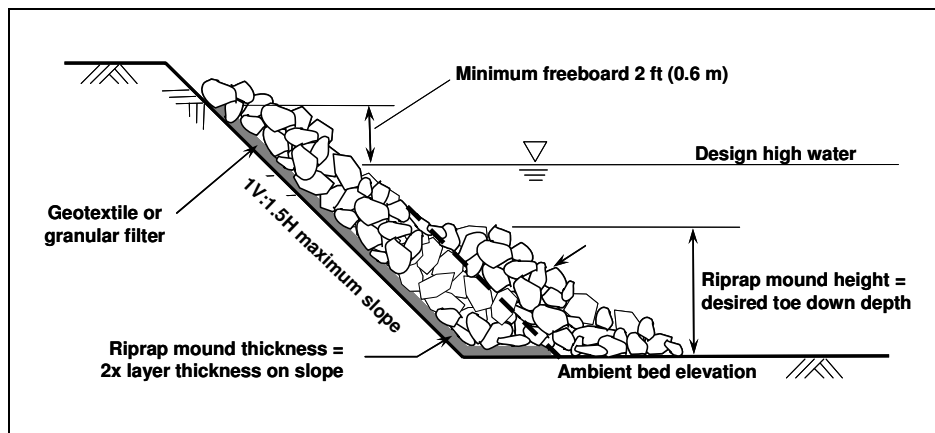

Figure 4.3. Riprap revetment with mounded toe.

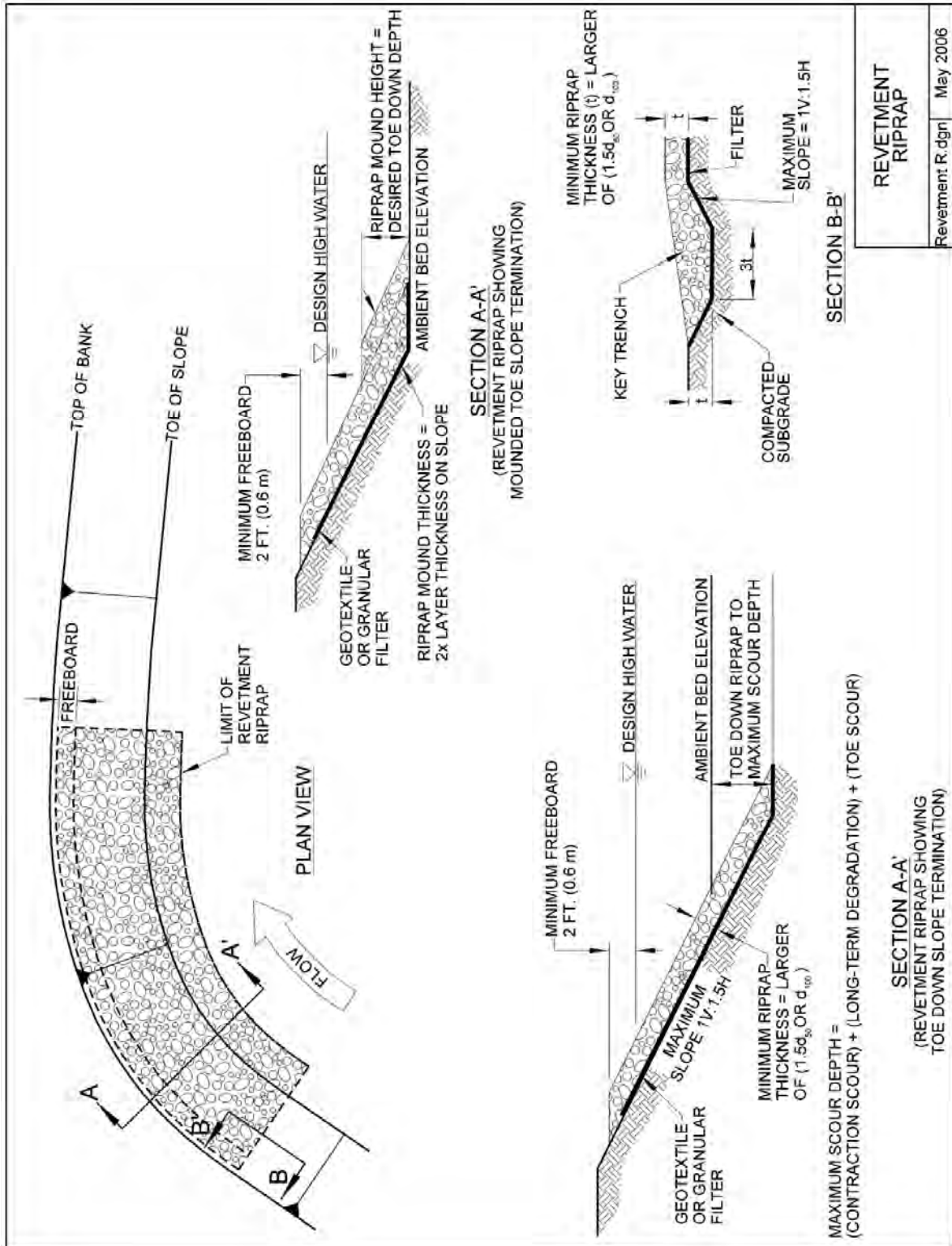

Figure 4.4. Riprap revetment details.

4.3 EXAMPLE APPLICATION

Riprap is to be designed for a 100 ft (30.5 m) wide natural channel on a bend that has a centerline radius (R_c) of 500 ft (152.4 m). The radius of curvature divided by width (R_c/W) is 5.0. The revetment will have a 1V:2H sideslope (26.6°) and the rounded riprap has a specific gravity of 2.54. A factor of safety (S_f) of 1.2 is desired. Toe scour on the outside of the bend has been determined to be 2.5 ft (0.76 m) during the design event.

The following data were obtained from hydraulic modeling of the design event.

Variable	English Units		SI Units	
	Units	Value	Units	Value
Average Channel Velocity	ft/s	7.2	m/s	2.19
Flow Depth at Bank Toe	ft	11.4	m	3.47

Step 1: Compute the side slope correction factor (or select from graph on Plate B-39 of EM 1601):

$$K_1 = \sqrt{1 - \left(\frac{\sin(\theta - 14^\circ)}{\sin(32^\circ)} \right)^{1.6}} = \sqrt{1 - \left(\frac{\sin(26.6^\circ - 14^\circ)}{\sin(32^\circ)} \right)^{1.6}} = 0.87$$

Step 2: Select the appropriate stability coefficient for rounded riprap: $C_s = 0.375$

Step 3: Compute the vertical velocity factor (C_v) for $R_c/W = 5.0$:

$$C_v = 1.283 - 0.2 \log(R_c/W) = 1.283 - 0.2 \log(5.0) = 1.14$$

Step 4: Compute local velocity on the side slope (V_{des}) for a natural channel with $R_c/W = 5.0$:

$$V_{des} = V_{avg} [1.74 - 0.52 \log(R_c/W)] = 7.2 [1.74 - 0.52 \log(5.0)] \\ = 9.9 \text{ ft/s (3.01 m/s)}$$

Step 5: Compute the d_{30} size using Equation 4.1:

$$d_{30} = S_f C_s C_v y \left[\frac{V_{des}}{\sqrt{(Sg - 1) K_1 g y}} \right]^{2.5} \\ = 1.2(0.375)(1.14)(11.4) \left[\frac{9.9}{\sqrt{(2.54 - 1)(0.87)(32.2)(11.4)}} \right]^{2.5} = 0.78 \text{ ft (0.24 m)}$$

Step 6: Compute the d_{50} size for a target gradation of $d_{85}/d_{15} = 2.0$:

$$d_{50} = 1.2 d_{30} = 1.2(0.78) = 0.94 \text{ ft} = 11.2 \text{ inches (0.29 m)}$$

Note: Use next larger size class (see Volume 1, Chapter 5)

Step 7: Select Class III riprap from Table 4.1 of this design guide: $d_{50} = 12 \text{ inches (0.3 m)}$

Step 8: Determine the depth of riprap embedment below the streambed at the toe of the bank slope:

Since toe scour is expected to be 2.5 ft (0.76 m), the 1V:2H slope should be extended below the ambient bed level 5 ft (1.52 m) horizontally out from the toe to accommodate this scour. Alternatively, a mounded riprap toe 2.5 ft (0.76 m) high could be established at the base of the slope and allowed to self-launch when toe scour occurs.

4.4 FIELD TESTS FOR RIPRAP GRADATION

4.4.1 At the Quarry

The Wolman Count method and Galay transect approach are designed to determine a size distribution based on a random sampling of individual stones within a matrix. Both methods are widely accepted in practice, and rely on samples taken from the surface of the matrix to make the method practical for use in the field. Details of the methods can be found in: Bunte and Abt 2001; Galay et al. 1987; and Wolman 1954. In general, these three references provide detailed descriptions of sampling methods, as well as analysis and reporting procedures for determining the size distribution of rock samples. The Wolman count method is illustrated in this section. The Galay transect approach is discussed in Section 4.4.2.

Material gradations for sand size and small gravel materials are typically determined through a sieve analysis of a bulk sample. The weight of each size class (frequency by weight) retained on each sieve is measured and the total percent of material passing that sieve is plotted versus size (sieve opening). The Wolman (1954) procedure measures frequency by size of a surface material rather than a bulk sample. The intermediate dimension (B axis) is measured for randomly selected particles on the surface.

One field approach for cobble size and larger alluvial materials is to select the particle under one's toe after taking a step with eyes averted to avoid bias in particle selection. Another field approach is to stretch a survey tape over the material and measure each particle located at equal intervals along the tape. The equal interval method is recommended for riprap. The interval should be at least 1 ft for small riprap and increased for larger riprap. The B axis is then measured for one hundred particles. The longer and shorter axes (A and C) can also be measured to determine particle shape. Kellerhals and Bray (1971) provide an analysis that supports the conclusion that a surface sample following the Wolman method is equivalent to a bulk sample sieve analysis. One rule that must be followed is that if a single particle is large enough to fall under two interval points along the tape, then it should be included in the count twice. It is probably better to select an interval large enough that this occurs infrequently.

Once 100 particles have been measured, the frequency curve is developed by counting the number of particles less than or equal to specific sizes. To obtain a reasonably detailed frequency curve, the sizes should increase by $(2)^{1/2}$. For uniform riprap the sizes may need to increase by $(2)^{1/4}$ to obtain a detailed frequency curve. The starting size should be small enough to capture the low range of sizes, with 64 mm being adequate for most riprap. This process should be repeated to obtain several samples at the riprap installation.

Figure 4.5 shows one of two riprap stockpiles that were sampled using a Wolman Count to determine whether the sizes met the design criteria of d_{50} equaling 6 and 12 inches (0.15 to 0.3 m). Three samples of 100 stones were measured at each pile and gradations curves were developed for each of the six samples. Table 4.4 includes the data and results for sample number 1 on the 12-inch (0.3 m) stockpile. The B axis was measured to the nearest 10 mm and the percent less than or equal to each size was computed. The starting size of 64 mm was used and size classes increased by $(2)^{1/2}$ (64 mm, 91 mm, 128 mm...). For 100 stones, the percent passing is equal to the number of stones less than or equal to a given size.



Figure 4.5. Riprap stockpile.

Count	mm	Count	mm	Count	mm	Count	mm
1	540	26	560	51	500	76	400
2	510	27	670	52	480	77	340
3	180	28	550	53	180	78	470
4	250	29	220	54	450	79	450
5	250	30	290	55	300	80	280
6	530	31	400	56	420	81	340
7	450	32	320	57	200	82	940
8	170	33	270	58	360	83	600
9	200	34	520	59	290	84	530
10	180	35	650	60	650	85	230
11	520	36	550	61	600	86	400
12	520	37	380	62	400	87	220
13	360	38	180	63	520	88	180
14	300	39	200	64	300	89	300
15	400	40	190	65	320	90	540
16	390	41	340	66	300	91	530
17	170	42	420	67	220	92	270
18	330	43	440	68	260	93	280
19	600	44	300	69	320	94	210
20	380	45	420	70	160	95	200
21	340	46	510	71	470	96	230
22	300	47	540	72	730	97	300
23	280	48	600	73	470	98	390
24	330	49	180	74	200	99	710
25	450	50	290	75	200	100	500

Size (mm)	Percent Passing
64	0
91	0
128	0
181	9
256	24
362	52
512	77
724	98
1024	100
1448	100
2048	100

Figure 4.6 shows the results of the gradation measurements of the two stockpiles. The average gradation was developed by averaging the three samples. The target d_{50} was achieved for the average sample for each stockpile. Also shown is the target or allowable range of sizes based on the recommended gradation discussed earlier. The recommended gradation is based on a target d_{50} and uniformity ratio ($S_t = d_{85}/d_{15}$) ranging from 1.5 to 2.5, which are the limits identified by CUR (1995) as "well-graded" riprap (Figure 4.6 and Section 4.2.4). The average curve for the 6-inch (0.15 m) material meets this gradation target but the 12-inch (0.3 m) material exceeds the target maximum d_{84} by 10%. This indicates that the 12-inch (0.3 m) material is approaching "quarry run" with the uniformity ratio for the 12-inch (0.3 m) material of $d_{85}/d_{15} = 510/187 = 2.7$. One solution to correcting this slight deficiency is to exclude the largest particles during placement. However, that would also reduce d_{50} so the smallest particles should also be excluded from the stockpile.

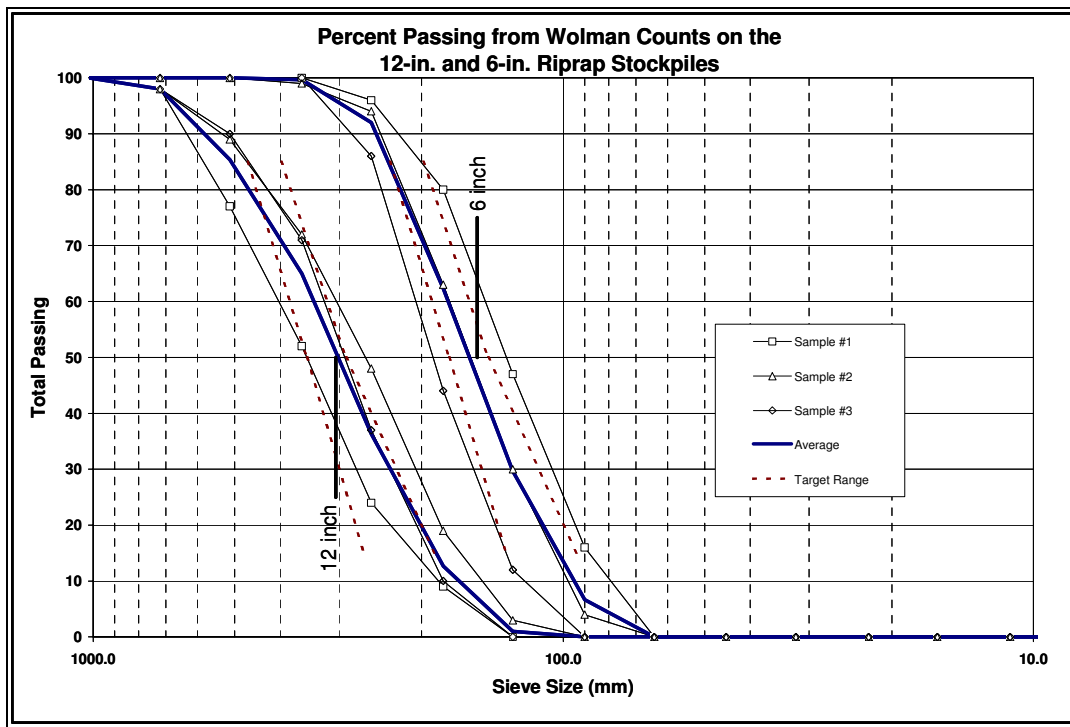

Figure 4.6. Example gradations from 6- and 12-inch (0.15 and 0.31 m) d_{50} stockpiles.

4.4.2 On Site

In reporting on Canadian practice, Galay et al. (1987) notes that typically, stone material used in the construction of riprapped banks and aprons is specified for design as a gradation on a by-weight basis. If it were required to monitor the stones being placed during construction, hypothetically it would be necessary to obtain a volumetric sample of the stone and pass it through a set of sieves. The accumulated weight retained on each sieve would then be plotted as a percentage of the total sample weight in relation to the grid sizes of each sieve. A volumetric or bulk sample in this instance would involve removal of all placed stones to total riprap layer depth within a specified surface area, or all stones within one or more truckloads being transported to the project site.

As this procedure is not practicable, a variety of methods have evolved to check the size gradation of stones being placed as riprap. Generally, the approach has been to assess stone sizes visually while having some impression of what the maximum, minimum, and average sizes of stone look like. This impression is sometimes obtained by actually weighing stones to find typical examples of these three sizes. For projects where extremely large amounts of stone are involved, inspectors sometimes go to the extent of dumping randomly selected truckloads of stone and sorting the stones into several piles of different size ranges. Each of these piles is weighed and related to the total sample weight and a typical size of stone for each pile (Galay et al. 1987).

There has been an effort to develop a simple but effective means of monitoring gradations of stone riprap material (Galay et al. 1987). Basically, what has evolved is a surface sampling technique, whereby stones exposed on the surface of a completed riprap layer are measured with respect to their sizes. Sampling is done in such a way that the measured stones give a representative picture of the proportional area occupied by various sizes. Rather than analyzing the distribution of the sample sizes on a by-weight basis, a by-number analysis is used instead. A gradation curve is then drawn relating stone sizes and frequency distribution. Since riprap specifications are typically provided in terms of stone weight, a link has to be established between stone size and weight. Several methods have been used to describe stone size, including: (1) a single measurement of a stone's intermediate dimension; or (2) relating a stone's volume to an equivalent spherical diameter. In any case, a sample set of stones is weighed and size dimensions determined so that the stone size versus weight relationship can be determined (see Section 4.2.4).

One approach has been to take line samples (that is, stretch a measuring tape across the riprap surface and select stones at even intervals) or an areal sample (select every surface stone within a randomly established boundary). The intermediate dimension of each sample stone is measured and the distribution plotted on a by-number basis in relation to stone size. A predetermined relationship between a stone's size and weight is then used to establish the gradation in terms of weight.

Another approach is to use field-testing procedures related to a visual interpretation of the stone weights that are being placed. Some stones are weighed so that the inspector can gain some appreciation of what minimum, mean, and maximum stone sizes look like. Frequently, this set of stones is marked and set aside at the quarry or the project site for reference by the loader operator and inspector. Rarely would large volumetric or bulk samples be collected so that individual stones could be weighed and the total sample analyzed on a by-weight basis. Occasionally, bulk samples might be collected and sizes segregated into several piles. Each pile would then be weighed and a representative size established for each pile; the distribution would then be plotted on a by-weight basis.

Basic to the argument that an analysis of surface samples can be considered reasonably equivalent to analysis of bulk sample is a paper by Kellerhals and Bray (1971). Although the subject of interest in the paper is sampling of river bed gravels, the conclusions presented are assumed to apply to all coarse materials, including riprap stone, i.e., 'grid sampling with frequency analysis by number is the only sampling procedure capable of describing a surface layer one grain thick, in equivalence with customary bulk sieve analysis' (Galay et al. 1987).

Figure 4.7 presents a plot of sampled stone sizes and their respective measured stone weight, which were selected from a quarry site in Alaska. During placement of stones from this quarry, line samples were collected and their distributions were plotted on a by-number basis. Figure 4.8 shows the results plotted for five samples in relation to the specified gradation envelope curves.

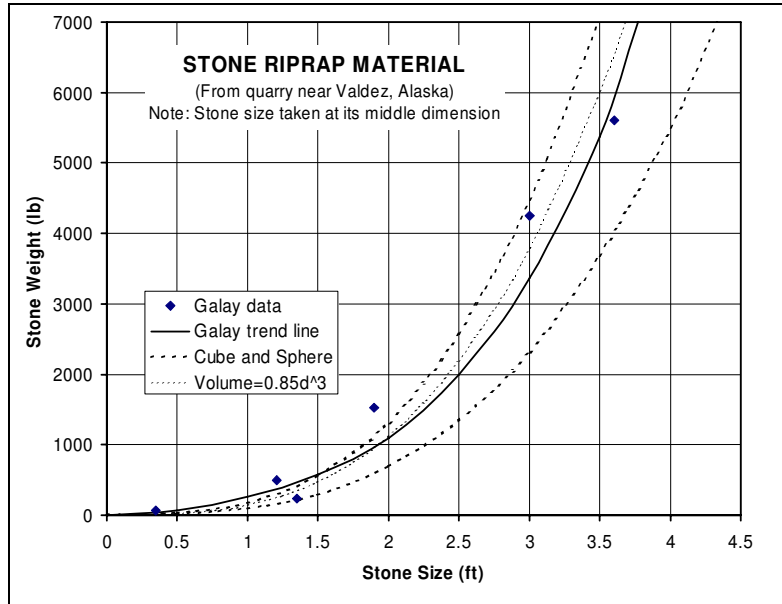

Figure 4.7. Stone weight versus stone size for riprap (Lagasse et al. 2006).

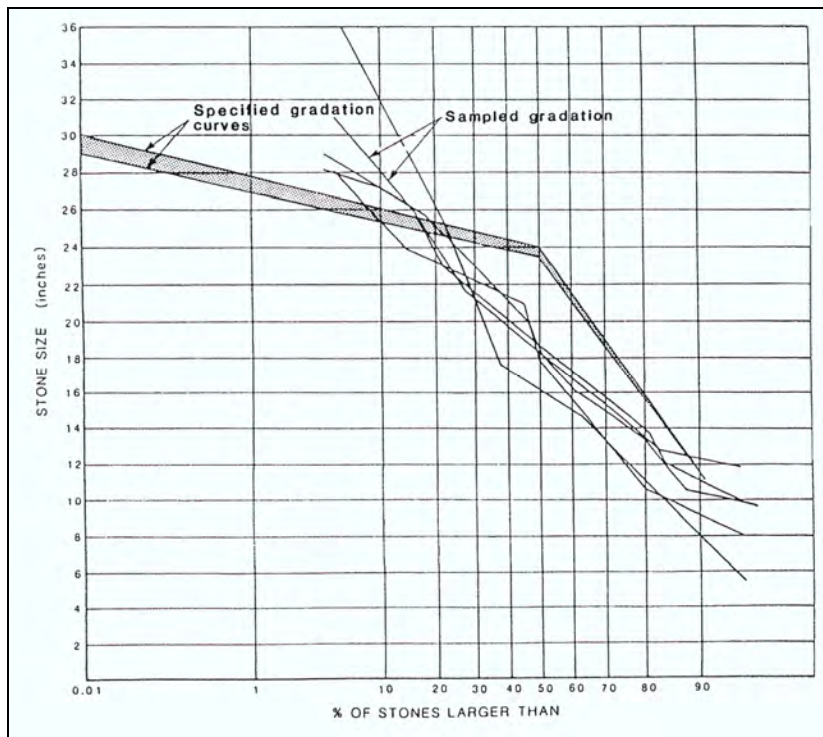

Figure 4.8. Stone riprap gradations: specified and sampled (Galay et al. 1987).

In this instance, stone placement was unsatisfactory and production procedures were subsequently revised in an attempt to achieve a more widely graded distribution. This required an inspector to be present at the quarry, continually working with the equipment operators to ensure that more stones in the middle and lower range were being loaded and hauled to the site (Galay et al. 1987). A similar field test, the Wolman Count, suitable for both quality control and post-construction/post-flood inspection of riprap is discussed in Section 4.4.1.

4.5 CONSTRUCTION

4.5.1 Overview

Riprap is placed in a riverine or coastal environment to prevent scour or erosion of the bed, banks, shoreline, or near structures such as bridge piers and abutments. Riprap construction involves placement of rock and stone in layers on top of a bedding or filter layer composed of sand, gravel and/or geotechnical fabric. The basis of the protection afforded by the riprap is the mass and interlocking of the individual rocks.

Factors to consider when designing riprap installations begin with the source for the rock, the method to obtain or manufacture the rock, competence of the rock, and the methods and equipment to collect, transport, and place the riprap. Rock for riprap may be obtained from quarries, by screening oversized rock from earth borrow pits, by collecting rock from fields, or from talus deposits. Screening borrow pit material and collecting field rocks present different problems such as rocks too large or with unsatisfactory length to width ratios for riprap.

Quarry stones are generally the best source for obtaining large rock specified for riprap. However, not all quarries can produce large stone because of rock formation characteristics or limited volume of the formation. Since quarrying generally uses blasting to fracture the formation into rock suitable for riprap, cracking of the large stones may only become evident after loading, transporting, and dumping at the quarry, after moving material from quarry to stockpile at the job site, or from the stockpile to the final placement location.

In most cases, the production of the rock material will occur at a source that is relatively remote from the construction area. Therefore, this discussion assumes that the rock is hauled to the site of the installation, where it is either dumped directly, stockpiled, or loaded onto waterborne equipment.

Quarry operations typically produce rock for riprap that falls into one of three broad categories based on gradation limits: (1) quarry run, (2) graded (blasted or plant run), and (3) uniform riprap.

Quarry run riprap sizing is established by controlling the borehole spacing and blasting technique. Some sorting may be required at the shot pile or a rock breaker may be used to reduce oversized rock to within the maximum size allowed.

Graded riprap sizing is established by controlling the borehole spacing and blasting technique, along with removal of small sizes by running the material over a grizzly, or by sizing it through a crusher. This material is more expensive

Uniform riprap is produced by removing the over- and undersized material by a series of grizzlies. This produces a one-sized gradation within a narrow size limit as dictated by the size of the grizzlies. Of the three types of riprap discussed here, this material is the most expensive to produce.

The objectives of construction of a good riprap installation are (1) to obtain a rock mixture from the source that meets the design specifications and (2) to place that mixture in a well-knit, compact and uniform layer without segregation of the mixture. The best time to control the gradation of the riprap mixture is during the quarrying operation. Sorting and mixing later in stockpiles or at the construction site is not satisfactory. In the past, control of the riprap gradation at the job site has almost always been carried out by visual inspection. Therefore, it is helpful to have a pile of rocks with the required gradation at a convenient location where inspectors can see and develop a reference to judge by eye the suitability of the rock being placed (see Sections 4.4.1 and 4.4.2).

The guidance in this section has been developed to facilitate the proper installation of riprap systems to achieve suitable hydraulic performance and maintain stability against hydraulic loading. The proper installation of riprap systems is essential to the adequate functioning and performance of the system during the design hydrologic event. Guidelines are provided herein for maximizing the correspondence between the design intent and the actual field-finished conditions of the project. This section addresses the preparation of the subgrade, placement of the filter, riprap placement, and measurement and payment.

4.5.2 General Guidelines

The contractor is responsible for constructing the project according to the plans and specifications; however, ensuring conformance with the project plans and specifications is the responsibility of the owner. This is typically performed through the owner's engineer and inspectors. Inspectors observe and document the construction progress and performance of the contractor. Prior to construction, the contractor should provide a quality control plan to the owner (for example, see USACE ER 1180-1-6, 1995, "Construction Quality Management") and provide labor and equipment to perform tests as required by the project specifications.

Designers should include construction requirements for riprap placement in the project plans and specifications. Standard riprap specifications and layout guidance are found in Section 4.2 of this document. Recommended requirements for the stone, including the tests necessary to ensure that the physical and mechanical properties meet the requirements of the project specifications are provided. Field tests can be performed at the quarry and/or on the job site, or representative samples can be obtained for laboratory testing. Additional riprap specifications can be found in manuals of most governmental agencies involved in construction (Federal Highway Administration 1981), (USACE 1991), (Racin et al. 2000).

Typically, one or more standard riprap gradations are specified and plan sheets show locations, grades, and dimensions of rock layers for the countermeasure. Additional drawings clarify features at the toe, at the end of the revetment, at transitions, or at other unusual changes in the structures. The stone shape is important and riprap should be blocky rather than elongated, platy or round. In addition, the stone should have sharp, angular, clean edges at the intersections of relatively flat surfaces.

Stone size and riprap layer thickness are related. Layer thickness is generally defined as not less than the spherical diameter of the upper limit W_{100} stone or not less than 1.5 times the spherical diameter of the upper limit of the W_{50} stone, whichever results in the greater thickness. Typically, project specifications call for a 50% increase in layer thickness if the riprap is to be placed underwater. Riprap should be placed on bedding stone and/or geotextile filter material.

On-site inspection of riprap is necessary both at the quarry and at the job site to ensure proper gradation and material that does not contain excessive amounts of fines. Breakage during handling and transportation should be taken into account. Segregation of material during transportation, dumping, or off-loading is not acceptable. Inspection of riprap placement consists of visual inspection of the operation and the finished surface. Inspection must ensure that a dense, rough surface of well-keyed graded rock of the specified quality and sizes is obtained, that the layers are placed such that voids are minimized, and that the layers are the specified thickness.

Inspection and quality assurance must be carefully organized and conducted in case potential problems or questions arise over acceptance of stone material. The engineer and inspectors reserve the right to reject stone at the quarry, at the job site or stockpile, and in place in the structures throughout the duration of the contract. Stone rejected at the job site should be removed from the project site. Stone rejected at the quarry should be disposed or otherwise prevented from mixing with satisfactory stone.

Construction techniques can vary tremendously due to the following factors:

- Size and scope of the overall project
- Size and weight of the riprap particles
- Whether placement is under water or in the dry
- Physical constraints to access and/or staging areas
- Noise limitations
- Traffic management and road weight restrictions
- Environmental restrictions
- Type of construction equipment available

Competency in construction techniques and management in all their aspects cannot be acquired from a book. Training on a variety of job sites and project types under the guidance of experienced senior personnel is required. The following sections provide some general information regarding construction of riprap installations and provide some basic information and description of techniques and processes involved.

4.5.3 European Installation Techniques

In Europe, riprap is considered an effective and permanent countermeasure against channel instability and scour, including local scour at bridge piers. Considerable effort has been devoted to techniques for determining size, gradation, layer thickness and horizontal extent, filters, and placement techniques and equipment for riverine and coastal applications (TRB 1999). Engineers in Europe emphasize the need for designing the riprap for a specific site, and in many cases a hydraulic model study will be performed to verify riprap stability. The intensity of turbulence in relation to the structure to be protected is analyzed to assist in developing the most economical riprap design, with larger rock being specified for areas of high turbulence (CUR 1995).

Great care is taken in placing the riprap at critical locations, and in many cases stones are placed individually in the riprap matrix. Highly specialized equipment has been developed by construction contractors in Europe for placing riprap, particularly for coastal installations. The use of bottom dump or side dump pontoons (barges) is common in both Germany and the Netherlands. By loading pontoon "bins" selectively with different sizes of rock, a design gradation in the riprap can be achieved. For large installations, vessels for placing riprap are equipped with dynamic positioning systems using Differential Global Positioning System

technology and thrusters to maintain position, and echo sounders (or divers) to verify the coverage of the riprap layer. Some of the smaller pontoon systems, particularly the bottom dump pontoons developed in Germany could be used to place riprap in water at larger bridges (Figure 4.9).



Figure 4.9. Bottom dump pontoon barge used in Germany for placing riprap (TRB 1999).

4.5.4 Materials

Stone

As noted, the best time to control the gradation of the riprap mixture is during the quarrying operation. Generally, sorting and mixing later in stockpiles or at the construction site is not recommended. Inspection of the riprap gradation at the job site is usually carried out visually. Therefore, it is helpful to have a pile of rocks with the required gradation at a convenient location where inspectors can see and develop a reference to judge by eye the suitability of the rock being placed. On-site inspection of riprap is necessary both at the quarry and at the job site to ensure proper gradation and material that does not contain excessive amounts of fines. Breakage during handling and transportation should be taken into account.

The Wolman Count method (Wolman 1954) as described in Section 4.4 may be used as a field test to determine a size distribution based on a random sampling of individual stones within a matrix. This method relies on samples taken from the surface of the matrix to make the method practical for use in the field. The procedure determines frequency by size of a surface material rather than using a bulk sample.

Filter Layer

Geotextile: Either woven or non-woven needle punched fabrics may be used. If a non-woven fabric is used, it must have a mass density greater than 12 ounces per square yard (400 grams per square meter). ***Under no circumstances may spun-bond or slit-film fabrics be allowed.*** Each roll of geotextile shall be labeled with the manufacturer's name, product identification, roll dimensions, lot number, and date of manufacture. Geotextiles shall not be exposed to sunlight prior to placement.

Granular filters: Samples of granular filter material shall be tested for grain size distribution to ensure compliance with the gradation specification used in design. Sampling and testing frequency shall be in accordance with the owner or owner's authorized representative.

Subgrade Soils

When placing in the dry, the riprap and filter shall be placed on undisturbed native soil, on an excavated and prepared subgrade, or on acceptably placed and compacted fill. Unsatisfactory soils shall be considered those soils having excessive in-place moisture content, soils containing roots, sod, brush, or other organic materials, soils containing turf clods or rocks, or frozen soil. These soils shall be removed, backfilled with approved material and compacted prior to placement of the riprap. Unsatisfactory soils may also be defined as soils such as very fine noncohesive soils with uniform particle size, gap-graded soils, laminated soils, and dispersive clays, per the geotechnical engineer's recommendations.

4.5.5 Installation

Subgrade Preparation

As noted, the subgrade soil conditions shall meet or exceed the required material properties described in Section 4.5.4 prior to placement of the riprap. Soils not meeting the requirements shall be removed and replaced with acceptable material.

When placing in the dry, the areas to receive the riprap shall be graded to establish a smooth surface and ensure that intimate contact is achieved between the subgrade surface and the filter, and between the filter and the riprap. Stable and compacted subgrade soil shall be prepared to the lines, grades and cross sections shown on the contract drawings. Termination trenches and transitions between slopes, embankment crests, benches, berms and toes shall be compacted, shaped, and uniformly graded. The subgrade should be uniformly compacted to the geotechnical engineer's site-specific requirements.

When placing under water, divers shall be used to ensure that the bed is free of logs, large rocks, construction materials, or other blocky materials that would create voids beneath the system. Immediately prior to placing the filter and riprap system, the prepared subgrade must be inspected.

Placing the Filter

Whether the filter is comprised of one or more layers of granular material or made of geotextile, its placement should result in a continuous installation that maintains intimate contact with the soil beneath. Voids, gaps, tears, or other holes in the filter must be avoided to the extent practicable, and replaced or repaired when they occur.

Placement of Geotextile: The geotextile shall be placed directly on the prepared area, in intimate contact with the subgrade. When placing a geotextile, it should be rolled or spread out directly on the prepared area and be free of folds or wrinkles. The rolls shall not be dragged, lifted by one end, or dropped. The geotextile should be placed in such a manner that placement of the overlying materials (riprap and/or bedding stone) will not excessively stretch or tear the geotextile.

After geotextile placement, the work area shall not be trafficked or disturbed in a manner that might result in a loss of intimate contact between the riprap stone, the geotextile, and the subgrade. The geotextile shall not be left exposed longer than the manufacturer's recommendation to minimize potential damage due to ultraviolet radiation; therefore, placement of the overlying materials should be conducted as soon as practicable.

The geotextile shall be placed so that upstream strips overlap downstream strips. Overlaps shall be in the direction of flow wherever possible. The longitudinal and transverse joints shall be overlapped at least 1.5 feet (46 cm) for dry installations and at least 3 feet (91 cm) for below-water installations. If a sewn seam is to be used for the seaming of the geotextile, the thread to be used shall consist of high strength polypropylene or polyester and shall be resistant to ultraviolet radiation. If necessary to expedite construction and to maintain the recommended overlaps anchoring pins, "U"-staples or weights such as sandbags shall be used. Figure 4.10 illustrates the placing of a geotextile for a coastal shoreline application.



Figure 4.10. Hand placing geotextile prior to placing riprap. Note sewn seam.

Placing Geotextiles Under Water: Placing geotextiles under water can be problematic for a number of reasons. Most geotextiles that are used as filters beneath riprap are made of polyethylene or polypropylene. These materials have specific gravities ranging from 0.90 to 0.96, meaning that they will float unless weighted down or otherwise anchored to the subgrade prior to placement of the riprap (Koerner 1998).

Flow velocities greater than about 1.0 ft/s (0.3 m/s) create large forces on the geotextile. These forces cause the geotextile to act like a sail, often resulting in wavelike undulations of the fabric (a condition that contractors refer to as "galloping") that are extremely difficult to control. The preferred method of controlling geotextile placement is to isolate the work area from river currents by a temporary cofferdam. In mild currents, geotextiles precut to length can be placed by divers, with sandbags to hold the filter temporarily.

Placement of Granular Filter: When placing a granular filter, front-end loaders are the preferred method for dumping and spreading the material on slopes milder than approximately 1V:4H. A typical minimum thickness for granular filters is 0.5 to 1.0 feet (0.15 to 0.3 m), depending on the size of the overlying riprap and whether a layer of bedding stone

is to be used between the filter and the riprap. When placing a granular filter under water, the thickness should be increased by 50%. Placing granular media under water around a bridge pier is best accomplished using a large diameter tremie pipe to control the placement location and thickness, while minimizing the potential for segregation. **NOTE: For riverine applications where dune-type bed forms may be present, it is strongly recommended that only a geotextile filter be considered.**

Placing the Riprap

Riprap may be placed from either land-based or water-based operations and can be placed under water or in the dry. Special-purpose equipment such as clamshells, orange-peel grapples, or hydraulic excavators (often equipped with a "thumb") is preferred for placing riprap. Unless the riprap can be placed to the required thickness in one lift using dump trucks or front-end loaders, tracked or wheeled vehicles are discouraged from use because they can destroy the interlocking integrity of the rocks when driven over previously placed riprap. Water-based operations may require specialized equipment for deep-water placement, or can use land-based equipment loaded onto barges for near-shore placement. In all cases, riprap should be placed from the bottom working toward the top of the slope so that rolling and/or segregation does not occur as shown in Figure 4.11.



Figure 4.11. Placing riprap with hydraulic excavators.

Riprap Placement on Geotextiles: Riprap should be placed over the geotextile by methods that do not stretch, tear, puncture, or reposition the fabric. **Equipment should be operated to minimize the drop height of the stone without the equipment contacting and damaging the geotextile. Generally, this will be about 1 foot of drop from the bucket to the placement surface (ASTM Standard D 6825).** Further guidance on recommended strength properties of geotextiles as related to the severity of stresses during installation are provided in Part 1 of this document. When the preferred equipment cannot be utilized, a bedding layer of coarse granular material on top of the geotextile can serve as a cushion to protect the geotextile. Material comprising the bedding layer must be more permeable than the geotextile to prevent uplift pressures from developing.

Riprap Placement Under Water: Riprap placed in water requires close observation and increased quality control to ensure a continuous well-graded uniform rock layer of the required thickness (ASTM Standard D6825). A systematic process for placing and continuous monitoring to verify the quantity and layer thickness is important. Typically, riprap thickness is increased by 50% when placement must occur under water.

Excavation, grading, and placement of riprap and filter under water require additional measures. For installations of a relatively small scale, diversion of the stream around the work area can be accomplished during the low flow season. For installations on larger rivers or in deeper water, the area can be temporarily enclosed by a cofferdam, which allows for construction dewatering if necessary. Alternatively, a silt curtain made of plastic sheeting may be suspended by buoys around the work area to minimize environmental degradation during construction.

Depending on the depth and velocity of the water, sounding surveys using a sounding pole or sounding basket on a lead line, divers, sonar bottom profiles, and remote operated vehicles (ROV) can provide some information about the riprap placement under water.

Inspection

Detailed guidance for inspecting riprap installations is provided in NCHRP Report 593 (Lagasse et al. 2007). The guidance includes inspection during construction, periodic inspection, and inspection after flood events (see Volume 1, Appendix D).

4.5.6 Measurement and Payment

Riprap satisfactorily placed can be paid for based on either volume or weight. When using a weight basis, commercial truck scales capable of printing a weight ticket including time, date, truck number, and weight should be used. When using a volumetric basis, the in-place volume should be determined by multiplying the area, as measured in the field, of the surface on which the riprap was placed, by the thickness of the riprap measured perpendicular as dimensioned on the contract drawings.

In either case, the finished surface of the riprap should be surveyed to ensure that the as-built lines and grades meet the design plans within the specified tolerance. Survey cross-sections perpendicular to the axis of the structure are usually taken at specified intervals. All stone outside the limits and tolerances of the cross sections of the structure, except variations so minor as not to be measurable, is deducted from the quantity of new stone for which payment is to be made. In certain cases, excess stone may be hazardous or otherwise detrimental; in this circumstance, the contractor must remove the excess stone at his own expense. Payment will be full compensation for all material, labor, and equipment to complete the work.

4.6 ROCK-FILLED TRENCHES AND WINDROW REVETMENT

Rock-filled trenches are structures used to protect banks from caving caused by erosion at the toe. A trench is excavated along the toe of the bank and filled with rocks as shown in Figure 4.12. The size of trench to hold the rock fill depends on expected depths of scour.

As the streambed adjacent to the toe is eroded, the toe trench is undermined and the rock fill slides downward to pave the bank. It is advantageous to grade the banks before placing riprap on the slope and in the toe trench. The slope should be at such an angle that the saturated bank is stable while the stream stage is falling.

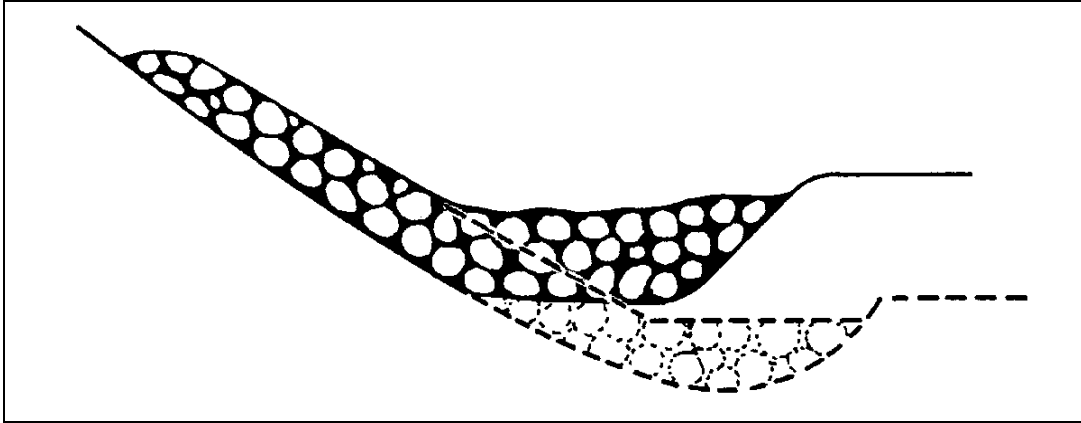

Figure 4.12. Rock-filled trench (after Richardson et al. 2001).

An alternative to a rock-fill trench at the toe of the bank is to excavate a trench above the water line along the top of the bank and fill the trench with rocks. As the bank erodes, stone material in the trench is added on an as-needed basis until equilibrium is established. This method is applicable in areas of rapidly eroding banks of medium to large size streams. Note that if a geotextile filter is used beneath the entire width of the trench, it will remain in place as adjustment occurs, whereas a granular filter is likely to be removed by particle displacement.

Windrow revetment (Figure 4.13) consists of a supply of rock deposited along an existing bank line at a location beyond which additional erosion is to be prevented. When bank erosion reaches and undercuts the supply of rock, it falls onto the eroding area, thus giving protection against further undercutting. The resulting bank line remains in a near natural state with an irregular appearance due to intermittent lateral erosion in the windrow location. The treatment particularly lends itself to the protection of adjacent wooded areas, or placement along stretches of presently eroding, irregular bank line.

The effect of windrow revetment on the interchange of flow between the channel and overbank areas and flood flow distribution in the flood plain should be carefully evaluated. Windrow installations will perform as guide banks or levees and may adversely affect flow distribution at bridges or cause local scour. Tying the windrow to the highway embankment at an abutment would be contrary to the purpose of the windrow since the rock is intended to fall into the channel as the bank erodes. This would potentially expose the abutment.

Note that the final configuration and thickness of the layer of launched stone is completely uncontrolled. In addition, there is no possibility of establishing any kind of filter (neither geotextile nor granular) with this type of placement.

The following observations and conclusions from model investigations of windrow revetments and rock-fill trenches may be used as design guidance. More definitive guidance is not presently available (USACE 1981).

- Application rate of stone is a function of channel depth, bank height, material size, and estimated bed scour.
- A triangular windrow is the least desirable shape, a trapezoidal shape provides a uniform blanket of rock on an eroding bank, and a rectangular shape provides the best coverage. A rectangular shape is most easily placed in an excavated trench.

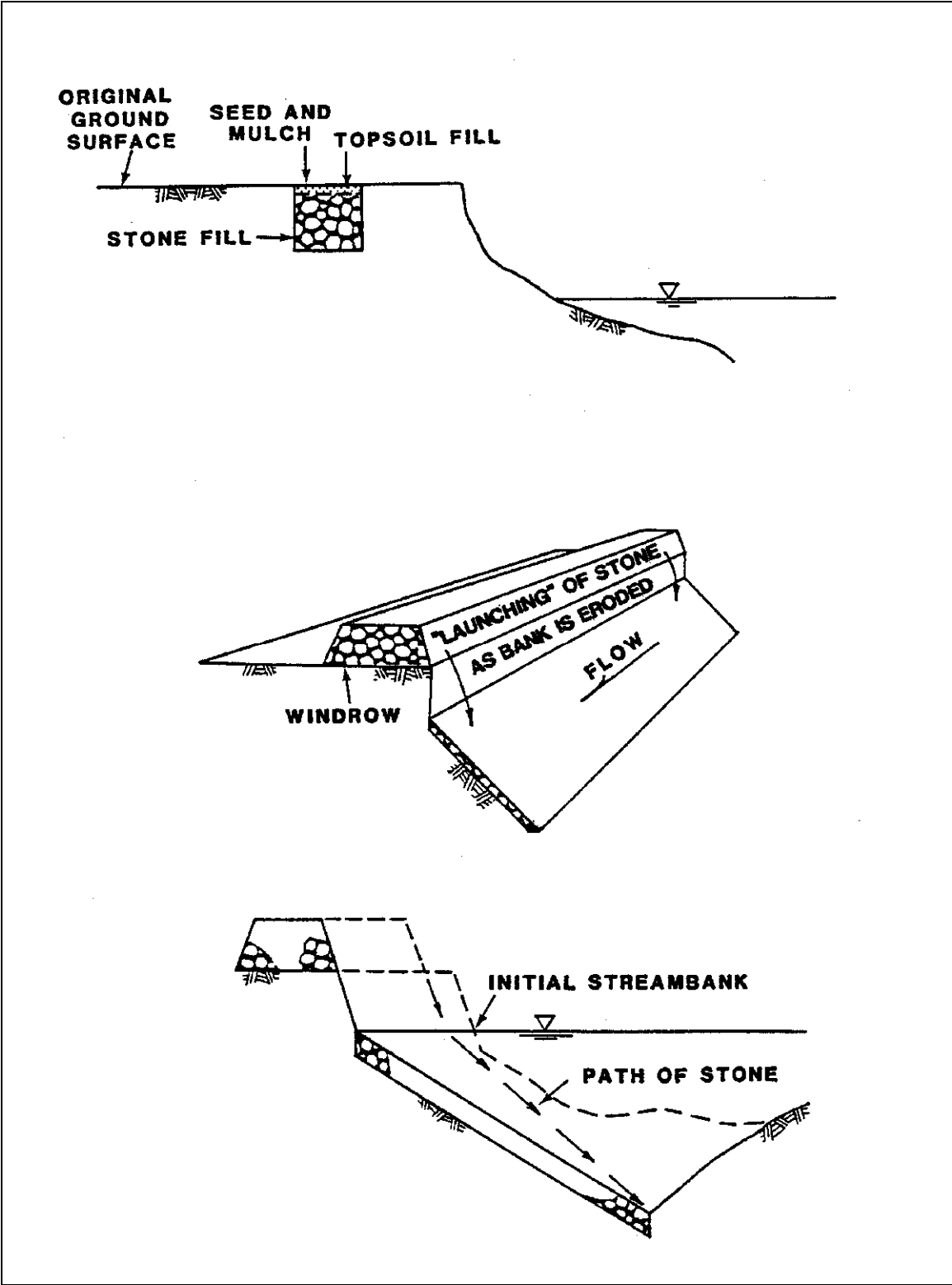

Figure 4.13. Windrow revetment, definition sketch (after USACE 1981).

- Bank height does not significantly affect the final revetment; however, high banks tend to produce a nonuniform revetment alignment. Large segments of bank tend to break loose and rotate slightly on high banks, whereas low banks simply "melt" or slough into the stream.
- Stone size influences the thickness of the final revetment, and a smaller gradation of stone forms a more dense, closely chinked protective layer. Stones must be large enough to resist being transported by the stream, and a well-graded stone should be used to ensure that the revetment does not fail from leaching of the underlying bank material. Large stone sizes require more material than smaller stone sizes to produce the same relative thickness of revetment. In general, the greater the stream velocity, the steeper the side slope of the final revetment. The final revetment slope will be about 15% flatter than the initial bank slope.
- A windrow segment should be extended landward from the upstream end to reduce the possibility of outflanking of the windrow.

4.7 RIGID REVETMENTS

Rigid revetments are generally smoother than flexible revetments and thus improve hydraulic efficiency and are generally highly resistant to erosion and impact damage. They are susceptible to damage from the removal of foundation support by subsidence, undermining, hydrostatic pressures, slides, and erosion at the perimeter. They are also among the most expensive streambank protection countermeasures. For the above reasons, rigid erosion protection measures such as cast-in-place concrete, fully grouted riprap, and rigid grout-filled mats are generally not recommended for bankline revetment applications.

Note that partially-grouted riprap is considered flexible in that its construction is designed to allow breaking of the partial grout, under stress, to result in conglomerate particles which are much larger than the individual stones of the matrix (see Design Guideline 12). Additional guidance on rigid revetments in this document include:

- Soil Cement - Design Guideline 7
- Grout-Filled Mattresses – Design Guideline 9

4.8 CONCRETE SLOPE PAVING

Concrete paving should be used only where the toe can be adequately protected from undermining and where hydrostatic pressures behind the paving will not cause failure. This might include impermeable bank materials and portions of banks which are continuously under water. Sections intermittently above water should be provided with weep holes.

4.9 SACKS

Burlap sacks filled with soil or sand-cement mixtures have long been used for emergency work along levees and streambanks during floods (Figure 4.14). Commercially manufactured sacks (burlap, paper, plastics, etc.) have been used to protect streambanks in areas where riprap of suitable size and quality is not available at a reasonable cost. Sacks filled with sand-cement mixtures can provide long-term protection if the mixture has set up properly, even though most types of sacks are easily damaged and will eventually deteriorate. Sand-cement sack revetment construction is not economically competitive in areas where good stone is available. However, where quality riprap must be transported over long distances, sack revetment can often be placed at a lesser cost than riprap.

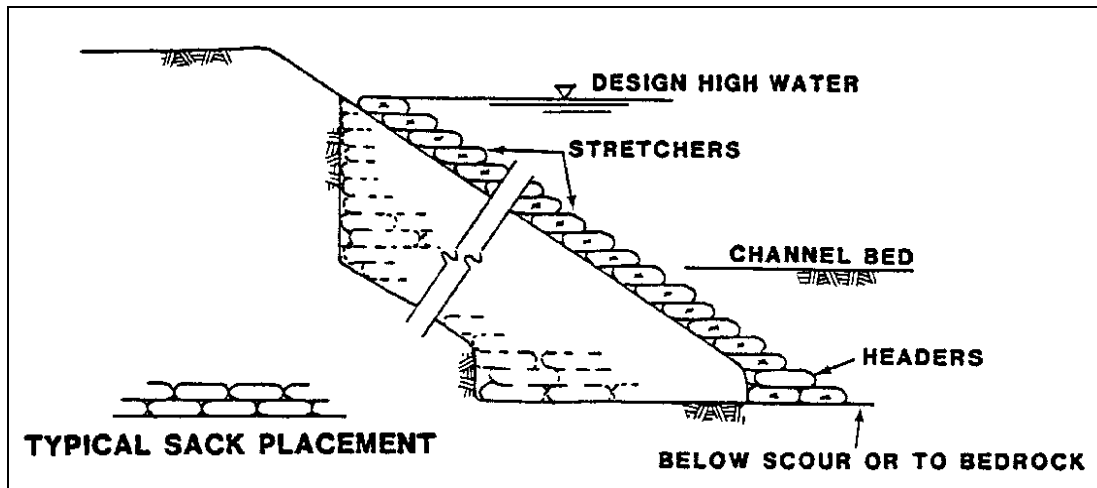

Figure 4.14. Typical sand-cement bag revetment.

If a sack revetment is to be constructed, the sacks should be filled with a mixture of 15% cement (minimum) and 85% dry sand (by weight). The filled sacks should be placed in horizontal rows like common house brick beginning at an elevation below any toe scour (alternatively, riprap can be placed at the toe to prevent undermining of the bank slope). The successive rows should be stepped back approximately one-half-bag width to a height on the bank above which no protection is needed. The slope of the completed revetment should not be steeper than 1:1. After the sacks have been placed on the bank, they can be wetted down for a quick set or the sand-cement mixture can be allowed to set up naturally through rainfall, seepage or condensation. If cement leaches through the sack material, a bond will form between the sacks and prevent free drainage. For this reason, weepholes should be included in the revetment design. The installation of weepholes will allow drainage of groundwater from behind the revetment thus helping to prevent a pressure buildup that could cause revetment failure. This revetment requires the same types of toe protection as other types of rigid revetment.

4.10 REFERENCES

Bunte, K. and Abt, S.R., 2001, "Sampling Surface and Subsurface Particle-Size Distributions in Wadable Gravel- and Cobble-Bed Streams for Analyses in Sediment Transport, Hydraulics, and Streambed Monitoring," Gen. Tech. Rep. RMRS-GTR-74, U.S. Department of Agriculture, Forest Service, Rocky Mountain Research Station, Fort Collins, CO, 428 p.

Centre for Civil Engineering Research and Codes (CUR), 1995, "Manual on the Use of Rock in Hydraulic Engineering," CUR/RWS Report 169, Road and Hydraulics Division, A.A. Balkema Publishers, Rotterdam, Netherlands.

Comité Européen de Normalisation (CEN), 2002, "European Standard for Armourstone," Report prEN 13383-1, Technical Committee 154, Brussels, Belgium.

Federal Highway Administration, 1981, "Standard Specifications for Construction of Roads and Bridges on Federal Highway Projects," U.S. Department of Transportation, FP-79 (Revised June 1981, Washington D.C.

Galay, V.J., Yaremko, E.K, and Quazi, M.E., 1987, "River Bed Scour and Construction of Stone Riprap Protection," in Hey, R.D., Bathurst, J.C., and Thorne, C.R. (Eds.), *Sediment Transport in Gravel-Bed Rivers*, John Wiley & Sons Ltd., pp. 353-383.

Kellerhals, R. and Bray, D., 1971, "Sampling Procedures for Coarse Fluvial Sediments," *Proc. Am. Soc. Civ. Engrs., J. Hyd. Div.*, 97(HY7).

Koerner, R.M., 1998, "Designing with Geosynthetics," 4th Edition, Prentice-Hall, Inc., Englewood Cliffs, NJ, 761 p.

Lagasse, P.F., Clopper, P.E., Zevenbergen, L.W., and Ruff, J.F., 2006, "Riprap Design Criteria, Recommended Specifications, and Quality Control," NCHRP Report 568, Transportation Research Board, National Academies of Science, Washington, D.C.

Lagasse, P.F., Clopper, P.E., Zevenbergen, L.W., and Girard, L.G., 2007, "Countermeasures to Protect Bridge Piers from Scour," NCHRP Report 593, Transportation Research Board, National Academies of Science, Washington, D.C.

Maynard, S.T., Ruff, J.F., and Abt, S.R., 1989, "Riprap Design," *ASCE Journal of Hydraulic Engineering*, Vol. 115, No. 7, pp 937-939.

Maynard, S.T., 1990, "Riprap Stability Results from Large Test Channel," *Hydraulic Engineering, Proceedings of the 1990 ASCE National Conference*, Volume 1, Chang, H.H. and Hill, J.C. (eds), San Diego, CA.

Racin, J.A., Hoover, T.P., and Crossett-Avila, C.M., 2000, "California Bank and Shore Rock Slope Protection Design," Final Report No. FHWA-CA-TL-95-10, Caltrans Study No. F90TL03 (Third Edition - Internet), California Department of Transportation, Sacramento, CA.

Richardson, E.V., Simons, D.B., and Lagasse, P.F., 2001, "River Engineering for Highway Encroachments - Highways in the River Environment," Report No. FHWA NHI 01-004, Hydraulic Design Series No. 6, Federal Highway Administration, Washington, D.C.

Transportation Research Board (TRB), 1999, "1998 Scanning Review of European Practice for Bridge Scour and Stream Instability Countermeasures," National Cooperative Highway Research Program, Research Results Digest, Number 241, Washington, D.C.

U.S. Army Corps of Engineers, 1981, "The Streambank Erosion Control Evaluation and Demonstration Act of 1974," Final Report to Congress, Executive Summary and Conclusions.

U.S. Army Corps of Engineers, 1991, "Hydraulic Design of Flood Control Channels," EM 1110-2-1601, Department of the Army, Washington, D.C.

U.S. Army Corps of Engineers, 1995, "Construction Quality Management," Engineering Regulation No. 1180-1-6, Washington, D.C.

Wolman, M.G., 1954, "A Method of Sampling Coarse Bed Material," *American Geophysical Union, Transactions*, 35: pp. 951-956.

DESIGN GUIDELINE 5

RIPRAP DESIGN FOR EMBANKMENT OVERTOPPING

(page intentionally left blank)

DESIGN GUIDELINE 5

RIPRAP DESIGN FOR EMBANKMENT OVERTOPPING

5.1 INTRODUCTION

When flow overtops an embankment, spur, or guide bank, locally high velocities and shear stresses will create strong erosion forces, typically at the downstream shoulder and on the embankment slope, that are too great for the soil of the embankment to withstand. Two primary processes of erosion occur during an overtopping event.

When the overtopping flow is submerged, erosion of the embankment typically begins with the downstream shoulder. This condition is often experienced by roadways and bridge approach embankments. Figure 5.1 (Chen and Anderson 1987) shows the progression of this type of failure at times t_1 , t_2 , and t_3 . As the flow accelerates over the embankment, a surging hydraulic jump is formed that causes a nick point between the shoulder and the downstream slope. This nick point will begin to migrate upstream because of the high velocities, and erosion will begin to move downstream. The downstream migration of the erosion is caused by the turbulence associated with the hydraulic jump. This condition would also apply to most river training countermeasures, such as spur and guide banks, under overtopping conditions.

The second general erosion pattern results from the case of free flow. With low tail water, the flow will accelerate down the slope with high velocity and shear stress associated with supercritical flow. Erosion typically initiates near the toe of the embankment, whether or not a hydraulic jump is present. Erosion progresses in the upslope and upstream direction through the embankment. Figure 5.2 (Chen and Anderson 1987) illustrates this progression.

This condition would typically apply to earth dams, spillways, or levees protected by revetment riprap.

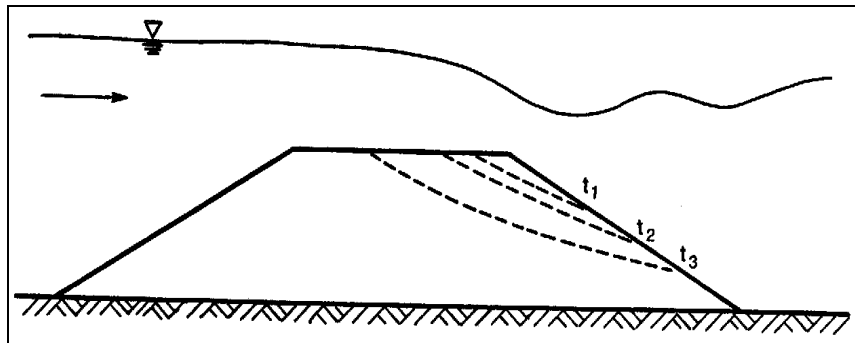

Figure 5.1. Typical embankment erosion pattern with submerged flow.

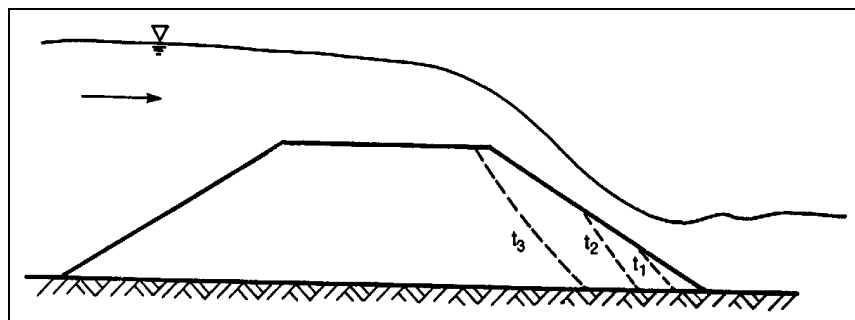

Figure 5.2. Typical embankment erosion pattern with free flow.

Traditionally, riprap has been placed on the downstream slope of embankment dams for erosion protection during heavy rainfall and has commonly been assumed inadequate for protection from overtopping flows. Although prototype verification is limited, several investigators have studied riprap stability on steep embankment slopes when subject to flow. Flow hydraulics on steep embankment slopes cannot be analyzed with standard flow and sediment transport equations. Uniform flow and tractive shear equations do not apply to shallow flow over large roughness elements or highly aerated flow, both of which can occur during overtopping. Riprap design criteria for overtopping protection of embankment dams should prevent stone movement and ensure the riprap layer does not fail. Empirically derived design criteria currently offer the best approach for design (Frizell et al. 1990).

Riprap design to resist overtopping flow is dependent upon the material properties (median size, shape, gradation, porosity, and unit weight), the hydraulic gradient or embankment slope, and the unit discharge. Flume studies were performed to investigate flow through and over rock fill dams, using crushed granite, pebbles, gravel, and cobbles on a range of slopes (Abt et al. 1987, 1988, 1991). Threshold flows where incipient stone movement occurs were defined. The maximum unit discharge that resists stone movement on steep slopes is a function of the mean water depth, the critical velocity at which the stone begins to move, and an aeration factor defined as the ratio of the specific weight of the air-water mixture to the specific weight of the water. A comparison of the various expressions for overtopping flow conditions shows them to be valid for crushed stone with angular shape (Abt and Johnson 1991). Knauss developed a rock stability function based on unit discharge, slope, rock packing, and air concentration for sizing riprap, and determined that aeration of flow increases the critical velocity for which riprap on a steep slope remains stable (Oswalt et al. 1994).

Studies were performed in a near-prototype-size embankment overtopping facility to establish new criteria relating the design of the riprap layer to the interstitial velocity of water flowing through the riprap layer (Mishra 1998). An equation was developed to predict the interstitial velocity of water through the rock layer. A universal formula for designing riprap was derived. This equation was tested for the data obtained in the 1998 study and previous research studies. The universal riprap design equation was found to satisfactorily predict the size of the riprap to be used for a specific unit discharge and a given embankment slope.

5.2 BACKGROUND

Near-prototype flume tests were conducted by CSU (Oswalt et al. 1994) with riprap placed on embankment slopes of 1, 2, 8, 10, and 20% and subjected to overtopping flows until failure. Failure was defined by exposure of the underlying sand and gravel bedding. Based on the results of five tests, rounded-shape riprap was found to fail at a unit discharge about 40% less than that of angular stones of the same median size, demonstrating the importance of stone shape on riprap layer stability. Angular stones tend to wedge or interlock and require fewer fines to fill voids, compared to similarly graded round stones. Rounded stones are much more likely to slide or roll, especially on the steeper slopes. Riprap specifications normally require angular shaped stone.

Channelization was observed to occur between the threshold and collapsing stages of the overtopping flow. Channels form in the riprap layer as the smaller stones are washed out, producing flow concentrations and increasing the localized unit discharge. Studies at Colorado State University (CSU) suggest flow concentrations of three times the normal unit discharge are possible. The average point of incipient channel formation was identified at about 88% of the unit discharge at failure.

Wittler and Abt (1990) investigated the influence of material gradation and the stability of the riprap layer with overtopping flow. In general, uniformly graded riprap displays a greater stability for overtopping flows but fails suddenly, while well-graded riprap resists sudden failure as voids are filled with smaller material from upstream; this process is referred to as "healing." Additional studies at CSU from 1994-1997 provided more details on the failure mechanism (Mishra 1998). Again, failure of the riprap slope was defined as removal or dislodgment of enough material to expose the bedding material. Failure of the riprap layer occurred with the measured water depth still within the thickness of the rock layer. A layer of highly aerated water was flowing over the surface of the riprap, but this surface flow was only a small portion of the total flow (see Figure 5.10).

5.3 LABORATORY STUDIES

Through the cooperative agreement signed in 1991, the U.S. Bureau of Reclamation (USBR) and Colorado State University (CSU) built a near-prototype size embankment overtopping research facility with a 50% slope (1V:2H). Riprap (angular) tests were conducted in the summers of 1994, 1995, and 1997 on this facility (Mishra 1998).

The first two riprap test sections covered the full width of the chute and extended 60 ft (18.29 m) down the slope from the crest. The first test (1994) consisted of a 0.67-foot (203-mm) thick gravel bedding material with a 2-foot (0.61-m) overlay of large riprap with a d_{50} of 1.27 ft (386 mm) (Figure 5.3). The second test (1995) utilized the first test bed with a second layer of approximately 2 ft (0.61 m) thick riprap with d_{50} of 2.15 ft (655 mm). The schematic diagram for this set up is presented in Figure 5.5.

The third test (1997) covered the full width of the chute and extended 100 ft (30.48 m) from the crest down the slope to the toe of the facility. A 0.67-foot (203-mm) thick gravel bedding material with a d_{50} of 0.16 ft (48 mm) was overlaid with a main riprap layer of thickness 1.75 ft (533 mm) with a d_{50} of 0.89 ft (271 mm). A berm was built at the bottom of the flume to simulate toe treatment at the base of the embankment. The configuration of the test setup in 1997 is given in Figure 5.4. The schematic diagram for the 1997 setup is illustrated in Figure 5.6.

For all the tests, a gabion composed of the same rocks used on the slope, was placed at the crest of the embankment. This was done to provide a smooth transition of water from the head box to the embankment and to prevent premature failure of the riprap at the transition between the concrete approach at the crest of the embankment and the concrete chute. The gabion covered the entire width of the flume and extended about 2.46 ft (0.75 m) down the flume from the crest. The top surface of the gabion was horizontal.

The test series provided the opportunity to gather important data regarding flow through large size riprap. The visual observations provided information on aeration, interstitial flow, stone movement, and the failure mechanism on the slope. Data was collected on discharge flowing down the chute through the riprap, the head box depth for overtopping heads, manometer readings for depth of flow down the chute and the pressure heads, and electronic recording of electrical conductivity versus time to determine interstitial velocities.



Figure 5.3. Test set up for 1994, $d_{50} = 1.27$ ft (386 mm).



Figure 5.4. Test set up for 1997, $d_{50} = 0.89$ ft (271 mm).

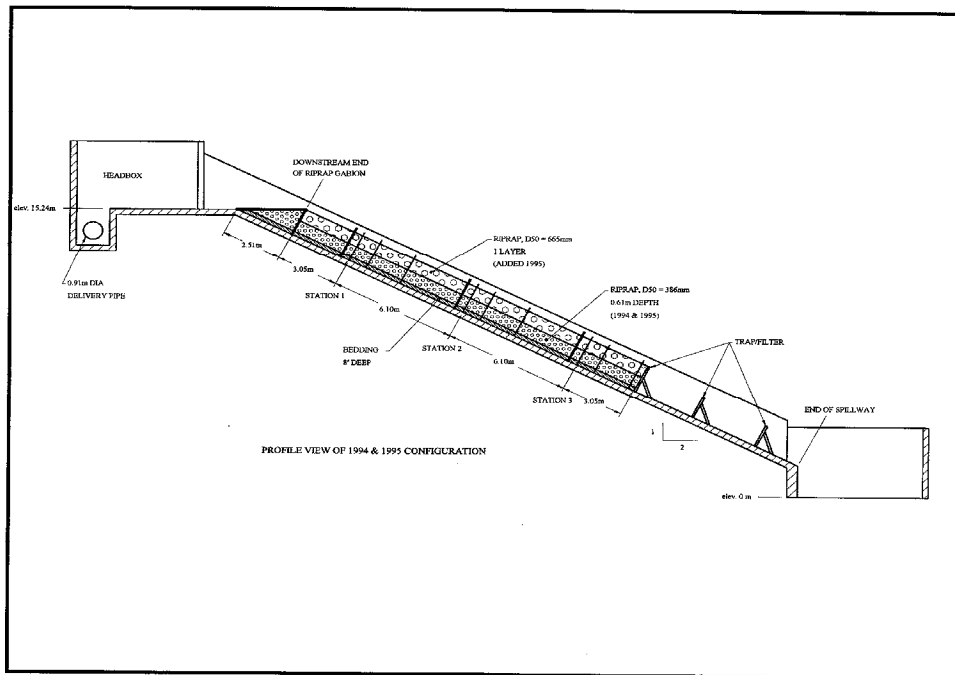

Figure 5.5. Riprap configuration in 1994 and 1995.

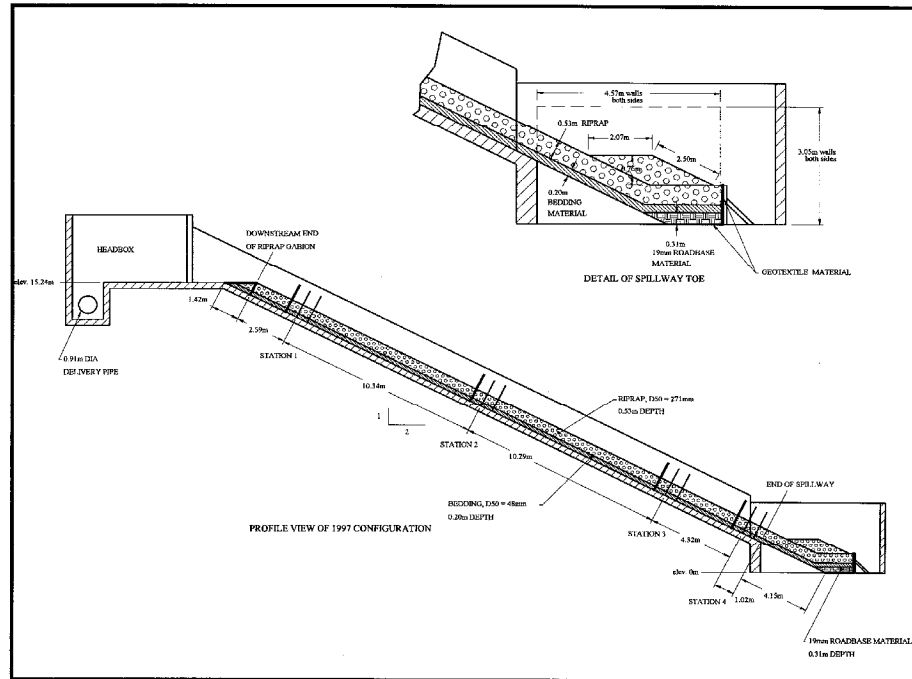

Figure 5.6. Riprap Configuration in 1997.

5.4 RIPRAP FAILURE ON EMBANKMENT SLOPES

Prior to failure of the riprap slope, many individual stones moved or readjusted locations throughout the test period. Movement of these stones is referred to as incipient motion. This occurs when the displacing and overturning moments exceed the resisting moments. The force in the resisting moment is given by the component of the weight perpendicular to the embankment and interlocking between stones in the matrix. The overturning forces are the drag (or the jet impact on a stone), the lift, buoyancy, and to a lesser degree, the component of the weight parallel to the embankment depending on the point(s) of contact with other stones. Even though buoyancy plays an important role in the removal of rocks, the hydrodynamic forces have the major role in producing failure of the protective layer. This observation is supported by the depth measurements, which revealed that the stones on the surface were not entirely submerged. It was also concluded that on steep embankments, riprap failure on the slope is more critical than the failure at the toe.

Failure of the riprap slope was defined as removal or dislodgement of enough material to expose the bedding material. Failure of the riprap layer occurred with the measured water depth still within the thickness of the rock layer. A layer of highly aerated water was flowing over the surface of the riprap, but this surface flow was only a small portion of the total flow and was not measurable by piezometers. Riprap failures are illustrated in Figures 5.7, 5.8, and 5.9 and failure characteristics are given in Table 5.1.

Table 5.1. Riprap Failure Characteristics.			
Year	d_{50} ft (mm)	Coefficient of Uniformity, C_u (d_{60}/d_{10})	Failure Discharge ft ³ /s/ft (m ³ /s/m)
1994	1.27 (386)	1.90	2.4 (0.223)
1995	2.15 (655)	1.55	10 (0.929)
1997	0.89 (271)	1.81	2.2 (0.204)



Figure 5.7. Riprap failure in 1994 tests ($d_{50} = 1.27$ ft (386 mm))



Figure 5.8. Failure of riprap in 1995 tests ($d_{50} = 2.15$ ft (655 mm))



Figure 5.9. Riprap failure in 1997 tests ($d_{50} = 0.89$ ft (271 mm)).

5.5 DESIGN OF RIPRAP FOR OVERTOPPING FLOW

5.5.1 Sizing the Riprap

When flow overtops an embankment, spur, or guide bank, locally high velocities occur at the downstream shoulder of the structure. When tailwater is low relative to the crest of the structure, the flow will continue to accelerate along the downstream slope. Guidance for riprap stability under these conditions was developed from the laboratory testing described in Section 5.3 (Mishra 1998). For slopes steeper than 1V:4H, the method requires that all the flow is contained within the thickness of the riprap layer (interstitial flow). For milder slopes, a portion of the total discharge can be carried over the top of the riprap layer. The three equations necessary to assess the stability of rock riprap in overtopping flow are given below. The design procedure is illustrated by examples in Sections 5.5.2 and 5.5.3.

$$V_i = 2.48 \sqrt{gd_{50}} \left(\frac{S^{0.58}}{C_u^{2.22}} \right) \quad (5.1)$$

where:

V_i	=	Interstitial velocity, ft/s (m/s)
g	=	Acceleration due to gravity, 32.2 ft/s ² (9.81 m/s ²)
d_{50}	=	Particle size for which 50% is finer by weight, ft (m)
C_u	=	Coefficient of uniformity of the riprap, d_{60}/d_{10}
S	=	Slope of the embankment, ft/ft (m/m)

$$d_{50} = \frac{K_u q_f^{0.52}}{C_u^{0.25} S^{0.75}} \left(\frac{\sin \alpha}{(S_g \cos \alpha - 1)(\cos \alpha \tan \phi - \sin \alpha)} \right)^{1.11} \quad (5.2)$$

where: d_{50} = Particle size for which 50% is finer by weight, ft (m)
 K_u = 0.525 for English units
 0.55 for SI units
 q_f = Unit discharge at failure, ft³/s/ft (m³/s/m)
 C_u = Coefficient of uniformity of the riprap, d_{60}/d_{10}
 S = Slope of the embankment, ft/ft (m/m)
 S_g = Specific gravity of the riprap
 α = Slope of the embankment, degrees
 ϕ = Angle of repose of the riprap, degrees

When the embankment slope is less than 1V:4H (25%), the allowable depth of flow (h) over the riprap is given by:

$$h = \frac{0.06(S_g - 1)d_{50} \tan \phi}{0.97(S)} \quad (5.3)$$

5.5.2 Example Application for Slopes Milder Than 1V:4H (25%)

Riprap is to be designed to protect a 1V:5H slope from overtopping flow. The riprap has a specific gravity (S_g) of 2.65, uniformity coefficient (C_u) of 2.1, porosity η of 0.45 and an angle of repose ϕ of 42°. The following data are provided for the design.

Variable	English Units		SI Units	
	Units	Value	Units	Value
Total discharge (Q)	cfs	2000	m ³ /s	56.63
Embankment overtopping length (L)	ft	1000	m	304.8
Unit discharge (q_f)	cfs/ft	2.0	m ² /s	0.186
Weir flow coefficient (C)	ft ^{0.5} /s	2.84	m ^{0.5} /s	1.57
Riprap sizing equation coefficient (K_u)	s ^{0.52} /ft ^{0.04}	0.525	s ^{0.52} /m ^{0.04}	0.55
Manning-Strickler coefficient		0.034		0.0414
Slope (S)	ft/ft	0.2	m/m	0.2
Slope angle (α)	degrees	11.3	degrees	11.3

Step 1: Determine the overtopping depth using the broad-crested weir equation:

$$Q = CLH^{1.5}$$

$$H = (Q/CL)^{2/3} = [2000/(2.84 \times 1000)]^{2/3} = 0.79 \text{ ft (0.24 m)}$$

Step 2: Compute the smallest possible median rock size (d_{50}) using Equation 5.2:

$$d_{50} = \frac{K_u q_f^{0.52}}{C_u^{0.25} S^{0.75}} \left(\frac{\sin \alpha}{(S_g \cos \alpha - 1)(\cos \alpha \tan \phi - \sin \alpha)} \right)^{1.11}$$

$$= \frac{0.525(2.0)^{0.52}}{(2.1)^{0.25}(0.2)^{0.75}} \left(\frac{\sin(11.3^\circ)}{[2.65 \cos(11.3^\circ) - 1][\cos(11.3^\circ) \tan(42^\circ) - \sin(11.3^\circ)]} \right)^{1.11}$$

$$= 0.31 \text{ ft} = 3.7 \text{ inches (0.094 m)}$$

Note: Use next larger size class (see Volume 1, Chapter 5).

Step 3: Select Class I riprap from Table 4.1 of Design Guideline 4: $d_{50} = 6$ inches (0.15 m)

Step 4: Compute the interstitial velocity and the average velocity using Equation 5.1:

$$V_i = 2.48 \sqrt{gd_{50}} \frac{S^{0.58}}{C_u^{2.22}} = 2.48 \sqrt{32.2(0.5)} \frac{(0.2)^{0.58}}{(2.1)^{2.22}}$$
$$= 0.75 \text{ ft/s (0.228 m/s)}$$

From V_i , find the average velocity V_{avg}

$$V_{ave} = \eta V_i = 0.45(0.75) = 0.34 \text{ ft/s (0.103 m/s)}$$

where: η is the porosity of the rock.

Step 5: Compute the average flow depth (y) as if all the flow is contained within the thickness (t) of the riprap layer (i.e., $t = y$):

$$y = q_f / V_{avg} = 2.0 / 0.34 = 5.9 \text{ ft (1.81 m)}$$

NOTE: If the average depth is less than $2d_{50}$ then the design is complete with a riprap thickness of $2d_{50}$. If the depth is greater than $2d_{50}$ and the slope is greater than 0.25, go to Step 11. Otherwise, go to Step 6.

5.9 ft > $2d_{50}$ (1.0 ft) and S (0.2) < 0.25, so go to step 6.

Step 6: Find the allowable flow depth over the riprap using Equation 5.3:

$$h = \frac{0.06(S_g - 1)d_{50} \tan \phi}{0.97(S)} = \frac{0.06(2.65 - 1)(0.5) \tan 42^\circ}{0.97(0.2)}$$
$$= 0.23 \text{ ft (0.069 m)}$$

Step 7: Calculate the Manning roughness coefficient, n

$$n = 0.034(d_{50})^{1/6} = 0.034(0.5)^{1/6} = 0.030$$

Step 8: Calculate the unit discharge, q_1 , which can flow over the riprap using Manning's equation:

$$q_1 = \frac{1.486}{n} y^{5/3} S^{1/2} = \frac{1.486}{0.03} (0.23)^{5/3} (0.2)^{1/2}$$
$$= 1.91 \text{ ft}^3/\text{s}/\text{ft} = 0.173 \text{ m}^3/\text{s}/\text{m}$$

Step 9: Calculate the required interstitial flow, q_2 , through the riprap and the flow provided by a riprap thicknesses of $2d_{50}$.

$$q_2 = q_f - q_1 = 2.0 - 1.91 = 0.09 \text{ ft}^3/\text{s}/\text{ft} (0.013 \text{ m}^3/\text{s}/\text{m})$$

$$q = 2d_{50}(V_{avg}) = 2(0.5)(0.34) = 0.34 \text{ ft}^3/\text{s}/\text{ft} (0.031 \text{ m}^3/\text{s}/\text{m})$$

NOTE: If the flow (q) provided by a $2d_{50}$ thickness is greater than or equal to the required flow (q_2), the design is complete with a thickness of $2d_{50}$. If the flow provided by $2d_{50}$ is less than the required flow, proceed to Step 10.

$$q (0.34 \text{ ft}^3/\text{s}/\text{ft}) > q_2 (0.09 \text{ ft}^3/\text{s}/\text{ft})$$

Therefore, the design is complete using a thickness of $2d_{50}$ and a riprap d_{50} of 6 inches.

Step 10: (not needed for this example). Calculate the flow provided by a $4d_{50}$ thickness of riprap. If the flow provided is greater than the required flow, the design is complete with a thickness of $4d_{50}$ (or an appropriate intermediate thickness). If the flow provided by a $4d_{50}$ thickness is less than the required flow, proceed to Step 11.

Step 11: (not needed for this example). Increase the riprap size to the next gradation class and return to Step 4.

5.5.3 Example Application for Slopes Steeper Than 1V:4H (25%)

Using the same data as the previous example, design riprap for a 1V:2H slope (50%). Because the slope is steeper than 1V:4H, the riprap is designed such that all the flow is through the riprap (interstitial flow).

Variable	English Units		SI Units	
	Units	Value	Units	Value
Total discharge (Q)	cfs	2000	m^3/s	56.63
Embankment overtopping length (L)	ft	1000	m	304.8
Unit discharge (q_f)	cfs/ft	2.0	m^2/s	0.186
Weir flow coefficient (C)	$\text{ft}^{0.5}/\text{s}$	2.84	$\text{m}^{0.5}/\text{s}$	1.57
Riprap sizing equation coefficient (K_u)	$\text{s}^{0.52}/\text{ft}^{0.04}$	0.525	$\text{s}^{0.52}/\text{m}^{0.04}$	0.55
Manning-Strickler coefficient		0.034		0.0414
Slope (S)	ft/ft	0.5	m/m	0.5
Slope angle (α)	degrees	26.6	degrees	26.6

Step 1: Determine the overtopping depth using the broad-crested weir equation:

$$Q = CLH^{1.5}$$

$$H = (Q/CL)^{2/3} = [2000/(2.84 \times 1000)]^{2/3} = 0.79 \text{ ft (0.24 m)}$$

Step 2: Compute the smallest possible median rock size (d_{50}):

$$\begin{aligned} d_{50} &= \frac{K_u q_f^{0.52}}{C_u^{0.25} S^{0.75}} \left(\frac{\sin \alpha}{(S_g \cos \alpha - 1)(\cos \alpha \tan \phi - \sin \alpha)} \right)^{1.11} \\ &= \frac{0.525(2.0)^{0.52}}{(2.1)^{0.25} (0.5)^{0.75}} \left(\frac{\sin(26.6^\circ)}{[2.65 \cos(26.6^\circ) - 1][\cos(26.6^\circ) \tan(42^\circ) - \sin(26.6^\circ)]} \right)^{1.11} \\ &= 0.96 \text{ ft} = 11.5 \text{ inches (0.29 m)} \end{aligned}$$

Step 3: Select Class III riprap from Table 4.1 of Design Guideline 4: $d_{50} = 12$ inches (0.15 m).

Step 4: Compute the interstitial velocity and the average velocity:

$$V_i = 2.48 \sqrt{gd_{50}} \frac{S^{0.58}}{C_u^{2.22}} = 2.48 \sqrt{32.2(1.0)} \frac{(0.5)^{0.58}}{(2.1)^{2.22}}$$
$$= 1.81 \text{ ft/s (0.548 m/s)}$$

$$V_{ave} = \eta V_i = 0.45(1.81) = 0.81 \text{ ft/s (0.247 m/s)}$$

Step 5: Compute the average flow depth (y) as if all the flow is contained within the thickness (t) of the riprap layer (i.e., t = y):

$$y = q_t / V_{avg} = 2.0 / 0.81 = 2.5 \text{ ft (0.75 m)}$$

NOTE: If the average depth is less than $2d_{50}$ then the design is complete with a riprap thickness of $2d_{50}$. If the depth is greater than $2d_{50}$ and the slope is greater than 0.25, go to step 11. Otherwise, go to Step 6.

2.5 ft > $2d_{50}$ (2.0 ft) and S (0.5) > 0.25, so go to Step 11.

Step 11: Increase the riprap size to the next gradation class and return to Step 4.

Step 12: Select Class IV riprap with d_{50} of 15 inches from Table 4.1 (Design Guideline 4) and return to Step 4.

Step 4 (trial 2): Compute the interstitial velocity and the average velocity:

$$V_i = 2.48 \sqrt{gd_{50}} \frac{S^{0.58}}{C_u^{2.22}} = 2.48 \sqrt{32.2(1.25)} \frac{(0.5)^{0.58}}{(2.1)^{2.22}}$$
$$= 2.03 \text{ ft/s (0.617 m/s)}$$

$$V_{ave} = \eta V_i = 0.45(2.03) = 0.91 \text{ ft/s (0.278 m/s)}$$

Step 5 (trial 2): Compute the average flow depth (y) as if all the flow is contained within the thickness (t) of the riprap layer (i.e., t = y):

$$y = q_t / V_{avg} = 2.0 / 0.91 = 2.2 \text{ ft (0.67 m)}$$

NOTE: If the average depth is less than $2d_{50}$ then the design is complete with a riprap thickness of $2d_{50}$. If the depth is greater than $2d_{50}$ and the slope is greater than 0.25, go to Step 11. Otherwise, go to Step 6.

2.2 ft < $2d_{50}$ (2.5 ft), so design is complete with $d_{50} = 15$ inches and a riprap thickness of 2.5 feet. This check ensures that all the flow is contained within the thickness of the riprap layer (interstitial flow).

5.6 FILTER REQUIREMENTS

The importance of the filter component of any embankment riprap installation should not be underestimated. Geotextile filters and granular filters may be used in conjunction with riprap embankment protection. When using a granular stone filter, the layer should have a minimum thickness of 4 times the d_{50} of the filter stone or 6 inches, whichever is greater.

The filter must retain the coarser particles of the subgrade while remaining permeable enough to allow infiltration and exfiltration to occur freely. It is not necessary to retain all the particle sizes in the subgrade; in fact, it is beneficial to allow the smaller particles to pass through the filter, leaving a coarser substrate behind. Detailed aspects of filter design are presented in Design Guideline 16 of this document.

5.8 REFERENCES

Abt, S.R. and Johnson, T.L., 1991, "Riprap Design for Overtopping Flow," ASCE Journal of Hydraulic Engineering, Vol. 117, No. 8, pp. 959-972.

Abt, S.R., Khattak, M.S., Nelson, J.D., Ruff, J.F., Shaikh, A., Wittler, R.J., Lee, D.W., and Hinkle, N.E., 1987, "Development of Riprap Design Criteria by Riprap Testing in Flumes: Phase I," NUREG/CR-4651, U.S. Nuclear Regulatory Commission, Vol. 1, 48-53.

Abt, S.R., Wittler, R.J., Ruff, J.F., Lagrone, D.L., Nelson, J.D., Hinkle, N.E., Lee, D.W., and 1988, "Development of Riprap Design Criteria by Riprap Testing in Flumes: Phase II," NUREG/CR-4651, U.S. Nuclear Regulatory Commission, Vol. 2, 57-65.

Abt, S.R., Ruff, J.F., and Wittler, R.J., 1991, "Estimating Flow Through Riprap," ASCE Journal of Hydraulics, Vol. 5, 670-675.

Chen, Y.H. and Anderson, B.A., 1987, "Development of a Methodology for Estimating Embankment Damage Due to Flood Overtopping," FHWA Report No. FHWA-RD-86/126.

Frizell, K.H., Mefford, B.W., Dodge, R.A., and Vermeyen, T.B., 1990, "Protecting Embankment Dams Subject to Overtopping During Major Flood Events," Proceedings American State Dam Safety Officials Conference, New Orleans, LA.

Oswalt, N.R., Buck, L.E., Hepler, T.E., and Jackson, H.E., 1994, "Alternatives for Overtopping Protection of Dams," ASCE, Task Committee on Overtopping Protection of the Hydraulics Division, New York, NY, pp 136.

Mishra, S.K., 1998, "Riprap Design for Overtopped Embankments," Ph.D. Dissertation, Department of Civil Engineering, Colorado State University, Fort Collins, CO, 140 pp.

Robinson, K.M., Rice, C.E., and Kadavy, K.C., 1995, "Stability of Rock Chutes," Proceedings, Water Resources Engineering, ASCE, San Antonio, TX, Vol. 2, 1476-1480.

Whittler, R.J. and Abt, S.R., 1990, "The Influence of Uniformity on Riprap Stability," Proceedings, Hydraulic Engineering Vol. 1, of the 1990 ASCE National Conference, San Diego, CA, July 30-August 3, pp. 251-265.

DESIGN GUIDELINE 6

WIRE ENCLOSED RIPRAP MATTRESS

(page intentionally left blank)

DESIGN GUIDELINE 6

WIRE ENCLOSED RIPRAP MATTRESS

6.1 INTRODUCTION

Wire enclosed riprap is commonly used in the state of New Mexico. The predecessor to this erosion control technique is known as rail bank protection and has been used in Arizona, Colorado and New Mexico since the 1970s. Wire enclosed riprap differs from gabions and gabion (Reno) mattresses in that it is a continuous framework rather than individual interconnected baskets. In addition, wire enclosed riprap is typically anchored to the embankment with steel stakes which are driven through the mattress. Construction of wire enclosed riprap is usually faster than gabions or gabion mattresses, and it also requires less wire mesh because internal junction panels are not used. Wire enclosed riprap is used primarily for slope protection. It has been used for bank protection, guide bank slope protection, and in conjunction with gabions placed at the toe of slope.

Successful long-term performance of wire enclosed riprap depends largely on the integrity of the wire. **Due to the potential for abrasion by coarse bed load, wire enclosed riprap is not appropriate for gravel bed streams and should only be considered for use in sand- or fine-bed streams.** Additionally, water quality of the stream must be noncorrosive (i.e., nonsaline and nonacidic). A polyvinyl chloride (PVC) coating should be used for applications where the potential for corrosion exists.

6.2 DESIGN GUIDELINES

Guidelines for the dimensions, placement, anchoring, splicing, and quantity formulas are shown on Figure 6.1. Design procedures for the selection of rock fill for wire enclosed riprap can be found in Simons et al. (1984), Maynard (1995), and Design Guideline 11. Guidelines on selection and design of filter material can be found in Holtz et al. (1995) and Design Guideline 16. The following guidelines and specifications reflect construction procedures for wire enclosed riprap recommended by the New Mexico State Highway and Transportation Department (NMSHTD).

1. Wire mesh fabric for riprap shall be hexagonal mesh or a "V" mesh meeting the requirements listed in the specifications.
2. Steel stakes may be railroad rails, not less than 30 lb per yard (14.9 kg/m), 4 in. (102 mm) O.D. standard strength galvanized steel pipe, or 4" x 4" x 3/8" (102 mm X 102 mm X 9.5 mm) steel angles.
3. If length of slope is 15 ft (4.6 m) or less, only one row of steel stakes 2 ft (610 mm) from the top edge of the riprap will be required unless otherwise noted on the plans.
4. Dimensions of the thickness, top of slope and toe of slope extents, and total length of protection shall be designated on the bridge or roadway plans.
5. The wire enclosed riprap thickness is usually 12 in. (300 mm) unless otherwise shown on the plans. Thickness is usually 18 in. (460 mm) at bridges.
6. Longitudinal splices may be made with one lap of galvanized 9 gage tie wire, 9 gage hog rings or 11 1/2 gage galvanized hard drawn interlocking wire clips.
7. In general, a minimum of 2 ft (0.6 m) of freeboard above the design water surface elevation should be maintained.

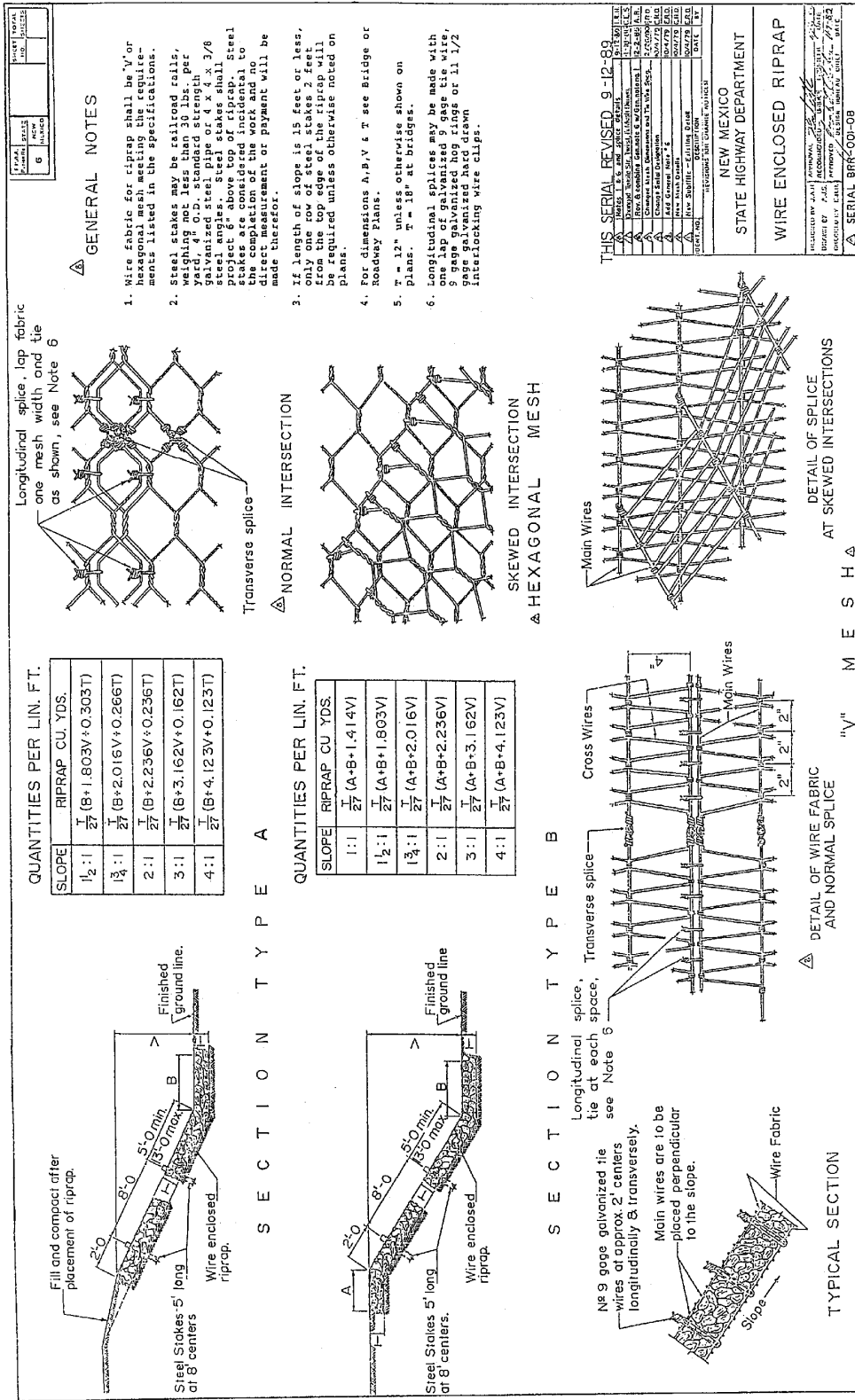

Figure 6.1. Wire enclosed riprap plans (NMSHTD).

6.3 SPECIFICATIONS

Wire Enclosed Riprap. Wire enclosed riprap shall consist of a layer of rock of the required thickness enclosed on all sides in wire fabric conforming with the details shown on the plans (Figure 6.1). The wire fabric shall be drawn tightly against the rock on all sides and tied with galvanized wire, locking clips, hog rings or connectors. When ties, locking clips, hog rings or connectors are used for tying mesh sections and selvages together, they shall be spaced 3 in. (76 mm) apart or less as shown on the plans. Galvanized wire ties shall be spaced approximately 2 ft (610 mm) on center and shall be anchored to the bottom layer of wire fabric, extended through the rock layer, and tied securely to the top layer of wire fabric. When indicated on the plans, wire enclosed riprap shall be anchored to the slopes by steel stakes driven through the riprap into the embankment. Stakes shall be spaced as indicated on the plans.

Filter. See Holtz et al. (1995) and Design Guideline 16 for selection, design, and specifications of filter materials.

6.4 INSTALLATION EXAMPLE

A typical example of wire enclosed riprap installed by NMSHTD is shown in Figure 6.2. A side slope of a guide bank at the I-25 crossing of the Rio Galisteo protected with wire enclosed riprap is shown.



Figure 6.2. Wire enclosed riprap used for guide bank side slope protection at I-25 crossing of Rio Galisteo, New Mexico (NMSHTD).

6.5 REFERENCES

Holtz, D.H., Christopher, B.R., and Berg, R.R., 1995, "Geosynthetic Design and Construction Guidelines," National Highway Institute, Publication No. FHWA HI-95-038, Federal Highway Administration, Washington D.C., May.

Maynard, S.T., 1995, "Gabion Mattress Channel-Protection Design," *Journal of Hydraulic Engineering*, ASCE, Vol. 121,7, pp. 519 - 522.

Simons, D.B., Chen, Y.H., Swenson, L.J., and Li, R., 1984, "Hydraulic Tests to Develop Design Criteria for the Use of Reno Mattresses," Civil Engineering Department - Engineering Research Center, Colorado State University, Fort Collins, CO, *Report*.

(page intentionally left blank)

DESIGN GUIDELINE 7

SOIL CEMENT

(page intentionally left blank)

DESIGN GUIDELINE 7

SOIL CEMENT

7.1 INTRODUCTION

In areas where high quality rock is scarce, the use of soil cement can provide a practical countermeasure alternative for channel stability and scour protection. Soil cement has been used to construct drop structures and armor embankments, dikes, levees, channels, and coastal shorelines. Soil cement is frequently used in the southwestern United States because the limited supply of rock makes it impractical to use riprap for large channel protection projects.

7.2 DESIGN GUIDELINES

The following design guidelines reflect guidance in information provided by the Pima County Department of Transportation in Tucson, Arizona (Pima County DOT) and the Portland Cement Association (1984, 1986, 1991). Typically, soil cement is constructed in a stair-step configuration by placing and compacting the soil cement in horizontal layers (Figure 7.1). However, soil cement can be placed parallel to the face of an embankment slope rather than in horizontal layers. This technique is known as plating.



Figure 7.1. Stair step facing on Bonny Reservoir, Colorado after 30 years (PCA).

7.2.1 Facing Dimensions for Slope Protection using Stair-Step Method

In stair-step installations soil cement is typically placed in 8 ft (2.4 m) wide horizontal layers. The width should provide sufficient working area to accommodate equipment. The relationship between the horizontal layer width (W), slope of facing (S), thickness of compacted horizontal layer (v), and minimum facing thickness measured normal to the slope (t_n) is quantified by the following equation:

$$W = t_n \sqrt{S^2 + 1} + vS \quad (7.1)$$

As illustrated in Figure 7.2, for a working width, W , of 8 ft (2.4 m), a side slope of 1V:3H (1V:(S)H), and individual layers, v , of 6 in. (150 mm) thick, the resulting minimum thickness, t_n , of facing would be 24 in. (620 mm) measured normal to the slope. Bank stabilization along major rivers in Pima County, Arizona is constructed by using 6 in. (150 mm) lifts of soil cement that are 8 ft (2.4 m) in width and placed on a 1V:1H face slope.

When horizontal layer widths do not provide adequate working widths, the stair-step layers can be sloped on a grade of 1V:8H or flatter toward the water line. Sloping the individual layers will provide a greater working surface without increasing the quantity of soil cement.

7.2.2 Facing Dimensions for Slope Protection Using Plating Method

On smaller slope protection projects a single layer of soil cement can be placed parallel to the embankment. In this technique, known as plating, a single lift of soil cement is applied on slopes of 1V:3H or flatter (Figure 7.3).

All extremities of the soil cement facing should be tied into nonerodible sections or abutments to prevent undermining of the rigid layer. Some common methods used to prevent undermining are placing a riprap apron at the toe of the facing, extending the installation below the anticipated degradation and contraction scour depth or providing a cutoff wall below that depth.

As with any rigid revetment, hydrostatic pressure caused by moisture trapped in the embankment behind the soil cement facing is an important consideration. Designing the embankment so that its least permeable zone is immediately adjacent to the soil cement facing will reduce the amount of water allowed to seep into the embankment. Also, providing free drainage with weep holes behind and through the soil cement will reduce pressures which cause hydrostatic uplift.

7.2.3 Grade Control Structures

Grade control structures (drop structures) are commonly used in Arizona to mitigate channel bed degradation (Figure 7.4). The location and spacing of grade control structures should be based on analysis of the vertical stability of the system. Toe-down depths for soil cement bank protection below drop structures should be deepened to account for the increased scour. Some typical sections of soil cement grade control structures are shown in Figure 7.5.

7.3 SPECIFICATIONS

In addition to application techniques, construction specifications are equally important to the use of soil cement for channel instability and scour countermeasures. Important design considerations for soil cement include: types of materials and equipment used, mix design and methods, handling, placing and curing techniques. The following list of specifications reflects guidance in the **Pima County Department of Transportation's guidelines** on applications and use of soil cement for Flood Control Projects (Shields et al. 1988).

Portland Cement. Portland Cement shall comply with the latest Specifications for Portland Cement (ASTM 150, CSA A-5, or AASHTO M85) Type II.

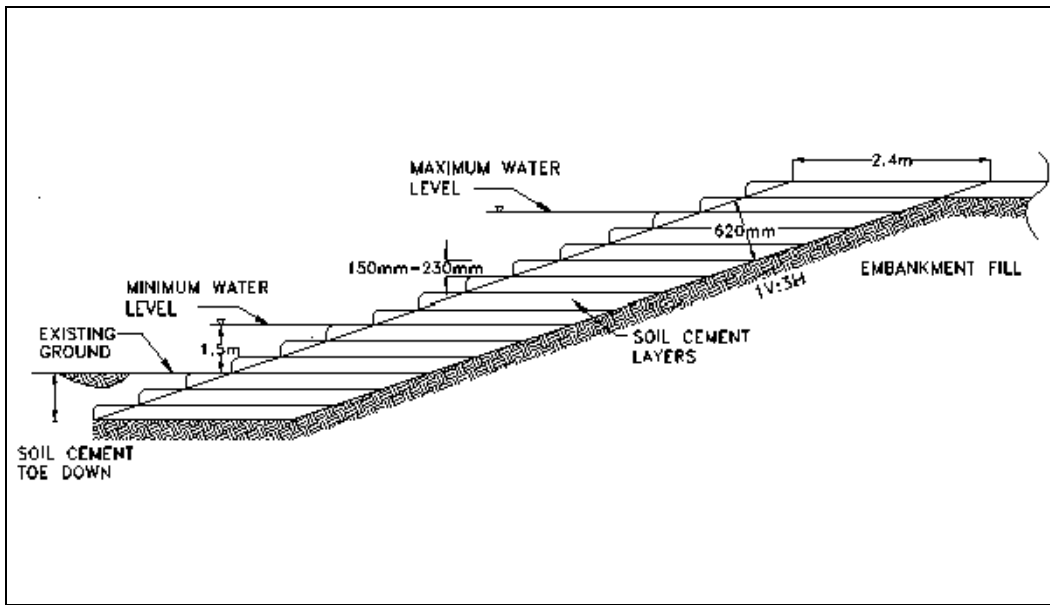

Figure 7.2. Typical section for soil cement slope protection (stair-step method).



Figure 7.3. Soil cement placed in the plating method parallel to the slope (PCA).

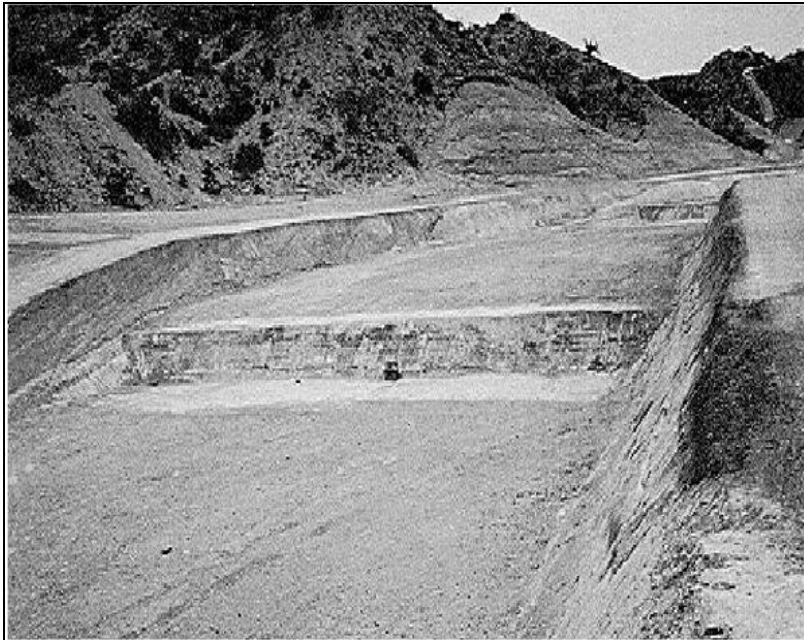

Figure 7.4. Soil cement bank protection and drop structures in Laughlin, NV (Hansen and Lynch 1995).

Fly Ash. The Portland Cement Association recommends that fly ash, when used, conform to ASTM Specification C-168.

Water. Water shall be clear and free from injurious amounts of oil, acid, alkali, organic matter or other deleterious substance.

Aggregate. The soil used in the soil cement mix shall not contain any material retained on a 1-1/2 in. (38.1 mm) sieve, nor any deleterious material. Soil for soil cement lining shall be obtained from the required excavations or from other borrow areas and stockpiled on the job site. The actual soil to be used shall be analyzed by laboratory tests in order to determine the job mix. The distribution and gradation of materials in the soil cement lining shall not result in lenses, pockets, streaks, or layers of material differing substantially in texture or gradation from surrounding material. Soil shall conform to the following gradation:

<u>Sieve Size</u>	<u>Percent Passing (Dry Weight)</u>
1-1/2 in. (38.1 mm)	98% - 100%
No. 4	60% - 90%
No. 200	5% - 15%

The Plasticity Index (PI) shall be a maximum of 3. Clays with a PI greater than 6 generally require a greater cement content and are more difficult to mix with cement.

Clay and silt lumps larger than 1/2 in. (12.7 mm) shall be unacceptable, and screening, in addition to that previously specified, shall be required whenever this type of material is encountered.

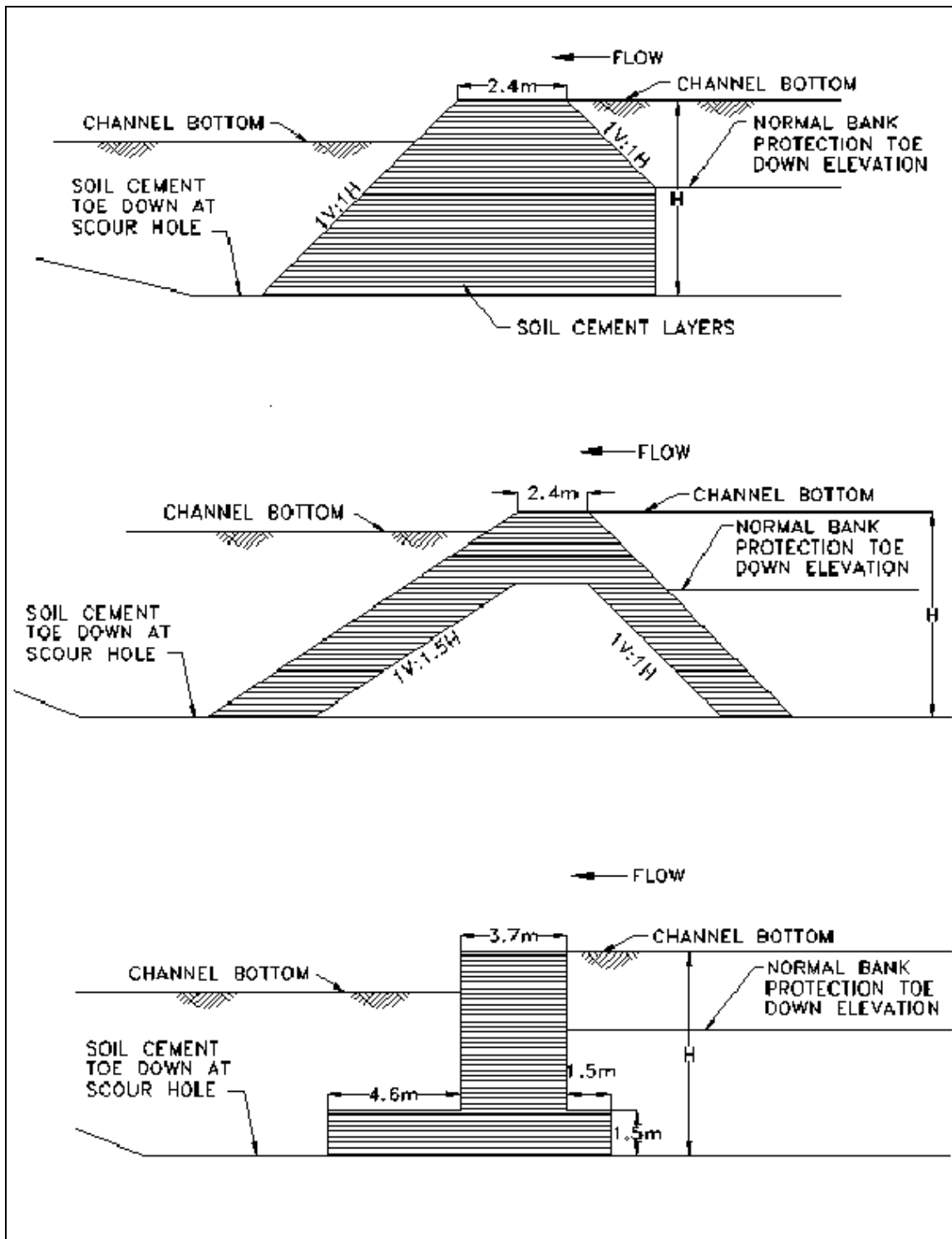

Figure 7.5. Typical sections for soil cement grade control structures (PCA).

Mix Design. The design requirements for the soil cement shall be such that it has a compressive strength of 750 psi (5170 kPa) at the end of 7 days unless otherwise specified. A 24-hour test shall be run to monitor the mix design on a daily basis. Experience has shown that 24-hour compressive strength results for moist cured samples are approximately 50 to 60% of the seven day strength (moist cured for six days and soaked in water for 24 hours). Once the design strength mix is determined, a 24-hour test shall be run using the mix to obtain a 24-hour compressive strength which will be used to monitor the daily output of the central plant. Seven (7) day samples shall also be taken for final acceptance. The amount of stabilizer thus determined by laboratory testing shall continue to be monitored throughout the life of the project with modifications as required for existing field conditions.

NOTE: The **stabilizer** is defined as the cementitious portion of the mix which may be composed of portland cement only or a mixture of portland cement and fly ash or other supplement.

The cementitious portion of the soil-cement mix shall consist of one of the following alternatives:

1. One hundred percent (100%) portland cement
2. Eighty five percent (85%) portland cement and fifteen percent (15%) fly ash by weight of stabilizer.

The ratio of replacement shall be one kilogram of fly ash to one kilogram of portland cement removed meaning one to one replacement by weight.

Mixing Method. Soil Cement shall be mixed in an approved central plant having a twin shaft continuous-flow or batch-type pugmill. The plant shall be equipped with screening, feeding and metering devices that will add the soil, cement, fly ash (if utilized), and water into the mixer in the specified quantities. Figure 7.6 illustrates a typical continuous flow mixing plant operation. In the production of the soil cement, the percent of cement content and the percent of the cement plus fly ash shall not vary by more than +/- 0.3% from the contents specified by the Engineer.

NOTE: Soil cement can also be mixed in place, although for most bank protection projects the central plant method is preferred.

Blending of Cement and Fly Ash. The blending procedure shall provide a uniform, thorough, and consistent blend of cement and fly ash. The blending method and operation shall be approved before soil cement production begins. In blending of the stabilizer, the percent of fly ash content shall not vary by more than +/- 0.50% of the specified content.

Scales are required at both the cement and fly ash feeds. An additional scale may also be required at the stabilizer feed.

Required Moisture. The moisture content of the mix shall be adjusted as needed to achieve the compressive strength and compaction requirements specified herein.

Handling. The soil cement mixture shall be transported from the mixing area to the embankment in clean equipment provided with suitable protective devices in unfavorable weather. The total elapsed time between the addition of water to the mixture and the start of compaction shall be the minimum possible. In no case should the total elapsed time exceed thirty (30) minutes. This time may be reduced when the air temperature exceeds 90° F (32° C), or when there is a wind that promotes rapid drying of the soil cement mixture.

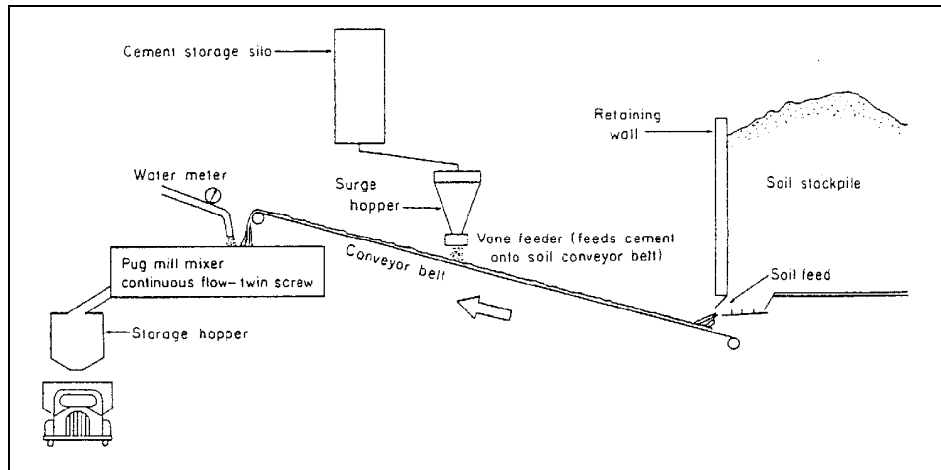

Figure 7.6. Schematic of continuous flow mixing plant for soil cement.⁽⁷⁾

Placing. The mixture shall be placed on the moistened subgrade embankment, or previously completed soil cement, with spreading equipment that will produce layers of such width and thickness as are necessary for compaction to the required dimensions of the completed soil cement layers. The compacted layers of soil cement shall not exceed 8 in. (200 mm), nor be less than 4 in. (100 mm) in thickness. Each successive layer shall be placed as soon as practical after the preceding layer is completed and certified.

All soil cement surfaces that will be in contact with succeeding layers of soil cement shall be kept continuously moist by fog spraying until placement of the subsequent layer, provided that the contractor will not be required to keep such surfaces continuously moist for a period of seven days.

Mixing shall not proceed when the soil aggregate or the area on which the soil cement is to be placed is frozen. Soil cement shall not be mixed or placed when the air temperature is below 45° F (7° C), unless the air temperature is 40° F (5° C) and rising.

Compaction. Soil Cement shall be uniformly compacted to a minimum of 98% of maximum density as determined by field density tests. Wheel rolling with hauling equipment only is not an acceptable method of compaction.

At the start of compaction the mixture shall be in a uniform, loose condition throughout its full depth. Its moisture content shall be as specified in the section on Required Moisture (above). No section shall be left undisturbed for longer than 30 minutes during compaction operations. Compaction of each layer shall be done in such a manner as to produce a dense surface, free of compaction planes, in not longer than one hour from the time water is added to the mixture. Whenever the operation is interrupted for more than two hours, the top surface of the completed layer, if smooth, shall be scarified to a depth of at least 1 in. (24.5 mm) with a spike tooth instrument prior to placement of the next lift. The surface after scarifying, shall be swept using a power broom or other method approved by the engineer to completely free the surface of all loose material prior to actual placement of the soil cement mixture for the next lift.

Finishing. After compaction, the soil cement shall be further shaped to the required lines, grades, and cross section and rolled to a reasonably smooth surface. Trimming and shaping of the soil cement shall be conducted daily at the completion of each day's production with a smooth blade.

Curing. Temporarily exposed surfaces shall be kept moist as set forth in the section on Placing (above). Care must be exercised to ensure that no curing material other than water is applied to the surfaces that will be in contact with succeeding layers. Permanently exposed surfaces shall be kept in a moist condition for seven days, or they may be covered with some suitable curing material, subject to the Engineer's approval. Any damage to the protective covering within 7 days shall be repaired to satisfaction of the Engineer.

Regardless of the curing material used, the permanently exposed surfaces shall be kept moist until the protective cover is applied. Such protective cover is to be applied as soon as practical, with a maximum time limit of 24 hours between the finishing of the surface and the application of the protective cover or membrane. When necessary, the soil cement shall be protected from freezing for seven days after its construction by a covering of loose earth, straw or other suitable material approved by the Engineer.

Construction Joints. At the end of each day's work, or whenever construction operations are interrupted for more than two hours, a 15% minimum skew transverse construction joint shall be formed by cutting back into the completed work to form a full depth vertical face as directed by the Engineer.

7.4 REFERENCES

Hansen, K.D. and Lynch, J.B., 1995, "Controlling Floods in the Desert with Soil-Cement," Authorized reprint from: Second CANMET/ACI International Symposium on Advances in Concrete Technology, Las Vegas, NV, June 11-14, 1995.

Pima County Department of Transportation Construction Specifications, "Soil-Cement for Bank Protection, Linings and Grade Control Structures," Section 920, undated.

Portland Cement Association, 1984, "Soil Cement Slope Protection for Embankments: Construction," Report PCA, IS173.02W.

Portland Cement Association, 1984, "Soil Cement Slope Protection for Embankments: Field Inspection and Control," Report PCA, IS168.03W.

Portland Cement Association, 1986, "Soil Cement for Facing Slopes and Lining Channels, Reservoirs, and Lagoons," Report PCA, IS126.06W.

Portland Cement Association, 1986, "Suggested Specifications for Soil Cement Slope Protection for Earth Dams (Central Plant Mixing Method)," Report PCA, IS052W.

Portland Cement Association, 1991, "Soil Cement Slope Protection for Embankments: Planning and Design," Report PCA, IS173.03W.

Sheilds, S.J., Maucher, L.E., Taji-Farouki, A.A., Osmolski, A., and Smutzer, D.A., 1988, "Soil Cement Applications and Use in Pima County for Flood Control Projects," prepared for the Board of Supervisors/Board of Directors.

DESIGN GUIDELINE 8
ARTICULATING CONCRETE BLOCK SYSTEMS

(page intentionally left blank)

DESIGN GUIDELINE 8

ARTICULATING CONCRETE BLOCK SYSTEMS

8.1 INTRODUCTION

Articulating concrete block systems (ACBs) provide a flexible alternative to riprap, gabions and rigid revetments. These systems consist of preformed units which either interlock, are held together by cables, or both to form a continuous blanket or block matrix (Figure 8.1). This design guideline considers two applications of ACB's: Application 1 – bank revetment and bed armor; and Application 2 - pier scour protection.

For over three decades, ACB systems have been used for streambank revetment or full channel armoring where the mat is placed across the entire channel cross section. For this reason, guidelines for these applications are well established (Harris County Flood Control District 2001). Guidance for the design of ACBs for protection against pier scour is derived from NCHRP Report 593, "Countermeasures for Protecting Bridge Piers from Scour" (Lagasse et al. 2007).

The term "articulating," as used in this document, implies the ability of individual blocks of the system to conform to changes in the subgrade while remaining interconnected by virtue of block interlock and/or additional system components such as cables, ropes, geotextiles, or geogrids. ACB systems include interlocking and non-interlocking block geometries; cabled and non-cabled systems; and vegetated and non-vegetated systems. Block systems are typically available in both open-cell and closed-cell varieties.

Manufacturers of ACBs have a responsibility to test their products and to develop design parameters based on the results from these tests. A standard performance test is given in ASTM D7277. Since ACBs vary in shape, size, and performance from one system to the next, each system will have unique design parameters. A procedure to develop hydraulic design criteria for ACBs given the appropriate hydraulic stability performance data for a particular block system is presented in this section.

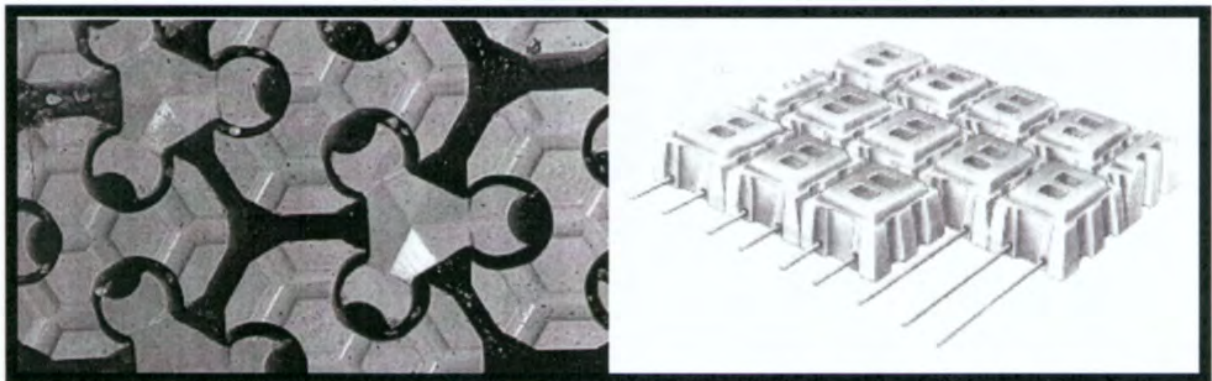

(a)

(b)

Figure 8.1. Examples of (a) interlocking block system (courtesy American Excelsior) and (b) cabled block system (courtesy Armortec).

8.2 BACKGROUND

Beginning in 1983, a group of agencies of the federal government, led by the Federal Highway Administration (FHWA), initiated a multi-year research and testing program in an effort to determine, quantitatively, the performance and reliability of commercially available erosion protection treatments. The research was concluded in 1989, with the final two years of testing concentrated on the performance of ACBs. Full-scale testing methodologies and results for embankment overtopping conditions from the FHWA research are published in Clopper and Chen (1988) and Clopper (1989).

The tests provided both qualitative and quantitative insight into the hydraulic behavior and stability of these types of revetments. Failure mechanisms were identified and quantitatively described as a result of that research effort. Threshold hydraulic loadings were related to forces causing instability in order to better define selection, design, and installation guidelines. Concurrently with the FHWA tests, researchers in the United Kingdom were also evaluating similar erosion protection systems at full scale. Both groups of researchers agreed that an accurate, yet suitably conservative, definition of "failure" for ACBs can be described as the local loss of intimate contact between the revetment and the subgrade it protects. This loss of contact can result in the progressive growth of one or more of the following destabilizing processes:

1. Ingress of flow beneath the armor layer, causing increased uplift pressure and separation of blocks from the subgrade.
2. Loss of subgrade soil through gradual piping erosion and/or washout.
3. Enhanced potential for rapid saturation and liquefaction of subgrade soils, causing shallow slip geotechnical failure (especially in fine-grained, low-cohesive soils on steep slopes).
4. Loss of block or group of blocks from the revetment matrix, directly exposing the subgrade to the flow.

Therefore, selection, design, and installation considerations must be concerned primarily with maintaining intimate contact between the block system and the subgrade for the stress levels associated with the hydraulic conditions of the design event. It should be noted that a suitable filter layer beneath the blocks, and in some cases a drainage layer of granular or synthetic material, are considered to be an integral component(s) of the overall ACB system.

The individual blocks of an ACB armor layer must be dense and durable, and the matrix must be flexible and porous. ASTM International has published Standard D-6684 (2005) specifically for ACB systems. Concrete properties required by this standard include the following:

	<u>Average of 3 Units</u>	<u>Individual Unit</u>
• Minimum allowable compressive strength, lb/in ²	4,000	3,500
• Maximum allowable water absorption, lb/ft ³ , (%)	9.1 (7.0%)	11.7 (9.4%)
• Minimum allowable density in air, lb/ft ³	130	125
• Freeze-thaw durability	As specified by owner in accordance with ASTM C-67, C-666, or C-1262	

ASTM Standard D-6684 also specifies minimum strength properties of geotextiles according to the severity of the conditions during installation. Harsh installation conditions (vehicular traffic, repeated lifting, realignment, and replacement of mattress sections, etc.) require stronger geotextiles.

8.3 APPLICATION 1: HYDRAULIC DESIGN PROCEDURE FOR ACB SYSTEMS FOR BANK REVETMENT OR BED ARMOR

8.3.1 Hydraulic Stability Design Procedure

The hydraulic stability of ACB systems is analyzed using a "discrete particle" approach. The design approach is similar to that introduced by Stevens and Simons (1971) as modified by Julien (1995) in the derivation of the "Factor of Safety" method for sizing rock riprap. In that method, a calculated factor of safety of 1.0 or greater indicates that the particles will be stable under the given hydraulic conditions and site geometry (e.g., side slope and bed slope). For ACBs, the Factor of Safety force balance has been recomputed considering the weight and geometry of the blocks, and the Shields relationship for estimating the particle's critical shear stress is replaced with actual test results (Clopper 1992).

Considerations are also incorporated into the design procedure to account for the additional forces generated on a block that protrudes above the surrounding matrix due to subgrade irregularities or imprecise placement. The analysis methodology purposely omits any restraining forces due to cables, because any possible benefit that cables might provide are reflected in the performance testing of the block. Cables may prevent blocks from being lost entirely, but they do not prevent a block system from failing through loss of intimate contact with the subgrade. Similarly, the additional stability afforded by vegetative root anchorage or mechanical anchoring devices, while recognized as potentially significant, is ignored in the stability analysis procedure for the sake of conservatism in block selection and design.

A drainage layer may be used in conjunction with an ACB system. A drainage layer lies between the blocks and the geotextile and/or granular filter. This layer allows "free" flow of water beneath the block system while still holding the filter material to the subsoil surface under the force of the block weight. This free flow of water can relieve sub-block pressure and has appeared to significantly increase the hydraulic stability of ACB systems based on full-scale performance testing conducted since the mid 1990s.

Drainage layers can be comprised of coarse, uniformly sized granular material, or can be synthetic mats that are specifically manufactured to permit flow within the plane of the mat. Granular drainage layers are typically comprised of 1- to 2-inch crushed rock in a layer 4 inches or more in thickness. The uniformity of the rock provides significant void space for flow of water. Synthetic drainage nets typically range in thickness from 0.25 to 0.75 inches and are manufactured using stiff nylon fibers or high density polyethylene (HDPE) material. The stiffness of the fibers supports the weight of the blocks, thus providing large hydraulic conductivity within the plane of the drainage net.

Many full-scale laboratory performance tests have been conducted with a drainage layer in place. When evaluating a block system, for which performance testing was conducted with a drainage layer, a drainage layer must also be used in the design. This recommendation is based on the improvement in the hydraulic stability of systems that have incorporated a drainage layer in the performance testing.

8.3.2 Selecting a Target Factor of Safety

The designer must determine what factor of safety should be used for a particular application. Typically, a minimum allowable factor of safety of 1.2 is used for revetment (bank protection) when the project hydraulic conditions are well known and the installation can be conducted under well-controlled conditions. Higher factors of safety are typically used for protection at bridge piers, abutments, and at channel bends due to the complexity in computing hydraulic conditions at these locations.

The Harris County Flood Control District, Texas (HCFCD 2001) has developed a simple flowchart approach that considers the type of application, uncertainty in the hydraulic and hydrologic models used to calculate design conditions, and consequences of failure to select an appropriate target factor of safety to use when designing an ACB installation. In this approach, the minimum allowable factor of safety is recommended based on the type of application (e.g., bank protection, bridge scour protection, dam overtopping, etc). This base value is then multiplied by two factors, each greater than 1.0, to account for risk and uncertainty. Figure 8.2 shows the Harris County flow chart method for determining the target factor of safety.

8.3.3 Design Method

Factor of Safety Method: The stability of a single block is a function of the applied hydraulic conditions (velocity and shear stress), the angle of the inclined surface on which it rests, and the weight and geometry of the block. Considering flow along a channel bank as shown in Figure 8.3, the forces acting on a concrete block are the lift force F_L , the drag force F_D , and the components of the submerged weight of the block, W_S , both into and along the plane of the slope. Block stability is determined by evaluating the moments about the point O about which rotation can take place. The components of these forces are shown in Figure 8.3.

The safety factor (SF) for a single block in an ACB matrix is defined as the ratio of restraining moments to overturning moments:

$$SF = \frac{l_2 W_S a_\theta}{l_1 W_S \sqrt{1 - a_\theta^2} \cos \beta + l_3 F_D \cos \delta + l_4 F_L + l_3 F'_D \cos \delta + l_4 F'_L} \quad (8.1)$$

Note that additional lift and drag forces F'_L and F'_D are included to account for protruding blocks that incur larger forces due to impact. The design implications regarding a protruding block are discussed in detail later in this section.

The moment arms l_1 , l_2 , l_3 , and l_4 are determined from the block dimensions shown in Figure 8.4. In the general case, the pivot point of overturning will be at the downstream corner of the block; therefore, the distance from the center of the block to the corner should be used for both l_2 and l_4 . Since the weight vector acts through the center of gravity, one half the block height should be used for l_1 . The drag force acts both on the top surface of the block (shear drag) and on the body of the block (form drag). Considering both elements of drag, eight-tenths the height of the block is considered a reasonable estimate of l_3 .

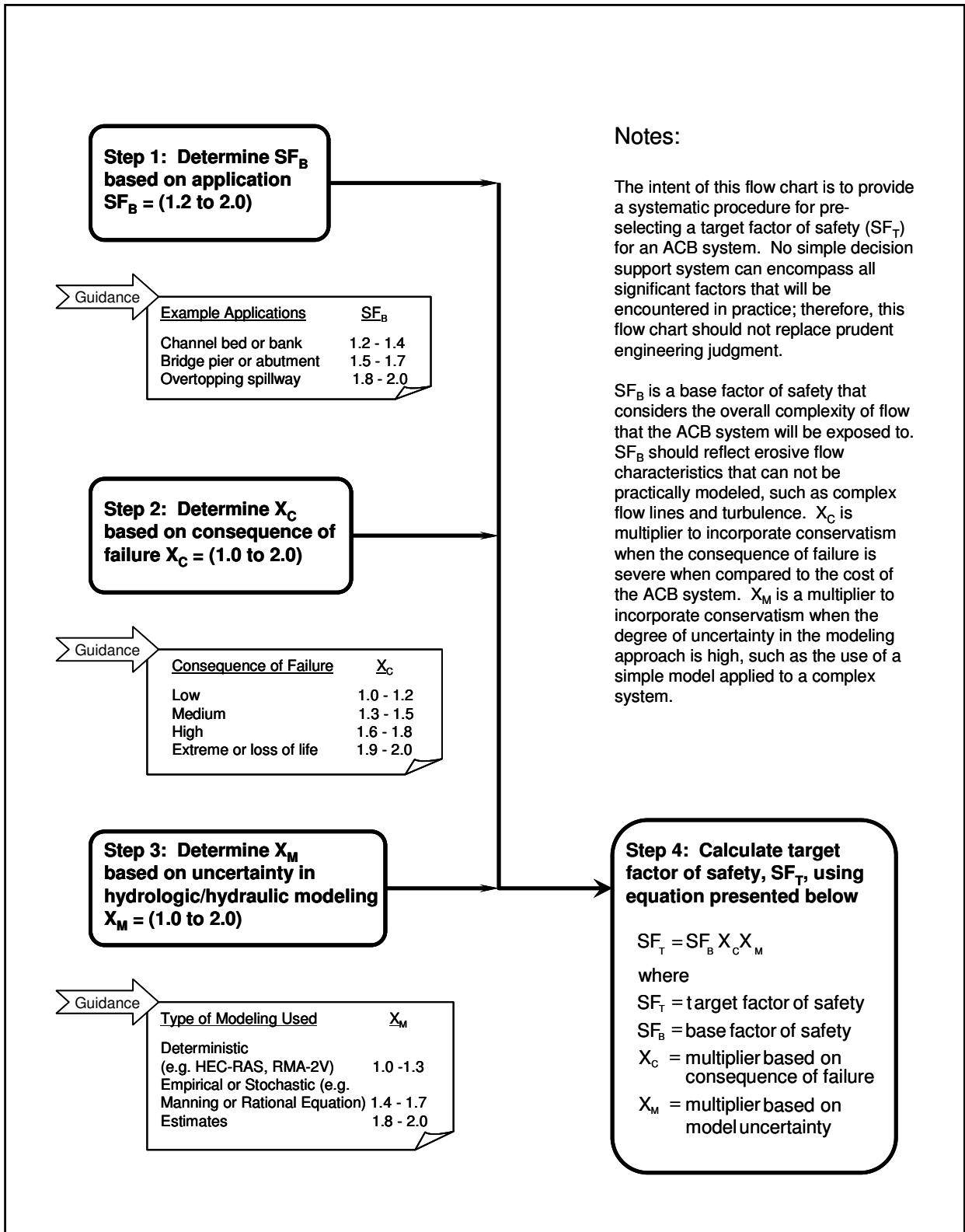

Figure 8.2. Selecting a target factor of safety (HCFCO 2001).

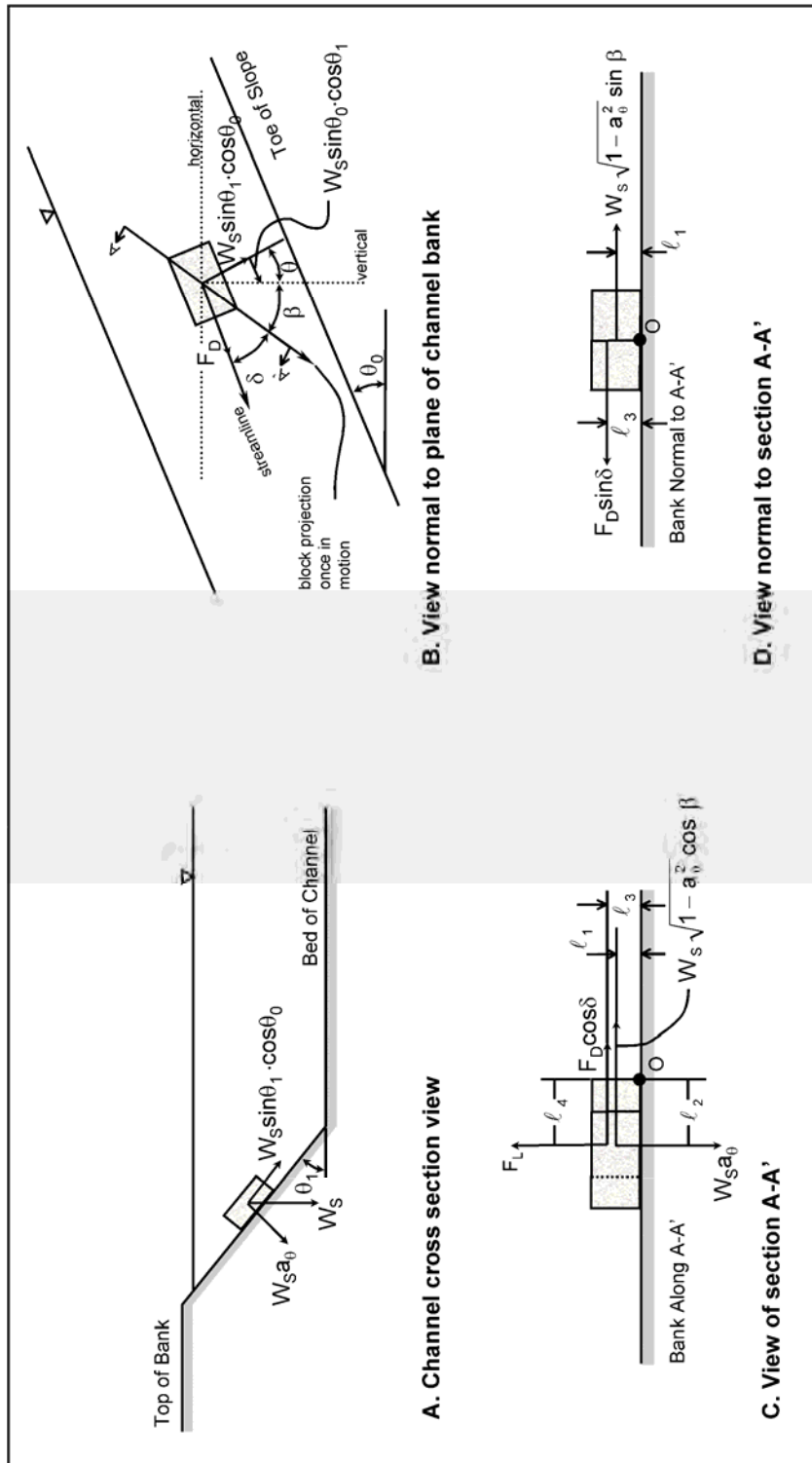

Figure 8.3. Single block on a channel side slope with factor of safety variables defined.

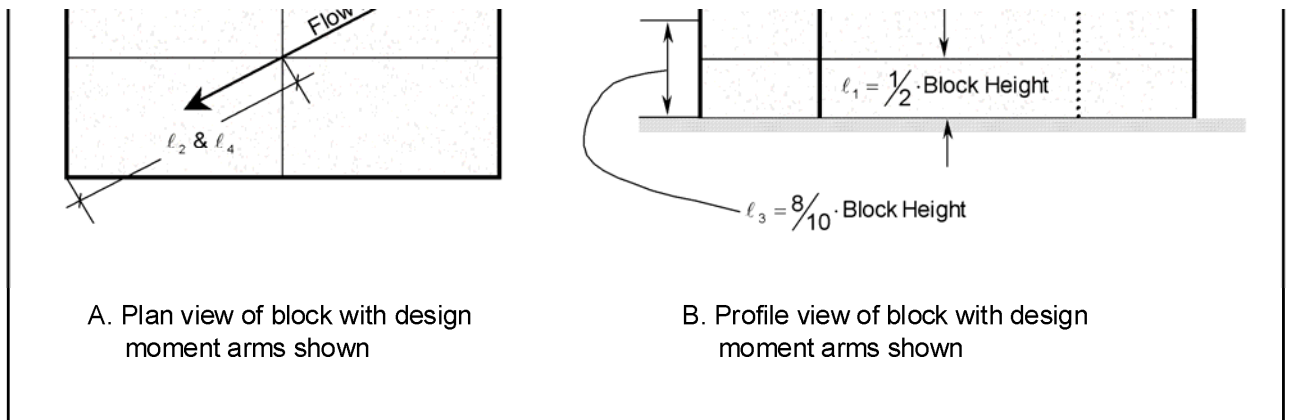

Figure 8.4. Schematic diagram of a block showing moment arms l_1 , l_2 , l_3 , and l_4 .

The shear stress on the block is calculated as follows:

$$\tau_{\text{des}} = K_b \gamma y S_f \quad (8.2)$$

where:

- τ_{des} = Design shear stress, lb/ft²
- K_b = Bend coefficient (dimensionless)
- γ = Unit weight of water, lb/ft³
- y = Maximum depth of flow on revetment, ft
- S_f = Slope of the energy grade line, ft/ft

The bend coefficient K_b is used to calculate the increased shear stress on the outside of a bend. This coefficient ranges from 1.05 to 2.0, depending on the severity of the bend. The bend coefficient is a function of the radius of curvature R_c divided by the top width of the channel T , as follows:

$$K_b = 2.0 \quad \text{for } 2 \geq R_c/T$$

$$K_b = 2.38 - 0.206 \left(\frac{R_c}{T} \right) + 0.0073 \left(\frac{R_c}{T} \right)^2 \quad \text{for } 10 > R_c/T > 2 \quad (8.3)$$

$$K_b = 1.05 \quad \text{for } R_c/T \geq 10$$

Protruding Blocks: While some manufacturers developed design charts to aid in the design of ACB systems, those charts generally are based on the assumption of a "perfect" installation (i.e., no individual blocks protrude into the flow). In reality, some placement tolerance must be anticipated and the factor of safety equation modified to account for protruding blocks, illustrated in Figure 8.5. Because poor installation, or differential settlement over time, can cause blocks to exceed the design placement tolerance, the actual factor of safety can be greatly reduced and may lead to failure. Therefore, subgrade preparation and construction inspection become critical to successful performance of ACB systems. Blocks must not be placed directly on an irregular surface such as cobbles or rubble. A suitably smooth subgrade can often be achieved by removing the largest blocky materials and placing imported sand or road base material prior to placing the geotextile.

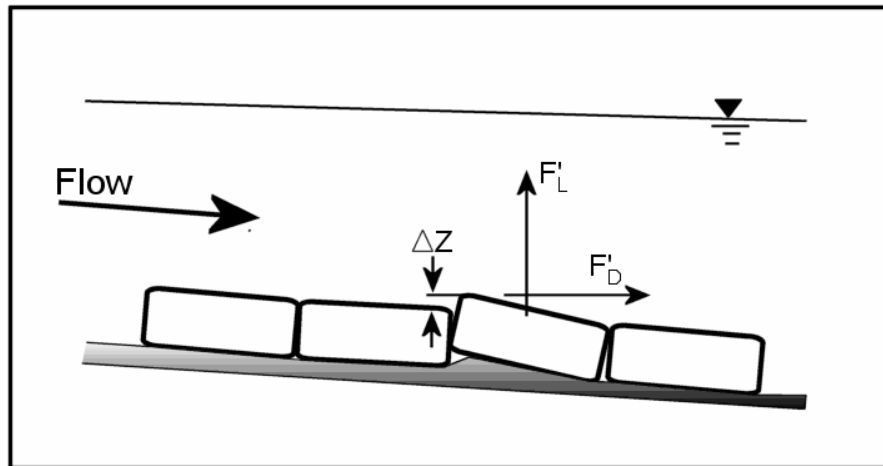

Figure 8.5. Sketch showing additional lift and drag forces on a protruding block.

The additional drag force on the block created by the protrusion is calculated as follows:

$$F'_D = \frac{1}{2} C [(\Delta z) b \rho (V_{des}^2)] \quad (8.4)$$

where:

- F'_D = Drag force due to protrusion, lb
- C = Drag coefficient assumed equal to 1.0
- Δz = Protrusion height, ft
- b = Projected block width, ft
(Note: This width is typically taken as 2 times the moment arm L_2 ; see Figure 8.4)
- ρ = Mass density of water, slugs/ft³
- V_{des} = Design velocity, ft/s

For typical revetment applications, the design velocity V_{des} is taken as the cross sectional average velocity. If a detailed hydraulic analysis has been performed, a more representative local velocity can be used for V_{des} .

Lastly, the additional lift force due to the protrusion F'_L is assumed equal to the drag force F'_D . Both of these forces create additional destabilizing moments associated with a protruding block.

Dividing Equation 8.1 by $l_1 W_S$ and substituting terms yields the final form of the factor of safety equations as summarized in Table 8.1. The equations can be used with any consistent set of units; however, variables are indicated here in U.S. customary (English) units.

8.3.4 Layout Details for ACB Bank Revetment and Bed Armor

Longitudinal Extent: The revetment armor should be continuous for a distance which extends both upstream and downstream of the region which experiences hydraulic forces severe enough to cause dislodging and/or transport of bed or bank material. The minimum distances recommended are an upstream distance of 1.0 channel width and a downstream distance of 1.5 channel widths. The channel reach which experiences severe hydraulic forces is usually identified by site inspection, examination of aerial photography, hydraulic modeling, or a combination of these methods.

Many site-specific factors have an influence on the actual length of channel that should be protected. Factors that control local channel width (such as bridge abutments) may produce local areas of relatively high velocity and shear stress due to channel constriction, but may also create areas of ineffective flow further upstream and downstream in "shadow zone" areas of slack water. In straight reaches, field reconnaissance may reveal erosion scars on the channel banks that will assist in determining the protection length required.

In meandering reaches, since the natural progression of bank erosion is in the downstream direction, the present limit of erosion may not necessarily define the ultimate downstream limit. FHWA's Hydraulic Engineering Circular No. 20, "Stream Stability at Highway Structures" (Lagasse et al. 2001) provides guidance for the assessment of lateral migration. The design engineer is encouraged to review this reference for proper implementation.

Vertical Extent. The vertical extent of the revetment should provide freeboard above the design water surface. A minimum freeboard of 1 to 2 ft should be used for unconstricted reaches and 2 to 3 ft for constricted reaches. If the flow is supercritical, the freeboard should be based on height above the energy grade line rather than the water surface. **The revetment system should either cover the entire channel bottom or, in the case of unlined channel beds, extend below the bed far enough so that the revetment is not undermined by the maximum scour which for this application is considered to be toe scour, contraction scour, and long-term degradation (Figure 8.7).**

Recommended revetment termination at the top and toe of the bank slope are provided in Figures 8.6 and 8.7 for armored-bed and soft-bottom channel applications, respectively. Similar termination trenches are recommended for the upstream and downstream limits of the ACB revetment.

Table 8.1. Factor of Safety Design Equations for ACB Systems.

$F_L' = F_D' = 0.5pb(\Delta z)(V_{des})^2$	(8.5)	<p>a_θ = Projection of W_s into plane of subgrade b = Block width normal to flow (ft) F_D, F_L' = added drag and lift forces due to protruding block (lb) l_x = Block moment arms (ft) γ_c = Concrete density, lb/ft³ γ_w = Density of water, lb/ft³ V_{des} = Design velocity (ft/s) W = Weight of block in air (lb) W_s = Submerged block weight (lb) Δz = Height of block protrusion above ACB matrix (ft) β = Angle between block motion and the vertical δ = Angle between drag force and block motion η_0 = Stability number for a block on a horizontal surface η_1 = Stability number for a block on a sloped surface θ = Angle between side slope projection of W_s and the vertical θ_0 = Channel bed slope (degrees) θ_1 = Side slope of block installation (degrees) ρ = Mass density of water (slugs/ft³) τ_c = Critical shear stress for block on a horizontal surface (lb/ft²) τ_{des} = Design shear stress (lb/ft²) SF = Calculated factor of safety</p>
$\eta_0 = \frac{\tau_{des}}{\tau_c}$	(8.6)	
$\theta = \arctan\left(\frac{\tan\theta_0}{\tan\theta_1}\right)$	(8.7)	
$a_\theta = \sqrt{(\cos\theta_1)^2 - (\sin\theta_0)^2}$	(8.8)	
$\beta = \arctan\left(\frac{\cos(\theta_0 + \theta)}{\left(\frac{l_4}{l_3} + 1\right)\left(\frac{\sqrt{1 - a_\theta^2}}{\eta_0(l_2/l_1)}\right) + \sin(\theta_0 + \theta)}\right)$	(8.9)	
$\delta = 90^\circ - \beta - \theta$	(8.10)	
$\eta_1 = \eta_0\left(\frac{(l_4/l_3) + \sin(\theta_0 + \theta + \beta)}{(l_4/l_3) + 1}\right)$	(8.11)	
$W_s = W\left(\frac{\gamma_c - \gamma_w}{\gamma_c}\right)$	(8.12)	
$SF = \frac{(l_2/l_1)a_\theta}{\cos\beta\sqrt{(1 - a_\theta)^2} + \eta_1(l_2/l_1) + \frac{(l_3F_D \cos\delta + l_4F_L')}{l_1W_s}}$	(8.13)	
<p>Note: The equations cannot be solved for $\theta_1 = 0$ (i.e., division by 0 in Equation 8.7); therefore, a very small but non-zero side slope must be entered for the case of $\theta_1 = 0$.</p>		

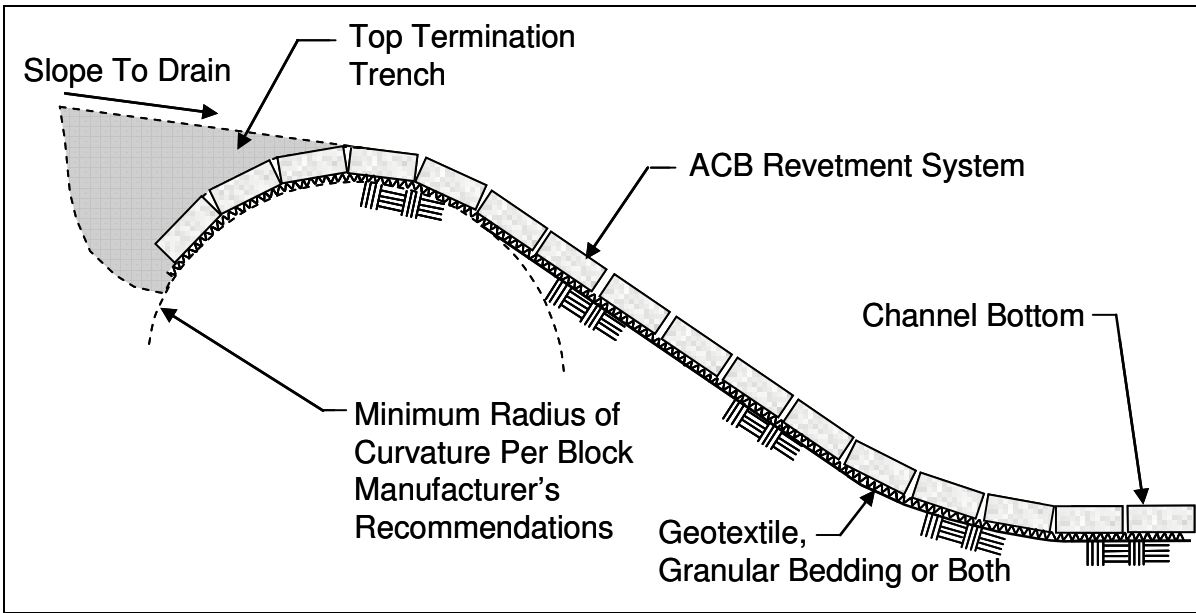

Figure 8.6. Recommended layout detail for bank and bed armor.

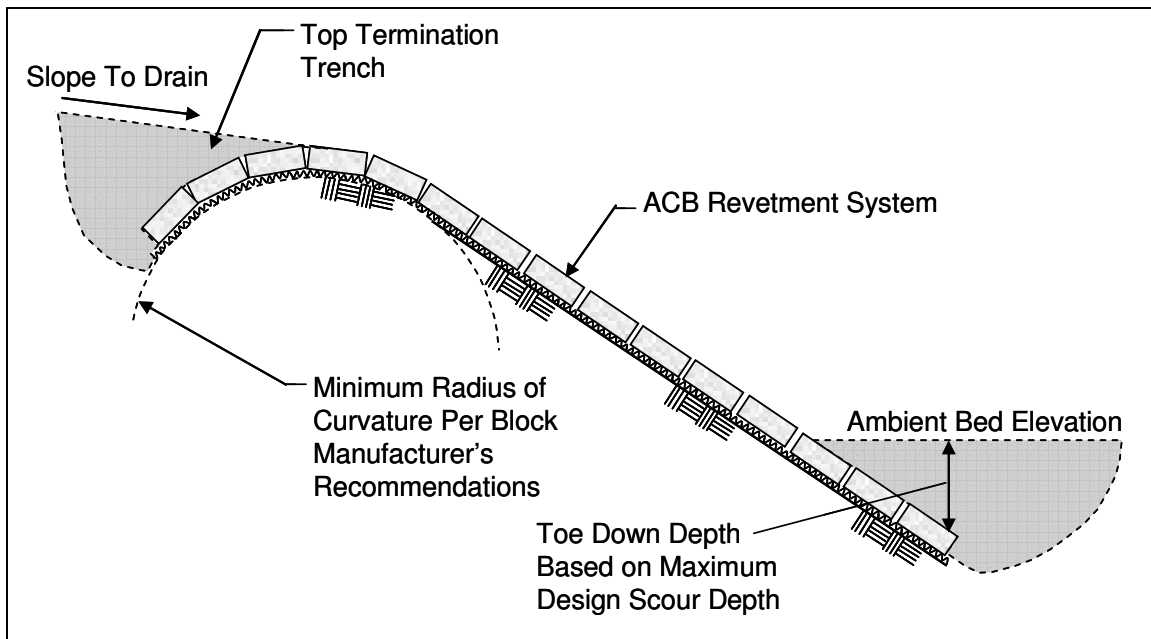

Figure 8.7. Recommended layout detail for bank revetment where no bed armor is required.

8.3.5 Filter Requirements

The importance of the filter component of an articulating concrete block installation should not be underestimated. Geotextile filters are most commonly used with ACBs, although coarse granular filters may be used where native soils are coarse and the particle size of the filter is large enough to prevent winnowing through the cells and joints of the ACB system. When using a granular stone filter, the layer should have a minimum thickness of 4 times the d_{50} of the filter stone or 6 inches, whichever is greater. The d_{50} size of the granular filter should be greater than one half the smallest dimension of the open cells of the system. When placing a granular filter under water, its thickness should be increased by 50%.

The filter must retain the coarser particles of the subgrade while remaining permeable enough to allow infiltration and exfiltration to occur freely. It is not necessary to retain all the particle sizes in the subgrade; in fact, it is beneficial to allow the smaller particles to pass through the filter, leaving a coarser substrate behind. Detailed aspects of filter design are presented in Design Guide 16 of this document.

Some situations call for a composite filter consisting of both a granular layer and a geotextile. The specific characteristics of the base soil determine the need for, and design considerations of the filter layer. ***In cases where dune-type bedforms may be present at the toe of a bank slope protected with an ACB system, it is strongly recommended that only a geotextile filter be considered.***

8.3.6 ACB Design Example

The following example illustrates the ACB design procedure using the Factor of Safety equations presented in Table 8.1. The example is presented in a series of steps that can be followed by the designer in order to select the appropriate ACB system based on a pre-selected target factor of safety. The primary criterion for product selection is if the computed factor of safety for the ACB system meets or exceeds the pre-selected target value. The example assumes that hydraulic testing has been performed to quantify a critical shear stress for that particular system. This problem is presented in English units only because ACB systems in the U.S. are manufactured and specified in units of inches and pounds.

Problem Statement:

Meandering River has a history of channel instability, both vertically and laterally. A quantitative assessment of channel stability has been conducted using the multi-level analysis from Hydraulic Engineering Circular No. 20, "Stream Stability at Highway Structures" (Lagasse et al. 2001). A drop structure has been designed at the downstream end of a bendway reach to control bed elevation changes. However, there is concern that lateral channel migration will threaten the integrity of the drop structure. An ACB system is proposed to arrest lateral migration. Figure 8.8 presents a definition sketch for this example problem.

The design procedure assumes that appropriate assessment of hydraulic and geomorphic conditions has been made prior to the design process. The US Army Corps of Engineers' HEC-RAS model has been used to determine the design hydraulic conditions for the project reach. A velocity distribution across the cross section was calculated at River Mile 23.4 using HEC-RAS. Figure 8.9 presents the velocity distribution as determined using 9 flow subsections across the main channel. The velocity distribution indicates that the maximum velocity expected at the outside of the bend is 11.0 ft/s, which will be used as the design value in the factor of safety calculations. The corresponding depth at this location, which is the channel thalweg depth at the toe of the bank slope, is 8.4 feet.

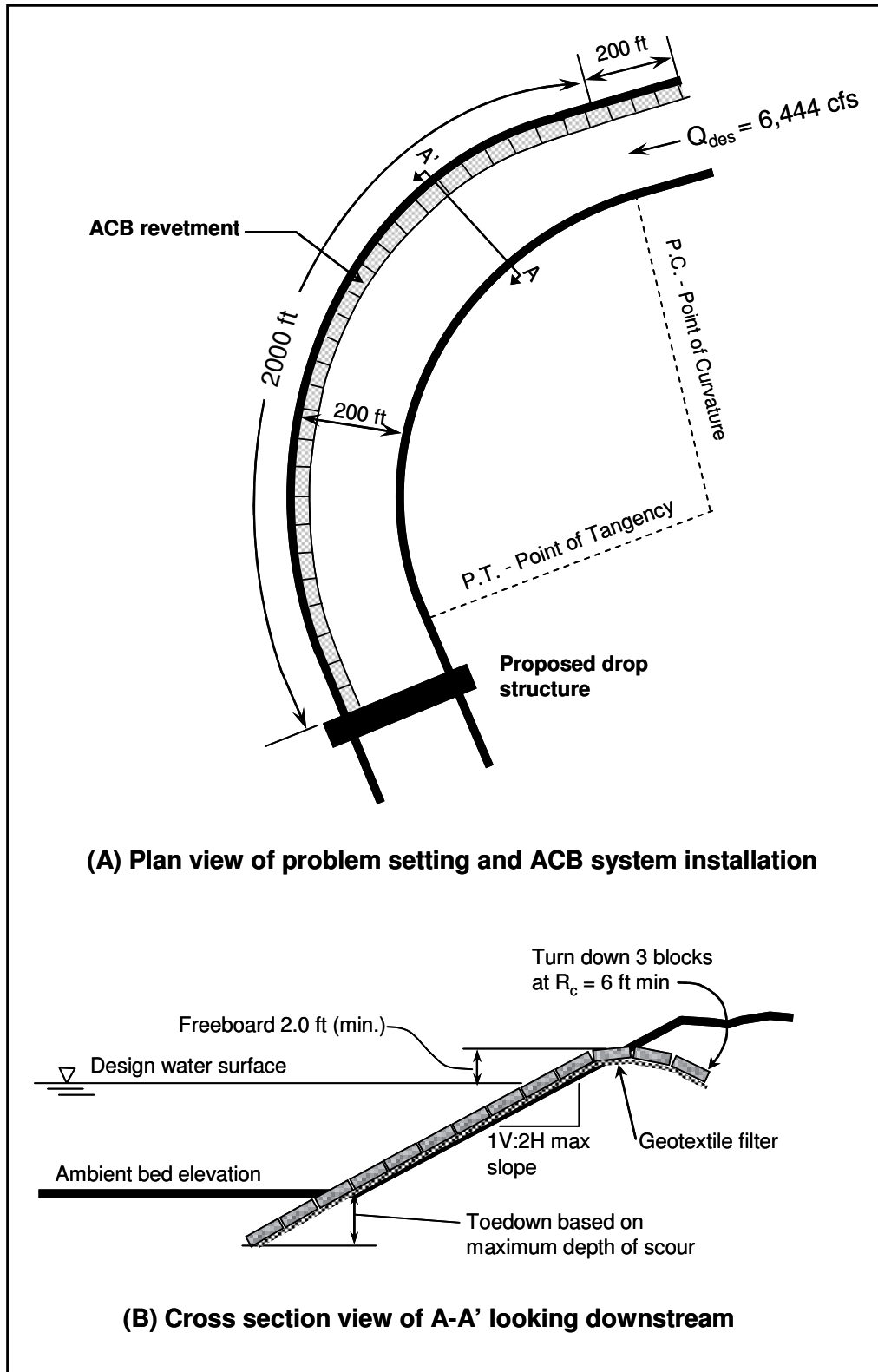

Figure 8.8. Definition sketch of example problem setting and ACB installation (not to scale).

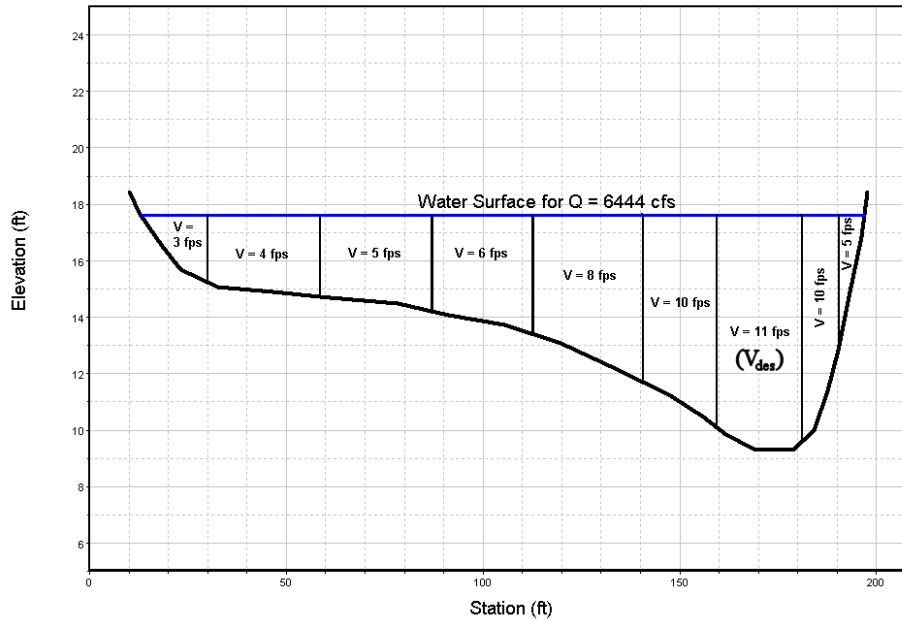

Figure 8.9. Velocity distribution at River Mile 23.4 from HEC-RAS model.

Table 8.2 presents pertinent results from the hydraulic model at the cross section (River Mile 23.4) that is exposed to the most severe hydraulic conditions.

Channel discharge Q (ft^3/s)	6,444
Cross section average velocity V_{ave} (ft/s)	8.1
Maximum velocity V_{des} (ft/s)	11.0
Hydraulic radius R (ft)	4.3
Maximum depth y (ft)	8.4
Side slope, V:H	1V:2H
Bed slope S_o (ft/ft)	0.010
Slope of energy grade line S_f (ft/ft)	0.007
Channel top width T (ft)	200
Radius of curvature R_c (ft)	750

Step 1. Determine a target factor of safety for this project:

Use Figure 8.2 to compute a target factor of safety. For this example, a target factor of safety of 1.7 is selected as follows:

- A base safety factor SF_B of 1.3 is chosen because the river is sinuous and high velocities can be expected on the outside of bends.
- The base safety factor is multiplied by a factor for the consequence of failure X_C using a value of 1.3, since at this location the consequence of failure is ranked as "low" to "medium."

- The uncertainty associated with the hydrology and hydraulic analysis is considered "low" for this site, based on available hydrologic and hydraulic data, and the recent study associated with the drop structure design. Therefore, the factor X_M for hydrologic and hydraulic uncertainty is given a value of 1.0.

The target factor of safety for this project site is calculated as:

$$SF_T = (SF_B)(X_C)(X_M) = 1.7$$

Step 2. Calculate design shear stress

The maximum bed shear stress at the cross section is calculated using Equation 8.2:

$$\tau_{des} = K_b(\gamma)(y)(S_f)$$

First calculate K_b using Equation 8.3:

$$\text{Since } R_c/T = 750/200 = 3.75,$$

$$K_b = 2.38 - 0.206(3.75) + 0.0073(3.75)^2 = 1.71$$

$$\text{so } \tau_{des} = 1.71 (62.4 \text{ lb/ft}^3) (8.4 \text{ ft}) (0.007 \text{ ft/ft}) = 6.3 \text{ lb/ft}^2$$

Step 3. Obtain ACB properties

Contact ACB manufacturers and/or review ACB catalogs and select several systems that are appropriate for the given application based on a preliminary assessment of the hydraulic conditions. At the same time obtain the block properties necessary for design. These properties generally include the moment arms in shown in Figure 8.4, the weight of the block, and the critical shear stress for the block on a horizontal surface.

For this example, two products from ACB Systems, Inc. are considered to be potential candidates based on guidance from the manufacturer. ACB Systems, Inc. suggests that the 106-OC or 108-OC systems would likely be appropriate for velocities in the range of 10 to 15 ft/s. The block properties provided by the manufacturer are shown in Table 8.4.

Block Designation	Block Thickness (in)	Block width (in)	Block length (in)	Weight in Air (lb)	Moment arms (inches)				τ_c (at horizontal) (lb/ft ²)
					l_1	l_2	l_3	l_4	
106-OC	6.0 ⁽¹⁾	15.5	17.25	99	3	11.6	4.8	11.6	19.2
108-OC	8.0	15.5	17.25	132	4	11.6	6.4	11.6	24.6

Notes: (1) Tested block

Step 4. Calculate the factor of safety parameters for each product

4a) Calculate the additional lift F_L' and drag F_D' on a protruding block using Equation 8.5 and assuming that the maximum allowable placement tolerance Δz is 1/2 inch:

$$F_L' = F_D' = 0.5\rho b(\Delta z)(V_{des})^2$$

Using the projected width of the block as 2 times the moment arm L_2 ,

Block System	Parameter: F_L' and F_D' (pounds)
106-OC block system	$0.5(1.94 \text{ slugs/ft}^3) \left(\frac{2(11.6 \text{ in})}{12 \text{ in/ft}} \right) \left(\frac{0.5 \text{ in}}{12 \text{ in/ft}} \right) (11.0 \text{ ft/s})^2 = 9.45 \text{ lb}$
108-OC block system	$0.5(1.94 \text{ slugs/ft}^3) \left(\frac{2(11.6 \text{ in})}{12 \text{ in/ft}} \right) \left(\frac{0.5 \text{ in}}{12 \text{ in/ft}} \right) (11.0 \text{ ft/s})^2 = 9.45 \text{ lb}$

4b) Calculate the stability number for a block on a horizontal surface using Equation 8.6:

$$\eta_0 = \frac{\tau_{des}}{\tau_c}$$

Block System	Parameter: η_0 (dimensionless)
106-OC block system	$\frac{6.3 \text{ lb/ft}^3}{19.2 \text{ lb/ft}^3} = 0.328$
108-OC block system	$\frac{6.3 \text{ lb/ft}^3}{24.6 \text{ lb/ft}^3} = 0.256$

4c) Calculate angle θ using Equation 8.7:

$$\theta = \arctan\left(\frac{\tan\theta_0}{\tan\theta_1}\right)$$

Note that the longitudinal channel slope is 0.01 ft/ft, therefore angle $\theta_0 = 0.57^\circ$

The side slope of the channel bank is 1:2H, therefore angle $\theta_1 = 26.6^\circ$

Block System	Parameter: Angle θ (degrees)
106-OC block system	$\arctan\left(\frac{\tan(0.57^\circ)}{\tan(26.6^\circ)}\right) = 1.14^\circ$
108-OC block system	$\arctan\left(\frac{\tan(0.57^\circ)}{\tan(26.6^\circ)}\right) = 1.14^\circ$

4d) Calculate a_θ using Equation 8.8:

$$a_\theta = \sqrt{(\cos\theta_1)^2 - (\sin\theta_0)^2}$$

Block System	Parameter: a_θ (dimensionless)
106-OC block system	$a_\theta = \sqrt{\cos^2(26.6) - \sin^2(0.57)} = 0.8943$
108-OC block system	$a_\theta = \sqrt{\cos^2(26.6) - \sin^2(0.57)} = 0.8943$

4e) Calculate angle β using Equation 8.9:

$$\beta = \arctan \left(\frac{\cos(\theta_0 + \theta)}{\left(\frac{\ell_4}{\ell_3} + 1\right) \frac{\sqrt{1 - a_\theta^2}}{\eta_0(\ell_2/\ell_1)} + \sin(\theta_0 + \theta)} \right)$$

Block System	Parameter: Angle β (degrees)
106-OC block system	$\beta = \arctan \left(\frac{\cos(0.57 + 1.14)}{\left(\frac{11.6}{4.8} + 1\right) \frac{\sqrt{1 - 0.8943^2}}{0.328\left(\frac{11.6}{3.0}\right)} + \sin(0.57 + 1.14)} \right) = 39.0^\circ$
108-OC block system	$\beta = \arctan \left(\frac{\cos(0.57 + 1.14)}{\left(\frac{11.6}{6.4} + 1\right) \frac{\sqrt{1 - 0.8943^2}}{0.256\left(\frac{11.6}{4.0}\right)} + \sin(0.57 + 1.14)} \right) = 30.0^\circ$

4f) Calculate angle δ using Equation 8.10:

$$\delta = 90^\circ - \beta - \theta$$

Block System	Parameter: Angle δ (degrees)
106-OC block system	$90^\circ - 39.0^\circ - 1.14^\circ = 49.86^\circ$
108-OC block system	$90^\circ - 30.0^\circ - 1.14^\circ = 58.86^\circ$

4g) Calculate the stability number η_1 on a sloped surface using Equation 8.11:

$$\eta_1 = \left(\frac{l_4/l_3 + \sin(\theta_0 + \theta + \beta)}{l_4/l_3 + 1} \right) \eta_0$$

Block System	Parameter: η_1 (dimensionless)
106-OC block system	$\eta_1 = \left\{ \frac{(11.6/4.8) + \sin(0.57^\circ + 1.14^\circ + 39.0^\circ)}{(11.6/4.8) + 1} \right\} 0.328 = 0.295$
108-OC block system	$\eta_1 = \left\{ \frac{(11.6/6.4) + \sin(0.57^\circ + 1.14^\circ + 50.3^\circ)}{(11.6/6.4) + 1} \right\} 0.256 = 0.213$

4h) Calculate the submerged weight of each block using Equation 8.12, assuming the density of the concrete is 140 lb/ft³ and using the density of fresh water which is 62.4 lb/ft³:

$$W_s = W \cdot \left(\frac{\gamma_c - \gamma_w}{\gamma_c} \right)$$

Block System	Parameter: Submerged block weight W_s (pounds)
106-OC block system	$99 \text{ lbs} \left(\frac{140 - 62.4}{140} \right) = 54.9 \text{ lbs}$
108-OC block system	$132 \text{ lbs} \left(\frac{140 - 62.4}{140} \right) = 73.2 \text{ lbs}$

4i) Calculate the factor of safety for each block using Equation 8.13:

$$SF = \frac{(l_2/l_1) a_\theta}{\cos\beta \sqrt{1 - a_\theta^2} + \eta_1 (l_2/l_1) + \frac{(l_3 F'_D \cos\delta + l_4 F'_L)}{l_1 W_s}}$$

Block System	Parameter: Submerged block weight W_s (pounds)
106-OC block system	$SF = \frac{\left(\frac{11.6}{3} \right) 0.8943}{\cos(39.0^\circ) \sqrt{1 - 0.8943^2} + 0.295 \left(\frac{11.6}{3} \right) + \frac{(4.8)(9.45) \cos(49.86^\circ) + 11.6(9.45)}{3(54.9)}} = 1.48$
108-OC block system	$SF = \frac{\left(\frac{11.6}{4} \right) 0.8943}{\cos(30.0^\circ) \sqrt{1 - 0.8943^2} + 0.213 \left(\frac{11.6}{4} \right) + \frac{(6.4)(9.45) \cos(58.86^\circ) + 11.6(9.45)}{4(73.2)}} = 1.74$

Step 5. Select and specify appropriate block

Given the project-specific hydraulic conditions and geometry, the 6-inch thick block ("106-OC") does not meet the target safety factor of 1.7 required for this project. Therefore, the 8-inch thick block ("108-OC") is selected for use. The recommended concrete quality and related physical properties of the block are provided by ASTM International standard D-6684.

8.4 APPLICATION 2: DESIGN GUIDELINES FOR ACB SYSTEMS FOR PIER SCOUR

8.4.1 Hydraulic Stability Design Procedure

The hydraulic stability of articulating block systems at bridge piers can be assessed using the factor of safety method as previously discussed. However, uncertainties in the hydraulic conditions around bridge piers warrant increasing the factor of safety in lieu of a more rigorous hydraulic analysis. Experience and judgment are required when quantifying the factor of safety to be used for scour protection at an obstruction in the flow. In addition, when both contraction scour and pier scour are expected, design considerations for a pier mat become more complex. The following guidelines reflect guidance from NCHRP Report 593, "Countermeasures to Protect Bridge Piers from Scour" (Lagasse et al. 2007).

8.4.2 Selecting a Target Factor of Safety

The issues involved in selecting a target factor of safety for designing ACBs for pier scour protection are described in Section 8.3.2, and illustrated in flowchart fashion in Figure 8.2. Note that for bridge scour applications, the minimum recommended factor of safety is 1.5, as compared to a value of 1.2 for typical bank revetment and bed armor applications.

8.4.3 Design Method

Design conditions in the immediate vicinity of a bridge pier are more severe than the approach conditions upstream. Therefore, the local velocity and shear stress should be used in the design equations. As recommended in NCHRP Report 593, the section-average approach velocity V_{avg} must be multiplied by factors that are a function of the shape of the pier and its location in the channel:

$$V_{des} = K_1 K_2 V_{avg} \quad (8.14)$$

where:

- V_{des} = Design velocity for local conditions at the pier, ft/s
- K_1 = Shape factor equal to 1.5 for round-nose piers and 1.7 for square-edged piers
- K_2 = Velocity adjustment factor for location in the channel (ranges from 0.9 for pier near the bank in a straight reach to 1.7 for pier located in the main current of flow around a sharp bend)
- V_{avg} = Section average approach velocity (Q/A) upstream of bridge, ft/s

If the velocity distribution is available from stream tube or flow distribution output from a 1-D model, or directly computed from a 2-D model, then only the pier shape coefficient should be used to determine the design velocity. The maximum velocity in the active channel V_{\max} is recommended since the channel could shift and the maximum velocity could impact any pier:

$$V_{\text{des}} = K_1 V_{\text{max}} \quad (8.15)$$

The local shear stress at a pier should be calculated as:

$$\tau_{\text{des}} = \left(\frac{nV_{\text{des}}}{K_u} \right)^2 \frac{\gamma_w}{y^{1/3}} \quad (8.16)$$

where:

- τ_{des} = Design shear stress for local conditions at pier, lb/ft²
- n = Manning's "n" value for block system
- V_{des} = Design velocity as defined by Equation 8.14 or 8.15, ft/s
- γ_w = Density of water, 62.4 lb/ft³ for fresh water
- y = Depth of flow at pier, ft
- K_u = 1.486 for English units, 1 for SI units

For pier scour applications, the angle θ_0 (bed slope) should be taken as the typical channel bed slope in the vicinity of the pier for use in the Factor of Safety equations. If the ACB system is toed down at a slope away from the pier (see Section 8.4.4 regarding layout details), then the angle θ_1 (side slope) should be taken as the lateral slope of the ACB system installation.

8.4.4 Layout Details for ACB Pier Scour Protection

Based on small-scale laboratory studies performed described in NCHRP Report 593, the optimum performance of ACBs as a pier scour countermeasure was obtained when the blocks were extended a distance of at least two times the pier width in all directions around the pier. Where only local scour is present, the ACB system may be placed horizontally such that the top of the blocks are flush with the bed elevation, with turndowns provided at the system periphery. However, when other processes or types of scour are present, **the block system must be sloped away from the pier in all directions such that the depth of the system at its periphery is greater than the maximum scour which for this application is considered to be the depth of contraction scour and long-term degradation, or the depth of bedform troughs, whichever is greater (Figure 8.10)**. The blocks should not be laid on a slope steeper than 1V:2H (50%). In some cases, this limitation may result in blocks being placed further than two pier widths away from the pier.

Methods of predicting bedform geometry can be found in Karim (1999) and van Rijn (1984). An upper limit on crest-to-trough height Δ is provided by Bennet (1997) as $\Delta < 0.4y$ where y is the depth of flow. This guidance suggests that the maximum depth of the bedform trough below ambient bed level is approximately 0.2 times the depth of flow.

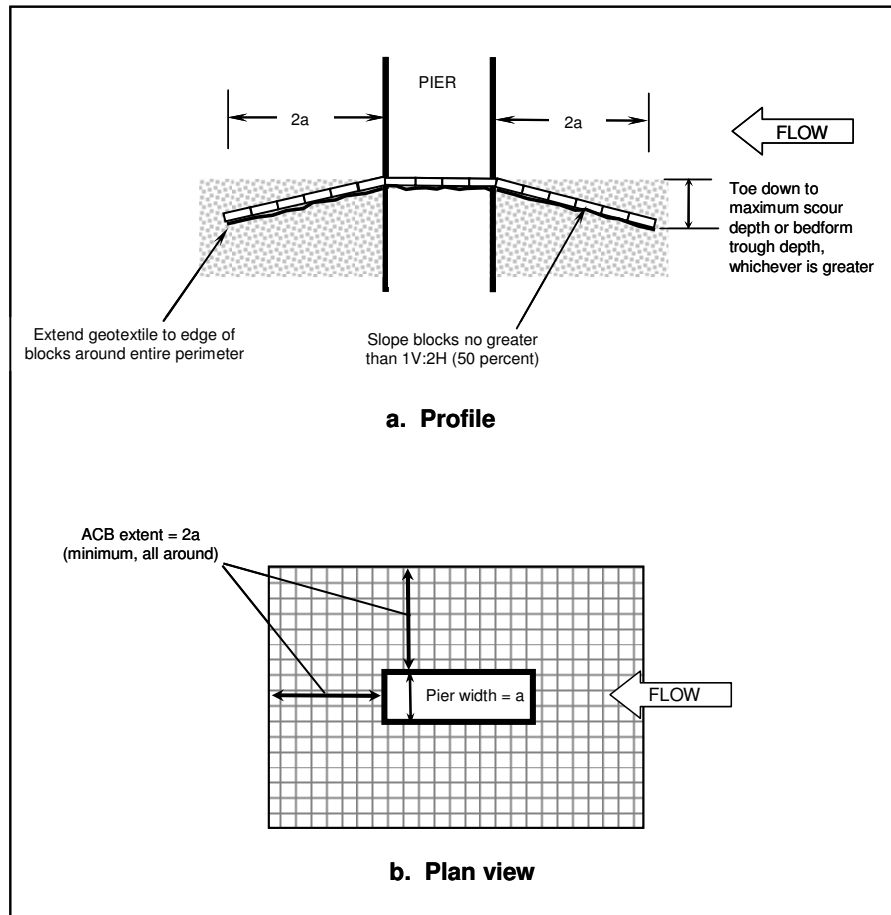

Figure 8.10. ACB layout diagram for pier scour countermeasures.

In the case of wall piers or pile bents consisting of multiple columns where the axis of the structure is skewed to the flow direction, the lateral extent of the protection should be increased in proportion to the additional scour potential caused by the skew. Therefore, in the absence of definitive guidance for pier scour countermeasures, it is recommended that the extent of the armor layer should be multiplied by a factor K_α , which is a function of the width (a) and length (L) of the pier (or pile bents) and the skew angle (α) as given below (after Richardson and Davis 2001):

$$K_\alpha = \left(\frac{a \cos \alpha + L \sin \alpha}{a} \right)^{0.65} \quad (8.17)$$

8.4.5 Filter Requirements

A filter is typically required for articulating concrete block systems at bridge piers. The filter should be extended fully beneath the ACB system. When using a granular stone filter, the layer should have a minimum thickness of 4 times the d_{50} of the filter stone or 6 inches, whichever is greater. The d_{50} size of the granular filter should be greater than one half the smallest dimension of the open cells of the system. When placing a granular filter under water, its thickness should be increased by 50%. When placing a geotextile filter under

water, the geotextile should be securely attached to the bottom of the pre-assembled ACB mat prior to lifting with crane and spreader bar. In shallow water where velocities are low, the geotextile may be placed under water and held in place temporarily with weights until the blocks are placed. Detailed procedures for filter design are presented in Design Guide 16 of this document.

As with ACB bank revetment, in cases where dune-type bedforms may be present, it is strongly recommended that only a geotextile filter be considered for use at bridge piers.

8.4.6 Guidelines for Seal Around a Pier

An observed point of failure for articulating block systems at bridge piers occurs at the seal where the mat meets the bridge pier. During NCHRP Projects 24-07, securing the geotextile to the pier prevented the leaching of the bed material from around the pier (Parker et al. 1998). During flume studies at the University of Windsor (McCorquodale 1993) and for the NCHRP Project 24-07(2) study (Lagasse et al. 2007), the mat was grouted to the pier.

A grout seal is not intended to provide a structural attachment between the mat and the pier, but instead is a simple method for plugging gaps to prevent bed sediments from winnowing out from beneath the system. In fact, structural attachment of the mat to the pier is strongly discouraged. The transfer of moments from the mat to the pier may affect the structural stability of the pier, and the potential for increased loadings on the pier must be considered. When placing a grout seal under water, an anti-washout additive is required.

The State of Minnesota Department of Transportation (MnDOT) has installed a cabled ACB mat system for a pier at TH 32 over Clearwater River at Red Lake Falls, Minnesota. MnDOT suggested that the riverbed could be excavated around the piers to the top of the footing. The mat could be put directly on top of the footing and next to the pier with concrete placed underneath, on top of, or both, to provide a seal between mat and pier.

The State of Maine Department of Transportation (MDOT) has designed an articulating block system for a pier at Tukey's Bridge over Back Cove. MDOT recommended a design in which grout bags were placed on top of the mat at the pier location to provide the necessary seal.

8.5 ANCHORS

MnDOT also recommends the use of anchors when installing a cabled ACB mattress, although as discussed in Section 8.3, no additional stability is attributed to the cables themselves. MnDOT requires duckbill-type soil anchors placed 3 to 4 feet deep at the corners of the ACB mattresses, and at regular intervals of approximately 8 feet on center-to-center spacing throughout the area of the installation.

In reality, if uplift forces on a block system were great enough to create tension in the cables, then soil anchors could provide a restraining force that is transmitted to a group of blocks in the matrix. Using the same reasoning, anchors would be of no use in an uncabled system, unless there was a positive physical vertical interlock from block to block in the matrix. It should be noted that the stability analysis procedure presented in Section 8.3.1 is intended to ensure that uplift forces do not exceed the ACB system's capability, irrespective of cables.

The layout guidance presented in Section 8.4 indicates that the system should be toed down to a termination depth at least as deep as any expected contraction scour and long-term degradation, or bed form troughs, whichever is greater. Where such toe down depth cannot be achieved, for example where bedrock is encountered at shallow depth, a cabled system with anchors along the front (upstream) and sides of the installation is recommended. The spacing of the anchors should be determined based on a factor of safety of at least 5.0 for pullout resistance based on calculated drag on the exposed leading edge. Spacing between anchors of no more than 4 feet (1.3 m) is recommended. The following example is provided:

Given:

ρ	=	Mass density of water (slugs/ft ³)	1.94
V	=	Approach velocity (ft/s)	10
Δz	=	Height of block system (ft)	0.5
b	=	Width of block installation (perpendicular to flow) (ft)	40

Step 1: Calculate total drag force F_d on leading edge of system:

$$F_d = 0.5\rho V^2(\Delta z)(b) = 0.5(1.94)(10^2)(0.5)(40) = \mathbf{1,940 \text{ lbs}}$$

Step 2: Calculate required uplift restraint using 5.0 safety factor:

$$F_{\text{restraint}} = 5.0(1,940) = \mathbf{9,700 \text{ lbs}}$$

Step 3: Counting anchors at corners of system, calculate required pullout resistance per anchor (rounded to the nearest 10 lb):

- a) Assume 11 anchors at 4 ft spacing: 9,700 lb/11 anchors = **880 lb/anchor**
- b) Assume 21 anchors at 2 ft spacing: 9,700 lb/21 anchors = **460 lb/anchor**

Anchors should never be used as a means to avoid toeing the system down to the full required extent where alluvial materials are present at depth. In this case, scour or bed form troughs will simply undermine the anchors as well as the system in general.

8.6 REFERENCES

ASTM International, 2005, "Standard D6684 – Specification for the Materials and Manufacture of Articulating Concrete Block Revetment Systems," West Conshohocken, PA.

ASTM International, 2008, "Standard D7277 – Standard Test Method for Performance Testing of Articulating Concrete Block (ACB) Revetment Systems for Hydraulic Stability in Open Channel Flow," West Conshohocken, PA.

Bennett, J.P., 1997, "Resistance, Sediment Transport, and Bedform Geometry Relationships in Sand-Bed Channels," in: Proceedings of the U.S. Geological Survey (USGS) Sediment Workshop, February 4-7.

Clopper, P.E. and Chen, Y., 1988, "Minimizing Embankment Damage During Overtopping Flow," FHWA-RD-88-181, Office of Engineering and Highway Operations R&D, McLean, VA.

Clopper, P.E., 1989, "Hydraulic Stability of Articulated Concrete Block Revetment Systems During Overtopping Flow," FHWA-RD-89-199, Office of Engineering and Highway Operations R&D, McLean, VA.

Clopper, P.E., 1992, "Protecting Embankment Dams with Concrete Block Systems," *Hydro Review*, Vol. X, No. 2, April.

Harris County Flood Control District, 2001, "Design Manual for Articulating Concrete Block Systems," prepared by Ayres Associates, Project No. 32-0366.00, Fort Collins, CO

Julien, P.Y. 1995, Erosion and Sedimentation, Cambridge University Press, Cambridge, UK.

Karim, F., 1999, "Bed-Form Geometry in Sand-Bed Flows," *Journal of Hydraulic Engineering*, Vol. 125, No. 12, December.

Lagasse, et al., 2007, "Countermeasures to Protect Bridge Piers from Scour," NCHRP Report 593, Transportation Research Board, National Academies of Science, Washington, D.C.

Lagasse, P.F., Schall, J.D., and Richardson, E.V., 2001, "Stream Stability at Highway Structures," Third Edition, Hydraulic Engineering Circular No. 20, FHWA-NHI-01-002, Washington, D.C.

McCorquodale, J.A., Moawad, A., and McCorquodale, A.C., 1993, "Cable-tied Concrete Block Erosion Protection," *Hydraulic Engineering '93*, San Francisco, CA, Proceedings (1993), pp. 1367-1362.

Parker, G., Toro-Escobar, C., and Voight, R.L., Jr., 1998, "Countermeasures to Protect Bridge Piers from Scour," User's Guide, Vol. 1, prepared for National Cooperative Highway Research Program, Transportation Research Board, National Research Council, NCHRP Project 24-7, St. Anthony Falls Laboratory, University of Minnesota, Minneapolis, MN (revised 7/1/99).

Parker, G., Toro-Escobar, C., and Voight, Jr., R.L., 1998, "Countermeasures to Protect Bridge Piers from Scour," Final Report, Vol. 2, prepared for National Cooperative Highway Research Program, Transportation Research Board, National Research Council, NCHRP Project 24-7, St. Anthony Falls Laboratory, University of Minnesota, Minneapolis, MN.

Stevens, M.A. and Simons, D.B., 1971, "Stability Analysis for Coarse Granular Material on Slopes," In: *River Mechanics*, Shen, H.E. (ed.), Water Resources Publications, Fort Collins, CO.

Transportation Research Board, 1999, "1998 Scanning Review of European Practice for Bridge Scour and Stream Instability Countermeasures," National Cooperative Highway Research Program, Research Results Digest Number 241, July, Washington, D.C.

van Rijn, L.C., 1984, "Sediment Transport, Part III: Bed Forms and Alluvial Roughness," *Journal of Hydraulic Engineering*, Vol. 110, No. 12, December.

DESIGN GUIDELINE 9
GROUT-FILLED MATTRESSES

(Page intentionally left blank)

DESIGN GUIDELINE 9

GROUT-FILLED MATTRESSES

9.1 INTRODUCTION

Grout-filled mattresses (mats) are comprised of a double layer of strong synthetic fabric, typically woven nylon or polyester, sewn into a series of pillow-shaped compartments that are connected internally by ducts. The compartments are filled with a concrete grout that flows from compartment to compartment via the ducts. Mats are typically sewn together or otherwise connected (less commonly) by special zips, straps, or ties prior to filling.

When set, the grout forms a mat made up of a grid of interconnected blocks. Grout-filled mats are reinforced by cables laced through the mat (Figure 9.1) before the concrete is pumped into the fabric form, creating what is often called an articulating block mat (ABM). Flexibility and permeability are important functions for stream instability and bridge scour countermeasures. Therefore, systems that incorporate filter points or weep holes (allowing for pressure relief across the mat) combined with relatively small-diameter ducts (to allow breakage and articulation between the grout blocks) are the preferred products. This design guideline considers two applications of grout-filled mattresses: Application 1 – bank revetment and bed armor; and Application 2 – pier scour protection.

Grout-filled mat systems can range from very smooth, uniform surface conditions that approach cast-in-place concrete in terms of surface roughness, to extremely irregular surfaces exhibiting the roughness of moderate size rock riprap. Because this type of revetment is fairly specialized, comprehensive technical information on specific mat types and configurations is available from a number of manufacturers of this type of revetment. Mats are typically available in standard nominal thicknesses of 4, 6, and 8 in. (100, 150, and 200 mm). A few manufacturers produce mats up to 12 in. (300 mm) thick.

There is limited field experience with the use of grout-filled mat systems as a scour countermeasure for bridge piers. More frequently, these systems have been used for shoreline protection, protective covers for underwater pipelines, bridge abutment spill slopes, and channel armoring where the mat is placed across the entire channel width and keyed into bridge abutments or stream banks. The guidance for pier scour applications provided in this document has been developed primarily from NCHRP Report 593 (Lagasse et al. 2007).

The benefits of grout-filled mats are that the fabric installation can be completed quickly, without the need for dewatering. Because of the flexibility of the fabric prior to filling, laying out the forms and pumping them with concrete grout can be performed in areas where room for construction equipment is limited. Figure 9.2 shows the inspection of a completed installation at an abutment with limited clearance.

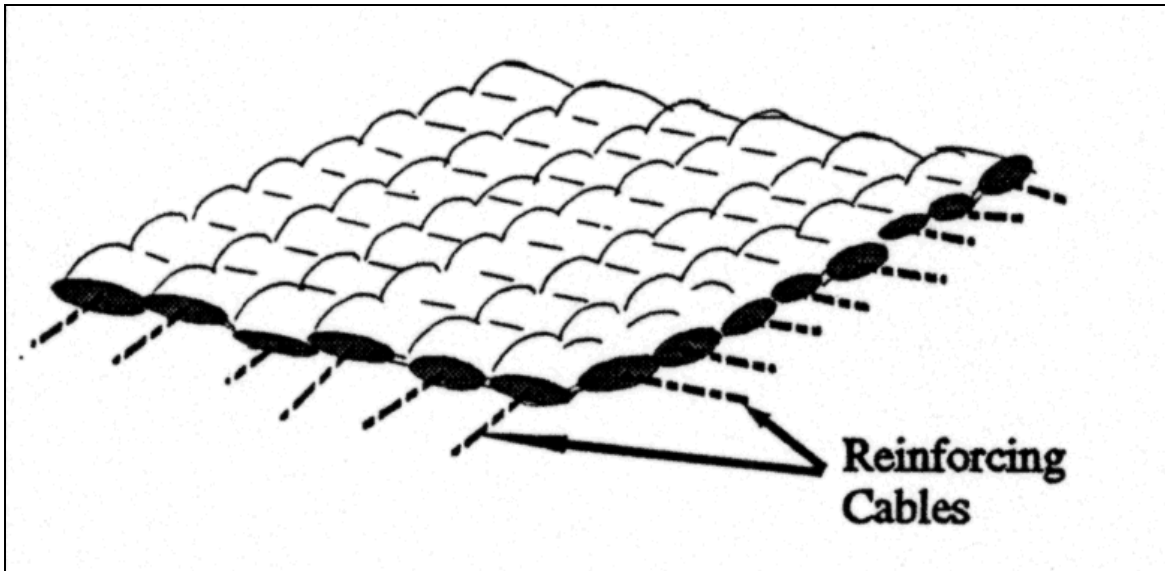

Figure 9.1. Grout-filled mat with reinforcing cables (Fotherby 1995).



Figure 9.2. Grout-filled mat used for scour protection at a bridge abutment.

9.2 MATERIALS

9.2.1 Geotextile Form

The geotextile comprising the fabric form must exhibit sufficient strength to resist the pressure of the grout during filling. Cords connect the upper layer of fabric to the lower layer at the center of each compartment. The cords are interwoven with the fabric in two sets of four cords each, one set for the upper layer and one set for the lower layer. Typical strength requirements call for each cord to have a minimum breaking strength of 160 lbs.

The grout-filled ducts should be no more than 10% of the maximum thickness of the block compartment so that flexibility and articulation can be achieved in the finished installation. Cables enter and exit each compartment through opposing grout ducts; alternatively, cable ducts may be provided for insertion of cables through each compartment. When cable ducts are used, the maximum allowable diameter should be limited to 1.0 in. (25 mm).

The geotextile comprising the fabric form should meet or exceed the values shown for the properties in Table 9.1 (Iowa Department of Transportation 2004).

Property	Test Method	Units	Value
Composition			Nylon or polyester
Mass per unit area (double layer)	ASTM D 5261	oz/yd ² (g/m ²)	12 (403)
Thickness	ASTM D 5199	mils (mm)	25 (0.6)
Mill width		in (m)	76 (1.92)
Wide-width tensile strength (Machine direction)	ASTM D 4595	lbf/in (kN/m)	140 (24.5)
(Cross direction)	ASTM D 4595	lbf/in (kN/m)	110 (19.3)
Elongation at break (Machine direction)	ASTM D 4595	%	20
(Cross direction)	ASTM D 4595	%	30
Wide-width tensile strength (Machine direction)	ASTM D 4533	lbf (N)	150 (665)
(Cross direction)	ASTM D 4533	lbf (N)	100 (445)
Apparent Opening Size	ASTM D 4751	US Std Sieve (mm)	40 (0.425)
Flow Rate	ASTM D 4491	gal/min/ft ² (l/min/m ²)	90 (3665)
Notes: 1. Conformance of fabric to specification property requirements per ASTM D 4759 2. Numerical values represent minimum average roll values (MARV). Lots shall be sampled per ASTM D 4354.			

9.2.2 Cables

Cables are installed between the two layers of fabric prior to filling with grout. The cables run through the individual compartments in a manner that provides for both lateral and longitudinal connection. The cables enter and exit the compartments through opposing grout ducts. Cables should be high tenacity, low elongation continuous filament polyester fibers, with a core contained within an outer jacket. The core should be between 65 to 75% of the total weight of the cable.

Cable splices are made with aluminum compression fittings such that a single fitting results in a splice strength of 80% of the breaking strength of the cable. Two fittings separated by a minimum of 6 in. (150 mm) should be used per splice. When the installation is completed, the cables and splices are completely encased by the concrete grout.

9.2.3 Grout

The concrete grout consists of a mixture of Portland cement, fine aggregate, water, admixtures, and fly ash (optional) to provide a pumpable slurry. The grout should have an air content of not less than 5% nor more than 8% of the volume of the grout, and should obtain a minimum 28-day compressive strength of 2,000 lb/in² (13,750kPa). The mix should result in a dry unit weight of the cured concrete of no less than 130 lb/ft³ (2,080 kg/m³). Prior to installation, the grout should be tested for flowability using the flow cone method of ASTM D 6449, with an efflux time not less than 9 seconds nor more than 12 seconds using this method.

The Engineer may require adjustment of the mix proportions to achieve proper solids suspension and optimum flowability. After the mix has been designated, it may not be changed without approval of the Engineer. A recommended basic mix design consists of the following:

Cement: Cement shall be Portland Type I or Type II, at the rate of 10 sacks (940 pounds) per cubic yard.

Fly Ash: Fly ash may be substituted for cement for up to 25% by weight (mass) of cement.

Fine Aggregate: Fine aggregate 2100 pounds (surface dry weight) per cubic yard.

Water: 45 gallons (375 pounds) per cubic yard, or enough to provide a thick creamy consistency.

Air-entraining Admixtures: Air-entraining admixtures may be required to achieve the required air content.

Liquid Curing Compounds: Liquid curing compounds may be required to achieve the required strength and set time.

9.2.4 Grout-Filled Mat

When installed, the grout-filled mat shall exhibit the nominal properties shown in Table 9.2.

Table 9.2. Nominal Properties of Grout-Filled Mats.			
Property	4-inch Mat	6-inch Mat	8-inch Mat
Average thickness, in.	4	6	8
Mass per unit area, lb/ft ²	45	68	90
Mass per individual compartment, lb	88	188	325
Nominal dimensions of individual compartment, in.	20x14	20x20	20x26
Cable diameter, in.	0.25	0.312	0.312
Cable breaking strength, lbf	3,700	4,500	4,500

Flexibility of the grout-filled mats is a major factor in the successful performance of these systems. The ability to adjust to differential settlement, frost heave, or other changes in the subgrade is desirable. For example, settlement around the perimeter of a grout-filled mat at a bridge pier is beneficial if scour occurs around the periphery of the mat. Some mat products are more rigid than others, and are therefore more prone to undermining and subsequent damage. Rigid systems are less suitable, in general, for use as bank protection or as a bridge scour countermeasure. Designers are encouraged to familiarize themselves with the flexibility and performance of various grout-filled mat materials and products for use in riverine environments.

9.3 APPLICATION 1: HYDRAULIC DESIGN PROCEDURE FOR GROUT-FILLED MATS FOR BANK REVETMENT OR BED ARMOR

9.3.1 Hydraulic Stability Design Procedure

Hydrodynamic forces of drag and lift both act to destabilize a grout-filled mattress. These destabilizing forces are resisted by the weight of the mat and the frictional resistance between the bottom of the grout-filled mat and the channel subgrade material. While the individual compartments may articulate within the mat and the mat remains structurally sound, the general design approach is to consider the mat as a rigid monolithic layer. This reflects the mode of failure observed at field installations, which is typically a sliding-type failure. In the following analysis, it is assumed that potential uplift force due to soil water pressure beneath the mat is negligible, or alternatively, that allowance for pressure relief has been made by installing weep holes or selecting a mat system manufactured with integral filter points between the individual compartments.

Grout-filled mat selection and sizing criteria are based on an analysis of sliding stability of the mat on the subgrade. In general, the sliding safety factor (SF) is a ratio of forces resisting sliding to forces causing sliding to occur. Figure 9.3 presents a schematic diagram of the forces acting to destabilize a grout-filled mat on a channel bank. The analysis methodology purposely omits any restraining forces due to cables or the additional stability afforded by mechanical anchoring devices for the sake of conservatism in design.

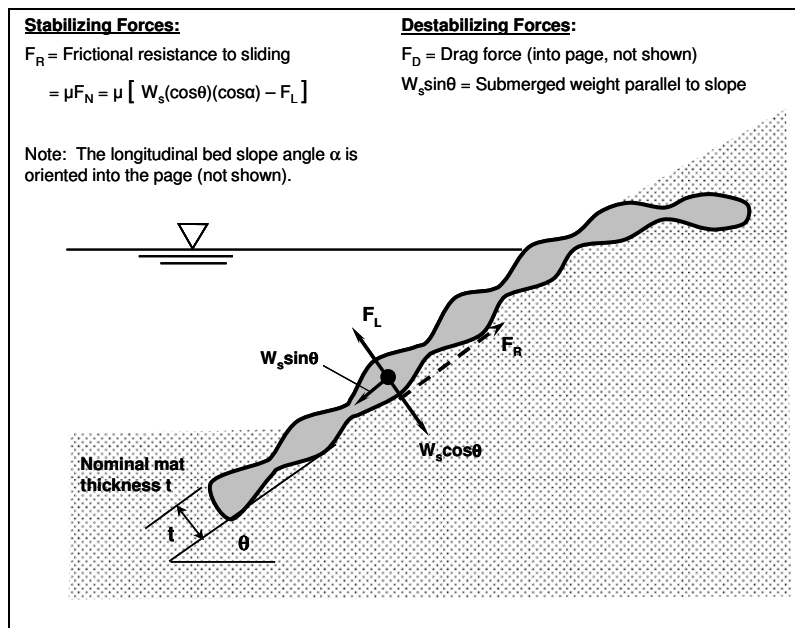

Figure 9.3. Forces acting on a grout-filled mat on a channel side slope.

9.3.2 Selecting a Target Factor of Safety

The designer must determine what factor of safety should be used for a particular application. Typically, a minimum allowable factor of safety of 1.2 is used for revetment (bank protection) when the project hydraulic conditions are well known and the installation can be conducted under well-controlled conditions. Higher factors of safety are typically used for protection at bridge piers, abutments, and at channel bends due to the complexity in computing hydraulic conditions at these locations.

The Harris County Flood Control District, Texas (HCFCD 2001) has developed a simple flow chart approach that considers the type of application, uncertainty in the hydraulic and hydrologic models used to calculate design conditions, and consequences of failure to select an appropriate target factor of safety to use when designing various types of Articulating Concrete Block (ACB) installations. In this approach, the minimum allowable factor of safety for ACBs at bridge piers, for example, is 1.5. This base value is then multiplied by two factors, each equal to or greater than 1.0, to account for risk and uncertainty. Figure 9.4 shows the HCFCD flow chart method. The method is also considered appropriate for grout-filled mats, since the design method results in a calculated safety factor.

9.3.3 Design Procedure

For grout-filled mats placed on channel beds or banks, the shear stress on the mattress is calculated as follows:

$$\tau_{des} = K_b \gamma y S_f \quad (9.1)$$

where:

- τ_{des} = Design shear stress, lb/ft²
- K_b = Bend coefficient (dimensionless)
- γ = Unit weight of water, 62.4 lb/ft³
- y = Maximum depth of flow on revetment, ft
- S_f = Slope of the energy grade line, ft/ft

The bend coefficient K_b is used to calculate the increased shear stress on the outside of a bend. This coefficient ranges from 1.05 to 2.0, depending on the severity of the bend. The bend coefficient is a function of the radius of curvature R_c divided by the top width of the channel T , as follows:

$$\begin{aligned} K_b &= 2.0 && \text{for } 2 \geq R_c/T \\ K_b &= 2.38 - 0.206 \left(\frac{R_c}{T} \right) + 0.0073 \left(\frac{R_c}{T} \right)^2 && \text{for } 10 > R_c/T > 2 \\ K_b &= 1.05 && \text{for } R_c/T \geq 10 \end{aligned} \quad (9.2)$$

The equation representing the ratio of stabilizing to destabilizing forces on a mat tending to slide is:

$$F.S. = \left[\frac{(\mu)(t)(\gamma_c - \gamma_w) \cos \theta \cos \alpha - \tau_{des}}{\sqrt{[t(\gamma_c - \gamma_w) \sin \theta]^2 + (\tau_{des})^2}} \right] \quad (9.3)$$

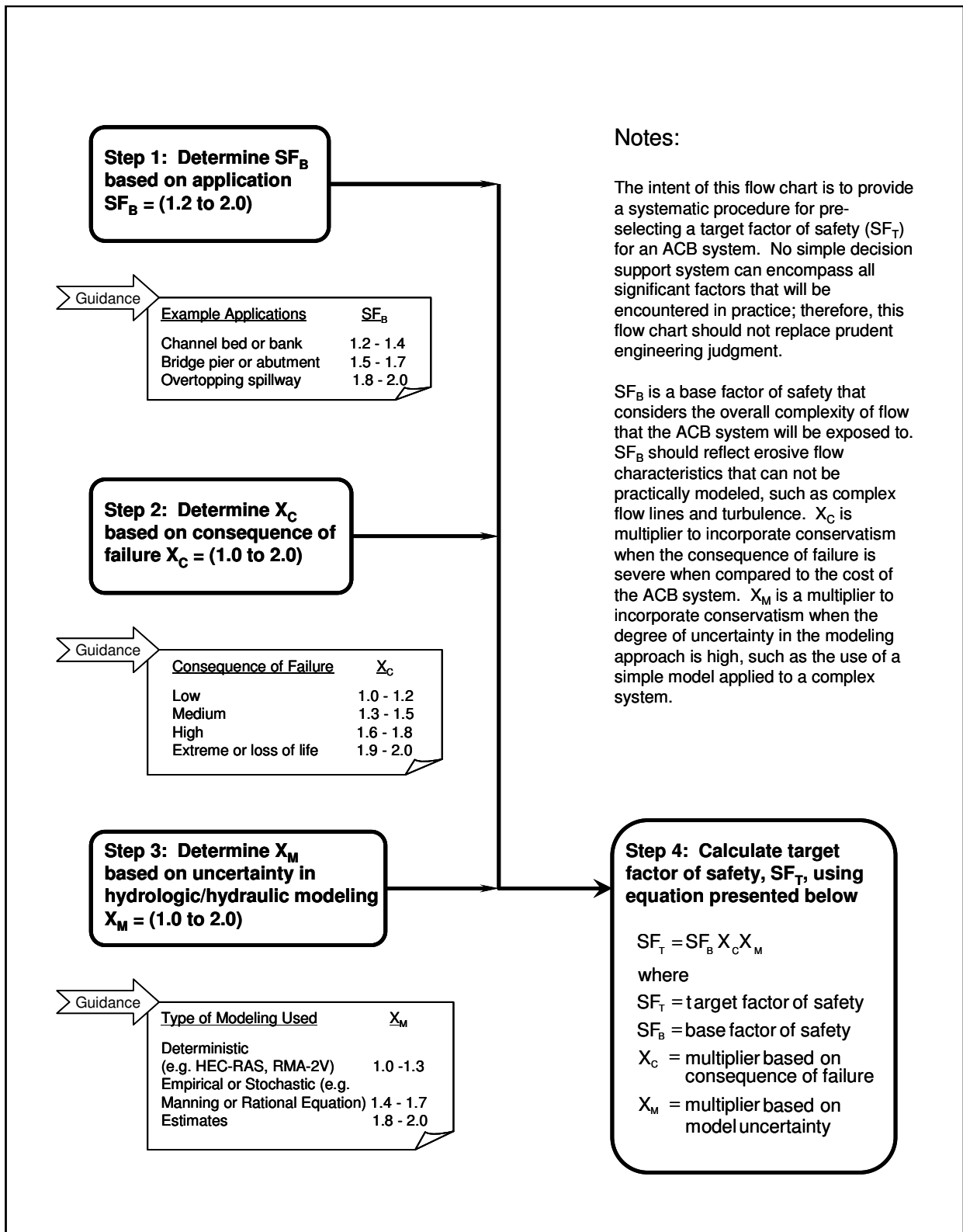

Figure 9.4. Selecting a target factor of safety (from HCFCD 2001).

where:

F.S.	=	Factor of Safety against sliding
μ	=	Coefficient of static friction (dimensionless)
t	=	Thickness of grout mat, ft
γ_c	=	Unit weight of grout, lb/ft ³
γ_w	=	Unit weight of water, 62.4 lb/ft ³
α	=	Angle of bed slope, degrees
θ	=	Angle of side slope, degrees
τ_{des}	=	Design shear stress on mat, lb/ft ²

In Equation 9.3, both the lift and drag forces are assumed equal to the applied shear stress τ_{des} . Note that for mats placed only on the channel bed, the side slope angle θ is zero, and Equation 9.3 reduces to:

$$F.S. = \left[\frac{(\mu)(t)(\gamma_c - \gamma_w) \cos \alpha - \tau_{des}}{\tau_{des}} \right] \quad (9.4)$$

In practice, the coefficient of static friction μ depends on the characteristics of the mat-subsoil interface, which is a function of the mat geometry, geotextile, soil type, and degree to which the mat can be seated into the subsoil to achieve intimate contact. Manufacturers typically supply the value of μ for use with their various products for different soil types. These design values may often be quoted as an equivalent friction angle δ , expressed in degrees. The relationship between μ and δ is:

$$\mu = \tan \delta \quad (9.5)$$

Typical values of the friction angle δ for grout-filled mats range from 25° on non-cohesive soils to as great as 45° on cohesive silts and clays. However, for mats underlain by a filter fabric, a maximum friction angle of 32.5° on cohesive soils is suggested for design (Bowser-Morner Associates Inc., 1989).

Manufacturers should also supply the appropriate Manning's n resistance coefficient for each product. Grout-filled mat systems can range from very smooth, uniform surface conditions approaching cast in place concrete in terms of surface roughness, to extremely irregular surfaces exhibiting substantial projections into the flow, resulting in boundary roughness approaching that of moderately-sized rock riprap.

Fabric forms might be considered to serve as filters as well as forms (Sprague and Koutsourais 1992). Water in the grout mix will bleed through the fabric, producing a reduction in the water/cement ratio, which increases strength and durability. The cement film provides a bond between the concrete fill and the fabric, as well as a degree of protection against ultraviolet degradation. *However, in view of the long-term performance that grout filled mats must provide, performance should not depend on the fabric form material, but instead upon the weight and durability of the (cured) concrete grout, its cabled connections, and its ability to articulate, combined with the effectiveness of the underlying filter.*

9.3.4 Layout Details for Grout-filled Mat Bank Revetment and Bed Armor

Longitudinal Extent: The revetment armor should be continuous for a distance which extends both upstream and downstream of the region which experiences hydraulic forces severe enough to cause dislodging and/or transport of bed or bank material. The minimum distances recommended are an upstream distance of 1.0 channel width and a downstream distance of 1.5 channel widths. The channel reach that experiences severe hydraulic forces is usually identified by site inspection, examination of aerial photography, hydraulic modeling, or a combination of these methods.

Many site-specific factors have an influence on the actual length of channel that should be protected. Factors that control local channel width (such as bridge abutments) may produce local areas of relatively high velocity and shear stress due to channel constriction, but may also create areas of ineffective flow further upstream and downstream in "shadow zone" areas of slack water. In straight reaches, field reconnaissance may reveal erosion scars on the channel banks that will assist in determining the protection length required.

In meandering reaches, since the natural progression of bank erosion is in the downstream direction, the present limit of erosion may not necessarily define the ultimate downstream limit. FHWA's Hydraulic Engineering Circular No. 20, "Stream Stability at Highway Structures" (Lagasse et al. 2001b) provides guidance for the assessment of lateral migration. The design engineer is encouraged to review this reference for proper implementation.

Vertical Extent. The vertical extent of the revetment should provide freeboard above the design water surface. A minimum freeboard of 1 to 2 ft should be used for unconstricted reaches and 2 to 3 ft for constricted reaches. If the flow is supercritical, the freeboard should be based on height above the energy grade line rather than the water surface. **The revetment system should either cover the entire channel bottom or, in the case of unlined channel beds, extend below the bed far enough so that the revetment is not undermined from maximum scour which for this application is considered to be toe scour, contraction scour, and long-term degradation (Figure 9.6).**

Recommended revetment termination at the top and toe of the bank slope are provided in Figures 9.5 and 9.6 for armored-bed and soft-bottom channel applications, respectively. Similar termination trenches are recommended for the upstream and downstream limits of the grout-filled mat revetment.

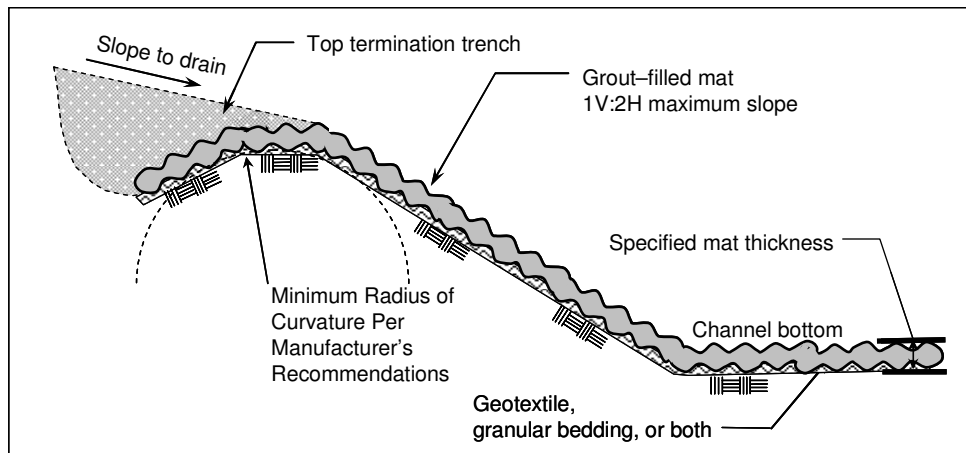

Figure 9.5. Recommended layout detail for bank and bed armor.

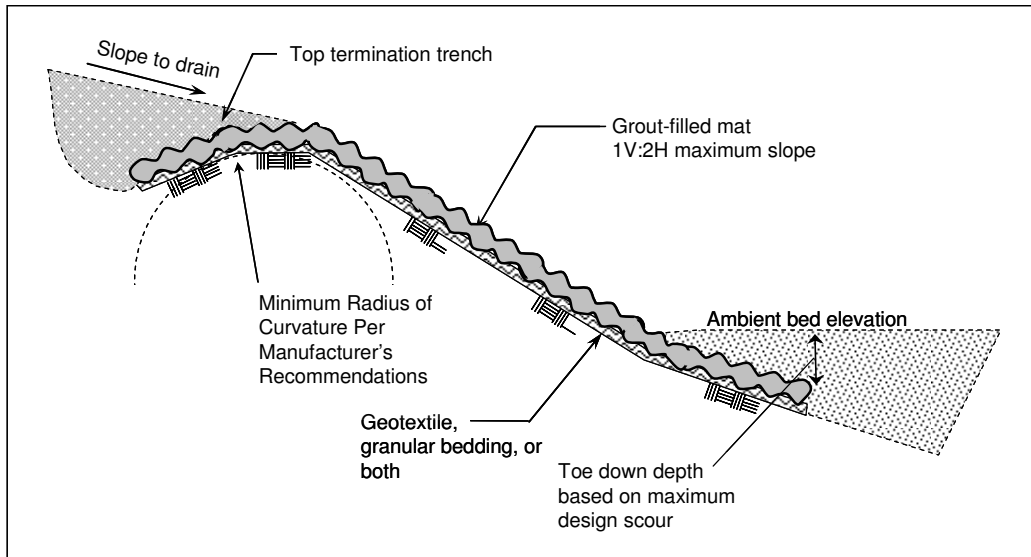

Figure 9.6. Recommended layout detail for bank revetment where no bed armor is required.

9.3.5 Grout-filled mat Design Example

The following example illustrates the grout-filled mat design procedure using the method presented in Section 9.3.3. The example is presented in a series of steps that can be followed by the designer in order to select the appropriate thickness of the grout-filled mat based on a pre-selected target factor of safety. The primary criterion for product selection is that the computed factor of safety for the armor meets or exceeds the pre-selected target value. This problem is presented in English units only because grout-filled mattresses in the U.S. are manufactured and specified in units of inches and pounds.

Problem Statement:

A grout-filled mat system is proposed to arrest lateral migration on the outside of a bend. The channel banks are cohesive, and the grout-filled mat will be placed on a properly selected nonwoven geotextile. The channel dimensions and design hydraulic conditions are given in Table 9.3.

Table 9.3. Channel Conditions for Grout-filled Mat Bank Revetment.	
Channel discharge Q (ft^3/s)	4,500
Cross section average velocity V_{ave} (ft/s)	8.7
Maximum depth y (ft)	5.0
Side slope, V:H	1V:3H (or 18.4°)
Bed slope S_o (ft/ft)	0.005 (or 0.3°)
Slope of energy grade line S_f (ft/ft)	0.005 (or 0.3°)
Channel top width T (ft)	120
Radius of curvature R_c (ft)	750

Step 1. Determine a target factor of safety for this project:

Use Figure 9.4 to compute a target factor of safety. For this example, a target factor of safety of 1.7 is selected as follows:

- A base safety factor SF_B of 1.3 is chosen because the river is sinuous and high velocities can be expected on the outside of bends.
- The base safety factor is multiplied by a factor for the consequence of failure X_C using a value of 1.3, since at this location the consequence of failure is ranked as "low" to "medium."
- The uncertainty associated with the hydrology and hydraulic analysis is considered "low" for this site, based on available hydrologic and hydraulic data.

The target factor of safety for this project site is calculated as:

$$SF_T = (SF_B)(X_C)(X_M) = (1.3)(1.3)(1.0) = 1.7$$

Step 2. Calculate design shear stress

The maximum bed shear stress at the cross section is calculated using Equation 9.1:

$$\tau_{des} = K_b(\gamma)(y)(S_i)$$

First calculate K_b using Equation 9.2:

$$\text{Since } R_c/T = 750/120 = 6.25$$

$$K_b = 2.38 - 0.206(6.25) + 0.0073(6.25)^2 = 1.38$$

$$\text{so } \tau_{des} = 1.38 (62.4 \text{ lb/ft}^3) (5.0 \text{ ft}) (0.005 \text{ ft/ft}) = 2.15 \text{ lb/ft}^2$$

Step 3. Determine the appropriate friction angle

Since the bank soil is cohesive and the grout-filled mat is to be placed on a geotextile filter, a friction angle of 32.5° is selected based on the discussion in Section 9.3.3. Using Equation 9.5, the coefficient of static friction μ is determined from the friction angle:

$$\mu = \tan(32.5^\circ) = 0.64$$

Note: Alternatively, laboratory testing can be performed to determine a specific friction angle using the site-specific soil with the proposed geotextile and the specific fabric used in the manufacture of the mat.

Step 4. Calculate safety factors for various mat thicknesses

From Equation 9.3,

$$F.S. = \left[\frac{(\mu)(t)(\gamma_c - \gamma_w)(\cos \theta)(\cos \alpha) - \tau_{des}}{\sqrt{[t(\gamma_c - \gamma_w)\sin \theta]^2 + (\tau_{des})^2}} \right]$$

Assuming a unit weight for grout of 130 lb/ft³, and substituting the known quantities for the unit weight of water (62.4 lb/ft³), the side slope and bed slope angles (θ and α), and the design shear stress (τ_{des}), the factor of safety equation for this application simplifies to:

$$F.S. = \left[\frac{(0.64)(t)(130 - 62.4)\cos(18.4^\circ)\cos(0.3^\circ) - 2.15}{\sqrt{[t(130 - 62.4)\sin(18.4^\circ)]^2 + (2.15)^2}} \right] = \frac{41(t) - 2.15}{\sqrt{455(t^2) + 4.62}}$$

Using nominal sizes of 4, 6, 8, and 12 in. (0.33, 0.5, 0.67, and 1.0 ft) for commercially-available grout-filled mats, the safety factors for this site-specific application are calculated as:

Mat thickness, inches (ft)	Factor of Safety
4 (0.33)	1.55
6 (0.50)	1.68
8 (0.67)	1.75
12 (1.0)	1.81

Step 5. Specify the grout-filled mat:

The calculated factor of safety for the 8-inch mat is larger than the site-specific target factor of safety of 1.7 for this project, therefore the 8-inch mat is specified. Material properties of the mat should be in accordance with the guidelines in Section 9.2 of this document. A filter should be provided beneath the grout-filled mat, designed in accordance with the procedures described in Design Guideline 16 of this document.

9.4 APPLICATION 2: HYDRAULIC DESIGN PROCEDURE FOR GROUT-FILLED MATS FOR PIER SCOUR PROTECTION

9.4.1 Hydraulic Stability Design Procedure

The hydraulic stability of grout-filled mats at bridge piers can be assessed using the factor of safety method as previously discussed. However, uncertainties in the hydraulic conditions around bridge piers warrant increasing the factor of safety in lieu of a more rigorous hydraulic analysis. Experience and judgment are required when quantifying the factor of safety to be used for scour protection at an obstruction in the flow. In addition, when both contraction scour and pier scour are expected, design considerations for a pier mat become more complex. The following guidelines reflect guidance from NCHRP Report 593, "Countermeasures to Protect Bridge Piers from Scour" (Lagasse et al. 2007).

9.4.2 Selecting a Target Factor of Safety

The issues involved in selecting a target factor of safety for designing grout-filled mats for pier scour protection are described in Section 9.3.2, and illustrated in flow chart fashion in Figure 9.4. Note that for bridge scour applications, the minimum recommended factor of safety is 1.5, as compared to a value of 1.2 for typical bank revetment and bed armor applications.

9.4.3 Design Method

It is important to note that the design conditions in the immediate vicinity of a bridge pier are more severe than the approach conditions upstream. Therefore, the local velocity and shear stress should be used in the design equations. As recommended in NCHRP Report 593 (Lagasse et al. 2007), the section-average approach velocity V must be multiplied by factors that are a function of the shape of the pier and its location in the channel:

$$V_{des} = K_1 K_2 V \quad (9.6)$$

where:

- V_{des} = Design velocity for local conditions at the pier, ft/s
- K_1 = Shape factor equal to 1.5 for round-nose piers and 1.7 for square-edged piers
- K_2 = Velocity adjustment factor for location in the channel (ranges from 0.9 for pier near the bank in a straight reach to 1.7 for pier located in the main current of flow around a sharp bend)
- V = Section average approach velocity (Q/A) upstream of bridge, ft/s

If the velocity distribution is available from stream tube or flow distribution output from a 1-D model, or directly computed from a 2-D model, then only the pier shape coefficient should be used to determine the design velocity. The maximum velocity in the active channel V_{max} is recommended since the channel could shift and the maximum velocity could impact any pier:

$$V_{des} = K_1 V_{max} \quad (9.7)$$

The local shear stress at the base of the pier, τ_{des} , is calculated using a rearranged form of Manning's equation:

$$\tau_{des} = \frac{\gamma_w}{y^{1/3}} \left(\frac{nV_{des}}{K_u} \right)^2 \quad (9.8)$$

where:

- τ_{des} = Applied shear stress, lb/ft²
- γ_w = Unit weight of water, 62.4 lb/ft³
- Y = Depth of flow at pier, ft
- N = Manning's n for the grout mattress
- K_u = 1.486 for English units

9.4.4 Layout Dimensions for Piers

Based on small-scale laboratory studies performed for NCHRP Project 24-07(2) (Lagasse et al. 2007), the optimum performance of grout-filled mats as a pier scour countermeasure was obtained when the mattresses were extended a distance of at least two times the pier width in all directions around the pier.

In the case of wall piers or pile bents consisting of multiple columns where the axis of the structure is skewed to the flow direction, the lateral extent of the protection should be increased in proportion to the additional scour potential caused by the skew. While there is no definitive guidance for pier scour countermeasures, it is recommended that the extent of the armor layer should be multiplied by a factor K_α , which is a function of the width (a) and length (L) of the pier (or pile bents) and the skew angle (α) as given below (after Richardson and Davis 2001):

$$K_\alpha = \left(\frac{a \cos \alpha + L \sin \alpha}{a} \right)^{0.65} \quad (9.9)$$

Grout-filled mats should be placed so that the long axis is parallel to the direction of flow. Where only local scour is present, the grout-filled mats may be placed horizontally such that the top of the mat is flush with the bed elevation; however, when other types of scour are present, **the mats must be sloped away from the pier in all directions such that the depth of the system at its periphery is greater than the maximum scour depth which for this application is considered to be contraction scour and long-term degradation (Figure 9.7)**. The mats should not be laid on a slope steeper than 1V:2H (50%). In some cases, this criterion may result in mats being placed further than two pier widths away from the pier.

Tests conducted under NCHRP Project 24-07(2) confirmed that grout filled mattresses can be effective scour countermeasures for piers under clear-water conditions. ***However, when dune-type bed forms were present, the mattresses were subject to both undermining and uplift, even when they were toed down below the depth of the bed form troughs. Therefore, grout-filled mattresses are not recommended for use as pier scour countermeasures under live-bed conditions where dunes may be present (Lagasse et al. 2007).***

A filter is typically required for grout-filled mats at bridge piers. The filter, whether geotextile or granular, should be extended fully beneath the grout-filled mat. When using a granular stone filter, the filter layer should have a minimum thickness of 4 times the d_{50} of the filter stone or 6 in., whichever is greater. The granular filter layer thickness should be increased by 50% when placing under water.

9.5 PLACING THE GROUT-FILLED MAT

9.5.1 General

Manufacturer's assembly instructions should be followed. Fabric forms should be placed on the filter layer and arranged according to the contract drawings prior to field seaming. *An excess of fabric should be included to allow for as much as a 10% contraction in size after filling of the fabric forms.* The manufacturer should be consulted to determine the amount of contraction anticipated for site specific conditions.

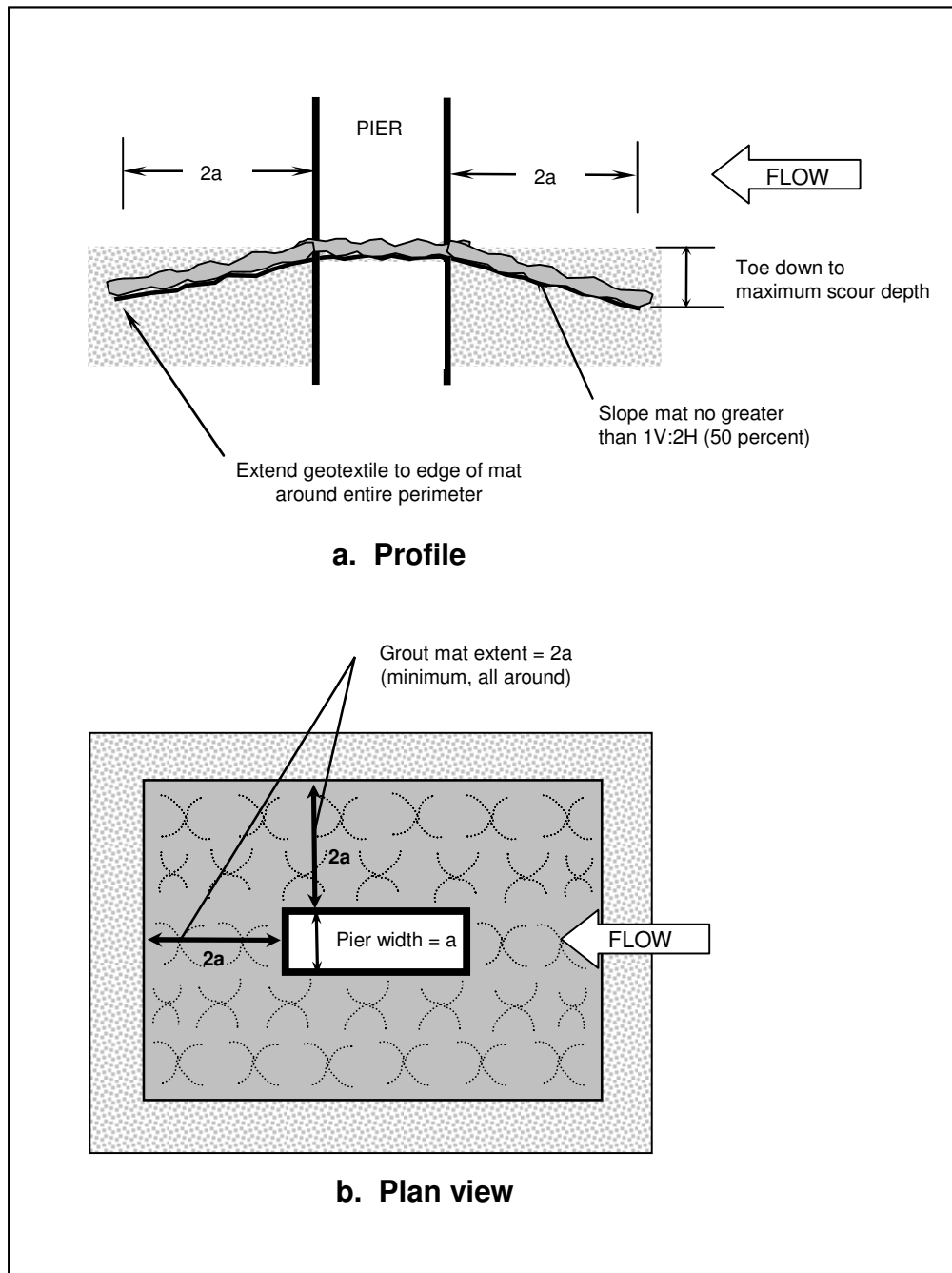

Figure 9.7. Suggested layout for grout-filled mats at bridge piers.

Fabric forms should be positioned so that the direction of grout placement shown on the contract drawing is followed, with the preferred direction being from upstream to downstream. Filling must always be performed from the lowest elevation first to the uppermost elevation last. Prior to filling, the double layers of adjacent mats should be connected by sewing with a hand held sewing machine or zipping, depending on manufacturers instructions. Custom fitting of mattresses around corners or curves should be done in accordance with the manufacturer's recommendations.

Care must be taken during installation so as to avoid damage to the geotextile or subgrade during the installation process. Preferably, the grout filled mat placement and filling should begin at the upstream section and proceed downstream. If a mat system is to be installed starting downstream and proceeding in the upstream direction, a contractor option is to construct a temporary toe trench at the front edge of the mat system to protect against flow which could otherwise undermine the system during flow events that may occur during construction. Only the amount of fabric forms that can be filled in a day should be laid into position. *After being filled with grout, the mattresses should not be pulled or pushed in any direction.*

9.5.2 Placement Under Water

Grout filled mattresses placed under water require close observation and increased quality control to ensure a continuous countermeasure system. A systematic process for placing and continuous monitoring to verify that the grout is flowing to achieve the desired thickness is important.

Excavation, grading, and placement of grout filled mattresses and filter under water require additional measures. For installations of a relatively small scale, diversion of the stream around the work area may be accomplished during the low flow season. For installations on larger rivers or in deeper water, the area can be temporarily enclosed by a cofferdam, which allows for construction dewatering if necessary. Alternatively, a silt curtain made of plastic sheeting may be suspended by buoys around the work area to minimize environmental degradation during construction. Once under water and in the correct positions, the individual fabric forms can be sewn together or otherwise connected by divers prior to filling with grout.

Depending on the depth and velocity of the water, sounding surveys using a sounding pole or sounding basket on a lead line, divers, sonar bottom profiles, and remote operated vehicles (ROV) can provide some information about the mat placement and toedown.

9.5.3 State DOT Installation Experience

A particular design called "articulating block mat" (ABM), used by the Oregon Department of Transportation, has two features which make it distinctive among fabric formed concrete mats. First, the horizontal seams within the mat are continuous, allowing the blocks to bend downward by hinging along this seam line. Second, the individual blocks are connected internally by a series of flexible polyester cables which keep the individual blocks firmly connected while allowing them to bend (Figure 9.8). Typical individual block sizes are on the order of 2.25 ft² to 4.0 ft² and the mass is approximately 400 lb each.

The following recommendations reflect experience from the Oregon Department of Transportation (ODOT) and Arizona Department of Transportation (ADOT). Research reports from an ODOT installation of an articulating grout filled mat erosion control system on Salmon Creek in Oakridge, Oregon also provide experience and insight on the use of these mats (Scholl 1991; Hunt 1993).

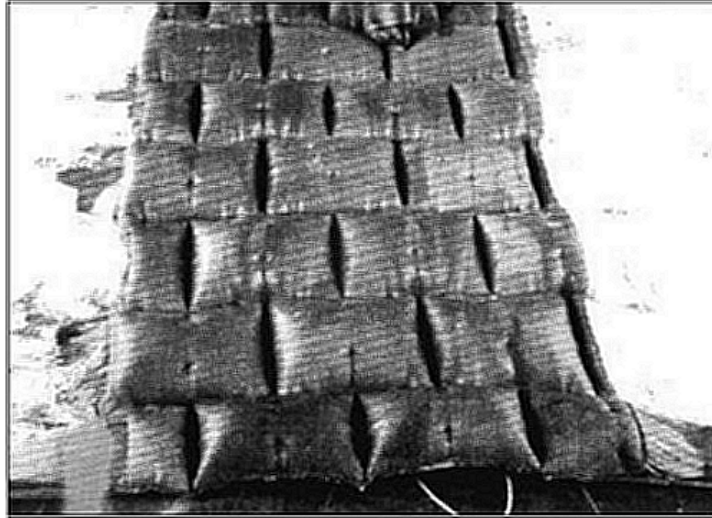

Figure 9.8. Articulating block mat appearance after filling (ODOT).

1. Both upstream and downstream ends of the mat should be trenched. The use of tension anchors can increase the stability of the mattress at the edges.
2. All edges should be keyed in and protected to prevent undermining and flow behind the mat.
3. At abutments, the mat can be wrapped around the abutment and buried to provide anchorage and to control flanking.
4. It is recommended that weep holes or "filter points" be provided within the fabric form to allow for proper drainage relief of pore pressure in the subgrade.
5. The mattress should be filled with portland cement slurry consisting of a mixture of cement, fine aggregate, and water. The mix should be in such proportion of water to be able to pump the mix easily. A recommended grout mix is presented in Section 9.2.
6. Fabric mats have been installed on slopes of 1V:1.5H or flatter.
7. Large boulders, stumps and other obstructions should be removed from slopes to be protected to provide a smooth application surface.
8. Use sand and gravel for any backfill required to level slopes. Silty sand is acceptable if silt content is 20% or less. Do not use fine silt, organic material or clay for backfill.
9. The grout injection sequence should proceed from toe of slope to top of slope, but the mat should be anchored at the top of slope first by pumping grout into the first rows of bags, by attaching the mat to a structure, or using tension anchors (see recommended injection sequence in Figure 9.9).
10. If the mat is to be permanently anchored to a pier or abutment, there are implications which must be considered when using this technique. The transfer of moments from the mat to the pier may affect the structural stability of the bridge. When the mat is attached to the pier the increased loadings on the pier must be investigated.
11. Curved edge designs may require communication with the fabric manufacturer on shaping limitations and field adjustments.
12. The need for a geotextile or granular filter should be addressed. Guidelines on the selection, design, and specifications of filter material can be found in Design Guideline 16.



Figure 9.9. Installation of articulating grout filled mat proceeding upslope (ODOT).

Scholl (1991) and Hunt (1993) describe some of the installation features specified by ODOT on the Salmon Creek Bridge as well as typical design features. For example, the original ODOT design was modified by the manufacturer due to the limitations of the product. The fabric forms could not be terminated in a smooth fan shaped pattern as shown in the original ODOT design. Therefore, the mat was cut at the seams to best fit the original design. It was anticipated that this would make the system somewhat less effective than the original design because of a greater susceptibility to undermining of the edges. Figures 9.10 and 9.11 show the final installation of the articulating block mat at Salmon Creek Bridge.

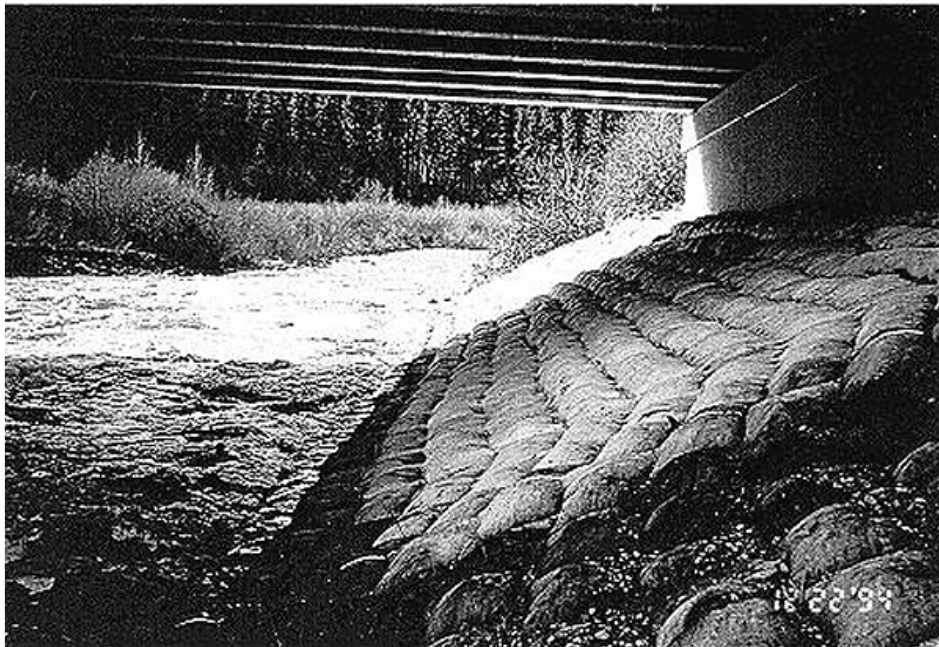

Figure 9.10. ABM underneath Salmon Creek Bridge (ODOT).



Figure 9.11. ABM installed on west bank of Salmon Creek (ODOT).

Some problems and solutions identified in the construction process by ODOT are:

- Problem:* In the original attempt to create a smooth working surface for laying the fabric, sand was placed over the native material. This was a problem because footprints readily disturbed the surface.
Solution: The native material (a gravelly sand) was used for the final surface by first clearing it of major rocks, then compacting it.
- Problem:* There was difficulty in estimating where the toe of the finished slope would be.
Solution: Assume that the fabric contracts by 10% in length after filling with grout.
- Problem:* It was difficult to maintain straight lines along the horizontal seams when pumping grout.
Solution: The fabric was kept straight by tying it to a series of #6 reinforcing bars.
- Problem:* Several of the bags were sewn in such a way that the grout ducts connecting them to the other bags were blocked off. This occurred mostly in areas where the bags were cut during fabrication to only 1/2 the original size.
Solution: The bags were split and filled individually. This should not affect the strength or function of the system.

9.6 FILTER REQUIREMENTS

9.6.1 General

The importance of the filter component of grout-filled mat installation should not be underestimated. Geotextile filters are most commonly used with grout-filled mats, although granular filters may be used. When using a granular stone filter, the layer should have a minimum thickness of 4 times the d_{50} of the filter stone or 6 in., whichever is greater. The d_{50} size of the granular filter should be determined by using the procedure presented in Design Guideline 16 of this document. When placing a granular filter under water, its thickness should be increased by 50%.

The filter must retain the coarser particles of the subgrade while remaining permeable enough to allow infiltration and exfiltration to occur freely. It is not necessary to retain all the particle sizes in the subgrade; in fact, it is beneficial to allow the smaller particles to pass through the filter, leaving a coarser substrate behind. Detailed aspects of filter design are presented in Design Guideline 16 of this document.

Some situations call for a composite filter consisting of both a granular layer and a geotextile. The specific characteristics of the base soil determine the need for, and design considerations of the filter layer. ***In cases where dune-type bedforms may be present, it is strongly recommended that only a geotextile filter be considered; furthermore, grout-filled mats are NOT recommended for use as an armor layer where dunes are expected.***

9.6.2 Placing a Filter Under Water

Sand-filled geotextile containers made of nonwoven needle punched fabric are particularly effective for placement under water. The fabric for the geotextile containers should be selected in accordance with the filter design criteria presented in Design Guideline 16, and placed such that the geotextile containers overlap to cover the required area. Geotextile containers can be fabricated in a variety of dimensions and weights. Each geotextile container should be filled with sand only to about two-thirds of the container's total volume so that it remains flexible and "floppy." The geotextile containers can also serve to fill a pre-existing scour hole around a pier prior to placing the grout-filled mats, as shown in Figure 9.12. For more detail, see Lagasse et al. (2007).

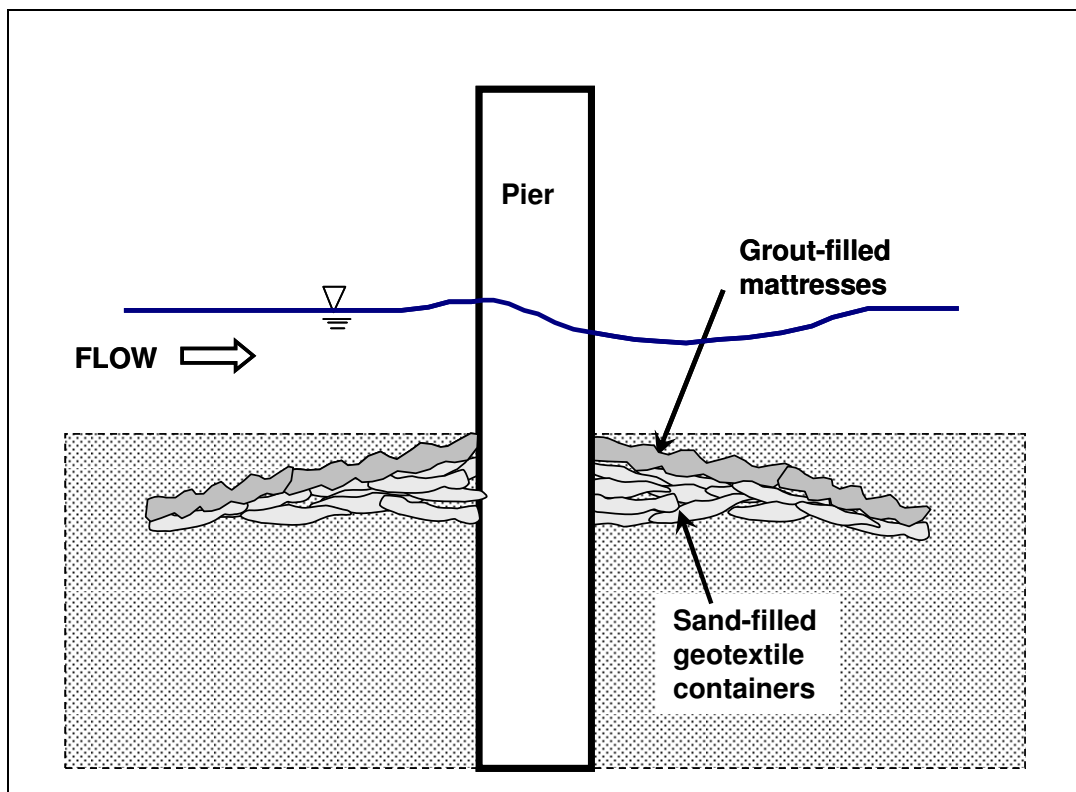

Figure 9.12. Schematic diagram showing the use of sand-filled geotextile containers as a filter.

9.7 GUIDELINES FOR SEAL AROUND THE PIER

An observed key point of failure for grout-filled mats at bridge piers during laboratory studies occurs at the interface where the mat meets the bridge pier. During NCHRP Project 24-07(2), securing the geotextile to the pier prevented the leaching of the bed material from around the pier. This procedure worked successfully in the laboratory, but there are constructability implications that must be considered when using this technique in the field, particularly when placing the mattress under water.

A grout seal between the mattress and the pier is recommended. A grout seal is not intended to provide a structural attachment between the mattress and the pier, but instead is a simple method for plugging gaps to prevent bed sediments from winnowing out between the mattress and the structure. In fact, structural attachment of the mattress to the pier is strongly discouraged. The transfer of moments from the mat to the pier may affect the structural stability of the pier, and the potential for increased loadings on the pier must be considered. When placing a grout seal under water, an anti-washout additive is required.

9.8 ANCHORS

Anchors are not typically used with grout-filled mat systems; however, the layout guidance presented in Section 9.4 indicates that the system should be toed down to a termination depth at least as deep as any expected contraction scour and long-term degradation (grout-filled mats are not recommended in live-bed environments where dune-type bedforms are anticipated). Where such toe down depth cannot be achieved, for example where bedrock is encountered at shallow depth, a grout-filled mat system with anchors along the front (upstream) and sides of the installation are recommended. The spacing of the anchors should be determined based on a factor of safety of at least 5.0 for pullout resistance based on calculated drag on the exposed leading edge. Spacing between anchors of no more than 4 ft is recommended. The following example is provided:

Given:

ρ	=	Mass density of water (slugs/ft ³)	=	1.94
V	=	Approach velocity (ft/s)	=	10
Δz	=	Height of grout-filled mat (ft)	=	0.5
b	=	Width of mattress installation (perpendicular to flow) (ft)	=	40

Step 1: Calculate total drag force F_d on leading edge of system:

$$F_d = 0.5\rho V^2(\Delta z)(b) = 0.5(1.94)(10^2)(0.5)(40) = \mathbf{1,940 \text{ lbs}}$$

Step 2: Calculate required uplift restraint using 5.0 safety factor:

$$F_{\text{restraint}} = 5.0(1,940) = \mathbf{9,700 \text{ lbs}}$$

Step 3: Counting anchors at the corners of the system, calculate required pullout resistance per anchor:

- a) Assume 11 anchors at 4 ft spacing: $9,700 \text{ lb}/11 \text{ anchors} = \mathbf{880 \text{ lb/anchor}}$
- b) Assume 21 anchors at 2 ft spacing: $9,700 \text{ lb}/21 \text{ anchors} = \mathbf{460 \text{ lb/anchor}}$

Anchors should never be used as a means to avoid toeing the system down to the full required extent where alluvial materials are present at depth. In this case, scour or bedform troughs will simply undermine the anchors as well as the system in general.

9.9 REFERENCES

ASTM International, 2005a, "ASTM Standards Volume 4.01: Cement; Lime; Gypsum," West Conshohocken, PA.

ASTM International, 2005b, "ASTM Standards Volume 4.02: Concretes and Aggregates," West Conshohocken, PA.

ASTM International, 2005c, "ASTM Standards Volume 4.08: Soil and Rock (I)," West Conshohocken, PA.

ASTM International, 2005d, "ASTM Standards Volume 4.09: Soil and Rock (II)," West Conshohocken, PA.

ASTM International, 2005e, "ASTM Standards Volume 4.13: Geosynthetics," West Conshohocken, PA.

Bowser-Morner Associates, Inc., 1989, "Design Theory Manual for Armorform Erosion Protection Mats," prepared for the Nicolon Corporation, Norcross, Georgia, September 25.

Fotherby, L.M., 1995, "Scour Protection at Bridge Piers: Riprap and Concrete Armor Units," Ph.D. Dissertation, Colorado State University, Fort Collins, CO.

Harris County Flood Control District, 2001, "Design Manual for Articulating Concrete Block Systems," prepared by Ayres Associates, Project No. 32-0366.00, Fort Collins, CO.

Hunt, L., 1993, "ARMORFORM® Articulating Block Mat Erosion Control System, Salmon Creek Bridge; Oakridge, Oregon, Interim Report," Oregon Experimental Feature #OR89-05, for Oregon Department of Transportation, Materials and Research Section, Salem, OR.

Iowa Department of Transportation, 2004, "Developmental Specifications for Fabric Formed Concrete Structure Revetment, Document No. DS-01041, May.

Lagasse, P.F., Zevenbergen, L.W., Schall, J.D., and Clopper, P.E., 2001a, "Bridge Scour and Stream Instability Countermeasures: Experience, Selection, and Design Guidance," Hydraulic Engineering Circular No. 23, Federal Highway Administration, Washington, D.C.

Lagasse, P.F., Schall, J.D., and Richardson, E.V., 2001b, "Stream Stability at Highway Structures," Hydraulic Engineering Circular No. 20, Federal Highway Administration, Washington, D.C.

Lagasse, P.F., Clopper, P.E., Zevenbergen, L.W., and Girard, L.G., 2007, "Countermeasures to Protect Bridge Piers from Scour," NCHRP Report 593, prepared by Ayres Associates for the National Cooperative Highway Research Program, Transportation Research Board, National Academies of Science, Washington, D.C.

Scholl, L.G., 1991, "ARMORFORM® Articulating Block Mat Erosion Control System, Salmon Creek Bridge; Oakridge, Oregon, Construction Report," Oregon Experimental Feature #OR89-05, for Oregon Department of Transportation, Materials and Research Section, Salem, OR.

Sprague, C.J. and Koutsourais, M.M., 1992, "Fabric Formed Concrete Revetment Systems," Journal of Geotextiles and Geomembranes, Vol. 11, pp. 587-609.

DESIGN GUIDELINE 10
GABION MATTRESSES

(Page intentionally left blank)

DESIGN GUIDELINE 10

GABION MATTRESSES

10.1 INTRODUCTION

Gabion mattresses are containers constructed of wire mesh and filled with rocks. The length of a gabion mattress is greater than the width, and the width is greater than the thickness. Diaphragms are inserted widthwise into the mattress to create compartments (Figure 10.1). Wire is typically galvanized or coated with polyvinyl chloride to resist corrosion, and either welded or twisted into a lattice. Stones used to fill the containers can be either angular rock or rounded cobbles; however, angular rock is preferred due to the higher degree of natural interlocking of the stone fill. During installation, individual mattresses are connected together by lacing wire or other connectors to form a continuous structure. Figure 10.2 shows the installation of a gabion mattress system.

The wire mesh allows the gabions to deform and adapt to changes in the subgrade while maintaining stability. Additionally, when compared to riprap, less excavation of the bed is required and smaller, more economical stone can be used. The obvious benefit of gabion mattresses is that the size of the individual stones used to fill the mattress can be smaller than stone that would individually be too small to withstand the hydraulic forces of a stream (Freeman and Fischenich 2000). This design guideline considers two applications of gabion mattresses: Application 1 – bank revetment and bed armor; and Application 2 - pier scour protection.

There is limited field experience with the use of gabion mattresses systems as a scour countermeasure for bridge piers alone. More frequently, these systems have been used for structures such as dams or dikes, or for channel slope stabilization. The guidance for pier scour applications provided in this document has been developed primarily from Federal Highway Administration (FHWA) Hydraulic Engineering Circular No. 23 (HEC-23) (Lagasse et al. 2001b), NCHRP Project 24-07(1) (Parker et al. 1998), and NCHRP Project 24-07(2) (Lagasse et al. 2007). Durability of the wire mesh under long term exposure to the flow conditions at bridge piers has not been demonstrated; therefore, the use of gabion mattresses as a bridge pier scour countermeasure has an element of uncertainty (Parker et al. 1998).

Successful long-term performance of gabion mattresses depends largely on the integrity of the wire. **Due to the potential for abrasion by coarse bed load, gabion mattresses are not appropriate for gravel bed streams and should only be considered for use in sand- or fine-bed streams.** Additionally, water quality of the stream must be noncorrosive (i.e., nonsaline and nonacidic). A polyvinyl chloride (PVC) coating should be used for applications where the potential for corrosion exists.

10.2 MATERIALS

10.2.1 Rock Fill

Standard test methods relating to material type, characteristics, and testing of rock and aggregates typically associated with riprap installations (e.g., filter stone and bedding layers) are provided in this section and are recommended for specifying the rock fill used in gabion mattresses. In general, the test methods recommended in this section are intended to ensure that the stone is dense and durable, and will not degrade significantly over time.

Rocks used for gabion mattresses should only break with difficulty, have no earthy odor, no closely spaced discontinuities (joints or bedding planes), and should not absorb water easily. Rocks comprised of appreciable amounts of clay, such as shales, mudstones, and claystones, are **never** acceptable for use as fill for gabion mattresses. Table 10.1 summarizes the recommended tests and allowable values for rock and aggregate.

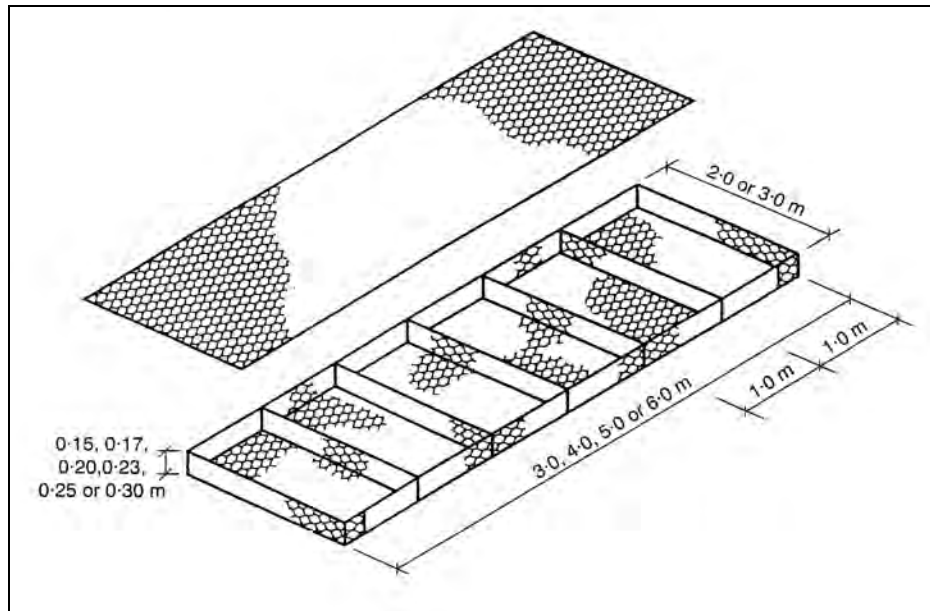

Figure 10.1. Gabion mattress showing typical dimensions (after Hemphill and Bramley 1989).



Figure 10.2. Field installation of gabion mattresses on channel bed and banks.

Table 10.1. Recommended Tests for Rock Quality.

Test Designation	Property	Allowable value	Frequency ⁽¹⁾	Comments	
AASHTO TP 61	Percentage of Fracture	< 5%	1 per 20,000 tons	Percentage of pieces that have fewer than 50% fractured surfaces	
AASHTO T 85	Specific Gravity and Water Absorption	Average of 10 pieces: $S_g > 2.5$ Absorption < 1.0%	1 per year	If any individual piece exhibits an S_g less than 2.3 or water absorption greater than 3.0%, an additional 10 pieces shall be tested. If the second series of tests also exhibits pieces that do not pass, the riprap shall be rejected.	
AASHTO T 103	Soundness by Freezing and Thawing	Maximum of 10 pieces after 25 cycles: < 0.5%	1 per 2 years	Recommended only if water absorption is greater than 0.5% and the freeze-thaw severity index is greater than 15 per ASTM D 5312.	
AASHTO T 104	Soundness by Use of Sodium Sulfate or Magnesium Sulfate	Average of 10 pieces: < 17.5%	1 per year	If any individual piece exhibits a value greater than 25%, an additional 10 pieces shall be tested. If the second series of tests also exhibits pieces that do not pass, the riprap shall be rejected.	
AASHTO TP 58	Durability Index Using the Micro-Deval Apparatus	<u>Value</u> > 90 > 80 > 70	<u>Application</u> Severe Moderate Mild	1 per year	Severity of application per Section 5.4, CEN (2002). Most riverine applications are considered mild or moderate.
ASTM D 3967	Splitting Tensile Strength of Intact Rock Core Specimens	Average of 10 pieces: > 6 MPa	1 per year	If any individual piece exhibits a value less than 4MPa, an additional 10 pieces shall be tested. If the second series of tests also exhibits pieces that do not pass, the riprap shall be rejected.	
ASTM D 5873	Rock Hardness by Rebound Hammer	See Note (2)	1 per 20,000 tons	See Note (2)	
Shape	Length to Thickness Ratio A/C	< 10%, $d_{50} < 24$ inch < 5%, $d_{50} > 24$ inch	1 per 20,000 tons	Percentage of pieces that exhibit A/C ratio greater than 3.0 using the Wolman Count method (Lagasse et al. 2006)	
ASTM D 5519	Particle Size Analysis of Natural and Man-Made Riprap Materials		1 per year	See Note (3)	
Gradation	Particle Size Distribution Curve		1 per 20,000 tons	Determined by the Wolman Count method (Lagasse et al. 2006), where particle size "d" is based on the intermediate ("B") axis	
<p>(1) Testing frequency for acceptance of riprap from certified quarries, unless otherwise noted. Project-specific tests exceeding quarry certification requirements, either in performance value or frequency of testing, must be specified by the Engineer.</p> <p>(2) Test results from D 5873 should be calibrated to D 3967 results before specifying quarry-specific minimum allowable values.</p> <p>(3) Test results from D 5519 should be calibrated to Wolman Count (Lagasse et al. 2006) results before developing quarry-specific relationships between size and weight; otherwise, assume $W = 85\%$ that of a cube of dimension "d" having a specific gravity of S_g</p>					

10.2.2 Gabion Mattresses and Components

Successful gabion performance depends not only on properly sizing and filling the baskets, but also on the quality and integrity of the wire comprising the basket compartments, diaphragms, lids, and lacing wire. Investigations conducted under NCHRP Project 24-07(1) (Parker et al. 1998) concluded that the lacing wire in particular proved to be the weakest link of gabion mattress systems. Wire should be single strand galvanized steel; a PVC coating may be added to protect against corrosion where required.

The wire mesh may be formed with a double twist hexagonal pattern or can be made of welded wire fabric. Fasteners, such as ring binders or spiral binders, must be of the same quality and strength as that specified for the gabion mattresses. The following recommendations are provided for twisted-wire and welded-wire gabions, respectively:

Twisted-Wire Gabion Mattresses: A Producer's or Supplier's certification shall be furnished to the Purchaser that the material comprising the gabion mattress components and lacing wire was manufactured, sampled, tested, and inspected in accordance with the specifications of: *ASTM A 975, "Standard Specification for Double-Twisted Hexagonal Mesh Gabions and Revet Mattresses (Metallic-Coated Steel Wire or Metallic-Coated Steel Wire with Poly Vinyl Chloride (PVC) Coating)."* The certification must indicate that the minimum requirements of this standard have been met.

Welded-Wire Gabion Mattresses: A Producer's or Supplier's certification shall be furnished to the Purchaser that the material comprising the gabion mattress components and lacing wire was manufactured, sampled, tested, and inspected in accordance with the specifications of: *ASTM A 974, "Standard Specification for Welded Wire Fabric Gabions and Gabion Mattresses (Metallic-Coated or Poly Vinyl Chloride (PVC) Coated)."* The certification must indicate that the minimum requirements of this standard have been met.

Flexibility of the gabion mattress units is a major factor in the successful performance of these systems. The ability to adjust to differential settlement, frost heave, or other changes in the subgrade is desirable. For example, settlement around the perimeter of a gabion mattress installation at a bridge pier is beneficial if scour at the edges of the mattresses occurs. Rigid systems are more prone to undermining and subsequent damage to the mesh, and are therefore less suitable for use at bridge piers. Designers are encouraged to further familiarize themselves with the flexibility and performance of various gabion mattress materials and proprietary products for use in riverine environments.

10.3 APPLICATION 1: HYDRAULIC DESIGN PROCEDURE FOR GABION MATTRESSES FOR BANK REVETMENT OR BED ARMOR

10.3.1 Hydraulic Stability Design Procedure

Gabion mattress design methods typically yield a required d_{50} stone size that will result in stable performance under the design hydraulic loading. Because stone is produced and delivered in a range of sizes and shapes, the required size of stone is often stated in terms of a minimum and maximum allowable size. For example, ASTM standard D 6711, "Standard Practice for Specifying Rock to Fill Gabions, Revet Mattresses, and Gabion Mattresses," recommends the following:

<u>Mattress thickness, inches</u>	<u>Range of stone sizes, inches</u>
6	3 to 5
9	3 to 5
12	4 to 8

ASTM standard D 6711 also indicates that the fill should be well graded with a full range of sizes between the upper and lower limits. The rocks used to fill gabion mattresses should be hard, dense, and durable. In general, rocks used for filling gabion mattresses should be of the same material quality as would be used for riprap, as described in Design Guide 4 of this document.

10.3.2 Selecting a Target Factor of Safety

The designer must determine what factor of safety should be used for a particular application. Typically, a minimum allowable factor of safety of 1.2 is used for revetment (bank protection) when the project hydraulic conditions are well known and the installation can be conducted under well-controlled conditions. Higher factors of safety are typically used for protection at bridge piers, abutments, and at channel bends due to the complexity in computing hydraulic conditions at these locations.

The Harris County Flood Control District, Texas (HCFCD 2001) has developed a simple flow chart approach that considers the type of application, uncertainty in the hydraulic and hydrologic models used to calculate design conditions, and consequences of failure to select an appropriate target factor of safety to use when designing various types of Articulating Concrete Block (ACB) installations. In this approach, the minimum allowable factor of safety for ACBs at bridge piers, for example, is 1.5. This base value is then multiplied by two factors, each equal to or greater than 1.0, to account for risk and uncertainty. Figure 10.3 shows the HCFCD flow chart method. The method is also considered appropriate for gabion mattresses, since the design method results in a calculated safety factor.

10.3.3 Design Procedure

For gabion mattresses placed on channel beds or banks, the shear stress on the mattress is calculated as follows:

$$\tau_{des} = K_b \gamma y S_f \quad (10.1)$$

where:

- τ_{des} = Design shear stress, lb/ft²
- K_b = Bend coefficient (dimensionless)
- γ = Unit weight of water, 62.4 lb/ft³
- y = Maximum depth of flow on revetment, ft
- S_f = Slope of the energy grade line, ft/ft

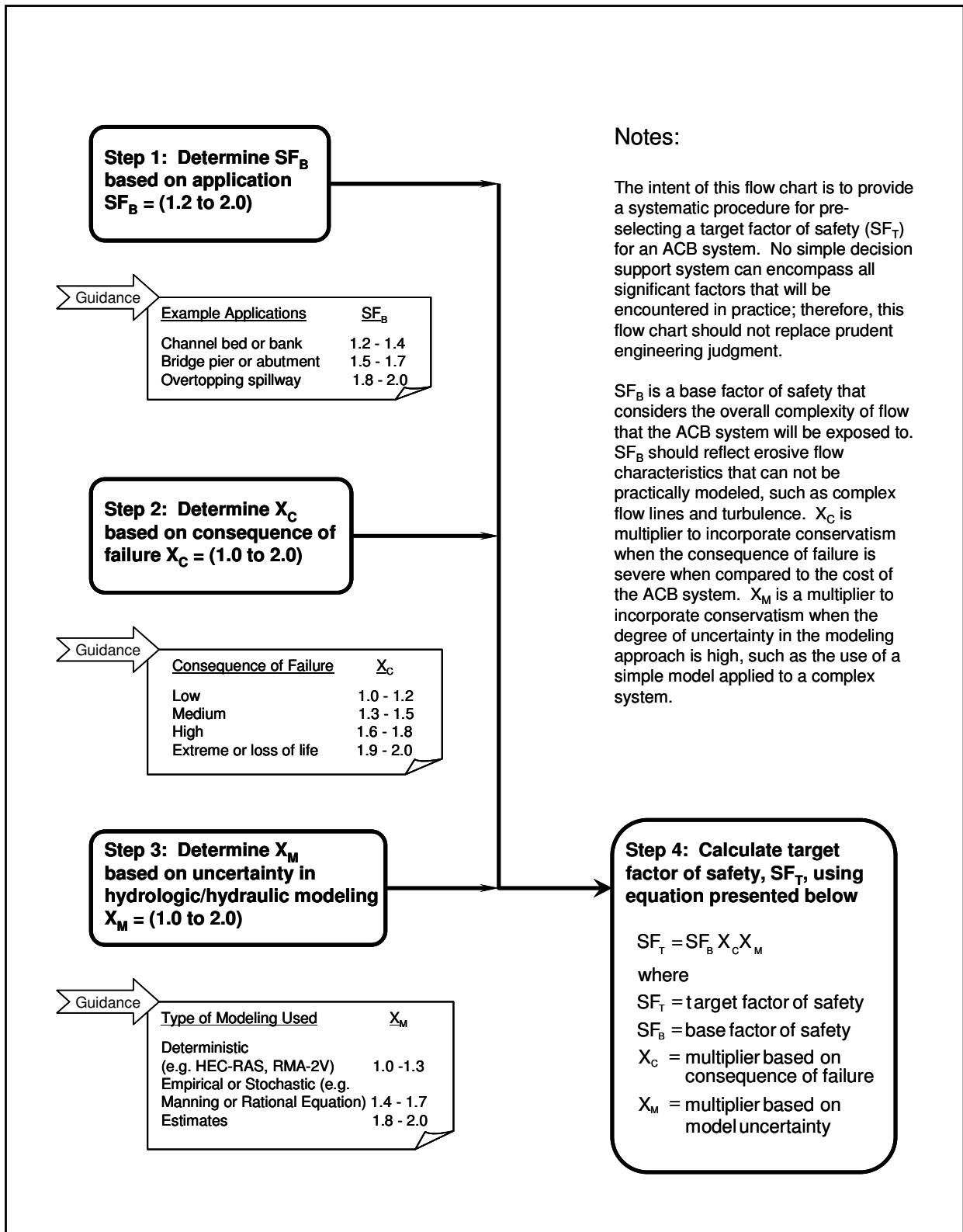

Figure 10.3. Selecting a target factor of safety (from HCFCD 2001).

The bend coefficient K_b is used to calculate the increased shear stress on the outside of a bend. This coefficient ranges from 1.05 to 2.0, depending on the severity of the bend. The bend coefficient is a function of the radius of curvature R_c divided by the top width of the channel T , as follows:

$$\begin{aligned}
 K_b &= 2.0 && \text{for } 2 \geq R_c/T \\
 K_b &= 2.38 - 0.206 \left(\frac{R_c}{T} \right) + 0.0073 \left(\frac{R_c}{T} \right)^2 && \text{for } 10 > R_c/T > 2 \\
 K_b &= 1.05 && \text{for } R_c/T \geq 10
 \end{aligned}
 \tag{10.2}$$

The recommended procedure for determining the permissible shear stress for a gabion mattress is determined using the relationship provided in Hydraulic Engineering Circular No. 15 (HEC-15) third edition (Kilgore and Cotton 2005):

$$\tau_p = C_s (\gamma_s - \gamma_w) d_{50}
 \tag{10.3}$$

where:

- τ_p = Permissible shear stress, lb/ft²
- d_{50} = Median diameter of rockfill in mattress, ft
- C_s = Stability coefficient for rock-filled gabion mattress equal to 0.10
- γ_w = Unit weight of water, 62.4 lb/ft³
- γ_s = Unit weight of stone, lb/ft³

The coefficient C_s is an empirical coefficient developed by Maynard (1995) from test data presented in Simons et al. (1984). Use of $C_s = 0.10$ is limited to the conditions of the testing program, which used angular rock and a ratio of maximum to minimum stone size from 1.5 to 2.0.

The Factor of Safety can be calculated as the ratio of the permissible shear stress divided by the applied shear stress:

$$F.S. = \frac{\tau_p}{\tau_{des}}
 \tag{10.4}$$

Minimum rock size should be at least 1.25 times larger than the aperture size of the wire mesh that comprises the mattress (Parker et al. 1998). Rock should be well graded between the minimum and maximum sizes to minimize the size of the voids in the matrix. If design criteria and economic criteria permit, standard gradations may be selected.

The thickness of the gabion mattress should be at least twice the average diameter of the rock fill, $T \geq 2 d_{50}$. If the computed thickness does not match that of a standard gabion thickness, the next larger thickness of mattress should be used (Maynard 1995). At a minimum, the thickness should be 6 in. (Parker et al. 1998).

10.3.4 Layout Details for Gabion Mattress Bank Revetment and Bed Armor

Longitudinal Extent: The revetment armor should be continuous for a distance which extends both upstream and downstream of the region which experiences hydraulic forces severe enough to cause dislodging and/or transport of bed or bank material. The minimum distances recommended are an upstream distance of 1.0 channel width and a downstream distance of 1.5 channel widths. The channel reach which experiences severe hydraulic forces is usually identified by site inspection, examination of aerial photography, hydraulic modeling, or a combination of these methods.

Many site-specific factors have an influence on the actual length of channel that should be protected. Factors that control local channel width (such as bridge abutments) may produce local areas of relatively high velocity and shear stress due to channel constriction, but may also create areas of ineffective flow further upstream and downstream in "shadow zone" areas of slack water. In straight reaches, field reconnaissance may reveal erosion scars on the channel banks that will assist in determining the protection length required.

In meandering reaches, since the natural progression of bank erosion is in the downstream direction, the present limit of erosion may not necessarily define the ultimate downstream limit. FHWA's Hydraulic Engineering Circular No. 20, "Stream Stability at Highway Structures" (Lagasse et al. 2001a) provides guidance for the assessment of lateral migration. The design engineer is encouraged to review this reference for proper implementation.

Vertical Extent. The vertical extent of the revetment should provide freeboard above the design water surface. A minimum freeboard of 1 to 2 ft should be used for unconstricted reaches and 2 to 3 ft for constricted reaches. If the flow is supercritical, the freeboard should be based on height above the energy grade line rather than the water surface. **The revetment system should either cover the entire channel bottom or, in the case of unlined channel beds, extend below the bed far enough so that the revetment is not undermined by the maximum scour which for this application is considered to be toe scour, contraction scour, and long-term degradation (Figure 10.5).**

Recommended revetment termination at the top and toe of the bank slope are provided in Figures 10.4 and 10.5 for armored-bed and soft-bottom channel applications, respectively. Similar termination trenches are recommended for the upstream and downstream limits of the gabion mattress revetment. This problem is presented in English units only because proprietary gabion mattresses in the U.S. are manufactured and specified in units of inches and pounds.

10.3.5 Gabion Mattress Design Example

The following example illustrates the gabion mattress design procedure using the method presented in Section 10.3.1. The example is presented in a series of steps that can be followed by the designer in order to select the appropriate thickness of the gabion mattress based on a pre-selected target factor of safety. The primary criterion for product selection is if the computed factor of safety for the armor meets or exceeds the pre-selected target value. This problem is presented in English units only because gabion mattresses in the U.S. are manufactured and specified in units of inches and pounds.

Problem Statement:

A gabion mattress system is proposed to arrest lateral migration on the outside of a bend. The channel dimensions and design hydraulic conditions are given in Table 10.3.

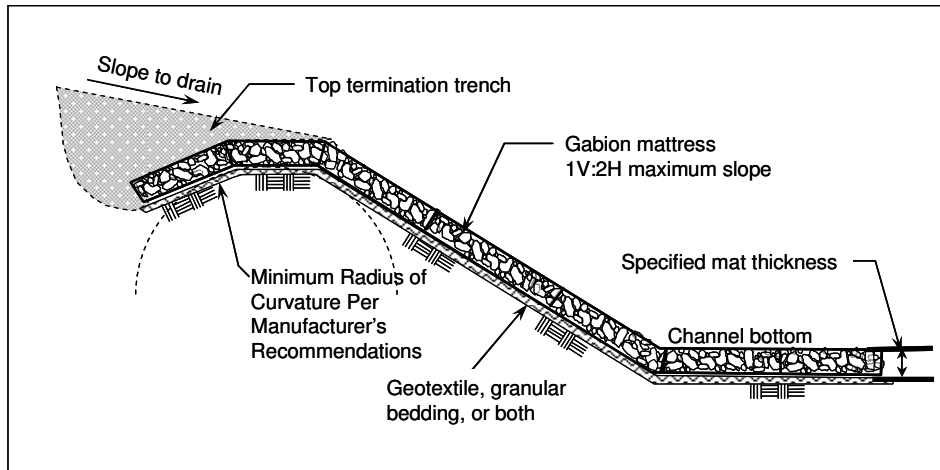

Figure 10.4. Recommended layout detail for bank and bed armor.

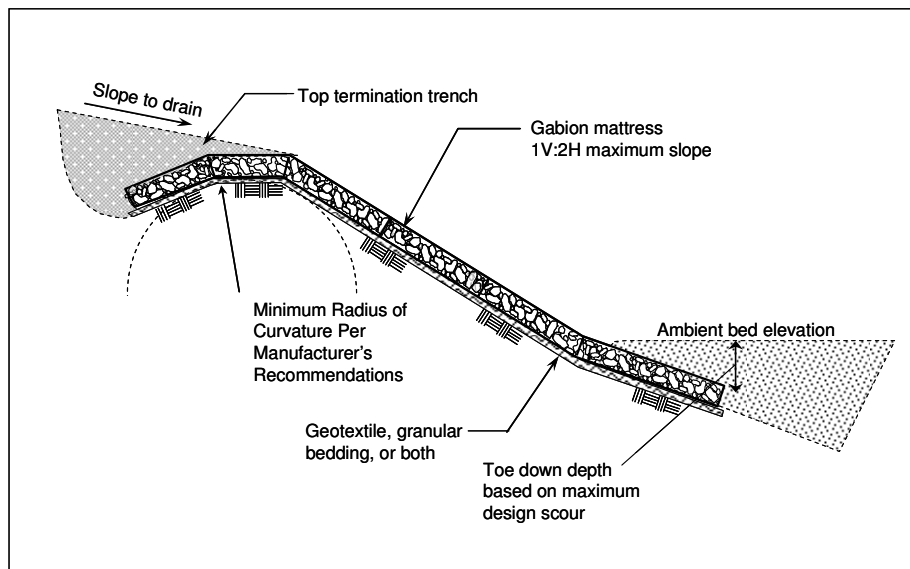

Figure 10.5. Recommended layout detail for bank revetment where no bed armor is required.

Channel discharge Q (ft ³ /s)	4,500
Cross section average velocity V_{ave} (ft/s)	8.7
Maximum depth y (ft)	5.0
Side slope, V:H	1V:3H
Bed slope S_o (ft/ft)	0.005
Slope of energy grade line S_f (ft/ft)	0.005
Channel top width T (ft)	120
Radius of curvature R_c (ft)	750

Step 1. Determine a target factor of safety for this project:

Use Figure 10.3 to compute a target factor of safety. For this example, a target factor of safety of 1.7 is selected as follows:

- A base safety factor SF_B of 1.3 is chosen because the river is sinuous and high velocities can be expected on the outside of bends.
- The base safety factor is multiplied by a factor for the consequence of failure X_C using a value of 1.3, since at this location the consequence of failure is ranked as "low" to "medium."
- The uncertainty associated with the hydrology and hydraulic analysis is considered "low" for this site, based on available hydrologic and hydraulic data. Therefore, the factor X_M for hydrologic and hydraulic uncertainty is given a value of 1.0.

The target factor of safety for this project site is calculated as:

$$SF_T = (SF_B)(X_C)(X_M) = 1.7$$

Step 2. Calculate design shear stress

The maximum bed shear stress at the cross section is calculated using Equation 10.1:

$$\tau_{des} = K_b(\gamma)(y)(S_i)$$

First calculate K_b using Equation 10.2:

$$\text{Since } R_c/T = 750/120 = 6.25$$

$$K_b = 2.38 - 0.206(6.25) + 0.0073(6.25)^2 = 1.38$$

$$\text{so } \tau_{des} = 1.38 (62.4 \text{ lb/ft}^3) (5.0 \text{ ft}) (0.005 \text{ ft/ft}) = 2.15 \text{ lb/ft}^2$$

Step 3. Calculate permissible shear stress

From Equation 10.3,

$$\tau_p = C_s(\gamma_s - \gamma_w)d_{50}$$

Assuming a specific gravity of 2.65 for the stone fill, the unit weight of the individual stones is $2.65 \times (62.4) = 165 \text{ lb/ft}^3$. Using the recommended value of 0.10 for C_s , the permissible shear stress is plotted as a function of the d_{50} size of the stone fill in Figure 10.6:

Using a d_{50} stone size of 4.5 in., a permissible shear stress is calculated using Equation 10.3:

$$\tau_p = 0.10 (165 \text{ lb/ft}^3 - 62.4 \text{ lb/ft}^3) \frac{4.5 \text{ in}}{12 \text{ in/ft}} = 3.85 \text{ lb/ft}^2$$

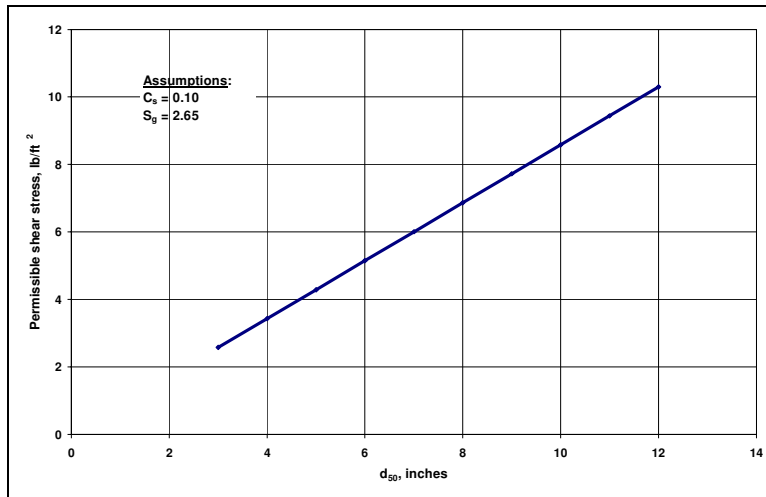

Figure 10.6. Permissible shear stress as a function of the median size of the stone fill.

Step 4. Calculate factor of safety:

Using Equation 10.4, the factor of safety is calculated as:

$$\text{F.S.} = \frac{\tau_p}{\tau_{\text{des}}} = \frac{3.85}{2.15} = 1.8$$

Since the calculated factor of safety is larger than the site-specific target factor of safety of 1.7 for this project, the stone sizing is appropriate.

Step 5. Specify the gabion mattress:

The thickness of the gabion mattress should be at least 2 times the d_{50} size of the stone fill. For this project, select a mattress with a thickness of at least $2 \times 4.5 \text{ in.} = 9 \text{ in.}$ A filter should be provided beneath the gabion mattress designed in accordance with the procedures described in Design Guide 16 of this document.

10.4 APPLICATION 2: HYDRAULIC DESIGN PROCEDURE FOR GABION MATTRESSES FOR PIER SCOUR PROTECTION

10.4.1 Hydraulic Stability Design Procedure

The hydraulic stability of gabion mattresses at bridge piers can be assessed using the factor of safety method as previously discussed. However, uncertainties in the hydraulic conditions around bridge piers warrant increasing the factor of safety in lieu of a more rigorous hydraulic analysis. Experience and judgment are required when quantifying the factor of safety to be used for scour protection at an obstruction in the flow. In addition, when both contraction scour and pier scour are expected, design considerations for a pier mat become more complex. The following guidelines reflect guidance from NCHRP Report 593, "Countermeasures to Protect Bridge Piers from Scour" (Lagasse et al. 2007).

10.4.2 Selecting a Target Factor of Safety

The issues involved in selecting a target factor of safety for designing gabion mattresses for pier scour protection are described in Section 10.3.2, and illustrated in flow chart fashion in Figure 10.3. Note that for bridge scour applications, the minimum recommended factor of safety is 1.5, as compared to a value of 1.2 for typical bank revetment and bed armor applications.

11.4.3 Design Method

The design hydraulic conditions in the immediate vicinity of a bridge pier are more severe than the approach conditions upstream. Therefore, at a pier, the local velocity and shear stress should be used in the design equations. As recommended in NCHRP Report 593, the section-average approach velocity V must be multiplied by factors that are a function of the shape of the pier and its location in the channel:

$$V_{des} = K_1 K_2 V \quad (10.5)$$

where:

- V_{des} = Design velocity for local conditions at the pier (ft/s)
- K_1 = Shape factor equal to 1.5 for round-nose piers and 1.7 for square-nosed piers
- K_2 = Velocity adjustment factor for location in the channel (ranges from 0.9 for pier near the bank in a straight reach to 1.7 for pier located in the main current of flow around a sharp bend)
- V = Section average approach velocity (Q/A) upstream of bridge (ft/s)

If the velocity distribution is available from stream tube or flow distribution output from a 1-D model, or directly computed from a 2-D model, then only the pier shape coefficient should be used to determine the design velocity. The maximum velocity in the active channel V_{max} is recommended since the channel could shift and the maximum velocity could impact any pier:

$$V_{des} = K_1 V_{max} \quad (10.6)$$

The local shear stress at the pier, τ_{des} , is calculated using a rearranged form of Manning's equation:

$$\tau_{des} = \frac{\gamma_w}{y^{1/3}} \left(\frac{nV_{des}}{K_u} \right)^2 \quad (10.7)$$

where:

- τ_{des} = Shear stress at base of pier, lb/ft²
- γ_w = Unit weight of water, 62.4 lb/ft³
- Y = Depth of flow at pier, ft
- N = Manning's n for the gabion mattress
- K_u = 1.486 for English units, 1 for SI units

10.4.4 Layout Dimensions for Piers

Based on small-scale laboratory studies performed for NCHRP Project 24-07(2) (Lagasse et al. 2007), the optimum performance of gabion mattresses as a pier scour countermeasure was obtained when the mattresses were extended a distance of at least two times the pier width in all directions around the pier.

In the case of wall piers or pile bents consisting of multiple columns where the axis of the structure is skewed to the flow direction, the lateral extent of the protection should be increased in proportion to the additional scour potential caused by the skew. While there is no definitive guidance for pier scour countermeasures, it is recommended that the extent of the armor layer should be multiplied by a factor K_α , which is a function of the width (a) and length (L) of the pier (or pile bents) and the skew angle α as given below (Richardson and Davis 2001):

$$K_\alpha = \left(\frac{a \cos \alpha + L \sin \alpha}{a} \right)^{0.65} \quad (10.8)$$

Gabion mattresses should be placed so that the long axis is parallel to the direction of flow (Yoon 2005). Where only local scour is present, the gabion mattresses may be placed horizontally such that the top of the mattress is flush with the bed elevation; however, when other types of scour are present, **the mattresses must be sloped away from the pier in all directions such that the depth of the system at its periphery is greater than the maximum scour which for this application is considered to be the depth of contraction scour and long-term degradation, or the depth of bedform troughs, whichever is greater (Figure 10.7)**. The mattresses should not be laid on a slope steeper than 1V:2H (50%). In some cases, this criterion may result in gabions being placed further than two pier widths away from the pier.

Methods of predicting bedform geometry can be found in Karim (1999) and also in van Rijn (1984). An upper limit on crest-to-trough height Δ is provided by Bennet (1997) as $\Delta < 0.4y$ where y is the depth of flow. This guidance suggests that the maximum depth of the bedform trough below ambient bed level is approximately 20% of the depth of flow.

A filter is typically required for gabion mattresses at bridge piers. The filter should **not** be extended fully beneath the gabions; instead, it should be terminated 2/3 of the distance from the pier to the edge of the gabion mattress. When using a granular stone filter, the layer should have a minimum thickness of 4 times the d_{50} of the filter stone or 6 in., whichever is greater. The granular filter layer thickness should be increased by 50% when placing under water.

10.5 PLACING THE GABION MATTRESS SYSTEM

10.5.1 General

Manufacturer's assembly instructions should be followed. Mattresses should be placed on the filter layer and assembled so that the wire does not kink or bend. Mattresses should be oriented so that the long dimension is parallel to the flow and internal diaphragms are perpendicular to the flow. Prior to filling, adjacent mattresses should be connected along the vertical edges and the top selvages by lacing, fasteners, or spirally binding. Custom fitting of mattresses around corners or curves should be done according to manufacturer's recommendations.

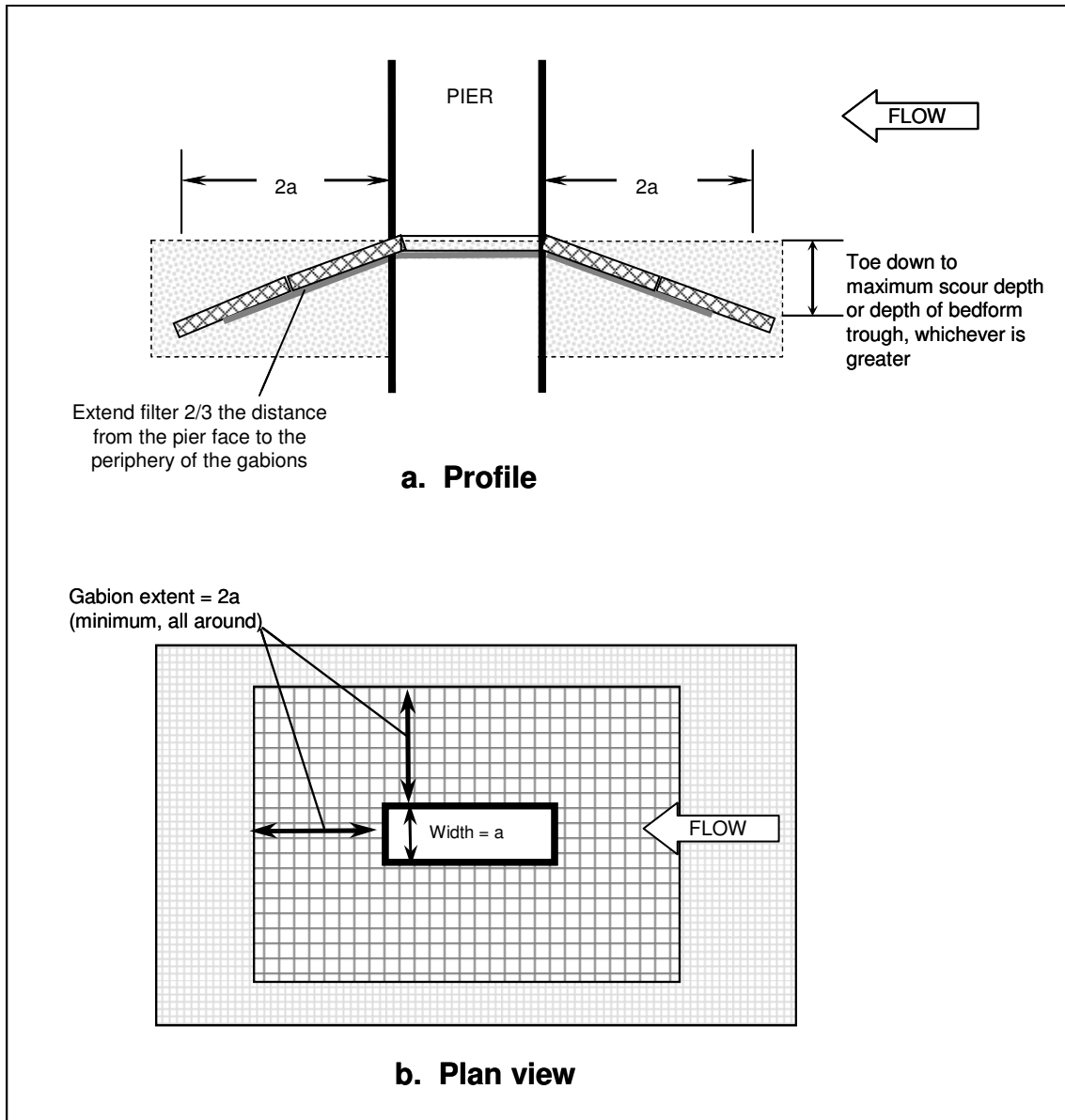

Figure 10.7. Gabion mattress layout diagram for pier scour countermeasures.

Care should be taken during installation so as to avoid damage to the geotextile or subgrade during the installation process. Mattresses should not be pushed or pulled laterally once they are on the geotextile. Preferably, the mattress placement and filling should begin at the upstream section and proceed downstream. If a mattress system is to be installed starting downstream and proceeding in the upstream direction, a contractor option is to construct a temporary toe trench at the front edge of the mattress system to protect against flow which could otherwise undermine the system during flow events that may occur during construction. On sloped sections where practical, placement and filling shall begin at the toe of the slope and proceed upslope.

10.5.2 Gabion Mattress Placement Under Water

Gabion mattresses placed in water require close observation and increased quality control to ensure a continuous countermeasure system. A systematic process for placing and continuous monitoring to verify the quantity and layer thickness is important.

Excavation, grading, and placement of gabion mattresses and filter under water require additional measures. For installations of a relatively small scale, diversion of the stream around the work area can be accomplished during the low flow season. For installations on larger rivers or in deeper water, the area can be temporarily enclosed by a cofferdam, which allows for construction dewatering if necessary. Alternatively, a silt curtain made of plastic sheeting may be suspended by buoys around the work area to minimize environmental degradation during construction.

Depending on the depth and velocity of the water, sounding surveys using a sounding pole or sounding basket on a lead line, divers, sonar bottom profiles, and remotely operated vehicles (ROVs) can provide some information about the mat placement and toedown.

10.6 FILTER REQUIREMENTS

10.6.1 General

The importance of the filter component of gabion mattress installation should not be underestimated. Geotextile filters are most commonly used with gabion mattresses, although coarse granular filters may be used where native soils are coarse and the particle size of the filter is large enough to prevent winnowing through the rock fill of the gabion mattresses. When using a granular stone filter, the layer should have a minimum thickness of 4 times the d_{50} of the filter stone or 6 in., whichever is greater. The d_{50} size of the granular filter should be determined by using the procedure presented in Design Guideline 16 of this document. When placing a granular filter under water, its thickness should be increased by 50%.

The filter must retain the coarser particles of the subgrade while remaining permeable enough to allow infiltration and exfiltration to occur freely. It is not necessary to retain all the particle sizes in the subgrade; in fact, it is beneficial to allow the smaller particles to pass through the filter, leaving a coarser substrate behind. Detailed aspects of filter design are presented in Design Guideline 16 of this document.

Some situations call for a composite filter consisting of both a granular layer and a geotextile. The specific characteristics of the base soil determine the need for, and design considerations of the filter layer. ***In cases where dune-type bedforms may be present at the toe of a bank slope protected with gabion mattresses, it is strongly recommended that only a geotextile filter be considered.***

10.6.2 Placing a Filter Under Water

Sand-filled geotextile containers made of nonwoven needle punched fabric are particularly effective for placement under water as shown in Figure 10.8. The fabric for the geotextile containers should be selected in accordance with the filter design criteria presented in Design Guideline 16, and placed such that they overlap to cover the required area. Geotextile containers can be fabricated in a variety of dimensions and weights. Each geotextile container should be filled with sand only to about 50 to 65% of the container's total volume so that it remains flexible and "floppy." The geotextile containers can also serve to fill a pre-existing scour hole around a pier prior to placing the gabion mattresses, as shown in Figure 10.7. For more detail, see Lagasse et al. (2007).

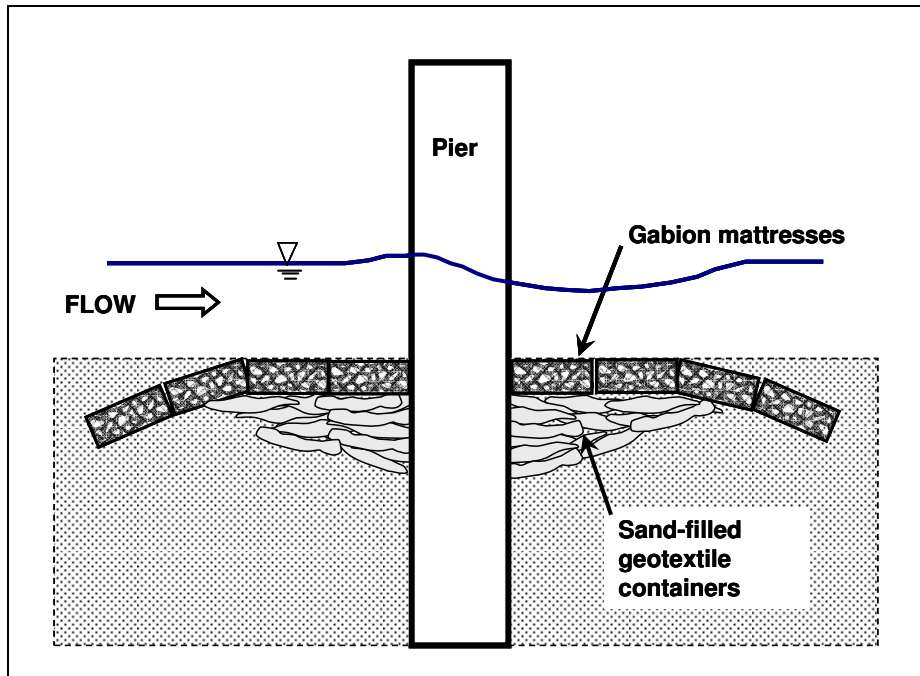

Figure 10.8. Schematic diagram showing the use of sand-filled geotextile containers as a filter.

10.7 GUIDELINES FOR SEAL AROUND THE PIER

An observed key point of failure for gabion mattress systems at bridge piers during laboratory studies occurs at the joint where the mat meets the bridge pier. During NCHRP Project 24-07(2), securing the geotextile to the pier prevented the leaching of the bed material from around the pier. This procedure worked successfully in the laboratory, but there are constructability implications that must be considered when using this technique in the field, particularly when placing the mattress under water.

A grout seal between the mattress and the pier is recommended. A grout seal is not intended to provide a structural attachment between the mattress and the pier, but instead is a simple method for plugging gaps to prevent bed sediments from winnowing out between the mattress and the structure. In fact, structural attachment of the mattress to the pier is strongly discouraged. The transfer of moments from the mat to the pier may affect the structural stability of the pier, and the potential for increased loadings on the pier must be considered. When placing a grout seal under water, an anti-washout additive is required.

10.8 ANCHORS

Anchors are not typically used with gabion mattress systems; however, the layout guidance presented in Section 10.4 indicates that the system should be toed down to a termination depth at least as deep as any expected contraction scour and long-term degradation, or bedform troughs, whichever is greater. Where such toe down depth cannot be achieved, for example where bedrock is encountered at shallow depth, a gabion mattress system with anchors along the front (upstream) and sides of the installation are recommended. The spacing of the anchors should be determined based on a factor of safety of at least 5.0 for pullout resistance based on calculated drag on the exposed leading edge. Spacing between anchors of no more than 4 ft is recommended. The following example is provided:

Given:

ρ	=	Mass density of water (slugs/ft ³)	=	1.94
V	=	Approach velocity (ft/s)	=	10
Δz	=	Height of grout-filled mat (ft)	=	0.5
b	=	Width of mattress installation (perpendicular to flow) (ft)	=	40

Step 1: Calculate total drag force F_d on leading edge of system:

$$F_d = 0.5\rho V^2(\Delta z)(b) = 0.5(1.94)(10^2)(0.5)(40) = \mathbf{1,940 \text{ lbs}}$$

Step 2: Calculate required uplift restraint using 5.0 safety factor:

$$F_{\text{restraint}} = 5.0(1,940) = \mathbf{9,700 \text{ lbs}}$$

Step 3: Counting anchors at the corners of the system, calculate required pullout resistance per anchor:

- a) Assume 11 anchors at 4 ft spacing: 9,700 lb/11 anchors = **880 lb/anchor**
- b) Assume 21 anchors at 2 ft spacing: 9,700 lb/21 anchors = **460 lb/anchor**

Anchors should never be used as a means to avoid toeing the system down to the full required extent where alluvial materials are present at depth. In this case, scour or bedform troughs will simply undermine the anchors as well as the system in general.

10.9 REFERENCES

American Association of State Highway and Transportation Officials (AASHTO), 2003, "Standard Specifications for Transportation Materials and Methods of Sampling and Testing," Washington, D.C.

ASTM International, 2005, "Test Method for Laboratory Compaction Characteristics of Soil Using Standard Effort," Standard No. D-698, West Conshohocken, PA.

ASTM International, 2005, "Specifications for Concrete Aggregates," Standard No. C-33, West Conshohocken, PA.

ASTM International, 2003, "Standard Specification for Double-Twisted Hexagonal Mesh and Revet Mattresses (Metallic-Coated Steel Wire or Metallic-Coated Steel Wire With Poly(Vinyl Chloride) (PVC) Coating)," Standard No. A-975, West Conshohocken, PA.

ASTM International, 2003, "Standard Specification for Welded Wire Fabric Gabions and Gabion Mattresses (Metallic Coated or Polyvinyl Chloride (PVC) Coated)," Standard No. A-974, West Conshohocken, PA.

ASTM International, 2001, "Standard Practice for Specifying Rock to Fill Gabions, Revet Mattresses, and Gabion Mattresses," Standard No. D-6701-01, West Conshohocken, PA.

ASTM International, 2005, "Standard Guide for Selecting Test Methods for Experimental Evaluation of Geosynthetic Durability," Standard No. D-5819-05, West Conshohocken, PA.

Bennett, J.P., 1997, "Resistance, Sediment Transport, and Bedform Geometry Relationships in Sand-Bed Channels," in: Proceedings of the U.S. Geological Survey (USGS) Sediment Workshop, February 4-7.

Brown, S.A. and Clyde, E.S., 1989, "Design of Riprap Revetment, Hydraulic Engineering Circular No. 11" (HEC-11), FHWA-IP-016, Federal Highway Administration, Washington, D.C.

Comité Européen de Normalisation (CEN), 2002, "European Standard for Armourstone," Report prEN 13383-1, Technical Committee 154, Brussels, Belgium.

Freeman, G.E. and Fischenich, J.C., 2000, "Gabions for Streambank Erosion Control," EMRRP Technical Notes Collection, EDC TN-EMRRP-SR-22, U.S. Army Engineer Research and Development Center, Vicksburg, MS.

Harris County Flood Control District, 2001, "Design Manual for Articulating Concrete Block Systems," prepared by Ayres Associates, Project No. 32-0366.00, Fort Collins, CO.

Heibaum, M.H., 2004, "Geotechnical Filters – The Important Link in Scour Protection," Federal Waterways Engineering and Research Institute, Karlsruhe, Germany, 2nd International Conference on Scour and Erosion, Singapore.

Hemphill, R.W. and Bramley, M.E., 1989, "Protection of River and Canal Banks," Construction Industry Research and Information Association (CIRIA), Butterworths, London.

Karim, F., 1999, "Bed-Form Geometry in Sand-Bed Flows," Journal of Hydraulic Engineering, Vol. 125, No. 12, December.

Kilgore, R.T. and Cotton, G.K., 2005, "Design of Roadside Channels with Flexible Linings" Hydraulic Engineering Circular No. 15, 3rd Edition, Washington D.C.

Lagasse, P.F., Schall, J.D., and Richardson, E.V., 2001a, "Stream Stability at Highway Structures," Hydraulic Engineering Circular 20, Third Edition, FHWA NHI 01-002, Federal Highway Administration, U.S. Department of Transportation, Washington, D.C.

Lagasse, P.F., Zevenbergen, L.W. Schall, J.D., and Clopper, P.E., 2001b, "Bridge Scour and Stream Instability Countermeasures: Experience, Selection, and Design Guidance," Hydraulic Engineering Circular No. 23, Federal Highway Administration, Washington, D.C.

Lagasse, P.F., Clopper, P.E., Zevenbergen, L.W., and Ruff, J.F., 2006, "Riprap Design Criteria, Recommended Specifications, and Quality Control," NCHRP Report 568, Transportation Research Board, National Academies of Science, Washington, D.C.

Lagasse, P.F., Clopper, P.E., and Zevenbergen, L.W., 2007, "Countermeasures to Protect Bridge Piers from Scour," NCHRP Report 593, Transportation Research Board, National Academies of Science, Washington, D.C.

Maynard, S.T. 1995, "Gabion-Mattress Channel-Protection Design," ASCE Journal of Hydraulic Engineering, Vol. 121, No.7, pp. 519-522.

Parker, G., Toro-Escobar, C, and Voight, Jr., R.L., 1998, "Countermeasures to Protect Bridge Piers from Scour," Final Report, Vol. 2, prepared for National Cooperative Highway Research Program, Transportation Research Board, National Research Council, NCHRP Project 24-07, St. Anthony Falls Laboratory, University of Minnesota, Minneapolis, MN.

Richardson, E.V. and Davis, S.R., 2001, "Evaluating Scour at Bridges," Hydraulic Engineering Circular 18, Fourth Edition, FHWA NHI 01-001, Federal Highway Administration, U.S. Department of Transportation, Washington, D.C.

Simons, D.B., Chen, Y.H., and Swenson, L.J., 1984, "Hydraulic Test to Develop Design Criteria for the Use of Reno Mattresses." Report prepared for Maccaferri Steel Wire Products, LTD. Ontario, Canada, Civil Engineering Department, Colorado State University, Fort Collins, CO.

U.S. Army Corps of Engineers, 1995, "Construction Quality Management," Engineering Regulation No. 1180-1-6, Washington D.C.

van Rijn, L.C., 1984, "Sediment Transport, Part III: Bed Forms and Alluvial Roughness," *Journal of Hydraulic Engineering*, Vol. 110, No.12

Yoon, T.H., 2005, "Wire Gabion for Protecting Bridge Piers," *ASCE Journal of Hydraulic Engineering*, Vol. 131, No. 11, pp. 942-949.

(page intentionally left blank)

SECTION 3 – COUNTERMEASURES FOR BRIDGE PIER PROTECTION

Design Guideline 8 – Articulating Concrete Block Systems at Bridge Piers

(see Design Guideline 8, Section 2, Pages DG8.21 through DG8.25)

Design Guideline 9 – Grout-Filled Mattresses at Bridge Piers

(see Design Guideline 9, Section 2, Pages DG9.14 through DG9.18)

Design Guideline 10 – Gabion Mattresses at Bridge Piers

(see Design Guideline 10, Section 2, Pages DG10.13 through DG10.19)

Design Guideline 11 – Rock Riprap at Bridge Piers

Design Guideline 12 – Partially Grouted Riprap at Bridge Piers

DESIGN GUIDELINE 8

Articulating Concrete Block Systems

See Section 2, Design Guideline 8, Pages DG8.21 through DG8.25

Design Guideline 8 - Articulating Concrete Block Systems contains two countermeasure applications: (1) bankline revetment or bed armor, and (2) pier scour protection. Design Guideline 8 appears in Section 2. The page citation to the pier protection application is given above.

DESIGN GUIDELINE 9

Grout-Filled Mattresses

See Section 2, Design Guideline 9, Pages DG9.14 through DG9.18

Design Guideline 9 - Grout-Filled Mattresses contains two countermeasure applications: (1) bankline revetment or bed armor, and (2) pier scour protection. Design Guideline 9 appears in Section 2. The page citation to the pier protection application is given above.

DESIGN GUIDELINE 10

Gabion Mattresses

See Section 2, Design Guideline 10, Pages DG10.13 through DG10.19

Design Guideline 10 - Gabion Mattresses contains two countermeasure applications: (1) bankline revetment or bed armor, and (2) pier scour protection. Design Guideline 10 appears in Section 2. The page citation to the pier protection application is given above.

DESIGN GUIDELINE 11
ROCK RIPRAP AT BRIDGE PIERS

(page intentionally left blank)

DESIGN GUIDELINE 11

ROCK RIPRAP AT BRIDGE PIERS

11.1 INTRODUCTION

When properly designed and used for erosion protection, riprap has an advantage over rigid structures because it is flexible when under attack by river currents, it can remain functional even if some individual stones may be lost, and it can be repaired relatively easily. Properly constructed riprap can provide long-term protection if it is inspected and maintained on a periodic basis as well as after flood events. This design guideline considers the application of riprap as a pier scour countermeasure.

Design of a pier scour countermeasure system using riprap requires knowledge of: river bed and foundation material; flow conditions including velocity, depth and orientation; pier size, shape, and skew with respect to flow direction; riprap characteristics of size, density, durability, and availability; and the type of interface material between the riprap and underlying foundation. The system typically includes a filter layer, either a geotextile fabric or a filter of sand and/or gravel, specifically selected for compatibility with the subsoil. The filter allows infiltration and exfiltration to occur while providing particle retention.

Bridge pier riprap design is based, primarily, on research conducted under laboratory conditions with little field verification. Flow turbulence and velocities around a pier are of sufficient magnitude that large rocks move over time. Bridges have been lost due to the removal of riprap at piers resulting from turbulence and high velocity flow. Usually this does not happen during one storm, but is the result of the cumulative effect of a sequence of high flows. **Therefore, if rock riprap is placed as scour protection around a pier, the bridge should be monitored and inspected during and after each high flow event to insure that the riprap is stable.**

The guidance provided in this document for pier protection applications of riprap has been developed primarily from the results of NCHRP Project 24-07(2) (Lagasse et al. 2007), NCHRP Project 24-23 (Lagasse et al. 2006), and NCHRP Project 24-07(1) (Parker et al. 1998).

11.2 BASIC CONCEPTS FOR BRIDGE PIER RIPRAP

11.2.1 Bridge Pier Scour

The basic mechanism causing local scour at piers is the formation of vortices (known as the horseshoe vortex) at their base (Figure 11.1). The horseshoe vortex results from the pileup of water on the upstream surface of the obstruction and subsequent acceleration of the flow around the nose of the pier or abutment. The action of the vortex removes bed material from around the base of the obstruction. The transport rate of sediment away from the base region is greater than the transport rate into the region, and, consequently, a scour hole develops. As the depth of scour increases, the strength of the horseshoe vortex is reduced, thereby reducing the transport rate from the base region. Eventually, for live-bed local scour, equilibrium is reestablished between bed material inflow and outflow and scouring ceases. For clear-water scour, scouring ceases when the shear stress caused by the horseshoe vortex equals the critical shear stress of the sediment particles at the bottom of the scour hole (Richardson and Davis 2001).

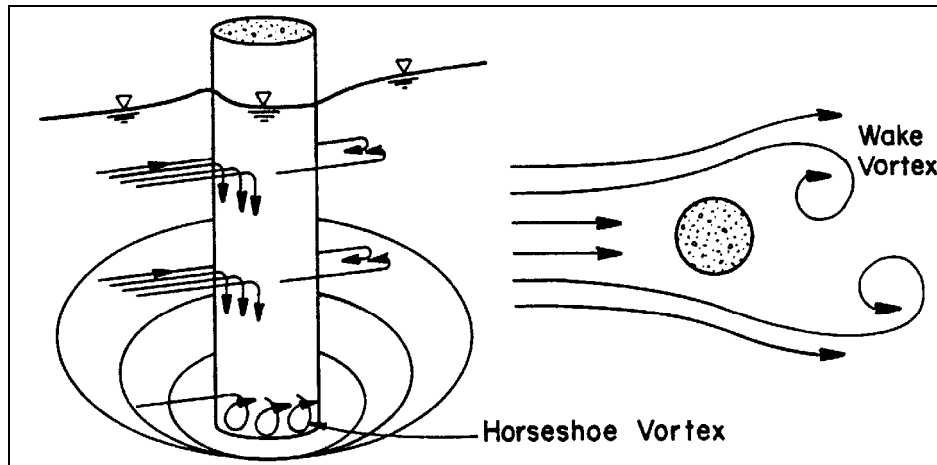

Figure 11.1. Schematic representation of scour at a cylindrical pier.

In addition to the horseshoe vortex around the base of a pier, there are vertical vortices downstream of the pier called the wake vortex (Figure 11.1). Both the horseshoe and wake vortices remove material from the pier base region. However, the intensity of wake vortices diminishes rapidly as the distance downstream of the pier increases. Therefore, immediately downstream of a long pier there is often deposition of material.

Factors which affect the magnitude of local scour depth at bridge piers are (1) velocity of the approach flow, (2) depth of flow, (3) width of the pier, (4) length of the pier if skewed to flow, (5) size and gradation of bed material, (6) angle of attack of the approach flow to the pier, (7) shape of the pier, (8) bed configuration, and (9) ice formation or jams and debris.

11.2.2 Bridge Pier Riprap

Most of the early work on the stability of pier riprap considers the size of the riprap stones and their ability to withstand high approach velocities and buoyant forces. Secondary currents induced by bridge piers cause high local boundary shear stresses, high local seepage gradients, and sediment erosion from the streambed surrounding the pier. The addition of riprap also changes the boundary stresses.

There are at least a dozen equations for sizing bridge pier riprap that can be considered for design (Lagasse et al. 2007, Melville and Coleman 2000). Typically, the stability of riprap is expressed in terms of the Stability Number, N_{sc} which is used in numerous equations to size riprap. This approach, which derives from the work of Isbash (1936) considers turbulence intensity to determine rock size (see Figure 11.2). Riprap stone size is designed using the critical velocity near the boundary where the riprap is placed. However, many of the pier riprap sizing equations are modified versions of bank or channel protection equations and, therefore, the use of this approach has limitations when applied at bridge piers because of the strongly turbulent flows near the base of a pier. Most of the remaining equations are based on threshold of motion criteria or empirical results of small-scale laboratory studies conducted under clear-water conditions with steady uniform flow.

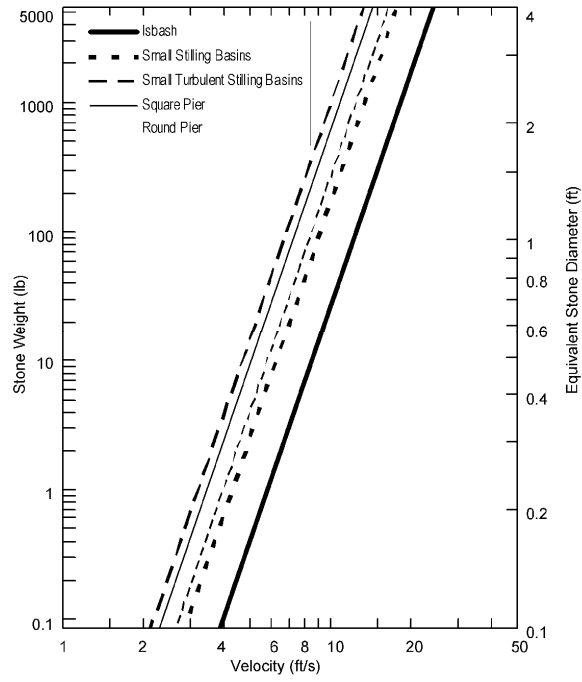

(English Units)

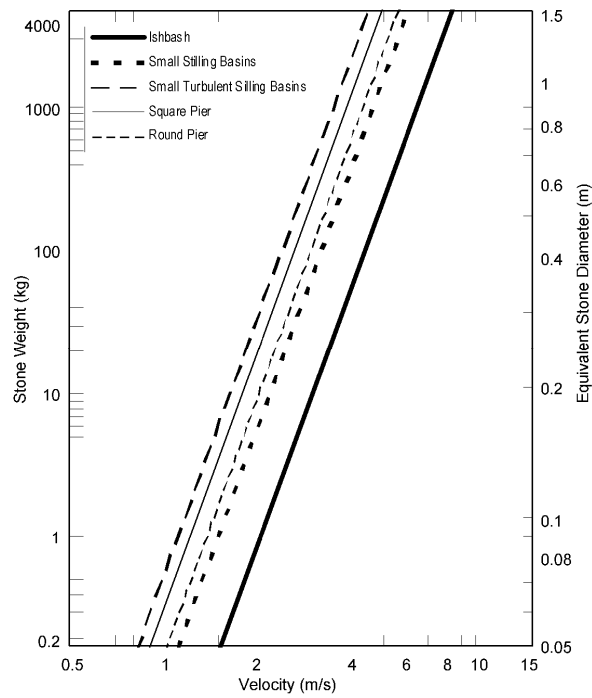

(SI Units)

Figure 11.2. Effect of turbulence intensity on rock size using the Ishbash approach.

11.3 SIZING ROCK RIPRAP AT BRIDGE PIERS

To determine the required size of stone for riprap at bridge piers, NCHRP Project 24-23 recommends using the rearranged Isbash equation from the Federal Highway Administration's Hydraulic Engineering Circular No. 23 (Second Edition) (Lagasse et al. 2001) to solve for the median stone diameter:

$$d_{50} = \frac{0.692(V_{des})^2}{(S_g - 1)2g} \quad (11.1)$$

where: d_{50} = Particle size for which 50% is finer by weight, ft (m)
 V_{des} = Design velocity for local conditions at the pier, ft/s (m/s)
 S_g = Specific gravity of riprap (usually taken as 2.65)
 g = Acceleration due to gravity, 32.2 ft/s² (9.81 m/s²)

It is important that the velocity used in Equation 11.1 is representative of conditions in the immediate vicinity of the bridge pier including the constriction caused by the bridge. If the cross-section or channel average velocity, V_{avg} , is used, then it must be multiplied by factors that are a function of the shape of the pier and its location in the channel:

$$V_{des} = K_1 K_2 V_{avg} \quad (11.2)$$

If a velocity distribution is available from stream tube or flow distribution output of a 1-D model or directly from a 2-D model, then only the pier shape coefficient should be used. The maximum velocity in the active channel V_{max} is often used since the channel could shift and the highest velocity could impact any pier.

$$V_{des} = K_1 V_{max} \quad (11.3)$$

where: V_{des} = Local velocity at pier, ft/s (m/s)
 K_1 = Shape factor equal to 1.5 for round-nose piers or 1.7 for square-faced piers
 K_2 = Velocity adjustment factor for location in the channel (ranges from 0.9 for a pier near the bank in a straight reach, to 1.7 for a pier located in the main current of flow around a sharp bend)
 V_{avg} = Channel average velocity at the bridge, ft/s (m/s)
 V_{max} = Maximum velocity in the active channel, ft/s (m/s)

Once a design size is established, a standard gradation class can be selected, if design criteria and economic considerations permit. Using standard sizes the appropriate gradation can be achieved by selecting the next size larger size class, thereby creating a slightly over-designed riprap installation, but economically a less expensive one.

11.4 SPECIFICATIONS FOR BRIDGE PIER RIPRAP

11.4.1 Size, Shape, and Gradation

Riprap design methods typically yield a required size of stone that will result in stable performance under the design loadings. Because stone is produced and delivered in a range of sizes and shapes, the required size of stone is often stated in terms of a minimum allowable representative size. For pier scour protection, the designer specifies a minimum allowable d_{50} for the rock comprising the riprap, thus indicating the size for which 50% (by weight) of the particles are smaller. Stone sizes can also be specified in terms of weight (e.g., W_{50}) using an accepted relationship between size and volume, and the known (or assumed) density of the particle.

For the shape, weight, density, and gradation of bridge pier riprap, specifications developed for revetment riprap are applicable (Lagasse et al. 2006). These specifications are provided in Design Guideline 4 of this document (see Section 4.2.4).

Design Guideline 4 recommends gradations for ten standard classes of riprap based on the median particle diameter d_{50} as determined by the dimension of the intermediate ("B") axis. These gradations were developed under NCHRP Project 24-23, "Riprap Design Criteria, Recommended Specifications, and Quality Control." The proposed gradation criteria are based on a nominal or "target" d_{50} and a uniformity ratio d_{85}/d_{15} that results in riprap that is well graded. The target uniformity ratio is 2.0 and the allowable range is from 1.5 to 2.5 (Lagasse et al. 2006).

11.4.2 Recommended Tests for Rock Quality

Standard test methods relating to material type, characteristics, and testing of rock and aggregates recommended for revetment riprap are applicable to bridge pier riprap (see Design Guideline 4). In general, the test methods recommended are intended to ensure that the stone is dense and durable, and will not degrade significantly over time.

Rocks used for riprap should only break with difficulty, have no earthy odor, no closely spaced discontinuities (joints or bedding planes), and should not absorb water easily. Rocks comprised of appreciable amounts of clay, such as shales, mudstones, and claystones, are **never** acceptable for use as riprap. The recommended tests and allowable values for rock and aggregate are summarized in Table 4.3 of Design Guideline 4.

11.5 LABORATORY TESTING OF BRIDGE PIER RIPRAP

11.5.1 Recent Studies

Laboratory studies of bridge pier riprap have been conducted to develop guidance on more than just the design size of bridge pier riprap. These studies have confirmed that a properly designed riprap system must integrate appropriately sized stone with adequate layout dimensions (extent and thickness) and an underlying filter (granular or geotextile) layer. This section summarizes the results of laboratory studies on bridge pier riprap conducted under NCHRP Projects 24-07(1) and 24-07(2) conducted at St. Anthony Falls Hydraulics Laboratory (Parker et al. 1998) and Colorado State University (Lagasse et al. 2007), respectively.

Some studies suggest that a filter may be unnecessary if the riprap layer is of sufficient thickness (Toro-Escobar 1998). Yet, a majority of the research on the stability of riprap at bridge piers to date indicates that the use of an underlying filter layer significantly increases the stability of the riprap layer. Many of the more recent experimental studies have evaluated the effects of a filter layer placed below a riprap layer on the stability of the riprap layer under live-bed conditions.

In general, granular filter layers should be of a gradation, size, and thickness sufficient to deter the effects of winnowing of the underlying bed sediments. Geotextiles should also have an effective pore size sufficiently small to block the passage of bed sediments, but have large enough permeability to deter or withstand buoyant forces and potential pressure gradients in the surface and subsurface in the area of the pier.

Parker et al. (1998) determined that placing a geotextile under a riprap with the same areal coverage as the riprap layer resulted in relatively poor performance of the riprap at bridge piers. As a result of the effects of live-bed conditions described above, the riprap at the edges tended to roll, slide or be plucked off exposing the underlying geotextile and ultimately resulting in failure of the riprap layer as successive bed forms pass and pluck more stones from the riprap layer. The failure of the geotextile was due in part to the impermeability of the fabric leading to the buildup of uplift forces and the creation of a bulge under the fabric, which contributed to the loss of riprap stones. In addition, the loss of the edge riprap and exposure of the geotextile allowed the geotextile to fold back on itself further reducing the stability of the riprap. If the geotextile was not sealed to the pier face, winnowing around the pier face resulted in a scour hole around the pier face and caused the geotextile and stones at the interface to fall into the scour hole.

For bridge piers, Parker et al. (1998) determined that the tendency for riprap to settle was arrested when: (a) the geotextile has 2/3 the areal coverage of the riprap, (b) the geotextile is sufficiently permeable, and (c) the geotextile is sealed to the pier. Lauchlan (1999) recommends that the geotextile have an areal coverage of 75% of the riprap layer so that the edges of the geotextile will be anchored when the edge stone of the riprap layer slide into the trough of passing bed forms.

At Colorado State University (CSU), a matrix of flume tests was completed for the NCHRP 24-07(2) research program (Lagasse et al. 2007). Both clear-water and live-bed conditions were examined. The laboratory tests were not designed to replicate any particular prototype scale conditions. However, in each case, the test countermeasure was "designed" to withstand the $2V_{crit}$ hydraulic condition. For example, the riprap size was selected such that particle dislodgement or entrainment was not anticipated during the $2V_{crit}$ run. This did not mean that the riprap wouldn't fail due to other factors, such as settling, edge undermining, or winnowing of substrate material. Runs utilizing an approach velocity of $2.5V_{crit}$ were intended to take the riprap system to failure by particle dislodgement.

As a baseline, maximum scour was determined for unprotected square and rectangular piers, under clear-water and live-bed conditions. A live-bed test was run for a sufficient duration (8 hours) to permit bed forms to migrate through the system. Figure 11.3 shows the results of unprotected square pier tests under live-bed conditions in the CSU indoor flume. Figure 11.4 shows the results of riprap tests under clear-water (Figure 11.4a) and live-bed (Figure 11.4b) conditions. **These tests validated the use of Equation 11.1 for sizing bridge pier riprap and the HEC-23 recommendations for riprap extent.**



Figure 11.3. Unprotected square piers.

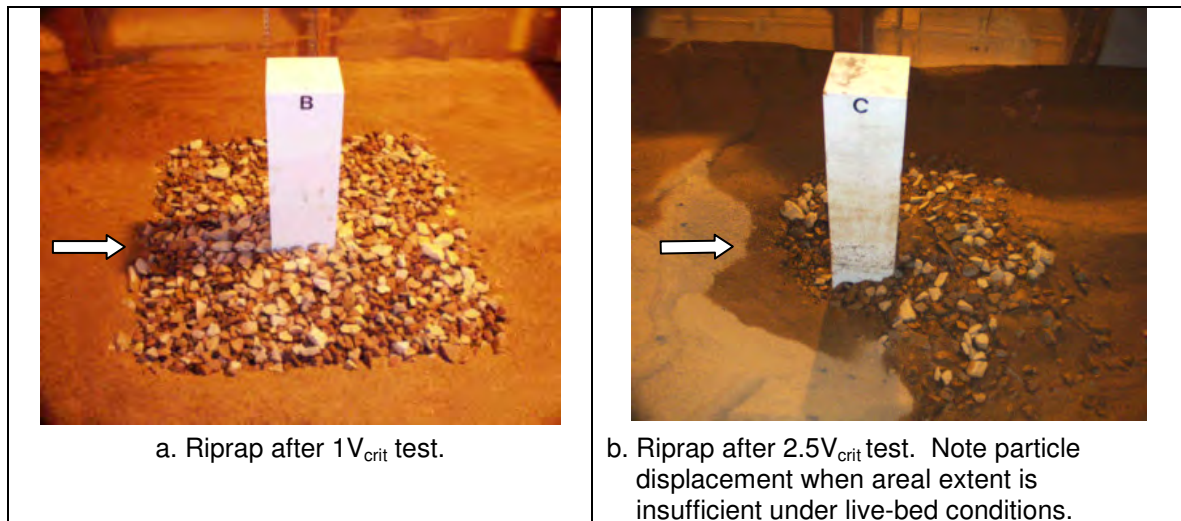

Figure 11.4. Riprap tests under clear-water and live-bed conditions.

11.5.2 Extent of Coverage

Typically, riprap used for pier scour protection is placed on the surface of the channel bed, in a pre-existing scour hole, or in a hole excavated around the pier. The Federal Highway Administration (Richardson and Davis 2001, Lagasse et al. 2001) recommends placing the top of the riprap layer flush with the channel bed for inspection purposes.

The design intent for the NCHRP 24-07(2) riprap coverage tests included (Lagasse et al. 2007):

- Areal riprap coverage and edge treatment with recommended geotextile
- Areal riprap coverage variation from HEC-23 with recommended geotextile
- Areal riprap coverage and thickness variation from HEC-23 with recommended geotextile
- Scour hole extent with recommended geotextile
- Scour hole extent without filter
- Thickness and filter variation from HEC-23 guidelines
- Examine mounded riprap without filter

Test results indicated that best performance was achieved when riprap extended at least 2 times the width of the pier (as measured perpendicular to the approach flow on all sides) in a flat pre-excavated hole with the top surface flush with the bed. Figure 11.5 shows the poor performance when the areal coverage was reduced to less than two pier widths on all sides.

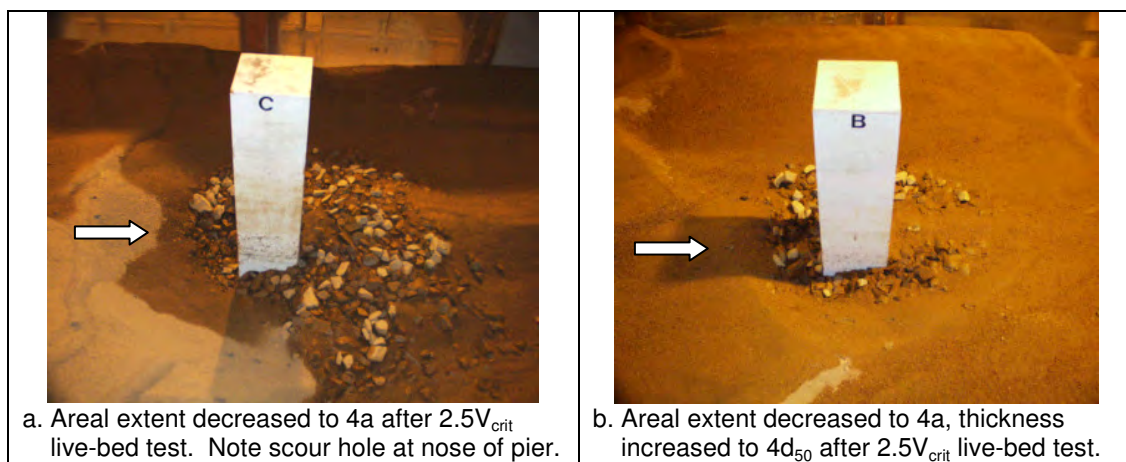

Figure 11.5. Decreased areal coverage riprap tests.

Riprap used for pier protection is often placed on the surface of the channel bed because of the ease and lower cost of placement and because it is more easily inspected. Test results indicated that when the stable baseline riprap configuration was mounded on the surface without a filter performance was poor. None of the tests with mounded riprap performed as well as tests with the top of the riprap level with the bed, given the same areal extent of riprap coverage. Figure 11.6 shows the results of a mounded riprap test.

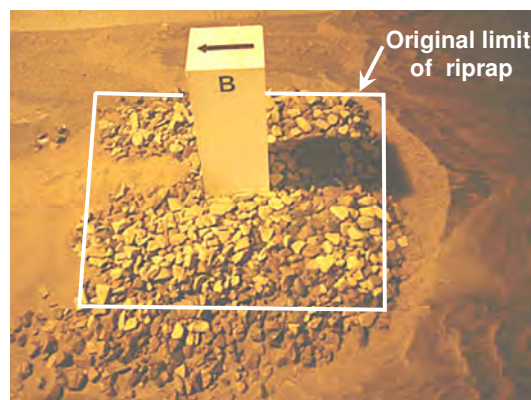

Figure 11.6. Mounded riprap after $2V_{crit}$ test.

Numerous riprap studies (see Lagasse et al. 2006) suggest that thickness of the riprap layer placed around the bridge piers should be between 2 to 3 times median stone size ($2-3d_{50}$) of the riprap. Testing results indicate that $3d_{50}$ is appropriate for specifying minimum thickness and that performance improved with increasing riprap layer thickness.

11.5.3 Filters

As noted, NCHRP Project 24-07(1) (Parker et al. 1998) determined that placing a geotextile under a riprap layer with the same areal coverage as the riprap layer resulted in a relatively poor performance of the riprap. Parker et al. suggested extending the geotextile from the pier to about 2/3 of the way to the periphery of the riprap would result in better performance. Additional test results for NCHRP Project 24-07(2) confirmed that riprap performance was best when a geotextile filter extended 2/3 the distance to the periphery of the riprap (Lagasse et al. 2007).

It was found that granular filters performed poorly in the case where bed forms are present. Specifically, during the passage of dune troughs past the pier that are deeper than the riprap armor; the underlying finer particles of a granular filter are rapidly swept away. The result is that the entire installation became progressively destabilized beginning at the periphery and working toward the pier. Figure 11.7 shows two piers after testing, one pier had a geotextile filter that extended 2/3 the distance from the pier face to the periphery (Figure 11.7a) and the other pier had a granular filter that extended the full distance from the pier face to the periphery of the riprap (Figure 11.7b).

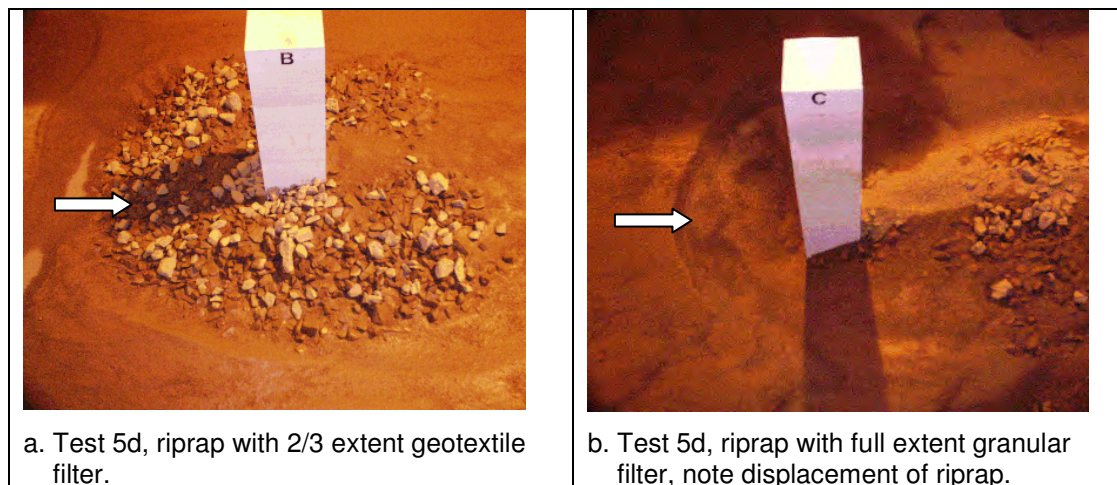

Figure 11.7. Testing of granular and geotextile filters.

For NCHRP Project 24-07(2) the use of sand filled geotextile containers as a filter under riprap was tested at a prototype scale pier (Lagasse et al. 2007). A test section was created that was 30.7 ft (9 m) long and spanned the width of the flume. It was filled with sand level with the approach section. Upstream and downstream of the test section the flume bed consists of smooth concrete floors. A rectangular pier measuring 1.5 ft (0.5 m) by 4.5 ft (1.5 m) was installed in the center of the test section. Figure 11.8 is a layout diagram for the prototype testing program. Surrounding the pier, a scour hole measuring 12 ft by 16 ft (4m x 5 m) was pre-formed into the sand bed to a maximum depth of 3 ft (0.4 m) as shown in Figure 11.9. For the geotextile containers the test at prototype scale was, primarily, to demonstrate constructability and performance in high velocity flow conditions.

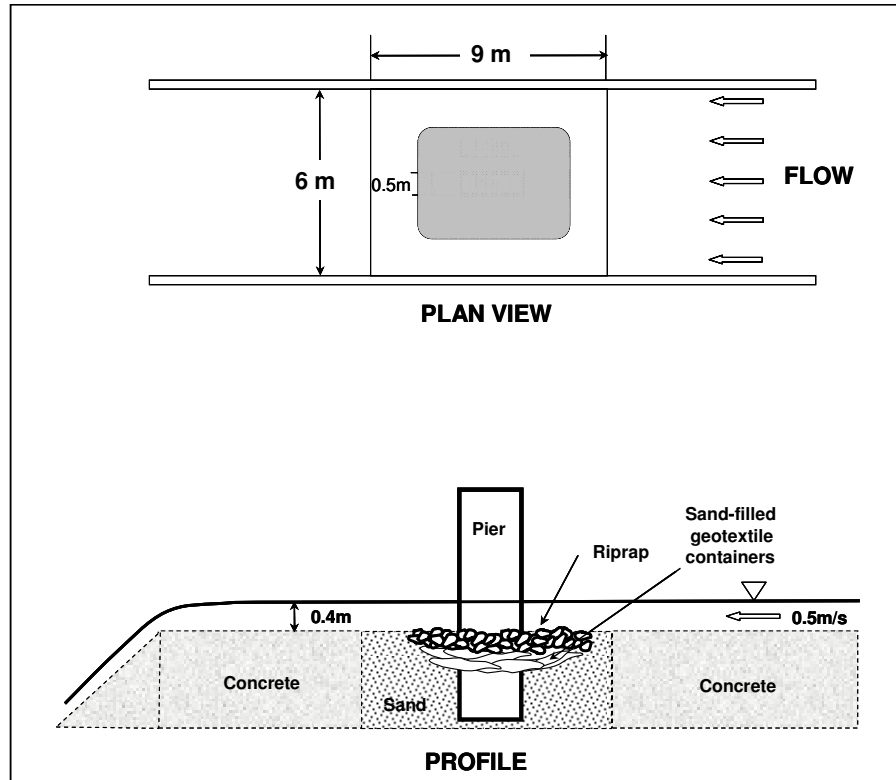

Figure 11.8. Schematic layout for sand filled geotextile containers and riprap tests (dimensions approximate).

Sand filled geotextile containers were constructed using a geotextile fabric with the characteristics presented in Table 11.1. The geotextile containers measured 4 ft x 1.5 ft x 0.33 ft (1.2 m x 0.5 m x 0.1 m) with a typical volume of 2 ft³ (0.6 m³). Approximately 220 lbs (100 kg) of sand was placed in each bag. Commercial concrete sand meeting appropriate filter criteria was used to fill the geotextile container. Figure 11.10 shows the geotextile containers before being placed around the pier.

Trade Name	Mass per Unit Area	AOS	Permeability	Geotextile Type	K _g /K _s
Mirafi® 180 N	278 g/m ²	0.18 mm	0.21 cm/s	Nonwoven needle punched	5.25

An approach flow 1 ft (0.305 m) deep at approximately 1.5 ft/s (0.5 m/s) was established. A total of 32 geotextile containers were placed around the pier by dropping from a height of about 5 ft (1.5 m) above the water surface. Installation was facilitated by a backhoe fitted with a special grapple attached to the bucket, which enabled the backhoe to pick up the geotextile container, position around the pier to a specified location, and release the container. Figure 11.11 is a photograph of a geotextile container being dropped near the pier; note the grapple plate attachment to the backhoe. Figure 11.12 shows the geotextile containers after installation in approximately 1 ft (0.305 m) of flowing water.

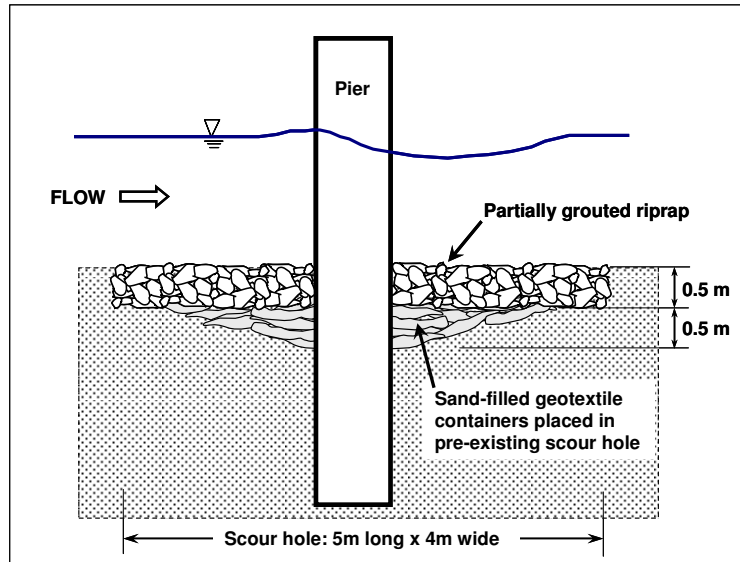

Figure 11.9. Schematic of geotextile container tests.



Figure 11.10. Geotextile containers before installation around the pier.

Next, riprap was positioned on top of the geotextile containers using the backhoe with the grapple removed. Figure 11.13 shows riprap being dropped near the pier and Figure 11.14 shows the riprap after installation. These tests confirmed that geotextile containers can be fabricated locally and that the containers and riprap can be placed with standard commercially available equipment. The final step in the testing procedure was to use partial grouting techniques (see Design Guideline 12) to demonstrate the enhanced stability of partially grouted riprap as a pier scour countermeasure.

11.6 LAYOUT DIMENSIONS

11.6.1 Riprap and Filter

Based on information derived primarily from NCHRP Project 24-07(2) the optimum performance of riprap as a pier scour countermeasure was obtained when the riprap extended a distance of 2 times the pier width in all directions around the pier (Lagasse et al. 2007).

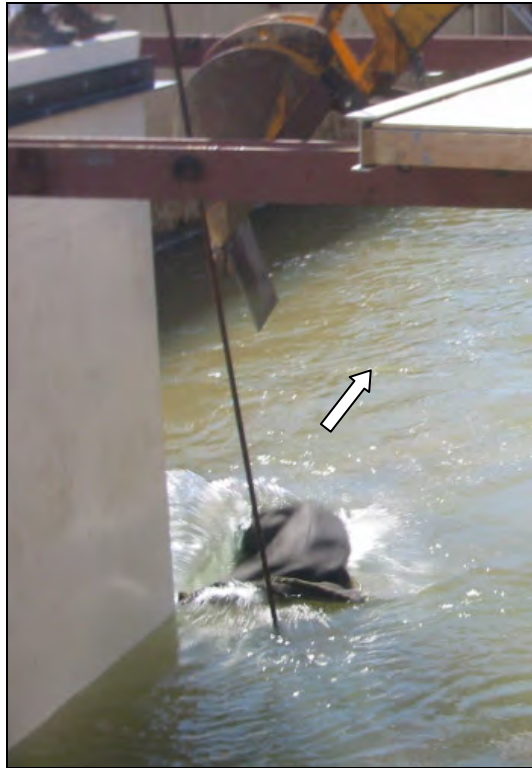

Figure 11.11. Installation of geotextile containers, pier is on the left.

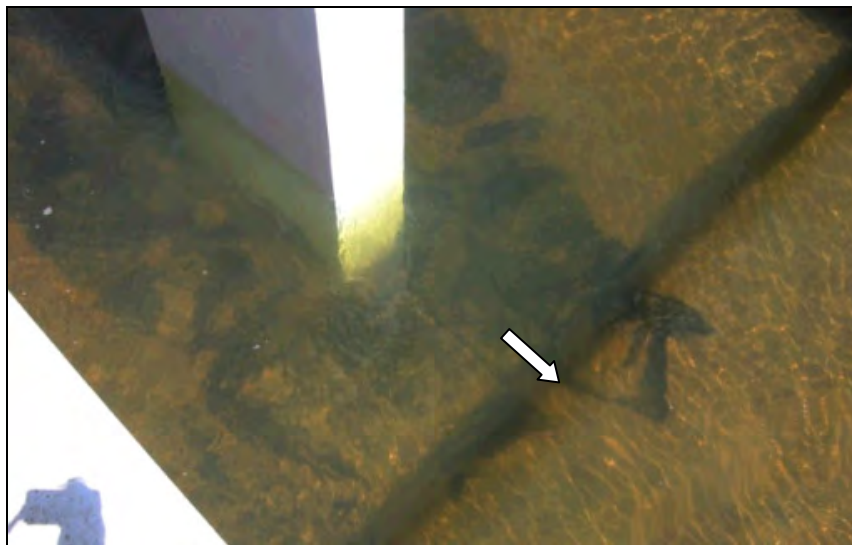

Figure 11.12. Geotextile containers after installation.

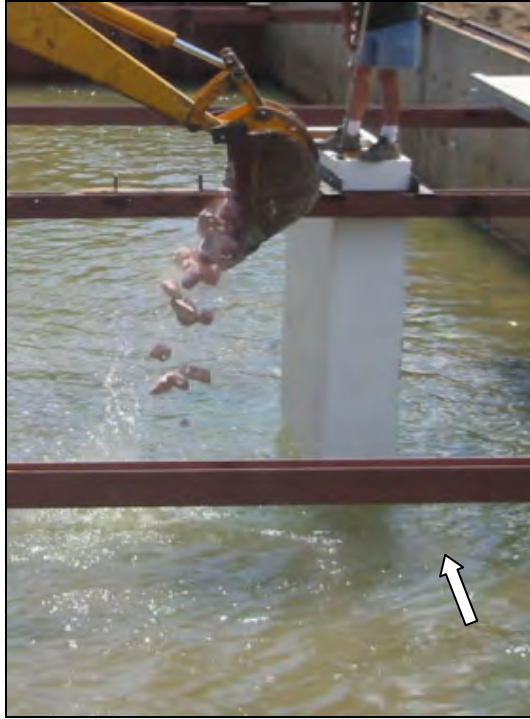

Figure 11.13. Installation of riprap around pier.



Figure 11.14. Riprap armor over geotextile containers.

In the case of wall piers or pile bents consisting of multiple columns where the axis of the structure is skewed to the flow direction, the lateral extent of the protection should be increased in proportion to the additional scour potential caused by the skew. While there is no definitive guidance for pier scour countermeasures, it is recommended that the extent of the armor layer should be multiplied by a factor K_{α} , which is a function of the width (a) and length (L) of the pier (or pile bents) and the skew angle α as given below (Richardson and Davis 2001):

$$K_{\alpha} = \left(\frac{a \cos \alpha + L \sin \alpha}{a} \right)^{0.65} \quad (11.4)$$

Riprap should be placed in a pre-excavated hole around the pier so that the top of the riprap layer is level with the ambient channel bed elevation. Placing the top of the riprap flush with the bed is ideal for inspection purposes, and does not create any added obstruction to the flow. Mounding riprap around a pier is not acceptable for design in most cases, because it obstructs flow, captures debris, and increases scour at the periphery of the installation (see Figure 11.6).

The riprap layer should have a minimum thickness of 3 times the d_{50} size of the rock. However, when contraction scour through the bridge opening exceeds $3d_{50}$, the thickness of the riprap must be increased to the full depth of the contraction scour plus any long-term degradation. In river systems where dune bed forms are present during flood flows, the depth of the trough below the ambient bed elevation should be estimated using the methods of Karim (1999) and/or van Rijn (1984). In general, an upper limit on the crest-to-trough height Δ is provided by Bennett (1997) as $\Delta < 0.4y$ where y is the depth of flow. This suggests that the maximum depth of the bed form trough below ambient bed elevation will not exceed 0.2 times the depth of flow. Additional riprap thickness due to any of these conditions may warrant an increase in the extent of riprap away from the pier faces, such that riprap launching at a 1V:2H slope under water can be accommodated. When placement of the riprap must occur under water, the thickness should be increased by 50%. Recommended layout dimensions for bridge pier riprap are provided in Figure 11.15.

The importance of the filter component of any riprap installation should not be underestimated. There are two kinds of filters used in conjunction with riprap; granular filters and geotextile filters. Some situations call for a composite filter consisting of both a granular layer and a geotextile. The specific characteristics of the base soil determine the need for, and design considerations of the filter layer. ***In cases where dune-type bed forms may be present, it is strongly recommended that only a geotextile filter be considered.*** Guidance on the design of granular and geotextile filters is provided in Design Guideline 16.

A filter layer is typically required for riprap at bridge piers. The filter should ***not*** be extended fully beneath the riprap; instead, it should be terminated 2/3 of the distance from the pier to the edge of the riprap. When using a granular stone filter, the layer should have a minimum thickness of 4 times the d_{50} of the filter stone or 6 in. (15 cm), whichever is greater. As with riprap, the layer thickness should be increased by 50% when placing under water.

Sand-filled geotextile containers made of properly-selected materials provide a convenient method for controlled placement of a filter in flowing water. This method can also be used to partially fill an existing scour hole when placement must occur under water, as illustrated in Figure 11.16. For more detail, see Sections 11.5.3 and 11.6.2.

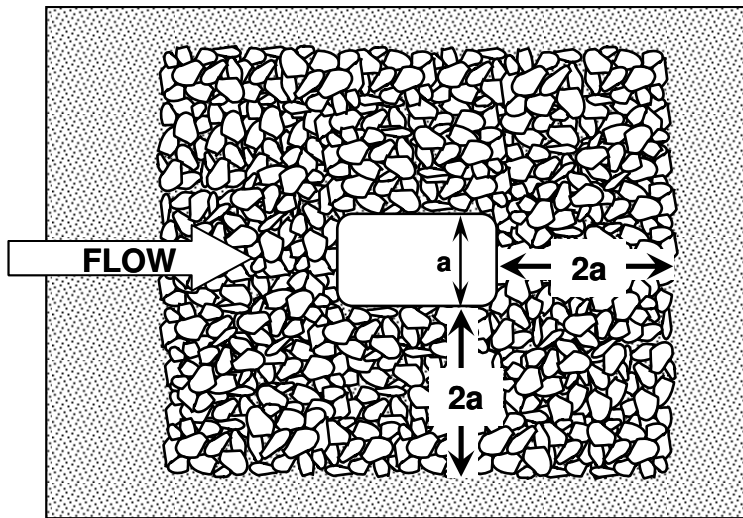

Pier width = "a" (normal to flow)
 Riprap placement = $2(a)$ from pier (all around)

a. Plan View

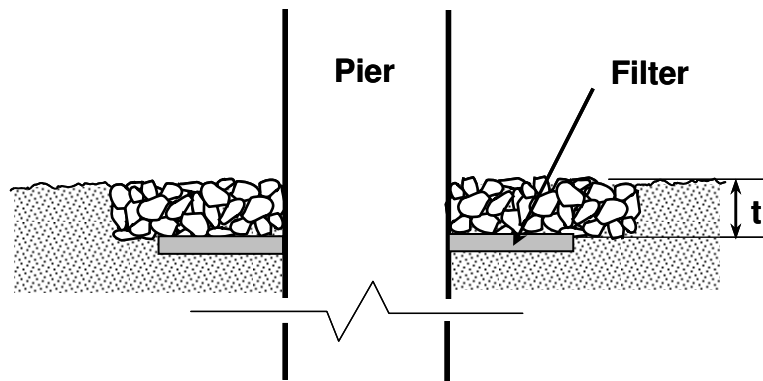

Minimum riprap thickness $t = 3d_{50}$, depth of contraction scour and long-term degradation, or depth of bedform trough, whichever is greatest

Filter placement = $4/3(a)$ from pier (all around)

b. Profile

Figure 11.15. Riprap layout diagram for pier scour protection.

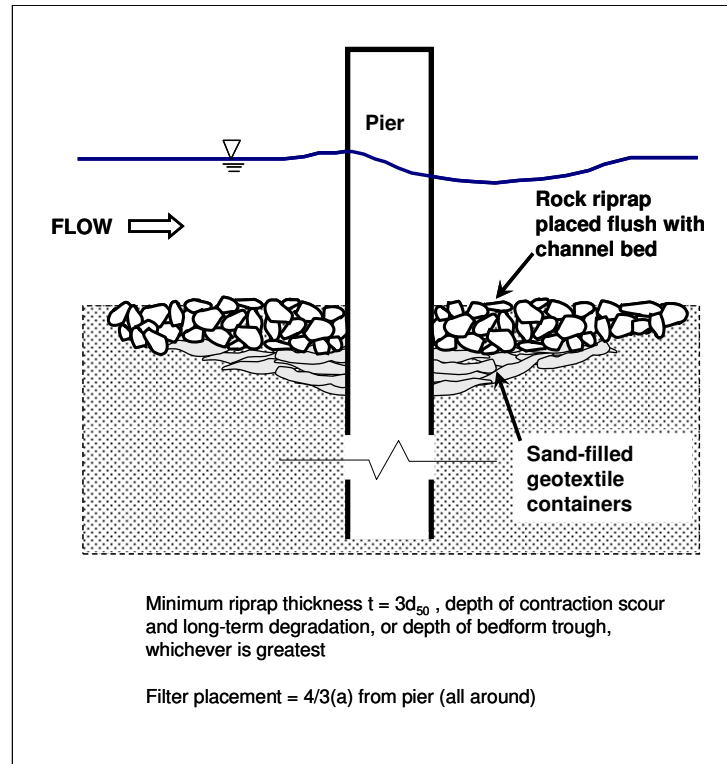

Figure 11.16. Schematic diagram showing sand-filled geotextile container filter beneath pier riprap.

11.6.2 Placing Geotextiles Under Water

Placing geotextiles under water is problematic for a number of reasons. Most geotextiles that are used as filters beneath riprap are made of polyethylene or polypropylene. These materials have specific gravities ranging from 0.90 to 0.96, meaning that they will float unless weighted down or otherwise anchored to the subgrade prior to placement of the riprap (Koerner 1998). In addition, unless the work area is isolated from river currents by a cofferdam, flow velocities greater than about 1.0 ft/s (0.3 m/s) create large forces on the geotextile. These forces cause the geotextile to act like a sail, often resulting in wavelike undulations of the fabric (a condition that contractors refer to as "galloping") that are extremely difficult to control. In mild currents, geotextiles (precut to length) have been placed using a roller assembly, with sandbags to hold the fabric temporarily.

To overcome these problems, engineers in Germany have developed a product known as SandMat™. This blanket-like product consists of two non-woven geotextiles (or a woven and a non-woven) with sand in between. The layers are stitch-bonded or sewn together to form a heavy, filtering geocomposite. The composite blanket exhibits an overall specific gravity ranging from approximately 1.5 to 2.0, so it sinks readily.

According to Heibaum (2002), this composite geotextile has sufficient stability to be handled even when loaded by currents up to approximately 3.3 ft/s (1 m/s). At the geotextile - subsoil interface, a non-woven fabric should be used because of the higher angle of friction compared to woven geotextiles. Figure 11.17 shows a close-up photo of the SandMat™ material. Figure 11.18 shows the SandMat™ blanket being rolled out using conventional geotextile placement equipment.



Figure 11.17. Close-up photo of SandMat™ geocomposite blanket.
(photo from NCHRP Project 24-07(2), courtesy Colcrete – Von Essen Inc.)

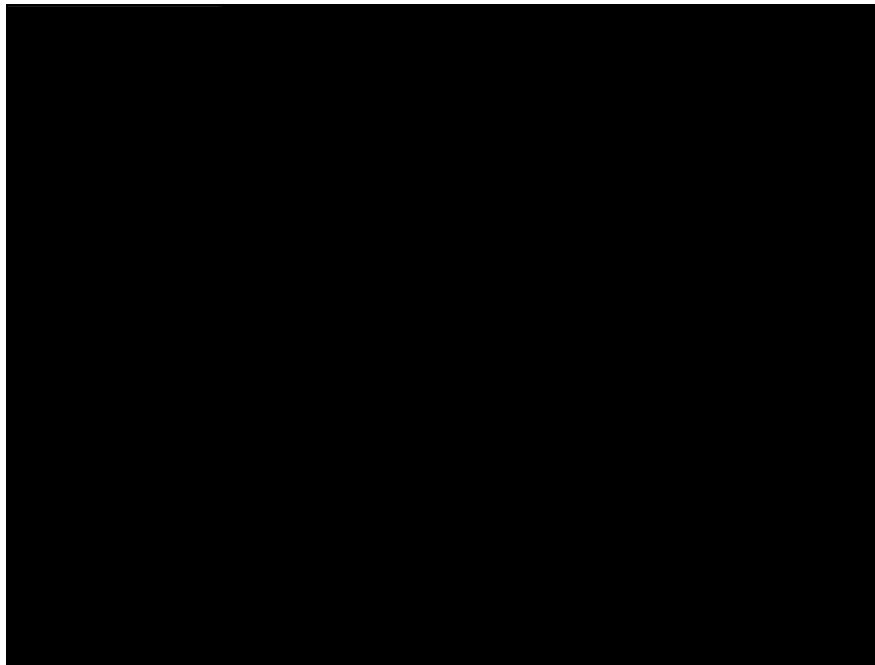

Figure 11.18. SandMat™ geocomposite blanket being unrolled.
(photo from NCHRP Project 24-07(2), courtesy Colcrete – Von Essen Inc.)

In deep water or in currents greater than 3.3 ft/s (1 m/s), German practice calls for the use of sand-filled geotextile containers. For specific project conditions, geotextile containers can be chosen that combine the resistance against hydraulic loads with the filtration capacity demanded by the application. Geotextile containers have proven to give sufficient stability against erosive forces in many applications, including wave-attack environments. The size of the geotextile container must be chosen such that the expected hydraulic load will not transport the container during placement (Heibaum 2002). Once placed, the geotextile containers are overlaid with the final armoring material (see Figure 11.16 and Section 11.5.3).

Figure 11.19 shows a large geotextile container being filled with sand. Figure 11.20 shows the sand-filled geotextile container being handled with an articulated-arm clam grapple. The filled geotextile container in the photograph is a nominal 1-metric-ton (1,000 kg or 2,200 lb) unit. The preferred geotextile for these applications is always a non-woven needle punched fabric, with a minimum mass per unit area of 500 grams per square meter. Smaller geotextile containers can be fabricated and handled by one or two people for smaller-sized applications.



Figure 11.19. Filling geotextile container with sand.
(photo from NCHRP Project 24-07(2), courtesy Colcrete – Von Essen Inc.)



Figure 11.20. Handling a one-tonne sand-filled geotextile container.
(photo from NCHRP Project 24-07(2), courtesy Colcrete – Von Essen Inc.)

11.7 EXAMPLE APPLICATION

Riprap is to be sized for an existing 2 ft (0.61 m) square pier (see Figure 11.21). The average velocity in the channel is 3.8 ft/s (1.16 m/s) and the pier is located in the main current around a mild bend. The average depth of flow is 6 ft (1.8 m). The riprap specific gravity is 2.5. The computed contraction scour is 2.0 ft (0.61 m). No long-term degradation is anticipated at this site.

Step 1: Select the appropriate shape coefficient (K_1) = 1.7.

Step 2: Determine the appropriate design velocity:

$$\begin{aligned} V_{des} &= K_1 K_2 V_{avg} \\ &= (1.7) (1.4) (3.8) \\ &= 9 \text{ ft/sec (2.7 m/s)} \end{aligned}$$

Step 3: Determine d_{50} from Equation 11.1:

$$d_{50} = \frac{0.692(V_{des})^2}{(S_s - 1)2g} = \frac{0.692(9)^2}{(2.5 - 1)2 \times 32.2} = 0.58 \text{ ft} \times 12 \frac{\text{in}}{\text{ft}} = 7.0 \text{ in. (0.18 m)}$$

Step 4: Select Class II riprap from Table 4.1 of Design Guide 4: $d_{50} = 9 \text{ in. (0.23 m)}$

Step 5: Determine the depth of riprap below the streambed at the pier:

The depth of riprap is the greater of $3d_{50}$, the contraction scour and long-term degradation depth, or the depth of bedform troughs.

$$\begin{aligned} 3 d_{50} &= 3 (9) = 27 \text{ in.} = 2.25 \text{ ft (0.69 m)} \\ \text{Contraction Scour} &= 2.0 \text{ ft (0.61 m)} \\ \text{Bed forms} &= 0.2 (6) = 1.2 \text{ ft (0.37 m)} \end{aligned}$$

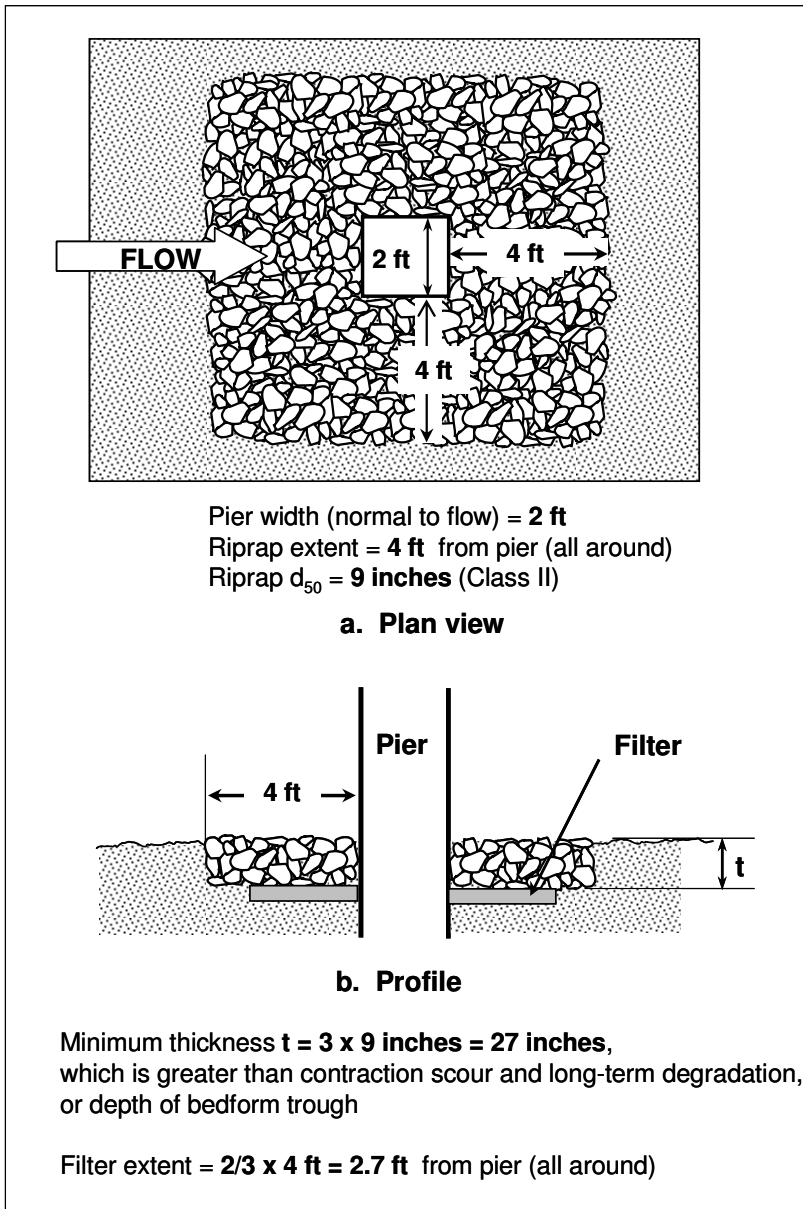

Figure 11.21. Riprap layout diagram for pier scour protection.

Step 6: Determine the riprap extent:

The recommended extent is at least two times the pier width. Therefore, the minimum riprap extent is 4 ft (1.22 m) from each face of the pier.

Step 7: Additional considerations:

- a. Place the top of a riprap mat at the same elevation as the streambed. Placing the bottom of a riprap mat on top of the streambed is discouraged. In all cases where riprap is used for scour control, the bridge must be monitored during and inspected after high flows.

It is important to note that it is a disadvantage to bury riprap so that the top of the mat is below the streambed because inspectors have difficulty determining if some or all of the riprap has been removed. Therefore, it is recommended to place the top of a riprap mat at the same elevation as the streambed.

- b. The maximum size rock should be no greater than twice the D_{50} size.

11.9 REFERENCES

Bennett, J.P., 1997, "Resistance, Sediment Transport, and Bedform Geometry Relationships in Sand-Bed Channels," in: Proceedings of the U.S. Geological Survey (USGS) Sediment Workshop, February 4-7.

Heibaum, M.H., 2002, "Geotechnical Parameters of Scouring and Scour Counter-measures," Mitteilungsblatt der Bundesanstalt für Wasserbau Nr. 85. (J. Federal Waterways Engineering and Research Institute, No. 85), Karlsruhe, Germany.

Isbash, S.V., 1936, "Construction of Dams by Depositing Rock in Running Water," Transactions, Second Congress on Large Dams, U.S. Government Report No. 3, Washington D.C.

Karim, F., 1999, "Bed-Form Geometry in Sand-Bed Flows," Journal of Hydraulic Engineering, Vol. 125, No. 12, December.

Koerner, R.M., 1998, "Designing with Geosynthetics," 4th Edition, Prentice-Hall, Inc., Englewood Cliffs, NJ, 761 p.

Lagasse, P.F., Zevenbergen, L.W., Schall, J.D., and Clopper, P.E., 2001, "Bridge Scour and Stream Instability Countermeasures," Hydraulic Engineering Circular No. 23 (HEC-23, Second Edition), Report FHWA NHI -01-003, Federal Highway Administration, Washington, D.C.

Lagasse, P.F., Clopper, P.E., Zevenbergen, L.W., and Ruff, J.F., 2006, "Riprap Design Criteria, Recommended Specifications, and Quality Control," NCHRP Report 568, Transportation Research Board, National Research Council, Washington, D.C.

Lagasse, P.F., Clopper, P.E., Zevenbergen, L.W., and Girard, L.G., 2007, "Countermeasures to Protect Bridge Piers from Scour," NCHRP Report 593, Transportation Research Board, National Research Council, Washington, D.C.

Lauchlan, C.S., 1999, "Pier Scour Countermeasures," Ph.D. Thesis, University of Auckland, Auckland, NZ.

Melville, B.W. and Coleman, S.E., 2000, "Bridge Scour," Water Resources Publications, LLC, Highlands Ranch, CO, 550 pp.

Parker, G., Toro-Escobar, C., and Voigt, R.L. Jr., 1998, "Countermeasures to Protect Bridge Piers from Scour," Users Guide (revised 1999) and Final Report, NCHRP Project 24-07, prepared for Transportation Research Board by St. Anthony Falls Laboratory, University of Minnesota, MN, 360 pp.

Richardson, E.V. and S.R. Davis, 2001, "Evaluating Scour at Bridges," Hydraulic Engineering Circular 18, Fourth Edition, FHWA NHI 01-001, Federal Highway Administration, U.S. Department of Transportation, Washington, D.C.

Toro-Escobar, C., Voigt, R., Jr., Melville, B., Chiew, M., and Parker, G., 1998, "Riprap Performance at Bridge Piers Under Mobile-Bed Conditions," Transportation Research Board, Transportation Research Record 1647, Paper No. 98-1165, pp. 27-33.

van Rijn, L.C., 1984, "Sediment Transport, Part III: Bed Forms and Alluvial Roughness," *Journal of Hydraulic Engineering*, Vol. 110, No. 12, December.

DESIGN GUIDELINE 12

PARTIALLY GROUTED RIPRAP AT BRIDGE PIERS

(page intentionally left blank)

DESIGN GUIDELINE 12

PARTIALLY GROUTED RIPRAP AT BRIDGE PIERS

12.1 INTRODUCTION

Partially grouted riprap, when properly designed and used for erosion protection, has an advantage over rigid structures because it is flexible when under attack by river currents, it can remain functional even if some individual stones may be lost, and it can be repaired relatively easily. Properly constructed, partially grouted riprap can provide long-term protection if it is inspected and maintained on a periodic basis as well as after flood events. Partially grouted riprap may be used for bank protection as well as a scour countermeasure at piers and abutments.

Partially grouted riprap consists of specifically sized rocks that are placed and grouted together, with the grout filling only 1/3 to 1/2 of the total void space (Figure 12.1). In contrast to fully grouted riprap, partial grouting increases the overall stability of the riprap installation unit without sacrificing flexibility or permeability. The voids of the riprap matrix are partially filled with a Portland cement based grout by hose or tremie, or by automated mechanical means. Hydraulic stability of the armor is increased significantly over that of loose riprap by virtue of the much larger mass and high degree of interlocking of the "conglomerate" particles created by the grouting process.



Figure 12.1. Close-up view of partially grouted riprap.

Various degrees of grouting are possible, but the optimal performance is achieved when the grout is effective at "gluing" individual stones to neighboring stones at their contact points, but leaves relatively large voids between the stones. Since riprap is a natural material and is readily available in many areas, it has been used extensively in erosion protection works.

Designing partially grouted riprap installations requires knowledge of: river bed and bank material; flow conditions including velocity, depth and orientation; pier size, shape, and skew with respect to flow direction; riprap characteristics of size, density, durability, and availability; and the type of interface material between the partially grouted riprap and underlying foundation. The system typically includes a filter layer, either a geotextile fabric or a filter of sand and/or gravel, specifically selected for compatibility with the subsoil. The filter allows infiltration and exfiltration to occur while providing particle retention.

The guidance for partially grouted riprap applications provided in this document has been developed primarily from the results of National Cooperative Highway Research Program (NCHRP) Report 593 (Lagasse et al. 2007) and publications from the German Federal Waterway Engineering and Research Institute (BAW) in Karlsruhe, Germany. Although partially grouted riprap has been used successfully for many applications in Europe, this Design Guideline has been developed specifically for bridge piers.

12.2 DESIGN AND SPECIFICATION

12.2.1 Riprap Properties

Riprap design methods typically yield a required size of stone that will result in stable performance under the design loadings. Because stone is produced and delivered in a range of sizes and shapes, the required size of stone is often stated in terms of a minimum allowable representative size. Typically, the designer specifies a minimum allowable d_{50} for the rock comprising the riprap, thus indicating the size for which 50% (by weight) of the particles are smaller. Stone sizes can also be specified in terms of weight (e.g., W_{50}) using an accepted relationship between size and volume, and the known (or assumed) density of the particle.

Shape: The shape of a stone can be generally described by designating three axes of measurement: Major, intermediate, and minor, also known as the "A, B, and C" axes, as shown in Figure 12.2. Riprap stones should not be thin and platy, nor should they be long and needle-like. Therefore, specifying a maximum allowable value for the ratio A/C , also known as the shape factor, provides a suitable measure of particle shape, since the B axis is intermediate between the two extremes of length A and thickness C. A maximum allowable value of 3.0 is recommended:

$$\frac{A}{C} \leq 3.0 \quad (12.1)$$

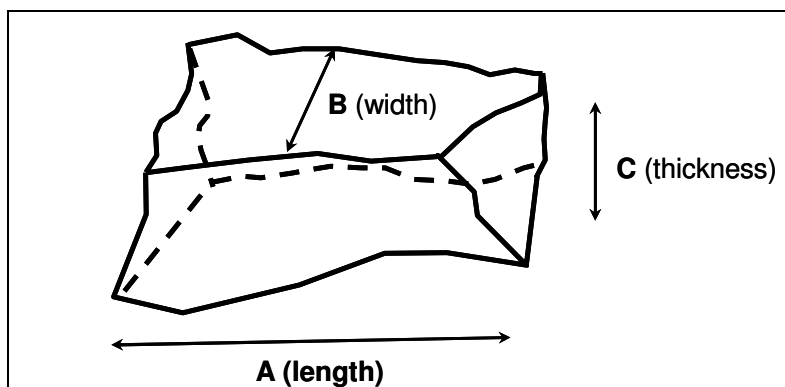

Figure 12.2. Riprap shape described by three axes.

For riprap applications, stones tending toward subangular to angular are preferred, due to the higher degree of interlocking, hence greater stability, compared to rounded particles of the same weight.

Density: A measure of density of natural rock is the specific gravity S_g , which is the ratio of the density of a single (solid) rock particle γ_s to the density of water γ_w :

$$S_g = \frac{\gamma_s}{\gamma_w} \quad (12.2)$$

Usually, a minimum allowable specific gravity of 2.5 is required for riprap applications. Where quarry sources uniformly produce rock with a specific gravity significantly greater than 2.5 (such as dolomite, $S_g = 2.7$ to 2.8), the equivalent stone size can be substantially reduced and still achieve the same particle weight gradation.

Size and weight: Based on field studies, the recommended relationship between size and weight is given by:

$$W = 0.85(\gamma_s d^3) \quad (12.3)$$

where:

- W = Weight of stone, lb (kg)
- γ_s = Density of stone, lb/ft³ (kg/m³)
- d = Size of intermediate ("B") axis, ft (m)

Table 12.1 provides recommended gradations for ten standard classes of riprap based on the median particle diameter d_{50} as determined by the dimension of the intermediate ("B") axis. These gradations were developed under NCHRP Report 568, "Riprap Design Criteria, Specifications, and Quality Control" (Lagasse et al. 2006). The proposed gradation criteria are based on a nominal or "target" d_{50} and a uniformity ratio d_{85}/d_{15} that results in riprap that is well graded. The target uniformity ratio is 2.0 and the allowable range is from 1.5 to 2.5.

Nominal Riprap Class by Median Particle Diameter		d_{15}		d_{50}		d_{85}		d_{100}
Class	Size	Min	Max	Min	Max	Min	Max	Max
I	6 in	3.7	5.2	5.7	6.9	7.8	9.2	12.0
II	9 in	5.5	7.8	8.5	10.5	11.5	14.0	18.0
III	12 in	7.3	10.5	11.5	14.0	15.5	18.5	24.0
IV	15 in	9.2	13.0	14.5	17.5	19.5	23.0	30.0
V	18 in	11.0	15.5	17.0	20.5	23.5	27.5	36.0
VI	21 in	13.0	18.5	20.0	24.0	27.5	32.5	42.0
VII	24 in	14.5	21.0	23.0	27.5	31.0	37.0	48.0
VIII	30 in	18.5	26.0	28.5	34.5	39.0	46.0	60.0
IX	36 in	22.0	31.5	34.0	41.5	47.0	55.5	72.0
X	42 in	25.5	36.5	40.0	48.5	54.5	64.5	84.0

Note: Only Classes II, III, and IV are suitable for use in partial grouting applications.

The intent of partial grouting is to "glue" stones together to create a conglomerate of particles (see Section 12.6, "Construction"). Each conglomerate is therefore significantly greater than the d_{50} stone size, and typically is larger than the d_{100} size of the individual stones in the riprap matrix. **Only three standard classes may be used with the partial grouting technique: Classes II, III, and IV.** Riprap smaller than Class II exhibits voids that are too small for grout to effectively penetrate to the required depth within the rock matrix, while riprap that is larger than Class IV has voids that are too large to retain the grout, and does not have enough contact area between stones to effectively glue them together.

Permeability of the completed installation is maintained because less than 50% of the void space is filled with grout. Flexibility of the installation occurs because the matrix will fracture into the conglomerate-sized pieces under hydraulic loading and/or differential settlement. The surface of each conglomerate particle is highly rough and irregular, and so maintains excellent interlocking between particles after fracturing occurs.

Based on Equation 12.3, which assumes the volume of the stone is 85% of a cube, Table 12.2 provides the equivalent particle weights for the same ten classes, using a specific gravity of 2.65 for the particle density.

Nominal Riprap Class by Median Particle Weight		W_{15}		W_{50}		W_{85}		W_{100}
Class	Weight	Min	Max	Min	Max	Min	Max	Max
I	20 lb	4	12	15	27	39	64	140
II	60 lb	13	39	51	90	130	220	470
III	150 lb	32	93	120	210	310	510	1100
IV	300 lb	62	180	240	420	600	1000	2200
V	1/4 ton	110	310	410	720	1050	1750	3800
VI	3/8 ton	170	500	650	1150	1650	2800	6000
VII	1/2 ton	260	740	950	1700	2500	4100	9000
VIII	1 ton	500	1450	1900	3300	4800	8000	17600
IX	2 ton	860	2500	3300	5800	8300	13900	30400
X	3 ton	1350	4000	5200	9200	13200	22000	48200

Note: Only Classes II, III, and IV are suitable for use in partial grouting applications.

12.2.2 Recommended Tests for Rock Quality

Standard test methods relating to material type, characteristics, and testing of rock and aggregates typically associated with riprap installations (e.g., filter stone and bedding layers) are provided in this section and are recommended for specifying the quality of the riprap stone. In general, the test methods recommended in this section are intended to ensure that the stone is dense and durable, and will not degrade significantly over time.

Rocks used for riprap should only break with difficulty, have no earthy odor, no closely spaced discontinuities (joints or bedding planes), and should not absorb water easily. Rocks comprised of appreciable amounts of clay, such as shales, mudstones, and claystones, are **never** acceptable for use as fill for gabion mattresses. Table 12.3 summarizes the recommended tests and allowable values for rock and aggregate.

Table 12.3. Recommended Tests for Riprap Quality.

Test Designation	Property	Allowable value		Frequency ⁽¹⁾	Comments
AASHTO TP 61	Percentage of Fracture	< 5%		1 per 20,000 tons	Percentage of pieces that have fewer than 50% fractured surfaces
AASHTO T 85	Specific Gravity and Water Absorption	Average of 10 pieces: $S_g > 2.5$ Absorption < 1.0%		1 per year	If any individual piece exhibits an S_g less than 2.3 or water absorption greater than 3.0%, an additional 10 pieces shall be tested. If the second series of tests also exhibits pieces that do not pass, the riprap shall be rejected.
AASHTO T 103	Soundness by Freezing and Thawing	Maximum of 10 pieces after 25 cycles: < 0.5%		1 per 2 years	Recommended only if water absorption is greater than 0.5% and the freeze-thaw severity index is greater than 15 per ASTM D 5312.
AASHTO T 104	Soundness by Use of Sodium Sulfate or Magnesium Sulfate	Average of 10 pieces: < 17.5%		1 per year	If any individual piece exhibits a value greater than 25%, an additional 10 pieces shall be tested. If the second series of tests also exhibits pieces that do not pass, the riprap shall be rejected.
AASHTO TP 58	Durability Index Using the Micro-Deval Apparatus	<u>Value</u> > 90 > 80 > 70	<u>Application</u> Severe Moderate Mild	1 per year	Severity of application per Section 5.4, CEN (2002). Most riverine applications are considered mild or moderate.
ASTM D 3967	Splitting Tensile Strength of Intact Rock Core Specimens	Average of 10 pieces: > 6 MPa		1 per year	If any individual piece exhibits a value less than 4MPa, an additional 10 pieces shall be tested. If the second series of tests also exhibits pieces that do not pass, the riprap shall be rejected.
ASTM D 5873	Rock Hardness by Rebound Hammer	See Note (2)		1 per 20,000 tons	See Note (2)
Shape	Length to Thickness Ratio A/C	< 10%, $d_{50} < 24$ inch < 5%, $d_{50} > 24$ inch		1 per 20,000 tons	Percentage of pieces that exhibit A/C ratio greater than 3.0 using the Wolman Count method (Lagasse et al. 2006)
ASTM D 5519	Particle Size Analysis of Natural and Man-Made Riprap Materials			1 per year	See Note (3)
Gradation	Particle Size Distribution Curve			1 per 20,000 tons	Determined by the Wolman Count method (Lagasse et al. 2006), where particle size "d" is based on the intermediate ("B") axis
<p>(1) Testing frequency for acceptance of riprap from certified quarries, unless otherwise noted. Project-specific tests exceeding quarry certification requirements, either in performance value or frequency of testing, must be specified by the Engineer.</p> <p>(2) Test results from D 5873 should be calibrated to D 3967 results before specifying quarry-specific minimum allowable values.</p> <p>(3) Test results from D 5519 should be calibrated to Wolman Count (Lagasse et al. 2006) results before developing quarry-specific relationships between size and weight; otherwise, assume $W = 85\%$ that of a cube of dimension "d" having a specific gravity of S_g</p>					

12.2.3 Grout

For partially grouted riprap applications, only Portland cement based grout is appropriate. General requirements for grouting materials are based on guidance developed by the Federal Waterway Engineering and Research Institute (BAW) in Germany (MAV 1990). The following provides guidance on the basic grout mix for one cubic yard (0.76 m³) of grout:

<u>Material</u>	<u>Quantity by weight (pounds)</u>
• Ordinary Portland cement	740 to 760
• Fine concrete aggregate (sand), dry	1,180 to 1,200
• ¼" crusher chips (very fine gravel), dry	1,180 to 1,200
• Water	420 to 450
• Air entrained	5 to 7%
• Anti-washout additive (Sicotan®) (used only for placement underwater)	6 to 8

The mix should result in a wet grout density ranging from 120 to 140 lb/ft³ (2.0 to 2.3 kg/dm³). Wet densities outside this range should be rejected and the mix re-evaluated for material properties of the individual constituents.

12.2.4 Recommended Tests for Grout Quality

A variety of tests have been developed by the BAW in Germany. The two most relevant tests are described below. The full document entitled, "Guidelines for Testing of Cement and Bitumen Bonded Materials for the Grouting of Armor Stones on Waterways" has been translated into English as part of NCHRP Project 24-07(2) and can be found in Volume 2 of the final report for that project (Lagasse et al. 2007).

Consistency Test: The consistency of Portland cement based grouting material is determined using a slump test. A standardized slump cone and portable test table has been developed for this purpose. Figure 12.3 provides photographs illustrating the method. The diameter of the slumped grout is measured after pulling the cone without tapping, and then again after 15 taps of the test table. Target values for the measurement are as follows:

For placement in the dry: 34 to 38 cm without tapping
 50 to 54 cm after 15 taps

For placement under water: 30 to 34 cm without tapping
 34 to 38 cm after 15 taps

Washout Test: The washout test provides an indication of resistance to erosion by measuring the loss of grout material when immersed in water. A screened basket 13 cm in diameter with a 3 mm mesh size is filled with 2.0 kg of fresh grout. The grout is lightly tamped and the grout filled basket is weighed. The basket is then dropped three times into a water tank of 1 m height. Afterwards the grout and basket are weighed again, and the loss of mass is determined. The maximum permissible loss of mass is 6.0%.



a. Slump cone and test table

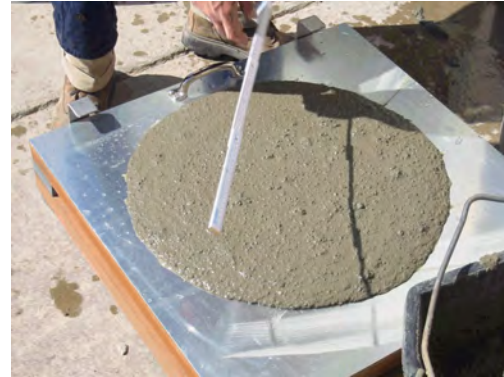

b. Measuring grout slump diameter

Figure 12.3. Consistency test for Portland cement grout

12.3 HYDRAULIC STABILITY DESIGN PROCEDURE

With partially grouted riprap, there are no relationships *per se* for selecting the size of rock, other than the practical considerations of proper void size and adequate stone-to-stone contact area as discussed in Section 12.2.

Prototype-scale tests of partially grouted riprap at a pier were performed for NCHRP Project 24-07(2) by Colorado State University (CSU) in 2005 (see Section 12.6). The CSU tests were conducted in a 20-foot (6m) wide outdoor flume. In the laboratory setting, Class I riprap with a d_{50} of 6 in. (15 cm) was partially grouted on one side of the pier and standard (loose) rock having the same gradation was placed on the other side. Discharge was steadily increased until an approach velocity of 6.6 ft/s (2.0 m/s) was achieved upstream of the pier, at which point the maximum discharge capacity of the flume was reached. Using a velocity multiplier of 1.7 to account for the square-nose pier shape, local velocity at the pier was estimated to be approximately 11 ft/s (3.4 m/s). The partially grouted riprap was undamaged after several hours of testing, whereas the loose riprap experienced damage by particle displacement.

Tests of partially grouted riprap at Braunschweig University, Germany demonstrated the ability of partially grouted riprap to remain stable and undamaged in high velocity flow of 26 ft/s (8 m/s). (Heibaum 2000). However, those tests were not conducted at a pier.

While Class I riprap was used in the laboratory setting, it is recommended that for field applications, the class of riprap (II, III, or IV) used for a partially grouted pier scour countermeasure be selected based on the economics of locally available riprap material that satisfies the gradation requirements of Section 12.2.

12.4 LAYOUT DIMENSIONS

In general, the layout dimensions for partially grouted riprap follow those for loose riprap in applications involving bank protection and for armoring bridge abutments (See Design Guidelines 4 and 14, respectively). At bridge piers, however, the recommended guidance for partially grouted riprap provides for a reduced lateral extent compared to loose riprap, as explained in this section.

Based on laboratory studies performed for NCHRP Project 24-07(2) (published as NCHRP Report 593, Lagasse 2007), the optimum performance of partially-grouted riprap as a pier scour countermeasure was obtained when the armor extended a distance of at least 1.5 times the pier width in all directions around the pier. In contrast, with loose (ungROUTED) riprap, the recommended extent is 2.0 times the pier width.

In the case of wall piers or pile bents consisting of multiple columns where the axis of the structure is skewed to the flow direction, the lateral extent of the protection should be increased in proportion to the additional scour potential caused by the skew. Therefore, in the absence of definitive guidance for pier scour countermeasures, it is recommended that the extent of the armor layer should be multiplied by a factor K_α , which is a function of the width (a) and length (L) of the pier (or pile bents) and the skew angle (α) as given below (after Richardson and Davis 2001):

$$K_\alpha = \left(\frac{a \cos \alpha + L \sin \alpha}{a} \right)^{0.65} \quad (12.4)$$

Riprap should be placed in a pre-excavated hole around the pier so that the top of the riprap layer is level with the ambient channel bed elevation. Placing the top of the partially grouted riprap flush with the bed is ideal for inspection purposes, and does not create any added obstruction to the flow. Mounding riprap around a pier is not acceptable for design in most cases, because it obstructs flow, captures debris, and increases scour at the periphery of the installation. The riprap layer should have a thickness of at least 2 times the d_{50} size of the rock, as shown in Figure 12.4. When placement must occur under water, the thickness of the riprap layer should be increased by 50% to account for uncertainties in placement; **however, in this case the recommended grout application quantity should not be increased in kind.**

When contraction scour through the bridge opening exceeds $2d_{50}$, the thickness of the armor must be increased to the full depth of the contraction scour plus any long-term degradation. In river systems where dune bedforms are present during flood flows, the depth of the trough below the ambient bed elevation should be estimated using the methods of Karim (1999) and/or van Rijn (1984). In general, an upper limit on the crest-to-trough height Δ is provided by Bennett (1997) as $\Delta < 0.4y$ where y is the depth of flow. This suggests that the maximum depth of the bedform trough below ambient bed elevation will not exceed 0.2 times the depth of flow. Additional armor thickness due to any of these conditions may warrant an increase in the extent of the partially grouted riprap away from the pier faces.

A filter layer is typically required for partially grouted riprap at bridge piers. The filter should **not** be extended fully beneath the armor; instead, it should be terminated 2/3 of the distance from the pier to the edge of the armor layer (Figure 12.4). When using a granular stone filter, the layer should have a minimum thickness of 4 times the d_{50} of the filter stone or 6 in., whichever is greater. As with riprap, the layer thickness should be increased by 50% when placing under water. Sand-filled geotextile containers made of properly-selected materials provide a convenient method for controlled placement of a filter in flowing water. This method can also be used to partially fill an existing scour hole when placement must occur under water, as illustrated in Figure 12.5. For more detail, see Lagasse et al. (2006). Design Guideline 11 describes prototype scale laboratory testing of constructability issues related to placing geotextile sand containers in a pier scour hole.

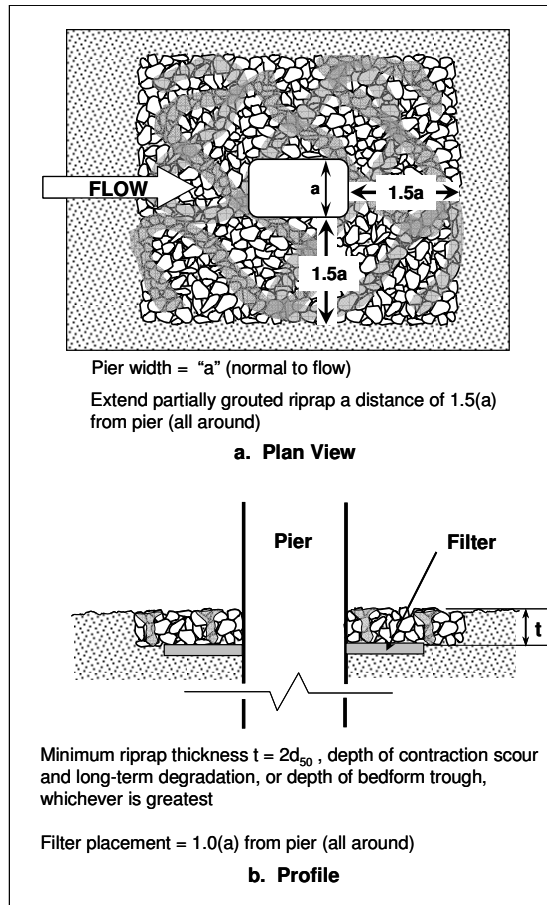

Figure 12.4. Partially-grouted riprap layout diagram for pier scour countermeasures.

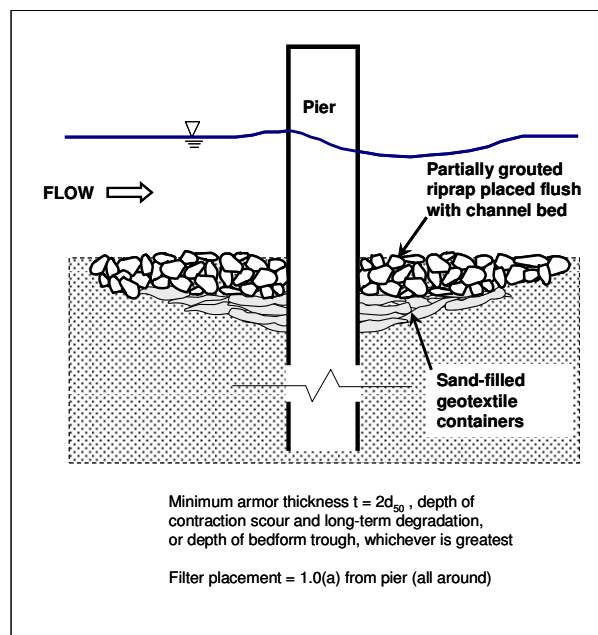

Figure 12.5. Schematic diagram showing sand-filled geotextile container filter beneath partially grouted riprap.

12.5 FILTER REQUIREMENTS

The importance of the filter component of a partially grouted riprap installation should not be underestimated. There are two kinds of filters used in conjunction with partially grouted riprap; granular filters and geotextile filters. Some situations call for a composite filter consisting of both a granular layer and a geotextile. The specific characteristics of the base soil determine the need for, and design considerations of the filter layer. ***In cases where dune-type bedforms may be present, it is strongly recommended that only a geotextile filter be considered.***

The filter must retain the coarser particles of the subgrade while remaining permeable enough to allow infiltration and exfiltration to occur freely. It is not necessary to retain all the particle sizes in the subgrade; in fact, it is beneficial to allow the smaller particles to pass through the filter, leaving a coarser substrate behind. Detailed aspects of filter design are presented in Design Guideline 16 of this document.

12.6 LABORATORY TESTING OF PARTIALLY GROUDED RIPRAP

12.6.1 Prototype Scale Laboratory Flume

For NCHRP Project 24-07(2) the use of sand filled geotextile containers as a filter under partially grouted riprap was tested at a prototype scale pier (Lagasse et al. 2007). A test section was created that was 30.7 ft (9 m) long and spanned the width of the flume. It was filled with sand level with the approach section. Upstream and downstream of the test section the flume bed consists of smooth concrete floors. A rectangular pier measuring 1.5 ft (0.5 m) by 4.5 ft (1.5 m) was installed in the center of the test section. Figure 12.6 is a layout diagram for the prototype testing program. Surrounding the pier, a scour hole measuring 12 ft by 16 ft (4m x 5 m) was pre-formed into the sand bed to a maximum depth of 3 ft (0.9 m).

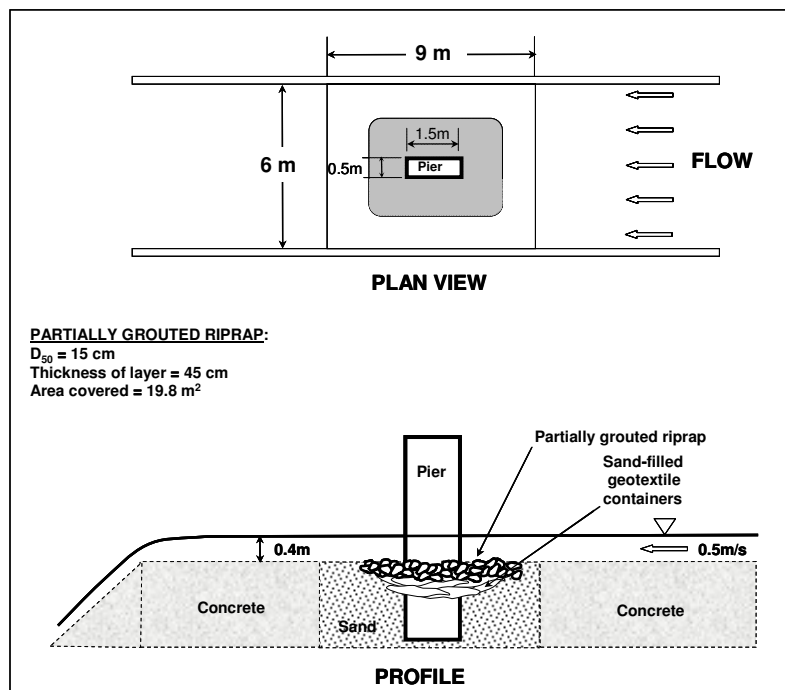

Figure 12.6. Schematic layout for sand filled geotextile containers and riprap tests (dimensions approximate).

An approach flow 1 ft (0.3 m) deep at approximately 1.5 ft/s (0.5 m/s) was established. A total of 32 geotextile containers were placed around the pier by dropping from a height of about 5 ft (1.5 m) above the water surface. For the geotextile containers the test at prototype scale was, primarily, to demonstrate constructability and performance in high velocity flow conditions. Details on the specifications, fabrication, and placement of the geotextile containers can be found in Design Guideline 11 (Section 11.5).

Next, riprap was positioned on top of the geotextile containers using a backhoe (see Design Guideline 11, Section 11.5). The final step in the testing procedure was to use partial grouting techniques to demonstrate the enhanced stability of partially grouted riprap as a pier scour countermeasure. The following sections describe the placing and testing of the partial grouting procedure in the laboratory flume.

12.6.2 Partial Grouting Procedure

Prior to underwater application of the grout in the flume, a preliminary grout application was performed in the dry on a pile of riprap about 1.5 ft (0.5 m) thick. The trial application was performed to determine if the equipment could supply and control the grout pumping rate as needed for the underwater installation conditions. Grout was dispensed from a flexible hose attached to a boom on a concrete pump truck. Grout was supplied to the pump truck from a standard concrete mixer truck, as shown in Figure 12.7. Figure 12.8 shows the preliminary trial grout application in the dry. Figure 12.9 shows the surface of the riprap after partial grouting, and Figure 12.10 shows the interior of the dry riprap pile after several exterior stones had been removed to display penetration of the grout. Note in Figures 12.9 and 12.10 how the grout bridges between riprap stones forming larger conglomerate particles. In Figure 12.10, note that less than 50% of the total void space has been filled with grout. The preliminary application confirmed that the equipment planned for the underwater partial grout application was satisfactory.



Figure 12.7. Concrete mixer truck and pump truck with boom.



Figure 12.8. Preliminary trial grout application in the dry.



Figure 12.9. Surface of the riprap after partial grouting.



Figure 12.10. Interior of the dry riprap pile (some surface rocks removed).

Grout placement in the flume was performed by an experienced underwater grout installation specialist from Germany. The specialist was located in the flume and placed the grout directly on the riprap in 1 ft (0.3 m) of water with a velocity 1 ft/s (0.3 m/s), as illustrated in Figure 12.11.

Application of grout on the riprap lasted approximately 20 minutes. Approximately 1.4 yd³ (1.1 m³) of grout was placed, resulting in an application of 1.6 ft³/yd² (56 liters/m²). Typical grout application rates in German practice are 60 liters/m², so this test was representative of standard practice for this countermeasure type. These tests confirmed that geotextile containers can be fabricated locally, that the containers and riprap can be placed with standard equipment, and that the grout mix can be batched, transported, and placed with commercially available equipment.



Figure 12.11. Underwater partial grouting of riprap.

12.6.3 Performance Testing

High Velocity Performance Test. After placing the grout in a zigzag pattern (see Figure 12.4) the flume was drained and prepared for high velocity performance testing. Loose riprap around the surface perimeter of the installation that was not firmly secured during the grouting process was removed and replaced with sand. In order to prevent degradation of the sand bed during high velocity testing, the upper 4 in. (100 mm) was stabilized by tilling 4% Portland cement by dry weight (of the sand) into the sand bed. The material was compressed with a vibrating plate compactor after addition of the Portland cement.

The high velocity test ran for two hours and was terminated when the soil cement bed began to visibly fail. Approach velocities at 60% of depth during the high velocity test ranged from 4.2 to 5.6 ft/s (1.3 to 1.7 m/s). After draining the flume, several scour holes were observed in the soil cement bed, and a significant scour hole was observed downstream of the riprap installation. The soil cement in these areas had been destabilized and the underlying sand scoured to a depth of about 2.5 ft (0.8 m). The partially grouted riprap and underlying geotextile containers remained intact.

High Velocity Comparison Test. To facilitate a comparison of the performance of loose riprap to partially grouted riprap, all riprap and grout were removed from the left side of the pier and replaced with loose riprap of the same gradation and d_{50} . Because the soil cement proved to be inadequate to stabilize the area around the partially grouted riprap, it was completely removed from the bed, exposing the underlying sand bed 4 in. (100 mm) lower than the surrounding flume floor and top surface of the riprap. A geotextile fabric was installed over the exposed sand portion of the test section. Four-inch (100 mm) thick articulating concrete blocks (ACBs) were installed on the geotextile fabric adjacent to the riprap. The ACBs were intended to prevent degradation of the bed in the test section as well as facilitate a smooth transition from the flume floor to the test section.

Temporary walls were installed to reduce cross sectional area of the flow and increase velocity in the test section. Walls were installed 2.5 ft (0.76 m) from the existing flume walls, transitioning the section from 20 ft (6 m) to 15 ft (4.6 m). Figure 12.12 shows the test section after the modifications were completed.

The high velocity comparison test ran for 4 hours, during which time the discharge was steadily increased to the full flow capacity. At maximum discharge, the approach velocity upstream of the pier reached a maximum of 6.4 ft/s (2 m/s). At the higher flows, the loose riprap began to displace. Figure 12.13 shows the loose riprap side of the installation after completion of the second half of the high velocity comparison test. Note the scour hole on the near side of the pier and the displaced riprap behind and downstream of the pier compared to the previous figure. The partially grouted side of the riprap installation can be seen in this figure, and remained essentially undisturbed. Figure 12.14 shows the partially grouted side of the installation after the end of this test.

12.6.4 Water Quality Testing

As part of the prototype scale laboratory testing, water quality was monitored before, during, and after the grout placement. Water quality parameters monitored continuously were pH, conductivity, temperature, and turbidity. Based on research performed by the Virginia DOT, pH is the only water quality parameter that is expected to change significantly during grout placement (Fitch 2003). In the VDOT study, permit conditions required that pH levels remain below a value of 9.0, otherwise grouting activities were to be stopped, and mitigation measures such as silt curtains were to be employed. VDOT did not monitor turbidity during their study.



Figure 12.12. Loose riprap, ACB, and contraction wall installation (note loose riprap on the near side of the pier and partially grouted riprap on the far side).

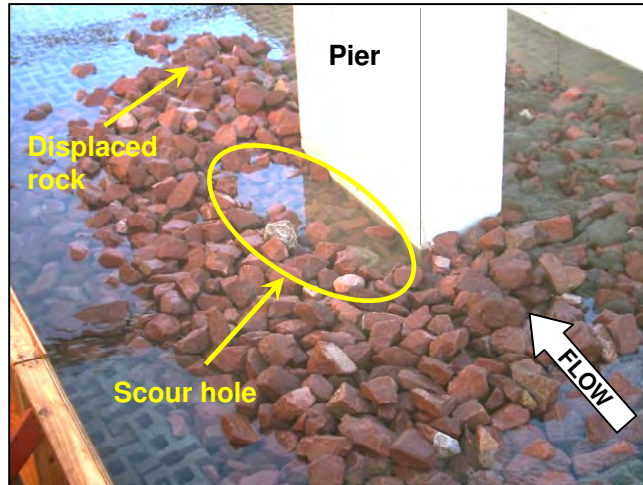

Figure 12.13. Loose riprap after completion of the high velocity comparison test.

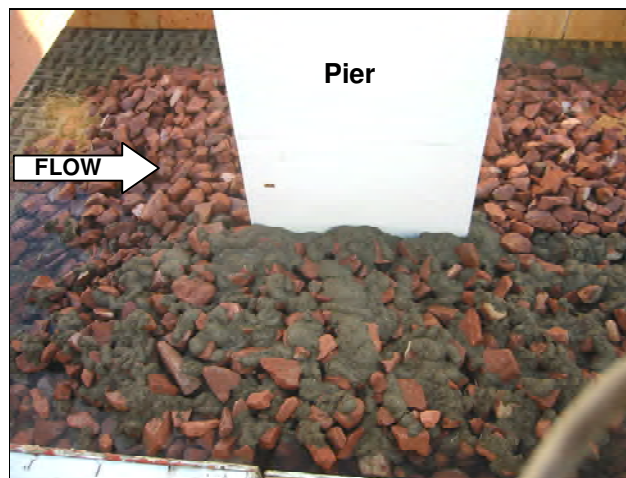

Figure 12.14. Partially grouted riprap after completion of the high velocity comparison test.

Water quality was monitored with a series of In-Situ Troll 9000 Profilers placed in stream at the seven locations depicted in Figure 12.15. The Troll 9000 Profilers continually recorded measurements of pH, conductivity, turbidity, and temperature. Baseline conditions were established prior to initiation of the grout placement 12 ft (3.7 m) upstream of the pier along the centerline of the flume (Station "A" in Figure 12.15).

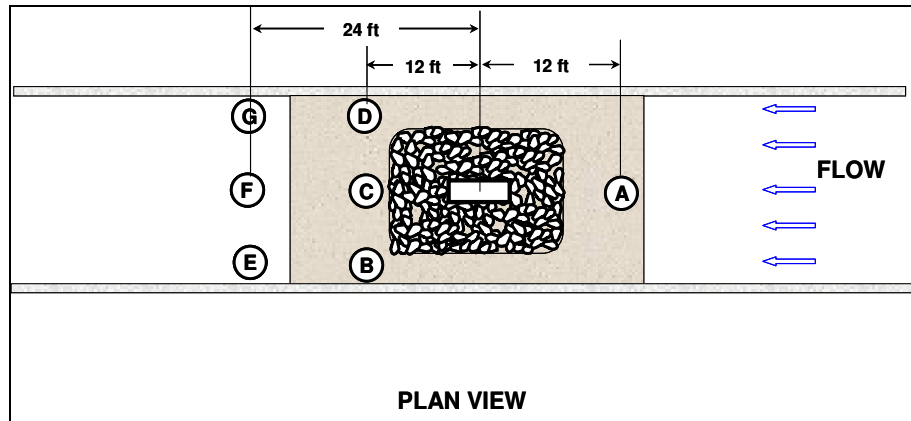

Figure 12.15. Location of water quality monitoring stations. Note: Stations H, I, and J are located further downstream and are not shown in this illustration.

During the test, the water discharge was 20 ft³/s (0.6 m³/s) and the average rate of grout placement was 0.032 ft³/s (0.001 m³/s); therefore, the water:grout dilution ratio was 20:0.032, or 625:1. Three grab samples were selected for analysis corresponding to a baseline sample taken at Station A when testing commenced, Station C five minutes after grout application began, and Station F when grout application finished. Grab samples were collected in 250 mL polyethylene bottles that had been washed and rinsed with distilled water. Bottles were filled by dipping the bottle into the water upstream of where the sampling personnel were standing in the flume. The grab samples were analyzed for selected inorganics and metals. The laboratory results for the samples are presented in Lagasse et al. (2007). Continuous water quality data, collected by the Troll 9000 Profilers, was calibrated to background data collected at Station A prior to grout placement.

Background pH was 7.0 at all stations located in the flume itself. Downstream of the flume, Station J (located in the natural channel 150 ft (46 m) downstream of the flume tailgates) exhibited a background pH of 7.4.

A spike in pH was observed at the locations directly downstream of the pier during grout pumping. A maximum pH of 9.9 was recorded by the continuous monitor located 12 ft (3.7 m) directly downstream of the pier three minutes after pumping began. After grout pumping was completed, pH values dropped off quickly and typically returned to baseline conditions within 30 minutes. The one exception was the probe at Station C, which was directly in the wake of the pier and at the downstream edge of the grouted area. At this location, the pH returned to background levels after about 4 hours. Considering its location, this probe was in position to record the cumulative effect of the entire grouted area for the duration required for it to cure. At Station F, located 12 ft (3.7 m) directly downstream of Station C, a much less pronounced pH profile and more rapid decay of concentration was observed. Results of monitoring by the Troll 9000 Profilers are presented in Table 12.4, and Figure 12.16 shows the pH measurements at all stations.

Table 12.4 Summary of pH Measurements (Lagasse et al. 2007).				
	Initial Condition	End Condition	Maximum value	Average During Grout Placement
Station A	6.9	7.1	7.1	7.0
Station B	6.9	7.1	9.4	8.4
Station C	6.9	7.3	9.9	9.7
Station D	6.9	7.0	8.6	7.8
Station E	6.9	7.1	9.2	7.9
Station F	6.9	7.1	9.5	9.0
Station G	6.9	6.9	8.5	7.8
Station H	7.0	7.0	8.3	7.1
Station I	7.0	7.2	8.6	7.3
Station J	7.4	7.5	8.4	7.7

Note: Data at Stations A-G from continuous monitors;
Data at Stations H-J from grab samples
End condition was 4 hours after initiation of grout placement

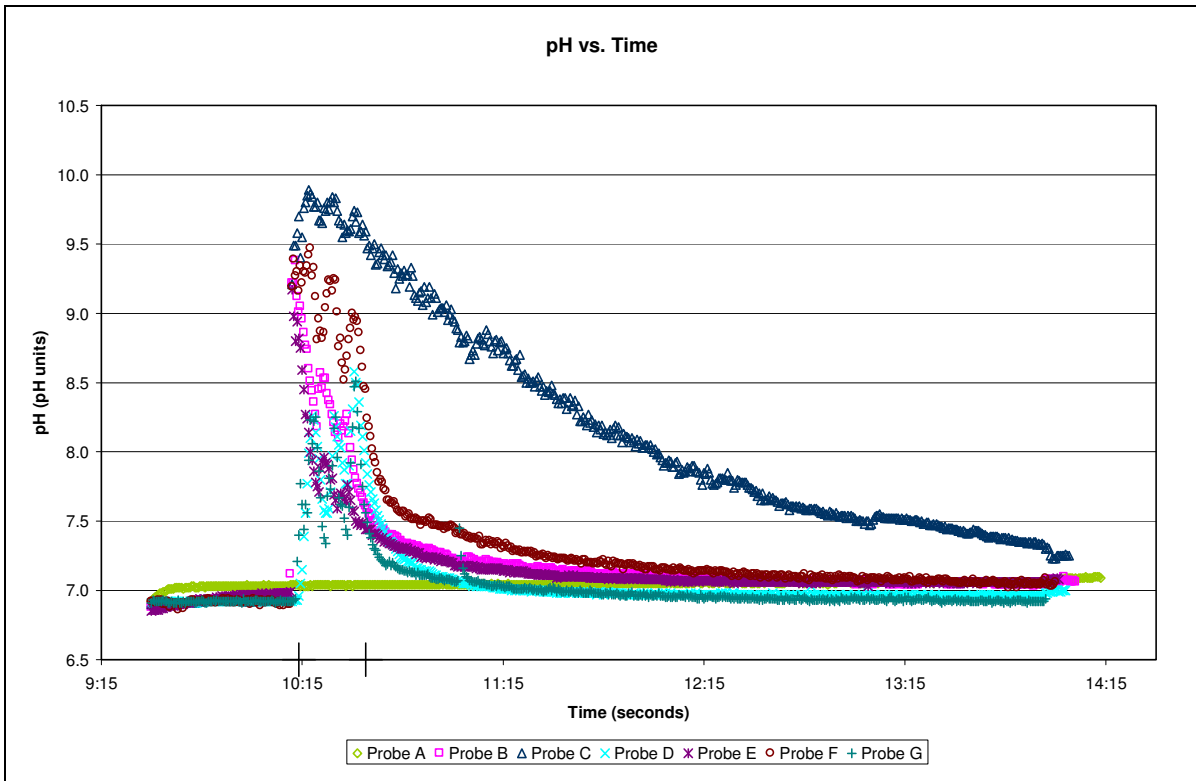

Figure 12.16. pH vs. time (Lagasse et al. 2007).

12.7 CONSTRUCTION

12.7.1 Overview

Partially grouted riprap is placed in a riverine or coastal environment to prevent scour or erosion of the bed, banks, shoreline, or near structures such as bridge piers and abutments. Partially grouted riprap construction involves placement of rock and stone in layers on top of a bedding or filter layer composed of sand, gravel and/or geotechnical fabric. The voids of the riprap matrix are then partially filled with a Portland cement based grout by hose or tremie, or by automated mechanical means. The final configuration results in an armor layer that retains approximately 50 to 65% of the void space of the original riprap. Hydraulic stability of the armor is increased significantly over that of loose (ungrouted) riprap by virtue of the much larger mass and high degree of interlocking of the "conglomerate" particles created by the grouting process.

Factors to consider when designing partially grouted riprap countermeasures begin with the source for the rock, the method to obtain or manufacture the rock, competence of the rock, and the methods and equipment to collect, transport, and place the riprap. Rock for riprap may be obtained from quarries, by screening oversized rock from earth borrow pits, by collecting rock from fields, or from talus deposits. Screening borrow pit material and collecting field rocks present different problems such as rocks that are too large, or that have unsatisfactory length to width ratios for riprap. Quarry stones are generally the best source for obtaining rock for riprap. **Because the partial grouting process effectively creates larger particles from smaller ones, potential concerns regarding quarrying practices needed to produce large, competent, and unfractured riprap sizes are essentially eliminated.**

In most cases, the production of the rock material will occur at a quarry that is relatively remote from the construction area. Therefore, this discussion assumes that the rock is hauled to the site of the installation, where it is dumped either directly, stockpiled, or loaded onto waterborne equipment.

Riprap should be fully grouted along vertical surfaces such as piers, where void space is higher and settling would result in larger gaps. Flowability of the grout should be tested prior to placement. Grout placed underwater requires special additives to prevent segregation of the aggregates and washout of the Portland cement during placement. "Stickiness" of the grout in underwater applications is important, therefore the Sicotan[®] product is recommended for this reason (see Section 12.2.3) based on extensive testing and field application by the Federal Waterway Engineering and Research Institute in Germany.

The construction objectives for a properly partially grouted riprap armor layer are:

1. Obtain a rock mixture from the quarry that meets the design specifications
2. Place that mixture in a well-knit, compact and uniform layer
3. Ensure proper grout coverage and penetration to the design depth

The guidance in this section has been developed to facilitate the proper installation of partially grouted riprap armor to achieve suitable hydraulic performance and maintain stability against hydraulic loading to protect against scour at bridge piers. The proper installation of partially grouted riprap systems is essential to the adequate functioning and performance of the system during the design hydrologic event. Guidelines are provided herein for maximizing the correspondence between the design intent and the actual field-finished conditions of the project. This document addresses the preparation of the subgrade, geotextile placement, and placement of the riprap and grout.

12.7.2 General Guidelines

The contractor is responsible for constructing the project according to the plans and specifications; however, ensuring conformance with the project plans and specifications is the responsibility of the owner. This is typically performed through the engineer and inspectors. Inspectors observe and document the construction progress and performance of the contractor. Prior to construction, the contractor should provide a quality control plan to the owner (for example, see USACE ER 1180-1-6, 1995, "Construction Quality Management") and provide labor and equipment to perform tests as required by the project specifications.

Construction requirements for riprap placement are included in the project plans and specifications. Recommended riprap specifications and layout guidance are found in Sections 12.2 and 12.4 of this document. Recommended requirements for the stone, including the tests necessary to ensure that the physical and mechanical properties meet the requirements of the project specifications are provided. Field tests can be performed at the quarry and/or on the job site, or representative samples can be obtained for laboratory testing.

Gradations are specified and plan sheets show locations, grades, and dimensions of rock layers for the revetment. The stone shape is important and riprap should be blocky rather than elongated, platy or round. In addition, the stone should have sharp, angular, clean edges at the intersections of relatively flat surfaces.

Segregation of rock material during transportation, dumping, or off-loading is not acceptable. Inspection of riprap placement consists of visual inspection of the operation and the finished surface. Inspection must ensure that a dense, rough surface of well-keyed graded rock of the specified quality and sizes is obtained, that the layers are placed such that voids are minimized, and that the layers are the specified thickness.

Inspection and quality assurance must be carefully organized and conducted in case potential problems or questions arise over acceptance of stone material. Acceptance should not be made until measurement for payment has been completed. The engineer and inspectors reserve the right to reject stone at the quarry, at the job site or stockpile, and in place in the structures throughout the duration of the contract. Stone rejected at the job site should be removed from the project site. Stone rejected at the quarry should be disposed or otherwise prevented from mixing with satisfactory stone.

Various degrees of grouting are possible, but the optimal performance is achieved when the grout is effective at "gluing" individual stones to neighboring stones at their contact points, but leaves relatively large voids between the stones.

Construction techniques can vary tremendously due to the following factors:

- Size and scope of the overall project
- Size and weight of the riprap particles
- Whether placement is under water or in the dry
- Physical constraints to access and/or staging areas
- Noise limitations
- Traffic management and road weight restrictions
- Environmental restrictions
- Type of construction equipment available

Competency in construction techniques and management in all their aspects cannot be acquired from a book. Training on a variety of job sites and project types under the guidance of experienced senior personnel is required. The following sections provide some general information regarding construction of partially grouted riprap installations and provide some basic information and description of techniques and processes involved in the construction of partially grouted riprap armor as a pier scour countermeasure.

12.7.3 Materials

Stone

The best time to control the gradation of the riprap mixture is during the quarrying operation. Generally, sorting and mixing later in stockpiles or at the construction site is not recommended. Inspection of the riprap gradation at the job site is usually carried out visually. Therefore, it is helpful to have a pile of rocks with the required gradation at a convenient location where inspectors can see and develop a reference to judge by eye the suitability of the rock being placed. On-site inspection of riprap is necessary both at the quarry and at the job site to ensure proper gradation and material that does not contain excessive amounts of fines. Breakage during handling and transportation should be taken into account.

The Wolman Count method (Wolman 1954) as described in NCHRP Report 568 (Lagasse et al. 2006, see also HEC-23, DG4, Section 4.4.1) may be used as a field test to determine a size distribution based on a random sampling of individual stones within a matrix. This method relies on samples taken from the surface of the matrix to make the method practical for use in the field. The procedure determines frequency by size of a surface material rather than using a bulk sample. The intermediate dimension (B axis) is measured for 100 randomly selected particles on the surface.

The Wolman Count method can be done by stretching a survey tape over the material and measuring each particle located at equal intervals along the tape. The interval should be at least one foot for small riprap and increased for larger riprap. The longer and shorter axes (A and C) can also be measured to determine particle shape. One rule that must be followed is that if a single particle is large enough to fall under two interval points along the tape, then it should be included in the count twice. It is best to select an interval large enough that this does not occur frequently.

Grout

The grout should not segregate when being applied to the riprap. When placing grout under water, segregation and dispersion of fine particles is prevented by use of a chemical additive (Sicotan[®]) as described in Section 12.2.3. The target distribution of grout within the riprap matrix is such that about 2/3 of the grout should reside in the upper half of the riprap layer, with 1/3 of the grout penetrating into the lower half.

The grout must not be allowed to pool on the surface of the riprap, nor puddle onto the filter at the base of the riprap. Therefore, prior to actual placement, rates of grout application should be established on test sections and adjusted based on the size of the grout nozzle and consistency of the grout. Construction methods should be closely monitored to ensure that the appropriate voids and surface openings are achieved.

Filter Layer

Geotextiles: Either woven monofilament or non-woven needle-punched geotextiles may be used. If a non-woven fabric is used, it must have a mass density greater than 12 ounces per square yard (400 grams per square meter). ***Under no circumstances may spun-bond or slit-film fabrics be allowed.*** Each roll of geotextile shall be labeled with the manufacturer's name, product identification, roll dimensions, lot number, and date of manufacture. Geotextiles shall not be exposed to sunlight prior to placement (see Design Guide 16 of this document).

Granular filters: Samples of granular filter material shall be tested for grain size distribution to ensure compliance with the gradation specification used in design (see Design Guide 16 of this document). Sampling and testing frequency shall be in accordance with the owner or owner's authorized representative.

Subgrade Soils

When placing in the dry, the riprap and filter shall be placed on undisturbed native soil, on an excavated and prepared subgrade, or on acceptably placed and compacted fill. Unsatisfactory soils shall be considered those soils having excessive in-place moisture content, soils containing roots, sod, brush, or other organic materials, soils containing turf clods or rocks, or frozen soil. These soils shall be removed, backfilled with approved material and compacted prior to placement of the riprap. Unsatisfactory soils may also be defined as soils such as very fine noncohesive soils with uniform particle size, gap-graded soils, laminated soils, and dispersive clays, per the geotechnical engineer's recommendations.

12.7.4 Installation

Subgrade Preparation

The subgrade soil conditions shall meet or exceed the required material properties described in Section 12.7.3 prior to placement of the riprap. Soils not meeting the requirements shall be removed and replaced with acceptable material.

When placing in the dry, the areas to receive the riprap shall be graded to establish a smooth surface and ensure that intimate contact is achieved between the subgrade surface and the filter, and between the filter and the riprap. Stable and compacted subgrade soil shall be prepared to the lines, grades and cross sections shown on the contract drawings. Termination trenches and transitions between slopes, embankment crests, benches, berms and toes shall be compacted, shaped, and uniformly graded. The subgrade should be uniformly compacted to the geotechnical engineer's site-specific requirements.

When placing under water, divers shall be used to ensure that the bed is free of logs, large rocks, construction materials, or other blocky materials that would create voids beneath the system. Immediately prior to placing the filter and riprap system, the prepared subgrade must be inspected.

Placing the Filter

Whether the filter is comprised of one or more layers of granular material or made of geotextile, its placement should result in a continuous installation that maintains intimate contact with the soil beneath. Voids, gaps, tears, or other holes in the filter must be avoided to the extent practicable, and replaced or repaired when they occur.

Placement of Geotextile: The geotextile shall be placed directly on the prepared area, in intimate contact with the subgrade. When placing a geotextile, it should be rolled or spread out directly on the prepared area and be free of folds or wrinkles. The rolls shall not be dragged, lifted by one end, or dropped. The geotextile should be placed in such a manner that placement of the overlying materials (riprap and/or bedding stone) will not excessively stretch or tear the geotextile.

After geotextile placement, the work area shall not be trafficked or disturbed in a manner that might result in a loss of intimate contact between the riprap stone, the geotextile, and the subgrade. The geotextile shall not be left exposed longer than the manufacturer's recommendation to minimize potential damage due to ultraviolet radiation; therefore, placement of the overlying materials should be conducted as soon as practicable.

The geotextile shall be placed so that upstream strips overlap downstream strips. Overlaps shall be in the direction of flow wherever possible. The longitudinal and transverse joints shall be overlapped at least 1.5 feet (46 cm) for dry installations and at least 3 feet (91 cm) for below-water installations. If a sewn seam is to be used for the seaming of the geotextile, the thread to be used shall consist of high strength polypropylene or polyester and shall be resistant to ultraviolet radiation. If necessary to expedite construction and to maintain the recommended overlaps anchoring pins, "U"-staples or weights such as sandbags shall be used. Figure 12.17 illustrates the placement of a geotextile for a coastal shoreline application.



Figure 12.17. Hand placing geotextile prior to placing partially grouted riprap.
Note sewn seam.

Placing Geotextiles Under Water: Placing geotextiles under water can be problematic for a number of reasons. Most geotextiles that are used as filters beneath riprap are made of polyethylene or polypropylene. These materials have specific gravities ranging from 0.90 to 0.96, meaning that they will float unless weighted down or otherwise anchored to the subgrade prior to placement of the riprap (Koerner 1998).

Flow velocities greater than about 1.0 ft/s (0.3 m/s) create large forces on the geotextile. These forces cause the geotextile to act like a sail, often resulting in wavelike undulations of the fabric (a condition that contractors refer to as "galloping") that are extremely difficult to control. The preferred method of controlling geotextile placement is to isolate the work area from river currents by a temporary cofferdam. In mild currents, geotextiles precut to length have been placed using a roller assembly, with sandbags to hold the filter temporarily.

For partially grouted riprap at piers, sand-filled geotextile containers made of nonwoven needle punched fabric are particularly effective for placement under water as shown in Figure 12.5. The geotextile fabric and sand fill that comprise the geotextile containers should be selected in accordance with appropriate filter design criteria, and placed such that they overlap to cover the required area. For more information, see Lagasse et al. (2006).

Placement of Granular Filter: When placing a granular filter, front-end loaders are the preferred method for dumping and spreading the material on slopes milder than approximately 1V:4H. A typical minimum thickness for granular filters is 0.5 to 1.0 feet (0.15 to 0.3 m), depending on the size of the overlying riprap and whether a layer of bedding stone is to be used between the filter and the riprap. When placing a granular filter under water, the thickness should be increased by 50%. Placing granular media under water around a bridge pier is best accomplished using a large diameter tremie pipe to control the placement location and thickness, while minimizing the potential for segregation. ***NOTE: For riverine applications where dune-type bedforms may be present, it is strongly recommended that only a geotextile filter be considered.***

Placing the Riprap

Riprap may be placed from either land-based or water-based operations and can be placed under water or in the dry. Special-purpose equipment such as clamshells, orange-peel grapples, or hydraulic excavators (often equipped with a "thumb") is preferred for placing riprap. Unless the riprap can be placed to the required thickness in one lift using dump trucks or front-end loaders, tracked or wheeled vehicles are discouraged from use because they can destroy the interlocking integrity of the rocks when driven over previously placed riprap. Water-based operations may require specialized equipment for deep-water placement, or can use land-based equipment loaded onto barges for near-shore placement. In all cases, riprap should be placed from the bottom working toward the top of the slope so that rolling and/or segregation does not occur, as shown in Figure 12.18.

Riprap Placement on Geotextiles: Riprap should be placed over the geotextile by methods that do not stretch, tear, puncture, or reposition the fabric. Equipment should be operated to minimize the drop height of the stone without the equipment contacting and damaging the geotextile. Generally, this will be about 1 foot of drop from the bucket to the placement surface (ASTM Standard D 6825). Further guidance on recommended strength properties of geotextiles as related to the severity of stresses during installation are provided in Part 1 of this document. When the preferred equipment cannot be utilized, a bedding layer of coarse granular material on top of the geotextile can serve as a cushion to protect the geotextile. Material comprising the bedding layer must be more permeable than the geotextile to prevent uplift pressures from developing.



Figure 12.18. Placing riprap with hydraulic excavators.

Riprap Placement Under Water: Riprap placed in water requires close observation and increased quality control to ensure a continuous well-graded uniform rock layer of the required thickness (ASTM Standard D6825). A systematic process for placing and continuous monitoring to verify the quantity and layer thickness is important. Typically, riprap thickness is increased by 50% when placement must occur under water.

Excavation, grading, and placement of riprap and filter under water require additional measures. For installations of a relatively small scale, diversion of the stream around the work area can be accomplished during the low flow season. For installations on larger rivers or in deeper water, the area can be temporarily enclosed by a cofferdam, which allows for construction dewatering if necessary. Alternatively, a silt curtain made of plastic sheeting may be suspended by buoys around the work area to minimize potential environmental degradation during construction.

Depending on the depth and velocity of the water, sounding surveys using a sounding pole or sounding basket on a lead line, divers, sonar bottom profiles, and remotely operated vehicles (ROVs) can provide some information about the riprap placement under water.

Placing the Grout

Table 12.5 presents the recommended values for quantity of grouting material as a function of the class (size) of the riprap. The quantities are valid for medium-dense armor layers with a thickness of 2 times the d_{50} size of the riprap stones. The application quantities should not be exceeded because too much grout can create an impermeable layer on the surface of the armor layer, or on the filter at the bottom of the riprap. In addition, the flexibility of an installation is reduced when grout is applied at greater than the recommended amount.

Two types of grouting procedures, line-by-line and spot-by-spot, produce the desired conglomerate-like elements in the riprap as shown in Figure 12.19, while Figure 12.20 shows line-by-line grout placement by hand. With a proper grout mixture and appropriate placement rate, partial grouting can be reliably accomplished underwater as well as in the dry. Grout placement can be done by hand only in water less than 3 ft (1 m). Special devices are required for placement in deeper water. Various countries in Europe have developed special grout mixes and construction methods for underwater installation of partially grouted riprap. Discussions with contractors and researchers in Germany indicate that grout placement can be reliably conducted in flowing water up to about 4 ft/s (1.2 m/s) flow velocity.

Riprap Size Class	Application Quantity	
	ft ³ /yd ²	L/m ²
Class II	2.0 – 2.2	70 – 85
Class III	2.7 – 3.2	90 – 110
Class IV	3.4 – 4.1	115 – 140

Notes:

1. When riprap is positioned loosely (e.g., dumped stone) the application quantity should be increased by 15 to 25%.
2. When stones are tightly packed (e.g., compacted or plated riprap) the application quantity should be decreased by 10%.



Figure 12.19. Conglomerate produced by spot grouting.



Figure 12.20. Grout placement by hand.

Grout application rate and associated penetration characteristics will be different in dry conditions compared to underwater placement. Usually test boxes having a surface area of at least 10 ft² (1 m²) and a depth equal to the armor layer thickness are placed on the bed when placing partially grouted riprap under water, as shown in Figure 12.21 (Heibaum 2000). The underwater boxes are filled in the water with riprap, and then removed after being grouted to confirm that the proper areal coverage and penetration depths have been achieved.



Figure 12.21. Test box used during underwater grout placement.

Inspection

Detailed guidance for inspecting partially grouted riprap installations is provided in NCHRP Report 593 (Lagasse et al. 2007). The guidance includes inspection during construction, periodic inspection, and inspection after flood events.

12.7 REFERENCES

Bennett, J.P., 1997, "Resistance, Sediment Transport, and Bedform Geometry Relationships in Sand-Bed Channels," in: Proceedings of the U.S. Geological Survey (USGS) Sediment Workshop, February 4-7, 1997.

Comité Européen de Normalisation (CEN), 2002, "European Standard for Armourstone," Report prEN 13383-1, Technical Committee 154, Brussels, Belgium.

Federal Waterway Engineering and Research Institute (BAW), 1990, "Code of Practice – Use of Cement Bonded and Bituminous Materials for Grouting of Armor Stones on Waterways," MAV, BAW, Karlsruhe, Germany.

Fitch, G.M., 2003, "Minimizing the Impact on Water Quality of Placing Grout Underwater to Repair Bridge Scour Damage," Final Report, VTRC 03-R16, Virginia Transportation Research Council, Charlottesville, VA.

Heibaum, M.H., 2000, "Scour Countermeasures Using Geosynthetics and Partially Grouted Riprap," Transportation Research Record 1696, Vol. 2, Paper No. 5B0106, pp. 244-250.

Karim, F., 1999, "Bed-Form Geometry in Sand-Bed Flows," Journal of Hydraulic Engineering, Vol. 125, No. 12, December.

Koerner, R.M., 1998, "Designing with Geosynthetics," 4th Edition, Prentice-Hall, Inc., Englewood Cliffs, NJ, 761 p.

Lagasse, P.F., Clopper, P.E., Zevenbergen, L.W., and Ruff, J.F., 2006, "Riprap Design Criteria, Specifications, and Quality Control," NCHRP Report 568, Transportation Research Board, National Academies of Science, Washington, D.C.

Lagasse, P.F., Clopper, P.E., Zevenbergen, L.W., and Girard, L.G., 2007, "Countermeasures to Protect Bridge Piers from Scour," NCHRP Report 593, Transportation Research Board, National Academies of Science, Washington, D.C.

Richardson, E.V. and Davis, S.R., 2001, "Evaluating Scour at Bridges," Hydraulic Engineering Circular No. 18 (HEC-18, Fourth Edition), Report FHWA NHI -01-001, Federal Highway Administration, Washington, D.C.

U.S. Army Corps of Engineers, 1995, "Construction Quality Management," Engineering Regulation No. 1180-1-6, Washington, D.C.

van Rijn, L.C., 1984, "Sediment Transport, Part III: Bed Forms and Alluvial Roughness," Journal of Hydraulic Engineering, Vol. 110, No. 12, December.

Wolman, M.G., 1954, "A Method of Sampling Coarse Bed Material," American Geophysical Union, Transactions, 35: pp. 951-956.

(page intentionally left blank)

SECTION 4 – COUNTERMEASURES FOR ABUTMENT PROTECTION

Design Guideline 13 – Grout/Cement Filled Bags

Design Guideline 14 – Rock Riprap at Bridge Abutments

Design Guideline 15 – Guide Banks

DESIGN GUIDELINE 13
GROUT/CEMENT FILLED BAGS

(page intentionally left blank)

DESIGN GUIDELINE 13

GROUT/CEMENT FILLED BAGS

13.1 INTRODUCTION

Grout/cement filled bags have been used to protect stream banks in areas where riprap of suitable size and quality is not available at a reasonable cost. Guidelines for the use of bags (sacks) as a streambank revetment can be found in HDS 6 (Richardson et al. 2001) and Keown (1983). Grout/cement filled bags have also been used as a countermeasure against scour at bridges. Historically they have been used to fill in undermined areas around bridge piers and abutments. As scour awareness increases, grout filled bags are being used to armor channels where scour is anticipated or where scour is detected. Whether they are implemented in a post- or pre-scour mode, grout bags are relatively easy to install and can shift to changes in the channel bed to provide effective scour protection.

13.2 DESIGN GUIDELINES

A precise quantitative factor of safety design procedure is not normally completed for the design of grout filled bags. This type of design would be beneficial in determining the hydraulic stability of the bags, but historically this has not been done for grout filled bags. It would require a comparison of the hydraulic shear stress and the critical shear stress to uplift the grout bag as is done with riprap using discrete particle analysis. Information on hydraulic performance of grout bags at bridge piers can be found in Bertoldi et al. (1996) and Fotherby (1997). More often, engineering judgment is used to select a bag size that will not be removed by the flow. Installation practices are critical to the success of the system. Guidelines for the use of grout filled bags for bridge scour reflect information provided by the Maryland State Highway Administration (MDSHA 1996 with 2008 revisions).

13.3 TIPS FOR CONCRETE BAG INSTALLATION (MDSHA): (see attached **Sheets 1 - 7**)

1. It is preferable to place a single layer of grout bags instead of stacking. Place filter fabric under all grout bags including a single layer of bags. Guidelines on the selection and design of filter material can be found in Holtz et al. (1995) and Design Guideline 16.
2. If bags are stacked, overlap the joints of the preceding layer.
3. If possible, bags should be buried so that the top of the bag is at or below the stream bottom. When filling a scour hole, keep the top of the bag at or below the stream bottom.
4. If the stream bed consists of soils that allow for settlement of the grout bags, do not tie the bags together. If the stream bed consists of a hard stiff soil/clay or an erodable rock, where the grout bags will never be able to settle, tie the grout bags together so they do not get washed away.
5. Grout bags should be no larger than 3' wide, 4' long and 1' thick.
6. The bag placed directly in front of the nose of the pier should be the width of the exposed portion of the pier. Similarly, make sure no gaps form between the bags and the front face of the footing.
7. Do not overfill the bags or allow grout to be poured between the seams of two bags.

13.4 CONCRETE BAG INSTALLATION AND GROUTING OF UNDERMINED AREA AT PIERS AND ABUTMENTS (MDSHA):

1. Depending on the depth of the undermining, place one concrete bag or stack several layers of concrete bags along the face of the abutment or pier in front of the undermined area.
2. Once the vent/fill pipes have been installed and the bags are filled, pump the grout into the undermined area. Cut the vent/fill pipes flush with the top of the bags after the pumping operation is complete. Debris could get caught up on these pipes and cause additional scour if left exposed.
3. Adequate venting of the water to be displaced in the undermined area is important. The water must be able to escape as it is displaced by the grout pumped into the cavity. A 4 ft (1.2 m) maximum spacing of the vent/fill pipes is recommended.
4. It is important to keep the nozzle buried in the grout during pumping. This is to reduce the amount of mixing of the grout and the water to be displaced.
5. Debonding jackets should be placed around piles to prevent the grout from adhering to the piles if the added weight from the grout would cause a significant reduction in the pile capacity.
6. If possible, clean out unstable material along the bottom of the undermined area prior to filling with grout. This would reduce the amount of loose sediment discharged through the vent pipes.
7. Pumping grout in the undermined area under a footing is not an underpinning for the footing. This is done only to fill the void area and stop the fill material located behind the footing from settling into the void area resulting in settlement of the roadway behind the structure.

13.5 SPECIFICATIONS (MDSHA)

Grout:

Portland cement concrete shall consist of nine bags, 94 lb per cubic yard (55.8 kg/m³) Type II Portland cement, air entrainment, 6 ± 1% mortar sand aggregate, and water so proportioned to provide a pumpable mixture. The 28-day minimum day strength shall be 3500 psi (24,140 kPa).

Bags:

Fabric bags shall be made of high strength water permeable material. Each bag shall be provided with a self closing inlet valve, to accommodate insertion of the concrete hose. A minimum of two valves shall be provided for bags more than 20 ft (6.1 m) long. Seams shall be folded and double stitched.

Dowels:

Reinforcing steel dowels, if specified on the plans, shall conform to ASTM A 615, Grade 60 and shall be epoxy coated.

Geotextile:

The geotextile shall exhibit the following properties in both the machine and cross-machine directions, in accordance with MDSHA "Standard Specifications for Construction and Materials," 2008, Section 921.09, Application Class SE geotextile:

Maryland Application Class	Type of Geotextile	Grab Strength lb D 4632	Puncture Strength lb D 6241	Permittivity sec ⁻¹ D 4491	Apparent Opening Size, max mm D 4751	Trapezoid Tear Strength lb D 4533
SE	Nonwoven	200	80	0.20	0.30	80
	Woven	250	90	0.20	0.30	90

Construction:

The bags shall be positioned and filled so that they abut tightly to each other and to the substructure units. Joints between bags in successive tiers shall be staggered.

Fabric porosity is essential to the successful execution of this work. Suitability of fabric design shall be demonstrated by injecting the proposed mortar mix into three 2 ft (610 mm) long by approximately 6 in. (150 mm) diameter fabric sleeves under a pressure of not more than 15 psi (103 kPa) which shall be maintained for not more than 10 minutes. A 12 in. (300 mm) long test cylinder shall be cut from the middle of each cured test specimen and tested in accordance with ASTM C 39. The average seven day test compressive strength of the fabric form shall be at least higher than that of companion test cylinders made in accordance with ASTM C 31.

Standoffs to provide a uniform cross section shall be used.

Ready mixed high strength mortar may be permitted by written permission of the Engineer. The ready mixed high strength mortar shall be furnished by a manufacturer approved by the Laboratory and the plan, equipment, etc., shall be subject to inspection and approval.

The concrete pump shall be capable of delivering up to 25 yd³/hr (19 m³/hr).

13.6 SUPPLEMENTAL OBSERVATIONS ON GROUT BAGS (MDSHA)

13.6.1 Design of Bags

Bags should be designed and constructed as flat mats, 3 to 4 ft (0.9 m to 1.2 m) wide and about 0.3 m (1 ft) thick. The bag lengths should be on the order of 4 ft (1.2 m). Bags should not be filled to the point that they look like stuffed sausages, since they will be much more vulnerable to undermining and movement, and will not fit properly into the mat.

Both the designer and the installer should understand how the mat is expected to perform. Each bag should be independent of other bags so that it is free to move; however, the bag should be snugly butted against adjoining bags to minimize gaps in the mat. This concept will result in a semi-flexible mat that will be able to adjust to a degree to changes in the channel bed. The mat should not be constructed as a rigid monolithic structure. It would be helpful to have a pre-construction conference with the designer, contractor and the State inspector.

The bags should be sized and located in accordance with the SHA Standards for the particular type of foundation and condition of scour. It is recommended that the type of grout bag installation and its design be reviewed by an engineer with experience in evaluating scour at bridges.

13.6.2 Installation

Careful attention should be given to preparation of the bed on which the bags are to be placed. **Where the bed is uneven, such as might occur in scour holes, best results will be obtained by planning for a sequence of placement of the bags so that each bag adds to the support of the other bags.** This is particularly important in locations where several layers of bags are to be placed. It is unlikely that detailed plans will be developed for such locations, and the integrity of the installation will depend on the skill of the persons placing the mat. If the bed is highly irregular, appropriate modification of the bed and removal of obstacles should be accomplished prior to placement of the bags.

Each bag should butt up firmly against its neighbor to provide a tight seal and to minimize the occurrence of gaps between bags. Particular attention should be given to obtaining this tight seal between the foundation and the first row of bags.

For piers, the bags should extend to a distance of 1.5 to 2 times the pier width on both sides as well as upstream of the pier nose and downstream of the pier end.

For abutments, the best results are obtained for most locations by placing the bags the full length along the upstream wingwall, abutment backwall and downstream wingwall to form a solid mat. This arrangement provides for a smooth streamlined design that locates the ends of the mat away from the main stream current or thalweg. Of course, there are a wide variation of conditions at abutments and each location needs to be designed for the site conditions.

In some cases, it may be necessary to provide for both grout bags and rock riprap to provide the desired degree of scour protection. As a general rule, however, it is preferable to provide either riprap or grout bags but not both at any one pier or abutment.

For small structures such as bridges or "bottomless" culverts with spans in the range of 15 to 25 ft (4.6 m to 7.6 m), there are essentially two choices for the design of the bags:

- Place the bags full width under the structure.
- Place the bags along each abutment/wingwall, leaving the center of the channel unprotected.

If the center channel is unprotected, it can be expected to scour as the bed degrades or large dunes migrate past the protective pad. This may result in undermining and displacement of the bags next to the channel or possibly of the whole installation. As an interim guide, it is suggested that consideration be given to lining the entire channel if more than half of the channel would be covered by grout bags placed along the abutments. **If the bags extend across the entire channel, attention needs to be given to the treatment of the upstream and downstream ends of the bag to avoid undermining and displacement.**

13.6.3 Filter Cloth

The following interim guidance is provided with regard to use of filter cloth:

Filter cloth should generally be used at locations where the bags are placed in a single layer along a level plane on the channel bed or flood plain. The filter cloth provides for additional support and stability in the event that the bags are subjected to undermining or movement as a result of scouring and hydraulic forces.

Where grout bags are placed in layers in a trenched condition, such as might occur in a scour hole, there is probably less need to provide for the filter cloth. At this point, however, it is recommended that the decision to eliminate filter cloth be made on a case by case basis.

The general rule should be to place filter cloth under the grout bags unless:

1. Multiple layers are carefully placed to cover spaces between bags in the bottom layer
2. Bags are stitched together and the bag fabric is durable enough to serve as a filter, or
3. Bags are poured in large masses such as might be used to fill a scour hole

13.6.4 Undermined Foundations

Grout bags provide for an efficient, cost effective means of underpinning foundations that have been scoured down below the bottom of the footing. General guidance on placement of bags and procedures for grouting the voids under the footing has been developed by MDSHA in standard drawings.

13.6.5 Appearance

If grout bags are placed under water, they are barely noticeable. A well designed and installed grout bag mat exposed to view under a bridge can be expected to have a streamlined and pleasing appearance. At some sites, the mats become covered with silt and are barely distinguishable from the channel banks or bed. Grout bags placed along wingwalls are usually exposed to the sun. Bags in these locations are likely to be covered by vegetation, especially when they have been covered by silt during high water events.

There were a few sites visited where the bags had an ungainly appearance. In most cases, these were bags that were pumped so full that they looked like sausages. Other reasons for a poor appearance include inadequate attention to design, installation, preparation of the bed on which the mat is placed, or a combination of these factors.

Early installations included bags with lengths of 15 ft (4.6 m) or more. In some cases, the bags were too long to fit properly into a compact mat. Use of shorter bags should help to minimize this problem in future installations.

13.7 MAINE DOT GUIDELINES

Specifications for grout bags for undermined areas at piers were also provided by the State of Maine Department of Transportation (1995) as follows:

The underwater grout bags shall be fabricated based on the dimensions of the existing voids to be filled. Bags should be on the order of 3 to 4 ft (0.9 m to 1.2 m) wide and 6 to 8 ft (1.8 to 2.4 m) long. Bags shall be securely placed to form a perimeter bulkhead to partially fill and enclose the substructure void. Grout shall be pumped to uniformly fill the secured bag with

sufficient restraint so as to not rupture the bag. Consecutive bag placement shall be in accordance with the manufacturer's requirements. At a minimum this will require: placement of reinforcing bar between successive layers, stitching together adjacent bags with an overlapping splice (where accessible), and covering holes left by grout and other inserts.

NOTE: The State of Maine recommends stitching bags together for protection of undermined areas at piers. This procedure conflicts with the guideline provided by the State of Maryland in Section 13.3, Item 4.

13.8 REFERENCES

Bertoldi, D.A., Jones, S.J., Stein, S.M., Kilgore, R.T., and Atayee, A.T., 1996, "An Experimental Study of Scour Protection Alternatives at Bridge Piers," FHWA-RD-95-187, Office of Engineering and Highway Operations R&D, McLean, VA.

Fotherby, L.M., 1997, "Footings, Mats, Grout Bags, and Tetrapods, Protection Method Against Local Scour at Bridge Piers," M.S. Thesis, Colorado State University.

Holtz, D.H., Christopher, B.R., and Berg, R.R., 1995, "Geosynthetic Design and Construction Guidelines," National Highway Institute, Publication No. FHWA HI-95-038, Federal Highway Administration, Washington D.C., May.

Keown, M.P., 1983, "Streambank Protection Guidelines for Landowners and Local Governments," U.S. Army Corps of Engineers, Waterways Experiment Station, Vicksburg, MS.

Maryland State Highway Administration, 1996, "Bridge Scour Notebook Supplement No. 1," MDSHA Office of Bridge Development, Bridge Hydraulics Unit (Revised 2008).

Maryland State Highway Administration, 2008, "Standard Specifications for Construction and Materials," July.

Richardson, E.V., Simons, D.B., and Lagasse, P.F., 2001, "River Engineering for Highway Encroachments - Highways in the River Environment," Report FHWA NHI 01-004, Federal Highway Administration, Hydraulic Design Series No. 6, Washington, D.C.

State of Maine Department of Transportation, 1995, "Supplemental Specifications for Underwater Grout Bags," Section 502, April.

GENERAL NOTES

1. It is preferable to place a single layer of grout bags instead of stacking. Place filter fabric under all grout bags including a single layer of bags.
2. If bags are stacked, overlap the joints of the preceding layer.
3. If possible, bags should be placed so that the top of the bag is at or below the stream bottom. (When filling a scour hole, keep the top of the bag at or below the stream bottom).
4. If the stream bed consists of soils that allow for settlement of the grout bags, do not tie the bags together. If the stream bed consists of a hard stiff soil/clay or an erodable rock, which the grout bags will never be able to settle, tie the grout bags together so they do not get washed away.
5. Grout bags should be no larger than 3' wide, 4' long and 1' thick.
6. The bag placed directly in front of the nose of the pier should be the width of the exposed portion of the pier. Similarly, make sure no gaps form between the bags and the front face of the footing.
7. Do not overfill the bags or allow grout to be poured between the seams of two bags.

FOR OFFICE USE ONLY

<table border="1" style="width: 100%; border-collapse: collapse;"> <tr> <th align="center" colspan="2">APPROVAL</th> </tr> <tr> <td colspan="2"><i>R. E. ...</i> DIRECTOR OFFICE OF BRIDGE DEVEL.</td> </tr> <tr> <td colspan="2">DATE: 11/6/96</td> </tr> <tr> <th align="center" colspan="2">REVISIONS</th> </tr> <tr> <th align="center">SHA</th> <th align="center">FHWA</th> </tr> <tr> <td align="center">8-5-08</td> <td></td> </tr> <tr> <td></td> <td></td> </tr> <tr> <td></td> <td></td> </tr> </table>	APPROVAL		<i>R. E. ...</i> DIRECTOR OFFICE OF BRIDGE DEVEL.		DATE: 11/6/96		REVISIONS		SHA	FHWA	8-5-08						STATE OF MARYLAND DEPARTMENT OF TRANSPORTATION STATE HIGHWAY ADMINISTRATION OFFICE OF BRIDGE DEVELOPMENT GROUT BAG INSTALLATION GENERAL NOTES	SHEET <u>1</u> OF <u>1</u>
APPROVAL																		
<i>R. E. ...</i> DIRECTOR OFFICE OF BRIDGE DEVEL.																		
DATE: 11/6/96																		
REVISIONS																		
SHA	FHWA																	
8-5-08																		
<table border="1" style="width: 100%; border-collapse: collapse;"> <tr> <td style="width: 50%;">FHWA APPROVAL</td> <td style="width: 50%;"></td> </tr> <tr> <td>DATE:</td> <td></td> </tr> </table>	FHWA APPROVAL		DATE:		STANDARD NO. BR-SR(0.07)-96-314													
FHWA APPROVAL																		
DATE:																		

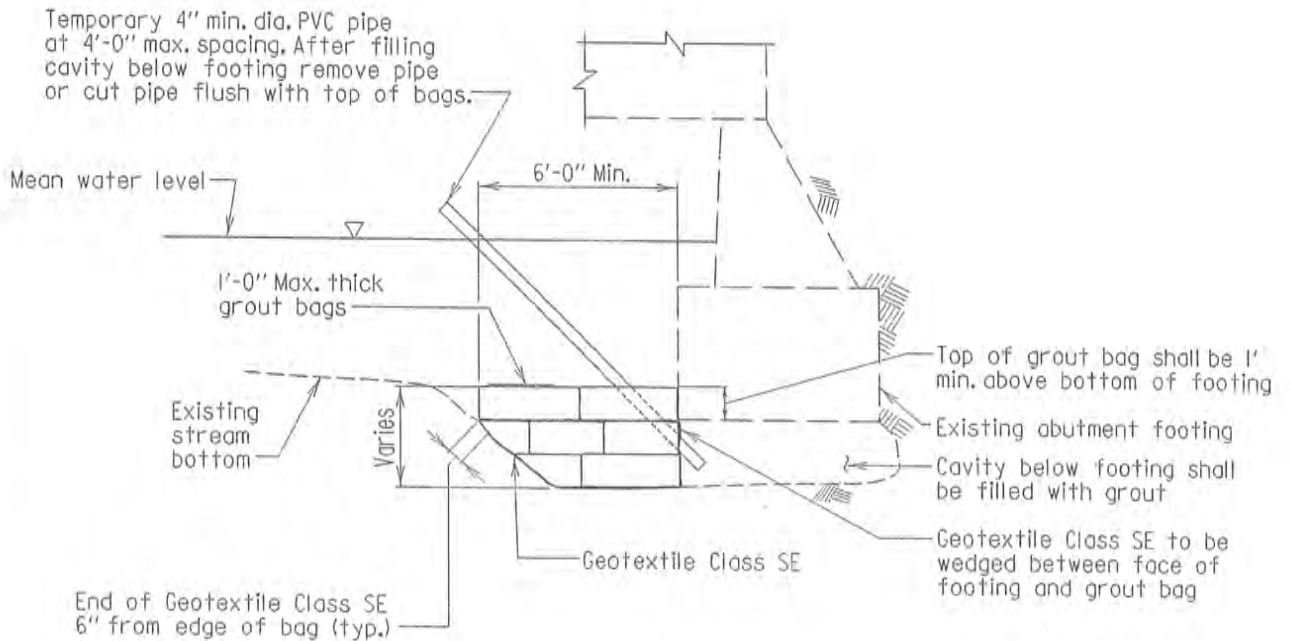

SECTION THRU ABUTMENT
Scale: 1/16" = 1'-0"

- Notes:
1. Stack bags as required. Joints between bags in successive rows and tiers shall be staggered.
 2. Refer to General Plan for any excavation requirements.
 3. Place top bag flush with face of footing.
 4. If on piles, place debonding material around piles with greater than 3'-0" exposure.
 5. All bags shall be 1 ft. max. thick, 3 ft. max. wide, and 4 ft. max. length.
 6. Remove debris before installation of bags.

FHWA APPROVAL
DATE:

APPROVAL	
<i>[Signature]</i> DIRECTOR OFFICE OF BRIDGE DEVEL.	
DATE: 11/6/96	
REVISIONS	
SHA	FHWA
8-5-08	

STATE OF MARYLAND
DEPARTMENT OF TRANSPORTATION
STATE HIGHWAY ADMINISTRATION
OFFICE OF BRIDGE DEVELOPMENT

GROUT BAG SECTION
CASE WHERE SCOUR AND UNDERMINING HAS OCCURRED AT ABUTMENT

STANDARD NO. BR-SR(0.09)-96-316

SHEET 1 OF 7

STRUCTURAL REPAIRS

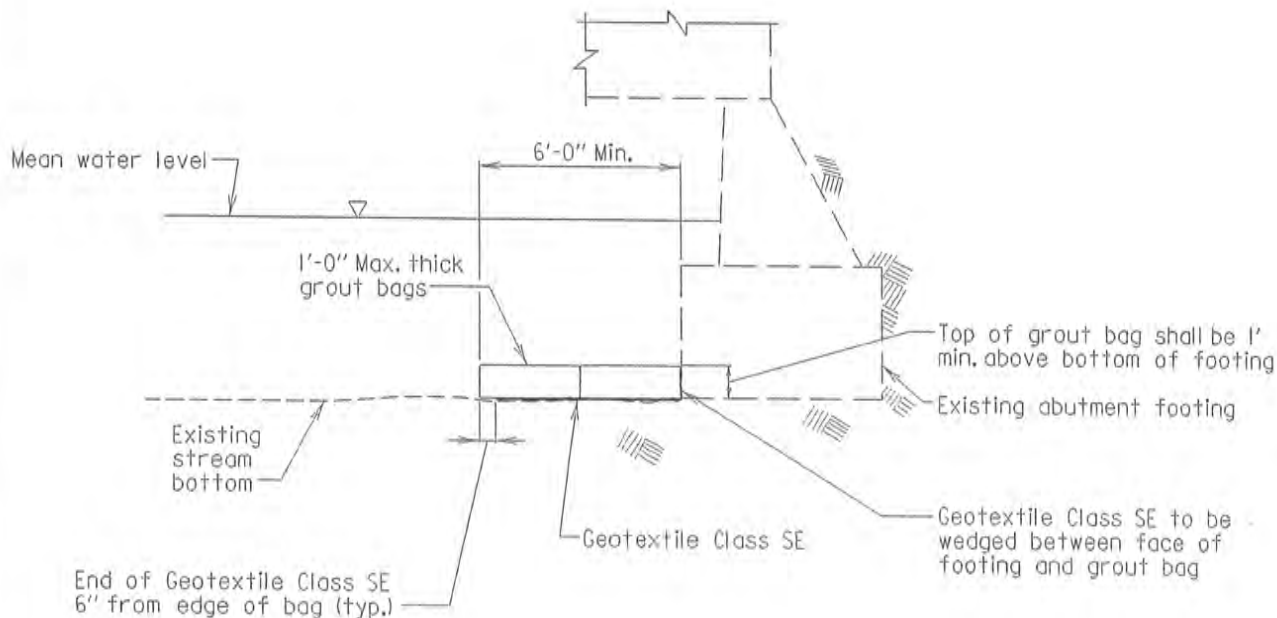

SECTION THRU ABUTMENT

Scale: $\frac{3}{16}'' = 1'-0''$

Notes:

1. Refer to General Plan for any excavation requirements.
2. Place bags flush with face of footing.
3. All bags shall be 1 ft. max. thick, 3 ft. max. wide, and 4 ft. max. length.

APPROVAL	
<i>[Signature]</i> DIRECTOR OFFICE OF BRIDGE DEVEL.	
DATE: 11/6/96	

REVISIONS	
SHA	FHWA
8-5-08	

FHWA APPROVAL	
DATE:	

STATE OF MARYLAND DEPARTMENT OF TRANSPORTATION STATE HIGHWAY ADMINISTRATION OFFICE OF BRIDGE DEVELOPMENT GROUT BAG SECTION CASE WHERE SCOUR POTENTIAL EXISTS AT ABUTMENT
STANDARD NO. BR-SR(0.09)-96-316
SHEET <u>2</u> OF <u>7</u>

STRUCTURAL REPAIRS

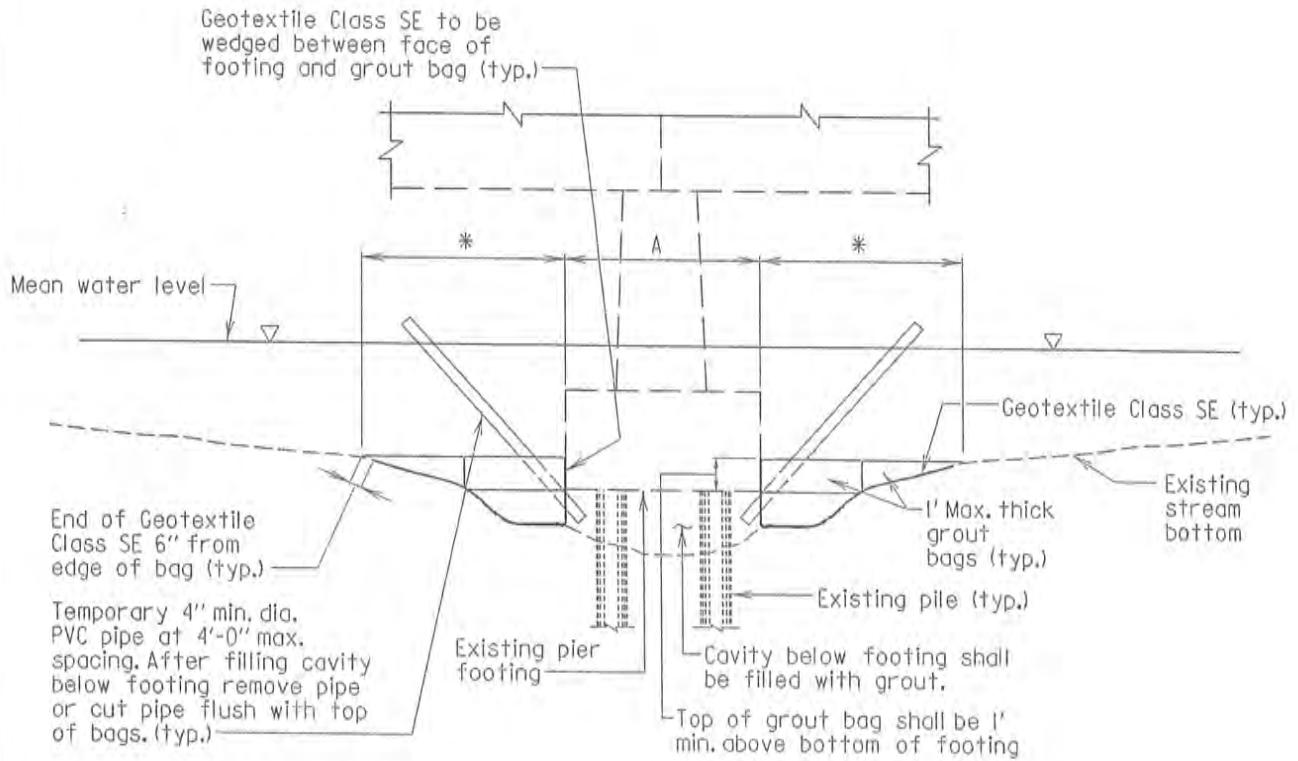

SECTION THRU PIER - ON PILES
 Scale: 3/16" = 1'-0"

* 2A or 6'-0", whichever is greater, with a maximum of 12'-0".

- Notes:
1. Stack bags as required. Joints between bags in successive rows and tiers shall be staggered.
 2. Refer to General Plan for any excavation requirements.
 3. Place top bag flush with face of footing.
 4. If on piles, place debonding material around piles with greater than 3'-0" exposure.
 5. All bags shall be 1 ft. max. thick, 3 ft. max. wide, and 4 ft. max. length.
 6. Remove debris before installation of bags.

FIWA APPROVAL
 DATE:

APPROVAL	
DIRECTOR OFFICE OF BRIDGE DEVELOP.	
DATE: 11/6/96	
REVISIONS	
SHA	FIWA
8-5-08	

STATE OF MARYLAND DEPARTMENT OF TRANSPORTATION STATE HIGHWAY ADMINISTRATION OFFICE OF BRIDGE DEVELOPMENT	
GROUT BAG SECTION CASE WHERE SCOUR AND UNDERMINING HAS OCCURED	
STANDARD NO. BR-SR(0,09)-96-316	SHEET <u>3</u> OF <u>7</u>

STRUCTURAL REPAIRS

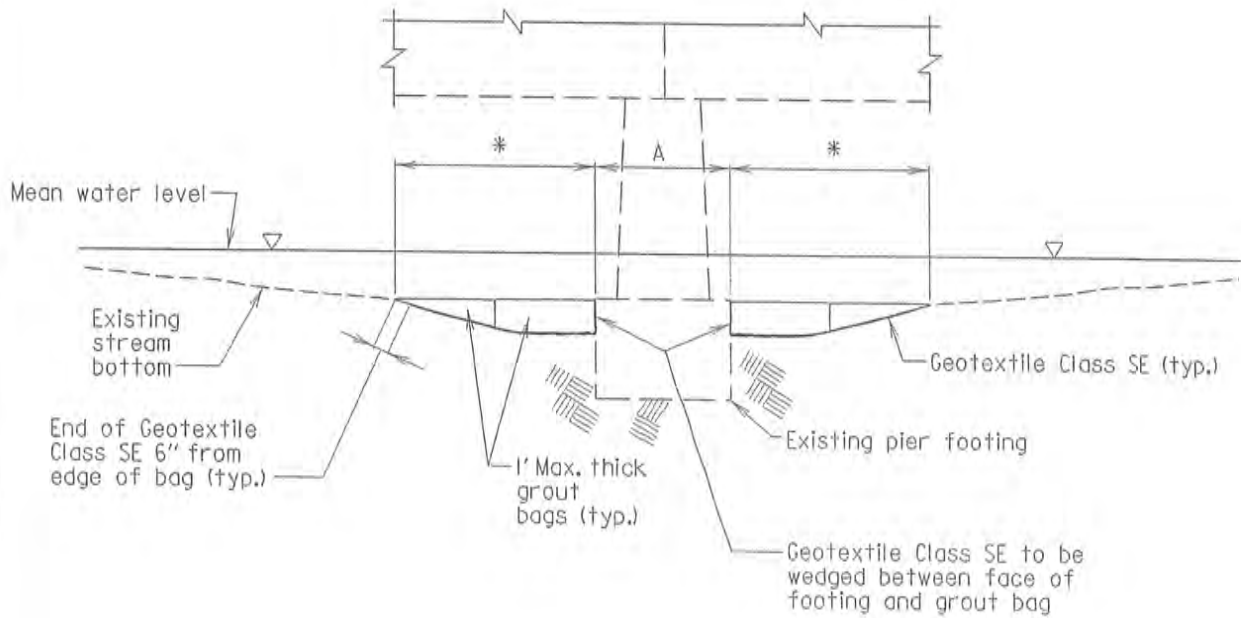

SECTION THRU PIER

Scale: $\frac{1}{16}'' = 1'-0''$

* 2A or 6'-0", whichever is greater, with a maximum of 12'-0".

Notes:

1. Refer to General Plan for any excavation requirements.
2. Place bags flush with face of footing.
3. All bags shall be 1 ft. max. thick, 3 ft. max. wide, and 4 ft. max. length.
4. Top of grout bags shall be 1 ft. min. above bottom of footing.
5. Refer to sheet 5 of 7 for plan view of grout bag installation at pier.

APPROVAL	
DIRECTOR OFFICE OF BRIDGE DEVELOPMENT DATE: 11/6/95	
REVISIONS	
SHA	FHWA
8-5-08	

FHWA APPROVAL
DATE:

STATE OF MARYLAND
DEPARTMENT OF TRANSPORTATION
STATE HIGHWAY ADMINISTRATION
OFFICE OF BRIDGE DEVELOPMENT
GROUT BAG SECTION
CASE WHERE SCOUR POTENTIAL EXISTS
AT PIER

STANDARD NO. BR-SR(0.09)-96-316

SHEET 4 OF 7

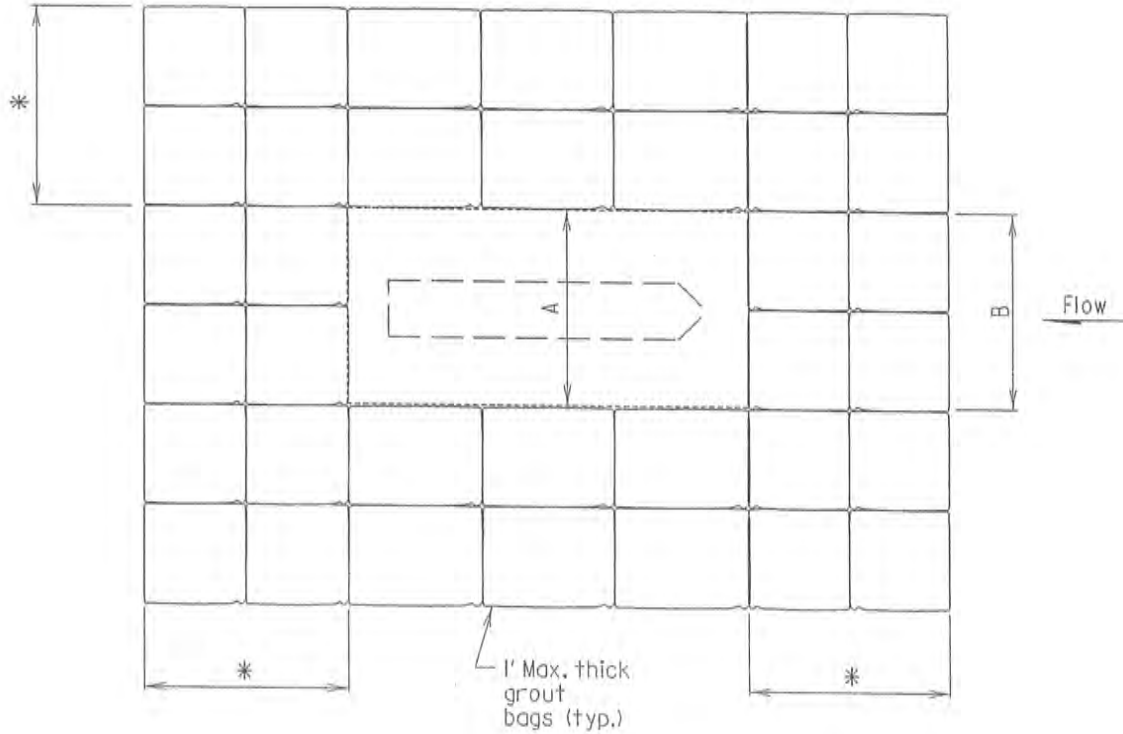

PLAN OF PIER
Scale: $\frac{3}{16}'' = 1'-0''$

* 2A or 6'-0", whichever is greater,
with a maximum of 12'-0".

A= Width of pier footing.

B= Length of grout bags in front and
behind pier to match pier footing width.

APPROVAL	
<i>[Signature]</i> DIRECTOR OFFICE OF BRIDGE DEVEL.	
DATE: 11/6/96	
REVISIONS	
SHA	FHWA

FHWA APPROVAL
DATE:

STATE OF MARYLAND
DEPARTMENT OF TRANSPORTATION
STATE HIGHWAY ADMINISTRATION
OFFICE OF BRIDGE DEVELOPMENT

PLAN VIEW OF GROUT BAG
INSTALLATION AT PIER

STANDARD NO. BR-SR(0.09)-96-316

SHEET 5 OF 7

DG13.14

STRUCTURAL REPAIRS

Note:
Grout bag entire stream channel
for clear spans measuring perpendicular
between footings of 16 ft. and less.

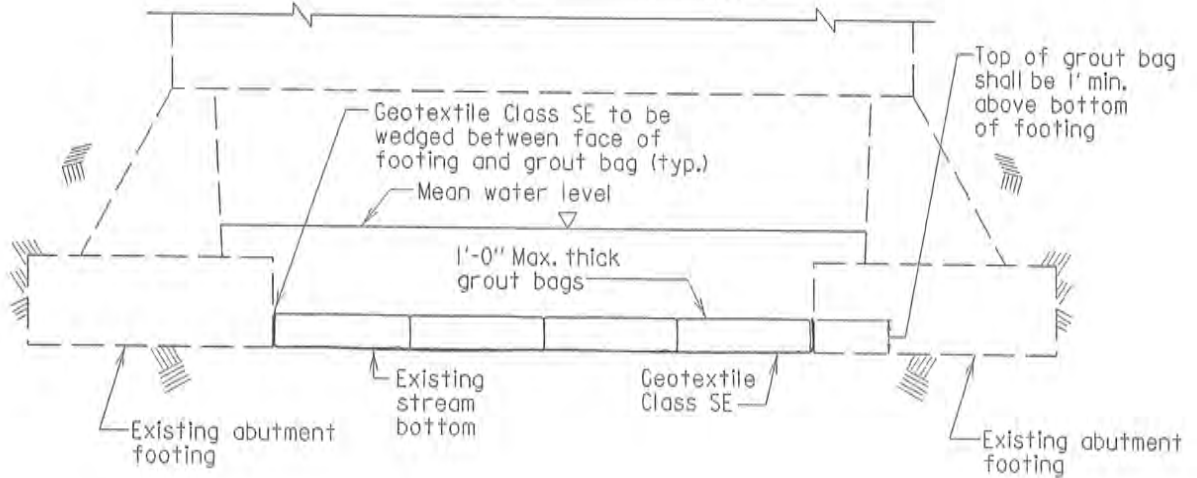

SECTION THRU ABUTMENTS AND CHANNEL

Scale: $\frac{3}{16}'' = 1'-0''$

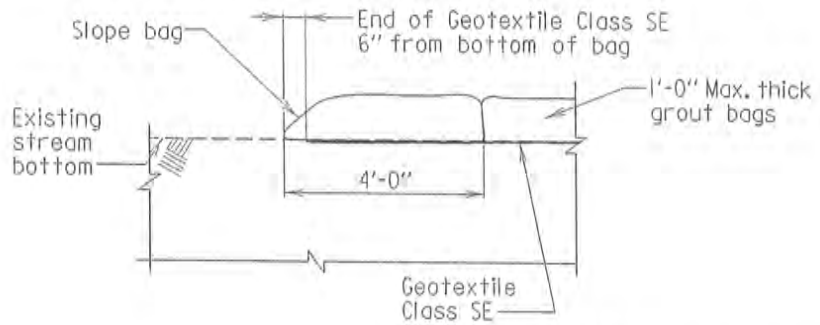

Note:
For location of Section A-A
see sheet 7 of 7.

SECTION A-A

Scale: $\frac{1}{4}'' = 1'-0''$

- Notes:
1. Lay bags on top of existing stream bottom.
 2. Bags shall be buried at the inlet and outlet end of the structure.
 3. Refer to General Plan for any excavation requirements.
 4. Place bag flush with face of footing.

FOR OFFICE USE ONLY

APPROVAL	
<i>[Signature]</i> DIRECTOR OFFICE OF BRIDGE DEVEL.	
DATE: 11/6/96	
REVISIONS	
SHA	FIWA
8-5-08	5-08

STATE OF MARYLAND
DEPARTMENT OF TRANSPORTATION
STATE HIGHWAY ADMINISTRATION
OFFICE OF BRIDGE DEVELOPMENT
SECTION VIEW OF GROUT BAGS
CASE WHERE SCOUR POTENTIAL EXISTS
FOR FULL CHANNEL WIDTH

FIWA APPROVAL
DATE:

STANDARD NO. BR-SR(0.09)-96-316

SHEET 6 OF 7

(page intentionally left blank)

DESIGN GUIDELINE 14
ROCK RIPRAP AT BRIDGE ABUTMENTS

(page intentionally left blank)

DESIGN GUIDELINE 14

ROCK RIPRAP AT BRIDGE ABUTMENTS

14.1 INTRODUCTION

Scour occurs at abutments when the abutment and embankment obstruct the flow. Several causes of abutment failures during post-flood field inspections of bridge sites have been documented (Parola et al. 1998):

- Overtopping of abutments or approach embankments
- Lateral channel migration or stream widening processes
- Contraction scour
- Local scour at one or both abutments

Abutment damage is often caused by a combination of these factors. Where abutments are set back from the channel banks, especially on wide floodplains, large local scour holes have been observed with scour depths of as much as four times the approach flow depth on the floodplain. As a general rule, the abutments most vulnerable to damage are those located at or near the channel banks.

The flow obstructed by the abutment and highway approach embankment forms a horizontal vortex starting at the upstream end of the abutment and running along the toe of the abutment, and a vertical wake vortex at the downstream end of the abutment. The vortex at the toe of the abutment is very similar to the horseshoe vortex that forms at piers, and the vortex that forms at the downstream end is similar to the wake vortex that forms downstream of a pier. Research has been conducted to determine the depth and location of the scour hole that develops for the horizontal (so called horseshoe) vortex that occurs at the upstream end of the abutment, and numerous abutment scour equations have been developed to predict this scour depth.

Abutment failures and erosion of the fill also occur from the action of the downstream wake vortex. However, research and the development of methods to determine the erosion from the wake vortex has not been conducted. An example of abutment and approach embankment erosion of a bridge due to the action of the horizontal and wake vortex is shown in Figure 14.1. The types of failures described above are initiated as a result of the obstruction to the flow caused by the abutment and highway embankment and subsequent contraction and turbulence of the flow at the abutments.

14.2 DESIGN APPROACH

The preferred design approach is to place the abutment foundation on scour resistant rock or on deep foundations. Available technology has not developed sufficiently to provide reliable abutment scour estimates for all hydraulic flow conditions that might be reasonably expected to occur at an abutment. Therefore, engineering judgment is required in designing foundations for abutments. In many cases, foundations can be designed with shallower depths than predicted by the equations when they are protected with rock riprap and/or with a guide bank placed upstream of the abutment designed in accordance with this design guide and Design Guideline 15. Cost will be the deciding factor (Richardson and Davis 2001).



Figure 14.1. Scour of bridge abutment and approach embankment.

The potential for lateral channel migration, long-term degradation and contraction scour should be considered in setting abutment foundation depths near the main channel. It is recommended that the abutment scour equations originally presented in HEC-18 (Richardson and Davis 2001) be used to develop insight as to the scour potential at an abutment.

Where spread footings are placed on erodible soil, the preferred approach is to place the footing below the elevation of total scour. If this is not practicable, a second approach is to place the top of footings below the depth of the sum of contraction scour and long-term degradation and to provide scour countermeasures. For spread footings on erodible soil, it becomes especially important to protect adjacent embankment slopes with riprap or other appropriate scour countermeasures. The toe or apron of the riprap serves as the base for the slope protection and must be carefully designed to resist scour while maintaining the support for the slope protection.

In summary, as a minimum, abutment foundations should be designed assuming no ground support (lateral or vertical) as a result of soil loss from long-term degradation, stream instability, and contraction scour. The abutment should be protected from local scour using riprap and/or guide banks. To protect the abutment and approach roadway from scour by the wake vortex several DOTs use a 50-foot (15-meter) guide bank extending from the downstream corner of the abutment (see Design Guideline 15). Otherwise, the downstream abutment and approach should be protected with riprap or other countermeasures.

14.3 SIZING ROCK RIPRAP AT ABUTMENTS

The FHWA conducted two research studies in a hydraulic flume to determine equations for sizing rock riprap for protecting abutments from scour (Pagán-Ortiz 1991, Atayee 1993). The first study investigated vertical wall and spill-through abutments which encroached 28 and 56% on the floodplain, respectively. The second study investigated spill-through abutments which encroached on a floodplain with an adjacent main channel (Figure 14.2).

Encroachment varied from the largest encroachment used in the first study to a full encroachment to the edge of main channel bank. For spill-through abutments in both studies, the rock riprap consistently failed at the toe downstream of the abutment centerline (Figure 14.3). For vertical wall abutments, the first study consistently indicated failure of the rock riprap at the toe upstream of the centerline of the abutment.

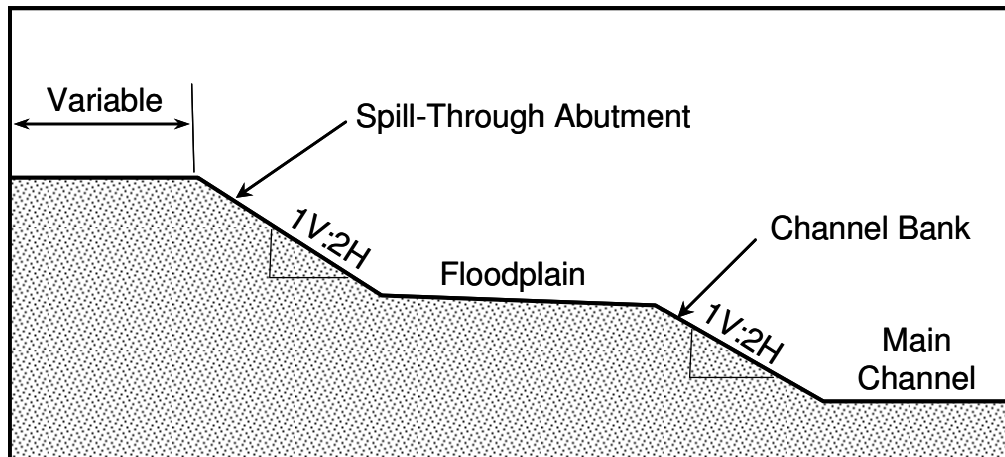

Figure 14.2. Section view of a typical setup of spill-through abutment on a floodplain with adjacent main channel.

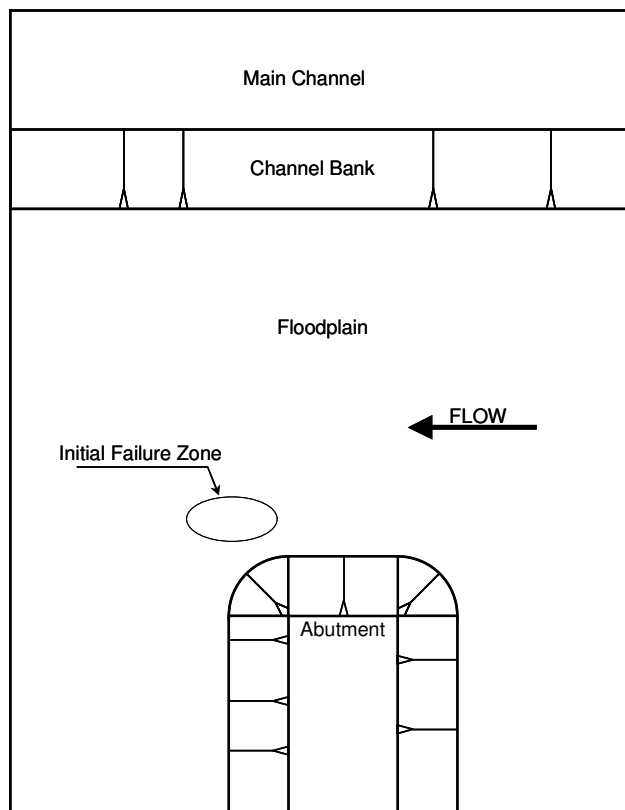

Figure 14.3. Plan view of the location of initial failure zone of rock riprap for spill-through abutment (Pagán-Ortiz 1991).

Field observations and laboratory studies reported in HDS 6 (Richardson et al. 2001) indicate that with large overbank flow or large drawdown through a bridge opening that scour holes develop on the side slopes of spill-through abutments and the scour can be at the upstream corner of the abutment. In addition, flow separation can occur at the downstream side of a bridge (either with vertical wall or spill-through abutments). This flow separation causes vertical vortices which erode the approach embankment and the downstream corner of the abutment.

For Froude Numbers $(V/(gy)^{1/2}) \leq 0.80$, the recommended design equation for sizing rock riprap for spill-through and vertical wall abutments is in the form of the Isbash relationship:

$$\frac{D_{50}}{y} = \frac{K}{(S_s - 1)} \left[\frac{V^2}{gy} \right] \quad (14.1)$$

where:

- D_{50} = median stone diameter, ft (m)
- V = characteristic average velocity in the contracted section (explained below), ft/s (m/s)
- S_s = specific gravity of rock riprap
- g = gravitational acceleration, 32.2 ft/s² (9.81 m/s²)
- y = depth of flow in the contracted bridge opening, ft (m)
- K = 0.89 for a spill-through abutment
1.02 for a vertical wall abutment

For Froude Numbers >0.80 , Equation 14.2 is recommended:

$$\frac{D_{50}}{y} = \frac{K}{(S_s - 1)} \left[\frac{V^2}{gy} \right]^{0.14} \quad (14.2)$$

where:

- K = 0.61 for spill-through abutments
- K = 0.69 for vertical wall abutments

In both equations, the coefficient K , is a velocity multiplier to account for the apparent local acceleration of flow at the point of rock riprap failure. Both of these equations are envelope relationships that were forced to over predict 90% of the laboratory data.

The recommended procedure for selecting the characteristic average velocity is as follows:

1. Determine the set-back ratio (SBR) of each abutment. SBR is the ratio of the set-back length to channel flow depth. The set-back length is the distance from the near edge of the main channel to the toe of abutment.

SBR = Set-back length/average channel flow depth

- a. If SBR is less than 5 for both abutments (Figure 14.4), compute a characteristic average velocity, Q/A , based on the entire contracted area through the bridge opening. This includes the total upstream flow, exclusive of that which overtops the roadway.

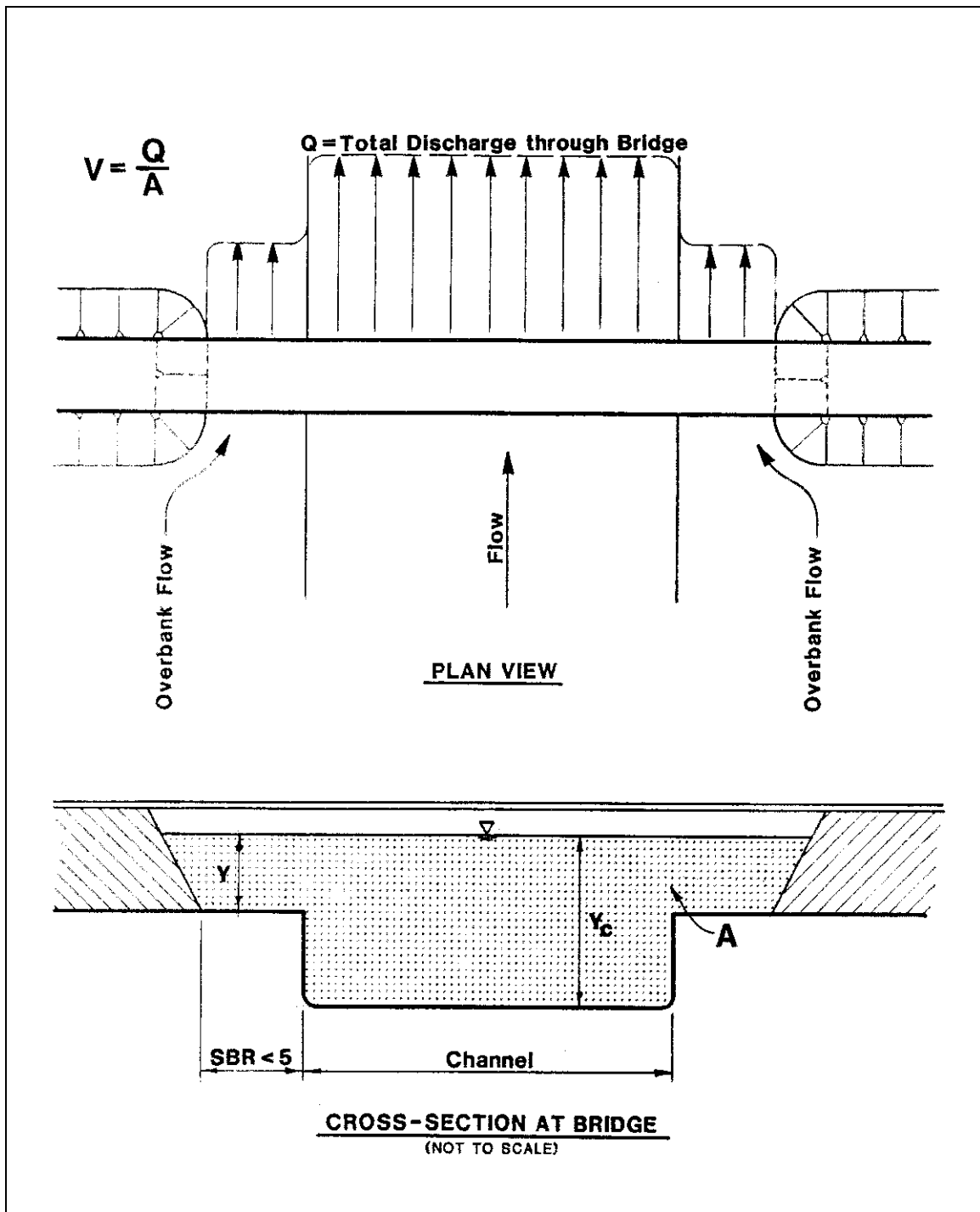

Figure 14.4. Characteristic average velocity for SBR<5.

- b. If SBR is greater than 5 for an abutment (Figure 14.5), compute a characteristic average velocity, Q/A , for the respective overbank flow only. Assume that the entire respective overbank flow stays in the overbank section through the bridge opening.
 - c. If SBR for an abutment is less than 5 and SBR for the other abutment at the same site is more than 5 (Figure 14.6), a characteristic average velocity determined from Step 1a for the abutment with SBR less than 5 may be unrealistically low. This would, of course, depend upon the opposite overbank discharge as well as how far the other abutment is set back. For this case, the characteristic average velocity for the abutment with SBR less than 5 should be based on the flow area limited by the boundary of that abutment and an imaginary wall located on the opposite channel bank. The appropriate discharge is bounded by this imaginary wall and the outer edge of the floodplain associated with that abutment.
2. Recent research results published by the Transportation Research Board as NCHRP Report 587, "Countermeasures to Protect Bridge Abutments from Scour," endorse the use of the SBR approach for sizing riprap at spill-through abutments (Barkdoll et al. 2007). NCHRP Report 568, "Riprap Design Criteria, Recommended Specifications, and Quality Control," recommends an additional criteria for selecting a characteristic average velocity when applying the SBR method (Lagasse et al. 2006). Based on the results of 2-dimensional computer modeling of a typical abutment configuration NCHRP Report 568 concludes:
 - a. Whenever the SBR is less than 5, the average velocity in the bridge opening provides a good estimate for the velocity at the abutment.
 - b. When the SBR is greater than 5, the recommended adjustment is to compare the velocity from the SBR method to the maximum velocity in the channel within the bridge opening and select the lower velocity.
 - c. The SBR method is well suited for estimating velocity at an abutment if the estimated velocity does not exceed the maximum velocity in the channel.
3. Compute rock riprap size from Equations 14.1 or 14.2, based on the Froude Number limitation for these equations. A recent study of riprap size selection for wing wall abutments (Melville et al. 2007) verified that these equations give stable stone size for riprap layers at wing wall abutments under subcritical mobile-bed conditions. Based on experimental results, this study concluded that with the SBR approach riprap size selection is appropriately based on stability against shear and edge failure. It is noted that stability against winnowing or bed-form undermining (see HEC-23, Volume 1, Chapter 4) is also important in design; however, adequate filter layer protection can prevent winnowing.
4. Determine extent of rock riprap.
 - a. The apron should extend from the toe of the abutment into the bridge waterway a distance equal to twice the flow depth in the overbank area near the embankment, but need not exceed 25 ft (7.5 m) (Atayee et al. 1993). There may be cases where an apron extent of twice the flow depth is not adequate (Melville et al. 2006). Melville's findings are based on data collected for NCHRP 24-18. Therefore, the engineer should consider the need for a greater apron extent. The downstream coverage should extend back from the abutment 2 flow depths or 25 ft (7.5 m), whichever is larger, to protect the approach embankment (Figure 14.7).

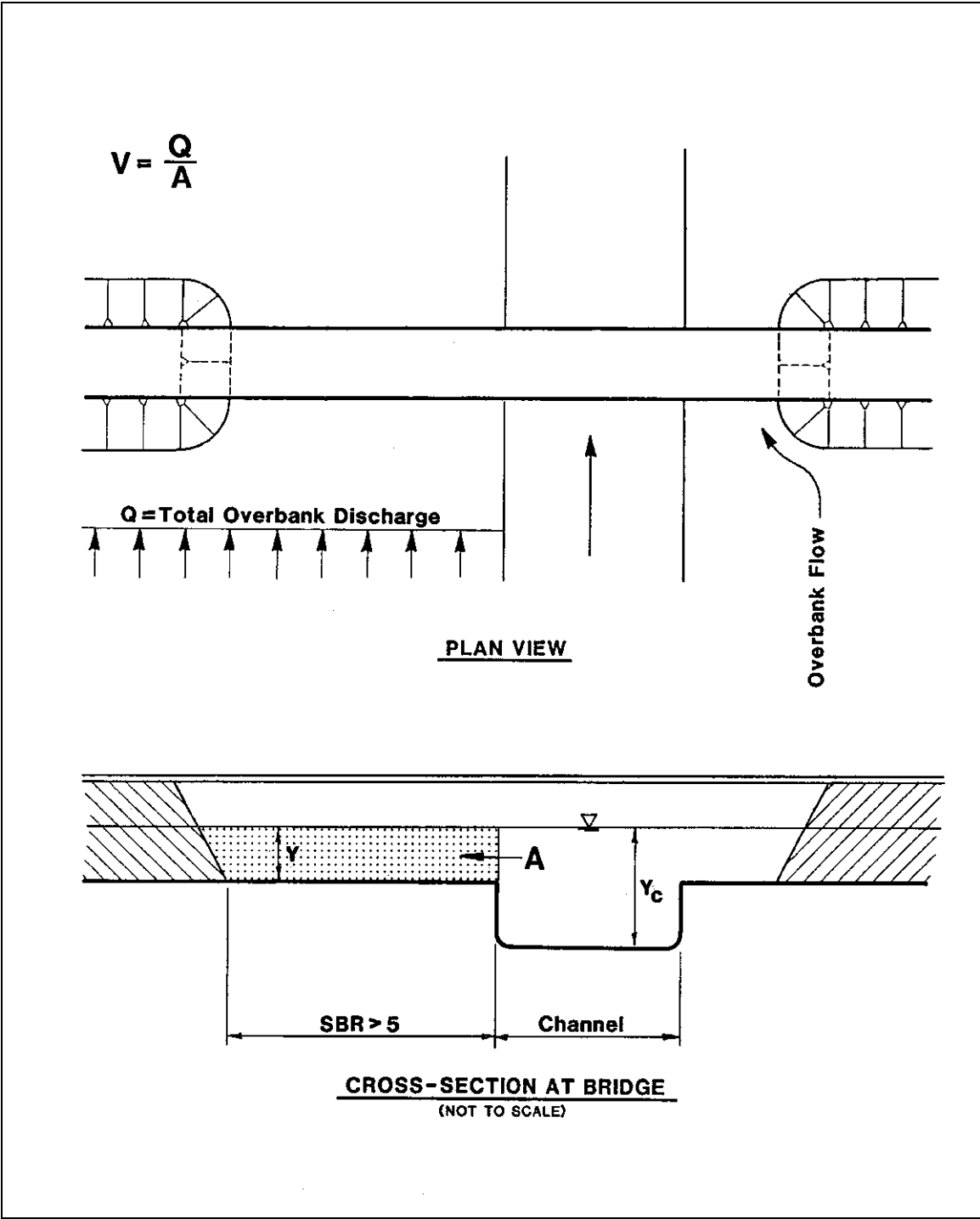

Figure 14.5. Characteristic average velocity for SBR>5.

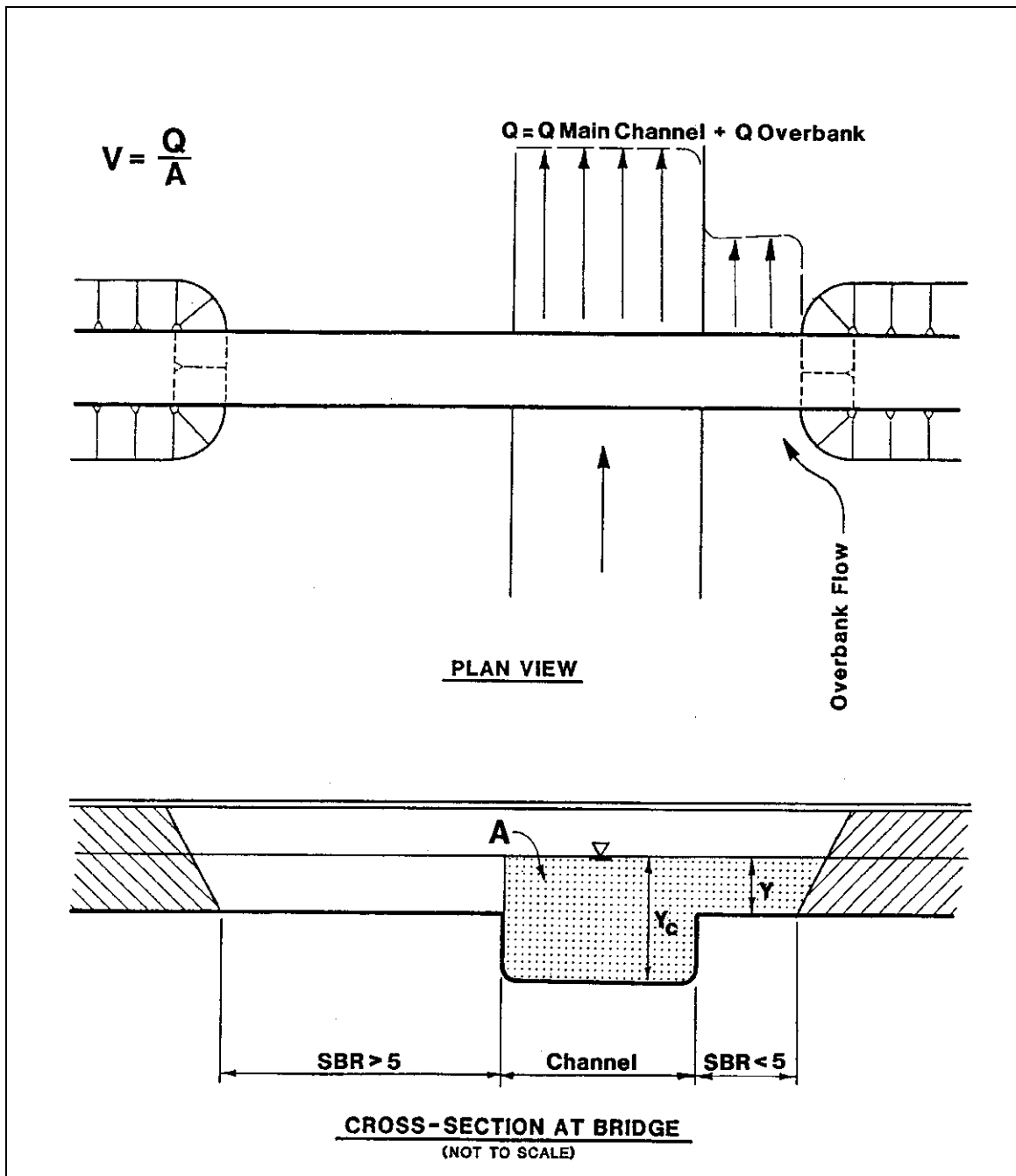

Figure 14.6. Characteristic average velocity for $SBR > 5$ and $SBR < 5$.

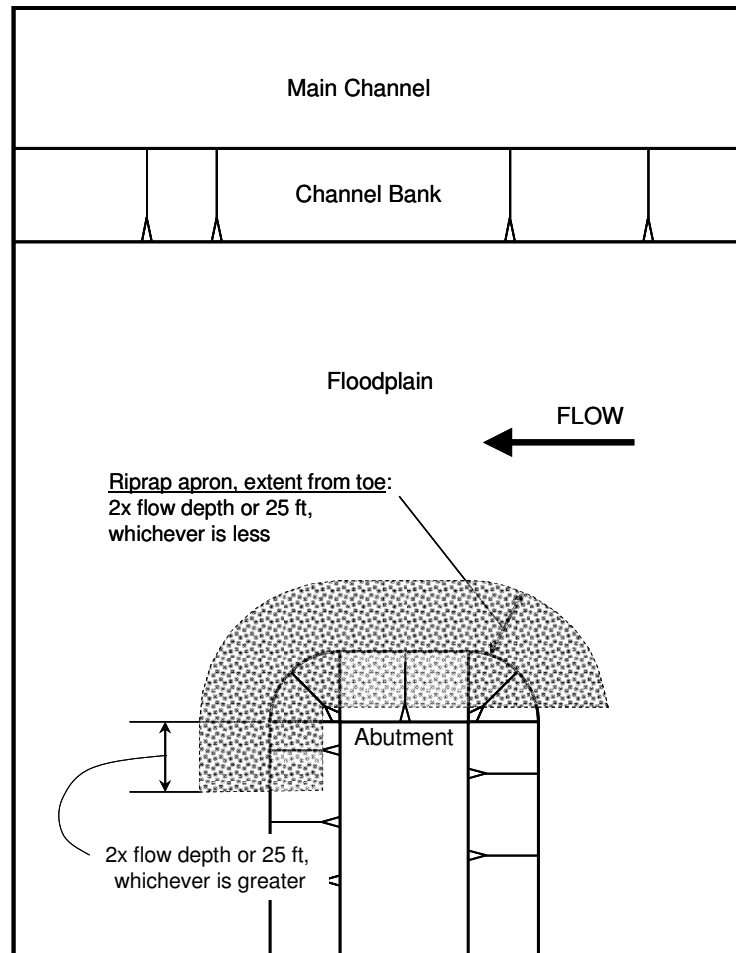

Figure 14.7. Plan view of the extent of rock riprap apron (Lagasse et al. 2006).

- b. Spill-through abutment slopes should be protected with the rock riprap size computed from Equations 14.1 or 14.2 to an elevation 2 ft (0.6 m) above expected high water elevation for the design flood. Several States in the southeast use a guide bank 50 ft (15 m) long at the downstream end of the abutment to protect the downstream side of the abutment.
- c. The rock riprap thickness should not be less than the larger of either 1.5 times D_{50} or D_{100} . The rock riprap thickness should be increased by 50% when it is placed under water to provide for the uncertainties associated with this type of placement. Figure 14.8 illustrates the recommendation that the top surface of the apron should be flush with the existing grade of the floodplain (Lagasse et al. 2006). This is recommended because the layer thickness of the riprap ($1.5 d_{50}$ or d_{100}) could block a significant portion of the floodplain flow depth (reducing bridge conveyance) and could generate significant scour around the apron. The apron thickness may also be increased to protect the edge of the apron from contraction scour, long-term degradation and/or channel migration.
- d. The rock riprap gradation and potential need for underlying filter material must be considered (see Design Guidelines 4 and 16).

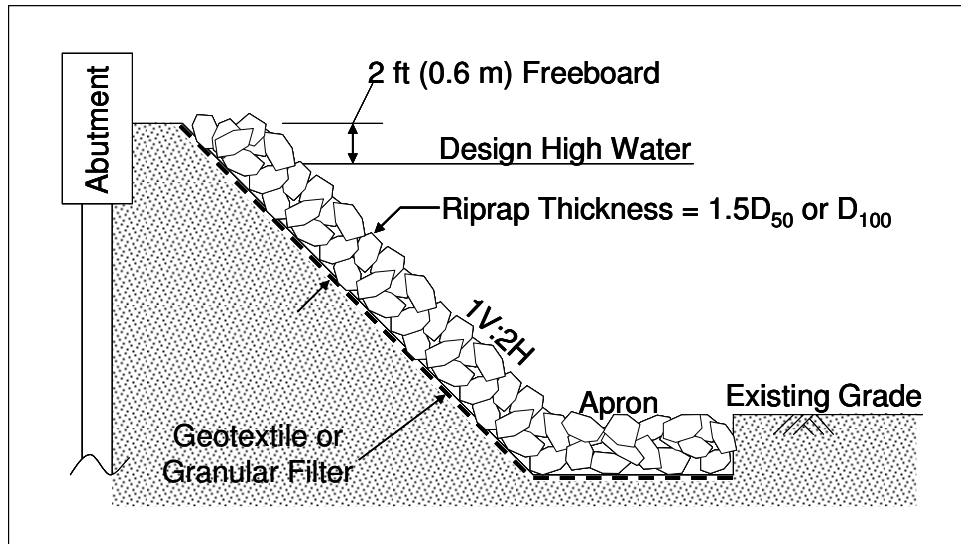

Figure 14.8. Typical cross section for abutment riprap (Lagasse et al. 2006).

- e. It is not desirable to construct an abutment that encroaches into the main channel. If abutment protection is required at a new or existing bridge that encroaches into the main channel, then riprap toe down or a riprap key should be considered. **In cases where the abutment extends into the main channel and dune-type bed forms may be present, it is strongly recommended that only a geotextile filter be considered for the riprap protection.**

14.4 DESIGN EXAMPLE FOR RIPRAP AT BRIDGE ABUTMENTS

Riprap is to be sized for an abutment located on the floodplain at an existing bridge. The bridge is 650 ft (198.12 m) long, has spill-through abutments on a 1V:2H side slope and 7 equally spaced spans. The left abutment is set back from the main channel 225 ft (68.58 m). Given the following tables of hydraulic characteristics for the left abutment size the riprap.

Overbank Property	Value	Value	Remarks
y	2.7 ft	0.83 m	Flow depth adjacent to abutment
Q	7,720 cfs	218.6 m ³ /s	Discharge in left overbank
A	613.5 ft ²	57 m ²	Flow area of left overbank
Channel Property	Value	Value	Remarks
y	9.7 ft	2.96 m	Flow depth in main channel
Q	25,500 cfs	722 m ³ /s	Discharge in main channel
A	1,977 ft ²	184 m ²	Flow area in main channel

Step 1. Determine the SBR (set-back distance divided by the average channel flow depth)

$$\text{SBR} = \frac{225}{9.7} = 23.2$$

Step 2. Determine characteristic average velocity, V . SBR is greater than 5, therefore overbank discharge and areas are used to determine V .

$$V = Q/A = 7720/613.5 = 12.6 \text{ ft/s (3.84 m/s)}$$

Step 3. Check SBR velocity against main channel velocity

$$V_c = \frac{Q_c}{A_c} = \frac{25,500}{1,977} = 12.89 \text{ ft/s (3.93 m/s)}$$

Velocity in channel is greater than SBR velocity, therefore, use SBR velocity.

Step 4. Determine the Froude Number of the flow.

$$Fr = V/(gy)^{1/2} = 12.6/(32.2(2.7))^{1/2} = 1.35$$

Step 5. Determine the D_{50} of the riprap for the left abutment. The Froude Number is greater than 0.8, therefore, use Equation 14.2.

$$\frac{D_{50}}{y} = \frac{K}{(S_s - 1)} \left[\frac{V^2}{gy} \right]^{0.14}$$
$$\frac{D_{50}}{2.7} = \frac{0.61}{2.65 - 1} \left[\frac{(12.6)^2}{(32.2)(2.7)} \right]^{0.14} = 0.40$$

$$D_{50} = 0.4(2.7) = 1.1 \text{ ft (0.33 m)}$$

Step 6. Determine riprap extent and layout.

- Extent into floodplain from toe of slope = $2(2.7) = 5.4 \text{ ft (1.66 m)}$
- Vertical extent up abutment slope from floodplain = $2.0 \text{ ft} + 2.7 \text{ ft} = 4.7 \text{ ft (1.4 m)}$
- Downstream face of the embankment should be protected a distance of 25 ft (7.5 m) from the point of tangency between the curved portion of the abutment and the plane of the embankment slope.
- Riprap mattress thickness = $1.5 (1.1) = 1.7 \text{ ft (0.5m)}$. Also, the thickness should not be less than D_{100} .
- Riprap gradation and filter requirements should be designed using Design Guideline 12. This portion of the design is not conducted for this example.

14.5 SPECIFICATIONS FOR BRIDGE ABUTMENT RIPRAP

14.5.1 Size, Shape, and Gradation

Riprap design methods typically yield a required size of stone that will result in stable performance under the design loadings. Because stone is produced and delivered in a range of sizes and shapes, the required size of stone is often stated in terms of a minimum allowable representative size. For abutment scour protection, the designer specifies a minimum allowable d_{50} for the rock comprising the riprap, thus indicating the size for which

50% (by weight) of the particles are smaller. Stone sizes can also be specified in terms of weight (e.g., W_{50}) using an accepted relationship between size and volume, and the known (or assumed) density of the particle.

For the shape, weight, density, and gradation of bridge abutment riprap, specifications developed for revetment riprap are applicable (Lagasse et al. 2006). These specifications are provided in Design Guideline 4 of this document (see Section 4.2.4).

Design Guideline 4 recommends gradations for ten standard classes of riprap based on the median particle diameter d_{50} as determined by the dimension of the intermediate ("B") axis. These gradations were developed under NCHRP Project 24-23, "Riprap Design Criteria, Recommended Specifications, and Quality Control." The proposed gradation criteria are based on a nominal or "target" d_{50} and a uniformity ratio d_{85}/d_{15} that results in riprap that is well graded. The target uniformity ratio is 2.0 and the allowable range is from 1.5 to 2.5 (Lagasse et al. 2006).

14.5.2 Recommended Tests for Rock Quality

Standard test methods relating to material type, characteristics, and testing of rock and aggregates recommended for revetment riprap are applicable to bridge abutment riprap (see Design Guideline 4). In general, the test methods recommended are intended to ensure that the stone is dense and durable, and will not degrade significantly over time.

Rocks used for riprap should only break with difficulty, have no earthy odor, no closely spaced discontinuities (joints or bedding planes), and should not absorb water easily. Rocks comprised of appreciable amounts of clay, such as shales, mudstones, and claystones, are **never** acceptable for use as riprap. The recommended tests and allowable values for rock and aggregate are summarized in Table 4.3 of Design Guideline 4.

14.6 REFERENCES

Atayee, A. Tamin, 1993, "Study of Riprap as Scour Protection for Spill Through Abutment," presented at the 72nd Annual TRB meeting in Washington, D.C., January.

Atayee, A. Tamin, Pagán-Ortiz, Jorge E., Jones, J.S., and Kilgore, R.T., 1993, "A Study of Riprap as a Scour Protection for Spill Through Abutments," ASCE Hydraulic Conference, San Francisco, CA.

Barkdoll, B.D., Ettema, R., and Melville, B.W., 2007, "Countermeasures to Protect Bridge Abutments from Scour," NCHRP Report 587, Transportation Research Board, National Academies of Science, Washington, D.C.

Lagasse, P.F., Clopper, P.E., Zevenbergen, L.W., and Ruff, J.F., 2006, "Riprap Design Criteria, Recommended Specifications and Quality Control," NCHRP Report 568, Transportation Research Board, Academies of Science, Washington, D.C.

Melville, B.W., van Ballegooy, S., Coleman, S., and Barkdoll, B., 2007, "Riprap Size Selection at Wing-Wall Abutments," Technical Note, ASCE, Journal of Hydraulic Engineering, Vol. 133, No. 11, November.

Melville, B.W., van Ballegooy, S., Coleman, S., and Barkdoll, B., 2006, "Countermeasure Toe Protection at Spill Through Abutments," ASCE Journal of Hydraulic Engineering, Vol. 132, No. 3.

Pagán-Ortiz, Jorge E., 1991, "Stability of Rock Riprap for Protection at the Toe of Abutments Located at the Floodplain," FHWA Research Report No. FHWA-RD-91-057, U.S. Department of Transportation, Washington, D.C.

Parola, A.C., Hagerty, D.J., and Kamojjala, S., 1998, NCHRP Report 417, "Highway Infrastructure Damage Caused by the 1993 Upper Mississippi River Basin Flooding," Transportation Research Board.

Richardson, E.V. and Davis, S.R., 2001, "Evaluating Scour at Bridges," Hydraulic Engineering Circular 18, Fourth Edition, FHWA NHI 01-001, Federal Highway Administration, U.S. Department of Transportation, Washington, D.C.

Richardson, E.V., Simons, D.B., and Lagasse, P.F., 2001, "River Engineering for Highway Encroachments - Highways in the River Environment," Report FHWA NHI 01-004, Federal Highway Administration, Hydraulic Design Series No. 6, Washington, D.C.

(page intentionally left blank)

DESIGN GUIDELINE 15

GUIDE BANKS

(page intentionally left blank)

DESIGN GUIDELINE 15

GUIDE BANKS

15.1 BACKGROUND

When embankments encroach on wide floodplains, the flows from these areas must flow parallel to the approach embankment to the bridge opening. These flows can erode the approach embankment. A severe flow contraction at the abutment can reduce the effective bridge opening, which could possibly increase the severity of abutment and pier scour.

Guide banks (formerly known as spur dikes) can be used in these cases to prevent erosion of the approach embankments by cutting off the flow adjacent to the embankment, guiding streamflow through a bridge opening, and transferring scour away from abutments to prevent damage caused by abutment scour. The two major enhancements guide banks bring to bridge design are (1) reduce the separation of flow at the upstream abutment face and thereby maximize the use of the total bridge waterway area, and (2) reduce the abutment scour due to lessening turbulence at the abutment face. Guide banks can be used on both sand- and gravel-bed streams.

Principal factors to be considered when designing guide banks, are their orientation to the bridge opening, plan shape, upstream and downstream length, cross-sectional shape, and crest elevation. Bradley is used as the principal design reference for this section.⁽¹⁾

Figure 15.1 presents a typical guide bank plan view. It is apparent from the figure that without this guide bank overbank flows would return to the channel at the bridge opening, which can increase the severity of contraction and scour at the abutment. Note, that with installation of guide banks the scour holes which normally would occur at the abutments of the bridge are moved upstream away from the abutments. Guide banks may be designed at each abutment, as shown, or singly, depending on the amount of overbank or floodplain flow directed to the bridge by each approach embankment.

The goal in the design of guide banks is to provide a smooth transition and contraction of the streamflow through the bridge opening. Ideally, the flow lines through the bridge opening should be straight and parallel. As in the case with other countermeasures, the designer should consider the principles of river hydraulics and morphology, and exercise sound engineering judgment.

15.2 DESIGN GUIDELINES

15.2.1 Orientation

Guide banks should start at and be set parallel to the abutment and extend upstream from the bridge opening. If there are guide banks at each abutment, the distance between them at the bridge opening should be equal to the distance between bridge abutments. Best results are obtained by using guide banks with a planform shape in the form of a quarter of an ellipse, with the ratio of the major axis (length L_s) to the minor axis (offset) of 2.5:1.0. This allows for a gradual constriction of the flow. Thus, if the length of the guide bank measured perpendicularly from the approach embankment to the upstream nose of the guide bank is denoted as L_s , the amount of expansion of each guide bank (offset), measured from the abutment parallel to the approach roadway, should be $0.4 L_s$.

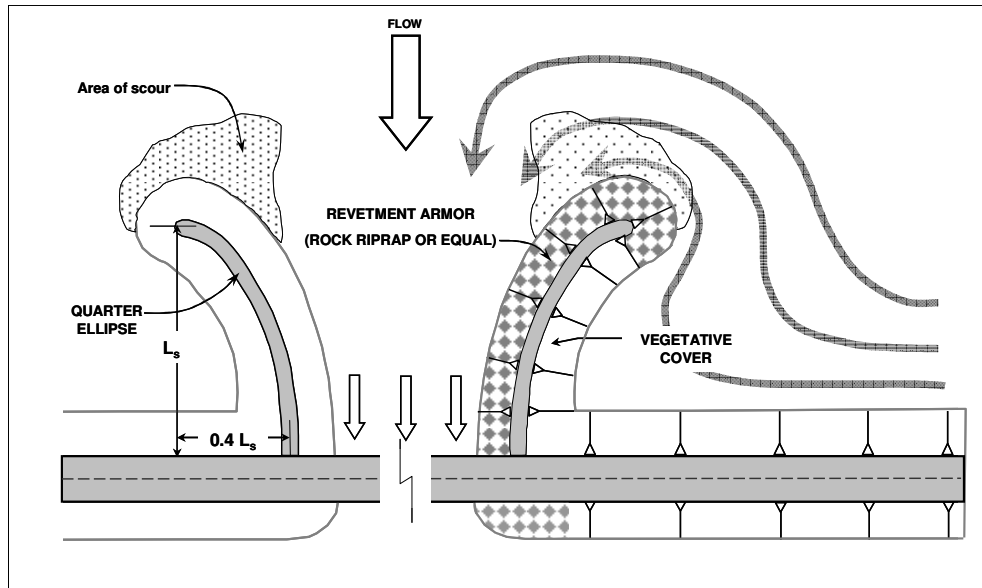

Figure 15.1. Typical guide bank (modified from Bradley 1978).

The plan view orientation can be determined using Equation 15.1, which is the equation of an ellipse with origin at the base of the guide bank. For this equation, X is the distance measured perpendicularly from the bridge approach and Y is the offset measured parallel to the approach embankment, as shown on Figure 15.1.

$$\frac{X^2}{L_s^2} + \frac{Y^2}{(0.4L_s)^2} = 1 \quad (15.1)$$

It is important that the face of the guide bank match the abutment so that the flow is not disturbed where the guide bank meets the abutment. For new bridge construction, abutments can be sloped to the channel bed at the same angle as the guide bank. For retrofitting existing bridges modification of the abutments or wing walls may be necessary.

15.2.2 Length

For design of guide banks, the length of the guide bank, L_s must first be determined. This can be easily determined using a nomograph which was developed from laboratory tests performed at Colorado State University and from field data compiled by the USGS (Karaki 1959, 1961, Neeley 1966). For design purposes the use of the nomograph involves the following parameters:

- Q = Total discharge of the stream, ft^3/s (m^3/s)
- Q_f = Lateral or floodplain discharge of either floodplain **intercepted by the embankment**, ft^3/s (m^3/s)
- Q_A = Discharge in 100 ft (30 m) of stream adjacent to the abutment, ft^3/s (m^3/s)
- b = Length of the bridge opening, ft (m)
- A_{n2} = Cross-sectional flow area at the bridge opening at normal stage, ft^2 (m^2)
- V_{n2} = $\frac{Q}{A_{n2}}$ = average velocity through the bridge opening, ft/s (m/s)

$$\frac{Q_f}{Q_A} = \text{Guide bank discharge ratio}$$

$$L_s = \text{Projected length of guide bank, ft (m)}$$

A nomograph is presented in Figure 15.2 (English) and Figure 15.3 (SI) to determine the projected length of guide banks. This nomograph should be used to determine the guide bank length for designs greater than 50 ft (15 m) and less than 250 ft (75 m). If the nomograph indicates the length required to be greater than 250 ft (75 m) the design should be set at 250 ft (75 m). It is recommended that the minimum length of guide banks be 50 ft (15 m). An example of how to use this nomograph is presented in the next section.

FHWA practice has shown that many guide banks have performed well using a standardized length of 150 ft (46 m). Based on this experience, guide banks of 150 ft (46 m) in length should perform very well in most locations. Even shorter guide banks have been successful if the guide bank intersects the tree line. If the main channel is equal to or less than 100 ft (30 m) use the total main channel flow in determining the guide bank discharge ratio (Q_f/Q_A).

15.2.3 Crest Height

As with deflection spurs, guide banks should be designed so that they will not be overtopped at the design discharge. If this were allowed to occur, unpredictable cross flows and eddies might be generated, which could scour and undermine abutments and piers. In general, a minimum of 2 ft (0.6 m) of freeboard, above the design water surface elevation should be maintained.

15.2.4 Shape and Size

The cross-sectional shape and size of guide banks should be similar to deflector, or deflector/retarder spurs discussed in Design Guideline 2. Generally, the top width is 10 to 13 ft (3 to 4 m), but the minimum width is 3 ft (1 m) when construction is by drag line. The upstream end of the guide bank should be round nosed. Side slopes should be 1V:2H or less.

15.2.5 Downstream Extent

In some states, highway departments extend guide banks downstream of the abutments to minimize scour due to rapid expansion of the flow at the downstream end of the abutments. These downstream guide banks are sometimes called "heels." If the expansion of the flow is too abrupt, a shorter guide bank, which usually is less than 50 ft (15 m) long, can be used downstream. Downstream guide banks should also start at and start parallel to the abutment and the distance between them should enlarge as the distance from the abutment of the bridge increases.

In general, downstream guide banks are a shorter version of the upstream guide banks. Riprap protection, crest height and width should be designed in the same manner as for upstream guide banks.

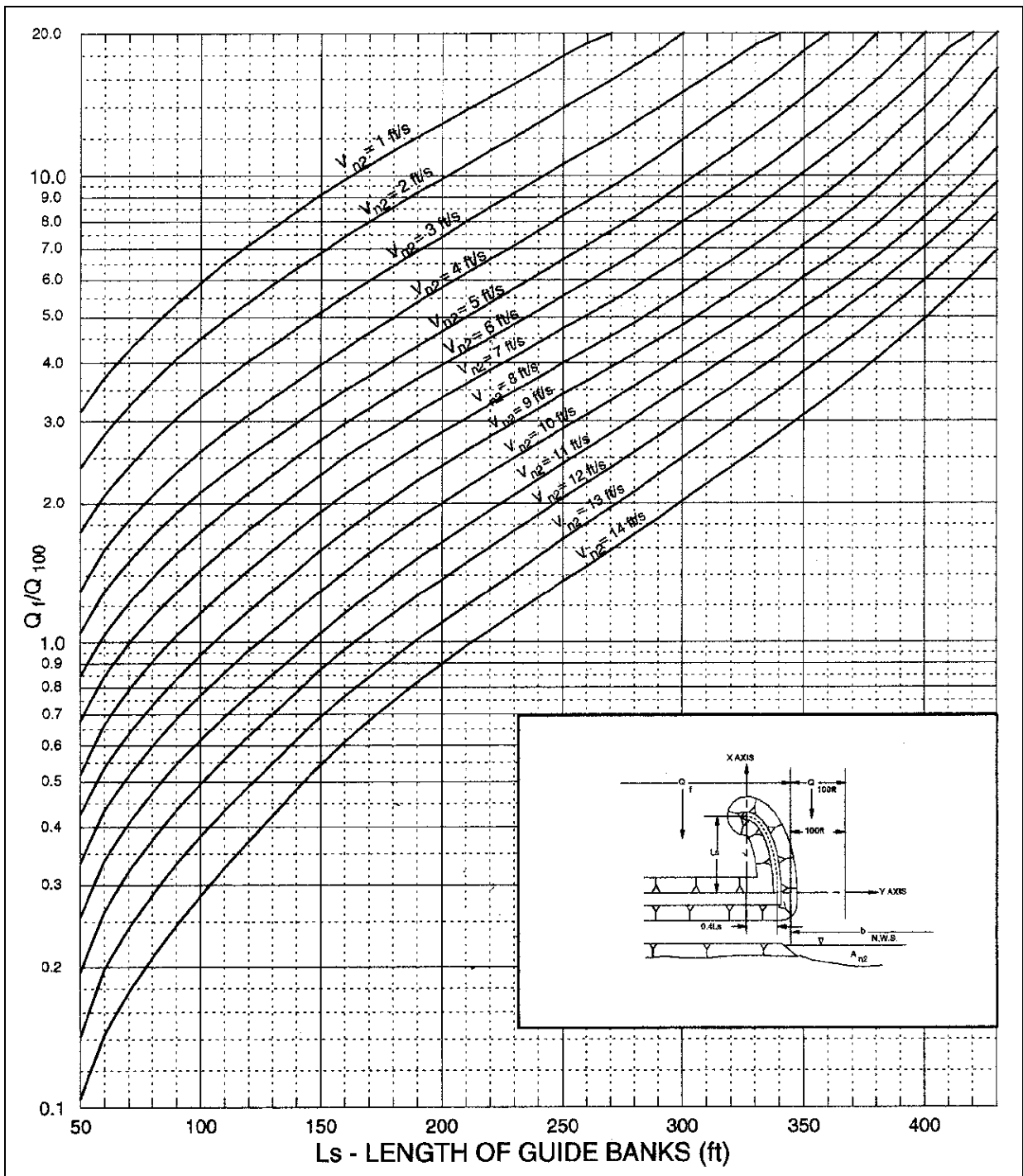

Figure 15.2. English nomograph to determine guide bank length (after Bradley 1978).

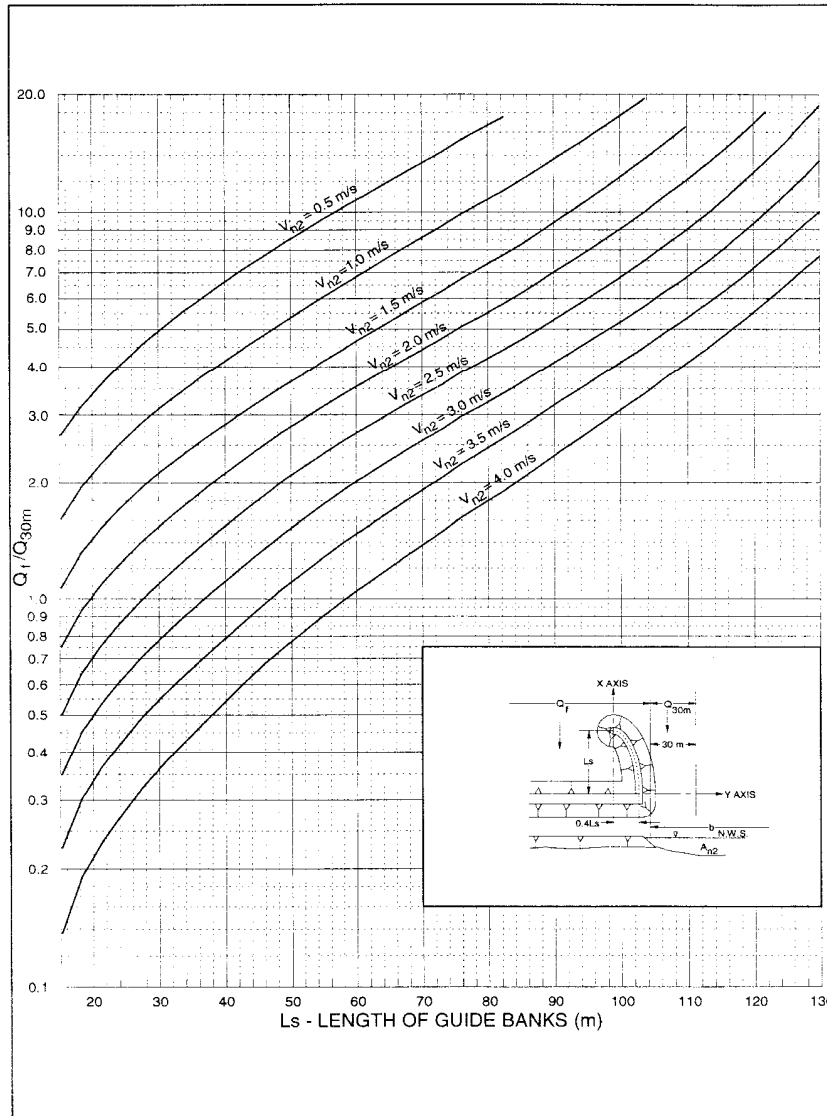

Figure 15.3. SI version of nomograph to determine guide bank length (after Bradley 1978).

15.2.6 Riprap

Guide banks are constructed by forming an embankment of soil or sand extending upstream from the abutment of the bridge. To inhibit erosion of the embankment materials, guide banks must be adequately protected with riprap or stone facing. Rock riprap should be placed on the stream side face as well as around the end of the guide bank. It is not necessary to riprap the side of the guide bank adjacent to the highway approach embankment. As in the case of spurs, a gravel, sand, or geotextile filter may be required to protect the underlying embankment material (see Design Guideline 16).

Because guide banks are designed to protect abutments from deep scour by providing a smooth flow transition through the bridge, it is reasonable to use the abutment riprap equations for guide banks. The designer is referred to Design Guideline 14 for design procedures for sizing riprap. Design guidance for riprap for countermeasures was investigated under NCHRP Project 24-23 (Lagasse et al. 2006). This study confirmed the applicability of the Set Back Ratio (SBR) approach for designing riprap at bridge abutments (Design Guideline 14) to riprap design for guide banks. **It is recommended that the riprap size for guide banks be computed using 0.85 times the characteristic average velocity computed using the SBR approach discussed in Design Guideline 14.**

Riprap should be extended below the bed elevation to a depth as recommended in Design Guideline 4 (below the combined long-term degradation and contraction scour depth), and extend up the face of the guide bank to 2 ft (0.6 m) above the design flow. Additional riprap should be placed around the upstream end of the guide bank to protect the embankment from scour.

As in the case of spurs, it is important to adequately tie guide banks into the approach embankment for guide banks on non-symmetrical highway crossings. Hydraulics of Bridge Waterways (Bradley 1978) states:

"From meager testing done to date, there is not sufficient evidence to warrant using longer dikes (guide banks) at either abutment on skewed bridges. Lengths obtained from [the nomograph] should be adequate for either normal or skewed crossings."

Therefore, for skewed crossings, the length of guide banks should be set using the nomograph for the side of the bridge crossing which yields the largest guide bank length.

15.2.7 Other Design Concerns

In some cases, where the cost of stone riprap facing is prohibitive, the guide bank can be covered with sod or other minimal protection. If this approach is selected, the design should allow for and stipulate the repair or replacement of the guide bank after each high water occurrence. Other measures which will minimize damage to approach embankments, and guide banks during high water are:

- Keep trees as close to the toe of guide bank embankments as construction will permit. Trees will increase the resistance to flow near and around the toe of the embankment, thus reducing velocities and scour potential.
- Do not allow the cutting of channels or the digging of borrow pits along the upstream side of approach embankments and near guide banks. Such practices encourage flow concentration and increase velocities and erosion rates of the embankments.
- In some cases, the area behind the guide bank may be too low to drain properly after a period of flooding. This can be a problem, especially when the guide bank is relatively impervious. Small drain pipes can be installed in the guide bank to drain this ponded water.
- In some cases, only one approach will cut off the overbank flow. This is common when one of the banks is high and well defined. In these cases, only one guide bank may be necessary.

15.3 DESIGN EXAMPLE OF GUIDE BANK INSTALLATION

For the example design of a guide bank, Figure 15.4 (English units) or Figure 15.5 (SI units) will be used. These figures show the cross-section of the channel and floodplain before the bridge is constructed and the plan view of the approach, guide banks, and embankments after the design steps outlined below are completed.

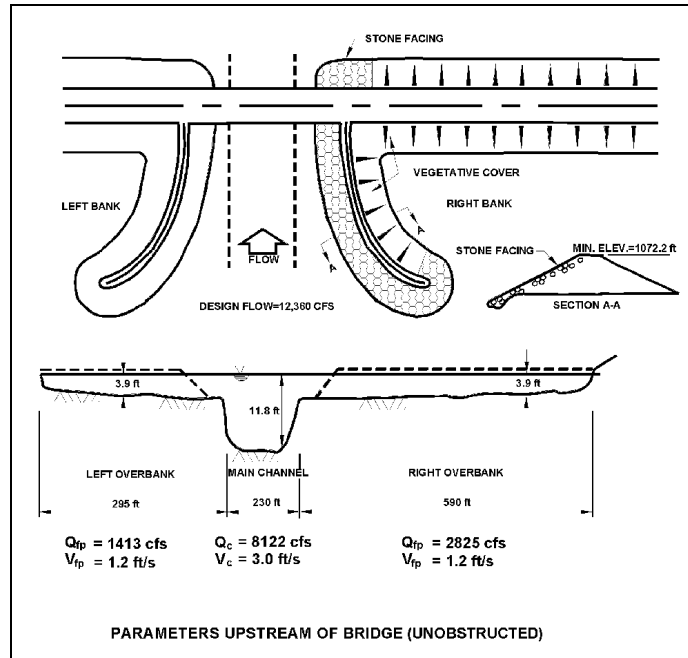

Figure 15.4. Example guide bank design (English).

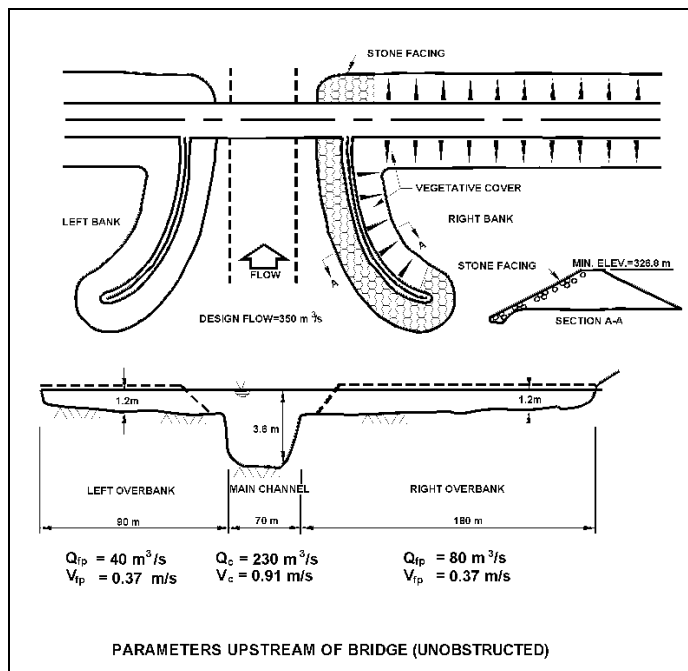

Figure 15.5. Example guide bank design (SI).

Step 1. Hydraulic Design Parameters

The first step in the design of guide banks requires the computation of the depth and velocity of the design flood in the main channel and in the adjacent overbank areas. These studies are performed by using step backwater computations upstream and through the bridge opening. The computer programs WSPRO or HEC River Analysis System (RAS) are suitable for these computations (Arneson and Shearman 1987, USACE 1998). Using these programs or by using conveyance curves developed from actual data, the discharges and depths in the channel and overbank areas can be determined.

To use the conveyance curve approach, the designer is referred to example problem number 4 in *Hydraulics of Bridge Waterways* (Bradley 1978) for methods to determine these discharges and areas. That publication also contains another example of the design of a guide bank.

For this example, the total, overbank, and channel discharges, as well as the flow area are given. We also assume that a bridge will span a channel with a bottom width of 230 ft (70 m) and that **the abutments will be set back 148 ft** (45 m) from each bank of the main channel.

The abutments of this bridge are spill-through with a side slope of 1V:2H. The design discharge is 12,360 cfs (350 m³/s), which after backwater computations, results in a mean depth of 11.8 ft (3.6 m) in the main channel and a mean channel velocity of 3 ft/s (0.91 m/s).

Step 2. Determine Q_f in the Left and Right Overbank

The depth in each overbank area is given as 3.9 ft (1.2 m) and the widths of the left and right overbank areas are 295 ft (90 m) and 590 ft (180 m), respectively. Velocity in the overbank areas (assuming no highway approach embankment, i.e., at an upstream cross section) is 1.2 ft/s (0.37 m/s). The floodplain flow is equal to 1,413 cfs (40 m³/s) for the left overbank and 2,825 cfs (80 m³/s) for the right overbank.

Using the continuity equation and noting that the abutments are set back 148 ft (45 m) from each bank, the floodplain discharge intercepted by each approach embankment is:

$$Q = AV$$

$$(Q_f)_{\text{right}} = 2,825 - (148)(3.9)(1.2) = 2132 \text{ cfs (60 m}^3/\text{s)}$$

$$(Q_f)_{\text{left}} = 1,413 - (148)(3.9)(1.2) = 720 \text{ cfs (20 m}^3/\text{s)}$$

Step 3. Determine Q_A and Q_f/Q_A for the Left and Right Overbank

The overbank discharge in the first 100 ft (30 m) of opening adjacent to the left and right abutments needs to be determined next. Since for this case the flow is of uniform depth [3.9 ft (1.2 m)] and velocity [1.2 ft/s (0.37 m/s)] over the entire width of the floodplain, and both abutments are set back more than 100 ft (30 m) from the main channel banks, the value of Q_A will be the same for both sides:

$$(Q_A)_{\text{right}} = (100)(3.9)(1.2) = 468 \text{ cfs (13.3 m}^3/\text{s)}$$

$$(Q_A)_{\text{left}} = (100)(3.9)(1.2) = 468 \text{ cfs (13.3 m}^3/\text{s)}$$

For the left and right overbanks the reference values of Q_f/Q_A can be determined by simple division of the discharges determined in previous steps:

$$\left(\frac{Q_f}{Q_A}\right)_{\text{right}} = \frac{2132}{468} = 4.5$$

$$\left(\frac{Q_f}{Q_A}\right)_{\text{left}} = \frac{720}{468} = 1.5$$

For design purposes, the largest value will result in the more conservative determination of the length of the guide banks, except where Step 4 indicates a guide bank is required for only one of the overbank areas.

Step 4. Determine the Length of the Guide Bank, L_s

The average channel velocity through the bridge opening can be determined by dividing the total discharge of the stream, Q , by the cross-sectional flow area at the bridge opening, A_{n2} , which in this case includes the main channel (2,714 ft²) plus 148 ft of the left and right overbank areas adjacent to the abutments at the bridge opening (1,154 ft²). Thus:

$$V_{n2} = \frac{Q}{a_{n2}} = \frac{12360}{(11.8)(230) + 2(3.9)(148)}$$

$$V_{n2} = 3.2 \text{ ft/s (0.97 m/s)}$$

For Q_f/Q_A equal to 4.5 and an average channel velocity of 3.2 ft/s (0.97 m/s), the length of the guide bank is determined using the nomograph presented in Figure 15.2.

$$(L_s)_{\text{right}} = 138 \text{ ft (42 m)}$$

For the left abutment, a Q_f/Q_A of 1.5 and V_{n2} of 3.2 ft/s (0.97 m/s) indicate that L_s would be less than 50 ft (15 m). Thus, no guide bank is required for the left overbank for this example.

Step 5. Miscellaneous Specifications

The offset of the guide bank is determined to be 55.2 ft (16.8 m) by multiplying L_s by 0.4. The offset and length determine the plan layout of the guide bank. Coordinates of points along the centerline can be determined using Equation 15.1, which is the equation of an ellipse with a major to minor axis ratio of 2.5:1. The coordinates for a 138 ft (42 m) long guide bank with a 55.2 ft (16.8 m) offset are presented in Table 15.2.

X (ft)	X (m)	Y (ft)	Y (m)
0	0	55.2	16.8
30	10	53.9	16.32
60	20	49.7	14.77
90	30	41.8	11.76
120	36	27.3	8.7
138	42	0.0	0.0

These coordinates would be used for conceptual level design. For construction, coordinates at an offset or along the toe of side slope would be necessary.

The crest of the guide bank must be a minimum of 2 ft (0.6 m) above the design water surface (elevation 1070.2 ft (326.2 m)). Therefore, the crest elevation for this example should be greater than or equal to 1072.2 ft (326.8 m). The crest width should be at least 3 ft (1 m). For this example, a crest width of 10 ft (3 m) will be specified so that the guide bank can be easily constructed with dump trucks.

Stone or rock riprap should be placed in the locations shown on Figure 15.4. This riprap should extend a minimum of 2 ft (0.6 m) above the design water surface (elevation 1070.2 ft (326.2 m)) and below the intersection of the toe of the guide bank and the existing ground to the combined long-term degradation and contraction scour depth.

15.5 REFERENCES

Arneson, L.A. and Shearman, J.O., 1987, "User's Manual for WSPRO - A Computer Model for Water Surface Profile Computations," Office of Technology Applications, Federal Highway Administration, FHWA Report No. FHWA-SA-98-080, June 1998.

Bradley, J.N., 1978, "Hydraulics of Bridge Waterways," Hydraulic Design Series No. 1 U.S. Department of Transportation, FHWA.

Karaki, S.S., 1959, "Hydraulic Model Study of Spur Dikes for Highway Bridge Openings," Colorado State University, Civil Engineering Section, Report CER59SSK36, September, 47 pp.

Karaki, S.S., 1961, "Laboratory Study of Spur Dikes for Highway Bridge Protection," Highway Research Board Bulletin 286, Washington, D.C., p. 31.

Lagasse, P.F., Clopper, P.E., Zevenbergen, L.W., and Ruff, J.F., 2006, "Riprap Design Criteria, Recommended Specifications, and Quality Control," NCHRP Report 568, Transportation Research Board, National Research Council, Washington, D.C.

Neeley, B.L., Jr., 1966, "Hydraulic Performance of Bridges in the State of Mississippi," U.S. Geological Survey, Jackson, MS, June. (Unpublished report).

U.S. Army Corps of Engineers, 1998, "HEC-RAS River Analysis System," User's Manual, Version 2.2, Hydrologic Engineering Center, Davis, CA.

SECTION 5 – FILTER DESIGN
Design Guideline 16 – Filter Design

DESIGN GUIDELINE 16

FILTER DESIGN

(page intentionally left blank)

DESIGN GUIDELINE 16

FILTER DESIGN

16.1 INTRODUCTION

National Cooperative Highway Research Program (NCHRP) Reports 568 and 593 (Lagasse et al. 2006, 2007) describe the importance of filters to the successful long-term performance of armoring-type countermeasures. Based on a survey of the existing state of practice, these reports indicate that filter design criteria has typically been the most overlooked aspect of revetment riprap design, and recommend that more emphasis be given to ensuring compatibility between the filter and the soil.

Correct filter design reduces the effects of piping by limiting the loss of fines, while simultaneously maintaining a permeable, free-flowing interface. Seepage flow and turbulence at the water-filter interface induces the migration of soil particles. The particle size distribution of the base soil underlying an armor layer must be determined to properly design a filter for particle retention. For example, when a filter with relatively large pores overlies a uniform fine-grained soil, piping of the fine particles may continue unabated, since there are no particles of large and intermediate sizes to prevent their migration. The presence of large and intermediate sized particles in the soil matrix prevents clogging from occurring at the soil-filter interface when filters with relatively small pores are used.

In addition to particle retention, filters must be have sufficient hydraulic conductivity (sometimes referred to as "permeability") to allow unimpeded flow of water from the base soil through the filter material. This is necessary for two reasons: (1) regulating the particle migration process at the soil-filter interface, and (2) minimizing hydrostatic pressure buildup from seepage out of the channel bed and banks, typically caused by seasonal groundwater fluctuations or flood events.

The hydraulic conductivity of the filter should never be less than the material below it (whether base soil or another filter layer). Figures 16.1 (a) through (c) illustrate the typical process that occurs during and after a flood event. Seepage forces can result in piping of the base soil through the armor layer. If a filter is less permeable than the base soil, an increase of hydrostatic pressure can build beneath the armor layer. A permeable filter material, properly designed, will alleviate problems associated with fluctuating water levels.

Base Soil Properties: Base soil is defined here as the subgrade material upon which the filter and armor layer (riprap, for example) will be placed. Base soil can be native in-place material, or imported and recompacted fill. The following properties of the base soil should be obtained for proper design of the filter, whether using a geotextile or a granular filter.

General Soil Classification. Soils are classified based on laboratory determinations of particle size characteristics and the physical effects of varying water content on soil consistency. Typically, soils are described as coarse-grained if more than 50% by weight of the particles is larger than a #200 sieve (0.075 mm mesh), and fine-grained if more than 50% by weight is smaller than this size. Sands and gravels are examples of coarse-grained soils, while silts and clays are examples of fine-grained soils.

The fine-grained fraction of a soil is further described by changes in its consistency caused by varying water content and by the percentage of organic matter present. Soil classification procedures are described in ASTM D 2487 "Standard Practice for Classification of Soils for Engineering Purposes: Unified Soil Classification System" (ASTM 2003a).

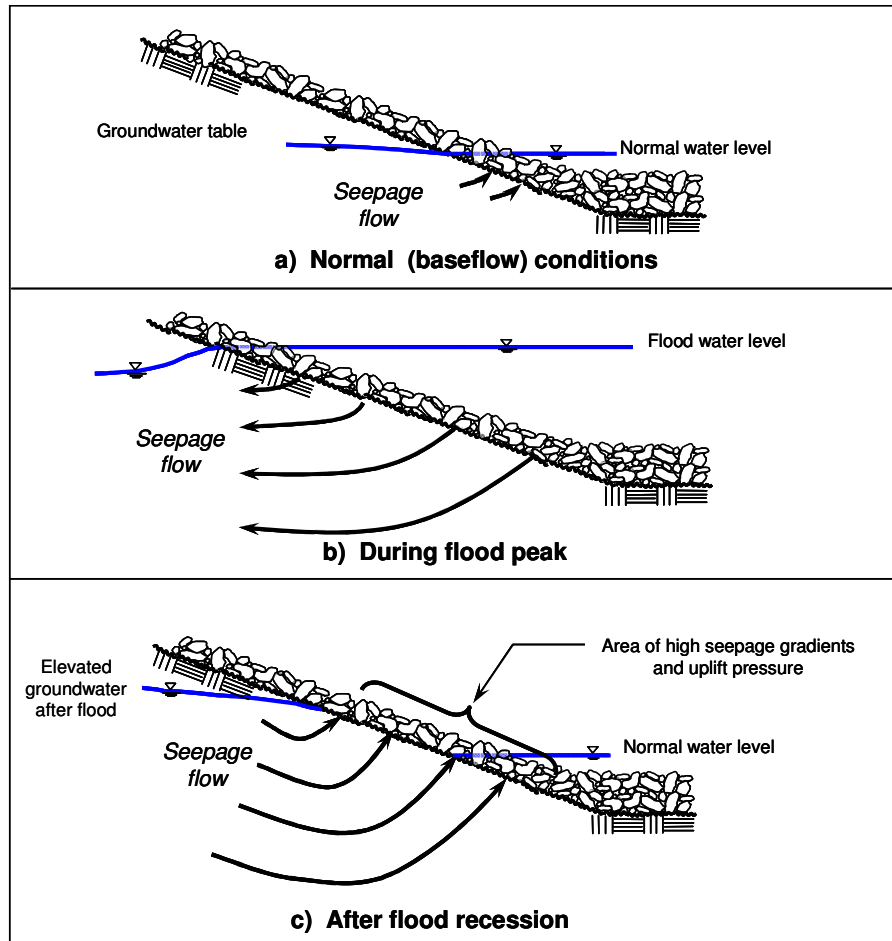

Figure 16.1. Changes in water levels and seepage patterns during a flood.

Particle Size Distribution. The single most important soil property for filter design is the range of particle sizes in the soil. Particle size is a simple and convenient way to assess soil properties. Also, particle size tends to be an indication of other properties such as hydraulic conductivity. Characterizing soil particle size involves determining the relative proportions of gravel, sand, silt, and clay in the soil. This characterization is usually done by sieve analysis for coarse-grained soils or sedimentation (hydrometer) analysis for fine-grained soils. ASTM D 422 "Standard Test Method for Particle-Size Analysis of Soils" describes the specific procedure (ASTM 2003a).

Plasticity. Plasticity is defined as the property of a material that allows it to be deformed rapidly, without rupture, without elastic rebound, and without volume change. A standard measure of the plasticity of soil is the Plasticity Index (PI), which should be determined for soils with a significant percentage of clay. The results associated with plasticity testing are referred to as the Atterberg Limits. ASTM D 4318 "Standard Test Methods for Liquid Limit, Plastic Limit, and Plasticity Index of Soils" defines the testing procedure (ASTM 2003a).

Porosity: Porosity is that portion of a representative volume of soil that is interconnected void space. It is typically reported as a dimensionless fraction or a percentage. The porosity of soils is affected by the particle size distribution, the particle shape (e.g., round vs. angular), and degree of compaction and/or cementation.

Hydraulic conductivity. Hydraulic conductivity, sometimes referred to as permeability, is a measure of the ability of soil to transmit water. ASTM provides two standard laboratory test methods for determining hydraulic conductivity. They are ASTM D 2434 "Standard Test Method for Permeability of Granular Soils (Constant Head)" and ASTM D 5084 "Standard Test Method for Measurement of Hydraulic Conductivity of Saturated Porous Materials Using a Flexible Wall Permeameter" (ASTM 2003b). In these tests, the amount of water passing through a saturated soil sample is measured over a specified time interval, along with the sample's cross-sectional area and the hydraulic head at specific locations. The soil's hydraulic conductivity is then calculated from these measured values. Hydraulic conductivity is related more to particle size distribution than to porosity, as water moves through large and interconnected voids more easily than small or isolated voids. Various equations are available to estimate hydraulic conductivity based on the grain size distribution, and the practitioner is encouraged to consult with geotechnical and materials engineers on estimating this property. Table 16.1 lists typical values of porosity and hydraulic conductivity for alluvial soils.

Type of Material	Porosity (vol/vol)	Hydraulic conductivity (cm/s)
Gravel, coarse	0.28	4×10^{-1}
Gravel, fine	0.34	
Sand, coarse	0.39	5×10^{-2}
Sand, fine	0.43	3×10^{-3}
Silt	0.46	3×10^{-5}
Clay	0.42	9×10^{-8}

Granular Filter Properties: Generally speaking, most required granular filter properties can be obtained from the particle size distribution curve for the material. Granular filters may be used alone or as a transitional layer between a predominantly fine-grained base soil and a geotextile.

Particle Size Distribution. As a rule of thumb, the gradation curve of the granular filter material should be approximately parallel to that of the base soil. Parallel gradation curves minimize the migration of particles from the finer material into the coarser material. Heibbaum (2004) presents a summary of a procedure originally developed by Cistin and Ziems whereby the d_{50} size of the filter is selected based on the coefficients of uniformity (d_{60}/d_{10}) of both the base soil and the filter material. With this method, the grain size distribution curves do not necessarily need to be approximately parallel.

Hydraulic conductivity. Hydraulic conductivity of a granular filter material is determined by laboratory test, or estimated using relationships relating hydraulic conductivity to the particle size distribution. The hydraulic conductivity of a granular layer is used to select a geotextile when designing a composite filter. For countermeasure installations, the hydraulic conductivity of the filter should be at least 10 times the hydraulic conductivity of the underlying material.

Porosity: Porosity is that portion of a representative volume of soil that is interconnected void space. It is typically reported as a dimensionless fraction or a percentage. The porosity of soils is affected by the particle size distribution, the particle shape (e.g., round vs. angular), and degree of compaction and/or cementation.

Thickness. Practical issues of placing a granular filter indicate that a typical minimum thickness of 6 to 8 inches should be specified. For placement under water, thickness should be increased by 50%.

Quality and Durability. Aggregate used for a granular filter should be hard, dense, and durable.

Geotextile Filter Properties: For compatibility with site-specific soils, geotextiles must exhibit the appropriate values of hydraulic conductivity, pore size (otherwise known as Apparent Opening Size, or AOS), and porosity (or percent open area). In addition, geotextiles must be sufficiently strong to withstand the stresses during installation. Values of these properties are available from manufacturers.

Only woven monofilament or nonwoven needle-punched geotextiles should be considered for filter applications. Slit-film, spun-bonded, or other types of geotextiles are not suitable as filters. If a woven monofilament fabric is chosen, it should have a Percent Open Area (POA) greater than, or equal to, 4%. If a nonwoven needle-punched fabric is chosen, it should have a porosity greater than, or equal to 30%, and a mass per unit area of at least 400 grams per square meter (12 ounces per square yard). The following list briefly describes the most relevant properties of geotextiles for filter applications.

Hydraulic conductivity: The hydraulic conductivity, K , of a geotextile is a tested property of geotextiles that is reported by manufacturers for their products. The hydraulic conductivity is a measure of the ability of a geotextile to transmit water across its thickness. It is typically reported in units of centimeters per second (cm/s). This property is directly related to the filtration function that a geotextile must perform, where water flows perpendicularly through the geotextile into a crushed stone bedding layer, perforated pipe, or other more permeable medium. The geotextile must allow this flow to occur without being impeded. A value known as the permittivity, ψ , is used by the geotextile industry to more readily compare geotextiles of different thicknesses. Permittivity, ψ , is defined as K divided by the geotextile thickness, t , in centimeters; therefore, permittivity has a value of $(s)^{-1}$. Hydraulic conductivity (and permittivity) are extremely important in filter design.

Transmissivity: The transmissivity, θ , of a geotextile is a calculated value that indicates the ability of a geotextile to transmit water within the plane of the fabric. It is typically reported in units of cm^2/s . This property is directly related to the drainage function, and is most often used for high-flow drainage nets and geocomposites, not geotextiles. Woven monofilament geotextiles have very little capacity to transmit water in the plane of the fabric, whereas non-woven needle punched fabric have a much greater capacity due to their 3-dimensional microstructure. Transmissivity is not particularly relevant to filter design.

Apparent Opening Size (AOS). Also known as Equivalent Opening Size, this measure is generally reported as O_{95} , which represents the aperture size such that 95% of the openings are smaller. In similar fashion to a soil gradation curve, a geotextile hole distribution curve can be derived. The AOS is typically reported in millimeters, or in equivalent U.S. standard sieve size.

Porosity. Porosity is a comparison of the total volume of voids to the total volume of geotextile. This measure is applicable to non-woven geotextiles only. Porosity is used to estimate the potential for long term clogging, and is typically reported as a percentage.

Percent Open Area (POA). POA is a comparison of the total open area to the total geotextile area. This measure is applicable to woven geotextiles only. POA is used to estimate the potential for long term clogging, and is typically reported as a percentage.

Thickness. As mentioned above, thickness is used to calculate hydraulic conductivity. It is typically reported in millimeters or mils (thousandths of an inch).

Grab Strength and Elongation. Force required to initiate a tear in the fabric when pulled in tension. Typically reported in Newtons or pounds as measured in a testing apparatus having standardized dimensions. The elongation measures the amount the material stretches before it tears, and is reported as a percent of its original (unstretched) length.

Tear Strength. Force required to propagate a tear once initiated. Typically reported in Newtons or pounds.

Puncture Strength. Force required to puncture a geotextile using a standard penetration apparatus. Typically reported in Newtons or pounds.

There are many other tests to determine various characteristics of geotextiles; only those deemed most relevant to applications involving countermeasures have been discussed here. As previously mentioned, geotextiles should be able to withstand the rigors of installation without suffering degradation of any kind. Long-term endurance to stresses such as ultraviolet solar radiation or continual abrasion are considered of secondary importance, because once the geotextile has been installed and covered by the armor layer, these stresses do not represent the long-term environment that the geotextile will experience. Table 16.2 provides recommended tests and allowable values for various geotextile properties.

16.2 FILTER DESIGN PROCEDURES

16.2.1 Granular Filter Design Procedure

Numerous texts and handbooks provide details on the well-known Terzaghi approach to designing a granular filter. That approach was developed for subsoils consisting of well-graded sands, and may not be widely applicable to other soil types. An alternative approach that is considered more robust in this regard is the Cistin – Ziems method.

The suggested steps for proper design of a granular filter using this method are outlined below. Note that " d_s " is used to represent the base (finer) soil, and an " d_f " is used to represent the filter (coarser) layer.

Step 1. Obtain Base Soil Information. Typically, the required base soil information consists simply of a grain size distribution curve, a measurement (or estimate) of hydraulic conductivity, and the Plasticity Index (PI is required only if the base soil is more than 20% clay).

Table 16.2. Recommended Tests and Allowable Values for Geotextile Properties.

Test Designation	Property	Allowable value ⁽¹⁾		Comments
		Elongation < 50% ⁽²⁾	Elongation > 50% ⁽²⁾	
ASTM D 4632	Grab Strength	> 315 lbs (Class 1) > 250 lbs (Class 2) > 180 lbs (Class 3)	> 200 lbs (Class 1) > 160 lbs (Class 2) > 110 lbs (Class 3)	From AASHTO M 288
ASTM D 4632	Sewn Seam Strength ⁽³⁾	> 270 lbs (Class 1) > 220 lbs (Class 2) > 160 lbs (Class 3)	> 180 lbs (Class 1) > 140 lbs (Class 2) > 100 lbs (Class 3)	From AASHTO M 288
ASTM D 4533	Tear Strength ⁽⁴⁾	> 110 lbs (Class 1) > 90 lbs (Class 2) > 70 lbs (Class 3)	> 110 lbs (Class 1) > 90 lbs (Class 2) > 70 lbs (Class 3)	From AASHTO M 288
ASTM D 4833	Puncture Strength	> 110 lbs (Class 1) > 90 lbs (Class 2) > 70 lbs (Class 3)	> 110 lbs (Class 1) > 90 lbs (Class 2) > 70 lbs (Class 3)	From AASHTO M 288
ASTM D 4751	Apparent Opening Size	Per design criteria (See section 16.2)		Maximum allowable value
ASTM D 4491	Permittivity and Hydraulic Conductivity	Per design criteria (See section 16.2)		Minimum allowable value
ASTM D 4355	Degradation by Ultraviolet Light	> 50% strength retained after 500 hours of exposure		Minimum allowable value
ASTM D 4873	Guide for Identification, Storage, and Handling			Provides information on identification, storage, and handling of geotextiles.
ASTM D 4759	Practice for the Specification Conformance of Geosynthetics			Provides information on procedures for ensuring that geotextiles at the jobsite meet the design specifications.

1) Required geotextile class for permanent erosion control design is designated below for the indicated application. The severity of installation conditions generally dictates the required geotextile class. The following descriptions have been modified from AASHTO M 288:

Class 1 is recommended for harsh or severe installation conditions where there is a greater potential for geotextile damage, including placement of riprap that must occur in multiple lifts, drop heights that may exceed 1 foot (0.3m) or when repeated vehicular traffic on the installation is anticipated.

Class 2 is recommended for installation conditions where placement in regular, single lifts is expected and little or no vehicular traffic on the installation will occur, or when placing individual rocks by clamshell, orange peel grapple or specially-equipped hydraulic excavator with drop heights less than 1 foot.

Class 3 is specified for the least severe installation environments, with drop heights less than 1 foot onto a bedding layer of select sand, gravel or other select imported material.

2) As measured in accordance with ASTM D 4632.

3) When seams are required.

4) The required Minimum Average Roll Value (MARV) tear strength for woven monofilament geotextiles is 55 pounds. The MARV corresponds to a statistical measure whereby 2.5% of the tested values are less than the mean value minus two standard deviations (Koerner 1998).

Step 2. Determine Key Indices for Base Soil. From the grain size information, determine the median grain size d_{50} and the Coefficient of Uniformity d_{60}/d_{10} of the base soil. Due to the inherent variability of natural soils, these parameters should be determined for a number of samples and a representative value, or range of values, should be used for design based on engineering judgment.

Step 3. Determine Key Indices for Granular Filter. One or more locally available aggregates should be identified as potential candidates for use as a filter material. The median grain size d_{50} and the Coefficient of Uniformity d_{60}/d_{10} should be determined for each candidate material. Alternatively, candidate materials may be identified from standard aggregate specifications (e.g., AASHTO, ASTM, DOT, etc.). A range of values corresponding to the allowable gradation limits should be evaluated to determine an appropriate value for design.

Step 4. Determine Maximum Allowable d_{50f} for Filter. Enter the Cistin - Ziems design chart (Figure 16.2) with the Coefficient of Uniformity for the base soil on the x-axis. Find the curve that corresponds to the Coefficient of Uniformity for the filter in the body of the chart, and from that point determine the maximum allowable A_{50} from the y-axis. Compute the maximum allowable d_{50f} of the filter using $d_{50f(max)} = A_{50max}$ times d_{50s} . Check to see if the candidate filter material conforms to this requirement. If it does not, continue checking alternate candidates until a suitable material is identified.

Step 5. Determine Hydraulic Conductivity Criterion. Check to ensure that the hydraulic conductivity of the filter is at least 10 times greater than that of the base soil.

Step 6. Check for Compatibility with Armor Layer. Repeat steps 1 through 4 above, considering that the filter material is now the "finer" soil and the particles comprising the armor are the "coarser" material. This check ensures that the particles of the granular filter will not be winnowed out through the voids of the armor layer. If the Cistin-Ziems criterion is not met, then multiple layers of granular filter materials should be considered.

Step 7. Filter Layer Thickness. For practicality of placement, the nominal thickness of a single filter layer should not be less than 6 inches (15 cm). Single-layer thicknesses up to 15 inches (38 cm) may be warranted where large riprap particle sizes are used as armor. When multiple filter layers are required, each individual layer should range from 4 to 8 inches (10 to 20 cm) in thickness (HEC-11 (Brown and Clyde 1989)).

16.2.2 Geotextile Filter Design Procedure

The suggested steps for proper design of a geotextile filter are outlined below:

Step 1. Obtain Base Soil Information. Typically, the required base soil information consists simply of a grain size distribution curve, a measurement (or estimate) of hydraulic conductivity, and the Plasticity Index (PI is required only if the base soil is more than 20% clay).

Step 2. Determine Particle Retention Criterion. A decision tree is provided as Figure 16.3 to assist in determining the appropriate soil retention criterion for the geotextile. The figure has been modified to include guidance when a granular transition layer (i.e., composite filter) is necessary. A composite filter is typically required when the base soil is greater than 30% clay having relatively low cohesion, or is predominantly fine-grained soil (more than 50% passing the #200 sieve). If a granular transition layer is required, the geotextile should be designed to be compatible with the properties of the granular layer.

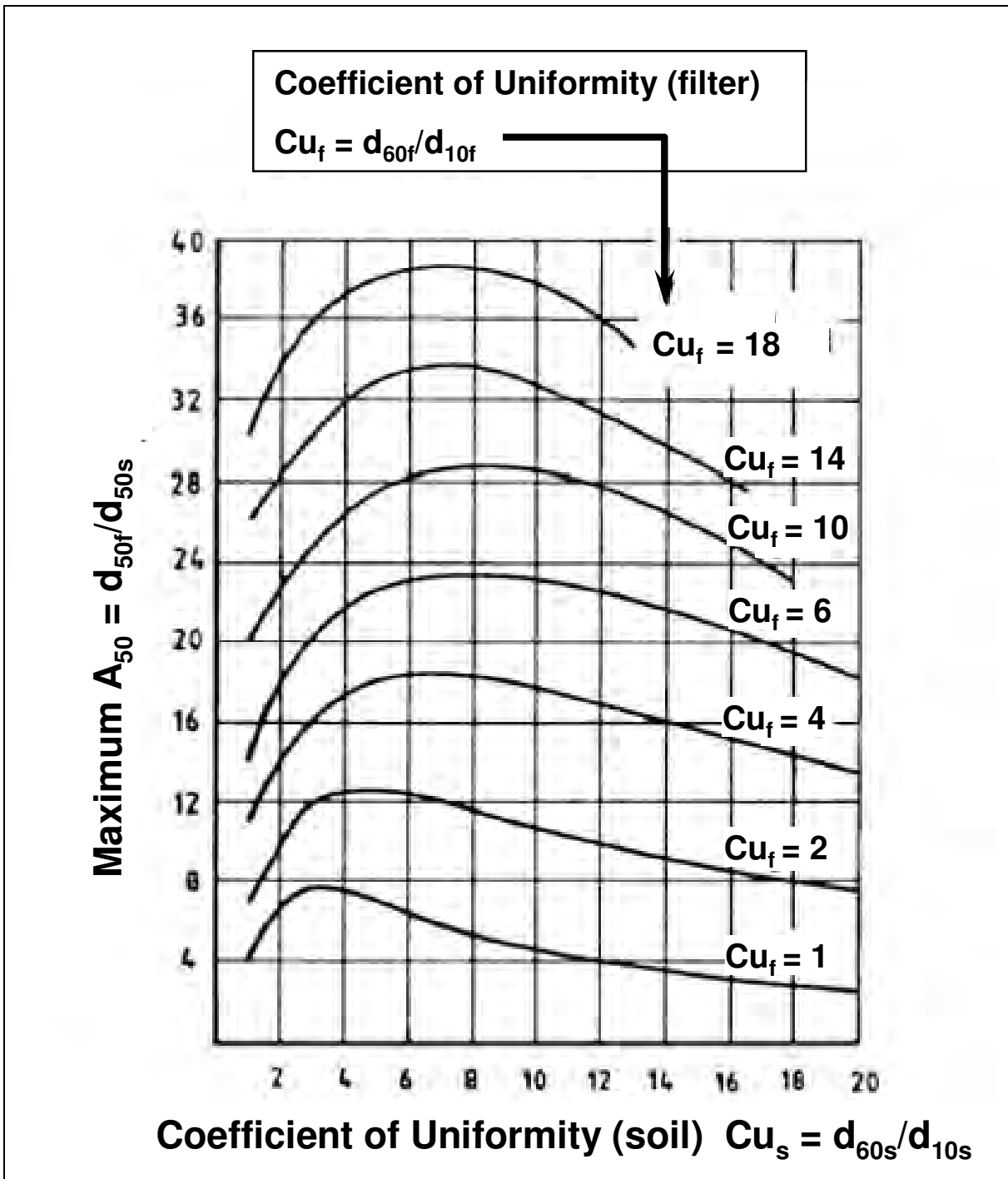

Figure 16.2. Granular filter design chart according to Cistin and Ziems (Heibaum 2004).

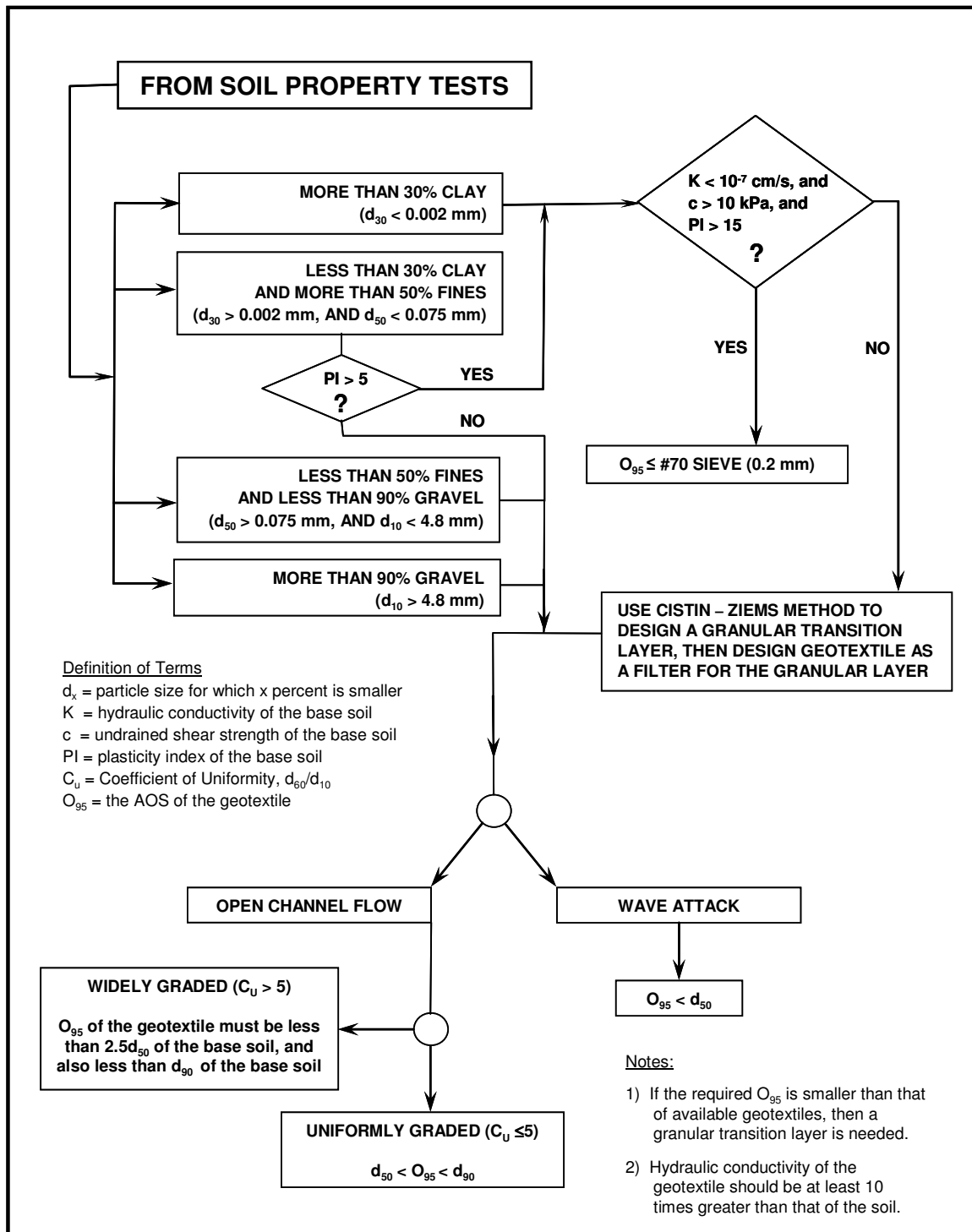

Figure 16.3. Geotextile selection for soil retention (modified from NCHRP Report 593).

Note: If the required AOS is smaller than that of available geotextiles, then a granular transition layer is required, even if the base soil is not clay. However, this requirement can be waived if the base soil exhibits the following conditions for hydraulic conductivity K , plasticity index PI , and undrained shear strength c :

$$K < 1 \times 10^{-7} \text{ cm/s}$$

$$PI > 15$$

$$c > 10 \text{ kPa}$$

Under these soil conditions there is sufficient cohesion to prevent soil loss through the geotextile. A geotextile with an AOS less than a #70 sieve (approximately 0.2 mm) can be used with soils meeting these conditions, and essentially functions more as a separation layer than a filter.

Step 3. Determine Geotextile Hydraulic Conductivity Criterion. The hydraulic conductivity criterion requires that the filter exhibit a hydraulic conductivity at least 4 times greater than that of the base soil (Koerner 1998) and for critical or severe applications, up to 10 times greater (Holtz et al. 1995). In riverine or coastal revetment works where floods or wave attack can create high seepage gradients, the application is considered severe and a minimum hydraulic conductivity ratio of 10 is adopted for filter design. Generally speaking, if the hydraulic conductivity of the base soil or granular filter has been determined from laboratory testing, that value should be used. If lab testing was not conducted, then an estimate of hydraulic conductivity based on the particle size distribution should be used.

To obtain the hydraulic conductivity of a geotextile in cm/s, multiply the thickness of the geotextile in cm by its permittivity in s^{-1} . Typically, the designer will need to contact the geotextile manufacturer to obtain values of permittivity and thickness.

Step 4. Minimize Long-Term Clogging Potential. When a woven geotextile is used, its percent open area (POA) should be greater than, or equal to, 4% by area. If a non-woven geotextile is used, its porosity should be greater than, or equal to, 30% by volume. A good rule of thumb suggests that the geotextile having the largest AOS that satisfies the particle retention criteria should be used (provided of course that all other minimum allowable values described in this section are met as well).

Step 5. Select a Geotextile that Meets the Required Strength Criteria. Strength and durability requirements depend on the installation environment and the construction equipment that is being used. AASHTO M-288, "Geotextile Specification for Highway Construction" provides guidance on allowable strength and elongation values for three categories of installation severity. These criteria are reflected in Table 16.2, presented previously. For additional guidelines regarding the selection of durability test methods, refer to ASTM D 5819, "Standard Guide for Selecting Test Methods for Experimental Evaluation of Geosynthetic Durability" (2003b).

16.3 DESIGN EXAMPLES

16.3.1 Granular filter

Revetment riprap using Class II riprap (nominal $d_{50} = 225$ mm, or 9 inches) is to be placed on a channel bank. The native soil on the channel banks is a silty sand. A locally produced medium to coarse sand is proposed as a granular filter material for the riprap. A number of samples of both the native soil and the candidate filter material have been collected and engineering properties determined. From the test results, representative values have been developed for designing the filter.

The grain size distribution curves for the native soil, candidate filter material, and riprap are shown in Figure 16.4. From this figure and supplemental laboratory tests, the other relevant characteristics of the materials in the design are summarized in Table 16.3.

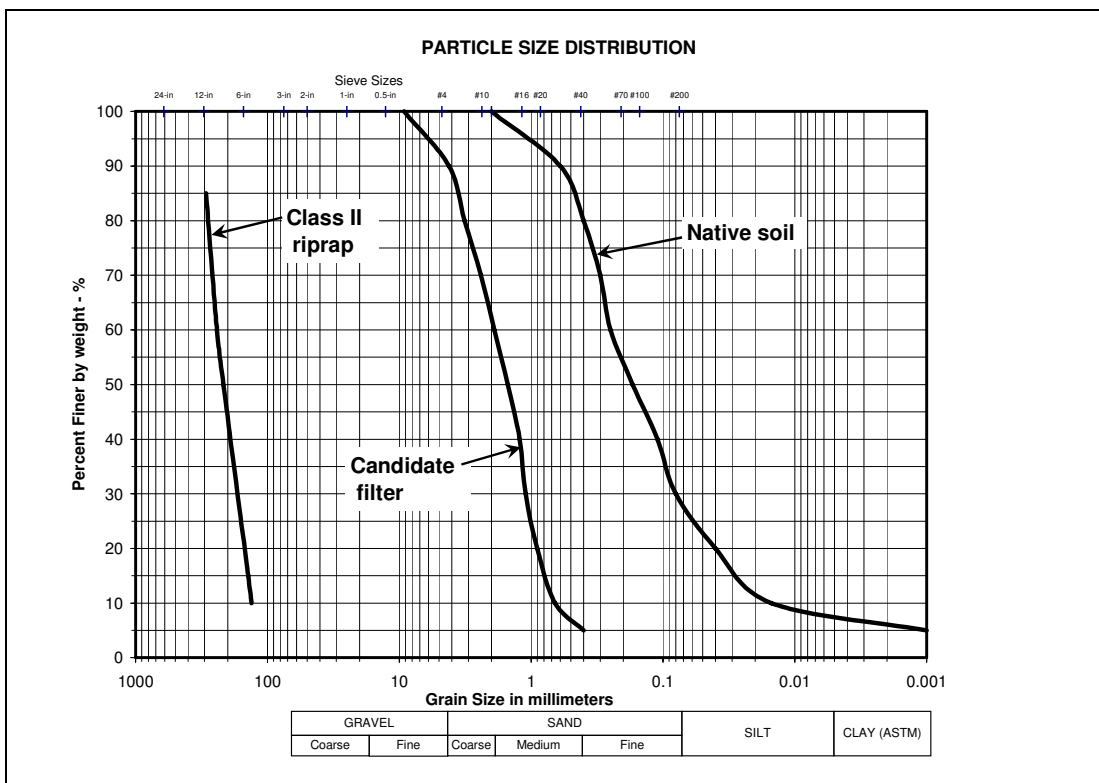

Figure 16.4. Grain size curves for design example.

Table 16.3. Soil, Filter, and Riprap Properties for Design Example.			
Soil Property	Native Soil	Granular Filter	Riprap Class II
Median diameter d_{50} , mm	0.17	1.5	225 (9 in.)
Coefficient of uniformity $C_u = d_{60}/d_{10}$	$0.24/0.014 = 17$	$1.9/0.7 = 2.7$	$230/120 = 1.9$
Hydraulic conductivity K , cm/s	4.2×10^{-4}	2.3×10^{-2}	n/a
Plasticity Index	3.3	(np)	(np)

Step 1. Obtain Base Soil Information: Base soil information is provided in Figure 16.4 and Table 16.3.

Step 2. Determine Key Indices for Base Soil: Key indices for the base soil are:

$$d_{50} = 0.17 \text{ mm}$$

$$C_u = 17$$

$$K = 4.2 \times 10^{-4} \text{ cm/s}$$

$$PI = 3.3$$

Step 3. Determine Key Indices for Granular Filter: Key indices for the candidate filter material are:

$$\begin{aligned}d_{50} &= 1.5 \text{ mm} \\C_u &= 2.7 \\K &= 2.3 \times 10^{-2} \text{ cm/s} \\PI &= \text{non-plastic}\end{aligned}$$

Step 4. Determine Maximum Allowable d_{50f} for Filter: Enter the Cisten – Ziems chart (Figure 16.2) with $C_u = 17$ of the native soil on the x-axis. Chart vertically up to a location corresponding to a C_u of 2.7 for the candidate filter material. Read a maximum allowable value A_{50} of approximately 11.5 on the y-axis.

$$\text{Max. allowable } d_{50f} = A_{50}(d_{50s}) = 11.5 \times 0.17 = 1.96 \text{ mm}$$

Because the granular filter has a d_{50} less than this value, it is suitable as a filter based on its ability to provide particle retention.

Step 5. Determine Hydraulic Conductivity Criterion: The ratio K_f/K_s is $0.023/0.00042 = 55$; therefore, the granular filter is suitable based on hydraulic conductivity considerations, because this ratio is greater than 10.

Step 6. Check for Compatibility with Armor Layer: Enter the Cisten – Ziems chart (Figure 16.2) with $C_u = 2.7$ of the filter material on the x-axis. Chart vertically up to a location corresponding to a C_u of 1.9 for the riprap. Read a maximum allowable value A_{50} of approximately 10 on the y-axis.

$$\text{Max. allowable } d_{50r} = A_{50}(d_{50f}) = 10 \times 1.5 = 15 \text{ mm}$$

Because the riprap has a d_{50} greater than this value, a second (coarser) granular filter layer should be designed and placed on top of the first filter layer. In this case, the first filter layer is now considered the "base soil." Alternatively, a geotextile filter may be considered.

Step 7. Filter Layer Thickness: Because multiple layers of granular filter materials are required for this example, each individual layer should not be less than 4 inches thick, nor greater than 8 inches, in accordance with HEC-11 (see section 16.2.1).

16.3.2 Geotextile filter

This example will use the soil information from the previous section to determine the geotextile properties required for a filter that is compatible with the base soil beneath the Class II riprap.

Step 1. Obtain Base Soil Information. Base soil information is provided in Figure 16.4 and Table 16.3. From the grain size curve, the percentage (by weight) of material classified as "fines" (i.e., silt and clay) and the percentage classified as "gravel" is determined:

Fines: 26%
Gravel: None

Step 2. Determine Particle Retention Criterion. Knowing the base soil characteristics, enter the geotextile design flowchart (Figure 16.3) using the soil properties at the box labeled, "Less than 50% fines and less than 90% gravel."

Follow the appropriate branches of the decision tree until you get to the "Open Channel Flow" box. The criteria for soil retention based on the O_{95} aperture size of the geotextile are based on the Coefficient of Uniformity C_u of the native soil. Because C_u of the native soil is greater than 5, it is considered "widely graded."

Therefore,

$$O_{95} < 2.5d_{50} \text{ and } O_{95} < d_{90}$$

From these criteria, the O_{95} of the geotextile must be less than 2.5 times d_{50} and also less than d_{90} of the native soil.

$$2.5 \times d_{50} = 2.5 \times 0.17 \text{ mm} = 0.425 \text{ mm}$$

$$D_{90} = 0.60 \text{ mm}$$

Therefore, O_{95} must be less than or equal to 0.425 mm since this is the more stringent requirement. This is approximately equal to a No. 40 U.S. standard sieve size.

Step 3. Determine Geotextile Hydraulic Conductivity Criterion. The geotextile must be at least 10 times more permeable than the base soil.

$$K_{\text{geotextile}} > 10K_s$$

The hydraulic conductivity of the base soil in this example is 4.2×10^{-4} cm/s. Therefore, the geotextile must have a hydraulic conductivity greater than 4.2×10^{-3} cm/s.

Step 4. Minimize Long-Term Clogging Potential. For filter applications, the recommended criteria are:

Woven monofilament fabrics: Percent Open Area (POA) \geq 4%

Nonwoven needle-punched fabrics: Porosity \geq 30%
Mass per Unit Area \geq 400 g/m² (12 oz/yd²)

Step 5. Select a Geotextile that Meets the Required Strength Criteria. The parameters regarding functional performance have been established via Steps 1 through 4. The strength properties of the geotextile are determined by the severity of the installation environment. For this example, assume that a severe installation environment is anticipated. This is referred to as a "Class 1" condition by AASHTO M288, and the associated minimum strength values are found in Table 16.2.

Summary: The recommended geotextile filter properties for the above example are summarized in Table 16.4. Examples of manufacturer's tables of woven and nonwoven geotextiles are provided in Tables 16.5 and 16.6 along with commentary that illustrates the selection process.

Geotextile Property	Nonwoven Needle-punched Fabric	Woven Monofilament Fabric
Maximum AOS, U.S. Standard Sieve	40	40
Minimum hydraulic conductivity, cm/s	4.2×10^{-3}	4.2×10^{-3}
Minimum mass per unit area, oz/yd ²	12	n/a
Minimum open area, percent	n/a	4.0
Minimum porosity, percent	30	n/a
Minimum strength properties	Per Table 16.2 "Class 1" condition	Per Table 16.2 "Class 1" condition

Property/Test Method	Units	W-Mf 300	W-Mf 400	W-Mf 402	W-Mf 403	W-Mf 404	W-Mf 500	W-Mf 700
MECHANICAL PROPERTIES								
Wide Width Tensile Strength								
ASTM D 4595								
MD @ Ultimate	kN/m (lbs/ft)	40 (2760)	26 (1800)	35 (2400)	47 (3240)	44 (3000)	32 (2200)	40 (2700)
CMD @ Ultimate	kN/m (lbs/ft)	39 (2700)	29 (1980)	24 (1680)	39 (2700)	40 (2760)	44 (3000)	26 (1740)
Grab Tensile Strength								
ASTM D 4632								
MD @ Ultimate	kN (lbs)	1.78 (400)	1.18 (265)	1.62 (365)	1.89 (425)	1.78 (400)	1.45 (325)	1.65 (370)
CMD @ Ultimate	kN (lbs)	1.49 (335)	1.13 (255)	0.89 (200)	1.56 (350)	1.40 (315)	1.89 (425)	1.11 (250)
MD Elongation @ Ultimate	%	20	16	24	21	15	15	16
CMD Elongation @ Ultimate	%	15	15	10	21	15	15	15
Mullen Burst Strength								
ASTM D 3786	kPa (psi)	4473 (650)	3441 (500)	3097 (450)	4479 (650)	5506 (800)	5171 (750)	3097 (450)
Trapezoidal Tear Strength								
ASTM D 4533								
MD @ Ultimate	kN (lbs)	0.65 (145)	0.36 (80)	0.51 (115)	0.65 (145)	0.67 (150)	0.60 (135)	0.45 (100)
CMD @ Ultimate	kN (lbs)	0.56 (125)	0.31 (70)	0.33 (75)	0.56 (125)	0.73 (165)	0.67 (150)	0.27 (60)
Puncture Strength								
ASTM D 4833	kN (lbs)	0.56 (125)	.56 (125)	0.40 (90)	0.67 (150)	0.67 (150)	0.62 (140)	0.53 (120)
UV Resistance after 500 hrs.								
ASTM D 4355	% Strength	90	90	90	90	90	70	90
HYDRAULIC PROPERTIES								
Apparent Opening Size								
(AOS) ASTM D 4751	mm (US Sieve)	0.600 (30)	0.425 (40)	0.425 (40)	0.425 (40)	0.425 (40)	0.300 (50)	0.212 (70)
Permittivity ASTM D 4491	sec	1.50	0.95	2.14	0.90	0.96	0.506	0.28
Percent Open Area								
COE-02215-86	%	8	10	10	6	1	4	4-6
Flow Rate	l/min/m ²	4685	2852	5907	2852	2852	1426	733
ASTM D 4491	(gal/min/ft ²)	(115)	(70)	(145)	(70)	(70)	(35)	(18)
Hydraulic Conductivity	cm/s	0.132	0.027	0.140	0.046	0.068	0.027	0.010
Note: Trade names shown in this table are fictitious and are provided for instructional purposes only.								

Commentary regarding woven monofilament geotextiles in Table 16.5:

- W-Mf 300: No – AOS is too large an opening size
- W-Mf 400: No – Grab tensile strength not high enough in the machine direction (MD) and also in the cross machine direction (CMD)
- W-Mf 402: No – Grab tensile strength (cross machine direction or CMD) not high enough; Tear strength (cross machine direction or CMD) not high enough; Puncture strength not high enough
- W-Mf 403: OK
- W-Mf 404: No – Percent Open Area not high enough
- W-Mf 500: OK, probably more expensive
- W-Mf 700: No – Tensile strength and Tear strength (CMD) not high enough

Table 16.6. Nonwoven Needle-punched Geotextile Filter Candidates.														
Property	Test Method	Unit	Value	X31	X35	X40	X45	X50	X60	X70	X80	X100	X120	X160
MECHANICAL														
Grab Tensile Strength	ASTM D-4632	lb	MARV	80	95	115	120	150	160	180	205	250	300	380
Grab Elongation	ASTM D-4632	%	MARV	50	50	50	50	50	50	50	50	50	50	50
Puncture Strength	ASTM D-4833	lb	MARV	50	55	65	65	85	85	100	110	150	175	240
Mullen Burst	ASTM D-3786	psi	MARV	150	185	210	230	280	280	330	350	460	580	750
Trapezoidal Tear	ASTM D-4533	lb	MARV	30	40	50	50	60	60	75	85	100	115	150
HYDRAULIC														
Apparent Opening Size (AOS)	ASTM D-4751	US Sieve	MaxARV	50	50	70	70	70	70	70	80	100	100	100
Permittivity	ASTM D-4491	sec ⁻¹	MARV	2.0	2.0	2.0	1.5	1.4	1.3	1.5	1.5	1.2	1.0	0.7
Hydraulic Conductivity	ASTM D-4491	cm/sec	MARV	0.22	0.25	0.22	0.22	0.23	0.24	0.34	0.38	0.30	0.29	0.27
Water Flow Rate	ASTM D-4491	gpm/ft ²	MARV	150	150	140	120	115	110	110	110	85	75	50
PHYSICAL														
Mass per Unit Area	ASTM D-5261	oz/yd ²	MARV	2.7	3.0	3.5	4.0	4.8	5.0	5.9	6.5	8.5	10.8	15.0
Thickness	ASTM D-5199	mils	MARV	30	40	50	45	55	60	70	70	100	105	145
ENDURANCE														
UV Resistance	ASTM D-4355	% Retained @ 500 hrs	MARV	70	70	70	70	70	70	70	70	70	70	70
Porosity		percent		38	38	36	36	36	36	36	34	32	32	32
Note: Trade names shown in this table are fictitious and are provided for instructional purposes only.														

Commentary regarding nonwoven needle-punched geotextiles in Table 16.6: The X160 fabric is the only nonwoven geotextile from this manufacturer that has a mass per unit area greater than 12.0 ounces per square yard, which is the minimum recommended. The strength properties of this product are sufficient to resist stresses of a Class 1 installation environment.

16.4 BEARING CAPACITY

Geotextiles are often used to improve the bearing capacity of weak, compressible and often-saturated soils for purposes of improving roadways and other vehicular access points. It stands to reason that the bearing capacity of weak soils can also be improved by the use of geotextiles to withstand loading by heavy rock riprap.

In essence, bearing capacity relies upon the ability of a soil (or reinforced soil) substrate to effectively spread a loading from a relatively small point to a larger area. This results in a counteracting effect such that any potential deformation of the soil surface is resisted by lateral and vertical forces that are mobilized in the substrate.

Improvements in bearing capacity ranging from about 100% for loose sands, to over 700% for soft clayey silts, using one layer of geotextile have been reported (Koerner 1998). In the reported studies, the difference in bearing capacity was quantified using the settlement ratio ρ/B (settled distance divided by footing width) as a function of applied load, compared to a non-reinforced control. Use of multiple geotextile layers, with a specified vertical spacing, increased the bearing capacity in all cases.

Koerner identified four distinct modes of failure when using a geotextile to improve bearing capacity:

Excessive depth of geotextile: Geotextile is placed deeper than about 1 ft (300 mm) below the soil surface. Failure takes place in the soil above the geotextile.

Insufficient embedment length: Geotextile does not extend far enough beyond the load point to mobilize sufficient frictional resistance against slippage.

Tensile failure of geotextile: Geotextile is not strong enough to resist tensile forces without excessive elongation or outright tearing.

Excessive long-term (creep) settlement: Geotextile is vulnerable to long-term, sustained forces that result in gradual overextension, and thus undesirable settlement at the load point.

The U.S. Army Corps of Engineers (Henry 1999) provides in-depth background regarding the issue of soil bearing capacity, albeit in the context of vehicular wheel loadings on unpaved roadways. Primarily a geotechnical study, this document nonetheless provides some valuable information regarding the effect of geotextiles in improving the quality of subgrade bearing capacity, particularly with respect to load redistribution.

Henry (1999) provides design curves that relate the required road base aggregate thickness to the undrained shear strength of the subsoil, with and without a geotextile. In all cases, the use of a geotextile provides a significant reduction in the required amount of road base aggregate to effectively resist deformation by wheeled vehicles. Geotextile strength and elongation specifications are also provided, using existing ASTM testing standards.

It can be concluded that the use of geotextiles beneath a riprap armor layer will provide additional support to the bearing capacity of the underlying subsoils. The use of multiple layers of geotextiles, each separated by 6 to 12 inches (0.15 to 0.3 m) of compatible soil or suitable granular material, will serve to increase the bearing capacity to resist either static loading from rock riprap, or dynamic loading from wheeled (or tracked) maintenance vehicles. Geotextiles are often supplemented with a geogrid when bearing capacity is a significant consideration in the design of countermeasures.

16.5 REFERENCES

American Association of State Highway Officials (AASHTO), 2003, "Standard Specifications for Transportation Materials and Methods of Sampling and Testing, Washington, D.C..

American Society for Testing of Materials (ASTM), 2003a, "Annual Book of ASTM Standards," Volume 4.08, West Conshohocken, PA.

American Society for Testing of Materials (ASTM), 2003b, "Annual Book of ASTM Standards," Volume 4.09, West Conshohocken, PA.

Brown, S.A. and Clyde, E.S., 1989, "Design of Riprap Revetment," Hydraulic Engineering Circular No. 11 (HEC-11), Report FHWA-IP-89-016, Federal Highway Administration, Washington, D.C.

Heibaum, M.H., "Geotechnical Filters – The Important Link in Scour Protection," 2004, Federal Waterways Engineering and Research Institute, Karlsruhe, Germany, 2nd International Conference on Scour and Erosion, Singapore (2004).

Henry, K.S., 1999, "Geotextile Reinforcement of Low-Bearing-Capacity Soils," Special Report 99-7, U.S. Army Corps of Engineers – Cold Regions Research and Engineering Laboratory, Hanover, NH 03755.

Holtz, D.H., Christopher, B.A., and Berg, R.E., 1995, "Geosynthetic Design and Construction Guidelines," Federal Highway Administration, Publication No. FHWA-HI-95-038, Washington, D.C.

Koerner, R.M., 1998, "Designing with Geosynthetics," 4th Edition, Prentice-Hall, Inc., Englewood Cliffs, NJ, 761 p.

Lagasse, P.F., Clopper, P.E., Zevenbergen, L.W., and Ruff, J.F., 2006, "Riprap Design Criteria, Recommended Specifications, and Quality Control," NCHRP Report 568, Transportation Research Board, National Academies of Science, Washington, D.C.

Lagasse, P.F., Clopper, P.E., and Zevenbergen, L.W., 2007, "Countermeasures to Protect Bridge Piers from Scour," NCHRP Report 593, Transportation Research Board, National Academies of Science, Washington, D.C.

McWhorter, D.B. and Sunada, D.K, 1977, "Ground-Water Hydrology and Hydraulics," 1st Edition, Water Resources Publications, Fort Collins, CO.

(page intentionally left blank)

SECTION 6 – SPECIAL APPLICATIONS

Design Guideline 17 – Riprap Design for Wave Attack

Design Guideline 18 – Riprap Protection for Bottomless Culverts

Design Guideline 19 – Concrete Armor Units

DESIGN GUIDELINE 17
RIPRAP DESIGN FOR WAVE ATTACK

(page intentionally left blank)

DESIGN GUIDELINE 17

RIPRAP DESIGN FOR WAVE ATTACK

17.1 INTRODUCTION

Environments subject to wave attack frequently require some type of protection to ensure the stability of highway and/or bridge infrastructure. Bank and shoreline protection measures may be classified according to the materials used for construction, the general shape of the device, or their function or application. For example, seawalls, groins, jetties, riprap, and precast concrete armor units have all been used for protecting banks or shorelines against wave-induced erosion. This design guideline provides information on wave characteristics and procedures for designing rock riprap as protection against wave attack.

Rock riprap is commonly used for bank and shoreline protection in rivers, lakes, and estuaries (Figure 17.1). In coastal applications subject to large sea states, very heavy rock slope protection is frequently used. When adequate stone size is not available, precast concrete armor units designed for specific purposes are used. Riprap protection is usually the most economical when stones of sufficient size, quality and quantity are available. The following determinations must be made in the design of rock slope protection for wave attack:

- Size and specific gravity of stone
- Foundation depth (below scour depth or to solid rock)
- Height of riprap placement (at an elevation above wave runup or deep water wave height for protection from splash and spray)
- Thickness (sufficient to accommodate the largest stones; additional thickness on the slope will not compensate for undersized stones)
- Filter blanket (uniformly graded stone filter, geotextile filter fabric, or both to prevent embankment material from being washed out through the voids of the stone.)
- Slope of bank or shoreline
- Uniform gradation is preferred

When used for shore protection, riprap has several advantages compared to other materials. For example, the rough surface of riprap reduces wave runup compared to smoother types of protection. Other types of armor can be used to protect a slope, but stone is frequently the least expensive and more readily available, particularly for projects for which the design wave height is not greater than about 6 feet (1.8 m). Equally important to the success of the protection is the placement of the stone and the underlying filter materials.

A typical section schematic is shown in Figure 17.2 (after AASHTO 2004). The figure shows a toe trench that is typical with all revetments. The toe trench is used to prevent scour from occurring and undermining the revetment. Sometimes a sheetpile wall at the toe of the revetment fulfills this function.



Figure 17.1. Riprap revetment in a wave environment, Pacific Coast Highway, California. (from HEC-25, 2nd Edition)

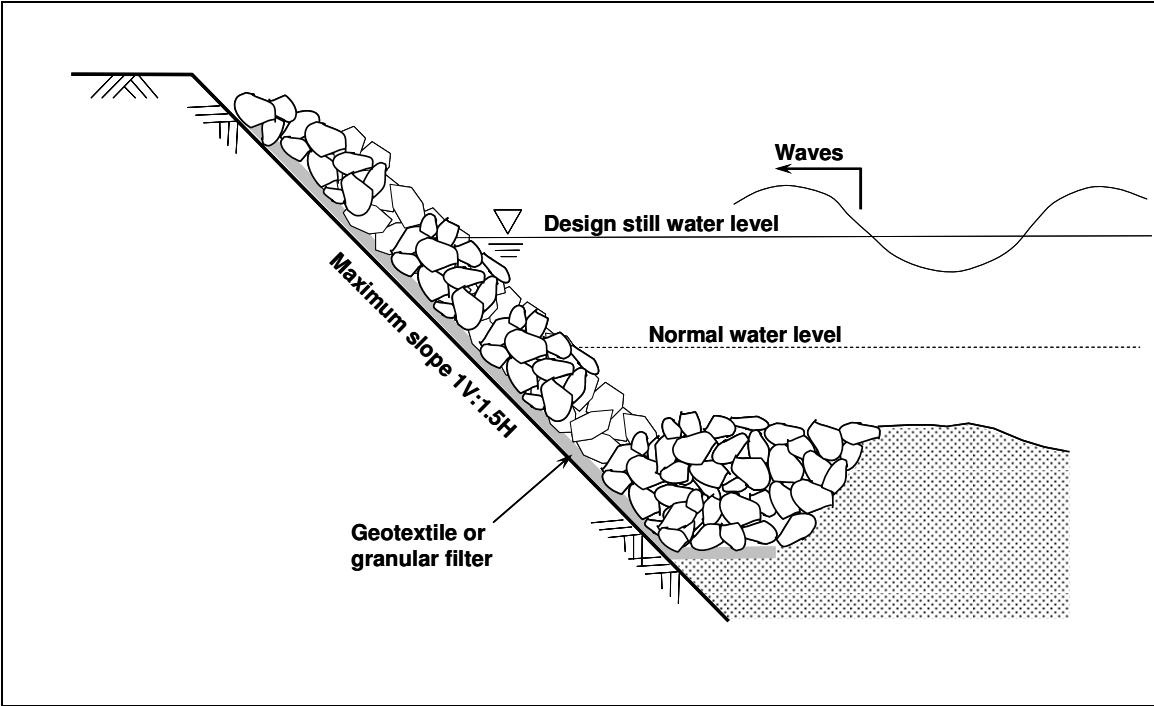

Figure 17.2. Riprap shore protection - typical design configuration.

17.2 WAVE CHARACTERISTICS

17.2.1 Wind Waves

In order to properly design riprap to resist wave forces, an understanding of the basic characteristics of waves is necessary. This section provides an introduction to short period waves and is primarily focused on defining the variables and characteristics that are pertinent to predicting wind-induced wave heights in the vicinity of roadways and bridges. The primary variables used in describing waves are wavelength L (the horizontal distance between wave crests), height H (the vertical difference between the wave crest and adjacent trough) and period T (the time between successive crests) (Figure 17.3). The wave speed, or celerity, is the wave length divided by the period ($C = L/T$). Another factor that affects wave height is the still-water depth D , which is the depth of water if there were no waves.

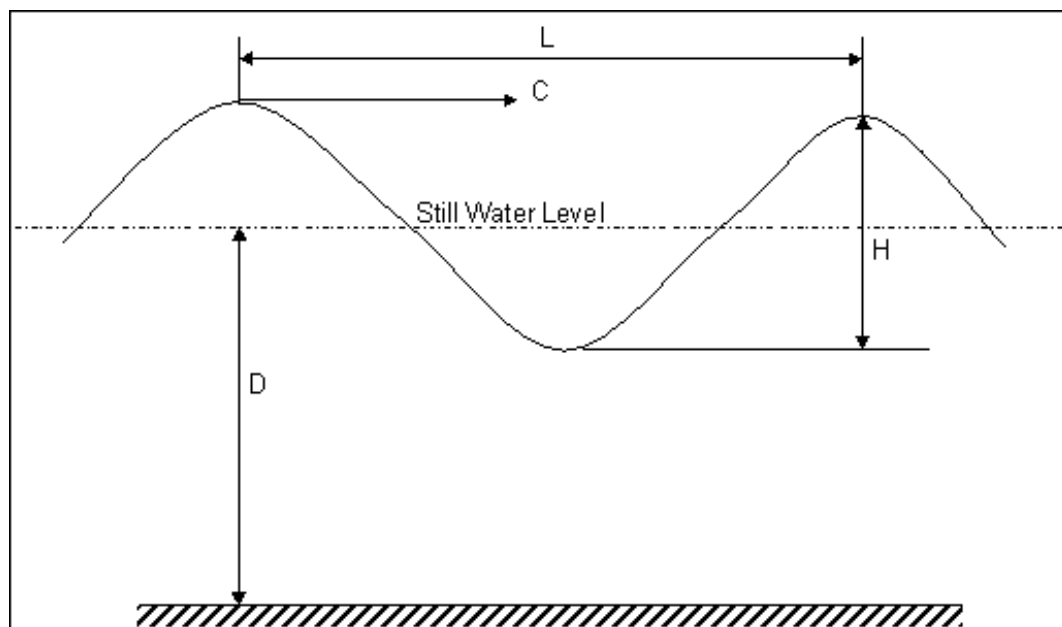

Figure 17.3. Wave characteristics.

Waves are classified as deep, transitional and shallow water waves. For deep water waves, the wave height is virtually unaffected by the depth and the wave celerity is unaffected by the bottom. For transitional water waves the bottom has some effect on the wave height and celerity. For shallow water waves the celerity is only a function of depth. If the water depth is greater than 0.5 times the wave length, it is considered a deep water wave. If the water depth is less than 0.04 times the wave length, it is a shallow water wave. Transitional water waves are in the range between 0.04 and 0.5 times the water depth.

Waves that are produced by wind are affected by the wind speed, wind duration and fetch. Fetch is the distance that an unobstructed and constant wind, both in terms of speed and direction, acts over a body of water. Land is an absolute limit to fetch but changes in water depth and wind direction can also limit fetch. For very large bodies of water, the change in wind directions due to the circular wind field of a hurricane can limit fetch.

It is possible to predict wave heights for specific wind and waterway conditions. The primary factors are water depth, wind speed and fetch. If the wind duration is not sufficient to produce the computed wave height, then the waves are duration-limited rather than fetch-limited. If the waves are duration-limited, the fetch distance used for computations should be reduced until the required duration equals the actual wind duration.

Wave heights and lengths also have a random nature such that successive waves, even in a constant wind field, do not have the same height or arrive at a consistent interval. Predictive equations have been developed to estimate the significant wave height, H_s , which is defined as the average of the highest one-third of all the waves. Thus the significant wave height H_s can also be denoted $H_{0.333}$. The heights of larger and less frequent waves can be estimated based on the significant wave height. For example, $H_{0.10}$, $H_{0.05}$, $H_{0.01}$, and $H_{0.001}$, the average of the ten, five, one, and one-tenth percent highest waves, are approximately 1.27, 1.38, 1.67, and 2.0 times the significant wave height. The frequency of these waves can be estimated by using the wave period (T) divided by the percentage represented as a fraction. Significant wave height can also be defined by a frequency spectrum representation of the water surface elevation that leads to a primary wave height, the notation for the spectral significant wave height is $H_s = H_{m0}$.

17.2.2 Determining the Design Wave Characteristics

The recommended methodology for computing wave characteristics is presented in the U.S. Army Corps of Engineers' Coastal Engineering Manual (USACE 2006). The data required to compute wave heights are: wind speed, water depth, and fetch length. Methods for determining the sustained wind speed for estimating the design wave height are provided in the Coastal Engineering Manual.

Because flow depth on a floodplain is typically much smaller than that in the main channel, separate wave height computations should be conducted for the channel and floodplain. The computed wave height is the significant wave height H_s as defined in the previous section. Depending on the riprap sizing equation and the desired safety factor, the significant wave height may be converted to a ten percent, five percent, or one percent wave, by multiplying H_s by 1.27, 1.38, or 1.67, respectively, for use as the design wave height.

For the purposes of computing wave heights at bridges or roadways in rivers, estuaries or lakes during a storm event, such as a hurricane, the definition of fetch requires the greatest judgment. Fetch is the distance of unobstructed wind with fairly uniform speed and direction. Figure 17.4 shows a road embankment and bridge crossing a floodplain and channel. The floodplain is assumed to have some relatively shallow depth of flooding during the storm surge. The wind is assumed to be oriented in the worst-case direction with respect to the channel, but within a range of directions that can be reasonably produced near the peak of the storm surge. The range of directions should be limited to within 45 degrees of the storm track. As noted, land is an absolute limit to the fetch. Because waves tend to break in shallow water, the length of deeper channel could limit the fetch. It is reasonable, however, to extend the fetch somewhat upwind of the deep channel area, perhaps by 1,000 to 2,000 feet. For small waterways with heavily wooded floodplains, it is reasonable to assume that wind waves will be minimal during a storm surge.

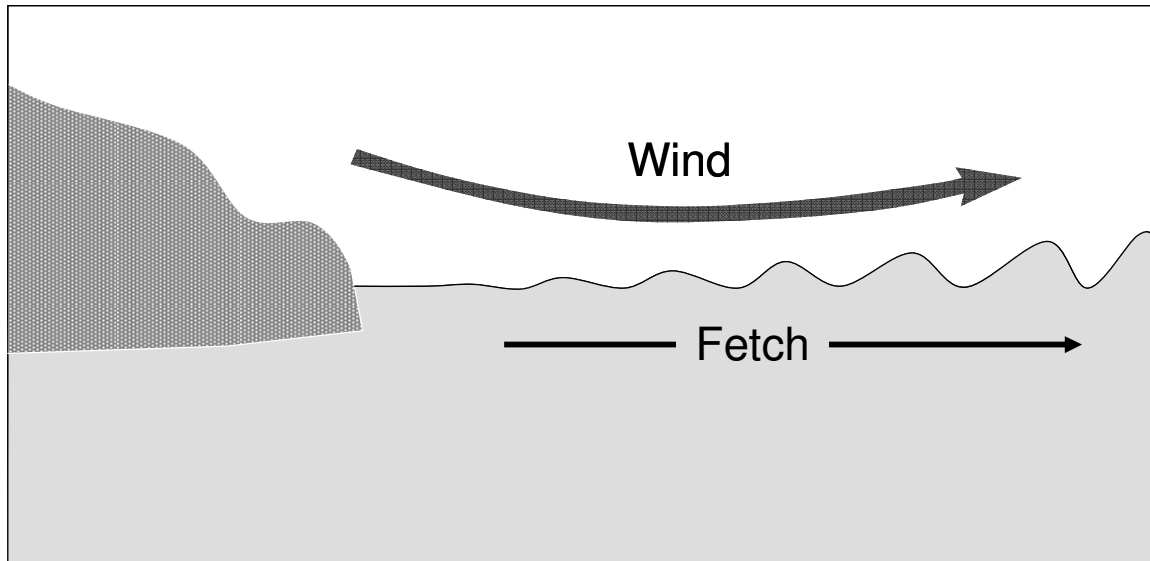

Figure 17.4. Definition sketch for wave calculations at channels and floodplains.

The Coastal Engineering Manual provides a simplified wave prediction method which is suitable for most riprap sizing applications. The method is described as follows:

Step 1: Estimate the wind speed, fetch length, and still water depth (USACE Coastal Engineering Manual).

Step 2: Calculate the drag coefficient (C_d):

$$C_d = 0.001 \times (1.1 + K_u V_{wind}) \quad (17.1)$$

where:

- C_d = Coefficient of drag, dimensionless
- V_{wind} = Sustained design wind velocity measured at 10 m height, ft/s (m/s)
- K_u = Coefficient equal to 0.0107 for wind velocity in ft/s, and 0.035 for wind velocity in m/s

Step 3: Calculate the friction velocity (u_*):

$$u_* = V_{wind} \sqrt{C_d} \quad (17.2)$$

where:

- u_* = Friction velocity, ft/s (m/s)

Step 4: Calculate dimensionless fetch length (\hat{X}) :

$$\hat{X} = \frac{gX}{u_*^2} \quad (17.3)$$

where:

$$\begin{aligned} \hat{X} &= \text{Dimensionless fetch length} \\ g &= \text{Gravity constant, } 32.2 \text{ ft/s}^2 \text{ (} 9.81 \text{ m/s}^2\text{)} \\ X &= \text{Actual fetch length, ft (m)} \end{aligned}$$

Step 5: Calculate dimensionless wave height (\hat{H}) :

$$\hat{H} = 0.0413(\hat{X}^{0.5}) \quad (17.4)$$

where:

$$\begin{aligned} \hat{H} &= \text{Dimensionless wave height} \\ \hat{X} &= \text{Dimensionless fetch length} \end{aligned}$$

Step 6: Calculate the significant wave height (H_s) :

$$H_s = \frac{\hat{H}(u_*^2)}{g} \quad (17.5)$$

where:

$$\begin{aligned} H_s &= \text{Significant wave height, ft (m)} \\ \hat{H} &= \text{Dimensionless wave height} \end{aligned}$$

Step 7: Calculate the dimensionless wave period (\hat{T}_p):

$$\hat{T}_p = 0.751(\hat{X}^{0.33}) \quad (17.6)$$

where:

$$\begin{aligned} \hat{T}_p &= \text{Dimensionless wave period} \\ \hat{X} &= \text{Dimensionless fetch length} \end{aligned}$$

Step 8: Calculate the wave period (T) :

$$T = \frac{\hat{T}_p(u_*)}{g} \quad (17.7)$$

where:

$$\begin{aligned} T &= \text{Wave period, sec} \\ \hat{T}_p &= \text{Dimensionless wave period} \end{aligned}$$

Step 9: Check the calculated wave height vs. still water depth:

If H_s is greater than 0.8 times the still water depth (d), use $H_s = 0.8d$.

17.3 DESIGN PROCEDURE FOR RIPRAP BANK REVETMENT IN WAVE ENVIRONMENTS

17.3.1 Riprap Size

Two methods for determining riprap size for stability under wave action are presented in this section: (1) the Hudson method (Douglass and Krolak 2008), and (2) the Pilarczyk method (Pilarczyk 1997). Riprap, when placed in a wave attack environment, should have a uniform gradation. A lot of riprap used in coastal areas have specific gravity values less than 2.65, designers should not assume specific gravity equal to 2.65.

(1) The Hudson method: The Hudson method considers wave height, riprap density, and slope of the bank or shoreline to compute a required weight of a median-size riprap particle:

$$W_{50} = \frac{\gamma_r H^3 (\tan \theta)}{K_d (S_r - S_w)^3} \quad (17.8)$$

where:

$$\begin{aligned} W_{50} &= \text{Weight of the median riprap particle size, lb (kg)} \\ \gamma_r &= \text{Unit weight of riprap, lb/ft}^3 \text{ (kg/m}^3\text{)} \\ H &= \text{Design wave height, ft (m)} \\ &\quad \text{(Note: Minimum recommended value for use with the Hudson equation is the 10 percent} \\ &\quad \text{wave, } H_{0.10} = 1.27H_s \text{)} \\ K_d &= \text{Empirical coefficient equal to 2.2 for riprap} \\ S_r &= \text{Specific gravity of riprap} \\ S_w &= \text{Specific gravity of water} \\ &\quad \text{(1.0 for fresh water, 1.03 for seawater)} \\ \theta &= \text{Angle of slope inclination} \end{aligned}$$

The median weight W_{50} can be converted to an equivalent particle size d_{50} by the following relationship (Lagasse et al. 2006):

$$d_{50} = \sqrt[3]{\frac{W_{50}}{0.85\gamma_r}} \quad (17.9)$$

(2) The Pilarczyk method: Compared to the Hudson method, the Pilarczyk method considers additional variables associated with particle stability in different wave environments, and therefore should more thoroughly characterize the rock stability threshold. As confirmed by Van der Meer (1990), the hydraulic processes that influence rock revetment stability are directly related to the type of wave that impacts the slope, as characterized by the breaker parameter. The breaker parameter is a dimensionless quantity that relates the bank slope, wave period, wave height, and wave length to distinguish between the types of breaking waves. This parameter is defined as:

$$\xi = \frac{\tan\theta}{\sqrt{H_s/L_o}} = \tan\theta \frac{K_u T}{\sqrt{H_s}} \quad (17.10)$$

where:

- ξ = Dimensionless breaker parameter
- θ = Angle of slope inclination
- L_o = Wave length, ft (m)
- H_s = Significant wave height, ft (m)
- T = Wave period, sec
- K_u = Coefficient equal to 2.25 for wave height in ft, and 1.25 for wave height in m

The wave types corresponding to the breaker parameter are listed in Table 17.1 and illustrated schematically in Figure 17.5.

Value of the Dimensionless Breaker Parameter ξ	Type of Wave
$\xi < 0.5$	Spilling
$0.5 < \xi < 2.5$	Plunging
$2.5 < \xi < 3.5$	Collapsing
$\xi < 3.5$	Surging

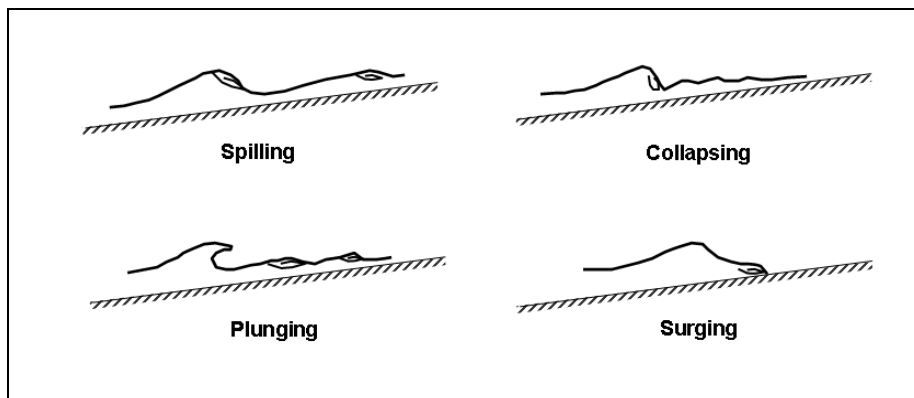

Figure 17.5. Schematic illustration of wave types (from HEC-25).

The Pilarczyk method, like the Hudson method, uses a general empirical relationship for particle stability under wave action. The Pilarczyk equation is:

$$\frac{H_s}{\Delta D} \leq \psi_u \phi \frac{\cos \theta}{\xi^b} \quad (17.11)$$

where:

- H_s = Significant wave height, ft (m)
- Δ = Relative unit weight of riprap, $\Delta = (\gamma_r - \gamma_w)/\gamma_w$
- D = Armor size or thickness, ft (m) (for riprap, $D = d_{50}$)
- ψ_u = Stability upgrade factor (= 1.0 for riprap)
- ϕ = Stability factor (= 1.5 for good quality, angular riprap)
- θ = Angle of slope inclination
- ξ = Dimensionless breaker parameter from Equation 17.10
- b = Exponent (= 0.5 for riprap)

Rearranging Equation 17.11 to solve for the required stone size, and inserting the recommended values for riprap with a specific gravity of 2.65 and a fresh water specific gravity of 1.0 yields the following equation for sizing rock riprap for wave attack:

$$d_{50} \geq \frac{2}{3} \left(\frac{H_s \xi^{0.5}}{1.64 \cos \theta} \right) \quad (17.12)$$

17.3.2 Layout Details for Riprap Bank Revetment

Elevation of Riprap Protection: The recommended vertical extent of riprap for wave attack includes consideration of high tide elevation, storm surge, wind setup, wave height, and wave runup. Details can be found in Hydraulic Engineering Circular 25 (HEC-25) (Douglass and Krolak 2006). The values for tide, storm surge and wind setup are considered part of the "design still water level" as described in that document (Figure 17.6). Adding the wave runup, which includes wave height, to the still water level, and including the required freeboard (typically 2 to 3 feet, or 0.6 to 1 meter) establishes the design elevation for a riprap installation.

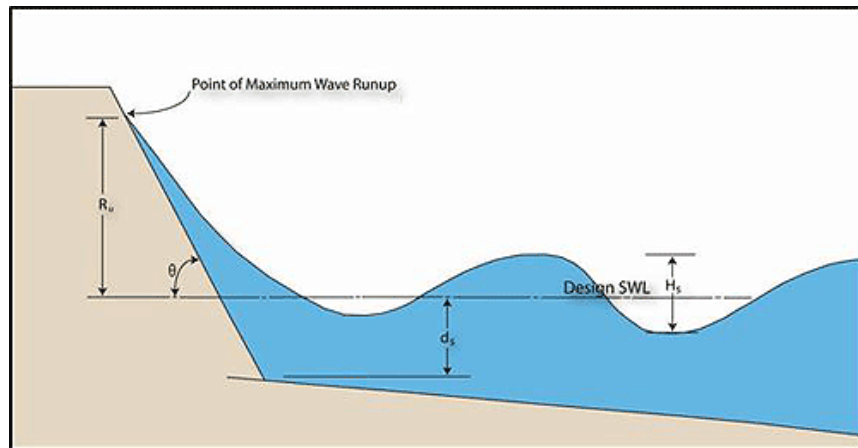

Figure 17.6. Wave runup schematic for freeboard calculations (from HEC-25).

Wave runup can be calculated using the following equation (Douglass and Krolak 2008):

$$R_u = 1.6H_s(r\xi), \text{ with an upper limit of } R_u = 3.2(rH_s) \quad (17.13)$$

where:

- R_u = Vertical height of runup on slope, ft (m)
- H_s = Significant wave height, ft (m)
- r = Coefficient for armor roughness (= 0.55 for riprap)
- ξ = Dimensionless breaker parameter from Equation 17.10

Thickness of Riprap Protection: The minimum riprap layer thickness should be the greater of 2 times the d_{50} stone size (calculated by either the Hudson or Pilarczyk equation), or the d_{100} (maximum stone size) of the specified gradation.

17.3.3 Filter Requirements

There are two kinds of filters used in conjunction with riprap; granular filters and geotextile filters. Some situations call for a composite filter consisting of both a granular layer and a geotextile. The specific characteristics of the base soil determine the need for, and design considerations of, the filter layer.

The filter must retain the coarser particles of the subgrade while remaining permeable enough to allow infiltration and exfiltration to occur freely. It is not necessary to retain all the particle sizes in the subgrade; in fact, it is beneficial to allow the smaller particles to pass through the filter, leaving a coarser substrate behind. Detailed aspects of filter design are presented in Design Guideline 16 of this document.

17.3.4 Design Example

A bank slope of 2H:1V is to be protected against wave attack in the vicinity of a bridge. The bridge is located in a fresh water reach of river that is tidally influenced. The significant wave height H_s is 4.9 ft (1.5 m), and the still-water depth (including the effects of tide, wave setup and storm surge) is 13 ft (4 m) at the toe of the slope. The wave period is estimated to be 3.0 seconds. Angular riprap with a specific gravity of 2.65 is locally available.

Calculate the required size of riprap using both the Hudson and Pilarczyk equations. Also, provide recommended specifications for the layout of the riprap protection.

A. Hudson Equation:

Step 1. Calculate the design wave $H_{0.10}$ for use with the Hudson Equation:

$$H_{0.10} = 1.27H_s = 1.27(4.9 \text{ ft}) = 6.2 \text{ ft (1.9 m)}$$

Step 2. Calculate the median stone weight W_{50} :

$$W_{50} = \frac{\gamma_r H^3 (\tan \theta)}{K_d (S_r - 1)^3} = \frac{2.65 (62.4 \text{ lb/ft}^3) (6.2 \text{ ft})^3 (\tan 26.6^\circ)}{2.2 (2.65 - 1)^3} = 2,000 \text{ lb (920 kg)}$$

Step 3. Convert W_{50} to d_{50} :

$$d_{50} = \sqrt[3]{\frac{W_{50}}{0.85\gamma_r}} = \sqrt[3]{\frac{2000 \text{ lb}}{0.85(2.65)(62.4 \text{ lb/ft}^3)}} = 2.4 \text{ ft or } 29 \text{ inches (0.74 m)}$$

B. Pilarczyk Equation:

Step 1. Calculate the dimensionless breaker parameter ξ :

$$\xi = \frac{\tan\theta}{\sqrt{H_s/L_o}} = \tan\theta \frac{K_u T}{\sqrt{H_s}} = \tan(26.6^\circ) \frac{2.26(3.0 \text{ sec})}{\sqrt{4.9 \text{ ft}}} = 1.53$$

Step 2. Calculate the minimum allowable median stone size d_{50} :

$$d_{50} \geq \frac{2}{3} \left(\frac{H_s \xi^b}{1.64 \cos\theta} \right) = \frac{2}{3} \left(\frac{(4.9 \text{ ft})(1.53)^{0.5}}{1.64 \cos 26.6^\circ} \right) = 2.8 \text{ ft or } 34 \text{ inches (0.84 m)}$$

C. Layout Specifications:

Step 1. Determine the wave runup:

$$R_u = 1.6H_s(r\xi) = 1.6(4.9 \text{ ft})(0.55)(1.53) = 6.6 \text{ ft (2.0 m)}$$

- Check the upper limit of $R_u = 3.2(rH_s) = (3.2)(0.55)(4.9 \text{ ft}) = 8.6 \text{ ft (2.6 m)}$
- Therefore use $R_u = 6.6 \text{ ft (2.0 m)}$

Step 2. Determine vertical height of riprap above the toe of slope:

$$\begin{aligned} \text{Vertical height} &= (\text{Still water depth}) + (\text{Runup}) + (\text{Freeboard}) \\ &= (13 \text{ ft}) + (6.6 \text{ ft}) + (2 \text{ ft}) = 21.6 \text{ ft (6.6 m)} \end{aligned}$$

Step 3. Determine minimum thickness of riprap layer:

Using the recommended standard gradations in NCHRP Report 568 (See Design Guideline 4 of HEC-23, 3rd Edition), Class VIII or Class IX riprap would be appropriate. Select Class VIII riprap for economy, because it has a nominal d_{50} size of 30 inches, with a minimum allowable d_{50} of 28.5 inches and a maximum allowable d_{50} of 34 inches.

- Minimum thickness of riprap layer $t_{\min} = 2.0(d_{50})$ or d_{100} , whichever is greater.
- For Class VIII riprap, $t_{\min} = \max[2.0 \times 28.5 \text{ inches, or } 60 \text{ inches}]$
- Specify minimum riprap thickness $t_{\min} = 60 \text{ inches (5 ft or 1.5 m)}$

Step 4: Sketch the recommended layout (Figure 17.5):

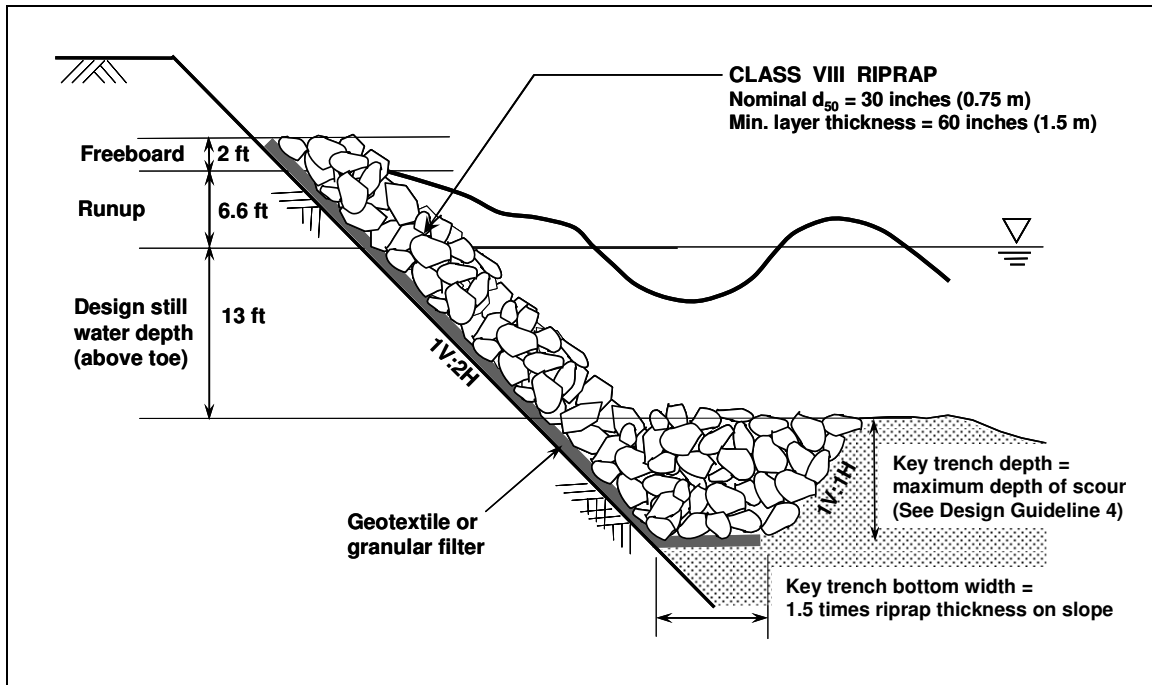

Figure 17.5. Recommended layout of riprap slope protection for example problem.

17.4 REFERENCES

Douglass, S.L. and Krolak, J., 2008. "Highways in the Coastal Environment." Federal Highway Administration, Hydraulic Engineering Circular No. 25, 2nd Edition, February.

Lagasse, P.F., Clopper, P.E., Zevenbergen, L.W., and Ruff, J.R., 2006. "Riprap Design Criteria, Recommended Specifications, and Quality Control." National Cooperative Highway Research Program Report No. 568, Transportation Research Board of the National Academies of Science, Washington, D.C.

Pilarczyk, K.W. (editor), 1998. "Dikes and Revetments – Design, Maintenance, and Safety Assessment." A.A. Balkema Publications, Rotterdam, Netherlands.

U.S. Army Corps of Engineers, 2006. "Coastal Engineering Manual." Part 2, Chapter 2, latest revision June 01.

Van der Meer, J.W., 1990. "Static and Dynamic Stability of Loose Materials," in *Coastal Protection* (Pilarczyk, ed.), A.A. Balkema Publications, Rotterdam, Netherlands.

Zevenbergen, L.W., Lagasse, P.F., and Edge, B.L., 2004. "Tidal Hydrology, Hydraulics, and Scour at Bridges." Federal Highway Administration, Hydraulic Engineering Circular No. 25, 1st Edition, December.

DESIGN GUIDELINE 18

RIPRAP PROTECTION FOR BOTTOMLESS CULVERTS

(page intentionally left blank)

DESIGN GUIDELINE 18

RIPRAP PROTECTION FOR BOTTOMLESS CULVERTS

18.1 INTRODUCTION

Bottomless (or three-sided) culverts are structures that have natural channel materials as the bottom. Figure 18.1 shows a common type of bottomless culvert that is over 10 feet (3 m) high and over 40 feet (12 m) wide. These cast-in-place, precast, or prefabricated structures may be rectangular in shape or may have a more rounded top. They are typically founded on spread footings although pile foundations and pedestal walls are also used. Regardless of the foundation type, the structure may be highly susceptible to scour. Bottomless culverts on spread footings are best suited for non-erodible rock but with caution and with scour protection can be used for other soils. Bottomless culverts with pile foundations may still require riprap protection because scour below the pile cap can cause the approach embankment to fail into the scour hole.

Scour is greatest at the upstream corners of the culvert entrance. Pressure flow can greatly increase scour potential. **This design guideline is only applicable for free-surface flow conditions (i.e., no pressure flow up to and including the 500-year flood event) so the shape of the culvert (rectangular or curved) does not significantly affect the hydraulic conditions, scour potential, or riprap size. Because bridges are checked for stability for the superflood condition, they are typically designed to withstand scour up through the 500-year event. Therefore, the riprap size should be determined for the worst-case condition, which may be the 500-year event or a lower flow.** This design guideline is also only applicable for culverts that include flared wing walls at the upstream and downstream ends. The riprap size and layout presented in this guideline are intended to protect the culvert foundations that act as abutments. If dual bottomless culverts (side-by-side) are used then the center foundation acts as a pier and must be designed to be stable for the total scour depth (degradation, contraction and pier scour) without a countermeasure.



Figure 18.1 Bottomless Culvert on Whitehall Road over Euclid Creek in Cuyahoga County, OH.

The following determinations must be made in the design of rock protection for bottomless culverts:

- Size of stone
- Foundation depth
- Layer thickness (sufficient to accommodate the largest stones and to account for contraction scour and long-term degradation)
- Horizontal extent of riprap (to account for contraction scour and long-term degradation)
- Filter type and extent (geotextile filter fabric to prevent substrate material from being washed out through the voids of the stone)

Bottomless culverts have several advantages over other crossing structures. The natural bottom material is more environmentally attractive than a traditional closed culvert, particularly where fish passage is a concern. They are also considered by many highway agencies to be economical alternatives to short bridges. They are more easily constructed than conventional bridges because they are commonly prefabricated.

18.2 LABORATORY INVESTIGATIONS OF SCOUR AND RIPRAP AT BOTTOMLESS CULVERTS

FHWA sponsored two laboratory studies of scour and riprap at bottomless culverts (Kerenyi, Jones and Stein 2003, 2007, Kerenyi and Pagan-Ortiz, 2007). The studies concluded that the scour is analogous to contraction scour caused by concentration of flow (primary flow) and to abutment scour caused by vortices and strong turbulence (secondary flow) (Figure 18.2). The studies included rectangular and arched shapes with and without wing walls (Figures 18.3 - 18.5). These figures show that scour is usually greatest at the upstream corners of the culvert entrance.

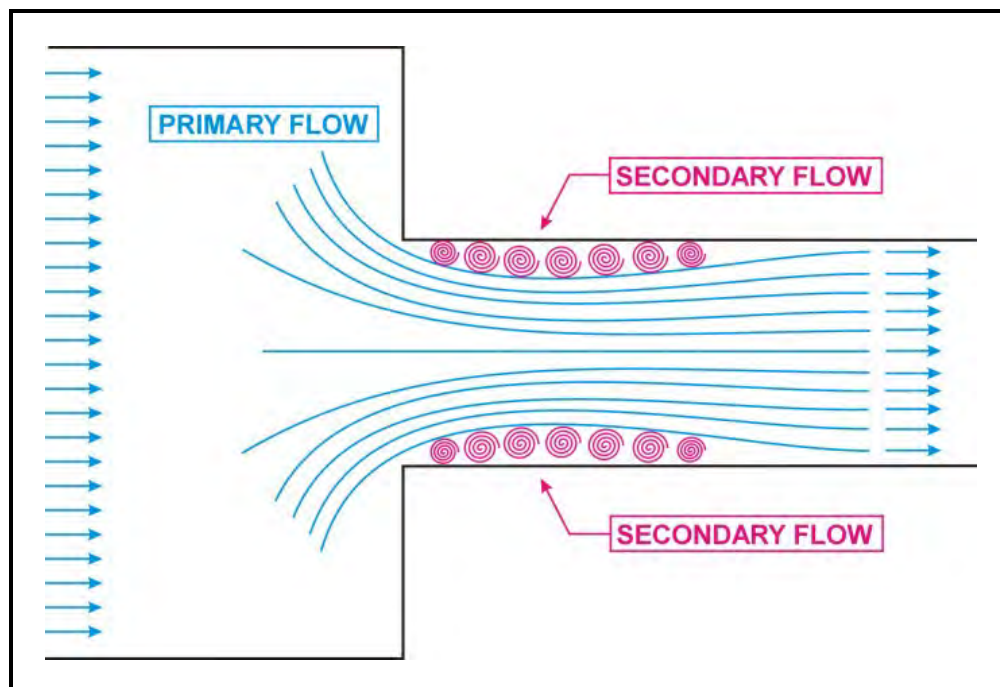

Figure 18.2. Flow concentration and separation zone (Kerenyi et al. 2007).

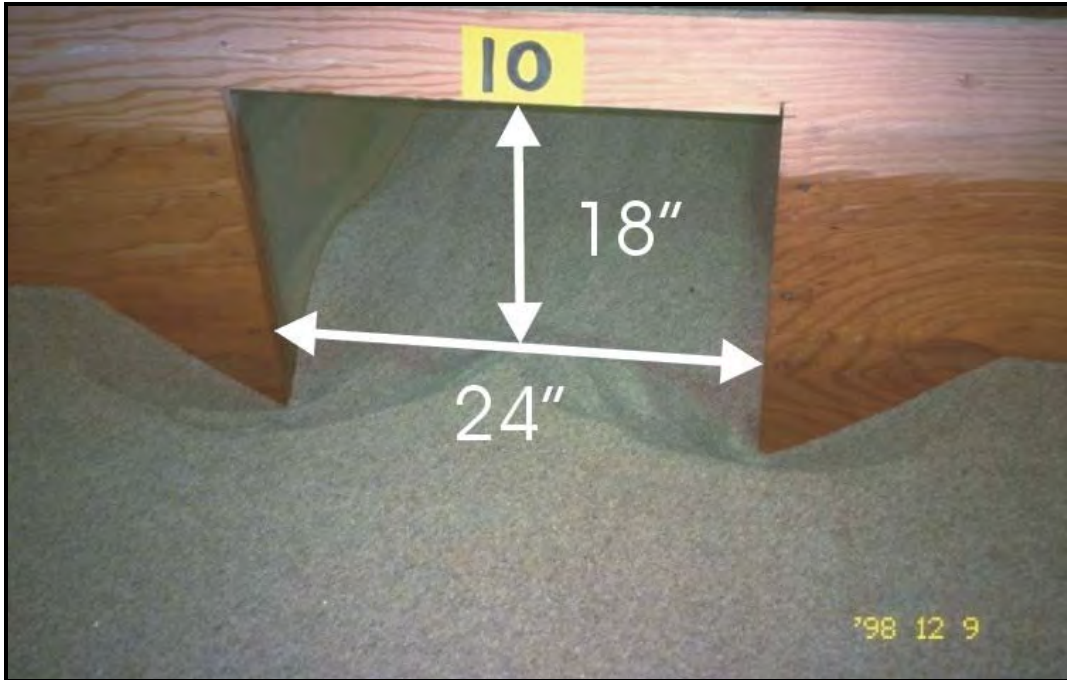

Figure 18.3. Rectangular model with vertical face (Kerenyi et al. 2003).

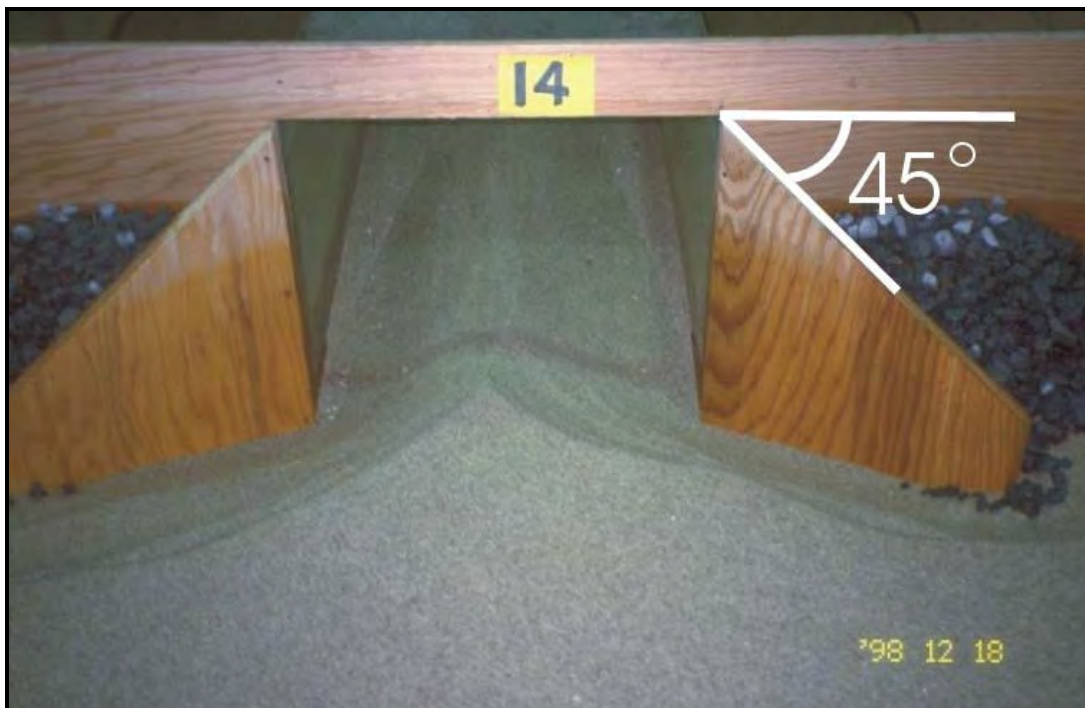

Figure 18.4. Rectangular model with wing walls (Kerenyi et al. 2003).



Figure 18.5. Arched model with wing walls (Kerenyi et al. 2003).

Riprap scour protection was also investigated in the two laboratory studies. Figure 18.6 shows a physical model of a bottomless culvert in a flume with riprap protection across the bottom. Another riprap placement alternative is the MDSHA (Maryland State Highway Agency 2005) standard plan (Figure 18.7). This alternative includes riprap placed along the wing walls and at the base of the vertical sides of the culvert.



Figure 18.6. Riprap scour protection with a rectangular model (Kerenyi et al. 2003).



Figure 18.7. Riprap protection at a bottomless culvert with the MDSHA Standard Plan (Kerenyi et al. 2007).

18.3 RIPRAP SIZE

The results obtained from the Phase II laboratory study (Kerenyi et al. 2007) were used to develop a riprap size equation that accounts for the local velocity at the corner of the culvert entrance and the vorticity and turbulence of the flow. The equation is:

$$d_{50} = \frac{K_r y_0}{(S_g - 1)} \left(\frac{V_{AC}^2}{g y_0} \right)^{0.33} \quad (18.1)$$

where:

- d_{50} = Riprap median size (50% finer) ft or m
- K_r = Sizing Coefficient equal to 0.38 from the best fit lab data, 0.68 for design curve that envelops the lab data
- V_{AC} = Average velocity at the culvert entrance, ft/s or m/s
- y_0 = Average flow depth at the culvert entrance before scour, ft or m
- S_g = Riprap specific gravity
- g = Acceleration of gravity ft/s² or m/s²

18.4 LAYOUT DETAILS

The MDSHA (Maryland State Highway Agency 2005) standard plan for riprap was tested as a countermeasure (Figure 18.7). When the plan was tested, riprap launched into the scour hole and then stabilized. Figure 18.8 shows the riprap condition after the test. Based on the results of the FHWA riprap experiments for bottomless culverts, the MDSHA standard plan tests, and on other design criteria found in HEC-18 (Richardson and Davis 2001) and other HEC-23 design guides, the following guidance is recommended for protecting the foundations of bottomless culverts with riprap. It should be noted that these layout details have not been tested in the laboratory or in the field. The designer is ultimately responsible for adapting these recommendations to a particular site installation.



Figure 18.8. MDSHA standard plan after test (Kerenyi et al. 2007).

Riprap Extent: Figure 18.9 shows the riprap layout based, in part, on the MDSHA standard plan. Riprap should extend along the entire length of the culvert wall and wing walls (upstream and downstream). The recommended wing wall flare is 45° for the entrance and 8° for the exit. The riprap should extend from the end of the wing wall along the toe of the embankment at least 10 feet (3 m) but not less than two times the local water depth on the upstream end and at least 20 feet (6 m) but not less than four times the local water depth on the downstream end. Riprap should also be placed up the embankment slopes. If a greater flare is used at the downstream end the flow may separate resulting in a vortex along the downstream wing wall.

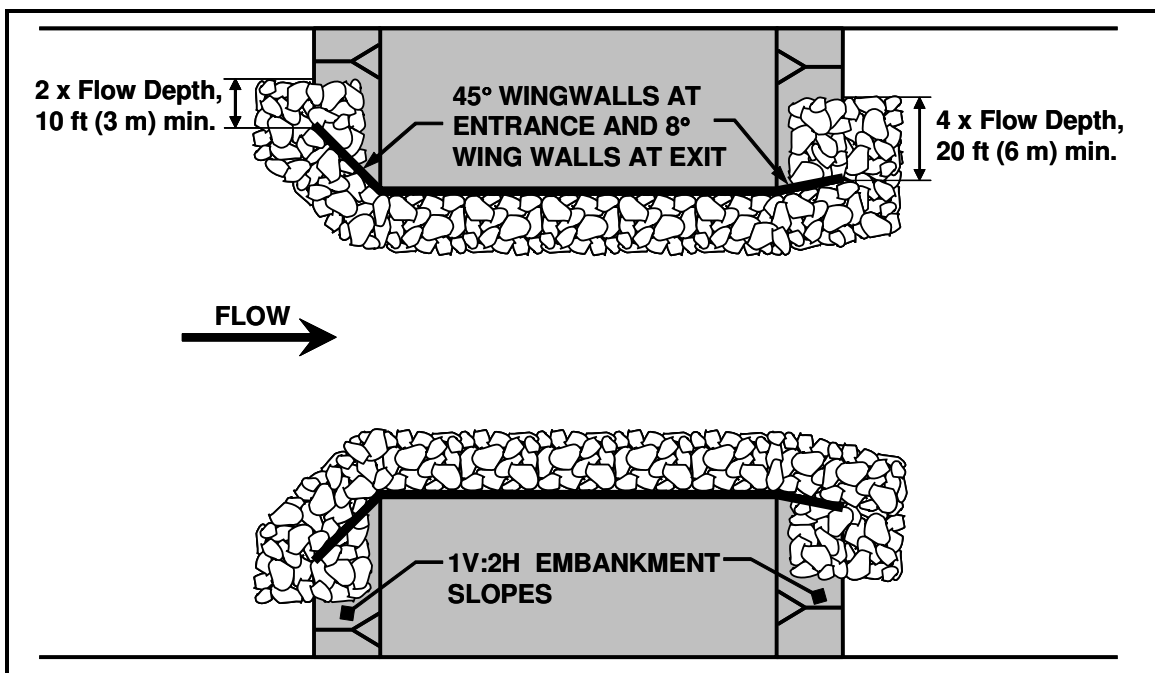

Figure 18.9. Riprap layout.

Elevation of Riprap Protection: The top of the riprap should be placed flush with the channel bed surface. This elevation is required for inspecting the riprap. The bottom of the riprap should be at least 1 ft below the top of footing. The thickness of the riprap layer should not be less than three times d_{50} of the riprap ($3xd_{50}$).

Footing Elevations: HEC-18 (Richardson and Davis 2001) provides guidance on the elevations of spread footings. The guidance indicates that for soil the top of the footing should be below the sum of long-term degradation, contraction scour and lateral migration. Erodible rock may require the same treatment as soil. For soils the guidance indicates that the bottom of the footing should be below the total scour (including local scour). In the case where riprap is used to protect spread footings that act as abutments at bottomless culverts, the HEC-18 bottom of footing recommendation does not apply.

Riprap Cross Section: MDSHA (2005) has a requirement to "Design the width and thickness of the riprap wall protection to keep contraction scour away from the wall footings..." This is the approach adopted in this design guide. Figure 18.10 shows riprap constructed with a horizontal bench adjacent to the culvert wall and a sloping surface down to the lower riprap elevation. The sloping riprap is constructed at a 1V:3H slope to provide a stable riprap mass that is not intended to launch. Regulatory requirements may also dictate the allowable extent of riprap. If environmental and regulatory requirements permit, armoring the entire bottom is an option. The riprap size determined from Equation 18.1 would also apply to a full armor.

Design Evaluation: If the width or thickness of the riprap is excessive either from the standpoint of construction or permitting, then a wider culvert or deeper foundation should be considered. A wider culvert will reduce velocity and flow concentration, which results in less contraction scour and smaller riprap. The designer could also consider using a pile foundation for culvert walls and wing walls. Erosion of material from under the pile-supported footing (pile cap) would remain as a concern because this could result in the failure of the approach embankment. The riprap design should be reviewed by structural and geotechnical engineers to determine whether the culvert foundation design is affected by the loading of the riprap.

18.5 FILTER REQUIREMENTS

There are two kinds of filters used in conjunction with riprap; granular filters and geotextile filters. For this application only geotextile filters are recommended. The geotextile filter should extend a distance of W_B out from the culvert walls and wing walls. Detailed guidance for filter design is provided in Design Guideline 16 of this document.

18.6 Design Example

A bottomless culvert is being installed on erodible materials with a spread footing foundation. The design discharge is 1000 cfs ($28 \text{ m}^3/\text{s}$). The culvert width is 30 ft (9.1 m) and the flow depth for the design discharge is 6.7 feet (2.0 m). The computed contraction scour is 2.6 ft (0.79 m), the anticipated long-term degradation is 1.0 ft (0.30 m) and the channel thalweg elevation is 100.7 ft (30.7 m), which is 1.5 ft (0.46 m) lower than the channel bed elevation along the culvert walls. The riprap specific gravity is 2.65. Calculate the riprap size, the top of footing elevation, Y_{Tot} , W_T and W_B for the sloping rock protection.

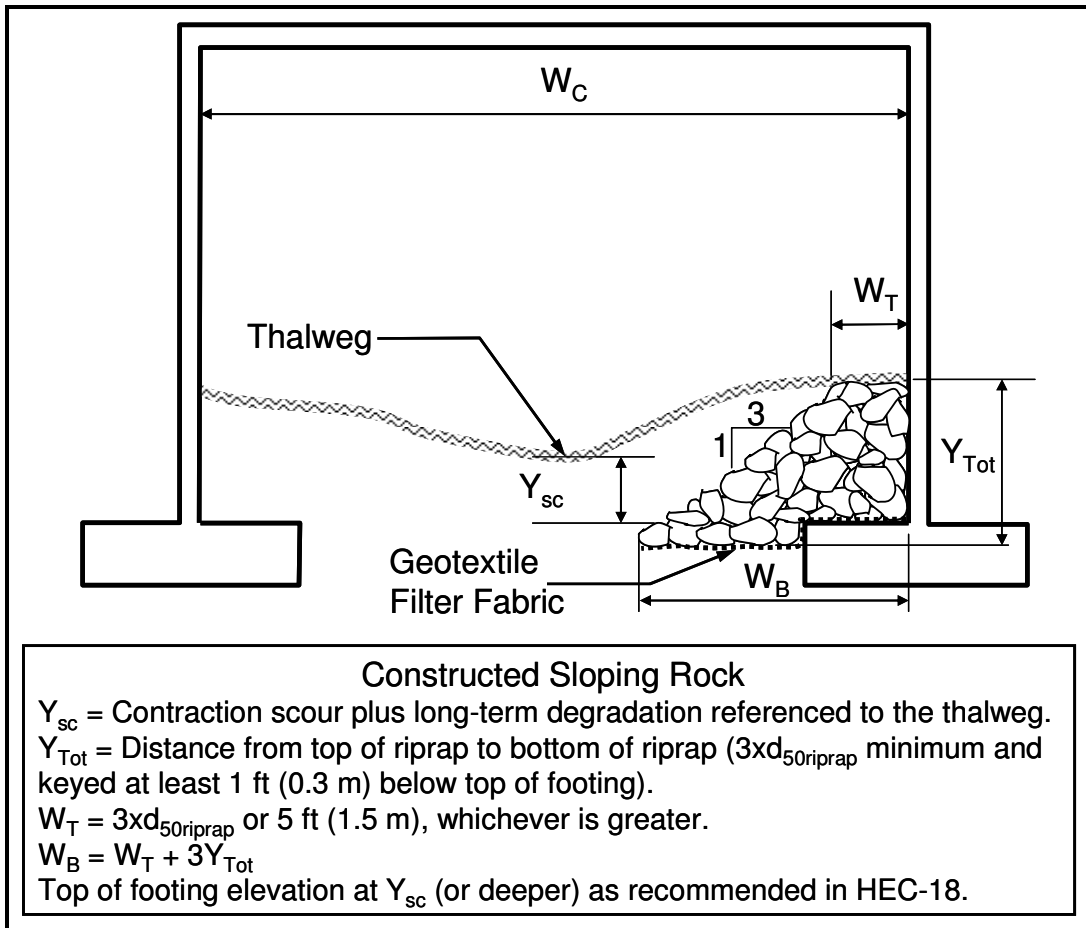

Figure 18.10. Cross Section for Sloping Rock.

Step 1. Calculate the average velocity in the culvert:

$$V_{AC} = Q/(W_C \times y_0) = 1000/(30 \times 6.7) = 5.0 \text{ ft/s (1.52 m/s)}$$

Step 2. Calculate the median stone diameter d_{50} :

$$d_{50} = \frac{K_r y_0}{(S_g - 1)} \left(\frac{V_{AC}^2}{g y_0} \right)^{0.33} = \frac{0.68 \times 6.7}{(2.65 - 1)} \left(\frac{5.0^2}{32.2 \times 6.7} \right)^{0.33} = 1.4 \text{ ft (0.43 m)}$$

Step 3. Calculate the top of footing elevation.

The top of footing is at or below the contraction scour plus long-term degradation relative to the channel thalweg.

$$Y_{SC} = \text{contraction scour} + \text{long-term degradation} = 2.6 + 1.0 = 3.6 \text{ ft (1.1 m)}$$

$$\text{Top of Footing Elevation} = \text{Invert elevation} - Y_{SC} = 100.7 - 3.6 = 97.1 \text{ ft (29.6 m)}$$

Step 4. Calculate the riprap layer thickness, Y_{Tot} :

Y_{Tot} is the riprap layer thickness. The top of riprap is the channel bed level at the culvert wall and the bottom of riprap is at least 1 ft (0.3 m) below the top of footing.

$Y_{Tot} = Y_{SC} + \text{difference between invert and bed at the culvert wall} + 1 = 3.6 + 1.5 + 1 = 6.1 \text{ ft (1.86 m)}$ (which is greater than $3 \times d_{50}$, therefore use 6.1 ft).

Step 5. Calculate the riprap top width, W_T :

W_T is $3 \times d_{50}$ or 5 ft, whichever is greater.

$W_T = 3 \times 1.4 = 4.2 \text{ ft}$, therefore $W_T = 5.0 \text{ ft (1.5 m)}$

Step 6. Calculate W_B :

$W_B = W_T + 3.0Y_{Tot} = 5.0 + (3.0 \times 6.1) = 23.3 \text{ ft (7.1 m)}$

Note: In this case the riprap will extend the full width of the opening and may not be acceptable from the standpoint of environmental permitting or fish passage. However, the natural bottom is expected to persist except during floods when the contraction scour would erode down to the riprap surface. The contraction scour hole is expected to refill after a flood if live-bed conditions exist. Increasing the culvert width will reduce the contraction scour and the riprap size. This reduces Y_{Tot} and the extent of riprap.

18.7 RIPRAP AS A RETROFIT SCOUR COUNTERMEASURE

If an existing culvert has a history of scour problems or is scour critical based on an analysis of flood conditions, then riprap can be considered as a scour countermeasure as part of a Plan of Action (see HEC-23, Volume 1, Chapter 2). A common approach to a retrofit includes:

1. Dewater the length of culvert and staging area. The upstream side could be dammed and the water pumped or piped through a pipe placed along one footing on the inside of the culvert span.
2. A small skid-steer loader can be used to remove stream bottom material. The bottom elevation of removal to the top-of-footing is preferable, but may have to be lower to accommodate the loader height.
3. Place the appropriately selected geotextile filter fabric under the specified location of the riprap.
4. Place riprap with the loader according to the construction plans and specifications. A bedding layer of clean granular material may be necessary to protect the filter fabric. The bedding layer should be more permeable than the filter fabric.
5. As the riprap is placed, backfill with natural streambed material on top of the riprap up to the stream invert elevation. This step can be omitted if a "natural" bed is not required in the culvert section.

18.8 REFERENCES

Kerenyi, K., Jones, J.S., and Stein, S., 2003. "Bottomless Culvert Scour Study: Phase I Laboratory Report," Federal Highway Administration, Report No. FHWA-RD-02-078.

Kerenyi, K., Jones, J.S., and Stein, S., 2007. "Bottomless Culvert Scour Study: Phase II Laboratory Report," Federal Highway Administration, Report No. FHWA-HRT-07-026.

Kerenyi, K. and Pagán-Ortiz, J., 2007. "Testing Bottomless Culverts," Public Roads, Vol. 70, No. 6, May/June 2007.

MDSHA, (Maryland State Highway Agency) 2005. "Office of Bridge Development Manual for Hydrologic and Hydraulic Design, Chapter 11, Evaluating Scour at Bridges, Appendix C, Estimating Scour at Bottomless Arch Culverts, September 2005.

Richardson, E.V. and Davis, S.R., 2001. "Evaluating Scour at Bridges," Fourth Edition, Hydraulic Engineering Circular No. 18, Federal Highways Administration Publication No. FHWA NHI 01-001, Washington, D.C.

DESIGN GUIDELINE 19
CONCRETE ARMOR UNITS

(page intentionally left blank)

DESIGN GUIDELINE 19

CONCRETE ARMOR UNITS

19.1 INTRODUCTION

Concrete armor units are man-made 3-dimensional shapes fabricated for soil stabilization and erosion control. These structures have been used in environments where riprap availability is limited or where large rock sizes are required to resist extreme hydraulic forces. They have been used as revetments on shorelines, channels, streambanks and for scour protection at bridges. Some examples of armor units include Toskanes, A-Jacks[®], tetrapods, tetrahedrons, dolos and Core-loc[™] (Figure 19.1).

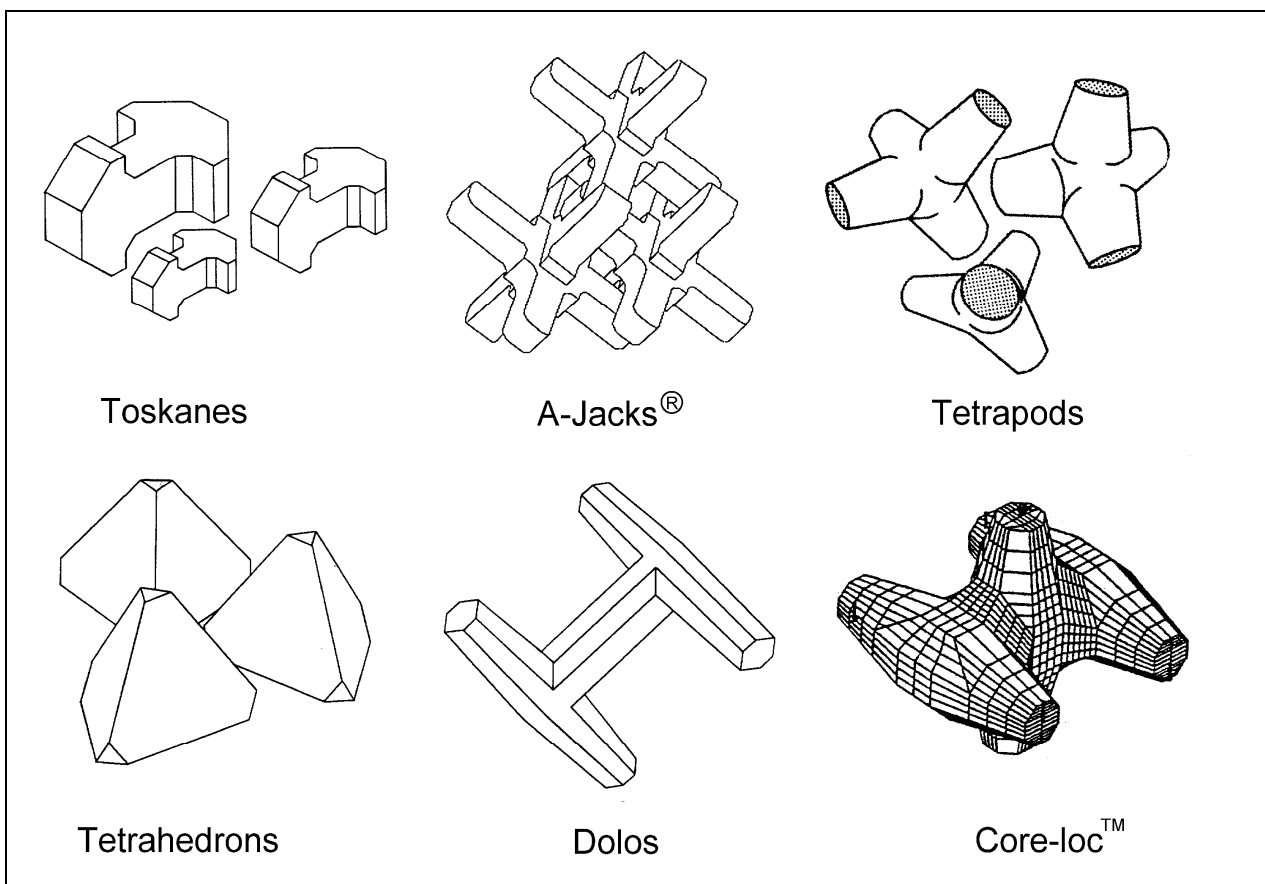

Figure 19.1. Armor units.

The primary advantage of armor units is that they usually have greater stability compared to riprap. This is due to the interlocking characteristics of their complex shapes. The increased stability allows their placement on steeper slopes or the use of lighter weight units for equivalent flow conditions as compared to riprap. This is significant when riprap of a required size is not available.

19.2 DESIGN CRITERIA FOR CONCRETE ARMOR UNITS IN OPEN CHANNELS

The design of armor units in open channels is based on the selection of appropriate sizes and placement patterns to be stable in flowing water. The armor units should be able to withstand the flow velocities without being displaced. Hydraulic testing is used to measure the hydraulic conditions at which the armor units begin to move or "fail," and dimensional analysis allows extrapolation of the results to other hydraulic conditions. Although a standard approach to the stability analysis has not been established, design criteria have been developed for various armor units using the following dimensionless parameters:

- Isbash stability number (Parola 1993, Fotherby and Ruff 1996, Bertoldi et al. 1996)
- Shields parameter (Bertoldi et al. 1996)
- Froude number (Brown and Clyde 1989)

The Isbash stability number and Shields parameter are indicative of the interlocking characteristics of the armor units. Froude number scaling is based on similitude of stabilizing and destabilizing forces. Quantification of these parameters requires hydraulic testing and, generally, regression analysis of the data. Prior research and hydraulic testing have provided guidance on the selection of the Isbash stability number and Shield's parameter for riprap and river sediment particles, but stability values are not available for all concrete armor units. Therefore, manufacturers of concrete armor units have a responsibility to test their products and to develop design criteria based on the results of these tests. Since armor units vary in shape and performance from one proprietary system to the next, each system will have unique design criteria.

Installation guidelines for concrete armor units in streambank revetment and channel armor applications should consider subgrade preparation, edge treatment (toe down and flank) details, armor layer thickness, and filter requirements. Subgrade preparation and edge treatment for armor units is similar to that required for riprap and general guidelines are documented in HEC-23 (see also NCHRP Report 568) (Lagasse et al. 2009 and 2006, respectively). Considerations for armor layer thickness and filter requirements are product specific and should be provided by the armor unit manufacturer.

19.3 APPLICATION OF CONCRETE ARMOR UNITS TO LOCAL SCOUR PROTECTION

Concrete armor units have shown potential for mitigating the effects of local scour in the laboratory, however limited field data are available on their performance. Research efforts are currently being conducted to test the performance of concrete armor units as pier scour countermeasures in the field.

Design methods which incorporate velocity (a variable which can be directly measured) are commonly used to select local scour countermeasures. Normally an approach velocity is used in the design equation (generally a modified Isbash equation) with a correction factor for flow acceleration around the pier or abutment (see for example, Design Guidelines 11 and 14). A specific design procedure for Toskanes has been developed for application at bridge piers and abutments and is described in Sections 19.4 and 19.5 to illustrate a general design approach where the Toskanes are installed as individual, interlocking units.

Another approach to using concrete armor units for pier scour protection has been investigated by the Armortec Company and involves the installation of banded modules of the A-Jacks[®] armor unit. Laboratory testing results and installation guidelines for the A-Jacks

system are presented in Section 19.6 to illustrate the "modular" design approach in contrast with the "discrete particle" approach for Toskanes.

19.4 TOSKANE DESIGN PROCEDURE FOR PIER SCOUR PROTECTION

The Pennsylvania Department of Transportation (PennDOT) contracted with Colorado State University (CSU) in 1992 to investigate concrete armor units as a countermeasure for local scour at bridge piers. The purpose of the research was to develop guidelines for selection and placement of cost-effective armor unit sizes to mitigate pier scour (Fotherby and Ruff 1995, Fotherby 1995). A literature review of concrete armor units used in coastal and river protection works led to the selection of the Toskane as the primary concrete armor unit for which guidelines were to be developed. The Toskanes were modified from those used in coastal applications by removing the pointed corners from the hammerheads, increasing the length and cross section of the beam, and including reinforcing steel in the beam.

Hydraulic tests to evaluate the performance of Toskanes were conducted in an indoor flume and two outdoor flumes at CSU. Over 400 test runs were conducted. These tests included random and pattern placement of Toskanes tested to failure around piers and abutments, determination of protective pad radius, determination of pad height (comparing installations in which the top of the pad was level with the bed and installations in which the pad protruded above the bed), comparison of gravel and geotextile filters, number of Toskanes per unit area, and effect of angle of attack on Toskanes at a round nose pier. The data were analyzed, and using dimensional analysis the significant parameters were determined.

The design equation developed from regression analysis of hydraulic test data at CSU allows the computation of the equivalent spherical diameter of a stable Toskane size. The equivalent spherical diameter is the size of a sphere that would have the same volume of material as the armor unit as determined by the following equation:

$$D_u = \frac{0.255 V_v \sqrt{\frac{b_a}{g}}}{(S_g - 1)} \quad (19.1)$$

where:

- D_u = equivalent spherical diameter, ft (m)
- V_v = corrected velocity value = $1.5 \cdot V_o \cdot C_l \cdot C_s \cdot C_h \cdot C_i$, ft/s (m/s)
- C_l = location coefficient
- C_s = shape coefficient
- C_h = height coefficient
- C_i = installation coefficient
- b_a = adjusted structure width normal to the flow (pier or abutment), ft (m)
- g = acceleration of gravity, ft/s² (m/s²)
- S_g = specific gravity of Toskanes

Given the hydraulic conditions and dimensions of the pier or abutment, Equation 19.1 can be solved to select an appropriate size of Toskane for local scour protection. The design parameters and dimensions of Toskanes are illustrated in Figure 19.2.

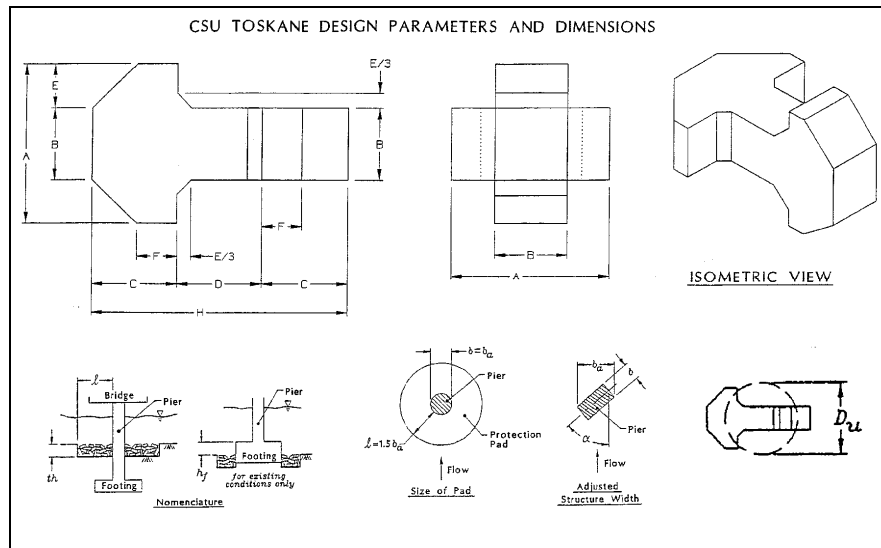

Figure 19.2. Toskane design parameters and dimensions.

The actual dimensions of the Toskanes are dependent on the size of unit constructed. Relative design dimensions are listed in Table 19.1.

Du	0.622H
A	0.616H
B	0.280H
C	0.335H
D	0.330H
E	0.168H
F	0.156H

The equivalent spherical diameter of the units constructed should equal or exceed the value determined from Equation 19.1. Custom sizes of Toskanes may be selected, but it may be more cost effective to use a standard size. Recommended standard sizes of Toskanes are listed in Table 19.2.

English Units		Metric Units	
Du (ft)	Weight (lb)	Du (m)	Mass (kg)
1.47	250	.430	100
1.85	500	.542	200
2.12	750	.653	350
2.33	1,000	.735	500
2.67	1,500	.823	700
2.94	2,000	.894	900

Tables 19.1 and 19.2 provide information necessary for construction of individual armor units once an appropriate size is selected. Design parameters for installation of a protection pad are provided in Table 19.3.

Table 19.3. Toskane Design Parameters and Dimensions.	
Design Parameter Dimension	
Toskane length (H)	1.608Du
Equivalent spherical diameter (Du)	0.622H
Volume (V)	$0.5236Du^3 = 0.1263H^3$
Specific weight (γ)	150 lb/ft ³ (23.5 KN/m ³)
Mass Density (ρ)	4.66 slug/ft ³ (2400 kg/m ³)
Number of Toskanes per unit area (N)**	$0.85V^{-2/3} = 1.309Du^{-2}$
2 layer thickness (th)	2.0Du = 1.24H
Filter requirements	$D_{85(\text{filter})} = 0.22Du$
Size of Pad (l)	$l_{\min} = 1.5b_a$ (piers) $l_{\min} = 2.0b_a$ (abutments)
**Toskanes per unit area assuming a 2-layer thickness of 2Du.	

19.5 TOSKANE DESIGN GUIDELINES

The following design guidelines reflect the results of the research conducted at CSU (Fotherby and Ruff 1995, Fotherby 1995):

1. Determine the velocity:

- a. Calculate the average velocity of the river directly upstream of the bridge (approximately 10 ft (3 m) upstream). Consider the number of substructure elements in the flow at the bridge cross section. If contraction scour could be significant, increase the approach flow velocity accordingly.

V_o = average velocity directly upstream of the bridge ft/sec (m/s)

- b. Select an adjustment coefficient to account for the location of the pier or abutment within the cross section. Some judgment is needed for selecting the coefficient, C_i , but generally a coefficient at 1.0 to 1.1 can be used.

$C_i = 0.9$, for a location near the bank of the river in a straight reach

$C_i = 1.0$, for most applications

$C_i = 1.1$, for a structure in the main current of flow at a sharp bend

$C_i = 1.2$, for a structure in the main current of the flow around an extreme bend, possible cross flow generated by adjacent bridge abutments or piers

NOTE: HEC-18 (Richardson and Davis 2001) recommends values of C_i as large as 1.7 (see Design Guideline 11).

Alternatively, a hydraulic computer model could be used to determine the local velocities directly upstream of bridge piers or abutments. A 1-dimensional hydraulic model (i.e., HEC-RAS, WSPRO) could be used to compute velocity distributions within a cross section on a relatively straight reach. A 2-dimensional hydraulic model (i.e., FST2DH, RMA-2V) could be used to estimate local velocities in meandering reaches or reaches with complex flow patterns.

- c. Select an adjustment coefficient for shape of the pier or abutment. As with the CSU equation for pier scour, if the angle of attack, θ , is greater than 5° , set all shape coefficients to 1.0.

For piers:

$C_s = 1.0$, for a circular pier.

$C_s = 1.1$, for a square nose pier.

$C_s = 0.9$, for a sharp nose pier streamlined into the approach flow.

For abutments:

$C_s = 1.1$, for a vertical wall abutment.

$C_s = 0.85$, for a vertical wall abutment with wingwalls.

$C_s = 0.65$, for a spill-through abutment.

- d. Determine if the top surface of the pad can be placed level with the channel bed and select the appropriate coefficient.

$C_h = 1.0$, Level - Top of pad is flush with the channel bed.

$C_h = 1.1$, Surface - Two layers of pad extend above channel bed.

NOTE: This is not a correction for mounding. Mounding is strongly discouraged because it generates adverse side effects. The effects of mounding were not addressed in the CSU study. Pad heights were kept at 0.2 times the approach flow depth or less.

- e. Select a random or pattern installation for the protection pad. A random installation refers to the units being dumped into position. In a pattern installation, every Toskane is uniformly placed to create a geometric pattern around the pier.

$C_i = 1.0$, Random Installation

$C_i = 0.9$, Pattern 1 - 2 Layers with Filter

$C_i = 0.8$, Pattern 2 - 4 Layers

- f. Calculate the Velocity Value:

Multiply the average approach flow velocity and coefficients by a safety factor of 1.5.

$$V_v = 1.5V_o C_l C_s C_h C_i \quad (19.2)$$

- f. Calculate adjusted structure width, b_a ft (m).

For a pier:

a. Estimate angle of attack for high flow conditions.

b. If the angle is less than 5° , use pier width b as the value b_a .

c. If the angle is greater than 5° , calculate b_a :

$$b_a = L \sin\theta + b \cos\theta \quad (19.3)$$

where:

- L = length of the pier, ft (m)
 b = pier width, ft (m)
 b_a = adjusted structure width, ft (m)
 θ = angle of attack

d. If a footing extends into the flow field a distance greater than: $0.1 * y_o$ (approach flow depth) use footing width instead of pier width for b .

e. For an abutment:

Estimate the distance the abutment extends perpendicular to the flow (b) during high flow conditions.

if $b \leq 5$ ft (1.5 m), then $b_a = 5$ ft (1.5m)

If 5 ft (1.5 m) $\leq b \leq 20$ ft (6 m), then $b_a = b$

if $b_a \geq 20$ ft (6 m), then $b_a = 20$ ft (6 m)

3. Select a standard Toskane size, D_u , using Equation 19.1 with the calculated velocity value, V_v , and the adjusted structure width, b_a . D_u represents the equivalent spherical diameter of riprap that would be required. This parameter can be related to dimensions of the Toskane by $D_u = 0.622H$, where H is the length of the Toskane (Figure 19.2 and Table 19.1).

Check the b_a/D_u ratio using the diameter, D_u , of a standard Toskane size in Table 19.2. If the ratio > 21 , select the next largest size of Toskane. Repeat until ratio < 21 .

4. Select pad radius, ℓ (ft) (m).

1.5 b_a for most piers and 2.0 b_a for most abutments.

Use a larger pad radius if:

- uncertain about angle of attack
- channel degradation could expose footing,
- uncertain about approach flow velocity
- surface area of existing scour hole is significantly larger than pad.

If more than one Toskane pad is present in the stream cross section, check the spacing between the pads. If a distance of 5 ft (1.5 m) or less exists between pads, extend the width of the pads so that they join.

5. Determine the number of Toskanes per unit area from Table 19.3.

a. Determine the protection pad thickness. Pads with randomly placed units have to be a minimum of two layers thick.

b. For a two layer pad with a filter, determine the pad thickness (th) from Table 19.3.

6. If bed material is sand, gravel, or small cobbles, add a cloth or granular filter. Toe in or anchor the filter. If the filter is granular, the d_{85} of the filter material directly below the Toskane layer can be determined from Table 19.3. Additional layers of filter, that may be needed based on the gradation of the bed material, can be designed according to standard requirements. Additional guidelines on the selection and design of filter material can be found in HEC-23 (Lagasse et al. 2009) and Holtz et al. (1995) (FHWA HI-95-038).
7. Information on Toskane fabrication and installation costs and design examples for bridge pier and abutment applications can be found in Fotherby and Ruff 1995 (PennDOT study).

19.6 A-Jacks® DESIGN PROCEDURE FOR PIER SCOUR PROTECTION

19.6.1 Background

The discrete particle design approach illustrated by the Toskane design guidelines concentrates on the size, shape, and weight of individual armor units, whether randomly placed or in stacked or interlocked configurations. In contrast, the basic construction element of A-Jacks for pier scour applications is a "module" comprised of a minimum of 14 individual A-Jacks banded together in a densely-interlocked cluster, described as a 5x4x5 module. The banded module thus forms the individual design element. Figure 19.3 illustrates the concept. (Note that the photograph of Figure 19.3 shows that a module larger than 5x4x5 can be configured).

In late 1998 and early 1999, a series of 54 tests of 6-inch model scale A-Jacks was conducted at Colorado State University (CSU) to examine their effectiveness in pier scour applications. This program is described in detail in CSU's test report entitled, "Laboratory Testing of A-Jacks Units for Inland Applications: Pier Scour Protection Testing" (Thornton et al. 1999a and b).

The CSU tests were conducted in an 8-foot (2.44 m) wide indoor flume with a sand bed, and examined a variety of conditions, including no protection (baseline conditions), banded 5x4x5 modules arrayed in several different configurations, and individual (unbanded) A-Jacks armor units. Both round and square piers were used in the program. The results indicated that, when used in combination with a bedding layer (either granular bedding stone or a properly selected geotextile), the A-Jacks 5x4x5 modules reduced scour at the pier from 70 percent to more than 95 percent (scour depths were from 30 percent to less than 5 percent of that in the unprotected baseline condition).

19.6.2 Design Guidelines

Hydraulic stability of a 5x4x5 A-Jacks module can be estimated by setting the overturning moment due to the total drag force equal to the resisting moment due to the submerged weight of the module:

$$F_d H_d = W_s L_w \quad (19.4)$$

where:

- F_d = drag force, equal to $0.5C_d\rho AV^2$, lb (N)
- C_d = drag coefficient (dimensionless)
- ρ = density of water, slugs/ft³ (kg/m³)
- A = frontal area of A-Jacks module, ft² (m²)
- V = flow velocity immediately upstream of A-Jacks module, ft/s (m/s)
- H_d = moment arm through which the drag force acts, ft (m)
- W_s = submerged weight of A-Jacks module, lb (N)
- L_w = moment arm through which the submerged weight acts, ft (m)

As a first estimate, the coefficient of drag C_d on an A-Jacks module can be assumed to be similar to that of a disc oriented normal to the flow velocity, with flow occurring over the top and around the sides. This value is approximately 1.2 (Venard and Street 1995). A conservative estimate for the location of the drag force would place it at the full height of the module, providing the greatest moment arm for overturning.

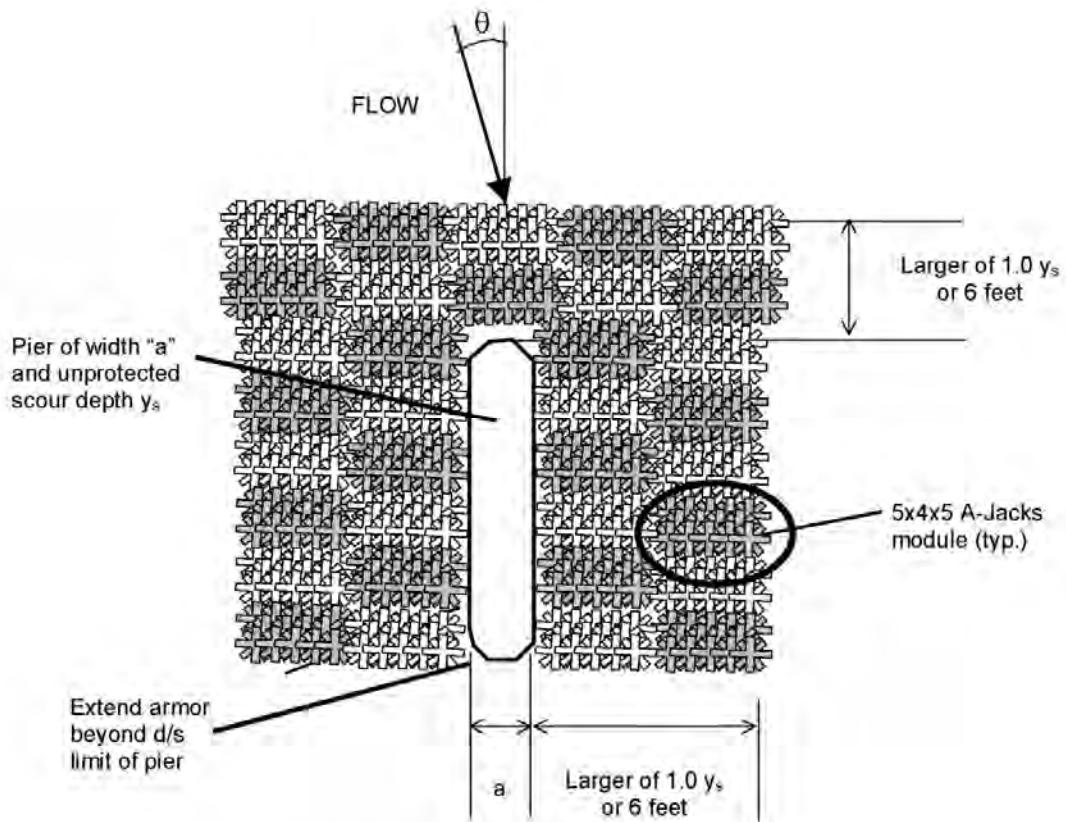

Note: For skew angle θ greater than 15 degrees, increase the above dimensions by $1/\cos\theta$.

Figure 19.3. A-Jacks modules for pier scour protection.

Tests were conducted at CSU in a steep (13 percent slope), fixed-bed flume to determine the hydraulic stability of the 5x4x5 A-Jacks modules in a typical pier scour configuration. Discharge was gradually increased until overturning of the module was achieved. Both submerged and unsubmerged conditions were examined.

Measuring hydraulic conditions at the threshold of overturning allows both the coefficient of drag, C_d , and the height of the drag force, H_d , to be determined directly from measured data. The other variables in Equation 19.4 are determined from the physical characteristics of the 5x4x5 A-Jacks module.

Using a drag coefficient C_d of 1.05 for the A-Jacks modules from the laboratory testing, and assuming that the drag force acts at the full height the module, the hydraulic stability of prototype scale A-Jacks modules can be determined. Table 19.4 provides the results of this hydraulic stability analysis (Clopper and Byars 1999).

A-Jacks System	Tip-to-Tip Dimension of Armor Unit (in)	Module Dimensions (HxWxL) (in)	Weight (or Mass) in Air, lbs (kg)	Submerged Weight (or Mass, lbs (kg)	Limiting Upstream Velocity, ft/s (m/s)
AJ-24	24	16 x 52 x 40	1,030 (467)	540 (245)	10.7 (3.3)
AJ-48	48	32 x 104 x 80	8,270 (375)	4,300 (1,950)	15.1 (4.6)
AJ-72	72	48 x 156 x 120	27,900 (12,655)	14,500 (6,577)	18.5 (5.6)
AJ-96	96	64 x 208 x 160	66,200 (30,028)	34,400 (15,604)	21.4 (6.5)
Notes:					
1. Volume of concrete in ft^3 for a 14-unit module is $14 \times 0.071 \times L^3$ where L is tip-to-tip dimension of armor unit in feet.					
2. Values in table assume a unit weight (or mass) of 130 lbs/ft^3 ($2,083 \text{ kg/m}^3$) for concrete.					

19.6.3 Layout and Installation

Geometry. The movable-bed tests conducted at CSU indicate that a chevron-style A-Jacks placement around a bridge pier does not improve performance beyond that afforded by simple rectangular geometries. As the rectangular shape accommodates the basic 5x4x5 A-Jacks module design unit, this geometry provides the recommended style for layout and placement of the armor units. Figure 19.3 provides recommended minimum dimensions for the placement of modules around a pier of width "a" and having an unprotected depth of scour y_s as determined by HEC-18 (Richardson and Davis 2001).

It should be noted that the CSU stability tests were conducted on a fully-exposed module; partial burial will result in a more stable installation. Also, the orientation of the modules in the stability tests exposed the maximum frontal profile to the flow (i.e., long axis perpendicular to the flow direction). Placement of the modules with the long axis parallel to the flow will result in a more stable arrangement than indicated by the recommended values in Table 19.4.

A-Jacks Placement. A-Jacks modules can be constructed onsite in the dry and banded together in 5x4x5 clusters in place around the pier, after suitable bedding layers have been placed. Alternatively, the modules can be pre-assembled and installed with a crane and spreader bar; this arrangement may be more practical for placement in or under water.

Bands should be comprised of cables made of UV-stabilized polyester, galvanized steel, or stainless steel, as appropriate for the particular application. Crimps and stops should conform to manufacturer's specifications. When lifting the modules with a crane and spreader bar, all components of the banding arrangement should maintain a minimum factor of safety of 5.0 for lifting.

Where practicable, burial or infilling of the modules to half-height is recommended so that the voids between the legs are filled with appropriate sized stone. Stone sizing recommendations are provided in the next section.

Bedding Considerations. The movable-bed tests conducted at CSU indicate that a bedding layer of stone, geotextile fabric, or both, should be included as part of the overall design of an A-Jacks installation. The purpose of a bedding layer is to retain the finer fraction of native bed material that could otherwise be pumped out between the legs of the A-Jacks armor units.

When bedding stone is placed directly on the streambed material at a pier, it must meet certain size and gradation requirements to ensure that it not only retains the bed material, but that it is permeable enough to relieve potential pore pressure buildup beneath the installation. In addition, the size of the bedding stone must be large enough to resist being plucked out through the legs of the A-Jacks by turbulent vortices and dynamic pressure fluctuations. In some cases, two or more individual layers of bedding stone, graded from finer in the lower layers to coarsest at the streambed, must be used to satisfy all the criteria. Figures 19.4a and 19.4b illustrate the bedding options discussed in this section.

Recommended sizing criteria for bedding stone (Escarameia 1998) are as follows:

$$\begin{aligned}
 \text{Retention:} \quad & D_{85(\text{Lower})} > 0.25D_{15(\text{Upper})} \\
 & D_{50(\text{Lower})} > 0.14D_{50(\text{Upper})} \\
 \text{Permeability:} \quad & D_{15(\text{Lower})} > 0.14D_{15(\text{Upper})} \\
 \text{Uniformity:} \quad & D_{10(\text{Upper})} > 0.10D_{60(\text{Upper})}
 \end{aligned}$$

In the above relations, D_x is the particle size for which x percent by weight are finer, and the designations Upper and Lower denote the respective positions of various granular bedding layers in the case when multiple layers are used. Each layer should be at least 6 to 8 inches (152 to 203 mm) thick, with the exception of uppermost layer which should be thicker, in accordance with Table 19.5. Note that the lowest layer of the system corresponds to the native streambed material.

A-Jacks System	D_{50} Size of Uppermost Layer, in (mm)	Recommended Minimum Thickness of Uppermost Layer, in (mm)
AJ-24	2-3 (50-75)	8 (200)
AJ-48	4-6 (100-150)	12 (300)
AJ-72	6-9 (150-225)	24 (600)
AJ-96	8-12 (200-300)	30 (750)

In lieu of multiple layers of granular bedding, it is often desirable to select a geotextile which is compatible with the native streambed material. However, placement of a geotextile may not always be practical, particularly when installing the system under flowing water. If a geotextile is used, it is recommended that a layer of ballast stone, with characteristics in accordance with Table 19.5, be placed on top prior to installing the A-Jacks modules.

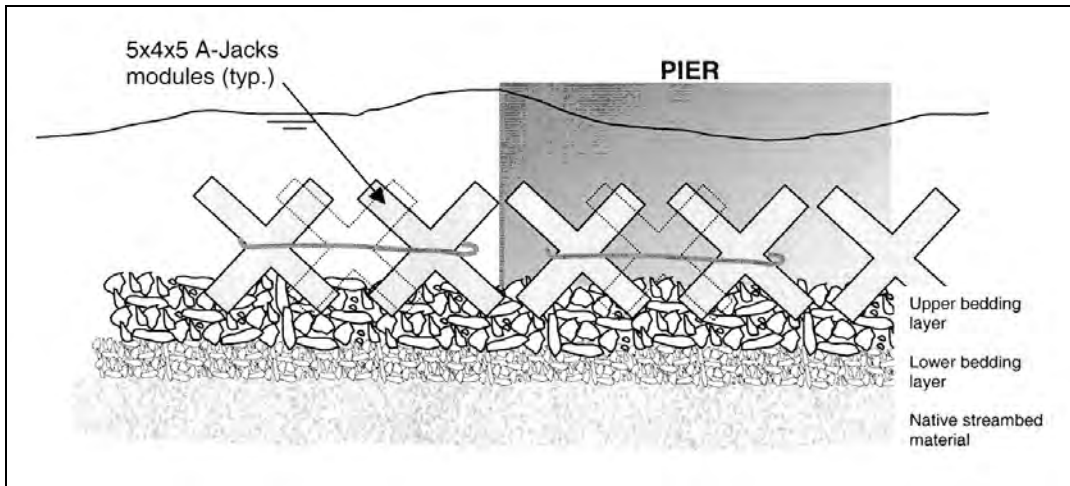

Figure 19.4a. Bedding detail showing two layers of granular bedding stone above native streambed material (Clopper and Byars 1999).

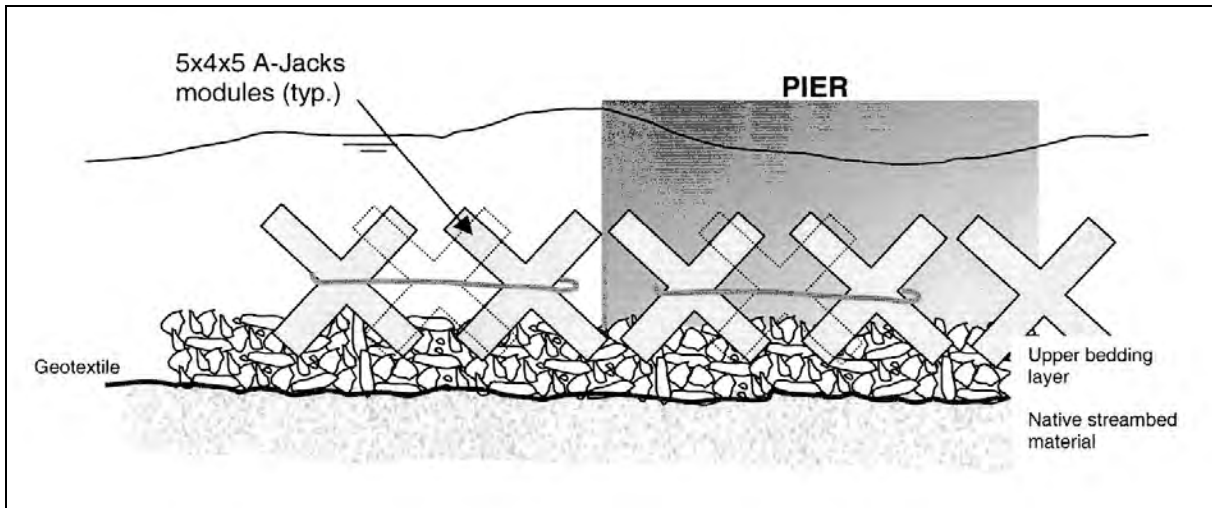

Figure 19.4b. Bedding detail showing ballast stone on top of geotextile (Clopper and Byars 1999).

When a geotextile is used, selection criteria typically require that the fabric exhibit a permeability at least 10 times that of the native streambed material to prevent uplift pressures from developing beneath the geotextile. In addition, the Apparent Opening Size (AOS) of the apertures of the geotextile should typically retain at least 30 percent, but not more than 70 percent, of the grain sizes present in the bed. Design procedures for determining geotextile properties are provided in Design Guideline 16. Finally, the geotextile must be strong enough to survive the stresses encountered during placement of stone and armor units.

Limited field testing using a design layout similar to Figure 19.3 and the guidelines of this section has been conducted. Figures 19.5 a, b, and c show a demonstration site installation of A-Jacks for pier scour protection in Kentucky.



Figure 19.5a. Scour hole debris at Bridge 133, Graves County, KY



Figure 19.5b. Newly-installed A-Jacks armor units at Bridge 133, Graves County, KY



Figure 19.5c. Close-up of armor units after several flow events at Bridge 133, Graves County, KY

19.11 REFERENCES

Bertoldi, D.A., J.S. Jones, S.M. Stein, R.T. Kilgore, and A.T. Atayee, 1996, "An Experimental Study of Scour Protection Alternatives at Bridge Piers," U.S. Federal Highway Administration Publication No. [FHWA-RD-95-187](#).

Brown, S.A. and E.S. Clyde, 1989, "Design of Riprap Revetment," [Hydraulic Engineering Circular No. 11](#), FHWA-IP-016, prepared for FHWA, Washington, D.C.

Clopper, P.E. and M.S. Byars, 1999, "A-Jacks Concrete Armor Units Channel Lining and Pier Scour Design Manual," prepared by Ayres Associates for Armortec, Inc., Bowling Green, KY, July.

Escarameia, M., 1998, "River and Channel Revetments: A Design Manual," Thomas Telford Publications, London.

Fotherby, L.M., 1995, "Scour Protection at Bridge Piers: Riprap and Concrete Armor Units," Dissertation, Colorado State University, Fort Collins, CO.

Fotherby, L.M. and J.F. Ruff, 1995, "Bridge Scour Protection System Using Toskanes - Phase 1," Pennsylvania Department of Transportation, Report 91-02.

Fotherby, L.M. and J.F. Ruff, 1996, "Riprap and Concrete Armor to Prevent Pier Scour," Hydraulic Engineering 1996, Session BS-20, Proceedings of 1996 Conference sponsored by the Hydraulics Division of the ASCE.

Holtz, D.H., B.R. Christopher, and R.R. Berg, 1995, "Geosynthetic Design and Construction Guidelines," National Highway Institute, Publication No. [FHWA HI-95-038](#), Federal Highway Administration, Washington D.C., May.

Lagasse, P.F., Clopper, P.E., Zevenbergen, L.W., and Ruff, J.F., 2006, "Riprap Design Criteria, Recommended Specifications, and Quality Control," NCHRP Report 568, Transportation Research Board, National Academies of Science, Washington, D.C.

Lagasse, P.F., Clopper, P.E., Zevenbergen, L.W., and Schall, J.D., 2009. "Bridge Scour and Stream Instability Countermeasures," Volume 1 (Third Edition), Publication FHWA-NHI___, Federal Highway Administration.

Parola, A.C., 1993, "Stability of Riprap at Bridge Piers," Journal of Hydraulic Engineering, ASCE, Vol. 119, No.10.

Richardson, E.V. and S.R. Davis, 2001, "Evaluating Scour at Bridges," Fourth Edition Report, FHWA NHI 01-004, Federal Highway Administration, [Hydraulic Engineering Circular No. 18](#), U.S. Department of Transportation, Washington, D.C.

Thornton, C.I., C.C. Watson, S.R. Abt, C.M. Lipscomb, and C.M. Ullman, 1999a, "Laboratory Testing of A-Jacks Units for Inland Applications: Pier Scour Protection Testing," Colorado State University research report for Armortec Inc., February.

Thornton, C.I., C.C. Watson, S.R. Abt, C.M. Lipscomb, C.L. Holmquist-Johnson, and C.M. Ullman, 1999b, "Laboratory Testing of A-Jacks Units for Inland Applications: Full Scale Testing," Colorado State University research report for Armortec Inc., February.

Vennard, J.K. and R.L. Street, 1975, "Elementary Fluid Mechanics," John Wiley & Sons, New York, NY.