

**REPORT OF THE
INTERNATIONAL TSUNAMI MEASUREMENTS
WORKSHOP**

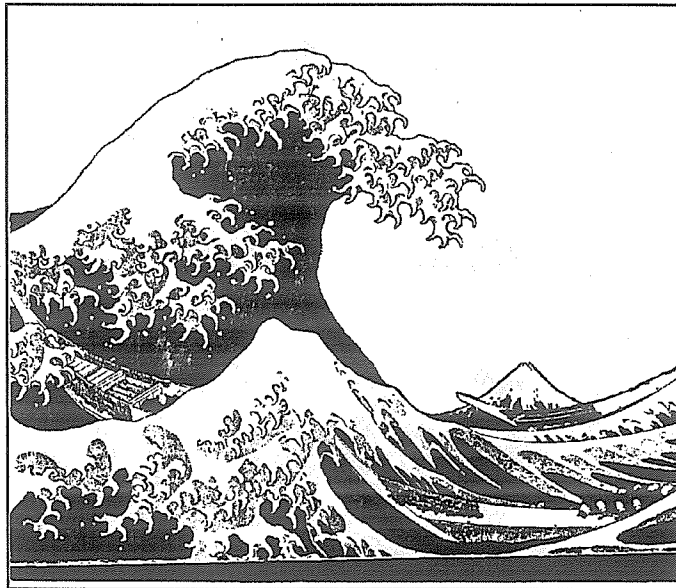

CO-CONVENERS

James F. Lander
University of Colorado, CIRES

Prof. Harry Yeh
University of Washington

Estes Park, CO, USA

June 28-29, 1995



INTERNATIONAL
TSUNAMI
MEASUREMENTS
WORKSHOP
Estes Park, Colorado, U.S.A.
June 28-30, 1995

Workshop Participants Photo

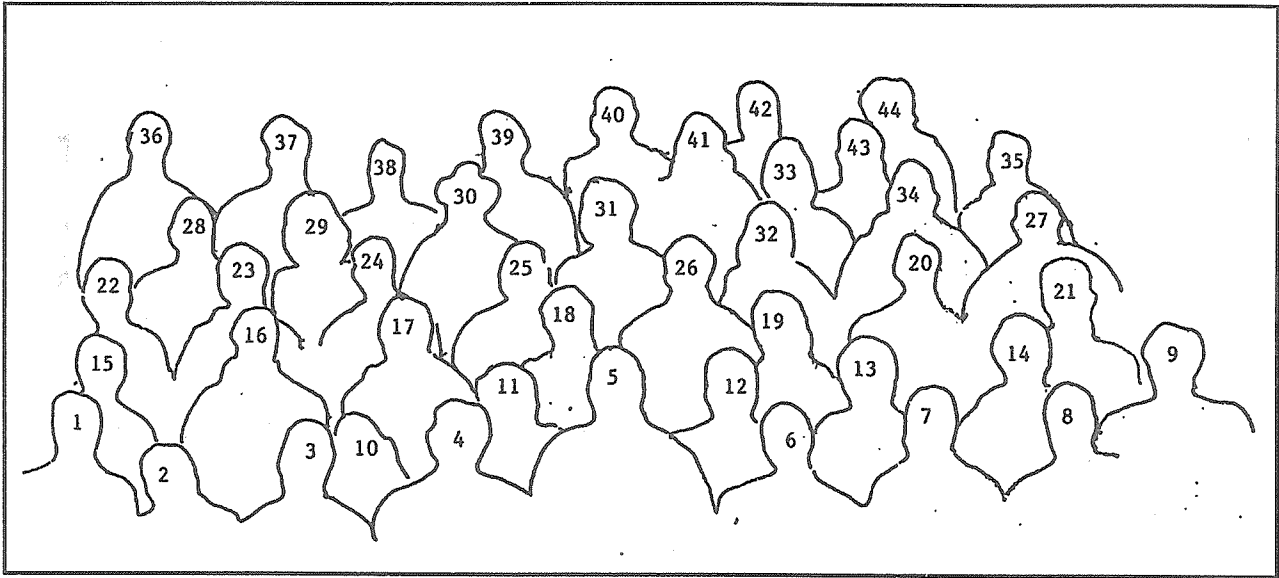

Row 1: Dennis Sigrist (1), Raymundo Punongbayan (2), Djoku Satudju (3),
Agustine Furumoto (4), James Lander (5), Modesto Oriiz (6),
Yoshinobu Tsuji (7), Aturo Daag (8), Viacheslav Gushiakov (9)

Row 2: Josephine Malilay (10), Peter Sloss (11), Boris Levin (12),
Harry Yeh (13), Kenji Satake (14)

Row 3: George Carrier (15), Guy Gelfenbaum (16), Fred Stephenson (17),
Alexander Rabinovitch (18), Jean Johnson (19), George Kaminsky (20),
Masami Okada (21)

Row 4: Toshihiko Nagai (22), Philip Liu (23), Salvador Farreras (24),
Emilio Lorca (25), Victor Kaistrenko (26), Mickey Moss (27)

Row 5: Fumihiko Imamura (28), Jane Preuss (29), R.J. Richter (30),
Catherine Peroff (31), Jeanne Bourgeois (32), Gary Howell (33),
Bruce Jaffe (34), Fred Raichlen (35)

Row 6: Michael Briggs (36), Costas Synolakis (37), Nobuo Shuto (38),
Jack Rynn (39), Cliff Astill (40), Sherrill Mausshardt (41),
Michael Blackford (42), Frank Gonzalez (43), Lev Utyakov (44)

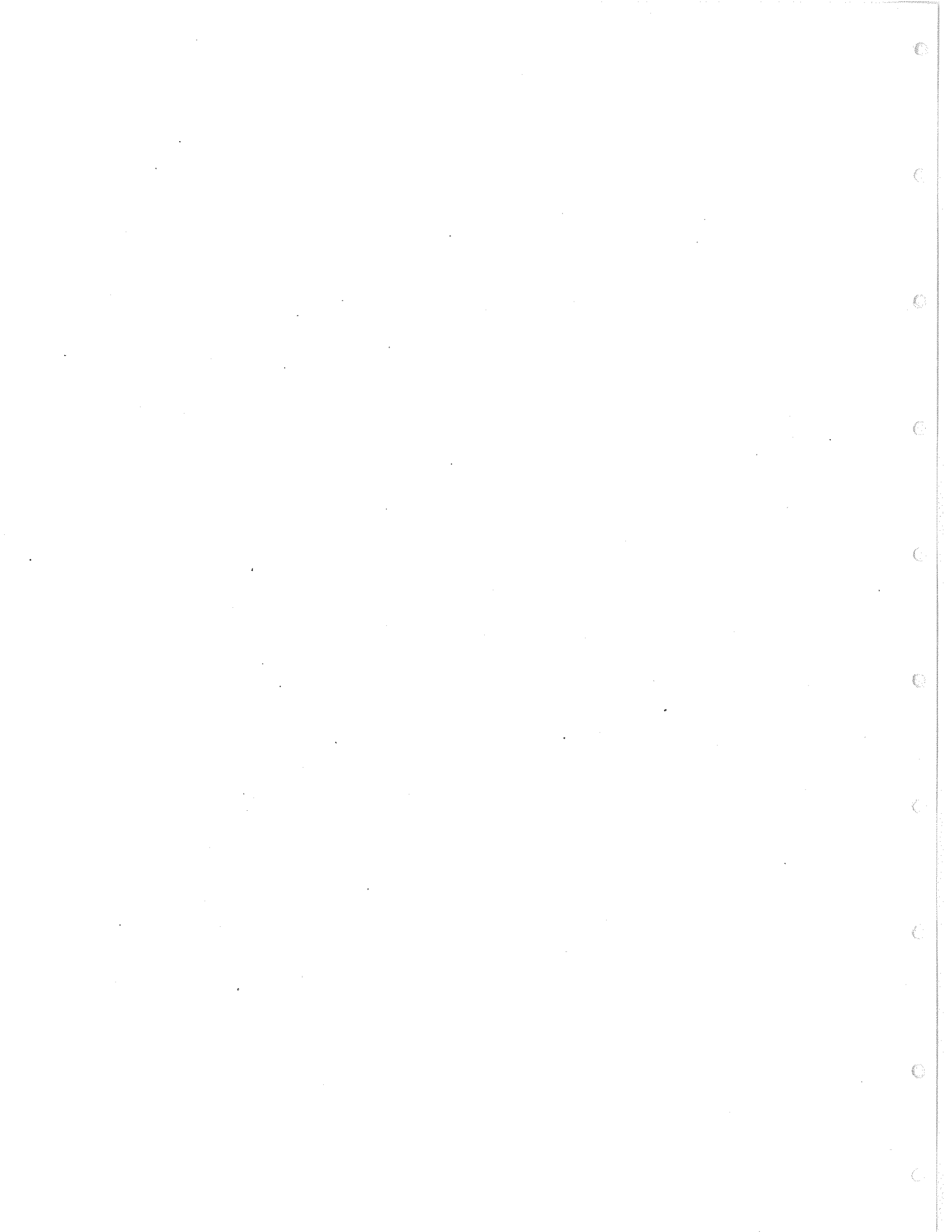
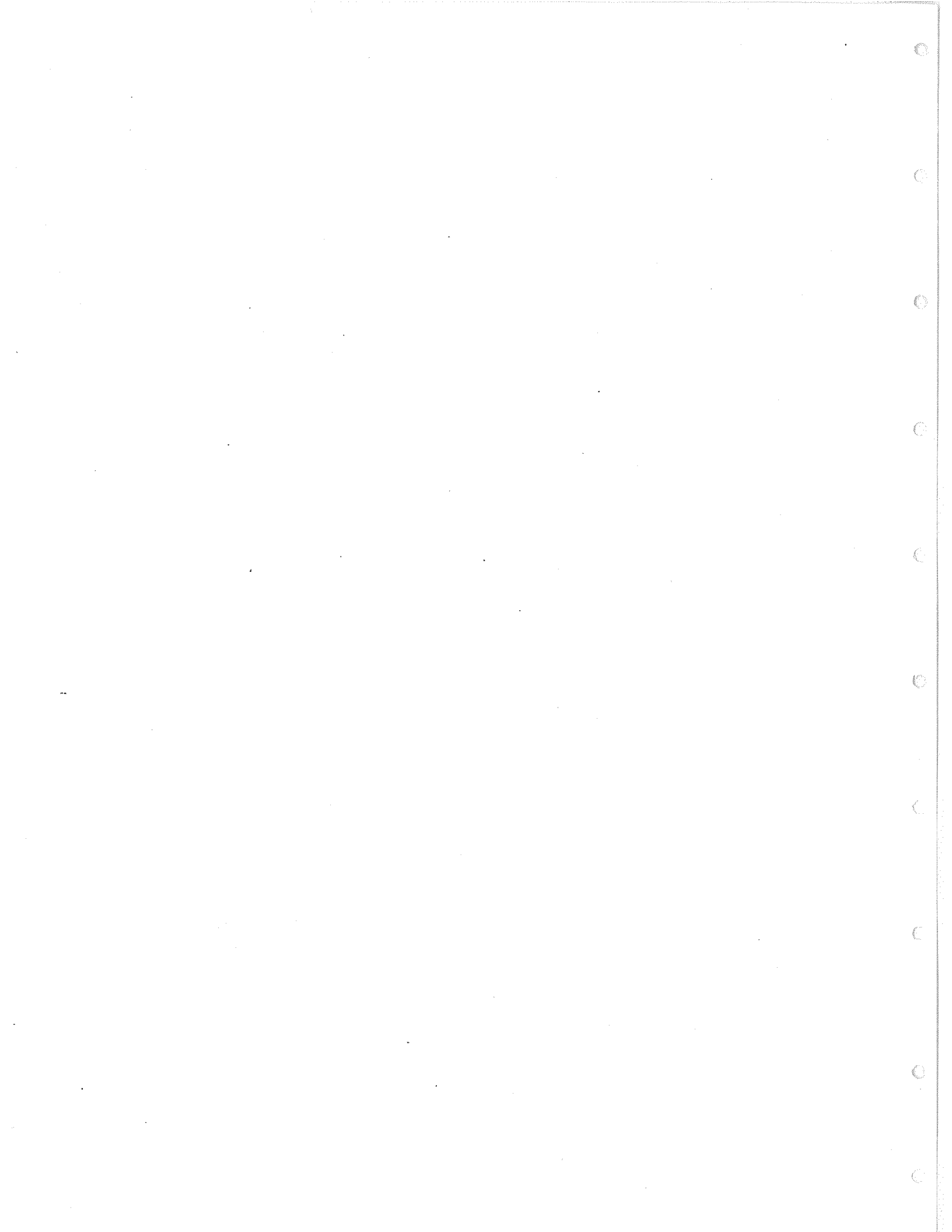

TABLE OF CONTENTS

| | |
|--|-----|
| ACKNOWLEDGMENTS | vii |
| INTRODUCTION | 1 |
| DISCUSSION TOPICS | 6 |
| 1. Post Tsunami International Surveys | 6 |
| 2. Instrumentation | 9 |
| 3. Modeling | 10 |
| 4. Mitigation | 10 |
| RECOMMENDATIONS | 11 |
| 1. Post Tsunami International Surveys | 11 |
| 2. Instrumentation | 13 |
| 3. Modeling | 14 |
| 4. Mitigation | 14 |
| 5. General Recommendations | 15 |
| APPENDICES | 17 |
| APPENDIX A — RECOMMENDATIONS | 19 |
| APPENDIX A1 — International Tsunami Survey Working Group Report | 19 |
| APPENDIX A2 — Recommended Components of a Post-Tsunami Eyewitness Interview | 25 |
| APPENDIX A3 — Instrumentation Group Report and Recommendations | 29 |
| APPENDIX A4 — Instrumentation — Preliminary Report | 37 |
| APPENDIX A5 — Modeling and Mitigation | 39 |
| APPENDIX B — REPORTS | 41 |
| APPENDIX B1 — ICG/ITSU Summary Report | 41 |
| APPENDIX B2 — Tsunami Warning System Workshop Report (September 14-15, 1994) | 43 |
| APPENDIX C — SELECTED PAPERS | 51 |
| APPENDIX C1 — Tsunami Reconnaissance Procedures | 51 |
| APPENDIX C2 — Standards for Tsunami Surveying | 69 |
| APPENDIX C3 — A Note on Recent Development of Tsunami Works in JMA | 77 |
| APPENDIX C4 — Characteristics of the 1994 Hokkaido-East-Off-Earthquake Tsunami, the 1994 Sanriku-Faroff-Earthquake Tsunami, and 1995 Hyogo-Prefecture South-Earthquake Tsunami based on the Field Observation Data | 81 |
| APPENDIX C5 — Research Needs: Public Health Impacts of Tsunamis A Briefing for the International Tsunami Measurements Workshop | 87 |
| APPENDIX C6 — Tsunami Profiles Observed at the NOWPHAS Offshore Wave Stations | 89 |
| APPENDIX C7 — On the Problems and Prospects of the Timely Tsunami Detection | 95 |
| APPENDIX D — WORKSHOP PARTICIPANTS LIST | 97 |
| APPENDIX E — ACRONYMS | 101 |



ACKNOWLEDGMENTS

The conveners wish to acknowledge the National Science Foundation for their support through project CMS-9501539, Workshop on Tsunami Measurements. We also acknowledge the support of the UNESCO Intergovernmental Oceanographic Commission for several scientists from developing countries with tsunami problems to participate. Also, we recognize the support of NOAA's National Geophysical Data Center in providing telephone, fax, and e-mail access and other logistic support necessary for organizing a large and scattered body of participants. We collectively thank the many organizations who supported participants either fully or by making them available to participate. Finally we thank the participants who gave freely of their time and expertise to make the workshop a success. Particularly, we acknowledge the individuals who agreed to act as group leaders and recorders and who prepared the draft reports for their groups. This includes Dr. Joanne Bourgeois of the University of Washington and Dr. Costas Synolakis of the University of Southern California with the Post Tsunami Survey Working Group, Mr. Gary Howell with the Army Corps of Engineers at Vicksburg and Dr. Alexander Rabinovitch visiting researcher at the Institute of Ocean Sciences in British Columbia, Canada, with the Instrumentation Working Group, Dr. Philip Liu of Cornell University and Dr. Kenji Satake, now with the Geological Survey of Japan, with the Models Working Group and Dr. Nobuo Shuto of Tokohu University, Sendai, Japan, and Ms. Jane Preuss of Urban Regional Research in Seattle with the Mitigation Working Group.

Harry Yeh
University of Washington

James Lander
University of Colorado

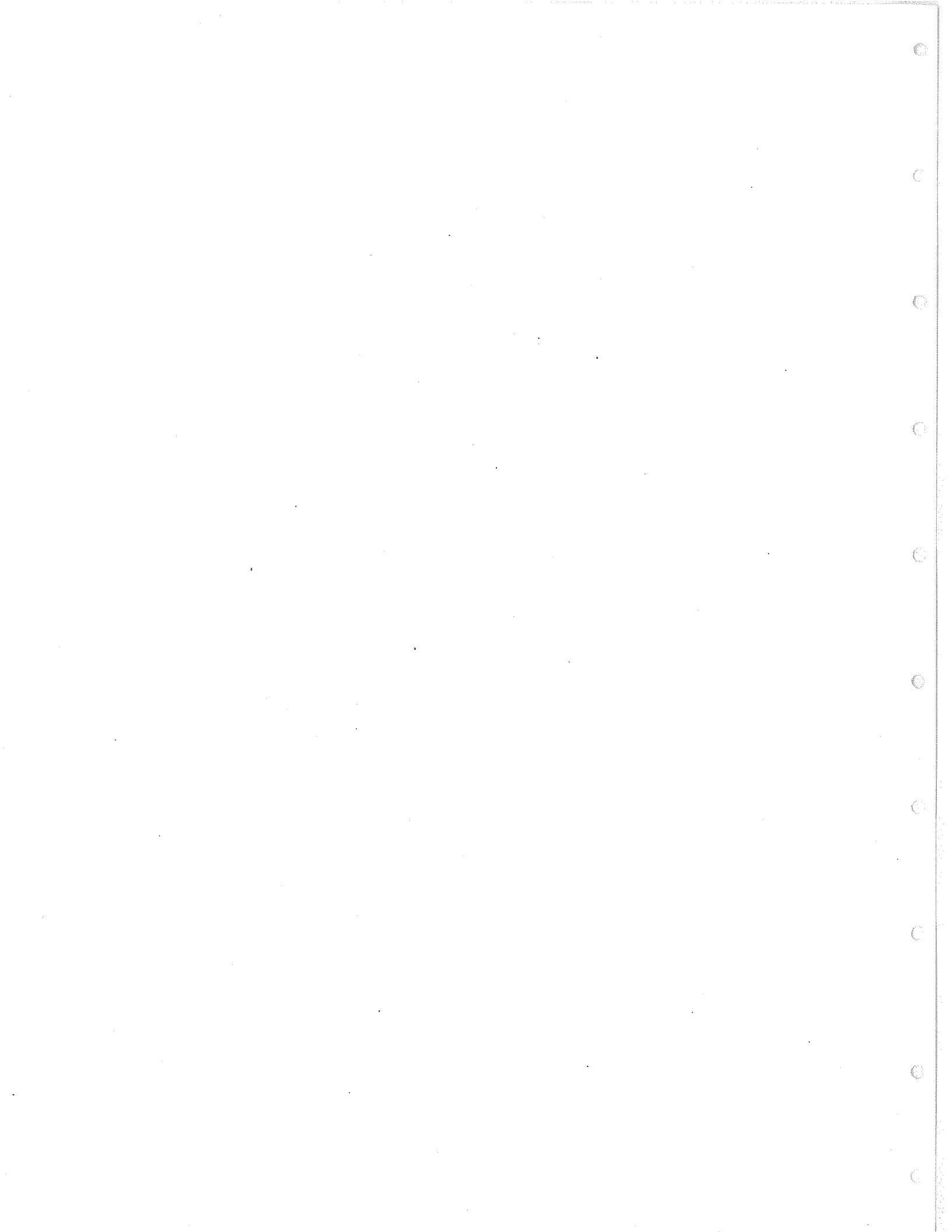

INTRODUCTION

In this century there have been 1.2 damaging tsunamis per year on average. Beginning in 1980 there was a long period of few damaging tsunamis with only three occurring from 1980 through 1991, the fewest since the 1800-1809 decade (Figure 1). Between 1992 and 1994, there was a series of eight damaging tsunamis causing about 1700 fatalities in Nicaragua, Japan, Indonesia, Russia, Alaska and the Philippines as listed in Table 1 and plotted in Figure 2. Six of these were investigated by *ad hoc* international teams of tsunami specialists and the results broadcast on the Tsunami Bulletin Board, an electronic mail system then operated by the National Oceanic and Atmospheric Administrations (NOAA) Pacific Marine Environmental Laboratory connecting nearly 100 tsunami scientists world-wide on the Internet.

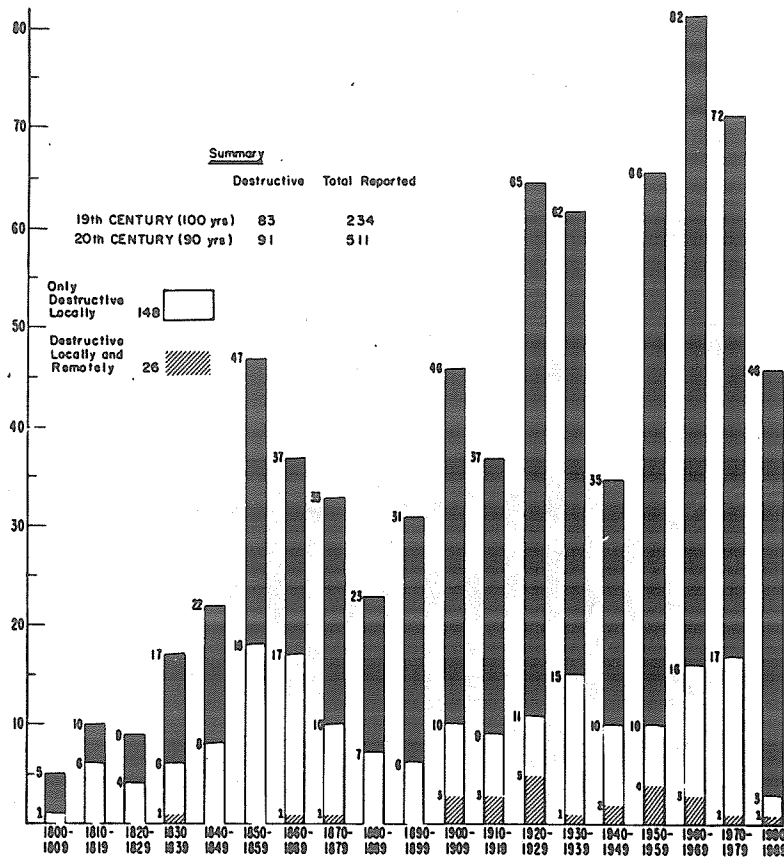

Figure 1. Number of tsunamis per decade reported since 1800. Increase following 1850 probably due to the introduction of tide gauges and the drops during 1910 and 1940 decades reflect decreased reporting during war years. (From Lander et al. 1993)

Based on recent tsunami investigations, questions were raised on the proper definitions of terms such as runup, on the best way to distribute the data, the availability of bathymetric and marigraphic data, and the proper conduct of such surveys. Problems with instrument distribution became obvious when only two of the eight tsunamis were recorded in the source region and problems with the instrumentation became apparent when one of the source region recordings (Figure 3) was of limited use due to poor instrumental response to short period waves. Recordings from the non-destructive tsunami from the 1993 Guam earthquake (Figure 4) were of limited use due to the-too-low sampling rate of 4 samples per hour by the digital recorders as well as the instrumental response limitations.

| Table 1. Destructive Tsunamis 1992-1994 | | | | | |
|---|----------------------|---------------|----------------------|---------------|------------|
| Date | Earthquake Magnitude | Location | Maximum Runup Meters | Damage | Fatalities |
| Sept. 1992 | 7.2 | Nicaragua | 9.7 | Extensive | 168 |
| Dec. 1992 | 7.5 | Indonesia | 26.0 | Extreme | 1000 |
| July 1993 | 7.6 | Japan Sea | 19.7 | \$1.5 Billion | 202 |
| June 1994 | 7.2 | Indonesia | | Extensive | 250 |
| Oct. 1994 | 8.1 | Kuril Islands | 9.0 | Some | 11 |
| Oct. 1994 | 7.0 | Indonesia | | Local | 0 |
| Nov. 1994 | Landslide | Alaska | 10.0 | \$21 Million | 1 |
| Nov. 1994 | 7.0 | Philippines | 10.0 | \$25 Million | 62 |

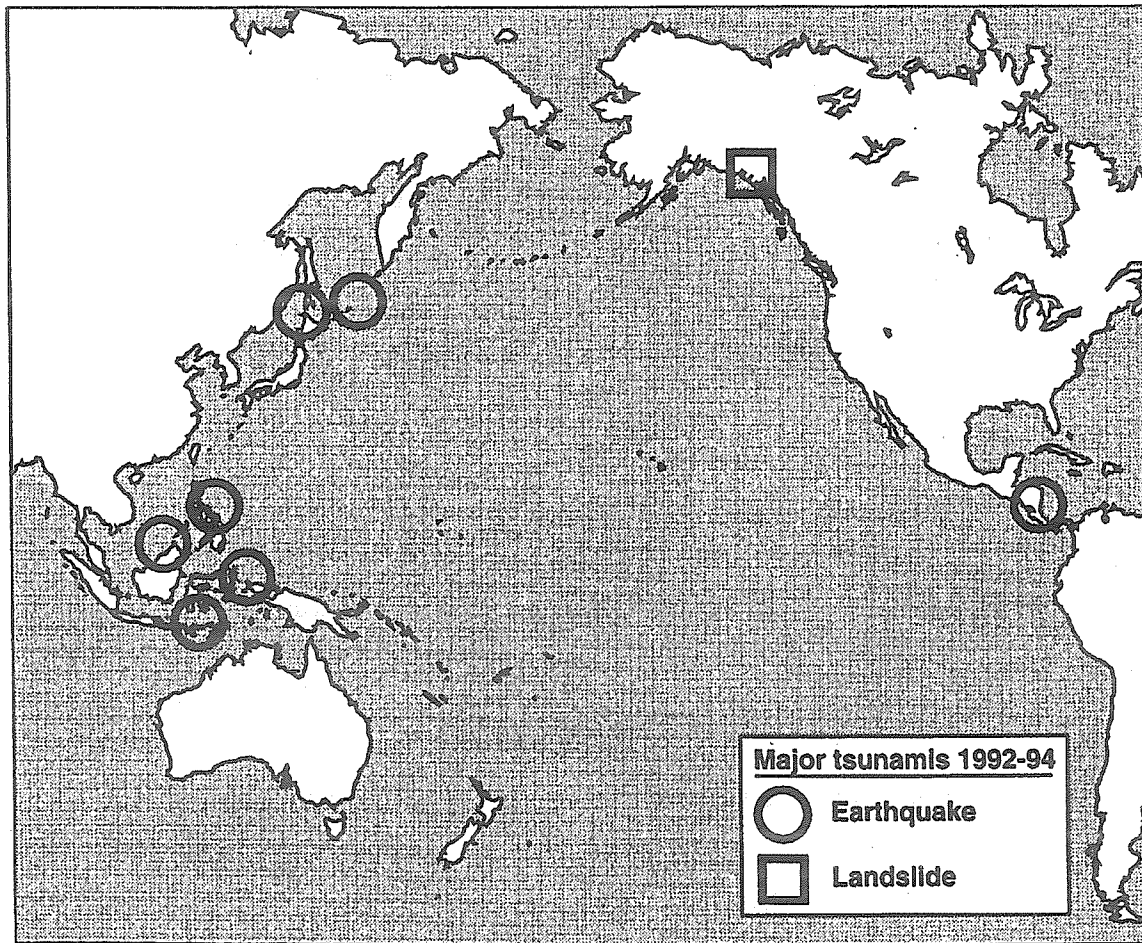

Figure 2. Location of Destructive Tsunamis of 1992-1994

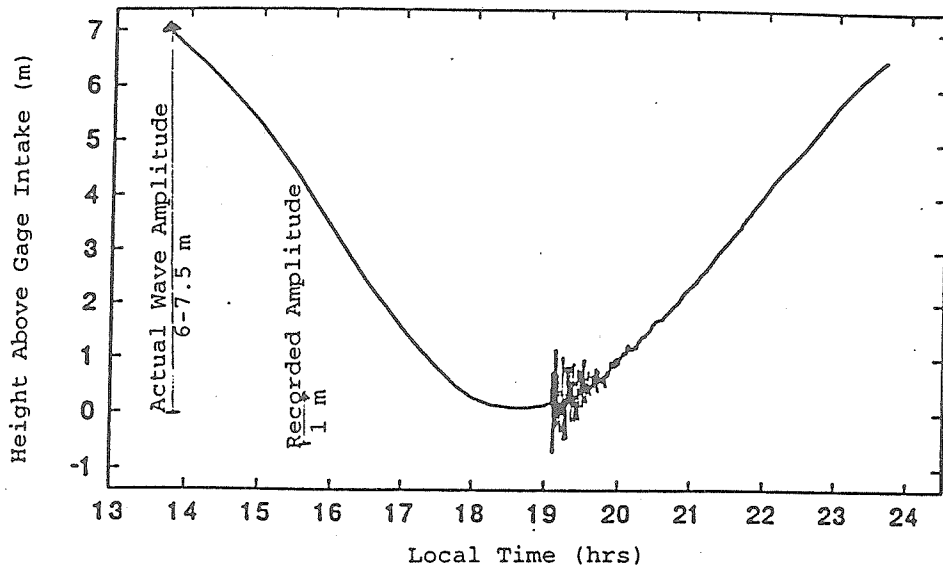

Figure 3. Marigram from the non-seismic landslide tsunami in Skagway Harbor, Alaska of November 4, 1994. Note short period resonance at 3 minutes, and maximum recorded amplitude of 1 meter for a wave over 8 meters in amplitude.

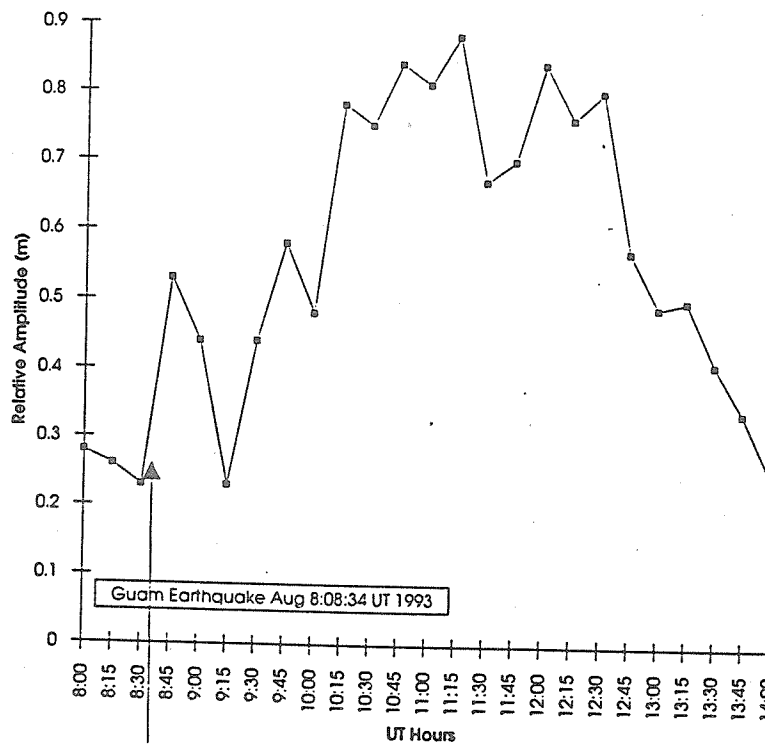

Figure 4. Marigram from Agana Harbor, Guam, for the tsunami of August 8, 1993 showing the effects of a digital sampling rate of one sample every 15 minutes.

All but three of the tsunamis were caused by earthquakes of magnitudes of less than 7.5 and the Skagway, Alaska, tsunami was not associated with an earthquake at all. The first of these events, occurring in Nicaragua, gave rise to the concept of "tsunami earthquakes" — lower magnitude earthquakes unusually efficient in producing tsunamis. These tsunamis also highlighted the general lack of success in predicting tsunami parameters from earthquake parameters and the importance of landslide-generated tsunamis, as three or four of the tsunamis were due to submarine landslides.

That nearly 1700 people were killed in the source regions and none beyond emphasized the fact that the local tsunami problem is the most acute and that systems to mitigate this type of tsunami are still far from satisfactory. Historically 98% of the fatalities have occurred within 1,000 km of the source (Figure 5).

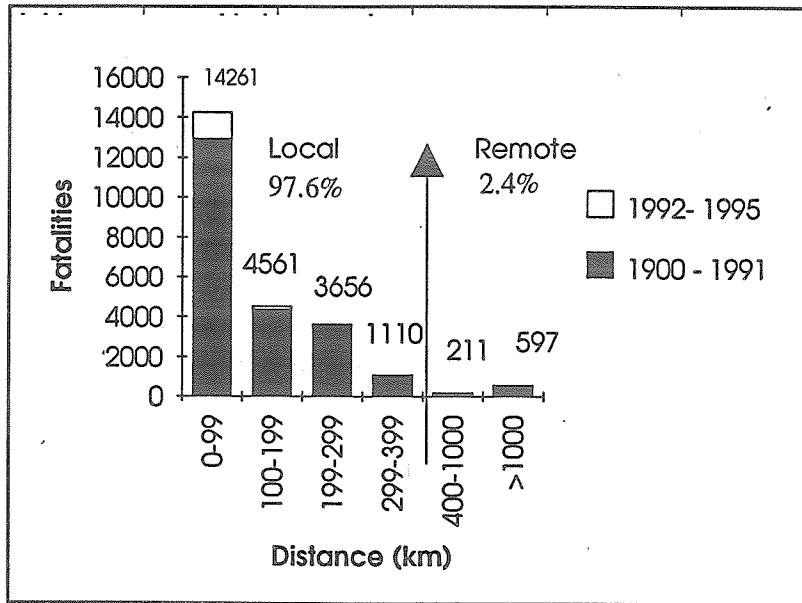

Figure 5. Fatalities caused by tsunamis in the last 100 years as a function of distance to the source. Note the scale change after 400 km, and that 97.6% of the fatalities occurred within 400 km of the source.

Additionally, some useful new technologies were becoming available. The surveys used geostationary satellites for fixing the locations of observations using GPS technology. Deep water gauges in Japan and the United States recorded the open ocean waves from several of these events. These gauges are among the very few instruments designed primarily for tsunami measurements in the hope of collecting data on tsunami wave forms unaffected by coastal shoaling distortions.

These were the conditions which prompted the need for a review of the problems associated with the collection and distribution of tsunami data. Further discussion of the topics to be addressed were held in San Francisco in December 1994, during the Fall American Geophysical Union meeting. The list of questions were combined to four general topics: 1) International Post Disaster Surveys; 2) Applications and Status of Modeling; 3) Questions about the Adequacy of Present Instrumentation and their Distribution; and 4) Mitigation Efforts.

The workshop was held in Estes Park, Colorado, just preceding the XXI General Assembly of the International Union of Geodesy and Geophysics (IUGG) in order to facilitate participation in both meetings. Forty-five scientists participated from ten countries. (See the List of Participants, p.97) The work was accomplished in four working groups as identified above with members moving freely between groups and

with frequent presentations of the status of discussions to the group as a whole. The objective was to develop recommendations which could be implemented to improve the mitigation efforts and the research capability in the tsunami field.

The results were reported at the International Tsunami Commission meeting on July 4th in Boulder and a preliminary report was made to the XV Meeting of the UNESCO Intergovernmental Oceanographic Commission's International Coordination Group for Tsunami Warning System in the Pacific (ICG/ITSU) meeting in Papeete, Tahiti, on July 24-28, 1995. The ICG/ITSU provides international guidance and coordination for the operation of the Pacific Tsunami Warning Center and the International Tsunami Information Center, key groups for the implementation of many of the recommendations. The preliminary reports of the Working Groups and the ICG/ITSU reports were also made available via the Internet on the Tsunami Bulletin Board and at the International Workshop on Long-Wave Runup Models at Friday Harbor, Washington, on September 12-16, 1995, to get the broadest possible comments. Copies of the Working Group reports and the results from the ICG/ITSU meeting relevant to the recommendations are presented in Appendices A -B. Comments from all of these sources are reflected in this final report. Appendix C comprises relevant papers and Appendix D a list of participants.

REFERENCES

Lander, J.F., P.A. Lockridge and M.J. Kozuch, 1993. Tsunamis affecting the West Coast of the United States, 1806-1902. *U.S. NOAA. National Geophysical Data Center. Geophysical Records Documentation* no. 29.

DISCUSSION TOPICS

1. *Post Tsunami International Surveys*

Since tsunamis are a rare phenomenon, with damaging events occurring about once a year on average around the Pacific and Indian oceans and much less often in the Atlantic Ocean, Caribbean and Mediterranean seas, it is important to learn as much as possible from each event. As destructive tsunamis are even rarer for any given country, it is unlikely that there will be in-country expertise experienced in conducting surveys. A solution to the problem of learning maximization from the disaster is that trained and experienced post-tsunami survey experts, drawn from an international pool, work together with local scientists and share their data and findings quickly with other countries and scientists. All countries in tsunami-affected areas can benefit from the results of such surveys. Presently, such teams have been organized on an *ad hoc* basis primarily on the initiative of individual scientists. This practice does not always lead to a good balance of skills, experience, disciplines, and nationalities on post-tsunami teams.

There are also problems with access to the affected areas — these are disaster areas and priority rightly must be given to treating emergency problems. However, some data are perishable and need to be collected as soon as practical. This requires the formation of teams quickly, support from the affected country to gain visas and access to the area, and funding either from sources available to the scientists or from international sources. Adequate funding is needed to be able to send the best mix of expertise and nationalities. The scientists who participate are not necessarily knowledgeable about the area of the disaster and need background information including topographic, geographic and bathymetric maps, historical data on earlier tsunamis in the area, information on the location of tide recorders, aerial photographic surveys, if available, and information on local organizations and personnel involved in the tsunami hazard. It may be useful to have had a tsunami model simulate areas of potentially significant impacts.

The survey teams should be trained and experienced field investigators. In order to assure a consistent level of investigations, a tsunami investigation field guide should be developed to include a list of questions to ask witnesses, how to determine runup heights and the direction of waves' approach, clues to scouring, erosion, deposition, and wave forces, how to use GPS technology to map effects and the need for photographs and VCR and film footage from local sources, including the local press and TV. For example, observed runup heights reported in the literature are often uncertain by several meters, partly because the height may refer inconsistently to the elevation above the sea level at the time of the survey, at the time of the tsunami, with reference to mean lower low water, to mean sea level or some other datum. There may also have been some uplift or subsidence of the land which would effect the datum used. The surveys should not be confined to inhabited areas; wave heights from other areas along the coast are important for modeling effects. Training, either formal or by pairing new investigators with an experienced team, is also needed.

The data and findings should be shared freely within the group and with other scientists, government officials and planners. This can be accomplished by using traditional scientific papers given at symposia and meetings and published in proceedings and journals, and by newer techniques of posting preliminary findings on the Internet and lengthier reports including photographs on the World Wide Web system. Figures 6-11 show selected photographs of effects from the eight recent destructive tsunamis.



Figure 6.



Figure 7.

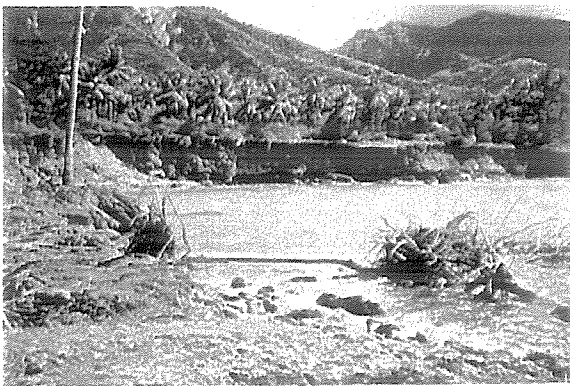

Figure 8.

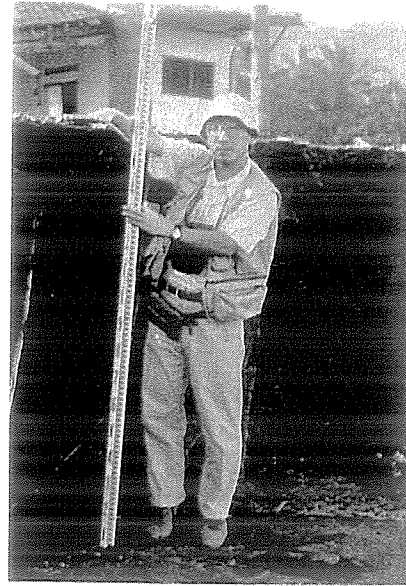

Figure 9



Figure 10.

Figure 6. Tsunami damage at El Tranisto (population 1,000)—the area most devastated by the September 1992 tsunami in Nicaragua. Sixteen people were killed (14 children and two elderly men) and 151 were injured. More than two hundred houses (nearly all the houses in El Tranisto) were destroyed by waves that reached more than nine meters at this site. It is thought that the first wave was relatively small, and that it provided a warning which allowed most of the able-bodied people to escape the force of the second and third very destructive waves.

Figure 7. A view of the Aonae, Okushiri Island, tsunami, July 12, 1993. Fishing boat (configured for catching squid) is beached high and dry near a damaged fire truck. Over 120 people were killed in Japan (Okushiri and Hokkaido islands) by the tsunami.

Figure 8. A view of the effects of the December 1992 tsunami at Leworahang, Indonesia. The measured runup height at this location is 10.9 m. The unofficial height was 14 m. The measured tsunami runup heights in this area are much larger than expected, and may be submarine landslide-generated waves rather than earthquake-generated waves. The slump in this area is almost vertical; it caused the disappearance of a shoreline area approximately 150 m wide and 2 km long, leaving behind steep vertical cliffs. A paved road comes to an abrupt halt at the edge of the vertical cliff.

Figure 9. Beach face scour found in Rajekwesi, East Java.

Figure 10. A view of the effects of the December 1992, tsunami at Wuhring, Flores Island. Although the tsunami heights at this location were lower than elsewhere (only about 3.5 m) the waves swept entirely over the 400 m by 200 m peninsula, inundating the densely populated community of Wuhring and killing 100. Here the damage was not as severe as on Babi Island. The waves left conical sand accumulations inside the houses, and at some locations the depth of the debris was about one meter.

2. Instrumentation

Since tsunamis are relatively rare, instrumentation dedicated to collecting tsunami data has been slow to be developed. Tide gauges were developed in the 1850s and a large tsunami from Japan was recorded on the U.S. West Coast in 1854 — the first tsunami to be recorded. These instruments have been the primary means of detecting teletsunamis, those detected at distances more than 1000 km from their source, which otherwise may be too small to notice or report. However, these instruments are designed to measure the diurnal tides and although of several designs, damp out the short period "noise", wind-generated waves, harbor-traffic waves, and unfortunately, tsunamis. The damping is severe as was seen in Figure 4 where an observed 8 meter wave at Skagway in 1994 was recorded as a one meter wave in the harbor. The arrival times are of limited accuracy as the scale is usually 2.5 cm per hour. The periods may be slightly distorted but are relatively accurate. The records are most useful in showing the relative sizes of the waves, their relationship to the state of the tide, the arrival time and periods. The amplitudes are most accurate at teletsunami distances when the amplitudes are small since the small aperture on the stilling well will admit only a limited amount of water during the period of the tsunami. The derived travel times and distances are also inaccurate as they are referenced to the earthquake epicenter while the tsunami source may be a large area, several hundreds of kilometers in length and generated several minutes after the beginning time of the earthquake. There are no direct instrumental measurements of the tsunami currents or runup. The instruments are not usually calibrated after a tsunami is recorded and the existing calibration is not readily available. The damping can be greatly effected by factors such as fouling of the aperture into the stilling well. Thus, the data from marigram tide gauges, which are essentially all of the quantitative data for all past tsunamis, are seriously inadequate for research purposes.

Given the inadequacy of the instrumental response, there is an additional problem in their placement. The instruments are usually mounted on the piers in harbors, in shoaling water and in bays or protected harbors. Many are lost to a destructive tsunami, the most valuable record that could be obtained. The heights recorded reflect the rising, but not maximum rise due to shoaling and are influenced by the sheltered nature of the harbor and the natural resonance of the harbor or bay. Measurements are needed in deeper water, uninfluenced by shoaling, and on exposed shores. Also, around the Pacific basin there are gaps in the distribution of instruments. Recent financial problems in Russia and damage from earlier tsunamis has eliminated vital instruments from that quadrant on the north Pacific such that the tsunami of October 1994, in the Kuril Islands resulted in a Pacific Tsunami Warning being issued although no destructive wave was observed outside of the generating area. Such "false alarms" are expensive and costs as high as \$30 million have been estimated for responses in the United States to this unnecessary alarm. Also, as noted earlier, only one of the eight destructive local tsunamis in 1992-1994 was recorded in the source region.

New digital technology has opened up a possibility of telemetering records continuously or on demand. It also makes certain processing easier in spectral analysis and correcting for instrumental responses if those are available. There is also a problem if the sampling rate is not adequate. The Skagway marigram was replaced with a digital instrument sampling at one sample every 6 minutes but the natural period of the harbor is three minutes. This is substantially worse than the inadequate analog record of Figure 3.

New instruments including ocean bottom pressure gauges, and reverse bathymetry gauges have the advantage of recording the tsunami wave in the open ocean undistorted by shoaling effects. They may be linked to land by cable, perhaps utilizing abandoned telephone cables, storing their data for later retrieval by surface vessel, which is not useful for real-time warnings, or be connected directly or via acoustic means to a tethered buoy for relay to land via radio or satellite. These systems are new, but already have recorded some tsunamis.

An ideal system would be digital recording, remotely accessible in real time, aperiodic in response, and relatively inexpensive to install and maintain. A practice of always checking the calibration of instruments after they record a tsunami and reporting the amplitudes only in corrected units would be desirable.

3. *Modeling*

Modeling is a way to study the effects of a tsunami analytically using mathematical or physical simulations. Physical models may include wave-making machines and scale models of harbors which can be very expensive to build, or models to study the effects of submarine or sub-aerial slides for sources or bottom displacements. While complex three-dimensional bathymetry and topography can be modeled, physical-model results always contain uncertainties due to scale effects, i.e., scaled down phenomena may not represent accurately the full-sized tsunami phenomenon. On the other hand, a full-sized simulation is possible by mathematical models. Mathematical models can predict travel times, tide states, amplitude, and perhaps, areas of inundation. However, mathematical models have problems in resolution, round-off errors, unreal numerical dissipation and dispersion, and the validity of the assumptions imposed. They are useful as a training and planning tool, such as Project TIME, in studying source mechanisms, in preparing inundation maps, and potentially, for real time amplitude predictions with warnings and post disaster guides for relief and study. Project TIME (Tsunami Inundation Modeling Effort), by Prof. Nubuo Shuto, is a set of models which is adaptable to local situations as planning and training tools. It has been distributed to 10 centers in 9 countries.

Modeling is an active area of development but there is not yet full agreement on the best methods to use or in getting models into a reliable application stage. The problems are the lack of data for operating models and the validation of model results against hard data. Detailed bathymetric data and initial conditions are needed for coastal inundation mapping, however, this is not usually readily available. As mentioned earlier, the instrumental data on amplitudes are not adequate for even approximating the runup.

4. *Mitigation*

The main rationale for the study of tsunamis is to mitigate the losses of life and property. Mitigation can take many forms including: detection and warnings, land-use planning, insurance, education, emergency response including evacuation and search and rescue, and engineering. The choice of type or types of mitigation to be undertaken is site dependent and involves choices limited by costs. Most of the engineering forms of mitigation are practiced in Japan which has the largest threat to developed coastal cities. Land use options have been practiced significantly in the US where the part of Hilo Harbor destroyed by the 1960 tsunami was left as a park. In Alaska, the towns of Chenega, Afoghak and Valdez were relocated to safer sites and the newer Alaska Pipeline terminal was built above any expected tsunami. The Scotch Cap Lighthouse site was automated. Warnings and evacuations are widely used where there is adequate time for evacuation. In Hawaii, one of the few areas where teletsunamis are the primary threat, evacuation maps are printed in the telephone books. This method is less effective for local tsunamis where time for communicated warnings may not exist. In Alaska many of the local tsunamis in the southeastern part of the state are due to landslides and there are only several minutes after the earthquake, if there is one, before the arrival of a large wave. Education is the best approach in such cases as people must begin to evacuate immediately on feeling a strong earthquake while near the coast or on seeing a peculiar action in the water. Education is also important in reminding people of the characteristics of tsunamis, for example, the maximum danger may come with later waves, particularly at high tide and that danger may persist for 24 hours. Most people who have been killed by the main tectonic tsunami in Alaska in 1964 were well aware that a tsunami was in progress but attempted to save property or move from a place of safety to another location between waves. The effects may vary considerably with the time of day, season, and other variables. One might expect that a tsunami occurring at an extra low tide would be less hazardous, but in some areas and seasons this low tide might attract many people to the beaches to fish and dig for clams and therefore into the danger zone.

Millions of dollars in damage have occurred in protected harbors of the US at San Francisco, Los Angeles, San Diego, and Crescent City, California, due to inadequate small craft mooring to withstand the rapid currents associated with tsunamis.

Detailed tsunami histories are a necessary starting point to understand and mitigate the tsunami hazard. This includes effects such as river bores, the nature of the source, such as teletsunamis, and local tectonic, landslide or volcanic tsunami sources, the amount of time from the occurrence of an earthquake, if one occurred, and the arrival of the wave, frequency of occurrence, maximum runup heights, etc.

RECOMMENDATIONS

The following recommendations were put forth by the respective working groups and accepted by the workshop participants as a whole, including three general recommendations adopted separately by the whole workshop. Those recommendations marked with an asterisk (*) may have been discussed in the working groups but were not formalized into a recommendation at the Workshop, or were suggested in subsequent discussions on the Internet or at one of the several meetings where the results were presented.

1. *Post Tsunami International Surveys*

Initiation Phase

- a) An international body such as the ITIC should maintain current lists of scientists available for tsunami field investigations who possess expertise in areas useful to tsunami field work, such as knowledge of tsunami effects, oceanography, engineering, seismology, marine geology, modeling, hazard mitigation, and sociology. (The ITIC has begun to develop such a list.)
- b) Creation of a fund of \$50,000 to \$100,000 to be maintained by the IOC to fund participation of scientists in post tsunami surveys. (It was recommended at the ICG/ITSU meeting in Tahiti that the IOC allocate funds for this purpose.)
- c) Funds should be sought for the training of scientists and students from countries vulnerable to tsunamis in tsunami hazard mitigation and post tsunami survey techniques. (The ITIC Associate Director and representatives from Australia, Canada, Colombia, and Mexico have been charged by the ICG/ITSU to develop a field handbook for tsunamis and to engage in training people in the proper way to conduct surveys.)
- d) There was no specific recommendation on the criteria to select tsunamis to qualify for an international survey. Some small tsunamis may merit international interest because of unusual circumstances due to their location or special effects, or they may be of use in training.

Access to the Affected Area

- a) At the time of a tsunami disaster there may be an excessive demand on officials, and national and local scientists in the affected country from scientists seeking information, visas, letters of invitation, etc. and an organization such as the ITIC should act as a channel for such communications to minimize the demands on locals and assure sensitivity to local customs. The interested scientists are encouraged to deal through their National Representative to the ICG/ITSU. (The ICG/ITSU meeting recommended that ITIC coordinate future international surveys if invited to do so by the ICG/ITSU representative of the affected country. This includes assembling a team of experts as soon as possible, keeping information available on bathymetry, topographic maps, location of marigraphs, etc.)
- b) Agreements should be prearranged as soon as possible to encourage rapid cooperation in the issuance of visas and letters of invitation in the event of a destructive tsunami qualifying for international study. This can be done without compromising the country's right to refuse such a visit if circumstances make this necessary. (The National Contacts of the ICG/ITSU should arrange, in advance, the procedures to allow access to the affected area, and to expedite and organize the survey.)
- c) To facilitate the effectiveness of an international survey, the ITIC should maintain an archive or know the source for information on the location of tide stations, national tsunami contact points,

aerial photography, bathymetry and topography maps at a scale of 1:50,000 or finer, histories and other information needed by the survey team. for all tsunamigenic areas of the world, as soon as possible. (The ICG/ITSU recommended that the ITIC keep information on available sources of bathymetry, topography maps, location on marigraph stations, etc., to assist in the preparation for a post tsunami field survey.)

Implementation

- a) A field manual (simple to understand and light weight) for conducting tsunami field surveys should be prepared. This guide book should be translated into the languages of potentially affected countries and be made available as soon as possible to local scientists and authorities. Diagrams of techniques, examples of collected field data, and a glossary of terms would be useful. More specific recommendations with regard to the manual are made below. (An *ad hoc* working group chaired by the Associate Director of ITIC, including experts from Australia, Canada, Colombia, and Mexico will prepare a draft Tsunami Survey Field Guide.)
- b) The community must agree on standards for runup measurements and reporting to make this data useful in the future. The group defined the "maximum runup" as the difference between the elevation of the maximum tsunami penetration from the shoreline elevation, corrected for the difference in tidal levels between the time of measurement and the time of the tsunami arrival. They defined the "maximum water level" as the difference between the elevation of the highest local water mark from the shoreline elevation, corrected for the difference in tidal levels between the time of measurement and the time of the tsunami attack. See Figure 5. Inundation was defined as the maximum horizontal penetration of the tsunami from the shoreline. (The UNESCO Tsunami Glossary will be revised by an ICG/ITSU working group chaired by the Associate Director of the ITIC.)
- c) Eyewitness interviews provide invaluable information not otherwise available. A prototype interview format should be prepared as soon as possible, translated into the languages of potentially affected countries, and included with the field manual.
- d) There were a number of recommendations regarding field measurements of which runup heights and interviews were viewed as paramount. Other recommendations include:
 - 1) Survey teams spend a day in training before breaking into field parties and each party include at least one local scientist or representative and one person experienced in field surveys.
 - 2) All physical measurements be located as precisely as possible on maps or aerial photographs which are more accurate than GPS measurements, particularly for vertical measurements.
 - 3) Information on damage, causalities, displaced people, health issues should be collected in enough detail to evaluate for possible future mitigation actions.
 - 4) Runup measurements and water level measurements should be plotted on different diagrams or otherwise differentiated.
 - 5) All physical measurements should be accompanied by a diagram indicating the topography near the water mark and a photograph of the site. Whenever possible a surveying transect should be drawn between the water mark and the shoreline.
 - 6) Evidence of direction of flow and strength should be sought including erosion and deposition. The latter may help understand paleotsunami deposits.
 - 7) Evidence of local topography and bathymetry, including evidence of co-seismic uplift or subsidence, and changes in bathymetry indicative of submarine landsliding should be noted along with data on the land surface roughness.
 - 8) At least one site for a detailed survey should be selected including a full transect, histories, and documented effects.

- 9) The survey team should obtain the nearest tidal gauge record available for the site together with calibration information, if possible.
- 10) Copies of newspaper and TV video film and official reports should be gathered, but they do not replace the need for detailed field notes and sketches.
- 11) The dimensions of surviving structures should be measured to provide a scale for aerial photographs.
- *12) Data should be gathered on secondary hazards such as chemical spills, fires, floating projectile damage, etc.

Data Availability

Data collected should be broadly disseminated in a timely manner and permanently archived. Initial reports should be made on the Internet as soon as possible after the teams return. Photographs, charts, and other forms of visual data should be made available on a World Wide Web site which should be further developed. The final reports and scientific papers should be made available on a CD ROM. Published reports are also useful for countries and users who do not have access to computer technology. Data centers are also useful for maintaining collections of reports, files, both computer and hard copy, of marigrams, photographs, maps, etc. (The ITIC will assume the management of the Tsunami Bulletin Board and will post the findings on the Internet and the World Wide Web.)

2. Instrumentation

- a. Shore-side tide gauges are needed for research data at sites outside of harbors in the most exposed area possible. Gauges within harbors are useful mainly for understanding flow within the harbor.
- b. Gauges of either bottom pressure or acoustic types are recommended for both operations and research for both shore-line and open ocean environments. However, these data need special analytic techniques involving an expert for the region affected to decide if a tsunami will result.
- c. Deep water, bottom-mounted pressure sensors, are recommended which should be able to transmit data in real time for warning purposes as well as record them for later retrieval for research purposes. An open ocean monitoring system consisting of three sensors placed in a triangular pattern about 15 km apart would be able to calculate the direction and speed of the tsunami. The information could be transmitted directly to national warning centers. An extensive net of such deep ocean stations is recommended for real time monitoring and research.
- d. The technology for measuring tsunami current flows near the coast should be improved.
- e. Deep water and additional near-shore gauges should be located based on the tsunami potential of the area such as the Aleutian Islands, Chile, Kamchatka, Philippine region, Kuril Islands, Indonesia and Mexico. The specific areas need to be identified and prioritized. A Pacific-rim consortium should be formed to seek national and international support for instrumentation in these regions.
- f. There is need for data on height of surges and inundation which may be detected by low-cost pressure gauges, surge gauges, videos, aerial and satellite imagery surveys and ground surveys. A study should be done to determine the best method of gathering these data.
- g. The data should be available on the Internet and personal communication services from satellite when these become available.
- *h. There was a general discussion that the quality of the instrumentation and its distribution should be improved. The recent loss of instruments in the Russian Far East marigrams due to budgetary problems and the lack of instruments elsewhere create gaps in the warning information system and the recent "false alarms" probably have cost the U.S. alone many tens of millions of dollars in unnecessary evacuations. (The ICG/ITSU commented on the need for instruments in Russia for the benefit of all of the North Pacific.)

3. Modeling

- a. All tsunami modeling efforts depend heavily on the assumed initial conditions. Accuracy of the input data for the model is critical to the predictions. The present practice in determination of the initial conditions is to assume that the initial water-surface displacement is the same as the sea floor deformation. The sea floor deformation is usually determined from seismic parameters using a model describing the fault zone motion, such as the elastic dislocation theory. There have been several clear examples that the prediction performance of the theory is not satisfactory. Improvements to the theory are urgently needed. Furthermore, deep-water or open-coast measurements, if available, should be used directly in numerical models as input data.
- b. To predict accurately the runup distribution in a coastal area, high resolution bathymetry and topography data are essential for the models. For modeling purposes, the post-tsunami survey should include the collection of detailed topography and bathymetry data. Also, the topography and bathymetry data in high-risk regions should be documented and be maintained in a designated data center.
- c. To create inundation maps, the "design tsunami" must be identified. Three methods of deciding the "design wave" are: 1) use of historical data when there are available over a long enough time period, 2) use of statistical properties of earthquake data, including geophysical factors such as the magnitude, depth, length of rupture, return interval and other fault parameters, 3) use of extreme event based on a seismic gap. For the projection of the extent of the evacuation zone, events with a long recurrence interval should be used.
- d. Models should be developed and used to predict, in real time, the amplitudes expected from tsunamis for use in warnings and emergency operations. The four divisions currently used by Japanese Meteorological Agency (JMA) for a major tsunami, expected amplitude greater than 3 meters, amplitudes between 1 and 3 meters, amplitudes of 1 meter or less expected, and no tsunami expected, should be applicable for most areas. The most important factor is that there be some breakdown with respect to risk. This should help reduce the "false alarm" problem of warnings and costly evacuations, when no hazardous tsunami is generated. These "false alarms" also reduce the credibility of future warnings.
- e. With real-time modeling computations it may be impossible at present, to produce the information for an initial warning for near-source tsunamis, which must be issued within 3 minutes of an earthquake. However, a catalog of tsunami runup along coastlines can be generated by the models using a set of various hypothetical earthquakes with different magnitudes, orientations, and locations. These results can be used to find the estimated tsunami effects in the event of a real earthquake by interpolating the preexisting predictions. This work is in progress by the JMA. Note that this procedure cannot give accurate results in the case of "tsunami earthquakes", hence some safety factor must be included. In addition, detailed numerical modeling is still required so that tsunami warnings can be modified or canceled.
- f. The whole workshop recommended continuation of support for the development of the TIME system for use as a planning and training tool. (The ICG/ITSU included this in its funding proposal.)

4. Mitigation

- a. Definition of the inundation zone can be used for land use planning, including the exclusion from the zone of critical facilities such as hospitals, police and fire stations, high occupancy buildings such as schools, etc., and potentially hazardous facilities such as chemical and oil storage facilities. Insurance and design standards can be required where critical facilities such as port and harbor facilities, bridges, etc., must be in the hazard zone.
- b. There needs to be a better understanding of the wave profile, current effects and wave impacts, and potential for floating projectiles for design standards.

- *c. Education is needed for both officials and the general public on the nature of tsunamis. Information such as: the first wave is not usually the highest, the hazard can continue for many hours, and when in a safe place one should remain there and not attempt to save property, or rejoin companions is significant. Education may be the best mitigation strategy for some local tsunamis where the evacuation time may be only several minutes.
- *d. Detailed histories of past occurrences are important in understanding the nature of the local hazard, a necessary first step in designing effective mitigation plans. Many areas do not yet have adequate histories, including localities in the South Pacific, Indonesia, South America and the Caribbean. (ICG/ITSU member countries were requested to develop and keep updated detailed historical tsunami catalogs of their countries and keep ITIC and IOC informed of the progress.)
- *e. Research is needed into the source mechanisms of tsunamis. Different types of tsunamis are generated by thrust faulting such as is associated with major Pacific-wide tsunamis originating in subduction zones, normal faulting, landslides, and the several types of volcanic sources. Seismic source information seems to have relevance only for the normal faulting type of source.

5. *General Recommendations*

In addition to the general recommendation regarding the continuation of support for the TIME Project, the group as a whole made three other recommendations.

- a. Support should continue for the development of the Expert Tsunami Data Base as an information source and training tool. (This is being developed by Dr. Gushiakov and supported by the IOC which has been requested to continue funding for this project, including full compatibility with NOAA's National Geophysical Data Center's tsunami event and effect files and bathymetry.)
- b. The workshop recommended the establishment of Tsunami Data Centers, initially in Japan, Russia, and the USA. The centers would manage and maintain data such as:
 - 1) Bathymetric and topographic data.
 - 2) Lists of available instruments including marigraphs, their location and managing agency.
 - 3) Tsunami occurrence and effects data, tide gauge data and bottom pressure sensor data, etc.
 - 4) Field survey data, documentation, WWW access.
 - 5) Lists of numerical models and their documentation.
 - 6) Available inundation maps.
 - 7) Tsunami literature.
- c. There was wide comment that the two days were not enough to adequately address all of the questions needing discussion and that another workshop should be held in the future. Such a follow-up workshop would have time for state of the art presentations and be focused on identified unanswered questions. Workshops have the potential to address broad strategic topics in the field which cannot be addressed at symposia and commission meetings. (ICG/ITSU recommended support, in the form of travel grants for a few participants, for a Russian proposal to hold a workshop at Lake Baikal, Russia, in August 1996 on Tsunami Mitigation and Risk Assessment.) This may address some of the questions remaining from the Measurements Workshop.

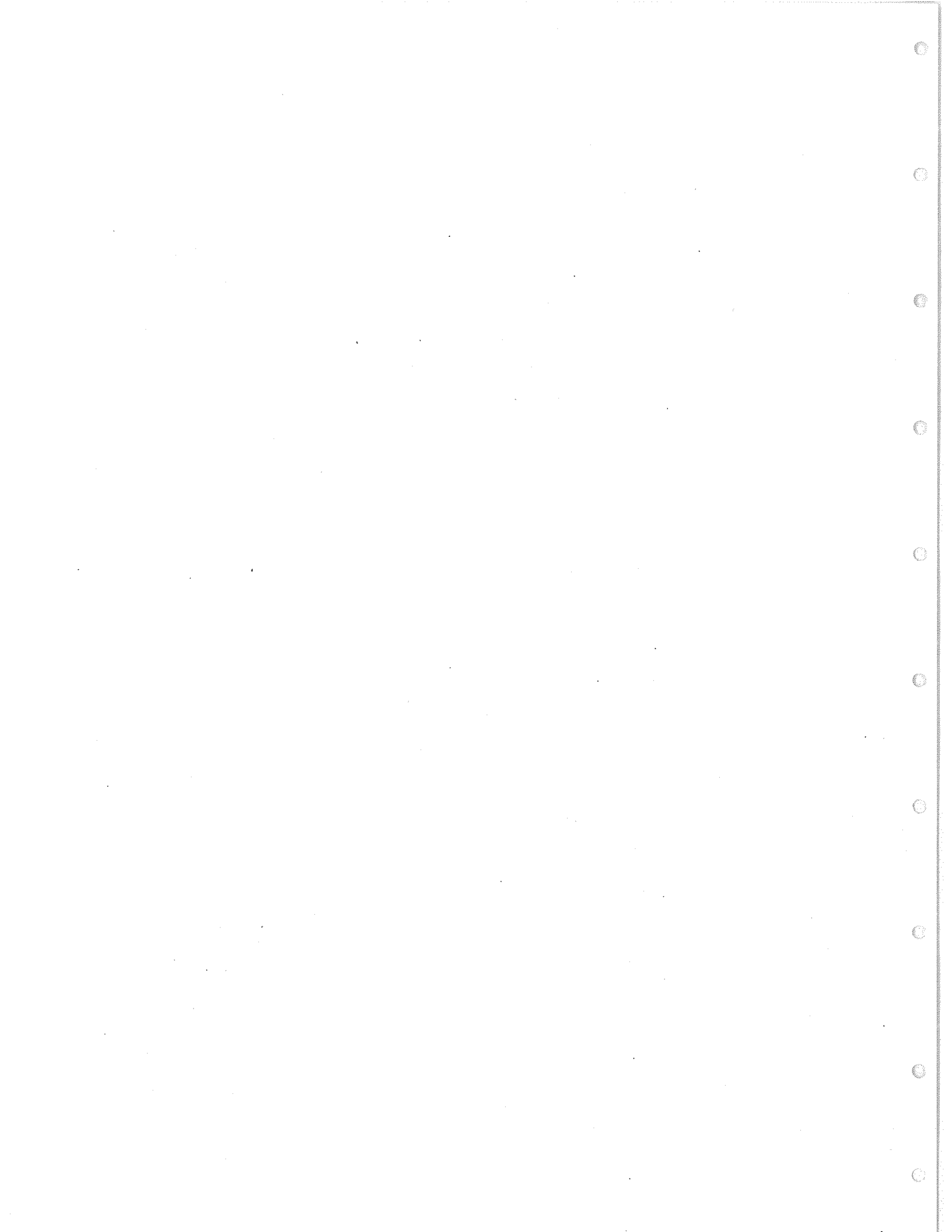

APPENDICES

The following are taken from the working group reports as background information on their recommendations given above, a summary of the UNESCO/IOC International Coordination Group for the Tsunami Warning System in the Pacific (ICG/ITSU) meeting relevant to the workshop, and copies of some of the papers distributed at the workshop.

| | |
|-------------|--|
| Appendix A1 | International Tsunami Survey Working Group Report |
| Appendix A2 | Recommended Components of a Post-Tsunami Eyewitness Interview |
| Appendix A3 | Instrumentation |
| Appendix A4 | Instrumentation - preliminary report |
| Appendix A5 | Modeling and Mitigation |
| Appendix B1 | ICG/ITSU Summary Report - Ferraras |
| Appendix B2 | Tsunami Warning System Workshop Report (September 14-15, 1994) by Michael Blackford and Hiroo Kanamori |
| Appendix C1 | Tsunami Reconnaissance Procedures by Harry Yeh |
| Appendix C2 | Standards for Tsunami Surveying by Dennis Sigrist and Salvador Ferraras |
| Appendix C3 | A Note on Recent Development of Tsunami Works in JMA by Masami Okada |
| Appendix C4 | Characteristics of the 1994 Hokkaido-East-Off Earthquake Tsunami, the 1994 Sanriku-far off Earthquake, and 1995 Hyogo-Prefecture South Earthquake Tsunami based on the Field Observation Data by T. Naigai, et al. |
| Appendix C5 | Research Needs: Public Health Impacts of Tsunamis by Josephine Malilay |
| Appendix C6 | On the Problems and Prospects of the Timely Tsunami Dection by E.A. Kulikov, et al. |
| Appendix C7 | Tsunami Profiles Observed at the NOWPHAS Offshore Wave Stations by T. Nagal, et al |
| Appendix D | Workshop Participants List |
| Appendix E | ACRONYMS |

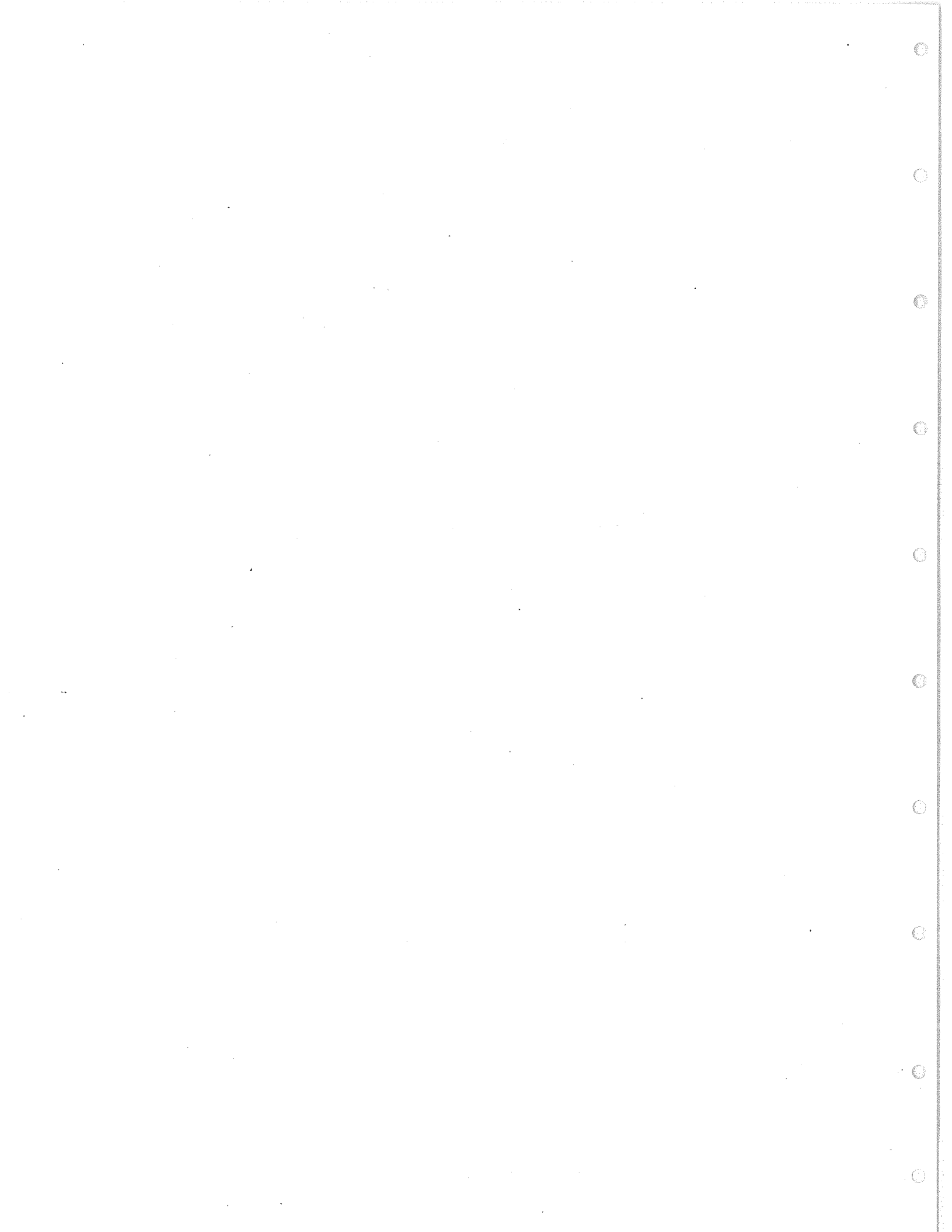

APPENDIX A1

INTERNATIONAL TSUNAMI SURVEY WORKING GROUP REPORT

RECOMMENDATIONS OF THE FIELD SURVEY GROUP REGARDING THE IMPLEMENTATION OF RECONNAISSANCE SURVEYS FOLLOWING TSUNAMI EVENTS

Compiled by Jody Bourgeois and Costas Synolakis

PREAMBLE

The Field Survey Group (FSG) first identified the mission of the group within the Measurements Workshop assembly:

1. to make recommendations for organizing field surveys;
2. to recommend guidelines for standardizing survey procedures; and
3. to identify needs for facilitating such surveys.

The FSG then outlined the goals of basic field measurements and assembly of field data, as follows:

1. to aid in natural-hazards planning;
2. to contribute to modeling of tsunami runup and of source motion; and
3. to evaluate and calibrate paleo-tsunami interpretations of sediment deposits.

Other goals include the use of this fortuitous immediate contact with local authorities and residents to communicate direct and indirect hazards, such as public-health risks, and to suggest, whenever possible, simple mitigation measures. Also, such surveys are important opportunities for the training of local and international scientists and students in tsunami surveying and hazard mitigation.

With these goals in perspective, members of the group shared experiences of the community from the six tsunami surveys of 1992-1994 and then discussed the current status of pre-survey preparation (e.g., communication, organization, funding, interaction with affected countries), field procedures (e.g., types of measurements needed, professional expertise required, survey protocol, time-frame and interview protocols), and post-survey data preparation and dissemination. In this manner, the group formulated recommendations in four areas: A) survey initiation, B) access to the affected area, C) field implementation and D) data dissemination. The group reached the following conclusions and recommendations which were presented and accepted by the entire workshop assembly.

A. Survey Initiation

To date, tsunami field surveys have been initiated primarily by individual scientists or small groups from individual countries who have arranged for their own funding from national and more rarely, from international sources. Pre-survey communication has been greatly facilitated by the Internet Tsunami Bulletin Board (TBB), initiated after the 1992 Nicaragua event. In general, international groups, coming together somewhat haphazardly, have met with national groups in affected countries, and after the survey, have reported their findings to local authorities. This process does not always ensure that the national or international community is well represented, and it relies on sources of funding which may not always be reliable, or may not respond quickly enough, so that valuable field data may be lost. Local scientists in particular have the opportunity for quick-response surveys, so it is important to provide opportunities for training in survey work to as many scientists as possible, particularly from countries vulnerable to tsunami attack. Therefore, funding should in particular be available to enable participation of scientists without direct access to funding in their own countries, as well as to ensure that necessary expertises be represented in any survey. To these ends, we recommend:

1. An international body such as the ITIC should enhance and maintain current lists of scientists with specific areas of field expertise useful in tsunami surveys. These areas include aspects of oceanography, engineering, seismology, geology, sedimentology, land-surveying, sociology, urban planning, and public health. The TBB should be used to develop and disseminate this information.
2. Following an event, international and local contacts ("point persons") should be identified (by ITIC?) in order to coordinate survey efforts — facilitating communication, easing the burden on locally affected regions and their residents, and eliminating duplication of effort insofar as possible. This coordination should not be aimed at excluding any individual from the effort, but rather at maximizing the effectiveness of surveys while remaining sensitive to local communities and cultures.
3. A fund of \$50K to \$100K (U.S.) per tsunami event should be sought and made available through the IOC to support participation of scientists with no access to other funding, and to ensure as thorough a survey as possible. (Other) potential sources of quick-response funding (such as the SGER program of the U.S. National Science Foundation) should be identified NOW so that surveyors are prepared to act quickly in seeking such funding after tsunami events.
4. Funds should also be made available for training scientists and students from countries vulnerable to tsunami attack both in field-survey techniques and in principles of hazard mitigation.
5. We have no specific recommendations regarding which events should be surveyed and which may not warrant the expense. We emphasize that even relatively small events may offer opportunities for basic research, education and training sufficient to warrant an international field survey.

B. Access to the Affected Area

International surveys not only benefit from cooperation of local communities, but also need to recognize that local scientists and authorities possess invaluable knowledge and expertise. Our group discussion noted that the organization of the international community and their communication with local authorities needs improvement, as the latter are usually inundated with requests for field reports, databases, invitation letters and visas, all at a rather inopportune time. To this end, the group recommends:

1. An international body such as the IOC or ITIC should maintain relevant lists of national and local scientists and officials in potentially affected countries. At the time of a natural catastrophe, the international community should strive to communicate with representatives of the affected region only through this international body, showing sensitivity to local needs, culture and customs.
2. International agreements should be pre-arranged NOW between or among different countries to enable the rapid issuance of visas and invitation letters as necessary.
3. An international body as above, or any of the tsunami warning or information centers, should assemble and maintain archives of maps (bathymetry and topography at a scale of 1:50,000 or finer), aerial photos and tidal gauge locations for areas of high vulnerability to tsunami attack. In addition, they should maintain lists of organization names, contact names and addresses of sources for these materials for all tsunami-prone areas of the world, including the Pacific, the Americas, and the Mediterranean. If such materials are not presently available for relevant areas, efforts to establish databases should be undertaken NOW.

C. Field Implementation

The group reviewed the various types of information past survey teams have gathered in the field. We attempted to identify all kinds of measurements that could be made, and to make recommendations for carrying out such measurements. This effort was significantly aided by a draft manuscript, "Standards for Tsunami Surveying" prepared by Dennis Sigrist and Salvador Ferreras (ITIC, IOC/UNESCO). In particular, our group concentrated on protocol for runup measurements and for conducting eyewitness interviews. General recommendations include:

1. A field manual (simple, easy to carry, read and understand!) for conducting tsunami field surveys

should be prepared. This guidebook should be translated into the languages of potentially affected countries and be made available NOW to local scientists and authorities. Diagrams of techniques, examples of collected field data, and a glossary of terms would be useful. We have made some more specific recommendations with regard to a manual (see details below) and have also provided feedback to Sigrist and Farreras for their prototype.

2. The community must agree on standards for runup measurements and reporting, in order to allow widespread use and future value of such data (see details below).
3. Eyewitness interviews provide invaluable information, commonly not otherwise available. A prototype interview format should be prepared NOW, translated into the languages of potentially affected countries, and included with the field manual (see details below).
4. Field Measurements. The group discussed at length the kinds of measurements a field survey should include, and noted that field surveyors must know how to evaluate and report on the quality of collected data. We recommend that the survey team as a whole include expertises as noted above (A.1), that the team spend a day in training before breaking up into field parties, and that each field party include at least one local scientist/representative, as well as at least one person with prior surveying experience. All physical measurements should be located as precisely as possible on maps or air photos; field notetaking may be aided by enlarging (by photocopy) maps before embarking. As much as possible, various measurements should be coupled to enhance their usefulness.

Foremost amongst recommended field measurements are a) runup data (and related measurements, see 5 below) and b) interviews (see 6 below). Other measurements that should be made (and/or collected in interviews) include, in no particular order: c) damage — both structural and non-structural (include damage report form in manual, distinguish earthquake from tsunami damage); d) casualties, displaced persons, post-tsunami effects, such as diseases, changes in water quality (if possible, distinguish earthquake from tsunami effects); e) tsunami erosion and deposition, including characteristics of deposits, possibly samples; f) local bathymetry and topography including changes produced by events; g) land surface roughness (as it would have been during events); h) evidence of flow direction and flow strength; and i) land-level changes (e.g., co-seismic subsidence). Evaluation would be aided by expertise in botany and coastal biology. Interviews can be invaluable in helping to distinguish actual effects of the events (earthquakes, tsunami waves) from pre-event conditions and post-event changes.

One or more detailed site surveys, complete case histories, documenting all effects of the events, should be conducted. In addition, sites for future detailed studies (e.g., of tsunami deposits) should be identified.

Written notes, report forms, sketches, photographs, and video and audio records may make up aspects of these measurements. The latter (photos, video, audio) should only augment and not replace field notetaking. Additional information may come from newspaper, radio and TV reports, videos, and other local sources.

Field equipment should be as simple and effective as possible for rapid surveying; fundamental measurements should include location, and vertical and horizontal differences. This equipment should be described in the field manual. Portable GPS systems may be useful, but currently, good maps and air photos are more accurate for plotting information than (easily) available GPS technology, particularly for vertical measurements.

If time, manpower and funding are sufficient, more advanced technologies may be used. In remote locations, portable seismographs may provide valuable aftershock data.

5. Runup. The group discussed the difficulties of interpreting runup data from different surveys and authors because of uncertainties relating to variances in definitions of "runup" and "inundation," in the chosen reference datum (not always reported!), and in quality control of collected data. The group also discussed that some indicators may be the result of "splash" or damage from floating

debris, but had no panacea for evaluating such effects, only recommending thorough reporting so that others can decide how to use the data. The group also discussed the difference between the vertical elevation at maximum penetration and the maximum water level inferred from water marks on buildings and trees, noting that both kinds of measurements can be important, especially where local topography is complex. The following recommendations, insofar as possible, should be represented in a field manual:

- a. The group advocated the following definitions of maximum runup, maximum water level, and inundation for field work.

Maximum runup is the difference between the elevation of maximum tsunami penetration and the elevation of the shoreline at the time of tsunami attack (i.e., corrected for the difference in shoreline elevation between the time of measurement and the time of tsunami attack).

Maximum water level is the difference between the elevation of the highest local water mark and the elevation of the shoreline at the time of tsunami attack (i.e., corrected for the difference in shoreline elevation between the time of measurement and the time of tsunami attack).

Inundation is the maximum horizontal penetration of the tsunami from the shoreline.

- b. As many measurements as possible should be made of runup and water level, with precise locations of measurements plotted on maps or air photos (optionally also by GPS), and preferably with sketches of the measurements, as well as photos. In order to make appropriate corrections, field parties **MUST** note the **TIME** of field measurements, must note local sea level at that time, and must seek out tide gauge data (or at minimum eyewitness information) so that they may ascertain sea level at the time immediately preceding the tsunami attack.
 - c. Field parties should be trained to identify various signs of tsunami water level, to evaluate the reliability of different kinds of field data, and to report such information as completely as possible.
 - d. At a minimum, at each site, maximum runup and maximum water level (which may in some cases be the same measurement) should be measured. The two kinds of data should either be plotted on separate diagrams or be distinguished by different symbols.
 - e. Whenever possible, a surveying transect should be measured and drawn between the watermark and the shoreline (and even into the surf zone). A full transect should be drawn for at least one site. These measurements of topography and near shore bathymetry can be invaluable for modeling tsunami runup and sediment transport. The field manual should review basic technique.
 - f. If possible, leave markers at key measurement sites for future reference.
 - g. The survey team should obtain the nearest tidal gauge records available for the site.
 - h. The dimensions of local reference points (e.g., of a remaining house) should be measured in order to calibrate stereo air photographs.
6. Interviews. Whenever possible, interviews should be conducted by local representatives, as interviewers should be sensitive to the emotional condition and cultural practices of interviewees. Also obviously, a native-language speaker will facilitate the process. Interviewers should also be aware of certain pitfalls in collecting eyewitness data (see Appendix A.2, p.25). Non-technical language should be used, and leading questions (i.e., questions that suggest an answer) should be avoided.

Although reliability of information will vary, interviews potentially provide significant information otherwise not available. Our group noted that such information includes the character of the wave(s), as well as the physical conditions preceding the events and changes made (such as damage

clean-up) after the event but before the survey. If both the earthquake and the tsunami were damaging, eyewitnesses will be able to help distinguish the two.

Appended is a sample draft of an eyewitness interview, based on group experience and discussions, and principally compiled at the meeting by Yoshinobu Tsuji and Victor Kaistrenko.

As noted above, we recommend that such an interview form be translated and made available to countries susceptible to tsunamis.

D. Data Dissemination

Clearly, results from surveys must be made widely available in order to benefit the public as well as the scientific community who will use these data. We recommend broad dissemination of survey reports and accessible storage of all types of survey and related data, as follows:

1. Basic field-survey reports should be posted on the Internet (Tsunami Bulletin Board) as soon as practical after the return of the survey team(s). The TBB has already been developed (by NOAA of the U.S.) and should now be maintained by the ITIC.
2. Photographs, charts and other forms of visual (and accompanying text) data should be posted on World Wide Web sites. The WWW can also be used effectively to point to data repositories. WWW sites should be further developed (with funding made available for such development), with attention to levels of interest and access, from general public to community planners to scientists. After development, the WWW network could also be maintained by the ITIC.
3. Survey reports can also be made available on CD-ROM.
4. Whereas some potentially affected countries (or parts thereof) do not have broad access to these technologies, concise written reports should also be made available.
5. All data accumulated from field surveys, as well as other relevant data (bathymetric maps, marigrams, modeling efforts, etc.) should be made broadly available through tsunami data centers.

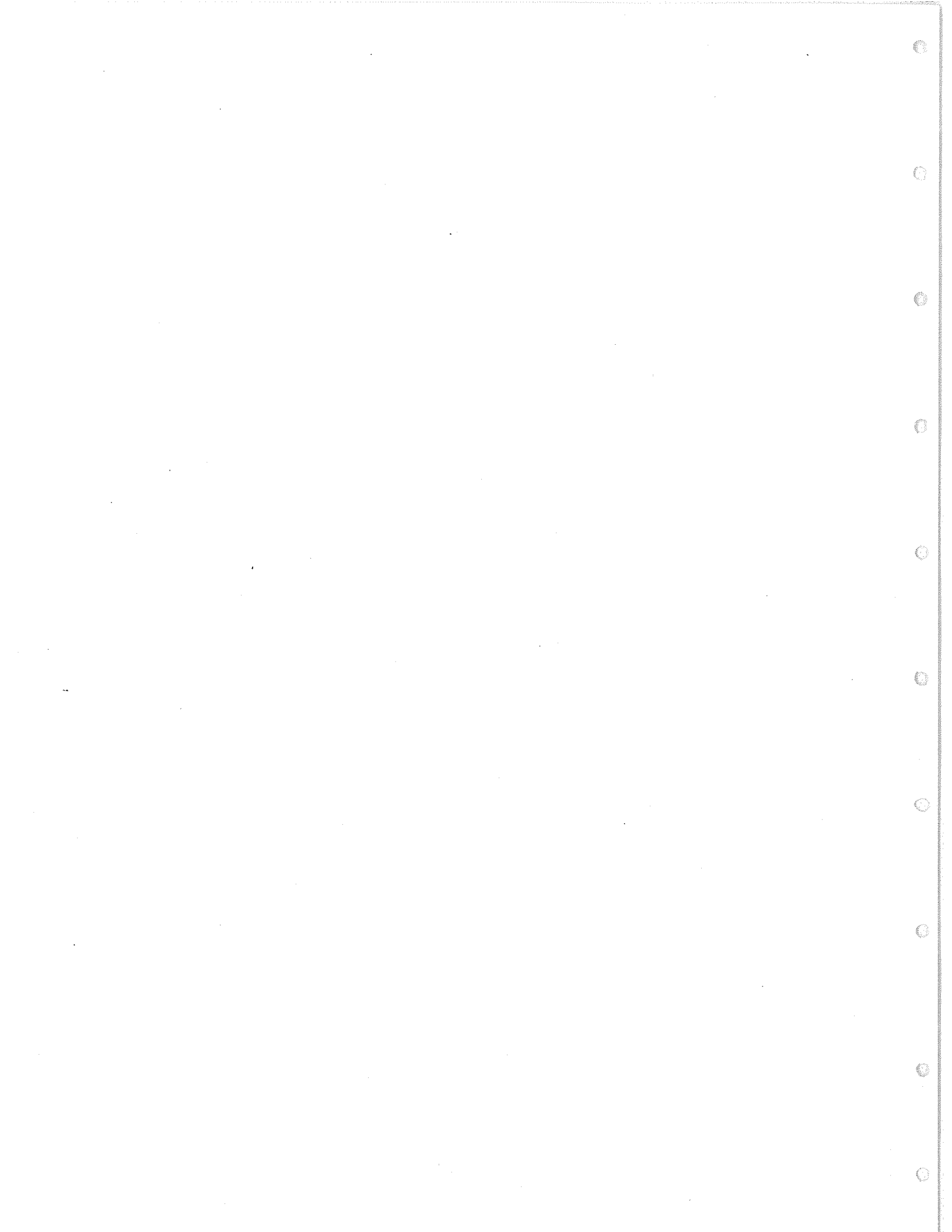

APPENDIX A2

RECOMMENDED COMPONENTS OF A POST-TSUNAMI EYEWITNESS INTERVIEW

As noted above, whenever possible, interviews should be conducted by local representatives, as interviewers should be sensitive to the emotional condition and cultural practices of interviewees. Also obviously, a native-language speaker will facilitate the process. Interviewers should also be aware of certain pitfalls in collecting eyewitness data. For example, interviewees should be asked to indicate physical location of water levels, rather than to state numerical elevations of water. Non-technical language should be used, and leading questions (i.e., questions that suggest the wording of an answer) should be avoided. In general, questions asking eyewitnesses to describe observations in their own words will elicit more reliable information than yes/no questions, or questions where certain words are suggested to the interviewee.

1. BASIC INFORMATION

- a. Interviewer's name, date and time of interview.
- b. Interviewee's name, address, profession, gender, age.

Collect various possible place names (town, village, colony, topographic), as these may vary from person to person, and may differ from maps; locate information on maps or air photos (GPS only if map not available).

- c. Where was interviewee 1) before, 2) during and 3) after the event(s)? (Distinguish earthquake, tsunami waves, etc.)

2. EARTHQUAKE INFORMATION

- a. What was the magnitude of the earthquake, as determined from the Mercalli scale — include MMI Table translated into native language.
- b. If earthquake occurred during night, how many people were awake or awakened?
- c. Distinguish mainshock from possible fore- or aftershocks.
- d. Identify casualties and damage from earthquake(s) (include damage report form?).
- e. Eyewitness accounts of liquefaction or sand blows? Cracks in ground? Landslides, rock falls, etc.?
- f. Did well water become muddy? Change level?
- g. Were any precursors to earthquake noticed?

3. TSUNAMI

- a. What was the situation before the tsunami — meteorological conditions, sea level, light conditions, sounds (noise)?
- b. Arrival time of wave(s)?
 - 1) absolute time — by clocks, TV programs, etc.
 - 2) by feeling — time between mainshock and wave arrival (Note that an aftershock may come between mainshock and tsunami arrival time.)
- c. Nature of first wave arrival? (Interviewer may ask, e.g., if water went out first, but this can be a leading question — try to get witness to describe water behavior without leading them on.)
- d. How many times did water rise (How many waves were there)?

How much time between waves? (Did water completely withdraw and come back again? Did people return to houses in between?...)

What was the relative size of waves (Which was largest, etc.)?

- e. What did the wave(s) look like?
e.g., calm, slow flooding (like a fast tide); like a river, like a swell (with white cap, like a breaking wave) like a wall (bore)?
- f. From what direction did the water come, in which direction did it go?
- g. Describe any sounds or noise associated with the tsunami waves — before the arrival? —at the time of arrival?
e.g., like a drum, like thunder, like an airplane, like rain, like a car, like a river, no sound....?
- h. What changes in the land surface did the tsunami make?
Places where there was erosion? (What did it look like before?) Places where it left sediment (deposits)? (What did it look like before?) — identify rocks, debris, houses, ships, etc., moved by tsunami (Where were they before?)
- i. Damage due to the tsunami?
Casualties: number of deaths, number of missing, number of serious injuries, number of minor injuries?
House damage (due to tsunami): number swept away, number totally destroyed, number partially destroyed, number flooded?
Damage to cars, ships, port facilities, roads, agricultural fields, etc.?
Health effects since the events — diseases, changes in water quality/availability, etc.?
- j. Area inundated by tsunami?
Indicate physical points (e.g., on houses, trees, fences) to which water rose; maximum distance inland water reached (locate physically)?
- k. Estimates of how far down/out the water shifted before or between waves (Reliability of these answers may be particularly shaky)
- l. Precaution and evacuation?
Did they have knowledge/expectation that tsunami would come, before the event? Had they received any education? Experience of or knowledge of previous events? How did they escape? Were there obstacles?

4. AFTERSHOCKS AND AFTERSHOCK TSUNAMIS?

If these occurred, the same basic questions need to be asked, as above, about earthquake(s) and tsunami.

5. CRUSTAL MOVEMENT?

These indicators may not be obvious or easy to distinguish in the time shortly following the event — weeks to months will help clarify temporary changes (e.g., flooding) from actual crustal deformation.

- a. Has sea level changed since the event(s)?
- b. Rocks or coral reefs emerged? By how much? (Be careful to distinguish rocks or coral moved by the tsunami from bedrock or attached coral uplifted by crustal deformation.)
- c. Areas now submerged? By how much? (Be careful to distinguish changes due to erosion or temporarily undrained flooding from indications of permanent land level change.)

6. OTHER INFORMATION/INFORMANTS

- a. Names of other eyewitnesses? In particular, names of others who may have seen events from different perspectives (e.g., from a hill, from a boat, etc.)?
- b. Knowledge of people who took photographs, videos, etc.?
- c. Knowledge of others who have collected interviews, data?

7. FOR THOSE WHO WERE IN BOATS

- a. (As above, determine where they were, etc., before, during and after — where is boat now?)
- b. What did the sea surface look like? (e.g., boiling, shaking, forming ripples or waves)
- c. How did the boat behave? Was there damage to the ship/boat?
- d. Did you note any other phenomena? (e.g., fish behavior, light, etc.)

8. FOR OLDER PERSONS

- a. Have you experienced any other events like this in your lifetime? (When? Describe such events.)
- b. Did your parents/grandparents experience any such events?
- c. Do you know of stories or legends of such events that have been handed down?

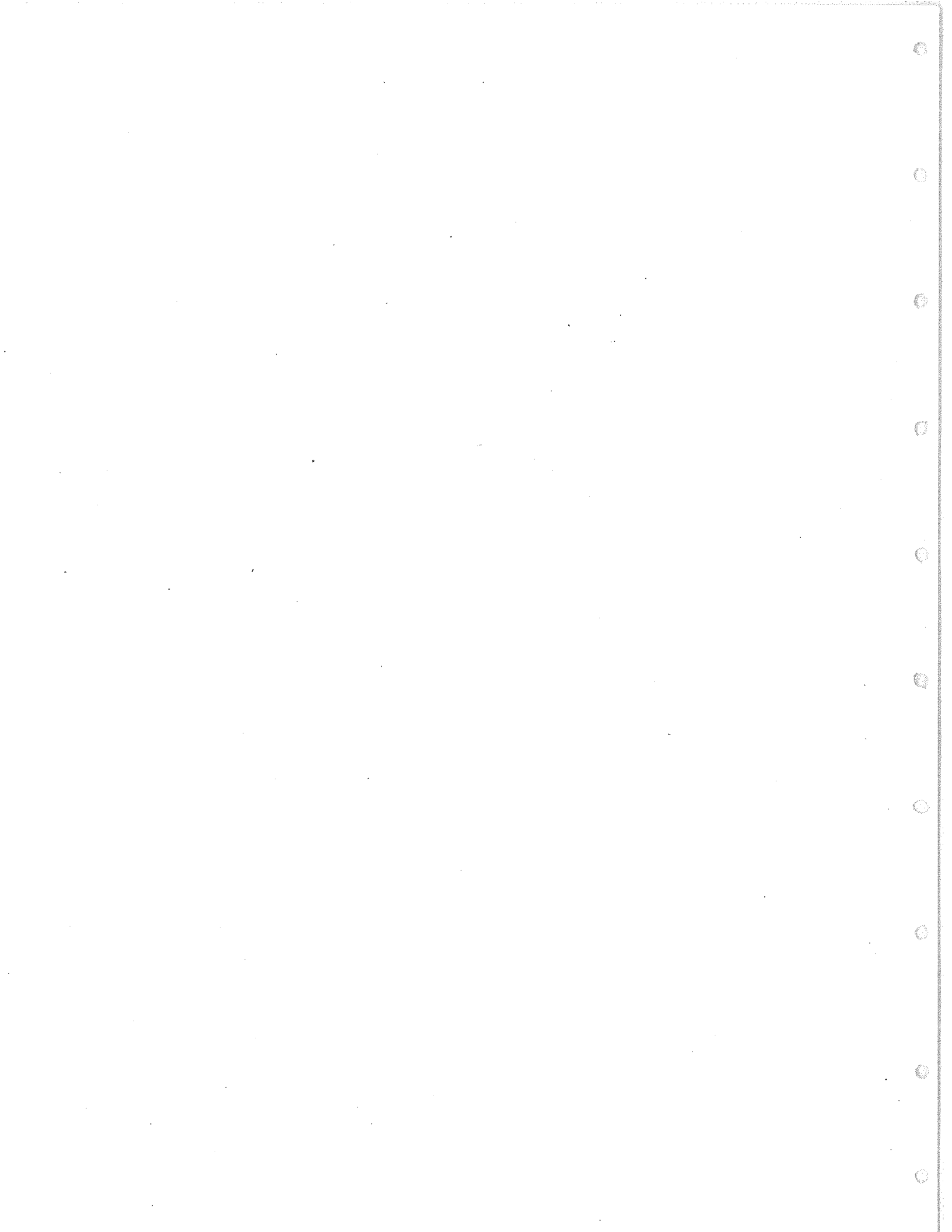

APPENDIX A3

INSTRUMENTATION

INSTRUMENTATION GROUP REPORT AND RECOMMENDATIONS

Prepared by A. Rabinovich, G. Howell, S. Mausshardt, F. Gonzalez

1. THE PROBLEM

The primary problem is the well-known lack of high quality tsunami field measurements, both for operational tsunami warning activities and for research.

2. INSTRUMENTATION GROUP GOAL AND PHILOSOPHY

The Instrumentation Group (IG) felt that our primary goal was to provide recommendations on how best to improve existing tsunami measurement capabilities for both operations and research.

Early in the deliberations, the group adopted three broad, fundamental principles regarding efforts to improve tsunami instrumentation:

- Concentrate instrumentation in potential tsunamigenic regions;
- Provide real-time data whenever possible;
- Exploit existing infrastructures and ensure multiple use of the data whenever possible.

These principles guided the discussion and provided a framework for the more specific recommendations, below.

3. MEASUREMENTS NEEDED AND EXISTING CAPABILITIES

More data are required in all phases of tsunami evolution, which we take here as: generation, propagation in the deep ocean, transformation in shallow coastal zones, and runup on land (Figure 1)

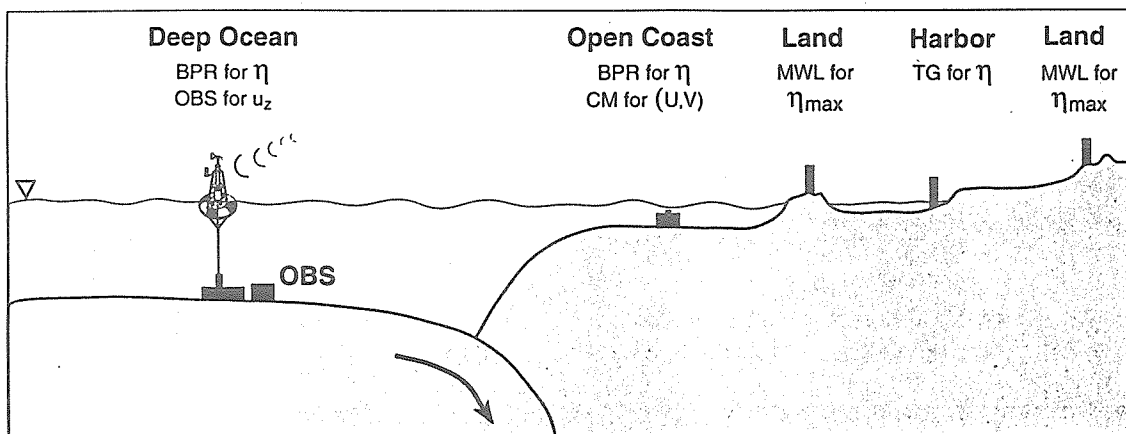

Figure 1. Schematic cross-section of typical tsunamigenic subduction zone with instrumentation sites and variables of interest. Vertical ocean bottom motion is symbolized by u_z .

The following summary table was developed as a guide.

Table 1. Summary of instrumentation which could provide measurements of tsunami variables during various tsunami evolutionary phases.

| Tsunami Phase | Tsunami Variable | Existing Instruments | Development Opportunities | Future Instruments? |
|------------------------------|------------------|------------------------------------|---------------------------|---------------------|
| Generation | Ground Motion | OBS | BPR GPS+model | |
| | Eta (U, V) | BPR Inv. Fath. Current Meter | HF Radar | |
| Deep Water Propagation | Eta | BPR | | KGPS + bouy |
| Shallow Water Transformation | Eta | BPR Inv. Fath. Tide Gauge | | |
| | (U,V) | Current meter | HF Radar | |
| Runup on Land | Max runup | MWL | Video Pressure loggers | |
| | (U,V) | Current meter | HF Radar | |

Eta = Estimated time of arrival tsunami wave; (U,V) = tsunami current velocities; BPR = Bottom Pressure Recorders; OBS = Ocean Bottom Seismometer; Inv. Fath. = Inverted Fathometer; HF Radar = High Frequency Radar; CM = Current Meter; TG = Tide Gauge; GPS = Geodetic Positioning System; KGPS = Kinematic GPS; MWL = Maximum Water Level gauge (surge gauge)

4. DISCUSSION

Generation. Real-time reporting, near-source BPRs (Figure 2) could provide quick estimates of tsunami amplitude (Eble and Gonzalez, 1991; Gonzalez et al., 1991; Gonzalez and Milburn, 1995). The main propagation direction could also be estimated if more than one unit was deployed. This real-time information would improve the quality and speed of the Tsunami Warning System and reduce the number of false alarms. If OBS units were also deployed in the crustal deformation region, a time history of the ocean bottom motion could be obtained. If the generating region was sufficiently shallow, tsunami currents might also be measurable by current meters. In addition to their immediate operational value, all of these data are especially important for research into details of the tsunami generation process that are presently poorly understood.

Deep Water Propagation. Once generated, the amplitude and direction of the tsunami in the deep ocean could be estimated and reported in real time, using deep ocean BPR stations (Figure 2), benefitting both operations and research. Another potential technology for this task is the use of KGPS to measure buoy movements due to the passage of the tsunami.

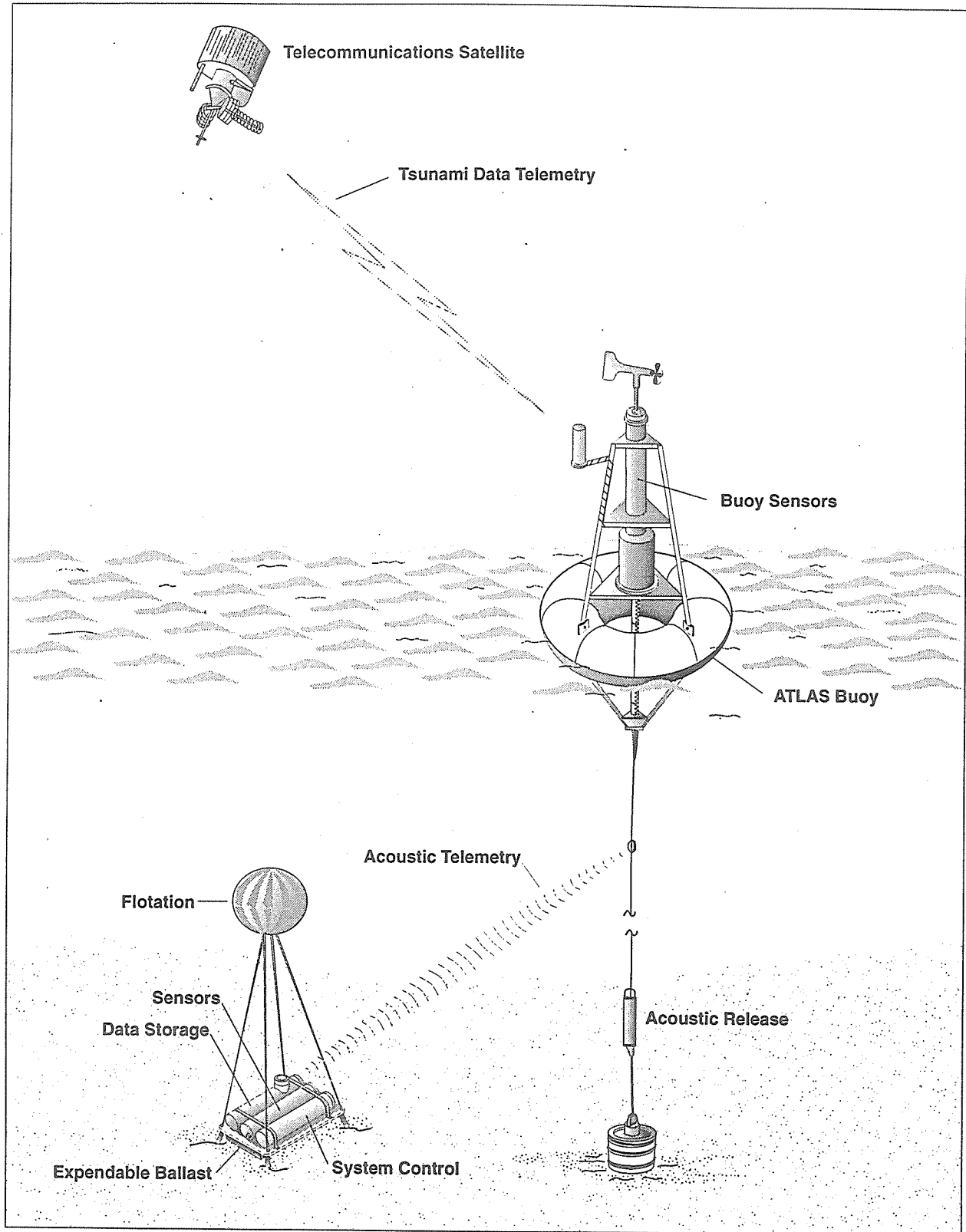

Figure 2. (a) Configuration of deep ocean Tsunami Real-Time Reporting (TR-TR) system, (b) Prototype deployment data. The system was deployed on 23 May 1995, and is successfully transmitting bottom pressure measurements via satellite.

Test Deployment of Prototype Tsunami Real-Time Reporting System

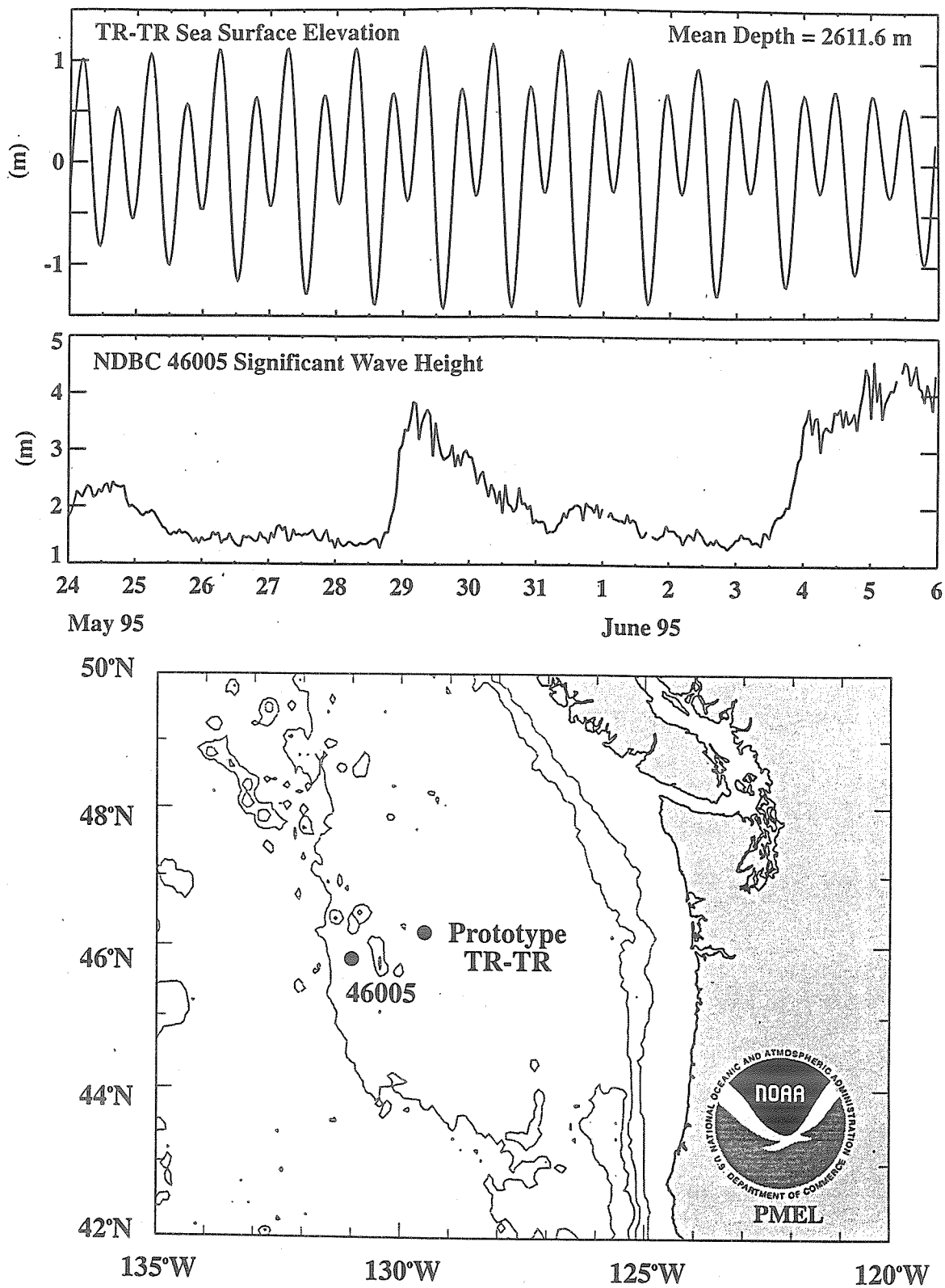
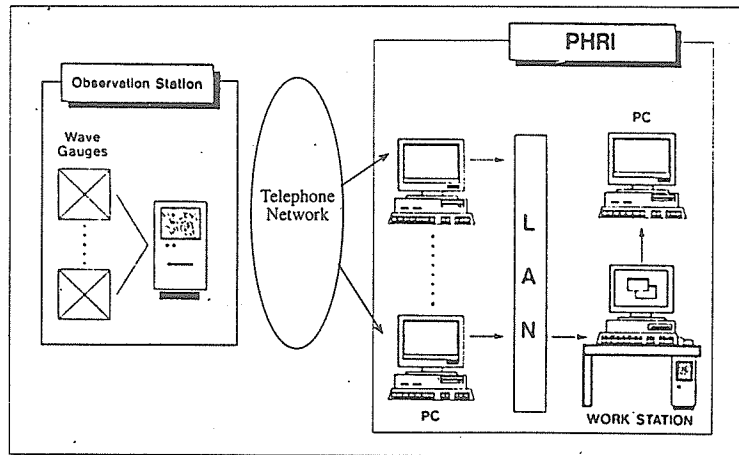
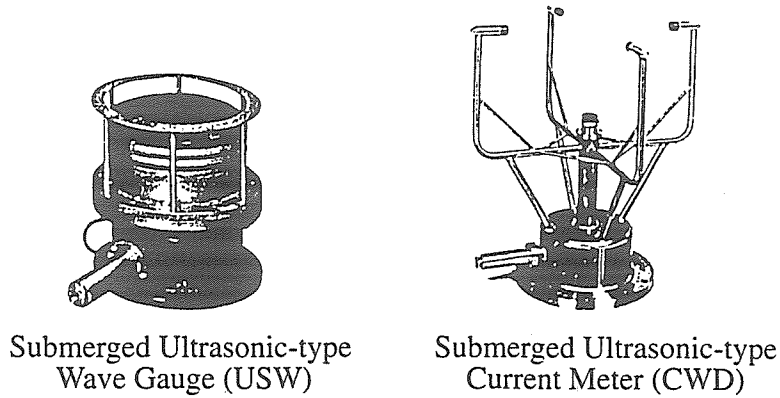

Figure 2b.

Shallow Water Transformation. Real-time BPR or Inverted Fathometer measurements, as well as current meter measurements (Nagai et al., 1994; Flick et al., 1995) at exposed, open coast locations are highly desirable for both operations and research (Figure 3). Tsunami current data in shallow water would be particularly useful to both operations and research. The technology for these flow measurements should be improved and tested. Because of local resonances, open coast measurements would be more appropriate than similar measurements inside of harbors. However, in the absence of open coast measurements, harbor measurements are still of use to both operations and research. In particular, harbor measurements are intrinsically useful for local tsunami-zoning and/or estimation of bay/harbor response.



Real-Time Data Collection System

Figure 3. Schematic of system for measurement and real-time reporting of coastal waves and currents (adapted from Nagai, et al., 1994).

Runup on Land. Maximum water level (MWL) recorders (Figure 4) have been used very effectively by the storm surge community (Saville, 1957; Howell et al., 1982). These are low-cost, passive devices which could be deployed either years in advance, or in a fast-response mode, along coastlines most likely to be hit by a tsunami. Similarly, low-cost pressure loggers could be developed that would be deployed on land and triggered by the tsunami to begin recording water level; this would have the great advantage of providing time series of runup on land. Videos are also very informative for runup measurements, but the technique is more expensive and the data are difficult to reduce and analyze. A study should be conducted about these various options.

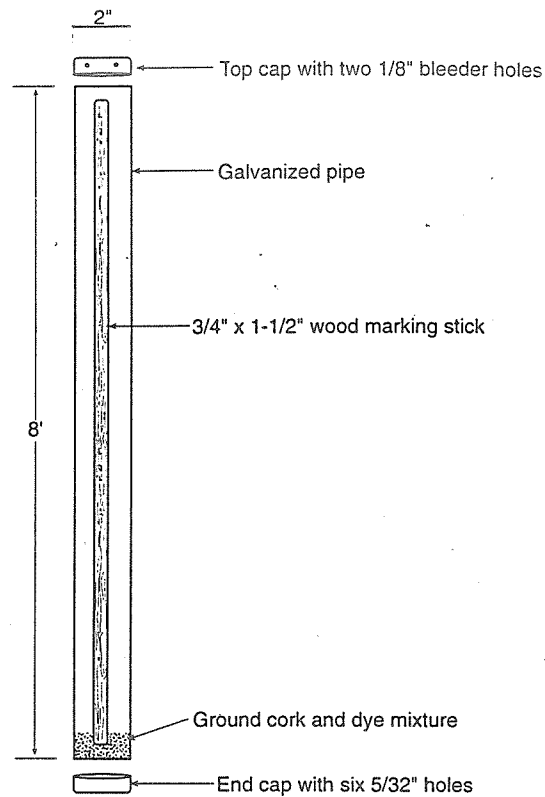

Figure 4. Schematic of Maximum Water Level (storm surge) gauge.

Cost Estimates. The IG attempted rough estimates of initial and maintenance costs for available field instrumentation. It is important to note that a benefit analysis was not attempted, and that this benefit analysis would be necessary before establishing spending priorities.

Table 2. Rough estimates of instrumentation cost.

| Instrumentation | Initial Cost | Yearly Maintenance |
|-------------------------|-----------------|--------------------|
| BPRS: | | |
| Deep Ocean | L | L |
| Deep Ocean/Real-Time | H | M |
| Shallow Water | M | L |
| Shallow Water/Real-Time | M | M |
| On Land | L | L |
| On Land/Real-Time | L | L |
| Harbor Tide Gauge | L | L |
| Current Meter: | | |
| Shallow Water | M | L |
| Shallow Water/Real-Time | M | M |
| Maximum Water Level | L | L |
| HF Radar | H | H |
| Video | L | H |
| L (Low) | = \$ 0 - 50 K | |
| M (Medium) | = \$ 50 - 100 K | |
| H (High) | => \$100 K. | |

Siting and maintenance. There is a need to focus measurement systems on tsunamigenic regions. However, there will almost certainly be economic and operational maintenance problems with individual sites. In terms of the operational setting, there is a need for continuity and maintenance. Warning specialists must be trained to interpret the data they receive and the tsunami gauges must be maintained. In order to facilitate these efforts, the development of the instrumentation network should exploit the appropriate existing infrastructure, and ensure that the data are collected and provided in such a way that they are of multiple use, i.e., that the data are perceived as valuable by other segments of the research or operational community. For example, open coast platforms such as an oil platforms should be used if possible, and deep ocean pressure data are also valuable for the study of tides and other sea-level phenomena.

Algorithm Development and Data Dissemination. The IG agreed that there is great immediate value in simply providing real-time tsunami measurements to warning centers. However, it was also agreed that this must be considered only a first step. The development of interpretive algorithms for decision making by the warning centers must also be pursued vigorously, to optimize the value of the data to operations. For example, algorithms for tsunami detection in the presence of background noise, and algorithms to relate the real-time measurements to potential impact on specific coastal communities must be developed. Dissemination of the data to the scientific community is also important, and the Internet should be used as much as possible to accomplish this.

Other Issues. Time did not permit full discussion of other measurement techniques important to the tsunami problem. However, the following issues were raised and briefly discussed:

- a. Bathymetry. Accurate near shore bathymetry is essential for modeling but rarely available. Ship-based swath-mapping systems are available, but are very expensive. Airborne lidar systems exist, and these are apparently quite effective, but accurate information on cost and operational status were not available to us.
- b. Topography. Accurate topography is also essential for runup modeling. These data should be somewhat easier to acquire than bathymetry. Again, airborne systems, particularly stereophotographic systems, are capable of providing such data.
- c. Maximum Runup via Aerial Photos. In some cases, aerial stereo photographs of an inundated region may provide estimates of maximum runup values, extending the sometimes limited coverage provided by field survey teams using standard surveying techniques.

5. RECOMMENDATIONS

Keeping in mind the three principles stated in Section 2, we make the following specific recommendations:

- a. Identify and prioritize potential tsunamigenic regions most in need of instrumentation;
- b. Form a "Pacific-Rim Consortium" to seek national and international support for the instrumentation of these regions;
- c. Utilize existing technology at these sites for tsunami measurements in the deep ocean, at open coastal locations, in harbors, and on land;
- d. Encourage research to develop algorithms for the full and effective use of real-time tsunami data into operational procedures.

6. REFERENCES

- Eble, M.C. and F.I. Gonzalez, 1991. Deep-ocean bottom pressure measurements in the Northeast Pacific. *Journal of Atmospheric and Oceanic Technology*, 8, p.221-233.
- Flick, R.E., D.D. McGehee, R.J. Seymour and R.T. Guza, 1995. Coastal Data Information Program. In: *Tsunami Warning System Workshop Report, NOAA Technical Memo ERL-PMEL-105*, p.79-83.
- Gonzalez, F.I., C.L. Mader, M.C. Eble and E.N. Bernard, 1991. The 1987-88 Alaskan bight tsunamis: deep ocean data and model comparisons. *Natural Hazards*, 4, p.119-139.
- Gonzalez, F.I. and H.M. Milburn, 1995. Near-source tsunami measurements for forecast and warning. In: *Tsunami Warning System Workshop Report, NOAA Technical Memo ERL-PMEL-105*, p.75-78.
- Howell, G., D.Y. Lee, and H. Wang, 1982. Storm surge measurements and computations for Hurricane David. *University of Florida, Gainesville. Coastal and Oceanographic Engineering Department, Technical Report UFL/COEL-82/005*.
- Kulikov, E.A., A.B. Rabinovich, A.I. Spirin, S.L. Poole, and S.L. Soloviev, 1983. Measurement of tsunamis in the open ocean. *Marine Geodesy*, 6, p.311-329.
- Kulikov, E.A., 1990. Sea level measurement and tsunami forecasting. *Soviet Meteorology and Hydrology*, no 6, p.61-68.
- Nagai, T., K. Sugahara, N. Hashimoto, T. Asai, S. Higashiyama, K. Toda, 1994. Introduction of Japanese NOWPHAS system and its recent topics. In: *Proceedings of the HYDRO-PORT '94, 19-21 October, 1994, Yokosuka, Japan*, p.67-82.
- Saville, T., 1957: Tests of river crest stage gauge under wave action. U.S Army Corps of Engineers, Washington, D.C. *Bulletin of the Beach Erosion Board*, 11(1).

APPENDIX A4

INSTRUMENTATION — PRELIMINARY REPORT

Prepared by Gary Howell and Alexander Rabinovich

ATTENDEES

Gary Howell (instrument developer in coastal measurement area, extreme events is his specialty), Alexander Rabinovich (Tsunami Center in Moscow, works with data), George Carrier (Harvard, analytic modeler), Lev Utyakov (new devices for long term devices like current meters, deep sea meters based on new principles), Sherrill Maussardt, Frank Gonzalez (PMEL, deep ocean measurements, bottom pressure, aerial photography), Fred Stevenson (dissemination of information to the coast line of Canada), Fredric Raichlen (CalTech, experimental and analytical, underwater landslide generation), Toshikiko Nagai (Japan Marine and Harbor Department), George Kaminsky (near-shore pressure sensors in Washington State, community planning and warning systems), Gus Furumoto (Hawaii, real-time data for near field on water level), Masami Okada (Japan, tsunami observation based on ocean bottom gauge), Yoshinobo Tsuti (Earthquake Institute in Tokyo, ultra-sonic sensors), Mic Moss (44 stations to be updated for tsunami data, 15 sec. data for Frank), Modesto Ortiz (Mexico, numerical modeling for inundation maps, primary sea-level stations), Mike Blackford (Pacific Tsunami Warning Center, real-time instrumentation for critical decisions for mitigation), Guy Gelfenbaum (USGS, flow and sediment transport in coastal areas), Bob Richter (real-time sensors and mitigation), Cliff Astill (NSF).

DISCUSSION OUTLINE

1. Status quo: available instruments and improveable
2. Requirements for new instruments
3. Runup
4. Flow
5. Siting in-situ measurements
6. Data acquisition and dissemination

AVAILABLE INSTRUMENTS

The next step was to list the various instruments which are available and may be in use:

bottom pressure recorders
normal tide gauges
stilling well tide gauge
acoustic-type tide gauges
satellite transmission of data
ADCP - currents
acoustic time transit - flow
HF surface current radar
Max level recorder (runup)
Aerial/satellite photography
Video imaging
sub-water-surface seismometers
differential GPS - kinematic GPS perhaps in the future
standard surveying
standard hydrographic
land pressure
helicopter - LIDAR

We continued our discussion by going over various measurement systems which are in existence today. We had representatives from 5 countries and individuals who had information to present from their respective agencies and countries. Mickey Moss, National Ocean Service (NOS), spoke first about what their work involves. They use a newer stilling well tide gauge which has a larger hole; the data are transmitted via satellite. NOS modified the collection system to collect 1 minute data (58 second avg.) for the Sutron 9000 DCP and it stores the most recent 22 days of 1 minute data. Data can be received from the first site in real-time. They have emergency GOES transmission which will be triggered when there is a dramatic change in pressure or the data can be phoned remotely. However, there is a potential problem with clipping of data. If there is a high tsunami, then there will be data clipping due to the finite height of the well. The second enhancement, the Sutron 8299 DCP, collects 15 second data (it is a pressure gauge) and it stores the most recent 5 days of 15 second data. Data cannot be accessed remotely. This second set of data is post-tsunami data funded by NOAA's Pacific Marine Environmental Laboratory (PMEL). The Tsunami Enhancement Program covers the West Coast of the U.S. roughly every 75 miles.

Frank Gonzalez (PMEL) went over the PMEL bottom pressure locations. There are six of them (about 4,000 ft. down). The probes are deployed for one year periods. They plan to install offshore probes near Alaska and near the Northwest coast which will collect and transmit data in real-time. We must realize that offshore deep ocean gauges are great except for the extremely high cost and retrieval/maintenance. Non-responsive harbors or near-shore locations need to be found and used. NOAA's existing tide gauge system has problems with sampling time, clipping and harbor interaction.

The Pacific Tsunami Group has 24 gauges located in semi-protected locations. What we need to know is how big will the tsunami be if we measure offshore data with a tsunami height of 1.8 cm?

A surge gauge on a utility pole can be used for tsunami: a galvanized pipe with a wood marking stick 8 feet long has ground cork and dye mixture at the bottom. This method would be a cheap and easy means of monitoring in all countries. The U.S. Army Corps of Engineers has pressure measurements offshore (U.S. West Coast) which can be modified and used for tsunami research and mitigation.

Japan (Dr. Tsuti) has local ultra-sonic tide gauges for many towns. The receiver is perched 7 meters above the water and a cable attaches it to a transmission post. Dr. Nagai (NOWPHAS in Japan) has been successful in ocean measuring pressure gauges. NOWPHAS is a system designed by the port authority for wind waves, but it can be improved for tsunami measurements.

APPENDIX A5

MODELING AND MITIGATION

MITIGATION GROUP

Prepared By Jane Preuss and Nobuo Shuto

Different types of measurements are needed for four basic functions:

1. Warning and evacuation
2. Damage reduction: Inundation hazard maps used for zoning and land use, building codes and standards for specific building types.
3. Response: Post-disaster search and rescue and reconstruction
4. Public education

Each of the above basic categories of mitigation activities address different needs and time frames.

1. REAL TIME WARNING

The real time warning must be issued in a very short time frame. Since the 1993 Okushiri tsunami, revised warning procedures have been developed by JMA. Previously JMA had 4 basic warning regions. The new method uses numerical simulation to forecast/generate the tsunami for many different points and takes into consideration the possible existence of seawalls and breakwaters. This is a rough model which does not need detailed information but contains enough information about the approximate magnitude of the event to give guidance.

The JMA approach, to be adopted April 1997, gives the public sufficient information for organized response. Categories are still being developed; tsunamis are presently being simulated. It is anticipated that the warning will be based on the following 6 categories:

- <0.5m
- 0.5-1 m
- 1.-2m
- 2-4m (possibly overflow seawall as well as breakwater)
- 4-8m
- >8m

Most countries do not have an elaborate system of breakwaters and seawalls. In such places the categories used by JMA since 1952 could be applicable:

- Major tsunami: >3 m possible
- Tsunami: >1 m
- Tsunami attention: some tsunami danger
- No tsunami.

All information is transmitted directly by JMA to television as well as to all local authorities, e.g. fire, mayor, etc.

Conclusion. There are different conditions among countries (with and without seawalls), thus for those countries outside of Japan, the most important factor is that there be some breakdown with respect to degree of risk. For projection of the evacuation zone, a large recurrence interval is assumed.

2. DAMAGE REDUCTION

Damage reduction measures are based on two types of measurements:

- a. *Indication of the hazard area, i.e., probable inundation area.* Once the inundation area is defined, additional measures can be developed based on recurrence interval. Utilization of the

inundation area, e.g., for zoning, assumes a lesser recurrence interval than is assumed for a warning. Purposes of the inundation map include: 1) zoning, 2) flood insurance, 3) definition of appropriate locations for critical facilities and high occupancy uses which should either not be in the zone or which should have special standards, e.g., hospitals, police and fire stations, schools, or town halls.

- b. *Design Criteria within the Inundation/Hazard Zone.* It is an underlying assumption that coastal areas will continue to accommodate critical uses and therefore it is important to develop models which can address issues pertaining to shore impacts. Such models are important for design specifications of uses which must occur within the tsunami hazard area and will be used to establish tolerance levels based on recurrence. Uses include: 1) ports and harbors, 2) port support structures, 3) nuclear power plants (tolerance), and 4) bridges.

For design standards there needs to be better understanding of tsunami characteristics: wave profile, current velocity, wave impacts.

Models must consider more than the impact of water, they must also consider impacts of dislodged debris (buildings, boats, etc.) on structures.

3. RESPONSE

As soon as possible after the tsunami arrives it is very important for responders, such as fire departments and mobilization of search and rescue efforts, to have an indication of the inundation/impact area. These data can be available on a preliminary basis within 2 to 3 hours of the arrival of the first wave, and subsequently revised as new data are available.

4. EDUCATION

In Japan, there are many additional users of tsunami information. For example, in education — Professor Shuto is using simulation and animation as part of science classes.

COMBINED MEETING OF MITIGATION AND MODELING GROUPS

The mitigation group determined that the top priority should be to develop assumptions with respect to identification of a "design wave" to be used for definition of the inundation area.

1. INUNDATION AREA-DESIGN WAVE

Three methods were identified for selecting a "design wave" in preparation of inundation (run-up) maps:

- a. Historical method which is used in such areas as Sanriku where the historical record is available for several events.
- b. An assumed tsunami selected on the basis of the statistical analysis of either tsunamis or earthquakes, or both. Recurrence of the "design wave" may be 100-200 years. If an earthquake is selected, the corresponding tsunami is computed from its fault parameters by use of the conventional dislocation model.

A problem, if only earthquakes area used, is the possible exclusion of such a "tsunami earthquake" such as the Nicaragua event.

- c. An extreme event is based on the maximum event and is applicable to areas with an identified seismic gap.

2. RECOMMENDATIONS

Prepare inundation maps for selected areas using each of the methods. In the U.S. it will probably be Method #2.

APPENDIX B1

ICG/ITSU SUMMARY REPORT

Salvador Ferreras
International Tsunami Information Center
NOAA/NWS Pacific Region Hq.
Honolulu, HI

The following are notes from the IOC/UNESCO International Coordination Group for the Tsunami Warning System in the Pacific, XV Session in Tahiti on July 24-28, 1995, relevant to the International Tsunami Measurements Workshop Recommendations.

The Summary Report of the Session will be published in September 1995 by UNESCO. Among the many discussions, decisions, and recommendations of the Group, some of the most relevant to the International Tsunami Measurements Workshop are:

1. Support would be sought for the continuation of the development of the Tsunami Expert Data Base, in the direction of further data collection and refinement, and development of the interface with the WDC-A data bank.
2. The ITIC will coordinate future international post-tsunami surveys, if an invitation to do so by the ICG/ITSU National Contact of the affected nation is extended. That includes assembling a team of experts as soon as possible, keeping information available on sources of bathymetry, topographic maps, location of marigraphs, etc., and posting the resulting findings on the Internet and the World Wide Web. The National Contact should arrange, in advance, the procedures to allow access to the affected area, and to expedite and organize the survey. It was recommended that IOC allocates a provision of funds, upon request, to support such surveys.
3. ITIC will begin managing the Tsunami Bulletin Board, and funding has been requested to support this operation, the development of a Tsunami Homepage, and a Web server.
4. An *ad-hoc* working group, chaired by the Associate Director ITIC, including experts from Australia, Canada, Colombia, and Mexico, will prepare the draft of a Tsunami Survey Field Guide.
5. A revision of the Tsunami Glossary, published by UNESCO, was recommended. This action was triggered by the need to improve the present definition of the term "runup", also providing the opportunity to clarify other terms relevant to tsunami measurements.
6. Member countries were requested to develop and keep updated detailed historical tsunami catalogs for their countries, and keep ITIC and IOC informed of the progress.
7. It was recommended that support for a Russian proposal to hold a Tsunami Mitigation and Risk Assessment Workshop, at Lake Baikal in August 1996, be given in the form of travel grants for a few participants, and it was requested that the Director of ITIC assist the organizers in formulating the program for the Workshop.
8. The Group felt that there was an urgent need to renovate and upgrade tsunami instrumentation (in the USSR) for the benefit of all countries in the Northern Pacific.
9. An *ad-hoc* working group, headed by Charles 'Chip' McCreery (new designate Director of ITIC) and including J. Lander, F. Schindele, V. Gusiakov, and S. Ferreras, was set up to review the database formats and actual availability of data, and report its findings at the next ICG/ITSU XVI Session in 1997.

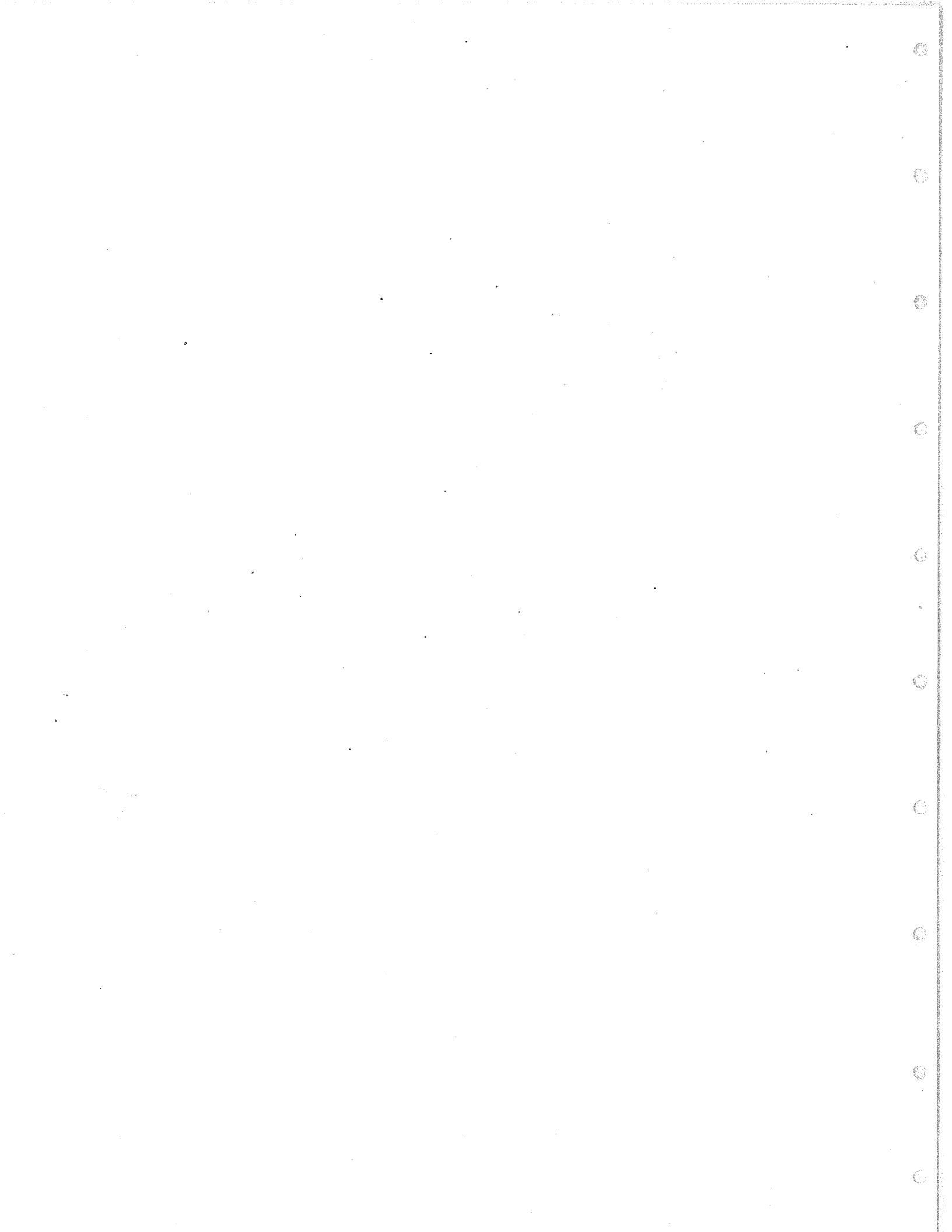

APPENDIX B2

TSUNAMI WARNING SYSTEM WORKSHOP REPORT (SEPTEMBER 14-15, 1994)

Michael Blackford
Pacific Tsunami Warning Center
National Oceanic and Atmospheric Administration
91-270 Fort Weaver Road
Ewa Beach, HI 96706-2928

Hiroo Kanamori
Seismological Laboratory
California Institute of Technology
Pasadena, CA 91125

NOAA TECHNICAL MEMORANDUM ERL PMEL, January 1995
Contribution No. 1614 from NOAA/Pacific Marine Environmental Laboratory

EXECUTIVE SUMMARY

The workshop attendees agreed that it is feasible to issue tsunami warnings for the U.S. within 3 minutes of earthquake origin time using existing technology. They further acknowledged that the existing tide gauge system is inadequate to detect and monitor a tsunami in excess of one meter along the U.S. coastline.

To implement 3-minute warnings, we recommend:

1. Upgrade the existing West Coast seismic net to include real-time telemetry of strong motion/broad band seismometers at several additional sites.
2. Increase the staff at the Alaska and Pacific Tsunami Warning Centers (ATWC and PTWC) to provide 24 hour/day in office operations.
3. Aggressively improve the automation of the processing of seismic data at the seismic centers and distribute these processed products via the Internet.
4. Implement a plan to coordinate information exchange between ATWC, PTWC, National Earthquake Information Center (NEIC), and the West Coast regional seismic networks. This will require additional hardware, software, and personnel for the existing seismic centers.
5. Add broad band seismometers to ATWC and PTWC, and access to existing broad band stations.

To establish an adequate water level system for tsunami warnings we recommend:

1. Install a network of real-time reporting, deep-water tsunami gauges.
2. Modify and utilize the existing network of NOAA tide gauges and Coastal Data Information Program instruments for the monitoring of tsunamis up to 5 m.
3. Make all water level data available on the Internet for use by a wide range of users.
4. Conduct a siting study to determine the optimal configuration of deep, shallow, and coastal instrumentation for tsunami detection and monitoring.
5. Develop warning procedures that incorporate water level data to forecast tsunami impact.

1. INTRODUCTION

The Tsunami Warning System Workshop represents a continuation of the effort of NOAA to establish an improved tsunami hazard reduction program. The overall goals of the program are to (1) develop model-based tsunami inundation maps for at-risk communities, (2) improve the tsunami detection/warning system,

and (3) conduct research to improve tsunami modeling and data collection. The first goal was addressed at a tsunami inundation modeling workshop held November 16-18, 1993, in Honolulu, Hawaii, and is reported in *NOAA Technical Memorandum ERL PMEL-100*. This workshop addressed the present state of the tsunami warning system and examined a number of other existing seismic and water level networks and data processing strategies that may be able to make significant improvements to the tsunami warning system.

Fifteen people attended the current Workshop, including the Geophysicists-in-Charge of the Pacific Tsunami Warning Center (PTWC) and the Alaska Tsunami Warning Center (ATWC), representatives of agencies and institutions operating extensive automated seismic networks in the western United States and operating a variety of water wave measurement systems, and others who have developed techniques applicable to timely tsunami analysis. A list of the participants may be found in Appendix A of the complete report.

Although there was a formal agenda, the workshop assumed a relatively free form almost immediately. This promoted lively and fruitful discussions at the expense of adhering to a strict time schedule. All speakers did, however, have an opportunity to make their presentations. The presentations followed the general themes already mentioned, namely current status of warning systems, existing seismic and water wave measurement systems, and seismic and tsunami analysis techniques. On the second day the group, as a whole, discussed and developed a set of recommendations for improving the tsunami warning system. A summary of the presentations and details of the recommendations are given in the following sections.

2. PRESENTATIONS

2.1 *Current Status of Tsunami Warning Systems*

Alaska Tsunami Warning Center — The ATWC provides regional tsunami warning service for Alaska, Oregon, Washington, California, and the Province of British Columbia, Canada. This area includes the tsunamigenic Alaska-Aleutian and Cascadian subduction zones. ATWC maintains a network of 15 seismic stations throughout Alaska and receives additional data from the National Earthquake Information Center (NEIC) that enables it automatically to locate and determine the size of earthquakes within its region within seconds after sufficient seismic data have been processed. Duty personnel, who must reside, as well as remain, within 5 minutes transit time of the office when on duty; are alerted by the seismic events. Depending on the location and severity of the event, the duty personnel will issue appropriate messages, typically within 12 minutes of the earthquake origin time. The type of message issued is based on the surface wave magnitude (M_s) of the earthquake. Because of the need to disseminate messages rapidly, water-level measurements are not considered in the initial message issued. Eight water-level instruments are maintained and used by the ATWC to verify the generation of a tsunami and to aid in the decision to continue or cancel tsunami warnings and watches. The ATWC employs a system of networked microcomputers to accomplish its analysis and message generation tasks.

Pacific Tsunami Warning Center — The PTWC functions primarily as the operational center for the Tsunami Warning System of the Pacific, which is comprised of a group of representatives of nations and states with interests in the Pacific basin who seek to coordinate tsunami detection and warning efforts within the area. In addition, the PTWC acts as a national tsunami warning center for events outside of the ATWC's area of responsibility that may affect the United States' interests and as a regional warning center for Hawaii. Similar to the ATWC, the PTWC operates a network of nine seismic stations and five tide stations within Hawaii to assist in meeting its responsibilities as a regional tsunami warning center and it also receives data from the NEIC to assist with events occurring outside of Hawaii. The real-time seismic data, however, is not routinely used for earthquake location determination. Instead, the PTWC receives, via The Internet, automatic solutions from the NEIC for Pacific basin events and automatic solutions from the Hawaii Volcano Observatory (HVO) for local Hawaiian earthquakes. The real-time seismic data is used as a backup if the automated solutions fail or are not available. The PTWC determines magnitudes from its own instrumentation. The type of message PTWC disseminates is also based on the M_s , magnitude. For local events in Hawaii, the PTWC can typically issue a voice message or warning, based strictly on earthquake data, to local authorities within 6 to 10 minutes of the

earthquake origin time. For events elsewhere, the PTWC's response ranges from 30 minutes to an hour after the earthquake origin time, mainly due to the time required for the magnitude-determining seismic waves to reach the PTWC instruments. The PTWC uses a mixed network of microcomputers and workstations for data acquisition and processing and for message generation and dissemination.

Tsunami Warning System in Japan — The Japanese Meteorological Agency (JMA) is responsible for the issuance of tsunami advisories and warnings in Japan. The JMA has six regional Tsunami Warning Centers (TWC) distributed among the islands of Japan from Hokkaido in the north to Okinawa in the south. Each center is staffed 24 hours a day and is equipped with an Earthquake and Tsunami Observation System (ETOS) that automatically detects earthquakes, picks P and S wave arrivals, estimates location, depth, and size, and generates tsunami messages based on these parameters. Seismologists determine dissemination of the messages. An ETOS acquires telemetered seismic and water level data from within a TWC region and processes it on a super-minicomputer. Tsunami messages are distributed to the government, TV and radio stations, and to JMA over a variety of telecommunications. Typical response time for message dissemination is currently about 5 minutes. JMA is working toward warnings issued in 3 minutes.

2.2 Seismic Networks

National Seismic Network — The National Seismic Network (NSN), when complete, will consist of a relatively sparse nation-wide network of highly reliable, highly linear, real-time, three-component, calibrated, broad-band instruments capable of on-scale monitoring of moderate to large earthquakes at local, regional, and teleseismic distances. As of 1 April 1994, the NSN had 17 stations in operation with another five planned for installation during the year. An additional 11 cooperating stations had been established with another 11 planned for installation during the year. The NSN is projected to grow to a network of 60 stations located in the 48 contiguous United States. A network processor automatically determines seismic phase arrival times and generates a preliminary event location. Later arrivals associated with the event are incorporated into subsequent solutions of the earthquake's location. The network-processor software has been designed to be very flexible, both in terms of load and capability. A multi-processing design with automatic load balancing provides redundancy and handles the highly variable real-time load. The results of the automatic processing are broadcast to the NEIC duty personnel and to a limited number of users with public safety responsibility. The results for larger events are also sent to the IRIS Data Management Center to trigger a data retrieval process from IRIS stations world-wide.

Southern California Seismic Network — A network of 224 high, low, and ultra-low gain seismic instruments, including forced balance accelerometers, and data from the broad band, high dynamic range, TERRAscope array make up the Southern California Seismic Network. On scale data from at least a portion of the integrated network allow for the rapid determination of both earthquake location and magnitude. Initial epicenters and magnitudes are available within a minute of the earthquake origin time and event parameters are typically finalized in about 90 seconds. The automatically processed results are disseminated over the CalTech/USGS Broadcast of Earthquakes (CUBE) system and are made available through the E-mail and Finger capabilities of the Internet around 2 minutes after the earthquake origin time. For larger events the initial magnitude estimate may be updated by data from the TERRAscope array at about 4 minutes after the origin time. The CUBE system transmits the earthquake parametric data to a commercial radio pager service where it is broadcast to over 120 pagers in the southern California area.

Northern California Seismic Network — The U.S. Geological Survey and the University of California at Berkeley operate two separate seismic networks to monitor earthquake activity in central and northern California. These networks transmit seismic data from 356 seismometers in real-time to central facilities where computers analyze these data in order to detect the occurrence of an earthquake. When an earthquake is detected, its location and magnitude are automatically calculated and the information is made available to the public through a variety of facilities. Although the two networks

overlap each other, they record different parts of the seismic spectrum and consequently complement each other. Both networks share real-time data and store their information on a common, public access data facility.

Pacific Northwest Seismograph Network — The Pacific Northwest Seismograph Network (PNSN) is a network of 134 short period and 6 broad band seismic instruments. The network covers the western portions of Washington and Oregon and is operated by the University of Washington, the University of Oregon, and Oregon State University. Data acquisition and processing are performed on a Concurrent 5600 computer using the HAWK real-time seismic recording and processing system. Since the end of 1989 the PNSN has been equipped with an automated detection and alert system that pages local seismologists on the occurrence of earthquakes over magnitude 2.9. In addition, the system E-mails the parametric information to other regional networks and the NEIC and FAXes the location and size of the event to local emergency managers. This information is updated as soon as it is reviewed by a seismologist, usually within an hour after the event.

IRIS Rapid Data Access Systems — The IRIS Data Management Center (DMC) is located at the University of Washington and has operated the SPYDER system to provide wave-form data of large earthquakes to seismologists worldwide within a few minutes to hours. The IRIS, or Incorporated Research Institutes for Seismology, seeks to provide seismologists around the world with relatively rapid access to reliable, calibrated and standardized, broad-band seismic waveform data through a process of electronic data transfer. The IRIS SPYDER system, using the NEIS preliminary earthquake location as input, calculates the P-wave arrival times to 60 of the Global Seismic Network stations around the world, and retrieves the data by telephoning each station and down-loading selected time wave-form segments to the main DMC machine. The actual telephone calls are placed by several different computers around the world interconnected by the The Internet. Since several different computers actually place telephone calls to stations physically near them, data retrieval from several stations takes place at the same time. Another system, CHEETAH, developed through a joint effort between NEIC and IRIS and in operation at the DMC, is a much more rapid data access system that allows the NEIC to have access to a limited set of stations that are important for a better earthquake location, within only a few minutes of the automatic alert request for data sent out by the NEIC.

2.3. *Water Level Measurement Networks*

Near-Source Tsunami Measurements for Forecast and Warning — Direct sea level measurements acquired near potential tsunami sources such as the Cascadia or Alaska-Aleutian subduction zones could greatly improve the speed and accuracy of tsunami hazard assessment, forecast and warning. The technology is now available to develop a deep ocean, real-time tsunami reporting system to provide these direct tsunami measurements near potential source regions in deep offshore waters. Subsurface acoustic links and deep ocean surface buoys that report in near real-time via satellite are now available. Improved satellite links, capable of reporting relatively high data rates in real-time, should be available within 2 years. Tsunami hazard assessments made on the basis of seismic data are, in the final analysis, indirect. Coastal tide gauge data are invaluable in assessing tsunami conditions, yet these data are often difficult to interpret because of a large number of factors that can affect the environment of the gauge location. Also, it is only possible to make an assessment after a tsunami has arrived and affected the coastal area.

Coastal Data Information Program — The Coastal Data Information Program (CDIP) is a cooperative effort managed jointly by the U.S. Army Engineers, Waterways Experiment Station and the State of California, Department of Boating and Waterways. The program is conducted by the University of California, Scripps Institution of Oceanography (SIO), for the purpose of collecting, analyzing and disseminating coastal environmental data, with an emphasis on nearshore wave climate. The CDIP typically relies on an inventory of 5 or 6 systems to measure shallow and deep water wave energy and directional distributions, as well as wind and currents. Most stations consist of offshore pressure sensors mounted on the bottom at depths between 5 and 15 meters. Instruments are typically configured in a 6-m square array of 4 pressure sensors or a single pressure sensor and a current meter located at a single

point. The instruments are connected to a field station on shore by an armored cable. Coastal data are typically collected by accelerometers on buoys that measure the pitch and roll of the buoys. The data are radioed to field stations on the nearby shore. Several times a day the central data gathering, processing and dissemination facility at SIO dials each field station and downloads the stored data. The data are screened for accuracy, analyzed and archived for research use. A window of data remains online and is available to a limited number of dial-up users. The station dial-up schedule can be modified to accommodate unusual circumstances, including intense storms or a tsunami alert. Under a cooperative arrangement with the Pacific Marine Environmental Laboratory (PMEL), a procedure has been developed to activate continuous sampling of certain modified stations when NOAA determines a tsunami is pending. The CDIP is a successful cooperation between federal and state government and academia.

2.4 Tsunami Analysis Strategies

Recent Analyses Using the TREMORS — The TREMORS, or Tsunami Risk Evaluation through seismic MOment in a Real-time System, has been fully operational at the Geophysical Laboratory in Papeete, Tahiti (PPT), since mid-1987. Its features include automatic detection of seismic waves, evaluation of the epicenter from the three-component record at a single station, and evaluation of the seismic moment through computation of the mantle magnitude, M_m. The system performs in real time and, at regional distances, begins computation of M_m as soon as the Airy R phase (in practice, the S-wave) is received. The computations are regularly updated using longer and longer period waves. The system works at regional distances greater than 150 km. Six recent earthquakes, most with locally destructive tsunamis, were analyzed. The single station locations were adequate but not very accurate, especially in the azimuthal estimate. The moment magnitude calculations made at PPT at epicentral distances ranging from 68 to 94 degrees compared quite favorably with calculations made at stations at much closer, or regional, distances that ranged from 7.7 to 24 degrees. The average difference was about 0.1 magnitude unit. It was concluded from the analyses that the moment could be correctly assessed for events at regional distances, even for "tsunami earthquakes." The real-time estimation of the moment should make warnings possible for tsunamis generated at an offshore trench. For local earthquake and tsunami, a global network of TREMORS-equipped broad-band stations at 15-degree intervals along coastlines with high tsunami potential would be a significant step towards efficient tsunami warnings.

3. SUMMARY OF CURRENT SYSTEMS

Based on reports from the existing U.S. seismic systems, there exists an extensive earthquake detection system of at least 834 seismic instruments reporting in real time (see Figure 1). The existing system is composed of the following elements:

| Network (Funding Source) | R.T. Seismic Stations | Capitol Cost (\$M) | Annual Operating Costs (\$M) |
|---|-----------------------|--------------------|------------------------------|
| Alaska (NOAA) | 15 | 0.5 | 0.2 |
| Hawaii (NOAA) | 9 | 0.5 | 0.1 |
| National Net (USGS) | 96 | | |
| Southern California (USGS/Cal Tech) | 224 | | |
| Central and Northern California (USGS/Berkeley) | 356 | | |
| Northwest (USGS/U. Washington) | 134 | | |
| TOTALS | 834 | | |

For U.S. water level information, the existing network consists of:

| Network (Funding Source) | R.T. Water Level | Capitol Cost (\$M) | Annual Operating Costs (\$M) |
|--------------------------|------------------|--------------------|------------------------------|
| Alaska (NOAA) | 8 | 1.0 | 0.2 |
| Hawaii (NOAA) | 5 | 0.6 | 0.1 |
| CDIP (ACOE/California) | 6 | | |
| TOTALS | 19 | | |

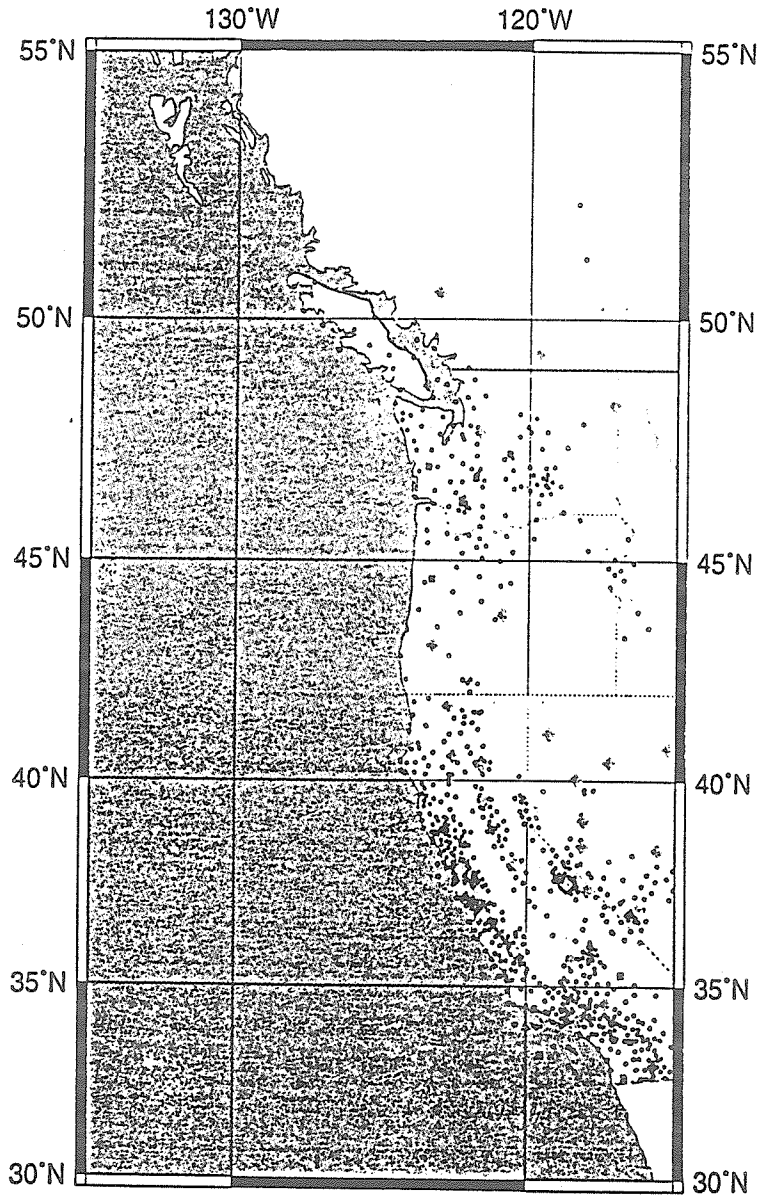

Figure 1. Map of western U.S. real-time seismograph stations. Dots are short-period analog stations, diamonds are telemetered three-component broad-band stations, squares are dial-up three-component broad-band stations. Organizations operating and recording these stations are: Canadian National Seismograph Network, U.S. National Seismograph Network, Pacific Geoscience Centre, Pacific Northwest Seismograph Network, Boise State University Seismograph Network, U.S. Geological Survey (Calnet, Menlo Park), University of Nevada-Reno, Southern California Seismograph Network.

4. RECOMMENDATIONS

The Workshop group met on the second day and discussed a number of issues that arose out of the presentations. The group arrived at two sets of recommendations, one for seismic considerations that should be made for tsunami hazard reduction, and another for water level measurement considerations.

4.1 Recommendations for Improving the Warning Centers' Capabilities for Parameterizing Earthquakes

1. Implement the Internet at ATWC so the Center can gain access to seismic data generated by other real-time networks and can have an additional means to disseminate tsunami information.
2. Adopt the use of moment calculations and moment magnitudes as a basis for generating appropriate tsunami information messages, watches, and warnings.
3. Expand the Centers' access to broad-band and strong motion data in order to provide them with an independent capability to make moment calculations.
4. Develop a fully-automated earthquake detection, location, and magnitude-determination system that can respond to nearby potentially tsunamigenic earthquakes and issue alarms in 3 or less minutes. The only human intervention would be to cancel the alarm.
5. Develop and implement a coordinated plan for information exchange between the Warning Centers, the NEIC, and the agencies and institutions operating seismic networks on the Pacific coast.
6. Use the real-time links between the Warning Centers and the NEIC to access the National Seismic Network more efficiently.
7. Staff both PTWC and ATWC to the extent necessary to provide 24-hour onsite operational service. This recommendation followed from the data from ATWC that showed warning response times averaged 6 minutes when the earthquake occurred while staff was in the office. In contrast, response was 15 minutes if staff were not in the office.

4.2 Recommendations for Improving the Warning Centers' Capabilities for Making More Efficient Use of Available Water Level Measurement Technology

1. Conduct siting surveys designed to optimize the water level measurement network, taking into consideration population density, tsunamigenic earthquake sources, and landslide potential.
2. Make use of the Coastal Data Information Program network of pressure sensors.
3. Increase the amount of near real-time water level data available to the Centers through the use of communications systems capable of transmitting relatively low sample rate data such as the the Internet.
4. Develop water level measurement instrumentation designed primarily to characterize tsunami signals, in contrast to those now in use that are designed primarily for measurement of the tides.
5. Preserve the subset of tide gauges that are particularly responsive to tsunami signals as a tie to older data sets.
6. Concentrate on the installation of pressure sensors in lieu of other types of water level measurement instrumentation and where possible collocate with seismic instruments.

- Notes: 1. Mention of a commercial company or product does not constitute an endorsement by NOAA/ERL. Use of information from this publication concerning proprietary products or the tests of such products for publicity or advertising purposes is not authorized.
2. Copies of all the complete report are available from the National Technical Information Service, 5285 Port Royal Road, Springfield, VA 22161.

The following Appendices are included:

Appendix A - Participants

Appendix B - Formal Agenda

Appendix C - Alaska Tsunami Warning Center

Appendix D - Pacific Tsunami Warning Center

Appendix E - Tsunami Warning System in Japan

Appendix F - National Seismic Network

Appendix G - Southern California Seismic Network

Appendix H - Northern California Seismic Network

Appendix I - Pacific Northwest Seismograph Network
IRIS Rapid Data Access Systems

Appendix J - Near Source Tsunami Measurements for Forecast and Warning

Appendix K - Coastal Data Information Program

Appendix L - Recent Analyses Using the TREMORS

Tsunami Reconnaissance Procedures

Harry Yeh

ABSTRACT

Recent tsunami surveys were conducted by multi-national tsunami reconnaissance teams mainly consisting of Japanese, U.S. and the local scientists. The organization and arrangement of the survey team have been made in a very informal manner. The survey procedures that took place and some typical results based on the surveyed data are discussed. Based on the experience, some improvements of the survey procedures are proposed, emphasizing on multi-national cooperation with multi-disciplinary personnel.

KEYWORDS: Tsunami, Survey, Runup, Reconnaissance, Measurement.

1. INTRODUCTION

There have been six major tsunami disasters within the last three years: first in Nicaragua (1992), then Flores Island, Indonesia (1992), Okushiri Island, Japan (1993), East Java, Indonesia (1994), Shikotan Island, the South Kuril Islands (1994), and most recently in Mindoro Island, Philippines (1994). All events were surveyed and documented by multi-national tsunami reconnaissance teams, e.g. Abe (1993) and Satake *et al.* (1993) for Nicaragua, Tsuji (1993) and Yeh *et al.* (1993) for Flores, Shuto (1994) and Hokkaido Tsunami Survey Group (1993) for Okushiri, Yeh *et al.* (1995) for Shikotan. This frequent occurrence of major tsunamis in such a short time is remarkable, especially considering the fact that before the Nicaragua tsunami, there had not been a major tsunami for more than nine years: the last major tsunami event was the 1983 Nihonkai-Chubu tsunamis. In the case of the 1983 Nihonkai-Chubu tsunamis, the tsunami survey was conducted mainly by the Japanese scientists, although the US reconnaissance team was sent shortly after the event (Hwang and Hammack, 1984). Korean coasts and Russian (then, USSR) coasts were surveyed independently by the scientists of each country.

The first international cooperative tsunami survey team was formed in a rather informal manner immediately after the 1992 Nicaragua tsunami. Since then, the five subsequent tsunamis were surveyed with international team cooperative efforts. Increasing trends of international cooperation must be the result of the recent advancement of world-wide communication systems, especially the development of the INTERNET system, improvement of transportation, and global political stabilization. Even if an earthquake occurred in a remote area, recent advancement of instrumentation and communication permit us to obtain fairly accurate information within a few hours (perhaps even minutes) through the INTERNET e-mail system. If the civil war had still existed in Nicaragua, the tsunami survey would have not been possible. Since the end of the US-USSR Cold War, more areas that used to be inaccessible can now be entered by scientists to conduct tsunami surveys, e.g., the South-Kuril Islands. Note that the tsunami effects of the 1983 Nihonkai-Chubu tsunamis on the Far-East-Region (USSR) coasts were very sketchy at that time and, due to military-security reasons, no quantitative data were presented by the Soviet scientists during the Tsunami Symposium that was held in Victoria, Canada in 1984.

This paper presents the recent tsunami survey results describing what we measured, observed and accomplished. Based on that experience, some improvements of the survey procedure are proposed, with an emphasis on international cooperative practice.

2. INTERNATIONAL TSUNAMI SURVEY

THE 1992 NICARAGUA TSUNAMIS (MS 7.2): This was the first major tsunami to cause substantial damage and casualties since 1983 when the Nihonkai-Chubu Tsunami struck the west coast of Honshu, Japan. As a result, in a very informal way, an ad hoc international tsunami survey team was formed for the first time. First, Japanese scientists, with leader Dr. Kuniaki Ade, formed their own team consisting of seismologists, tsunami specialists, and geophysicists. Meanwhile, the United States government agencies attempted to organize a U.S. team. Without clear jurisdiction and funding structures, this attempt did not materialize except for sending three scientists from the U.S. Geological Survey. Several U.S. scientists in academia approached the Japanese colleagues directly for a possible cooperative survey. Interestingly, this was also done independently by two separate groups of U.S. scientists; one group contacted Dr. Katsuyuki Abe of the University of Tokyo and the other group contacted Dr. Shuto of Tohoku University. In the end, four U.S. scientists from academia joined the Japanese scientists, thus forming the first "international" survey team.

A pre-survey meeting with the local agency, INETER (Instituto Nicaraguense de Estudios Territoriales), was arranged by the Japanese team. All the parties, including those from the U.S. government agencies, attended this meeting which essentially became the Nicaragua-Japan-U.S. "international" pre-tsunami-survey meeting.

The actual tsunami survey was conducted by the international team consisting of six Japanese, two Nicaraguan, and four U.S. scientists. At the same time, three scientists from the U.S. Geological Survey mainly surveyed seismological strong motion effects and building damage. One scientist from the U.S. National Oceanic and Atmospheric Administration (NOAA) conducted an aerial tsunami survey and one independent scientist from the U.S. examined tsunami damage and social effects. Six months later, another survey party consisting of two U.S. and one Canadian scientists visited the tsunami sites for further runup survey. Since then, the U.S. geologist who had been a member of the "international" survey team returned to the sites twice to examine the effects of tsunami sediment deposits in conjunction with the paleo-tsunami evidence elsewhere. Another U.S. scientist, also a member of the "international" team, returned to the sites for a detailed bathymetry survey. After this event, NOAA established an e-mail bulletin board called 'Tsu-Nica' to exchange tsunami-related information. Later on, the name of the bulletin board was changed to the more generic name: the 'Tsunami' Bulletin Board. This Nicaragua event is now considered to be the corner stone of tsunami survey practice in terms of the international cooperation and establishment of the e-mail bulletin board.

THE 1992 FLORES ISLAND TSUNAMIS (MS 7.5): The international survey team was formed in a very informal manner, just like the team for the Nicaragua tsunamis. First, the Japanese officially formed a survey team under leader Dr. Y. Tsuji. Three U.S. scientists in academia contacted Dr. Tsuji and the local agency (National Meteorology and Geophysics Agency or MGA) in Jakarta. Most of the communications were made through fax, although the e-mail 'Tsu-Nica' Bulletin Board was also used between Japan and the United States. Another attempt was made to form an official U.S. survey team but this never materialized. However, four Indonesian, one British, one Korean and three U.S. scientists joined the Japanese team to form a truly international (five nations) survey team. Because of strong economical and political ties between Japan and Indonesia, prior to the tsunami survey, an immediate reconnaissance was made by the Japanese Government special team that was formed to provide humanitarian aid. Over a year later, the tsunami attack sites were revisited by the U.S. team, mainly to investigate submarine landslide effects. A few months after this U.S. team visit, the Japan-U.K. international team members also revisited the sites to investigate tsunami sediment deposits.

THE 1993 OKUSHIRI TSUNAMIS (MS 7.8): An official U.S.-Japan cooperative survey team was formed based on the UJNR program. It consisted of three U.S. and two Japanese members. Besides this UJNR team, other Japanese teams conducted tsunami surveys on Okushiri Island and in Hokkaido. They were the Tohoku University team, the University of Tokyo team, the Public Works Research Institute team,

the Port and Harbor Research Institute team, the Hokkaido Development Bureau team, and the Japan Meteorological Agency team. Evidently, the survey of this event was very intense, and many valuable data were obtained. Important information were conveyed through the e-mail 'Tsunami' Bulletin Board: note that the name of the bulletin board was changed from 'Tsu-Nica' to 'Tsunami' in the fall of 1993.

THE 1994 JAVA TSUNAMIS (MS 7.2): The formation of the international survey team, with the leader Dr. Tsuji, was very informal, consisting of twenty-one Indonesian, five Japanese, two U.S., one Thai, and three Italian scientists. Prior to the participation of the International survey team, Indonesian and three U.S. scientists conducted a preliminary survey, reported through the e-mail Tsunami Bulletin Board.

THE 1994 SHIKOTAN TSUNAMIS (MS 8.1): This was the only event in which the Japanese team did not participate. The team was formed with fifteen Russian scientists and two scientists from the U.S. Many communications were made via e-mail Tsunami Bulletin Board. The actual tsunami survey plan was made at the Institute of Marine Geophysics and Geology (IMGG), Sakhalin, Russia. Some locations could not be surveyed due to lack of transportation. The preliminary survey results were posted on the e-mail Tsunami Bulletin Board immediately after the survey.

THE 1994 MINDORO TSUNAMIS (MS. 7.0): Again, an informal international tsunami survey team was formed with the aid of the e-mail Tsunami Bulletin Board. The team consisted of three members from the Philippines, two from the U.S., two from Thailand, two from Japan, and one from Korea.

3. SURVEY PROCEDURE

Although case-by-case details were different in the aforementioned six tsunami surveys, the following general procedure was taken for all the surveys. *Pre-Survey Data Collections and Preliminary Modellings:* Prior to the survey, preliminary information on tsunami damage and data were collected utilizing all available means. This data gathering included compiling the information provided by local agencies and local and international news media (e.g. NHK, BBC, Reuters). Immediate preliminary surveys were often made by local scientists and the information was disseminated through the e-mail Tsunami Bulletin Board: e.g. in the case of the Java tsunamis, a survey was conducted by scientists from the National Meteorology and Geophysics Agency (MGA) in Jakarta. In the case of the Flores tsunamis, an emergent team for humanitarian aid was dispatched by the Japanese Government. For the Shikotan tsunamis, the scientists from the Institute of Marine Geophysics and Geology reported the preliminary runup data. Meanwhile, based on preliminary seismic data (e.g. earthquake magnitude, fault parameters, aftershock distributions, rigidity of the earth crust), numerical simulations were performed. Numerical models used for this purpose were typically based on the linearized shallow-water-wave theory without modelling detailed runup on dry beaches. Instead the model assuming the presence of fictitious vertical walls offshore, typically along the 10 m deep contour. Based on the preliminary numerical simulations and reports from news media and local agencies, the hardest hit areas and the coverage of the planned tsunami survey were identified.

Pre-Survey Meeting: For the final planning, a pre-survey meeting was normally held at the local agency, for example, at INETER (Managua, Nicaragua) for the 1992 Nicaragua tsunamis, at MGA (Jakarta, Indonesia) for the 1992 Flores tsunamis and the 1994 Java tsunamis, and at IMGG (Yuzhuno-Sakhalinsk, Russia) for the 1994 Shikotan tsunamis. The main purposes of the surveys were to measure tsunami runup distributions, to observe tsunami effects on natural and manmade environments and structures, to collect any instrumental measurements such as tide gages, to interview local residents for tsunami attack conditions including its arrival time and socio-economical impacts to the community, and to examine the effectiveness of any existing tsunami warning systems and preparedness efforts. It is important to keep in mind that a primary survey purpose is to learn from the disasters in order to mitigate future tsunami events.

Transportation: It is sometimes formidable to reach the tsunami affected sites. Most of the time, automobiles with four-wheel drives are sufficient means for transportation. However, boats, special military ground vehicles (Fig. 1) and helicopters (Fig. 2) are often needed and the cooperation of government military agencies are often critical to the survey.

Tsunami Runup Survey: Tsunami runup heights and distances were measured with simple surveying hand-levels, staffs, and tapes. Vertical heights of runup marks were measured from the mean sea level at the time of the measurements by noting the measurement time and location (Fig. 3). After the survey, the measured runup heights were converted to the values of runup at the time of tsunami attack: this conversion was made based on the tide levels at the time of measurement and at the time of tsunami attack. The measurement locations were recorded with the portable Global Positioning System (GPS) together with the topography map. Because of the many uncertainties involved in measured data, an approximate 25 cm error in runup heights is acceptable. Tsunami runup marks were identified by the following conditions. Flooding water marks on a structural wall are considered to be reliable evidence of runup height. Accumulated marine-origin objects are considered to be another type of reliable runup marks (Fig. 4). Other types of runup marks are scratch marks on tree trunks caused by the collision of water-born objects (Fig. 5), and marine-origin vegetation (e.g. seaweed) on tree branches (Fig. 6). The runup distances from the shoreline were usually measured with a surveying tape (100 m long). Again, this type of survey does not require high accuracy. In addition to the runup marks, flow directions for both runup and rundown processes were inferred from the direction of tree falls (Fig. 7) and patterns of debris accumulations.

Interviews: Interview procedure and a systematic questionnaire were developed and has been improved by Dr. Tsuji of Tokyo University and Dr. Kawata of Kyoto University. Nonetheless, further improvement in this area would evolve by including input from other scientists.

Post-Survey Briefing: After the survey, the results and recommendations were presented at the local host agency. This meeting is important for the local government who attempts to mitigate future tsunami disasters by learning lessons from the present event. The information and data reported by the scientists immediately after the event are reliable and valuable for the damage assessment.

4. POST-SURVEY ANALYSES

A wide variety of data analyses were performed based on the collected data and information. The following are some examples that might be useful to consider when the next tsunami survey is planned. Measured runup height distributions and flow patterns are essential information to understand tsunami phenomena. By utilizing numerical simulation models, the initial source pattern can be identified by matching the measured runup distribution. (This practice is considered to be the inverse problem of tsunami runup: i.e. given the runup distribution, the initial condition of tsunami generation is computed.) With the identified initial source pattern, the earthquake mechanism is often clarified. This type of exercise was conducted for almost all tsunami events by the Tohoku University group and the U.S. group at the University of Southern California. For example, the deformations of sea bottom associated with the 1983 Nihonkai Chubu earthquake and the 1993 Okushiri earthquake are now understood to have very complex patterns (Shuto, 1991; Takahashi et al., 1994). The 1992 Nicaragua earthquake was identified as a so-called tsunami earthquake (Kanamori and Kikuchi, 1993).

Detailed runup distribution patterns often reveal the tsunami characteristics. For example, locally high anomalous runup in Flores Island led us to suspect the occurrence of massive submarine landslides that generated waves. Later on, this conjecture was verified by a bathymetry survey (Plafker, 1995). Fairly uniform runup heights along the south side of Shikotan Island and much smaller runup along the north side led to the estimation that the tsunamis of the 1994 Shikotan earthquake had their wave periods of approximately 20 minutes (Yeh, et al., 1995). The disaster on Babi Island (the 1992 Flores tsunamis) received special attention and, in fact, was discussed prior to the survey. Observations of the topography maps and bathymetry charts showed its unique location and simple island shape: the island has a cone shape with a steep beach surrounding it. Early reports to the speculation that the cause of disaster was 1) tsunami focusing of the reflected waves from Flores Island, as seen in Fig. 8, or 2) trapping wave energy around the island. It is well known that a conical-shaped island is capable of trapping quasi-steady oscillatory waves around an island due to wave refraction and that trapping occurs when the wavelength is comparable to the island dimension, although the behavior of transient waves like tsunamis were unknown at that time. Based

on the runup measurements, subsequent detailed numerical simulations for a cone-shaped island and large-scale laboratory experiments, the cause of total disaster, where 263 people were killed by the tsunamis, can now be explained (Yeh, et al., 1994). When the tsunami hit the island, the tsunami split in two. The split tsunami wrapped around the island and joined to create a new, larger wave that crashed into the wave-shadow side of the island (Fig. 8). Another anomalous runup which was identified by the survey at Hamatsumae on Okushiri Island is explained from the results of numerical and laboratory experiments (Tanaka et al., 1995). Not only wave refraction but also the effects of wave dispersion were found to have enhanced the tsunami runup heights near Hamatsumae. The wave dispersion could have been triggered when the tsunami propagated around the southern tip of Okushiri Island, where the water is shallow.

In addition to obtaining the data for the tsunami runup heights and flow patterns, tsunami surveys provided us with many important information that might be useful for future disaster mitigation. Figure 9a and b show the contrast of houses along the beach of El Popoyo, Nicaragua. Almost all beach houses were destroyed and washed away by 5 m high tsunamis, as shown in Fig. 9b. Because there was no strong ground shaking, all damage was due solely to tsunamis. Two quite dissimilar structures (Fig. 9a) survived: one made of very rigid concrete blocks, and the other made of wood supported with extremely flexible slender columns. Evidently, slender columns are capable of withstanding tsunami flows. This appeared to hold true in many cases. For example, trees often remained standing while nearby houses were totally destroyed in El Transitio, Nicaragua.

Scouring effects of tsunamis were often observed. Figure 10 shows the approximately 1.6 m step formation on the beach due to tsunami scour at Rajekwesi, East Java, during the 1995 Java tsunami survey. Similar beach scouring effects were found in Aonae, Okushiri Island (Fig. 11). Tsunamis are also often capable of transporting rocks and boulders, as well as sediments. Figures 12a, b, and c show that, respectively, a beach rock was transported at El Popoyo, Nicaragua, large corals were transported at Riangkroko, Flores (for a scale reference, note a person standing at lower left corner in Fig. 12b), and another large beach rock was transported near Monai, Okushiri Island. These types of information and data are important not only for future prevention of beach scouring and structure damages, but also for the assessment of geological evidence of prehistoric tsunami events.

Another remarkable tsunami/earthquake effect was discovered in the 1992 Flores tsunami survey. Several extremely large subaqueous slumps were observed, as shown in Fig. 13, and tsunami runup heights measured in the vicinity of slumping were much higher than those measured several kilometers away. As mentioned earlier, this observation led us to conjecture that the high tsunami runup was caused by the waves generated by the slumping. Also this gave us a typical example of the fact that significant geomorphologic changes are often caused by extreme events.

Observations of land uplift and/or subsidence were often made during the survey. Such data collected in Flores Island and Okushiri Island gave important information to determine the mechanisms of the earthquakes. Collection and retrieval of tsunami records such as tide gage records are also an important task for the tsunami survey. Figure 14a shows the tide gage record in the Malokurilskaya Bay, Shikotan Island. The data after removing astronomical tides are shown in Fig. 14b which displays the evident mean water-level shift of 53 cm after the earthquake. The data presented in Fig. 14b are considered to be a rare quantitative recording of the land subsidence with the tide gage.

5. CLOSING REMARKS

Based on my experience, the following comments with regard to tsunami survey procedure are made:

1. When a tsunamigenic earthquake occurs, the decision must be made whether or not a tsunami survey is necessary, especially one with international cooperative efforts. Considering the limited resources, the decision must be made prudently and correctly based upon all the available information of the event. In spite of some evidence of measurable tsunamis, tsunami effects associated with the 1993

Guam earthquake were not surveyed; perhaps because the event occurred immediately after the 1993 Okushiri event that caused significantly greater tsunami damage, hence the Guam tsunamis were simply overlooked.

2. For given seismic parameters, a quick numerical simulation should be made. The results will be used for the decision making for the tsunami survey discussed in item 1, as well as for the determination of the hardest hit areas, tsunami magnitudes, and the extent of affected areas. Both Japanese and U.S. scientists should make this type of simulation independently for the comparison purpose.
3. All the available information from local and international media must be analyzed prior to the survey. In the past tsunami surveys, the news media, in particular NHK and Reuters, contributed significantly to our scientific tsunami survey plans. Establishment of formal cooperative procedures between scientific community and news media is desirable. It is also preferable that local scientists commence their preliminary survey immediately after the earthquake with the preliminary survey results disseminated immediately, perhaps through the e-mail Tsunami Bulletin Board: the preliminary surveys done by the local scientists in the past have been extremely useful for planning the subsequent international tsunami survey.
4. Should a tsunami survey be performed with multi-national cooperation or by local scientists alone? Probably so, not only because scientists from abroad (in particular, Japanese scientists) have better technological facilities and are more experienced at carrying out the survey more effectively and efficiently than local scientists, but also, unlike other natural disasters (e.g. earthquake, hurricanes, tornadoes, droughts, floods), tsunamis can affect broader areas. The 1960 Chile tsunamis caused substantial damage in Hawaii and Japan; the 1964 Alaskan tsunamis greatly affected Hawaii and California. More recently, after the 1994 Shikotan tsunamis, Pacific wide tsunami warnings were issued and consequently large-scale evacuations from coastal zones in Hawaii and the U.S. west coasts were enforced, although the effects of tsunamis were minimal. Consequently, substantial economical damage resulted indirectly from the South-Kuril tsunamis. Tsunamis are not only the local problem but also potential problems for many distant countries. From this view point, tsunami survey by a multi-national team is not only justified, but critical.
5. Financial supports for tsunami surveys must be identified. The past surveys described above were funded by Japan Monbusho, the U.S. National Science Foundation (NSF), Russian Fund of Basic Research, and others. All the U.S. NSF funds had not been allocated for the survey but the principle investigators of an existing NSF funded research were allowed to use monies for the emergent surveys: the monies had originally been allocated for their tsunami-related research purpose but not for the survey. This funding structure was only a temporary measure and will not be available in the future. For this reason, it is essential to identify the agencies willing to be responsive to the international tsunami survey supports. As a first step for the long-term survey plan, perhaps, the U.S. and Japan should establish a protocol for the international survey procedure and should identify the U.S. and Japanese agencies for the survey support.
6. The survey is not only for the maximum runup distribution measurements but also for other important observations: sediment transport, erosion effects, tsunami flow effects on man-made structures and natural geomorphologic features, social impacts, identifications of all salient features for the use of future mitigation. For this reason, the survey should be conducted by multi-disciplinary personnel including civil engineers with surveying experience, applied mathematicians, geologists, sedimentologists, seismologists, physical oceanographers, hydrodynamists, disaster-mitigation planners, and sociologists. The survey team should consist of a mixture of well-experienced scientists and those without tsunami-survey experience. Simple-but-important tsunami survey technique must be taught to as many tsunami-related scientists as possible to cope with quick response to future tsunami events. It is emphasized that a quick dispatching capability

is crucial for the tsunami survey, in order to capture as much information as possible. Tsunami runup marks, destruction patterns, and other detailed tsunami-affected features can be disappear within a few weeks. For this reason, it is preferable that the survey be conducted within a month of the earthquake.

Assumption has been that once a major tsunami occurred, no large event would happened for a long time based on its probability based concept. Every time, I participated in the past tsunami survey, I thought that that was the last event for a long time. Because of this, the survey organization had been done in a temporary manner, anticipating to establish better survey procedures in later time. Apparently this assumption was wrong: six major tsunami events occurred in a little over three years. There is evidently no time for us to wait; serious discussions and actions for the survey procedures are urgently needed.

REFERENCES

- Abe, K. (1993) Research on the 1992 Nicaragua earthquake and tsunamis. *Report*, 106 pp.
- Hwang, L.-S. and Hammack, J. (1984) *Japan Sea Central Region Tsunami of May 26, 1983: A Reconnaissance Report*. National Academy Press.
- Hokkaido Tsunami Survey Group (1993) Tsunami devastates Japanese coastal region. *EOS*, 74, 417-432.
- Kanamori, H. and Kikuchi, M. (1993) 1992 Nicaragua earthquake: a slow tsunami earthquake associated with subducted sediments. *Nature*, 361, 714-716.
- Plafker, G. (1995) personal communication.
- Satake, K., Bourgeois, J., Abe, K., Tsuji, Y., Imamura, F., Iio, Y., Katao, H., Noguera, E., and Estrada, F. (1993) Tsunami field survey of the 1992 Nicaragua earthquake. *EOS*, 74, 145, 156-157.
- Shuto, N. (1991) *Tsunami Engineering Technical Report*, no.8, 55-81.
- Shuto, N. (1994) Survey Data. *Tsunami Engineering Technical Report*, no.11, 1-120.
- Takahashi, T., Shuto, N., Ortiz, M., and Imamura, F. (1994) 1993 Hokkaido Nanse-Oki earthquake tsunami. In: *International Symposium: Waves - Physical and Numerical Modelling*, Univ. of British Columbia, Canada, *Proceedings*, 456-465.
- Tanaka, S., Sato, S., and Noguchi, K. (1995) Propagation of Hokkaido-Nansei-Oki earthquake tsunami around Cape Aonae. In: *International Workshop on Wind and Earthquake Engineering for Offshore and Coastal Facilities, 2nd, University of California at Berkeley*.
- Tsuji, Y. (1993) *Report of the Field Survey of the Flores Island Earthquake-Tsunami of December 12, 1992*.
- Yeh, H., Imamura, F., Synolakis, C., Tsuji, Y., Liu, P., and Shi, S. (1993) Flores Island tsunamis. *EOS*, 74, 369, 371-373.
- Yeh, H., Liu, P., Briggs, M., and Synolakis, C. (1994) Propagation and amplification of tsunamis at coastal boundaries. *Nature*, 372, 353-355.
- Yeh, H., Titov, V., Gusiakov, V., Pelinovsky, E., Khrumushin, V., and Kaistrenko, V. (1995) The 1994 Shikotan Earthquake Tsunamis. *Pure and Applied Geophysics*, (in press).

Figure 1. A Russian Army tank used for the 1994 Shikotan tsunami survey.

Figure 2. Indonesian military helicopters used for the 1992 Flores tsunami survey; the photo was taken at Riangkroko.

Figure 3. Tsunami runup heights were measured from the local mean sea level (Riangkroko, Flores Island).

Figure 4. Tsunami runup mark -- accumulated marine-origin objects (Babi Island, Flores).

Figure 5. Tsunami runup mark -- scratch marks on tree trunks caused by the collision of water-born objects (El Transito, Nicaragua).

Figure 6. Tsunami runup mark -- marine-origin vegetation (e.g. seaweed) on tree branches (Shikotan Island).

Figure 7. Flow directions were inferred from the direction of tree falls (Babi Island, Flores).

Figure 8. A map of Babi Island.

Figure 9. Beach houses in El Popoyo, Nicaragua: a) two dissimilar houses survived from the tsunami attack; b) a typical tsunami damage.

Figure 10. Beach face scour found in Rajekwesi, East Java.

Figure 11. Beach scour in Aonae, Okushiri Island.

Figure 12. Rocks transported by tsunamis: a) beach rock at El Popoyo, Nicaragua; b) corals at Riangkroko, Flores; c) beach rock at Monai, Okushiri.

Figure 13. Subaqueous slump that is approximately 2 km long at Leworahang, Flores.

Figure 14. The tide-gage record in Malokurilskaya Bay: a) raw data, b) after removal of the astronomical tides.



Figure 1

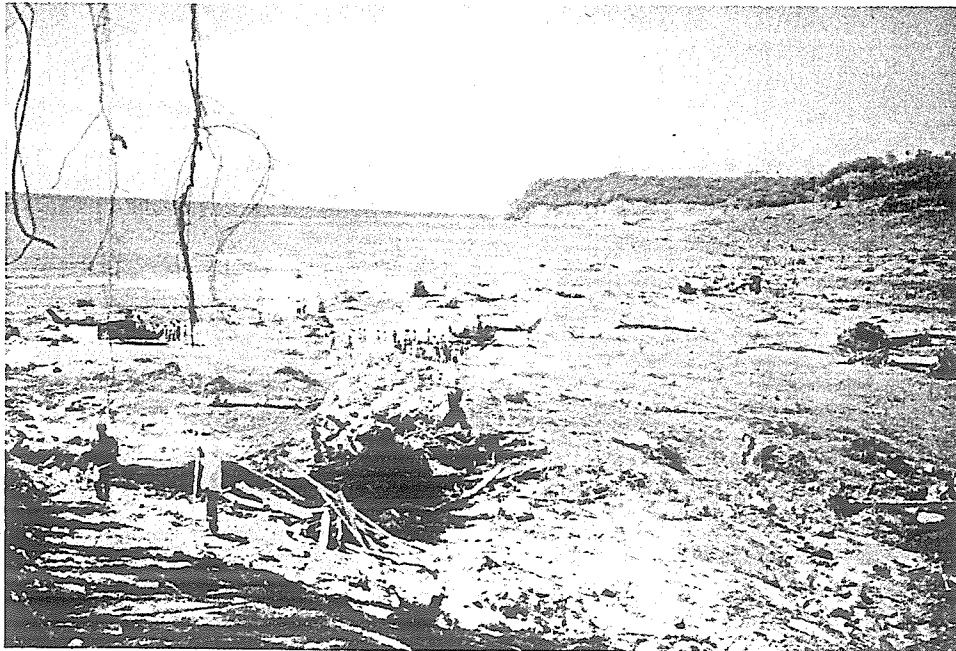

Figure 2



Figure 3



Figure 4

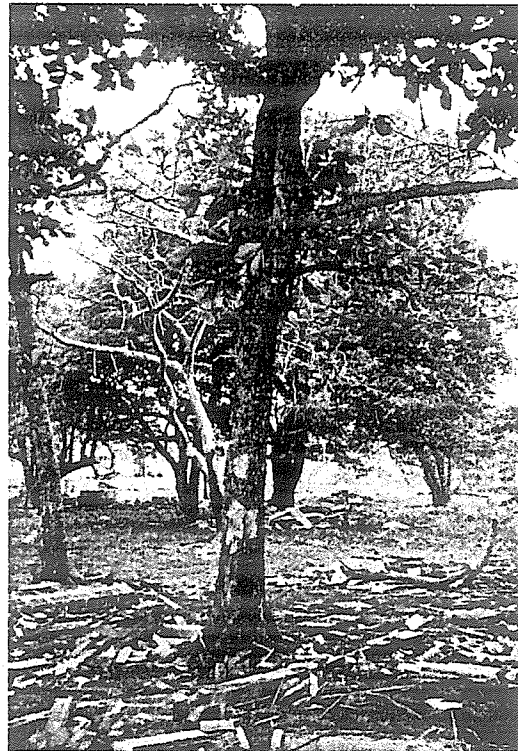

Figure 5



Figure 6



Figure 7

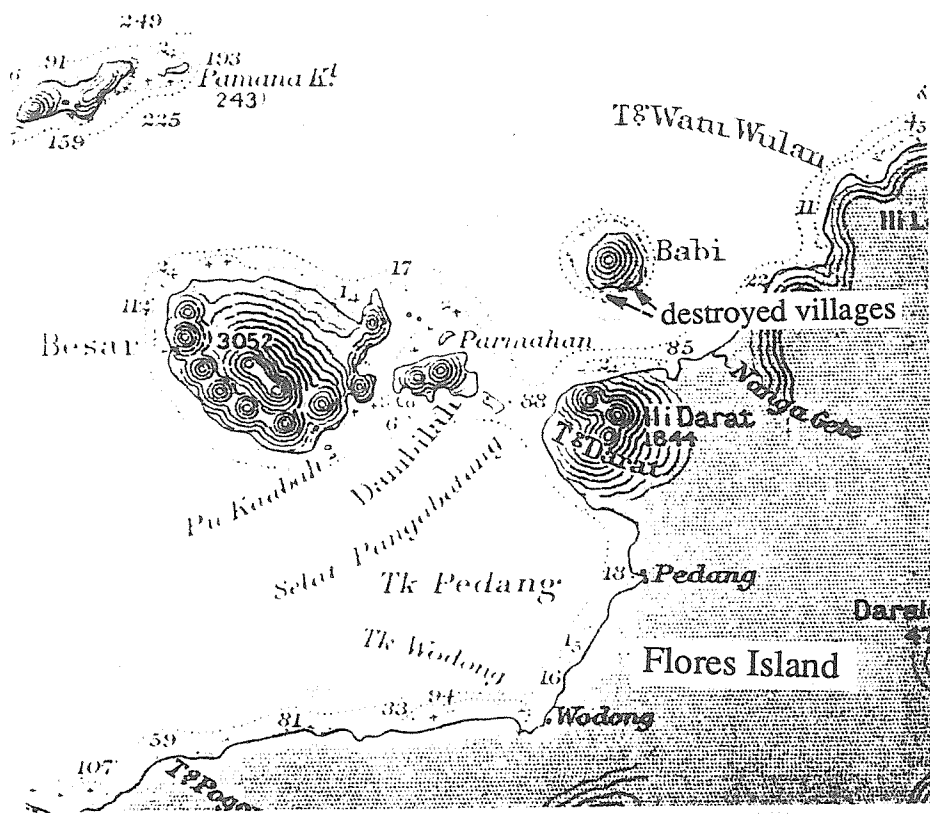

Figure 8. A map of Babi Island.

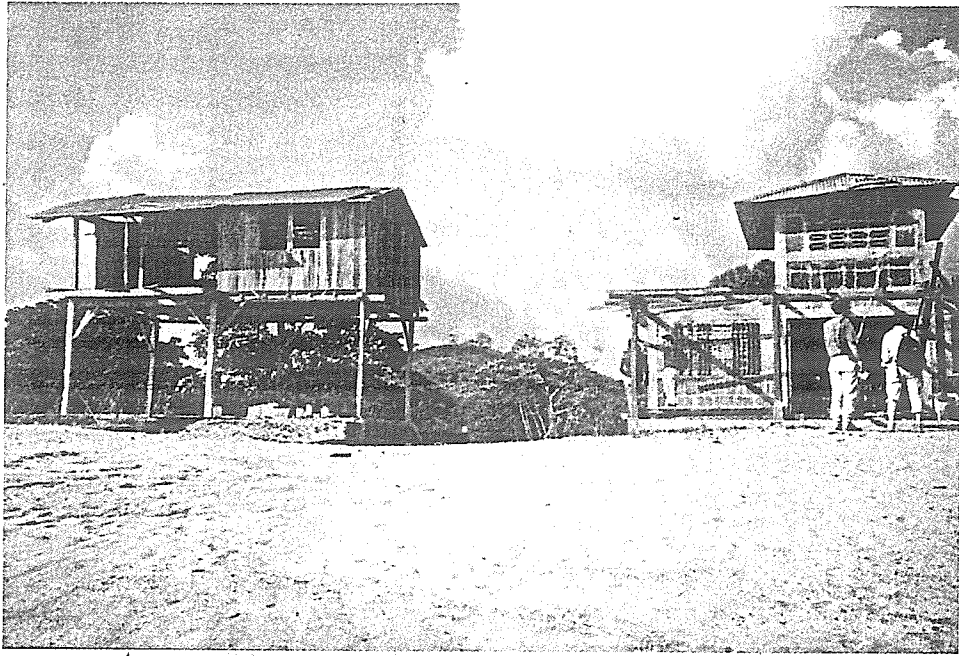

Figure 9a

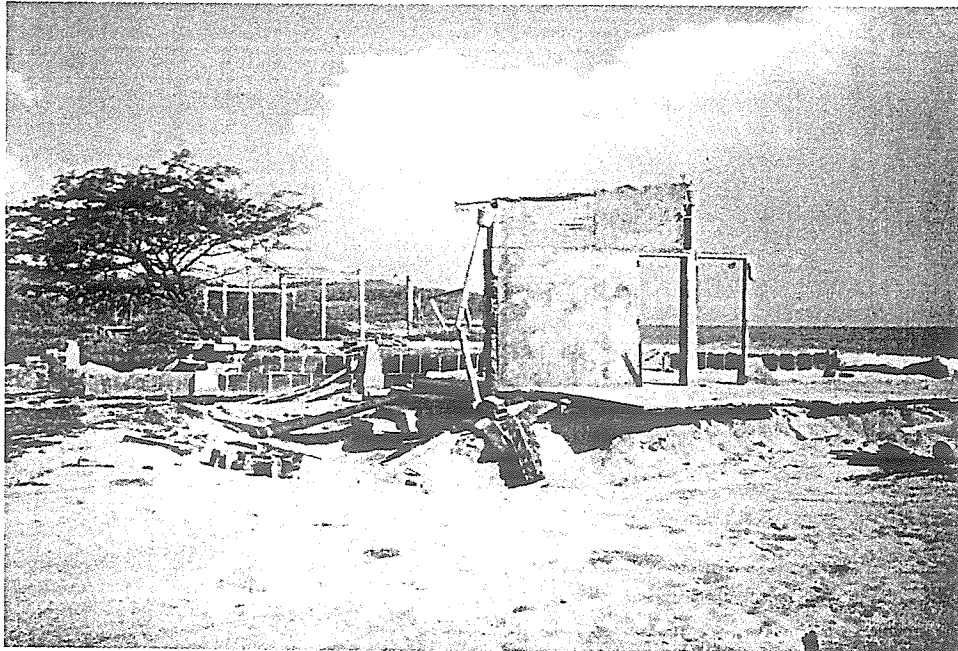

Figure 9b



Figure 10

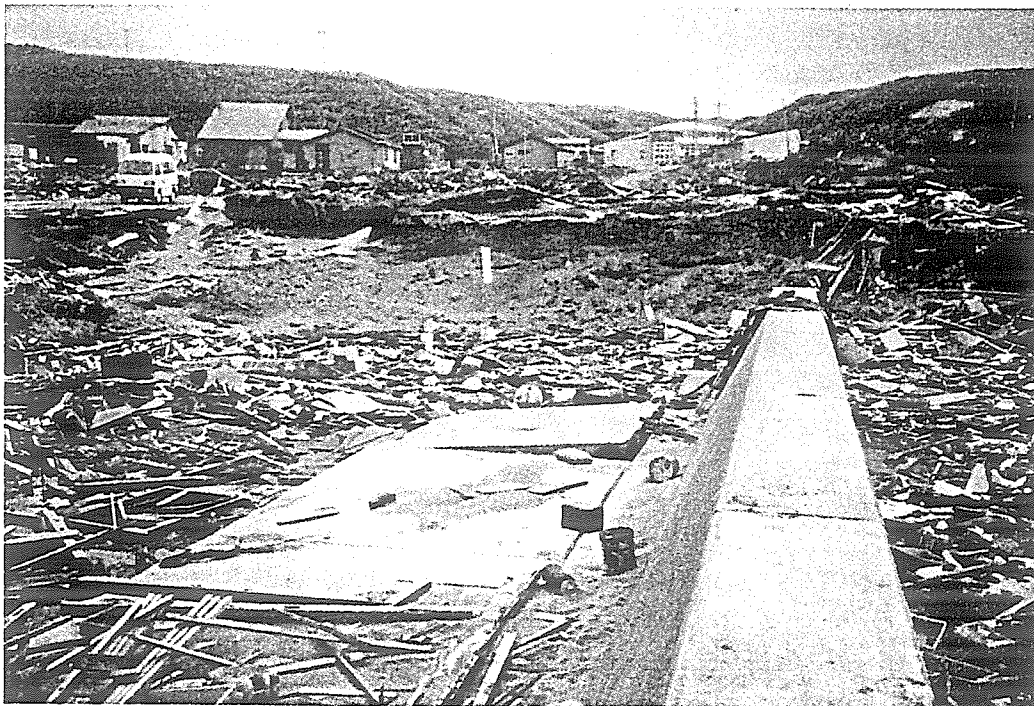

Figure 11

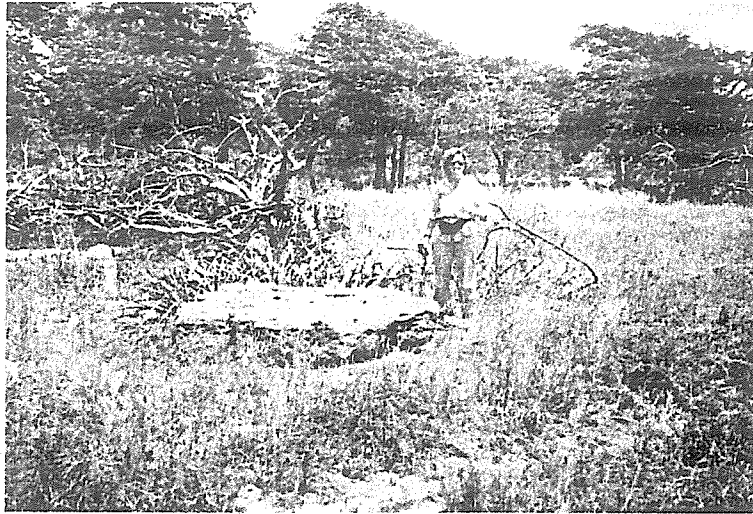

Figure 12a

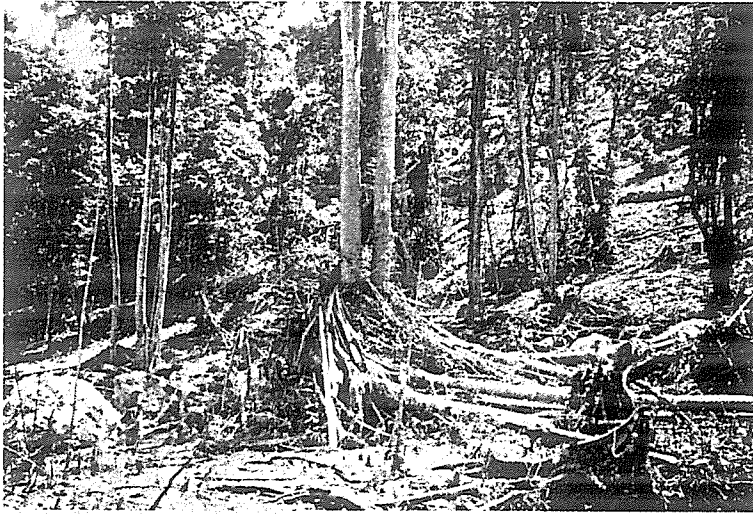

Figure 12b

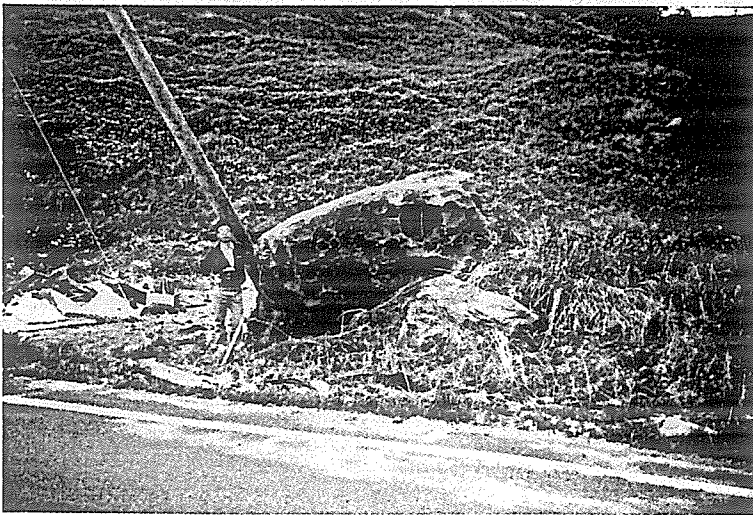

Figure 12c

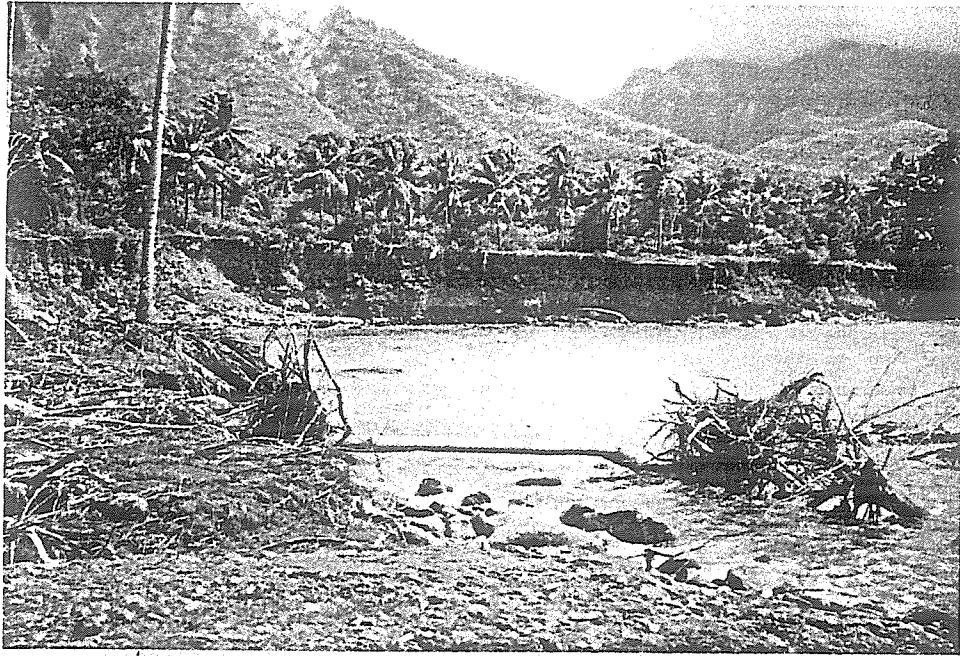

Figure 13a

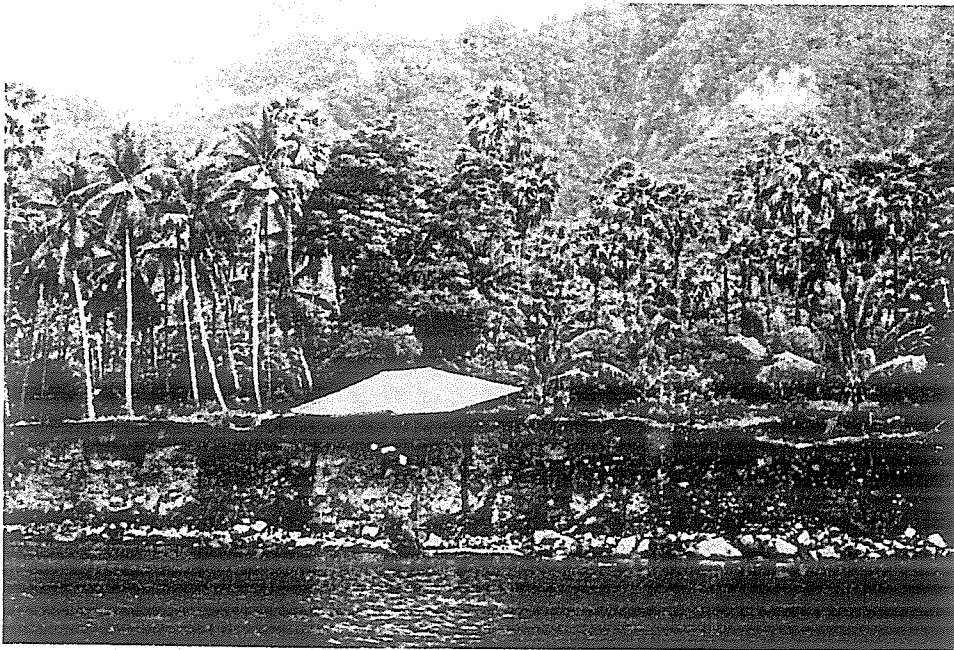

Figure 13b

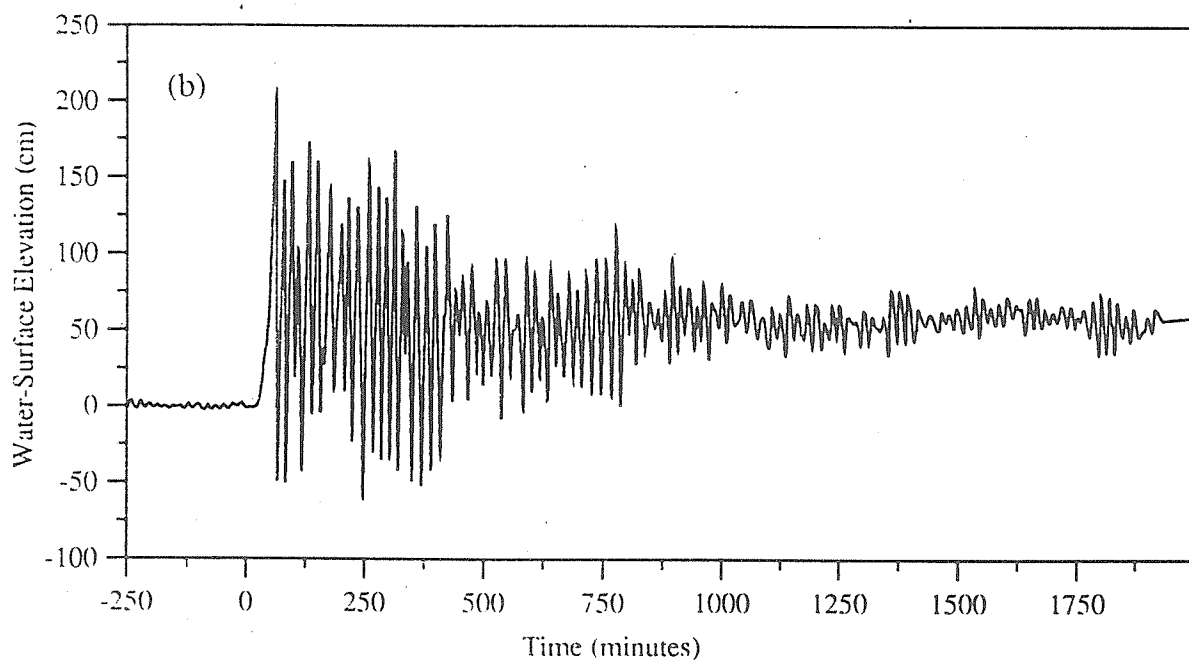
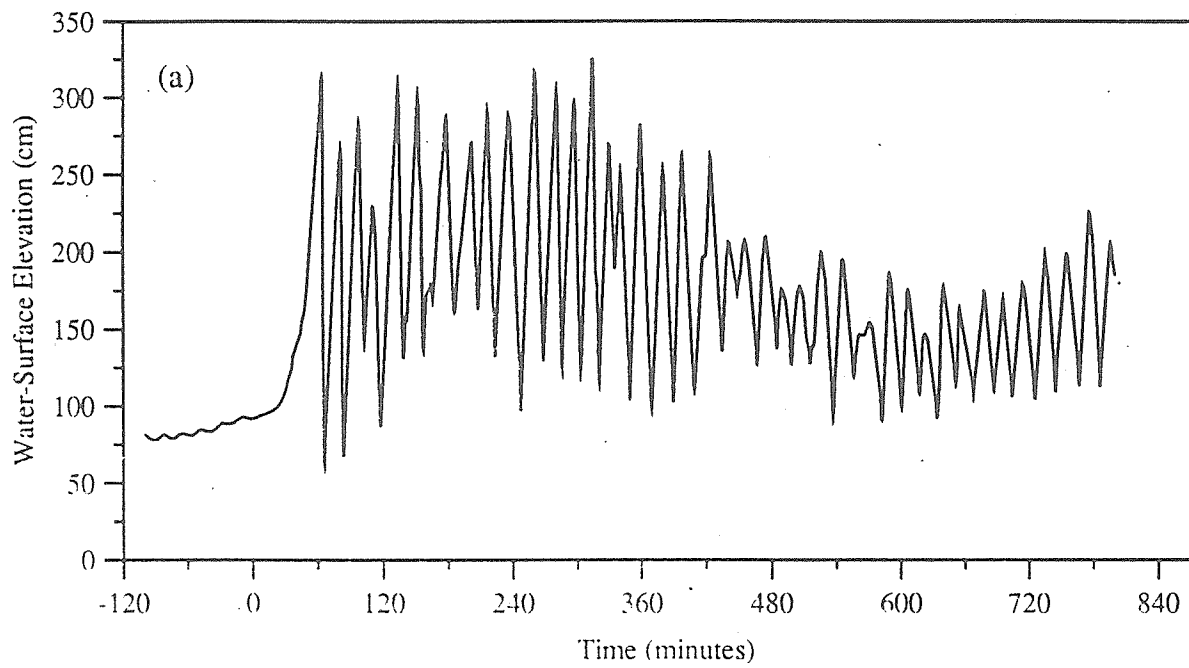
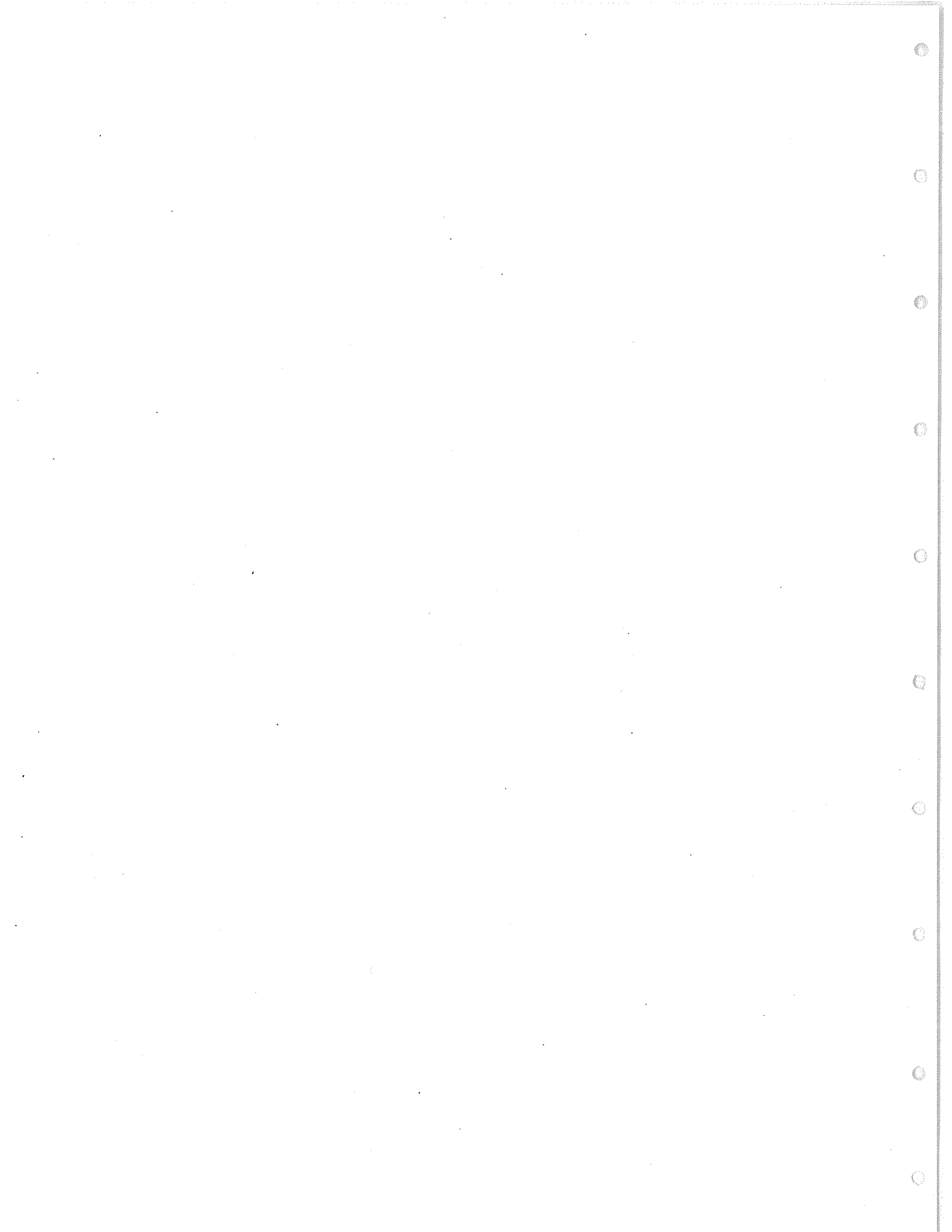

Figure 14. The tide-gage record in Malokurilskaya Bay: a) raw data, b) after removal of the astronomical tides.



APPENDIX C2

STANDARDS FOR TSUNAMI SURVEYING*

Dennis Sigrist and Salvador Farreras
International Tsunami Information Center (IOC/UNESCO)

INTRODUCTION

With what seems to be an unprecedented number of locally destructive tsunamis occurring during the last three years in the Pacific, the need to develop systematic procedures for the collection and utilization of post-disaster survey data has become apparent. The international tsunami research community has been actively involved in collecting time-critical data sets that include field surveys, mareographic records, anecdotal reports, aerial reconnaissance surveys (by plane and satellite) and geodetic/bathymetric information. This collection of data has been helpful in verifying and refining numerical generation and run-up models with the purpose of mitigating the loss of life and associated property damage from future tsunami events.

The period of time immediately following a destructive tsunami can be an agonizing ordeal for local communities and their citizens. People have been killed or lost, buildings and homes are damaged, transportation and lifeline infrastructures may be wiped out and people are in a state of shock. Clearly the first order of business for any country and affected community following a tsunami is a period of grieving and rehabilitation. Recognizing these important human needs, post-disaster tsunami surveys must be conducted with sensitivity to these cultural requirements and with complete coordination with the host country. Every effort should be made to fully involve the host country in any post-disaster tsunami survey field work. Coordination through the ICG/ITSU (national contact) provides an excellent mechanism to ensure that field surveys will be sanctioned at the national and local levels.

A tsunami monitoring program must be organized in advance to plan for the post-tsunami measurements. For small to medium tsunamis, the after-event information is quickly perishable, especially for "unprepared observers". Water level measuring devices to detect and measure the presence of substantial water on land beyond the normal limits must be in place, and observers in target locations must be trained to note and preserve the effects before their disappearance, in all regions susceptible to tsunami attack.

TSUNAMI FIELD SURVEYS AND THE ICG/ITSU

PURPOSE: Improve post-tsunami surveys.

PROCEDURE: Establish standards for observations, measurements, and assessments on how to properly collect the data in a timely manner, and decide on the data to be collected. Develop guidelines for the conduct of the field investigation, so as to enable the consistency of these data. Set procedures to organize survey teams, and dispatch them quickly and effectively, that is, almost immediately following the tsunami. Identify the needs to facilitate such surveys. Identify simple and efficient field survey equipment. Establish policies to manage and distribute post-tsunami survey data.

FINAL PRODUCT: Field Guide or Manual for Post-Tsunami Surveys, targeted to scientists, engineers, government officials, planners, and field survey personnel in general, to whom copies should be distributed as soon as possible at low cost or free of charge. This Field Guide should be simple — easy to carry, read and understand, be translated into the languages of potentially affected countries, and be periodically updated. A prototype interview format, translated also into the local languages, must be included in the Guide.

*Presented at the XV Session of the International Coordinating Group for the Tsunami Warning System in the Pacific, in Papeete, French Polynesia, on July 24-28, 1995.

TOPICS (ISSUES):

1. Before the Field Survey

Selectivity. Develop criteria to judge, on a case by case basis, which tsunamis have the merits (based on preliminary information of the severity or accountable size of their effects, or the new scientific knowledge that might be learned, or the accessibility of the affected area, or availability of enough field personnel and funding) to qualify for a survey by an international team of experts. Define who is going to make the decision on the above.

Financial Support. Allocate a reasonable amount of money in the regular IOC budget for emergency operations immediately after the occurrence of each tsunami, to be assigned on a case by case basis. Voluntary contributions from other national sources (governmental or private) or international agencies are welcomed.

Funding from the IOC should in particular be made available to enable participation of scientists without direct access to funding in their own countries, as well as to ensure that the necessary expertise be represented in any survey.

Make-up of the Survey Teams. Multidisciplinary composition is essential (oceanographers, engineers, seismologists, geologists, specialists in soil liquefaction, and in sediment transport, sociologists, urban planners, community leaders, etc.). From a previously made list of potential field survey personnel, indicating their field of expertise, previous experience, special skills, and time of the year when they are available, a selection of interested and capable persons, according to the specific needs of each case, should be made. Team members in target locations must be trained to note and preserve the effects before their disappearance, in all regions susceptible to tsunami attack. Training sessions may be needed.

In response to a request by the ICG/ITSU Chairman, after a recommendation of ITSU-XIV Session, the following Member States: Colombia, Fiji, Indonesia, Japan, Mexico, New Zealand, Nicaragua, Philippines, Russian Federation, and the USA, provided a total of 41 names as a preliminary, potential list of field survey experts. The participation of more experts can be enhanced by a blanket call to all Tsunami Bulletin Board members at the time of each event.

Basic training for the team to help in disaster relief efforts, first aid, communications, and public education, may be needed; although it should be stressed that these activities are not the main purpose of the field survey.

It is highly desirable that at least one of the team members represents the affected country and speaks the local language of the survey area. A limit on the size of the team, based on the availability of funds and the efficiency in operating under the difficult conditions of the affected area, should be set. Who is going to make the selection of the members of the team, needs to be defined.

Pre-Travel Procedures. Consider ways to facilitate the access of the teams to the survey area. Visa arrangements, immunizations, letters of introduction or other identification documents, permits to access the affected area, transportation, accommodation and food for the team should *be arranged in advance* with the help of ICG/ITSU National Contacts in-place to expedite the surveys. Accident, health, and life insurances should be arranged by the participants themselves. Contact with national academic institutions, international organizations (ITIC, etc.), Consular officers, relief agencies (UNDRO, Red Cross), etc., may also be helpful. Agreements should be reached in advance on the procedures for the admission of the teams and customs clearance of the survey equipment and sediment samples, as well as other logistical matters.

Communication and Coordination. A national authority of the country to be surveyed (i.e., the ICG/ITSU National Contact) should be named and made available through a real-time accessible address (e-mail, telephone, FAX) to the international community to coordinate the main aspects of the survey. Establish also the necessary links with the academic and operational community of the affected nations, who will be involved in the surveys, to help recruit local members for the team, and agree on how the

information to be obtained will be shared, and eventually develop joint research activities. The electronic Tsunami Bulletin Board may be useful for this purpose. Those participating international experts must work hand-in-hand with the local survey experts.

Determine also the communication and logistical support needed from local sources, such as: photocopiers, FAX and telephone lines, Internet accessibility, modems, cellular telephones, etc. Select a common meeting site adjacent to the stricken area. Coordinate with other groups who are performing similar surveys in the same place, so as to minimize duplication and share information.

Instrumentation. Identify types of instruments that might be permanently available for the infrequent occurrence of tsunamis, specifically sea-water level gauges and current meters, their adaptation to tsunami measurement digital sampling rates and record lengths (i.e., bottom or surface pressure transducers for low frequencies), their calibration, and/or the conversion of their measurements into valid tsunami information. Consider their survivability in the tsunami source and arrival regions.

Simple and reliable water level measuring devices to detect and measure the presence of substantial water on land beyond the normal limits must be in place. In advance of the survey, identify the existing instruments in the site, and collect their information.

Survey Equipment, Baggage, and Documents. Identify and select the most suitable, portable, and easily accessible instruments for the parameters to be measured.

Identify sources where to buy, rent, borrow, or get them through inter-institutional cooperation. Eventually, stock pile basic equipment (or at least, have a computerized list of what and where to get it) in storage at some facility.

Optical survey equipment, hand levels, stadia rods, synchronized chronographs, inclinometers, measuring tape, compass, and a small scale may be essential. Arrange for piston cores to take sediment samples and shovels to dig. A digital survey fathometer coupled to a Global Positioning System (GPS) may be needed. Consider the use of photographic, audio, or video recorders, and carry enough rolls of film, cassettes, tapes and battery supplies.

For remote locations, portable seismographs may provide valuable aftershock data.

Include: portable light weight energy sources (i.e., solar panels to recharge batteries, small natural gas tanks or generators, fuel) as required by the survey equipment and camping needs (stove, lamp, tent, etc.); flashlights with extra batteries and lamps, matches in waterproof containers. A portable radio, portable (lap-top) computers, papers, pens, portable telephones, clipboard, pocket knife, and waterproof packaging for documents should be carried. Appropriate clothing, hat, and shoes or boots for the climate and season of the year will be needed. Don't forget sun-screen and insect repellent lotions to complement the protective clothing.

Archives of maps (bathymetry and topography at a scale of 1:25,000 or finer), aerial photos, tidal gauge locations, and tide tables (or computer tide programs) to correct runup measurements for areas of high vulnerability to tsunami attack, should be assembled and maintained. Enlarge the maps by photocopying before embarking, to aid field note taking. In addition, lists of organization names, contact names and addresses of sources for these materials for all tsunami-prone areas of the world, including the Pacific, the Atlantic, and the Mediterranean, should be maintained. If such materials are not presently available for relevant areas, efforts to establish databases should be undertaken as soon as possible.

Design a pre-departure checklist including:

- a) personal effects (toilet articles, Kleenex, Wash'n Dry, toilet paper, safety pins, scissors, sunglasses, alarm clock, sewing kit, etc.)
- b) non-perishable emergency food and water supplies to survive (canned meat, poultry, fish, fruit, vegetables, and beverages; dry milk, cereals, coffee, tea, creamer, salt, pepper, sugar; disposable plates, cups, and napkins, a can opener, and pills to purify water); and

- c) first aid kit and prescriptions (adhesive tape, sterile cotton, antiseptic solution, aspirin, prescribed antibiotics, bandages, diarrhea medication, ear drops, laxative, petroleum jelly, rubbing alcohol, toothache remedy, thermometer, etc.) Include this list in the Guide.

Credit cards and foreign currency (if you survey outside your country) are also a need.

Education, Training, and Information. Identify means or ways to transfer and disseminate survey technology, standards, and procedures, to all potential field survey personnel (scientists, engineers, government officials, and planners) from tsunami-prone countries (expected to be affected by local or remote source generated tsunamis), so it becomes common practice for them.

The formulation of a proposal similar to EERI's current LFE Project supported by National Science Foundation, but called "Learning from Tsunamis", with the primary purpose to observe and document the effects of tsunamis and the resulting economic, social, and policy impacts, could be a useful means for training and methodology transfer.

2. While in the Field Survey

Logistics and Generalities. Set operational procedures in the field, task, role, expectations and responsibility assignments to each specialist according to his/her expertise.

Use a Log-book, as part of or attached to the Field Guide, with the outline of basic procedures, a checklist of data to be collected, forms to record the data in a way that can be archived and retrieved in a standard fashion during post-processing, and free space for sketches and additional notes and comments on unusual observations. Guidelines can be provided in the form of a list or a questionnaire.

Site Selection. Select specific sites, like small bays, stretches of open coast, estuaries, beaches, trying to obtain sets of coherent stand-alone data of the parameters to be measured. If possible, capture a broad overview of the area with photographs.

Parameters. Identify a set of parameters, simple and fast to measure or estimate, so as to make them easily comparable and valid for subsequent surveys and research applications.

Horizontal Positioning. Determine position with enough accuracy by means of GPS.

Water Upper Vertical Reach. Measure by standard line of sight levels, GPS, or other methods to, if possible, 25 cm accuracy.

Runup definition and Reference Datum for runup: agree on a single definition and a unique reference level (i.e., Mean Sea Level, Mean Lower Low Water if referred to a chart datum, or local tide level (LTL) at the time of arrival or during the tsunami). Runup heights measured relative to the local tide level and time of each particular measurement should be corrected to the common Reference Datum selected.

For the above mentioned correction, it is essential that all hand watches used by the surveying personnel should be synchronized and set to a standard time signal, and each runup measurement time be recorded. Find out if standard or daylight savings time was locally used at the time of the tsunami occurrence, during the survey, in the local tide gauge records, and tide tables.

Be aware that a proper correction to a common Reference Datum and a standard time is a critical and important issue for further interpretation of the data.

Locate existing benchmarks in the area and use them as reference to check data and measurements. Obtain GPS corrected vertical positions of the benchmarks to detect possible land uplifting or subsidence due to the earthquake.

Be able to identify localized extreme runups due to "funneling" in narrow valleys, channels, and creeks, or "seiches" in semi-enclosed bays. Agree on a criteria when to: a) perform averaging of runup values on beaches of complex topography, where randomness of the flooding process occurs, to obtain a single representative value; or b) avoid averaging of runups, but rather report crude observed data.

Use of GPS as compared to Traditional Techniques. Use of GPS technology may help in more timely and efficient collection of tsunami runup data following destructive tsunami events, and to identify land subsidence or uplifting due to the earthquake. Where traditional surveying techniques using measuring tapes, parallax distance finders and bubble levels produce satisfactory results, they are not necessarily the most efficient in time and manpower. Traditional techniques are, however, relatively inexpensive. While GPS technology has shown dramatic improvements in accuracy and cost, the equipment remains relatively expensive for the high accuracy systems.

Accuracy and Equipment

Traditional techniques used in past tsunami field surveys yield accuracy in the horizontal and vertical planes on the order of 5% of the total distance or height measured. Equipment requirements are modest. Recording keeping, a running log of measurements, and personnel (at least 3) are the most demanding aspects of traditional survey techniques.

GPS equipment has basically automated the measurement and record keeping aspects of surveying. Unfortunately, to obtain the same level of accuracy requires fairly sophisticated equipment that is easy to use (with appropriate training) but still expensive. Four price points and hence four levels of accuracy in equipment are available.

- 1) Lowest Accuracy, +/- 100 meters horizontal and vertical resolution, is available using off-the-shelf consumer equipment priced at less than \$1,000 per hand-held unit. A single hand-held unit by itself provides the position.
- 2) Meter accuracy equipment, about 1 meter in the horizontal and about 3 meters in the vertical, are the next two price points. Equipment in this category is either hand held or a small back-pack w/antenna. Price varies between \$7,500 to \$20,000. Data logging capability is included. A base-station GPS receiver, separate from the hand-held or back pack receiver, is required to obtain GPS corrections used in obtaining and maintaining the high level of accuracy needed for this price-point and better. Telemetry linking the base-station and the roving GPS receiver is required for real-times fixes; without this option the final, corrected fix is obtained after the day's work running a post-processing program.
- 3) Survey equipment in the submeter accuracy range provides horizontal control of 10 cm or less and vertical accuracy better than 0.5 m. Expect to pay \$40,000 to \$60,000 for this equipment. Data logging capability is included. A base-station GPS receiver is required.
- 4) Geodetic equipment, in the millimeter range, is cumbersome and even more expensive and not appropriate for this application.

Mobilization

Traditional survey equipment is easily mobilized for field work. Transportation is generally not a problem to the survey site.

GPS equipment is, even with the more accurate systems, not particularly cumbersome. It is, however, more delicate and is packed in oversized, foam-lined containers for air transport as accompanying baggage. Since it is sophisticated electronic equipment, there may be hassles clearing foreign country customs without some local, on-site help. Once in the field, the equipment is ready to operate; most are powered by rechargeable batteries that are recharged overnight. So, power is required to maintain and operate the equipment for day-to-day operations.

Markings. To help identify maximum horizontal and vertical runup, use high water marks ("bathtub rings") on walls and structures, and other indicators, such as lines of landward limit of sea grass, debris, sediment, or floating garbage deposition (distinguish from deposition due to normal high tides), horizontal boundaries between vegetation killed or damaged by saltwater and surviving vegetation (discoloration after a few weeks is a good indicator), amounts of bark stripped from trees, and levels of seaweed or debris caught in screens or other structures. Notice if upper, middle or lower parts of houses

(windows, roofs, etc.) or structures are damaged, semi-destroyed, or intact, and identify if this was due to earthquake shaking or tsunami arrival. Clothes, fishes, dead cattle, and/or other objects or animals caught and hanging in upper branches of trees. Be able to distinguish real runup marks from splashes. Notice: trees broken, bent, uprooted, or overturned; vegetation destroyed and transported; Debris transported and deposited inland. Its type, size (boulders, rocks, driftwood, sand, etc.) and weight (or density) should be measured if possible. Overtopping of coastal structures and destruction of existing tide stations may also be an indicator.

Horizontal Flooding. Determine this maximum intrusion inshore from MLLW line or other reference line. Delineate in a map, and estimate distances by means of tape, laser, radio frequency equipment, or by visual range (parallax) finder, or (exceptionally) with a car odometer or counting paces.

Currents. Estimate magnitudes through their effects (drag, inertia) on fixed sizable objects and structures, and in floating objects (boats, ships) carried inland. Measure grain size and density of the sediments being transported.

Geological Information. Identify, locate and estimate the extent of possible coastal uplift or subsidence and their influence in the tsunami runup. GPS vertical positioning of existing benchmarks, as mentioned before, may be useful. Submerged vegetation or the presence of green leafy plants growing in the intertidal zone, or uplifted barnacles, may be also an indicator of subsidence or uplifting, as well as changes in the level of high tides reaches after the tsunami.

Presence of cracks, liquefaction, tilting or warping in the ground should be noticed and documented, as well as evidences of fault creep and direction of the motion.

Observe and detect the presence of sand, silt or mud sheets eventually deposited by the tsunami beneath tidal marshes, in flat "meadows" shoreward of ponds, above the height of barrier beaches, or in coastal lagoons. Take vertical core samples with plastic tubes on lines perpendicular to the shoreline, across the surfaces of transport and deposition, to the reach of maximum incursion. Dig trenches and photograph the sediments. Measure the thickness and horizontal extent of the sand layer deposits, and their vertical distribution of grain sizes inside them (use settling tube analysis for fine resolution in a range of 1.5 microns to 2 mm, roughly, if it is possible), and detect the presence of wood detritus and rooted plants as evidence of sudden sand coverage by the tsunami. Identify the areas of eventual erosion, motion and settlement of the sediments by the tsunami waves, but distinguish between beach erosion caused by the tsunami itself from long-term ones.

Identify the presence and eventual influence of landslides, of earth or ice in water bodies, in the generation of the tsunami.

Seismological Information. During the survey, at remote areas, obtain aftershock data from portable seismographs.

Profile. Estimate beach slopes with hand-held inclinometers, or other optical survey equipment. To save time, do the profiles in conjunction with other field observations.

Bathymetry. With the help of a fathometer coupled to a GPS or to UHF radio links for positioning, perform a survey of the near-shore bottom of those coastal areas not covered with enough resolution by the available charts, or where substantial changes due to sediment transport by the tsunami may have taken place. A small boat or vessel will be needed.

Timing and Other Characteristics. Document, through eyewitness interviews, instrument measurements or local press reports, the times of arrival and periods of the tsunami waves, their number, time of tsunami arrival after earthquake shaking, and the total duration of the tsunami. Did the water recede before the arrival of the first wave or not? Were there "noises" heard? Were the waves of a bore type or not? What was the approach direction of the incoming waves? Be aware of eyewitness interviews, which may vary significantly in reliability.

Document the eventual propagation of tsunami bores upstream in estuaries. Detect or identify the influence of any local basin resonance amplifying the tsunami response, and the influence of existing islands, offshore rock formations, or other local bathymetric features present in the continental shelf. Consider the width of the continental shelf. Notice any influence of local topographic geometry in the runup patterns, and damping due to bottom friction.

Make an attempt to describe qualitatively or quantitatively the tsunami waves behavior in the beaches, harbors, etc. (i.e., by refraction, diffraction, scattering, trapping or other physical phenomena) and give a preliminary explanation of the observed inundation patterns.

Non-Traditional Survey Methods. Photogrammetry, aerial videos, side scan bottom profilers to assess sea bottom ground deformation, and other methods, should be considered if there is a need, and financial support.

Damage Assessment. Make rough (non specialized) classifications, estimate the nature and category of the damage, and to what apparent cause damage is due: a) primary agents — hydrostatic (pressure, buoyancy) or hydrodynamic (surge, drag), or b) secondary — impact by debris or driftwood, fires from electrical vaults or oil ignition, explosions, contamination from hazardous materials or toxic fume releases, lack of ground support by scouring torrent of receding waters, etc. Also look at overtopping of breakwaters, docks, or other coastal structures and sand erosion or deposition in beaches. Distinguish earthquake from tsunami damage.

Ancillary (Auxiliary) Data and Background Information. Early availability of good resolution bathymetry, coastal topography (scale 1:25,000 or less) including coastal configuration, geological maps, and seismotectonic information (name and strike or slip type of existing main and subsidiary faults, their location, total length and eventual portion ruptured), is needed to help define the source region and mechanisms for early model simulation that may identify most probably affected areas and locations for the survey teams to visit.

Check availability of and use aerial photographs and satellite images to help locate affected areas to be surveyed.

Social Impact. Make a rough estimate towards gaining an overview of the impact of the tsunami on: human behavior, public services, communication lifelines (roads, rail lines, airport runways, utilities, etc.), disruption of everyday activities, casualties and injuries, performance of emergency management agencies and the degree of effectiveness of the response plans in effect, and homeless and displaced persons due to the tsunami.

Evaluate the response of different segments of the population (elderly, disabled, minors, etc.) to the warnings. Review for lives lost: inadequate warning, inadequate evacuation, inadequate preparedness? Make general recommendations.

If needed, get involved in seminars or short lectures for community leaders, government officials, and the general public, on tsunami risk, simple mitigation measures, preparedness, and response issues.

Computer Modeling. Consider the type and quality of data to be collected during the survey for modeling requirements.

State the purpose and time frame of the simulation: a) to help determine runup and inundated areas in almost real time to improve the early warnings, or b) for future better understanding of the phenomena in general, or of any particular event, or c) to do risk mapping for preparedness planning.

Ultimately, for what is the model run to be used: research, or operational warnings, or early estimates of flooding, or for better determination of the source mechanisms by inverse methods, or for engineering design purposes.

Consider the simulation of specifically unusual cases, like tsunamis generated by landslides.

(These are also issues for Section 3.- After Field Survey-below.)

Reconnaissance. The team should be able to assess and report the need for follow-up research and recommend specific areas that merit attention for subsequent surveys. Any new data collection technique which may arise and help to improve future surveys should be reported too.

3. After the Field Survey

Report. Write down the basic general information, with enough detail as might be needed, and report it to the sponsoring agency (IOC) and the International Tsunami Information Center (ITIC). Participants in the surveys are expected to voluntarily, upon request, contribute brief reports for the Tsunami Newsletter edited by the ITIC. Comprehensive reports may be required by sponsoring institutions or for presentation at international meetings and symposiums. Brief reports submitted on the electronic bulletin board can be helpful for other members of the tsunami community, and should be posted as soon as practical after the return of the survey teams.

Gathering, Processing, Sharing and Distribution of Post-Tsunami Data. Adopt as policy, to share the information for the benefit of all parties (broad dissemination and accessible storage are the key issues).

Establish uniform procedures and guidelines to standardize the collection, formats, processing, archiving, distribution, dissemination and availability of the data through existing Centers (ITIC, NGDC, JMA, WDC A and B) or new ones. Funding should be requested to establish new or to expand the present tsunami repositories.

Examples of data to be managed include: a) bibliographic, b) marigrams, c) tables, d) charts and graphics, e) photos and videos, f) audios.

Options of media to store it include: publications, reports, cassettes, disketts, CD-ROMs, etc.

Classical (photocopies, mail, FAX) as well as the most advanced electronic superhighway technology should be employed to distribute and give access to the community to the information, such as the development of interactive multimedia documentation (use of World Wide Web browsers like Mosaic or Netscape for digital images, graphs, interactive maps, computer generated animations in MPEG or Quicktime formats), and on-line Bulletin Board via the Internet for text and tables, etc.

APPENDIX C3

A NOTE ON RECENT DEVELOPMENT OF TSUNAMI WORKS IN JMA

Masami Okada
MRI, JMA, Japan

The Japan Meteorological Agency (JMA) is responsible for tsunami warning in Japan and has been making efforts to improve the tsunami warning system including the observational network. After the 1993 Japan Sea tsunami, a new seismic observational network with about 180 seismographs was deployed to shorten the lapse time for a warning. It now takes several minutes in many cases, but JMA is trying to issue warnings more quickly after an earthquake occurrence. Tsunami arrival time is also forecasted for many ports and it is useful for disaster mitigation planning.

Tide gauges are the most popular instrument for tsunami observation, however they cannot record large tsunamis as high as three meters above sea level. JMA is going to install a pressure gauge near the tide station, shown in figure 1, in order to observe destructive tsunamis on shore. A receiver for tide gauge and pressure gauge information will be stored in a repeater house built as a sill higher than 10 meters above sea level, if possible. Numerical data about the tsunami are gathered by the telemetry system from tide gauges.

The coastal wave recorders shown in figure 2, installed on the sea bottom at the depth of 20 to 50 meters, have the capability to measure large tsunamis as the measurement of wind waves. Their data, however, are usually intermittently recorded, an observation period consists of 20 minutes every hour. A tsunami record is shown in figure 3. The data acquired in shallow water will be valuable for tsunami study as well as for warnings, if the systems are improved in order to obtain a continuous record of sea surface elevation.

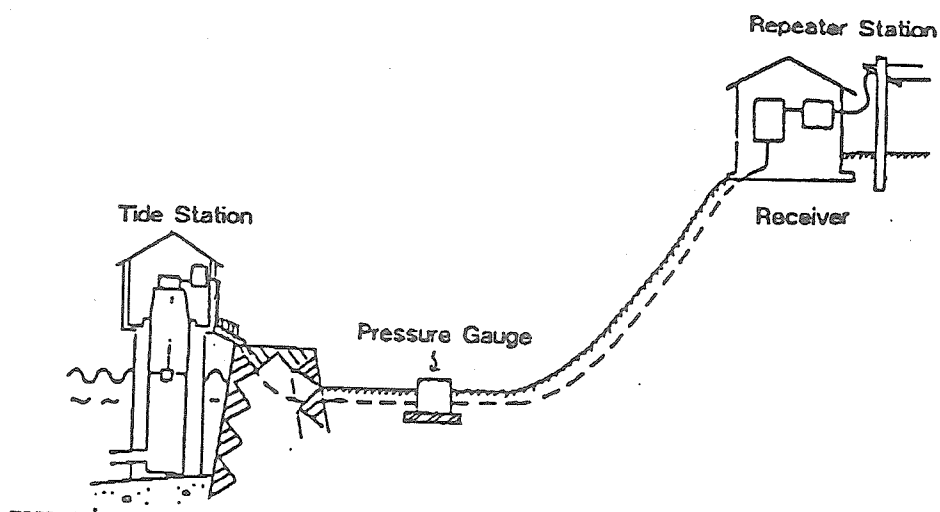

Figure 1. New type of tide station for observing tides and large tsunami.

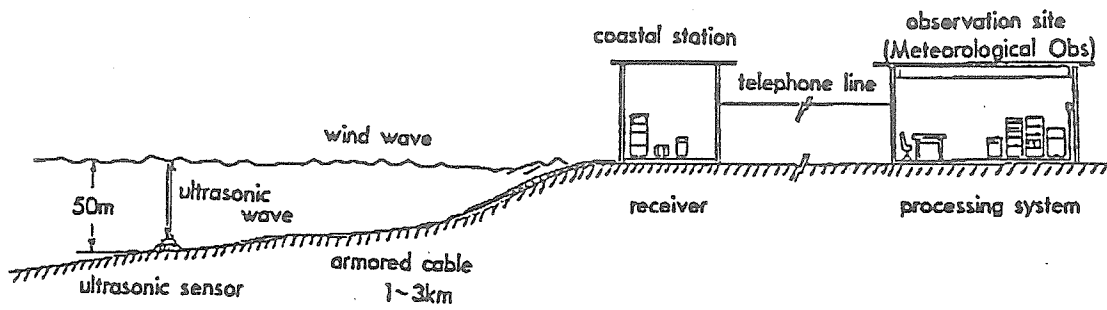

Figure 2. Coastal wave recorder (CWR) system.

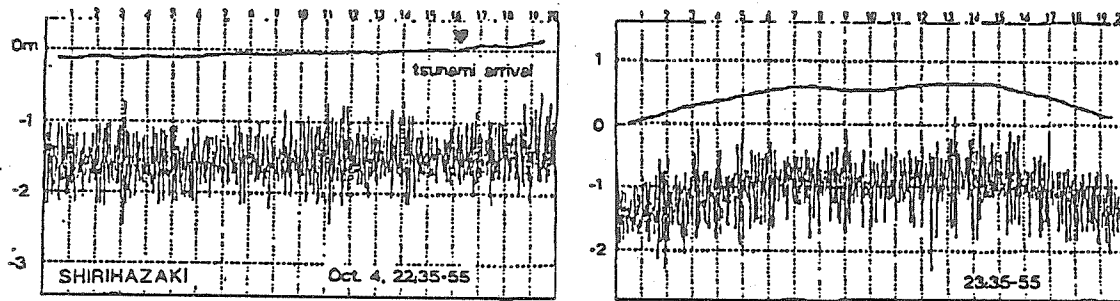

Figure 3. A tsunami record by CWR off Kushiro on October 4, 1994.

The ocean bottom pressure gauges deployed off southern Honshu (see figure 4) recorded the tsunami in deep water from the earthquake near Guam Island on August 8, 1993, shown in figure 5. We plan to observe tsunamis at three stations, shown in figure 4, in the VERNUS Project (Versatile Ecomonitoring Network by Undersea-cable System). One station near Okinawa Island will be in operation in 1997.

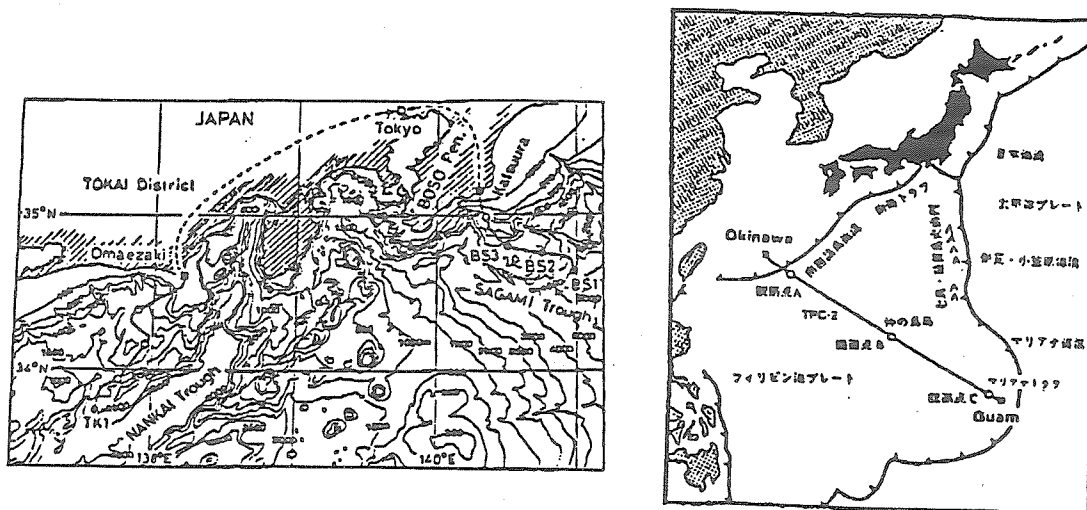

Figure 4. Locations of bottom pressure gauges and cable routes.
 Left: Ocean bottom seismograph systems. Right: VERNUS Project.

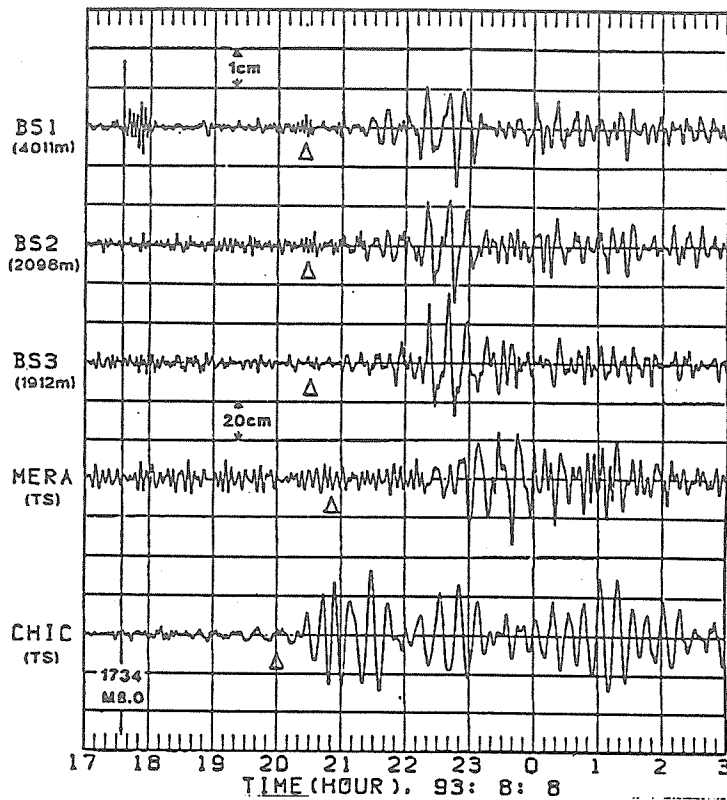

Figure 5. Records of tsunami generated by the Mariana earthquake of Ms8.0 on August 8, 1993.

Table 1. Characteristics of instruments for tsunami observation in Japan

| | tide gauge | coastal wave recorder | ocean bottom pressure gauge |
|----------------------------|---------------|-----------------------|-----------------------------|
| location | port seashore | coastal sea | ocean |
| water depth | 0-2m | 20-50m | 2000-4000m |
| distance from shore | 0-10m | 500-5000m | 30-150km |
| quantity | ca. 500 | 53 | 4+ several in plan |
| tsunami amplitude | large | middle | small |
| construction (million yen) | 10-40 | 50-300 | 1,500-3,000 /OBS system |
| maintenance | cheap | expensive | expensive |
| obs. range | 0-3.5m | 0-20m | 0-30m ? |
| response | non-linear | linear | linear |
| telemetry | possible | possible | yes(cable) |
| numerical data | possible | possible | yes |
| other usage | tide | wind wave | earthquake |



CHARACTERISTICS OF THE 1994 HOKKAIDO-EAST-OFF-EARTHQUAKE TSUNAMI,
THE 1994 SANRIKU-FAROFF-EARTHQUAKE TSUNAMI, AND 1995 HYOGO-PREFECTURE
SOUTH-EARTHQUAKE TSUNAMI BASED ON FIELD OBSERVATION DATA

T. Nagai, N. Hashimoto, T. Hiraishi, K. Shimizu
Port and Harbour Research Institute, Ministry of Transport

T. Ichikawa
Second District Port Construction Bureau, M.O.T.

S. Miyabe
Hokkaido Development Agency

M. Kudaka
Echo Company

S. Kawamata
Penta Ocean Company

Abstract

NOWPHAS offshore wave observation records, tide stations' records inside the harbours, field runup survey results, and numerical tsunami transformation simulations on the 1994 Hokkaido-East-Off-Earthquake tsunami are introduced in this report. Zero-up-cross tsunami heights and periods, seabed horizontal current, and frequency spectrum are discussed on the tsunami profiles.

An offshore tsunami profile of the 1994 Sanriku-Faroff-Earthquake and the 1995 Hyogo-Prefecture-South-Earthquake are also introduced.

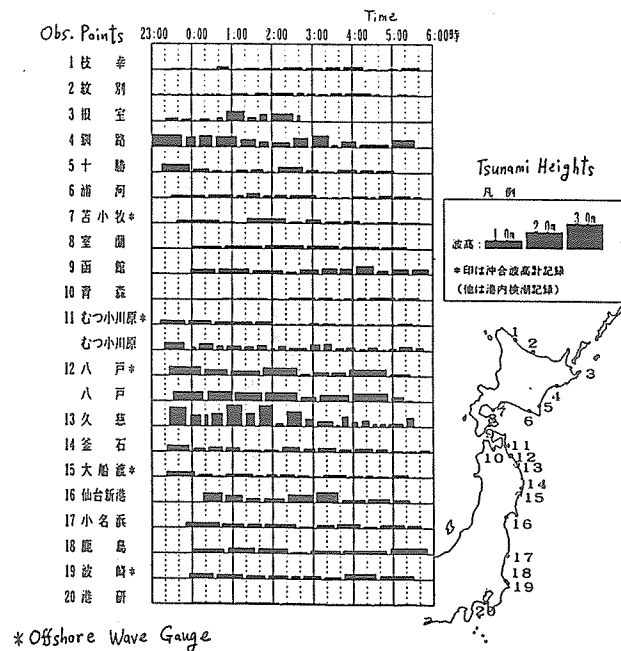

Fig. 1 1994 Hokkaido-East-Off-Earthquake Tsunami Heights and Periods

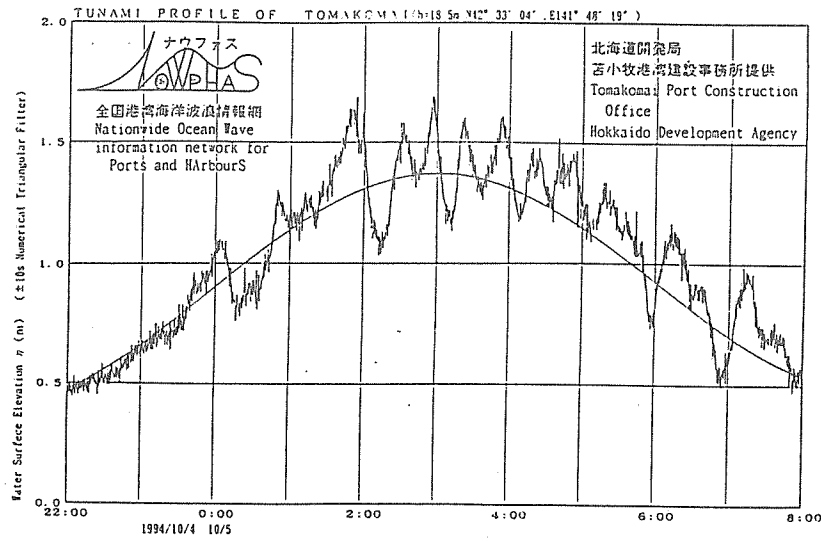

Fig. 2 Tsunami Profile off No.7 Tomakomai Port

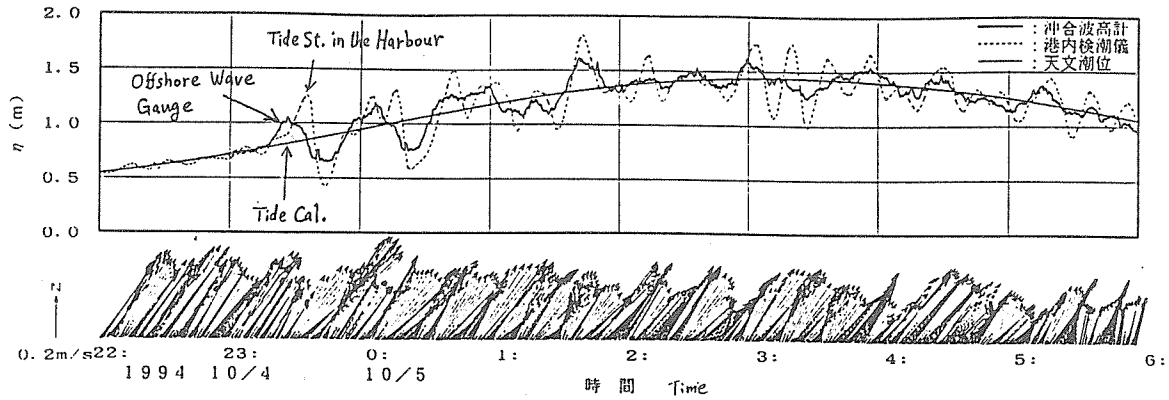

Fig. 3 Tsunami Profile off No.11 Mutsu Ogawara Port

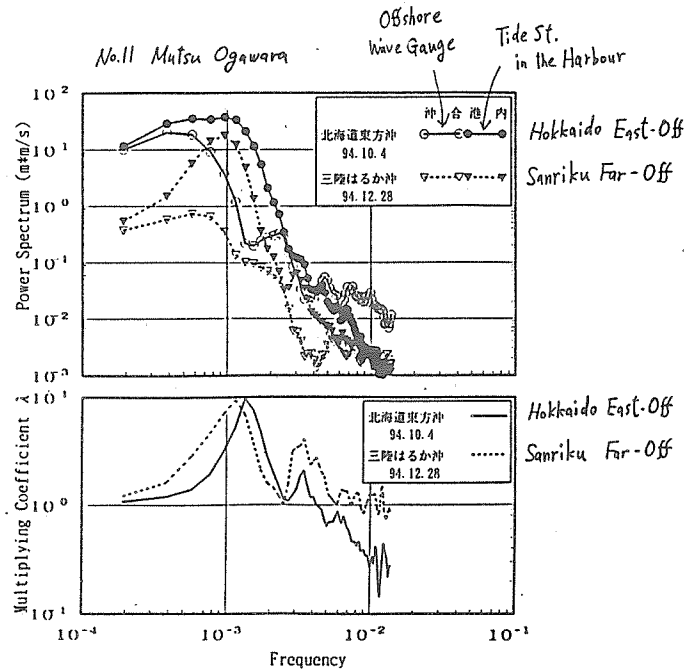

Fig.4 Tsunami Frequency Spectra (No.11 Mutsu Ogawara Port)

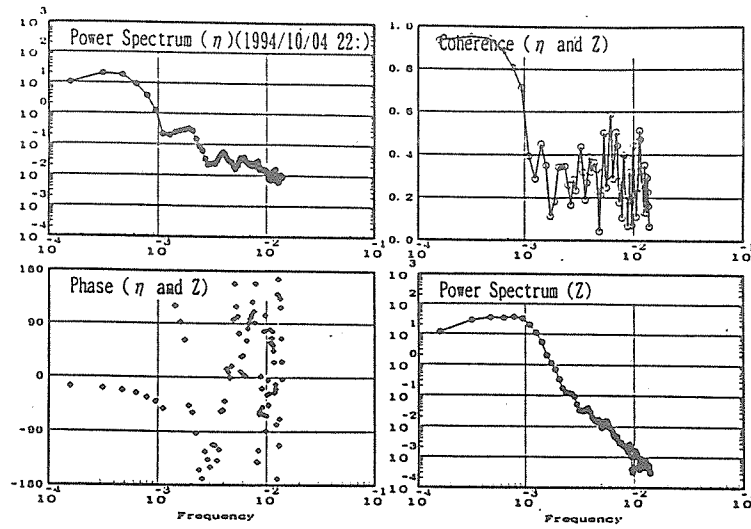

Fig.5 Spectra Relation between η and Z

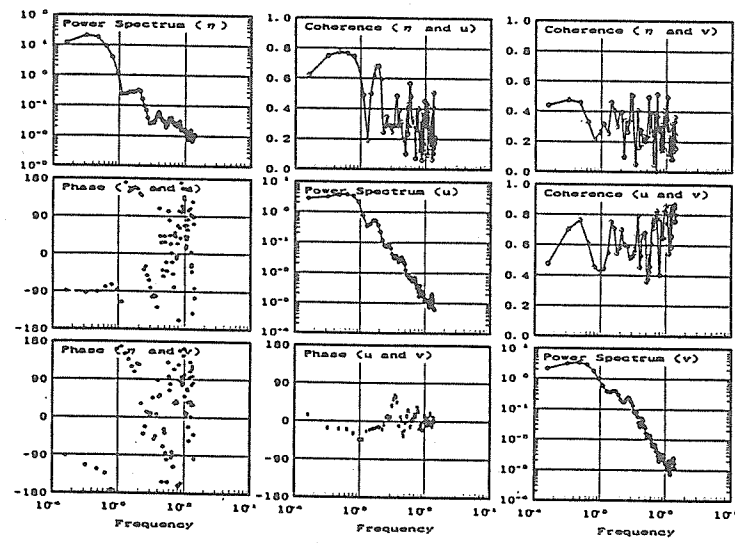

Fig.6 Spectra Relation among η , u , and v

1994 Hokkaido East-Off Earthquake Tsunami
 No.11 Matsu Ogiwara η vs u

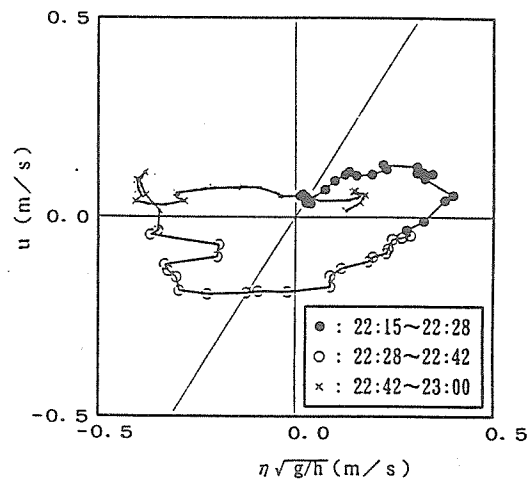

Fig.7 Relation between η and u

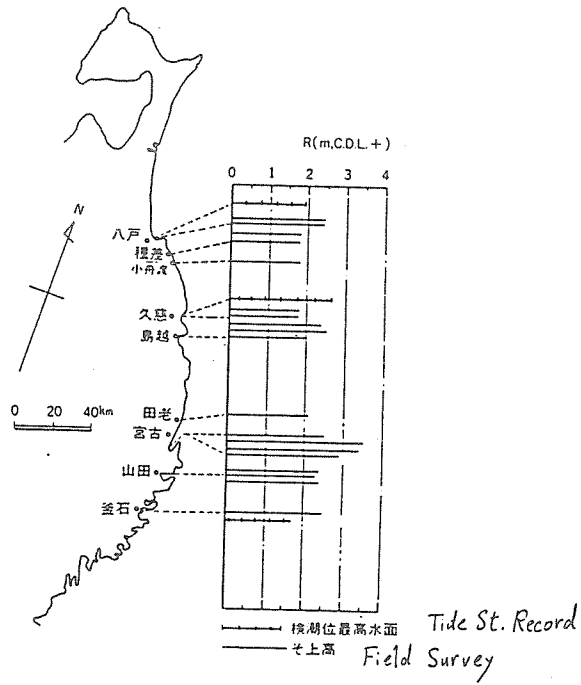

Fig. 8 Tsunami Runup Heights v.s. Tide Stations' Records

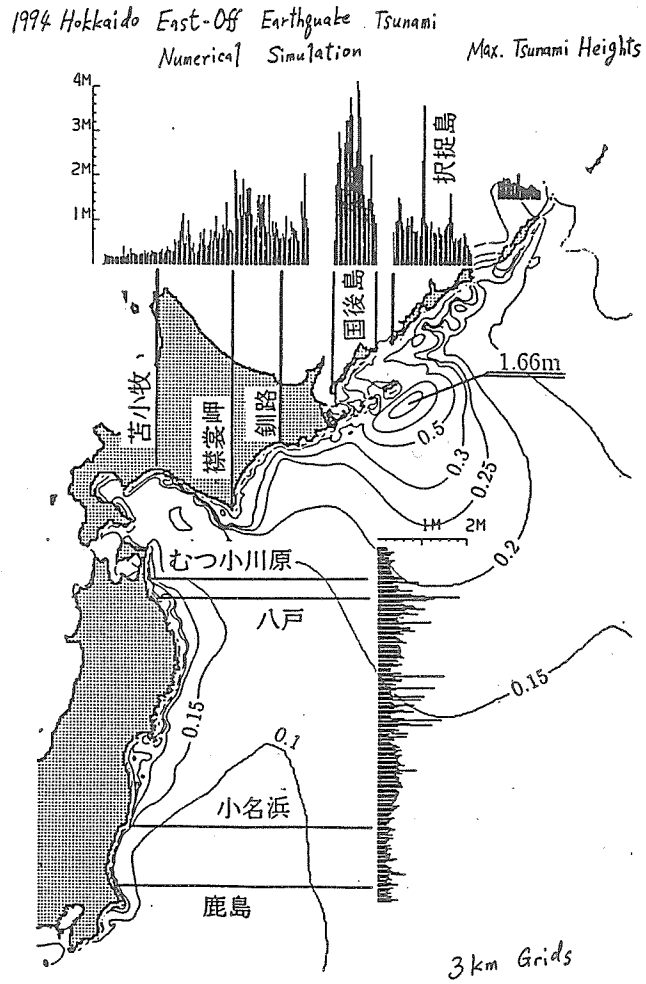

Fig. 9 Calculated Maximum Tsunami Heights along the Coasts

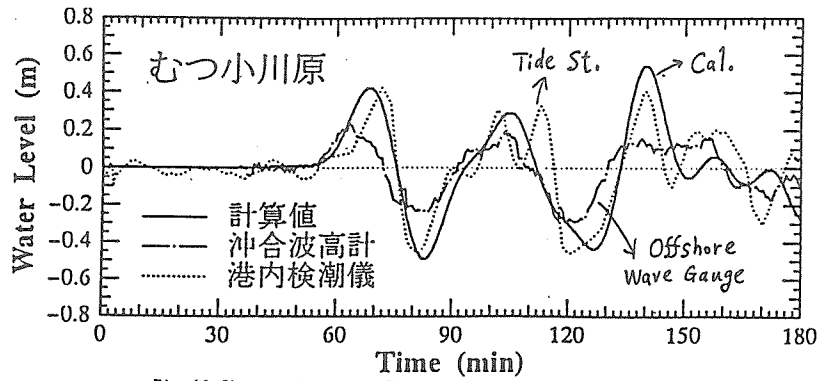

Fig.10 Observation v.s. Simulation of the Tsunami Profile
(No.11 Mutu Ogawara Port)

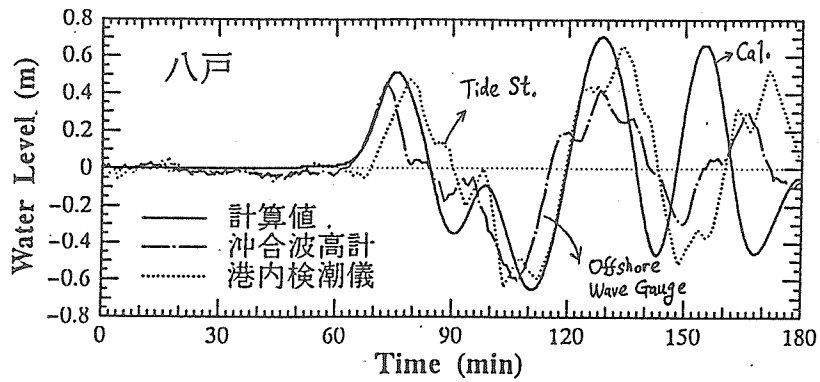

Fig.11 Observation v.s. Simulation of the Tsunami Profile
(No.12 Hachinohe Port)

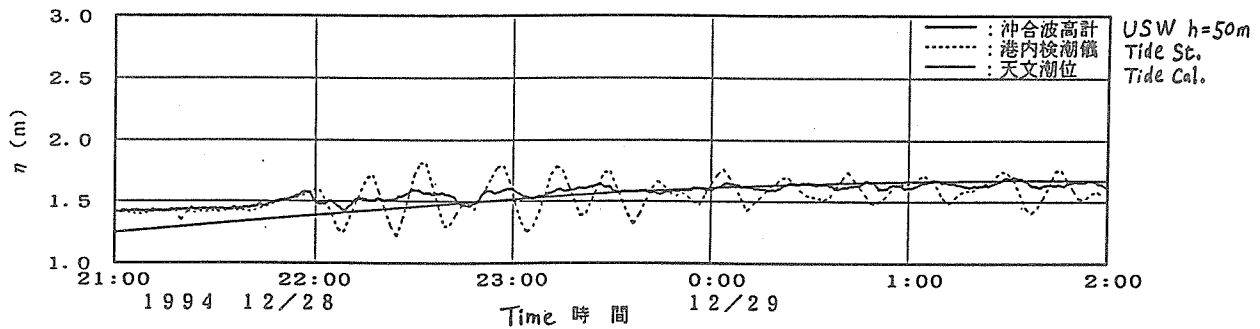

Fig.12 Observed Tsunami Profile of the 1994 Sanriku-Faroff-Earthquake
(No.11 Mutu Ogawara Port)

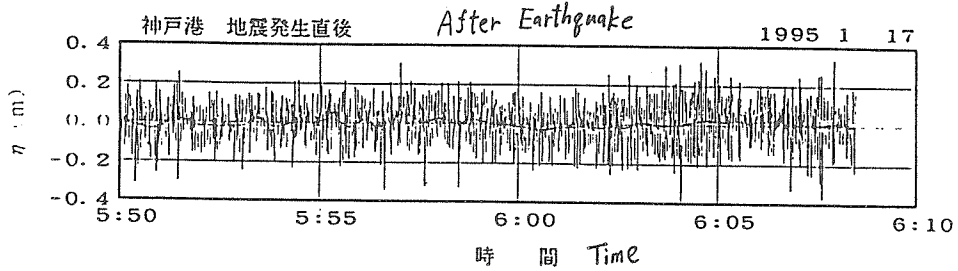
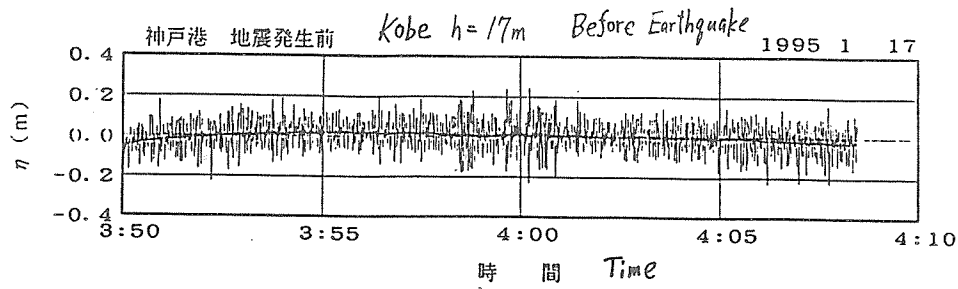

Fig. 13 Observed Tsunami Profile of the 1995 Hyogo-Prefecture-South-Earthquake (Off the Kobe Port h = 17m)

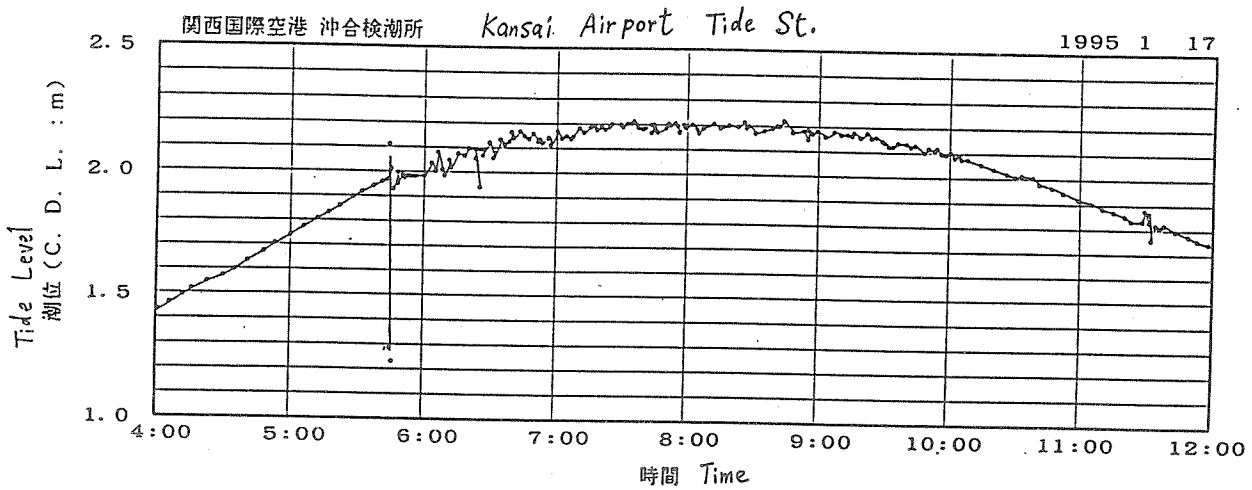

Fig. 14 Observed Tsunami Profile of the 1995 Hyogo-Prefecture-South-Earthquake (Off the Kansai Airport)

APPENDIX C5

RESEARCH NEEDS: PUBLIC HEALTH IMPACTS OF TSUNAMIS A BRIEFING FOR THE INTERNATIONAL TSUNAMI MEASUREMENTS WORKSHOP

Josephine Malilay, Ph.D.
Disaster Assessment and Epidemiology Section
National Center for Environmental Health, Centers for Disease Control and Prevention
Atlanta, Georgia, U.S.A.

The hazards of tsunamis can lead to potentially serious public health problems. Tsunamis can strike more frequently when compared to other natural disasters: six major events occurred worldwide in the past three years. These disasters can impact areas far more extensively than those affected by other natural disasters such as hurricanes, earthquakes, and tornadoes. Tsunamis can accompany a major earthquake or volcanic eruption in the same area within a few minutes, and they can affect distant countries after several days. Although they may occur secondary to earthquakes and volcanic eruptions, they may cause a greater number of deaths than the primary events themselves.

Little is known of the public health impacts of tsunamis. We propose to determine systematically these impacts by the following: 1) characterize deaths and injuries in terms of demographics, time, characteristics of the setting, and other determinants to provide a descriptive overview of these effects; and 2) from the information in 1, determine risk factors that predispose individuals to injury or death to provide strategies for preventing or reducing adverse health effects in future events.

We invite discussion on the following:

1. Identify databases with mortality counts from past events. The current summary statistics of deaths and injuries from individual events is sketchy at best. According to the *World Disasters Report* (International Federation of the Red Cross and Red Crescent Societies, 1993), 20 tsunami events occurred from 1967 to 1991, when 6,390 persons were killed, 30 injured, and 918 affected. Clearly, these data need to be verified and compared against similar information from other databases, particularly from the physical sciences.
2. Identify vulnerable sites worldwide to include physical characteristics of these areas and inhabitants.
3. Identify forecasting, watch and warning systems in vulnerable areas. Determine how these systems were associated with the evacuation of vulnerable populations in previous tsunamis.
4. Identify specific characteristics used by physical scientists to explain tsunami-related deaths or injuries.

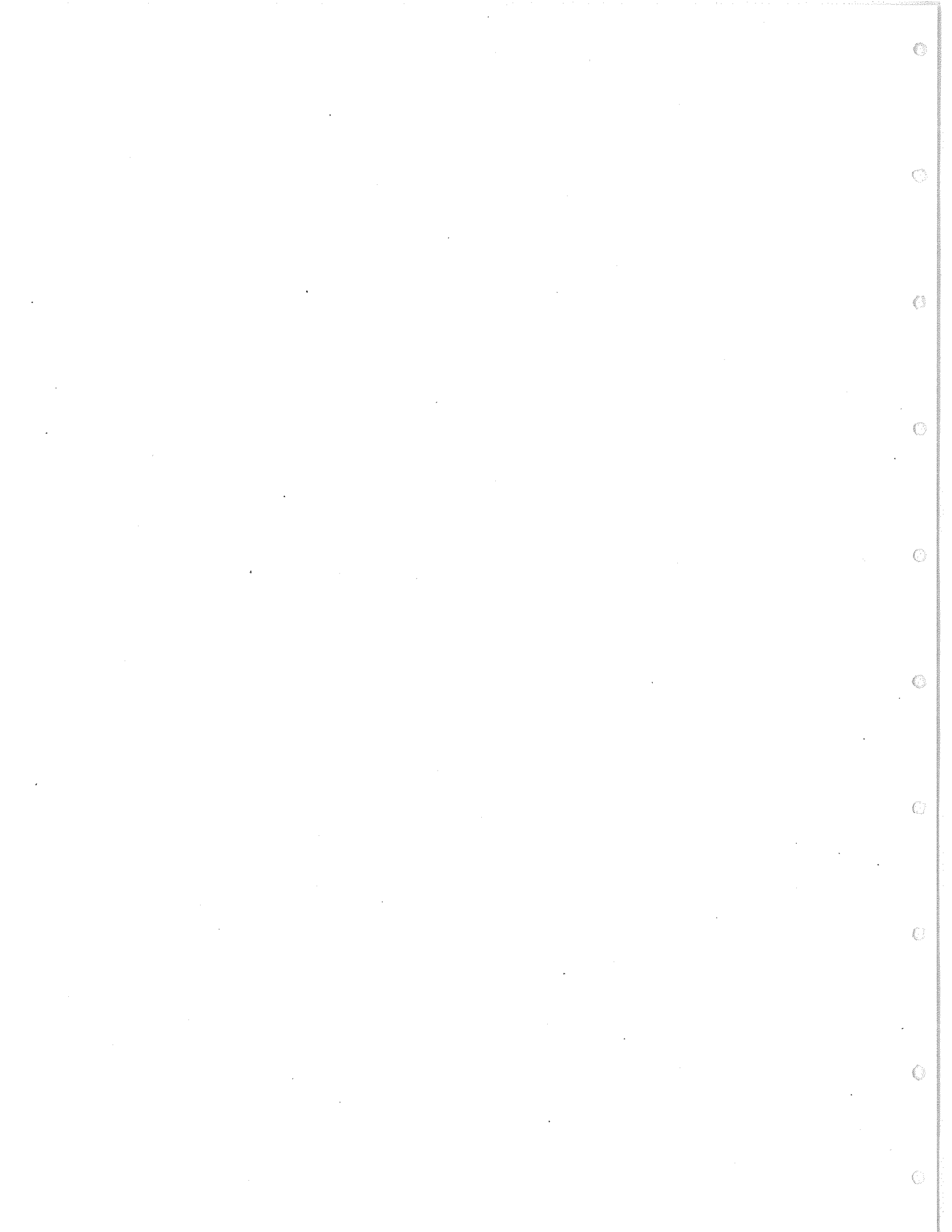

**TSUNAMI PROFILES OBSERVED AT THE NOWPHAS
OFFSHORE WAVE STATIONS**

Toshihiko NAGAI, Noriaki HASHIMOTO, Katsuyoshi SHIMIZU and Tomotuka TAKAYAMA
Port and Harbour Research Institute, Ministry of Transport 3-1-1 Nagase, Yokosuka 239, Japan

SUMMARY

The profiles of two recent major tsunamis, from the 1993 Hokkaido-Southwest-Earthquake and the 1994 Hokkaido-Eastoff-Earthquake, observed at the Nationwide Ocean Wave Information Network for Ports and HarbourS (NOWPHAS) offshore wave stations are introduced in this report. Offshore wave data will help us to better understand the tsunami. To obtain long wave characteristics of tsunamis however, the NOWPHAS data acquisition system is not yet sufficient, because wave observations are made for only 20 minutes every 2 hours. Further improvements are needed for continuous data acquisition.

INTRODUCTION

Investigation of offshore tsunami profiles is important to clarify tsunami characteristics and to prevent disasters. Recently Japan suffered two major tsunamis, from the Hokkaido-Southwest-Earthquake on 12 July 1993, and the other from the Hokkaido-Eastoff-Earthquake on 4th October 1994. Since the study of tsunami profiles was conducted only by using tide stations' records, very few offshore wave records were reported.

This report introduces several interesting facts obtained by the NOWPHAS offshore wave observation network.

NOWPHAS INSTRUMENTS

Fig.1 shows the NOWPHAS wave observation network in Japan. The Ports and Harbours Bureau of the Ministry of Transport (MOT) and its associated agencies, including the Port and Harbour Research Institute (PHRI), have for years made efforts to obtain more precise coastal wave information for port planning, design and construction. Figure 2 shows the ultrasonic wave gauge (USW) and current meter type ultrasonic directional wave meter (CWD); these two types of wave gauges are the most widely used in the NOWPHAS network.

OFFSHORE TSUNAMI PROFILE

Figure 3 shows an example of offshore wave profiles before the 1993 Hokkaido-Southwest-Earthquake tsunami. Twenty minutes of wave records of the water surface elevation, η , and seabed horizontal current vector and components (U, θ) are shown at the NOWPHAS St. 8, Wajima. The water depth of the USW wave gauge (η) is 50m, and the CWD directional wave meter (U, θ) is 27m. Figure 4 shows the profile just after the tsunami. The center line of (η) moves slowly with the long periods of the

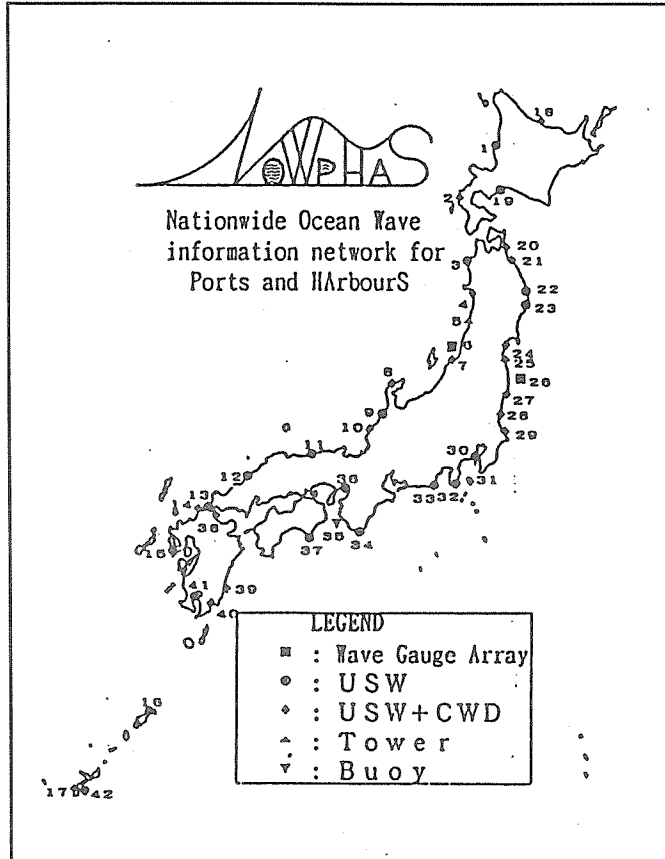

Figure 1. NOWPHAS Wave Observation Network

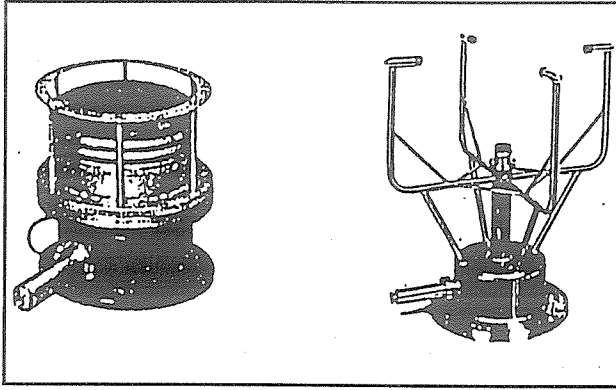

Figure 2. USW and CWD Wave Gauges

tsunami. The current also shows the tsunami clearly. The center thick lines in the figure indicate the long-period fluctuation components calculated by ± 10 seconds numerical triangular low-pass-filter.

Table.1 shows offshore low-pass-filtered tsunami components at each NOWPHAS station. The maximum fluctuation range of η ($= \eta_{\max} - \eta_{\min}$), maximum current velocity U ($= U_{\max}$) and current direction θ at U_{\max} are described.

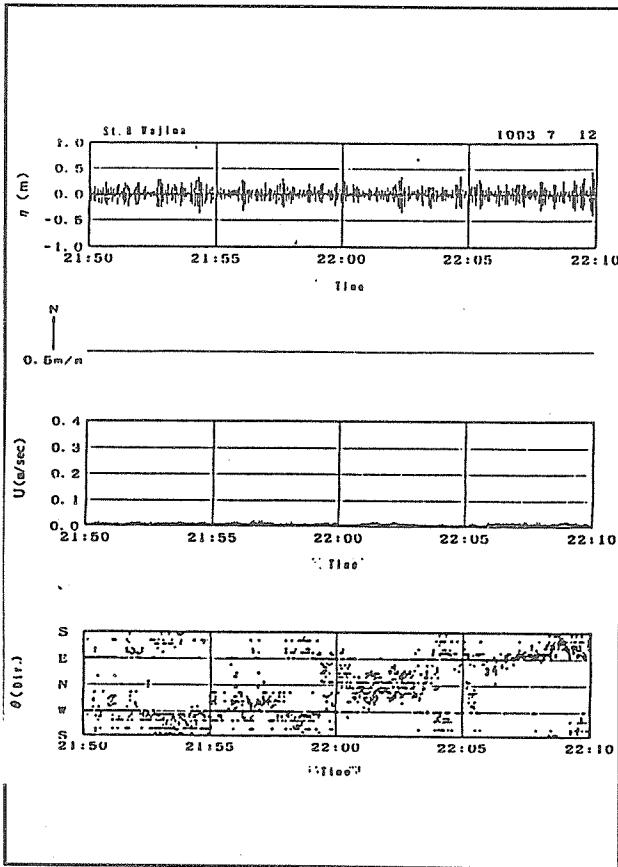

Figure 3. Example of Offshore Wave Data Before the Tsunami Attack

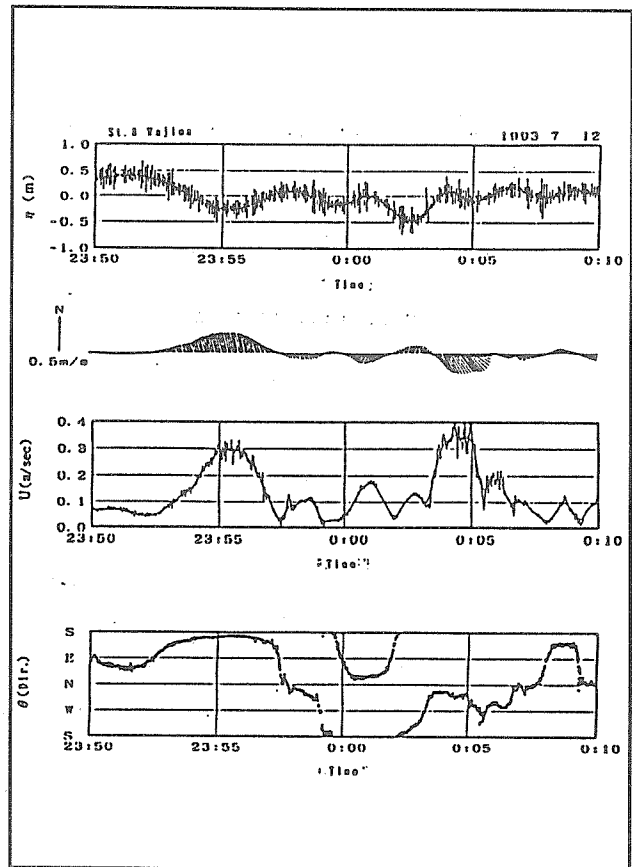

Figure 4. Example of Offshore Wave Data After the Tsunami Attack

Table 1. 1993 Hokkaido-Southwest-Earthquake Offshore Tsunami Components

| NOWPHAS Observation St. | Item | Depth | 7/12 22:00 | 7/13 0:00 | 0:30 | 1:00 | 1:30 | 2:00 | 2:30 | 3:00 | 3:30 | 4:00 | 4:30 | 5:00 | 5:30 | 6:00 | Max. |
|-------------------------|----------|--------|---------------|--------------|------|------|------|------|------|------|------|------|------|------|------|------|------|
| No. 2 Sedana | η | -52.9m | 0.05 | - | - | - | - | - | - | - | - | - | - | - | - | - | 0.05 |
| | U | -20.0m | 0.07 | - | - | - | - | - | - | - | - | - | - | - | - | - | 0.07 |
| | θ | | WNW | - | - | - | - | - | - | - | - | - | - | - | - | - | WNW |
| No. 1 Runoi | η | -50.0m | 0.12 | - | 0.23 | 0.40 | 0.18 | 0.25 | 0.33 | 0.20 | 0.20 | 0.41 | 0.15 | 0.37 | - | 0.16 | 0.41 |
| No. 18 Monbetsu | η | -52.0m | 0.06 | 0.07 | 0.04 | 0.05 | 0.05 | 0.06 | 0.08 | 0.08 | 0.07 | 0.08 | 0.07 | 0.07 | 0.12 | 0.10 | 0.12 |
| | U | -18.0m | 0.03 | 0.02 | 0.03 | 0.02 | 0.02 | 0.04 | 0.03 | 0.04 | 0.05 | 0.04 | 0.05 | 0.05 | 0.04 | 0.04 | 0.05 |
| | θ | | NW | ESE | ESE | ESE | SSE | SE | NNW | SE | NNW | NE | ESE | WNW | SE | WSW | ESE |
| No. 3 Fukaura | η | -49.6m | 0.03 | 0.55 | - | - | - | 0.25 | - | - | - | 0.23 | - | - | - | 0.30 | 0.55 |
| No. 4 Akita | η | -29.5m | 0.06 | 0.17 | 0.26 | 0.34 | 0.38 | 0.25 | 0.28 | 0.29 | 0.18 | 0.20 | 0.24 | 0.21 | 0.20 | 0.20 | 0.38 |
| | P | | 0.02 | 0.17 | 0.27 | 0.33 | 0.39 | 0.26 | 0.27 | 0.29 | 0.16 | 0.20 | 0.25 | 0.21 | 0.19 | 0.19 | 0.39 |
| | U | | 0.03 | 0.06 | 0.07 | 0.07 | 0.08 | 0.07 | 0.05 | 0.09 | 0.06 | 0.06 | 0.06 | 0.05 | 0.06 | 0.07 | 0.09 |
| | θ | | S | WSW | E | E | ESE | E | NW | SW | ESE | WNW | E | WSW | WSW | E | SW |
| No. 5 Sakata | η | -45.0m | 0.07 | 0.28 | - | - | - | 0.26 | - | - | - | 0.28 | - | - | - | 0.15 | 0.28 |
| No. 6 Niigata-Oki | η | -35.0m | 0.14 | 0.39 | - | - | - | 0.32 | - | - | - | 0.21 | - | - | - | 0.16 | 0.39 |
| | U | | 0.03 | 0.14 | - | - | - | 0.15 | - | - | - | 0.06 | - | - | - | 0.05 | 0.15 |
| | θ | | WSW | NW | - | - | - | SE | - | - | - | NNW | - | - | - | NNW | SE |
| | P | | 0.14 | 0.45 | - | - | - | 0.42 | - | - | - | 0.22 | - | - | - | 0.23 | 0.45 |
| No. 8 Wajima | η | -50.0m | 0.04 | 0.87 | 0.62 | 0.40 | 0.27 | 0.16 | 0.37 | 0.27 | 0.24 | 0.24 | 0.21 | 0.26 | 0.16 | 0.37 | 0.87 |
| | U | -27.0m | 0.02 | 0.35 | 0.29 | 0.17 | 0.19 | 0.23 | 0.16 | 0.23 | 0.13 | 0.09 | 0.10 | 0.12 | 0.07 | 0.15 | 0.35 |
| | θ | | SE | NW | NNW | N | NNW | NNW | S | NNW | NNW | SSE | NW | N | N | NNW | NW |
| No. 10 Fukui | η | -21.3m | 0.05 | 0.31 | - | - | - | 0.40 | - | - | - | 0.28 | - | - | - | 0.29 | 0.40 |
| | U | | 0.02 | 0.06 | - | - | - | 0.13 | - | - | - | 0.08 | - | - | - | 0.05 | 0.13 |
| | θ | | SW | WSW | - | - | - | WNW | - | - | - | ESE | - | - | - | E | WNW |
| No. 12 Hamada | η | -51.0m | 0.08 | 0.06 | - | - | - | 0.21 | - | - | - | 0.15 | - | - | - | 0.11 | 0.21 |
| No. 13 Ainosima | η | -20.7m | 0.05 | 0.03 | - | - | - | 0.07 | - | - | - | 0.13 | - | - | - | 0.10 | 0.13 |
| No. 20 MutsuOgawara | η | -49.0m | 0.08 | 0.09 | 0.25 | 0.09 | 0.14 | 0.07 | 0.06 | 0.16 | 0.05 | 0.05 | 0.08 | 0.07 | 0.08 | 0.06 | 0.25 |
| | U | -27.8m | 0.03 | 0.03 | 0.03 | 0.03 | 0.03 | 0.03 | 0.03 | 0.03 | 0.04 | 0.05 | 0.02 | 0.05 | 0.09 | 0.08 | 0.09 |
| | θ | | N | N | S | S | S | S | S | S | S | S | S | N | N | N | N |

Water Surface Fluctuation η : $\eta_{max} - \eta_{min}$ (m) . Seabed Dynamic Water Pressure P : $P_{max} - P_{min}$.
 Seabed Current Velocity U : U_{max} (m/s) . Seabed Current Direction θ : θ at U_{max}

ANALYSIS

Comparison of η and ρ

Figure 5 shows an example of comparison of η and ρ at NOWPHAS St. 4, Akita. The horizontal axis is the filtered water surface elevation obtained by USW, while the vertical axis shows the seabed pressure fluctuation obtained by CWD. Before the tsunami (Left figure), no long-period fluctuations are seen and all the obtained data are concentrated at $\eta = \rho = 0$. After the tsunami's arrival (Right figure), 20 minutes of observation data at a sampling interval of 0.5s are shown between 23:50 and 0:10. All the data are plotted on the $\eta = \rho$ line (linear long wave theory). The result proves the reliability of the observed wave data.

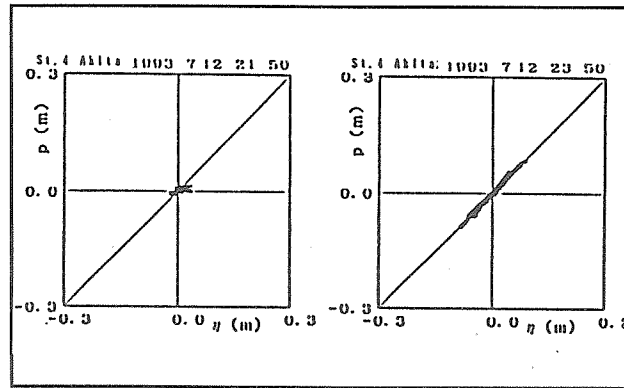

Figure 5. Comparison of η and ρ

Comparison of η and U

Figure 6 shows comparison between η and U of Table 1. Due to the linear progressive long wave theory, the following equation (1) should be satisfied.

$$U = (\eta/2) \sqrt{g/h} \quad (45^\circ \text{ line of the Fig.6}) \quad (1)$$

where U is maximum horizontal seabed water velocity, $(\eta/2)$ is amplitude of water surface elevation $[= (\eta_{\max} - \eta_{\min})/2]$, g is the gravity acceleration, and h is the water depth. In case of the standing wave condition, $\eta = 0$ is at the nodes (vertical axis of Figure 6) and $U = 0$ (horizontal axis) at the antinodes. Taking into consideration the equations, Figure 6 indicates that the observed tsunami is not completely progressive, but has characteristics of standing waves due to the effect of reflections at coasts.

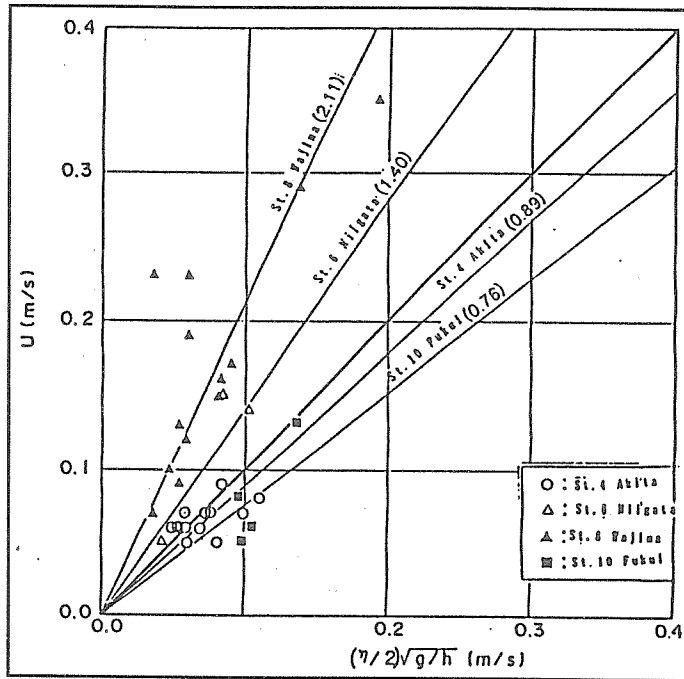

Figure 6. Comparison of η and U

Seabed Water Particle Motion

Figure 7 shows examples of seabed water particle motion during the 20 minutes of wave observation before and after the tsunami, obtained by the time integration of current velocity. The horizontal axis, X , means the East(positive) - West(negative) directions, and the vertical axis, Y , means the North(positive) - South (negative) directions. In addition to the tsunami effects, constant steady flow due to the tidal effects can be observed.

Figure 8 shows the modified seabed water particle motion by neglecting the net mass transport during the 20 minutes of observation time. Figures 7 and 8 explain that the amplitude of the seabed water particle motion due to the tsunami is a very large one, about 50m. Such large motion cannot be observed even by the highest wind wave conditions.

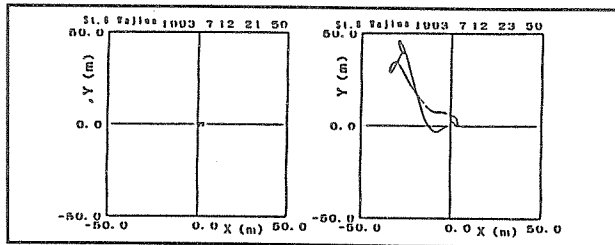

Figure 7. Seabed Water Particle Movement (Before Correction of Tide)

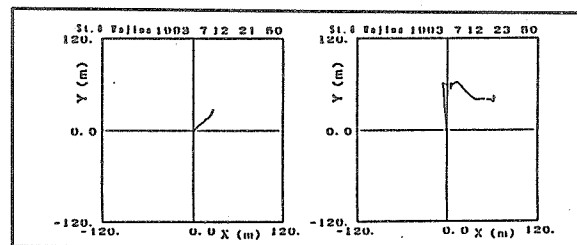

Figure 8. Seabed Water Particle Movement (After Correction of Tide)

Comparison of Offshore Wave Profile and Tide Record

Figure 9 is a comparison between the offshore wave profile (η) and the tide record (Z) at St. 8, Wajima Port. The tide station is located inside the Wajima Port and the distance between the offshore wave gauge and the tide station is about 3km. The η record is a filtered one shown previously in Figure 4. There are many differences between η and Z profiles. Relatively short-period oscillations of less than 10 minutes are not observed in the Z record due to the low-pass-filter effects in the sea-water training tube of the tide station. Such relatively high frequency components of a tsunami can be measured only by offshore wave gauges.

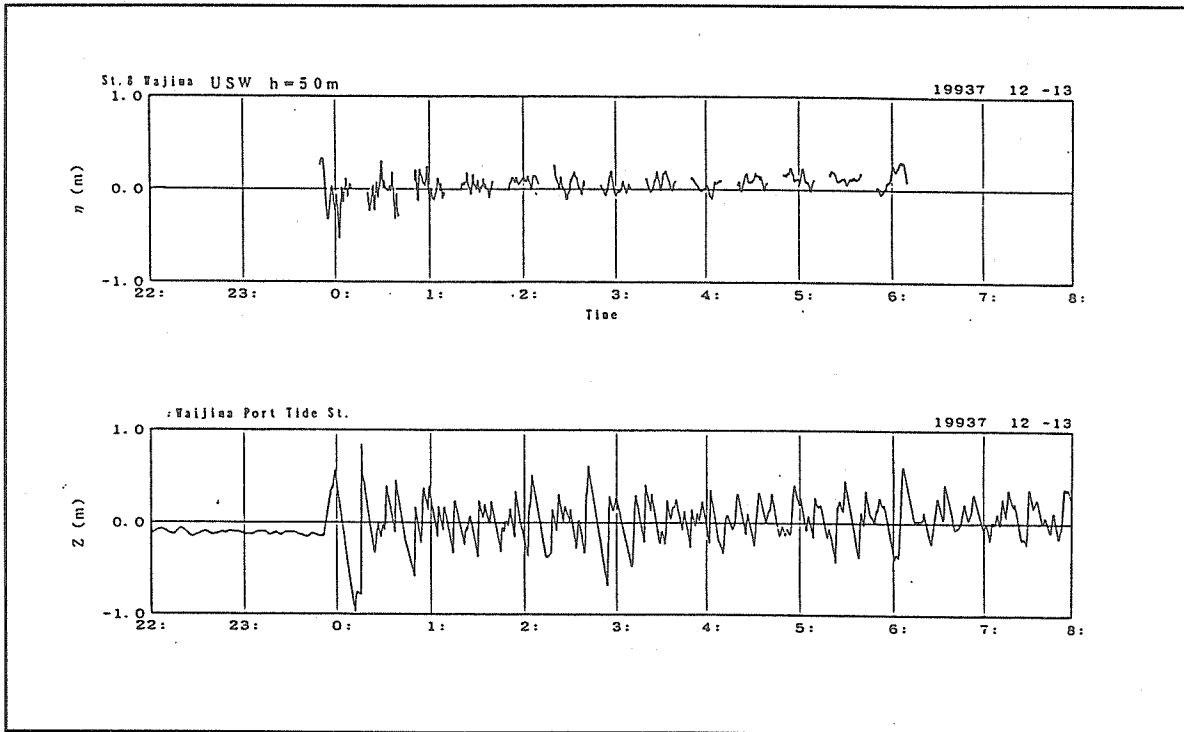

Figure 9. Comparison of Offshore Wave Profile and Tide Record

1994 Hokkaido-Eastoff-Earthquake Tsunami Profile

Figure 10 is a continuous tsunami record of another major tsunami caused by 1994 Hokkaido-Eastoff-Earthquake at NOWPHAS St. 19 of the water depth at 18.5m off the Tomakomai Port. The Tomakomai Port Construction Office of the Hokkaido Development Agency conducted the offshore, continuous long-wave observations in order to clarify the port resonance problem due to long waves during October 1994, and by chance obtained the offshore continuous tsunami data. Although η is numerically low-pass-filtered one, due to high wave conditions with more than 2m wave heights, and the high range of tides, it is not easy to distinguish the tsunami clearly from wind waves and tides. Nevertheless Figure 10 proves that the tsunami periods are very long, between 30 and 60 minutes.

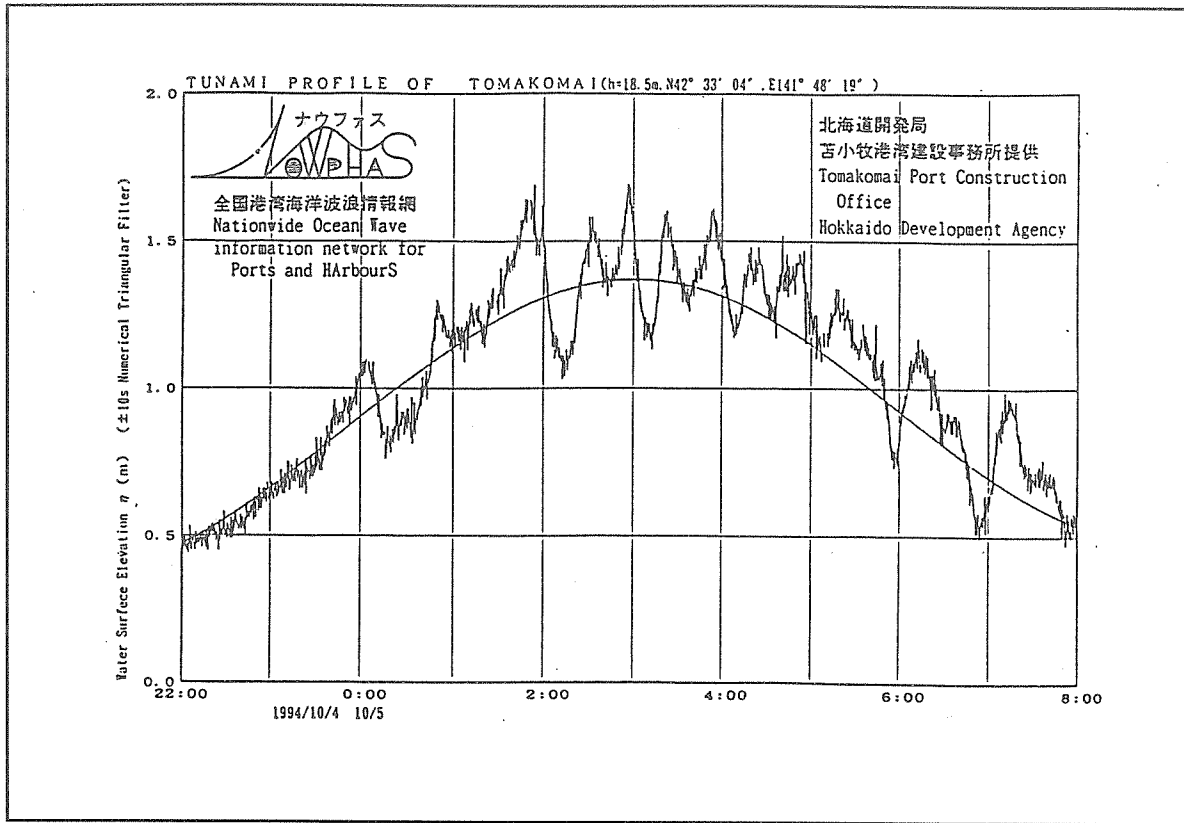

Figure 10. Hokkaido-East Off-Earthquake Tsunami Profile

CONCLUDING REMARKS

Two recent major tsunamis' profiles obtained by the NOWPHAS offshore wave gauges are introduced and several interesting facts are clarified. Offshore wave data will help us to better understand tsunamis. To obtain long-wave characteristics, such as tsunamis, however, the NOWPHAS data acquisition system is not yet sufficient. Wave observations are made for only 20 minutes every 2 hours and further improvements are needed for continuous data acquisition.

ACKNOWLEDGEMENT

NOWPHAS has been established and operated by the cooperation of the Ports and Harbours Bureau and the Districts Port Construction Bureaus of MOT, the Hokkaido and Okinawa Development Agencies, and PHRI. The authors would like to express sincere gratitude to all involved.

REFERENCES

- Nagai, T., K. Sugahara, N. Hashimoto, N., T. Asai, S. Higashiyama, and K. Toda, K. (1994) Introduction of Japanese NOWPHAS System and its Recent Topics. Proceedings of HYDRO-PORT'94, PHRI, p.67-82.
- Nagai, T., K. Sugahara, N. Hashimoto, and T. Asai (1994) Annual Report on Nationwide Ocean Wave information network for Ports and HarbourS (NOWPHAS 1992). Technical Note of the PHRI, No.770, 301p. (1994) from 1970 to 1991 year's versions of the same series of the Annual Reports. See the Technical Notes of the PHRI, No.137, 158, 178, 209, 233, 258, 282, 311, 332, 373, 417, 445, 480, 517, 545, 574, 612, 642, 666, 712, 721, and 745 respectively
- Nagai, T., N. Hashimoto, and T. Asai (1993) The Hokkaido-Southwest-Earthquake Tsunami profiles observed at the NOWPHAS offshore stations. Rept. of PHRI, Vo I. 3 2. No. 4, p. 51-97.

ON THE PROBLEMS AND PROSPECTS OF TIMELY TSUNAMI DETECTION

E.A.Kulikov, B.M.Levin, L.L.Utyakov, (Russian Federation)

J.L. Spisberger, (USA)

Well-timed and high-quality forecast of tsunami waves is an urgent task which is of great economic importance for the developing coastal areas of the Far East. The forecasts of the tsunami-alarm service have, until recently, been found on the data of the seismic stations on the basis of the geographical criterion (underwater earthquake epicenter) and threshold criterion (energetic class of earthquake). The adopted methods secure rather low reliability of forecasts with a relatively small number of failures. The great number of false alarms is to be accounted for by low efficiency threshold criterion. Though considerable progress has been achieved in the seismic method, it will hardly bring about an improvement of forecast quality. The solution of the tsunami warning problem mainly depends upon hydrophysical forecast methods.

The catastrophic tsunami on the southern Kuril Islands caused by the earthquake on October 4th, 1994, demonstrated the low efficiency tsunami alarm system and the need for a new generation of tsunami registration systems to be expanded.

The idea of creating a network of hydrophysical stations drifting in the ocean to register the tsunami waves approaching the coast was formulated in the early 1960s. The Far East Scientific Center began work on the creation and testing of remote-control registers of open sea level, cabled with on-shore registering gear. Cable devices are sufficiently safe and long lasting but extremely expensive, particularly in case of an ocean detached post that requires expensive equipment for their construction.

Sea level is usually measured by highly sensitive devices of bottom hydrostatic pressure, generally situated at a depth of more than 50 meters. Thus, the water pillar is "weighed" as it was, without regard for the small-scale wind waves. The special processing system of the frequency-modulated signal coming from the measuring element helps to increase the vibrotrone sensitivity up to 0.5 cm and the quartz sensor sensitivity up to 1 mm of the water pillar.

The Institute of Oceanology (Russian Academy of Science) worked out jointly with TSAGI (Central Air - Hydrodynamic Institute) a model of a precision laser interference pressure sensor. The change of pressure is determined with the help of a laser photoheterodyne interferometer by the changed refraction reading of the working element situated in one of its arms under water pressure. The given sensor, unlike the traditional ones, possesses high sensitivity to small pressure changes and does not depend on the absolute pressure value (depth of submersion). The application of an interferometer with a 4-channel differential scheme and special construction design makes up for the compensation of temperature changes and its gradients on the length of arms and refraction index of the working body. The sensitivity of this device is several millimeters for the 8,000 meters deep deployment. Scientists and engineers of the Institute of Oceanology have proposed the principles of a tsunami registration record system to be based on a network of autonomous bottom stations (BPR) deployed in the deep ocean. The final construction of this system is as follows: it will comprise a net of observation sites directly placed in the tsunamigenetic zones of the ocean. Each observation site includes a minimum of three BPR (autonomous bottom stations) placed in the apexes of a conventional triangle with sides 10...20 km long. Each station is supplied with a microcomputer, the necessary measuring channels and channels of a duplex hydroacoustic communication system to carry out continuous measurements of the ocean parameters, their analysis, and detection of a tsunami-wave. In the case of tsunami detection each station transmits this information by the hydroacoustic channel to other stations.

Thus each station possesses information on the tsunami arrival received by its own technical means as well as by the other site stations. On the basis of this information each station can define by the triangulation method the direction and velocity of the wave. The velocity of the wave can be an additional and highly

reliable characteristic of the arrival of a tsunami wave. In order to receive this information, each station's microcomputer is to possess information of the mean depth of each observation site and each station's geographical location. These data can be fed into the microcomputer before a station is placed on the sea-floor or after it is submerged by a hydroacoustic channel from aboard.

Tsunami warning wave's parameters can be transmitted to a coastal observation site by a hydroacoustic channel via the necessary number of retransmitting bottom stations. Retransmitting stations are established in the direction to the coast as far as the shelf zone. Information may be received by hydrophone placed at a short distance from the coast.

APPENDIX D — WORKSHOP PARTICIPANTS LIST

Dr. Clifford J. Astill

National Science Foundation
4201 Wilson Blvd., Rm 545
Arlington, VA 22230 U.S.A.
Telephone: 703 306 1362
Fax: 703 306 0291
e-mail: castill@nsf.gov

Dr. Michael Blackford, Director
Pacific Tsunami Warning Center

91-270 Fort Weaver Road
Ewa Beach, HI 96706 U.S.A.
Telephone: 808 689 8207
Fax: 808 689 4543
e-mail: mike@ptwc.noaa.gov

Dr. Joanne Bourgeois

Dept. of Geological Sciences AJ-20
Univ. of Washington
Box 351310
Seattle, WA 98195-1310 U.S.A.
Telephone: 206 685 2443
Fax: 206 543 3836
e-mail: jbourgeo@u.washington.edu

Mr. Michael Briggs

CEWES-CW-P
U.S. Army Corps of Engineers
Waterways Experiment Station
3909 Halls Ferry Rd.
Vicksburg, MS 39180-6199 U.S.A.
Telephone: 601 634-2005
Fax: 601 634 3433
e-mail: briggs@wdd.wes.army.mil

Prof. George Carrier

311 Pierce Hall
Harvard University
Cambridge, MA 02138 U.S.A.
Telephone: 617 495 3788
Fax: 617 495 9837

Arturo S. Daag

5th and 6th floor, Hizon Bldg.
Philippine Inst. of Vol. and Seis.
Department of Science and Technology
29 Quezon Avenue
Quezon City, Republic of the Philippines
Fax: 632 711 3077
e-mail: daag@x5.phivolcs.dost.gov.ph

Salvador Farreras, Associate Director
International Tsunami Information Center
Grosvenor Center

Mauka Tower Suite 2200
737 Bishop St.
Honolulu, HI 96813 U.S.A.
Telephone: 808 532 6424 after Sept 1
Fax: 808 532 5560
e-mail: itic@ptwc.noaa.gov

Prof. Augustine S. Furumoto

349 Kekupua St.
Honolulu, HI 96825 U.S.A.
Telephone: 808 395 1485

Dr. Guy Gelfenbaum

USGS Center for Coastal Geology
600 4th St. South
St. Petersburg, FL 33701 U.S.A.
Telephone: 813 893 3100 ex 3017
Fax: 813 893 3333
e-mail: guy@wayback.er.usgs.gov

Dr. Frank Gonzalez

NOAA/PMEL
7600 Sand Point Way NE, Bldg. 3
Seattle WA 98115-0700 U.S.A.
Telephone: 206 526 6803
Fax: 206 526 6485
e-mail: gonzalez@pmel.noaa.gov

Dr. Viacheslav K. Gusiakov

Computing Center
Pr. Lavrentieva, 6
Novosibirsk, 630090 Russia
e-mail: slava@comcen.nsk.su

Gary Howell
Coastal Engineering Research Center
Army Corps of Engineers
4309 Shenandoah Rd.
Vicksburg, MS 39180 U.S.A.
Telephone: 601 634 2006
Fax: 601 634 3151
e-mail: howell@pmab.wes.army.mil

Dr. Fumihiko Imamura
Disaster Control Research Center
Faculty of Engineering
Tohoku University
Aoba Sendai 980-77 Japan
Telephone: 81 22 217 7513
Fax: 81 22 217 7514

Dr. Bruce Jaffe
U.S. Geological Survey
Mail Stop 999
345 Middlefield Rd.
Menlo Park, CA 94025 U.S.A.
Telephone: 415 345 3108
Fax: 415 345 3191
e-mail: bruce@octopus.wr.usgs.gov

Jean Johnson
Dept of Geological Sciences
University of Michigan
Ann Arbor, MI 48109 U.S.A.
Telephone: 313 763 4069
Fax: 313 763 4690
e-mail: tsunami@umich.edu

Dr. Victor Kaistrenko
Inst. of Marine Geology and Geophysics
Yuzhno-Sakhalinsk, Sakhalin
693002 Russia
Fax: 7 424 22 240 91 or 7 424 22 515 09
E-mail: victor@ocean.sakhalin.su

Mr. George Kaminsky
State of Washington
Dept. of Ecology
P.O. Box 47600
Olympia, WA 98504-7600 U.S.A.
Telephone: 360 407 6797
Fax: 360 407 6535
e-mail: gkam461@ecy.wa.gov

Mr. James F. Lander
University of Colorado
Campus Box 449, CIRES
Boulder, CO 80309 U.S.A.
Telephone: 303 497 6446
Fax: 303 497 6513
e-mail: jlander@ngdc.noaa.gov

Prof. Boris Levin, Director
Dept of Earth Sciences
Russian Foundation for Research
32a Leninsky Prosp.
117334 Moscow, Russia
Telephone: 7 095 938 1795
Fax: 7 095 938 1931
e-mail: levin@rbrf.msk.su

Prof. Philip Liu
Dept. of Civil Engineering
Cornell University
Ithaca, NY 14850 U.S.A.
Telephone: 607 255 5090
Fax: 607 255 9004
e-mail: plliu@bridge.cce.cornell.edu

Mr. Emilio Lorca
Rosas 1910
Santiago, Chile
Telephone: 56 2 6724494 or 56 2 6984045
Fax: 56 2 6985474

Dr. Josephine N. Malilay
Ctr for Disease Control and Prevention
4770 Buford Hwy, NE (Mail Stop F-46)
Atlanta, GA 30341-3724 U.S.A.
Telephone: 404 488 7350
Fax: 404 488 7335
e-mail: jym7@cehdeh1.em.cdc.gov

Ms. Sherrill Mausshardt
Dept of Civil Engineering
University of Washington
Seattle, WA 98115-0070 U.S.A.
Telephone: 206 543 4322
Fax: 206 685 3836
e-mail: sherrill@aa.washington.edu

Mickey Moss, Chief
Sea Level Measurement Group
Pacific Operations Section, M/OES 214
7600 Sand Point Way, NE
Seattle, WA 98115-0070 U.S.A.
Telephone: 206 526 6360
Fax: 206 526 6365
e-mail: mmos@pactide.noaa.gov

Dr. Toshihiko Nagai, Chief
Marine Hydrodynamics Div., PHRI
3-1-1 Nagase Yokosuka 239, Japan
Telephone: 81 468 445017
Fax: 81 468 425246

Dr. Masami Okada
Seismology and Volcanology Div.
Meteorological Research Institute
1-1 Nagamine Tsukuba-shi
Ibaraki-ken, 305, Japan
Telephone: 81 298 53 8677
Fax 81 289 51 3730
e-mail: mokada@mri.jmt.go.jp

Mr. Modesto Ortiz
Department of Oceanography/CICESE
P.O. Box 43-4844
San Diego, CA 92143-4844 U.S.A.
Telephone: 52 617 45050 ext 2928
Fax: 52 617 44880
52 617 45154
52 617 44848
e-mail: ortizf@cicese.mx

Prof. Catherine Petroff
Civil Engineering Dept.
University of Washington
Seattle, WA 98195 U.S.A.
Telephone: 206 685 7594
Fax: 206 685 3836
e-mail: catpet@u.washington.edu

Dr. Jane Preuss
Urban Regional Research
Suite 1000 Tower Building
1809 Seventh Avenue
Seattle, WA 98101 U.S.A.
Telephone: 206 642 1669
Fax: 206 626 5324
e-mail: 7422.2652@compuserve.com

Dr. Raymundo S. Punongbayan, Director
Philippine Inst. of Vol. and Seis.
Department of Science and Technology
29 Quezon Avenue
Quezon City, Republic of the Philippines
Telephone: 632 712 4669
Fax: 632 711 30 77

Dr. Alexander B. Rabinovitch (currently at)
P.O. Box 6000, W. Saanich Rd. 9860
Sidney BC, V8L 4B2 Canada
Telephone: 604 363 6837
Fax: 604 363 6746
e-mail: abr@ios.bc.ca

Dr. Alexander B. Rabinovitch (permanent)
IORAS
Tsunami Center
Krasikova 23
117218 Moscow, Russia
e-mail: eugene@mplws.msk.so

Prof Fredric Raichlen
Professor of Civil Engineering
Mail Code 138-78
Caltech
Pasadena, CA 91125 U.S.A.
Telephone: 818 395 4403
Fax: 818 395 2940
e-mail: raichlen@romeo.caltech.edu

R. J. Richter, consultant
Journey's End
Croton, NY 10520 U.S.A.
Telephone: 914 271 5356
Fax: 914 271 8169

Dr. Jack Rynn
Director of Research
The Centre for Eq. Res. in Australia
P.O. Box 276
Indooroopilly, QLD 4068
Australia
Telephone: 61 7 374 2260
Fax: 61 7 878 1252

Dr. Elena Sasorva
State Oceanographic Institute
Kzopotkinshy per. 6
Moscow, Russia
Telephone: 7 095 315 27 09
Fax: 7 095 246 72 88
e-mail: sasor@geoph.ioras.msk.ru

Dr. Kenji Satake
Seismotectonics
Geological Survey of Japan
Tsukuba 305 Japan
Telephone: 81 298 54 3694
Fax: 81 298 52 3461
e-mail: sataki@gsj.go.jp

Mr. Djoko Satudju
Department of Communications
Meteorological and Geophysical Agency
Jl. Angkasa I Nr. 2
Kemayoran
Jakarta 10720, Indonesia
Telephone: 62 21 4248015
Fax: 62 21 4246703

Prof. Nobuo Shuto
Dept of Civil Engineering
Tokohu University
Aoba Aramaki
Sendai, Japan 980
Telephone: 81 22 217 7512
Fax: 81 22 217 7514
e-mail: shuto@tsunami2.civil.tokohu.ac.jp

Mr. Dennis Sigrist, Acting Director
International Tsunami Information Center
P.O. Box 50027
Honolulu, HI 96850-4993 U.S.A.
Telephone: 808 541 1657
Fax: 808 541 1678
e-mail: itic@ptwc.noaa.gov

Dr. Peter Sloss
Marine Geology and Geophysics Div.
National Geophysical Data Center
Boulder, CO 80303-3328 U.S.A.
Telephone: 303 497 6119
Fax: 303 497 6513
e-mail: psloss@ngdc.noaa.gov

Mr. Fred Stephenson
Canadian Hydrographic Service
Institute of Ocean Services
P.O. Box 6000
Sidney, B.C.
V8L 4B2 Canada
Telephone: ~~604~~ 363 6349
Fax: ~~250~~ ~~604~~ 363 6323
e-mail: stephenso@ios.bc.ca

Prof. Costas Synolakis
University of Southern California
Kaprielian Hall 206C
University Park
Los Angeles, CA 90089 U.S.A.
Telephone: 213 740 0613
Fax: 213 744 1426
e-mail: costas@mizar.usc.edu

Dr. Yoshinobu Tsuji
Earthquake Research Institute
University of Tokyo
Yayoi-1-1-1, Bunkyo-ku
Tokyo, 113 Japan
Telephone: 81 3812-2111 ext 5724
Fax: 81 3 3816 1159

Dr. Lev L. Utyakov, Dep. Dir.
P.P. Shirshov Institute of Oceanography
Russian Academy of Sciences
23, Krasikova
Telephone: 095 129 21 36
Fax: 095 124 59 83

Prof. Harry Yeh
Dept. of Civil Engineering, FX10
Univ. of Washington
Seattle, WA 98195 U.S.A.
Tel: 206 685 8655
Fax: 206 685 3836
e-mail: harryeh@u.washington.edu

APPENDIX E

ACRONYMS

| | |
|------|--|
| ACOE | - U.S. Army Corps of Engineers |
| ATWC | - Alaska Tsunami Warning Center |
| BPR | - Bottom pressure recorders |
| CDIP | - Coastal Data Information Program (U.S.) |
| CM | - Current meter |
| CUBE | - CalTech/USGS Broadcast of Earthquakes |
| ETOS | - Earthquake and Tsunami Observation System (Japan) |
| FSG | - Field Survey Group |
| GOES | - Geostationary Operational Environmental Satellite |
| GPS | - Global Positioning Systems |
| HF | - High frequency |
| ICG | International Coordination Group |
| IG | - Instrumentation Group |
| IOC | - Intergovernmental Oceanographic Commission |
| IRIS | - Incorporated Research Institutes for Seismology |
| ITIC | - International Tsunami Information Center |
| ITSU | - International Tsunami Warning System in the Pacific |
| IUGG | - International Union of Geodesy and Geophysics |
| JMA | - Japan Meteorological Agency |
| KGPS | - Kinematic Global Positioning System |
| LTL | - Local tide level |
| MLLW | - Mean lower low water |
| MMI | Modified Mercalli Intensity |
| MOT | - Ministry of Transport (Japan) |
| MSL | - Mean sea level |
| MWL | - Maximum water level |
| NCSN | - Northern California Seismograph Network |
| NEIC | - National Earthquake Information Center (U.S.) |
| NGDC | - National Geophysical Data Center (U.S.) |
| NOAA | - National Oceanic and Atmospheric Administration (U.S.) |
| NOS | - National Ocean Service (U.S.) |

- NOWPHAS - Nationwide Ocean Wave Information Network for Ports and Harbours (Japan)
- NSF - National Science Foundation (U.S.)
- NSN - National Seismic Network (U.S.)
- NVO - Hawaii Volcano Observatory
- OBS - Ocean bottom seismometer
- PHRI - Port and Harbour Research Institute (Japan)
- PMEL - Pacific Marine Environmental Laboratory (U.S.)
- PNSN - Pacific Northwest Seismograph Network (U.S.)
- PPT - Papeete, Tahiti
- PTWC - Pacific Tsunami Warning Center (U.S.)
- SIO - Scripps Institution of Oceanography
- TBB - Tsunami Bulletin Board
- TG - Tide gauge
- TIME - Tsunami Inundation Modeling Effort
- TREMORS - Tsunami Risk Evaluation through Seismic MOment in a Real-Time System
- TSAGI - Central Air-Hydrodynamic Institute (Russia)
- TWC - Tsunami Warning Centers (Japan)
- UNDRO - United Nations Disaster Relief Office
- UNESCO - United Nations Educational, Scientific and Cultural Office
- USGS - U.S. Geological Survey
- VERNUS - Versatile Ecomonitoring Network by Undersea-Cable System (Japan)
- WDC - World Data Center
- WWW - World Wide Web