



University of Puerto Rico Mayagüez
College of Engineering

NOAA's 2021 Hurricane Webinar series:
**¿Cómo se está recuperando Puerto Rico?
Cuatro años después del huracán María**

May 10, 2021 · **Revisiting Hurricane Maria's impact to Puerto Rico: Topographic wind speed-up in complex terrains and lessons learned**

Luis D. Aponte-Bermúdez, Ph.D., P.E., Professor, University of Puerto Rico at Mayagüez
e-mail: luisd.aponte@upr.edu

with contributions from

Forrest J. Masters, Ph.D., P.E., Professor and Associate Dean for Research and Facilities, University of Florida
Jorge X. Santiago-Hernandez, Ryan Catarelli, and Brian Phillips, Engineering School for Sustainable Infrastructure & Environment, University of Florida
Edward L. Cruz-García, Department of Civil Engineering and Surveying, University of Puerto Rico at Mayagüez



Agenda

- Hurricane Maria: Motivation for advance research towards Hazard Mitigation
 - Multiple projects → composite goals
 - FEMA STARR II Project → (short fuse) large scale BLWT study
 - New 2018 Puerto Rico Hurricane design Maps
 - NSF EAGER Project (ongoing) – University of Florida & University of Puerto Rico Mayagüez
 - FEMA STARR II data → shallow neural network to predict “point” speedup
 - Particle image velocity (PIV) → neural network to predict ABL properties
 - Assessment of numerical weather prediction tools to simulate speedup
- Lessons learned to address informal construction challenges in Puerto Rico
 - 2018 Puerto Rico Building Code Prescriptive Residential Design Plans

Hurricane Maria (2017)

- Category 4 at landfall (155 mph sustain winds)
- Worst storm to strike Puerto Rico in 80 yrs
- More than 3000 people killed
- Damage estimate > \$100B
- Country is still recovering ...

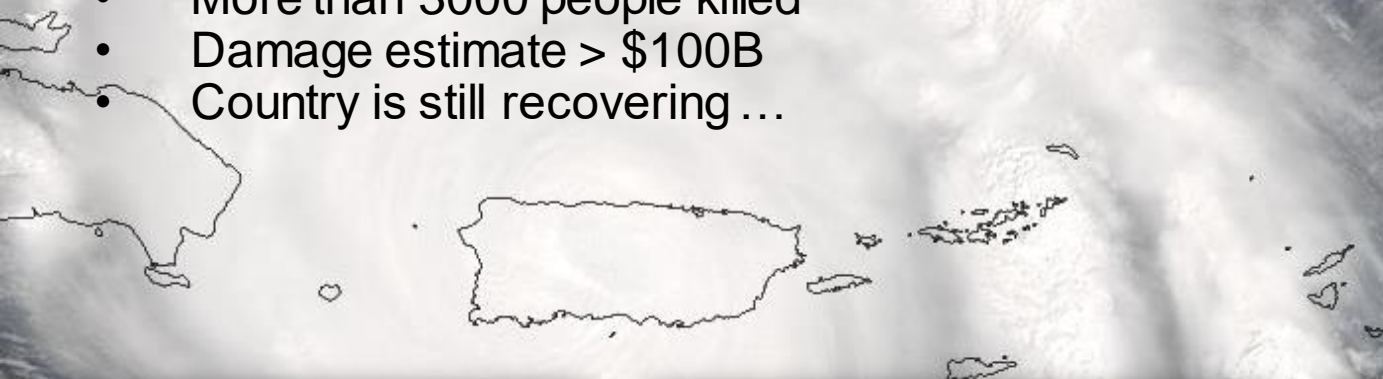

The Saffir-Simpson Hurricane Wind Scale

The Saffir-Simpson Team (Timothy Schott, Chris Landsea, Gene Hafele, Jeffrey Lorens, Arthur Taylor, Harvey Thurm, Bill Ward, Mark Willis, and Walt Zaleski)

Updated 2 January 2019 to include central North Pacific examples

The Saffir-Simpson Hurricane Wind Scale is a 1 to 5 categorization based on the hurricane's intensity at the indicated time. The scale – originally developed by wind engineer Herb Saffir and meteorologist Bob Simpson – has been an excellent tool for alerting the public about the possible impacts of various intensity hurricanes¹. The scale provides examples of the type of damage and impacts in the United States associated with winds of the indicated intensity. In general, damage rises by about a factor of four for every category increase². The maximum sustained surface wind speed (peak 1-minute wind at the standard meteorological observation height of 10 m [33 ft] over unobstructed exposure) associated with the cyclone is the determining factor in the scale. (Note that sustained winds can be stronger in hilly or mountainous terrain – such as the over the Appalachians or over much of Puerto Rico - compared with that experienced over flat terrain³.) The historical examples provided in each of the categories correspond with



5

Relación de Velocidad de Viento de: Escala Saffir-Simpson Velocidad de Diseño ASCE 7

La escala de vientos huracanados Saffir-Simpson: Define **vientos sostenidos de 1 minuto** medido a 10 m de altura en una exposición abierta al mar.



La velocidad de diseño según el ASCE 7 se define como una **ráfaga de viento de 3 segundos** medido a 10m de altura en una exposición de terreno abierto

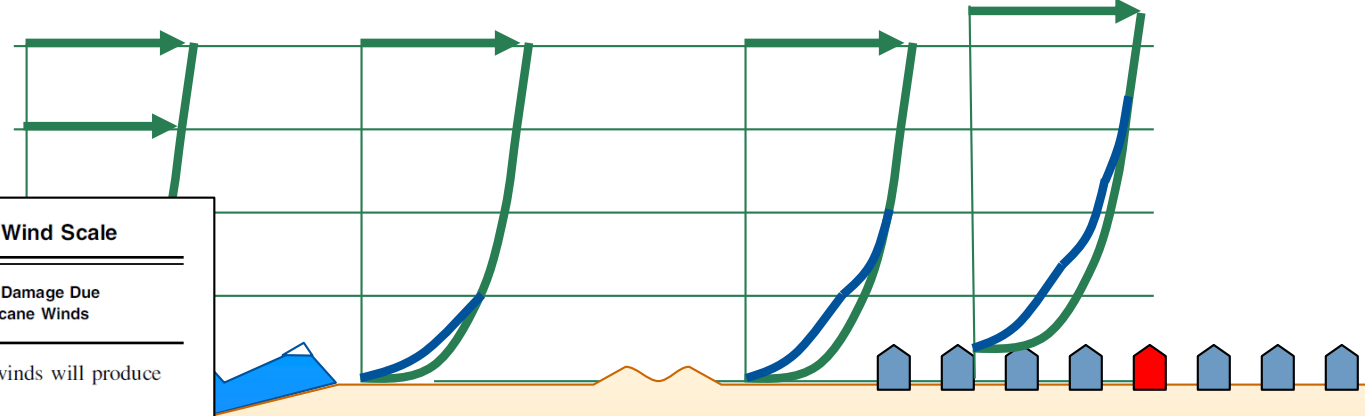

Table C26.5-1 Saffir-Simpson Hurricane Wind Scale

Hurricane Category	Sustained Wind Speed ^a mph (m/s)	Types of Damage Due to Hurricane Winds
1	74–95 (33–42)	Very dangerous winds will produce some damage
2	96–110 (43–49)	Extremely dangerous winds will cause extensive damage
3	111–129 (50–57)	Devastating damage will occur
4	130–156 (58–69)	Catastrophic damage will occur
5	≥157 (70)	Highly catastrophic damage will occur

^a1-minute average wind speed at 33 ft (10 m) above open water.



Relación de Ráfagas de Diseño a la escala Saffir-Simpson

Table C26.5-2 Approximate Relationship between Wind Speeds in ASCE 7 and Saffir-Simpson Hurricane Wind Scale

Saffir-Simpson Hurricane Category	Sustained Wind Speed over Water ^a		Gust Wind Speed over Water ^b		Gust Wind Speed Over Land ^c	
	mph	m/s	mph	m/s	mph	m/s
	1	74–95	33–42	90–116	40–51	81–105
2	96–110	43–49	117–134	52–59	106–121	48–54
3	111–129	50–57	135–157	60–70	122–142	55–63
4	130–156	58–69	158–190	71–84	143–172	64–76
5	>157	>70	>191	>85	>173	>77

^a1-min average wind speed at 33 ft (10 m) above open water.

^b3-s gust wind speed at 33 ft (10 m) above open water.

^c3-s gust wind speed at 33 ft (10 m) above open ground in Exposure Category C. This column has the same basis (averaging time, height, and exposure) as the basic wind speed from Figs. 26.5-1 and 26.5-2.

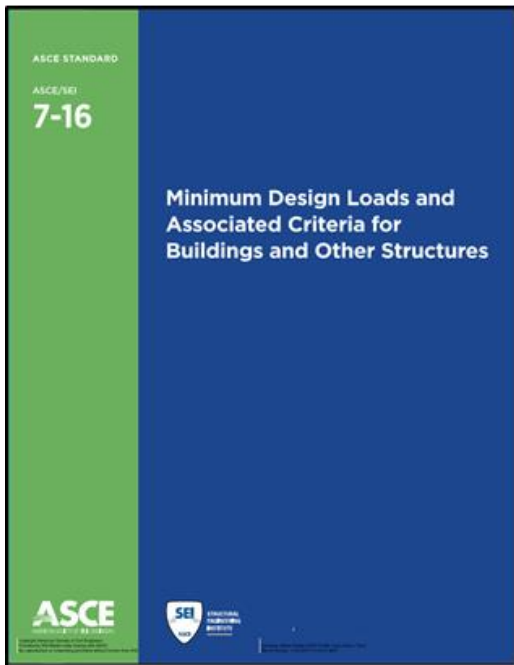

Ground elevation along Maria's track



Image Landsat / Copernicus
© 2018 Google
Data LDEO-Columbia, NSF, NOAA
Data SIO, NOAA, U.S. Navy, NGA, GEBCO

1. Min, Avg, Max Elevation: 0, 636, 2133 ft
Range Totals: Distance: 84.6 mi Elev Gain/Loss: 20913 ft, -20913 ft Max Slope: 45.2%, -42.4% Avg Slope: 5.5%, -6.1%





Evidence of topographic wind speedup



(left pane) Loiza, PR after Hurricane Georges. Photo obtained from the FEMA (1999) Building Performance Assessment Report

(right pane) Yabucoa, PR after Hurricane Maria (1997). Photo obtained from the NSF RAPID Award CMMI-1761461 (PI Tracy Kijewski-Correa) and the FEMA Mitigation Assessment Team

Figure 1. Damage associated with topographic wind speed up

↑ This group grew and became StEER in the NHERI program



Puerto Rico's Radar – Cayey, PR

Tweet

NWS San Juan @NWSSanJuan · Sep 24, 2017

Actual situation of Doppler radar after Hurricane María.
 Situación actual del radar Doppler luego del paso del huracán María. #huracán #usviwx



114 replies 2.8K retweets 1.7K likes

Replies

Remy Mermelstein | WeatherInTheHud @Weather... · Sep 24, 2017

Replying to @NWSSanJuan

How are you forecasting w/out radar? Or do you have mobile unit already?

4 replies 1 retweet 6 likes



WEATHER NEWS

Puerto Rico's Radar Restored 9 Months After Hurricane Maria's Wrath

June 18, 2018

The image above shows a radome being lifted onto a tower in San Juan, Puerto Rico. Nine months after being ravaged by Hurricane Maria, the U.S. territory has restored its radar.

(Facebook/US Nexrad Radar Operations Center)



Past research (experimental, strong winds)

- BLWT studies dominantly focused on flows over hills and other simple landforms, e.g., Teunissen et al., 1987; Salmon et al., 1988, Kondo et al., 2002; Ngo and Letchford, 2009; Kilpatrick et al, 2016
- Field experiments (e.g., FLUXNET, Perdigão, MATERHORN) have played a critical role in this work, elucidating flow separation, the effect of surface roughness and canopy morphology on flows, etc.
- Far fewer studies of complex topography (our focus), e.g., Chock and Cochran, 2005; Rasouli et al., 2009; McAuliffe and Larose, 2012
- Recent summary: Finnegan et al., 2020: Boundary layer flow over complex topography, *Boundary-Layer Meteorology*, DOI: [10.1007/s10546-020-00564-3](https://doi.org/10.1007/s10546-020-00564-3)



Evidence of topographic wind speedup

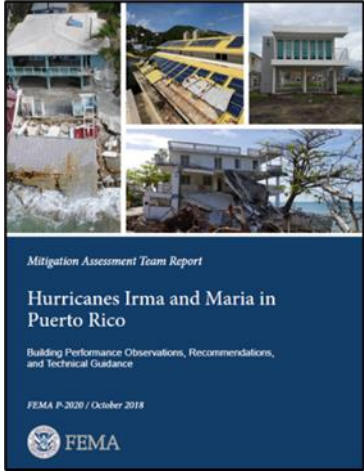

FEMA P-2020 Hurricanes Irma and Maria in Puerto Rico: Conclusion PR-36

Topography affected (increased) wind speeds through mountain areas of Puerto Rico: The MAT observed the effects of topography on the wind speeds across the islands. Many locations were observed to have experienced higher wind speeds due to the channeling of the wind through the mountains. Designing for these effects involves using a complicated method for estimating wind speed-up in ASCE 7 (incorporated by referenced by the IBC). *To improve performance of buildings in the portions of the island where wind speed-up occurs, better design guidance is required along with an outreach campaign.* Most locations impacted on the island did not appear to have hardened buildings to resist the higher wind speeds.

Recommendation PR-36. Develop new design guidance for wind speed-up in Puerto Rico. Puerto Rico should develop and include guidance on topographic effects in the PRBC. A study to *produce guidance or wind maps similar to what was produced for Hawaii* would provide a more useful approach for designers to address wind speed-up appropriately in building design. If this guidance can be developed and adopted in Puerto Rico, it can be proposed for incorporation into the next edition of ASCE 7.



FEMA STARR II

- STARR II Production and Technical Services Architectural and Engineering contracted **Applied Research Associates (ARA)** to create a special wind region map for the mountainous areas in Puerto Rico, as defined by Section 26.5.2 in the ASCE 7-16 Standard *Minimum Design Loads and Associated Criteria for Buildings and Other Structures*
 - Also known as **Microzonation**
- The map depicts the ultimate wind speed contours to design civil infrastructure, accounting for (a) hurricane climatology and surface wind field characteristics and (b) **Topographic wind speed up** caused by Puerto Rico's extensive mountainous terrain
- The **University of Florida** supported this effort by experimentally characterizing speedup on the main island of Puerto Rico and the municipal Islands of Vieques and Culebra in a boundary layer wind tunnel (BLWT), with the goal of collecting data for ARA to validate wind speedup predictions informed by studies of geographic regions outside of Puerto Rico

Six study regions

1:3100 scale | 12.2 km diameter in the projected state plane coordinate system



Measurement
"Cruciform"

Six 4 m diameter models
Up to 75 measurement locations per model
16 wind directions per measurement location
5,969 total measurements (in three months!)

Measurement
"Cruciform"

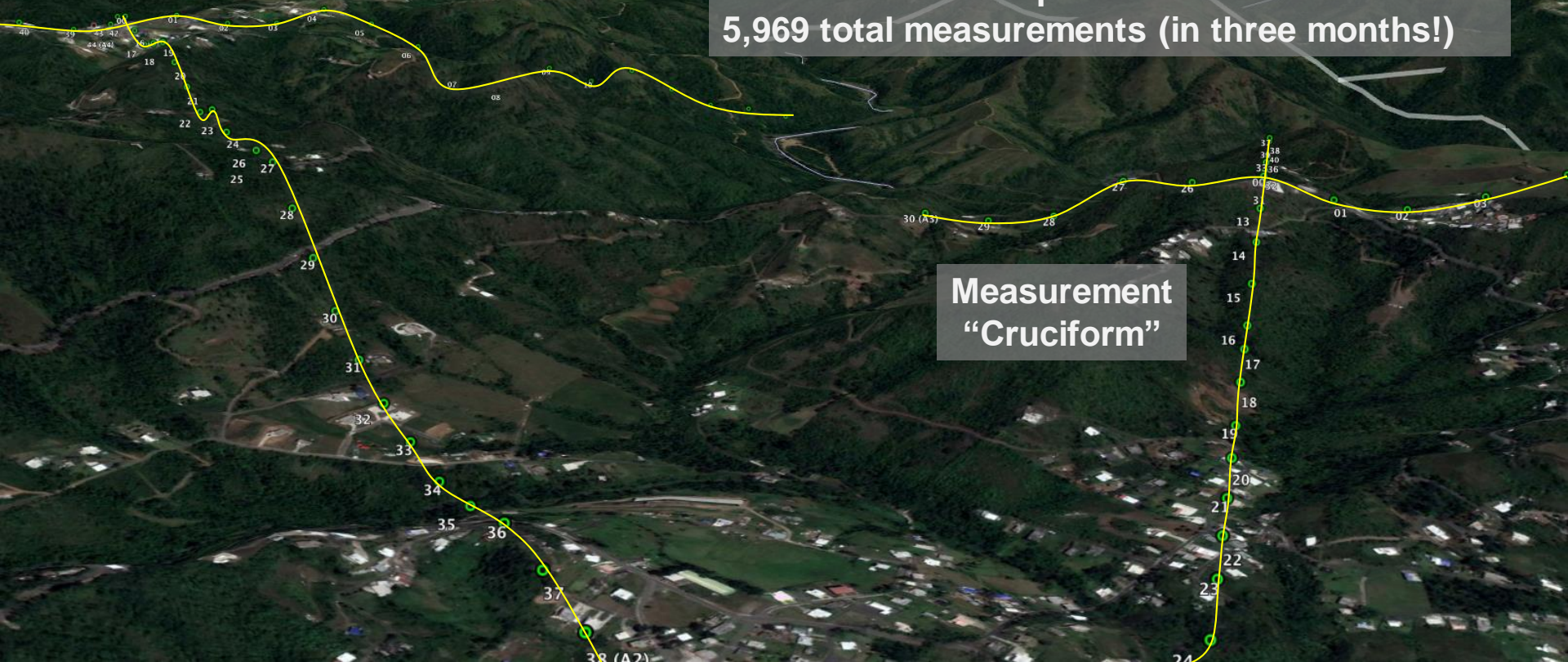

Powell Laboratory

High Performance Computing Center

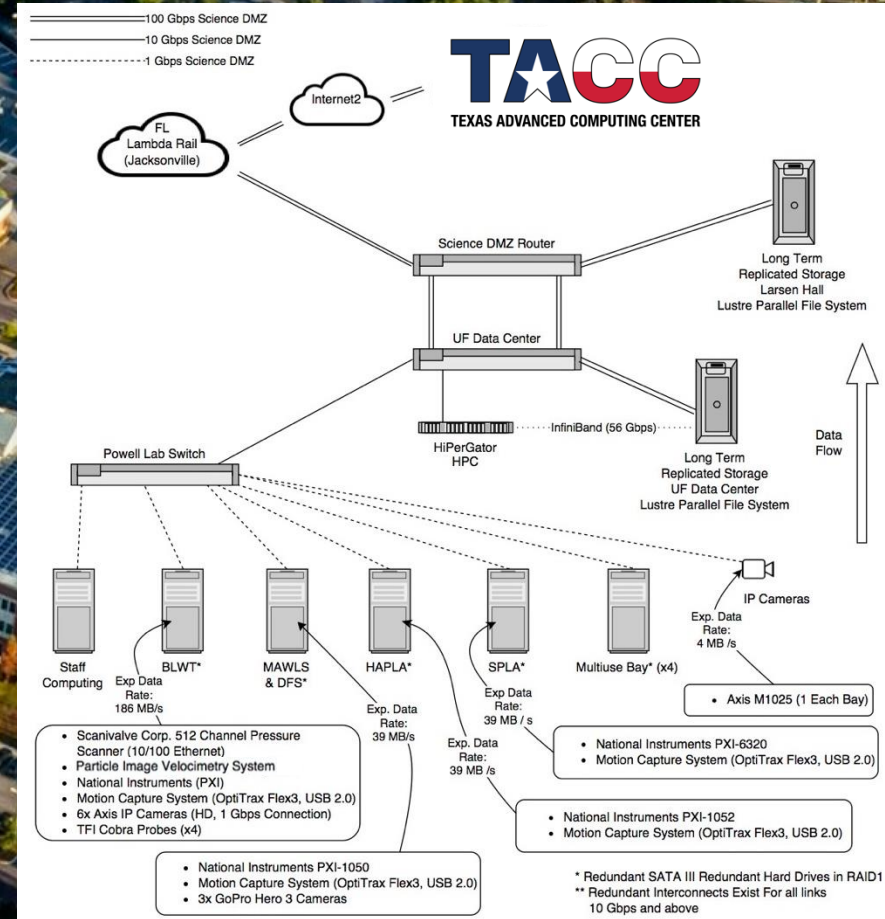

Boundary Layer Wind Tunnel (BLWT)



Specifications

120 ft L X 20 ft W X 10 ft H

+/- 3 deg adjustable ceiling pitch

8 vaneaxial fans (270 bhp each)

1-4 m adjustable turntable

Overhead gantry

Limitations (and tradeoffs) of physical modeling

- 1:3100 geometric scale < 1:5000 allowed by ASCE 49
- Hill height $Re \sim 250,000 > 100,000$ recommended by Bowen (2003) ... But ratio of FS/MS $Re \sim 7,000$
- Simulated rough wall boundary layer behavior in the freestream but measured in the eddy surface layer
- Probe interference $\rightarrow 8$ mm (25 m instead of 10 m FS)
- Turbulence intensity vs. router fabrication time
 - At this scale, roughness elements are generally modelled as disproportionately large to maintain turbulence
 - Tested “calibration ramp” with a slope that linearly varied from 0-45 degrees. Terrace heights = smooth, 1, 3 and 5 mm
 - 5 mm caused rise in mechanical turbulence along ramp
 - 1 mm routing takes three times as long to fabricate
 - Chose 3 mm (9.3 m FS) ...
- Approach flow transition from development section to model where complex terrain is present led to use of 7 deg tapered sections ...

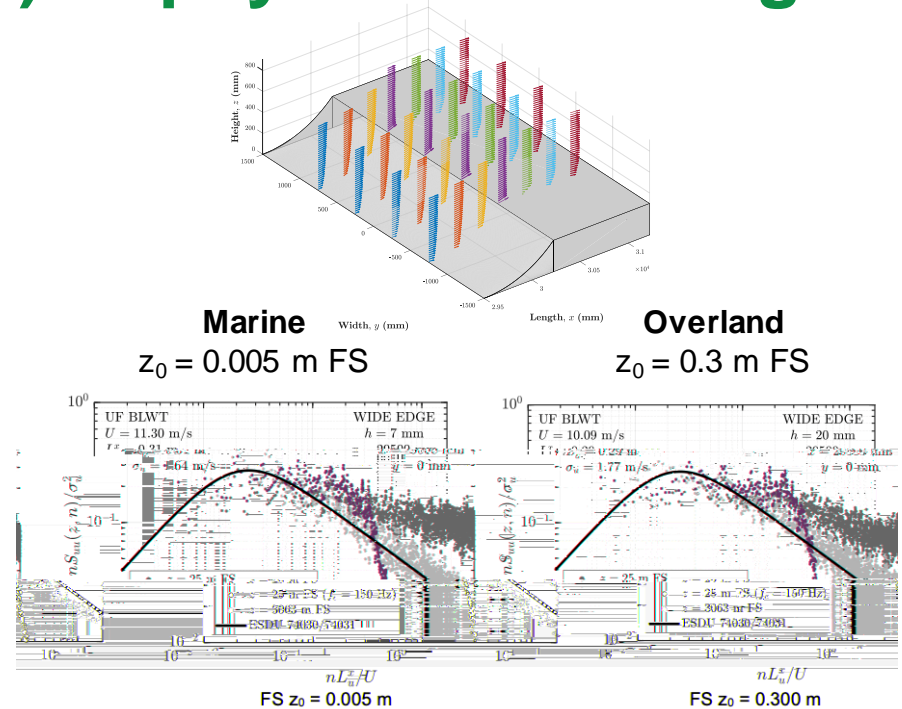

Figure 4. Power spectra

Measurement in the eddy surface layer anisotropic spectral decay proportional to k^{-1} is visible at the $z = 8$ mm measurement height, and an isotropic spectral decay proportional to $k^{-5/3}$ in the inertial subrange at $z = 988$ m outer layer indicate high-Reynolds-number flow has been achieved (McAuliffe and Lorose, 2012).

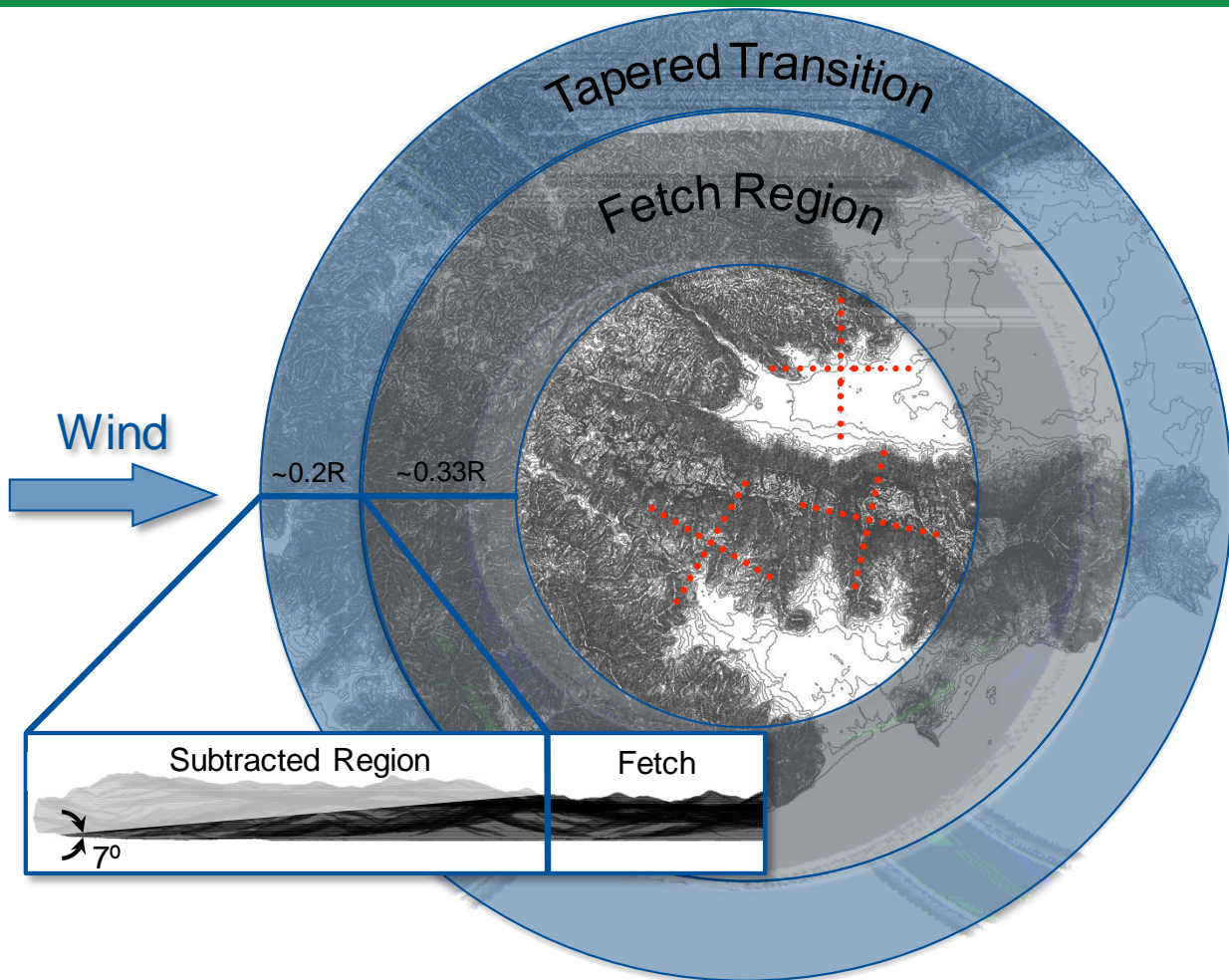
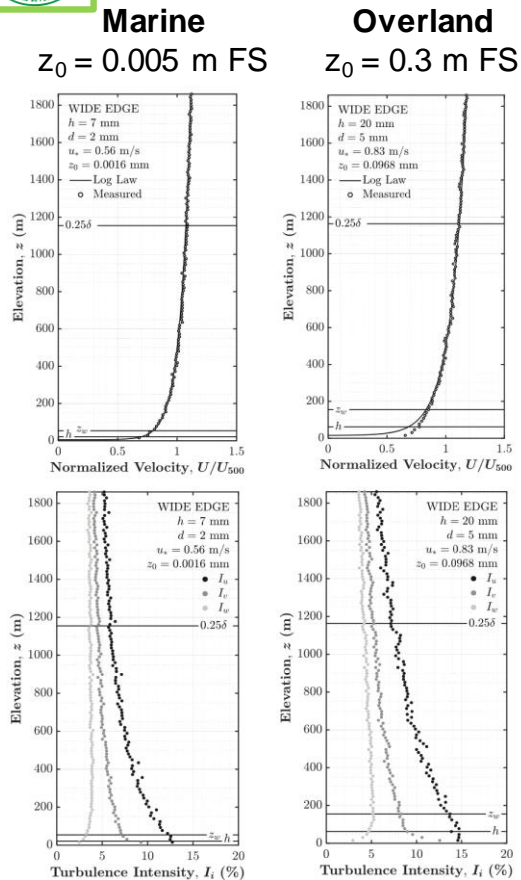

Figure 4-13. Representative mean velocity and turbulence intensity profiles for the approach flow.

UNIVERSITY of
FLORIDA
NHRI Experimental Facility

Utuado, Puerto Rico



TRANSITION
REGION

Converted bare-earth surface coordinates at a resolution of 1/3 arc-second (~10 m) referenced to NAVD88 into toolpaths that the Multicam APEX304 3D CNC router read to route foam sheets under three-axis motion control

3D instrument control of the Cobra Probe Rake for measurement of surface flows. Positional accuracy = ± 1 mm

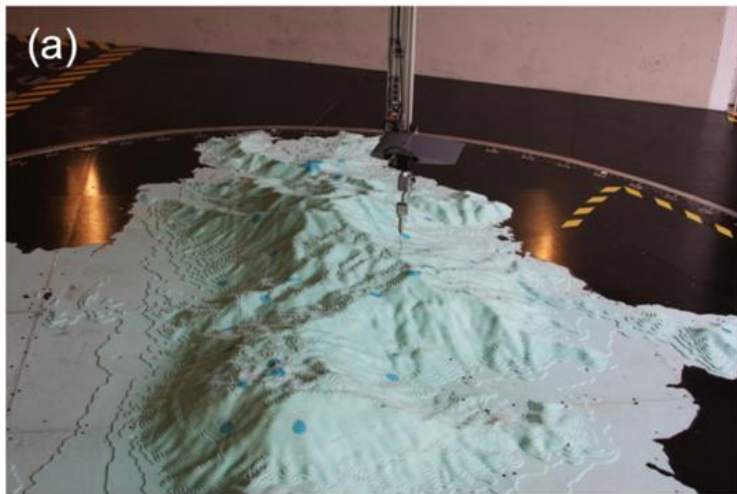

(a) Cobra Probe installed in instrument traverse

(b) Zoomed in view of the Cobra Probe over the topographic model surface



Outcomes

- ARA used data to validate speedup maps in adopted in the 2018 Puerto Rico Building Code
- Incorporated into the Applied Technology Council (ATC) *Hazards by Location Tool*
- Currently under consideration for adoption in ASCE 7-22
- A wealth of data to validate speedup models and numerical weather prediction

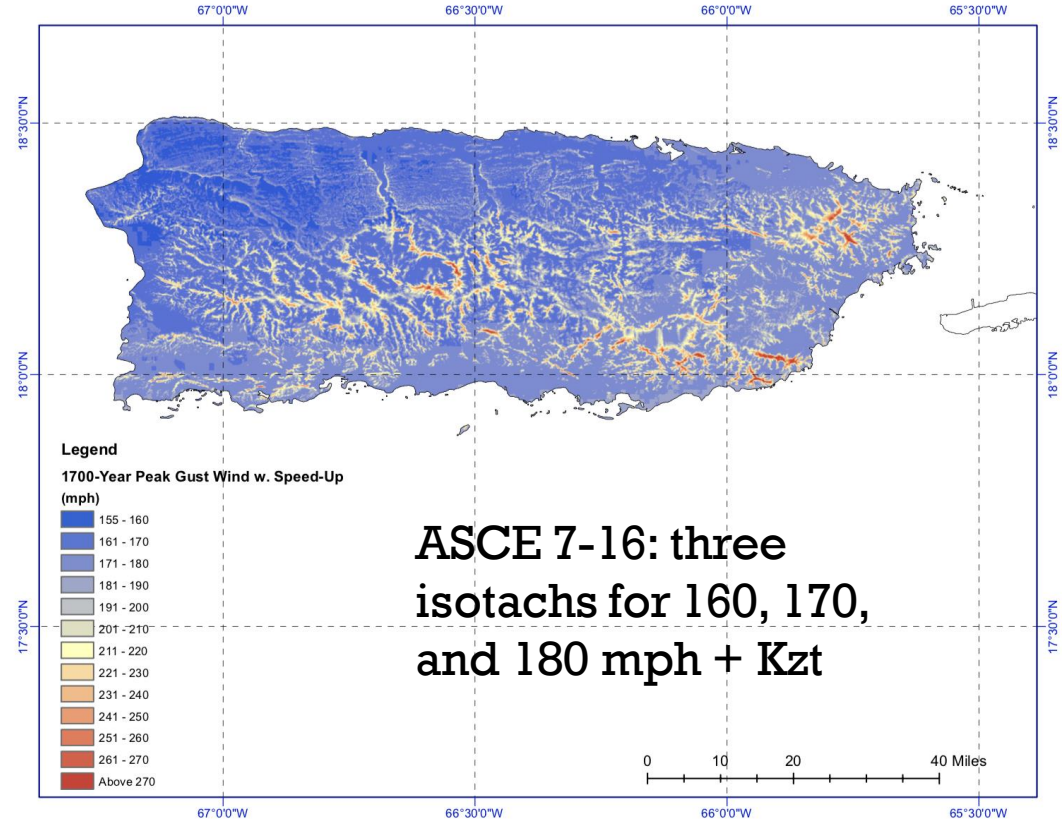



NIST – Disaster & Failure Studies

Hurricane Maria | NIST

nist.gov/topics/disaster-failure-studies/hurricane-maria

An official website of the United States government [Here's how you know](#)

NIST Search NIST Menu

Resilience

DISASTER & FAILURE STUDIES

Hurricane Maria

- News and Updates
- Progress
- Hurricane Maria Projects
- Image Gallery
- Hurricane Maria Team
- Cooperating Organizations
- NIST's Authority
- Hurricane Maria Program Fact Sheet
- Frequently Asked Questions

Share

f in

✉

Hurricane Maria

NIST Research and Investigation

[Español sitio web](#)

On September 20, 2017, Hurricane Maria devastated much of Puerto Rico, damaging buildings that its communities relied on for medical care, safety, communications and more. To better understand how the buildings and infrastructure failed, and how we can prevent such failures in the future, in 2018 NIST launched a multi-year effort to study how critical buildings performed during the storm, as well as how emergency communications systems worked.

The goal of this effort is to make recommendations to improve building codes, standards and practices to make communities across the U.S. more resilient to hurricanes and other disasters. NIST has

Hurricane Maria - VIIRS - I-Band 5 - 11µm
20 September 2017, 21:13 am EDT (AST)

NIST progress report (January 2021)

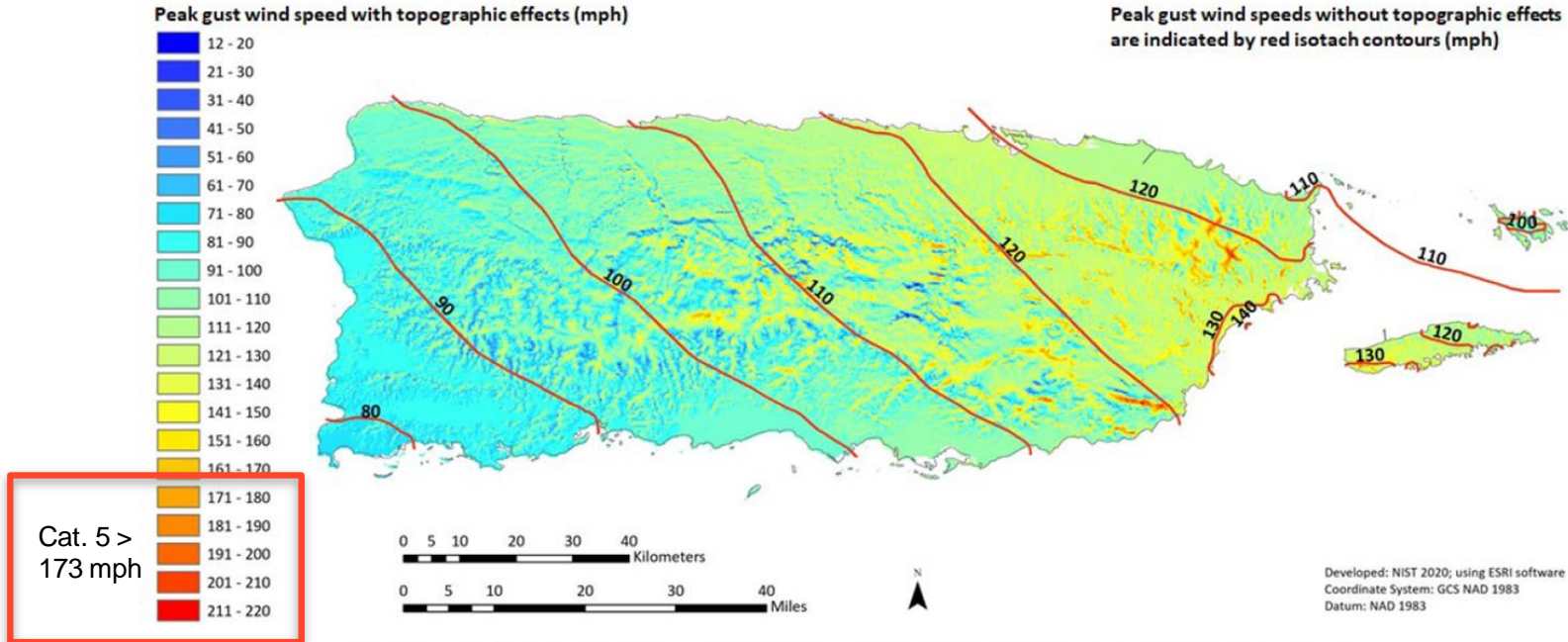

Figure 5. Estimated peak gust wind speeds with and without topographic effects from initial wind field model for Hurricane Maria.

Reference: Main, J. A., Dillard, M., Kuligowski, E. D., Davis, B., Dukes, J., Harrison, K., Helgeson, J., Johnson, K., Levitan, M., Mitrani-Reiser, J., Weaver, S., Yeo, D., Aponte-Bernúdez, L. D., Cline, J., & Kirsch, T. (2021). Learning from Hurricane Maria's Impacts on Puerto Rico: A Progress Report. National Institute of Standards and Technology.

<https://doi.org/10.6028/NIST.SP.1262>



FEMA STARR II → NSF EAGER

- Investigate machine learning and multiscale atmospheric simulations—i.e., computational fluid dynamics (CFD) nested within a numerical weather prediction (NWP) framework—to assess their potential for predicting wind ‘speedup’ in mountainous areas and other regions with steep slopes
 - Added CFD-LES work in OpenFoam
- EAGER = NSF’s high-risk, high-reward program
 - Relies heavily on high throughput automation and data processing
 - Produce preliminary data for future studies
- Cobra probe → stereoscopic PIV measurements under instrument control

Anemometric measurements



Particle Image Velocity (PIV)

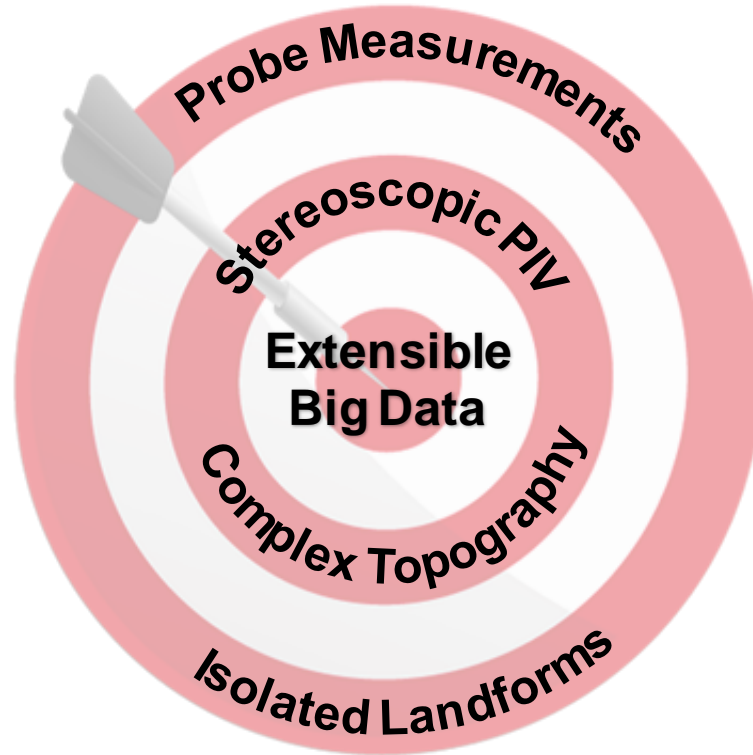
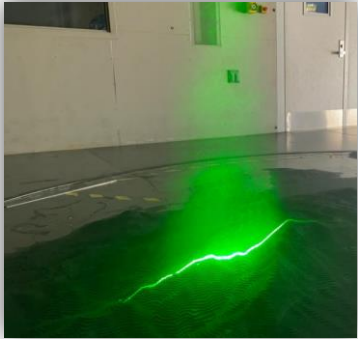

Validation

- Semi-empirical methods
- Computational fluid dynamics (CFD)
- Numerical weather prediction (NWP)

Training

- Machine learning (ML) approaches
- ML + CFD/NWP

FEMA STARR II → NSF EAGER

- Investigate machine learning and multiscale atmospheric simulations—i.e., computational fluid dynamics (CFD) nested within a numerical weather prediction (NWP) framework—to assess their potential for predicting wind ‘speedup’ in mountainous areas and other regions with steep slopes
 - Added CFD-LES work in OpenFoam (not covered today)

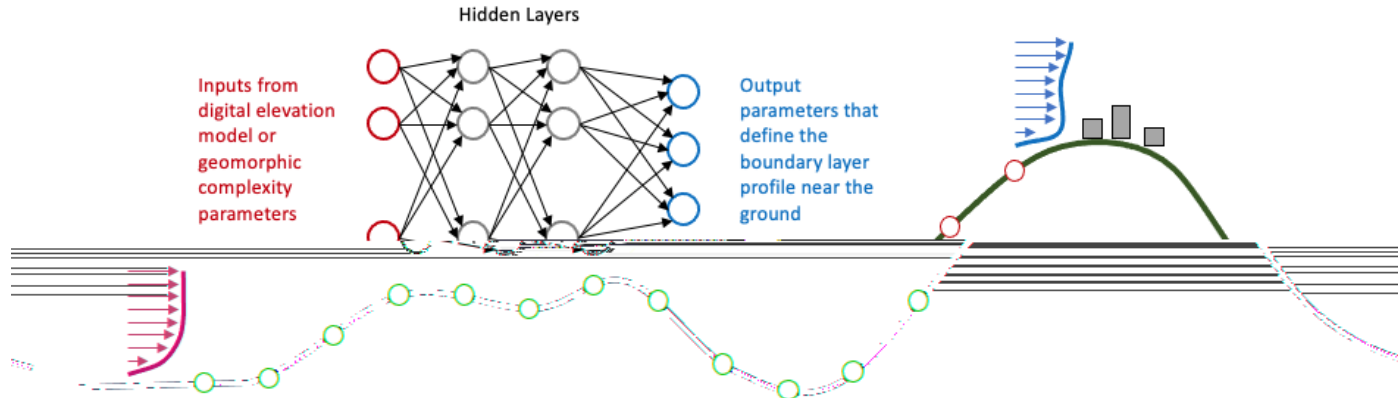



FEMA STARR II → NSF EAGER

- Investigate machine learning and multiscale atmospheric simulations—i.e., computational fluid dynamics (CFD) nested within a numerical weather prediction (NWP) framework—to assess their potential for predicting wind ‘speedup’ in mountainous areas and other regions with steep slopes
 - Added CFD-LES work in OpenFoam
- EAGER = NSF’s high-risk, high-reward program
 - Relies heavily on high throughput automation and data processing
 - Produce preliminary data for future studies
- Cobra probe → stereoscopic PIV measurements under instrument control → complete profile measurements (not omnidirectional point measurements)
- **My favorite part of the project ...**

UPRM REUs

Bucknell REU
(family from PR)



UF PhD student
from UPRM



ML prediction

- Two-layer feedforward network with 15 neurons (tangent sigmoid) using the Levenberg-Marquardt backpropagation training algorithm
- Inputs = elevation data sampled at 100 m intervals over 2 km upwind and 1 km downwind (33 values)
- Outputs = maximum speedup ratio for all directions measured by the Cobra probes at 25 m FS (8 mm above model)
- Data divided into 70% training (3470 samples), 15% validation (743 samples), and 15% testing (743 samples)
- Produced 50 m resolution map over 113 km² in ~5 mins (training + fitting) with a single compute core
- Predicting point speedup, not profiles

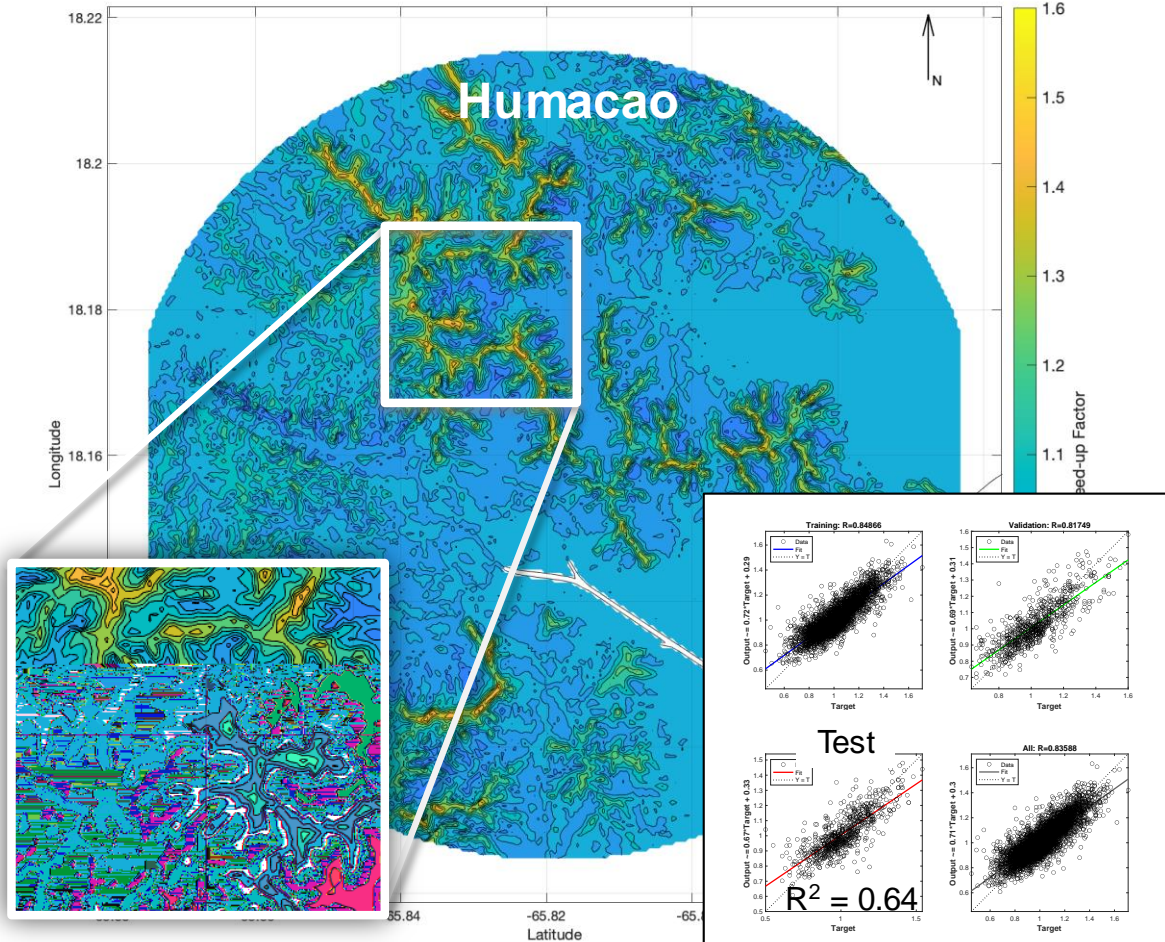

Stereoscopic PIV System

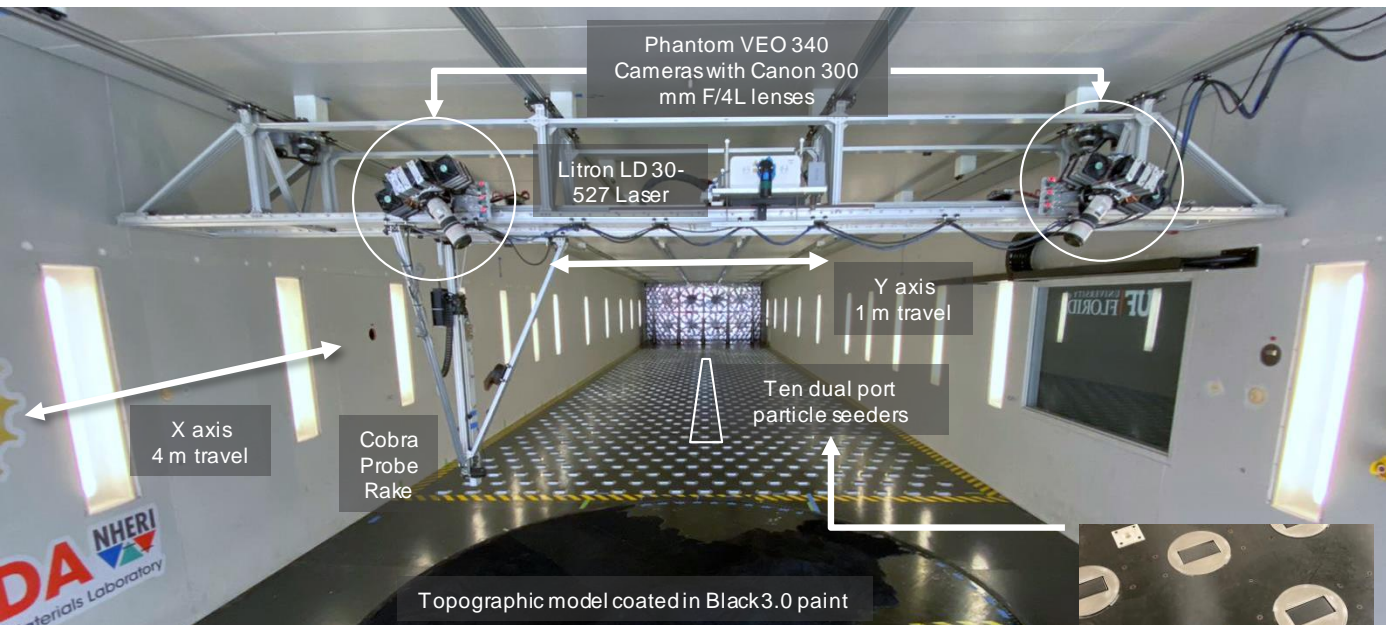

- Stereoscopic PIV setup captures 3D flow component
- Litron LD 30-527 Nd:YLF Laser
- 1KHz double pulse
- Records 15 s of data at 300 fps
- 3-5 Gbps throughput → 5 min per run
- Scheimpflug mounts provide in-plane focus at any height
- 55 deg angle helps camera “see” into valleys but images must be dewarped
- Olive Oil particles (Stokes number < 1) mixed with the flow upwind





Planar image stabilization and pre-processing in Dynamic Studio

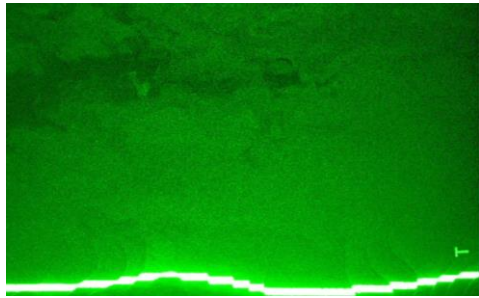

Correct for vibrations

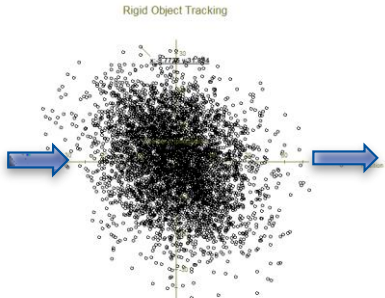
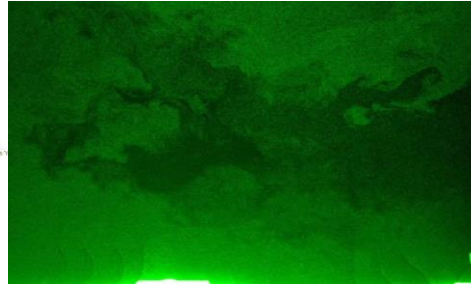
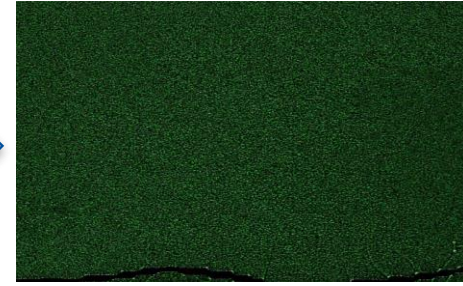

Image stabilization tracks the movement of the camera



Vibration eliminated



Normalization of the pixels to remove glare

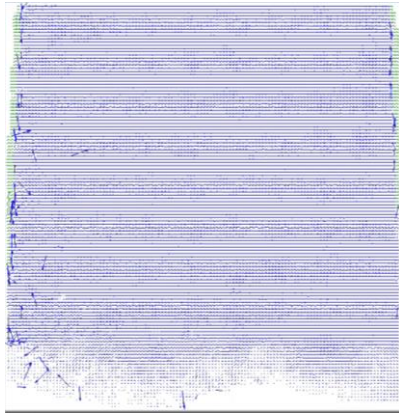

PIV processing results in detailed flow field



Dataset is de-warped into real coordinate system

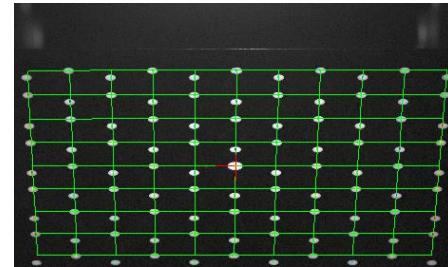

Setup of real coordinate system reference to the laser light sheet



PIV data collection

PIV Testing Culebra Region

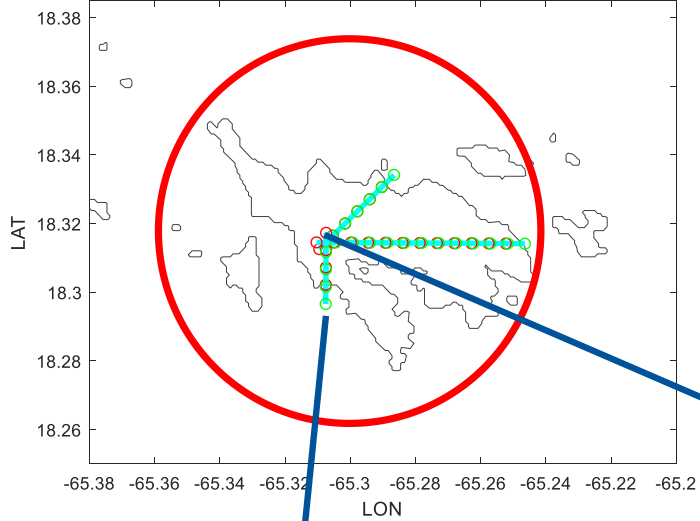

“Stitching”

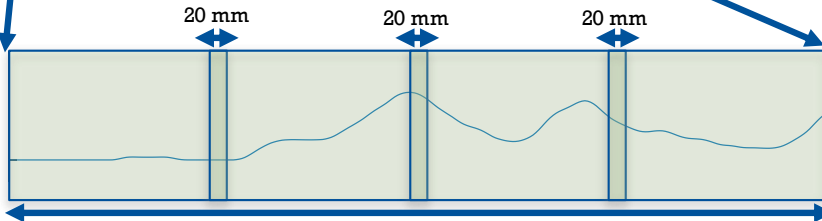

4 @ 200 mm

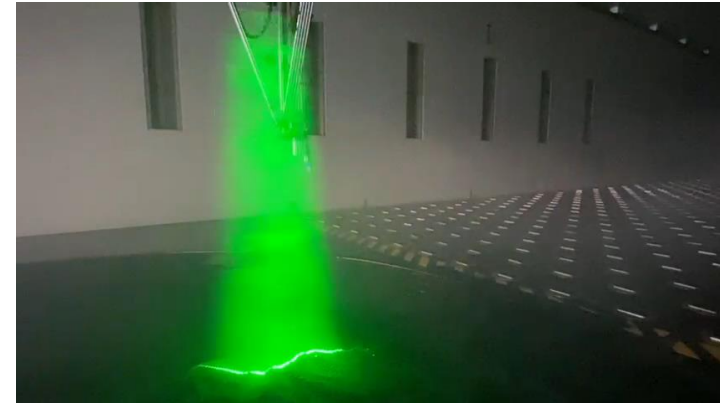



Testing now underway ...

- Work is still ongoing (thank you, COVID-19)
- Culebra data received just last night (118 levels from ~5-600 m FS)

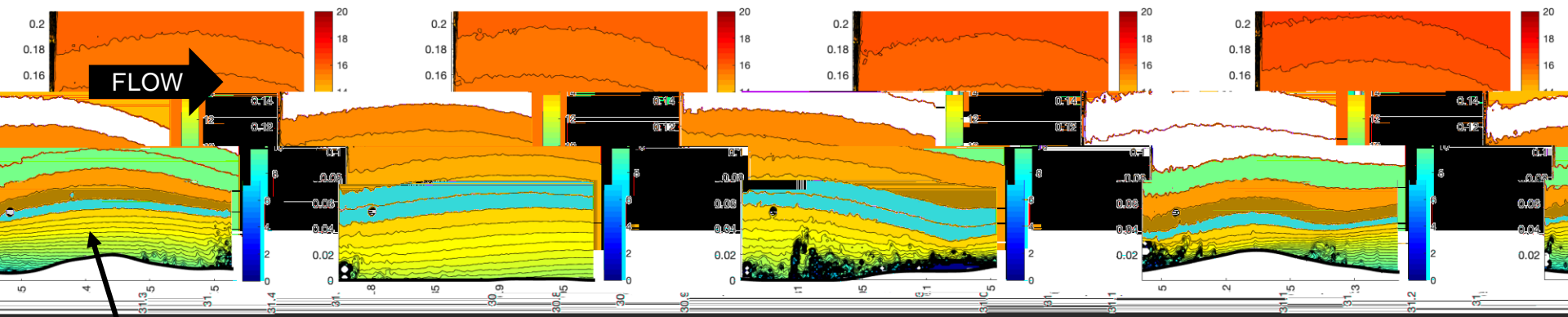

Reference point for image stabilization

Longitudinal mean wind velocity

- Produce 13 transects with up 15 frames each (~9 km FS) → 100+ TB



NWP Modeling – WRF-ARW (LES)

- The simulations were performed using the **Advanced Research WRF (WRF-ARW) model**, version 4.2.2 from NWS UEMS 21.1.2 using the computational capabilities of the Texas Advanced Computing Center (TACC) of The University of Texas at Austin.
- The model initial and boundary conditions were obtained from the Global Forecast System Analysis (GFS-ANL) data set of 0.5° (~55.6 km)
- Sea Surface Temperature (SST) data was obtained from 8.33 km Global data set
- The model consists of six (6) one-way nesting domain configuration ranging from a 12.15 km course horizontal **resolution down to 50 m** using a 1/3 ratio, with 61 vertical levels and a large time step of 40 second for the parent domain. Time is also scale down using a 1/3 ratio
- Physics schemes shown to right ...

Planetary Boundary Layer	1	Yonsei University scheme	Skamarock et. al. 2005
Cumulus	14	Kim Simplified Arakawa-Schubert (KASA) [Only for Parent Domain]	Han and Pan, 2011
Land Surface	2	NOAH Land Surface Model	Chen and Dudhia, 2001
Microphysics	24	WRF Single Moment 7-Class (WSM7)	Bae et. al., 2018
Radiation (LW/SW)	1/1	(RRTM) / (Dudhia scheme)	Mlawer et. al., 1997) and Dudhia, 1989
Surface Layer	1	Revised MM5 - Monin-Obukhov scheme	



NWP Modeling – WRF-ARW (LES) - Model Setup

Domains d01, d02, & d03

Yabucoa Region (d04, d05, & d06)

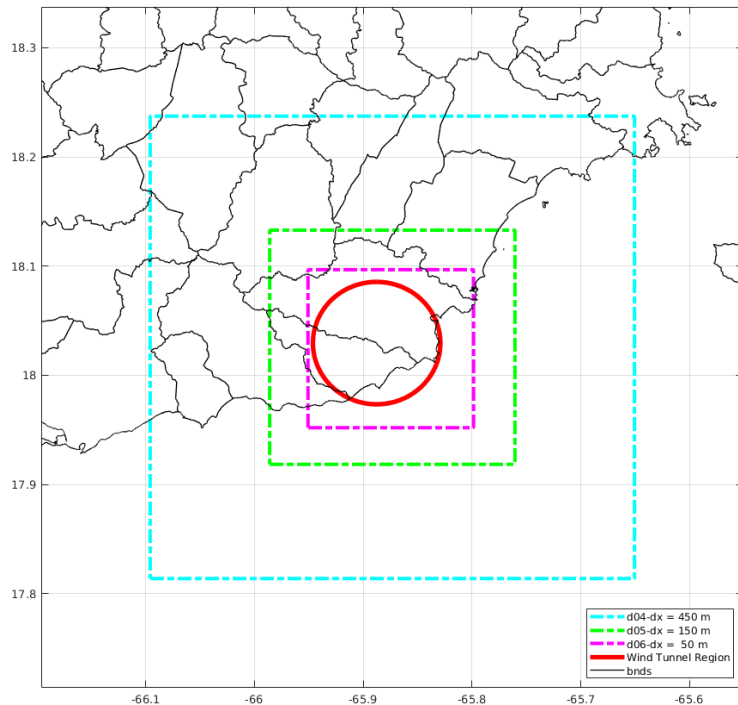
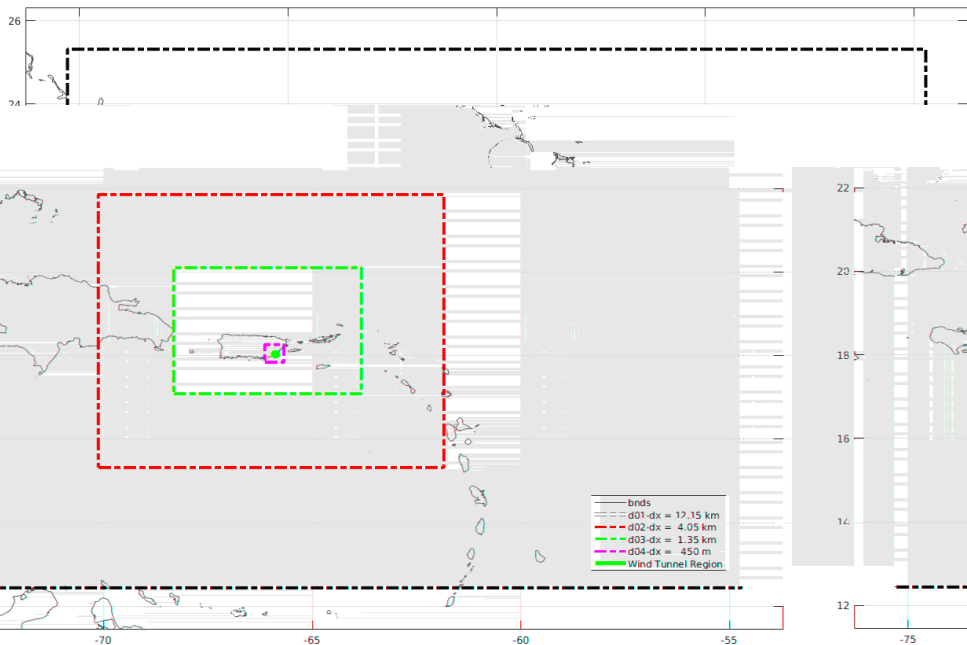



Cruciform A – Wind Direction NNE Normalized by A05

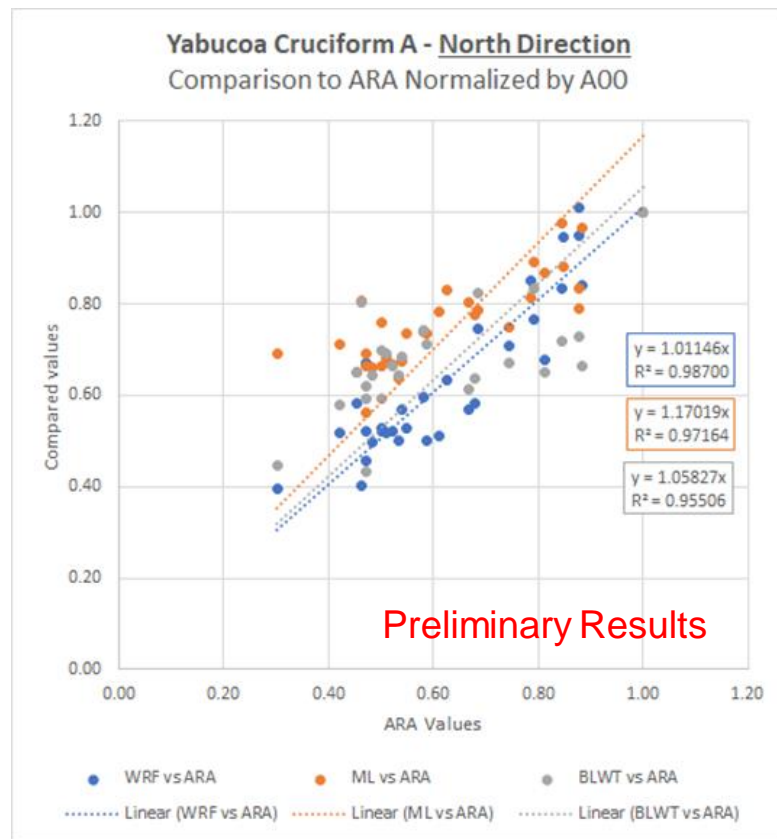
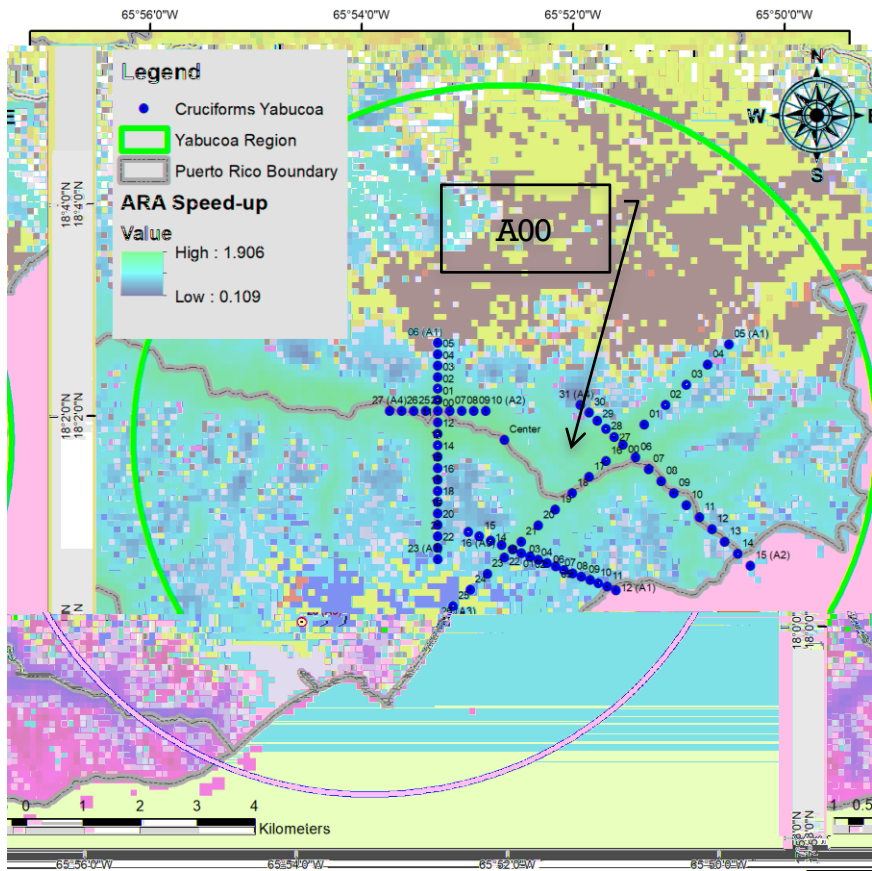



Product: Puerto Rico Building Code 2018 New Wind Map

Number: 9049
 Date: November 15, 2018
 Approved: Hon. Lais G. Rivera Marín
 Secretary of State



[Signature]

By: Eduardo Arosemena
 Assistant Secretary
 Department of State

Permits Management Office (OGPe-DDEC)
 Department of Economic Development and Commerce

Puerto Rico Codes 2018

- Puerto Rico Building Code
- Puerto Rico Residential Code
- Puerto Rico Mechanical Code
- Puerto Rico Plumbing Code
- Puerto Rico Fire Code
- Puerto Rico Fuel Gas Code
- Puerto Rico Energy Conservation Code
- Puerto Rico Existing Building Code
- Puerto Rico Private Sewage Disposal Code
- Puerto Rico Swimming Pool and Spa Code

2018
 PUERTO RICO CODES

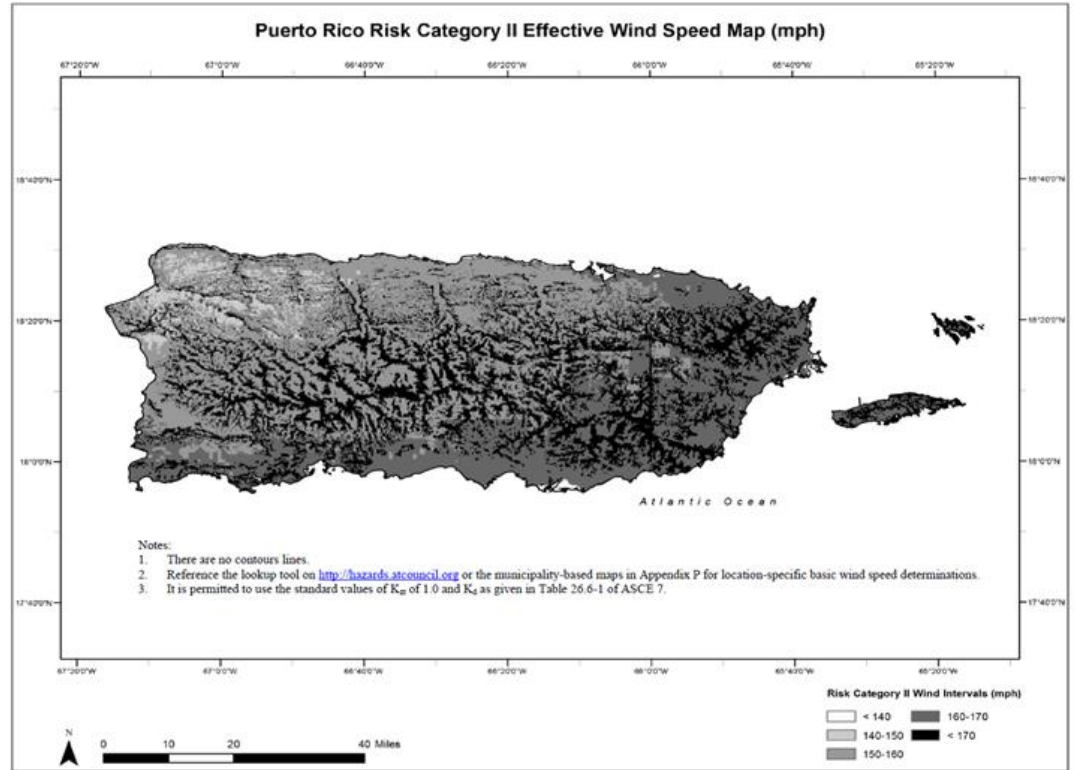
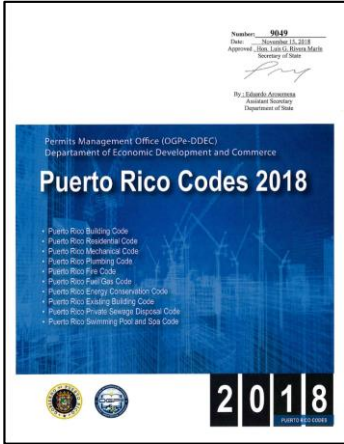

FIGURE 1609.3(9)

BASIC DESIGN WIND SPEEDS, V, FOR RISK CATEGORY II BUILDINGS AND OTHER STRUCTURES (PUERTO RICO)



Product: Puerto Rico Building Code 2018 New Wind Map



APPENDIX P

MICROZONE WIND MAPS FOR PUERTO RICO

The maps provided in this appendix should be considered as the reference for wind design criteria.

USER NOTE:

About this appendix: This wind speed maps for Puerto Rico were specifically developed to consider areas with significant topographic features. Puerto Rico can evaluate the wind speed from these revised basic wind speed maps that consider topographic effects as a simplified and acceptable, alternative method to determine wind loads and pressures (using $K_{zt}=1.0$ during calculation) on a building or structure. The revised basic wind maps do not change the design wind criteria of ASCE 7. For location-specific basic wind speed determinations reference the lookup tool on <http://hazards.atcouncil.org> or the municipality-based maps in this Appendix.



Product: Puerto Rico Building Code 2018 New Wind Map



Municipio de Vieques Risk Category II Effective Wind Speed Map (mph)





Product: Puerto Rico Building Code 2018 New Wind Map

ATC Hazards by Location

Search by Address: 18.096487 Search by Coordinate: -65.476966 Search

Wind Snow Tornado Seismic

Print these results Save these results

Puerto Rico Building Code 2018 Contours unavailable.

MRI 10-Year	72 mph
MRI 25-Year	101 mph
MRI 50-Year	119 mph
MRI 100-Year	134 mph

You are in a wind-borne debris region if you are also within 1 mile of the coastal mean high water line.

Risk Category I	154 mph
Risk Category II	168 mph

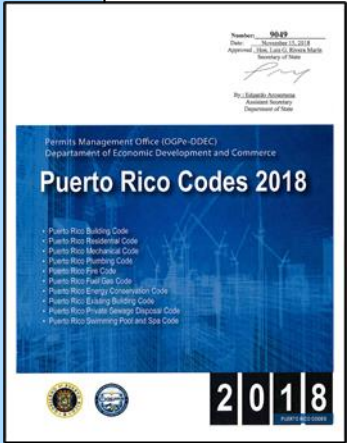

Puerto Rico Building Code 2018
Section 1609.3
New Special Wind Regions
Maps are available at
<https://hazards.atcouncil.org/>

1609.3 Basic design wind speed. The basic design wind speed, V , in mph, for the determination of the wind loads shall be determined by Figures 1609.3(1) through (12). The basic design wind speed, V , for use in the design of Risk Category II buildings and structures shall be obtained from Figures 1609.3(1), 1609.3(5), and for Puerto Rico 1609.3(9). The basic design wind speed, V , for use in the design of Risk Category III buildings and structures shall be obtained from Figures 1609.3(2), 1609.3(6), and for Puerto Rico 1609.3(10). The basic design wind speed, V , for use in the design of Risk Category IV buildings and structures shall be obtained from Figures 1609.3(3), 1609.3(7), and for Puerto Rico 1609.3(11). The basic design wind speed, V , for use in the design of Risk Category I buildings and structures shall be obtained from Figures 1609.3(4), 1609.3(8), and for Puerto Rico 1609.3(12). The basic design wind speed, V , for the special wind regions indicated near mountainous terrain and near gorges shall be in accordance with local jurisdiction requirements. The basic design wind speeds, V , determined by the local jurisdiction shall be in accordance with Chapter 26 of ASCE 7.



2018 Puerto Rico Building Code Prescriptive Residential Design Plans

- Recommendation PR-27.
 - OGPe, with support from stakeholders, should develop prescriptive design plans
 - and make them available to support affordable, code-compliant construction of homes and residential buildings.
- Reconstruction post-Hurricanes Irma and Maria (DR-4339) and Puerto Rico Earthquakes (DR-4473)





Workgroup - 2018 Puerto Rico Building Code Prescriptive Residential Design Plans





PLANO SEGURO - <https://ddec.gobierno.pr/en/plano-seguro-en/>

DEPARTMENT OF
ECONOMIC DEVELOPMENT
AND COMMERCE
DEDC



[Home](#) [About DEDC](#) [Business in Puerto Rico](#) [Incentives](#) [Offices and Programs](#) [Strategic Projects](#) [News](#) [External Resources](#)

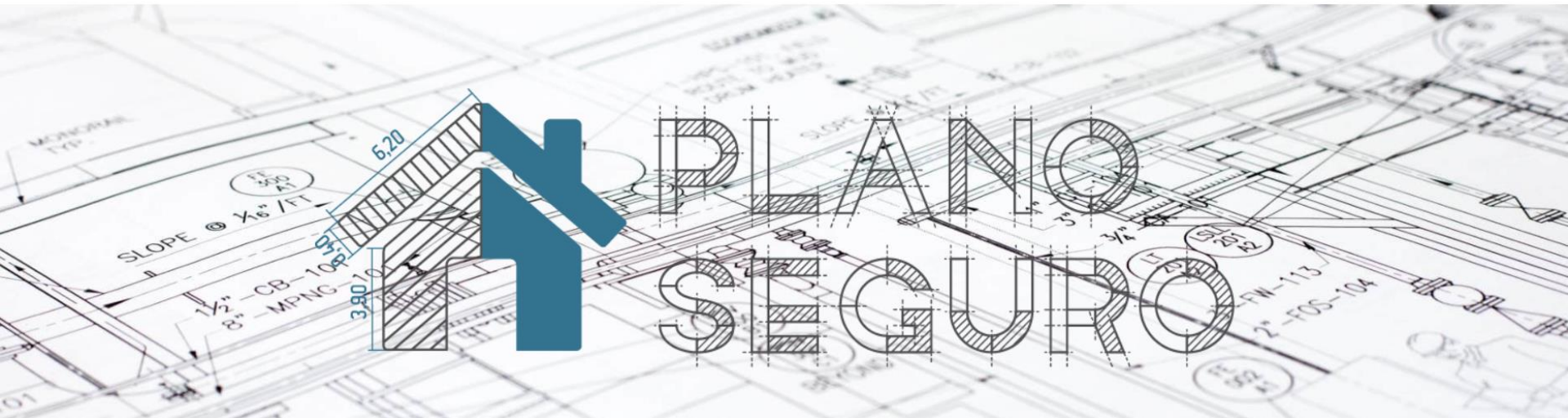



Four Prototypes identified



1 Story House: CMU Walls with Flat Concrete Roof



1 Story House: CMU Walls with Wood Roof



1 Story House: Wood Walls with Wood Roof



2 Story House: 1st Floor CMU Walls with Concrete 2nd Floor and Wood Walls at 2nd Floor with Wood Roof

Similar Components Across Prototypes

- Main Structure Plan Dimensions (24 feet x 20 feet)
- Two Optional Modules (10 feet x 24 feet each)
- FEMA P-361 Safe Room
- Concrete Floors
- Jalousie Windows
- Bathroom and Kitchen with Equipment
- Optional Entryway Porch
- Optional Potable Water and Rain Water Cisterns
- Optional Washer and Dryer Machine Hookups
- Optional A/C Unit Hookup

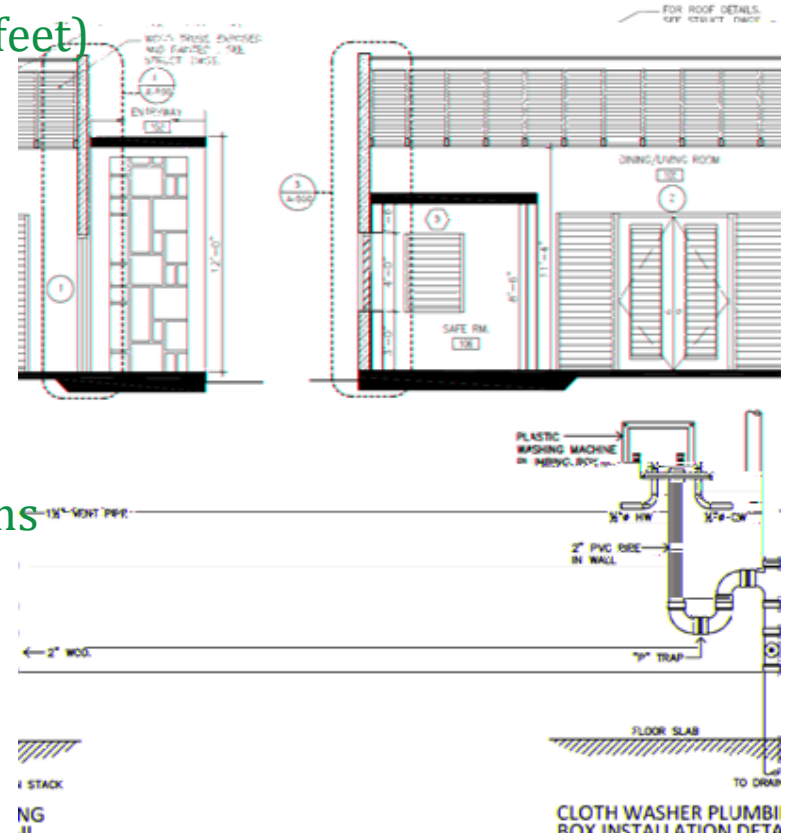



Purpose

- **How are these plans supposed to be used?**
 - These plans are meant to be a guide, to all interested parties, to provide code-compliant home designs
 - These plans are not meant to be a substitute for a stamped drawing set and shall be reviewed and stamped by a registered design professional
 - These plans are based upon a flat site that should be modified for particular site conditions and home-owner construction preferences





Design Criteria: Codes and Standards

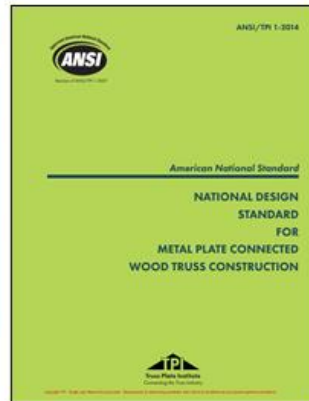
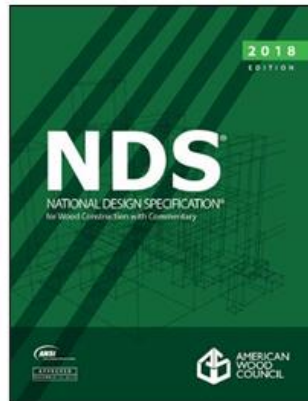
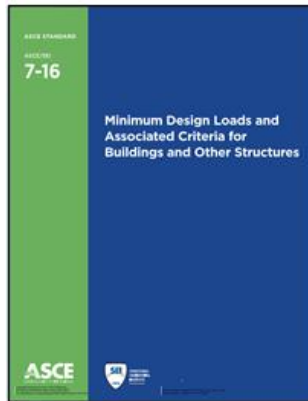
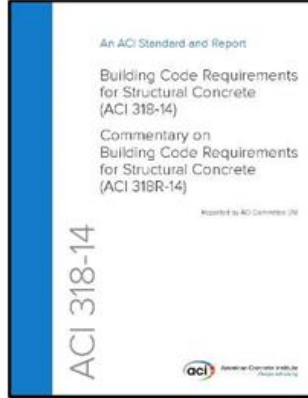



Design Loads: Primary Structure and Modules

Dead Load

The weight of all permanent construction including but not limited to: walls, floors, ceilings, roof cladding.

Roof

Self Weight

Live Load

Roof

20 PSF

Second Floor

40 PSF

Grade Level

40 PSF



Design Loads: Primary Structure and Modules

Wind Load	
Basic Wind Speed (Ultimate)	190 MPH
Basic Wind Speed (Nominal)	147 MPH
Risk Category	II
Exposure Category	D
Enclosure Classification	Partially Open
Internal Pressure Coefficients	+/- 0.18



Design Loads: Primary Structure and Modules

Seismic Load	
Seismic Importance Factor	1.0
S_s	1.35
S_1	0.53
Site Class	D (Stiff Soil)
S_{DS}	0.9
S_{D1}	0.642
Seismic Design Category	D

Prototype 1 – CMU with Concrete Roof: Rendering & Foundation Plan

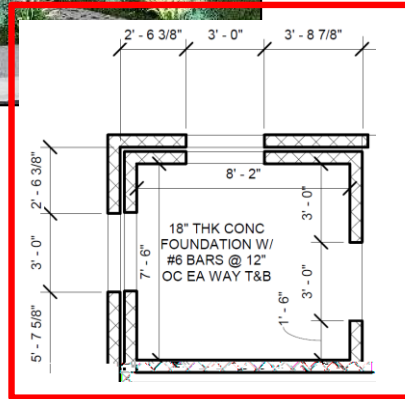

FUTURE MODULE

MAIN STRUCTURE

FUTURE MODULE

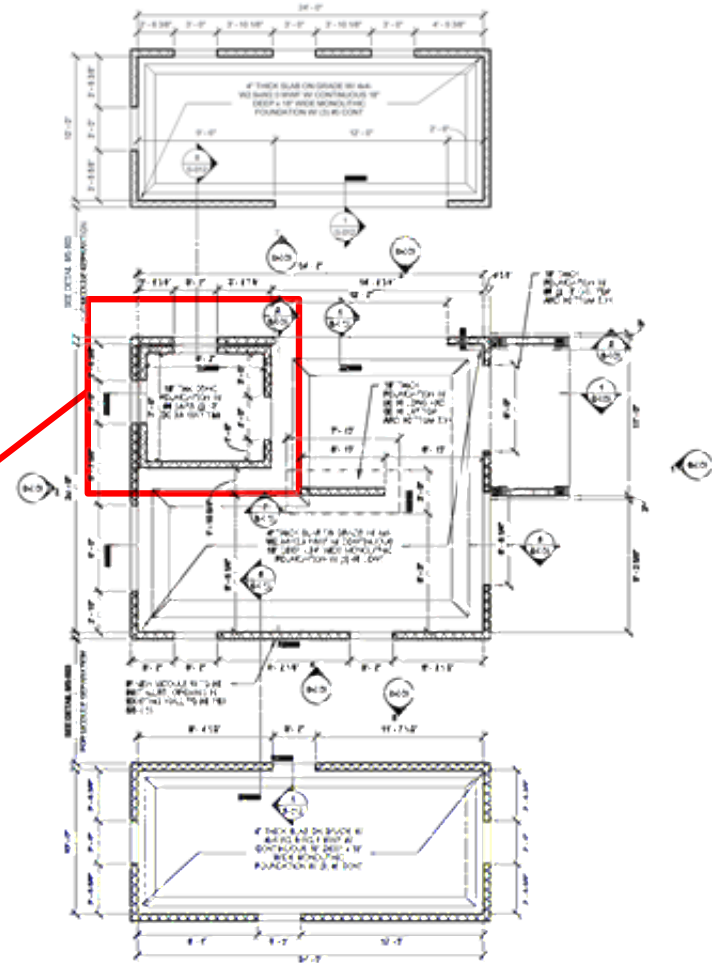



Design Criteria of Safe Room: Codes, Standards, & Guidance

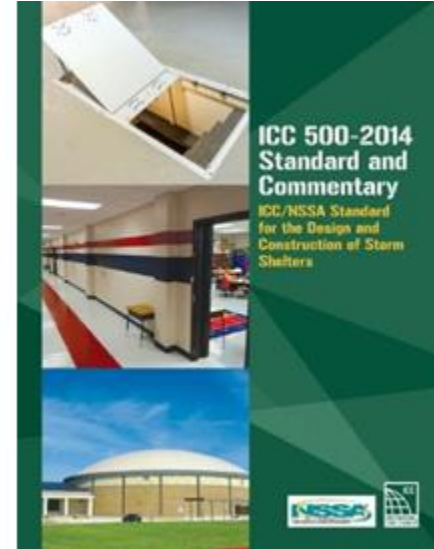
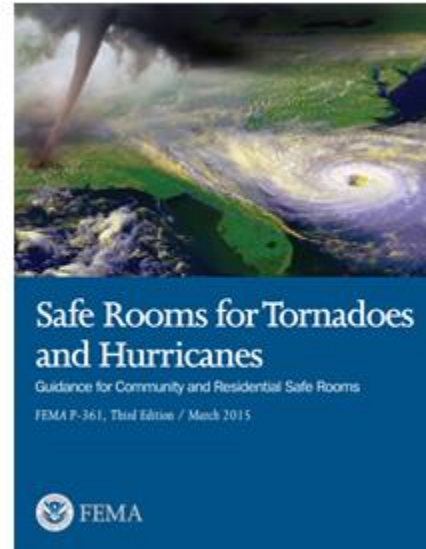



Design Loads of Safe Room

Dead Load

The weight of all permanent construction including but not limited to: walls, floors, ceilings, roof cladding.

Roof

Self Weight

Collateral Load

5 PSF

Live Load

Roof

150 PSF



Design Loads of Safe Room

Wind Load	
Basic Wind Speed (Ultimate)	250 MPH
Basic Wind Speed (Nominal)	194 MPH
Risk Category	II
Exposure Category	D
Enclosure Classification	Partially Enclosed
Internal Pressure Coefficients	+/- 0.55
Safe Room Door and Window Shutter	
Missile Impact Criteria	
Vertical Surfaces	15 LB 2 x 4 AT 100 MPH
Horizontal Surfaces	15 LB 2 x 4 AT 67 MPH

Prototype 2 – CMU with Wood Roof: Rendering & Roof Framing Plan

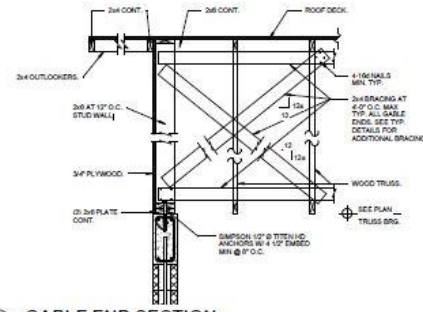
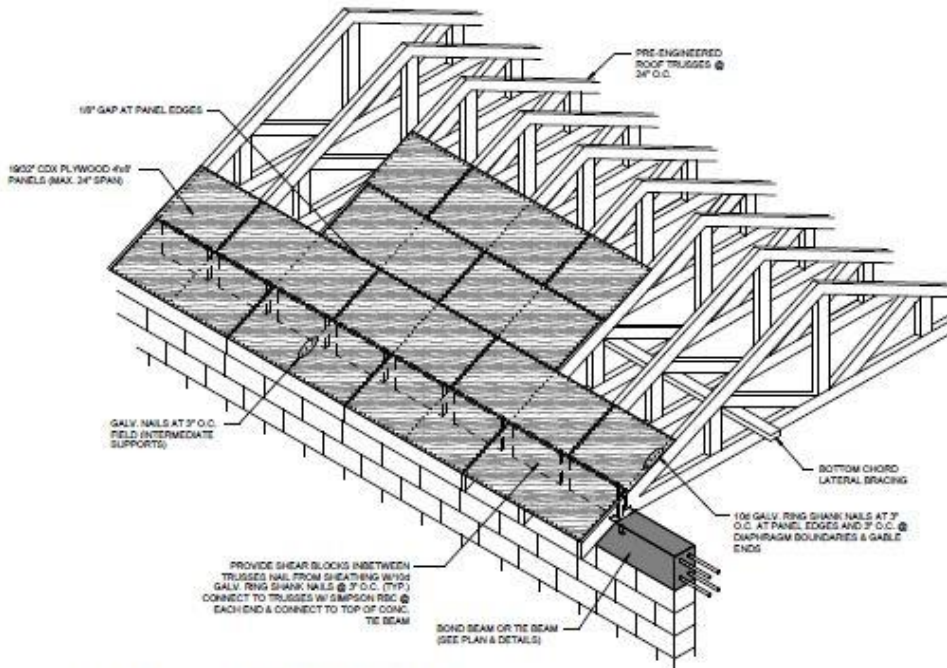

3 GABLE END SECTION
SCALE: 3/4" = 1'-0"

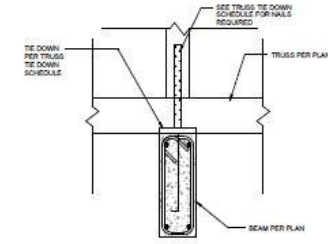

4 TRUSS MIDDLE CONNECTOR
SCALE: 1 1/2" = 1'-0"

1 ROOF NAILING PLAN W/ BLOCKING
SCALE: 3/8" = 1'-0"



Prototype 3 Wood: Rendering & Elevation

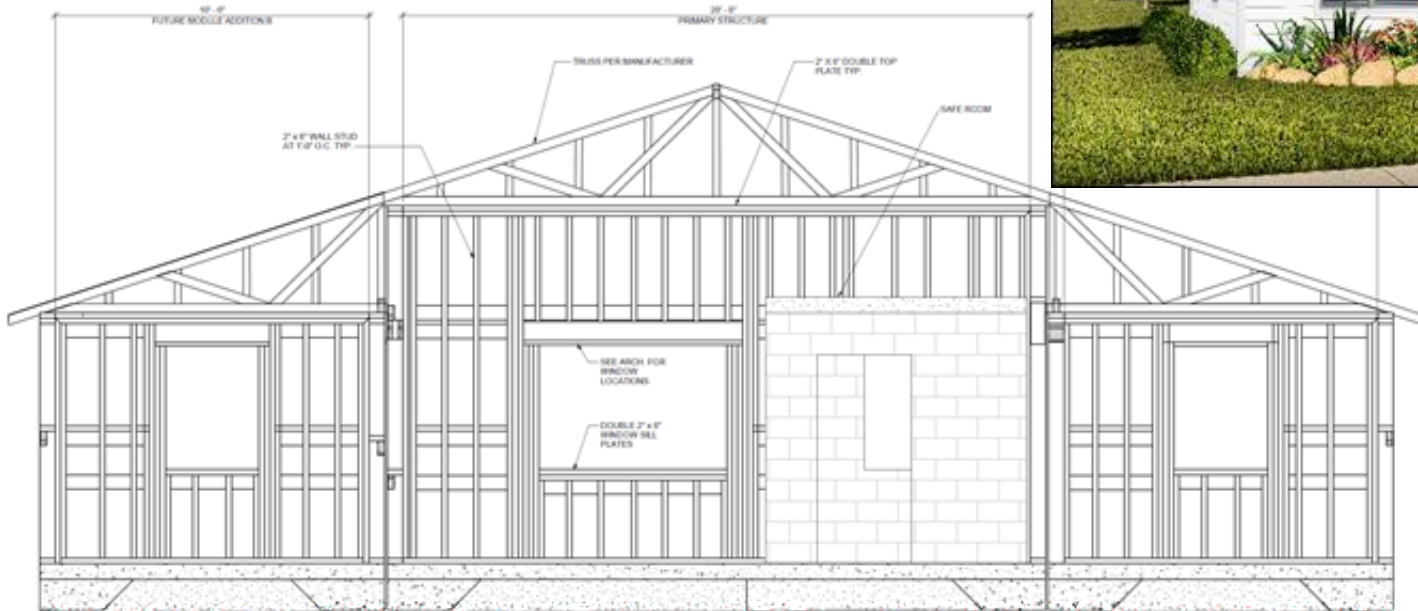

1 FULL HOUSE SECTION
1/8" = 1'-0"

Prototype 3 – Wood: Details

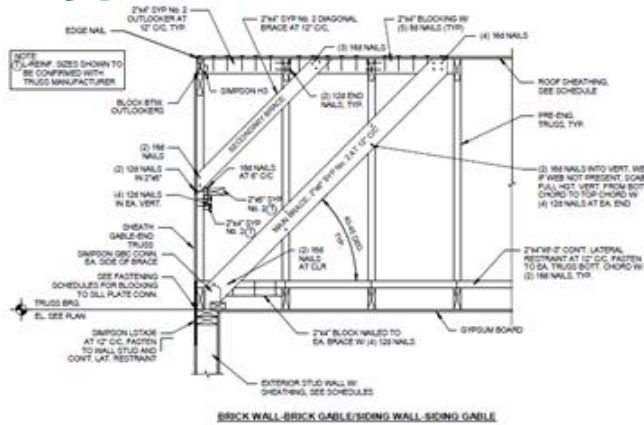

1 TYPICAL GABLE END BRACING DETAILS
S-415 3/4" x 1'-0"

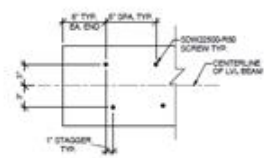

4 TYPICAL LVL BEAM PLY CONNECTION
S-415 1'-0" x 1'-0"

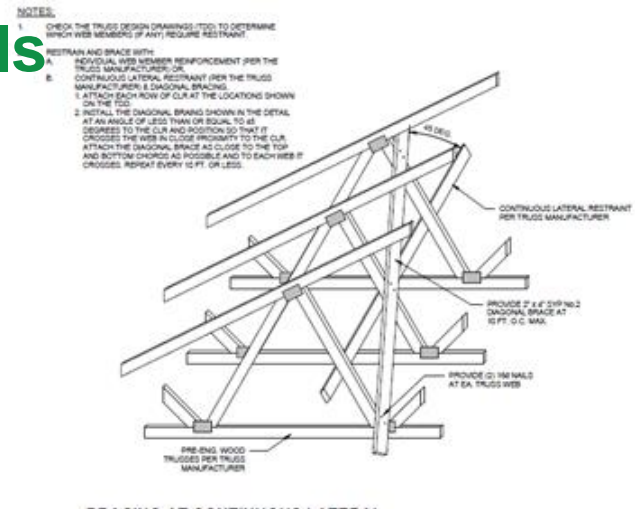

2 BRACING AT CONTINUOUS LATERAL RESTRAINT (CLR)
S-415 N.T.S.

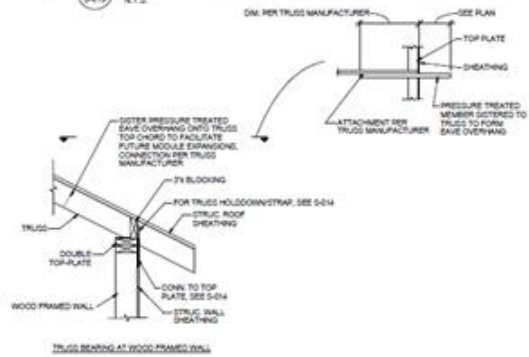

5 TYPICAL ROOF TRUSS BEARING
S-415 3/4" x 1'-0"

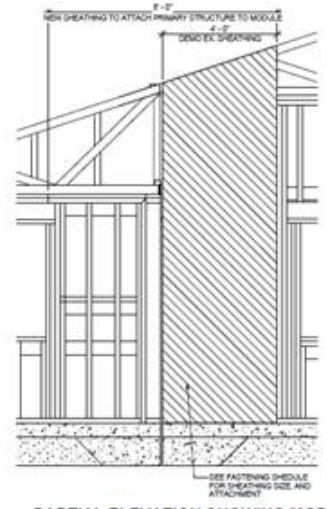

3 PARTIAL ELEVATION SHOWING MODULE ATTACHMENT TO PRIMARY STRUCTURE
S-415 5/2" x 1'-0"

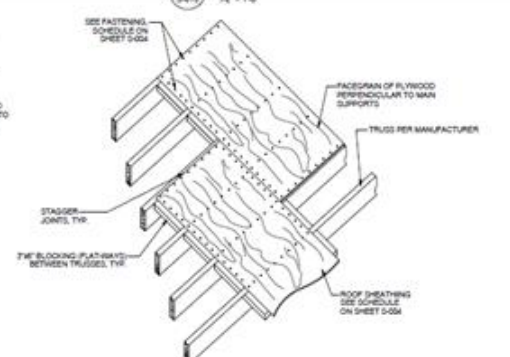

6 TYPICAL ROOF SHEATHING DETAIL
S-415 N.T.S.



Prototype 4 – CMU 1st Floor with Wood 2nd Floor: Rendering & Isometric Views

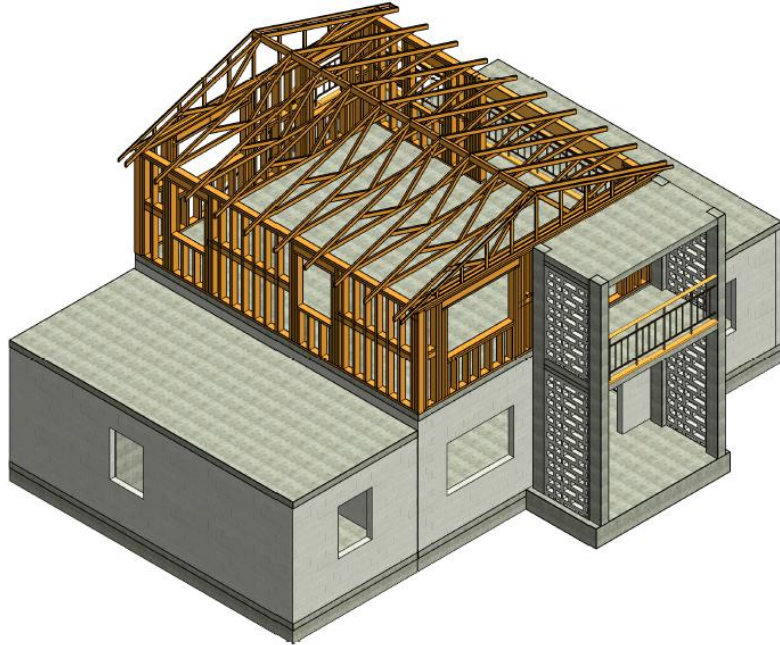

ISOMETRIC VIEW OF
PRIMARY STRUCTURE WITH
MODULES ATTACHED





Prototype 4 – CMU 1st Floor with Wood 2nd Floor: Rendering & Isometric Views

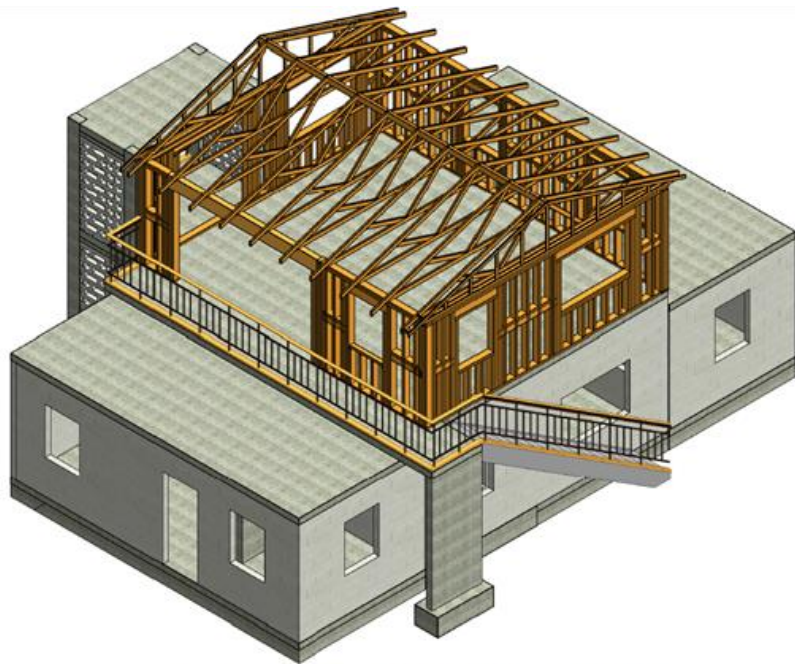

**ISOMETRIC VIEW OF PRIMARY STRUCTURE
WITH MODULES ATTACHED**





Acknowledgements

- NSF NHERI Experimental Facility at UF
 - Award No. 2037725. *Natural Hazards Engineering Research Infrastructure: Experimental Facility with Boundary Layer Wind Tunnel 2021-2025*
 - Award No. 1520843. *Natural Hazards Engineering Research Infrastructure: Experimental Facility with Boundary Layer Wind Tunnel, Wind Load and Dynamic Flow Simulators, and Pressure Loading Actuators*
- NSF Award No. 1841979. *EAGER: Exploring Machine Learning and Atmospheric Simulation to Understand the Role of Geomorphic Complexity in Enhancing Civil Infrastructure Damage during Extreme Wind Events*
- FEMA. *Modelling of Wind Speed Up for Microzoning of Design Wind Speeds in Puerto Rico. Strategic Alliance for Risk Reduction (STARR II)*
- 2018 Puerto Rico Building Code Prescriptive Residential Design Plans: Presentation