

BUILDING PERFORMANCE ASSESSMENT REPORT

*...Building
for Success*

**OKLAHOMA AND
KANSAS**



Midwest Tornadoes of May 3, 1999

**OBSERVATIONS, RECOMMENDATIONS,
AND TECHNICAL GUIDANCE**



WIND ENGINEERING RESEARCH CENTER

**TEXAS TECH
UNIVERSITY**



FEDERAL EMERGENCY MANAGEMENT AGENCY

Mitigation Directorate, Washington DC
and Region VI, Denton, TX
and Region VII, Kansas City, MO



Dedication

In areas devastated by tornadoes, American flags are often placed in remembrance of individuals who lost their lives. This report is dedicated to the individuals, families, and friends who suffered devastating losses from the tornadoes of May 3, 1999.



OKLAHOMA AND KANSAS

*Midwest Tornadoes of
May 3, 1999*



OBSERVATIONS,
RECOMMENDATIONS,
AND TECHNICAL GUIDANCE



The Building Performance Assessment Team Process

In response to hurricanes, floods, earthquakes and other disasters, the Federal Emergency Management Agency (FEMA) often deploys Building Performance Teams (BPATs) to conduct field investigations at disaster sites. The members of a BPAT include representatives of public sector and private sector entities who are experts in specific technical fields such as structural and civil engineering, building design, and construction, and building code development and enforcement. BPATs inspect disaster-induced damages incurred by residential and commercial buildings and other manmade structures; evaluate local design practices, construction methods and materials, building codes, and building inspection and code enforcement processes; and make recommendations regarding design, construction, and code issues. With the goal of reducing the damage caused by future disasters, the BPAT process is an important part of FEMA's hazard mitigation activities.

The statements and recommendations in this report are those of the individual team members and do not necessarily represent the views of the organizations they belong to, the U.S. Government in general, or FEMA or other Federal agencies in particular. The U.S. Government, FEMA, and other Federal agencies assume no responsibility for the accuracy or completeness of the information herein.

Table of Contents

- List of Figures and Tables v
- List of Acronyms xiii
- Executive Summary xv
- 1 Introduction 1-1
 - 1.1 Purpose 1-1
 - 1.2 Team Composition 1-1
 - 1.3 Methodology 1-1
 - 1.4 Presentation of Findings 1-4
- 2 Background on Tornadoes and History of the Storm 2-1
 - 2.1 The Fujita Scale and Tornado Probability 2-1
 - 2.2 Tornadoes and Associated Damage 2-4
 - 2.3 Background of the Event 2-5
- 3 General Assessment and Characterization of Damage 3-1
 - 3.1 Property Protection 3-1
 - 3.1.1 Overview of Buildings Evaluated 3-2
 - 3.1.1.1 Residential Buildings 3-2
 - 3.1.1.2 Non-Residential Buildings 3-3
 - 3.1.2 Continuous Load Path and Wind Loads 3-3
 - 3.2 Windborne Debris 3-12
 - 3.2.1 Missile Types and Sizes 3-13
 - 3.2.2 Windborne Missile Quantity 3-19
 - 3.3 Personal Protection and Sheltering 3-22
 - 3.4 Local, State, and Federal Regulations 3-22
 - 3.4.1 Oklahoma 3-24

TABLE OF CONTENTS

3.4.2	Kansas	3-24
4	Observations on Residential Property Protection	4-1
4.1	Single-Family Conventional Construction	4-1
4.1.1	Load Paths	4-3
4.1.2	Roof and Wall Sheathing	4-3
4.1.3	Structural Connections	4-6
4.1.4	Increased Load	4-10
4.1.5	Roof Coverings	4-11
4.1.6	Exterior Wall Coverings	4-12
4.1.7	Garage Doors	4-14
4.1.8	Windows and Doors	4-20
4.1.9	Masonry Veneer	4-24
4.1.10	Masonry Chimneys	4-29
4.2	Multi-Family Construction	4-33
4.3	Manufactured Housing	4-33
5	Observations on Non-Residential Property Protection	5-1
5.1	Continuous Load Path	5-1
5.1.1	Tilt-Up Precast Concrete Walls with Steel Joists	5-2
5.1.2	Load Bearing Masonry with Steel Joists	5-2
5.1.3	Steel Frame with Masonry Infill Walls	5-4
5.1.4	Light Steel Frame Buildings	5-7
5.1.5	Laminated Wood Arches with Wood Frame Roof	5-7
5.1.6	Masonry Walls with Pre-Cast Hollow Core Floors	5-8
5.2	Increased Load	5-9
5.2.1	Tilt-Up Precast Concrete Walls with Steel Joists	5-11
5.2.2	Load Bearing Masonry with Steel Joists	5-14
5.2.3	Masonry Walls with Pre-Cast Hollow Core Floors	5-14
5.3	Non-Residential Building Envelopes	5-16
5.3.1	Roof Coverings	5-16
5.3.2	Wall Coverings	5-18

- 5.3.3 Laminated Glass 5-20
- 5.3.4 Garage Doors, Exterior Doors and Windows 5-20
- 6 Observations on Personal Protection and Sheltering 6-1
 - 6.1 Shelters 6-1
 - 6.1.1 Types of Shelters 6-1
 - 6.1.2 Use of Shelters 6-4
 - 6.1.3 Maintenance and Design Issues of Shelters 6-8
 - 6.1.4 Shelter Accessibility 6-11
 - 6.1.5 Shelter Ventilation 6-12
 - 6.1.6 Shelter Location 6-14
 - 6.2 Other Places of Refuge 6-15
 - 6.2.1 Refuge in Residences 6-15
 - 6.2.1.1 General Observations 6-16
 - 6.2.1.2 Case Study of Residential Core Remnants 6-20
 - 6.2.2 Refuge in Non-Residential Buildings 6-23
- 7 Conclusions 7-1
 - 7.1 Residential Property Protection 7-1
 - 7.1.1 Single- and Multi-Family Homes 7-2
 - 7.1.1.1 Load Path and Structural Systems 7-2
 - 7.1.1.2 Increased Load Caused by Breach of Envelope 7-5
 - 7.1.1.3 Roof and Wall Coverings 7-5
 - 7.1.1.4 Masonry Veneer 7-6
 - 7.1.2 Manufactured Housing 7-8
 - 7.1.2.1 Foundations 7-8
 - 7.1.2.2 Anchors 7-9
 - 7.1.2.3 Strapping 7-9
 - 7.1.2.4 Superstructure 7-10
 - 7.2 Non-Residential Property Protection 7-11
 - 7.2.1 Load Path 7-11
 - 7.2.2 Increased Load Caused by Breach of Envelope 7-12

TABLE OF CONTENTS

7.3	Personal Protection and Sheltering	7-13
7.3.1	Residential Shelters	7-13
7.3.2	Group Shelters	7-14
7.3.3	Community Shelters	7-14
7.3.4	Other Places of Refuge	7-14
8	Recommendations	8-1
8.1	General Recommendations	8-1
8.2	Property Protection	8-1
8.2.1	Residential and Non-residential Buildings	8-2
8.2.2	Codes and Regulations, Adoption and Enforcement	8-6
8.2.3	Voluntary Actions	8-7
8.3	Personal Protection	8-15
8.3.1	Residential Sheltering	8-15
8.3.2	Group and Community Sheltering	8-15
8.3.3	Places of Refuge	8-17
9	References	9-1
Appendixes		
Appendix A	Members of the Building Performance Assessment Team	
Appendix B	Acknowledgments	
Appendix C	Taking Shelter From the Storm Brochure	
Appendix D	National Performance Criteria for Tornado Shelters	
Appendix E	List of Websites	

List of Figures and Tables

Figure 1-1 BPAT meeting with State of Kansas and local government officials 1-3

Figure 1-2 BPAT meeting with a local fire official in Midwest City .. 1-4

Table 1-1 BPAT damage assessment 1-5

Figure 2-1 Probability of tornado occurrence in the United States ... 2-3

Figure 2-2 Impact of a tornado 2-6

Figure 2-3 Outbreak map of May 3, 1999, tornadoes in Oklahoma .. 2-8

Figure 2-4 Radar reflectivity map showing hook echo 2-9

Figure 2-5 Radar cross-section through F5 tornado 2-10

Figure 2-6 Outbreak map of May 3, 1999, tornadoes in Kansas 2-11

Table 2-1 Fujita Damage Scale 2-2

Table 2-2 Potential damage table for impact from a tornado 2-7

Figure 3-1 Non-residential building not damaged 3-4

Figure 3-2 Continuous load path for a two-story wood frame building 3-6

Figure 3-3 Building failure due to inward wind and uplift 3-7

Figure 3-4 Comparison of engineered and non-engineered buildings in the path of a tornado 3-7

Figure 3-5 Wind uplift on residential home 3-8

Figure 3-6 Increased loads due to breach in envelope 3-8

Figure 3-7 Hip roof failure due to internal pressure and leeward wind forces 3-9

Figure 3-8 Failure of gable wall due to suction forces of leeward wall 3-9

Figure 3-9	Failure of exterior wall and roof due to increased internal pressure	3-10
Figure 3-10	EIFS and metal component damage	3-10
Figure 3-11	URM wall failure due to inflow winds	3-11
Figure 3-12	Failure of steel frame structural system with masonry infill walls	3-11
Figure 3-13	Picture of small missiles	3-12
Figure 3-14	Picture of moderate sized missiles	3-13
Figure 3-15	Large, high energy missiles	3-13
Figure 3-16	Examples of board missiles	3-15
Figure 3-17	Windborne missile striking house	3-15
Figure 3-18	Vertical striking missile	3-16
Figure 3-19	Board missile penetrating brick veneer	3-16
Figure 3-20	Board missile penetrating refrigerator	3-17
Figure 3-21	Steel deck missile	3-17
Figure 3-22	Power pole missile	3-18
Figure 3-23	Displaced large propane tank due to wind	3-18
Figure 3-24	Tree missile	3-19
Figure 3-25	Quantity of flying debris	3-19
Figure 3-26	Miscellaneous debris	3-20
Figure 3-27	Close-up of polyisocyanurate roof insulation	3-20
Figure 3-28	Missiles that struck roof	3-21
Figure 3-29	Missiles that struck exterior wall of house	3-21
Figure 3-30	Missiles that struck interior wall of house	3-22
Figure 3-31	Underground residential shelter	3-23
Table 3-1	Windborne debris (missiles) and rolling debris classifications	3-14
Figure 4-1	Platform construction	4-2
Figure 4-2	Lateral load transfer	4-3
Figure 4-3	Failed stapling of boards to rafters	4-4

Figure 4-4 Staggering joints in sheathing application 4-4

Figure 4-5 Shear load force offset by wall sheathing 4-5

Figure 4-6 Wall failure due to inadequate lateral load resistance 4-6

Figure 4-7 Roof truss failure 4-7

Figure 4-8 Roof-framing to wall failure 4-8

Figure 4-9 Top plate to supporting stud connection failure 4-8

Figure 4-10 Wall framing to bottom plate failure 4-9

Figure 4-11 Stud wall and sole plate to floor failure 4-9

Figure 4-12 Bottom plate foundation failure at wall 4-10

Figure 4-13 Bottom plate to foundation failure 4-11

Figure 4-14 Asphalt shingles on roof 4-12

Figure 4-15 T-lock shingles on roof 4-12

Figure 4-16 Vinyl siding damage 4-13

Figure 4-17 Vinyl siding damage 4-14

Figure 4-18 Garage door failure under suction load 4-15

Figure 4-19 Plan view of typical garage door 4-15

Figure 4-20 Garage door failure at track 4-16

Figure 4-21 Partial schematic of subdivision 4-16

Figure 4-22 Partial roof loss versus total loss under internal pressure 4-18

Figure 4-23 Garage and roof failure 4-19

Figure 4-24 Garage door failure 4-19

Figure 4-25 Roof uplift 4-20

Figure 4-26 Missile damage at garage 4-20

Figure 4-27 Missile penetrated door 4-21

Figure 4-28 Roof sheathing failure 4-22

Figure 4-29 Roof sheathing failure 4-23

Figure 4-30 Interior of home with roof failure 4-23

Figure 4-31 Brick veneer wall defeated inward with only hand pressure 4-24

Figure 4-32 Failure of masonry construction 4-25

Figure 4-33	Brick masonry veneer failure	4-25
Figure 4-34	Failure of masonry veneer wall	4-26
Figure 4-35	Failure of brick veneer, close-up	4-27
Figure 4-36	Inadequate bond of mortar to galvanized brick ties	4-28
Figure 4-37	Failure of masonry veneer wall	4-28
Figure 4-38	Failure of masonry veneer wall	4-29
Figure 4-39	Failure of masonry veneer wall	4-30
Figure 4-40	Failure of chimney onto home	4-30
Figure 4-41	Failure of chimney, close-up	4-31
Figure 4-42	Failure of chimney onto home	4-31
Figure 4-43	Failure of masonry veneer, single-family attached housing	4-32
Figure 4-44	Failure of masonry veneer, single-family attached housing	4-32
Figure 4-45	Failure of masonry veneer, multi-family	4-33
Figure 4-46	Failure of masonry veneer, multi-family	4-34
Figure 4-47	Destroyed chassis	4-35
Figure 4-48	Failed straps	4-35
Figure 4-49	Displaced chassis	4-36
Figure 4-50	Pulled anchor	4-36
Figure 4-51	Pulled and bent anchor	4-37
Figure 4-52	Strap failure	4-37
Figure 4-53	Roof uplift	4-38
Figure 4-54	Manufactured home damage	4-38
Figure 4-55	View of displaced chassis foundation	4-39
Figure 4-56	View of removed chassis	4-40
Figure 4-57	Laterally shifted manufactured home	4-40
Figure 4-58	Pulled anchors and lateral displacement	4-40
Figure 4-59	Strap and lateral shifting	4-41
Figure 4-60	Shifted manufactured home	4-42

Figure 5-1 Failure of critical connections in load path 5-2

Figure 5-2 Failure of tilt-up precast concrete walls 5-3

Figure 5-3 Damage displaying separation of bond beams 5-3

Figure 5-4 Broken deck welds and no effective vertical reinforcement 5-4

Figure 5-5 Blown off metal roof decking 5-5

Figure 5-6 Foundation and wall attachments 5-5

Figure 5-7 Column anchors exhibiting ductile failure 5-6

Figure 5-8 Column anchors withdrawn from concrete foundation 5-6

Figure 5-9 Stroud Regional Outlet Mall 5-7

Figure 5-10 Loss of church roof 5-8

Figure 5-11 Motel damage from violent tornado vortex 5-8

Figure 5-12 Out-of-plane buckling of the main girder 5-9

Figure 5-13 Collapsed roof structure and exterior 5-10

Figure 5-14 Blown off roof over school auditorium 5-11

Figure 5-15 Exterior of an undamaged reinforced concrete wall 5-11

Figure 5-16 Failure of tilt-up concrete wall 5-12

Figure 5-17 Top of failed tilt-up wall 5-12

Figure 5-18 Top of failed tilt-up wall 5-13

Figure 5-19 Failed roof system with intact tilt-up concrete walls 5-13

Figure 5-20 Damage to unreinforced masonry walls 5-14

Figure 5-21 Hollow core planks formed on second floor of a hotel .. 5-15

Figure 5-22 Failure of powder-driven anchors 5-15

Figure 5-23 EPDM with aggregate ballast roof covering 5-16

Figure 5-24 Built-up roof covering 5-17

Figure 5-25 Metal panel roof covering 5-17

Figure 5-26 Tile roof covering 5-18

Figure 5-27 Failed roof coping and nailer 5-19

Figure 5-28 Collapsed metal clad wall covering 5-19

Figure 5-29 Penetration of laminated glass 5-20

Figure 5-30	Roof and wall failure	5-21
Figure 5-31	Structural damage due to breach in envelope	5-22
Figure 5-32	Damaged exterior door	5-22
Figure 6-1	Aboveground in-residence shelter	6-2
Figure 6-2	Surrounding damage near shelter	6-2
Figure 6-3	Entrance to ICF shelter	6-3
Figure 6-4	Precast concrete storm cellar	6-4
Figure 6-5	Storm cellar constructed of steel sheets with a concrete cover	6-4
Figure 6-6	Aboveground in-residence shelters	6-5
Figure 6-7	Entrance to manufacturing plant group shelter	6-6
Figure 6-8	Group shelters at manufactured home development	6-6
Figure 6-9	Manufactured home development community shelter	6-7
Figure 6-10	Community shelter in school gymnasium	6-8
Figure 6-11	Unmaintained underground shelter door	6-9
Figure 6-12	Failed wooden door of belowground shelter	6-10
Figure 6-13	Inadequate shelter door locking device	6-10
Figure 6-14	Ballast roof covering on community shelter	6-11
Figure 6-15	Stairway to manufactured home community shelter	6-12
Figure 6-16	Stairway access to group shelter	6-13
Figure 6-17	Heavy gauge ventilation pipe for below ground shelter .	6-13
Figure 6-18	Belowground shelter susceptible to water runoff	6-14
Figure 6-19	Remains of interior core room	6-15
Figure 6-20	Remaining interior core of house	6-16
Figure 6-21	Interior bathroom of damaged home	6-17
Figure 6-22	Missile penetrating exterior wall	6-17
Figure 6-23	Missile piercing wall stud	6-18
Figure 6-24	Bathroom located along exterior wall	6-18
Figure 6-25	Second-story damage	6-19

Figure 6-26 Basement windows to home vulnerable to debris 6-19

Figure 6-27 Damaged and destroyed manufactured homes 6-20

Figure 6-28 Core remnant study 6-21

Figure 6-29 Core remnant study 6-22

Figure 6-30 Core remnant study 6-22

Figure 6-31 Core remnant study 6-23

Figure 6-32 Locker room – designated place of refuge 6-24

Figure 6-33 School hallway 6-25

Figure 6-34 Unsafe corridor place of refuge in school 6-26

Figure 6-35 Unsafe corridor place of refuge in school 6-26

Figure 6-36 Unsafe corridor place of refuge in school 6-27

Figure 6-37 EIFS wall system torn from studs 6-27

Figure 6-38 Collapsed non-reinforced interior CMU walls
in school 6-28

Figure 6-39 Blown off roof and ceiling over interior bathroom 6-29

Figure 7-1 Roof geometries and resultant wind loads 7-4

Figure 7-2 Proper connection of brick masonry to wood frames 7-7

Figure 7-3 Proper connection of manufactured home to block
foundation 7-10

Figure 8-1 Typical double-wide garage door elevation 8-3

Figure 8-2 Recommended retrofit for garage door latch
mechanism 8-3

Figure 8-3 Detail from Figures 8-1 and 4-19 illustrates
recommended improvements 8-4

Figure 8-4 Proper welded connection 8-5

Figure 8-5 Proper connections of wood frame construction 8-8

Figure 8-6 Wall connections at crawl space foundation 8-9

Figure 8-7 Roof truss to top-of-wall connection 8-10

Figure 8-8 Roof rafter to top-of-wall connection 8-11

Figure 8-9	Roof rafters to ridge beam connection	8-12
Figure 8-10	Connection methods for asphalt roof shingle system	8-13
Figure 8-11	Proper connections in a reinforced masonry wall	8-14
Figure 8-12	Tornado shelter	8-16

List of Acronyms

ADA	Americans with Disabilities Act
ASCE	American Society of Civil Engineers
ASTM	American Society for Testing and Materials
BOCA	Building Officials and Code Administrators, International
BPAT	Building Performance Assessment Team
CABO	Council of American Building Officials
CDT	Central Daylight Time
COHBA	Central Oklahoma Home Builders Association
CMU	Concrete Masonry Unit
DFO	Disaster Field Office
EIFS	exterior insulating finishing system
EPDM	ethylene propylene diene monomer
EPS	expanded polystyrene
FEMA	Federal Emergency Management Agency
GIS	Geographic Information System
HUD	U.S. Department of Housing and Urban Development
HVAC	heating, ventilation, and air-conditioning

LIST OF ACRONYMS

IBC	International Building Code
ICBO	International Conference of Building Officials
ICC	International Code Council
ICF	Insulated Concrete Form
IRC	International Residential Code
MHCSS	Manufactured Home Construction and Safety Standards
NBC	National Building Code
NCSBCS	National Conference of States on Building Codes and Standards
NFIP	National Flood Insurance Program
NFPA	National Fire Protection Association
NOAA	National Oceanic and Atmospheric Administration
NSSL	National Severe Storms Laboratory
NWS	National Weather Service
PSF	Pounds per square foot
OSB	oriented strand board
SBC	Standard Building Code
SBCCI	Southern Building Code Congress International
UBC	Uniform Building Code
URM	unreinforced masonry

Executive Summary

On the evening of May 3, 1999, an outbreak of tornadoes tore through parts of Oklahoma and Kansas, in areas that are considered part of “Tornado Alley”, leveling entire neighborhoods and killing 49 people. The storms that spawned the tornadoes moved slowly, contributing to the development and redevelopment of individual tornadoes over an extended period of time.

On May 10, 1999, the Federal Emergency Management Agency’s (FEMA’s) Mitigation Directorate deployed a Building Performance Assessment Team (BPAT) to Oklahoma and Kansas to assess damage caused by the tornadoes. The BPAT was composed of national experts including FEMA Headquarters and Regional Office engineers and staff; a meteorologist; architects; planners; wind engineers; structural engineers; and forensic engineers. Members of the BPAT are presented in Appendix A. The mission of the BPAT was to assess the performance of buildings affected by the tornadoes, investigate losses, and describe the lessons learned. This report presents the BPAT’s observations, conclusions, and recommendations, which are intended to help communities, businesses, and individuals reduce future injuries and the loss of life and property resulting from tornadoes and other high-wind events. The observations, conclusions, and recommendations in this report are grouped to address issues concerning residential property protection, non-residential property protection, and personal protection and sheltering.

The BPAT’s findings are correlated with the Fujita damage scale, which ranks tornadoes according to the damage they cause, and general tornado intensity (Tables 1-1 and 2-1). It is not the intent of this report to reclassify the strength of the May 3 tornadoes or the ratings of the damage observed, or to debate the magnitude of the wind speeds associated with those tornadoes.

Tornadoes are extremely complex wind events that cause damage ranging from minimal or minor to absolute devastation. For the purposes of this report, tornado intensity is simplified and referred to by three categories: violent, strong, and weak. The greatest damage occurs in a violent tornado. Typically, all buildings are destroyed and trees are uprooted, debarked, and splintered. In a strong tornado, some buildings may be destroyed, but most suffer less damage, such as the loss of exterior walls, the roof structure, or both. Even when buildings affected by a strong tornado lose their exterior

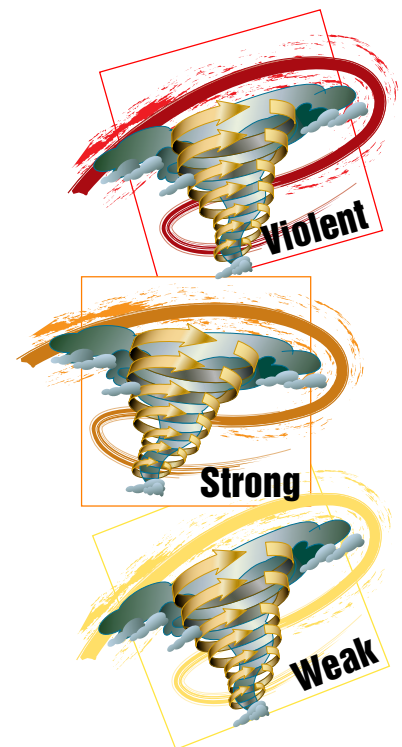

walls and roofs, interior rooms may survive. In weak tornadoes, damage to buildings primarily affects roofs and windows. Roof damage ranges from loss of the entire roof structure to the loss of all or part of the roof sheathing or roof coverings. Typically, many of the windows in buildings will be broken by windborne debris. Weak tornadoes can often cause significant damage to manufactured housing.

The BPAT investigated buildings to identify successes and failures that occurred during the tornadoes. Buildings were classified as being directly struck by the vortex (i.e., core) of a tornado, affected by winds outside (but near) the vortex of a tornado, or out on the extreme edge (i.e., periphery) of a tornado path. Few successes were observed by the BPAT. Successes consisted of the utilization of engineered shelters within a home or commercial building or voluntary utilization of known construction techniques that strengthened the structural system of a building. Considerable damage occurred to all types of structures throughout the areas observed in Oklahoma and Kansas. Failures occurred when extreme winds produced forces on the buildings that they were not designed to withstand. Failures also occurred when windborne debris penetrated the building envelope, allowing wind inside the building that again produced forces on the buildings that they were not designed to withstand. Additional failures observed were attributed to the construction techniques used, the selection of construction materials, the fasteners used, and the design of, or lack of, connections. It was a goal of the BPAT to determine if the damage observed to both residential and non-residential buildings was preventable.

Most residential construction in Oklahoma and Kansas is currently required to be designed per the 1995 Council of American Building Officials (CABO) One- and Two-Family Dwelling Code. Although some amendments have been adopted by local municipalities, this code does not incorporate wind speed design parameters used by the newer 1997 Uniform Building Code (UBC) and 1996 National Building Code (NBC). Furthermore, engineering standards such as the American Society of Civil Engineers (ASCE) 7-98 design standard provide better guidance for determining design wind loads than these newer codes. Although designing for tornadoes is not specifically addressed in any of these newer codes or standards, constructing homes to these codes and standards would improve the strength of the built environment. The BPAT concluded that buildings constructed to these newer codes and standards would have experienced less damage in areas that were affected by the inflow winds of all tornadoes and reduced the damage where weak tornado vortices directly affected buildings.

The BPAT concluded that the best means to reduce loss of life and minimize personal injury during any tornadic event is to take refuge in specifically designed tornado shelters. Although improved construction may reduce damage to buildings and provide for safer buildings, an engineered shelter is the best means of providing individuals near absolute protection.

The BPAT developed recommendations for reducing future tornado damage to property and providing personal protection. Broad recommendations include:

- **Building Code Recommendations.** Neither building codes nor engineering standards explicitly address design for tornadoes. However, designing to the wind loads in ASCE 7-98 can reduce damages from both weak tornadoes and in outlying areas damaged by strong and violent tornadoes. The model building codes consider these latest engineering standards, such as ASCE 7, when model building codes are revised, usually on a 3-year cycle. In order that design and construction practices reflect our improved understanding of high winds, jurisdictions having authority should consider the following alternatives in amending their current building code or in adopting new building codes:
 - Adopt the International Building Code (IBC) and the International Residential Code (IRC) upon their expected release in February 2000.
 - As an interim step to adopting the IBC and IRC, adopt the 1997 UBC, the 1997 Standard Building Code, (SBC), or the 1996 NBC as the building code until the IBC or IRC can be adopted. To further improve the wind resistance of buildings, adopt an amendment that requires the use of ASCE 7-98 to calculate wind loads.
 - As an interim step to adopting the IRC, State and local governments should adopt the 1995 edition of the CABO One- and Two-Family Dwelling Code for jurisdictions using previous editions of this code or having no residential code in place. This will provide some guidance for designing for wind loads.
- Communities should consider the need for adopting ordinances and regulations that promote disaster-resistant communities by incorporating tornado shelters into new construction and communities.
- The Federal Government (HUD) should review its standards and enforcement program in an effort to improve the performance of manufactured homes in moderately high wind events, such as in inflow areas of all tornadoes and the tracks of weak tornadoes. Specifically, the capacity of anchoring and strapping equipment and systems needs to be evaluated to eliminate the discontinuity between the Federal standard and the State and local installation and enforcement process.

- Consideration should be given to permanently connecting the manufactured home unit to its foundation. The BPAT observed newer double-wide manufactured houses on permanent foundations and did not see significant differences in damage between these manufactured homes on permanent foundations and conventionally built houses. Double-wide manufactured housing on permanent foundations performed better than both double-wide and single units on non-permanent foundations.
- Construction techniques and materials to provide a continuous load path for wind loads should be incorporated into the construction of buildings, including houses. This will reduce their vulnerability to damages during extreme wind events. There are existing proven construction practices to minimize damages in other wind-prone areas (hurricane areas) of the country.
- Construction should be regulated and better inspected to ensure that buildings (including residences) meet current building code requirements. A lack of compliance with building codes was observed in many of the damaged buildings.
- Garage doors are an extremely important residential building component. Failure of these doors led to catastrophic progressive failures of primary structural systems that could have been avoided. New garage doors should be installed with improved resistance to high wind loads.
- Where new doors are not installed, retrofits should be made to improve the wind resistance of existing garage doors, particularly double-wide garage doors. These retrofits and new doors will better resist wind forces and should reduce the roof and wall damage that was observed in homes that experienced garage door failures.
- Architectural features should be appropriately designed, manufactured, and installed to resist wind loads and to minimize the creation of windborne debris. To accomplish this, the local community may want to further regulate these features to ensure a reduction in potential debris materials.
- The brick masonry industry should consider re-evaluating attachment criteria of masonry, specifically regarding product usage. Greater emphasis should be given to code compliance for the bond between the mortar and brick tie, the mortar and the brick, and the spacing of brick ties.

- In areas subjected to high winds from either tornadoes or hurricanes, masonry chimneys should have continuous vertical reinforcing steel placed in the corners to provide greater resistance to wind loads. This reinforcing steel should be placed to the requirements set forth in the 1995 CABO One-and Two- Family Dwelling Code (Requirements for Masonry Fireplaces and Chimneys for seismic zones 3 and 4) or the masonry fireplace provisions of the IRC; available in February 2000.
- Shelters are the best means of providing near absolute protection for individuals who are attempting to take refuge during a tornado. All shelters should be designed and constructed in accordance with either *FEMA 320: Taking Shelter From the Storm* or *the National Performance Criteria For Tornado Shelters* (Appendixes C and D). All shelters should provide access to persons with disabilities as necessary and in conformance with the Americans with Disabilities Act (ADA). Local officials should monitor the installation of shelters to ensure that the floors of all shelters are located at or above expected flood levels.
- Manufactured homes typically offer little protection from severe wind storms and tornadoes. In the event of such storms, occupants of manufactured homes should exit their home and seek shelter in storm cellars, basements, or above-ground shelters. If shelters are provided in manufactured home parks, which is recommended, dispersed shelters, which can be accessed in a short time period, are recommended.
- Prospective occupants of community shelters should be acutely alert to storm warnings in order to allow sufficient time for the travel distance to the community shelter. Custodians of the shelter should be similarly alert so that the shelter is unlocked at appropriate times. Community shelters should be ADA compliant and the admission rules permanently posted (i.e. “No Pets Allowed,” etc.).
- Existing essential facilities that offer inadequate protection should have shelters retrofitted or a shelter added. New essential facilities should be designed with shelters. Interested states should form a committee to evaluate the need for tornado plans and shelters in essential facilities and other establishments serving the public (e.g., schools, hospitals, and critical facilities). All facilities for public accommodation should have a National Oceanic and Atmospheric Administration (NOAA) weather radio in continuous operation.

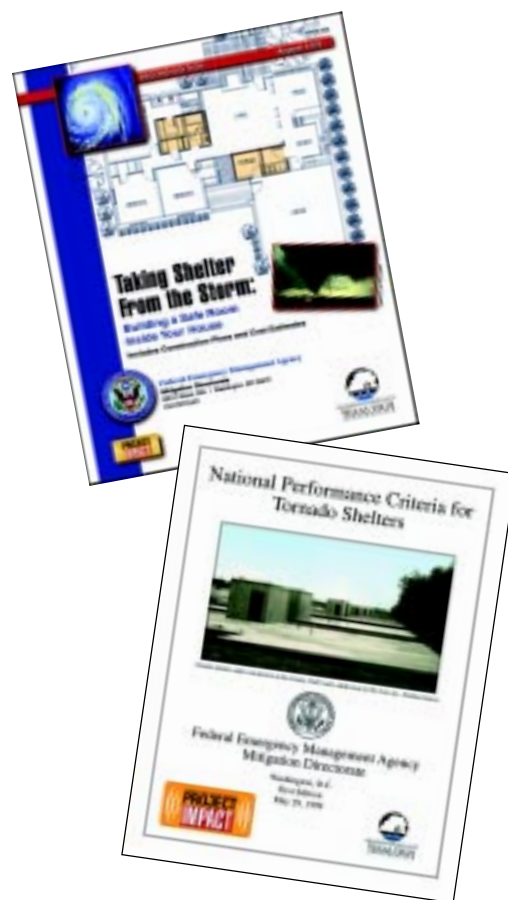

- The installation of laminated glass in essential facilities should be considered because of the substantial protection that it offers from debris missiles. A recommended standard for determining minimum strength of openings with laminated glass is to conduct testing, in accordance with ASTM E 1886, in consideration of the load criteria given in ASTM E 1996.
- Fire departments and emergency services agencies should make a list of addresses with shelters both above ground and below ground. This list will assist post disaster response teams and agencies in checking after a tornado to see if people are trapped inside their shelters.

1 Introduction

1.1 Purpose

The number of tornadoes that occurred on May 3, 1999, in Oklahoma and Kansas, their severity, and the level of devastation they caused have not been seen in a generation within the United States. One of the missions of the Federal Emergency Management Agency (FEMA) that directly supports the *National Mitigation Strategy* is:

to significantly reduce the risk of loss of life, injuries, economic costs and destruction of natural and cultural resources that result from natural hazards.

In response to the disasters caused by the May 3 tornadoes, FEMA deployed a Building Performance Assessment Team (BPAT), composed of national experts to Oklahoma and Kansas. The mission of the BPAT was to assess the performance of buildings affected by the tornadoes, investigate losses, and describe the lessons learned. This report presents the BPAT's observations, conclusions, and recommendations, which are intended to help communities, businesses, and individuals reduce future injuries and the loss of life and property resulting from tornadoes and other high-wind events.

1.2 Team Composition

The BPAT included FEMA Headquarters and Regional Office engineers and staff; a meteorologist; planners; architects; wind engineers; structural engineers; and forensic engineers. The members of the BPAT are listed in Appendix A.

1.3 Methodology

The FEMA Mitigation Directorate deployed the BPAT to Oklahoma and Kansas on May 10, 1999. The team inspected both residential and non-residential buildings, as discussed below. By assessing the performance of these buildings, the team was able to develop technical guidance concerning new construction and post-tornado reconstruction for state and local governments, building owners, architects, engineers, and contractors.

In addition to assessing building performance, the BPAT:

- inspected designated shelter areas in public buildings (e.g., schools, churches, day care centers, nursing homes),
- investigated successes and failures of existing shelters used during the tornadoes, and
- evaluated existing tornado response plans within buildings intended for high occupancy, such as schools and private industry facilities.

Field investigations began on May 10 and were conducted through May 18. In Oklahoma, inspections were made in Bridge Creek (about 50 miles southwest of Oklahoma City); the Oklahoma City Metroplex, including the suburbs of Moore, Del City, and Midwest City; the Project Impact community of Tulsa; and Stroud and Mulhall. In Kansas, inspections were made in unincorporated Sedgwick County, the City of Haysville, and Wichita.

BPATs frequently conduct aerial assessments of damaged areas to gather general data on damage sites, acquire aerial photographs of those sites, and determine the focus and final composition of the BPAT. For the May 3 tornado disasters, adequate information was provided to the team by the FEMA Disaster Field Offices (DFOs) and by state and local government agencies. Therefore, the BPAT did not conduct an aerial assessment of the damage areas.

The BPAT inspected the following types of residential buildings:

- single- and multi-family, one- to two-story residences
- manufactured and modular homes
- accessory structures

Many of the houses inspected in Kansas were constructed on basement or crawl space foundations; most of the houses inspected in Oklahoma were constructed on slab-on-grade foundations. From its observations, the BPAT formed conclusions concerning the structural performance of residential buildings exposed to the May 3 tornadoes. The BPAT also formed conclusions regarding exterior architectural systems, such as roof coverings, brick veneer and other siding materials, windows, garage doors, and masonry chimneys.

The non-residential building types observed included the following:

- tilt-up pre-cast concrete walls with steel joists
- load-bearing masonry walls with steel joists
- load-bearing masonry with pre-cast concrete hollow-core floor and roof slabs
- pre-engineered metal buildings (light steel frames)
- buildings constructed of laminated wood arches with wood framing
- buildings with masonry veneer and pre-cast concrete floors

- industrial plants
- a regional shopping outlet mall
- public use buildings, which included a hospital, a nursing home, day care centers, hotels, and schools

Other important issues such as windborne debris (missiles), personal protection, and sheltering were investigated and are discussed in individual sections of this report.

FEMA encouraged the participation of state and county government officials and locally based experts in the assessment process. Their involvement was critical and:

- ensured that state and local building code and other requirements were properly interpreted,
- increased the likelihood that local construction practices were fully appreciated and understood,
- established positive relationships among Federal, state, and local governments and the private sector, and
- encouraged development of recommendations that were both economically and technically realistic.

Under this premise, the BPAT met with local government officials upon arriving in Oklahoma and Kansas to partner in the overview and identification of damage areas (Figures 1-1 and 1-2). Team members were briefed by staff members of the FEMA regional DFOs and representatives of state, county, and local government agencies on the extent and types of damage. GIS maps were provided and reviewed to select field investigation sites and establish an itinerary.



FIGURE 1-1: BPAT meeting with State of Kansas and local government officials in Wichita, Kansas.

FIGURE 1-2: Meeting with local fire official in Midwest City, Oklahoma.



Collectively, the team spent over 1,500 hours in the field conducting site investigations and inspecting damage. Documentation of observations made during the site visits consisted of field notes and photographs. The BPAT's mission did not include recording the numbers of buildings damaged by the tornadoes, determining the frequency of specific types of damage, or collecting data that could serve as the basis of statistical analysis.



1.4 Presentation Of Findings

The observations, conclusions, and recommendations in this report are grouped to address issues concerning (1) residential property protection, (2) non-residential property protection, and (3) personal protection and sheltering.

Table 1-1 correlates the BPAT's findings with the Fujita damage scale (which ranks tornadoes according to the damage they cause) and general tornado intensity in terms that will be used throughout this report. For the purposes of this report, tornado intensity is referred to by the three categories listed in Table 1-1: weak, strong, and violent. When appropriate, damage observations in this report are presented in terms of the Fujita scale ratings. Table 1-1 is intended to help the reader better understand tornadoes, the damage associated with them, and how mitigation efforts can reduce the property damage and loss of life caused by tornadoes. Further discussions regarding the makeup of a tornado, the damage associated with the winds of a tornadic event, and the Fujita scale are presented in Chapter 2.

This report provides information related to mitigation efforts that communities, businesses, and individuals can undertake to reduce future injuries and the loss of life and property. This report is not intended to reclassify the strength of the May 3 tornadoes or the ratings of the damage observed, or to debate the magnitude of the wind speeds associated with those tornadoes. The Fujita scale ratings mentioned in this report are based on ratings issued by the local National Weather Service (NWS) offices in Oklahoma and Kansas after the tornado outbreaks. The National Severe Storms Laboratory (NSSL) in Norman, Oklahoma, provided additional information regarding the tornadoes.

TABLE 1-1: The BPAT Damage Assessment Table

Fujita Scale	BPAT Characterization	Windborne Debris	Property Protection	Personal Protection	Sheltering
F5		Large, medium, and small airborne and rolling debris	Protecting entire buildings other than critical facilities is uneconomical and impractical.	Must have an area specifically engineered for extreme wind protection such as that described under "Sheltering".	To attain near absolute protection, a shelter should be constructed that is built in accordance with FEMA 320: <i>Taking Shelter From the Storm</i> , or the <i>National Performance Criteria for Tornado Shelters</i> , within or adjacent to a home, office, or business.
F4					
F3		Medium and small airborne and rolling debris	Voluntary retrofitting and strengthening of homes and buildings with existing technology.	Additional strengthening of building structure and envelope may reduce risk; a specifically engineered area is suggested such as that described under "Sheltering".	
F2					
F1		Small airborne and rolling debris	Constructing to newer building codes and standards strengthens buildings.	Constructing building envelope to newer building codes and standards, such as those described under "Sheltering", minimizes risk and injury.	
F0					

2 Background on Tornadoes and History of the Storm



This chapter presents both a history of the May 3, 1999, tornadoes as they affected Oklahoma and Kansas and insight into the interaction between a tornado and a populated area. The Fujita scale for classifying tornado damage is presented in this chapter. A discussion on tornadoes and tornado damage is also included.

2.1 The Fujita Scale and Tornado Probability

Of the approximately 1,000 tornadoes reported in the United States each year, only a few are rated as “violent” events (F4 or F5 on the Fujita scale). The Fujita scale (Table 2-1), which was created by the late Tetsuya Theodore Fujita, University of Chicago, categorizes tornado severity based on damage observed and not on recorded wind speeds. Wind speeds have been associated with the damage descriptions of the Fujita scale, but the accuracy of these wind speeds is limited. The wind speeds are estimates that are intended to represent the observed damage. They are not calibrated wind speeds, nor do they account for the buildings’ design and construction variabilities.

Although the number of violent tornadoes varies considerably from year to year, the average during the period from 1980 to 1989 was about 10 per year. On average, only one or two of these per year were rated F5 and this number has not increased as the number of reported tornadoes has increased. Historical data indicate that the number of tornado reports have been rising, in general, since tornado data began to be collected in the early 1900s. However, the data suggest that a long-term increase in the frequency of tornadoes is unlikely. Rather, increased reporting of tornadic events has caused the numbers of documented tornadoes to rise.

TABLE 2-1: The Fujita Damage Scale

	<p>F-0: (Light Damage) Chimneys are damaged, tree branches are broken, shallow-rooted trees are toppled.</p>
	<p>F-1: (Moderate Damage) Roof surfaces are peeled off, windows are broken, some tree trunks are snapped, unanchored manufactured homes are overturned, attached garages may be destroyed.</p>
	<p>F-2: (Considerable Damage) Roof structures are damaged, manufactured homes are destroyed, debris becomes airborne (missiles are generated), large trees are snapped or uprooted.</p>
	<p>F-3: (Severe Damage) Roofs and some walls are torn from structures, some small buildings are destroyed, non-reinforced masonry buildings are destroyed, most trees in forest are uprooted.</p>
	<p>F-4: (Devastating Damage) Well-constructed houses are destroyed, some structures are lifted from foundations and blown some distance, cars are blown some distance, large debris becomes airborne.</p>
	<p>F-5: (Incredible Damage) Strong frame houses are lifted from foundations, reinforced concrete structures are damaged, automobile-sized debris becomes airborne, trees are completely debarked.</p>

Even today, tornadoes are unlikely to be rated as violent unless they interact with the built environment, so the actual number of violent tornadoes per year is probably somewhat larger than the reporting statistics suggest. According to calculations performed by the National Severe Storms Laboratory (NSSL) using the most recent data (1980-1994), the regions of the United States with

the highest frequency of tornado occurrence, an area of 2,500 square miles, should expect about one tornado (of any intensity) per year (Figure 2-1). In other words, the chance of any particular square mile experiencing a tornado in a given year, within the designated area of “Tornado Alley,” is about one in 2,500. The map in Figure 2-1 indicates by color band the probability of tornado occurrence in the continental United States during any given year.

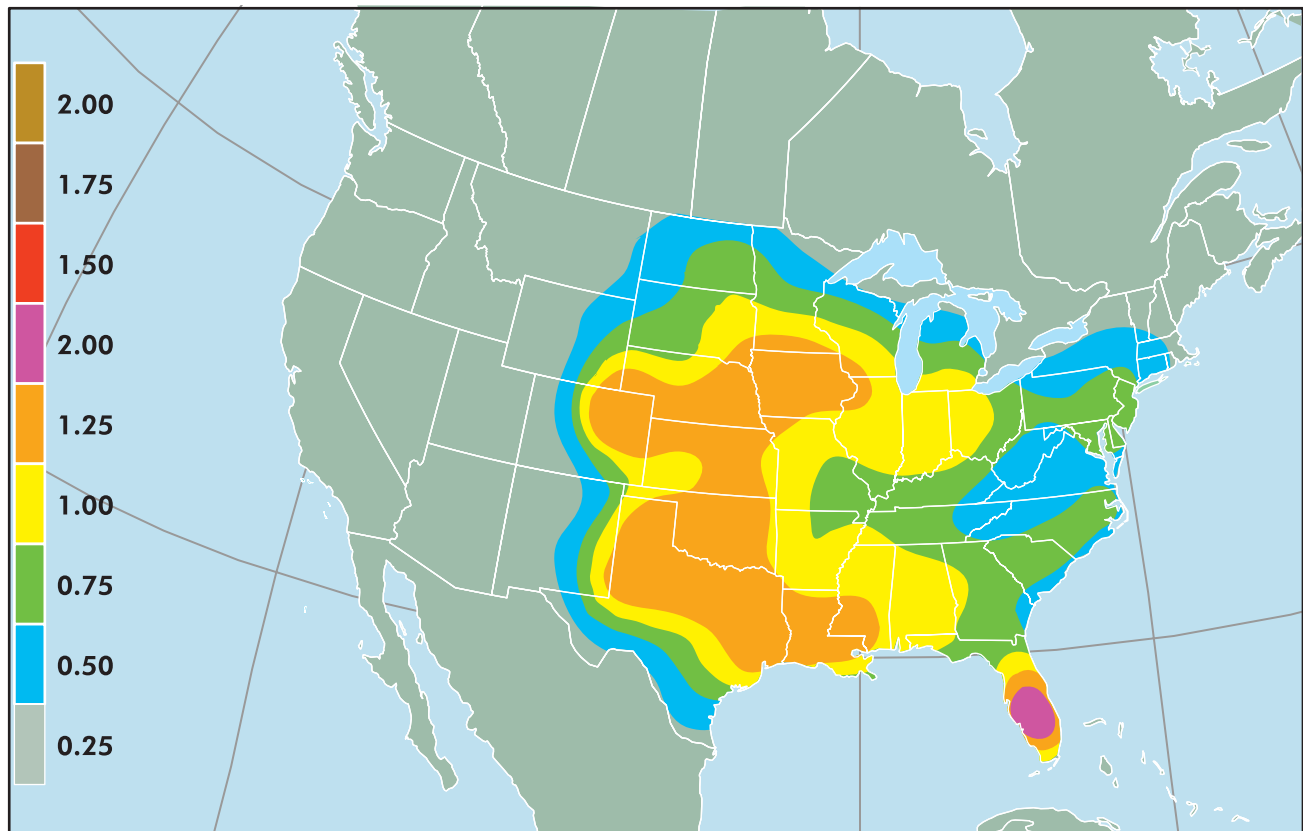

FIGURE 2-1: Annual probability of tornado occurrence in the continental United States. The numbers in the scale on the left side of the map indicate the number of days per year with at least one tornado within the 2,500 square mile area around specific geographic points.

Violent tornadoes correspond to the top 2 percent of all tornadoes; thus an area of 2,500 square miles in the area of peak frequency would be expected to experience a violent tornado only about once every 50 years. Alternatively, a given square mile’s chances of being hit in a given year by a violent tornado is about one in 125,000.

Fujita estimated that the total area within a violent tornado’s path that actually experiences damage associated with the violent wind speeds (i.e., the area directly impacted or struck by the tornado vortex) is only on the order of 1 percent of the total area affected. That means that a given square mile in

“Tornado Alley” has only about 1 chance in 12,500,000 of being hit by violent tornadic winds. Given that our knowledge of actual tornado occurrences is not complete or perfectly accurate, the true chances of being hit by a violent tornado might vary from these estimates. However, the NSSL believes these estimates to be broadly representative of the probabilities of being affected by a violent F4/F5 tornado.

2.2 Tornadoes and Associated Damage

Tornadoes are extremely complex wind events that cause damage ranging from minimal or minor to absolute devastation. Providing a complete and thorough explanation or definition of tornadoes and tornado damage is not the intent of this section. Rather, the intent is to clearly define some basic concepts associated with tornadoes and tornado damage that will be referred to throughout this report.

In a simplified tornado model, there are three regions of tornadic winds:

1. Near the surface, close to the core (i.e., vortex) of the tornado. In this region, the winds are complicated and include the peak low-near surface wind speeds, but are dominated by the tornado’s strong rotation. It is in this region that strong upward motions occur that carry debris upward, as well as around the tornado.
2. Near the surface, away from the tornado’s vortex. In this region, the flow is dominated by inflow to the tornado. The inflow can be complicated and is often concentrated into relatively narrow swaths of strong inflow rather than a uniform flow into the tornado’s vortex circulation. These winds are typically called inflow winds; this term will be used throughout the report.
3. Above the surface, typically above the tops of most buildings. In this region, the flow tends to become nearly circular.

In an actual tornado, the diameter of the vortex circulation can change with time, so it is impossible to say precisely where one region of the tornado’s wind flow ends and another begins. Also, the visible funnel cloud associated with and typically labeled the vortex of a tornado is not always the edge of the strong extreme winds. Rather, the visible funnel cloud boundary is determined by the temperature and moisture content of the tornado’s inflowing air. The highest wind speeds in a tornado occur at a radius measured from the tornado vortex that can be larger than the visible funnel cloud’s radius. It is important to remember that a tornado’s wind speeds cannot be determined just by looking at the tornado.

Figure 2-2 shows the types of damage that can be caused by the tornadic winds of a violent tornado similar to the one that passed through the Oklahoma City Metroplex on May 3, 1999. In general, as shown in the figure, the severity of the damage varies with distance from the vortex and wind speeds

within the vortex. Note, however, that the rotation of a tornado can cause winds flowing into the vortex on one side to be greater than those on other sides. As a result, it is not uncommon for the area of damage on one side of the tornado to be more extensive. Figure 2-2 and Table 2-2 reflect this situation.

In a violent tornado, the most severe damage occurs in the area directly affected by the vortex (the area shaded dark red in Figure 2-2). Typically, in this area, all buildings are destroyed and trees are uprooted, debarked, and splintered. In the immediately adjacent area, shaded orange in the figure, buildings may also be destroyed, but others may suffer less severe damage, such as the loss of exterior walls, the roof structure, or both. Even when buildings in this area lose their exterior walls and roofs, interior rooms may survive. In the outer portion of this area, further from the vortex, damage to buildings affects primarily roofs and windows. Roof damage ranges from loss of the entire roof structure to the loss of all or part of the roof sheathing or roof coverings. Typically, most or all of the windows in buildings in this area will be broken by windborne debris. In the area shaded yellow, damage is again primarily to roof coverings and windows. However, roof damage is lighter, and although windborne debris damage still occurs here, not all windows are broken. Damage to buildings in the outer fringe of this area is even lighter. Beyond this area, where the figure shows blue shading, buildings typically suffer no damage.

2.3 Background of the Event







On May 3, 1999, a widespread outbreak of tornadoes occurred in the south central United States, primarily in Kansas and Oklahoma. A strong upper-level storm system moved eastward toward the southern Plains from the Rockies during the day. Winds aloft over Kansas and Oklahoma intensified as the upper-level system approached. Atmospheric conditions indicated that rotating thunderstorms known as “supercells” were quite likely. The flow of moisture northward from the Gulf of Mexico, and daytime heating that pushed ambient surface temperatures up to at least 80 degrees, combined to produce an extremely unstable atmosphere across the southern Plains. In situations like this, forecasters are usually able to predict the tornado threat with reasonable accuracy, as opposed to more isolated tornado events, for which favorable conditions may not be so obvious. See the National Weather Service’s (NWS’s) “Service Assessment” for details of forecasting performance in this event (see Appendix E). The tornado outbreak was anticipated and, once supercells were detected by the WSR-88D radar, the tornado warnings from the NWS were accurate and timely, the first being issued at 4:47 p.m. (all times Central Daylight Time [CDT]). The WSR-88D radar is the advanced Doppler radar system that is now being used nationwide to track and forecast weather.

FIGURE 2-2: Potential impact of a tornado.



Impact of a Tornado

TABLE 2-2: Potential damage table for impact from a tornado.

Managing Risk	Damage Color Code	Description of Damage
<p>The Threat to Property and Personal Safety Can Be Minimized Through Compliance With Up-To-Date Model Building Codes and Engineering Standards</p>		Some damage can be seen to poorly maintained roofs. Unsecured light-weight objects, such as trash cans, are displaced.
		Minor damage to roofs and broken windows occur. Larger and heavier objects become displaced. Minor damage to trees and landscaping can be observed.
<p>Property and Personal Protection Can Be Improved Through Wind Hazard Mitigation Techniques Not Normally Required by Current Building Codes</p>		Roofs are damaged, including the loss of shingles and some sheathing. Manufactured homes, on nonpermanent foundations can be shifted off their foundations. Trees and landscaping either snap or are blown over. Medium-sized debris becomes airborne, damaging other structures.
		Roofs and some walls, especially unreinforced masonry, are torn from structures. Small ancillary buildings are often destroyed. Manufactured homes on nonpermanent foundations can be overturned. Some trees are uprooted.
<p>Personal Protection Can Only Be Achieved Through Use of a Specially Designed Extreme Wind Refuge Area, Shelter, or Safe Room</p>		Well constructed homes, as well as manufactured homes, are destroyed, and some structures are lifted off their foundations. Automobile-sized debris is displaced and often tumbles. Trees are often uprooted and blown over.
		Strong frame houses and engineered buildings are lifted from their foundations or are significantly damaged or destroyed. Automobile-sized debris is moved significant distances. Trees are uprooted and splintered.

The number of tornadoes that occurred in this outbreak was just over 70, according to the “Service Assessment”. Within this outbreak, there were four violent (F4 or F5) tornadoes according to surveys performed by the NWS. Figure 2-3 shows the outbreaks in Oklahoma; Figure 2-6 shows the outbreaks in Kansas.

The tornado that caused the greatest damage and that had the greatest effect on residential areas was the reported F5 tornado that struck the south side of the Oklahoma City Metroplex. Its source was a supercell thunderstorm that had spawned several tornadoes earlier (Figure 2-4). This tornado had a track 38 miles long and lasted more than an hour, from 6:23 p.m. to 7:50 p.m. The track began between the towns of Chickasha and Amber, Oklahoma, southwest of Oklahoma City.

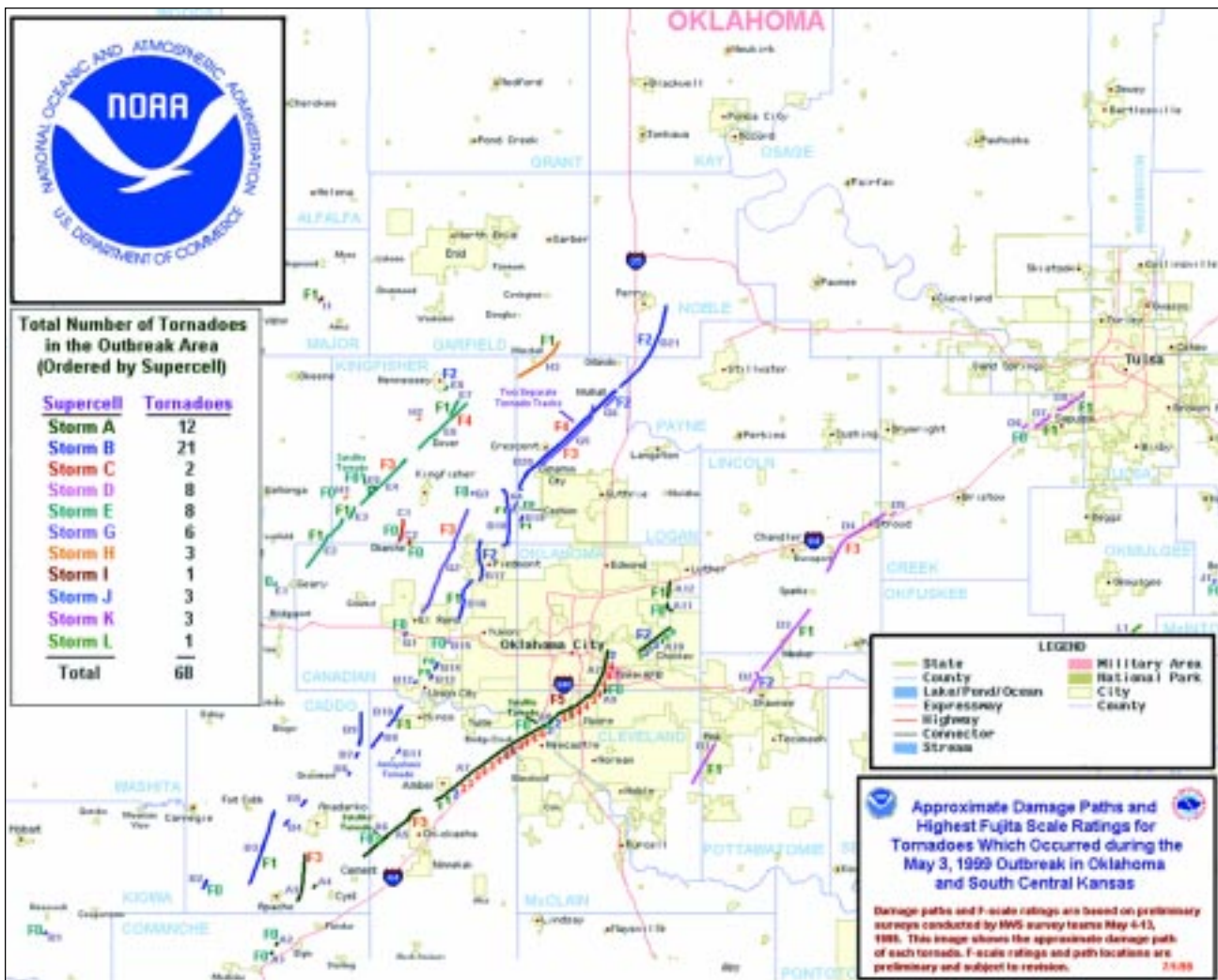

FIGURE 2-3: Outbreak map of tornadoes in Oklahoma that struck on May 3, 1999. Courtesy of the National Weather Service.

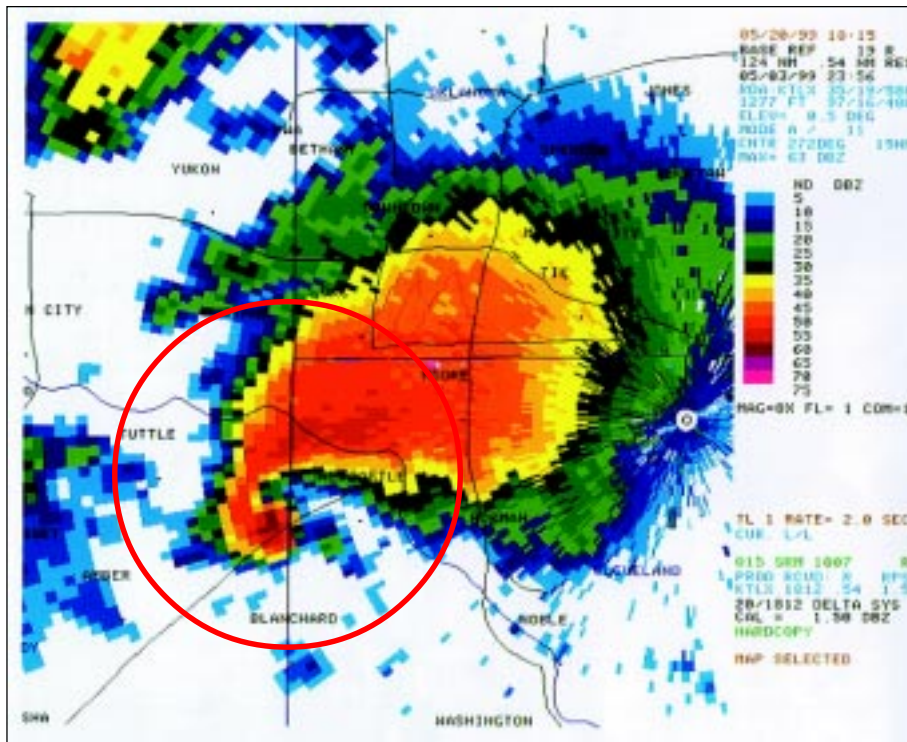

FIGURE 2-4: Radar reflectively map at 6:56 p.m., showing hook echo (circled). A hook echo is a structure associated with supercell storms. In many instances, the radar echo shows this type of structure when tornadoes are present. Courtesy of the National Severe Storms Laboratory.

From its touchdown point, the tornado moved northeastward, nearly parallel to I-44, toward Oklahoma City, hitting the town of Bridge Creek, Oklahoma, at 6:55 p.m. and crossing I-44 at about 7:05 p.m. near the South Canadian River. From there, it moved through several small subdivisions before slamming into the city of Moore, Oklahoma, and crossing I-35 near an overpass for Shields Boulevard. Continuing through a less densely populated area, the tornado crossed I-240 at about 7:35 p.m., began a wide left turn to travel along a north-northeast path that took it into Del City, Oklahoma, skirted Tinker Air Force Base, and then moved into Midwest City, Oklahoma, where it finally dissipated.

Analyses by the NWS in Norman, Oklahoma, indicated that this single tornado destroyed over 2,750 homes and apartments, damaged approximately 8,000 homes, and was responsible for 41 fatalities and approximately 800 injuries. Early damage estimates were on the order of at least \$750 million. There has not been a tornadic event even approaching this magnitude since the F4 tornado that devastated Wichita Falls, Texas, on April 10, 1979. Magnitude relates to the severity of the storm, impacted area, and loss of life.

Figure 2-5 presents four WSR-88D images of the reported F5 tornado as it tracked from Moore to Midwest City. Figures 2-5a and 2-5b are actual radar cross-sections of the tornado taken at the location identified by the white line in Figure 2-5c. Figure 2-5a represents reflectively, while Figure 2-5b represents storm-relative radial velocity (wind velocities, however, are not speci-

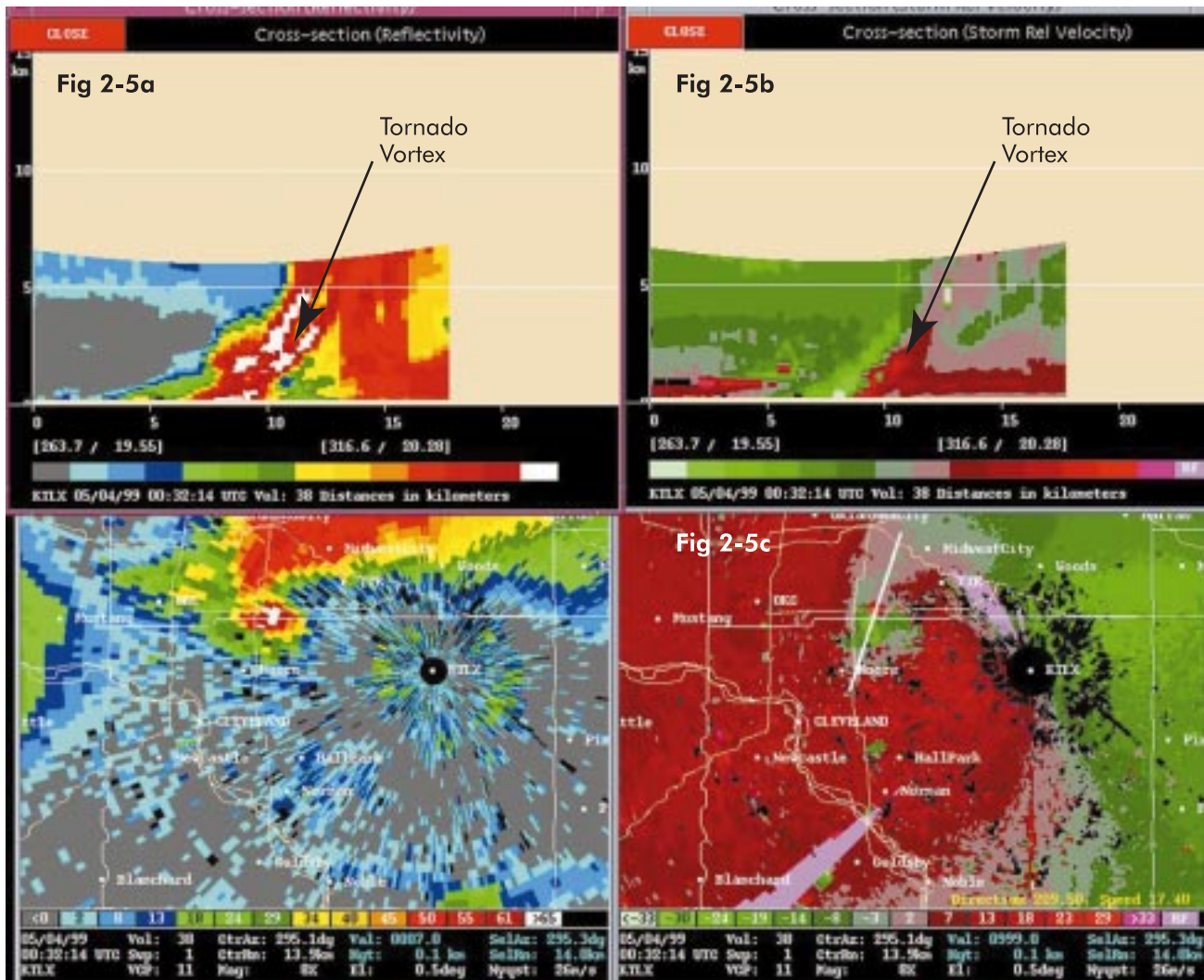

FIGURE 2-5: WSR-88D radar cross-section through the reported F5 tornado located approximately halfway between Moore and Midwest City, showing the debris and an apparent “eye.”

cally indicated). These images were recorded at 7:32 p.m. on May 3, 1999. Horizontal and vertical scales are in kilometers. The vortex walls and the core of the tornado itself are delineated by different color patterns that relate to debris in the vortex and the wind speeds of the tornado.

Another violent tornado (rated F4) struck the small town of Mulhall, Oklahoma, which is located about 50 miles north of Oklahoma City. This tornado was produced by a different supercell storm to the north of the Oklahoma City Metroplex supercell. This second supercell produced approximately 19 tornadoes. The F4 tornado that struck Mulhall originated in open country, northwest of the town of Cashion, Oklahoma, at about 9:25 p.m. It spent the majority of its life in relatively unpopulated open country, hitting Mulhall around 10:15 p.m., late in its life cycle. Most of the homes and businesses in

the Mulhall downtown area, including a school, a post office, and many historic buildings, were damaged or destroyed. There were no fatalities recorded in Mulhall. However, the tornado was responsible for one fatality in Logan County and one fatality in Payne County.

Dover, Oklahoma, was hit by a violent F4 tornado around 9:20 p.m. from another supercell that produced a “family” of tornadoes. This tornado was responsible for one fatality. This track was not investigated by the BPAT.

The fourth violent tornado (a reported F4) struck the Town of Haysville, Kansas, and the southern portion of the City of Wichita, Kansas (Figure 2-6) and was responsible for 6 fatalities. This tornado began around 8:13 p.m. in open country, west of the town of Riverdale, Kansas, in the unincorporated areas of Sedgwick County. Moving north-northeastward, close to the Union Pacific railroad tracks, the tornado hit Haysville at roughly 8:39 p.m., and continued into southern Wichita, crossing I-235, at about 8:44 p.m. It then veered to the east-northeast for a few miles, before turning north-northeastward again and dissipating in eastern Wichita at about 9:00 p.m. The track of this tornado was 24 miles long and extended east-northeastward through southern Wichita. The track was similar to that of the deadly tornado of April 26, 1991, that hit the Golden Spur Manufactured Home Park in Andover, Kansas. The 1991 tornado produced 17 fatalities, more than 100 serious injuries, and \$140 million in damage, according to preliminary estimates by the NWS in Wichita, Kansas.

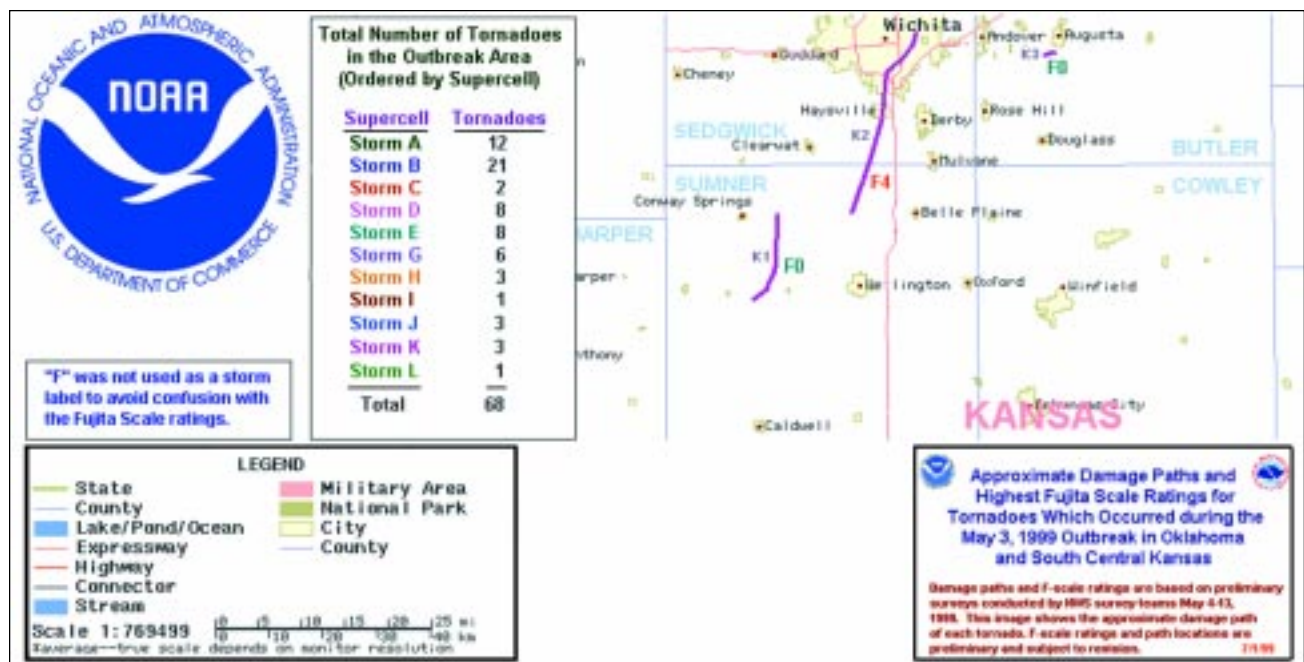

FIGURE 2-6: Preliminary outbreak map of tornadoes in Kansas that struck on May 3, 1999. Courtesy of the National Oceanic and Atmospheric Administration.

There were numerous less violent tornadoes on May 3, 1999. One of these was a strong F3 tornado that struck near the town of Stroud, Oklahoma, around 10:40 p.m. Damage associated with this tornado included a regional outlet mall along I-44 in Stroud that was destroyed, a manufacturing building that was heavily damaged, and the roof covering on a hospital in the town that was blown off. No fatalities were associated with this tornado.

Another less violent tornado was the weak tornado that struck Tulsa, Oklahoma, in the southwest neighborhood of Sapulpa, where it destroyed or heavily damaged several manufactured homes and site built structures. The tornado moved northeast to the Mountain Manor neighborhood, where it damaged roofs and uprooted trees. The roof at Remington School was extensively damaged, and several industrial and commercial structures on the south side of I-44 experienced roof and siding damage, including the Carbondale Assembly of God Church, on the north side of I-44, which suffered significant structural damage. No fatalities were reported.

The NOAA and NWS provided timely and accurate information that saved many lives and avoided numerous injuries by providing time for individuals to seek shelter. In the Oklahoma and Kansas tornadoes studied in the “Service Assessment”, tornado warnings ranged from 13 to 65 minutes. Using back-up WSR-88D radar, the Wichita, Kansas office of NWS was able to continue operating after their primary radar malfunctioned. Many lives were saved during the May 3rd tornado outbreak due to the efforts of the Norman and Wichita NWS offices.

3 General Assessment and Characterization of Damage

The general types of damage the BPAT observed following the May 3 tornadoes are discussed below. This chapter presents a general assessment of four areas:

- property protection
- windborne debris
- personal protection and sheltering
- local, state, and Federal regulations.

Chapters 4, 5, and 6, respectively, describe residential damage, non-residential damage, and personal protection in more detail.

3.1 Property Protection

During the field investigation, the BPAT investigated buildings to identify successes and failures that occurred during the tornadoes. Building successes and failures are presented in this report based on the tornadic winds that caused the damage (i.e., buildings directly struck (or nearly struck) by the winds associated with the vortex of a tornado, buildings affected by winds outside the vortex of the tornado, or buildings on the extreme edge (periphery) of the tornado path). Few successes were observed by the BPAT. These successes were either the utilization of engineered shelters within a home or commercial building or the voluntary utilization of known construction technologies that strengthen the structural system of the building. The BPAT observed considerable damage to all types of buildings throughout Oklahoma and Kansas. Failures occurred when extreme winds produced forces on the buildings that they were not designed to withstand. Failures also occurred when windborne debris penetrated the building envelope, allowing wind inside the building that again produced forces on the buildings that they were not designed to withstand. However, other failures observed were attributed to poor construction (i.e., attachment of sill plates to slabs with cut nails), improper construction techniques (i.e., toenailing trusses and studs to wall plates), and poor selection of construction materials (i.e., wood fiber board sheathing in place of structural sheathing like plywood and OSB).

It was a goal of the BPAT to determine if any of the damage observed to both residential and non-residential buildings was preventable. As a result, the BPAT classified damage assessment according to the general intensity of the tornado affecting an area and the damage associated with that area. Mitigation opportunities for property protection were identified along the periphery of strong and violent tornadoes and in the path of the vortex of weak tornadoes. In these areas, damage to property was investigated to determine if losses could have been minimized through compliance with up-to-date model building codes and engineering standards. Construction techniques proven to minimize damage in other wind-prone areas (e.g., hurricane areas), but not required by current building codes for this area of the county, were seldom observed. Personal protection and sheltering were examined in areas located directly in the path of the strong and violent tornado vortices. Engineered shelters were determined to provide the only means of providing near absolute protection in these areas.

3.1.1 Overview of Buildings Evaluated

The damage assessment of buildings was divided into residential and non-residential sections. The residential buildings were further categorized into single-family housing, multi-family housing, and manufactured and modular housing. The non-residential buildings were further categorized into the various engineered types of construction observed. These groupings were made to focus on the structural performance of each type of building. In both cases, observations were also made concerning exterior architectural systems, such as roof and wall coverings, windows and doors, and masonry chimneys.

Significant time was spent by the BPAT investigating damaged buildings and little time was spent investigating totally destroyed buildings. Buildings that are partially destroyed provided the BPAT the opportunity to investigate why some structures survived the tornadoes and why some of the structures experienced failures. In many cases, the damaged buildings inspected revealed weakness in building design common to Oklahoma and Kansas.

3.1.1.1 Residential Buildings

The residential buildings were categorized into the various types of construction investigated and the structural performance. The residential buildings investigated by the BPAT were:

- single- and multi-family, one- to two-story residences
- manufactured and modular homes
- accessory structures

Residential buildings that were directly struck by the vortex of strong and violent tornadoes were substantially or completely destroyed. Residential buildings that experienced a direct strike from weak tornado vortices or

experienced inflow winds from strong and violent tornadoes saw a wide range of damage. This damage included broken windows and light building damage, to partial loss of roofs and walls, to separation of buildings from their foundations, total roof loss, and only remnants of core rooms surviving. A core room is a small interior room, such as a bathroom or closet, that frequently survives even when there may be substantial damage to the rest of the house.

3.1.1.2 Non-Residential Buildings

The non-residential buildings were categorized into the various *engineered* types of construction investigated focusing on the structural performance of each type of building. The non-residential buildings investigated included:

- tilt-up pre-cast concrete walls with steel joists
- load-bearing masonry walls with steel joists
- load-bearing masonry walls with pre-cast concrete hollow core floors and roof slabs
- steel frame
- steel frame with masonry infill walls

The non-residential buildings investigated by the BPAT are normally designed by a design professional. In some cases, non-residential buildings experienced different damage from the same tornadoes that damaged residential buildings. Non-residential buildings that were directly struck by the vortex of strong and violent tornadoes were substantially damaged or destroyed; however, some were not reduced to rubble like the residential buildings (Figure 3-1). This could be attributed to different construction technologies and crews, type of structure, or the use of more detailed plans and specifications required in non-residential construction.

Non-residential buildings that experienced a direct strike from weak tornado vortices or experienced inflow winds from strong and violent tornadoes saw a wide range of damage. This damage included broken windows and light building damage, to partial loss of roof and wall coverings, to partial loss of roof and wall systems, to complete roof loss, and partial upper level damage with minimal lower level damage on multi-level buildings.

3.1.2 Continuous Load Path and Increased Wind Loads on Buildings

Site visits in both Oklahoma and Kansas of wind-induced damage to residential and commercial buildings indicated that internal pressurization due to breach of the building envelope (i.e., broken windows and doors, failed garage doors, partial roof failures, etc.) was a major contributor to poor building performance under severe wind loading conditions. It is recognized that maintaining the exterior envelope of a building has a large effect on the

FIGURE 3-1: Differences in the performance of non-residential (engineered) buildings and residential buildings. The violent tornado that passed through Moore, Oklahoma, severely damaged the Kelly Elementary School (Figure 3-1, photo A) but left some elements standing. By contrast the neighborhood directly across the street, (Figure 3-1, photo B) was reduced to rubble. Note: The utility poles in photo B were replaced after the tornado, original poles are on the ground on the left side of the photo,

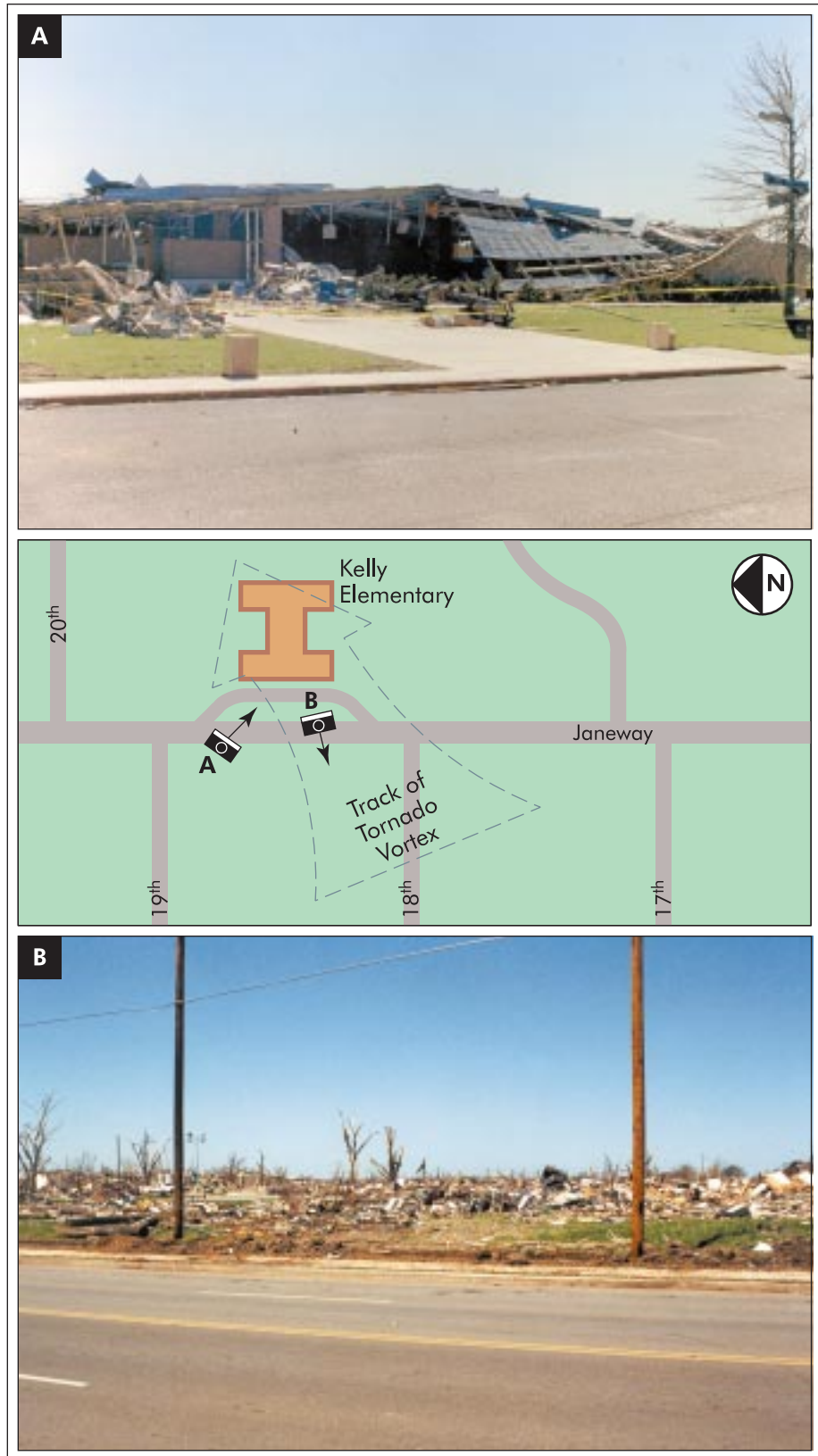

performance of the elements of the structural system. In spite of loss of a portion of the exterior envelope, the construction must provide a continuous load path in order to increase survivability of the building in events that marginally exceed the design winds.

Primary structural systems are those that support the building against all lateral and vertical loads. Many buildings inspected had structural systems capable of providing a continuous load path for gravity loads, but were unable to provide a continuous load path for the lateral and vertical uplift forces generated by the tornado winds. The team looked at how this property damage could have been prevented or reduced in all areas of the windfield, with the exception of that directly under the vortex of violent tornadoes. Figure 3-2 shows a continuous load path in a wood frame (stick built) house.

Winds moving around a building or structure will create uplift, overturning, and sliding forces that act on buildings (Figure 3-3). Uplift is the force caused by the wind accelerating around and over buildings and other structures (Figure 3-4). An example of uplift strong enough to move a house off its foundation is presented in Figure 3-5. This house was separated from its foundation when it experienced winds associated with a strong tornado that passed through the city of Haysville, Kansas. Although anchor bolts extended from the concrete foundation into the wood floor framing, nuts and washers were not attached to the bolts to provide a continuous load path at the connection points. The use of nuts and washers in combination with anchor bolts is essential for this connection to provide a continuous load path that would have resisted the uplift forces. This type of deficiency was observed at more than just this one house.

The other primary effects of wind are overturning (discussed in the Manufactured Housing sections of Chapter 4), internal pressurization of a building when winds enter a building, and the lateral force acting inward created by the wind blowing directly on the face of a building or outward due to low pressure suction on the forces of a building. Most buildings are designed as enclosed structures with no large or dominant openings that allow the inside of the building to experience the winds of a wind event. However, a breach in the building envelope due to broken windows, failed entry doors, or failed garage doors may cause a significant increase in the net wind loads acting on the building under strong wind conditions. In such cases, the increased wind load may initiate a partial failure or propagate into a total failure of the primary structural system. A schematic diagram illustrating the increased loads due to a breach in the building envelope is shown in Figure 3-6.

Failures due to combined internal pressures and leeward roof pressures, failure due to leeward suction pressures only, and failures due to internal pressurization only are presented in Figures 3-7, 3-8, and 3-9, respectively. These failures were typical of wind induced failures observed along the inflow wind areas of violent and strong tornadoes.

FIGURE 3-2: Diagram showing a continuous load path for a two-story wood frame building.

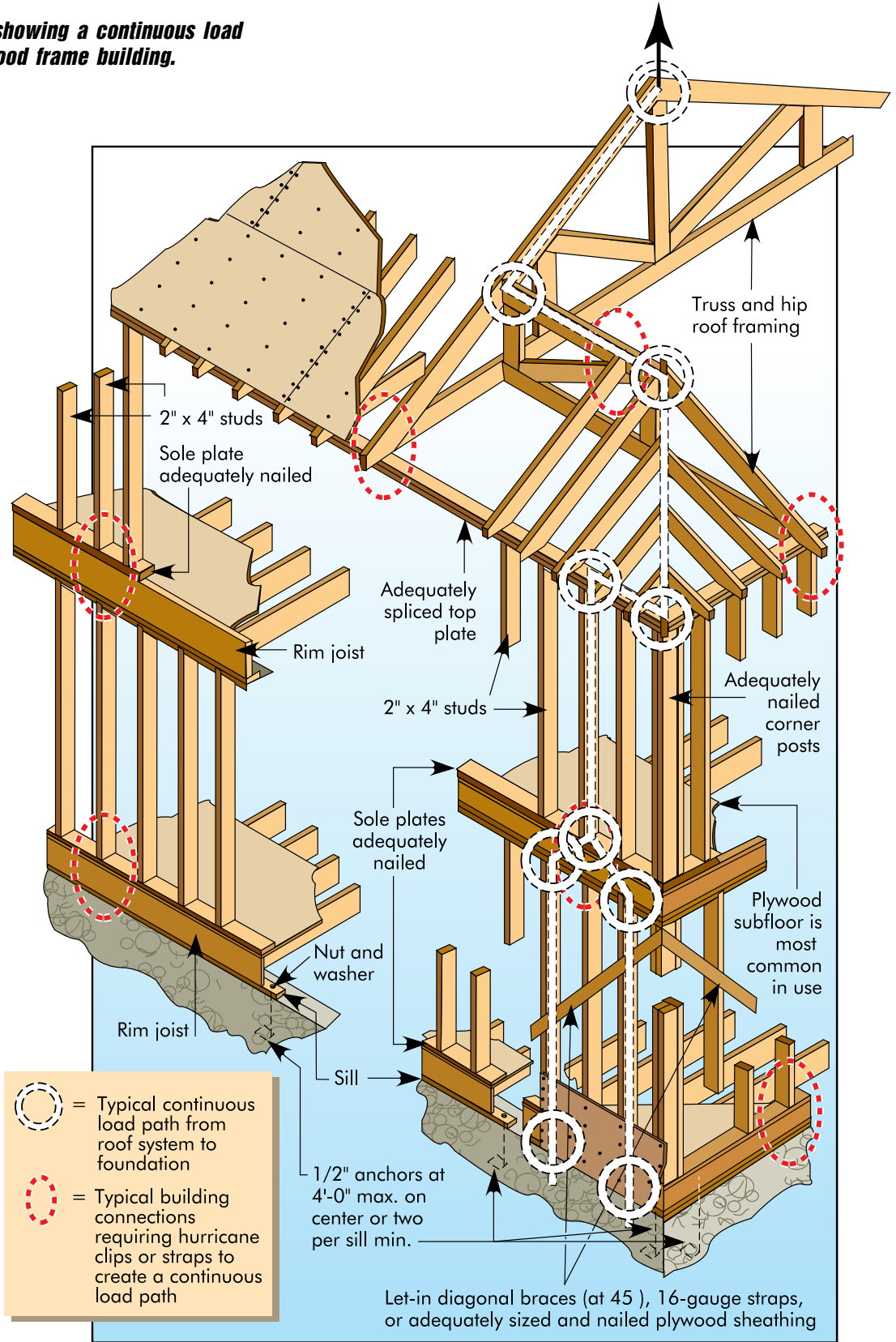

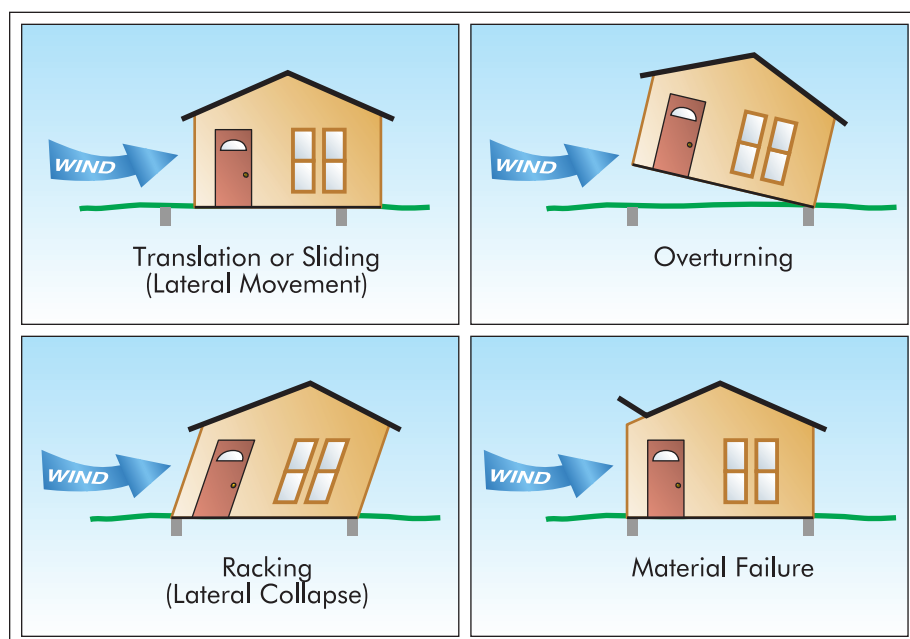

FIGURE 3-3: Building failure may occur in several ways.



FIGURE 3-4: This building failure is the result of inward wind forces and uplift wind forces acting on a building during a high wind event.

Depending on factors such as building size, number of interior rooms, number of stories, and size of the building envelope breach, laboratory tests in wind tunnels indicate that, when wind can enter the building, the uplift forces on the roof system can be doubled during extreme wind conditions.

Buildings that have significant openings or are mostly open structures are characterized as partially enclosed. Model building codes incorporate provisions that take into account the effects of internal pressurization on partially enclosed buildings by increasing required design wind loads. However, most residential buildings are considered as enclosed buildings, and when a breach of the building envelope occurs (e.g., when a garage door fails), they become

FIGURE 3-5: Wind uplift acting on this house in Haysville, Kansas, resulted in this corner of the building being lifted off its foundation.



Figure 3-6: Increased loads on roof and walls due to breach in envelope.

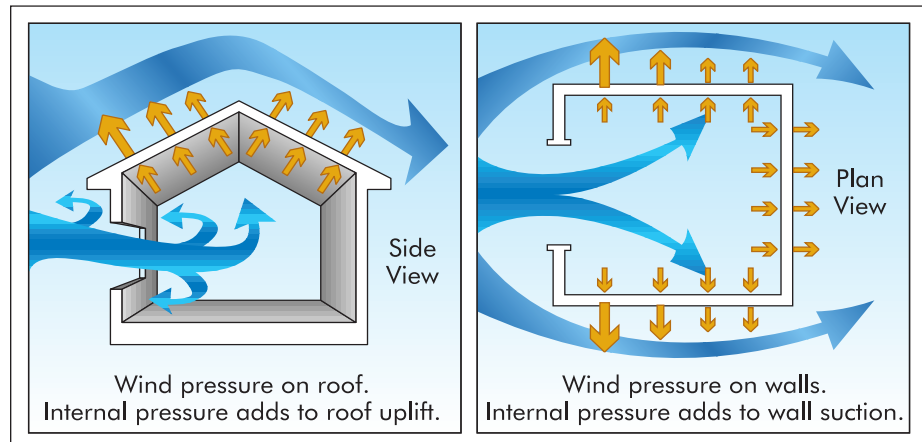

in effect partially enclosed buildings and are subject to wind load increases. The failure of openings, such as windows and doors, causes greatly increased air pressures in buildings. In areas not prone to hurricane force winds (such as the tornado prone areas of Oklahoma and Kansas), houses are not normally designed for these increased pressures, which can result in structural failure.

A number of non-residential buildings, such as schools, factories, warehouses, and commercial buildings were in the direct path of the weak tornado vortices or in the inflow of strong and violent tornadoes. In a few cases, damage could be considered non-structural because architectural and decorative materials on the exterior were the only damage to the buildings. Engineering standards such



FIGURE 3-7: Failure of hip roof due to internal pressures and leeward roof (uplift) wind forces acting together. This house, which was exposed to inflow winds on the periphery of a violent tornado, is located in a suburb of Oklahoma City, Oklahoma.



FIGURE 3-8: Failure of this gable wall section was due to wind suction forces on the leeward wall. This church was on the outer edge of a violent tornado path.

as American Society of Civil Engineers: Minimum Design Loads for Buildings and Other Structures (ASCE 7-98) identify these elements as *components and cladding*, and provide guidance for determining wind loads acting upon them; this will be discussed more in Section 3.4. The failure of an exterior insulating finishing system (EIFS) exterior wall covering and roof parapet is shown in Figure 3-10 at the Regional Mall at Stroud, Oklahoma. This was the only damage experienced by this particular store. However, other significant

FIGURE 3-9: Failure of this exterior wall and roof section in Moore, Oklahoma, occurred when the windows broke and the front room saw a rapid increase in internal pressure. Most of the debris from the roof and exterior wall had been cleaned up prior to this photograph. This home was located on the periphery of a violent tornado track.



FIGURE 3-10: EIFS and metal fascia damage at the regional outlet mall in Stroud, Oklahoma. This is a typical example of a components and cladding failure.



damage was experienced at the mall that was struck by a strong tornado, which is discussed later in this report.

In other cases, structural damage occurred due to the lack of capacity in the structure to resist wind-induced uplift and lateral loads. Once this initial failure occurred, elements within the structural system exceeded their capacity and

failure progressed because of lack of redundancy in the structural system. Similar to the residential damage observed, some non-residential buildings did not have a primary structural system capable of providing a continuous load path sufficient to withstand the lateral and uplift wind loads generated by the tornadoes. Figures 3-11 and 3-12 show non-residential buildings that were unable to withstand the wind forces once the building envelope had been



FIGURE 3-11: *This un-reinforced masonry (URM) wall failed when inflow winds from a strong tornado acted on this building in Wichita, Kansas.*



FIGURE 3-12: *The vortex of a violent tornado passed within 100 yards of this plastics manufacturing plant in the city of Haysville, Kansas. The wind forces caused the failure of its primary structural system: a pre-engineered steel frame with masonry infill walls.*

breached. Figure 3-11 was a building with load bearing masonry walls and a steel joist roof system. Figure 3-12 is a steel frame building with masonry infill walls.

3.2 Windborne Debris

The quantity, size and force of windborne debris (missiles) generated by tornadoes is unequalled by any other type of wind storm. Windborne debris is a danger during tornadoes because the debris can damage homes, causing a breach in the building envelope that results in overpressurization of the building that leads to structural failures. Also, windborne debris may cause severe injury and death to individuals who cannot find shelter or refuge and are exposed to the winds and windborne debris of a tornado.

The visible funnel cloud described in Chapter 2 (Figure 2-2) is composed of water vapor and debris. Both the inflow winds and vortex winds of a tornado carry this debris. The smaller missiles (e.g., aggregate [stone] surfacing from built-up flat roofs, pieces of tree limbs, pieces of shredded wood framing members, Figure 3-13) can easily break common window glass, which can then cause a rapid increase in internal air pressure. Medium sized missiles (e.g., appliances, furniture, HVAC units, long wooden framing members) can also become airborne and cause considerable damage to buildings (Figure 3-14). Large high-energy missiles (e.g., roof trusses, automobiles, propane tanks) are often observed as rolling debris and may become airborne (Figure 3-15). These large missiles can easily destroy framing members and structural systems of buildings. The following sections describe the types, sizes, and quantity of missiles observed during the BPAT investigations.

FIGURE 3-13: Small missiles commonly observed during the field investigations.



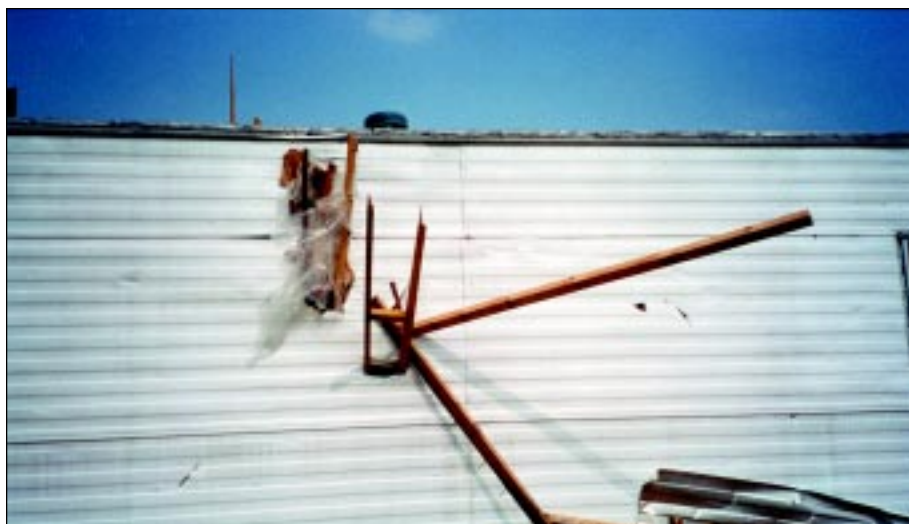

FIGURE 3-14: *These medium sized missiles struck and remained embedded within this manufactured home in Wichita, Kansas.*



FIGURE 3-15: *These trusses and roof covering (still attached to the roof sheathing) were displaced by the winds of a violent tornado and are capable of becoming large, windborne missiles. These trusses were originally attached to this apartment building.*

3.2.1 Missile Types and Sizes

The majority of the investigated tornado tracks were through residential areas, which were predominantly constructed of wood framing with asphalt shingle roofs. Hence, along most of the track, wood framing members (e.g., studs, joists, trusses, sheathing, and household contents) were the most common windborne missile types. Many of the framing members and roof shingles were broken, thereby creating an enormous number of small missiles that were only a few inches long. Although small, they had sufficient energy to break glass and injure people. Other missiles were quite large and delivered

significant impact force. Table 3-1 lists typical debris observed during the field investigation.

Table 3-1: Windborne Debris (Missiles) and Rolling Debris Classifications

Missile Size	Typical Debris	Associated Damage Observed
Small	Aggregate roof surfacing, pieces of trees, pieces of wood framing members, bricks	Broken windows, doors, and other glazing, some light roof covering damage
Medium	Appliances, HVAC units, long wood framing members, steel deck, trash containers, furniture	Considerable damage to walls, roof coverings, and roof structures
Large	Structural columns, beams, joists, roof trusses, large tanks, automobiles, trees	Damage to wall and roof framing members and structural systems

Figure 3-16 shows missile impacts on the roof of Westmoore High School in Moore, Oklahoma. The missile sticking out of the roof surface in the foreground is a double 2-in by 6-in. The portion sticking out of the roof is 13 feet long. It penetrated a ballasted ethylene propylene diene monomer (EPDM) membrane, approximately 3-in of polyisocyanurate roof insulation and the steel roof deck. The missile laying on the roof just beyond it is a 2-in by 10-in wood member that is 16 feet long. The missile in the background that penetrated the roof deck is a 2-in by 6-in that had a total length of 16 feet. The source of missiles was not determined, hence the distance to their origin is unknown. However, because this school building was located within 100 yards of a violent tornado, it is likely that they traveled at least a few hundred feet from a subdivision of wood-frame houses that were in the direct path of the tornado.

Figures 3-17 and 3-18 show board missiles that struck and remained embedded in the roofs of homes that were located on the periphery of tornado tracks. Figure 3-19 shows a 2-in by 6-in missile completely penetrating the brick veneer of a home. Figure 3-20 shows a 2-in by 6-in missile penetrating several inches into the freezer compartment of a refrigerator located in a home that was on the periphery of a violent tornado track. The portion that is visible is 4-ft, 8-in long.



FIGURE 3-16: *Medium and small missiles through and on Westmoore High School's roof, Moore, Oklahoma*



FIGURE 3-17: *This missile struck a house located in Moore, Oklahoma.*

Small-sized missiles also included brick, concrete masonry unit (CMU), aggregate (stone) surfacing from built-up and single-ply membrane roofs, roof tiles, asphalt shingles, fences, shrubs, and tree limbs. Medium-sized missiles included appliances (e.g., hot water heaters, refrigerators, dishwashers), rooftop HVAC units, metal roof panels, steel deck (Figure 3-21), car axles and transformers from power poles. Large-sized missiles and debris included automobiles, a power pole (Figure 3-22). The pole was 28-ft, 4-in long and had an 8½-in diameter at one end and a 7-in diameter at the other end. It was

FIGURE 3-18: *This missile fell nearly vertical, illustrating the importance of a strong cover over the top of a tornado shelter to protect against free-falling debris. This home was located in Midwest City,*



FIGURE 3-19: *A 2-in by 6-in missile can be seen completely penetrating the brick veneer of a home in Moore, Oklahoma.*





FIGURE 3-20: A 2-in by 6-in missile penetrating a refrigerator located inside a home in the Country Place subdivision outside Oklahoma City, Oklahoma.



FIGURE 3-21: This piece of steel deck landed at the periphery of a violent tornado damage area in Moore, Oklahoma. The building it likely came off of was a few hundred feet away.

FIGURE 3-22: This power pole penetrated a window and extended several feet into the house after traveling approximately 40 feet from its original location. This home was located in Moore, Oklahoma, along the track of a violent tornado.



roughly 40 feet to the original location of the pole from the window. Manufactured home chassis, a large propane tank (Figure 3-23), pre-cast concrete hollow core panels (see Chapter 5), steel dumpsters, a steel deck (Figure 3-21), and trees (Figure 3-24) were among other large missiles observed by the BPAT. Automobiles were observed to have been significantly displaced and destroyed in areas under the vortex of and in the inflow wind field near the vortex of violent tornadoes.

FIGURE 3-23: Wind displaced this very large propane tank in Bridge Creek, Oklahoma; its original location could not be determined. This area was hit by the vortex of a violent tornado.





FIGURE 3-24: This building was on the periphery of a violent tornado damage area in Haysville, Kansas. One large tree fell near the corner of the house and collapsed a large portion of the roof and the corner walls. A smaller tree caused minor damage on the other corner of the house.

3.2.2 Windborne Missile Quantity

In areas where buildings were totally or nearly totally destroyed by a violent tornado, missiles were in such great quantity (Figure 3-25) that they often made a layer of rubble that completely covered the ground (Figure 3-26). In many houses, the floors were covered with small tree branches and fragments of broken framing members. Figures 3-26 through 3-30 give some idea of the number of missiles that were flying during the storm.



FIGURE 3-25: Wood framing members and plywood sheathing near the periphery of a violent tornado damage area in Moore, Oklahoma, displaying quantity of flying debris.

FIGURE 3-26: Debris generated by the vortex of a violent tornado in Moore, Oklahoma, created a layer of rubble across the ground.



FIGURE 3-27: Close-up view of polyisocyanurate roof insulation boards (the boards are 4-ft by 8-ft) at Westmoore High School. This roof is approximately 25 feet above grade. Some of the missiles only caused superficial damage to the insulation; but several others had sufficient force to make large gouges in the insulation. For scale, the square metal fastener plates near the board corners are 3-in by 3-in.





FIGURE 3-28: This house was on the periphery of a violent tornado damage area in Moore, Oklahoma. Two medium missiles are embedded this area of the roof and additional holes due to windborne missiles are also visible.



FIGURE 3-29: Several missiles struck the wall of this house in Del City, Oklahoma, including a medium sized piece of debris in the center of the photo.

FIGURE 3-30: *Several missiles struck and perforated the interior wall of this house in Moore, Oklahoma.*



3.3 Personal Protection and Sheltering

The purpose of a shelter is to provide a safe refuge in the event of a tornado or an extreme wind storm. The BPAT observed three types of shelters: residential, group, and community.

The residential shelters included above-ground in-resident shelters as well as underground storm cellars (Figure 3-31). A basement should not be considered to be an adequate shelter unless it has a concrete slab roof above because the wood framing of the floor above the basement can be lost or the floor can be penetrated by flying or falling debris. This can lead to injury from a collapsing basement or from debris. The group shelters observed included one at a manufactured housing park and one at a plastics manufacturing plant. Community shelters observed included one at a manufactured housing park and another at a high school. Shelters are further discussed in Chapter 6.

3.4 Local, State, and Federal Regulations

Building codes and regulations for both residential and commercial/industrial buildings varied because of the states involved. However, regulations dealing with the fabrication of manufactured housing fall under U.S. Department of Housing and Urban Development (HUD) preemptive construction and safety standards. This section identifies the building codes that were in effect in the areas that were struck by the May 3 tornadoes.

Building codes and standards are considered important in the mitigation of tornado damage even though they do not currently provide design guidance for tornadic winds. Application of known design and construction techniques



FIGURE 3-31: Underground residential shelter, viewing door and stairway leading down to shelter. This shelter was located outside a residence.

for high wind areas included in newer building codes may reduce property losses on the periphery of violent and strong tornadoes as well as beneath the vortex winds of weak tornadoes.

The design and construction of manufactured housing has been governed since 1976 by Federal preemptive standards that are enforced by HUD under Federal Regulation and through a Monitoring and Enforcement Contractor, the National Conference of States on Building Codes and Standards (NCSBCS). Recently, the HUD Standard has been placed under a consensus process administered by National Fire Protection Association (NFPA). Another tool used by HUD to regulate the manufactured home industry is the Federal Manufactured Home Construction and Safety Standards (MHCSS).

MHCSS (24 CFR 3280) requires each manufactured home to have support and anchoring systems. The manufacturer is required to provide drawings and specifications, certified by a registered professional engineer that indicates the system of anchorage needed to transfer lateral, overturning, and uplift loads from the manufactured home to ground anchors or foundations. In high wind areas (Zone II and III, 100 mph and 110 mph Basic Wind Zone Map from ASCE 7-88), fastening and anchoring systems are required to be designed by a Professional Engineer or Architect. Actual installation is generally left to an installer or dealer, without any inspection required to ensure compliance. Installation guidance is contained in *“Manufactured home Installation Training Manual,”* U.S. Department of Housing and Urban Development (HUD), Washington, DC (April 1999).

However, if HUD/FHA, VA, or Farmers Home Administration mortgages are used to purchase the manufactured home, “permanent foundations” are required. These foundations must be designed, constructed, and inspected to ensure compliance with model building codes, and to provide resistance to wind and earthquake forces specified in ASCE 7-93. Design and construction recommendations for permanent foundations are contained in “*Permanent Foundations Guide for Manufactured Housing*,” U.S. Department of Housing and Urban Development (HUD), Washington, DC (HUD-7584, September 1996).

Four model building codes are currently used throughout the country, the National Building Code (NBC) promulgated by the Building Officials and Code Administrators International (BOCA), Uniform Building Code (1997 UBC) as promulgated by the International Conference of Building Officials (ICBO), and the Standard Building Code (SBC) promulgated by the Southern Building Code Congress International (SBCCI). A residential specific building code that is also used by many communities is the Council of American Building Officials’ (CABOs’) One and Two Family Dwelling Code. These codes all address wind loads to different degrees, but the most recent editions of the UBC, NBC, and SBC provide some guidance for designing in high wind areas.

ASCE 7 is an engineering standard that provides design guidance for determining loads acting on structures. The guidance found in ASCE 7 is often more detailed than the guidance provided by older versions of the building codes. ASCE 7-98 is the current edition of the standard. Both ASCE 7-98 and ASCE 7-95 provide wind load determination guidance that is more detailed than what is found in the latest model building codes and this guidance will often result in high loads being applied to a structure.

3.4.1 Oklahoma

Throughout the State of Oklahoma, two of the model building codes in the United States are used. In the incorporated areas affected by this storm, the NBC has been adopted. The 1996 edition of the NBC had been adopted by most communities for all construction other than detached one and two family buildings. The 1995 CABO One and Two Family Dwelling Code is the currently adopted code for detached one and two family dwellings.

Buildings located in the unincorporated areas of Oklahoma were not covered by a model building code. This included buildings that suffered damage during this event and buildings that experienced no damage.

3.4.2 Kansas

Most communities in the State of Kansas have adopted the 1997 UBC for commercial and industrial buildings. The UBC defers to the CABO One and

Two Family Dwelling Code for detached single-family residential occupancy (Classified as R-4). The City of Haysville had adopted the 1994 UBC. Wichita and the unincorporated areas of Sedgwick County had adopted the 1997 UBC.

Wichita has local ordinance provisions that address sheltering. These ordinance provisions state that, as of April 15, 1994, all manufactured home parks of 10 or more manufactured home spaces are required to have storm shelters (above or below grade). For parks with 20 or more manufactured home spaces that did not have a shelter as of April 15, 1994, a shelter must be provided by April 15, 1999. The ordinance also indicates that the shelter must be designed by a licensed engineer or architect to applicable codes and laws, including the UBC, ADA, and the local floodplain management requirements that comply with FEMA's National Flood Insurance Program (NFIP).

4 Observations on Residential Property Protection

The damage assessment of buildings was divided into residential and non-residential property protection. This section presents the BPAT’s observations on residential property protection. Specifically, residential buildings were categorized into three types of housing: single-family, multi-family, and manufactured and modular.

The BPAT assessed the performance of primary structural systems of buildings, which are those systems that support the building against gravity loads and the lateral and vertical loads generated by high winds during a tornado or other high wind event. Within a tornado’s impacted area, these systems are typically constructed of wood framing, sheathing, anchor bolts, and other connections. In residential applications, the structural system of a house comprises the roof framing and the sheathing bearing walls and sheathing, floor framing, the foundation system, and the connections and fasteners used to fasten these parts of the house together. Roof structure, diaphragms, and foundation are components of the building that are also part of this system or affect the performance of the system. The integrity of the overall building and structural systems depends not only on the strength of these components, but also on the adequacy and strength of the connections between them. Observations were also made concerning exterior architectural systems (e.g., roof and wall coverings, windows and doors, and masonry chimneys).

4.1 Single-Family Conventional Construction

The BPAT observed damage to a large number of wood frame single-family houses, which are commonly referred to as “conventional,” “site built,” or “stick-built” construction. These houses were mostly one- or two-story buildings, many with pre-engineered wood trusses with metal truss plate connectors. Several homes had hip roofs with site-built rafter construction and board roof sheathing (typically 1-in by 8-in boards). Platform construction was observed in all cases (Figure 4-1). The buildings observed in Oklahoma were commonly brick veneer and wood frame walls on “slab-on-grade” foundations with some “crawl-space” foundation construction. In Kansas, the buildings were predominantly wood frame construction placed on a basement or crawl space foundation.

FIGURE 4-1: Platform construction typically observed during the field investigation.

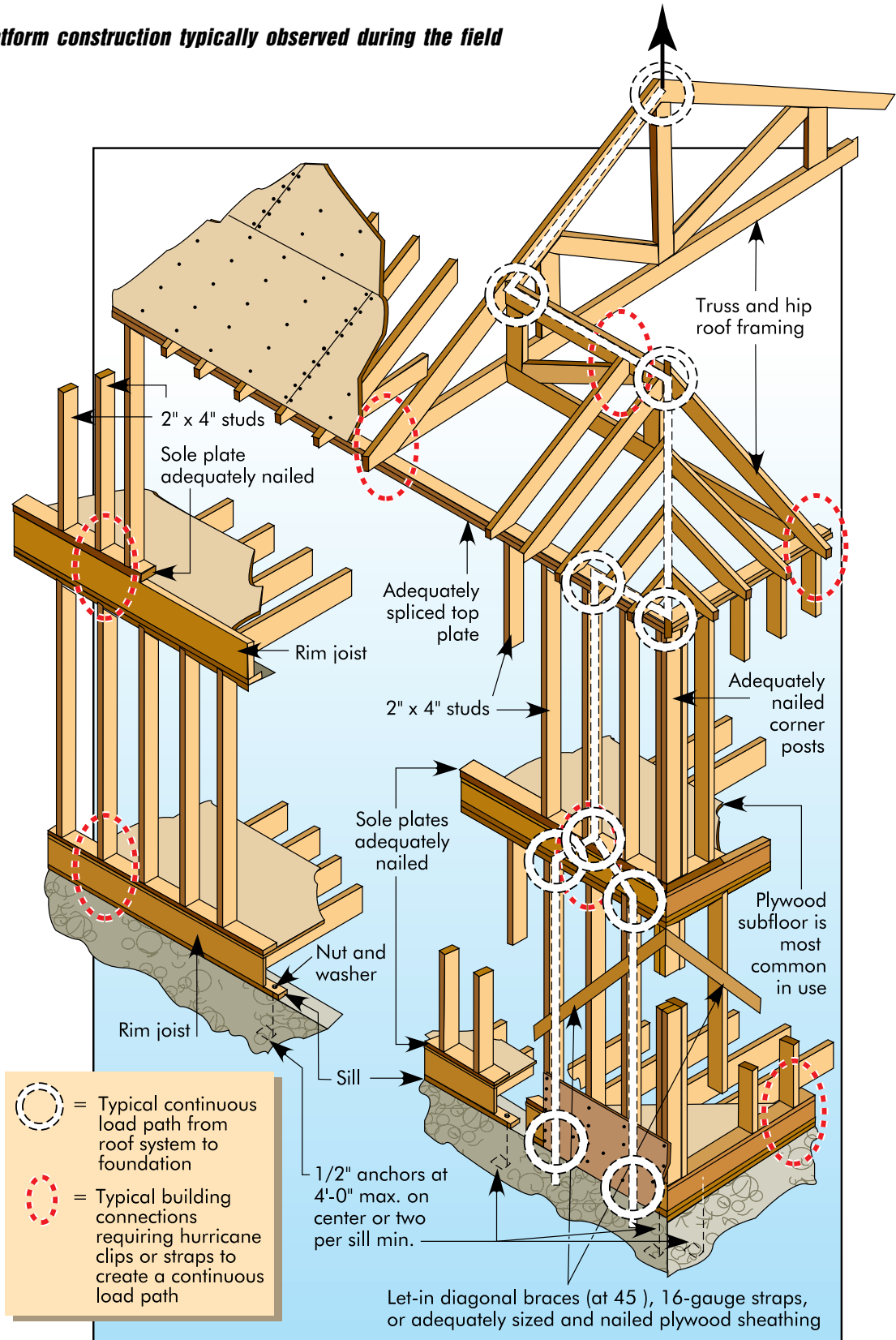

4.1.1 Load Paths

The preparation of quality construction plans that assure the construction of a continuous load path – from the roof sheathing to the ground – are key to maintaining structural integrity, regardless of the magnitude of the wind loads. Several different building materials and systems are usually involved in constructing and completing this continuous load path and, like a chain, the system is only as good as its weakest link. The team focused on how this damage could have been prevented or reduced in all areas of the tornado windfield, with the exception of directly under the vortex of violent tornadoes (where extensive building damage is expected).

Damage or failure was observed in essentially all building elements that constitute the lateral and vertical force resisting systems. Those elements are the roof sheathing, roof framing, load bearing wall framing, diaphragms, diaphragm chords, attachments and connections, and foundation systems. If the elements are not adequately tied together or connected, the structural system will fail. As discussed in the following sections, the damage ranged from considerable to total, depending on the type of roof framing, construction methods, and wind load experienced at the building.

4.1.2 Roof and Wall Sheathing

Sheathing in light-frame construction can serve more than one purpose. One is to receive the gravity and wind uplift loads and distribute or carry the load to its supporting members such as the roof rafters or wall studs. The second purpose is to provide resistance to lateral wind loads in the direction of the sheathing. This second purpose is illustrated in Figure 4-2; the roof sheathing acts as a horizontal diaphragm and transfers lateral loads to the supporting walls.

Roof sheathing observed in Oklahoma consisted primarily of rough sawn 1-in by 8-in planks placed side by side or 4-ft by 8-ft plywood sheets. The fasten-

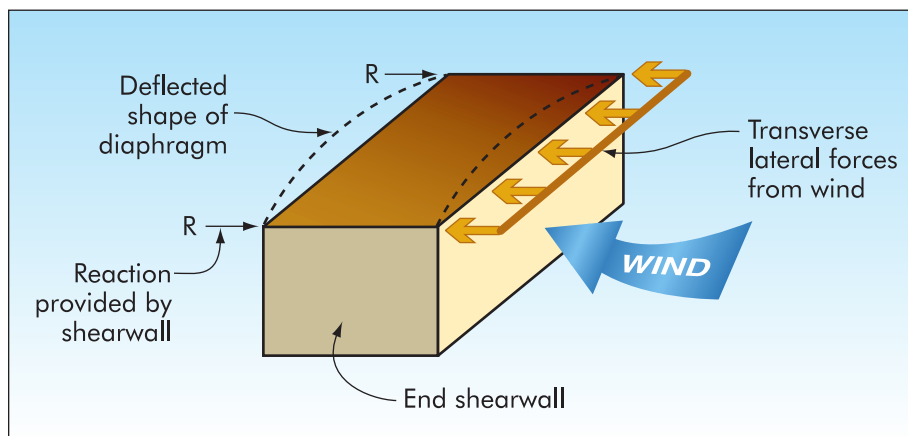

FIGURE 4-2: Lateral load transfer to supporting walls by roof and wall sheathing.

ers observed connecting the sheathing to the supporting rafters or truss top chords were nails or staples. Figure 4-3 shows a typical situation where the stapling of the boards to the rafters or trusses was not adequate to resist the wind uplift. In the application of both the plank and sheet sheathing materials, it appeared there was a concerted effort to stagger the joints as required by code as shown in Figure 4-4.

FIGURE 4-3: Failed stapling of boards to rafters viewed from home in Moore, Oklahoma.



FIGURE 4-4: Although roof sheathing was lost at this Wichita, Kansas, home, code requirements of staggering joints in sheathing applications was observed. This house experienced inflow winds from a strong tornado.



As wind induced loads reach the top of the walls, the shear has to be transferred to the top plate by some method of fastening. After the fasteners transfer the load from the roof system, there will be a force at the top of the supporting wall that is intended to be resisted by the shear wall. The wall sheathing and the connection to the wall framing (Figure 4-5) establish the capacity of a shear wall.

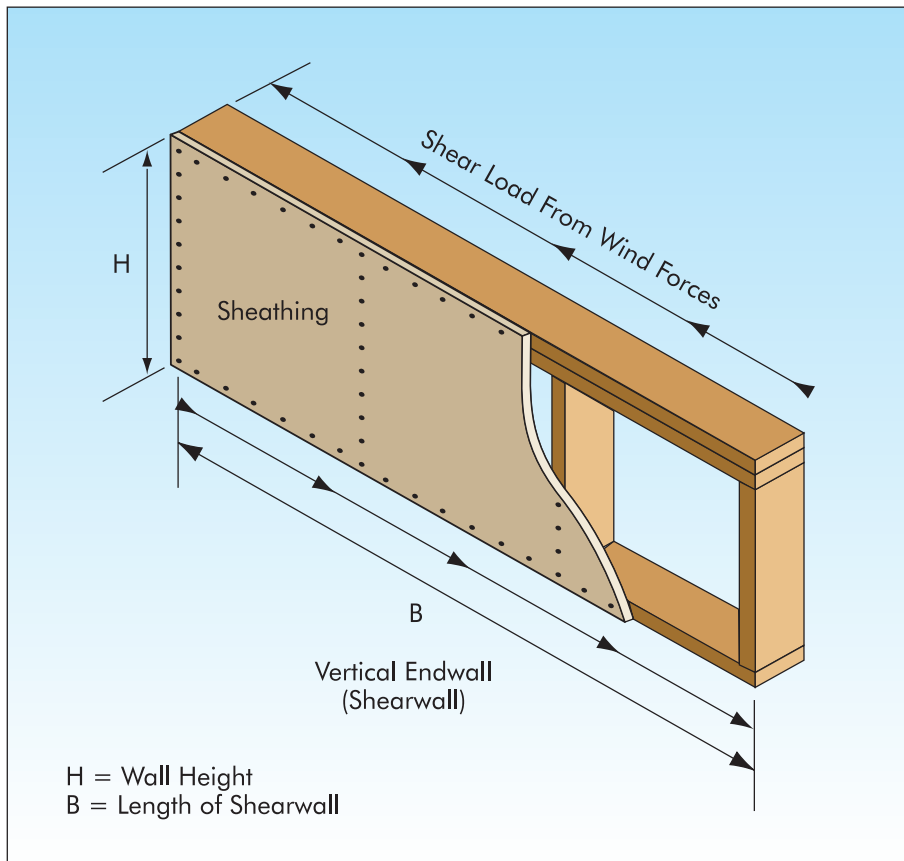

FIGURE 4-5: Shear load carried by wall sheathing.

The force in the wall then must be transferred to the floor below, which in turn must transfer it in a similar manner to the foundation. It is this load transfer mechanism that the BPAT attempted to observe.

Wall sheathing observed consisted primarily of wood fiberboard or combination siding/sheathing. With the exception of garage end walls, it was difficult to ascertain any consistent failure of wall sheathing because it appeared the entire wall was either lifted or blown inward or outward as the result of windward pressure or a combination of windward/leeward pressure (Figure 4-6).

The construction of exterior shear walls to carry lateral loads requires special design and construction attention when there are large openings such as for

FIGURE 4-6: Wall failure due to inadequate lateral load resistance in Wichita, Kansas. The return wall at this garage was inadequate to carry wind loads and may have led to this failure.



garage doors. The exterior walls with garage doors that the team observed were not constructed or designed to act as shear walls. This lack of shear capacity along with roof uplift and other problems discussed in Section 4.1.7 make garages particularly vulnerable to wind damages.

4.1.3 Structural Connections

Post-disaster assessments continue to support the fact that improved connections could result in better performance of building structural systems, and a reduction in loss of life, injuries, and property damage. The BPAT observed a wide range of connection deficiencies or failures in areas subjected to weak-tornado generated winds. It is important to keep in mind that the loads seen by these connections were not known, but the nailed connections observed in most wood frame homes in both Oklahoma and Kansas appeared to be in accordance with connection requirements of the building codes in effect for these areas.

The wind forces that act on the roof of a building make the roof sheathing-to-roof framing connection the important first line of defense. Unfortunately, the nails and spacing used for the roof sheathing and the use of only nails to fasten the roof framing to the walls provided only minimal resistance to the uplift and lateral forces created by high wind. When the roof envelope is breached (i.e., roof sheathing is blown off), additional damage is likely to occur as wind forces enter the building and act on interior walls not designed for lateral loads. Figure 4-7 shows a typical example of inadequate fastening not meeting minimum building code requirements. Using a nail type or spacing in accor-



FIGURE 4-7: Roof truss failure. A single nail (circled) was used to connect each truss to the top plate. This house was in Midwest City, Oklahoma, and experienced inflow winds from a violent tornado.

dance with current or newer building codes could have produced a sufficient connection for the wind load believed to have occurred at this location.

Working from the roof system down toward the foundation, the next critical connection is the connection between the roof framing and the wall system. The result of failure of this connection is shown in Figure 4-8. If the roof-framing-to-wall-connection was adequate to withstand uplift forces, lateral load, and shear transfer, the ability of the structure to withstand the loads generated by moderate winds is increased.

Figure 4-8 shows a seldom seen type of failure caused strictly by uplift of the roof truss attached to the double top-plate. There were few observed failures of the connection of the double-top-plate to the supporting studs below, although one example is shown in Figure 4-9.

Once the wall is erected, the bottom plate should be connected to the foundation or to the floor. In Oklahoma, the foundation was typically a slab-on-grade foundation. In Kansas, basement and crawl space foundations were more common than slab-on-grade construction. Figure 4-10 represents one of many observed failures of the wall-to-bottom plate connection. In this instance, the bottom plate remained anchored to the foundation, but the toe-nailed or face-nailed connection of the studs to the bottom plate were inadequate to resist uplift loads from a violent tornado that struck this Oklahoma home.

FIGURE 4-8: Failure of a double top-plate. The uplift of the roof truss previously attached to this double top-plate caused separation of the two members that comprise this top-plate.



FIGURE 4-9: Failures of the connection of the double-top-plate to the supporting studs below at a home in Moore, Oklahoma. This home was located along the periphery of a violent tornado.





FIGURE 4-10: Wall framing to bottom plate failure. This house in Del City, Oklahoma, experienced a direct hit from the vortex of a violent tornado.

Failures between the bottom plate and the foundation or floor below were observed. Some of these failures occurred when the bottom plate itself failed due to extreme winds associated with the vortex of a violent tornado, as seen in Figure 4-11. In this figure, nails were used to secure the bottom plate to the second story floor system.

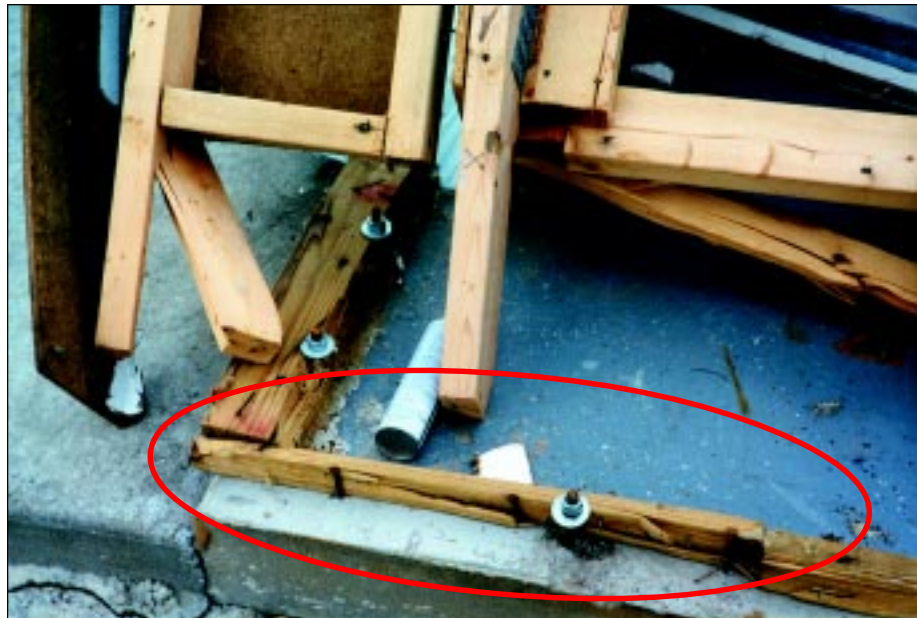

FIGURE 4-11: Stud-wall and sole-plate-to-floor failure on a second story wall. This multi-family residence in Moore, Oklahoma, was located a few hundred feet from the vortex of a violent tornado and was exposed to inflow winds.

Another factor observed that contributed to failures of wall systems was that the bottom-plate (sole- or sill plate) was not integral with the siding or other means of transferring the force. The connection was weak as seen in Figure 4-12. In both Oklahoma and Kansas, bolts, nails, and epoxy anchors were observed securing bottom plates to foundations. In one instance in Oklahoma, straps from the foundation were observed securing the bottom plate to the foundation.

In the event adequate connections and structural elements are provided in the wall system and above, the bottom plate-to-foundation connection is one of the last links in the continuous load path chain that may fail. The BPAT saw many examples of failures at the connection to the foundation. Figures 4-12 and 4-13 highlight these weaknesses. Uplift, racking, and moderate windward forces combined to cause separation of this connection.

FIGURE 4-12: Failure at base of wall between wall studs and bottom plate. The bottom plate, which was connected to the foundation slab with anchor bolts and nails, has splintered.



4.1.4 Increased Load

Houses are not designed to be open to the wind. When windows break, entry doors fail, or garage doors fail, the internal pressures can increase greatly and work in concert with the outward (suction) forces on the outside of the house, causing structural failures. ASCE 7-98 presents a more thorough engineering discussion of how building openings affect the design for wind loads. A schematic diagram illustrating the increased loads due to a breach in the building envelope was shown in Figure 3-6. Depending on the building size, number of interior rooms, number of stories, size of the breach, etc., wind tunnel tests indicate that the net increase in uplift on the roof system can



FIGURE 4-13: Failure of this bottom plate to wall stud connection occurred at this home outside Oklahoma City, Oklahoma. The vortex of a violent tornado passed very close to this home.

exceed a factor of two. The increased load on the roof and wall systems may cause connections between these systems to fail, possibly at wind speeds below the design speed.

4.1.5 Roof Coverings

Virtually all of the residential roof coverings in the areas the BPAT investigated in Oklahoma and Kansas were asphalt shingles (Figure 4-14). Almost all of the shingles were three-tab or laminated, but a small number of T-lock shingles were also observed (Figure 4-15). Shingle age ranged from relatively new to quite old (more than 15 years). It was observed, that for homes located near the far periphery of the tornado, damage was typically limited to intermittent shingle damage. Shingle damage increased dramatically as the distance from the vortex decreased.

FIGURE 4-14: *Asphalt shingles covering a residential roof.*



FIGURE 4-15: *Several T-lock shingles on this house were lifted and torn. This house was on the periphery of a weak tornado in Wichita, Kansas.*



4.1.6 Exterior Wall Coverings

Brick veneer over wood framing was a common wall covering in the investigated areas. A large number of houses on the periphery of the tornado tracks lost siding. In many cases (Figure 4-16), vinyl had been installed over wood or hardboard siding. In all of the investigated cases, although the vinyl was blown off, the underlying wood or hardboard siding was undamaged (except for



FIGURE 4-16: The vinyl (white) that was installed over wood siding experienced damage; however, the wood siding was undamaged. The home was located along the periphery of a violent tornado in Wichita, Kansas.

missile impacts). A number of houses with vinyl siding were completely sheathed with plywood or oriented strand board (OSB). This allowed a nailing surface for the vinyl siding that was not dependent on the spacing of the framing members (studs). Houses that had walls that were fully sheathed with plywood or OSB generally performed better than houses that used other methods, such as let-in bracing, to brace the walls.

The siding of the home in Figure 4-16 was attached with roofing nails. In one area, the nails were 30-in and 21-in apart. The failure of the siding occurred when the vinyl pulled over the nailheads. Additionally, the home in Figure 4-16 suffered some asphalt shingle damage. Houses with vinyl siding that were closer to the vortex commonly had extensive missile damage (Figure 4-17). The siding on the home in Figure 4-17 was fastened with roofing nails placed at 13.5-in, 10-in, and 20-in along one length of siding. The vinyl pulled over the nailheads. Most of the siding failures observed were in areas that experienced straight inflow winds from the tornadoes that were likely at or slightly above the design wind speeds of the current building codes wind speeds (e.g., 70-80 mph, fastest mile or 90-mph 3-second peak gust).

Wood siding and hardboard siding and panels were also observed. In a few instances along the periphery of the tornado tracks, blow-off of these materials was observed. However, it appeared that these materials typically exhibited good resistance to wind speeds that were in the range of current design conditions (e.g., 70-80 mph, fastest mile or 90-mph 3-second peak gust) of the 1997 UBC, 1996 NBC, and 1995 CABO codes.

FIGURE 4-17: *Some pieces of vinyl siding were blown off and in other areas the siding was torn away by missiles. The home was located along the periphery of a violent tornado in Mullhall, Oklahoma.*



4.1.7 Garage Doors

Along the track periphery, it was common to see residential garage door failures (Figure 4-18). The door in this figure likely had a laboratory tested positive load resistance of 12.5 psf, a common test pressure for doors of similar construction. The design load on this door would be 13 psf negative and 11 psf positive using UBC 1997 and 18 psf negative and 14 psf positive using ASCE 7-98. Hence using a 1.5 safety factor, the positive load derived from ASCE 7-98 is 68 percent higher than the resistance of the door. Had this door met the wind loading derived from ASCE 7-98, this failure may have been avoided. This observation is important because it highlights the advanced guidance given by engineering standards as opposed to the basic guidance given by the model building codes for components and cladding elements such as exterior wall systems, windows and doors, and garage doors.

Most of the doors investigated were made of thin metal. Failures were typically caused by wind pressure, rather than by missiles. The most common failure mode observed was the door rollers disengaging from the door tracks, most likely caused by excessive door deformation (see Figures 4-19 and 4-20). Door failure resulted in increased load on the buildings.

The BPAT conducted an extensive assessment of garage door performance at Greenbriar Eastlake Estates in Oklahoma City. A violent tornado directly struck this subdivision and destroyed many homes. The house in Figure 4-18 was located approximately 1200 feet away from the vortex of the tornado as it moved from the southwest to the northeast of this neighborhood. A partial schematic map of the Greenbriar Eastlake Estates is shown in Figure 4-21. The rectangles represent the average dimensions of homes surveyed with



FIGURE 4-18: This double-width garage door failed under a suction load in Moore, Oklahoma.

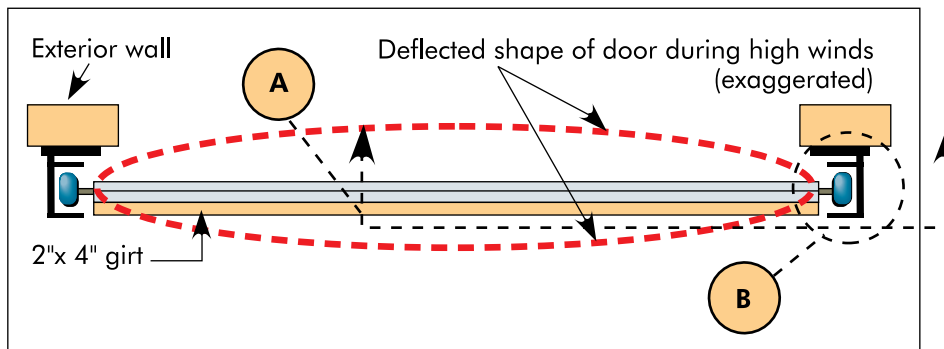

FIGURE 4-19: Plan view of typical garage door shown in Figure 4-18.

house labels appearing within the rectangles. The homes surveyed in this subdivision are constructed of wood framing with brick veneer. The roofs on these homes were hip, gable, or a combination of the two. The majority of the homes were single-story, some with cathedral ceilings. Most house floor plan configurations are simple L, T, or rectangle shapes. Roof decking was observed to be mostly 1-in by 8-in board sheathing with some OSB and plywood sheathing. Roof rafter and wall top-plate connections were typically toe nailed with two 16d nails with no added straps or clips. Overall, material quality was observed to be typical for the Oklahoma City area. Windows were observed to be of average quality, as were front, back, and side entry doors. The large majority of the homes observed had single skin aluminum, non-insulated, and non-reinforced double width garage doors.

FIGURE 4-20: Detail B from Figures 4-19. Garage door failure at track and recommend assembly improvements.

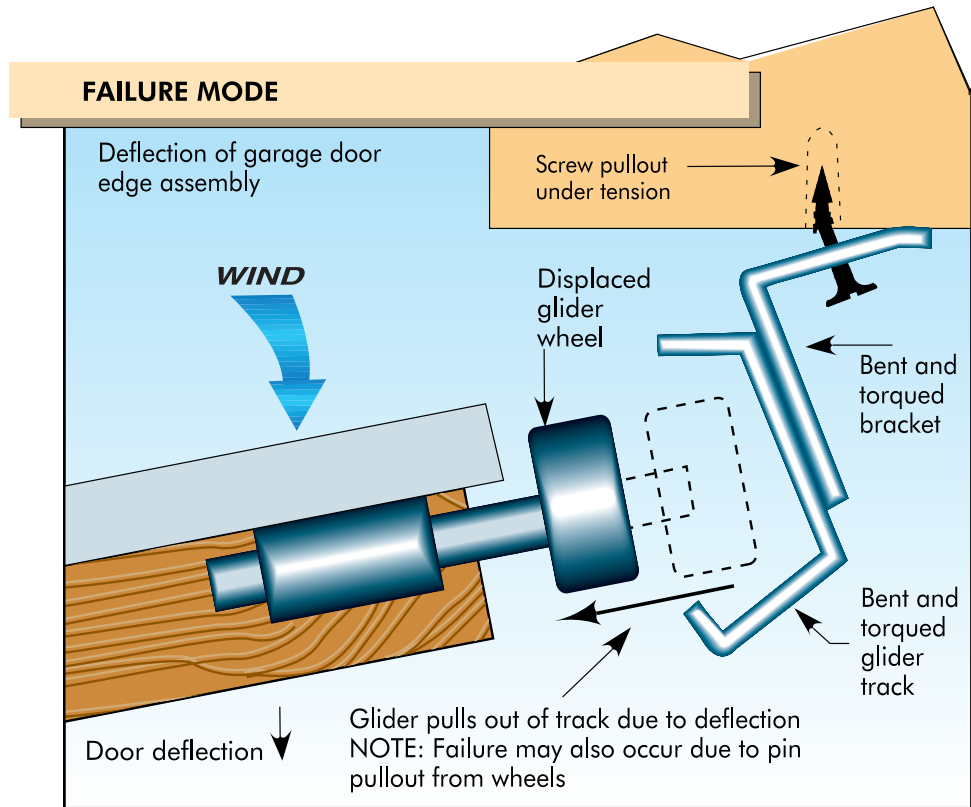
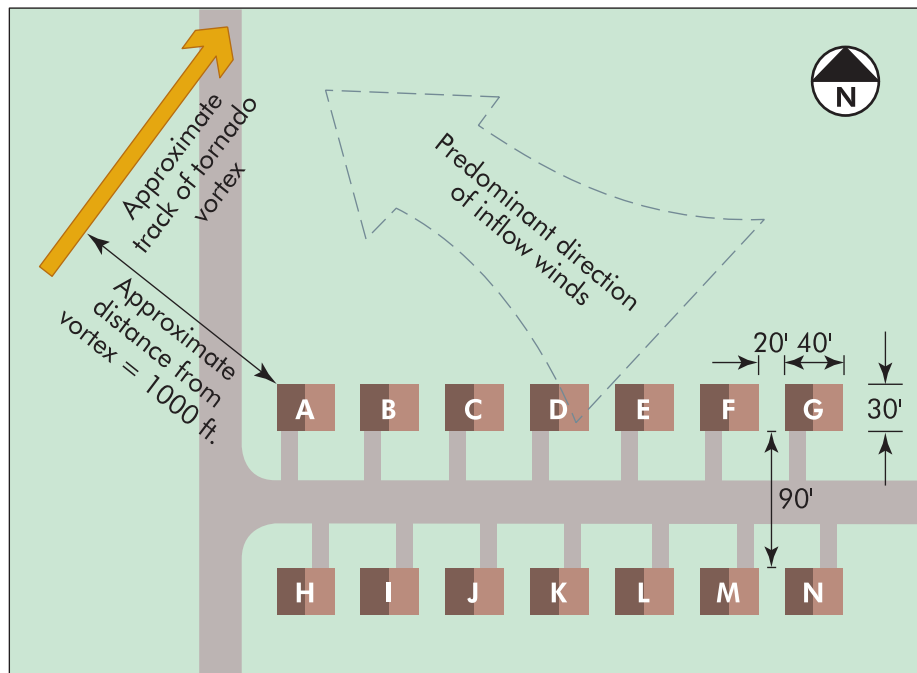

FIGURE 4-21: Partial schematic map of an Oklahoma City subdivision that was affected by inflow winds from a violent tornado.



Homes located at H and A are shown in Figure 4-22. The damage states of the two homes are significantly different even though they are located directly across the street, approximately 95 feet apart, from one another and may have experienced relatively similar wind conditions based on the approximate track location (Figure 4-21). The home located at H had seven broken windows, primarily at the back of the home as a result of debris generated from a failed wooden fence. It also had one breached glass entry door, and lost approximately 60% of its roof covering. The home located at A lost its entire roof structure and several exterior walls. This was likely due to the failure of the garage door from inward wind forces. For the remaining houses, similar “across-the-street” damage gradients were observed between the homes, A through G and H through N, with the exceptions of the home at location F, which did not lose its entire roof structure, and the home at location G, which did not lose any roof structure, but did sustain severe roof framing damage due to uplift.

Several failed garage doors were observed lying at the back of the garage for many homes (A through G), indicating that the garage doors failed due to positive (inward) pressure. These failures of the garage doors are believed to have initiated or contributed to the catastrophic roof and exterior wall failures for homes A through G, a direct consequence of load increase due to a large breach in the building envelope. Examples of this may be seen in Figures 4-22 and 4-23. Note that the failed garage door in Figure 4-22 is crumpled up against the car, suggesting a door failure under positive pressure. A partial roof failure (house F) is depicted in Figure 4-23. In this case, the garage door was also found within the garage as shown in the picture inset. The observed location of the failed garage door and the localized roof damage suggests that the failed garage door may have initiated or played an important role in the roof failure. Many of the moderately to severely damaged homes observed had a significant amount of structural damage to the garage area and to the immediate surrounding area, but did not necessarily have the same magnitude of structural damage at the opposite side of the building where no garage was located.

A final example of observed internal pressurization and roof uplift is shown in Figures 4-24 and 4-25 for the house located at G. The garage door failed by positive pressure and was found inside the garage. Figure 4-24 shows strong evidence of the early stages of roof uplift between the garage roof and exterior wall. The ceiling was observed to have pulled away from the exterior wall perimeter, indicating that the whole roof frame was lifted up. The space shown in Figure 4-25 was apparent along most of the perimeter of the garage ceiling. Figure 4-26 shows an exterior view of the roof and wall interface where the initiation of roof uplift was observed. Tension cracks in the brick veneer and a large gap along the length of the right exterior wall between the roof and top plate were also observed.

FIGURE 4-22: Home in Moore, Oklahoma, with partial roof loss and garage door in place (H) vs. home with total roof loss due to garage door failure (A) under positive pressure.



For several of the homes, H through N, it was observed that the garage doors had sustained permanent deformation due to negative (outward) pressure loads. This observation supports the assumption that the garage doors for homes A through G located across the street failed in positive pressure, as shown in Figure 4-22 for the home located at A. This door failed under a positive load. Full scale pressure tests on garage doors performed in laboratories have demonstrated that a typical garage door is significantly stronger in negative (outward) loading than in positive (inward) loading, which may explain why no garage doors completely failed on the homes, H through N (assuming comparable winds).



FIGURE 4-23: Garage door failure possibly resulting in the localized partial roof failure on the left side of this home located in Moore, Oklahoma.



FIGURE 4-24: A view of home G with a garage door that failed due to positive (inward) acting wind loads.

FIGURE 4-25: *Roof uplift between garage ceiling/roof structure and exterior wall at home G.*

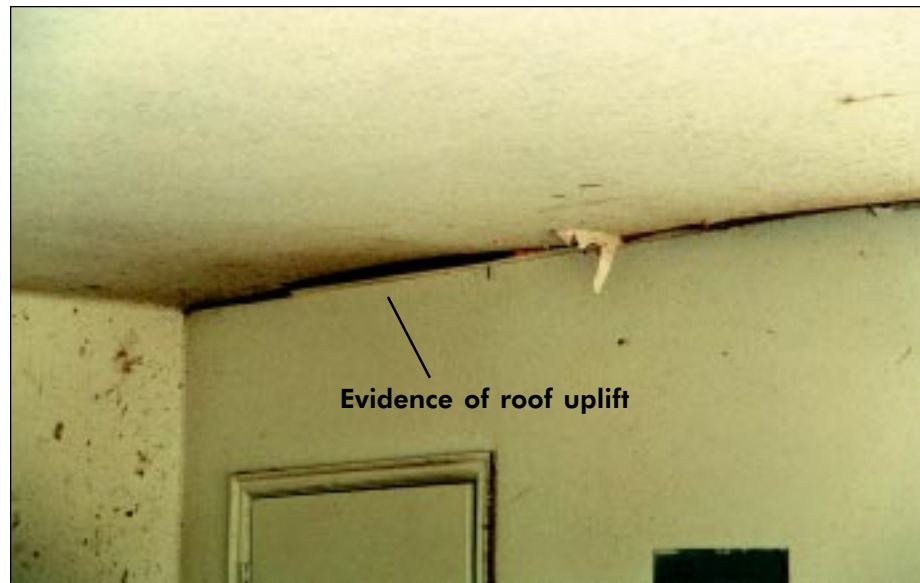

FIGURE 4-26: *A 2x4 member extends out of the gap that runs the length of this garage wall between the top of the wall and the roof framing.*



4.1.8 Windows and Doors

If the building envelope is breached (e.g., windows, wall and roof coverings), the building may experience rapid pressurization, which may well lead to structural failure (Figure 4-27). The failure of a door or window may start this process. Window failures were commonly observed because windows can be broken by both large and small missiles in addition to the wind pressure acting on the windows. Exterior doors and windows failed from the wind pressures of the tornadoes. Garage doors failed from both wind pressures and debris,



FIGURE 4-27: A missile penetrated this exterior door in Del City, Oklahoma. Interior hollow-core doors typically offer even less missile protection than common exterior doors.

and were less common than window failure. However, when the failure of garage doors occurred, it appeared to have caused additional failures at other parts of the house as was briefly described previously.

Glass in exterior windows and doors, glass storm doors, and glass sliding doors in buildings in or along the track of the tornado vortex rarely survived. It was common for virtually every pane of glass to be broken on all sides of a house. Further from the track of the tornado vortex, it was common to see several broken panes on only one or two sides of the house. As the distance from the track of the vortex increased, the incidence of glass breakage decreased.

Depending on room size, the existence of interior doors, and the ability of internal pressures to propagate through multiple rooms within the building, the breach of windows or a failed entry or garage door may cause pressurization of only a portion of the building interior and may be often limited to the room where the breach occurred. In order for the breach to increase the overall uplift loads acting on the roof, the internal pressures must be able to propagate through to the attic space. For this to occur, the initial breach and subsequent internal pressurization must also breach through to the attic, typically through the attic entryway. If the attic entry door consists of a set of pull down stairs, the likelihood of attic pressurization is minimal. When the attic opening is a scuttle access, covered with a simple unattached push-to-open panel, the BPAT observed the risk of attic pressurization is dramatically increased. Another way in which the attic can become pressurized is by failure of the ceiling drywall between roof trusses or framing members, thus providing an opening to the attic space. Also, depending upon the location of attic vent openings, the attic could be pressurized through the vents.

A window or entry door failure may be unlike a garage door failure where the internal pressure is directly transferred to most of the roof system via the ceiling rafters or to the bottom roof truss chords. When a window or door fails, interior doors may slam closed and contain the effects of internal pressurization to a single room. If the room is isolated from roof framing (e.g., a first-story window on a two-story home), very little increase in roof uplift may occur. If the interior doors or walls attached to the rooms fail, the pressurization process will be repeated for adjoining rooms.

Several window failures at the back of the home located in Country Place, a subdivision of Oklahoma City, are shown in Figure 4-28. This home was located along the periphery of a violent tornado. Other than a small piece of sheathing missing from the roof edge, the roof damage in the back of the home is limited to the loss of roof covering material only. In contrast, several pieces of roof sheathing failed on the front portion of the roof as depicted in Figure 4-29. Note that no breaches to the front exterior wall were observed. Figure 4-30 shows a view of the interior of the same dwelling taken from outside the left-hand window breach seen in Figure 4-28. The photograph of the interior suggests the possibility that internal pressurization may have contributed to the roof sheathing loss. This is suggested by the holes in the ceiling, in particular the right-hand hole above the interior doorway. There was evidence to suggest that internal pressure may have pushed the ceiling away from the top of the interior wall where the ceiling drywall failed. Note that there was no evidence of drywall debris on the floor directly below the drywall failure, suggesting the drywall was ejected into the attic. Internal pressurization may have caused the ceiling drywall to fail between the roof structural members that led to the pressurization of the attic space and contributed to the

FIGURE 4-28: *Damage to back of home in the Country Place Subdivision in Oklahoma City, was limited to several window failures and roof covering damage. The home was located along the periphery of a violent tornado.*





FIGURE 4-29: Front of home in Figure 4-28 where several pieces of roof sheathing failed.



FIGURE 4-30: View of interior of the home shown in Figures 4-28 and 4-29.

sheathing failure shown in Figure 4-29. Drywall debris on the floor in front of the door belonged to the collapsed ceiling drywall to the left and was likely the result of rain water damage entering through the roof.

A more serious effect of a failed or breached window or door is when the pressurization results in the partial or total loss of an adjoining exterior wall. When this failure mode occurs, the breach is often located near a corner

where high suction (negative) loads occur on the adjacent wall. The consequence of losing an exterior wall may initiate the partial or total loss of the roof if the wind speed and direction are favorable.

4.1.9 Masonry Veneer

The BPAT observed brick masonry veneer construction and its failure from moderate wind loads at numerous locations throughout the inspected subdivisions of the Oklahoma City Metroplex and the Willow Lake Estates in Bridge Creek, Oklahoma. Brick veneer often appeared to have withstood the wind forces of the tornadoes, but closer inspection revealed the veneer on many homes, although still standing, was easily moved with light hand pressure (Figure 4-31). In Figure 4-32, the north wall of a house had been framed with 2-in by 6-in studs with 1-in by 4-in let-in corner bracing, covered with 1-in thick plastic foam insulation boards and brick veneer. Several studs remained upright, but the brick veneer lay on the ground. Corrugated metal brick ties remained fastened to the studs, and had pulled out of mortar joints. On-site evaluation indicated that much of the damage had been caused by straight

FIGURE 4-31: *This brick veneer appears to be undamaged but close inspection indicated that this wall could be deflected inward with only hand pressure.*



inflow winds associated with a strong tornado, similar to that experienced from severe thunderstorms or other typical design events, and not from a tornado vortex (Figures 4-32 and 4-33).



FIGURE 4-32: Failure of brick masonry veneer construction. The vortex of the strong tornado that caused the winds at this site passed approximately 300 feet from this building in Bridge Creek, Oklahoma.



FIGURE 4-33: Brick veneer failure at the house shown in Figure 4-32.

Informal discussions with the Central Oklahoma Home Builders Association (COHBA) indicated that almost all residences constructed in the last several years in the Oklahoma City area had framed walls and brick veneer on all four sides. COHBA also indicated that this construction complied with the 1995 CABO One and Two Family Dwelling Code. However, many of the brick masonry veneer failures observed by the BPAT did not comply with the CABO code with respect to the spacing and anchoring of the masonry ties.

At Country Place and Eastlake Estates in the southwest suburbs of Oklahoma City, the BPAT observed a large number of 1- to 5-year-old homes with brick veneer failures. The wind speeds at these locations could not be determined. However, based on the team's observation of the damage and debris, including standing wood framed walls, it appeared that most homes with brick veneer failure were outside the vortex of a violent tornado (Figure 4-34).

FIGURE 4-34: Failure of masonry veneer wall of a home located along the periphery of a violent tornado near Moore, Oklahoma.



The BPAT also observed several problems that led to failure of the brick veneer, such as inadequate bonding of mortar to galvanized brick ties, inadequate bonding of mortar to brick, corroded brick ties, and nail pull-out at brick ties. The BPAT observed that brick veneer was generally constructed using 3-in brick. Location and number of brick ties varied considerably, from 16-in on center vertically and horizontally, to ties at top, midheight, and near bottom of walls. There were several walls with up to 1.5-in to 2.0-in gaps behind brick and with brick ties only inserted $\frac{3}{4}$ -in to 1.0-in into mortar joints. Most ties were fastened through plastic foam insulation sheathing into studs with one 6d common nail per tie.

In many cases, sections of brick veneer wall panels could be easily pulled loose by hand, and where brick veneer was left standing, it could easily be pushed in with hand pressure (Figures 4-35, 4-36, and 4-37). Walls with no visible failure could also be pushed over. This occurred when suction loads acting on the walls broke the bond with the ties, but did not result in brick veneer failure.

In Del City and Midwest City, and Oklahoma City, the BPAT observed several more examples of brick veneer (both clay and concrete brick) failure. Most of the failures appeared to have been caused by negative wind pressure (suction) on leeward and side walls (Figures 4-35, 4-36, and 4-37). These walls were also in an area that was in the inflow wind area of a violent tornado, but outside the vortex. The house in Figure 4-38 experienced only brick masonry and window damage when exposed to the winds on the periphery of a violent tornado.



FIGURE 4-35: *Inadequate bonding of mortar to galvanized brick ties contributed to this masonry failure at a home in Bridge Creek, Oklahoma.*

FIGURE 4-36: *Inadequate bonding of mortar to galvanized brick ties, Bridge Creek, Oklahoma.*



FIGURE 4-37: *Failure of brick veneer wall, Del City, Oklahoma.*





FIGURE 4-38: Failure of brick veneer wall, collapsed on the ground. This home, located outside Oklahoma City was on the periphery of a violent tornado.

4.1.10 Masonry Chimneys

In Moore, Oklahoma, at a subdivision south of Westmoore High School that was in the direct path of a violent tornado, newer homes located in the periphery of the damaged areas a few hundred feet from the vortex had failures of brick chimneys and brick veneer walls. Brick chimneys snapped off near the eave and crashed through the house roof, breaching the building envelope and placing occupants at risk of injury or death from falling masonry and other debris. Again, the majority of masonry veneer was single width, 3-in brick.

Chimneys were typically 28-in wide by 24-in deep and made of 3-in brick, with a 10-in by 10-in clay tile flue in the center, leaving a large gap between flue and exterior brick. The height of chimney was about 8 ft above eave height. No vertical or horizontal reinforcement was present. Ages of houses did not appear to make any difference on bonding of mortar to brick ties or bonding of mortar to brick, because they ranged in age from 1 to 30 years old. (Figures 4-39 through 4-44).

Basic calculations performed by the BPAT indicated a varying magnitude of wind speeds that caused failure of the different chimneys observed. Using the wind guidance given in the 1995 CABO One- and Two-Family Dwelling Code (the code governing most residential construction in the impacted area) wind speed ranges for some of the chimney failures observed were calculated. The chimney failure in Figures 4-40 and 4-41 (a 32-in by 36-in brick chimney) and the failure of the brick chimney in Figure 4-42 (a 30-in by 30-in chimney) were likely due to wind speeds of no greater than 136-139 mph (fastest mile). Calculations were also performed on a brick chimney (30-in by 42-in) that

FIGURE 4-39: Failure of brick veneer wall of home located along the periphery of a violent tornado in Oklahoma City. Masonry ties are circled.

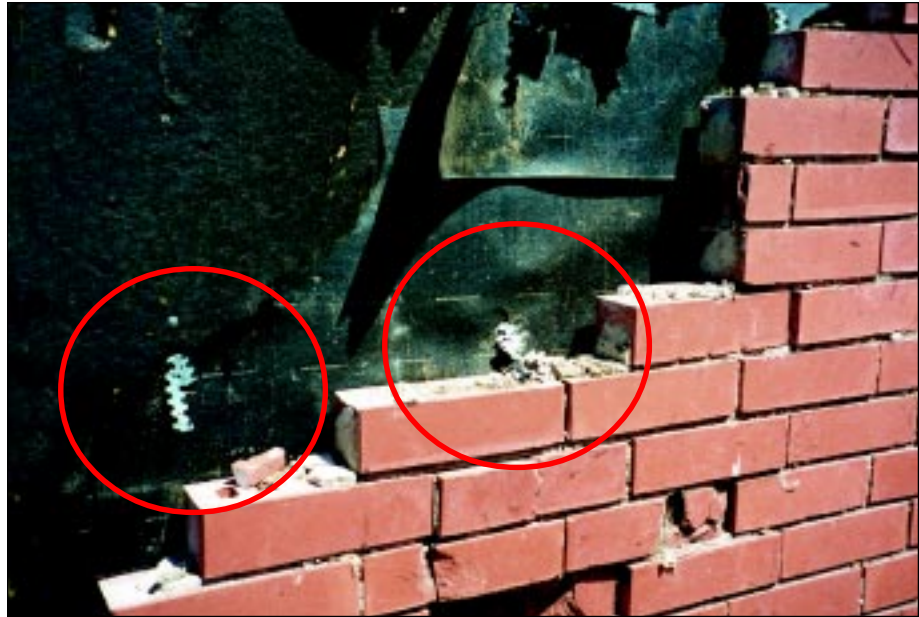

FIGURE 4-40: Failure of brick chimney onto roof of home located along the periphery of a violent tornado, Moore, Oklahoma.





FIGURE 4-41: Close-up view of brick chimney failure in Figure 4-40.



FIGURE 4-42: Failure of brick chimney onto top of home located along the periphery of a violent tornado, Moore, Oklahoma.

FIGURE 4-43: Chimney failure onto roof of single-family attached housing, Wichita, Kansas. This building was located along the periphery of a strong tornado.



FIGURE 4-44: Chimney failure onto roof of single-family attached housing located along the periphery of a strong tornado, Wichita, Kansas.



was similar to the chimneys presented in Figures 4-43 and 4-44. These rectangular chimneys were calculated to have failed at wind speeds ranging from 75-85 mph (fastest mile). No reinforcing bars were observed in any of the chimneys in which calculations were performed.

4.2 Multi-Family Construction

Members of the BPAT inspected the Emerald Springs Apartments in Moore, Oklahoma. The two-story buildings were about 15 years old and constructed of wood framed bearing walls and floors, wood roof trusses, and brick veneer and hardboard siding exterior finish. There was extensive damage of roof systems, primarily caused by wind uplift forces on large (6.5-ft long) overhangs with bottom chords of the roof trusses only toe-nailed to the wall top plate of the load bearing wall. Brick veneer also failed from excessive negative (suction) pressure, and many windows were blown inward by positive wind pressure or broken by small gravel or wood missiles.

There were several two-story apartments in the Wichita, Kansas, area that also had extensive damage to roofs and brick veneer walls (Figures 4-45 and 4-46).

4.3 Manufactured Housing

Damage to manufactured homes was observed in Oklahoma and Kansas. Performance of units on non-permanent foundations utilizing ground anchors and straps were assessed as well as the performance of units on permanent foundations. Although units installed on non-permanent foundations were observed to have performed relatively poorly, units (especially double-wide units) on permanent foundations performed considerably better.

In Bridge Creek, Oklahoma, 11 deaths were reported from a violent tornado; most of these deaths were individuals taking refuge in manufactured housing. Although some manufactured homes were directly hit by the vortex, observed



FIGURE 4-45: Failure of brick veneer at a multi-family housing unit in Wichita, Kansas. This building experienced inflow winds from a strong tornado.

FIGURE 4-46: Failure of brick veneer in multi-family housing located along the periphery of a strong tornado, Wichita, Kansas.



damage to buildings and trees during the site visit indicated that most buildings were impacted by straight inflow winds and not by the tornado vortex.

At several sites in the area, the BPAT observed manufactured houses completely destroyed and separated from the twisted remains of the steel chassis. The chassis and debris traveled distances of 20 feet to over 200 yards from the original anchorage site. Ages of homes could not be determined; no data plates or labels could be found. Most of the manufactured homes in this location were single-wide, 14-ft by 60- or 70-ft units, originally connected to the ground by helical ground anchors and galvanized steel straps fastened to the steel chassis beams.

Foundation support was typically provided by ungrouted (dry stacked) concrete masonry unit (CMU) piers at 6 to 8 feet on center under each chassis beam. The total number of anchors per home varied considerably, from four to eight per home. The most spectacular failure observed was a 14-ft by 60-ft manufactured home chassis found about 200 yards to the northeast of its original anchorage site (Figure 4-47). This home was not affected by the vortex of a tornado; rather, it was affected by the inflow winds whose violent



FIGURE 4-47: This 14-ft x 60-ft manufactured home chassis in the background of this photo moved about 200 yards from its original anchoring site in Figure 4-49, Bridge Creek, Oklahoma.

tornado vortex was approximately 300-400 ft away from this home. At the original site, vertical and diagonal straps remained attached to the ground anchor, but had failed about 2 to 3 ft from the anchors (Figure 4-48). The first anchors had been fastened about 12-ft from the east end. Both the number of anchor straps and tensile capacity of the straps were inadequate to resist wind uplift forces (Figure 4-49).



FIGURE 4-48: Failed straps at the anchorage of a manufactured home in Bridge Creek, Oklahoma. This site was 300-400 feet from a violent tornado vortex.

FIGURE 4-49: Strap anchoring failure most likely led to the displacement of this chassis, Bridge Creek, Oklahoma.



After completing several site visits in the Oklahoma City Metroplex, the BPAT visited Mulhall, Oklahoma, and then Wichita, Kansas. There several double-wide manufactured houses damaged by a strong tornado were inspected. One 28-ft by 60-ft home had rotated on its piers, 2 ft to the east at the north end and 1 ft to the west at the south end. Three helical anchors were pulled out of the ground that had been installed about 1 ft into the ground on the northwest end of the home (Figure 4-50). Anchor straps that were still attached to ground anchors and chassis beams were loose, which allowed lateral move-

FIGURE 4-50: Ground anchor of manufactured home pulled from soil. This home in Wichita, Kansas, was located within the inflow area of a strong tornado.



ment of the unit. Anchor depth into the loose sandy soil did not appear to be adequate to resist wind uplift and overturning forces (Figures 4-51 and 4-52) generated by a strong tornado whose vortex passed nearby, but did not directly strike the homes.



FIGURE 4-51: Anchor of manufactured home bent and pulled up from soil. This home in Wichita, Kansas, was located within the inflow area of a strong tornado.



FIGURE 4-52: Strap torn off from chassis of manufactured home. This home in Wichita, Kansas, was located within the inflow area of a strong tornado.

Several manufactured homes lost plywood roof sheathing and roof trusses, and some only lost asphalt roof shingles. Fastening of the roof sheathing and roofing materials was inadequate to resist wind uplift (Figures 4-53 and 4-54) from inflow winds of a strong tornado.

FIGURE 4-53: *Manufactured home roof and wall damage experienced due to inadequate resistance to lateral and uplift wind forces associated with straight inflow winds of a weak tornado, Wichita, Kansas.*



FIGURE 4-54: *Damage to a manufactured home located on the periphery of a strong tornado, Wichita, Kansas.*



In Haysville, Kansas, the BPAT visited the Sunset Field Addition on South 65th Street near the historic district, where several double-wide manufactured housing units were constructed on permanent concrete crawl space foundations. It was reported that roofs and several walls of the units had been destroyed, but that the floors and chassis had remained on the foundation walls. Although the floors and chassis had remained on the concrete walls, there were no bolts or positive connections between the chassis or perimeter wood joists and the bottom plate, pockets in the concrete walls, or center piers (Figure 4-55). Straps that had been stapled to wall studs and to perimeter joists did not appear adequate to resist wind uplift or lateral loads (Figure 4-56), and fastening of the roof system to walls had been inadequate. Figures 4-46 and 4-56 were taken after demolition and cleanup had begun. The floor system and steel chassis beams (with steel outriggers and steel angle bracing) had been lifted off the foundation by a contractor prior to the photographs being taken.

Several double-wide manufactured housing units in Haysville and Wichita, Kansas, partially survived high wind forces. However, ground anchors were pulled out of the soil, or they were bent over, loosening tie-down straps. Homes shifted laterally from wind forces and fell off un-reinforced and ungrouted CMU block piers. In some cases, tie-down straps with metal clips for attachment to chassis beams were loose and lying on the ground (Figures 4-57 through 4-60).



FIGURE 4-55: *Lack of bolts or positive connectors present between the chassis and foundation of a double-wide manufactured house, Haysville, Kansas. The floor framing of the house was still resting on the foundation after the tornado passed.*

FIGURE 4-56: A close-up of the manufactured home floor and chassis after it was removed by a contractor from the permanent foundation in Figure 4-55.



FIGURE 4-57: This manufactured home laterally shifted from wind force generated along the periphery of a violent tornado, Haysville, Kansas.





FIGURE 4-58: View of anchor strap and attachment indicating lateral shifting of a manufactured home, Haysville, Kansas. This home was located along the periphery of a violent tornado.



FIGURE 4-59: View of anchor strap and attachment indicating some lateral shifting of a manufactured home located along the periphery of a violent tornado, Wichita, Kansas.

FIGURE 4-60: *Manufactured home laterally shifted off its dry-stacked masonry block foundation from wind force generated along the periphery of a violent tornado, Wichita, Kansas.*



5 Observations on Non-Residential Property Protection

This section presents the BPAT's observations on non-residential property protection. The non-residential buildings were categorized into the various engineered types of construction focusing on the structural performance of each type of building. Important observations were also made concerning exterior architectural systems (e.g., roof and wall coverings, windows and doors).

A number of non-residential buildings, such as schools, factories, warehouses, and commercial buildings were in the direct path of the tornado vortexes or in the inflow/outflow areas of tornadoes and received damage. In a few cases, damage could be considered non-structural because architectural and decorative materials were the only damage to the buildings; in engineering standards such as ASCE 7, these materials are referred to as *components and cladding*. In other cases, structural damage occurred due to the lack of capacity in the structural system. Failure of a component, because of lack of capacity results in the load getting transferred to the next member component which then fails because of lack of capacity leading to progressive failure.

5.1 Continuous Load Path

A continuous load path from the roof structure to a building foundation is essential for a building to resist not only gravity loads, but lateral and uplift loads generated by high winds as well. Figure 5-1 shows critical connections in the continuous load paths for representative types of non-residential buildings that sustained structural damage. To resist these loads, adequate connections must be provided between the roof sheathing and roof structural support, steel joists or other structural roofing members and walls, and foundation and walls or structural columns. Each of these connections must be capable of resisting uplift and lateral loads as well as gravity loads.

FIGURE 5-1: Critical connections that failed in the load path, resulting in structural damage or collapse.

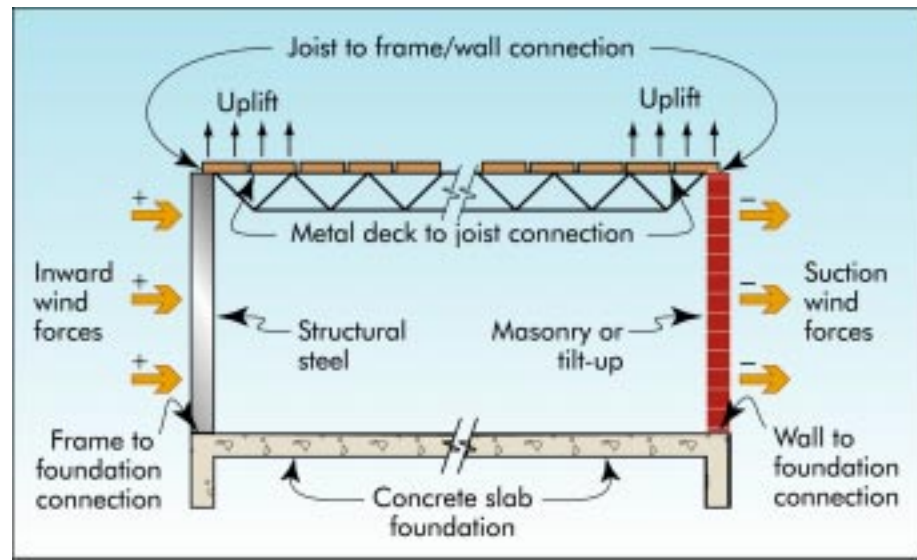

5.1.1 Tilt-Up Precast Concrete Walls with Steel Joists

Inspection of a damaged tilt-up precast concrete wall building in Moore, Oklahoma, found no deficiencies with connections between the tilt-up walls and the foundation. However, connections between the roof system and the tilt-up walls failed in some buildings. In a commercial building along Interstate I-35 outside Del City, Oklahoma, failure of these connections caused a loss of diaphragm action, which then led to collapse of the endwalls of this building. This will be discussed further in Section 5.2.1. Figure 5-2 is a photograph of this building. The vortex of a violent tornado passed approximately 200 yards from this building, generating inflow winds that removed the roof of this structure. Once the roof of the building was removed and diaphragm action was lost, the endwall that was already being acted upon by outward (suction) wind forces failed.

5.1.2 Load Bearing Masonry with Steel Joists

The BPAT inspected Kelly Elementary School in Moore, Oklahoma, which was in the direct path of the vortex of the violent tornado. The school included a steel frame building in the main section, and a section that was constructed with load bearing masonry walls with steel joists.

This section discusses the damage associated with the masonry wall section of the building; Section 5.1.3 will discuss the steel frame section of the school. Figure 5-3 shows damage to the Kelly Elementary School. A circle indicates the separation between the bond beam and its supporting wall. Connections between the bond beam, joists, and walls were adequate for gravity load, but could not carry the high uplift loads that were caused by winds associated with the vortex of violent tornado.



FIGURE 5-2: Tilt-up precast concrete walls at a storage building located outside Del City, Oklahoma. After the roof joists separated from the walls, this end wall became unable to withstand suction forces and failed.



FIGURE 5-3: Kelly Elementary School, in Moore, Oklahoma, hit by vortex of violent tornado. Damage to school displaying separation between the bond beam and supporting wall and separation between bond beam and roof bar joists.

Figure 5-4 shows a close-up of a joist end over the cafeteria. The circle shows a location where the roof deck was supported for gravity load, but not sufficiently welded for uplift. Below the circle, broken welds can be seen. Some of the welds appeared to provide adequate diaphragm action based on deck material that remained at the welds; the deck appeared to fail at the welds only due to uplift. Spacing of the welds appeared to be consistent with standard weld spacing for deck welds.

Also visible in Figure 5-4 is the lower portion of the exterior wall. As illustrated in the photograph, no effective vertical reinforcement was found in the wall. Consequently, the wall had low resistance to uplift in combination with high lateral wind loads.

FIGURE 5-4: Failed structure showing broken deck welds (top circle), and no effective vertical reinforcement (bottom circle). Kelly Elementary School, Moore, Oklahoma, hit by vortex of violent tornado.



5.1.3 Steel Frame with Masonry Infill Walls

The BPAT visited a regional outlet mall in Stroud, Oklahoma, where most of the roof covering was blown away and significant damage to the building was evident. This mall was struck by a strong tornado that collapsed the central portion of the building's steel frame and damaged many of its masonry and steel frame walls. Figure 5-5 shows standing seam metal roof clips still attached to the purlins in one area of the mall that failed under the uplift loading. It was observed that metal wall panels attached with exposed fasteners performed better than the standing seam roof panels.

Figure 5-6 shows the attachment of columns to the foundation and attachment of the wall bottom plates to slab concrete. At the circle on the right in Figure 5-6, anchor bolts were provided, but the apparent lack of nuts on the anchor



FIGURE 5-5: Metal roof deck (missing in photo) of regional outlet mall, Stroud, Oklahoma, was blown off when hit by a strong tornado vortex.



FIGURE 5-6: Attachment of columns to foundation and attachment of wall bottom plates to concrete slab. Regional outlet mall, Stroud, Oklahoma, hit by a strong tornado vortex.

bolts permitted the column to lift off of the foundation. At the center circle, anchor bolts with properly attached nuts provided a high level of restraint to column uplift. The circle at the left shows a wall bottom plate that was attached to the concrete slab by powder-driven fasteners. Although the plate held at this location, lack of penetration by the nails into the concrete permitted the plate to pull out at many other locations. Additional fastener penetration would be needed to ensure consistent attachment of wall bottom plates to the slab.

Most bolts with nuts exhibited a ductile steel failure as shown in Figure 5-7. This was the failure mode observed in most cases. This was also the failure mode for the anchorages at the steel water tower in Mulhall, Oklahoma. However, some of the bolts observed at the mall did pull out of the concrete foundation, indicating a failure either in the concrete bond or inadequate embedment of the anchor bolts (see Figure 5-8).

FIGURE 5-7: Column anchors that exhibited ductile failure at the regional outlet mall in Stroud, Oklahoma, hit by a strong tornado vortex.

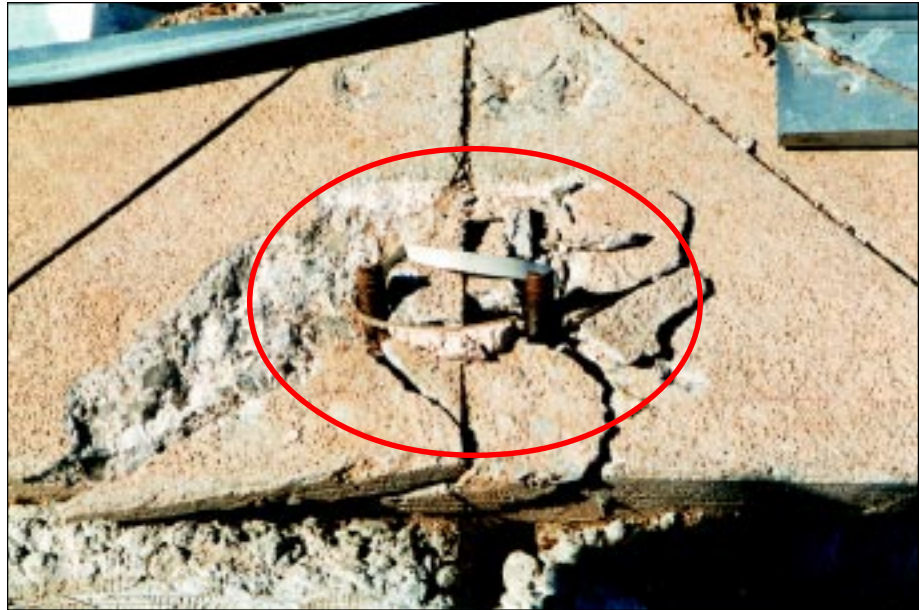

FIGURE 5-8: Column anchors that withdrew from concrete foundation at the regional outlet mall in Stroud, Oklahoma, hit by a strong tornado vortex.



5.1.4 Light Steel Frame Buildings

The BPAT investigated the regional outlet mall that was destroyed in Stroud, Oklahoma. Figure 5-9 shows damage to the outlet mall. In this structure, most of the metal roof panels were blown off by the tornado. In addition, most of the glass curtainwalls at the storefronts experienced failures.



FIGURE 5-9: *Stroud Regional Outlet Mall, Stroud, Oklahoma, was struck by the vortex of a weak tornado.*

In addition to the building failures at the regional outlet mall site in Stroud, numerous light poles failed. The BPAT documented the failures of these poles and calculated an approximate wind speed at this site from 180-210 mph (fastest mile wind).

5.1.5 Laminated Wood Arches with Wood Frame Roof

Lack of load path resulted in severe damage to the Regency Park Baptist Church in Moore, Oklahoma. This building was approximately one block north and across the street from Kelly Elementary School. The vortex of a violent tornado passed approximately a few hundred yards to the south. Figure 5-10 shows the rigid frames remaining after the roof had been removed by the tornado. Loss of load path between the rigid frames and the roof purlins resulted in severe damage to the facility.

FIGURE 5-10: *This church suffered loss of roof due to lack of load path between the rigid laminated wood arches and the roof purlins (missing in photo) that supported roof sheathing. Inflow area of a violent tornado, Moore, Oklahoma.*



5.1.6 Masonry Walls with Pre-Cast Hollow Core Floors

In several locations, combined effects of wind uplift and horizontal wind loads caused damage to structures. A continuous load path is often observed in this type of construction at the connection of the floor slabs to the walls. However, at many of the buildings of this type of construction, a continuous load path for uplift and lateral loads did not exist and roof failures and upper level floor failures were observed. Figure 5-11 shows the remains of a motel in Midwest City, Oklahoma, hit by a violent tornado vortex. The circle shows a steel beam

FIGURE 5-11: *Motel in Midwest City, Oklahoma that experienced major damage when struck by the vortex of a violent tornado.*



that had been deflected inward significantly when the floor slab was lifted during the tornado. There was no positive connection between the steel beam and the floor above.

5.2 Increased Load

At a plastics manufacturing plant in Haysville, Kansas, a combination of uplift and horizontal wind caused out-of-plane buckling of the bottom flange of a main girder supporting the roof (Figure 5-12) when the plant site was struck by a strong tornado. One circle shows the column that supports the girder, while the other circle shows the bottom flange of the girder. It can be seen that the bottom flange has displaced significantly sideways in relation to the top flange of the girder. Inspection along the length of the girder indicated that the bottom flange was braced along its length at every purlin except at the location of the supporting column. This lack of bracing permitted buckling and out-of-plane displacement of the bottom flange. However, due to the light gravity loads left on the roof after the wind forces diminished, collapse did not occur.



FIGURE 5-12: Out-of-plane buckling of the main girder supporting the roof created by a combination of uplift and horizontal wind loads. Plastics plant, Haysville, Kansas, hit by violent tornado. This building was in the inflow area of a strong tornado.

Another example of the effects of uplift and horizontal wind forces is seen in Figure 5-13 at Kelly Elementary School in Moore, Oklahoma. The exterior wall collapsed inward, indicating that the roof had lifted up as the wind loads acted inward on the wall. Failure to have a continuous load path from the joists supports into the masonry wall to resist uplift forces contributed to collapse of the wall. The exterior masonry wall is seen lying on the floor beneath the collapsed roof structure.

FIGURE 5-13: Collapsed roof structure and exterior wall at Kelly Elementary School in Moore, Oklahoma, struck by the vortex of a violent tornado.



The Westmoore High School in Moore, Oklahoma, was a relatively new structure that was within 100 yards of the vortex of a violent tornado. A portion of the roof deck and supporting steel joists over the auditorium stage was blown off. Figure 5-14 shows the walls where the steel joists had been attached prior to the tornado. In all cases, welds failed between joist ends and embedments in the walls. This loss of continuous load path permitted the roof to be lifted up off of the reinforced concrete walls.

Figure 5-15 shows the exterior of the reinforced concrete wall at Westmoore High School following the tornado. This 12-in thick by approximately 35-ft-tall wall remained essentially undamaged, except for loss of the metal wall covering, even though the diaphragm action of the roof was lost. The construction of the stage area integrated an I-beam horizontal frame, shown in Figure 5-14, with the reinforced concrete walls. This frame helped to stabilize the walls. Prior to the tornado, the bare concrete had been covered with a decorative metal curtainwall. The entire curtainwall blew off during the tornado, while brick masonry veneer on the lower wall remained, with virtually no damage.



FIGURE 5-14: Roof blown off over top of auditorium at Westmoore High School, Moore, Oklahoma, hit by inflow winds of violent tornado.



FIGURE 5-15: Exterior view of an undamaged reinforced concrete wall, Westmoore High School, Moore, Oklahoma, hit by inflow winds of a violent tornado. Note: decorative metal wall covering was peeled from this wall.

5.2.1 Tilt-Up Precast Concrete Walls with Steel Joists

Lateral support is needed at the tops of exterior walls of commercial buildings with large open interior space, such as warehouses and open office buildings. When the support is lost, wind load resistance is greatly reduced and structural failure often follows.

Figure 5-16 shows a tilt-up concrete wall that failed after loss of a roof diaphragm made up of steel joists and metal deck. This building was located

FIGURE 5-16: Failure of tilt-up concrete wall in Del City, Oklahoma, hit by inflow winds of a violent tornado.



approximately 200 yards from a violent tornado vortex near Del City, Oklahoma. As can be seen in Figure 5-16, the wall was heavily reinforced at the foundation level. However, lack of support at the top of the wall permitted the wall to blow outward and collapse.

Figures 5-17 and 5-18 show the top of the tilt-up precast concrete wall that failed. Figure 5-17 shows that lateral resistance provided by a beam supported by the wall was lost when the beam pulled out of the wall pocket. Failed welds

FIGURE 5-17: Top of failed tilt-up end wall.





FIGURE 5-18: Top of failed tilt-up wall.

tying the roof joist into plates embedded in the top of the tilt-up wall can also be seen in Figure 5-18. Visual inspection showed that only one of the four walls of the building collapsed. The other walls continued to provide lateral resistance because portions of the roof remained.

Tilt-up walls at a facility that was located under the vortex of a weak tornado in Wichita, Kansas, survived virtually undamaged, despite loss of metal roof decking. As can be seen in Figure 5-19, trusses spanning the open area maintained enough lateral support for the walls that failure did not occur.



FIGURE 5-19: The tilt-up precast concrete walls in this building did not fail when the roof system failed. The masonry walls shown at the left of the photo were damaged. Note: many roof joists are still in place. Building was located in Wichita, Kansas, and was hit by weak tornado vortex.

5.2.2 Load Bearing Masonry with Steel Joists

In Figure 5-19, damage to a portion of the building having steel roof joists supported on masonry walls can be seen at the left. Walls in this portion of the building collapsed when subjected to the vortex winds of a weak tornado. Even though some diaphragm action was maintained, the masonry walls did not have enough lateral load resistance under the combined uplift and horizontal load of the tornado.

Figure 5-20 shows damage to both interior and exterior unreinforced masonry walls (URM) at Kelly Elementary in Moore, Oklahoma. Wind loads due to the vortex of a violent tornado lifted the roof system until the bond beam atop the URM wall failed. When this bond beam failed, the roof separated from the building and some interior walls failed.

Figure 5-20: Damage to interior and exterior unreinforced masonry walls when bond beams failed at Kelly Elementary School in Moore, Oklahoma. The school was struck by the vortex of a violent tornado.



5.2.3 Masonry Walls with Pre-Cast Hollow Core Floors

At a motel in Midwest City, Oklahoma, which was hit directly by the vortex of a strong tornado, failures occurred between the second floor precast hollow core panels and their supporting walls.

Figure 5-21 shows the location where hollow core planks had formed the second floor. The circle at the right shows a dowel from the masonry wall into grout between the ends of two hollow core panels. One of the panels that had been at the edge of the building was found up on the second level and across on the far side of the building as shown by the circle on the left of Figure 5-21. The wind uplift forces from the tornado were large enough to



FIGURE 5-21: Hollow-core plank formed on second floor of a Midwest City, Oklahoma, hotel that was struck by the vortex of a strong tornado.

overcome the tie-down force provided by the very short dowels. The hollow core planks were been lifted and blown across the width of the building.

Elsewhere along the edge of the second floor of the motel, failure occurred between the hollow core planks and exterior walls of the building. As shown in Figure 5-22, lower plates for the walls had been attached to the hollow core planks using powder-driven anchors. As indicated by the circles, the powder-driven anchors pulled out during the tornado.



FIGURE 5-22: Attachments of lower plates for wall to hollow core plank using powder driven anchors failed when required to carry loads generated by the winds of a strong tornado vortex. This motel was located in Midwest City, Oklahoma.

5.3 Non-Residential Building Envelopes

In many cases, tornado damage patterns observed demonstrated that additional collapse of buildings was caused by breach of the building envelope. Openings in the envelope caused by loss of roll-up garage doors, entry doors, or broken windows frequently contributed to loss of roofs or walls of the building. The following is based on a limited number of non-residential building site visits by the BPAT.

5.3.1 Roof Coverings

The following roof types were observed:

- Ethylene propylene diene monomer (EPDM) with aggregate (stone) ballast
- built-up (aggregate surface and cap sheet)
- metal panel (architectural and structural)
- tile

All of the roofs observed experienced blow-off problems, except for a built-up cap sheet roof that was at the periphery of a tornado damaged area. Windborne missiles punctured some of the roofs. In the case of metal panels on pre-engineered frames, it was not determined whether the panels blew off before or after failure of the supporting frames.

FIGURE 5-23: EPDM with aggregate (stone) ballast roof covering.

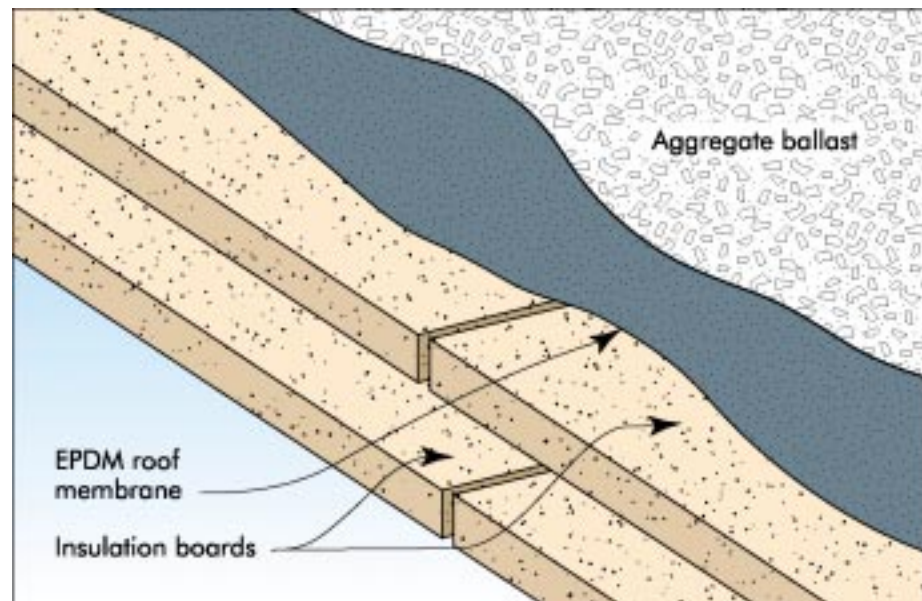

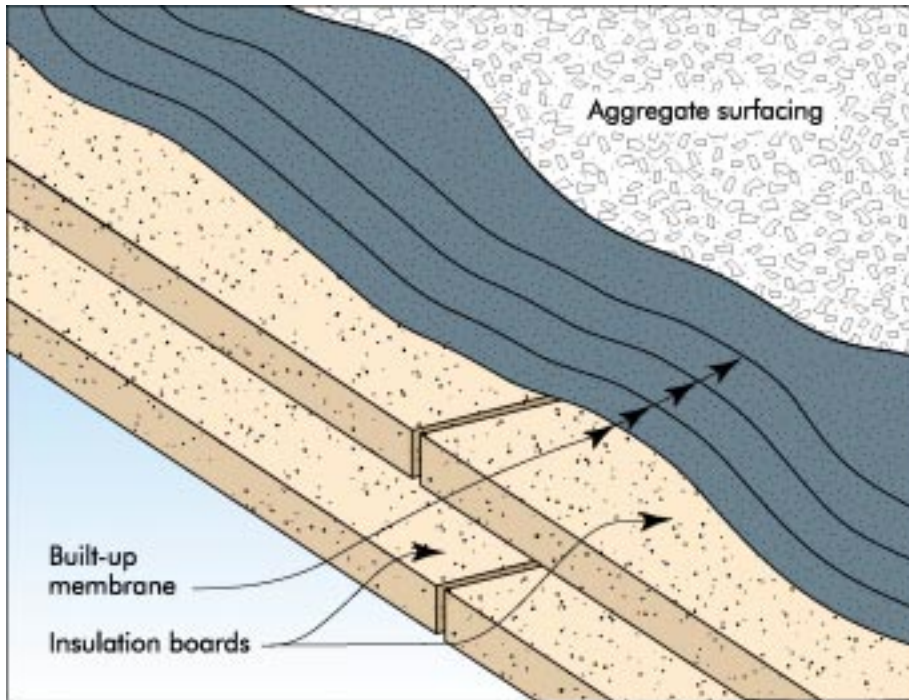

FIGURE 5-24: Built-up (aggregate ballast surface and cap sheet) roof covering.

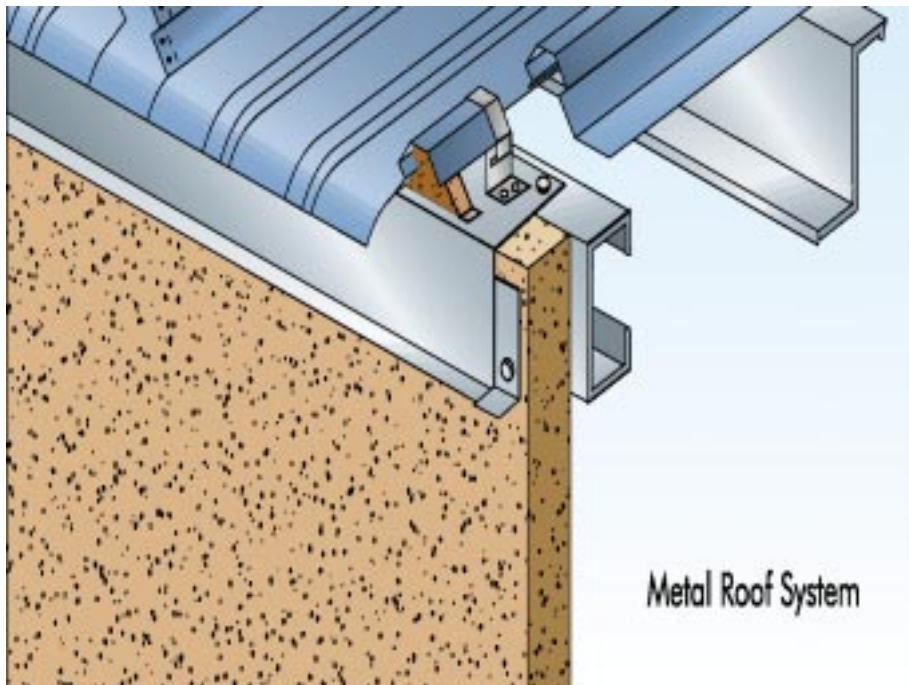
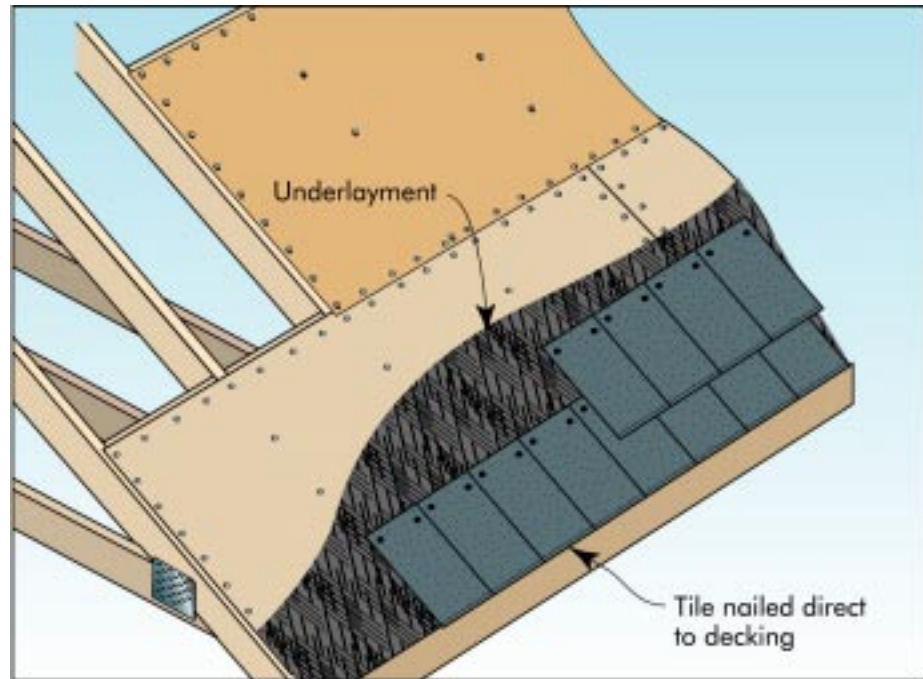

FIGURE 5-25: Metal panel roof covering (architectural and structural), including standing seam.

FIGURE 5-26: Tile roof covering.



Investigations revealed poor connections between wood nailers (used for flashing attachment) and the structure at roof perimeters. In one case, roofing nails were used to attach perlite insulation. This type of attachment offered very little uplift resistance.

In at least one observed case, loss of a large portion of a built-up roof with aggregate surfacing resulted in significant water infiltration into a hospital in Stroud, Oklahoma. After the storm, the hospital was closed and the patients moved to a facility about 30 miles away, which significantly reduced the availability of emergency medical services in this area of rural Oklahoma. The characteristics of the damage to the hospital were not indicative of tornado winds. Rather, it is likely that the damage was caused by thunderstorm winds. The failure initiated when the coping lifted off the edge of the roof, in turn, lifting the nailer beneath (Figure 5-27). The nailer was poorly attached to a 4-in CMU that formed the parapet wall. In some areas, the CMU parapet lifted slightly.

5.3.2 Wall Coverings

Brick veneer is discussed in Section 4.1.9. Some metal wall coverings over steel studs collapsed (Figure 5-28). All the metal wall systems at this building that experienced suction wind forces failed at this site. Although it did result in structural failures it exposed some internal areas to tornado winds. Some exterior insulating finishing system (EIFS) failures were observed (Figure 3-10). EIFS wall failures observed were the result of impact of windborne missiles and suction wind forces.



FIGURE 5-27: *Nailer at the roof of the hospital in Stroud, Oklahoma. The roof surface in this photo was replaced prior to this photo, but the same nailer was used again during repairs.*



FIGURE 5-28: *This metal-clad wall covering collapsed and in other areas it was blown completely away.*

5.3.3 Laminated Glass

In a few instances, examples of laminated glass performance were observed. In some cases, the glass remained in the frame after missile impact (Figure 5-29). In another case, the glass was punched out of its frame. The school in Figure 5-29 is located adjacent to the Regency Park Baptist Church in Moore, Oklahoma, shown in Figure 5-10. The vortex of a violent tornado passed a few hundred yards south of this building.

FIGURE 5-29: *The corner of a table penetrated this laminated glass, but the glass remained in its frame. This school suffered major damage from inflow winds of a violent tornado in Moore, Oklahoma.*



5.3.4 Garage Doors, Exterior Doors and Windows

The breach of overhead rollup commercial doors resulted in internal pressurization of several structures leading to significant load increases. Not unlike the residential case, where a breach in the building envelope was observed at a roll-up door, this breach initiated a partial or total failure of primary structural systems. This was particularly true for pre-engineered buildings, which typically had little redundancy in load transfer of their structural systems. Figure 5-30 shows a breached commercial rollup door at a bread manufactur-



FIGURE 5-30: Failure of roof and walls on structure due to increased loads caused by initial failure of a rollup door, Wichita, Kansas.

ing and distribution center in Wichita, Kansas. The building exterior walls were constructed using both CMU and tilt-up concrete panels. The standing seam metal roof panels were on a Z purlin system. The rollup door failure appears to be a result of positive (inward) pressure. The breach may have caused a sufficient enough rapid increase in load to produce failure of the URM wall. Note the location of the failed door near a corner where high suction (outward) pressure is likely to occur on the adjacent wall. As a result of the exterior wall collapse, severe damage to the roof system occurred due to the loss of the load bearing exterior support wall. However, notice that the roof collapsed to the interior of the building, which may indicate that uplift loads acting on the roof were insufficient to cause progressive peeling failure of the roof decking.

Figure 5-31 illustrates another condition in Wichita, Kansas, where breach of the building envelope contributed to additional structural damage. In this case, loss of showroom windows and a rollup door greatly increased loads in the showroom and on the wall at the left of the photograph. These increased loads caused the walls to fail and the roof to partially collapse, thereby greatly increasing structural damage.

Figure 5-32 shows a steel door that appears to have been opened by impact of a heavy object. This door at Kelly Elementary School in Moore, Oklahoma, led into an area where the roof was completely missing. The breached door may have caused an increase in load that propagated damage to that part of the building envelope. A nearby door, which was also heavily impacted, but did not open, was located in an area of the school that saw less damage to the wall and roof of the building.

FIGURE 5-31: *Additional structural damage caused by breach of envelope in Wichita, Kansas.*



FIGURE 5-32: *Damaged door most likely opened by impact with heavy object. Kelly Elementary School, Moore, Oklahoma.*



6 Observations on Personal Protection and Sheltering

Existing and new construction can be strengthened to better resist wind forces associated with inflow winds of tornadoes and weak tornado vortices; however, sometimes more protection is required. To survive a violent or severe tornado directly beneath or adjacent to the vortex or to minimize potential loss of life for any tornadic event, a hardened aboveground or belowground shelter specifically designed and constructed to provide near absolute protection is the best alternative.

However, a shelter or safe room is not effective if ample warning time is not provided. The NOAA/NWS “Service Assessment” for the May 3, 1999 Tornado Outbreak (see Appendix E) provides information on the warning times for the May 3, 1999 tornadoes. Tornado warnings for smaller tornadoes is typically 5-10 minutes. For the tornadoes studied in the “Service Assessment”, the warning times ranged from 13-65 minutes. These warnings allowed those individuals with access to shelters time to take refuge. Additional lives would have been lost by individuals attempting to seek refuge in shelters if this ample warning time had not been provided.

6.1 Shelters

Engineered shelters not only provide the best protection against loss of life for individuals subjected to a tornado, but also furnish the only protection reliably capable of providing survivable places of refuge. This section presents observations on the types of shelters observed by the BPAT.

6.1.1 Types of Shelters

Both aboveground in-resident shelters and belowground shelters were successfully utilized in the May 3 storms in Oklahoma and Kansas, and were responsible for saving many lives. The aboveground in-residence shelters observed were constructed of cast-in-place concrete. Figure 6-1 shows an aboveground in-residence shelter located in Del City, Oklahoma, that consists of a reinforced concrete room (including a roof slab) located behind the brick veneer that was affected by inflow winds and was about 100 feet from the vortex of a violent tornado. Figure 6-2 shows the extent of damage the tornado caused on

the homes surrounding the shelter. Homes in the foreground were hit by the tornado vortex and were located behind the home shown in Figure 6-1. The other type of residential aboveground shelter observed is an insulated concrete formed (ICF) shelter shown in Figure 6-3 that was hit by inflow winds of a violent tornado in Bridge Creek, Oklahoma.

FIGURE 6-1: *Aboveground in-residence shelter hit by strong inflow winds near the vortex of a violent tornado in Del City, Oklahoma. Arrows indicate the extent of this reinforced concrete shelter that cannot be seen due to the brick veneer.*



FIGURE 6-2: *Damage to houses near the home in Figure 6-1. This photo is taken from the roof of the concrete shelter.*





FIGURE 6-3: Entrance to the ICF shelter in Bridge Creek, Oklahoma. This residence and shelter were on the periphery of the inflow winds of a strong tornado, and damage was limited to light missile impacts.

Belowground shelters included shelters constructed in basements as well as self-contained shelters located out of the building footprint, sometimes known as storm cellars. Basements were typically constructed of cast-in place concrete or CMU walls, and ceilings were normally wood framed structures constituting the structure for the floor above. Basements intended for occupancy and normal use contained windows, some of which were planned for egress from sleeping spaces. A basement may function as a place of refuge, but can not be considered an engineered shelter unless it has been designed to perform as a shelter. Refer to Section 6.2.1 for use of typical basements for refuge. The storm cellars observed by the BPAT were constructed of cast-in-place or precast concrete (Figure 6-4), and prefabricated steel with a concrete roof slab (Figure 6-5). The BPAT did not observe fiberglass or steel tank storm cellars, although numerous proprietary storm cellar systems are available that are constructed of these materials.

FIGURE 6-4: *This precast concrete storm cellar was located immediately behind a single-family residence in Sedgwick County, Kansas. This residence and shelter were on the periphery of a violent tornado path.*



FIGURE 6-5: *Del City storm cellar constructed of welded steel sheets with a concrete roof slab. This area was directly struck by the vortex of a violent tornado.*



6.1.2 Use of Shelters

Shelters observed by the BPAT appeared to be constructed and located by occupant type. Family-size shelters situated near or in the residence for immediate use in the case of danger were evident throughout Oklahoma and Kansas. In Oklahoma, the BPAT observed a few aboveground in-residence shelters that had been added to existing homes or incorporated into the

construction of new homes. In Kansas, no aboveground in-residence shelters damaged by the tornadoes were inspected by the BPAT. However, the BPAT did inspect new reinforced concrete aboveground in-residence shelters that were being constructed in Wichita, Kansas (Figure 6-6).



FIGURE 6-6: Aboveground in-residence shelters under construction in Wichita, Kansas.

The second type of shelters observed by the BPAT were designed to accommodate small groups of people. The group shelters inspected by the team were located relatively close to the individuals for which the shelter was provided or within the actual building in which individuals were located. A group-sized shelter located within a plastics manufacturing plant in Haysville, Kansas, is intended to accommodate factory workers (Figure 6-7). The plant's shelter functioned daily as a conference room and lunchroom for employees. Although a violent tornado damaged other buildings on the plant site, the building containing this shelter received damage only in one isolated area, where a partial roof collapse occurred. Other smaller group-sized shelters were observed at a new manufactured home rental development, which provided precast concrete shelters (1 per 4 homes) (Figure 6-8). None of the group-size shelters observed by the BPAT were directly impacted by a tornado on May 3, 1999.

Deficiencies and vulnerabilities were observed in the group shelter presented in Figures 6-7 and 6-8. The shelters in both figures are only accessible by stairs and, depending upon the emergency plan, are possibly non-compliant by ADA requirements. The interior of the shelter in Figure 6-7 was also very damp, signifying a moisture problem that may be a problem for long duration stays within the shelter. The group shelter in Figure 6-8 has a vent on the top that is

FIGURE 6-7: Entrance to the plastics manufacturing plant group shelter in Haysville, Kansas.



FIGURE 6-8: Group shelters at a manufactured home rental community in Wichita, Kansas.



very susceptible to damage and removal by wind and windborne debris. The door, specifically the latch mechanism, is vulnerable to windborne debris. Damage to either of these two elements would result in experiencing wind, windborne debris, and hail and rain from a storm event within the shelter.

Community-sized or mass shelters were also inspected by the BPAT. Community or mass shelters are designed to accommodate over 100 individuals and

may often be located up to ½ mile from the individuals requiring use of the shelter. A manufactured home community shelter in Wichita, Kansas, was constructed partially underground and located at one end of the large development. The shelter was intended to house all residents of the development (Figure 6-9). Approximately 200 people reportedly sought shelter in this building during the May 3 tornadoes. Another community-sized shelter was located underground and under the concrete bleachers in the Midwest High School gymnasium in Midwest City, Oklahoma (Figure 6-10). Approximately 500 people sought shelter here during the May 3 tornadoes (the shelter has a capacity of 3,500). A similar shelter is located at Del City, Oklahoma High School in Del City. Members of the community are generally aware of the location of these shelters. Interviews with residents of the manufactured home community indicated that parking was a problem at the community shelter. In contrast to the shelter at the manufactured home community, ample parking is available near the high school gymnasiums for those seeking shelter.



FIGURE 6-9: Partially belowground community shelter in a manufactured home park in Wichita, Kansas.

The shelter in Figure 6-10 had the following vulnerabilities. According to residents, the shelter was constructed in a flood-prone area that often causes access problems to the shelter and could result in the shelter being inundated by floodwaters. Residents also indicated that only a few people had keys to open the shelter and, during this event, other residents had to wait to gain access because they did not have keys. Similar to the shelters shown in Figures 6-7 and 6-8, access was limited to stairwells at each end of the shelter. Numerous windows along the sides of the building are vulnerable to damage. Finally, the roof covering of aggregate surfacing may become air-

FIGURE 6-10: *Community shelter, Midwest High School gymnasium in Midwest City, Oklahoma.*



borne during high-wind events and tornadoes. If this ballast becomes airborne, it could damage the windows of the facility and seriously injure individuals attempting to take refuge within the shelter.

6.1.3 Maintenance and Design Issues of Shelters

The BPAT observed deficiencies in some shelters inspected during the field investigation. Underground, partially underground shelters, or shelters located exterior to buildings were subject to moisture and the associated deterioration. Insufficient attention often was paid to these shelters with regard to waterproofing of walls and roofs and resulted in musty and damp environments. These conditions were perhaps merely an inconvenience for the family-size or small group shelter, but were potentially environmentally hazardous to occupants with allergies or respiratory ailments in the large group and community shelters.

In numerous cases, the BPAT observed that construction practices, the selection of materials, and maintenance can impact the effectiveness of shelters (Figure 6-11). Storm cellar doors observed by the BPAT were often covered with thin gauge sheet-metal and exhibited corrosion. The sheet-metal storm cellar doors were often backed with untreated plywood that was usually found to be rotted, delaminated, or otherwise deteriorated to the point where it was no longer useful in providing protection to the shelter opening.

Numerous other deficiencies were observed regarding shelter doors and hardware. Most of the storm cellar doors were of insufficient thickness to withstand tornadic wind forces and windborne missiles. Most shelter door latching devices were also insufficient to withstand wind forces and windborne



FIGURE 6-11: Door to underground shelter with rotting wood and corroded hinges.

missiles and one observed failure resulted in the door destruction and the partial filling of the storm cellar with debris (Figure 6-12). Widespread door failures were observed on the belowground shelters; this included both metal and wooden doors. The aboveground in-resident shelters observed had hollow metal doors and three hinges on one side and an insufficient single deadbolt locking device (Figure 6-13). The door metal skin thickness and the single lock would have probably been insufficient to secure the door had they experienced a direct strike from a high-energy windborne missile.

Other shortcomings of shelters were observed by the BPAT. The community shelter in Figure 6-14 produced a potential safety hazard to nearby buildings resulting from windborne missile generation from a fence and roof ballast. A security fence that surrounded this roof area was damaged and removed by the winds of the violent tornado that impacted the opposite side of this community. Aggregate ballast shown in the photo may become airborne during high wind events and cause damage to other properties and injure individuals attempting to access the shelter. In addition, the ventilation covers are inadequate to stop free-falling debris via the penetrations that are in the roof for ventilation.

FIGURE 6-12: Failed wooden door at a belowground shelter in Oklahoma. Note the medium-size debris (clothes dryer) immediately adjacent to the shelter access.



FIGURE 6-13: Shelter door of home in Del City, Oklahoma, showing an insufficient deadbolt locking device. The bottom circled area on the door frame is the catch for the only latching mechanism on the door. Note: the second opening in the door frame was not used to provide a second latching point (top circled area).





FIGURE 6-14: Ballast roof covering on a community shelter in Wichita, Kansas was a potential source of deadly windborne missiles to those seeking to access the shelter. Circles identify covers protecting roof penetrations intended for ventilation, but unable to provide adequate resistance to windborne debris.

6.1.4 Shelter Accessibility

The observed aboveground in-residence shelters were easily accessible by the home occupants. Observed door widths would have allowed access by wheelchair or otherwise disabled occupant. The group or community shelters observed by the BPAT had restrictive entrances that may have hampered access to the shelters by persons with disabilities. Although privately owned, residential below-grade shelters also were limited to stairs to provide access. Figure 6-15 shows stairs leading to the entrance of a community shelter in Kansas. Additionally, several of the community shelters were locked and required authorized admission. Access to the community shelter in Figure 6-15 was restricted to community members without pets and the travel distance from the far end of the development to the shelter was approximately several city blocks. The group shelters observed also require access via stairs at both the plastics manufacturing plant and the manufactured home rental development. Figure 6-16 shows the stairs required to access the group shelter at the manufactured home rental development.

The gymnasium community shelters required suitable storm warnings because of travel time, and time required to open the facility. In unincorporated Sedgwick County, Kansas, residents indicated that a wheelchair bound individual, who resided in a manufactured home, was unable to traverse the stairs into a neighbor's home and down into the basement. The individual attempted to take shelter back in his manufactured home and was killed by a violent tornado that destroyed the manufactured home.

FIGURE 6-15: Stairway leading to entrance of manufactured home community shelter, Wichita, Kansas. The only means of accessing this structure were this stairway and an identical one at the other side of the shelter.



6.1.5 Shelter Ventilation

The observed aboveground in-residence shelters did have ceiling and/or wall penetrations outlets for forced air ventilation from the home HVAC system; however, no other method of natural ventilation was included. All observed underground or partially underground shelters outside the building footprint had some means of natural passive ventilation. The most common types of ventilation mechanism observed were vent pipes (Figure 6-17) or turbine ventilators (Figure 6-8). The vent pipe in Figure 6-17 was sufficiently thick enough to not be broken by windborne debris and was capped to prevent the intrusion of debris. The turbine ventilator observed in Figure 6-8 was 8-in in diameter and made of light gauge metal. It would have been easily destroyed by flying debris if impacted by even a weak tornado, thereby allowing free-falling debris to enter the shelter through the 8-in diameter opening in the roof of the shelter, placing the safety of the occupants at considerable risk.



FIGURE 6-16: Stairway access to group shelter at manufactured home rental development, Wichita, Kansas, shown in Figure 6-9. This development was not affected by any of the tornadoes that struck on May 3, 1999.



FIGURE 6-17: Heavy gauge ventilation pipe for a belowground shelter in Oklahoma withstood considerable debris impact.

6.1.6 Shelter Location

Most aboveground in-resident shelters observed were easily accessible by the occupants. Their location within the house allowed access with minimal threat to wind and windborne debris. Below-grade shelters offered the same advantages, but posed an access problem to occupants with disabilities.

Storm cellars (belowground shelters) were located either in the front, side, or rear yards of the homes. Front yard locations were vulnerable to vehicular traffic and water runoff. The side and rear yard cellars were also vulnerable to water runoff (Figure 6-18). In many cases, the cellar entrance was insufficiently raised above grade and would have allowed for easy entrance of surface water.

FIGURE 6-18: *This belowground shelter is susceptible to water runoff.*



6.2 Other Places of Refuge

If a specially designed tornado shelter is not available for refuge, people are forced to seek shelter in areas not designed or constructed to be places of refuge. Some areas within buildings typically offer a greater level of protection than other areas. However, when people take refuge in a portion of a building not specifically designed and built as a tornado shelter, they are at significant risk of being injured or killed if a tornado of any intensity directly strikes the building or passes nearby. The following sections discuss occupant protection areas within residential and non-residential buildings that do not have specifically designed tornado shelters.

6.2.1 Refuge in Residences

For conventionally-constructed residences without basements or specially designed tornado shelters, observations following the Oklahoma and Kansas tornadoes, as well as previous post-tornado damage investigations, consistently revealed that interior bathrooms and closets offer the greatest occupant protection. Interior bathrooms and closets are small rooms that do not have an exterior wall (Figure 6-19). These areas are referred to as core remnants and are further discussed in Section 6.2.1.2.



FIGURE 6-19: *Remains of an interior room (or core) of a home in a Moore, Oklahoma, subdivision that was hit by a violent tornado.*

6.2.1.1 General Observations

In many instances, only the interior core of the residence was left standing while the exterior walls and other interior walls and the roof structure and ceiling were blown away. The surviving core typically was composed of a bathroom, a closet or two, and perhaps a kitchen wall that was stiffened by cabinets (Figure 6-20). Although interior bathrooms and closets typically offer the greatest protection, people taking refuge in them are still at great risk during a tornado, as illustrated by Figures 6-21, 6-22, 6-23, and 6-24. Some minimal protection from smaller missiles is provided by the core walls and cabinets, but, in many cases, the rooms were left open to the sky when the building's roof was blown away and occupants were then totally unprotected from free-falling missiles (see Figure 3-16).

If the residence was more than one floor above grade, the first floor consistently was found to suffer less structural damage than the second floor (Figure 6-25). Therefore, greater protection was afforded when refuge was taken in interior bathrooms or closets on the first floor rather than the second.

Basements were uncommon in the areas investigated in Oklahoma; however, many of the houses investigated in Kansas did have basements. Basements typically provided greater occupant protection than first floor bathrooms or closets; however, as with first floor bathrooms and closets, basements were not immune to tornado damage. In one instance, a vehicle was blown into a house, penetrated the first floor, and hit or nearly hit the basement slab and then was blown back out of the house. In other instances, missiles traveled

FIGURE 6-20: Interior core of house remains, consisting of a bathroom, closets, and a wall with kitchen cabinets after being struck by a strong tornado.





FIGURE 6-21: This apartment complex in Kansas was affected by inflow winds associated with a strong tornado. The roof and ceiling were blown off of the interior bathroom of this house, the door was blown into the bathroom, and the tub was full of debris. This bathroom would not have provided a safe place of refuge.



FIGURE 6-22: A 10-ft long 2-in by 6-in missile penetrated the exterior wall of an apartment in this multi-family house, which was sheathed with hardboard panels. The missile, which was generated from the vortex of a strong tornado, then penetrated the gypsum board and plastic tile tub enclosure, the tempered glass shower door, and the interior partition near the door frame. At the interior partition, it pierced through a stud and projected a few inches into the hallway (Figure 6-23).

FIGURE 6-23: The missile in Figure 6-22 impacted and broke a 2-in by 4-in stud after traveling through the bathroom.



FIGURE 6-24: This bathroom was on an exterior wall and had a window. It did not provide a safe place of refuge.





FIGURE 6-25: *The second story of single-and multi-family houses typically experienced far greater damage than the first story. This multi-family home in Wichita, Kansas, was affected by inflow winds of a strong tornado.*

down the stairway to the basement and flew into rooms at the bottom of the stairway. Basements, that were partially above grade and had windows, were observed to be susceptible to missile penetration (Figure 6-26).



FIGURE 6-26: *Basement windows of a single-family residence, showing vulnerability to debris.*

Below-grade crawl spaces were also observed in Kansas. These spaces provided protection from windborne missiles traveling horizontally, but, as with basements, minimal protection was provided from free-falling missiles. In one case, a person in a below-grade crawl space was seriously injured even though the floor sheathing remained in place. There was reportedly sufficient high-speed wind flow within the crawl space to blow the person around, causing numerous injuries that required hospitalization.

Based on the BPAT observations, persons taking refuge in bathrooms or closets in manufactured houses on non-permanent foundations appear to be at significantly greater risk of injury or death than persons taking similar refuge in conventionally constructed housing (Figure 6-27). The bathrooms and closets of single-width manufactured houses typically provide very little protection because all of the rooms have at least one exterior wall. The BPAT observed a possible exception in some of the newer manufactured homes placed on permanent foundations, and designed and constructed to resist wind forces specified in U.S. Department of Housing and Urban Development's (HUD's) latest Manufactured Home Construction and Safety Standards (MHCSS). Specifically, improved sheltering is achieved in double-wide manufactured homes placed on permanent foundations since they offered the refuge of interior rooms.

FIGURE 6-27: Damaged and destroyed manufactured homes on non-permanent foundations in Wichita, Kansas, that were in the direct path of a strong tornado.



6.2.1.2 Case Study of Residential Core Remnants

As part of the BPAT effort, data were collected to further ascertain which locations within residential buildings are most likely to resist the wind loads of a weak or strong tornado and provide some personal protection in the absence of a designed shelter. To this end, members of the BPAT members surveyed 89 residential core remnants along the center of the Oklahoma City tornado track (see Figure 2-3). Sampling was carried out by systematically

inspecting all accessible core remnants. The size and location of the survey along the tornado track were ultimately limited due to safety considerations and time constraints. In collecting the core remnant data, no effort was made to assess the likelihood that a core remnant would in fact survive a weak or strong tornadic event. Consequently, the data collected only suggest the most likely locations within a residential structure that may survive as a core remnant.

A core remnant is defined as a group of interior walls that may remain following the failure of the roof and some or all of the exterior wall framing. Core remnants are partially enclosed areas and have at least four surviving walls. Overhead floor or ceiling joists may or may not be present. A sampling of core remnants studied are shown in Figures 6-28, 6-29, and 6-30. Each core remnant was photographed and inspected. Given the broad definition of a core remnant, there was no requirement that the remnant provide protection from free-falling debris, because it was assumed that roof framing is completely destroyed. Consequently, individuals seeking refuge in core remnant locations maybe susceptible to serious injury or death from free-falling debris. In the absence of a designed shelter, cellar, or basement refuge area, core remnant locations will provide an individual with the best chance of survival within their home.

Only three categories of interior rooms were observed as core remnants with any significant frequency of occurrence: first floor interior bathrooms, interior closets, and kitchens. Interior bathrooms were the most likely room to be part or all of a core remnant 81% of the time; interior closets were next at 75%. These values add up to more than 100% because core remnants are often composed of multiple interior rooms. Kitchens were also observed and made



FIGURE 6-28: *The core remnant of this house consisted of a central room and closets.*

FIGURE 6-29: *The core remnant of this house consisted of a central room and adjacent closets.*



FIGURE 6-30: *The core remnant of this house was a central room on the back of the kitchen.*



up roughly 16% of all survivable core remnants surveyed. Although kitchens were often attached to core remnants, most of their walls had failed, except where they were attached to the core remnant. Thus, kitchens alone cannot always be considered to be a viable place to seek shelter. It is interesting to note that roughly 63% of all core remnants surveyed consisted of both an interior bathroom and an adjacent interior closet. The combined framing from adjoining interior closets and bathrooms may contribute to the stiffness of the

core remnant. Other observed core remnants had kitchen cabinets and counter tops mechanically attached to a least one surviving wall of the core remnant. In other cases, it is the added framing from staircases that may have provided the added stiffness to resist wind loads (Figure 6-31).

The BPAT's observations of residential core remnants supports theories held prior to the BPAT investigation that indicated small interior locations, principally first floor interior closets and bathrooms, are locations that may provide some personal protection during weak or strong tornadoes and outside a violent tornado's vortex in the absence of a designed tornado shelter.



FIGURE 6-31: *The core remnant of this house was beneath the staircase to the second floor.*

6.2.2 Refuge in Non-Residential Buildings

The BPAT also investigated a selected number of public use buildings to determine the existence of formalized emergency plans for tornado refuge. These buildings included public schools, nursing homes, and a day-care center. In all cases, each had a formal tornado refuge plan.

The nursing home tornado refuge plan, which was successfully exercised during the storm, consisted of evacuating staff and residents to the central core of the building and evacuating the long, exposed corridors of the building. The day-care center's plan similarly utilized a central corridor; however, the building was not occupied during the storm. Neither building was directly hit by a tornado or suffered major damage.

The emergency plans of five public schools were reviewed by the BPAT. Westmoore High School, located in the City of Moore, was within 100 yards

of the vortex of a violent tornado and received building envelope and roof structure damage. Just prior to the storm, several hundred students and parents occupied the auditorium. In accordance with the emergency plan, most of the students and parents were moved to a predetermined area in a central core of the building where they successfully took refuge (Figure 6-32). Other individuals reportedly took refuge in a reinforced concrete stairwell adjacent to the auditorium.

FIGURE 6-32: Westmoore High School, Moore, Oklahoma, central locker core – a designated place of refuge.



Eastlake Elementary in Moore, Oklahoma, was on the outer periphery of a violent tornado and received minor building envelope damage. The building construction consists of CMU walls with brick veneer and built-up roof over steel decking and steel joists. Interior classroom walls were also built of CMU. The tornado plan for the school indicated that the places of refuge consisted of each classroom within the building, even though each classroom entrance door (from the interior hallway) was flanked by a large glass sidelight (Figure 6-33). There were no exterior windows in the exterior wall of most of the classrooms. Centrally located offices were also identified as places of refuge with the building. None of the identified areas appeared sufficiently constructed to withstand a direct hit by a violent tornado.



FIGURE 6-33: Eastlake Elementary, Moore, Oklahoma, glazed sidelight at classroom entrance.

Tornado refuge plans for Northmoor Elementary and Kelly Elementary in Moore and Sooner Rose Elementary in Midwest City were reviewed by the BPAT. None of the schools were occupied during the storm. Northmoor and Kelly were of a similar design and construction and had similar emergency plans of taking refuge in the central corridors.

Figure 6-34 shows a central corridor of Northmoor that illustrates the corridor masonry walls topped with windows, called “clerestory”. These types of walls have limited capacity to resist lateral forces because of the windows located along the tops of the wall systems. Figure 6-35 shows a corridor in Kelly Elementary of nearly identical construction to the hallway in Figure 6-34. The inability of the corridor walls to withstand extreme loads due to lateral and uplift wind forces resulted in the collapse of this corridor. Many schools identify their central corridors as places of refuge in their tornado plans. Obviously, had these corridors been used for shelter during the tornado, numerous injuries or deaths would have occurred. Sooner Rose Elementary was a different construction type from the above, but contained similar windowed corridors (see Figure 6-36).

FIGURE 6-34: Northmoor Elementary place of refuge, Moore, Oklahoma – corridor with clerestory windows. This corridor offers little protection from tornadoes as shown in a school of similar design in Figure 6-35.



FIGURE 6-35: Kelly Elementary School, Moore, Oklahoma, place of refuge – corridor with clerestory windows. These interior corridor walls had brick masonry up to a height of approximately 7 ft. Glass extended from the top of the brick masonry to the top of the wall.



If a tornado is approaching an occupied non-residential building that does not have a specifically designed tornado shelter, or a tornado plan indicating places of refuge (based on an evaluation by a qualified architect or engineer), it is difficult for building occupants to quickly determine where persons should be directed to take refuge. Some walls appear to offer substantial resistance to wind and windborne missile loads, but, in fact, have very little resistance. For example, an exterior insulation finish system (EIFS) can be mistaken for a concrete wall. However, most EIFS wall assemblies consist only of a thin layer of synthetic stucco over expanded polystyrene (EPS) insulation and



FIGURE 6-36: *Sooner Rose Elementary School, Midwest City, Oklahoma. According to the tornado plan for this school, this hallway is designated as a place of refuge.*

gypsum board that is supported by studs, and a layer of gypsum board on the interior side of the studs (Figure 6-37). Brick and CMU walls can also be deceiving. If they are adequately reinforced and braced, they can offer a significant level of protection. But if they are inadequately reinforced or braced, they can collapse, thereby trapping and crushing people (Figure 6-38).



FIGURE 6-37: *This EIFS wall system was penetrated by numerous windborne missiles.*

FIGURE 6-38: *The non-reinforced interior CMU walls in this area of Kelly Elementary collapsed after the roof system was removed by vortex winds of a violent tornado.*



Basement areas without windows and concrete stair towers in multi-story buildings, while not specifically designated as shelters, generally provide a reasonable level of protection from weak and strong tornadoes for occupants. Interior corridors and smaller rooms that do not have glass openings in doors or walls, and are inward as far as possible from exterior walls, may provide protection or a false sense of security, depending on the severity of the tornado and the proximity to the tornado vortex (Figure 6-39). Rooms with large ceiling spans (rooms with more than 40 ft between walls or columns) such as auditoriums and gymnasiums should be avoided unless specifically designed as shelters. Large-span rooms often provide a lower level of occupant protection than rooms with smaller spans. Again, these areas of refuge have been shown to provide little protection from the effects of a direct hit by a tornado vortex unless specifically designated as shelters.



FIGURE 6-39: *The roof and ceiling over this interior bathroom blew off. CMU from a firewall a few feet away blew into the bathroom, which was located on a motel's second floor in Midwest City, Oklahoma. This bathroom would not have provided a safe refuge.*

7 Conclusions

The conclusions presented in this report are based on the BPAT's observations, an evaluation of relevant codes and regulations, and meetings with state and local officials, and other interested parties such as organizations representing builders and contractors. The conclusions of this report are intended to assist states, communities, businesses, and individuals, and to provide technical guidance for personal and property protection.

7.1 Residential Property Protection

The BPAT observed considerable damage to single-family housing, multi-family housing, and manufactured housing. Failures observed resulted from windborne debris and high winds that often produced forces on buildings not designed to withstand such forces. Failures, in some cases, also were observed that were due to improper construction techniques, poor selection of construction materials, and ineffective detailing of connections. Damage, in some situations, could have been reduced or avoided if newer building codes and engineering standards that provided better guidance for high wind events had been adopted, followed, and enforced.

The majority of residential construction in Oklahoma and Kansas is currently required to be designed and constructed in accordance with the 1995 CABO One- and Two-Family Dwelling Code. Although local municipalities have adopted some amendments to this code, it does not incorporate wind speed design parameters used by the newer 1997 UBC, 1997 SBC, and 1996 NBC codes. Furthermore, engineering standards such as ASCE 7-98 and its predecessor 7-95, provide better structural and non-structural design guidance for determining design wind loads than the most recent versions of the UBC, NBC, or SBC. Although designing for tornadic wind events is not specifically addressed in any of these newer codes or standards, constructing homes to the most recent versions of these codes and standards would improve the strength of these structures. Building to these codes and standards would have reduced damage in areas that were affected by the inflow winds of all tornadoes and reduced the damage to residences impacted by the vortices of weak and possibly strong tornadoes.

7.1.1 Single- and Multi-Family Homes

The BPAT observed many single-family residential buildings that were in the inflow areas of violent and strong tornadoes and in the direct path of weak tornado vortices that received avoidable structural damage. This damage was typically a result of the lack of capacity in the structural system to resist wind-induced uplift loads, wind-induced lateral loads, or increased loads on the building due to internal pressurization after the building envelope was breached. It is crucial to establish a continuous load path to provide improved resistance to wind forces.

It is neither economical nor practical to construct an entire home that is resistant to tornadoes of all strengths. However, improved design and construction and implementation of details and techniques that are used in other high wind regions of the country may have significantly reduced the property damage caused by weak tornado vortices and inflow winds of strong and violent tornadoes.

7.1.1.1 Load Path and Structural Systems

Foundations in conventionally constructed single- and multi-family homes performed adequately during the tornadoes in both Oklahoma and Kansas. The deficiency or failure mode of the load path at this point was the connection of the structural systems to the foundation. Wood framing relied on the connection of the sole plate or floor framing to the foundation wall or slab to maintain the load path. Straps, anchor bolts, epoxy set anchors, and nails were the most common fasteners. When properly used, the straps, anchor bolts, and epoxy set bolts maintained the connection of sole plate and floor framing to the foundations for most wind conditions. However, numerous instances of anchor bolts without nuts or misaligned anchor bolts at the sole plate and floor framing resulted in the house lifting off the foundation. Nailing of the sole plate to the foundation was adequate only in the areas that incurred minimal damage from inflow winds along the periphery of the tornado paths.

Wall framing in single- and multi-family houses commonly failed at the sole plate to stud connection. This was the most common failure observed by the BPAT in wall framing. Revisions in the normal way of constructing wall framing are necessary if these weak links are to be addressed. A positive method of connecting the studs to the sole plate that can resist design uplift forces is a necessity for providing a continuous load path. Recommendations regarding the construction of this connection are illustrated in Chapter 8.

Wood framed walls also saw failures at the double top plate connection with the wall and the roof systems. Attention must be given to ensure a positive connection is provided for the uplift load transfer from the double top plate to the wall below. Straps or other connectors that would ensure a continuous load path to resist uplift loads were not observed at this location. Nails were

the primary fasteners at this connection. Failures were observed between the studs and the top plate and between the two top plates. Typically, when this connection failed, no continuous structural sheathing was observed to help with this load transfer. Full length wood structural panels (e.g., plywood), from the top plates to the sill plate or floor framing, could act as the uplift load transferring mechanism. The sheathing or other means of transferring the force must be connected to the double top plate by sufficient fasteners such as those noted in the model building codes.

The primary shear wall failure observed was that of garage return end walls that frame the garage door. The narrow walls where failure was observed have an aspect ratio (height to width ratio) that generally was less than that allowed by model building codes. The current building codes, which contain industry recommendations that are intended to provide a narrower shear wall, but yet be capable of resisting the design wind loads, should be followed.

Although most of the roof framing configurations observed did not include a sufficient connection of the rafter to the ceiling joist, at least one of the model building codes does require such connection. In those cases where the ceiling joists existed and were parallel and adjacent to the roof rafters, additional resistance would have been provided if roof framing was connected to the ceiling joists. For the cases where the roof framing and ceiling joists were not parallel or adjacent, an insufficient number of observations were made to be able to draw any conclusions. Recommendations to improve the strength of these connections are illustrated in Chapter 8.

Roof geometry was observed to affect building performance in two significant ways. First, the roof geometry affected both the local and overall wind loads acting on the roof. Second, the roof geometry affected the overall strength of the roof system based on its framing configuration (e.g., hip versus gable framing).

In general, for flat, gable, and hip roof geometry, the largest uplift loads occurred near the corners, the gable ends, and the edges of the roof ridge. However, the largest localized loads for gable roofs are noticeably higher than those for hip roofs. Although a localized load may fail a single piece of roof sheathing, it will not always cause the entire roof to fail. Such localized roof failures often allow rainfall to enter the structure, causing significant collateral damage to the building interior and furnishings. When the roof fails as a single entity, it is the overall combination of all wind loads that will cause this failure. The magnitude of the loads that will cause roof failures are influenced by the roof geometry, slope, pressure of roof overhangs, and location on the roof. Roof geometry and their effect on resultant wind loads are illustrated in Figure 7-1.

The effect of roof shape on the performance of residential buildings in high winds varies with the size of the roof element being considered (e.g., roof covering, roof sheathing, single truss, entire roof, etc.), the wind directions producing the high winds, and the quality of the design and construction.

FIGURE 7-1: Relative uplift pressures as a function of roof geometry, roof slope and location on roof. Negative values indicate that wind pressures act upward and perpendicular to the roof surface.

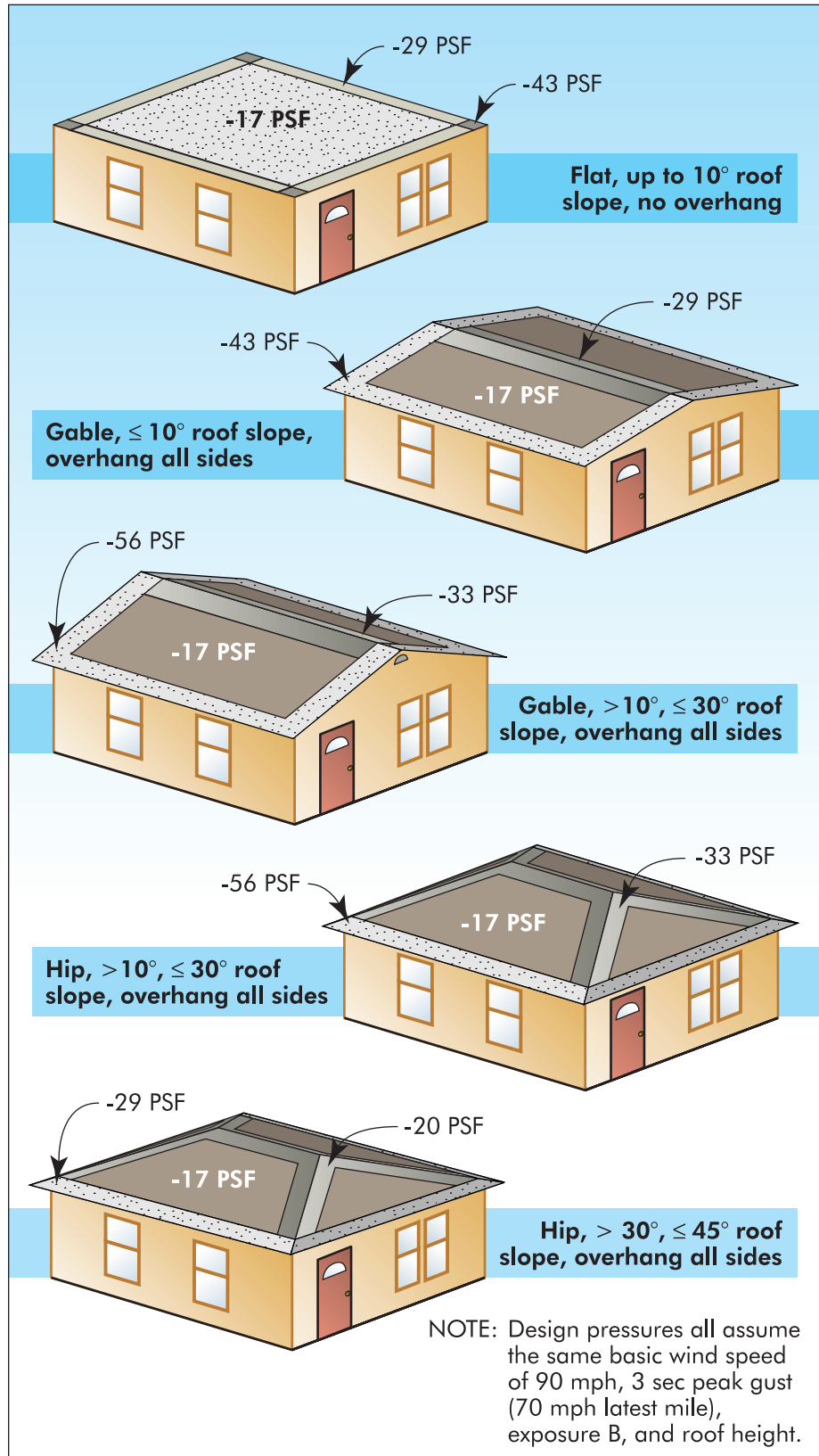

However, hip roof systems are generally stronger than gable roofs because of the bracing that is imported by their construction.

7.1.1.2 Increased Load Caused by Breach of Envelope

BPAT inspections of wind-induced damage to residences indicate that internal pressurization is a major contributor to poor building performance under weak to strong wind loading conditions. Field observations provided strong evidence of partial and total roof and exterior wall failures that may have been initiated by breaches in the building envelope. These breaches lead to internal pressurization, significant load increases, and failures. The structural elements, roof and wall coverings, garage doors, entry doors, and windows that are exposed to strong or violent tornado vortex winds are not expected to survive. However, on the periphery of strong and violent tornado tracks and in the path of weak tornado vortices where the wind speeds were near or below design wind speed conditions prescribed in model building codes, the performance of these elements was less than expected. If the structural and non-structural envelope elements are suitably designed and tested to meet the wind loads derived from ASCE 7-98, and are appropriately installed, much of the damage on the periphery of strong and violent tornado tracks and in the track of the vortex of weak tornadoes would be significantly reduced. An exception is windborne missile-induced damage.

For residences, a significant contributor to catastrophic failures due to internal pressurization appeared to be the failure of single skin, non-insulated, and non-reinforced double width garage doors. Breaches of windows and entry doors also caused significant damage to the residential building through internal pressurization. However, where wind speed and direction did not produce high local loads on the building, the breach of a window or door might not be as dramatic as that associated with a larger breach such as a garage door. Preliminary investigations determined that most garage doors were not rated or tested for wind pressures calculated from the design wind speeds indicated in the current 1995 CABO One- and Two-Family Dwelling Code. Although this code does not specifically address designing garage doors and other architectural finishes for the wind speeds prescribed in the code, if these doors had been designed for the design wind speed indicated, damage in the inflow areas of the weak and strong tornadoes might have been significantly reduced.

7.1.1.3 Roof and Wall Coverings

The observed wind performance of T-lock asphalt shingles was not significantly better than that of three-tab or laminated strip asphalt shingles. Wind-induced damage to T-lock shingles was observed on roofs that were likely exposed to wind speeds that were in the range of design conditions (i.e., 70-80 mph fastest mile sustained or 90-mph 3-second peak gust).

Vinyl siding offered very limited resistance to low-energy windborne missiles. The vinyl siding investigated also offered limited wind load resistance. Although the nailing patterns were erratic and the distance between nails was relatively large, it is difficult to envision that the investigated products had sufficient strength to meet the wind loads derived from the 1997 UBC, 1996 NBC, 1997 SBC, or ASCE 7-98.

7.1.1.4 Masonry Veneer

The BPAT observed extensive brick veneer loss in homes of all ages, indicating inadequate composite action caused by a failure of the brick ties. Masonry veneer and framed walls should provide some level of composite action to resist wind forces, even though this is not considered explicitly in design. However, to act as a composite section, the connection between the veneer and backup wall (normally galvanized steel brick ties) needs to be maintained. Extensive brick veneer loss in homes of all ages indicates a failure of the brick ties, a failure of the nailing of the ties to the wood framing, or failure of the mortar bond to the ties. Even though some walls appeared undamaged, they could be deflected with hand pressure.

Many of the failures observed stemmed from brick-tie to mortar bond failure. In a majority of cases of masonry veneer loss, either corrugated or scalloped-edge galvanized steel brick ties remained attached to wall studs with one 6d common nail (withdrawal load = +/- 30 lb times a safety factor of 4 or 5), when a rigid insulation board was used as wall sheathing. The bond between mortar and brick tie was often not sufficient to even exceed the withdrawal capacity of the tie nail. Therefore, there was inadequate bond between mortar and brick tie to resist the wind forces experienced. The 1995 CABO One- and Two-Family Dwelling Code specifies that the maximum horizontal spacing of brick ties is 24 in on center, and each tie shall support not more than 3.25 sq. ft of wall area. At the code-required spacing to support 3.25 sq. ft, the maximum wind suction pressure on the veneer prior to failure could not have exceeded 37 psf, unless the rigid brick facing failed prior to the deflection required to allow the brick tie to develop its full capacity.

There were a few instances of nail pull-out at brick ties fastened to wall studs. Therefore, in these cases, the wind suction pressure exceeded the withdrawal strength of the one nail holding the brick tie. Causes of failure could be insufficient nail length or diameter, low withdrawal resistance, or ties having too high a tributary area. There were many instances of brick ties spaced at greater distances than stated in the building codes. Proper connection of brick masonry to a wood frame wall system is shown in Figure 7-2.

The 1995 CABO One- and Two-Family Dwelling Code also requires that if sheet metal ties are used, they shall not be less than No. 22 U.S. gauge by 7/8 in corrugated. The most common form of tie was a 7/8-in wide galvanized steel strip with a 1/4-in deep scalloped edge on each side (steel strip was 3/8 in wide, with very minor corrugation less than 0.5 mm). There was

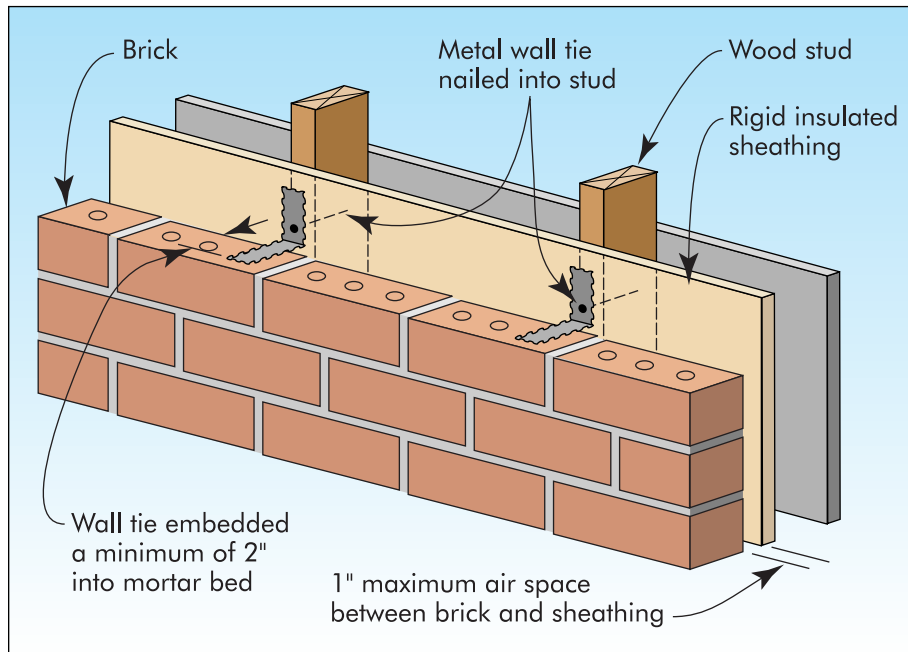

FIGURE 7-2: Illustration of a proper connection of brick masonry to a wood frame wall system.

notable absence of compliance with these specifications in what could be considered a random sample of homes impacted by the tornadoes.

Because failures of brick masonry veneer were found at homes from less than 1 year old to over 20 years old, mortar bonding strength did not seem to vary with age. There were several instances of loose brick on the ground with no mortar attached or only attached to one side. Mortar bond strength was inadequate to bond bricks together and to bond mortar to brick ties to resist negative (suction) wind pressures experienced. Some possible causes could be from a weak mortar mix, a too dry mortar, or use of low porosity brick.

There were several instances where an air space between brick veneer and plastic foam insulation sheathing was 1.5 in or more, which reduced embedment length of brick ties in mortar joints to 1 in or less. Some model building codes specify 1-in maximum air space or grouted space, and 1.5 in minimum embedment of brick tie into mortar.

The BPAT observed masonry chimneys that had fallen on roofs causing considerable damage to houses that otherwise had very minor wind damages. This damage placed the occupants of the house at a significant risk of death or injury from falling masonry debris. Calculations performed by the BPAT indicated the wind speeds necessary to cause the chimney failures were as low as 75-85 mph (fastest mile).

7.1.2 Manufactured Housing

The design and construction of manufactured housing has been governed since 1976 by Federal preemptive standards that are enforced by the U.S. Department of Housing and Urban Development (HUD) under Federal Regulation and through a Monitoring and Enforcement Contractor, the National Conference of States on Building Codes and Standards (NCSBCS). Recently, the HUD Standard has been placed under a consensus process administered by National Fire Protection Association (NFPA).

Wind resistance standards for manufactured housing differ from and are less than model building code provisions and standards for conventional site-built and modular or panelized construction. Minimum wind pressures for design of all homes located outside of hurricane coastline areas are 15 psf for horizontal wind loads and 9 psf for net uplift load (equivalent to about a 65-mph fastest-mile wind speed, less than the 70-mph fastest-mile wind speed specified in the CABO One- and Two-Family Dwelling Code, and less than the 70-to 80-mph fastest-mile wind speed specified in the 1997 UBC for this area of the country). Explicit engineering or test-based performance provisions require a minimum safety factor of 1.5 relative to these design loads. However, simplified design wind loads and the required safety factors do not consider the rare but significant overload that may occur due to inflow winds of violent and strong tornadoes or direct strike by the vortex of weak tornadoes. Design loads are primarily associated with the level of risk that is associated with extreme thunderstorm winds.

Installation and setup of manufactured housing, including foundations, ground anchors, and strapping or cables, are enforced by state and local officials. The Federal standards only address the design of the overall anchoring and tie-down systems and require that they be designed by a qualified professional.

In general, manufactured housing did not resist wind forces as well as conventional site-built detached single-family dwellings for inflow winds of violent and strong tornadoes and vortex winds from all tornadoes. This was primarily because of inadequate fastening of roof systems to wall systems and inadequate resistance to uplift and overturning provided by anchorage and tie-downs. An exception to this was the observed improved performance of newer manufactured home especially double-wide models that had been installed on permanent foundations.

7.1.2.1 Foundations

Permanent foundations performed better in resisting lateral wind loads than did ungrouted and unreinforced CMU piers having wood leveling shims under the chassis beams. However, the BPAT observed that connections of chassis and perimeter joists to permanent foundations were inadequate to resist the moderate wind uplift and overturning forces generated at the periphery of

most tornado tracks investigated. It is difficult to make positive connections between the units and the non-permanent foundations. Furthermore, these connections are difficult to inspect once the units are installed. In addition, local building officials who were interviewed by the BPAT did not seem to be aware of manufacturers' installation or setup instructions with specific connection requirements for permanent foundations.

7.1.2.2 Anchors

Depths and locations of helical ground anchors and soil conditions varied considerably from site to site. Ground anchors pulled out of the soil because of inadequate depth, or steel anchor shafts bent over from lateral wind forces, thus leading to failure of the superstructure. Some ground anchors were installed at an angle with the base under the home, leading to bending of the shaft from lateral wind forces. Thus, deformation of the anchor and strapping arrangement could allow significant movement (vertically and horizontally) prior to developing substantial resistance to wind loads. Most observed ground anchors did not appear to comply with requirements of the Federal Manufactured Home Construction and Safety Standards (MHCSS), which state the following:

“Sec. 3280.306(f) Anchoring equipment shall be capable of resisting an allowable working load equal to or exceeding 3,150 pounds and shall be capable of withstanding a 50 percent overload (4,725 pounds total) with out failure of either the anchoring equipment or the attachment point on the manufactured home.”

In 1994, the standard was revised to add Sec. 3280.306(b)(2) For anchoring systems, the instructions (provided by the manufacturer) shall indicate:

“(ii) That anchors should be certified by a professional engineer, architect, . . . as to their resistance, based on the maximum angle of diagonal tie and/or vertical tie loading . . . and angle of anchor installation, and type of soil in which the anchor is to be installed; (iv) That ground anchors should be installed to their full depth, and stabilizer plates should be installed to provide added resistance to overturning or sliding forces.”

7.1.2.3 Strapping

Galvanized steel strapping in several instances failed in tension from wind uplift and overturning forces, or became loose when the home moved laterally from wind forces. An example of a properly restrained chassis member is shown in Figure 7-3. In addition, connections of strapping to chassis beams often came loose and were on the ground, and there was no positive bolted or welded connection. The apparently premature failure of these ties was related to the number of ties, location of first ties from end of

FIGURE 7-3: Illustration of a proper connection of a manufactured home to a dry-stacked CMU foundation using straps only; L-clips are not illustrated here.

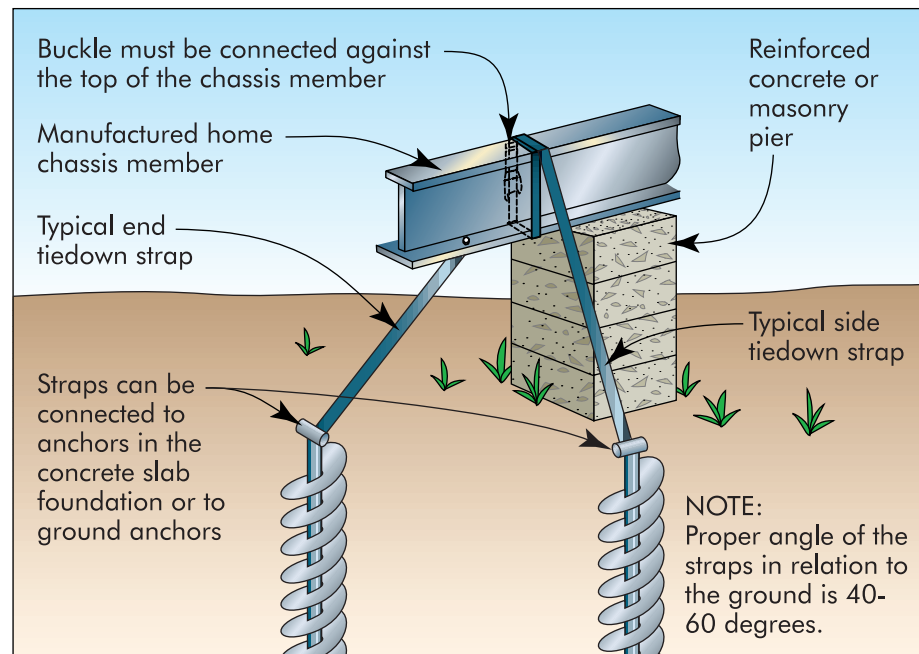

chassis, and tensile strength or ductility of steel. Several of the following provisions of the Federal MHCSS appeared to not be consistently complied with, possibly leading to failure:

“Sec. 3280.306(c)(1) The minimum number of ties required per side shall be as required to resist the design loads . . .”

(2) Ties shall be evenly spaced as practicable along the length of the manufactured home with not more than 8 feet open-end spacing on each end.” (This provision was revised in 1994 to require not more than 2 feet open-end spacing on each end.)

The current material specification for manufactured home strapping “Strapping, Steel, and Seals, with Notice #1 and Amendment #2, only Type 1, Finish B, Grade 1 of the plating/coating sections,” was Federal Spec. FS QQ-S-781H-1974 with 1977 amendments. (This was revised in 1994 to “Standard Specification for Strapping, Flat Steel and Seals – ASTM D 3953-91”).

7.1.2.4 Superstructure

Generally, newer manufactured housing units, particularly multi-wide units on permanent foundations, resisted straight-line inflow wind forces better than older single-wide units. Newer units are generally constructed of more conventional wall and roof framing, and connections between roof systems and walls, and walls to floors, provide load paths to transmit wind uplift,

lateral, and overturning forces to the foundations. Internal shear walls, and bolted or steel strapped floors and roofs of multiple units at marriage walls provide a stiffer three-dimensional structure. Additional attention, however, needs to be paid to the design of uplift straps from roofs to walls and walls to floors, and to bolting of units to permanent foundations, similar to conventional site-built home construction in tornado-prone areas.

7.2 Non-Residential Property Protection

Visual observations indicated that non-residential structures were, with few exceptions, as vulnerable to damage as conventionally built residential construction. Many non-residential buildings received structural damage as a result of a lack of capacity in the load path to resist wind-induced uplift loads. Observed damage, however, was typically not as complete or devastating for non-residential buildings that were exposed to similar vortex winds of violent and strong tornadoes as that observed in residential construction. This was primarily due to the engineering that is required by model building codes for non-residential buildings and that is not typically required for one and two family residential buildings.

Non-residential construction in Oklahoma is currently required to be designed per 1996 NBC and non-residential construction in Kansas is designed per the 1994 and 1997 UBC, depending upon local jurisdiction. Although local municipalities have adopted some amendments, these amendments were not significant relative to the structural issues discussed in this report. For current construction, these model building codes provide guidance for loads other than gravity loads. However, engineering standards such as ASCE 7-98 provide better structural and non-structural guidance for determining design wind loads than these newer model building codes. Although designing for tornadic wind events is not specifically addressed in any of these newer model building codes or standards, constructing non-residential buildings to these codes and standards would improve the strength of the buildings. Building to ASCE 7-98 would have reduced or minimized damage in areas that were affected by the inflow winds of all tornadoes and reduced the damage observed where vortices of weak and possibly strong tornadoes impacted non-residential construction.

7.2.1 Load Path

Although non-residential construction is currently designed to specifically consider some wind load resistance, in many cases, a lack of attention to uplift and lateral loads resulted in failure to provide a continuous load path and greatly increased damage to the buildings. In many cases, structural damage would have been reduced if adequate uplift resistance had been provided to steel roof joists and metal roof deck systems. Additional resistance to uplift could have significantly reduced damage to engineered con-

struction on the periphery of strong and violent tornadoes or in the vortex of a weak and possibly strong tornado track.

Continued construction with materials such as URM that is capable of carrying gravity loads, but unable to carry uplift loads, will continue to lead to wall and roof failures during moderately high wind events. Better attention to the design of and selection of materials for connections throughout the structural system will also minimize and reduce the number of failures that are currently observed in non-residential construction after moderately high wind events such as along the periphery of strong and violent tornadoes or in the vortices of weak and possibly strong tornadoes.

After roof decking and other parts of the structure were blown loose by the wind, these pieces became windborne missiles that created additional damage to nearby structures. Greater attention to attachment of perimeter wood nailers, copings and metal edge flashings, and perimeter attachment of metal roofing panels will enhance performance of roof coverings and reduce the debris on the periphery of strong and violent tornadoes and in the vortices of weak tornadoes.

7.2.2 Increased Load Caused by Breach of Envelope

The BPAT observed that the failure of commercial rollup (overhead) doors, depending on their location, may initiate or contribute to major failures of primary structural systems. Observations suggest that overhead doors failing near building corners may significantly contribute to catastrophic failures of exterior walls and roof systems. This is particularly true for pre-engineered metal (light-steel frame) buildings that typically have little redundancy in their load transfer paths. For buildings that have several interior rooms or partitions, the propagation of internal pressures may be hindered and collateral damage to exterior walls minimized.

Breach of the building envelope was observed to result in extensive collateral damage to non-residential buildings. Garage doors and large windows were particularly vulnerable. All garage and rollup doors should have adequate strength to resist wind loads derived from ASCE 7-98, which provides design guidance for determining wind loads on non-structural elements such as garage doors and windows. Also, owners of buildings that use EIFS for exterior walls should be advised by the building designer that, although the wall has the appearance of concrete, it offers minimal resistance to high wind pressures and windborne missiles unless the EIFS is installed over concrete or reinforced CMU.

To reduce the number of windborne missiles generated from roofs on essential facilities (e.g., hospitals) and buildings such as schools, aggregate and paver surfacing should not be used. Aggregate and paver surfacing can

be picked up by winds and cause injury or death and significant damage to architectural finishes, windows, and doors.

Protection of windows from wind pressures and windborne debris was not extensively investigated by the BPAT. However, it is important to consider protecting glass in essential facilities. Laminated glass and shutter protection systems can offer substantial protection from modest-energy windborne missiles. Laminated glass has the potential to offer significant occupant protection along the periphery of strong tornado tracks and in the vortex of weak tornadoes and is a permanent protection device that does not need warning time to be installed, which can be a problem with many storm shutter systems.

7.3 Personal Protection and Sheltering

The best way to reduce loss of life and minimize personal injury during any tornadic event is to take refuge in a specifically designed tornado shelter. Although improved overall construction may reduce damage to buildings and contribute to safer buildings, an engineered shelter is the only means of providing individuals with near absolute protection from strong and violent tornadoes.

7.3.1 Residential Shelters

The residential shelters observed by the BPAT included aboveground in-residence shelters and storm cellars. Although the aboveground in-residence shelters provided safety for the occupants, no direct windborne missile strikes were recorded on the shelter doors that the BPAT was able to locate and visit. The doors observed were light gauge hollow metal with a single deadbolt locking device, which is less than the 14 gauge hollow metal door held by three hinges and three deadbolts, as required in *FEMA 320: Taking Shelter From the Storm: Building a Safe Room Inside Your House* (see a summary in Appendix C) and *FEMA's National Performance Criteria for Tornado Shelters* (see Appendix D).

Assuming proper construction and location outside flood-prone areas, storm cellars offered safety during severe wind events. Observed problems with storm cellars included lightweight doors and hardware, poor maintenance, and unprotected ventilators. Storm cellars are typically not fully waterproofed and, therefore, can be damp, musty environments with poor ventilation. Ventilators were not constructed of heavy gauge steel or protected by heavy gauge shrouds or saddles that would have prevented their removal by windborne debris or extreme winds during a tornado, allowing the subsequent entrance of free-falling missiles and debris through the remaining openings in the shelter roof.

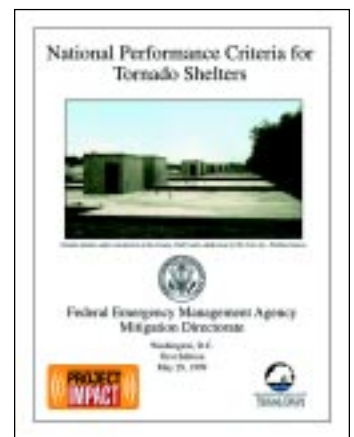
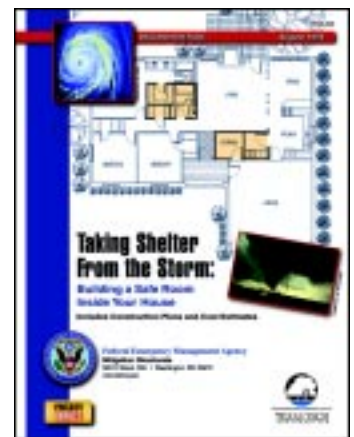

7.3.2 Group Shelters

The BPAT observed group shelters at a manufactured housing rental development and at a plastics manufacturing plant in Haysville, Kansas. A rental development of manufactured homes provided shelters at a rate of one shelter per four homes. Shelters were located in close proximity to the homes and were accessible by the occupants, but none of these shelters were easily accessible to persons with disabilities. All group shelters were below or partially below ground and required access by stairs.

The group shelter at the plastics manufacturing plant functions daily as a conference room and lunchroom. On May 3, 1999, it performed its third function as a tornado shelter. Although the building housing the shelter was not significantly damaged (one area suffered roof damage), other buildings that are part of the plant complex suffered substantial damage. The workers at the plant when the tornadoes struck and who were able to utilize the shelter were uninjured.

7.3.3 Community Shelters

The BPAT observed two community shelters that were utilized during the May 3 storm. One shelter was located in a manufactured housing park in Wichita, Kansas. The second shelter was located in Midwest City at the Midwest City High School gymnasium. Both were partially belowground shelters and suffered from problems of moisture infiltration, mustiness, poor ventilation, and poor exterior doors and hardware. Other concerns common to community shelters include travel time required to access the shelter, accessing the shelter when the shelter is locked, accessibility for persons with disabilities (ADA compliance), and rules for gaining admittance.

7.3.4 Other Places of Refuge

Not all buildings, residential or non-residential, have designated tornado shelters or staffs with tornado plans for implementation during an event. Subsequently, in buildings without designated shelters or places of refuge, occupants are left on their own to identify places of refuge appropriate in a tornado event. The observations of the Oklahoma and Kansas tornadoes, as well as other tornado events, indicate that small interior rooms within buildings often survive when the other portions of the building are destroyed. Rooms such as closets beneath staircases, small bathrooms, or other small interior rooms are the preferred place of refuge when no hardened shelter is provided in the building.

Basements can also offer another alternative place of refuge. However, basements demonstrated vulnerability from windborne missiles through windows, window wells, and through the wood floor/ceiling structure. Although not observed in this storm event, previous observations have shown

unreinforced basement walls collapsed as the result of the floor/ceiling diaphragm displacement by the winds of the tornadoes.

The BPAT visited public use facilities during the field investigations to determine how these facilities addressed tornado threats that affect the users of the facilities. The team interviewed staff at schools, day-care centers, nursing homes, and churches, and found that not all public use facilities had a formalized tornado emergency refuge plan. Additionally, not all public facilities had a NOAA weather radio in continuous operation to monitor storm events that may lead to a tornado. When tornado plans were implemented by a facility, these plans were often not conspicuously posted and the plans were not always exercised as drills so building occupants could become familiar with the plan. It is unclear whether all plans allow sufficient time for the building occupant type (e.g., children, elderly, etc.) and if the shelter had adequate capacity for the quantity of building occupants and others who may attempt to seek shelter in the planned place of refuge.

The BPAT also observed a significant number of destroyed cars and trucks in the debris of the tornadoes in Oklahoma and Kansas. Cars and trucks do not provide a safe refuge from the winds of any tornado and should not be used as a shelter.

8 Recommendations

The recommendations contained in this report are based solely on the BPAT's observations and conclusions. These recommendations are intended to facilitate future personal and property protection from tornadic wind events.

8.1 General Recommendations

The May 3, 1999, tornadoes were disastrous in terms of lives lost and property destroyed, but this disaster comes the opportunity to reflect on what is important in peoples' lives. As a result of these reflections, Oklahoma and Kansas communities can commit to planning for future tornadoes through promoting sustainable construction and tornado-resistant communities.

As the people of Oklahoma and Kansas rebuild their lives, homes, and businesses and plan for future economic development, there are several ways they can reduce the effects of future tornadoes, including:

- Design buildings to the most current building codes and engineering standards that provide greater protection against tornado-generated winds or, at a minimum, improve compliance with existing codes.
- Provide safe refuge in the event of a strong or violent wind storm or tornado in the form of engineered shelters.

More specific recommendations are included in the following subsections. Mitigating future losses, however, will not be accomplished by simply reading this report; mitigation is achieved when a community actively seeks and applies methods and approaches that lessen the degree of damage, injuries, and loss of life that may be sustained from future tornadoes.

8.2 Property Protection

Property protection recommendations have been divided into subsections on residential and non-residential building considerations, codes and regulations, and voluntary actions.

8.2.1 Residential and Non-Residential Buildings

Proper construction techniques and materials must be incorporated into the construction of buildings to reduce their vulnerability to damage during moderately high wind events. Existing construction techniques proven to minimize damage in wind-prone areas such as coastal areas subject to hurricanes are not always being utilized in areas that are subject to tornadoes. Construction must be regulated and inspected to ensure that buildings meet the most current model building code requirements.

It is recommended that, for engineered buildings, the engineer review structural connections to ensure adequate capacity for design uplift and lateral loads that may be in excess of loads based on the building codes currently in effect. To address the issues of construction that may be mitigated to improve building performance, the following recommendations are provided:

- Sheathing areas of discontinuity should be fastened in a manner that will resist design uplift forces with a factor of safety over the design wind pressure stipulated in applicable building codes and standards. Some current building codes reflect an increased fastener size intended to address high wind areas.
- The brick masonry industry should consider re-evaluating attachment criteria of brick veneer, specifically regarding product usage. Greater emphasis should be given to code compliance for the bond between the mortar and brick ties, the mortar and the brick, and to the spacing of brick ties.
- Garage doors are an extremely important residential building component. Failure of these doors led to catastrophic progressive failures of primary structural systems that could have been significantly reduced in areas other than those impacted by violent and strong tornado vortices. New garage doors should be manufactured to comply with design wind loads using a safety factor of 2. Retrofits should be made to improve the wind resistance of existing garage doors, particularly double-wide garage doors. Figures 8-1, 8-2, and 8-3 present retrofit measures that have been successfully implemented in Florida after Hurricane Andrew. Use of these retrofits and installation of new reinforced doors should better resist wind forces and, as a result, reduce the type of roof and wall damage that was observed in homes that experienced garage door failures.

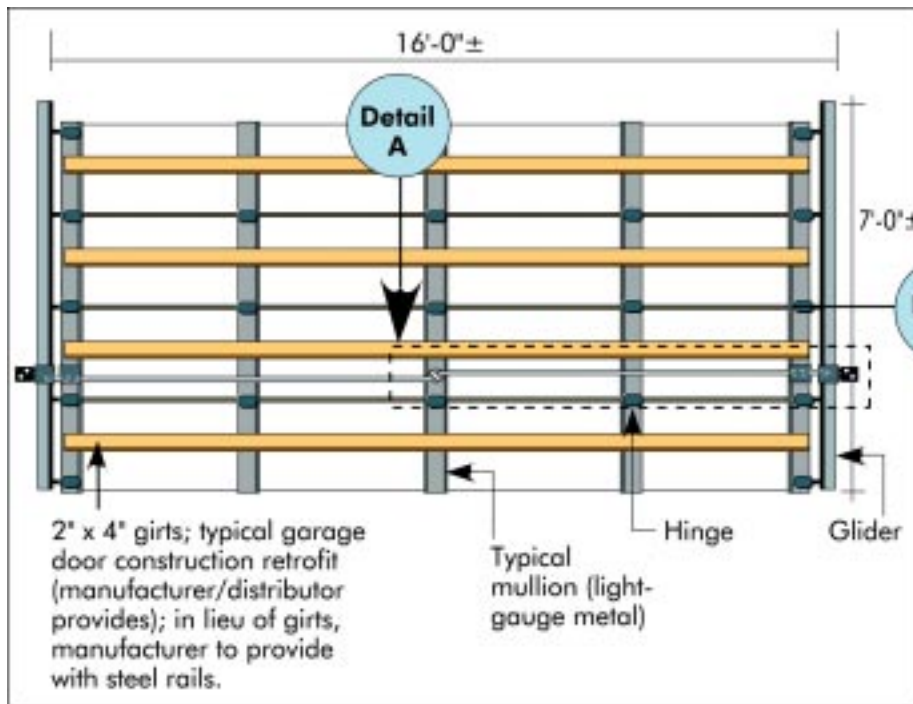

FIGURE 8-1: Typical double-wide garage door elevation.

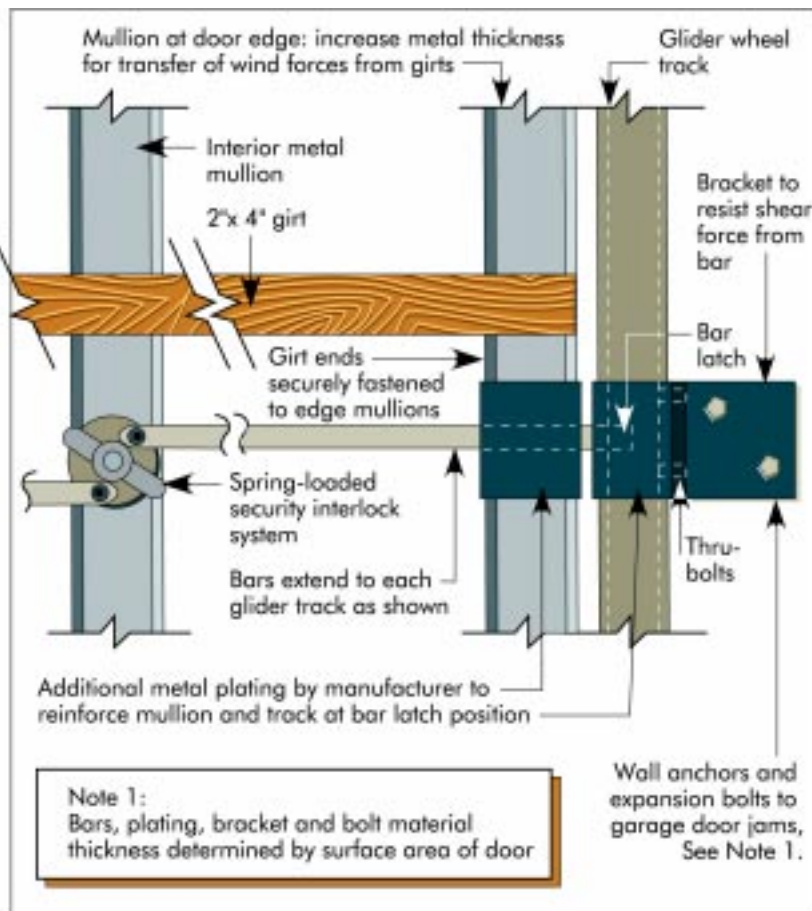
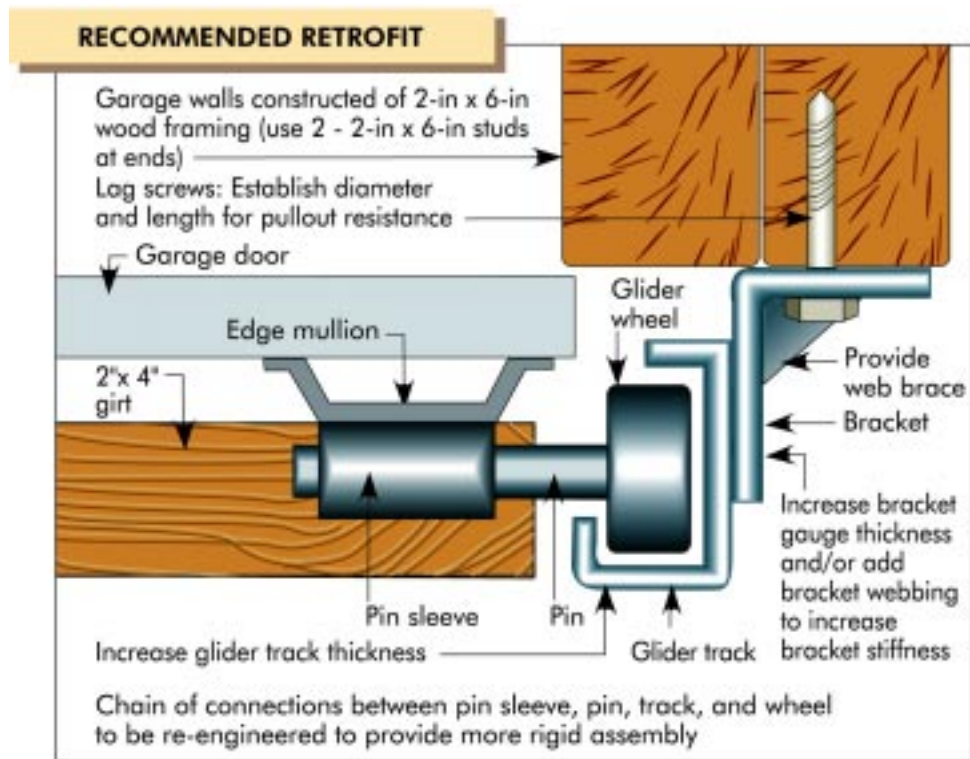

FIGURE 8-2: Detail A from Figures 8-1 and 4-19. Recommended reinforced horizontal latch system for garage door.

FIGURE 8-3: Detail B from Figures 8-1 and 4-19 illustrating recommended improvements to the garage door track.



- The Federal Government (HUD) should review its standards and enforcement program in an effort to improve the performance of manufactured homes in moderately high wind events, such as in inflow areas of strong to violent tornadoes and the vortices of weak tornadoes. Specifically, the capacity of anchoring and strapping equipment and systems needs to be evaluated to eliminate the discontinuity between the Federal standard and the state and local installation and enforcement process.
- Consideration should be given to permanently connecting the manufactured home unit to its foundation. The BPAT observed newer double-wide manufactured homes on permanent foundations and did not see significant differences in damage between these manufactured homes on permanent foundations and conventionally built houses. The double-wide manufactured homes on permanent foundations performed better than both double-wide and single-width units on non-permanent foundations.
- For non-residential buildings, the BPAT recommends using threaded fasteners to attach metal decking to itself and to supporting frames. In many of the roof system failures observed by the BPAT, welds were insufficient to carry loads and weld failures were common.

- To reduce the number of windborne missiles generated from roofs on essential facilities (e.g., hospitals) and buildings such as schools, aggregate and paver roof surfacing should not be used.
- Enhanced wind design for the roof coverings on essential facilities should be considered for those facilities located in tornado-prone areas.
- When used in areas with a high probability of being hit by a tornado, reinforced concrete and partially reinforced masonry should have adequate ties to foundations and roofs. Ties between concrete and other materials should be made with drilled-in fasteners or cast-in-place fasteners (Figure 8-4).
- Diaphragm action to resist shear forces must be maintained and reinforcement must be properly placed in concrete and masonry walls to reduce the possibility of collapse. Masonry walls should be engineered and constructed to support the specific architecture of the building (i.e., exterior wall panels, parapets, and decorative finishes).

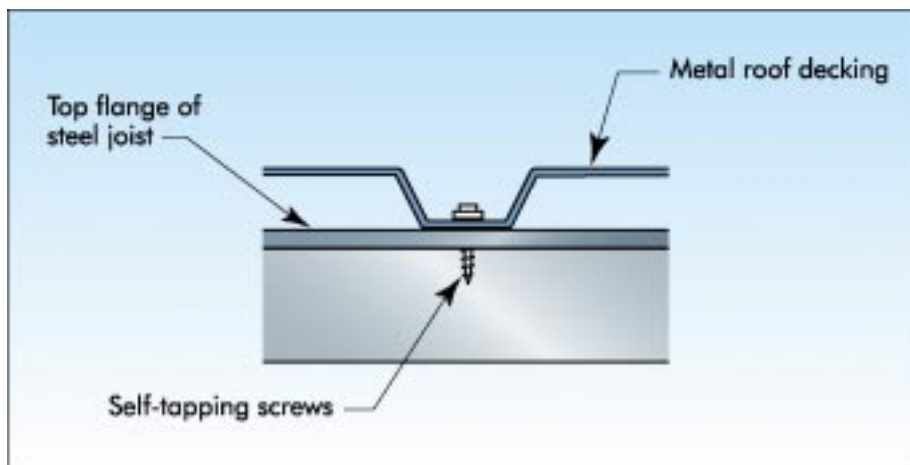

FIGURE 8-4: *Illustration of a proper screw-type or drilled-in connection.*

- Precast concrete buildings should have anchors to prevent the uplift of hollow core planks and other precast elements. Better performance would have been obtained if drilled-in expansion anchors or thru-bolts had been used to attach the walls to the floors. Use of powder-driven anchors to attach bottom plates of walls to concrete should be avoided unless they are very closely spaced to achieve sufficient pull-out resistance.
- A brick veneer wall system should be designed as a “stand alone” system or construction practices for brick veneer need

to be improved and changed so that a flexible connection between the framed wall and the veneer does not result.

- Ring or screw-shank nails are recommended to fasten brick ties to increase nail pull-out resistance.
- In areas subjected to high winds from either tornadoes or hurricanes, the BPAT recommends that for masonry chimneys that extend more than 6 feet above the roof or have a width of 40 inches or more, continuous vertical reinforcing steel be placed in the corners to provide greater resistance to wind loads. This reinforcing steel should be placed either to the requirements of the 1995 CABO One-and Two-Family Dwelling Code, Table 1003.2, Requirements for Masonry Fireplaces and Chimneys, for seismic zones 3 and 4 or to the requirements of the masonry fireplace provisions of the International Residential Code (IRC) when it becomes available in February 2000.
- Architectural features should be appropriately designed, manufactured, and installed to minimize the creation of windborne debris. To accomplish this, the local community may want to further regulate these features to ensure a reduction in potential debris materials.
- The installation of laminated glass in essential facilities should be considered because of the substantial protection that it offers from modest-energy windborne missiles. As a minimum standard, testing should be conducted in accordance with ASTM E 1886, based on load criteria given in ASTM E 1996.

8.2.2 Codes and Regulations, Adoption and Enforcement

To better address structural and architectural issues related to moderately high wind events, state and local governments should consider adopting the most current edition of a model building code. Other recommendations related to building codes and enforcement are provided below:

- The International Building Code (IBC) and the International Residential Code (IRC) should be adopted upon their release in February 2000. Although these codes do not directly address the threat of tornadoes, they address wind load issues using ASCE 7-98 for both non-residential and residential construction, respectively. Use of these codes in conjunction with ASCE 7-98 will reduce future losses from moderately high wind loads such as those associated with many tornadoes.

- As an interim step to adopting the IBC, Cities and appropriate local governments should adopt the 1997 UBC, the 1996 NBC, or the 1997 SBC, as the local building code as an interim step to adopting the IBC and IRC. Amendments that require calculation of wind loads via ASCE 7-98 should also be adopted. Currently, the 1997 UBC and 1996 NBC reference ACSE 7-95, but allow their own UBC/NBC methods to be used. It is important to note that wind calculations from the building code methods may result in lower loads than calculations from ASCE 7-95 for certain buildings and typically for components and cladding systems.
- As an interim step to adopting the IRC, State and local governments should adopt the 1995 edition of the CABO One- and Two-Family Dwelling Code for jurisdictions using previous editions of this code or having no residential code in place. This will provide some guidance for designing for wind loads.
- Greater emphasis should be given to code compliance, particularly for wall and roof covering wind loads and resistance. Homebuilders and code enforcement agencies should consider developing an active education and outreach program with contractors to emphasize the importance of code compliance for wind resistance.

8.2.3 Voluntary Actions

There are a number of voluntary actions that can be undertaken to reduce the risk of property damage in inflow areas of strong and violent tornadoes and in weak tornado vortices. Some of these are included in the following recommendations and are further illustrated in Figures 8-5 through 8-12.

- To improve tornado resistance, existing hurricane-resistant technologies (e.g., straps, clips, etc.) should be used to protect individuals, their property, and the buildings themselves.”
- The design of wood frame buildings should utilize connection devices such as anchors, clips, and straps to provide a continuous load path for all loads: gravity, uplift, and lateral.
- Simple roof geometries (e.g., hip and gable roofs with no dormers) should be used to simplify construction and reduce uplift loads.
- Similarly, other building types should utilize connection devices that provide a continuous load path for all loads: gravity, uplift, and lateral.

FIGURE 8-5: Illustrations of proper connections of wood frame construction to foundation slabs and walls. The first detail illustrates the minimum connection that should be used in areas with basic wind speeds not exceeding 90 mph peak gust. Alterations A-C illustrate connections that provide increasingly greater uplift resistance. * 1995 CABO One- and Two-Family Dwelling Code.

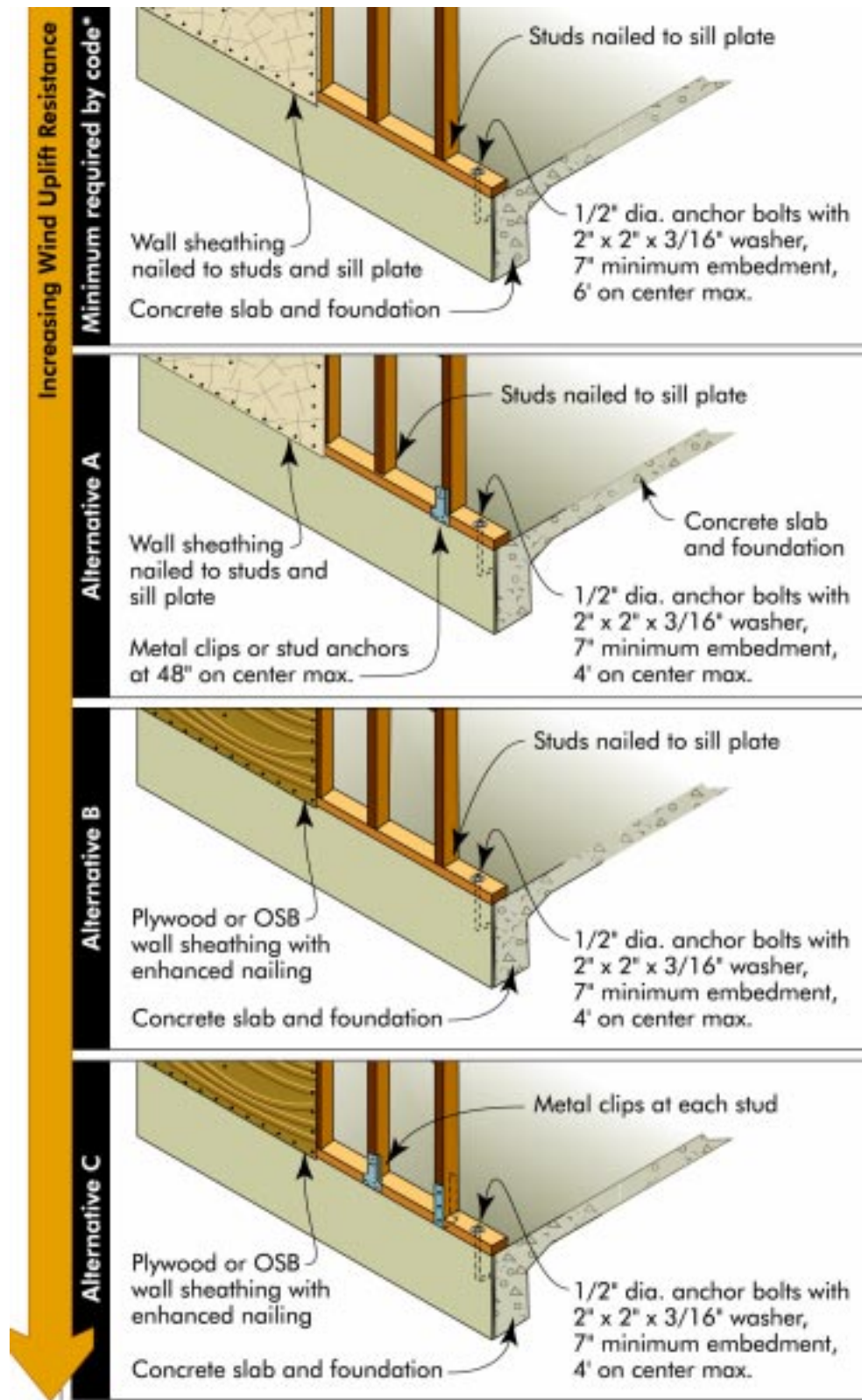

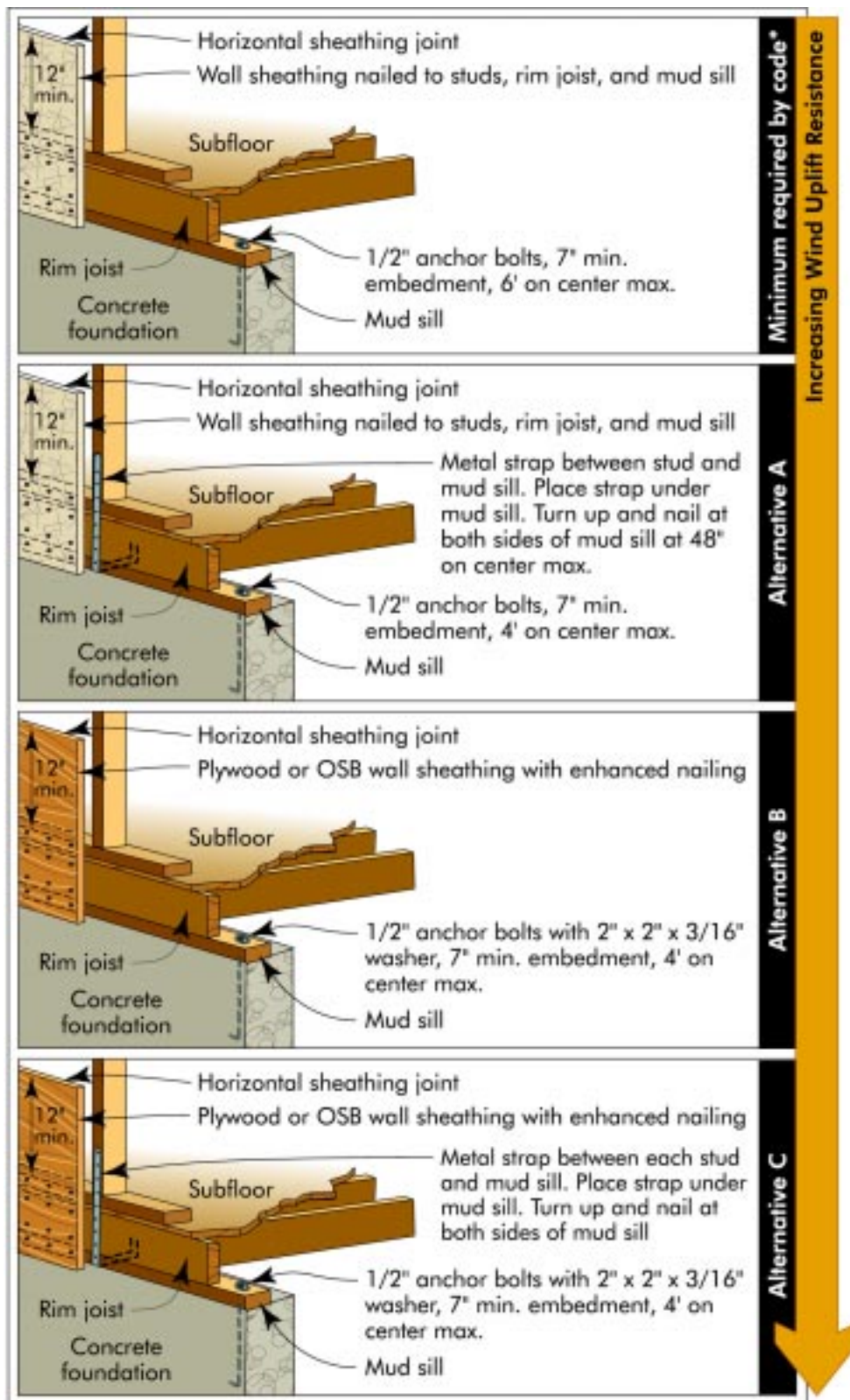
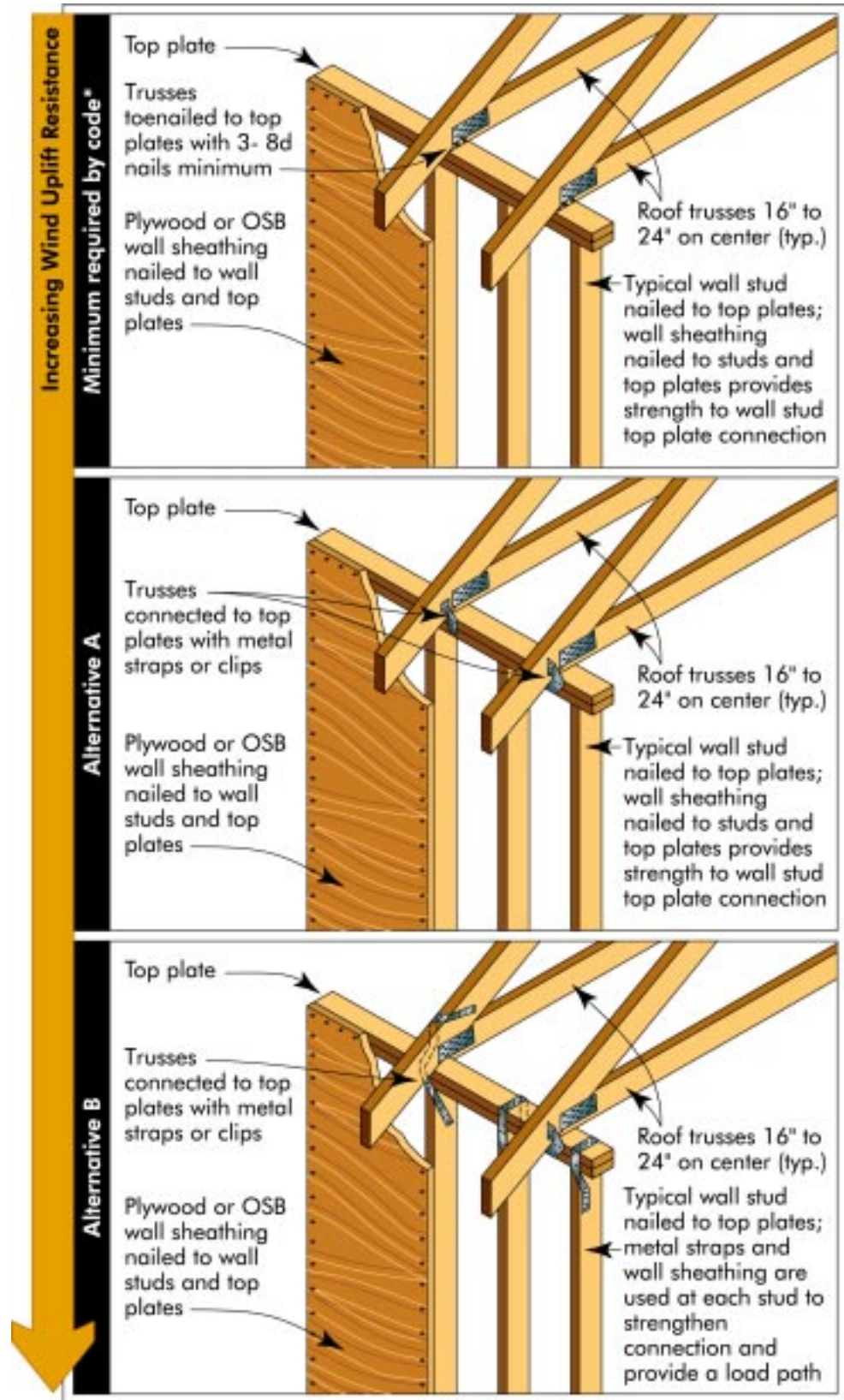

FIGURE 8-6: Wall connections at crawl space foundations. The first detail illustrates the minimum connection that should be used in areas with basic wind speeds not exceeding 90 mph peak gust. Alterations A-C illustrate connections that provide increasingly greater uplift resistance. * 1995 CABO One- and Two-Family Dwelling Code.

FIGURE 8-7: Roof truss to top-of-wall connection. The top detail illustrates the minimum connection that should be used in areas with basic wind speeds not exceeding 90-mph, 3 second peak gust (70-mph, fastest mile). Alternatives A and B illustrate connections that provide increasingly greater uplift resistance. * 1995 CABO One- and Two-Family Dwelling Code.



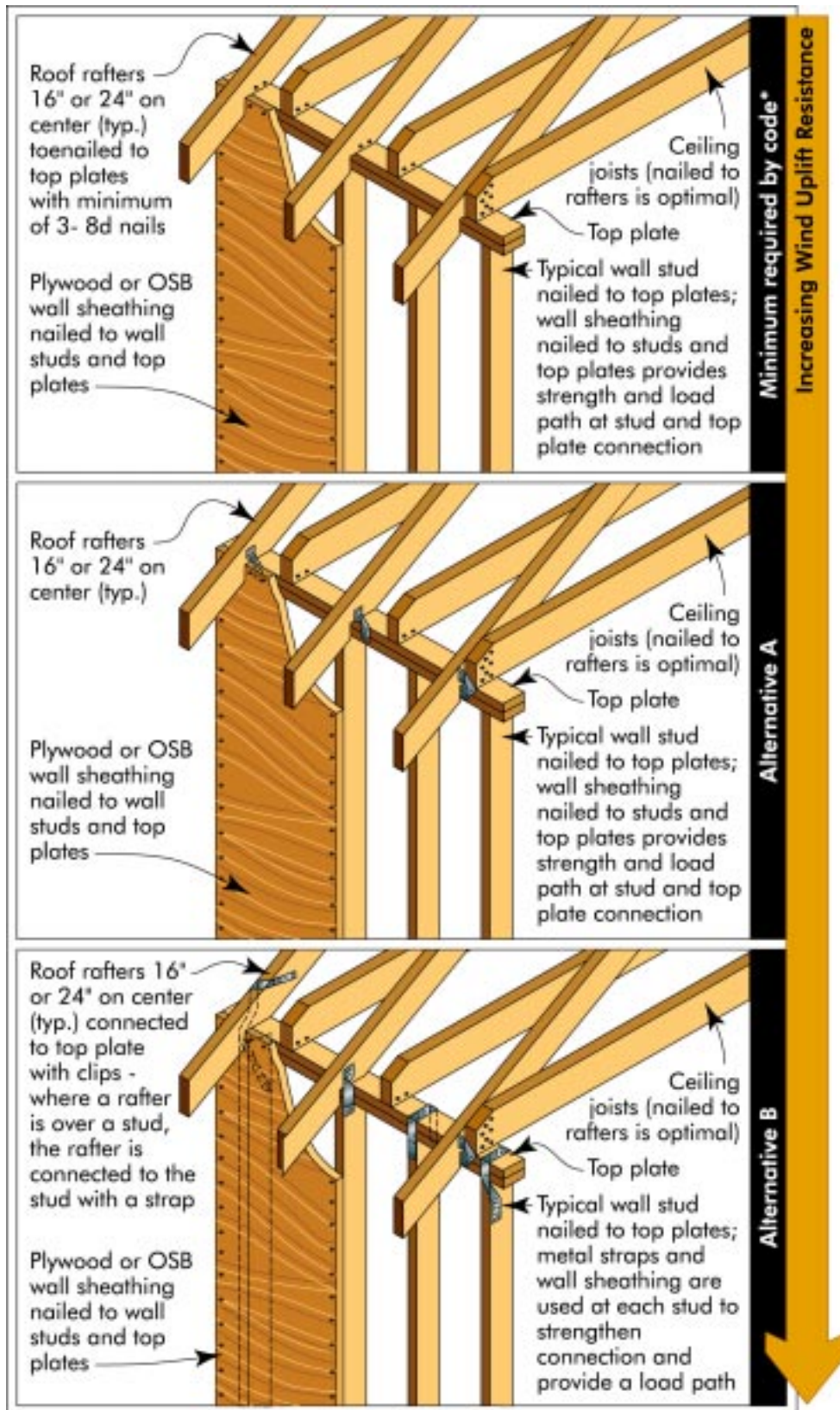
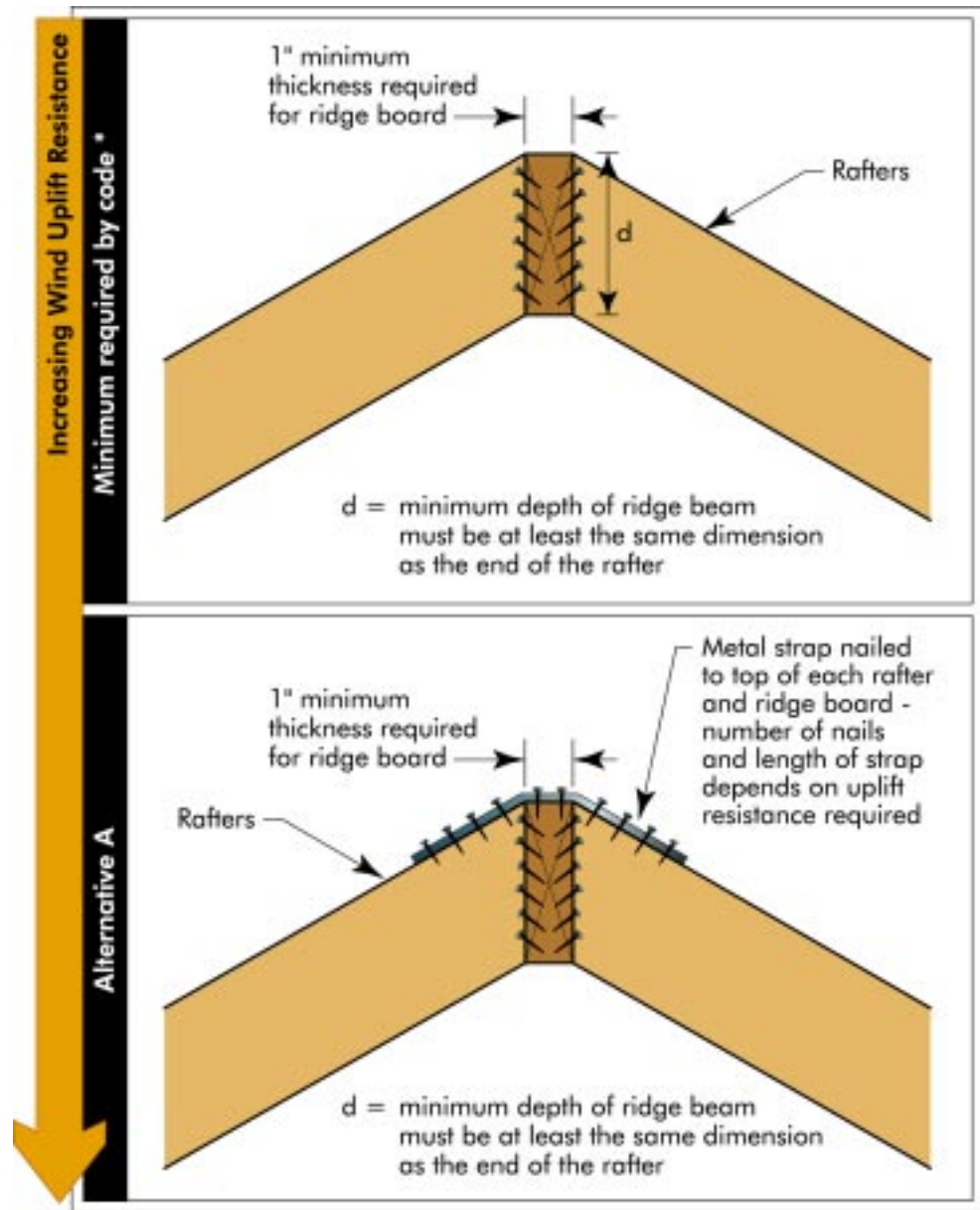

FIGURE 8-8: Roof rafter to top of wall connection. This connection is strongest when rafter is connected to ceiling joist as shown in this series of illustrations. The top detail illustrates the minimum connection that should be used in areas with basic wind speeds not exceeding 90-mph, 3 second peak gust (70-mph, fastest mile). Alternatives A and B illustrate connections that provide increasingly greater uplift resistance. * 1995 CABO One- and Two-Family Dwelling Code.

FIGURE 8-9: Roof rafters to ridge beam connection. The top detail illustrates the minimum connection that should be used in areas with basic wind speeds not exceeding 90-mph, 3 second peak gust (70-mph, fastest mile). Alternatives A and B illustrate connections that provide increasingly greater uplift resistance. * 1995 CABO One- and Two-Family Dwelling Code.



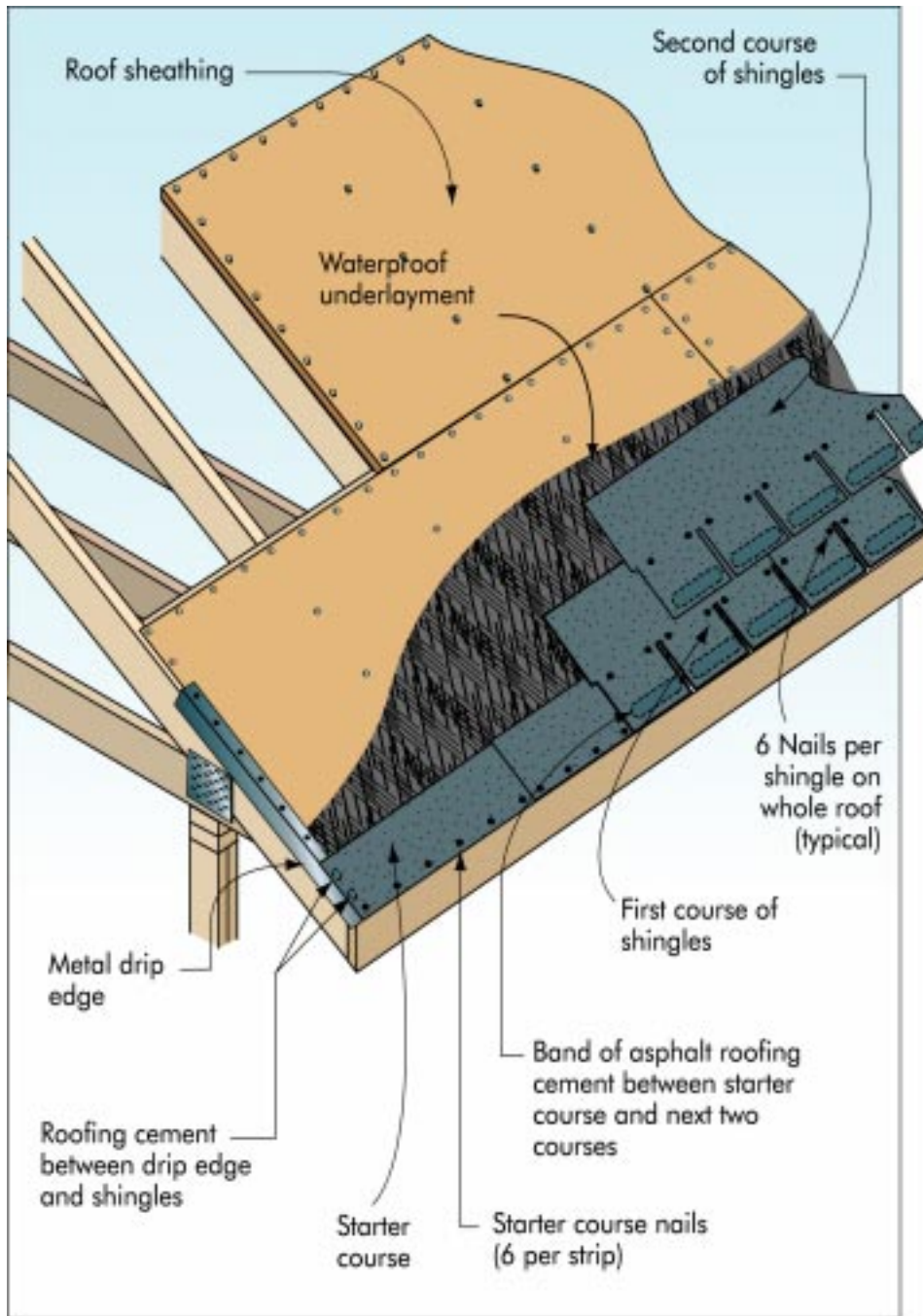
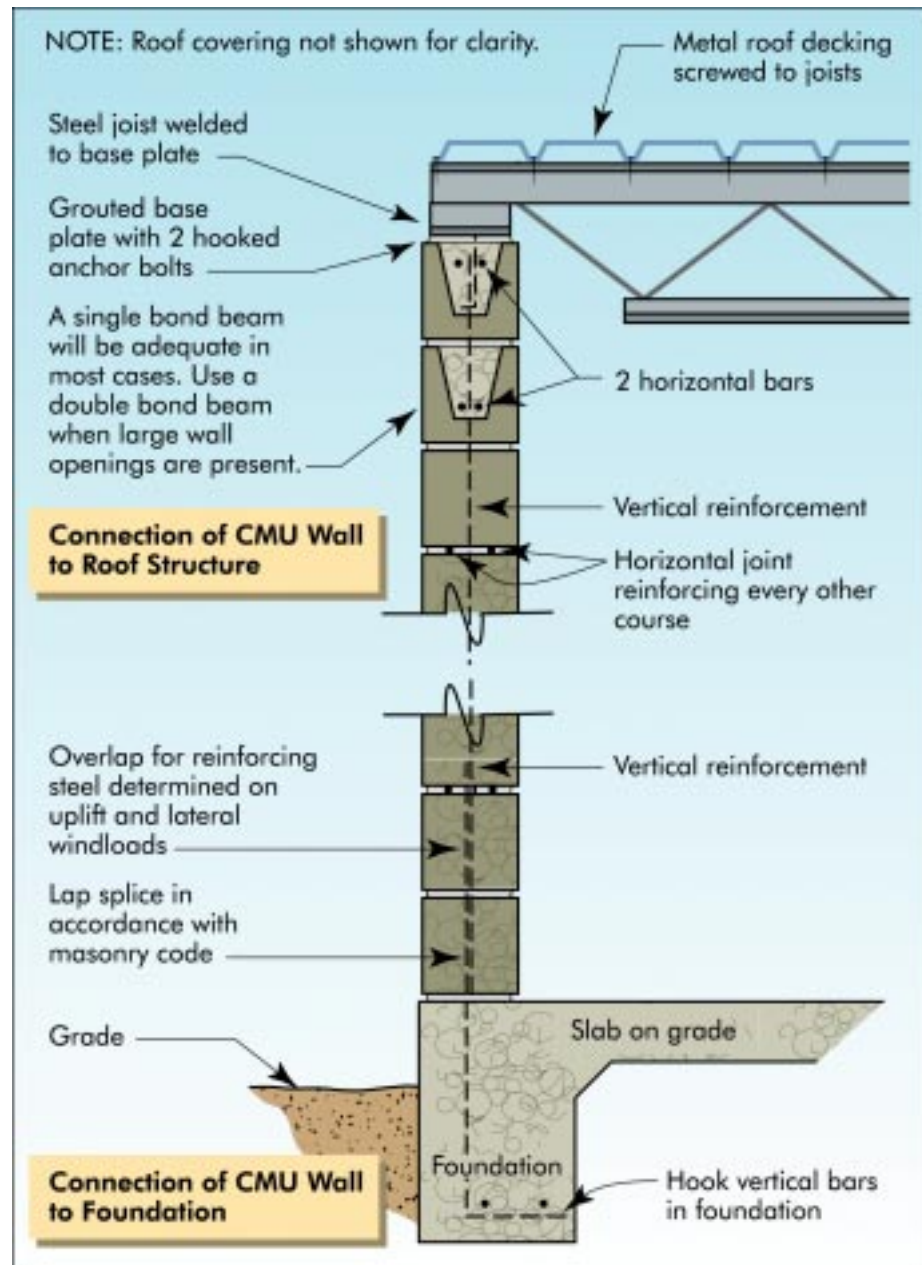

FIGURE 8-10: This illustration shows construction methods for asphalt roof shingle systems that provides improved resistance to uplift wind forces.

FIGURE 8-11: Proper connections in a reinforced masonry wall provide a continuous load path.



- Masonry walls that provide structural support to a building should be reinforced to resist gravity, lateral, and uplift loads.
- The model code organizations, in cooperation with the insurance industry and other interested parties should consider developing a wind speed map based upon probabilities, that demonstrates the increased risk associated with areas prone to high wind events such as tornadoes. This map could be based upon the research used to develop the wind speed risk

map in FEMA 320. Technical provisions provided with this new map could allow communities to identify their risk and decide if they would like to require higher design wind speeds.

- Communities should consider the need for adopting ordinances and regulations that promote disaster-resistant communities by incorporating tornado shelters into new construction and communities.
- Fire departments and Emergency Services agencies should make a list of addresses with shelters, to assist in checking after a tornado to see if people are trapped inside.

8.3 Personal Protection

Shelters are the best means of providing near absolute protection for individuals who are attempting to take refuge during a tornado. Whether a shelter is constructed by a homeowner for protection of his or her family or is constructed as a group or community shelter, all shelters should be designed and constructed in accordance with either FEMA 320: *Taking Shelter from the Storm* (Appendix C) or *The National Performance Criteria For Tornado Shelters* (Appendix D). At a minimum, shelter doors should be constructed of 14 gauge hollow metal and be held by three hinges and three deadbolts. Ventilators should be constructed of heavy gauge steel or protected by heavy gauge shrouds or saddles to prevent their removal by the storm and the entrance of debris through the remaining openings. Below-grade portions of the shelter should be waterproof. All shelters should provide access to persons with disabilities as necessary and in conformance with the ADA. Local officials must monitor the installation of shelters to ensure that the floors of all shelters are located at or above expected flood levels and shelters in seismic areas must be designed and constructed to be seismic resistant in accordance with up-to-date building codes and engineering standards.

8.3.1 Residential Sheltering

People should be encouraged to have in-residence or nearby shelters. Although this report advocates strengthening buildings to better resist high wind events, a shelter is still considered the only means of providing near absolute personal protection.

8.3.2 Group and Community Sheltering

The following recommendations are given regarding group and community shelters, and also address the reason people have congregated (i.e., residential, public areas, etc.):

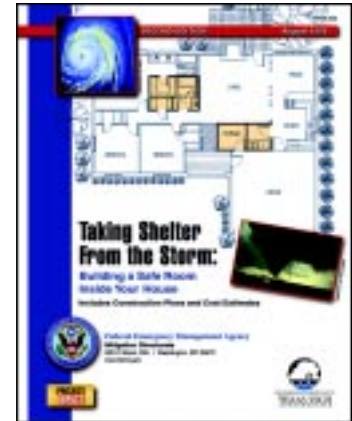

See summary in Appendix C

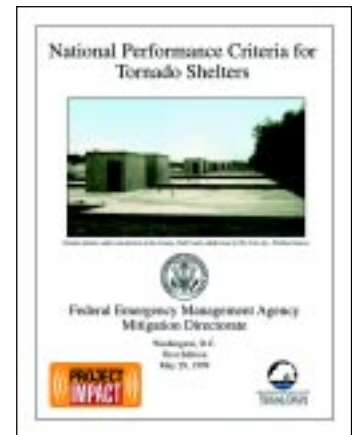

See Appendix D

FIGURE 8-12: Example of a tornado shelter provided in a place of business in Haysville, Kansas.



- Single-width manufactured homes on permanent foundations typically offer little protection from severe wind storms and tornadoes. In the event of such storms, occupants of manufactured homes should exit their homes and seek shelter in storm cellars, basements, or above-ground shelters. If shelters are provided in manufactured home parks, which is recommended, dispersed shelters, which can be accessed in a short time period, are recommended.
- Prospective occupants of community shelters should be acutely alert to storm warnings in order to allow sufficient time for the travel distance to the community shelter. Custodians of the shelter should be similarly alert so that the shelter is unlocked at appropriate times. Group and community shelters should be ADA compliant and the admission rules permanently posted (i.e. “No Pets Allowed,” etc.). A group shelter provided by an employer in Wichita, Kansas is shown in Figure 8-12.

- Essential facilities are critical to government response following a severe wind event or tornado. Site-specific evaluations should be made at essential facilities and other important facilities such as schools and daycare centers to determine the best locations for occupants during a storm. An assessment should be conducted to identify and provide signage to the designated refuge within or at the facility. The adequacy of the identified refuge to ensure people have a safe place to go and ample time to get there should be evaluated. Communities should consider enforcing this requirement by adopting an appropriate law or ordinance.
- Existing essential facilities that offer inadequate protection should have shelters retrofitted or a shelter added. New essential facilities should be designed with shelters. Interested states should form a committee to evaluate the need for tornado plans and shelters in essential facilities and other establishments serving the public (e.g., schools, hospitals, and critical facilities).
- All buildings in tornado-prone areas should have a tornado refuge plan of where to send people. In addition, all facilities for public accommodation should have a NOAA weather radio in continuous operation.

8.3.3 Places of Refuge

If a specifically designed tornado shelter is not available and refuge has to be taken in a residential or non-residential building, the following are recommended:

- State and local governments should develop education programs to assist homeowners and other property owners in developing a tornado safety plan similar to a fire safety plan. The plan should include the identification of a place of refuge and essential supplies. A tornado safety plan should include:
 - Seek refuge in a basement or below-grade crawl space, in an area away from the entry to the basement or crawl space. If the basement is partially above grade and has windows, seek shelter in a room within the basement that does not have windows.
 - If a residence does not have a basement or below-grade crawl space, seek refuge on the first floor in an interior bathroom or closet. If refuge is taken in a bathroom, lay in the tub.

- In a non-residential building that does not have a basement, seek refuge on the first floor in a concrete stair tower, interior corridor, or a small room that does not have glass openings in doors or walls and is as far inward as possible from exterior walls. Avoid rooms that have long roof spans more than 40 feet between walls or columns.
- Wherever refuge is taken, lay on the floor if space permits, or kneel down. Cover up with pillows or heavy blankets for added protection.

9 References

Bledsoe, Bob, May 10, 1999, Interoffice Memo, Public Works/Community Affairs, Tulsa, Oklahoma.

Doswell, C.A. III, and D.W. Burgess, 1988: Some issues of United States tornado climatology. *Monthly Weather Review*, Vol. 116, pp. 495-501.

Grazulis, T.P., 1993: *Significant Tornadoes, 1680-1991*. Environmental Films, St. Johnsbury, VT, 1326 pp.

Kelly, D.L., J.T. Schaefer, R.P. McNulty, C.A. Doswell III, and R.F. Abbey, Jr., 1978: An augmented tornado climatology. *Monthly Weather Review*, Vol. 106, pp. 1172-1183.

FEMA 320: *Taking Shelter from the Storm*

National Performance Criteria for Tornado Shelters (see Appendix C)

Note: See Appendix E for related worldwide websites

1994 and 1997 Uniform Building Code

1996 National Building Code

1997 Standard Building Code

1995 CABO One and Two Family Dwelling Code

ASCE 7-98: Minimum Design Loads for Buildings and Other Structures

Appendix A

Members of the Building Performance Assessment Team For the Oklahoma and Kansas Tornadoes

Team Management

CLIFFORD OLIVER, CEM
Co-Team Leader
Mitigation Directorate, Headquarters
Federal Emergency Management Agency
Washington, DC

PAUL TERTELL, P.E.
Project Officer and Co-Team Leader
Mitigation Directorate, Headquarters
Federal Emergency Management Agency
Washington, DC

E. SCOTT TEZAK, P.E.
Team Manager
Structural Engineer
Greenhorne & O'Mara, Inc.
Greenbelt, Maryland

TEAM MEMBERS

W. GENE CORLEY, Ph.D., S.E., P.E.
Structural Engineer
Vice President
Construction Technology Laboratories, Inc.
Skokie, Illinois

CHARLES A. DOSWELL III, Ph.D.
Research Meteorologist
National Severe Storms Laboratory
National Oceanic Atmospheric Administration
Norman, Oklahoma

G. ROBERT FULLER, P.E.
Research Structural Engineer
National Association of Home Builders Research Center
Upper Marlboro, Maryland

JERRY MALLORY
Kansas State Emergency Management Agency Representative
Johnson County Office of Planning, Development and Codes
Olathe, Kansas

PETER R. MONTPELLIER, M.E.Sc., B.Eng.
Scientist
Applied Research Associates, Inc.
Raleigh, North Carolina

ROBIN P. MUNNIKHUYSEN
Environmental Scientist
Greenhorne & O'Mara, Inc.
Greenbelt, Maryland

ROBERT NAUMANN
Environmental Scientist
Greenhorne & O'Mara, Inc.
Greenbelt, Maryland

PAUL ROHNE, JR., P.E.
Region VI Liaison
Disaster Field Office
Federal Emergency Management Agency
Oklahoma City, Oklahoma

LIZ SINTAY
Public Affairs Officer
Disaster Field Office
Federal Emergency Management Agency
Oklahoma City, Oklahoma

PAM SOPER
Region VII Liaison
Disaster Field Office
Federal Emergency Management Agency
Wichita, Kansas

THOMAS L. SMITH, A.I.A
Architect
TLSmith Consulting Inc.
Rockton, Illinois

LARRY J. TANNER, P.E.
Research Associate
Wind Engineering Research Center
Texas Tech University
Lubbock, Texas

WILLIAM D. WALL, P.E.
Engineer
International Conference of Building Officials
Kansas City Conference Services Office
Gladstone, Missouri

Appendix B

Acknowledgements

The BPAT would like to thank the following people for their assistance with the site visits or review of the BPAT report:

Mike Abedini, Norland Plastics Company, Haysville, Kansas

Dale Arnold, Consultant to NCMA, Washington, DC

Laurie Bestgen, FEMA, Region VII, Kansas City, Missouri

Chad Bettles, Building Inspector, City of Haysville, Kansas

Bob Bissell, FEMA, Deputy Federal Coordinating Officer-Mitigation (DFCO-M), Region VII, Kansas City, Missouri

Greg Borchelt, Brick Industrial Association, Reston, VA

Jim Cranford, Code Administrator, City of Wichita, Kansas

Kevin Daves, J & D Properties, Wichita, Kansas

Randal Dorner, Public Works Director, City of Haysville, Kansas

Keith Eaton, Project Superintendent, Tanger Outlet Centers, Stroud Oklahoma

Jim Gilliam, FEMA Mitigation Division Director, Region VII, Kansas City, Missouri

Dr. Joseph Golden, NOAA, Office of Oceanic and Atmospheric Research, Washington, DC

Dennis Graber, National Concrete Masonry Association (NCMA) Herndon, VA

Kenny Heitzman, Fire Marshall, Midwest City, Oklahoma

Dennis Lee, FEMA Deputy Federal Coordinating Officer-Mitigation (DFCO-M), Region VI, Denton, Texas

A.D. Lewis, Bridge Creek, Oklahoma

Edwin Murabito, Architect, Edw.Murabito and Associates, Wichita, Kansas

Frank Pagano, FEMA Mitigation Division Director, Region VI, Denton, Texas

John Pangburn, Mayor, Mulhall, Oklahoma

Frank Walker, Manufactured Housing Institute, Arlington, VA

Bruce Wedel, Principal, Bridge Creek High School, Oklahoma

Glen Wiltsee, Department of Code Enforcement, Sedgwick County, Kansas

Samuel Winningham, FEMA, Region VII, Kansas City, Missouri

Appendix C

Taking Shelter From the Storm Brochure

Did You Know...

... Almost every state in the United States is subject to hurricanes, tornadoes, or both. These extreme windstorms can cause extensive damage to buildings, and they threaten the lives of building occupants.

... FEMA, in cooperation with the Wind Engineering Research Center of Texas Tech University, has developed designs for wind shelters that homeowners can build inside their houses.

... These shelters are designed to provide protection from the forces of extreme winds as high as 250 mph, including the impact of windborne debris.

... FEMA has prepared **Taking Shelter From the Storm: Building a Safe Room Inside Your House** for homeowners and builders.

- The booklet includes:
- A homeowner risk assessment worksheet
 - Guidance for selecting a shelter design
 - Detailed construction plans for builders and contractors
 - Cost estimates



The worksheet helps homeowners determine their risk from extreme winds and assist them in their consideration of a shelter.



Detailed construction plans provide all the information a builder or contractor needs to build a shelter.

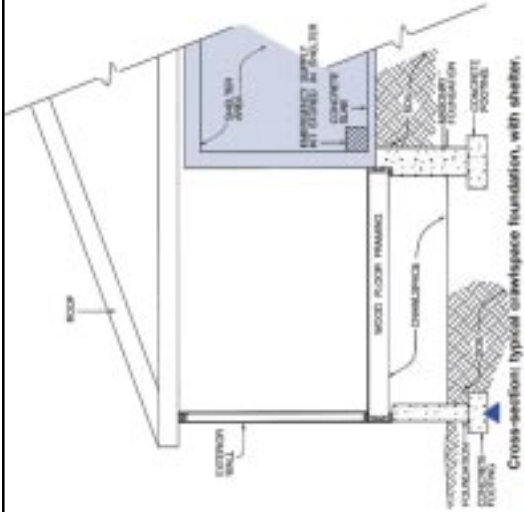
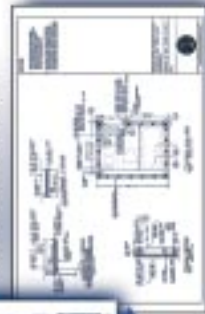

Want To Learn More?

Taking Shelter From the Storm: Building a Safe Room Inside Your House, FEMA publication 320 (booklet and construction plans), is available from FEMA Publications (1-888-565-3896). The construction plans are also available separately – ask for FEMA publication 320a. The booklet is also available on the FEMA website (www.fema.gov/mit/tsis01.htm).

Federal Emergency Management Agency
 Mitigation Directorate
 500 C Street, SW
 Washington, DC 20472
www.fema.gov



Taking Shelter From the Storm:

Building a Safe Room Inside Your House



Federal Emergency Management Agency

Extreme windstorms such as tornadoes and hurricanes pose a serious threat to buildings and their occupants in many areas of the United States. Tornadoes strong enough to damage roofs, destroy mobile homes, snap or uproot large trees, and turn debris into damaging windborne missiles have occurred in virtually every state. Hurricanes have affected all Atlantic and Gulf of Mexico coastal areas in the United States, including Puerto Rico and the U.S. Virgin Islands. Hawaii has also been affected by hurricanes. Even states not normally considered susceptible to extreme windstorms include areas threatened by dangerous high winds. These areas, typically near mountain ranges, include the Pacific Northwest coast.



Do You Need a Shelter?

The wind zone map on this page shows how the frequency and strength of extreme windstorms vary across the United States. This map is based on 40 years of tornado history and over 100 years of hurricane history. Zone IV, the darkest area on the map, has experienced both the greatest number of tornadoes and the strongest tornadoes. As shown by the map key, wind speeds in Zone IV can be as high as 250 mph. The tornado hazard in Zone III, while not as great as in Zone IV, is still significant. In addition, Zone III includes coastal areas susceptible to hurricanes.

Your house was probably built in accordance with local building codes that consider the effects of minimum design winds. These are winds that, according to building code requirements, your house must be able to withstand. However, a tornado or hurricane can often cause winds much greater than those on which local building code requirements are based. Your house may be built "to code," but that does not mean that it can withstand winds from extreme events. If you are concerned about wind hazards where you live, especially if you live in Wind Zone III or IV, you should consider building a shelter.

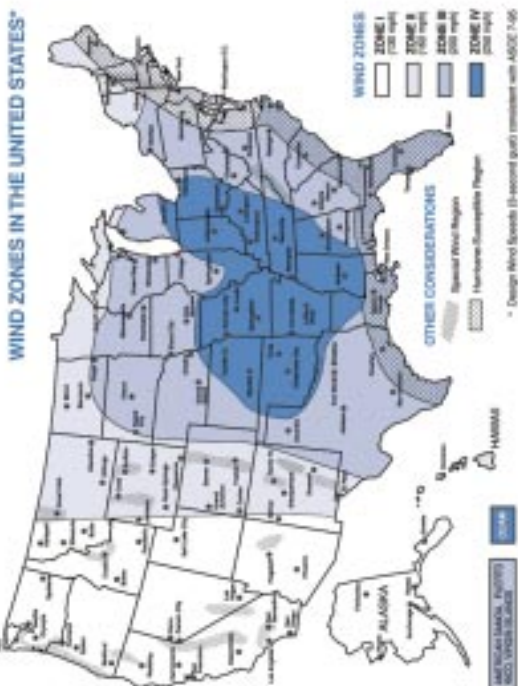

Basis of Shelter Design

The purpose of a wind shelter is to provide a space where you and your family can survive a tornado or hurricane with little or no injury. You can build a shelter in one of several places in your house – in your basement, beneath a concrete slab-on-grade foundation or garage floor, or in an interior room on the first floor. Shelters built below ground level provide the greatest protection, but a shelter built in a first-floor interior room can also provide the necessary protection. Emergency response personnel and people cleaning up after tornadoes have often found an interior room of a severely damaged house still standing when little of the house remains above ground.



Surviving Interior Room

To protect its occupants, an in-house shelter must be able to withstand the forces exerted by high winds and remain standing, even if the rest of the house is severely damaged. Therefore:

- The shelter must be adequately anchored to resist overturning and uplift.
- The walls, ceiling, and door of the shelter must withstand wind pressure and resist penetration by windborne missiles and falling debris.
- The connections between all parts of the shelter must be strong enough to resist the wind forces without failing.
- If sections of either interior or exterior house walls are used as walls of the shelter, they must be separated from the structure of the house, so that damage to the house will not cause damage to the shelter.

The shelter booklet described on the other side of this brochure provides the information that you or your contractor will need to build a shelter that meets these requirements.

Appendix D

National Performance Criteria for Tornado Shelters

National Performance Criteria for Tornado Shelters



Tornado shelters under construction in the Country Club Courts subdivision by J & D Properties Inc., Wichita, Kansas



Federal Emergency Management Agency Mitigation Directorate

Washington, D.C
Second Edition
August 31, 1999



National Performance Criteria for Tornado Shelters
Federal Emergency Management Agency
Mitigation Directorate
Washington, D.C.

Comments and Questions

The Federal Emergency Management Agency, in cooperation with the Wind Engineering Research Center at Texas Tech University, has developed these performance criteria for tornado shelters. Comments on these criteria should be directed to:

Program Policy and Assessment Branch
Mitigation Directorate
Federal Emergency Management Agency
500 C Street, S.W.
Washington, D.C. 20472
e-mail: building.science@fema.gov

Technical questions on these performance criteria should be directed to:

Wind Engineering Research Center
Texas Tech University
Box 41023
Lubbock, TX, 79409-1023
(888) 946-3287 ext. 336
e-mail: ltanner@coe.ttu.edu

Limit of Liability

These performance criteria are based on extensive research of the causes and effects of windstorm damage to buildings. Shelters designed and built to these performance criteria should provide a high degree of occupant protection during severe windstorms. Any variation from these design or construction performance criteria, or deterioration of the structure, may decrease the level of occupant protection during a severe wind event.

Because it is not possible to predict or test for all potential conditions that may occur during severe wind storms or control the quality of the design and construction, the Federal Emergency Management Agency, Texas Tech University and others involved in the development of this performance criteria do not warrant these performance criteria.

The Federal Emergency Management Agency, Texas Tech University and others involved in the development of these performance criteria neither manufacture nor sell shelters based on these performance criteria. The Federal Emergency Management Agency, Texas Tech University and others involved in the development of these performance criteria do not make any representation, warranty, or covenant, expressed or implied, with respect to these performance criteria, or the condition, quality, durability, operation, fitness for use, or suitability of the shelter in any respect what so ever. The Federal Emergency Management Agency, Texas Tech University and others involved in the development of these performance criteria shall not be obligated or liable for actual, incidental, consequential, or other damages of or to users of shelters or any other person or entity arising out of or in connection with the use, condition, and other performance of shelters built from these performance criteria or from the maintenance thereof.

Introduction

Shelters constructed to these performance criteria are expected to withstand the effects of the high winds and debris generated by tornadoes such that all occupants of the shelter during a tornado will be protected without injury. These performance criteria are to be used by design professionals, shelter manufacturers, building officials, and emergency management officials to ensure that shelters constructed in accordance with these criteria provide a consistently high level of protection. The following describes the performance criteria.

Performance Criteria

1. Resistance to Loads from Wind Pressure for Shelters

- a) Wind pressures are to be determined using ASCE 7-95 *Minimum Design Loads for Buildings and Other Structures* (or revisions to this standard). Pressures for the Main Wind Force Resisting System (MWFRS) are to be used for the walls, ceiling, structural attachments and foundation system. Pressures for Components and Cladding are to be used for the door(s) and other attachments to the exterior of the shelter. For computing wind pressures to be used as a service load, the wind velocity (V) shall be 250 mph (3-second peak gust).
- b) The shelter walls, ceiling and floor will withstand design pressures such that no element shall separate from another (such as walls to floor, ceiling to walls). Such separation shall constitute a failure of the shelter.
- c) The entire shelter structure must resist failure from overturning, shear (sliding), and uplift from design pressures. *Note: For the in-residence shelter designs described in FEMA 320, ceiling spans and wall lengths were less than 8 feet and the design of the wall and ceiling was governed by the need for missile protection. For larger shelters, the capacity of structural elements to withstand the forces described in above in 1. (a) shall be determined by engineering analysis. For larger shelters, the plans in FEMA 320 can be used only for missile (airborne debris) resistance.*
- d) The Allowable Stress Design (ASD) method shall be used for the shelter design for any of the construction materials selected (concrete, concrete masonry, wood, etc.). Unfactored load combinations shall be used in accordance with ASCE 7-95 for allowable stress design. Because of the extreme nature of this design wind speed, other environmental loads, such as flood or earthquake loads, should not be added. An alternative design method for materials with accepted Load and Resistance Factor Design (LRFD) standards may be used in lieu of ASD.

- e) No importance factor shall be added to the pressure calculations because the extreme nature of the design event already accounts for critical nature of the shelter. Therefore, the importance factor (I) used in the design computations shall equal one. The internal gust coefficient (GC_{pi}) shall be for buildings with no openings.
- f) In the event that the roof of the shelter is exposed at grade, the roof of the shelter shall be able to resist wind pressures as determined in sections 1(a) through (e).

2. Windborne Missile Impact Resistance On Shelter Walls and Ceiling

- a) Loads from windborne missile impacts must be considered. For design purposes, it is assumed that the design wind speed of 250 mph propels a 15-lb. missile horizontally at 100 mph. The design missile is a nominal 2x4 wood board, weighing 15 lbs., striking the shelter enclosure on end 90° to the surface. The vertical missile design speed is $2/3$ of the horizontal speed or 67 mph. For Below-Grade Shelters, only the impact from vertical missiles on the shelter roof must be considered. *Note: From testing, it has been shown that the primary failure of enclosure materials from missile impact has been shearing of the material due to the high velocity and that missile perforation resistance is provided by a material (or combination of materials) that provide energy dissipation of the missile impact.*
- b) The walls and ceiling of a shelter must resist perforation by the design missile such that the missile does not perforate the inside most surface of the shelter. Only shelter wall openings used for access are permitted. Windows, skylights, or other similar openings shall not be used unless they have been laboratory tested to meet the missile impact criteria of section 2(a). *Note: The Wind Engineering Research Center at Texas Tech University has tested numerous materials and material combinations and should be contacted regarding performance of those materials. For in-residence shelters, the designs of FEMA Publication No. 320 Taking Shelter From the Storm: Building a Safe Home in Your Home should be used. For other than in-residence shelters, it is recommended that materials proven to provide the required stiffness and missile impact resistance such as reinforced concrete or reinforced concrete masonry should be used.*
- c) Alternative materials and material combinations for both shelter walls and ceilings shall be permitted after testing has proven the alternative materials will meet the missile impact criteria contained herein. *Note: Existing missile impact standards in the Standard Building Code, the South Florida Building Code, the Texas Department of Insurance Code, and ASCE 7 do not include missiles of the size, weight or speed of those discussed in these performance criteria. Therefore, those standards may not be used to determine applicability of alternative materials and material combinations for tornado-generated missiles.*

3. Other Loads

- The designer should assess whether an adjacent structure is a liability to the shelter, that is, if it poses a threat to the shelter from collapse. If the adjacent structure is deemed a liability, the loads imposed upon the shelter due to the collapse of this adjacent structure shall be considered as an additional impact load on the shelter.

4. Shelter Access Doors and Door Frames

- a) Shelter entry doors and their frames shall resist the design wind pressures for components and cladding in section 1 of this criteria and the missile impact loads of section 2 of this criteria. Only doors and their frames that can resist calculated design wind pressures and laboratory tested missile impacts are acceptable. All doors shall have sufficient points of connection to their frame to resist design wind pressure and impact loads. Unless specifically designed for, each door shall be attached to their frame with a minimum six points of connection. *Note: See the design specifications and details for shelter doors in FEMA publication 320 for additional guidance. Door designs and materials of construction included in FEMA publication 320 were developed through calculations and laboratory testing at Texas Tech University.*
- b) A protective missile resistant barrier is permitted to protect the door opening. The door should then be designed to resist wind pressures.
- c) The size and number of shelter doors shall be determined in accordance with applicable fire safety and building codes. In the event the community where the shelter is to be located has not adopted current fire safety and building codes, the requirements of the most recent editions of a model fire safety and a building code shall be used. *Note: The design specifications and details for shelter doors in FEMA publication 320 are for single swinging doors not exceeding 3 feet in width. No laboratory missile impact testing has been performed on double swinging doors or other door configurations other than 3 feet wide single swinging doors.*

5. Shelter Ventilation

- a) Ventilation for shelters shall be provided through either the floor or the ceiling of the enclosure. A protective shroud or cowling, meeting the missile impact requirements of section 2 of these criteria, must protect any ventilation openings in the shelter ceiling. The ventilation system must be capable of providing the minimum number of air changes for the shelter's occupancy rating. In the event the community where the shelter is to be located has not adopted a current building and/or mechanical code, the requirements of the most recent edition of a model building code shall be used. *Note: Ventilation may be provided with ducts to an outside air supply.*

- b) If ventilation to the shelter is provided by other than passive means, then all mechanical, electrical and other equipment providing this ventilation must be protected to the same standard as the shelter. In addition, appropriate design, maintenance and operational plans must ensure operation of this equipment following a tornado.
6. Emergency Lighting
- Emergency lighting shall be provided to all shelters serving over 15 persons.
7. Shelter Sizing
- The following are minimum floor areas for calculating the size of shelters:
 - Adults 5 square feet per person standing
 - Adults 6 square feet per person seated
 - children (under the age of 10) 5 square feet per person
 - Wheelchair bound persons 10 square feet per person
 - Bed-ridden persons 30 square feet per person
8. Shelter Accessibility
- a) The needs of persons with disabilities requiring shelter space must be considered, and the appropriate access for such persons must be provided in accordance with the Americans with Disabilities Act (ADA).
- b) In designing shelter(s), the designer shall consider the time required for all occupants of a building and facility to reach refuge in the shelter(s). *Note: While the National Weather Service has made great strides in providing warnings, to provide greater protection, it is recommended that in locating shelters or multiple shelters, all occupants of a building or facility should be able to reach a shelter within 5 minutes, and that all occupants should be in a shelter with doors secured within 10 minutes.*
9. Emergency Management Considerations for Shelters
- a) Each shelter shall have a tornado emergency refuge plan; this plan is to be exercised at least twice per year.

- a) Shelter space shall contain, at a minimum, the following safety equipment:
 - Fire extinguisher surface mounted on the shelter wall. In no case shall a fire extinguisher cabinet or enclosure be recessed into interior face of the exterior wall of the shelter.
 - Flashlights with continuously charging batteries
 - First aid kit rated for the shelter occupancy
 - Potable water in sufficient quantity to meet the drinking needs of the shelter rated occupancy for 8 hours
 - A NOAA weather radio with continuously charging batteries
- b) The following placards and identification shall be installed in each building with a shelter other than shelters within single family residences:
 - The location of each shelter shall be clearly and distinctly identified with permanently mounted wall placards located throughout the building that direct the building occupants to the shelter.
 - The outside of all doors providing access to a shelter shall be clearly identified as a location to seek refuge during a tornado.
 - Placards shall be installed on the inside of each shelter access door or immediately adjacent that instructs shelter occupants on how to properly secure the shelter door(s).

10. Additional Requirements for Below Grade Shelters:

- The shelter must be watertight and resist flotation due to buoyancy from saturated soil.
- The shelter must contain either battery-powered radio transmitters or a signal-emitting device to signal the location of the shelter to local emergency personnel should occupants in the shelter become trapped due to debris blocking the shelter access door.

11. Multihazard Mitigation Issues

- a) Flooding
 - No below grade shelter shall be constructed in a Special Flood Hazard Area or other area known as being flood prone.
 - In the event that an above ground shelter is located in a Special Flood Hazard Area (SFHA) or other known flood prone area, the floor of the shelter shall be elevated to or above the Base Flood Elevation or other expected level of flooding.
 - All shelters constructed in a SFHA and/or other regulatory floodplain areas shall conform to state and local floodplain management requirements.

b) Earthquake

- Shelters located in earthquake prone areas shall be designed and constructed in accordance with seismic safety provisions contained in local building codes. In the event the community where the shelter is to be located has not adopted a current building code, the requirements of the most recent edition of a model building code and/or the National Earthquake Hazard Reduction Program Recommended Provisions shall be used.

12. Construction Plans and Specifications

- Complete detailed plans and specifications shall be provided for each shelter design. Sufficient information to ensure that the shelter is built in accordance with both the specific requirements and intent of these performance criteria shall be provided. *Note: The plans and specifications found in FEMA publication 320 are a good basis for developing plans (including standardized details) and specifications.*

13. Quality Control

- The quality of both construction materials and methods shall be ensured through the development of a quality control program. This quality control program shall identify roles and responsibilities of the contractor, design professional, and local permit official in ensuring that the shelter is constructed with materials and methods that meet the requirements stipulated in the plans and specifications developed from these performance criteria.

14. Obtaining Necessary Permits

- Prior to beginning construction, all necessary state and local building and other permits shall be obtained and clearly posted on the job site. *Note: Model building codes do not address the design of a tornado shelter. Therefore the owner and the design professional should ensure that the shelter is properly designed and constructed.*

Sources of Additional Information

FEMA has developed two publications that may be of assistance in developing tornado shelter designs:

- FEMA TR-83B *Tornado Protection: Selecting and Designing Safe Areas in Buildings*
- FEMA 320 *Taking Shelter From the Storm: Building a Safe Room Inside Your House*

A copy of FEMA 320 can be ordered by calling 1-888-565-3896. FEMA TR-83B, and all other FEMA publications, may be ordered by calling 1-800-480-2520.

Appendix E

List of Websites

FEMA: Saferoom Site

<http://www.fema.gov/mit/saferoom>

FEMA: National Performance Criteria for Tornado Shelters

http://www.fema.gov/library/npc_ts.htm

FEMA: Taking Shelter From the Storm: Building a Safe Room Inside Your House

<http://www.fema.gov/mit/tsfs01.htm>

FEMA: Taking Shelter From the Storm Plans

<http://www.fema.gov/mit/shplans/index.htm>

Wind Engineering Research Center, Texas Tech University
Tornado Safe Room

<http://www.wind.ttu.edu>

The NOAA Site on Tornadoes

<http://www.outlook.noaa.gov/tornadoes>

The NOAA/NWS “Service Assessment: Oklahoma/Southern Kansas
Tornado Outbreak of May 3, 1999”

<http://www.nws.noaa.gov/om/omdis.html>

Center for Disease Control, Website on Mortality Information

<http://www2.cdc.gov/mmwr/mmwr.html>

