

Analysis Report on
Fire fighter Fatalities

Prepared by

Fire Analysis and Research Division
National Fire Protection Association
#1 Batterymarch Park
Quincy, MA 02269

Prepared for

Federal Emergency Management Agency
U.S. Fire Administration
Contract No. EMW-88-C-2868

August 1989

Any opinions, findings, conclusions or recommendations expressed in this publication do not necessarily reflect the views of the Federal Emergency Management Agency.

This document was scanned from hard copy to portable document format (PDF) and edited to 99.5% accuracy. Some formatting errors not detected during the optical character recognition process may appear.

ACKNOWLEDGEMENTS

This study was funded by the U.S. Fire Administration of the Federal Emergency Management Agency (FEMA). It would not have been possible without the cooperation and assistance of the U.S. fire service, the United States Fire Administration, the Public Safety Officers' Benefits Program of the Department of Justice, the National Wildfire Coordinating Group, the Bureau of Land Management of the Department of the Interior, the Bureau of Indian Affairs, the U.S. Department of Energy and the U.S. military, all of whom contributed data to this study.

The assistance of other NFPA staff members is also acknowledged: A. Elwood Willey, Assistant Vice President, Research and Fire Information Services; Dr. John Hall, Director, Fire Analysis and Research Division; Martin Henry, Director, Public Fire Protection Division; Kenneth Tremblay, Alison Norton, John Barry, Michael Karter, and Kenneth Taylor, Fire Analysis and Research Division; and William Baden and Carl Peterson, Public Fire Protection Division.

The authors also wish to acknowledge the assistance of USFA staff, particularly John Ottoson, Project Officer, for their suggestions and support.

Special thanks go to Nancy Schwartz for typing the several drafts of this report.

Rita F. Fahy
Arthur E. Washburn
Paul R. LeBlanc
Project Staff

TABLE OF CONTENTS

| | <u>Page</u> |
|---|-------------|
| Table of Contents | i |
| List of Figures | ii |
| List of Tables | iv |
| Background | V |
| I. Introduction | 1 |
| A. Who Is a Fire Fighter? | 1 |
| B. What Constitutes an On-Duty Fatality? | 2 |
| C. Sources of Initial Notification | 3 |
| D. Procedure for Including a Fatality in the Study | 4 |
| E. Additional Data Collection Completed for the Contract. | 5 |
| II. 1988 Findings | 6 |
| A. Type of Duty. | 6 |
| B. Cause and Nature of Fatal Injury or Illness | 9 |
| C. Ages of Fire Fighters | 13 |
| D. Fire Ground Deaths. | 16 |
| E. TimeofDay | 18 |
| F. Month of the Year | 20 |
| G. State and Region. | 21 |
| H. Analysis of Urban/Rural/Suburban Patterns in Fire Fighter Fatalities. | 26 |
| III. Fire Fighter Deaths in Structural Collapses 1979-1988 | 29 |
| IV. Fire Fighter Deaths While Responding to Alarms 1979-1988. | 37 |
| V. Fire Fighters Struck by Vehicles 1979-1988. | 46 |
| VI. Conclusions and Recommendations | 50 |
| References | 52 |

LIST OF FIGURES

| <u>Figure</u> | <u>Title</u> | <u>Page</u> |
|---------------|---|-------------|
| 1 | Line of Duty Fire Fighter Deaths 1979-1988 | 7 |
| 2 | Fire Fighter Deaths 1988 by Type of Duty | 8 |
| 3 | Fire Fighter Deaths 1988 by Cause of Injury | 11 |
| 4 | Fire Fighter Deaths 1988 by Nature of Injury | 12 |
| 5 | Fire Fighter Deaths 1988 by Age and Cause of Death | 14 |
| 6 | Average Death Rates per 10,000 Fire Fighters 1984-1988 | 15 |
| 7 | Fire Ground Deaths in 1988 by Fixed Property Use | 17 |
| 8 | Fire Fighter Fatalities 1988 by Time of Day | 19 |
| 9 | Fire Fighter Fatalities by Time of Day 1979-1988 | 21 |
| 10 | Fire Fighter Fatalities 1988 by Month of Year | 22 |
| 11 | Fire Fighter Fatalities by Month of Year 1979-1988 | 23 |
| 12 | Fire Fighter Fatalities in Structural Collapses 1979-1988 | 30 |
| 13 | Fire Fighters Caught or Trapped in Structural Collapses by Fixed Property Use 1979-1988 | 32 |
| 14 | Fire Fighters Struck by Objects in Structural Collapses by Fixed Property Use 1979-1988 | 33 |
| 15 | Fatalities in Structural Collapses by Year 1979-1988 | 35 |
| 16 | Fatalities in Structural Collapses by Region 1979-1988 | 36 |

BACKGROUND

For more than a decade, the National Fire Protection Association (NFPA) has developed the most complete records on U.S. fire fighter fatalities - both in breadth of coverage and depth of detail - of any organization. This data base has been used to support the fire fighter fatality studies produced each year by NFPA since 1974.

Over the past eight years, NFPA also has worked with FEMA's U.S. Fire Administration (USFA) to provide, in a timely manner, lists of fire fighter fatalities and their next of kin to support the National Fire Academy's annual Fire Fighter Memorial Service, analyses of each year's fire fighter fatalities and briefings on the latest experience. Under the present contract, NFPA has provided the USFA with lists, both hand lettered and typed, of 1988 fire fighter fatalities and with a list of names and addresses of next of kin and of fire department chiefs for use in the Memorial Service in October 1989.

In August, a briefing on the 1988 experience and three special analyses was presented by NFPA staff to USFA staff in Emmitsburg, MD. Through the briefing and analysis, this contract continued the trend toward more extensive analysis of patterns and trends in specific parts of the fire fighter fatality problem. With over a decade of experience now classified in a computer data base, NFPA is able to provide increasingly detailed and focused examinations of the specific parts of the problem addressable by particular strategies.

The deliverables under this contract are (a) this analysis report, (b) the incident and casualty data on diskette in NFIRS Version 4.0 format, which is being delivered separately, (c) the various lists described above, and (d) the briefing provided in August.

I. INTRODUCTION

The purpose of this study is to analyze the circumstances surrounding fire fighter fatalities in the United States in 1988 in an attempt to identify potential means for reducing the number of deaths that occur each year. In addition to the 1988 findings, this study will also include special analyses of particular recurring scenarios, using NFPA's data base of fire fighter fatalities from 1979 through 1988.

A. Who Is a Fire Fighter?

For the purpose of this study, the term "fire fighter" covers all members of organized fire departments, whether career, volunteer or mixed; full-time public service officers acting as fire fighters; state and federal government fire service personnel: temporary fire suppression personnel operating under official auspices of one of the above; and privately employed fire fighters including trained members of industrial or institutional fire brigades, whether full- or part-time.

Under this definition, the study includes not just municipal fire fighters, but also seasonal and full-time employees of the U.S. Forest Service and state forestry agencies; prison inmates serving on state forest service crews; fire fighters for the Bureau of Land Management, the Bureau of Indian Affairs, the Bureau of Fish and Wildlife, the National Park Service, and the U.S. Department of Energy; military personnel performing assigned fire suppression activities; civilian fire fighters working at military installations; and members of industrial fire brigades.

B. What Constitutes an On-Duty Fatality?

The term "on-duty" refers to being at the scene of an alarm, whether a fire or non-fire incident; being en route while responding to or returning from an alarm; performing other assigned duties such as training, maintenance, public education, inspection, investigations, court testimony and fund raising; performing non-fire duties on official assignment; and being on call, under orders or on stand-by duty other than at home or at the individual's place of business.

On-duty fatalities include any injury sustained while on duty that proves fatal, any illness that was incurred as a result of actions while on duty that proves fatal, and fatal mishaps involving occupational hazards that occur while on duty. The types of injuries included in the first category are mainly those that occur on the fire ground, in training, or in accidents while responding to or returning from alarms. The most common examples of fatal illnesses incurred on duty are fatal heart attacks. Another example is a fire fighter who contracted hepatitis when a victim being transported by ambulance pulled out his intravenous needle and stuck the fire fighter. A few examples of fatal occupational mishaps include fire fighters who died of asphyxiation while working on fire apparatus in closed garages, a fire fighter who fell through a slide pole hole, a fire fighter electrocuted while raising a banner for a town event, a volunteer fire fighter who was fatally injured when he fell down a flight of stairs in his home while responding to an alarm, and a fire inspector who fell through a skylight.

Also included in the study are fire fighters who were murdered while on duty. These include fire fighters shot by snipers while on the fire ground, fire fighters shot in the station by off-duty or former fire fighters, and one who was kidnapped and shot after responding to a verbal request for assistance.

Fatal injuries and illnesses are included even in cases where death is considerably delayed. When the onset of the condition and death occur in different years, the incident is counted on the basis of the former. For example, a Michigan fire fighter died in 1986 of a brain injury received in 1979 when he was struck by a hose coupling, resulting in recurring seizures. Because his death was the direct result of his injury, and the injury occurred in 1979, he is counted as a 1979 fatality.

The NFPA recognizes that these definitions should include chronic illnesses (such as cancer) that prove fatal and that arise from occupational factors. In practice, there is as yet no mechanism for identifying fatalities that are due to illnesses that develop over long periods of time and that thereby present an ambiguous picture on the issue of occupational versus other factors as causes. This is recognized as a gap that cannot now be filled because of the limitations of the state of the art in tracking and analysis.

C. Sources of Initial Notification

As an integral part of its ongoing program to collect and analyze fire data, NFPA solicits information on fire fighter fatalities from the U.S. fire service and a wide range of other sources. These include the U.S. Fire Administration and the Public Safety Officers' Benefits Program (PSOB). Both are organizations with whom NFPA has maintained long-standing cooperative efforts in collecting and analyzing fire fighter fatality data. Other contacts include federal agencies such as the U.S. Forest Service of the

Department of Agriculture, the Bureau of Indian Affairs and the Bureau of Land Management of the Department of Interior, the U.S. military, the Department of Energy, and the Occupational Safety and Health Administration (OSHA). In recent years, significant assistance has been received from the National Wildfire Coordinating Group, an organization made up of representatives of state and federal forestry agencies.

We also receive notification from fire service organizations such as the International Association of Fire Fighters, state fire associations, state training organizations, state and local fire marshals, and fire service publications. A network developed over the years of individuals interested in the area of fire fighter fatalities also assists in identifying incidents, especially those that occur outside of large urban areas or that involve non-fire-incident-related fatalities. Among these individuals are fire fighters, photographers, fire buffs, and members of the insurance industry.

Notification of fatal incidents also comes from NFPA members and staff and through the use of a newspaper clipping service that reads all daily and weekly newspapers in the country.

D. Procedure for Including a Fatality in the Study

After initial notification of a fatal incident is received, contact with the local fire department is made by telephone to verify the incident, its location and the fire department involved. Data collection forms for the fatality and the fire, if it was a fire incident, are sent to the responsible local official identified during the telephone follow-up. After the forms are returned to NFPA, a final decision is made to include or exclude the fatality,, based on the inclusion criteria described previously. In order to make a

final determination, additional information is sometimes sought, either by contacting the fire department directly to clarify some of the details or by obtaining data elsewhere, such as medical documentation frequently available from PSOB.

Some of the material that might be received to document an incident includes casualty forms, both NFPA fire fighter fatality study reporting forms and NFIRS-type forms; NFPA's Fire Incident Data Organization major-fire report form or the department's own incident reporting form, if a fire incident was involved in the fatality; medical data such as death certificates or autopsy reports; special investigation reports from other agencies; police and motor vehicle accident reports, if applicable; photographs and diagrams; and additional newspaper accounts. Incidents to be included in the study are then coded into NFPA's Fire Incident Data Organization (FIDO), which includes both incident and casualty information. By mutual agreement of the USFA and NFPA project staff, the same inclusion criteria were used for the USFA study as are used in the NFPA study.

Work described to this point was done as part of NFPA's ongoing program of data collection and analysis in the area of fire fighter fatalities and was completed at no cost to FEMA.

E. Additional Data Collection Completed for the Contract

To meet FEMA's request for a list of the next-of-kin of the 1988 fatalities and the names and addresses of the fire chiefs, a follow-up mailing was sent to all departments asking them to verify the victims' names and dates of fatal injury, the names and addresses of the departments and chiefs, and the names and relationships of the next of kin. Telephone calls were made to non-responding fire departments to obtain the information.

II. 1988 FINDINGS

One hundred thirty-two fire fighters died in the line of duty in 1988. As shown in Figure 1, this is a slight increase of 1.5 percent from the year before. The totals for 1987 and 1988 are the highest since 1981.* Although it is too soon to suggest an established upward trend, these findings do underline the urgent need for strong, effective action to reduce the death toll. This study will report some of the most frequently occurring scenarios and will present some conclusions and recommendations to address the problem.

A. Type of Duty

The distribution of deaths by type of duty being performed is shown in Figure 2. The largest proportion of deaths occurred during fire ground operations. Eleven of the 63 fire ground deaths occurred in two incidents. One involved the collapse of a truss roof that killed five fire fighters in Hackensack, New Jersey. The other incident occurred at a construction site in Kansas City, Missouri, and involved the explosion of a trailer filled with ammonium nitrate and fuel oil (ANFO) blasting agent. That incident resulted in six deaths.

Of the 63 fire ground deaths, 24 were due to heart attacks, 12 to internal trauma, 11 to asphyxiation, 10 to crushing injuries, and one each to burns, fractures, electrocution, stroke (CVA), aneurysm and heat stroke. Twenty-five of the victims were career fire fighters and 38 were volunteers.

* The totals for some earlier years have been adjusted to reflect new information received since the earlier studies.

Figure 1
Line of Duty Fire Fighter Deaths
1979 - 1988

Number of Deaths

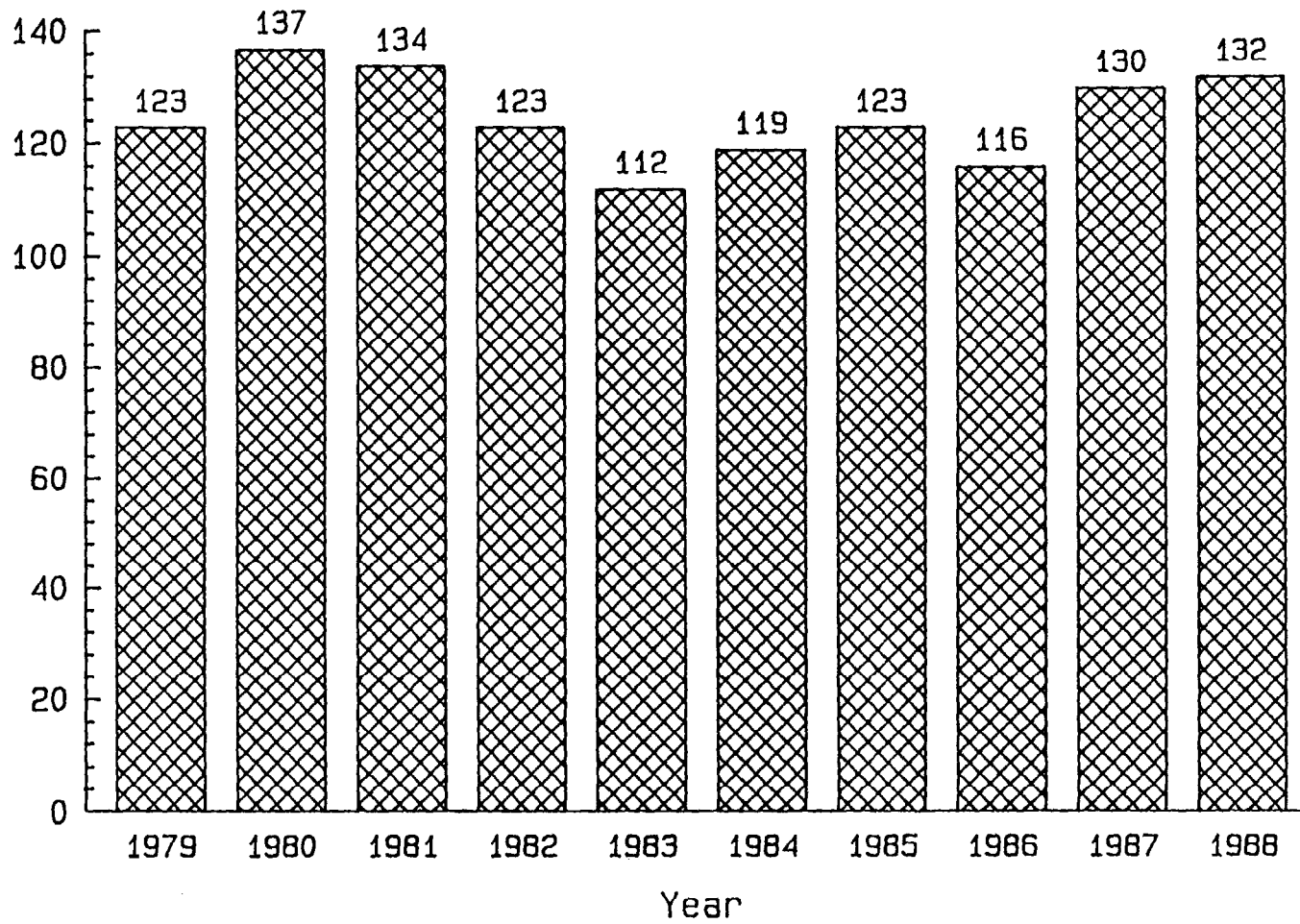
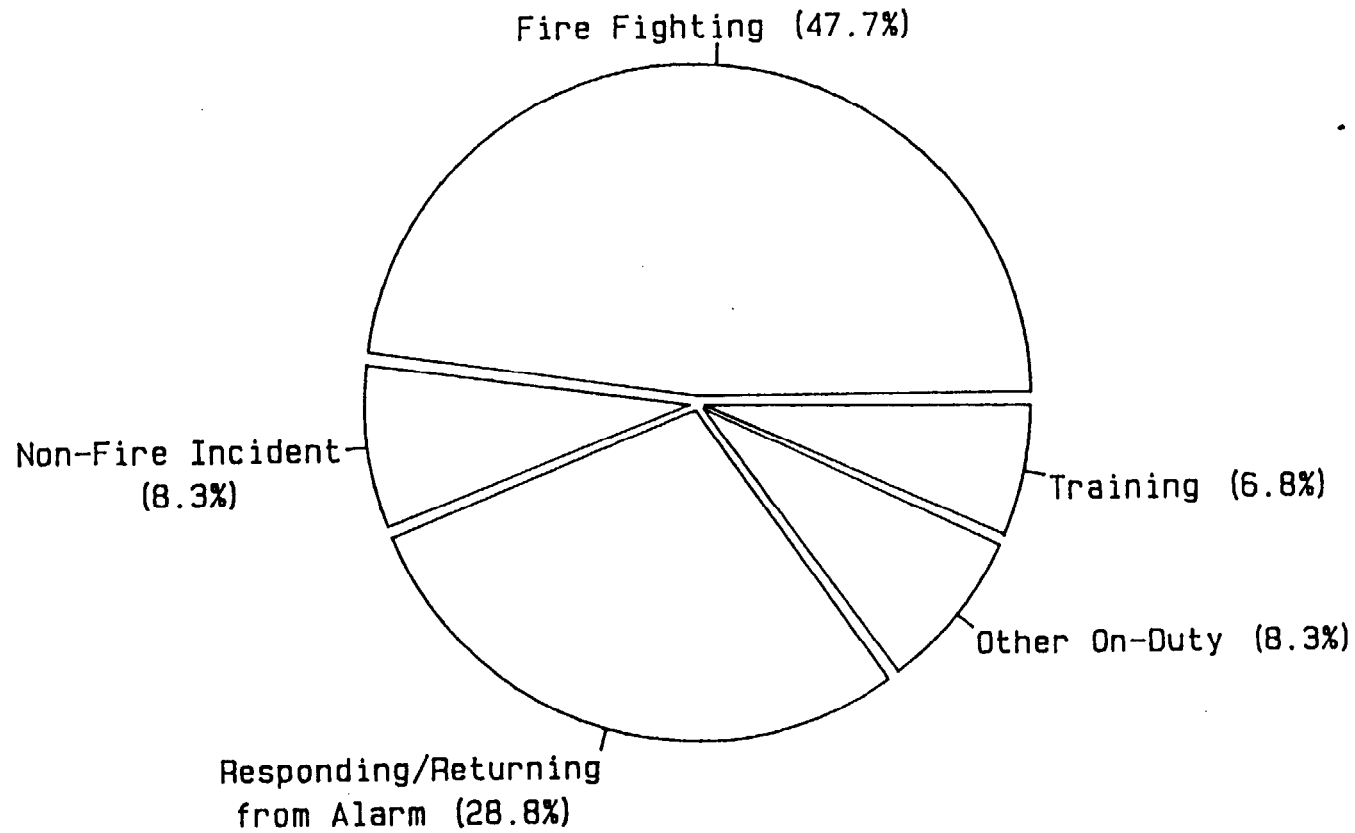

Figure 2
Fire Fighter Deaths 1988
by Type of Duty



The second largest category involved responding to and returning from alarms, which accounted for over a quarter of the deaths -- a result consistent with the findings in previous years. Fifteen of these 38 deaths were due to heart attacks, one to gunshot wounds, and the remaining 22 to collisions.

There were 11 deaths while working at non-fire incidents. These included three fire fighters who suffered heart attacks while working at motor vehicle accidents, three fire fighters struck by passing vehicles while working at motor vehicle accidents, two electrocuted while removing cats from power poles, one due to traumatic injuries when a malfunctioning steam boiler exploded, one due to asphyxiation while attempting to rescue a trapped worker from a ship's tank and one struck by a falling tree limb while investigating an arcing power line.

The number of deaths related to training activities dropped to nine in 1988 from 15 in 1987. This reflects, in part, a rare, multiple-fatality training accident that occurred in 1987. In 1988, one death occurred during a live fire training exercise.

The remaining 11 deaths occurred while performing other duties -- 10 deaths during normal station and administrative duties and one while piloting an aircraft transporting wildland fire personnel.

B. Cause and Nature of Fatal Injury or Illness

As used in this study, the term "cause" refers to the action, lack of action, or circumstances that directly resulted in the fatal injury while the term "nature" refers to the medical nature of the fatal injury or illness or what is often referred to as the cause of death. Often, the fatal injury is

the result of a chain of events, the first of which is recorded as the cause. For example, if a fire fighter is struck by a collapsing wall, becomes trapped by the debris, runs out of air before being rescued and dies of asphyxiation, the cause of fatal injury recorded is "struck by collapsing wall" and the nature of fatal injury is "asphyxiation."

Figure 3 shows the distribution of deaths by cause of fatal injury or illness. As found in most previous years, the largest proportion of deaths were due to stress. Five of these 54 deaths were specifically attributed to strenuous physical activities. The second major category was struck by or contact with objects. These 50 deaths included 32 motor vehicle accidents, five fire fighters struck by collapsing walls, four struck by falling tree limbs or snags, three by electrocution, two struck by hoses, one who came in contact with fumes, one felled by exposure to extreme weather, one due to complications after dislocating his knee while working around equipment at the station and one fatally shot after being kidnapped when he responded to a verbal request for assistance.

Twenty-four fire fighters were caught or trapped -- seven by explosions, five in a roof collapse, four by interior collapse, three by being lost inside a building, two by fire progress, two by flashover, and one underwater, where he drowned. Three fire fighters died as a result of falls -- two from fire apparatus and one from a ladder. One fire fighter died as a result of exposure to smoke.

Fire fighter deaths over the past ten years that occurred as a result of structural collapse are discussed in more detail in a separate section of the report.

Figure 4 shows the distribution of deaths by the medical nature of the fatal injury or illness. The largest proportion of deaths were due to heart attacks. Of these 53 deaths, medical documentation indicated that 11 of the

Figure 3
Fire Fighter Deaths 1988
by Cause of Injury

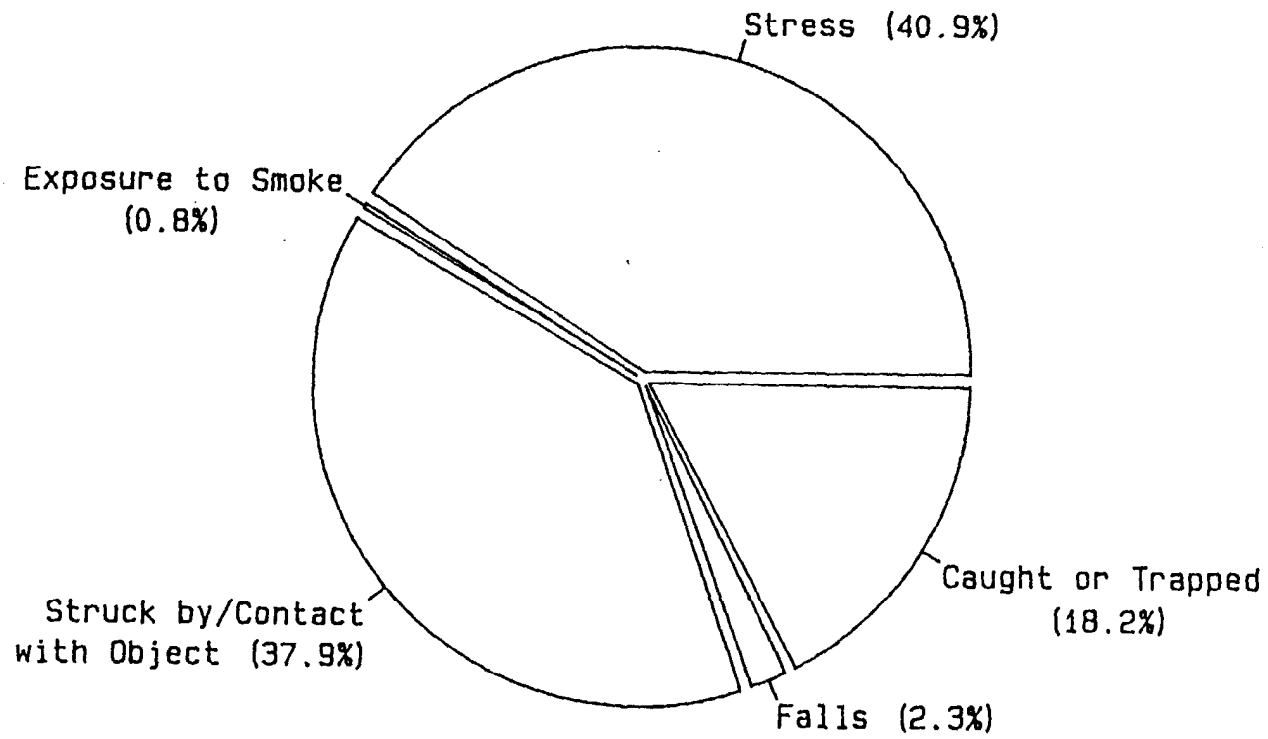
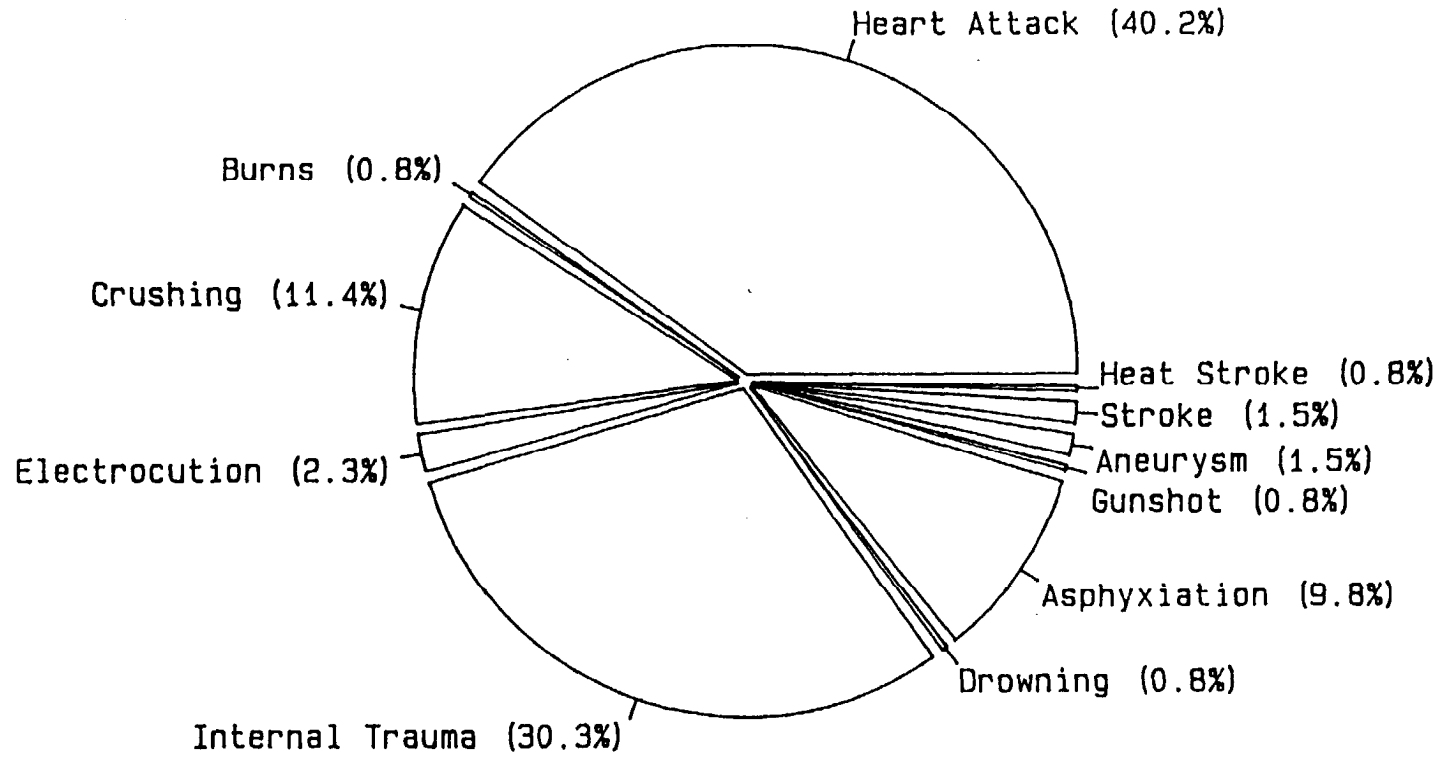

Figure 4
Fire Fighter Deaths 1988
by Nature of Injury



victims had prior heart problems, either previous heart attacks or bypass surgery, and two others had severe arteriosclerotic heart disease (defined for this study as arterial occlusion of at least 50 percent). Four other victims suffered from hypertension and four were diabetics. Medical documentation was not available for the other 32 heart attack victims.

The other categories of nature of fatal injury were internal trauma (40 deaths), crushing (15 deaths), asphyxiation (13 deaths), electrocution (3 deaths), stroke (2 deaths), aneurysm (2 deaths), and one each due to burns, drowning, gunshot wounds and heat stroke.

C. Ages of Fire Fighters

The ages of fire fighters who died in 1988 ranged from 18 to 81 years with a median age of 46 years.

The distribution of fire fighter deaths by age and cause of death is displayed in Figure 5. Almost two-thirds of the fire fighters over age 40 who died were killed by heart attacks. The youngest heart attack victim was 38 years old.

Figure 6 shows the death rates by age categories using estimates of the number of fire fighters in each age group from NFPA's 1986 profile of fire departments and the fatality data from 1984 through 1988'. As the graph shows, the death rate is lowest for fire fighters aged 20 to 39, slightly above the average rate for those aged 40 to 49, and much higher than average for fire fighters aged 50 and over. This is a reflection of the fact that although fewer than 15 percent of all fire fighters are over age 50, that age group accounted for over a third of the deaths from 1984 through 1988.

Figure 5
Fire Fighter Deaths 1988
by Age and Cause of Death

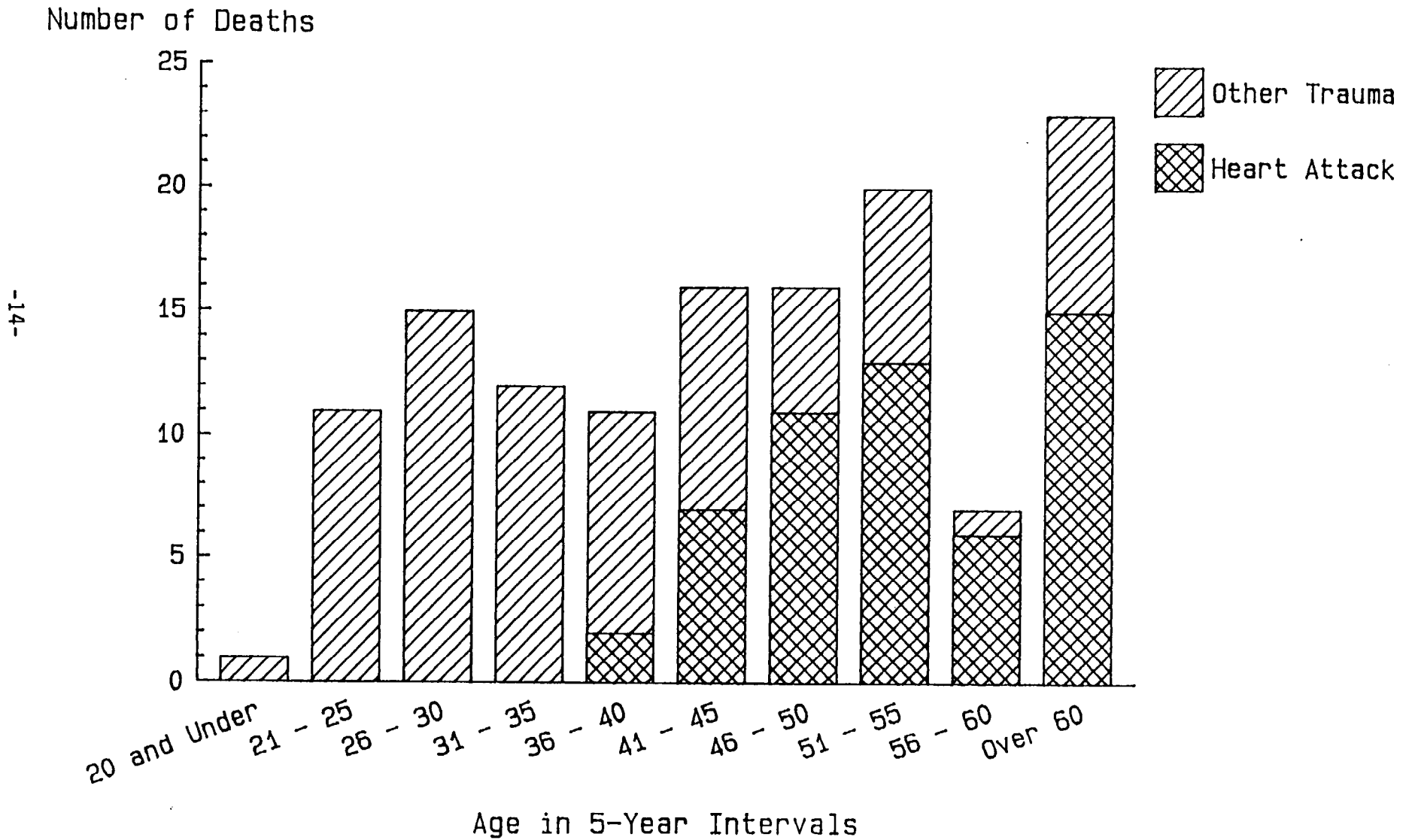
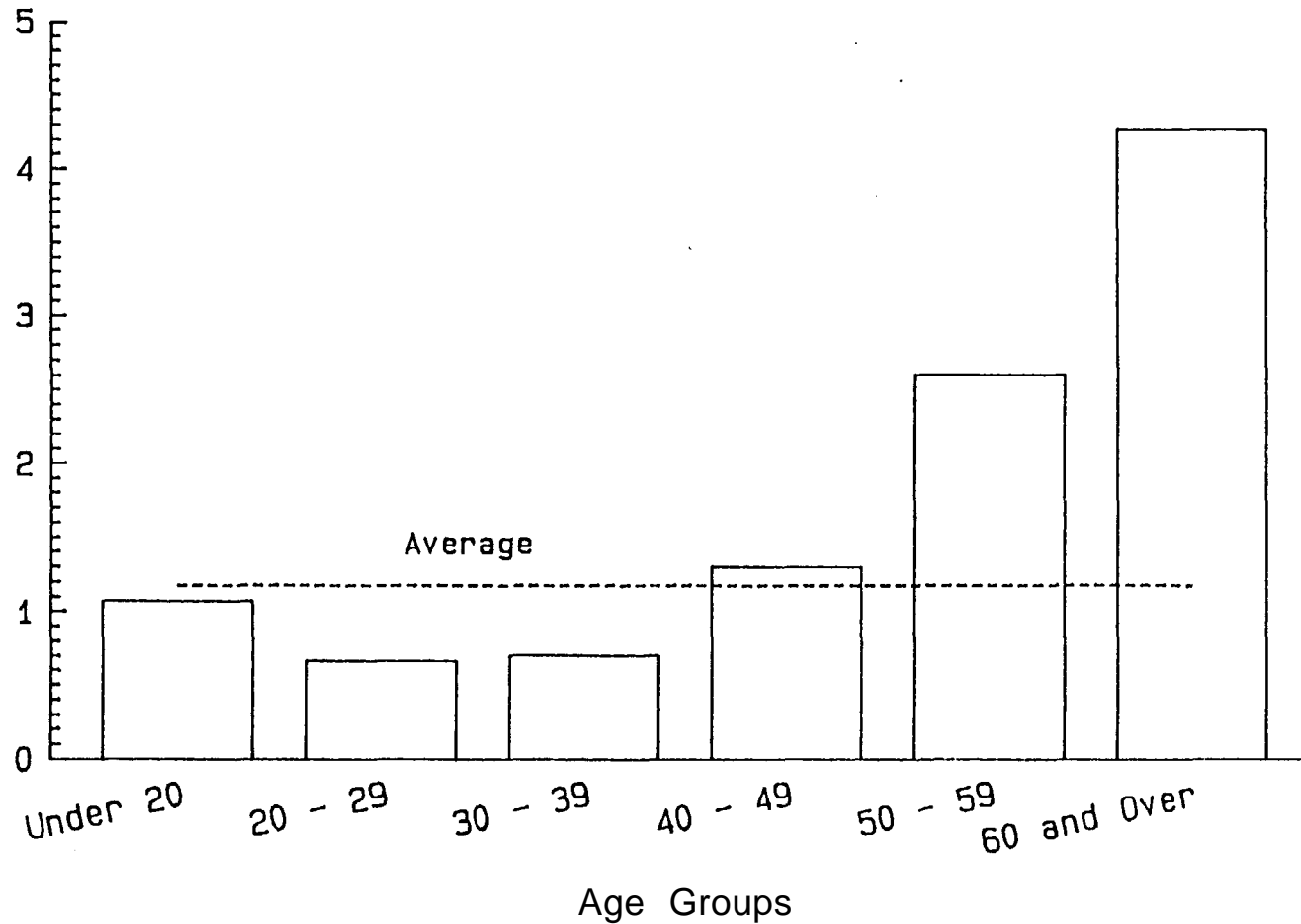

Figure 6
Average Death Rates per 10,000 Fire Fighters
1984 - 1988

Deaths per 10,000 Fire Fighters

-15-



Note: These figures combine career and volunteer fire fighters. The two groups may have very different age distributions, which are not reflected here.

D. Fire Ground Deaths

The distribution of the 63 fireground deaths by fixed property use is shown in Figure 7. As has been the case every year except 1987, the largest proportion of fire ground deaths occurred in residential properties - 20 deaths in 1988, including 16 deaths in one- and two-family dwellings and four in apartment buildings.

Thirteen deaths occurred in wildland fires, an improvement over the 1987 experience when there were 17 fatalities at wildland fires. Four fire fighters died of heart attacks -- one due to smoke exposure, the other three due to stress. Another fire fighter had a stroke, while another died of heat stroke. In separate incidents, three fire fighters were killed when they were struck by falling tree sections. One fire fighter was electrocuted when he came in contact with a downed power line that had started a small grass fire. The pilot of a spotter plane guiding air tankers over a forest fire was killed when his plane crashed. A fire fighter standing on the side of a moving tanker was killed when the vehicle overturned in a ditch and he was pinned underneath. Another fire fighter was crushed when a parked brush fire unit began to roll on a hillside and then overturned as she was starting the pump on the back of the vehicle.

There were ten deaths each in mercantile and storage properties. These incidents include five deaths that occurred when the wood truss roof of an automobile dealership collapsed, and six deaths that occurred at a construction site when a trailer storing 45,000 pounds of ANFO blasting agent exploded. (For full descriptions of these incidents, see "The Hackensack Fatalities" in the October 1988 issue of Fire Command and "The Kansas City Tragedy" in the April and May 1989 issues of Fire Command.)

Figure 7
Fire Ground Deaths in 1988
by Fixed Property Use

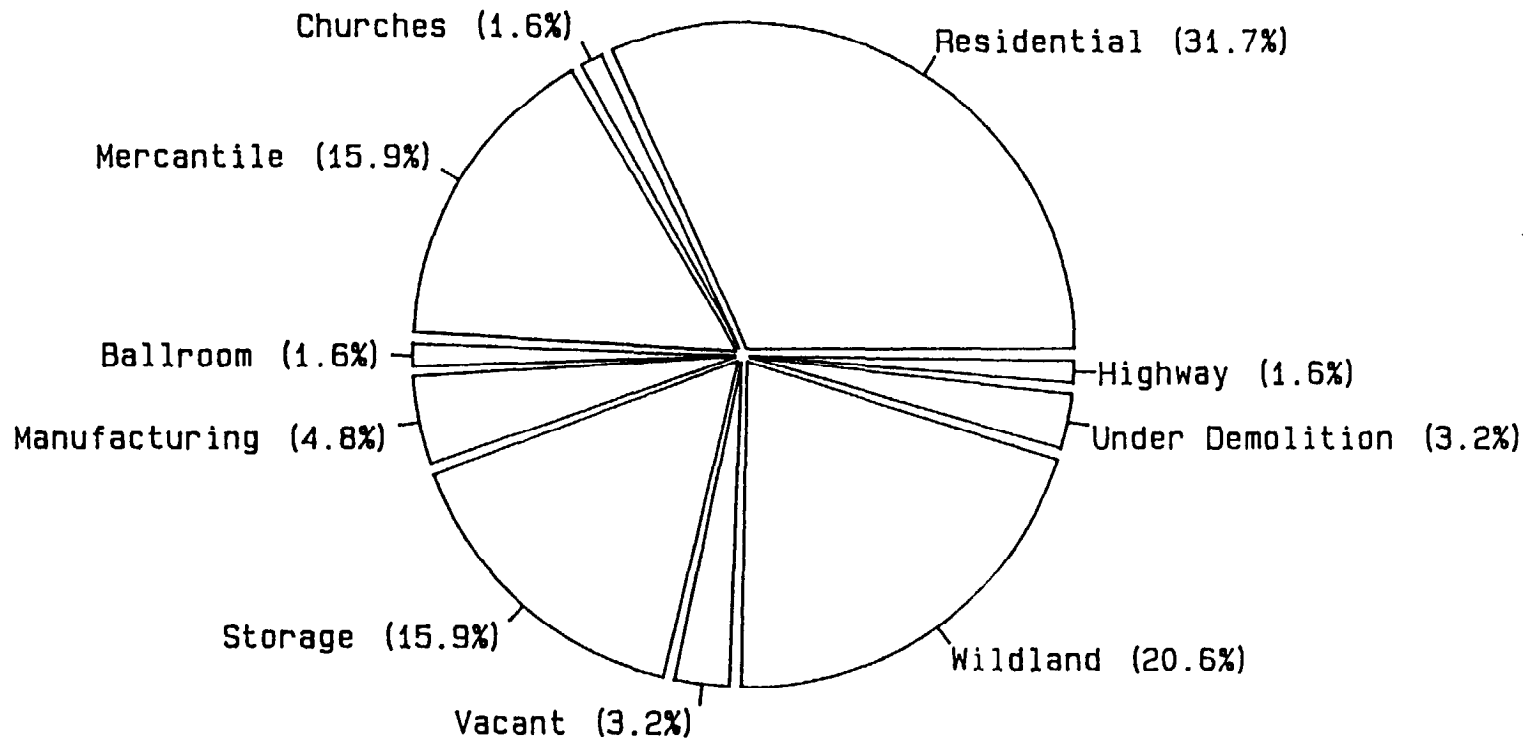

Three fire fighters were killed in fires in manufacturing properties and one each at a church fire and in a fire at a ballroom. In separate incidents, two fire fighters were killed when walls collapsed on them at fires involving buildings under demolition. One fire was of incendiary origin. In two other incidents, fire fighters suffered fatal heart attacks at the scene of fires in vacant buildings. And one fire fighter died of a heart attack at the scene of a vehicle fire.

In all, 18 fire fighters died at the scene of incendiary or suspicious fires. Ten of these deaths were at structure fires, two were at wildland fires and the remaining six occurred at the incident involving trailers storing ANFO at a construction site. (Six other fire fighters were killed en route to incendiary or suspicious fires.)

To put the hazards of fire fighting in various types of occupancies into perspective, the number of deaths per 100,000 structure fires was examined by fixed property use. The rates were calculated using the estimates of fire experience from NFPA's 1988 fire loss study³. There were 3.6 fire fighter deaths per 100,000 residential structure fires, compared to 11.9 deaths per 100,000 nonresidential structure fires. Although almost three times as many fires occurred in residential structures, the size, complexity and special hazards often associated with nonresidential structures result in a much greater risk at such fires.

E. Time of Day

The distribution of 1988 fire ground deaths and total deaths by time of alarm is shown in Figure 8. The two peaks are the time periods where the large multiple-fatality incidents fall -- five deaths at the Hackensack, New Jersey, fire at 2:59 pm and six deaths in the Kansas City, Missouri, fire at

Figure 8

Fire Fighter Fatalities 1988 by Time of Day

Number of Deaths

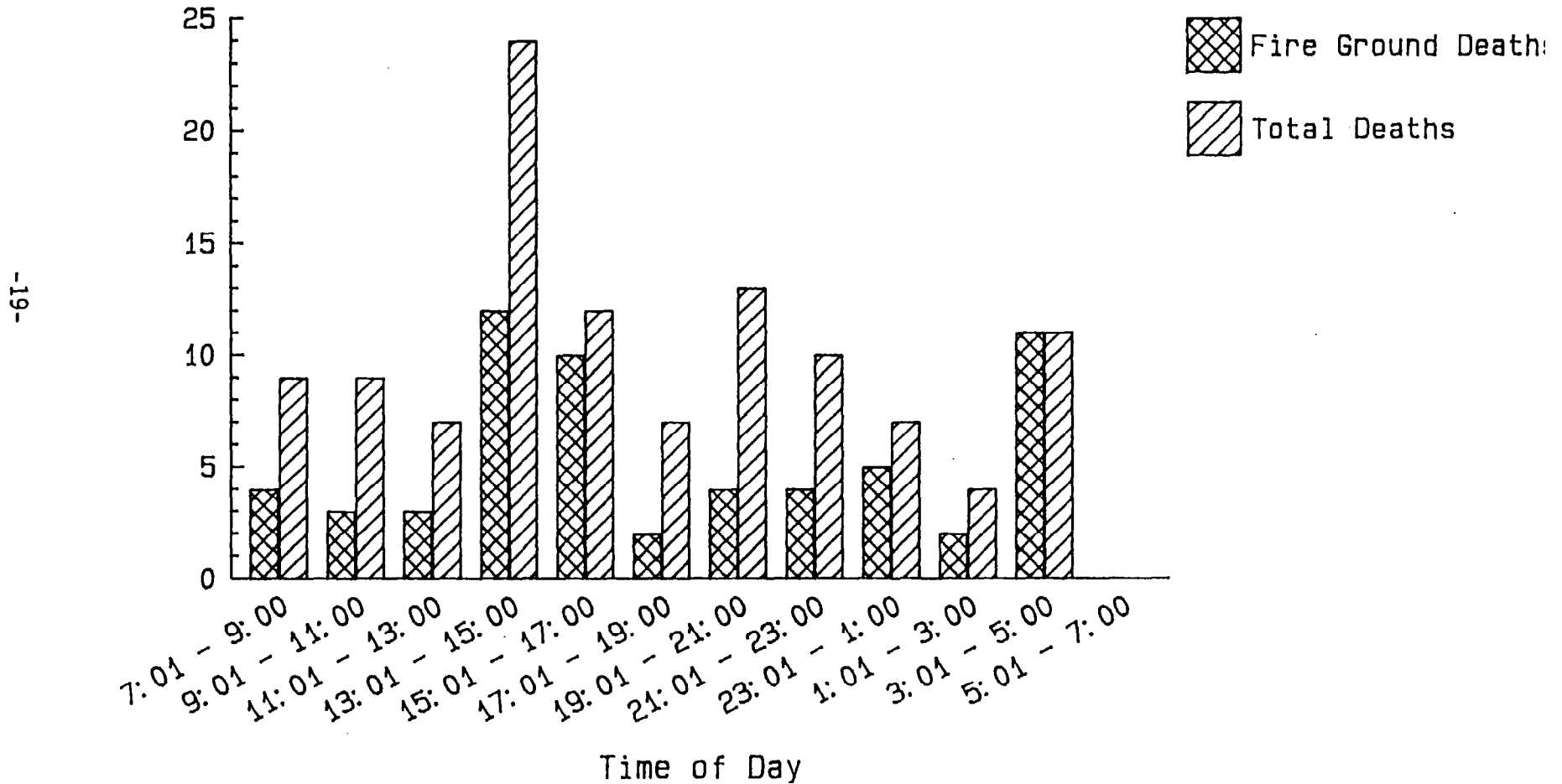

Based on 60 fire ground fatalities and
113 total fatalities for which time
was known.

3:41 am. The distribution of deaths by time of day over a ten-year period is shown in Figure 9. The number of deaths in both categories was at the highest between 1:00 and 9:00 pm and drops to the lowest level in the early morning hours.

F. Month of the Year

Figure 10 shows the distribution of 1988 fire fighter deaths by month. The same information for 1979 through 1988 is shown in Figure 11. The deaths in July 1988 include the five deaths in Hackensack. November includes the six deaths in Kansas City. The ten-year analysis shows that fire ground deaths are higher in the winter months and in midsummer.

G. State and Region

The distribution of fire fighter deaths by state is shown in Table 1. Thirty-four states are represented on the list, led by Pennsylvania with 17 deaths. The experience by region⁴ is displayed in Table 2. The Northeast lost the largest number of fire fighters (481, followed by the South (321, the Northcentral region (29) and the West (23). When looking at fire ground deaths, we see that the Northeast and Northcentral regions both have higher than average death rates. The fire ground death rate was higher in the West than in the South because so many of the wildland deaths occurred in the West, while the South has many more fires overall than the West.

Figure 9

Fire Fighter Fatalities by Time of Day

1979 - 1988

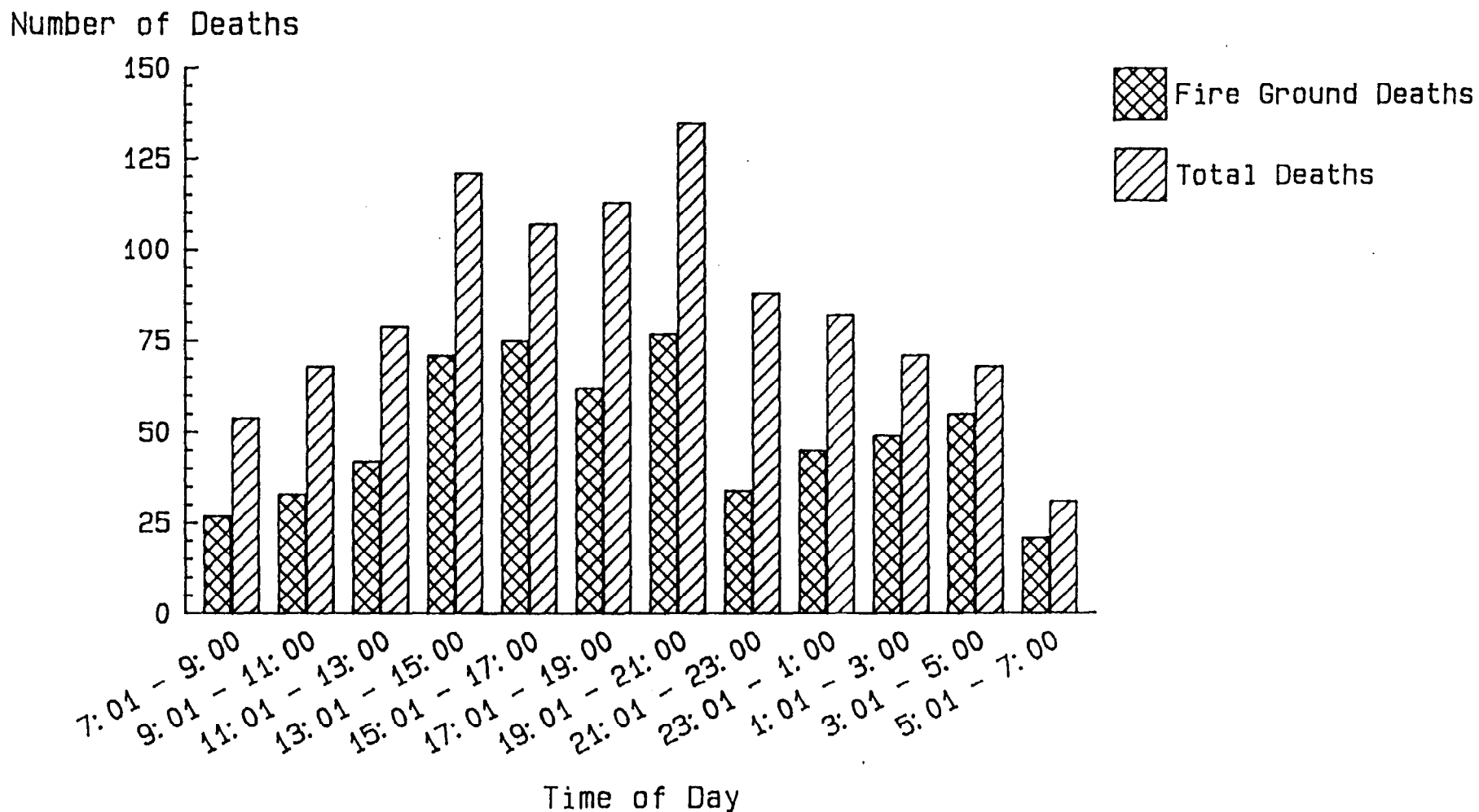

Based on 591 fire ground fatalities and 1017 total fatalities for which time was known.

Figure 10 Fire Fighter Fatalities 1988 by Month of Year

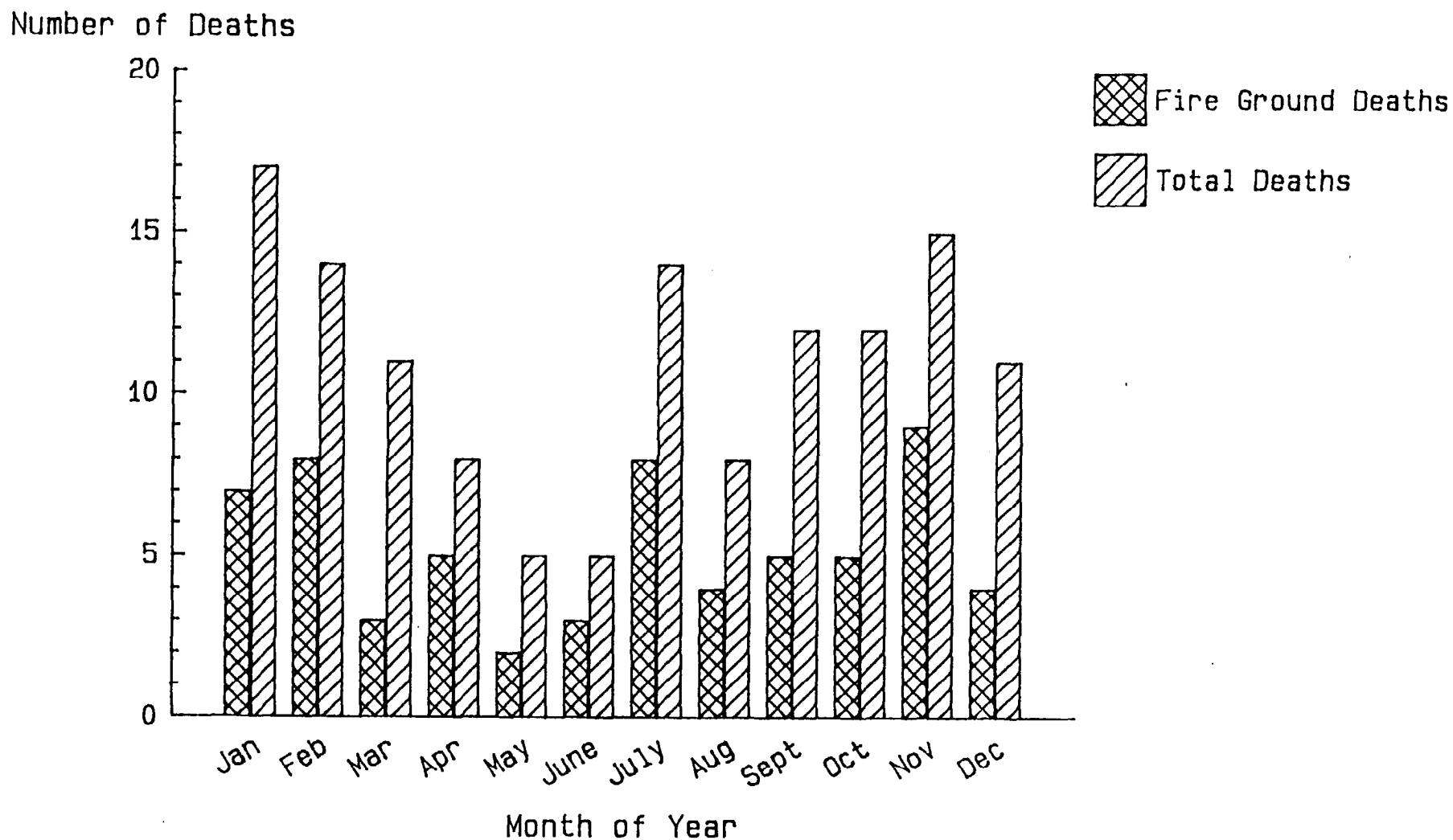

Based on 63 fire ground deaths and
132 total fatalities.

Figure 11
Fire Fighter Fatalities by Month of Year
1979 - 1988

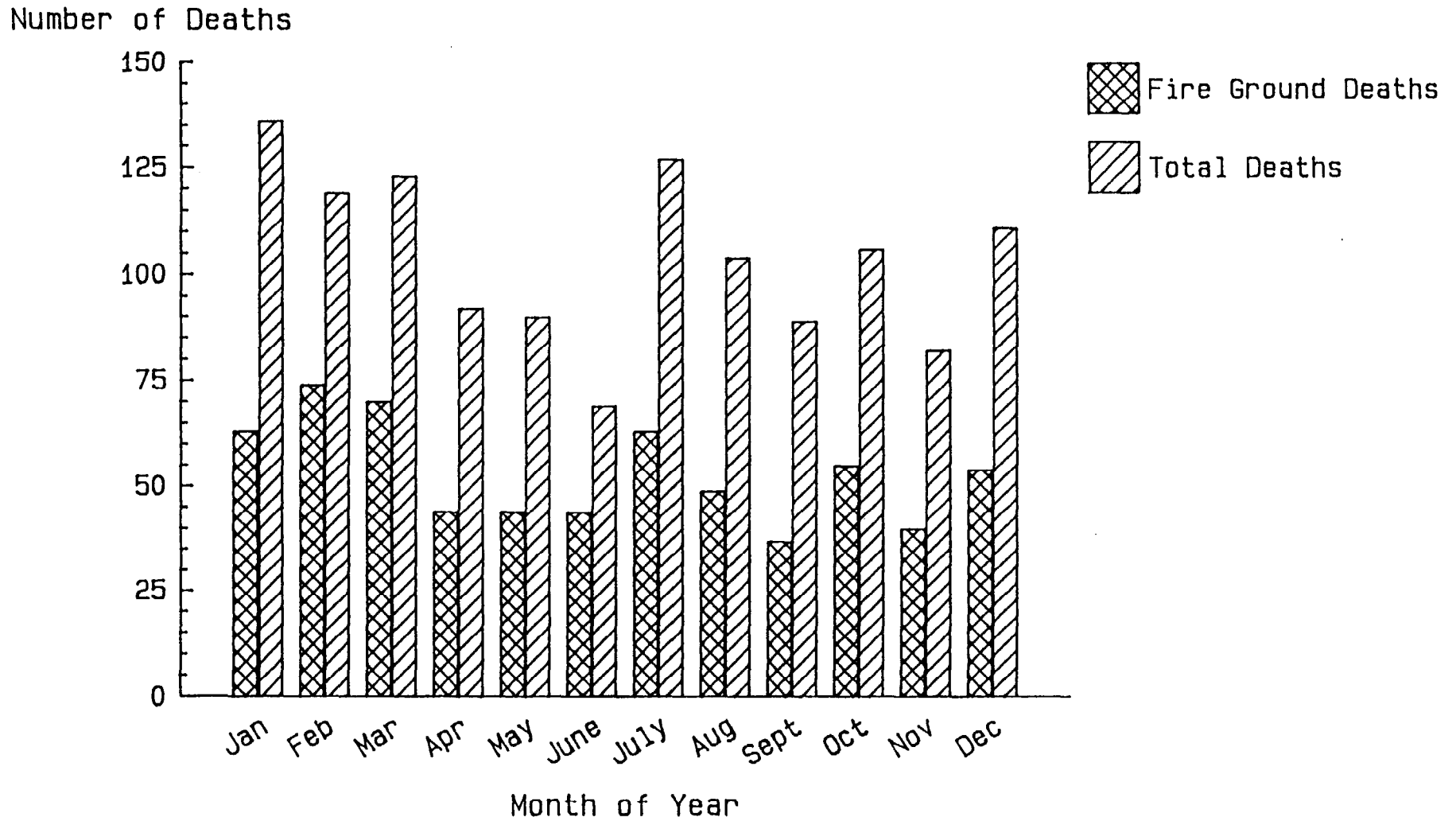

Based on 637 fire ground deaths and
1249 total fatalities.

Table 1
1988 Line of Duty
Fire Fighter Fatalities

| <u>State</u> | <u>Number of Deaths</u> | <u>State</u> | <u>Number of Deaths</u> |
|---------------|-------------------------|----------------|-------------------------|
| Alabama | 1 | Montana | 2 |
| California | 4 | New Hampshire | 1 |
| Colorado | 3 | New Jersey | 11 |
| Florida | 3 | New York | 14 |
| Georgia | 2 | North Carolina | 2 |
| Idaho | 2 | Ohio | 5 |
| Illinois | 2 | Oregon | 4 |
| Indiana | 4 | Pennsylvania | 17 |
| Kansas | 2 | South Carolina | 3 |
| Kentucky | 3 | South Dakota | 2 |
| Louisiana | 1 | Tennessee | 3 |
| Maine | 1 | Texas | 4 |
| Maryland | 6 | Vermont | 1 |
| Massachusetts | 3 | Virginia | 1 |
| Michigan | 4 | Washington | 3 |
| Mississippi | 3 | Wisconsin | 1 |
| Missouri | 9 | Wyoming | 5 |

TOTAL: 132

Table 2
 Fire Fighter Death Rate by Region
 1988

| <u>Region</u> | <u>Number of Fatalities</u> | <u>Number of Fire Ground Deaths</u> | <u>Fire Ground Death Rate per 100,000 Fires</u> |
|---------------|-----------------------------|-------------------------------------|---|
| Northeast | 48 | 25 | 4.77 |
| Northcentral | 29 | 18 | 3.00 |
| South | 32 | 11 | 1.19 |
| West | 23 | 9 | 2.31 |
| Nationwide | 132 | 63 | 2.59 |

H. Analysis of Urban/Rural/Suburban Patterns in Fire Fighter Fatalities

The U.S. Bureau of the Census defines "urban" as a place having at least 2,500 population or lying within a designated urbanized area. "Rural" is defined as any community that is not urban. "Suburban" is not a Census term but may be taken to refer to any place, urban or rural, that lies within a metropolitan area defined by the Census but is not one of the designated central cities of that metropolitan area.

Fire department coverage areas do not always conform to the boundaries of Census places. For example, fire departments defined by counties or special fire protection districts may have both urban and rural sections, and there are Federal, state, and private fire fighters. In such cases, it may not be possible to characterize the entire coverage area of a fire department as rural or urban, and one must assign a fire fighter death as urban or rural based on the particular community in which he was operating when fatally injured.

Based on these rules, the following patterns were found and are shown with available patterns for the general population and for the population of fire fighters specifically in local fire departments:

| | <u>Urban</u> | <u>Rural</u> | <u>Total</u> |
|------------------------------------|--------------|--------------|--------------|
| Total 1988 fire fighter fatalities | 74 (56%) | 58 (44%) | 132 (100%) |
| Suburban location | 40 | 21 | 61 |

| | <u>Urban</u> | <u>Rural</u> | <u>Total</u> |
|-------------------------------------|--------------|--------------|--------------|
| Local fire department only* | 72 (60%) | 48 (40%) | 132 (100%) |
| U.S. population (1980) | 74% | 26% | 100% |
| U.S. fire fighters (1987), total** | 58% | 42% | 100% |
| U.S. fire fighters (1987), career** | 97% | 3% | 100% |
| U.S. fire fighters (1987), volun.** | 46% | 54% | 100% |

In 1988, the distribution of fire fighter fatalities from local fire departments (60 percent urban, 40 percent rural) was closer to the 1987 distribution of fire fighters from local fire departments (58 percent urban, 42 percent rural) than to the 1980 distribution of the whole U.S. population (74 percent urban, 26 percent rural), suggesting that the the risk of dying, as measured by local fire fighter deaths per 100,000 local fire fighters, is nearly the same in urban and rural areas. The result is surprising, however, since rural areas are generally served by volunteer fire fighters, who typically would average fewer work (exposure) hours per year than career fire fighters and who would therefore be expected to have a lower risk of death per 100,000 fire fighters, as a separate career/volunteer analysis did show. A similar result was found in 1986.

For 1987, however, the distribution of fire fighter fatalities from local fire departments was closer to the distribution of the whole U.S. population than to the distribution of fire fighters from local fire departments. That suggested that, for 1987, urban fire fighters faced a greater risk of dying than fire fighters in rural areas, which was not unexpected since urban areas

* Excludes two military service fire fighter killed in an urban location and 10 Federal, state and contract fire fighters killed in rural locations.

** "U.S. Fire Department Profile Through 1987," Quincy, Massachusetts: National Fire Protection Association, Fire Analysis Division, November 1988. All percentages are for fire fighters in local fire departments.

*** Note that the classification of fire fighters into urban and rural is based strictly on the population protected by the fire department and not on metropolitan area considerations. However, if fire fighter fatalities were similarly classified, the distribution would shift by at most two percentage points, so the points here are not affected.

are generally served by career fire fighters who average more hours of exposure per year than volunteer fire fighters and therefore would be expected to have a higher risk of death per 100,000 fire fighters.

Since the results fluctuate back and forth each year, it is not worthwhile to read too much in to them. It will be necessary to collect several years worth of data and do a multi-year analysis before any firm conclusions can be drawn.

III. FIRE FIGHTER DEATHS IN STRUCTURAL COLLAPSES 1979 - 1988

From 1979 through 1988, 93 of the 474 fire fighters who were killed at structure fires died as a result of structural collapse. For the purpose of this analysis, the following definition of structural collapse is used: the failure of structural member(s) resulting in the collapse of a structure or portion(s) of a structure. Two categories of structural collapse are described. The first includes incidents where fire fighters were caught or trapped by a collapsing roof, wall, floor or ceiling. Most victims in this category were inside or on the roof of the building. The second category includes incidents where fire fighters were struck by a collapsing roof, wall, or ceiling or pieces of a wall. In these cases, the injury occurred when the victim was outside a structure. The breakdown for the 93 fatalities is shown in Figure 12.

Fatalities as a Result of Being Caught or Trapped

Of the 93 victims, 56 were caught or trapped by structural collapse -- 31 of the victims were asphyxiated, 13 died of burns and 12 died as a result of crushing injuries or internal trauma. The building components involved in the collapses were the roof (30 deaths), floor (19 deaths), ceiling (5 deaths) and wall (2 deaths). Another 140 fire fighters were injured in these incidents, and one fire fighter was killed when he jumped from a window to escape flashover in a fire where a collapse killed two other fire fighters.

The 30 deaths in roof collapses occurred in 21 incidents. Ten of the victims in seven incidents were on the roof performing ventilation, 17 were inside performing fire suppression activities, two were inside pulling ceilings, and one was involved in a search for occupants.

Figure 12
Fire Fighter Fatalities
in Structural Collapses
1979 - 1988

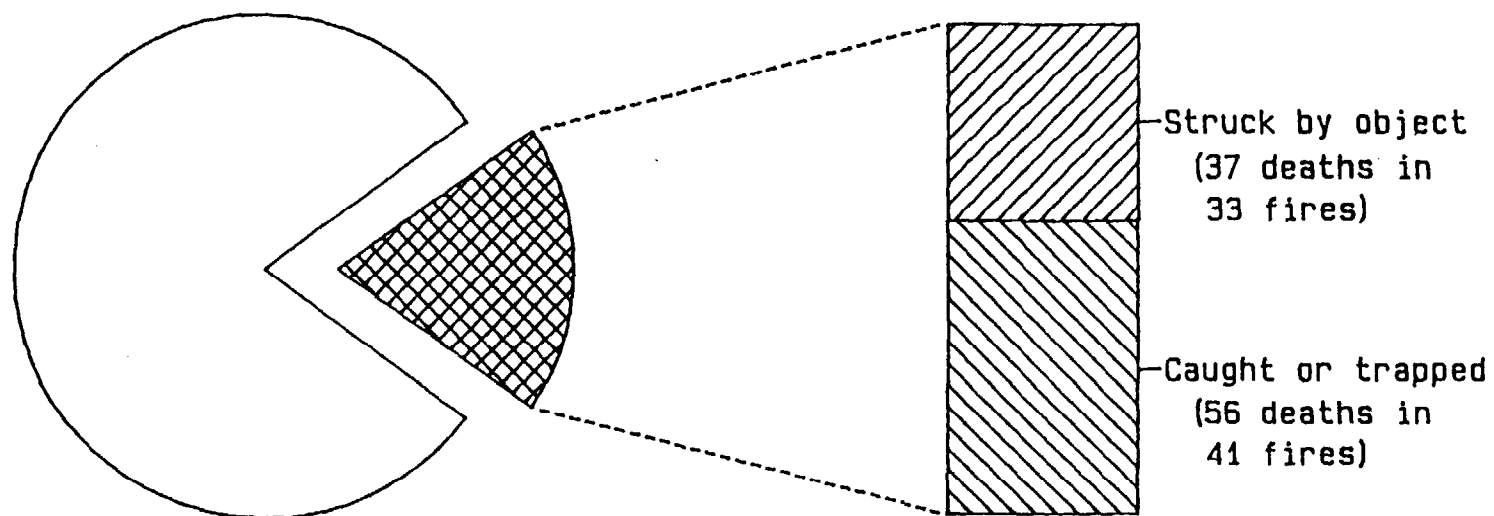

93 of 474 structure fire deaths
occurred in structural collapses

Fifteen of the 26 victims caught or trapped by floor, wall or ceiling collapse were involved in fire fighting activities, four were performing search and rescue, three were killed during overhaul (one was supervising), two were performing ventilation, and two were supervising operations.

Figure 13 shows the distribution of the 56 fatalities by fixed property use.

Fatalities as a Result of Being Struck by Collapse

Of the 93 victims of structural collapse, 37 were struck by collapsing walls or pieces of walls -- 20 died of crushing injuries and 17 as a result of internal trauma. Another 74 fire fighters were injured in these incidents.

The 37 deaths in wall collapses occurred in 33 incidents. All of these victims were outside the structure at the time of the collapse. At the time of the collapse, 30 of the victims were operating handlines (one from an elevated platform) or performing other suppression activities, including supervision of hoseline operations, setting up a master stream appliance and ventilation. Three fire fighters were killed as they were escaping the building and two (in separate incidents) were attempting to move vehicles. One died when a natural gas explosion caused a wall collapse as he and others attempted to rescue an elderly woman from a fire escape. One fire fighter was attempting to open a door with a ceiling hook when the wall collapsed on him.

In 12 of the 33 incidents mentioned above, the roof was reported to have collapsed, and in another the floors collapsed, pushing the walls out and causing them to collapse. Three explosions caused fatal wall collapses -- one incident killed four fire fighters. The failure of fire fighters to maintain a safe distance between themselves and the building appears to have been a factor in almost all of the wall collapse fatalities.

Figure 14 shows the distribution of the 37 fatalities by fixed property use.

Figure 13
Fire Fighters Caught or Trapped
in Structural Collapses
1979 - 1988

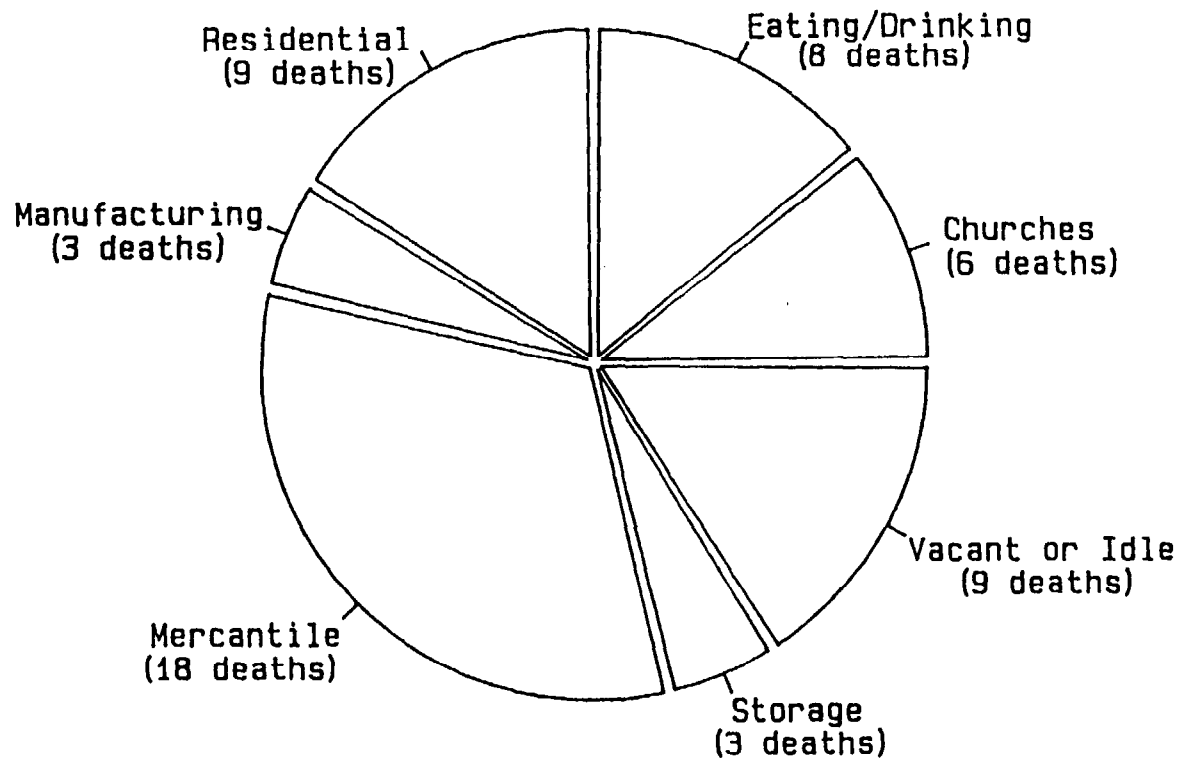
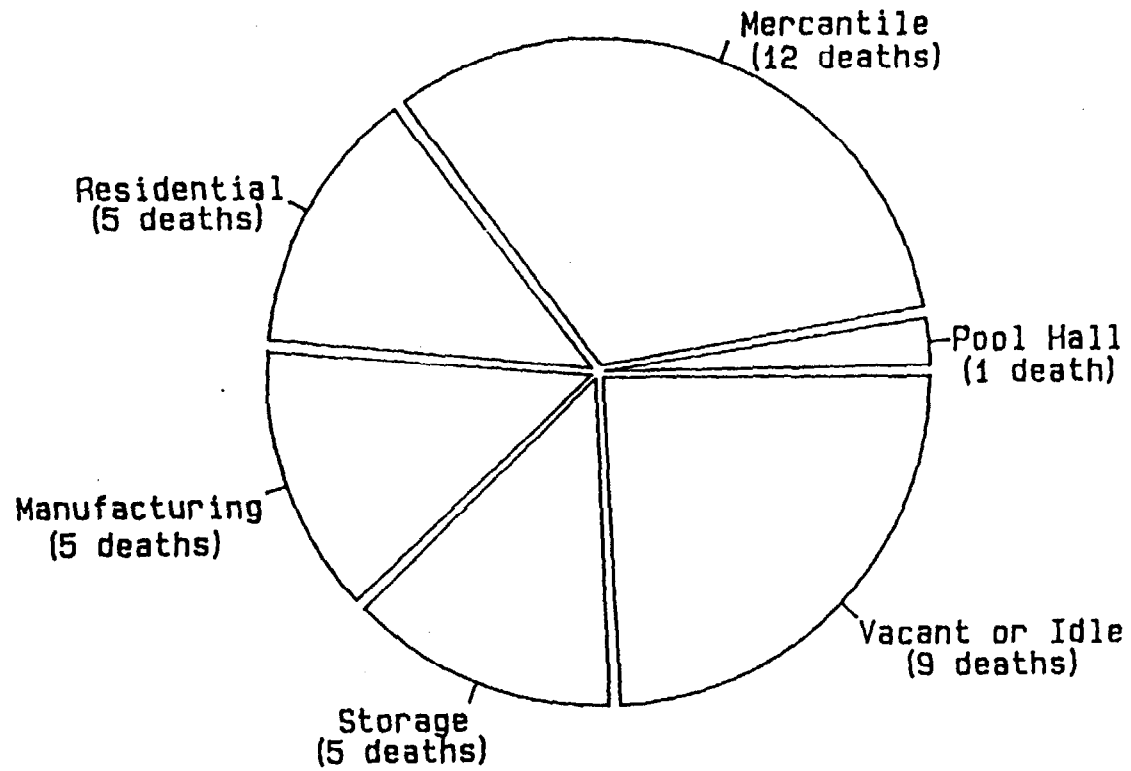

Figure 14
Fire Fighters Struck by Objects
in Structural Collapses
1979 - 1988



Collapses Involving Truss Roofs

Seven of the collapses were reported to involve truss roofs. (This analysis does not include the 1978 fire where six New York City fire fighters were killed when the roof of a supermarket collapsed.) Six of these collapses resulted in 11 fire fighters being caught or trapped. (Nine of these fire fighters were inside buildings; one was on the roof.) The seventh collapse resulted in a fire fighter being struck by a collapsing wall after the roof collapsed. The most severe incident, in terms of loss of life, occurred in 1988 when five fire fighters were killed when the wood bowstring truss roof of a New Jersey automobile dealership suddenly collapsed while the men were working inside.

Summary

Over the 10-year period, 93 fire fighters died on the fire ground as a result of structural collapses. Fifty-six were caught or trapped in the collapse, and 37 were struck by collapsing walls or sections of walls.

Thirty-nine of the 74 fires were of incendiary or suspicious origin and resulted in 50 deaths. Fifty-one of the structures were one or two stories high, while 22 others were three stories or higher. No information was available on the height of the other building.

The distribution of the 93 deaths by year is shown in Figure 15. Sixty-six of the victims were career fire fighters and 27 were volunteers. The distribution of deaths by region is shown in Figure 16.

As mentioned in the discussion above, the failure of fire fighters to maintain a safe distance between themselves and the building was a factor in almost all of the cases where fire fighters were struck by wall collapses. As for the cases of fire fighters caught or trapped by structural collapse, fire fighters operating in or on buildings rely on good fire ground supervision that can alert them to the danger of possible collapse of the involved

Figure 15
Fatalities in Structural Collapses
1979 - 1988

Number of Deaths

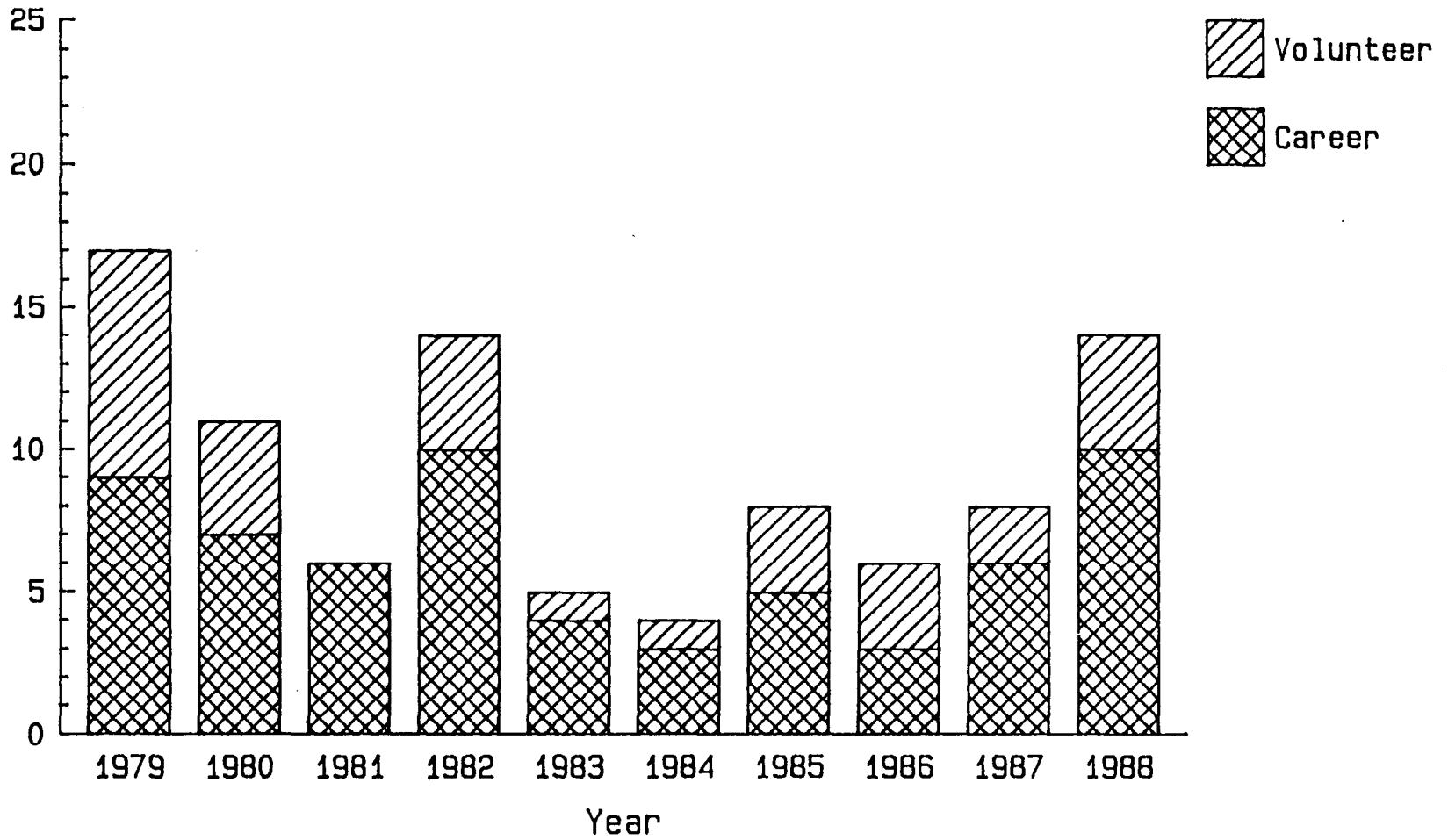
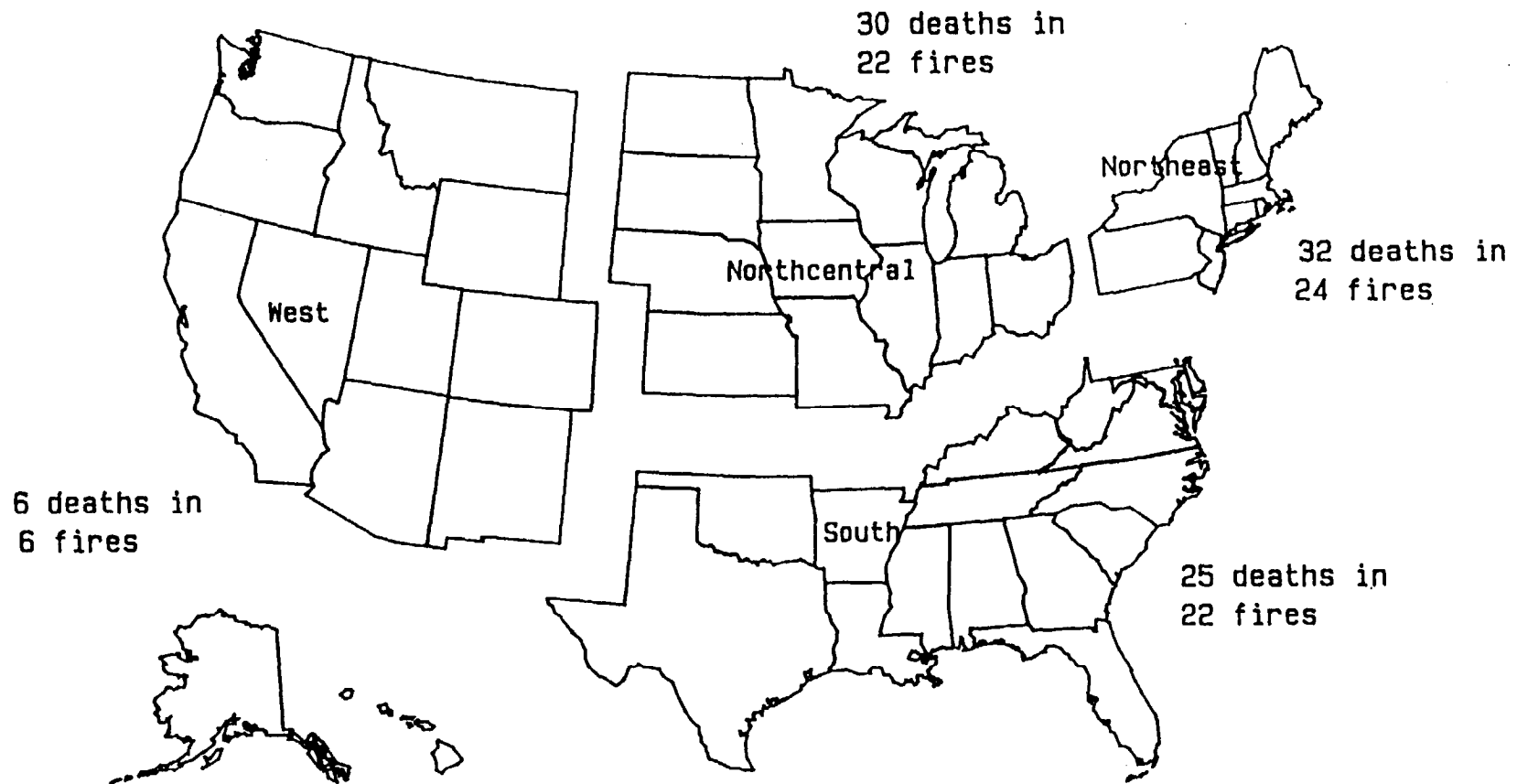

Figure 16
Fatalities in Structural Collapses by Region
1979 - 1988



IV. FIRE FIGHTER DEATHS WHILE RESPONDING TO ALARMS

1979-1988

From 1979 through 1988, 335 fire fighters died while responding to or returning from emergencies or other incidents. As shown in Figure 17, these deaths accounted for slightly more than a quarter of all fire fighter fatalities and bear closer examination because so many of the deaths involve factors that should be preventable.

Of these 335 deaths, 235 involved fire fighters responding to alarms. Most of the 100 deaths while returning from alarms were due to heart attacks. It may not be surprising, given the emotional stress of responding to an incident, that 73 of the deaths while responding were due to heart attacks and two others were due to strokes. But at least 36 of the heart attack victims had existing heart problems or prior heart attacks. illustrating once again the danger of heart-impaired fire fighters continuing to participate actively on their fire departments. Four other heart attack victims had hypertension. The importance of regular physical monitoring, as called for by NFPA 1500, could not be more clear.

Almost all of the remaining 160 deaths while responding to alarms were the result of motor vehicle accidents. See Figure 18.1 These included 109 collisions and vehicle overturns, 30 falls from apparatus, and 11 cases of victims struck by vehicles. (The other 10 deaths include three drownings, two struck by doors, one struck by a falling tree, one fall on stairs, one fall over an object, one gunshot victim, and one carbon monoxide poisoning.)

The problem of fire fighters falling from apparatus was discussed in the 1987 contract report and the problem of fire fighters being struck while operating at or approaching incident scenes is discussed in the next section

Figure 17
Fire Fighter Deaths While Responding to
or Returning from Incidents
1979 - 1988

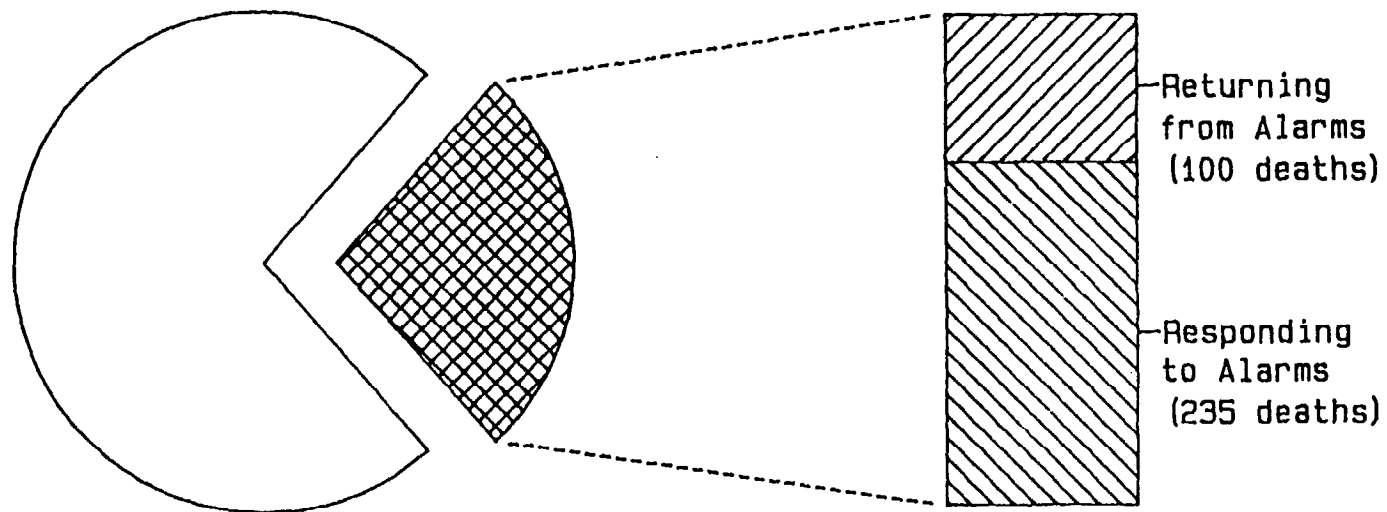

335 of the 1249 total deaths occurred while responding to or returning from alarms.

Figure 18
Fire Fighter Deaths While Responding
by Cause of Injury
1979 - 1988

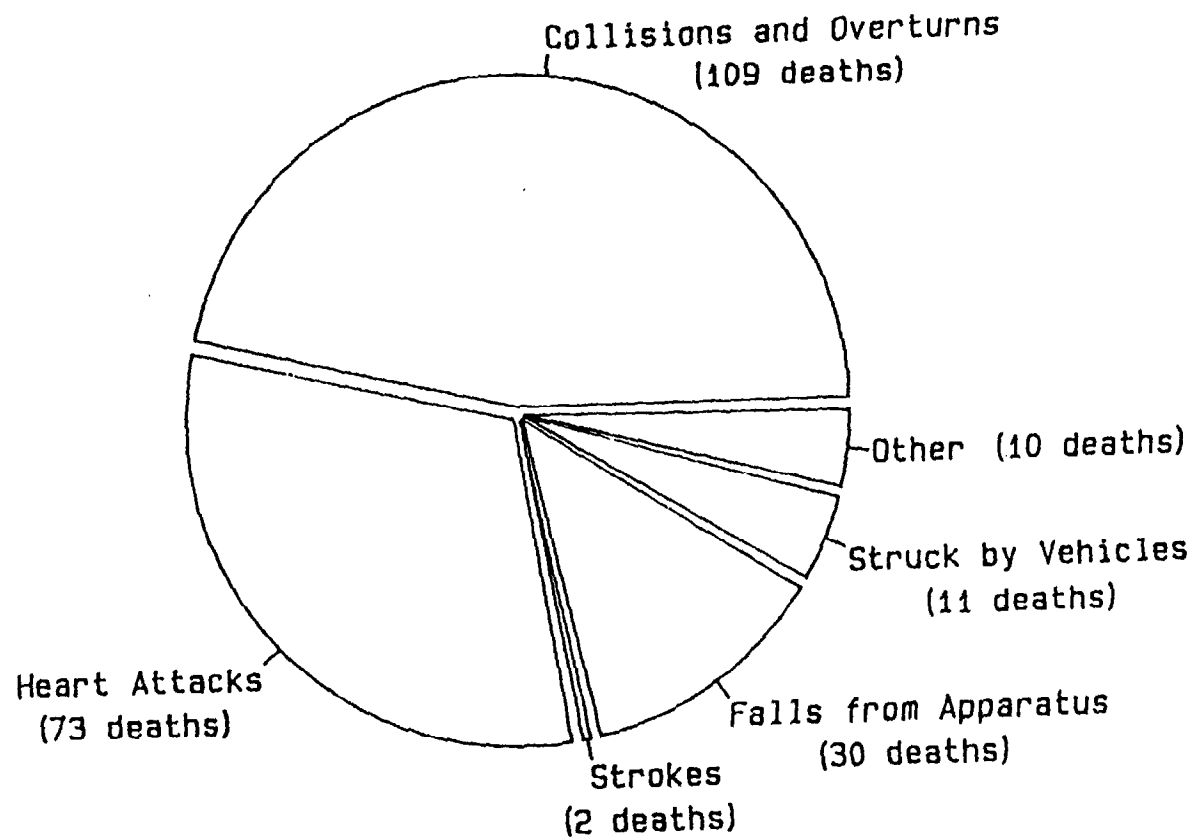

of this report. The analysis of incidents involving falls from apparatus showed that in the most common scenario, the victims were thrown from the back step of pumpers as the apparatus rounded a curve. Others were bounced off when the apparatus went over a rut, curb or speed bump or lost their grip when vehicles stopped at incident scenes or stopped and started up again in traffic. Fire fighters struck at or near incident scenes most often were operating at traffic accidents or vehicle fires. Most incidents occurred after dark or under conditions of poor visibility.

The rest of this section will concentrate on the 109 deaths that resulted from collisions or vehicles overturning. As shown in Figure 19, the greatest proportion of these 109 deaths involved private vehicles (38.5 percent), followed by engines or pumpers (21.1 percent) and tankers (19.3 percent).

Twenty-three of the 44 deaths involving private vehicles were the result of collisions with other vehicles; 16 involved collisions with objects such as utility poles, trees and bridge abutments; and two resulted from vehicles overturning. There were no details given on the other three accidents. Five of the deaths were the result of four incidents involving motorcycles. Factors reported concerning the collisions with other vehicles were failure to stop at a red light or stop sign (5 deaths), failure to yield (4 deaths), failure to heed railroad crossing warning lights (3 deaths), and failure of other drivers to yield (2 deaths). In five of the 16 accidents resulting in collisions with objects and in the two overturning accidents, excessive speed was mentioned as a factor. In another accident, the fire fighter's vehicle hydroplaned during a severe rainstorm, indicating excessive speed for the existing road conditions. In eight of the accidents, the roads were wet. In another, the driver lost control on a patch of ice. Drunk driving by fire fighters was mentioned as a factor in two of the accidents.

Figure 19
Fire Fighter Deaths While Responding
by Type of Vehicle Involved
1979 - 1988

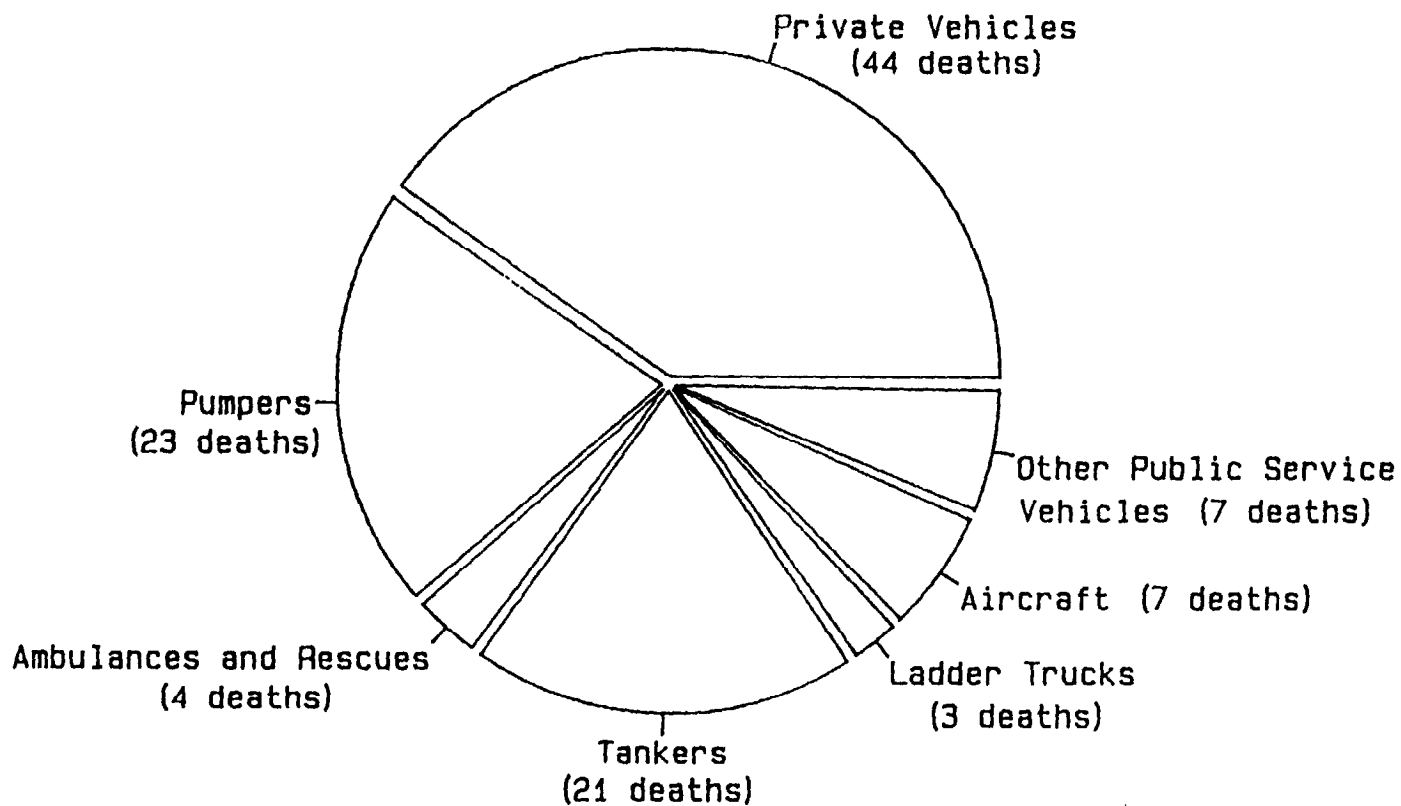

The problem of collisions while responding to alarms in private vehicles involves volunteer fire fighters almost exclusively. The only career fire fighter involved in such an incident was a full-time forestry employee who was called back to duty to fight a wildfire and was responding in his own car. The frequency of these accidents has been increasing in recent years. (See Figure 20.) Over half of the accidents occurred in the last three years, an average of eight deaths per year.

The 23 deaths involving pumper-type apparatus were the result of 17 accidents. These accidents included one five-fatality and one three-fatality incident. Six of the accidents were the result of collisions with other vehicles, two were the result of brake failure, and the remainder were due to drivers losing control either when failing to negotiate a curve or when driving off the pavement. No details were available on one incident. Speeding was mentioned as a factor in five of the accidents, including two where the fire fighters driving had blood alcohol levels greater than 0.1%. The failure of other drivers to respond appropriately to the flashing lights and sirens of the apparatus was mentioned in four of the six collisions and one of the lost control incidents. Another collision involved two fire department vehicles responding by different routes from the same station. Both trucks slowed at the intersection, but neither one stopped. The sixth collision occurred when an engine responding to an EMS call was struck by a train. The warning lights at the crossing were operating but the driver apparently was not aware how close the approaching train was.

The 21 deaths in tanker collisions while responding to alarms were the result of 19 accidents.

Figure 20
Fatalities in Private Vehicles
1979 - 1988

Number of Deaths

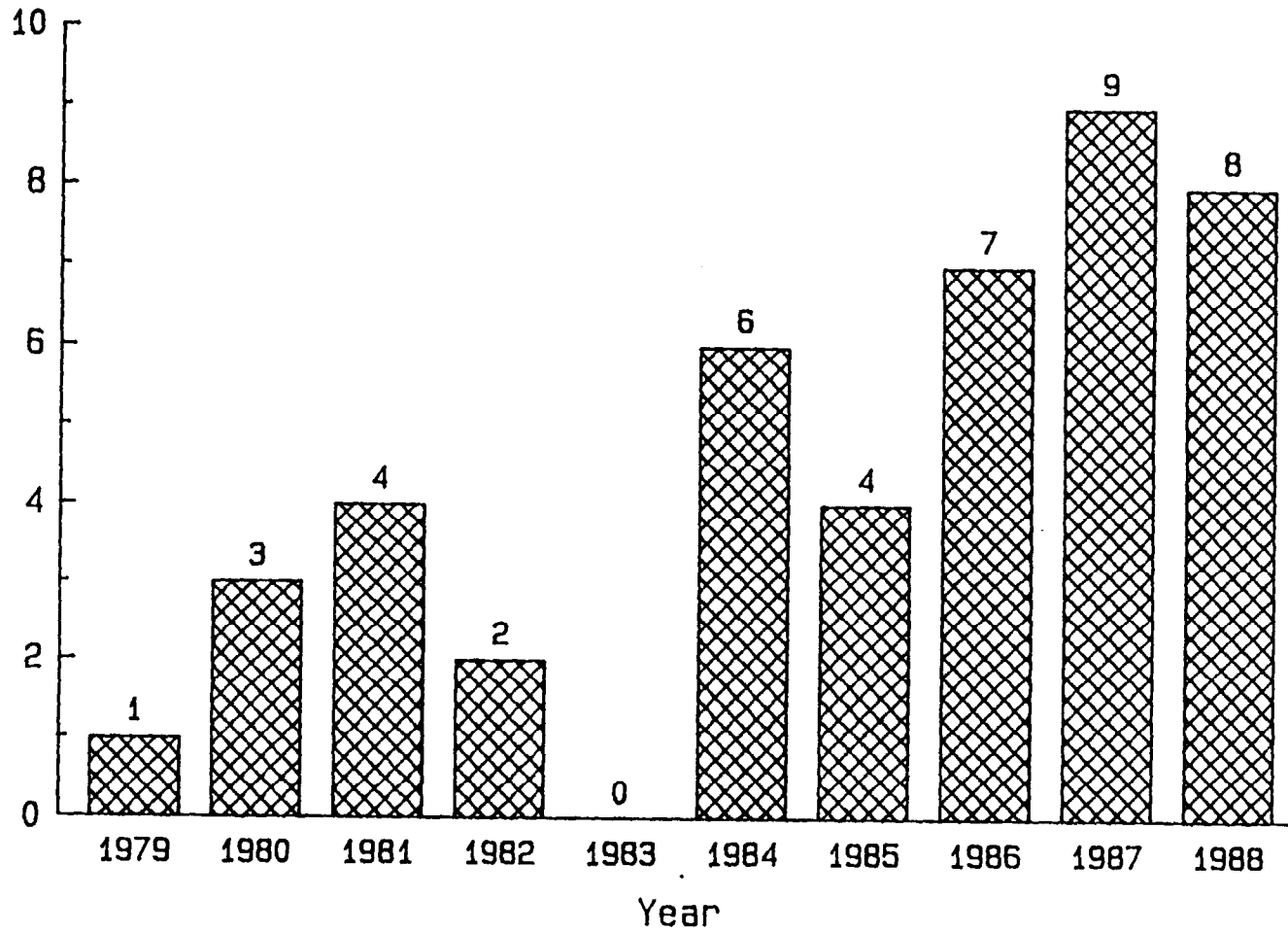

There are basically three types of tankers in use by fire departments -- those built from the ground up as tankers, former military and other vehicles converted to tankers, and new chassis with tanks added. Of the 19 tankers involved in these accidents, seven were known to be converted. Details on baffling were not generally available.

The use of tankers is essential in rural fire fighting, but extra care must be taken to consider their stability. Military vehicles have a high center of gravity as originally designed. Adding a tank above increases the vehicle's instability at higher speeds and on turns, and the weight of the water can seriously tax the truck's suspension, brakes and tires.

Fifteen of the accidents were attributed to failure to negotiate curves and losing control of the vehicles. Two fire fighters were killed in separate collisions when the drivers of the tankers failed to heed stop signs at intersections and were struck by trucks. Two other tankers overturned when their drivers swerved at intersections to avoid hitting other vehicles. Excessive speed was cited as a factor in seven of the accidents.

The inexperience of drivers also played a role in the incidence of fatal tanker accidents. Inexperienced drivers include not only young people but also older fire fighters who are infrequently called upon to drive a vehicle that requires handling quite different from a passenger car or truck.

Other types of vehicles involved in accidents while responding to alarms were aircraft (7 deaths), ambulances and rescue vehicles (4 deaths), ladder trucks (3 deaths), brush fire vehicles (3 deaths), other fire department vehicles (2 deaths), a marine fire/rescue boat (1 death), and a National Guard truck (1 death).

Over the ten-year period, almost 20 percent of all fire fighters who died in the line of duty died while responding to alarms. One-third of those deaths were the result of heart attacks and strokes. Almost half were killed

in collisions and vehicle overturns. Excessive speed for the road conditions or type of vehicle, failure to observe traffic laws, driving while intoxicated and lack of safety procedures or equipment are all factors cited in these accidents,

Fire fighting is a hazardous enough profession without such a high loss of life while trying to reach the emergency scene. In addition to careful driving on their own part, fire fighters driving any type of vehicle in a response must be alert to the actions of other drivers who may not be aware of or heed operating emergency lights and sirens.

V. FIRE FIGHTERS STRUCK BY VEHICLES

1979 - 1988

From 1979 through 1988, 34 fire fighters were struck and killed by private vehicles or fire department apparatus. These include only those incidents where the accident victim was a pedestrian; they do not include incidents where fire fighters fell from vehicles and then were struck. Although this is a fairly small portion of deaths over the ten-year period, these deaths are particularly tragic because they were so preventable.

As shown in Figure 21, the activities of the fire fighters at the time of the accidents were: operating at a traffic accident (9 deaths); directing traffic (8 deaths); operating at a vehicle fire (4 deaths); operating at a brush or forest fire (4 deaths); operating at a structure fire (3 deaths); working at a training exercise (1 death); evacuating flood victims (1 death); removing rocks from a highway (1 death); refilling a pumper (1 death); responding to a fire station on foot (1 death); and waiting along a road to be picked up while en route to an accident (1 death). Seventeen of the accidents occurred between 6 pm and 7 am; fifteen occurred between 7 am and 6 pm. Time was not reported for the other two incidents.

The drivers in nine of the incidents were reported to be intoxicated. Fire fighters operating on or near roadways need to be aware that the unpredictable behavior of drunk drivers can compromise even the most careful precautions. In two incidents, fire fighters were killed by drivers who veered around fire police attempting to block the road or divert traffic.

Three of the eight fire fighters who were killed while directing traffic were not wearing any reflective clothing or using flashlights or flares. All

Figure 21
 Activities of Fire Fighters Struck by Vehicles
 at the Time of the Incidents
 1979 - 1988

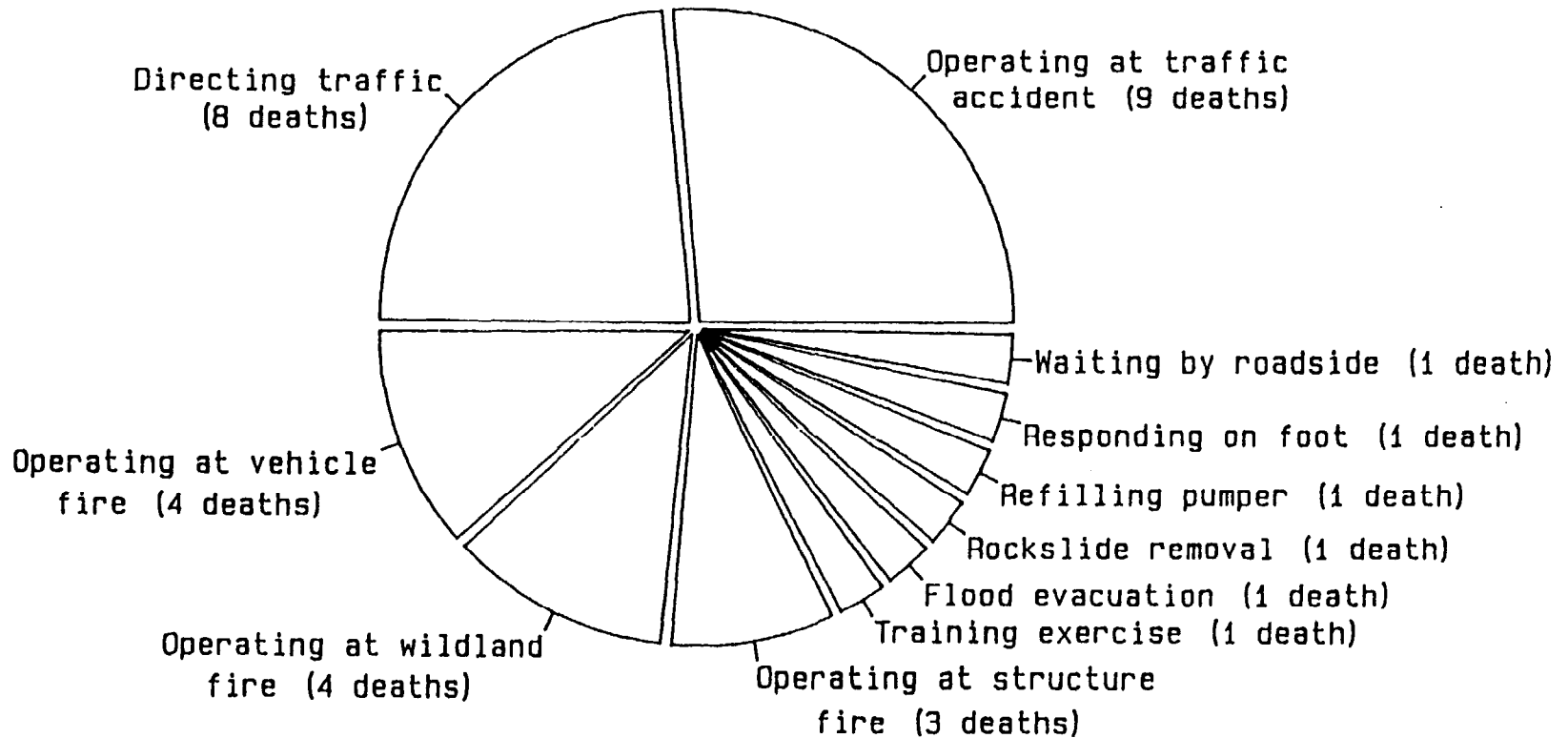

of the drivers reported that they did not see the fire fighters. Another fire fighter, who was tending to a person ejected in a motor vehicle rollover, was struck by a vehicle he was trying to wave away from the victim. The road was dark and the fire fighter had no flashlight or flares.

In at least two cases, the warning lights that fire fighters relied on to increase the safety of their operations actually seemed to be contributing factors in the accidents. In one, a pumper being refilled at a pond was parked two feet off the road facing oncoming traffic with headlights and four-way hazard flashers on in dense fog. The driver of a pickup truck thought the pumper was coming at him and swerved off the road to avoid it, striking the fence around the pond and eventually hitting the pumper and one of the fire fighters. In the other incident, a driver passing a fire scene reportedly was distracted by the vehicles of volunteer fire fighters parked on both sides of the road with their blue lights flashing. This driver hit a fire fighter who was directing traffic.

Seven fire fighters were killed crossing roads or highways while responding to the fire station or to motor vehicle accidents or fires. In another accident, a fire fighter was struck and killed as he stepped out from behind the engine to stretch a line across the street. The driver of the car, a volunteer fire fighter headed to the station, was blinded by the engine's high beams. The victim was carrying a hydrant-assist valve on his right shoulder that apparently obstructed his ability to see the oncoming vehicle. Another fire fighter stepped in front of a work train while evacuating a flooded area. Another stepped in front of an approaching vehicle that she believed was driven by another fire fighter coming to pick-her up to respond to a motor vehicle accident. It was actually a police car responding to the same incident, whose driver did not see her.

Five fire fighters were killed when they crossed or moved onto road; that had not been closed to traffic. Three were operating at wildland fires, one was extinguishing bales of hay on the roadway, and the fifth was removing rocks from a rockslide.

One fire fighter at the scene of a structure fire was struck by a dump truck that had been ordered for use during cleanup. Another was directing a tanker backing down a road to a dwelling fire, when he fell and was run over.

These incidents illustrate the need for fire fighters to exercise caution while crossing streets and highways or operating on them. Fire fighters may not be as visible to drivers as they believe themselves to be. The use of flashlights, flares, and protective clothing with reflective stripes should be mandatory when directing traffic or operating at accident scenes. Warning lights on vehicles should be in operation, but fire fighters must be aware that drivers can be confused by them. Care must be exercised when stepping onto or operating on roadways. When fire fighters are operating along a roadway where visibility is obscured, the road should be closed to traffic. Fire fighters should not assume a road is closed and should be aware that fire apparatus still might be moving along a road that is closed to the public. They also must be aware of the danger of intoxicated drivers whose behavior will be unpredictable and who can defeat even the most careful deployment of apparatus and fire fighters.

VI. CONCLUSIONS AND RECOMMENDATIONS

Although it would be premature to suggest that fire fighter fatalities are definitely on the increase, it is apparent that no significant gains have been made in recent years to reduce the overall death toll. Some encouragement can be found in the reduction of deaths due to smoke exposure (one death in 1988) and falls from apparatus while responding (no deaths in 1988), but areas where significant reductions could be made still exist. For example, this year, as in every previous year but one, heart attacks continue to be the major cause of death, and most of those victims had suffered previous heart attacks, had had bypass surgery or had severe, detectable heart disease.

This year's report focused on three other areas: fatalities in structural collapses, deaths while responding to alarms and fire fighters fatally struck at the scene of incidents. The first analysis was prompted to some degree by the five-fatality incident that occurred in New Jersey. The other analyses address areas where attention is needed in order to reduce needless fatalities.

The structural collapse analysis serves as a reminder of the need of fire fighters to maintain a safe distance between themselves and the building when operating outside of an involved structure and the need of careful fire ground supervision so that fire fighters operating inside a building can be warned in time of an impending collapse. The continued use throughout the country of truss roof construction will pose risks of building collapse to fire fighters and underlines the need for them to be familiar with the buildings within their jurisdiction and the hazards associated with their construction.

Deaths while responding to alarms continue to make up a significant proportion of the total deaths, and so, a special analysis of these deaths was

included in this year's report. The findings highlighted the need for driver training, both for apparatus drivers and drivers of personal vehicles.

Traffic laws need to be obeyed, even during a response. Apparatus drivers need to be aware of the handling problems associated with emergency vehicles, particularly tankers. Fire fighting is a hazardous enough occupation without the high loss of life that is occurring annually before even reaching the fire ground.

The analysis of fire fighters fatally struck by vehicles while operating at incidents serves to highlight an area of particularly preventable deaths. A factor commonly observed in these deaths was the inattention of the victim to his or her surroundings. Another was the failure to use reflective clothing or special lighting when operating on or near a roadway. The problem of drunk drivers is more difficult for the fire fighter to deal with, but awareness of the danger they pose and reasonable defense against them are necessary.

Further reductions in fire fighter deaths can be accomplished if changes in operating procedures and attitudes are made in order to improve fire fighter safety.

REFERENCES

1. Michael J. Karter, Jr., "U.S. Fire Department Profile through 1987," Quincy, MA: National Fire Protection Association, Fire Analysis and Research Division, November 1988.
2. The full reports from the investigations of these fires are also available from NFPA's Fire Investigations Division.

Thomas J. Klem. "Summary Investigation Report - Five Fighter Fatalities, Hackensack, New Jersey, July 1, 1988"

Michael S. Isner, "Investigation Report - Blasting Agent Explosion, Six Fire Fighters Killed, Kansas City, Missouri, November 29, 1988"

See also:

Jack Yates, "Six Firefighter Fatalities in Construction Site Explosion, Kansas City, Missouri (November 29, 1988," Report 024 of the Major Fire Investigations Project conducted by TriData Corporation under contract to the U.S. Fire Administration, Federal Emergency Management Agency.

3. Michael J. Karter, Jr., "U.S. Fire Loss in '1988," Fire Journal, Vol. 83, No. 5, (September 1989).
4. The four regions as defined by the U.S. Census Bureau include the following 50 states and the District of Columbia:

Northeast: Connecticut, Maine, Massachusetts, New Hampshire, New Jersey, New York, Pennsylvania, Rhode Island, and Vermont.

Northcentral: Illinois, Indiana, Iowa, Kansas, Michigan, Minnesota, Missouri, Nebraska, North Dakota, Ohio, South Dakota, and Wisconsin.

South: Alabama, Arkansas, Delaware, District of Columbia, Florida, Georgia, Kentucky, Louisiana, Maryland, Mississippi, North Carolina, Oklahoma, South Carolina, Tennessee, Texas, Virginia, and West Virginia.

West: Alaska, Arizona, California, Colorado, Hawaii, Idaho, Montana, Nevada, New Mexico, Oregon, Utah, Washington, and Wyoming.