



NOAA

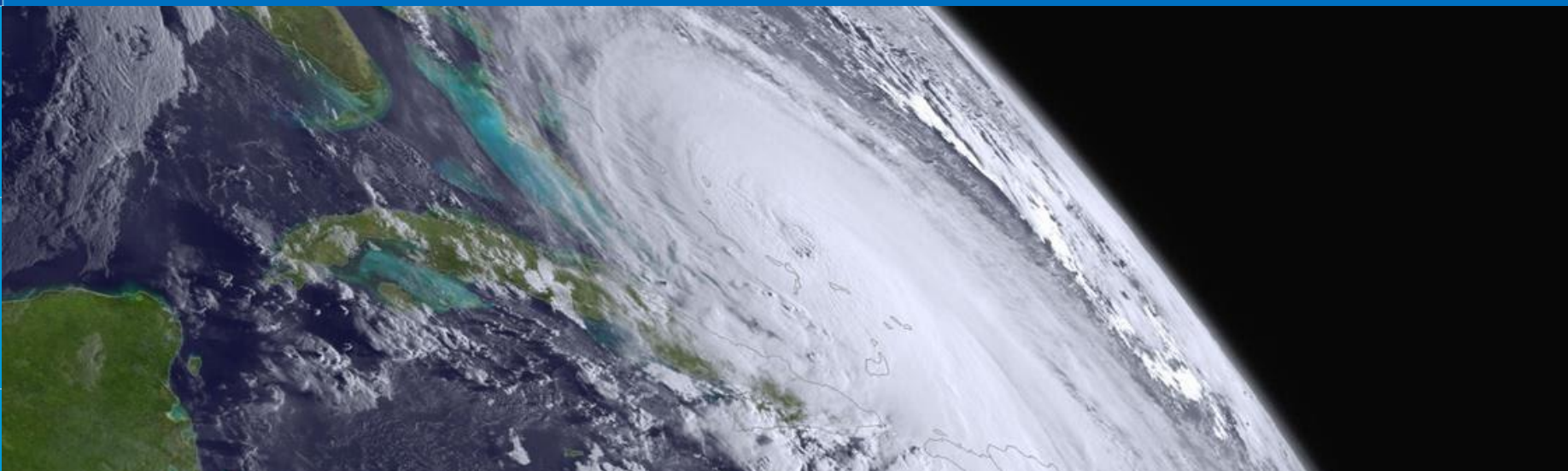


07 April 2022

Ian Avruch
NESDIS/OSPO/DSB



GRB & HRIT/EMWIN Joint User Group Meeting





GRB/HRIT Joint User Group Agenda



7 April 2022 14:00-15:15 EDT (18:00-17:15 UTC)

1. (5 min) GOES-17 ABI Cooling Timeline Update (Matt Seybold)
2. (10 min) GOES-18 Post-Launch Testing (PLT) and Transition to Operations (Matt Seybold)
3. (5 min) GOES-17/18 Interleave Periods and GRB/HRIT Impacts (Ian Avruch)
4. (5 min) EMWIN Updates (Bob Gillespie)
5. (5 min) RFIMS Updates (Todd Williams)
6. (10 min) GEO-XO Updates (Craig Keeler)
7. (5 min) CSPP GEO software update (Graeme Martin)
8. (5 min) GRB and HRIT Quarterly statistics (Ian Avruch)
9. (5 min) GRB/HRIT Hobbyist Updates (Carl Reinemann)
10. (10 min) HRIT User Outreach (Ian Avruch)
11. (10 min) Discussion





GOES R

GOES-17 ABI Update (5 min)
GOES-18 PLT & T20 Plans (10 min)

Matt Seybold, GOES-R Data Ops Manager

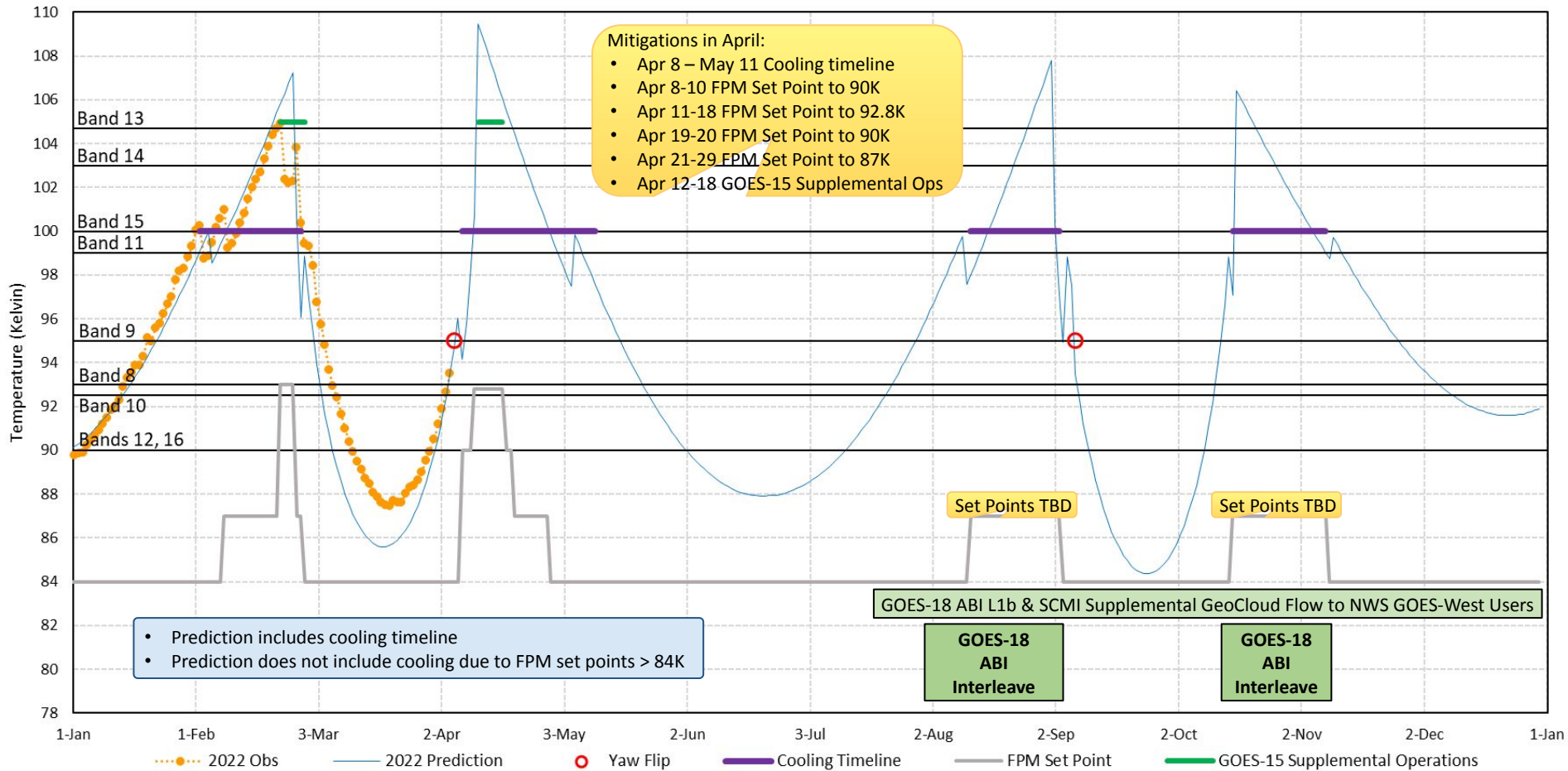
Co-Authors: E. Kline, T. Feroli, J. Fiore, M. McHugh

Joint GRB/HRIT Users Group Meeting
April 7, 2022





2022: GOES-17 ABI Daily Peak Longwave Infrared Focal Plane Module Temperatures



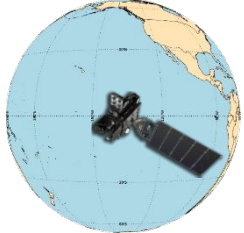
This plot shows daily maximum temperature of the ABI focal plane module. These maximums occur at night. The higher the temperature, the more saturated imagery becomes. Where the temperature rises to approach a black line for each band, marginal saturation may be observed in imagery. Where the temperature curve exceeds a black line for each band, the imagery may begin to saturate so much that it becomes unusable.



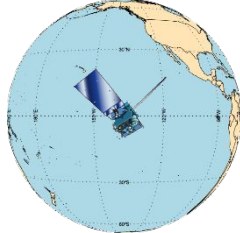
GOES Constellation

GOES-18 PLT Part 1: GOES-T achieves checkout orbit, designated GOES-18, pre-drift

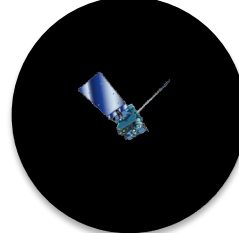
GOES-West
GOES-17
137.2° West



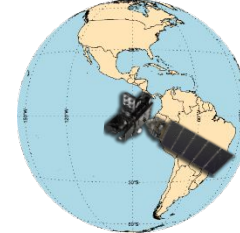
Supplemental Ops
GOES-15
136.8° West



Standby
GOES-14
105° West



Checkout
GOES-18
89.5° West

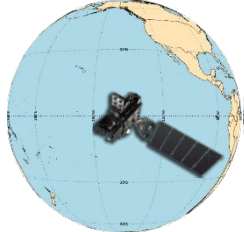


GOES-East
GOES-16
75.2° West

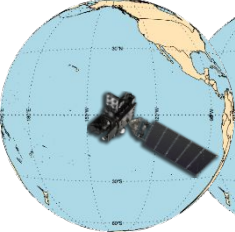


GOES-18 PLT Part 2: GOES-18 post-drift

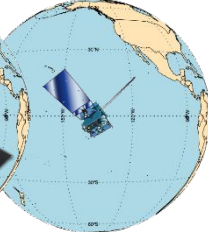
GOES-West
GOES-17
137.2° West



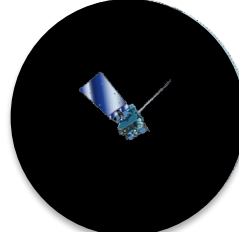
Checkout
GOES-18
136.8° West



Supp. Ops.
GOES-15
136.8° West



Standby
GOES-14
105° West

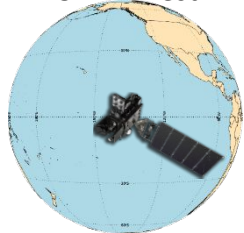


GOES-East
GOES-16
75.2° West

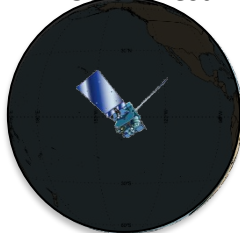


GOES-18 as GOES-West

GOES-West
GOES-18
137.2° West



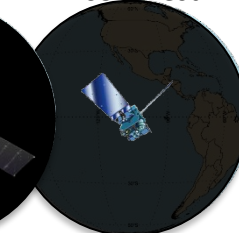
Storage
GOES-15
136.8° West



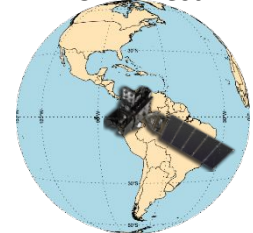
Standby
GOES-17
105° West



Storage
GOES-14
105° West



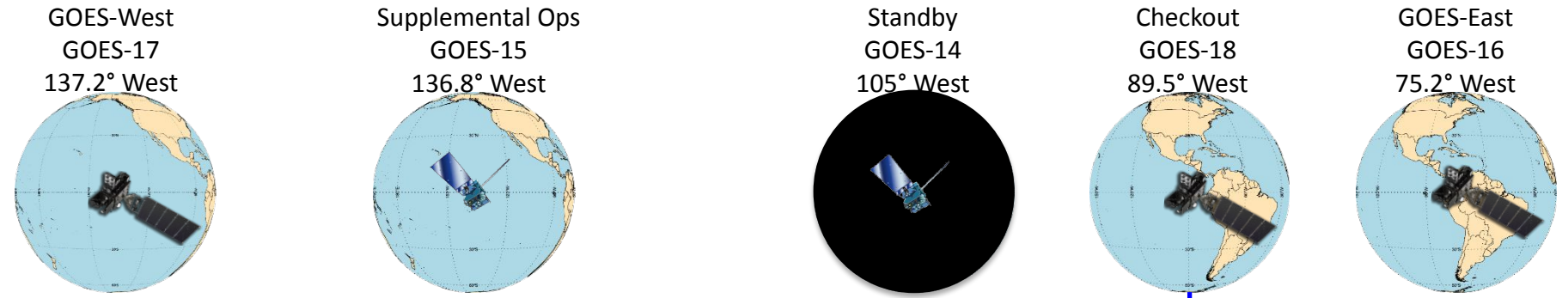
GOES-East
GOES-16
75.2° West



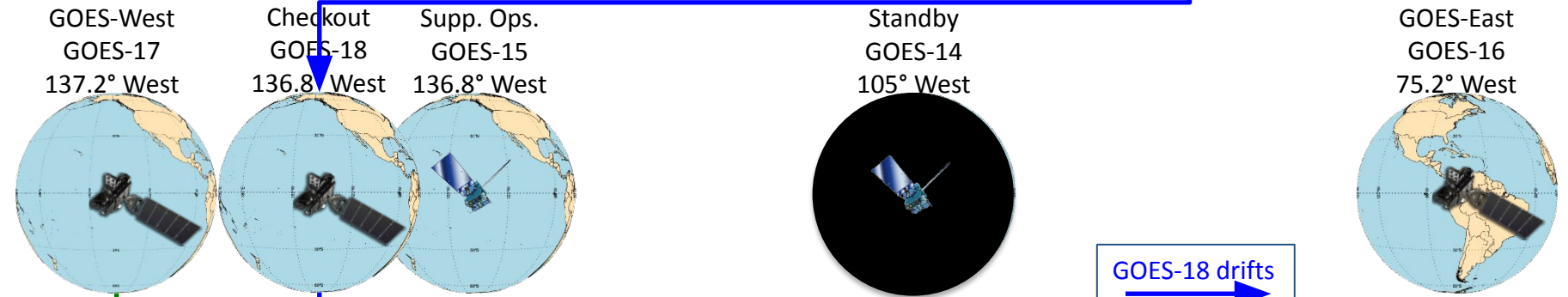


GOES Constellation

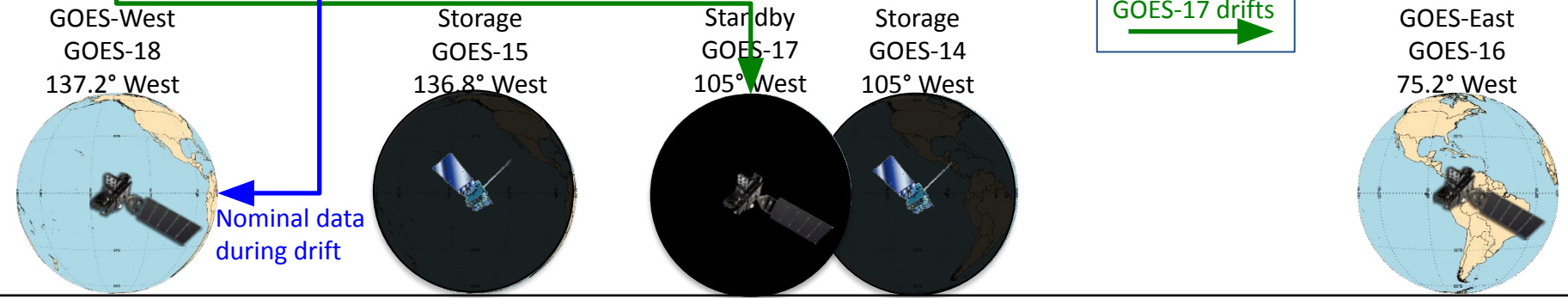
GOES-18 PLT Part 1: GOES-T achieves checkout orbit, designated GOES-18, pre-drift



GOES-18 PLT Part 2: GOES-18 post-drift



GOES-18 as GOES-West





GOES-18 T20 Overview

Activity	March							April							May							June							July							August							September							October							November							December							January		
	3/1	3/8	3/15	3/22	3/29	4/5	4/12	4/19	4/26	5/3	5/10	5/17	5/24	5/31	6/7	6/14	6/21	6/28	7/5	7/12	7/19	7/26	8/2	8/9	8/16	8/23	8/30	9/6	9/13	9/20	9/27	10/4	10/11	10/18	10/25	11/1	11/8	11/15	11/22	11/29	12/6	12/13	12/20	12/27	1/3	1/10	1/17																										
	L+0	7	14	21	28	35	42	49	56	63	70	77	84	91	98	105	112	119	126	133	140	147	154	161	168	175	182	189	196	203	210	217	224	231	238	245	252	259	266	273	280	287	294	301	308	315	322																										
G18 Events	▲ Launch	Raise Orbit	PLT & PLPT Part 1 @ 89.5W							Drift to 136.8W							PLT & PLPT Part 2 @ 136.8W							▲ PLPT Continues Handover to OSPO							G18 = GOES-West Nudge to 137.2W							▲																																			
G18 Maturity	ABI 1st Public Image														▲	ABI Beta							▲ ABI L1b/CMI Provisional							▲ ABI Tier 1 L2+ Provisional							▲ ABI other L2+ Provisional																																				
	GLM 1st Public Image															GLM Beta							▲ GLM Beta							▲ GLM Provisional																																											
	MAG 1st Public Data															GMAG Beta							▲ GMAG Provisional																																																		
	SEISS 1st Public Data															SEISS Beta							▲ SGPS							▲ MPS-Hi							▲ EHIS, MPS-Lo Provisional																																				
	EXIS 1st Public Data															EXIS Beta														▲ EXIS Provisional																																											
	SUVI 1st Public Image															SUVI Beta														▲ SUVI Provisional																																											
G18 ABI PD	GRB																																	Ops																																							
	Cal/Val Purposes														Cal/Val Purposes														Ops (L1b & CMI, not L2+)							Cal/Val							Ops (L1b & CMI, not L2+)							Cal/Val							Ops																
	Cal/Val Purposes														Cal/Val Purposes														G18 ABI L1b & SCMI 'supplemental' via GeoCloud for NWS GOES-West Users																																Ops												
	AWIPS																																Ops - GS																																								
	HRIT/EMWIN																																Ops																																								
	GNC-A																																Ops																																								
G17 ABI PD	G17 ABI Warm Period														G17 ABI Warm Period														G17 ABI Warm Period																																												
	Ops	17 w/ 18 ABI Interleave														17 w/ 18 ABI Interleave														Ops																																											
	Ops																																																																								
	Ops																																																																								
	Ops	18 ABI SCMI														18 ABI SCMI																																																									
	Ops	17 ABI L2+ w/ 18 ABI CMI														17 ABI L2+ w/ 18 ABI CMI																																																									
	Ops	17 ABI L2+, GLM w/ 18 ABI CMI														17 ABI L2+, GLM w/ 18 ABI CMI																																																									
West PD																																																																									
	Ops																																																																								
	Ops																																																																								

Legend: GOES-18 GOES-17 PD = Product Distribution G17 ABI Warm Period 17 w/ 18 ABI Interleave ◆ 1st Public Image ▲ Beta Maturity ▲ Provisional Maturity

Planning a 'split' Post Launch Test phase, beginning at 89.5°W and then drifting to 136.8°W in order to have early use of the GOES-18 Imager in the West location to mitigate the GOES-17 Imager thermal anomaly



GOES-18 L1b Science Product Validation Status

ABI L1b Product	Beta	Provisional	Full
Radiances	5/11/2022	7/27/2022	FY23
GLM L2 Product			
Lightning: Events, Groups, Flashes	9/19/2022	10/31/2022	FY23
SEISS L1b Products			
Energetic Heavy Ions	7/28/2022	11/15/2022	FY23
Magnetospheric e ⁻ /p ⁺ : Low Energy	7/28/2022	11/17/2022	FY23
Magnetospheric e ⁻ /p ⁺ : High Energy	7/28/2022	10/11/2022	FY23
Solar & Galactic Protons	7/28/2022	9/13/2022	FY23
EXIS L1b Products			
Solar Flux: EUV	7/22/2022	11/14/2022	FY23
Solar Flux: X-ray Irradiance	7/22/2022	11/14/2022	FY23
SUVI L1b Product			
Solar EUV Imagery	8/2/2022	11/22/2022	FY23
GMAG L1b Product			
Geomagnetic Field	7/11/2022	9/6/2022	FY23

*EXIS and SUVI Provisional dates may be affected by final scheduling of ECI test

Validation Maturity Levels:

Not Validated	Beta Maturity	Provisional Maturity	Full Maturity
---------------	---------------	----------------------	---------------



GOES-18 L2+ Science Product Validation Status

L2+ Products	Beta	Prov	Full
Cloud and Moisture Imagery (CMI) and Sectorized CMI (KPP)	5/11/2022	9/24/2022	FY23
Aerosol Detection (Smoke & Dust)	5/11/2022	12/1/2022	
Aerosol Optical Depth	5/11/2022	12/1/2022	
Bidirectional Reflectance Factor	5/11/2022	12/1/2022	
Clear Sky Mask	5/11/2022	9/24/2022	
Cloud Cover Layers	5/11/2022	12/1/2022	
Cloud Optical Depth	5/11/2022	12/1/2022	
Cloud Particle Size Distribution	5/11/2022	12/1/2022	
Cloud Top Height	5/11/2022	9/24/2022	
Cloud Top Phase	5/11/2022	9/24/2022	
Cloud Top Pressure	5/11/2022	9/24/2022	
Cloud Top Temperature	5/11/2022	9/24/2022	
Derived Motion Winds	5/11/2022	9/24/2022	
Derived Stability Indices	5/11/2022	12/1/2022	

L2+ Products	Beta	Prov	Full
Downward S/W Radiation: Surface	5/11/2022	12/1/2022	FY23
Fire/Hot Spot Characterization	5/11/2022	12/1/2022	
Ice Age & Thickness	5/11/2022	12/1/2022	
Ice Concentration & Extent	5/11/2022	12/1/2022	
Ice Motion	5/11/2022	12/1/2022	
Land Surface Albedo	5/11/2022	12/1/2022	
Land Surface Temperature	5/11/2022	12/1/2022	
Legacy Vertical Moisture Profile	5/11/2022	12/1/2022	
Legacy Vertical Temperature Profile	5/11/2022	12/1/2022	
Rainfall Rate/QPE	5/11/2022	12/1/2022	
Reflected S/W Radiation: TOA	5/11/2022	12/1/2022	
Sea Surface Temperature	5/11/2022	12/1/2022	
Snow Cover	5/11/2022	12/1/2022	
Total Precipitable Water	5/11/2022	12/1/2022	

Validation Maturity Levels:

Not Validated	Beta Maturity	Provisional Maturity	Full Maturity
---------------	---------------	----------------------	---------------



GOES-18 Data Sharing Policy

Not Allowed
Caveats
Allowed

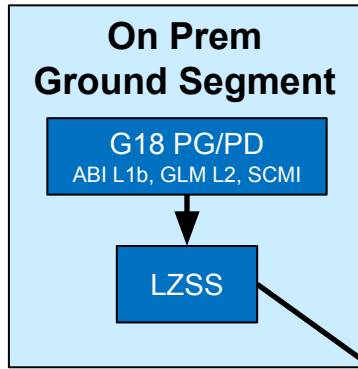
	Images/Social Media	Data Files	Publications
Between Launch and "First Light" Public Release	Not allowed	Not allowed	Allowed; You may include pre-Provisional instrument data/images/plots as long as it will not be published until after Provisional validation is declared for that instrument. Exercise caution in publishing data regarding apparent anomalies or artifacts especially during ongoing instrument and product tests (PLTs and PLPTs).
Between First Public Release and Beta Certification	Allowed; must contain the caveat: "GOES-18 Preliminary, Non-Operational Data"	Not allowed	
Between Beta and Provisional	Allowed; must contain the caveat: "GOES-18 Preliminary, Non-Operational Data"	Not allowed	
ABI Interleaved Data	Allowed (ABI Only)	Allowed (ABI Only)	
Between Provisional (or Interleave Period(s) for ABI) and Operational Declaration	Allowed; must contain the caveat: "GOES-18 Preliminary, Non-Operational Data"	Allowed; must contain the caveat: "GOES-18 Preliminary, Non-Operational Data"	
GOES-West Operations onwards	Allowed	Allowed	

Table description: Policy for sharing images on social media, data files, and publications as it evolves during post-launch phases of satellite testing and data maturity.



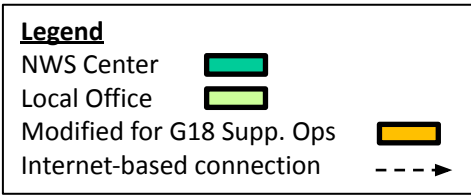
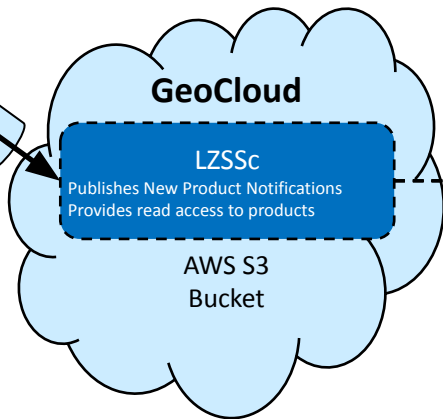
GOES-18 PLT

Supplemental Cloud Data Flow to NWS

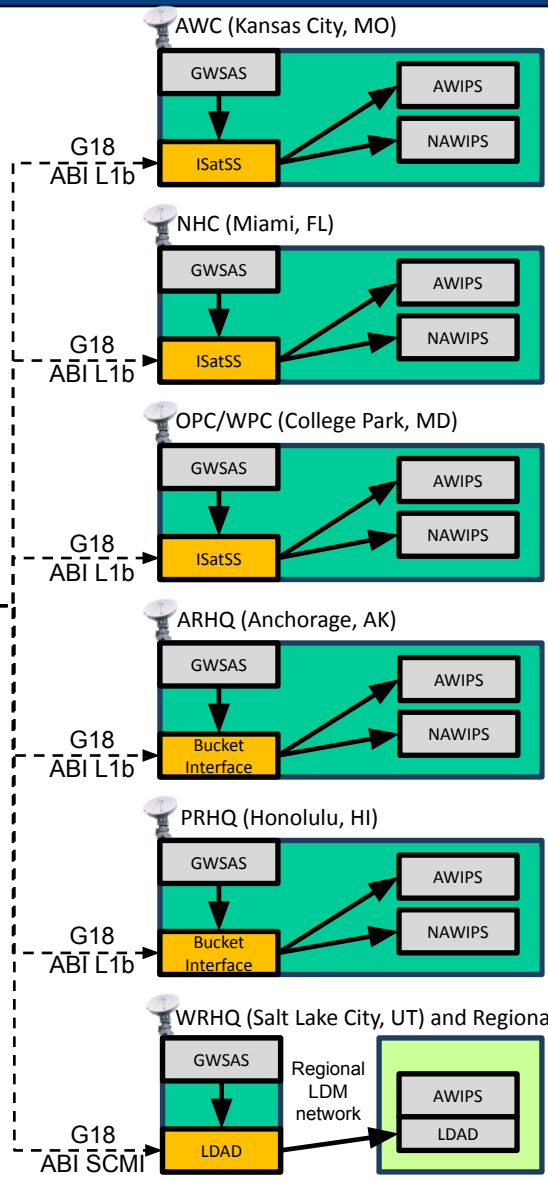


DOE-T3:
E2E verification of both
AWIPS II and NAWIPS

LZSS push to LZSSc
Nwave-based dedicated
VRF



1. G18 ABI products created in GOES-R GS and published to GeoCloud
2. Delivery of ABI L1b files to NWS Centers via GeoCloud services
3. Additional WFO Option under consideration: Delivery of SCMI to WRHQ, which uses Regional LDM network to forward SCMI to 24 WFOs
4. All products delivered to and integrated with key NWS Centers within latency goals and bandwidth constraints



Ready

Proxy products being transmitted for operational experience and performance assessment.

Proven manifest may down-select by tile, band or spatial res. This capability is most relevant for AR and PR as no need is anticipated for the centers.

I&T Underway. Expect "Ready" in May. Many steps, but date includes risk mitigation.



PLTs of Interleave vs Nominal Interleave

	G18 PLT Test "GND-006"	G18 PLT Test "GND-009"	G18 PLT Test "GND-008"	Nominal Interleave
Description	Test of GRB interleave logic early during G18 PLT	Pre-drift test of Interleave	Post-drift test of Interleave	Early ops access to G18 ABI data as a mitigation for G17 ABI saturated images
Duration	2 hours	30 minutes	2-4 hours	36 days
Dates	May 9, 2022 prior to drift	~May 11, 2022 prior to drift after test "GND-006"	June 30, 2022 prior to Interleave	1 st : August 1 – September 6, 2022 2 nd : October 15 – November 11, 2022
GRB Content	<u>G18 GRB</u> at 89.5° West: <ul style="list-style-type: none"> G16 ABI L1b G17 GLM L2+, Space Wx L1b 	<u>G18 GRB</u> at 89.5° West: <ul style="list-style-type: none"> N/A 	<u>G18 GRB</u> at 136.8° West: <ul style="list-style-type: none"> N/A 	<u>G18 GRB</u> at 136.8° West: <ul style="list-style-type: none"> N/A
	<u>G16 GRB</u> at 75.2° West: G16 L1b	<u>G16 GRB</u> at 75.2° West: G16 L1b	<u>G16 GRB</u> at 75.2° West: G16 L1b	<u>G16 GRB</u> at 75.2° West: G16 L1b
	<u>G17 GRB</u> at 137.2° West: G17 L1b	<u>G17 GRB</u> at 137.2° West: <ul style="list-style-type: none"> G18 ABI L1b (from 89.5° West)* G17 GLM L2, Space Wx L1b ~1 hour post-test impact to GRB user's trending of G17 ABI L2+ products (e.g., CSPP Geo products) 	<u>G17 GRB</u> at 137.2° West: <ul style="list-style-type: none"> G18 ABI L1b (from 136.8° West) G17 GLM L2, Space Wx L1b 	<u>G17 GRB</u> at 137.2° West: <ul style="list-style-type: none"> G18 ABI L1b (from 136.8° West) G17 GLM L2, Space Wx L1b
PDA Content	Nominal G16/17 G18 L1b and L2 products will not be distributed to PDA	<ul style="list-style-type: none"> Potential G17 GLM, Space Wx metadata inaccuracies All other G16/17/18 data nominal 	Nominal G16/17/18	Nominal G16/17/18
AWIPS NCF Content	Nominal G16/17 SCMI		G18 ABI SCMI Nominal G16	G18 ABI SCMI Nominal G16
LZSS Content	Nominal G16/17 The G18 GRB interleave products will not go to LZSS	*G18 ABI L1b mapped to 89.5°W but delivered via G17 GRB at 137.2°W	Nominal G16/17/18	Nominal G16/17/18



GRB Interleave Spacecraft IDs & Metadata

		G17 GRB Nominal	G17 GRB Interleaved with G18 ABI L1b	G18 GRB Nominal
Applicable G18 PLT Configurations			GND-008, -009	GND-006
Data Relay	GRB Spacecraft ID (SCID) AOS frame header (8 bits)	0x82	0x82	0xE4
Data Source	platform_ID metadata within ABI packets	G17	G18	G18
	instrument_ID metadata within ABI packets	FM2	FM3	FM3



Backup Slides



GOES-R New Products & Enhancements



Baseline GOES-R Algorithm “Enterprise Updates”

ABI L2+ Products	Distribution to PDA
Clear Sky Mask* (M. Kulie, AWG)	11/29/2021
Reduced Levels Soundings# (T. Schmit, AWG)	11/8/2021
Cloud Optical Depth & Size Distribution* (M. Kulie, AWG)	10/27/2022
Cloud Top Height/Temp/Pressure * (M. Kulie, AWG)	10/27/2022
Derived Motion Winds * (J. Daniels, AWG)	10/27/2022
Cloud Cover Layer *^#& (M. Kulie, AWG)	3/2/2023
Ice Concentration & Extent *^ (J. Key, AWG)	TBD
Downward & Reflected S/W Radiation* (I. Laszlo, AWG)	12/1/2022
Aerosol Optical Depth* (I. Laszlo, AWG)	1/12/2023
Aerosol Particle Size*^ (I. Laszlo, AWG)	1/12/2023

ABI L2+ Products	Distribution to PDA
Rainfall Rate/QPE* (B. Kuligowski, AWG)	6/9/2022
Aerosol Detection (Smoke & Dust)* (S. Kondragunta, AWG)	2/9/2023
Sea Surface Temperature (ACSPO)* (A. Ignatov, AWG)	10/13/2022
Ice Age & Thickness *^ (J. Key, AWG)	TBD
Ice Motion *^ (J. Key, AWG)	TBD
Enterprise Soundings Algorithm* (T. Schmit, AWG)	TBD
Enterprise Fractional Snow Cover * (J. Key, AWG)	9/8/2022
Cloud Base Height (Intermediate for CCL)%^ (M. Kulie, AWG)	N/A

Legend: * Enterprise Algorithm with GOES-17 LHP mitigation
% Enterprise Algorithm without LHP mitigation

^ NOAT Funded Algorithm
& Enables Provisional

New Product to PDA



PRO PASS Product Change Summary FY21

ABI L2+ Algorithm / Change	Purpose and New/Modified Products	Operations Date
Baseline Fire Hot Spot (I. Csiszar, AWG)	LHP Mitigation to Baseline Algorithm Existing Products Updated <ul style="list-style-type: none"> ● Fire / Hot Spot Characterization (Full Disk, 10km) ● Fire / Hot Spot Characterization (CONUS, 2km) 	10/23/2020
Baseline Fire Hot Spot (I. Csiszar, AWG)	Addition of Mesoscale Scene Product New Products Produced <ul style="list-style-type: none"> ● Fire / Hot Spot Characterization (Mesoscale, 2km) 	4/28/2021
GOES-R Land Surface Albedo (B. Yu, AWG)	Implementation of GOES-R Specific Land Surface Albedo Algorithm. New Products Produced <ul style="list-style-type: none"> ● Land Surface Albedo (Full Disk, 2km) ● Land Surface Albedo (CONUS, 2km) ● Land Surface Albedo (Mesoscale, 2km) ● Land Surface Bidirectional Reflectance (Full Disk, 2km) ● Land Surface Bidirectional Reflectance (CONUS, 2km) ● Land Surface Bidirectional Reflectance (Mesoscale, 2km) 	9/7/2021



PRO PASS Product Change Summary FY22

ABI L2+ Algorithm / Change	Purpose and New/Modified Products	Operations Date
<p>Enterprise Land Surface Temperature (M. Kulie, AWG)</p>	<p>Implementation of the Enterprise Land Surface Temperature Algorithm. This contains LHP mitigations. 2km Full Disk product added to satisfy EMC user request.</p> <p>New Products Produced</p> <ul style="list-style-type: none"> Land Surface Temperature (Full Disk, 2km) <p>Existing Products Updated</p> <ul style="list-style-type: none"> Land Surface Temperature (Full Disk, 10km) Land Surface Temperature (CONUS, 2km) Land Surface Temperature (Mesoscale, 2km) 	<p>10/13/2021</p>
<p>Enterprise Cloud Top Phase (M. Kulie, AWG)</p>	<p>Enterprise Cloud Top Phase algorithm implemented. This contains LHP mitigations.</p> <p>Existing Products Updated</p> <ul style="list-style-type: none"> Cloud Top Phase (Full Disk, 2km) Cloud Top Phase (CONUS, 2km) Cloud Top Phase (Mesoscale, 2km) 	<p>10/15/2021</p>
<p>Baseline Soundings (T. Schmit, AWG)</p>	<p>Creation of Tailored Vertical Profile Soundings Products for NWS use in AWIPS, reducing the number of levels from 101 to 34</p> <p>New Products Produced</p> <ul style="list-style-type: none"> Reduced Level Legacy Vertical Moisture Profile (Full Disk, 10km) Reduced Level Legacy Vertical Moisture Profile (CONUS, 10km) Reduced Level Legacy Vertical Moisture Profile (Mesoscale, 10km) Reduced Level Legacy Vertical Temperature Profile (Full Disk, 10km) Reduced Level Legacy Vertical Temperature Profile (CONUS, 10km) Reduced Level Legacy Vertical Temperature Profile (Mesoscale, 10km) 	<p>11/8/2021</p>



PRO PASS Product Change Summary FY22

ABI L2+ Algorithm / Change	Purpose and New/Modified Products	Operations Date
<p>Enterprise Cloud Mask* (M. Kulie, AWG)</p>	<p>Implementation of the Enterprise Cloud Mask algorithm. This contains LHP mitigation. Product have been modified to include 4-level mask and cloud probability environmental parameters</p> <p>Existing Products Updated</p> <ul style="list-style-type: none"> • Clear Sky Masks (Full Disk, 2km) • Clear Sky Masks (CONUS, 2km) • Clear Sky Masks (Mesoscale, 2km) 	<p>11/22/2021</p>
<p>Enterprise Cloud Height * (M. Kulie, AWG)</p>	<p>Implementation of the Enterprise Cloud Height algorithm. This contains LHP mitigation. 2km Full disk will be produced and distributed.</p> <p>New Products Produced</p> <ul style="list-style-type: none"> • Cloud Top Height (Full Disk, 2km) • Cloud Top Height (CONUS, 2km) • Cloud Top Height (Mesoscale, 2km) • Cloud Top Pressure (Full Disk, 2km) • Cloud Top Pressure (CONUS, 2km) • Cloud Top Pressure (Mesoscale, 2km) <p>Existing Products Updated</p> <ul style="list-style-type: none"> • Cloud Top Height (Full Disk, 10km) • Cloud Top Height (CONUS, 10km) • Cloud Top Height (Mesoscale, 10km) • Cloud Top Pressure (Full Disk, 10km) • Cloud Top Pressure (CONUS, 10km) • Cloud Top Pressure (Mesoscale, 10km) • Cloud Top Temperature (Full Disk, 2km) • Cloud Top Temperature (CONUS, 2km) • Cloud Top Temperature (Mesoscale, 2km) 	<p>10/27/2022</p>



PRO PASS Product Change Summary FY22

ABI L2+ Algorithm / Change	Purpose and New/Modified Products	Operations Date
<p>Enterprise Derived Motion Winds* (J. Daniels, AWG)</p>	<p>Implementation of the Enterprise Derived Motion Winds algorithm. This contains LHP mitigation.</p> <p>Existing Products Updated</p> <ul style="list-style-type: none"> • Derived Motion Winds bands 2, 7, 8, 9, 10, 14 (Full Disk, 10km) • Derived Motion Winds bands 2, 7, 8, 9, 10, 14 (CONUS, 10km) • Derived Motion Winds bands 2, 7, 8, 9, 10, 14 (Mesoscale, 10km) 	<p>10/17/2022</p>
<p>Enterprise Cloud Optical Microphysics* (M. Kulie, AWG)</p>	<p>Implementation of the Enterprise Cloud Optical Microphysics algorithm. This contains LHP mitigation. 2km Full disk Cloud Optical Depth will be produced and distributed.</p> <p>New Products Produced</p> <ul style="list-style-type: none"> • Cloud Optical Depth (Full Disk, 2km) <p>Existing Products Updated</p> <ul style="list-style-type: none"> • Cloud Optical Depth (Full Disk, 10km) • Cloud Optical Depth (CONUS, 2km) • Cloud Optical Depth (Mesoscale, 2km) • Cloud Particle Size Distribution (Full Disk, 2km) • Cloud Particle Size Distribution (CONUS, 2km) • Cloud Particle Size Distribution (Mesoscale, 2km) 	<p>10/17/2022</p>
<p>Enterprise Cloud Cover Layer *^#& (M. Kulie, AWG)</p>	<p>Implementation of the Enterprise Cloud Cover Layer algorithm. This contains LHP mitigation.</p> <p>New Products Produced</p> <ul style="list-style-type: none"> • Cloud Layers (Full Disk, TBD km) • Cloud Layers (CONUS, TBD km) • Cloud Layers (Mesoscale, TBD km) 	<p>3/2/2022</p>



PRO PASS Product Change Summary FY22

ABI L2+ Algorithm / Change	Purpose and New/Modified Products	Operations Date
Enterprise Ice Concentration & Extent *^ (J. Key, AWG)	<p>Implementation of the Ice Concentration and Extent algorithm. This contains LHP mitigation.</p> <p>New Products Produced</p> <ul style="list-style-type: none"> ● Ice Concentration and Extent (Full Disk, 2km) ● Ice Concentration and Extent (Full Disk, 10km) ● Ice Concentration and Extent (CONUS, 2km) 	TBD
Enterprise Shortwave Radiation* (I. Laszlo, AWG)	<p>Implementation of the Enterprise Shortwave Radiation algorithm. This contains LHP mitigation.</p> <p>New Products Produced</p> <ul style="list-style-type: none"> ● Downward Shortwave Radiation (Full Disk, 2km) ● Reflected Shortwave Radiation (Full Disk, 2km) <p>Existing Products Updated</p> <ul style="list-style-type: none"> ● Downward Shortwave Radiation (Full Disk, 50km) ● Downward Shortwave Radiation (CONUS, 25km) ● Downward Shortwave Radiation (Mesoscale, 5km) ● Reflected Shortwave Radiation (Full Disk, 50km) ● Reflected Shortwave Radiation (CONUS, 25km) ● Reflected Shortwave Radiation (Mesoscale, 5km) 	12/1/2022
Enterprise Aerosol Optical Depth* (I. Laszlo, AWG)	<p>Implementation of the Enterprise Aerosol Optical Depth algorithm. This contains LHP mitigation. Included is the NOAT funded computation of Aerosol Particle Size environmental parameter.</p> <p>Existing Products Updated</p> <ul style="list-style-type: none"> ● Aerosol Optical Depth and Particle Size (Full Disk, 2km) ● Aerosol Optical Depth and Particle Size (CONUS, 2km) 	1/12/2023



PRO PASS Product Change Summary FY22

ABI L2+ Algorithm / Change	Purpose and New/Modified Products	Operations Date
<p>Enterprise Rainfall Rate (B. Kuligowski, AWG)</p>	<p>Implementation of the Enterprise Rainfall Rate algorithm. This contains LHP mitigation. This will include an offline algorithm that will compute a LEO RF / GEO BT coefficient to improve product quality.</p> <p>Existing Products Updated</p> <ul style="list-style-type: none"> Rainfall Rate/QPE (Full Disk, 2km) 	<p>6/9/2022</p>
<p>Enterprise Aerosol Detection (S. Kondragunta, AWG)</p>	<p>Implementation of the Enterprise Aerosol Detection algorithm. This contains LHP mitigation. CONUS and Mesoscale products will move from 15 minute cadence to native ABI cadence.</p> <p>Existing Products Updated</p> <ul style="list-style-type: none"> Aerosol Detection (Full Disk, 2km) Aerosol Detection (CONUS, 2km) Aerosol Detection (Mesoscale, 2km) 	<p>2/9/2023</p>
<p>Advanced Clear-Sky Processor for Oceans (A. Ignatov, AWG)</p>	<p>The Enterprise Advanced Clear-Sky Processor for Oceans (ACSP0) algorithm is currently running in STAR for distribution to PDA. GOES-R GS will retire the baseline SST products and will take over production of the STAR produced L2P and L3C ASCPO SST products.</p> <p>New Products Produced</p> <ul style="list-style-type: none"> ASCOP SST L2P (Full Disk, 2km) ACSP0 SST L3C (Full Disk, 2km) <p>Decommissioned Products</p> <ul style="list-style-type: none"> Sea Surface Temperature (Full Disk, 2km) 	<p>10/13/2022</p>



PRO PASS Product Change Summary FY22

ABI L2+ Algorithm / Change	Purpose and New/Modified Products	Operations Date
Enterprise Ice Age & Thickness *^ (J. Key, AWG)	<p>Implementation of the Ice Age and Thickness algorithm. This contains LHP mitigation.</p> <p>Existing Products Updated</p> <ul style="list-style-type: none"> Ice Age and Thickness (Full Disk, 2km) Ice Age and Thickness (Full Disk, 10km) Ice Age and Thickness (CONUS, 2km) 	<p>TBD</p>
Enterprise Ice Motion *^ (J. Key, AWG)	<p>Implementation of the Enterprise Ice Motions algorithm. This contains LHP mitigation. This update will include a coalition algorithm to improve product quality. This will enable a provisional declaration for the Ice Motion products.</p> <p>New Products Produced</p> <ul style="list-style-type: none"> Ice Motion(Full Disk, 2km) Ice Motion (Full Disk, 10km) Ice Motion (CONUS, 2km) 	<p>TBD</p>
Enterprise Fractional Snow Cover* (J. Key, AWG)	<p>Implementation of the Enterprise Fractional Snow Cover algorithm. This contains LHP mitigation. This would enable provisional validation of the Fractional Snow Cover product.</p> <p>New Products Produced</p> <ul style="list-style-type: none"> Snow Cover (Full Disk, 2km) Snow Cover (CONUS, 2km) Snow Cover (Mesoscale, 2km) 	<p>9/8/2022</p>



PRO PASS Product Change Summary FY22

ABI L2+ Algorithm / Change	Purpose and New/Modified Products	Operations Date
Enterprise Cloud Base Height (M. Kulie, AWG)	This algorithm is a required input for Cloud Cover Layers	3/2/2022
Enterprise Cloud Cover Layer *^#& (M. Kulie, AWG)	<p>Implementation of the Enterprise Cloud Cover Layer algorithm. This contains LHP mitigation.</p> <p>New Products Produced</p> <ul style="list-style-type: none"> • Cloud Layers (Full Disk, TBD km) • Cloud Layers (CONUS, TBD km) • Cloud Layers (Mesoscale, TBD km) 	3/2/2022
Enterprise Soundings Algorithm* (T. Schmit, AWG)	This implements the Enterprise Soundings algorithm. This algorithm is fundamentally identical to the baseline algorithm theoretical basis.	TBD



GOES-R Funded FY19/20 Composite/Blended NDE Algorithms

Complete
In Progress
Not Started/ECD
Not Started/ECD Changed

Product	Critical Design Review (CDR)	Initial DAP Delivery	Software Code Review (SCR)	Algorithm Readiness Review (ARR)	DAP Delivery	Operations Readiness Review (ORR)	Operational Declaration (SPSRB)	
MTCSWA Upgrades	Complete						1/26/2022	
ADT Upgrades	Complete						1/6/22	3/3/22
High Resolution Geo-Polar Blended Regional SST Analyses*	Complete	N/A*	02/22	N/A*	2/22	2/23	2/23	

SST DAP delivered to OSGS Red Team on schedule. OSGS Red Team cannot start work on integration until 6-9 months later.

- *(1) Not doing initial CCAPs because the Red Team is not taking them
- (2) Combining the ARR and ORR to speed up the process and combine work
- (3) The schedule has been pushed back to accommodate code conversion on the STAR side (to get rid of Matlab code) and the Red Team integration schedule which has slipped to the right due to personnel limitations vs the workload



GOES-R Funded FY21 Legacy Algorithm Migration to NCCF

Complete
In Progress
Not Started/ECD
Not Started/ECD Changed

	Expected Ops Date	PI Planning 5 (Oct~Dec 2021)	PI Planning 6 (Jan~Mar 2022)	PI Planning 7 (Apr~Jun 2022)	PI Planning 8 (Jul~Sep 2022)	PI Planning 9 (Oct~Dec 2022)	PI Planning 10 (Jan~Mar 2023)
Enterprise Rainfall Estimates	Jul 2022	Data Onboarding	PG	PG T2O/Parallel OPs			
eTRaP	Jul 2022	Data Onboarding	PG	PG T2O/Parallel OPs			
Arctic Composite Imagery Migration	Jan 2023			Data Onboarding	PG	PG T2O/Parallel OPs	
Global Geostationary Mosaic Imagery Migration	Jan 2023			Data Onboarding	PG	PG T2O/Parallel OPs	
Enterprise SST Migration-Geo SST	Apr 2023				Data Onboarding	PG	PG T2O/Parallel OPs
PI = Planning Increment							
Final CCAP delivery dates from ASSISTT expected at, or before, the end of the Data Onboarding phase							
Expected Ops dates at the end of Parallel Ops phase							
Non-GEO legacy algorithms being migrated at the same time							

Legacy Migration of Enterprise Rainfall Estimates and eTRaP:

- Software Code Reviews completed on schedule
- Integrating final updates
- The CCAPs for both Rainfall Rate and eTRaP will be delivered in April



NESDIS T20 Miscellaneous Algorithms

Complete
In Progress
Not Started/ECD
Not Started/ECD Changed

FED: L3H started work Jan 2022

Algorithm	Product/Description	GOES-R Series Satellite(s)		SPSRB User Request Received	OSAAP Prioritization Complete	ROM Costs Obtained - OSGS/STAR	Pre-Funding Technical Assessment	Funding Obligated	Ready for Development	In Development	Ready for Operations	Operational
ABI Flood	Merge GOES-R code into existing VIIRS code and create an Enterprise Algorithm	G16	G17	Complete	Complete	Complete	Complete	Complete	Complete	In Progress	FY23	FY23
GASP	Add total column smoke	G16	G17	Complete	Complete	Not started	Not started	Not Started	Not Started	Not Started	Not Started	Not Started
GeoColor	Produce blended multispectral images with variable transparencies from ABI bands	G16	G17	N/A - NWS Implementation				Complete	Complete	Complete	In Progress	
GeoViz	New ability to visualize clouds in visible bands at night. Galina Chirokova PI.	G16	G17	Not started	Not started	Not started	Not started	Not started	Not started	Not started	Not started	Not started
GLM Flash Extent Density	AWIPS-compatible tiled and gridded GLM flash extent product	G16	G17	Complete	Complete	Complete	Complete	Complete	Complete	In Progress	8/22	9/22
Land Surface Albedo	Land Surface Albedo, Bidirectional reflectance	G16	G17	Complete	Complete	Complete	Complete	Complete	Complete	Complete	Complete	Complete
NDE migration	Move NDE algorithms to NESDIS Cloud Framework	G16	G17	N/A	N/A	Complete	N/A	Complete	In Progress			FY23
Sky Cover	Run existing legacy GEO Sky Cover algorithm on GOES-R data	G16	G17	Complete	Complete	Complete	Complete	Complete	Complete	In Progress		4/23
Solar Insolation	GSIP (GOES Solar Insolation Products)	G16	G17	Complete	Complete	Complete	Not started	In Progress	Not Started	Not Started	Not Started	Not Started
Stereo AMVs	GOES Stereo AMVs	G16	G17	Complete	Complete	Not started	Not started	Not Started	Not Started	Not Started	Not Started	Not Started

- Products not listed here are either already in operations, being tracked as an update to the baseline algs, non-NOAA, or are still in early exploratory algorithm development e.g., NASA ROSES projects
- GeoColor: Not yet operational at all requested NWS sites
- NDE Migration: Now led by newly created OSGS-led Purple Team
- N/A in NDE schedule: NDE is migrating existing, funded algorithms to Cloud

GeoColor: Updates to 26 sites (16 complete and 10 left) will start in next few weeks



Mesoscale Domain Sector (MDS) Charts & Notification Charts

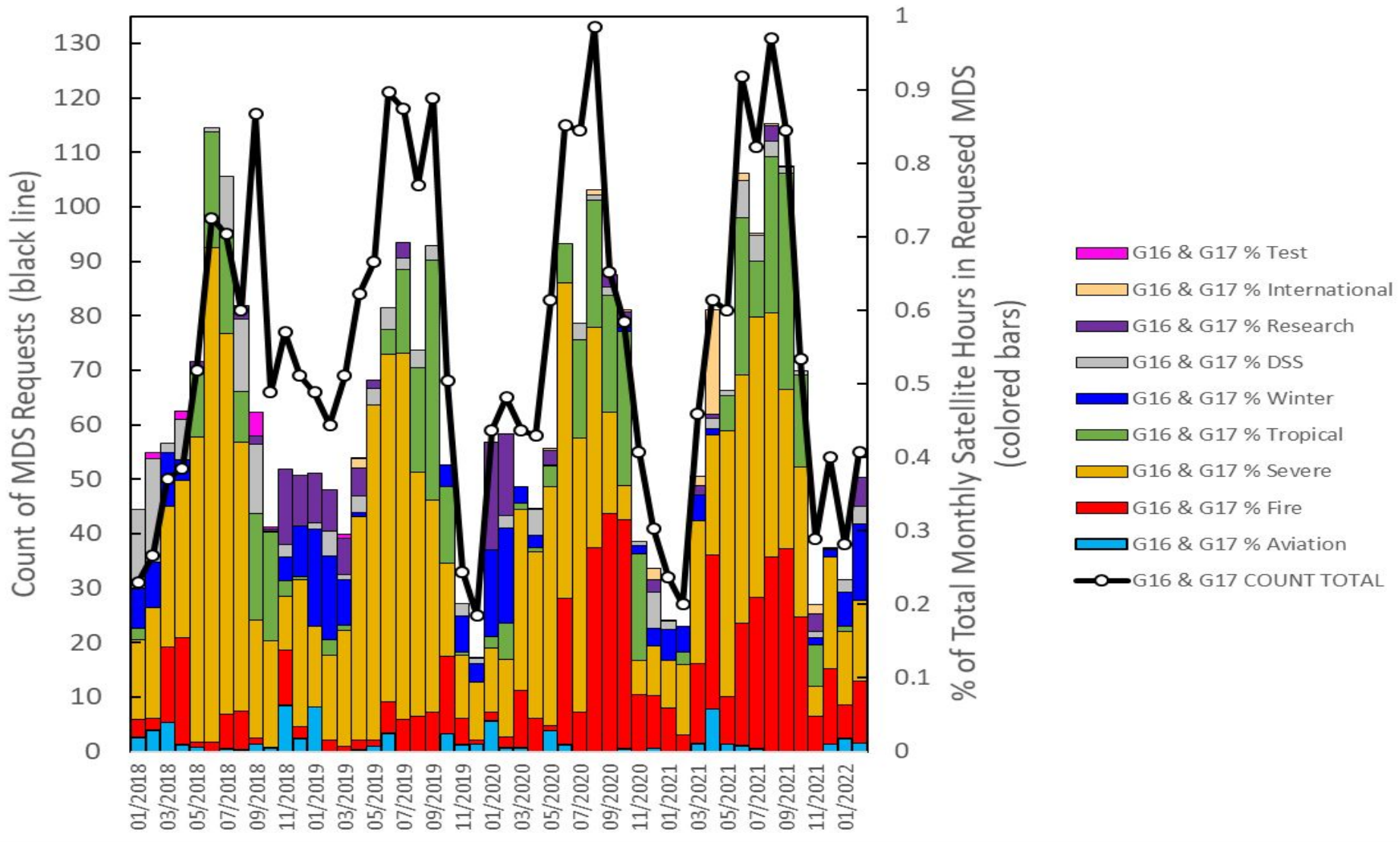


Recent MDS (Meso Domain Sector) Requests

Receipt Date	Inquiry Type	Requestor	Sector	Description of Inquiry
February 2	GOES-16 Research	Tim Schmitt	Government NOAA NESDIS STAR	30-second GOES-16 MESO for the launch of the GOES-T Satellite (March 1 20:40Z-23:40Z) granted center point 29N/80W. Launch plume caught by MESO on March 1
February 2	GOES-17 Research	Tim Schmitt	Government NOAA NESDIS STAR	30-second GOES-17 MESO for the launch of the GOES-T Satellite (March 1 21:37Z-21:47Z) granted center point 30N/78W. Launch plume caught by MESO on March 1
February 8	GOES-16 Research	Jeff Key	Government NOAA NESDIS STAR	1-minute GOES-16 MESO for the UAS Great Lakes Ice Experiment 1-minute MESO February 14-18 10 AM-3PM granted center point 45.7N/84.72W
March 4	GOES-17 Research	Scott Powell	Academia Professor Naval Post Graduate School	1-minute GOES-17 MESO for the CALICO field experiment integrating aircraft and radar data to investigate the life cycle of clouds. Center point: 36.7N, 122W. Default MESO on west coast was used for this test. March 5, 1300Z – March 6, 0200Z.
March 14	GOES-17 Research	Scott Powell	Academia Professor Naval Post Graduate School	1-minute GOES-17 MESO for the CALICO field experiment integrating aircraft and radar data to investigate the life cycle of clouds. Center point 40N 125W. March 15, 1400Z – March 16, 0100Z.

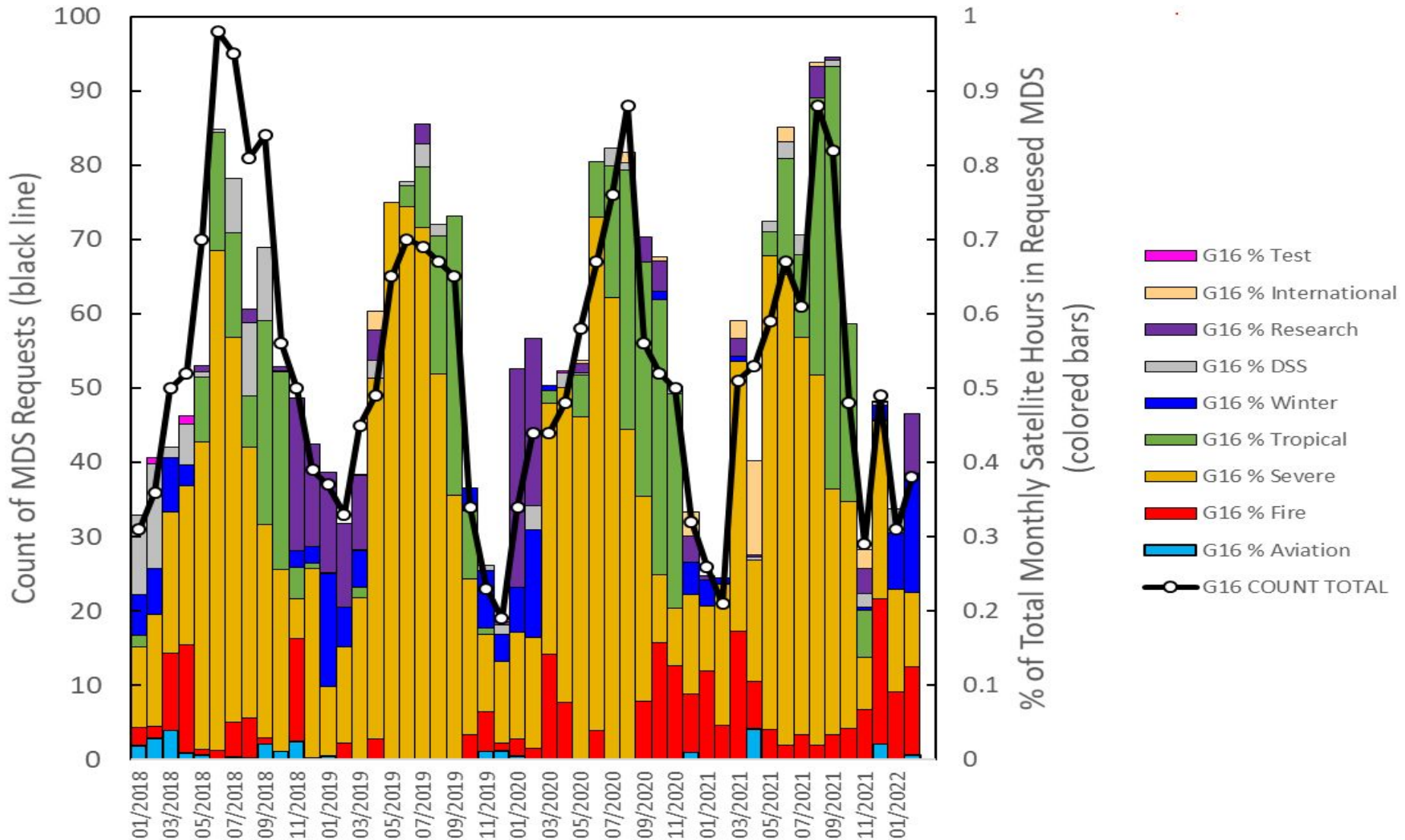


GOES-16/17 Mesoscale Domain Sector (MDS) Requests at GOES-East/West



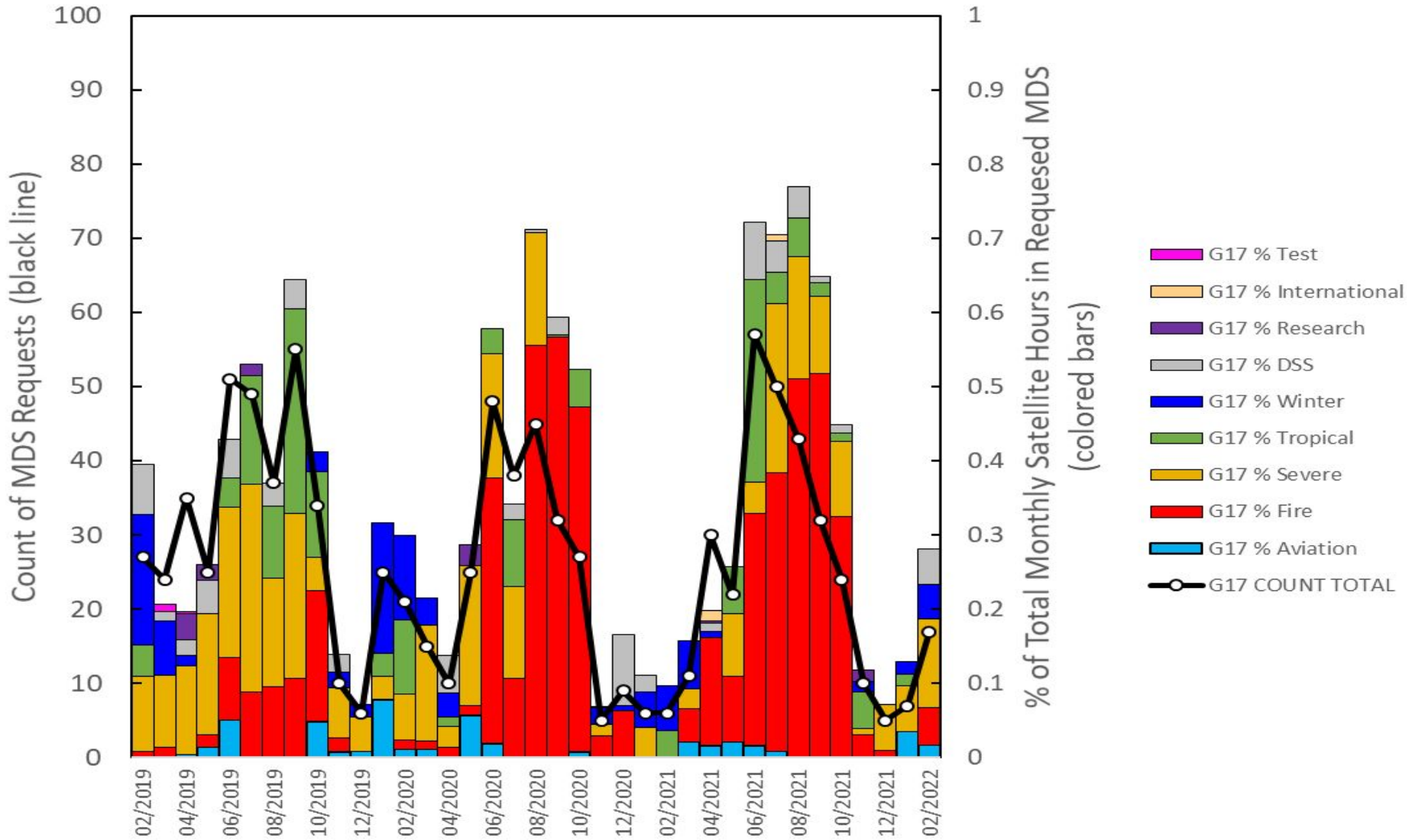


GOES-16 Mesoscale Domain Sector (MDS) Requests at GOES-East



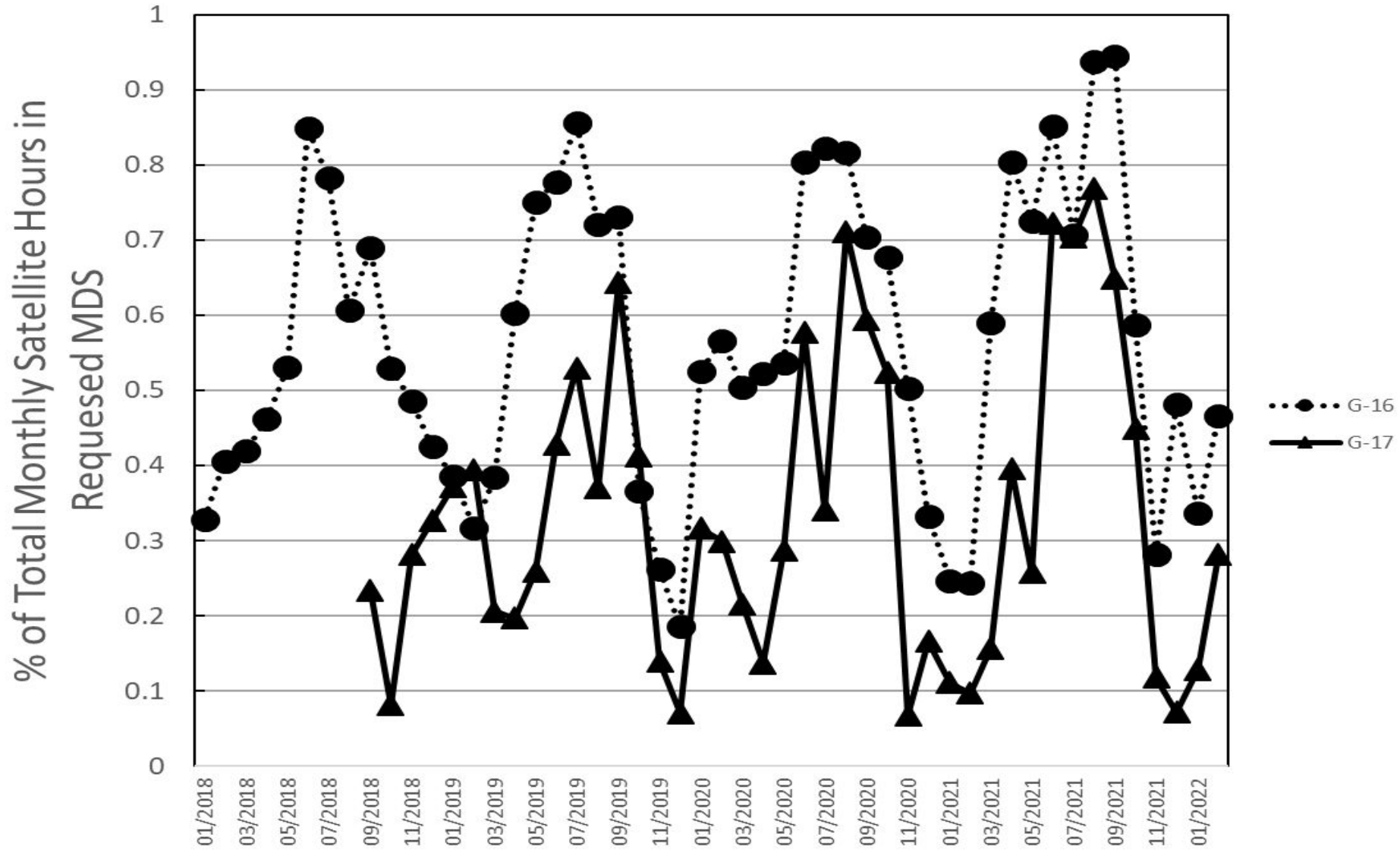


GOES-17 Mesoscale Domain Sector (MDS) Requests at GOES-West





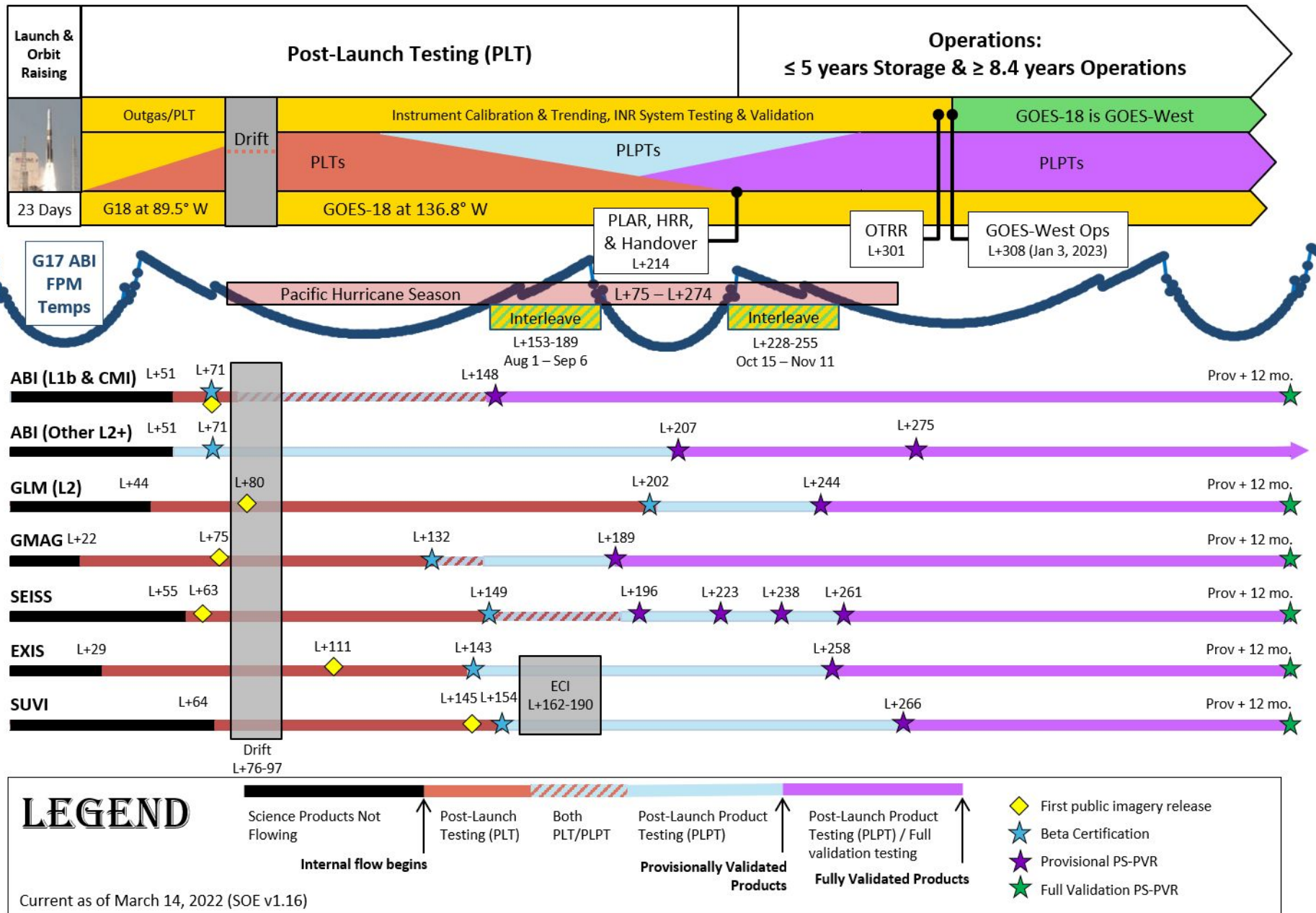
GOES-16/17 Mesoscale Domain Sector (MDS) Requests at GOES-East/West





More GOES-18 T20 Charts

GOES-18 Post-Launch Science Product Validation Schedule





GOES-West Transition Plan - Swap of GOES-17/18

Date (Based on 3/1/22 Launch)	GOES-17		GOES-18	
	Location	Activity	Location	Activity
3/1 – 3/23	137.2°W	GOES-West Operations		Launch and Orbit Raising
3/24 – 5/15			89.5°W	GOES-18 PLT Part 1 <ul style="list-style-type: none"> Instrument Outgassing, Spacecraft PLT First ABI Image (Vis & IR) @ 89.5W
5/16 – 6/6			<i>Drift to 136.8W</i>	GOES-18 Drift from 89.5W to 136.8W <ul style="list-style-type: none"> PLT activities paused; No GOES-18 product data
6/7			136.8°W	GOES-18 PLT Part 2 begins and PLPT begins
7/25			136.8°W	GOES-18 ABI reaches Beta maturity <ul style="list-style-type: none"> GOES-18 ABI 'supplemental' data via Cloud for NWS until GOES-18 Ops
8/1-9/6	137.2°W	GOES-17 ABI Warm Period <ul style="list-style-type: none"> GOES-18 ABI interleaved in GOES-17 data 	136.8°W	GOES-18 ABI data interleaved in GOES-17 data
9/6-10/15	137.2°W	GOES-West Operations <ul style="list-style-type: none"> GOES-17 Nominal Distribution 	136.8°W	GOES-18 product maturation continues <ul style="list-style-type: none"> GOES-18 ABI 'supplemental' data via Cloud for NWS until GOES-18 Ops
10/15-11/11	137.2°W	GOES-17 ABI Warm Period <ul style="list-style-type: none"> GOES-18 ABI interleaved in GOES-17 data 	136.8°W	GOES-18 ABI data interleaved in GOES-17 data
11/11-1/3	137.2°W	GOES-West Operations <ul style="list-style-type: none"> GOES-17 Nominal Distribution 	136.8°W	GOES-18 product maturation continues <ul style="list-style-type: none"> GOES-18 ABI 'supplemental' data via Cloud for NWS until GOES-18 Ops
1/3	137.2°W	Full G-18 GRB relayed through GOES-17 GRB <ul style="list-style-type: none"> Users do not need to re-point antennas X-band downlink off and instruments shut down 	136.8°W	GOES-18 Declared operational GOES-West <ul style="list-style-type: none"> Begin full GOES-18 GRB broadcast (relay through GOES-17 GRB)
1/4 – 1/11		Full G-18 GRB relayed through GOES-17 during longitude shift	Slow drift to 137.2°W	GOES-18 gradual shift to 137.2
1/12	Drift to 105°W	End GOES-18 data relay through GOES-17 GRB GOES-17 drift to 105°W followed by storage mode	137.2°W	GOES-18 Nominal Distribution <ul style="list-style-type: none"> End GOES-18 GRB relay through G-17 GRB Begin GOES-18 GRB broadcast / nominal distribution SAR/DCS services transitioned to GOES-18



User Training & Workshops



Science Products Training – Future Events

- Collective Madison Meeting (CMM) 08-12 August, Madison, WI
 - Abstract Deadline: 14 April 2022
 - NOAA Satellite Conference (NSC) will participate in coordination with 3 AMS Conferences (25th SATMOC, 17th PMO, 16th CPAR)
 - Budget and NOAA/AMS contract in final approval stages
 - Joint Satellite Short Course with Regional Lake focus
- SatMOC Summer Series (virtual) four consecutive weeks June - Aug
 - Update on GLM Applications, Severe Weather Nowcasting, Tropical Meteorology, Volcanic Detection and Monitoring
- 2023 Annual Meeting 8-12 January, Denver CO
 - Short Course Proposal: "Making Beautiful Images of GOES-R & JPSS Satellite Data using Python"

GOES-17/18 Interleave Periods and GRB/HRIT Impacts (Ian Avruch)



Background

- GOES-17 ABI performance is degraded during four warm periods each year (the ‘Loop Heat Pipe’ anomaly).
- As a mitigation, when a temperature threshold is expected for Band 15, a Cooling Timeline is implemented: ABI Mode 3, wherein Full Disk Images are taken less frequently (15 min. vs. Mode 6 10min.)

Interleaving: GOES-18 will not broadcast GRB/HRIT on L-band during Interleaving.

GOES-17 GRB and HRIT broadcasts will substitute GOES-18 data for some GOES-17 products:

- GOES-18 ABI L1b (calibrated radiance) will replace GOES-17’s on the **GRB** broadcast
- GOES-18 CMIP Full Disk and Meso products will be broadcast in lieu of the GOES-17 products on **HRIT**. In this period the GOES-17 CMIPF/M will not be broadcast by **HRIT**, but the G17 non-CMIPF Level2 products (VC25) will remain in the broadcast.

Interleaving Periods:

- **30 June 2022 for 2-4 hours** PLT Test “GND-008” a post-drift (89.5W to 136.8W) test of the Interleave configuration. GOES-18 CMI data distributed by HRIT (planned)
- **1 August - 6 September 2022** Nominal Interleave: GOES-18 CMI data distributed by HRIT
- **15 October - 11 November 2022** Nominal Interleave: GOES-18 CMI data distributed by HRIT

NWS enterprise architecture
Emergency Managers
Weather Information
Network (eEMWIN)

GRB/HRIT-EMWIN User Group

April 7, 2022

Robert Gillespie, NWS EMWIN Manager



eEMWIN Service Information



- The eEMWIN dissemination services:
 - GOES-16/17 Satellite HRIT/EMWIN broadcast
 - Anonymous FTP File Server – satellite broadcast archived .zip files
(text: 2, 6, 20-min. / 1, 3-hr. image: 15-min. / 1, 3-hr.)

<https://tgftp.nws.noaa.gov/SL.us008001/CU.EMWIN/DF.xt/DC.gsatsR/OPS/>

- HRIT/EMWIN Virtual Channel IDs (VCID) assigned to eEMWIN:
 - VCID 20 Text Products, priority 1 & 2
 - VCID 21 Image Files
 - VCID 22 Text products, priority 3 & 4
 - Operational composite data rate: 32 – 60 kbps



Text Product Examples



- Watches, Warning & Alerts, including:

- Tsunami
- Tornado
- Flood
- Severe Storms

- Forecasts

- Observations

- Climate Data

- Sever Weather Programs:

- RA-IV Hurricane Operations Plan
- Tsunami Warning Program

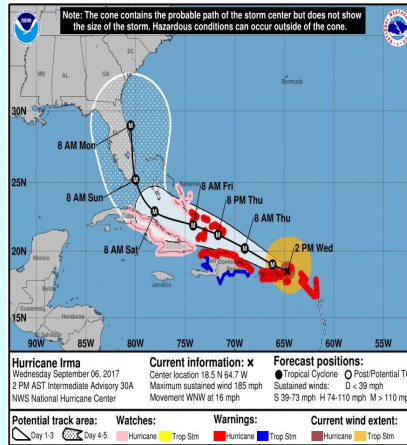
- All Non-Weather Emergency Alerts, including:

- Avalanche Warning
- Child Abduction Emergency
- Civil Emergency Message
- Earthquake Warning
- Radiological Hazard Warning
- Volcano Warning

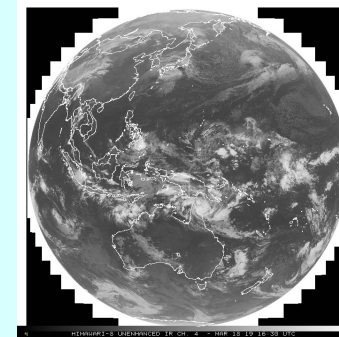


Image Product Examples

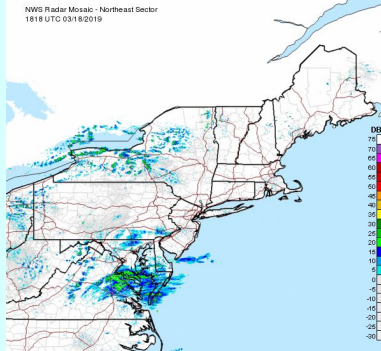
Hurricane Forecast Tracts



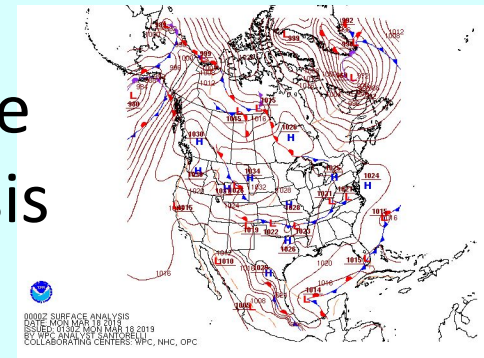
Satellite Imagery



Radar Mosaic Products



Surface Analysis





EMWIN Information References



- NWS EMWIN Documents Web Site:
 - <https://www.weather.gov/emwin/> ... then click “Documents” tab
- Documents Identifying Products on the EMWIN Service:
 - EMWIN_Text_Product_Catalog (Updated 02/14/2022)
 - EMWIN Image Product Catalog (Updated 03/29/2022)
- Service and Operational Reference Documents:
 - EMWIN FTP Service Description v1.1
 - EMWIN GOES-R Filename Convention Document (Draft)



NWS EMWIN Contact Information



Service Operational Issues:

Product support: email to: nws.emwin.support@noaa.gov

EMWIN operations: email to: nco.ops@noaa.gov
cc: nws.emwin.support@noaa.gov

phone: 301-683-1518

General Support:

Email to: nws.emwin.support@noaa.gov

NWS EMWIN Web Page: <https://www.weather.gov/emwin/>

Robert Gillespie robert.gillespie@noaa.gov (301) 427-9396
NWS EMWIN Manager, Dissemination Systems Team, Office of
Dissemination, NWS

Craig Hodan craig.hodan@noaa.gov (301) 427-9678
Chief, Dissemination Systems Branch, Office of Dissemination, NWS



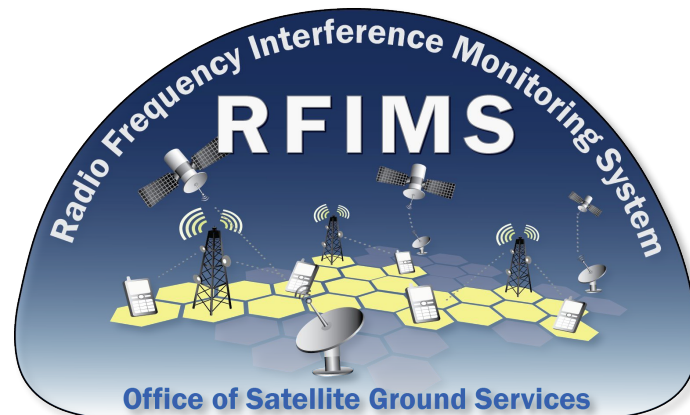
GRB/HRIT-EMWIN Users Group



Questions ?

Radio Frequency Interference Monitoring System (RFIMS)

**High Rate Information Transmission/
Emergency Managers Weather Information Network
(HRIT/EMWIN) User Group
April 7 , 2022**



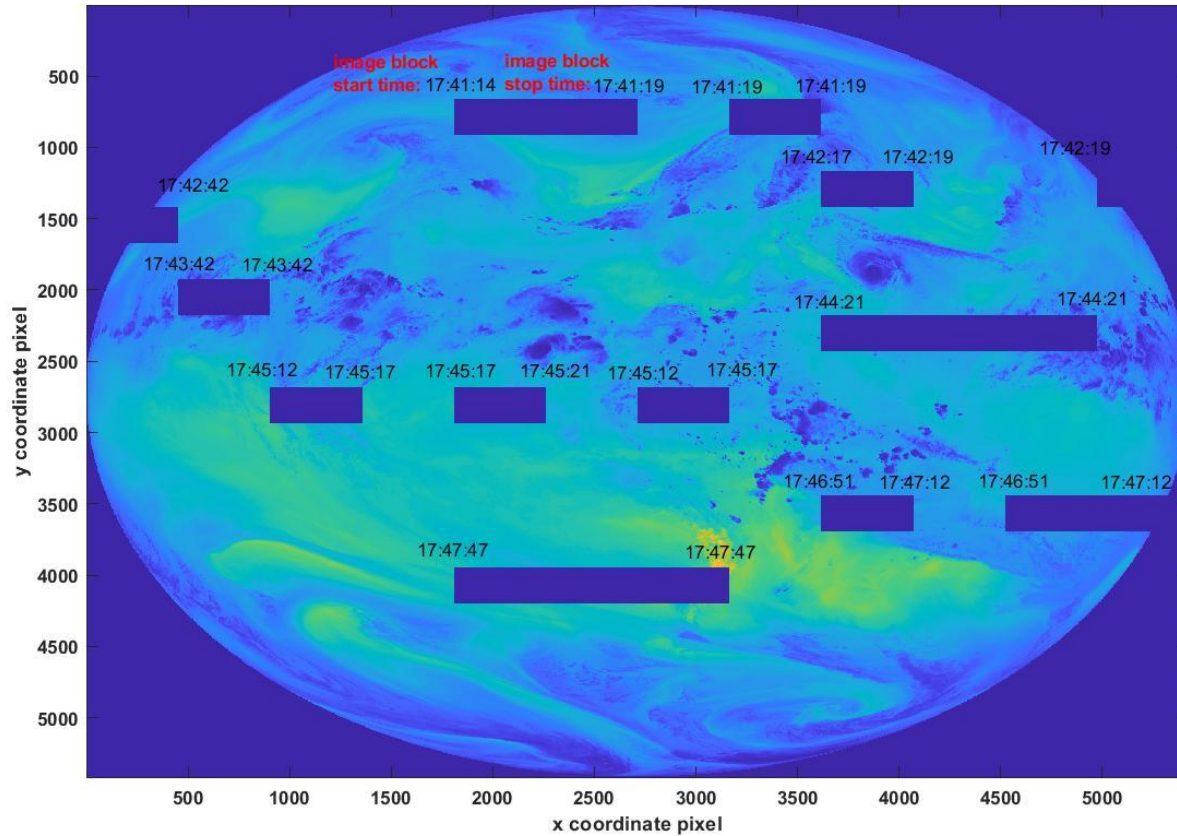


GRB Interference Study

- Investigate quantifiable metrics for assessing degradation in GRB performance
- Investigate available diagnostics to determine if a KPI exists that will predict future image degradation
 - GRB-200 Demodulator diagnostics
 - GRB Appliance diagnostics
- Performed wired and radiated measurements of in-band and out-of-band interference
- Multi-phase approach
 - Phase 0: Investigate interference error conditions and available diagnostics
 - Completed October 2020
 - Phase 1: Examine effects of in-band and out-of-band interference to GRB signal
 - Completed March 2021
 - Phase 2: Examine effects of radiated signals
 - Completed August 2021
 - Phase 3: Measure the correlation between image degradation/loss (or the efficient KPI) versus RFIMS RFI events
 - Completed October 2021



GRB Image Errors



GRB Phase 3 - Results

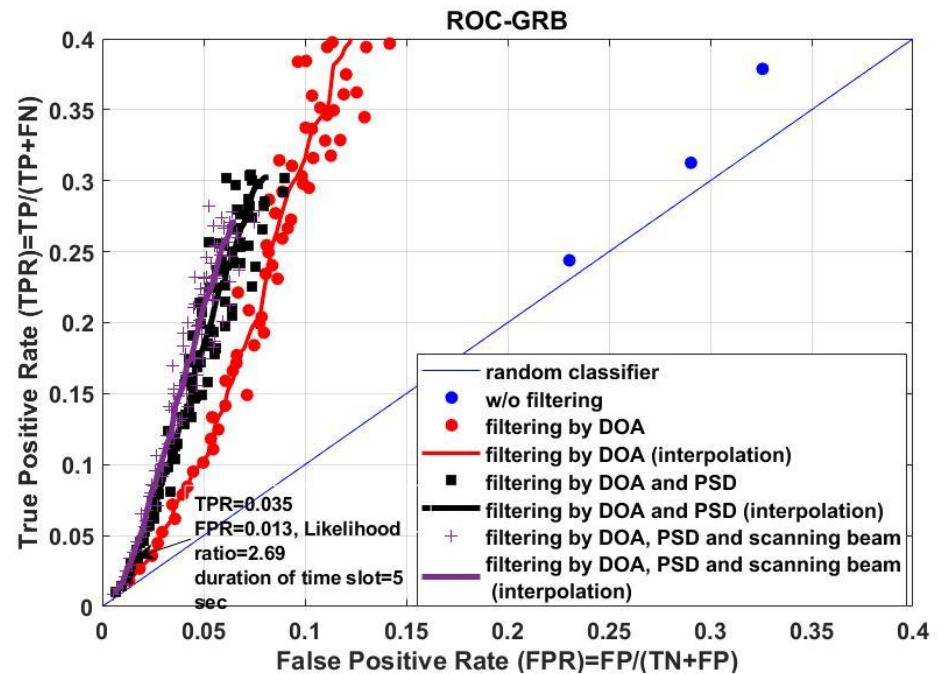
True Positive (TP): when a RFI RFIMS event is generated and pixel loss is observed in the ingested image received by ground stations during the associated time slot.

False Positive (FP): when a RFIMS event is generated and no pixel loss is observed in the ingested image received by ground stations during the associated time slot.

True Positive Rate (TPR): TPR is the ratio of the number TP to the total number of time slots that have pixel loss in reality.

False Positive Rate (FPR): FPR is the ratio of the number FP to the total number of time slots that have no pixel loss in reality.

By filtering the RFIMS RFI events by DOA and PSD, the graphs are getting closer to the top and left-hand borders than the random classifier shown by blue lines in the figures. From this observation, we can conclude that by filtering the RFIMS RFI events, the performance of the system is getting better than a random classifier in terms of TPR and FPR.

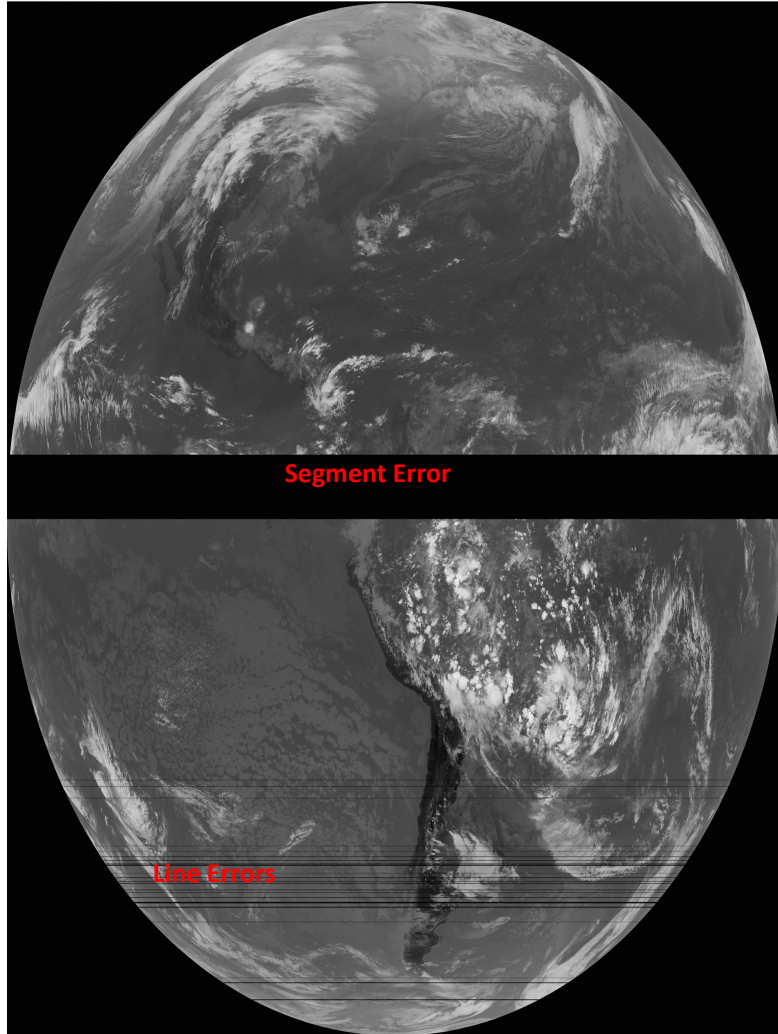




HRIT/EMWIN Interference Study

- RFIMS PMO has conducted an HRIT/EMWIN study to determine the system's interference susceptibility
- Testing employed the Dartcom (Global LG) HRIT/EMWIN earth station
- RFIMS can monitor 1670 – 1710 MHz, which includes an HRIT/EMWIN downlink center frequency of 1694.1MHz
- Multiple phase approach
 - Phase 0: Investigate interference error conditions and KPIs.
 - Examine potential key performance indicators (KPIs) when interference is injected in the HRIT/EMWIN band (1694.1 MHz)
 - KPI: Packet sequence error and uncorrectable frames
 - Completed in Feb 2022
 - Phase 1: Investigate Interference effects of 1695-1710 MHz transmissions using 5G user equipment spectral emissions mask power levels
 - Radiated measurements included in testing

HRIT/EMWIN Phase 0 - Results



- HRIT/EMWIN full disk images consist of 5424 x 5424 resolution
- Transmitted in 16 segments of 339 lines each
- Measurement data are analyzed to correlate image degradation to log file data:
 - Line error \longleftrightarrow Packet sequence errors
 - Number of missing lines \rightarrow Number of fill bytes inserted
 - Missing line location \rightarrow Fill byte location
- Types of errors
 - Line errors: inserted in increments of 5424 bytes into image
 - Segment errors: 339 contiguous lines in image



HRIT Phase 1 - Approach and Test Objectives

- This phase will build on the previous phase effort that identified two key performance indicators (KPIs) that are natively available from the system, namely *uncorrectable frames* and *packet sequence errors*.
- Investigate the susceptibility of interference in the HRIT/EMWIN downlink signal at 1694.1 MHz from **5G LTE uplink transmissions in the AWS-3 A1 Block (1695-1700 MHz) as well as its out-of-band roll off emissions.**
- 5G user equipment spectral emission mask specified in 3GPP standard TS 38.101-1
 - The A1 Block is the nearest adjacent band to the HRIT/EMWIN frequency band
- Planning to include **5G waveforms** in the next phase of testing



GeoXO Program Update

Craig Keeler, NOAA/NESDIS

April 7, 2022

GeoXO Program

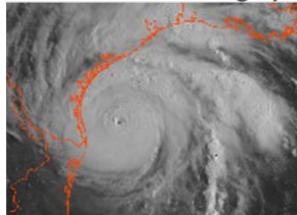
- **NOAA's Geostationary Extended Observations (GeoXO)** satellite system is the next generation mission that will advance Earth observations from geostationary orbit.
- **GeoXO** will supply vital information to address major environmental challenges of the future in support of U.S. weather, ocean, and climate.
- The GeoXO mission will continue and expand observations provided by the **GOES-R Series** as NOAA's next generation of geostationary satellites.
- NOAA is working to ensure these critical observations are in place by the early 2030s as the GOES-R Series nears the end of its operational lifetime.
- **GeoXO Program Formally Initiated Nov. 9**



User Needs Inform GeoXO Capabilities

- NOAA, its users, and industry partners conducted capability studies, observation simulation experiments, value assessments, future scenario evaluations, societal and economic benefit evaluations, and user needs workshops, surveys, and interviews to determine which observations are the highest priority for GeoXO to provide.

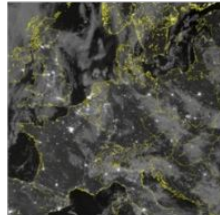
Visible & Near-IR Imagery



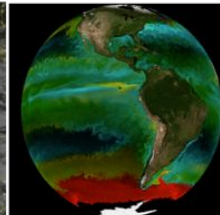
Lightning Mapping



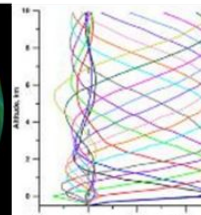
Day/Night Imagery



Ocean Color



Sounding



Atmospheric Composition





New and Improved Observations



- New technology and scientific advancements will improve observations for weather forecasting and provide new ocean and atmospheric measurements.
- GeoXO will provide real-time, high-resolution visible and infrared imagery for monitoring Earth's weather, oceans, and environment.
- Data from GeoXO will contribute to weather forecast models and drive short-term weather forecasts and severe weather warnings.
- GeoXO will also provide advanced detection and monitoring of environmental hazards like wildfires, smoke, dust, volcanic ash, drought, and flooding.



Advancing NOAA's Mission



- The GeoXO observing system will power increasingly sophisticated models that forecast climate-change-driven weather patterns.
- Made-to-order data delivery will allow users to customize data access to facilitate more accessible and usable environmental information.
- Multiple data delivery options will be available, including an internet storefront, mobile device access, and satellite broadcast.
- Cloud-based product generation will expand data access, increase community involvement, and continuously evolve service.



GeoXO Recommended Capabilities



- **Lightning Mapping**
Data continuity; spatial resolution improvements
- **Infrared Sounding**
New capability for numerical weather prediction and nowcasting
- **Day/Night Imagery**
New capability for nighttime cloud, fog, and smoke tracking
- **Ocean Color Imagery**
New capability for ocean health and productivity monitoring
- **Atmospheric Composition Measurement**
New capability for detection of air quality threats

Recommended GeoXO Constellation



GEO-West

Vis/IR
Imager
Lightning
Mapper
Ocean Color

GEO-Central

IR Sounder
Atmospheric
Composition
Partner Payload

GEO-East

Vis/IR
Imager
Lightning
Mapper
Ocean Color



HRIT/EMWIN
Direct Broadcast
Services via
Commercial
Satellite

DCS data relay
planned for
GOES-East
and West
satellites

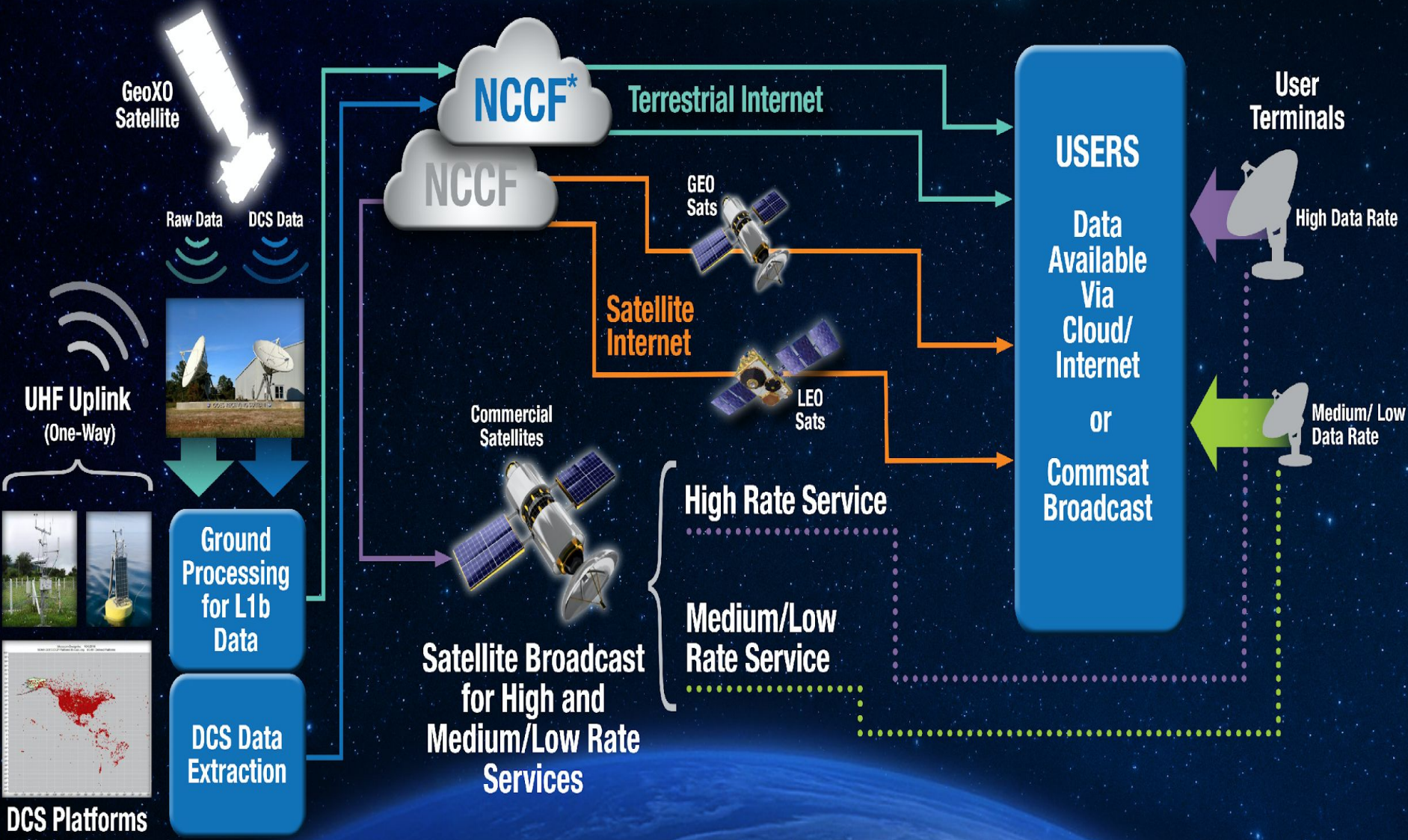


GeoXO Core Capabilities



- **Visible/Infrared Imagery**
Data continuity; spatial and spectral resolution improvements
- **Data Collection System Ingest**
Service continuity of data relay from remote user platforms
- **Data Collection System (DCS), Emergency Managers Weather Information Network (EMWIN), High-Rate Information Transmission (HRIT) Data Rebroadcast**
Service continuity via use of Commercial Satellite services

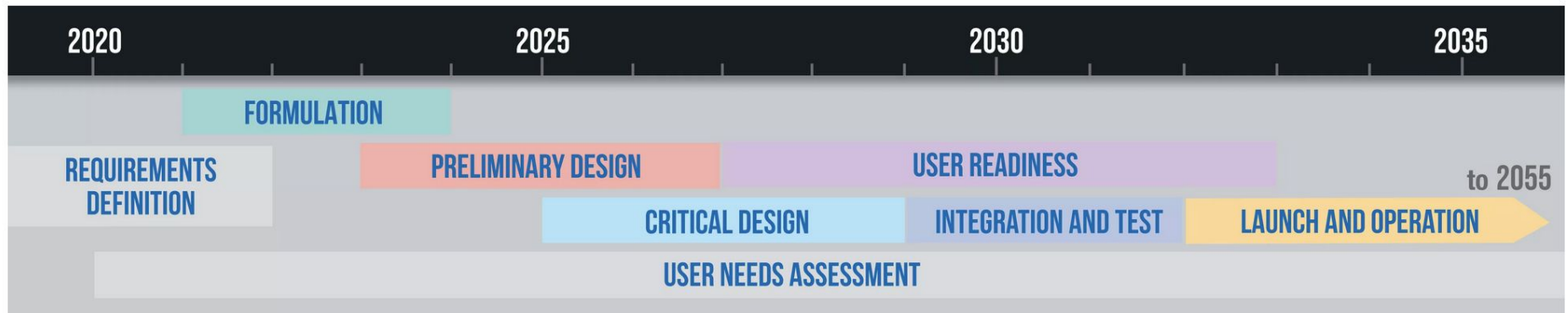
GeoXO Data Delivery



*NESDIS Common Cloud Framework

GeoXO Timeline

- NOAA assessing user needs and potential observational capabilities.
- Key decisions made in 2021 led GeoXO Program initiation.
- GeoXO requirements definition and pilot studies underway will lead to the preliminary design of the spacecraft and instruments.
- In critical design stage, NOAA will provide data to users on new capabilities.
- The first GeoXO launch is planned for the early 2030s to maintain and advance NOAA's critical geostationary observations through 2055.





For more Information



Contact Craig Keeler: Craig.a.Keeler@noaa.gov

Or Visit

<https://www.nesdis.noaa.gov/next-generation-satellites/geostationary-extended-observations-geoxo>

CSPP Geo: Support for GOES-18 and interleaving in the GRB package

- Users should be able to process GOES-18 or interleaved GRB data with the current version of the GRB package (v1.0.26)
 - Users on older software versions are advised to update
- No configuration changes should be needed to handle interleaving
 - Users receiving the GOES-West (GOES-17) GRB stream will see GOES-18 ABI L1B products during interleaving periods
- A configuration change will be needed to process GRB data received from the GOES-18 satellite
 - This will be needed when GOES-18 becomes the operational GOES-West satellite, in order to process GRB data received from GOES-18
 - Details on configuration changes will be posted to the CSPP Geo User Forum before the GND-006 test of the GOES-18 GRB stream in early May
- If any issues are discovered during interleaving tests, the CSPP Geo team will release a software patch or post required configuration changes to the CSPP Geo User Forum

CSPP Geo User Forum: <https://forums.ssec.wisc.edu/viewforum.php?f=67>

Technical support: csppgeo.issues@ssec.wisc.edu

CSPP Geo: Support for GOES-18 in other software packages

AIT Framework Level 2 package

- A v2.1 beta release is planned for June 2022, which will add preliminary GOES-18 support for the current GOES-17 product set
- Contingent on receiving a delivery of the underlying software from NOAA in early April
- Will include mainly logic updates to handle GOES-18; science updates will come later

Gridded GLM

- Release planned for May 2022 will add preliminary support for GOES-18

Geo2Grid

- Release planned for end of May 2022 will add preliminary support for GOES-18



THIRD ROCK FROM THE SUN



NOAA GRB/HRIT USER GROUP

HOBBYIST UPDATES

CARL G. REINEMANN
[HTTPS://USRADIOGUY.COM](https://usradioguy.com)

April 7, 2022

☐ Guides, Builds, Forums-


- ☐ USRadioguy <https://usradioguy.com/>
- ☐ A minimal LRIT/HRIT receiver https://pietern.github.io/goestools/guides/minimal_receiver.html
- ☐ RTL-SDR.com Comprehensive Tutorial <https://www.rtl-sdr.com/rtl-sdr-com-goes-16-17-and-gk-2a-weather-satellite-reception-comprehensive-tutorial/>
- ☐ Open Satellite Project <https://osp.teske.net.br/channel/opensateliteproject>
- ☐ Geo Stationary Satellite Group <https://www.facebook.com/groups/gswsg>

☐ Software

- ☐ Goestools <https://github.com/pietern/goestools>
- ☐ Raydel XRIT Decoder <http://www.geo-web.org.uk/XRITDecoder.php>
- ☐ XRIT Decoder for GOES <https://usa-satcom.com/>
- ☐ GRB Play and SUVI Play <https://usa-satcom.com/>
- ☐ GRB Streamer and Imager- Bret Casebolt
- ☐ CSPP Geo software <https://cimss.ssec.wisc.edu/csppgeo/>
- ☐ SATDUMP <https://github.com/altillimity/> A multi satellite decoder and image processor.
- ☐ GK-2A Decoder <https://github.com/sam210723/xrit-rx><https://usradioguy.com>
- ☐ XRIT Decoder Open Satellite Project <https://github.com/opensatelliteproject/xritdemod>
- ☐ Sanchez <https://github.com/nullpainter/sanchez>



GRB Hardware

 @usa_satcom

Satellite: GOES-16/17
Freq: 1686.6 MHz
Symbol Rate: 8666 Ksps
Data Rate: 31 Mbps (L+R)
Mode: DVB-S2 QPSK 9/10 FEC



3m Prime Focus Dish
(some get by with 2.1m)
RF Hamdesign

Septum Dish Feed
Dual Mode Circular (LHCP + RHCP)
RF Hamdesign

Nooelec SAWbird+ GOES
1 for each polarization



Novra S400 GRB Pro



\$\$\$



TBS 6903* DVB-S2



\$

*not all DVB-S2 cards work for GRB

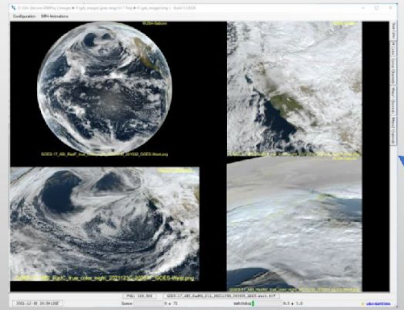
© USA-Satcom

Copyrights and Trademarks belong to respective owners

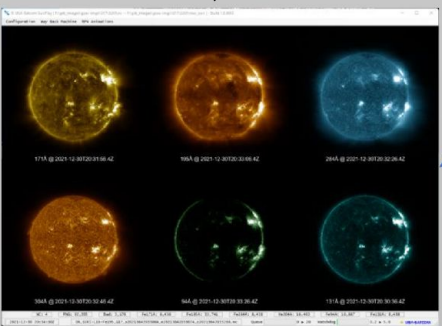
GRB Software

@usa_satcom

GRB Play by USA-Satcom
(Viewer and Animations)



SUVI Play by USA-Satcom
(Creates SUVI Products, Viewer and Animations)



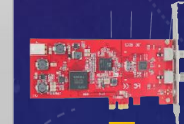
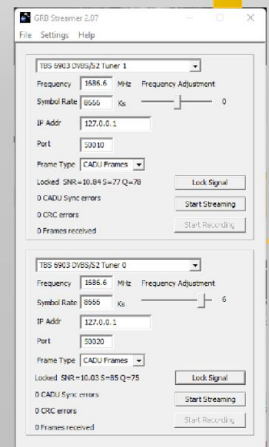
1TB
SSD
NetCDFs

12 Core Hyper-V 32GB
Ubuntu 20.04
CIMSS
CSPP Geo GRB Version 1.0.26
Handles CADU -> NetCDF

24 Core Hyper-V 64GB
Ubuntu 20.04
CIMSS
CSPP Geo2GRID Version 1.0.2
Handles NetCDF -> TIF/PNG
(+custom scripts from Luc Fontaine / VE2FXL)

4TB
SSD
30 days of
Products
+VM Space

CADUs ← S400
or
CADUs ← DVB-S2



BB Frames

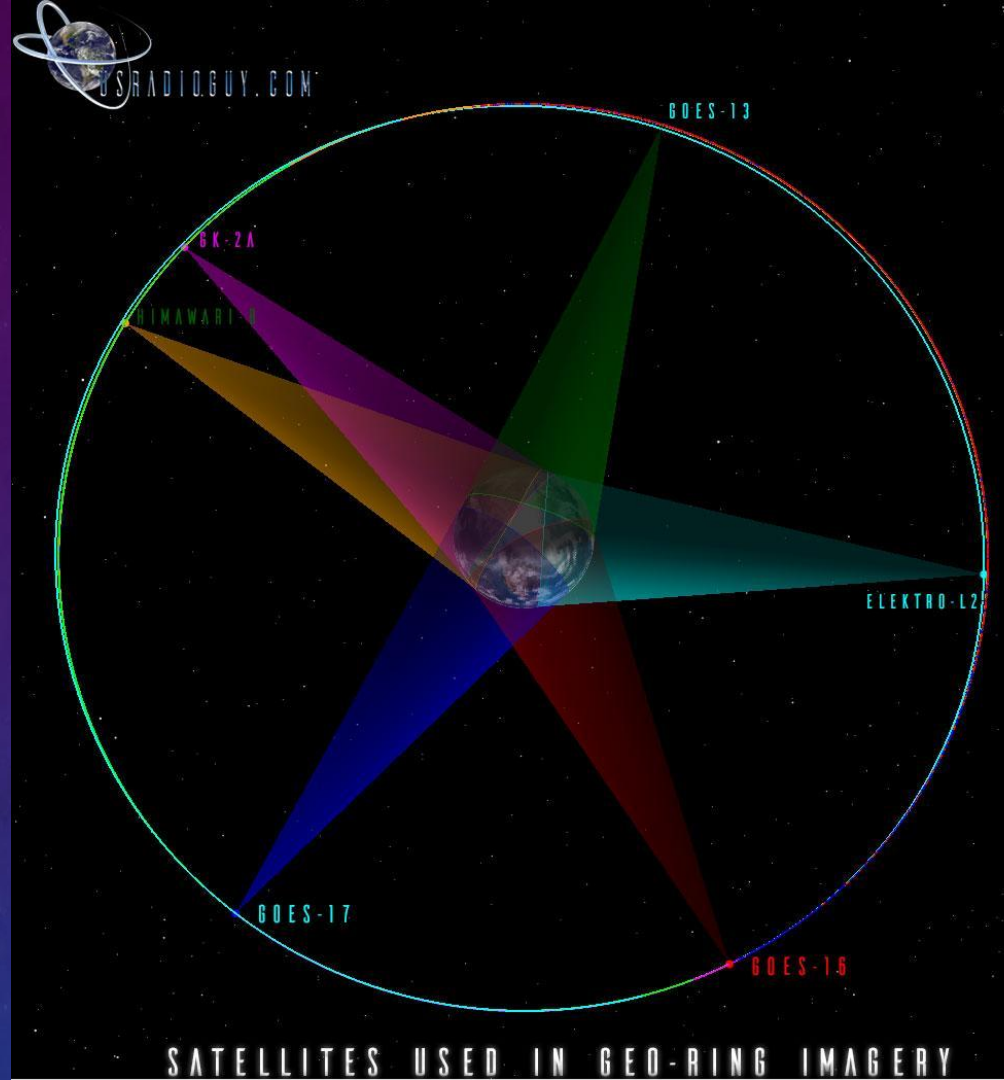
Host: AMD 4GHz 64-Core 128GB Windows 11 x64

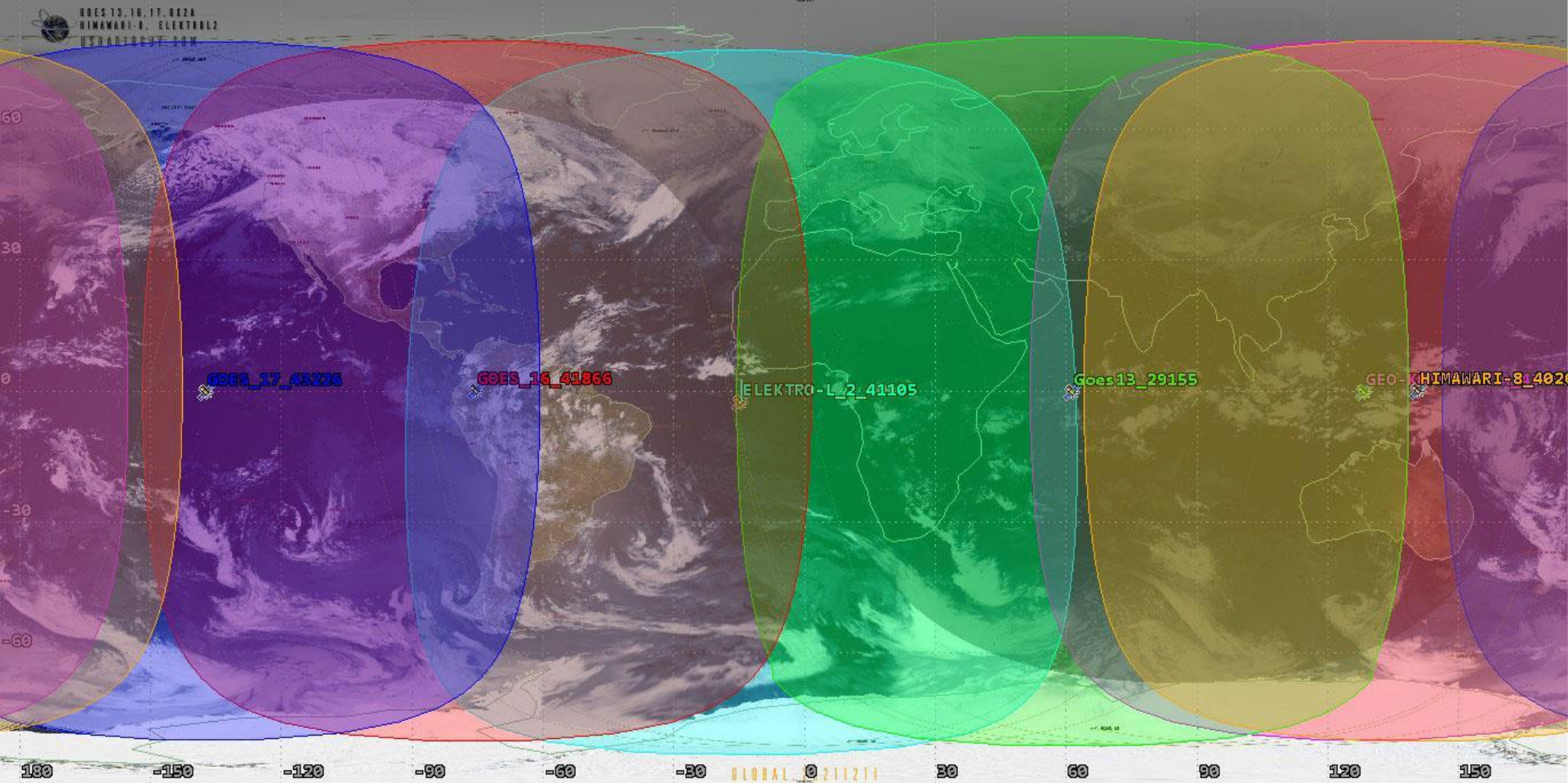
GRB Streamer by Brett Casebolt

Using satellite imagery from multiple satellites it is possible for the end user to create full global composite meteorological satellite imagery of the entire planet.

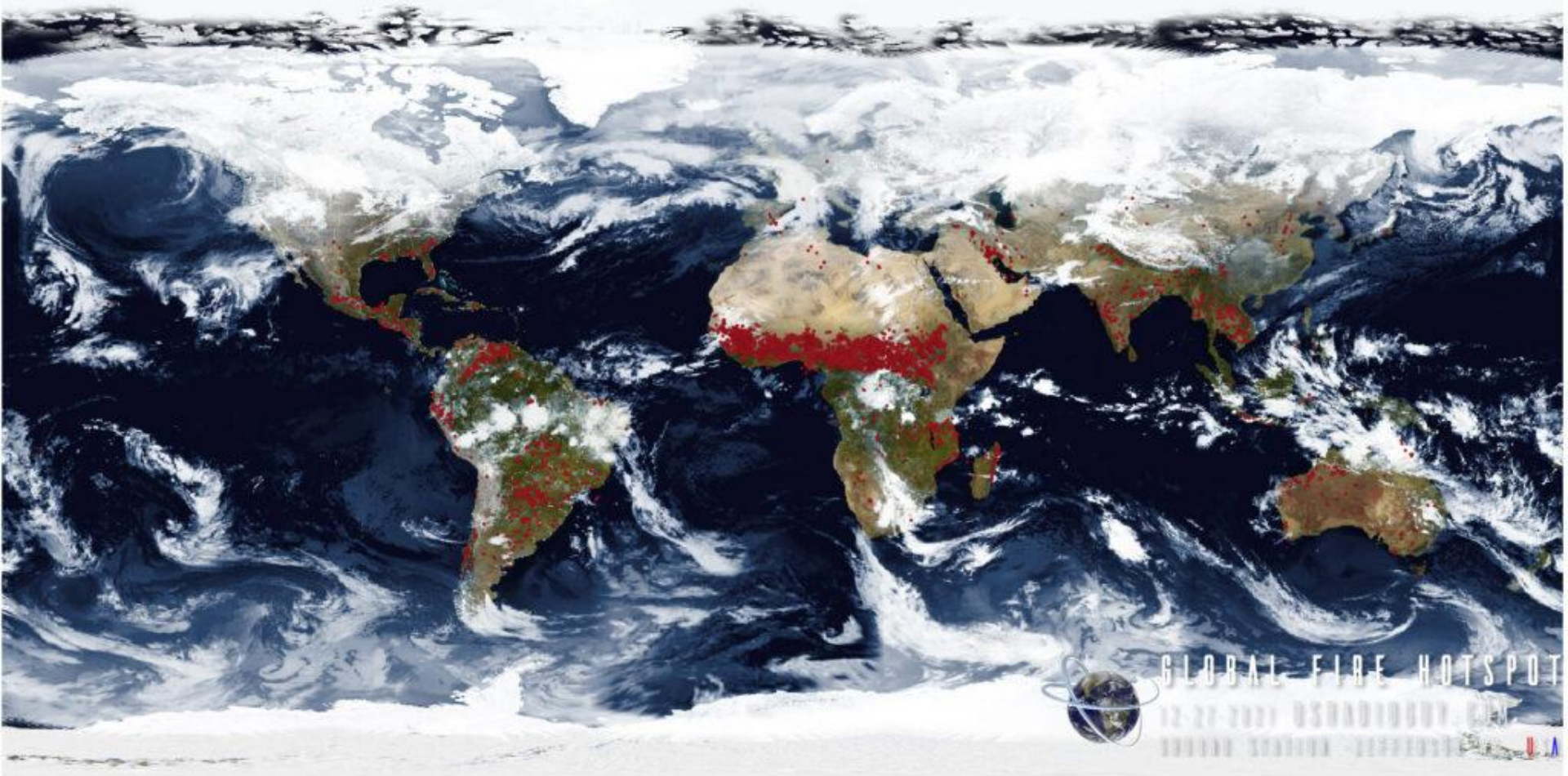
Shown to the right are the 6 satellites used to render the geo ring composite imagery.

Note that imagery from three satellites out of the six used, are obtained from other receiving stations around the globe as it is not possible to receive all imagery from a single ground station unless it is relayed via satellite as is the case for Himawari-8 being relayed via GOES 17.

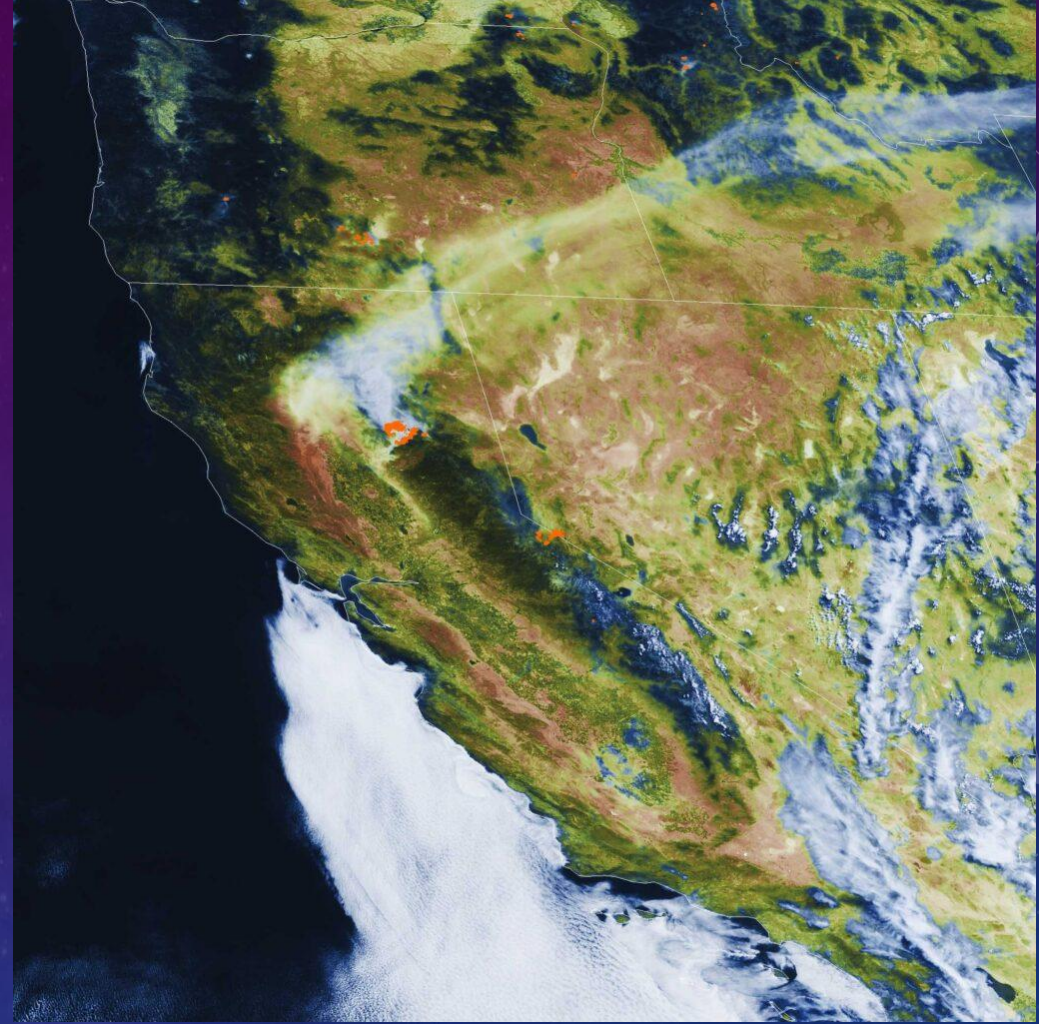




View of Global Coverage provided by each Geostationary satellite used in the following composites



Using MODIS and VIIRS Fire and Hotspot data it is then possible to overlay the GIS data onto the global imagery



Fires in Quebec and Ontario, 2021

Using MODIS and VIIRS Fire/Hotpot data applied to HRIT imagery. The data comes from NASA - The Fire Information for Resource Management System (FIRMS) distributes Near Real-Time (NRT) active fire data within 3 hours of satellite.

GOES 17 showing the fires in July 2021 including

HRIT User Outreach 1/2 (Ian Avruch)



- GeoXO Plans and HRIT
 - The requirements for GeoXO stemming from HRIT/EMWIN and DCS will be set in the near future, likely by August 2022
 - As described in this presentation, shifting the HRIT/EMWIN broadcast to commercial satellite providers is contemplated.
 - Users' needs and continuity of service are explicit factors in the decision. Therefore, input from users is key to planning.
 - portability of the relatively small L-band stations
 - capability to receive meteo and hydro data, imagery, and DCS in the same broadcast at remote sites.
 - security benefits, for critical infrastructure, of direct NOAA broadcast
 - The potential benefits of change
 - mitigate interference associated with L-band AWS-3 Spectrum Sharing.

Feel free to contact the HRIT/EMWIN Program Manager Ian Avruch (ian.avruch@noaa.gov) to share your use cases and requirements, these will be shared with the GeoXO team.

We will schedule one or more open meetings to take input from the user community. Email Ian to ensure you get the invitations, and to share your concerns.

The DCS program has scheduled a series of Open Fora to take input from the user community. Contact William Dronen (william.dronen@noaa.gov).

HRIT User Outreach 2/2 (Ian Avruch)



- HRIT Response to Disaster and Emergency
 - The HRIT/EMWIN Broadcast does not generally change the timing or frequency of data products in response to events.
 - In contemplating a more dynamic broadcast, user needs are the paramount interest. User input is key, again.
 - Constraints may include:
 - unambiguous trigger events and durations
 - limited bandwidth usage to avoid unacceptable slowing or loss of other HRIT data products

Input from the community is welcomed!

Contact HRIT/EMWIN Program Manager Ian Avruch (ian.avruch@noaa.gov) with your suggestions or concerns.

ESPC Notifications, Status, and Contacts



Subscribe to ESPC for notifications -- this is the primary way for you to receive notifications!

24/7 Help Desk	ESPCOperations@noaa.gov
ESPC Messages	http://www.ssd.noaa.gov/PS/SATS/messages.html
User Services	SPSD.UserServices@noaa.gov
Data Access	NESDIS.Data.Access@noaa.gov
Facebook	www.facebook.com/NOAANESDIS
Twitter	www.twitter.com/noaasatellites
Press releases	http://www.nesdis.noaa.gov/news_archives/
GOES Status	http://www.ospo.noaa.gov/Operations/GOES/status.html
GOES User Information and Documents	http://www.ospo.noaa.gov/Operations/GOES/documents.html
POES Status	http://www.ospo.noaa.gov/Operations/POES/status.html

GRB/HRIT Joint User Group



Ian Avruch

HRIT/EMWIN Direct Broadcast Manager

Satellite Products and Services Division

Office of Satellite and Product Operations

NOAA/NESDIS

Email: Ian.Avruch@noaa.gov

Phone: (240) 410-3546

GRB/HRIT Joint User Group



Seth Clevenstine

GNC-A Direct Broadcast Manager

Satellite Products and Services Division

Office of Satellite and Product Operations

NOAA/NESDIS

Email: seth.clevenstine@noaa.gov

Phone: 240-560-8557

GRB/HRIT Joint User Group



Paul Seymour

NOAA (NESDIS/OSPO/SPSD/DSB) Affiliate
Systems Integration & Development, Inc (SID)

Email: paul.seymour@noaa.gov