

WORLD METEOROLOGICAL ORGANIZATION

COMMISSION FOR BASIC SYSTEMS

TWELFTH SESSION

GENEVA, 29 NOVEMBER–8 DECEMBER 2000

ABRIDGED FINAL REPORT WITH RESOLUTIONS AND RECOMMENDATIONS

Copyright in this electronic file and its contents is vested in WMO. It must not be altered, copied or passed on to a third party or posted electronically without WMO's written permission.



WMO-No. 923

Secretariat of the World Meteorological Organization - Geneva - Switzerland

WORLD METEOROLOGICAL ORGANIZATION

COMMISSION FOR BASIC SYSTEMS

TWELFTH SESSION

GENEVA, 29 NOVEMBER–8 DECEMBER 2000

ABRIDGED FINAL REPORT WITH RESOLUTIONS AND RECOMMENDATIONS



WMO-No. 923

**Secretariat of the World Meteorological Organization - Geneva - Switzerland
2001**

REPORTS OF RECENT WMO SESSIONS

Congress and Executive Council

- 867 — **Executive Council**. Forty-ninth session, Geneva, 10–20 June 1997.
880 — **Twelfth World Meteorological Congress**. Proceedings, Geneva, 30 May–21 June 1995.
883 — **Executive Council**. Fiftieth session, Geneva, 16–26 June 1998.
902 — **Thirteenth World Meteorological Congress**. Geneva, 4–26 May 1999.
903 — **Executive Council**. Fifty-first session, Geneva, 27–29 May 1999.
915 — **Executive Council**. Fifty-second session, Geneva, 16–26 May 2000.

Regional associations

- 851 — **Regional Association II** (Asia). Eleventh session, Ulaanbaatar, 24 September–3 October 1996.
868 — **Regional Association IV** (North and Central America). Twelfth session, Nassau, 12–21 May 1997.
874 — **Regional Association III** (South America). Twelfth session, Salvador, 17–26 September 1997.
882 — **Regional Association VI** (Europe). Twelfth session, Tel Aviv, 18–27 May 1998.
890 — **Regional Association V** (South–West Pacific). Twelfth session, Denpasar, 14–22 September 1998.
891 — **Regional Association I** (Africa). Twelfth session, Arusha, 14–2 October 1998.

Technical commissions

- 854 — **Commission for Basic Systems**. Eleventh session, Cairo, 28 October–7 November 1996.
860 — **Commission for Marine Meteorology**. Twelfth session, Havana, 10–20 March 1997.
870 — **Commission for Climatology**. Twelfth session, Geneva, 4–14 August 1997.
879 — **Commission for Atmospheric Sciences**. Twelfth session, Skopje, 23 February–4 March 1998.
881 — **Commission for Instruments and Methods of Observation**. Twelfth session, Casablanca, 4–12 May 1998.
893 — **Commission for Basic Systems**. Extraordinary session, Karlsruhe, 30 September–9 October 1998.
899 — **Commission for Aeronautical Meteorology**. Eleventh session, Geneva, 2–11 March 1999.
900 — **Commission for Agricultural Meteorology**. Twelfth session, Accra, 18–26 February 1999.
921 — **Commission for Hydrology**. Eleventh session, Abuja, 6–16 November 2000.

In accordance with the decision of Thirteenth Congress,
the reports are published in the following languages:

Congress	— Arabic, Chinese, English, French, Russian, Spanish
Executive Council	— Arabic, Chinese, English, French, Russian, Spanish
Regional Association I	— Arabic, English, French
Regional Association II	— Arabic, Chinese, English, French, Russian
Regional Association III	— English, Spanish
Regional Association IV	— English, Spanish
Regional Association V	— English, French
Regional Association VI	— Arabic, English, French, Russian
Technical Commissions	— Arabic, Chinese, English, French, Russian, Spanish

WMO issues authoritative publications on scientific and technical aspects of meteorology, hydrology and related subjects.
These include manuals, guides, training materials, public information and the WMO *Bulletin*.

© 2001, World Meteorological Organization

ISBN 92-63-10923-0

NOTE

The designations employed and the presentation of material in this publication do not imply the expression of any opinion whatsoever on the part of the Secretariat of the World Meteorological Organization concerning the legal status of any country, territory, city or area, or of its authorities, or concerning the delimitation of its frontiers or boundaries.

CONTENTS

Page

GENERAL SUMMARY OF THE WORK OF THE SESSION

1.	OPENING OF THE SESSION	1
2.	ORGANIZATION OF THE SESSION	2
2.1	Consideration of the report on credentials.....	2
2.2	Adoption of the agenda.....	2
2.3	Establishment of committees	2
2.4	Other organizational questions	2
3.	REPORT BY THE PRESIDENT OF THE COMMISSION	2
4.	REVIEW OF DECISIONS OF THIRTEENTH CONGRESS AND THE EXECUTIVE COUNCIL RELATED TO THE COMMISSION	3
5.	STATUS OF THE WORLD WEATHER WATCH IMPLEMENTATION AND OPERATION.....	4
6.	WORLD WEATHER WATCH PROGRAMME, SUPPORT FUNCTIONS AND PUBLIC WEATHER SERVICES, INCLUDING THE REPORTS BY THE CHAIRPERSONS OF THE OPEN PROGRAMME AREA GROUPS.....	5
6.1	Integrated observing system.....	5
6.2	Information systems and services.....	13
6.3	Data-processing and forecasting systems	27
6.4	Public weather services	33
6.5	Operational information service	37
7.	LONG-TERM PLANNING RELEVANT TO THE COMMISSION.....	38
8.	REVIEW OF THE WORKING STRUCTURE OF THE COMMISSION.....	39
9.	WORK PROGRAMME OF THE COMMISSION; ESTABLISHMENT OF OPEN PROGRAMME AREA GROUPS AND TEAMS	41
10.	REVIEW OF PREVIOUS RESOLUTIONS AND RECOMMENDATIONS OF THE COMMISSION AND RELEVANT EXECUTIVE COUNCIL RESOLUTIONS	42
11.	ELECTION OF OFFICERS.....	42
12.	DATE AND PLACE OF THE NEXT SESSION.....	42
13.	CLOSURE OF THE SESSION.....	42

RESOLUTIONS ADOPTED BY THE SESSION

Final Session

No. No.

1	8/1	Working structure of the Commission	44
2	8/2	CBS Management Group.....	45
3	9/1	Open Programme Area Groups	45
4	10/1	Review of previous resolutions and recommendations of the Commission for Basic Systems	46

RECOMMENDATIONS ADOPTED BY THE SESSION

		<i>Page</i>
<i>Final</i>	<i>Session</i>	
<i>No.</i>	<i>No.</i>	
1	6.1/1	Amendments to the <i>Manual on Codes</i> (WMO-No. 306), Volume I.1, Part A, FM 71-XI CLIMAT and FM 75-X CLIMAT TEMP 47
2	6.2/1	Amendments to the <i>Manual on the Global Telecommunication System</i> (WMO-No. 386), Volume I, Parts I and II 47
3	6.2(3)/1	Amendments to the <i>Manual on Codes</i> (WMO-No. 306), Volume I.1, Alphanumeric codes and Volume I.2, Binary codes and common features 81
4	6.2(3)/2	Rules and procedures for amending the <i>Manual on Codes</i> (WMO-No. 306) 87
5	6.2(3)/3	Addition to new Code form FM 92-XII GRIB 88
6	6.3/1	Amendments to the <i>Manual on the Global Data-processing System</i> (WMO-No. 485) 132
7	6.3/2	Designation of a Regional Specialized Meteorological Centre (RSMC) on tropical cyclones 136
8	10/1	Review of resolutions of the Executive Council based on previous recommendations of the Commission for Basic Systems or related to the World Weather Watch 136

ANNEXES

I	Figures from general summary paragraphs (paragraphs 6.1.14, 6.2.35, 6.2.40, 6.2.48, 6.2.64 and 6.4.6 of the general summary) 137
II	Satellite data distribution service via the United Kingdom Satellite Facility (UKSF) (paragraph 6.2.4 of the general summary) 141
III	Integrated World Weather Watch monitoring (paragraph 6.2.56 of the general summary) 141
IV	CBS Technical Conference on WMO Information Systems and Services (paragraph 6.2.83 of the general summary) 146
V	Procedures to evaluate the impact of changes on the GOS on NWP and the exchange and dissemination of results (paragraph 6.3.6 of the general summary) 146
VI	Guidelines where action is required to minimize the impact of a loss of observations on the operation of the GDPS (paragraph 6.3.7 of the general summary) 147
VII	Verification systems for long-range forecasts—revised experimental scores to be exchanged (paragraph 6.3.14 of the general summary) 149
VIII	Role of Lead Centres (paragraph 6.3.15 of the general summary) 153
IX	GPCC procedures for precipitation quality monitoring (paragraph 6.3.21 of the general summary) 153
X	Terms of reference of OPAG teams and rapporteurs (paragraph 9.4 of the general summary) 154
XI	Membership of OPAG teams and rapporteurs (paragraph 9.5 of the general summary) 160

APPENDICES

A.	List of persons attending the session 163
B.	Agenda 166
C.	List of abbreviations 168

GENERAL SUMMARY OF THE WORK OF THE SESSION

1. OPENING OF THE SESSION (agenda item 1)

1.1 The twelfth session of the Commission for Basic Systems was held in Geneva from 29 November to 8 December 2000. The session, which took place in the Headquarters of the World Meteorological Organization, was opened at 10 a.m. on 29 November 2000 by the president of the Commission, Mr S. Mildner (Germany).

1.2 The Secretary-General of WMO, Professor G. O. P. Obasi, welcomed the participants to the session on behalf of the Organization. He thanked the president and vice-president of the Commission as well as the chairpersons of the OPAGs and expert and implementation/coordination teams for their leadership, dedication and hard work.

1.3 Professor Obasi noted that many political and technological challenges faced the Commission but the primary function of CBS remained the planning and development of the basic systems in support of the WWW. He reminded the participants that in order to continue to serve the needs of the WWW and the other WMO and related international programmes in the coming years, the basic systems must continue to develop and adapt to meet changing conditions and changing requirements and make the best use of new knowledge. He noted that the Commission must also strive to ensure that developing countries were also able to contribute effectively to the WWW, despite the difficult financial situation in many countries.

1.4 The Secretary-General stated that several global forums concerned with WCP and GCOS had stressed the need for Governments to strengthen observational networks in order to identify possible climate changes and to assess its potential impacts. He pointed out that as we strived to respond to global concerns relating to the environment, climate change and climate variability, and severe weather events, we must continue to develop approaches to changing socio-economic conditions while making best use of improving technologies and techniques. That was particularly important in the area of information and communication technology. In that regard, the CBS Technical Conference on WMO Information Systems and Services (Geneva, 27-28 November 2000) provided an important forum on the latest developments in that field and on related training and capacity building aspects. He also noted with pleasure that over the past few years, and with a minimum of resources, the Commission had made substantial progress in the implementation of the PWS Programme.

1.5 The Secretary-General noted that in view of its growing tasks and responsibilities, the extraordinary session of the Commission in 1998 had agreed to implement a new working structure. Since several of the tasks assigned to the Commission involved participation and contributions of other technical commissions and

relevant international organizations, he was pleased to note that it had been possible to establish formal links with those organizations and other WMO technical commissions. Those links resulted in the inclusion of experts designated by the presidents of other commissions and other international organizations as members or invited experts in several CBS expert teams.

1.6 The president of CBS welcomed the participants and expressed his pleasure that the session could be held in the new WMO Headquarters building since it provided an opportunity for delegates to work closely with staff of the Secretariat. He noted that advances in information systems and the efficient management of tasks allowed the Commission to cover a more complex agenda in less time that had been allocated to earlier sessions. The president also commented on the success of the Commission's new working structure. The trial conducted over the past two years had demonstrated that the new structure was effective and efficient. He emphasized that its continuing success required a high level of communication and consultation with CBS members and urged all members to keep abreast of the activities of the various teams and provide feedback on their working results.

1.7 The president reminded the session that CBS played an important role in providing infrastructure to all WMO Programmes. So far, CBS had successfully coped with that responsibility but it must recognize limitations, especially due to dwindling staff resources. Thus, he was pleased that members had responded so generously with their nomination of experts to contribute to the CBS teams. That commitment demonstrated the high priority that members had assigned to CBS business.

1.8 The Secretary-General of WMO presented outstanding service awards to Messrs A. A. Vasiliev and F. Zbar for their long standing distinguished contributions to WMO and, particularly, to CBS. He noted that Mr Vasiliev had been involved with the Commission for more than 25 years, serving as vice-president from 1978 to 1988 and as president from 1988 to 1996. He noted that Mr Zbar was extensively involved with CBS for nearly 20 years, serving as chairperson of the Working Group on Observations from 1988 to 1998. Mr Vasiliev expressed his sincere honour and appreciation in accepting his award. Mr J. Jones, the principal delegate of the United States, accepted the certificate on behalf of Mr F. Zbar.

1.9 There were 185 participants at the session which included representatives of 82 Members of WMO and 11 international organizations. A complete list of participants is given in Appendix A to this report. The Commission was pleased to note that the session was the largest meeting of a WMO technical commission ever held.

2. ORGANIZATION OF THE SESSION (agenda item 2)

2.1 CONSIDERATION OF THE REPORT ON CREDENTIALS (agenda item 2.1)

The Commission decided that in accordance with General Regulation 22, it was not necessary to establish a Credentials Committee. The Commission approved the report of the representative of the Secretary-General.

2.2 ADOPTION OF THE AGENDA (agenda item 2.2)

The provisional agenda was adopted by the session. The final agenda is reproduced in Appendix B to this report.

2.3 ESTABLISHMENT OF COMMITTEES (agenda item 2.3)

2.3.1 One working committee was established to examine the various agenda items in detail. Following proposals by the president, the following chairpersons were appointed for consideration of the individual items:

Mr K. Essendi (Kenya) for agenda items 6.2, 6.5 and 10;

Mr A. I. Gusev (Russian Federation) for agenda items 6.1, 6.3 and 6.4.

Agenda items 4, 5, 7, 8 and 9 were considered in the Committee of the Whole, chaired by the vice-president, Mr G. Love (Australia), and the remainder of the items were considered in plenary, chaired by the president.

2.3.2 In accordance with General Regulations 24 and 28, a Nomination Committee and a Coordination Committee were established. The Nomination Committee comprised Messrs A. H. M. Al-Harthy (Oman), D. F. Molotsi (Botswana), J. Mauro de Rezende (Brazil), P. Dubreuil (Canada), Yap Kok Seng (Malaysia) and E. De Dycker (Belgium). The Coordination Committee comprised the president and vice-president of the Commission, the co-chairpersons of the working committee and the representative of the Secretary-General. Ms C. Richter (Germany) was appointed Rapporteur on Previous Recommendations and Resolutions of the Commission.

2.4 OTHER ORGANIZATIONAL QUESTIONS (agenda item 2.4)

It was agreed that, with the exception of agenda item 2.1, summarized minutes of the plenary meetings would not need to be prepared. Furthermore, in accordance with General Regulation 3, it was agreed to waive General Regulation 109 (i.e., the 18-hour rule). The session agreed upon the working hours for the duration of the session. A complete list of documents presented at the session is contained in Appendix B to this report.

3. REPORT BY THE PRESIDENT OF THE COMMISSION (agenda item 3)

3.1 The Commission noted with appreciation the report of its president, Mr S. Mildner (Germany), which provided information on the activities of the Commission since its extraordinary session in September/October 1998. It noted with satisfaction that the trial of more flexible and cost-effective working arrangements had worked well and the 23 expert and implementation/coordination teams, which included more than 160 experts, had accomplished

a great deal of work. There had been more than 35 meetings during the period on matters falling under the Commission's purview or otherwise related to the WWW. Further details of the activities and accomplishments were provided in the reports of the chairpersons of the working groups and discussed under the relevant agenda items. The Commission agreed that a summary of the significant achievements of the Commission in relationship to the goals and objectives of the Long-term Plans would be a useful addition to the report of the president. It therefore requested that such a summary be included in the president's report in the future.

3.2 The Commission noted that during the inter-sessional period the president was actively involved in many activities dealing with matters of general importance to WMO, representing CBS and the WWW Programme in numerous meetings and providing input to the discussions in various forums dealing with issues like the structure and the future of WMO, the exchange of meteorological data and products, the establishment of a WMO mechanism for dealing with high-level policy matters on satellites, infrastructure needs for seasonal and inter-annual forecasting, the AMDAR programme, coordination with EUMETNET and its WWW related sub-projects and many other items. The Commission noted the intense collaboration that existed with the GCOS science panels and steering committee of which Mr Mildner was a member appointed in his personal capacity.

3.3 Apart from his role as programme representative for the WWW and the PWS Programmes, reporting regularly to Congress and the Executive Council, the president represented the Commission in sessions of other constituent bodies (CAeM-XI and RA VI-XII) and in the yearly Meetings of the Presidents of Technical Commissions. Given the fact that the WWW was the provider of basic infrastructures for most of the WMO Programmes, the inter-programme collaboration was a matter of overriding importance which required a high level of attention. The Commission was pleased to note that the numerous activities of the president had been accomplished successfully and expressed its appreciation for the substantial amount of work and personal dedication involved.

3.4 The Commission expressed its appreciation for the extensive guidance provided by the two sessions of the AWG, which had kept under review the follow-up to the decisions of CBS, and for the various actions taken by the president especially as regarded the participation of the Commission in the work of other constituent bodies and for representing the Commission at Thirteenth Congress and at two sessions of the Executive Council. The Commission noted the various requests for action made by the Executive Council, particularly regarding the structure and working arrangements within CBS, the use of Internet and the new WMO practice for the international exchange of data and products, and considered those under the appropriate agenda items.

3.5 The Commission noted that the implementation of the new working structure constituted a major step towards modern management and increased

efficiency and flexibility. It acknowledged the substantial effort made by the officers, the AWG and, in particular, the chairpersons of the OPAGs and their teams in implementing the new structures in accordance with the instructions given by CBS/Ext.(98), which included a continuous learning process over the past two years. The Commission noted with great satisfaction that the ambitious aims set by CBS/Ext.(98) were reached in demonstrating the usefulness of the new working structure. In particular, the AWG had assumed its new role as a management body with a high level of competence, efficiency and responsiveness. The Commission was particularly pleased to see the increase in the flow of information through the use of the Internet and e-mail functions which had contributed in no small measure to the CBS work on all levels. In that context, the Secretariat was complimented for its efficiency in arranging timely access to all CBS relevant information through the Internet. The Commission agreed that the new working and management structures of CBS had successfully demonstrated that it was on the right path toward increasing its efficiency and responsiveness to deal with the future challenges of WMO.

3.6 In recognizing the substantial progress that had been made, the Commission considered that a number of major issues and challenges were still before the Commission, as had been indicated by the Executive Council, and should be kept in mind when dealing with the details of its work programme. Among those were:

- (a) Optimization of various mixes of observing elements in the composite GOS and development of observing networks that were adaptable to changing requirements;
- (b) Exploration of ways for Members to contribute to the GOS, including joint funding arrangements, to ensure that adequate observations were made in remote and data-sparse areas;
- (c) Development of future WMO information systems that took advantage of advances in technology and met the requirements of all WMO and related international programmes;
- (d) Implementation or utilization of suitable telecommunication systems and services, in particular in specific areas where the GTS was weak or deficient;
- (e) Management and coordination of radio-frequency allocations to meteorological systems;
- (f) Further coordination of infrastructure for enhanced operation of extended-range and long-range forecasts;
- (g) Implementation of advances in data assimilation techniques to facilitate the operational utilization of new types of observational data;
- (h) Development and introduction of improved automated monitoring functions;
- (i) Further development of the PWS Programme, in particular with respect to preparedness for, and mitigation of, natural disasters;
- (j) Refinement of the CBS working and management structures and strengthen the links to other WMO programme bodies.

3.7 The Commission noted that the emergence of unofficial weather forecasts disseminated via the Internet was seen as a concern by some members. Consequently, the Commission agreed that an additional issue that should be considered was the establishment of agreed standards for the identification and exchange of warnings, advisories and forecasts.

3.8 The Commission noted that some members had undertaken to implement the concept of total quality management and that ISO9000 certification was increasingly being called for by users, including the aviation community. The Commission agreed to appoint Mr P. Vangrunderbeeck (France) as Rapporteur on Total Quality Management to investigate whether and how the concept of total quality management could be applied to the WWW system. The Rapporteur should report to the Management Group on his investigation, including proposals for further possible action on that topic.

3.9 The president expressed his sincere appreciation to all CBS members who had participated in the activities of the Commission for their enthusiastic cooperation. In particular, he thanked the vice-president, Mr G. Love, the chairpersons of the OPAGs and teams and the rapporteurs for their outstanding work, which had made his task so much easier. On behalf of CBS, the president also thanked the Secretary-General of WMO and the staff of the Secretariat, in particular the WWW—Basic Systems and the Applications Departments, for their support and cooperation.

4. REVIEW OF THE DECISIONS OF THIRTEENTH CONGRESS AND THE EXECUTIVE COUNCIL RELATED TO THE COMMISSION (agenda item 4)

4.1 The outcome of the discussions at Thirteenth Congress and the fifty-first and fifty-second sessions of the Executive Council relevant to CBS were reviewed with particular emphasis on decisions impacting the future work programme of the Commission. The Commission noted that Thirteenth Congress reconfirmed the crucial importance of the WWW in support of the day-to-day operations of the NMHSs, for research and for many other programme activities. Congress decided that the substance of the WWW should be as indicated in the Fifth WMO Long-term Plan adopted under Resolution 23 (Cg-XIII) — Fifth WMO Long-term Plan.

4.2 The Commission noted that both Thirteenth Congress and the Executive Council had made favourable and supportive comments on the new CBS structure and the revised working mechanisms which were recorded in the final reports of the corresponding sessions. The Commission further noted that the Executive Council requested the president to provide a progress report on the implementation of the new structure after the present session of CBS. The Commission also noted that Congress had stressed the importance of the links between CBS and the regional associations with respect to achieving a coordinated implementation of the WWW and had urged the regional associations to strengthen their collaboration with CBS.

4.3 Congress requested the Executive Council to continue to monitor the implementation and implications of Resolution 40 (Cg-XII) — WMO policy and practice for the exchange of meteorological and related data and products including guidelines on relationships in commercial meteorological activities, with the assistance of CBS. In that connection, Congress requested the president of CBS to arrange for a survey to collect information from each Member on what changes, if any, it had implemented in the volume of meteorological and related data and products available on the GTS since the adoption of Resolution 40 (Cg-XII). The survey was undertaken in late 1999 and the president reported on the results to the fifty-second session of the Executive Council. The Executive Council expressed its satisfaction that the survey indicated that there had been no decrease in the volume of data and products exchanged, which was one of the principal goals of Resolution 40 (Cg-XII).

4.4 Congress, noting the serious probability of computer failures due to the Y2K problem, requested CBS to monitor the preparations of Members and to develop a mechanism to monitor the operation of the WWW over the change to the year 2000 and to respond to problems that might be detected. The Commission was pleased to note that there had been no serious interruptions in the provision or quality of data and products produced by WMO Members due to computer problems resulting from the transition to the year 2000 or over the leap day of February 29. The Commission thanked Members and satellite operators for their concerted efforts to ensure that their essential systems were Y2K compliant. It also thanked donors for their timely and generous donations and the Secretariat for its education and coordination activities. Finally, the Commission thanked the numerous staff who worked around the clock at the Y2K Situation Centres and at NMHSs around the world for their dedication and commitment to ensure that all required actions were undertaken.

4.5 The Commission noted that the Executive Council, considering activities being undertaken to develop an effective framework for seasonal to interannual prediction, had recognized that those activities required close collaboration between various WMO Programmes. The Executive Council consequently established an Intercommission Task Team on Regional Climate Centres involving CCI, CBS, CAS, and CAgM. The team should define the need for, and the role of, Regional Climate Centres. The team should also review existing methodologies for the production and verification of seasonal to interannual forecasts, propose an infrastructure for the dissemination of those forecasts to the Members that satisfied user requirements, evaluate existing facilities in terms of the proposed infrastructure, and advise on mechanisms and options for future cross-programme cooperation between the technical commissions concerned. The Commission considered that ways should be found to address the identified need for regional balance through the participation of, at least, some user Members from RAs I and III in the Intercommission Task Team.

4.6 The Executive Council urged CBS to continue, and to enhance coordination efforts with GCOS on the design and implementation of the GSN and GUAN networks. It welcomed the ongoing collaboration between CBS and GCOS lead centres concerning practical aspects of monitoring the performance and data availability of the GSN and GUAN stations. The Council also reiterated that monitoring the operations of the GCOS network in each WMO Region should be carried out by CBS in collaboration with appropriate regional working bodies of the WWW (see also agenda item 6.1). The Commission noted in that context that the review of the GSN and GUAN parts pertaining to each Region was already an established agenda item of the sessions of the regional associations. It invited GCOS, in the process of its updates to the design and implementation of the GSN and GUAN networks, to consider consulting further with regional associations to assure that their requirements for special distribution of the networks were met.

4.7 The Commission noted that the Executive Council had considered that the current activities of CAgM were complementary with those of other commissions and suggested that CAgM, CBS and CIMO enhance collaboration in instrumentation and operation and applications of automated weather stations data in agriculture.

4.8 The Executive Council had noted with appreciation that, as a longer-term strategy, CBS had initiated a study of the future WMO information systems that would address the requirements of all WMO and related international programmes. However the Council emphasized that, while it understood that it was necessary for WMO Members to take advantage of advances in technology when modernizing their systems, it must be ensured that those advances were made accessible and sustainable for developing countries as far as possible. CBS noted that the Council requested the Commission to continue to develop proposals to help developing countries modernize their systems and develop their capabilities in an affordable and sustainable manner and to coordinate those efforts closely with the regional associations. CBS recognized the importance of that issue, which could affect the future viability of some NMHS. It considered that additional approaches should be developed, such as regional partnerships and partnerships between individual NMHS. Some urgency was required as competition in the provision of weather services was likely to continue to accelerate.

4.9 The remaining decisions of Congress and the Executive Council related to the Commission were comprehensively addressed under agenda item 3 as well as the relevant agenda items.

5. STATUS OF THE WORLD WEATHER WATCH IMPLEMENTATION AND OPERATION (agenda item 5)

5.1 The Commission was informed of the results of monitoring the operation of the WWW. The monitoring activities included two types of monitoring exercises:

the AGM and the SMM. About 100 WWW centres provided monitoring results for the AGM exercises, which were carried out every year from 1 to 15 October. Eight MTN centres from Regions I, II, V and VI participated in the SMM exercises, which were carried out from 1 to 15 February, April, July and October. The session noted with appreciation the diagrams depicting the trend and geographical distribution of observational data that were extracted from SMM results.

5.2 The percentage of SYNOP reports available at MTN centres in comparison with the number of reports required from RBSN stations remained at the same level (about 72 per cent) during the period 1992–2000. There were still deficiencies in the availability of SYNOP reports from areas in Region I (47 per cent), Region III (64 per cent) and Region V (67 per cent), although a significant amelioration occurred in Region III. The deficiency in Region I was attributed among many other reasons, to poor infrastructure and lack of personnel.

5.3 The percentage of TEMP reports available at MTN centres decreased from 65 to 58 per cent during the period 1992–2000. That decrease was mainly due to a deterioration in the operation of the upper-air observation network in the northern part of Region II. There was an increase in the availability of TEMP reports from Region III. The availability of TEMP reports was relatively satisfactory for the eastern and southern parts of Region II, the western part of Region III, the northern part of Region IV, some countries in Region V and the western part of Region VI. The availability of TEMP reports was generally insufficient for most of the other parts of the world.

5.4 There was no major evolution in the availability of SHIP and AIREP reports since 1996. The availability of BUOY reports had been increasing (an increase of 40 per cent since 1996). The availability of AMDAR reports had been increasing (an increase of 80 per cent since 1996). Half of the AMDAR reports were issued from Europe (an increase of 230 per cent since 1996), about one quarter from Australia (no major change since 1996), and about one quarter from the rest of the world (an increase of 83 per cent since 1996). The Commission recognized the major contribution made by the AMDAR Panel to increase the availability of AMDAR reports.

6. **WORLD WEATHER WATCH PROGRAMME, SUPPORT FUNCTIONS AND PUBLIC WEATHER SERVICES, INCLUDING THE REPORTS BY THE CHAIRPERSONS OF THE OPEN PROGRAMME AREA GROUPS** (agenda item 6)

6.1 **INTEGRATED OBSERVING SYSTEMS** (agenda item 6.1)

6.1.1 The Commission thanked the chairperson of the OPAG/IOS for his comprehensive report covering essential areas of the observational data requirements and redesign of the GOS, system utilization and products, and requirements and representation of data from AWSs. It also expressed its gratitude to all experts who contributed to the effective work of the expert and implementation/coordination teams established within that OPAG.

STATUS OF IMPLEMENTATION AND OPERATION OF THE SURFACE-BASED GOS

6.1.2 The Commission noted with satisfaction that, in the past two years, the overall implementation of surface and upper-air stations in the RBSNs had shown an increasing positive stability and the most recent monitoring results had not revealed warning trends like those between 1995–1997.

6.1.3 The Commission noted that according to information provided by Members, the level of implementation of the RBSN surface stations in 1999 varied from 76 per cent in Region III to 99 per cent in Region VI, with a global average of 89 per cent. However, the results of the 1999 annual global monitoring of the operation of the WWW indicated that the maximum number of reports actually received at MTN centres ranged from 52 per cent of those required in Region I to 92 per cent in Region VI with a global average of 72 per cent. While slightly surpassing the 1998 level, the overall results showed that almost the quarter of expected reports were still missing in the international exchange. The main reason for that data loss continued to be either the absence of observations or telecommunication problems.

6.1.4 The Commission was informed that the status of implementation of upper-air observations in 1999 varied from 51 per cent in Regions I and III to 94 per cent in Region VI, with a global average of 81 per cent. The number of upper-air reports actually received during that period at MTN centres varied from 29 per cent of those required in Region I to 84 per cent in Region IV, providing a global average of 57 per cent, which was less than in 1998 (60 per cent) but surpassed the level of 1997 (55 per cent). It expressed its concern that big gaps in upper-air data coverage still persisted in certain regions of Africa, South America and central and northern Asia, mainly due to lack of consumables and obsolete equipment. In reviewing the current trends in the upper-air network performance in the Regions, the Commission noted with appreciation that the number of stations transmitting more than 50 per cent of reports had increased in Regions I, IV and VI. It noted within that context that the major reason for that improvement was the coordinated action taken by the Members concerned, the Secretariat and donor countries, mostly related to the replacement of OMEGA-based equipment.

6.1.5 The Commission noted with concern the loss of both surface and upper-air data revealed in the monitoring statistics of the surface-based GOS. The chairperson of the OPAG/IOS was requested to refer that issue to the ICT on the GOS with the intention of identifying more closely individual problem areas and of working with Members and regional associations to reduce the data losses.

6.1.6 The Commission was pleased to note, that following the request of Thirteenth Congress, the matter regarding reliability of GPS-based radiosondes was kept under permanent review in close collaboration with CIMO. According to the results of a survey conducted in January–June 1999 among Members operating GPS-based sondes, about every fifth launch of GPS-based

sondes was faulty. The detailed information was submitted to CIMO, which had been working with relevant manufactures to improve the situation. The Commission was informed that improvements achieved through those joint activities showed that the windfinding performance would soon be returned to at least the same level as it was with OMEGA-based radiosondes before its termination. A WMO intercomparison of GPS-based radiosondes would be carried out under tropical conditions in the near future and the Commission expressed a keen interest in the results. The Commission reiterated that cooperation and consultation with CIMO on that matter should be continued and strengthened.

OTHER NETWORKS, INCLUDING SEA STATIONS

6.1.7 The total number of ships recruited by Members to the VOS scheme had increased slightly in recent years. Fifty-two Members presently operated VOS, with the total number of ships increasing from 6 747 in 1996 to 6 921 in 1999. The number of ship reports received at MTN centres had also increased over the period, from a daily average of 5 000 over the 15-day monitoring period in October 1996 to a daily average of 5 500 over the same period in 1999. In addition, the WMO/IOC JCOMM was now in the process of implementing a project for the operational maintenance of a subset (around 200, distributed globally) of the VOS to provide a high-quality reference set of VOS data for global climate studies and other applications.

6.1.8 There had also been a continuing significant increase in the deployment of other types of sea stations. In May 2000, the total number of active drifting buoys deployed globally and reporting data to the GTS increased to 807, compared with 218 in May 1996. At the same time, on average some 78 moored buoys were reporting data to the GTS in May 2000, compared with only 63 in May 1996. Approximately 30 per cent of the buoys were reporting pressure on the GTS.

6.1.9 As far as upper-air observations over the oceans were concerned, fully automated systems under the ASAP had been considered for a number of years as a fully operational component of the WWW. A total of 22 ASAP and related sounding units were operated during 1999 by nine countries, primarily in the North Atlantic, although there were some observations from all ocean basins. The ASAP Panel was now in the process of implementing a round-the-world ASAP line, which would in particular provide much needed upper-air data from southern hemisphere waters.

6.1.10 The Commission stressed that the fifty-second session of the Executive Council had recognized the importance of the AMDAR programme and its contribution in establishing an effective upper-air observing system. It was pleased to note that the current volume of AMDAR data had reached about 78 000 observations per day and that that volume was expected to be of 150 000 observations per day over the next five to 10 years. However, it was noted that about 50 per cent of the aircraft providing AMDAR data flew predominantly between Europe and North America and within those continents.

The remainder operated typically from their hubs (i.e. Buenos Aires, Johannesburg, Mauritius, Jeddah, etc.) to destinations in the Middle East, South America, North America, Europe and the Far East. Therefore, there were still relatively few AMDAR data available over Regions I and II.

6.1.11 The Commission recalled that Thirteenth Congress had stressed that attention should be focused on data-sparse areas and, in particular, that NMSs in the developing countries should have access to real-time wind and temperature data. In that connection, the Commission noted that Hong Kong, China and other Members were working collectively to acquire and make available AMDAR data in Region II. It also noted that, within ICAO, automated air reporting would be carried out in association with ADS and that currently, first ADS meteorological reports available from the North Atlantic and Pacific regions were being routed to the WAFCS in London and Washington.

STATUS OF IMPLEMENTATION AND OPERATION OF THE SPACE-BASED GOS

6.1.12 The Commission noted with deep appreciation the contribution made by satellite operators during the past two years in providing valuable data, products and services from the space-based GOS. The overall implementation of space-based GOS had shown an increase in coverage and reliability with the positioning of a EUMETSAT satellite over the data-sparse Indian Ocean and the recent launch and commissioning of China's geostationary satellite, FY-2B. The Commission was informed that the EUMETSAT Council had recently agreed to extend the coverage over the Indian Ocean by Meteosat-5 until the end of 2003. The Commission expressed the hope that it would be possible to ensure coverage of the Indian Ocean area by a geostationary satellite beyond 2003.

6.1.13 In particular, the Commission noted that the present geostationary constellation of satellites consisted of Meteosat-7 at 0° longitude and Meteosat-5 at 63°E (operated by the EUMETSAT), GOMS-1 at 76°E (operated by the Russian Federation), FY-2B at 105°E (operated by China), GMS-5 at 140°E (operated by Japan), and GOES-10 at 135°W and GOES-8 at 75°W (operated by the United States). The polar-orbiting constellation consisted of METEOR-2 and 3 series satellites operated by the Russian Federation, NOAA-14 and NOAA-15 operated by NOAA/NESDIS and FY-1C operated by China. With regard to GMS-5, the Commission was informed that all onboard systems were functioning optimally and were expected to do so until the launch of MTSAT-1R in early 2003. The Commission also noted that EUMETSAT's Meteosat-6 would provide rapid scan capabilities over northern Africa and Europe up to, and including, the Baltic Sea starting in 2001.

6.1.14 The Commission recalled that the goals for the percentage of implementation for WMO Members equipped with satellite receiving equipment were 100 per cent for polar-orbiting satellite data receivers (either APT or HRPT) and 100 per cent for geostationary

satellite data receivers (either WEFAX or HR). That meant that each WMO Member should be equipped with at least one polar-orbiting satellite data receiver and one geostationary satellite data receiver. The Commission noted that WMO Regions had achieved an overall implementation of 82 per cent. With regard to each category of receivers, WMO Regions had achieved an overall implementation of 84 and 87 per cent for polar-orbiting and geostationary satellite receivers, respectively. The Commission also noted the present regional implementation of the goals for satellite receiving stations and changes since 1992 as shown in Figure 1 in Annex I to this report. The Commission was pleased with the increase in implementation while noted that the apparent decrease in Region V was due to the increase of new Members in that Region.

WMO MECHANISM FOR POLICY LEVEL INTERACTION WITH OPERATORS OF ENVIRONMENTAL SATELLITES

6.1.15 The Commission was informed of activities related to the formation of a WMO mechanism for policy level interaction with operators of environmental satellites. It was informed that the fifty-first session of the Executive Council had noted the need to build a new and closer partnership under the auspices of WMO between the Meteorological and Hydrological Services and environmental satellite communities. As a result, the Council had requested the Secretary-General to arrange, in consultation with the President and the Permanent Representatives of satellite operating countries, a meeting between representatives of the Executive Council and directors of agencies providing environmental observation satellites. The intent of the meeting would be to provide guidance on the best way to deal with the policy level decisions of the Organization in satellite matters.

6.1.16 The Commission was also informed that the fifty-second session of the Executive Council had noted the guidance provided by the Executive Council Meeting on a Mechanism for Policy Level Interaction with Operators of Environmental Satellites, held from 24 to 25 January 2000 in Geneva. The Council agreed that a mechanism for such discussions should be provided through the convening of Consultative Meetings on High-level Policy on Satellite Matters at one- to two-year intervals and endorsed the guidelines for those meetings.

6.1.17 The Commission noted that the Council was of the opinion that the Consultative Meetings should give early consideration to:

- (a) Evaluating satellite missions to ensure, *inter alia*, the better use of existing and planned research and development missions in support of WMO Programmes and provide an assessment on their operational utility;
- (b) Reviewing and revising the space-based component of the GOS to take into account both operational and research and development opportunities and the need to maximize cost efficiency and effectiveness of satellite observing programmes.

6.1.18 The Commission also noted that the Council had agreed that the first of the Consultative Meetings on

High-level Policy on Satellite Matters would be held in 2001.

6.1.19 The Commission also noted the early preparatory activities for the first Consultative Meeting that would occur in 2001. The Commission further noted that the Council had agreed that WMO should develop, in partnership with the space agencies providing environmental observation satellites, guidelines for minimum requirements that would be agreed upon in order to provide operational users a measure of confidence in the availability of research and development observational data. Furthermore, the Consultative Meetings would provide the necessary high-level forum for a review of the present configuration of the space-based GOS.

6.1.20 While stressing the need for, and the potential contributions from, Consultative Meetings, the Commission agreed with the need to maintain the present close and ongoing coordination between WMO and CGMS, CEOS and IGOS-P. Such coordination would assist in the implementation of recommendations and decisions derived from Consultative Meetings.

6.1.21 The Commission agreed with the Council that the Consultative Meetings should take into account the needs of developing countries to ensure that they kept up with advances in satellite products and services. The Commission also stressed the need for access to satellite data, products and services and appropriate education and training programmes to be able to realize the potential from that most valuable data.

6.1.22 The Commission thanked its president for his active participation in representing CBS during the activities related to the Consultative Meetings on High-level Policy on Satellite Matters. The Commission noted the importance and potential of a new and closer partnership under the auspices of WMO between the Meteorological and Hydrological Services and environmental satellite communities, especially those entities operating research and development satellite systems. Thus, the Commission was of the opinion that the Consultative Meetings would be of utmost importance to the future of CBS and its space-based GOS and requested the president, with appropriate support from the OPAG/IOS, to remain active in providing all the necessary support.

OBSERVATIONAL DATA REQUIREMENTS AND REDESIGN OF THE GOS

6.1.23 The Commission noted with appreciation the work carried out by the Expert Team on Observational Data Requirements and Redesign of the GOS ET/ODRRGOS in updating the CEOS/WMO database on observational data requirements, in expanding the rolling review requirements process with respect to *in situ* observing system capabilities, in developing the *Statement of Guidance Regarding How Well Satellite Capabilities Meet WMO User Requirements in Several Application Areas* (WMO/TD-No. 992). The database contained descriptions of all GOS systems, both *in situ* and space-based, including expected performances for each

system in one of 34 homogeneous geographical areas. Furthermore, the databases contained all WMO and supported programme observational requirements. The observational requirements were categorized according to specific programme areas. The database also allowed a comparison between observational requirements and how well an observing system met them. The database was available on CD ROM as well as on the WMO Satellite Activities Web page.

6.1.24 The Commission was pleased to note that as a part of its terms of reference, ET/ODRRGOS had prepared a comprehensive report on candidate observing system technologies and their use which provided substantial information on *in situ* surface, marine and upper-air measurements, satellite measurements as well as on adaptive strategies for specific events. The Commission felt that the report would serve as useful guidance material for Members in their efforts to redesign national or regional networks and requested the Secretary-General to distribute the report among Members.

6.1.25 The Commission was informed that a review of how well satellite capabilities meet WMO user requirements had been finalized by ET/ODRRGOS for some WMO applications (NWP, synoptic meteorology, nowcasting, hydrology, agricultural meteorology, and atmospheric chemistry). The *Statement of Guidance Regarding How Well Satellite Capabilities Meet WMO User Requirements in Several Application Areas* was published as Satellite Report No. 22. The Commission noted with satisfaction that ET/ODRRGOS had successfully continued the Rolling Review Requirements process approved by CBS for several applications areas (global NWP, regional NWP, nowcasting and very-short range forecasting, seasonal and interannual forecasts, and aeronautical meteorology) with respect to satellite and *in situ* observing system capabilities. In doing that, ET/ODRRGOS expanded the database for user requirements in several application areas and for observing system capabilities for associated measurements. It developed a new Critical Review and prepared a draft Statement of Guidance on the feasibility of meeting requirements for the several above-mentioned applications. A new version of the Statement of Guidance would be published as a WMO Satellite Activities technical document. The Commission noted the importance of including observational requirements for volcanic ash stated by ICAO and encouraged CAeM to continue its participation in the activities of ET/ODRRGOS.

6.1.26 The Commission noted that the Expert Team had also considered some proposals for redesigning the marine part of the GOS on the basis of input provided by the JCOMM. It was pleased to note that JCOMM would use the Rolling Review Requirements process in developing a statement on how well the requirements of WMO Programmes would be met by present and planned marine surface and remote-sensing observing systems.

6.1.27 The Commission was informed that in the course of the development of a global approach to the

redesign of the GOS, the Expert Team kept under permanent review the impact assessments studies being conducted by NWP centres under regional programmes such as COSNA, EUCOS and NAOS. It also noted that representatives of the Team actively participated in the second CGC/WMO Workshop on the Impact of Various Observing Systems on Numerical Weather Prediction (Toulouse, France, 6–8 March 2000) whose major goal was to present and discuss new results of the global and regional data impact studies carried out by leading NWP centres, and attempt to establish an updated assessment on contributions of traditional and new components of the observing system to forecasting skill. The Commission agreed that findings of COSNA, EUCOS and NAOS as well as the conclusions and recommendations of the Workshop could provide an essential input to the redesign process of the GOS. However, it strongly supported the Workshop recommendation that impact studies should be carried out for a sufficiently long period, preferably in each of the four seasons and that the statistical significance of the results should be established.

6.1.28 The Commission stressed the need to identify a realistic system design by developing observing system scenarios to be tested through OSEs and OSSEs and by comparing the results with the observational requirements of all WMO Programmes. In that regard, the Commission endorsed the following guidelines for OSEs/OSSEs developed by ET/ODRRGOS:

- (a) All experiments (global and regional) should be done in each of the four seasons;
- (b) The credibility of the system should be established through the proper calibration (e.g. test the impact of simulated real data and proceed with the OSSE only if results were in agreement with measured impact data);
- (c) Specifications for ranges of performances provided by manufactures should be used rather than discrete values;
- (d) Validation of OSEs/OSSEs should include the use of analyses and observations;
- (e) In global impact studies, validation should take regional aspects into account, stratification by weather events, severe weather, etc.;
- (f) Consideration should be given to the use of ensemble forecasts to increase the significance of the results;
- (g) Forecasters/users should be involved in the evaluation of the experiments.

6.1.29 The Commission encouraged leading NWP centres to evaluate the redesign the options for the GOS that would be proposed by ET/ODRRGOS.

6.1.30 The Commission felt that a closer interaction between WMO, including CAS and the CAS/JSC Working Group on Numerical Experimentation, and those entities involved with the scientific evaluation of OSEs and OSSEs was needed, including the preparation of scenarios, analyses and support to focused workshops where such topics would be discussed. For that purpose, the Commission decided that within the OPAG/IOS, a

Rapporteur on Scientific Evaluation of OSEs and OSSEs should be nominated to study that issue and to report to the CBS Management Group (see also agenda item 9).

IMPACT OF REDESIGN OF THE GOS ON DEVELOPING COUNTRIES

6.1.31 The Commission recalled the deficiencies in the current RBSNs, the reasons for which ranged from financial considerations to telecommunications difficulties, in some countries linked to civil unrest or war situations. The Commission felt that some of the difficulties could be eased if measures taken in some regions could be adopted in other regions. Those included:

- (a) Joint arrangements by countries to operate observing stations;
- (b) Roving Instruments Maintenance Teams;
- (c) Weather radar networks.

6.1.32 The Commission also suggested that data from the RBSNs could be supplemented if centres such as RSMCs with geographical specialization could consider making available such other data as satellite imagery and derived products for their areas of responsibility (e.g. on a Web site) and AMDAR data, to assist Members who were experiencing difficulties in accessing that information.

6.1.33 The Commission also noted the valuable products available from research satellites. For instance, QuikSCAT was proving to be useful in many countries and its availability and use could be extended. Capacity building in the use of satellite data should include suitable products from the research and development satellites.

6.1.34 The Commission further agreed that AWSs and buoys could be useful in many areas including inaccessible regions, where the limited observational package could provide significant inputs to weather models to produce improved forecasts. The fact that countries hosting such stations would most probably require external funding and maintenance support was not forgotten.

6.1.35 On the question of funding, the Commission agreed that the concept of national commitments of Member countries for providing observation data was of major importance for international cooperation. Such national commitments as were made for land-based observations (SYNOP, TEMP), should be continued also when redesigning the GOS. The Commission, nevertheless, felt that funding costs should not exceed the possibilities of individual Member countries. That should be particularly so when observations were of substantial value for international use (e.g. in unpopulated areas). In that context, some funding mechanism aiming at a better balance between funding costs and national budgets could be beneficial for observing network operations. The basis for a funding mechanism could aim at covering the running costs. In that context, quality and reliability performance aspects could also be taken into consideration.

6.1.36 The Commission discussed the principle that some form of joint funding or cost-sharing mechanism could be a promising way forward to overcome that problem. Ultimately, all Members would benefit from a

comprehensive and reliable network of observations. The Commission felt that the need for such a funding mechanism should be brought to the attention of the Executive Council (see also agenda item 7).

SATELLITE SYSTEM UTILIZATION AND PRODUCTS

6.1.37 The Commission noted with appreciation the work carried out by the Expert Team on Satellite Systems Utilization and Products (ET/SSUP) in developing guidelines for the Strategy to Improve Satellite System Utilization. The Commission noted that among the many activities, the Expert Team had developed the concept of a Virtual Laboratory for Training in Satellite Meteorology, had reviewed the concept of direct broadcast from meteorological satellites, had reviewed the WWW implementation goals for satellite ground-receiving stations in WMO Members, had reviewed the new *Guidelines for the Education and Training of Personnel in Meteorology and Operational Hydrology* (WMO-No. 258), and had assisted in the development of a new WMO Satellite Activities Technical Document on the change from analogue APT/WEFAX to digital LRPT/LRIT services.

6.1.38 The Commission noted that its president had provided the WMO Executive Council Panel of Experts on Education and Training information related to the ET/SSUP development of the concept of a Virtual Laboratory for Training in Satellite Meteorology. Additionally, the fifty-second session of the Executive Council had noted the participation of the satellite operators to strengthen further the training in satellite system utilization, including sponsorship of centres of excellence. Six such centres were now sponsored by the satellite operators and thus provided a worldwide nucleus RMTCs in Niger and Kenya for RA I, in China for RA II, in Costa Rica and Barbados for RA IV as well as the Australian BMTC for RA V. The fifty-second session of the Executive Council recognized the potential for expansion of the training component by linking the RMTCs and recommended the establishment of close coordination and interactions between RMTCs by involving relevant science groups in a systematic manner and by using the idea of a virtual laboratory for training in satellite meteorology.

6.1.39 With regard to the Strategy to Improve Satellite System Utilization and Products, the Commission was informed that the ET/SSUP had re-formulated WWW goals for satellite ground-receiving stations by adapting them to the expected evolutions in telecommunication technology, data availability/use and to the specific needs of the "centres of excellence in satellite meteorology". The ET/SSUP had also adapted a questionnaire to be a tool for periodic identification of user requirements and problem areas, including reviews by "centres of excellence" to provide focused regional analyses of training needs, as part of biennial calls for reporting on satellite activities by WMO Members. The ET/SSUP also recommended a revision to the *Guidelines for the Education and Training of Personnel in Meteorology and Operational Hydrology* to refer more specifically to required satellite meteorology competencies.

6.1.40 The Commission noted that the ET/SSUP had evaluated specific pilot projects and had made recommendations for projects and activities recently (or soon to be) implemented, in particular with regard to maximizing equipment life and data use. The ET/SSUP also gave consideration to problems towards an optimal phasing between the start of data utilization and operations of new satellite generations. One project reviewed by the ET/SSUP was PUMA. The Commission was pleased to note that the European Commission had recently approved funding for the PUMA project. PUMA and bilateral arrangements would provide high resolution MSG receivers for all Members of RA I starting in 2003 and thus achieve 100 per cent implementation for ground receiving stations.

6.1.41 The Commission expressed its appreciation for preliminary guidelines that would be used as part of a rolling review of the Strategy to Improve Satellite System Utilization and Products. The rolling review process would be initiated by the issuance of a biennial questionnaire. An analysis of the questionnaire would provide an input to the guideline for the Strategy. The Strategy was based on three cornerstones: data access, data use, and education and training. The questionnaire would be analysed with regard to each cornerstone in seeking problem areas and solutions that would enable increased utilization of the satellite system. A first analysis of the questionnaire for 1999 was prepared by members of the ET/SSUP and was published as the *Status of the Availability and Use of Satellite Data and Products by WMO Members* (Satellite Report No. 23, WMO/TD-No. 994).

6.1.42 With regard to the Virtual Laboratory for Training in Satellite Meteorology, the Commission noted that the ET/SSUP had developed the concept of a virtual laboratory for improved training and education in satellite meteorology in the form of a global network of specialized meteorological training institutions and their sponsoring satellite operators. Furthermore, the ET/SSUP had refined the virtual laboratory concept to respond to the need for two basic streams of learning (basic and specialist skills) and a resource library, had solicited the formation of focused science groups, and had developed a list of guidelines to increase further the utilization of satellite system use and products by concentrating on three cornerstones — data/product access and presentation, data/product use, and product development, education and training. The Commission acknowledged the valuable contribution made thus far and the future potential for education and training through the concept of the virtual laboratory as expressed by the ET/SSUP. The Commission also noted the continuing contribution in support of training events by China, Japan, the United States and EUMETSAT.

6.1.43 The Commission noted that the ET/SSUP had also reviewed the direct broadcasting concept that so far served very successfully and efficiently the meteorological user community and proposed preliminary guidance for future telecommunication alternatives, noting certain shortcomings in the current receiving concept and the enormous increase in data through the next decade.

The Commission agreed to explore further the possibility that broadcast service onboard meteorological satellites could be complemented and supplemented by alternative telecommunication services with the ultimate goal for a smooth and orderly transition to the full use of alternative telecommunication service for broadcast service starting with the future generation of satellites.

REQUIREMENTS AND REPRESENTATION OF DATA FROM AUTOMATIC WEATHER STATIONS

6.1.44 The Commission noted with appreciation the work carried out by the Expert Team on Requirements and Representation of Data from Automatic Weather Stations (ET/AWS) in developing operational requirements for AWSs and in assessing their potential impact on the existing and future observing networks. It confirmed the importance of observational user requirements expressed in terms of specific variable description, minimum reported resolution, maximum effective range, mode of observation and minimum reporting interval. The Commission therefore agreed to refer to the WMO technical commissions concerned for review and for validation of the draft the functional specifications to support present and future AWS applications for final approval by CBS as a matter of urgency. The Commission also felt that coordinating activities related to AWS information exchange issues should be continued with other relevant international bodies and programmes and, in particular, with EUMETNET.

6.1.45 The Commission noted the results of the review of the quantitative definitions of meteorological/geophysical phenomena currently reported by the various types of AWSs. It agreed that BUFR and CREX would be the best means for reporting the full range of observational data from AWS without deviating from existing WMO recommendations and procedures. The Commission also noted the newly developed proposals for quantitative definitions and agreed to invite CIMO to give consideration to those proposals in particular in the light of emerging requirements and technical opportunities. As regarded the recommendation to use the physical units mm h^{-1} and $\text{kg m}^{-2} \text{s}^{-1}$ to express the intensity of all types of precipitation, the Commission was pleased to note that the appropriate proposal was already included for adoption in the proposals submitted under agenda item 6.2.

6.1.46 The Commission noted with satisfaction the close collaboration of relevant teams of the OPAGs on IOS and on ISS with respect to developing new additions to BUFR/CREX tables for the purpose of reporting quantitative values of precipitation and other weather phenomena. That work resulted in comprehensive proposals for adoption under agenda item 6.2. The Commission realized that those proposals did not yet include the capability to identify and report which of the phenomena could or could not be reported by a given AWS nor the capability to report on the status of the sensor. It decided therefore to keep that specific issue under review and to ask the OPAGs on IOS and on ISS to

develop the required solution. Concerning the tables for present weather, the Commission agreed to inform CIMO of the new tables and to invite it to keep those under review in light of newly emerging opportunities for modifying or improving the corresponding measurement techniques.

6.1.47 The Commission reiterated that standardization and quality control for AWS data were becoming more important with the introduction of new more sophisticated sensors and processing algorithms, and emphasized the strong need to develop and implement the basic guidelines for quality management. It agreed that the real-time quality control of data from AWS should be performed at two levels with the information on quality control output represented in the BUFR code and disseminated to users:

- (a) Basic quality control procedures should be applied at the AWS. That would have to take care of technical monitoring (instrument and measurement status) as well as monitoring of measurement range and the time variance of the signal;
- (b) Extended quality control procedures should be applied at the national Data-processing Centre. That would include logical relations among a number of variables (inconsistencies). It should take advantage of the BUFR code, which allowed better representation of all data.

MANUAL ON THE GLOBAL OBSERVING SYSTEM (WMO-No. 544)

6.1.48 The Commission recalled that at its extraordinary session in 1998 it had requested OPAG/IOS to review all relevant WMO *Manuals*, especially the *Manual on Codes* (WMO-No. 306) as well as the *Guide to Meteorological Instruments and Methods of Observation* (WMO-No. 8), with a view to identifying all regulations concerning meteorological observations and incorporating them in a revised *Manual on the GOS*.

6.1.49 The Commission recalled the role and purpose of the relevant publications as followed:

- (a) The *Manual on the GOS* described what was to be measured, where and when;
- (b) The *Guide on the GOS* (WMO-No. 488) provided guidance on how to set up and manage observing stations and networks, and observing and reporting programmes;
- (c) The *Guide to Meteorological Instruments and Methods of Observation* provided guidance on how and with what instruments to make the required measurements and observations;
- (d) The *Manual on Codes* gave instructions for reporting procedures and coding.

6.1.50 The session noted that relatively little duplication between the various publications had been found. The *Guide to Meteorological Instruments and Methods of Observation* did obviously contain material relevant to the *Manual on the GOS* but, with the exception of definitions of elements to be observed and units used, that was mainly guidance material and not regulatory.

6.1.51 The *Manual on Codes* did contain regulatory material other than straightforward coding instructions, but

that concerned reporting procedures and practices (e.g. how to identify and report intermittent rain and how to select significant levels for upper-air reports). It was agreed that those were directly related to coding and would not be appropriate in the *Manual on the GOS*. It realized that it would in any case be very difficult to separate completely reporting procedures from coding instructions.

6.1.52 It was therefore concluded that no major revisions were required in order to incorporate material presently contained in other *Manuals* and *Guides* into the *Manual on the GOS*. However, the Commission agreed that there was a need to update certain sections of the *Manual on the GOS*, to introduce new material on definitions and units, and to reorganize its contents to make it more user-friendly. It was noted with appreciation that a first draft of that revised *Manual* had been prepared in the Secretariat with the help of a consultant. The Commission decided that that draft should be reviewed by a small group of experts to be set up within OPAG/IOS and then submitted to the next session for approval.

COMPOSITION OF THE RBSNS

6.1.53 The Commission took note of a proposal for criteria to assist in the selection of stations to be included in the RBSN. The criteria should be objective and be based upon, *inter alia*, spatial distribution as well as performance and availability of data confirmed by regular monitoring. It agreed that such criteria could be very useful. It therefore invited regional associations to consider the development of such criteria in order to ensure a more objective selection of RBSN stations within the Regions.

6.1.54 The Commission felt that the regional Rapporteurs on the GOS should be kept fully informed on the status of the performance of the RBSNs. It invited Members, possibly through designated focal points within each NMS, and the WMO Secretariat to advise the regional rapporteurs of any changes in the status of the RBSN in their respective Regions.

WEATHER REPORTING (WMO-No. 9), VOLUME A

6.1.55 The Commission considered possible measures to improve the accuracy of *Weather Reporting*, Volume A in order to make the publication more useful to Members. It noted that the updating of Volume A was not always possible in an adequate and timely manner. The Commission recommended therefore that Members should designate focal points in NMSs who were authorized to inform the WMO Secretariat directly on changes. The Commission also agreed that the following matters should receive attention:

- (a) The re-use of index numbers and the limitation of the index numbering system;
- (b) Changes in coordinates which might be the result of either corrections or station moves;
- (c) History of station changes;
- (d) The need for station elevations.

AIRCRAFT SYSTEMS

6.1.56 The Commission noted that AMDAR showed great promise in meeting some of the needs for upper-air

observations during ascent and descent: RAOB data at one main observation time could be supplemented by AMDAR data at another. In that connection, the Commission expressed appreciation to the AMDAR Panel for its activities in developing AMDAR as a major source of upper-air data. In particular, it noted that EUMETNET had launched the E-AMDAR project which included an effective method of controlling the flow of AMDAR data. It further noted that the AMDAR pilot projects on southern Africa and on the Middle East were being implemented under the WMO AMDAR Programme. However, in some countries, notably in those of RAs I and II, although AMDAR data were available, it could not be accessed by the NMSs. The Commission expressed the hope that Members would ensure and facilitate the exchange of AMDAR data between government departments and the NMS. The Commission also suggested that Members, wishing to establish or join AMDAR programmes, should seek information and advice from the WMO AMDAR Panel, through the WMO Secretariat.

MARINE SYSTEMS

6.1.57 The Commission recognized that *in situ* marine observing networks were, in general, coordinated and managed globally by specialist, platform-based groups. Those included the DBCP and its regional and specialized Action Groups (drifting and moored surface platforms); and the Ship-of-Opportunity Programme Implementation Panel Subgroup (surface meteorology and oceanography). All those bodies fell within the responsibility of JCOMM, which was developing overall coordination and integration of the individual *in situ* systems into a fully integrated operational ocean observing system to include also satellite and other remote-sensing observations.

6.1.58 The Commission recognized that the advent of JCOMM represented a major step forward in the international coordination, integration and management of operational marine observing systems, with JCOMM eventually assuming a role for the oceans somewhat analogous to that of CBS for the WWW. That would clearly necessitate very close interaction in the future between CBS and JCOMM. The Commission agreed to give close attention to ways in which that interaction could be effected. In particular, and in view of the importance given by both CBS and JCOMM to programme implementation at the regional/ocean basin level, the Commission agreed that there should be much closer interaction and coordination between the regional Rapporteurs on the GOS and on Marine Meteorological Services, and recommended that that be reflected in the terms of reference of the rapporteurs.

INTERRELATION BETWEEN GOS AND GCOS

6.1.59 The Commission noted with appreciation the presentation of the chairperson of the GCOS/WCRP AOPC, Mr M. Manton, regarding the needs of GCOS for baseline networks to provide consistent, long-term, homogeneous, high quality atmospheric observations,

and the important role of GSN and GUAN in fulfilling those requirements for the surface and the free atmosphere. Mr Manton expressed his sincere thanks to CBS and its Members for their support of those networks and looked forward to its continuation. He reiterated the GCOS requirements for daily temperature, pressure and rainfall data, as well as historical data and metadata, from GSN stations, as had been requested in the Secretary-General's letter to Members in late 1999. He recalled the need for twice-daily upper-air data to 5 hPa, as well as historical data, from the GUAN stations. Mr Manton expressed the appreciation of GCOS and the AOPC to the *Deutscher Wetterdienst* and the Japan Meteorological Agency, as well as to the Hadley Centre, ECMWF, and the NCDC for their contributions to the important activity of monitoring the performance of the GSN and the GUAN. He noted that recent results had demonstrated that the reporting performance of the GSN, for example, was not significantly improved from that of the complete network of CLIMAT stations, and looked forward to close cooperation between GCOS and CBS members, through their respective panels, working groups and monitoring centres, in identifying and overcoming the problems involved.

6.1.60 The Commission was pleased to note that its relationship with the AOPC Panel during the inter-sessional period had been very fruitful and had resulted in the establishment of the GCOS networks as well as a number of GCOS monitoring centres.

6.1.61 The Commission noted that GUAN and GSN had been approved by presidents of regional associations in mid-1999. It also noted with appreciation that ECMWF had issued regular six-month reports on the availability and quality of upper-air data from GUAN stations and that the UKMO/Hadley Centre had in 1999, started monitoring the availability of CLIMAT TEMP reports from GUAN stations.

6.1.62 As regarded GSN, the Commission was pleased that two GSN Monitoring Centres in Offenbach (Germany) and Tokyo (Japan) had successfully commenced monitoring GSN implementation from 1 January 1999. Two six-month monitoring reports were jointly issued by the *Deutscher Wetterdienst* and the Japan Meteorological Agency.

6.1.63 The Commission recalled that the fifty-second session of the Executive Council had urged CBS to continue and enhance coordination efforts with GCOS on the implementation of the GSN and GUAN and reiterated that monitoring the performance of the GCOS networks in each WMO Region should be carried out by CBS in collaboration with appropriate regional Working Groups on Planning and Implementation of the WWW. The Commission felt that implementation of that task would be more effective if the reports produced by monitoring centres for GUAN and GSN could be made available to the regional Rapporteurs on the GOS via Internet or by other means. The results of monitoring, particularly with reference to individual stations, would be very helpful to the rapporteurs in carrying out a survey of "silent" stations or of stations providing

insufficient numbers of CLIMAT or CLIMAT TEMP reports, to identify problems and to propose remedial action.

6.1.64 The Commission urged Members to continue and, where possible, to strengthen their support for the implementation of the GSN and GUAN, noting that those backbone networks which met the goals of GCOS could also provide benefits for many other objectives.

AVAILABILITY OF CLIMAT AND CLIMAT TEMP REPORTS

6.1.65 The Commission recalled that CBS-IX (1988) had concluded from Technical Regulation [B.1.] 3.1.1.2, that the network density of stations reporting CLIMAT and CLIMAT TEMP messages should be similar to the RBSN. As a result, the regional associations (except RA IV) had agreed that it was no longer necessary to adopt formally a separate fixed network of CLIMAT and CLIMAT TEMP stations by a specific resolution.

6.1.66 The number of CLIMAT and CLIMAT TEMP reports available during the last 10 years was far from an "ideal" network and reached only about 40 per cent of the total number of RBSN stations. The establishment of GUAN and GSN in 1996 and 1999, respectively, did not increase the availability of the reports. Moreover, due to different requirements for RBSN and GSN observing programmes, about 20 per cent of stations selected for GSN were not in RBSN and consequently they were not monitored during the WWW monitoring exercises.

6.1.67 The Commission noted with pleasure that, in view of that situation, a study had been initiated by the Secretary-General to identify the reasons of low availability of CLIMAT and CLIMAT TEMP reports and to make proposals for improving the situation. According to the results of the study, the main reasons of low availability of reports were identified as followed:

- (a) The stations were completely "silent" (no SYNOP or TEMP reports);
- (b) The stations were operational, but CLIMAT and CLIMAT TEMP reports were not generated;
- (c) The reports were generated and provided but not by the stations requested, however for (a) different (nearby) station(s);
- (d) The reports were generated, but not properly communicated to the RTH;
- (e) The reports were communicated, but not according to the WMO formatting and coding procedures;
- (f) The reports were in good order, but the transmission between RTHs failed;
- (g) The monitoring procedures between centres might be different, causing different results of the availability of the reports.

6.1.68 In order to increase the availability of CLIMAT and CLIMAT TEMP reports, the Commission requested the RTHs to provide regular information on the availability of the reports from their zones of responsibility during the WWW monitoring. It also requested the Secretary-General to urge Members to ensure that their operational observing stations which belonged to climate reporting networks compiled and transmitted CLIMAT/CLIMAT TEMP messages according to existing regulations.

6.1.69 Recognizing that the above study had detected many types of errors in formatting and coding, the Commission recommended to enhance coordination and collaboration between CBS, CCI and GCOS lead centres concerning practical aspects of monitoring the performance and data quality of CLIMAT/CLIMAT TEMP reporting stations. In particular, CBS requested that the existing monitoring centres of CBS and GCOS take steps to review how the existing formal and informal arrangements, e.g. technical level contacts between centres and operators, could be used to improve the monitoring of CLIMAT and CLIMAT TEMP reports.

6.1.70 The Commission agreed that some improvement could also be reached by adjusting the relevant procedure and recommended to amend the *Manual on Codes* accordingly. Recommendation 1 (CBS-XII) was adopted.

6.1.71 The Commission noted that although the basic idea to have the network of CLIMAT reporting stations identical to the RBSN might have been defensible, practice showed that it did not help to improve the availability of CLIMAT reports. The Commission had been informed of the proposal made by the Working Group on Planning and Implementation of the WWW in Region II to establish by Resolution 4 (XII-RA II) — Regional Basic Climatological Network in Region II, a so-called RBCN. That network should include GSN and GUAN stations supplemented by other CLIMAT and CLIMAT TEMP reporting stations needed to meet regional requirements as requested by Thirteenth Congress. The Commission also noted the responsibility of CCI for activities relating to the coordination of general requirements for observations, data collection and supply for all components of the WCP, as well as for the identification of best practices relating to collection. It thus endorsed collaboration with CCI on matters regarding climate networks. The Commission felt that Resolution 4 (XII-RA II) would provide a valuable justification for maintaining a minimum number of CLIMAT reporting stations, and the list of stations given in the annex to this resolution could serve as a target list for WWW monitoring. The Commission noted that RA II, at its twelfth session, had established an RBCN within the Region, and that the matter would also be discussed at the forthcoming session of RA IV.

6.2 INFORMATION SYSTEMS AND SERVICES (agenda item 6.2)

6.2.1 The Commission thanked the chairperson for his report and was pleased to note that work in that area was progressing well despite the challenge required to integrate the work of the many teams working under the auspices of that OPAG. The Commission also expressed its thanks to the many experts who had served on the various expert and implementation/coordination teams.

GLOBAL TELECOMMUNICATION SYSTEM

STATUS OF IMPLEMENTATION AND OPERATION OF THE GTS

6.2.2 All 23 MTN circuits were in operation and all MTN centres were automated. Seven out of 23 circuits were using digital technology at speeds from 64 to

128 kbit/s⁻¹. Except for the circuit New Delhi-Cairo, the other MTN circuits were operating at data rate greater than 4.8 kbit/s. All but one of the MTN circuits currently used X.25 or TCP/IP protocols. The Commission noted that TCP/IP procedures were implemented on a rapidly increasing number of MTN circuits and other GTS circuits as well as on national meteorological telecommunications networks. It also noted that the implementation of computer-based systems for GTS/GDPS functions in WWW centres were making important progress, in particular through the introduction of cost-effective PC-based data handling systems in several developing countries. The Commission was pleased with the significant progress made in the implementation of RMTNs, but it also noted that serious shortcomings were still existing in some regions at the regional and national levels.

6.2.3 In Region I, the development of subregional networks, such as the satellite-based network SATCOM coordinated by ASECNA in the western/central part of Africa, appeared to be promising solutions for upgrading the RMTN. Several GTS circuits were upgraded via leased lines or public data networks, including the Internet. Satellite-based data-distribution systems (MDD, RETIM, SADIS) played a crucial role. The collection of observation data remained unsatisfactory (less than 50 per cent) due to national difficulties in the implementation and maintenance of equipment. General telecommunication infrastructures and services were in fast development including the Internet, but still at costs that were difficult to afford by several NMHSs. The DCS/DCPs via METEOSAT were offering the potential for a considerable improvement of data collection in the Region. The Commission noted with interest that a regional meteorological data-communication strategy within the framework of the RA I rehabilitation and capacity building plan for the WWW was under development, with a view to addressing shortcomings in the basic systems in a coordinated manner.

6.2.4 The observational data collection system in Region II was in general quite satisfactory, except in a few countries where serious shortcomings still existed. Most of the Region II GTS circuits were operating at medium or high speed, but there were still a number of low-speed connections. There was a plan for an improved RMTN based on a cluster of networks using cost-effective network services such as frame relay. Several satellite-based data-distribution systems were operating in Region II. The EUMETSAT MDD was recently integrated into the RMTN of Region II. A pilot project was developed for improving the dissemination of meteorological data and products via the satellite facilities operated by the United Kingdom, which also supported SADIS. The operational phase of the pilot project had just started; more details are provided in Annex II to this report.

6.2.5 Region III made significant progress in the implementation plan for upgrading the RMTN, which was currently mainly consisting of low-speed point-to-point circuits, by a new network, based on managed

data-communication network services. A satellite-based data-distribution system was operated by RTH Buenos Aires. All 13 NMCs were also equipped with receiving systems in the framework of WAFS via the ISCS operated by the United States. In Region IV, the two-way satellite-based network RMTN which was integrated in the ISCS was fully operational in all countries concerned (except Haiti), and all NMCs were equipped with computer-based terminal equipment.

6.2.6 In Region V, all circuits of the RMTN, except one, were operating at medium or high speed, and the first frame relay network being part of the GTS was operational for one year between WMC/RTH Melbourne and two NMCs. The ISCS operated by the United States was implemented to support the distribution of WAFS data and products and OPMET messages and its GTS component was integrated into the RMTN. The DCS of the GMS and GOES satellites, the GOES EMWIN, the INMARSAT system, as well as public data-communication networks and/or the Internet were operated for improving the RMTN, in particular with respect to linking small nations in the Pacific.

6.2.7 In Region VI, the RMDCN was put into operation. The RMDCN, managed by the ECMWF, interconnected 32 RTHs and NMCs using a shared, commercially-provided managed network service to which NMCs and RTHs were or would be connected via a national access, replacing all current point-to-point circuits. The other 15 RTHs and NMCs would join the RMDCN in the future. The RMDCN met RA VI GTS requirements as well as data exchange requirements between ECMWF and its Member States and Cooperating States. France was implementing the RETIM 2000 project to renew the current RETIM satellite-based distribution system by using cost-effective DVB transmission techniques.

6.2.8 The Commission underlined that the Region VI RMDCN was an excellent example of a cost-effective upgrade of the GTS taking advantage of the increasing development of new telecommunication services and the competitive market, which was made possible through the dedicated international coordination and cooperation between NMHSs and organizations concerned. It also noted that the use of standard data-communication techniques and procedures for the GTS had greatly facilitated the utilization of cost-effective telecommunication services. It expressed its appreciation that several other Regions were following a similar trend towards the improvement of the GTS, taking into account their respective situation and requirements.

6.2.9 The Commission noted the extensive implementation of satellite-based multipoint telecommunications systems. Each WMO Region was completely covered by at least one satellite data-distribution system. Several Members already discontinued the operation of high frequency broadcasts, which had high recurrent operational costs and a limited efficiency, in some instances replacing them by satellite distribution systems. The Commission stressed the importance of considering alternative means at the regional level to

satisfy the few remaining requirements for high frequency broadcasts in some areas, with a view to using more cost-effective systems.

DATA-COMMUNICATION SYSTEMS AND TECHNIQUES

6.2.10 The Commission noted with appreciation the work carried out by the Expert Team on Data-Communication Systems and Techniques (ET/DCST) in further developing procedures and implementation guidance for using TCP/IP and related protocols on the GTS, including the refinement of TCP sockets procedures to mitigate possible loss of data, guidance for the migration and transition from X.25 to TCP/IP, as well as procedures for IP addressing and routing. The Commission reviewed the revised Attachment II-15 to the *Manual on the GTS* (WMO-No. 386), Volume I, Part II.

6.2.11 The Commission noted in that respect that an ever-increasing number of GTS centres (NMCs and RTHs) implemented TCP/IP for internal and national purposes and that the migration towards TCP/IP on the GTS circuits was progressing quickly. The use of TCP/IP had also facilitated the replacement and upgrade of GTS systems as well as the introduction of PC-based systems for GTS/GDPS operation in the NMCs of several developing countries. The Commission re-affirmed the benefits of the TCP/IP-based strategy for the development of the GTS. That had equated to direct savings in financial and human resource to Members by reduced costs for communications equipment, reduced software development work through use of industry standard software systems and had also facilitated the use of a larger panel of cost-effective telecommunication services.

6.2.12 The Commission recognized that the implementation of TCP/IP sockets had facilitated the migration of GTS applications to TCP/IP, although it did not provide for end-to-end protocol mechanisms. It agreed that TCP/IP sockets should be a transitory implementation, which nevertheless might last some time, towards the implementation of standard end-to-end procedures, such as FTP. It also noted that the use of FTP on the GTS had achieved widespread acceptance among NMHSs. The mechanism for the transmission of "normal" GTS messages (with abbreviated heading line) batched in files exchanged via FTP, as described in Attachment II-15 of the *Manual on the GTS*, was widely adopted for operational use by many centres, including on the MTN. The Commission noted however, that the file exchange procedure for new message types (see existing AHL) had not been tested yet on the GTS, and it requested OPAG/ISS to study further the matter, in relation with the development of filenaming and metadata conventions. Guidelines and procedures for using e-mail for the exchange of meteorological reports should also be developed.

6.2.13 The Commission emphasized the critical importance of adequate security measures to ensure efficient and safe operations for the GTS in view of the fact that all WWW centres had already implemented, or would in the future implement, access to the Internet. It noted with appreciation that the ET/DCST further developed

guidance in that respect, with a view to ensuring a reasonable and affordable level of security and protection of GTS systems and centres to prevent the proliferation of possible problems on the whole GTS. It emphasized that a level of 100 per cent security was not achievable and that an acceptable compromise between the equipment and human resources involved and the accepted level of risk should be found at each centre. It urged all GTS centres to pay due attention to that important matter and tasked the ET/DCST to pursue the development of relevant guidance.

6.2.14 The Commission also noted with appreciation that on-line information resources on data-communication systems and techniques had been included on the WMO Web server for making available to all Members practical information and guidance on the actual implementation of data-communication systems and techniques. It invited all WWW centres to contribute to, and make use of, those information resources. The Commission also agreed that Attachment II-15 of the *Manual on the GTS*, which was quite comprehensive, should eventually only contain the fundamental elements of the recommended practices and procedures and that implementation guidance would be provided on DCST information resources to keep the information up-to-date easily.

GTS OPERATION AND INFORMATION EXCHANGE

6.2.15 The Commission noted that the AGM and SMM results revealed that there were still discrepancies in the exchange of observational data on the MTN. Since observational data (excluding radar and satellite data) represented a small amount of the total set of data exchanged on the MTN, it could be exchanged through different routes on the MTN without overloading it. The Commission considered the recommendation that, in order to overcome routeing discrepancies, any MTN centre should relay all the observational data for global exchange that it received from an adjacent MTN centre to all other adjacent RTHs on the MTN. The procedures to detect and eliminate duplicated bulletins at MTN centres would avoid loops in the transmission of the bulletins on the MTN. The Commission was informed of the results of the tests that were carried out. It noted that the test had some positive impact on the exchange of bulletins involved in the test, and had also revealed some operational difficulties, in particular as regarded the elimination of duplicated bulletins. The Commission agreed that the new proposed procedure needed further development. It noted with appreciation that a spontaneous group of experts from RTHs started to exchange views on the test. It invited that ad hoc group to continue working on the test and related proposed changes to routeing procedures under the coordination of Mr F. Branski (United States) and to report to the chairperson of OPAG/ISS. Relevant proposals would then be submitted to the relevant OPAG/ISS team.

6.2.16 The Commission agreed to review the principles for the exchange of observational data on the MTN to

take into account better the requirements of GDPS centres as well as the current capacity of the GTS. It agreed that all observational data, with the exception of radar and satellite data, available from the WMO Member countries should be globally exchanged on the MTN. Such a change in the principle for routing data on the MTN would need a modification of the definition and use of the group ii of the data designator of abbreviated headings in order to allocate the series 01–39 for global distribution. The Commission requested OPAG/ISS to review procedures with a view to facilitating the implementation of the new principles for routing data on the MTN. In the meantime, the centres located on the MTN should strive to exchange the newly-defined global datasets. The Commission also agreed that “essential data”, as defined in Resolution 40 (Cg-XII) — WMO policy and practice for the exchange of meteorological and related data and products including guidelines on relationships in commercial meteorological activities, should be compiled into bulletins with ii in the series 01 to 19 and that other types of data, including “additional data”, should be compiled in the ii series above 19 as a goal for the future.

6.2.17 The Commission endorsed the following operational procedures that were recommended by the Implementation/Coordination Team on Information Exchange Management (ICT/IEM):

- (a) Five-digit sequence number in the starting line of the meteorological messages used under bilateral agreement;
- (b) Revision of allocation of data type designators for information in BUFR format (Attachment II-5 to the *Manual on the GTS*, Volume I, Part II);
- (c) Deletion of the older form RTD of the indicator BBB, replaced by the new provisions RRx by CBS-Ext.(85);
- (d) Revision of Table A of Attachment II-5 to reflect the new maximum length of alphanumeric messages (15 000 octets instead of 3 800 octets) in force since 6 November 2000.

6.2.18 The Commission reviewed the mechanisms for exchanging data on the GTS. It endorsed the analysis that, in view of time delay constraints and general data requirements, the distribution mechanism (data push) for observational data remained the most effective system for the foreseeable future. On the other hand, it was of the opinion that the exchange mechanisms for processed products needed to be reviewed, taking into consideration the limited number of sources (WMCs and RSMCs) as well as the different requirements from user centres. Downloading product files (data pull) would have a significant number of advantages, including access to metadata. However, coordination and efficient management mechanisms should be in place to ensure a guaranteed level of quality of data-communication services on the GTS and to prevent a system overload, which might be inherent to data pull services (too many users accessing data at the same time). The Commission agreed that that matter should be carefully studied as a matter of urgency.

6.2.19 The Commission re-affirmed the crucial importance of standard conventions for file naming and metadata for WMO Programmes in general, and for WWW in particular, in order to promote the transfer of information files other than traditional GTS messages on the GTS, and to take full benefit of the improved GTS infrastructure. It noted that the ICT/IEM had considered a proposal for the access to, and format of, metadata metafile, which was already in operation at WMC/RTH Washington. That format and procedure presented several strengths and opportunities, including a full compatibility with current Internet standards and offered several interesting options to users while avoiding the systematic transfer of metadata that was not likely needed.

6.2.20 The Commission agreed that some design principles of the GTS should be updated to reflect the evolving telecommunication techniques and services, and in particular the increasing importance of data-communication network services to implement the GTS for the MTN and RMTNs.

6.2.21 The Commission noted a number of serious operational issues associated with a possible migration strategy towards CREX and BUFR that needed a thorough analysis of data exchange management. It noted the issue of conversion from one data representation form to another and the likely impact on delay in the availability of observational data. It also stressed that the impact on the GTS of multiple data forms in parallel would be more significant and possibly serious on the number of messages to be handled (e.g. on routing directories) rather than on the data volume itself.

AMENDMENTS TO THE MANUAL ON THE GTS (WMO-No. 386), VOLUME I

6.2.22 Subsequent to the conclusions reflected above, the Commission adopted Recommendation 2 (CBS-XII) concerning amendments to the *Manual on the GTS*, Volume I, Parts I and II.

GTS MANAGEMENT INFORMATION

6.2.23 The Commission noted with appreciation that eight MTN centres (Bracknell, Melbourne, Moscow, Nairobi, Offenbach, Sofia, Tokyo and Toulouse) had implemented the procedures for the comprehensive *Catalogue of Meteorological Bulletins* (Volume C1), which were adopted at its extraordinary session (Karlsruhe, 1998). That implementation had already resulted in significant improvements of the information on actual GTS bulletins. That confirmed that the comprehensive *Catalogue* procedures would enable a major improvement to the content of the *Catalogue*. The Commission invited all MTN centres to implement those procedures with a view to achieving a complete *Catalogue*.

6.2.24 The Commission was informed that the Secretariat developed and ran a PC-based application to maintain and update the comprehensive *Catalogue of Meteorological Bulletins* on the basis of the information (advanced notifications and relevant catalogue part) provided by the MTN centres. The application was developed using the database software Microsoft

Access-97 under Windows 95 or 98. The application included tools for maintaining the parts of the *Catalogue* for which the respective MTN centres were not yet providing the expected information files. The Commission noted with appreciation that the PC-based application was made available to MTN centres which had not yet implemented the new procedures agreed to by CBS-Ext.(98), with a view to facilitating their implementation.

6.2.25 The Commission underlined that the routing catalogues, which were prepared by RTHs and made available to other RTHs and NMCs, provided very useful information for the management of the GTS operation. It urged all RTHs to implement fully those procedures, as prescribed in the *Manual on the GTS* (Volume I, Part II, paragraph 2.10.3.3). It noted that the comparison of the information contained in the RTH routing catalogues, the *Catalogue of Meteorological Bulletins* and the monitoring results made it possible to identify specific deficiencies and to overcome them.

PROJECT FOR IMTN

6.2.26 The Commission reviewed the project for IMTN, which was developed by the Expert Team on the IMTN (ET/IMTN), at its first session (Geneva, October 1999), and was reviewed by the CBS/Expert Team Meeting on Improved Main Telecommunications Network (Geneva, October 1999). All Members operating an RTH on the MTN were consulted to seek their comments, possible preliminary agreement on the general concept and indication of their willingness and ability to proceed with the implementation. The Commission noted with satisfaction that all the replies received supported the IMTN project. The Commission also noted that the fifty-second session of the Executive Council had felt that it was important that the fundamental principles and concepts of the projects for the development of the MTN and the GTS be submitted to the Executive Council for consideration and approval.

6.2.27 The Commission agreed that the project was the best solution taking into account MTN requirements, technical efficiency, cost effectiveness, implementation feasibility and early benefits for the whole GTS. The Commission also noted from preliminary cost estimates obtained from some potential telecommunication service providers, that the IMTN was expected to permit significant savings on recurrent costs for most centres in comparison with the current leased circuits, while enabling capacity upgrades.

APPLICATIONS TO BE SUPPORTED BY THE IMTN

6.2.28 The IMTN should support current GTS applications (e.g. data collection and distribution of data and products) as well as new emerging applications (e.g. operational DDBs, servers of operational data, file transfer). The MTN must be flexible to support various current and emerging applications, which should be ensured by the use of standard data transport services. Any change or new application would require a careful analysis and planning in order to avoid any disruption of GTS

operation. There were increasing requirements for the exchange of data (e.g. satellite data); an essential criterion was the scalability of the capacity of the IMTN to match the volume of the data exchange required. The MTN should support bilateral and multilateral data exchange between Members in order to improve the cost-effectiveness of meteorological data exchange. The Commission noted that the requirements for the MTN that were agreed upon by CBS-Ext.(94) were still fully valid.

6.2.29 The MTN, as the core network of the GTS, should meet the needs for routine and special time-critical (real-time or near real-time) data exchange between Members, including the needs of WMO Programmes other than the WWW. Non-real-time data exchange could also be carried on the MTN to take advantage of spare capacity available, in particular at some period of the day. The MTN (and the GTS as a whole) should be complemented by public networks and, in particular the Internet, for the cost-effective support of meteorological and related data exchange that were not time-critical.

DESIGN PRINCIPLES FOR THE IMTN

6.2.30 The IMTN should be based on the organizational principles of the GTS and the functions and characteristics of the MTN and RTHs. The IMTN should include and involve all designated MTN centres, taking into account their respective ability and status of implementation. Two elements of the MTN functions were identified. The "interregional" MTN element provided for the inter-connectivity between the WMO Regions; the "intra-regional" MTN element provided for the continuity of MTN functions, but within a WMO Region. The "intra-regional" MTN element should, as a general principle and for cost-effectiveness, be implemented as part of the respective RMTN. The "interregional" MTN element was crucial and should be addressed with the highest priority in the implementation plans for the IMTN.

6.2.31 The current MTN flow of data on the MTN should be maintained in an initial configuration of the IMTN, with a view to ensuring that the same level of service was achieved as by the existing system. The required interconnectivity and flow of data within the IMTN would be optimized in a future step. MTN centres in both Regions III and V had each only one link to the rest of the MTN, which represented a single point of failure. Therefore there was a need to improve that aspect of the current MTN as soon as possible.

RECOMMENDED DATA TRANSPORT NETWORK FOR THE IMTN

6.2.32 The Commission underlined that the network services ("clouds") technology had several benefits for the implementation of the GTS and the MTN, as followed:

- (a) Cost-effectiveness, generally more cost-effective than dedicated leased circuits;
- (b) Economy of scale for larger centres;
- (c) Capacity could be selected incrementally;
- (d) Flexibility: virtual circuits could be added or removed easily and virtual circuit capacity (CIR in frame relay networks) could be easily adapted, including for asymmetric traffic;

- (e) Technical support and services from the network service provider facilitated the operation and management;
- (f) Opportunity for an acceleration of TCP/IP implementation and related benefits.

6.2.33 On the other hand, issues arose from the necessity to use a common provider for each "cloud". The MTN centres concerned needed to agree on a process for procurement leading to a contractual framework which all could accept. Within that framework, there needed to be clarity about financial matters. Also, there needed to be a common understanding on operational procedures, including the security aspects related to TCP/IP and a mixed Internet/GTS environment.

6.2.34 The Commission agreed upon the IMTN project, based on data-communication techniques and services that were available for the foreseeable future, described as followed:

An improved MTN implemented through network services from a small number of providers ("clouds"). Some MTN centres would provide gateway functions between the "clouds". A first implementation phase (Phase I) would mix "clouds" and point-to-point circuits; a second phase (Phase II) would provide the full MTN connectivity through the "clouds".

The shorthand word "cloud" was used in the text with the following summary definition:

Three or more centres use a common provider of network services within a contractual framework to implement the required connectivity among the centres concerned.

6.2.35 The Commission underlined that the IMTN project depended upon effective multilateral cooperation to implement a small number of "clouds". A diagram of the IMTN, Phase II is shown in Figure 2 in Annex I to this report.

IMPLEMENTATION PLAN FOR THE IMTN PROJECT

6.2.36 The Commission agreed that implementation of the IMTN project should be a progression. In its first stage (Phase I), there would be a mix of "clouds" and existing point-to-point links. That mix might arise through:

- (a) One centre joining an existing "clouds" (such as a possible extension of the RA VI RMDCN);
- (b) Three (or more) centres working together to implement a new "cloud";
- (c) Continued use of bilaterally-agreed links.

6.2.37 That arrangement would be an improvement upon the existing MTN, but clearly lacked the fuller flexibility that a more homogeneous implementation would provide. Phase I should therefore evolve quickly towards Phase II in which all the MTN links would be provided via a small number of "clouds". It was important to view that process as evolutionary. Some network clouds might grow at the expense of others because:

- (a) One service provider had lower prices or better performance than another, or;
- (b) One service provider was taken over by another, or;

- (c) Changes in technology lead to new opportunities, e.g. Internet with sufficient quality of service to meet GTS requirements.

6.2.38 The Commission emphasized that the recommended IMTN project had the attraction that its evolution was not rigidly programmed but could respond to changing requirements and external circumstances. It also avoided the need for a centrally-managed plan, giving close alignment to the needs and resources of the Members concerned.

6.2.39 The recommended plan also had the advantage of permitting the MTN (as defined in terms of MTN centres and links) to keep open the possibility of changes. It was possible to envisage that some centres, not currently designated as MTN centres, might join one or more "clouds" and help to support interregional data flow. Also, there were existing bilateral interregional links which were not part of the MTN but which were playing an increasingly important role; other links might be added. By including such centres and links within the implementation plan, their utility would be demonstrated and CBS and the Executive Council could decide, at an appropriate time, to adjust the formal designation of MTN centres and links.

6.2.40 With a view to facilitating the prompt transition towards the IMTN, Phase I and eventually Phase II, the Commission encouraged the establishment of lead groups of MTN centres sharing a common interest and requirement for MTN (and possibly other) connectivity among them. Those lead groups were encouraged to consider the implementation of "clouds" within the MTN to replace efficiently part of the existing MTN dedicated point-to-point circuits. The Commission identified the following possible groups for the implementation of Phase I:

- A Brasilia, Buenos Aires, Washington;
- B Melbourne, Tokyo, Washington, Bracknell;
- R Bracknell, Toulouse, Offenbach, Moscow, Prague and Sofia with respect to MTN requirements supported by the RA VI RMDCN.

A diagram of possible implementation of the IMTN, Phase I is shown in Figure 3 in Annex I to this report.

- 6.2.41 The Commission identified the following possible additional groups for the implementation of Phase II:
- B' Melbourne, Tokyo, Washington, Bracknell, Moscow;
 - C Toulouse, Offenbach, Nairobi, Dakar, Algiers, Cairo;
 - D Tokyo, Beijing, Offenbach, Jeddah, New Delhi, Moscow.

A diagram of possible implementation of the IMTN, Phase II is shown in Figure 2 in Annex I to this report.

6.2.42 The Commission urged MTN centres to begin discussions as soon as possible so that real progress could be done. Such discussions could be focused on drafting a Memorandum of Understanding among the centres concerned, which would form the foundation for implementing a "cloud". Issues to be covered in such a Memorandum of Understanding might include:

- (a) Responsibilities of each centre;
- (b) Method of procurement of the service;
- (c) Funding of the various stages;

- (d) Ongoing coordination and management of the relationship with the supplier;
- (e) Procedure for adding another centre to the cloud, etc.

6.2.43 Given such a Memorandum of Understanding, work could proceed on the preparation of documents to support a competitive procurement process (e.g. specifications of requirements, criteria for selection, draft contractual terms, etc.). In some cases, a group of centres would have sufficient expertise and/or administrative flexibility to do that work among themselves; in other cases, the assistance of the WMO Secretariat might be considered. The assistance of the Secretariat might consist, if needed and requested, in carrying out the invitation-to-tender, in assisting in the selection process and in implementing a framework contract (not including financial commitments).

6.2.44 The Commission tasked the ET/IMTN to ensure the general coordination of the development of the IMTN project and to foster the early implementation of Phase I in the year 2001. The Commission agreed that on-line IMTN information resources should be developed for making available to all Members operating an RTH practical information on the actual development of the IMTN project. MTN centres and, in particular those centres involved in Phase I, would be invited to contribute their own experience and progress to those IMTN information resources, after a prompt review by the ET/IMTN. The information might include examples of Memoranda of Understanding, general information on network service providers, progress status in implementing clouds, etc. The Secretariat was invited to maintain the on-line IMTN information resources on the WMO Web server.

6.2.45 The Commission requested its president, with the assistance of the Secretary-General, to submit the fundamental principles and concepts of the IMTN project to the forthcoming session of the Executive Council for consideration and approval, with a view to enabling an early implementation of the project and early benefits for the GTS as a whole.

IMPACT OF THE INTERNET

6.2.46 The Commission recognized that the development of Internet technology and practices was so diversified and fast that there was a real danger that NMHSs might adopt techniques individually which might not be inter-operable. It was pleased to note that the WMO *Guide on Internet Practices* had been developed and made available on the WMO Internet server and it congratulated the Expert Team on Internet Practices for its excellent work. It noted that the Team had considered the best format for the publication or dissemination of the *Guide* (solid-bound, loose-leaf updateable, on-line, etc.). The *Guide* dealt with technical and procedural issues that would be strongly influenced by changing technology and it contained many hyperlinks to comprehensive reference material available on the Internet. The Commission therefore agreed that the *Guide* should be published in HTML format on the Internet, and that

regular updates should be done by the Secretariat in coordination with the Expert Team on enhanced utilization of data-communication systems. The Commission discussed the relative advantages and disadvantages of printed versus on-line dissemination of the *Guide* and agreed that the on-line version be definitive. It agreed that the on-line version should therefore be available in at least English, French, Spanish and Russian.

6.2.47 The Commission recognized that many Members that did not have access to the Internet could benefit from the material included in the *Guide*. It therefore requested the Secretariat to print all of the information in the *Guide* concerning the merits and procedures of establishing a connection to the Internet and to distribute that information via hardcopy to NMHSs that were not yet connected. It should also make printed copies of the *Guide* available to any NMHS that requested it.

6.2.48 The Commission noted that activities in relation to data-communication networks had been heavily influenced by the ever-increasing importance of the Internet. The Commission considered a proposed view of information flow and data-communication network relationships at each NMHS, as shown in Figure 4 in Annex I to this report. In that scenario, the GTS connections would continue to be dedicated to the exchange of real-time and critical data and products and the Internet would be used for the exchange of less time-critical information and for the supply of data and products to other users. Relevant WWW centres, and in particular RTHs, would be expected to implement and operate adequate Internet servers (Web or FTP) to post information that NMHS/NMCs could download. The Commission noted that some WWW centres had already implemented that scheme. The need to ensure an appropriate level of security and protection of operational systems was also underlined.

DATA MANAGEMENT

PROPOSAL FOR AN INTEGRATED QUANTITY MONITORING

6.2.49 The Commission noted that it has been recognized for some time that global quantity monitoring procedures had not satisfied all requirements and that further measures were necessary. One of the main reasons for that was that the resources available at centres for monitoring activities were limited. The Commission considered a proposal for experimental implementation of new procedures to monitor the quantity of data exchanged on the GTS. The proposed procedure would distribute monitoring efforts to a number of levels to minimize the impact on any one centre. NMCs, RTHs, RTHs on the MTN, GDPS centres and the WMO Secretariat would each have a specified role and thus share the load in accordance with their responsibilities.

6.2.50 The Commission noted that in accordance with existing WMO guidelines, real-time operational monitoring of the data exchanged between NMCs and their responsible RTHs should be conducted. To take advantage of the information gleaned from that important activity, the proposal recommended that NMCs, based

on real-time or AGM, prepare quarterly summary reports of the monitoring of their national data and forward them to their responsible RTH.

6.2.51 Each RTH in the course of its operations should also conduct monitoring on a continuous basis. The proposal recommended that four times per year each RTH should prepare a report compiled from its own statistics of data it had inserted onto the GTS compared with the consolidated reports of the NMCs in its area of responsibility. RTHs would send the reports to the WMO Secretariat and to their responsible RTH on the MTN. The Secretariat would prepare summaries and statistics based upon the results from all RTHs.

6.2.52 The Commission approved SMM for experimental use beginning in 1995 and it became operational in 1997. The SMM was a highly automated monitoring procedure that was carried out four times per year, in February, April, July and October. It involved the collection of raw data files by several RTHs on the MTN, shared the workload between centres, and eliminated differences in procedures by having only one centre do a pre-analysis of each type of data. The proposal recommended that an expanded SMM form one of the major components of expanded automated monitoring procedures.

6.2.53 The Commission noted that in order to ensure that the maximum amount of monitoring information was collected, RTHs on the MTN that did not participate in the SMM should produce a report on all of the data received at their centre and should pass those reports to the WMO Secretariat for comparison with other MTN centres.

6.2.54 In accordance with their operational responsibilities, GDPS centres routinely monitored the receipt of observational data. It was proposed that participating GDPS centres prepare a list of stations whose data could not be decoded and send a copy of that report to the responsible NMC for remedial action. It also recommended that GDPS centres prepare quarterly reports, on the same schedule as the NMC/RTH monitoring, describing the volume of data received at the centre. A comparison with the NMC/RTH reports could assist in identifying data or telecommunications problems.

6.2.55 The Commission was pleased to note that as a result of implementation of that monitoring it was expected that it would be possible to increase the performance of the GTS and the operation of the WWW as a whole. The new procedure would ensure that effective feedback systems were in place and timely enough to contribute to the resolution of short-term problems or outages while also being comprehensive enough to allow identification of more subtle problems. It would monitor all observational data types (except radar and satellite) and thus facilitate the evaluation of the impact of Resolution 40 (Cg-XII) — WMO policy and practice for the exchange of meteorological and related data and products including guidelines on relationships in commercial meteorological activities, on data exchange. The Commission agreed that, since that integrated WWW monitoring would provide all essential information,

centres that participated in that monitoring would no longer need to conduct AGM.

6.2.56 The Commission, noting that the proposal was developed by the Expert Team on Quantity Monitoring of the WWW and was coordinated with all members of OPAG/ISS, thanked all contributors for their excellent work. It agreed that an operational trial of the proposed integrated WWW monitoring be conducted beginning no later than October 2001. To be viable, the trial should include at least one MTN centre, one associated RTH and two associated NMCs. The Commission also requested OPAG/ISS to assess further the impact of the implementation of the proposal, in particular as regarded the resources needed at RTHs and NMCs to implement and operate the proposal *vis-à-vis* the benefits resulting from its implementation. The Commission requested that the results of the trial and the final procedures and formats of the integrated monitoring be presented for consideration by the Commission at its next session in 2002. Additional information on the proposed monitoring are provided in Annex III to this report. The Commission noted that for centres wishing to participate in the trial, the Secretary-General had made the details of file names and exchange formats available in the form of a WWW technical document.

6.2.57 The use of dedicated PCs at WWW centres for monitoring applications should facilitate the implementation of the monitoring activities. The Commission requested OPAG/ISS to consider further the development of a PC-based application, which could be used by any WWW centre.

FUTURE WMO INFORMATION SYSTEMS

6.2.58 The Commission noted the recommendations made by the Inter-programme Task Team on Future WMO Information Systems. The team had concluded that currently, the WMO information system comprised a combination of private GTS and public Internet. The GTS consisted of a private telecommunication network, satellite broadcast and collection systems and an evolving set of managed network "clouds". It could accommodate a variety of protocols (e.g. X.25 and TCP/IP) and supported the current GTS message switch system as its single most important application. The Internet was playing an increasingly important role, particularly for the exchange of non-real-time products, and supported a variety of applications, some of which were pertinent to WMO requirements. Most GTS centres now had links to the Internet and a few GTS circuits had recently been implemented over the Internet. Considering the current state of the WMO information system and the overall vision of a future system, the experts highlighted the following key points:

- (a) There was now limited utilization of the Internet for operational store and forward applications;
- (b) There was limited connectivity between applications developed to serve the needs of the different technical commissions;
- (c) There were a large number of different applications whose development had not been coordinated,

making integration of datasets a technically challenging task;

- (d) Multidisciplinary application of meteorological, hydrological and oceanographic data was hampered by the lack of agreed standards needed to identify, acquire and use effectively all of the relevant data;
- (e) Greater use of commercially-accepted standards and off-the-shelf hardware could increase the responsiveness and decrease the costs of operating current systems.

6.2.59 The Commission noted that a major achievement of WMO had been the creation of the policy on a free and unrestricted exchange of meteorological and related data, and the implementation of an information system to put that policy into practice. Currently, the WMO information system comprised:

- (a) WMCs and RSMCs for the preparation of products for global and regional distribution. Those WMCs and RSMCs collected data from, and provided data and products to, NMCs, which in turn addressed the national requirements for them;
- (b) 32 RTHs which managed the GTS that moved the data and products between the WMCs, RSMCs and NMCs. The GTS consisted of an MTN carrying high volume traffic between 18 of the larger centres and a range of other non-MTN links;
- (c) A large number of centres (including WMCs, RSMCs and NMCs) which used the Internet for the ad hoc exchange of data and products on a request-reply basis, and for the routine accessing of datasets that, for a variety of reasons (including capacity limitations), could not be carried on the GTS.

That was an effective but extremely complex and expensive system, with a two-level hierarchy of communication system centres and a three-level hierarchy of data-processing centres. The most significant challenges for the system's managers were to respond appropriately to evolving requirements and technological changes occurring in the area of information systems.

6.2.60 The Commission agreed that if the basic systems were to meet the requirements of the WWW, other WMO Programmes and related international programmes, it would need to plan properly to ensure that its information system continued to be relevant and of use to its Members into the future. The technologies available for the collection, exchange and management of information were changing at an unprecedented rate, and with that change came the opportunity to access a broader range of meteorological data and information, more rapidly and at lower cost than had previously been possible. The development and implementation of new systems to take best advantage of those emerging technologies would, however, be a major challenge for WMO as a whole and its Members individually.

6.2.61 There was a great potential that the evolution of data management technologies could lead to the availability of an integrated system capable of meeting the requirements of the WWW, the WMO Programmes not managed by CBS, and the broader environment

community. In that discussion, it was noted that there might be some advantage in maintaining a logical separation of the WMO system for exchanging data from others. That separation could possibly be supported by modern security features (e.g. firewalls, virtual channels, encryption, etc.), rather than by relying on relatively expensive technologies that were unique to WMO (such as GTS message switches, communication lines leased on a bilateral basis, etc.). In light of such an approach, modern security systems should be studied in detail to identify the best solution for the issues faced by WMO.

6.2.62 The Commission agreed that the future WMO information system should provide an integrated approach to meeting the requirements of:

- (a) Routine collection of observed data;
- (b) Automatic dissemination of scheduled products, both real- and non-real-time;
- (c) Ad hoc non-routine applications (e.g. requests for non-routine data and products).

The system should be:

- (a) Reliable;
- (b) Cost effective and affordable for developing as well as developed Members;
- (c) Technologically sustainable and appropriate to local expertise;
- (d) Modular and scalable;
- (e) Flexible and able to adjust to changing requirements and to allow dissemination of products from diverse data sources.

The system should also support:

- (a) Different user groups and access policies;
- (b) The integration of diverse datasets;
- (c) Data as well as network security;
- (d) Ad hoc as well as routine requests for data and products ("pull" as well as "push");
- (e) Timely delivery of data and products (appropriate to requirements).

6.2.63 The ad hoc distribution of non-routine products could best be accomplished via request/reply or "pull" systems. Routine collection and dissemination of data and products were best accomplished via a "push" system, which could be implemented via a combination of technologies. It could include store-and-forward systems, point-to-point communications (including use of simple technologies such as e-mail) and satellite DCP and broadcast. Push systems were the most appropriate approach for both the routine collection of observations and the routine dissemination of observations and other products. It was noted, however, that the collection of observations from the many possible suppliers and the dissemination of products from a few suppliers to many recipients were different problems best met through different logical topologies. The "push" and "pull" systems, operating in parallel, should be available to all users of WMO data and products.

6.2.64 The Commission considered a proposal for the future WMO information system developed by the Inter-programme Task Team on Future WMO Information Systems. It noted that in the proposal the future WMO information systems would rely upon a combination of

public and private networks and would ensure coordinated development and operation of the participating systems through reliance on international protocols and standards and off-the-shelf software. The proposed system defined participating centres according to their functions and responsibilities and included three levels of responsibilities: GISCs, SPCs and National Centres. The possible flow of data and products between those centres is illustrated in Figures 5(a) and (b) in Annex I to this report. Figure 5(a) outlined the collection of observations and products and Figure 5(b) illustrated the dissemination of products (both routine and non-routine).

GLOBAL INFORMATION SYSTEM CENTRES

6.2.65 The Commission noted that several (perhaps four to 10) GISCs formed the top level of the proposed future WMO information system. Those centres would collect all observations and products intended for global distribution from supplying centres within their area of responsibility. Each supplier, which could be an NMHS, an organization (e.g. ARGOS, ARINC), a research project, etc., would send its observations to its designated GISC. Observations would be combined into large aggregated datasets. The GISC would then forward its datasets to all of the other GISCs. The collection of observations would be organized into a series of star networks connected by a logical ring between the GISCs at the top. It would most likely be unnecessary to standardize the physical links and protocols to be used between all of the suppliers and collectors, but rather those should be decided by bilateral agreement to best match the requirements and capabilities of the parties involved. That approach was currently used between a number of NMHSs with effective results.

6.2.66 It was noted that the Task Team had assumed that the GISCs would usually be located within, or closely associated with, a centre running a global data assimilation or having some other global commitment. However, the proposed architecture did not dictate that that be a requirement.

6.2.67 It was noted that dissemination of products through a store-and-forward based "push" system implemented as a single layer would, in many cases, require excessive resources at some centres. Therefore, product dissemination would probably be best addressed through a variety of technologies including hierarchical store and forward systems similar to the current GTS message switches, satellite broadcast, and perhaps network multicast. High capability recipients requiring large-volume products could be served by one mechanism while less developed recipients with less demanding requirements could be served by another.

6.2.68 The responsibilities of a GISC could be summarized as followed. Each GISC would:

- (a) Collect observational data and products that were intended for global exchange from national centres within their area of responsibility, reformatted as necessary and aggregated into data products that covered their responsible area;

- (b) Collect products that were intended for global exchange from Specialized Product Centres within their area of responsibility;
- (c) Receive data and products intended for global exchange from other GISCs;
- (d) Disseminate the entire set of data and products agreed by WMO for routine global exchange (that dissemination could be via any combination of the Internet, satellite, multicasting, etc., as appropriate to meet the needs of Members that required its products);
- (e) Hold the entire set of data and products and make it available via WMO request/reply ("pull") mechanisms;
- (f) Provide around-the-clock connectivity to the public and private networks at a bandwidth that was sufficient to meet its global and regional responsibilities;
- (g) Perform, if necessary, the functions of a Specialized Product and/or a National Centre.

6.2.69 Within Europe, France, Germany and the United Kingdom were discussing how the role of a GISC could be fulfilled jointly by several centres acting together. The RMDCN, the use of Internet technology and metadata standards offered the technical ability to implement a GISC across several centres, and that had the benefits of sharing and reducing overall costs, of reducing the complexity of RTH network within Europe and of giving increased resilience for such a critical role.

SPECIALIZED PRODUCT CENTRES

6.2.70 Several dozen centres would serve as SPCs. Existing RSMCs would function as SPCs. However, many additional centres would also serve as SPCs. That would include suppliers of special observations (e.g. ARGOS, ARINC), research projects, and centres producing products related to a specific discipline. SPCs would:

- (a) Collect special programme-related data and products, as appropriate;
- (b) Produce agreed products;
- (c) Provide products intended for global exchange to their responsible GISC;
- (d) Disseminate products not intended for global exchange in whatever manner was agreed upon between the centre and the users of the product;
- (e) Support access to its products via WMO request/reply ("pull") mechanisms in an appropriate manner (i.e. dynamically-generated products would require around-the-clock connectivity to the Internet);
- (f) Perform the functions of a National Centre.

NATIONAL CENTRES

6.2.71 It was noted that National Centres would form the foundation of the proposed future WMO information system. Many National Centres would be a part of an NMHS but others would have national responsibility for functions falling within WMO Programmes but be located outside the NMHS. The Permanent Representatives of the countries concerned with WMO would coordinate their participation in that system. Their functions would be to:

- (a) Collect observational data;
- (b) Provide observations and products to their responsible GIS;
- (c) Collect and generate products for national use.

6.2.72 The Commission noted that although the design, development and implementation of the envisioned future WMO information system would be a formidable task, it would not face any serious technical difficulties and could be successfully implemented with existing technology. However, its development would require both several years and a substantial commitment of staff representing Members and participating in WMO Programmes.

6.2.73 The Commission welcomed, in general, the proposed vision for a future WMO information system. It was agreed that future work should focus around two key aspects:

- (a) Re-developing the current store and forward GTS to take best advantage of the new technologies;
- (b) Coordinating the development of the request-reply capability of the WMO's information systems.

6.2.74 It further agreed that the most straightforward way to test the feasibility of the proposal would be to examine successful implementations of promising new technologies by those outside of the WMO community and to undertake pilot projects which utilized critical aspects of those new technologies. Examples of technologies that showed promise for upgrading the capability of the "store-and-forward" GTS included, among other things, the Unidata Internet data distribution system, IP multicast and the new http "smart download" functionality. It requested its OPAG/ISS to coordinate testing and evaluation of promising technologies through pilot projects.

6.2.75 The Commission agreed that with regard to the further development of the request-reply capability, the most pressing requirement was the development of a catalogue of products that could be searched on-line via the Internet. While satellite-based broadcast systems were generally regional in scope, request-reply systems implemented over the Internet were intrinsically global in scope. Therefore, the interface to that system (including the product catalogue) must be globally uniform. It was noteworthy that a number of major WMO centres already had on-line catalogues in place and the harmonization of those systems to a common standard would be a challenging task. As additional centres developed catalogue systems and brought them on-line it would become increasingly difficult and expensive to implement a global standard. Therefore, there was an urgent need for that standard to be developed as quickly as possible. The Commission agreed that development of a WMO catalogue of products should be a high priority task for OPAG/ISS, noting that the talents of an interdisciplinary group of experts would be required.

6.2.76 Noting that technology was constantly evolving and new technologies that could improve WMO information systems could emerge, a group with representation from many WMO and related international programmes should be tasked to stay abreast of

developments and assess possible applicability of new technologies to WMO requirements. The Commission agreed that that task should be included in the future work programme of the Inter-programme Task Team.

6.2.77 Finally, while it seemed clear that the conceptual vision for the future WMO information system could be implemented with existing technology, to do so satisfactorily might require changes in responsibilities between Members and between centres as they were currently configured. The Commission agreed that that matter should be further investigated, ideally by a group with representation across all WMO Programmes. Therefore, it agreed that that task should be included in the future work programme of the Inter-programme Task Team and requested it to present a report on that issue to the Commission at its next session.

YEAR 2000 PROBLEM

6.2.78 The Commission noted that, following a request made by the fifty-first session of the Executive Council, the Expert Team on the Year 2000 Problem had developed the International WMO Y2K Monitoring and Contingency Plan, which recommended actions to be undertaken by all WMO Members in the few days immediately before and after 1 January 2000. In accordance with the Plan, Members implemented monitoring activities to detect outages and undertook actions to minimize the impact of any problems that might have occurred. The Commission was pleased that due to those actions and the concerted efforts of NMHSs there had been no significant interruption in the provision or quality of data and products produced by WMO Members due to computer problems resulting from the transition to the year 2000. It congratulated Members and the satellite operators on their successful efforts, thanked donors for their timely and generous donations, and thanked the Secretary-General for the education and coordination conducted by the Secretariat.

6.2.79 The Commission noted that although computers had now safely managed the year 2000 transition and the 2000 leap day, there was at least one more key date to come, the roll-over from 2000 to 2001, which affected data in GRIB format. In GRIB, the century and year were coded separately. Come midnight on 31 December 2000, the GRIB century would change from 20 to 21, and the GRIB year would change from 100 to 1. The Commission reminded Members to ensure that any software that processed GRIB was properly written to account for that transition.

RADIO FREQUENCIES FOR METEOROLOGICAL ACTIVITIES

6.2.80 The Commission noted with appreciation the very favourable outcome of the WRC-2000 as regarded the several items of concern for meteorology. The active participation of WMO in the ITU preparatory activities was instrumental in ensuring that meteorological requirements were recognized and supported. The Commission expressed its appreciation for the effective coordination and preparatory activities undertaken by

the Steering Group on Radio-frequency Coordination and the Secretariat, and the fruitful cooperation from several NMHSs and meteorological satellite agencies, in particular EUMETSAT.

6.2.81 The main decisions of WRC-2000 relevant to meteorological activities were summarized as followed:

- (a) Meteorological requirements in the band 401–406 MHz for meteorological aids (radiosondes) and meteorological satellite operation were acknowledged for the foreseeable future. Resolution 219 (WRC-97), which requested the assessment of meteorological requirements in the band 401–406 MHz and the possible transition out of the band 405–406 MHz, was suppressed. That decision was an important achievement for meteorological operations, concluding a tough debate since 1992. The issue might, however, be reconsidered by WRC-2003 under Resolution 214 (WRC-2000) which addressed frequency allocation for MSS below 1 GHz;
- (b) Current allocations were not changed in the band 1 670–1 710 MHz, which was a main band for meteorological satellite operation worldwide and for radiosondes operation by many NMHSs in its lower part. The possible allocation of part of the band to the mobile-satellite service had also been debated since 1992. WRC-2000 adopted a new resolution on sharing studies and possible allocations to the mobile-satellite service in the 1–3 GHz range, including consideration of the band 1 683–1 690 MHz and the assessment, with the participation of WMO, of the current and future meteorological spectrum requirements. That resolution replaced a previous resolution that addressed the whole band 1 675–1 710 MHz;
- (c) The allocations to space-borne passive remote sensing in the Earth Exploration Satellite Service in the frequency range 71–275 GHz were re-organized to meet present and foreseeable future requirements, taking into account technological and scientific advances. Those decisions complemented those taken by WRC-97 in the frequency range 50–71 GHz;
- (d) The band 18.6–18.8 GHz was allocated worldwide to space-borne passive remote sensing, solving an issue that was debated for 15 years;
- (e) Regulatory provisions were decided to ensure an acceptable protection of space-borne passive sensors in the band 55.78–56.26 GHz (oxygen absorption band);
- (f) The 2 700–2 900 MHz band, which was worldwide allocated to meteorological radars and aeronautical radionavigation radars, was not selected as a band for the IMT-2000 operation (third generation of mobile phones). The question was however included in the agenda of WRC-2006.

6.2.82 The Commission noted that the pressure on radio-frequency bands would continue with the increasing development and expansion of new radio-communication systems. It noted that the fifty-second session of the Executive Council re-emphasized the

importance of continuing to defend the frequency allocations to meteorological systems and environmental satellites, and the Commission fully concurred with that analysis. It also noted that the preliminary agenda for the next WRC-2003 included items of importance for meteorology, including the band 1 683–1 690 MHz, and it invited Members and the Secretariat to pursue their participation in the relevant ITU-R activities. The Commission underlined the importance of the participation of WMO representative(s) in ITU-R activities, on behalf of WMO Members which could not afford participation of their own experts. It requested its Steering Group on Radio-frequency Coordination to continue its activities related to ITU-R studies and to operational frequency coordination, in particular the use by both Met-Aids and Met-Sat systems of the 401–403 MHz and 1 670–1 700 MHz bands. It further noted with appreciation that the *Handbook on the Use of Radio Spectrum for Meteorological Activities* was being published in cooperation between WMO and ITU.

CBS TECHNICAL CONFERENCE ON WMO INFORMATION SYSTEMS AND SERVICES

6.2.83 The Commission expressed its appreciation for the convening of the CBS Technical Conference on WMO Information Systems and Services, which was held over the two days immediately preceding the present session. It was attended by 156 international participants from 74 countries and 13 organizations. The Commission specifically thanked the Conference Director, Mr G. R. Hoffmann (Germany), and the Secretariat for their excellent preparatory work. It also expressed special thanks to the session chairpersons and the 22 lecturers for their thought-provoking presentations. The Commission reviewed the summaries of each of the sessions. It recorded its deliberations relating to topics discussed at the Conference in Annex IV to this report.

DATA REPRESENTATION AND CODES: STRATEGY FOR MIGRATION TO TABLE-DRIVEN CODES

6.2.84 The Commission noted with appreciation the work of the Expert Team on Evolution of Data Formats and the ICT on Data Representation and Codes (ICT/DR&C) and thanked Mr C. Dey, (United States), who chaired both teams, for his excellent work.

6.2.85 Taking note of the work achieved, the Commission recognized that the table-driven codes BUFR and CREX offered great advantages compared to the traditional alphanumeric codes (e.g. FM 12 SYNOP, FM 13 SHIP, FM 18 BUOY, FM 35 TEMP). The Commission appreciated that the table-driven codes were universal and flexible, and could be easily expanded to satisfy all observational requirements including national needs for specific data exchange.

6.2.86 BUFR was initially approved by CBS-IX for operational use in November 1988. It had since been used mainly for satellite, aircraft and wind profiler observations, as well as for tropical cyclone information and for archiving all types of observational data. CBS-Ext.(98)

recommended CREX as an operational data representation code form from 3 May 2000, which was endorsed by the fifty-first session of the Executive Council. CREX was being used for the exchange of ozone data, radiological data, hydrological data, tide gauge data and soil temperature data. CREX should be used in lieu of BUFR if binary data handling or transmission were not possible. The self-description, flexibility and expandability of those codes were fundamental in light of the fast evolution of science and technology, which regularly requested representation forms for new data types.

6.2.87 Already at present, several new requirements could not be met by traditional alphanumeric codes. Examples were: AWSs which were able to report several parameters which were not defined in the alphanumeric codes; high resolution models required observations with a higher resolution in time and in the vertical dimension; parameters like soil temperature and humidity at various levels, atmospheric chemistry data, new oceanographic data, specific climatological data and all kinds of metadata. BUFR and CREX could meet those requirements. In addition BUFR provided for condensation (packing) of the data and allowed coding of quality flags and associated values. CREX offers direct human readability. To achieve the same functionality in traditional alphanumeric codes would require substantive modifications, which would be far too costly. A change once and for all to the use of BUFR and CREX seemed to be the only solution in the longer term.

6.2.88 Ultimately, all observations should be exchanged in BUFR, which offered more features than CREX. The use of BUFR required data-communication links supporting binary data; for the majority of GTS centres that stage had been reached or would be reached soon. However, some countries would need more time before being able to receive binary observations and a far longer period to be able to encode observations in BUFR. For some countries, the use of CREX might be an interim solution.

6.2.89 In light of the above, the Commission considered a phased approach that would comprise progressive steps for a shift (or migration strategy) to the use of table-driven codes for transmission of surface and upper-air observations, whereby synoptic data producers and originating/processing centres of ships, buoys, satellites, aircraft observations and other new types of observing sensors and platforms would be invited to transmit data in BUFR or CREX. The Commission invited already manufacturers of AWSs and other observing platforms to take into account the coming shift to table-driven codes for their software development. The Commission agreed to establish milestones leading to a plan for the migration to table-driven codes and the gradual phasing out of traditional character codes:

(a) As from November 2002, in a voluntary and experimental manner, some data producers, might transmit in real time observations in BUFR or CREX (and also in traditional alphanumeric codes, i.e. double dissemination, if the voluntary experimental users requested it);

(b) CBS-Ext. (2002) to review the migration process and consider a detailed plan for the elimination of all traditional WMO code forms for observations and retaining only table-driven codes FM 94 BUFR and FM 95 CREX.

6.2.90 The Commission recognized that provision of, and support for, encoding and decoding software for the table-driven code forms was an indispensable part of any migration plan. It noted with appreciation that application software on the official United States National Weather Service Web site was freely available to WMO Members, although support could not be extended to non-NWS users at the present time. It further noted that other WMO centres had encoding and decoding software that could be made available under certain conditions through bilateral arrangements. In particular, the United Kingdom informed CBS that it was developing GRIB edition 2 encoding and decoding software and that, when ready, it would be made available to NMHSs for their use similar to the software already made available for GRIB edition 1. CBS also noted that the implementation and integration of decoder/encoder “plugged in” an operational chain of programs was not a trivial issue.

6.2.91 The Commission considered that a successful migration to table-driven codes would depend on several supporting projects, new measures and assistance to Member countries. Those would have to include information dissemination, training, software distribution and possible assistance in implementation.

6.2.92 The Commission considered that the migration to table-driven codes would have implications in all the elements of the WWW system. However, the Commission requested that it should be a smooth transition without negative impacts on the WWW operations. The Commission therefore requested the OPAGs on ISS, on IOS and on DPFS to collaborate, under the leadership of OPAG/ISS, in studying and developing an implementation plan on the migration to table-driven codes. That should:

- (a) Identify and analyse problems due to the migration of data representation at every step of the WWW data flow. In particular, study the impact of the migration process on the GTS and data-processing centres. Develop proposals for solutions;
- (b) Define a software project to distribute universal BUFR, CREX and GRIB edition 2 encoding/decoding software to all requesting countries;
- (c) List in general terms the possible implications, due to the migration process, on WMO Members' resources for development and operation, and propose solutions to mitigate the impact on Members;
- (d) Develop a detailed migration plan to be considered by CBS-Ext.(2002);
- (e) Monitor the experience gained in bilateral tests;
- (f) Evaluate the relevant training needs and propose an appropriate training programme;
- (g) Examine the observation data flows within the WWW, from the view of the end user, in an “application-oriented manner”; to define new flows,

procedures or structures aiming at optimizing the benefit of the migration of data representation for better data acquisition and satisfaction of the requirements for more frequent observations, new parameters and new data types.

6.2.93 In the meantime, and with a view to promote further the use and understanding of the table-driven codes and GRIB edition 2 among all Members, the Commission requested:

- (a) The Secretariat to distribute guidance information describing in a simple manner the table-driven codes and explaining their advantages to the meteorological operational and research communities and to other associated scientific communities and organizations;
- (b) The ET/DR&C to define data templates (i.e. layout of the observation report) in BUFR and CREX for all observations (not all in CREX, e.g. satellite data) for inclusion in the *Manual on Codes* (in an attachment) in the summer of 2001. It requested the ET/DR&C to produce before the end of 2001 for distribution as guidance an improved guide on table-driven codes;
- (c) The understanding of the table-driven codes should be put as a first priority in the current Data Management Training Programme. It recommended the implementation of an additional training programme specifically on table-driven codes for all developing countries and invited other countries to train their own staff. Such training should be completed by October 2005.

6.2.94 CBS noted that those proposals had implications for technical cooperation activities and the work of other technical commissions, in particular JCOMM, CCI and CAS. It invited those commissions to comment on the feasibility of the proposals and to participate in the detailed planning process outlined in general summary paragraph 6.2.92 above.

MODIFICATIONS TO DATA REPRESENTATION TABLES APPROVED DURING THE INTER-SESSIONAL PERIOD

6.2.95 The Commission recalled the following two recommendations approved during the inter-sessional period by the president of CBS and the President of WMO:

- (a) Recommendation 8 (CBS-99) for implementation on 3 May 2000;
 - (i) Adding entries in the table giving the method of current measurement;
 - (ii) Adding entries for satellite numbers in Common Code Table C-5;
 - (iii) Enabling the coding of storm names and the addition of the RSMC Fiji zone in the South Pacific;
 - (iv) Adding entries to encode in BUFR data of NASA's QUIKSCAT ocean-viewing satellite;
 - (v) Adding entries for EUMETSAT's new radiance products and future MSG radiance products;
 - (vi) Updating the definition of two entries in BUFR Code Table 0 02 023 (satellite derived

wind computation method) to eliminate ambiguities at the request of EUMETSAT;

- (vii) Adding new entries for the exchange of radiological soundings in CREX;
- (b) Recommendation 9 (CBS-00) for use as from 8 November 2000:
 - (i) Adding a note under Table 30 (image) to clarify the representation of pixel values;
 - (ii) Adding new table entries for the interchange of windprofiler and radio-acoustic sounding system data;
 - (iii) Replacing notes under Table 13 (hygrographic and hydrological elements) to clarify the representation of trace and snow cover;
 - (iv) Adding new temperature descriptors to enable the proper representation of temperature measurements performed with increased accuracy and the correct conversion from Celsius to Kelvin and vice versa;
 - (v) Adding entries for the representation of QUIKSCAT SEAWINDS data;
 - (vi) Adding entries for the representation of the new ATSR SST products (SADIST-2);
 - (vii) Adding entries for the transmission of soil temperature data;
 - (viii) Adding entries for the representation of retrieved atmospheric gases data;
 - (ix) Adding entries for the representation of AWS data;
 - (x) Adding entries for reporting turbulence in automated aircraft reports;
 - (xi) Adding one entry to Code table 0 33 026 (moisture quality).

NEW MODIFICATIONS TO THE *MANUAL ON CODES* (WMO-No. 306)

6.2.96 Noting the stated requirements and the resulting proposals developed by several expert groups and CBS teams, the Commission recommended additions to FM 94 BUFR and FM 95 CREX tables to improve the transmission of data from AWS data, especially related to present weather to report observed quantities rather than qualitative parameters (see Annex 1 to Recommendation 3 (CBS-XII)).

6.2.97 In response to requirements stated by the DBCP, the Commission recommended the inclusion of drifting buoy metadata information in FM 18 BUOY (see Annex 2 to Recommendation 3 (CBS-XII)).

6.2.98 ICAO had expressed requirements to amend the FM 15 METAR, FM 16 SPECI, FM 51 TAF code forms and to add a note to the FM 53 ARFOR code form (explaining that a requirement by ICAO for that code did not exist). Those amendments resulted from the changes in aeronautical requirements contained in ICAO Annex 3 WMO Technical Regulation [C.3.1]. The Commission recommended the corresponding additions to FM 15 METAR, FM 16 SPECI, FM 51 TAF and FM 53 ARFOR (see Annex 3 to Recommendation 3 (CBS-XII)).

6.2.99 The Commission adopted Recommendation 3 (CBS-XII).

6.2.100 The Commission endorsed the rules and procedures for amending the *Manual on Codes* for inclusion in the "Introduction" of the *Manual on Codes* and adopted Recommendation 4 (CBS-XII).

6.2.101 The Commission noted with satisfaction that BUFR, CREX and Common Code Tables were accessible on the WMO server for digital processing. The Commission requested the Secretariat to take action to provide other parts of the volumes of the *Manual on Codes* also on digital media.

DATA REPRESENTATION AND CODES: INTRODUCTION OF FM 92 GRIB EDITION 2

6.2.102 The Commission recalled the freeze placed on FM 92 GRIB edition 1 as well as the need to develop a new edition 2 for FM 92 GRIB (see general summary paragraph 6.4.12 of the *Abridged Final Report with Resolutions and Recommendation of the Eleventh Session of the Commission for Basic Systems* (WMO-No. 854)). After several years of development and two years of experimentation and validation tests, the Commission considered the final proposal for the new FM 92 GRIB edition 2, which would enable the coding of new products, such as the output of ensemble prediction systems, long-range forecasts, climate predictions, ensemble wave forecasts or transport models. The Commission noted, however, that GRIB edition 2 was not the ultimate solution for gridded data but was rather another step in a continuous evolutionary process. In particular, the Commission recommended that ICT/DR&C further work urgently to define additional templates for the transmission in GRIB edition 2 of cross-sections and Hovmöller type diagrams.

6.2.103 The Commission thanked members of the Expert Team on Evolution of Data Formats and the ICT/DR&C as well as relevant previous existing bodies for contributing to the development and validation tests of GRIB edition 2. Based on the results of the validation tests, the Commission had confidence that the overall structure of GRIB edition 2 was sound. The Commission agreed that FM 92 GRIB edition 2 (see the annex to Recommendation 5 (CBS-XII)) should be adopted as an operational WMO code as from 7 November 2001. CBS noted that GRIB edition 1 was still a valid code and would remain in use, for example, for aviation purposes.

6.2.104 The Commission adopted Recommendation 5 (CBS-XII).

6.3 DATA-PROCESSING AND FORECASTING SYSTEMS (agenda item 6.3)

6.3.1 The Commission thanked Ms A. Simard (Canada), chairperson of OPAG/DPFS, who also served as chairperson of its ICT/DPFS, for her report. It noted with pleasure that work in that area had made considerable progress notwithstanding challenges of coordinating the work of many teams and addressing requirements of other programmes in collaboration with experts of other Commissions working under the auspices of that OPAG. The Commission expressed its thanks to all experts who served on OPAG/DPFS implementation/coordination and expert teams.

EVALUATION OF THE IMPACT OF CHANGES OF THE GOS ON NWP

6.3.2 The Commission noted with appreciation the conclusions and recommendations of the Expert Team to Evaluate the Impact of Changes of the GOS on NWP. It commended the chairperson, Mr T. Hart (Australia), and members of the Expert Team for the work accomplished. The Expert Team needed to be congratulated for the impressive amount of work that had been done by electronic mail.

6.3.3 The Commission noted that, in principle, NWP verification statistics potentially provided a tool to assist in monitoring the operation and performance of the GOS. If the statistics could be used to assess the impact of changes in the GOS, they would complement the previous OSEs or OSSEs studies, vindicating the claims made in advance, adding credibility to such design procedures and confirming the delivery of improved performance to operational products.

6.3.4 While the single case study based on failure of the TOVS instrument on NOAA-11 in February 1999 supported the potential use of the routinely exchanged verification statistics, the results were not conclusive due to the many changes that took place at the same time, such as the use of new AMSU instruments, the use of radiances, etc. However, that study helped develop the procedures to be used in further studies. The Expert Team carried out a further case study based on the reduction in the number of Russian radiosondes during late 1990s. The Commission noted with interest the Study of the Impact of the Loss of Russian Federation RAOBs on NWP Verification Statistics in the Northern Hemisphere carried out by the Expert Team of OPAG/DPFS. It noted the difficulty to detect a clear signal in the NWP verification statistics and emphasized that the conclusion applied only to global models as the impact on regional models had not been investigated. It noted that it was not possible to prove or to disprove whether it was possible to establish a meaningful impact of reductions in the radiosonde network in Russia through evaluation of readily available verification scores of global and/or regional-scale operational forecast models. The main question was how to determine the impact of a particular observation system. The Commission agreed that a more rigorous methodology must be used and that the matter should be pursued further. The use of verification statistics would not answer many questions covering the impact of observing systems on the GDPS. OSEs had been successfully used in the past and should have a role in future impact studies. It therefore endorsed a plan to conduct a specific OSE using a reanalysis system and dataset to test the hypothesis that loss of the RAOB data from the Russian Federation did have an impact on the quality of the NWP analysis and forecast. The Commission invited OPAG/DPFS to keep that OSE under review and to make recommendations on the potential for using verification scores and on possible changes in verification procedures to facilitate impact assessment.

6.3.5 The Commission agreed on the need to establish mechanisms for the more timely assessment of

changes in the GOS that might affect the quality of the NWP analyses and forecasts. It invited OPAG/DPFS to address the issue.

6.3.6 The Commission noted with satisfaction the procedures to evaluate the impact of changes of the GOS on NWP and the exchange and dissemination of results developed by the Expert Team as given in Annex V to this report. It invited ICT/DPFS, in consultation with Lead Centres, to develop further an appropriate attachment to the *Manual on the GDPS* (WMO-No. 485).

6.3.7 The Commission considered guidelines for action to minimize the impact of loss of observations on the operation of the GDPS. The guidelines were based on experience with the shutdown of the OMEGA system and the action taken on year 2000 compliance. They were intended to minimize the impact of planned or unplanned changes to the GOS and are given in Annex VI to this report. Those guidelines would be published in the *Guide on the Global Data-processing System* (WMO-No. 305).

6.3.8 The Commission also agreed that the Lead Centre for the quality monitoring process had an important role to play in that process. It was agreed that the list of stations identified as having problems should be made more widely available to Members. It stressed the importance for all centres participating in the exchange of CBS scores to adhere, to the extent possible, to the recognized procedures as laid down in Table F, Attachment II.7 of the *Manual on the GDPS* (WMO-No. 485), and agreed that arrangements should be pursued to have a reliable climatology available to all the centres for the purpose of the computation.

6.3.9 It endorsed the following actions to provide more timely alerts to Members concerning changes in the GOS:

- (a) Members should establish a data users e-mail news-group;
- (b) The Secretariat should implement flashing "What's New" icons to links on the WWW section of the WMO Web page referring to recent updates on the GOS.

6.3.10 The Commission decided to entrust the future work on that subject to ICT/DPFS as indicated under agenda item 9.

DEVELOPMENT OF A VERIFICATION SYSTEM FOR LONG-RANGE FORECASTS

6.3.11 The Commission noted with appreciation the conclusions and recommendations of the Expert Team to Develop a Verification System for Long-range Forecasts. It commended the chairperson, Mr F. Lalaurette (ECMWF), and members of the Expert Team for the work accomplished. It also acknowledged the work that had been done through correspondence.

6.3.12 The Commission noted with appreciation that the Expert Team, in collaboration with CCI and CAS, had developed a standard verification system for long-range forecasts on the basis of updates to the CBS adopted verification system. The Commission agreed that verification in hindcast mode was of crucial

importance to determine the forecast skill of a product. The new system being implemented on an experimental basis to exchange scores among various centres included a method of attaching information on the forecast skill of a product which would provide users with substantial guidance on the extent to which they might rely on the product in planning applications. Detailed specified arrangements and procedures to use operationally and exchange verification scores, including a specification document that described in detail the mechanism for the verification of long-range forecasts and the calculation of all proposed scores including the status of availability of verification datasets, had been developed.

6.3.13 The Commission was pleased to note the actions successfully taken by the Expert Team on its coordinated implementation action plan covering the activities for the period since the fourth quarter of 1999, and the foreseen start of the experimental exchange of LRF verification scores between all participating centres and institutes by the first quarter of 2001.

6.3.14 The Commission endorsed, in the first place, the experimental implementation of the revised version of the Verification Systems for Long-range Forecasts — Revised Experimental Scores to be Exchanged as given in Annex VII to this report. The Commission noted that the proposed verification areas for the tropics were different from the current standard verification areas for short- and medium-range forecast. It invited ICT/DPFS to address those issues with a view to updating the current verification areas for the tropics. It considered that in the light of the results and the experience on experimental use and subsequent consultations with CAS and CCI, the fine tuned standard verification system would be proposed for consideration by CBS not later than its CBS-Ext. (2002) session.

6.3.15 The Commission noted the contribution made by the CMC/RSMC Montreal, in the preparation of the specification document that described in detail the mechanism for the verification of long-range forecasts and the calculation of all proposed scores, and the definition of a template for the exchange of verification results. CMC also had offered software to other centres for implementing some aspects of the system. In order to facilitate timely implementation and operational success of the standard verification system, the Commission received with appreciation the offer of Australia to provide lead center functions and agreed to designate WMC Melbourne as the lead GDPS Centre on implementation and operational aspects of the verification system for long-range forecasts. The designated lead centre would provide the centralized Web site functions indicated in Annex VIII to this report.

6.3.16 The Commission recognized that there were several questions that had yet to be studied in that specific area and recorded its decisions on that work under agenda item 9.

METHODS USED IN LAND SURFACE DATA QUALITY MONITORING

6.3.17 The Commission noted with appreciation the conclusions and recommendations of the Expert Team

to Review and Fine-tune Methods Used in the Land Surface Data Quality Monitoring. It commended the chairperson, Mr N. Sato (Japan) and members of the Expert Team for the work accomplished.

6.3.18 The Commission noted the findings on the feasibility of quality control of amounts of precipitation in synoptic reports. To address the shortcomings identified in accounting for correct accumulation of precipitation amounts reported over a 24-hour period, the Commission recommended that RA II members consider aligning their reporting practices so as to report precipitation for the preceding six and 24 hours in accordance with global procedures. The Expert Team had also recommended that 24-hour precipitation should be reported by all Members and measured zero precipitation should be reported as zero in the code. The latter proposal would however entail changes to the correct global reporting practices, so that the Commission invited the ET/DR&C to revise the procedures with a view to the mandatory reporting of 24-hour precipitation and reporting zero measured precipitation as zero in the code as recommended by the Expert Team on Land Surface Data Quality Monitoring. It was noted that the reporting of zero precipitation in the code would lead to a slight increase of volume in data exchange but the benefits outweighed the telecommunication cost implication of that increase.

6.3.19 The Commission welcomed the GPCC's offer to provide the results of global precipitation monitoring to the WMO Regional Lead Centres on Data Quality Monitoring. It recognized the GPCC as the global centre for quality monitoring of precipitation and invited GPCC to provide the results of its monthly precipitation monitoring to the lead centres for surface data monitoring for their use in developing six-month consolidated reports.

6.3.20 The Commission considered that verification of precipitation including snow depth in the short- and medium-range would, for the time being, continue to be an area of research and development and should remain under the auspices of the CAS/JSC Working Group on Numerical Experimentation and GCOS/AOPC. It further noted that other surface weather forecast elements, such as wind and temperature, were tailored for national users by using MOS/PPM procedures to correct for local effects. Their verification required a high density observation network that was available only at the national level. The Commission therefore recommended that all GDPS centres make their results from verification of surface weather elements available to users on their Web site.

6.3.21 The Commission reviewed current procedures in the *Manual of the GDPS* and endorsed the recommendation of lead centres for quality monitoring of surface observations for the addition of standards for the monitoring of geopotential height from surface observations. Although the recommendation specified an absolute value of the mean bias of 25 m as one of the criteria for designation as a suspect station, the Commission encouraged NMHSs to pursue investigating stations with mean biases less than 25 m in their own countries but

not to include them on monitoring lists. It was also agreed to include general guidance reflecting GPCC procedures for precipitation quality monitoring under section 6.3.3.1 of the *Guide on the GDPS* (WMO-No. 305) as given in Annex IX to this report. It invited the lead centres for the other types of observations to develop and complete procedures and formats for the exchange of monitoring results for inclusion in the *Manual of the GDPS*, in accordance with the provisions of Attachment II.8, paragraph 1.1.

6.3.22 Recommendation 6 (CBS-XII) was adopted.

6.3.23 The Commission, noting the work achieved by the the Expert Team on Land Surface Data Quality Monitoring, agreed that it be dissolved but activities related to data monitoring would be addressed through ICT/DPFS.

IMPLEMENTATION OF DPFS

ENSEMBLE PREDICTION SYSTEM

6.3.24 The Commission, taking into account the views of ICT/DPFS, and the request of the fifty-second session of the Executive Council regarding making EPS products more widely available, urged those Members producing global ensemble products to make them available. A basic list of EPS products to be distributed should at least include:

- (a) Probability of precipitation;
- (b) Ensemble mean at 500 hPa;
- (c) Some indication of variability (e.g. spaghetti plots, spread).

Ranges to be covered were at least D4 (96 hours) to D7 (168 hours).

6.3.25 The Commission recommended four types of EPS training as followed:

- (a) Regional WMO workshops to explain the EPS approach, its usefulness and its limitations. It should concentrate on the products which were available. Those workshops would be mainly useful for those who intended to use EPS end products;
- (b) Technical cooperation type of training for those who intended to make their own products and/or who would need more specific training about products or the methodology of the forecast. Training could be organized on individual request or through WMO voluntary cooperation arrangements;
- (c) Workshops or seminars developed by centres running EPS. Those centres were encouraged to open them to a wide range of participants. Co-sponsorship with WMO should be considered;
- (d) Universities engaged in training in meteorology should be encouraged by Members to include topics related to EPS in their programme.

6.3.26 To assure the coordinated implementation of initial procedures for making EPS products available, the Commission endorsed the following action plan:

- (a) The CBS Newsletter should be used as a means to publicize Web sites where information on ensemble forecasting and products were available. Centres making available EPS products were invited to inform the Secretariat of the relevant URL;

- (b) As a first step, and starting immediately, regional associations were invited to refine EPS requirements and initial individual requests from NMHSs and interested EPS running centres should be acted upon;
- (c) The WMO Secretariat should plan to hold regional workshops focusing on EPS training under the appropriate WMO Programme;
- (d) Create under OPAG/DPFS an Expert Team on EPS with the work programme as given under agenda item 9.

SEVERE WEATHER FORECASTING

6.3.27 The Commission, when considering the availability and use of NWP guidance on the occurrence of severe weather, noted that user requirements would vary depending on the expertise and capabilities of different centres. It further noted that not every centre would be able to run their own NWP system although a number of centres had been successful in doing so over the past few years. It felt that centres planning to set up their own NWP system should:

- (a) Undertake a feasibility study so that the shortcomings could be addressed. The shortcomings might include the initial and ongoing cost of hardware and software, telecommunications cost, maintenance cost, human resources and scientific capability;
- (b) Contact one of the lead centres for initial and boundary conditions, as appropriate.

It should be realized by the centres that that was a long-term commitment and that it would take years to establish.

6.3.28 The Commission noted that some centres had the capabilities to do post processing. Those centres did receive the GRIB data but might not be able to exploit the use of that data to their benefit yet. They were encouraged to develop value-added products adapted to their local needs. Other centres that did not have those capabilities should be encouraged to strive for that solution. It should be realized that it would take time to set up such a system as well.

6.3.29 It encouraged centres that had only static display systems to upgrade to a post-processing system because static display had several limitations. If the centre stayed dependent on those static displays, the following was recommended:

- (a) The special products needed to forecast severe weather must be requested by the individual NMC. An agreement by RSMCs to provide NWP guidance already existed and Members were encouraged to utilize the products made available;
- (b) The centre providing diagnostic products relevant to severe weather, based on NWP, would not take into account local conditions. The centre that used those calculated indices must be aware that those products were solely NWP-based with no human intervention or quality control. Those products should therefore be carefully evaluated;
- (c) Diagnostic products relevant to severe weather might need to be adapted to local conditions, following evaluation and case studies. Examples of diagnostics products were noted by CBS-Ext.(98);

- (d) The specialized centres should then monitor requests and provide the special products agreed upon.

6.3.30 The regional associations were invited to address the above requirements where appropriate. The Commission encouraged exchange visits of forecasters from centres that dealt with forecasting of severe weather. The Commission was informed that in the case of RA VI, the ECMWF was developing and implementing an operational medium-range severe weather programme for the benefit of the Members of the Region and other Regions, as appropriate.

6.3.31 The Commission endorsed the following identified training needs:

- (a) Training to implement a model;
- (b) How to handle the post-processing system acquired;
- (c) Applications and interpretation of model products;
- (d) How to develop conceptual models;
- (e) Development, interpretation and use of model-generated severe weather diagnostics.

ACTION PLAN

6.3.32 The following action plan was suggested:

In order to facilitate coordinated implementation of procedures for assuring availability and use of NWP guidance on the occurrence of severe weather at NMHSs, the Commission emphasized the important role of protection of life and property, and endorsed the following action plan:

- (a) Urge Members to create or develop further GDPS facilities, taking into account the levels of expertise;
- (b) Urge leading centres to assist other centres in developing more expertise;
- (c) Recommend that the different centres assess their training needs for severe weather forecasts and convey them to the WMO Secretariat;
- (d) Recommend that WMO set up training workshops;
- (e) Stress the importance of severe weather forecasts and encourage centres to conduct research on their own local severe weather;
- (f) Nominate under agenda item 9 a Rapporteur on the Application of NWP to Severe Weather Forecasting.

LONG-RANGE FORECASTING INFRASTRUCTURE

6.3.33 The Commission noted that the issue of an appropriate infrastructure for the provision of long-range forecasts was an active concern within several WMO Commissions. The issue had been discussed extensively at the Initial Planning Meeting on the Coordination of Infrastructure Needs for Seasonal and Interannual Climate Prediction, held in Geneva in April 1999. Arising from that meeting, specific action had been included in two resolutions at Thirteenth Congress, namely Resolutions 2 — World Weather Watch Programme for 2000–2003, and 8 (Cg-XIII) — Climate Information and Prediction Services Project. The Commission noted the particular role assigned in both resolutions to OPAG/DPFS in enhancing existing RSMCs functions and, where appropriate, in designating RSMCs specializing in the area of climate monitoring

and prediction. It noted that pursuant to the Congress resolutions, ICT/DPFS had developed a proposal for an infrastructure for the generation of seasonal-to-interannual long-range forecasts.

6.3.34 The Commission noted the proposed general approach of ICT/DPFS for a global long-range forecasting system which included the following three components:

- (a) RSMCs with activity specialization in long-range forecasting providing global and/or broad-scale regional products (Level 1);
- (b) Entities and mechanisms to develop consensus forecast products (Level 2);
- (c) NMHSs having the ultimate responsibility for the preparation and delivery of long-range forecasts (Level 3).

6.3.35 Upon further elaboration, based on the ICT's recommendations, the president of CBS presented that approach to the presidents of CCI and CAS and also made it available to OPAG/DPFS. The Commission noted that by Resolution 2 (EC-LII) — Intercommission Task Team on Regional Climate Centres, the Executive Council had established such a body. It agreed that the above approach on a global long-range forecasting system formed the basis of its input to the intercommission task team, although consideration would also need to be given to other reports and to the emerging regional views on infrastructure. The Commission recognized that there were issues and procedures to be further developed in that area and recorded its decision under agenda item 9.

ECMWF PRODUCTS

6.3.36 The Commission noted with appreciation that the ECMWF Council decided in December 1999 to make available global seasonal forecast products to the NMHSs via its Web site subject to obtaining a user ID and password so as to ensure NMHSs' advance access to the Web site before the forecasts became public. The Commission noted with satisfaction that the fifty-third session of the ECMWF Council (November 2000) had approved most of the requirements submitted by WMO for the dissemination on the GTS of several additional ECMWF products including EPS products.

EMERGENCY RESPONSE AND RELATED ACTIVITIES

6.3.37 The Commission noted with appreciation the conclusions and recommendations of the Expert Team on Emergency Response and related activities. It commended the chairperson, Mr P. Chen (Canada), and members of the Expert Team for the work accomplished.

6.3.38 The Commission's areas and means of cooperation with CTBTO were being developed. It was noted that the plans discussed between CTBTO and WMO included:

- (a) The daily provision of global NWP gridded fields to drive CTBTO models and auxiliary data for quality control;
- (b) The provision of atmospheric transport model products from selected WMO specialized centres;

- (c) The provision of meteorological data from CTBTO monitoring stations to WMO through the CTBTO; and

- (d) Assistance in the development and operation of CTBTO's own atmospheric transport model capability International Data Centre. It noted with satisfaction the status of implementation of Recommendation 4 (CBS-Ext.(98)) — WMO/CTBTO cooperation in areas related to meteorological measurements and transport modelling. It was informed of the successful testing of the concepts, exploring in a practical way, some of the possible avenues for cooperation as they applied to long-range transport and dispersion modelling as applied to treaty verification purposes. An additional trial was planned for the near future. It was noted that the results, lessons learned and areas of further exploration of the systems/products would be discussed at a workshop of the Provisional Technical Secretariat of the CTBTO, to be held in 2001.

6.3.39 The CTBTO representative informed the session that the CTBTO Preparatory Commission had approved the draft relationship agreement between the Commission and WMO on 21 November 2000. In light of that, the provisional measures could be implemented by the WMO Secretary-General and the Executive Secretary of the Commission following the endorsement of the agreement by the WMO Executive Council. He underlined that the agreement built on the working relations already established between the Secretariats of the two Organizations. He noted aspects of the work of the CTBTO that might be of interest to WMO. Firstly, their unique global network of radionuclide surveillance stations would occasionally detect signals from small accidental radioactive releases; such events would provide good benchmarks for atmospheric transport modellers. Secondly, the CTBTO monitoring network included remote stations that would also collect meteorological data, which would be transmitted in real time to the International Data Centre in Vienna. Such data should be made available to the WMO Members. In the future, it might also be useful to investigate the feasibility of their sharing certain means of data communication.

6.3.40 The session noted that the CTBTO real-time infrasonics and seismic data could also be used for the detection of volcanic eruptions, which were a serious danger to aviation. An initial presentation of the related ICAO requirements had been made to CTBTO in August 2000. The next step would be to develop a joint ICAO/WMO statement of requirements for presentation to the CTBTO specifying the aeronautical needs in detail for access to CTBTO monitoring data to support the ICAO IAVW.

6.3.41 The Commission noted that various exercises involving some RSMCs were carried out. It noted the successful conduct and evaluation of the environmental emergency response global WMO/IAEA exercise conducted in June 2000. In accordance with the specific aims, tests were made on the proposed modified ERA

and related activities in terms of procedures, validation and effectiveness of the new arrangements, and procedures, standards and confirmation to the adequacy of existing procedures. It was noted with satisfaction that the exercise further demonstrated that ERA could realistically deliver authoritative and timely meteorological advice through nearly all of its Members NMSs throughout the world. The modified procedures, as recommended to CBS-XII, were tested and worked. At the same time, the experience of the exercises had pointed to some areas which could be further improved and should be considered by the Expert Team on Emergency Response. For example, the implementation of the clarified notification procedures and practices by the IAEA of the WMO Secretariat and RTH Offenbach could benefit from additional testing and confirmation (see general summary paragraphs 6.3.43 and 6.3.44). In particular, in a safety critical regime where a few minutes delay could have consequences, the implementation of coordinated, frequent, including impromptu, regional and global exercises with clear objectives, should be further explored. The Commission agreed that other proposals for enhancing shortcomings in notification procedures and in the regional and global arrangements should be considered. The Commission invited its OPAG/DPFS to address the relevant issues resulting from the conduct and evaluation of exercises.

6.3.42 To address the issue of current disadvantages in the use of telefax as a means of communication, the Commission noted that WMO, IAEA and the RSMCs Montreal and Washington had jointly explored other as well as better means of transmitting the information to the NMSs that had the required technology (e-mail, www, ftp, etc.) with very promising results. Faxing would remain the official means of transmitting the information to the countries unless otherwise requested. It was agreed that the list for delegated authorities and NMS operational contact continued to be regularly updated by Members and accessible from the WMO Web site.

6.3.43 The Commission endorsed clarification of the procedures and practices relating to the notification of WMO by the IAEA in the context of, and based on, its obligations specified in the Convention on Early Notification of A Nuclear Accident. As regarded WMO, the IAEA would notify the WMO Secretariat and the RTH Offenbach (Germany). The latter would notify the NMCs by means of the EMERCON message through the GTS. It recommended regulatory text on notification to be included in Appendix I-3 in the *Manual on the GDPS* (WMO-No. 485).

6.3.44 To improve procedures and practices, the Commission also considered operational procedures for response to nuclear accident taking into account new IAEA requirements and the fact that the RSMCs might also make use of other appropriate technologies in addition to fax.

6.3.45 The Commission noted with satisfaction the IAEA statement indicating its intention to continue collaboration with WMO through mutual consultations

and participation in the work of OPAG/DPFS's ICT on Emergency Response and Related Activities and the Interagency Committee on the Response to Nuclear Accidents.

6.3.46 Recommendation 6 (CBS-XII) contained the text to be included in the *Manual on the GDPS*.

6.3.47 With regard to guidance for response to chemical incidents and forest fires, the Commission noted that the CBS-Ext.(98) guidance on chemical incident supplemented by input from the Royal Netherlands Meteorological Institute on their experience in setting up an emergency response organization on serious chemical accidents had been included in the *Documentation on RSMC Support for Environmental Emergency Response* (WMO/TD-No. 778). It was noted with satisfaction that the RSMC Melbourne (Australia) had been active in the provision of transport model products in response to forest fires in the South-East Asia region, and that procedures to integrate and activate NMSs/RSMCs in case of chemical incidents and forest fires developed by the RSMC and endorsed by the Expert Team on ERA had been included in the *Documentation*. The Commission noted with appreciation those useful additions made by the Netherlands and RSMC Melbourne.

6.3.48 As regarded the products to be made available and the procedures for meteorological support services to humanitarian missions, it was noted that WMO had already established a Web server which contained links to the NMSs. The list of the NMS contact points had been implemented under the PWS Programme and the RSMC backup access included, under the GDPS Programme, links to RSMCs Web pages. As regarded the provision of climate database envisaged by CBS-Ext.(98), it was felt that there was no clear requirement provided from UN/OCHA to consider constructively data content and possible access mechanisms. The Commission agreed that the existing arrangements be tested and evaluated as regarded their suitability to meet UN/OCHA's requirements before additional resources would be committed.

6.3.49 The Commission recognized that there were several questions that had yet to be studied in that specific area and recorded its decision on that work under agenda item 9.

CBS RAPPORTEUR ON WORKSTATIONS

6.3.50 The Commission commended Ms L. Jones (United Kingdom), the CBS Rapporteur on Workstations, on her report covering the uses made of various workstations in NMHSs including such items as the costs, software and support. The report was based on a survey to capture the necessary information and to analyse current practise in NMHSs and develop guidelines, which could be used by NMHSs that considered investing in a forecaster workstation system. The Commission agreed that the report should be made available to all NMHSs. The Commission invited its OPAG/DPFS to address the recommended actions which included provisional information to countries without forecast workstations, encouraged sharing and development of first-guess graphics/text, determined why commercial databases

were not used and ways of development of skills to run and maintain such systems.

DESIGNATION OF AN RSMC

6.3.51 The Commission noted the request of the president of RA V for the designation of Tropical Cyclone Warning Centre, Honolulu, Hawaii, as an RSMC with activity specialization in tropical cyclones on the basis of requirements for cyclone warning and forecasting in the Central Pacific Ocean basin, north of the Equator from 180° to 140°W, as stated by the third Tropical Cyclone RSMCs Technical Coordination Meeting (November 1999). The Commission was informed of the formal commitment of the United States that their Tropical Cyclone Warning Centre in Honolulu, Hawaii, would fulfil those functions. The Commission expressed appreciation for the presentation made on the capability of that Centre and agreed that the relevant provisions of the designation procedures had been fulfilled by the Centre. The Commission, therefore, recommended the designation of Honolulu, Hawaii, as an RSMC with activity specialization in tropical cyclones for the Central Pacific, and adopted Recommendation 7 (CBS-XII).

6.4 PUBLIC WEATHER SERVICES (agenda item 6.4)

6.4.1 The Commission noted with appreciation the report of the chairperson of OPAG/PWS, Mr K. Essendi (Kenya). It expressed satisfaction that the PWS Programme had made significant strides during the two years since the restructuring of CBS and considered that the efficiency with which the various teams in the OPAG/PWS had dealt with their terms of reference, had been instrumental in promoting and advancing the aims and objectives of the Programme according to the decisions of Congress.

6.4.2 The Commission recalled that when establishing OPAG/PWS at CBS-Ext.(98), a number of factors had played a key role in the working structure of the OPAG. Those factors stemmed largely from challenges faced by NMSs and were subsequently formulated into the mandate of the PWS Programme. A major challenge for the NMSs then, which was even stronger today, was the recognition that in the face of the global economic situation and a changing environment, they were forced to make a strong case for a share of national public funding. As a result, NMSs needed the capability to demonstrate the usefulness of services to their Governments, the public and other users in support of safety of life and national development.

6.4.3 The Commission agreed that the overarching framework within which the individual components of the PWS Programme were developed was to provide comprehensive assistance and support to NMSs to increase their capabilities to meet the above challenge through:

- (a) Developing a clear vision and focus on users of services;
- (b) Delivering vital public weather services in support of safety of life and protection of property to the community in an effective and timely manner;

- (c) Addressing broader community and government interest in weather, climate, the environment and human health issues (ultraviolet, pollution);
- (d) Contributing to improved international and national coordination of natural disaster reduction including enhancing public awareness and responsiveness;
- (e) Enhancing awareness of the economic benefits of meteorological services;
- (f) Complementing the upgrade of technical components of NMS infrastructure with capacity building in the areas of design, development and delivery of services, especially in developing countries;
- (g) Determining the most suitable dissemination methods and packaging of products to ensure rapid and efficient service delivery.

MEDIA ISSUES

6.4.4 The Commission recalled that one of the major undertakings within the PWS Programme since its establishment had concerned the role of the media, both national and international, *vis-à-vis* NMSs. It had been recognized that dialogue and discussions with the media were essential in order to address the concerns of both the NMSs and media organizations. The Expert Team on Media Issues (ET/MI) had been established to concentrate primarily on promoting better partnerships with the media by focusing on the requirements and constraints of both the NMSs and the media and on the issue of "single official voice". For that reason, representatives of the international media and the IABM had been kept informed of activities within the PWS Programme as regarded the media issues and had actively participated in the discussions at the Meeting of the Expert Team on Media Issues (Orlando, United States, June 1999).

6.4.5 The Commission felt that it was essential to ensure the efficient and effective flow of information between the NMSs and the media. It was pleased to note that the representatives of international broadcasters had re-affirmed their intention to make use of official warnings and information prepared by NMSs. A major obstacle to achieve that, however, was lack of a single and centralized source of such information. To be useful and used by broadcasters, who often operated under severe time constraint, information had to be accessible easily and in a media-friendly format. For their part, the broadcasters had agreed that benefits of acknowledging NMSs as sources of data and detailed information on severe weather warnings included increasing the visibility of NMSs and lending credibility to broadcasts. The Commission noted an important issue concerning the due recognition of the authority of an RSMC in its assigned region of responsibility and requested the international media to make every effort to familiarize itself with the rules of operation of RSMCs in order to avoid broadcasts of warnings which were in conflict with the guidance and advisory issued by the responsible RSMC.

6.4.6 The Commission concluded that in order to overcome some of those difficulties, the ideal long-term

solution would be the use of a centralized Web site. It welcomed the work already done by the Expert Team on Product Development and Verification and Service Evaluation (ET/PDVS) to initiate a pilot project to demonstrate the viability of a trial centralized Web site that worked through the existing NMC/RSMC structure. It also noted with gratitude that Hong Kong, China had offered to host and develop a demonstration site to display the warnings of tropical cyclones in the ESCAP/WMO Typhoon Committee region with voluntary contributions from the NMSs in the region. The Commission was pleased to note that that proposal, which would be implemented in close cooperation with the Tropical Cyclone Programme, had been endorsed by the fifty-second session of the Executive Council. Members in the Typhoon Committee region had been invited to nominate focal points to cooperate with the Secretariat and the experts from Hong Kong, China in the implementation of the pilot project. The Commission noted with appreciation that as a result of such cooperation, a prototype had been completed and its operational feasibility would be tested. Figure 6 in Annex I to this report showed the Web page developed under the pilot project.

6.4.7 The Commission expressed its appreciation to Hong Kong, China for the excellent work done in developing the pilot project. It further expressed its full support for the pilot project and stressed that although successful, the project had only been the first step in achieving the objective of ET/MI. The Commission requested that the development of the project should continue without delay and at a rapid pace with voluntary participation by Members with a view to making the Web site accessible by all users. The Commission further agreed that work on the long-term development of the concept to cover other major weather events and other regions of the globe should continue. In that connection, the Commission noted with gratitude the offer made by several Members to assist with that work.

6.4.8 In view of the importance of a good relationship between NMSs and the media to help NMSs in informing the public and to improve their own visibility, the Commission noted with satisfaction that ET/MI had prepared guidance for strengthening links and improving communications between NMSs and the media. Those included *inter alia* establishing procedures and mechanisms for dealing with the media, particularly in times of severe weather, getting to know the media's expectations and procedures, cultivating working relationship with the media during periods of normal weather so that during severe weather it would effectively inform the public correctly and in a timely manner, adopting a "model" appropriate to their own culture and circumstance on how to designate staff to deal with media issues, including TV weather producers in training activities of NMSs aimed at weather presenters.

6.4.9 The Commission expressed strong support for continued efforts to develop better a partnership between NMSs and the media and for ongoing dialogue between the international broadcasters and WMO so as

to carry forward the progress made by ET/MI in implementing practical solutions for Members' concerns.

PRODUCT DEVELOPMENT AND VERIFICATION AND SERVICE EVALUATION

6.4.10 The Commission recalled that both Congress and CBS had requested that, through the PWS Programme, high priority be given to assisting Members on how to quantify forecast uncertainty, on conducting verification of warnings and forecasts and service evaluation, and on the overall improvement in dissemination and presentation of public weather products and services. The ET/PDVS was set up to address those specific areas and had had its session in Hong Kong, China, in November 1999.

6.4.11 The Commission noted that ET/PDVS had developed an outline of a technical framework for data and products in support of PWS. The outline had since been developed into a WMO technical document to provide guidance to NMSs, especially smaller Services and those in developing countries, in keeping pace with developments in technology. The Commission agreed, as part of its work on the future WMO information system, to give greater attention to the needs of NMSs in the area of delivery of public weather services.

6.4.12 The Commission noted with interest the development of the RANET project, which was a cooperative effort initiated by ACMAD in order to improve access to climate and weather-related information throughout Africa. RANET made it possible to receive information in the form of bulletins, reports, observations, satellite imagery and products of NMSs that were placed in the public domain. The Commission agreed that the utilization of RANET in developing countries in Africa, Asia and South America should be encouraged and promoted.

6.4.13 The Commission noted that in view of an increased demand for graphical public weather products, ET/PDVS had developed an outline of guidance material for developing a presentation system, including both technical and design aspects. The guidance material was in the process of being produced in the form of a WMO technical document.

6.4.14 The Commission noted that ET/PDVS had considered the key purposes of a performance evaluation programme and had recognized the necessity of the two types of information gathered in such an assessment, namely technical evaluation or verification and user-based assessment. The Commission expressed satisfaction that the *Guidelines on Performance Assessment of Public Weather Services* (WMO/TD-No. 1023), prepared by ET/PDVS, had been published.

6.4.15 The Commission was of the opinion that work needed to continue beyond preparation of guidance materials in order to assist members with the implementation phase of recommendations and guidelines.

WARNING AND FORECAST EXCHANGE ISSUES

6.4.16 The Commission recalled that the Expert Team on Warnings and Forecasts Exchange Issues (ET/WFEI) had been established to:

- (a) Develop a methodology for the international exchange of NMS forecasts for the public as part of the efforts to enhance the visibility of NMSs;
- (b) Develop a methodology for the cross-border exchange of warnings.

6.4.17 The Commission noted the concerns of Members, especially from developing countries, regarding the forecasts broadcasted by international media organizations and made available on the Internet. In particular, those Members were concerned about the impact of those activities on the recognition of the PWS that NMSs provided. The Commission felt that a solution would be to make available the major city forecasts prepared by NMSs to other NMSs. It therefore agreed that, as a pilot project, a Collecting Centre should be designated to collect the weather forecasts supplied by participating NMSs to generate an integrated product of major city forecasts around the world. The Commission noted with appreciation that such a concept in the form of a Web site had been developed by Hong Kong, China, which included forecasts of temperature and weather for selected cities for the next few days or climatological information in the absence of such forecasts. The Web pages would clearly display the source of the information and would also allow all WMO Members to participate and to establish an international presence. The Commission agreed that Hong Kong, China would take the lead in further developing the concept and act as the Collecting Centre. It further agreed that that pilot project should be launched and should take the form of an operational trial involving as many Members as possible sending their city forecasts to the Collecting Centre.

6.4.18 As regarded cross-border exchange of warnings, the Commission was of the opinion that although the exchange of information existed in some regions, there was still room for improvement and expansion, especially with respect to warnings. In some areas, cross-border exchange was non-existent. The Commission recommended that bilateral and/or regional cooperation should be encouraged and expanded according to local requirements. There should be common agreement as to the types of weather phenomena warnings to be exchanged and on the format for such exchange. In addition, information on national criteria for warning thresholds should be made available. The Commission noted that a list of hazard types that could be selected for such exchange had been developed by ET/WFEI, and some examples of thresholds, which were already in use by some NMSs, were provided.

6.4.19 The Commission noted the available communication methods used for the exchanges, including the Internet and recommended the use of standardized format and content of messages.

6.4.20 The Commission recommended the organization of regional workshops to train forecasters in severe weather forecasting, to issue severe weather warnings, to improve communication skills, and to familiarize them with practices and procedures of other NMSs in their region. It was noted that exchange

guidelines to initiate or enhance bilateral agreements on the exchange of warnings should be prepared by ET/WFEI.

6.4.21 The Commission concluded that work needed to continue on keeping under review the implementation of methodologies for the exchange of forecasts and warnings.

IMPLEMENTATION COORDINATION ACTIVITY

6.4.22 The Commission noted with appreciation the work carried out by ICT/PWS, which focused on coordinating the implementation aspects of the work of the expert teams in OPAG/PWS. It also noted that in addition to its coordinating function, ICT/PWS had addressed several specific issues concerning capacity building and disaster management at its meeting in Langen, Germany, in December 1999.

GUIDE TO PUBLIC WEATHER SERVICES PRACTICES (WMO-No. 834)

6.4.23 The Commission noted with satisfaction that the second edition of the *Guide to Public Weather Services Practices* had been published in 1999. That new edition particularly highlighted the concept of user-focused service provision and delivery. The results of a global survey on the current status of Members' PWS, published in 1999 (*Public Weather Services in Focus*, WMO/TD-No. 974), had been very valuable in the preparation of the *Guide*. The Commission was pleased that a series of four CD-ROMs based on the *Guide* had also been distributed to Members. The CD-ROMs aimed at providing additional material to assist Members with improving their national PWS programmes.

GUIDELINES FOR NMSs FOR "BEST PRACTICE"

6.4.24 The Commission noted with appreciation that ICT/PWS had developed guidelines for NMSs for "best practice" on relationships between NMSs and emergency management organizations. ICT/PWS had encouraged more efficient communication between the two for the benefit of the public but recognized that "best practice" by an NMS would be dependent on socio-economic norms, national and local policies and existing organizational mechanisms for disaster management in the country.

SUPPORT FOR CAPACITY BUILDING AND TRAINING

6.4.25 In view of the major role that effective, high quality PWS could play in demonstrating the value of government investment in NMSs, the Commission highlighted the importance of giving high priority to capacity building projects and activities in PWS. The Commission was pleased to note that in order to ensure optimum use of the resources available, most of the training events had been held in collaboration with other scientific and technical programmes of WMO. It further noted with satisfaction that since CBS-Ext.(98), several training events had been organized on a regional basis and urged that continued high priority be given to education and training.

6.4.26 The Commission noted with satisfaction that in an effort to expand further valuable capacity-building activities within the PWS Programme and to build on the achievements of workshops already conducted, ICT/PWS had made proposals and had identified syllabi for roving seminars in each of WMO Regions. ICT/PWS had also prepared programmes for regional seminars and workshops on methods of improving relationships with the Government, the media and key user-groups of national PWS programmes, as well as on improving PWS products and services to meet user needs.

SYDNEY 2000 OLYMPICS

6.4.27 The Commission was pleased to note that the Sydney 2000 Olympic weather-support Web site had been linked to the WMO50 Web site so that international media and visitors to the Olympics could access official weather information issued by NMSs. Similarly, the PWS Web site had been linked to the Sydney Olympics Web site to allow viewers of the PWS site to find directly all the information available about the Sydney Olympics.

LINKS WITH THE WWRP

6.4.28 The Commission welcomed the collaboration with the WWRP which involved the PWS Programme in activity areas such as development of methods of assessing socio-economic benefits of weather services to the users and a forecast demonstration project for weather support for the Sydney 2000 Olympics. The demonstration project aimed at testing the latest now-cast techniques as well as the effectiveness of the dissemination of forecasts and warnings, and had significant potential to indicate new products and service methodologies relevant to improved PWS.

PWS IN SUPPORT OF NATURAL DISASTER REDUCTION

6.4.29 The Commission noted with satisfaction that many of the activities of the PWS Programme and, in particular the training events, had supported the IDNDR efforts in disaster mitigation and reduction. The Commission further noted that cooperation continued between WMO and UN/OCHA and involved the PWS Programme for the provision of meteorological and hydrological information in support of United Nations humanitarian missions related to natural disasters and other crises. The continued usefulness and success of the cooperation between the two Organizations had been demonstrated through the provision of arrangements and coordination of information during the Mozambique floods in early 2000.

FUTURE DIRECTIONS

6.4.30 The Commission reaffirmed that a core function of any NMS was to support the safety of life and the protection of property. It further agreed that an essential step in preparing and planning for improved and more effective PWS was to take stock of the changes taking place both within and outside the sphere of meteorology. It was clear that changes in global and national

scenes — including changes in politics and economics; developments in technology; environmental matters such as climate change, urbanization, and pollution problems; improved observational and communication systems, continued enhancement in weather forecasting capabilities; and dramatic progress in product dissemination systems — would continue to influence greatly the way in which NMSs operated in the future. Those influences would almost certainly be felt to the greatest degree in the area of service delivery. On the one hand, as a result of the developments in communication technology, much more information would become available to the users and in particular the public, from sources other than the NMS. On the other hand, the same technology would have the potential to assist NMSs to provide high quality, authoritative and official information direct to users and, in that way, demonstrate the benefits of investments in meteorological infrastructure. That was essentially important for official warnings. As resources for NMSs continued to become scarcer, effective public weather services should have the capability to provide convincing arguments to justify expenditures and to demonstrate the benefits derived from the services and official information provided by the NMS.

6.4.31 The Commission stressed that it was therefore becoming increasingly important to grasp the opportunities provided by the global and national changes taking place in the meteorological environment to ensure that the core function of providing and delivering PWS remained useful and relevant and became more visible. The Commission concluded that if the above goal was to be achieved, continuous attention to assessing user requirements, meeting those requirements, ensuring that the users knew how to make best use of the products and services provided by the NMS and assessing the accuracy and usefulness of those products and services were essential.

6.4.32 The Commission considered the above and requested that high priority be placed on the following main areas:

- (a) Capacity building and transfer of technology;
- (b) Likely future requirements of PWS for new and improved products;
- (c) Assessing user needs;
- (d) Effective forecast verification and service assessment procedures;
- (e) Enhancing visibility through improved dissemination and presentation of effective and high quality public weather products and services;
- (f) Coordination and cooperation with the disaster management community, media and the private sector;
- (g) Exchange of NMSs' official public forecasts;
- (h) Cross-border exchange of warnings;
- (i) Improving partnership with the international media;
- (j) Single official voice and attribution;
- (k) Collaboration with other relevant WMO scientific and technical programmes.

The various activities related to those areas of high priority were reflected in the future work programme under agenda item 9.

6.4.33 The Commission noted that activities within the PWS Programme related also to climate, climate change, the environment including urbanization, pollution and health problems, and disaster preparedness. It thus agreed that collaboration with other Commissions, including CCI, CHy and CAgM, was necessary in order to meet the objectives of the Programme.

6.4.34 To address those issues, the Commission agreed on the future work plan of the PWS Programme as given under agenda item 9.

6.5 OPERATIONAL INFORMATION SERVICE (agenda item 6.5)

6.5.1 The Commission recalled that the objective of the OIS was to collect from, and distribute to, WMO Members and WWW Centres detailed and up-to-date information on facilities, services and products made available in the day-to-day operation of the WWW. That service included *Weather Reporting* (WMO-No. 9), Volumes A, B, C1, C2 and D as well as the *International List of Selected, Supplementary and Auxiliary Ships* (WMO-No. 47), METNO messages and the *WWW Operational Newsletter*.

6.5.2 The Commission noted with appreciation that in order to improve data reliability, timeliness of distribution, and the provision of additional information to Members, significant progress was made in the operation of the OIS, which had been implemented at the Secretariat. The publications mentioned above were maintained on databases operated on PCs, thus enabling the Secretariat to maintain and update the data on a near-real-time basis, as far as updated information was notified to the Secretariat, and to provide much greater flexibility for dissemination. The Commission expressed satisfaction that the new arrangements had resulted in improved and timely access to the information.

6.5.3 The Commission was informed that *Weather Reporting*, Volumes A and C1, the *International List of Selected, Supplementary and Auxiliary Ships*, and the RBSN lists were available on the Internet via the WMO Home page at the following site: <http://www.wmo.ch/web/ddbs/publicat.html>. Volumes A and C1 were updated weekly and the updated data were made available every Monday via the Internet. Data from all the above publications were also available via FTP from:

WMO-No. 9, Vol. A: <ftp://www.wmo.ch/wmo-ddbs/Pub9volAymmdd.flatfile>

WMO-No. 9, Vol. C1: <ftp://www.wmo.ch/wmo-ddbs/Pub9volCyymmdd.flatfile>

WMO-No. 47: <ftp://www.wmo.ch/wmo-ddbs/Pub47.ships.yymmdd.data>

RBSN lists: <ftp://www.wmo.ch/wmo-ddbs/rbsn.rax>

The information was also available in printed form and Members could request it through e-mail

(PWOI@www.wmo.ch) or by fax. In addition, access to the expanded diskette service and the printed editions had been improved by eliminating long delays. For rapid access by those subscribers who had the required facilities, the *WWW Operational Newsletter* was also available on the Internet at the following site: <http://www.wmo.ch/web/ddbs/jen/Newsletters/index.html>.

6.5.4 The Commission noted with concern that despite repeated appeals made to Members to notify the Secretariat of the changes in their observation networks, there were discrepancies in the information contained in *Weather Reporting*, Volume A and the real operation of the observing stations. The Commission recognized that there was a necessity to re-examine Volume A with respect to its contents and the procedures for updating the information submitted by Members to ensure that an improved Volume A would serve the purpose for which it was intended. In addition, due to the importance of validated information on observing stations for operational purposes, the Commission noted the need for a proposal for developing and making available to NMSS, a master reference operational catalogue of observing stations. The information in the catalogue would be based on that provided by Members as input to Volume A, but would also take due account of the information provided by quality monitoring lead centres as well as quantitative information with respect to the actual implementation of observing programmes. The Commission agreed that OPAG/IOS should develop further the concept in coordination with other OPAGs and the Secretariat, as appropriate. Subsequently, the Commission designated a rapporteur within the OPAG/IOS to work closely with lead centres and the Secretariat to develop measures for improving the utility of *Weather Reporting*, Volume A. The terms of reference of the rapporteur are given under agenda item 9.

6.5.5 The Commission further noted that an extensive redesign of the *International List of Selected, Supplementary and Auxiliary Ships* was under way to expand the type and to enhance the precision of metadata provided by the publication on the size, identity and meteorological instrumentation of the mobile ship stations included in the surface-based synoptic network subsystem of the GOS. Metadata contained in that publication were increasingly being incorporated into various ocean observation and climate research programmes, including in a new JCOMM programme set up to merge the new metadata set with the observational weather data transmitted by VOS ships in order to incorporate updated calculations of biases and corrections into the processing of observed data.

6.5.6 The Commission recalled that CBS-Ext.(98) had decided that, as part of their responsibilities, WMCs and RTHs on the MTN should review the *Catalogue of Meteorological Bulletins* as regarded bulletins issued by their relevant zones and should notify the Secretariat by transferring updated files, of changes to be included in Volume C1 of *Weather Reporting*. The Secretariat was tasked with maintaining a global database of Volume C1 accessible on its FTP server, and with issuing regularly

the updated editions of Volume C1. The Secretariat had developed a system to update Volume C1 and to prepare automatically METNO (Vol. C1) messages. Under the new system, each RTH on the MTN was expected to transfer the advanced notifications in the form of a file and at least twice per year of its part of Volume C1 on the WMO FTP server and inform the Secretariat of the transfer by an Internet message (see also general summary paragraph 6.2.23).

6.5.7 The Commission emphasized that the objective of the OIS could not be achieved unless the Secretariat received prompt communication of the changes which had to be reflected in the relevant publications. In that connection, the Commission strongly urged the designated RTHs as well as the Members to assist the Secretariat in keeping WWW operational publications current by ensuring that all changes reached the Secretariat without delay.

7. LONG-TERM PLANNING RELEVANT TO THE COMMISSION (agenda item 7)

FIFTH WMO LONG-TERM PLAN

7.1 The Commission noted the adoption by Thirteenth Congress of the 5LTP as well as the guidelines and directives developed by the Executive Council for its monitoring and evaluation. Since the 5LTP had been under implementation for less than a year, the Commission made no attempt to review its implementation but requested the chairpersons of the OPAGs to keep that constantly under review. The AWG, at its twenty-fourth meeting, planned for the third quarter of 2001, was requested to advise on the first report on the evaluation of the impacts of activities performed under the Plan, to be submitted by the president of the Commission to the Executive Council Working Group on Long-term Planning early in 2002.

SIXTH WMO LONG-TERM PLAN

7.2 The Commission noted that the Executive Council, at its fifty-second session, had provided guidance on the preparation of the 6LTP and that the Council had agreed that the Long-term Plan should form the basis for the preparation of the programme and budget as well as the relevant programme activities. It had therefore considered that the timing of the Long-term Plan preparation was crucial and agreed that the draft 6LTP should be prepared for consideration and endorsement by the fifty-third session of the Executive Council in 2001. The earlier availability of the draft 6LTP would also provide guidance to the technical commissions and regional associations in the detailed planning of their programmes.

7.3 Following the guidance of the fifty-second session of the Executive Council, the Executive Council Working Group on Long-term Planning prepared a draft proposal containing a broad vision statement, outcomes, strategies and associated goals for the 6LTP. The Commission noted that the vice-president had attended a meeting in conjunction with the Meeting of Presidents

of Technical Commissions in early October 2000, which had reviewed that material and had provided further input. Much work still needed to be done and the chairperson of the Working Group had requested additional input on the revised draft from all technical commissions as quickly as possible.

7.4 In view of those decisions and the urgent need for a draft 6LTP to be prepared by early 2001, the Commission discussed several important long-term goals and objectives that should be included in the Plan and agreed that its Management Group should consider that matter and provide input to the Working Group as a matter of urgency. It also requested the chairpersons of the OPAGs to develop key goals and implementation priorities for their respective subprogrammes and to seek input from the chairpersons of the Regional Working Groups on Planning and Implementation of the WWW. Those would be reviewed by the Management Group and by the Commission at its extraordinary session in 2002.

THE SIGNIFICANCE OF INNOVATION IN IMPLEMENTING THE WWW

7.5 In keeping with its role to assist Members in achieving the most effective and efficient implementation and sustainable operation of WWW system components, the Commission discussed the concepts of joint operation, joint funding and burden sharing in the context of the WWW. The implementation of the WWW had always been based on the strategy of each Member undertaking to meet certain responsibilities in the agreed globally cooperative scheme according to its means. Capacity building and technical assistance programmes were essential components of that strategy.

7.6 That approach had worked well but not perfectly and there was a growing need for Members to seek innovative approaches to solving issues associated with operating shared facilities. Areas of WWW where joint action might increasingly be needed included:

- (a) Shared observing systems (e.g. in international waters or spanning a river catchment);
- (b) Long-term support of complex software which many Members needed, e.g. BUFR and GRIB encoders/decoders suitable for a selection of operating environments;
- (c) Use of a shared telecommunication network (e.g. RMDCN in RA VI and similar plans in RAs II and III);
- (d) Web-based approaches to data dissemination (where most of the cost might fall to one centre operating a server but the benefits were mainly to other NMHSs acting as clients of that server).

7.7 It was apparent from Members that many different approaches to collaboration were being adopted. Those ranged from full global or regional cooperation through CBS and regional associations to bilateral arrangements. Some groups of countries had successfully set up joint institutions either to carry out specific major tasks or to provide a framework to run joint projects. For some functions, an NMHS could act on behalf of other services (with agreement). The right approach

depended on the particular problem being addressed and was a matter of choice for each NMHS.

7.8 The Commission recalled that the Executive Council, and in particular its Advisory Group on the Role and Operation of NMHSs, had studied related policy aspects and considered mechanisms to further the ideas discussed at the session within the context of WWW. It agreed that a study should be undertaken to investigate existing cooperative arrangements and agreements and evaluate the results of those efforts so that all Members might benefit from the experience gained. It agreed to assign that task to a Rapporteur on Innovative Collaboration and thanked the United Kingdom for its kind offer to nominate Ms R. Patton to serve in that capacity. The Commission requested the Rapporteur to undertake the study and to report the results to the CBS Management Group.

8. REVIEW OF THE WORKING STRUCTURE OF THE COMMISSION (agenda item 8)

8.1 The Commission recalled that in view of the further growing tasks and responsibilities, CBS-Ext.(98) had agreed that the system of large "open" CBS working groups meeting every four years was no longer appropriate and cost-effective. The Commission further recalled that by way of adopting Resolution 2 (CBS-Ext.(98)) — Working structure of the Commission for Basic Systems, it had implemented a new working structure, which grouped the activities of CBS into four main programme areas:

- (a) Integrated Observing Systems (IOS);
- (b) Information Systems and Services (ISS);
- (c) Data-processing and Forecasting Systems (DPFS);
- (d) Public Weather Services (PWS).

The activities of those programme areas were handled by OPAGs whose members were regularly consulted and informed by correspondence.

8.2 The Commission further recalled that CBS-Ext.(98) had requested its president to keep the impact and effectiveness of the new working structure under review and to provide a report to the next session. The Commission received that report with appreciation and thanked the president for the excellent and thorough analysis of the working structure and his proposals for its improvement.

GUIDANCE FROM WMO CONGRESS AND THE EXECUTIVE COUNCIL

8.3 The Commission noted with satisfaction that the Executive Council had complimented the Commission on adopting new arrangements to carry out the Commission's work, and that Thirteenth Congress had encouraged the Commission to develop the new working structure further with a view towards realizing its full benefits. As the success of the new structure depended critically upon the dedication of experts to serve on the various teams, the Commission welcomed the fact that the Executive Council had urged Members, individually and collectively, to consider ways and means of providing support to assist CBS in achieving its goals.

COMPOSITION AND EFFECTIVENESS OF THE EXPERT AND IMPLEMENTATION/COORDINATION TEAMS

8.4 CBS-Ext.(98) had entrusted its AWG with establishing the necessary teams and their membership. In accordance with the resolutions adopted at that session, the AWG had established three ETs and one ICT under the IOS, seven ETs and one ICT under the ISS, four ETs and one ICT under the DPFS, and three ETs and one ICT under the PWS, in total 21 teams, and several rapporteurs. As a balanced compromise between the heavy workload associated with the tasks given and the limited financial resources available in the regular budget of WMO, it was agreed that 31 team meetings and two meetings of the AWG were at least necessary to attain the set targets prior to CBS-XII. While most teams and their work was recognized at the time of CBS-Ext.(98), there was also a requirement for the formation of small teams to deal with urgent issues. About 160 experts from CBS member countries were designated as members of the teams.

8.5 WMO General Regulation 35 requested to obtain the concurrence of the Permanent Representatives for persons to participate in the work of the teams, which was often a time-consuming process. Appreciating that the Secretary-General had, in preparation for the present CBS session, invited the Permanent Representatives to send proposals for their experts' candidate membership in teams of their preference together with their formal concurrence, the Commission concluded that it would be possible for the teams to begin working much sooner after the session. The Commission agreed that a similar practice should be used again in the future to ensure prompt activation of the teams after a session of CBS.

8.6 The Commission felt that the relationship between the ETs and ICTs was particularly important and some differences were noted in that respect between the OPAGs. The Commission underlined that the ICTs should not only coordinate implementation of decisions of CBS, but also evaluate proposals developed by related ETs, provide feedback to the ETs concerned, and contribute their conceptual ideas as proposals were being developed. The ETs should develop proposals, circulate the proposals for comment and consider all of the feedback received when preparing recommendations for consideration by the Commission. Proposals agreed at team meetings were not final. The teams should continue to refine their ideas through correspondence as feedback was received from other members of the OPAGs. The Commission confirmed that ETs were established by each CBS session with attainable goals and tasks and that they should operate in most cases with a project management approach.

8.7 In the context of General Regulations 42 and 43, the Commission recalled that recommendations resulting from the work of a team had no status within the Organization until the responsible constituent body adopted them. Exceptionally, the president of that body might adopt it, on behalf of the constituent body, if the matter was urgent and did not imply new obligations for Members.

8.8 The Commission understood that in view of the broad scope and variety of tasks given to the OPAGs, a large number of teams and meetings were necessary during the past two years. That had placed a heavy burden both on the team members and the Secretariat in terms of pre-session preparation (mostly by e-mail) and documentation as well as post-session in feeding the results to the OPAG members and in coordinating them with other CBS teams concerned. The Commission commended in that context the tremendous amount of work accomplished by the OPAG teams in rather short meetings and even more by correspondence during the whole inter-sessional period, particularly due to the untiring efforts of the chairpersons.

8.9 The Commission noted that CBS had expected that most of the work of the teams would be done by correspondence and that short meetings normally would suffice for reviewing the working results and the feedback received and for preparing the input to the session of CBS. However, with the experience gained to date, the Commission recognized the limits of working by correspondence and shorter meetings had been realized. In some cases, the volume of the material to be discussed and the complexity of tasks given to the teams could not be fully covered within the time-frame and working conditions available. In view of the limitation of financial resources, the availability of experts and Secretariat support, all being critical to the success of the CBS OPAGs, the Commission considered that additional efforts were necessary to adapt the work programmes and tasks of the ETs to the resources available to accomplish them.

8.10 The Commission reiterated the importance of attaining the optimal membership of the various teams taking into account technical expertise, capacity building and a balanced representation. It emphasized that while the most important qualification for ET members was their technical expertise, the teams must also benefit from experience needed to assess requirements, proposals and constraints of all Members in the light of their geographical and economical diversity. Thus, appropriate representation must be carefully considered while selecting the membership of the teams. The Commission noted that it was particularly difficult to ensure the balance of inter-commission teams since CBS could not determine the experts selected by the presidents of the other technical commissions.

8.11 The Commission appreciated the progress achieved by the teams and their high-quality working results in the vast range of issues covered by the OPAGs. In the light of the many different proposals and draft plans, the Commission stressed the need for increased integration and assessment of the working results generated within the OPAGs. That should be achievable in the future by strengthening the coordination function of the ICTs by including in their membership the chairpersons of the ETs of the parent OPAG. A meeting of the ICT should best be held five to six months prior to the session of the Commission in order to review, assess and consolidate the input to the Commission across all the activities of that OPAG. The chairperson of the OPAG

should normally chair an ICT. The Commission recognized that the workload to be coped with by the OPAG chairpersons had been extremely heavy and had often been difficult to reconcile with their national duties. It had been a major challenge to maintain close contact with the team leaders and rapporteurs and to span the full range of the different activities and problems handled in the teams. It was agreed that a co-chairperson, to be designated by the Commission, could assist and strengthen the role of the OPAG chairperson in coordinating and overseeing the work progress and priorities of the teams. It would be desirable to select an OPAG co-chairperson from among the chairpersons of the teams of the corresponding OPAG.

LIAISON WITH OTHER TECHNICAL COMMISSIONS AND ORGANIZATIONS

8.12 According to its terms of reference requesting CBS to respond to requirements of all WMO Programmes, several of the tasks given by CBS-Ext.(98) to the OPAGs involved participation and contributions of other technical commissions and relevant international organizations. The Commission was pleased that it had been possible to establish, on the one hand, formal links with the other WMO technical commissions, which had resulted mostly in the inclusion of experts designated by the presidents of those commissions as members or invited experts in relevant teams. Similarly, on the other hand, it was possible to incorporate in certain teams experts from international organizations concerned, including CTBTO, ECMWF, EUMETSAT, IABM, IAEA, ICAO and IOC. There had also been formal links from the OPAG/IOS to EUMETNET/EUCOS, COSNA and NAOS. The Commission agreed that each OPAG chairperson should ensure that the appropriate liaison with other relevant technical commissions was established.

LIAISON WITH THE REGIONAL ASSOCIATIONS

8.13 The Commission recalled that much emphasis was put by CBS-Ext.(98) on improving and strengthening the links to the regional associations through ensuring their greater involvement in planning, implementation and coordination of the WWW and, most importantly, through an improved mechanism for providing feedback to CBS. The Commission felt that much progress had been achieved through the arrangements implemented, which included:

- (a) The ICTs focusing on implementation issues of the regions;
- (b) The membership of the regional rapporteurs on the WWW component programmes in the corresponding ICTs (who were thus able to present early the regional views on emerging WWW implementation aspects);
- (c) The inclusion of two experts from the regions in the ICTs of their choice as a capacity building measure;
- (d) The regular (since CBS-XI) participation of the chairpersons of the Regional Working Groups on Planning and Implementation of the WWW in sessions of CBS (who were thus able to present the views of their Region on all activities of CBS).

The Commission re-emphasized the importance of the involvement and the active participation of experts from developing countries in the ETs and ICTs of each OPAG. The Commission also felt that the technical conferences held in conjunction with sessions of CBS had, *inter alia*, helped more developing countries from all regions to participate in the session of the Commission.

FLOW OF INFORMATION TO THE OPAG MEMBERS AND FEEDBACK

8.14 Members voiced a strong interest in making the work of CBS as transparent and communicative as possible. They wished to be fully informed of the development, relevant decisions and monitoring results of the WWW, and involved in the management of the Programme. The Commission was pleased with the very active approach which the chairpersons of the OPAGs and teams as well as the Secretariat had taken in providing information at the various stages of discussions, in particular by using the Web pages established by the Secretariat for that purpose. The quarterly CBS *Newsletter*, started in June 1999, was regularly sent to about 520 experts via e-mail and 300 addressees via regular mail. The OPAG chairpersons had published an annual activity report that was distributed to the members of their respective OPAG. In the time period from April 1999 to October 2000 about 15 000 visits were registered on the WMO Web server calling on the CBS page, team reports, or the page containing WWW technical reports and publications. The Commission noted with considerable satisfaction that most of the CBS members felt well or very well informed, as a survey had shown.

CBS AWG — CBS MANAGEMENT GROUP (CBS-MG)

8.15 The Commission appreciated the important role of the AWG in coordinating and integrating the work of the 21 teams and several rapporteurs. It recognized that such a complex structure of teams and the many active links to other technical commissions, regional associations and relevant organizations outside WMO required an effective and flexible management. That was made possible through intense consultation among the members of the AWG via e-mail and the annual meetings of the group. In particular, the agreement of CBS-Ext.(98) to entrust the AWG with taking management decisions during the inter-sessional period had ensured that the work of the teams was conducted in an effective and coordinated manner and could deal effectively with any emerging urgent issues. The Commission agreed to establish again such a group and, in underlining the management responsibility of the AWG, to call it CBS Management Group (CBS-MG).

8.16 The co-chairpersons of the OPAGs (see general summary paragraph 8.11) should also be members of the CBS-MG. That would slightly enlarge the group to 10 members and would ensure regional representation within the group.

FUTURE WORKING STRUCTURE OF CBS

8.17 In view of the above considerations, the Commission decided to maintain Resolution 2

(CBS-Ext.(98)) — Working structure of CBS, to implement with immediate effect several adjustments to the working structure as given and adopted in Resolution 1 (CBS-XII). The Commission further decided to establish the CBS-MG by adopting Resolution 2 (CBS-XII).

9. WORK PROGRAMME OF THE COMMISSION: ESTABLISHMENT OF OPEN PROGRAMME AREA GROUPS AND TEAMS (agenda item 9)

9.1 Under agenda item 8, the Commission had agreed on certain adjustments to the working structure of the Commission and had established the CBS-MG and OPAGs. The Commission agreed on its work programme, based on the relevant sections of the 5LTP and the relevant decisions of the Executive Council and taking into account the detailed discussions held under the various agenda items. In the light of that, and noting its deliberations under agenda item 8, the Commission decided to re-establish the four OPAGs on Integrated Observing Systems, on Information Systems and Services, on Data-processing and Forecasting Systems, and on Public Weather Services and adopted Resolution 3 (CBS-XII) to that effect.

9.2 With a view to making the necessary arrangement for efficiently carrying out the various tasks under the agreed work programme and the corresponding activities, the Commission agreed to establish within each of the OPAGs an ICT and ET as well as rapporteurs. The Commission established an open Ad Hoc Group on the CBS Structure, chaired by Mr J. Riissanen (Finland), to consolidate the terms of reference of the respective ICTs and ETs of the four OPAGs on the basis of the relevant deliberations, in particular under agenda item 6, and to develop a proposed membership. A core group of the open Ad Hoc Group, consisting of the president and vice-president of the Commission plus a member from each Region, was established to consolidate the outcome of the discussions. The open Ad Hoc Group and its core group carried out its tasks through several meetings and iterations.

9.3 The Commission confirmed the principles for the role and composition of the ETs and ICTs of the OPAGs, as defined in Resolution 2 (CBS-Ext.(98)) — Working structure of CBS, taking into account the adjustments agreed by the Commission under agenda item 8. It noted that the composition of the ICT membership, which included the chairpersons of the ETs of the corresponding OPAG and the relevant regional rapporteurs as *ex officio* members, ensured a balanced regional representation. It also re-affirmed the importance that each regional association nominate two experts for inclusion in the ICT membership for capacity building, in consultation with the chairpersons of the regional Working Groups on Planning and Implementation of the WWW. The Commission agreed upon the following criteria for the selection of experts for the respective membership of the ETs:

- (a) Expertise shall be the prime criteria. The expertise required included the expertise on the relevant technology, but also the expertise related to the

feasibility, constraints and impact of the introduction and operation of new proposed techniques, taking account of the various environment and capabilities of NMSs. Experts from developing countries or countries with economies-in-transition might in particular provide the latter expertise;

- (b) The optimum number of experts in any ET should be in the range five to seven, taking into account both the working efficiency and the financial support for meetings. Experts from relevant international organizations were supplementary experts;
- (c) The balance or diversity of regional representation might be difficult to achieve but should be taken into consideration, provided that the above criteria could be met.

The Commission emphasized that the essential overall criteria for establishing ETs and for defining their membership was the achievement of the identified tasks in order to ensure that the whole work programme of the Commission was carried out. It agreed that the adequate flexibility should be maintained with a view to facilitating that objective.

9.4 The Commission identified the main elements of the work programme and agreed on the terms of reference of teams and rapporteurs of each OPAG as listed in Annex X to this report. The Commission also requested each of the OPAG chairpersons to ensure that the specific tasks, which were identified in the respective parts of the general summary (agenda items 6.1–6.5), be adequately addressed. As regarded the working programme and the tasks allocated to the OPAG/IOS, the Commission noted the regional requirements for data from mesoscale observing systems, in particular Doppler radar systems, and concluded that for the next two-year period, appropriate action should be referred to the regional Working Groups on Planning and Implementation of the WWW. The OPAG/IOS should keep those activities under continuous review.

9.5 The Commission noted with appreciation the considerable interest expressed by Members in the work of CBS by nominating experts to participate in OPAG activities. The Commission particularly welcomed the large number of volunteering experts. It invited the chairpersons of the OPAGs and respective teams, in cooperation with the Secretariat, to develop adequate working mechanisms such as e-mail groups or forums to ensure that all those experts could actively participate and contribute to the work programme and assist the respective teams. The Commission established the membership of the ICTs, ETs and OPAG rapporteurs, as listed in Annex XI to this report.

10. REVIEW OF PREVIOUS RESOLUTIONS AND RECOMMENDATIONS OF THE COMMISSION AND RELEVANT EXECUTIVE COUNCIL RESOLUTIONS (agenda item 10)

In accordance with established practice, the Commission examined those resolutions and recommendations adopted prior to its twelfth session which

were still in force and adopted Resolution 4 (CBS-XII) and Recommendation 8 (CBS-XII).

11. ELECTION OF OFFICERS (agenda item 11)

The Commission unanimously elected Messrs G. Love (Australia) and A. Gusev (Russian Federation) as president and vice-president, respectively, of the WMO Commission for Basic Systems.

12. DATE AND PLACE OF THE NEXT SESSION (agenda item 12)

The Commission agreed that, subject to the receipt of any formal offer, the date and place of its next extraordinary session, tentatively planned for the fourth quarter of 2002, should be determined by the president after consultation with the Secretary-General and in accordance with the provisions of General Regulation 187.

13. CLOSURE OF THE SESSION (agenda item 13)

13.1 In his closing remarks, the president of the Commission, Mr S. Mildner, reviewed the significant accomplishments of the Commission over the past four years and the major issues affecting the Commission over the past decade. He noted two items in particular — WWW had been recognized as providing the basic infrastructure for all WMO and several related international programmes, and PWS had become a well-developed programme — both under the auspices of CBS. He noted that changes in the policy environment and rapid technological evolution had led to unprecedented opportunities for the Commission but also presented a challenge to cope with, and take best advantage of, the opportunities presented.

13.2 The president expressed his satisfaction with the results of the first two years under the Commission's new working structure. He noted that the new structure had provided some unexpected benefits in streamlining the work of the Commission and felt that an amazing amount of work had been accomplished. He stated that everyone involved was still learning but that the Commission was clearly on the right path. He felt that one area which the Commission could investigate to improve its future work would be to streamline its decision-making processes to increase its responsiveness to a fast-changing environment.

13.3 The president thanked the Secretary-General and the staff of the Secretariat for their dedication and support over the past four years of his term and during the present session of the Commission. He thanked all of the delegates for their contributions and for the spirit of cooperation and flexibility in which they had conducted their deliberations. He thanked the vice-president, the chairpersons of the OPAGs and all of the experts who contributed to the work of the Commission for the work accomplished during the inter-sessional period. Stating that the Commission had embarked into a new era, he wished everyone in the Commission and all of the teams success.

13.4 In his closing remarks, the president-elect, Mr G. Love, described a number of the most significant

challenges facing the Commission. The IOS must ensure the continued operation and evolution of the *in situ* network, the ISS must evolve the GTS into a true WMO Intranet that made best use of the technology available, the DPFS must take advantage of the new technologies and tools to respond to new requirements, and the PWS must strengthen smaller NMHSs while adapting to a changing world. He stressed that training and pursuit of innovative approaches must play a key role.

13.5 Mr Love thanked Mr Mildner for his dedication and outstanding leadership as president during the challenge of restructuring the Commission.

13.6 On behalf of the Secretary-General, Mr D. Schiessel thanked the delegates for their hard work and the support staff for their untiring efforts during the session. He expressed his appreciation to the OPAG chairpersons and to the ETs and ICTs for their many accomplishments during the inter-sessional period. Finally, he thanked Mr Mildner for his dedicated work and excellent leadership and presented him with a small gift as a token of appreciation.

13.7 The twelfth session of the Commission for Basic Systems closed at 12 p.m. on 8 December 2000.

RESOLUTIONS ADOPTED BY THE SESSION

RESOLUTION 1 (CBS-XII)

WORKING STRUCTURE OF THE COMMISSION

THE COMMISSION FOR BASIC SYSTEMS,

RECALLING:

- (1) The request made by the forty-eighth session of the Executive Council (Geneva, June 1996) for the Commission to study the most efficient way of organizing the working structure of CBS,
- (2) That CBS-Ext.(98) implemented a new working structure as given in Resolution 2 (CBS-Ext.(98)) — Working structure of the Commission for Basic Systems,
- (3) That CBS-Ext.(98) had agreed to assess the impact and effectiveness of the new working structure at the twelfth session,

RECALLING FURTHER:

- (1) That the requirements determined by CBS-Ext.(98) as given in Resolution 2 (CBS-Ext.(98))

CONSIDERING (1) to (5) for implementing a new working structure continue to be valid,

- (2) That the working structure implemented by CBS-Ext.(98) proved effective and successful in meeting these requirements,

DECIDES to maintain the working structure as given in Resolution 2 (CBS-Ext.(98)) and to implement adjustments to the working structure as given in the annex to this resolution;

REQUESTS the president of the Commission to keep the effectiveness of the working structure under review and to provide a report to the next session of the Commission.

ANNEX TO RESOLUTION 1 (CBS-XII)

WORKING STRUCTURE OF THE COMMISSION FOR BASIC SYSTEMS

1. The working structure of the Commission will continue to comprise a system of small, task-focused teams and rapporteurs complemented by suitable ways to involve and inform all CBS members in the process. The activities of CBS are grouped under four main programme areas. The activities under each of these programme areas are handled by Open Programme Area Groups (OPAGs), the members of which are regularly consulted and informed by correspondence.

Open Programme Area Groups

2. The chairperson of each OPAG is assisted by a co-chairperson. The terms of reference, terms of office and designation of the chairpersons and co-chairpersons are decided by the Commission by means of a resolution. As the terms of reference are normally of a general nature, the Commission agrees, in addition, on the respective work programmes. The chairperson, assisted by the co-chairperson, of each OPAG is the coordinator of the work of the small teams and rapporteurs established by the Commission to carry out specific tasks derived from the specific work programmes. The co-chairperson of an OPAG should normally be the chairperson of one of the teams of that OPAG.

Implementation/Coordination Teams

3. The membership of the ICTs includes the chairpersons of the ETs of the parent OPAG. The chairperson of the OPAG should normally chair the ICT. These arrangements should facilitate an increased level of coordination of the working results of an OPAG in preparation of input to the session of the Commission.

CBS Management Group

4. The new strengthened role of the previous Advisory Working Group had proven very effective. That group had carried out management functions by ensuring integration of the programme areas, deciding on strategic planning issues, evaluating the progress achieved in the agreed work programme, and making related necessary adjustments to the working structure in the inter-sessional period. With a view to underlining the "management by committee" working mechanism of that group, it is renamed CBS Management Group (CBS-MG). The CBS-MG should consist of the president, vice-president, the chairpersons and the co-chairpersons of the four OPAGs, normally not exceed 10 members in total, with balanced regional representation, and meet annually.

RESOLUTION 2 (CBS-XII)

CBS MANAGEMENT GROUP

THE COMMISSION FOR BASIC SYSTEMS,

NOTING:

- (1) General summary paragraph 7.13.5 of the *Abridged Final Report with Resolutions of the Fifth World Meteorological Congress* (WMO-No. 213.RC.28),
- (2) Resolution 2 (CBS-Ext.(98)) — Working structure of the Commission for Basic Systems,
- (3) Resolution 3 (CBS-Ext.(98)) — Advisory Working Group of the Commission for Basic Systems,

RECOGNIZING:

- (1) That the effectiveness of the Commission depends to a large extent on the effective management of its activities between sessions,
- (2) That a management group would be required to ensure the integration of the programme areas, to evaluate the working progress achieved, to coordinate strategic planning and to decide on necessary adjustments to the working structure in the inter-sessional period,

DECIDES:

- (1) To establish the CBS Management Group (CBS-MG) with the following terms of reference:
 - (a) To advise the president on all matters related to the work of the Commission;
 - (b) To assist the president in planning and coordinating the work of the Commission and its working groups;
 - (c) To keep under review the internal structure and working methods of the Commission

and to make necessary adjustments to the working structure in the inter-sessional period;

- (d) To assess and evaluate the progress achieved in the agreed work programme of the Commission and give guidance and advice on the activities of the working groups and the corresponding teams established under their responsibility;
- (e) To monitor the implementation of the World Weather Watch Programme in relation to the WMO Long-term Plans and to advise the president on the appropriate actions;
- (f) To ensure the overall integration of the programme areas and to coordinate strategic planning issues;
- (g) To advise the president on matters related to cooperation with other technical commissions and support to other WMO and related programmes;
- (h) To advise the president on all team leader designations necessary between sessions of the Commission;
- (2) That the composition of the CBS Management Group shall be as follows:
 - (a) The president of CBS (chairperson);
 - (b) The vice-president of CBS;
 - (c) The chairpersons and co-chairpersons of the OPAGs.

RESOLUTION 3 (CBS-XII)

OPEN PROGRAMME AREA GROUPS

THE COMMISSION FOR BASIC SYSTEMS,

CONSIDERING that there is a need for the continued development and coordination of the:

- (a) Surface- and space-based components of integrated observing systems;
- (b) Information systems and services;
- (c) Data-processing and forecasting systems;
- (d) Public weather services;

RECALLING that the working structure implemented by CBS-Ext.(98) has been maintained according to Resolution 1 (CBS-XII),

DECIDES:

- (1) To establish:
 - (a) The OPAG on Integrated Observing Systems;
 - (b) The OPAG on Information Systems and Services;
 - (c) The OPAG on Data-processing and Forecasting Systems;
 - (d) The OPAG on Public Weather Services;

with the terms of reference for each OPAG as given in Resolution 4 (CBS-Ext.(98)) — Open Programme Area Groups (OPAGs) of the Commission for Basic Systems;

- (2) To select, in accordance with General Regulation 32:
 - (a) Messrs J. Purdom (United States) and M. Saloum (Niger) as chairperson and co-chairperson, respectively, of the OPAG on Integrated Observing Systems;
 - (b) Messrs G. R. Hoffmann (Germany) and P. Shi (China) as chairperson and co-chairperson, respectively, of the OPAG on Information Systems and Services;
 - (c) Ms A. Simard (Canada) as chairperson and Mr N. Sato (Japan) as co-chairperson of the OPAG on Data-processing and Forecasting Systems;
 - (d) Mr K. O'Loughlin (Australia) as chairperson and Ms V. Dall'Antonia (Brazil) as co-chairperson of the OPAG on Public Weather Services;

REQUESTS:

- | | |
|--|---|
| <ul style="list-style-type: none"> (1) The chairpersons of the OPAGs to act upon matters referred to the OPAG by the president of CBS; (2) The chairpersons of the OPAGs: <ul style="list-style-type: none"> (a) To prepare an activity report at the end of 2001 for distribution to CBS members; (b) To submit a report to the Commission not later than three months prior to its session; | <ul style="list-style-type: none"> (c) Specifically the chairperson of the OPAG on Integrated Observing Systems to submit, through the president of CBS, a report on matters of operational importance relating to satellite activities to the Executive Council under the World Weather Watch Programme, if required. |
|--|---|

RESOLUTION 4 (CBS-XII)

**REVIEW OF PREVIOUS RESOLUTIONS AND RECOMMENDATIONS OF THE
COMMISSION FOR BASIC SYSTEMS**

THE COMMISSION FOR BASIC SYSTEMS,

NOTING the action taken on the resolutions and recommendations adopted by the Commission prior to its twelfth session,

DECIDES:

- | | |
|---|--|
| <ul style="list-style-type: none"> (1) To keep in force Resolutions 1, 2 and 4 (CBS-Ext.(98)); | <ul style="list-style-type: none"> (2) To replace Resolutions 3 and 5 (CBS-Ext.(98)) with new resolutions; (3) To replace Recommendation 7 (CBS-Ext.(98)) with a new recommendation; (4) Not to keep in force the other recommendations adopted prior to its twelfth session. |
|---|--|

RECOMMENDATIONS ADOPTED BY THE SESSION

RECOMMENDATION 1 (CBS-XII)

AMENDMENTS TO THE *MANUAL ON CODES* (WMO-No. 306), VOLUME I.1, PART A, FM 71-XI CLIMAT AND FM 75-X CLIMAT TEMP

THE COMMISSION FOR BASIC SYSTEMS,

NOTING:

- (1) Resolution 3 (EC-LII) — Global Climate Observing System,
- (2) Recommendation 7 (CBS-XI) — Amendments to the *Manual on Codes*, Volume I.1, Alphanumeric codes and Volume I.2, Binary codes and common code tables,
- (3) The conclusions of the study on the availability of CLIMAT/CLIMAT TEMP reports,

CONSIDERING that the the fifty-second session of the Executive Council urged CBS to continue and to enhance coordination efforts with GCOS on the design and implementation of the GSN and GUAN,

CONSIDERING FURTHER the need to prohibit the inclusion of monthly mean data for different months in the same bulletin,

RECOMMENDS to insert in the *Manual on Codes* Volume I.1, Part A under FM 71-XI CLIMAT as a new paragraph 71.1.4, and under FM 75-X CLIMAT TEMP as a new paragraph 75.8 the following regulation:

A CLIMAT/CLIMAT TEMP bulletin shall contain reports for one specific month only.

RECOMMENDS FURTHER to make this regulation effective as from 1 July 2002;

REQUESTS the Secretary-General to arrange the inclusion of this addition in Volume I.1 of the *Manual on Codes*.

RECOMMENDATION 2 (CBS-XII)

AMENDMENTS TO THE *MANUAL ON THE GLOBAL TELECOMMUNICATION SYSTEM* (WMO-No. 386), VOLUME I, PARTS I AND II

THE COMMISSION FOR BASIC SYSTEMS,

NOTING:

- (1) Resolution 2 (Cg-XIII) — World Weather Watch Programme for 2000–2003,
- (2) The *Manual on the Global Telecommunication System*, Volume I, Parts I and II,

RECOMMENDS that the *Manual on the Global Telecommunication System*, Volume I, Parts I and II be amended as

given in the annex to this recommendation, with effect from 7 November 2001;

REQUESTS the Secretary-General to make the amendments as given in the annex to this recommendation, to the *Manual on the Global Telecommunication System*, Volume I, Parts I and II;

AUTHORIZES the Secretary-General to make any consequent purely editorial amendments of the *Manual on the Global Telecommunication System*, Volume I.

ANNEX TO RECOMMENDATION 2 (CBS-XII)

AMENDMENTS TO THE *MANUAL ON THE GLOBAL TELECOMMUNICATION SYSTEM* (WMO-No. 386), VOLUME I

PART I

Replace in paragraph 1.3 the text of Principles 2 and 4 to read:

Principle 2

The system shall comprise an integrated network of point-to-point circuits, point-to-

multipoint circuits, broadcast and multipoint-to-point circuits which are reliable and have suitable technical and operational characteristics. These circuits may be established via a combination of terrestrial and satellite telecommunication links, and data-communication network services.

Principle 4

In the planning of the circuits and transmission schedules, daily volume of traffic to be passed over any one circuit shall not exceed 80 per cent of its theoretical capacity. The circuits shall be designated to ensure the highest practicable reliability and availability.

Replace in Attachment I-3, the text of paragraphs 2 and 3 to read:

2. Principles for the establishment of the exchange programme for observational data on the Main Telecommunication Network

2.1 The types of meteorological messages containing observational data to be exchanged on the MTN are given below.

2.2 Type of information

(a) Surface observations on land and sea, including data from ships and buoys;

(b) Upper-air observations including data from aircraft;

(c) Climatological data;

(d) Selected satellite data;

(e) Seismic data (level 1), tsunami and other types of data as agreed.

NOTE: Items (a) to (e) do not indicate priorities.

2.3 Stations/areas from which reports should be included in the bulletins that are to be exchanged

The list of stations from which reports should be included in the bulletins that are to be exchanged are established as follows:

(a) All surface stations. The SYNOP reports from land stations exchanged on the MTN shall include at least Sections 0 and 1 of the SYNOP code form. As an interim measure, Section 3 of the SYNOP code form shall also be included in the global exchange on the MTN;

(b) All stations (on land or at sea) making radiosonde/radiowind observations;

(c) All aircraft;

(d) All climatological stations;

(e) All oceanographical stations;

3. Responsibilities of centres located on the Main Telecommunication Network for the exchange and distribution of processed information and satellite data

The exchange of processed information and satellite data on the MTN should be arranged between the MTN centres to meet the requirements of the WWW centres.

PART II

Add the following note at the end of paragraph 2.3.1.2:

NOTE: A five digit-group could be used by bilateral agreement; it should be used on circuits with a speed of

64 Kbit/s or above to enable appropriate recovery procedures.

Replace the text of paragraph 2.3.2.2 to read:

2.3.2.2 The symbols shall have the following meanings:

$T_1T_2A_1A_2ii$ Data designators.

NOTE: The WMO standard data designators are given in Attachment II-5.

T_1T_2 Data type and/or form designators.

A_1A_2 Geographical and/or data type and/or time designators.

ii It shall be a number with two digits. It is used to differentiate two or more bulletins which contain data in the same code and which originate from the same geographical area and have the same originating centre. The following sets of ii numbers shall be used for indicating the bulletins for global, interregional, regional and national distribution.

ii = 01-19 inclusive for global distribution;

ii = 20-39 for regional and interregional distribution;

ii = 40-89 inclusive national and bilaterally-agreed distribution;

ii = 90-99 reserved.

In the case of bulletins containing observational data and climatic data (surface and upper air) from land stations, with the exception of bulletins with $T_1 = I$ or K , separate ii number shall be allocated to each bulletin containing reports from a different list of stations. This list shall be determined for each particular group $T_1T_2A_1A_2ii$ YGGgg.

In the case of bulletins containing ships weather reports and aircraft reports, the number ii should be used for facilitating the selective distribution of ships weather reports and aircraft reports (surface and upper air). Whenever practicable, a fixed number of ii should be allocated to the bulletins for those reports which are collected from a certain area within each Region (e.g. southern Indian Ocean in Region I, southern Atlantic in Region III, etc.), and separate bulletins should be prepared for northern and southern hemispheres, respectively.

The use of ii in respect of bulletins containing satellite data, processed information, and pictorial information in digital form and certain bulletins coded in BUFR is defined in Tables A and D2 of Attachment II-5.

CCCC International four-letter location indicator of the station originating or compiling the bulletin, as agreed internationally, and published in WMO-No. 9, Volume C1, *Catalogue of Meteorological Bulletins*. Once a bulletin has been originated or compiled, the CCCC must not

be changed even if (because of inadequate reception, or for any other reason) the bulletin in question has to be re-compiled at another centre.

- YYGGgg International date-time group.
- YY Day of the month.
- GGgg For bulletins containing meteorological reports intended for standard times of observation, the time shall be the standard time of observation in UTC.

For aerodrome, route and area (aeronautical) forecasts: the full hour in UTC (the last two digits shall be 00) preceding the transmission time.

For other forecasts and analyses: standard time of observation in UTC on which forecast or analysis is based.

For other messages: the time shall be the time of compilation in UTC.

- BBB An abbreviated heading defined by $T_1T_2A_1A_2ii$ CCCC YYGGgg shall be used only once. Consequently, if this abbreviated heading has to be used again for an addition, a correction or an amendment, it shall be mandatory to add an appropriate BBB indicator, identified by a three-letter indicator which shall be added after the date-time group. The indicator BBB shall have the following forms:
 RRx for delayed routine meteorological reports;
 CCx for corrections to previously relayed reports;
 AAx for amendments to processed information;
 Pxx for segmenting a large set of information into several bulletins;
 where x is an alphabetic character of A through X;

NOTE: See Attachment II-12 for detailed explanation on the use of BBB.

The abbreviated headings and the contents of bulletins shall be published in WMO-No. 9, Volume C1 — *Catalogue of Meteorological Bulletins*.

Replace the text of paragraph 2.3.3.1 to read:

2.3.3.1 The following procedures shall apply to the compilation of the text of a meteorological bulletin:

- (a) The text of a bulletin shall be in one code form only;
- (b) The text of a bulletin shall not contain both “essential” and “additional” data as defined in Resolution 40 (Cg-XII);
- (c) [text of former (b)].

Replace the text of paragraph 5.2.3 to read:

5.2.3 METNO and WIFMA messages shall be compiled in the standard format for routine

meteorological messages using the abbreviated heading NOXX02 LSSW for changes related to Volume C1 — *Catalogue of Meteorological Bulletins*, of WMO-No. 9 and NOXX01 LSSW for the changes to the other volumes of WMO-No. 9.

Insert the following changes in Attachment II-5:

1. Replace in Table A the content of row $T_1 = J$ by:

T_1	Data type	T_2	A_1	A_2	ii	Priority	Max length
J	Forecast information (Binary coded) — BUFR	B3	C6	C4	D2	3	15 000

2. Modify the title of Table C4 to read:
 Reference time designator A_2
 (when $T_1 = D, G, H, J, O, P$ or T)
3. Add in Table C6, in the sub-table $T_1 = J$ (Forecast products) and $T_2 = U$ (Upper air), the following entries:

Designator	Data type
B	Binary coded SIGWX, Embedded Cumulonimbus
C	Binary coded SIGWX, Clear-air turbulence
F	Binary coded SIGWX, Fronts
N	Binary coded SIGWX, Other SIGWX parameters
O	Binary coded SIGWX, Turbulence
T	Binary coded SIGWX, Icing/Tropopause
V	Binary coded SIGWX, Tropical storms, sandstorms, volcanoes
W	Binary coded SIGWX, High-level winds

4. Modify the title of Table D2 to read:
 Level designator ii
 (when $T_1 = D, G, H, J, P, Q, X$ or Y)

Replace the text of Attachment II-15 with the following new text:

FOREWORD

The strategic direction for development of the GTS, as endorsed by CBS, has since the early eighties, been based on the OSI standards, especially the ITU-T recommendation X.25. However, CBS now considers that the TCP/IP protocols as used on the Internet, should replace X.25 for supporting GTS operations in the future.

The change in strategic direction has evolved within CBS in recent years. It has occurred for various reasons, including the expanding functional needs of the various WMO Programmes and the evolution of the Internet and its supporting technical standards, as a dominant force in the information technology industry, supplanting the OSI standards in many areas.

The transition to TCP/IP is considered appropriate because:

- (a) Vendor support for X.25 technology is declining and becoming more expensive due to industry concentration on TCP/IP;
- (b) TCP/IP supports numerous application utilities available off the shelf, which offer solutions to information communications needs of Members, such as file transfer, Web browsers, electronic mail and future applications such as multimedia communications;
- (c) TCP/IP provides connectivity between Members in a more flexible and versatile manner than the X.25 based equivalent.

These benefits equate to direct savings in financial and human resource costs to Members by:

- (a) Reduced costs for communications equipment purchase and maintenance; and
- (b) Reduced software development work through use of industry standard software systems.

Considerable efforts have been applied in defining the framework for applying TCP/IP to the GTS and for the orderly transition from the OSI/X.25-based origin of the GTS. In particular, this attachment on the use of TCP/IP on the GTS has been produced.

Procedures are defined to ensure that the primary function of the GTS in carrying real time operational traffic with minimum delay is preserved. The issue of securing the GTS from interference via the Internet is also addressed in general terms. Reliance must however be placed on all Members with a TCP/IP-based connection to the GTS, who are also connected to the Internet, to implement and maintain thorough security practices.

This attachment was originally written as the culmination of work undertaken by CBS WG-TEL during 1997 and 1998. The TCP/IP procedures have since been implemented by many national Centres. The opportunity has been taken to capture the practical experiences gained in the use of TCP/IP and update material accordingly. In addition, a World Wide Web resource has been set-up which gives further details of the technical implementation of many of the concepts and procedures introduced within this attachment. This is available on the ET/DCST information pages at <http://www.wmo.ch>.

Members are strongly advised to take account of the adoption of the TCP/IP-based strategy for the future development of the GTS, in planning the future development of systems within their national Centres.

1. Introduction

Historical perspective

The GTS at present is predominantly used to support the message switching application using message exchange in WMO format over a limited OSI transport service based on point-to-point X.25 supplemented by broadcasts. This limited implementation has been adequate for the legacy application of message switching but is not capable of meeting new requirements for

support of various WMO Programmes, especially the World Weather Watch, as developed within the CBS. These requirements include support for:

- (a) Distributed databases (DDB);
- (b) Data exchange between non-adjacent Centres;
- (c) Exchange of information that cannot readily be handled by message switching systems (MSSs).

The full list of requirements to be fulfilled by the Main Telecommunications Network (MTN) of the GTS were agreed upon by CBS-Ext. 1994. The use of TCP/IP services was endorsed by CBS-Ext. 1994 as a means of fulfilling these new requirements.

Purpose of this attachment

This Attachment is intended to assist Centres to implement Transmission Control Protocol/Internet Protocol (TCP/IP) based services on the GTS. The aim of this Attachment is to describe those aspects of the application of TCP/IP that apply specifically to the GTS to meet new requirements and also the long established routine data exchange undertaken by message switching systems (MSSs). The attachment takes account of the technical evolution of the GTS from an X.25 based network and maintains the philosophy that Centres continue to be autonomous as far as possible. It is recognized that the timing for the implementation of new systems is determined by individual Members in the light of their available resources and relative priorities.

This attachment does not cover fundamentals of TCP/IP but focuses on those aspects that are essential for successful application on the GTS. Such aspects include appropriate use of the GTS compared with the Internet, co-existence of the GTS and the Internet, IP and X.25 and autonomous system addressing, router management, TCP/IP application services (such as FTP) and fault management. The attachment gives an overview of recommended security practices with TCP/IP, but does not comprehensively address security issues and practices, this being a highly complex subject in itself. Some references on TCP/IP and on computer security are given in Appendix III.

Relationship of the Internet and GTS

The recent and rapid emergence of the Internet poses issues to be decided as regards its role in relation to the GTS in meeting operational communications requirements of National Meteorological Services. The Internet has grown rapidly in capacity, penetration and diversity of applications. Its bandwidth greatly exceeds that of the GTS and it could potentially take over some functions of the GTS. The weakness of the Internet, as of 1999, is that its performance from day to day, even hour to hour is unpredictable due to its variable and rapidly growing traffic load. Furthermore, its availability at various Centres differs in reliability and capacity. For some Centres it is quite possible that the absolute level of Internet performance can be unacceptably low, while for others the Internet presents an

adequate, cost-effective alternative to the traditional GTS point-to-point links. We must assume therefore that there will be a need for the Internet and the GTS to co-exist and plan accordingly.

The attachment is based therefore on the assumption that the GTS with its limited but assured capacity will continue to be required for essential exchange between WMO Members. It should however, where appropriate, adopt Internet technology and the Internet itself to improve versatility and maximize the scope for using standard software tools and services for the exchange of data and information. The limited capacity of the GTS creates a need for a practice of "acceptable" use and for it to be engineered in such a way that it is protected from general Internet traffic and preserves security against inappropriate use and unauthorized access. In particular, the use of IP and dynamic routing protocols such as BGP4 (border gateway protocol) on the GTS will have to be managed in such a way as to allow communication between non-adjacent Centres only with the knowledge and concurrence of all intermediate Centres. Otherwise there is a danger that large amounts of GTS capacity could be consumed by non-routine traffic, to the detriment of real time operational data exchange.

Evolution of the GTS

The use of the ISO/ITU standard X.25 was adopted by WMO in the early 1980's to facilitate the exchange of data and products encoded in WMO binary code forms (GRIB, BUFR, etc.) and to act as a base for higher level OSI applications. OSI was regarded at the time, as the strategic direction for the evolution of data communications. Since then, X.25 at OSI layers 2 and 3 has been implemented on much of the GTS and virtually all of the MTN. The implementation has been predominantly one of permanent virtual circuits (PVCs) directly linking the MSSs of Members. There has been some movement towards switched virtual circuits (SVCs) as a result of the strategic deployment of packet switches by some Centres as the first move towards making the GTS more of a true network and less a series of bilateral links. Such a strategy could be pursued but the emergence of the Internet and TCP/IP networking offers an alternative that appears much more attractive, particularly for non-MSS requirements.

The evolution of the GTS to adopt TCP/IP is now appropriate because:

- (a) It has become the dominant protocol suite in everyday use being now packaged with virtually all implementations of Unix and many PC operating systems such as Windows 95 and NT;
- (b) It offers a wide range of standard applications (file transfer, electronic mail, remote logon, World Wide Web, etc.) that will greatly reduce the need for the WMO community to develop special procedures and protocols as it has had to do in the past.

- (c) It provides useful features such as automatic alternate routing (in a meshed network) which could improve the reliability of the GTS.

This attachment however takes account of the fact that Centres have based plans and developed systems in line with the OSI standards, particularly X.25, as endorsed by WMO and specified in the *Manual on the GTS*. The adoption of TCP/IP-based services must be implemented in an orderly transition from the X.25 based links in such a way that operation of the GTS is not disrupted or put at risk.

The attachment provides for this by defining procedures for:

- (a) An interim hybrid based on:
 - (i) Carrying TCP/IP-based services over an X.25 network service; or
 - (ii) Carrying X.25 data over IP-based network service via directly connected routers;
- (b) Subsequent transition to pure IP utilizing directly connected routers, together with TCP/IP-based application services, such as TCP sockets or file transfer protocol (FTP).

The transition to the second step (pure IP) is desirable because:

- (a) Operating TCP/IP over X.25 may not provide expected throughput because of router processing overheads involved in packet encapsulation of IP frames within X.25 packets. This appears to become worse as line speeds increases. Limited tests which have been done between Centres in Region VI indicate efficiency less than 70 per cent at 64Kbps;
- (b) The management and maintenance activities required for the X.25 network and associated packet switches can be avoided;
- (c) Carrying X.25 over IP requires use of proprietary features of specific router brands;

In order to move to pure IP, it is necessary to modify MSSs at each Centre to make use of TCP/IP services such as FTP and sockets. This is covered in some detail in section 4.

Other related issues

Many Centres now have experience of TCP/IP on the GTS. Experience has shown that the main technical issues, which need to be addressed to establish widespread use of TCP/IP on the GTS, are:

- (a) Agreed methods for the message switching application to use TCP/IP either directly or via higher level applications e.g. FTP;
- (b) An agreed file naming convention and standard for metadata associated with files;
- (c) A community-wide naming and addressing agreement.

It is the aim of this attachment to make some progress with these issues, some of which lie in the domain of data management as much as telecommunications. It must also be recognized that the existing

GTS is not a true network, but a collection of discrete point-to-point links. Adoption of TCP/IP by some Centres has started to create a true network. Also managed networks using frame relay technology are now being introduced to the GTS. These developments introduce new issues regarding multi lateral cooperation in operating the GTS. While these issues are raised, they are beyond the scope of this attachment.

2. Principles governing the use of TCP/IP on the GTS

Management of traffic on GTS and Internet

The TCP/IP protocol suite provides the potential to use the full range of TCP/IP applications on the GTS. Some applications such as file transfer and World Wide Web have potential to place heavy loads on the limited bandwidth circuits that comprise the GTS. Limits need to be applied to ensure that the GTS carries only important traffic such as the real time data and products currently exchanged on the GTS plus data to be carried to fulfil new requirements such as DDBs, and routinely exchanged large data files such as satellite imagery. Less important traffic such as ad hoc file exchange, e-mail, general World Wide Web and such-like should be carried on the Internet. To protect the GTS, the full capabilities of TCP/IP connectivity and information exchange must be restricted. In practical terms, TCP/IP traffic carried on the GTS could be restricted on the basis of

- (a) Protocol type (e.g. FTP, HTTP, SMTP etc);
- (b) Originating and destination IP address;
- (c) A combination of the above.

If the measures adopted are to be successful, it is necessary that they be:

- (a) Not confined to a single router brand since it cannot be assumed that all Centres will have the same brand of router; and
- (b) Be reasonably straightforward to configure, so that there is minimum risk that configuration errors or omissions will endanger the GTS.

After considering these factors, the approach recommended is that only a small number of selected hosts in each Centre (e.g. the MSSs) be allowed to use the GTS, with no restriction placed on the protocol type. The concept is illustrated in Figure 2.1. Hosts A_{NMC1} and A_{NMC2} , are "GTS designated" hosts. They are allowed to exchange traffic on the GTS using any TCP/IP protocol.

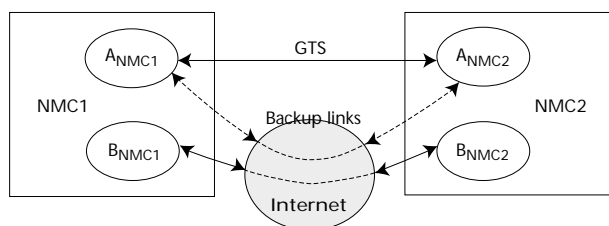

Figure 2.1 — Connectivity between hosts in GTS Centres.

Hosts B_{NMC1} and B_{NMC2} represent all other hosts in the two Centres which are not "GTS designated". They must communicate via the Internet.

To achieve this functionality, the site manager at each Centre must nominate which hosts are allowed to use the GTS. The GTS routers in each Centre must be configured so as to advertise only routes to "A" hosts, with packet filtering set to block packets from and to "B" hosts. A consequence of this is that A_{NMC2} will be unable to communicate with B_{NMC1} (and vice versa) even though both "A" and "B" hosts can access the Internet at large.

The actual configuration details to invoke the above functions in the Cisco family of routers are given in Appendix I.

In certain cases such as testing or backup to GTS dedicated links, it may be necessary for communication between "A" hosts to be via Internet. In this case, access lists in Internet access routers should permit only the specific "A" host in the neighbouring Centre to communicate via the Internet.

As a further precaution to protecting the GTS from traffic overload, the "A" hosts in a non-adjacent Centre should only be permitted to communicate with the knowledge and concurrence of intermediate Centres.

Security issues and segregation of Internet and GTS traffic

Any Centre which has a TCP/IP-based GTS connection and a connection to the Internet, is a potential weak point where the GTS could be exposed to deliberate or inadvertent interference through unwanted traffic or unauthorized connection to GTS hosts.

Centres are strongly encouraged to implement protective barriers such as firewall systems on the connection of their Centre with the Internet. It is important that every practical step is taken to prevent accidental or deliberate use of GTS links or unauthorized access to GTS Centres, by Internet users.

When setting up IP on the GTS, it is vital to ensure that the GTS does not become part of the Internet or an unintended transmission path for Internet traffic. Each Centre must consider the GTS and the Internet as two separate networks and ensure that inappropriate flow of traffic from one to the other cannot occur. This will ensure that the GTS is used only for transferring bona fide meteorological data between authorized hosts.

Some basic principles for implementing basic security measures for the GTS are shown in Figure 2.2. It illustrates in a general way, how a Centre with TCP/IP connection to the GTS and an Internet connection might be set up. Functions to be implemented include:

- (a) Allowing only GTS-designated hosts to communicate through the GTS router;
- (b) Blocking access to GTS-designated hosts through the firewall and Internet router;

- (c) Firewall allows only approved hosts on the Internet to access B hosts and then, only for approved applications such as FTP;
- (d) Prevention of access to A hosts from Internet via B hosts.

The actual choice of routers and firewall and the setting up of these will require expertise in the design and configuration of networking and security systems. It is not intended here, to provide detailed coverage of security system implementation and management as it is a large and complex topic. It is simply emphasized that it is important that every Centre should implement the best practical security measures, appropriate to its system complexity and capabilities. Some additional material relevant to small Centres is given in Appendix III.

In addition to network security measures, it is vital that good security practices are followed in the management of all hosts in a Centre. Computer security is a complex subject in itself and Centres are encouraged to study this in depth and apply appropriate practices. Some references in computer security are given in Appendix IV. As a bare minimum, good password practices should be followed in the management of all host machines in a Centre. Some recommended practices are given in Appendix V.

Routing and traffic management

Routing algorithms

In order to be able to send a packet, every host, router or equipment connected on an IP network must have a routing table. The table tells the system where to send the packet. This may be achieved by:

- (a) Static routing; or
- (b) Dynamic routing.

Static routing

With static routing, every required destination and next hop must be entered in the routing tables by the system administrator. Alternatively, a default route can be declared, although this option is mainly applicable to sites with only one connection to the outside

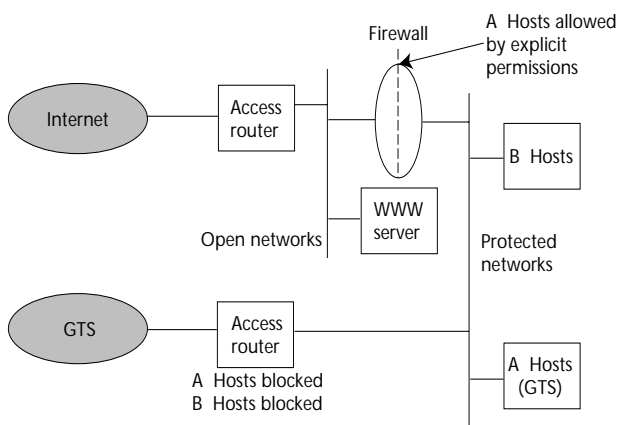

Figure 2.2 — Generic arrangement for protecting GTS systems.

world. If a default route is set up, filters must be established to ensure that only authorized hosts can access the GTS.

Whenever a new Centre is connected to the GTS with IP protocol, the site managers of all other IP capable Centres must add the new address to their routing tables. This might become a major task as IP connectivity spreads over the GTS.

Dynamic routing

With dynamic routing, the routing information is automatically exchanged between routers. This enables the network to learn new addresses and to use alternative paths under fault conditions in a partially meshed network topology. The initial set-up of dynamic routing may be somewhat more complex, but the ongoing management task is greatly reduced.

Use of dynamic routing requires selection of an appropriate routing protocol to operate over the links of the GTS. The protocol must be an exterior gateway protocol (e.g. EGP, BGP) as opposed to an interior gateway protocol (such as IGRP, RIP, OSPF) because interior gateway protocols are intended for use within a single management domain. The GTS is an aggregation of many separate management domains. As such, it is necessary to select a gateway protocol that can be autonomously managed by each Centre to implement routing and hence traffic flow, consistent with its particular requirements.

Two exterior gateway protocols are defined by RFCs — EGP and BGP (now release 4 — RFC 1771). As the GTS is not a tree structure, setting up routing with EGP may be difficult. BGP 4 does not suffer topological constraints. It is more powerful, but a little more difficult to configure.

BGP can distribute subnetted routes. This feature might be very useful for the GTS. Instead of propagating host-based routes or full network routes, routing can be based on subnetted networks. Instead of declaring hosts eligible to use the GTS, a Centre could declare a full subnet of eligible hosts. In that case, the routing information consists of just an IP address and a subnet mask. For example, if a Centre has a class C addresses 193.168.1.0, by declaring that the subnet 193.168.1.16 with mask 255.255.255.248 is allowed to use the GTS, all hosts with IP address 193.168.1.17 to 193.168.1.22 will be routable on the GTS.

Recommended routing method

Based on consideration of the above factors the BGP4 routing protocol should be used between Centres on the GTS, unless an alternative is bilaterally agreed on individual links. Examples of BGP4 set-up for the Cisco router family are given in Appendix II.

Registered and private addresses

It is recommended that Centres use officially registered IP addresses issued by their national Internet authority

or by an Internet Service Provider (ISP). Nowadays, IP address space is administered by these organizations, rather than the global or regional authorities. These authorities are however a useful source of information on existing address allocations, through database lookup services such as 'whois'. Major regional authorities are:

- (a) Asia Pacific Network Information Centre (APNIC) <http://www.apnic.net>
- (b) American Registry for Internet Numbers (ARIN) <http://www.arin.net>
- (c) Reseau IP Europeens (RIPE NCC) <http://www.ripe.net>.

If Centres use private IP addresses on their internal networks, then network address translation (NAT) must be adopted for any hosts requiring to communicate over the GTS or the Internet. A sufficient number of official addresses must be obtained to correspond to the number of hosts required to communicate externally, and the type of NAT supported by the Centre's access router. If static NAT is adopted, then a one-to-one correspondence of internal and official addresses is required. If dynamic NAT is used, then there can be more internal addresses than official addresses, with the router allocating the pool of official addresses dynamically as necessary. The documentation for the Centre's access router should be consulted to ascertain the NAT support provided.

Private addresses must not be visible on the GTS or Internet. Figure 2.3 shows simplified examples of allowable and non-allowable arrangements.

Implementation of GTS links via Internet

CBS has expressed the view¹ that the use of Internet for GTS links can be considered in circumstances where they are cost effective, offer an acceptable level of service and where adequate security measures are implemented. In general, the same principles for

¹ General summary paragraphs 4.4.35-4.4.45, particularly paragraph 4.4.40 of the *Abridged Final Report with Resolutions and Recommendations of the Extraordinary Session of the Commission for Basic Systems* (WMO-No. 893).

routing and security described above, apply where Internet links are used instead of dedicated links. Further details applying to the use of Internet based links, especially related to small GTS Centres, are given in Appendix III.

Summary of tasks to ensure proper use of IP on the GTS

1. Use only official IP addresses for external communication on the GTS.
2. Declare which IP addresses in your Centre designates as eligible to use the GTS. (A list of allowed hosts and/or subnets is kept on the WMO FTP server.)
3. Obtain an autonomous-system number through the WMO Secretariat (which will maintain a list of AS numbers to be used on the GTS — refer to section 3) to be used for BGP configuration on the GTS.
4. Establish an IP connection with one or more Centres. This connection will be pure IP using PPP as a level 2 protocol on the link, (or a proprietary protocol such as Cisco HDLC by bilateral agreement) or IP over X.25 (RFC 1356). In this case use X.121 addresses as defined in section 3.
5. Configure dynamic routing with BGP (unless you are a Centre with only one GTS connection and have agreed with your neighbouring Centre to use static routing).
6. Check the barrier between Internet and the GTS (prevent routing from the Internet to the GTS).
7. Filter incoming and outgoing traffic in accordance with the requirements described above.

3. Implementation guidelines

Introduction

The introduction of IP-based services on the GTS will, in many cases, be implemented initially by using a mixture of X.25 and IP, because of the technical evolution of the GTS as described in section 1. IP services may be carried over an X.25 network by encapsulating IP packets within X.25 packets. An appropriately configured router at each GTS Centre carries out this function. Alternatively, where routers of the same brand are used in adjacent Centres, X.25 data may be

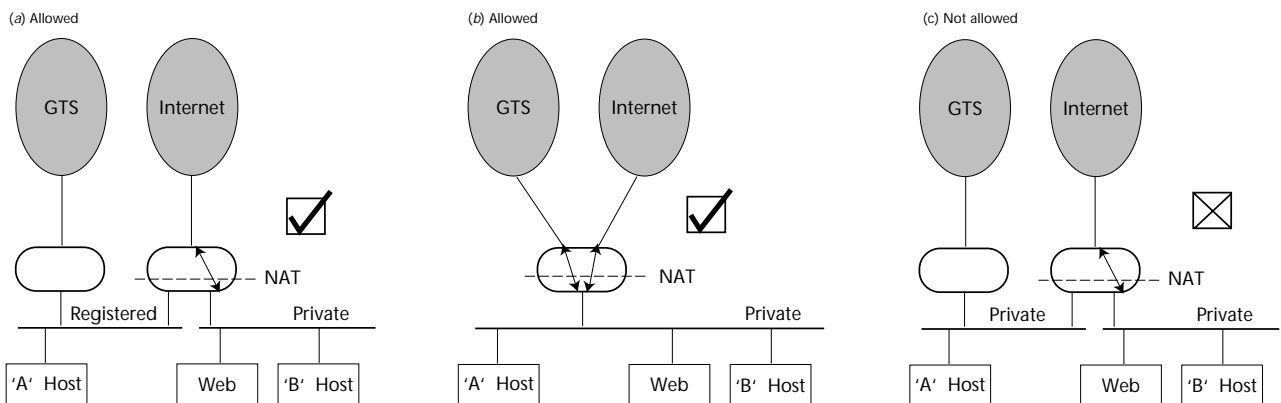

Figure 2.3 — Simplified examples of allowable and non-allowable arrangements.

carried on an IP link using X.25 switching capability of the routers.

It is desirable ultimately for Centres to adopt through bilateral agreement, direct IP connections with TCP/IP application services (FTP, sockets) superseding IP over X.25, or X.25 over IP as the case may be.

It is necessary to have an addressing framework for:

- (a) X.25 packet switching between Centres;
- (b) IP over X.25;
- (c) Direct IP (including X.25 over IP).

The use of BGP requires introduction of the concept of the autonomous system (AS)². Each GTS Centre manages an AS number to enable the Centre to adopt BGP with neighbouring Centres. In addition to addressing, this section shows allocation scheme of AS numbers.

Addressing for X.25 packet switching between Centres

Many Centres have adopted X.25 for point to point connections between message switching systems (MSS). A number of Centres have installed, or plan to install packet switches to provide capability for connections between non-adjacent Centres. An addressing scheme has been developed for this purpose. It is a 14-digit scheme of the form 0101xxxiiyyzz where:

- 0101 is a pseudo DNIC which does not correspond to any actual DNIC and therefore will ensure calls cannot be mistakenly switched to any network other than the GTS;
- xxx is the X.121 country code of the Centre;

² An autonomous system is defined in RFC1630 as “a set of routers number under a single technical administration, using an interior gateway protocol and common metrics to route packets within the AS, and using an exterior gateway protocol to route packets to other ASs.”

- ii is a protocol indicator, being 00 for MSS, 11 for TCP/IP, 22 for OSI CONS, 33 for OSI CLNS;
- yyy is the nationally-assigned port number;
- zz is the nationally-assigned subaddress number.

This addressing scheme is to be used for setting up virtual calls (VCs) for MSS applications and for any other GTS applications including carriage of IP traffic over X.25.

Addressing for IP over X.25

In order to carry IP traffic over X.25, two globally coordinated address schemes are necessary:

- (a) An X.25 scheme as described above; and
- (b) An IP address scheme to apply to the interface between the router and packet switch to enable the router to encapsulate the IP packets into X.25 packets.

The general arrangement is shown in Figure 3.1.

For IP over X.25 to function correctly, it is necessary for the underlying X.25 network to be allocated a single IP network address and for each Centre to have an address within this network for the connection point between its router and its packet switch. The Class C network address 193.105.177.0 has been allocated for this purpose, by agreement between *Météo-France* (the registered holder of this address) and WMO. Each IP node on the network will be assigned a sequential host address within this single Class C IP address as illustrated in Figure 3.1. The Class C address can provide for 254 Centres to be connected using a subnet mask of 255.255.255.0.

The routers at each Centre have to be set up so that they issue an X.25 call request to the X.25 port of the final destination Centre. This means that IP traffic passes through the packet switch only, and not the router of the intermediate Centre.

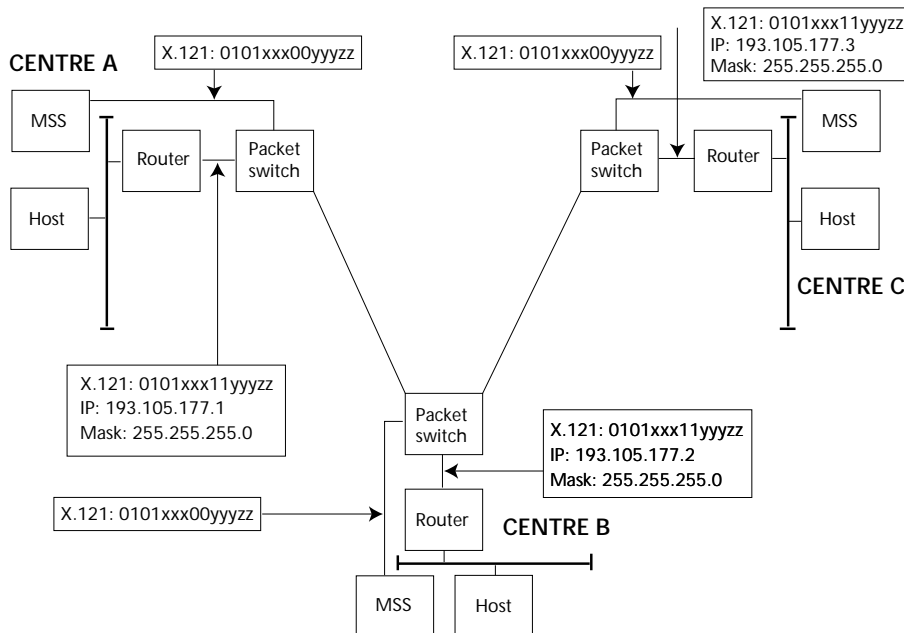

Figure 3.1 — IP implemented over X.25 network.

Addressing for direct IP

At an appropriate future time, Centres may wish to replace IP over X.25 with direct IP links with neighbouring Centres under bilateral agreement. This transition would be appropriate when the volume of IP traffic predominates and the MSSs are capable of communication using TCP/IP. A further seven Class C network addresses have been allocated for direct IP links between Centres, by agreement between *Météo France* (the registered holder of these addresses) and WMO. Each Class C network address can provide 62 links (see box 'Allocation of class C addresses for direct IP links'). The network addresses are:

MTN and interregion links	193.105.178.0
Links within RA I	193.105.179.0
Links within RA II	193.105.180.0
Links within RA III	193.105.181.0
Links within RA IV	193.105.182.0
Links within RA V	193.105.183.0
Links within RA VI	193.105.184.0

Further Class C addresses will be sought should the addresses available above be used up.

Figure 3.2 illustrates how pair of Centres have agreed to implement a direct IP connection using the first available pair of 'host' numbers from the 193.105.178.0 network.

Addressing for X.25 over IP

Where two Centres have a common brand of router (e.g. Cisco), and the traffic is mostly IP with some X.25, it may be appropriate to carry the X.25 over the directly connected routers as shown for the link between Centre B and Centre C in Figure 3.3. The X.25 packets are carried within IP packets over the serial link between the routers, which may be a proprietary HDLC protocol, or a standard protocol such as PPP.

This functionality requires that routers in each Centre contain X.25 packet switching software and that the X.25 route details are included in the router configuration. Examples of typical configurations are given in Appendix II.

Autonomous system numbers

The use of BGP4 as the recommended dynamic routing protocol for the GTS (section 2) requires allocation of autonomous system (AS) numbers to each GTS Centre.

The Internet Assigned Numbers Authority (IANA), through RFC1930, has reserved the block of AS numbers 64512 through 65535 for private use (not to be advertized on the global Internet). This provides eight groups of 128 AS numbers to be assigned to GTS Centres, satisfying the current and foreseeable future needs of the GTS. The AS numbers will be assigned as follows:

MTN Centres and reserve	64512 to 64639
Centres within RA I	64640 to 64767
Centres within RA II	64768 to 64895
Centres within RA III	64896 to 65023
Centres within RA IV	65024 to 65151
Centres within RA V	65152 to 65279
Centres within RA VI	65280 to 65407
Antarctic and reserve	65408 to 65471
*Private use by GTS Centres	65472 to 65535

* These AS numbers are for national use and are not to be advertized on the GTS.

Implementation details

In order to implement IP services Centres need to know certain details of IP and X.25 addressing at other Centres on the GTS. The following diagrams and associated tables explain in detail, the information required at various Centres:

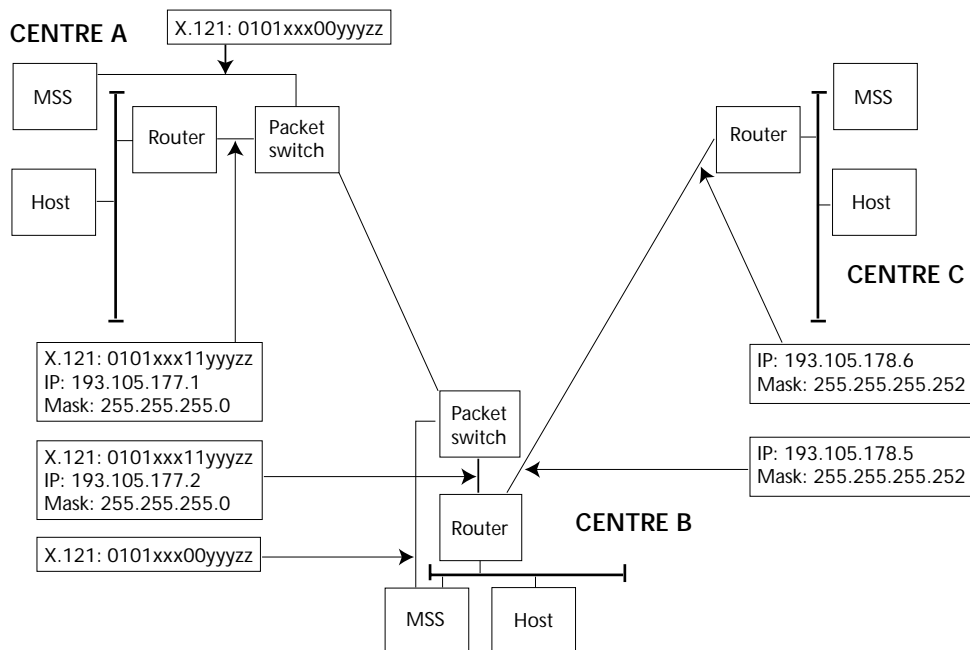

Figure 3.2 — Direct IP link between Centres B and C.

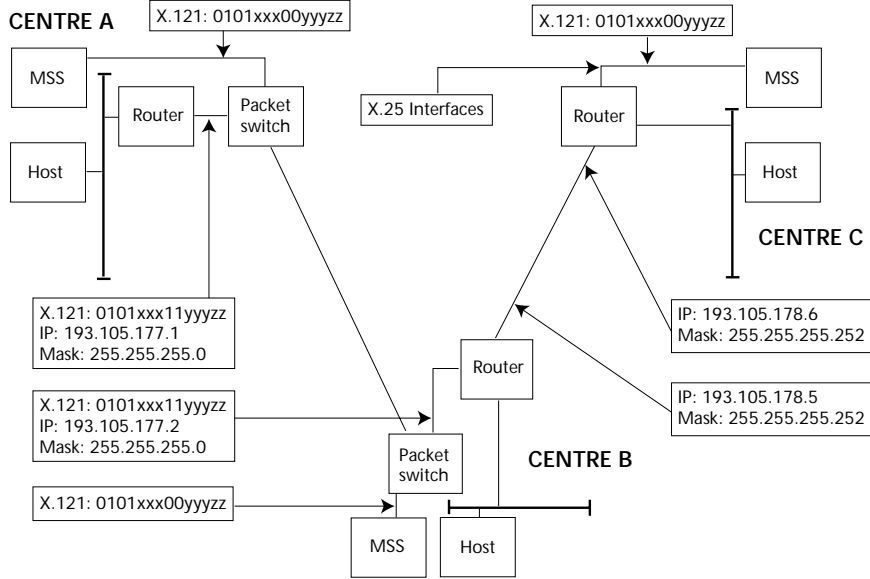

Figure 3.3 — Combination of IP over X.25 and X.25 over IP.

Allocation of Class C addresses for direct IP links

Routers have to be connected by links having unique subnet numbers. To achieve this, a Class C address is used (for example 193.105.178.0) with a mask of 255.255.255.252. This provides 62 subnets each with two hosts. These two host numbers are allocated to the ends of the link connecting the routers between the two Centres. The lowest useable network number is 193.105.178.4, with host addresses of 193.105.178.5 and 6. The next network number is 193.105.178.8, with host addresses of 193.105.178.9 and 10, followed by:

- 193.105.178.12, with host addresses of 193.105.178.13 and 14, followed by
- 193.105.178.16, with host addresses of 193.105.178.17 and 18, followed by
- 193.105.178.20, with host addresses of 193.105.178.21 and 22, and so on, up to
- 193.105.178.248, with host addresses of 193.105.178.249 and 250.

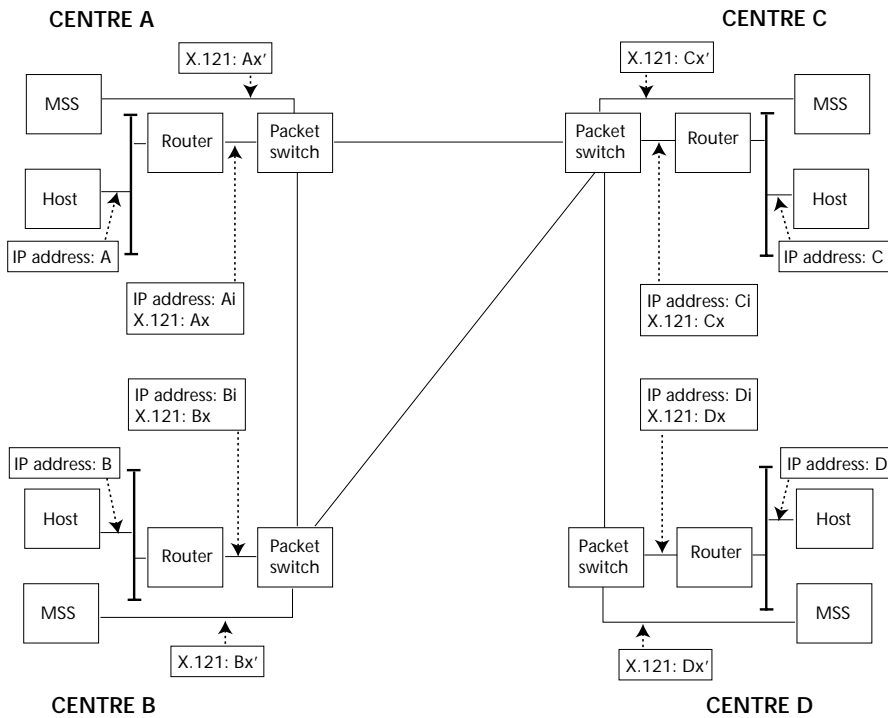

Figure 3.4 — IP over X.25 network.

Table 3.4a
IP and X.121 addresses to be known at CENTRE A

<i>Destination</i>	<i>Addresses to be known</i>		<i>Suitable route</i>
	<i>For communication between ends</i>	<i>For communication between routers</i>	
CENTRE B (Host to host)	IP address : B	IP address : Bi X.121 : Bx	CENTRE A – CENTRE B
CENTRE C (Host to host)	IP address : C	IP address : Ci X.121 : Cx	CENTRE A – CENTRE C
CENTRE D (Host to host)	IP address : D	IP address : Di X.121 : Dx	CENTRE A – CENTRE C – CENTRE D (Host [A] – Router [A] – Packet switch [A] – Packet switch [C] – Packet switch [D] – Router [D] – Host [D]) [x] : CENTRE x
CENTRE B (MSS to MSS)	X.121 : Bx' (X.25 traffic)		CENTRE A – CENTRE B
CENTRE C (MSS to MSS)	X.121 : Cx' (X.25 traffic)		CENTRE A – CENTRE C
CENTRE D (MSS to MSS)	X.121 : Dx' (X.25 traffic)		CENTRE A – CENTRE C – CENTRE D (MSS [A] – Packet switch [A] – Packet switch [C] – Packet switch [D] – MSS [D])

Table 3.4b
IP and X.121 addresses to be known at CENTRE B

<i>Destination</i>	<i>Addresses to be known</i>		<i>Suitable route</i>
	<i>For communication between ends</i>	<i>For communication between routers</i>	
CENTRE A (Host to host)	IP address : A	IP address : Ai X.121 : Ax	CENTRE B – CENTRE A
CENTRE C (Host to host)	IP address : C	IP address : Ci X.121 : Cx	CENTRE B – CENTRE C
CENTRE D (Host to host)	IP address : D	IP address : Di X.121 : Dx	CENTRE B – CENTRE C – CENTRE D
CENTRE A (MSS to MSS)	X.121 : Ax' (X.25 traffic)		CENTRE B – CENTRE A
CENTRE C (MSS to MSS)	X.121 : Cx' (X.25 traffic)		CENTRE B – CENTRE C
CENTRE D (MSS to MSS)	X.121 : Dx' (X.25 traffic)		CENTRE B – CENTRE C – CENTRE D

Table 3.4c
IP and X.121 addresses to be known at CENTRE C

<i>Destination</i>	<i>Addresses to be known</i>		<i>Suitable route</i>
	<i>For communication between ends</i>	<i>For communication between routers</i>	
CENTRE A (Host to host)	IP address : A	IP address : Ai X.121 : Ax	CENTRE C – CENTRE A
CENTRE B (Host to host)	IP address : B	IP address : Bi X.121 : Bx	CENTRE C – CENTRE B
CENTRE D (Host to host)	IP address : D	IP address : Di X.121 : Dx	CENTRE C – CENTRE D
CENTRE A (MSS to MSS)	X.121 : Ax' (X.25 traffic)		CENTRE C – CENTRE A
CENTRE B (MSS to MSS)	X.121 : Bx' (X.25 traffic)		CENTRE C – CENTRE B
CENTRE D (MSS to MSS)	X.121 : Dx' (X.25 traffic)		CENTRE C – CENTRE D

Table 3.4d
IP and X.121 addresses to be known at CENTRE D

Destination	Addresses to be known		Suitable route
	For communication between ends	For communication between routers	
CENTRE A (Host to host)	IP address : A	IP address : Ai X.121 : Ax	CENTRE D – CENTRE C – CENTRE A
CENTRE B (Host to host)	IP address : B	IP address : Bi X.121 : Bx	CENTRE D – CENTRE C – CENTRE B
CENTRE C (Host to host)	IP address : C	IP address : Ci X.121 : Cx	CENTRE D – CENTRE C
CENTRE A (MSS to MSS)	X.121 : Ax' (X.25 traffic)		CENTRE D – CENTRE C – CENTRE A
CENTRE B (MSS to MSS)	X.121 : Bx' (X.25 traffic)		CENTRE D – CENTRE C – CENTRE B
CENTRE C (MSS to MSS)	X.121 : Cx' (X.25 traffic)		CENTRE D – CENTRE C

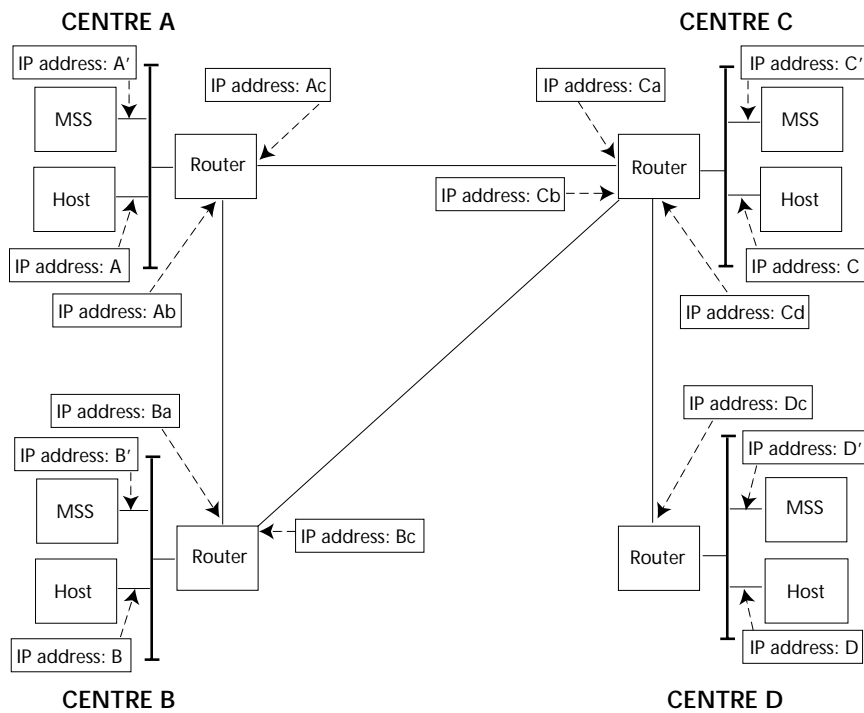

Figure 3.5 — Direct IP network.

Table 3.5a
IP address to be known at CENTRE A

Destination	Addresses to be known		Suitable route
	For communication between ends	For communication between routers	
CENTRE B (Host to host)	IP address : B	IP address : Ba	CENTRE A – CENTRE B
CENTRE C (Host to host)	IP address : C	IP address : Ca	CENTRE A – CENTRE C
CENTRE D (Host to host)	IP address : D	IP address : Ca	CENTRE A – CENTRE C – CENTRE D (Host [A] – Router [A] – Router [C] – Router [D] – Host [D]) [x] : CENTRE x
CENTRE B (MSS to MSS)	IP address : B'	IP address : Ba	CENTRE A – CENTRE B
CENTRE C (MSS to MSS)	IP address : C'	IP address : Ca	CENTRE A – CENTRE C
CENTRE D (MSS to MSS)	IP address : D'	IP address : Ca	CENTRE A – CENTRE C – CENTRE D

Table 3.5b
IP address to be known at CENTRE B

<i>Destination</i>	<i>Addresses to be known</i>		<i>Suitable route</i>
	<i>For communication between ends</i>	<i>For communication between routers</i>	
CENTRE A (Host to host)	IP address : A	IP address : Ab	CENTRE B – CENTRE A
CENTRE C (Host to host)	IP address : C	IP address : Cb	CENTRE B – CENTRE C
CENTRE D (Host to host)	IP address : D	IP address : Cb	CENTRE B – CENTRE C – CENTRE D
CENTRE A (MSS to MSS)	IP address : A'	IP address : Ab	CENTRE B – CENTRE A
CENTRE C (MSS to MSS)	IP address : C'	IP address : Cb	CENTRE B – CENTRE C
CENTRE D (MSS to MSS)	IP address : D'	IP address : Cb	CENTRE B – CENTRE C – CENTRE D

Table 3.5c
IP address to be known at CENTRE C

<i>Destination</i>	<i>Addresses to be known</i>		<i>Suitable route</i>
	<i>For communication between ends</i>	<i>For communication between routers</i>	
CENTRE A (Host to host)	IP address : A	IP address : Ac	CENTRE C – CENTRE A
CENTRE B (Host to host)	IP address : B	IP address : Bc	CENTRE C – CENTRE B
CENTRE D (Host to host)	IP address : D	IP address : Dc	CENTRE C – CENTRE D
CENTRE A (MSS to MSS)	IP address : A'	IP address : Ac	CENTRE C – CENTRE A
CENTRE B (MSS to MSS)	IP address : B'	IP address : Bc	CENTRE C – CENTRE B
CENTRE D (MSS to MSS)	IP address : D'	IP address : Dc	CENTRE C – CENTRE D

Table 3.5d
IP address to be known at CENTRE D

<i>Destination</i>	<i>Addresses to be known</i>		<i>Suitable route</i>
	<i>For communication between ends</i>	<i>For communication between routers</i>	
CENTRE A (Host to host)	IP address : A	IP address : Cd	CENTRE D – CENTRE C – CENTRE A
CENTRE B (Host to host)	IP address : B	IP address : Cd	CENTRE D – CENTRE C – CENTRE B
CENTRE C (Host to host)	IP address : C	IP address : Cd	CENTRE D – CENTRE C
CENTRE A (MSS to MSS)	IP address : A'	IP address : Cd	CENTRE D – CENTRE C – CENTRE A
CENTRE B (MSS to MSS)	IP address : B'	IP address : Cd	CENTRE D – CENTRE C – CENTRE B
CENTRE C (MSS to MSS)	IP address : C'	IP address : Cd	CENTRE D – CENTRE C

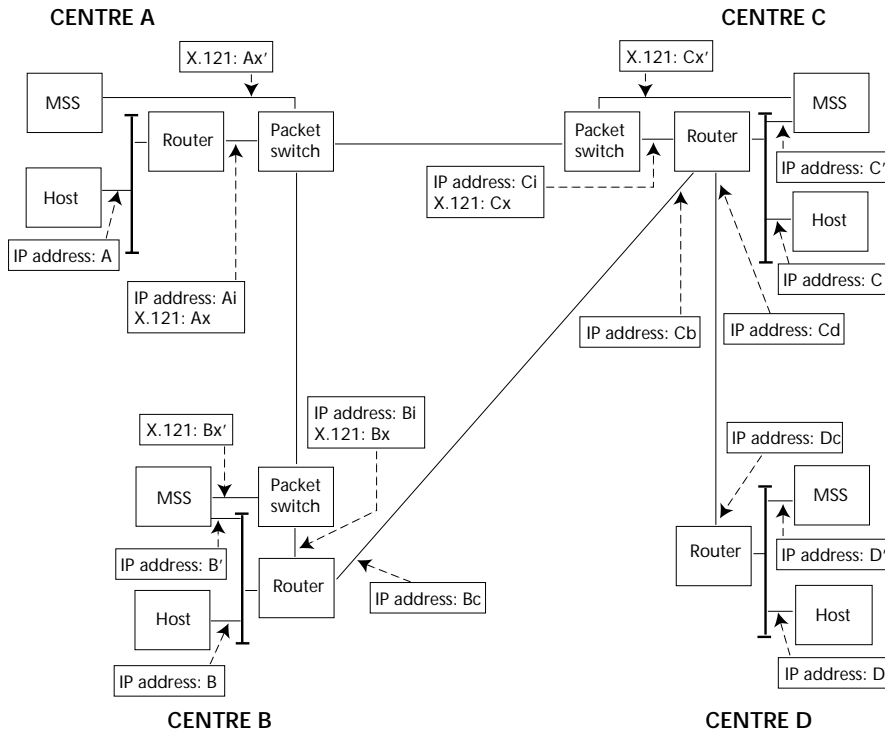

Figure 3.6 — Coexistence of direct IP with IP over X.25.

Table 3.6a
IP and X.121 addresses to be known at CENTRE A

Destination	Addresses to be known		Suitable route
	For communication between ends	For communication between routers	
CENTRE B (Host to host)	IP address : B	IP address : Bi X.121 : Bx	CENTRE A – CENTRE B
CENTRE C (Host to host)	IP address : C	IP address : Ci X.121 : Cx	CENTRE A – CENTRE C
CENTRE D (Host to host)	IP address : D	IP address : Ci X.121 : Cx	CENTRE A – CENTRE C – CENTRE D
CENTRE B (MSS to MSS)	X.121 : Bx' (X.25 traffic)		CENTRE A – CENTRE B
CENTRE C (MSS to MSS)	X.121 : Cx' (X.25 traffic)		CENTRE A – CENTRE C
CENTRE D (MSS to MSS)	Possible only by store and forward via MSS at Centre C (X.25 traffic)		

Table 3.6b
IP and X.121 addresses to be known at CENTRE B

Destination	Addresses to be known		Suitable route
	For communication between ends	For communication between routers	
CENTRE A (Host to host)	IP address : A	IP address : Ai X.121 : Ax	CENTRE B – CENTRE A
CENTRE C (Host to host)	IP address : C	IP address : Cb	CENTRE B – CENTRE C
CENTRE D (Host to host)	IP address : D	IP address : Cb	CENTRE B – CENTRE C – CENTRE D
CENTRE A (MSS to MSS)	X.121 : Ax' (X.25 traffic)		CENTRE B – CENTRE A
CENTRE C (MSS to MSS)	IP address : C'	IP address : Cb	CENTRE B – CENTRE C
CENTRE D (MSS to MSS)	IP address : D'	IP address : Cb	CENTRE B – CENTRE C – CENTRE D

Table 3.6c
IP and X.121 addresses to be known at CENTRE C

Destination	Addresses to be known		Suitable route
	For communication between ends	For communication between routers	
CENTRE A (Host to host)	IP address : A	IP address : Ai X.121 : Ax	CENTRE C - CENTRE A
CENTRE B (Host to host)	IP address : B	IP address : Bc	CENTRE C - CENTRE B
CENTRE D (Host to host)	IP address : D	IP address : Dc	CENTRE C - CENTRE D
CENTRE B (MSS to MSS)	X.121 : Ax' (X.25 traffic)		CENTRE C - CENTRE A
CENTRE C (MSS to MSS)	IP address : B'	IP address : Bc	CENTRE C - CENTRE B
CENTRE D (MSS to MSS)	IP address : D'	IP address : Bc	CENTRE C - CENTRE D

Table 3.6d
IP and X.121 addresses to be known at CENTRE D

Destination	Addresses to be known		Suitable route
	For communication between ends	For communication between routers	
CENTRE A (Host to host)	IP address : A	IP address : Cd	CENTRE D - CENTRE C - CENTRE A
CENTRE B (Host to host)	IP address : B	IP address : Cd	CENTRE D - CENTRE C - CENTRE B
CENTRE C (Host to host)	IP address : C	IP address : Cd	CENTRE D - CENTRE C
CENTRE A (MSS to MSS)	Possible only by store and forward via MSS at Centre C (X.25 traffic)		
CENTRE B (MSS to MSS)	IP address : B'	IP address : Cd	CENTRE D - CENTRE C - CENTRE B
CENTRE C (MSS to MSS)	IP address : C'	IP address : Cd	CENTRE D - CENTRE C

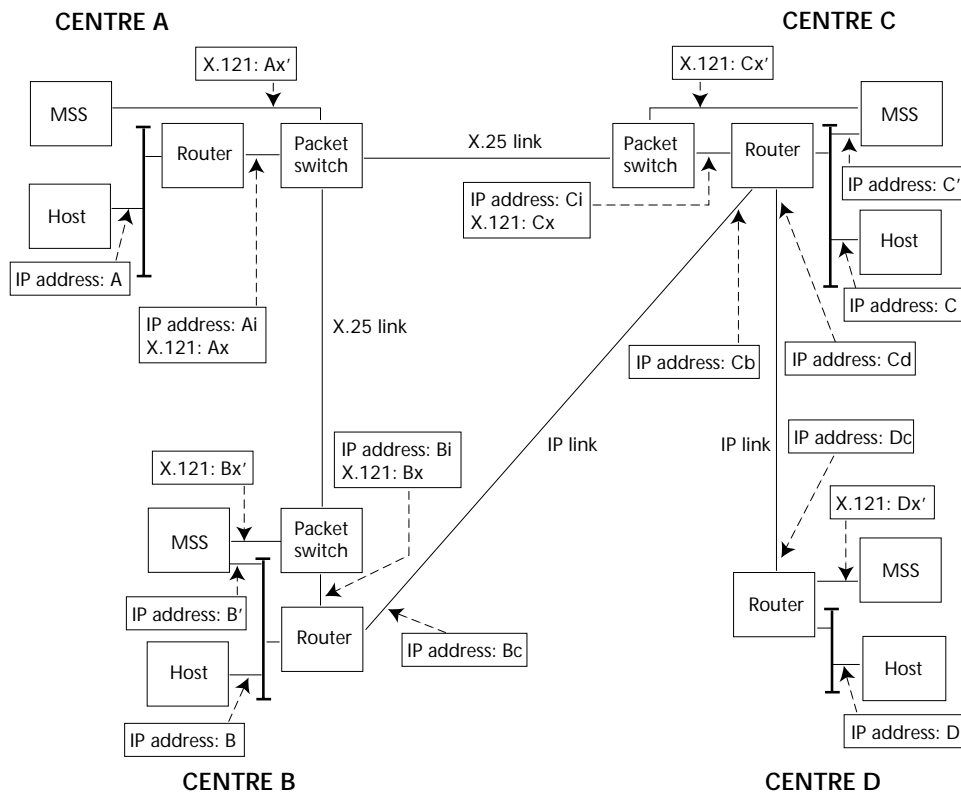

Figure 3.7 — Coexistence of direct IP, IP over X.25 and X.25 over IP.

Table 3.7a
IP and X.121 addresses to be known at CENTRE A

<i>Destination</i>	<i>Addresses to be known</i>		<i>Suitable route</i>
	<i>For communication between ends</i>	<i>For communication between routers</i>	
CENTRE B (Host to host)	IP address : B	IP address : Bi X.121 : Bx	CENTRE A – CENTRE B (Host [A] – Router [A] – “IP over X.25” – Packet switch [A] – “IP over X.25” – Packet switch [B] – “IP over X.25” – Router [B] – Host [B])
CENTRE C (Host to host)	IP address : C	IP address : Ci X.121 : Cx	CENTRE A – CENTRE C (Host [A] – Router [A] – “IP over X.25” – Packet switch [A] – “IP over X.25” – Packet switch [C] – “IP over X.25” – Router [C] – Host [C])
CENTRE D (Host to host)	IP address : D	IP address : Ci X.121 : Cx	CENTRE A – CENTRE C – CENTRE D (Host [A] – Router [A] – “IP over X.25” – Packet switch [A] – “IP over X.25” – Packet switch [C] – “IP over X.25” – Router [C] – “Direct IP” – Router [D] – Host [D])
CENTRE B (MSS to MSS)	X.121 : Bx' (X.25 traffic)		CENTRE A – CENTRE B (MSS [A] – Packet switch [A] – Packet switch [B] – MSS [B])
CENTRE C (MSS to MSS)	X.121 : Cx' (X.25 traffic)		CENTRE A – CENTRE C (MSS [A] – Packet switch [A] – Packet switch [C] – MSS [C])
CENTRE D (MSS to MSS)	X.121 : Dx' (X.25 traffic)		CENTRE A – CENTRE C – CENTRE D (MSS [A] – Packet switch [A] – Packet switch [C] – Router [C] – “X.25 over IP” – Router [D] – MSS [B])

Table 3.7b
IP and X.121 addresses to be known at CENTRE B

<i>Destination</i>	<i>Addresses to be known</i>		<i>Suitable route</i>
	<i>For communication between ends</i>	<i>For communication between routers</i>	
CENTRE A (Host to host)	IP address : A	IP address : Ai X.121 : Ax	CENTRE B – CENTRE A
CENTRE C (Host to host)	IP address : C	IP address : Cb	CENTRE B – CENTRE C (Host [B] – Router [B] – “Direct IP” – Router [C] – Host [C])
CENTRE D (Host to host)	IP address : D	IP address : Cb	CENTRE B – CENTRE C – CENTRE D (Host [B] – Router [B] – “Direct IP” – Router [C] – “Direct IP” – Router [D] – Host [D])
CENTRE A (MSS to MSS)	X.121 : Ax' (X.25 traffic)		CENTRE B – CENTRE A
CENTRE C (MSS to MSS)	IP address : C'	IP address : Cb	CENTRE B – CENTRE C (MSS [B] – Router [B] – “Direct IP” – Router [C] – MSS [C])
CENTRE D (MSS to MSS)	X.121 : Dx' (X.25 traffic)		CENTRE B – CENTRE C – CENTRE D (MSS [B] – Packet switch [B] – Router [B] – “X.25 over IP” – Router [C] – “X.25 over IP” – Router [D] – MSS [D])

Table 3.7c
IP and X.121 addresses to be known at CENTRE C

<i>Destination</i>	<i>Addresses to be known</i>		<i>Suitable route</i>
	<i>For communication between ends</i>	<i>For communication between routers</i>	
CENTRE A (Host to host)	IP address : A	IP address : Ai X.121 : Ax	CENTRE C – CENTRE A
CENTRE B (Host to host)	IP address : B	IP address : Bc	CENTRE C – CENTRE B
CENTRE D (Host to host)	IP address : D	IP address : Dc	CENTRE C – CENTRE D (Host [C] – Router [C] – “Direct IP” – Router [D] – Host [D])
CENTRE A (MSS to MSS)	X.121 : Ax' (X.25 traffic)		CENTRE C – CENTRE A
CENTRE B (MSS to MSS)	IP address : B'	IP address : Bc	CENTRE C – CENTRE B
CENTRE D (MSS to MSS)	X.121 : Dx' (X.25 traffic)		CENTRE C – CENTRE D (MSS [C] – Packet switch [C] – Router [C] – “X.25 over IP” – Router [D] – MSS [D])

Table 3.7d
IP and X.121 addresses to be known at CENTRE D

<i>Destination</i>	<i>Addresses to be known</i>		<i>Suitable route</i>
	<i>For communication between ends</i>	<i>For communication between routers</i>	
CENTRE A (Host to host)	IP address : A	IP address : Cd	CENTRE D – CENTRE C – CENTRE A
CENTRE B (Host to host)	IP address : B	IP address : Cd	CENTRE D – CENTRE C – CENTRE B
CENTRE C (Host to host)	IP address : C	IP address : Cd	CENTRE D – CENTRE C
CENTRE A (MSS to MSS)	X.121 : Ax' (X.25 traffic)		CENTRE D – CENTRE C – CENTRE A
CENTRE B (MSS to MSS)	X.121 : Bx' (X.25 traffic)		CENTRE D – CENTRE C – CENTRE B
CENTRE C (MSS to MSS)	X.121 : Cx' (X.25 traffic)		CENTRE D – CENTRE C

Management and allocation of addresses and AS numbers

X.25 addresses

The framework described above allows Centres full autonomy in allocating X.25 numbers. The WMO Secretariat will maintain a current list of X.25 addresses which Centres have allocated for use on the GTS. Centres are requested to notify the Chief of Telecommunications and Monitoring Unit, WWW Basic Systems Department, WMO Secretariat by e-mail or fax of X.25 addresses allocated.

IP addresses

IP addresses for use with IP over X.25 or for pure IP links will be coordinated and issued by the WMO Secretariat as required. Centres should direct requests for IP numbers to WMO as described above.

GTS nominated host/network addresses

Host and subnet IP addresses for use with GTS nominated Centres should be notified to WMO as described above.

AS numbers

AS numbers for use on the GTS will be coordinated and issued by the WMO Secretariat as required. Centres

should direct their requests for AS numbers to WMO as described above.

Publication of addresses and AS numbers

The WMO will publish updated lists of addresses and AS numbers in the monthly *WWW Operational Newsletter* and will also make these lists available in ASCII text form for access by FTP on the WMO web server and in World Wide Web format at <http://www.wmo.ch>.

4. Adapting message switching systems to TCP/IP

Introduction

Although there are new requirements emerging, for the time being GTS usage is dominated by the traditional message switching application, which has been developed to use X.25 packet switching. We now need to consider how best to migrate the message switching task to use TCP/IP to satisfy the new requirements by providing “Internet like” facilities on the GTS, and to stay aligned with IT industry trends. Additionally, migration of message switching systems (MSS) to use TCP/IP means that X.25 infrastructure can be removed, greatly simplifying the technology of the GTS by moving to a pure IP network rather than a mixture of IP and X.25.

There are two possible technical approaches to this problem, one using TCP sockets and the other FTP. In the long term, the FTP approach is thought to be the most strategically attractive but may require more work to implement in operational MSSs. It may suit some Centres to adopt an approach based on TCP sockets as the first step towards a TCP/IP based GTS.

The transition of the MSSs to TCP/IP does not imply any change in the basic store and forward architecture of the GTS. It is envisaged that the store and forward architecture, with automatic on forwarding based on routing tables, will remain. However, the adoption of FTP means there is an additional option for data exchange to be achieved through bilateral arrangements, by the use of FTP retrieve initiated by the receiving Centre.

TCP sockets based MSS

TCP socket is an approach which is highly suitable for a programmatic implementation to provide regular exchange of messages. As such it should simply be regarded as an alternative protocol to X.25. A Centre will be required to produce MSS application programs capable of transmitting and receiving via a TCP socket. Centres with current applications capable of driving an X.25 virtual circuit should be able to very quickly and simply produce a sockets version by changing a few system calls (see Appendix II for sample programs). The programming work involved is minimal and, more importantly, all other areas of the MSS such as queuing, routing, data management, operator interfaces etc. remain unchanged because the communication exchange is still based on the traditional message.

The protocol defined here is based on the assumption that the physical circuit over which the data is to be transmitted has low error rate and is subject to interruptions rarely. On such circuits, the TCP protocol can be expected to deliver error free data. However, some GTS circuits may not be of sufficient quality for the standard TCP socket to function reliably. The development of special protocols for use on low quality circuits may be studied further.

Loss of data may occur if the TCP session is lost. This may be due to MSS hardware, application or communications failure. A special case of this is when a Centre with more than one MSS switches from the primary to the backup systems. Recommendations to avoid this problem are given below.

One useful feature of the X.25 based communication that is not available using TCP sockets, is the

ability to detect start and end of message by reference to the M bit in the X.25 packet header. No such bit or any equivalent feature exists in TCP. Therefore, to enable receiving Centres to detect end of message, each message is preceded with an eight-character string giving the message length, plus two characters indicating message type (binary, alphanumeric or fax). Thereafter the message is structured within an SOH/ETX envelope as for exchange via X.25. The complete structure is illustrated in Figure 4.1. Note that the message length does not include itself or the type indicator. It should always be eight characters long and include leading zeroes as required. The message type indicator should be encoded using ASCII characters BI for binary, AN for alphanumeric, and FX for facsimile. All new connections established must begin with a message length and type structure.

The rules for use of TCP/IP socket exchange can be summarized as:

1. All new connections must start from a new message.
2. Each message is preceded by a message length field of eight ASCII characters and a message type field of two ASCII characters.
3. Message length is counted from SOH to ETX inclusive and must contain leading zeroes as necessary.
4. Message type must be encoded as BI for binary, AN for alphanumeric or FX for facsimile.
5. Receiving Centres will check synchronization as follows:
 - (a) Check that the first eight characters are ASCII numeric;
 - (b) Check that the 9th and 10th characters are BI, AN or FX;
 - (c) Check that the 11th character is SOH;
 - (d) Check that the last character is ETX.
6. If synchronization is lost the receiver shall break the connection using the following sequence of TCP user primitives:
 - (a) Shutdown (to make sure that all data in the TCP send buffer has been transferred);
 - (b) Close.
7. It is recommended to use separate sockets for ASCII and binary messages and separate connections for sending and receiving. The sender should always be responsible for establishing the connection.
8. Once a connection is established, it should be maintained.

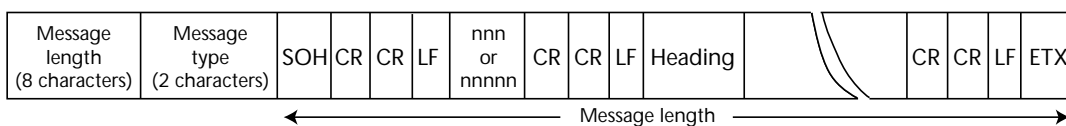

Message length: Length from SOH to ETX (e.g. 00001826 = 1826 bytes)
 Message type AN: Alphanumeric, BI: Binary, FX: facsimile

Figure 4.1 — Message structure for socket exchange applications.

9. If there should be a need to close a socket, the procedure should be as follows:
 - (a) Shutdown (to make sure that all data in the TCP send buffer has been transferred);
 - (b) Close.
10. This procedure should also be used when a MSS is being shutdown.
11. If the receiving side receives a new unexpected connection request on a port for which it has an established socket, the old socket should be closed and the new socket accepted.
12. TCP/IP service/port numbers for these connections will be decided by bilateral agreement. The use of reserved ports (1 to 1 023) should be avoided. The use of ports above 10 000 is recommended.
13. To reduce the amount of data lost if an established connection fails, the TCP send and receive buffer sizes can be adjusted. The recommended value for the buffer size is 4KByte, however this value may be agreed on a bilateral basis.
14. To enable detection of message loss, the use of the channel sequence number (CSN) is mandatory. When using the CSN to check for missing messages, the WMO request/repeat procedures should be used to recover these. It may be useful to automate this mechanism to avoid delays caused by manual interaction. In order to minimize data loss it is strongly recommended that Centres implement a five-character long CSN in the future.
15. The channel sequence number 000 (or 00 000, respectively) should indicate an initialisation, and should not cause retransmission requests.

FTP procedures

Introduction

File transfer protocol (FTP) is a convenient and reliable method for exchanging files, especially large files. The protocol is defined in RFC 959.

The main issues to be considered are:

1. Procedures for accumulating messages into files so as to minimize FTP overheads with short messages (applies only to existing message types);

2. File naming conventions for existing message types (existing AHL);
3. File naming conventions for new message types (no existing AHL);
4. File renaming;
5. Use of directories;
6. Account names and passwords;
7. FTP sessions;
8. Local FTP requirements;
9. File compression.

Accumulating messages into files

One of the problems with using FTP to send traditional GTS messages is the overhead if each message is sent in a separate file. To overcome this problem, multiple messages in the standard GTS message envelope should be placed in the same file according to the rules set out below. This method of accumulating multiple messages applies only to messages for which AHLs have been assigned.

Centres have the option of including or deleting the Starting Line and End of Message strings and indicating which option they are using via the format identifier (refer to points 2 and 4 below).

1. Each message should be preceded by an eight-octet message length field (eight ASCII characters). The length includes the starting line (if present), AHL, text and end of message (if present).
2. Each message should start with either:
 - (a) The currently defined starting line and AHL as shown in Figure 4.2, option 1; or
 - (b) The AHL as shown in Figure 4.2, option 2.
3. Messages should be accumulated in files thus:
 - (a) Length indicator, message 1 (eight characters);
 - (b) Format identifier (two characters);
 - (c) Message 1;
 - (d) Length indicator, message 2 (eight characters);
 - (e) Format identifier (two characters);
 - (f) Message 2;

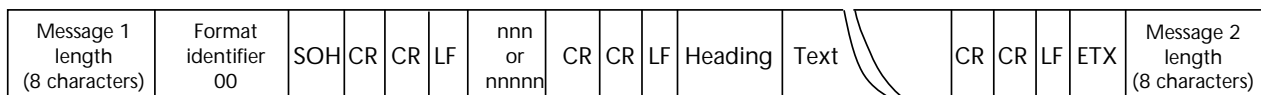

← Message length →

Option 1. Starting line and end of message present.
Message length: Length from SOH to ETX (e.g. 00001826 = 1826 bytes)

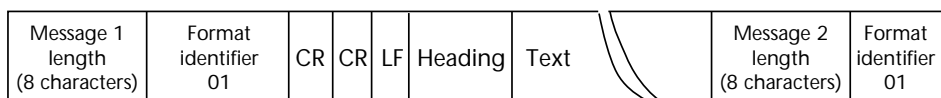

← Message length →

Option 2. Starting line and end of message absent.
Message length: Length from first CR to end of text (e.g. 00001826 = 1826 bytes)

Figure 4.2 Structure of a typical message in a file.

- (g) And so on, until the last message;
- (h) If necessary, and subject to bilateral agreement, a 'dummy' message of zero length may be inserted after the last real message, to assist with end of file detection in certain MSS systems. This requirement does not exist in most cases and need only be implemented where necessary, and agreed between Centres.

4. Format identifier (two ASCII characters) has the following values:
 - (a) 00 if starting line and end of message strings present;
 - (b) 01 if starting line and end of message strings absent.
5. The sending Centre should combine messages in the file for no more than 60 seconds to minimize transmission delays.
6. The sending Centre should limit the number of messages in a file to a maximum of 100.
7. The format applies regardless of the number of messages, i.e. it applies even if there is only one message in the file.

File naming conventions for existing message types (existing AHL)

The file naming convention is:

CCCCNNNNNNNN.ext

where:

CCCC is the international four letter location identifier of the sending Centre, as defined in WMO-No. 9, Volume C;

NNNNNNNN is a sequential number from 0 to 99999999 generated by the sending Centre;

ext is:

'ua' for urgent alphanumeric information

'ub' for urgent binary information

'a' for normal alphanumeric information

'b' for normal binary information

'f' for facsimile information

NOTE: Where, through bilateral agreement, Centres allow alphanumeric and binary data in the one file, the b or ub extent shall be used.

File naming conventions for new message types (no existing AHL)

Warning: The following procedure is indicative and has not yet been tested on the GTS. It is subject to review by the CBS OPAG/ISS, in particular in the context of the development of file naming and metadata convention.

The procedure is based on transmission of file pairs, one file being the information file and the other being the associated metadata file. The concept of file pairs allows the communications function to be implemented independently data management requirements for structure of metadata, yet provides for the carriage of whatever metadata is required. It is

not compulsory to always have a .met file, such as when the information file itself is self-specifying.

The name of the information file shall be:

CCCCNNNNNNNN.ext

where:

CCCC is the international four letter location identifier of the sending Centre, as defined in WMO-No. 9, Volume C;

NNNNNNNN is a sequential number from 0 to 99999999 generated by the sending Centre;

ext indicates the file type, e.g.

.tif for TIFF file

.gif for GIF file

.ps for postscript file

.mpg for MPEG file

.jpg for JPEG file

.txt for text file

.htm for HTML file

.bin for a file containing data encoded in a WMO binary code form such as GRIB or BUFR

.doc for a MS Word file

.wpd for a WordPerfect file

The name of the corresponding metadata file shall be:

CCCCNNNNNNNN.met

where CCCCCNNNNNNNN is the same as the corresponding information file.

The structure of the '.met' file is not defined in this guide. It will be as specified by CBS WG-DM.

File renaming

The method used by receiving Centres to detect the presence of a new file may depend on the type of machine used. However most Centres will do this by scanning a directory for new files.

To avoid problems with the receiving Centre processing a file before it has completely arrived, all sending Centres must be able to remotely rename the files they send.

The file shall be sent with the extent '.tmp' and then renamed to use the appropriate extent defined above when the transfer is completed.

e.g.:

(a) put xxxxx RJTD00220401.tmp (xxxxx = local file name)

rename RJTD00220401.tmp RJTD00220401.a

(b) put xxxxx AMMC09871234.tmp

rename AMMC 09871234.tmp AMMC09871234.gif

Use of directories

Some receiving Centres may wish the files to be placed in specific sub-directories. This should be limited to require only that all files of the same type be delivered to the same directory. It is recommended that a separate directory be used for each host system which is initiating FTP sessions to avoid the possibility of file-name duplication.

Account names and passwords

Using FTP the sender “logs in” to a remote machine using a specific account name and password. The receiving Centre defines the account name and the password. There are potential security implications for Centres so care needs to be taken.

The following general rules should however apply.

1. The receiving Centre defines the user account and password for the sending Centre.
2. Anonymous FTP may be used or a specific account may be created. (If anonymous FTP is used, each sending Centre must have its own sub-directory on the FTP server).

FTP sessions

To limit the load on both the sending and receiving systems, no more than one FTP session per file type should exist at the same time. If for example, Centre A wishes to send two files to Centre B of the same type (say .ua), the second file must not be sent until the first is finished. Centres should limit the number of concurrent sessions with a particular Centre to five maximum.

Local FTP requirements

All sending Centres will need to allow for additional “static” FTP commands to be included in the FTP commands that they issue. For example some MVS Centres may require the inclusion of “SITE” commands to define record and block lengths. Centres should support FTP commands as specified in RFC 959 unless some are excluded by bilateral agreement. There may also need to be bilaterally agreed procedures and commands.

It is the responsibility of receiving Centres to delete files after they have been processed.

Use of file compression

If large files are to be sent then it is often desirable to compress them first.

Centres should only use compression by bilateral agreement.

If possible, Centres should support the following two compression methods. Other methods may be used by bilateral agreement.

1. UNIX “compress”
2. Gzip

This means that a received file could be of the form: “xxxxxxx.ext.Z” or “xxxxxxx.ext.gz”.

Backup with an IP based GTS

A final consideration is that of MSS backup. The new GTS will use IP addresses, where an individual address is usually associated with only one system. Should a system fail and an alternative be used there are implementation issues to be considered by transmitting Centres. Ideally a transmitting Centre should be unaffected by a receiving Centre’s backup arrangements. This is a good principle, which all Centres should seek

to adhere to. However it may not always be possible to achieve complete IP transparency. If this cannot be done sending Centres must be prepared to try an alternate IP address. Once using such an alternate address it must periodically try the primary address. It is suggested that such periodicity be established by bilateral agreement between Centres because it will be heavily influenced by each Centres backup strategy.

5. Trouble shooting and problem resolution

IP layer tools

In a large IP network, every router involved in the path between two hosts must know the next hop to be used to reach the destination address. As every router and/or link might be a point of failure, it is very important to determine rapidly where the problem is, and then how to solve it.

Suggested steps in resolving problems (not necessarily in the order given) are:

- (a) Check the remote Centre (if the security policy of the remote Centre allows it);
- (b) Check if the link to the “outside” network is reachable;
- (c) Check the local network by trying to reach the next/default gateway;
- (d) Check the local IP stack and configuration.

Some basic tools that can be used such as PING, TRACEROUTE and NETSTAT are described below. PING and TRACEROUTE provide information on paths between hosts. They both use ICMP (traceroute also need UDP), but it should be noted that many sites block ICMP packets as part of their firewall security measures. To be able to locate problems in a network, it is necessary to have an exact documentation of the network.

PING

PING will check if the destination IP address can be reached. This tool is standard in almost every operating system with TCP/IP. On a Unix host, the output looks like:

```
zinder# ping -s cadillac
PING cadillac : 56 data bytes
64 bytes from cadillac (193.168.1.17): icmp_seq=
0. time=3. ms
64 bytes from cadillac (193.168.1.17): icmp_seq=
1. time=2. ms
64 bytes from cadillac (193.168.1.17): icmp_seq=
2. time=3. ms
64 bytes from cadillac (193.168.1.17): icmp_seq=
3. time=3. ms
64 bytes from cadillac (193.168.1.17): icmp_seq=
4. time=5. ms
64 bytes from cadillac (193.168.1.17): icmp_seq=
5. time=3. ms
64 bytes from cadillac (193.168.1.17): icmp_seq=
6. time=3. ms
```

----cadillac PING statistics----

7 packets transmitted, 7 packets received, 0% packet loss

round-trip (ms) min/avg/max = 2/3/5

A useful test could be to ping the MSS of the neighbouring Centre. If this PING succeeds with an acceptable time delay, it would indicate that the network is operating correctly. If the PING fails, it could mean that the circuit is down or the ICMP PING packets are being blocked by the neighbouring Centre's router or firewall. In this event, it could be useful to PING the serial interface of the neighbouring Centre's router. If this succeeds, then the communications link to the neighbouring Centre is working. Any malfunction would then be within the neighbouring Centre.

PING can be used to check whether the network performance is reasonable. The time is the delay between sending and receiving back the packet. It is not really possible to give an average value of the delay, but it is more important to notice any variation.

Finally, it might happen that packets are lost. In this case, there are missing numbers in the icmp_seq number. Either packet loss or variation in delays will badly degrade the performance.

TRACEROUTE

This tool is used to show which routers are transitted on the network between A and B. As said above, TRACEROUTE need UDP and ICMP packets to work. Firewalls or packet filter on router may block such traffic as part of local security policy. It is not available on all systems, but is rather easy to compile. It is a free tool available on the Internet.

TRACEROUTE output looks like:

```
cadillac 22: traceroute ftp.inria.fr
traceroute to ftp.inria.fr (192.93.2.54), 30 hops
max, 40 byte packets
```

```
 1 antonio.meteo.fr (137.129.1.5) 3 ms 2 ms 2 ms
 2 clara.meteo.fr (137.129.14.249) 1 ms 2 ms 2 ms
 3 andrea.meteo.fr (193.105.190.253) 4 ms 3 ms 2 ms
 4 octares1.octares.ft.net (193.48.63.5) 30 ms 35 ms
 10 ms
 5 192.70.80.97 (192.70.80.97) 9 ms 15 ms 27 ms
 6 stamand1.renater.ft.net (195.220.180.21) 40
ms 96 ms 29 ms
 7 stamand3.renater.ft.net (195.220.180.41) 56 ms
100 ms 108 ms
 8 stlambert.rerif.ft.net (195.220.180.10) 63 ms
56 ms 34 ms
```

```
 9 193.55.250.34 (193.55.250.34) 46 ms 28 ms 26 ms
10 rocq-gwr.inria.fr (192.93.122.2) 21 ms 147 ms 85 ms
11 ftp.inria.fr (192.93.2.54) 86 ms 58 ms 128 ms
When a router does not know where to send the
packet, the result may be like the following:
cadillac 22: traceroute 193.105.178.5
traceroute to 193.105.178.5 (193.105.178.5), 30
hops max, 40 byte packets
 1 antonio.meteo.fr (137.129.1.5) 2 ms 1 ms 1 ms
 2 clara.meteo.fr (137.129.14.249) 1 ms 4 ms 1 ms
 3 andrea.meteo.fr (193.105.190.253) 4 ms 11 ms 4 ms
 4 octares1.octares.ft.net (193.48.63.5) 42 ms 39 ms
42 ms
 5 192.70.80.97 (192.70.80.97) 8 ms 7 ms 7 ms
 6 stamand1.renater.ft.net (195.220.180.5) 48 ms
86 ms 113 ms
 7 rbs1.renater.ft.net (195.220.180.50) 63 ms 107 ms
154 ms
 8 Paris-EBS2.Ebone.net (192.121.156.105) 146 ms
167 ms 140 ms
 9 stockholm-ebs-s5-2.ebone.net (192.121.154.21)
100 ms 80 ms 92 ms
10 Amsterdam-ebs.Ebone.NET (192.121.155.13) 249
ms 227 ms 205 ms
11 amsterdam1.NL.EU.net (193.0.15.131) 257 ms
249 ms 316 ms
12 *Amsterdam5.NL.EU.net (134.222.228.81) 300
ms 297 ms
13 Amsterdam6.NL.EU.net (134.222.186.6) 359 ms
218 ms 304 ms
14 Paris1.FR.EU.net (134.222.228.50) 308 ms 311 ms
388 ms
15 *Etoile0.FR.EU.net (134.222.30.2) 177 ms *
16 Etoile0.FR.EU.net (134.222.30.2) * * *
```

In the second case, cadillac would not be able to reach 193.105.178.5 because the router Etoile0.fr.eu.net failed to send the packet. With TRACEROUTE, it is not possible to know if it is a router failure or a link failure.

NETSTAT

This is a command available on most computing platforms. It gives information about the set up of the host's IP stack.

NETSTAT can be used to find out if the local IP address and subnet mask are configured correctly as well as if the routing information is still correct. There are many other options but is it not the intention of this guide to describe them all.

A sample output looks like:

```
$ netstat -rn
Routing tables

Internet:
Destination      Gateway          Netmask         Flags           Refs            Use             Interface
default          141.38.48.2     UG              12              4014211         ec0
127.0.0.1        127.0.0.1      UH              9                2321           lo0
141.38.48        141.38.48.12   0xffffffff      U                3              68981          ec0
141.38.48.12     127.0.0.1      UGH             10              253410         lo0
195.37.164.100  141.38.48.5    UGH             2                345            lo0
224              141.38.48.12   0xf0000000     U                1              19848          ec0
$
```

The output shows that this particular host has the IP address 141.38.48.12 with a subnet mask of 24 bit (0Xffff00 or 255.255.255.0). It also shows that the host 195.37.164.100 can be reached via the gateway 141.38.48.5, and the flags indicate that the route is up (U), that it is a route to a gateway (G) and that it is a host route (H). The first line indicates that all other destinations are reachable via the hosts default gateway 141.38.48.2.

The only difference to the first sample output is, that the host route to 195.37.164.100 is now flagged with a M, which means that this route was modified by an ICMP redirect message from the old gateway 141.38.48.5. This usually means that the router with the IP address 141.38.48.5 has lost its route to 195.37.164.100 and may indicate a problem with the link to the remote network.

Other monitoring tools

Verifying correct IP connectivity is a necessary first step. Other tools can be used to provide more information on what is happening. There are many options. It is possible to use protocol analysers and SNMP based software tools. For example, Sun Microsystems bundles with Solaris a tool called snoop who can replace in most cases a local area network analyser. Others tools such as TCPDUMP are available free on the Internet and can be installed on various systems. TCPDUMP is often bundled in various Linux distributions. These tools require a rather good knowledge of IP protocol. But, for example, TCPDUMP might be used to diagnose application level problems.

The following is a simple example on the host 'pontiac', of the capture of ICMP exchanges between zinder and cadillac.

```
pontiac# /usr/local/bin/tcpdump -i nf0 host cadillac
and zinder and proto icmp
15:28:06.68 cadillac.meteo.fr > zinder.meteo.fr:
icmp: echo request
15:28:06.68 zinder.meteo.fr > cadillac.meteo.fr:
icmp: echo reply
15:28:19.45 cadillac.meteo.fr > zinder.meteo.fr:
icmp: echo request
15:28:19.45 zinder.meteo.fr > cadillac.meteo.fr:
icmp: echo reply
```

```
15:28:29.44 cadillac.meteo.fr > zinder.meteo.fr:
icmp: echo request
15:28:29.45 zinder.meteo.fr > cadillac.meteo.fr:
icmp: echo reply
```

SNMP

Simple network management protocol was developed in the late 1980s in order to offer to network manager a standard tool for controlling networks. In most case SNMP could be used to replace more crude tools describe above. Unfortunately, good SNMP software is not cheap. SNMP is a client-server protocol. In order to be able to gather information with SNMP, the equipment connected on the network must have management information base (MIB). These bases are catalogues of integer, counters, strings, etc. The manager asks the agents to send it some values. These values might be for example, IP routing table. The example below is obtained by requesting with HP Open View (a commercial package) the routing table on the host monica.meteo.fr.

Information given above with TCPDUMP might be obtained with SNMP but to do so, probes running the remote monitoring MIB must be connected on the network.

On a bilateral basis, it might be useful for Centres to allow SNMP access to their router from the other NMC. However, regular polling of other Centres' routers should be avoided to avoid overloading of circuits.

MRTG

Another public domain package, called MRTG, is a very helpful tool to gather information about the local network and about connected links. The multirouter traffic grapher (MRTG) is a tool to monitor the traffic load on networks and links. It generates HTML pages containing images which provide a live visual representation of this traffic. It can also be implemented to indicate failures of network links. MRTG consists of a Perl script which uses SNMP to read the traffic counters of your router(s) and a fast C program which logs the traffic data and creates graphs representing the traffic on the monitored network connection(s). Below is a sample output. It shows traffic statistics for a dedicated link and gives information about the traffic pattern on the link. This is just one

Title : monica.meteo.fr

Name or IP address: monica.meteo.fr

<i>ipRouteDest</i>	<i>ipRouteMask</i>	<i>ipRouteNextHop</i>	<i>ipRouteProto</i>	<i>ipRouteMetric1</i>
0.0.0.0	0.0.0.0	137.129.1.5	local	0
136.156.0.0	255.255.0.0	137.129.1.5	ciscoIgrp	8786
137.129.1.0	255.255.255.0	137.129.1.6	local	0
137.129.2.0	255.255.255.0	137.129.1.5	ciscoIgrp	1110
137.129.3.0	255.255.255.0	137.129.3.254	local	0
137.129.4.0	255.255.255.0	137.129.4.254	local	0
137.129.5.0	255.255.255.0	137.129.5.254	local	0
137.129.6.0	255.255.255.0	137.129.1.62	local	0
137.129.7.0	255.255.255.0	137.129.7.254	local	0
137.129.8.0	255.255.255.0	137.129.8.254	local	0
137.129.9.0	255.255.255.0	137.129.1.5	ciscoIgrp	1110

of many other graphs one can create with MRTG. More information about MRTG can be found at <http://ee-staff.ethz.ch/~oetiker/webtools/mrtg>.

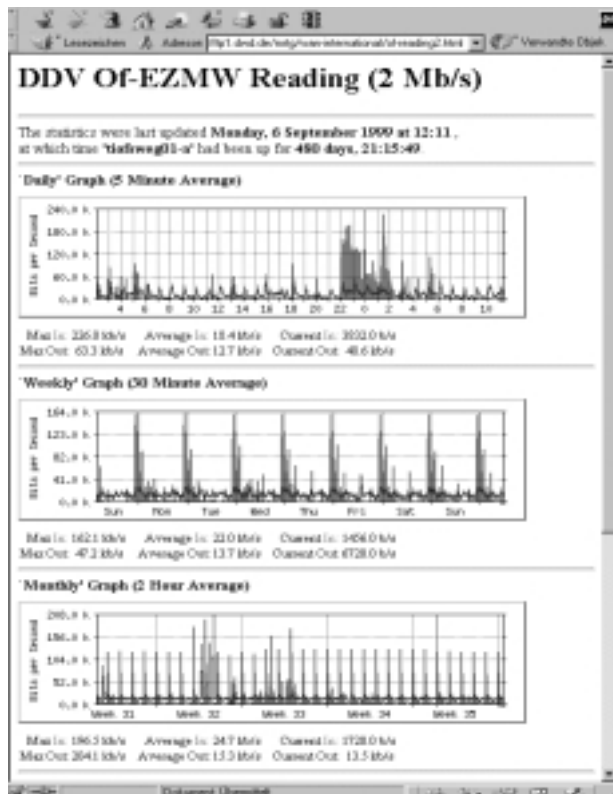

SYSLOG

Many of the possible problems can be located if one not only looks at the SYSLOG files on the hosts, but uses a SYSLOG server as well and lets the router(s) send their messages to it. This file can then be checked regularly, e.g. for messages that indicate high CPU load, processes that use up much memory or CPU cycles, lines going up and down, and messages about events regarding the used routing protocol.

There are eight different levels of messages the router will log to the SYSLOG server. They are:

Emergencies	0	System unusable
Alerts	1	Immediate action needed
Critical	2	Critical conditions
Errors	3	Error conditions
Warnings	4	Warning conditions
Notifications	5	Normal but significant condition
Informational	6	Informational messages only
Debugging	7	Debugging messages

The default logging facility on a Cisco router is set to local7, this is important to know when configuring a host to be a SYSLOG server and will be explained there.

The configuration commands on a Cisco router to activate logging are:

```
cisco-gts-1(config)#logging trap level-of-messages-to-log
```

```
cisco-gts-1(config)#logging 141.38.48.12
```

and can be checked with the command "show logging":

```
cisco-gts-1#sho logging
```

```
Syslog logging: enabled (0 messages dropped, 0 flushes, 0 overruns)
```

```
Console logging: level debugging, 117892 messages logged
```

```
Monitor logging: level debugging, 8317 messages logged
```

```
Trap logging: level debugging, 117150 message lines logged
```

```
Logging to 141.38.48.12, 117150 message lines logged
```

```
Buffer logging: disabled
```

```
cisco-gts-1#
```

In this example, logging is set to the level debugging ("logging trap debugging"), and all messages from level 7 up to level 0 will be sent to the SYSLOG server with the IP address 141.38.48.12.

To activate the SYSLOG server on for instance a SGI UNIX machine, the following entries should be there:

In the file /etc/services: `syslog 514/udp`

In the file /etc/syslog.conf: `local7.debug /usr/people/cisco/logs/cisco.log`

The local7.debug relates to the default facility of logging that is defined on a Cisco router as mentioned (local7). The file above will be the file to which the SYSLOG daemon writes all incoming SYSLOG messages for local7.

The last action on the host is to have the SYSLOG daemon reread it's config file (`kill -1 pid-of-syslogd`).

Bandwidth management

On an IP network, all packets will be routed over the links without any prioritization mechanism. Therefore an FTP transfer can occupy all the bandwidth available starving all others applications. When traffic increases, it might therefore be needed to introduce some bandwidth management in the network configuration. Further information may be available on the online reference (<http://www.wmo.ch/>).

APPENDICES

I. Cisco router configurations

This appendix is not intended to be a complete description of all available commands in a Cisco, nor a full course on this equipment, but it is useful to describe more precisely the configuration tasks in order to comply with the policy outlined in section 2.

The configuration described below respects what is available in release 11.1 of Cisco IOS software. Some features are not available in previous releases, and some will be modified in the future.

We are going to describe different steps:

1. Establishing IP connection

(a) IP over PPP;

(b) IP over X25;

(c) X25 over IP (in fact it is X25 over TCP, the XOT protocol).

2. Routing configuration
 - (a) Leaf node with static routes (Centre A);
 - (b) Leaf node with dynamic routing (Centre C);
 - (c) Configuration in a non-leaf node (in our case two different GTS connections, Centre B).
3. Security configuration
 - (a) Filtering traffic based on declared IP addresses;
 - (b) Controlling routing exchanges between GTS and the Internet.

In our example A is connected to B with IP over X25 link, B is connected to C with IP over PPP. There is also the option for the MSSs at B and C to communicate using X.25 over TCP/IP. A is a leaf node, B and C are non-leaf nodes. B and C are also connected to the Internet. B and its Internet provider use static routes³, C and its Internet provider use RIP⁴.

The following will be used along this appendix:

	X121 router address	IP router address	IP hosts address for GTS	Autonomous system
Centre A	0101666 1166666	193.105.177.1	194.168.1.16/ 255.255.255.248	N.A.
Centre B	0101777 1177777	193.105.177.2 193.105.178.5	137.129.9.0/ 255.255.255.0	65001
Centre C	0101888 1188888	193.105.178.6	195.1.1.0/ 255.255.255.0	65200

3 B cannot use EGP and BGP on the same router; one router cannot belong to more than one AS.
 4 RIP is not a good choice for such type of configuration. But as RIP is the most basic protocol, it is used in this case too.

Centres A and B use serial interface 0 to connect to the packet switches. Centres B and C use serial interfaces 1 for the PPP link.

Step 1: Establishing connections

Centre A:

```
interface serial 0
encapsulation X25
! depending on local set-up (virtual channels,
! windows...) extra configuration might be necessary
x25 address 01016661166666
ip address 193.105.177.1 255.255.255.0
!
x25 map ip 193.105.177.2 01017771177777
```

Centre B:

```
interface serial 0
encapsulation X25
x25 address 01017771177777
! depending on local set-up (virtual channels,
! windows... ) extra configuration might be necessary
ip address 193.105.177.2 255.255.255.0
!
x25 map ip 193.105.177.1 01016661166666
!
interface serial 1
encapsulation PPP
ip address 193.105.178.5 255.255.255.252
!
! X25 over TCP commands
x25 routing
x25 route 01018881* ip 193.105.178.6
x25 route 01017771* interface serial 0
```

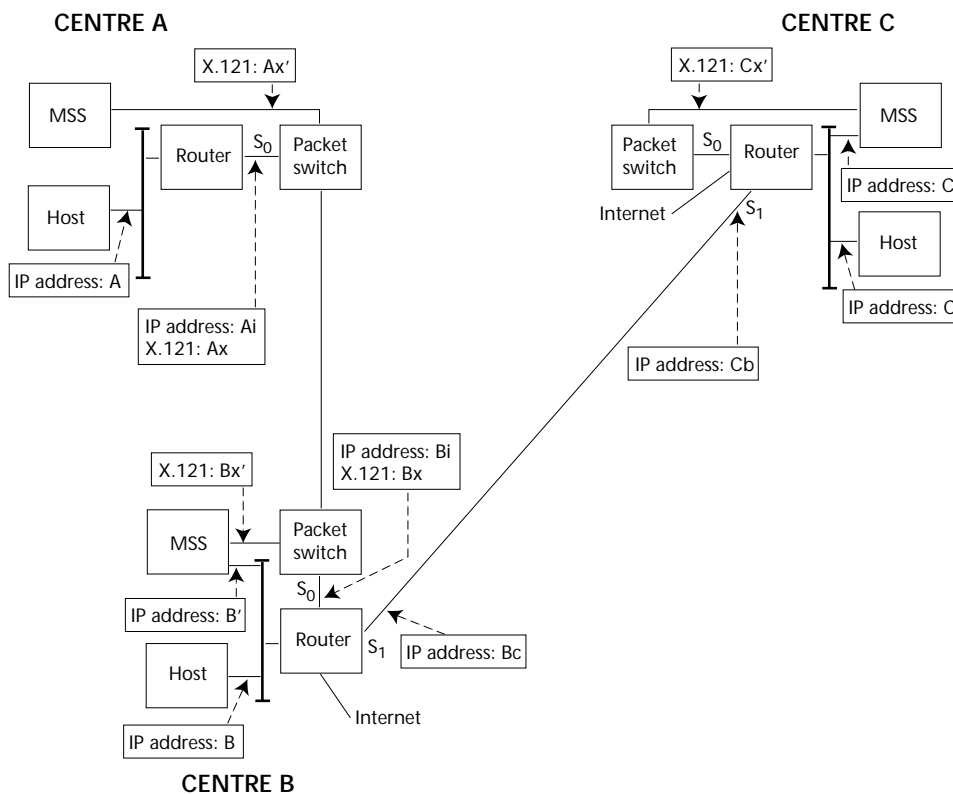

```

Centre C:
interface serial 0
encapsulation X25
x25 address 01018881188888
! depending on local set-up (virtual channels,
! windows...) extra configuration might be necessary
interface serial 1
encapsulation PPP
ip address 193.105.178.6 255.255.255.252
!
! X25 over TCP commands
x25 routing
x25 route 010177711* ip 193.105.178.5
x25 route 010188811* interface serial 0

```

After this first step, IP configuration between the routers is complete. The router in Centre A can then PING router in B. B can PING A and C, but A and C cannot communicate because there is no routing set up.

MSS at B and C can communicate with IP (once end-to-end routing is established) or with X25 over TCP. Experience has shown that all the X25 parameters on router in Centres B and C must be the same (packet size, window size) to avoid any strange behaviour.

Step 2: Routing

Centre A:

```

! Simply define a default route with a metric 10
! (the price) via B
ip route 0.0.0.0 255.255.255.255 193.105.177.2 10

```

Centre B:

```

! First define static route with A
ip route 194.168.1.16 255.255.255.248 193.105.177.1 10
ip route 0.0.0.0 ip_provider_address 10
! BGP routing
router bgp 65001
network 137.129.9.0 mask 255.255.255.0
neighbour 193.105.178.6 remote-as 65200
! Route to A is static, force sending to C
redistribute static

```

Centre C:

```

! BGP routing
router bgp 65200
network 195.1.1.0
neighbour 193.105.178.5 remote-as 65001
! 196.1.1.0 is network address for non-GTS hosts
in C router rip version 2
network 195.1.1.0
no auto-summary

```

A defines a default route. So, when A wants to communicate with C, the router knows where to send packets. C is going to receive routing information from B, so A is also reachable from C. It is also important to note that if A tries to reach an Internet site, attempts will be made through B's Internet connection. It will fail because the Internet site A tries to reach cannot return packets to A (only B's address is reachable on the internet via B's Internet connection). The link A to B

link will thus carry some inappropriate data. Also note that we use RIP version 2.

Step 3: Security

Centre A:

```

! Declare which hosts can use GTS
access-list 1 permit 194.168.1.16 0.0.0.7
! Declare which hosts can come from GTS
access-list 2 permit 195.1.1.0 0.0.0.255
access-list 2 permit 137.129.9.0 0.0.0.255
!
interface serial 0
ip access-group 1 out
ip access-group 2 in

```

Centre B:

```

! Declare which hosts can use GTS
access-list 1 permit 137.129.9.0 0.0.0.255
! Declare which hosts can come from GTS
access-list 2 permit 195.1.1.0 0.0.0.255
access-list 2 permit 194.168.1.16 0.0.0.7
! Only accept BGP updates from AS neighbour
ip as-path access-list 3 permit ^$
ip as-path access-list 3 permit ^65200
!
interface serial 0
ip access-group 1 out
ip access-group 2 in
!
interface serial 1
ip access-group 1 out
ip access-group 2 in
! Restrict BGP updates
router bgp 65001
network 137.129.9.0 mask 255.255.255.0
neighbour 193.105.178.6 remote-as 65200
neighbour 193.105.178.6 filter-list 3 in
neighbour 193.105.178.6 filter-list 3 out
redistribute static

```

Centre C:

```

! Declare which hosts can use GTS
access-list 1 permit 195.1.1.0 0.0.0.255
! Declare which hosts can come from GTS
access-list 2 permit 137.129.9.0 0.0.0.255
access-list 2 permit 194.168.1.16 0.0.0.7
! Only accept BGP updates from AS neighbour
ip as-path access-list 3 permit ^$
ip as-path access-list 3 permit ^65001
!
interface serial 0
ip access-group 1 out
ip access-group 2 in
! Restrict BGP updates
router bgp 65200
network 195.1.1.0 mask 255.255.255.0
neighbour 193.105.178.5 remote-as 65001
neighbour 193.105.178.5 filter-list 3 in
neighbour 193.105.178.5 filter-list 3 out

```

In these configurations, there are two important features used:

(a) BGP filtering

The access-list 3 in both B and C checks the autonomous system number sent by its neighbour. By filtering in and out in the BGP process this guarantees that all known routes must be issued from one of these ASs.

(b) IP filtering

The access-list 1 list allows IP addresses issued from within each Centre. This list should be quite stable. The access-list 2 checks the incoming IP addresses. As new Centres are added to the IP network, the corresponding addresses must be added to these access-lists.

It must also be noted that despite Internet connections in B and C no extra attention is required to control routing exchange. A static default route is not sent even if «redistribute static» is enabled. RIP and BGP ignore routing information known via the other protocol.

II. Sample socket send and receive routines

```

/*****
* Sample TCP/IP Socket program that SENDS a single
* message
*****/
#include <stdio.h>
#include <unistd.h>
#include <stdlib.h>
#include <signal.h>
#include <string.h>
#include <memory.h>
#include <sys/socket.h>
#include <netinet/in.h>
#include <netdb.h>

/* TCP/IP DESTINATION and SERVICE ARE DEFINED
BY THE RECEIVING CENTRE */
#define DESTINATION "localhost"
#define SERVICE 39000
#define GTS_LENFIELD 8
#define MAX_MSGSIZE 15000 /* value of the send
buffer size, recommended: 4096 */

static void GetDestinationInfo();
static void SetupSocket();
static void SendData();
static void MakeConnection();

static struct sockaddr_in dest;
static int pr_sock;
/*****
*
* MAINLINE
* 1. Ignore SIGPIPE signals. These are generated if a
* connection is lost. By default they cause a
* program to terminate.
* 2. Get information about the destination
* (GetDestinationInfo):
* - IP number (and name)

```

```

* - Service/Port number
* 3. Create a TCP/IP Socket (SetupSocket).
* 4. Connect to the destination Centre
* (MakeConnection).
* 5. Send the message (SendData).
* 6. Close the socket (shutdown + close).
*****/
main(int argc, char *argv[])
{
    signal(SIGPIPE,SIG_IGN);

    GetDestinationInfo();
    SetupSocket();
    MakeConnection();
    SendData();
    /* shutdown(pr_sock,1) */
    close(pr_sock);
}

/*****
*
* GET DESTINATION INFO
* Store the destination IP number and service number
* in a socket structure (dest).
* 1. Convert the destination name to an IP number
* (gethostbyname).
* 2. Store the IP number and service number in the
* "dest" structure.
*****/
static void GetDestinationInfo()
{
    struct hostent *hp;

    hp = gethostbyname (DESTINATION);
    if ( hp == NULL ) {
        printf("host error\n");
        exit(1);
    }

    memset ((char *)&dest, 0, sizeof dest);
    memcpy (&dest.sin_addr.s_addr, hp->h_addr, hp->h_length);
    dest.sin_family = AF_INET;
    dest.sin_port = SERVICE;
}

/*****
*
* SETUP SOCKET
* Setup a TCP/IP Socket
* 1. Create the socket.
* 2. Set the socket KEEPALIVE option.
* This enables the automatic periodic transmission of
* "check" messages to be sent on the connection. If
* the destination does not respond then it is
* considered broken and this process is notified
* (by SIGPIPE or end-of-file).
* 3. Set the socket REUSEADDR option. Enable quicker
* restarting of terminated processes.

```

- *4. Reduce the size of the Socket send buffer to
 * reduce the amount of data lost if the connection
 * fails.

```

*****/
static void SetupSocket()
{
int  on = 1;
int  rc;
int  bufsize = MAX_MSGSIZE;

pr_sock = socket (AF_INET, SOCK_STREAM, 0);
if (pr_sock < 0) {
printf("sock error\n");
exit(1);
}
rc = setsockopt(pr_sock,SOL_SOCKET,SO_KEEPALIVE,
(char *)&on,sizeof(on));
if (rc != 0) {
printf("keepalive error\n");
}

rc = setsockopt(pr_sock,SOL_SOCKET,SO_REUSEAD-
DR,(char *)&on,sizeof(on));
if (rc != 0) {
printf("reuse error\n");
}

rc = setsockopt(pr_sock,SOL_SOCKET,SO_SNDBUF,
(char *)&bufsize,sizeof(bufsize));
if (rc != 0) {
printf("unable to set send buffer size\n");
}

}

/*****
*          MAKE CONNECTION
*  Attempt to make a TCP/IP Socket connection to
*  the destination on the agreed service/port
*  number.
*****/
static void MakeConnection()
{
int    length;

length = sizeof (dest);
if ( connect (pr_sock,(struct sockaddr *)&dest,length)
== -1) {
printf("connection error\n");
exit(1);
}

printf("connected\n");
}
/*****
*          SEND DATA
*  Send a message on the socket (5 times actually).

```

- * NOTE: A real program would check the return
 * code from the write and if the write failed
 * it would close the socket, raise an
 * operator alarm, and then try to re-send
 * from the start of the message.

```

*****/
static void SendData()
{
char  msg[MAX_MSGSIZE+1], buffer[MAX_MSG-
SIZE+GTS_LENFIELD+3];
int    buflen, i, rc = 0;
strcpy(msg,"\001\r\r\n\001\r\r\nTTAA01 AMMC
000000\r\r\n");
for (i=0;i<60;i++)
    strcat(msg,"THE QUICK BROWN FOX JUMPS OVER
THE LAZY DOG 0123456789\r\r\n");
strcat(msg,"\r\r\n\003");

sprintf(buffer,"%0*dAN%s",GTS_LENFIELD,strlen(msg
),msg);
buflen = strlen(buffer);

for (i=0; i<5; i++) {
    rc = write(pr_sock,buffer,buflen);
    printf("write. rc = %d\n",rc);
}

}

/*****
*          TEST TCP/IP SOCKET RECEIVING PROGRAM
*  Program is designed to give some ideas as to how
*  to receive GTS style messages on a TCP/IP socket
*  connection.
*****/
#include <stdio.h>
#include <unistd.h>
#include <stdlib.h>
#include <signal.h>
#include <string.h>
#include <memory.h>
#include <sys/socket.h>
#include <netinet/in.h>
#include <netdb.h>

#define SERVICE        39000
#define MAX_MSGSIZE   15000
#define MAX_BUFLLEN   MAX_MSGSIZE + 100
#define SOH            '\001'
#define ETX            '\003'
#define GTS_LENFIELD  8
#define GTS_SOCKET_HEADER  10

static void SetupService();
static void RecvData();
static void AcceptConnection();
static int ExtractMsg(char *buffer, int *buflen);
static int CheckMsgBoundaries (char *, int);

```

```

static int FindMessage (char *, int, int *);
static void ShiftBuffer (char *, int *, int);

static struct sockaddr_in dest;

static int      pr_sock, msgsock;
static char     buffer[MAX_BUFLEN+1];
static int      buflen = 0;

/*****
*
*          MAIN
* Listen for incoming IP calls and read any incoming
* messages on the first call established.
* 1. Ignore SIGPIPE signals. These are generated if a
* connection is lost. By default they cause a
* program to terminate.
* 2. Set-up a listening socket for incoming msgs
* (SetupService).
* 3. Accept the first call received (AcceptConnection).
* 4. Read any messages on this connection
* (RecvData).
* 5. Close the call and close the listening socket.
*****/
main(int argc, char *argv[])
{
    signal (SIGPIPE,SIG_IGN);

    SetupService();
    AcceptConnection();
    RecvData();

    close(msgsock);
    /* shutdown(pr_sock,1) */
    close(pr_sock);
}

/*****
*
*          SETUP SERVICE
* Listen for calls on a given Service/Port.
* 1. Create a socket
* 2. Set the socket KEEPALIVE option.
* This enables the automatic periodic transmission
* of "check" messages to be sent on the
* connection. If the destination does not respond
* then it is considered broken and this process
* is notified (by SIGPIPE or end-of-file).
* 3. Set the socket REUSEADDR option. Enable
* quicker restarting of terminated processes.
* 4. Bind the socket to the required Service/Port.
* 5. Start listening for calls.
*****/
static void SetupService()
{
    int      on = 1;
    int      rc;

```

```

/* adjust the TCP receive buffer size
int      bufsize = MAX_MSGSIZE; */

memset ((char *)&dest, 0, sizeof dest);
dest.sin_addr.s_addr = INADDR_ANY;
dest.sin_family = AF_INET;
dest.sin_port = SERVICE;

pr_sock = socket (AF_INET, SOCK_STREAM, 0);
if (pr_sock < 0) {
    printf("sock error\n");
    exit(1);
}

rc = setsockopt(pr_sock,SOL_SOCKET,SO_KEEPALIVE,
(char *)&on,sizeof(on));
if (rc != 0) {
    printf("keepalive error\n");
    exit(1);
}
rc = setsockopt(pr_sock,SOL_SOCKET,SO_REUSEADDR,
(char *)&on,sizeof(on));
if (rc != 0) {
    printf("reuse error\n");
    exit(1);
}
/* adjust the TCP receive buffer size
rc = setsockopt(pr_sock,SOL_SOCKET,SO_RCVBUF,
(char *)&bufsize,sizeof(bufsize));
if (rc != 0) {
    printf("unable to set send receive size\n");
}
*/
rc = bind(pr_sock,(struct sockaddr *)&dest,sizeof dest);
if ( rc < 0) {
    printf("bind error\n");
    exit(1);
}

rc = listen(pr_sock,1);
if ( rc < 0) {
    printf("listen error\n");
    exit(1);
}

printf("listening\n");
}

/*****
*
*          ACCEPT CONNECTION
* Wait for an incoming call (accept).
* Return the socket of the call established.
*****/
static void AcceptConnection()
{
    int      addrlen;

    printf("waiting connection\n");

```

```

addrlen = sizeof(sockaddr_in);
msgsock = accept (pr_sock,&dest,&addrlen);
if ( msgsock < 0 ) {
    printf("accept error\n");
    exit(1);
}
printf("connected\n");
}

/*****
*
*          RECV DATA
*
* Read data from the message/call socket.
* Extract GTS messages from this data.
* Keep reading until the sender drops the call or
* there is an error.
*
*****/
static void RecvData()
{
    int    numr = 1;
    int    rc = 0;

    while (numr > 0 && rc >= 0) {
        numr = read(msgsock,buffer+buflen, MAX_BUFLen-
        buflen);
        if (numr > 0) {
            buflen += numr;
            buffer[buflen] = '\0';
            printf("buffer = %s\n",buffer);
            rc = ExtractMsg(buffer,&buflen);
        }
    }
}

/*****
*
*          EXTRACT MSG
*
* DESCRIPTION
*
* This function accepts a buffer of data on input,
* along with the amount of data in the buffer, and
* extracts GTS messages from this buffer.
*
* Messages that are in the buffer are identified as
* follows...
*
* - The first 8 bytes of the message buffer HAVE to
* be a message length in character format.
* If the length exceeds the GTS defined maximum
* message size, or does not consist of numeric
* characters, then an error is returned (lost
* synchronization).
*
* - Immediately following the message length is a
* 2 character
* Message Type: "AN" = Alphanumeric,"BI" =
* binary, "FX" = Fax
*
* - The GTS message begins with a SOH character,
* and is terminated with a ETX character, if this

```

```

* does not occur, then an error is returned (lost
* synchronization).
*
* - If a GTS message is identified, then it is extracted
* and the message is shifted out of the buffer.
*
* - As there may be more than 1 message in the
* buffer, this function will loop (extracting
* messages) until either an error or incomplete
* message is detected.
*
* RETURNS = 0 - Not a complete message in the
* buffer.
* < 0 - Fatal error in the format of the buffer.
* > 0 - Success, the message(s) have been extracted.
*****/
static int ExtractMsg(char *buffer, int *buflen)
{
    int    rc, msglen;
    char   msg[MAX_MSGSIZE+1];

    /* FIND THE FIRST MESSAGE IN THE BUFFER */
    rc = FindMessage (buffer, *buflen, &msglen);

    /* WHILE A VALID MESSAGE LENGTH IS FOUND IN
    THE MESSAGE BUFFER... */
    while ( rc > 0 ) {

        /* ENSURE THAT THE FIRST CHARACTER AFTER
        THE MESSAGE LENGTH IS
        A 'SOH' CHARACTER, AND THE LAST CHARACTER
        AS INDICATED BY
        THE MESSAGE LENGTH IS AN 'ETX' CHARACTER.
        */
        if ( (rc = CheckMsgBoundaries (buffer, msglen)) < 0 )
            continue;

        /* PRINT THE EXTRACTED MESSAGE */
        memcpy(msg,buffer+GTS_SOCKET_HEADER,msglen);
        msg[msglen] = '\0';
        printf("GTS MSG = \n%s\n",msg);

        /* SHIFT THE JUST INJECTED MESSAGE OUT OF
        THE MESSAGE BUFFER,
        AND LOOP BACK TO LOOK FOR A NEW MESSAGE.
        */
        ShiftBuffer (buffer, buflen, msglen);

        /* FIND THE FIRST MESSAGE IN THE SHIFTED
        BUFFER */
        rc = FindMessage (buffer, *buflen, &msglen);
    }

    return (rc);
}

```

```

/*****
*
*           FIND MESSAGE
*   Check that the complete message is at the start
*   of the buffer.
* 1. Check the first 8 characters which are the
*   message length.
* 2. Check the next 2 characters - Message Type.
* 3. Check that the complete message, as defined by
*   the "message length" field, is in the buffer.
*   Return codes:
*   0 = message incomplete
*   1 = message complete
*   -1 = error
*****/
static int FindMessage (char *buffer, int buflen, int
*mlen)
{
    char charlen[GTS_LENFIELD+1];
    int intlen;

    *mlen = 0;

    /* IF THE LENGTH OF THE PASSED MESSAGE
    BUFFER IS NOT GREATER THAN
    10 CHARACTERS THEN RETURN 'INCOMPLETE'. */
    if ( buflen < GTS_SOCKET_HEADER ) {
        return (0);
    }

    /* CHECK THAT THE MESSAGE TYPE IS VALID */
    if (strncmp(buffer+GTS_LENFIELD,"AN",2) &&
    strncmp(buffer+GTS_LENFIELD,"BI",2) &&
    strncmp(buffer+GTS_LENFIELD,"FX",2)) {
        printf("ERROR: Message Type field invalid");
        return (-1);
    }

    /* EXTRACT THE MESSAGE LENGTH */
    strncpy (charlen, buffer, GTS_LENFIELD);
    charlen[GTS_LENFIELD] = '\0';

    /* CHECK THAT THE MESSAGE LENGTH CHARAC-
    TER STRING COMPRISES
    ENTIRELY OF DIGITS. RETURN AN ERROR IF THIS
    IS NOT THE CASE. */
    if ( strspn (charlen, "0123456789") != strlen
(charlen) ) {
        printf("ERROR: length not numeric");
        return (-1);
    }

    /* CONVERT THE MESSAGE LENGTH CHARACTER
    STRING TO AN INTEGER. */
    intlen = atoi (charlen);

    /* CHECK THAT THE LENGTH EXTRACTED FROM
    THE BUFFER IS NOT GREATER

```

```

    THAN THE GTS DEFINED MAXIMUM MESSAGE
    SIZE - RETURN AN ERROR IF

```

```

    THIS IS THE CASE. */
    if ( intlen > MAX_MSGSIZE ) {
        printf("ERROR: message overlength");
        return (-1);
    }

```

```

/* CHECK IF THE ENTIRE MESSAGE HAS BEEN
RECEIVED. RETURN IF NOT */

```

```

    if ( buflen < intlen + GTS_SOCKET_HEADER ) {
        return (0);
    }

```

```

    *mlen = intlen;
    return (1);
}

```

```

/*****

```

CHECK MSG BOUNDARIES

```

*   Confirm the first character after the Socket
*   Header is a SOH, and the last character in the
*   message (given by the message
*   length) is an ETX.
*****/

```

```

static int CheckMsgBoundaries (char *buffer, int
msglen)
{

```

```

    /* CHECK THAT THE FIRST CHARACTER (AFTER
    THE MESSAGE LENGTH
    FIELD) IS AN SOH CHARACTER - RETURN AN
    ERROR IF IT ISN'T. */

```

```

    if ( buffer[GTS_SOCKET_HEADER] != SOH ) {
        printf("ERROR: SOH not found\n");
        return (-1);
    }

```

```

    /* CHECK THAT THE LAST CHARACTER (ACCORD-
    ING TO THE MESSAGE LENGTH
    FIELD) IS AN ETX CHARACTER - RETURN AN
    ERROR IF IT ISN'T. */

```

```

    if ( buffer[msglen+GTS_SOCKET_HEADER-1] != ETX
) {
        printf("ERROR: ETX not found\n");
        return (-1);
    }

```

```

    return (1);
}

```

```

/*****

```

SHIFT BUFFER

```

*   Shift the leading message in the buffer out of the
*   buffer. This may either empty the buffer, or move
*   all or part of a new message to the start of the
*   buffer.
*****/

```

```

/*****

```

```
static void ShiftBuffer (char *buffer, int *buflen, int
msglen)
{
    int shiftlen;

    /* CALCULATE THE AMOUNT OF DATA TO BE
SHIFTED OUT OF THE BUFFER. */
    shiftlen = msglen + GTS_SOCKET_HEADER;

    /* SHIFT THE 'PROCESSED' DATA OUT OF THE
BUFFER BY MOVING THE
UNPROCESSED DATA OVER THE TOP OF IT.
CALCULATE THE NEW AMOUNT OF DATA IN THE
BUFFER. */
    *buflen = *buflen - shiftlen;
    memcpy (buffer, buffer + shiftlen, *buflen);
}

```

III. Some security arrangements for small GTS Centres

This appendix provides information on low-cost measures to secure GTS Centres, when they are connected to the Internet. The traditional GTS with MSSs passing bulletins over point-to-point circuits is inherently secure, while the Internet is inherently insecure. So, it is important to prevent Internet users from being able to traverse GTS links, where they may be able to cause damage to neighbouring Centres.

Security policy

In a mixed Internet/GTS environment, a security hole at a GTS Centre may compromise other GTS segments. It is very likely that sooner or later, most of the GTS Centres will be connected to the Internet, so a solution for the security aspects must be found, which are practical for all Centres and especially, small Centres. Different levels of network security can be achieved with the tools available today at costs that vary from a few dollars (freeware) to expensive proprietary solutions.

There are, however, other important aspects besides costs. Technical expertise and strong management support are indispensable elements to implement and enforce an effective security policy.

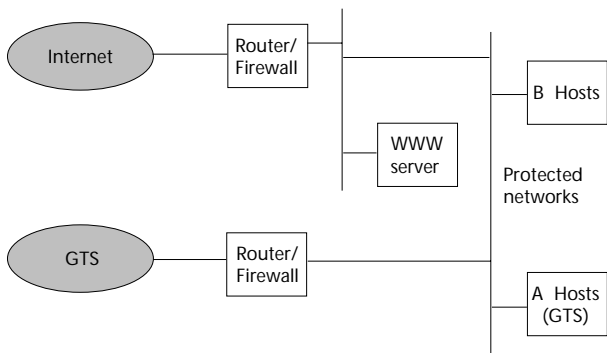

Figure 1 — Coexistence of GTS and Internet – separate access routers.

Without them, no protection will be achieved, even with the best and most expensive firewall systems.

Coexistence of Internet and dedicated GTS links

There are many options for the general configuration of systems in small Centres. Figure 1 shows an arrangement where separate routers are used to provide access to Internet and GTS.

To achieve cost reduction, GTS Centres, may wish to consolidate the GTS and Internet networks, while still providing a level of security for their GTS systems. Figure 2 depicts a low cost configuration that may meet this objective.

Protecting the GTS links from the Internet

It is important that the exterior router(s), connected to both GTS and Internet links be securely passworded, and protected so that it may not be configured via the Internet. Additionally, no Internet traffic should be allowed to propagate down GTS links, nor GTS traffic be sent to the Internet unless specifically intended to do so. This can be achieved by carefully filtering routing updates.

There should be a definite separation between general Internet services (www/http, e-mail access) and the GTS system (e. g. message switch). They should be in separate machines. Additionally, use of firewalling technology should be undertaken to limit general Internet access to the GTS Centre internal network, possibly restricting incoming connections to SMTP on the mail server, HTTP on the web server and DNS on the domain name servers.

In between the exterior router and critical systems, a firewall should be deployed. This firewall must have the capacity to limit, proxy or redirect access to internal hosts in order to protect them. Several brands of firewall are on the market, with ranges of capabilities. In most cases because of the simple nature of the network in small Centres, a simple firewall may be deployed.

When connecting to the Internet, deploying some sort of firewall is virtually mandatory. The risks for internal data and systems would justify this. In order to allow the access control some low-cost options are available:

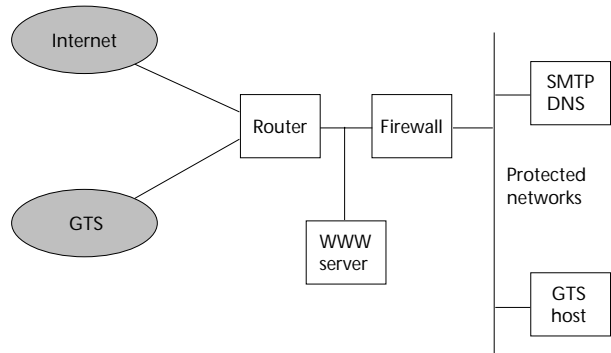

Figure 2 — Coexistence of GTS and Internet – common access router.

Linux computers

Linux Operating system is free, and runs on a variety of hardware platforms, notably on PCs. The newest versions of Linux (Kernel version 2.2) come with fire-walling software called ipchains. Additionally, they support routing protocols through a routing program called gated. Centres with some experience with UNIX will be able to get a working firewall setting up linux from scratch.

Windows NT

A variety of commercial packages exist. The familiarity with the Windows and relatively low cost of PC hardware is seen as main advantage.

Free toolkits

A company called TIS (trusted information systems) has released a set of source code, mainly for UNIX/LINUX hosts, which is freely available. This requires access to UNIX/LINUX machines, compilers, and requires good knowledge of Internet security issues.

Routers

Many routers have packet filtering capabilities. It is possible to deploy one of these as firewall, although they are not very flexible. Smaller Centres may want to consider this.

Desirable solution

Some firewall vendors have been providing firewall solutions, based on their hardware. Cisco's IOS firewall is a notable example. This type of solution is depicted in Figure 3.

GTS using the Internet

There will be situations where GTS Centres will use Internet to transport data and products. Security concerns are also applicable here. The arrangement shown below in Figure 4 represents a simple and safe way to use the Internet to connect neighbouring GTS Centres that may become popular in small Centres in future. Firewalling is done using access lists.

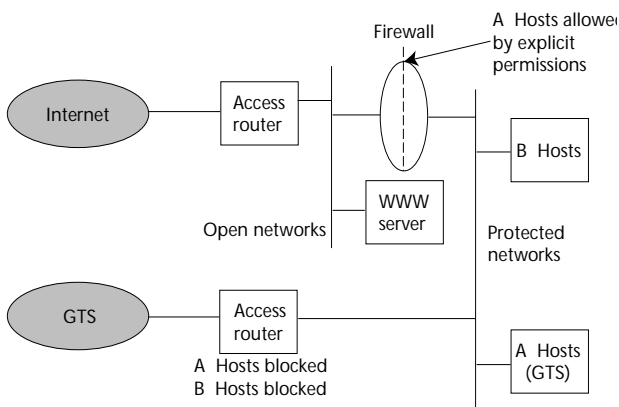

Figure 3 — Coexistence of GTS and Internet – separate access routers plus firewall.

IV. Reference material

General references on TCP/IP

1. *Internetworking TCP/IP Vol. 1 (2/E)*, Douglas Comer, Prentice Hall.
2. *TCP/IP Illustrated Vol. 1.*, Stevens, Addison-Wesley.
3. *TCP/IP Architecture, Protocols and Implementation*, Feit, McGraw Hill.
4. *TCP/IP and Related Protocols*, Black, McGraw Hill.
5. *TCP/IP Running a Successful Network*, Washburn and Evans, Addison-Wesley.
6. *TCP/IP and ONC/NFS (2/E)*, Santifaller, Addison-Wesley.
7. *Inside TCP/IP*, Arnett et al., New Riders Publishing.
8. *Teach Yourself TCP/IP in 14 Days*, Parker, SAMS.
9. *Introduction to TCP/IP*, Davidson, Springer.

References on security

1. *Firewalls and Internet Security*, Cheswick and Bellovin, Addison-Wesley.
2. *Building Internet Firewall*, Chapman, O'Reilly.
3. *Practical Unix Security*, Garfinkel and Spafford, O'Reilly.
4. *Internet RFC 2196 (Site Security Handbook)*.
5. <http://www.securityportal.com>: a Web site with a lot of reference documents on implementing security (include Cisco routers, Windows NT, Linux boxes, and various flavours of Unix).

V. Suggested password management practices

Passwords are the system's first line of defence against unauthorized intrusion. While it is possible to violate system security without logging in, a poorly protected or chosen password can make a hacker's task a lot easier.

GOOD PASSWORDS:

1. Have both upper-case and lower case letters, and/or.
2. Have digits and/or non-alphanumeric characters.
3. Are six to eight characters long.
4. Should consist of at least two words or groups of characters.
5. Should not be shared or used by more than one user.
6. Should not be used on more than one computer.
7. Should be changed regularly, e.g. monthly.

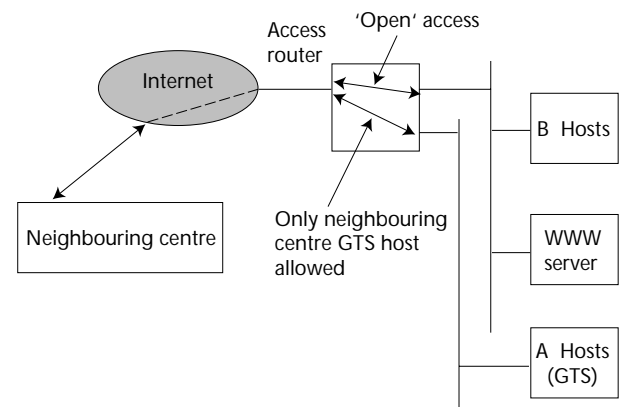

Figure 4 — The use of Internet between neighbouring GTS centres.

<p>8. Can be typed quickly and easily, so that an observer cannot follow the keystrokes.</p> <p>9. Are easy to remember — so that they should not have to be written down. (e.g. use first letter of words in a well known phrase).</p> <p>BAD PASSWORDS:</p> <p>1. The name of: yourself, your spouse, your children, your parents, your pet, your friends, your favourite film stars/characters, anyone associated with you, your workstation or its host.</p> <p>2. The number of: your telephone, your car's license plate, your user ID, any part of your credit cards' numbers, or any number associated with you.</p> <p>3. The birthday of yourself or anyone associated with you.</p>	<p>4. Any word from any dictionary, any place name, any proper noun.</p> <p>5. The name of a well known public identity such as a sporting hero, entertainer or well known fictional character.</p> <p>6. Simple patterns: aaaaaaa, qwerty.</p> <p>7. Any of 1–6 spelled backwards.</p> <p>8. Any of 1–6 preceded or followed by a digit.</p> <p>9. Any password that has been written down and left in an unlocked drawer or unsecured computer file.</p> <p>10. Any password that has been on a machine that may have been successfully hacked (except as part of authorized exercises).</p> <p>11. Any password on a machine that has been left unattended when any user is logged on.</p>
---	---

RECOMMENDATION 3 (CBS-XII)

AMENDMENTS TO THE *MANUAL ON CODES* (WMO-No. 306), VOLUME I.1, ALPHANUMERIC CODES AND VOLUME I.2, BINARY CODES AND COMMON FEATURES

THE COMMISSION FOR BASIC SYSTEMS,
NOTING:

- (1) The *Abridged Final Report with Resolutions and Recommendations of the Extraordinary Session of the Commission for Basic Systems* (WMO-No. 893), general summary paragraph 4.4.13,
- (2) The report of OPAG/ISS, ICT/DR&C (10–14 April 2000),

CONSIDERING the requirement:

- (1) To report observed quantities rather than qualitative parameters for present weather in observation from automatic stations in FM 94 BUFR and FM 95 CREX,
- (2) For the inclusion of drifting buoy metadata information in FM 18 BUOY,
- (3) For amendments to aeronautical codes resulting from corresponding changes in ICAO Annex 3 —

Meteorological Service for International Air Navigation/WMO Technical Regulation [C.3.1.],

RECOMMENDS that the following amendments be adopted for use as from 1 November 2001:

Amendments to FM 15-X Ext. METAR, FM 16-X Ext. SPECI, FM 51-X Ext. TAF and FM 53-X Ext. ARFOR, defined in Annex 3 to this recommendation;

RECOMMENDS that the following amendments be adopted for use as from 7 November 2001:

- (1) Additions to FM 94-XI Ext. BUFR and FM 95-XI Ext. CREX tables, defined in Annex 1 to this recommendation;
- (2) Amendments to FM 18-XI BUOY, defined in Annex 2 to this recommendation;

REQUESTS the Secretary-General to arrange for the inclusion of these amendments in Volumes I.1 and I.2 of the *Manual on Codes*.

ANNEX 1 TO RECOMMENDATION 3 (CBS-XII)

ADDITIONS TO FM 94-XI EXT. BUFR AND FM 95-XI EXT. CREX TABLES

Add in BUFR and CREX the following entries:

Class 13 — Hygrographic and hydrological elements

Reference	Element name	Unit	Scale	Reference value	Data width
0 13 055 B 13 055	Intensity of precipitation	kg m ⁻² s ⁻¹	4	0	8
		mm h ⁻¹	1	0	4
0 13 058 B 13 058	Size of precipitating element	m	4	0	7
		mm	1	0	3
0 13 059 B 13 059	Number of flashes (thunderstorm)	Numeric	0	0	7
			0	0	3

Class 20 — Observed phenomena

<i>Reference</i>	<i>Element name</i>	<i>Unit</i>	<i>Scale</i>	<i>Reference value</i>	<i>Data width</i>
0 20 021	Type of precipitation	Flag table	0	0	21
B 20 021			0	0	7
0 20 022	Character of precipitation	Code table	0	0	4
B 20 022			0	0	2
0 20 023	Other weather phenomena	Flag table	0	0	18
B 20 023			0	0	6
0 20 024	Intensity of phenomena	Code table	0	0	3
B 20 024			0	0	1
0 20 025	Obscuration	Flag table	0	0	21
B 20 025			0	0	7
0 20 026	Character of obscuration	Code table	0	0	4
B 20 026			0	0	2
0 20 027	Phenomena occurrence	Flag table	0	0	9
B 20 027			0	0	3

Flag table	0 20 021
	Type of precipitation
1	Precipitation-unknown type
2	Liquid precipitation not freezing
3	Liquid freezing precipitation
4	Drizzle
5	Rain
6	Solid precipitation
7	Snow
8	Snow grains
9	Snow pellets
10	Ice pellets
11	Ice crystals
12	Diamond dust
13	Small hail
14	Hail
15	Glaze
16	Rime
17	Hoar frost
18	Dew
19–20	Reserved
All 21	Missing value

NOTE: Mixed precipitation is indicated by setting to one the bits of all the observed single types of precipitation.

Code table	0 20 022
	Character of precipitation
0	No precipitation
1	Continuous
2	Intermittent
3	Shower
4	Not reaching ground
5	Deposition
6–14	Reserved
15	Missing value

Flag table	0 20 023
	Other weather phenomena
1	Dust/sand whirl
2	Squalls
3	Sand storm
4	Dust storm
5	Lightning — cloud to surface
6	Lightning — cloud to cloud
7	Lightning — distant
8	Thunderstorm
9	Funnel cloud not touching surface
10	Funnel cloud touching surface
11	Spray
12–17	Reserved
All 18	Missing value
Code table	0 20 024
	Intensity of phenomena
0	No phenomena
1	Light
2	Moderate
3	Heavy
4	Violent
5–6	Reserved
7	Missing value

Flag table	0 20 025
	Obscuration
1	Fog
2	Ice fog
3	Steam fog
4–6	Reserved
7	Mist
8	Haze
9	Smoke
10	Volcanic ash

<p>Flag table 0 20 025 (<i>continued</i>)</p> <p>11 Dust 12 Sand 13 Snow 14-20 Reserved All 21 Missing value</p> <p>Code table 0 20 026 Character of obscuration</p> <p>0 No change 1 Shallow 2 Patches 3 Partial 4 Freezing 5 Low drifting 6 Blowing 7 Increasing 8 Decreasing 9 In suspension in the air 10 Wall 11 Dense 12 Whiteout 13-14 Reserved 15 Missing value</p> <p>Flag table 0 20 027 Phenomena occurrence</p> <p>1 At time of observation 2 In past hour 3 In time period for past weather W₁W₂</p>	<p>4 In time period specified 5-6 Reserved 7 At the station 8 In the vicinity All 9 Missing value</p> <p>NOTE: Phenomenon in 0 20 027 means any phenomenon, including precipitation and obscuration. Add in BUFR Table for Class 20: 0 20 003 Present weather (See Note 1) 0 20 004 Past weather (1) (See Note 2) 0 20 005 Past weather (2) (See Note 2) Add in BUFR Table for Class 20, the following notes: NOTES: (1) When encoding present weather reported from an automatic weather station, the appropriate combination of descriptors 0 20 021, 0 20 022, 0 20 023, 0 20 024, 0 20 025, 0 20 026 and 0 20 027 should be used and preferred. A descriptor 0 20 003 should be used only when descriptors mentioned above are not applicable. (2) When encoding past weather reported from an automatic weather station, the appropriate combination of descriptors 0 20 021, 0 20 022, 0 20 023, 0 20 024, 0 20 025, 0 20 026 and 0 20 027 should be used and preferred. Descriptors 0 20 004 or 0 20 005 should be used only when descriptors mentioned above are not applicable.</p> <p>Modify in Table for Class 20, the following descriptor: 0 020 038 Bearing of ice edge (See Note 3) and renumber the asterisks to read Note 3.</p>
--	---

ANNEX 2 TO RECOMMENDATION 3 (CBS-XII)

MODIFICATIONS TO FM 18-XI BUOY

Change Section 4 as follows:

SECTION 4 444 (1Q_pQ₂Q_{TW}Q₄) (2Q_NQ_LQ_AQ_Z)
 {(Q_cL_aL_aL_aL_aL_a) (L_oL_oL_oL_oL_oL_o) or (YYMMJ GGgg/)}
 (3Z_hZ_hZ_hZ_h 4Z_cZ_cZ_cZ_c) (5B_tB_tX_tX_t)
 (6A_hA_hA_hA_h) (7V_BV_Bd_Bd_B) (8V_iV_iV_iV_i) (9/Z_dZ_dZ_d)

Q_Z Indicates whether or not depths are corrected using hydrostatic pressure
 Z_hZ_hZ_hZ_h Hydrostatic pressure of lower end of cable (1 000 Pa)
 Z_cZ_cZ_cZ_c Length of cable in metres (thermistor string)
 B_tB_tX_tX_t Buoy type and drogue type
 A_hA_hA_h Anemometer height
 A_N Type of anemometer

Modify group in existing regulation 18.6.3 to read (2Q_NQ_LQ_AQ_Z) and add after the last sentence:

Q_Z indicates whether or not probe depths as reported in Section 3 are corrected using hydrostatic pressure.

Insert regulation 18.6.4:

In Section 4, presence of fields (Q_cL_aL_aL_aL_aL_a L_oL_oL_oL_oL_oL_o) and (YYMMJ GGgg/) is driven by the value of the Q_L indicator:

- (a) Group 2Q_NQ_LQ_AQ_Z absent: fields (Q_cL_aL_aL_aL_aL_a) (L_oL_oL_oL_oL_oL_o) and (YYMMJ GGgg/) not coded
- (b) Q_L = 1: fields YYMMJ GGgg/ coded (fields Q_cL_aL_aL_aL_aL_a L_oL_oL_oL_oL_oL_o absent)
- (c) Q_L = 2: fields Q_cL_aL_aL_aL_aL_a L_oL_oL_oL_oL_oL_o coded (fields YYMMJ GGgg/ absent)

Renumber existing regulations 18.6.4 to 18.6.6, which become regulations 18.6.5 to 18.6.7. Similarly, existing regulations 18.6.7 and 18.6.8 become regulations 18.6.12 and 18.6.13, taking account of the insertion of the following new regulations.

Insert regulation 18.6.8:

Group 3 ($3Z_h Z_h Z_h Z_h$)

Hydrostatic pressure of lower end of cable. Pressure is expressed in units of 1 000 Pa (i.e. centibars). If group 3 is present, then group 4 is mandatory.

Insert regulation 18.6.9:

Group 4 ($4Z_c Z_c Z_c Z_c$)

Length of cable in metres (thermistor strings).

Insert regulation 18.6.10:

Group 5 ($5B_t B_t X_t X_t$) should be omitted if buoy type and drogue type information is not available.

Insert regulation 18.6.11:

Group 6 ($6A_h A_h A_h A_h$) should be omitted if the buoy is not reporting wind or the information is not available for both anemometer height and anemometer type. $A_h A_h A_h$ is the anemometer height above station level. Height is expressed in decametres. For drifting and moored buoys, station level is assumed to be sea level. /// shall be used for unknown values. A value of 999 shall be used to say that anemometer height is artificially corrected to 10 metres by applying a formula.

Add new Code tables:

3318	
Q_z	Depth correction indicator (Indication whether probe depths are corrected using hydrostatic pressure or not)
Code figure	
0	Depths are not corrected
1	Depth are corrected
/	Missing

0370	
$B_t B_t$	Type of Buoy
Code figure	
00	Unspecified drifting buoy
01	Standard Lagrangian drifter (Global Drifter Programme)
02	Standard FGGE type drifting buoy (non-Lagrangian meteorological drifting buoy)
03	Wind measuring FGGE type drifting buoy (non-Lagrangian meteorological drifting buoy)
04	Ice float
05-07	Reserved
08	Unspecified subsurface float
09	SOFAR
10	ALACE
11	MARVOR
12	RAFOS
13-15	Reserved
16	Unspecified moored buoy

17	Nomad
18	3-metre discus
19	10-12-metre discus
20	ODAS 30 series
21	ATLAS (e.g. TAO area)
22	TRITON
23	Reserved
24	Omnidirectional wave-rider
25	Directional waverider
26-62	Reserved
//	Missing value (coded 63 in BUFR)

4880	
$X_t X_t$	Type of drogue
Code figure	
0	Unspecified drogue
1	Holey sock
2	TRISTAR
3	Window shade
4	Parachute
5	Non-Lagrangian sea anchor
6-30	Reserved (to be developed)
//	Missing value (coded 31 in BUFR)

0114	
A_h	Type of anemometer
Code figure	
0	Cup rotor
1	Propeller rotor
2	Wind Observation through Ambient Noise (WOTAN)
/	Missing value (coded 15 in BUFR)

ANNEX 3 TO RECOMMENDATION 3 (CBS-XII)

MODIFICATIONS TO CODE FORMS

FM 15-X Ext. METAR

FM 16-X Ext. SPECI

Delete in the Code form the brackets from the time group YGGggZ.

Add in the Code form “or NSC” under SKC.

Add in the Code form “(WT_ST_S/SS)” after the group WS RWYD_RD_R or WS ALL RWY.

Add in the Code form “(D_RD_RE_RC_Re_Re_RB_RB_R)” after (WT_ST_S/SS).

Delete in regulation 15.1.1 the last sentence.

Amend regulation 15.3.1 to read:

The day of the month and the time of observation in hours and minutes UTC followed, without a space, by the letter indicator Z shall be included in each individual METAR report.

Amend in regulation 15.3.2 the first sentence only to read:

This group shall be included in each individual SPECI report.

Amend in regulation 15.5.2 the second sentence to read:

A variable wind at higher speeds shall be reported only when the variation of wind direction is 180° or more or when it is impossible to determine a single wind direction, for example when a thunderstorm passes over the aerodrome.

Add in regulation 15.5.3 “but less than 180°” after “60° or more”.

Add in regulation 15.5.6 a new sentence at the end of the paragraph to read:

When the wind speed is 100 knots or more (50 m s⁻¹ or 200 km h⁻¹), the groups ff and f_mf_m shall be preceded by the letter indicator P and reported as P99KT (P50MPS or P199KMH).

Introduce after regulation 15.5.6 the following note:

NOTE: There is no aeronautical requirement to report surface wind speeds of 200 km h⁻¹ (100 kt) or more; however, provision has been made for reporting wind speeds up to 399 km h⁻¹ (199 kt) for non-aeronautical purposes, as necessary.

Introduce after regulation 15.6 the following note:

NOTE: The coding of visibility is based on the use of the metre and kilometre, in accordance with the units specified in ICAO Annex 5. However, some Members in Region IV use statute miles and fractions thereof in accordance with national coding procedures as indicated in Volume II of this *Manual*.

Delete in regulation 15.6.4 the word “horizontal” and amend in (a) and (b) “500 metres” to read “800 metres”.

Introduce after regulation 15.7 the following note:

NOTE: The coding of runway visual range is based on the use of the metre, in accordance with the unit specified in

ICAO Annex 5. However, some Members in Region IV use feet in accordance with national coding procedures as indicated in Volume II of this *Manual*.

Add in regulation 15.7.2 “up to a maximum of four” after “each runway”.

Amend in regulation 15.7.3 the third and fourth sentences to read:

The letter shall be appended to D_RD_R, as necessary, in accordance with the standard practice for runway designation, as laid down by ICAO in Annex 14 — Aerodromes, Volume I — Aerodrome Design and Operations, paragraphs 5.2.2.4 and 5.2.2.5.

Add in regulation 15.9 “or NSC” under “SKC”.

Add in regulation 15.9.1.1 a new sentence at the end of the paragraph to read:

If there are no clouds below 1 500 m (5 000 ft) or below the highest minimum sector altitude, whichever is greater, no Cumulonimbus and no restriction on vertical visibility and the abbreviations CAVOK and SKC are not appropriate, then the abbreviation NSC shall be used.

Add in regulation 15.13 “(WT_ST_S/SS)” after the group WS RWYD_RD_R or WS ALL RWY.

Add at the end of regulation 15.13.1 “and, subject to regional air navigation agreement, sea-surface temperature and state of the sea, and also subject to regional air navigation agreement, the state of the runway.”

Add in regulation 15.13.2.1 a new sentence at the end of the paragraph to read:

No intensity of the recent weather phenomena shall be indicated.

Delete regulation 15.13.2.2.

Add after regulation 15.13.4 the following regulations:

15.13.5 Sea-surface temperature and the state of the sea (WT_ST_S/SS).

15.13.5.1 The sea-surface temperature shall, by regional agreement, be reported according to the regional ICAO Regulation 15.11. The state of the sea shall be reported in accordance with Code table 3700.

15.13.6 State of the runway (D_RD_RE_RC_Re_Re_RB_RB_R).

15.13.6.1 Subject to regional air navigation agreement, information on the state of the runway provided by the appropriate airport authority shall be included. The runway designator D_RD_R shall be reported according to Regulation 15.7.3. The runway deposits E_R, the extent of runway contamination C_R, the depth of deposit e_Re_R and the friction coefficient/braking action B_RB_R shall be indicated in accordance with Code tables

<p>0919, 0519, 1079 and 0366, respectively. The state of the runaway group shall be replaced by the abbreviation SNOCLO when the aerodrome is closed due to extreme deposit of snow.</p> <p>FM 51-X Ext. TAF Delete in the Code form the brackets from the time group YGGggZ. Delete in the Code form the brackets from "(or NSC)". Delete in the Code form groups (6I_ch_ih_it_i) and (5B_hh_Bh_Bt_i). Amend in the Code form the temperature forecast group to read: (T_XT_FT_F/G_FG_FZ T_NT_FT_F/G_FG_FZ). Delete in regulation 51.1.1 the last sentence. Delete in regulation 51.1.2 the words "if required". Introduce after regulation 51.4 the following note: NOTE: The coding of visibility is based on the use of the metre and kilometre, in accordance with the units specified in ICAO Annex 5. However, in Region IV, statute miles and fractions thereof are used in accordance with national coding procedures as indicated in Volume II of this <i>Manual</i>. Delete in regulation 51.6.3 the words "When so determined by regional air navigation agreement". Delete regulations 51.8 and 51.9 and renumber the subsequent regulations accordingly. Amend regulation 51.12 to read: Group ((T_XT_FT_F/G_FG_FZ T_NT_FT_F/G_FG_FZ). Amend regulation 51.12.1 to read: To indicate forecast maximum and minimum temperatures expected to occur at the time indicated by G_FG_FZ, the letter indicator TX for the maximum forecast temperature and TN for the minimum forecast temperature shall precede T_FT_F without a space. Delete regulation 51.12.3.</p> <p>FM 53-X Ext. ARFOR Add the following note after the Code form: NOTE (4): No aeronautical requirement for this Code form is stated by ICAO for international air navigation in ICAO Annex 3/WMO Technical Regulation [C.3.1.].</p>	<p>/ Type of deposit not reported (e.g. due to runway clearance in progress)</p> <p>0519 C_R Extent of runway contamination</p> <p>Code figure</p> <p>1 Less than 10 per cent of runway contaminated (covered)</p> <p>2 11 per cent to 25 per cent of runway contaminated (covered)</p> <p>3 Reserved</p> <p>4 Reserved</p> <p>5 26 per cent to 50 per cent of runway contaminated (covered)</p> <p>6 Reserved</p> <p>7 Reserved</p> <p>8 Reserved</p> <p>9 51 per cent to 100 per cent of runway contaminated (covered)</p> <p>/ Not reported (e.g. due to runway clearance in progress)</p> <p>1079 e_Re_R Depth of deposit</p> <p>Code figure</p> <p>00 Less than 1 mm</p> <p>01 1 mm</p> <p>02 2 mm</p> <p>03 3 mm</p> <p>.....</p> <p>89 89 mm</p> <p>90 90 mm</p> <p>91 Reserved</p> <p>92 10 cm</p> <p>93 15 cm</p> <p>94 20 cm</p> <p>95 25 cm</p> <p>96 30 cm</p> <p>97 35 cm</p> <p>98 40 cm or more</p> <p>99 Runway or runways non-operational due to snow, slush, ice, large drifts or runway clearance, but depth not reported</p> <p>// Depth of deposit operationally not significant or not measurable</p>
<p style="text-align: center;">CODE TABLES</p> <p style="text-align: center;">0919</p> <p>E_R Runway deposits</p> <p>Code figure</p> <p>0 Clear and dry</p> <p>1 Damp</p> <p>2 Wet and water patches</p> <p>3 Rime and frost covered (depth normally less than 1 mm)</p> <p>4 Dry snow</p> <p>5 Wet snow</p> <p>6 Slush</p> <p>7 Ice</p> <p>8 Compacted or rolled snow</p> <p>9 Frozen ruts or ridges</p>	<p style="text-align: center;">0366</p> <p>B_RB_R Friction coefficient/braking action</p> <p>Code figure</p> <p>00 Friction coefficient 0.00</p> <p>01 Friction coefficient 0.01</p> <p>.....</p> <p>88 Friction coefficient 0.88</p>

89	Friction coefficient 0.89	96	Reserved
90	Friction coefficient 0.90	97	Reserved
91	Braking action poor	98	Reserved
92	Braking action medium/poor	99	Unreliable
93	Braking action medium	//	Braking conditions not reported and/or runway not operational
94	Braking action medium/good		
95	Braking action good		

RECOMMENDATION 4 (CBS-XII)

RULES AND PROCEDURES FOR AMENDING THE *MANUAL ON CODES* (WMO-No. 306)

THE COMMISSION FOR BASIC SYSTEMS,

NOTING:

- (1) Resolution 5 (CBS-XI) — Working Group on Data Management,
- (2) Report of the Meeting of the CBS Working Group on Data Management/Subgroup on Data Representation and Codes (20–24 April 1998),
- (3) Report of the third session of the CBS Working Group on Data Management (8–12 June 1998),
- (4) *Abridged Final Report with Resolutions and Recommendations of the Extraordinary Session of the Commission for Basic Systems* (WMO-No. 815), general summary paragraph 5.4.31,
- (5) *Abridged Final Report with Resolutions and Recommendations of the Eleventh Session of the Commission for Basic Systems* (WMO-No. 854), general summary paragraph 6.4.14,
- (6) *Abridged Final Report with Resolutions and Recommendations of the Extraordinary Session of the Commission*

for Basic Systems (WMO-No. 893), general summary paragraph 4.4.14,

- (7) Report of the Implementation/Coordination Team on Data Representation and Codes (10–14 April 2000),

CONSIDERING the requirements for:

- (1) General validation and implementation procedures,
- (2) Fast-track validation and implementation procedures for BUFR and CREX,
- (3) Procedures for correction of existing entries in the BUFR and CREX tables,
- (4) Rules for the development and maintenance of new BUFR Master Tables,

RECOMMENDS that the following rules and procedures, defined in the annex to this recommendation, be applied from 1 July 2001;

REQUESTS the Secretary-General to arrange for the inclusion of these procedures in the introduction chapter of Volumes I.1 and I.2 of the *Manual on Codes*.

ANNEX TO RECOMMENDATION 4 (CBS-XII)

PROCEDURES FOR AMENDING THE *MANUAL ON CODES* (WMO-No. 306)

1. General validation and implementation procedures

- 1.1 Amendments to the *Manual on Codes* must be proposed in writing to the WMO Secretariat. The proposal shall specify the needs, purposes and requirements and include information on a contact point for technical matters.
- 1.2 The Expert Team on Data Representation and Codes (ET/DR&C)*, supported by the Secretariat, shall validate the stated requirements (unless it is

consequential to an amendment to the WMO Technical Regulations) and develop a draft recommendation to respond to the requirements, as appropriate.

- 1.3 A draft recommendation developed by the ET/DR&C must be endorsed by the Implementation/Coordination (ITC) of the Open Programme Area Group on Information Systems and Services (OPAG/ISS) prior to its consideration by CBS, which subsequently submits it for approval to the Executive Council. Draft recommendations must have followed the procedures described in paragraph 5.4.31 of the *Abridged Final Report with Resolutions and Recommendations of the*

* The ET/DR&C and the OPAG/ISS are, in the year 2000, the current bodies dealing with data representation and codes within CBS. If they were replaced by other bodies performing the same function, the same rules would apply, by replacing the means of the entities approximately.

<p><i>Extraordinary Session of the Commission for Basic Systems</i> (WMO-No. 815) before being submitted to a CBS session. These procedures are given in section 4 below. During inter-sessional periods, the “fast track” mechanism, described in section 2 below, is used to ensure the necessary flexibility in responding to urgent requirements of users.</p> <p>1.4 Updates of the <i>Manual on Codes</i> shall be issued as supplements only once a year in August, and include all changes implemented since the previous update and those approved for implementation on the first Wednesday following 1 November.</p> <p>2. Fast track mechanism for validation and implementation</p> <p>2.1 Fast track mechanism shall be used during the inter-sessional periods of CBS for additions to BUFR or CREX Tables A, B, and D with associated Code tables or flag tables and to Code Tables in GRIB, to common tables related to character codes, e.g. radiosonde entries, and to other simple additional table entries in character codes.</p> <p>2.2 Draft recommendations developed by the ET/DR&C must follow the validation procedures described in subsections 4.1, 4.2 and 4.3 below and must be endorsed by the chairperson of OPAG/ISS, the president of CBS on behalf of the Commission, and approved by the President of WMO on behalf of the Executive Council. However, the filling of reserved and unused entries in the existing Code and Flag tables are considered minor adjustments and will be effected by the Secretary-General in consultation with the president of CBS.</p> <p>2.3 The implementation of amendments approved through the fast track shall normally be limited to one per year and the implementation date should be fixed as the first Wednesday following 1 November. If the chairpersons of ET/DR&C and OPAG/ISS agree that an exceptional situation exists, a second fast track implementation can be initiated.</p>	<p>2.4 WMO Members shall be notified of amendments approved through the fast track timely enough to allow a period of at least three months between the receipt of the notification and the date of implementation.</p> <p>3. Procedures for the correction of existing entries in the BUFR and CREX tables</p> <p>3.1 If an erroneous specification of an entry is found in a BUFR or CREX table, a new descriptor should normally be added to the table through the fast track procedures and should be used instead of the old one for encoding (especially if it concerns data width). An appropriate explanation shall be added to the notes of the table to clarify the practice along with the date of the change.</p> <p>3.2 This situation is considered a minor adjustment according to subsection 2.2 above.</p> <p>4. Validation procedures with respect to proposed changes to WMO codes and data representation forms</p> <p>4.1 The need for, and the purpose of, the proposed changes should be fully documented.</p> <p>4.2 This documentation must include the results of non-operational testing of the changes as described below.</p> <p>4.3 For new or modified WMO code and data representation forms, proposed changes should be tested by the use of at least two independently developed encoders and two independently developed decoders which incorporated the proposed change. Where the data originated from a necessarily unique source (for example the data stream from an experimental satellite), the successful testing of a single encoder with at least two independent decoders would be considered adequate. Results should be made available to the ET/DR&C with a view to verifying the technical specifications.</p> <p>4.4 Draft recommendations to be submitted to CBS sessions must be published as pre-session documents at least three months prior to the session.</p>
---	--

RECOMMENDATION 5 (CBS-XII)

ADDITION TO NEW CODE FORM FM 92-XII GRIB

THE COMMISSION FOR BASIC SYSTEMS,

NOTING:

- (1) The *Abridged Final Report with Resolutions and Recommendations of the Eleventh Session of the Commission for Basic Systems* (WMO-No. 854), general summary paragraph 6.4.12,
- (2) The *Abridged Final Report with Resolutions and Recommendations of the Extraordinary Session of the*

Commission for Basic Systems (WMO-No. 893), general summary paragraphs 4.4.5 and 4.4.6,

- (3) The report of the Implementation/Coordination Team on Data Representation and Codes (10-14 April 2000),

CONSIDERING the requirement:

- (1) To alleviate the freeze placed on Edition 1 of FM 92 GRIB,

- (2) To code new analysis, forecast, climate, satellite and radar products, such as the output of ensemble prediction systems, long-range forecasts, climate predictions, ensemble wave forecasts or transport models,
- (3) To provide easy facilities in FM 92 GRIB for expansion and additions,

RECOMMENDS that Edition 2 of FM 92 GRIB (FM 92-XII GRIB), defined in the annex to this recommendation, be adopted for use as from 7 November 2001 and that Edition 1 of FM 92 GRIB (FM 92-XII GRIB) remain in use; REQUESTS the Secretary-General to arrange for the inclusion of Edition 2 of FM 92 GRIB, as defined in the annex to this recommendation, in Volume I.2 of the *Manual on Codes*.

ANNEX TO RECOMMENDATION 5 (CBS-XII)

FM 92-XII GRIB — GENERAL REGULARLY-DISTRIBUTED INFORMATION IN BINARY FORM

CODE FORM:

SECTION 0	Indicator section			
SECTION 1	Identification section			
SECTION 2	(Local use section)			
SECTION 3	Grid definition section			
SECTION 4	Product definition section	}	(repeated)	}
SECTION 5	Data representation section			
SECTION 6	Bit-map section			
SECTION 7	Data section			
SECTION 8	End section			

NOTES:

- (1) GRIB is the name of a data representation form for general regularly-distributed information in binary.
- (2) Data encoded in GRIB consists of a continuous bit-stream made of a sequence of octets (1 octet = 8 bits).
- (3) The octets of a GRIB message are grouped into sections:

<i>Section number</i>	<i>Section name</i>	<i>Section contents</i>
0	Indicator section	"GRIB", discipline, GRIB edition number, length of message
1	Identification section	Length of section, section number, characteristics that apply to all processed data in the GRIB message
2	Local use section (optional)	Length of section, section number, additional items for local use by originating centres
3	Grid definition section	Length of section, section number, geometry of values within the plane described by the two fixed coordinates
4	Product definition section	Length of section, section number, description of the data that follows, including the two fixed coordinates
5	Data representation section	Length of section, section number, description of how the data that follows is represented
6	Bit-map section	Length of section, section number, indication of presence or absence of data at each of the grid points, as applicable
7	Data section	Length of section, section number, data values
8	End section	"7777"

- (4) Sequences of GRIB sections 2 to 7, sections 3 to 7 or sections 4 to 7 may be repeated within a single GRIB message. All sections within such repeated sequences must be present and shall appear in the numerical order noted above. Unrepeated sections remain in effect until redefined.
- (5) It will be noted that the GRIB code is not suitable for visual data recognition without computer interpretation.

- (6) The representation of data by means of series of bits is independent of any particular machine representation.
- (7) Message and section lengths are expressed in octets. Octets are numbered 1, 2, 3, etc., starting at the beginning of each section. Therefore, octet numbers in a template refer to the respective section.
- (8) Bit positions within octets are referred to as bit 1 to bit 8, where bit 1 is the most significant and bit 8 is the least significant. Thus, an octet with only bit 8 set to 1 would have the integer value 1.
- (9) As used in "GRIB", "International Alphabet No. 5" is regarded as an 8-bit alphabet with bit 1 set to zero.
- (10) The IEEE single precision floating point representation is specified in the standard ISO/IEC 559-1985 and ANSI/IEEE 754-1985 (R1991), which should be consulted for more details. The representation occupies four octets and is:

seeeeee emmmmmm mmmmmmm mmmmmmm

where

s is the sign bit, 0 means positive, 1 negative

e...e is an 8 bit biased exponent

m...m is the mantissa, with the first bit deleted

The value of the number is given by the following table:

<i>e...e</i>	<i>m...m</i>	<i>Value of number</i>
0	Any	$(-1)^s (m...m)2^{-23}2^{-126} = (-1)^s (m...m)2^{-149}$
1...254	Any	$(-1)^s (1.0 + (m...m)2^{-23})2^{(e...e)-127}$
255	0	Positive (s=0) or Negative (s=1) infinity
255	>0	NaN (Not a valid number, result of illegal operation)

Normally, only biased exponent values from 1 through 254 inclusive are used, except for positive or negative zero which are represented by setting both the biased exponent and the mantissa to 0.

The numbers are stored with the high order octet first. The sign bit will be the first bit of the first octet. The low order bit of the mantissa will be the last (eighth) bit of the fourth octet.

This floating point representation has been chosen because it is in common use in modern computer hardware. Some computers use this representation with the order of the octets reversed. They will have to convert the representation, either by reversing the octets or by computing the floating point value directly using the above formulas.

REGULATIONS:

92.1 General

- 92.1.1 The GRIB code shall be used for the exchange and storage of general regularly-distributed information expressed in binary form.
- 92.1.2 The beginning and the end of the code shall be identified by 4 octets coded according to the International Alphabet No. 5 to represent the indicators "GRIB" and "7777" in Indicator section 0 and End section 8, respectively. All other octets included in the code shall represent data in binary form.
- 92.1.3 Each section included in the code shall always end on an octet boundary. This rule shall be applied by appending bits set to zero to the section where necessary.
- 92.1.4 All bits set to "1" for any value indicates that value is missing. This rule shall not apply to packed data.
- 92.1.5 If applicable, negative values shall be indicated by setting the most significant bit to "1".
- 92.1.6 Latitude, longitude, and angle values shall be in units of 10⁻⁶ degree, except for specific cases explicitly stated in some grid definitions.
- 92.1.7 The latitude values shall be limited to the range 0 to 90 degrees inclusive. Orientation shall be north latitude positive, south latitude negative. Bit 1 is set to 1 to indicate south latitude.
- 92.1.8 The longitude values shall be limited to the range 0 to 360 degrees inclusive. Orientation shall be east longitude positive, with only positive values being used.
- 92.1.9 The latitude and longitude of the first grid point and the last grid point shall always be given for regular grids.
- 92.1.10 Vector components at the North and South Poles shall be coded according to the following conventions.
- 92.1.10.1 If the resolution and component flags in section 3 (Flag table 3.3) indicate that the vector components are relative to the defined grid, the vector components at the Pole shall be resolved relative to the grid.

92.1.10.2 Otherwise, for projections where there are multiple points at a given pole, the vector components shall be resolved as if measured an infinitesimal distance from the Pole at the longitude corresponding to each grid point. At the North Pole, the West to East (x direction) component at a grid point with longitude L shall be resolved along the meridian 90 degrees East of L, and the South to North (y direction) component shall be resolved along the meridian 180 degrees from L. At the South Pole the West to East component at a grid point with longitude L shall be resolved along the meridian 90 degrees East of L and the South to North component shall be resolved along L.

92.1.10.3 Otherwise, if there is only one Pole point, either on a cylindrical projection with all but one Pole point deleted, or on any projection (such as polar stereographic) where the Pole maps to a unique point, the West to East and South to North components shall be resolved along longitudes 90 degrees W and 0 degree, respectively at the North Pole and along longitudes 90 degrees W and 180 degrees, respectively at the South Pole.

NOTE: This differs from the treatment of the Poles in the WMO traditional alphanumeric codes.

92.1.11 The first and last grid points shall not necessarily correspond to the first and last data points, respectively, if the bit-map is used.

92.2 Section 0 – Indicator section

92.2.1 Section 0 shall always be 16 octets long.

92.2.2 The first four octets shall always be character coded according to the International Alphabet No. 5 as “GRIB”.

92.2.3 The remainder of the section shall contain reserved octets, followed by the Discipline, the GRIB edition number, and the length of the entire GRIB message (including the Indicator section).

92.3 Section 1 – Identification section

92.3.1 The length of the section, in units of octets, shall be expressed over the group of the first four octets, i.e., over the first 32 bits.

92.3.2 The section number shall be expressed in the fifth octet.

92.3.3 Octets beyond 21 are reserved for future use and need not be present.

92.4 Section 2 – Local use section

92.4.1 Regulations 92.3.1 and 92.3.2 shall apply.

92.4.2 Section 2 is optional.

92.5 Section 3 – Grid definition section

92.5.1 Regulations 92.3.1 and 92.3.2 shall apply.

92.6 Section 4 – Product definition section

92.6.1 Regulations 92.3.1 and 92.3.2 shall apply.

92.7 Section 5 – Data representation section

92.7.1 Regulations 92.3.1 and 92.3.2 shall apply.

92.8 Section 6 – Bit-map section

92.8.1 Regulations 92.3.1 and 92.3.2 shall apply.

92.9 Section 7 – Data section

92.9.1 Regulations 92.3.1 and 92.3.2 shall apply.

92.9.2 Data shall be coded using the minimum number of bits necessary to provide the accuracy required by international agreement. This required accuracy/precision shall be achieved by scaling the data by multiplication by an appropriate power of 10 (which may be 0) before forming the non-negative differences, and then using the binary scaling to select the precision of the transmitted value.

92.9.3 The data shall be packed by the method identified in section 5.

92.9.4 Data shall be coded in the form of non-negative scaled differences from a reference value of the whole field plus, if applicable, a local reference value.

NOTES:

(1) A reference value is normally the minimum value of the dataset which is represented.

(2) For grid-point values, complex packing features are intended to reduce the whole size of the GRIB message (data compression without loss of information with respect to simple packing). The basic concept is to reduce data size

thanks to local redundancy. This is achieved just before packing, by splitting the whole set of scaled data values into groups, on which local references (such as local minima) are removed. It is done with some overhead, because extra descriptors are needed to manage the groups characteristics. An optional pre-processing of the scaled values (spatial differencing) may also be applied before splitting into groups, and combined methods, along with use of alternate row scanning mode, are very efficient on interpolated data.

- (3) For spectral data, complex packing is provided for better accuracy of packing. This is because many spectral coefficients have small values (regardless of sign), especially for large wave numbers. The first principle is to not pack a subset of coefficients, associated with small wave numbers so that the amplitude of the packed coefficients is reduced. The second principle is to apply an operator to the remaining part of the spectrum; with appropriate tuning it leads to a more homogeneous set of values to pack.
- (4) The original data value Y (in the units of Code table 4.2) can be recovered with the formula:

$$Y * 10^D = R + (X1+X2) * 2^E$$

For simple packing and all spectral data:

- E = Binary scale factor,
- D = Decimal scale factor,
- R = Reference value of the whole field,
- X1 = 0,
- X2 = Scaled (encoded) value.

For complex grid point packing schemes, E, D, and R are as above, but:

- X1 = Reference value (scaled integer) of the group the data value belongs to,
- X2 = Scaled (encoded) value with the group reference value (X1) removed.

92.10 Section 8 – End section

92.10.1 The end section shall always be 4 octets long, character coded according to the International Alphabet No. 5 as “7777”.

SPECIFICATION OF OCTET CONTENTS

Section 0 – Indicator section

<i>Octet No.</i>	<i>Contents</i>
1-4	“GRIB” (coded according to the International Alphabet No. 5.)
5-6	Reserved
7	Discipline – GRIB Master table number (see Code table 0.0)
8	GRIB edition number (currently 2)
9-16	Total length of GRIB message in octets (including Section 0)

Section 1 – Identification section

<i>Octet No.</i>	<i>Contents</i>							
1-4	Length of section in octets (21 or nn)							
5	Number of section (“1”)							
6-7	Identification of originating/generating centre (see Common Code table C-1)							
8-9	Identification of originating/generating sub-centre (allocated by originating/generating centre)							
10	GRIB Master tables version number (see Code table 1.0)							
11	GRIB Local tables version number (see Code table 1.1)							
12	Significance of reference time (see Code table 1.2)							
13-14	<table border="0" style="display: inline-table;"> <tr> <td style="padding-right: 10px;">Year (4 digits)</td> <td rowspan="5" style="font-size: 3em; vertical-align: middle;">}</td> <td rowspan="5" style="vertical-align: middle;">Reference time of data</td> </tr> <tr> <td>Month</td> </tr> <tr> <td>Day</td> </tr> <tr> <td>Hour</td> </tr> <tr> <td>Minute</td> </tr> </table>	Year (4 digits)	}	Reference time of data	Month	Day	Hour	Minute
Year (4 digits)		}			Reference time of data			
Month								
Day								
Hour								
Minute								
15	Month							
16	Day							
17	Hour							
18	Minute							
19	Second							
20	Production status of processed data in this GRIB message (see Code table 1.3)							
21	Type of processed data in this GRIB message (see Code table 1.4)							
22-nn	Reserved: need not be present							

Section 2 – Local use section

<i>Octet No.</i>	<i>Contents</i>
1-4	Length of section in octets (nn)
5	Number of section ("2")
6-nn	Local use

Section 3 – Grid definition section

<i>Octet No.</i>	<i>Contents</i>
1-4	Length of section in octets (nn)
5	Number of section ("3")
6	Source of grid definition (see Code table 3.0 and Note 1)
7-10	Number of data points
11	Number of octets for optional list of numbers defining number of points (see Note 2)
12	Interpretation of list of numbers defining number of points (see Code table 3.11)
13-14	Grid definition template number (= N) (see Code table 3.1)
15-xx	Grid definition template (see Template 3.N, where N is the Grid definition template number given in octets 13-14)
[xx+1]-nn	Optional list of numbers defining number of points (see Notes 2, 3 and 4)

NOTES:

- (1) If octet 6 is not zero, octets 15-xx (15-nn if octet 11 is zero) may not be supplied. This should be documented with all bits set to 1 (missing value) in Grid definition template number.
- (2) An optional list of numbers defining number of points is used to document a quasi-regular grid, where the number of points may vary from one row to another (row being defined as adjacent points in a coordinate line, so this is dependent from data layout). In such a case, octet 11 is non zero, and gives the number of octets on which each number of points is encoded. For all other cases, such as regular grids, octets 11 and 12 are zero and no list is appended to the grid definition template.
- (3) If a list of numbers defining number of points is present, it is appended at the end of the Grid definition template (or directly after the Grid definition template number if template is missing), the length of the list is given by the Grid definition. When the Grid definition template is present, the length is given according to bit 3 of scanning mode flag octet (length is N_j or N_y for flag value 0). List ordering is implied by data scanning.
- (4) Depending on code value given in octet 12, the list of numbers defining number of points corresponds either to the coordinate lines as given in the grid definition, or to a full circle.

Section 4 – Production definition section

<i>Octet No.</i>	<i>Contents</i>
1-4	Length of section in octets (nn)
5	Number of section («4»)
6-7	Number of coordinates values after template (see Note 1)
8-9	Product definition template number (see Code table 4.0)
10-xx	Product definition template (see Template 4.X, where X is the product definition template number given in octets 8-9)
[xx+1]-nn	Optional list of coordinates values (see Notes 2 and 3)

NOTES:

- (1) Coordinate values are intended to document the vertical discretization associated with model data on hybrid coordinate vertical levels. A number of zero in octets 6-7 indicates that no such values are present. Otherwise the number corresponds to the whole set of values.
- (2) Hybrid systems, in the context, employ a means of representing vertical coordinates in terms of a mathematical combination of pressure and sigma coordinates. When used in conjunction with a surface pressure field and an appropriate mathematical expression, the vertical coordinate parameters may be used to interpret the hybrid vertical coordinate.
- (3) Hybrid coordinate values, if present, should be encoded in IEEE 32-bit floating point format. They are intended to be encoded as pairs.

Section 5 – Data representation section

<i>Octet No.</i>	<i>Contents</i>
1-4	Length of section in octets (nn)
5	Number of section ("5")
6-9	Number of data points where one or more values are specified in Section 7 when a bit map is present, total number of data points when a bit map is absent.
10-11	Data representation template number (see Code table 5.0)
12-nn	Data representation template (see Template 5.x, where x is the data representation template number given in octets 10-11)

Section 6 – Bit-map section

<i>Octet No.</i>	<i>Contents</i>
1-4	Length of section in octets (nn)
5	Number of section ("6")
6	Bit-map indicator (see Code table 6.0 and the Note)
7-nn	Bit-map

NOTE: If octet 6 is not zero, the length of the Section is 6 and octets 7-nn are not present.

Section 7 – Data section

<i>Octet No.</i>	<i>Contents</i>
1-4	Length of section in octets (nn)
5	Number of section ("7")
6-nn	Data in a format described by data template 7.x, where x is the data representation template number given in octets 10-11 of Section 5.

Section 8 – End section

<i>Octet No.</i>	<i>Contents</i>
1-4	"7777" (coded according to the International Alphabet No. 5.)

TEMPLATE DEFINITIONS USED IN SECTION 3**Grid definition template 3.0: Latitude/longitude (or equidistant cylindrical, or Plate Carrée)**

<i>Octet No.</i>	<i>Contents</i>
15	Shape of the Earth (see Code table 3.2)
16	Scale factor of radius of spherical Earth
17-20	Scaled value of radius of spherical Earth
21	Scale factor of major axis of oblate spheroid Earth
22-25	Scaled value of major axis of oblate spheroid Earth
26	Scale factor of minor axis of oblate spheroid Earth
27-30	Scaled value of minor axis of oblate spheroid Earth
31-34	N _i — number of points along a parallel
35-38	N _j — number of points along a meridian
39-42	Basic angle of the initial production domain (see Note 1)
43-46	Subdivisions of basic angle used to define extreme longitudes and latitudes, and direction increments (see Note 1)
47-50	La1 — latitude of first grid point (see Note 1)
51-54	Lo1 — longitude of first grid point (see Note 1)
55	Resolution and component flags (see Flag table 3.3)
56-59	La2 — latitude of last grid point (see Note 1)
60-63	Lo2 — longitude of last grid point (see Note 1)
64-67	Di — i direction increment (see Note 1)
68-71	Dj — j direction increment (see Note 1)
72	Scanning mode (flags — see Flag table 3.4)

NOTES:

- (1) Basic angle of the initial production domain and subdivisions of this basic angle are provided to manage cases where the recommended unit of 10⁻⁶ degrees is not applicable to describe the extreme longitudes and latitudes, and direction increments. For these last six descriptors, unit is equal to the ratio of the basic angle and the subdivisions number. For ordinary cases, zero and missing values should be coded, equivalent to respective values of 1 and 10⁶ (10⁻⁶ degrees unit).
- (2) For data on a quasi-regular grid, in which all the rows or columns do not necessarily have the same number of grid points, either Ni (octets 31-34) or Nj (octets 35-38) and the corresponding Di (octets 64-67) or Dj (octets 68-71) shall be coded with all bits set to 1 (missing). The actual number of points along each parallel or meridian shall be coded in the octets immediately following the Grid definition template (octets [xx+1] - nn), as described in the description of the Grid definition section.
- (3) A quasi-regular grid is only defined for appropriate grid scanning modes. Either rows or columns, but not both simultaneously, may have variable numbers of points. The first point in each row (column) shall be positioned at the meridian (parallel) indicated by octets 47-54. The grid points shall be evenly spaced in latitude (longitude).

Grid definition template 3.1: Rotated latitude/longitude (or equidistant cylindrical, or Plate Carrée)

<i>Octet No.</i>	<i>Contents</i>
15-72	Same as Grid definition template 3.0 (see Note 1)
73-76	Latitude of the southern pole of projection
77-80	Longitude of the southern pole of projection
81-84	Angle of rotation of projection

NOTES:

- (1) Basic angle of the initial production domain and subdivisions of this basic angle are provided to manage cases where the recommended unit of 10⁻⁶ degrees is not applicable to describe the extreme longitudes and latitudes, and direction increments. For these last six descriptors, unit is equal to the ratio of the basic angle and the subdivisions number. For ordinary cases, zero values should be coded, equivalent to respective values of 1 and 10⁶ (10⁻⁶ degrees unit).
- (2) Three parameters define a general latitude/longitude coordinate system, formed by a general rotation of the sphere. One choice for these parameters is:
 - (a) The geographic latitude in degrees of the southern pole of the coordinate system, Thetap for example.
 - (b) The geographic longitude in degrees of the southern pole of the coordinate system, Lambdap for example.
 - (c) The angle of rotation in degrees about the new polar axis (measured clockwise when looking from the southern to the northern pole) of the coordinate system, assuming the new axis to have been obtained by first rotating the sphere through Lambdap degrees about the geographic polar axis, and then rotating through (90 + Thetap) degrees so that the southern pole moved along the (previously rotated) Greenwich meridian.

Grid definition template 3.2: Stretched latitude/longitude (or equidistant cylindrical, or Plate Carrée)

<i>Octet No.</i>	<i>Contents</i>
15-72	Same as Grid definition template 3.0 (see Note 1)
73-76	Latitude of the pole of stretching
77-80	Longitude of the pole of stretching
81-84	Stretching factor

NOTES:

- (1) Basic angle of the initial production domain and subdivisions of this basic angle are provided to manage cases where the recommended unit of 10⁻⁶ degrees is not applicable to describe the extreme longitudes and latitudes, and direction increments. For these last six descriptors, unit is equal to the ratio of the basic angle and the subdivisions number. For ordinary cases, zero values should be coded, equivalent to respective values of 1 and 10⁶ (10⁻⁶ degrees unit).
- (2) The stretching is defined by three parameters:
 - (a) The latitude in degrees (measured in the model coordinate system) of the "pole of stretching";
 - (b) The longitude in degrees (measured in the model coordinate system) of the "pole of stretching"; and
 - (c) The stretching factor C in units of 10⁻⁶ represented as an integer.
 The stretching is defined by representing data uniformly in a coordinate system with longitude Y and latitude X1, where:

$$X1 = \sin^{-1} \frac{(1 - C2) + (1 + C2) \sin X}{(1 + C2) + (1 - C2) \sin X}$$

and Y and X are longitude and latitude in a coordinate system in which the "pole of stretching" is the northern pole. C = 1 gives uniform resolution, while C > 1 give enhanced resolution around the pole of stretching.

Grid definition template 3.3: Stretched and rotated latitude/longitude (or equidistant cylindrical, or Plate Carrée)

<i>Octet No.</i>	<i>Contents</i>
15-72	Same as Grid definition template 3.0 (see Note 1)
73-76	Latitude of the southern pole of projection
77-80	Longitude of the southern pole of projection
81-84	Angle of rotation of projection
85-88	Latitude of the pole of stretching
89-92	Longitude of the pole of stretching
93-96	Stretching factor

NOTES:

- (1) Basic angle of the initial production domain and subdivisions of this basic angle are provided to manage cases where the recommended unit of 10^{-6} degrees is not applicable to describe the extreme longitudes and latitudes, and direction increments. For these last six descriptors, unit is equal to the ratio of the basic angle and the subdivisions number. For ordinary cases, zero values should be coded, equivalent to respective values of 1 and 10^6 (10^{-6} degrees unit).
- (2) See Note (2) under Grid definition template 3.1 — Rotated latitude/longitude (or equidistant cylindrical, or Plate Carrée).
- (3) See Note (2) under Grid definition template 3.2 — Stretched latitude/longitude (or equidistant cylindrical, or Plate Carrée).

Grid definition template 3.10: Mercator

<i>Octet No.</i>	<i>Contents</i>
15	Shape of the Earth (see Code table 3.2)
16	Scale factor of radius of spherical Earth
17-20	Scaled value of radius of spherical Earth
21	Scale factor of major axis of oblate spheroid Earth
22-25	Scaled value of major axis of oblate spheroid Earth
26	Scale factor of minor axis of oblate spheroid Earth
27-30	Scaled value of minor axis of oblate spheroid Earth
31-34	Ni — number of points along a parallel
35-38	Nj — number of points along a meridian
39-42	La1 — latitude of first grid point
43-46	Lo1 — longitude of first grid point
47	Resolution and component flags (See Flag table 3.3)
48-51	LaD — latitude(s) at which the Mercator projection intersects the Earth (latitude(s) where Di and Dj are specified)
52-55	La2 — latitude of last grid point
56-59	Lo2 — longitude of last grid point
60	Scanning mode (flags — see Flag table 3.4)
61-64	Orientation of the grid, angle between i direction on the map and the Equator (see Note 1)
65-68	Di — longitudinal direction grid length (see Note 2)
69-72	Dj — latitudinal direction grid length (see Note 2)

NOTES:

- (1) Limited to the range of 0 to 90 degrees; if the angle of orientation of the grid is neither 0 nor 90 degrees, Di and Dj must be equal to each other.
- (2) Grid lengths are in units of 10^{-3} m, at the latitude specified by LaD.

Grid definition template 3.20: Polar stereographic projection

<i>Octet No.</i>	<i>Contents</i>
15	Shape of the Earth (see Code table 3.2)
16	Scale factor of radius of spherical Earth
17-20	Scaled value of radius of spherical Earth
21	Scale factor of major axis of oblate spheroid Earth
22-25	Scaled value of major axis of oblate spheroid Earth
26	Scale factor of minor axis of oblate spheroid Earth
27-30	Scaled value of minor axis of oblate spheroid Earth
31-34	Nx — number of points along x-axis

Grid definition template 3.20: Polar stereographic projection (*continued*)

<i>Octet No.</i>	<i>Contents</i>
35-38	Ny — number of points along y-axis
39-42	La1 — latitude of first grid point
43-46	Lo1 — longitude of first grid point
47	Resolution and component Flag (See Flag table 3.3 and Note 1)
48-51	LaD — latitude where Dx and Dy are specified
52-55	LoV — orientation of the grid (see Note 2)
56-59	Dx — x-direction grid length (see Note 3)
60-63	Dy — y-direction grid length (see Note 3)
64	Projection centre flag (See Flag table 3.5)
65	Scanning mode (See Flag table 3.4)

NOTES:

- (1) The resolution flag (bit 3-4 of Flag table 3.3) is not applicable.
- (2) LoV is the value of the meridian which is parallel to the y-axis (or columns of the grid) along which latitude increases as the y-coordinate increases (the orientation longitude may or may not appear on a particular grid).
- (3) Grid length is in units of 10^{-3} m at the latitude specified by LaD.
- (4) Bit 2 of the projection flag is not applicable to the polar stereographic projection.

Grid definition template 3.30: Lambert conformal

<i>Octet No.</i>	<i>Contents</i>
15	Shape of the Earth (see Code table 3.2)
16	Scale factor of radius of spherical Earth
17-20	Scaled value of radius of spherical Earth
21	Scale factor of major axis of oblate spheroid Earth
22-25	Scaled value of major axis of oblate spheroid Earth
26	Scale factor of minor axis of oblate spheroid Earth
27-30	Scaled value of minor axis of oblate spheroid Earth
31-34	Nx — number of points along the x-axis
35-38	Ny — number of points along the y-axis
39-42	La1 — latitude of first grid point
43-46	Lo1 — longitude of first grid point
47	Resolution and component flags (See Flag table 3.3)
48-51	LaD — latitude where Dx and Dy are specified
52-55	LoV — longitude of meridian parallel to y-axis along which latitude increases as the y-coordinate increases
56-59	Dx — x-direction grid length (see Note 1)
60-63	Dy — y-direction grid length (see Note 1)
64	Projection centre flag (see Flag table 3.5)
65	Scanning mode (see Flag table 3.4)
66-69	Latin 1 — first latitude from the pole at which the secant cone cuts the sphere
70-73	Latin 2 — second latitude from the pole at which the secant cone cuts the sphere
74-77	Latitude of the southern pole of projection
78-81	Longitude of the southern pole of projection

NOTES:

- (1) Grid lengths are in units tenths of 10^{-3} m, at the latitude specified by LaD.
- (2) If Latin 1 = Latin 2, then the projection is on a tangent cone.
- (3) The resolution flags (bits 3-4 of Flag table 3.3) are not applicable.
- (4) LoV is the value of the meridian which is parallel to the y-axis (or columns of the grid) along which latitude increases as the y-coordinate increases (the orientation longitude may or may not appear on a particular grid).

Grid definition template 3.40: Gaussian latitude/longitude

<i>Octet No.</i>	<i>Contents</i>
15	Shape of the Earth (see Code table 3.2)
16	Scale factor of radius of spherical Earth

Grid definition template 3.40: Gaussian latitude/longitude (*continued*)

<i>Octet No.</i>	<i>Contents</i>
17-20	Scaled value of radius of spherical Earth
21	Scale factor of major axis of oblate spheroid Earth
22-25	Scaled value of major axis of oblate spheroid Earth
26	Scale factor of minor axis of oblate spheroid Earth
27-30	Scaled value of minor axis of oblate spheroid Earth
31-34	N _i — number of points along a parallel
35-38	N _j — number of points along a meridian
39-42	Basic angle of the initial production domain (see Note 1)
43-46	Subdivisions of basic angle used to define extreme longitudes and latitudes, and direction increments (see Note 1)
47-50	La1 — latitude of first grid point (see Note 1)
51-54	Lo1 — longitude of first grid point (see Note 1)
55	Resolution and component flags (see Flag table 3.3)
56-59	La2 — latitude of last grid point (see Note 1)
60-63	Lo2 — longitude of last grid point (see Note 1)
64-67	Di — i direction increment (see Note 1)
68-71	N — number of parallels between a pole and the Equator (see Note 2)
72	Scanning mode (flags — see Flag table 3.4)

NOTES:

- (1) Basic angle of the initial production domain and subdivisions of this basic angle are provided to manage cases where the recommended unit of 10^{-6} degrees is not applicable to describe the extreme longitudes and latitudes, and direction increments. For these last six descriptors, unit is equal to the ratio of the basic angle and the subdivisions number. For ordinary cases, zero values should be coded, equivalent to respective values of 1 and 10^6 (10^{-6} degrees unit).
- (2) The number of parallels between a pole and the Equator is used to establish the variable (Gaussian) spacing of the parallels; this value must always be given.

Grid definition template 3.41: Rotated Gaussian latitude/longitude

<i>Octet No.</i>	<i>Contents</i>
15-72	Same as Grid definition template 3.40 (see Note 1)
73-76	Latitude of the southern pole of projection
77-80	Longitude of the southern pole of projection
81-84	Angle of rotation of projection

NOTES:

- (1) Basic angle of the initial production domain and subdivisions of this basic angle are provided to manage cases where the recommended unit of 10^{-6} degrees is not applicable to describe the extreme longitudes and latitudes, and direction increments. For these last six descriptors, unit is equal to the ratio of the basic angle and the subdivisions number. For ordinary cases, zero values should be coded, equivalent to respective values of 1 and 10^6 (10^{-6} degrees unit).
- (2) The number of parallels between a pole and the Equator is used to establish the variable (Gaussian) spacing of the parallels; this value must always be given.
- (3) See Note (2) under Grid definition template 3.1 — Rotated latitude/longitude grid (or equidistant cylindrical, or Plate Carrée).

Grid definition template 3.42: Stretched Gaussian latitude/longitude

<i>Octet No.</i>	<i>Contents</i>
15-72	Same as Grid definition template 3.40 (see Note 1)
73-76	Latitude of the pole of stretching
77-80	Longitude of the pole of stretching
81-84	Stretching factor

NOTES:

- (1) Basic angle of the initial production domain and subdivisions of this basic angle are provided to manage cases where the recommended unit of 10^{-6} degrees is not applicable to describe the extreme longitudes and latitudes, and direction increments. For these last six descriptors, unit is equal to the ratio of the basic angle and the subdivisions number. For ordinary cases, zero values should be coded, equivalent to respective values of 1 and 10^6 (10^{-6} degrees unit).

- (2) The number of parallels between a pole and the Equator is used to establish the variable (Gaussian) spacing of the parallels; this value must always be given.
- (3) See Note (2) under Grid definition template 3.2 — Stretched latitude/longitude (or equidistant cylindrical, or Plate Carrée).

Grid definition template 3.43: Stretched and rotated Gaussian latitude/longitude

<i>Octet No.</i>	<i>Contents</i>
15–72	Same as Grid definition template 3.40 (see Note 1)
73–76	Latitude of the southern pole of projection
77–80	Longitude of the southern pole of projection
81–84	Angle of rotation of projection
85–88	Latitude of the pole of stretching
89–92	Longitude of the pole of stretching
93–96	Stretching factor

NOTES:

- (1) Basic angle of the initial production domain and subdivisions of this basic angle are provided to manage cases where the recommended unit of 10^{-6} degrees is not applicable to describe the extreme longitudes and latitudes, and direction increments. For these last six descriptors, unit is equal to the ratio of the basic angle and the subdivisions number. For ordinary cases, zero values should be coded, equivalent to respective values of 1 and 10^6 (10^{-6} degrees unit).
- (2) The number of parallels between a pole and the Equator is used to establish the variable (Gaussian) spacing of the parallels; this value must always be given.
- (3) See Note (2) under Grid definition template 3.1 — Rotated latitude/longitude (or equidistant cylindrical, or Plate Carrée).
- (4) See Note (2) under Grid definition template 3.2 — Stretched latitude/longitude (or equidistant cylindrical, or Plate Carrée).

Grid definition template 3.50: Spherical harmonic coefficients

<i>Octet No.</i>	<i>Contents</i>
15–18	J — pentagonal resolution parameter
19–22	K — pentagonal resolution parameter
23–26	M — pentagonal resolution parameter
27	Representation type indicating the method used to define the norm (see Code table 3.6).
28	Representation mode indicating the order of the coefficients (see Code table 3.7)

NOTE: The pentagonal representation of resolution is general. Some common truncations are special cases of the pentagonal one:

Triangular	$M = J = K$
Rhomboidal	$K = J + M$
Trapezoidal	$K = J, K > M$

Grid definition template 3.51: Rotated spherical harmonic coefficients

<i>Octet No.</i>	<i>Contents</i>
15–28	Same as Grid definition template 3.50
29–32	Latitude of the southern pole of projection
33–36	Longitude of the southern pole of projection
37–40	Angle of rotation of projection

NOTES:

- (1) See Note (1) under Grid definition template 3.50 — Spherical harmonic coefficients.
- (2) See Note (2) under Grid definition template 3.1 — Rotated latitude/longitude grid (or equidistant cylindrical, or Plate Carrée).

Grid definition template 3.52: Stretched spherical harmonic coefficients

<i>Octet No.</i>	<i>Contents</i>
15–28	Same as Grid definition template 3.50
29–32	Latitude of the pole of stretching
33–36	Longitude of the pole of stretching
37–40	Stretching factor

NOTES:

- (1) See Note (1) under Grid definition template 3.50 — Spherical harmonic coefficients.
- (2) See Note (2) under Grid definition template 3.2 — Stretched latitude/longitude grid (or equidistant cylindrical, or Plate Carrée).

Grid definition template 3.53: Stretched and rotated spherical harmonic coefficients

<i>Octet No.</i>	<i>Contents</i>
15-28	Same as Grid definition template 3.50
29-32	Latitude of the southern pole of projection
33-36	Longitude of the southern pole of projection
37-40	Angle of rotation of projection
41-44	Latitude of pole of stretching
45-48	Longitude of pole of stretching
49-52	Stretching factor

NOTES:

- (1) See Note (1) under Grid definition template 3.50 — Spherical harmonic coefficients.
- (2) See Note (2) under Grid definition template 3.1 — Rotated latitude/longitude (or equidistant cylindrical, or Plate Carrée).
- (3) See Note (2) under Grid definition template 3.2 — Stretched latitude/longitude (or equidistant cylindrical, or Plate Carrée).

Grid definition template 3.90: Space view perspective or orthographic

<i>Octet No.</i>	<i>Contents</i>
15	Shape of the Earth (see Code table 3.2)
16	Scale factor of radius of spherical Earth
17-20	Scaled value of radius of spherical Earth
21	Scale factor of major axis of oblate spheroid Earth
22-25	Scaled value of major axis of oblate spheroid Earth
26	Scale factor of minor axis of oblate spheroid Earth
27-30	Scaled value of minor axis of oblate spheroid Earth
31-34	N _x — number of points along x-axis (columns)
35-38	N _y — number of points along y-axis (rows or lines)
39-42	Lap — latitude of sub-satellite point
43-46	Lop — longitude of sub-satellite point
47	Resolution and component flags (see Flag table 3.3)
48-51	dx — apparent diameter of Earth in grid lengths, in x-direction
52-55	dy — apparent diameter of Earth in grid lengths, in y-direction
56-59	X _p — x-coordinate of sub-satellite point (in units of 10 ⁻³ grid length expressed as an integer)
60-63	Y _p — y-coordinate of sub-satellite point (in units of 10 ⁻³ grid length expressed as an integer)
64	Scanning mode (flags — see Flag table 3.4)
65-68	Orientation of the grid; i.e., the angle between the increasing y-axis and the meridian of the sub-satellite point in the direction of increasing latitude (see Note 3)
69-72	N _r — altitude of the camera from the Earth's centre, measured in units of the Earth's (equatorial) radius multiplied by a scale factor of 10 ⁶ (see Notes 4 and 5)
73-76	X _o — x-coordinate of origin of sector image
77-80	Y _o — y-coordinate of origin of sector image

NOTES:

- (1) It is assumed that the satellite is at its nominal position, i.e., it is looking directly at its sub-satellite point.
- (2) Octets 46-49 shall be set to all ones (missing) to indicate the orthographic view (from infinite distance).
- (3) It is the angle between the increasing y-axis and the meridian 180°E if the sub-satellite point is the North Pole; or the meridian 0° if the sub-satellite point is the South Pole.
- (4) The apparent angular size of the Earth will be given by $2 * \text{Arcsin} (10^6/N_r)$.
- (5) For orthographic view from infinite distance, the value of N_r should be encoded as missing (all bits set to 1).
- (6) The horizontal and vertical angular resolutions of the sensor (R_x and R_y), needed for navigation equation, can be calculated from the following:

$$R_x = 2 * \text{Arcsin} (10^6/N_r) / dx$$

$$R_y = 2 * \text{Arcsin} (10^6/N_r) / dy$$

Grid definition template 3.100: Triangular grid based on an icosahedron

<i>Octet No.</i>	<i>Contents</i>
15	n2 — exponent of 2 for the number of intervals on main triangle sides
16	n3 — exponent of 3 for the number of intervals on main triangle sides
17–18	ni — number of intervals on main triangle sides of the icosahedron
19	nd — number of diamonds
21–23	Latitude of the pole point of the icosahedron on the sphere
24–27	Longitude of the pole point of the icosahedron on the sphere
28–331	Longitude of the centre line of the first diamond of the icosahedron on the sphere
32	Grid point position (see Code table 3.8)
33	Numbering order of diamonds (flag — see Flag table 3.9)
34	Scanning mode for one diamond (flags — see Flag table 3.10)
35–38	nt — total number of grid points

NOTES:

- (1) For more details see attachment in the *Manual of Codes*, Vol. 1.2, Part B — Definition of the triangular grid based on an icosahedron [in preparation].
- (2) The origin of the grid is an icosahedron with 20 triangles and 12 vertices. The triangles are combined to nd quadrangles, the so-called diamonds (e.g. if nd = 10, two of the icosahedron triangles form a diamond, and if nd = 5, 4 icosahedron triangles form a diamond). There are two resolution values called n2 and n3 describing the division of each triangle side. Each triangle side is divided into ni equal parts where $ni = 3^{n3} \cdot 2^{n2}$ with n3 either equal to 0 or to 1. In the example of the attachment, the numbering order of the rectangles is anti-clockwise with a view from the pole point on both hemispheres. Diamonds 1 to 5 are northern hemisphere and diamonds 6 to 10 are southern hemisphere.
- (3) The exponent of 3 for the number of divisions of triangle sides is used only with a value of either 0 or 1.
- (4) The total number of grid points for one global field depends on the grid point position. If e.g. the grid points are located at the vertices of the triangles $nt = (ni + 1) \cdot (ni + 1) \cdot nd$ since grid points at diamond edges are contained in both adjacent diamonds and for the same reason the pole points are contained in each of the five adjacent diamonds.

Grid definition template 3.110: Equatorial azimuthal equidistant projection

<i>Octet No.</i>	<i>Contents</i>
15	Shape of the Earth (see Code table 3.2)
16	Scale factor of radius of spherical Earth
17–20	Scaled value of radius of spherical Earth
21	Scale factor of major axis of oblate spheroid Earth
22–25	Scaled value of major axis of oblate spheroid Earth
26	Scale factor of minor axis of oblate spheroid Earth
27–30	Scaled value of minor axis of oblate spheroid Earth
31–34	Nx — number of points along x-axis
35–38	Ny — number of points along y-axis
39–42	La1 — latitude of tangency point (centre of grid)
43–46	Lo1 — longitude of tangency point
47	Resolution and component flag (see flag table 3.3)
48–51	Dx — x-direction grid length in units of 10^{-3} m as measured at the point of the axis
52–55	Dy — y-direction grid length in units of 10^{-3} m as measured at the point of the axis
56	Projection centre flag
57	Scanning mode (see Flag table 3.4)

Grid definition template 3.120: Azimuth-range projection

<i>Octet No.</i>	<i>Contents</i>
15–18	Nb — number of data bins along radials (see the Note)
19–22	Nr — number of radials
23–26	La1 — latitude of centre point
27–30	Lo1 — longitude of centre point
31–34	Dx — spacing of bins along radials

35-38 Dstart — offset from origin to inner bound
 39-(38+4Nr) For each of Nr radials:
 (39+4(X-1)) — (40+4(X-1)) Azi — starting azimuth, degree x 10 (degrees as north)
 (41+4(X-1)) — (42+4(X-1)) Adelta — azimuthal width, degrees x 100,
 (+ clockwise — counterclockwise)
 with X = 1 to Nr

NOTE: A data bin is a data point representing the volume centred on it.

TEMPLATE DEFINITIONS USED IN SECTION 4

Product definition template 4.0: Analysis or forecast at a horizontal level or in a horizontal layer at a point in time

<i>Octet No.</i>	<i>Contents</i>
10	Parameter category (see Code table 4.1)
11	Parameter number (see Code table 4.2)
12	Type of generating process (see Code table 4.3)
13	Background generating process identifier (defined by originating centre)
14	Analysis or forecast generating processes identifier (defined by originating centre)
15-16	Hours of observational data cutoff after reference time (See the Note)
17	Minutes of observational data cutoff after reference time
18	Indicator of unit of time range (see Code table 4.4)
19-22	Forecast time in units defined by octet 18
23	Type of first fixed surface (see Code table 4.5)
24	Scale factor of first fixed surface
25-28	Scaled value of first fixed surface
29	Type of second fixed surface (see Code table 4.5)
30	Scale factor of second fixed surface
31-34	Scaled value of second fixed surface

NOTE: Hours greater than 65534 will be coded as 65534.

Product definition template 4.1: Individual ensemble forecast, control and perturbed, at a horizontal level or in a horizontal layer at a point in time

<i>Octet No.</i>	<i>Contents</i>
10	Parameter category (see Code table 4.1)
11	Parameter number (see Code table 4.2)
12	Type of generating process (see Code table 4.3)
13	Background generating process identifier (defined by originating centre)
14	Forecast generating process identifier (defined by originating centre)
15-16	Hours after reference time of data cutoff (see the Note)
17	Minutes after reference time of data cutoff
18	Indicator of unit of time range (See Code table 4.4)
19-22	Forecast time in units defined by octet 18
23	Type of first fixed surface (see Code table 4.5)
24	Scale factor of first fixed surface
25-28	Scaled value of first fixed surface
29	Type of second fixed surface (see Code table 4.5)
30	Scale factor of second fixed surface
31-34	Scaled value of second fixed surface
35	Type of ensemble forecast (see Code table 4.6)
36	Perturbation number
37	Number of forecasts in ensemble

NOTE: Hours greater than 65534 will be coded as 65534.

Product definition template 4.2: Derived forecast based on all ensemble members at a horizontal level or in a horizontal layer at a point in time

<i>Octet No.</i>	<i>Contents</i>
10	Parameter category (see Code table 4.1)
11	Parameter number (see Code table 4.2)
12	Type of generating process (see Code table 4.3)
13	Background generating process identifier (defined by originating centre)
14	Forecast generating process identifier (defined by originating centre)
15–16	Hours after reference time of data cutoff (see the Note)
17	Minutes after reference time of data cutoff
18	Indicator of unit of time range (See Code table 4.4)
19–22	Forecast time in units defined by octet 18
23	Type of first fixed surface (see Code table 4.5)
24	Scale factor of first fixed surface
25–28	Scaled value of first fixed surface
29	Type of second fixed surface (see Code table 4.5)
30	Scale factor of second fixed surface
31–34	Scaled value of second fixed surface
35	Derived forecast (see Code table 4.7)
36	Number of forecasts in ensemble

NOTE: Hours greater than 65534 will be coded as 65534.

Product definition template 4.3: Derived forecasts based on a cluster of ensemble members over a rectangular area at a horizontal level or in a horizontal layer at a point in time

<i>Octet No.</i>	<i>Contents</i>
10	Parameter category (see Code table 4.1)
11	Parameter number (see Code table 4.2)
12	Type of generating process (see Code table 4.3)
13	Background generating process identifier (defined by originating centre)
14	Forecast generating process identifier (defined by originating centre)
15–16	Hours after reference time of data cutoff (see the Note)
17	Minutes after reference time of data cutoff
18	Indicator of unit of time range (See Code table 4.4)
19–22	Forecast time in units defined by octet 18
23	Type of first fixed surface (see Code table 4.5)
24	Scale factor of first fixed surface
25–28	Scaled value of first fixed surface
29	Type of second fixed surface (see Code table 4.5)
30	Scale factor of second fixed surface
31–34	Scaled value of second fixed surface
35	Derived forecast (see Code table 4.7)
36	Number of forecasts in the ensemble (N)
37	Cluster identifier
38	Number of cluster to which the high resolution control belongs
39	Number of cluster to which the low resolution control belongs
40	Total number of clusters
41	Clustering method (see Code table 4.8)
42–45	Northern latitude of cluster domain
46–49	Southern latitude of cluster domain
50–53	Eastern longitude of cluster domain
54–57	Western longitude of cluster domain
58–(57+N)	List of N ensemble forecast numbers

NOTE: Hours greater than 65534 will be coded as 65534.

Product definition template 4.4: Derived forecasts based on a cluster of ensemble members over a circular area at a horizontal level or in a horizontal layer at a point in time

<i>Octet No.</i>	<i>Contents</i>
10	Parameter category (see Code table 4.1)
11	Parameter number (see Code table 4.2)
12	Type of generating process (see Code table 4.3)
13	Background generating process identifier (defined by originating centre)
14	Forecast generating process identifier (defined by originating centre)
15-16	Hours after reference time of data cutoff (see the Note)
17	Minutes after reference time of data cutoff
18	Indicator of unit of time range (See Code table 4.4)
19-22	Forecast time in units defined by octet 18
23	Type of first fixed surface (see Code table 4.5)
24	Scale factor of first fixed surface
25-28	Scaled value of first fixed surface
29	Type of second fixed surface (see Code table 4.5)
30	Scale factor of second fixed surface
31-34	Scaled value of second fixed surface
35	Derived forecast (see Code table 4.7)
36	Number of forecasts in the ensemble (N)
37	Cluster identifier
38	Number of cluster to which the high resolution control belongs
39	Number of cluster to which the low resolution control belongs
40	Total number of clusters
41	Clustering method (see Code table 4.8)
42-45	Latitude of central point in cluster domain
46-49	Longitude of central point in cluster domain
50-53	Radius of cluster domain
54-(53+N)	List of N ensemble forecast numbers

NOTE: Hours greater than 65534 will be coded as 65534.

Product definition template 4.5: Probability forecasts at a horizontal level or in a horizontal layer at a point in time

<i>Octet No.</i>	<i>Contents</i>
10	Parameter category (see Code table 4.1)
11	Parameter number (see Code table 4.2)
12	Type of generating process (see Code table 4.3)
13	Background generating process identifier (defined by originating centre)
14	Forecast generating process identifier (defined by originating centre)
15-16	Hours after reference time of data cutoff (see the Note)
17	Minutes after reference time of data cutoff
18	Indicator of unit of time range (See Code table 4.4)
19-22	Forecast time in units defined by octet 18
23	Type of first fixed surface (see Code table 4.5)
24	Scale factor of first fixed surface
25-28	Scaled value of first fixed surface
29	Type of second fixed surface (see Code table 4.5)
30	Scale factor of second fixed surface
31-34	Scaled value of second fixed surface
35	Forecast probability number
36	Total number of forecast probabilities
37	Probability type (see Code table 4.9)
38	Scale factor of lower limit
39-42	Scaled value of lower limit
43	Scale factor of upper limit
44-47	Scaled value of upper limit

NOTE: Hours greater than 65534 will be coded as 65534.

Product definition template 4.6: Percentile forecasts at a horizontal level or in a horizontal layer at a point in time

<i>Octet No.</i>	<i>Contents</i>
10	Parameter category (see Code table 4.1)
11	Parameter number (see Code table 4.2)
12	Type of generating process (see Code table 4.3)
13	Background generating process identifier (defined by originating centre)
14	Forecast generating process identifier (defined by originating centre)
15-16	Hours after reference time of data cutoff (see the Note)
17	Minutes after reference time of data cutoff
18	Indicator of unit of time range (See Code table 4.4)
19-22	Forecast time in units defined by octet 18
23	Type of first fixed surface (see Code table 4.5)
24	Scale factor of first fixed surface
25-28	Scaled value of first fixed surface
29	Type of second fixed surface (see Code table 4.5)
30	Scale factor of second fixed surface
31-34	Scaled value of second fixed surface
35	Percentile value (from 100 per cent to 0 per cent)

NOTE: Hours greater than 65534 will be coded as 65534.

Product definition template 4.7: Analysis or forecast error at a horizontal level or in a horizontal layer at a point in time

<i>Octet No.</i>	<i>Contents</i>
10	Parameter category (see Code table 4.1)
11	Parameter number (see Code table 4.2)
12	Type of generating process (see Code table 4.3)
13	Background generating process identifier (defined by originating centre)
14	Analysis or forecast generating process identifier (defined by originating centre)
15-16	Hours after reference time of data cutoff (see the Note)
17	Minutes after reference time of data cutoff
18	Indicator of unit of time range (See Code table 4.4)
19-22	Forecast time in units defined by octet 18
23	Type of first fixed surface (see Code table 4.5)
24	Scale factor of first fixed surface
25-28	Scaled value of first fixed surface
29	Type of second fixed surface (see Code table 4.5)
30	Scale factor of second fixed surface
31-34	Scaled value of second fixed surface

NOTE: Hours greater than 65534 will be coded as 65534.

Product definition template 4.8: Average, accumulation, and/or extreme values at a horizontal level or in a horizontal layer in a continuous or non-continuous time interval

<i>Octet No.</i>	<i>Contents</i>
10	Parameter category (see Code table 4.1)
11	Parameter number (see Code table 4.2)
12	Type of generating process (see Code table 4.3)
13	Background generating process identifier (defined by originating centre)
14	Analysis or Forecast generating process identifier (defined by originating centre)
15-16	Hours after reference time of data cutoff (see Note 2)
17	Minutes after reference time of data cutoff
18	Indicator of unit of time range (See Code table 4.4)
19-22	Forecast time in units defined by octet 18 (see Note 2)
23	Type of first fixed surface (see Code table 4.5)
24	Scale factor of first fixed surface
25-28	Scaled value of first fixed surface

Product definition template 4.8: Average, accumulation, and/or extreme values at a horizontal level or in a horizontal layer in a continuous or non-continuous time interval (*continued*)

<i>Octet No.</i>	<i>Contents</i>
29	Type of second fixed surface (see Code table 4.5)
30	Scale factor of second fixed surface
31-34	Scaled value of second fixed surface
35-36	Year
37	Month
38	Day
39	Hour
40	Minute
41	Second
42	n — Number of time range specifications describing the time intervals used to calculate the statistically processed field
43-46	Total number of data values missing in statistical process.
47-48	<i>Specification or the outermost (or only) time range over which statistical processing is done</i>
47	Statistical process used to calculate the processed field from the field at each time increment during the time range (see Code table 4.10)
48	Type of time increment between successive fields used in the statistical processing (See Code table 4.11)
49	Indicator of unit of time for time range over which statistical processing is done (See Code table 4.4)
50-53	Length of the time range over which statistical processing is done, in units defined by the previous octet
54	Indicator of unit of time for the increment between the successive fields used (See Code table 4.4)
55-58	Time increment between successive fields, in units defined by the previous octet (See Note 3)
59- <i>nn</i>	These octets are included only if $n > 1$, where $nn = 45 + 12 * n$
59-70	As octets 47 to 58, next innermost step of processing
71- <i>nn</i>	Additional time range specifications, included in accordance with the value of <i>n</i> . Contents as octets 47 to 58, repeated as necessary.

NOTES:

- (1) Hours greater than 65534 will be coded as 65534.
- (2) The reference time in section 1 and the forecast time together define the beginning of the overall time interval.
- (3) An increment of zero means that the statistical processing is the result of a continuous (or near continuous) process, not the processing of a number of discrete samples. Examples of such continuous processes are the temperatures measured by analogue maximum and minimum thermometers or thermographs, and the rainfall measured by a rain gauge.
- (4) The reference and forecast times are successively set to their initial values plus or minus the increment, as defined by the type of time increment (one of octets 46, 58, 70 ...). For all but the innermost (last) time range, the next inner range is then processed using these reference and forecast times as the initial reference and forecast time.

Product definition template 4.20: Radar product

<i>Octet No.</i>	<i>Contents</i>
10	Parameter category (see Code table 4.1)
11	Parameter number (see Code table 4.2)
12	Type of generating process (see Code table 4.3)
13	Number of radar sites used
14	Indicator of unit of time range
15-18	Site latitude (in 10^{-6} degree)
19-22	Site longitude (in 10^{-6} degree)
23-24	Site elevation (metres)
25-28	Site ID (alphanumeric)

Product definition template 4.20: Radar product (*continued*)

<i>Octet No.</i>	<i>Contents</i>
29–30	Site ID (numeric)
31	Operating mode (see Code table 4.12)
32	Reflectivity calibration constant (tenths of dB)
33	Quality control indicator (see Code table 4.13)
34	Clutter filter indicator (see Code table 4.14)
35	Constant antenna elevation angle (tenths of degree true)
36–37	Accumulation interval (minutes)
38	Reference reflectivity for echo top (dB)
39–41	Range bin spacing (m)
42–43	Radial angular spacing (tenths of degree true)

Product definition template 4.30: Satellite product

<i>Octet No.</i>	<i>Contents</i>
10	Parameter category (see Code table 4.1)
11	Parameter number (See Code table 4.2)
12	Type of generating process (see Code table 4.3)
13	Observation generating process identifier (defined by originating centres)
14	Number of contributing spectral bands (NB)

Repeat the following 10 octets for each contributing band (nb = 1, NB)

(15+10(nb-1))–(16+10(nb-1))	Satellite series of band nb (code table defined by originating/generating centre)
(17+10(nb-1))–(18+10(nb-1))	Satellite numbers of band nb (code table defined by originating/generating centre)
(19+10(nb-1))	Instrument types of band nb (code table defined by originating/generating centre)
(20+10(nb-1))	Scale factor of central wave number of band nb
(21+10(nb-1))–(24+10(nb-1))	Scaled value of central wave number of band nb (units: m ⁻¹)

Product definition template 4.254: CCITTIA5 character string

<i>Octet No.</i>	<i>Contents</i>
10	Parameter category (see Code table 4.1)
11	Parameter number (see Code table 4.2)
12–15	Number of characters

TEMPLATE DEFINITIONS USED IN SECTION 5**Data representation template 5.0: Grid point data — simple packing**

<i>Octet No.</i>	<i>Contents</i>
12–15	Reference value (R) (IEEE 32-bit floating-point value)
16–17	Binary scale factor (E)
18–19	Decimal scale factor (D)
20	Number of bits used for each packed value for simple packing, or for each group reference value for complex packing or spatial differencing
21	Type of original field values (see Code table 5.1)

Data representation template 5.1: Matrix values at grid point — simple packing

<i>Octet No.</i>	<i>Contents</i>
12–21	Same as Data representation template 5.0
22	0, no matrix bit maps present; 1 matrix bit maps present

Data representation template 5.1: Matrix values at grid point — simple packing (*continued*)

<i>Octet No.</i>	<i>Contents</i>
23-26	Number of data values encoded in Section 7
27-28	NR — first dimension (rows) of each matrix
29-30	NC — second dimension (columns) of each matrix
31	First dimension coordinate value definition (Code table 5.2)
32	NC1 — number of coefficients or values used to specify first dimension coordinate function.
33	Second dimension coordinate value definition (Code table 5.2)
34	NC2 — number of coefficients or values used to specify second dimension coordinate function
35	First dimension physical significance (Code table 5.3)
36	Second dimension physical significance (Code table 5.3)
37-(36+NC1*4)	Coefficients to define first dimension coordinate values in functional form, or the explicit coordinate values (IEEE 32-bit floating-point value)
(37+NC1*4)-(36+4(NC1+NC2))	Coefficients to define second dimension coordinate values in functional form, or the explicit coordinate values (IEEE 32-bit floating-point value)

NOTES:

- (1) This form of representation enables a matrix of values to be depicted at each grid point; the two dimensions of the matrix may represent coordinates expressed in terms of two elemental parameters (e.g. direction and frequency for wave spectra). The numeric values of these coordinates, beyond that of simple subscripts, can be given in a functional form, or as a collection of explicit numbers.
- (2) Some simple coordinate functional forms are tabulated in Code table 5.2. Where a more complex coordinate function applies, the coordinate values shall be explicitly denoted by the inclusion of the actual set of values rather than the coefficients. This shall be indicated by a code figure 0 from Code table 5.2; the number of explicit values coded shall be equal to the appropriate dimension of the matrix for which values are presented and they shall follow octet 36 in place of the coefficients.
- (3) Matrix bit maps will be present only if indicated by octet 22. If present, there shall be one bit map for each grid point with data values, as defined by the primary bit map in Section 6, each of length (NR*NC) bits: a bit set to 1 will indicate a data element at the corresponding location within the matrix. Bit maps shall be represented end-to-end, without regard for octet boundaries; the last bit map shall, if necessary, be followed by bits set to zero to fill any partially used octet.
- (4) Matrices restricted to scanning in the + i direction (left to right) and in the - j direction (top to bottom).

Data representation template 5.2: Grid point data — complex packing

<i>Octet No.</i>	<i>Contents</i>
12-21	Same as Data Representation Template 5.0
22	Group splitting method used (see Code table 5.4)
23	Missing value management used (see Code table 5.5)
24-27	Primary missing value substitute
28-31	Secondary missing value substitute
32-35	NG — Number of groups of data values into which field is split
36	Reference for group widths (see Note 12)
37	Number of bits used for the group widths (after the reference value in octet 36 has been removed)
38-41	Reference for group lengths (see Note 13)
42	Length increment for the group lengths (see Note 14)
43-46	True length of last group
47	Number of bits used for the scaled group lengths (after subtraction of the reference value given in octets 38-41 and division by the length increment given in octet 42)

NOTES:

- (1) Group lengths have no meaning for row by row packing, where groups are coordinate lines (so the Grid description section and possibly the Bit-map section are enough); for consistency associated field width and reference should then be encoded as 0.
- (2) For row by row packing with a bit-map, there should always be as many groups as rows. In case of rows with only missing values, all associated descriptors should be coded as zero.

- (3) Management of widths into a reference and increments, together with management of lengths as scaled incremental values, are intended to save descriptor size (which is an issue as far as compression gains are concerned).
- (4) Management of explicitly missing values is an alternative to bit-map use within Section 6; it is intended to reduce the whole GRIB message size.
- (5) There may be two types of missing value(s), such as to make a distinction between static misses (for instance, due to a land/sea mask) and occasional misses.
- (6) As an extra option, substitute value(s) for missing data may be specified. If not wished (or not applicable), all bits should be set to 1 for relevant substitute value(s).
- (7) If substitute value(s) are specified, type of content should be consistent with original field values (floating-point — and then IEEE 32-bit encoded — or integer).
- (8) If primary missing values are used, such values are encoded within appropriate group with all bits set to 1 at packed data level.
- (9) If secondary missing values are used, such values are encoded within appropriate group with all bits set to 1, except the last one set to 0, at packed data level.
- (10) A group containing only missing values (of either type) will be encoded as a constant group (null width, no associated data) and the group reference will have all bits set to 1 for primary type, and all bits set to 1, except the last bit set to 0, for secondary type.
- (11) If necessary, group widths and/or field width of group references may be enlarged to avoid ambiguities between missing value indicator(s) and true data.
- (12) The group width is the number of bits used for every value in a group.
- (13) The group length (L) is the number of values in a group.
- (14) The essence of the complex packing method is to subdivide a field of values into NG groups, where the values in each group have similar sizes. In this procedure, it is necessary to retain enough information to recover the group lengths upon decoding. The NG group lengths for any given field can be described by $L_n = \text{ref} + K_n * \text{len_inc}$, $n = 1, \text{NG}$, where ref is given by octets 38-41 and len_inc by octet 42. The NG values of K (the scaled group lengths) are stored in the Data section, each with the number of bits specified by octet 47. Since the last group is a special case which may not be able to be specified by this relationship, the length of the last group is stored in octets 43-46.

Data representation template 5.3: Grid point data — complex packing and spatial differencing

<i>Octet No.</i>	<i>Contents</i>
12-47	Same as Data representation template 5.2
48	Order of spatial differencing (see Code table 5.6)
49	Number of octets required in the Data section to specify extra descriptors needed for spatial differencing (octets 6-ww in data template 7.3)

NOTES:

- (1) Spatial differencing is a pre-processing before group splitting at encoding time. It is intended to reduce the size of sufficiently smooth fields, when combined with a splitting scheme as described in Data Representation Template 5.2. At order 1, an initial field of values f is replaced by a new field of values g , where $g_1 = f_1$, $g_2 = f_2 - f_2$, ..., $g_n = f_n - f_{n-1}$. At order 2, the field of values g is itself replaced by a new field of values h , where $h_1 = f_1$, $h_2 = f_2$, $h_3 = g_3 - g_2$, ..., $h_n = g_n - g_{n-1}$. To keep values positive, the overall minimum of the resulting field (either g_{\min} or h_{\min}) is removed. At decoding time, after bit string unpacking, the original scaled values are recovered by adding the overall minimum and summing up recursively.
- (2) For differencing of order n , the first n values in the array that are not missing are set to zero in the packed array. These dummy values are not used in unpacking.

Data representation template 5.50: Spectral data — simple packing

<i>Octet No.</i>	<i>Contents</i>
12-15	Reference value (R) (IEEE 32-bit floating-point value)
16-17	Binary scale factor (E)
18-19	Decimal scale factor (D)
20	Number of bits used for each packed value (field width)
21-24	Real part of (0,0) coefficient (IEEE 32-bit floating-point value)

NOTES:

- (1) Removal of the real part of (0,0) coefficient from packed data is intended to reduce the variability of the coefficients, in order to improve packing accuracy.
- (2) For some spectral representations, the (0,0) coefficient represents the mean value of the parameter represented.

Data representation template 5.51: Spherical harmonics data — complex packing

<i>Octet No.</i>	<i>Contents</i>
12-20	Same as Data representation template 5.50
21-24	P — Laplacian scaling factor (expressed in 10^{-6} units)
25-26	J_S — pentagonal resolution parameter of the unpacked subset (see Note 1)
27-28	K_S — pentagonal resolution parameter of the unpacked subset (see Note 1)
29-30	M_S — pentagonal resolution parameter of the unpacked subset (see Note 1)
31-34	T_S — total number of values in the unpacked subset (see Note 1)
35	Precision of the unpacked subset (see Code table 5.7)

NOTES:

- (1) The unpacked subset is a set of values defined in the same way as the full set of values (on a spectrum limited to J_S , K_S and M_S), but on which scaling and packing are not applied. Associated values are stored in octets 6 onwards of Section 7.
- (2) The remaining coefficients are multiplied by $(n*(n+1))^P$, scaled and packed. The operator associated with this multiplication is derived from the laplacian operator on the sphere.
- (3) The retrieval formula for a coefficient of wave number n is then:

$$Y = (R+X*2^E)*10^{-D*} (n*(n+1))^{-P} \text{ where } X \text{ is the packed scaled value associated with the coefficient.}$$

TEMPLATE DEFINITIONS USED IN SECTION 7**Data template 7.0: Grid point data — simple packing**

<i>Octet No.</i>	<i>Contents</i>
6-nn	Binary data values — binary string, with each (scaled) data value

Data template 7.1: Matrix values at grid point — simple packing

<i>Octet No.</i>	<i>Contents</i>
6-nn	Binary data values — binary string, with each (scaled) data value

NOTE: Group descriptors mentioned above may not be physically present; if associated field width is 0.

Data template 7.2: Grid point data — complex packing

<i>Octet No.</i>	<i>Contents</i>
6-xx	NG group reference values (XI in the decoding formula), each of which is encoded using the number of bits specified in octet 20 of Data representation template 5.0. Bits set to zero shall be appended as necessary to ensure this sequence of numbers ends on an octet boundary
[xx+1]-yy	NG group widths, each of which is encoded using the number of bits specified in octet 37 of Data representation template 5.2. Bits set to zero shall be appended as necessary to ensure this sequence of numbers ends on an octet boundary
[yy+1]-zz	NG scaled group lengths, each of which is encoded using the number of bits specified in octet 47 of Data representation template 5.2. Bits set to zero shall be appended as necessary to ensure this sequence of numbers ends on an octet boundary (see Note 14 of Data representation template 5.2)
[zz+1]-nn	Packed values (X2 in the decoding formula), where each value is a deviation from its respective group reference value

NOTES:

- (1) Group descriptors mentioned above may not be physically present; if associated field width is 0.
- (2) Group lengths have no meaning for row by row packing; for consistency associated field width should then be encoded as 0. So no specific test for row by row case is mandatory at decoding software level to handle encoding/decoding of group descriptors.
- (3) Scaled group lengths, if present, are encoded for each group. But the true last group length (unscaled) should be taken from Data representation template.
- (4) For groups with a constant value, associated field width is 0, and no incremental data are physically present.

Data template 7.3: Grid point data — complex packing and spatial differencing

<i>Octet No.</i>	<i>Contents</i>
6-ww	First value(s) of original (undifferenced) scaled data values, followed by the overall minimum of the differences. The number of values stored is 1 greater than the order of differentiation, and the field width is described at octet 49 of Data representation template 5.3 (See Note 1)
[ww+1]-xx	NG group reference values (X1 in the decoding formula), each of which is encoded using the number of bits specified in octet 20 of Data representation template 5.0. Bits set to zero shall be appended where necessary to ensure this sequence of numbers ends on an octet boundary
[xx+1]-nn	Same as for Data representation template 7.2

NOTES:

- (1) Referring to the notation in Note (1) of Data representation template 5.3, at order 1, the values stored in octets 6-ww are g_1 and g_{min} . At order 2, the values stored are h_1 , h_2 , and h_{min} .
- (2) Extra descriptors related to spatial differencing are added before the splitting descriptors, to reflect the separation between the 2 approaches. It enables to share software parts between cases with and without spatial differencing.
- (3) The position of overall minimum after initial data values is a choice that enables less software management.
- (4) Overall minimum will be negative in most cases. First bit should indicate the sign: 0 if positive, 1 if negative.

Data template 7.50: Spectral data — simple packing

<i>Octet No.</i>	<i>Contents</i>
6-nn	Binary data values — binary string, with each (scaled) data value

Data template 7.51: Spherical harmonics — complex packing

<i>Octet No.</i>	<i>Contents</i>
6-(5+I*T _S)	Data values from the unpacked subset (IEEE floating-point values on I octets)
(6+I*T _S)-nn	Binary data values — binary string, with each (scaled) data value out of the unpacked subset

NOTES:

- (1) Values ordering within the unpacked subset is defined according to the source of grid definition associated with the data.
- (2) Number of octets associated with each value of the unpacked subset (I) is defined in Code table 5.7, according to the actual value in octet 35 of Data representation template 5.51.
- (3) Values ordering within the packed data is done according to the source of grid definition, skipping the values processed in the unpacked subset.

CODE AND FLAG TABLES**CODE TABLES USED IN SECTION 0****Code table 0.0: Discipline of processed data in the GRIB message, number of GRIB Master table**

<i>Code figure</i>	<i>Meaning</i>
0	Meteorological products
1	Hydrological products
2	Land surface products
3	Space products
4-9	Reserved
10	Oceanographic products
11-191	Reserved
192-254	Reserved for local use
255	Missing

CODE TABLES USED IN SECTION 1

Code table 1.0: GRIB Master tables version number

<i>Code figure</i>	<i>Meaning</i>
0	Experimental
1	Initial operational version number
2-254	Future operational version numbers
255	Local table used

Code table 1.1: GRIB Local tables version number

<i>Code figure</i>	<i>Meaning</i>
0	Local tables not used
1-254	Number of local tables version used
255	Missing

Code table 1.2: Significance of reference time

<i>Code figure</i>	<i>Meaning</i>
0	Analysis
1	Start of forecast
2	Verifying time of forecast
3	Observation time
4-191	Reserved
192-254	Reserved for local use
255	Missing

Code table 1.3: Production status of data

<i>Code figure</i>	<i>Meaning</i>
0	Operational products
1	Operational test products
2	Research products
3	Re-analysis products
4-191	Reserved
192-254	Reserved for local use
255	Missing

Code table 1.4: Type of data

<i>Code figure</i>	<i>Meaning</i>
0	Analysis products
1	Forecast products
2	Analysis and forecast products
3	Control forecast products
4	Perturbed forecast products
5	Control and perturbed forecast products
6	Processed satellite observations
7	Processed radar observations
8-191	Reserved
192-254	Reserved for local use
255	Missing

NOTE: An initialized analysis is considered a zero-hour forecast.

CODE AND FLAG TABLES USED IN SECTION 3

Code table 3.0: Source of grid definition

<i>Code figure</i>	<i>Meaning</i>	<i>Comments</i>
0	Specified in Code table 3.1	
1	Predetermined grid definition	Defined by originating centre
2-191	Reserved	
192-254	Reserved for local use	
255	A grid definition does not apply to this product	

Code table 3.1: Grid definition template number

<i>Code figure</i>	<i>Meaning</i>	<i>Comments</i>
0	Latitude/longitude	Also called equidistant cylindrical, or Plate Carrée
1	Rotated latitude/longitude	
2	Stretched latitude/longitude	
3	Stretched and rotated latitude/longitude	
4-9	Reserved	
10	Mercator	
11-19	Reserved	
20	Polar stereographic	Can be south or north
21-29	Reserved	
30	Lambert conformal	Can be secant or tangent, conical or bipolar. (also called Albers equal-area)
31-39	Reserved	
40	Gaussian latitude/longitude	
41	Rotated Gaussian latitude/longitude	
42	Stretched Gaussian latitude/longitude	
43	Stretched and rotated Gaussian latitude/longitude	
44-49	Reserved	
50	Spherical harmonic coefficients	
51	Rotated spherical harmonic coefficients	
52	Stretched spherical harmonic coefficients	
53	Stretched and rotated spherical harmonic coefficients	
54-89	Reserved	
90	Space view perspective orthographic	
91-99	Reserved	
100	Triangular grid based on an icosahedron	
101-109	Reserved	
110	Equatorial azimuthal equidistant projection	
111-119	Reserved	
120	Azimuth-range projection	
121-32767	Reserved	
32768-65534	Reserved for local use	
65535	Missing	

Code table 3.2: Shape of the Earth

<i>Code figure</i>	<i>Meaning</i>
0	Earth assumed spherical with radius = 6 367.47 km
1	Earth assumed spherical with radius specified by data producer
2	Earth assumed oblate spheroid with size as determined by IAU in 1965 (major axis = 6 378.160 km, minor axis = 6 356.775 km, $f = 1/297.0$)
3	Earth assumed oblate spheroid with major and minor axes specified by data producer
4-191	Reserved
192-254	Reserved for local use
255	Missing

Flag table 3.3: Resolution and component flags

<i>Bit No.</i>	<i>Value</i>	<i>Meaning</i>
1-2		Reserved
3	0	i direction increments not given
	1	i direction increments given
4	0	j direction increments not given
	1	j direction increments given
5	0	Resolved u and v components of vector quantities relative to easterly and northerly directions
	1	Resolved u and v components of vector quantities relative to the defined grid in the direction of increasing x and y (or i and j) coordinates, respectively
6-8		Reserved — set to zero

Flag table 3.4: Scanning mode

<i>Bit No.</i>	<i>Value</i>	<i>Meaning</i>
1	0	Points of first row or column scan in the +i (+x) direction
	1	Points of first row or column scan in the -i (-x) direction
2	0	Points of first row or column scan in the -j (-y) direction
	1	Points of first row or column scan in the +j (+y) direction
3	0	Adjacent points in i (x) direction are consecutive
	1	Adjacent points in j (y) direction is consecutive
4	0	All rows scan in the same direction
	1	Adjacent rows scans in the opposite direction
5-8		Reserved

NOTES:

- (1) i direction: west to east along a parallel or left to right along an X-axis.
- (2) j direction: south to north along a meridian, or bottom to top along a Y-axis.
- (3) If bit number 4 is set, the first row scan is as defined by previous flags.

Flag table 3.5: Projection centre

<i>Bit No.</i>	<i>Value</i>	<i>Meaning</i>
1	0	North Pole is on the projection plane
	1	South Pole is on the projection plane
2	0	Only one projection centre is used
	1	Projection is bipolar and symmetric

Code table 3.6: Spectral data representation type

<i>Code figure</i>	<i>Meaning</i>
1	The associated Legendre functions of the first kind are defined by:

$$P_n^m(m) = \sqrt{(2n+1) \frac{(n-m)!}{(n+m)!} \frac{1}{2^n n!}} (1-m^2)^{\frac{m}{2}} \frac{d^{n+m}}{dm^{n+m}} (m^2-1)^n, m \geq 0$$

$$P_n^{-m}(m) = P_n^m(m)$$

A field $F(\lambda, \mu)$ is represented by:

$$F(\lambda, \mu) = \sum_{m=-n}^M \sum_{n=|m|}^{N(m)} F_n^m P_n^m(\mu) e^{im\lambda}$$

where λ is the longitude
 μ the sine of latitude
and F_n^{-m} the complex conjugate of F_n^m

Code table 3.7: Spectral data representation mode

<i>Code figure</i>	<i>Meaning</i>
0	Reserved
1	The complex numbers F_n^m (see Code figure 1 in Code table 3.6 above) are stored for $m \geq 0$ as pairs of real numbers $\text{Re}(F_n^m)$, $\text{Im}(F_n^m)$ ordered with n increasing from m to $N(m)$, first for $m=0$ and then for $m=1, 2, \dots M$. (see the Note)
2–254	Reserved
255	Missing

NOTE: Values of $N(m)$ for common truncations cases:

Triangular	$M = J = K,$	$N(m) = J$
Rhomboidal	$K = J + M,$	$N(m) = J+m$
Trapezoidal	$K = J, K > M,$	$N(m) = J$

Code table 3.8: Grid point position

<i>Code figure</i>	<i>Meaning</i>
0	Grid points at triangle vertices
1	Grid points at centres of triangles
2	Grid points at midpoints of triangle sides
3–191	Reserved
192–254	Reserved for local use
255	Missing

Flag table 3.9: Numbering order of diamonds as seen from the corresponding pole

<i>Bit No.</i>	<i>Value</i>	<i>Meaning</i>
1	0	Clockwise orientation
	1	Anti-clockwise (i.e. counter-clockwise) orientation
2–8		Reserved

Flag table 3.10: Scanning mode for one diamond

<i>Bit No.</i>	<i>Value</i>	<i>Meaning</i>
1	0	Points scan in +i direction, i.e. from pole to the Equator
	1	Points scan in -i direction, i.e. from the Equator to pole
2	0	Points scan in +j direction, i.e. from west to east
	1	Points scan in -j direction, i.e. from east to west
3	0	Adjacent points in i direction are consecutive
	1	Adjacent points in j direction is consecutive
4–8		Reserved

Code table 3.11: Interpretation of list of numbers defining number of points

<i>Code figure</i>	<i>Meaning</i>
0	There is no appended list
1	Numbers define number of points corresponding to full coordinate circles (i.e. parallels), coordinate values on each circle are multiple of the circle mesh, and extreme coordinate values given in grid definition (i.e. extreme longitudes) may not be reached in all rows
2	Numbers define number of points corresponding to coordinate lines delimited by extreme coordinate values given in grid definition (i.e. extreme longitudes) which are present in each row
3–254	Reserved
255	Missing

CODE AND FLAG TABLES USED IN SECTION 4

Code table 4.0: Product definition template number

<i>Number</i>	<i>Description</i>
0	Analysis or forecast at a horizontal level or in a horizontal layer at a point in time
1	Individual ensemble forecast, control and perturbed, at a horizontal level or in a horizontal layer at a point in time
2	Derived forecast based on all ensemble members at a horizontal level or in a horizontal layer at a point in time
3	Derived forecasts based on a cluster of ensemble members over a rectangular area at a horizontal level or in a horizontal layer at a point in time
4	Derived forecasts based on a cluster of ensemble members over a circular area at a horizontal level or in a horizontal layer at a point in time
5	Probability forecasts at a horizontal level or in a horizontal layer at a point in time
6	Percentile forecasts at a horizontal level or in a horizontal layer at a point in time
7	Analysis or forecast error at a horizontal level or in a horizontal layer at a point in time
8	Average, accumulation, extreme values or other statistically processed value at a horizontal level or in a horizontal layer in a continuous or non-continuous time interval
9-19	Reserved
20	Radar product
21-29	Reserved
30	Satellite product
31-253	Reserved
254	CCITTIA5 character string
255-32767	Reserved
32768-65534	Reserved for local use
65535	Missing

Code table 4.1: Category of parameters by product discipline

Product discipline 0: Meteorological products

<i>Category</i>	<i>Description</i>
0	Temperature
1	Moisture
2	Momentum
3	Mass
4	Short-wave radiation
5	Long-wave radiation
6	Cloud
7	Thermodynamic stability indices
8	Kinematic stability indices
9	Temperature probabilities
10	Moisture probabilities
11	Momentum probabilities
12	Mass probabilities
13	Aerosols
14	Trace gases (e.g., ozone, CO ₂)
15	Radar
16	Forecast radar imagery
17	Electro-dynamics
18	Nuclear/radiology
19	Physical atmospheric properties
20-189	Reserved
190	CCITTIA5 string
191	Miscellaneous
192-254	Reserved for local use
255	Missing

Product discipline 1: Hydrological products

<i>Category</i>	<i>Description</i>
0	Hydrology
1	Hydrology probabilities
2-191	Reserved
192-254	Reserved for local use
255	Missing

Product discipline 2: Land surface products

<i>Category</i>	<i>Description</i>
0	Vegetation/biomass
1	Agri-/aquacultural special products
2	Transportation-related products
3	Soil products
4-191	Reserved
192-254	Reserved for local use
255	Missing

Product discipline 3: Space products

<i>Category</i>	<i>Description</i>
0	Image format products (see Note 1)
1	Quantitative products (see Note 2)
2-191	Reserved
192-254	Reserved for local use
255	Missing

NOTES:

- (1) Data are numeric without units, although they might be given quantitative meaning through a Code table defined external to this document. The emphasis is on a displayable “picture” of some phenomenon, perhaps with certain enhanced features. Generally, each datum is an unsigned, one octet integer, but some image format products might have another datum size. The size of a datum is indicated in Section 5.
- (2) Data are in specified physical units.

Product discipline 10: Oceanographic products

<i>Category</i>	<i>Description</i>
0	Waves
1	Currents
2	Ice
3	Surface properties
4	Sub-surface properties
5-191	Reserved
192-254	Reserved for local use
255	Missing

Code table 4.2: Parameter number by product discipline and parameter category**Product discipline 0: Meteorological products, Parameter category 0: Temperature**

<i>Number</i>	<i>Parameter</i>	<i>Units</i>
0	Temperature	K
1	Virtual temperature	K
2	Potential temperature	K
3	Pseudo-adiabatic potential temperature or equivalent potential temperature	K
4	Maximum temperature	K

Product discipline 0: Meteorological products, Parameter category 0: Temperature (*continued*)

<i>Number</i>	<i>Parameter</i>	<i>Units</i>
5	Minimum temperature	K
6	Dew point temperature	K
7	Dew point depression (or deficit)	K
8	Lapse rate	K m ⁻¹
9	Temperature anomaly	K
10	Latent heat net flux	W m ⁻²
11	Sensible heat net flux	W m ⁻²
12	Heat index	K
13	Wind chill factor	K
14	Minimum dew point depression	K
15	Virtual potential temperature	K
16-191	Reserved	
192-254	Reserved for local use	
255	Missing	

Product discipline 0: Meteorological products, Parameter category 1: Moisture

<i>Number</i>	<i>Parameter</i>	<i>Units</i>
0	Specific humidity	kg kg ⁻¹
1	Relative humidity	%
2	Humidity mixing ratio	kg kg ⁻¹
3	Precipitable water	kg m ⁻²
4	Vapor pressure	Pa
5	Saturation deficit	Pa
6	Evaporation	kg m ⁻²
7	Precipitation rate	kg m ⁻² s ⁻¹
8	Total precipitation	kg m ⁻²
9	Large scale precipitation (non-convective)	kg m ⁻²
10	Convective precipitation	kg m ⁻²
11	Snow depth	m
12	Snowfall rate water equivalent	kg m ⁻² s ⁻¹
13	Water equivalent of accumulated snow depth	kg m ⁻²
14	Convective snow	kg m ⁻²
15	Large scale snow	kg m ⁻²
16	Snow melt	kg m ⁻²
17	Snow age	day
18	Absolute humidity	kg m ⁻³
19	Precipitation type	Code table (4.201)
20	Integrated liquid water	kg m ⁻²
21	Condensate	kg kg ⁻¹
22	Cloud mixing ratio	kg kg ⁻¹
23	Ice water mixing ratio	kg kg ⁻¹
24	Rain mixing ratio	kg kg ⁻¹
25	Snow mixing ratio	kg kg ⁻¹
26	Horizontal moisture convergence	kg kg ⁻¹ s ⁻¹
27	Maximum relative humidity	%
28	Maximum absolute humidity	kg m ⁻³
29	Total snowfall	m
30	Precipitable water category	Code table (4.202)
31	Hail	m
32	Graupel (snow pellets)	kg kg ⁻¹
33-191	Reserved	
192-254	Reserved for local use	
255	Missing	

Product discipline 0: Meteorological products, Parameter category 2: Momentum

<i>Number</i>	<i>Parameter</i>	<i>Units</i>
0	Wind direction (from which blowing)	Deg true
1	Wind speed	m s ⁻¹
2	u-component of wind	m s ⁻¹
3	v-component of wind	m s ⁻¹
4	Stream function	m ² s ⁻¹
5	Velocity potential	m ² s ⁻¹
6	Montgomery stream function	m ² s ⁻²
7	Sigma coordinate vertical velocity	s ⁻¹
8	Vertical velocity (pressure)	Pa s ⁻¹
9	Vertical velocity (geometric)	m s ⁻¹
10	Absolute vorticity	s ⁻¹
11	Absolute divergence	s ⁻¹
12	Relative vorticity	s ⁻¹
13	Relative divergence	s ⁻¹
14	Potential vorticity	K m ² kg ⁻¹ s ⁻¹
15	Vertical u-component shear	s ⁻¹
16	Vertical v-component shear	s ⁻¹
17	Momentum flux, u component	N m ⁻²
18	Momentum flux, v component	N m ⁻²
19	Wind mixing energy	J
20	Boundary layer dissipation	W m ⁻²
21	Maximum wind speed	m s ⁻¹
22	Wind speed (gust)	m s ⁻¹
23	u-component of wind (gust)	m s ⁻¹
24	v-component of wind (gust)	m s ⁻¹
25-191	Reserved	
192-254	Reserved for local use	
255	Missing	

Product discipline 0: Meteorological products, Parameter category 3: Mass

<i>Number</i>	<i>Parameter</i>	<i>Units</i>
0	Pressure	Pa
1	Pressure reduced to MSL	Pa
2	Pressure tendency	Pa s ⁻¹
3	ICAO Standard atmosphere reference height	m
4	Geopotential	m ² s ⁻²
5	Geopotential height	gpm
6	Geometric height	m
7	Standard deviation of height	m
8	Pressure anomaly	Pa
9	Geopotential height anomaly	gpm
10	Density	kg m ⁻³
11	Altimeter setting	Pa
12	Thickness	m
13	Pressure altitude	m
14	Density altitude	m
15-191	Reserved	
192-254	Reserved for local use	
255	Missing	

Product discipline 0: Meteorological products, Parameter category 4: Short-wave radiation

<i>Number</i>	<i>Parameter</i>	<i>Units</i>
0	Net short-wave radiation flux (surface)	W m ⁻²
1	Net short-wave radiation flux (top of atmosphere)	W m ⁻²
2	Short wave radiation flux	W m ⁻²
3	Global radiation flux	W m ⁻²
4	Brightness temperature	K
5	Radiance (with respect to wave number)	W m ⁻¹ sr ⁻¹
6	Radiance (with respect to wave length)	W m ⁻³ sr ⁻¹
7-191	Reserved	
192-254	Reserved for local use	
255	Missing	

Product discipline 0: Meteorological products, Parameter category 5: Long-wave radiation

<i>Number</i>	<i>Parameter</i>	<i>Units</i>
0	Net long-wave radiation flux (surface)	W m ⁻²
1	Net long-wave radiation flux (top of atmosphere)	W m ⁻²
2	Long-wave radiation flux	W m ⁻²
3-191	Reserved	
192-254	Reserved for local use	
255	Missing	

Product discipline 0: Meteorological products, Parameter category 6: Cloud

<i>Number</i>	<i>Parameter</i>	<i>Units</i>
0	Cloud Ice	kg m ⁻²
1	Total cloud cover	%
2	Convective cloud cover	%
3	Low cloud cover	%
4	Medium cloud cover	%
5	High cloud cover	%
6	Cloud water	kg m ⁻²
7	Cloud amount	%
8	Cloud type	Code table (4.203)
9	Thunderstorm maximum tops	m
10	Thunderstorm coverage	Code table (4.204)
11	Cloud base	m
12	Cloud top	m
13	Ceiling	m
14-191	Reserved	
192-254	Reserved for local use	
255	Missing	

Product discipline 0: Meteorological products, Parameter category 7: Thermodynamic stability indices

<i>Number</i>	<i>Parameter</i>	<i>Units</i>
0	Parcel lifted index (to 500 hPa)	K
1	Best lifted index (to 500 hPa)	K
2	K index	K
3	KO index	K
4	Total totals index	K
5	Sweat index	Numeric
6	Convective available potential energy	J kg ⁻¹
7	Convective inhibition	J kg ⁻¹
8	Storm relative helicity	J kg ⁻¹
9	Energy helicity index	Numeric
10-191	Reserved	
192-254	Reserved for local use	
255	Missing	

Product discipline 0: Meteorological products, Parameter category 13: Aerosols

<i>Number</i>	<i>Parameter</i>	<i>Units</i>
0	Aerosol type	Code table (4.205)
1-191	Reserved	
192-254	Reserved for local use	
255	Missing	

Product discipline 0: Meteorological products, Parameter category 14: Trace gases

<i>Number</i>	<i>Parameter</i>	<i>Units</i>
0	Total ozone	Dobson
1-191	Reserved	
192-254	Reserved for local use	
255	Missing	

Product discipline 0: Meteorological products, Parameter category 15: Radar

<i>Number</i>	<i>Parameter</i>	<i>Units</i>
0	Base spectrum width	m s^{-1}
1	Base reflectivity	dB
2	Base radial velocity	m s^{-1}
3	Vertically-integrated liquid	kg m^{-1}
4	Layer-maximum base reflectivity	dB
5	Precipitation	kg m^{-2}
6	Radar spectra (1)	-
7	Radar spectra (2)	-
8	Radar spectra (3)	-
9-191	Reserved	
192-254	Reserved for local use	
255	Missing	

Product discipline 0: Meteorological products, Parameter category 18: Nuclear/radiology

<i>Number</i>	<i>Parameter</i>	<i>Units</i>
0	Air concentration of Caesium 137	Bq m^{-3}
1	Air concentration of Iodine 131	Bq m^{-3}
2	Air concentration of radioactive pollutant	Bq m^{-3}
3	Ground deposition of Caesium 137	Bq m^{-2}
4	Ground deposition of Iodine 131	Bq m^{-2}
5	Ground deposition of radioactive pollutant	Bq m^{-2}
6-191	Reserved	
192-254	Reserved for local use	
255	Missing	

Product discipline 0: Meteorological products, Parameter category 19: Physical atmospheric properties

<i>Number</i>	<i>Parameter</i>	<i>Units</i>
0	Visibility	m
1	Albedo	%
2	Thunderstorm probability	%
3	mixed layer depth	m
4	Volcanic ash	Code table (4.206)
5	Icing top	m
6	Icing base	m
7	Icing	Code table (4.207)
8	Turbulence top	m
9	Turbulence base	m

Product discipline 0: Meteorological products, Parameter category 19: Physical atmospheric properties
(continued)

<i>Number</i>	<i>Parameter</i>	<i>Units</i>
10	Turbulence	Code table (4.208)
11	Turbulent kinetic energy	J kg ⁻¹
12	Planetary boundary layer regime	Code table (4.209)
13	Contrail intensity	Code table (4.210)
14	Contrail engine type	Code table (4.211)
15	Contrail top	m
16	Contrail base	m
17-191	Reserved	
192-254	Reserved for local use	
255	Missing	

Product discipline 0: Meteorological products, Parameter category 253: ASCII character string

<i>Number</i>	<i>Parameter</i>	<i>Units</i>
0	Arbitrary text string	CCITTIA5
1-191	Reserved	
192-254	Reserved for local use	
255	Missing	

Product discipline 2: Land surface products, Parameter category 0: Vegetation/biomass

<i>Number</i>	<i>Parameter</i>	<i>Units</i>
0	Land cover (1=land, 2=sea)	Proportion
1	Surface roughness	m
2	Soil temperature	K
3	Soil moisture content	kg m ⁻²
4	Vegetation	%
5	Water runoff	kg/m ⁻²
6	Evapotranspiration	kg —2 s ⁻¹
7	Model terrain height	m
8	Land use	Code table (4.212)
9-191	Reserved	
192-254	Reserved for local use	
255	Missing	

Product discipline 2: Land surface products, Parameter category 2: Soil Products

<i>Number</i>	<i>Parameter</i>	<i>Units</i>
0	Soil type	Code table (4.213)
1	Upper layer soil temperature	K
2	Upper layer soil moisture	kg m ⁻³
3	Lower layer soil moisture	kg m ⁻³
4	Bottom layer soil temperature	K
5-191	Reserved	
192-254	Reserved for local use	
255	Missing	

Product discipline 3: Space products, Parameter category 0: Image format products

<i>Number</i>	<i>Parameter</i>	<i>Units</i>
0	Scaled radiance	Numeric
1	Scaled albedo	Numeric
2	Scaled brightness temperature	Numeric
3	Scaled precipitable water	Numeric
4	Scaled lifted index	Numeric

Product discipline 3: Space products, Parameter category 0: Image format products (*continued*)

<i>Number</i>	<i>Parameter</i>	<i>Units</i>
5	Scaled cloud top pressure	Numeric
6	Scaled skin temperature	Numeric
7-191	Reserved	
192-254	Reserved for local use	
255	Missing	

Product discipline 3: Space products, Parameter category 1: Quantitative products

<i>Number</i>	<i>Parameter</i>	<i>Units</i>
0	Estimated precipitation	kg m ⁻²
1-191	Reserved	
192-254	Reserved for local use	
255	Missing	

Product discipline 10: Oceanographic products, Parameter category 0: Waves

<i>Number</i>	<i>Parameter</i>	<i>Units</i>
0	Wave spectra (1)	–
1	Wave spectra (2)	–
2	Wave spectra (3)	–
3	Significant height of combined wind waves and swell	m
4	Direction of wind waves	Degree true
5	Significant height of wind waves	m
6	Mean period of wind waves	s
7	Direction of swell waves	Degree true
8	Significant height of swell waves	m
9	Mean period of swell waves	s
10	Primary wave direction	Degree true
11	Primary wave mean period	s
12	Secondary wave direction	Degree true
13	Secondary wave mean period	s
14-191	Reserved	
192-254	Reserved for local use	
255	Missing	

Product discipline 10: Oceanographic products, Parameter category 1: Currents

<i>Number</i>	<i>Parameter</i>	<i>Units</i>
0	Current direction	Degree true
1	Current speed	m s ⁻¹
2	u-component of current	m s ⁻¹
3	v-component of current	m s ⁻¹
4-191	Reserved	
192-254	Reserved for local use	
255	Missing	

Product discipline 10: Oceanographic products, Parameter category 2: Ice

<i>Number</i>	<i>Parameter</i>	<i>Units</i>
0	Ice cover	Proportion
1	Ice thickness	m
2	Direction of ice drift	Degree true
3	Speed of ice drift	m s ⁻¹
4	u-component of ice drift	m s ⁻¹
5	v-component of ice drift	m s ⁻¹

Product discipline 10: Oceanographic products, Parameter category 2: Ice (continued)

<i>Number</i>	<i>Parameter</i>	<i>Units</i>
6	Ice growth rate	m s ⁻¹
7	Ice divergence	s ⁻¹
8-191	Reserved	
192-254	Reserved for local use	
255	Missing	

Product discipline 10: Oceanographic products, Parameter category 4: Surface properties

<i>Number</i>	<i>Parameter</i>	<i>Units</i>
0	Water temperature	K
1	Deviation of sea level from mean	m
2-191	Reserved	
192-254	Reserved for local use	
255	Missing	

Product discipline 10: Oceanographic products, Parameter category 5: Sub-surface properties

<i>Number</i>	<i>Parameter</i>	<i>Units</i>
0	Main thermocline depth	m
1	Main thermocline anomaly	m
2	Transient thermocline depth	m
3	Salinity	kg kg ⁻¹
4-191	Reserved	
192-254	Reserved for local use	
255	Missing	

Code table 4.3: Type of generating process

<i>Code figure</i>	<i>Meaning</i>
0	Analysis
1	Initialization
2	Forecast
3	Bias corrected forecast
4	Ensemble forecast
5	Probability forecast
6	Forecast error
7	Analysis error
8	Observation
9-191	Reserved
192-254	Reserved for local use
255	Missing

Code table 4.4: Indicator of unit of time range

<i>Code figure</i>	<i>Meaning</i>
0	Minute
1	Hour
2	Day
3	Month
4	Year
5	Decade (10 years)
6	Normal (30 years)
7	Century (100 years)
8-9	Reserved
10	3 hours

Code table 4.4: Indicator of unit of time range (*continued*)

<i>Code figure</i>	<i>Meaning</i>
11	6 hours
12	12 hours
13	Seconds
14–191	Reserved
192–254	Reserved for local use
255	Missing

Code table 4.5: Fixed surface types and units

<i>Code figure</i>	<i>Meaning</i>	<i>Units</i>
0	Reserved	
1	Ground or water surface	–
2	Cloud base level	–
3	Level of cloud tops	–
4	Level of 0°C isotherm	–
5	Level of adiabatic condensation lifted from the surface	–
6	Maximum wind level	–
7	Tropopause	–
8	Nominal top of the atmosphere	–
9	Sea bottom	–
10–19	Reserved	
20	Isothermal level	K
21–99	Reserved	
100	Isobaric surface	Pa
101	Mean sea level	
102	Specific altitude above mean sea level	m
103	Specified height level above ground	m
104	Sigma level	“sigma” value
105	Hybrid level	–
106	Depth below land surface	m
107	Isentropic (theta) level	K
108	Level at specified pressure difference from ground to level	Pa
109	Potential vorticity surface	$\text{K m}^2 \text{ kg}^{-1} \text{ s}^{-1}$
110	Reserved	
111	Eta* level	–
112–116	Reserved	
117	Mixed layer depth	m
118–159	Reserved	
160	Depth below sea level	m
161–191	Reserved	
192–254	Reserved for local use	
255	Missing	

* The ETA vertical coordinate system involves normalizing the pressure at some point and a specific level by the mean sea level pressure at that point.

Code table 4.6: Type of ensemble forecast

<i>Code figure</i>	<i>Meaning</i>
0	Unperturbed high-resolution control forecast
1	Unperturbed low-resolution control forecast
2	Negatively perturbed forecast
3	Positively perturbed forecast
4–191	Reserved
192–254	Reserved for local use
255	Missing

Code table 4.7: Derived forecast

<i>Code figure</i>	<i>Meaning</i>
0	Unweighted mean of all members
1	Weighted mean of all members
2	Standard deviation with respect to cluster mean
3	Standard deviation with respect to cluster mean, normalized
4-191	Reserved
192-254	Reserved for local use
255	Missing

Code table 4.8: Clustering method

<i>Code figure</i>	<i>Meaning</i>
0	Anomaly correlation
1	Root mean square
2-191	Reserved
192-254	Reserved for local use
255	Missing

Code table 4.9: Probability type

<i>Code figure</i>	<i>Meaning</i>
0	Probability of event below lower limit
1	Probability of event above upper limit
2	Probability of event between lower and upper limits
3-191	Reserved
192-254	Reserved for local use
255	Missing

Code table 4.10: Type of statistical processing

<i>Code figure</i>	<i>Meaning</i>
0	Average
1	Accumulation
2	Maximum
3	Minimum
4	Difference (value at the end of time range minus value at the beginning)
5	Root mean square
6	Standard deviation
7	Covariance (temporal variance)
8	Difference (value at the start of time range minus value at the end)
9-191	Reserved
192-254	Reserved for local use
255	Missing

Code table 4.11: Type of time intervals

<i>Code figure</i>	<i>Meaning</i>
0	Reserved
1	Successive times processed have same forecast time, start time of forecast is incremented
2	Successive times processed have same start time of forecast, forecast time is incremented
3	Successive times processed have start time of forecast incremented and forecast time decremented so that valid time remains constant
4	Successive times processed have start time of forecast decremented and forecast time incremented so that valid time remains constant
5-191	Reserved
192-254	Reserved for local use
255	Missing

Code table 4.12: Operating mode

<i>Code figure</i>	<i>Meaning</i>
0	Maintenance Mode
1	Clear
2	Precipitation
3–191	Reserved
192–254	Reserved for local use
255	Missing

Code table 4.13: Quality control indicator

<i>Code figure</i>	<i>Meaning</i>
0	No quality control applied
1	Quality control applied
2–191	Reserved
192–254	Reserved for local use
255	Missing

Code table 4.14: Clutter filter indicator

<i>Code figure</i>	<i>Meaning</i>
0	No clutter filter used
1	Clutter filter used
2–191	Reserved
192–254	Reserved for local use
255	Missing

Code table 4.201: Precipitation type

<i>Code figure</i>	<i>Meaning</i>
0	Reserved
1	Rain
2	Thunderstorm
3	Freezing rain
4	Mixed/ice
5	Snow
6–191	Reserved
192–254	Reserved for local use
255	Missing

Code table 4.202: Precipitable water category

<i>Code figure</i>	<i>Meaning</i>
0–191	Reserved
192–254	Reserved for local use
255	Missing

Code table 4.203: Cloud type

<i>Code figure</i>	<i>Meaning</i>
0	Clear
1	Cumulonimbus
2	Stratus
3	Stratocumulus
4	Cumulus
5	Altostratus
6	Nimbostratus

Code table 4.203: Cloud type (*continued*)

<i>Code figure</i>	<i>Meaning</i>
7	Alto cumulus
8	Cirrostratus
9	Cirrocumulus
10	Cirrus
11	Cumulonimbus — ground-based fog beneath the lowest layer
12	Stratus — ground-based fog beneath the lowest layer
13	Stratocumulus — ground-based fog beneath the lowest layer
14	Cumulus — ground-based fog beneath the lowest layer
15	Altostratus — ground-based fog beneath the lowest layer
16	Nimbostratus — ground-based fog beneath the lowest layer
17	Alto cumulus — ground-based fog beneath the lowest layer
18	Cirrostratus — ground-based fog beneath the lowest layer
19	Cirrocumulus — ground-based fog beneath the lowest layer
20	Cirrus — ground-based fog beneath the lowest layer
21-190	Reserved
191	Unknown
192-254	Reserved for local use
255	Missing

NOTE: Code figures 11-20 indicate all four layers were used and ground-based fog is beneath the lowest layer.

Code table 4.204: Thunderstorm coverage

<i>Code figure</i>	<i>Meaning</i>
0	None
1	Isolated (1%-2%)
2	Few (3%-15%)
3	Scattered (16%-45%)
4	Numerous (> 45%)
5-191	Reserved
192-254	Reserved for local use
255	Missing

Code table 4.205: Aerosol type

<i>Code figure</i>	<i>Meaning</i>
0	Aerosol not present
1	Aerosol present
2-191	Reserved
192-254	Reserved for local use
255	Missing

Code table 4.206: Volcanic ash

<i>Code figure</i>	<i>Meaning</i>
0	Not present
1	Present
2-191	Reserved
192-254	Reserved for local use
255	Missing

Code table 4.207: Icing

<i>Code figure</i>	<i>Meaning</i>
0	None
1	Light

Code table 4.207: Icing (*continued*)

<i>Code figure</i>	<i>Meaning</i>
2	Moderate
3	Severe
4–191	Reserved
192–254	Reserved for local use
255	Missing

Code table 4.208: Turbulence

<i>Code figure</i>	<i>Meaning</i>
0	None (smooth)
1	Light
2	Moderate
3	Severe
4	Extreme
5–191	Reserved
192–254	Reserved for local use
255	Missing

Code table 4.209: Planetary boundary layer regime

<i>Code figure</i>	<i>Meaning</i>
0	Reserved
1	Stable
2	Mechanically-driven turbulence
3	Forced convection
4	Free convection
5–191	Reserved
192–254	Reserved for local use
255	Missing

Code table 4.210: Contrail intensity

<i>Code figure</i>	<i>Meaning</i>
0	Contrails not present
1	Contrails present
2–191	Reserved
192–254	Reserved for local use
255	Missing

Code table 4.211: Contrail engine type

<i>Code figure</i>	<i>Meaning</i>
0	Low bypass
1	High bypass
2	Non bypass
3–191	Reserved
192–254	Reserved for local use
255	Missing

Code table 4.212: Land use

<i>Code figure</i>	<i>Meaning</i>
0	Reserved
1	Urban land
2	Agriculture

Code table 4.212: Land use (*continued*)

<i>Code figure</i>	<i>Meaning</i>
3	Range land
4	Deciduous forest
5	Coniferous forest
6	Forest/wetland
7	Water
8	Wetlands
9	Desert
10	Tundra
11	Ice
12	Tropical forest
13	Savannah
14-191	Reserved
192-254	Reserved for local use
255	Missing

Code table 4.213: Soil type

<i>Code figure</i>	<i>Meaning</i>
0	Reserved
1	Sand
2	Loamy sand
3	Sandy loam
4	Silt loam
5	Organic (redefined)
6	Sandy clay loam
7	Silt clay loam
8	Clay loam
9	Sandy clay
10	Silty clay
11	Clay
12-191	Reserved
192-254	Reserved for local use
255	Missing

CODE AND FLAG TABLES USED IN SECTION 5

Code table 5.0: Data representation template number

<i>Code figure</i>	<i>Meaning</i>
0	Grid point data — simple packing
1	Matrix value — simple packing
2	Grid point data — complex packing
3	Grid point data — complex packing and spatial differencing
4	Spectral data — simple packing
5	Spectral data — complex packing
6-191	Reserved
192-254	Reserved for local use
255	Missing

Code table 5.1: Type of original field values

<i>Code figure</i>	<i>Meaning</i>
0	Floating point
1	Integer
2-191	Reserved
192-254	Reserved for local use
255	Missing

Code table 5.2: Matrix coordinate value function definition

<i>Code figure</i>	<i>Meaning</i>
0	Explicit coordinate values set
1	Linear coordinates $f(1)=C1$ $f(n)=f(n-1)+C2$
2-10	Reserved
11	Geometric coordinates $f(1)=C1$ $f(n)=C2*f(n-1)$
12-191	Reserved
192-254	Reserved for local use
255	Missing

Code table 5.3: Matrix coordinate parameter

<i>Code figure</i>	<i>Meaning</i>
1	Direction degrees true
2	Frequency (s^{-1})
3	Radial number ($2\pi/\lambda$) (m^{-1})
4-191	Reserved
192-254	Reserved for local use
255	Missing

Code table 5.4: Group splitting method

<i>Code figure</i>	<i>Meaning</i>
0	Row by row splitting
1	General group splitting
2-191	Reserved
192-254	Reserved for local use
255	Missing

Code table 5.5: Missing value management for complex packing

<i>Code figure</i>	<i>Meaning</i>
0	No explicit missing values included within data values
1	Primary missing values included within data values
2	Primary and secondary missing values included within data values
3-191	Reserved
192-254	Reserved for local use
255	Missing

Code table 5.6: Order of spatial differencing

<i>Code figure</i>	<i>Meaning</i>
0	Reserved
1	First-order spatial differencing
2	Second-order spatial differencing
3-191	Reserved
192-254	Reserved for local use
255	Missing

Code table 5.7: Precision of floating-point numbers

<i>Code figure</i>	<i>Meaning</i>
0	Reserved
1	IEEE 32-bit (I=4 in Section 7)
2	IEEE 64-bit (I=8 in Section 7)

Code table 5.7: Precision of floating-point numbers (*continued*)

<i>Code figure</i>	<i>Meaning</i>
3	IEEE 128-bit (I=16 in Section 7)
4-254	Reserved
255	Missing

CODE AND FLAG TABLES USED IN SECTION 6**Code table 6.0**

<i>Code figure</i>	<i>Meaning</i>
0	A bit map applies to this product and is specified in this section
1-253	A bit map pre-determined by the originating/generating centre applies to this product and is not specified in this section
254	A bit map defined previously in the same GRIB message applies to this product
255	A bit map does not apply to this product

RECOMMENDATION 6 (CBS-XII)**AMENDMENTS TO THE *MANUAL ON THE GLOBAL DATA-PROCESSING SYSTEM*
(WMO-No. 485)**

THE COMMISSION FOR BASIC SYSTEMS,

NOTING:

- (1) The report of the meeting of the CBS Expert Team on Emergency Response and Related Activities (September 1999),
- (2) The report of the meeting of the CBS Expert Team to Review and Fine-tune Methods Used in the Land Surface Data Quality Monitoring by Lead Centres and the Exchange of Results (June 2000),
- (3) The *Manual on the Global Data-processing System* (WMO-No. 485),

CONSIDERING:

- (1) That there is a need, in the light of experience, to update further current procedures for provision of transport model products for environmental emergency response,

- (2) That there is a need to clarify further methods used in land surface data quality monitoring,

RECOMMENDS that the amendments to the *Manual on the Global Data-processing System*, Appendix I-3, Appendix II-7 and Attachment II.8, given in the annexes to this recommendation, be adopted for inclusion in the *Manual on the Global Data-processing System* to take effect from 1 July 2001;

REQUESTS the Secretary-General to make appropriate changes, as given in the annexes to this recommendation, in the *Manual on the Global Data-processing System*;

AUTHORIZES the president of CBS, in consultation with the Secretary-General to make any consequential purely editorial amendments with respect to the *Manual on the Global Data-processing System*.

ANNEX 1 TO RECOMMENDATION 6 (CBS-XII)**APPENDIX I-3****REGIONAL AND GLOBAL ARRANGEMENTS FOR THE PROVISION OF TRANSPORT MODEL PRODUCTS FOR ENVIRONMENTAL EMERGENCY RESPONSE
SUPPORT FOR NUCLEAR ENVIRONMENTAL EMERGENCY RESPONSE****Notification of WMO**

In accordance with the IAEA Convention on Early Notification of Nuclear Accidents, the IAEA shall notify the WMO Secretariat and the RTH Offenbach

(Germany) of an accident occurrence and/or whether emergency meteorological support is required. RTH Offenbach will put the EMERCON message on the GTS in the form of an alphanumeric bulletin in plain-text

English language under the abbreviated heading WNXX01 IAEA for global distribution to the NMCs and RSMCs (see also the WMO *Manual on the Global Telecommunication System*, WMO-No. 386).

For an IAEA-notified emergency for which emergency meteorological support was requested, the IAEA shall send a timely message to the RSMCs, the WMO Secretariat and the RTH Offenbach informing that the IAEA no longer requires emergency meteorological support. RTH Offenbach will put the EMERCON message on the GTS in the form of an alphanumeric bulletin in plain-text English language under the abbreviated heading WNXX01 IAEA for global distribution to the NMCs.

Regional arrangements

The RSMCs designated by WMO for the provision of atmospheric transport model products for nuclear environmental emergency response shall:

1. Provide products only when either the Delegated Authority¹ of any country in the RSMC region of responsibility or the IAEA, requests RSMC support. Upon receipt of a request from the Delegated Authority² or from the IAEA, the RSMC shall provide basic information to the national Meteorological Service of that country or to the IAEA, respectively.
2. Upon receipt of a first request for services related to a nuclear incident and, in the absence of a prior notification by the IAEA, inform the WMO Secretariat, all designated RSMCs and the IAEA of the request.
3. For an IAEA notified emergency, distribute the basic products to the IAEA and all national Meteorological Services in the Region³. For a request for services without notification by IAEA, basic information provided to the national Meteorological Service of the requesting country will not be disclosed to the public in that country nor distributed by the RSMCs to other national Meteorological Services.
4. Provide, on request, support and advice to the IAEA and WMO Secretariats in the preparation of public and media statements.
5. Determine the standard set of products and the method of delivery in consultation with users and the IAEA.

6. Provide product interpretation guidelines to users.
7. Provide support and technology transfer to national and regional meteorological centres that want to become designated RSMCs.
8. Make arrangements to provide backup services. These would normally be between the two designated centres in a Region. Interim arrangements should be made by centres in regions with a single designated RSMC.

Global arrangements

Until such time as new RSMCs have been designated, it is proposed that Regional Association VI-designated RSMCs be responsible for providing services for radiological emergencies to Regional Association I; Regional Association IV-designated RSMCs be responsible to provide services to Regional Association III; while the Regional Association V-designated RSMC, in collaboration with Regional Association IV-designated RSMCs, will be responsible to provide services to Regional Association V.

In cases of radiological emergencies where coordination is required between RSMCs of different Regions, the RSMCs of the Region where the emergency has occurred will provide this coordination.

Support for non-nuclear environmental emergency response

If support is required for response to a non-nuclear environmental emergency related to atmospheric transport of pollutants, the Permanent Representative with WMO of the affected country may direct its request for support to the operational contact point of the designated RSMC(s) for its Regional Association.

1. Due to the potentially broad range of environmental emergencies, the RSMC shall consider each request with regard to its capabilities and the suitability of its products to address the emergency requirements and will then respond accordingly.
2. The RSMC shall inform all other designated RSMCs and the WMO Secretariat of the request and the agreed actions.

1 The person authorized by the Permanent Representative of the country to request RSMC support.

2 The RSMC products will be provided to the NMS Operational Contact Point designated by the Permanent Representative.

3 The basic information will normally be provided by the NMS to the IAEA national contact point.

ANNEX 2 TO RECOMMENDATION 6 (CBS-XII)

APPENDIX II-7

STANDARDS IN THE PROVISION OF INTERNATIONAL SERVICES BY RSMCs FOR NUCLEAR ENVIRONMENTAL EMERGENCY RESPONSE

The Delegated Authority requests for WMO RSMC support for atmospheric transport modelling products by using the form entitled "Environmental Emergency Response Alert — Request for WMO RSMC Support by Delegated Authority". The Delegated Authority then sends the completed form immediately to the RSMCs as per regional and global arrangements.

The designated RSMCs shall implement agreed standard procedures and products by:

- (a) The adoption of the following common default source parameters for the initial run of the transport/dispersion models;
- (b) The provision of the following standard set of basic products within two to three hours of reception of a request and according to the general rules for displaying results;
- (c) The adoption of the following forecast periods for the numerical calculations;
- (d) The adoption of a joint response approach;
- (e) The adoption of the general rules for displaying results.

1. Default source parameters for the initial run¹

- (a) Uniform vertical distribution up to 500 m above the ground;
- (b) Uniform emission rate during six hours;
- (c) Starting time 0000 or 1200 UTC if not known;
- (d) Total pollutant release 1 Bq (Becquerel) over six hours;
- (e) Type of radionuclide ¹³⁷Cs.

2. Standard set of products for initial response

Five maps consisting of:

- (a) Three-dimensional trajectories starting at 500, 1 500 and 3 000 m above the ground, with particle locations at six-hour intervals (main synoptic hours up to the end of the dispersion model forecast);
- (b) Time-integrated airborne concentrations within the layer 500 m above the ground, in Bq s m⁻³ for each of the three forecast periods;
- (c) Total deposition (wet + dry) in Bq m⁻² from the release time to the end of the dispersion model forecast.

3. Forecast periods for numerical calculations

The initial set of products will cover the period from T, the start time of the release, through a forecast of 72 hours from t, the start time of the current output from the operational NWP model.

The first 24-hour period for integrated exposures in the dispersion model will start at the nearest synoptic time (0000 or 1200 UTC) prior to or equal to T. Subsequent 24-hour integrations of the dispersion model will be made up to, but not exceeding, the synoptic time nearest to t+72.

If T is earlier than t, then the first response will use hindcasts to cover the period up to t.

4. Joint response and joint statements

A joint response means that the two collaborating RSMCs shall immediately inform each other of any request received; initially, both should produce and send the standard set of products (charts) independently and then move rapidly towards providing fully coordinated response and services for the duration of the response. Following the initial response, the RSMCs shall develop, provide and update, as required, a "joint statement" to describe a synopsis of the current and forecast meteorological conditions over the area of concern, and the results from the transport models, their differences and similarities and how they apply to the event.

5. General rules for displaying results

In order to make the interpretation of the maps easier, the producing centres should adopt the following guidelines:

General guidelines for all maps:

- (a) Provide labelled latitude and longitude lines at 10° intervals and sufficient geographic map background (shore lines, country borders, etc.) to be able to locate precisely the trajectories and contours;
- (b) Indicate the source location with a highly visible symbol (●, ▲, ✕, *, ■, etc.);
- (c) Indicate the source location in decimal degrees² (latitude — N or S specified, longitude — E or W specified, plotting symbol used), date/time of release (UTC), and the meteorological model initialization date/time (UTC);

¹ This concept is based on the understanding that the first (initial) run of the transport/dispersion models needs to be carried out with default parameters because little or no information (except location and accident time) will be available to the RSMC at this early stage. RSMCs are, however, requested to conduct subsequent model runs with more realistic parameters as they become available. This may, for example, refer to a more precise assumption of the vertical distribution or the need to conduct a model run for the release of noble gases.

² Change request form to "decimal degrees".

- (d) Each set of maps should be uniquely identified by at least product issue date and time (UTC) and issuing centre;
- (e) Previously transmitted products from the dispersion model need not be re-transmitted;
- (f) Indicate with a legend if this is an exercise, requested services, or an IAEA notified emergency.

Specific guidelines for trajectories map:

- (a) Distinguish each trajectory (500, 1 500, 3 000 m) with a symbol (▲, ●, ■, etc.) at synoptic hours (UTC);
- (b) Use solid lines (darker than map background lines) for each trajectory;
- (c) Provide a time-height (m or hPa) diagram, preferably directly below the trajectory map, to indicate vertical movement of trajectory parcels.

Specific guidelines for concentration and deposition maps:

- (a) Adopt a maximum of four concentration/deposition contours corresponding to powers of 10;
- (b) A legend should indicate that contours are identified as powers of 10 (i.e. $-12 = 10^{-12}$). If grey-shading is used between contours, then the individual contours must be clearly distinguishable

after facsimile transmission and a legend provided on the chart;

- (c) Use solid dark lines (darker than map background lines) for each contour;
- (d) Indicate the following input characteristics: (i) source assumption (height, duration, isotope, amount released); (ii) the units of time integrated concentration ($Bq\ s\ m^{-3}$) or deposition ($Bq\ m^{-2}$). In addition, charts should specify: (i) "Time integrated surface to 500 m layer concentrations"; (ii) "Contour values may change from chart to chart", and if the default source is used; (iii) "results based on default initial values";
- (e) Indicate, if possible, the location of the maximum concentration/deposition with a symbol on the map and include a legend indicating the symbol used and the maximum numerical value;
- (f) Indicate the time integration starting and ending date/time (UTC).

The RSMCs will normally provide the products in the ITU-T T4 format suitable for both group 3 facsimile machines and transmission on parts of the GTS. The RSMC may also make use of other appropriate technologies.

ENVIRONMENTAL EMERGENCY RESPONSE ALERT

REQUEST FOR WMO RSMC SUPPORT BY DELEGATED AUTHORITY

This form should be sent by fax to the RSMC. At the same time, the Delegated Authority must immediately call the RSMC to confirm the transmission of this request for RSMC support

(This section must be completed in full)

STATUS:	(EVENT OR EXERCISE)	Date/time of request:	(UTC)
NAME OF DELEGATED AUTHORITY:			
COUNTRY:			
DELEGATED AUTHORITY TELEPHONE/FAX NUMBERS:		(.....)	(Tel)
		(.....)	(Fax)
REPLY TELEPHONE/FAX NUMBERS FOR NMS OF REQUESTING COUNTRY:		(.....)	(Tel)
		(.....)	(Fax)
NAME OF RELEASE SITE:		(facility and place)	
GEOGRAPHICAL LOCATION OF RELEASE:		(lat./long. decimal degrees N or S; E or W)	

(essential accident information for model simulation — if not available, model will execute with standard default values)

RELEASE CHARACTERISTICS:

START OF RELEASE: (date/time, UTC)

DURATION: (hours), or end of release (date/time, UTC)

RADIONUCLIDE SPECIES:

TOTAL RELEASE QUANTITY: (Becquerel)

OR POLLUTANT RELEASE RATE: (Becquerel/hour)

EFFECTIVE HEIGHT OF RELEASE: Surface: or Stack height: (m), or Aloft: top (m), base (m)

(helpful information for improved simulation)

SITE ELEVATION: (m)

LOCAL METEOROLOGICAL CONDITIONS NEAR ACCIDENT:

..... (wind speed and direction/weather/cloudiness, etc.)

OTHER INFORMATION:

..... (nature of accident, cause, fire explosion, controlled release, foreseeable development, normal activity, projected conditions, etc.)

(to be completed by RSMC)

DATE/TIME OF RECEIPT OF REQUEST: (UTC)

DATE/TIME OF RETURN CONFIRMATION OF RECEIPT: (UTC)

NOTE: All times in UTC.

ANNEX 3 TO RECOMMENDATION 6 (CBS-XII)

ATTACHMENT II.8

PROCEDURES AND FORMATS FOR THE EXCHANGE OF MONITORING RESULTS

Add the following text after paragraph 3.1.1 and before the NOTES:

3.1.2 List 2: GEOPOTENTIAL HEIGHT

Element: Geopotential height, from surface synoptic observations or derived from station-level pressure, temperature and published station elevations at 0000, 0600, 1200 or 1800 UTC compared to the first-guess field of a data assimilation model (usually a six-hour forecast).
Number of observations: at least five for at least one observation time, without distinguishing between observation times.

One or more of the following:

Absolute value of the mean bias 25 m

Standard deviation 35 m

Percentage gross error 20 per cent (gross error limit: 100 m).

3.1.3 PRECIPITATION

General guidance reflecting Global Precipitation Climatology Centre (GPCC) procedures for precipitation quality monitoring is given in section 6.3.3.1 of the *Guide on the Global Data-processing System*.

RECOMMENDATION 7 (CBS-XII)

DESIGNATION OF A REGIONAL SPECIALIZED METEOROLOGICAL CENTRE (RSMC) ON TROPICAL CYCLONES

THE COMMISSION FOR BASIC SYSTEMS,

NOTING:

- (1) The requirements stated by RA V for cyclone warnings and forecasts in the central Pacific Ocean, north of the Equator from 180°W to 140°W, and the objectives and implementation, in connection with the Tropical Cyclone Programme, as stated in the Fifth WMO Long-term Plan (WMO-No. 908),
- (2) Appendix I-2 of the *Manual on the Global Data-processing System* (WMO-No. 485) — Procedures for broadening the functions of existing RSMCs and for designation of new RSMCs,

CONSIDERING that the Meteorological Centre in Honolulu, Hawaii (United States) provides tropical cyclone forecasts and advisory services on an operational basis and has fulfilled the relevant designation procedures for new RSMCs,

RECOMMENDS that the Meteorological Centre in Honolulu, Hawaii (United States), be designated as an RSMC with activity specialization in tropical cyclone analysis tracking and forecasting with effect from 1 July 2001;

REQUESTS:

- (1) The Member operating the designated RSMC to make available its specialized products, as required, to Members concerned on a regional basis and to coordinate such activities with the relevant Programmes of WMO;
- (2) The Secretary-General to arrange for the inclusion of the newly designated RSMC and the outline of its specialized functions in the *Manual on the Global Data-processing System* as soon as the Executive Council has approved this recommendation.

RECOMMENDATION 8 (CBS-XII)

REVIEW OF RESOLUTIONS OF THE EXECUTIVE COUNCIL BASED ON PREVIOUS RECOMMENDATIONS OF THE COMMISSION FOR BASIC SYSTEMS OR RELATED TO THE WORLD WEATHER WATCH

THE COMMISSION FOR BASIC SYSTEMS,

NOTING with satisfaction the action taken by the Executive Council on the previous recommendations of the Commission for Basic Systems or related to the WWW in general,

CONSIDERING that some of the previous Executive Council resolutions are still valid,

RECOMMENDS that the following Executive Council resolutions be kept in force:

Resolutions 1 and 2 (EC-XXXVI) and 5 (EC-XLII).

ANNEXES

ANNEX I

Annex to paragraphs 6.1.14, 6.2.35, 6.2.40, 6.2.48, 6.2.64 and 6.4.6 of the general summary

FIGURES FROM GENERAL SUMMARY PARAGRAPHS

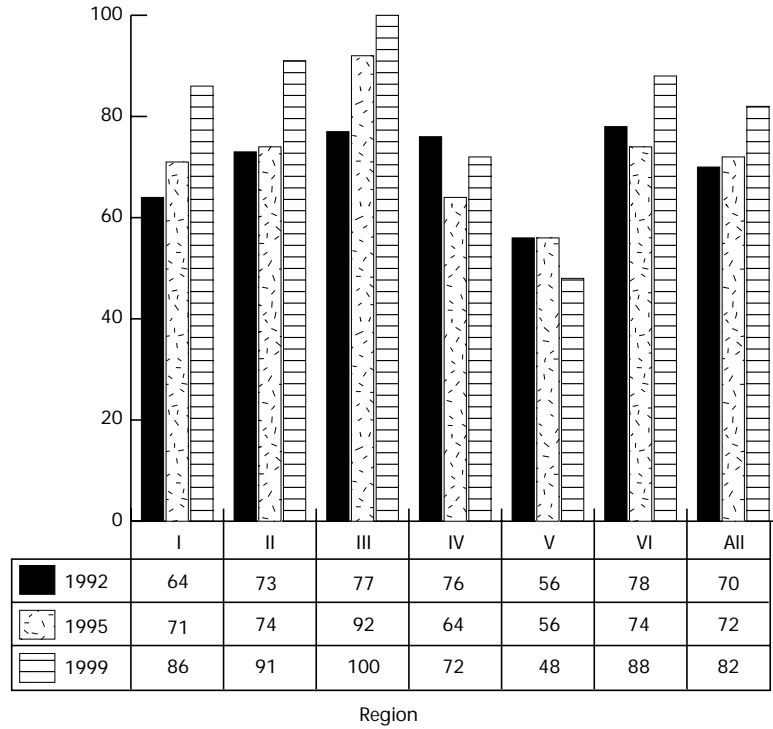

Figure 1 — WWW implementation goals: percentage of Members with at least one polar-orbiting and one geostationary receiver (general summary paragraph 6.1.14).

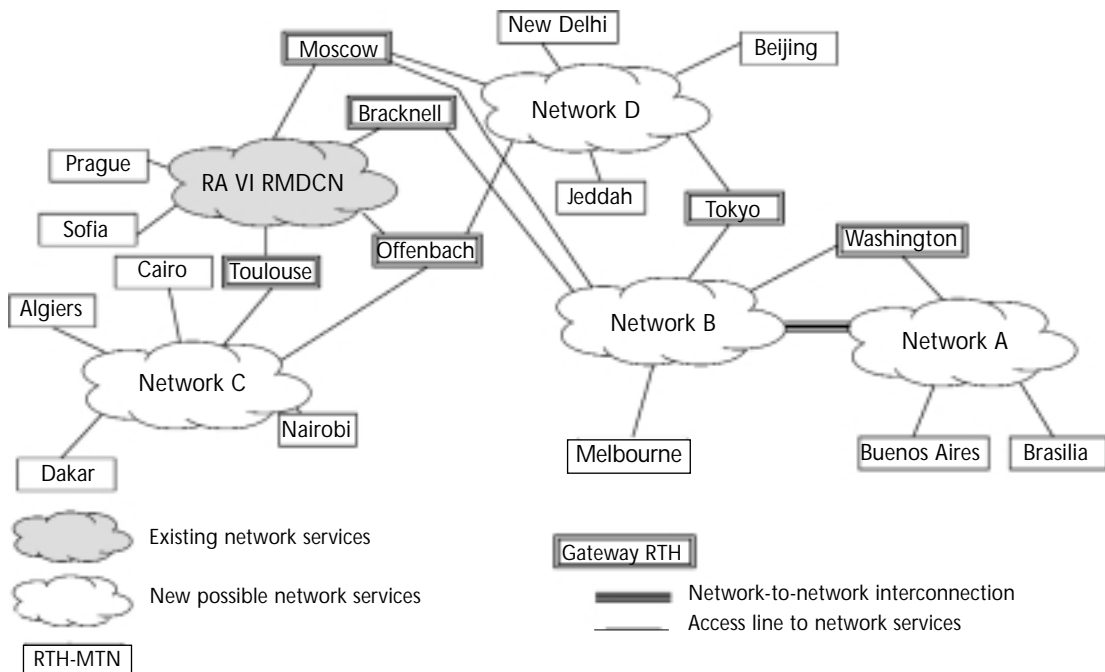

Figure 2 — The IMTN, Phase II: example of possible implementation of the MTN — use of data communication network services (general summary paragraph 6.2.35).

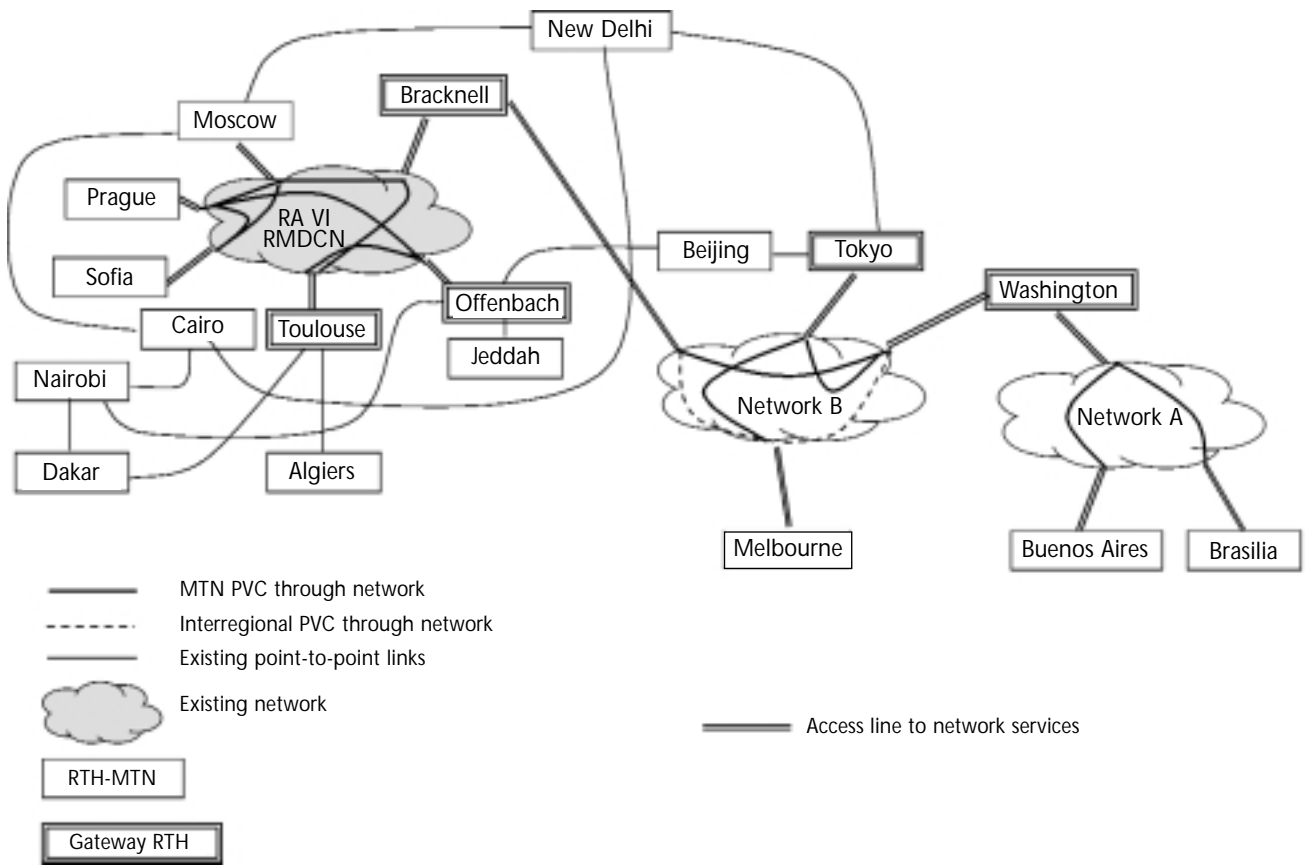

Figure 3 — The IMTN, Phase I: example of possible implementation of the MTN — mixed use of data communication network services and point-to-pint circuits (general summary paragraph 6.2.40).

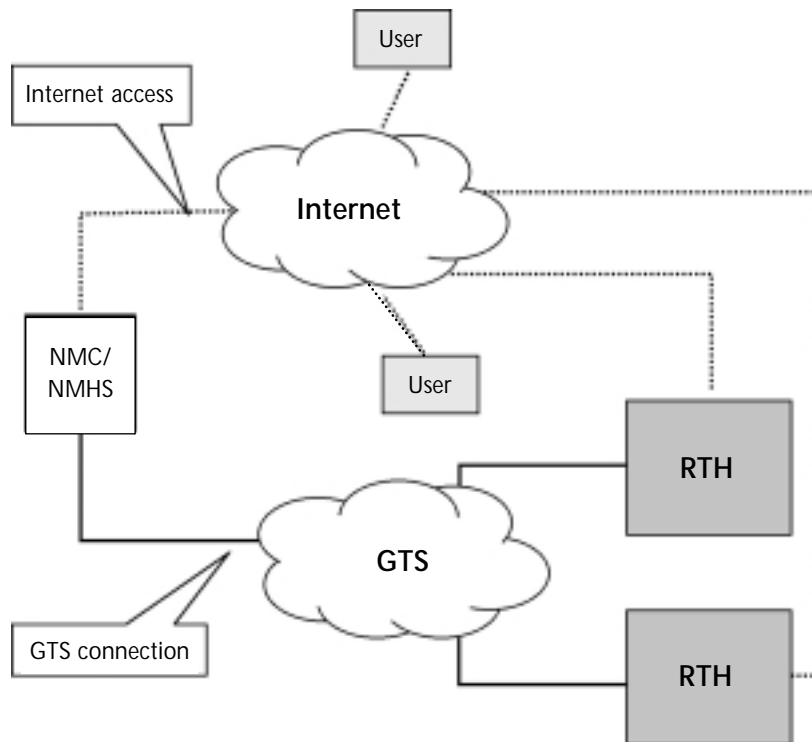

Figure 4 — Schematic view of data communication network accesses for NMHSs (general summary paragraph 6.2.48).

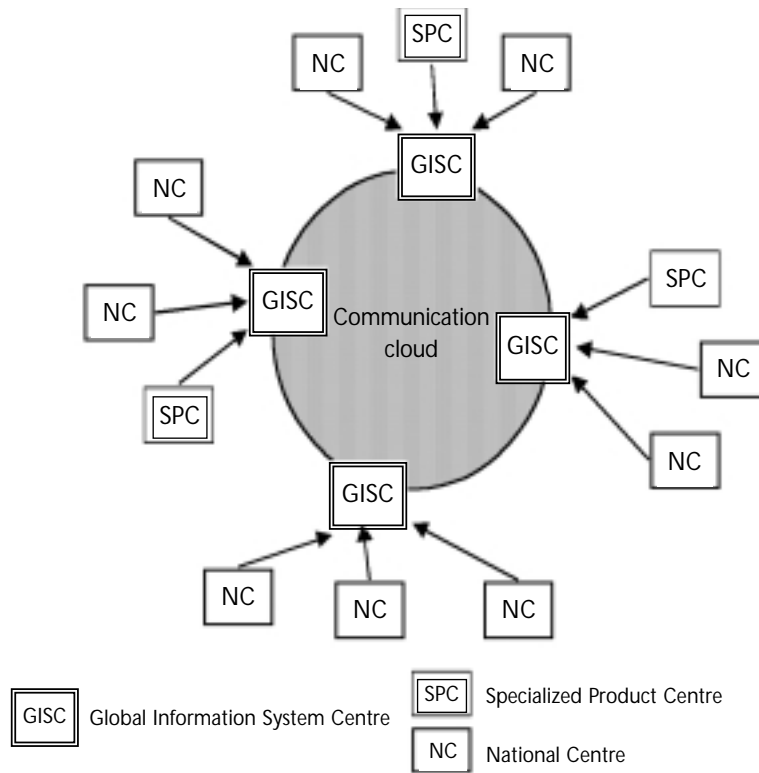

Figure 5(a) — Data and product collection (general summary paragraph 6.2.64).

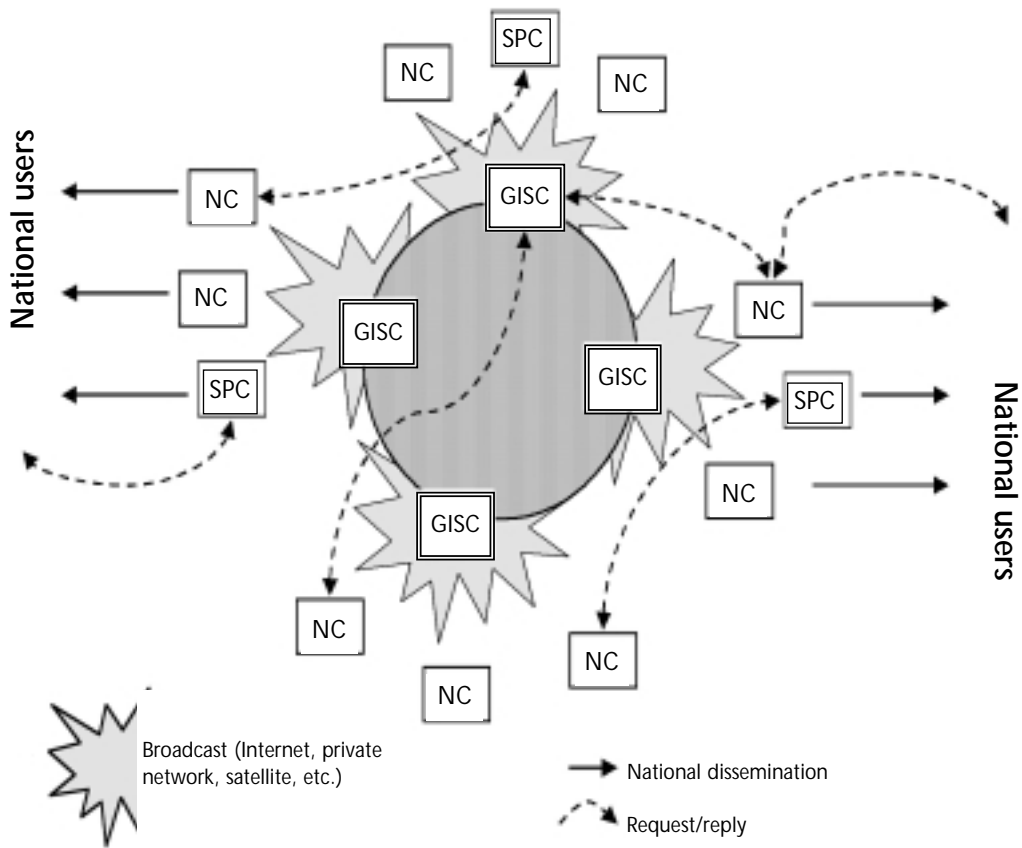

Figure 5(b) — Data and product distribution (general summary paragraph 6.2.64).

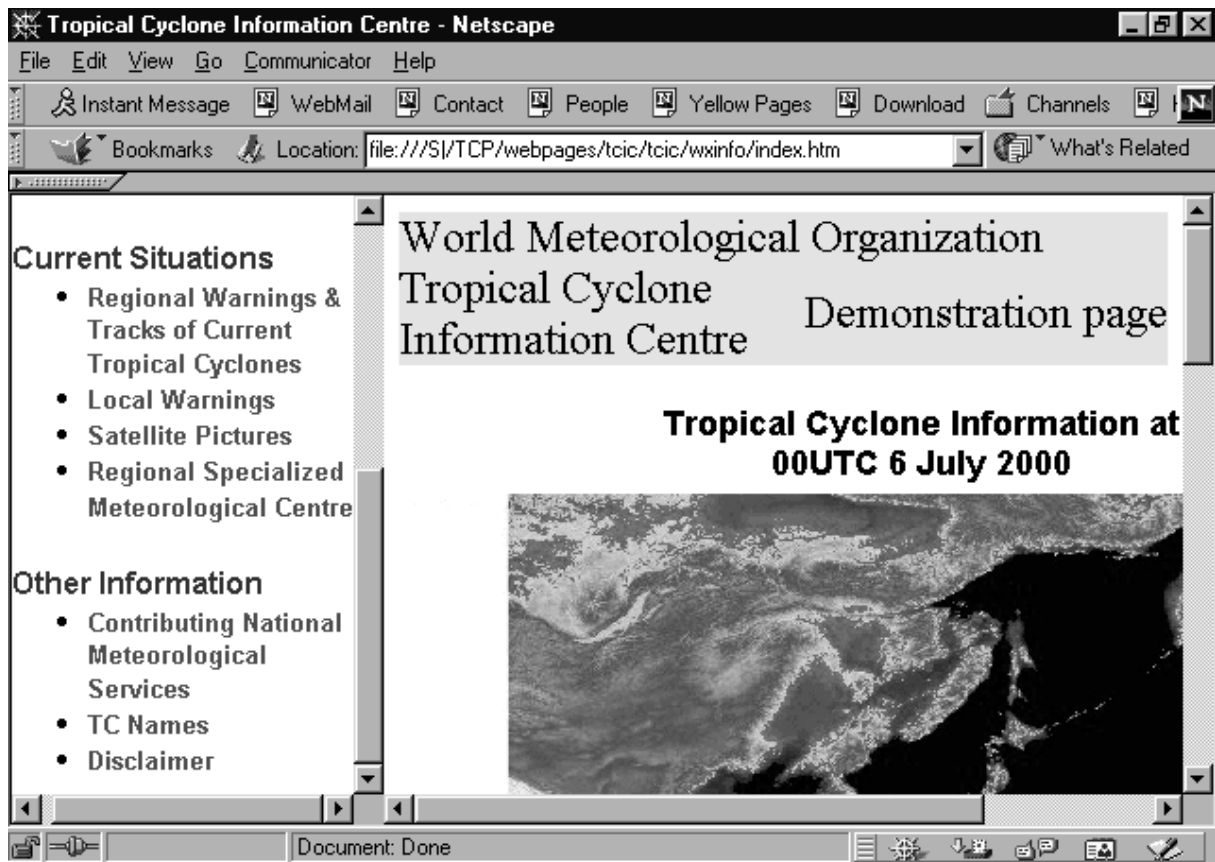

Figure 6 — Prototype of a Web page on tropical cyclone warnings in the ESCAP/WMO Typhoon Committee Region (general summary paragraph 6.4.6).

ANNEX II

Annex to paragraph 6.2.4 of the general summary

**SATELLITE DATA DISTRIBUTION SERVICE VIA THE UNITED KINGDOM
SATELLITE FACILITY (UKSF)**

The Commission was informed by the United Kingdom of an important milestone in the provision of a satellite distribution service in support of the WWW. Bulletins are now being carried out by the United Kingdom Satellite Facility (UKSF), as originally offered at CBS-XI. The selection of bulletins (initially about 6 000 per day) is based on the needs of Region II. The next step is for a small group of NMHSs to have their existing receiving equipment modified, in line with the agreed pilot project to Region II. It was emphasized that the UKSF is

intended to supplement the link between an NMC and its RTH for the GTS in Region II. RTH Bracknell will liaise with GTS centres in Region II to optimize the contents of the broadcast. The footprint of UKSF is the same as that of SADIS, covering Region I and Region VI, as well as most of Region II. Access to UKSF is only open to users authorized by the NMHS in the country concerned; the United Kingdom will only enable use once it has been authorized by the relevant NMHS.

ANNEX III

Annex to paragraph 6.2.56 of the general summary

INTEGRATED WORLD WEATHER WATCH MONITORING

1. Continuous real-time quantity monitoring

1.1 In order to ensure that all operational data are collected and transmitted over the GTS, many Members conduct real-time monitoring in accordance with the current plan for monitoring the operation of the WWW. However, some Members are not currently conducting monitoring at this level. Standard procedures and formats of reports of real-time operational monitoring have not been defined. To assist Members that are not yet conducting this monitoring, procedures for conducting real-time operational monitoring have been proposed as part of the integrated WWW monitoring.

2. Quarterly WWW monitoring

Monitoring periods

2.1 Monitoring should be conducted four times per year for the following periods:

1-15 February

1-15 April

1-15 July

1-15 October

February has been selected rather than January to conform to the current requirements for Antarctic monitoring. The possibility of moving the February monitoring to January should be investigated.

Types of data to be monitored

2.2 Table A lists all the observational data types that should be monitored, together with the associated T_1T_2 of the abbreviated header line (AHL) and the data type indicator to be used in the construction of names of report files. Note that observational data in BUFR format also needs to be monitored, since data in this format is now being transmitted.

Table A - Data subject to monitoring and corresponding report file data type indicators

<i>Type of data</i>	T_1T_2	<i>Data type indicator</i>
SYNOP	SM, SI, SN	SY
TEMP part A	US	TT
PILOT part A	UP	PP
CLIMAT	CS	CL
CLIMAT TEMP	CU	CT
SHIP	SM, SI	SH
SHIP TEMP	US	TS
SHIP PILOT	UP	PS
BUOY	SS	BU
BATHY, TESAC,	SO	BT
TRACKOB, WAVEOB		
AIREP (CODAR)	UA	AI
AMDAR	UD	AM
BUFR aircraft reports	IUA	BA
BUFR wind profiler	IUP	BP
Other BUFR data	All observational data transmitted in BUFR (except radar and satellite)	To be allocated as required

NOTES:

- (1) Land-based and ocean-based data need to be separated by use of the geographic designator A_1A_2 of the AHL.
- (2) At first, monitoring will be limited to Part A of TEMP and PILOT reports. However, it is recommended that this be expanded to include Parts B, C and D as resources permit.

Monitoring reports

2.3 To participate in the integrated WWW monitoring, each NMC and every RTH should compile reports four times per year, once for each monitoring period. The reports should be transmitted to the receiving centre as text format data files grouped by data type. For the NMC and RTH quarterly monitoring, described later in this section, the names of the files should consist of month (two digits), year (two digits), NMC or RTH (CCCC), data type indicator (two characters, see Table A) with an extension of TXT. The details of the file names and formats for the special MTN monitoring are described in section 2.8.

2.4 The contents of the quarterly monitoring reports must necessarily depend upon the data type as follows:

- (a) SYNOP — number of reports available within 60 minutes after the observation time and the total available;
- (b) Part A of TEMP and PILOT — number of reports available within 120 minutes after the main synoptic hours (0000, 0600, 1200 and 1800 UTC) and the total available;
- (c) BUOY, BATHY, TESAC, TRACKOB, WAVEOB, AIREP and AMDAR — number of bulletins and reports compiled from 2100 to 0259 UTC, 0300 to 0859 UTC, 0900 to 1459 UTC and 1500 to 2059 UTC;
- (d) SHIP, TEMP SHIP, PILOT SHIP — number of bulletins and reports available for each observation time;
- (e) CLIMAT and CLIMAT TEMP — station identifiers for all relevant stations and an indication of whether or not they were available during the monitoring period;
- (f) BUFR — report content should be based upon the type of data contained in the message.

2.5 NMC quarterly monitoring

2.5.1 Real-time operational monitoring of the data exchanged between NMCs and their responsible RTHs should be conducted. At the end of each of the four periods of the integrated WWW monitoring periods, each NMC should provide reports on the observational data available at the centre during the monitoring period (first 15 days of the month). If an NMC prefers it can send reports based on the summaries it had prepared for the AGM (but run four times per year). The reports, in digital format, should be forwarded to the centre's responsible RTH as soon as possible, preferably within 10 days.

2.5.2 The report should be based on the information collected in the real-time quantity monitoring (see paragraph 1.1 above).

2.5.3 Each report shall consist of a number of data lines organized into files defined by data type and formatted, as given below. All fields would be surrounded by double-quotation marks (“”) and separated by commas.

- (a) SYNOP — Each data line would consist of the station index number, hour UTC, number of reports available within 60 minutes, and total number of reports available;
- (b) TEMP and PILOT — Each data line would consist of the station index number, hour UTC, number of

reports available within 120 minutes, and total number of reports available;

- (c) BUOY, BATHY, TESAC, TRACKOB, WAVEOB, AIREP and AMDAR — Monitoring reports should list the number of bulletins and reports compiled from 2100 to 0259 UTC, 0300 to 0859 UTC, 0900 to 1459 UTC and 1500 to 2059 UTC with one data line per time period;
Each data line would consist of the abbreviated header, ending hour UTC of time period, and number of bulletins available, and number of reports available;
- (d) SHIP, TEMP SHIP, PILOT SHIP — Each data line would consist of the abbreviated header, hour UTC, number of bulletins available, and number of reports available;
- (e) CLIMAT, CLIMAT TEMP — Each data line would consist of station index number and an indicator of whether the report is available at the NMC (0 = yes, 1 = no);
- (f) BUFR — Format appropriate to the type of data in the report (e.g. reports of BUFR aircraft observations will be in the format as described in (c) above).

2.6 RTH quarterly monitoring

2.6.1 Four times per year every RTH, including RTHs on the MTN, should provide monitoring reports on the availability of observations within its area of responsibility. The reports should list the number of observations reported as available by the associated NMCs in their quarterly reports (defined in section 2.5) compared with the number of observations received at the RTH during the monitoring period. The reports should be sent to the Secretariat and to the RTH's associated RTH on the MTN as quickly as possible, preferably within 10 days.

2.6.2 Each report shall consist of a number of data lines organized into files defined by data type and formatted as given below. All fields would be surrounded by double-quotation marks (“”) and separated by commas.

- (a) SYNOP — Each data line would consist of the station index number, hour UTC, number of reports reported as available by the NMC within 60 minutes, total number of reports reported as available by the NMC, number of reports received by the RTH within 60 minutes, and total number of reports received by the RTH;
- (b) TEMP and PILOT — Each data line would consist of the station index number, hour UTC, number of reports reported as available by the NMC within 120 minutes, total number of reports reported as available by the NMC, number of reports received by the RTH within 120 minutes, and total number of reports received by the RTH;
- (c) BUOY, BATHY, TESAC, TRACKOB, WAVEOB, AIREP and AMDAR — Reports containing the number of bulletins and reports compiled from 2100 to 0259 UTC, 0300 to 0859 UTC, 0900 to 1459 UTC and 1500 to 2059 UTC with one data line per time period;
Each data line would consist of the abbreviated header, ending hour UTC of time period, number of

bulletins reported as available by the NMC, number of reports reported as available by the NMC, number of bulletins received by the RTH, and number of reports received by the RTH;

- (d) SHIP, TEMP SHIP, PILOT SHIP — Each data line would consist of the abbreviated header, hour UTC, number of bulletins reported as available by the NMC, number of reports reported as available by the NMC, number of bulletins received by the RTH, and number of reports received by the RTH;
- (e) CLIMAT, CLIMAT TEMP — Each data line would consist of the station index number and indicators of whether the report is available at the NMC and at the RTH;
- (f) BUFR — Format appropriate to the type of data in the report.

2.7 RTH/MTN quarterly monitoring

In addition to the RTH quarterly monitoring reports produced by every RTH, it is recommended that RTHs on the MTN that do not participate in the SMM (described below) also produce a report on all of the data received at their centre and pass these reports to the WMO Secretariat for comparison with other MTN centres. The report should monitor all data of all of the types listed in Table A that are received at the RTH. The formats and file names of the reports should conform to those defined for the NMC quarterly reports in section 2.5.

2.8 Special MTN monitoring (SMM)

2.8.1 The SMM involves the collection of raw data files by several RTHs on the MTN. It is recommended that there be at least one MTN centre from each Region participating. It is hoped that the centres currently involved in the SMM would continue to participate and that additional MTN centres in Regions III and IV agree to participate. Furthermore, additional MTN centres that are prepared to collect data on a global basis are encouraged to participate in the SMM.

2.8.2 All bulletins, with indicators *ii* = 01–39, matching the data types given in Table A, should be monitored by each centre. This is a modification to the current SMM, where only certain centres monitor certain data types. It is proposed that all centres monitor all of the data types specified in Table A. All bulletins containing observations designated as “additional” as defined in Resolution 40 (Cg-XII) — WMO policy and practice for the exchange of meteorological and related data and products including guidelines on relationships in commercial meteorological activities, should be included in the monitored data set regardless of their *ii*.

The set of collected messages (“raw data”)

2.8.3 The format of the messages should be in international alphabet No. 5. The complete message, including the starting line, the abbreviated header, the text and the end-of-message signal should be included. The raw data files should be grouped by data type. Some data types will result in very large datasets, for example

15 days of synoptic data will be in excess of 50Mb. Such data types should be subdivided into daily sets of data.

2.8.4 The raw data files should be sent to the WMO FTP server and should also be stored on the monitoring centre’s FTP server. However some MTN centres may not be able to comply with this requirement but may still wish to be involved in the monitoring. One method to facilitate participation of such centres would be for the MTN centre to provide access by WMO to the centres raw data on an FTP server. The format and method of transfer of the data would need to be arranged bilaterally between the MTN centre and the WMO Monitoring Unit. It must be emphasized that all bulletins need to be available for access, including bulletins designated as “additional” as defined in Resolution 40 (Cg-XII).

Pre-analysis files

2.8.5 One of the key features of the SMM is that the sets of raw bulletins provided by the participating MMCs are analysed in a standard and consistent manner. In the current SMM, several MTN centres have offered assistance by preparing the report files from the individual raw data files collected by the various MMCs. This feature has helped to eliminate discrepancies in the availability of the data reported in previous monitoring efforts, such as the AGM, that were due to differences in the monitoring procedures implemented in different centres.

2.8.6 Extraction of the reports from the raw data bulletins requires considerable software. This software is based on decoder software similar to that used by many Members in their message switching systems. It is not possible for the WMO Monitoring Unit to develop this software itself, and it will therefore be necessary for the WMO Secretariat to solicit assistance from MTN centres to prepare the pre-analysis report files from the sets of raw data provided by the MMCs. This is the current situation with the SMM. The centres currently involved in preparing these pre-analysis report files are shown in Table B. It will be necessary to solicit assistance from other MTN centres in the preparation of pre-analysis of data types currently not being processed. In particular, it will be necessary to extract the observational data from the raw BUFR files. It is hoped an MTN centre will be able to assist with this task.

2.8.7 The resultant report files, one for each of the 14 data types, will constitute a unique reference set for each type of data, and will be able to be used for analysis at the report and bulletin level by the Secretariat, and also at the bulletin level by centres who would like to be involved and who wish to assist WMO in this activity.

3. Analyses and reports of the Integrated WWW Monitoring

3.1 The Secretariat should prepare the lists of those “additional” bulletins and the lists of the stations included in those bulletins. Those lists will be used as the reference lists for the analysis of the monitoring results. A report showing the availability of the “additional” bulletins including SYNOP reports as currently defined in Resolution 40 (Cg-XII) should be prepared at

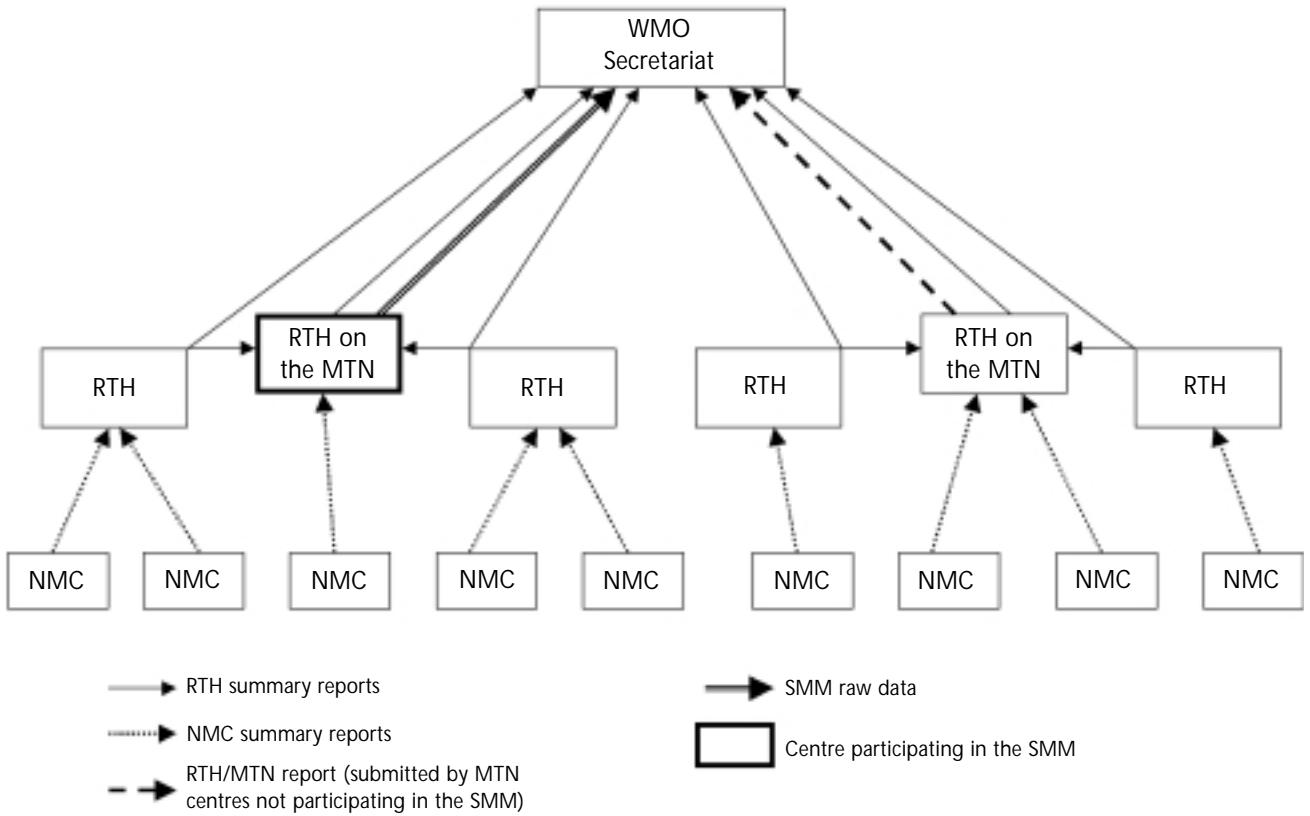

Flow of monitoring information.

Table B - Responsibilities of SMM centres (as of August 2000)

<i>Set of data</i>	<i>Centres providing raw data</i>	<i>Centres preparing pre-analysis of the raw data</i>
Surface data from fixed stations: SYNOP reports (TT=SY)	Algiers Melbourne Offenbach Toulouse Tokyo	Tokyo
Upper-air data from fixed stations: Parts A of TEMP (TT), PILOT (PP) reports, Proposed extension: BUFR wind profiler (BP)	Melbourne Nairobi Toulouse Tokyo	Tokyo
Climate data: CLIMAT (CL) and CLIMAT TEMP (CT) reports	Cairo Melbourne New Delhi Toulouse	Cairo
Data from marine stations: SHIP (SH), TEMP SHIP (TS), PILOT SHIP (PS), BUOY (BU), BATHY/TESAC/TRACKOB (BT) reports	Cairo Melbourne Offenbach Toulouse	Offenbach
Data from aircraft: AIREP (AI) and AMDAR (AM) reports, Proposed extension: BUFR aircraft reports (BA)	Melbourne Nairobi Toulouse Tokyo	Toulouse

least annually by the Secretariat. Reports should be made available on a monitoring page of the WMO server and the WMO Secretariat should inform the monitoring centres concerned of the availability of the reports when they are placed on the server.

3.2 At least once per year, in October if only annual reports are produced, the WMO Secretariat should provide a detailed monitoring report to each WMO Member. The report should list information about stations, reports and bulletins that only apply to that Member, thus facilitating any corrective actions by that Member.

3.3 The WMO Secretariat should prepare files at the report level showing the availability of the reports at the NMCs, RTHs and RTHs on the MTN, and GDPS centres. In this respect, the Secretariat should process the quarterly monitoring reports and the SMM reports. The Secretariat should produce maps showing the discrepancies of the data between the MTN centres.

3.4 The WMO Secretariat should process the SMM pre-analysis files at the report level and RTH Toulouse should process these files at the bulletin level. Priority should be given to determining silent stations and to the bulletins not received by every SMM monitoring centre.

3.5 The WMO Secretariat and RTH Toulouse should produce an analysis of the monitoring results showing the main anomalies and distribute it to all RTH focal points concerned. The RTH focal points should provide comments on the analysis to the WMO Secretariat and inform the Secretariat of the actions that have been undertaken to eliminate deficiencies. The Secretariat will coordinate further action to eliminate any remaining deficiencies.

4. GDPS quantity monitoring

4.1 One of the purposes of monitoring is to ensure that observational data injected into the GTS by NMCs adhere to WMO coding procedures. This is being done operationally at the NMC-RTH level by some centres. However, detection of coding errors introduced by the NMC or by transmission errors is best performed by a GDPS centre.

4.2 Some GDPS centres routinely produce monthly reports on the volume of data received and decoded at their centre. However, it is difficult to compare these reports because of the differences in their operational procedures and capabilities. Decoding and assimilation algorithms vary from centre to centre. Therefore, the monthly statistics from these centres are currently not optimal for detecting the reason for data losses.

4.3 It is recommended that participating GDPS centres record reports which cannot be decoded or in which coding errors are detected. While a failure to decode a large number of reports could be due to problems in decoder software, detection of a few faulty reports is likely due to coding errors by the observing stations or transmission problems. The centre should prepare a list of stations whose data could not be decoded and should send a copy of this report to the responsible NMC for remedial action. It would be advantageous if the GDPS centre could identify in detail the type of error and include this in the report.

4.4 For detecting the loss of data in transit it is suggested that, simultaneously with the quarterly NMC and RTH monitoring described in section 2, GDPS centres monitor the volume of data received at their centre during the monitoring period and provide the results to their associated RTH. In order to minimize differences due to decoding and assimilation algorithms, the GDPS centre should monitor the data as early in their processing cycle as possible.

4.5 It is recommended that some GDPS centres also produce quarterly reports on the data received at their centre. The reports should monitor all data of all of the types listed in Table A that are received at the GDPS centre and should be produced for the same monitoring periods as defined for the other components of the integrated WWW monitoring. The formats and file names of the reports should conform to those defined for the NMC quarterly reports in section 2.5. These GDPS quantity monitoring reports should be sent to the WMO Secretariat for comparison with reports from MTN centres to identify data or telecommunication problems. It is recommended that the responsibility for this monitoring activity be assigned to centres in accordance with the roles of the Lead Centres for Quality Monitoring.

5. Transition from the current monitoring to the integrated monitoring

Implementation of the integrated monitoring

5.1 The integrated monitoring should be implemented during a transition period agreed by the Commission. NMCs, RTHs, RTHs on the MTN, and GDPS centres should implement the quarterly monitoring as soon as possible during the transition period. Once a centre has fully implemented the quarterly monitoring, the centre would no longer need to send AGM results to the WMO Secretariat. About 100 centres presently participate in the AGM. Since the integrated WWW monitoring can be highly automated and thus require little manual effort, all WWW centres should strive to participate in the integrated monitoring.

5.2 The responsibilities taken by eight MTN centres (Algiers, Cairo, Melbourne, Nairobi, New Delhi, Offenbach, Tokyo and Toulouse) in the current implementation of the SMM are given in Table B. The present participation in the SMM should be extended. It is also recommended that centres contribute to the monitoring of the BUFR data according to the type of data for which they already contribute. For example, the responsibilities of the SMM centres for the monitoring of the BUFR wind profiler data and aircraft reports should be extended as given in Table B.

Assistance in the implementation of the integrated monitoring

5.3 It is recommended that the Secretariat coordinate the development of application(s), e.g. using Microsoft Access software, for the preparation of the quarterly reports from the raw data or from the AGM results.

ANNEX IV

Annex to paragraph 6.2.83 of the general summary

CBS TECHNICAL CONFERENCE ON WMO INFORMATION SYSTEMS AND SERVICES

1. The CBS Technical Conference on WMO Information Systems and Services highlighted a number of significant technical issues and emerging technologies.

2. The session on requirements for information systems and services emphasized the problems experienced by countries with struggling economies, in particular the need for the basic national infrastructure of observations. It was also noted that it will not be possible, or indeed necessary, for all the NMCs to fulfil all of the stated requirements and it is therefore appropriate to distinguish between the requirements for the information system at the national, regional and global levels. Ensuring that developing countries can effectively contribute to the operation of the WMO basic systems, the future WMO information system should be scalable, flexible and affordable. The participants felt that this could be best achieved by increased reliance on inexpensive standard equipment and software to transmit, receive and manipulate data and products.

3. The session on the evolution of the GTS demonstrated that the network level of the GTS is evolving to use a mix of facilities (private links, network services, satellite-based services and public Internet) to meet user requirements. The unifying factor at the network level is TCP/IP. The session was informed of several technical developments and new telecommunication services but concluded that technology alone was insufficient; change and innovation at the management and administrative level are needed to realize full benefit from the activities of the Implementation-Coordination Teams. File-based techniques are critical to the evolution of the

GTS, given the increasingly large volumes of data to be transmitted. Major evolution of the GTS is essential for it to support future WMO information systems.

4. During the session on other information systems, papers were presented that described a variety of systems utilizing the new tools of the information age that might be of use to NMHSs. New hardware and software systems to store, retrieve and distribute meteorological information are now available and very cost-effective. The wide acceptance by industry of Internet techniques and protocols has been particularly important and Internet protocols were utilized by the majority of systems presented. The participants felt that several of the systems described had the potential to contribute to WMO information systems and merited more formal evaluation and review.

5. The papers presented in the session on visions for the future followed a common theme: if existing techniques and technologies are fully utilized, then WMO information systems can evolve to satisfy WMO data exchange requirements while being affordable to install, operate and maintain. Systems must be dynamic and evolve with changes in technology. A request and reply capability must be part of the future information system along with the ability to search easily for data and products on-line. Finally, the session recommended increased use of the Internet and related technologies. Use of its standardized protocols and tools would allow WMO to take advantage of the large amount of research and development committed to its operation and growth.

ANNEX V

Annex to paragraph 6.3.6 of the general summary

PROCEDURES TO EVALUATE THE IMPACT OF CHANGES OF THE GOS ON NWP AND THE EXCHANGE AND DISSEMINATION OF RESULTS

Procedure for using verification statistics to assess the effect of changes to the GOS on NWP

1. Should the proposed specific OSE case study (which will assess the effect of the loss of Russian sondes on NWP as described in general summary paragraph 6.3.4) find a significant signal in the verification, then it is recommended that:

The monitoring and verification systems of Lead Centres and other centres should be modified as recommended, following results from the case study.

Information on NWP system changes

2. The Commission recommended that centres should provide timely details of major changes to their NWP system including:

- (a) Date of change;
- (b) Description of change;
- (c) Impact of change on verification from parallel testing.

The above details should be available on the centre's Web site. A summary should be included in the centre's annual GDPS progress report that is provided to WMO.

Extra data monitoring from Lead Centres

3. The Commission recognized the need to monitor and exchange information on the availability of data (along the lines of that currently displayed by the ECMWF). Such an exchange of information would alert the Centres about changes in the GOS. It is therefore recommended that the Lead Centres and the centres

participating in monitoring should extend their monitoring procedures to include information about regional variations in data volumes. Such information could include counts by:

- (a) WMO block number;
- (b) Latitude /longitude box;
- (c) Individual platforms.

These counts should be compared with long-term averages to indicate areas of declining reports.

4. For each type of observation, the Lead Centres should consult other centres and agree on the exact procedures for monitoring, for information exchange and for alerting Members and WMO about problems.

ANNEX VI

Annex to paragraph 6.3.7 of the general summary

GUIDELINES WHERE ACTION IS REQUIRED TO MINIMIZE THE IMPACT OF A LOSS OF OBSERVATIONS ON THE OPERATION OF THE GDPS

1. The guidelines are based on experience with the shutdown of the OMEGA system and the action taken on year 2000 compliance. The action proposed addresses the various phases into which such problems can be divided.

2. While the guidelines focus on the loss of observations, they could just as well apply to maximizing the impact of positive changes in the GOS. Such situations may arise as part of a planned programme change such as targeted observations, special observing period data or implementation of a new observing platform. A need for information on a coordinated basis is also required in such situations to allow the data-processing system to both cope with and optimally use such new observations.

Alerting

3. The change in the observing systems may be known in advance or it may be unplanned.

For known changes:

- (a) Operators should provide notification to WMO following the current procedures where these are specified;
- (b) Otherwise information should be provided giving adequate notice through means such as:
 - (i) Official advice from the Secretary-General to NMHSs;
 - (ii) Notification through the technical commissions, in particular CBS and CIMO;
 - (iii) Use of specialist groups established for particular observation types (e.g. satellite soundings);
 - (iv) A data user's e-mail news group.

Unplanned changes:

- (a) Lead Centres should maintain reliable monitoring procedures to detect any problems;
- (b) RTHs should identify any communications problems restricting the flow of data;
- (c) Lead Centres should alert data providers (if necessary) through designated contact points (such as the Technical Coordinator of the AMDAR Panel). The WMO Secretariat may be able to assist in identifying relevant contact points.

4. Problems should be detectable with the quantity and quality monitoring systems established within CBS. Although many centres carry out data monitoring, the Lead Centres responsible for particular observation types should alert the operators and user community to a potential problem, particularly if the loss is due to a change in quality rather than to a loss of the observations itself (such changes may be due to changes in calibration of satellite instruments which may not be apparent to all users). For the NHMSs, this alerting can be through designated points of contact. The established network of focal points for data quality monitoring was not established for this purpose but may be suitable. This network needs to be updated regularly.

Assessment of the problem

5. In order to assess the problem:

- (a) Define the nature of the problem:
 - (i) Collect authoritative information from operating agencies;
 - (ii) Obtain guidance from relevant technical experts within CBS or other Commissions;
- (b) Obtain information on the scope of the problem and the timing of planned changes:
 - (i) Range of users and programmes likely to be affected;
 - (ii) Geographical extent;
 - (iii) Duration of the problem (if temporary);
- (c) Assess the likely impact on a range of users:
 - (i) NWP;
 - (ii) General use of the observations in the operations of NMHSs such as forecasting, and climate or marine services;
 - (iii) Other WMO Programmes especially GCOS, hydrology, GAW;
 - (iv) Other WMO commitments e.g. UN/OCHA, GCOS, IPCC, and the Montreal Protocol.

6. The WMO system should act as an advocate for the broad range of its Members and users and be aware of the sensitivities of NHMSs and programmes to data losses.

7. For NWP, the impact can be based on surveys of previous observation impact studies and the work of

organizations such as NAOS, COSNA, and EUCOS, the CBS OPAG/IOS and the OPAG/DPFS expert team. These studies can be used as the basis for an extrapolation to the current observation problem.

8. The assessment of the problem needs to be a collective effort. However, suitable individuals to initiate and coordinate action may be the chairpersons of the OPAGs on IOS or DPFS, or if the problem is confined to within one or two Regions, the appropriate RA chairperson of the regional Working Groups on Planning and Implementation of the World Weather Watch.

Problem prevention where possible

9. This includes, for example, to make submissions to data providers to influence decisions.

10. Expert and representative impact assessments provide an authoritative basis for such submissions. This strategy was used unsuccessfully in the case of the OMEGA system, but is being used to preserve the microwave frequencies allocated for meteorological and remote-sensing purposes. It may also be used to make representations to NMHSs on planned closures of particularly valuable observing stations through:

- (a) Dissemination of information to highlight the impact of the loss of observations;
- (b) Form alliances with other users affected (e.g. radioastronomy in the case of microwave frequencies).

Responsibility for such tasks is best suited to the Secretariat.

Investigate mitigation strategies

11. This includes:

- (a) Preserve maximum components possible of the observation: In the case of the OMEGA system, for example, WMO advocated the continuation of soundings for temperature and humidity even if wind observations were not possible;
- (b) Assist in implementing replacement systems: In the case of soundings from NOAA-11, for example, an informal group worked by e-mail with NOAA/NESDIS to facilitate the implementation of the new message type for soundings from NOAA-15 through message decoding and testing, feedback on errors and sharing information among the user community. The process was assisted by a responsive attitude and helpful advice from NESDIS;
- (c) Use alternative sources of data: This may be a longer strategy as in the future composite GOS but there may be short-term possibilities such as use of AMDAR ascent and descent profiles for radiosonde

flights. CBS can assist by providing information and training in such possibilities;

- (d) Establish back-up systems (e.g. satellites);
- (e) Build-in redundancy in the GOS: This may also be a longer strategy for the future composite GOS.

The responsibility for such task is best suited to CBS.

Finding and allocating resources to ameliorate the problem

12. This could range from funding for particular observation types to relocation of back-up satellites. The impact statements referred to above may be used in developing priorities for the allocation of funding. Other criteria may be:

- (a) Effectiveness in ameliorating the problem;
- (b) Reliability;
- (c) Meeting of functional requirements (e.g. reaching 5 hPa for GUAN radiosondes);
- (d) Quality (e.g. as assessed through the Lead Centre monitoring);
- (e) Long-term continuity (especially for GCOS);
- (f) Support for multiple programmes;
- (g) Unique characteristics.

The responsibility for such task is best suited to Members.

Monitoring the problem

13. This includes:

- (a) Assessing the extent of the problem and comparison with projections;
- (b) Fine-tuning and adaptation of responses where possible.

Post-event review

14. After the event, conduct a review to record any lessons learnt and document any procedures for future events.

The responsibility for such task is best suited to CBS.

Administrative aspects

15. This second point worked successfully in the case of the termination of the OMEGA system. The team made recommendations to alleviate the problem and to assign priorities for use of the available funding for installation of alternative (GPS) radiosondes, for example:

- (a) Utilize existing formal and informal groups within CBS and WMO in general (CIMO, CAS, CCI);
- (b) If the problem is of a significant scale establish a task team to analyse the problem, share existing information and develop expert advice.

ANNEX VII

Annex to paragraph 6.3.14 of the general summary

VERIFICATION SYSTEMS FOR LONG-RANGE FORECASTS — REVISED EXPERIMENTAL SCORES TO BE EXCHANGED

Preamble

CBS-Ext.(98) adopted procedures that defined the core standardized verification system (SVS) for long-range forecasts, as proposed jointly by CAS, CCI and CBS experts. The core SVS was designed to provide a straightforward assessment system for all predictions in the medium-range and longer time-scales; nevertheless it can be used at the short range also. The objectives of the SVS are covered in detail in Annex 1. The two prime objectives are:

- (a) To provide ongoing standardized verification statistics on real-time forecasts for exchange between GDPS centres and for annual submission to CBS;
- (b) To provide standardized methods of verification that can be attached to any real-time prediction in order that information concerning the inherent skill of the forecast system is passed to the recipient.

Proposed principles

Verification histories may be produced through a combination of hindcasts and real-time forecasts. However, the forecast method should remain consistent throughout the entire history period, with hindcasts using no information that would not have been available for a real-time forecast produced at that time. If real-time forecasts are used within the verification history then they should not be included in the verification record of real-time forecasts.

Climatologies should be calculated consistently within the verification history. Dataset statistics, such as means and standard deviations, should be calculated across the period of the verification history and should be applied to the verification of subsequent real-time forecasts.

Where bias correction, statistical post-processing or other forms of intervention are applied which result in differences in forecast production methodology between verification history and real-time forecast periods, an attempt may be made to verify the unmodified forecast system in addition to the real-time system with results presented for both.

Formulation

The SVS is formulated in four parts:

- (a) Diagnostics. Two diagnostics are included and are closely defined. Additional diagnostics are suggested but are not incorporated into the core SVS as yet. Use of the additional diagnostics is optional;
- (b) Parameters. Key variables for initial inclusion are proposed. However the list is flexible to ensure that all producers can contribute regardless of the structure of individual forecast systems;
- (c) Verification datasets. Key datasets of observations against which forecasts may be verified are

proposed. This list is also flexible to ensure that all producers can contribute regardless of the structure of individual forecast systems;

- (d) System details. Details of forecast systems employed.

Diagnostics

Two diagnostics are incorporated in the core SVS: relative operating characteristics and root-mean-square skill scores. Both provide standardized values permitting direct intercomparison of results across different predicted variables, geographical regions, forecast ranges, etc. Both may be applied in the verification of most forecasts and it is proposed that, except where inappropriate, both diagnostics are used on all occasions.

- (a) Relative operating characteristics. Calculation details are discussed in Annex 2. For deterministic forecasts, the full contingency table should be provided. In addition, values of the hit and the false alarm rates should be supplied. Other contingency measures, as listed in Annex 4, may be added. For probabilistic forecasts, maps providing the standardized area under the curve (such that perfect forecasts, give an area of 1 and a curve lying along the diagonal gives 0.5) should be provided, as a map for gridded data or as a curve for single point/region predictions. Probability values should be labelled on any relative operating characteristics curves.

A number of contingency table-based diagnostics are listed within Annex 4 in addition to hit and false alarm rates, including the Kuiper score and per cent correct (both used in assessing deterministic forecasts); these provide valuable, readily-assimilable information for developers, producers and users of long-range forecasts. They may be considered for inclusion within information supplied to users;

- (b) Root-mean-square skill scores. Calculation details are discussed in Annex 3. Root-mean-square skill scores are appropriate only for deterministic forecasts. In general two skill scores should be provided: against persisted anomalies and against climatology. Where persistence is not relevant as a predictor (such as for some seasonal rainfall regimes) only skill against climatology should be assessed. Additionally, persistence may not be relevant once the skill of a persistence forecast is exceeded by that of a climate forecast; in this circumstance, use of persistence is optional. A further three individual values (two when persistence is not used) should be provided: RMS error values for the forecast, for persistence and for climatology. Root-mean-square skill scores provide useful data to the developer and producer but are thought to

carry less information to the user, particularly those served by the NMHS. Hence provision of root-mean-square skill scores to users is optional.

Parameters

The key list of parameters in the core SVS is provided below. Any verification for these key parameters, for either the verification history or for real-time forecasts, should be assessed using both core SVS techniques wherever possible (given the exceptions noted above). Many long-range forecasts are produced which do not include parameters in the key list (for example, there are numerous empirical systems that predict seasonal rainfall over part of, or over an entire, country). The core SVS diagnostics should be used to assess these forecasts also, but full details of the predictions will need to be provided.

(a) Sea-surface temperature predictions. Predictions for:

NINO1+2

NINO3

NINO3.4

NINO4

Pacific Warm Pool (4°N to 0°N; 130°E to 150°E)

Tropical Indian Ocean

Tropical Atlantic Ocean

(b) Atmospheric parameters. Predictions for:

T2m screen temperature

with standard regions: Tropics 30°N to 30°S
Northern extratropics $\geq 30^\circ\text{N}$
Southern extratropics $\leq 30^\circ\text{S}$
For both extratropical regions split also into separate land and oceanic regions
Tropical Africa (10°N to 10°S; 15°W to 45°E)
Tropical South America (10°N to 10°S; 80°W to 35°W)
Tropical South-East Asia (10°N to 10°S; 95°E to 150°E)
NINO3 region

Precipitation

with standard regions: Tropics 30°N to 30°S
Northern extratropics $\geq 30^\circ\text{N}$
Southern extratropics $\leq 30^\circ\text{S}$
For both extratropical regions split also into separate land and oceanic regions
Tropical Africa (10°N to 10°S; 15°W to 45°E)
Tropical South America (10°N to 10°S; 80°W to 35°W)
Tropical South-East Asia (10°N to 10°S; 95°E to 150°E)
Southern Asia (30°N to 5°N; 70°E to 90°E)
NINO3 region

500 hPa geopotential height

with standard regions: Northern extratropics $\geq 30^\circ\text{N}$
Southern extratropics $\leq 30^\circ\text{S}$

850 hPa temperature

with standard regions: Tropics 30°N to 30°S
Northern extratropics $\geq 30^\circ\text{N}$
Southern extratropics $\leq 30^\circ\text{S}$
For both extratropical regions split also into separate land and oceanic regions
Tropical Africa (10°N to 10°S; 15°W to 45°E)
Tropical South America (10°N to 10°S; 80°W to 35°W)
Tropical South-East Asia (10°N to 10°S; 95°E to 150°E)
NINO3 region

Mean sea-level surface pressure

with standard regions: Northern extratropics $\geq 30^\circ\text{N}$
Southern extratropics $\leq 30^\circ\text{S}$

Southern Oscillation Index

Tahiti-Darwin index (complete definition)

In using relative operating characteristics a definition of the binary "event" being predicted is required. While flexibility in defining the event is proposed, the recommendation is that each event be either above or below normal or a tercile of the climatological distribution.

Additional diagnostics that might aid centres in verification of long-range forecasts are listed in Annex 4.

Verification datasets

The key list of datasets to be used in the core SVS for both climatological and verification information is provided below. The same data should be used for both climatology and verification, although the centre's analysis (where available) and the ECMWF and NCEP/NCAR reanalyses and subsequent analyses may be used when other data are not available. Many seasonal forecasts are produced that may not use the data in either the key climatology or verification datasets (for example, there are numerous systems which predict seasonal rainfall over part of, or over an entire, country). Appropriate datasets should then be used with full details provided.

(a) Sea-surface temperature:

Reynolds OI, with option for additional use of GISST;

(b) Precipitation:

Xie-Arkin; GPCP data; GCOS network once data readily available; ECMWF and NCEP/NCAR reanalyses and operational analysis data;

(c) T2m screen temperature:

GCOS network once data readily available; ECMWF and NCEP/NCAR reanalyses and operational analysis data; UKMO/CRU T2m data set;

(d) 500 hPa geopotential height:

ECMWF and NCEP/NCAR reanalyses and operational analysis data; own centre operational analysis data if available; GUAN data once available; UKMO RS dataset;

(e) 850 hPa temperature:

ECMWF and NCEP/NCAR reanalyses and operational analysis data; own centre operational

analysis data if available; GUAN data once available; UKMO RS data set;

- (f) Sea-surface pressure:
ECMWF and NCEP/NCAR reanalyses and operational analysis data; own centre operational analysis data if available; UKMO GMSLP dataset.
When gridded datasets are used, a 2.5° by 2.5° grid is recommended.

System details

Information will be requested for the exchange of scores concerning the following details of the forecast system. Information labelled with an asterisks should also be attached to user information:

- (a) Is the system numerical/hybrid/empirical*?
(b) Do the results relate to the verification history or to real-time forecasts*?
(c) Is the system deterministic/probabilistic*?
(d) List of parameters being assessed*;
(e) List of regions for each parameter*;
(f) List of forecast ranges (lead times) and periods (e.g. seasonal average) for each parameter*;
(g) The number of hindcasts/predictions incorporated in the assessment and the dates of these hindcasts/predictions;
(h) Details of climatological and verification datasets used (with details of quality controls when these are not published);
(i) If appropriate, resolution of fields used for climatologies and verification;
(j) The period over which data are averaged to produce persisted anomalies;
(k) Results of significance tests (Monte Carlo tests are recommended) on the historical verification period*;
(l) Bias correction.

ANNEX 1 OBJECTIVES OF THE STANDARDIZED VERIFICATION SYSTEM

The standardized verification system has two major objectives:

- (a) To provide a standardized method whereby forecast producers can exchange information on the quality of longer-range predictions on a regular basis and can also report results to WMO annually as part of a consolidated annual summary;
(b) To provide a standardized method whereby forecast producers can add information on the inherent qualities of their forecasts for the information and advice of recipients.

In order to achieve the first major objective, the SVS incorporates two diagnostics and a series of recommended forecast parameters and verification and climatological statistics against which to assess the forecasts which can be applied to real-time forecasts, either on an individual basis, or preferably, accumulated over a sequence of predictions.

The second major objective is achieved using the same diagnostics, forecast parameters and verification

and climatological statistics but applied to historical tests of the system. It is made clear whether the historical tests are based on methods that can be considered to represent a true forecast had the test been run in real-time or otherwise. Producers will be requested to add this information to issued predictions; recommendations for methods by which this might be done may be formulated later.

Other objectives of the SVS are:

- (a) To encourage both the regular verification of forecasts and the verification according to international standards;
(b) To encourage information on inherent forecast quality to be added to all predictions as a matter of course and to encourage forecast recipients to expect receipt of the information;
(c) To encourage producers to use consistent datasets and to encourage production of these datasets;
(d) To provide verifications that permit direct inter-comparison for forecast quality regardless of predicted variable, method, forecast range, geographical region, or any other consideration;
(e) To encourage producers to work towards a common method for presenting forecasts.

ANNEX 2 RELATIVE OPERATING CHARACTERISTICS

The derivation of relative operating characteristics is given below. The following will be required for purposes of reporting forecast quality for exchange between centres and for annual submission to WMO:

- (a) For deterministic forecasts, hit rates and false alarm rates together with essential details of the forecast parameter and verification data sets;
(b) For probabilistic forecasts, hit rates and false alarm rates for each probability interval used. Frequent practice is for probability intervals of 10 per cent to be used. However other intervals may be used as appropriate (for example, for nine-member ensembles, an interval of 33.3 per cent could be more realistic). Additionally, the area under the curve should be calculated.

Relative operating characteristics (ROC), derived from signal detection theory, are intended to provide information of the characteristics of systems upon which management decisions can be taken. In the case of weather forecasts, the decision might relate to the most appropriate manner in which to use a forecast system for a given purpose. ROCs are useful in contrasting characteristics of deterministic and probabilistic systems.

The following 2×2 contingency table provides information for any yes/no forecast for a specific binary event:

	Forecasts			
	Yes	Hits (H)	Misses (M)	
Observed	Yes	Hits (H)	Misses (M)	H+M
	No	False Alarms (FA)	Correct rejections (CR)	FA + CR
		H + FA	M + CR	

The binary 'event' can be defined quite flexibly, e.g. as positive/negative anomalies, anomalies greater/less than a specific amount, values between two limits, etc. If terciles are used, then the binary event can be defined in terms of predictions of one tercile against the remaining two.

Using stratification by observed (rather than by forecast) the following can be defined:

$$\text{Hit rate} = H/(H + M)$$

$$\text{False alarm rate} = FA/(FA + CR)$$

For deterministic forecasts, the hit rate and false alarm rate only need to be calculated; for probabilistic forecasts, the procedure outlined below should be followed.

A probabilistic forecast can be converted into a 2x2 table as follows. Tabulate probabilities in, say, 10 per cent ranges stratified against observations, i.e.:

<i>Probability range</i>	<i>Number of observed events for each probability range</i>	<i>Number of non-Observed events for each probability range</i>
90-100%	O ₁₀	NO ₁₀
80-90%	O ₉	NO ₉
70-80%	O ₈	NO ₈
60-70%	O ₇	NO ₇
50-60%	O ₆	NO ₆
40-50%	O ₅	NO ₅
30-40%	O ₄	NO ₄
20-30%	O ₃	NO ₃
10-20%	O ₂	NO ₂
0-10%	O ₁	NO ₁
Totals	ΣO _i	ΣNO _i

For any threshold, such as 50 per cent, the hit rate (false alarm rate) can be calculated by the sum of O_s (NO_s) at and above the threshold value divided by ΣO_i (ΣNO_i). In other words, for a value of 50 per cent, the calculation is as if the event is predicted given any forecast probability of 50 per cent or more. So for the above case:

$$\text{Hit rate} = (O_{10} + O_9 + O_8 + O_7 + O_6) / \Sigma O_i$$

$$\text{False alarm rate} = (NO_{10} + NO_9 + NO_8 + NO_7 + NO_6) / \Sigma NO_i$$

This calculation can be repeated at each threshold and the points plotted to produce the ROC curve, which, by definition, must pass through the points (0,0) and (100,100) (for events being predicted only for 100 per cent probabilities and for all probabilities exceeding 0 per cent, respectively). The further the curve lies towards the upper left-hand corner the better. No-skill forecasts are indicated by a diagonal line.

Areas under ROC curves can be calculated using the Trapezium rule. Areas should be standardized against the total area of the figure such that a perfect forecast system (i.e. one that has a curve through the top-left-hand corner of the figure) has an area of one and a curve lying along the diagonal (no information) has an area of 0.5. Alternatively, but not recommended in the standard, the 0.5 to 1.0 range can be rescaled to 0 to 1 (thus allowing negative values to be allocated to cases with the curve lying below the diagonal — such curves can be generated). Not only can the areas be used to contrast different curves but they are also a basis for Monte Carlo significance tests. Monte Carlo testing should be done within the forecast dataset itself.

In order to handle spatial forecasts, predictions for each point within the grid should be treated as individual forecasts but with all results combined into the final outcome. Categorical predictions can be treated for each category separately.

ANNEX 3 ROOT-MEAN-SQUARE SKILL SCORES

Root-mean-square skill scores are calculated from:

$$\left[1 - \frac{\text{RMS (forecast)}}{\text{RMS (standard)}} \right] \times 100$$

RMS (forecast) refers to the RMS error of the forecast. RMS (standard) refers to the RMS error of the standard when verified against the same observations as the forecast — the standard can be either climatology or persistence. When persistence is used, the persistence should be defined in a manner appropriate to the time-scale of the prediction, although it is left to the producer to determine whether persistence over, perhaps, one month or an entire season is used in assessing a seasonal prediction. No portion of the persistence period should overlap into the forecast period and the forecast range should be calculated from no sooner than the time at which any observed information (i.e. information which could not be known at the time of a real forecast) is no longer included. Both of these requirements are placed to ensure that all forecasts and test predictions only use data that were available at the time of the prediction or would have been available at that time had a prediction been made (in the case of historical test).

ANNEX 4 ADDITIONAL DIAGNOSTICS

1. Categorical forecasts
 - Linear error in categorical space for categorical forecasts (LEPSCAT)
 - Bias
 - Post agreement
 - Per cent correct
 - Kuiper score
2. Probability forecasts of binary predictands
 - Brier score
 - Brier skill score with respect to climatology
 - Reliability
 - Sharpness (measure to be decided)
 - Continuous rank probability score
3. Probability of multiple-category predictands
 - Ranked probability score
 - Ranked probability skill score with respect to climatology
4. Continuous forecasts in space
 - Murphy-Epstein decomposition (phase error, amplitude error, bias error)
 - Anomaly correlation
5. Continuous forecasts in time
 - Mean-square-error
 - Correlation
 - Bias
 - Anomaly correlation

ANNEX VIII

Annex to paragraph 6.3.15 of the general summary

ROLE OF LEAD CENTRES

Create and maintain a Web site for exchange. The Web site will provide access to:

- (a) Standardized software for calculating scoring information (ROC curves, areas, contingency table scores, hit rates, etc.) and software for producing standardized output;
- (b) Template to enter details of a forecast system;
- (c) Access to Web sites of participating centres;
- (d) Relevant documentation;
- (e) Access to verification results;
- (f) Access to available verification datasets;

Work towards:

- (a) Producing monthly verification datasets in common format on $2.5^\circ \times 2.5^\circ$ grid where appropriate (apart from those available at ECMWF);
- (b) Displaying information graphically (provided format of information sent is amenable to this);

Liase with other groups involved in verification (e.g. CLIVAR's Working Group on Seasonal to Interannual Prediction, the Centre for Ocean-Land-Atmosphere Interactions, etc.).

Collate results of limited exchange into a report for distribution.

Collate information annually from 2001 for possible publication in a GDPS Technical Progress Report.

ANNEX IX

Annex to paragraph 6.3.21 of the general summary

GPCC PROCEDURES FOR PRECIPITATION QUALITY MONITORING

Data which arrived at GPCC are partly affected by reading or coding errors and other modifications happening during the transmission from the originator to the archive. In many questionable cases it is not possible to get replies from the data originator. The following problems occur:

- (a) Important metadata (station identifications, format descriptions) are missing and have to be procured;
- (b) Delivered datasets are irregularly formatted;
- (c) Delivered station coordinates are erroneous (occurs frequently);
- (d) Doublettes of stations have to be eliminated;
- (e) Missing precipitation is not clearly indicated in the data;
- (f) Recorded precipitation depths are affected by coding/decoding errors;
- (g) Temporal misplacement of data in time-series.

A fully automatic quality-control would eliminate all questionable data and, with regard to the high variability of precipitation, also remove a large amount of true data, in particular extreme values. These data, however, are very important to describe the real structure of the spatial distribution and the variability within the gridded analysis results. In order to keep the true extreme data in, and also to remove obviously wrong data from, the analysis system, a visual check of questionable data — although very time-consuming — seems to be inalienable (Rudolf, *et al.*, 1994).

Treatment of errors

Area means of precipitation derived from raingauge data are contaminated by errors of different origin:

- (a) Systematic measuring errors depend on the characteristics of the instrument type, size and exposition and on the meteorological conditions during the individual event. Any correction will not result in the true individual local precipitation amount, but will put the data closer to the truth in a statistical sense. Corrected data are still contaminated by stochastic errors from approximative corrections;
- (b) Erroneous individual data which are not discovered by quality control cause a stochastic error of a data collective;
- (c) The sampling error is area-related and depends on the number of observations per area and on the regional precipitation variability;
- (d) The methodical error represents approximations of the used interpolation scheme or the method for calculation of area mean precipitation.

These error types must be treated and quantified separately and the results need to be merged to a total error of the area mean precipitation (Rudolf, *et al.*, 1994).

A central part of the GPCC operational data processing system, which is described in Rudolf (1993), is the precipitation point data bank (PDB) consisting of three major parts:

- (a) The continuous monthly precipitation data of the different sources (for each station data from up to five sources are stored separately, as there are monthly precipitation totals from CLIMAT reports, totals calculated from synoptic reports at the CPC and the GPCC and additional regional as well as national datasets);
- (b) The climatological normals for different base periods; and

- (c) A station catalogue containing the station-related information, such as geographical coordinates, elevation above mean sea level, station name and WMO and/or national station number.

Another important part of the data-processing system is the quality control of the gauge-measured monthly precipitation data and station meta data. First of all, the station metadata (identification, geographical location) have to be checked, corrected (geographical coordinates are partly erroneous) or complemented. If monthly precipitation data at a station are available from more than one source, then an "optimal" value is selected automatically based on statistically-predefined random errors of the data from the different sources and intercomparisons between them. The quality control of the precipitation data at the GPCP is semi-automatic. In the automatic check of the full raingauge dataset, the precipitation data at a station are checked are flagged against the climatological normal and for spatial homogeneity and questionable data.

Data marked as questionable in the automatic quality-control process can be subsequently manually reviewed by a trained expert using an interactive programme on a graphics workstation. This software shows all relevant information of the station being checked as well as the precipitation data of the neighbouring stations and background fields such as gridded climatologies or a three dimension orography (the data source is displayed by symbol, stations with data flagged as questionable are marked by colour). Obvious errors in the precipitation data are corrected, if possible. Otherwise incorrect data are set to the code for missing values or, if available, the monthly precipitation from another source can be selected for the analysis. If a

station is misplaced, its geographical location can also be corrected. All these corrections are then archived in the PDB.

The automatic part of the control procedure has not been designed to correct data, but rather to reduce the number of data for which a visual control is necessary. A fully automatic quality control would eliminate all questionable data and, with regard to the high variability of precipitation, also remove a large amount of true data, in particular extreme values. These data, however, are very important to describe the real structure of the spatial distribution and the variability within the gridded precipitation analysis. In order to keep the true extreme data and also to remove obviously wrong data from the analysis system, a visual check of the questionable data, although very time-consuming, seems to be inalienable.

The final analysis of gridded area-average precipitation is performed on the basis of the quality-controlled data by using the objective analysis method Spheremap, which is based on an inverse distance and directional weighting scheme.

References

- Rudolf, B., 1993: Management and analysis of precipitation data on a routine basis. *Proceedings of the International Symposium on Precipitation and Evaporation* (B. Sevruk and M. Lapin, eds.), ETH Zurich, Volume 1, pp. 69–76.
- Rudolf, B., H. Hauschild, W. Rueth and U. Schnieder, 1994: Terrestrial precipitation analysis: operational method and required density of point measurements. NATO ASI I/26, *Global Precipitations and Climate Change* (M. Desbois and F. Desalmand, eds.), Springer Verlag Berlin, pp. 173–186.

ANNEX X

Annex to paragraph 9.4 of the general summary

TERMS OF REFERENCE OF OPAG TEAMS AND RAPORTEURS

OPAG ON INTEGRATED OBSERVING SYSTEMS

Implementation/Coordination Team on Integrated Observing Systems

- (a) Monitor, report and make recommendations on the capability and utilization of composite observing systems comprising different observing networks to meet the requirements of the WMO Programmes;
- (b) Review deficiencies in coverage and performance of the existing GOS, in particular in the implementation of the RBSNs, the GSN and GUAN (of GCOS) as well as related regional climate networks, on the basis of monitoring results and regional studies, and to make proposals to improve the availability of data to meet stated requirements;
- (c) Coordinate the development of standardized high-quality observing practices and prepare related recommendations;

- (d) Assess the impacts of introducing new technology systems into the GOS on the status of regional observing networks, particularly those affecting the role of developing countries;
- (e) Consider and report on the issues of costing, joint funding and management of the GOS;
- (f) Strengthen collaboration between CBS and the regional associations by providing advice on possible solutions for newly identified requirements.

Expert Team on Observational Data Requirements and Redesign of the GOS

- (a) Update and report on observational data requirements of the WWW as well as other WMO and international programmes supported by WMO;
- (b) Review and report on the capability of both surface-based and space-based systems that are candidate components of the evolving composite GOS;

- (c) Carry out the rolling requirements review of several application areas using subject area experts (including atmospheric chemistry, marine meteorology and oceanography through liaison with JCOMM, aeronautical meteorology through liaison with CAeM, and seasonal to inter-annual forecasting as well as climate change detection through liaison with CCI and GCOS);
- (d) Review the implications of the Statements of Guidance concerning the strengths and deficiencies in the existing GOS and evaluate the capabilities of new observing systems and possibilities for improvements of existing observing systems to reduce deficiencies in the existing GOS; taking particular care to examine the implications of changes in observing technology, in particular changes to automated techniques (such as automated surface observing stations), on the effectiveness of all WMO Programmes, and report on major consequences in a timely fashion;
- (e) Carry out studies of hypothetical changes to the GOS with the assistance of NWP centres;
- (f) Prepare a prioritized list of proposals for modification to the GOS that are both practicable and amenable to testing, and propose mechanisms for testing them; offer redesign options for CBS consideration;
- (g) Develop criteria for dealing with design issues of the composite GOS, paying particular attention to developing countries and the southern hemisphere;
- (h) Prepare a document to assist Members, summarizing the results from the above activities.

Rapporteur on Scientific Evaluation of Observing System Experiments (OSEs) and Observing System Simulation Experiments (OSSEs)

Prepare and maintain reviews of OSEs and OSSEs that are being undertaken by various NWP Centres around the globe and provide information for consideration by the OPAG/IOS.

Expert Team on Satellite System Utilization and Products

- (a) Evaluate results of projects identified through the use of the questionnaire and guidelines;
- (b) Assist the OPAG/PWS in the development of appropriate materials for use in the PWS Programmes;
- (c) Working with WMO Members to promote the development of Web-based tutorials and computer-based modules which deal with improved utilization of satellite data for use within the virtual laboratory;
- (d) Based on analyses of the questionnaire, identify new application areas for satellite data and needs for new satellite data products;
- (e) Complete the review of the concept of direct broadcast from the space-based global observing system through the use of focused studies on impacts;
- (f) Provide guidance on migration of low-cost satellite receiving stations to LRIT/LRPT;

- (g) Update WMO Satellite Activities Technical Document A *Description of a Standard Small Satellite Groundstation for Use by WMO Members* (WMO/TD-No. 660, Satellite Reports No. 13);
- (h) Review the *Guidelines for the Education and Training of Personnel in Meteorology and Operational Hydrology* (WMO-No. 258) based on experiences indicated in the questionnaire and within the virtual laboratory;
- (i) Develop implementation goals for ground-receiving equipment for the space-based component of the GOS;
- (j) Develop further guidelines for the Strategy to Improve Satellite System Utilization.

Rapporteur on GCOS Matters

Continue the preparation and maintenance of reviews of observing systems that are being designed under the auspices of GCOS (e.g., GUAN, GSN and space-based observing systems (GOSSP and CGMS)) and provide feedback to Members in maintaining the quality of the networks.

Expert Team on Requirements for Data from Automatic Weather Stations

- (a) Review the functional requirements for automated weather observing systems (AWOS) for all WMO Programmes in order to provide functional specification for BUFR/CREX table-driven codes and make proposals for new BUFR/CREX descriptors and ensure the validation of BUFR/CREX templates for AWS data;
- (b) Review requirements for automated observations of "present weather", clouds, water vapour and the "state of the ground" in order to identify the necessity to develop or refine quantitative definitions and report on it;
- (c) Review and refine practices for reporting the instantaneous precipitation intensity, total cloud amount and cloud height, taking into account user recommended measurement practices and report on it;
- (d) Make suggestions on possible replacement of manually-observed types of clouds using automated technology;
- (e) Make proposals for improved quality control procedures for data from AWS for inclusion into the *Guide on the Global Data-processing System* (WMO-No. 305).

Rapporteur on Regulatory Material

Review and update regulatory and guidance material on the GOS, as required, and make recommendations for amendments.

Rapporteur on Improvement of Volume A

To work closely with Lead Centres and the WMO Secretariat to develop measures for the improvement of the utility of *Weather Reporting* (WMO-No. 9), Volume A with emphasis on completeness, accuracy of the information and adding indications of operational performance as derived from monitoring results. Such measures may refer to:

- (a) Procedures for the exchange of information between individual Members and the WMO Secretariat;
- (b) Procedures for monitoring the information quality and initiating corrections;
- (c) The layout of the information, including presentation;
- (d) Insertion of information from lead monitoring centres.

OPAG ON INFORMATION SYSTEMS AND SERVICES

Implementation/Coordination Team on Information Systems and Services

- (a) Monitor the operational information flow in relation to the GTS and further develop operational information exchange procedures with a view to improve WWW operation, especially the GTS, including:
 - (i) Data collection and distribution (e.g. updating abbreviated headings tables);
 - (ii) Routing and traffic management for the exchange of observational data and processed products (routine and non-routine exchange);
 - (iii) Procedures for enhanced exchange of information in the form of files (e.g. file naming, FTP flow between centres);
 - (iv) Proposal for a migration strategy to use table-driven representation forms;
- (b) Coordinate and further develop recommended practices and guidance on the management of, and access to, operational information related to WWW information exchange, especially to the GTS operation (abbreviated heading tables, catalogue of bulletins and files, routing directories, etc.);
- (c) Review and endorse updates to the *Manual on Codes* (WMO-No. 306), as required and proposed by the Expert Team on Data Representation and Codes.

Expert Team on Data Representation and Codes

Requirements for changes to representation forms should be provided by the other OPAGs, especially IOS and DPFS.

- (a) Maintain all WMO data representation forms and further develop table-driven codes by defining descriptors, common sequences and data templates, so they meet the requirements of all Members most efficiently;
- (b) Invite and assist Members to participate in the experimental exchange of data encoded in modified or new formats, in BUFR, CREX, and GRIB edition 2 on a bilateral basis;
- (c) Define standards for meteorological information using XML, as appropriate;
- (d) Produce a guide on table-driven codes as an updated version of the current *Guide to BUFR and GRIB*;
- (e) Determine the continuing use of the different WMO data representation forms and recommend options for their future roles or disposition.

Expert Team on Migration to Table-driven Code Forms

- (a) Develop in liaison with other Commissions (e.g. JCOMM, CCI, etc.) a detailed migration plan to table-driven representation forms to be presented to CBS-Ext.(2002) including options for disposition of character codes following migration;
- (b) Define a software project to specify, develop and distribute universal BUFR, CREX and GRIB encoding/decoding software, as available, to all requesting countries and propose a training programme;
- (c) Identify and analyse problems due to the migration of data representation at every step of the WWW data flow. In particular, study the impact of the migration process on the GTS and data-processing centres. Develop proposals for solutions;
- (d) List in general terms the possible implications, due to the migration process, on WMO Members' resources for development and operation, and propose solutions to mitigate the impact on Members and optimize the benefit of the migration of data representation for better data acquisition and satisfaction of the requirements for more frequent observations, new parameters and new data types;
- (e) Monitor the experience gained in bilateral tests and incorporate lessons learned into the migration implementation plan.

Expert Team on Integrated Data Management

- (a) Develop a metadata standard to be used in future WMO information systems. The standard should be defined as a WMO community profile within the context of the ISO metadata standard. This would include definition of new elements and extensions to the ISO standard and definition of keyword and code lists;
- (b) Recommend a standard Internet technology representation of the metadata for use on the World Wide Web (e.g. XML);
- (c) Advise on re-organization of the *Guide on WWW Data Management* (WMO-No. 788) and coordinate the development of the *WMO Guide on Data Management*, including preparation of the sections relating to the WMO metadata standards.

Expert Team on the IMTN and GTS

Focus on the medium-term (two to four years) improvement of the GTS and, in particular, the MTN.

- (a) Develop and implement the IMTN project, including supported applications, data transport functions, responsibilities of MTN centres, interfaces and gateways between the MTN and RMTNs, and administrative aspects, with a view to implementation by the year 2002;
- (b) Review and propose updates to the organization and design principles for the GTS, to take the best benefits of ICT development;

- (c) Provide guidance on technical, operational and administrative/financial aspects of telecommunication techniques and services for WWW operations, especially for the implementation of the GTS (in particular for RMTNs), including dedicated and public services (e.g. satellite-based telecommunication services, managed data-communication network services, ISDN, the Internet), including informing members of relevant developments in ITU and ISO.

Interprogramme Task Team on Future WMO Information Systems

Focus on the long-term (4+ years) development of WMO information systems with a view toward the development of implementation plans.

- (a) Review data exchange requirements (volume, timeliness, connectivity) of the WWW and other WMO Programmes as well as other information system requirements, from the view of the end user, in an "applications oriented manner";
- (b) Review the current and anticipated capabilities of public and dedicated data communication networks and services (the Internet, FR and ATM networks, satellite-based distribution, etc.) and conduct pilot studies;
- (c) Develop a vision for future WMO information systems to meet cost-effectively WMO requirements for real and non-real-time data exchange. This would include:
- (i) Basic concepts for information handling systems (databases, servers, etc.);
 - (ii) More efficient data collection, exchange and distribution mechanisms (store-and-forward, multicast, download, etc.);
 - (iii) Cost-effective utilization of public and dedicated data communication networks and services;
- (d) Develop a project plan including proposed applications and responsibilities of centres. Propose steps toward the implementation of the improved information system.

Expert Team on Enhanced Utilization of Data Communication Systems

- (a) Develop recommended practices and technical guidance material for the implementation of data communication facilities (GTS and Internet) at WWW centres, including security aspects, with a view to ensuring the efficient and safe operation of information systems;
- (b) Review current and anticipated telecommunication and information system requirements of the WWW and other WMO Programmes that can be effectively met by the Internet;
- (c) Review standard TCP/IP procedures and applications, including new developments (e.g. IPv6) that are relevant to WWW and other WMO Programme requirements, and develop recommended practices;
- (d) Develop recommendations on the coordinated use of the Internet to meet in the relevant short term

(one to three years) requirements of all WMO Programmes and update the *Guide on Internet Practices*, as required.

Steering Group on Radio-frequency Coordination

- (a) Keep under review allocations of radio-frequency bands and assignments of radio frequencies to meteorological activities for operational requirements (telecommunications, instruments, sensors, etc.) and research purposes, in coordination with other technical commissions;
- (b) Coordinate with WMO Members, with the assistance of the WMO Secretariat, to:
- (i) Ensure the proper notification and assignment of frequencies used for meteorological purpose;
 - (ii) Determine the future use of the radio spectrum for meteorological purposes;
- (c) Keep abreast of the activities of the Radiocommunication Sector of the International Telecommunication Union (ITU-R) and, in particular, of the Radiocommunication Study Groups, on frequency matters pertaining to meteorological activities and assist the WMO Secretariat in its participation in ITU-R work;
- (d) Prepare and coordinate proposals and advice to WMO Members on radio-regulation matters pertaining to meteorological activities with a view to presenting contributions to the ITU Radiocommunication Study Groups, the Radiocommunication Assembly, the World Radio Communication Conferences and related regional/global preparatory meetings;
- (e) Facilitate the coordination between WMO Members for the use of frequency bands allocated to meteorological activities with respect to:
- (i) Coordination of frequency use/assignments between countries;
 - (ii) Coordination of frequency use/assignments between various radiocommunication services (e.g. meteorological aids and DCPs) sharing the same band;
- (f) Facilitate the coordination of WMO with other international organizations which address radio-spectrum planning, including specialized organizations (e.g. CGMS, SFCG) and regional telecommunication organizations (e.g. CEPT, CITELE, APT);
- (g) Assist WMO Members, upon request, in the ITU coordination procedure of frequency assignment for radiocommunication systems sharing a frequency band with meteorological radiocommunication systems.

Rapporteur on WWW Monitoring

- (a) Coordinate the operational trial of the proposed integrated WWW monitoring;
- (b) Assess the impact of the implementation of the proposal, in particular as regards the resources needed at RTHs and NMCs;

- (c) Review and adapt the proposed integrated WWW monitoring in view of experience gained.

OPAG ON DATA-PROCESSING AND FORECASTING SYSTEMS

Implementation/Coordination Team on Data-processing and Forecasting Systems

- (a) Identify new emerging requirements (input required from RAs);
- (b) Determine how GDPS Centres can best contribute to fulfil emerging requirements;
- (c) Identify needs for workshops/training;
- (d) Review the procedures and scope of verification statistics on the performance of NWP systems and provide recommendations;
- (e) Review the monitoring of the quality of land surface observations (including possible extension to other observation types) and provide recommendations;
- (f) Propose recommendations for future work;
- (g) Coordinate the implementation of decisions by CBS related to GDPS;
- (h) Consider proposals from related expert teams and provide feedback to the teams concerned.

Emergency Response Activities Coordination Group

- (a) Test and improve the collective ability of all RSMCs in EER to fulfil the operational requirements specified in global and regional arrangements, according to adopted standards and procedures;
- (b) Develop and test detailed operational procedures for IAEA's notification of the WMO (RTH Offenbach, WMO Secretariat and RSMCs);
- (c) Explore improved distribution/access methods of specialized products to/by NMHS, and the IAEA in collaboration with the IAEA and other relevant organizations;
- (d) Examine the development of detailed procedures to activate additional observations in the event of nuclear accident (requires coordination with OPAG/IOS);
- (e) Demonstrate the role of NMHSs in EER;
- (f) Explore possible cooperation with the CTBTO, including testing of concepts of operational arrangements and participation in a technical workshop;
- (g) Study the feasibility of using atmospheric transport modelling for the prediction of volcanic ash in relation to general public safety.

Expert Team to Develop a Verification System on Long-range Forecasts

- (a) Coordinate the experimental exchange of long-range forecasts verification scores between participating centres and institutes;
- (b) Evaluate results of the exchange of experimental scores and provide a report;
- (c) Recommend operational practices to be followed in terms of the information on validation

results to be attached to the long-range forecasts products;

- (d) In consultation with CAS and CCI, propose recommendations for improvement and future work;
- (e) In consultation with CAS and CCI, refine procedures and recommend operational procedures for consideration by CAS, CCI and CBS.

Expert Team on Ensemble Prediction Systems

- (a) Review the list of fields and products that should be distributed taking into account the requirement of all relevant WMO Programmes;
- (b) Propose an update to the *Manual on the GDPS* (WMO-No. 485) (Appendix II-6) concerning the list of output products available for international exchange and dissemination;
- (c) Develop and test procedures for the exchange of EPS GRIB data, including the needs of large centres to exchange their ensemble;
- (d) Provide requirements for the dissemination of the products to help OPAG/ISS in determining appropriate means of dissemination to assess telecommunication implications;
- (e) Report on the operational use of EPS, to forecast severe weather and extreme events;
- (f) Develop standard verification measures for EPS utilizing the experience gained from the Expert Team on verifying long-range forecasts.

Expert Team on the Infrastructure for Long-range Forecasting

- (a) On the basis of stated requirements for LRF products and their improvements, provide input to the Inter-commission Task Group on Regional Climate Centres, concerning the establishment of appropriate operational infrastructure for the production and exchange of LRF;
- (b) Develop procedures for the exchange of LRF forecasts between potential centres and agencies concerned including defining products (model output, forecast skill, etc.) and defining terms and conditions for experimental exchange;
- (c) Begin experimental exchange of long-range forecasts between potential RSMCs and agencies;
- (d) Report on experimental exchange and provide recommendations for future consideration and adoption by CAS, CCI and CBS.

Rapporteur on the Application of NWP to Severe Weather Forecasting

- (a) Survey the application of NWP other than EPS to severe weather forecasting;
- (b) Report on new developments and advances in severe weather forecasting.

Rapporteur on the Impact of Changes to GOS on NWP

- (a) Monitor changes to the GOS that may impact on NWP;

- (b) Propose a mechanism for more timely assessment of changes in the GOS that might affect the quality of NWP analyses and forecasts;
- (c) Suggest studies as appropriate to evaluate impact of changes to the GOS for consideration by the GDPS centres;
- (d) Report on the outcome of NCEP/ECMWF reanalysis as they apply to the reduction of Russian Federation RAOBS and/or other significant changes in the GOS;
- (e) Review and report on sensitivities studies undertaken by GDPS centres and activities of NAOS, EUCOS, etc., as appropriate.

OPAG ON PUBLIC WEATHER SERVICES

Implementation/Coordination Team on Public Weather Services

- (a) Coordinate and keep under review the work of the PWS expert teams;
- (b) Make appropriate arrangements for consultation, collaboration and input into the work of the OPAG from other CBS OPAGs and the relevant technical commissions;
- (c) Promote greater mutual awareness of the relevant needs of public weather services and of the capability of meteorological systems between public weather service experts and basic system experts;
- (d) Promote the development of appropriate information material on technical aspects of meteorological systems suitable for the users of public weather services;
- (e) Keep under review and update guidelines developed on relationships between NMSs and emergency management authorities;
- (f) Keep abreast of information supplied by regional rapporteurs on the PWS training activities in their respective regions;
- (g) Document improvements in National Public Weather Services as a result of the above activities;
- (h) Review and report on results of public satisfaction assessments.

Expert Team on Product Development and Service Assessment

- (a) Evaluate developments and provide appropriate guidance on new technologies, e.g. the Internet, as applicable to public weather services;
- (b) Investigate and document opportunities for capitalizing on the benefits of research and improved technology for more effective production and delivery of public weather services;

- (c) Identify and study the likely future requirements of public weather services for new and improved products;
- (d) Provide advice on the exchange of such products to be delivered through a modernized WMO information system, with emphasis on the needs of developing countries;
- (e) Develop further guidance material, including relevant case studies and quantitative information, to assist NMSs in developing their skills in the planning and implementation of effective service assessment procedures to monitor user satisfaction and act on the findings.

Expert Team on Media Issues

- (a) Develop further the concept of effective media access to warnings provided by NMHSs via the Internet;
- (b) Continue to develop appropriate mechanisms for improved consistency between official information issued by NMSs and information disseminated by other sources;
- (c) Develop guidelines to assist NMSs in improving the effectiveness of public weather services, improving public understanding, and enhancing NMSs visibility through improved collaboration and partnerships with their national and local media with a view to ensuring correct attribution of NMSs in weather broadcasts;
- (d) Examine and advise on the increasing demand by national and local media for international weather information especially as regards weather-related disasters;
- (e) Advise on the changing demand for weather information via emerging communication media, such as the Internet;
- (f) Provide NMSs with guidance on effective two-way communication with the media.

Expert Team on Warnings and Forecast Exchange, Understanding and Use

- (a) Develop further the concept and conduct pilot tests on improved international exchange of NMSs' public forecasts and warnings via the Internet as part of efforts to enhance the visibility of NMSs;
- (b) Provide guidance to Members and regional associations on the implementation of public forecast exchange on the Internet;
- (c) Provide guidance to Members on the implementation of cross-border exchange of warnings;
- (d) Prepare guidelines on ways to improve public understanding of, and response to, warnings, including issues related to terminology.

ANNEX XI

Annex to paragraph 9.5 of the general summary

MEMBERSHIP OF OPAG TEAMS AND RAPPORTEURS

OPAG ON INTEGRATED OBSERVING SYSTEMS

Implementation/Coordination Team on
Integrated Observing Systems

Mr Harald Daan, Netherlands, RA VI Rapporteur

Mr Mahaman Saloum, Niger, RA I Rapporteur

Mr Yongqing Chen, China, RA II Rapporteur

Mr Luis Farias, Chile, RA III Rapporteur

Mr Terrence Hart, Australia, RA V Rapporteur

Mr Guillermo Vega, Costa Rica, RA IV Rapporteur

Chairpersons of IOS Expert Teams

Organizations with interest may include:

GCOS

CCI

Expert Team on Observational Data
Requirements and Redesign of the GOS

Mr Paul Menzel (chairperson), United States, RA IV

Mr Tom Schlatter with alternate (Mr Rainer

Dumbrowsky), United States, RA IV

Mr Alan Sharp, Australia, RA V

Ms Florence Rabier, France, RA VI

Mr Wenjian Zhang, China, RA II

Organizations with interest may include:

ECMWF

EUMETSAT

CCI

JCOMM

CAeM

GCOS – AOPC

EUCOS

CAS

Rapporteur on Scientific Evaluation of
Observing System Experiments (OSEs) and
Observing System Simulation Experiments
(OSSEs)

To be nominated by CBS/MG

Expert Team on Satellite System Utilization
and Products

Mr Hans Peter Roesli (chairperson), Switzerland, RA VI

Mr Wolfgang Benesch, Germany, RA VI

Mr Vasilii Asmus, Russian Federation, RA VI

Mr Anthony Mostek, United States, RA IV

Mr Xu Jianmin, China, RA II

Mr Ryoji Kumabe, Japan, RA II

Mr James G. Kongoti, Kenya, RA I

Mr Jeff Wilson, Australia, RA V

Organizations with interest may include:

EUMETSAT

RMTC

ASECNA

Rapporteur on GCOS Matters
Mr Stefan Rosner, Germany, RA VI

Expert Team on Requirements for Data
from Automatic Weather Stations

Mr Miroslav Ondráš (chairperson), Slovakia, RA VI

Mr Herbert Gmoser, Austria, RA VI

Mr Malcolm Gifford, United States, RA IV

Mr Darryl Lynch, Canada, RA IV

Mr Jorge Emilio Rodrigues, Brazil, RA III

Organizations with interest may include:

CIMO

EUMETNET

Rapporteur on Regulatory Material

Mr Alexander Vasiliev, Russian Federation, RA VI

Rapporteur on the Improvement of Volume A

Mr H. Daan, Netherlands, RA VI

OPAG ON INFORMATION SYSTEMS AND SERVICES

Implementation/Coordination Team on
Information Systems and Services

Chairperson of OPAG/ISS

Mr Malamine Sonko, Senegal, RA I, Rapporteur GTS

Mr Alexander Gusev (may be replaced), Russian
Federation, RA II, Rapporteur GTS

Mr Jose-Mauro de Rezende, Brazil, RA III,
Rapporteur GTS

Mr James Fenix, United States, RA IV, Rapporteur GTS

Mr Michael Hassett, Australia, RA V, Rapporteur GTS

Ms Pamela Dickinson, United Kingdom, RA VI,
Rapporteur GTS

Mr G. H. Obua, Uganda, RA I, Rapporteur DM

Mr Atsushi Shimazaki, Japan, RA II, Rapporteur DM

Mr Ernesto Grammelsbacher, Brazil, RA III,
Rapporteur DM

Mr Edward Young, (Hawaii) United States, RA V,
Rapporteur DM

Mr Igor Záhumenský, Slovakia, RA VI, Rapporteur DM

Chairperson of ET/DR&C

Chairperson of ET/MTDC

Chairperson of ET/IDM

Chairperson of ET/IMTN

Chairperson of ET/EUDCS

Chairperson of the Steering Group on Radio-frequency
Coordination

Expert Team on Data Representation and Codes

Mr Jean Clochard, France (chairperson), RA VI

Mr Scylla Silayo, United Republic of Tanzania, RA I

Mr Atsushi Shimazaki, Japan, RA II

Mr Jeff Ator, United States, RA IV
 Mr Charles Sanders, Australia, RA V
 Ms Eva Červená, Czech Republic, RA VI
 Organizations with interest may include:

ECMWF
 EUMETSAT
 ICAO
 IOC

Expert Team on Migration to Table-driven
 Code Forms

Mr Fred Branski, (chairperson), United States, RA IV
 Mr Seid Amedie, Ethiopia, RA I
 Mr Keiichi Kashiwagi, Japan, RA II
 Mr Vladimir Antsyovich, Russian Federation,
 RA II/VI

Mr Heinrich Knottenberg, Germany, RA VI
 Mr Dick Blaenboer, Netherlands, RA VI
 Chairperson of ET/DR&C

Organizations with interest may include:

ECMWF
 EUMETSAT
 IOC
 ICAO

Expert Team on Integrated Data Management
 Mr Steve Foreman (chairperson), United Kingdom,
 RA VI

Ms Fang Zhao, China, RA II
 Ms Irina Zhabina, Russian Federation, RA II/VI
 Mr Lawrence Buja, United States, RA IV
 Mr Jürgen Seib, Germany, RA VI

Expert Team on the IMTN and GTS

Mr Peiliang Shi, (chairperson), China, RA II
 Mr George M. Kibiru, Kenya, RA I
 Mr Hiroyuki Ichijo Japan, RA II
 Mr Leonid Bezrouk, Russian Federation, RA II/VI
 Mr Jose-Mauro de Rezende, Brazil, RA III
 Mr William Brockman, United States, RA IV
 Mr Ian Senior, Australia, RA V
 Mr Dominique Andre, France, RA VI
 Ms Ilona Glaser, Germany, RA VI
 Mr Robert Stephens, United Kingdom, RA VI

Organizations with interest may include:

ECMWF
 ASECNA

Interprogramme Task Team on Future
 WMO Information Systems

Chairperson of OPAG on ISS (chairperson)
 Mr Alexander Frolov, Russian Federation, RA II/VI
 Mr Ted Tsui, United States, RA IV
 Mr Kevin Alder, New Zealand, RA V
 Mr Kok Seng Yap, Malaysia, RA V
 Mr Robert Stanek, Germany, RA VI
 Mr Tom Potgieter, South Africa, RA I

Organizations with interest may include:

CAGM
 CAeM

CAS
 CHy
 CCI
 JCOMM

Expert Team on Enhanced Utilization of
 Data Communication Systems

Mr Jean-François Gagnon (chairperson), Canada,
 RA IV

Ms Xiang Li, China, RA II
 Mr Walter Mussante, United States, RA IV
 Mr Niyazi Yaman, Turkey, RA VI
 Mr Dave Tinkler, United Kingdom, RA VI
 Mr Hans Janssen, Germany, RA VI

Organizations with interest may include:

ECMWF
 ITU

Steering Group on Radio-frequency
 Coordination

Mr Hans Richner (chairperson), Switzerland, RA VI
 Mr Jixin Yu, China, People's Republic, RA II
 Mr Yuichi Sakoda, Japan, RA II
 Ms Elena Manaenkova, Russian Federation,
 RA II/VI

Mr Wilson Sandoval, Brazil, RA III
 Mr David Franc, United States, RA IV

Mr John Beard, Australia, RA V
 Mr Guy Rochard, France, RA VI
 Mr John Nash, United Kingdom, RA VI

Organizations with interest may include:

EUMETSAT
 ITU-R

Rapporteur on WWW Monitoring
 Mr Jean-Pierre Bourdette, France, RA VI

OPAG ON DATA-PROCESSING AND FORECASTING SYSTEMS

Implementation/Coordination Team on
 Data-processing and Forecasting Systems
 Rapporteurs on Regional Aspects of GDPS
 Chairpersons of DPFS Expert Teams

Emergency Response Activities
 Coordination Group

RSMCs with ERA activity specialization:

RSMC Montreal — Mr Peter Chen
 (chairperson)

RSMC Beijing — Mr Yuetang Zhang

RSMC Tokyo — Mr Keiichi Katayama

RSMC Washington

RSMC Melbourne — Mr Terry Hart

RSMC Toulouse — Mr Frederic Chavaux

RTH Offenbach — Mr Ingo Jacobsen

RSMC Obninsk — Mr Vjacheslav Shershakov

RSMC Bracknell — Mr Dave Smith

One expert for one NMHS: Ms Ludmila
 Voronina, Kazakhstan, RA II

Experts from CTBTO and IAEA

Expert Team to Develop a Verification System on Long-range Forecasts

Mr Terry Hart (chairperson), Australia, RA V
 Ms Laura Ferranti, ECMWF
 Mr Robert Livezey, United States, RA IV
 Mr Richard Graham, United Kingdom, RA VI
 Mr Richard Verret, Canada, RA IV
 Mr Kusunoki Shoji, Japan, RA II
 Mr Peiqun Zhang, China, RA II

Expert Team on Ensemble Prediction Systems

Mr Nobuo Sato (chairperson), Japan, RA II
 Mr Steve Tracton, United States, RA IV
 Mr Louis Lefaivre, Canada, RA IV
 Mr Abdalah Mokssit, Morocco, RA I
 Mr Anthony Simmers, New Zealand, RA V
 An expert from Oman
 Mr Lee Woo-Jin, Korea, RA II
 Mr Pierre Eckert, Switzerland, RA VI
 Mr François Lalaurette (ECMWF)

Expert Team on the Infrastructure for Long-range Forecasting

Mr Alexander Frolov (chairperson), Russian Federation, RA VI/II
 Mr Scott Power, Australia, RA V
 Mr Jean-Guy Desmarais, Canada, RA IV
 Mr Vernon Kousky, United States, RA IV
 Mr Mike Davey, United Kingdom, RA VI
 Mr Taira Ryusuke, Japan, RA II
 Mr Winfred Jordan, South Africa, RA I
 Mr Park Chung-Kyu, Korea, RA II

Organizations with interest may include:

CCI
 CAS
 CAgM
 ECMWF
 ACMAD

Rapporteur on the Application of NWP to Severe Weather Forecasting

Mr Jean Coiffier, France, RA VI

Rapporteur on the Impact of Changes to GOS on NWP

Mr Steve Lord, United States, RA IV

OPAG ON PUBLIC WEATHER SERVICES

Implementation/Coordination Team on Public Weather Services

Chairperson of OPAG/PWS
 Co-chairperson of OPAG/PWS
 Mr Michael de Villiers, South Africa, Rapporteur RA I
 Mr Ginn Wing-lui Edwin, Hong Kong, China, Rapporteur RA II
 Mr José Manuel Afonso, Argentina, Rapporteur RA III
 Mr Mario Sanchez, Costa Rica, Rapporteur RA IV
 Ms Imelda Valeroso, Philippines, Co-rapporteur RA V
 Mr Wolfgang Kusch, Germany, Rapporteur RA VI
 Chairpersons of PWS Expert Teams
 Organization with interest may include:
 CCI

Expert Team on Product Development and Service Assessment

Mr James Lee (chairperson), United States, RA IV
 Mr C. C. Chan, Hong Kong, China, RA II
 Ms Maria Teresa Martinez Gomez, Colombia, RA III
 Mr Joseph Shaykewich, Canada, RA IV
 Ms Hwang Yung Fong, Malaysia, RA V
 Mr Samuel Shongwe, Swaziland, RA I
 Mr Wolfgang Kusch, Germany, RA VI

Expert Team on Media Issues

Mr Gerald Fleming (chairperson), Ireland, RA VI
 Mr Samuel Muchemi, Kenya, RA I
 Mr Ahmed H. M. Al Harthy, Oman, RA II
 Mr Jose Rubiera, Cuba, RA IV
 Ms Claire Martin, Canada, RA IV
 Mr Tarini Casinader, Australia, RA V
 Mr Ivan Cacic, Croatia, RA VI
 Mr Roman Vilfand, Russian Federation, RA II/VI
 Ms Elaine Cordoneanu, Romania, RA VI

Expert Team on Warnings and Forecast Exchange, Understanding and Use

Mr C. Y. Lam (chairperson), Hong Kong, China, RA II
 Ms Amy Holman, United States, RA IV
 Mr Jim Davidson, Australia, RA V
 Mr Constante De Simone, Italy, RA VI
 Mr Christian Blondin, France, RA VI
 Mr Stewart Wass, United Kingdom, RA VI

APPENDIX A

LIST OF PERSONS ATTENDING THE SESSION

A. OFFICERS OF THE SESSION

S. Mildner President
G. B. Love Vice-president

B. REPRESENTATIVES OF WMO MEMBERS

<i>Member</i>	<i>Name</i>	<i>Capacity</i>
Algeria	M. Haouach A. A. Aoune S. Benmati (Ms)	Principal delegate Delegate Observer
Australia	G. B. Love K. J. O'Loughlin	Principal delegate Delegate
Austria	H. Gmoser K. Panosch	Principal delegate Delegate
Bahamas	B. A. Dean	Principal delegate
Belarus	I. M. Skuratovich	Principal delegate
Belgium	E. De Dycker W. Struijlaert	Principal delegate Delegate
Benin	F. J. B. Hounton	Principal delegate
Botswana	D. F. Molotsi W. Minja	Principal delegate Alternate
Brazil	J. M. de Rezende P. B. Silos C. Gomes	Principal delegate Delegate Adviser
Brunei Darussalam	M. H. Aji A. L. H. Abdullah	Principal delegate Alternate
Burkina Faso	A. J. Garane	Principal delegate
Cameroon	B. H. Mbifngwen E. G. Ondoua	Principal delegate Delegate
Canada	P. Dubreuil A. Simard (Ms) J.-F. Gagnon B. Greer M. Jean	Principal delegate Alternate Delegate Delegate Delegate
China	Zheng Guoguang Wang Caifang (29.XI-2.XII) Shi Peiliang Xu Xiaofeng	Principal delegate Alternate Delegate Adviser
Congo	D. Evouya E. J. Biyot (Ms)	Principal delegate Alternate
Croatia	K. Pandžić	Principal delegate
Czech Republic	E. Červená (Ms)	Principal delegate

<i>Member</i>	<i>Name</i>	<i>Capacity</i>
Democratic Republic of the Congo	A. Muyeno K. Mupande	Principal delegate Alternate
Denmark	N. J. Pedersen	Principal delegate
Egypt	M. S. Hammad M. M. El-Bakry N. M. Hassan (Ms)	Principal delegate Alternate Delegate
Estonia	P. Koiva (29.XI-2.XII)	Principal delegate
Finland	J. Riissanen H. Juntti K. Soini (Ms)	Principal delegate Delegate Delegate
France	F. Duvernet J-P. Bourdette J. Clochard	Principal delegate Delegate Adviser
Germany	S. Mildner G.-R. Hoffmann H. Dunke W. Kusch C. Richter (Ms) G. Steinhorst	Principal delegate Alternate Delegate Delegate Delegate Delegate
Ghana	G. A. Wilson	Principal delegate
Greece	G. Sakellaridis	Principal delegate
Hong Kong, China	C. Y. Lam H.-G. Wai	Principal delegate Alternate
Hungary	M. Buranszki Sallai (Ms)	Principal delegate
Iceland	G. Hafsteinsson H. Baldursdottir (Ms)	Principal delegate Adviser
India	P. R. Rao	Principal delegate
Iran, Islamic Republic of	A. M. Noorian B. Sanaei A. Haratian M. Jabbari (Ms)	Principal delegate Alternate Delegate Delegate
Ireland	P. Halton	Principal delegate
Israel	A. Goldmann	Principal delegate
Italy	G. Tarantino C. de Simone M. Crespi	Principal delegate Alternate Delegate
Japan	N. Sato K. Kashiwagi	Principal delegate Delegate
Jordan	A. I. Saleh	Principal delegate

<i>Member</i>	<i>Name</i>	<i>Capacity</i>	<i>Member</i>	<i>Name</i>	<i>Capacity</i>
Kazakhstan	O. Abramenko (Ms)	Principal delegate	Russian Federation	A. Frolov	Delegate
	P. Kozhakhmetov	Delegate		A. Vasiliev	Delegate
Kenya	J. R. Mukabana	Principal delegate	(Contd.)	A. Solomakhov	Adviser
	K. I. Essendi	Alternate	G. Vaisman	Adviser	
Latvia	A. Leitass	Principal delegate	Saudi Arabia	S. A. H. Habis	Principal delegate
Lebanon	A. Bejjani	Principal delegate	Senegal	C. A. Diallo (Ms)	Principal delegate
	I. Barakat-Diab	Alternate		A. Ndiaye	Alternate
Madagascar	V. Randriamampianina	Principal delegate	A. Dieye	Adviser	
			Slovakia	M. Ondráš	Principal delegate
Malaysia	K.-S. Yap	Principal delegate	M. Majek	Delegate	
			Slovenia	J. Roskar	Principal delegate
Mauritius	U. Munbodh	Principal delegate	South Africa	T. I. J. Potgieter	Principal delegate
Mongolia	D. Tungalag	Principal delegate	Spain	R. Riosalido	Principal delegate
	B. Suvd (Ms)	Delegate		C. Callejas (Ms)	Alternate
Morocco	M. L. Selassi	Principal delegate	M. Lambas	Delegate	
			A. Paredes (Ms)	Delegate	
Netherlands	S. Barlag (Ms)	Principal delegate	Sudan	F. E. Sayem	Principal delegate
	J. P. van der Meulen	Alternate	Swaziland	S. Gumede	Principal delegate
H. Daan	Delegate	Sweden	S. Nilsson	Principal delegate	
New Zealand	R. D. Stainer	Principal delegate	Switzerland	P. Rauh	Principal delegate
	M. Overdale	Delegate		P. Müller	Alternate
Niger	I. Also	Principal delegate	Syrian Arab Republic	N. Al-Shalabi	Principal delegate
	M. Saloum	Alternate	Thailand	T. Damrak	Principal delegate
B. Magagi	Delegate	M. Kiran	Delegate		
Nigeria	T. Obidike	Principal delegate	Togo	A. A. Egbare	Principal delegate
Norway	J. Sunde	Principal delegate	Tunisia	A. Ben Jemaa	Principal delegate
	K. Bjørheim	Alternate	Turkey	R. Yilmaz	Principal delegate
Oman	A. H. M. Al-Harthy	Principal delegate	K. Dokuyucu	Delegate	
	S. M. S. Al-Harthy	Delegate	N. Yaman	Delegate	
Pakistan	M. Z. Baloch (Ms)	Principal delegate	Turkmenistan	S. Bayramow	Principal delegate
Philippines	M. A. Sta Catalina	Principal delegate	Uganda	E. Bazira	Principal delegate
Poland	J. Zielinski	Principal delegate	United Arab Emirates	K. A. Ahmed	Principal delegate
Portugal	M. Almeida	Principal delegate	A. M. Al-Dhanhani	Delegate	
	R. Carvalho	Delegate	H. S. Al-Reyami	Delegate	
Republic of Korea	S.-J. Kim	Principal delegate	H. R. Sayed	Delegate	
	S.-K. Chung	Delegate	United Kingdom of Great Britain and Northern	C. Flood	Principal delegate
B.-H. Lim	Delegate	P. Francis	Alternate		
J.-G. Park	Delegate	S. J. Foreman	Delegate		
Romania	E. Cordoneanu (Ms)	Principal delegate	A. McIlveen	Delegate	
			United Republic of Tanzania	P. F. Tibaijuka	Principal delegate
Russian Federation	V. Dyadyuchenko	Principal delegate			
	A. Gusev	Alternate			
B. Antsyovich	Delegate				
L. Bezruk	Delegate				

<i>Member</i>	<i>Name</i>	<i>Capacity</i>
United States of America	J. Jones	Principal delegate
	J. Purdom	Alternate
	W. Brockman	Delegate
Uzbekistan	D. Zabarin	Principal delegate
Venezuela	H. O. Sanz López	Principal delegate
	A. J. Piñero Díaz	Alternate
	V. Gonzalez Villaparedes	Delegate
Viet Nam	Tran Van Sap	Principal delegate

C. INVITED EXPERTS

J. M. Nicholls	Commission for Climatology
K. Essendi	Chairperson of RA I Working Group on Planning and Implementation of the WWW
P. R. Rao	Chairperson of RA II Working Group on Planning and Implementation of the WWW
R. Brook	Chairperson of RA V Working Group on Planning and Implementation of the WWW
M. Kurz	Chairperson of RA VI Working Group on Planning and Implementation of the WWW
M. Manton	Chairperson GCOS/AOPC

D. REPRESENTATIVES OF INTERNATIONAL ORGANIZATIONS

<i>Organization</i>	<i>Name</i>
Agency for Air Safety in Africa and Madagascar (ASECNA)	J. D. Ago M. Sissako L. Finke-Fictime
Comprehensive Nuclear Test Ban Treaty Organization (CTBTO)	R. Kebeasy P. McRae
European Centre for Medium-Range Weather Forecasts (ECMWF)	H. Böttger D. Marbouty
European Space Agency (ESA)	E. Oriol-Pibernat (Ms)
European Meteorological Services Network (EUMETNET)	F. Gérard
European Organization for the Exploitation of Meteorological Satellites (EUMETSAT)	S. Elliott B. E. McWilliams R. Wolf
International Association of Broadcast Meteorology (IABM)	G. Fleming B. Giles I. Niedek (Ms) J. Teather D. W alch
International Astronautical Federation (IAF)	L. Adame
International Civil Aviation Organization (ICAO)	O. M. Turpeinen
League of Arab States (LAS)	M. Benani M. H. Elsayed M. Lamine
Organization of African Unity (OAU)	V. Wege-Nzomwita

APPENDIX B

AGENDA

<i>Agenda item</i>	<i>Document Nos.</i>	<i>PINK Nos. and person submitting</i>	<i>Resolutions and recommendations adopted</i>
1. OPENING OF THE SESSION		1, president of CBS	
2. ORGANIZATION OF THE SESSION		1, president of CBS	
2.1 Consideration of the report on credentials			
2.2 Adoption of the agenda	2.2(1); 2.2(2)		
2.3 Establishment of committees			
2.4 Other organizational questions			
3. REPORT BY THE PRESIDENT OF THE COMMISSION	3(1)	3; 3, CORR.1, president of CBS	
4. REVIEW OF THE DECISIONS OF THIRTEENTH CONGRESS AND THE EXECUTIVE COUNCIL RELATED TO THE COMMISSION	4	4, vice-president of CBS	
5. STATUS OF THE WORLD WEATHER WATCH IMPLEMENTATION AND OPERATION	5	5, chairperson, Committee of the Whole	
6. WORLD WEATHER WATCH PROGRAMME, SUPPORT FUNCTIONS AND PUBLIC WEATHER SERVICES INCLUDING THE REPORTS OF THE CHAIRPERSONS OF THE OPEN PROGRAMME AREA GROUPS			
6.1 Integrated observing systems	6.1(1); 6.1(1), ADD.1; 6.1(2)	6.1, co-chairperson, Working Committee	Rec. 1
6.2 Information systems and services	6.2(1); 6.2(1), ADD.1; 6.2(2); 6.2(3); 6.2(3), ADD.1; 6.2(3), ADD.2; 6.2(3), ADD.3; 6.2(3), ADD.4; 6.2(3), ADD.5; 6.2(4); 6.2(4), ADD.1; 6.2(4), ADD.2; 6.2(5)	6.2(1); 6.2(3); 6.2(3), ADD.1, co-chairperson, Working Committee	Rec. 2; 3; 4; 5
6.3 Data-processing and forecasting systems	6.3; 6.3, ADD.1; 6.3, ADD.2; 6.3(1); 6.3(2)	6.3; 6.3(1), co-chairperson, Working Committee	Rec. 6; 7
6.4 Public weather services	6.4	6.4, co-chairperson, Working Committee	
6.5 Operational information service	6.5	6.5, co-chairperson, Working Committee	
7. LONG-TERM PLANNING RELEVANT TO THE COMMISSION	7; 7, REV.1; 7(2)	7, vice-president of CBS	
8. REVIEW OF THE WORKING STRUCTURE OF THE COMMISSION	8	8, chairperson, Committee of the Whole	Res. 1; 2
9. WORK PROGRAMME OF THE COMMISSION; ESTABLISHMENT OF OPEN PROGRAMME AREA GROUPS AND TEAMS	9	9, chairperson, Committee of the Whole	Res. 3
10. REVIEW OF PREVIOUS RESOLUTIONS AND RECOMMENDATIONS OF THE COMMISSION AND RELEVANT EXECUTIVE COUNCIL RESOLUTIONS	10; 10, REV.1	10, chairperson, Working Committee	Res. 4 Rec. 8

<i>Agenda item</i>	<i>Document Nos.</i>	<i>PINK Nos. and person submitting</i>	<i>Resolutions and recommendations adopted</i>
11. ELECTION OF OFFICERS		11, chairperson, Nomination Committee; 11(2), president of CBS	
12. DATE AND PLACE OF THE NEXT SESSION		12, president of CBS	
13. CLOSURE OF THE SESSION		13, president of CBS	

APPENDIX C

LIST OF ABBREVIATIONS

ACMAD	African Centre of Meteorological Applications for Development
ADS	Automatic Dependent Surveillance
AGM	Annual Global Monitoring
AHL	Abbreviated Header Line
AMDAR	Aircraft Meteorological Data Relay
AMSU	Advanced Microwave Sounding Unit
AOPC	Atmospheric Observation Panel for Climate
APT	Automatic Picture Transmission
ARGOS	Data Relay and Platform Location System
ARINC	Aeronautical Radio, Incorporated
ASAP	Automated Shipboard Aerological Programme
ASECNA	Agency for Air Safety in Africa and Madagascar
AWG	Advisory Working Group
AWOS	Automated Weather Observing System
AWS	Automatic Weather Station
BMTC	Australian Bureau of Meteorology
CAeM	Commission for Aeronautical Meteorology
CAGM	Commission for Agricultural Meteorology
CAS	Commission for Atmospheric Sciences
CBS	Commission for Basic Systems
CBS-MG	Commission for Basic Systems-Management Group
CCI	Commission for Climatology
CEOS	Committee on Earth Observation Satellites
CEPT	European Conference of Postal and Telecommunications Administrations
CGC	Coordination Group for the Composite Observing System for the North Atlantic
CGMS	Coordination Group for Meteorological Satellites
CHy	Commission for Hydrology
CIMO	Commission for Instruments and Methods of Observation
CIR	Committed Information Rate
CITEL	Inter-American Telecommunication Commission
CLIVAR	Climate Variability and Predictability
CMC	Canadian Meteorological Centre
COSNA	Composite Observing System for the North Atlantic
CPC	Climate Prediction Center
CSN	Channel Sequence Number
CTBTO	Comprehensive Nuclear Test Ban Treaty Organization
DBCP	Data Buoy Cooperation Panel
DCP	Data Collection Platform
DCS	Data Collection System
DCST	Data-collection Systems and Techniques
DDB	Distributed Databases
DPFS	Data-processing and Forecasting Systems
DR&C	Data Representation and Codes
DVB	Digital Video Broadcast
ECMWF	European Centre for Medium Range Weather Forecasts
EER	Environmental Emergency Response
EMWIN	Emergency Managers Weather Information Network
EPS	Ensemble Prediction System
ERA	Emergency Response Activities
ESA	European Space Agency

ESCAP	Economic and Social Commission for Asia and the Pacific
ET	Expert Team
EUCOS	European Composite Observing System
EUDCS	Enhanced Utilization of Data Communication System
EUMETNET	European Meteorological Network
EUMETSAT	European Organization for the Exploitation of Meteorological Satellites
5LTP	Fifth WMO Long-term Plan
FTP	File Transfer Protocol
GCOS	Global Climate Observing System
GDPS	Global Data-processing System
GISC	Global Information System Centre
GMS	Geostationary Meteorological Satellite
GOES	Geostationary OPERational Environmental Satellite
GOS	Global Observing System
GOSSP	Global Observing Systems Space Panel
GPCC	Global Precipitation Climatology Centre
GPS	Global Positioning System
GSN	GCOS Surface Network
GTS	Global Telecommunication System
GUAN	GCOS Upper-air Network
HR	High Resolution
HRPT	High Resolution Picture Transmission
IABM	International Association of Broadcast Meteorology
IAEA	International Atomic Energy Agency
IAF	International Astronautical Federation
IAVW	International Airways Volcano Watch
ICAO	International Civil Aviation Organization
ICT	Implementation/Coordination Team
IDM	Integrated Data Management
IDNDR	International Decade for Natural Disaster Reduction
IEM	Information Exchange Management
IGOS-P	Integrated Global Observing Strategy Partnership
IMT	International Mobile Telecommunications
IMTN	Improved Main Telecommunication Network
INMARSAT	International Maritime Satellite System
IOC	Intergovernmental Oceanographic Commission
IOS	Integrated Observing Systems
IPCC	Intergovernmental Panel on Climate Change
ISCS	International Satellite Telecommunications System
ISO	International Organization for Standardization
ISS	Information Systems and Services
ITU	International Telecommunication Union
ITU-R	ITU Radiocommunication Sector
ITU-T	ITU Telecommunication Standardization Sector
JCOMM	Joint WMO/IOC Technical Commission for Oceanography and Marine Meteorology
JSC	Joint Scientific Committee
LAS	League of Arab States
LEPSCAT	Linear Error in Probability Space for Categorical Forecasts
LRF	Long-range Forecasting
LRIT	Low Rate Information Transmission
LRPT	Low Resolution Picture Transmission
MDD	Meteorological Data Distribution
MI	Media Issues

MIB	Management Information Base
MOS	Model Output Statistics
MRTG	Multi-router Traffic Grapher
MSG	METEOSAT Second Generation
MSS	Message Switching System
MTDC	Migration to Table-driven Code Forms
MTN	Main Telecommunication Network
NAOS	North Atlantic Ocean Stations
NASA	National Aeronautics and Space Administration
NAT	Network Address Translation
NCAR	National Center for Atmospheric Research
NCDC	National Climatic Data Center
NCEP	National Centres for Environmental Predictions
NESDIS	National Environmental Satellite, Data and Information Service
NMC	National Meteorological Centre
NMHS	National Meteorological and Hydrological Service
NMS	National Meteorological or Hydrometeorological Service
NOAA	National Oceanic and Atmospheric Administration
NWP	Numerical Weather Prediction
NWS	National Weather Service
ODRRGOS	Observational Data Requirements and Redesign of the GOS
OIS	Operational Information Service
OPAG	Open Programme Area Group
OPMET	Operational Meteorological Information
OSE	Observing System Experiment
OSI	Open Systems Interconnection
OSSE	Observing Systems Simulation Experiment
OAU	Organization of African Unity
PDB	Point Data Bank
PDVS	Product Development and Verification and Service Evaluation
PPM	Perfect Prognosis Method
PUMA	Preparation for the Use of Meteosat Second Generation in Africa
PVC	Permanent Virtual Circuit
PWS	Public Weather Services
RA	Regional Association
RANET	Radio and Internet
RBCN	Regional Basic Climatological Network
RBSN	Regional Basic Synoptic Network
RMDCN	Regional Meteorological Data Communication Network
RMTC	Regional Meteorological Training Centre
RMTN	Regional Meteorological Telecommunication Network
ROC	Relative Operating Characteristics
RSMC	Regional Specialized Meteorological Centre
RTH	Regional Telecommunication Hub
6LTP	Sixth WMO Long-term Plan
SADIS	Satellite Distribution System
SFCG	Space Frequency Coordination Group
SMM	Special MTN Monitoring
SPC	Specialized Product Centre
SSUP	Satellite System Utilization and Products
SVC	Switched Virtual Circuit
SVS	Standardized Verification System

TCP/IP	Transmission Control Protocol/Internet Protocol
TIS	Trusted Information Systems
TOVS	TIROS Operational Vertical Sounder
UKMO	United Kingdom Meteorological Office
UKSF	United Kingdom Satellite Facility
UN/OCHA	United Nations Office for the Coordination of Humanitarian Affairs
URL	Universal Resource Locator
VC	Virtual Call
VOS	Voluntary Observing Ship
WAFC	World Area Forecast Centre
WAFS	World Area Forecast System
WCP	World Climate Programme
WCRP	World Climate Research Programme
WEFAX	Weather Facsimile
WFEI	Warnings and Forecasts Exchange Issues
WG-DM	Working Group on Data Management
WG-TEL	Working Group on Telecommunications
WMC	World Meteorological Centre
WMO	World Meteorological Organization
WMO50	World Meteorological Organization Fiftieth Anniversary
WRC	World Radiocommunication Conference
WWRP	World Weather Research Programme
WWW	World Weather Watch
XBT	Expendable Bathythermograph
Y2K	Year 2000
