

NOAA Technical Memorandum NWS WR-183

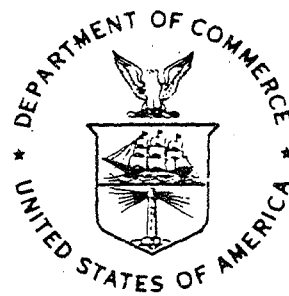

500 MILLIBAR SIGN FREQUENCY TELECONNECTION CHARTS - SPRING

Salt Lake City, Utah
January 1984

**U.S. DEPARTMENT OF
COMMERCE**

/ National Oceanic and
Atmospheric Administration

/ National Weather
Service



NOAA TECHNICAL MEMORANDA
National Weather Service, Western Region Subseries

The National Weather Service (NWS) Western Region (WR) Subseries provides an informal medium for the documentation and quick dissemination of results not appropriate, or not yet ready, for formal publication. The series is used to report on work in progress, to describe technical procedures and practices, or to relate progress to a limited audience. These Technical Memoranda will report on investigations devoted primarily to regional and local problems of interest mainly to personnel, and hence will not be widely distributed.

Papers 1 to 25 are in the former series, ESSA Technical Memoranda, Western Region Technical Memoranda (WRTM); papers 24 to 59 are in the former series, ESSA Technical Memoranda, Weather Bureau Technical Memoranda (WBTM). Beginning with 60, the papers are part of the series, NOAA Technical Memoranda NWS. Out-of-print memoranda are not listed.

Papers 2 to 22, except for 5 (revised edition), are available from the National Weather Service Western Region, Scientific Services Division, P. O. Box 11188, Federal Building, 125 South State Street, Salt Lake City, Utah 84147. Paper 5 (revised edition), and all others beginning with 25 are available from the National Technical Information Service, U. S. Department of Commerce, Sills Building, 5285 Port Royal Road, Springfield, Virginia 22151. Prices vary for all paper copy; \$3.50 microfiche. Order by accession number shown in parentheses at end of each entry.

ESSA Technical Memoranda (WRTM)

- 2 Climatological Precipitation Probabilities. Compiled by Lucianne Miller, December 1965.
- 3 Western Region Pre- and Post-FP-3 Program, December 1, 1965, to February 20, 1966. Edward D. Diemer, March 1966.
- 5 Station Descriptions of Local Effects on Synoptic Weather Patterns. Philip Williams, Jr., April 1966 (revised November 1967, October 1969). (PB-17800)
- 8 Interpreting the RAREP. Herbert P. Benner, May 1966 (revised January 1967).
- 11 Some Electrical Processes in the Atmosphere. J. Latham, June 1966.
- 17 A Digitalized Summary of Radar Echoes within 100 Miles of Sacramento, California. J. A. Youngberg and L. B. Overaas, December 1966.
- 21 An Objective Aid for Forecasting the End of East Winds in the Columbia Gorge, July through October. D. John Coparanis, April 1967.
- 22 Derivation of Radar Horizons in Mountainous Terrain. Roger G. Pappas, April 1967.

ESSA Technical Memoranda, Weather Bureau Technical Memoranda (WBTM)

- 25 Verification of Operational Probability of Precipitation Forecasts, April 1966-March 1967. W. W. Dickey, October 1967. (PB-176240)
- 26 A Study of Winds in the Lake Mead Recreation Area. R. P. Augulis, January 1968. (PB-177830)
- 28 Weather Extremes. R. J. Schmidl, April 1968. (Revised December 1983)
- 29 Small-Scale Analysis and Prediction. Philip Williams, Jr., May 1968. (PB-178425)
- 30 Numerical Weather Prediction and Synoptic Meteorology. Capt. Thomas D. Murphy, U.S.A.F., May 1968. (AD-673365)
- 31 Precipitation Detection Probabilities by Salt Lake ARTC Radars. Robert K. Belesky, July 1968. (PB-179084)
- 32 Probability Forecasting--A Problem Analysis with Reference to the Portland-Fire Weather District. Harold S. Ayer, July 1968. (PB-179289)
- 35 Joint ESSA/FAA ARTC Radar Weather Surveillance Program. Herbert P. Benner and DeVon B. Smith, December 1968 (revised June 1970). AD-681857)
- 36 Temperature Trends in Sacramento--Another Heat Island. Anthony D. Lentini, February 1969. (PB-183055)
- 37 Disposal of Logging Residues without Damage to Air Quality. Owen P. Cramer, March 1969. (PB-183057)
- 39 Upper-Air Lows over Northwestern United States. A. L. Jacobson, April 1969. (PB-184296)
- 40 The Man-Machine Mix in Applied Weather Forecasting in the 1970's. L. W. Snellman, August 1969. (PB-185068)
- 42 Analysis of the Southern California Santa Ana of January 15-17, 1966. Barry B. Aronovitch, August 1969. (PB-185670)
- 43 Forecasting Maximum Temperatures at Helena, Montana. David E. Olsen, October 1969. (PB-185762)
- 44 Estimated Return Periods for Short-Duration Precipitation in Arizona. Paul C. Kangieser, October 1969. (PB-187763)
- 46 Applications of the Net Radiometer to Short-Range Fog and Stratus Forecasting at Eugene, Oregon. L. Yee and E. Bates, December 1969. (PB-190476)
- 47 Statistical Analysis as a Flood Routing Tool. Robert J. C. Burnash, December 1969. (PB-188744)
- 48 Tsunami. Richard P. Augulis, February 1970. (PB-190157)
- 49 Predicting Precipitation Type. Robert J. C. Burnash and Floyd E. Hug, March 1970. (PB-190962)
- 50 Statistical Report on Aeroallergens (Pollens and Molds) Fort Huachuca, Arizona, 1969. Wayne S. Johnson, April 1970. (PB-191743)
- 51 Western Region Sea State and Surf Forecaster's Manual. Gordon C. Shields and Gerald B. Burdwell, July 1970. (PB-193102)
- 52 Sacramento Weather Radar Climatology. R. G. Pappas and C. M. Veliquette, July 1970. (PB-193347)
- 54 A Refinement of the Vorticity Field to Delineate Areas of Significant Precipitation. Barry B. Aronovitch, August 1970.
- 55 Application of the SSARR Model to a Basin without Discharge Record. Vail Schermerhorn and Donald W. Kuehl, August 1970. (PB-194394)
- 56 Areal Coverage of Precipitation in Northwestern Utah. Philip Williams, Jr., and Werner J. Heck, September 1970. (PB-194389)
- 57 Preliminary Report on Agricultural Field Burning vs. Atmospheric Visibility in the Willamette Valley of Oregon. Earl M. Bates and David O. Chilcote, September 1970. (PB-194710)
- 58 Air Pollution by Jet Aircraft at Seattle-Tacoma Airport. Wallace R. Donaldson, October 1970. (COM-71-00017)
- 59 Application of PE Model Forecast Parameters to Local-Area Forecasting. Leonard W. Snellman, October 1970. (COM-71-00016)

NOAA Technical Memoranda (NWS WR)

- 60 An Aid for Forecasting the Minimum Temperature at Medford, Oregon. Arthur W. Fritz, October 1970. (COM-71-00120)
- 63 700-mb Warm Air Advection as a Forecasting Tool for Montana and Northern Idaho. Norris E. Woerner, February 1971. (COM-71-00349)
- 64 Wind and Weather Regimes at Great Falls, Montana. Warren B. Price, March 1971.
- 66 A Preliminary Report on Correlation of ARTCC Radar Echoes and Precipitation. Wilbur K. Hall, June 1971. (COM-71-00829)
- 69 National Weather Service Support to Soaring Activities. Ellis Burton, August 1971. (COM-71-00956)
- 71 Western Region Synoptic Analysis-Problems and Methods. Philip Williams, Jr., February 1972. (COM-72-10433)
- 74 Thunderstorms and Hail Days Probabilities in Nevada. Clarence M. Sakamoto, April 1972. (COM-72-10554)
- 75 A Study of the Low Level Jet Stream of the San Joaquin Valley. Ronald A. Willis and Philip Williams, Jr., May 1972. (COM-72-10707)
- 76 Monthly Climatological Charts of the Behavior of Fog and Low Stratus at Los Angeles International Airport. Donald M. Gales, July 1972. (COM-72-11140)
- 77 A Study of Radar Echo Distribution in Arizona During July and August. John E. Hales, Jr., July 1972. (COM-72-11136)
- 78 Forecasting Precipitation at Bakersfield, California, Using Pressure Gradient Vectors. Earl T. Riddiough, July 1972. (COM-72-11146)
- 79 Climate of Stockton, California. Robert C. Nelson, July 1972. (COM-72-10920)
- 80 Estimation of Number of Days Above or Below Selected Temperatures. Clarence M. Sakamoto, October 1972. (COM-72-10021)
- 81 An Aid for Forecasting Summer Maximum Temperatures at Seattle, Washington. Edgar G. Johnson, November 1972. (COM-73-10150)
- 82 Flash Flood Forecasting and Warning Program in the Western Region. Philip Williams, Jr., Chester L. Glenn, and Roland L. Raetz, December 1972, (revised March 1978). (COM-73-10251)
- 83 A Comparison of Manual and Semiautomatic Methods of Digitizing Analog Wind Records. Glenn E. Rasch, March 1973. (COM-73-10669)
- 86 Conditional Probabilities for Sequences of Wet Days at Phoenix, Arizona. Paul C. Kangieser, June 1973. (COM-73-11264)
- 87 A Refinement of the Use of K-Values in Forecasting Thunderstorms in Washington and Oregon. Robert Y. G. Lee, June 1973. (COM-73-11276)
- 89 Objective Forecast Precipitation over the Western Region of the United States. Julia N. Paegle and Larry P. Kierulff, Sept. 1973. (COM-73-11946/3AS)
- 91 Arizona "Eddy" Tornadoes. Robert S. Ingram, October 1973. (COM-73-10465)
- 92 Smoke Management in the Willamette Valley. Earl M. Bates, May 1974. (COM-74-11277/AS)
- 93 An Operational Evaluation of 500-mb Type Regression Equations. Alexander E. MacDonald, June 1974. (COM-74-11407/AS)
- 94 Conditional Probability of Visibility Less than One-Half Mile in Radiation Fog at Fresno, California. John D. Thomas, August 1974. (COM-74-11555/AS)
- 96 Map Type Precipitation Probabilities for the Western Region. Glenn E. Rasch and Alexander E. MacDonald, February 1975. (COM-75-10428/AS)
- 97 Eastern Pacific Cut-Off Low of April 21-28, 1974. William J. Alder and George R. Miller, January 1976. (PB-250-711/AS)
- 98 Study on a Significant Precipitation Episode in Western United States. Ira S. Brenner, April 1976. (COM-75-10719/AS)
- 99 A Study of Flash Flood Susceptibility--A Basin in Southern Arizona. Gerald Williams, August 1976. (COM-75-11360/AS)
- 102 A Set of Rules for Forecasting Temperatures in Napa and Sonoma Counties. Wesley L. Tuft, October 1975. (PB-246-902/AS)
- 103 Application of the National Weather Service Flash-Flood Program in the Western Region. Gerald Williams, January 1976. (PB-253-053/AS)
- 104 Objective Aids for Forecasting Minimum Temperatures at Reno, Nevada, During the Summer Months. Christopher D. Hill, January 1976. (PB-252-866/AS)
- 105 Forecasting the Mono Wind. Charles P. Ruscha, Jr., February 1976. (PB-254-650)
- 106 Use of MOS Forecast Parameters in Temperature Forecasting. John C. Plankinton, Jr., March 1976. (PB-254-649)
- 107 Map Types as Aids in Using MOS PoPs in Western United States. Ira S. Brenner, August 1976. (PB-259-594)
- 108 Other Kinds of Wind Shear. Christopher D. Hill, August 1976. (PB-260-437/AS)
- 109 Forecasting North Winds in the Upper Sacramento Valley and Adjoining Forests. Christopher E. Fontana, September 1976. (PB-273-677/AS)
- 110 Cool Inflow as a Weakening Influence on Eastern Pacific Tropical Cyclones. William J. Denney, November 1976. (PB-264-655/AS)
- 112 The MAN/MOS Program. Alexander E. MacDonald, February 1977. (PB-265-941/AS)
- 113 Winter Season Minimum Temperature Formula for Bakersfield, California, Using Multiple Regression. Michael J. Oard, February 1977. (PB-273-694/AS)
- 114 Tropical Cyclone Kathleen. James R. Fors, February 1977. (PB-273-676/AS)
- 116 A Study of Wind Gusts on Lake Mead. Bradley Colman, April 1977. (PB-268-847)
- 117 The Relative Frequency of Cumulonimbus Clouds at the Nevada Test Site as a Function of K-Value. R. F. Quiring, April 1977. (PB-272-831)
- 118 Moisture Distribution Modification by Upward Vertical Motion. Ira S. Brenner, April 1977. (PB-268-740)
- 119 Relative Frequency of Occurrence of Warm Season Echo Activity as a Function of Stability Indices Computed from the Yucca Flat, Nevada, Rawinsonde. Darryl Randerson, June 1977. (PB-271-290/AS)

NOAA Technical Memorandum NWS WR-183

500 MILLIBAR SIGN FREQUENCY TELECONNECTION CHARTS - SPRING

Lawrence B. Dunn

Scientific Services Division
National Weather Service Western Region
Salt Lake City, Utah
January 1984

UNITED STATES
DEPARTMENT OF COMMERCE
Malcolm Baldrige, Secretary

National Oceanic and
Atmospheric Administration
John V. Byrne, Administrator

National Weather
Service
Richard E. Hallgren, Director



This publication has been reviewed
and is approved for publication by
Scientific Services Division,
Western Region.



Glenn E. Rasch, Chief
Scientific Services Division
Western Region Headquarters
Salt Lake City, Utah

TABLE OF CONTENTS

	<u>Page</u>
I. Introduction	1
II. Description of Data	2
III. Creation of Sign-Frequency Teleconnection Charts	3
IV. Description of Charts	5
V. How to Use Sign-Frequency Teleconnection Charts	6
VI. Acknowledgment	9
VII. References	10
Figure 1	11
Sign Frequency Teleconnection Charts	

I. INTRODUCTION

The question of spacial relationships (teleconnectivity) between anomalies in the upper-air flow patterns is an old one, but one that recently has received a great deal of attention. Forecasters are frequently confronted with the question: "What is the probability of a trough developing or remaining over a given latitude and longitude given the presence of a trough or ridge at some other latitude and longitude?".

Recent work on the conditional climatology of the upper-level flow, (Blackmon, Lee, Wallace, 1983; Blackmon, Lee, Wallace, Hsu, 1983) has been geared toward determining the correlation between different geographic locations on various time scales. Correlation maps produced for long time scales (periods much longer than 30 days) have been found to be meridionally oriented dipoles, geographically fixed and typically found in the jet exit regions over the oceans. Intermediate time scales (10-30 days) produce correlation patterns associated with more zonally oriented wave trains. They do not appear to be as geographically fixed as are the long-term correlations. Correlation patterns on a short time scale (2.5 to 6 days) are also zonally oriented wave trains which appear dominated by wave numbers 6 and 7. These short-term correlations, like the intermediate time scale correlations, do not appear strongly geographically fixed. The above discussion may be further investigated by consulting the cited references.

One way to make use of the correlation patterns in operational forecasting is through the use of sign-frequency teleconnection charts. In this report a sign frequency chart gives the probability of above or below normal heights around the northern hemisphere given a height anomaly at a particular latitude/longitude. The charts contained in this and 3 other Technical Memoranda are sign-frequency charts for 500-mb 5-day means. They are similar to the hemispheric charts produced in 1955 using 700-mb data and published as an Air Weather Service Technical Report (Martin, 1955). There are some major differences between these new charts and those produced in 1955, in the quality of data used and the method of case selection. Additionally, the new charts are divided into four seasons (Winter-December, January, February...Spring-March, April, May...Summer-June, July, August...Autumn-September, October, November) and contain conditional climatology based on more than twice as many latitude/longitude locations as the 1955 charts.

II. DESCRIPTION OF DATA

The raw data consisted of Northern Hemispheric five-day mean 500-mb data on a $5^{\circ} \times 5^{\circ}$ grid from 20 degrees North to 65 degrees North for January 1958 through mid-1980. Each year was divided into 73 five-day periods starting with January 1st. Thus, period one always consisted of the 500-mb hemispheric analyses for January 1st through 5th, while period two always consisted of data for January 6th through 10th and so on. The creation of these five-day means was done at the University of Washington Atmospheric Sciences Department in connection with the work described in the introduction of this paper.

III. CREATION OF THE SIGN-FREQUENCY TELECONNECTION CHARTS

A. Monthly Means

Monthly mean 500-mb data were produced by averaging individual 5-day means from each year. These averages of 5-day means were then grouped by month. Overlap was permitted in order for a month to be completely represented by the 5-day means. For example, period 17 represents the mean of data from March 31 through April 4th, while period 24 represents data from April 30th through May 4th. The April monthly mean data were made up of periods 17 through 24 even though a few days from both March and May were included.

B. Anomaly Charts

Each 5-day mean chart was converted to an anomaly chart by subtracting the monthly mean chart from it. Thus, the anomalies for periods near the beginning and end of a given month may be slightly larger or smaller than those near the center of the month particularly in the transition of seasons when the jet stream goes through the most rapid meridional displacement.

C. Monthly Standard Deviations of Anomalies

The magnitude of one standard deviation from the mean anomaly was calculated at each grid point for each month. The standard deviations were greatest at high latitudes and smallest at low latitudes. The greatest values were frequently in areas of cyclogenesis such as the Gulf of Alaska and the North Atlantic. These results also point to the generally small fluctuations at 500-mb in the subtropics.

D. Individual Case Selection

Two sign-frequency charts were produced for each of 144 given points for each of the four seasons. These points are referred to as key areas. These key areas were at 30, 40, 50 and 60 degrees North, every 10 degrees of longitude. Thus, 10E/30N, 10E/40N, 10E/50N, 10E/60N, 20E/30N, and so forth are all key areas. One chart was produced for positive anomalies at each key area and one for negative anomalies.

A case for a sign-frequency chart was defined by the following criteria: 1) The magnitude of 5-day mean anomalies at key area locations must exceed one standard deviation of the monthly mean anomaly at that grid point. 2) The value of the anomaly at the grid location was a relative maximum for positive cases and a relative minimum for negative cases. In order to be a maximum or minimum, the value of the anomaly must exceed (maximum) or be less than (minimum) the values at the grid points 10 degrees of longitude and latitude away (2 grid points) from the key area. The only exception to this was for key areas at 60 degrees North. Since the data only extended to 65 degrees North, the value one grid length to the North was used to determine maximum or minimum status.

Thus, only cases with relatively large centered anomalies were chosen in preparing a given sign-frequency chart. Three-month periods were used in order to get enough cases for each key area.

E. Sign-Frequency Calculation

Sign-frequency teleconnection charts were created by combining all the cases that were selected by criteria given in 'D' above for each key area. The percentage of time that each grid point other than the key grid point was above or below the monthly mean 500-mb height was calculated. This was done twice for each key area, once for positive and once for negative anomalies at the key location. The magnitude of the value at each grid point was always between 50% and 100% with negative anomalies identified as minus values, and positive anomalies plus values. These values were then slightly smoothed in order to produce a more readable percentage analysis. Due to the smoothing values at the key areas may not always be 100 percent.

IV. DESCRIPTION OF CHARTS

The lower left-hand corner of each chart indicates whether the chart is based on a positive or negative key area. In other words the criteria used in case selection were for centered maxima or minima that exceeded one standard deviation of the mean monthly anomaly at the grid point.

The location of the key area is given by a latitude/longitude intersection. This is followed by the number of cases (individual 5-day mean anomalies) that went into the creation of the chart. The number of cases that were used in creation of the chart should be taken as a confidence factor in the validity of the pattern the chart depicts.

A contoured analysis of the percentage results extends from 20 degrees North to 65 degrees North. All maxima and minima percentages are indicated by a number with either a '+' or '-' sign above the number. A '+' sign indicates that the number below is the percentage of all cases in which this grid point was above the monthly mean 500-mb height. A '-' sign indicates percentage of cases below the monthly mean. The isopleths are either solid lines or dashed lines. Solid lines enclose areas of below normal height probabilities, while dashed lines enclose areas of above normal height probabilities. The lines are labeled as either 60, 80, 100 or -60, -80, -100. This indicates the percentage of cases that either above or below normal 500-mb heights were observed for this key area. Thus, the analysis near the key area should always be near 100 or -100 since this was the condition used in selecting the cases for each chart. The area between a -60 and -80 isopleth was below the monthly mean 500-mb height in 60 to 80 percent of all the cases. The area between a 60 and 80 isopleth was conversely above normal 60 to 80 percent of the time. The area between a 60 and -60 isopleth was either above or below the monthly mean height 50 to 59 percent of the time. The actual location of maxima and minima are at the lower left corner of the printed number.

V. HOW TO USE SIGN-FREQUENCY TELECONNECTION CHARTS

The question that was posed in the introduction, namely, "What is the probability of above- or below-normal heights at a given location given the presence of a significant positive or negative anomaly at some other given geographic location?", may be addressed by using the sign-frequency teleconnection charts. The purpose of these charts is to help one evaluate and better understand available numerical predictions and, not to provide an independent basis for a forecast. Since the advent of Numerical Weather Prediction, it is no longer necessary to create manual prognoses. The value of these teleconnection charts is giving forecasters the facility to apply conditional climatology as a critique of the NWP guidance. By doing this it is possible to determine a confidence factor in the guidance, particularly in the 3-to 10-day range, and also to point out in what way the NWP guidance may err should it be wrong.

The most difficult problem in the use of these charts is the selection of appropriate key areas. A key area location must be a significant positive or negative anomaly at 500 mb that persists at a geographic location over a 5-day period. This will usually, but not always be a long-wave trough or ridge. An example of when this might not hold true is if the observed positive anomaly is found in an area in which there is a distinct trough in the monthly mean pattern. In this case the 500-mb pattern may be zonal or even show a slight trough if the positive anomaly is relatively small and the monthly mean trough is deep.

Ideally, a key area should be: 1) A location in which the 5-day mean 500-mb height anomaly is greater than the standard deviation of the monthly mean anomaly at that spot. 2) An anomaly that is a maximum or minimum with respect to the surrounding latitude/longitude intersection.

The Western Region Scientific Services Division currently calculates 5-day mean 500-mb height anomaly data in order to facilitate evaluation of large scale flow patterns and to aid in selection of sign-frequency teleconnection charts. This is done daily based on the 00Z spectral run. The current 00Z hemispheric analysis, the 00Z analysis from the previous day, and the current 24-hour, 48-hour, 72-hour, and 96-hour prognoses are converted from Automation of Field Operation and Services (AFOS) graphics to grid-point fields. Each individual grid chart is converted to an anomaly field by subtracting the monthly mean 500-mb data from each chart. Six individual anomaly graphics are produced and these anomaly fields are summed and averaged to create a 5-day mean anomaly graphic in the AFOS computer system. An example is presented in Figure 1.

The maxima and minima are located and compared to the standard deviation of the monthly mean anomaly at that location. Maxima and minima that exceed the standard deviation are indicated on the AFOS graphic by an asterisk beneath the maximum or minimum value. It is important to note that the monthly mean 500-mb heights and the monthly mean standard deviations are exactly the same as those used in selection of cases for the sign-frequency teleconnection charts. Thus, any 5-day mean anomaly center marked with an asterisk would

have gone into the creation of a sign-frequency chart for the appropriate key area if it had been part of the historical data.

The appropriate sign-frequency chart may be consulted for each asterisked anomaly to determine the climatologically based probability of above- and below-normal heights elsewhere around the hemisphere based on the presence of the chosen anomaly.

At this point a number of questions must be asked in order to evaluate the information in the sign-frequency charts.

1) Do any of the sign-frequency charts for the significant anomalies agree with the current 5-day mean anomaly chart? Agreement would exist if generally the areas with high probabilities of above-normal heights coincided with areas of 5-day mean positive anomalies and vice versa. High probabilities do not necessarily mean large anomalies. If a given area was only 10 meters above normal in 9 out of the 10 cases that went into the sign-frequency chart, then in this case the 5-day mean flow would probably be an area of flat ridging or even zonal flow, even though this area would be enclosed by a 90% isopleth. Thus, the sign-frequency charts do not say anything about the amplitude of anomalies; they only give the probability of above- or below-normal heights. Consequently, high probabilities do not necessarily mean deep troughs or high amplitude ridges.

2) Do more than one of the sign-frequency charts agree with the 5-day mean anomaly chart or do the various teleconnection patterns conflict? These are not actual correlation maps but only a measure of the probability of one of two discrete states, namely, above or below normal. Thus, if a given location is above normal in 90% of the cases for a given positive key area, it is not always true that the area around this former key area will be above normal in 90% of the cases that make up the sign-frequency chart when the new given location is the key area. Similarity among various sign-frequency charts applicable to the current 5-day anomaly field indicates good climatological support for the pattern.

3) Do the key areas seem valid with respect to other data? Animation of hemispheric analyses and prognoses may point to changes in the large-scale pattern toward the end of a prognosis series. Thus, the first four of the six charts that make up a current 5-day mean anomaly chart may lead to an asterisked negative anomaly center when the animation of the 500-mb charts shows short-wave troughs bottoming out farther West in the last few charts, which portends a change in the large-scale pattern. Animation of individual anomaly charts may show anomalies reaching their greatest intensity on the extended prognoses in a different location than the 5-day mean anomaly center. This may also be an indicator of a change in the large-scale pattern. Another indication of an invalid key area is when a 5-day mean anomaly center shows large displacement between successive 5-day mean charts. This could mean a transition is taking place in the large-scale pattern or it could point to major inconsistencies between two successive 00Z spectral model runs.

Once these questions have been addressed, the information may be applied a number of ways. A high probability of below-normal heights over an area that is suggested by different applicable teleconnection charts may lead one to conclude that a major development in the prognosis is correct or that the weakening of a short wave in this area by the models has better than 50% probability of being incorrect. The probability distribution of a sign-frequency chart chosen because the last few charts of a model run show a transition, such as a shift in the position of maximum short-wave development, may indicate the most likely new configuration of the long-wave troughs and ridges after the transition takes place.

Sign-frequency teleconnection charts make use of conditional climatology to define a confidence factor in the model's extended guidance, suggest modifications in the guidance, or simply estimate the stability of the current large-scale pattern. An understanding of the large-scale pattern is essential in order to evaluate critically the guidance even in short-term forecasts. These charts make climatology a readily available tool for application to real-time forecast problems.

VI. ACKNOWLEDGMENTS

University of Washington, Atmospheric Sciences
for providing the data and advice.

Leonard W. Snellman
for his input and criticism.

VII. REFERENCES

- [1] Martin, "Atlas of 700 Millibar 5-Day Mean Northern Hemisphere Anomaly Charts," AWS Technical Report 105-10012, July 1955.
- [2] Blackmon, M.L., Lee, Y.H., Wallace, J.M., and Hsu, H., "Time Variation of 500 mb Height Fluctuations with Long, Intermediate, and Short Time Scales as Deduced from Lag-Correlation Statistics," Journal of Atmospheric Science, In Press late 1983/early 1984.
- [3] Blackmon, M.L., Lee, Y.H., and Wallace, J.M., "Horizontal Structure of 500 mb Height Fluctuations with Long, Intermediate and Short Time Scales," Journal of Atmospheric Science, In Press late 1983/early 1984.



U.S. DEPARTMENT OF COMMERCE
National Oceanic and Atmospheric Administration
National Weather Service Western Region
P.O. Box 11188 Federal Building
Salt Lake City, Utah 84147

Date: October 31, 1985
To: Recipients of Western Region Technical Memoranda
From:  W/WR3 - Glenn E. Rasch
Subject: Plotting Errors on Sign-frequency Teleconnection charts
Reference: Western Region Technical Memoranda -- WRTM 182, 183, 185, 187

We have recently discovered some minor errors which occurred during the plotting procedure of the sign-frequency teleconnection charts (WRTMs 182, 183, 185, 187). The errors found were associated with an offset of the map background grids. The data presented are still good; the problem is that the data are often located incorrectly over the background.

The degree of error is variable from chart to chart. Some maps have very little error; others are offset by up to 3/8". This degree of error may cause over a 20-degree longitudinal error in some locations of the higher latitudes and up to a 10-degree latitudinal shift at higher latitudes in the direction of the error. SSD does not plan to recreate these figures in the immediate future due to the extensive amount of time that it would take.

An example of the error is shown on the enclosed figure. The case is from the Fall Teleconnection Charts, for a negative anomaly at 120W/60N. The solid circle is 20N. It is at this location that the plotted data should end around the entire hemisphere. The outer dashed circle is where the plotted data actually ends. The offset between the data and map background is obvious in this example. Likewise, the polar extent of the data should be at 65N. The inner dashed circle shows where the plotted data actually ends. The center of the circle should be at the North Pole. The error again is obvious. By checking where the data ends in this manner, it becomes apparent to the user which way the plotted data should be shifted. In this case, visually shifting the data linearly to the left over the entire hemisphere by approximately 1/4" would yield the correct sign-frequency teleconnection pattern for this key anomaly center. The higher probabilities for negative height anomalies would be over the Western Region rather than over the Rockies and Great Plains. The probabilities for higher than normal heights would also shift from their plotted location toward the central U.S. Applying this correction may give the forecasters across the country a significantly different large scale base upon which to make their forecast. It should be noted that this example is one of the worst cases. Most are not this bad. Each case should be examined individually.

This error was found because the location of the key anomaly was often not at or near the center of the plotted anomaly, as should have been expected. This correction also resolves this problem, as evidenced in the example.



A copy of this memo should be filed with the teleconnection tech memos. Any questions or comments regarding either this memo or the teleconnections in general should be directed to WRH/SSD.

Attachment

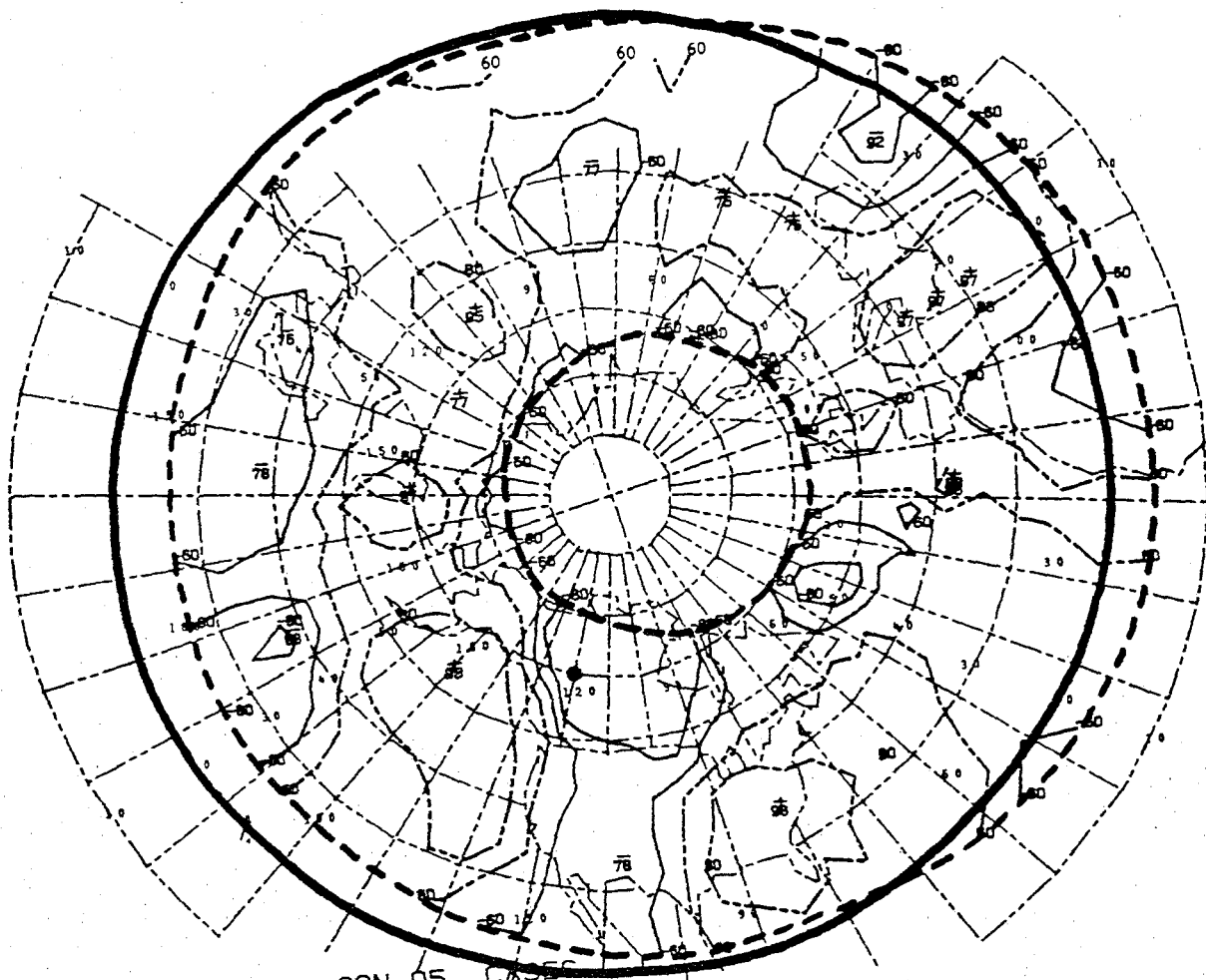

- KEY AT120W 60N 05 C

11

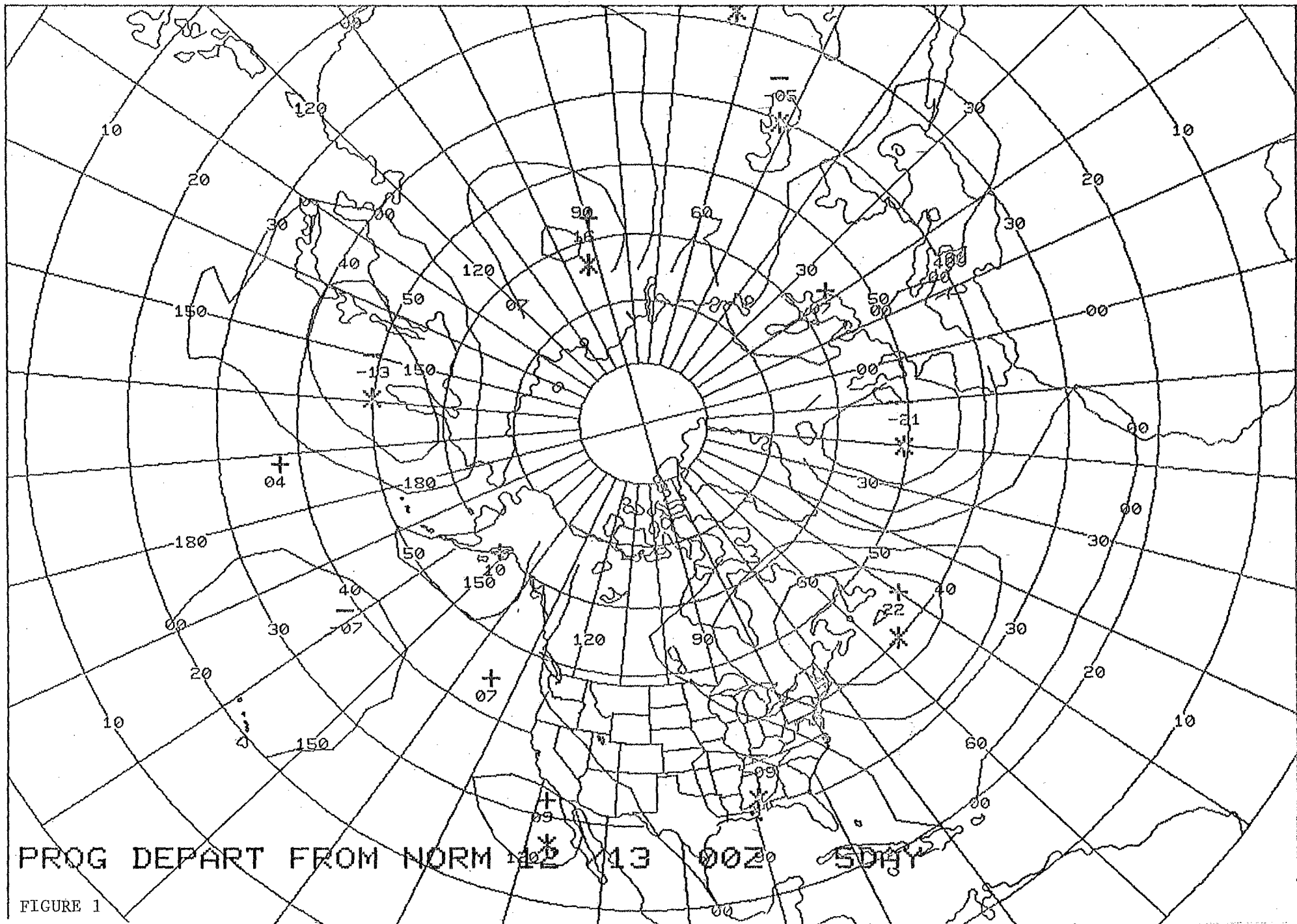
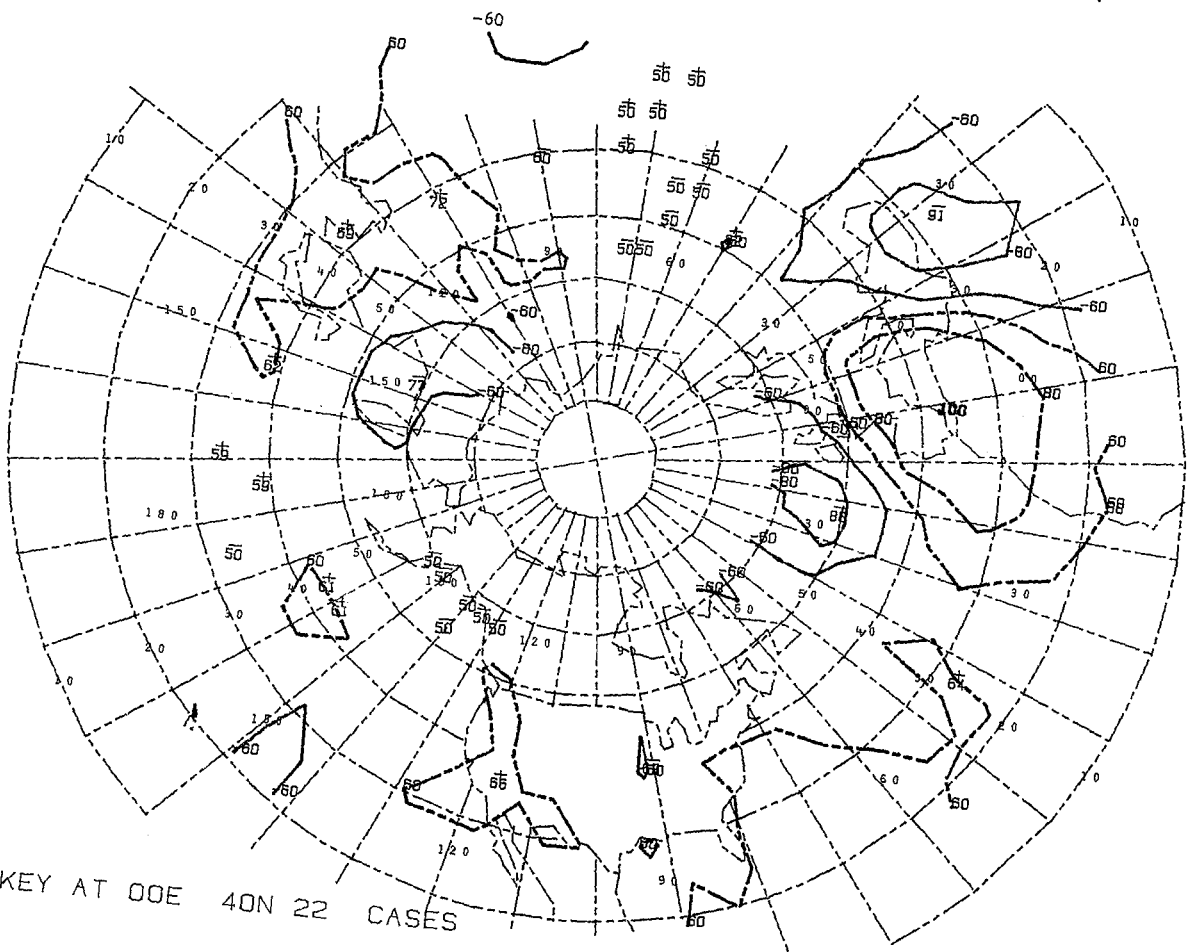
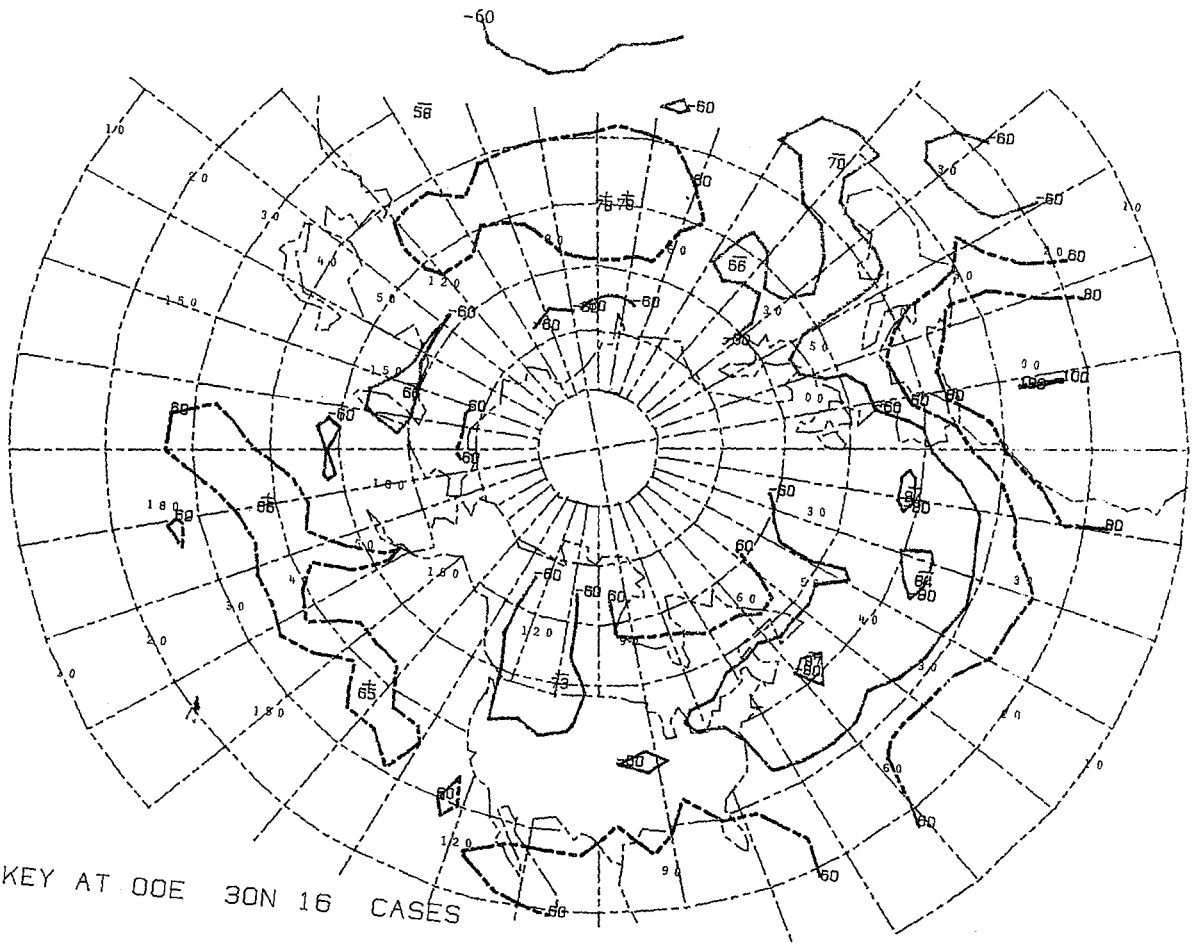
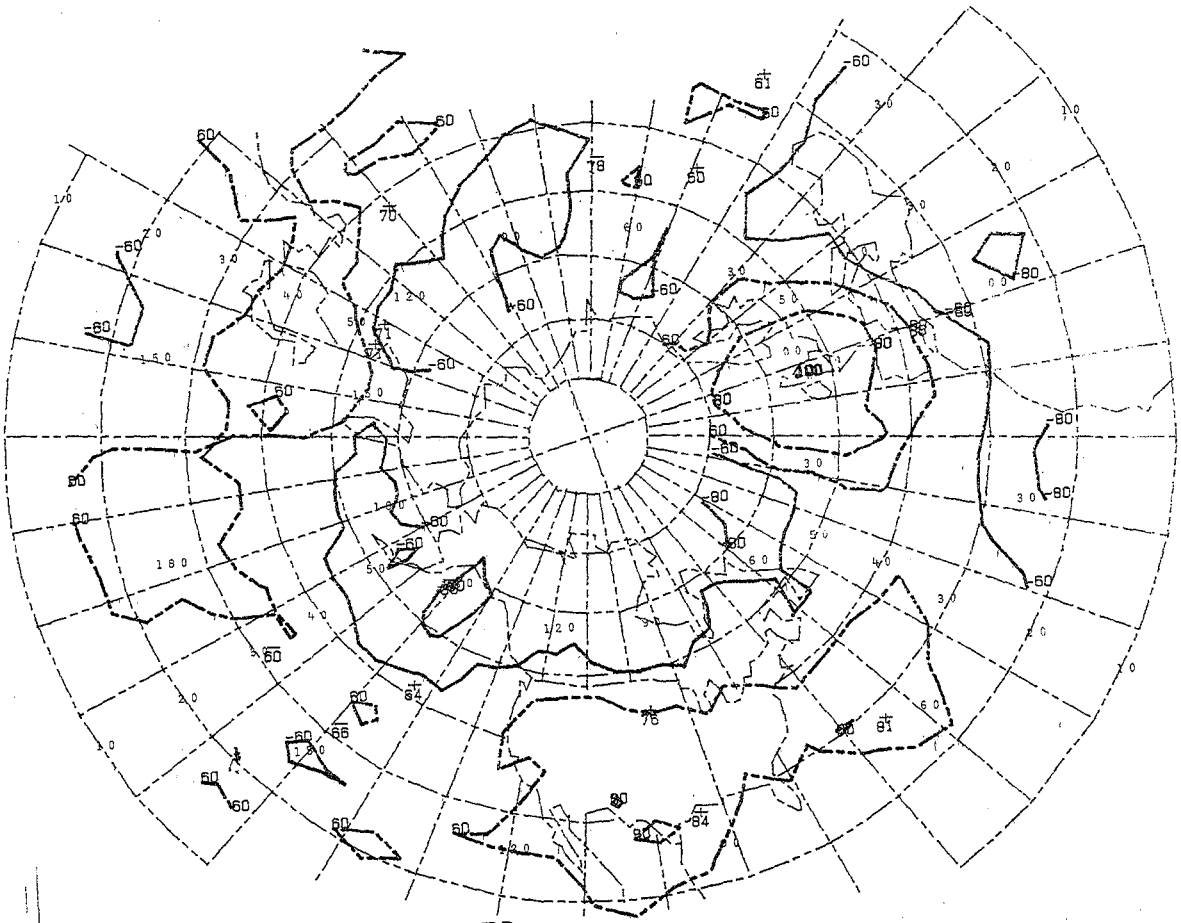

FIGURE 1

SPRING POSITIVE





+ KEY AT 00E 50N 11 CASES

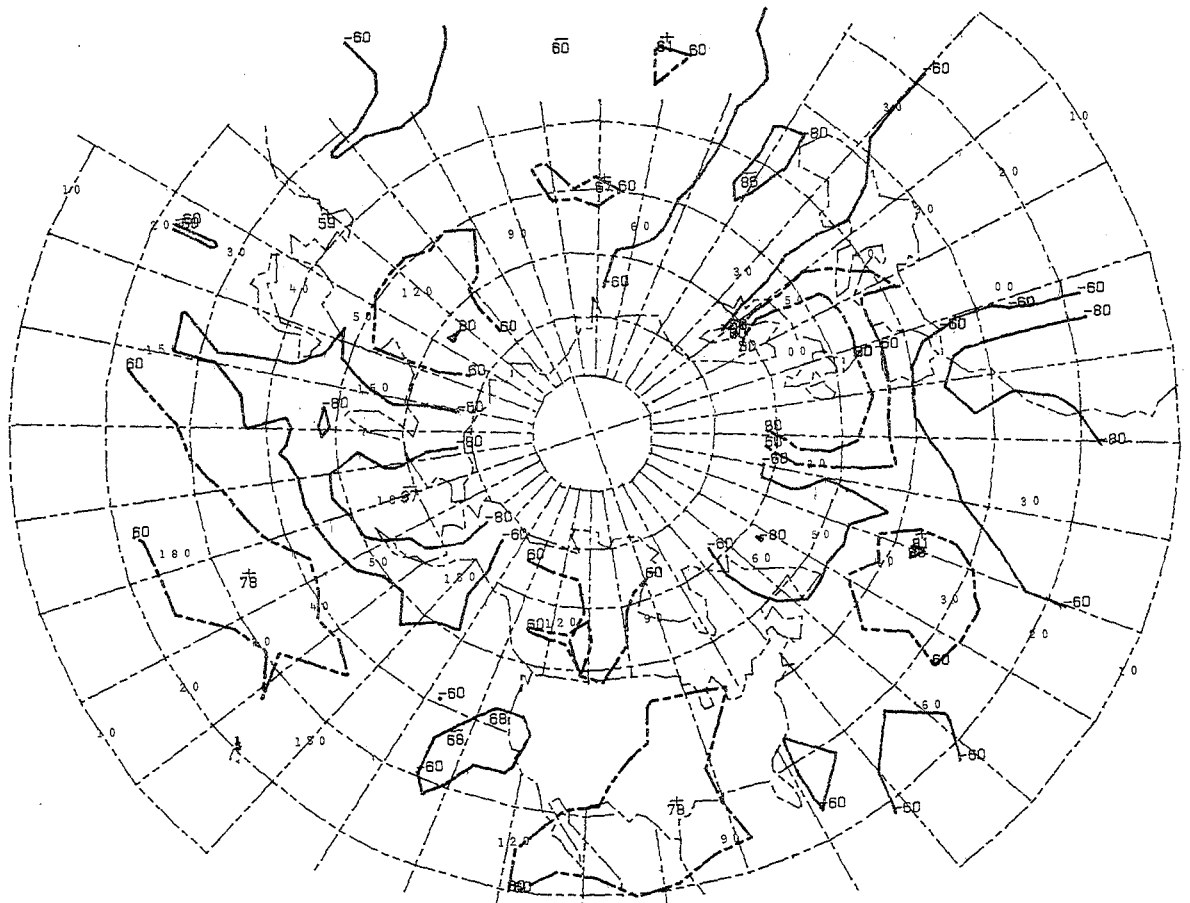

+ KEY AT 00E 60N 11 CASES

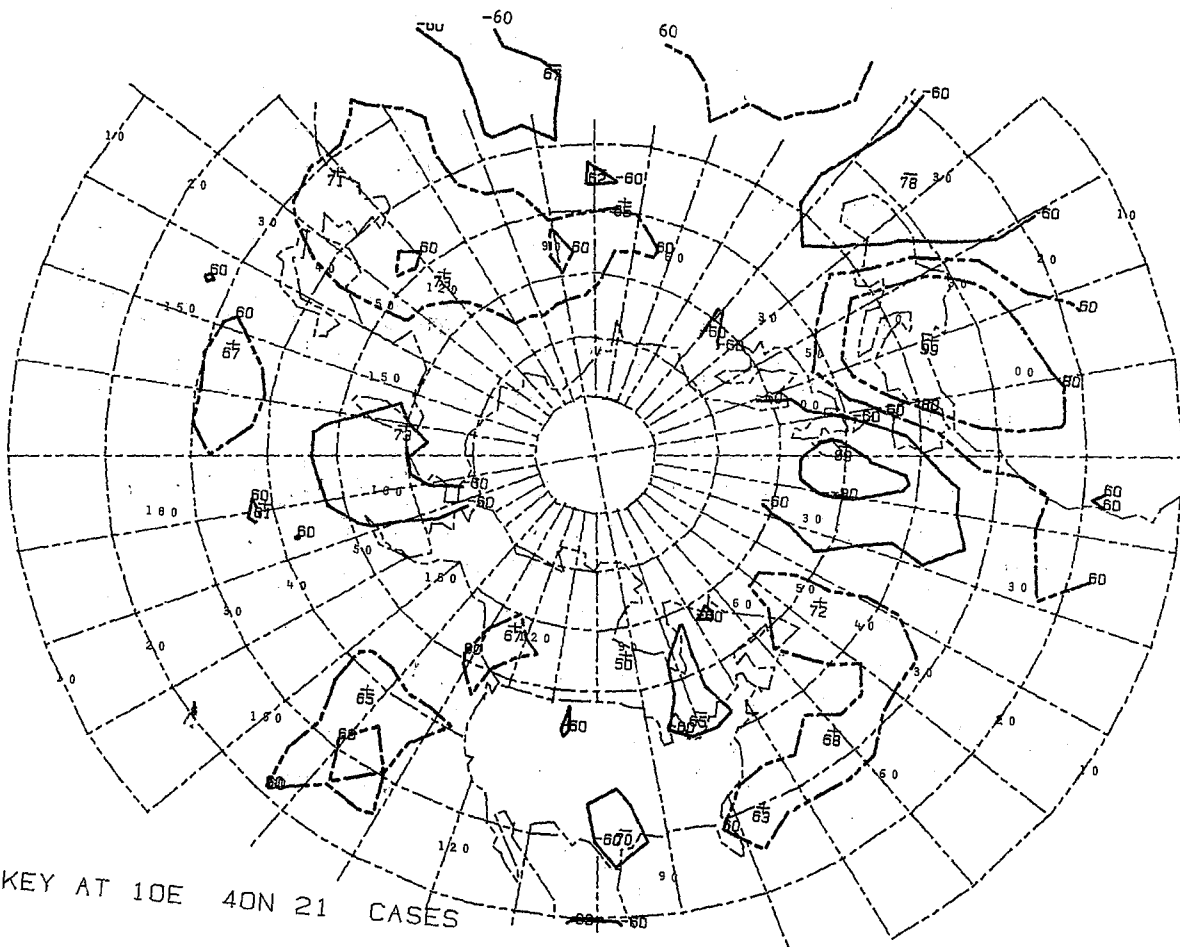
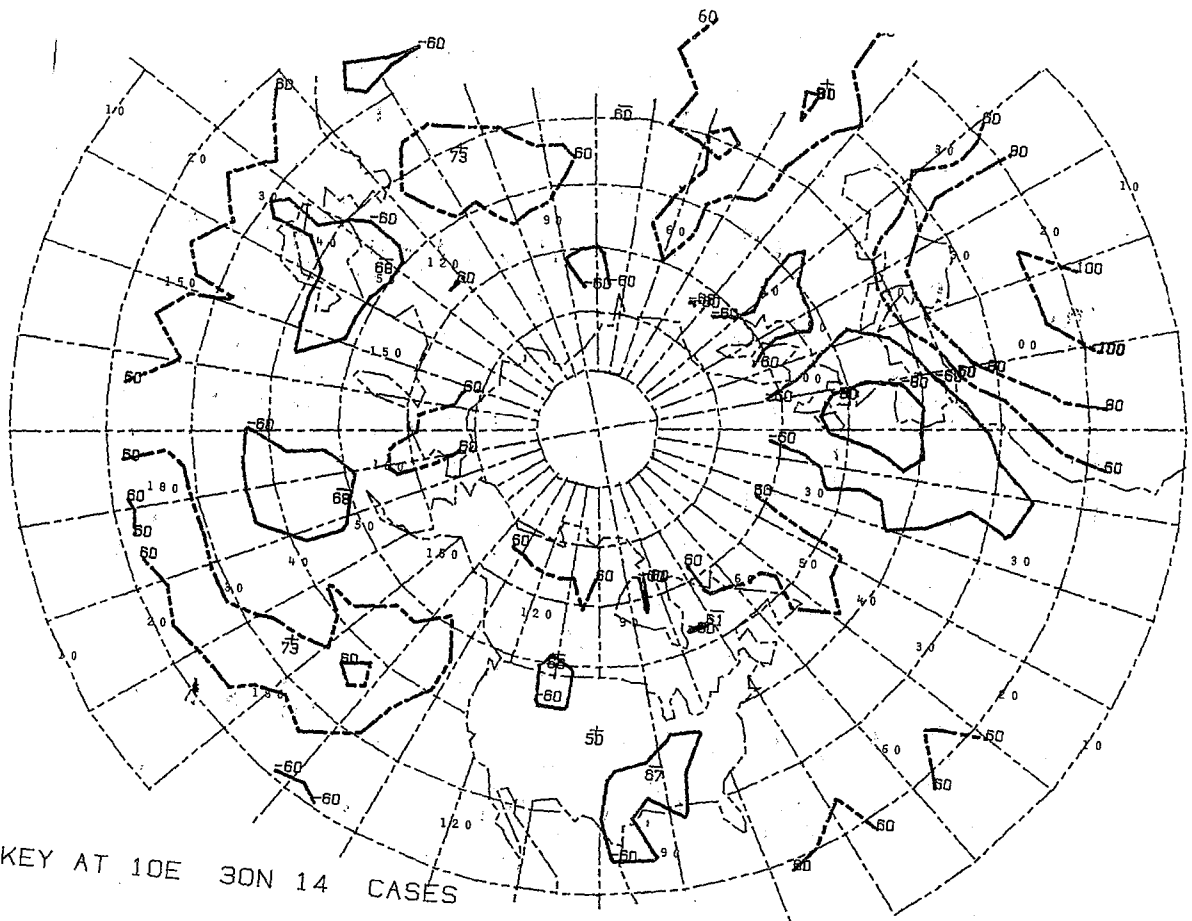

-60

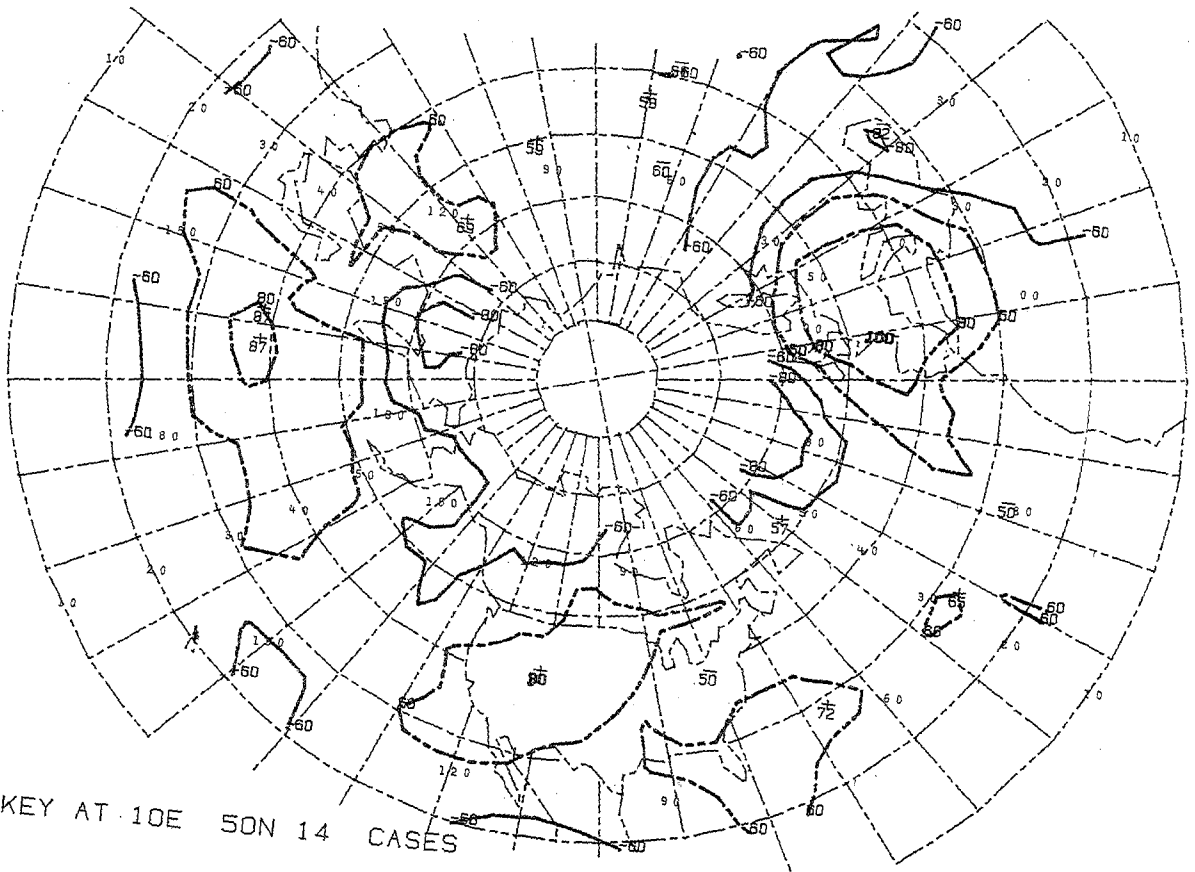

+ KEY AT 10E 50N 14 CASES

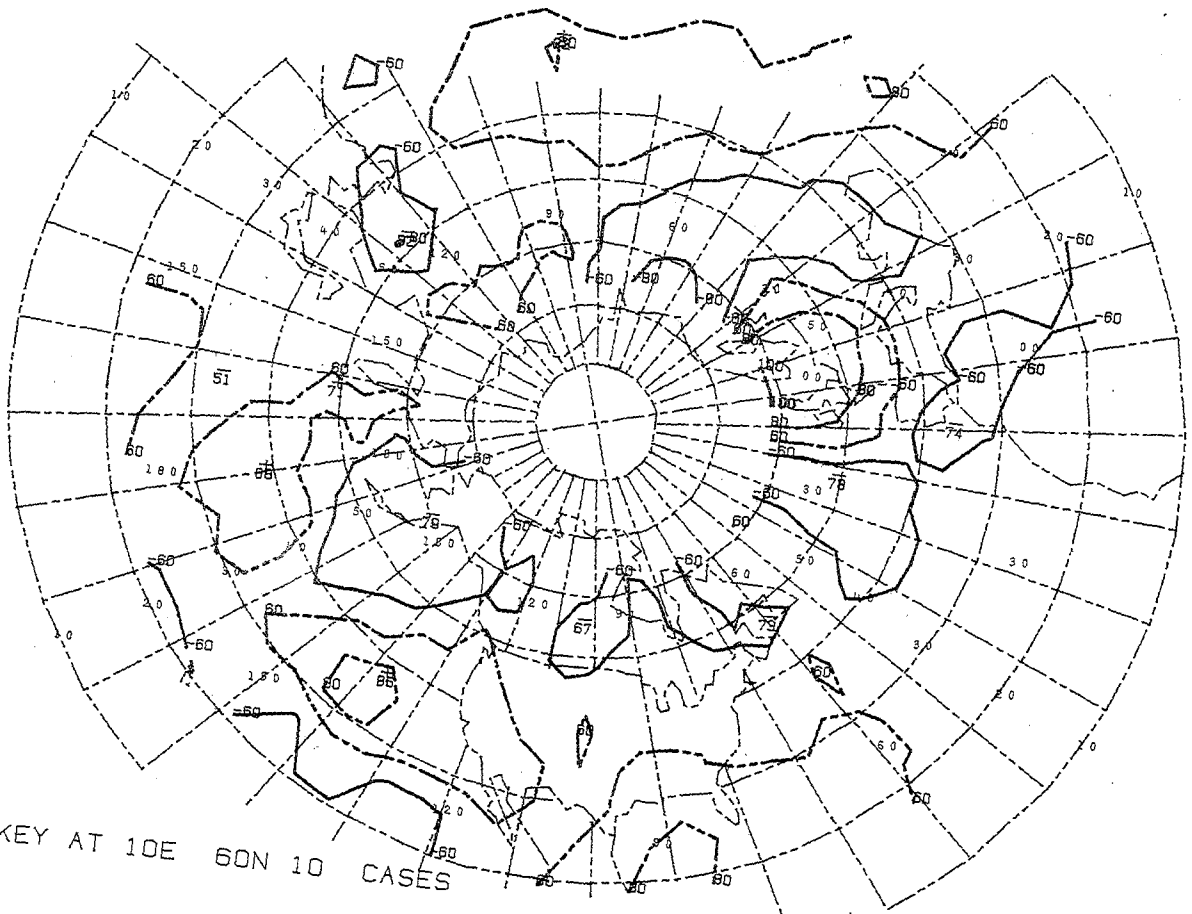

+ KEY AT 10E 60N 10 CASES

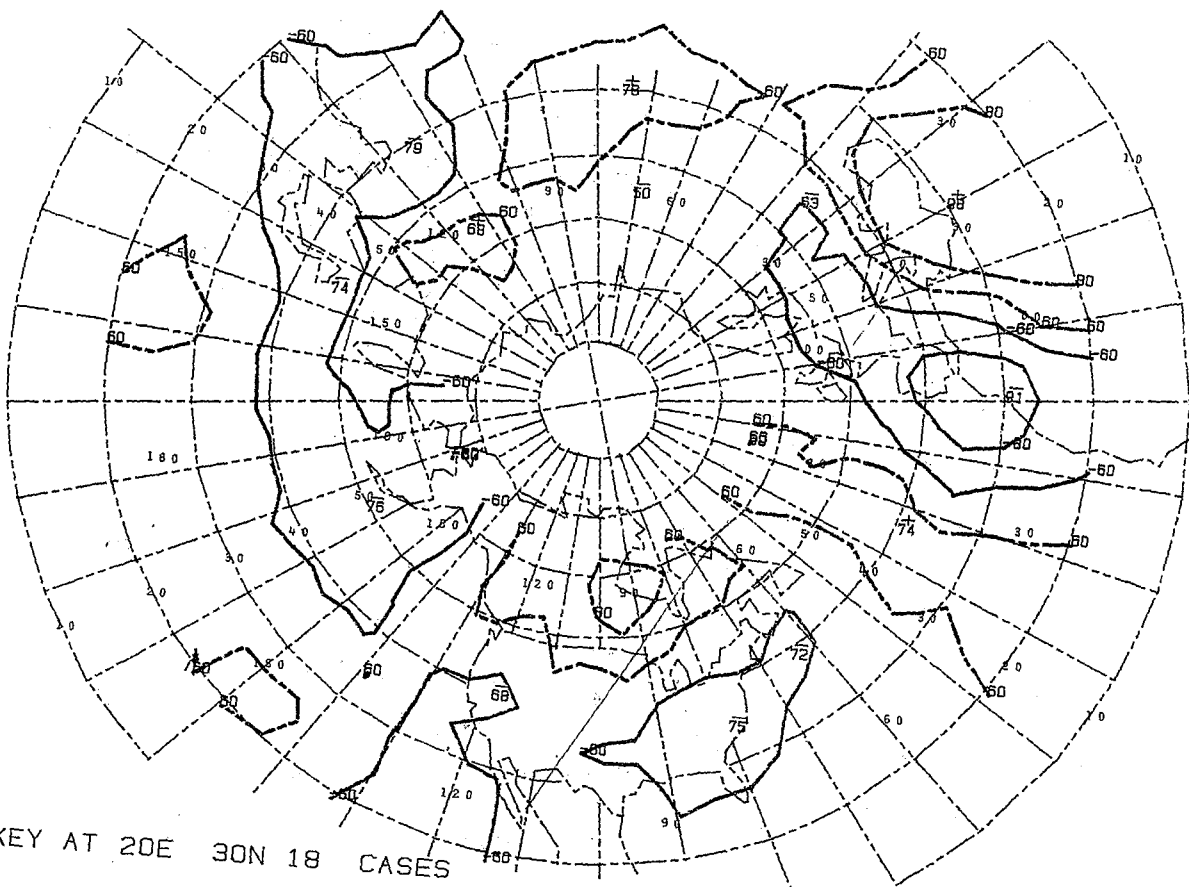

+ KEY AT 20E 30N 18 CASES

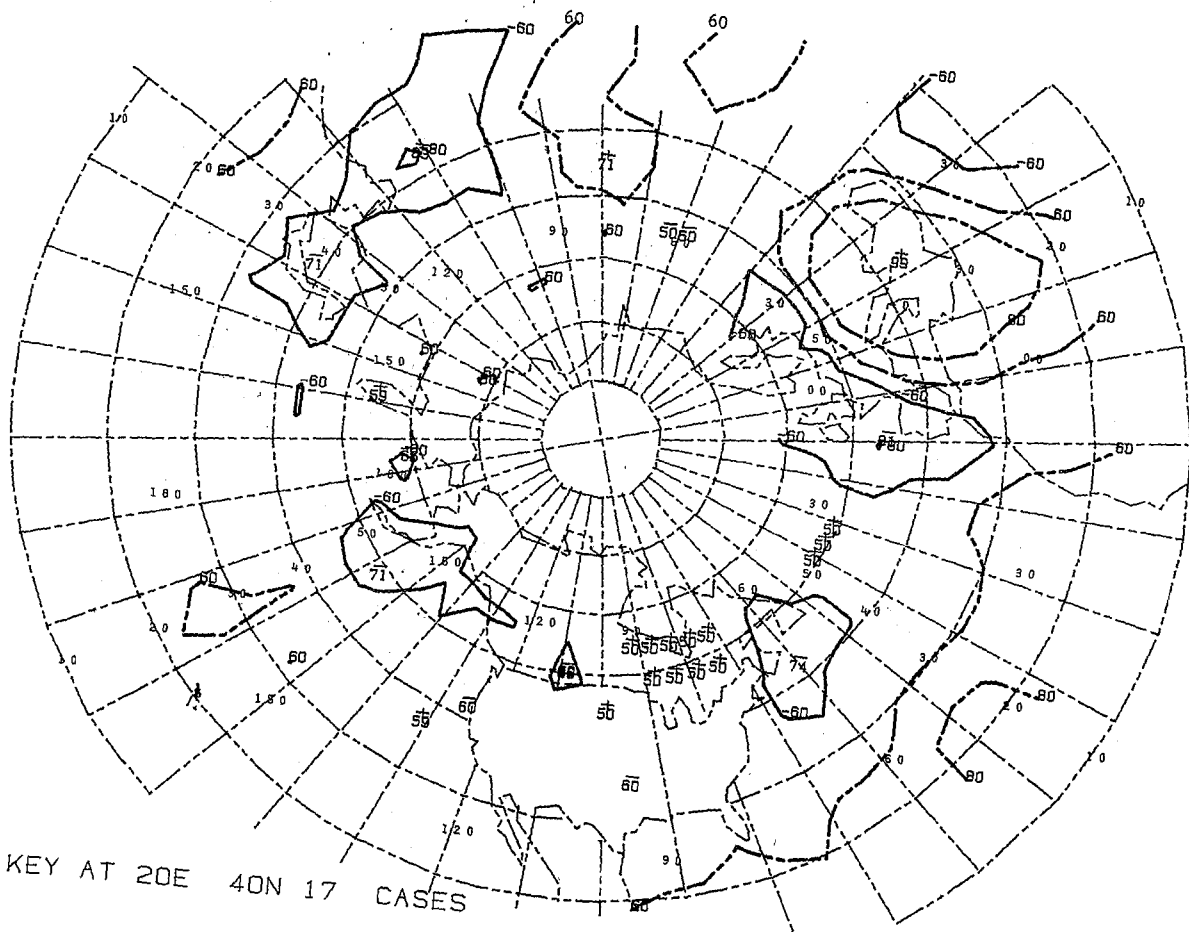

+ KEY AT 20E 40N 17 CASES

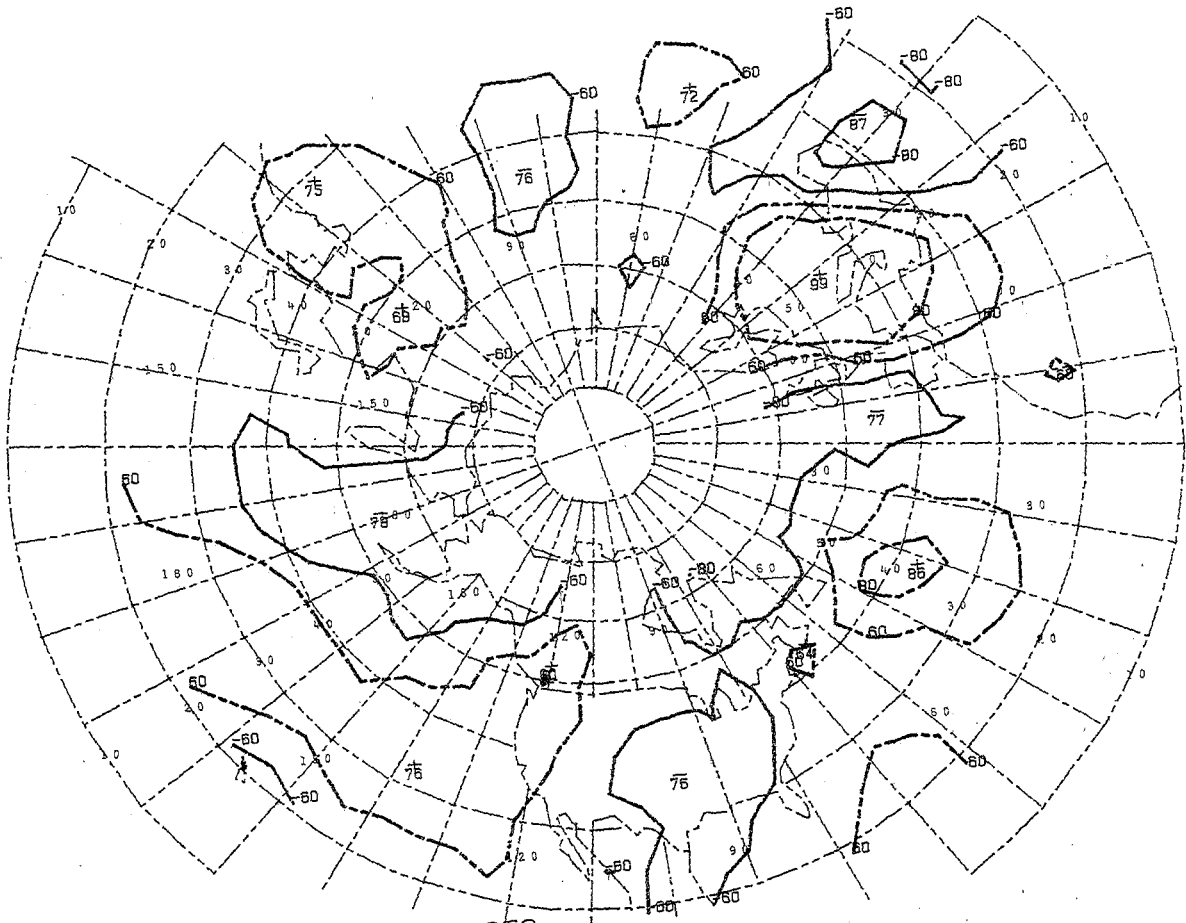

+ KEY AT 20E SON 10 CASES

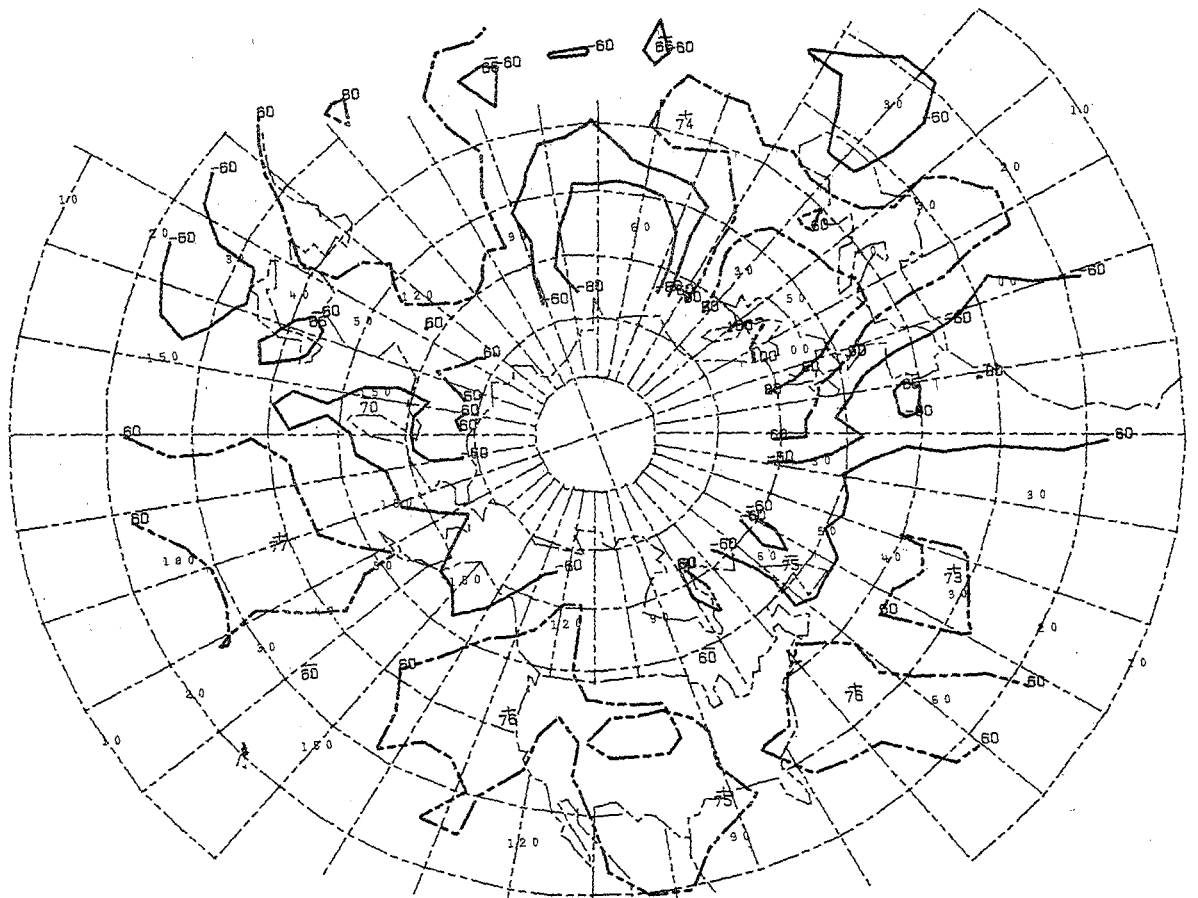

+ KEY AT 20E 60N 11 CASES

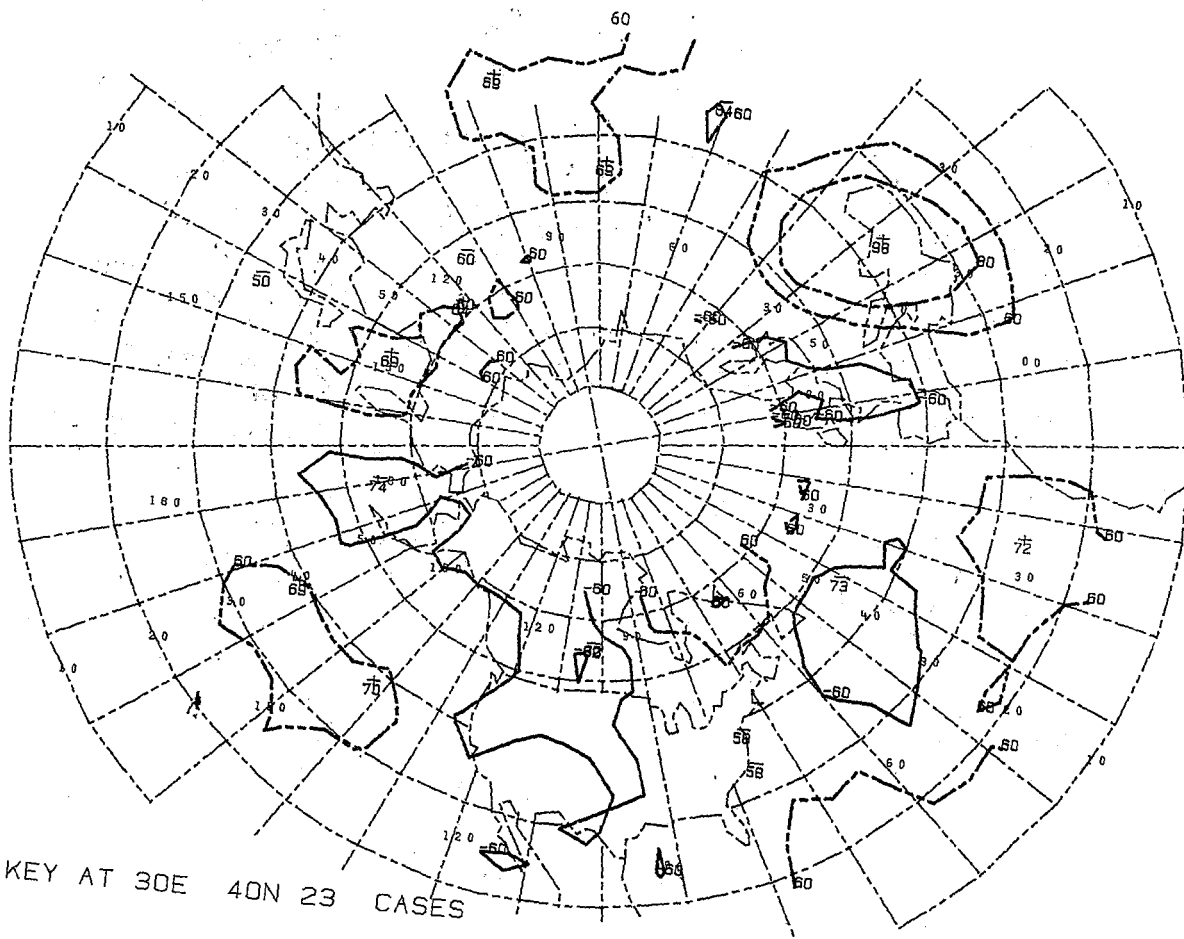
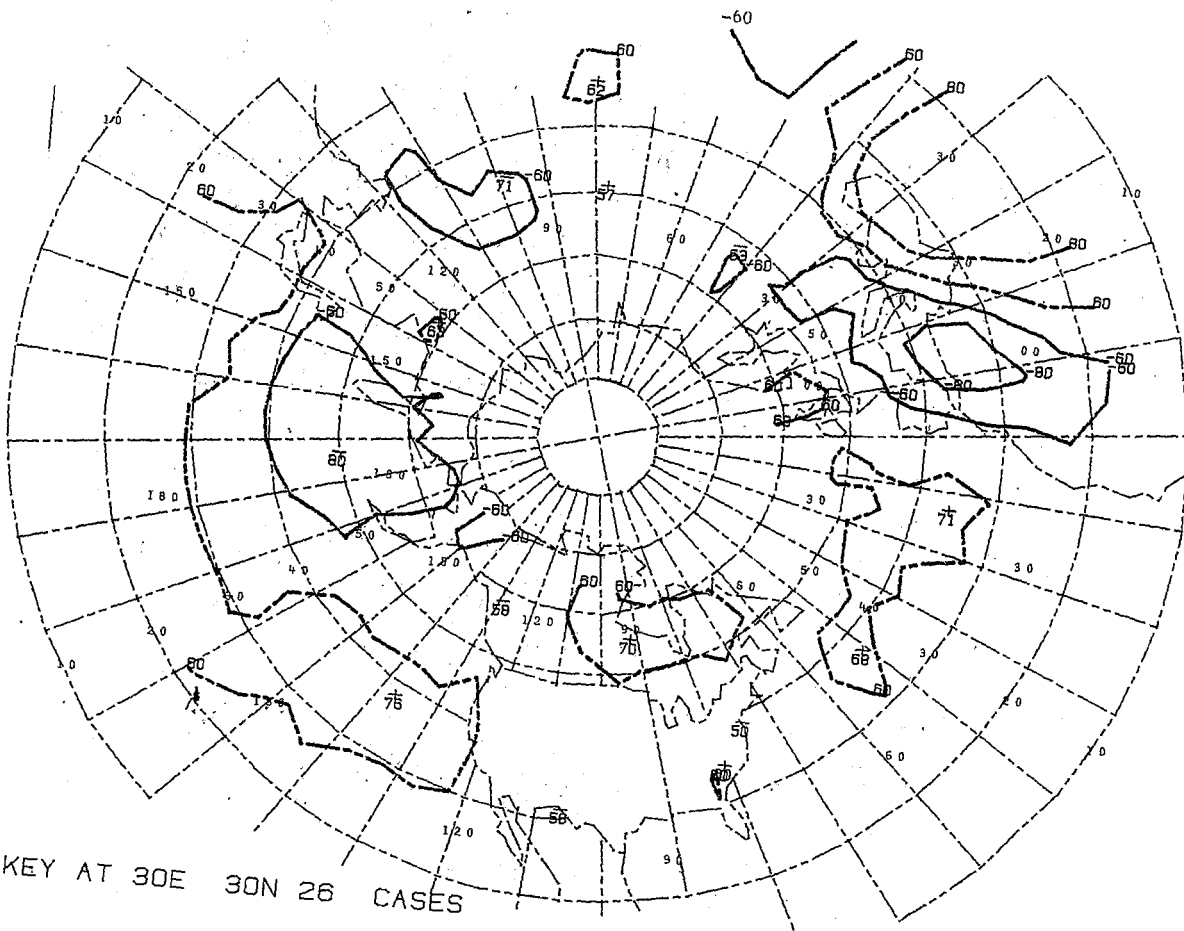

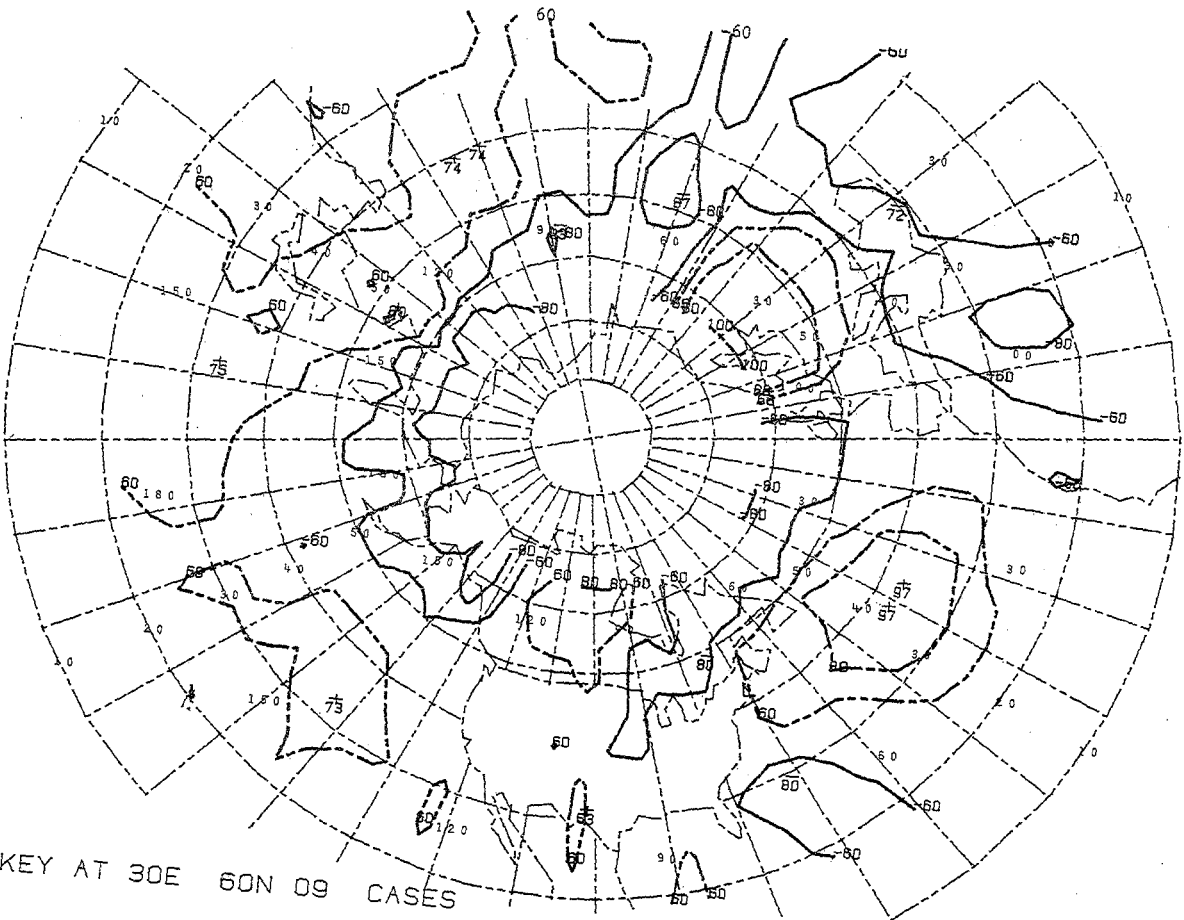
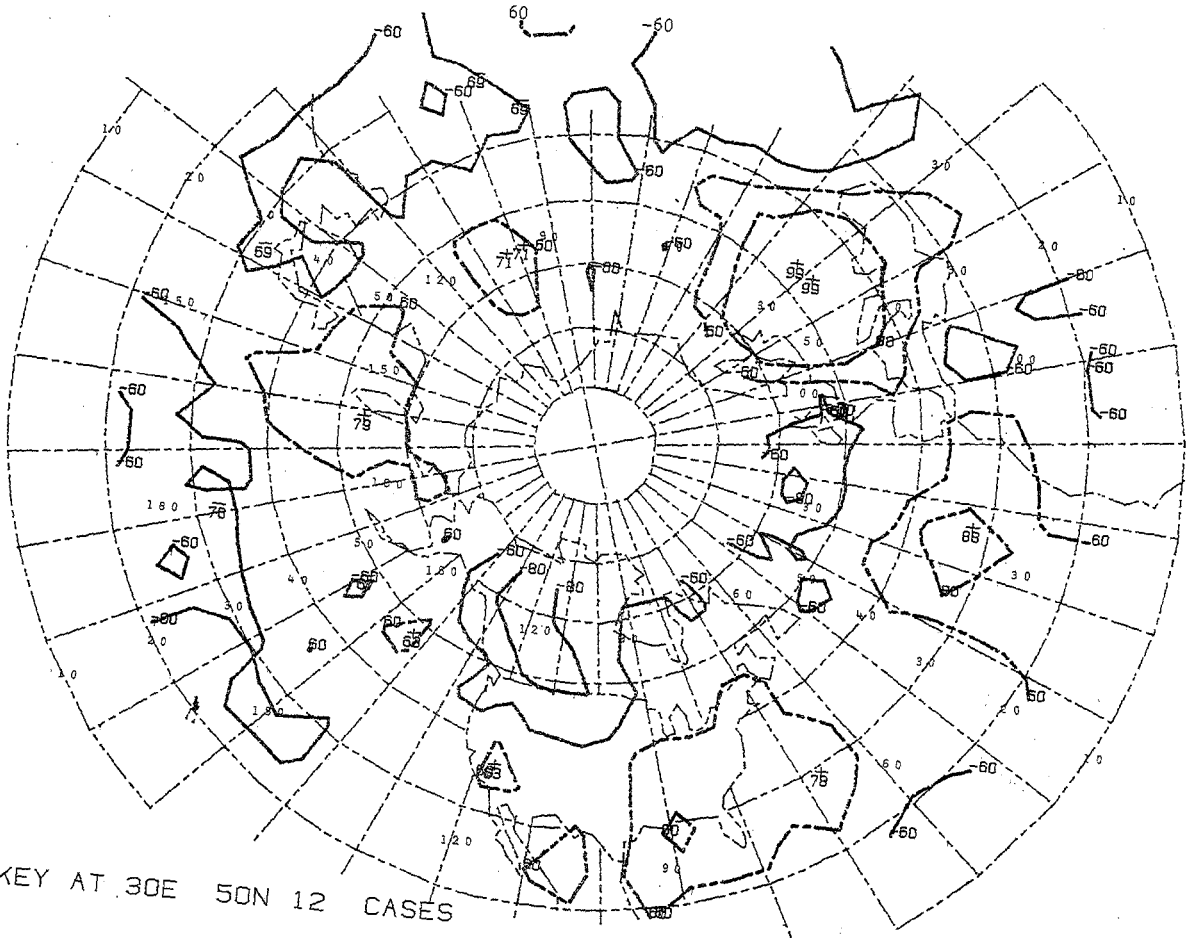

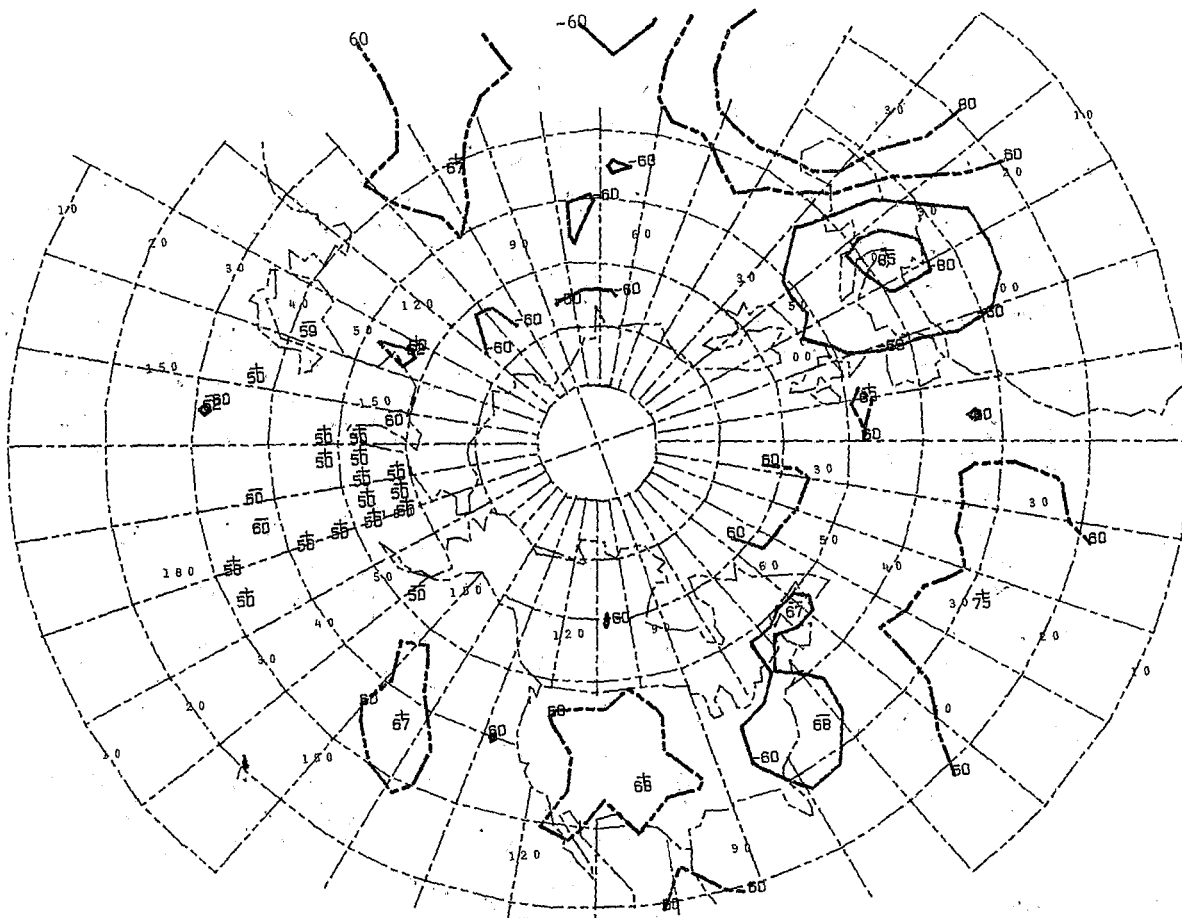

+ KEY AT 40E 30N 24 CASES

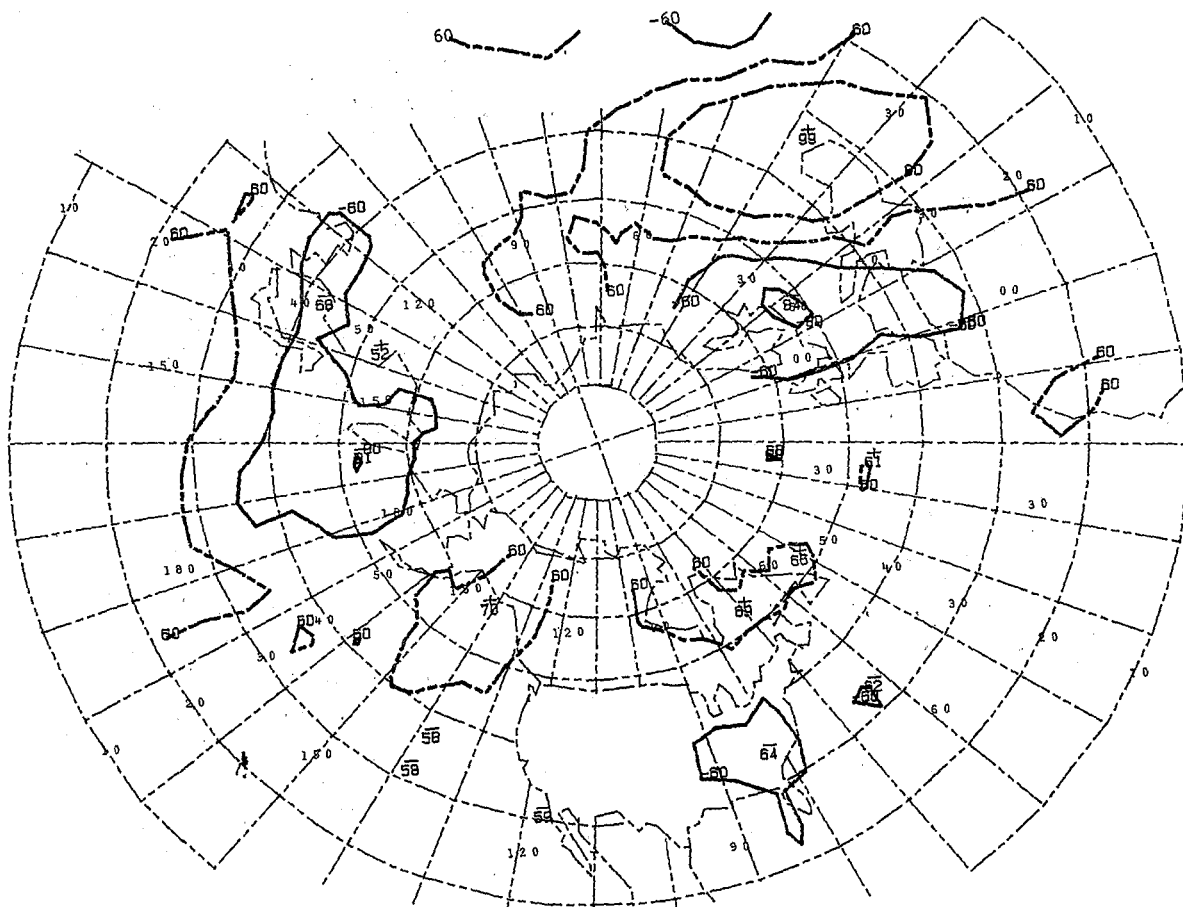

+ KEY AT 40E 40N 23 CASES

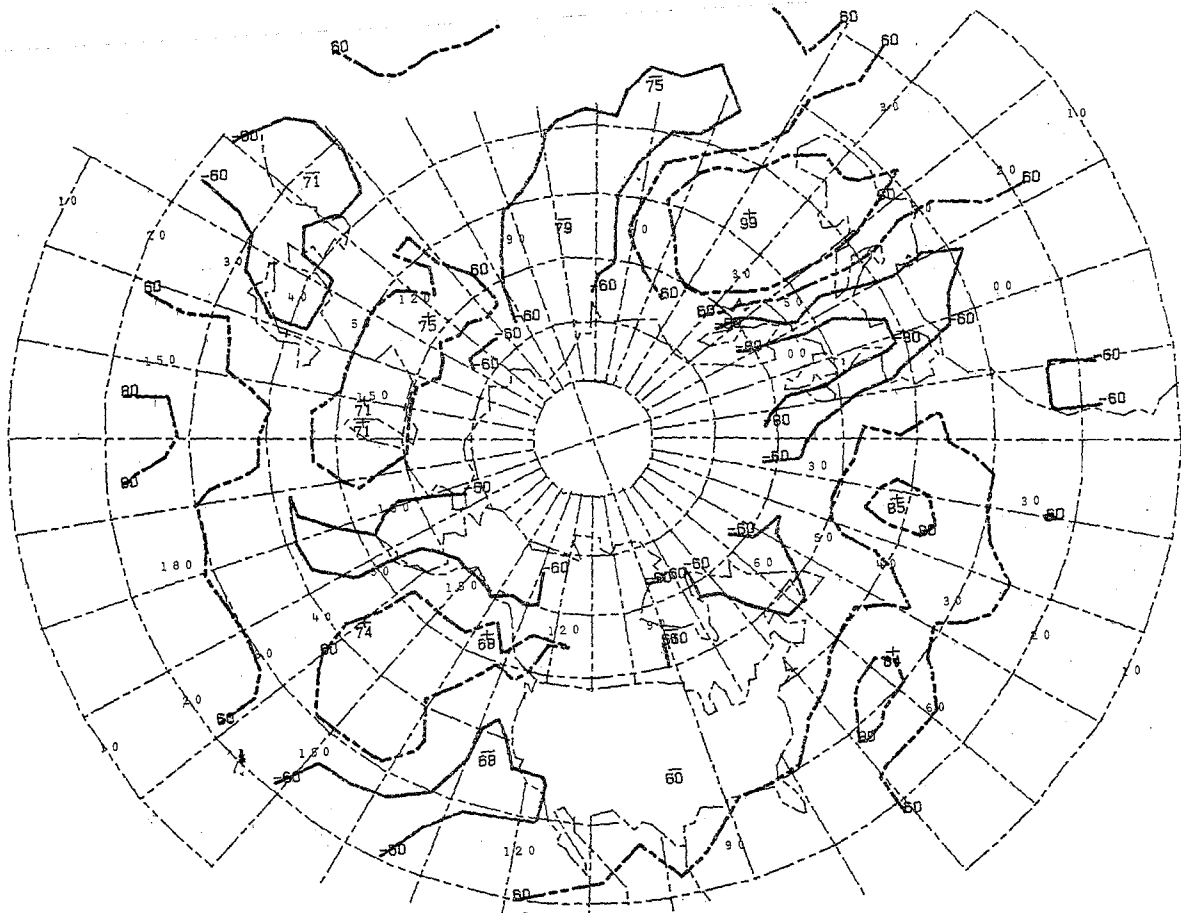

+ KEY AT 40E 50N 11 CASES

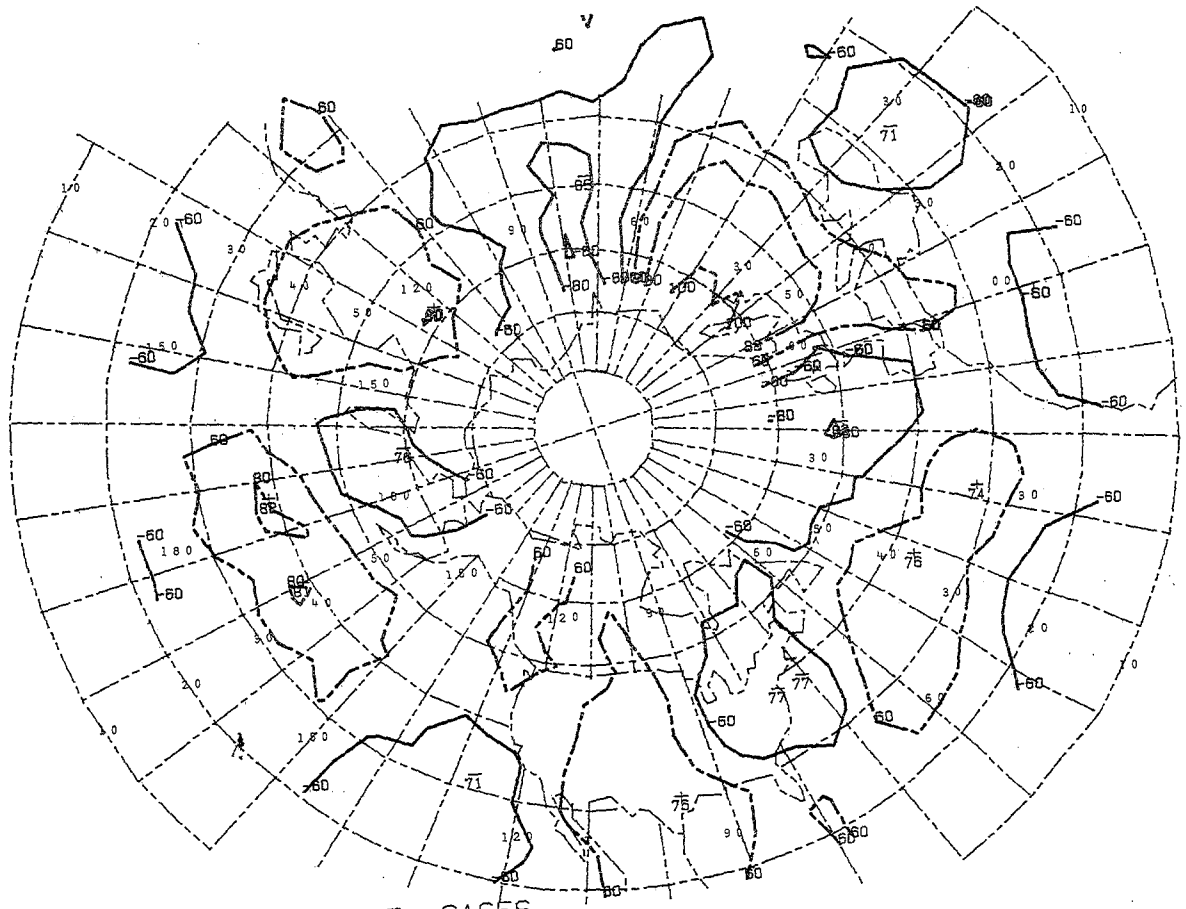

+ KEY AT 40E 60N 15 CASES

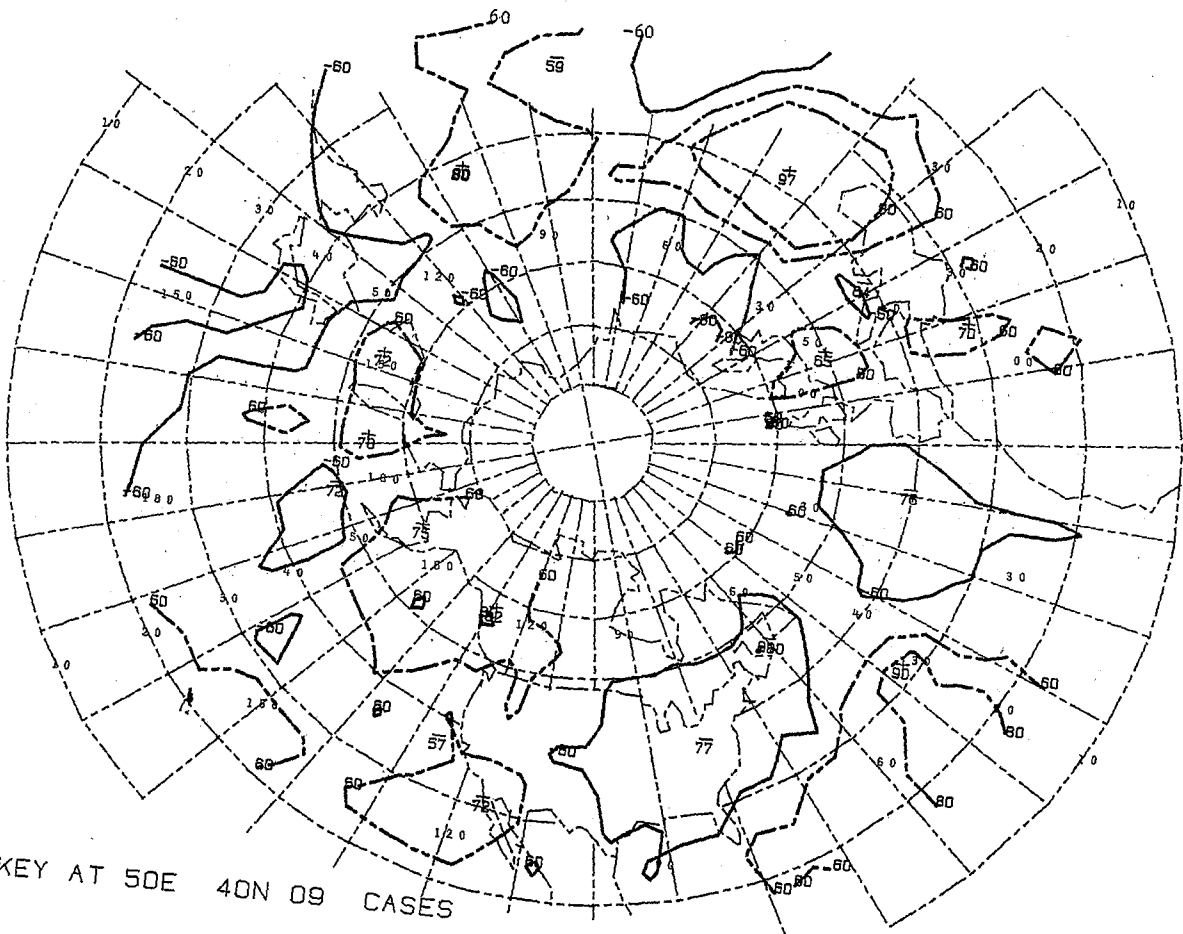
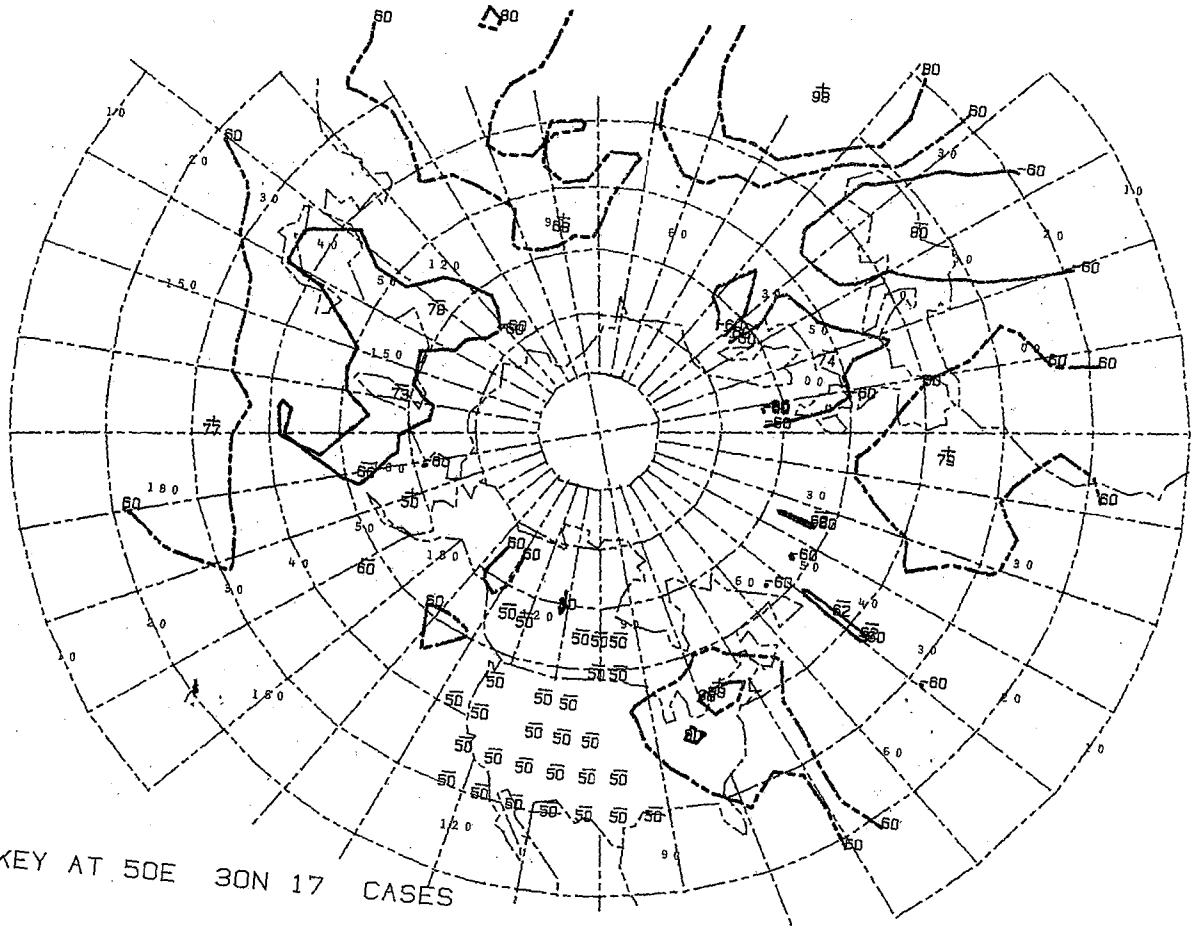

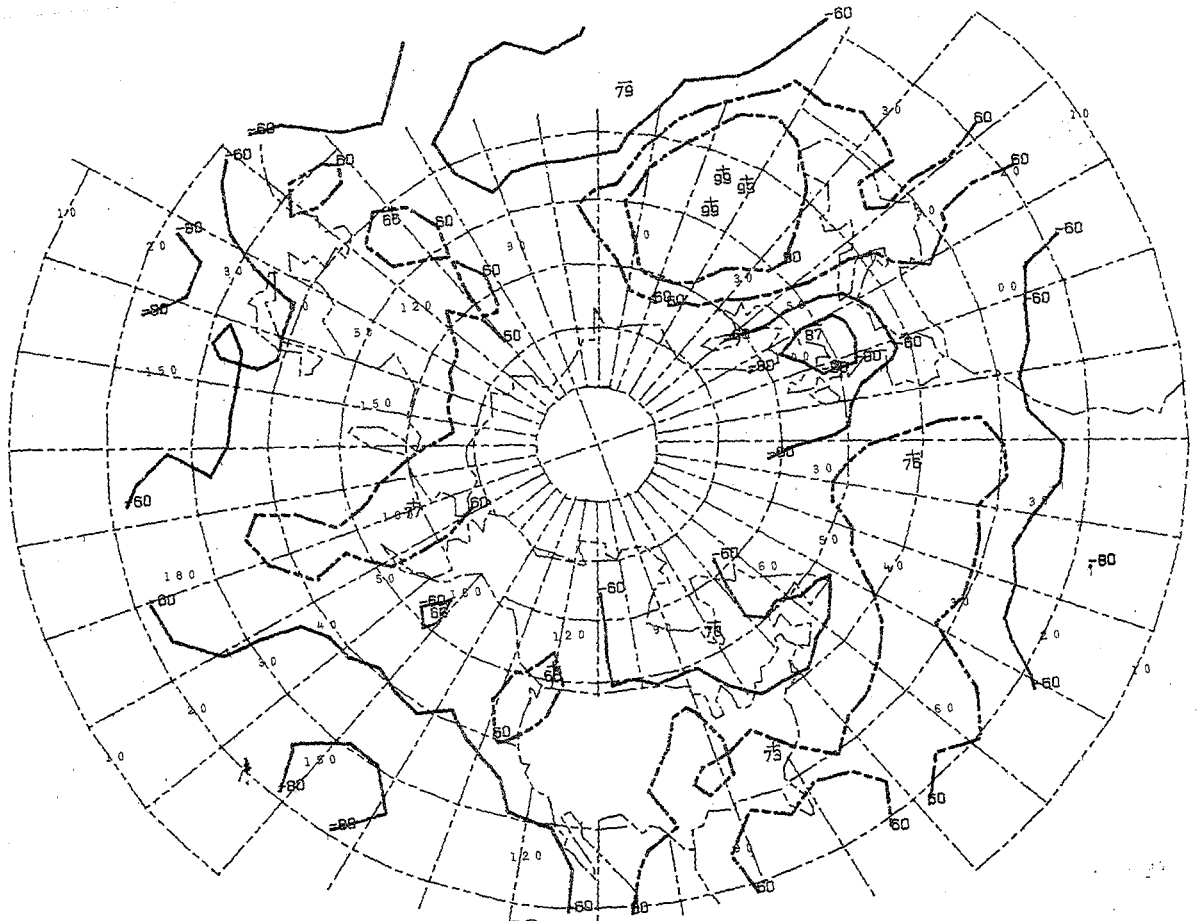

+ KEY AT 50E 50N 10 CASES

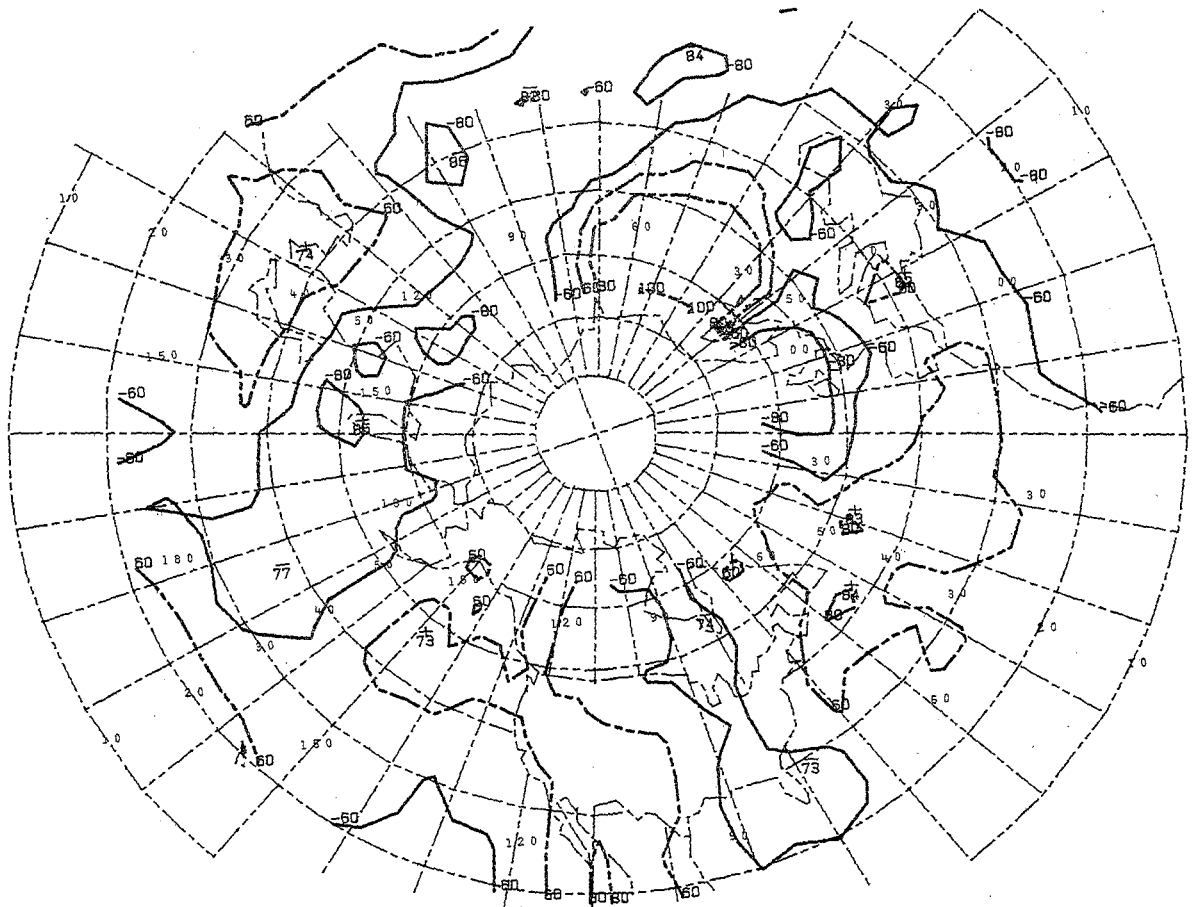

+ KEY AT 50E 60N 09 CASES

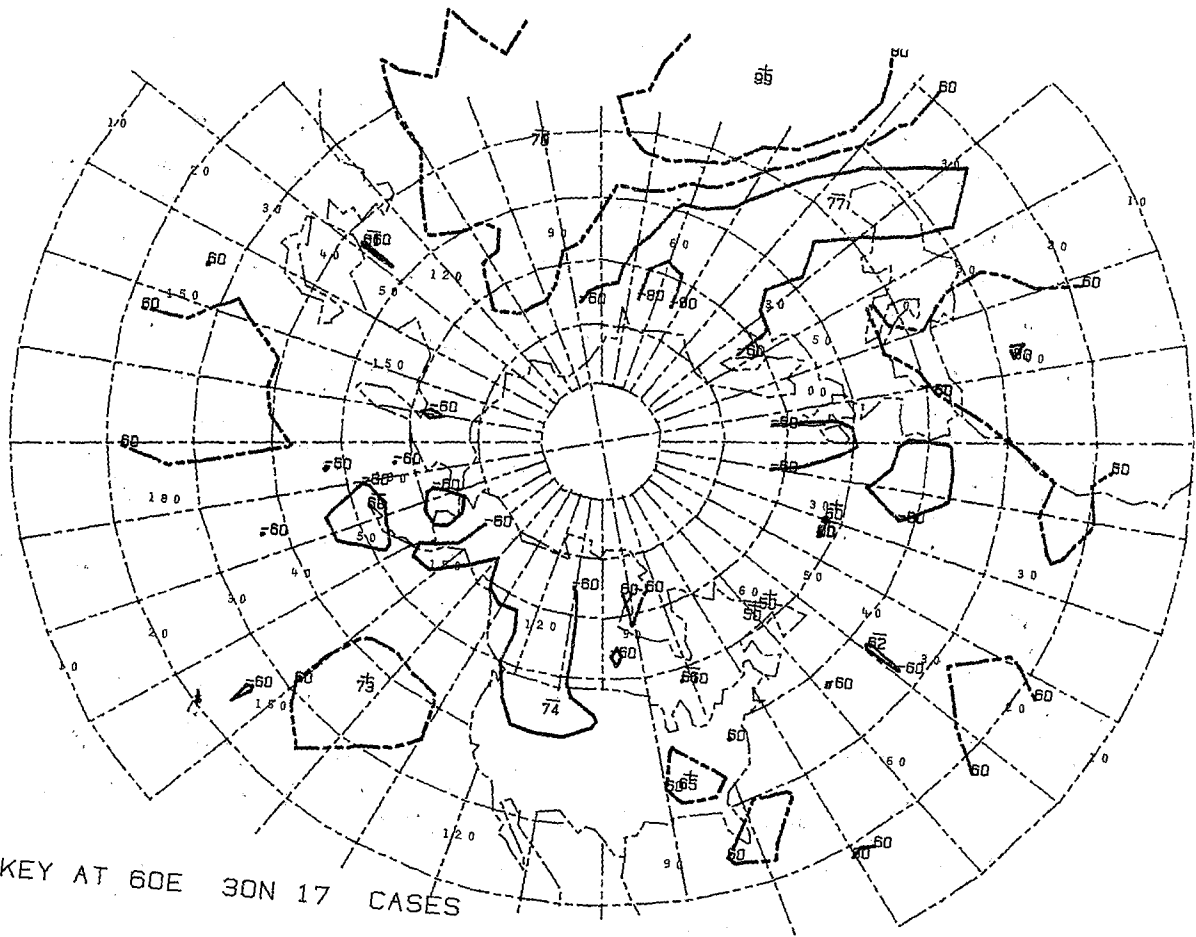

+ KEY AT 60E 30N 17 CASES

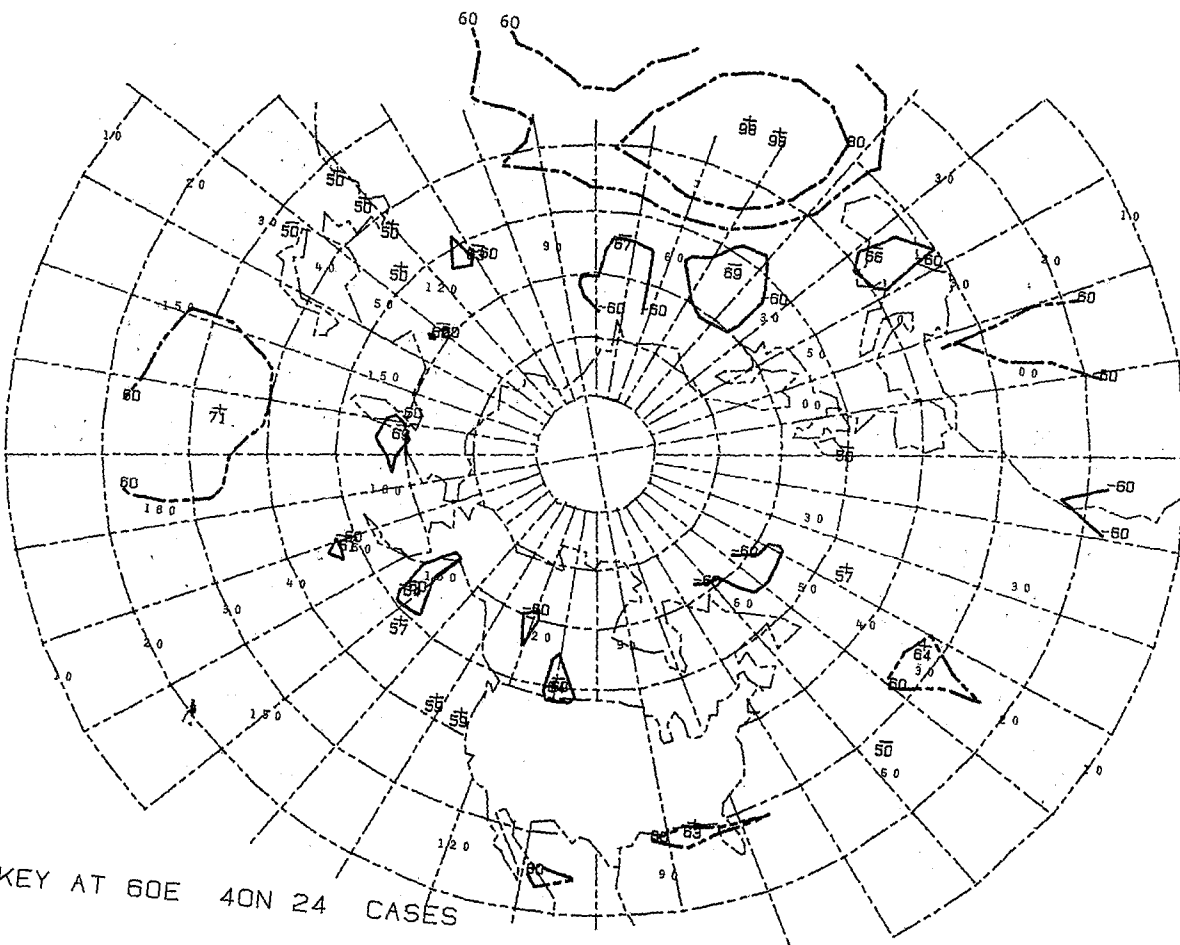

+ KEY AT 60E 40N 24 CASES

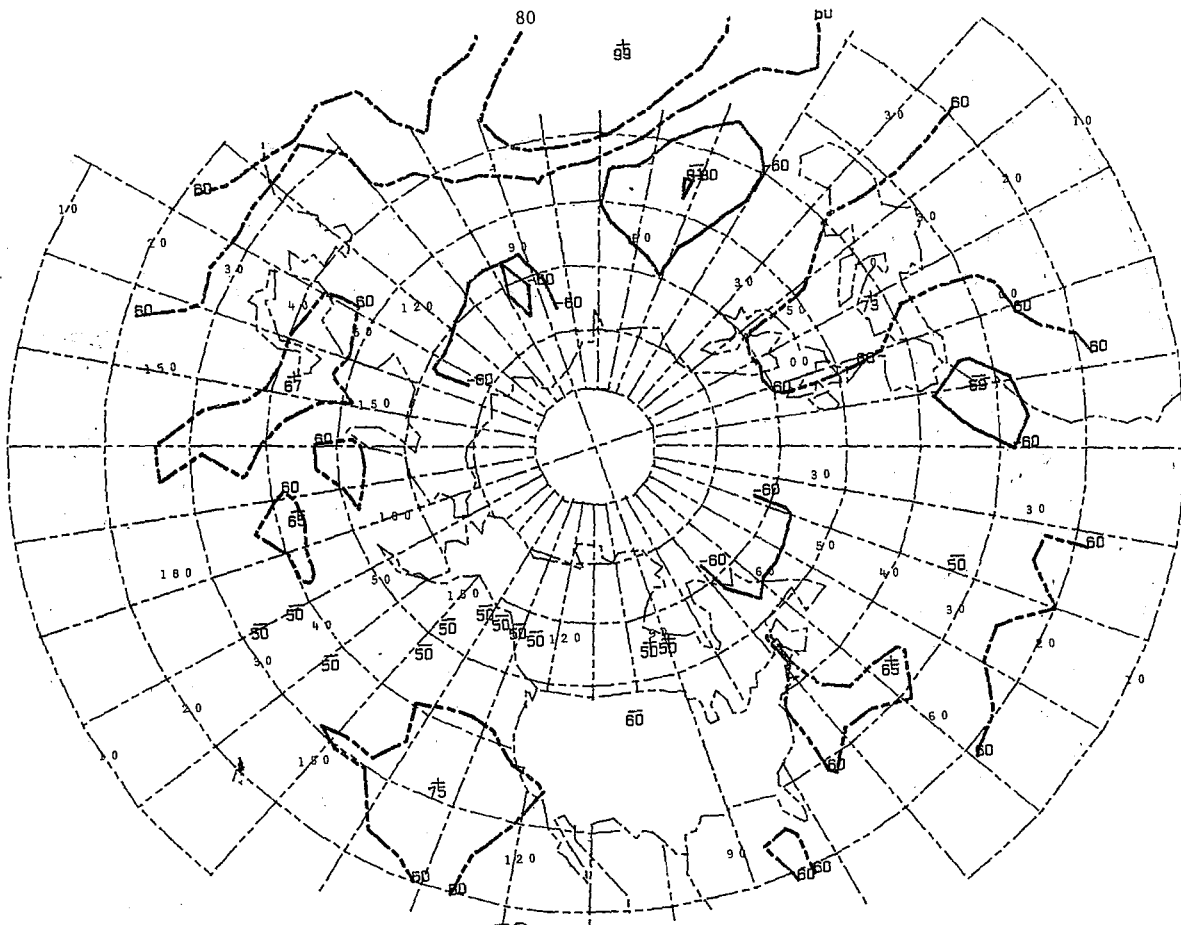

+ KEY AT 70E 30N 29 CASES

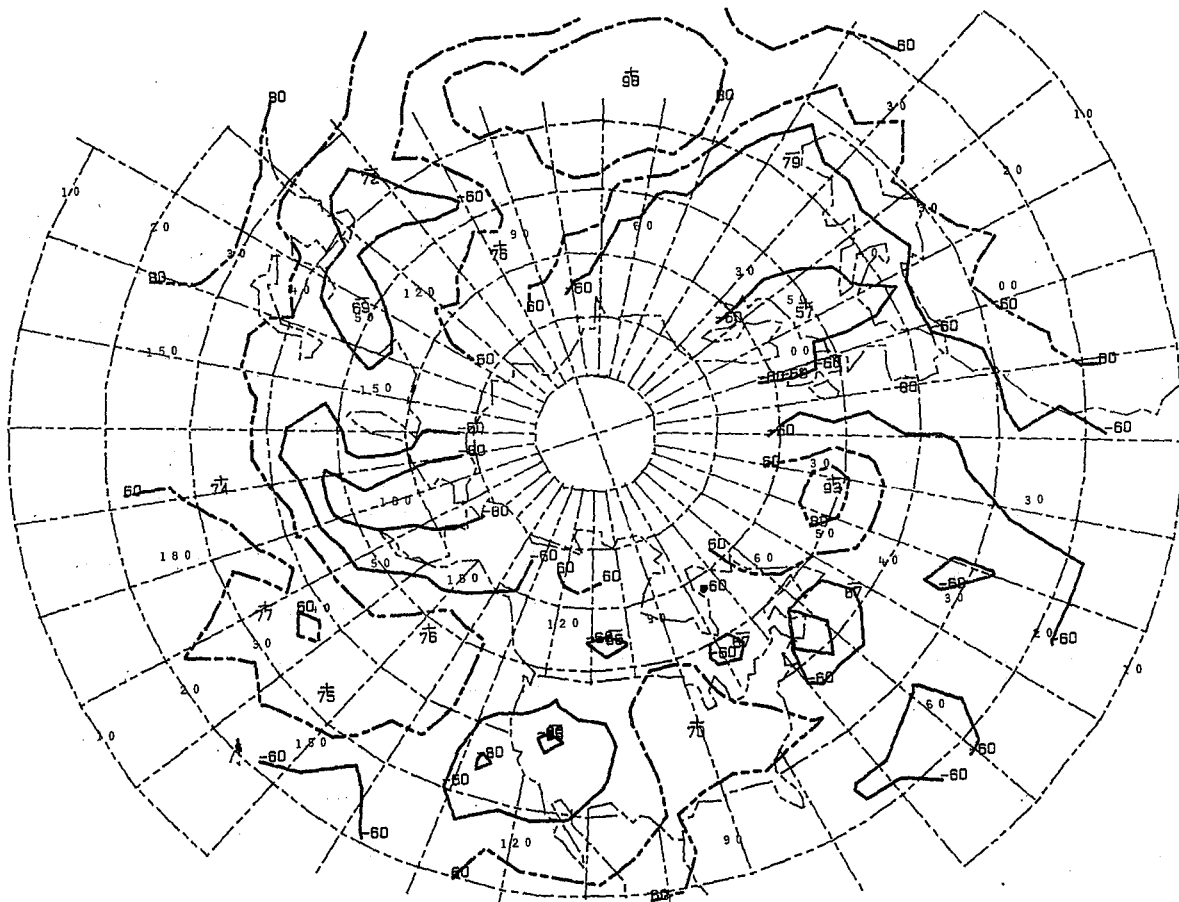

+ KEY AT 70E 40N 11 CASES

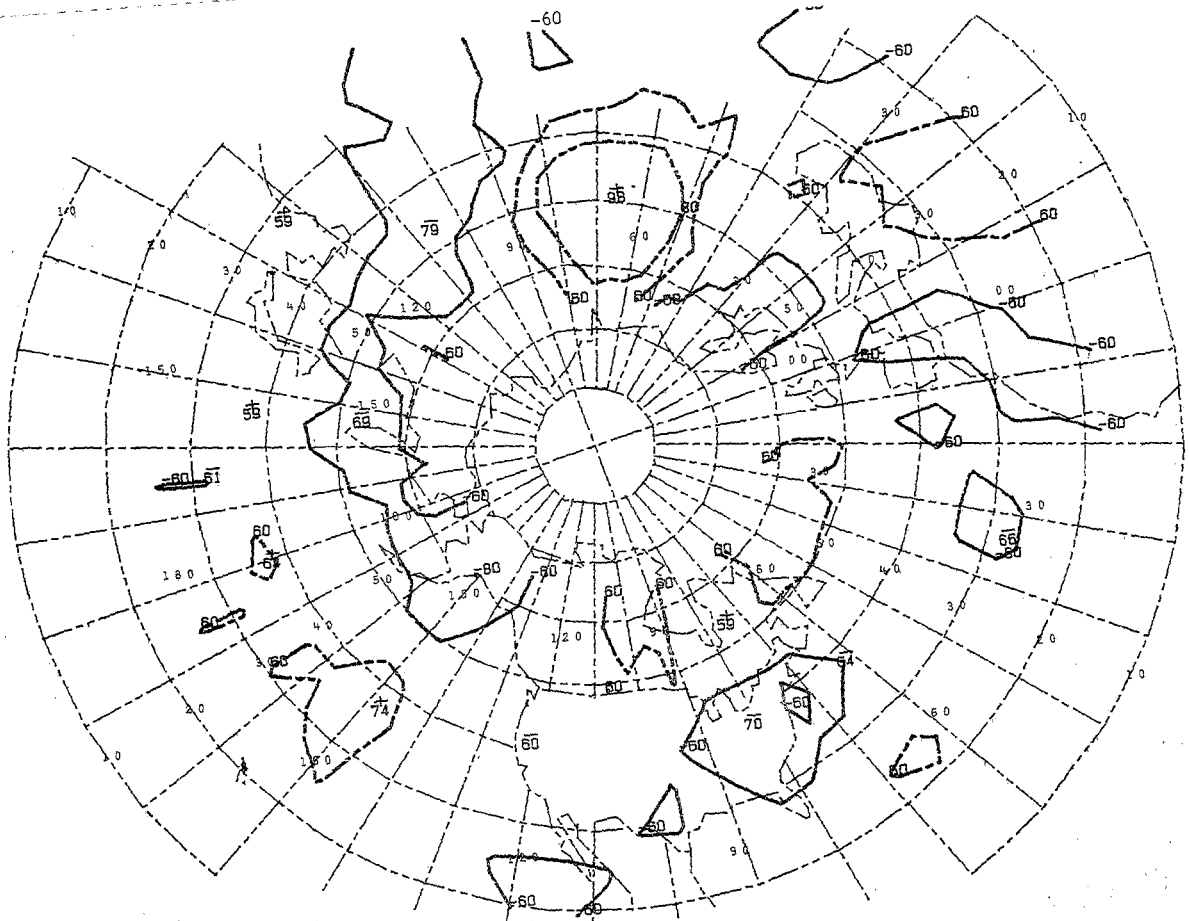

+ KEY AT 70E 50N 17 CASES

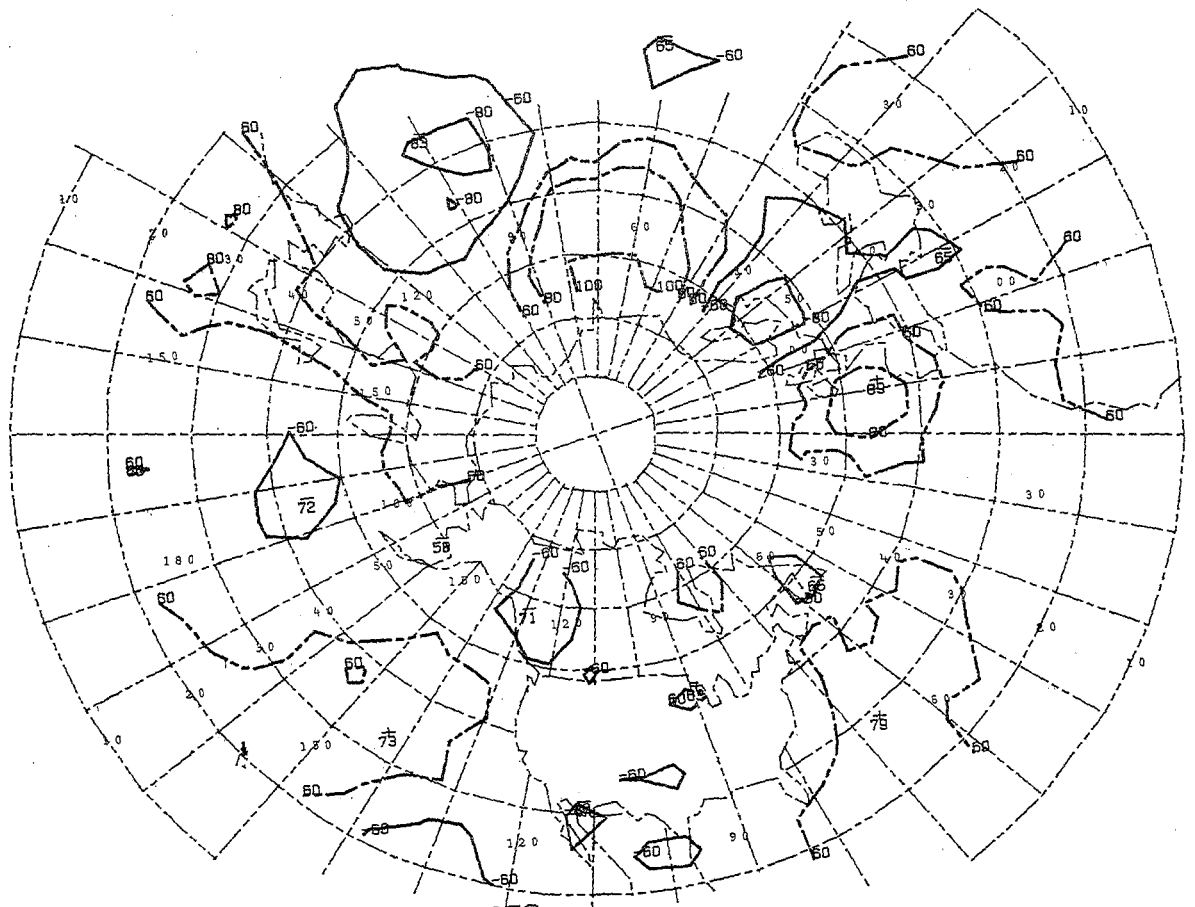

+ KEY AT 70E 60N 13 CASES

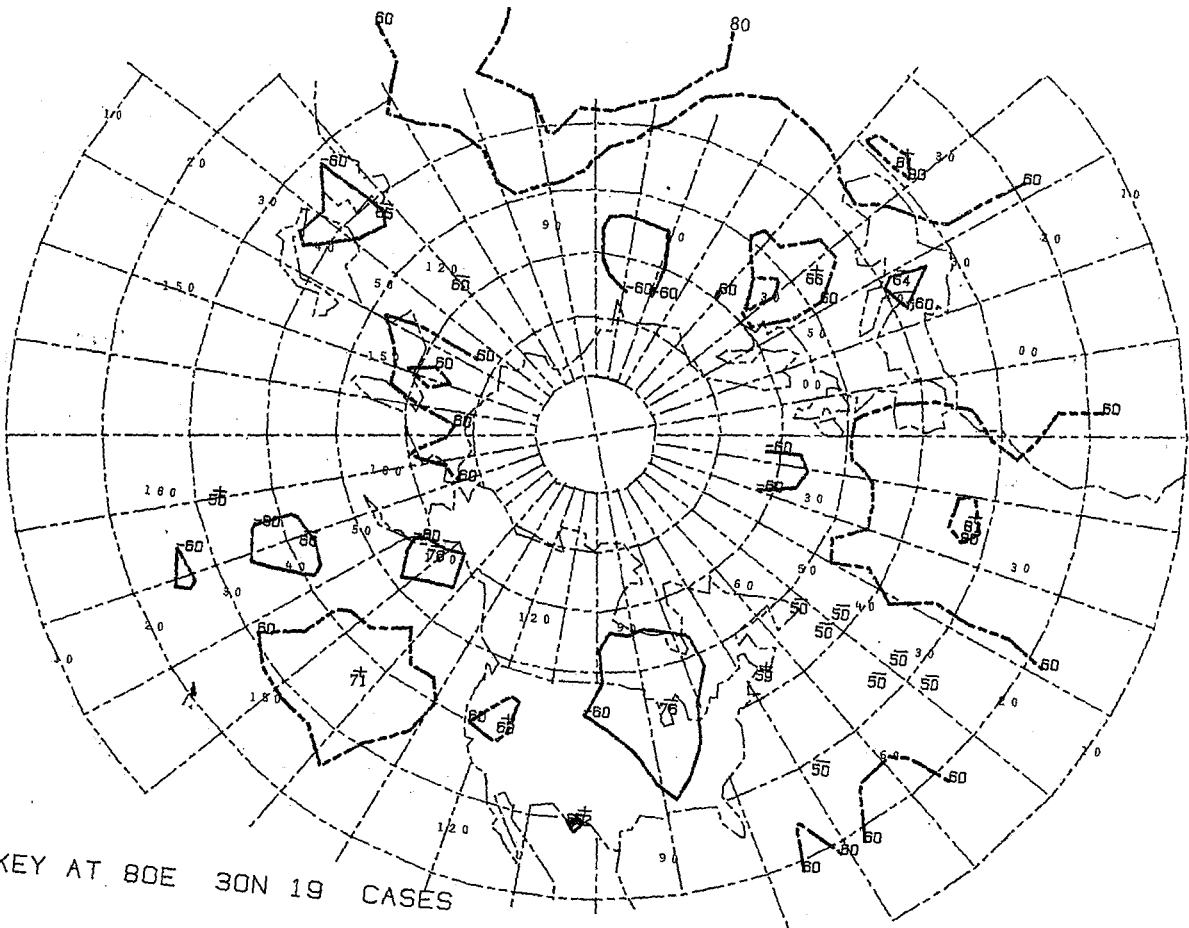

+ KEY AT 80E 30N 19 CASES

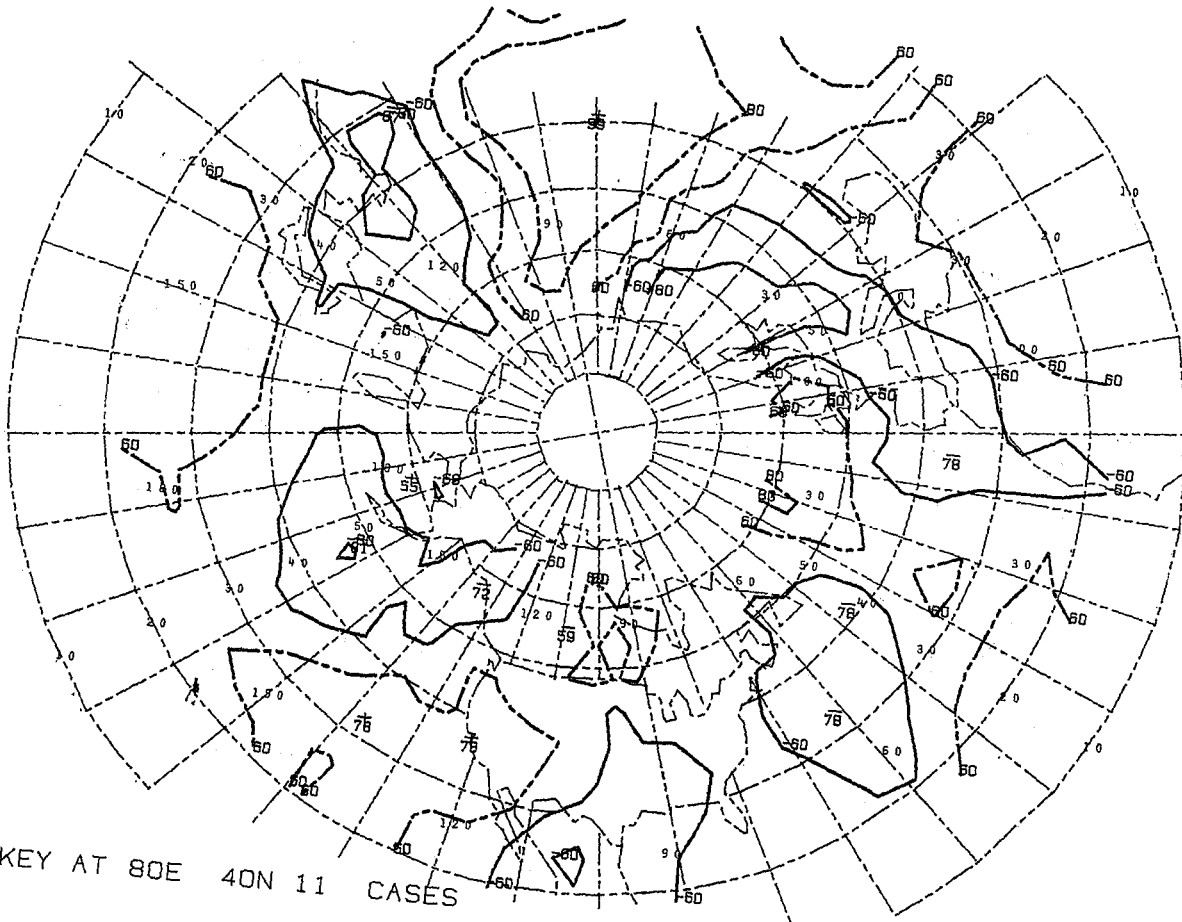

+ KEY AT 80E 40N 11 CASES

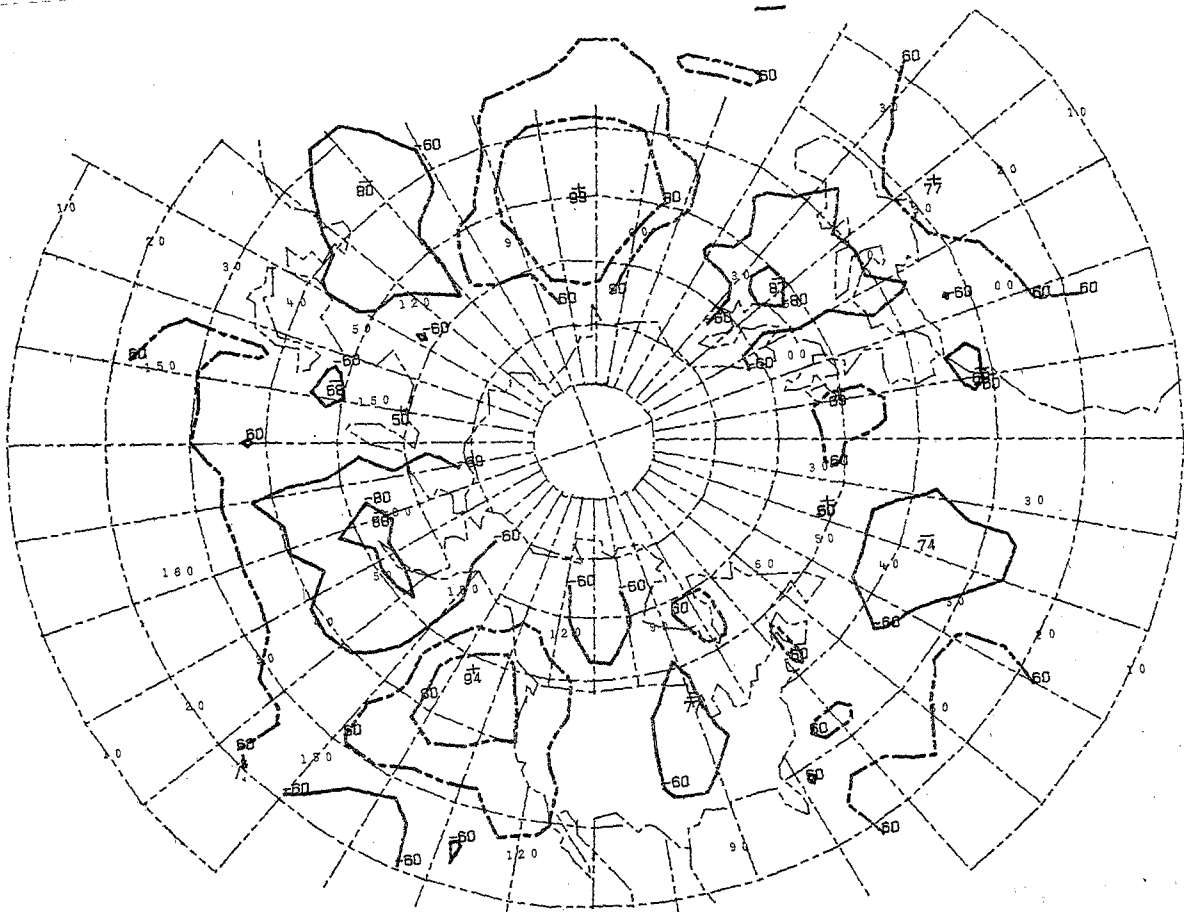

+ KEY AT 80E 50N 12 CASES

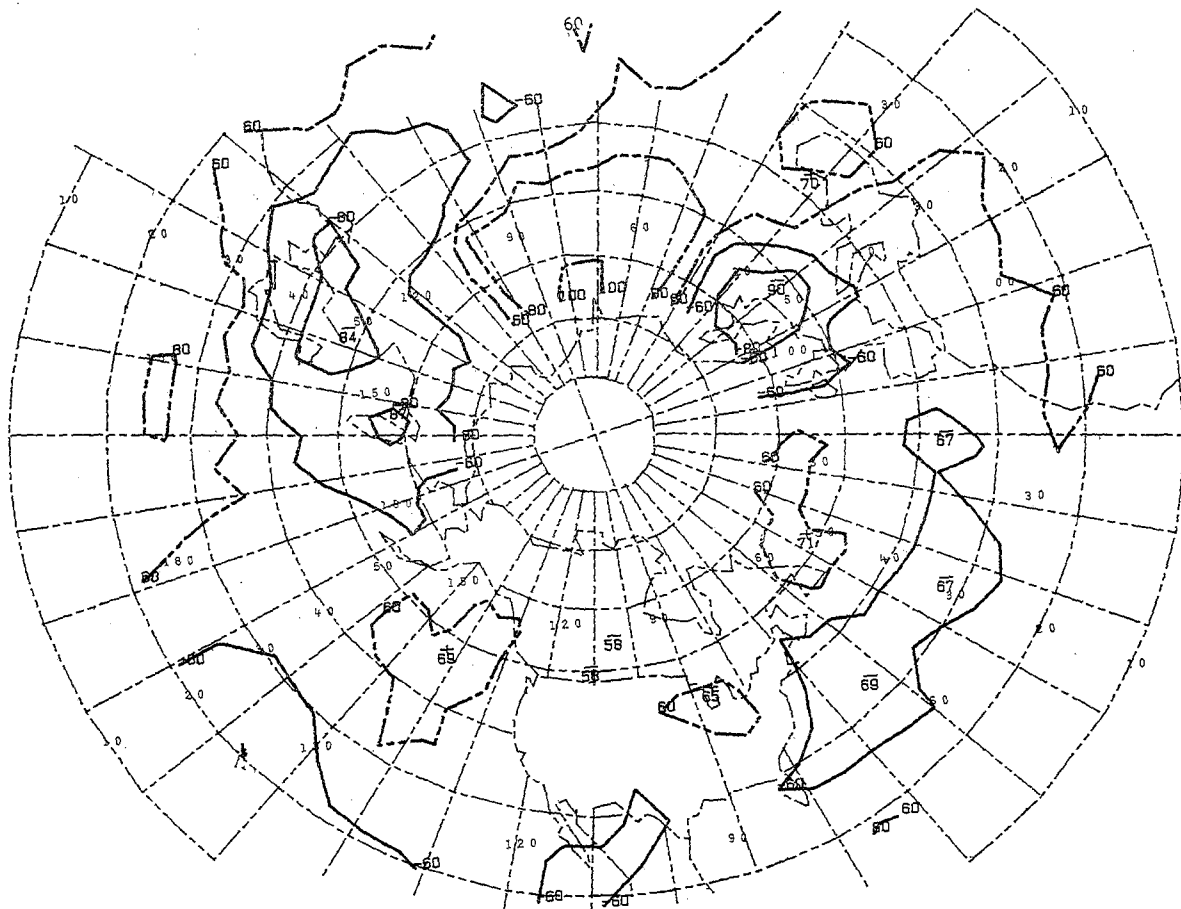

+ KEY AT 80E 60N 13 CASES

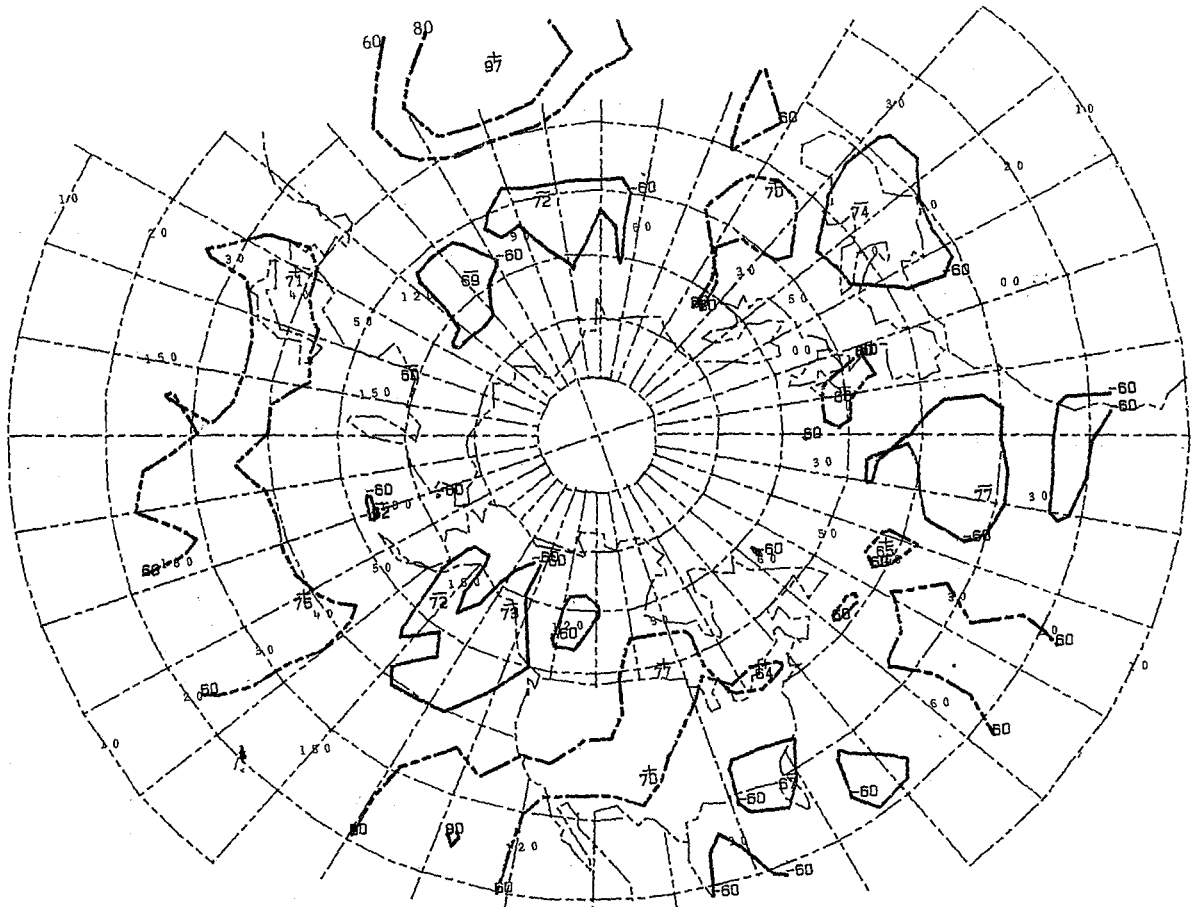

+ KEY AT 90E 30N 17 CASES

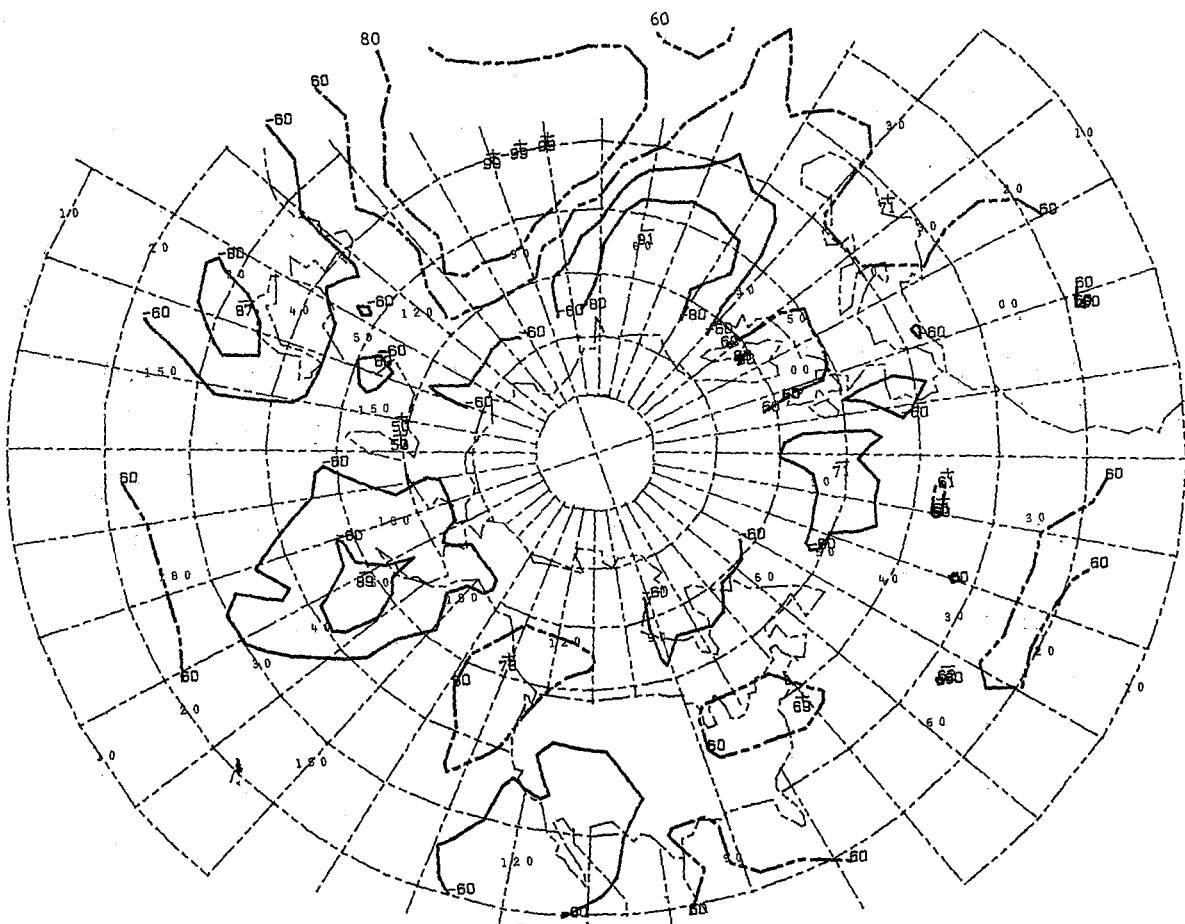

+ KEY AT 90E 40N 12 CASES

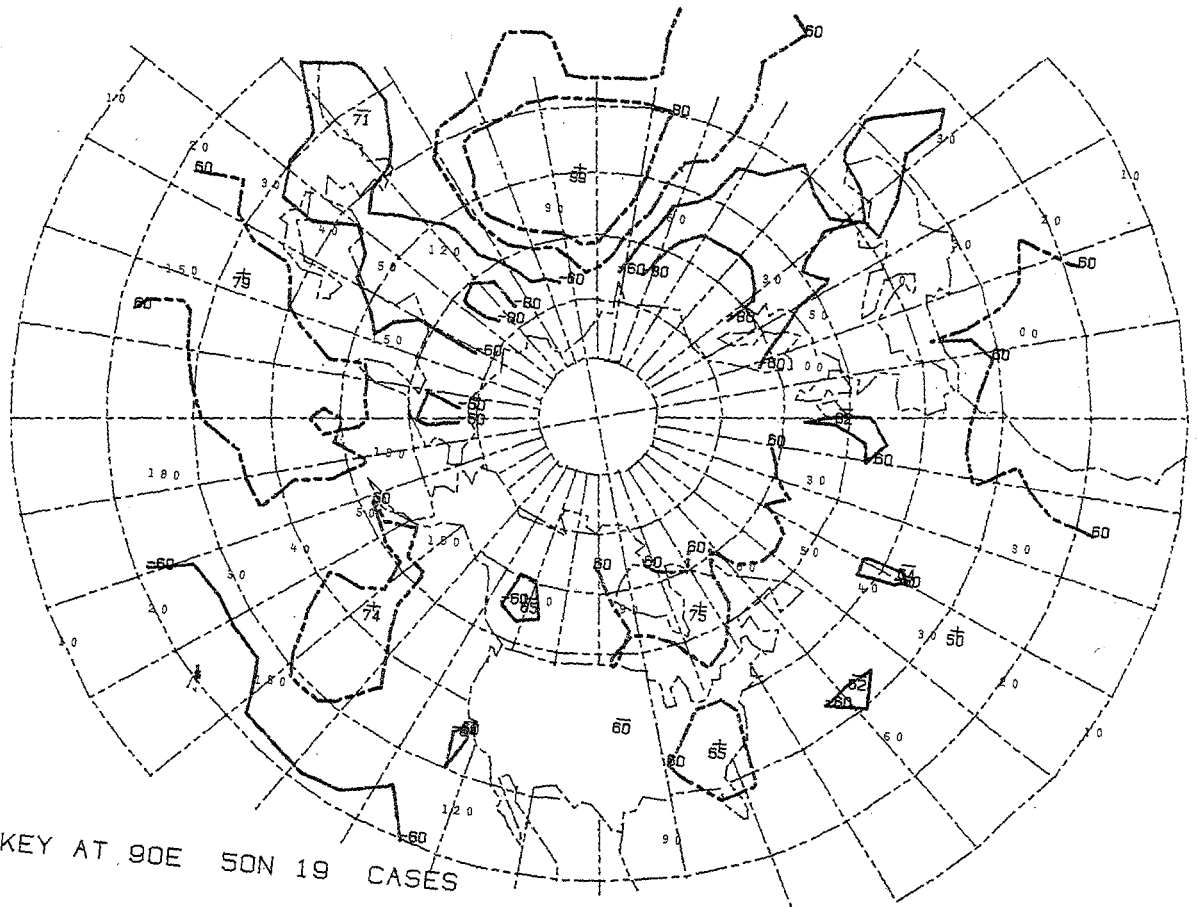

+ KEY AT 90E 50N 19 CASES

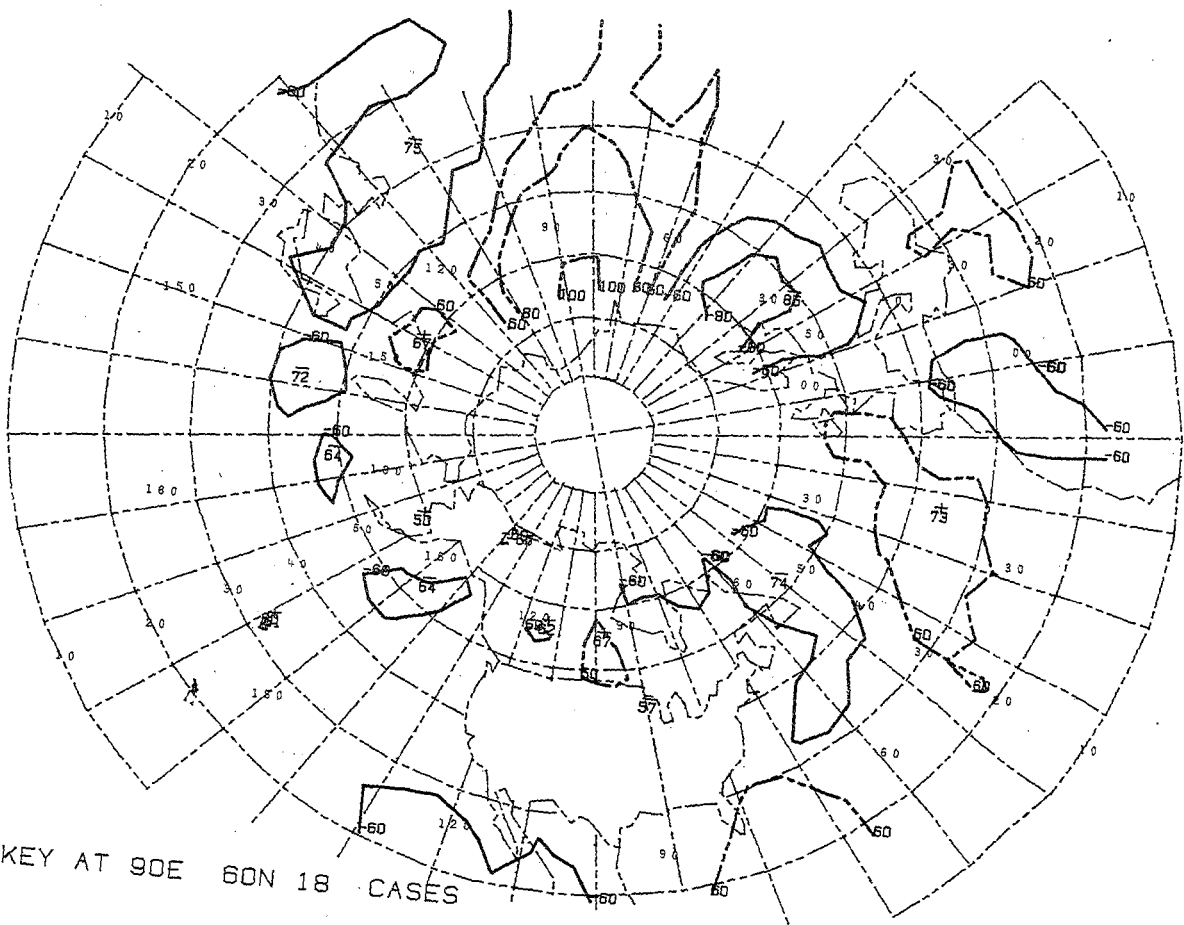

+ KEY AT 90E 60N 18 CASES

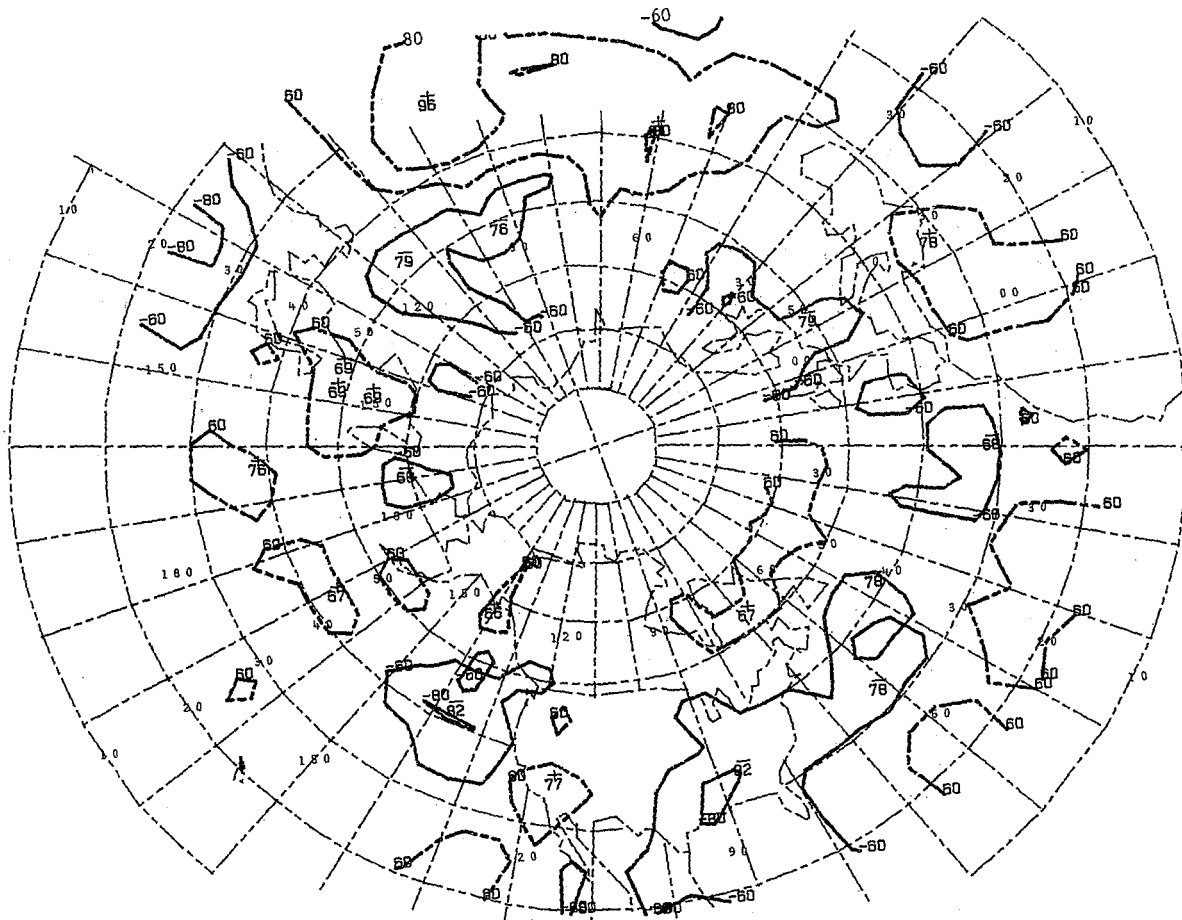

+ KEY AT100E 30N 07 CASES

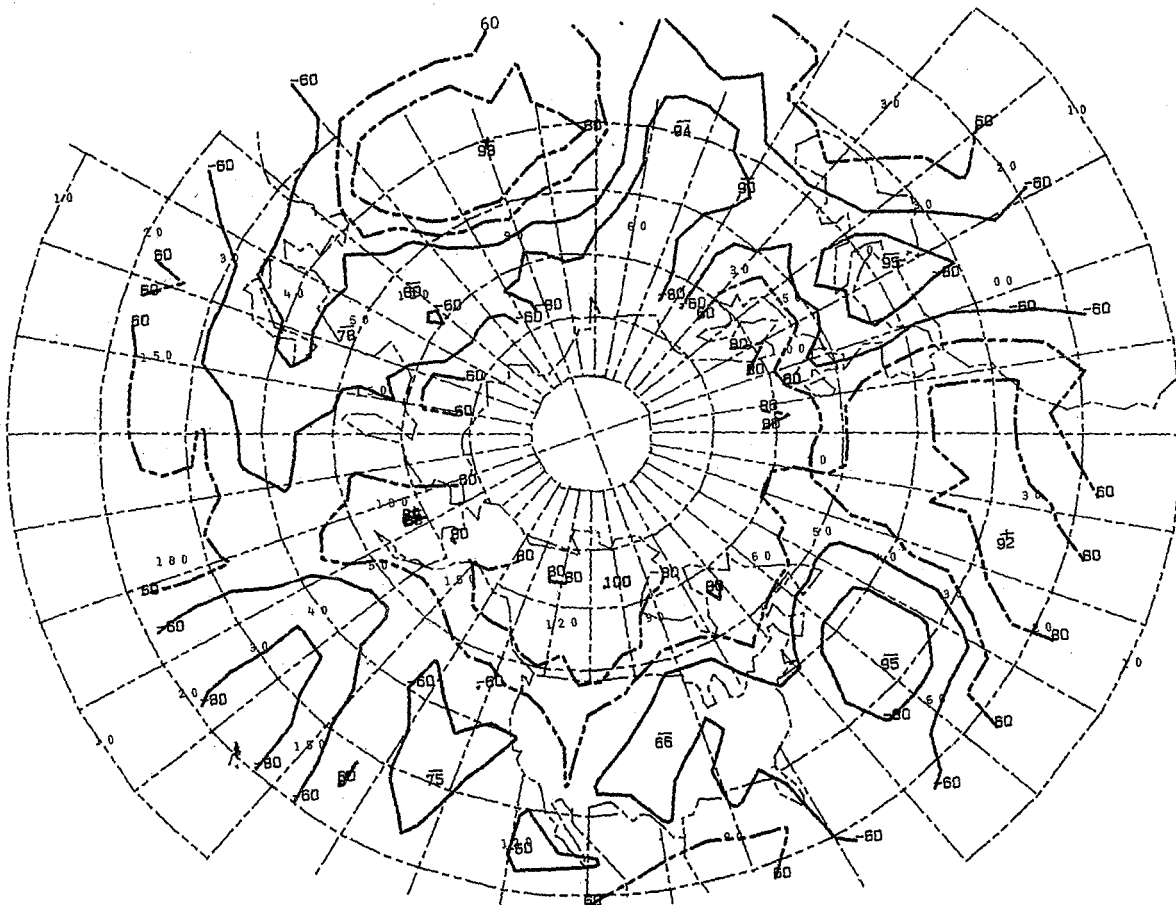

+ KEY AT100E 40N 06 CASES

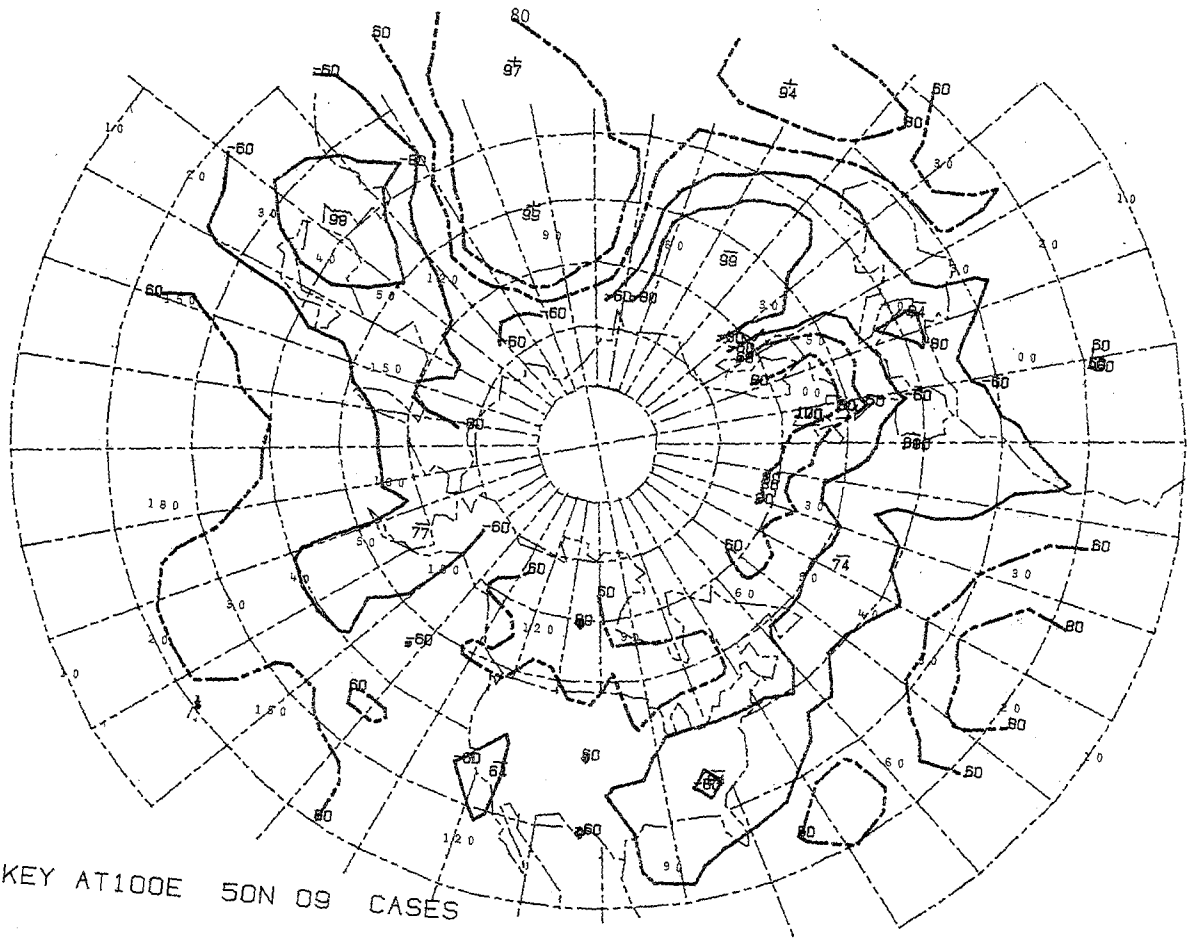

+ KEY AT100E 50N 09 CASES

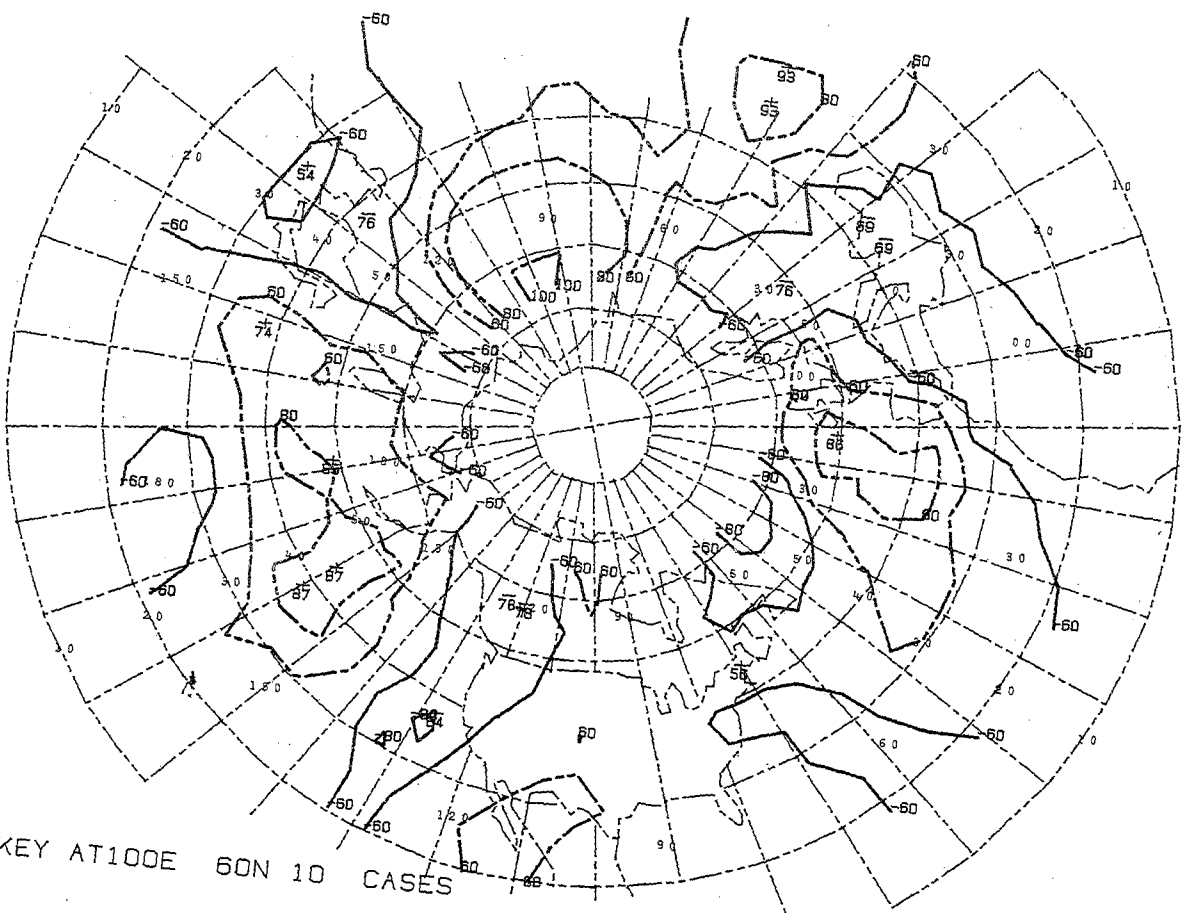

+ KEY AT100E 60N 10 CASES

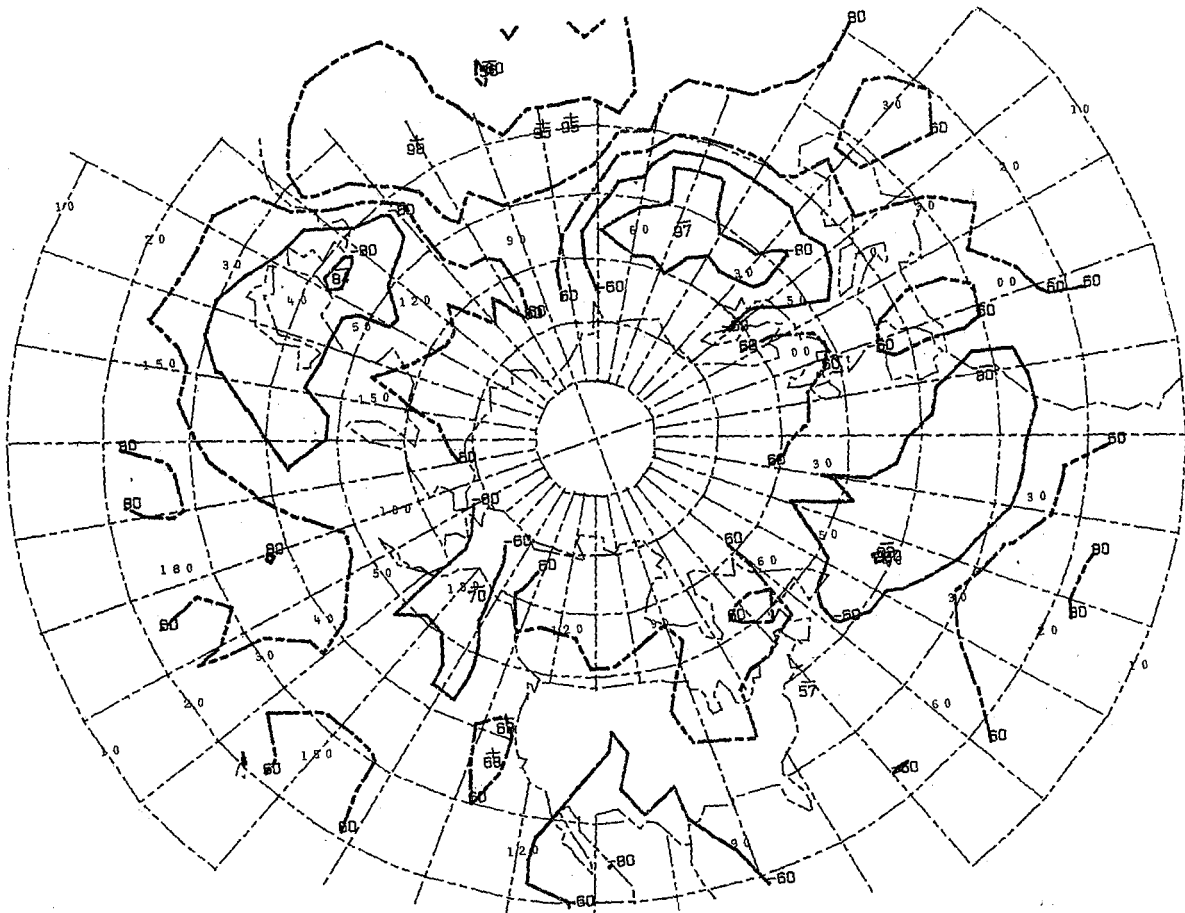

+ KEY AT110E 30N 08 CASES

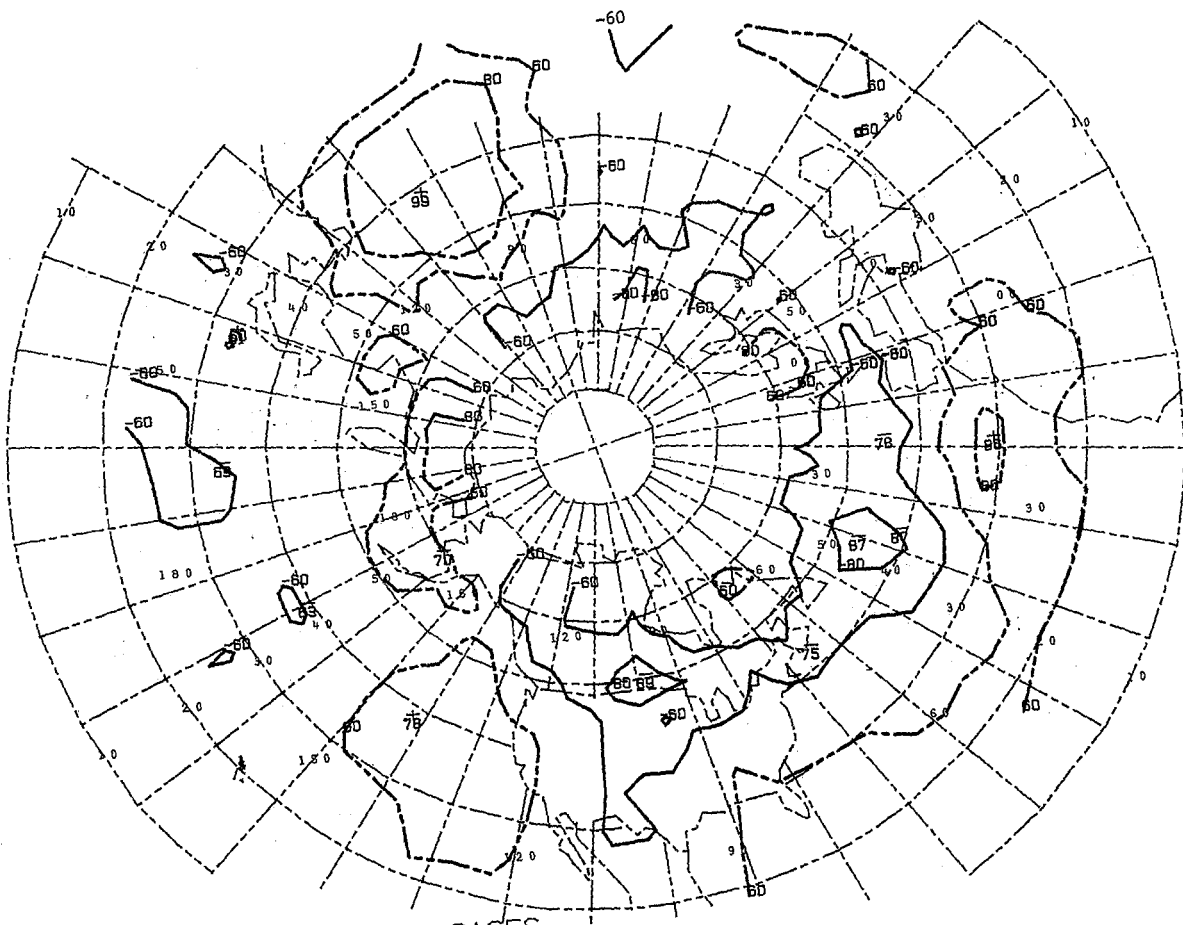

+ KEY AT110E 40N 12 CASES

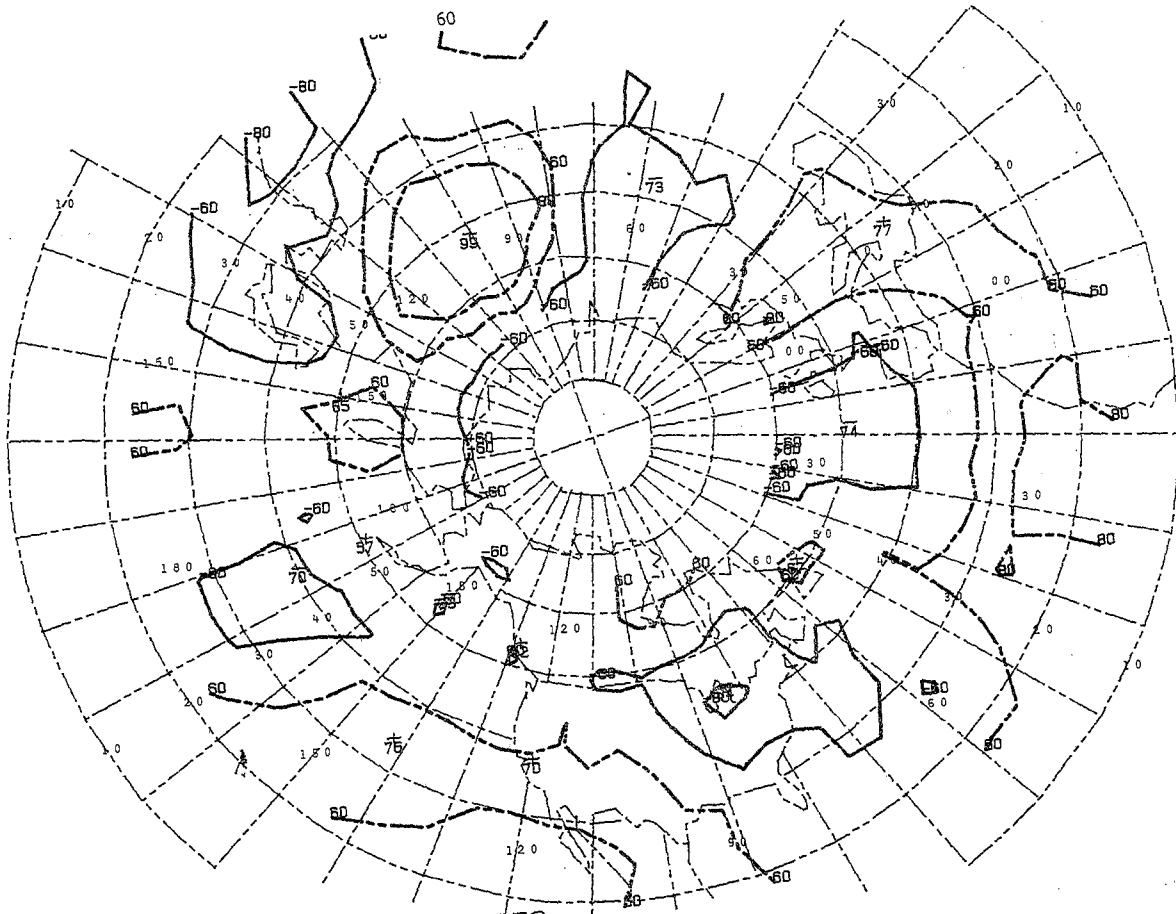

+ KEY AT110E 50N 16 CASES

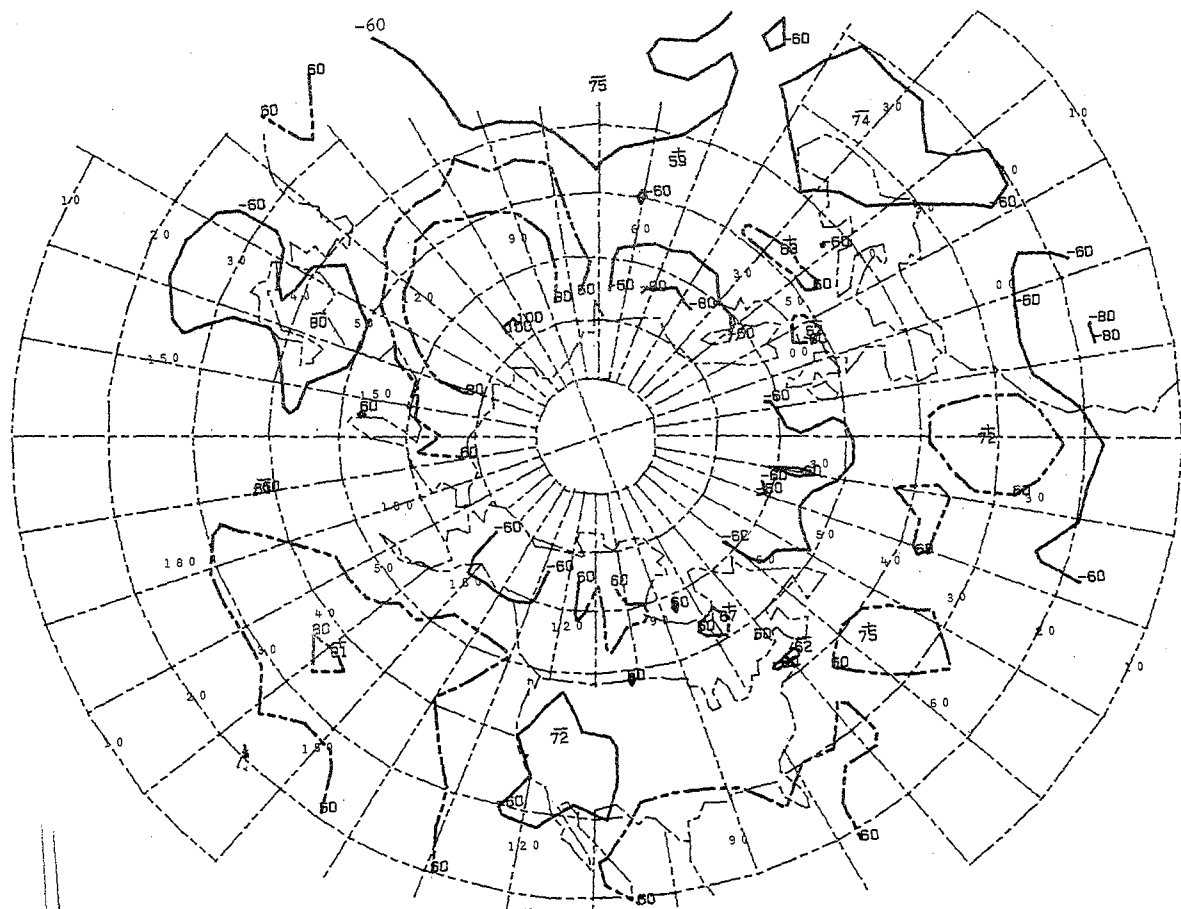

+ KEY AT110E 60N 12 CASES

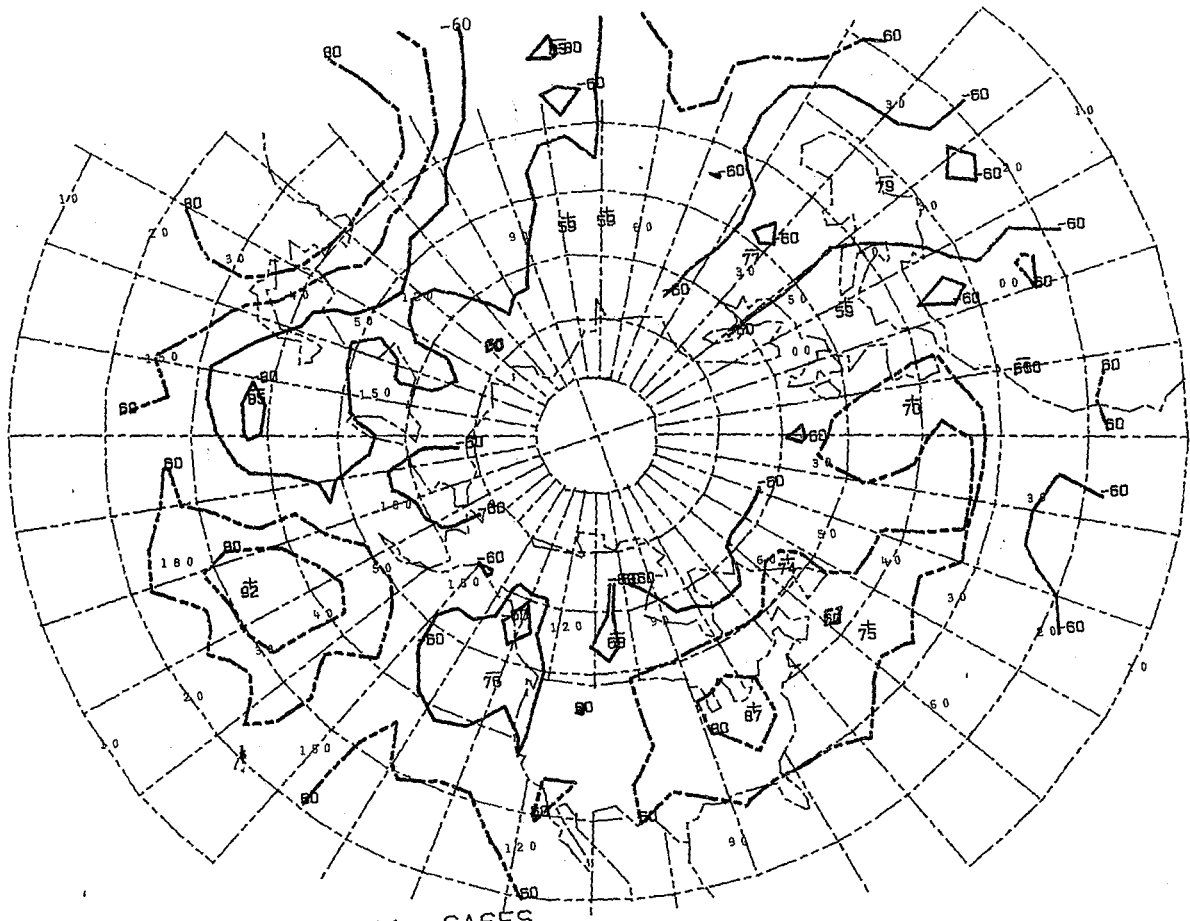

+ KEY AT120E 30N 11 CASES

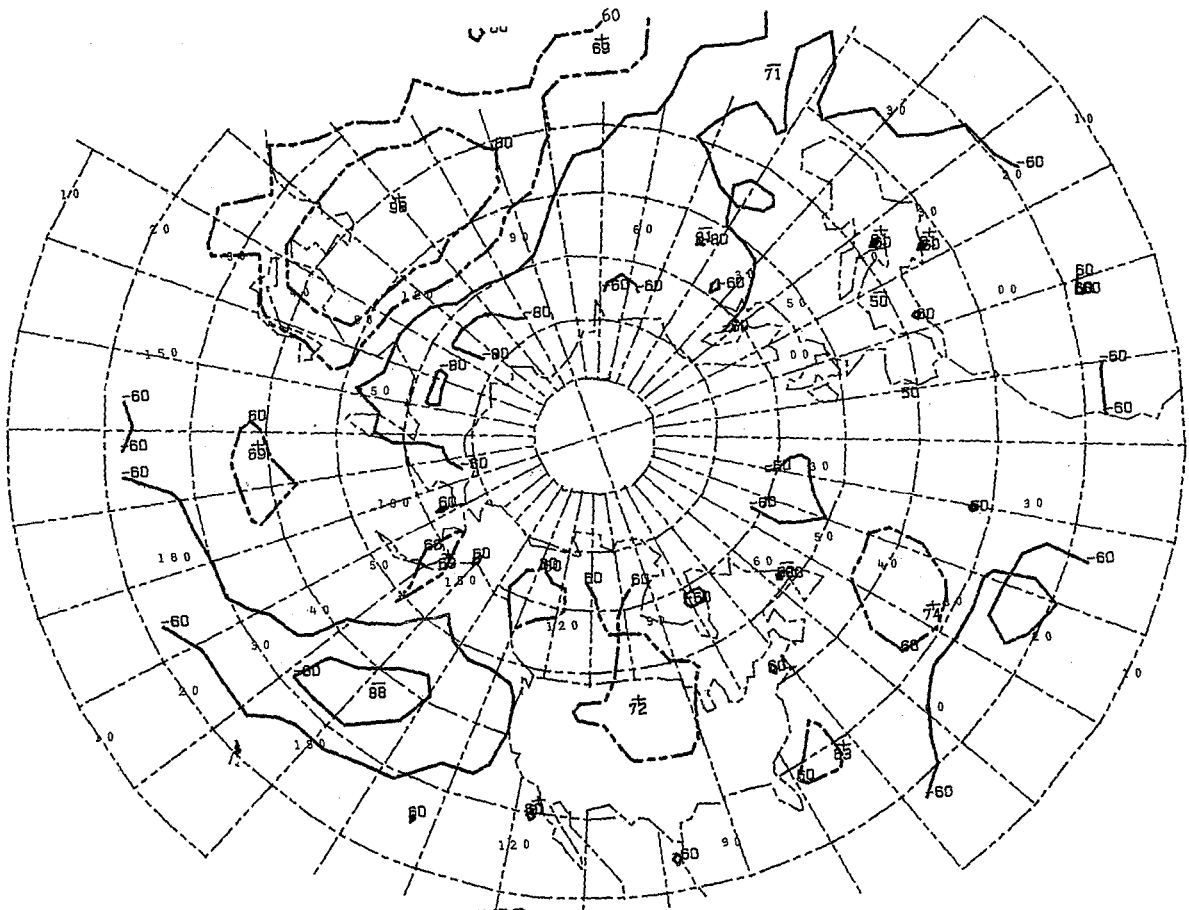

+ KEY AT120E 40N 12 CASES

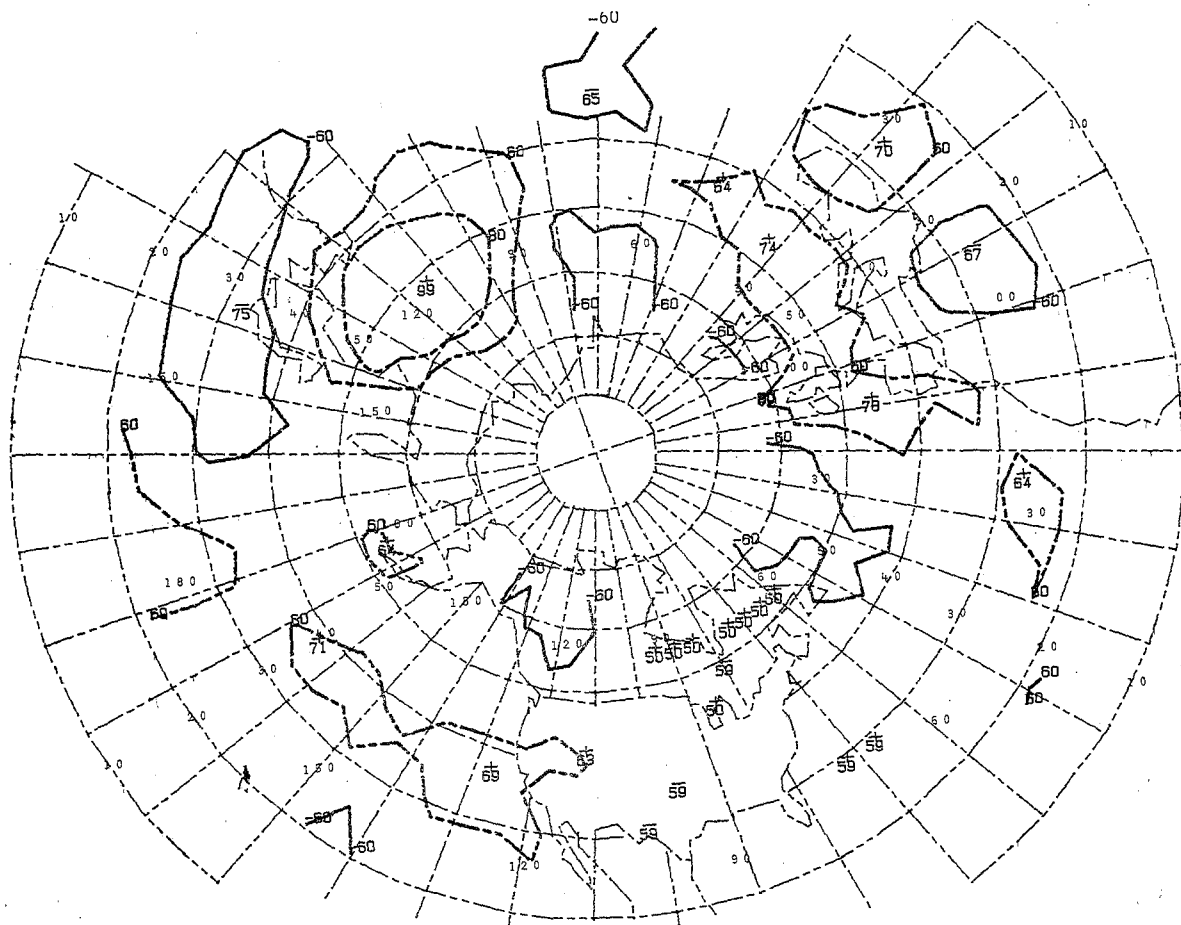

+ KEY AT120E 50N 19 CASES

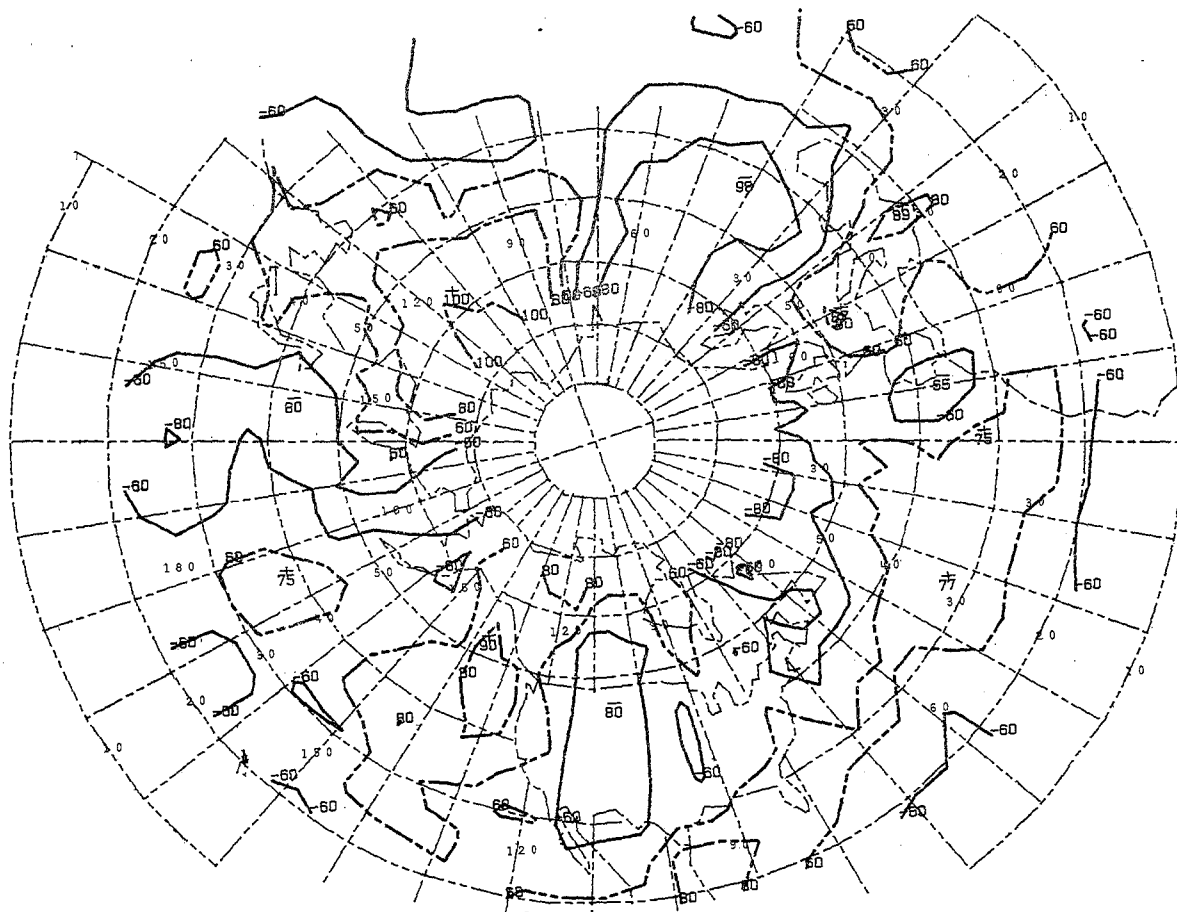

+ KEY AT120E 60N 06 CASES

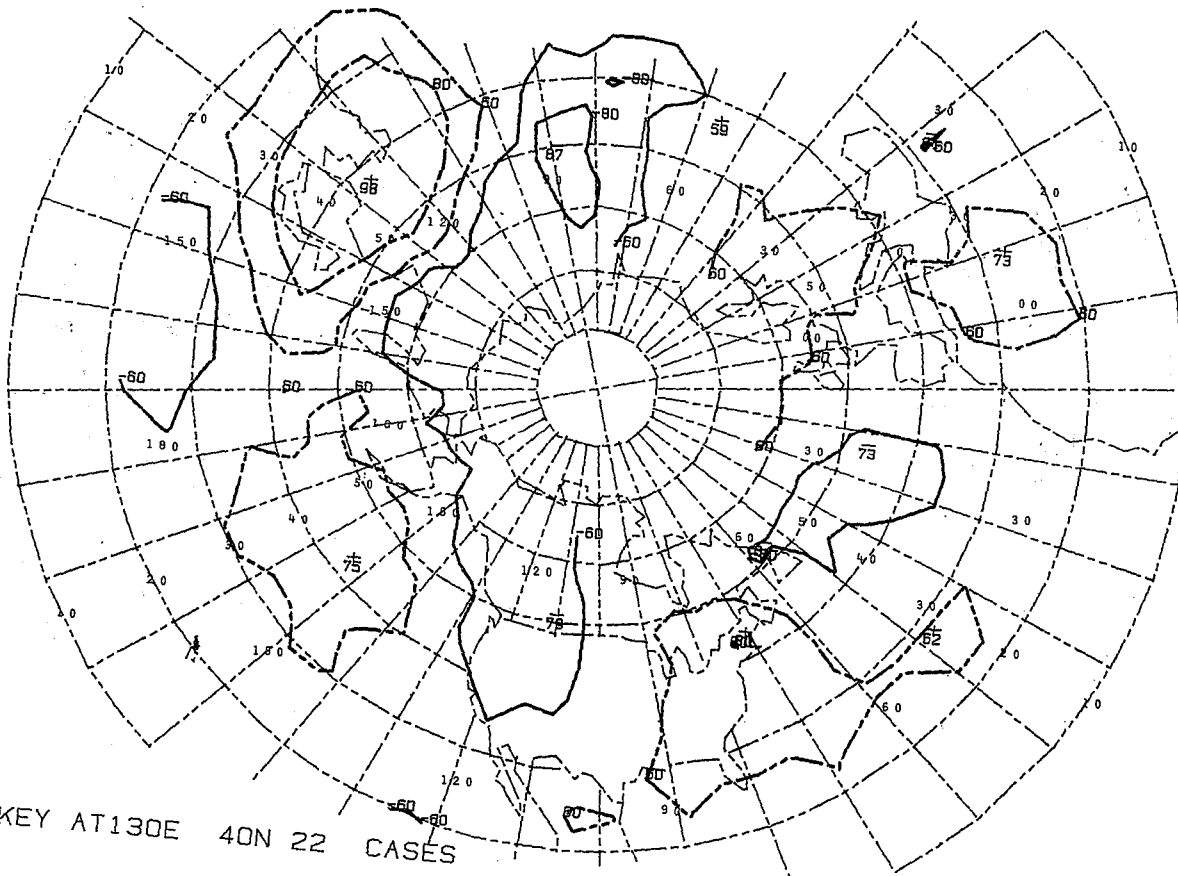
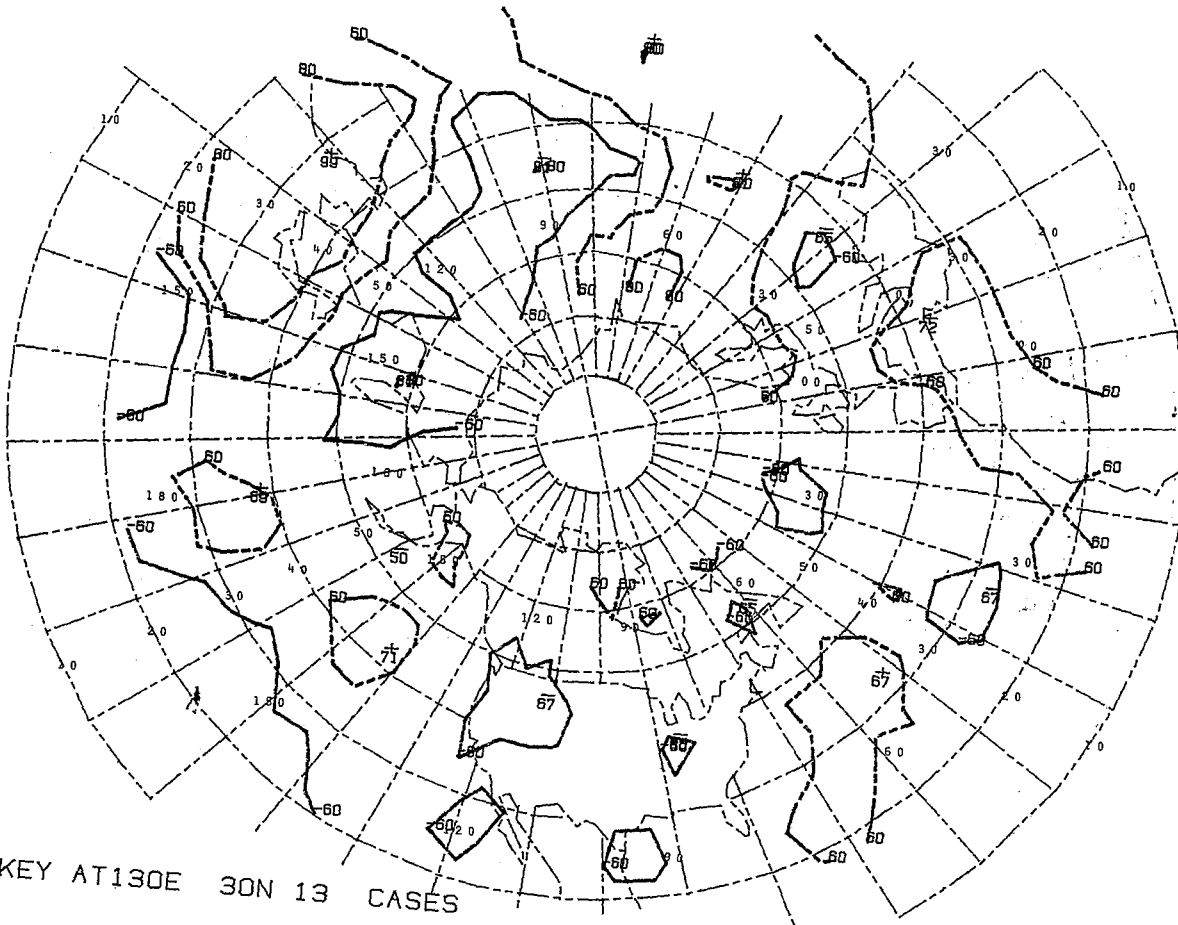

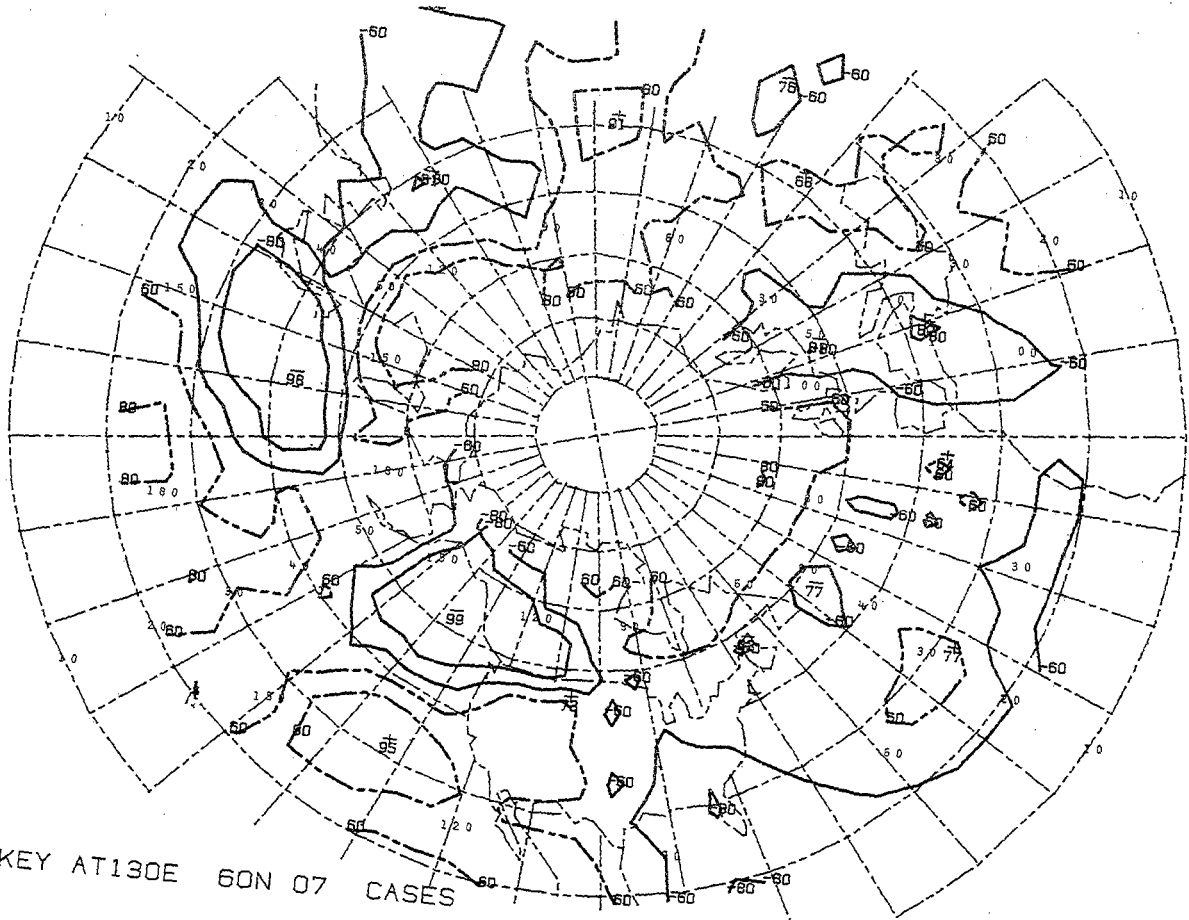
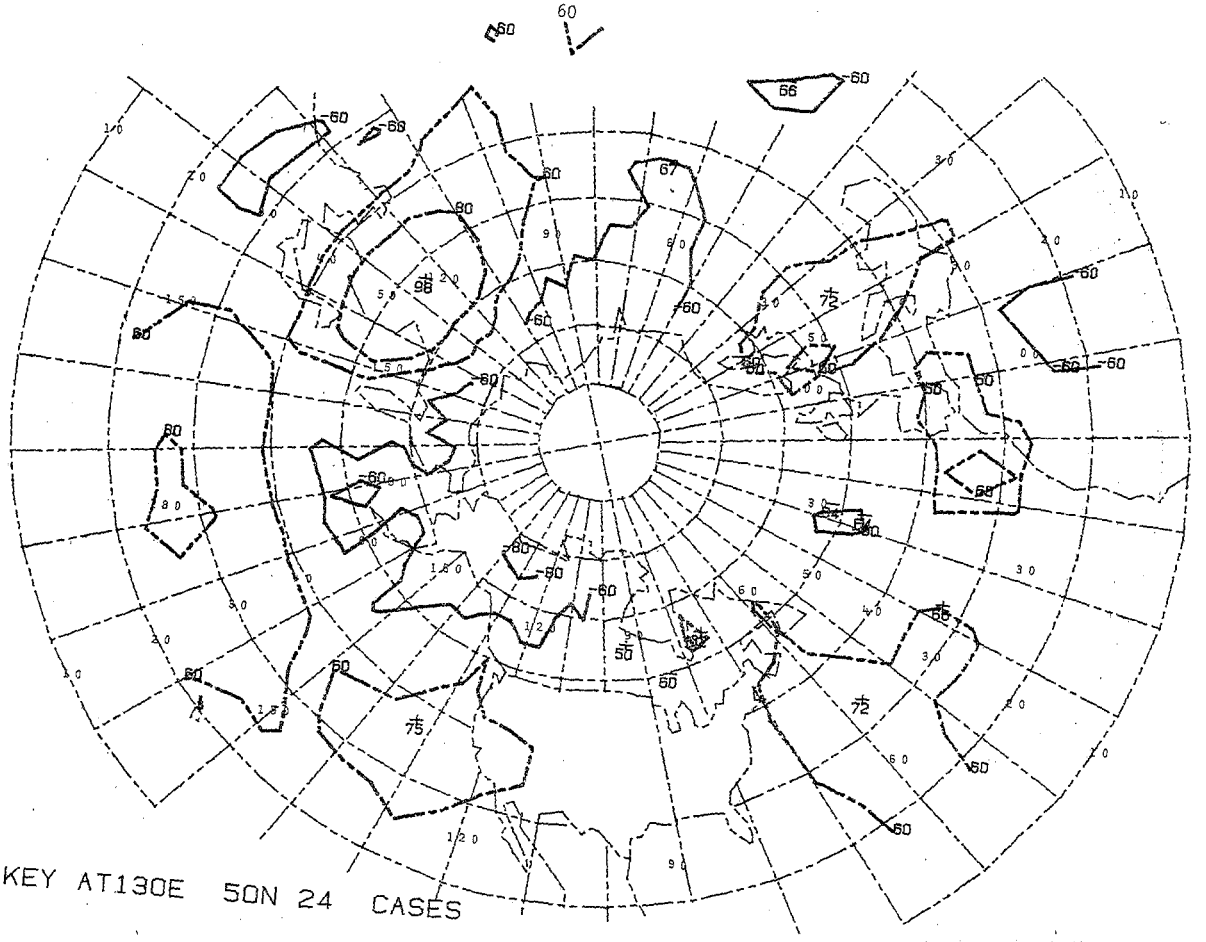

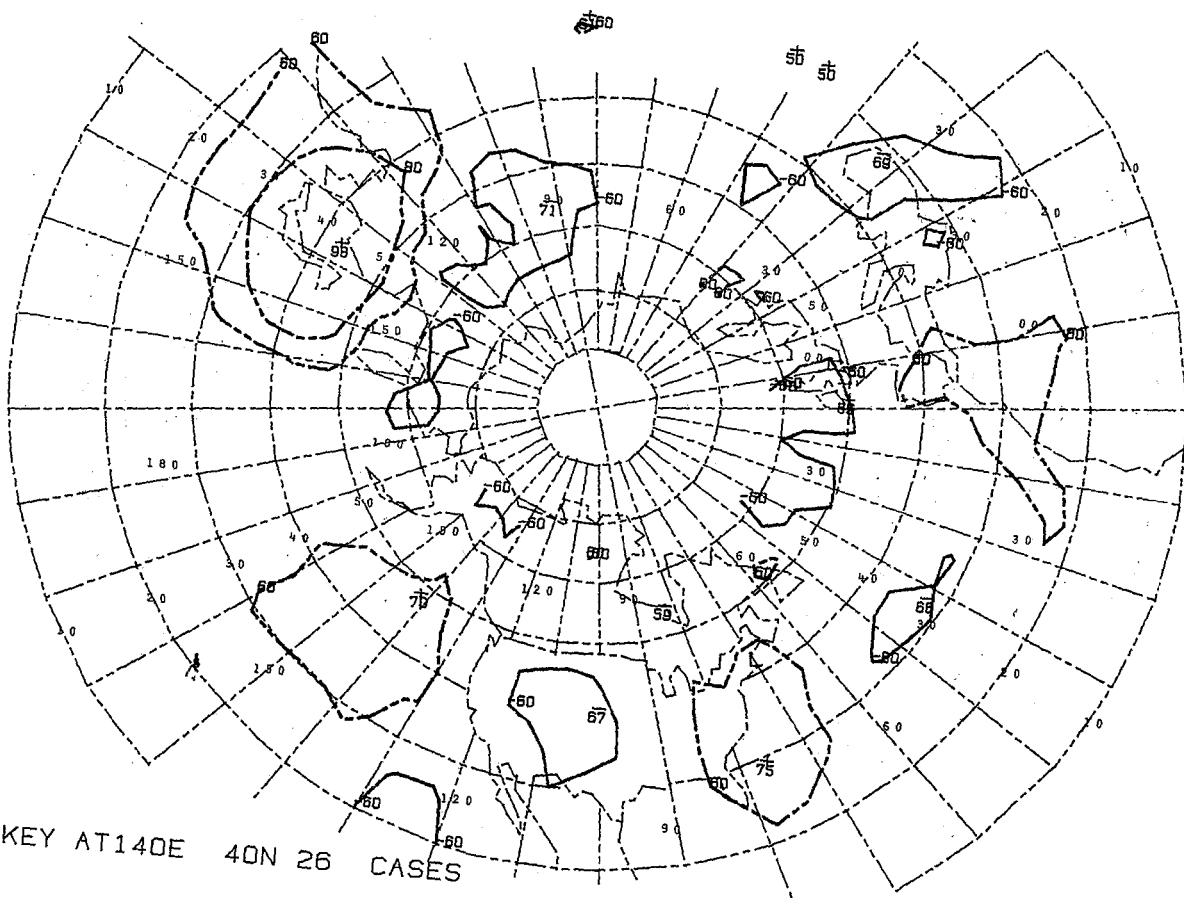
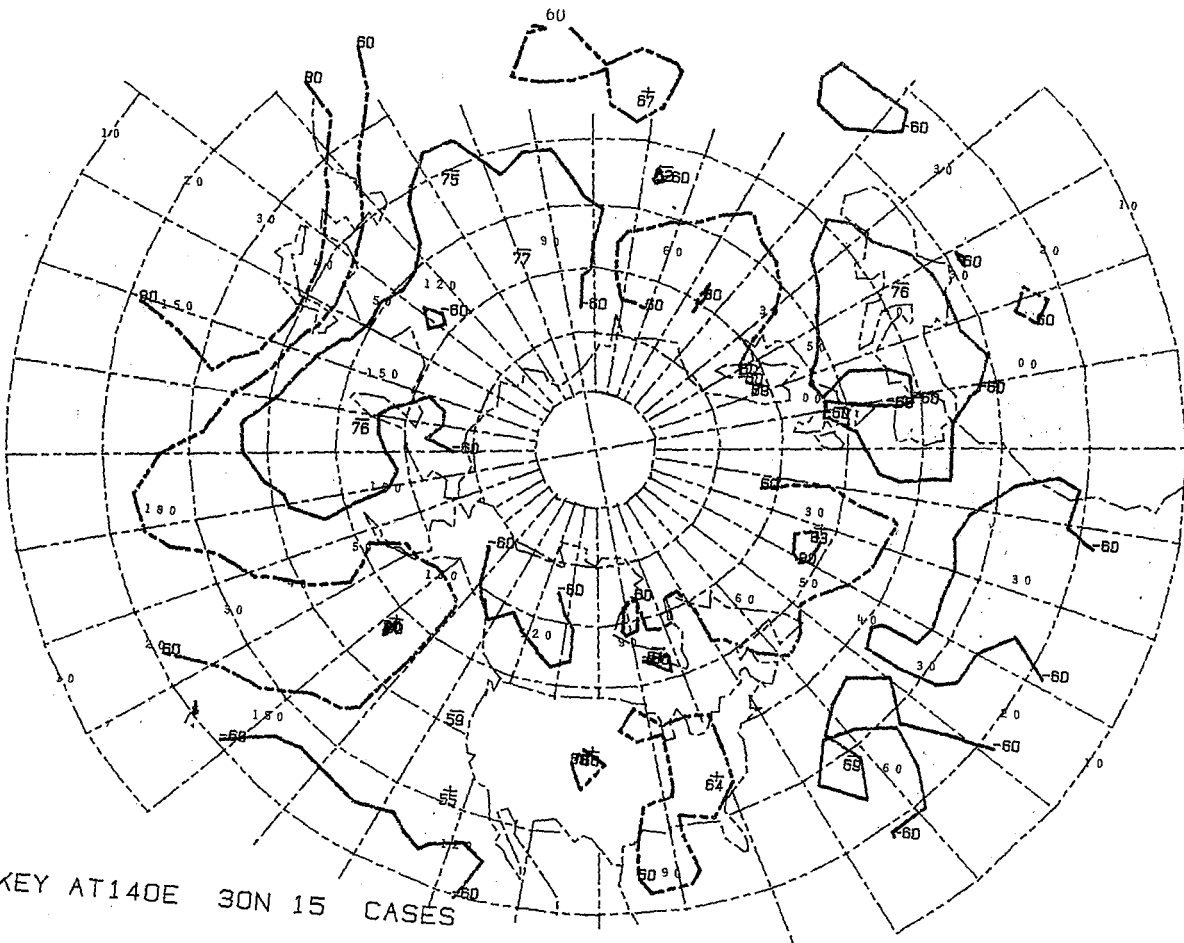

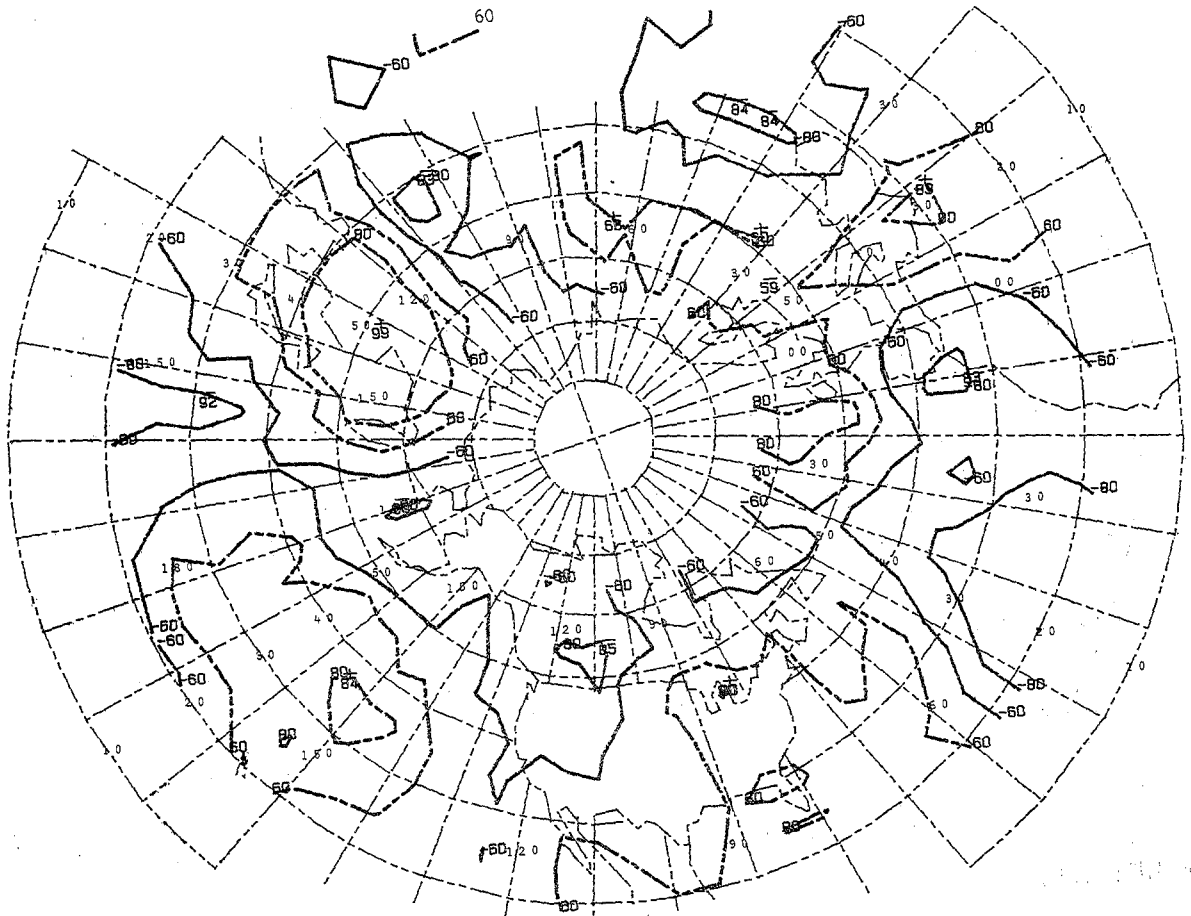

+ KEY AT140E 50N 08 CASES

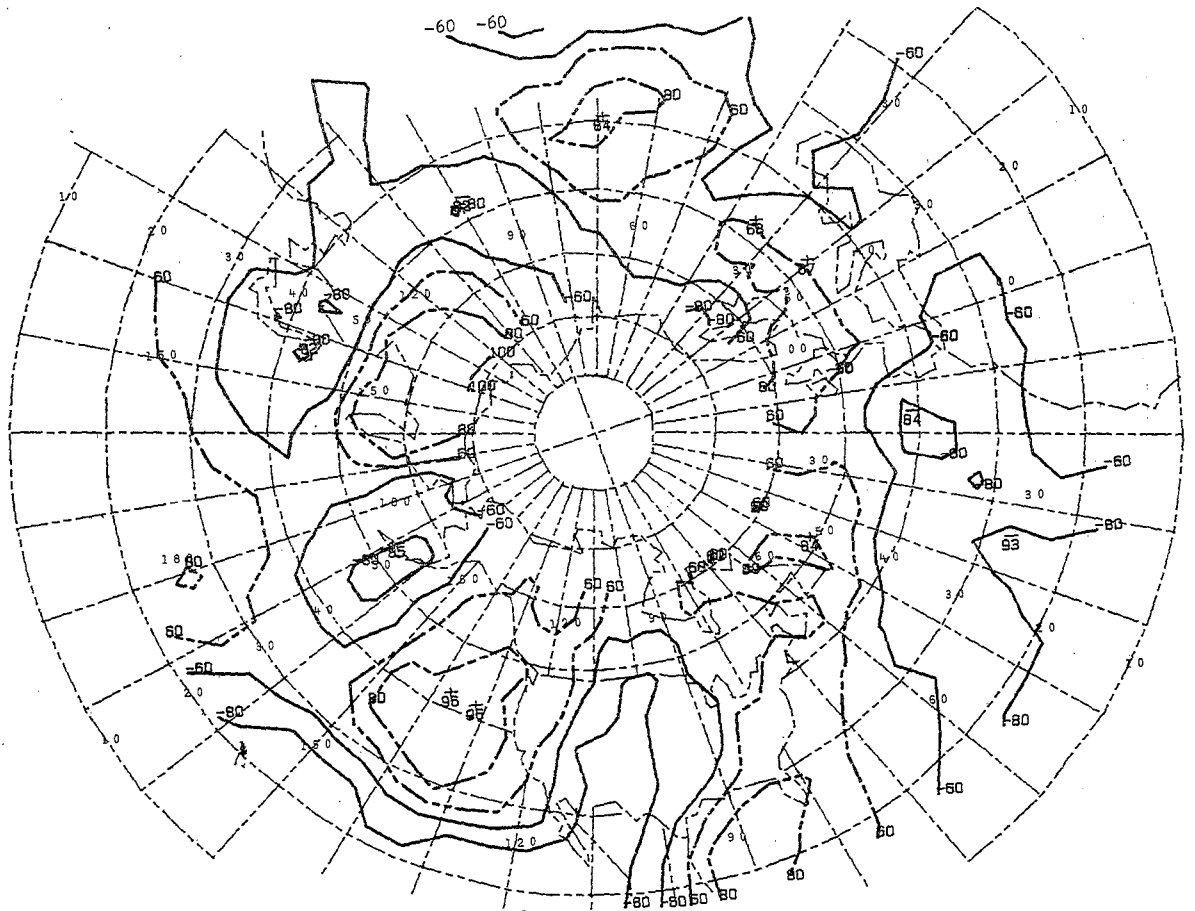

+ KEY AT140E 60N 08 CASES

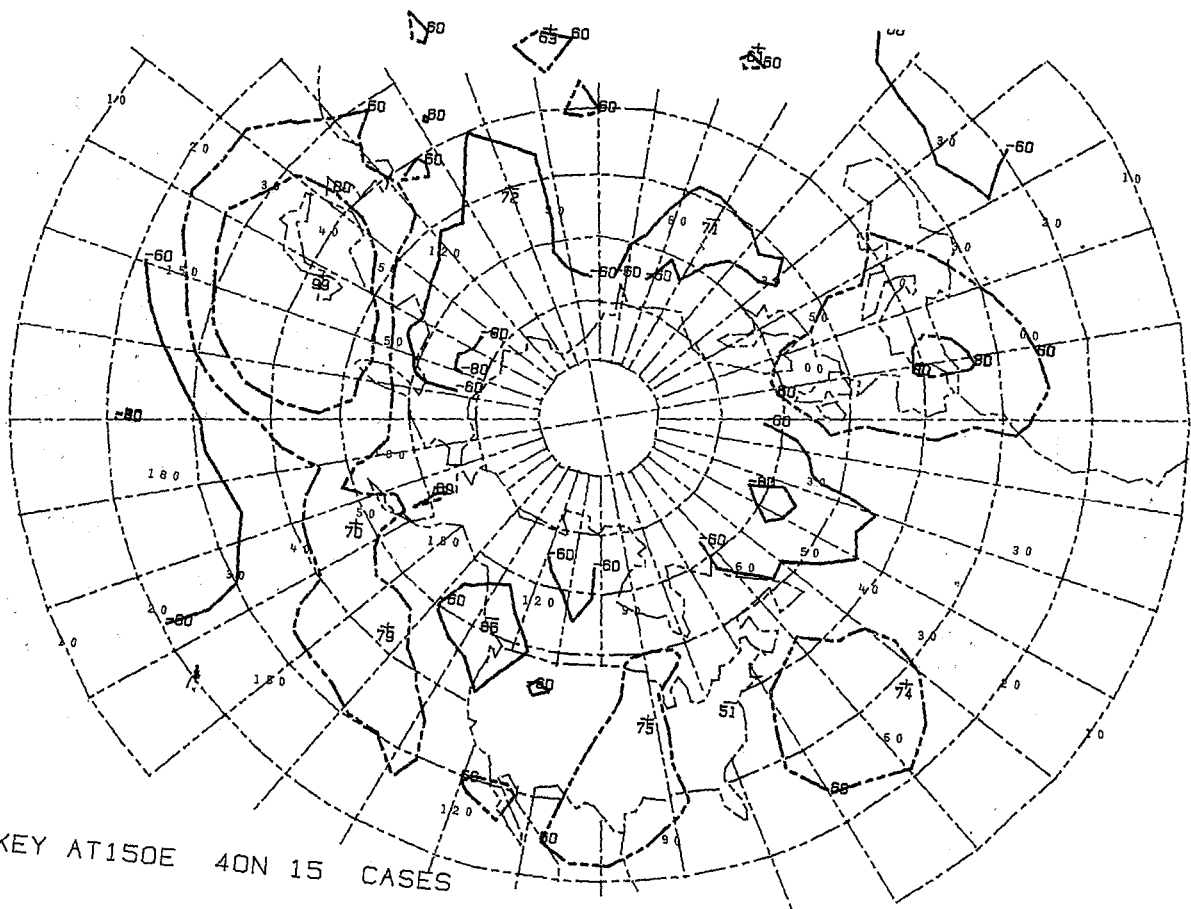
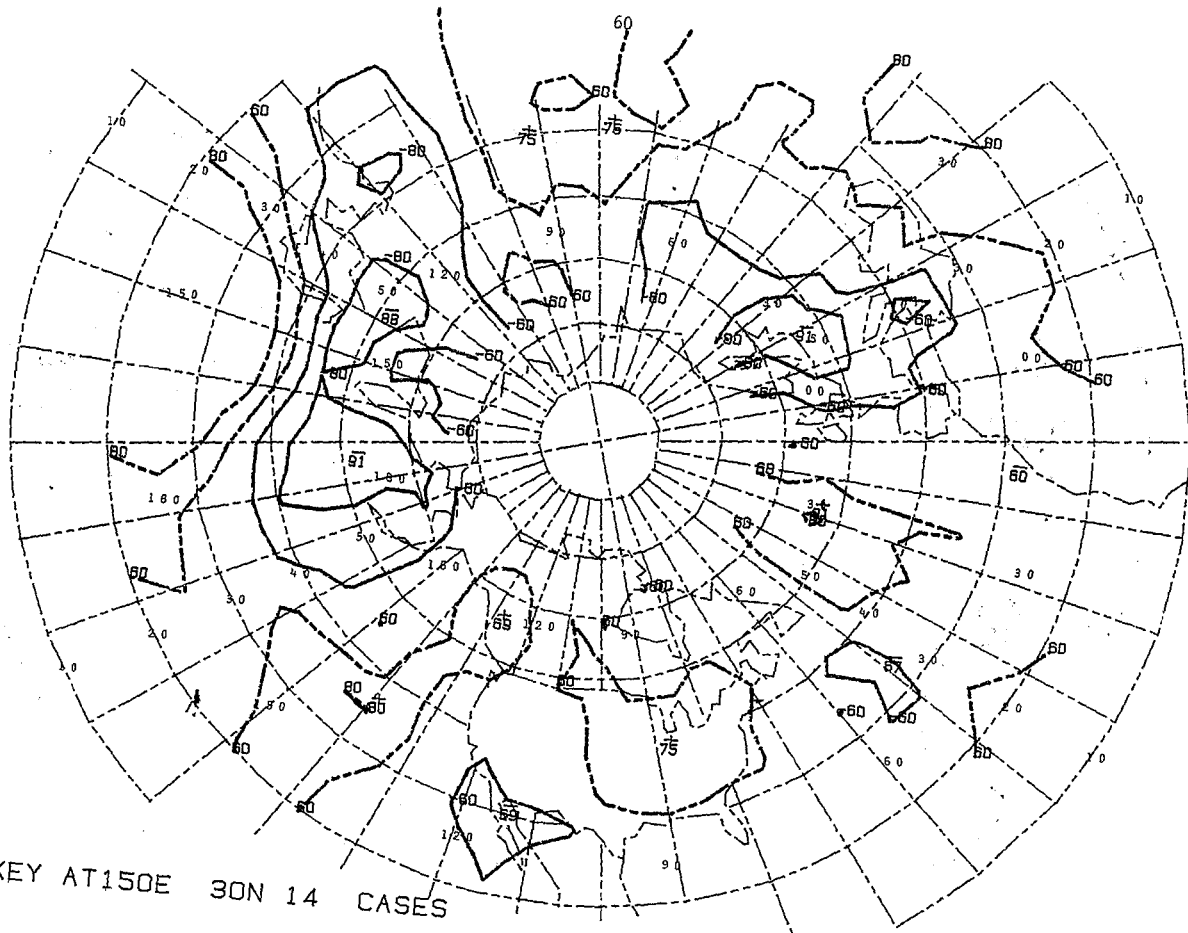

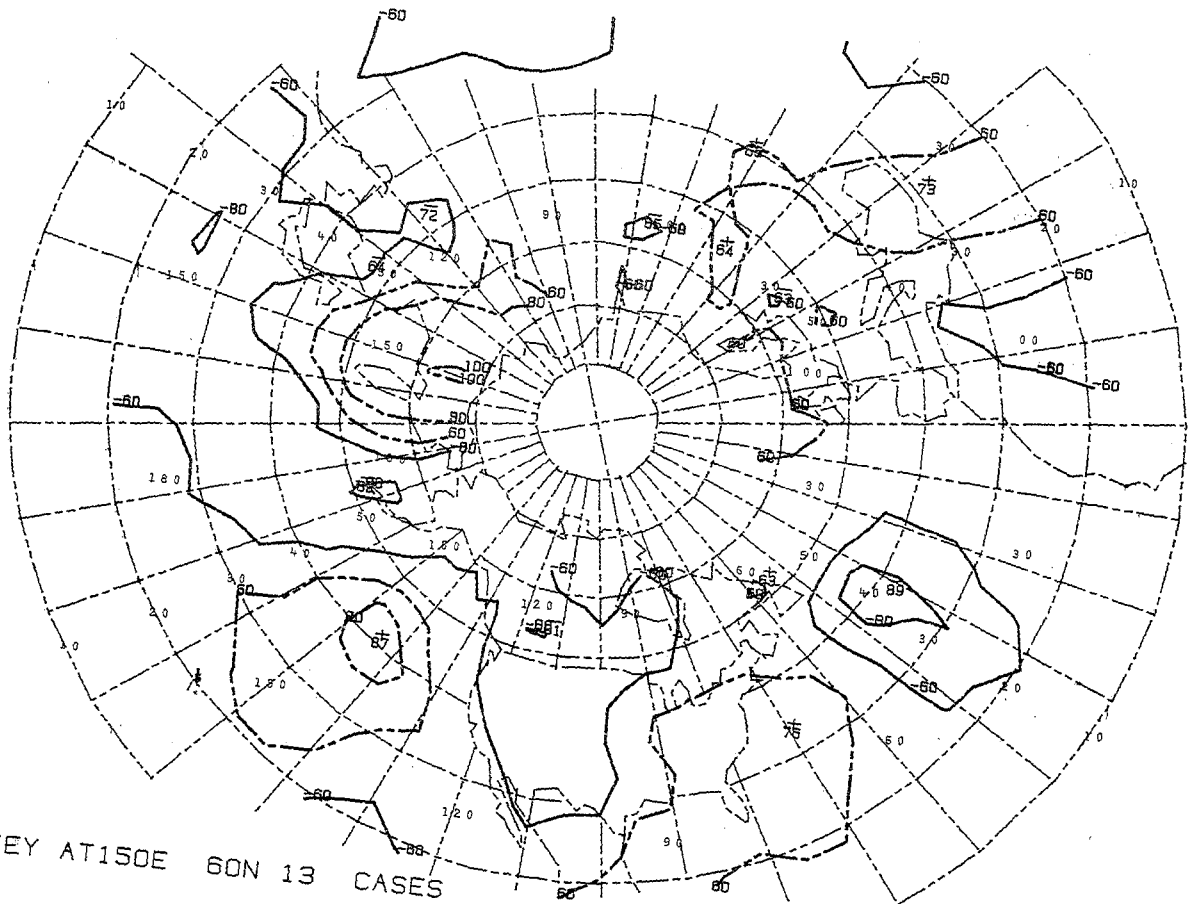
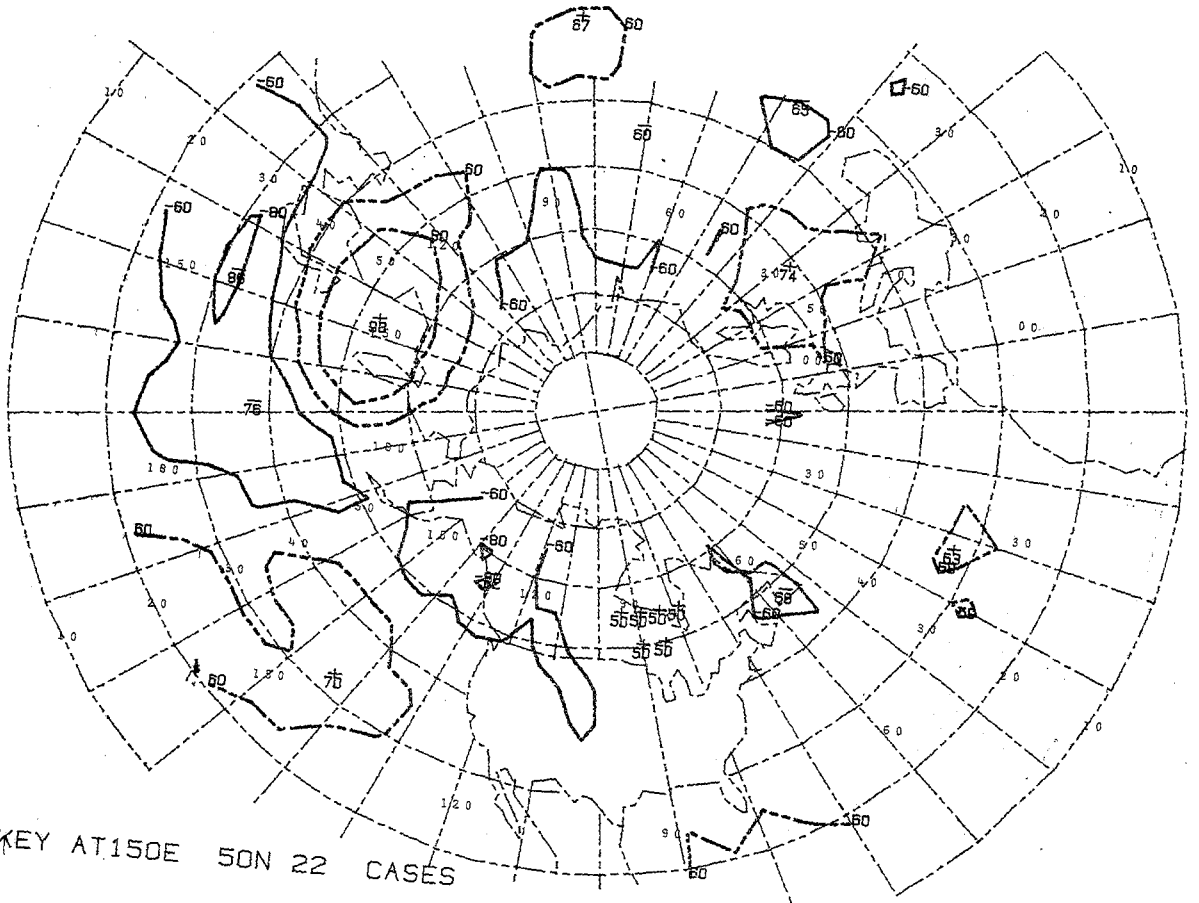

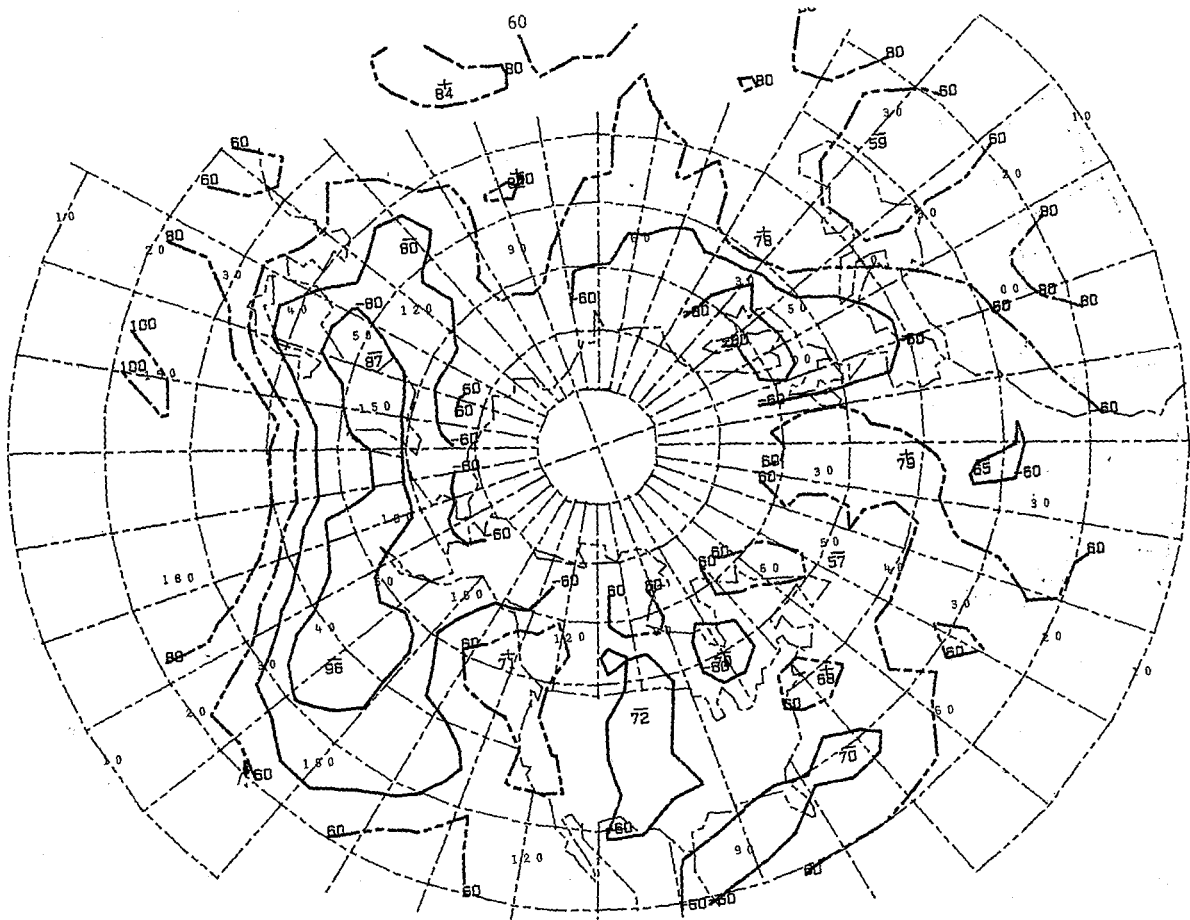

+ KEY AT160E 30N 08 CASES

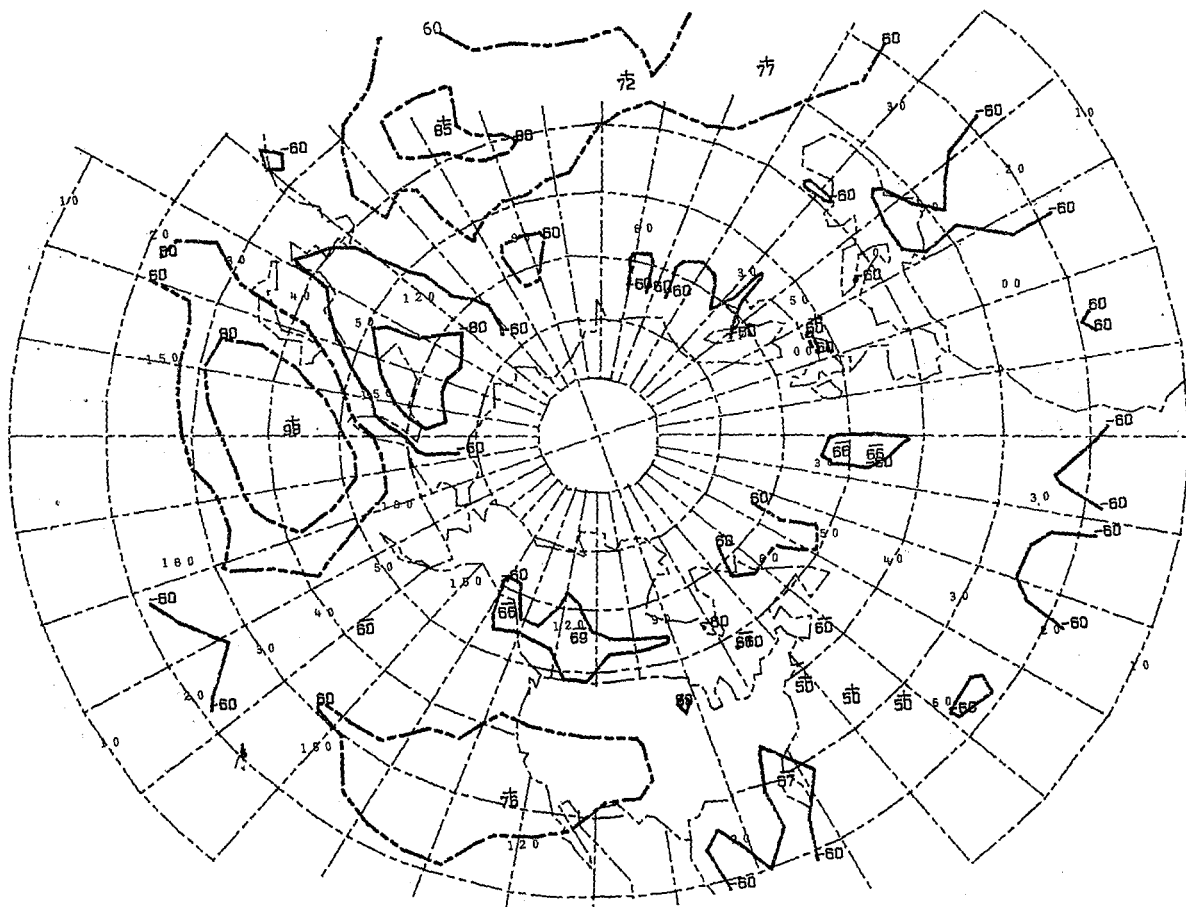

+ KEY AT160E 40N 17 CASES

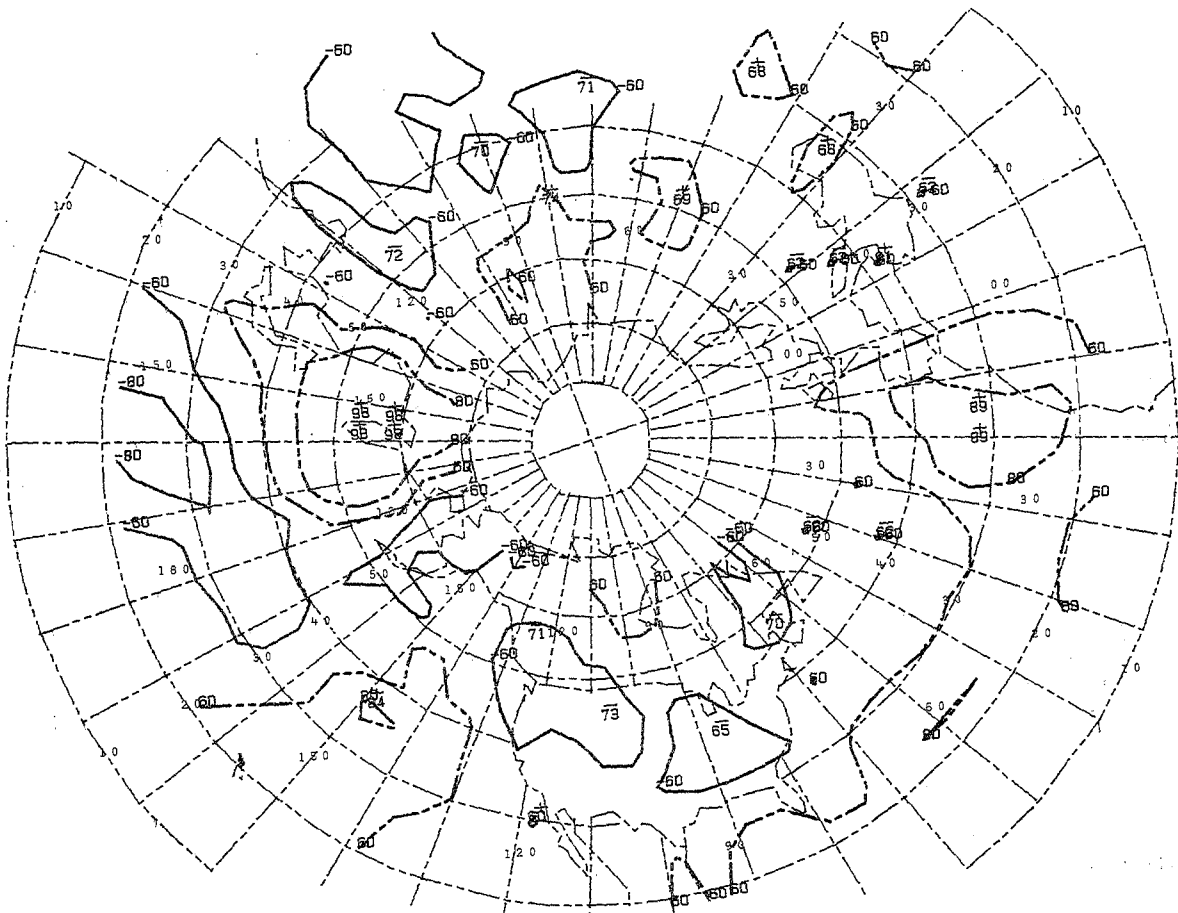

± KEY AT160E 50N 12 CASES

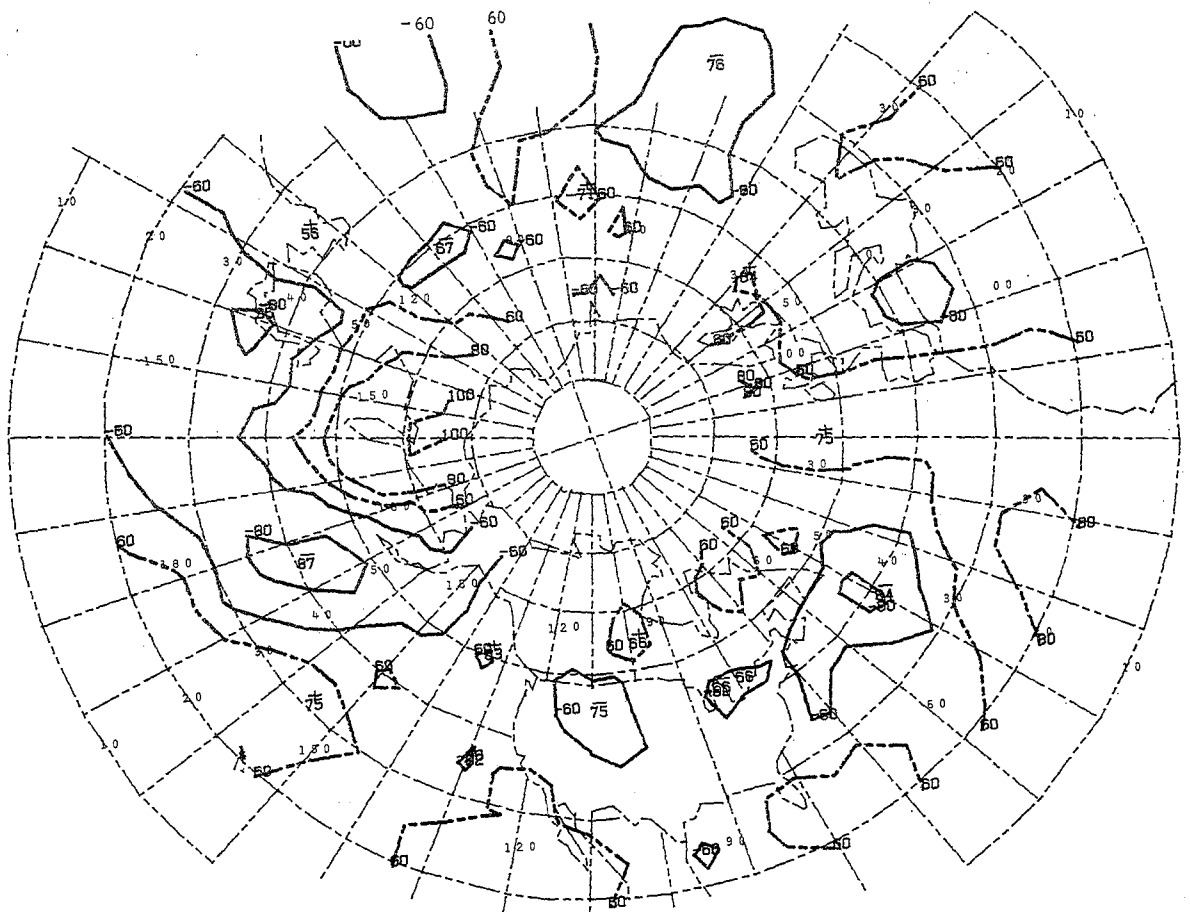

± KEY AT160E 60N 10 CASES

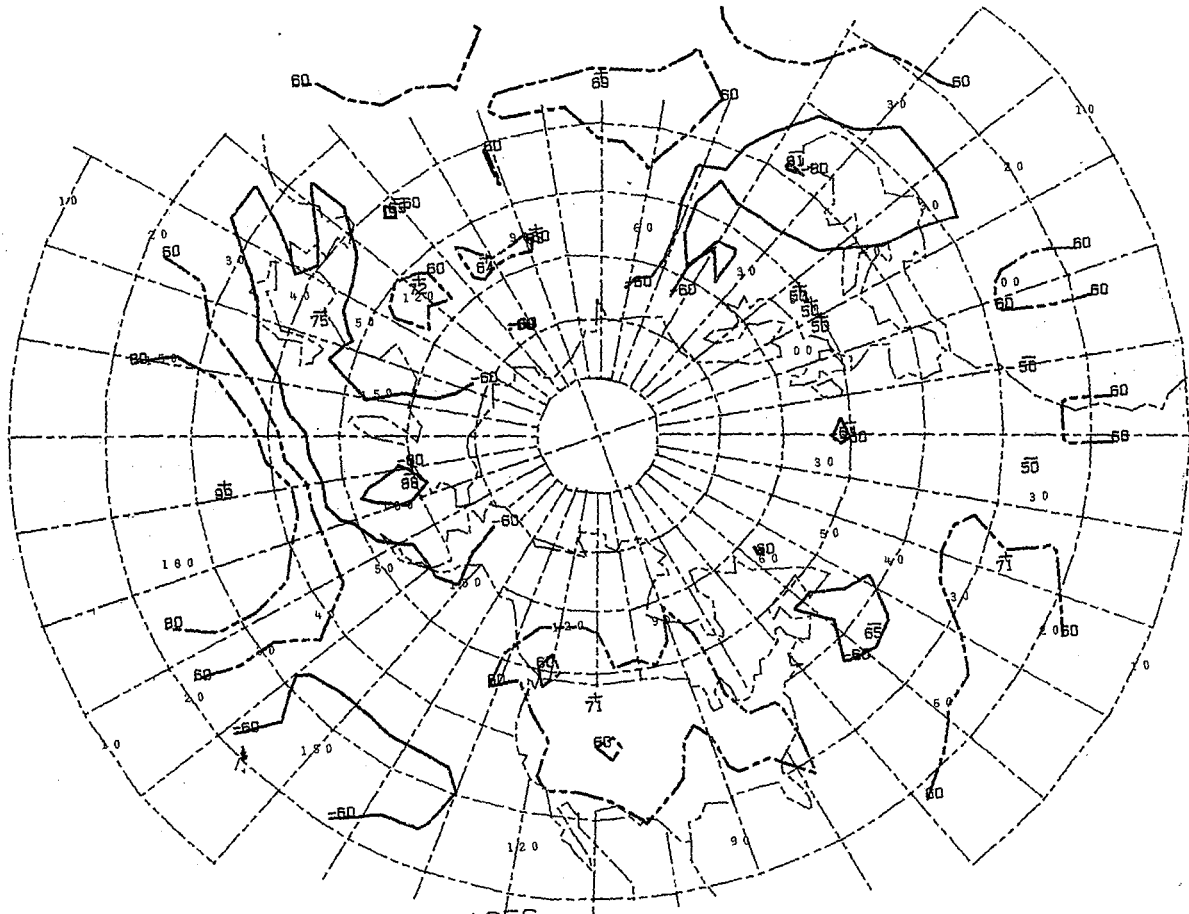

+ KEY AT170E 30N 22 CASES

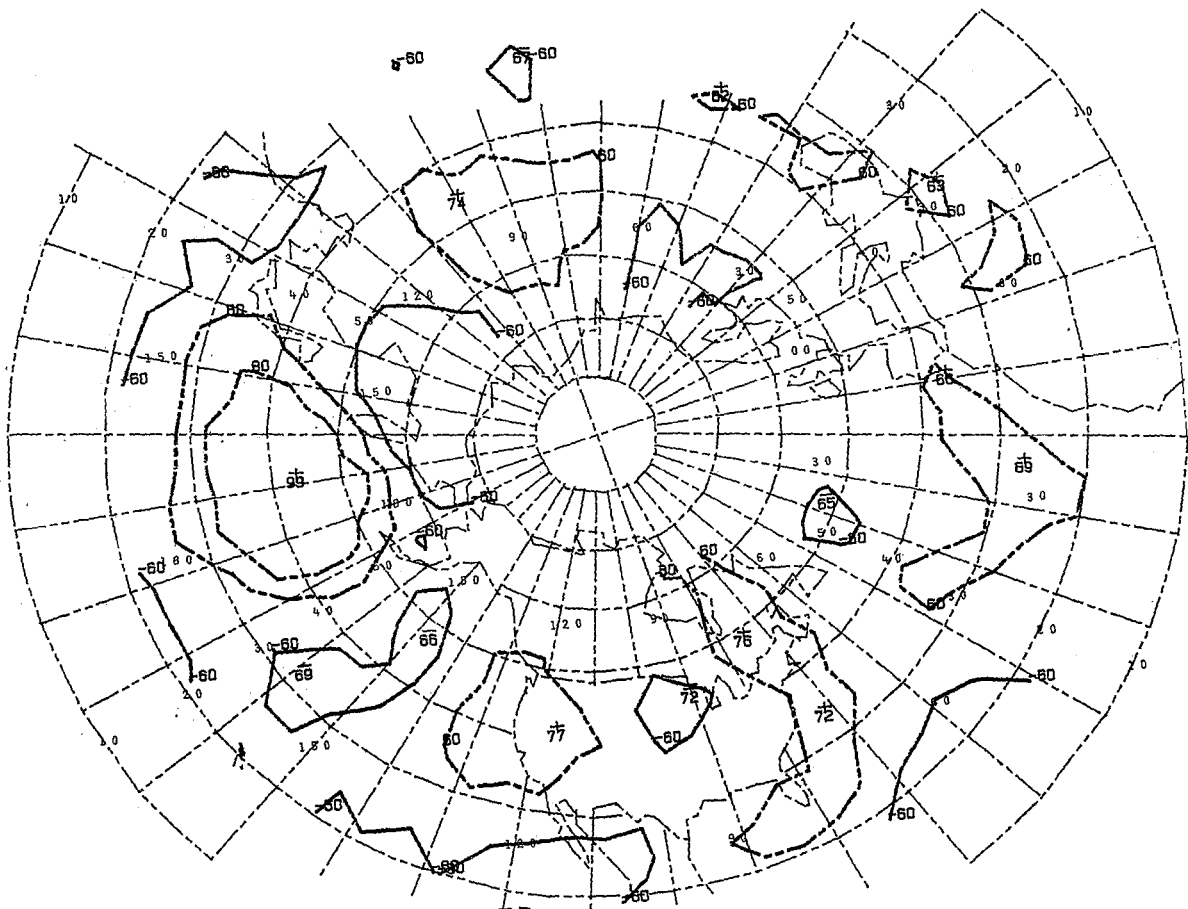

+ KEY AT170E 40N 18 CASES

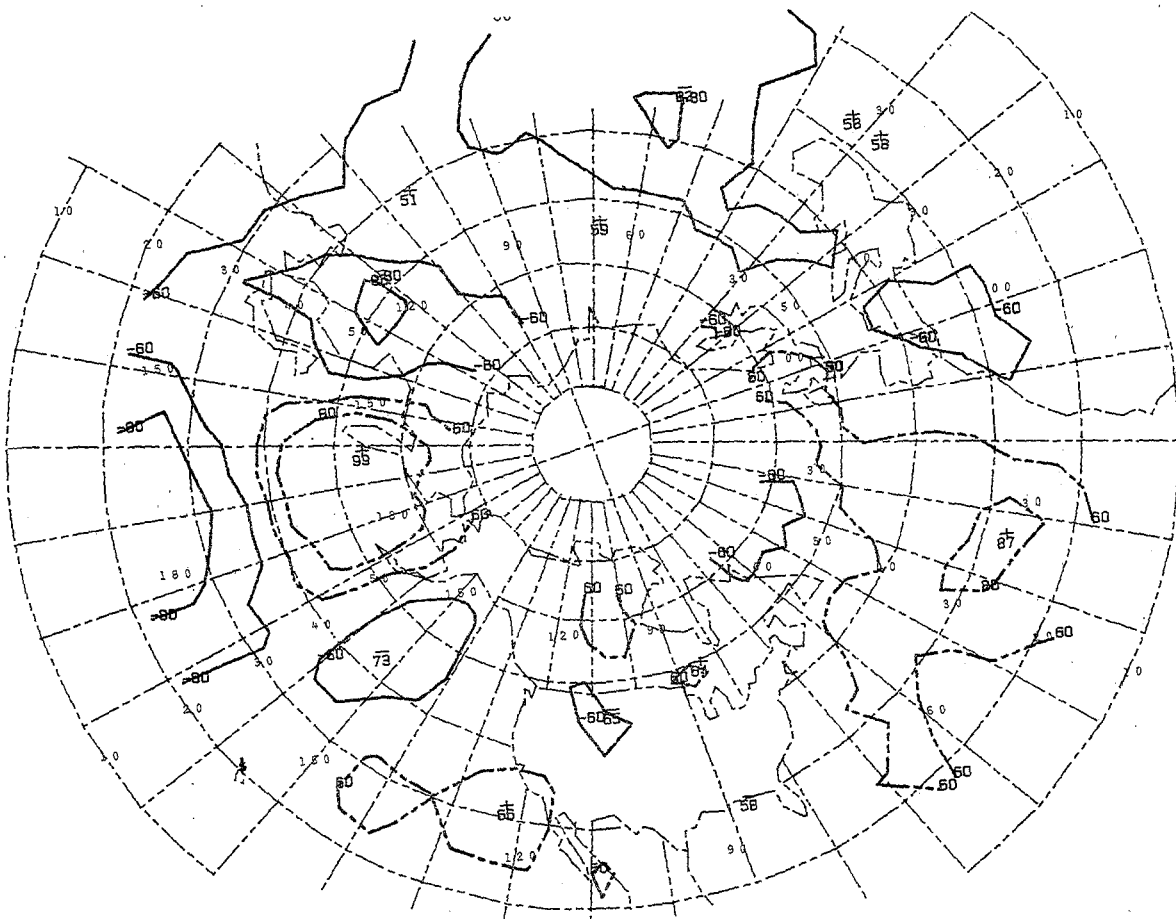

+ KEY AT170E 50N 13 CASES

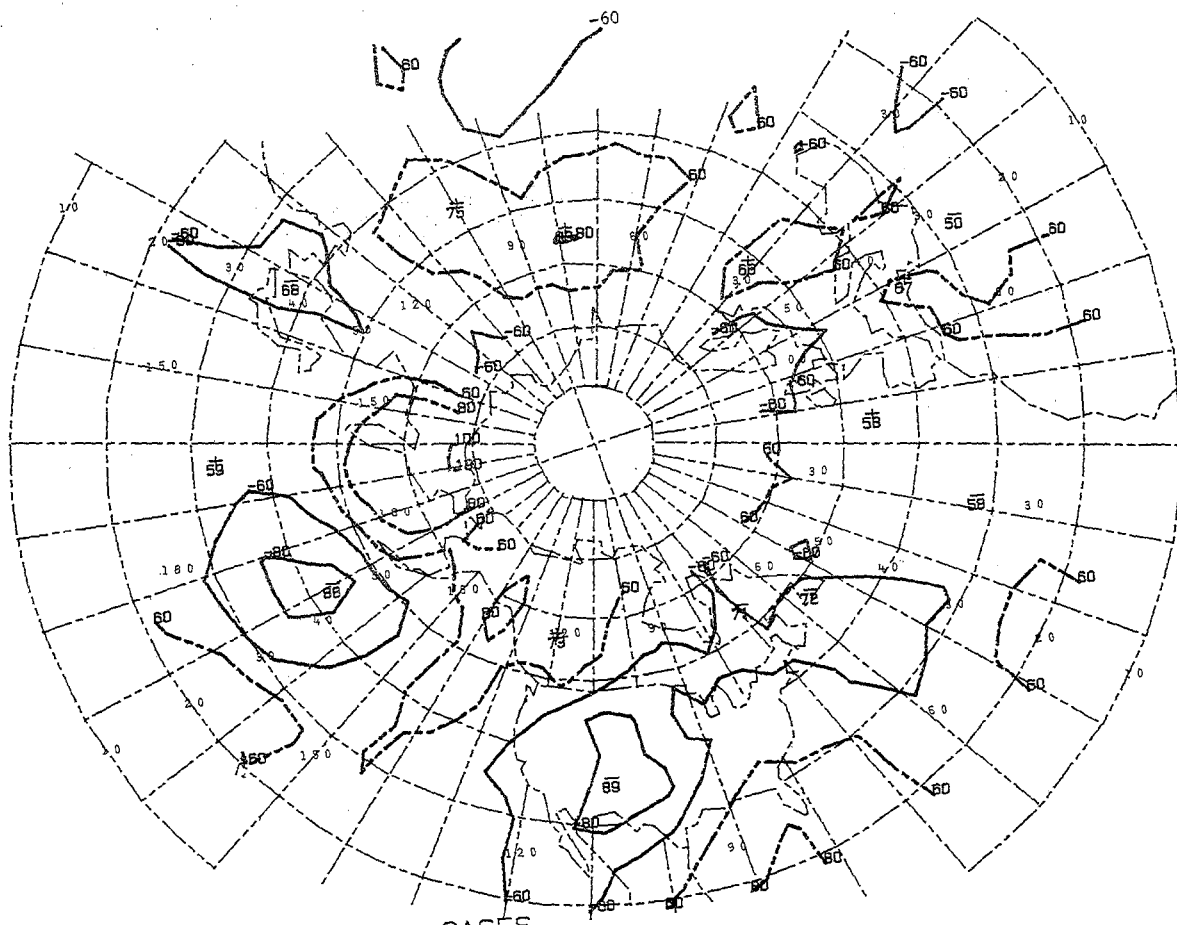

+ KEY AT170E 60N 13 CASES

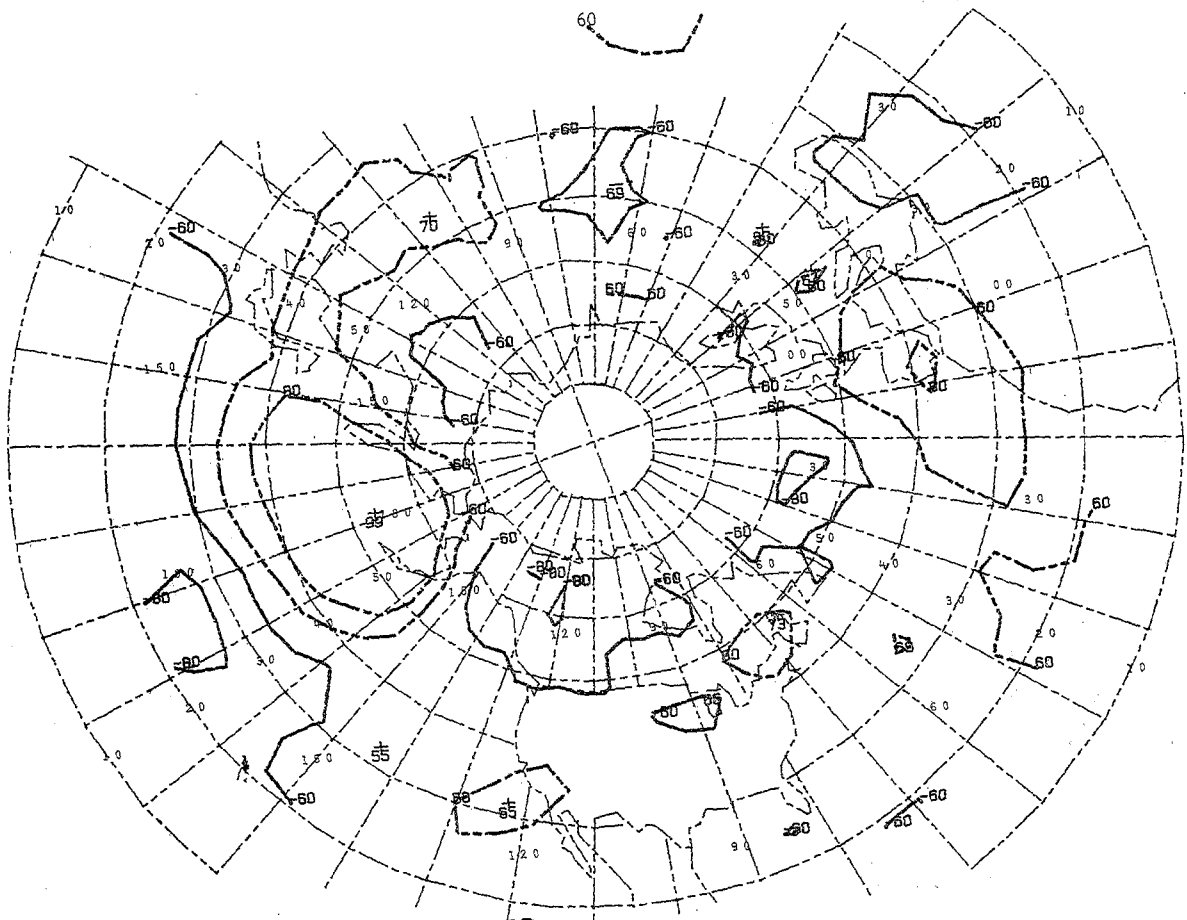

+ KEY AT180 50N 20 CASES

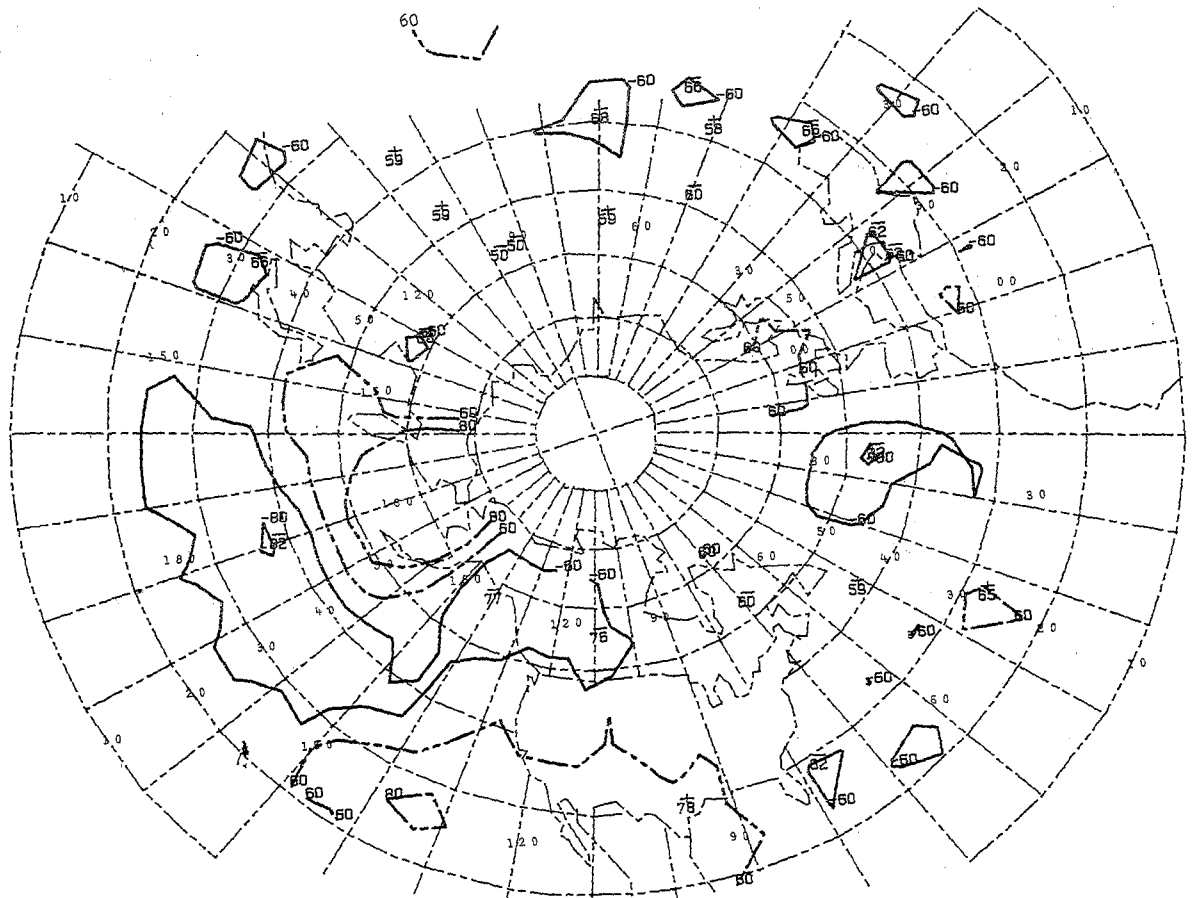

+ KEY AT180 60N 14 CASES

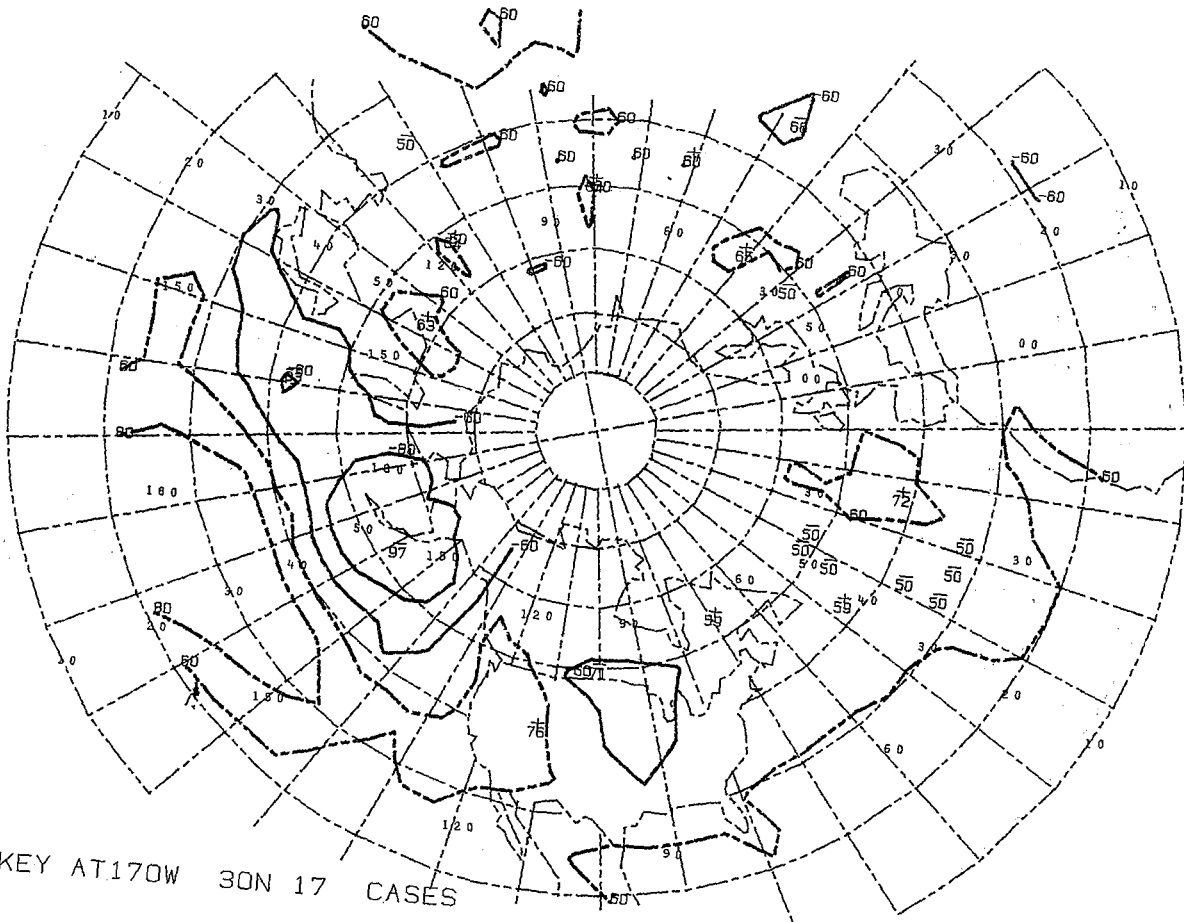

+ KEY AT170W 30N 17 CASES

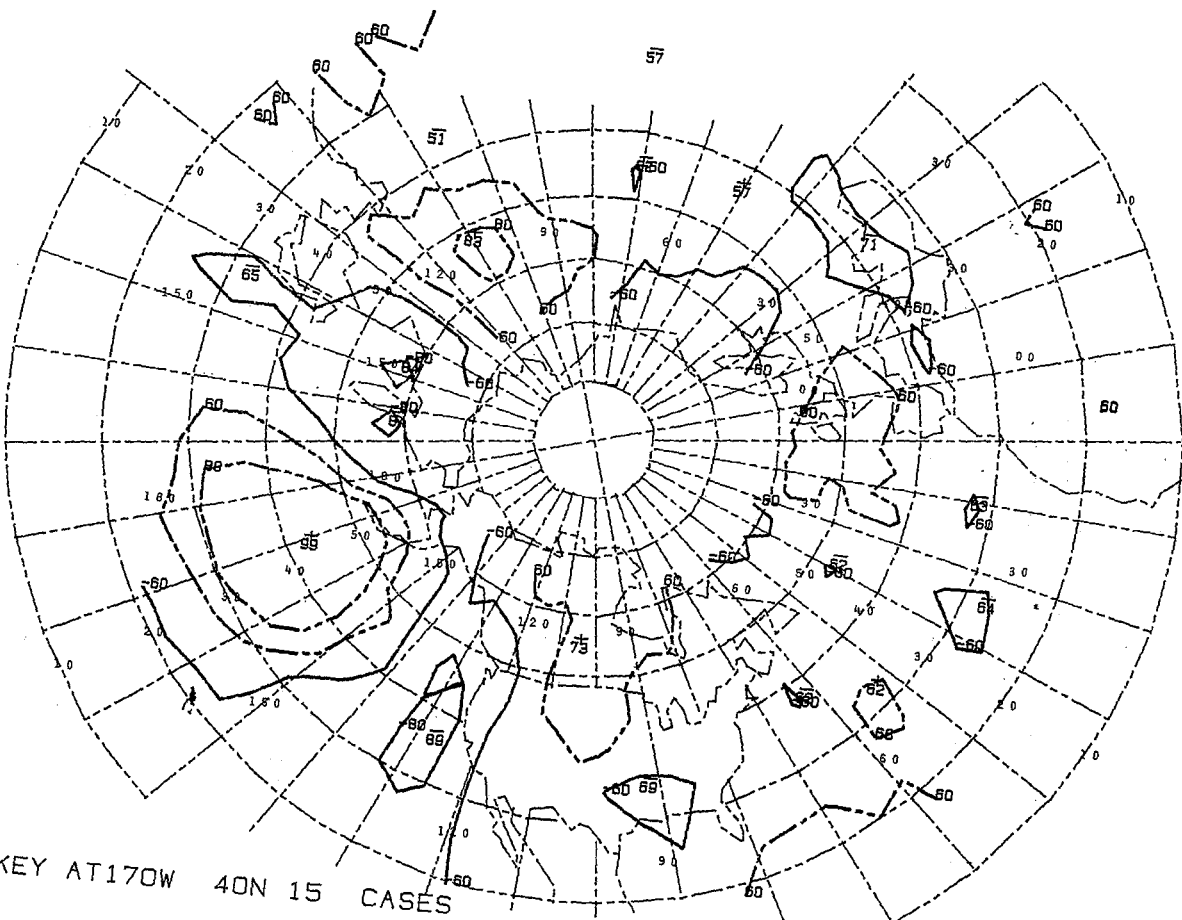

+ KEY AT170W 40N 15 CASES

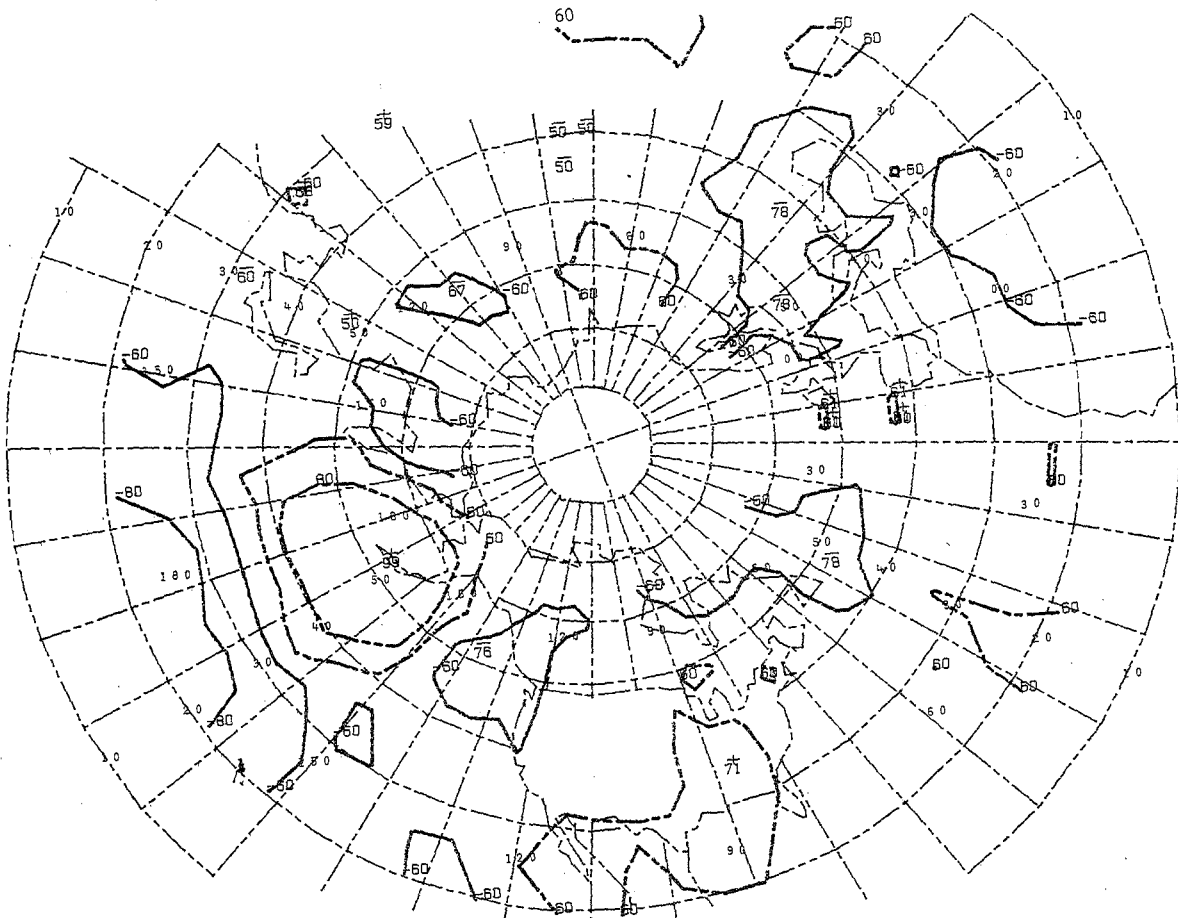

+ KEY AT170W 50N 17 CASES

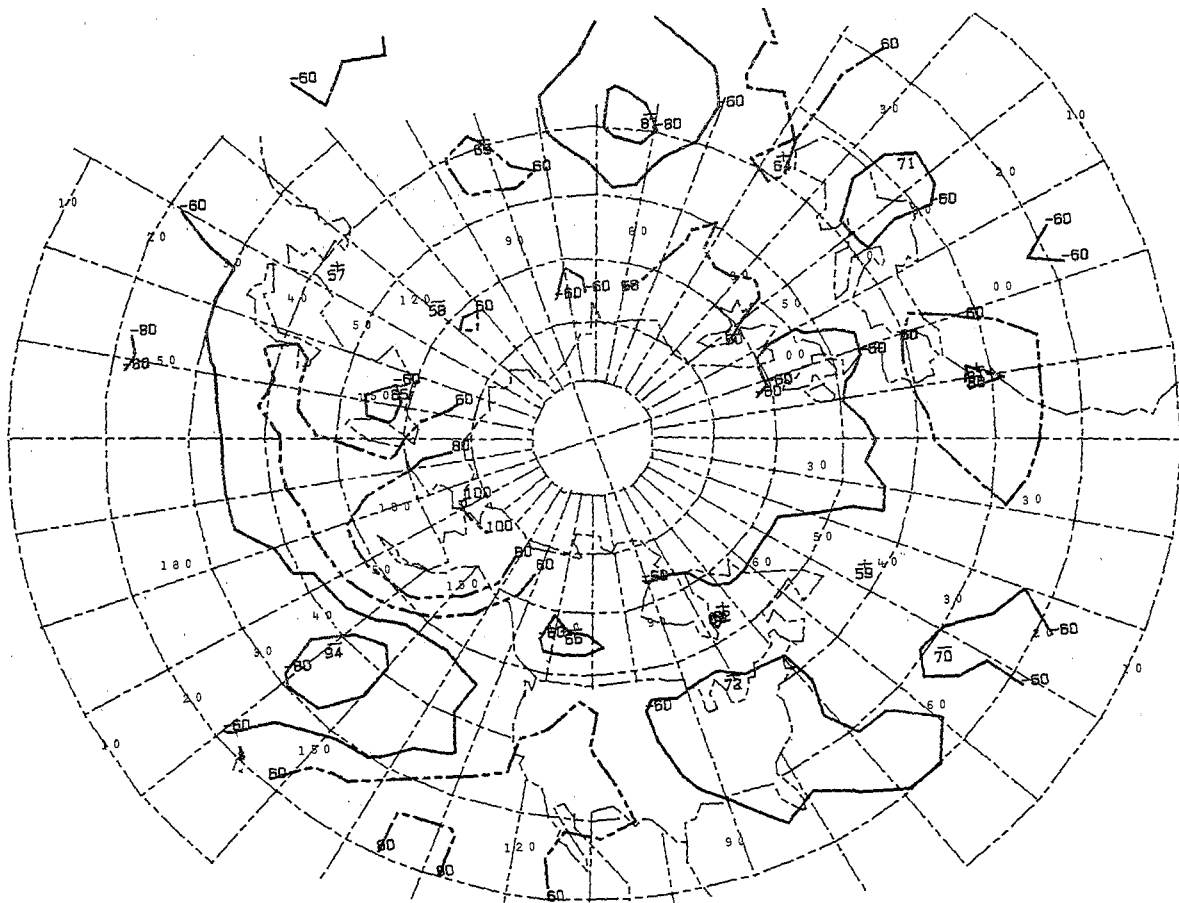

+ KEY AT170W 60N 13 CASES

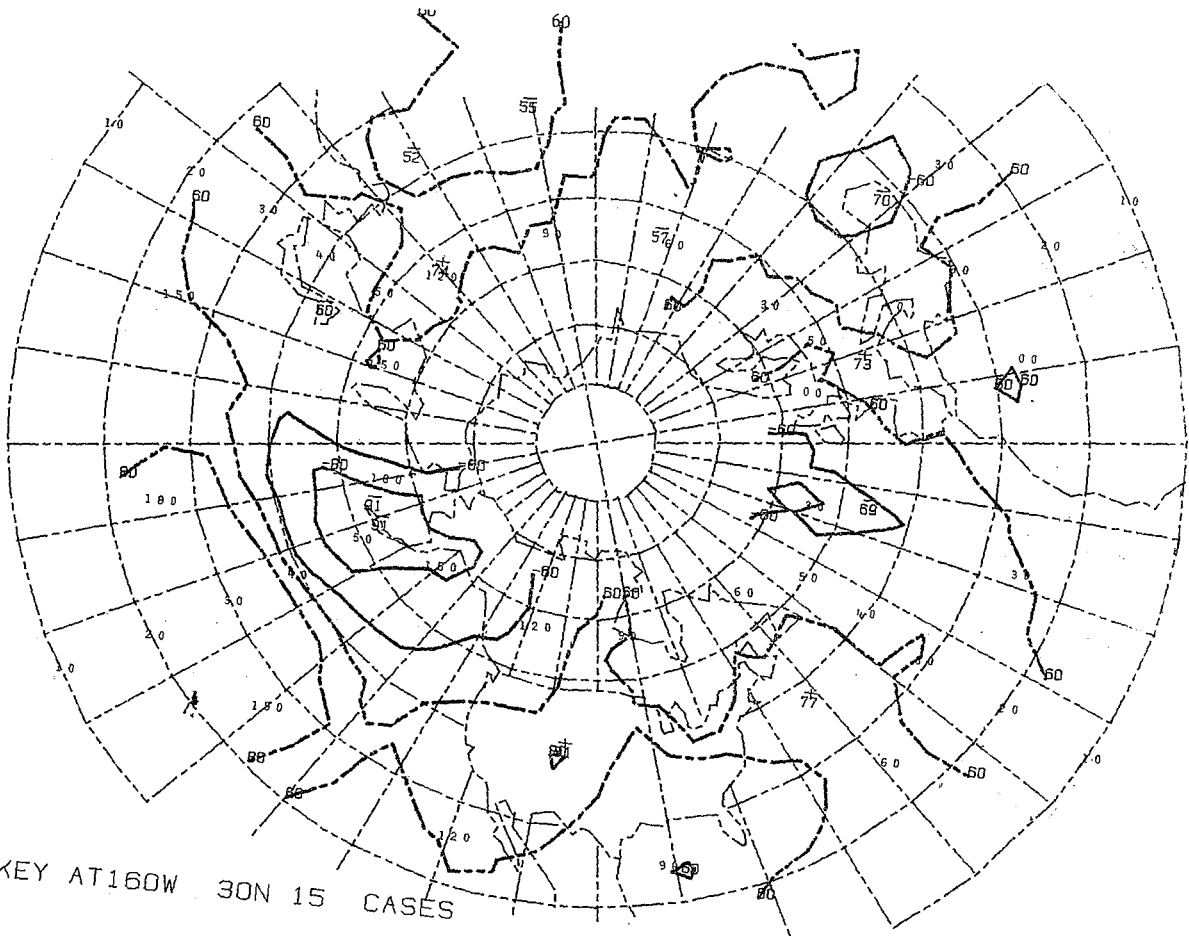

+ KEY AT 160W 30N 15 CASES

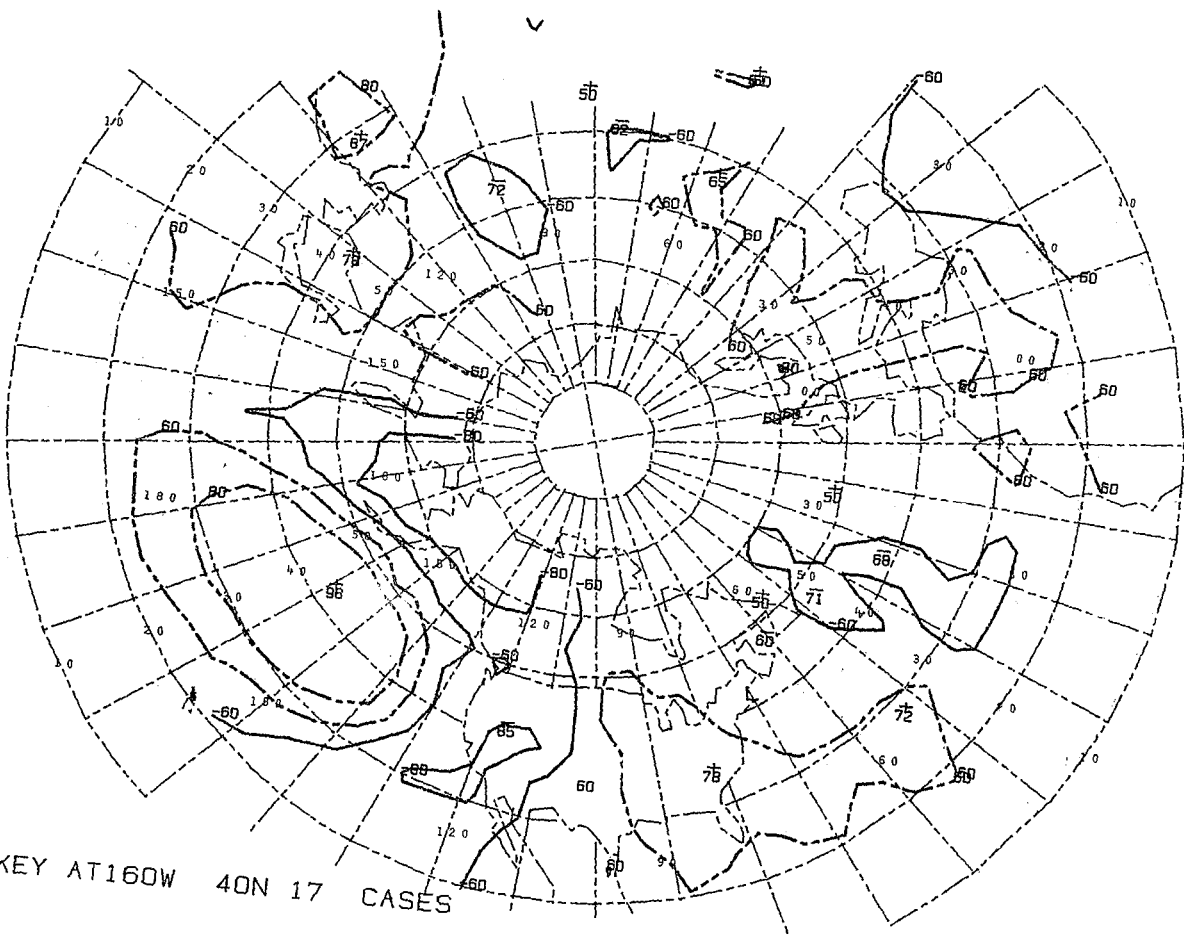

+ KEY AT 160W 40N 17 CASES

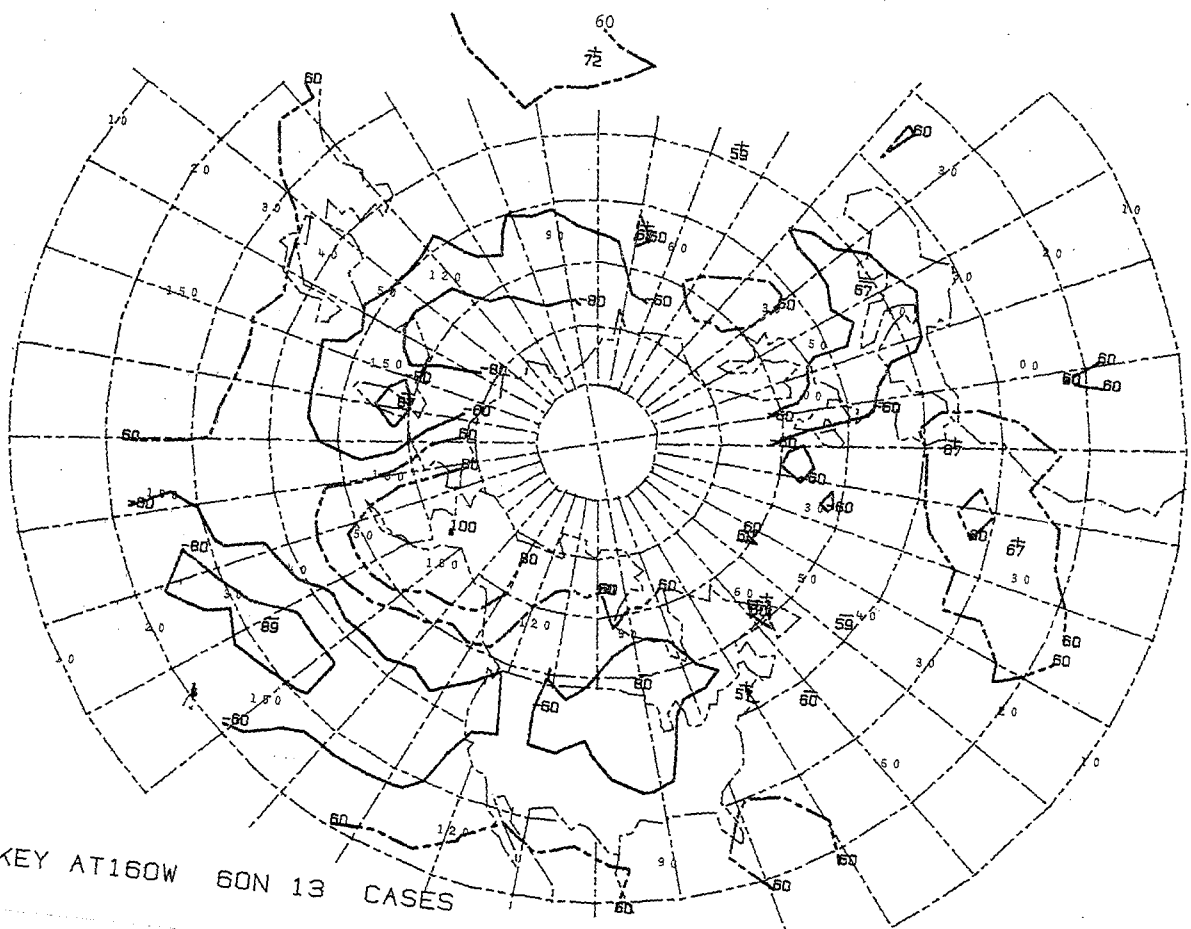
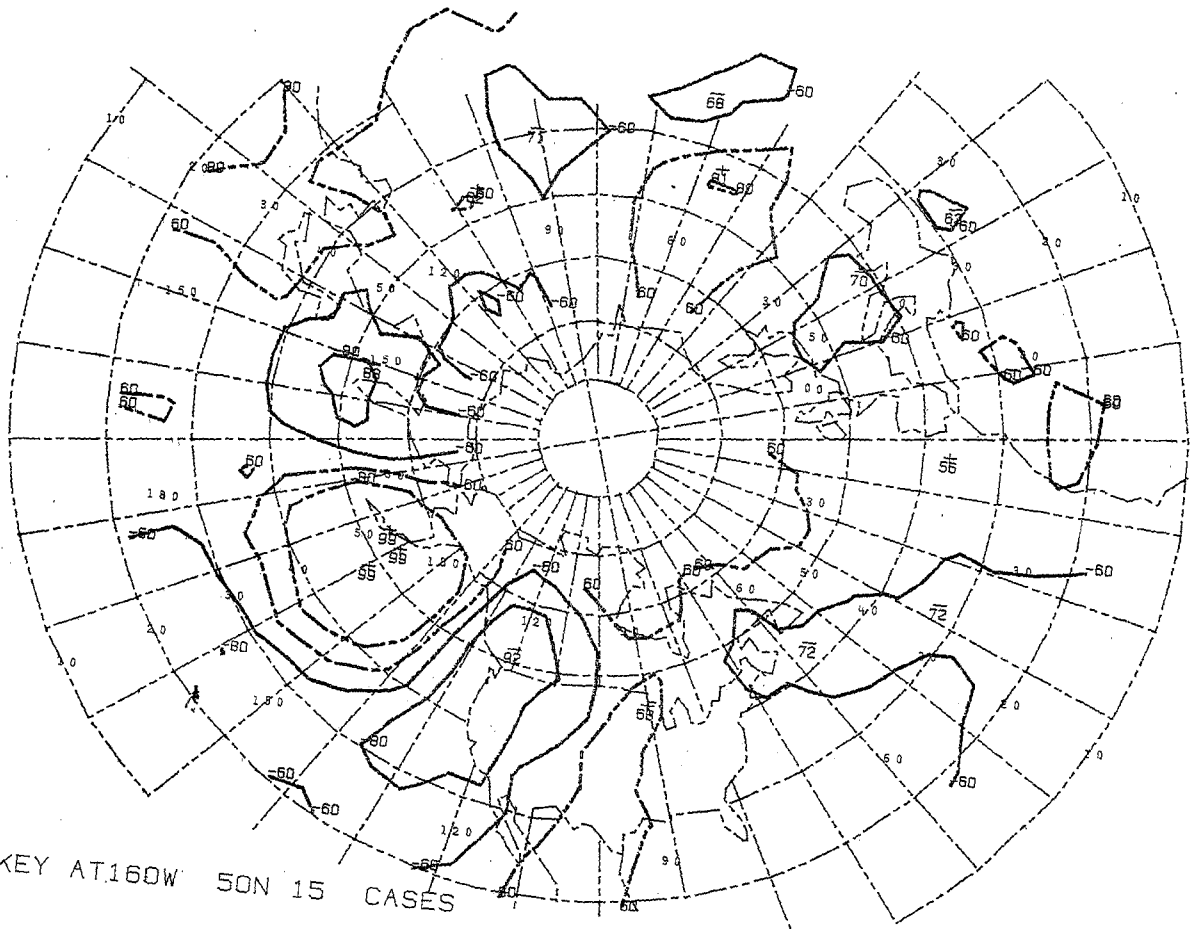

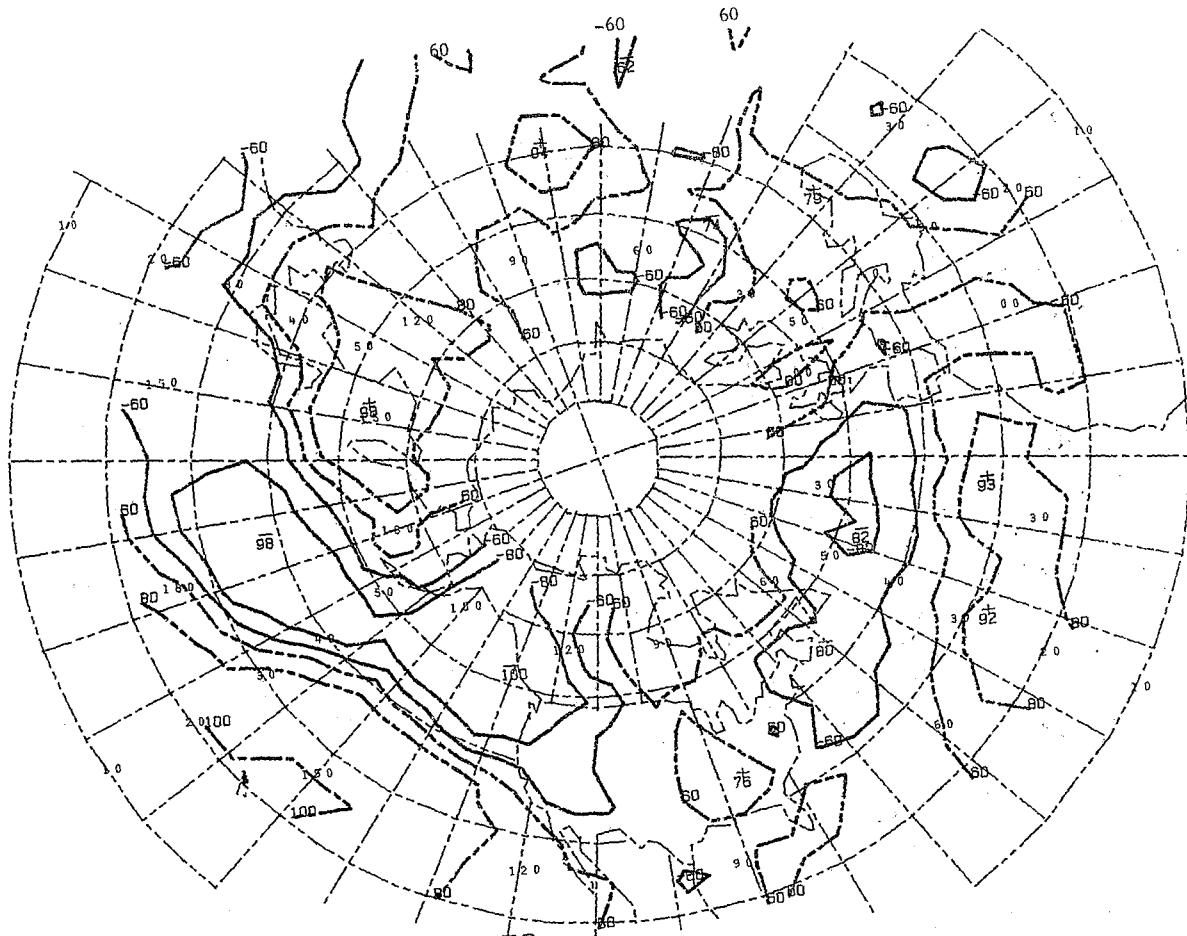

+ KEY AT150W 30N 06 CASES

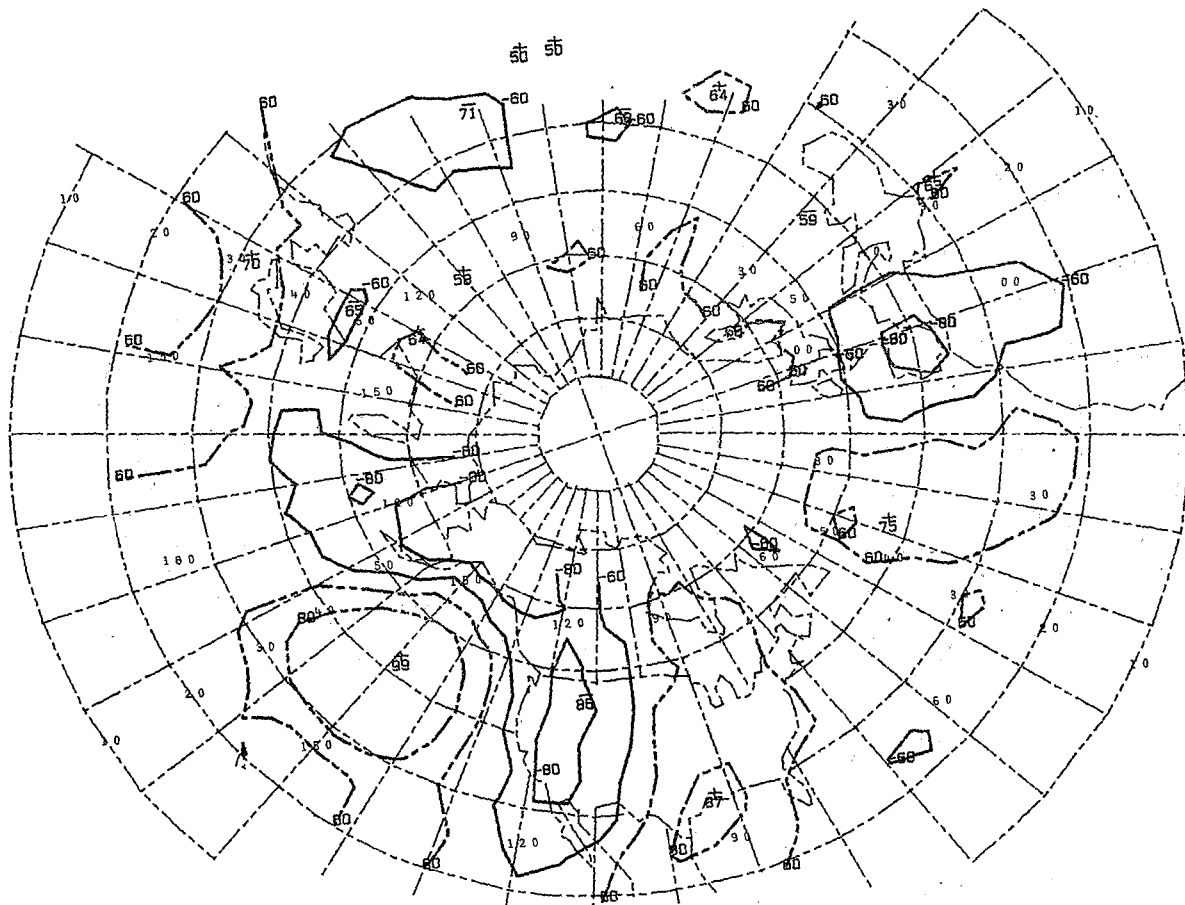

+ KEY AT150W 40N 16 CASES

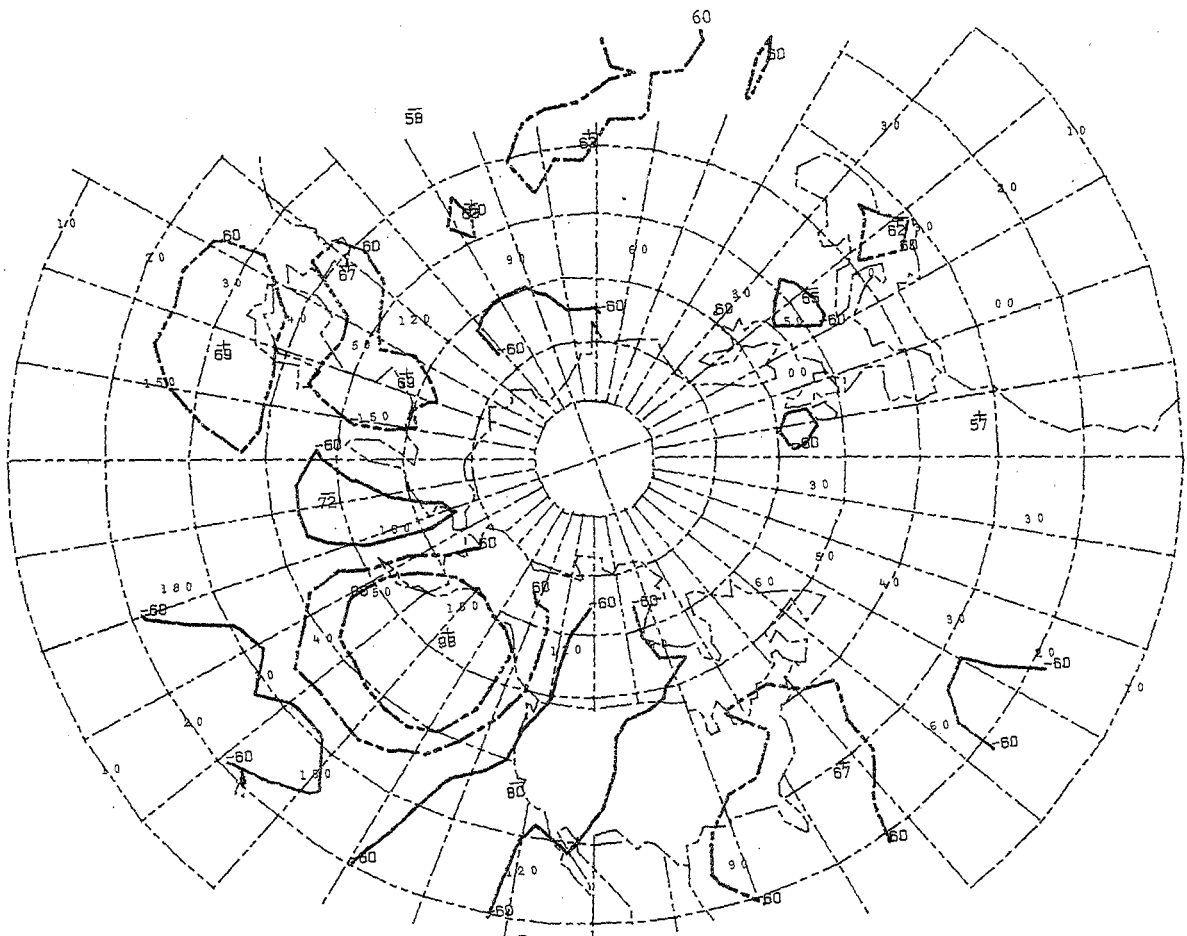

+ KEY AT15W 50N 25 CASES

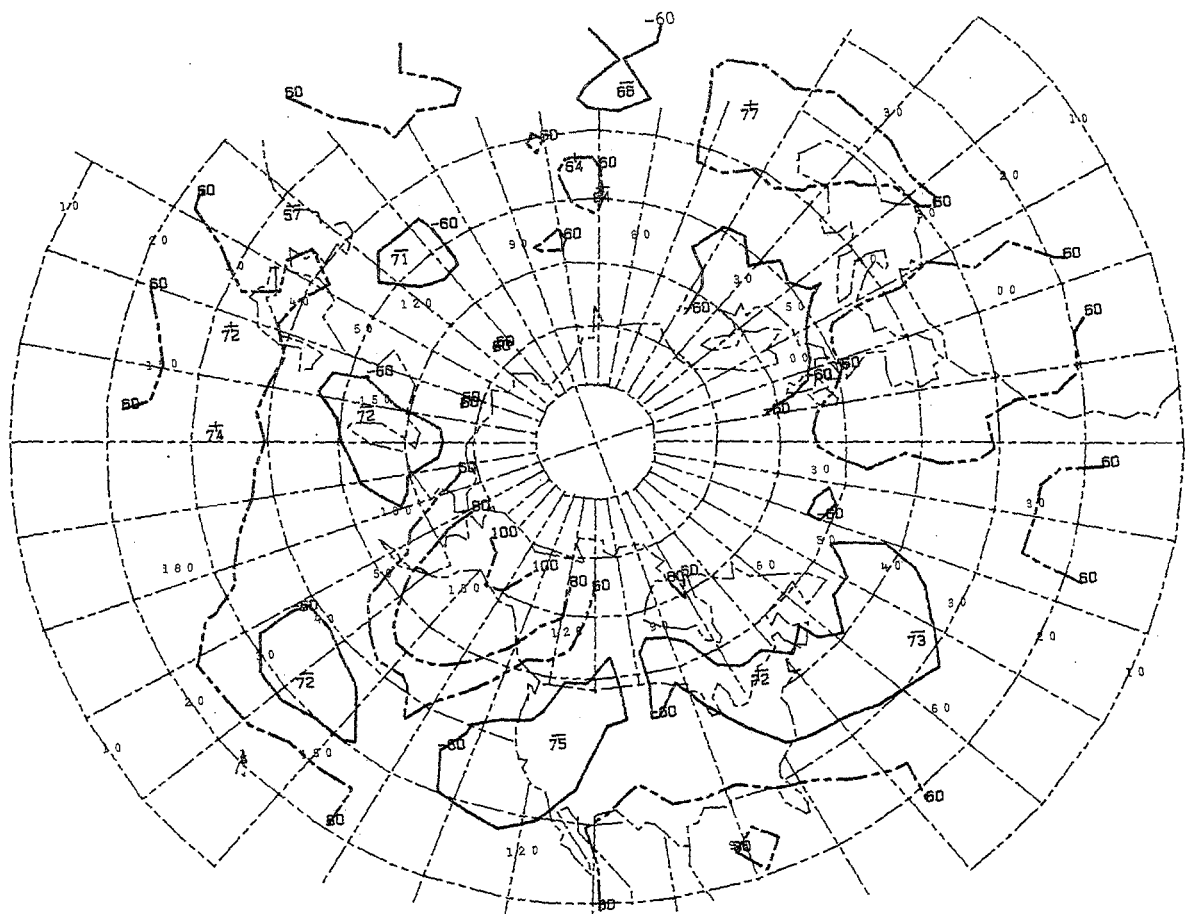

+ KEY AT15W 60N 13 CASES

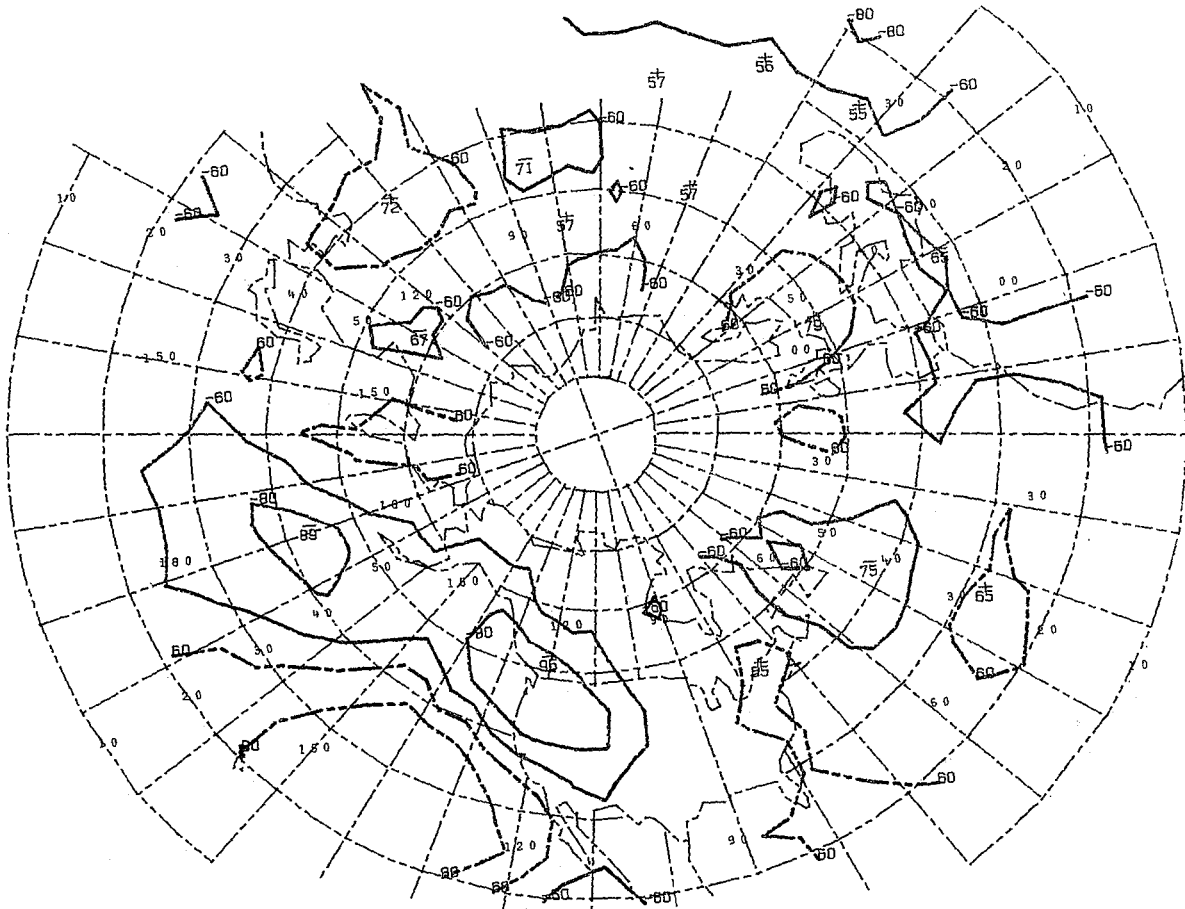

+ KEY AT140W 30N 13 CASES

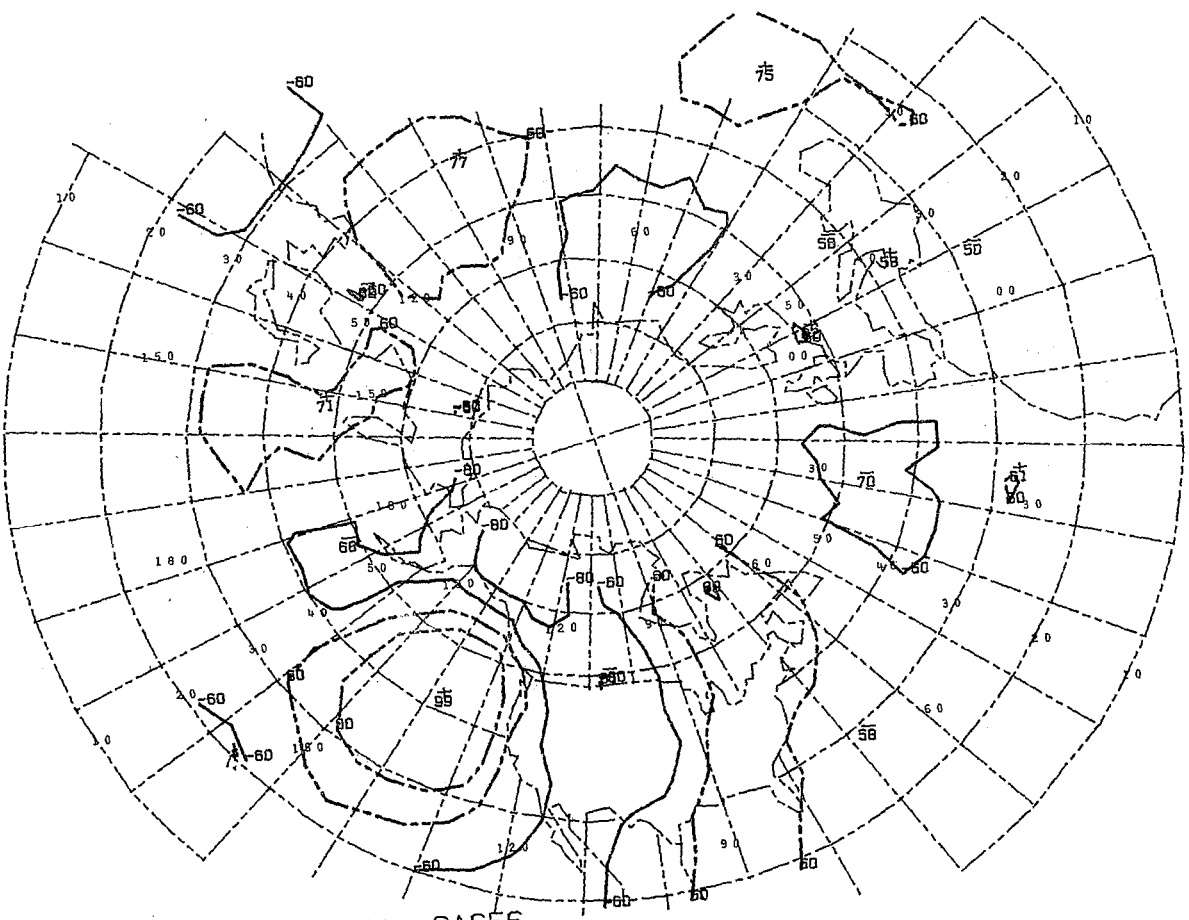

+ KEY AT140W 40N 21 CASES

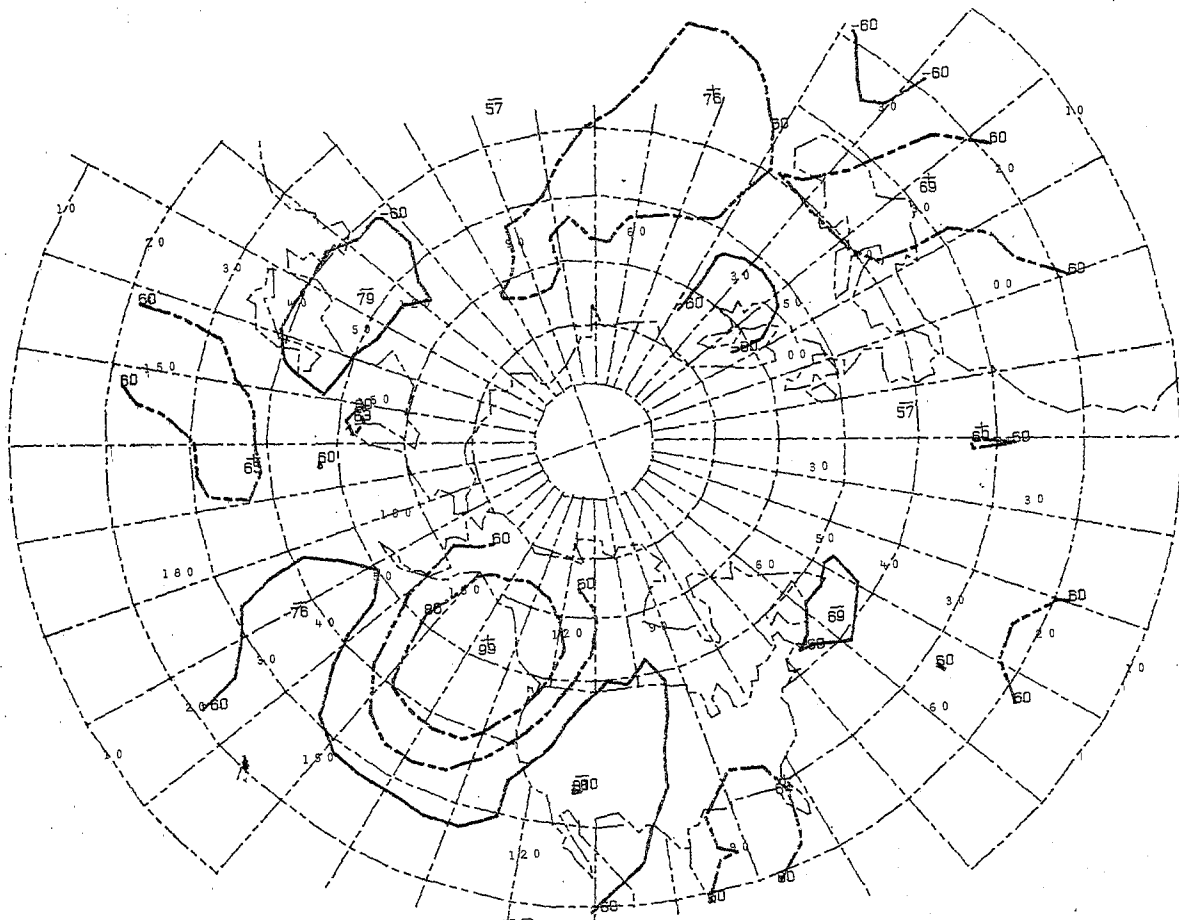

+ KEY AT140W 50N 25 CASES

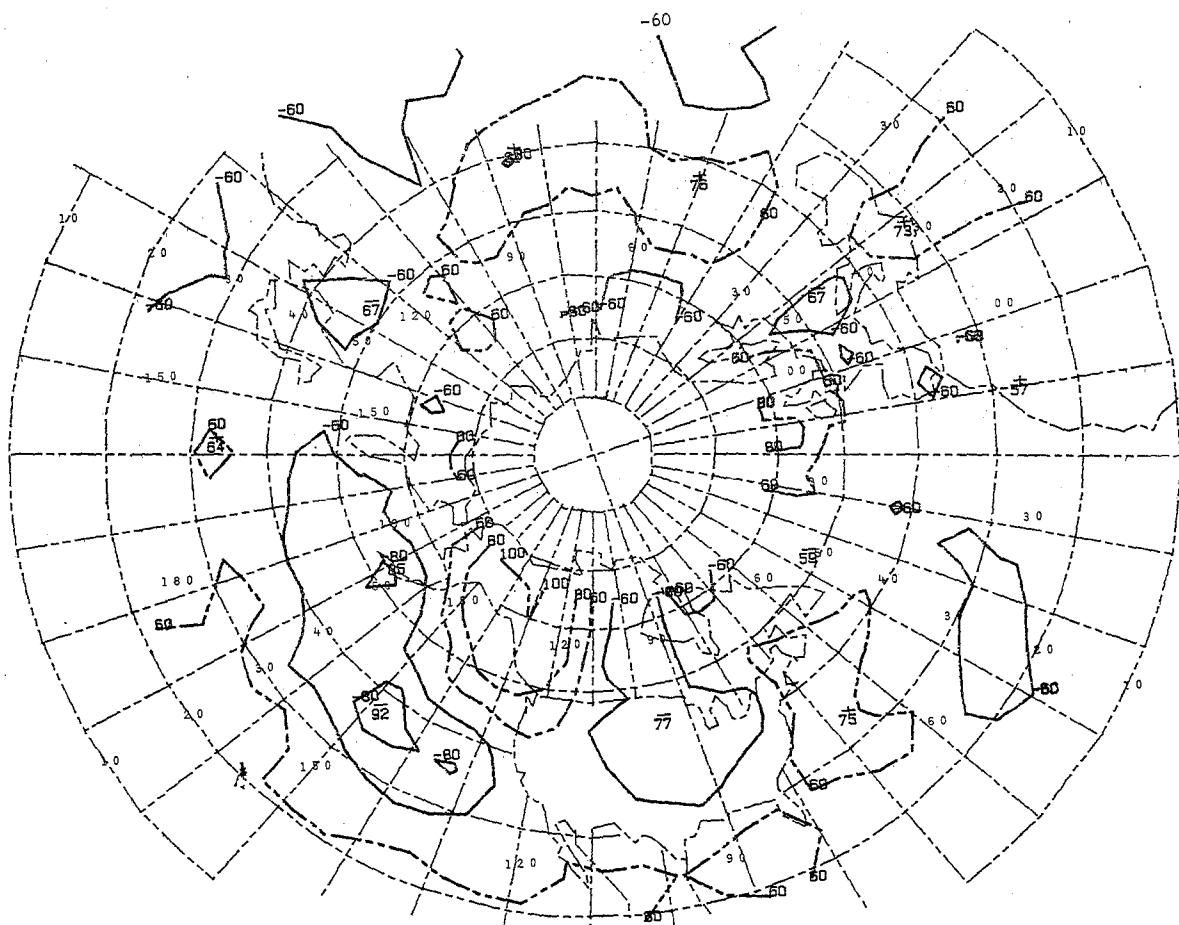

+ KEY AT140W 60N 10 CASES

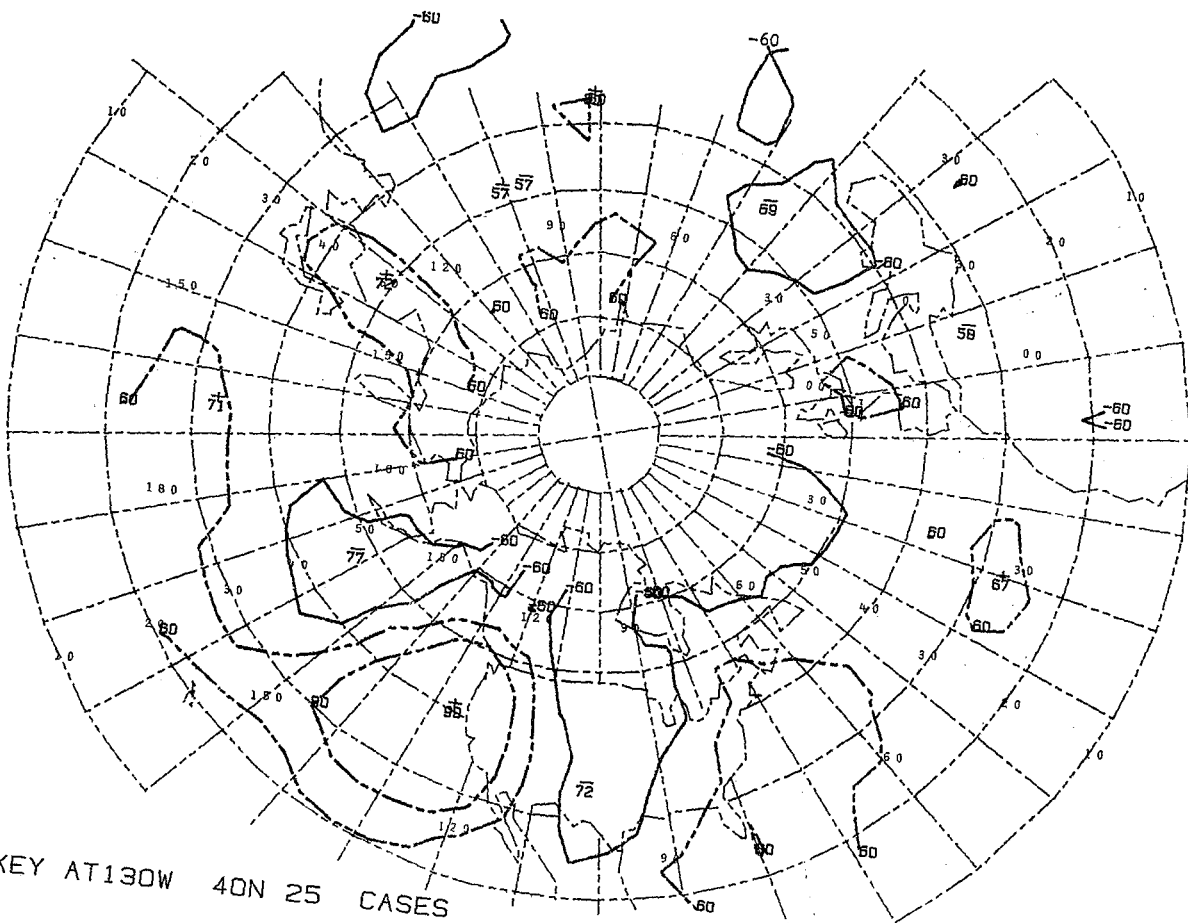
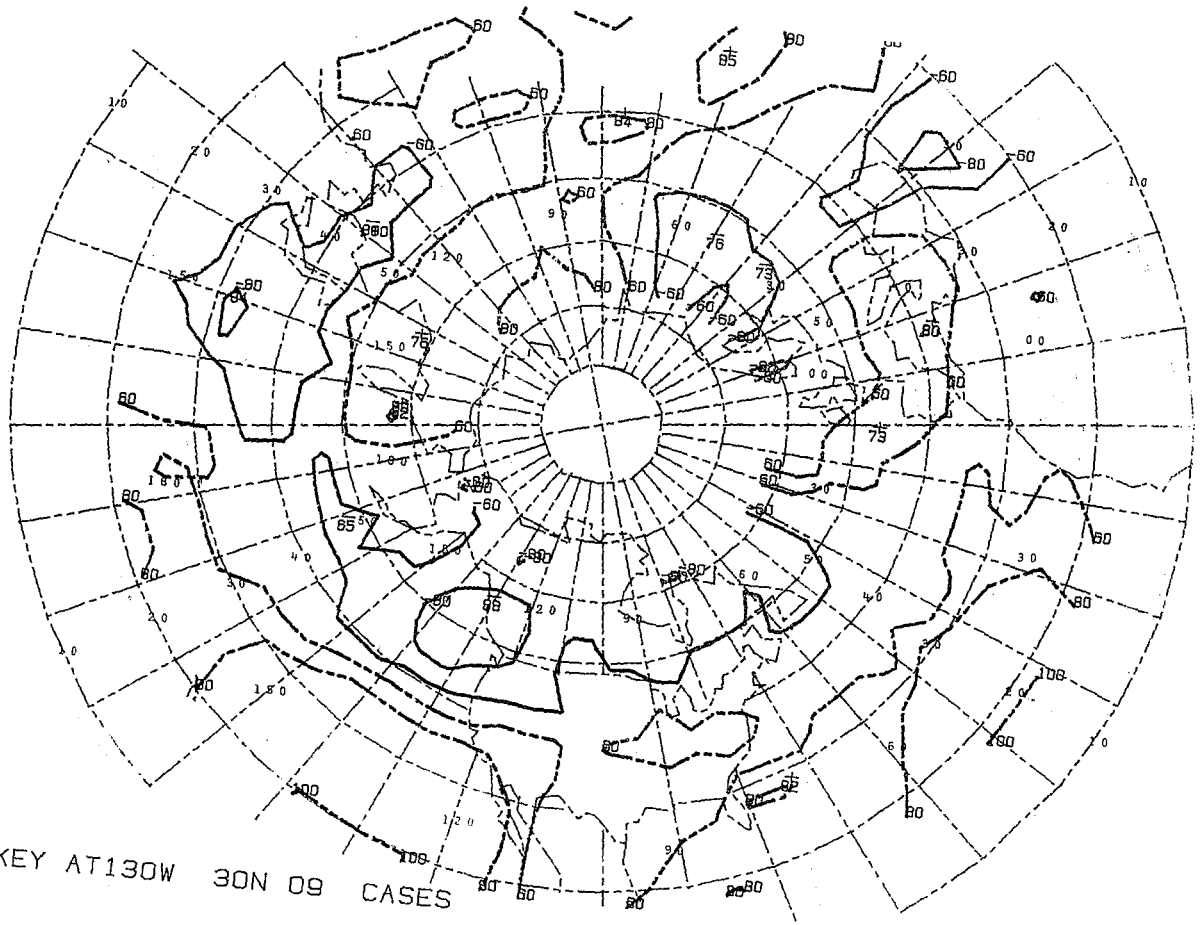

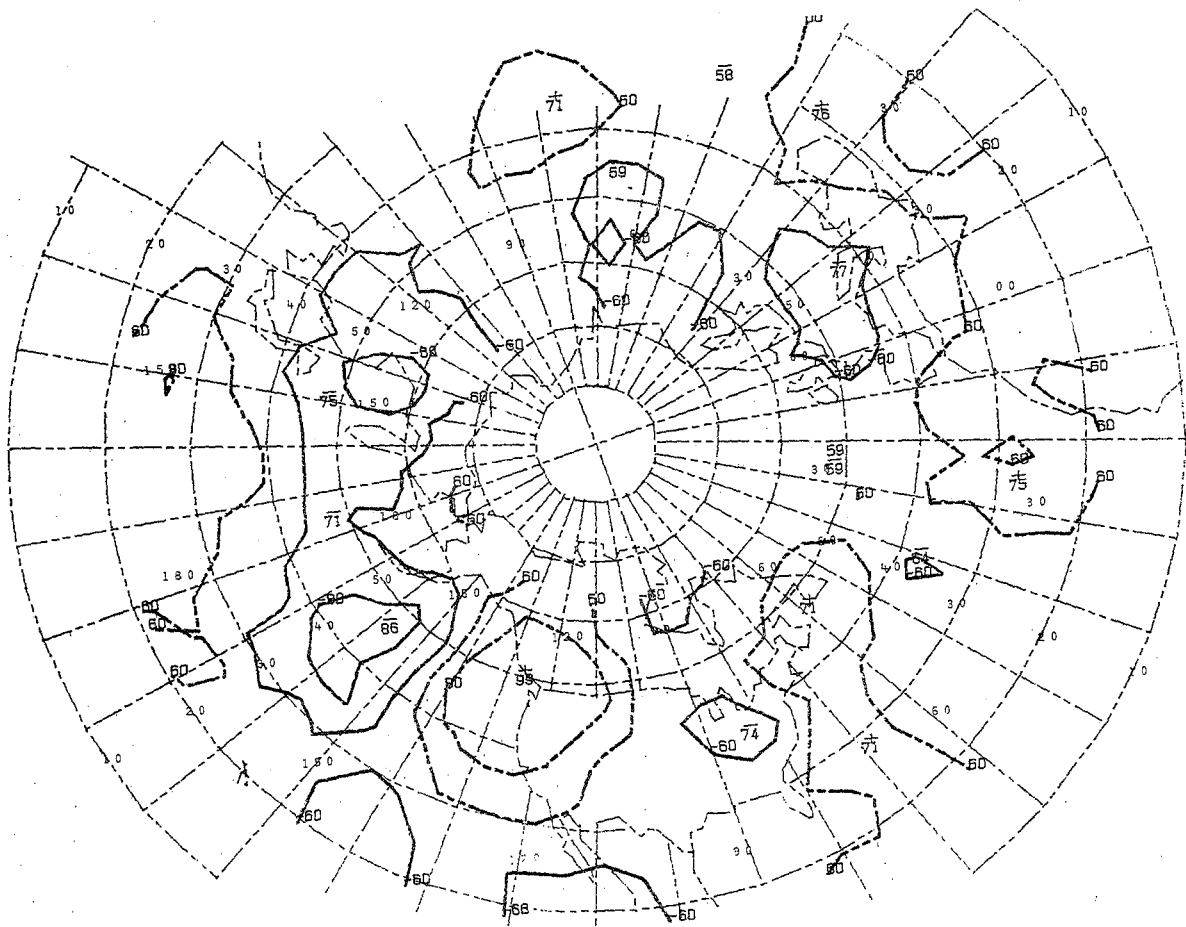

+ KEY AT130W 50N 16 CASES

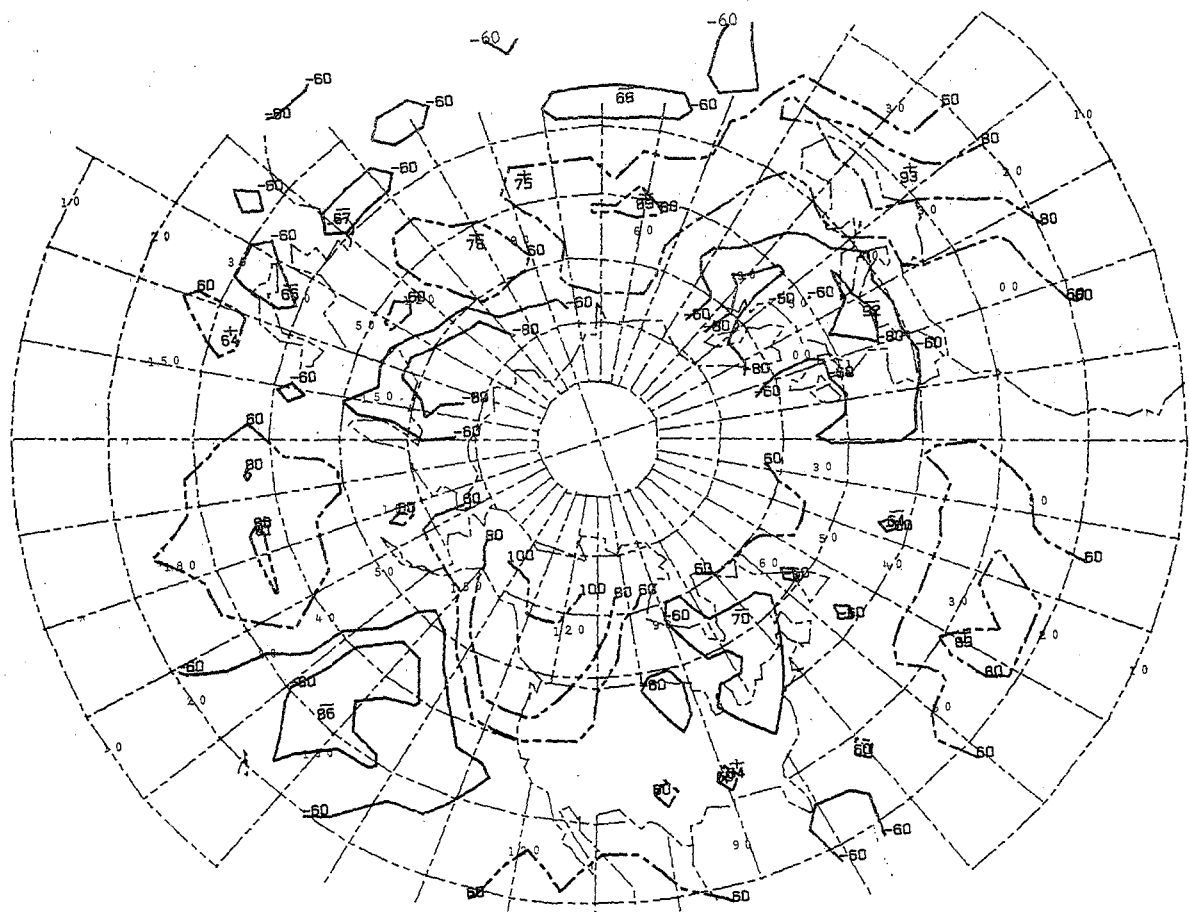

+ KEY AT130W 60N 07 CASES

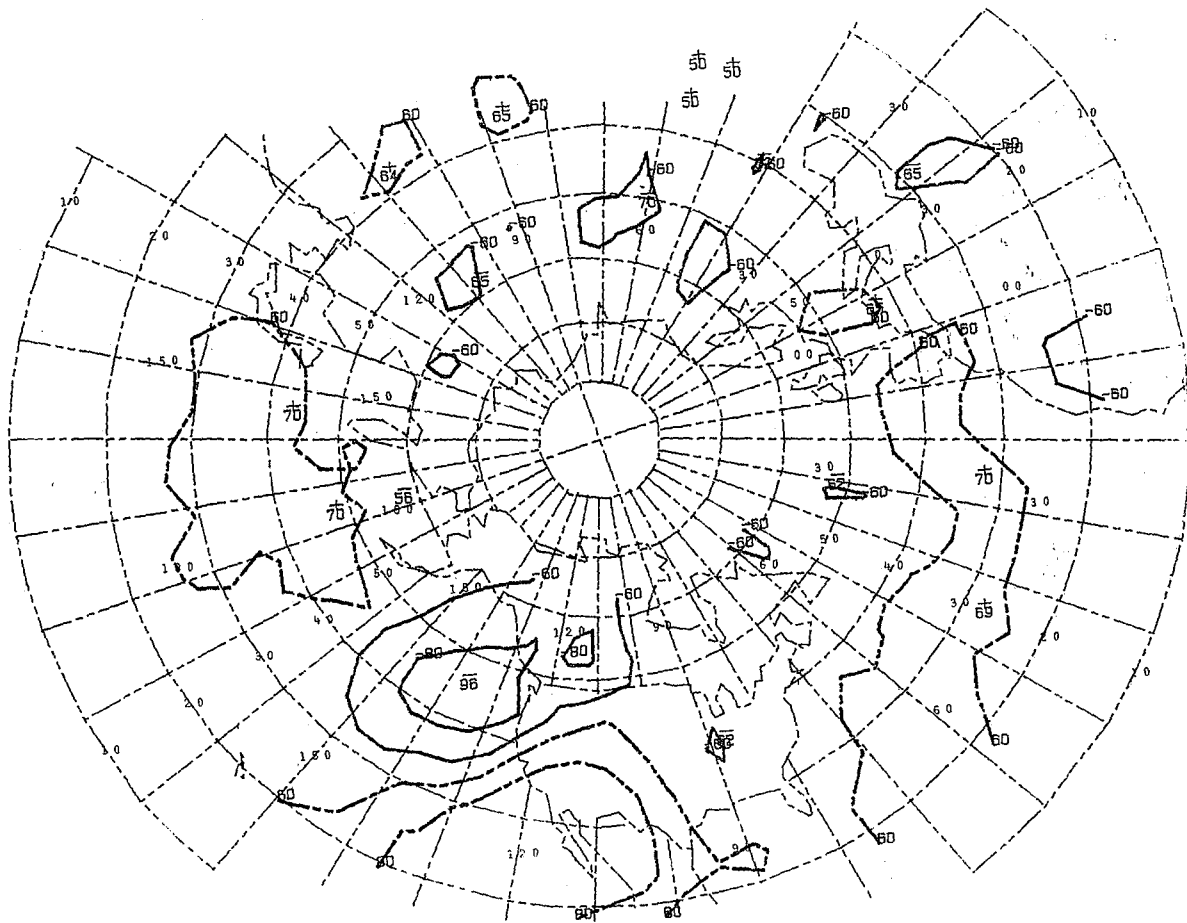

+ KEY AT120W 30N 23 CASES

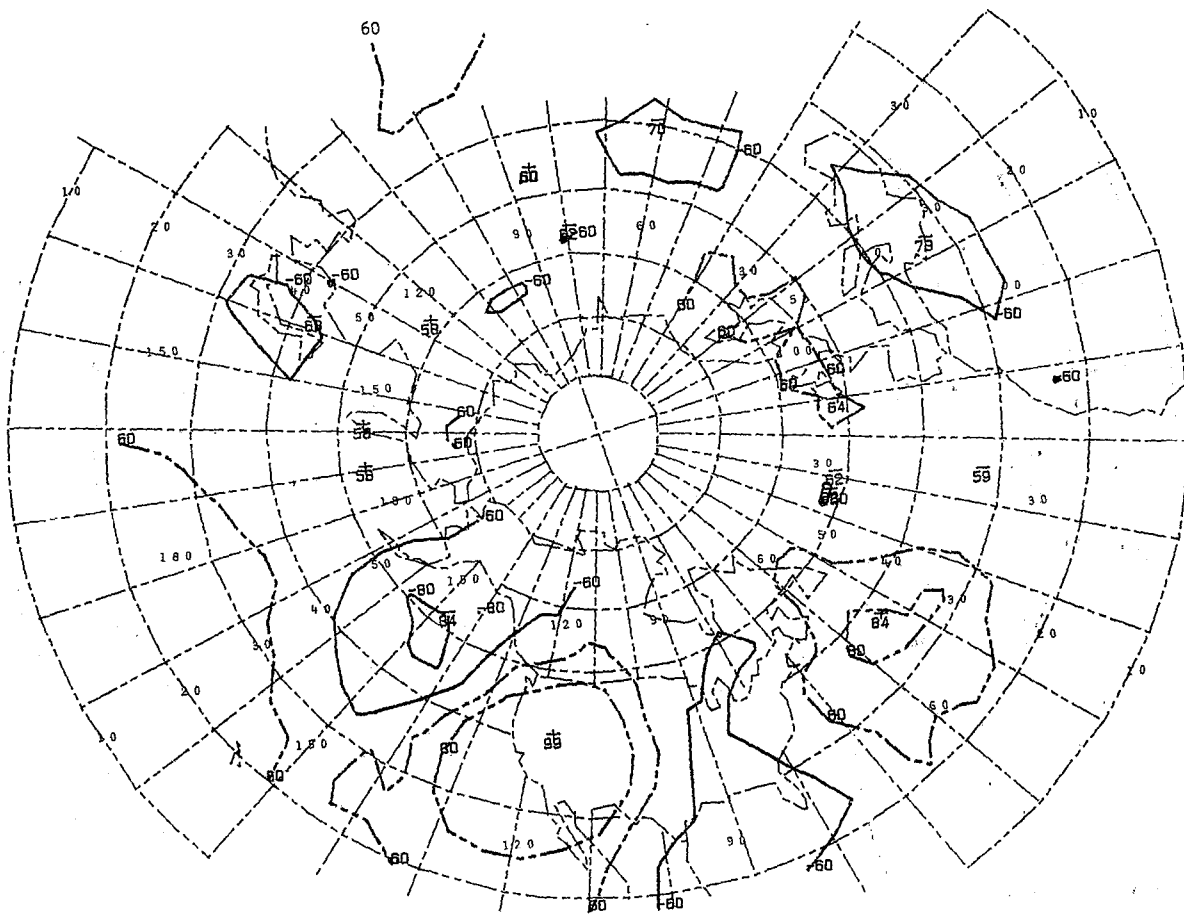

+ KEY AT120W 40N 29 CASES

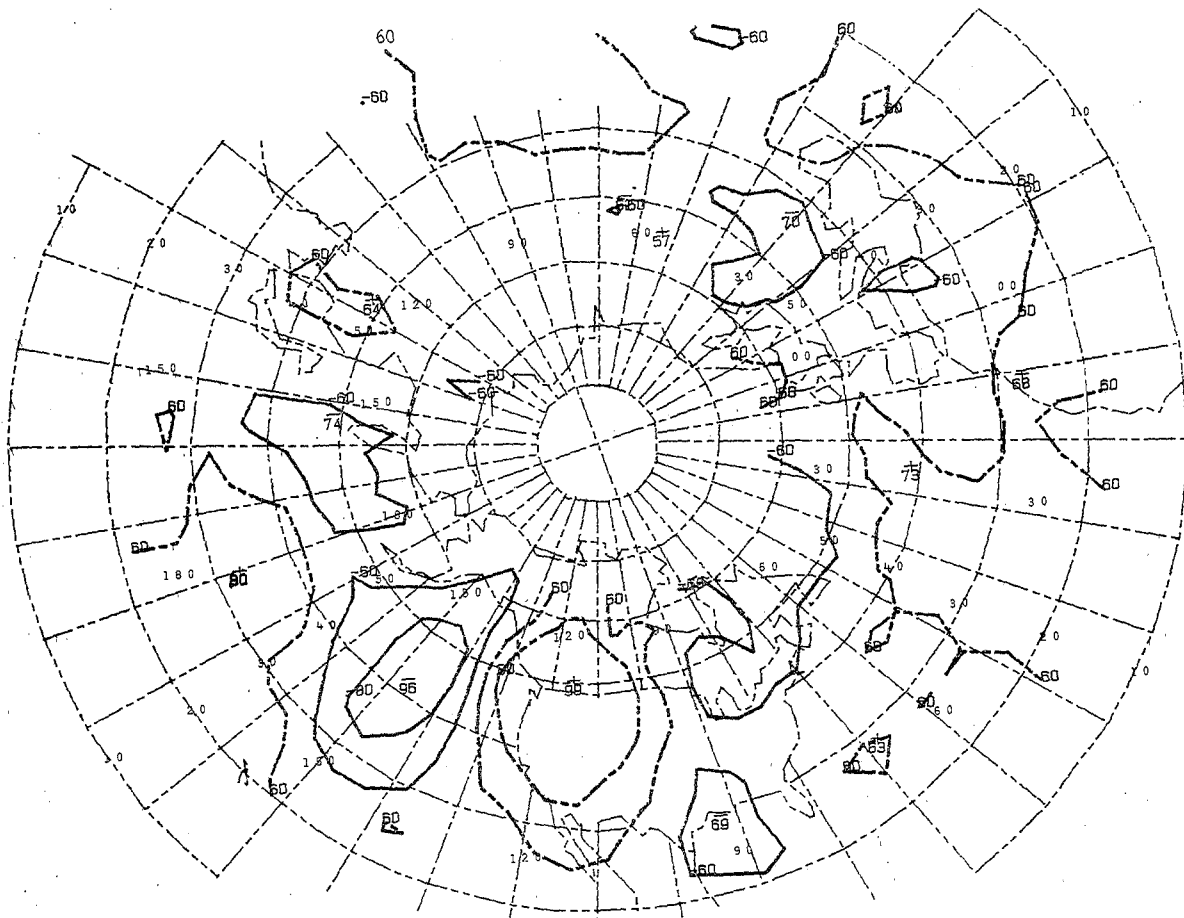

+ KEY AT120W 50N 18 CASES

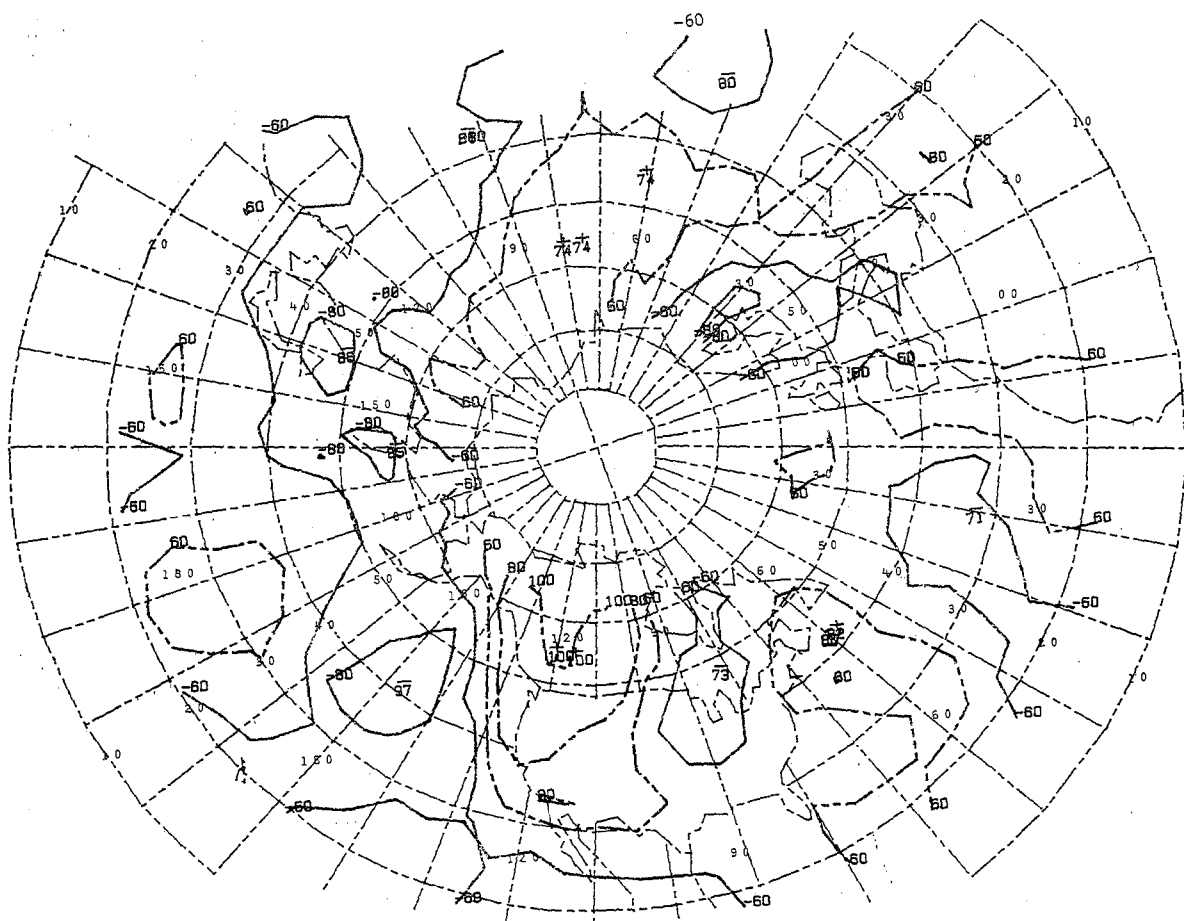

+ KEY AT120W 60N 08 CASES

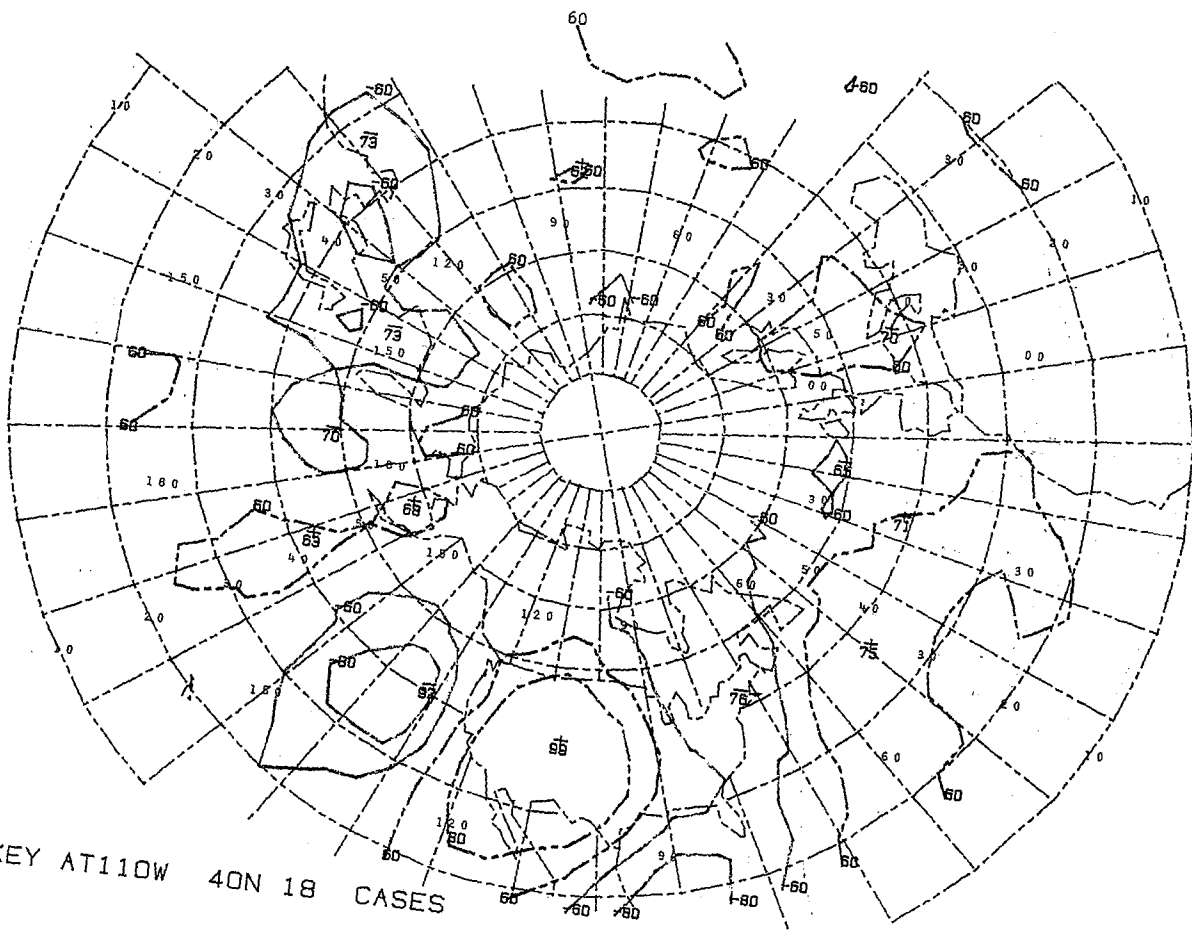
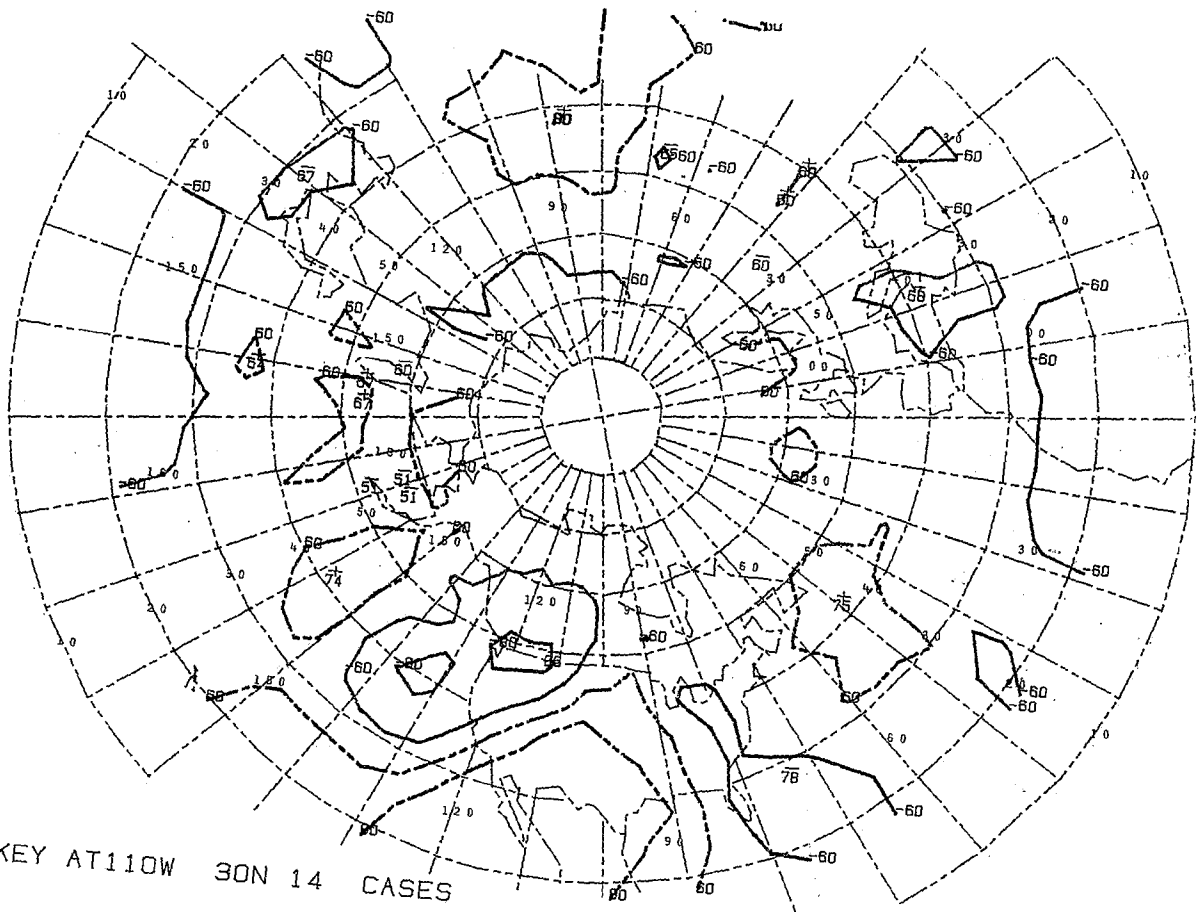

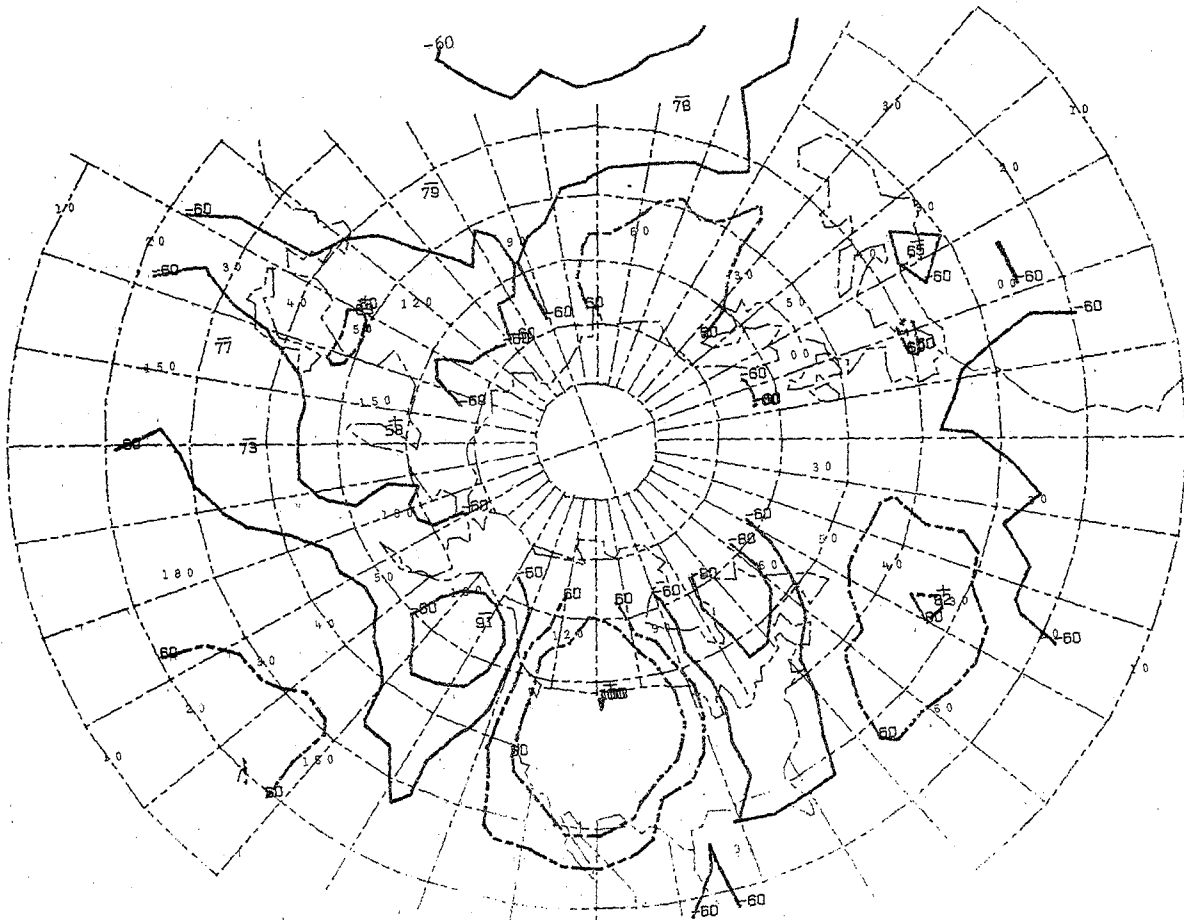

+ KEY AT110W SON 16 CASES

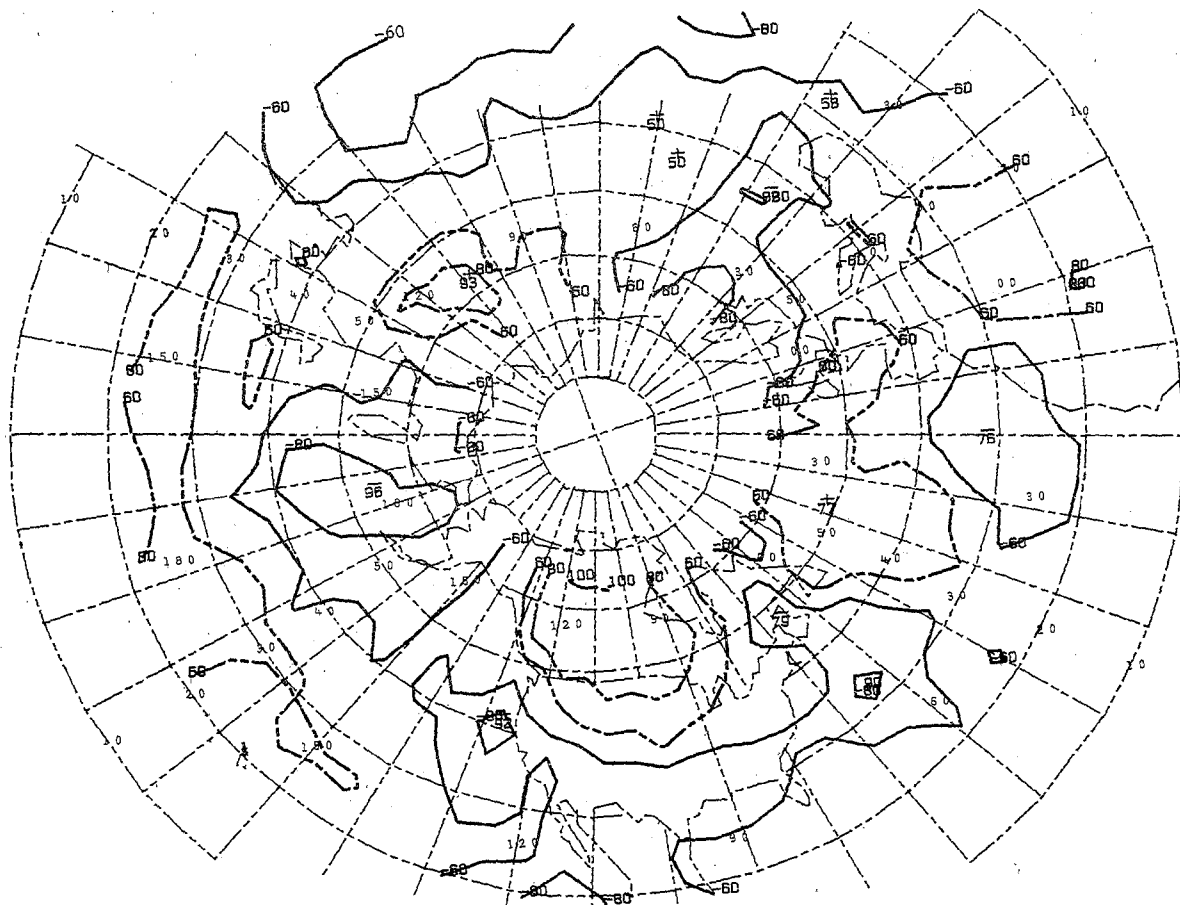

+ KEY AT110W 60N 09 CASES

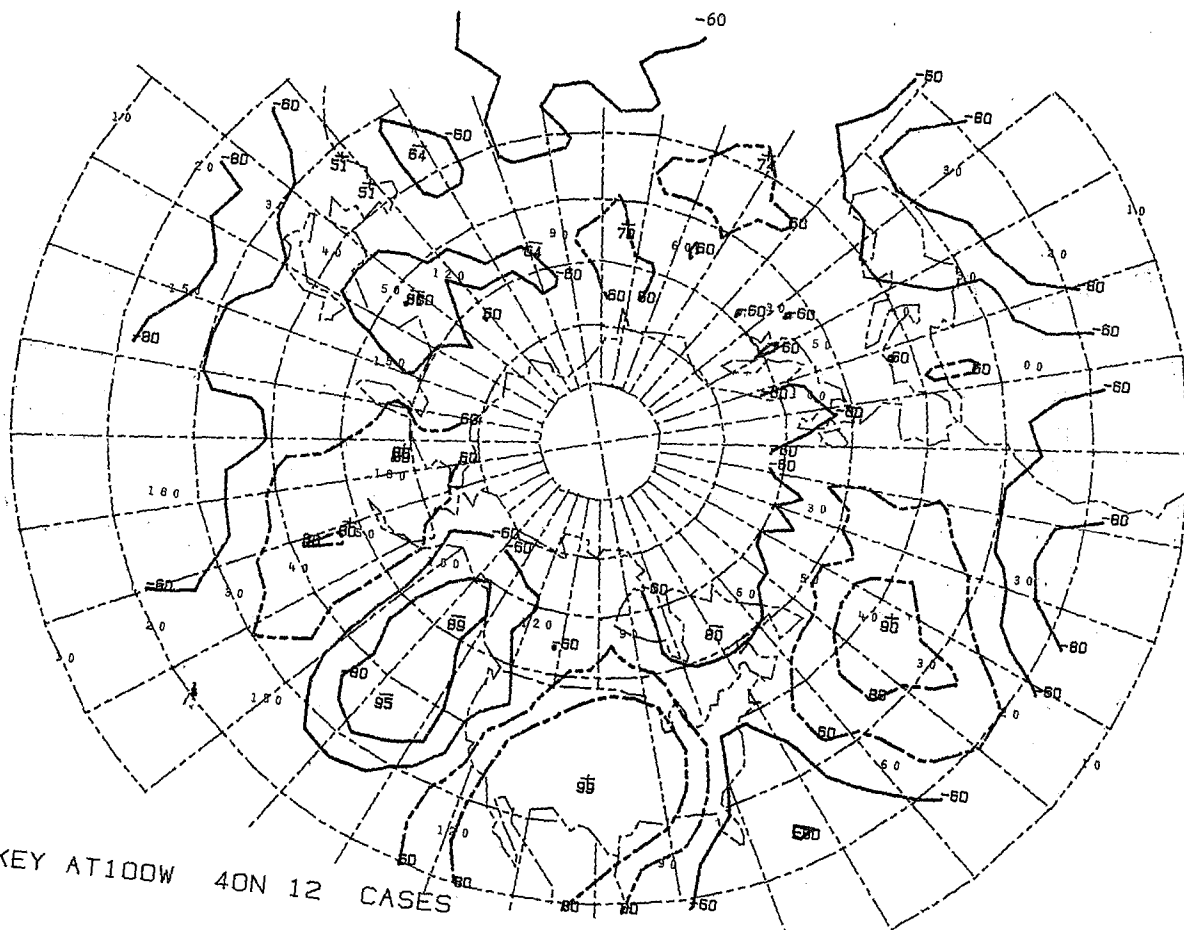
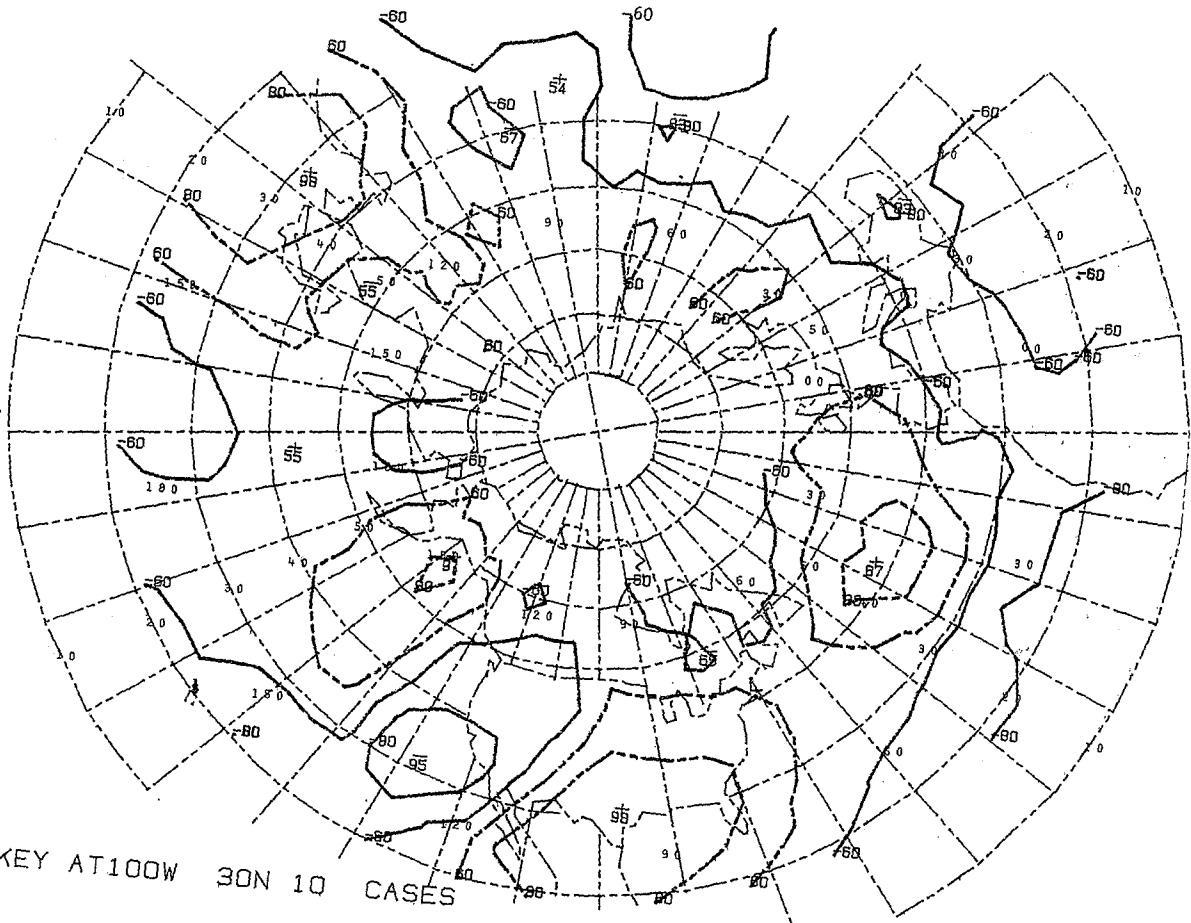

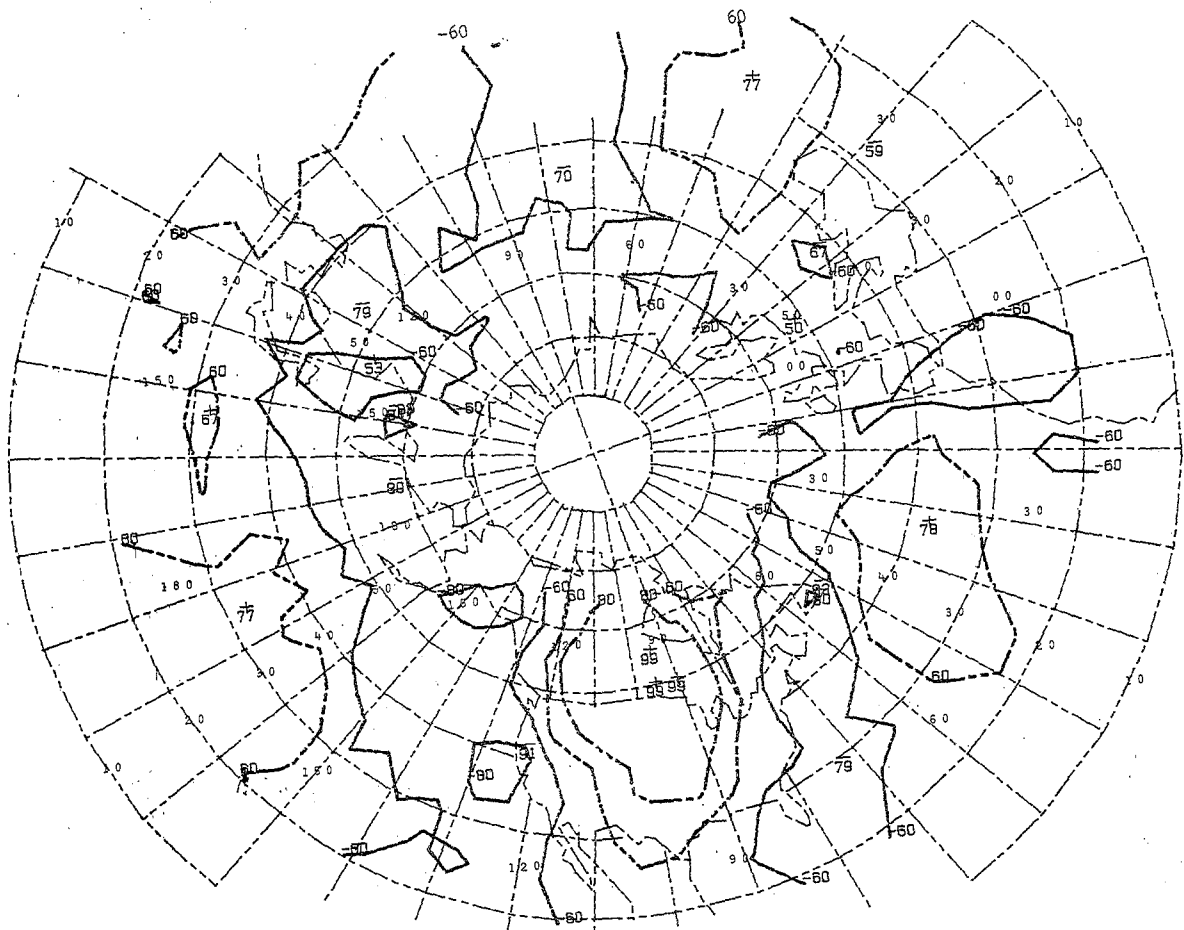

+ KEY AT100W 50N 11 CASES

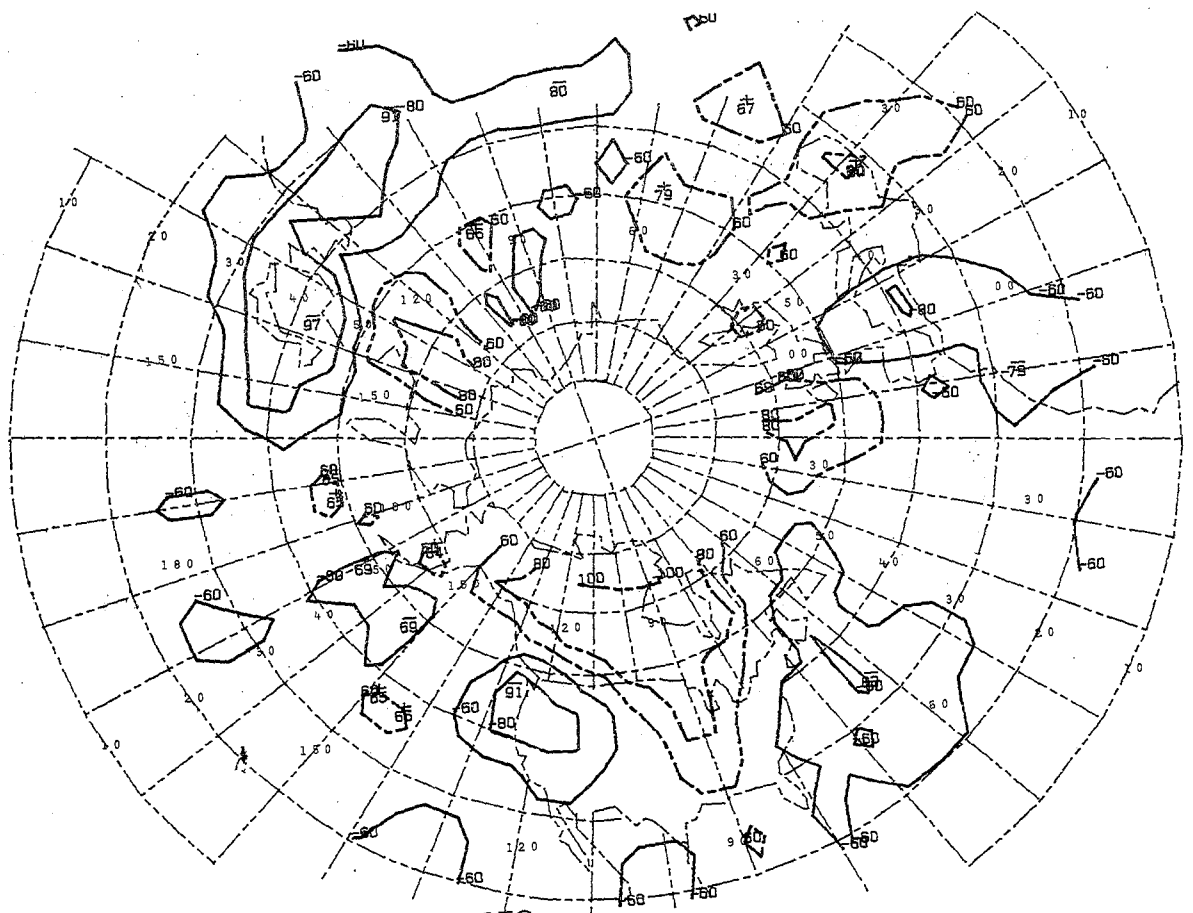

+ KEY AT100W 60N 07 CASES

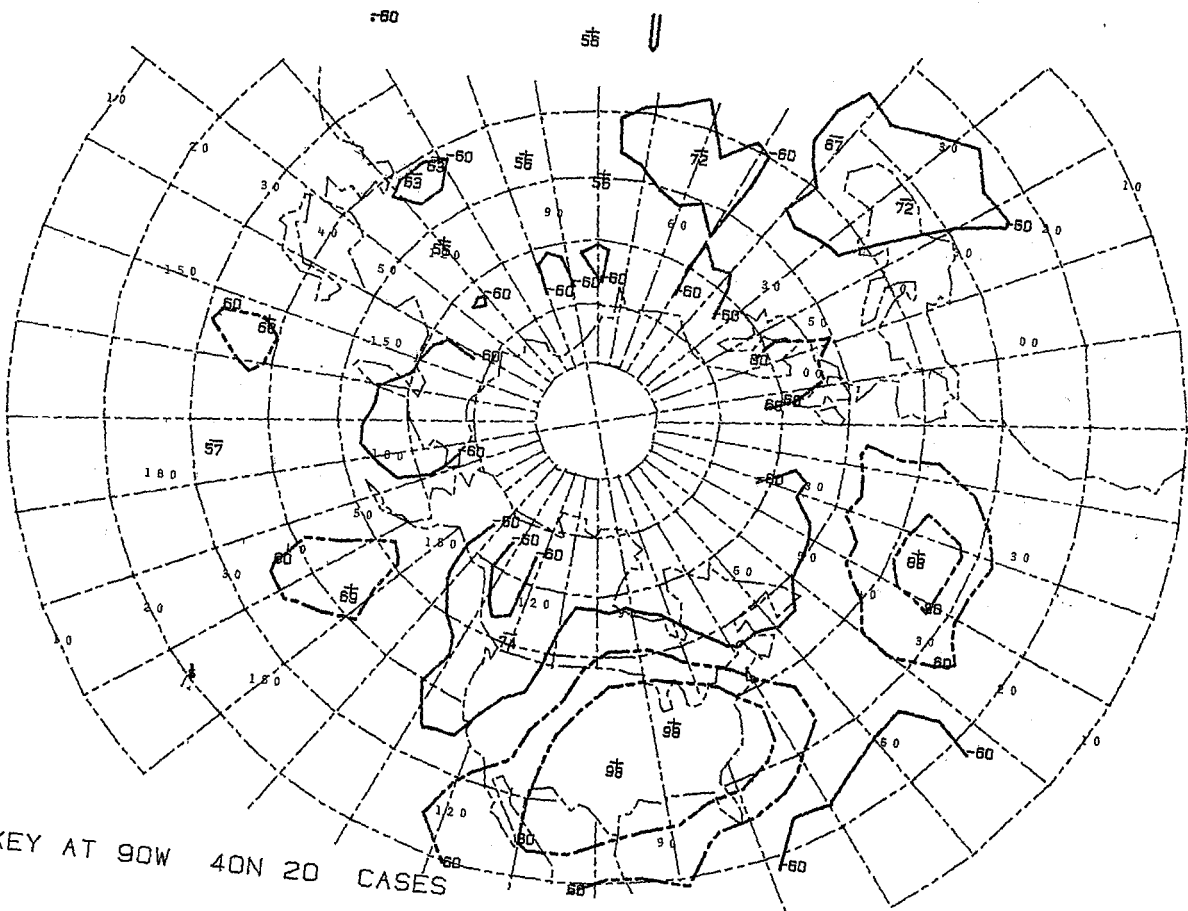
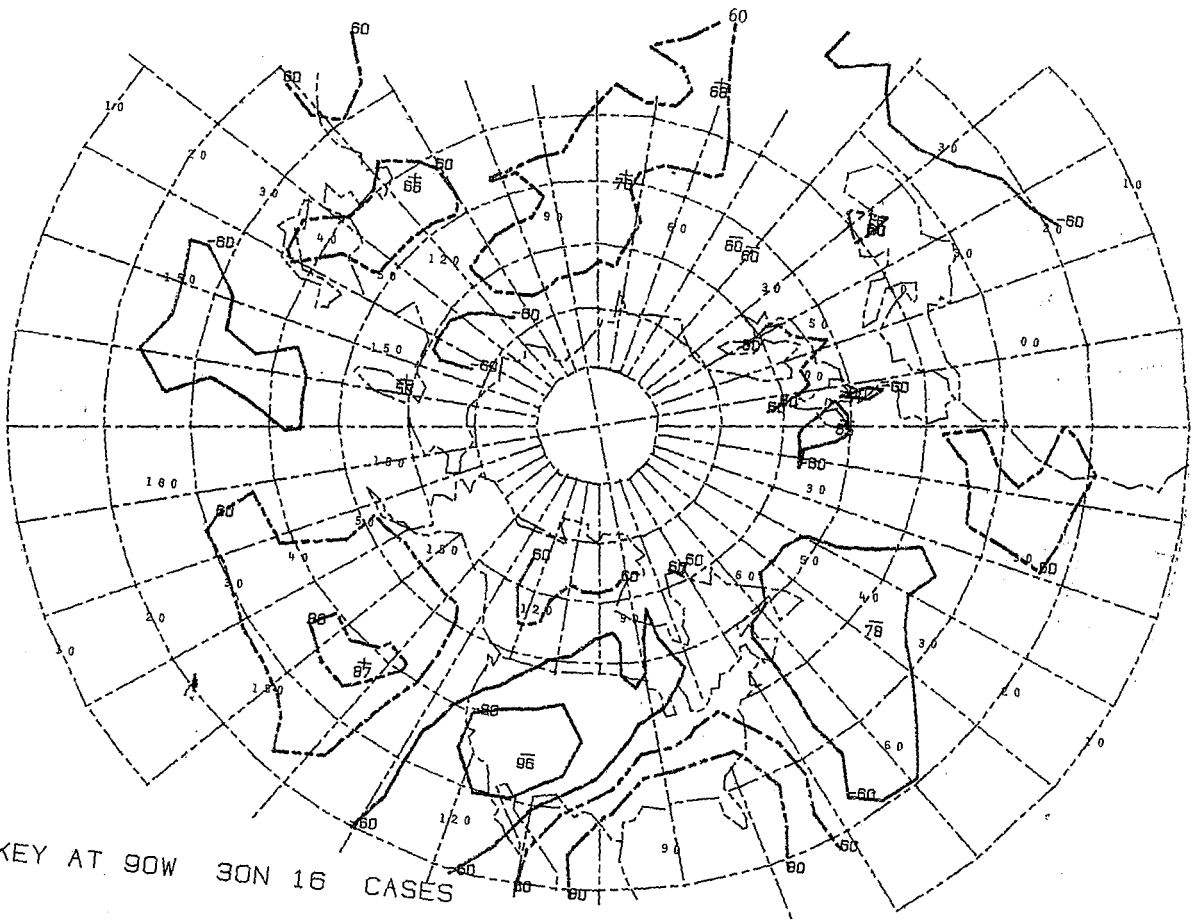

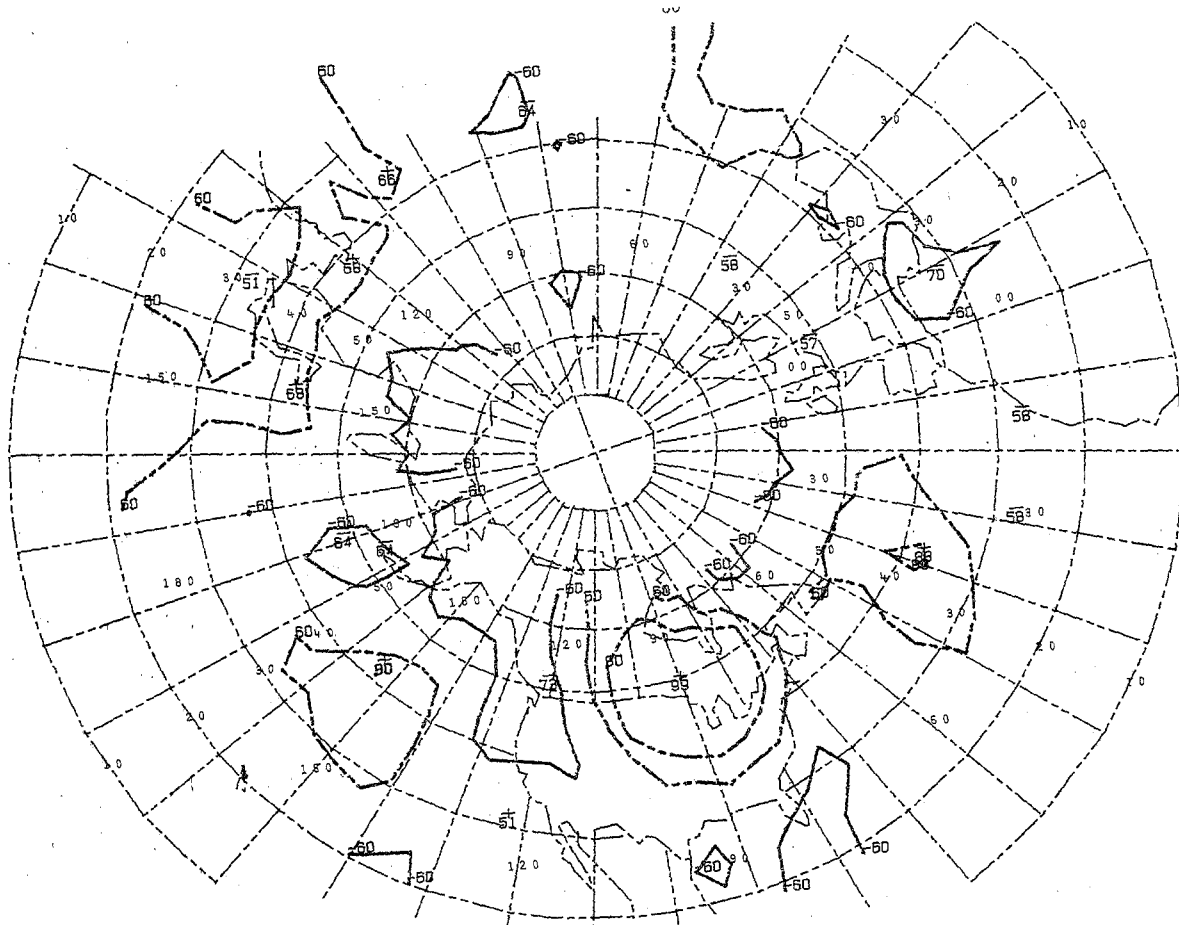

+ KEY AT 90W 50N 18 CASES

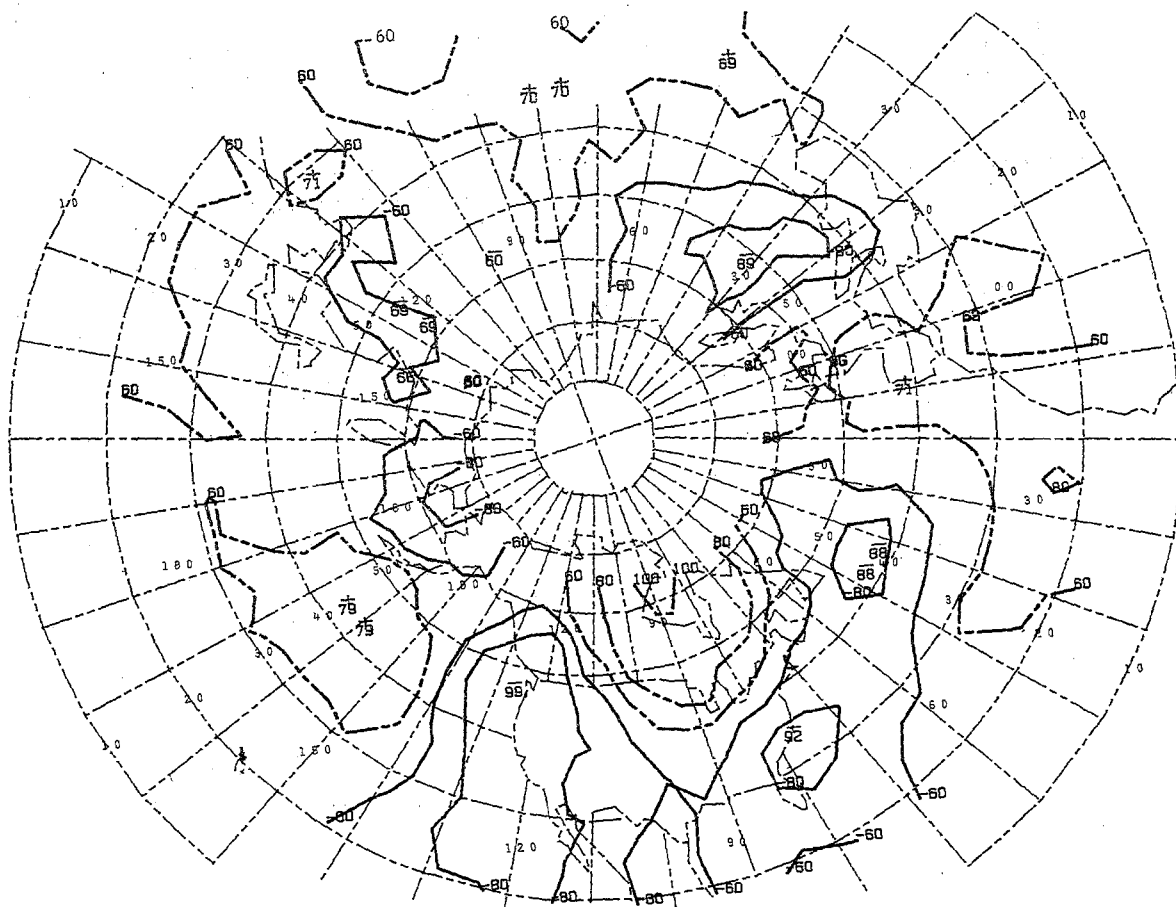

+ KEY AT 90W 60N 11 CASES

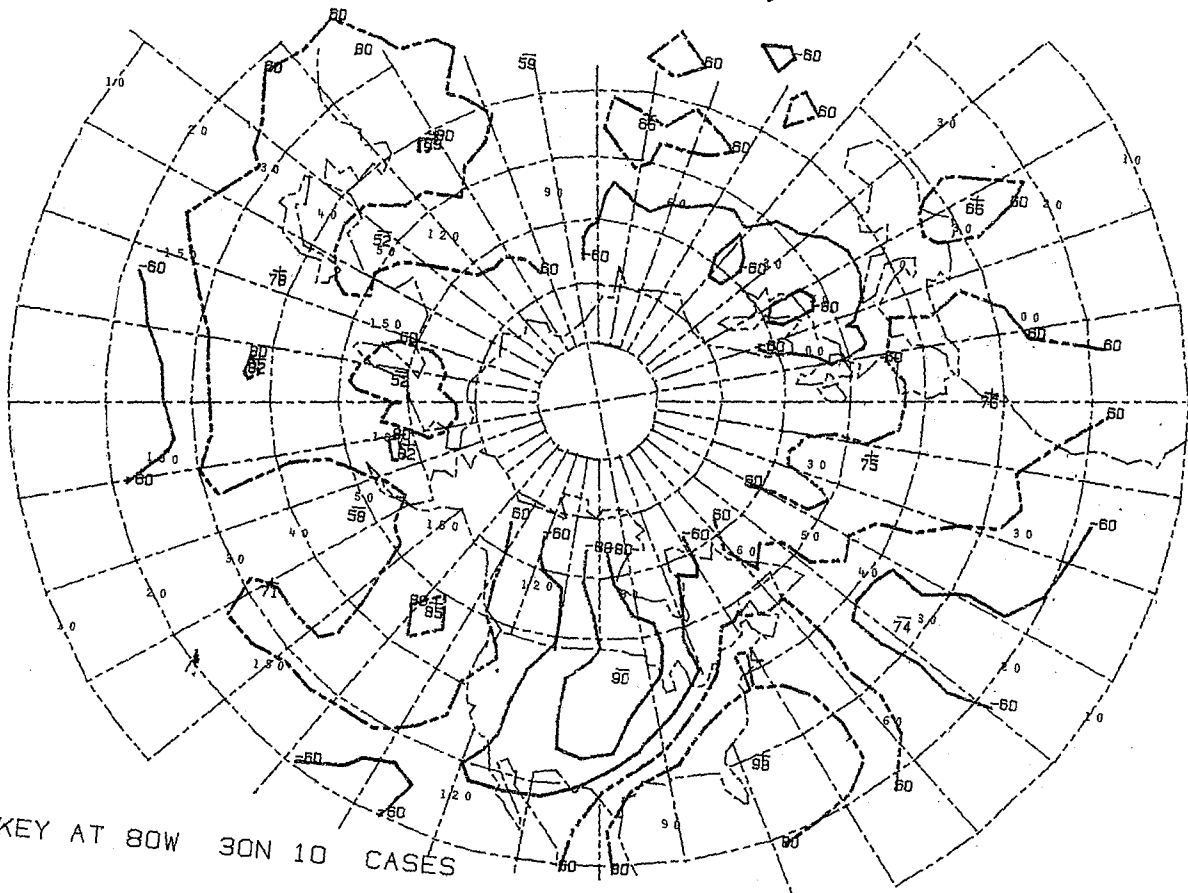

+ KEY AT 80W 30N 10 CASES

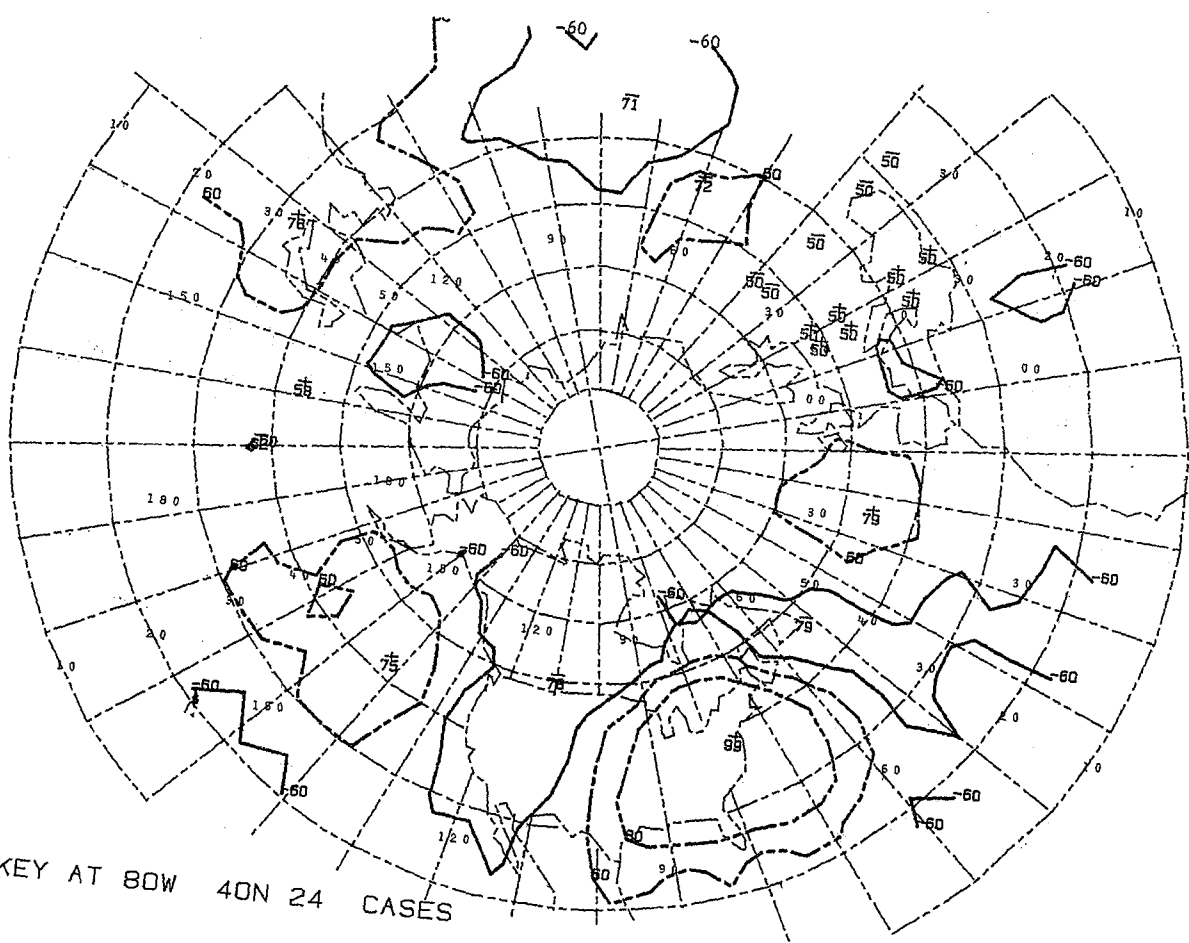

+ KEY AT 80W 40N 24 CASES

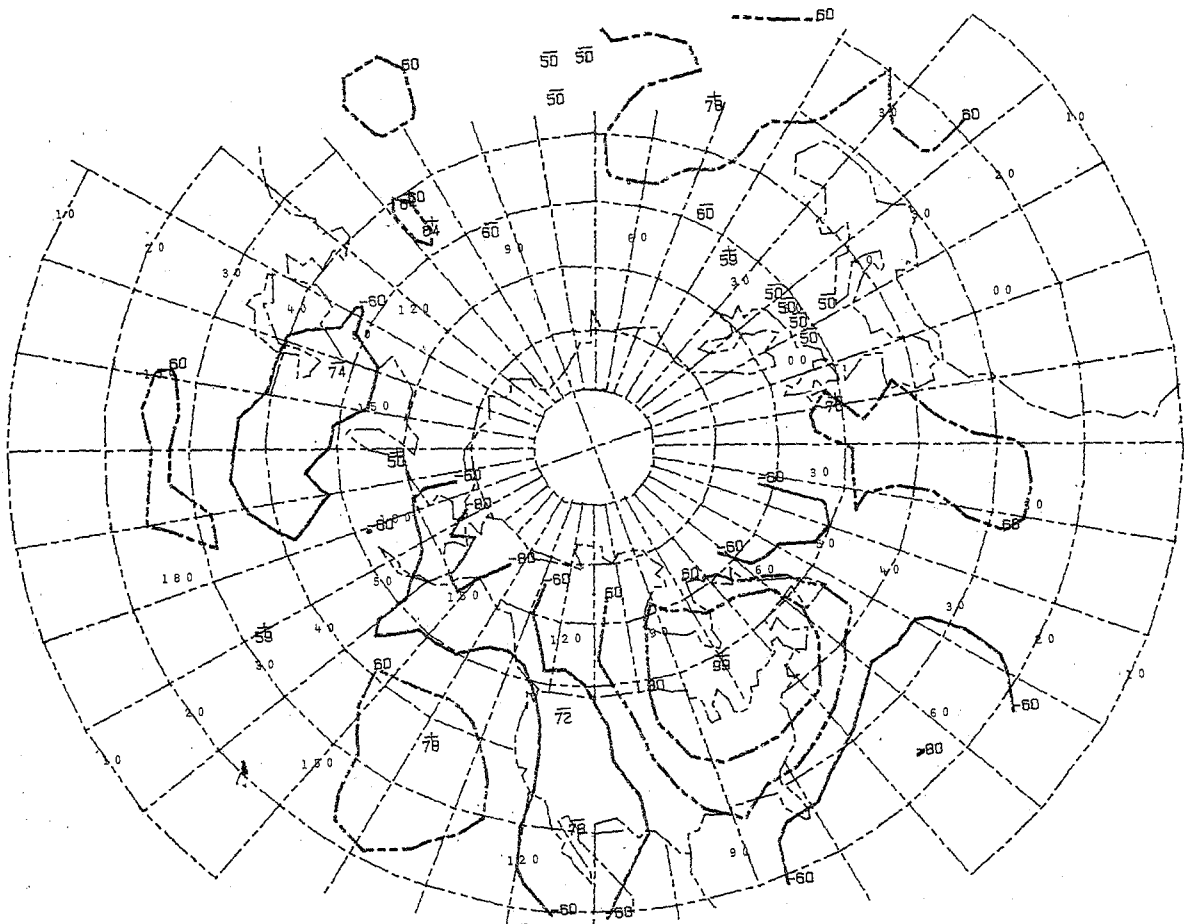

+ KEY AT 80W 50N 17 CASES

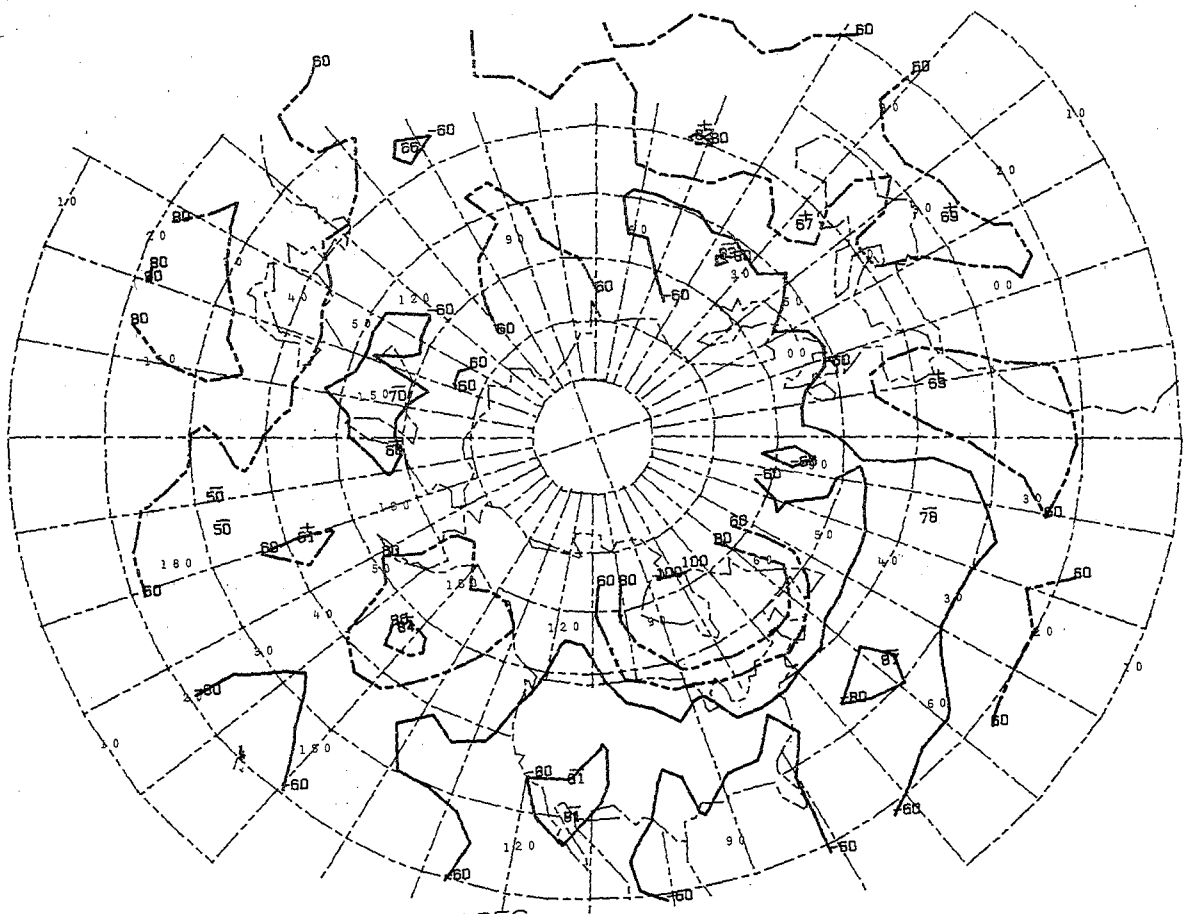

+ KEY AT 80W 60N 11 CASES

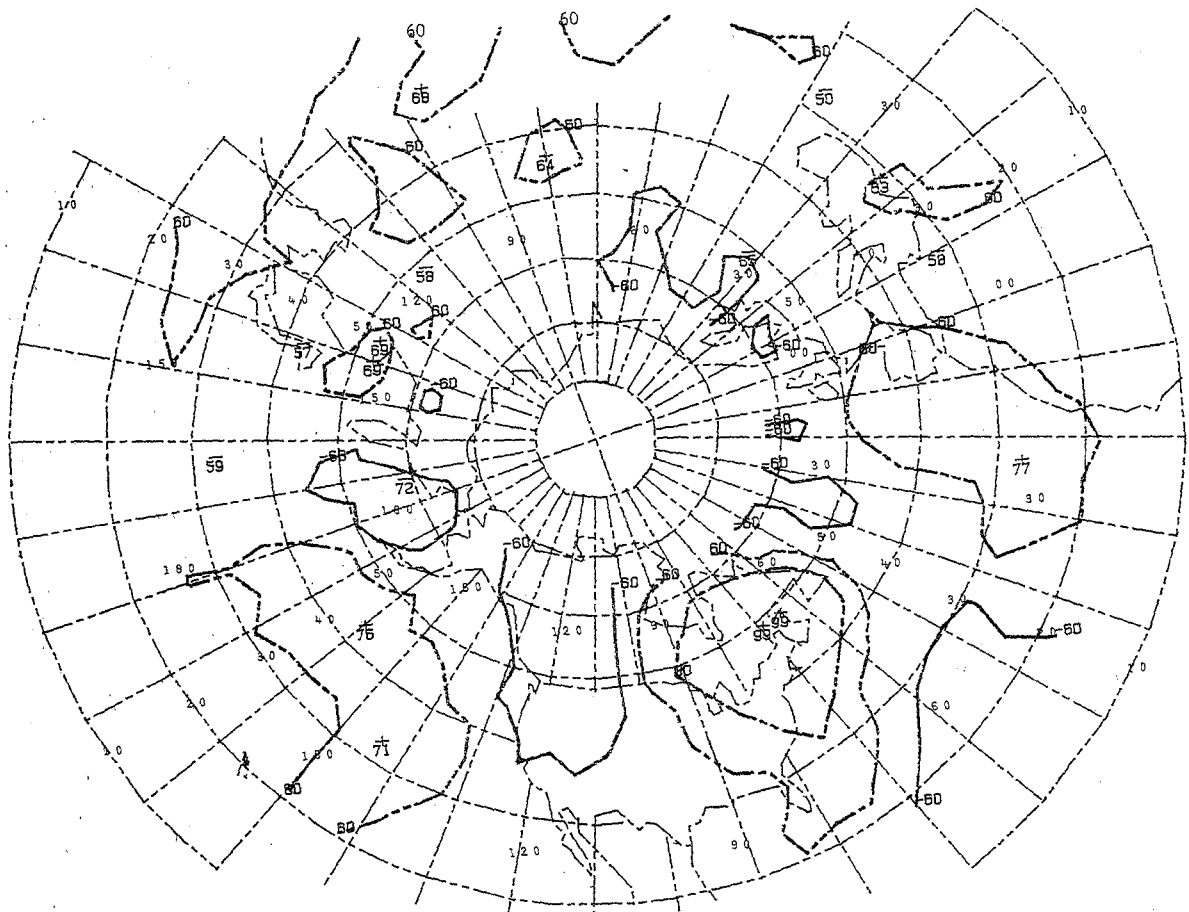

+ KEY AT 70W 50N 16 CASES

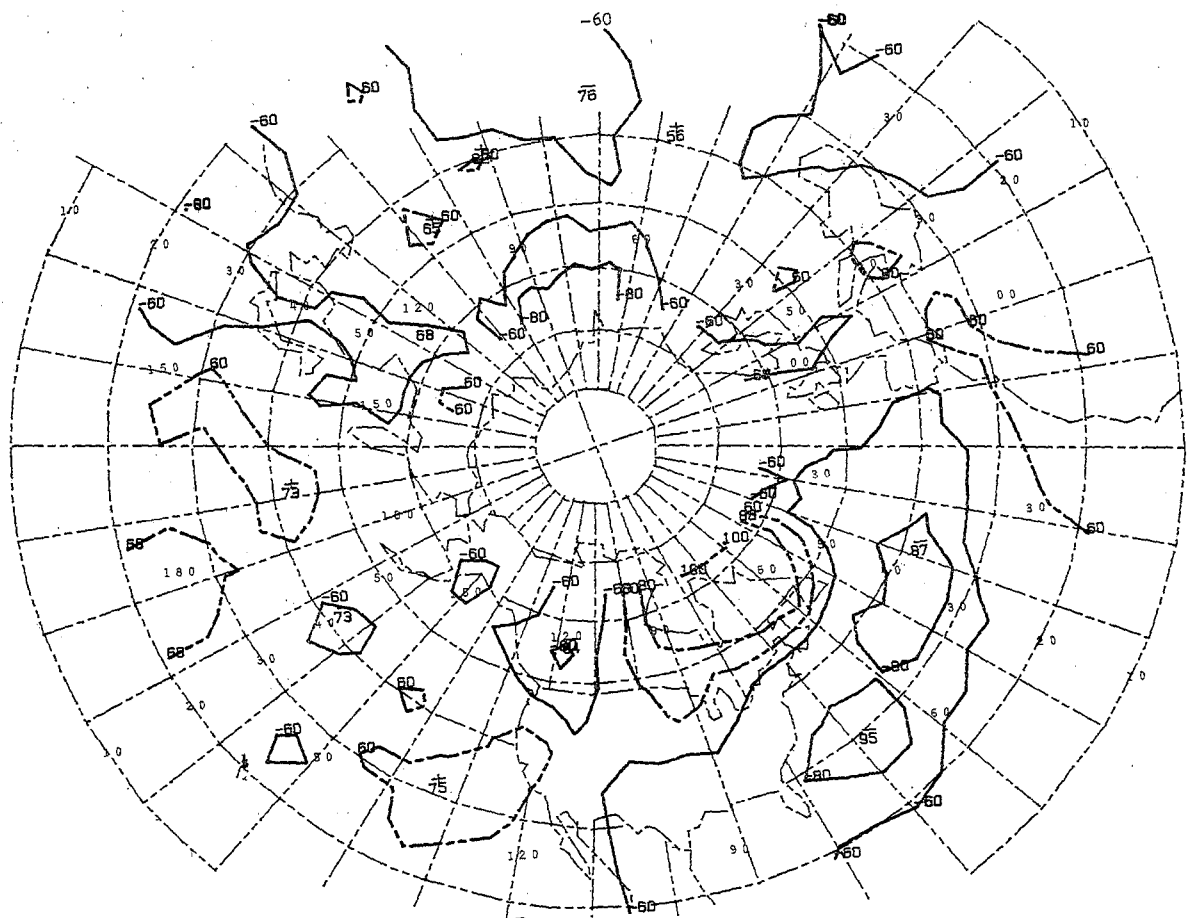

+ KEY AT 70W 60N 10 CASES

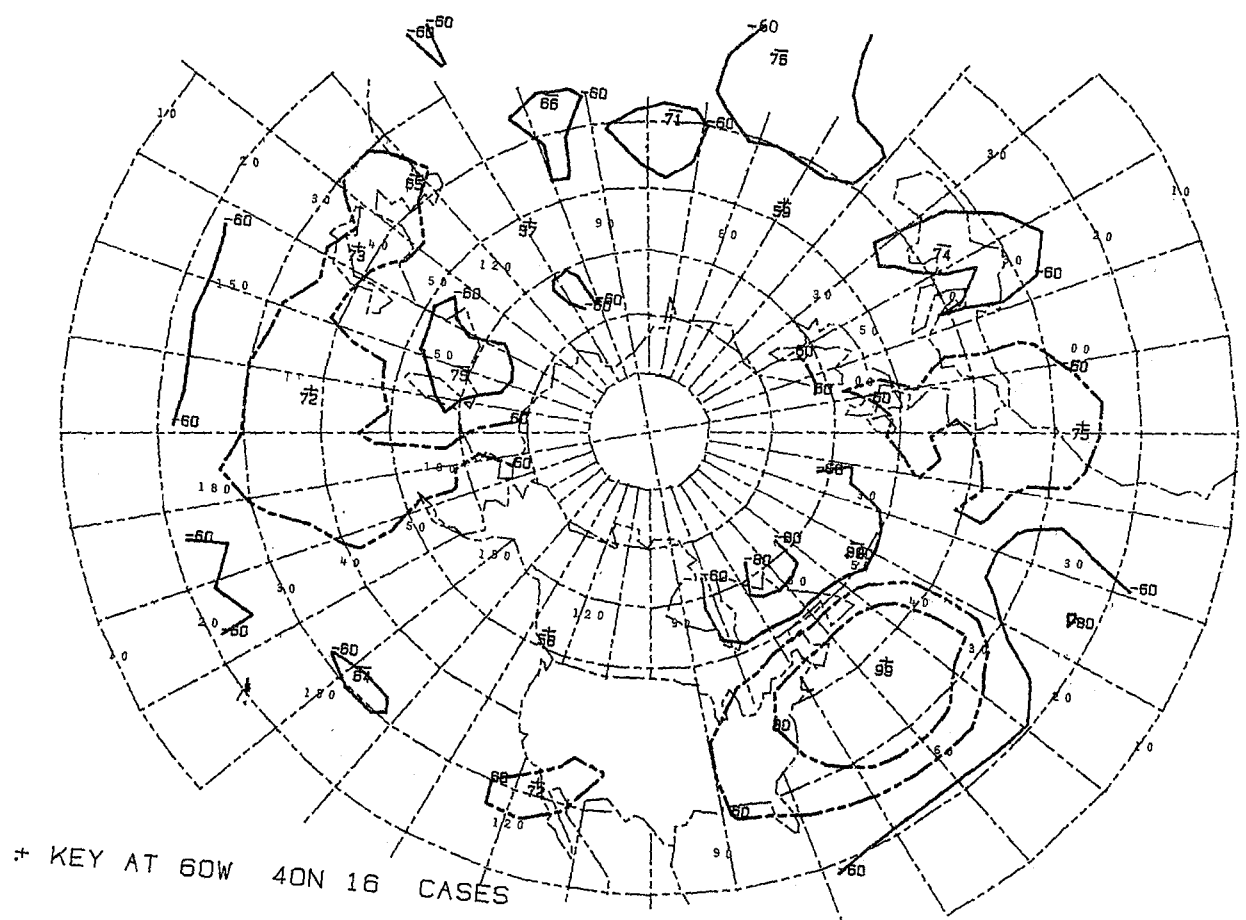
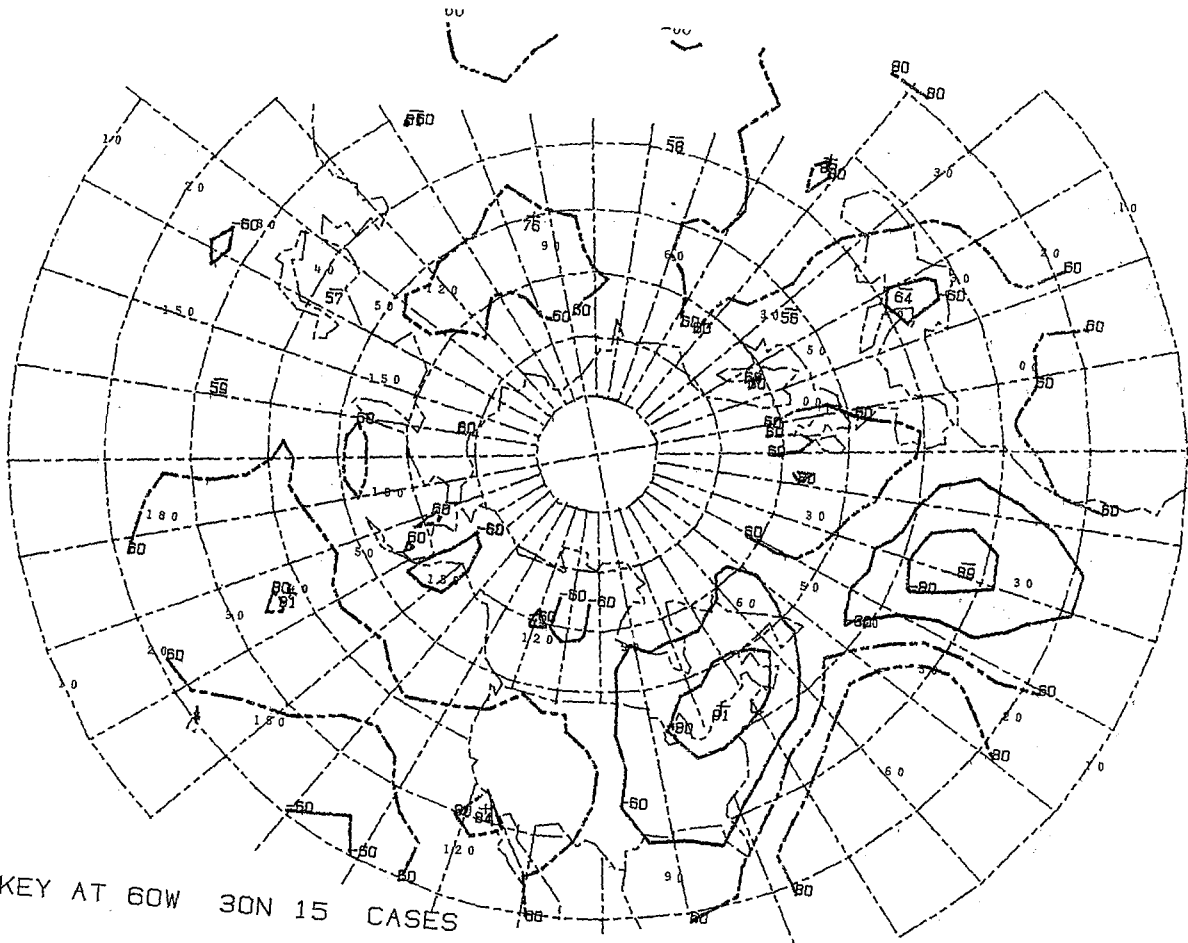

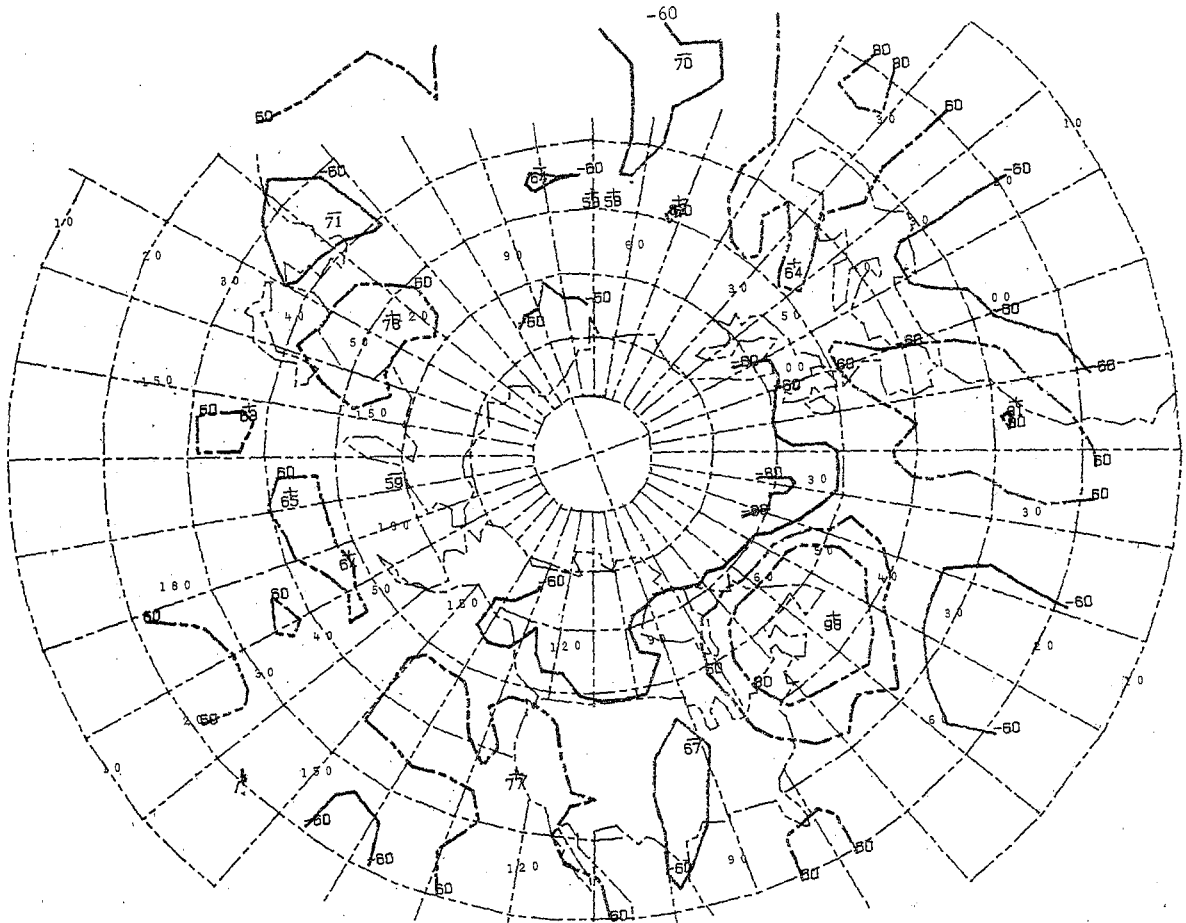

+ KEY AT 60W 50N 16 CASES

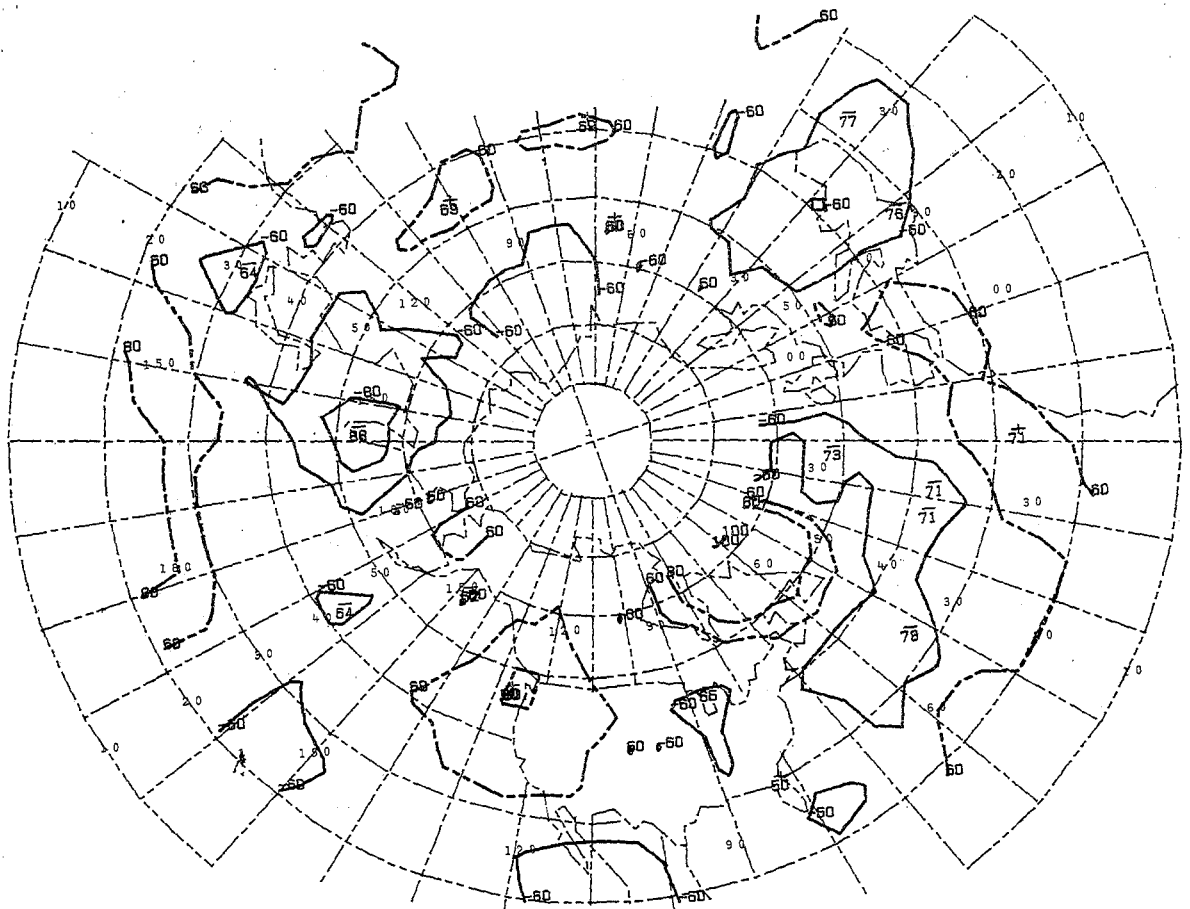

+ KEY AT 60W 60N 12 CASES

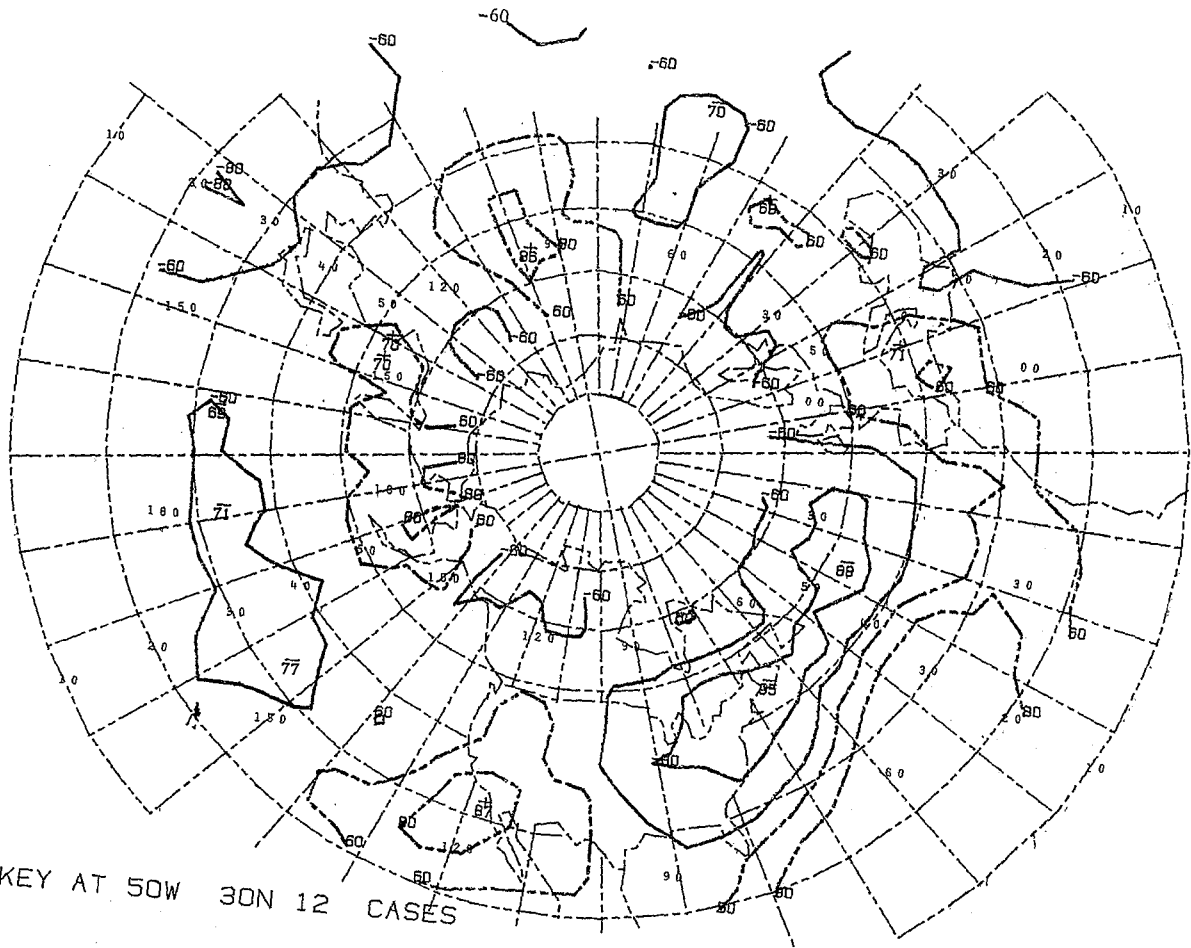

+ KEY AT 50W 30N 12 CASES

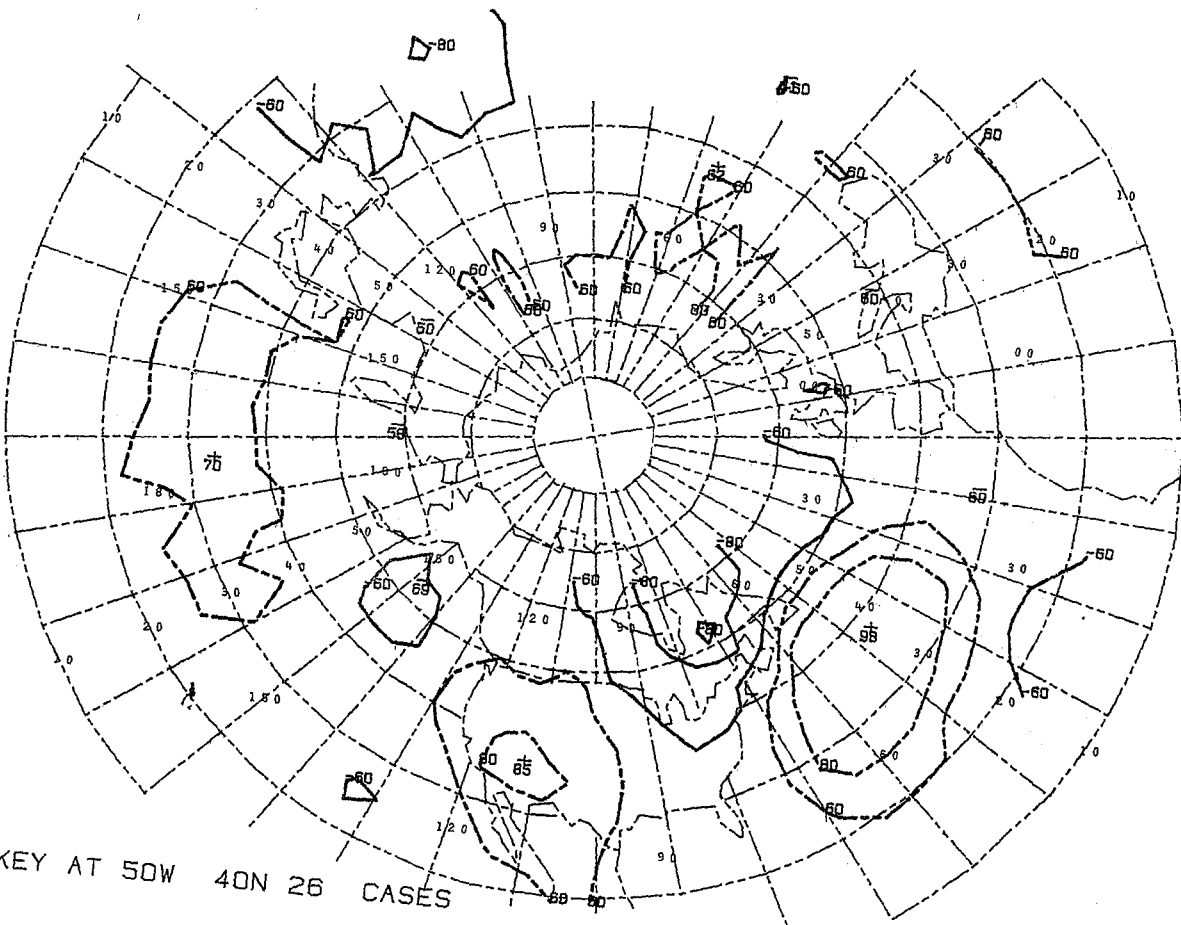

+ KEY AT 50W 40N 26 CASES

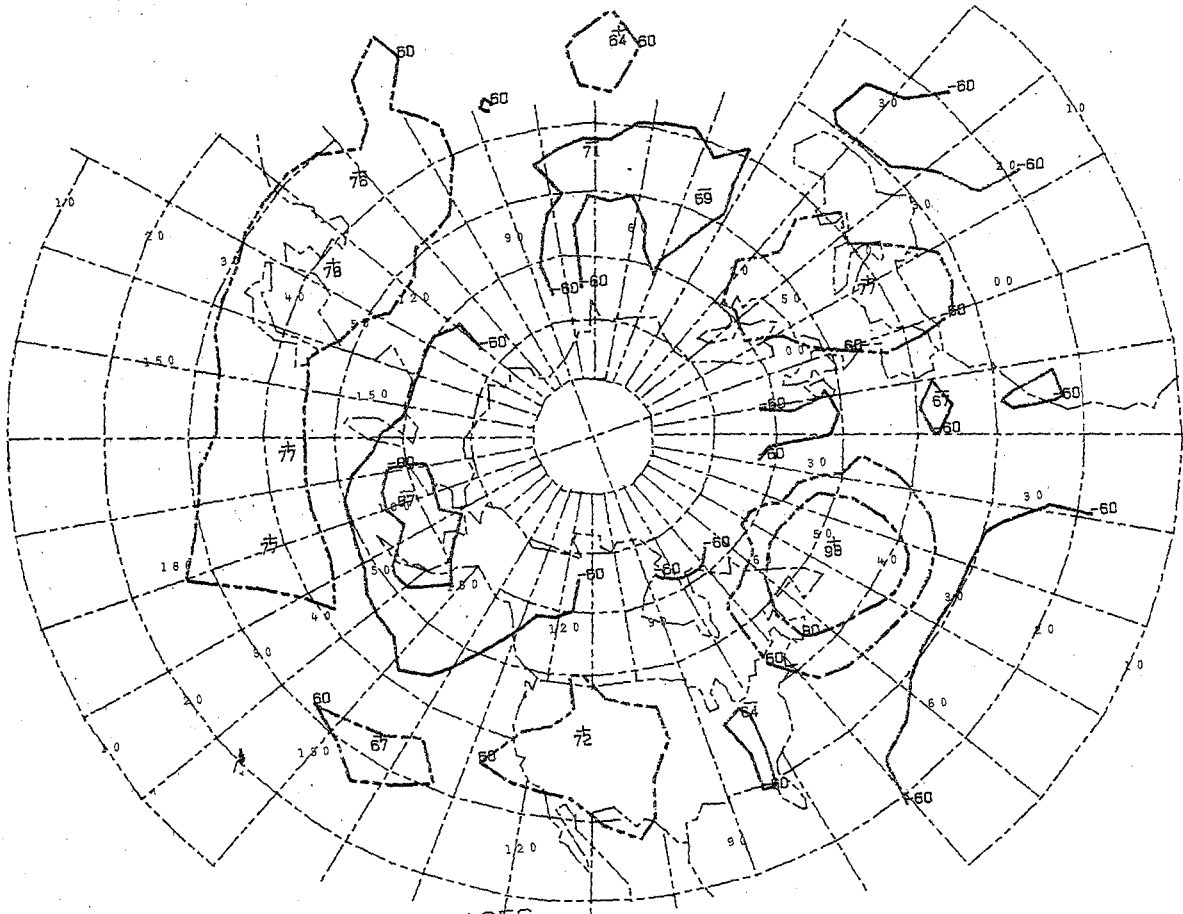

+ KEY AT 50W 50N 21 CASES

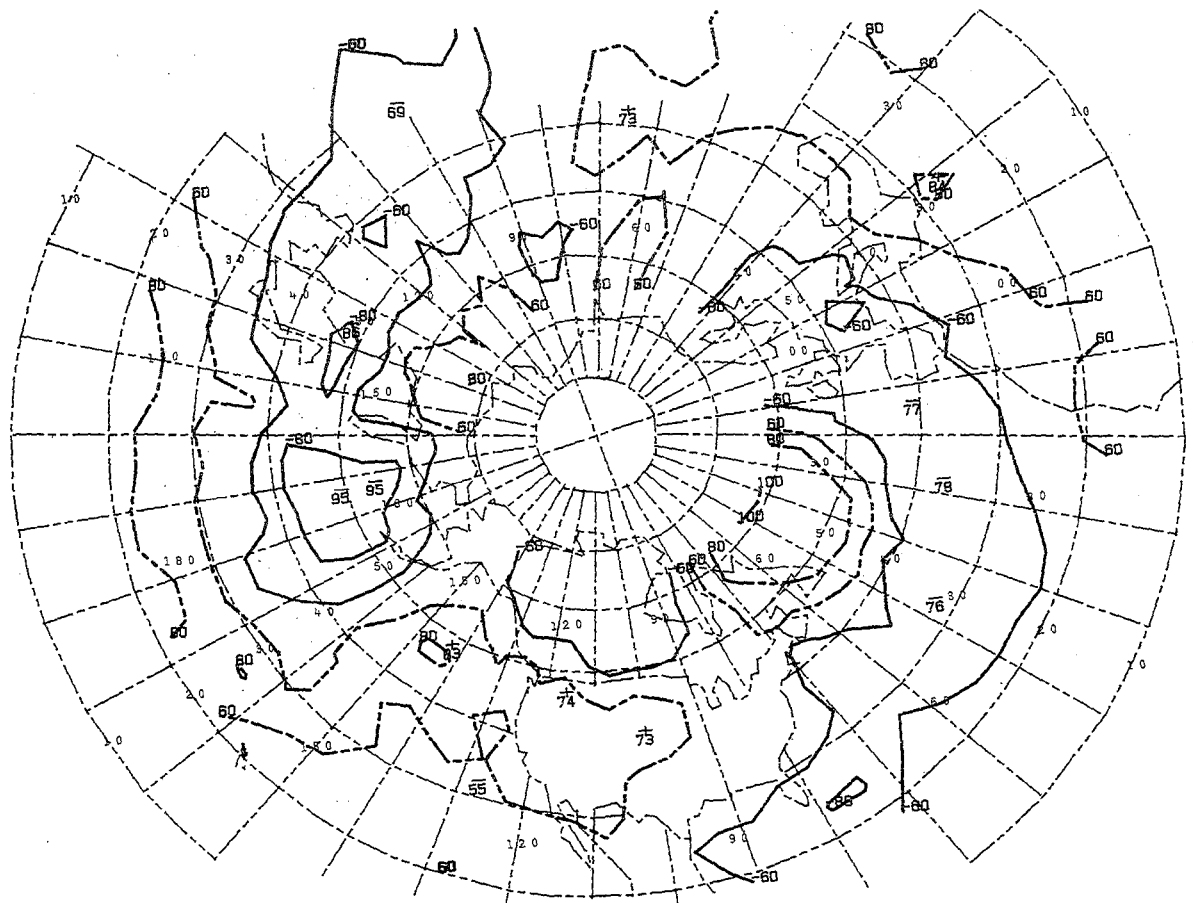

+ KEY AT 50W 60N 10 CASES

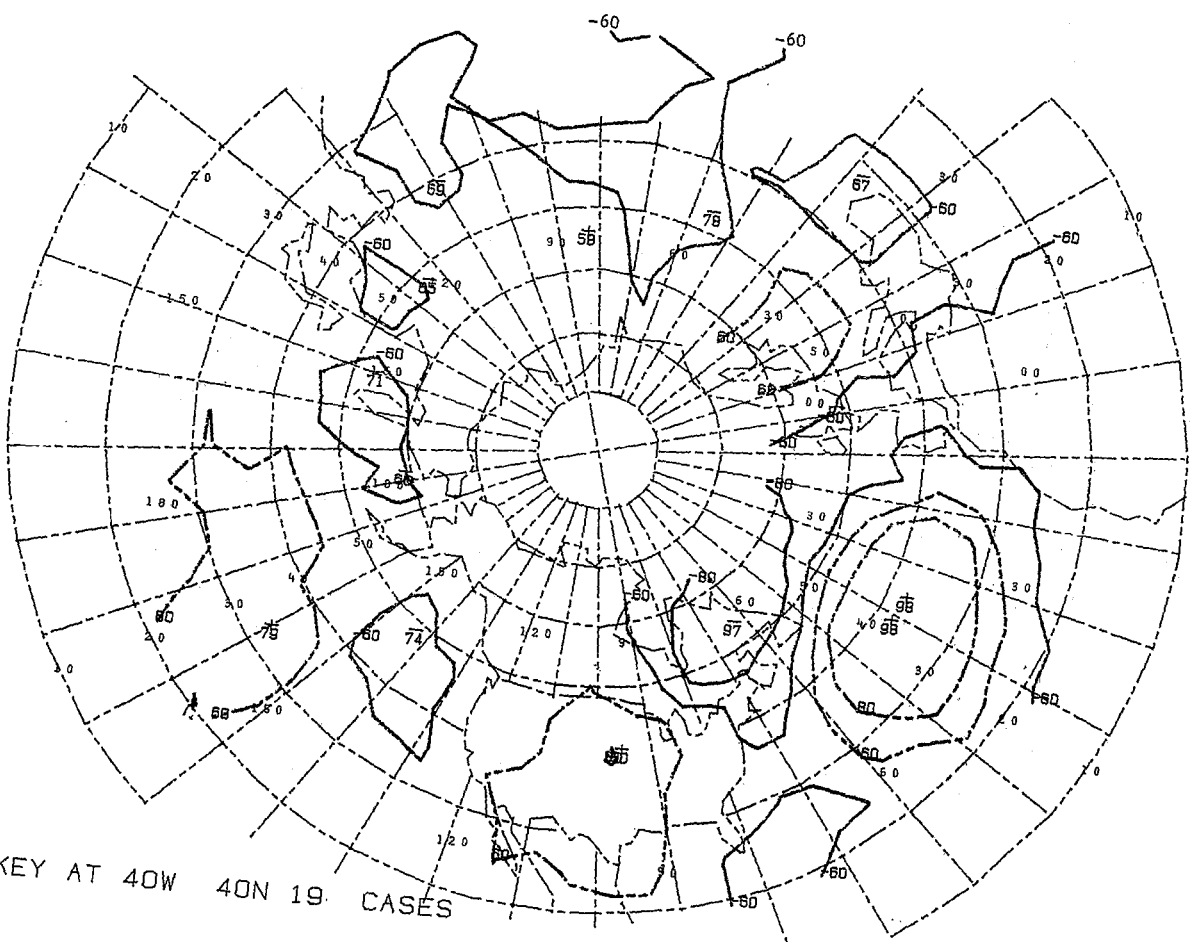
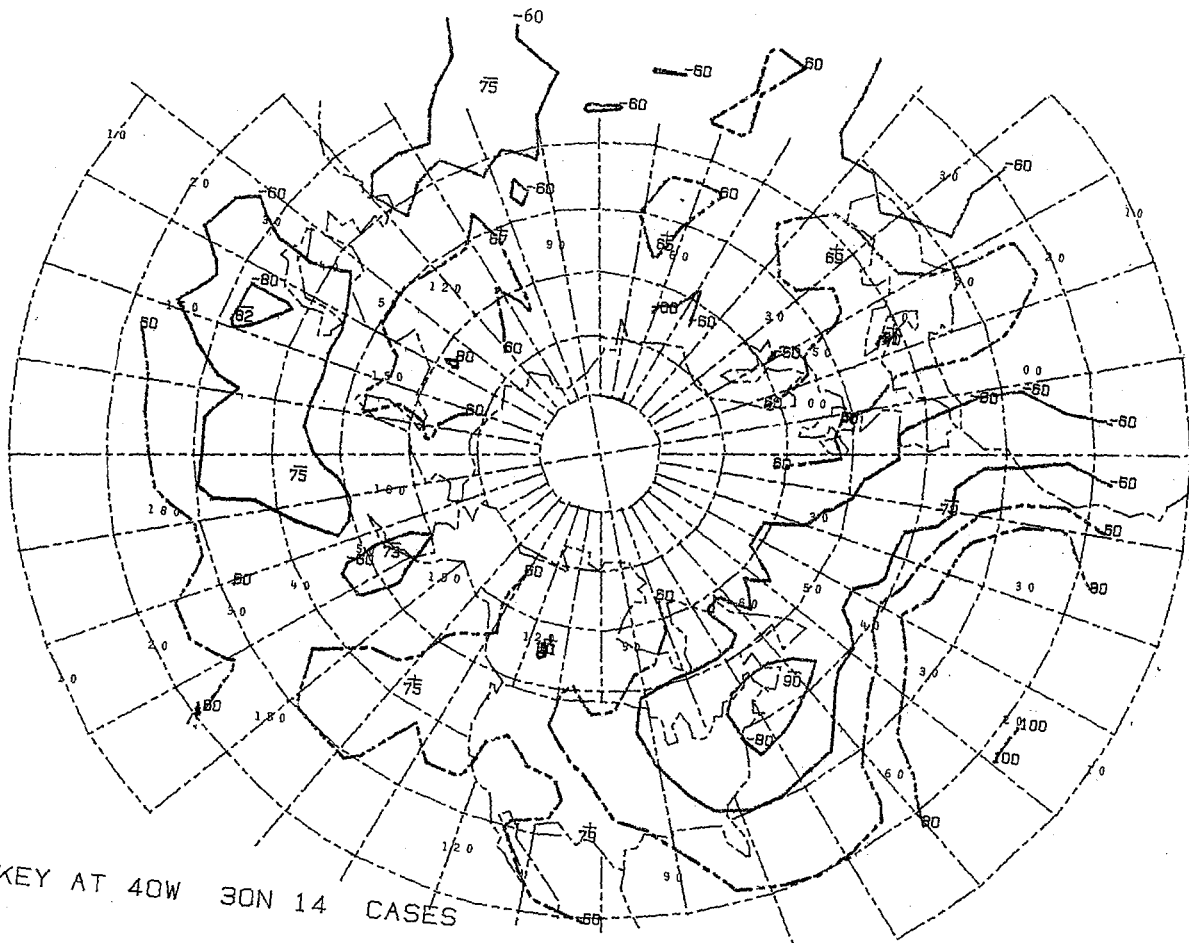

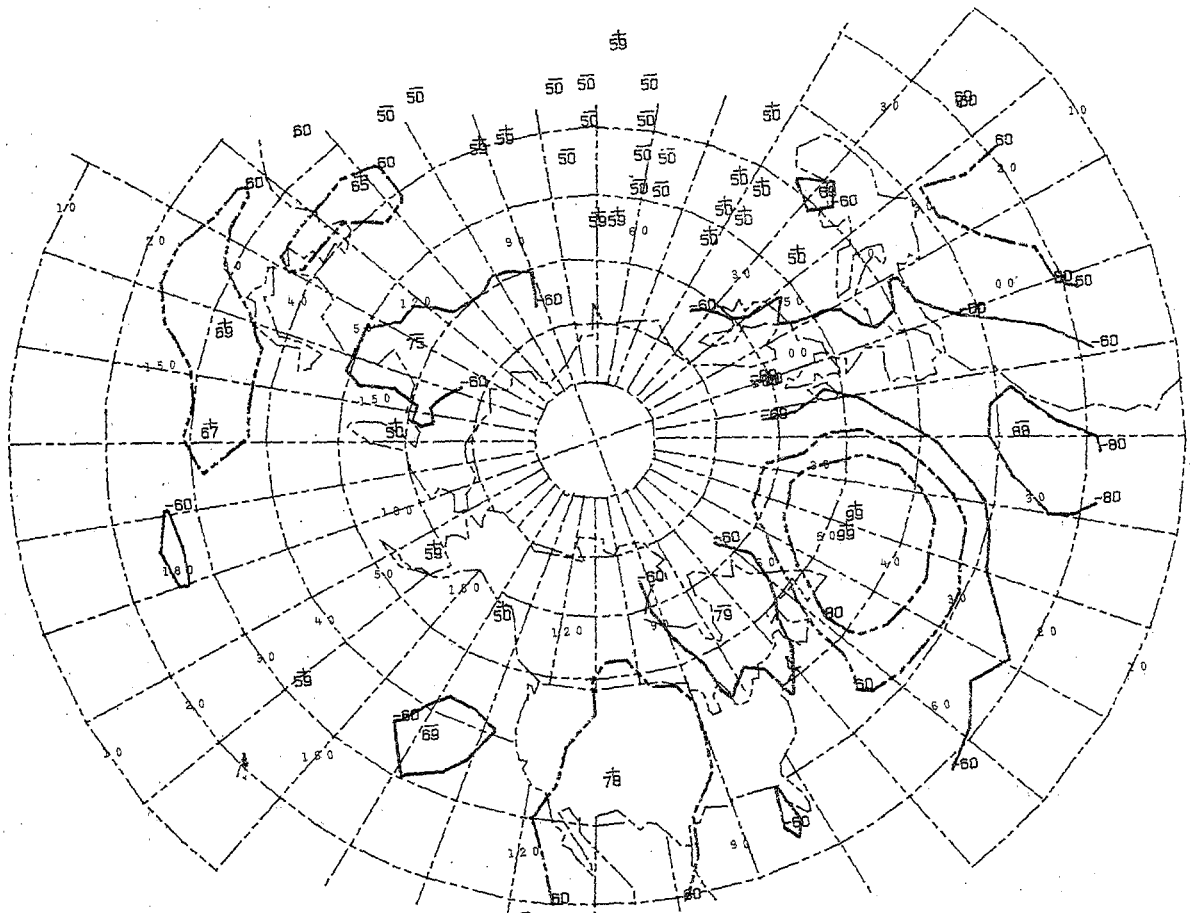

+ KEY AT 40W 50N 22 CASES

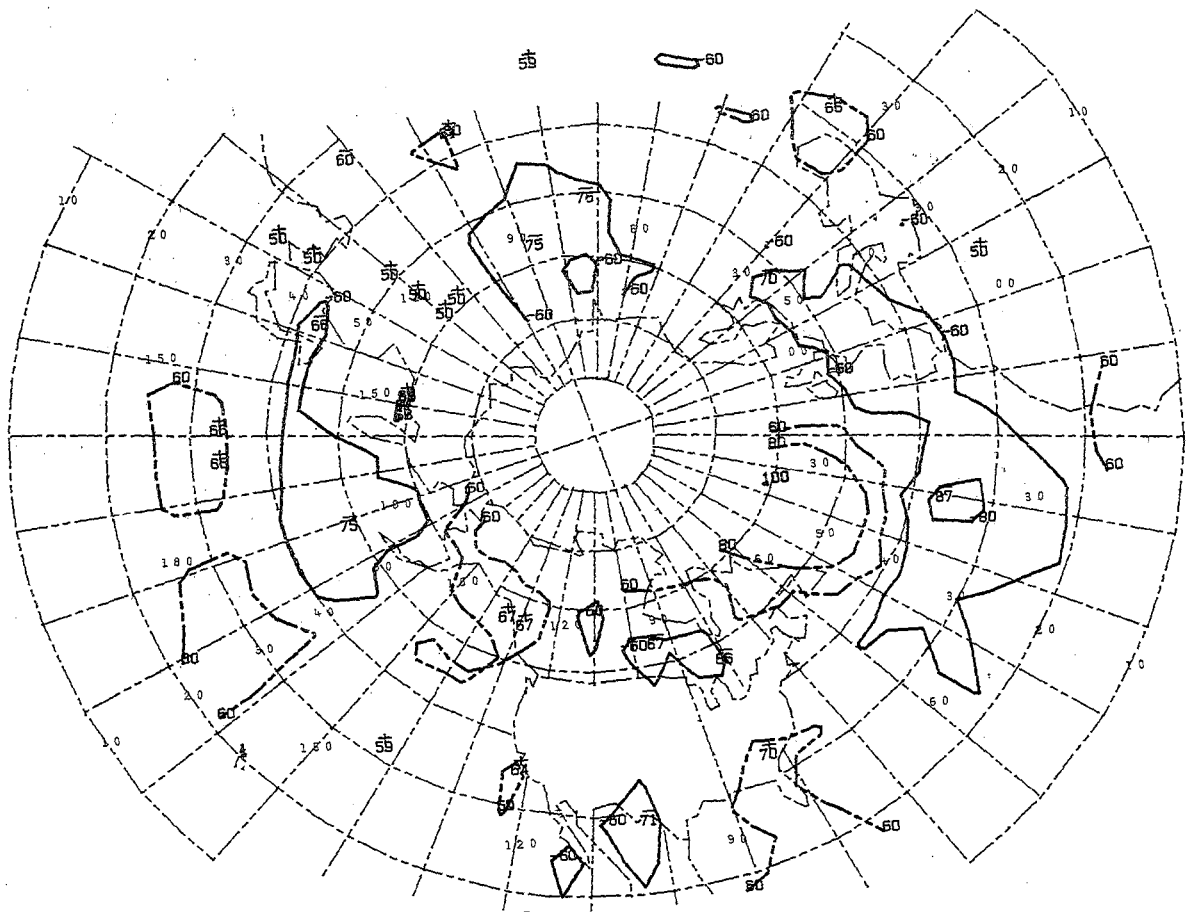

+ KEY AT 40W 60N 17 CASES

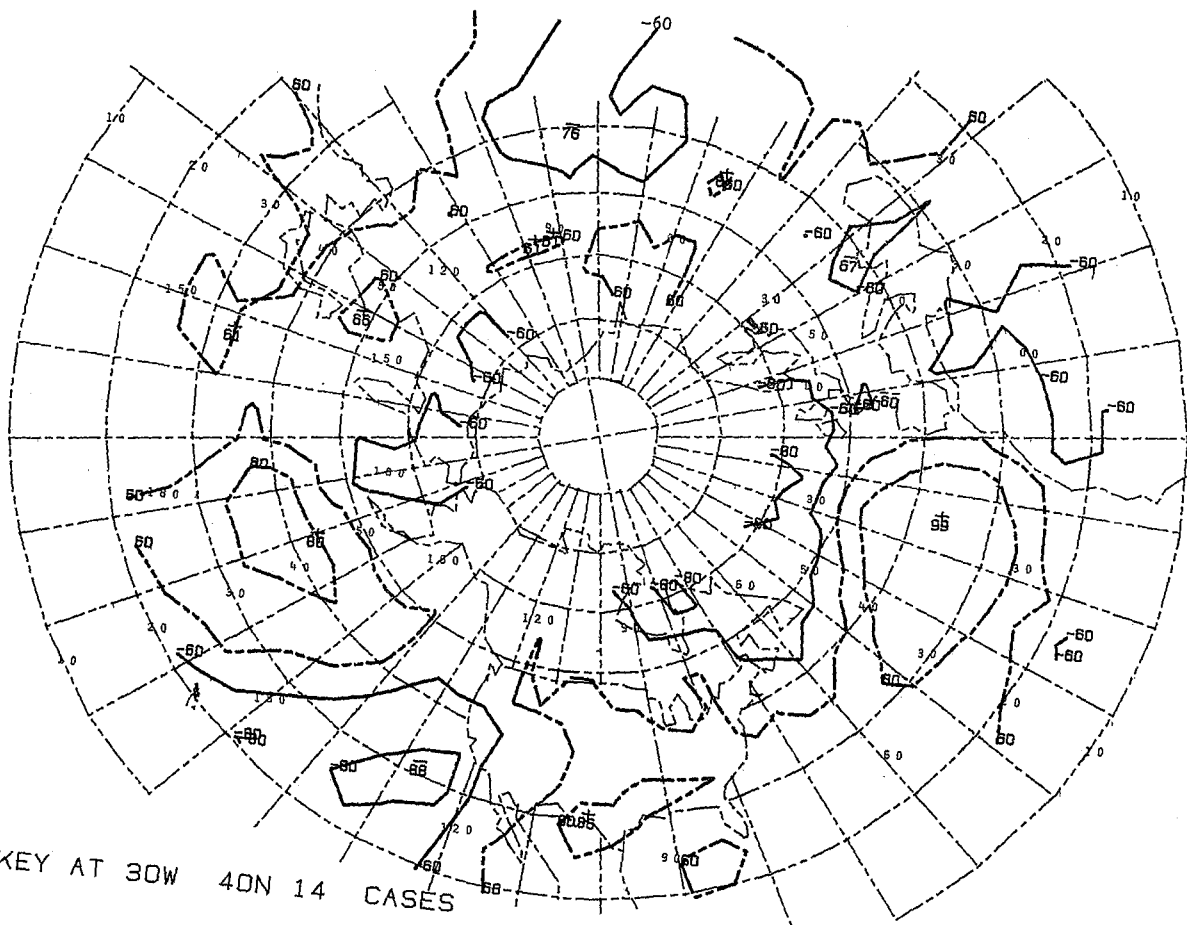
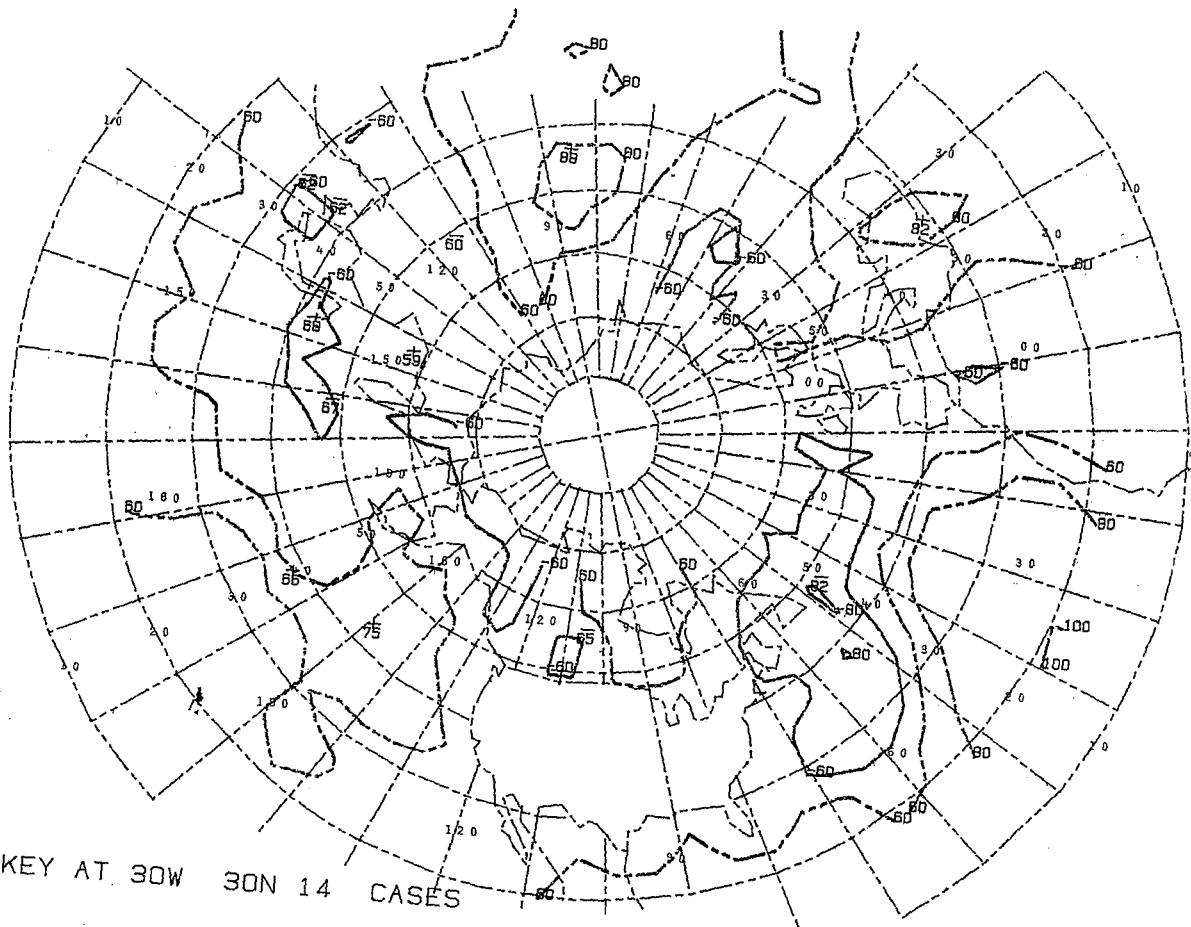

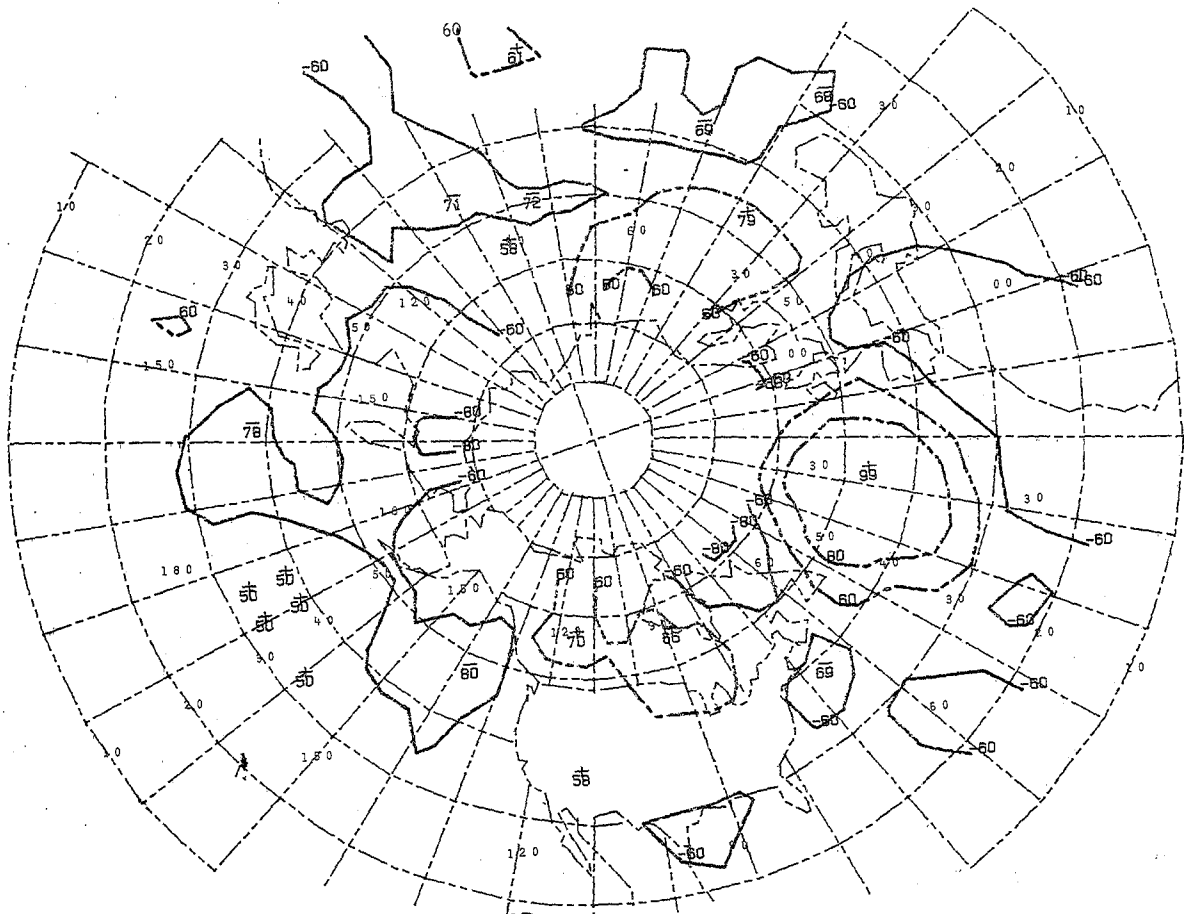

+ KEY AT 30W 50N 19 CASES

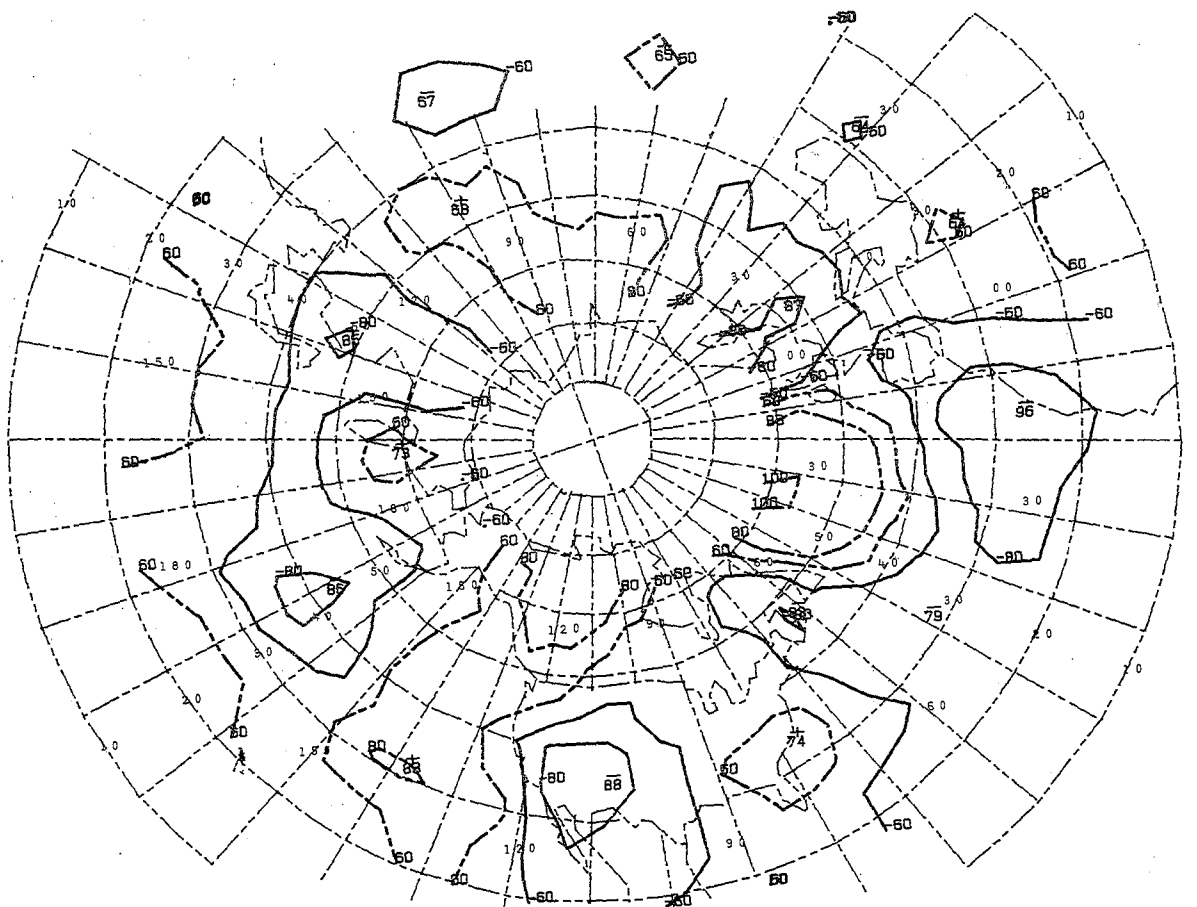

+ KEY AT 30W 60N 10 CASES

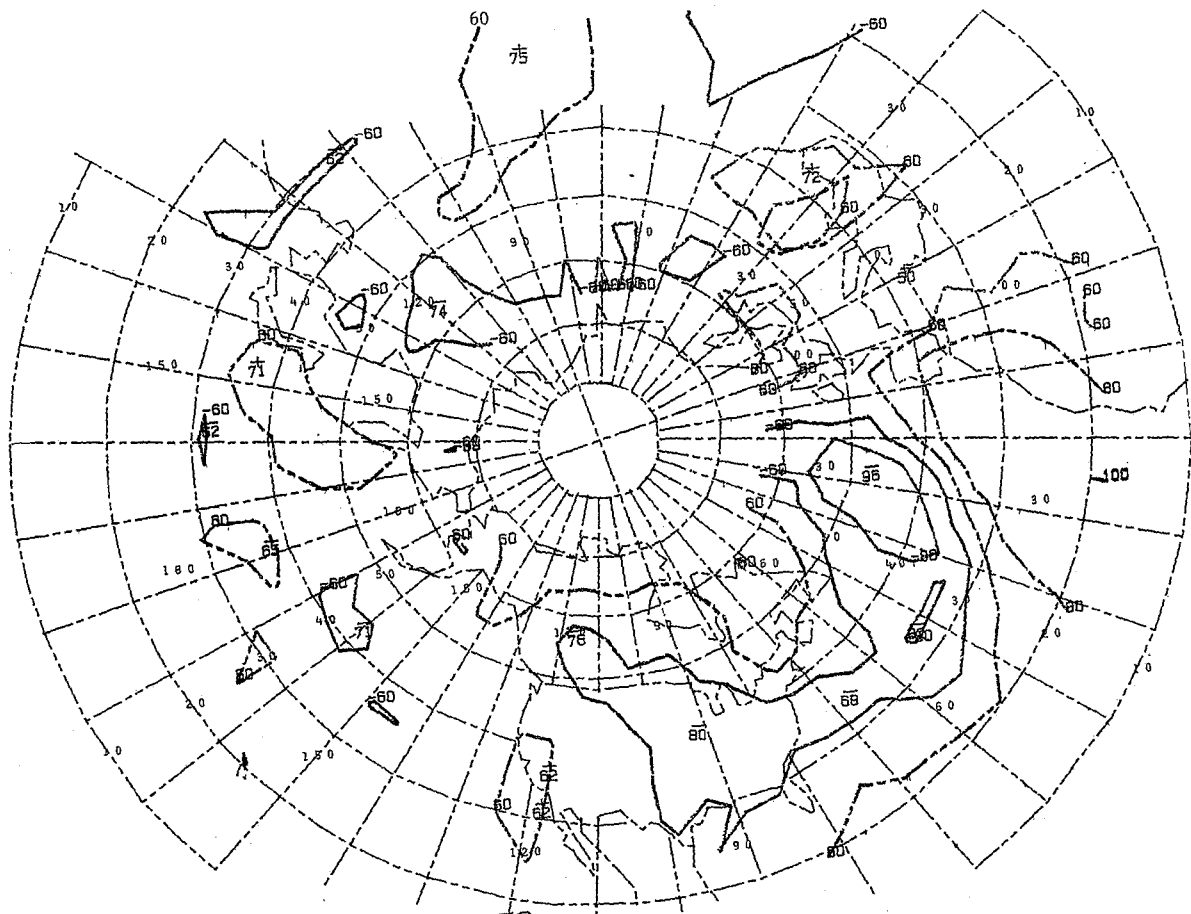

+ KEY AT 20W 30N 14 CASES

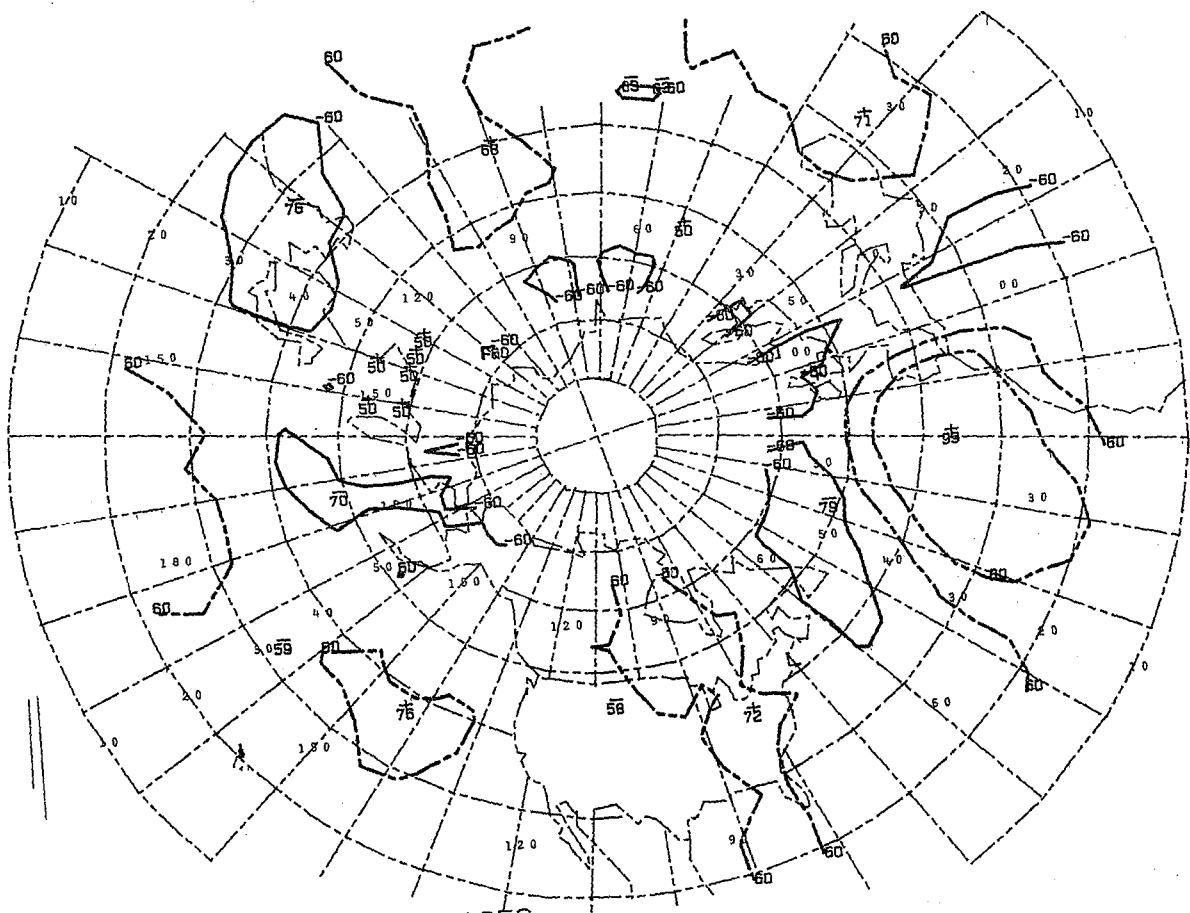

+ KEY AT 20W 40N 27 CASES

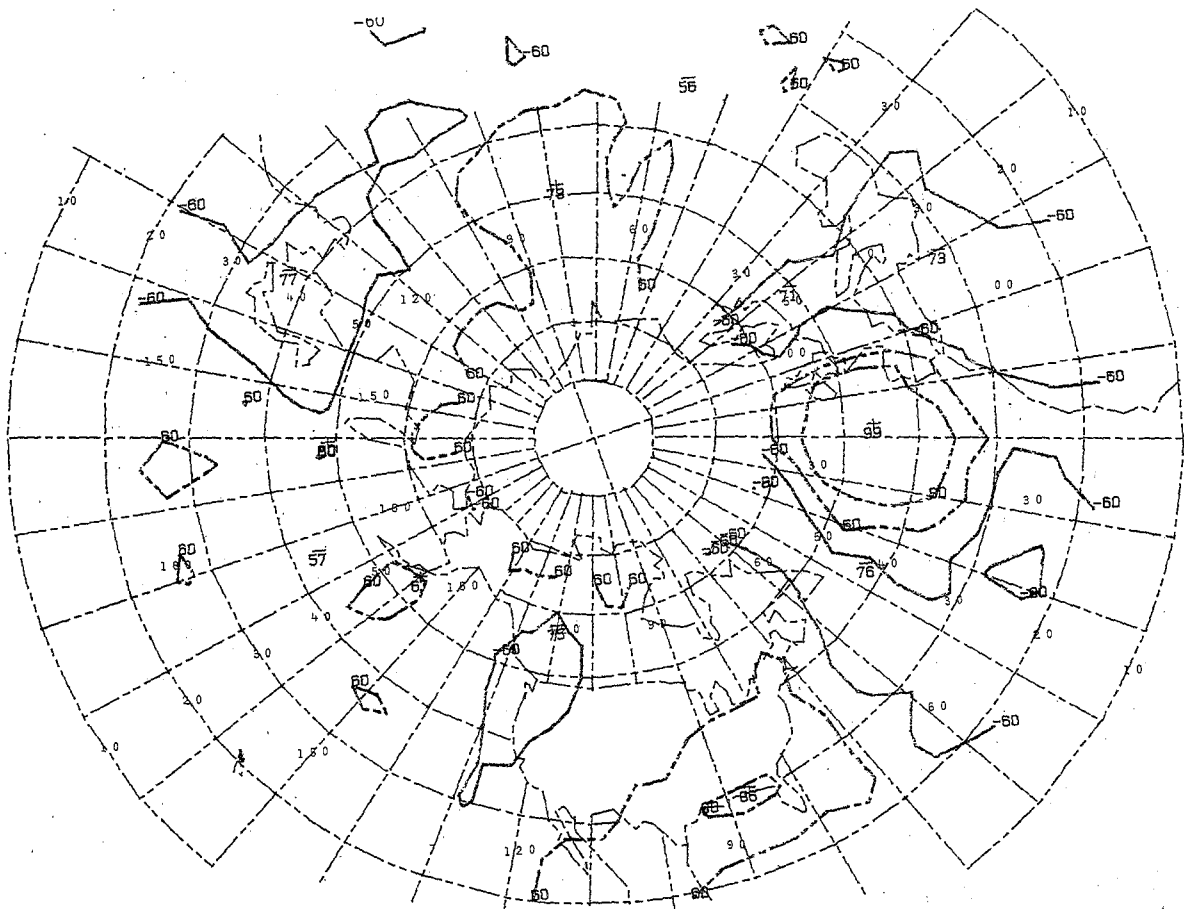

+ KEY AT 20W 50N 15 CASES

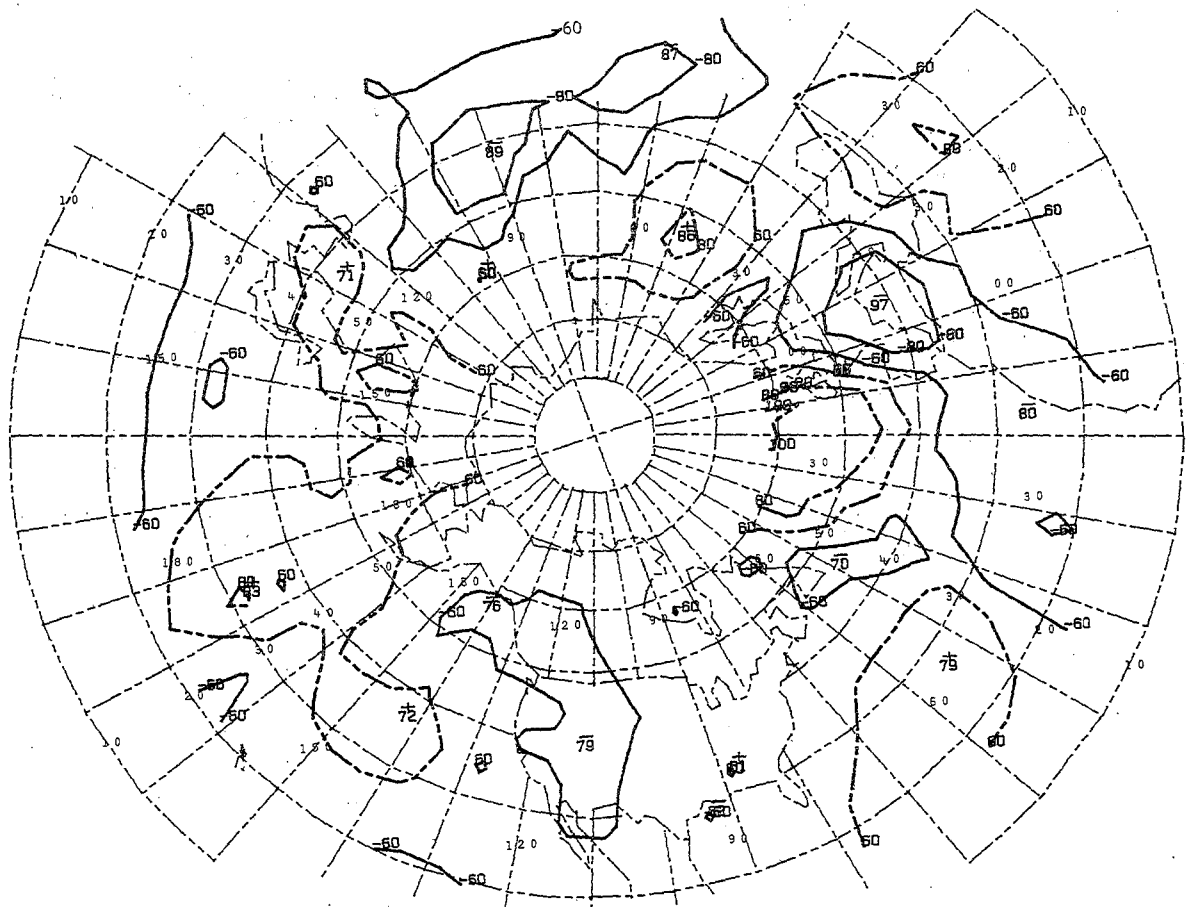

+ KEY AT 20W 60N 12 CASES

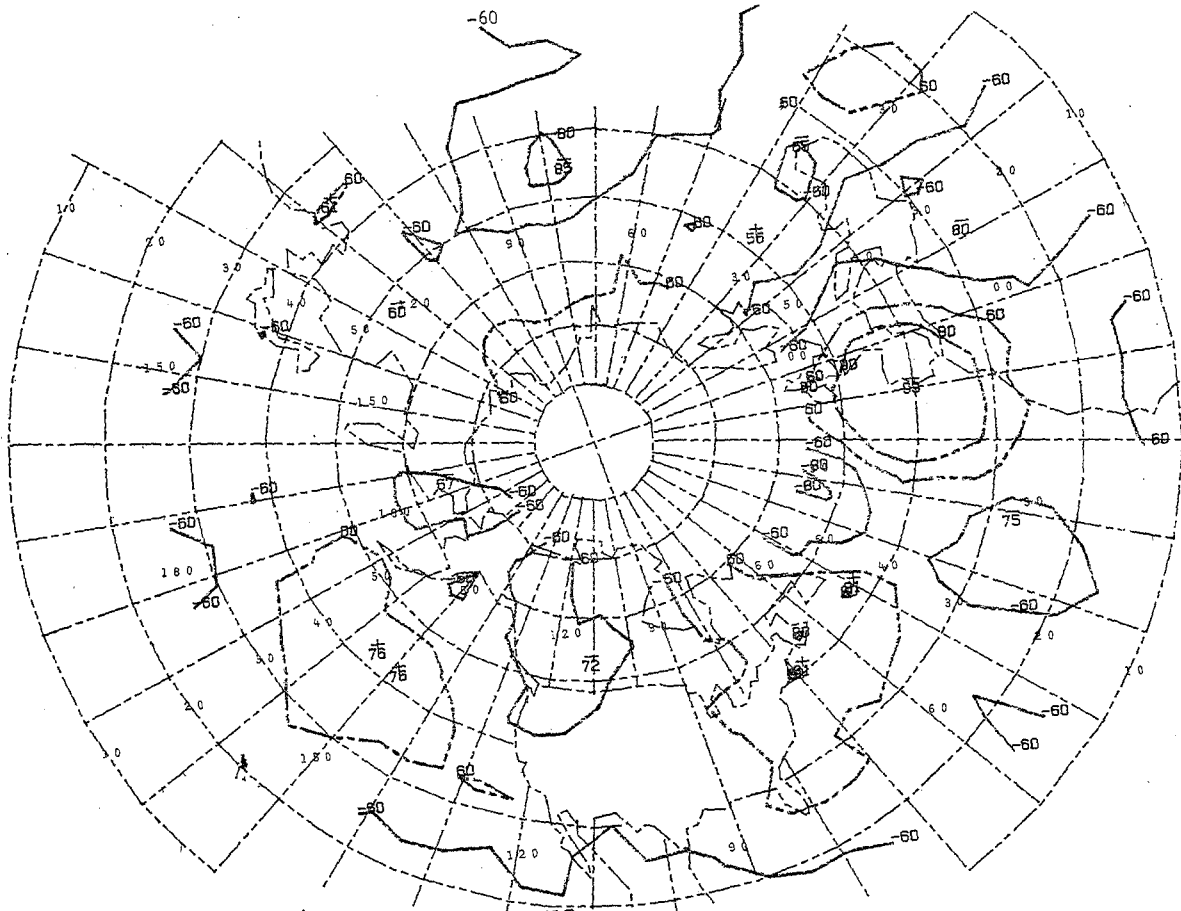

+ KEY AT 10W 50N 20 CASES

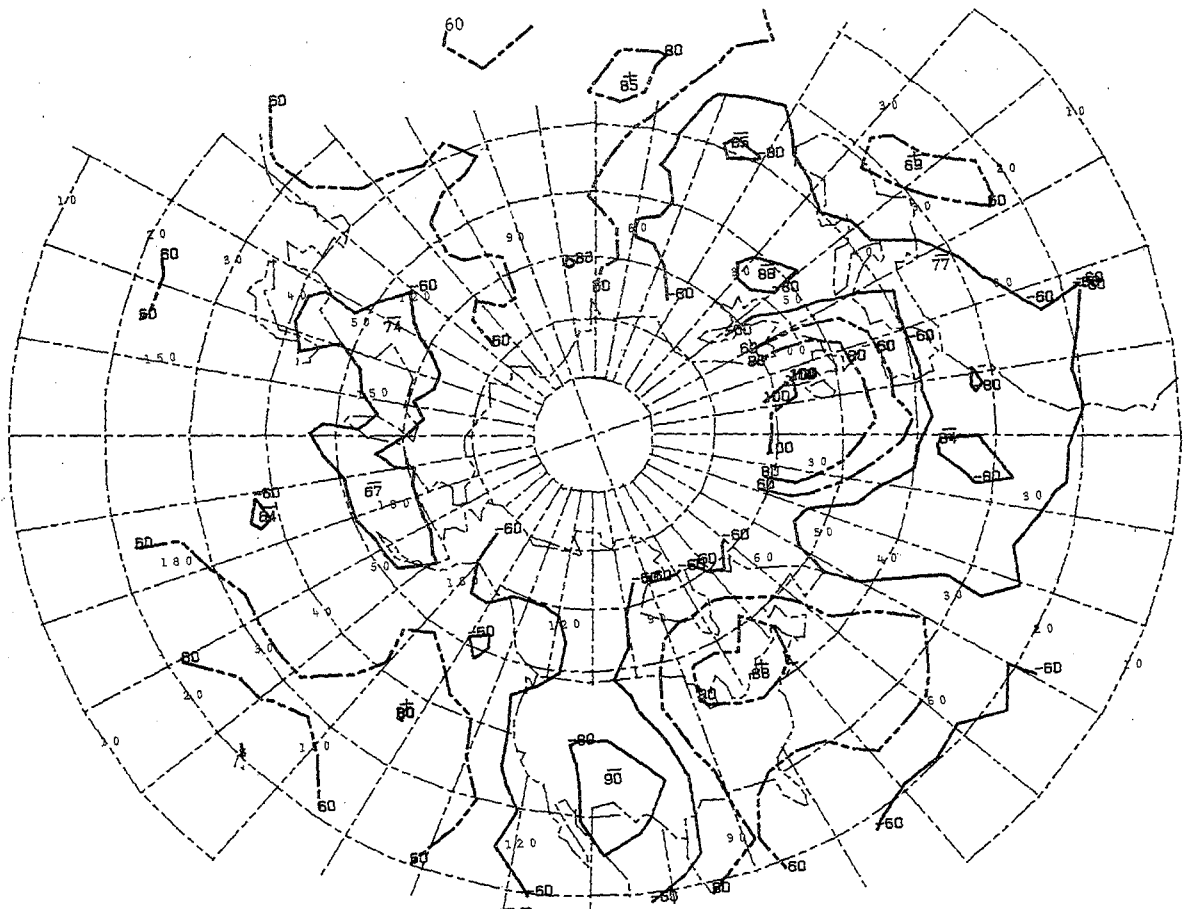

+ KEY AT 10W 60N 13 CASES

SPRING NEGATIVE

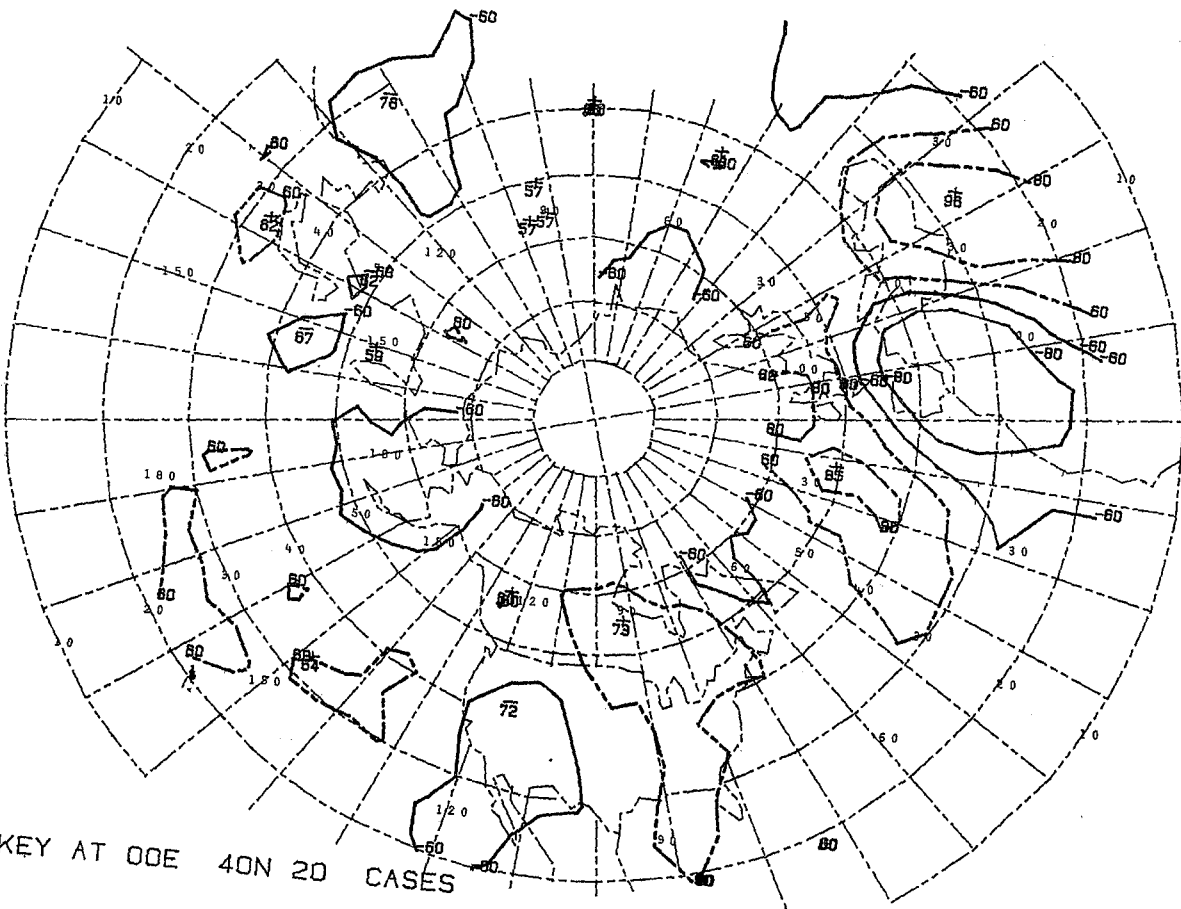
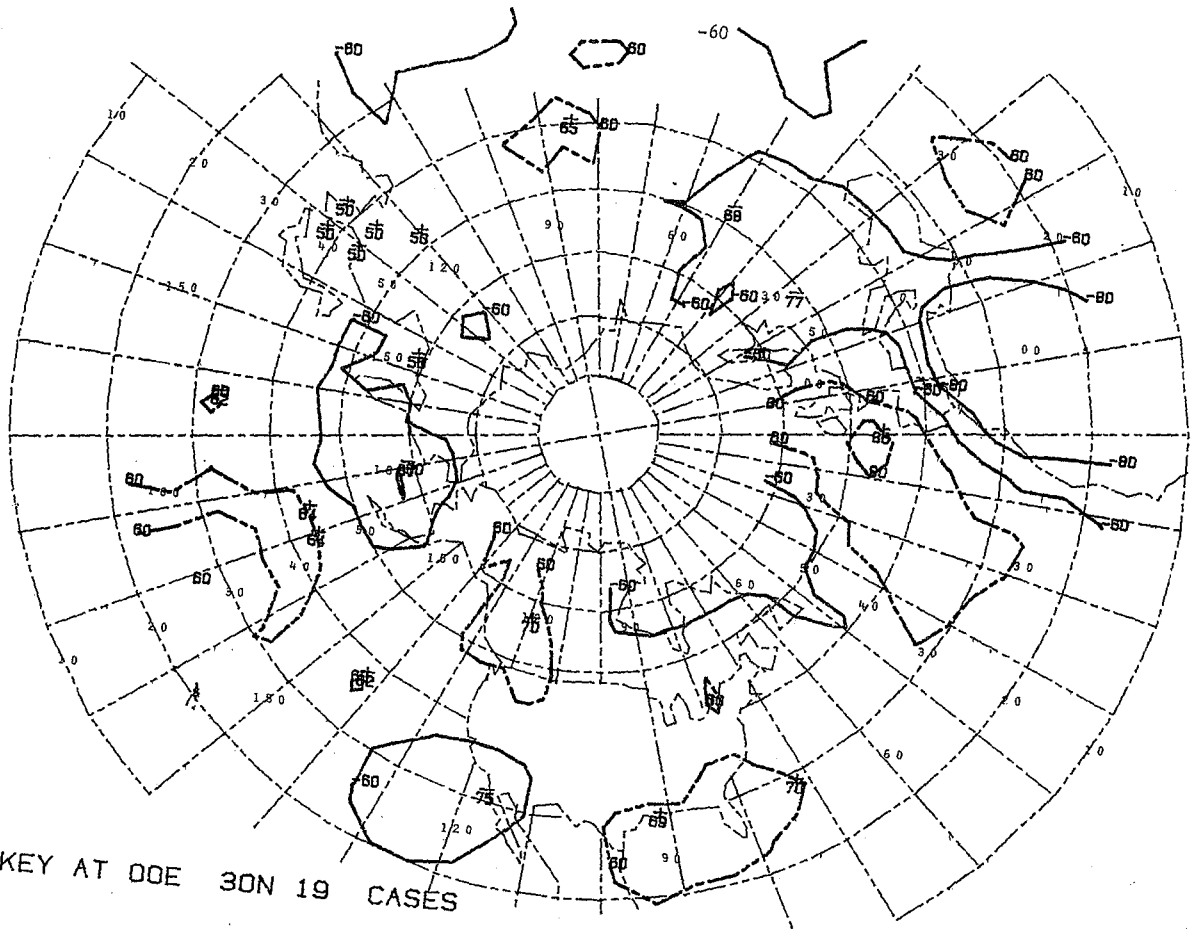

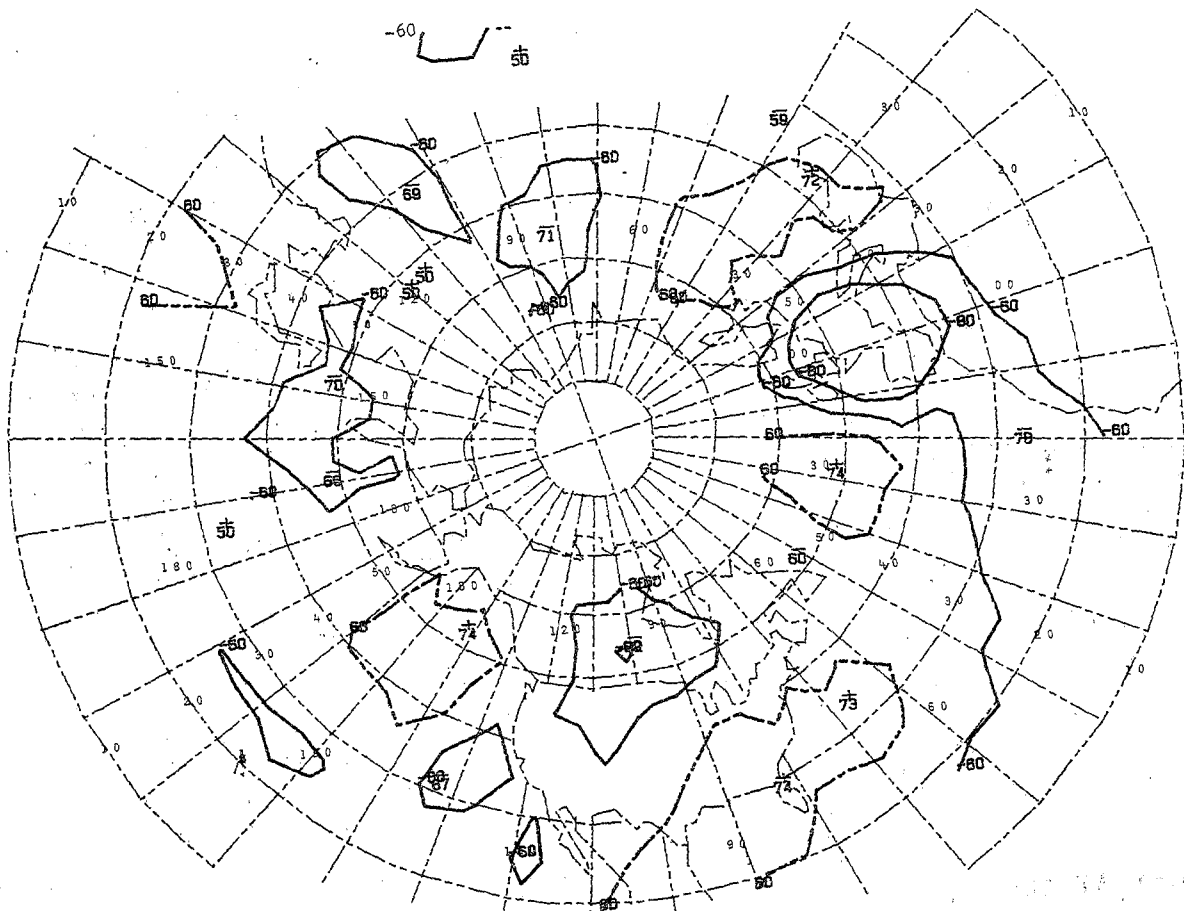

- KEY AT OOE 50N 22 CASES

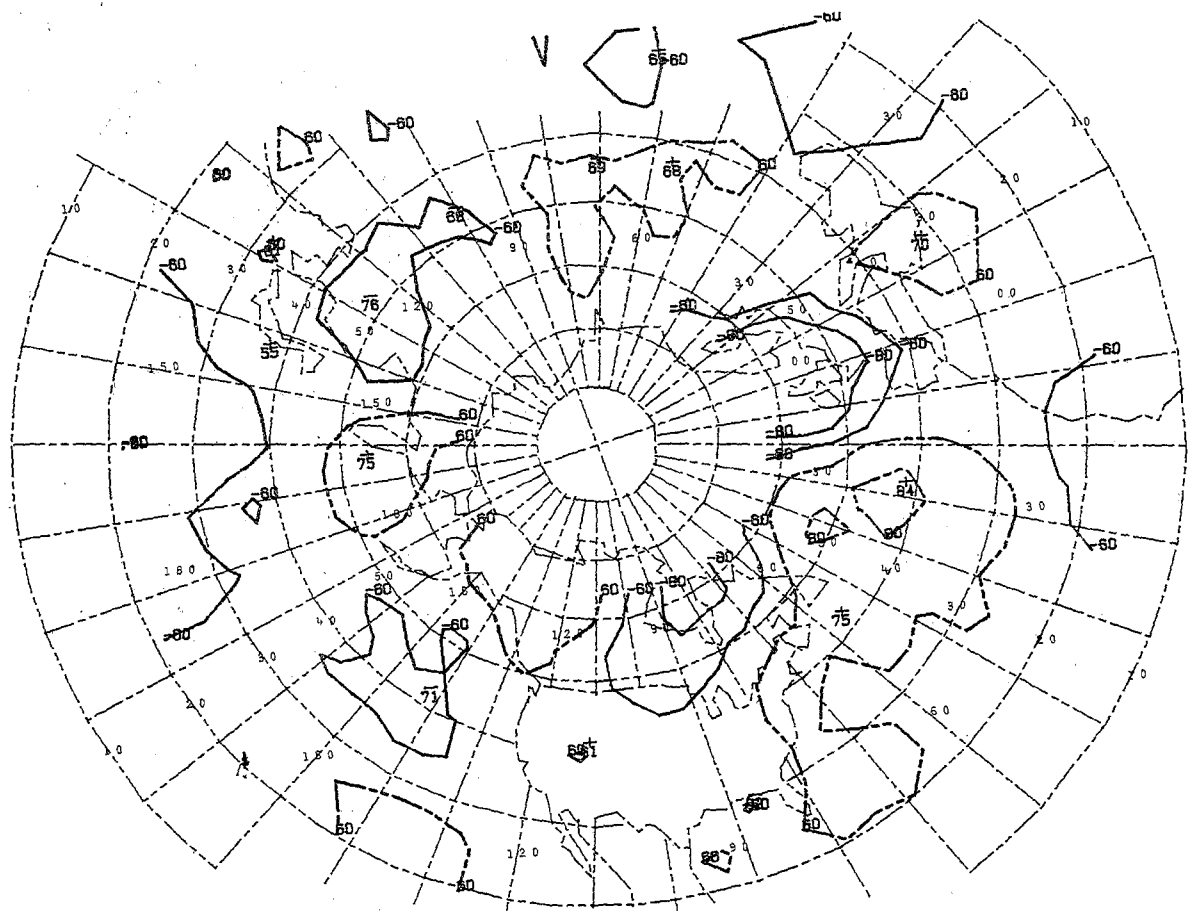

- KEY AT OOE 60N 15 CASES

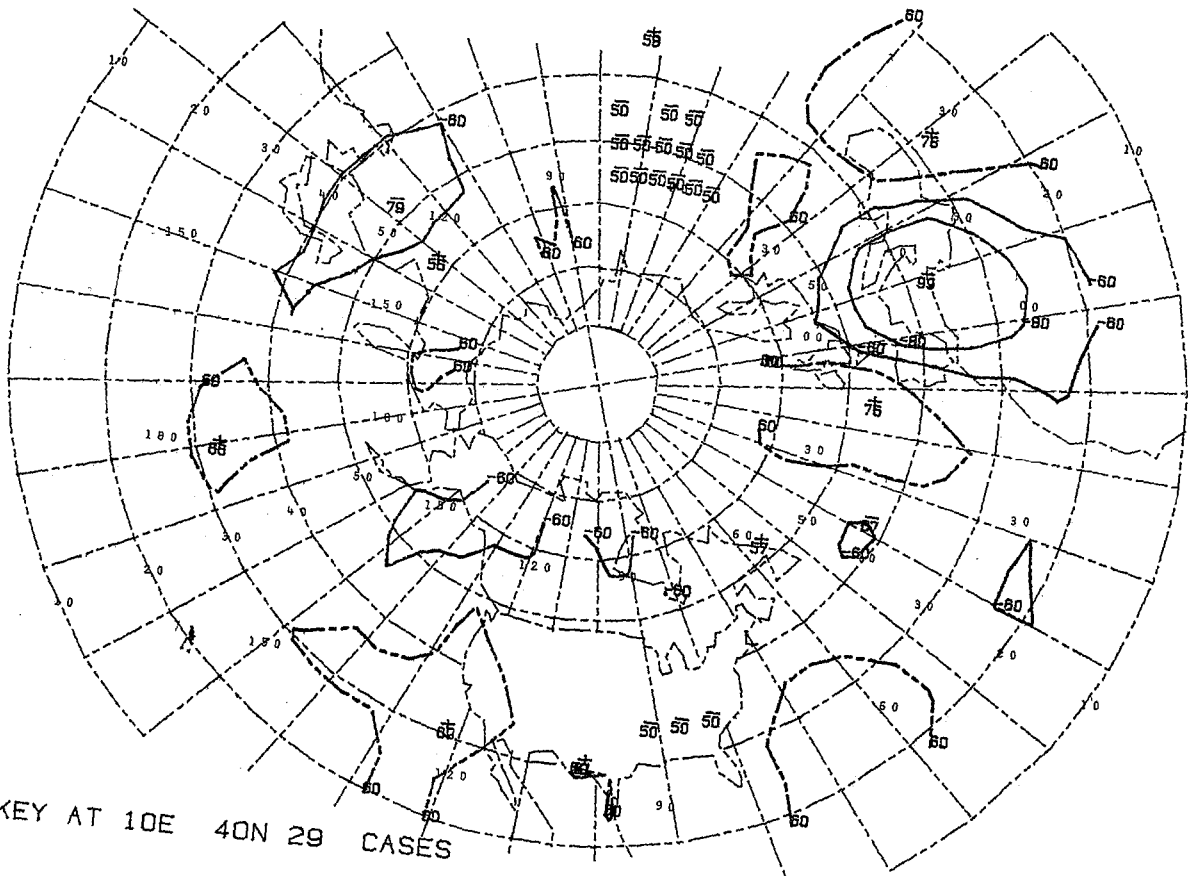
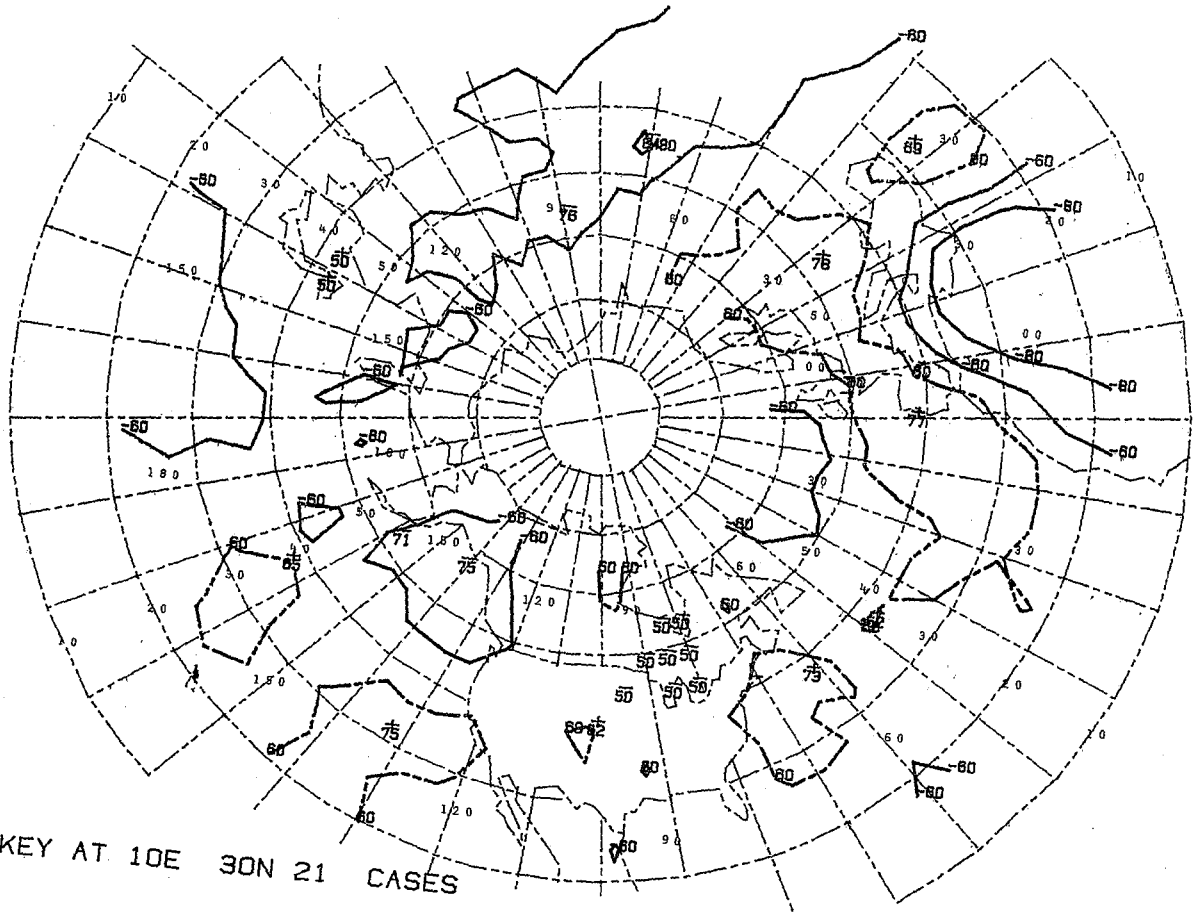

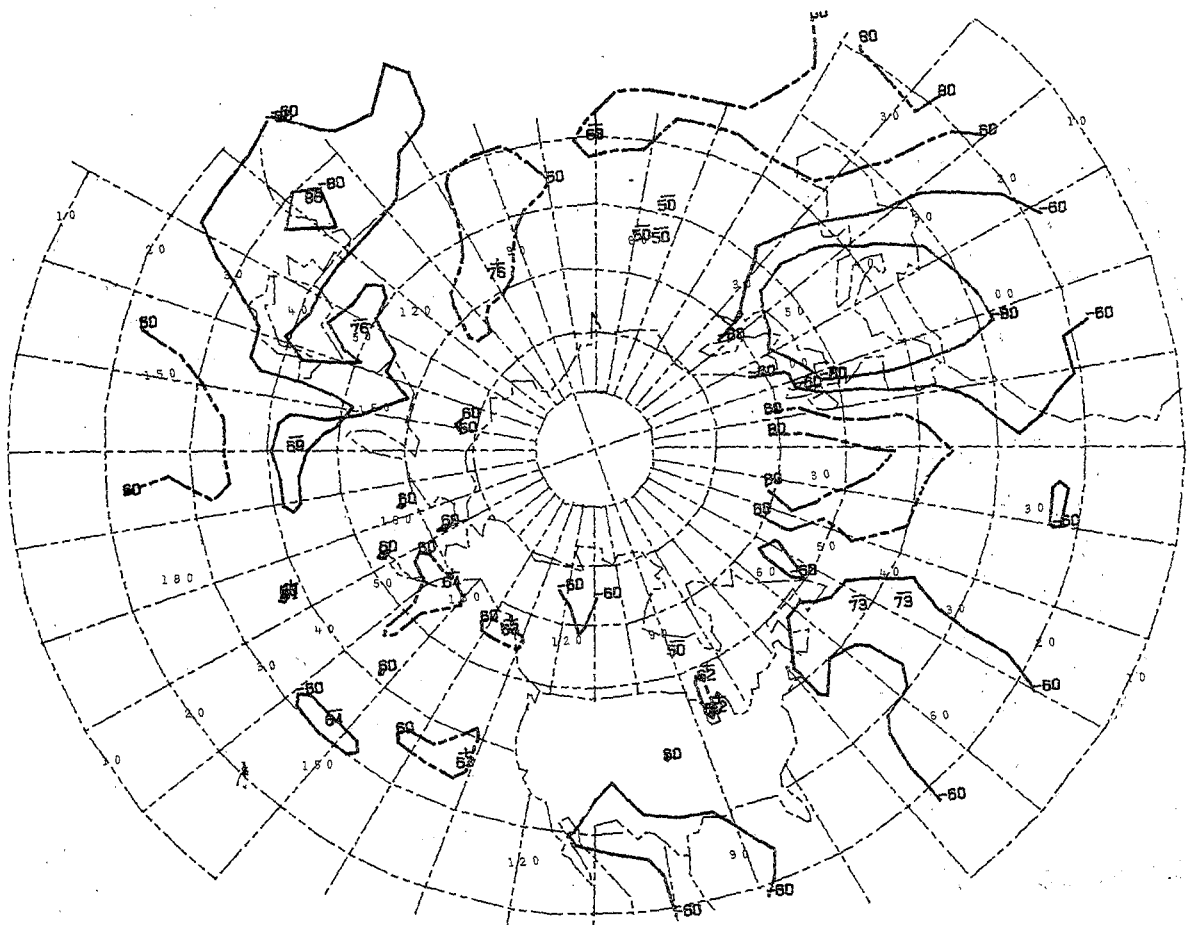

- KEY AT 10E 50N 12 CASES

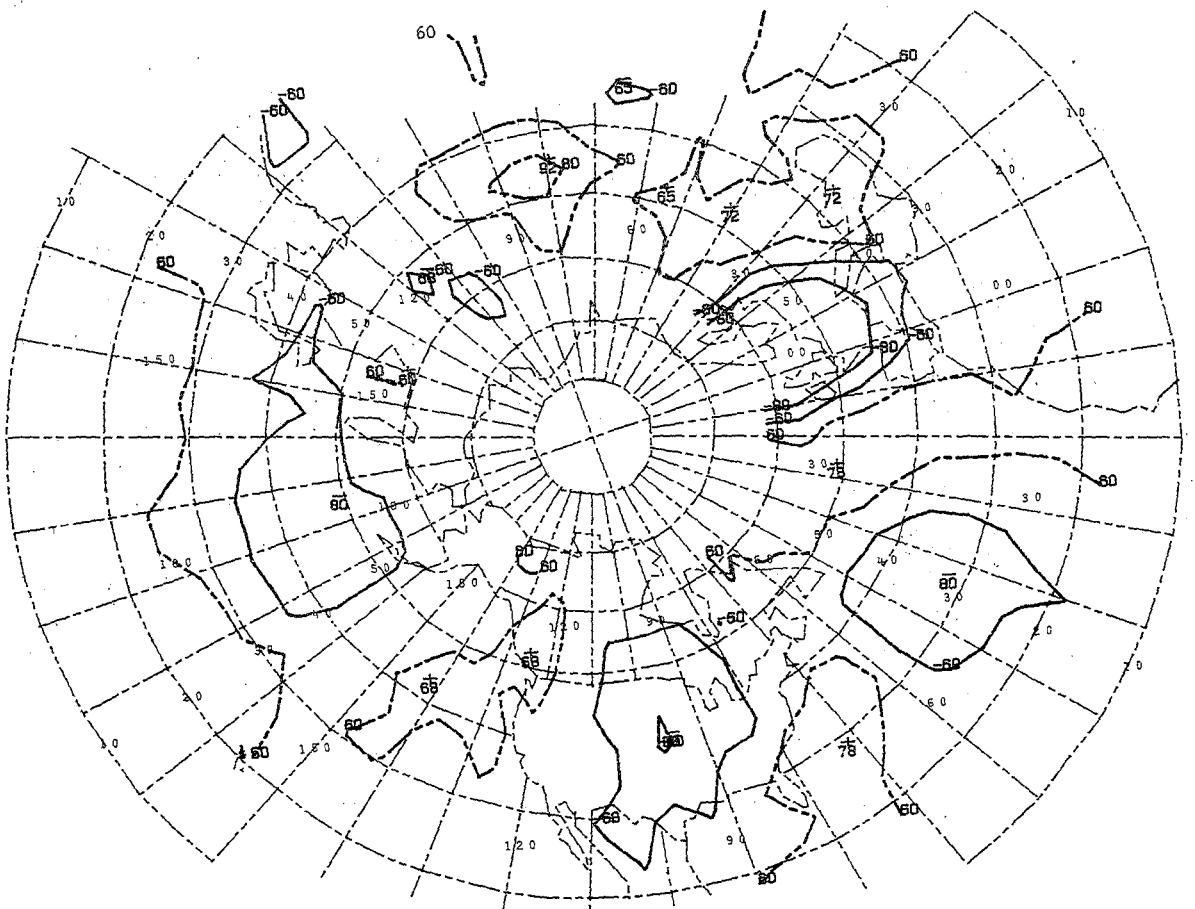

- KEY AT 10E 60N 17 CASES

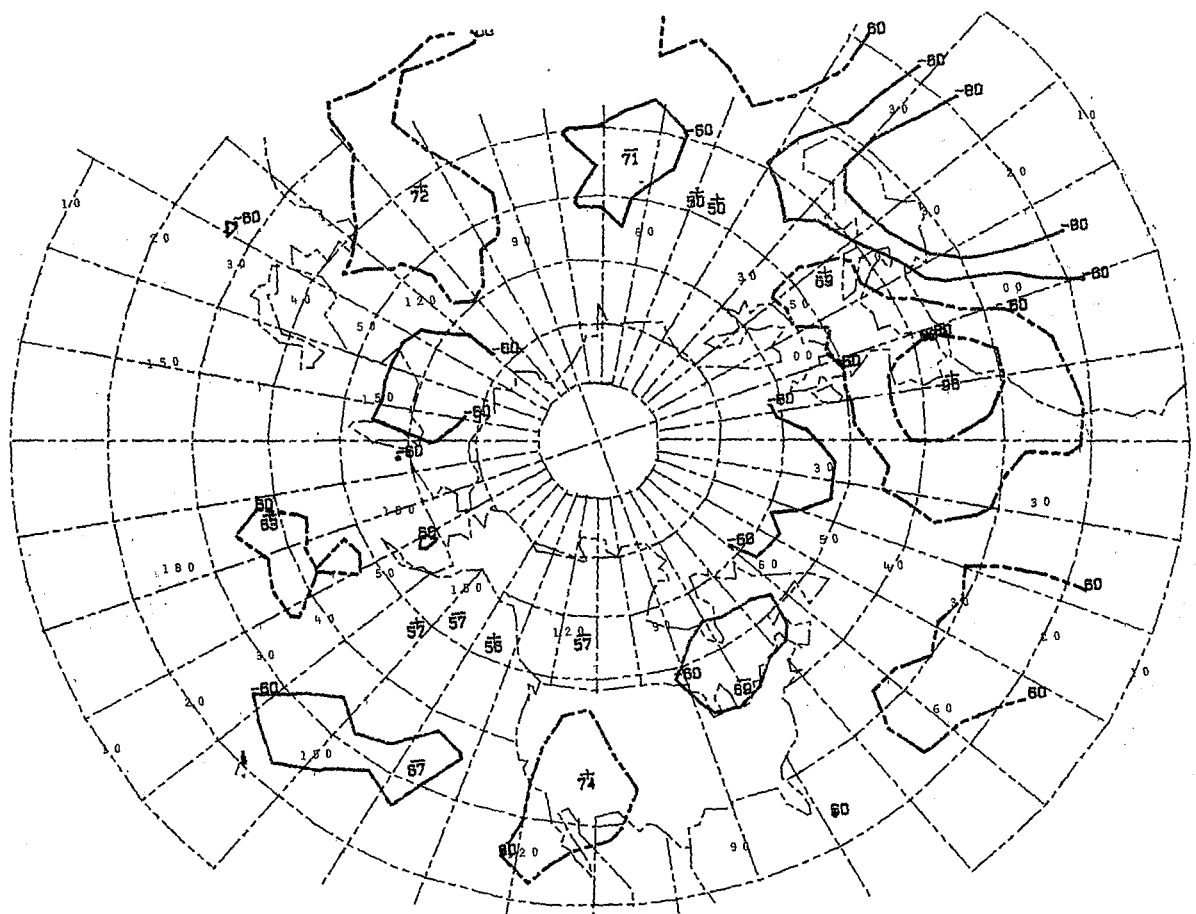

- KEY AT 20E 30N 23 CASES

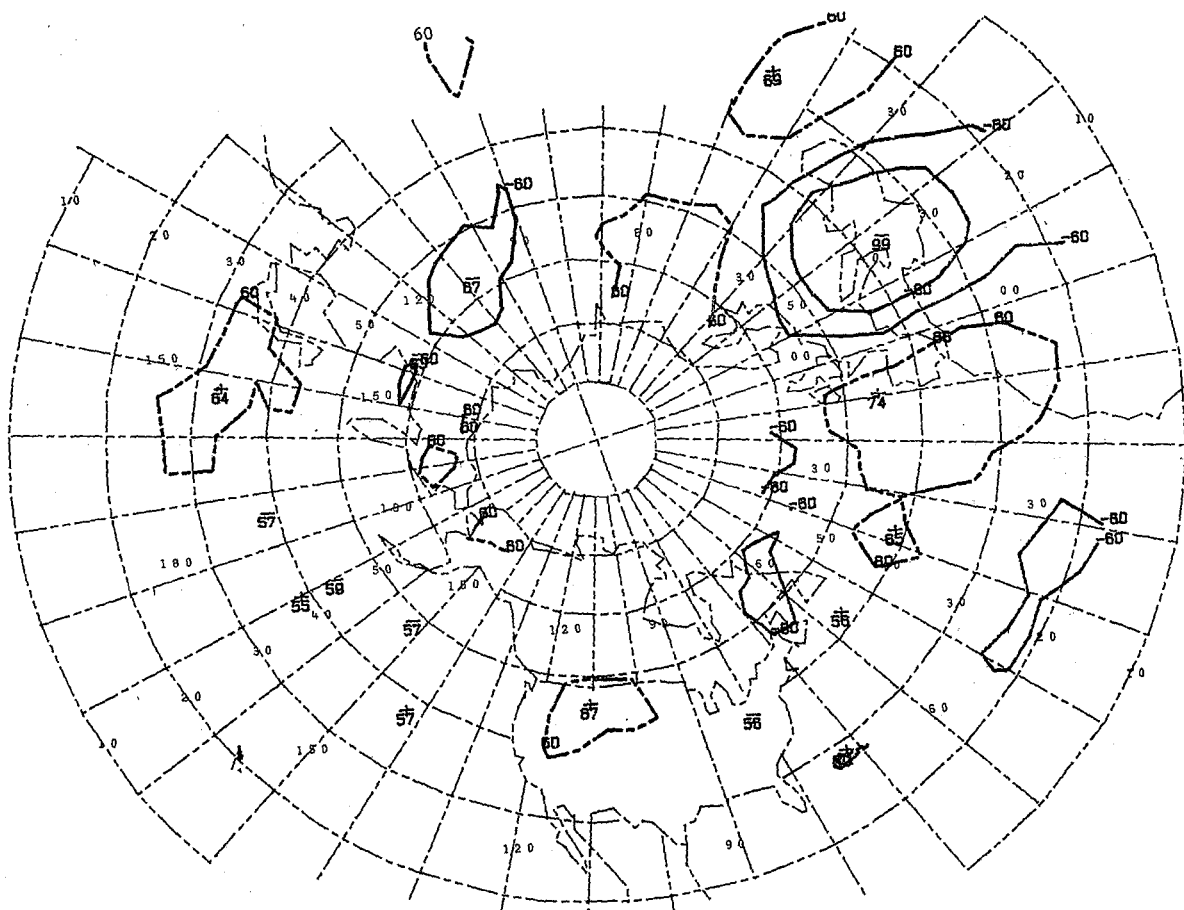

- KEY AT 20E 40N 35 CASES

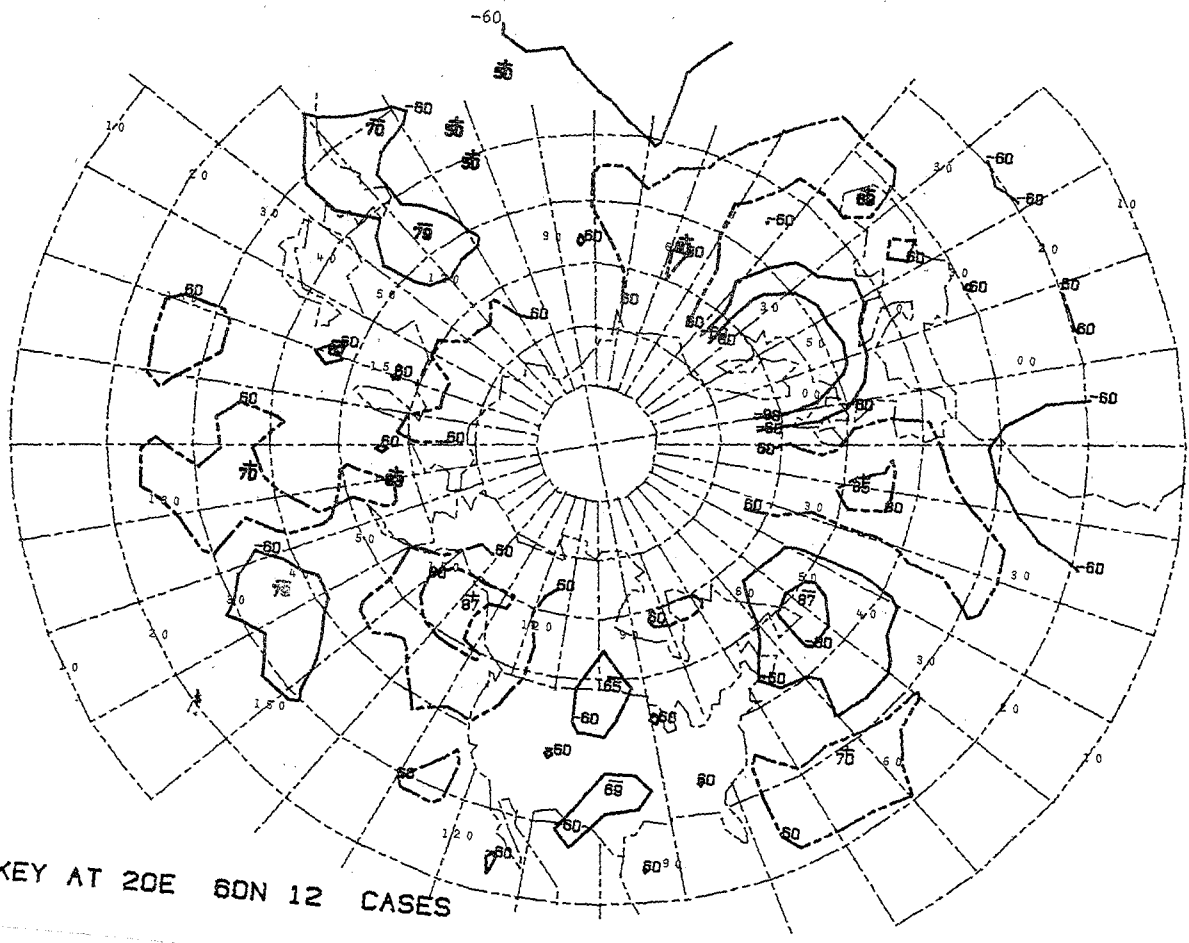
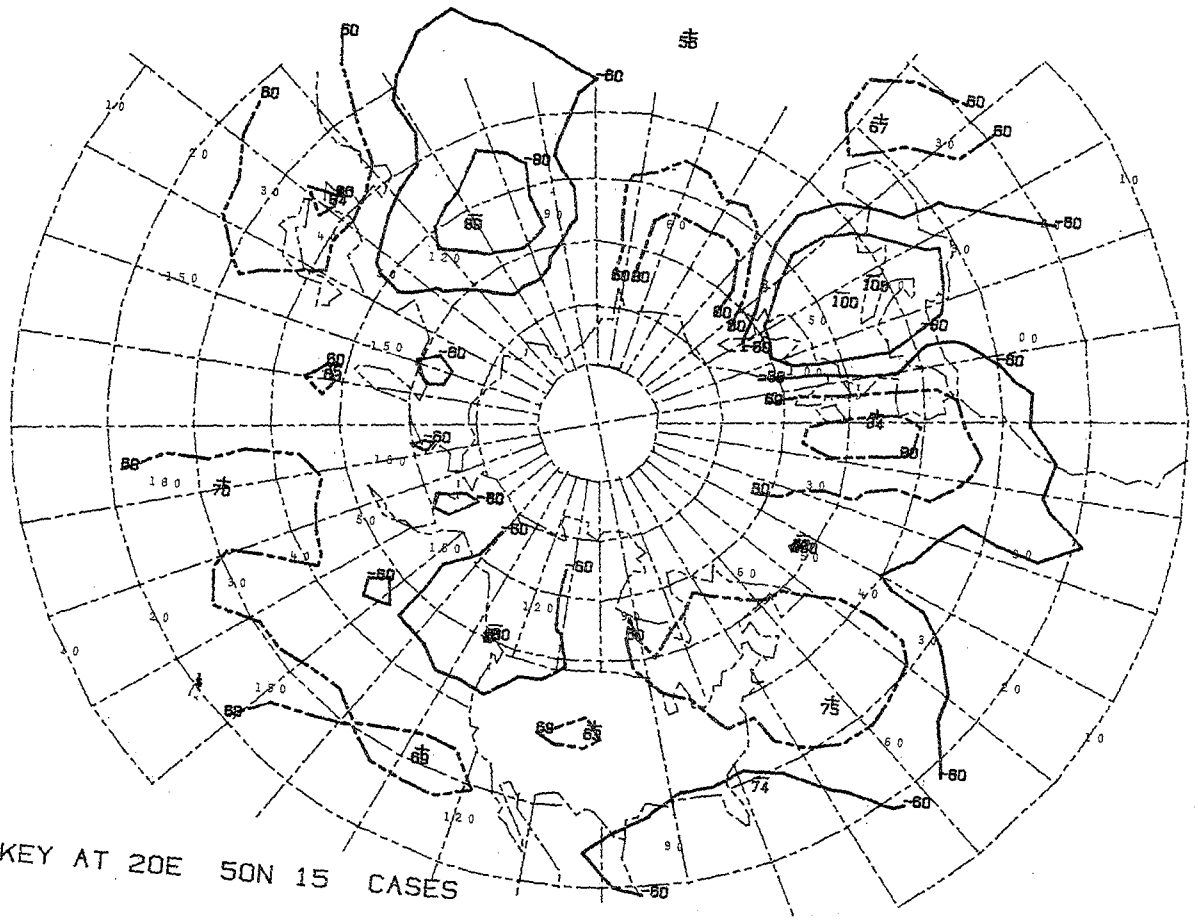

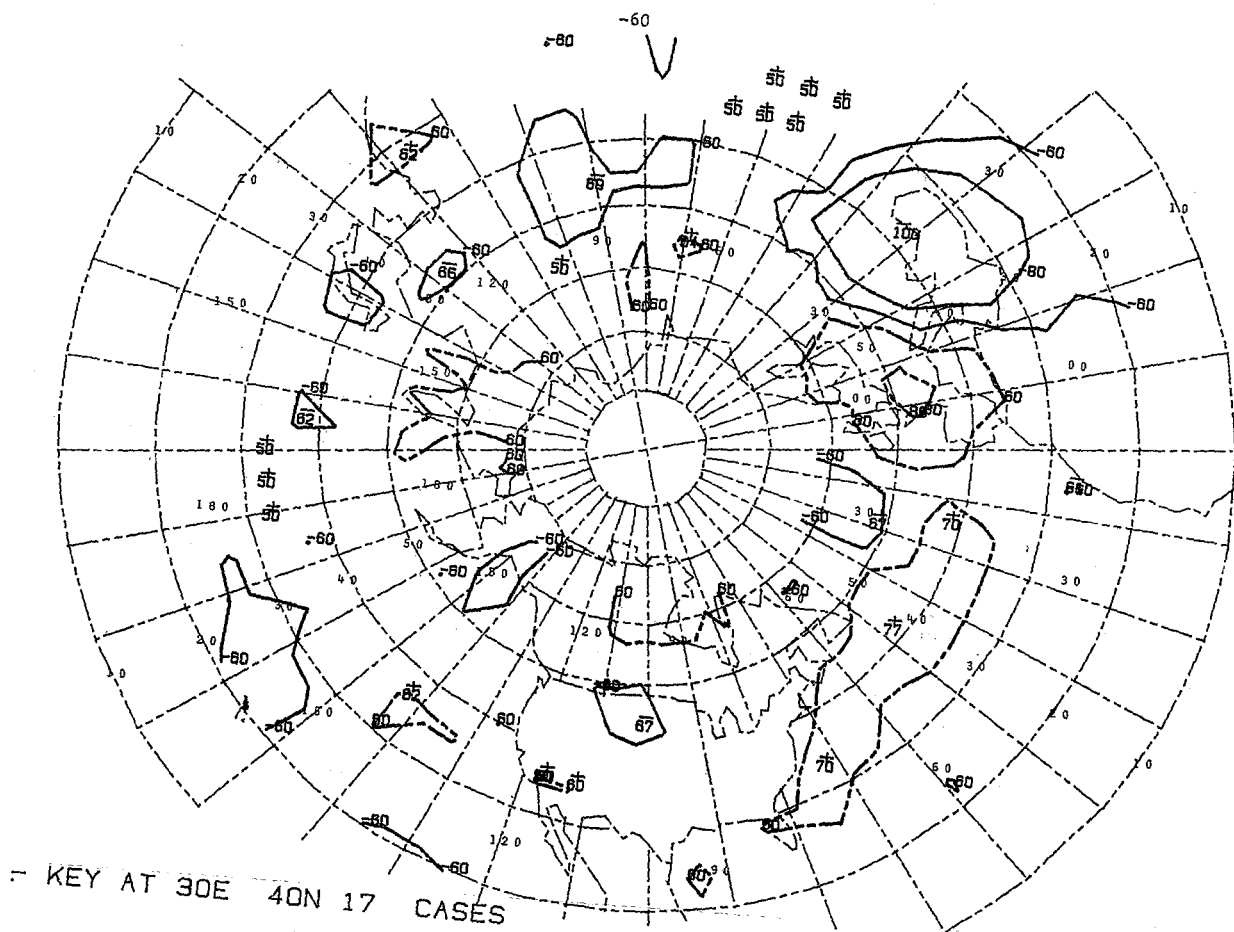
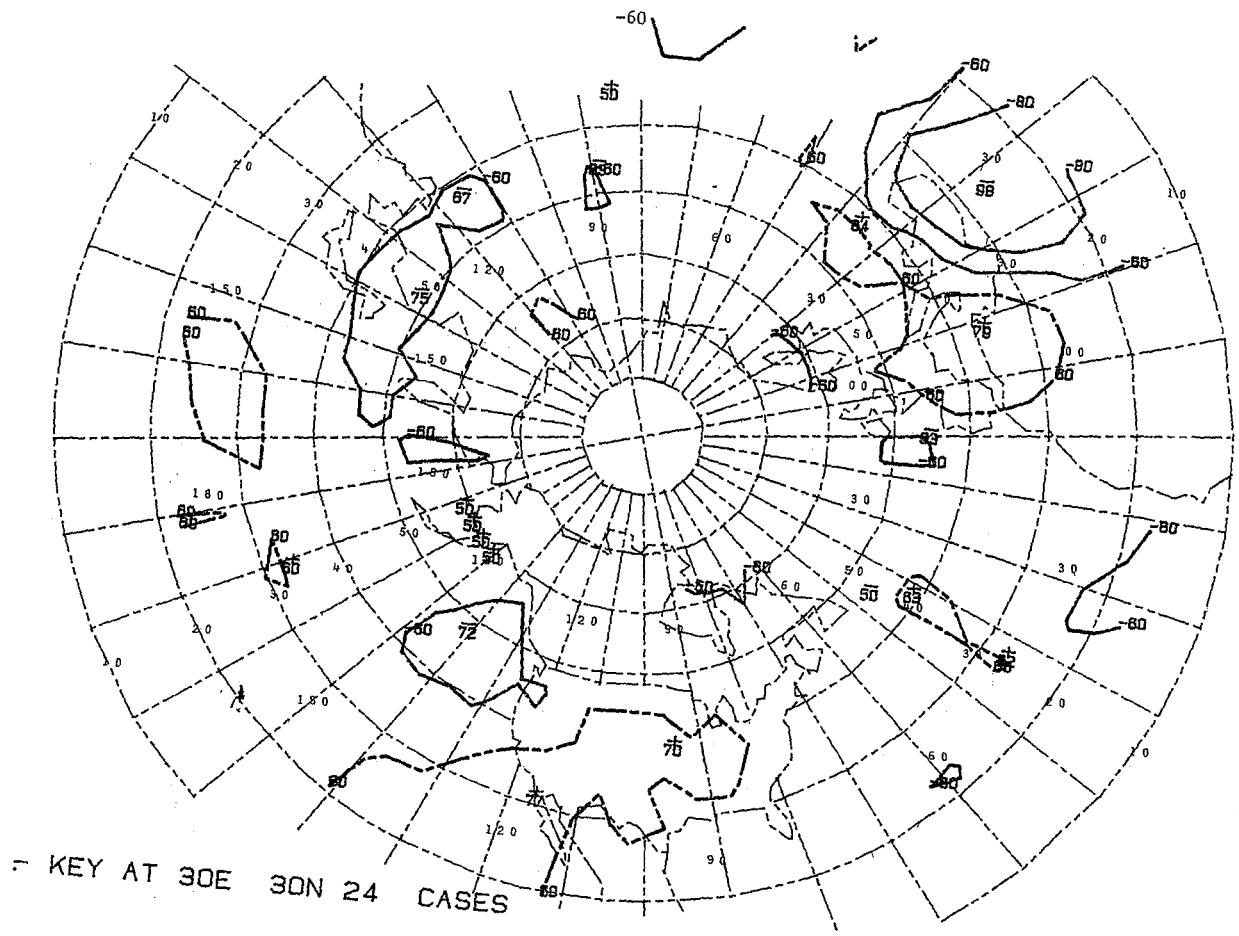

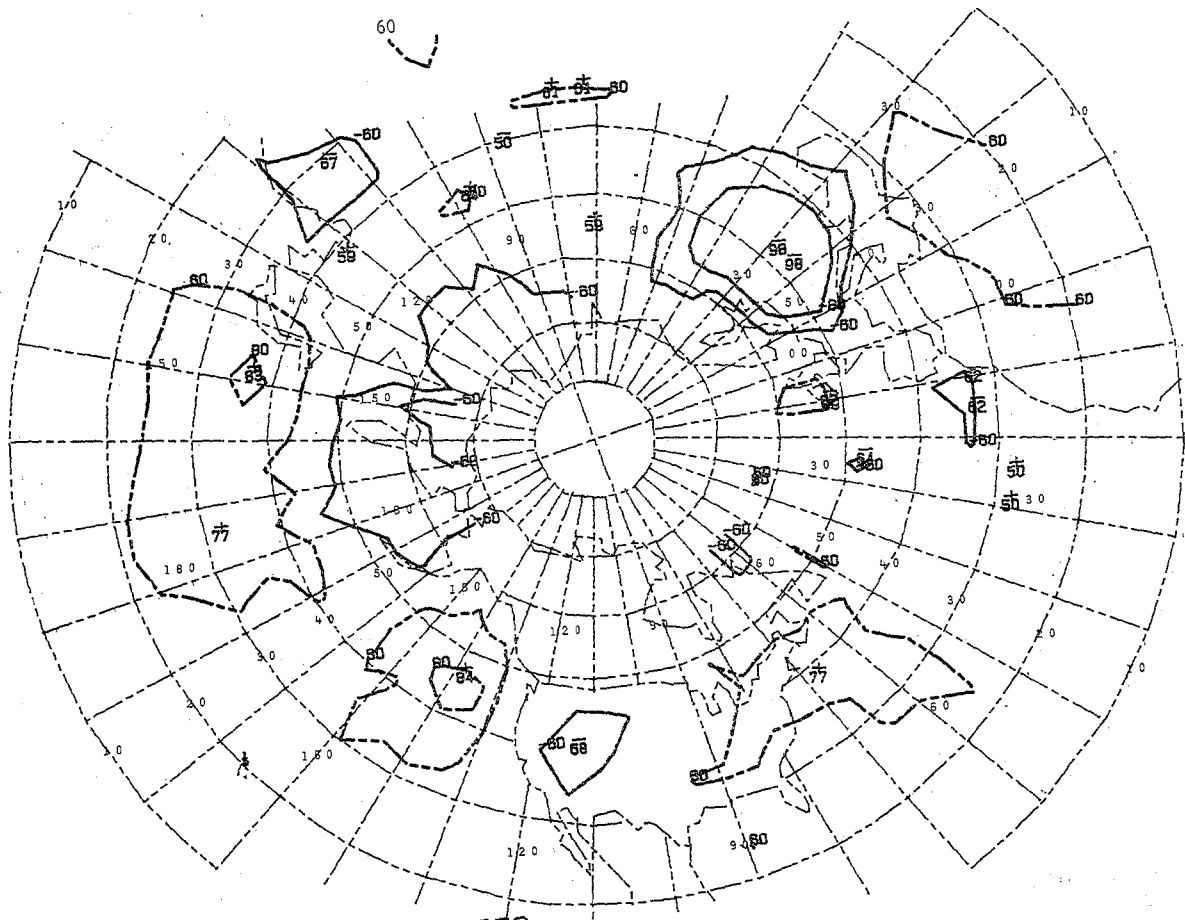

- KEY AT 30E 50N 17 CASES

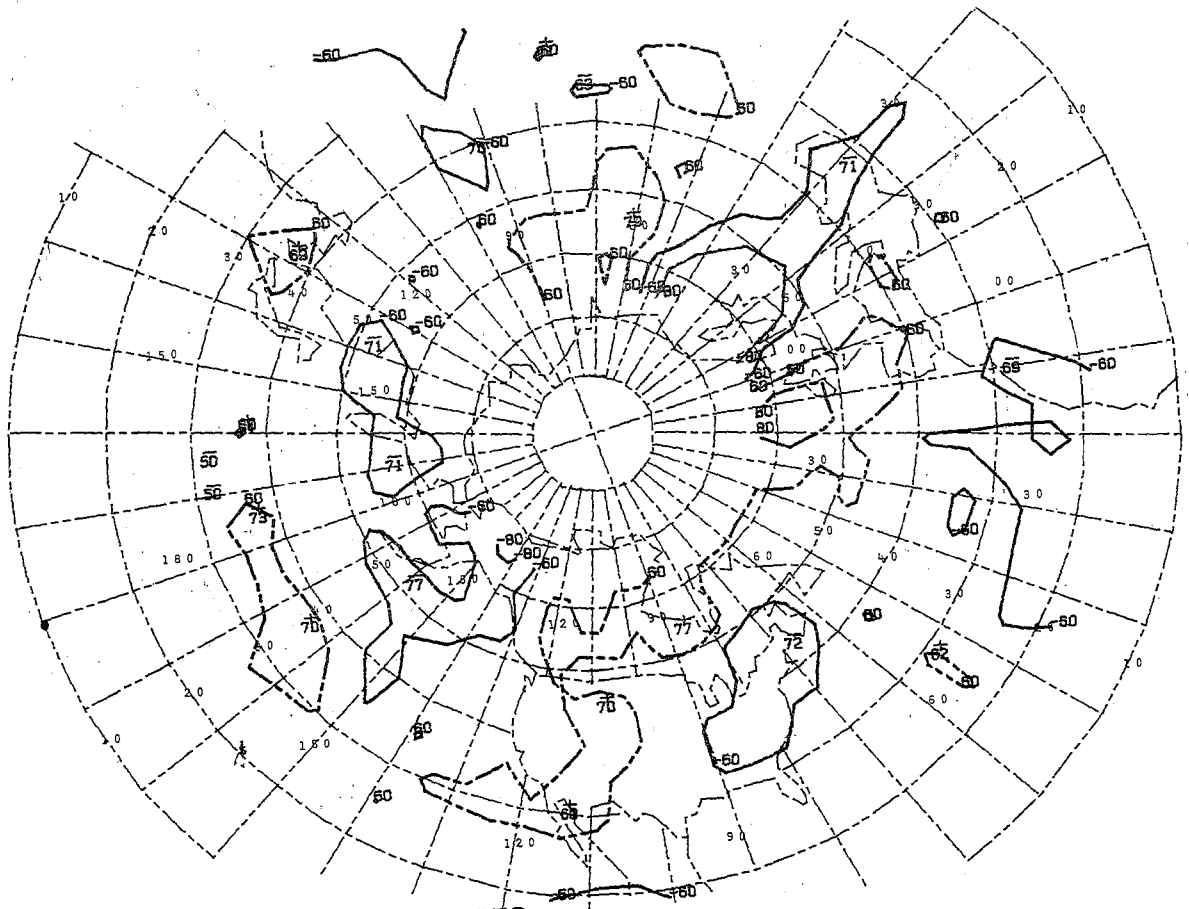

- KEY AT 30E 60N 12 CASES

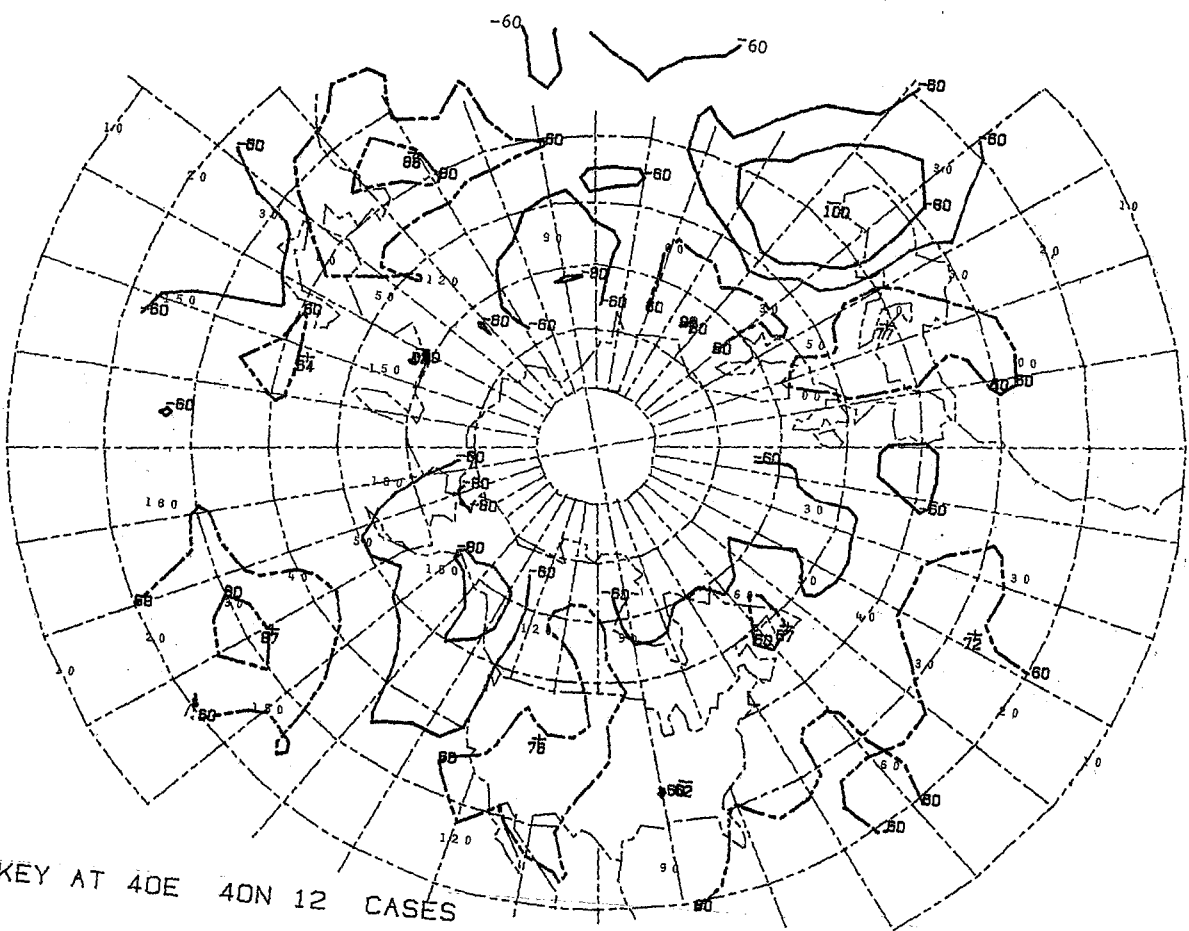
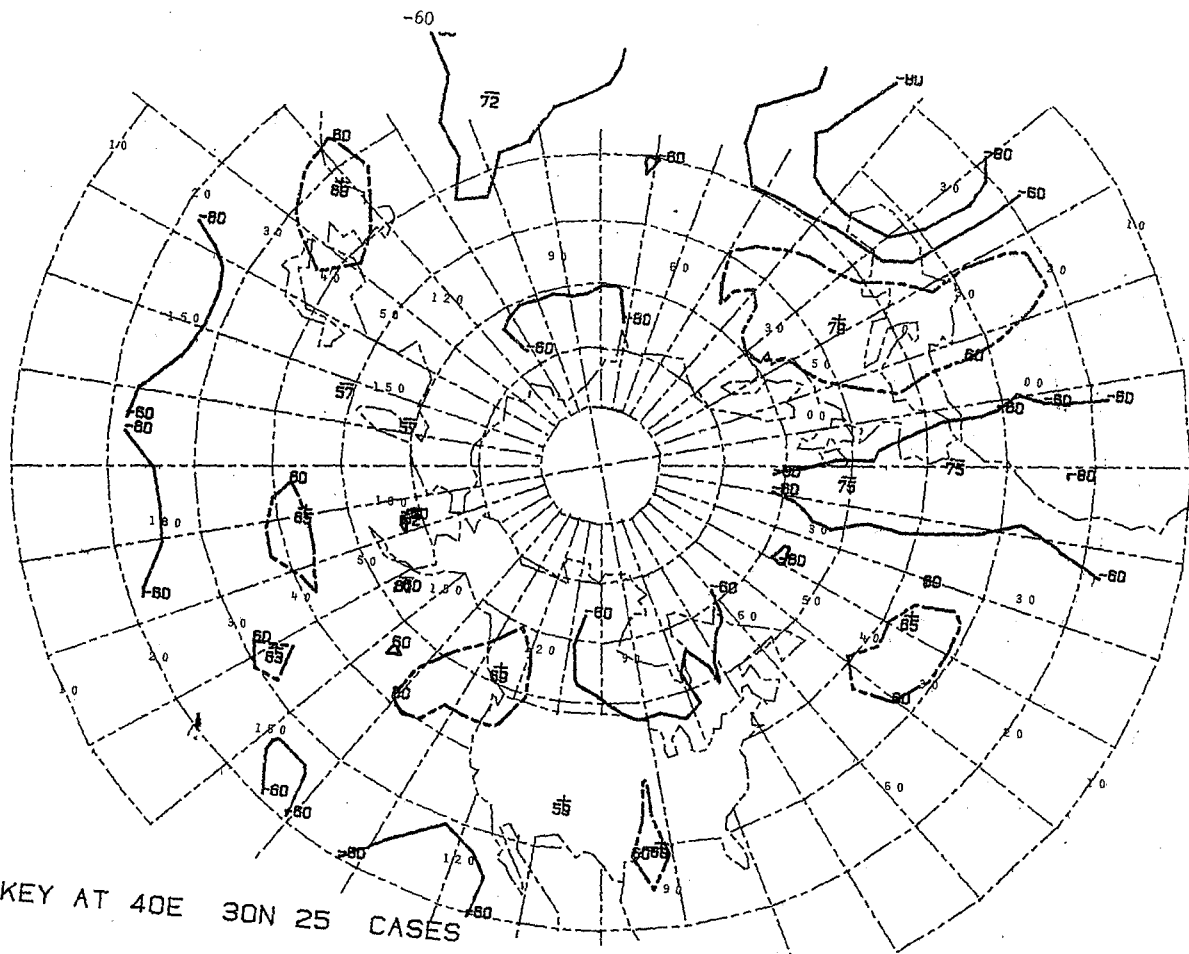

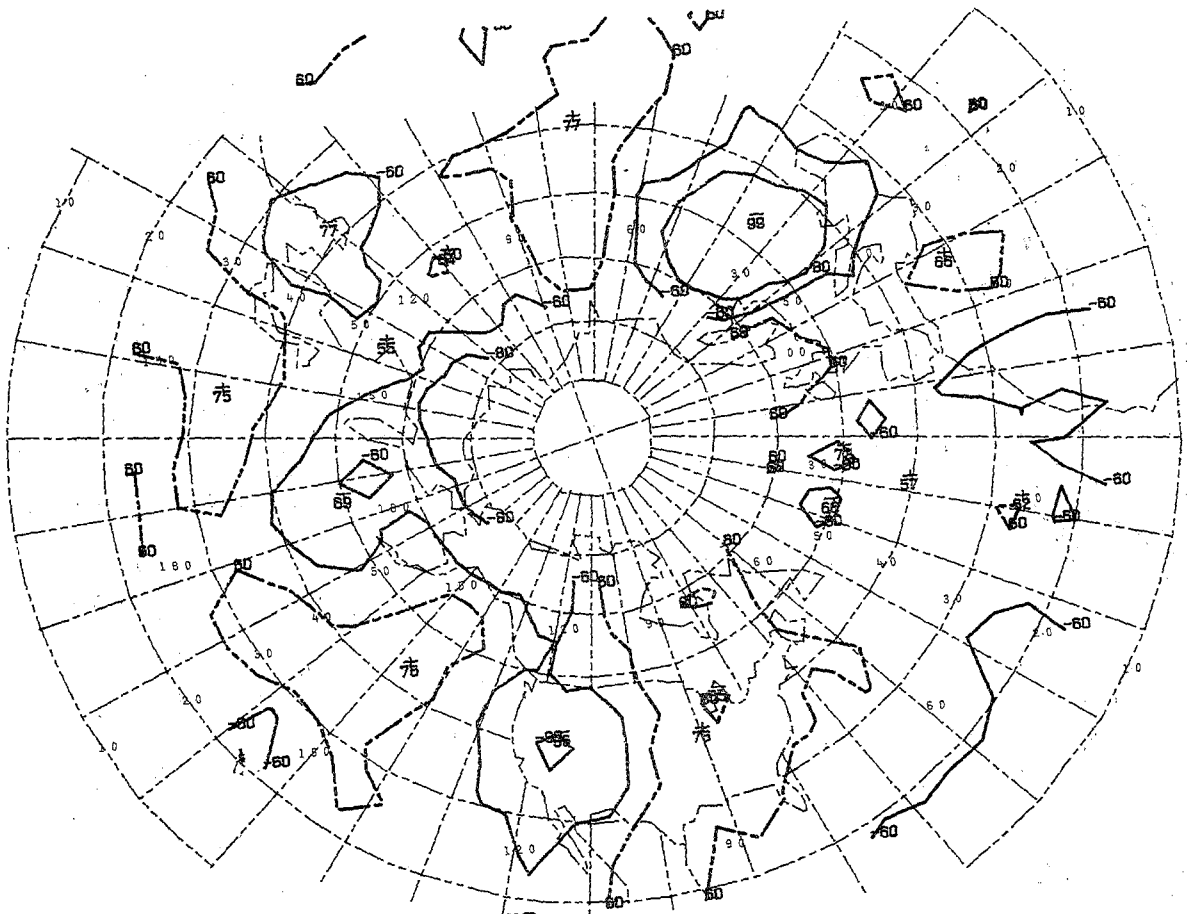

KEY AT 40E 50N 10 CASES

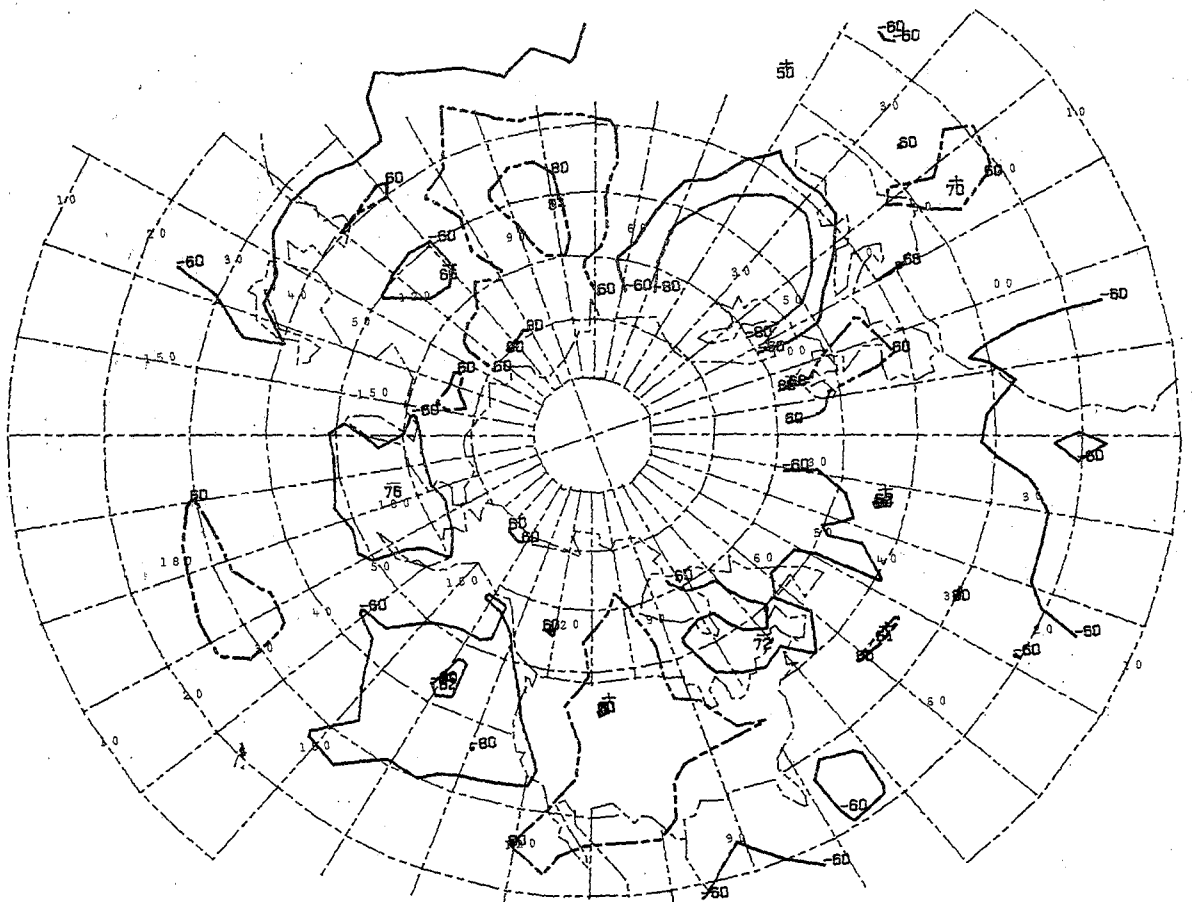

KEY AT 40E 60N 14 CASES

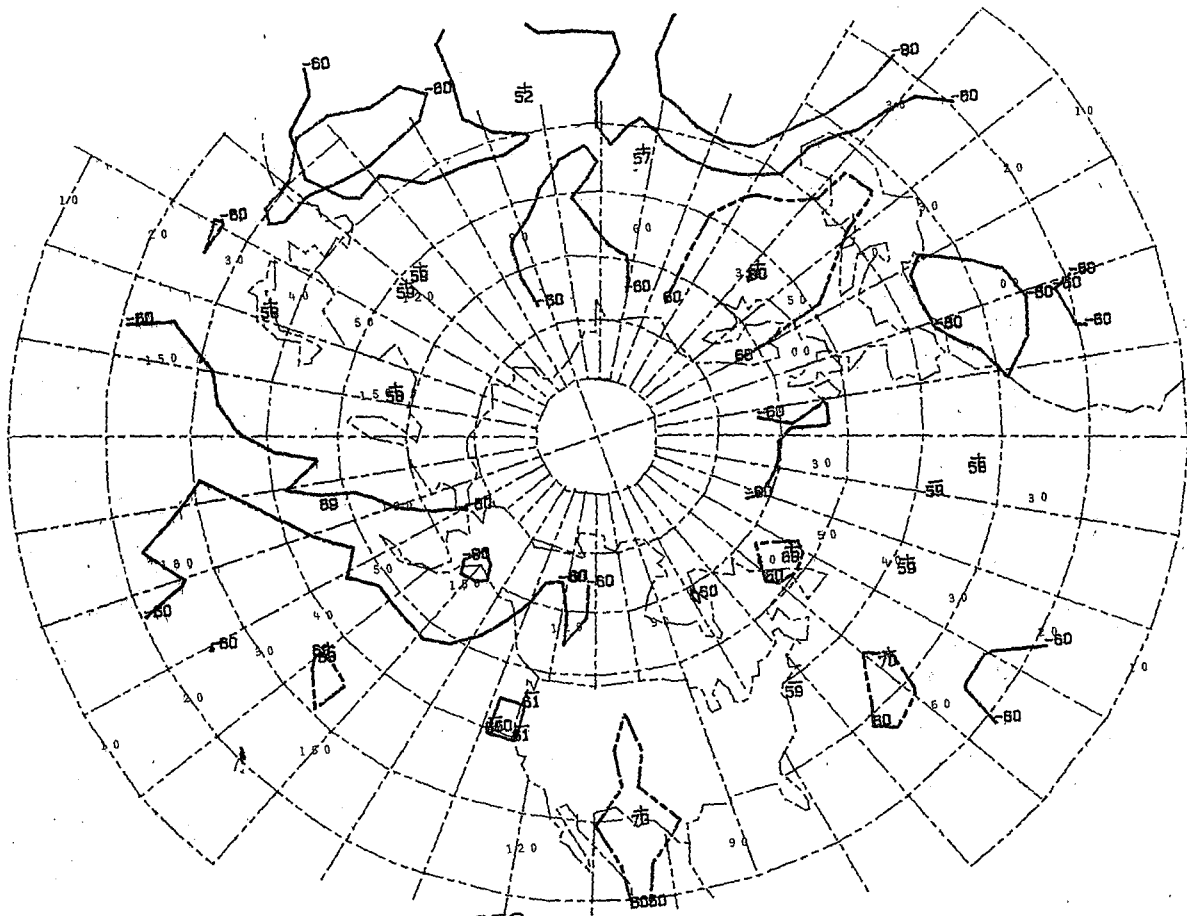

- KEY AT 50E 30N 19 CASES

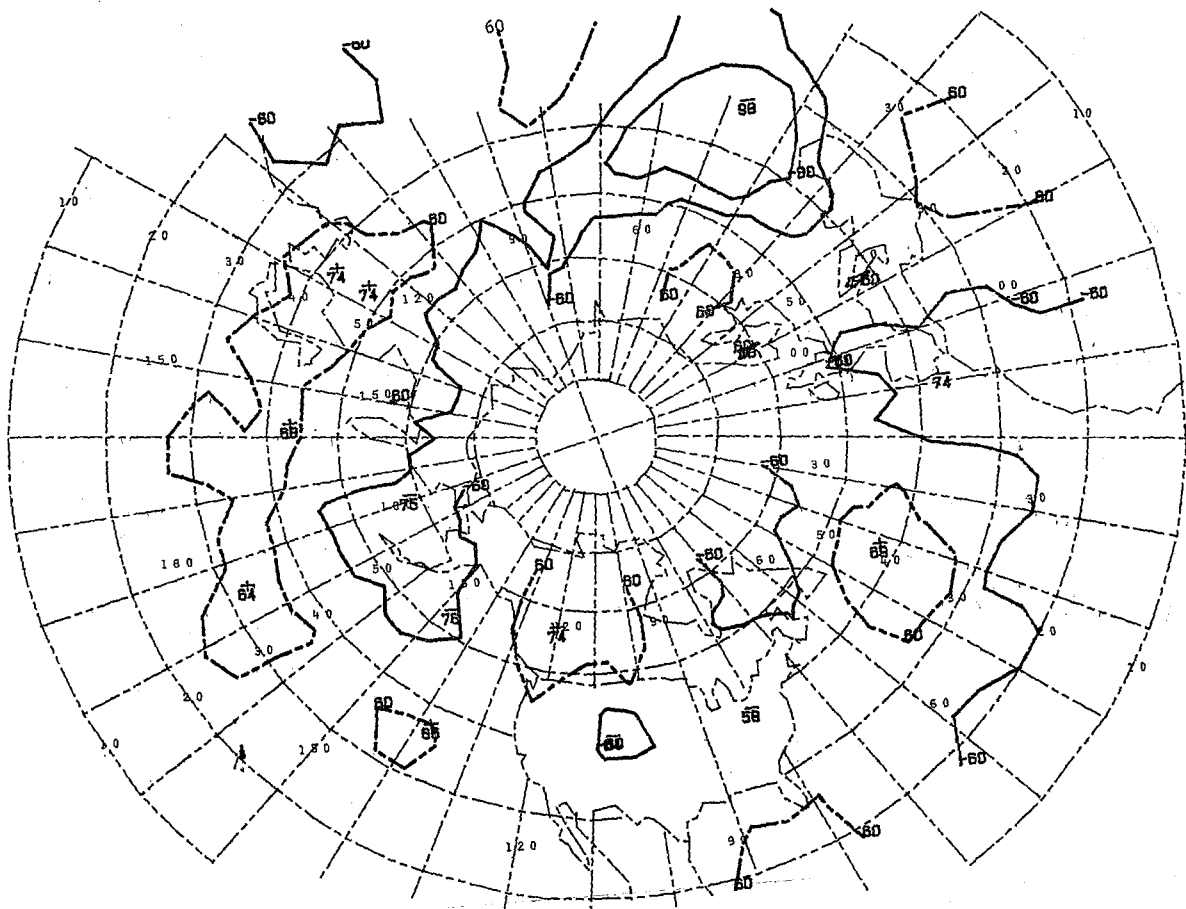

- KEY AT 50E 40N 18 CASES

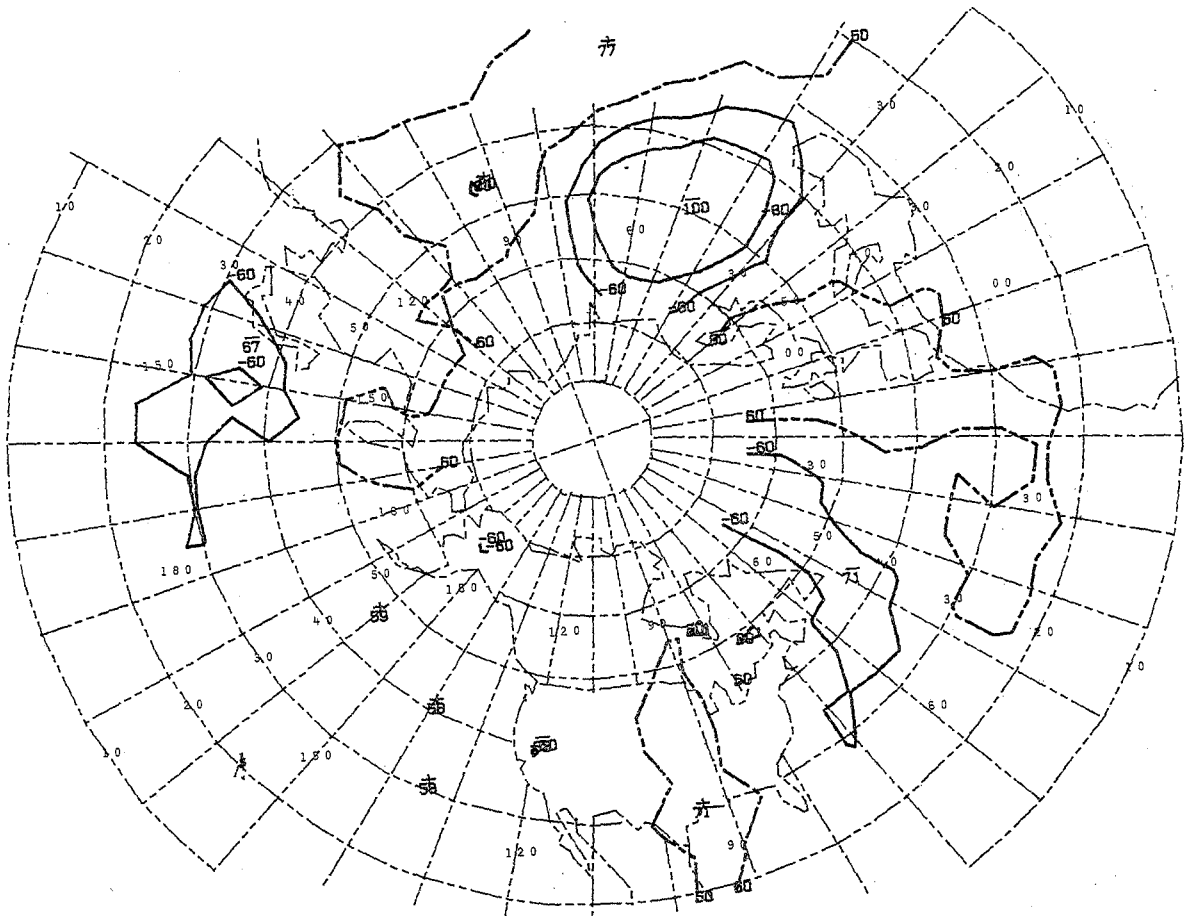

- KEY AT 50E 50N 24 CASES

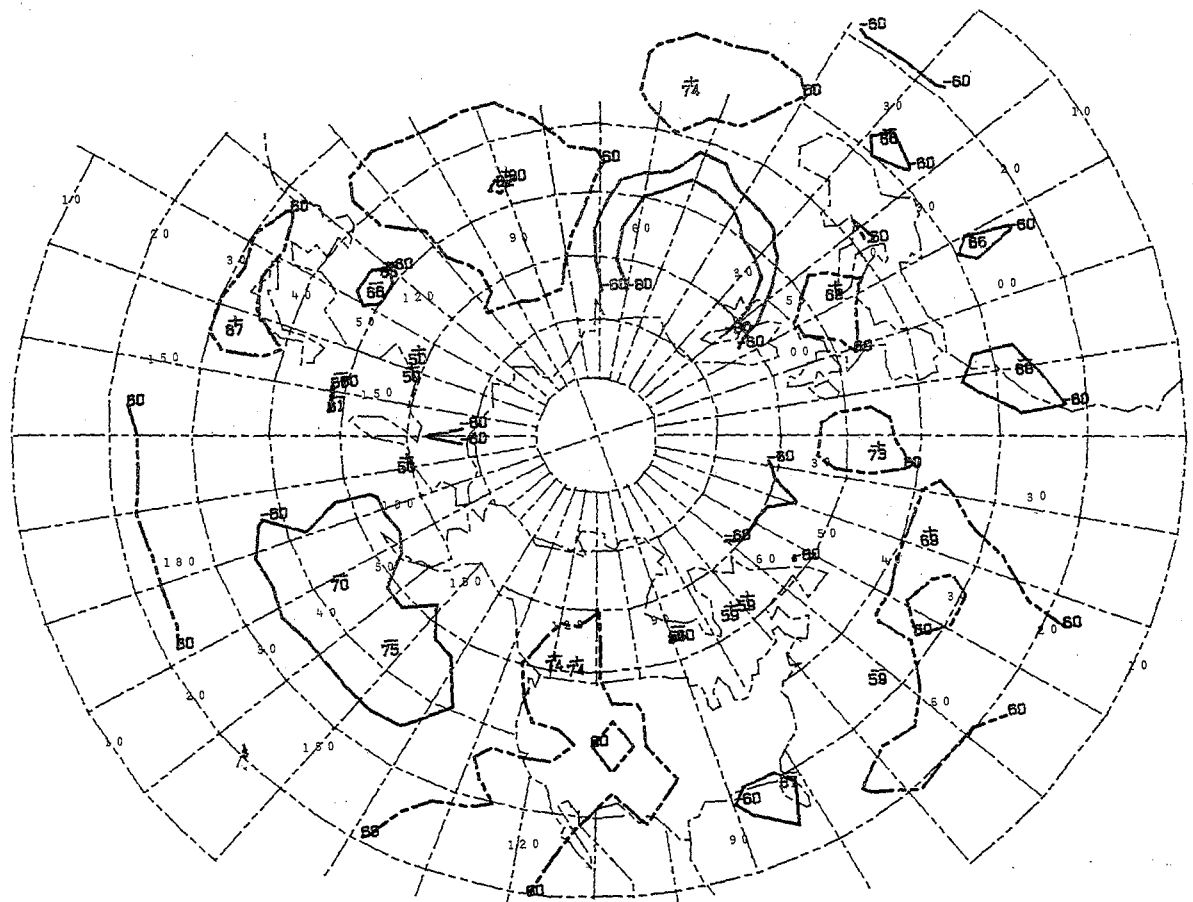

- KEY AT 50E 60N 14 CASES

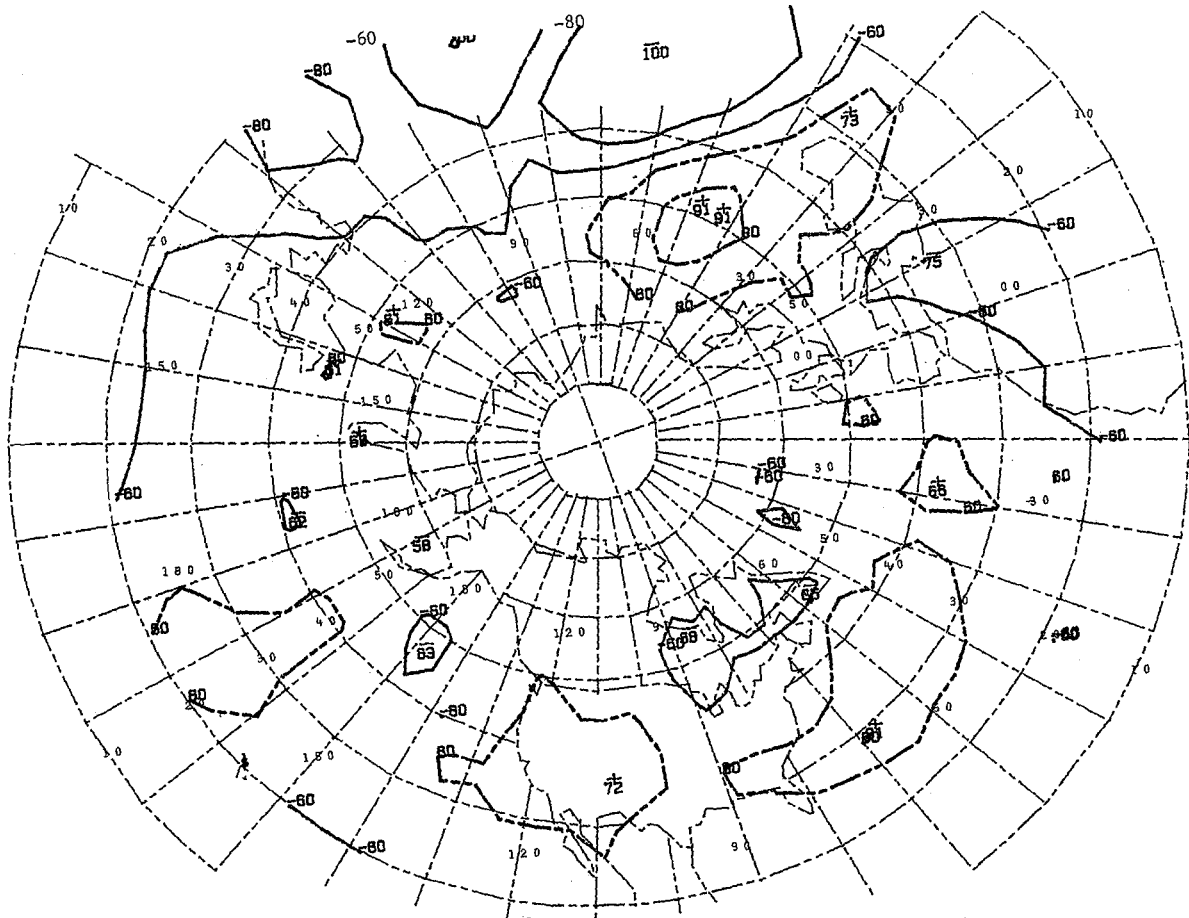

- KEY AT 60E 30N 20 CASES

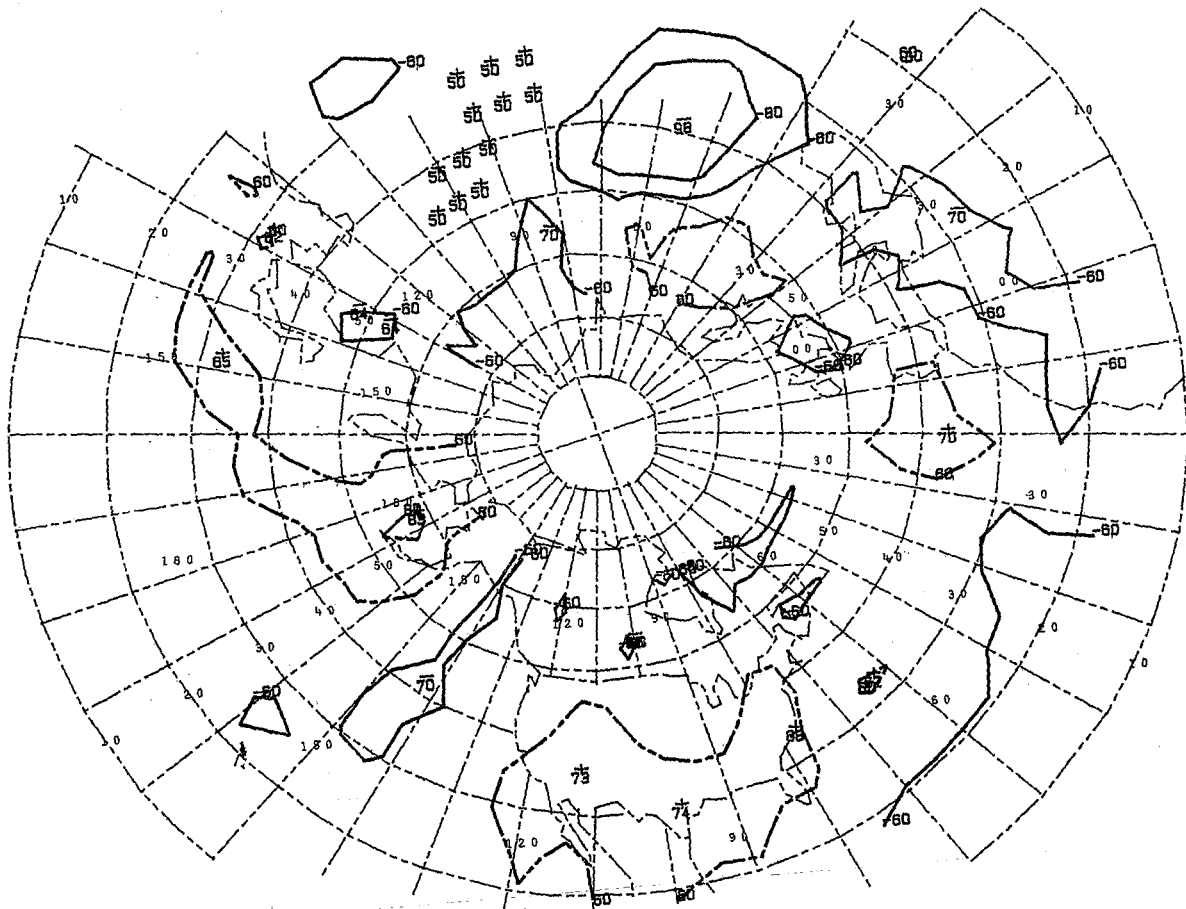

- KEY AT 60E 40N 22 CASES

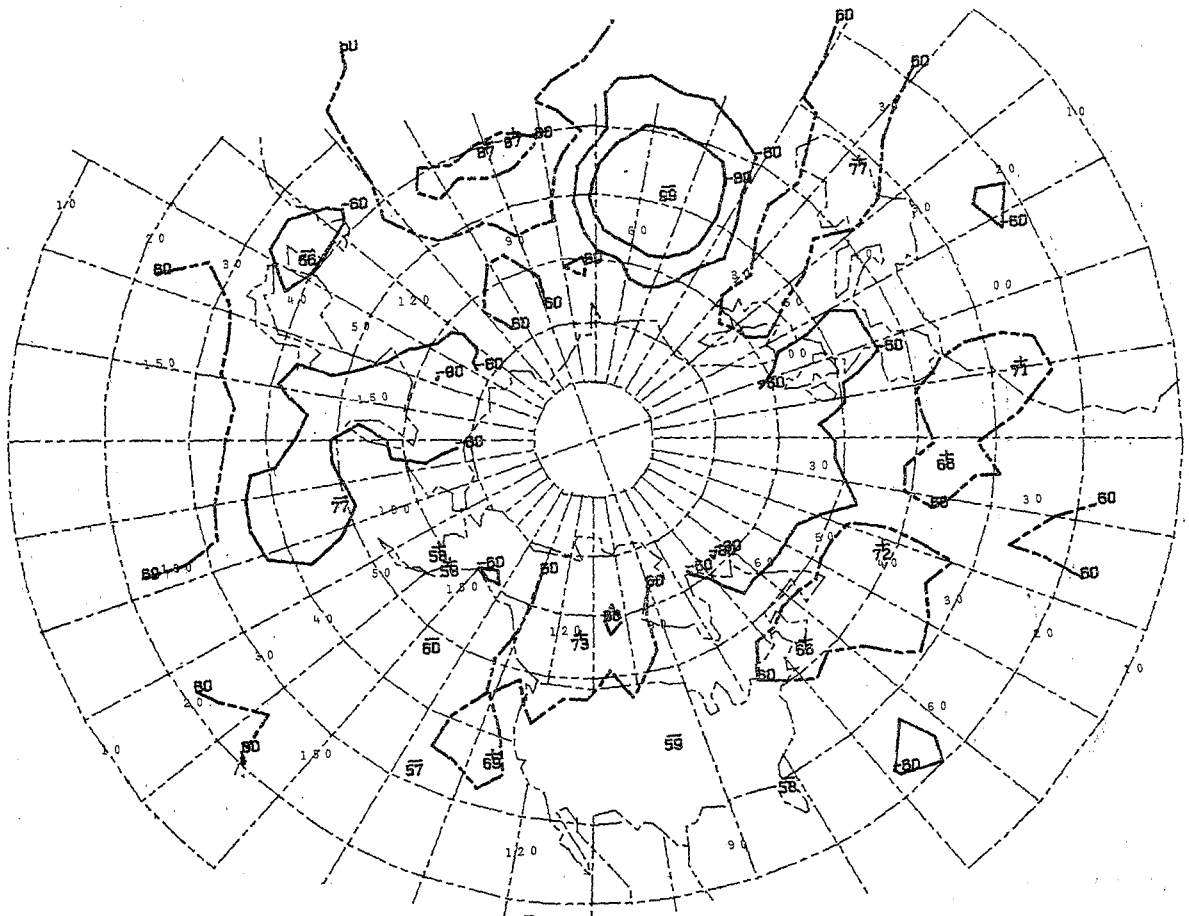

- KEY AT 60E 50N 13 CASES

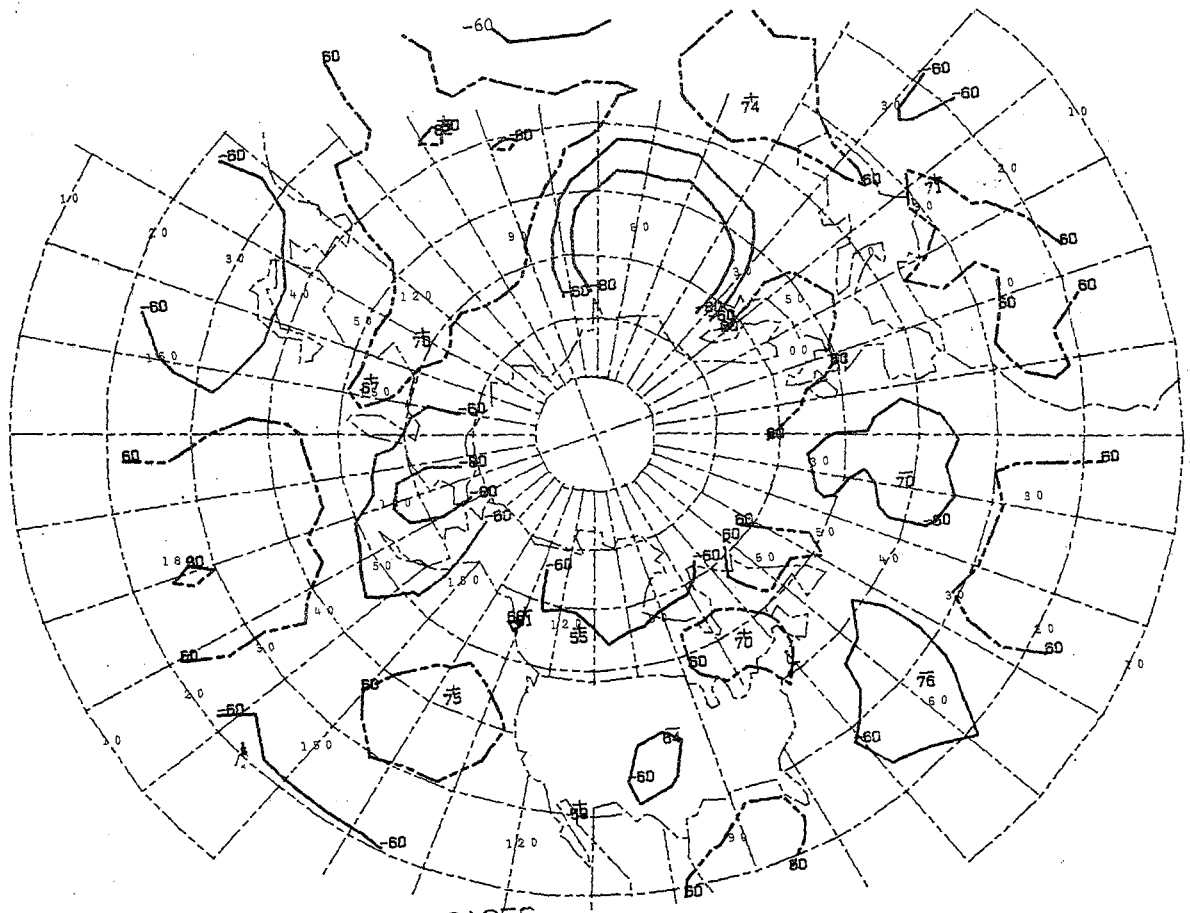

- KEY AT 60E 60N 15 CASES

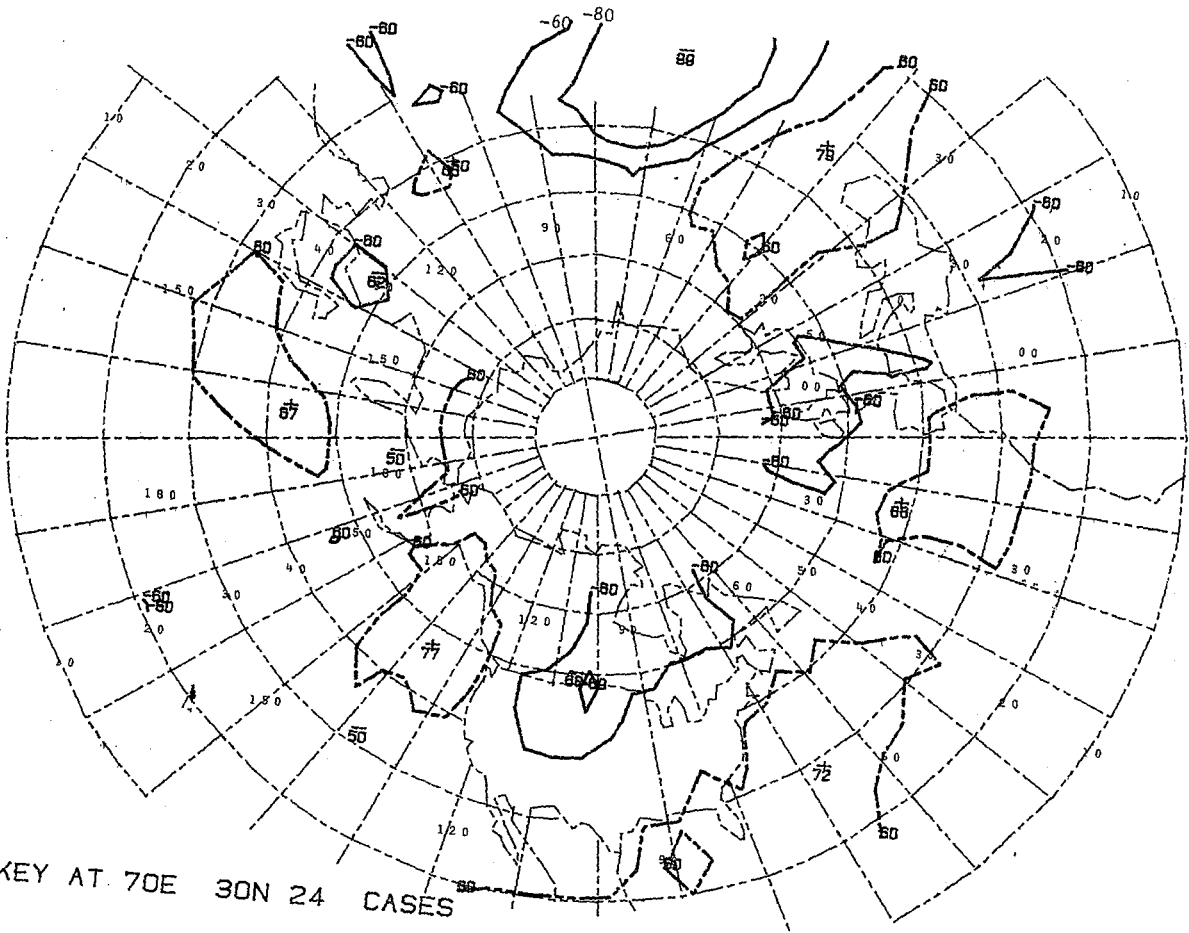

= KEY AT 70E 30N 24 CASES

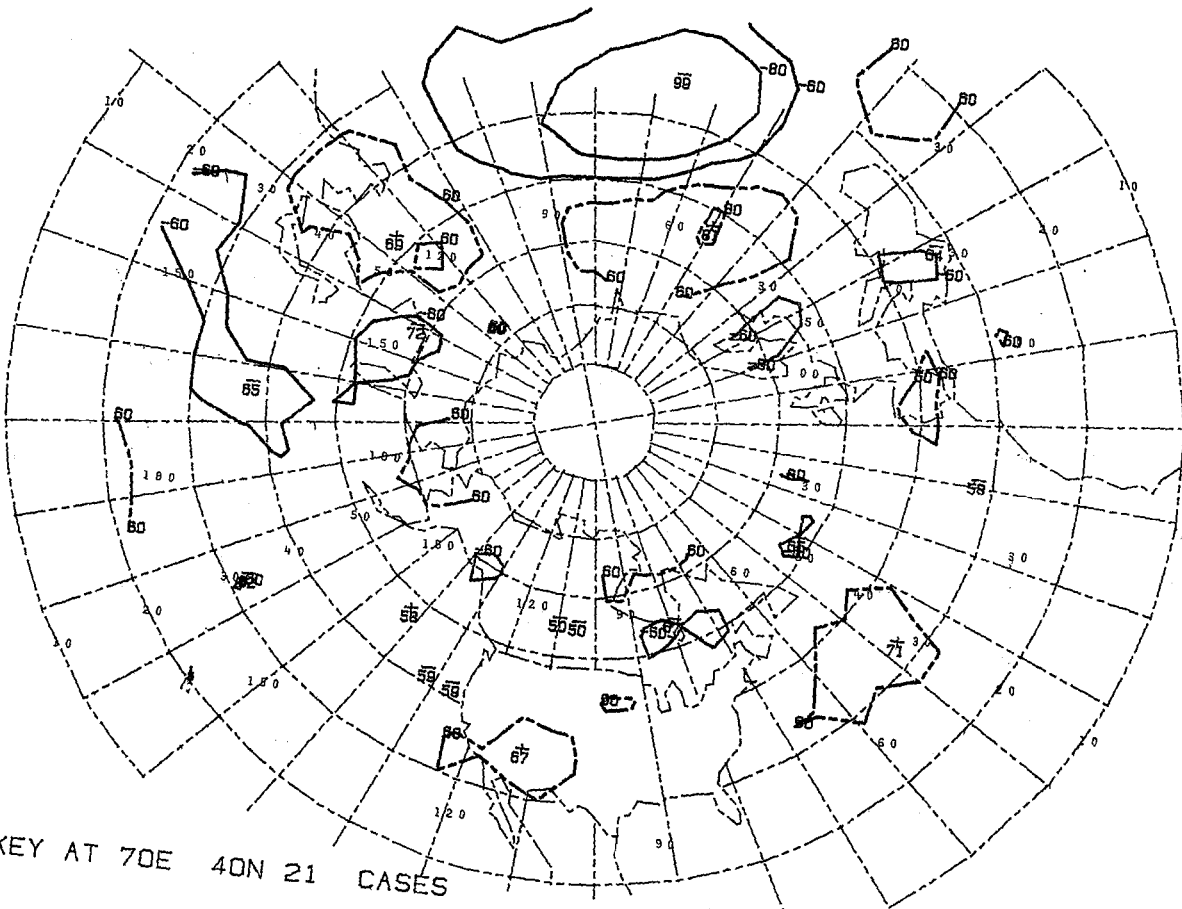

= KEY AT 70E 40N 21 CASES

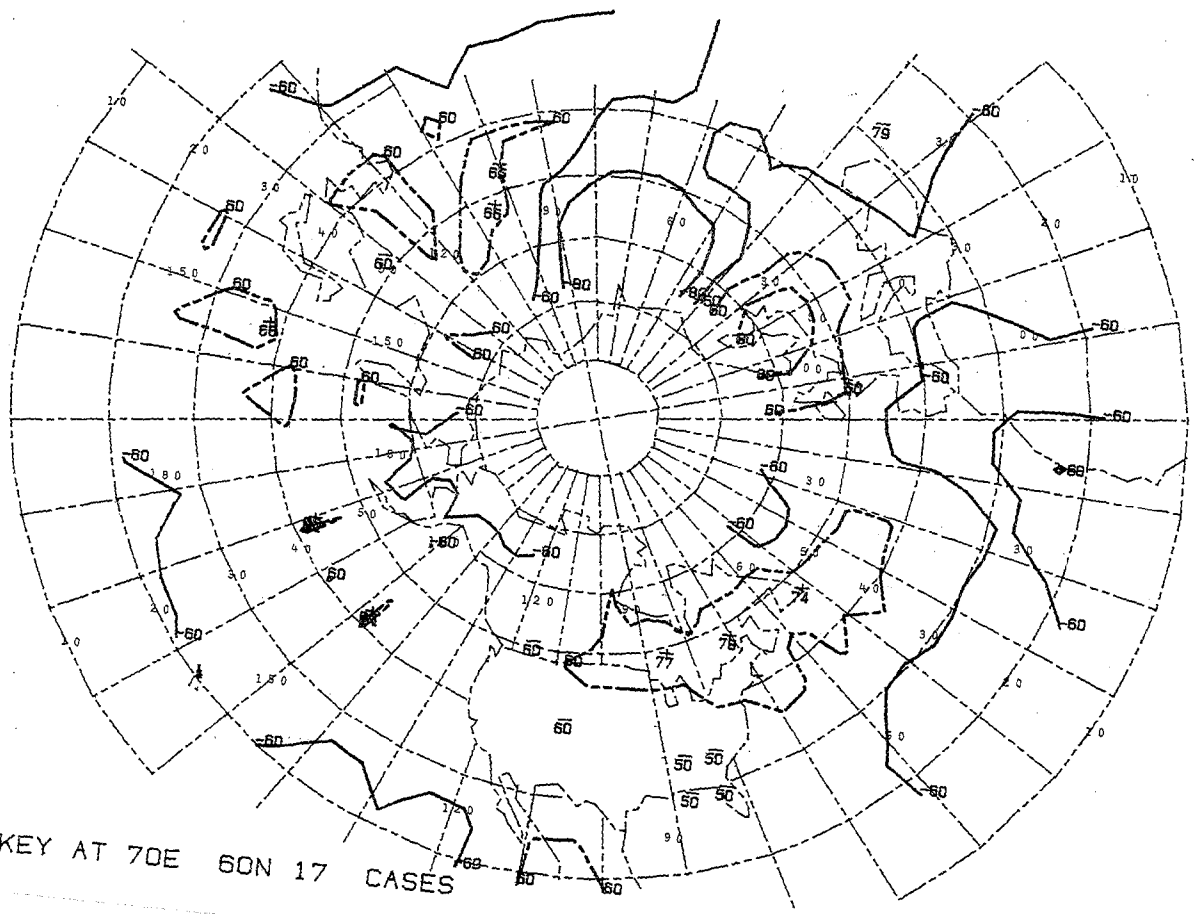
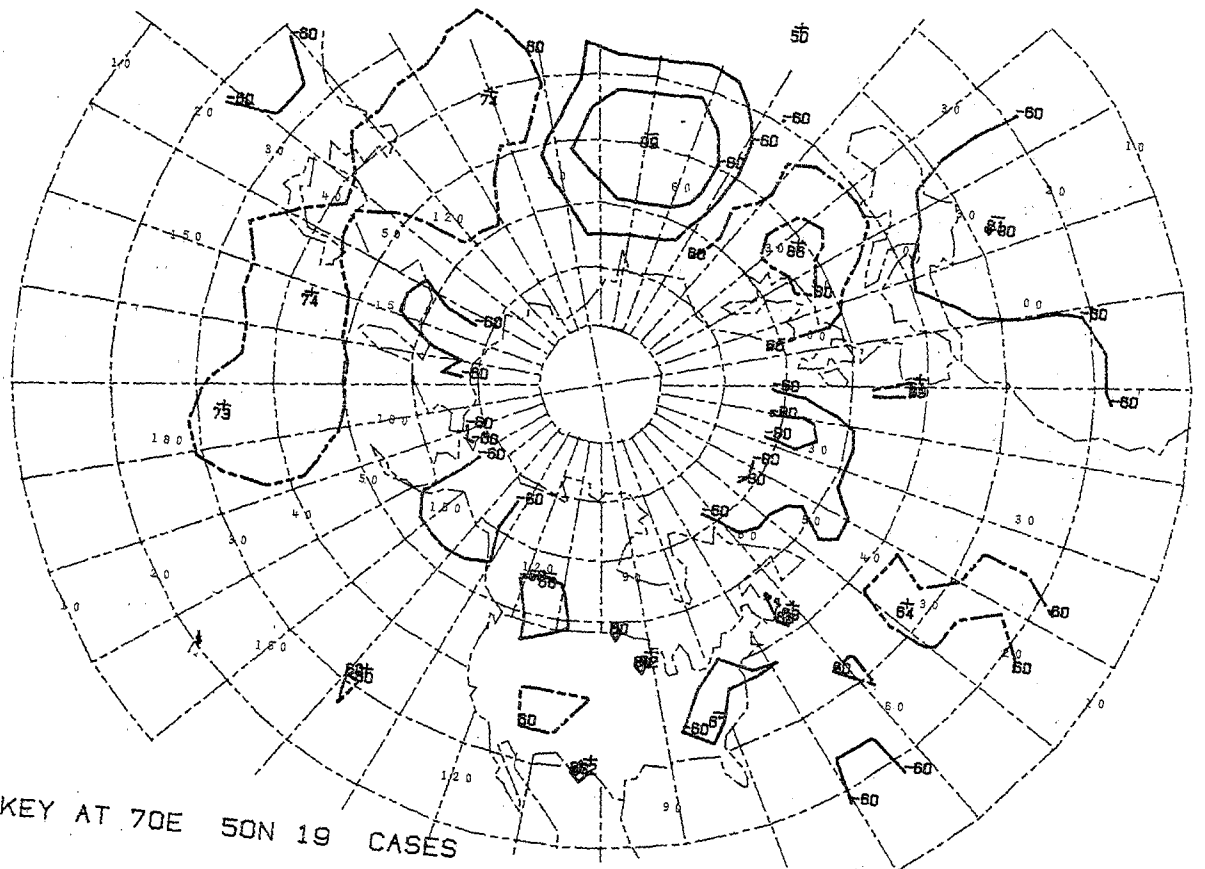

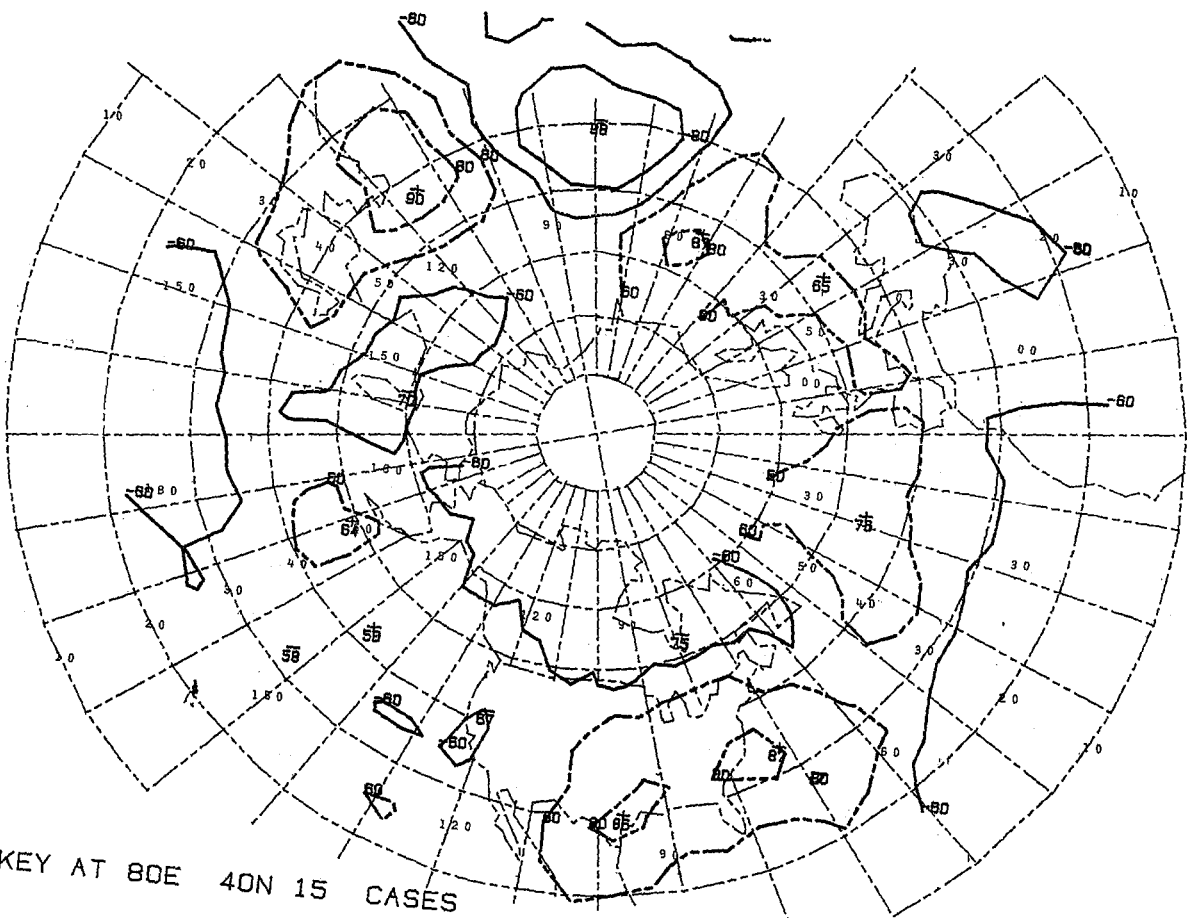
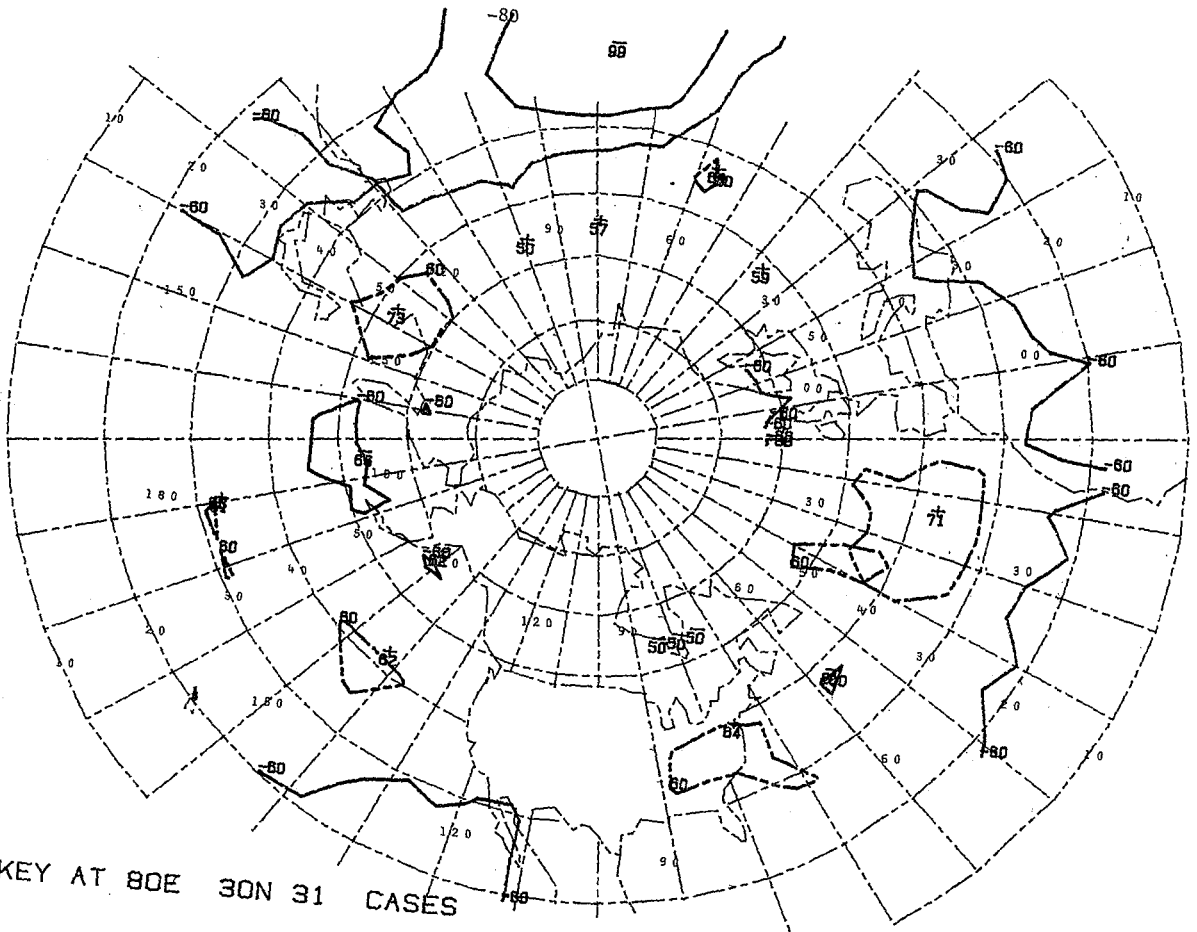

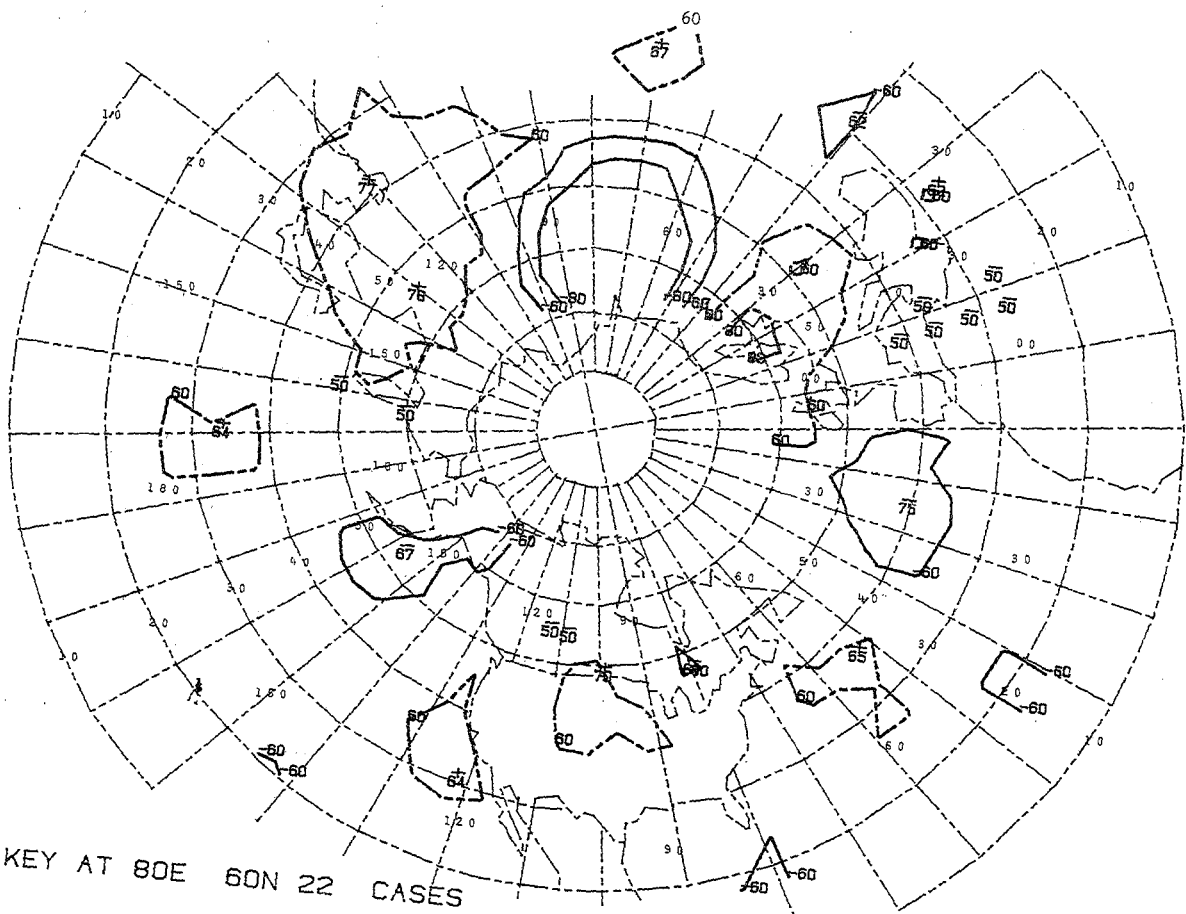
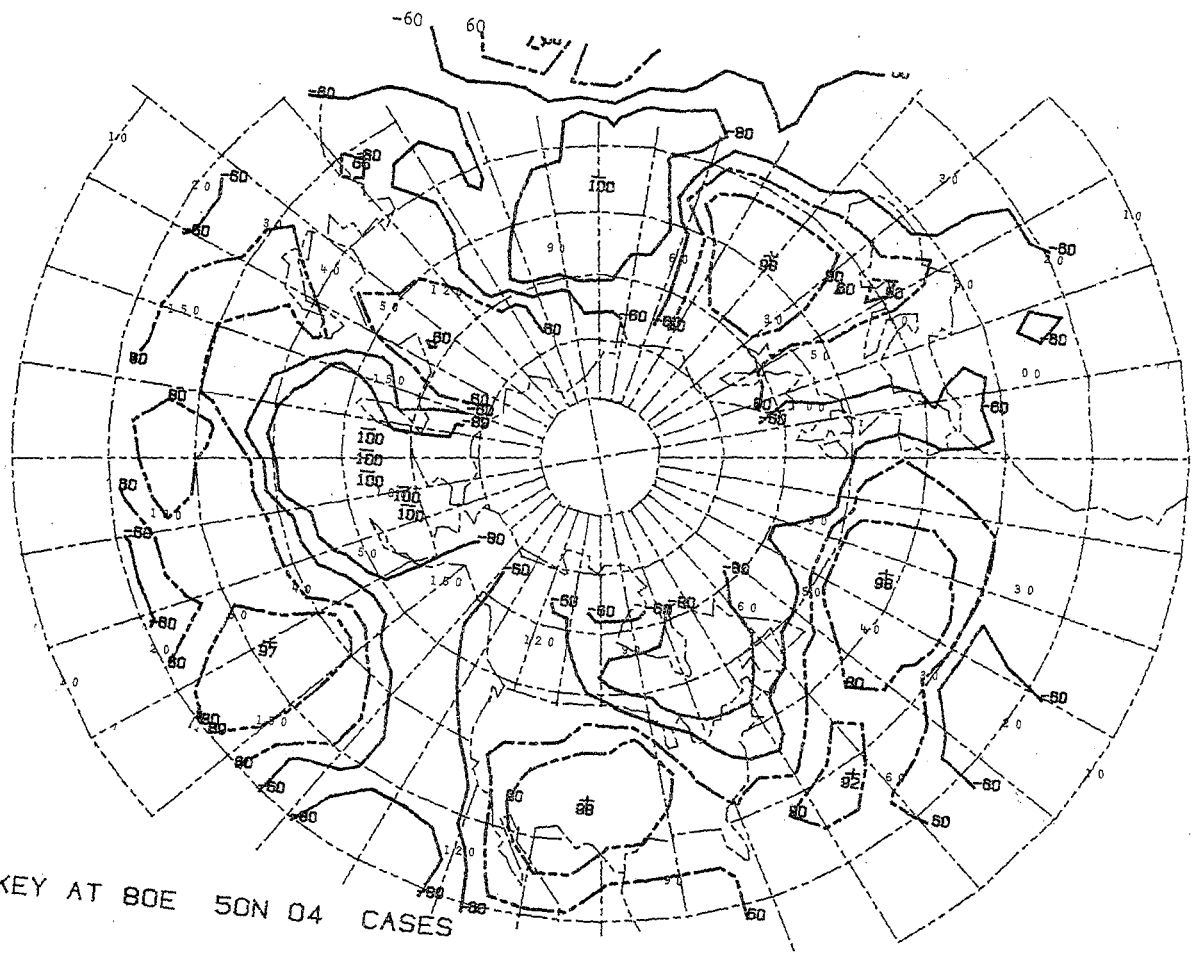

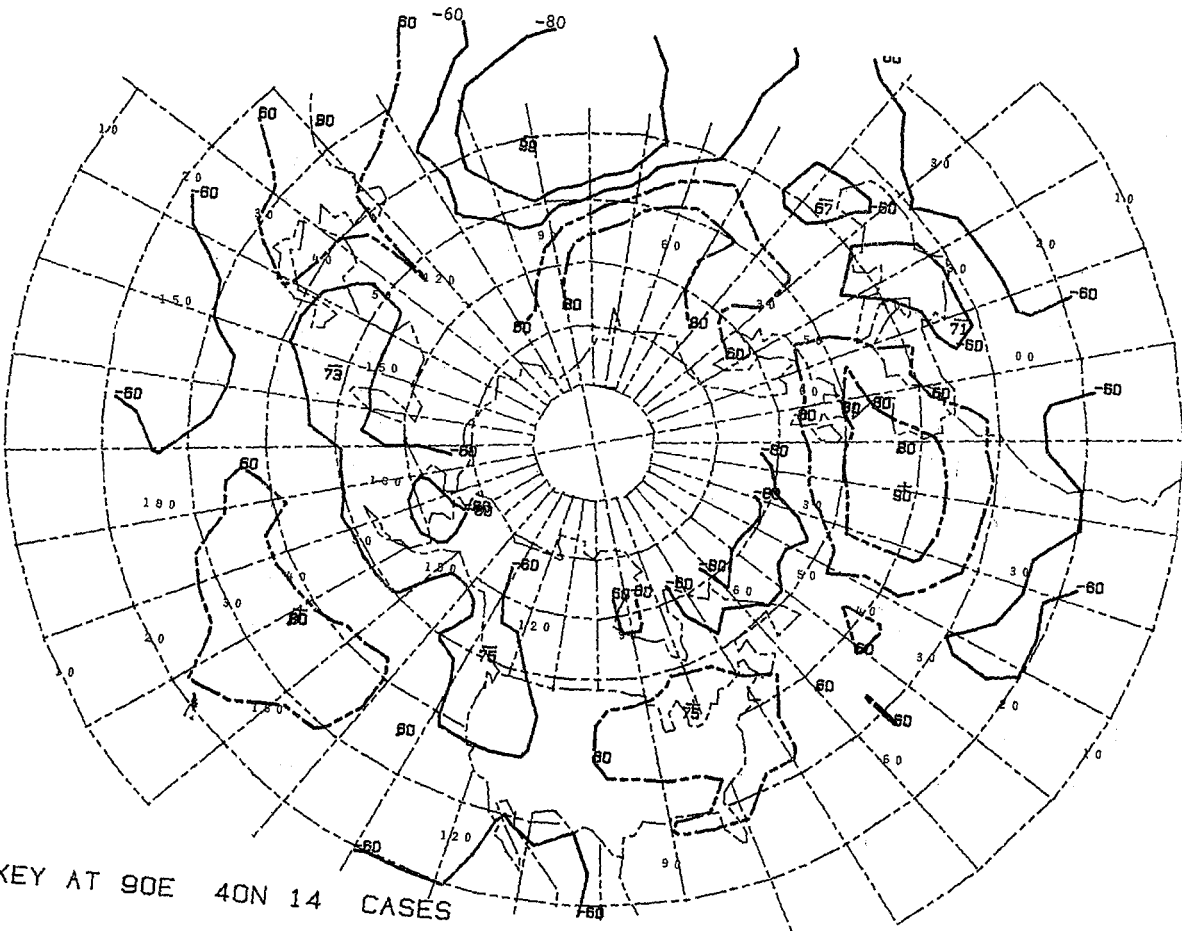
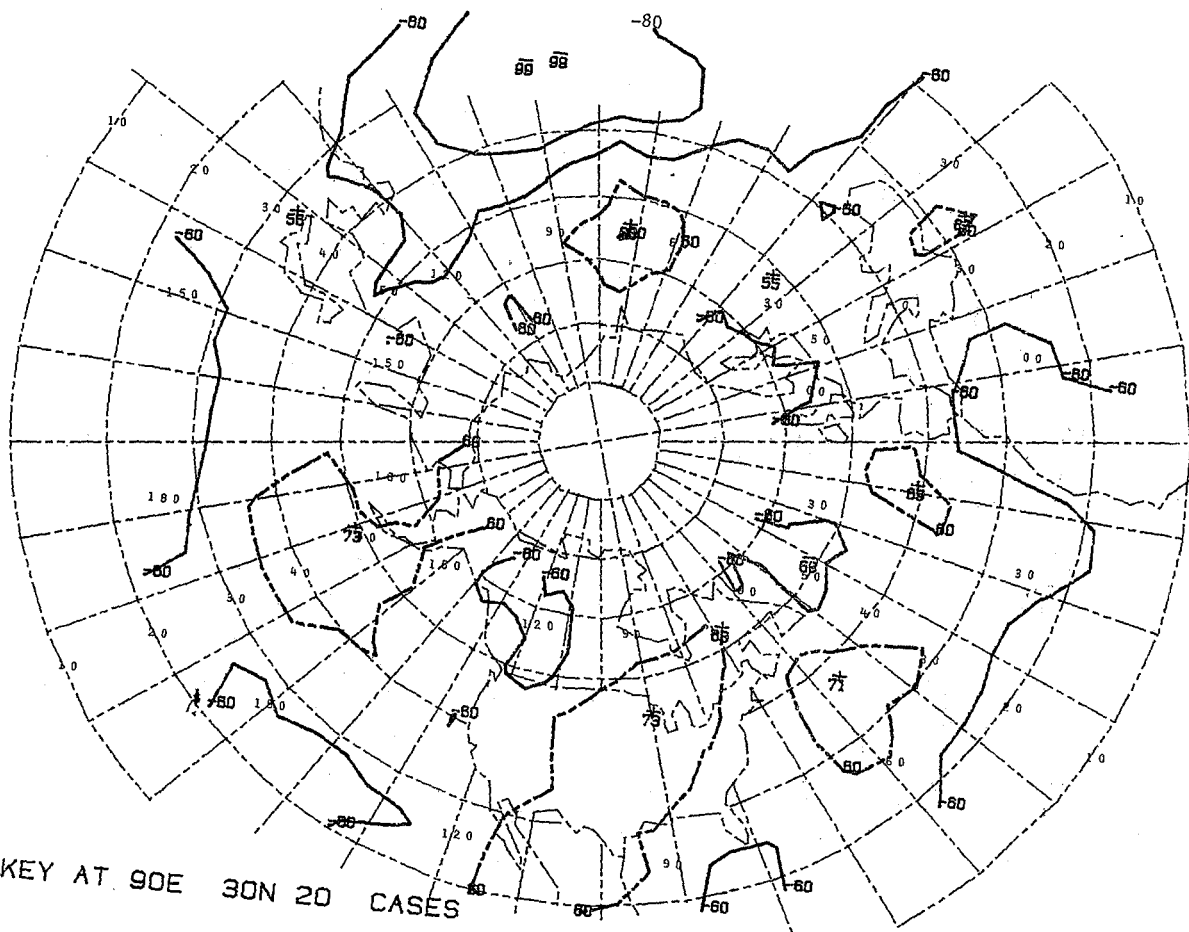

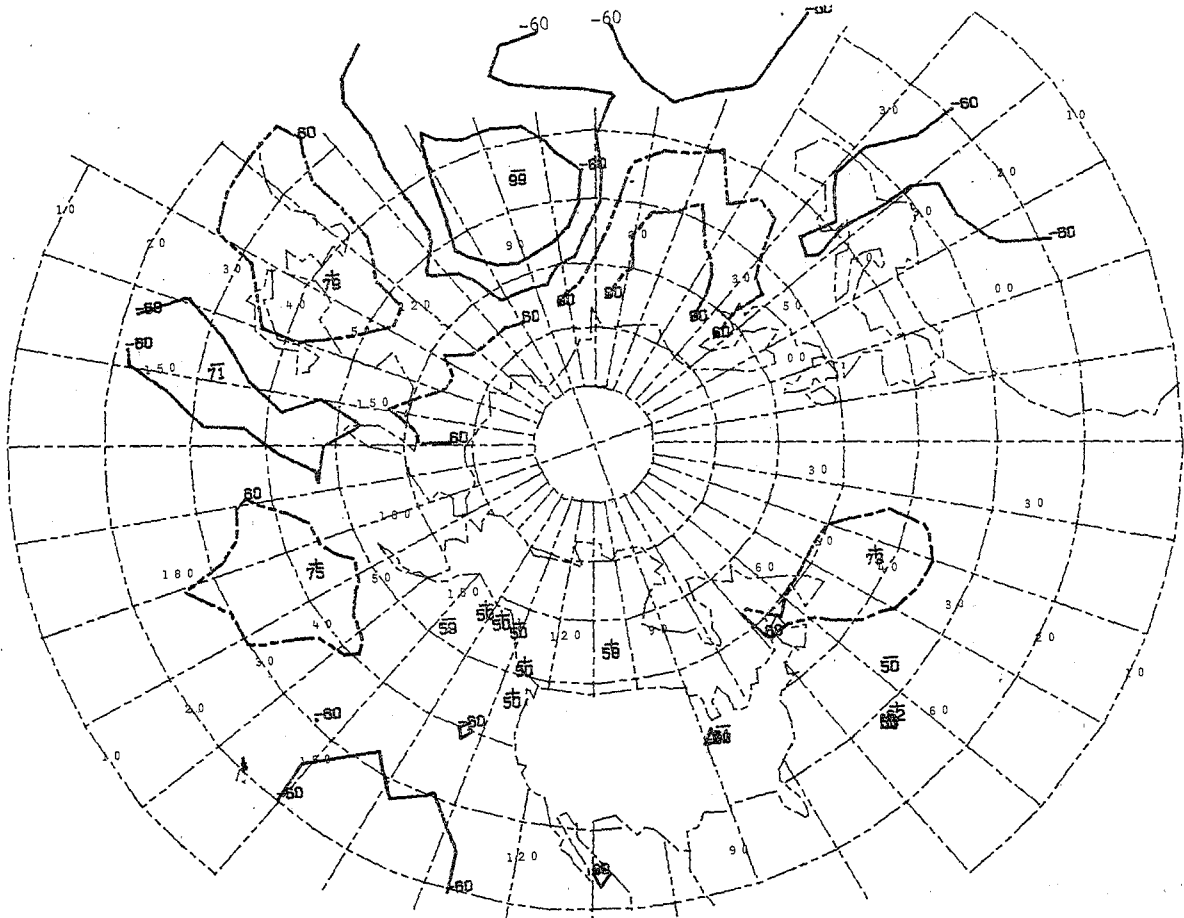

- KEY AT 90E 50N 19 CASES

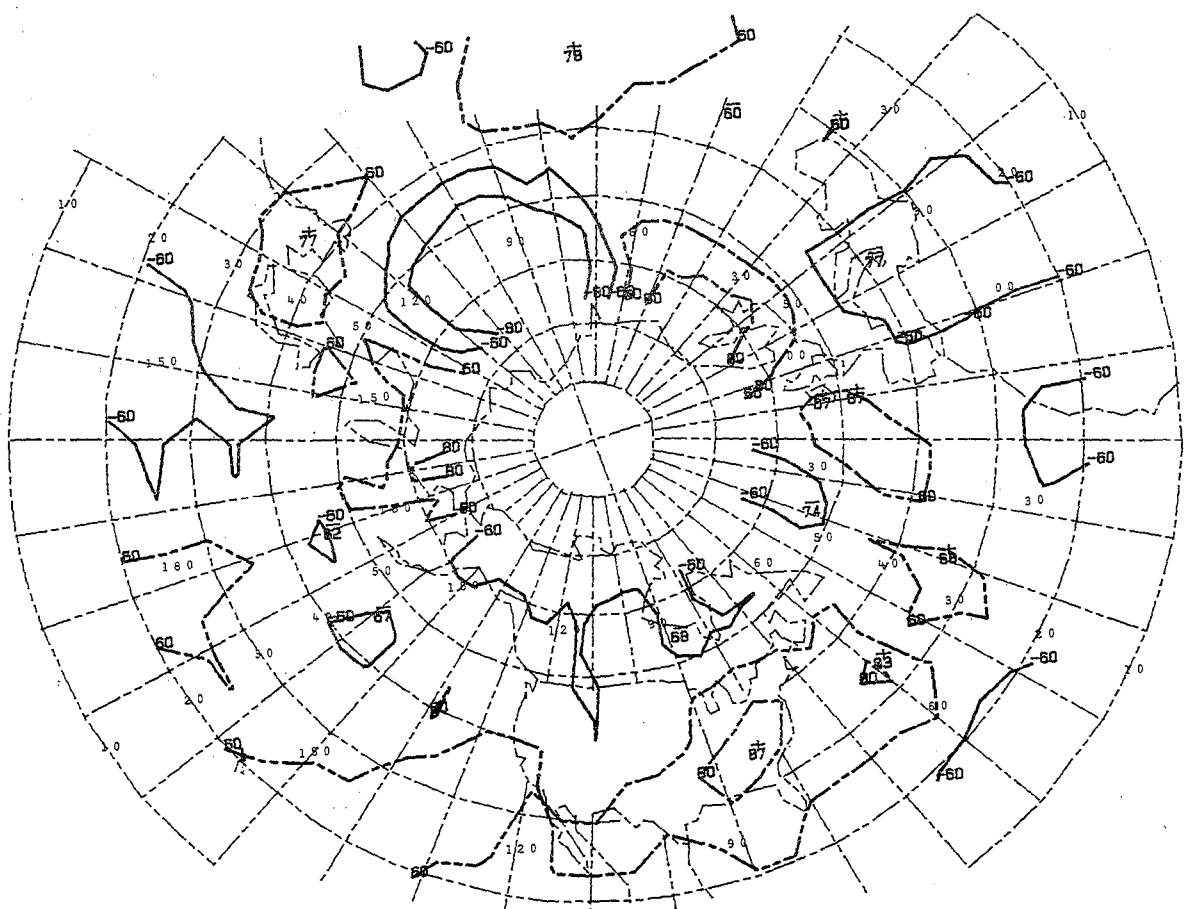

- KEY AT 90E 60N 11 CASES

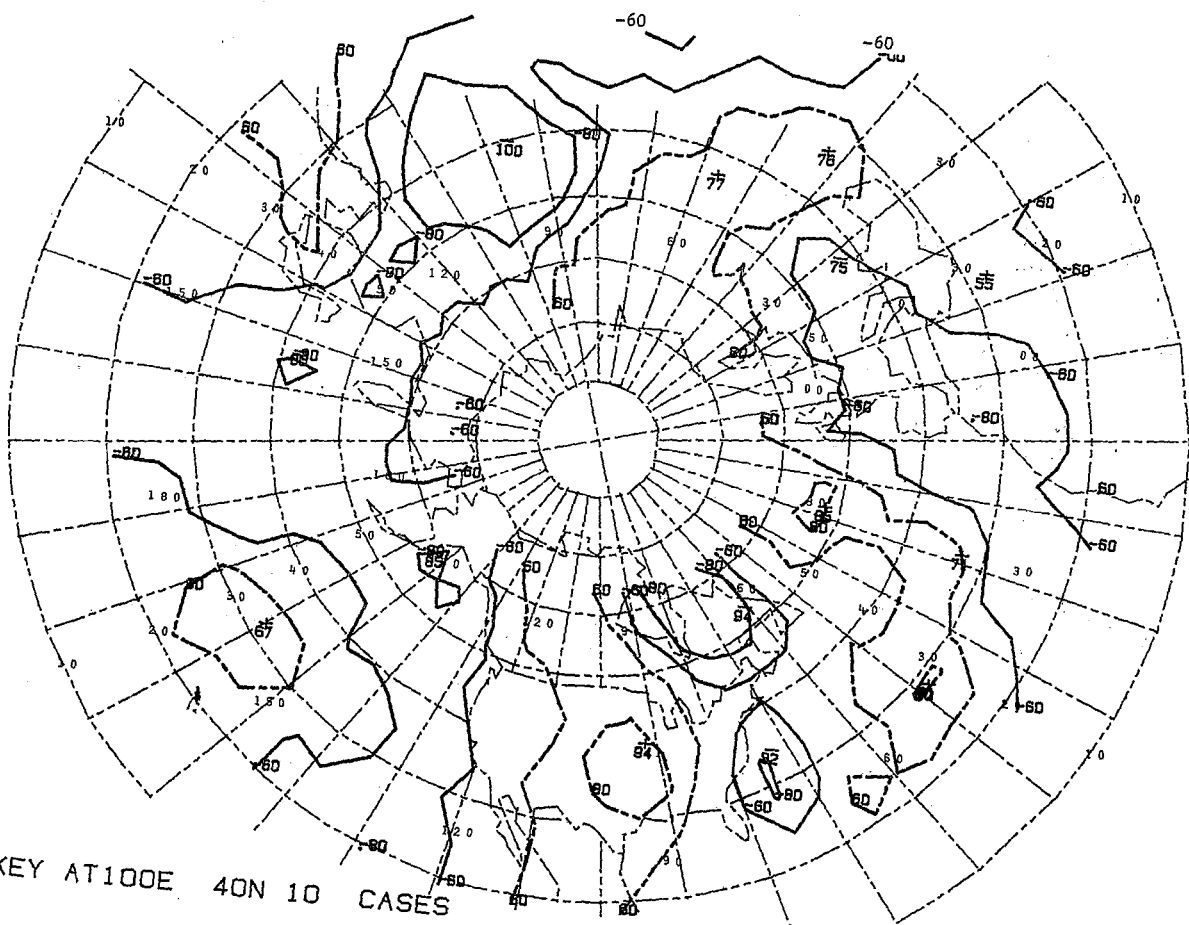
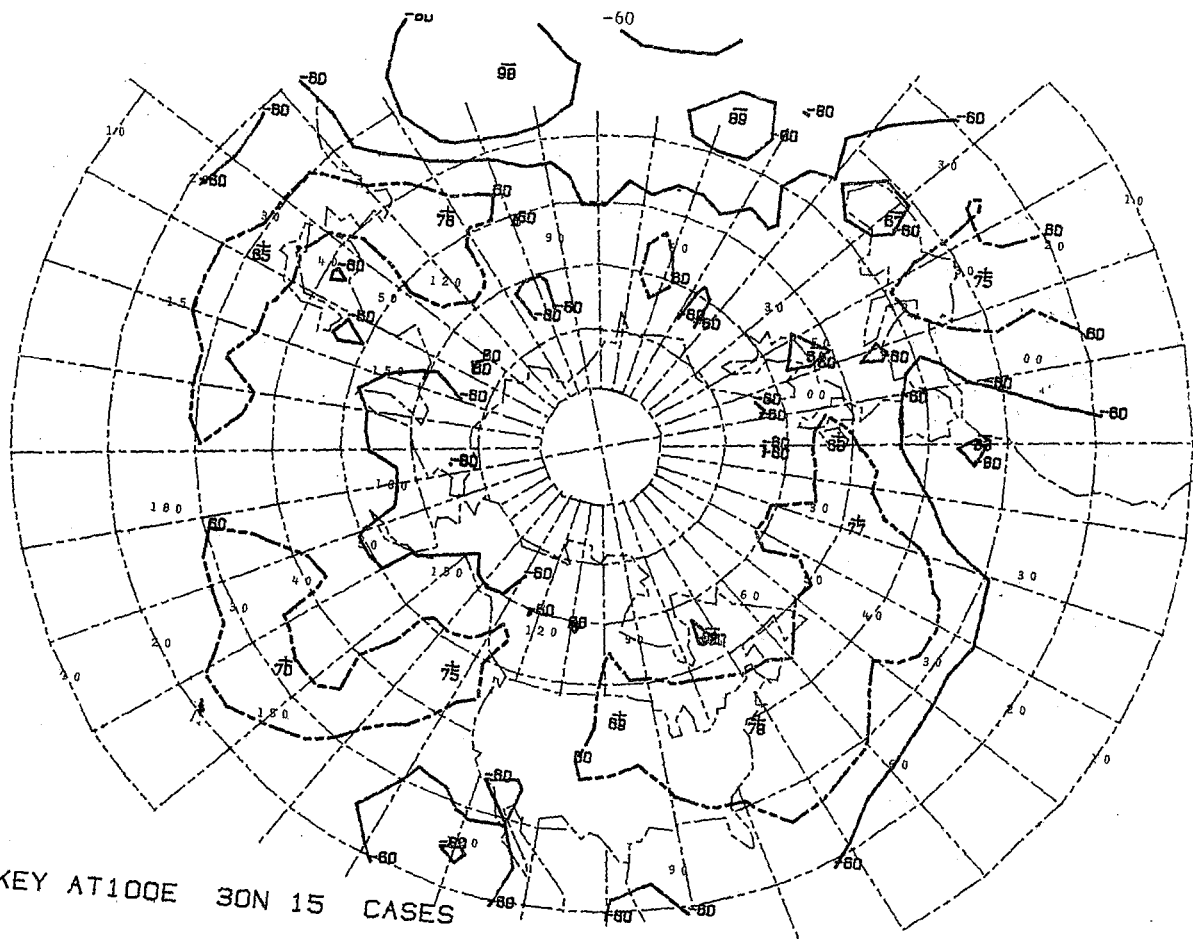

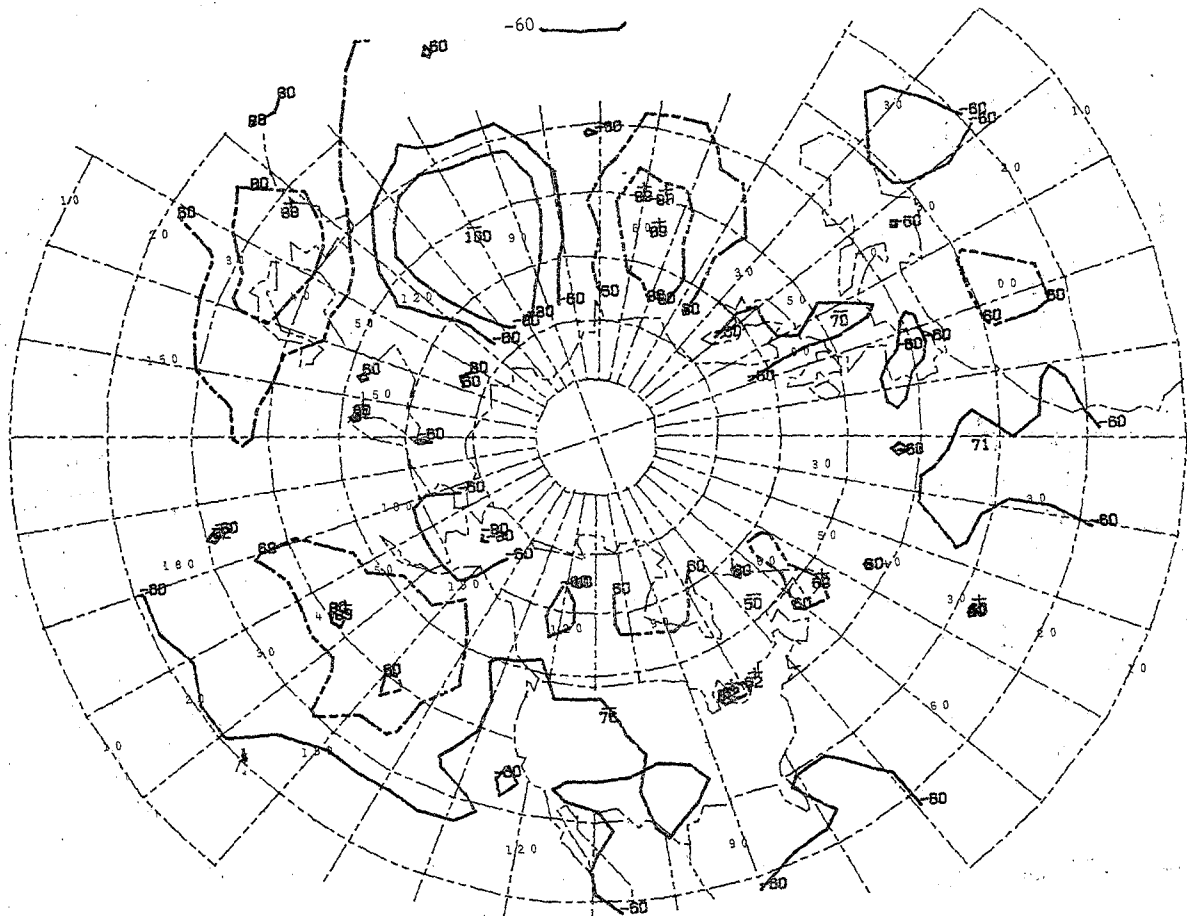

- KEY AT100E 50N 12 CASES

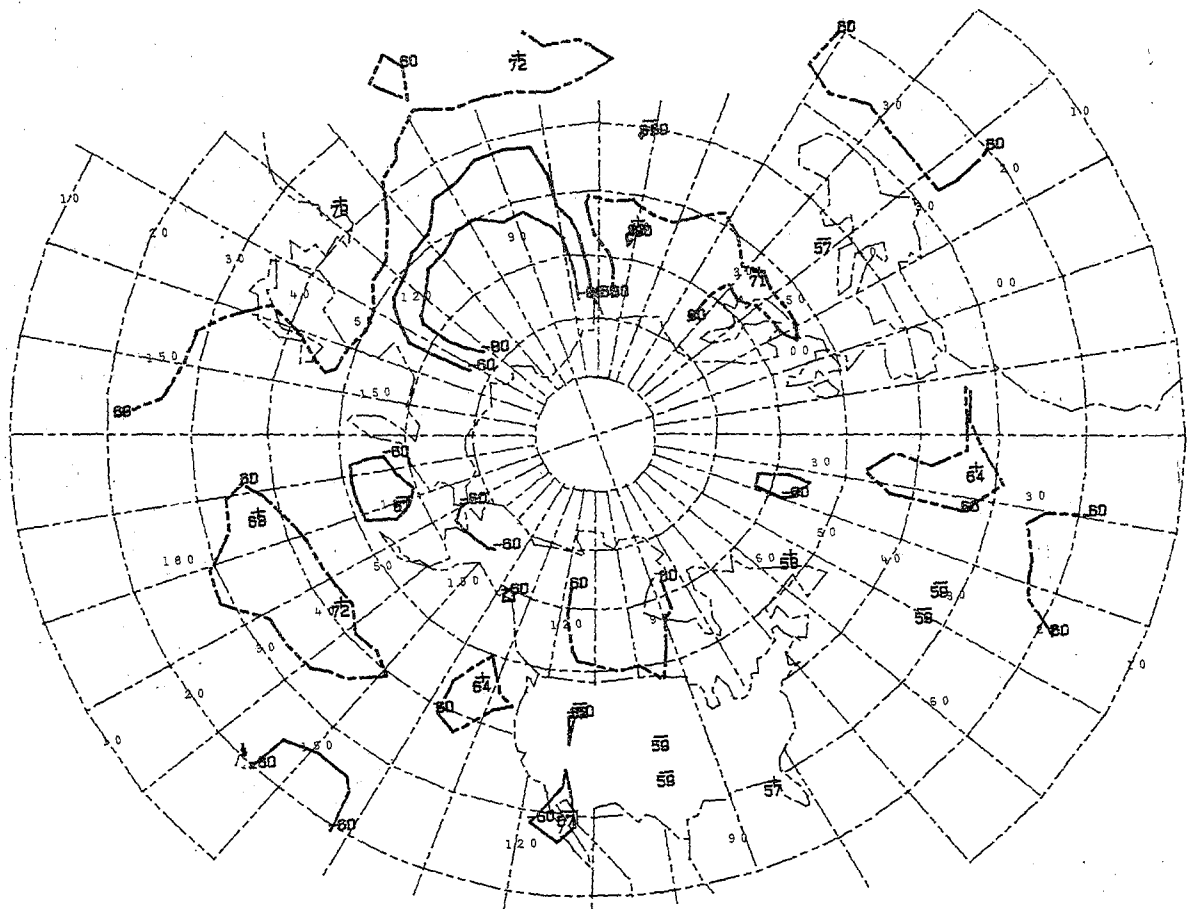

- KEY AT100E 60N 18 CASES

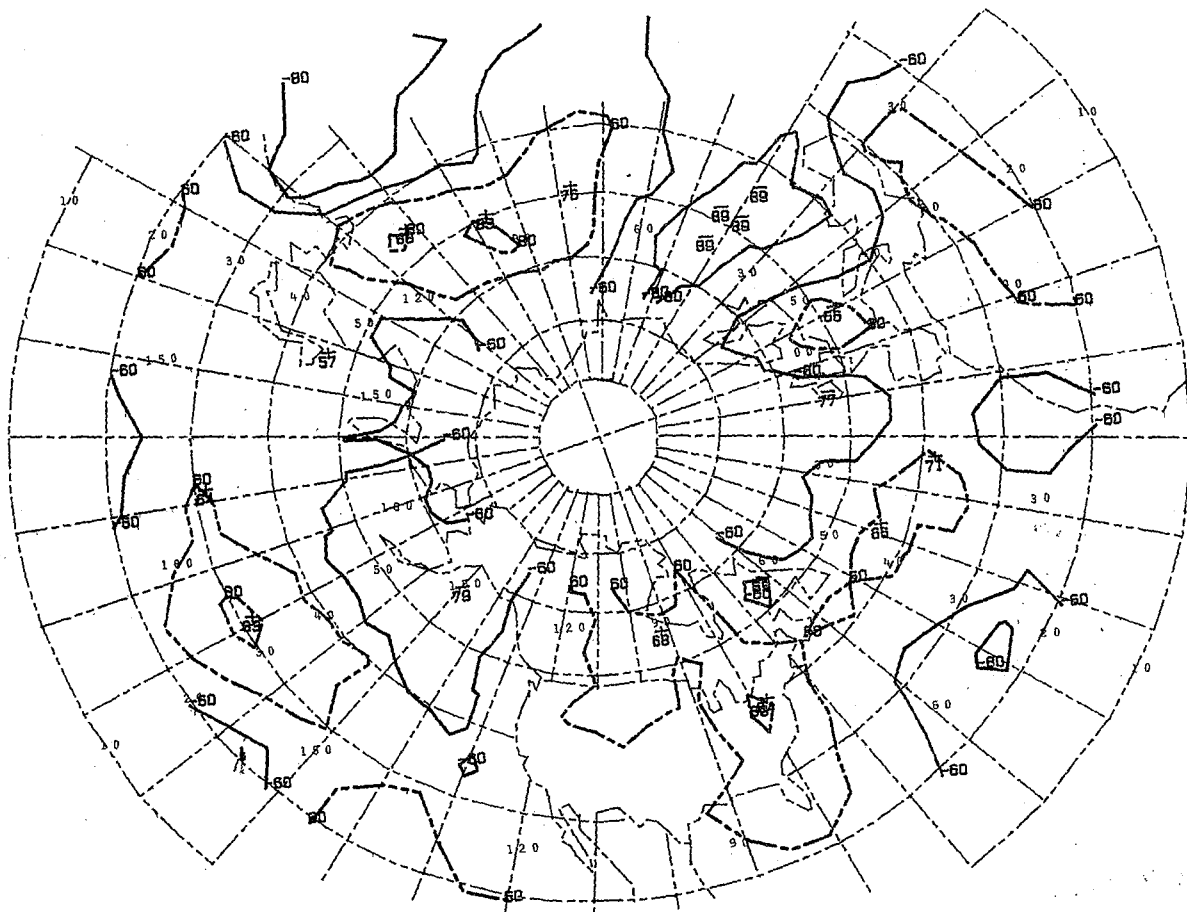

- KEY AT110E 30N 10 CASES

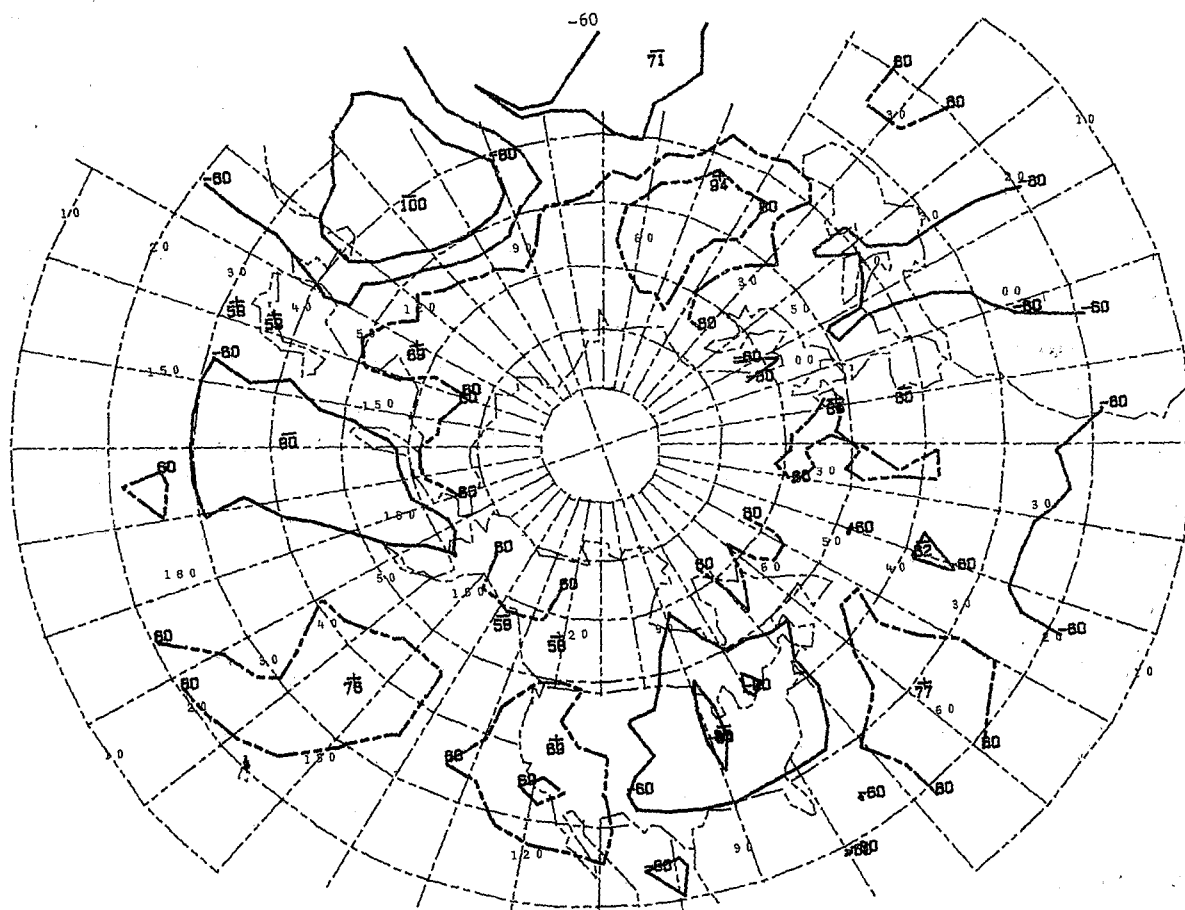

- KEY AT110E 40N 11 CASES

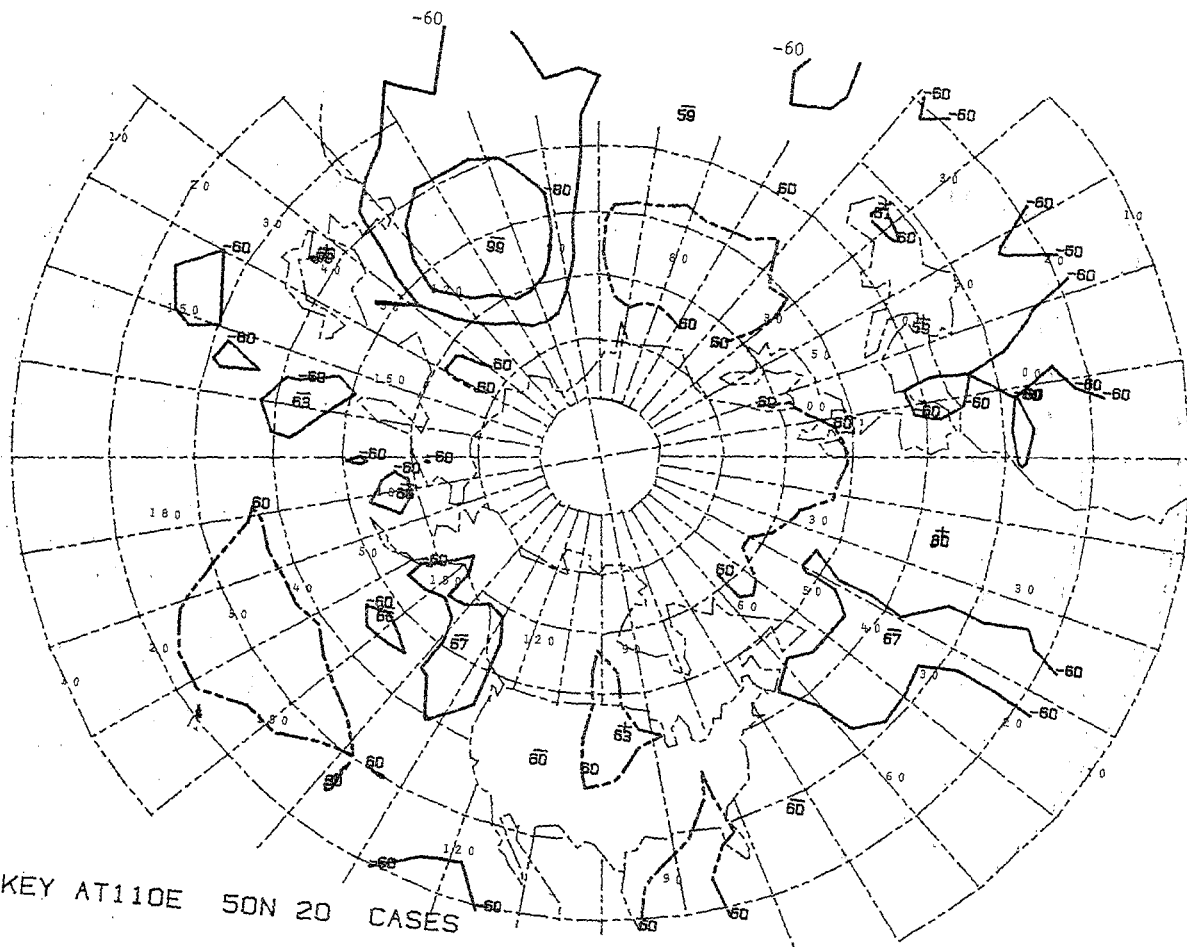

- KEY AT110E 50N 20 CASES

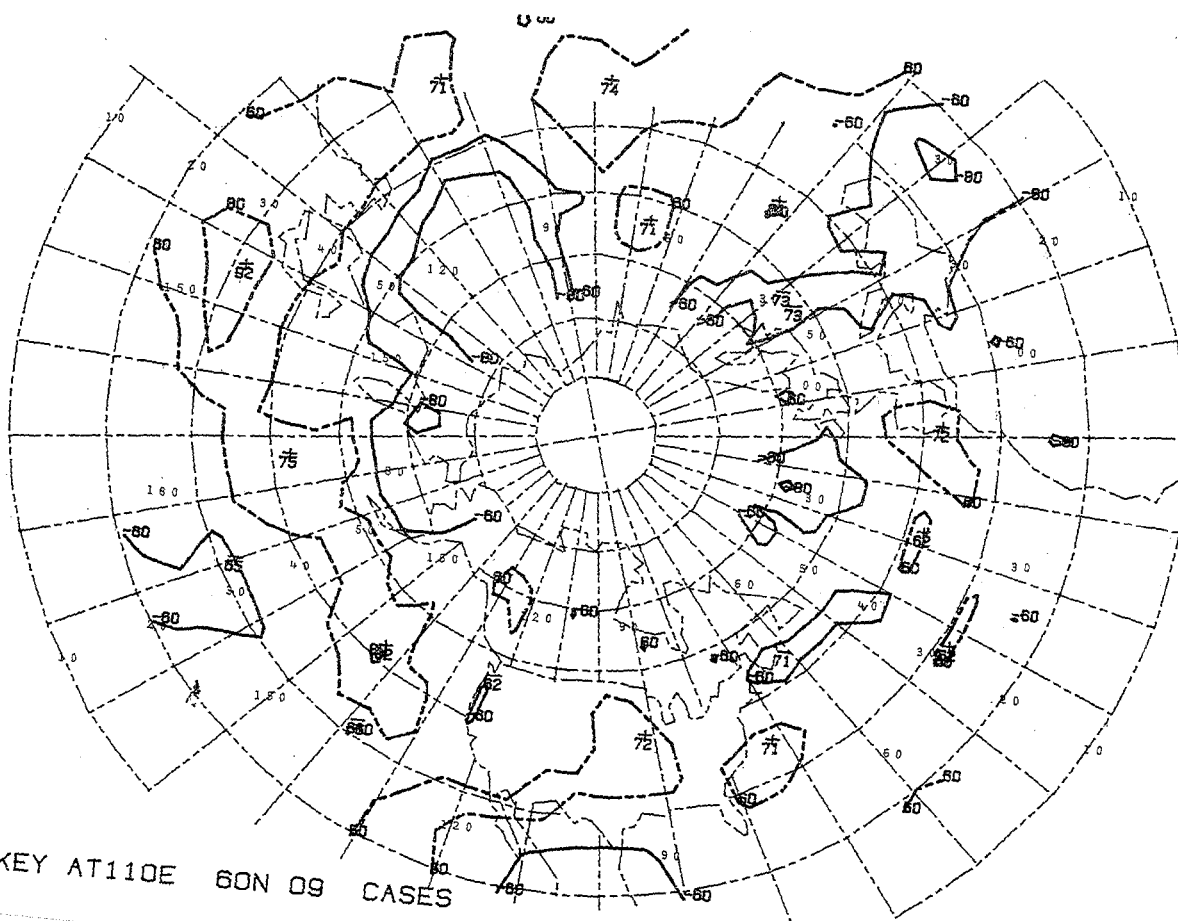

- KEY AT110E 60N 09 CASES

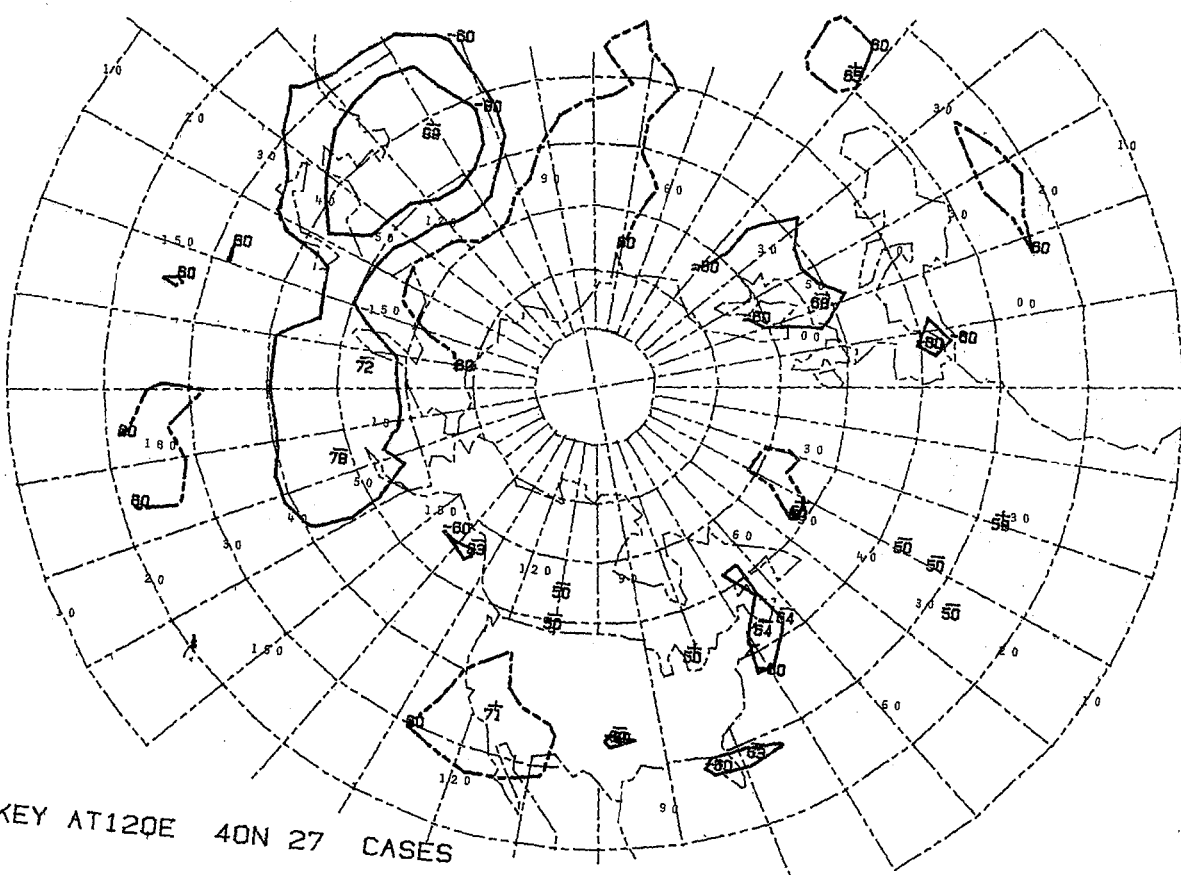
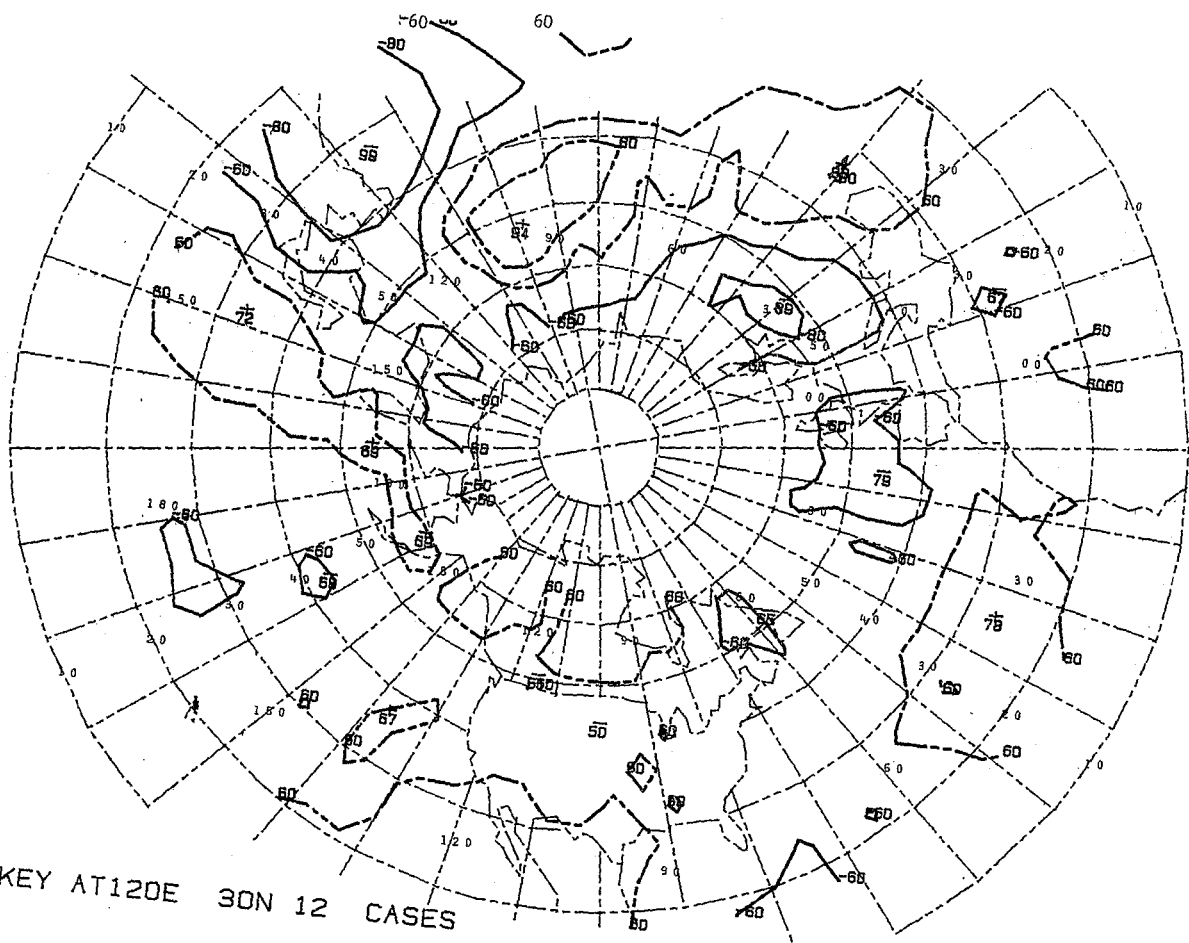

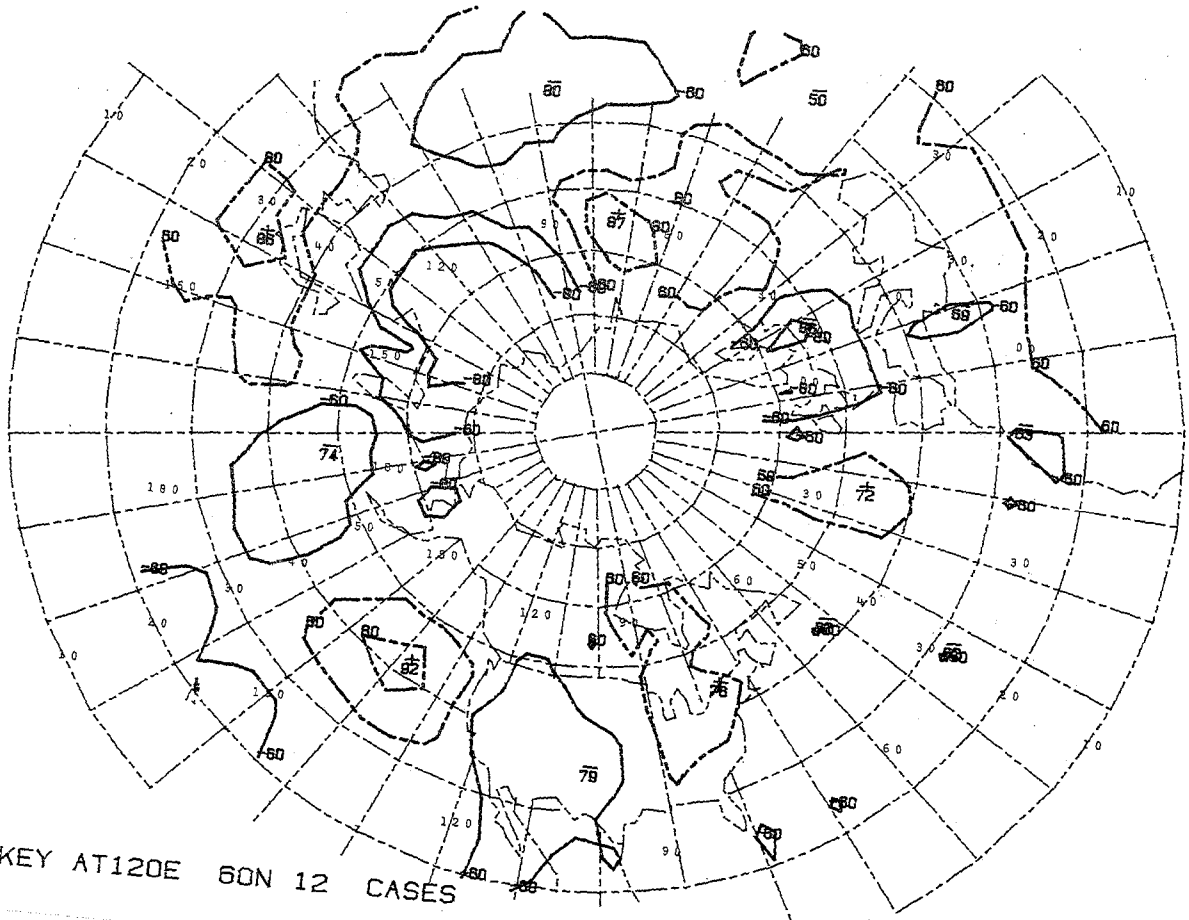
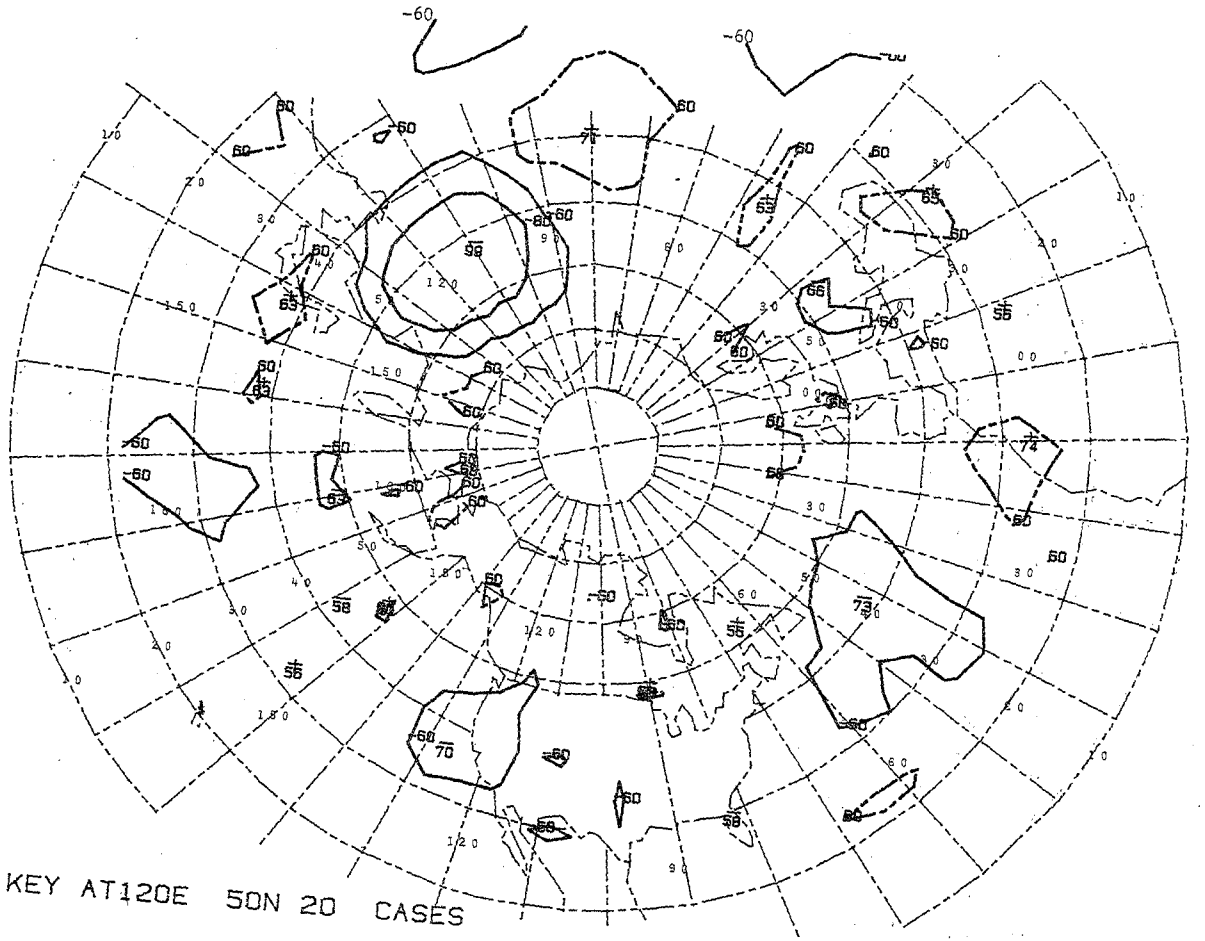

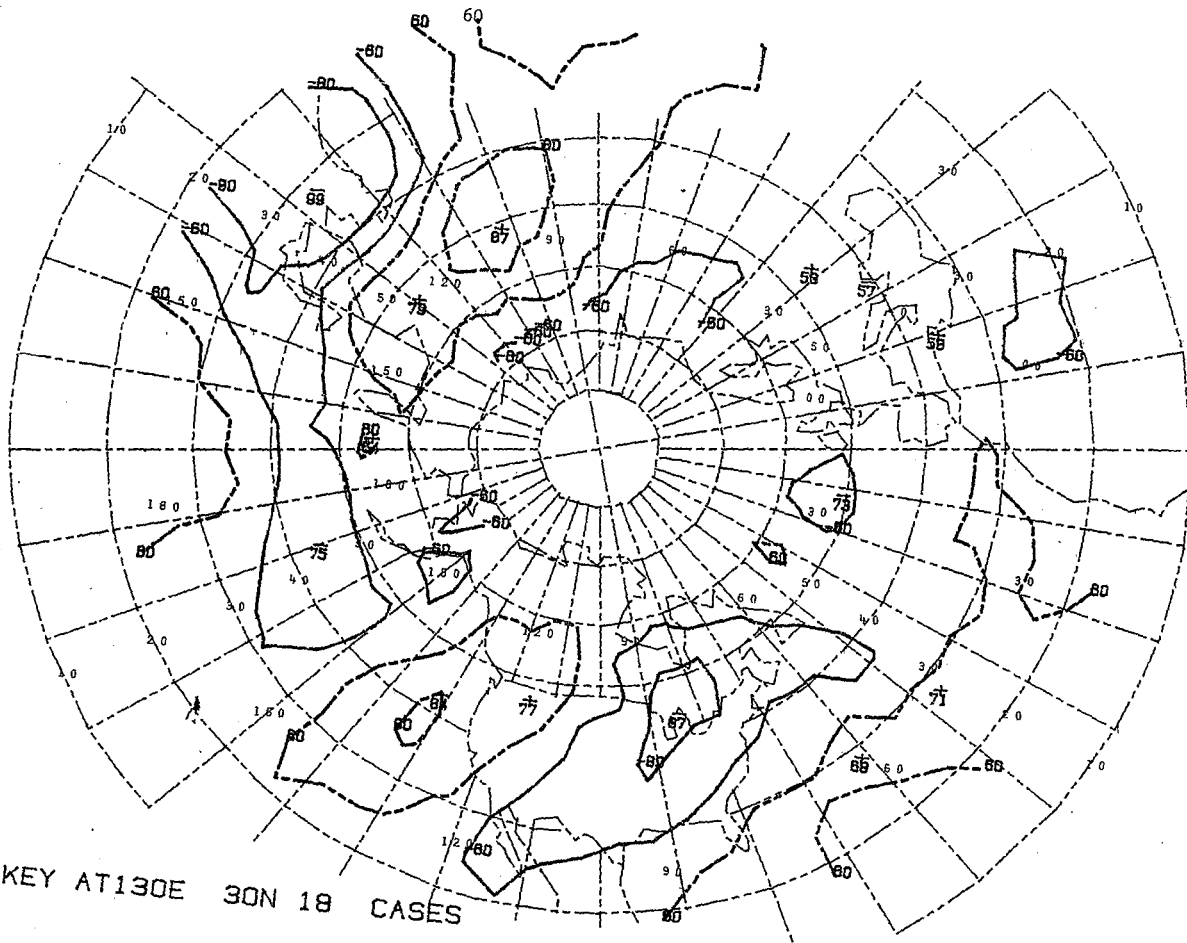

= KEY AT130E 30N 18 CASES

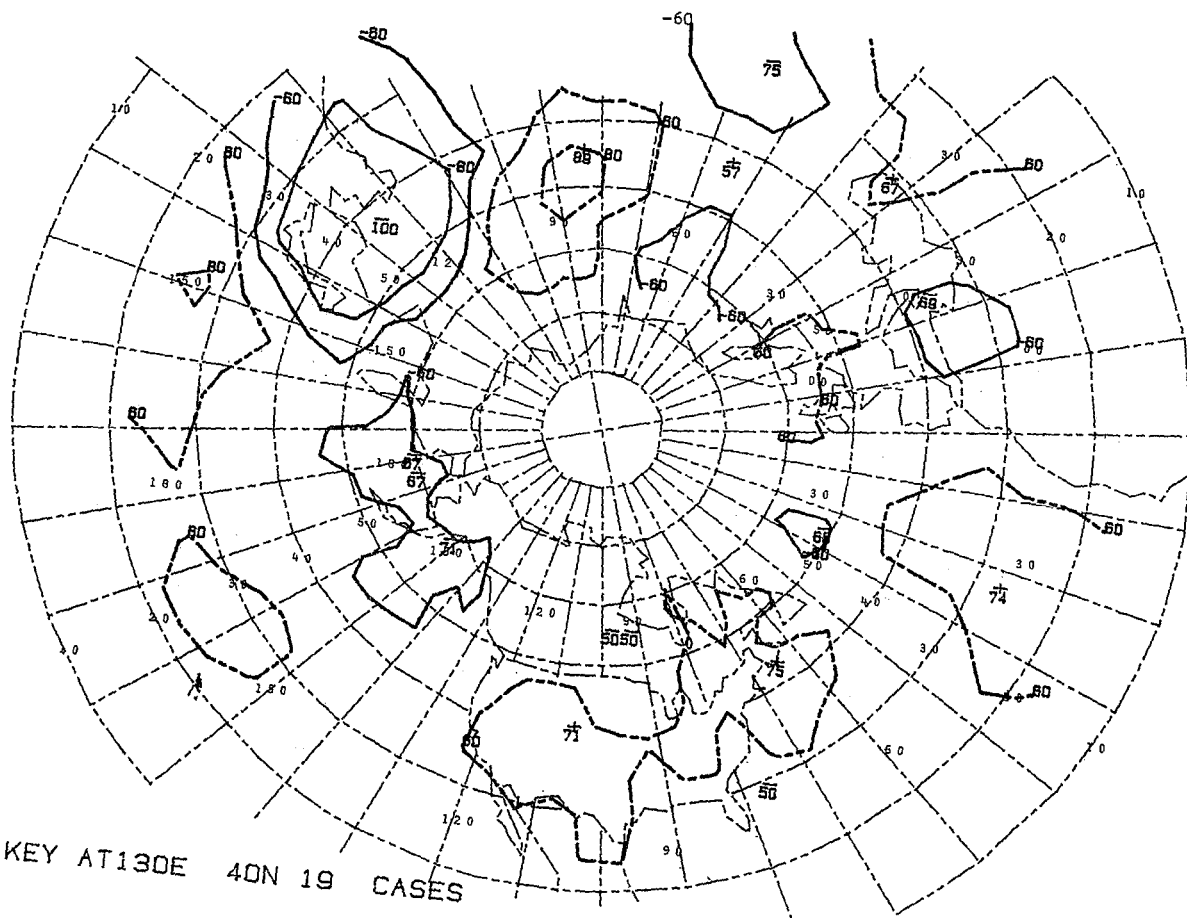

= KEY AT130E 40N 19 CASES

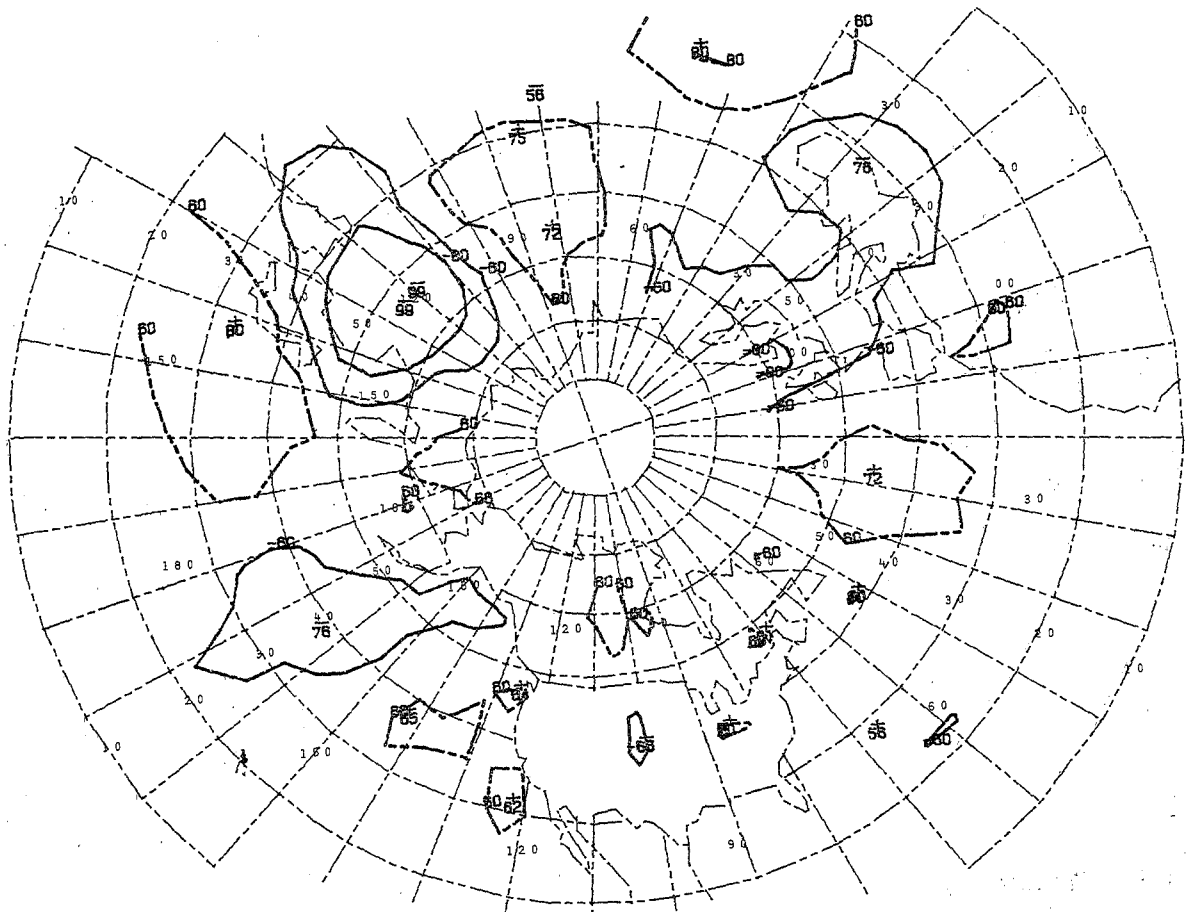

- KEY AT130E 50N 20 CASES

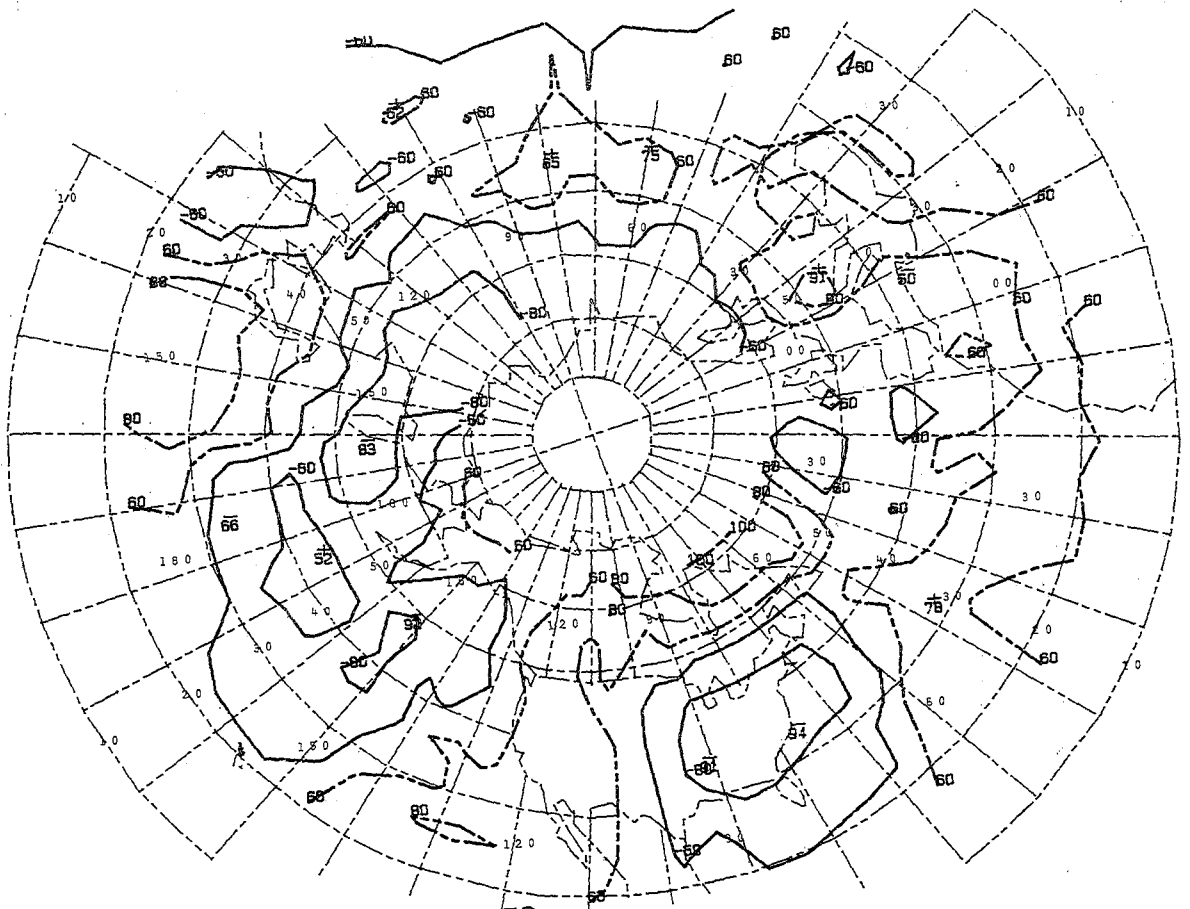

- KEY AT130E 60N 06 CASES

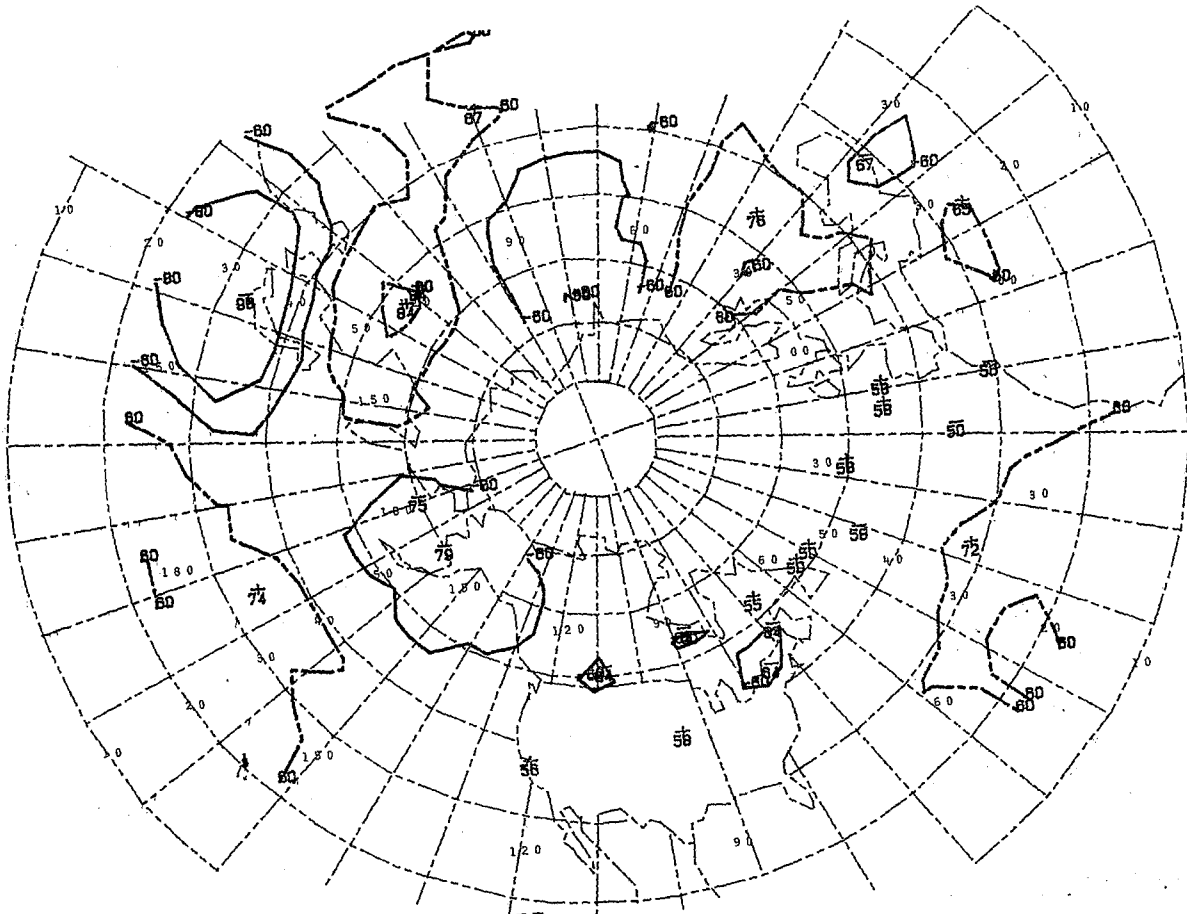

- KEY AT140E 30N 18 CASES

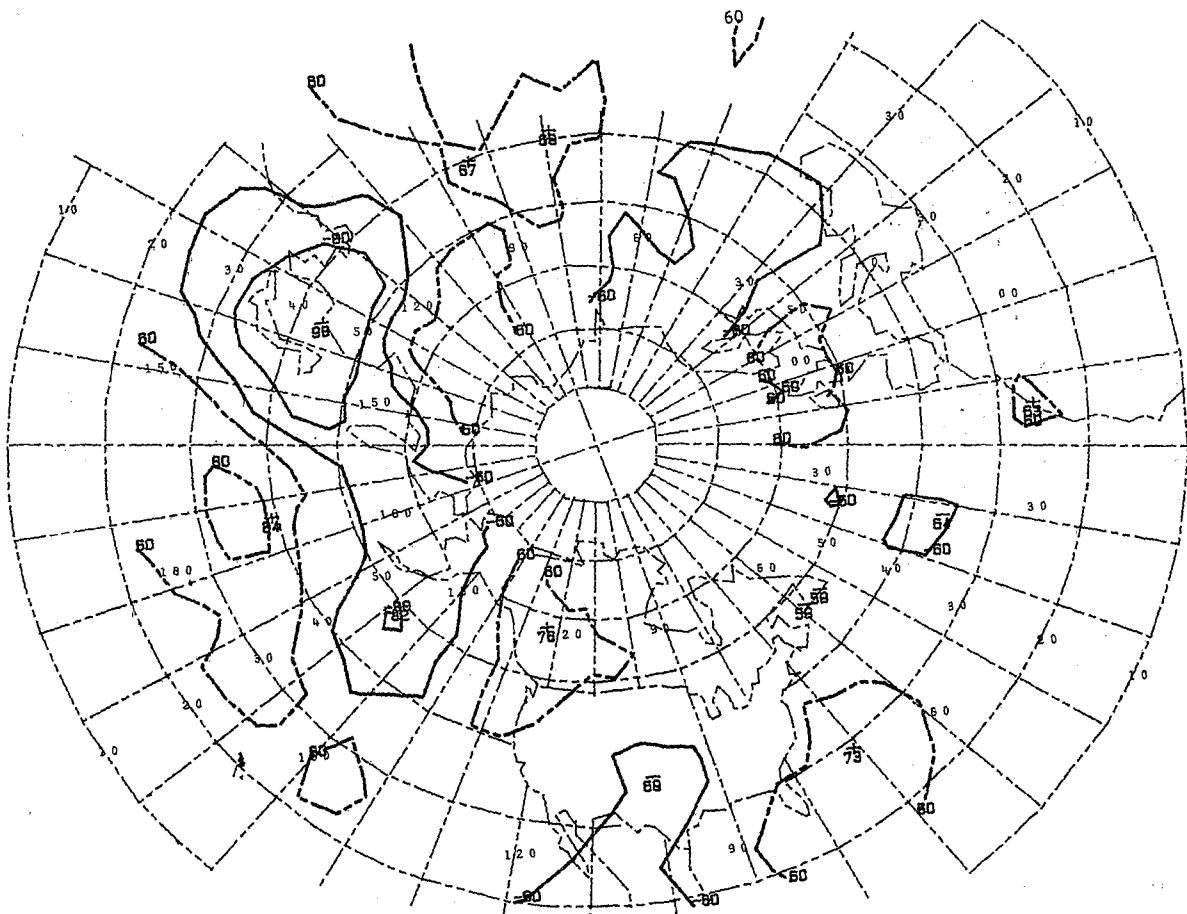

- KEY AT140E 40N 21 CASES

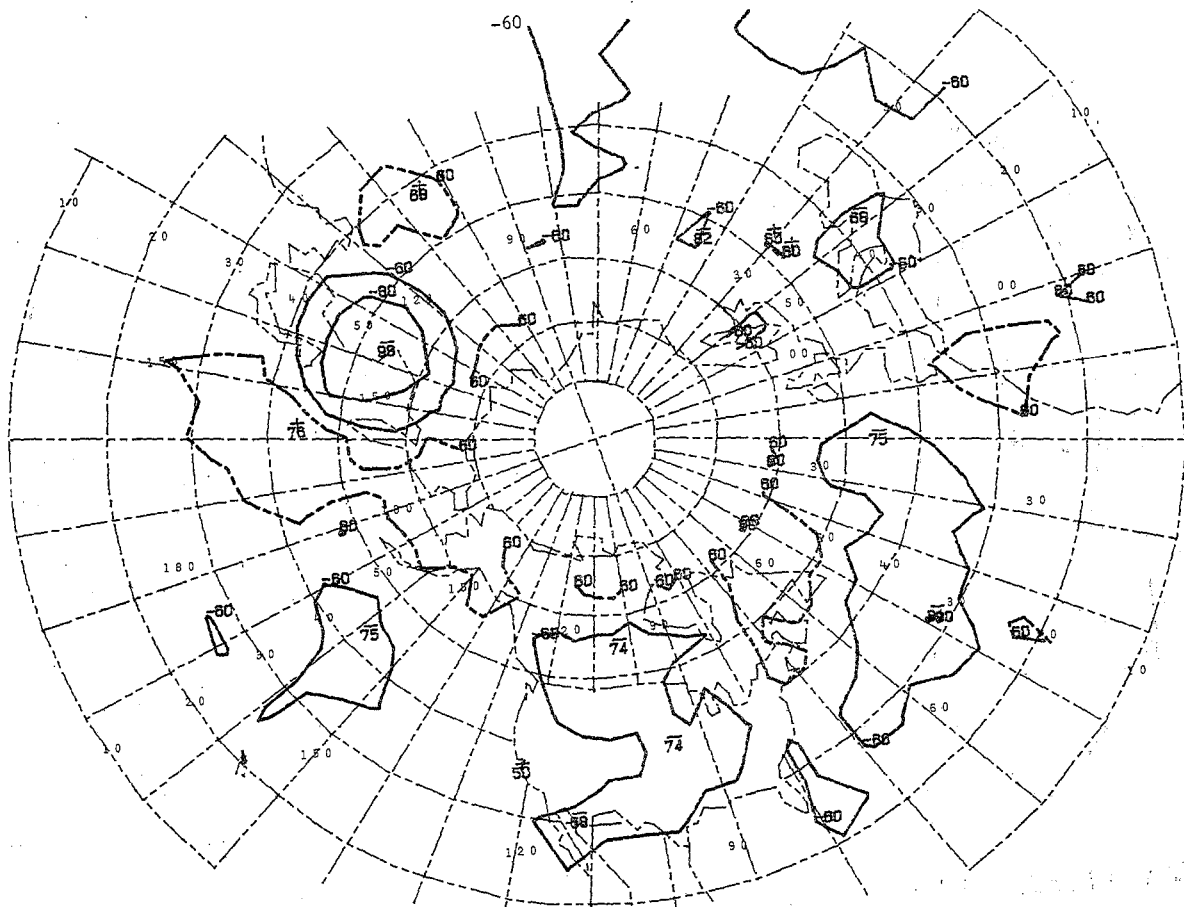

- KEY AT140E 50N 14 CASES

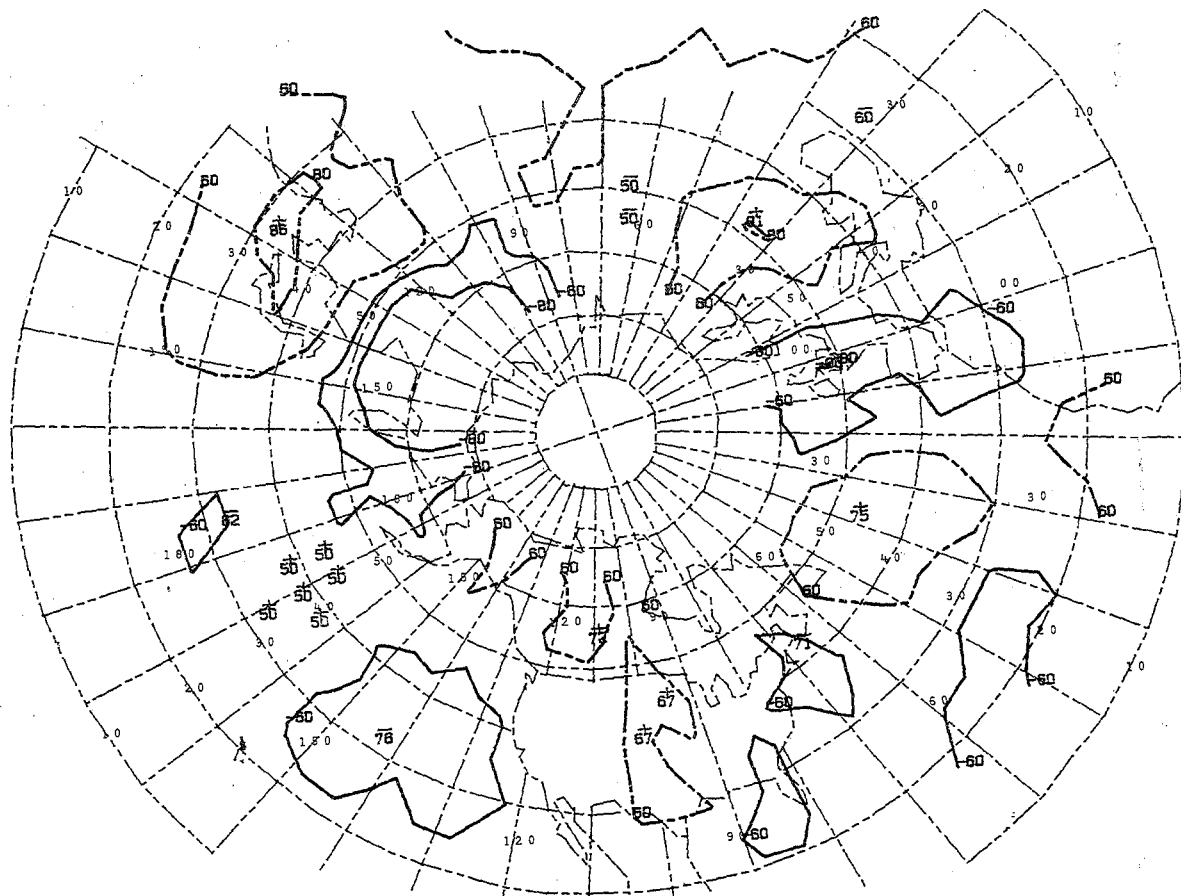

- KEY AT140E 60N 14 CASES

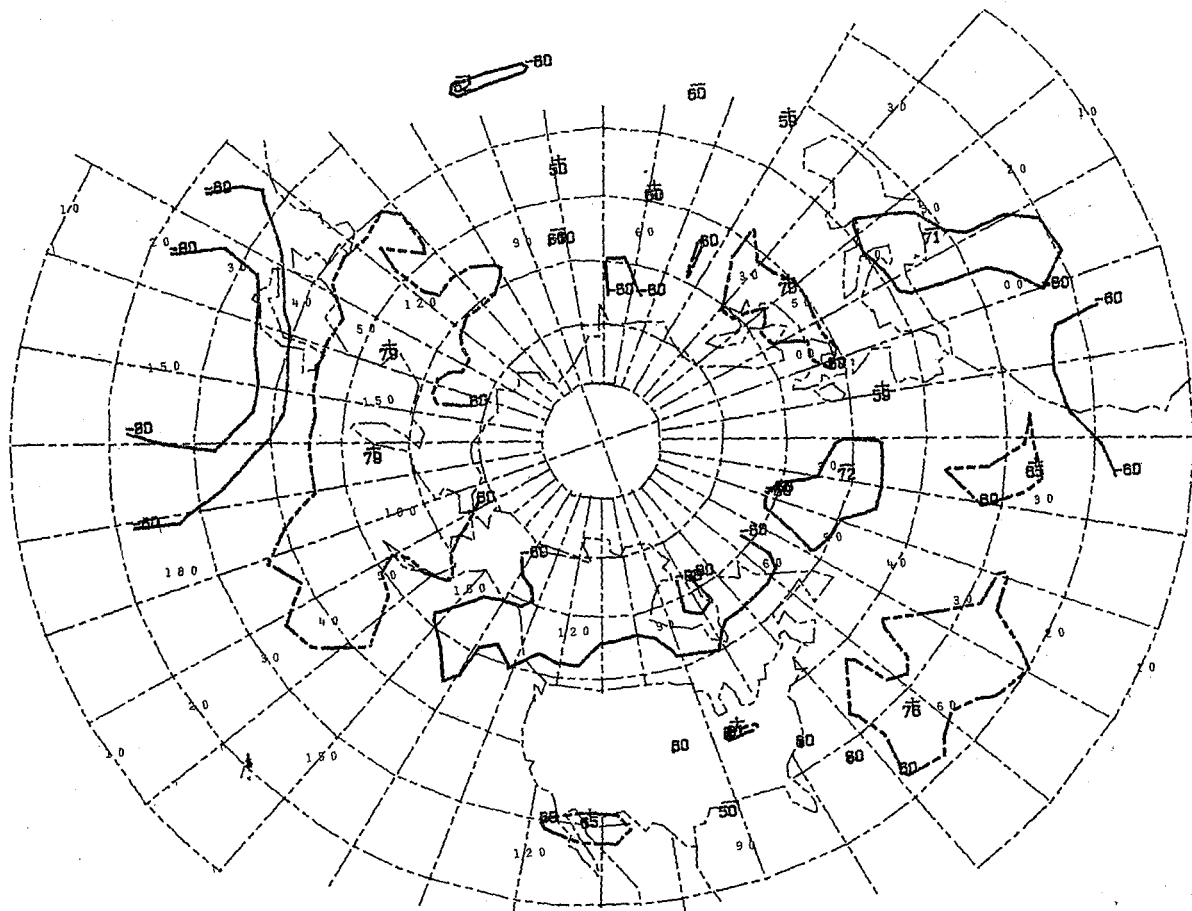

- KEY AT150E 30N 17 CASES

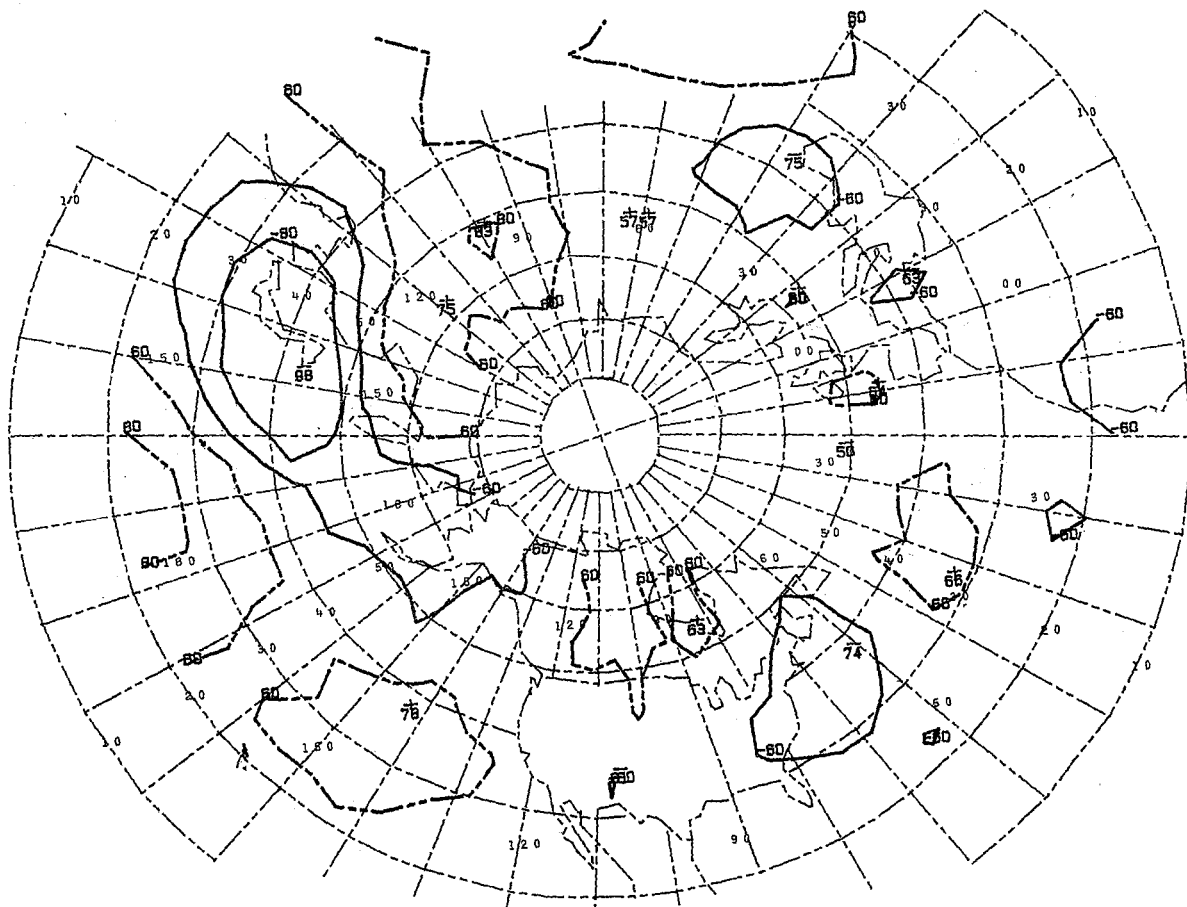

- KEY AT150E 40N 23 CASES

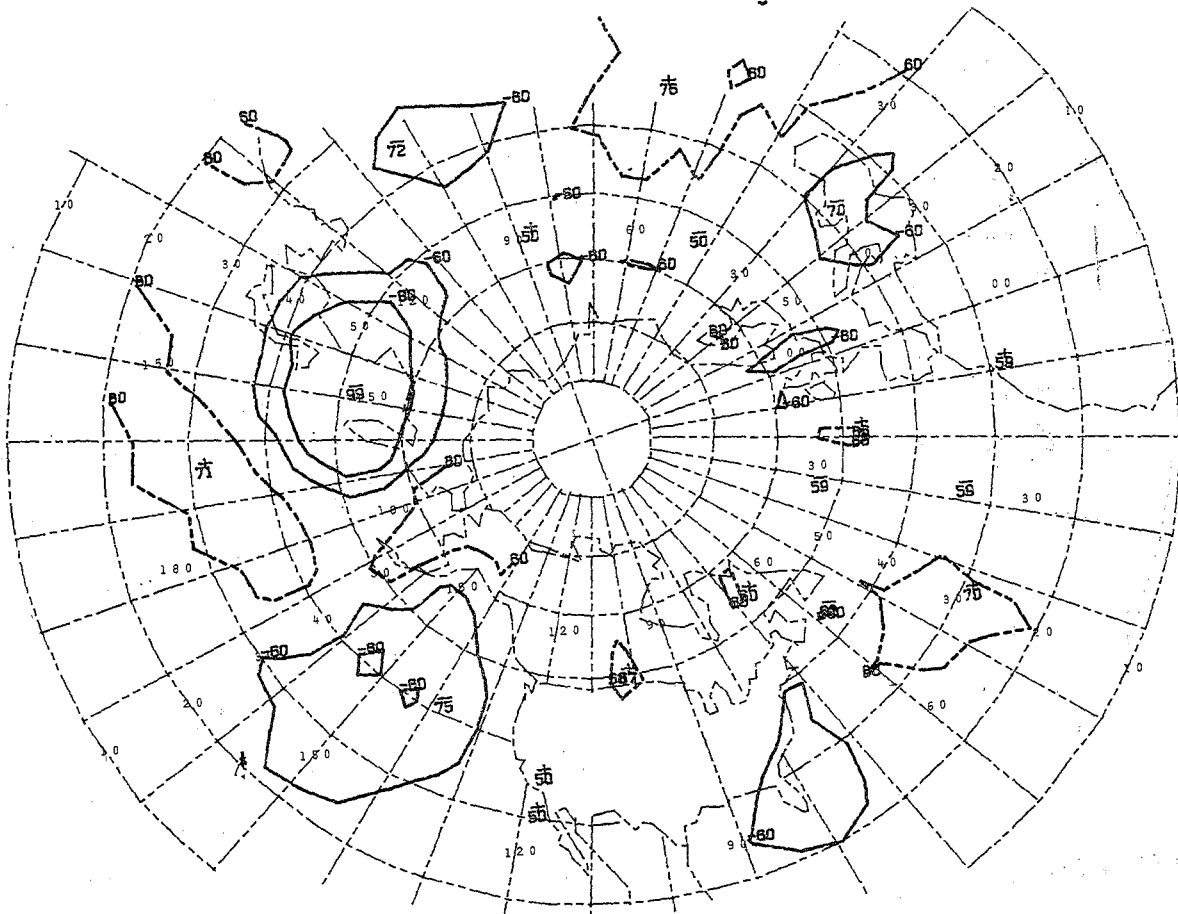

- KEY AT150E 50N 19 CASES

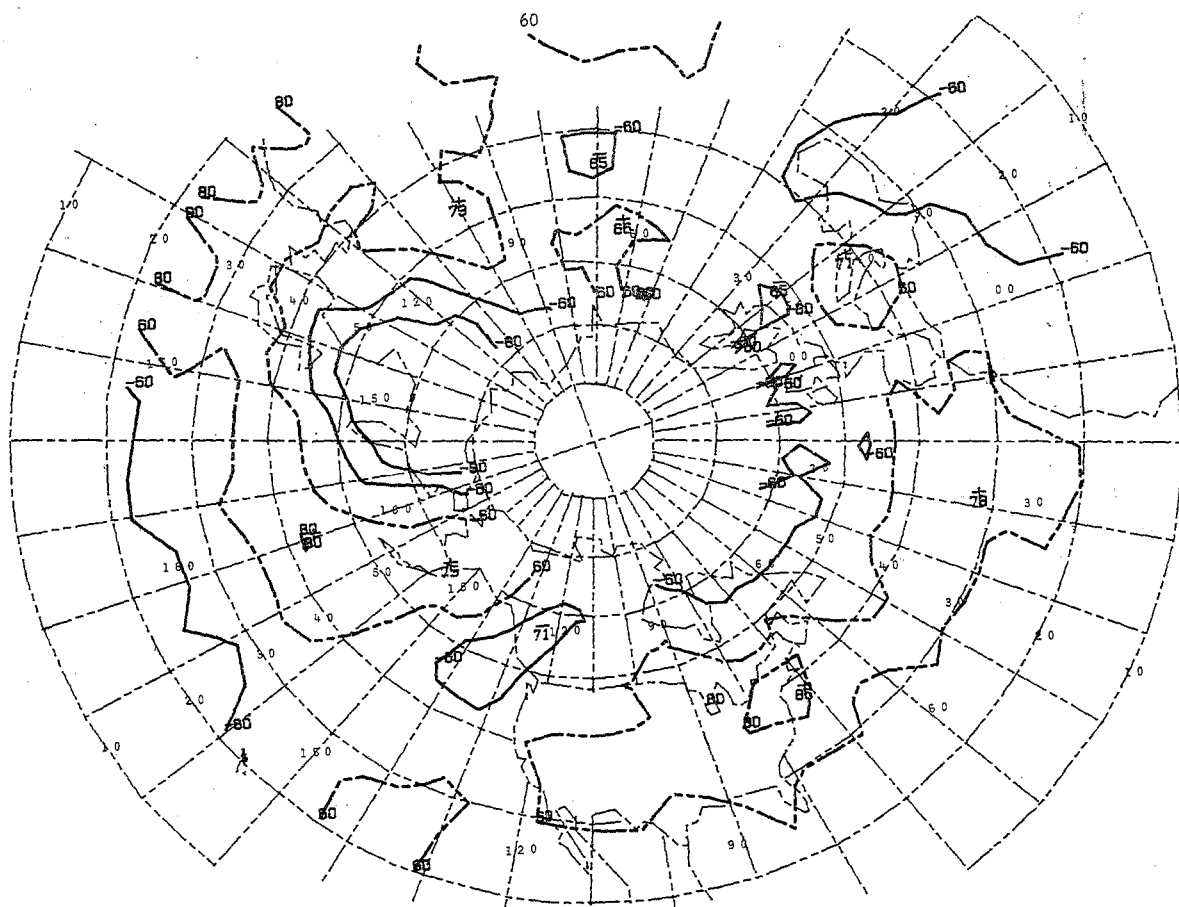

- KEY AT150E 60N 13 CASES

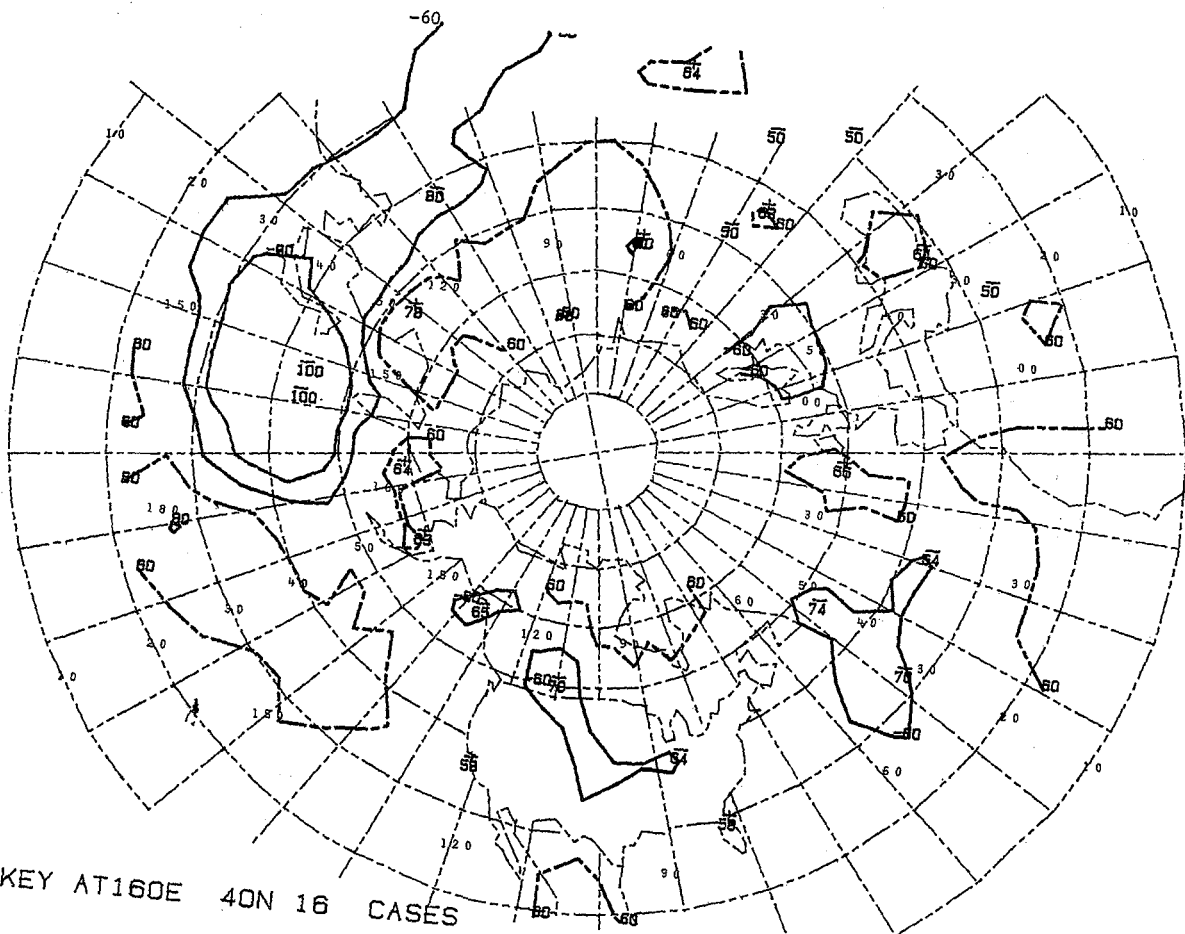
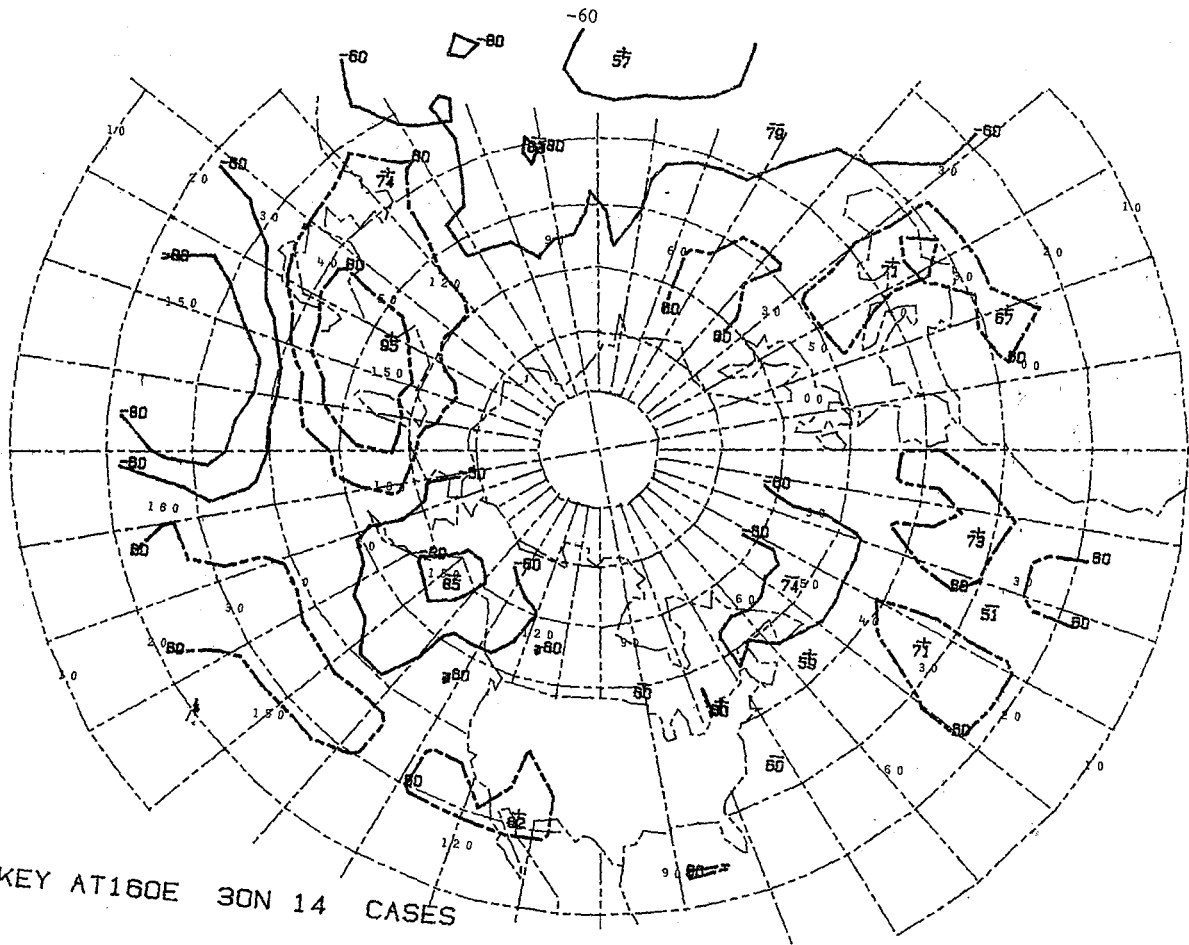

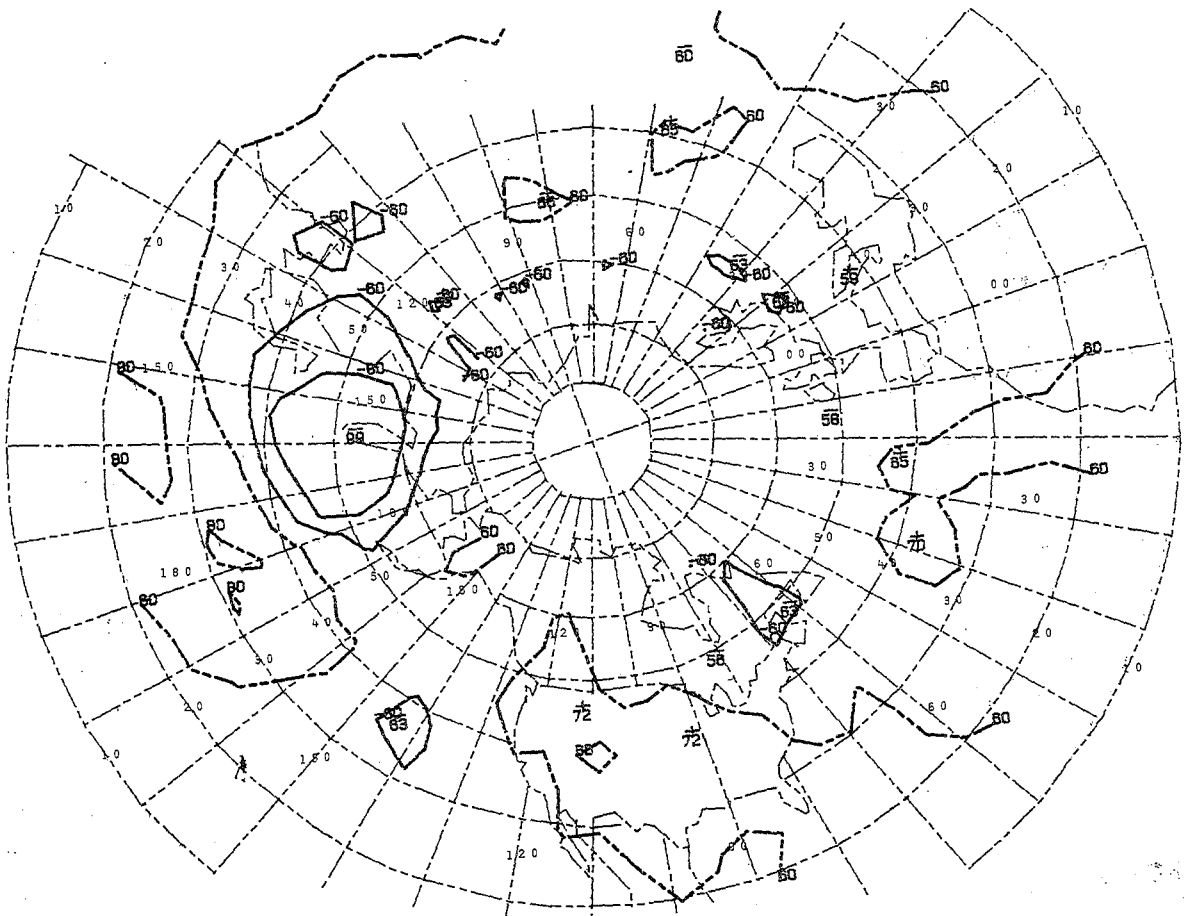

- KEY AT160E 50N 20 CASES

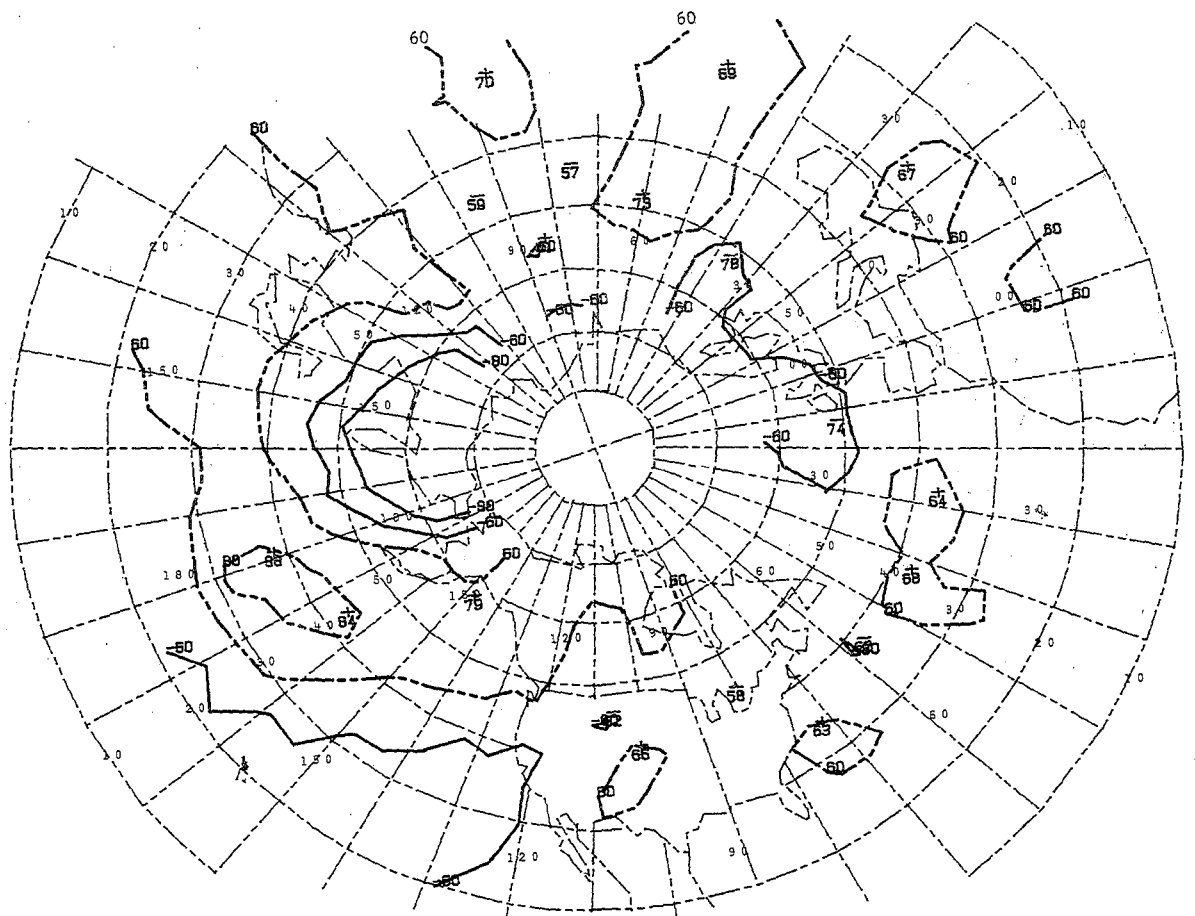

- KEY AT160E 60N 18 CASES

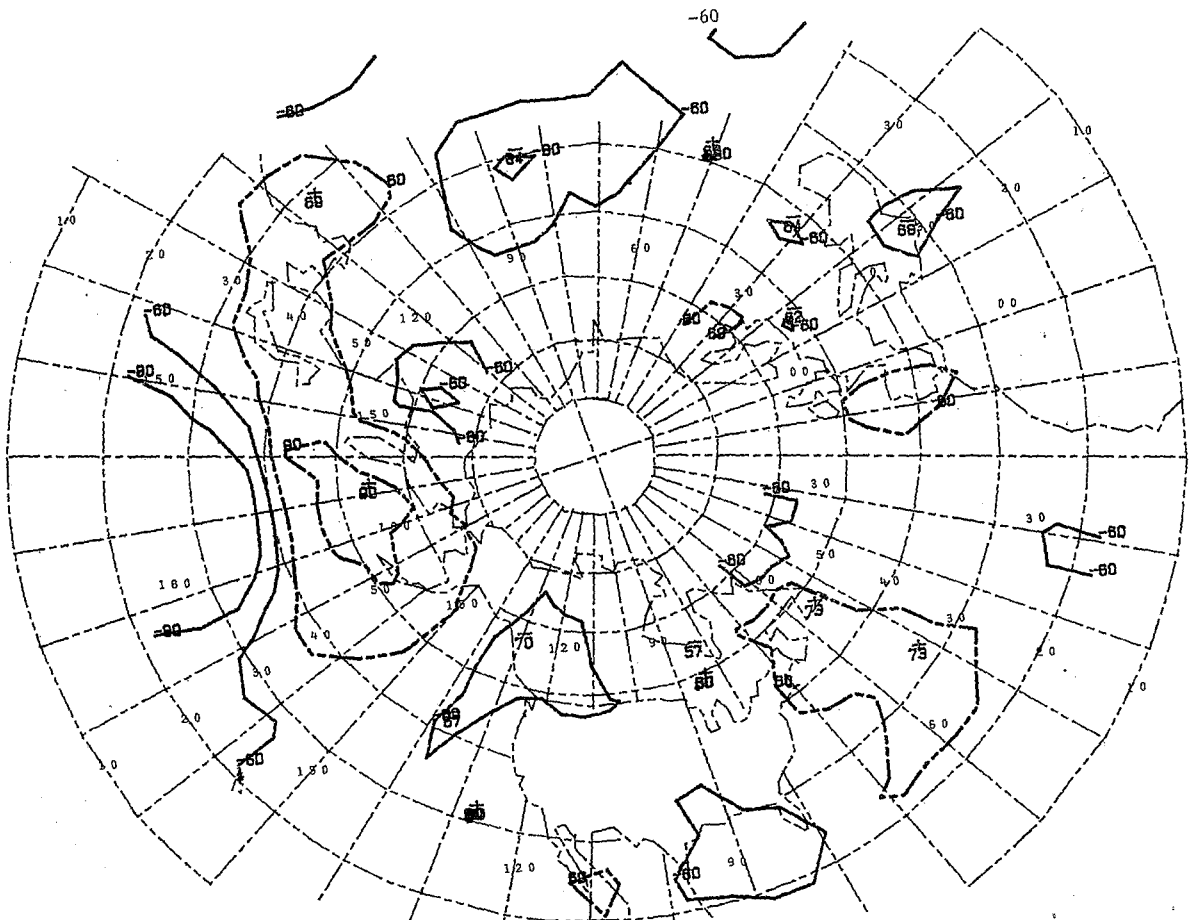

- KEY AT170E 30N 18 CASES

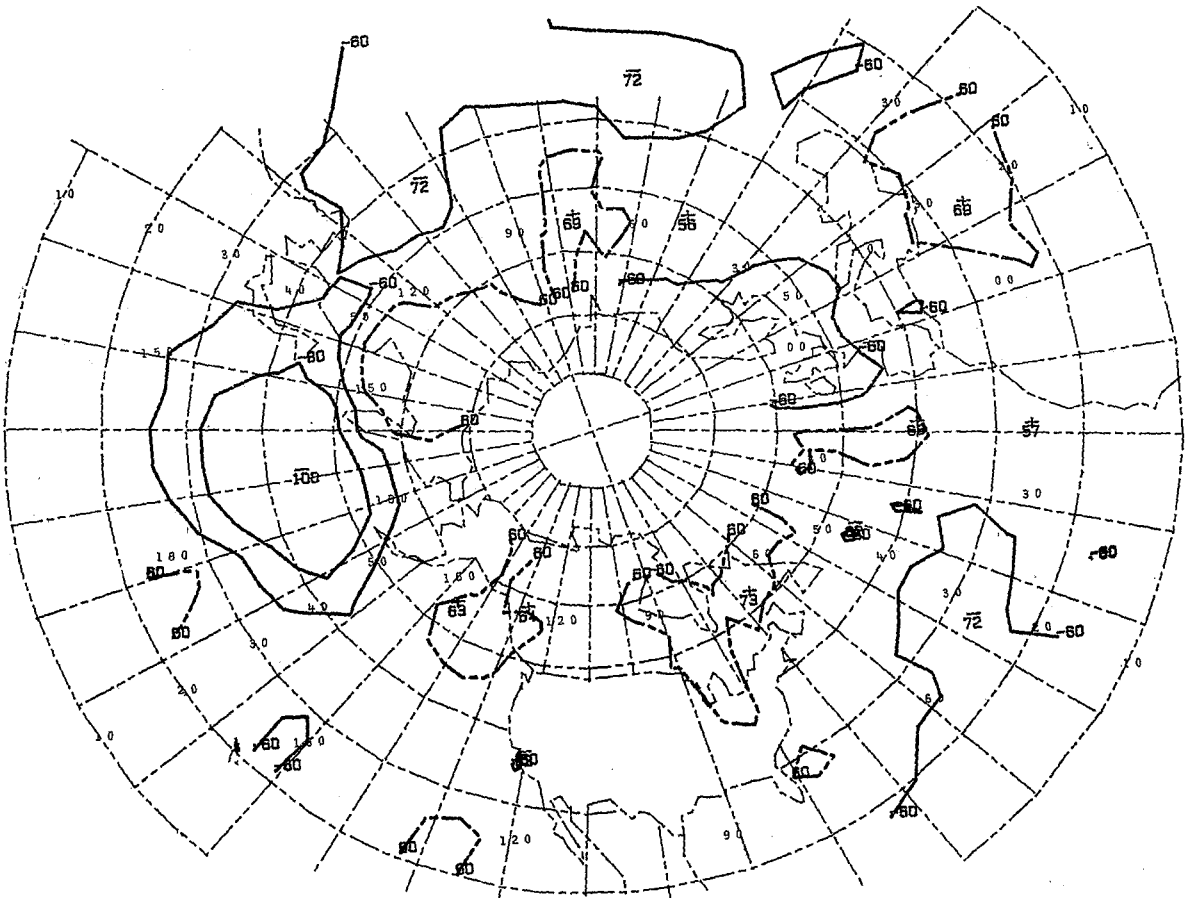

- KEY AT170E 40N 15 CASES

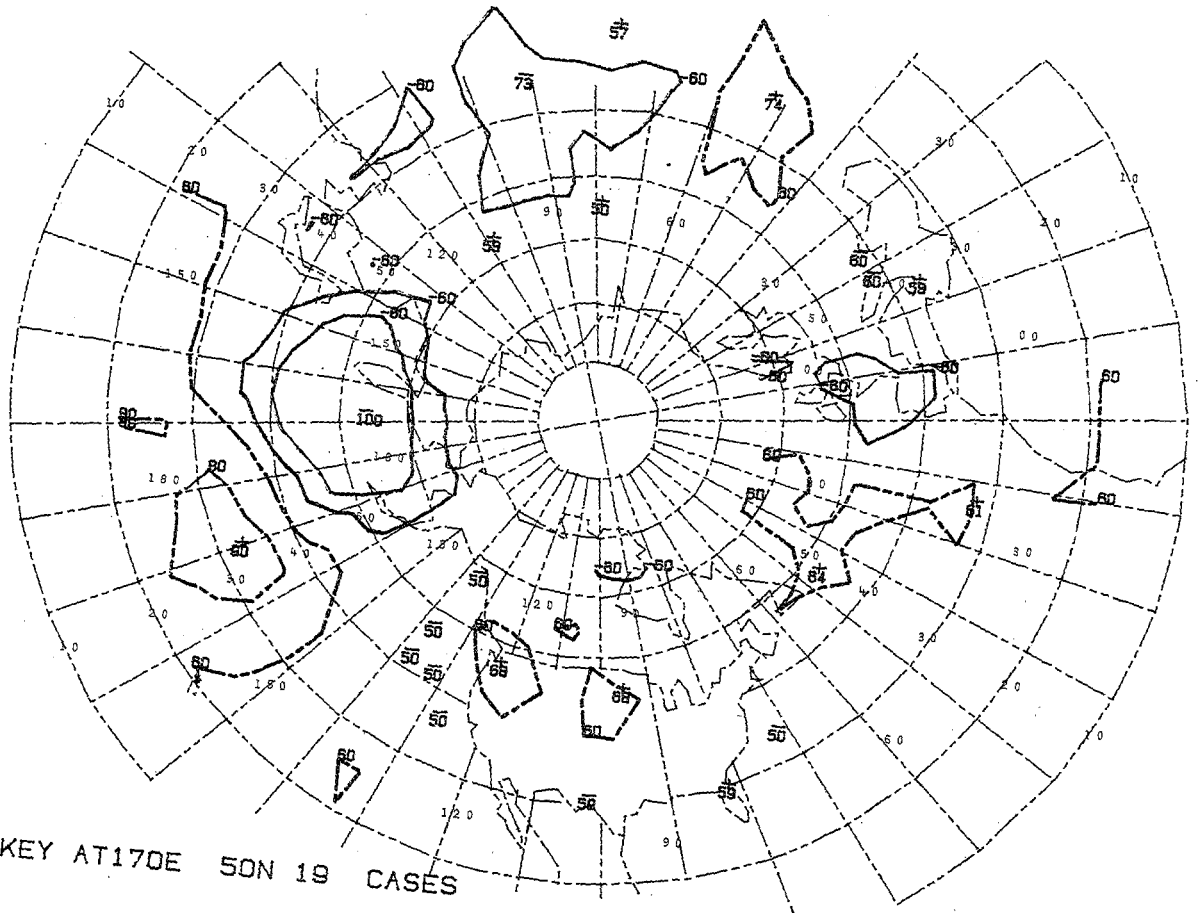

- KEY AT170E 50N 19 CASES

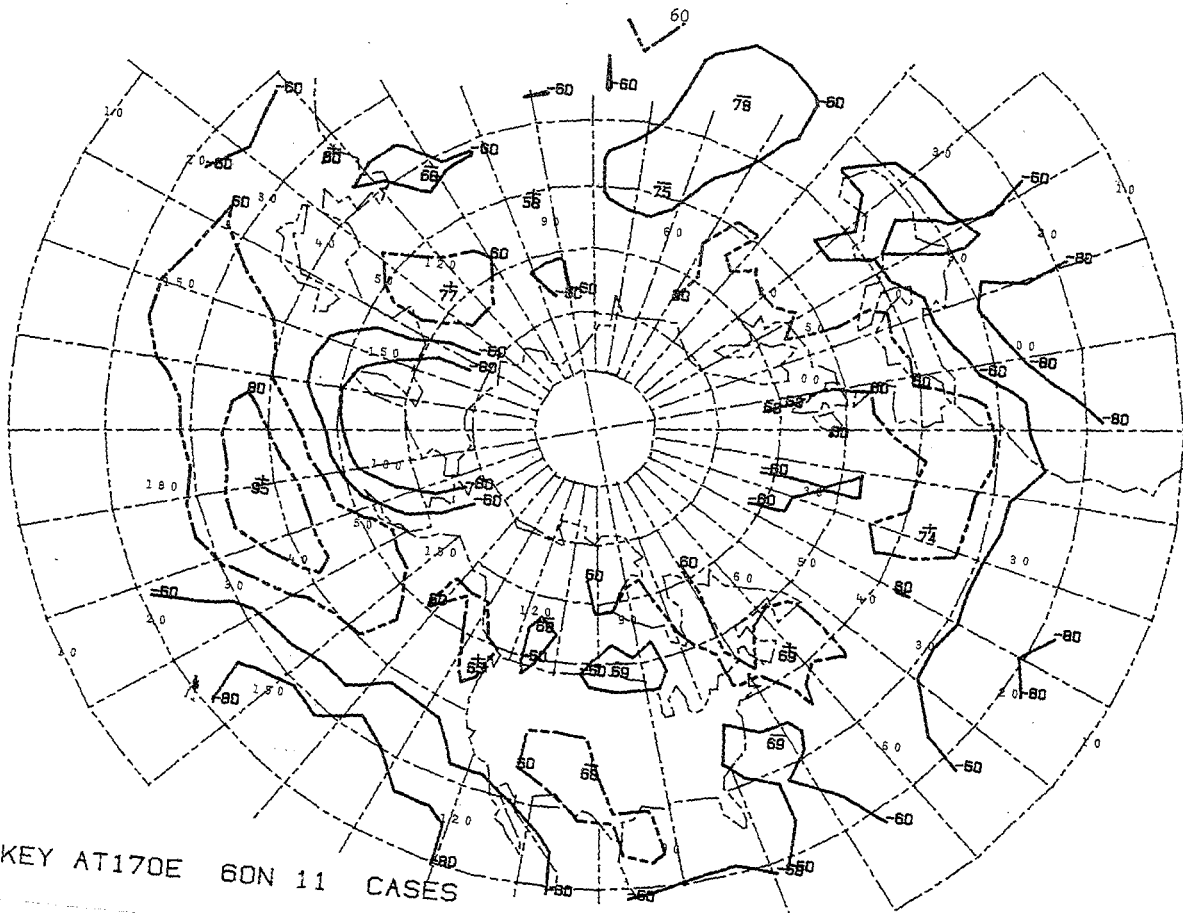

- KEY AT170E 60N 11 CASES

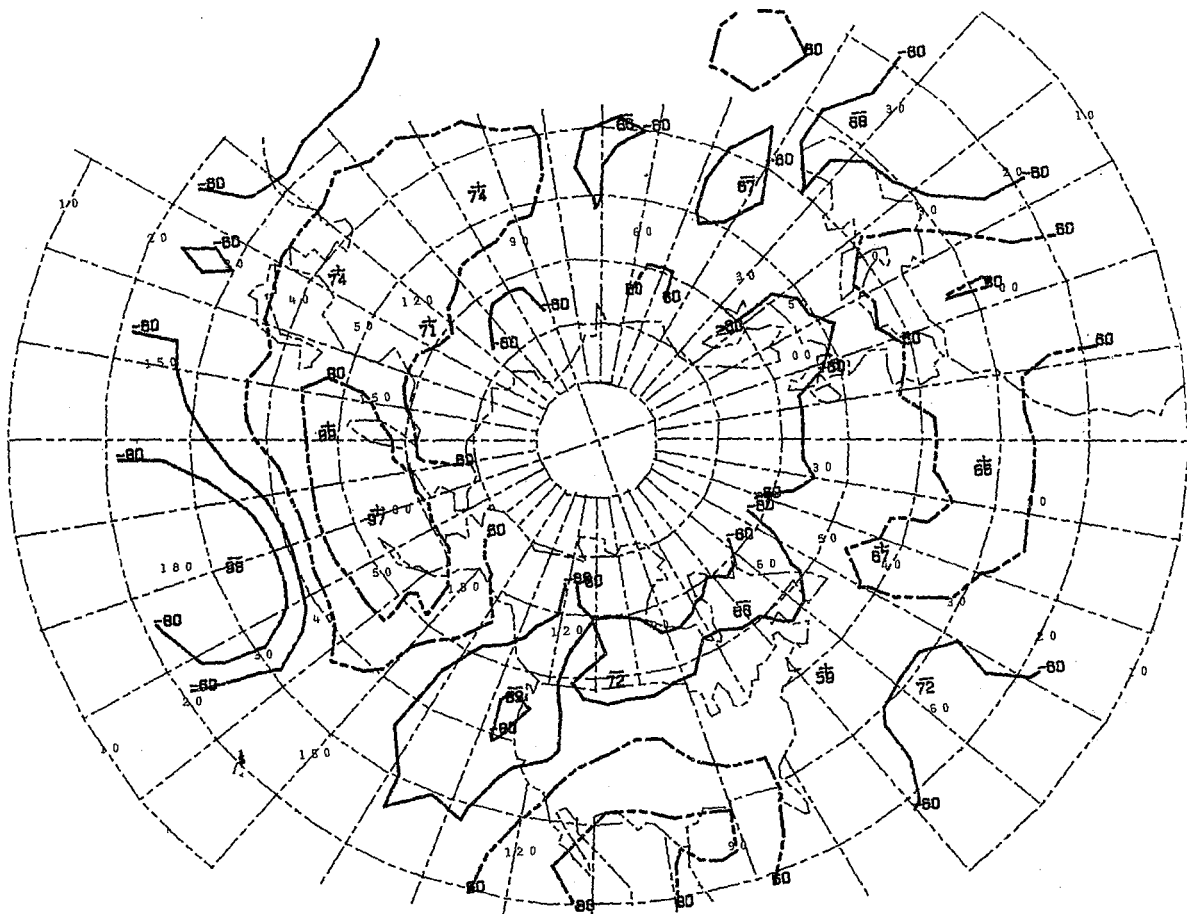

- KEY AT180 30N 13 CASES

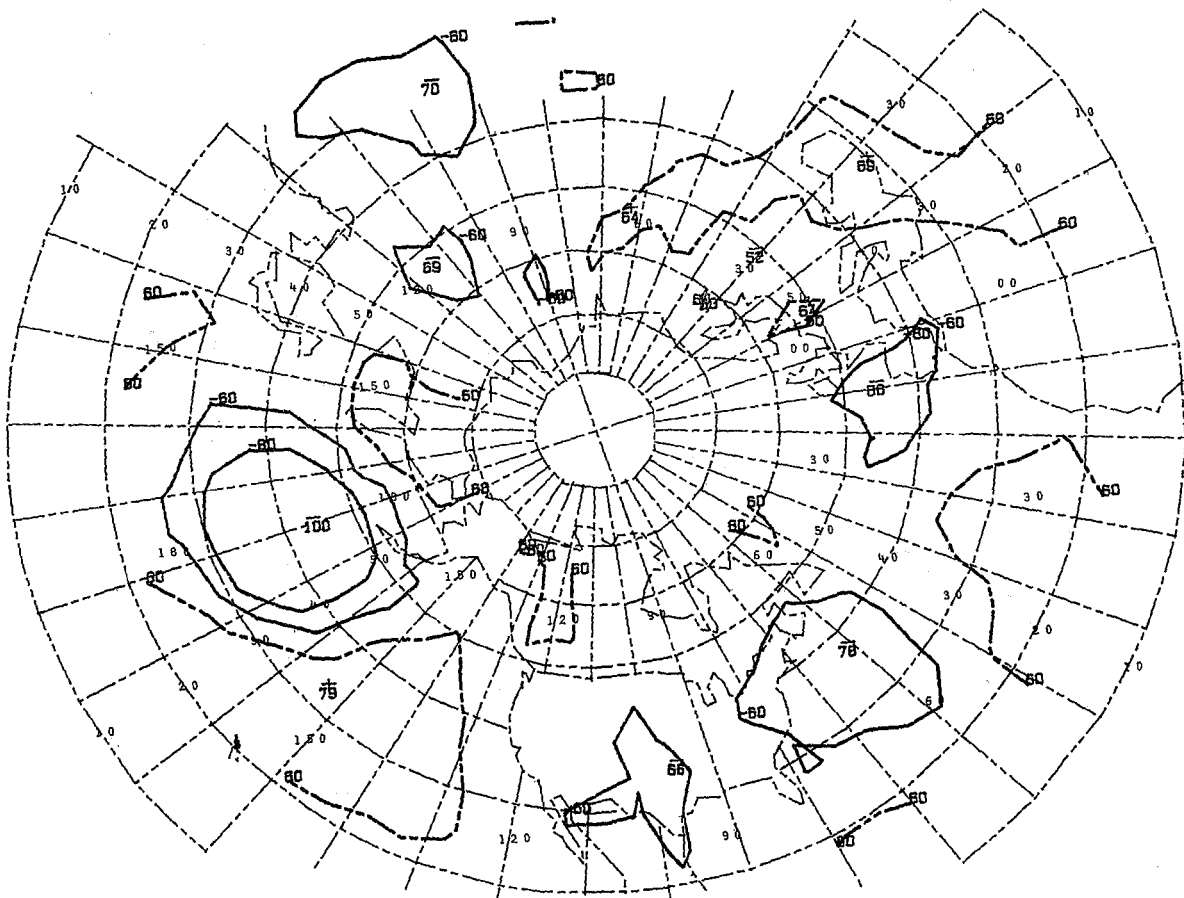

- KEY AT180 40N 25 CASES

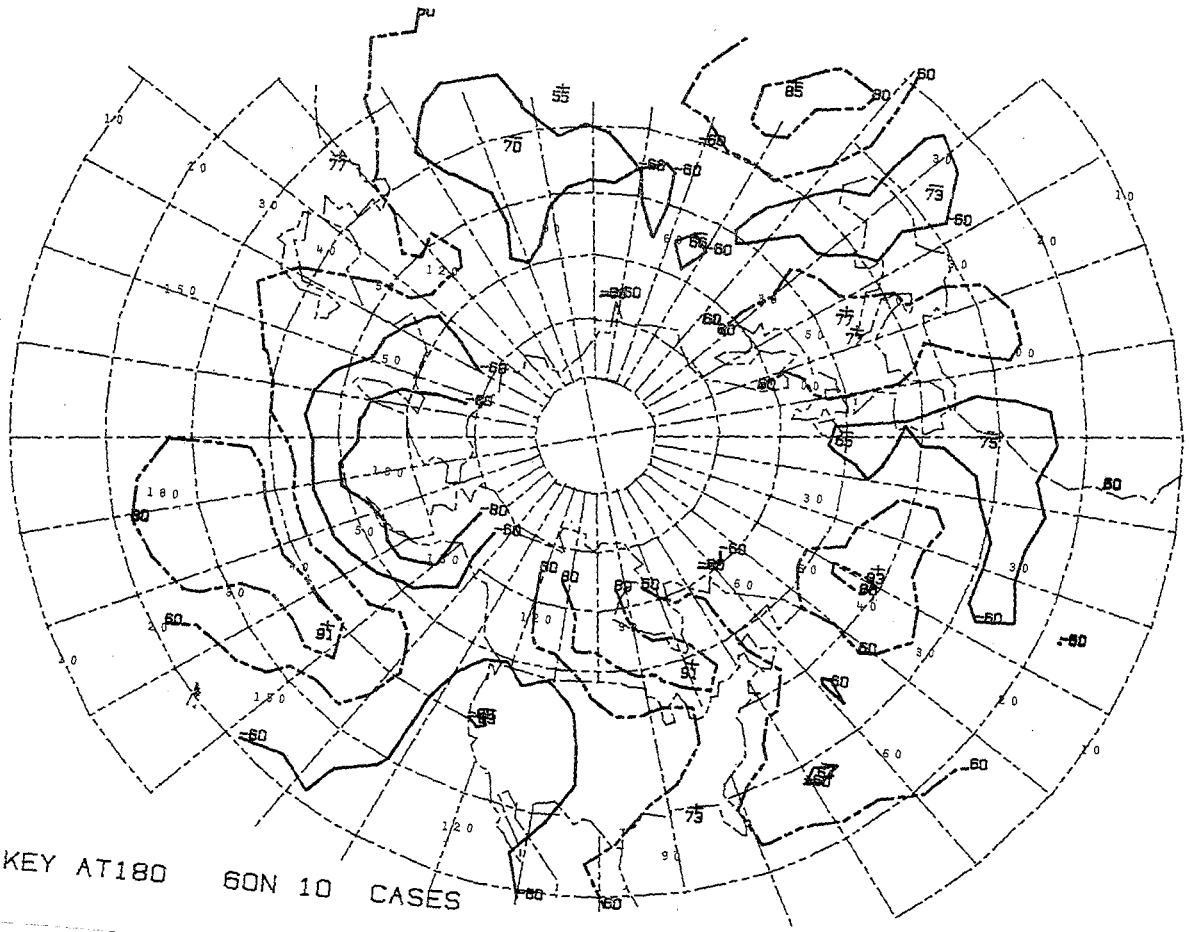
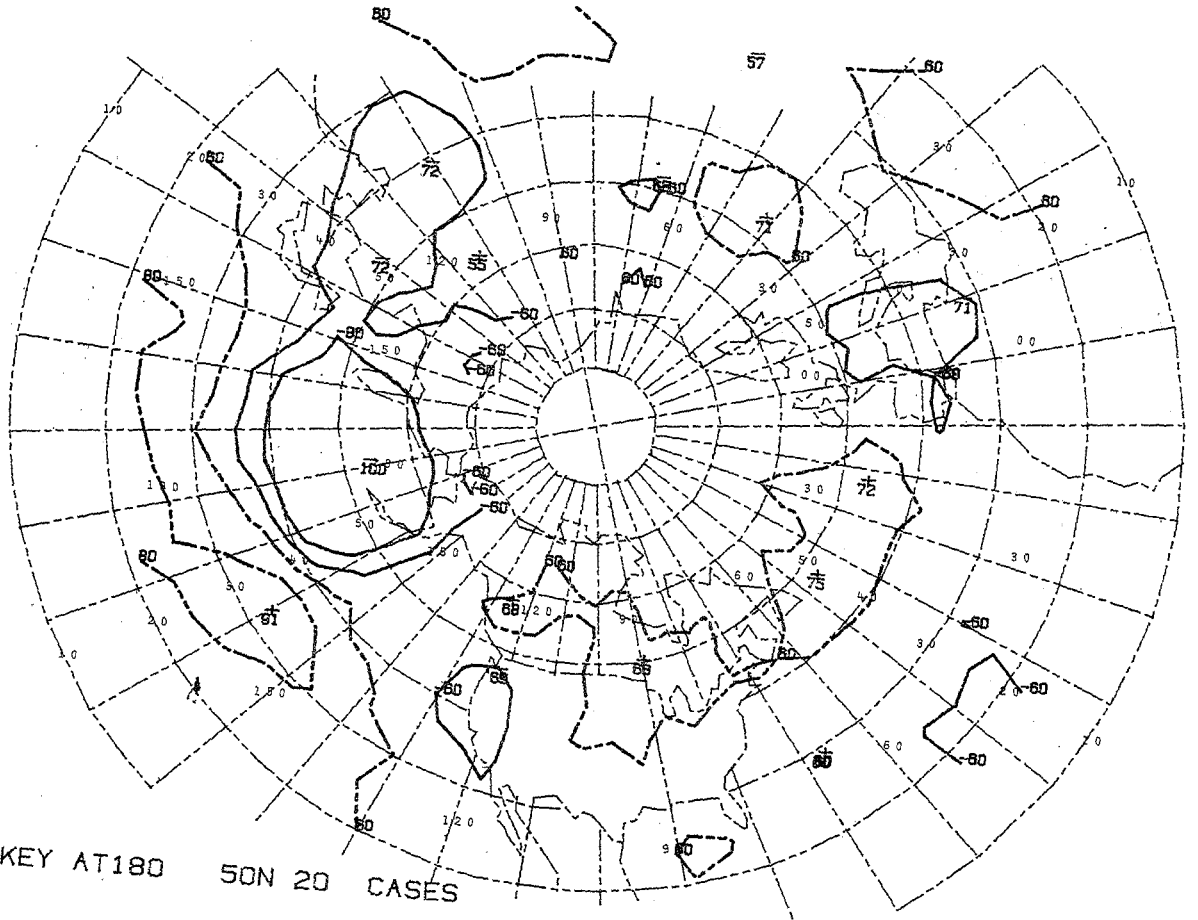

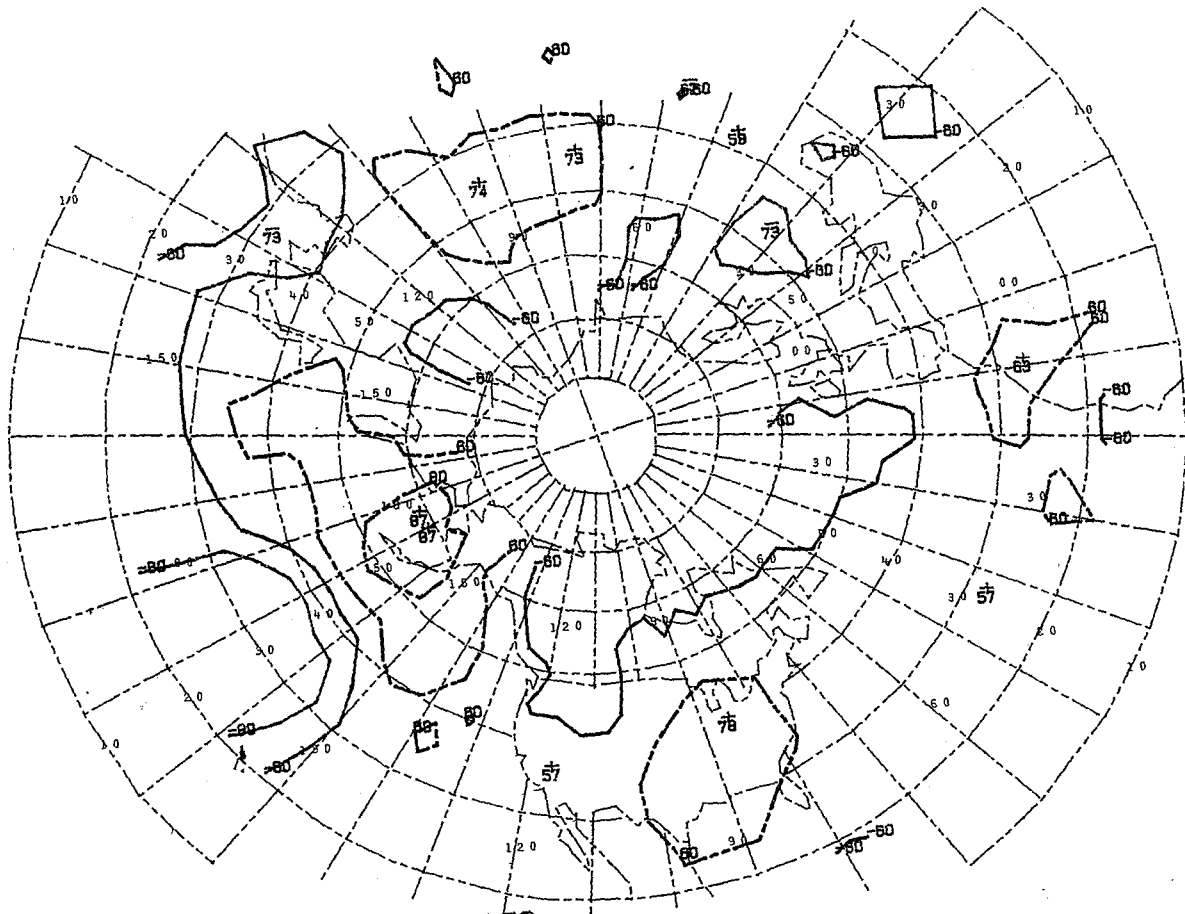

- KEY AT170W 30N 18 CASES

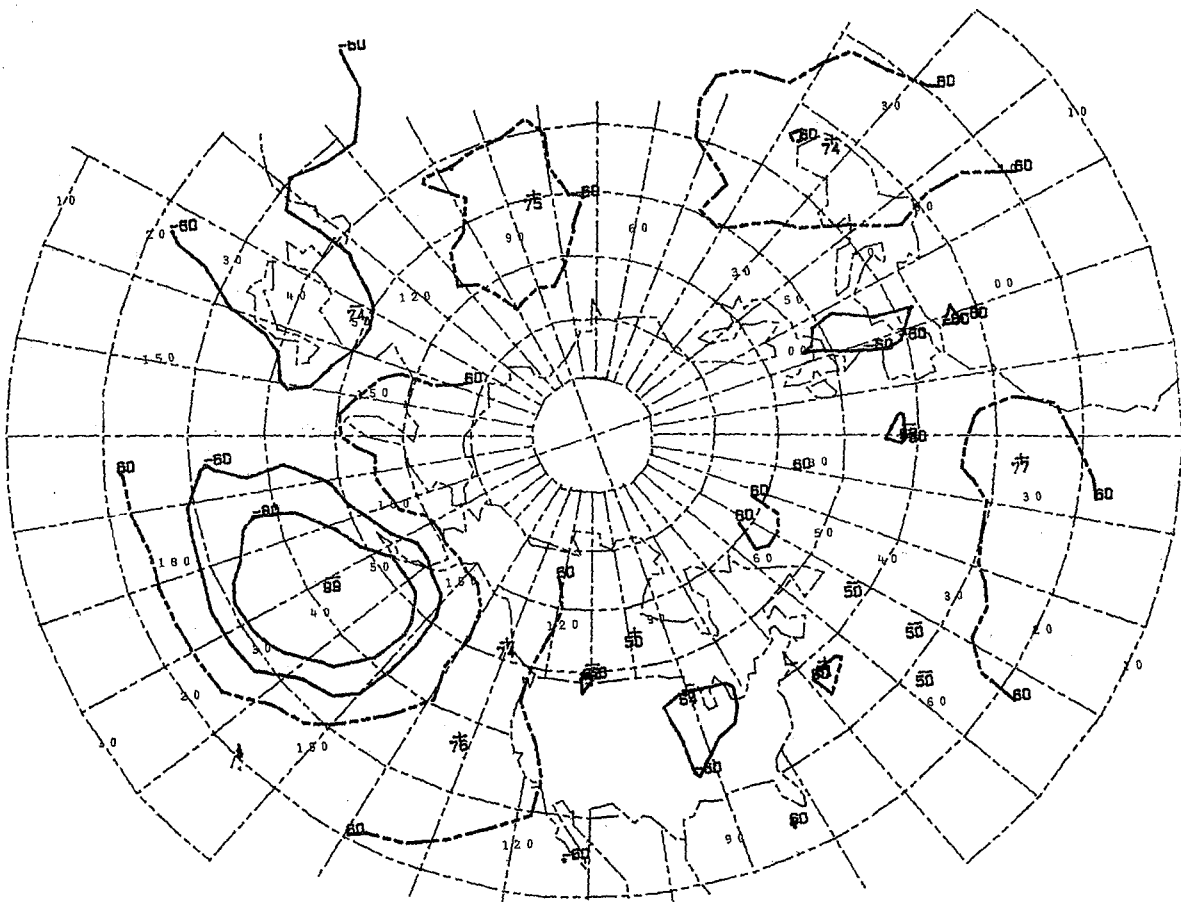

- KEY AT170W 40N 23 CASES

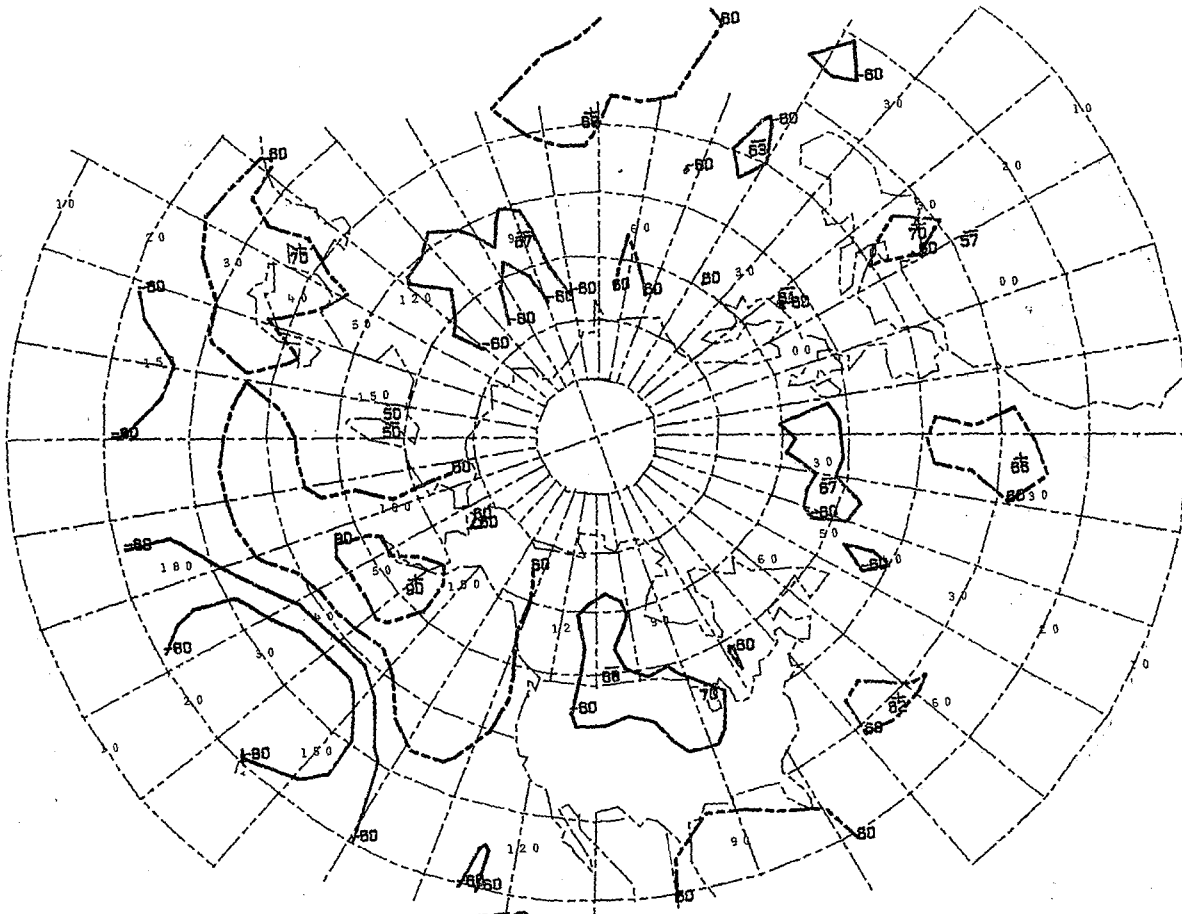

- KEY AT160W 30N 23 CASES

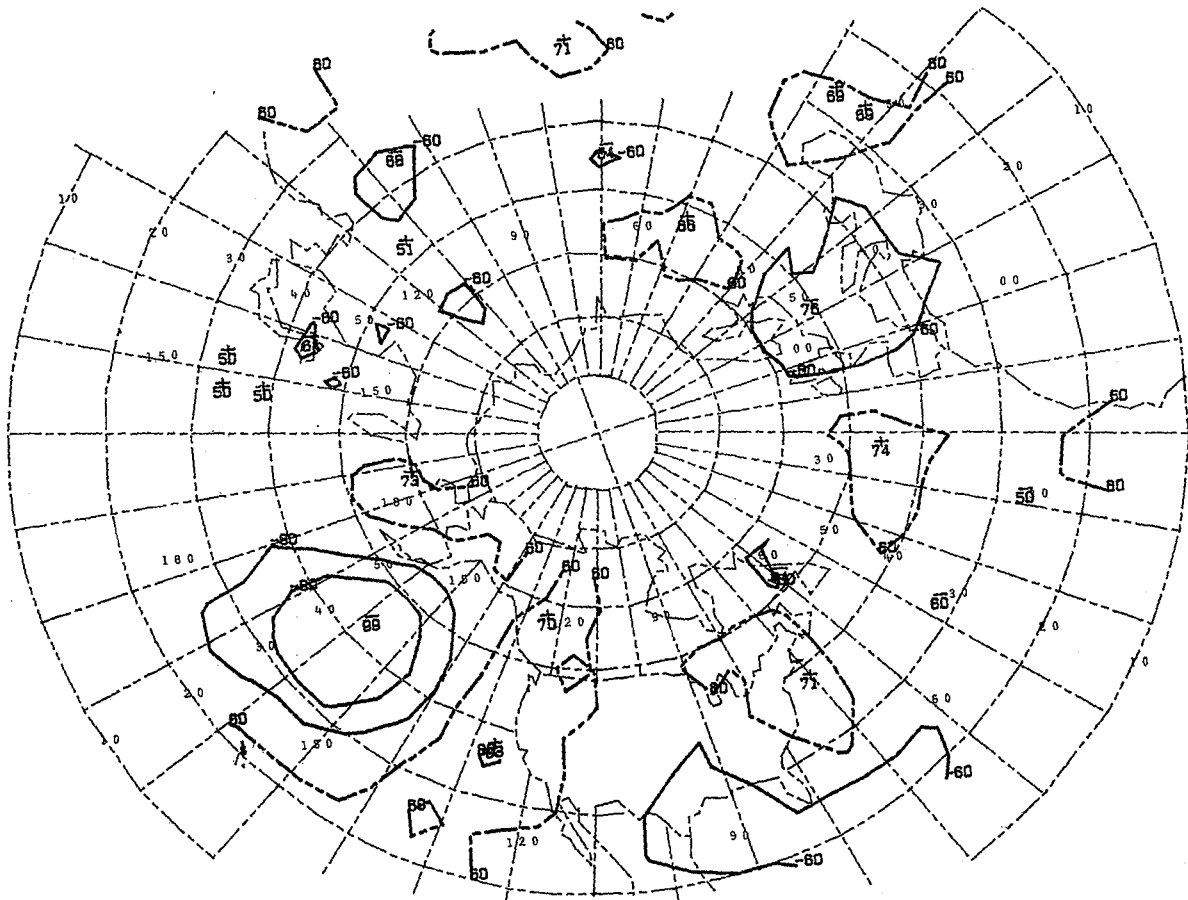

- KEY AT160W 40N 19 CASES

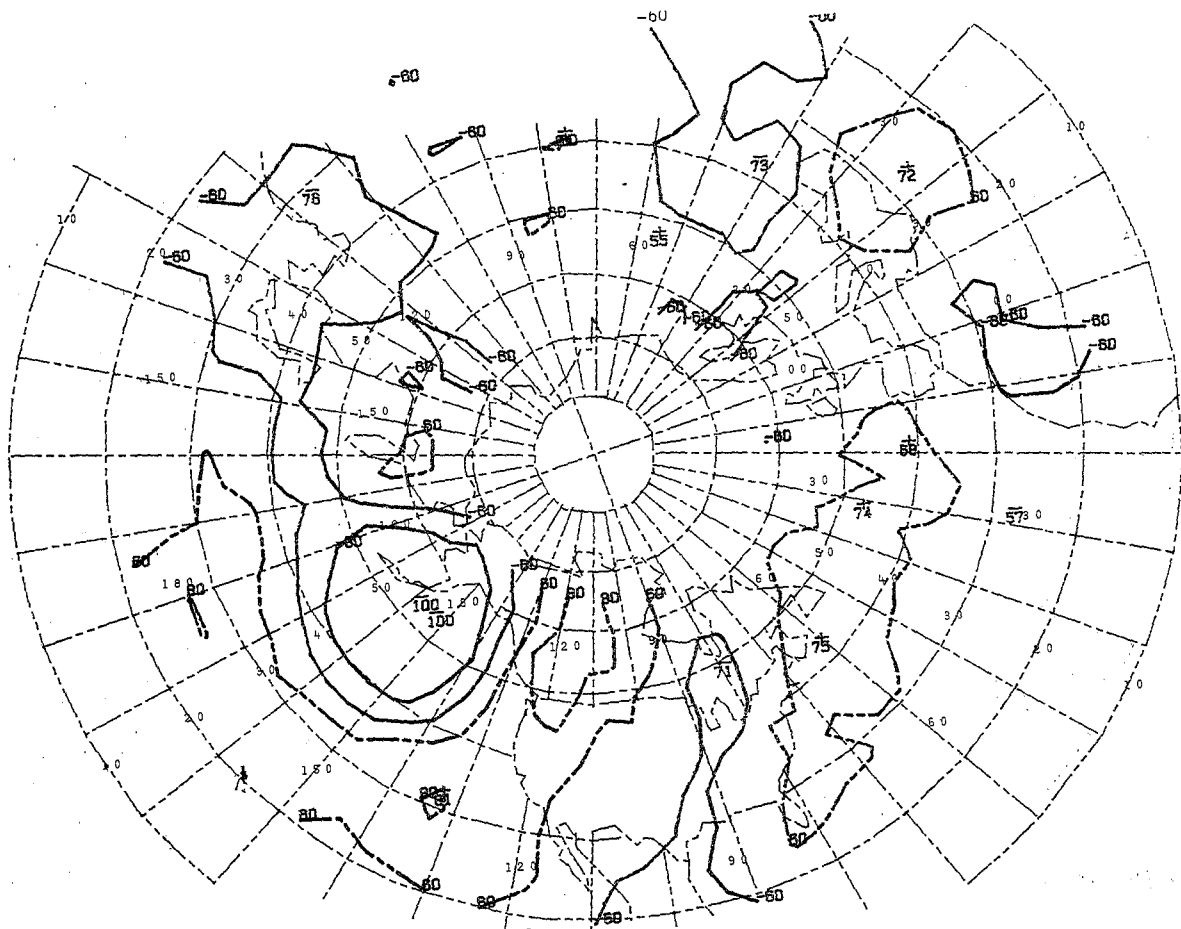

- KEY AT160W 50N 20 CASES

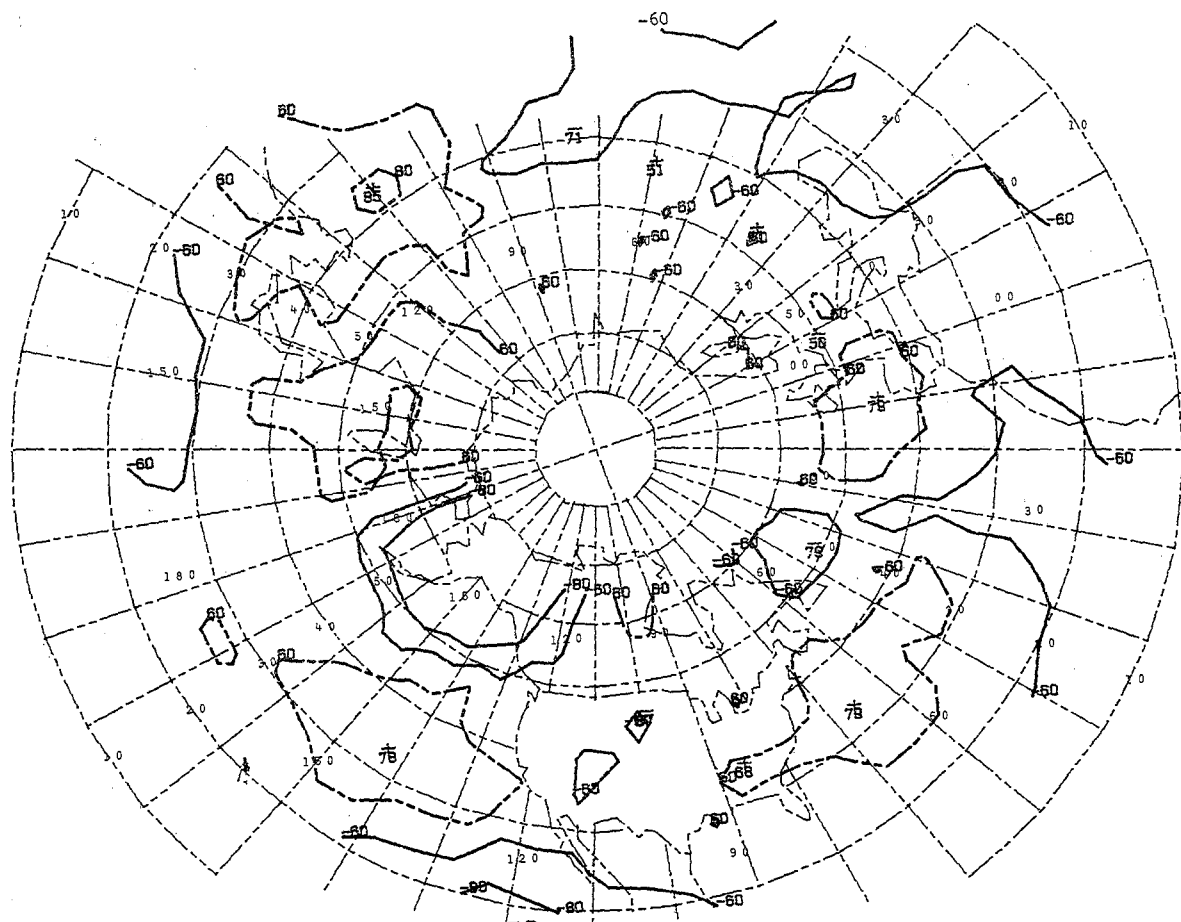

- KEY AT160W 60N 12 CASES

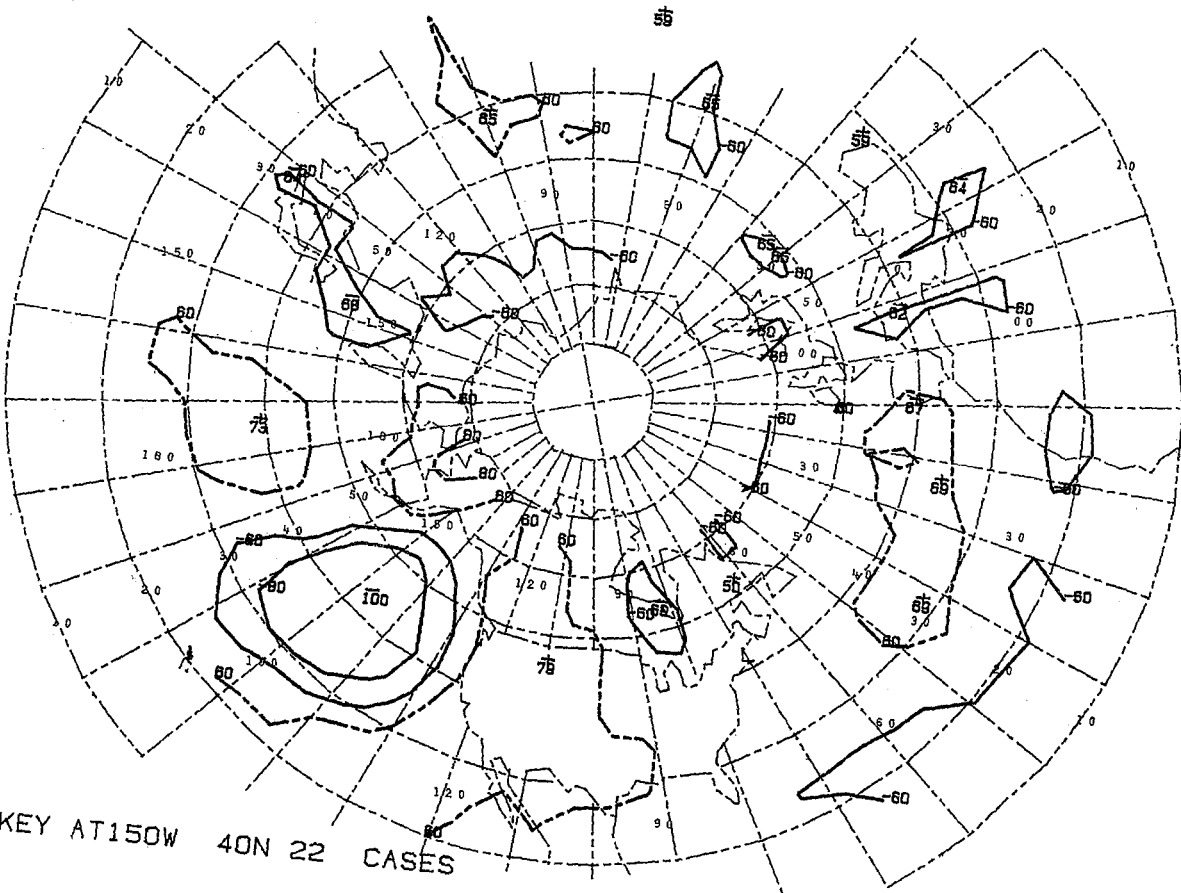
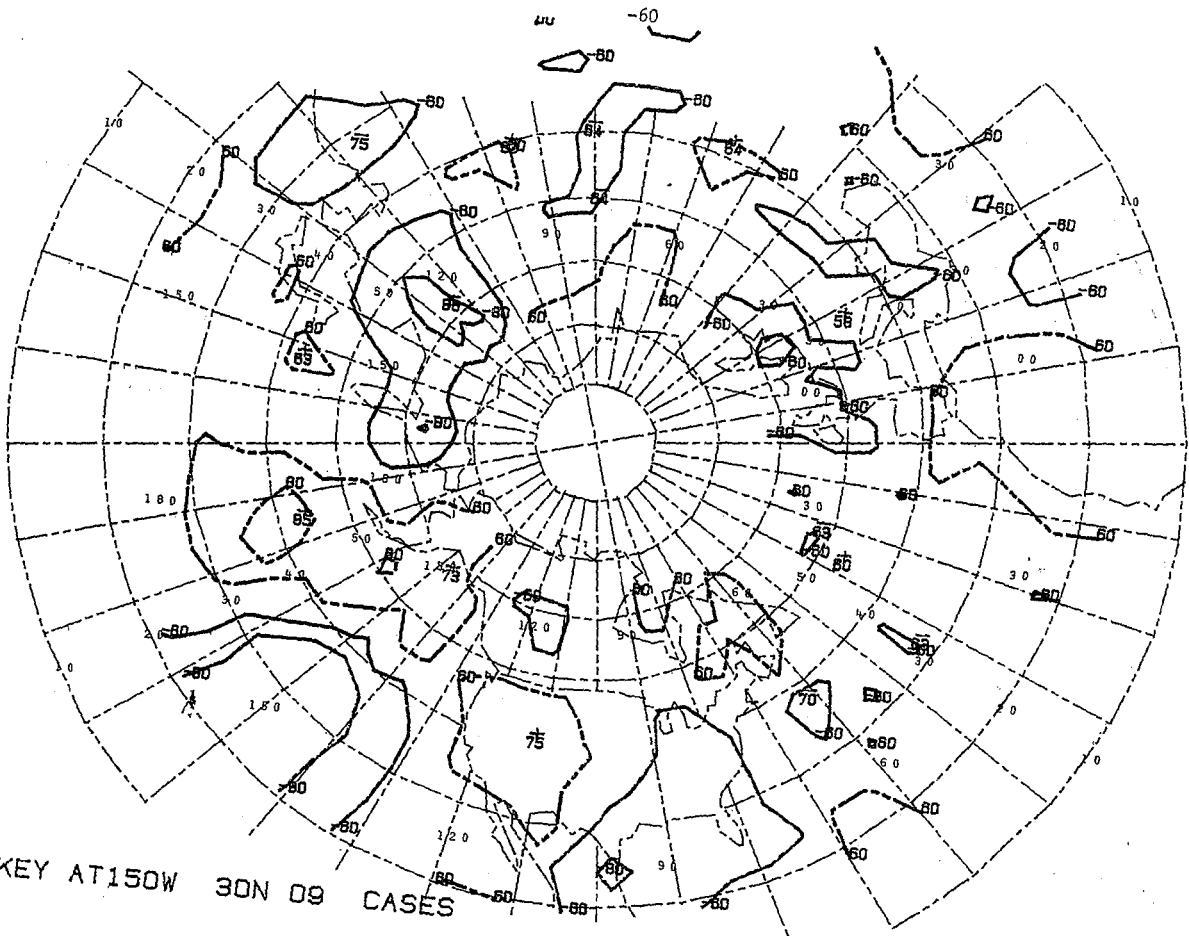

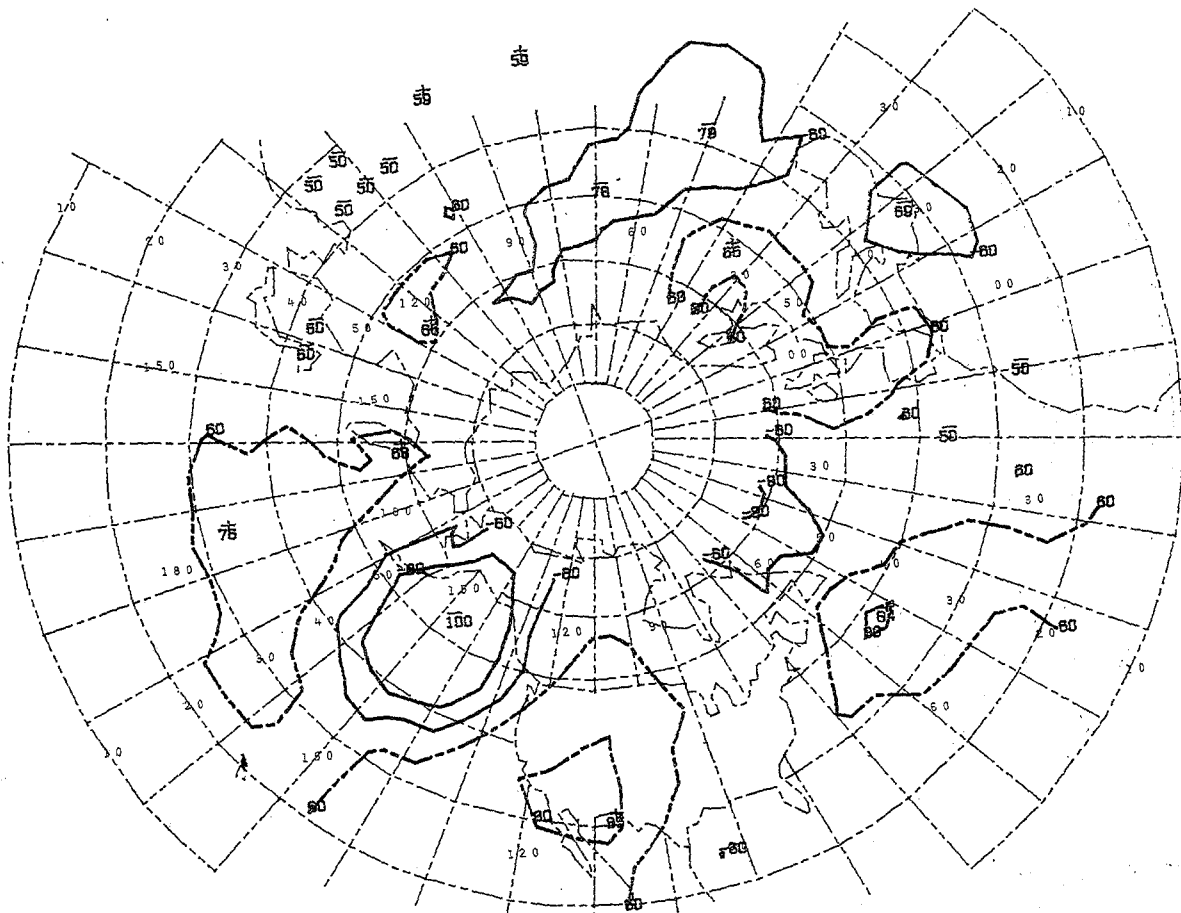

- KEY AT150W 50N 22 CASES

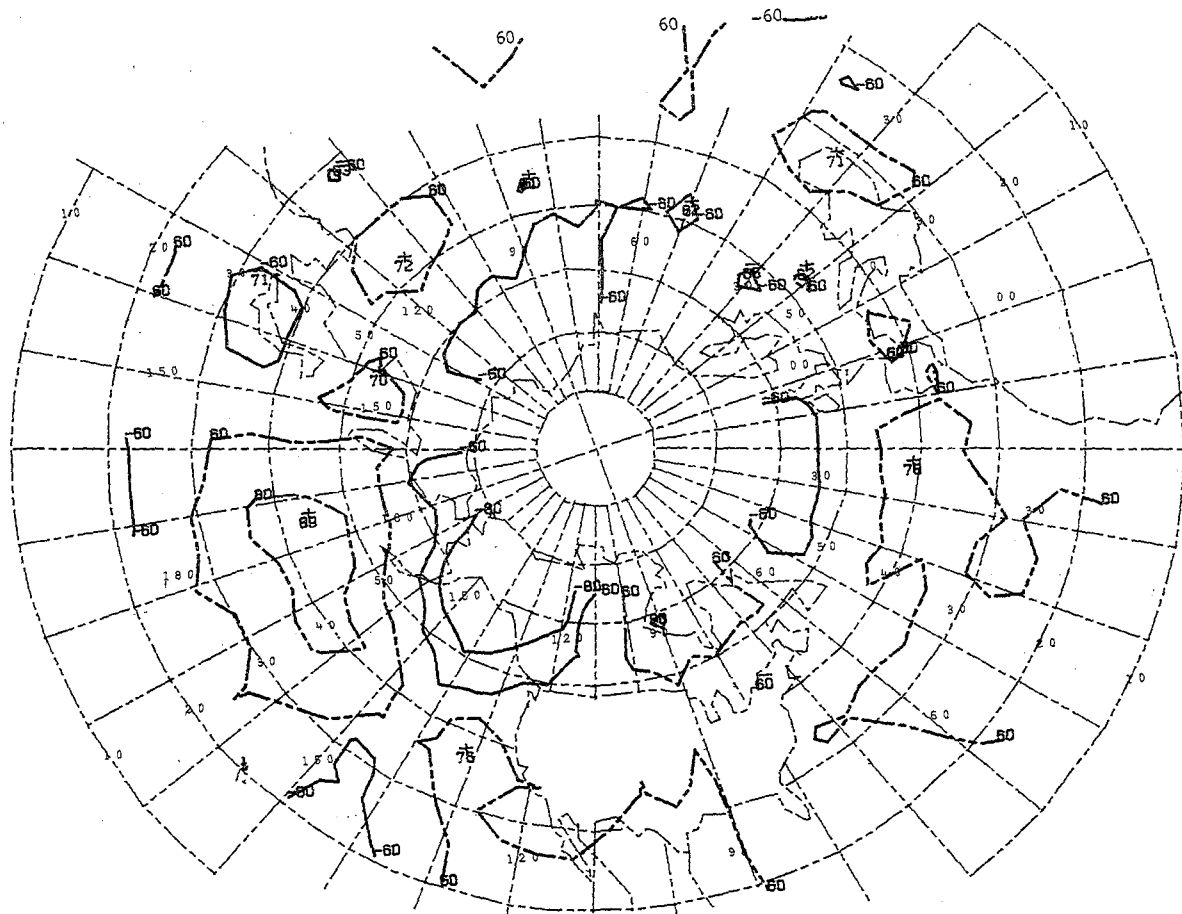

- KEY AT150W 60N 13 CASES

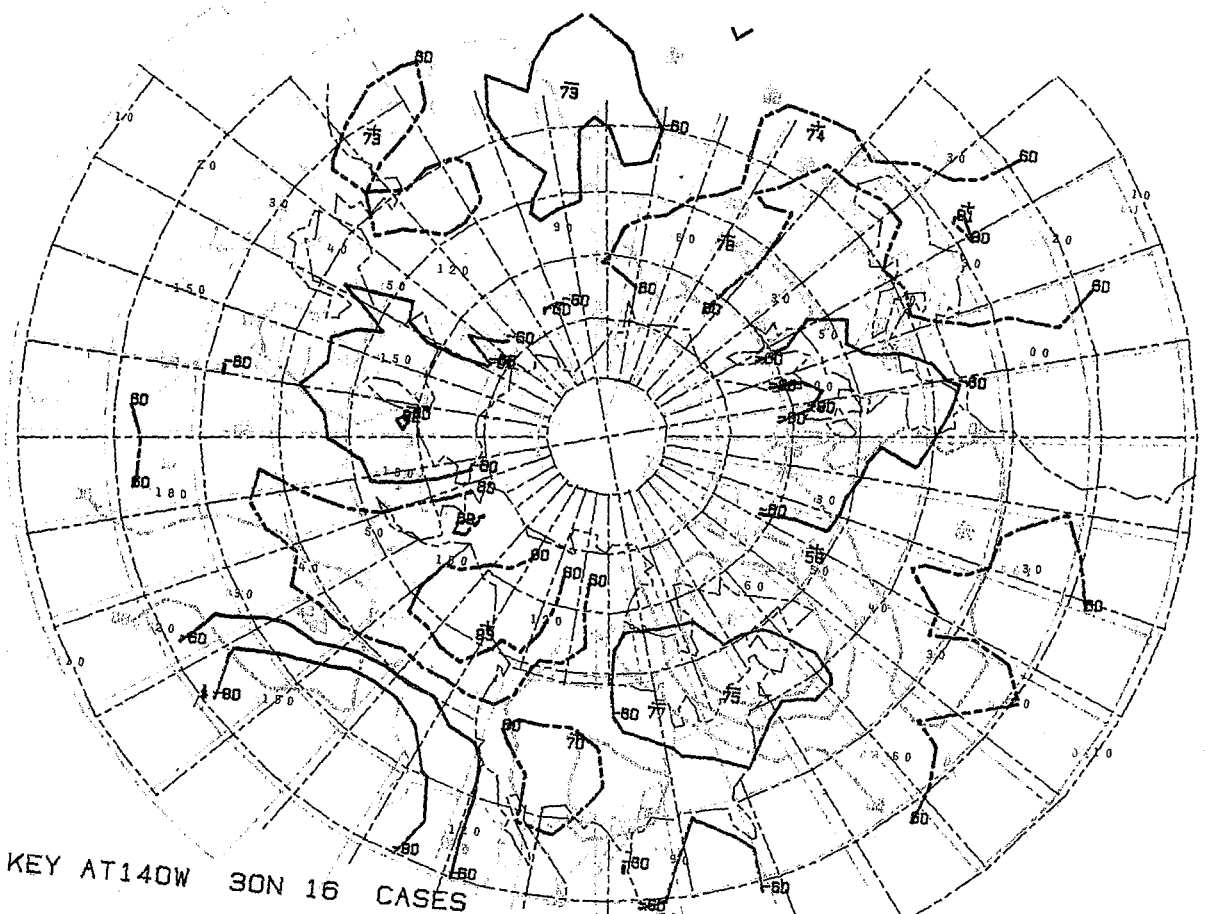

- KEY AT140W 30N 16 CASES

KEY AT140W 30N 16 CASES

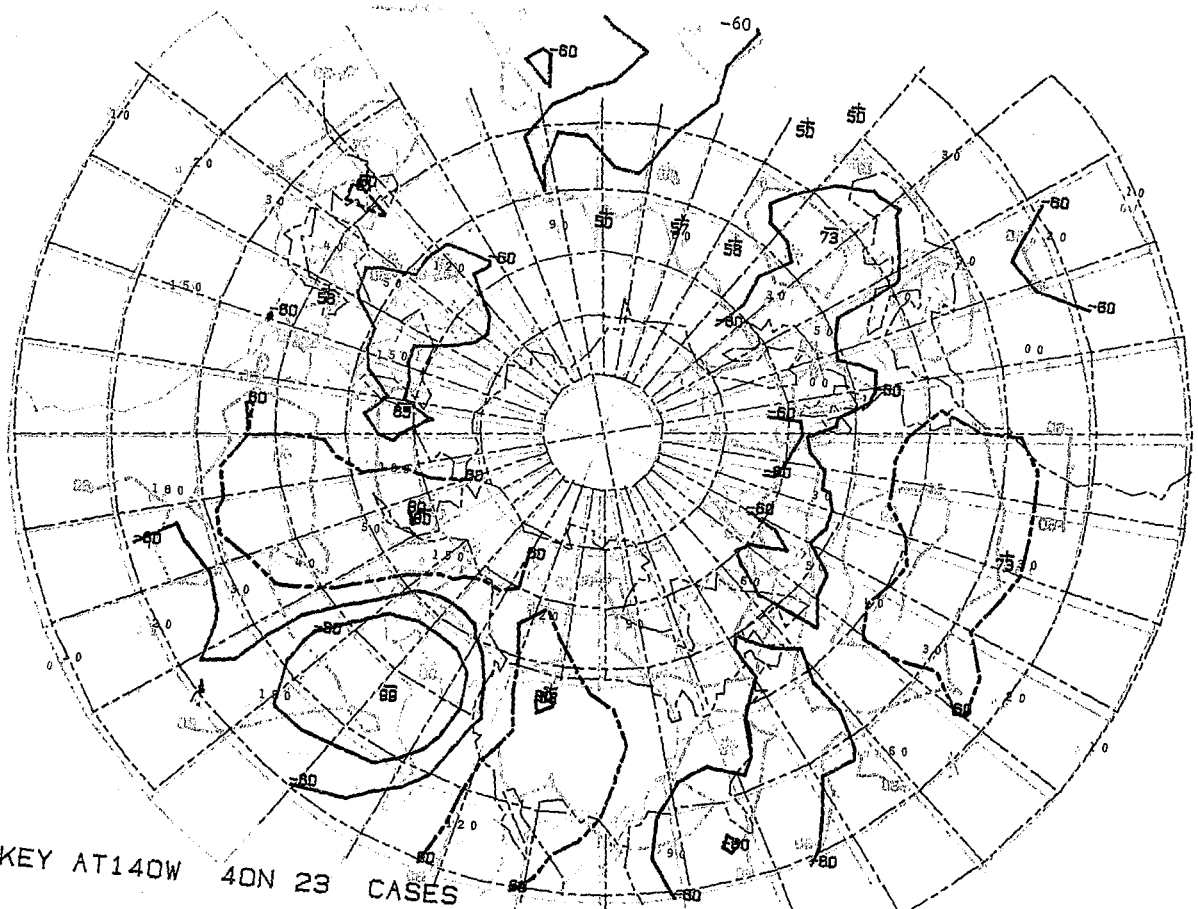

- KEY AT140W 40N 23 CASES

KEY AT140W 40N 23 CASES

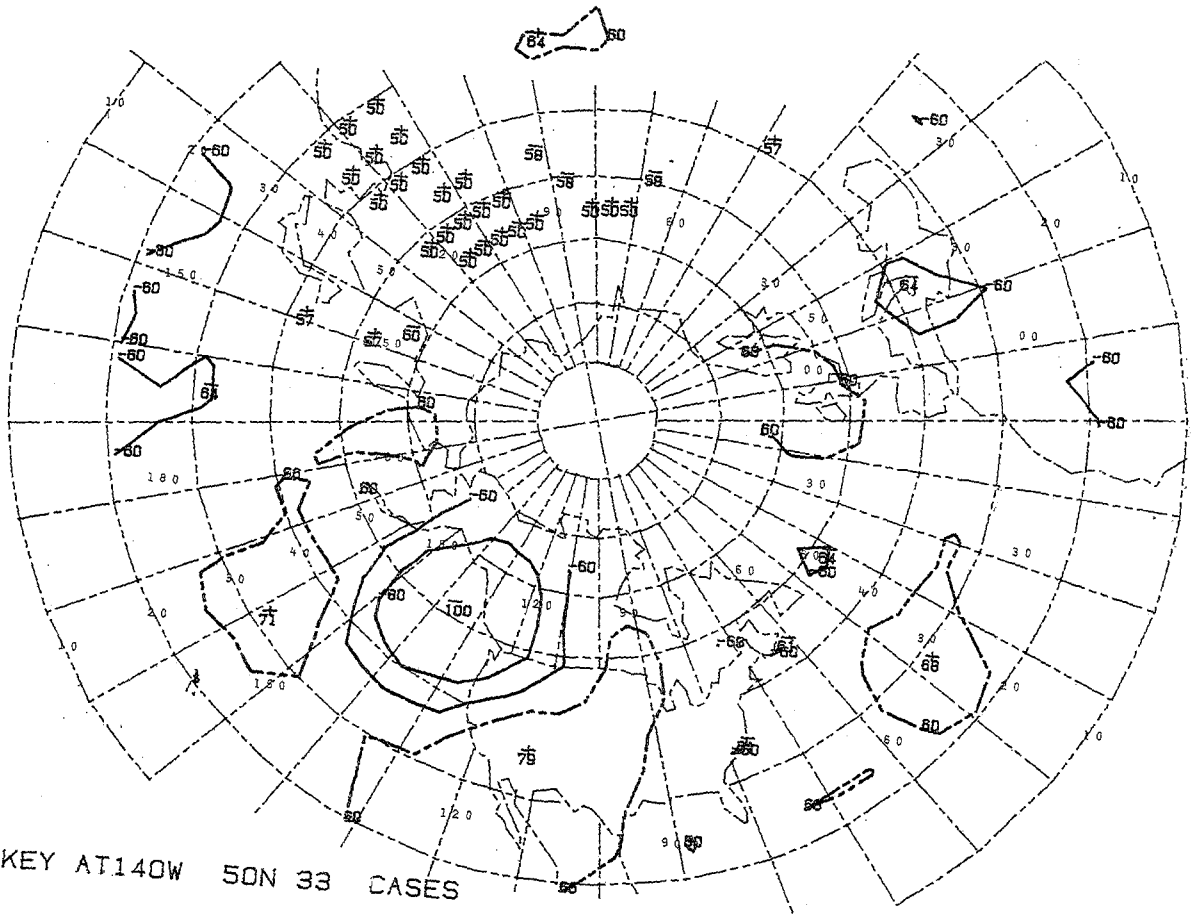

- KEY AT140W 50N 33 CASES

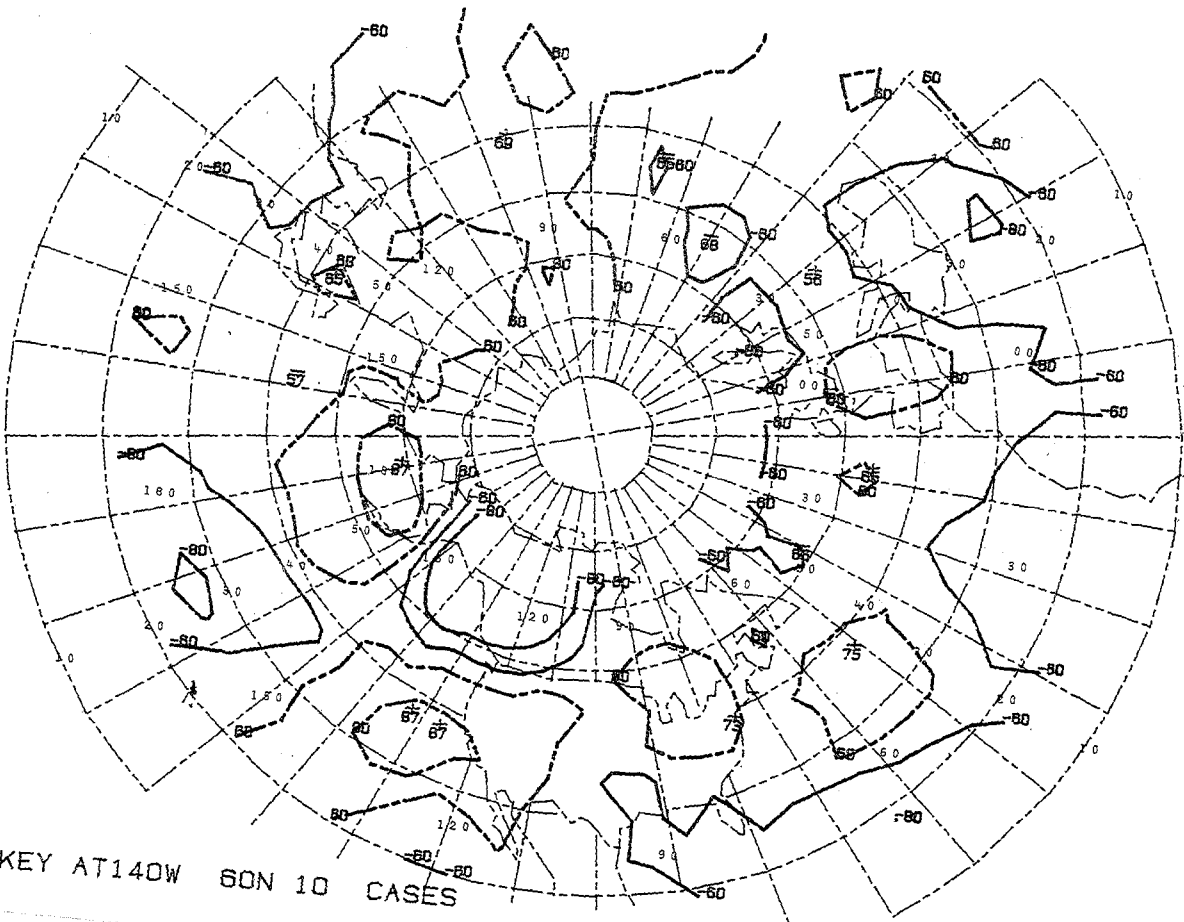

- KEY AT140W 60N 10 CASES

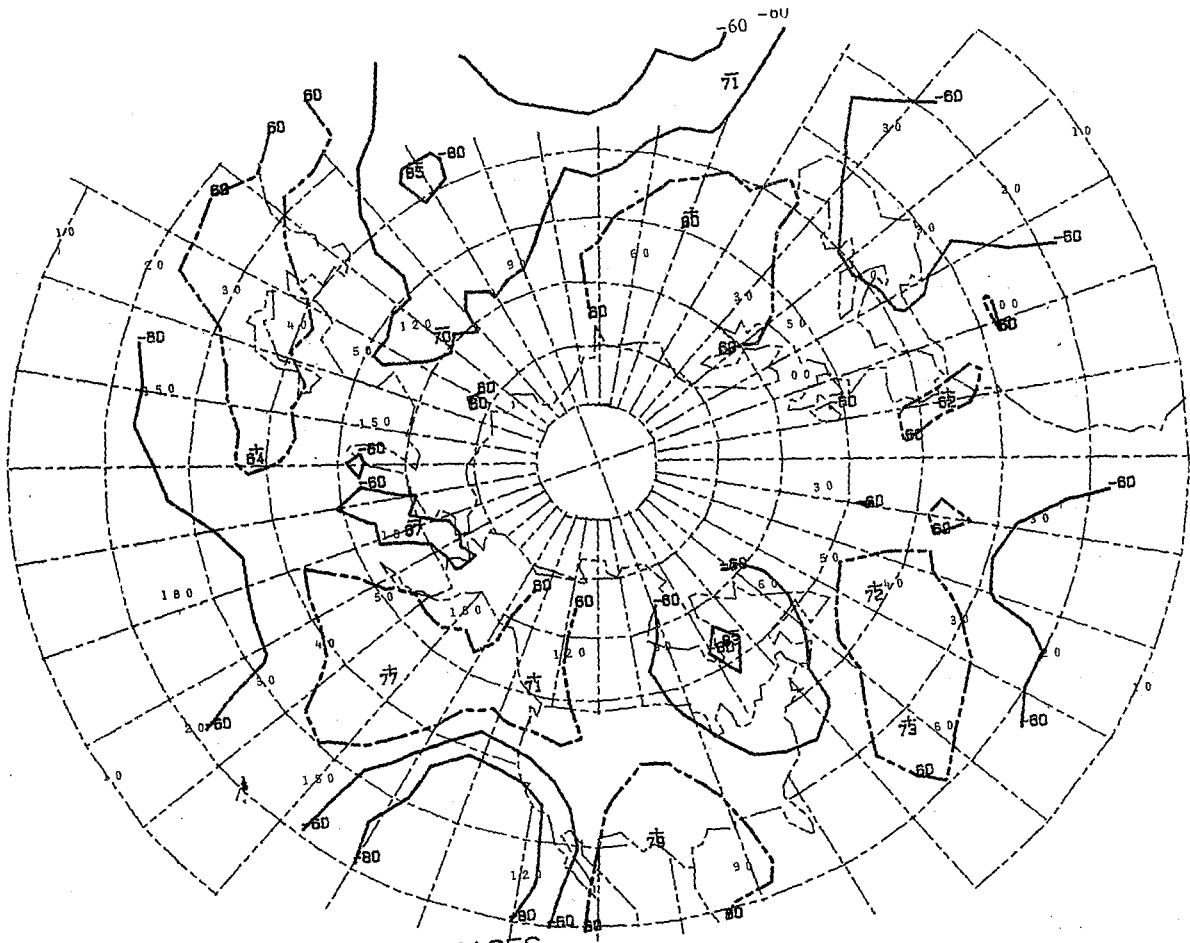

- KEY AT130W 30N 20 CASES

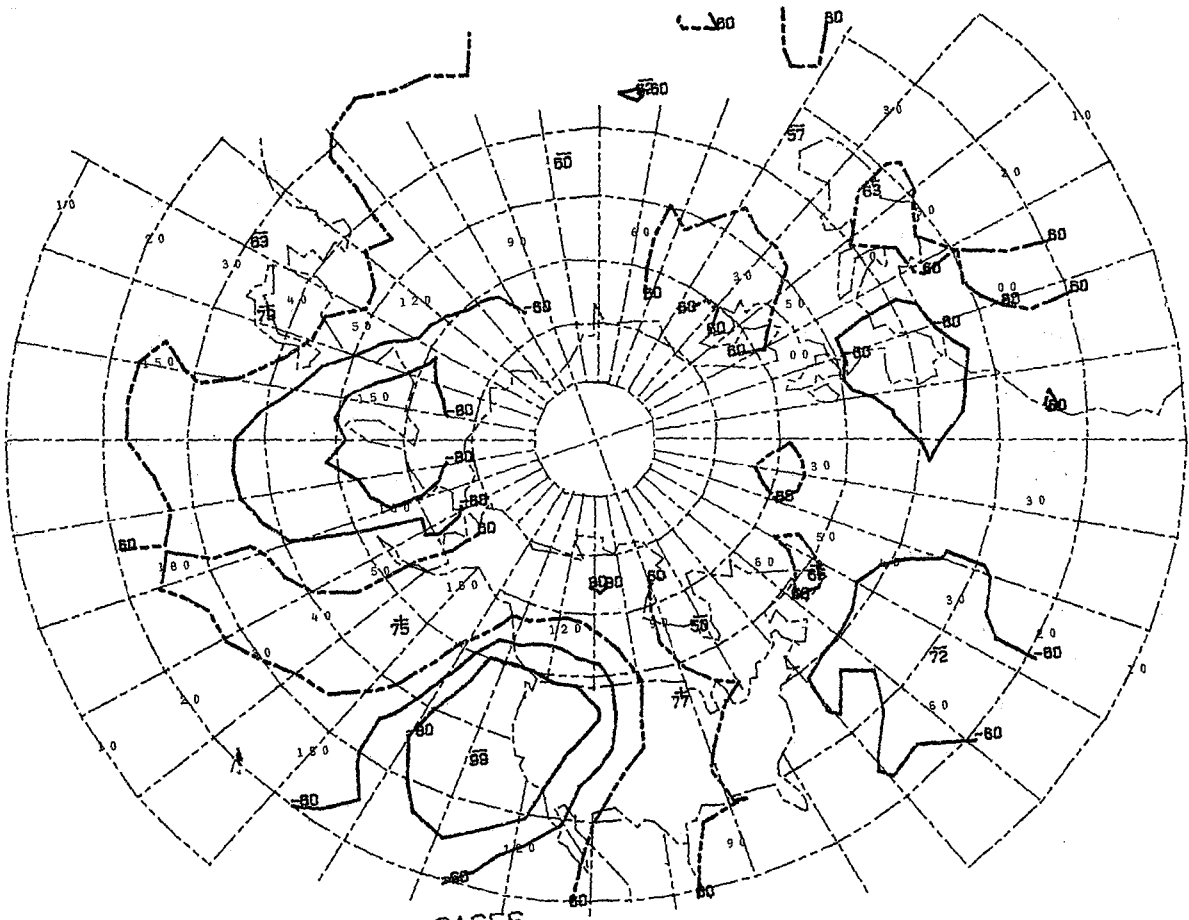

- KEY AT130W 40N 18 CASES

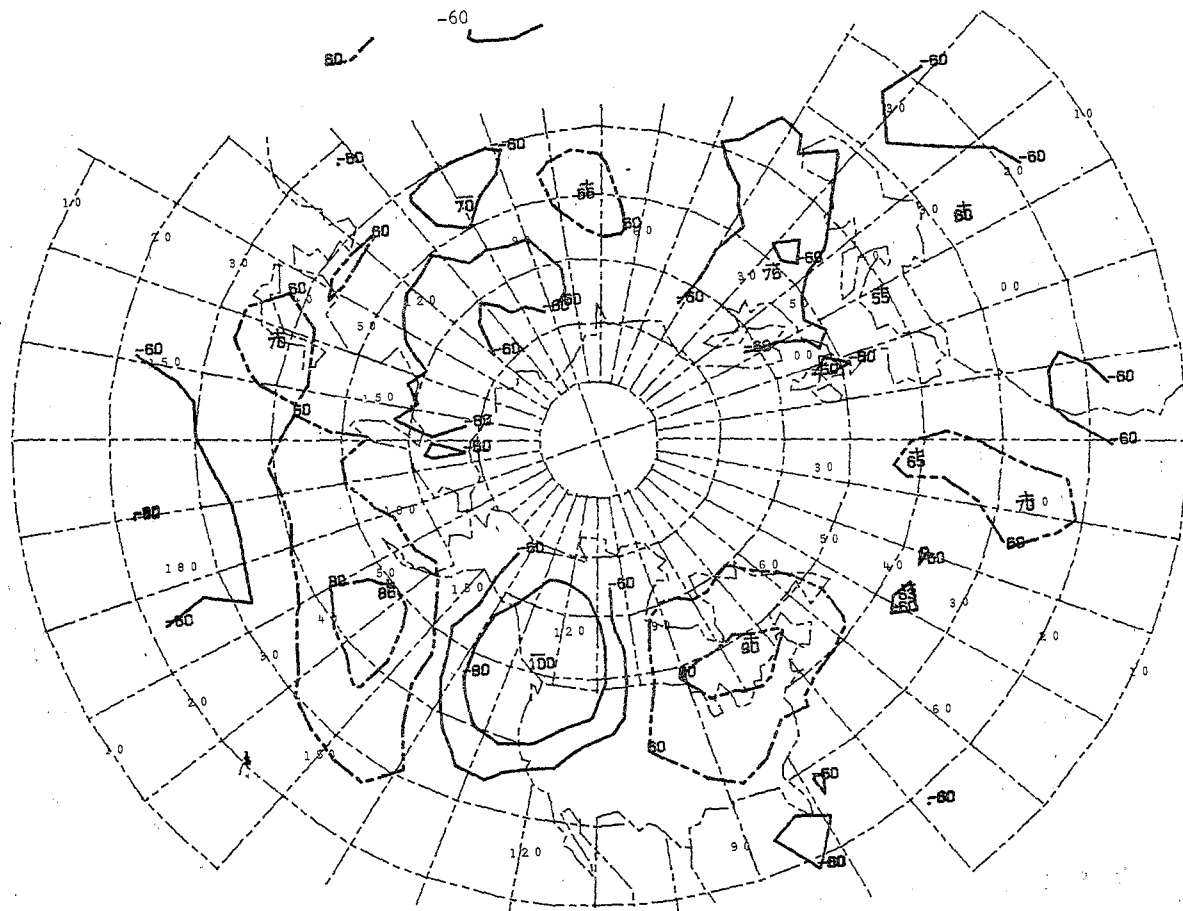

- KEY AT130W 50N 20 CASES

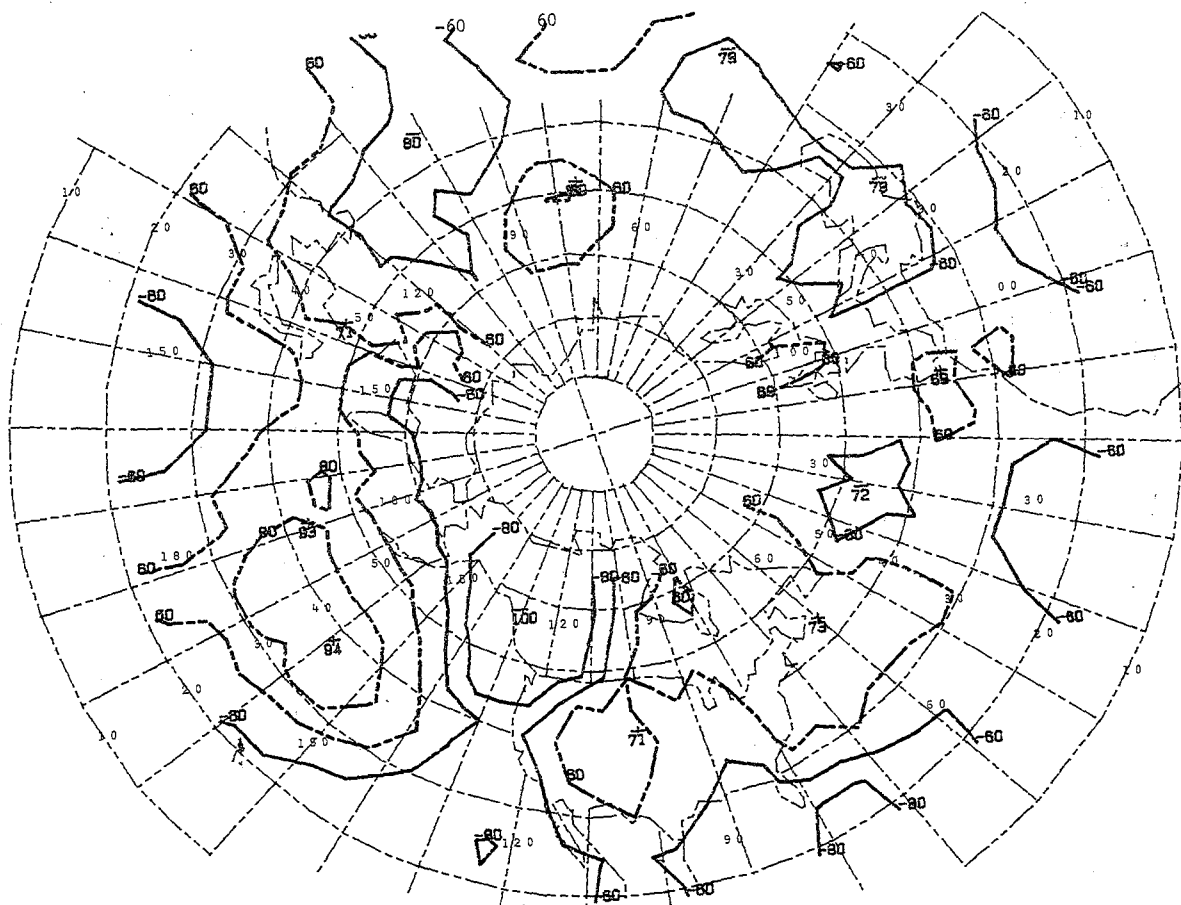

- KEY AT130W 60N 08 CASES

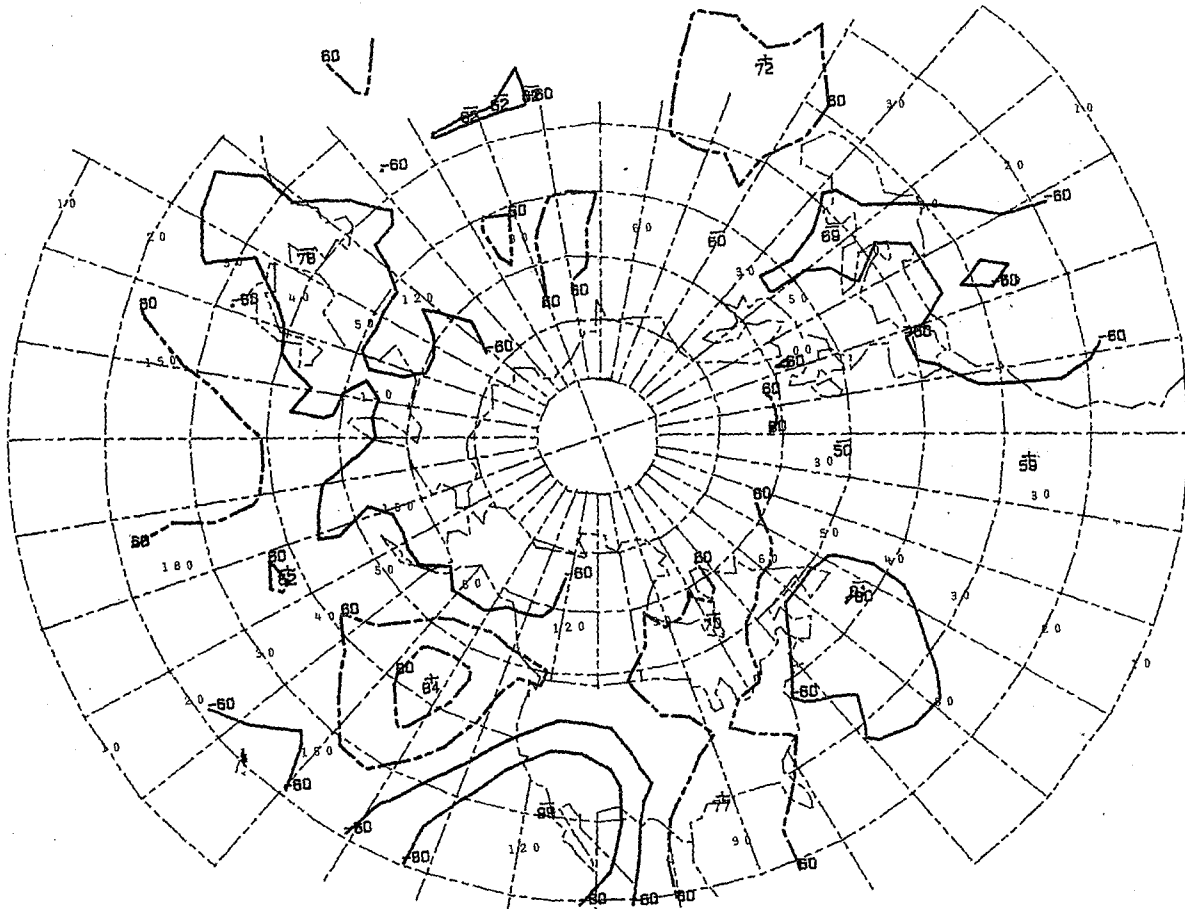

- KEY AT120W 30N 22 CASES

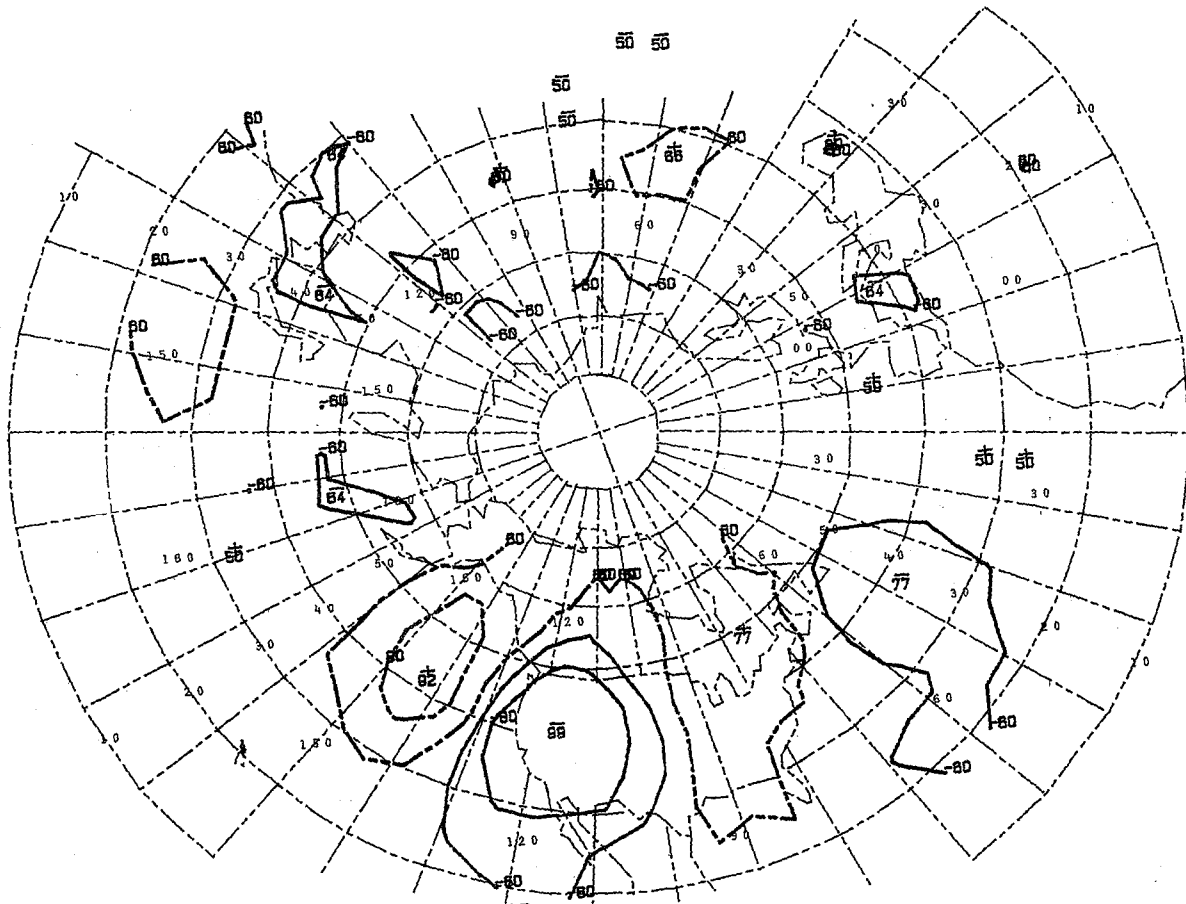

- KEY AT120W 40N 33 CASES

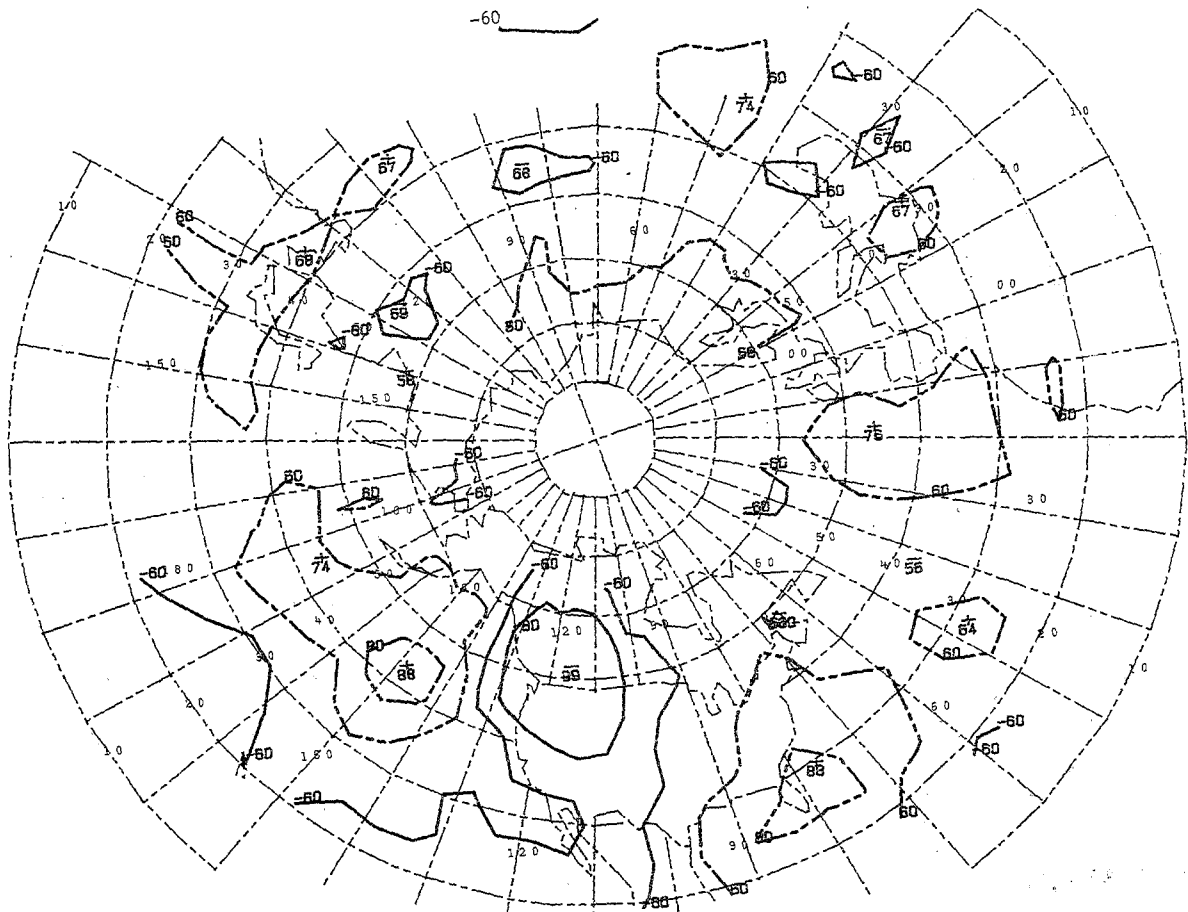

- KEY AT120W 50N 15 CASES

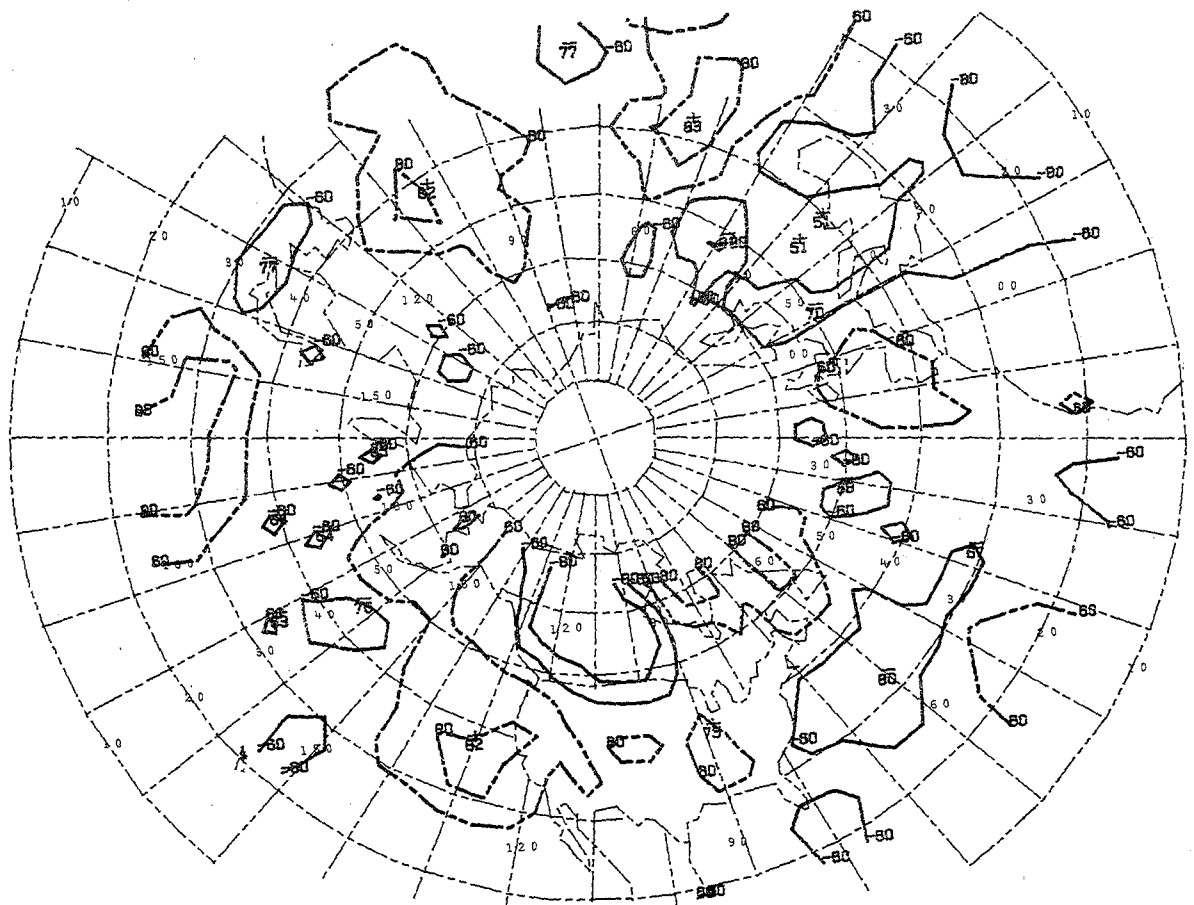

- KEY AT120W 60N 07 CASES

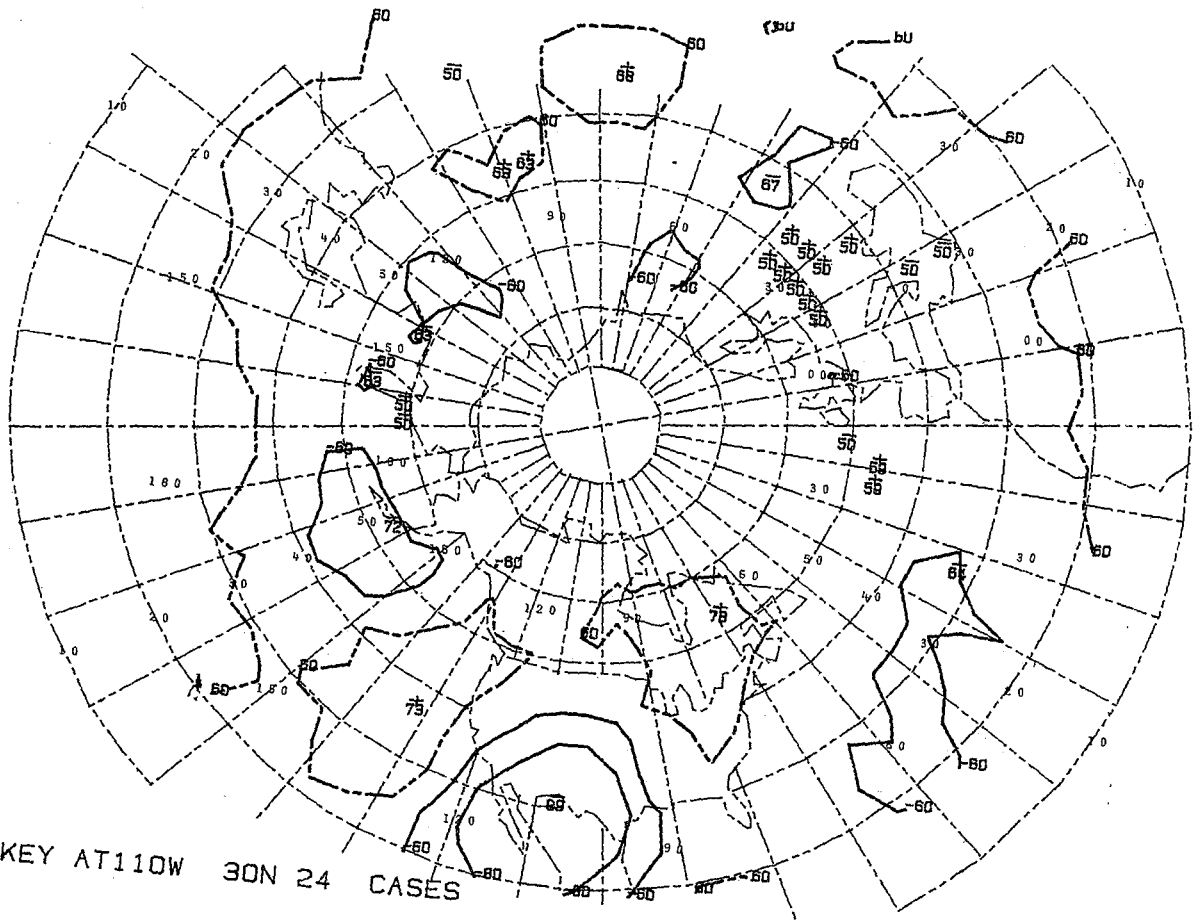

- KEY AT110W 30N 24 CASES

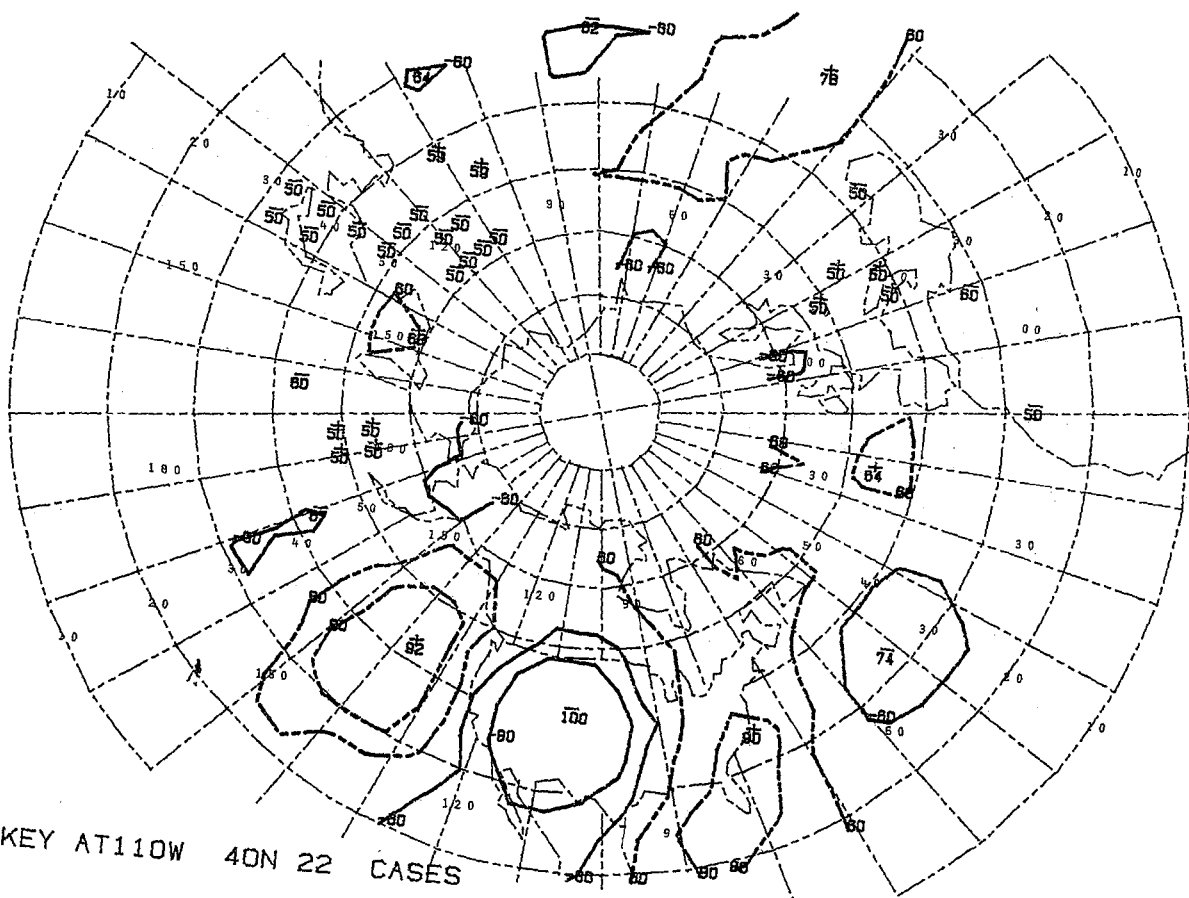

- KEY AT110W 40N 22 CASES

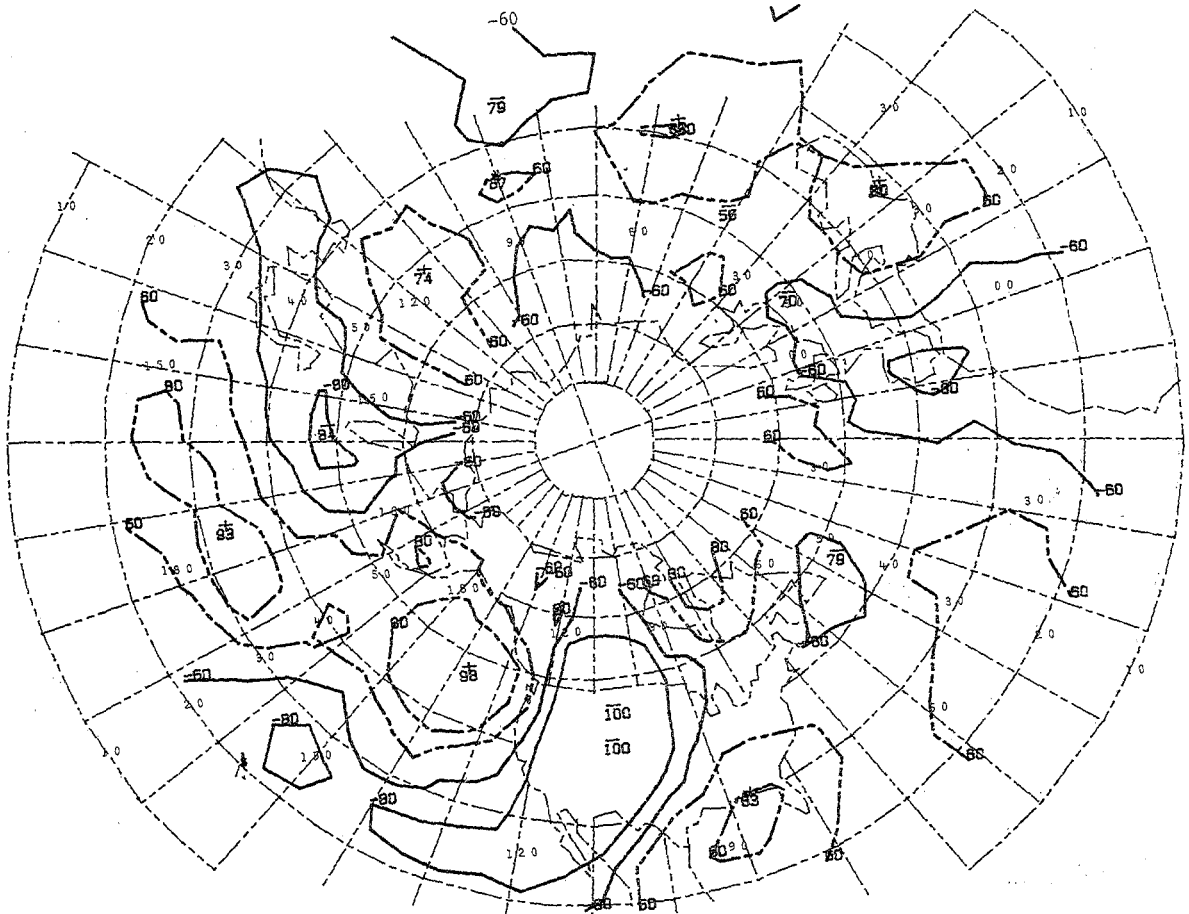

- KEY AT110W 50N 08 CASES

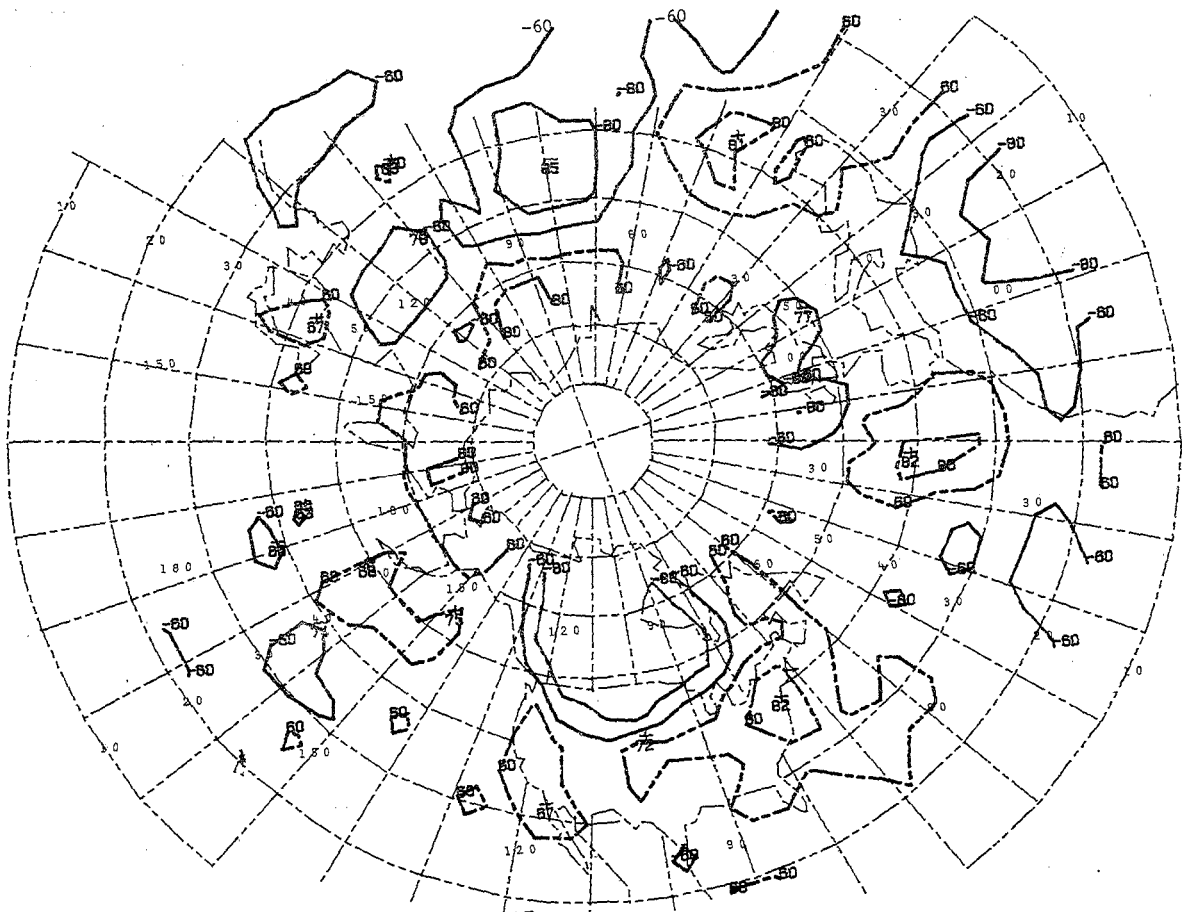

- KEY AT110W 60N 07 CASES

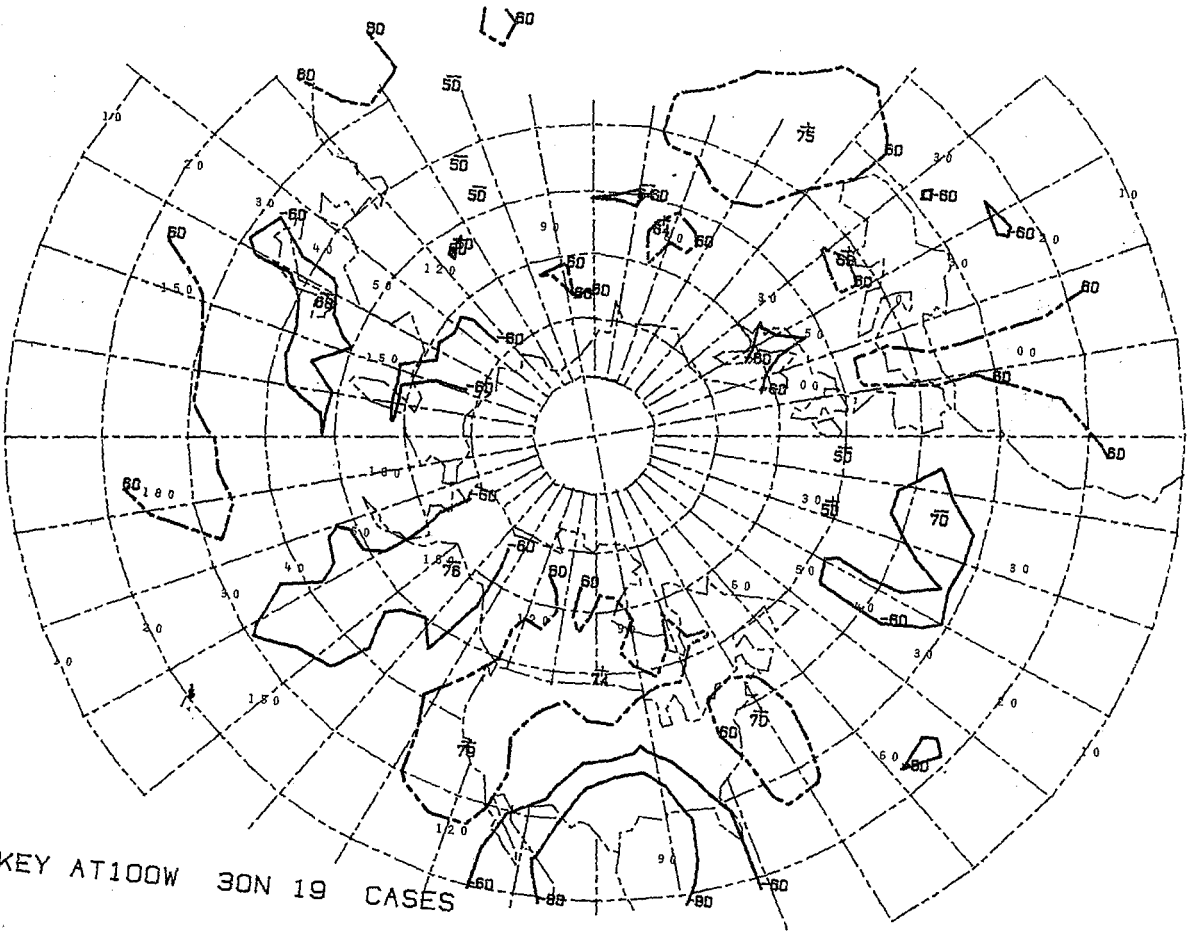

KEY AT100W 30N 19 CASES

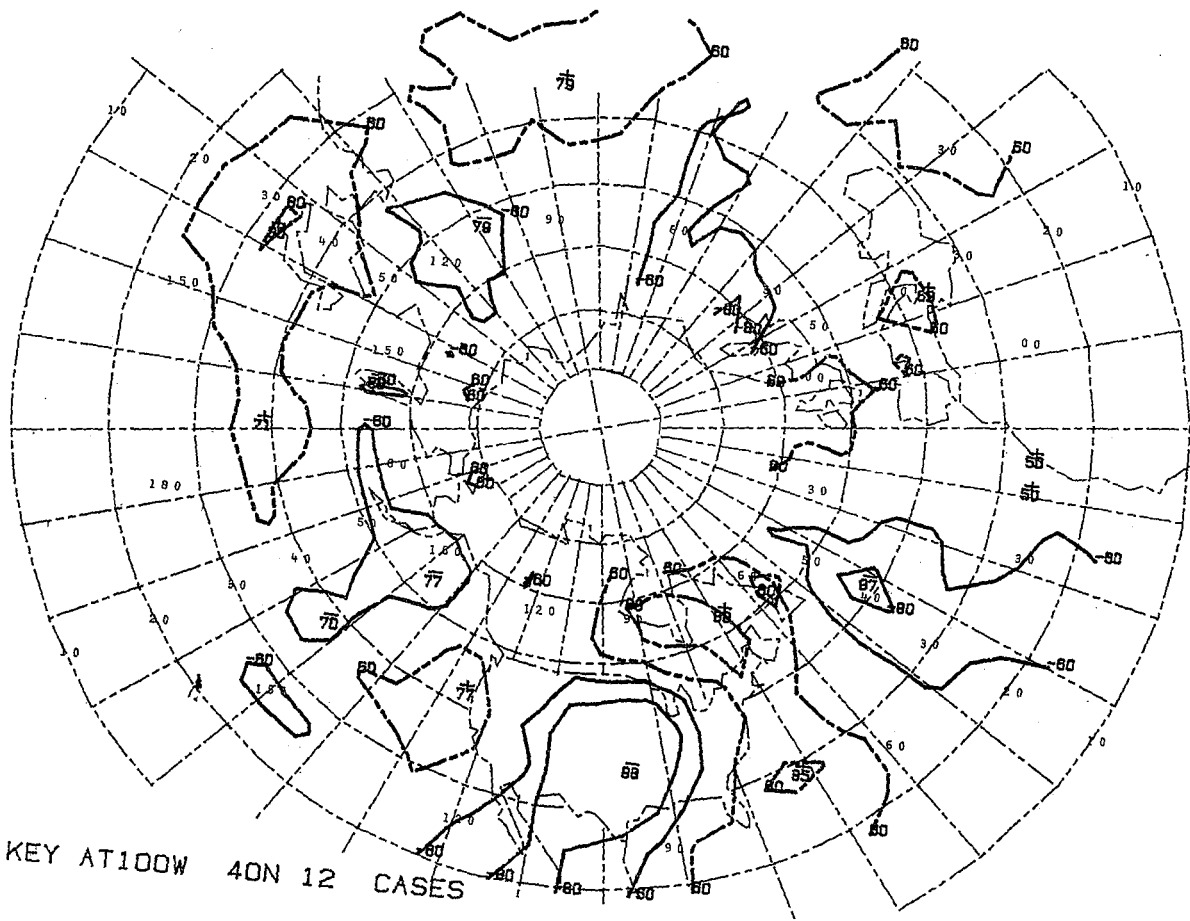

KEY AT100W 40N 12 CASES

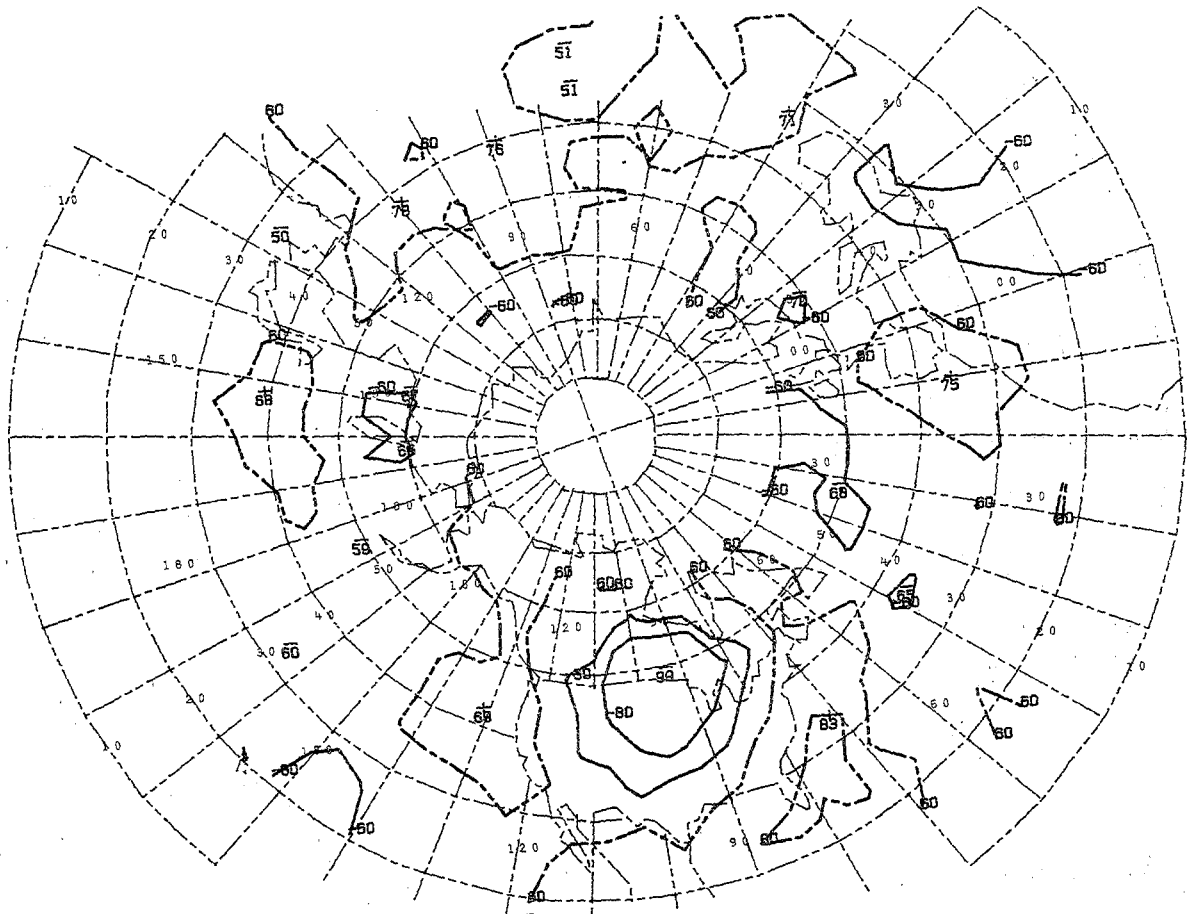

- KEY AT100W 50N 14 CASES

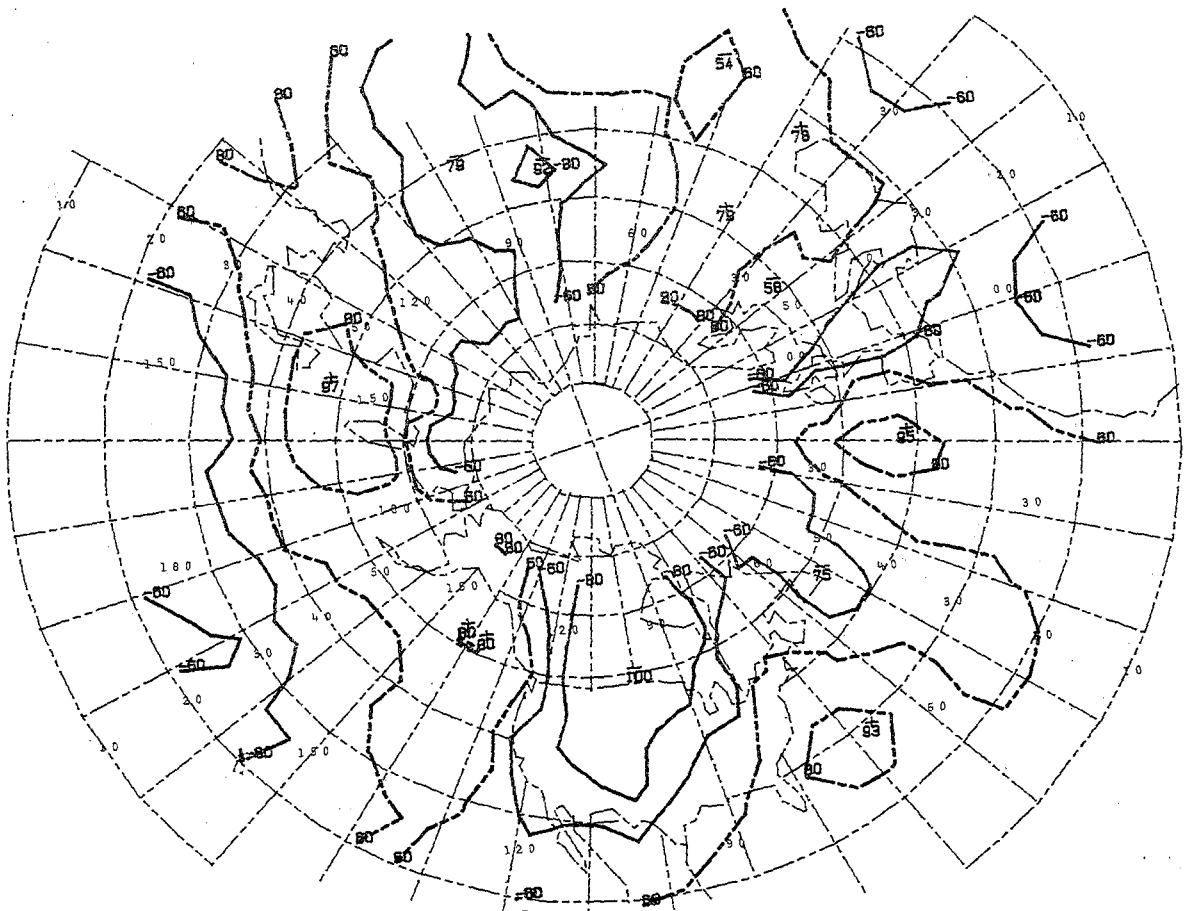

- KEY AT100W 60N 05 CASES

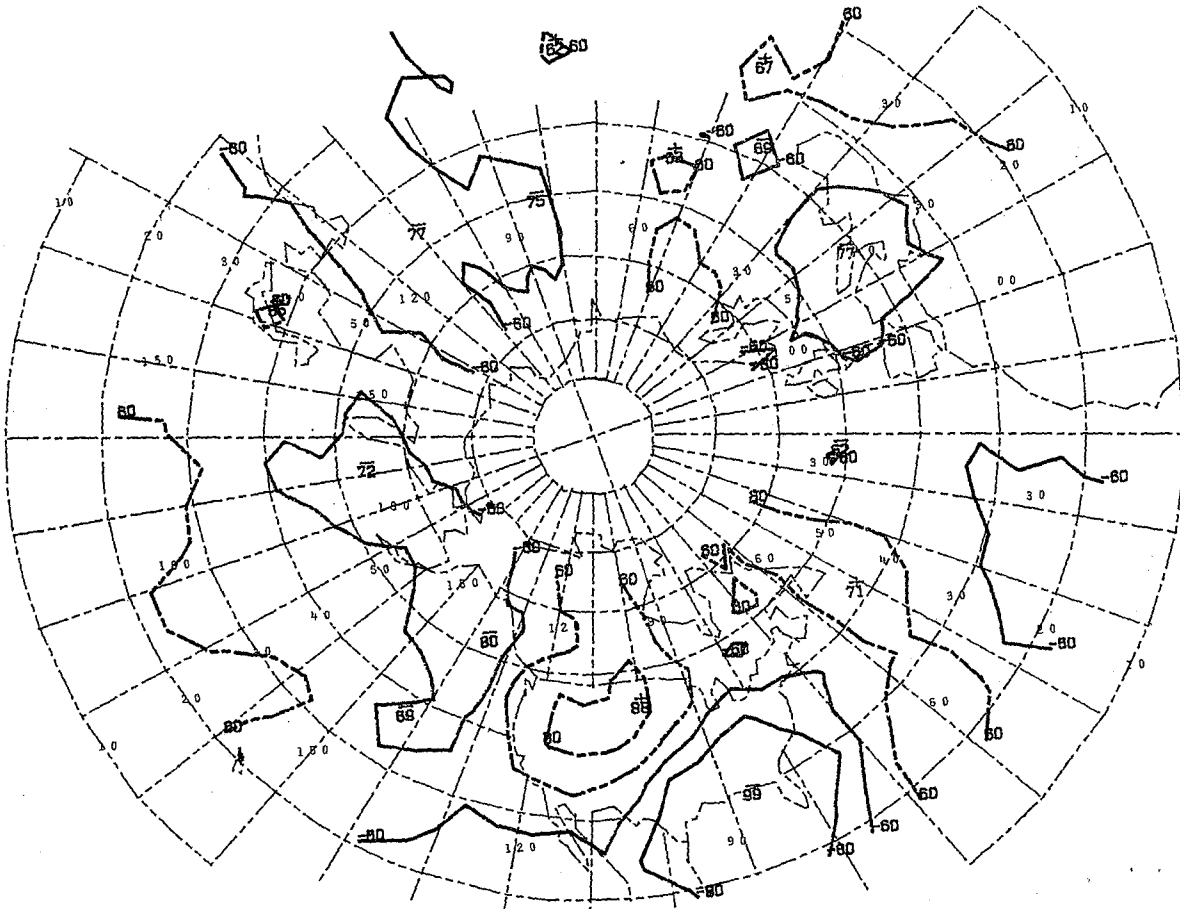

- KEY AT 90W 30N 15 CASES

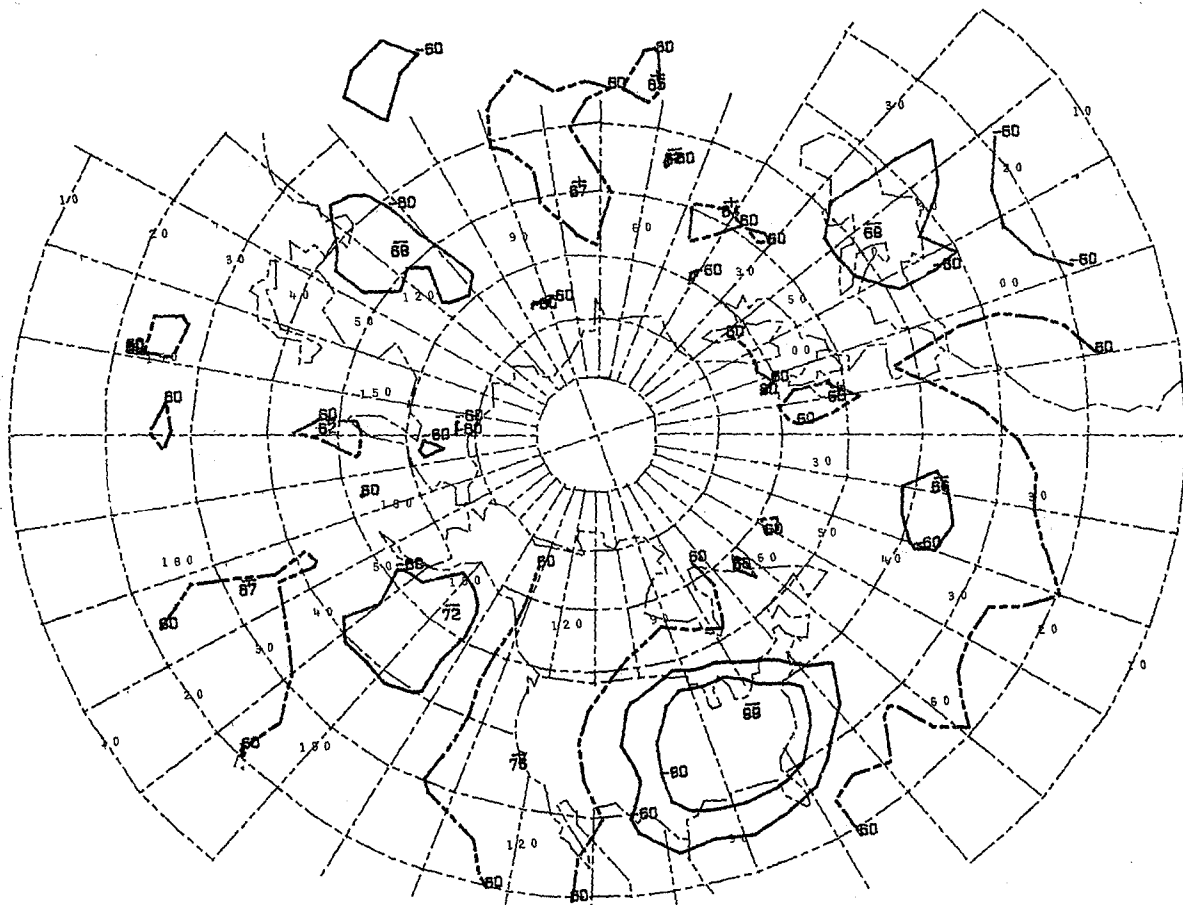

- KEY AT 90W 40N 20 CASES

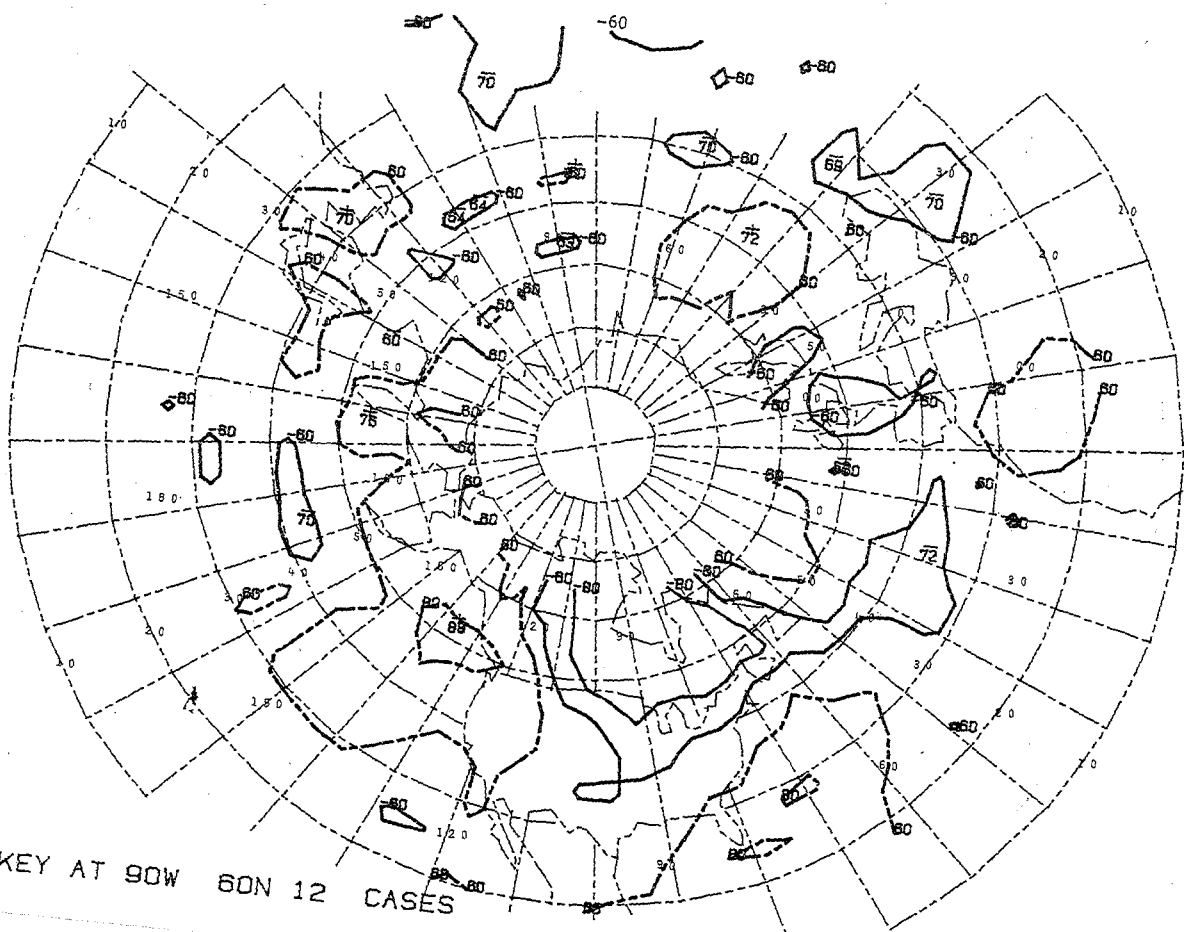
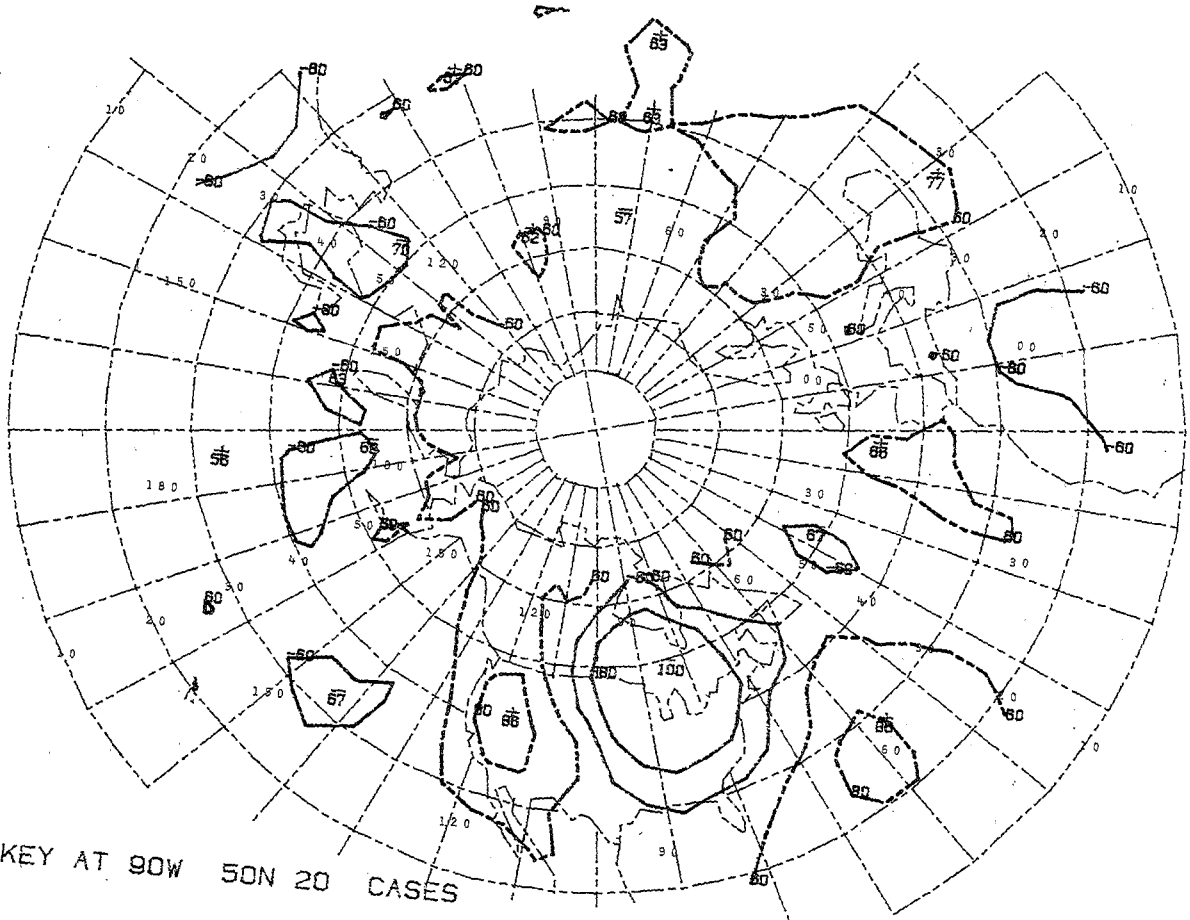

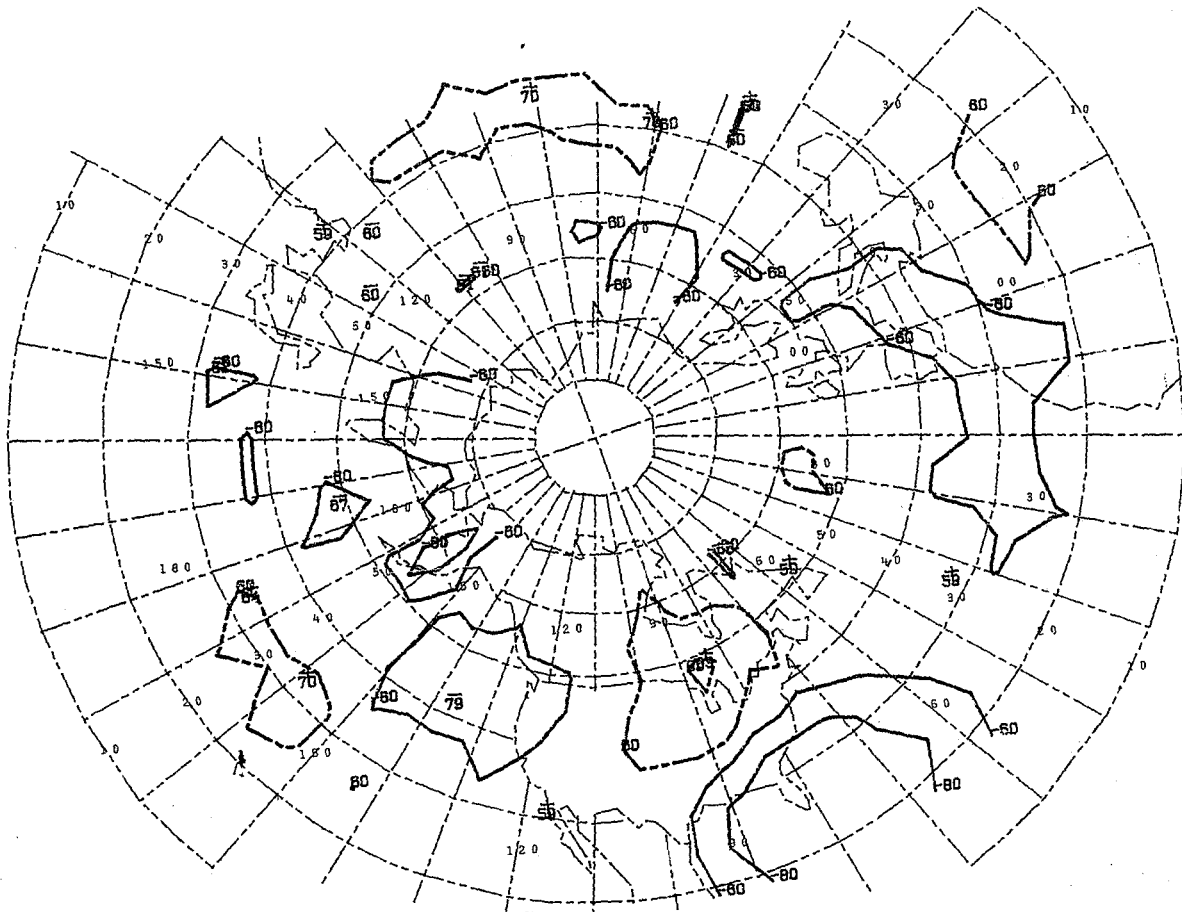

- KEY AT 80W 30N 17 CASES

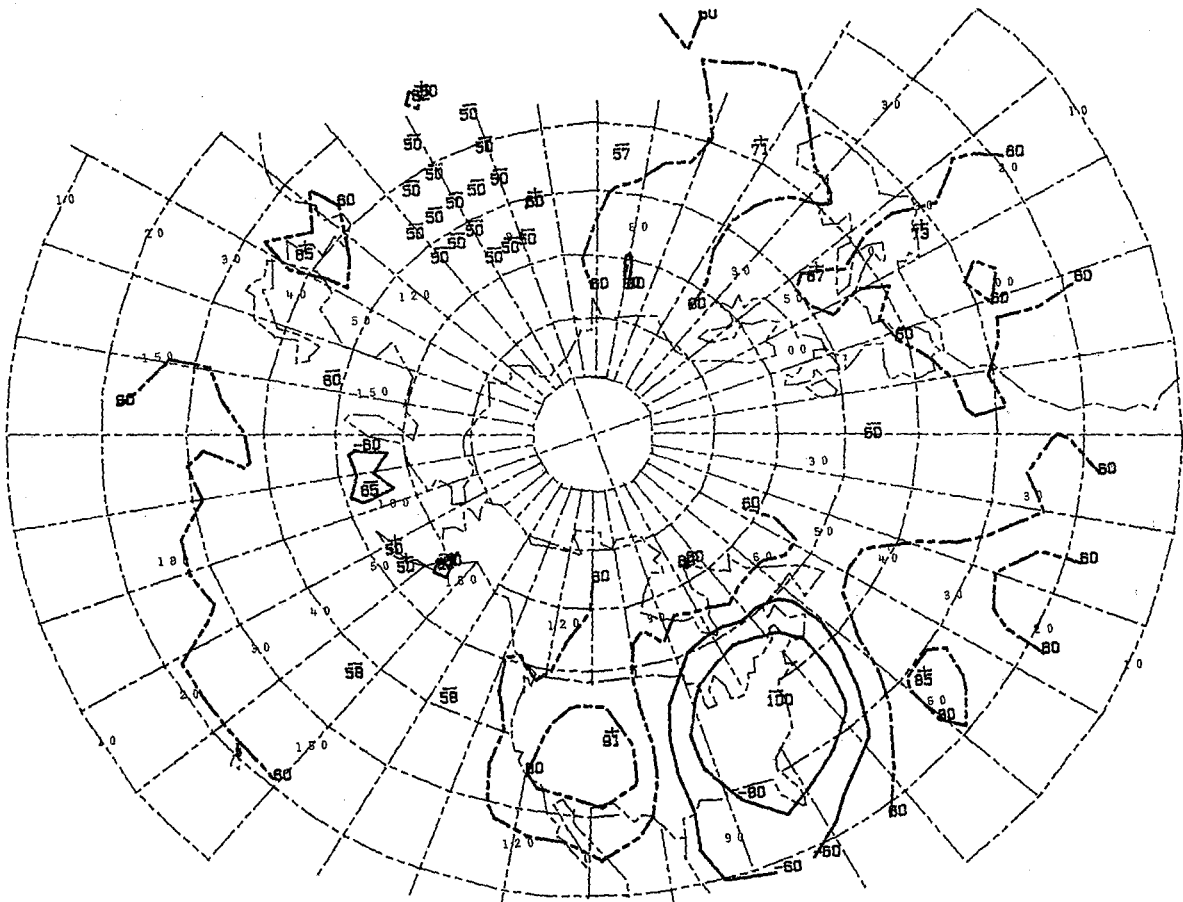

- KEY AT 80W 40N 26 CASES

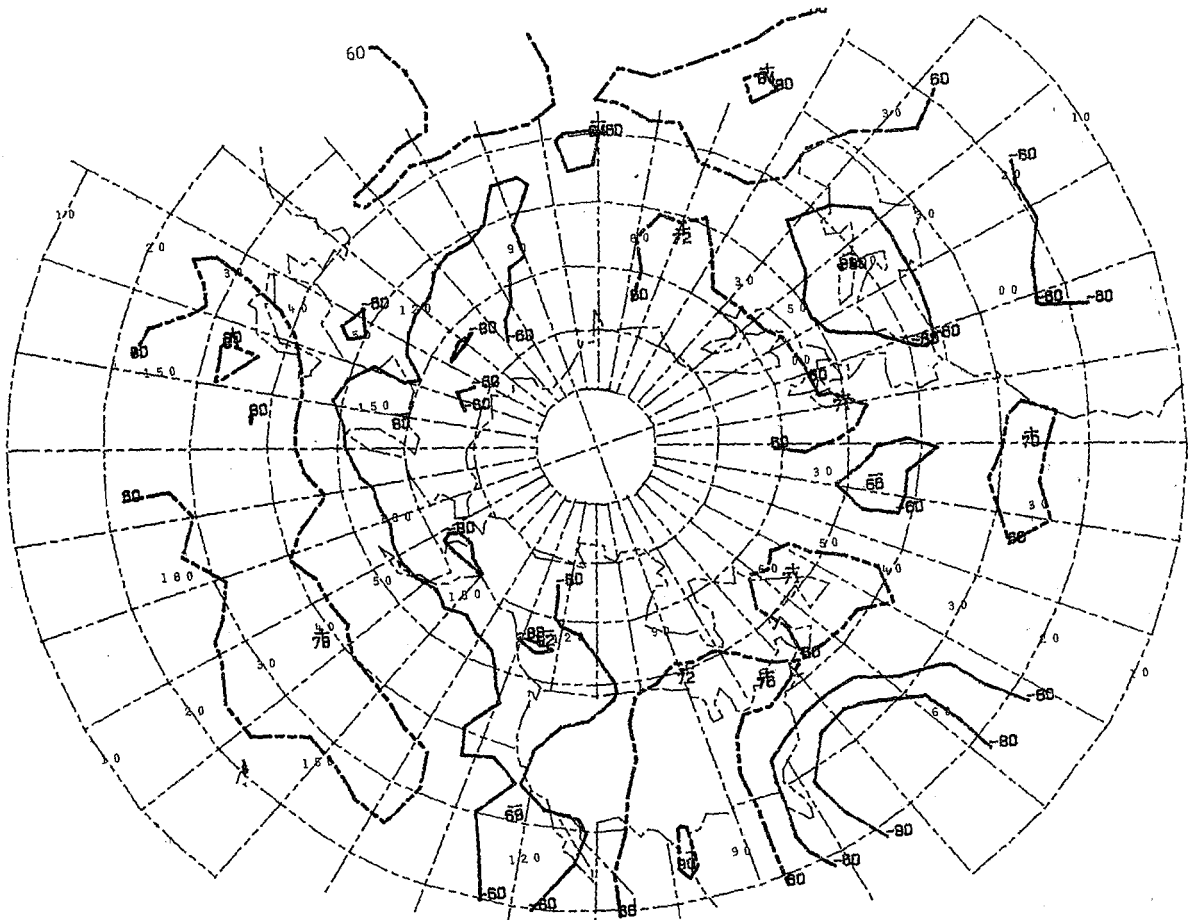

- KEY AT 70W 30N 13 CASES

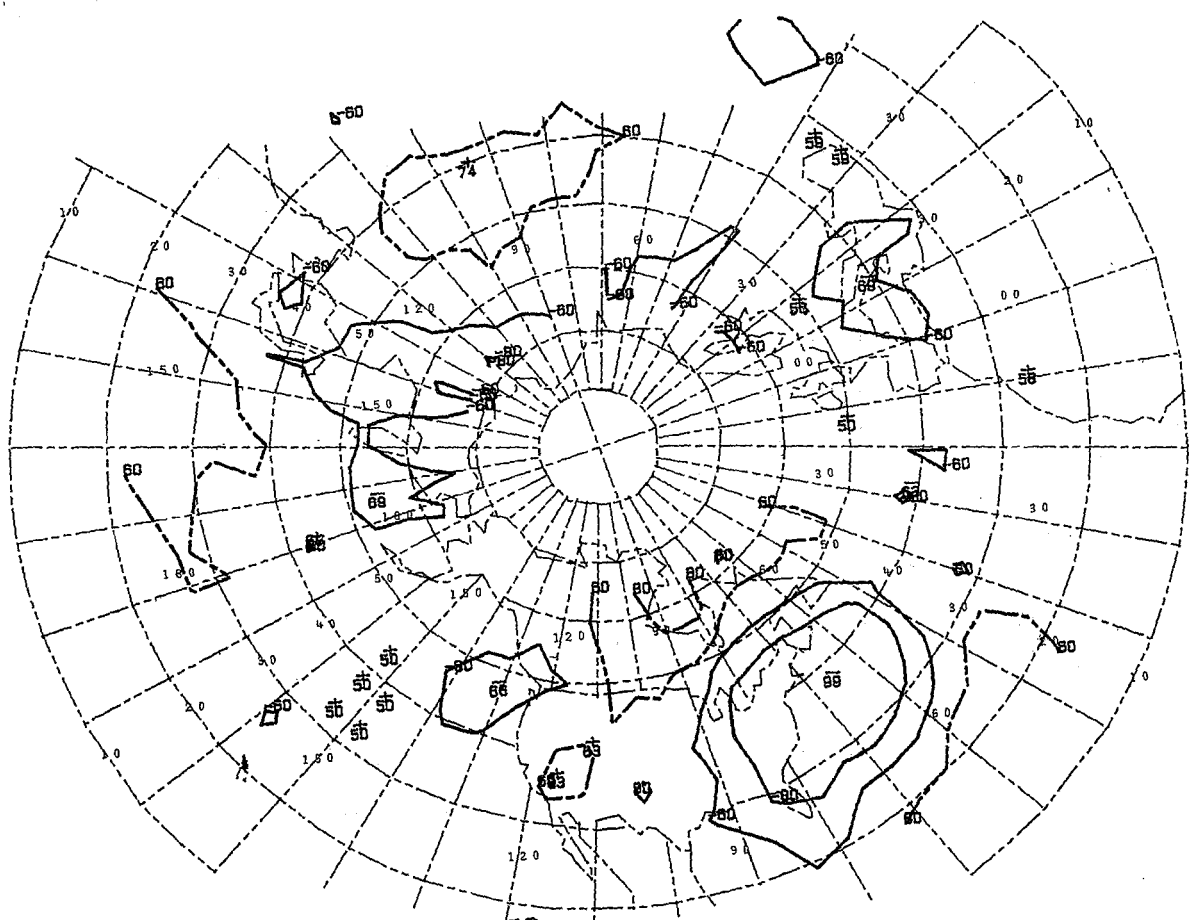

- KEY AT 70W 40N 19 CASES

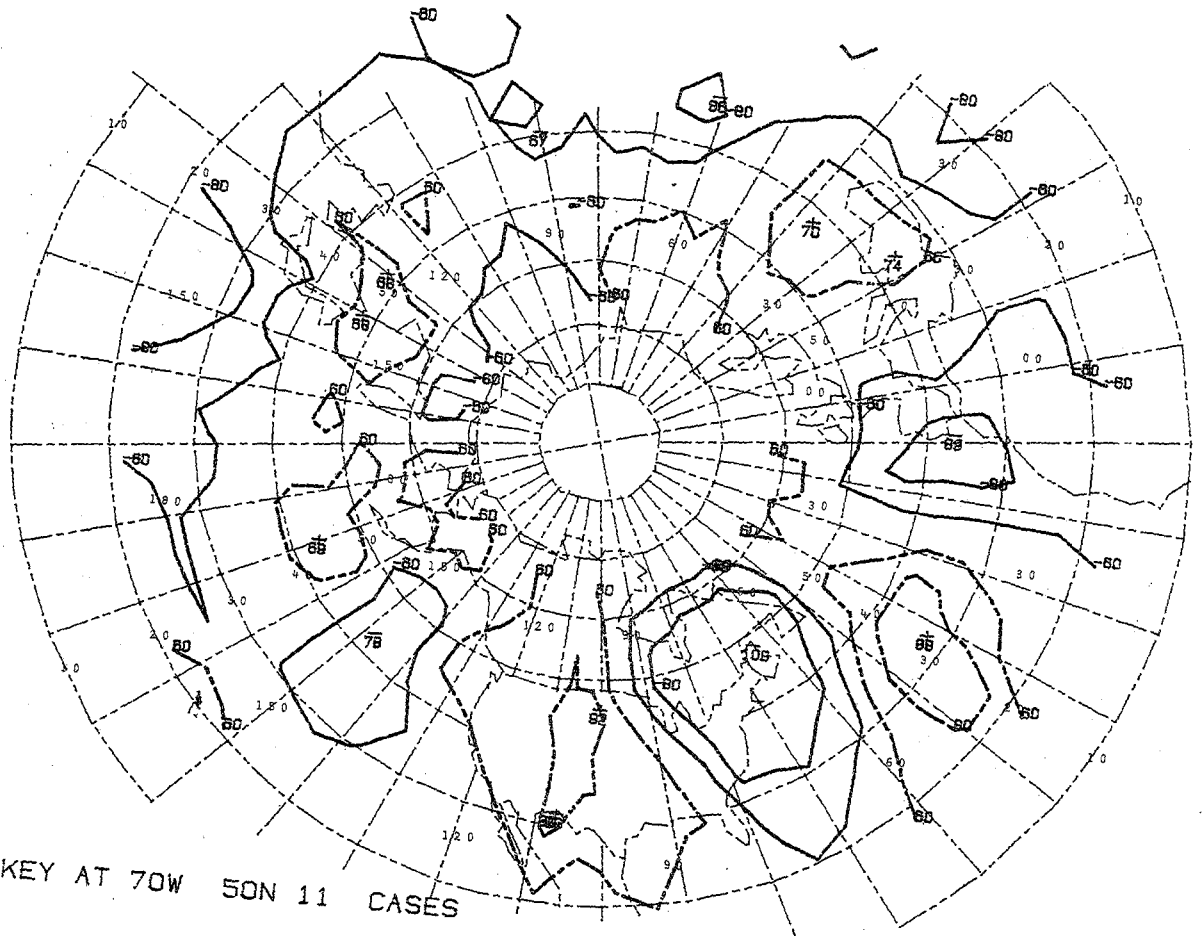

- KEY AT 70W 50N 11 CASES

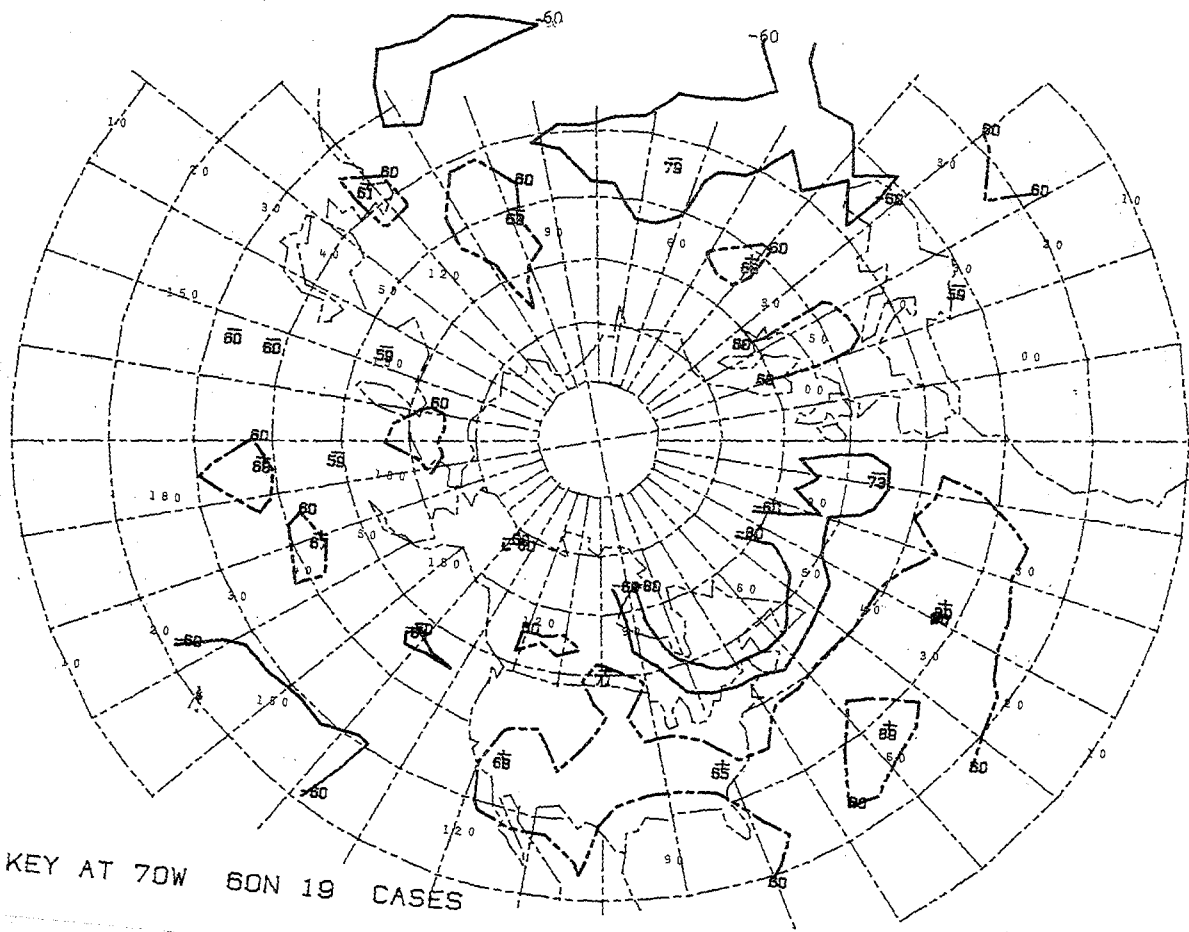

- KEY AT 70W 60N 19 CASES

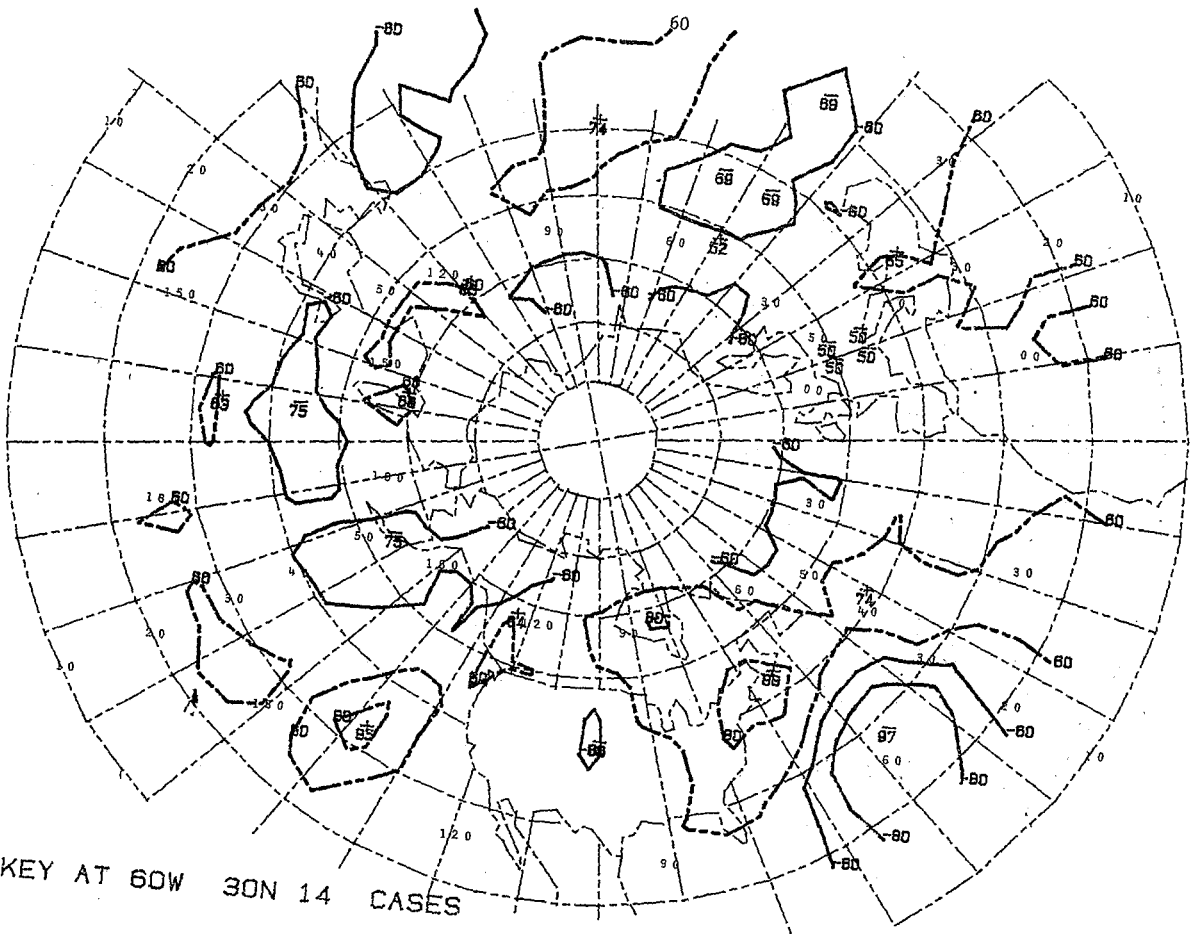

- KEY AT 60W 30N 14 CASES

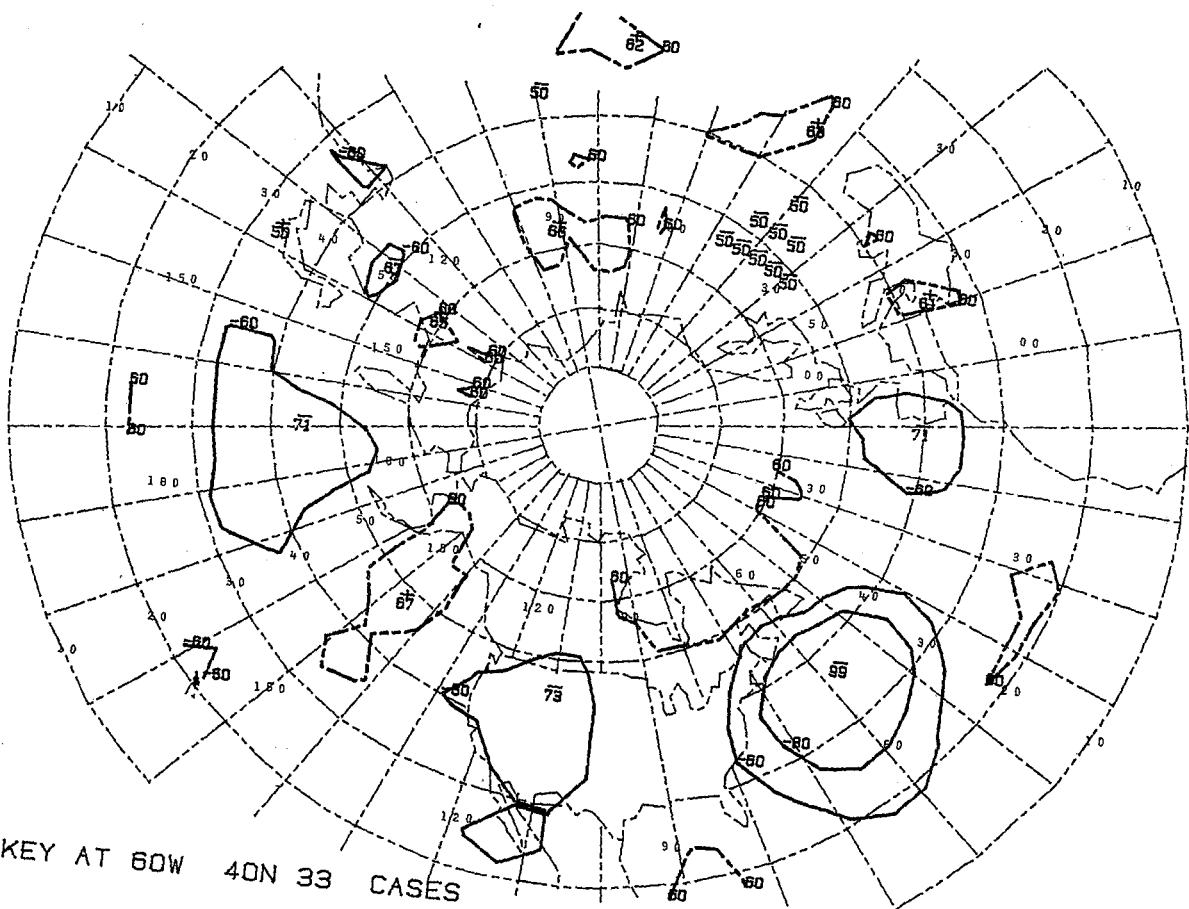

- KEY AT 60W 40N 33 CASES

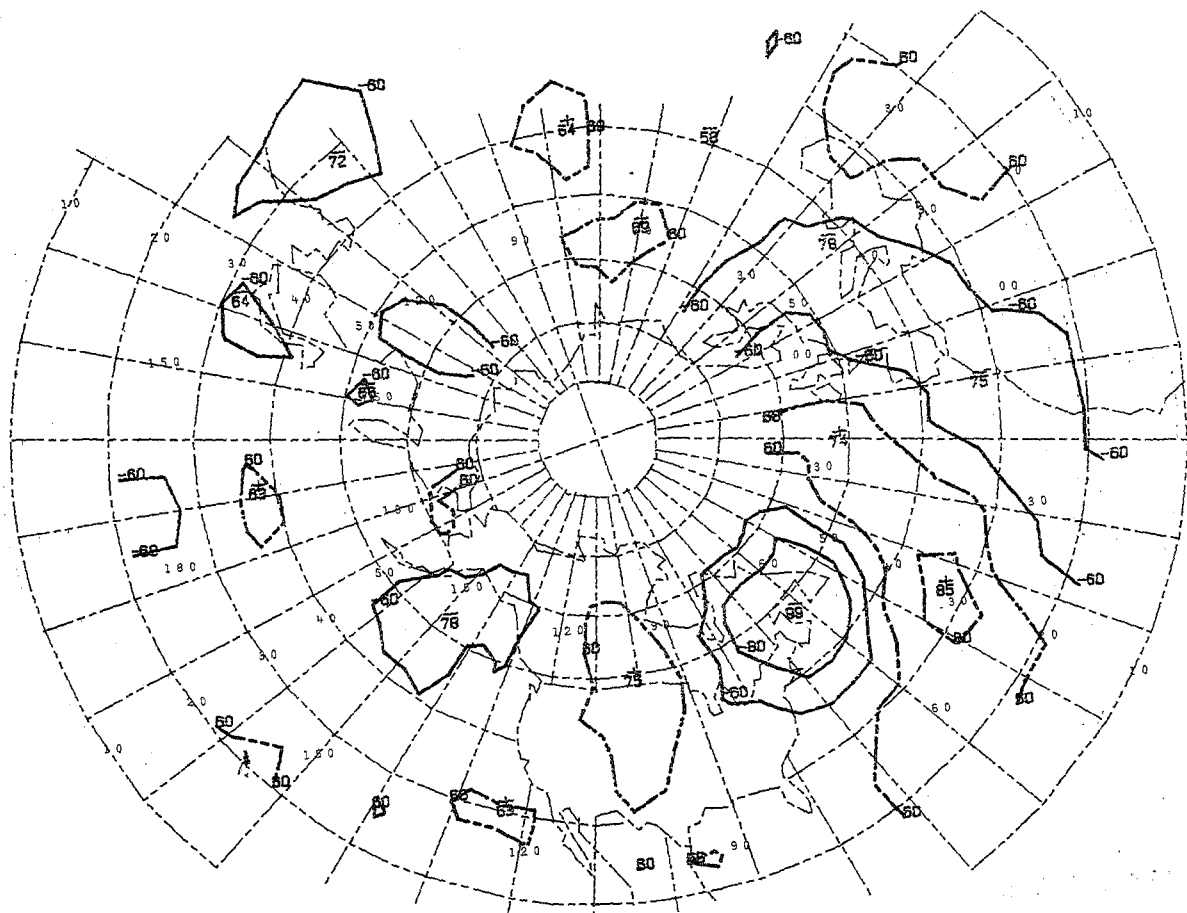

- KEY AT 60W 50N 18 CASES

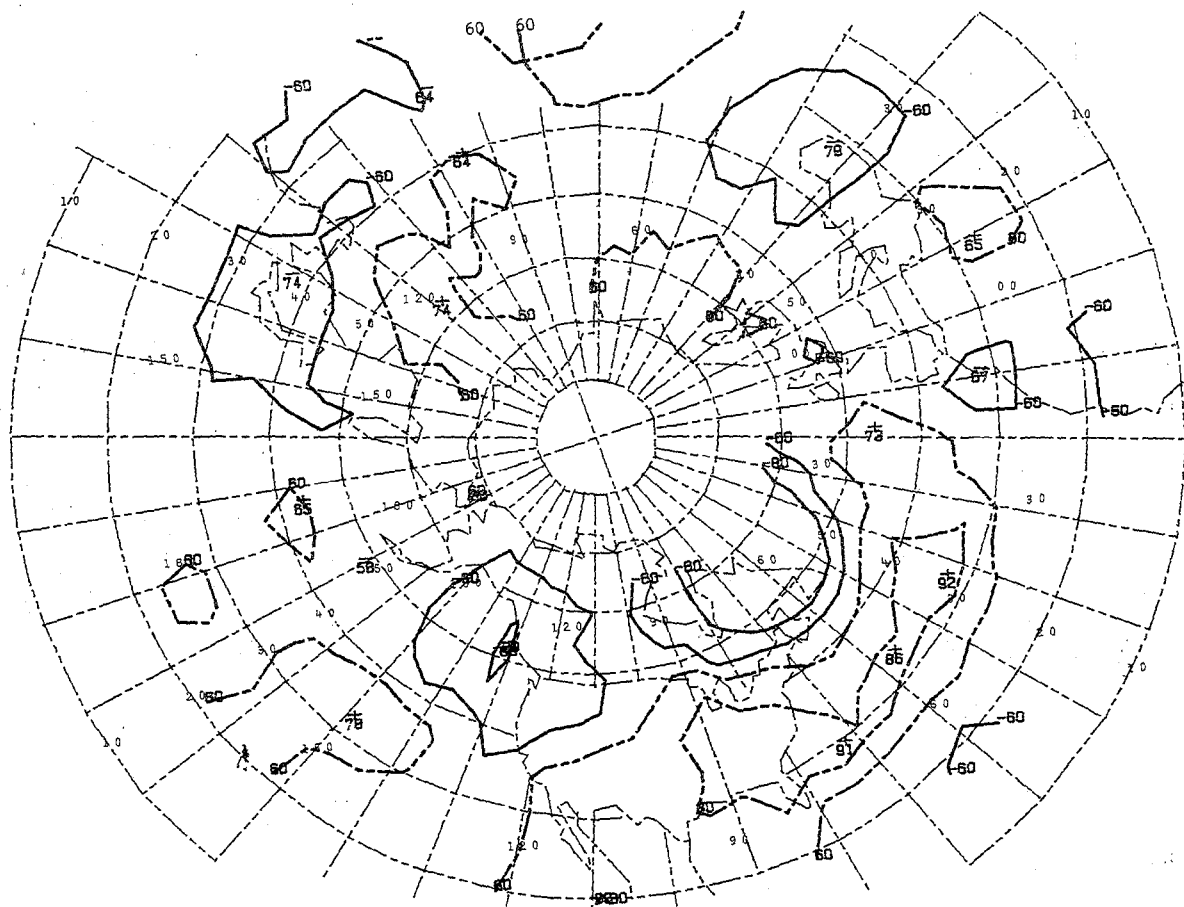

- KEY AT 60W 60N 13 CASES

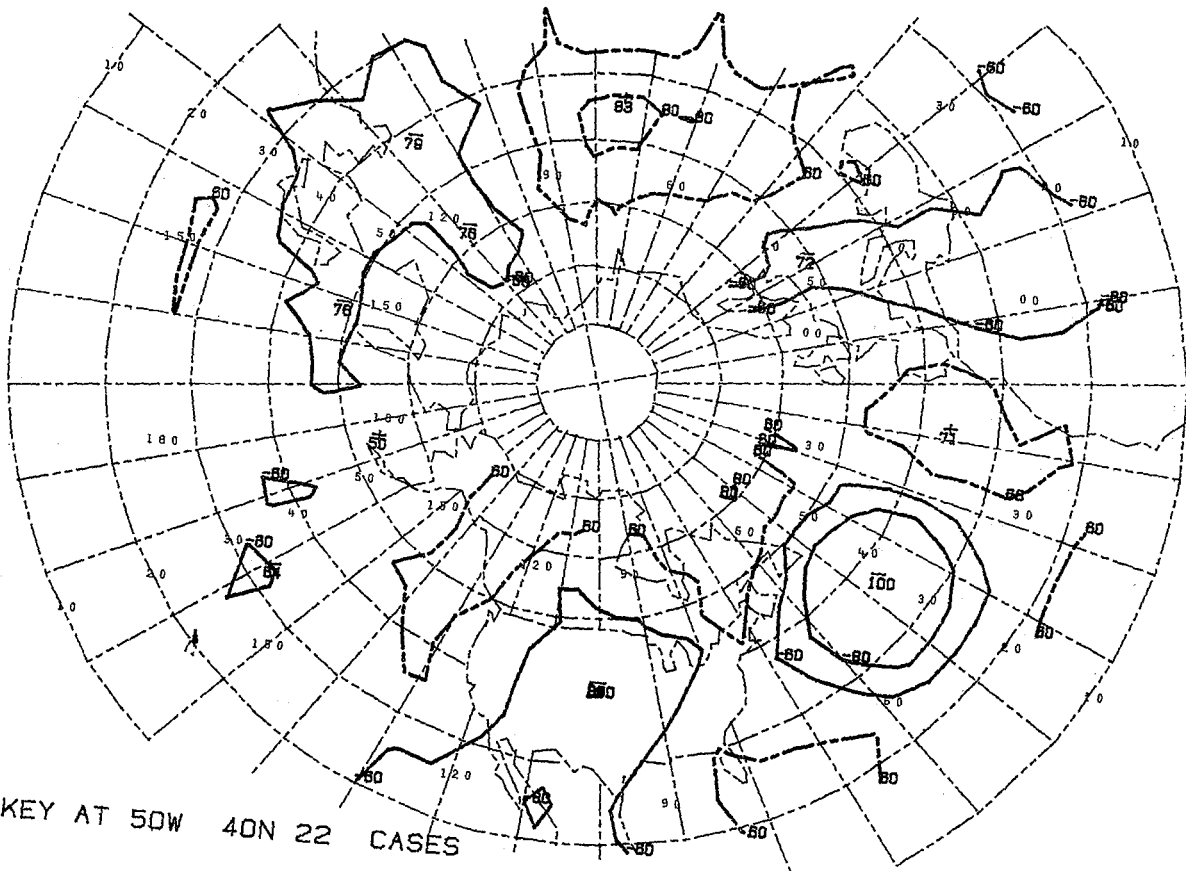
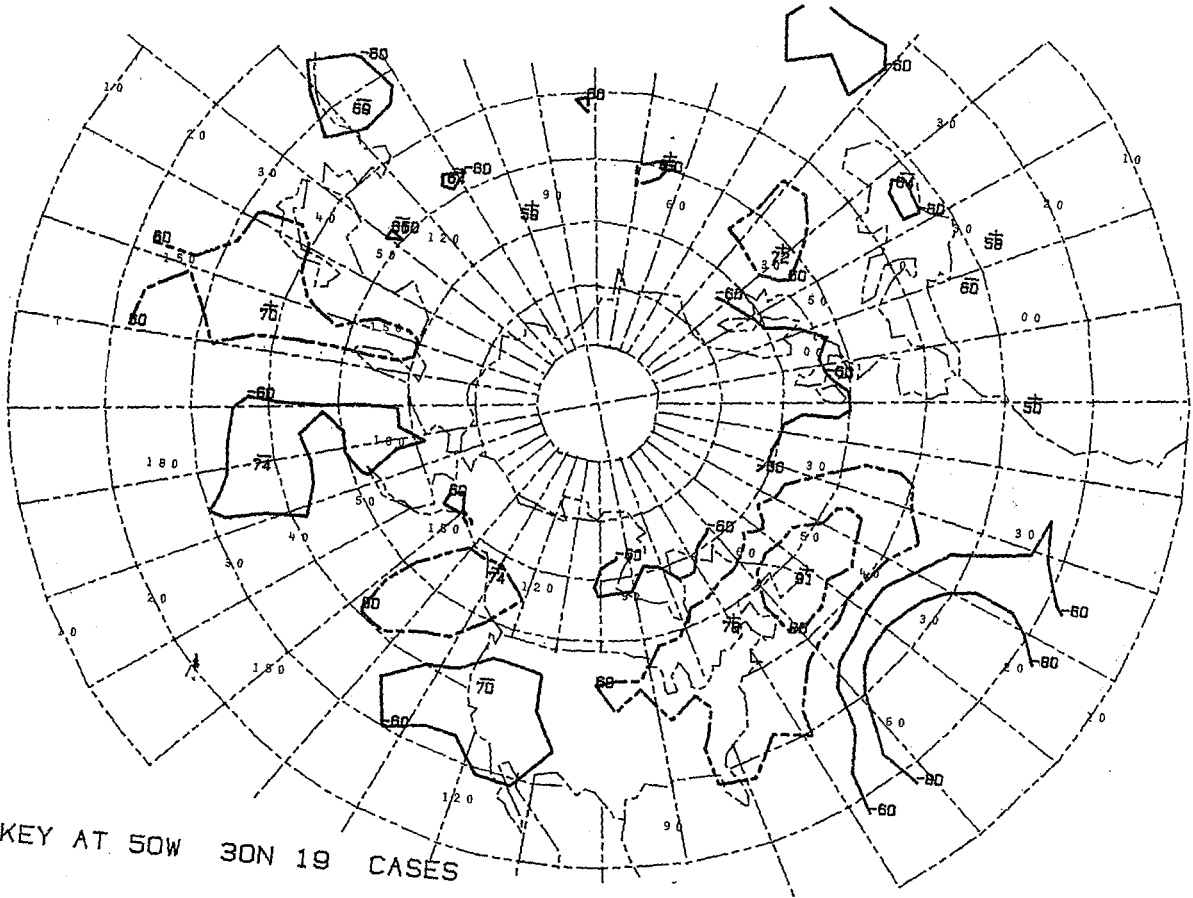

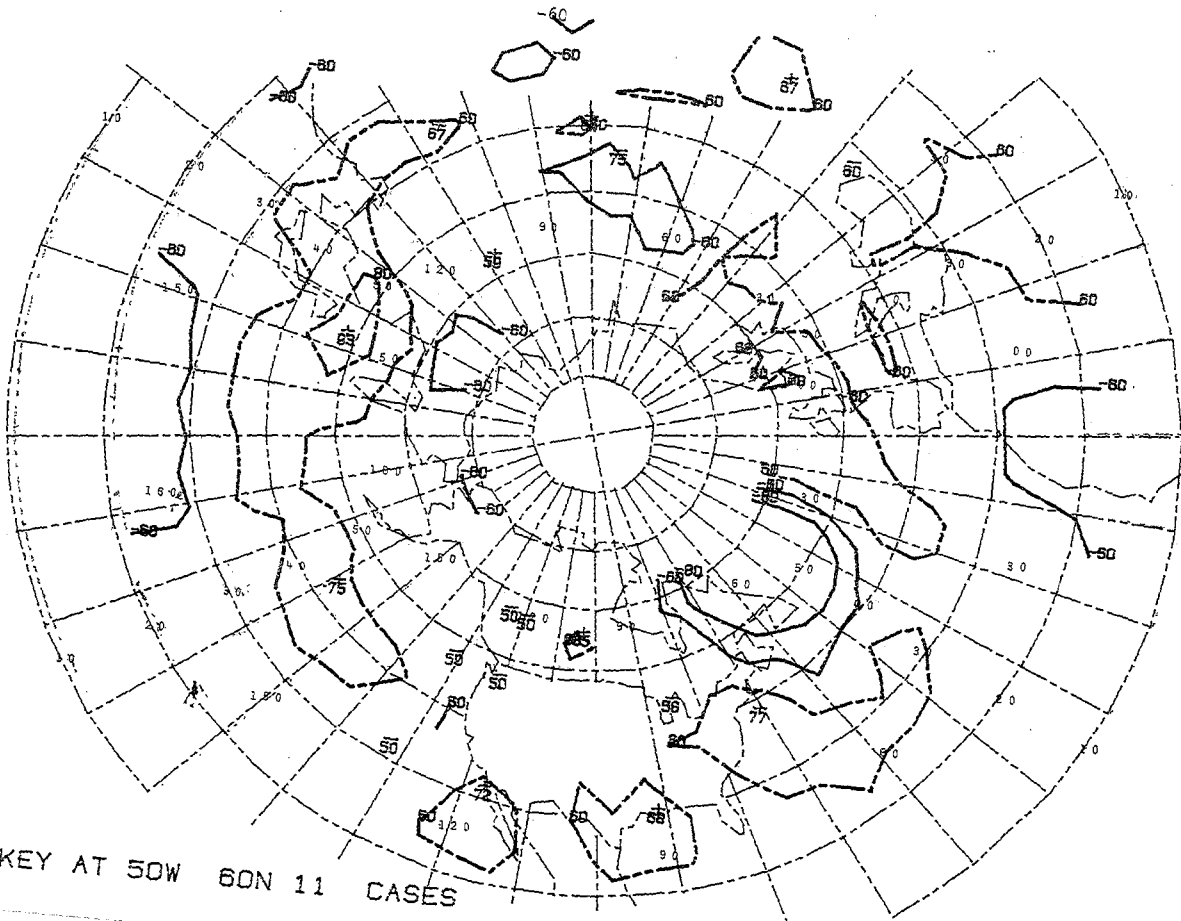
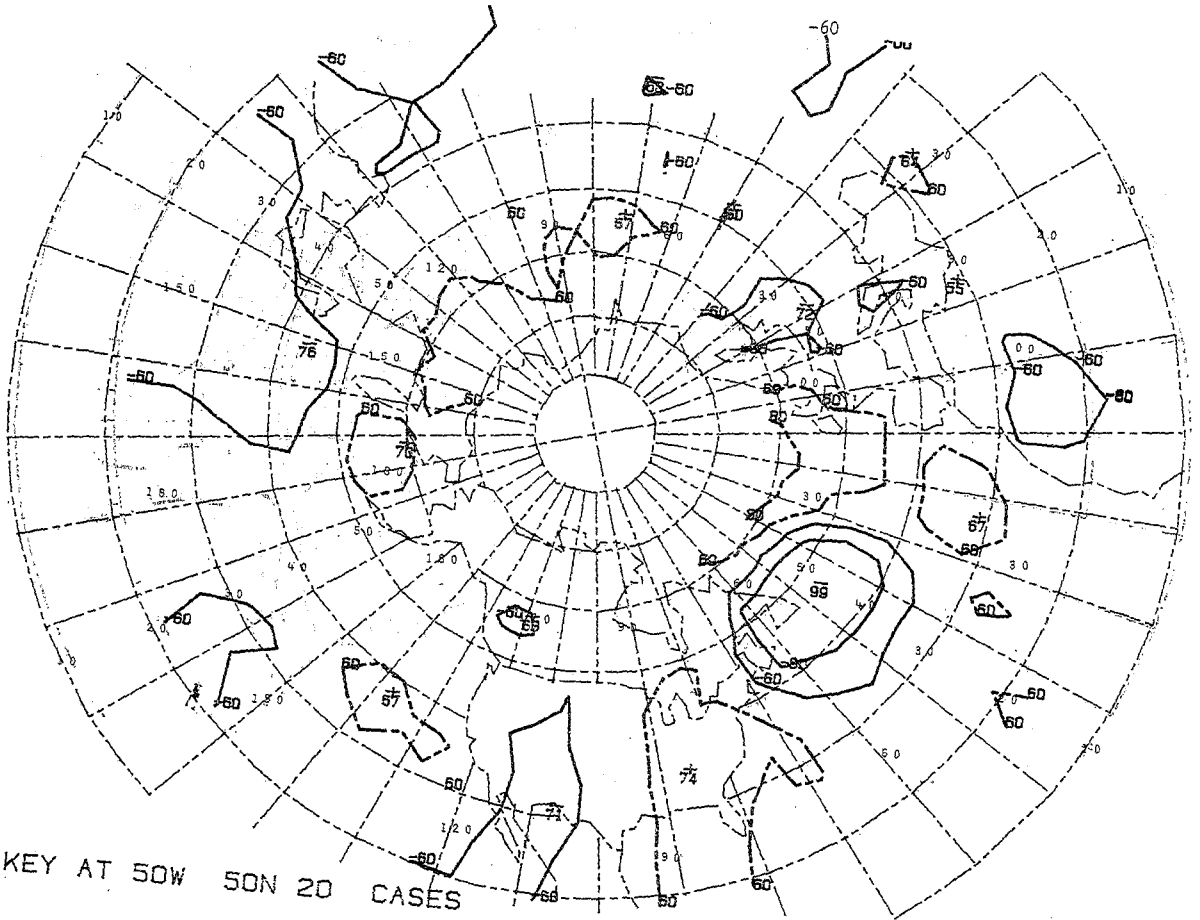

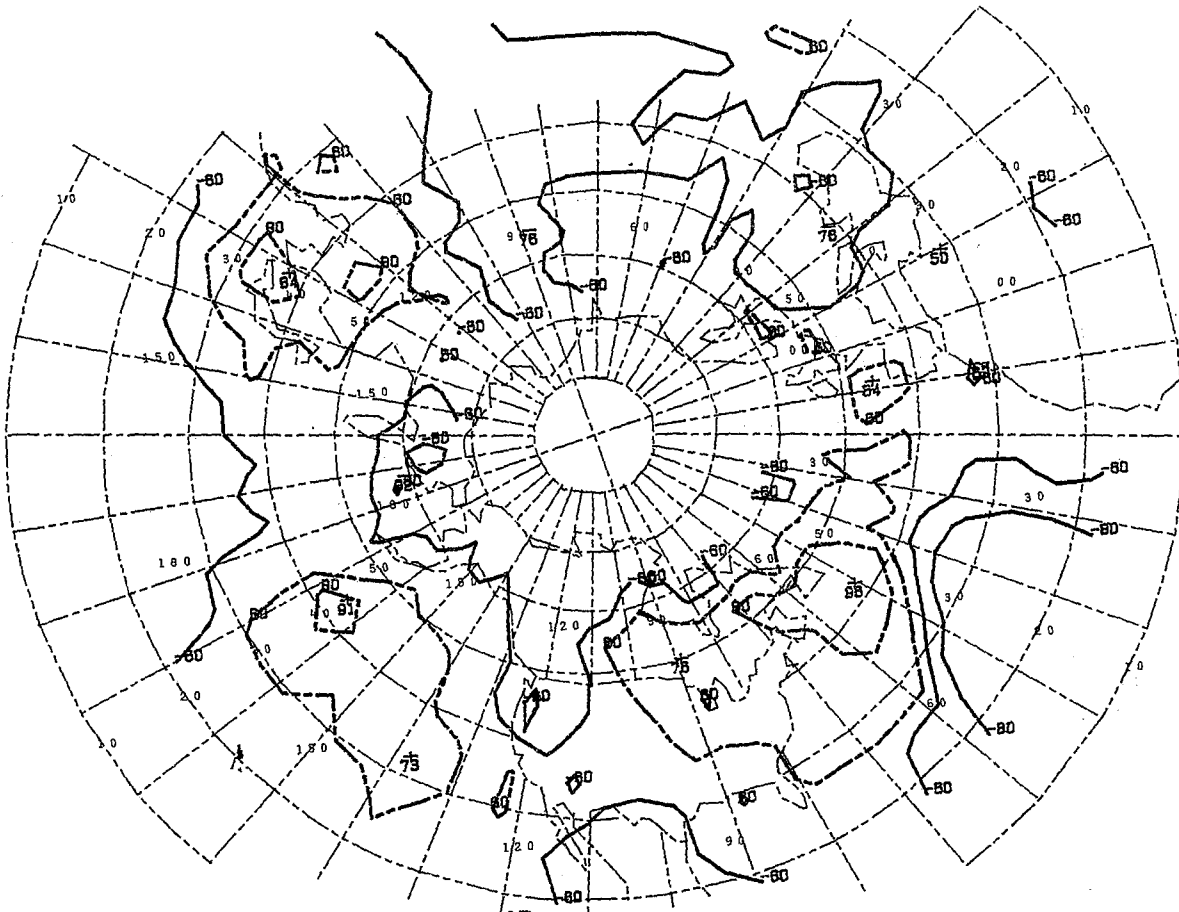

- KEY AT 40W 30N 09 CASES

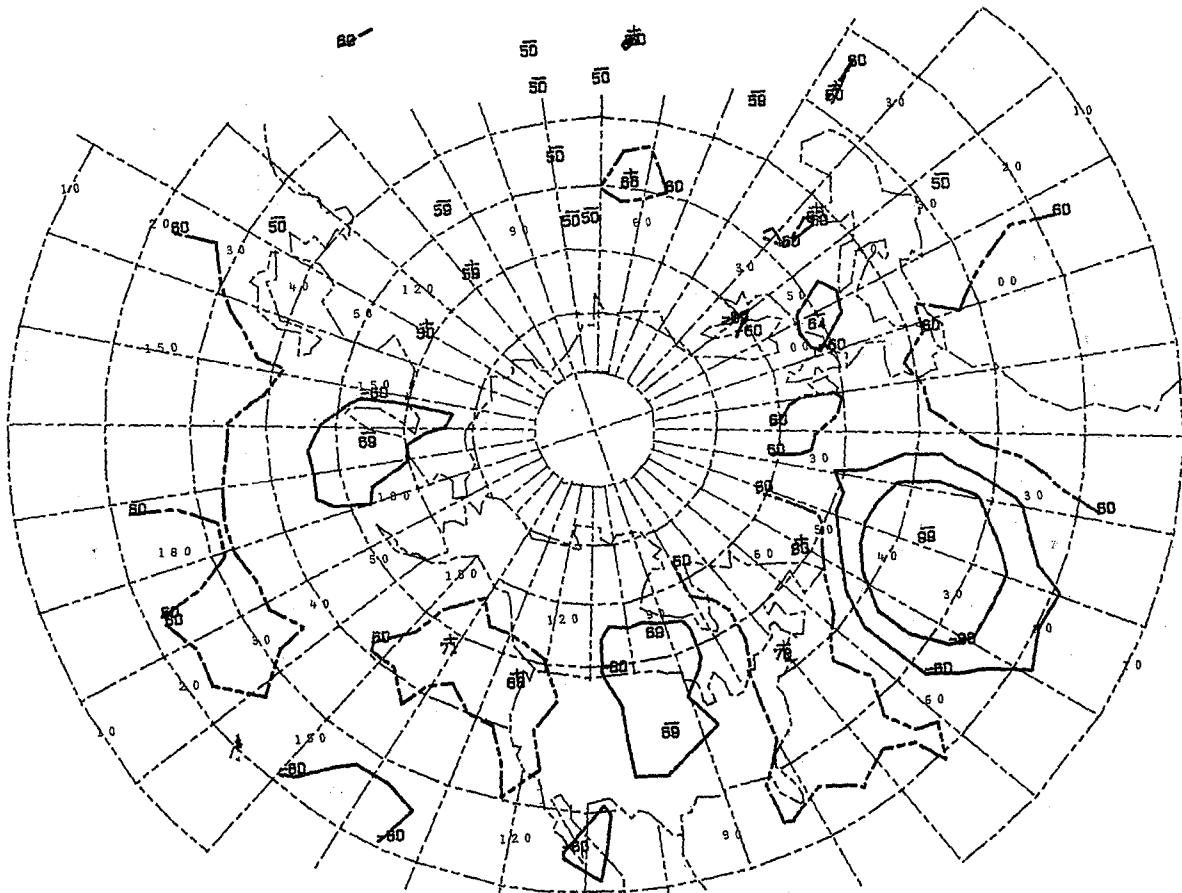

- KEY AT 40W 40N 24 CASES

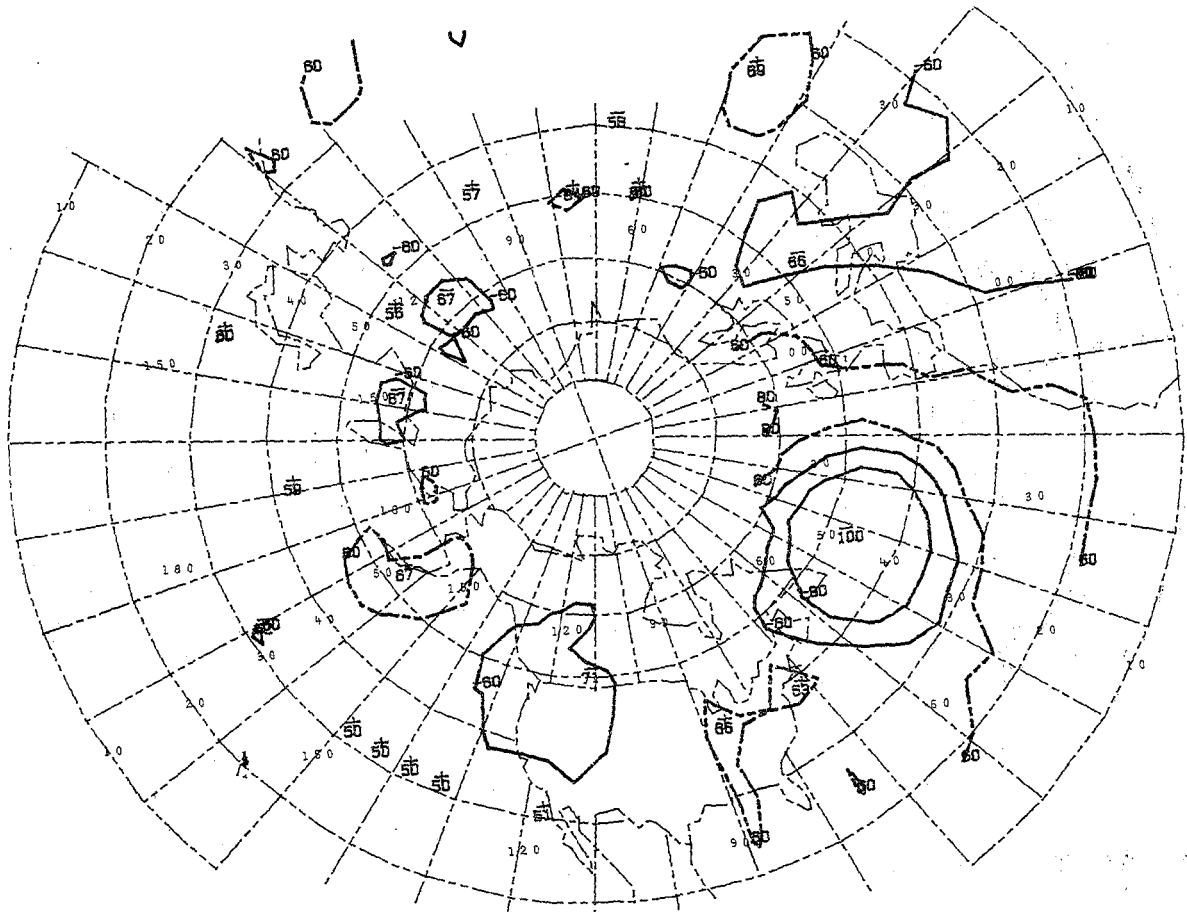

- KEY AT 40W 50N 23 CASES

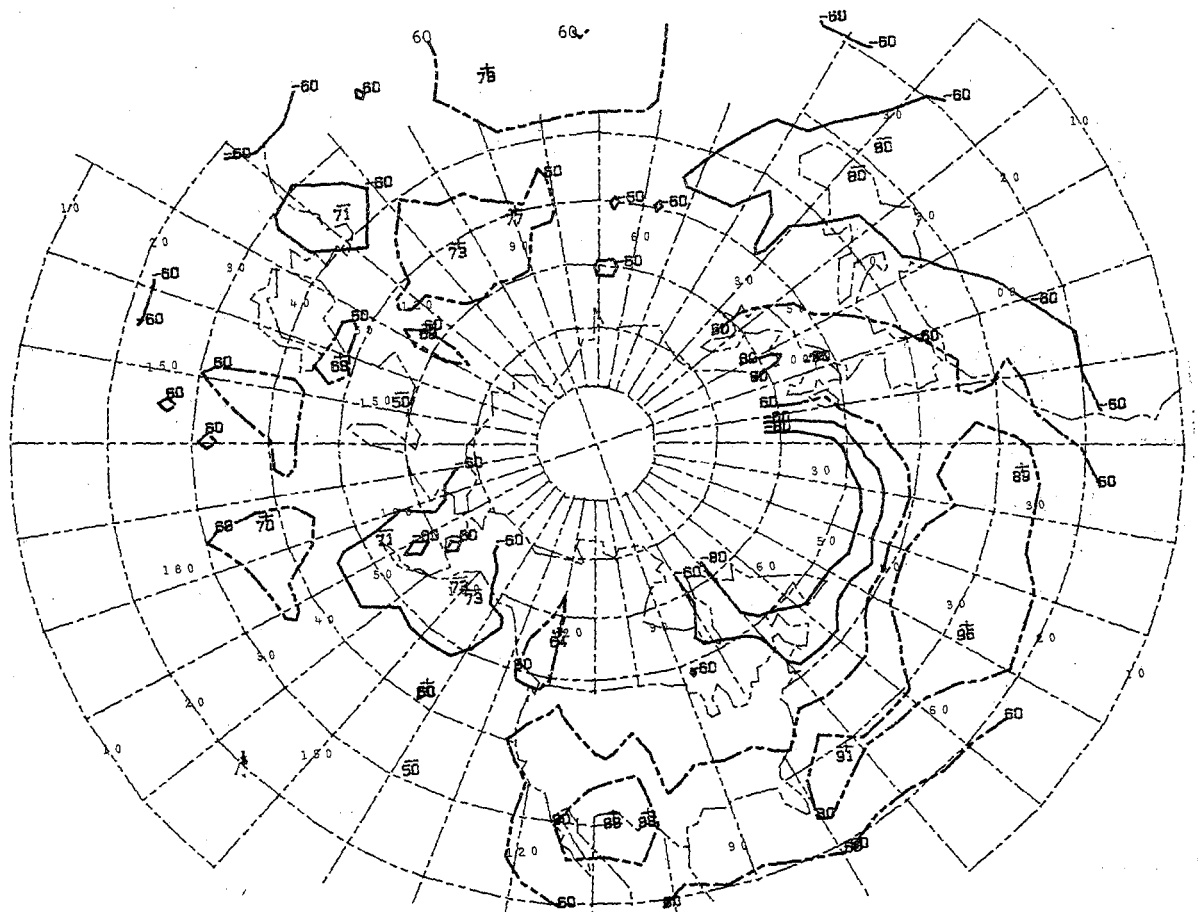

- KEY AT 40W 60N 12 CASES

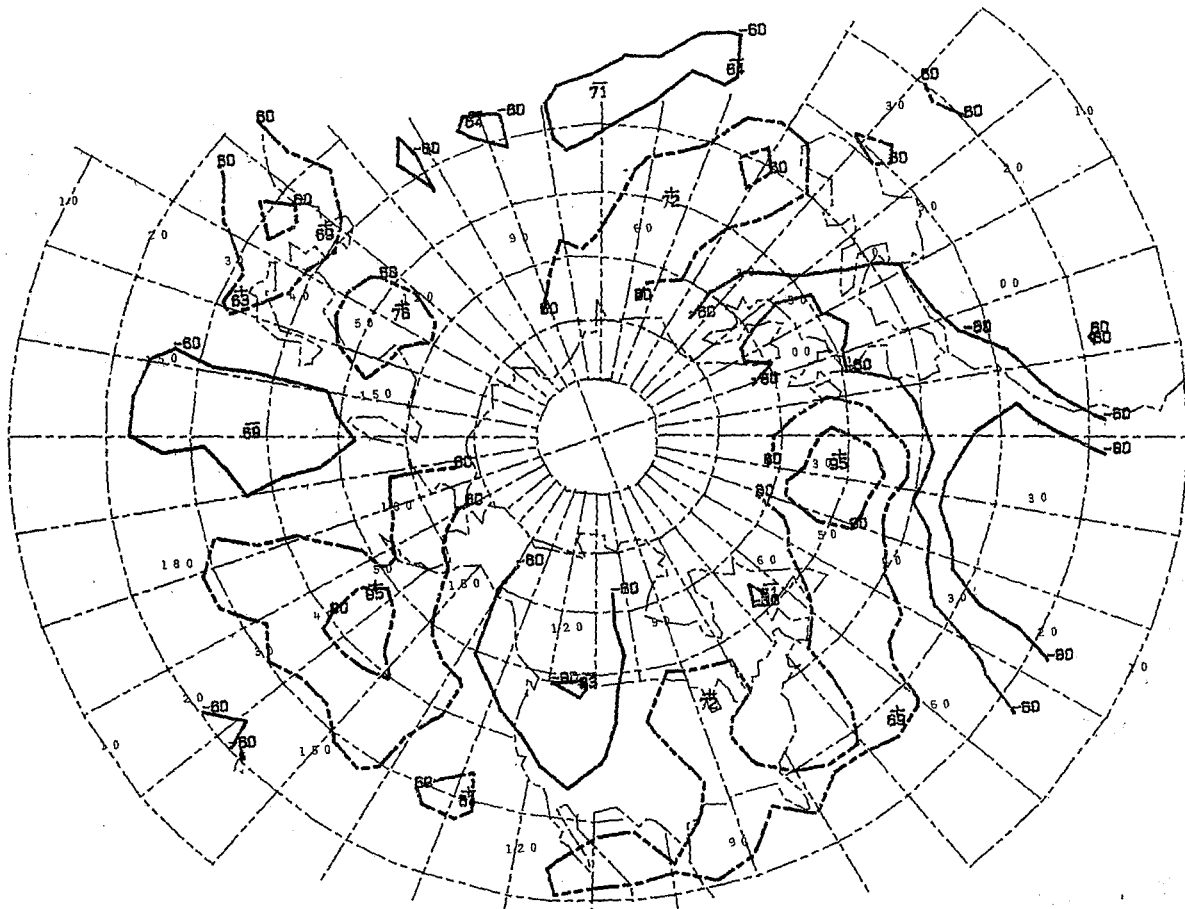

- KEY AT 30W 30N 16 CASES

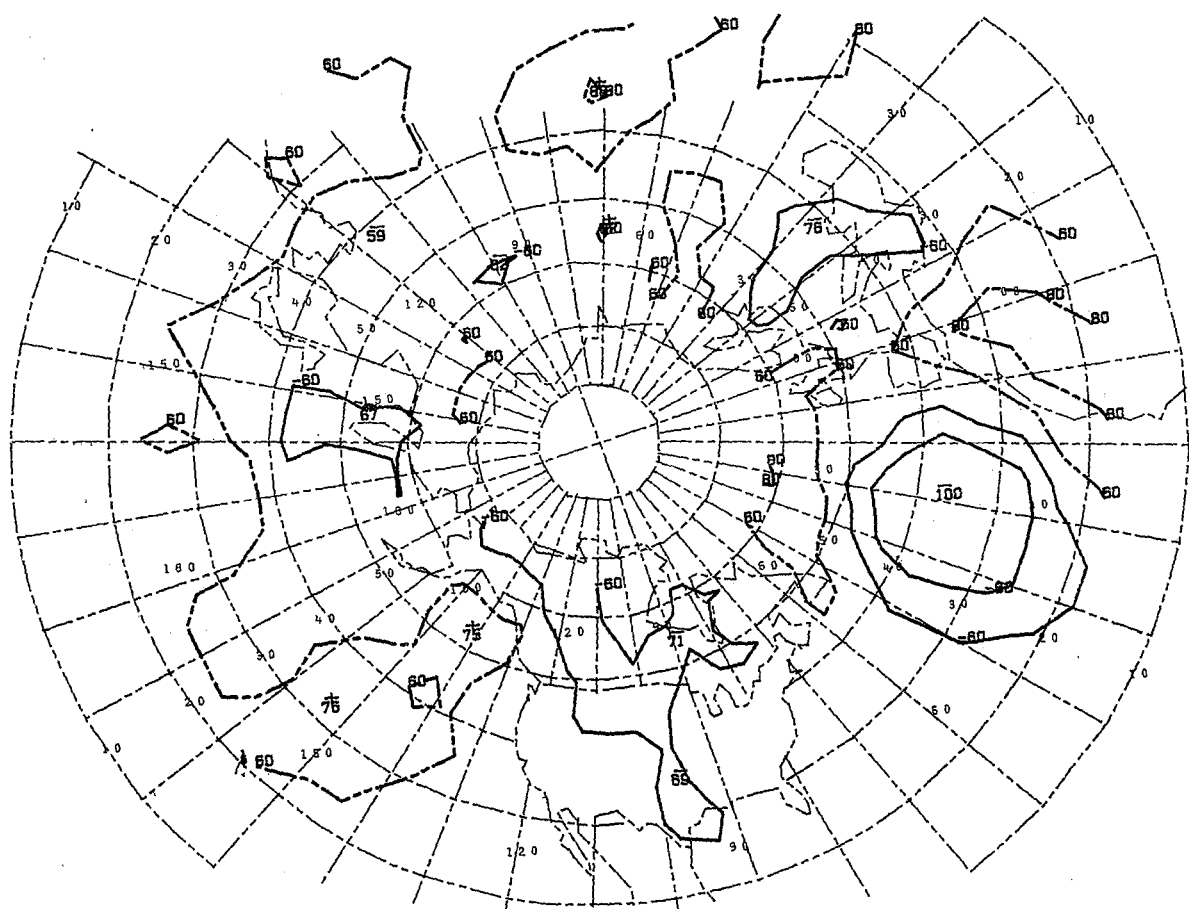

- KEY AT 30W 40N 16 CASES

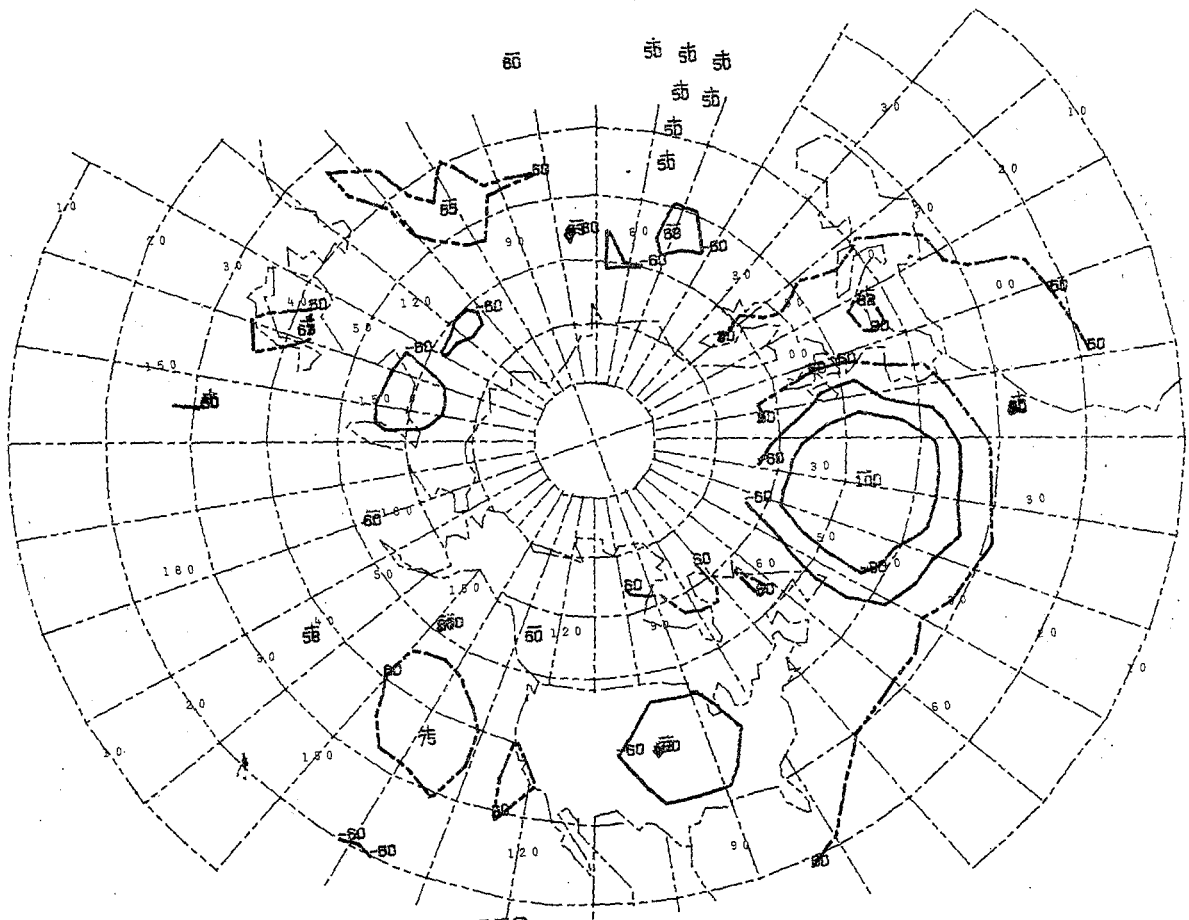

- KEY AT 30W 50N 22 CASES

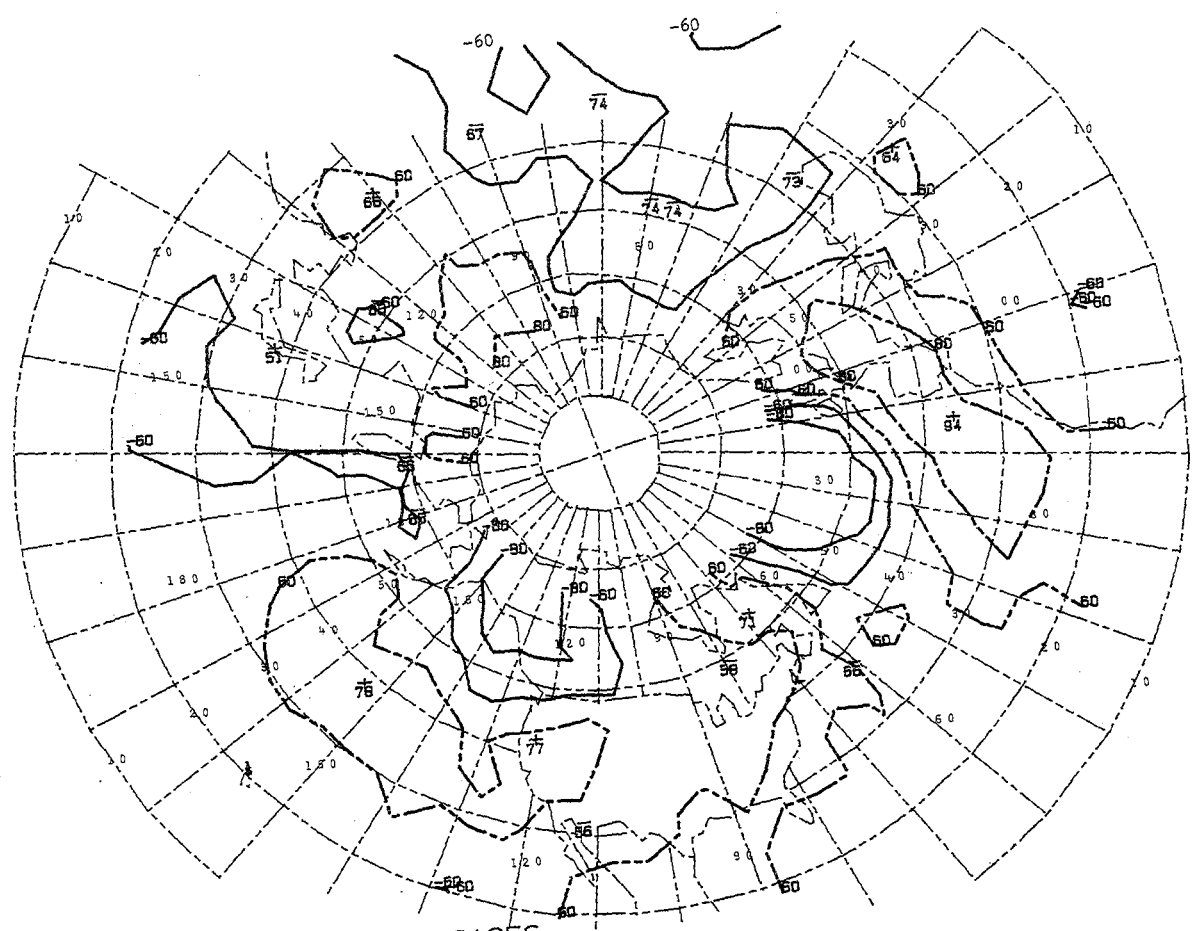

- KEY AT 30W 60N 13 CASES

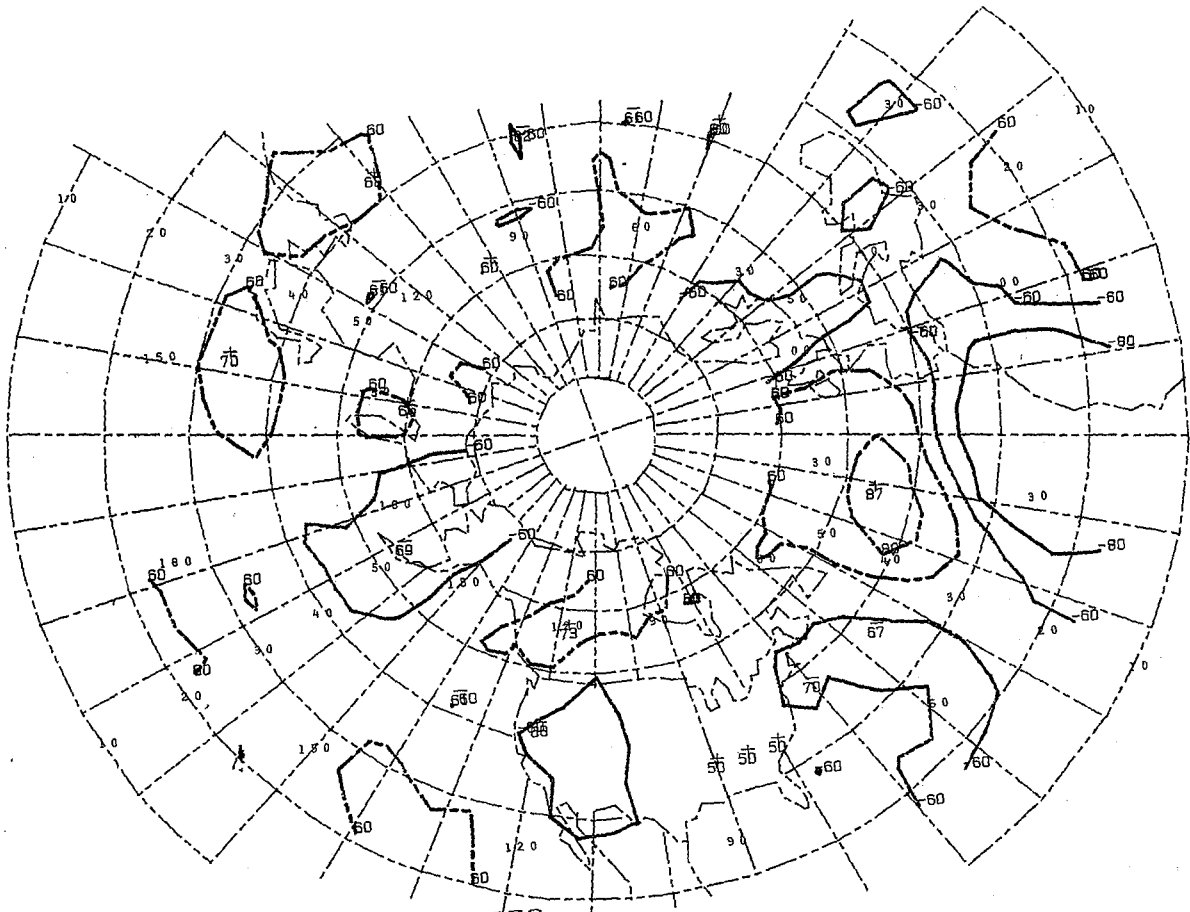

- KEY AT 20W 30N 20 CASES

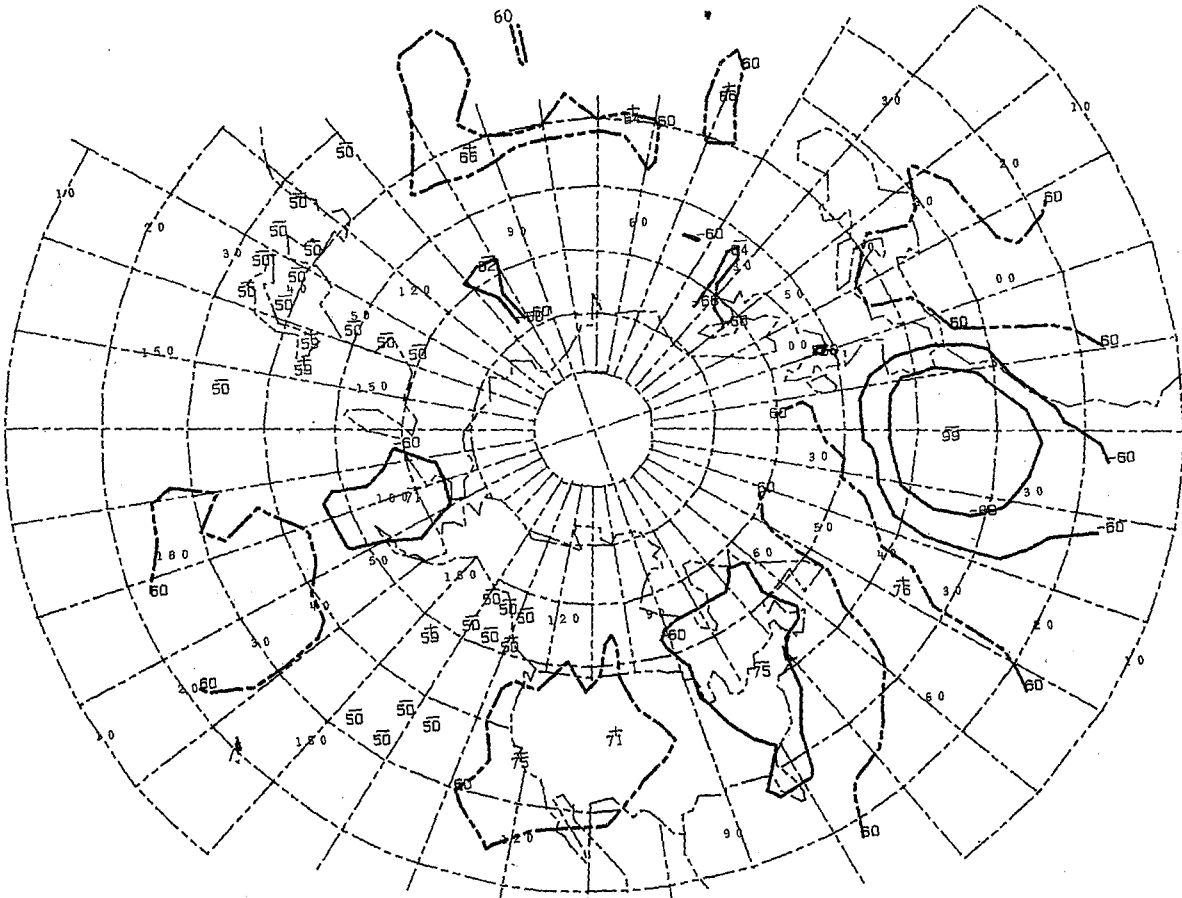

- KEY AT 20W 40N 22 CASES

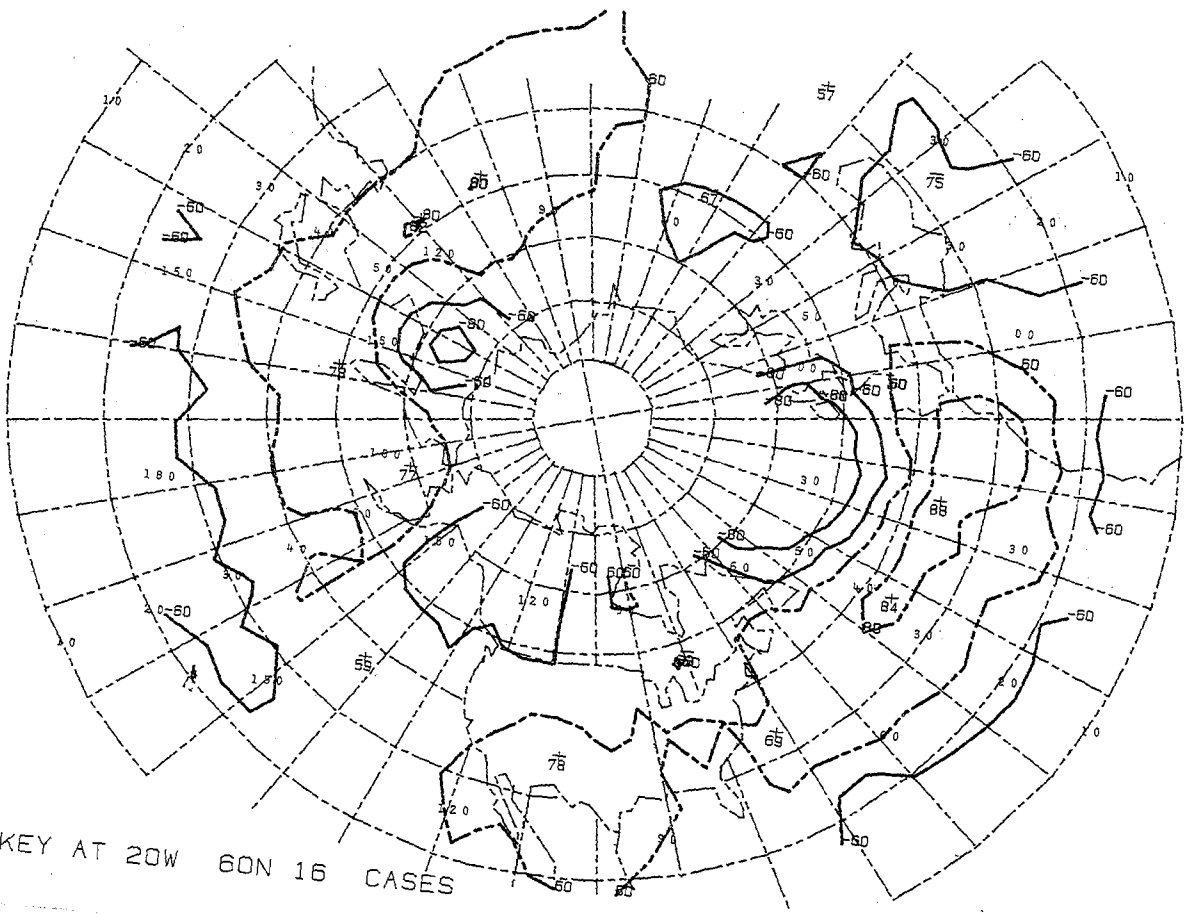
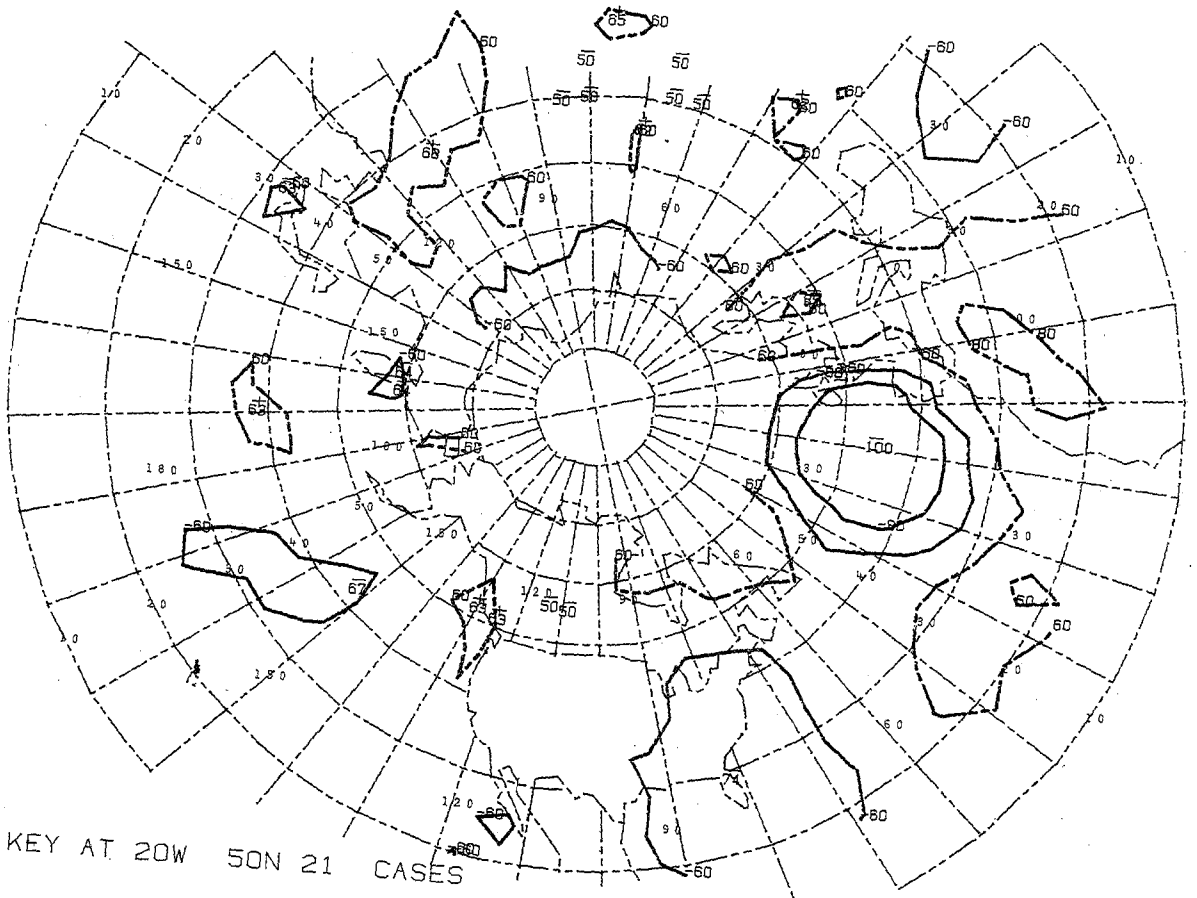

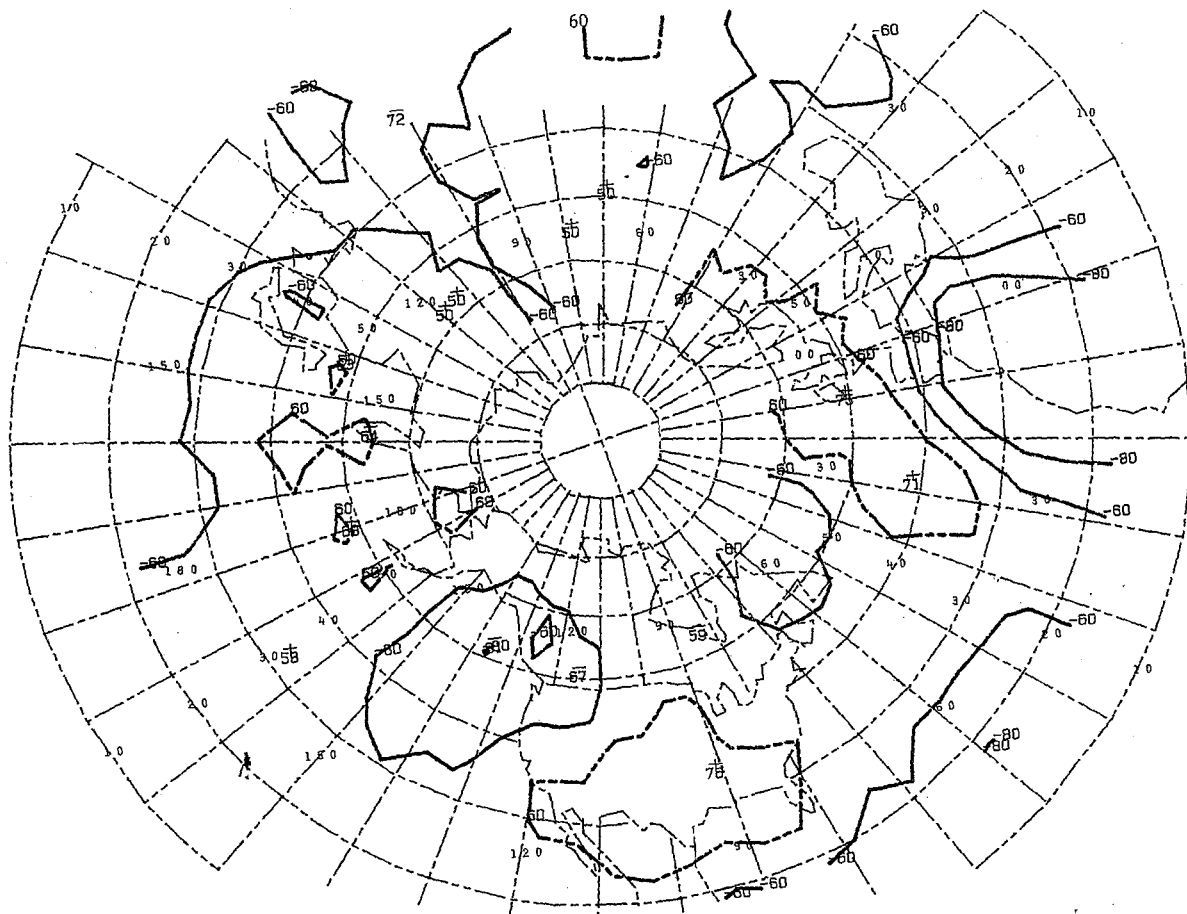

= KEY AT 10W 30N 19 CASES

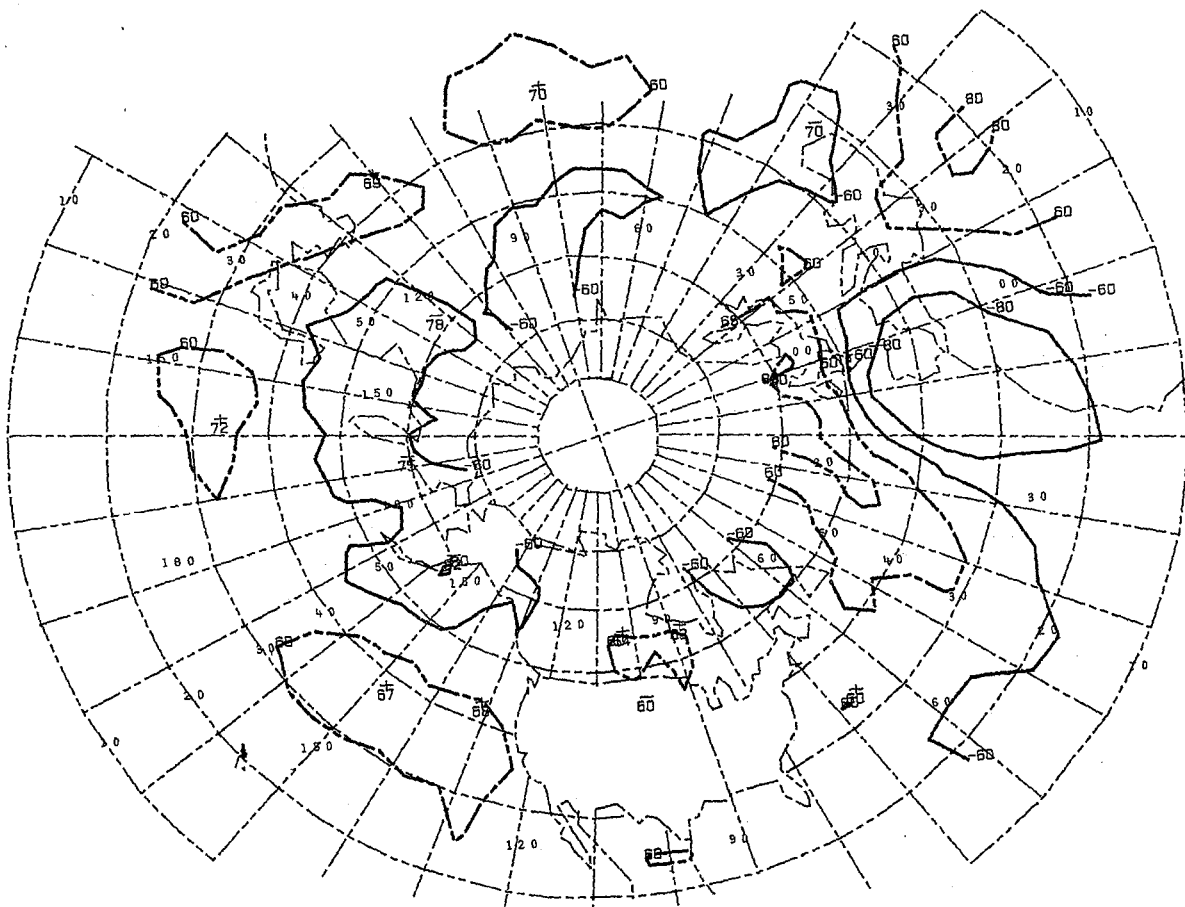

= KEY AT 10W 40N 23 CASES

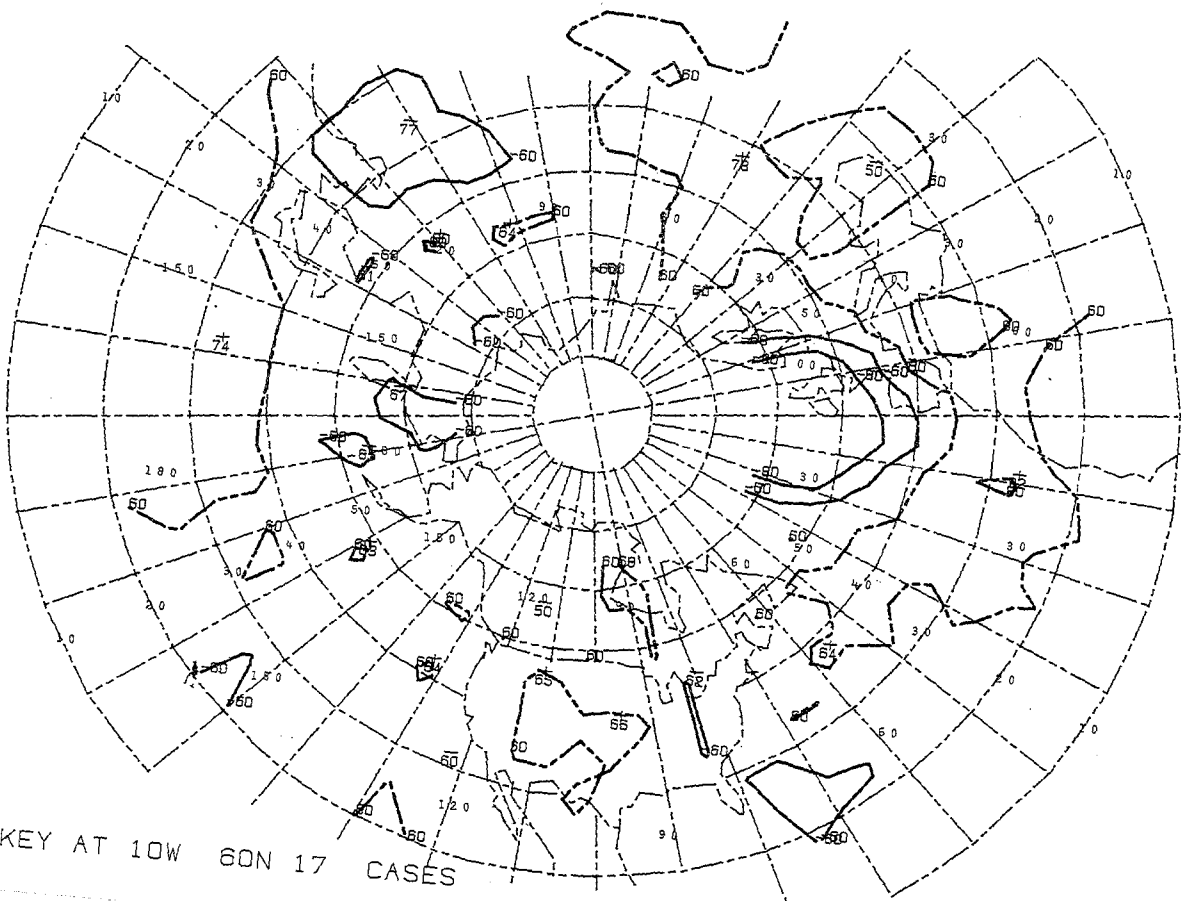
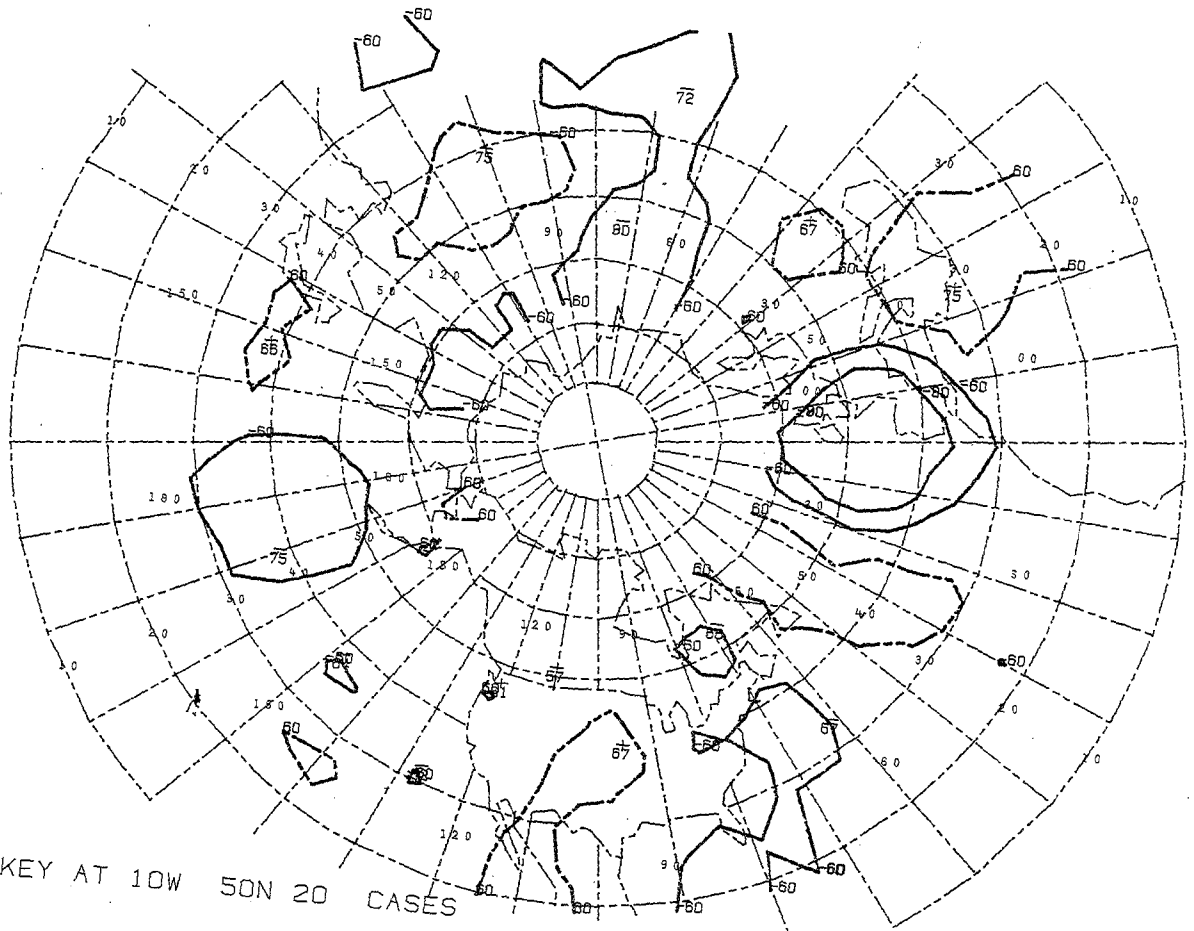

- 121 Climatological Prediction of Cumulonimbus Clouds in the Vicinity of the Yucca Flat Weather Station. R. F. Quiring, June 1977. (PB-271-704/AS)
- 122 A Method for Transforming Temperature Distribution to Normality. Morris S. Webb, Jr., June 1977. (PB-271-742/AS)
- 124 Statistical Guidance for Prediction of Eastern North Pacific Tropical Cyclone Motion - Part I. Charles J. Neumann and Preston W. Leftwich, August 1977. (PB-272-661)
- 125 Statistical Guidance on the Prediction of Eastern North Pacific Tropical Cyclone Motion - Part II. Preston W. Leftwich and Charles J. Neumann, August 1977. (PB-273-155/AS)
- 127 Development of a Probability Equation for Winter-Type Precipitation Patterns in Great Falls, Montana. Kenneth B. Mielke, February 1978. (PB-281-387/AS)
- 128 Hand Calculator Program to Compute Parcel Thermal Dynamics. Dan Gudge, April 1978. (PB-283-080/AS)
- 129 Fire Whirls. David W. Goens, May 1978. (PB-283-866/AS)
- 130 Flash-Flood Procedure. Ralph C. Hatch and Gerald Williams, May 1978. (PB-286-014/AS)
- 131 Automated Fire-Weather Forecasts. Mark A. Mollner and David E. Olsen, September 1978. (PB-289-916/AS)
- 132 Estimates of the Effects of Terrain Blocking on the Los Angeles WSR-74C Weather Radar. R. G. Pappas, R. Y. Lee, B. W. Finke, October 1978. (PB289767/AS)
- 133 Spectral Techniques in Ocean Wave Forecasting. John A. Jannuzzi, October 1978. (PB291317/AS)
- 134 Solar Radiation. John A. Jannuzzi, November 1978. (PB291195/AS)
- 135 Application of a Spectrum Analyzer in Forecasting Ocean Swell in Southern California Coastal Waters. Lawrence P. Kierulff, January 1979. (PB292716/AS)
- 136 Basic Hydrologic Principles. Thomas L. Dietrich, January 1979. (PB292247/AS)
- 137 LFM 24-Hour Prediction of Eastern Pacific Cyclones Refined by Satellite Images. John R. Zimmerman and Charles P. Ruscha, Jr., Jan. 1979. (PB294324/AS)
- 138 A Simple Analysis/Diagnosis System for Real Time Evaluation of Vertical Motion. Scott Heflick and James R. Fors, February 1979. (PB294216/AS)
- 139 Tides for Forecasting Minimum Temperature in the Wenatchee Frost District. Robert S. Robinson, April 1979. (PB298339/AS)
- 140 Influence of Cloudiness on Summertime Temperatures in the Eastern Washington Fire Weather District. James Holcomb, April 1979. (PB298674/AS)
- 141 Comparison of LFM and MFM Precipitation Guidance for Nevada During Doreen. Christopher Hill, April 1979. (PB298613/AS)
- 142 The Usefulness of Data from Mountaintop Fire Lookout Stations in Determining Atmospheric Stability. Jonathan W. Corey, April 1979. (PB298899/AS)
- 143 The Depth of the Marine Layer at San Diego as Related to Subsequent Cool Season Precipitation Episodes in Arizona. Ira S. Brenner, May 1979. (PB298817/AS)
- 144 Arizona Cool Season Climatological Surface Wind and Pressure Gradient Study. Ira S. Brenner, May 1979. (PB298900/AS)
- 145 On the Use of Solar Radiation and Temperature Models to Estimate the Snap Bean Maturity Date in the Willamette Valley. Earl M. Bates, August 1979. (PB80-160971)
- 146 The BART Experiment. Morris S. Webb, October 1979. (PB80-155112)
- 147 Occurrence and Distribution of Flash Floods in the Western Region. Thomas L. Dietrich, December 1979. (PB80-160344)
- 149 Misinterpretations of Precipitation Probability Forecasts. Allan H. Murphy, Sarah Lichtenstein, Baruch Fischhoff, and Robert L. Winkler, February 1980. (PB80-174576)
- 150 Annual Data and Verification Tabulation - Eastern and Central North Pacific Tropical Storms and Hurricanes 1979. Emil B. Gunther and Staff, EPHC, April 1980. (PB80-220486)
- 151 NMC Model Performance in the Northeast Pacific. James E. Overland, PMEL-ERL, April 1980. (PB80-196033)
- 152 Climate of Salt Lake City, Utah. Wilbur E. Figgins, June 1980. (PB80-225493) (Out of print.)
- 153 An Automatic Lightning Detection System in Northern California. James E. Rea and Chris E. Fontana, June 1980. (PB80-225592)
- 154 Regression Equation for the Peak Wind Gust 6 to 12 Hours in Advance at Great Falls During Strong Downslope Wind Storms. Michael J. Oard, July 1980. (PB81-108367)
- 155 A Raininess Index for the Arizona Monsoon. John H. TenHarkel, July 1980. (PB81-106494)
- 156 The Effects of Terrain Distribution on Summer Thunderstorm Activity at Reno, Nevada. Christopher Dean Hill, July 1980. (PB81-102501)
- 157 An Operational Evaluation of the Scofield/Oliver Technique for Estimating Precipitation Rates from Satellite Imagery. Richard Ochoa, August 1980. (PB81-108227)
- 158 Hydrology Practicum. Thomas Dietrich, September 1980. (PB81-134033)
- 159 Tropical Cyclone Effects on California. Arnold Court, October 1980. (PB81-133779)
- 160 Eastern North Pacific Tropical Cyclone Occurrences During Intraseasonal Periods. Preston W. Leftwich and Gail M. Brown, February 1981. (PB81-205494)
- 161 Solar Radiation as a Sole Source of Energy for Photovoltaics in Las Vegas, Nevada, for July and December. Darryl Randerson, April 1981. (PB81-224503)
- 162 A Systems Approach to Real-Time Runoff Analysis with a Deterministic Rainfall-Runoff Model. Robert J. C. Burnash and R. Larry Ferral, April 1981. (PB81-224495)
- 163 A Comparison of Two Methods for Forecasting Thunderstorms at Luke Air Force Base, Arizona. Lt. Colonel Keith R. Coolcy, April 1981. (PB81-225393)
- 164 An Objective Aid for Forecasting Afternoon Relative Humidity Along the Washington Cascade East Slopes. Robert S. Robinson, April 1981. (PB81-23078)
- 165 Annual Data and Verification Tabulation, Eastern North Pacific Tropical Storms and Hurricanes 1980. Emil B. Gunther and Staff, May 1981. (PB82-230336)
- 166 Preliminary Estimates of Wind Power Potential at the Nevada Test Site. Howard G. Booth, June 1981. (PB82-127036)
- 167 ARAP User's Guide. Mark Mathewson, July 1981. (revised September 1981). (PB82-196783)
- 168 Forecasting the Onset of Coastal Gales Off Washington-Oregon. John R. Zimmerman and William D. Burton, August 1981. (PB82-127051)
- 169 A Statistical-Dynamical Model for Prediction of Tropical Cyclone Motion in the Eastern North Pacific Ocean. Preston W. Leftwich, Jr., October 1981.
- 170 An Enhanced Plotter for Surface Airways Observations. Andrew J. Spry and Jeffrey L. Anderson, October 1981. (PB82-153883)
- 171 Verification of 72-Hour 500-mb Map-Type Predictions. R. F. Quiring, November 1981. (PB82-158098)
- 172 Forecasting Heavy Snow at Wenatchee, Washington. James W. Holcomb, December 1981. (PB82-177783)
- 173 Central San Joaquin Valley Type Maps. Thomas R. Crossan, December 1981. (PB82-196064)
- 174 ARAP Test Results. Mark A. Mathewson, December 1981. (PB82-193103)
- 175 Annual Data and Verification Tabulation Eastern North Pacific Tropical Storms and Hurricanes 1981. Emil B. Gunther and Staff, June 1982. (PB82-252420)
- 176 Approximations to the Peak Surface Wind Gusts from Desert Thunderstorms. Darryl Randerson, June 1982. (PB82-253089)
- 177 Climate of Phoenix, Arizona. Robert J. Schmidli, April 1969 (revised March 1983).
- 178 Annual Data and Verification Tabulation, Eastern North Pacific Tropical Storms and Hurricanes 1982. E. B. Gunther, June 1983.
- 179 Stratified Maximum Temperature Relationships Between Sixteen Zone Stations in Arizona and Respective Key Stations. Ira S. Brenner, June 1983. (PB83-242904)
- 180 Standard Hydrologic Exchange Format (SHEP) Version I. Phillip A. Pasteries, Vernon C. Bissel, David G. Bennett, August, 1983.
- 181 Quantitative and Spatial Distribution of Winter Precipitation Along Utah's Wasatch Front. Lawrence B. Dunn, August, 1983.
- 182 500 Millibar Sign Frequency Teleconnection Charts - Winter. Lawrence B. Dunn, December, 1983.

NOAA SCIENTIFIC AND TECHNICAL PUBLICATIONS

The National Oceanic and Atmospheric Administration was established as part of the Department of Commerce on October 3, 1970. The mission responsibilities of NOAA are to assess the socioeconomic impact of natural and technological changes in the environment and to monitor and predict the state of the solid Earth, the oceans and their living resources, the atmosphere, and the space environment of the Earth.

The major components of NOAA regularly produce various types of scientific and technical information in the following kinds of publications:

PROFESSIONAL PAPERS — Important definitive research results, major techniques, and special investigations.

CONTRACT AND GRANT REPORTS — Reports prepared by contractors or grantees under NOAA sponsorship.

ATLAS — Presentation of analyzed data generally in the form of maps showing distribution of rainfall, chemical and physical conditions of oceans and atmosphere, distribution of fishes and marine mammals, ionospheric conditions, etc.

TECHNICAL SERVICE PUBLICATIONS — Reports containing data, observations, instructions, etc. A partial listing includes data serials; prediction and outlook periodicals; technical manuals, training papers, planning reports, and information serials; and miscellaneous technical publications.

TECHNICAL REPORTS — Journal quality with extensive details, mathematical developments, or data listings.

TECHNICAL MEMORANDUMS — Reports of preliminary, partial, or negative research or technology results, interim instructions, and the like.

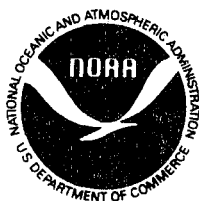

Information on availability of NOAA publications can be obtained from:

**ENVIRONMENTAL SCIENCE INFORMATION CENTER (D822)
ENVIRONMENTAL DATA AND INFORMATION SERVICE
NATIONAL OCEANIC AND ATMOSPHERIC ADMINISTRATION
U.S. DEPARTMENT OF COMMERCE**

**6009 Executive Boulevard
Rockville, MD 20852**