

# **SAFETY OF IDAHO RURAL HIGHWAYS UNDER 129,000-POUND TRUCKS FINAL PROJECT REPORT**

by

Nicholas Saras, M.S Graduate Student  
and

Ahmed Ibrahim, Ph.D., P.E.  
University of Idaho

National Institute for Advanced Transportation Technology  
Department of Civil Engineering, University of Idaho  
Moscow, ID, 83844-1022  
aibrahim@uidaho.edu

Sponsorship

Pacific Northwest Transportation Consortium (PacTrans)

for

Pacific Northwest Transportation Consortium (PacTrans)  
USDOT University Transportation Center for Federal Region 10  
University of Washington  
More Hall 112, Box 352700  
Seattle, WA 98195-2700

In cooperation with US Department of Transportation-Research and Innovative Technology  
Administration (RITA)



## **Disclaimer**

**The contents of this report reflect the views of the authors, who are responsible for the facts and the accuracy of the information presented herein. This document is disseminated under the sponsorship of the U.S. Department of Transportation's University Transportation Centers Program, in the interest of information exchange. The Pacific Northwest Transportation Consortium, the U.S. Government and matching sponsor assume no liability for the contents or use thereof.**

## Technical Report Documentation Page

<b>1. Report No.</b>	<b>2. Government Accession No.</b>	<b>3. Recipient's Catalog No.</b>	
<b>4. Title and Subtitle</b> Safety of Idaho Rural Highways under 129k Trucks		<b>5. Report Date</b>	
		<b>6. Performing Organization Code</b>	
<b>7. Author(s)</b> Nicholas Saras, and Ahmed Ibrahim		<b>8. Performing Organization Report No.</b>	
<b>9. Performing Organization Name and Address</b> University of Idaho National Institute for Advanced Transportation Technology 115 Engineering Physics Building Moscow, ID 83844-0901		<b>10. Work Unit No. (TRAIS)</b>	
		<b>11. Contract or Grant No.</b> DTRT13-G-UTC40	
<b>12. Sponsoring Organization Name and Address</b> United States of America Department of Transportation Research and Innovative Technology Administration		<b>13. Type of Report and Period Covered</b> Research	
		<b>14. Sponsoring Agency Code</b>	
<b>15. Supplementary Notes</b> Report uploaded at <a href="http://www.pacTrans.org">www.pacTrans.org</a>			
<b>16. Abstract</b> <p>This report presents guidelines and procedures for local highway jurisdictions to use in evaluating requests to allow 129,000-pound trucks on local routes in the state of Idaho. The procedures outlined in this report are based on and follow the Idaho Code 49-1004A (1), which states, "the authority having jurisdiction may designate routes ... for vehicles not exceeding ... 129,000-pounds, utilizing criteria established by the board based upon road and bridge structural integrity and engineering standards." All the results of the report are presented under four main categories: offtracking, bridges and culverts, pavement and gravel roads, and crash analysis. All procedures presented herein must be satisfied before the route request is approved.</p>			
<b>17. Key Words</b>		<b>18. Distribution Statement</b> No restrictions.	
<b>19. Security Classification (of this report)</b> Unclassified.	<b>20. Security Classification (of this page)</b> Unclassified.	<b>21. No. of Pages</b>	<b>22. Price</b> NA



## Table of Contents

List of Abbreviations.....	viii
Acknowledgments.....	ix
Executive Summary.....	xi
<b>Chapter 1 Introduction.....</b>	<b>1</b>
<b>Chapter 2 Literature Review .....</b>	<b>3</b>
2.1 Background.....	3
2.2 Truck Axle Loads .....	5
<b>Chapter 3 Methodology.....</b>	<b>11</b>
3.1 Offtracking.....	11
3.1.1 Background .....	11
3.1.2 Procedure .....	13
3.2 Bridges and Culverts.....	15
3.2.1 Background .....	15
3.2.2 Procedure .....	19
3.3 Pavement and Gravel Roads .....	19
3.3.1 Pavement .....	19
3.3.1.1 Procedure .....	20
3.3.1.2 Types of Cracking.....	20
3.3.2 Gravel Roads.....	28
3.3.2.1 Background.....	28
3.3.2.1 Procedure .....	30
3.4 Crash Analysis .....	30
3.4.1 Crash Analysis Procedure.....	31
3.4.2. Intersection Safety Evaluation.....	31
<b>Chapter 4 Conclusions.....</b>	<b>33</b>
<b>References .....</b>	<b>35</b>

## List of Figures

Figure 2.1 Pilot project truck configured for 105,500 to 129,000 pounds GVW (10 axles). (ITD 2013) .....	4
Figure 2.2 Examples of exempt agriculture trucks with GVWs of 57,800 and 79,000 pounds. ....	6
Figure 2.3 Examples of exempt agriculture trucks with GVWs of 80,000 and 84,000 pounds .....	7
Figure 2.4 LHTAC suggested procedure for 129,000-pound truck permits .....	8
Figure 3.1 Offtracking illustration for a typical tractor-semitrailer combination truck [source: AASHTO 2011 Design Controls and Criteria] .....	11
Figure 3.2 AASHTO interstate semitrailer design vehicle (WB-62), offtracking = 6.53 feet.....	12
Figure 3.3 129,000-pound truck configuration, offtracking = 5.45 feet .....	12
Figure 3.4 Procedure used to calculate the absolute maximum moments. ....	16
Figure 3.5 Example of longitudinal and transverse cracking, slight severity. ....	21
Figure 3.6 Example of longitudinal and transverse cracking, medium severity.....	21
Figure 3.7 Example of longitudinal and transverse cracking, heavy severity .....	22
Figure 3.8 Example of alligator cracking, slight severity .....	22
Figure 3.9 Example of alligator cracking, moderate severity. ....	23
Figure 3.10 Example of alligator cracking, heavy severity. ....	23
Figure 3.11 Example of block cracking, slight severity. ....	24
Figure 3.12 Example of block cracking, moderate severity. ....	24
Figure 3.13 Example of block cracking, high severity. ....	25
Figure 3.14 Example of potholes, slight severity .....	25
Figure 3.15 Example of potholes, moderate severity .....	26
Figure 3.16 Example of potholes, high severity .....	26
Figure 3.17 Example of rutting, low severity .....	27
Figure 3.18 Example of rutting, medium severity .....	27
Figure 3.19 Example of rutting, high severity .....	28
Figure 3.20 Gravel road with adequate crown.....	29
Figure 3.21 Gravel road with inadequate crown.....	29
Figure 3.22 Gravel road with excessive crown.....	29
Figure 3.23 Gravel road with good condition shoulders.....	30

## List of Tables

Table 3.1 ITD routes for trucks between 80,000 pounds and 105,500 pounds .....	13
Table 3.2 Conditions to determine whether offtracking should be allowed on roadways.....	14
Table 3.3 Absolute maximum moments of various trucks for bridges with spans of 20 feet. ....	17
Table 3.4 Absolute maximum moments of various trucks for bridges with spans of 15 feet. ....	18

## **List of Abbreviations**

GVW: Gross vehicle weight

ITD: Idaho Department of Transportation

LHJ: Local highway jurisdictions

LHTAC: Local Highway Technical Assistance Council

PacTrans: Pacific Northwest Transportation Consortium

PASER: Pavement Surface and Evaluation Rating



## **Acknowledgments**

The authors would like to thank the Idaho Transportation Department and the Pacific Northwest Transportation Consortium. Their support is greatly appreciated for accomplishing this work.



## **Executive Summary**

The purpose of this report is to provide assistance to local highway jurisdictions in evaluating requests to increase weight allowances on local roadways for trucks of up to 129,000 pounds. Route requests for 129,000-pound trucks fall under Idaho Code 49- 1004A (1), which states, “the authority having jurisdiction may designate routes ... for vehicles not exceeding ... 129,000 pounds, utilizing criteria established by the board based upon road and bridge structural integrity and engineering standards.” This report provides procedures to be followed by local highway jurisdictions to help in approving or declining weight limit increase requests on Idaho local roads for 129,000-pound trucks. The report is divided into four sections: offtracking, bridges and culverts, pavement and gravel roads, and crash analysis. In each section, the authors provide a procedure that leads either to approval of the 129,000-pound truck request or to performance of an engineering analysis to ensure the safety of Idaho local roads and infrastructure.

129,000-pound trucks have more axles than standard 80,000-pound trucks. Because 129,000-pound trucks distribute their loads on more axles, they have less impact on local roads. The offtracking section offers field verification procedures that local highway jurisdictions should apply to ensure safe roads and to avoid trucks encroaching into intersections, sidewalks, traffic signals, etc. 129,000-pound trucks also have less impact on bridges and culverts that have spans of less than 20 feet as long as the bridges and culverts are structurally fit. The quality of pavement and gravel roads under heavier loads such as 129,000-pound trucks should be checked by using the Idaho pavement manual and the Pavement Surface and Evaluation Rating system (PASER). Finally, local highway jurisdictions should follow the proposed procedure to perform

crash safety analyses and to determine whether to allow 129,000-pound trucks on Idaho local roads.

## **Chapter 1 Introduction**

The purpose of this report is to provide assistance to local highway jurisdictions in evaluating requests to increase weight allowances on local roadways for trucks of up to 129,000 pounds. The 129,000-pound route requests fall under Idaho Code 49- 1004A (1), which states, “the authority having jurisdiction may designate routes ... for vehicles not exceeding ... 129,000 pounds, utilizing criteria established by the board based upon road and bridge structural integrity and engineering standards.”

This report is limited to providing assistance in the following four engineering-based categories only: offtracking, structural safety of bridges and culverts, pavement and gravel roads, and crash data and safety evaluation. Each section of this guide covers one of these four categories. Before a route request is approved, the conditions in all four categories must be met and satisfied.

Section 3.1: Offtracking provides guidelines for assessing offtracking limitations for the route on the basis of roadway geometric characteristics.

Section 3.2: Bridges and Culverts provides guidelines for examining the structural health of bridges and culverts along the route.

Section 3.3: Pavement and Gravel Roads provides guidelines for examining the condition of pavement and gravel roads on the route;.

Section 3.4: Crash Data and Safety Evaluation provides procedures and guidelines for conducting a safety evaluation for the proposed route on the basis of crash history.



## **Chapter 2 Literature Review**

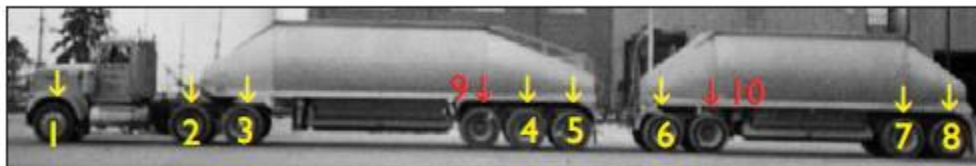
### 2.1 Background

The state of Idaho gives permission for 80,000-pound and 105,500-pound trucks to utilize its highway system. However, truck loads higher than the 80,000 pounds need to be assigned certain routes, and that designation is controlled by the Idaho Transportation Department (ITD). A significant number of local highway jurisdictions (LHJs) in Idaho lack the engineering expertise and financial resources to conduct detailed assessments when requests are received to increase weight allowances for local roadways beyond the current legal limit for a gross vehicle weight (GVW) of 80,000 pounds. Idaho Code 49-1004A (1) states, "the authority having jurisdiction may designate routes ... for vehicles not exceeding ... 129,000 pounds, utilizing criteria established by the board based upon road and bridge structural integrity and engineering standards." These higher load limits can enable private freight organizations to better compete in domestic and global markets by allowing them to distribute freight more efficiently. The ITD has the engineering staff and database resources available to evaluate road and bridge capacities on state and federal highways; however, local highway districts may not have such resources. This limits the local districts' ability to expeditiously consider higher load requests, which in turn limits freight organizations' ability to operate more efficiently on rural highways, resulting in less competitive Idaho industries. Additionally, many local roadways are not designed or constructed to accommodate any type of heavy load. In 2013, ITD allowed heavier trucks, such as 105,500- and 129,000-pound trucks, on 35 specific routes. The ITD also approved 129,000-pound trucks to pass over some local roads under the approval of LHJs.

This collaborative study between the Idaho Transportation Department and the Local Highway Technical Assistance Council (LHTAC) provides local highway jurisdictions guidance

for conducting roadway assessments by reviewing available data and current conditions to conducting full engineering studies, where appropriate.

The trucking industry has requested that the Idaho Legislature increase the maximum allowable gross vehicle weight on Idaho state routes. It has stated that the truck weight increase would reduce the number of trips, therefore reducing costs. House Bill 623 established the first 129,000-pound pilot project in 1998, allowing 129,000-pound GVW trucks on two state routes. The project ran from 1998-2001, but because of only partial contributions, industry savings and the effect on pavements, bridges, and safety were inconclusive. In 2003, the Idaho Legislature regenerated the 129,000-pound pilot project program with the passage of House Bill 395. The bill established a new 10-year study similar to the one conducted in 1998, providing carriers the option to transport heavier loads (up to a GVW of 129,000 pounds) if they purchased a special permit from ITD and used trucks specifically configured to carry the extra weight, as shown in figure 2.1. The bill also granted local public highway agencies the authority to permit or deny the 129,000-pound vehicles on roads in their jurisdiction. Additional routes were added in 2005 (House Bill 146) and 2007 (Senate Bills 1138 and 1180), for a total of 35 designated routes. At the time the Idaho pilot project began, four states that border Idaho (Montana, Utah, Nevada, and Wyoming) already permitted trucks with GVWs of greater than 105,500 pounds. More information about routinely permitted oversize and overweight vehicles can be found in [3].



**Figure 2.1** Pilot project truck configured for 105,500 to 129,000 pounds GVW (10 axles). (ITD 2013)



## 2.2 Truck Axle Loads

The Idaho Transportation Department mandated that all trucks on its highway system follow the bridge formula B shown in equation 1.

$$W = 500 \left[ \frac{LN}{N-1} + 12N + 36 \right] \quad (1)$$

where:

W = maximum weight in pounds carried on any group of two or more consecutive axles.

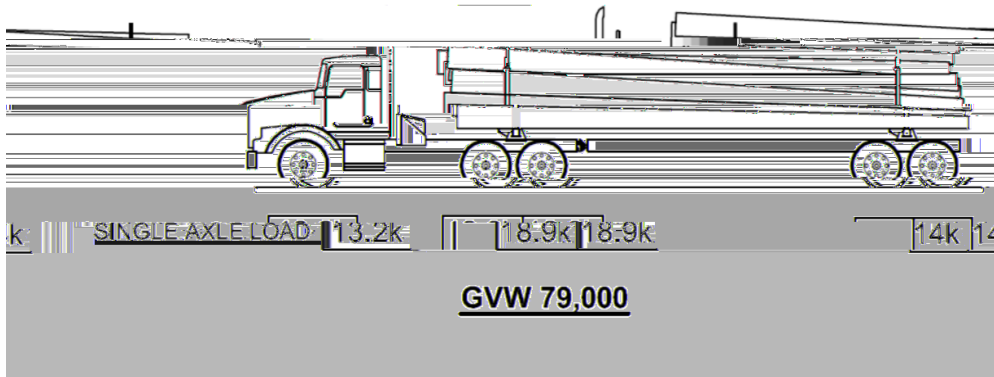
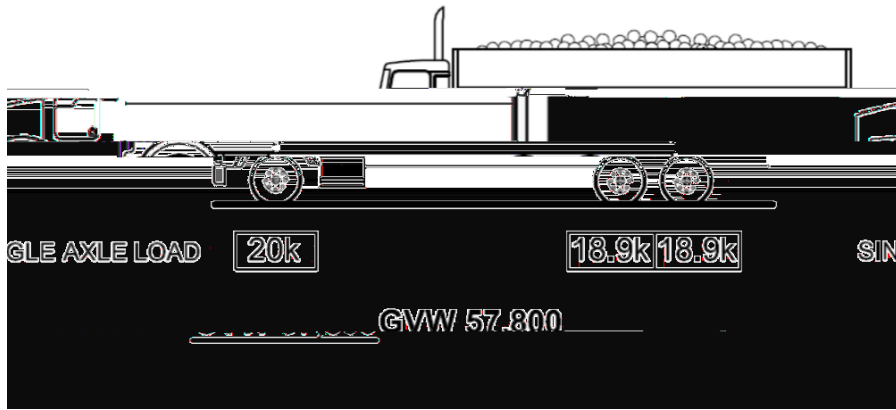
L = distance in feet between the extremes of the axle group

N= number of axles in the axle group.

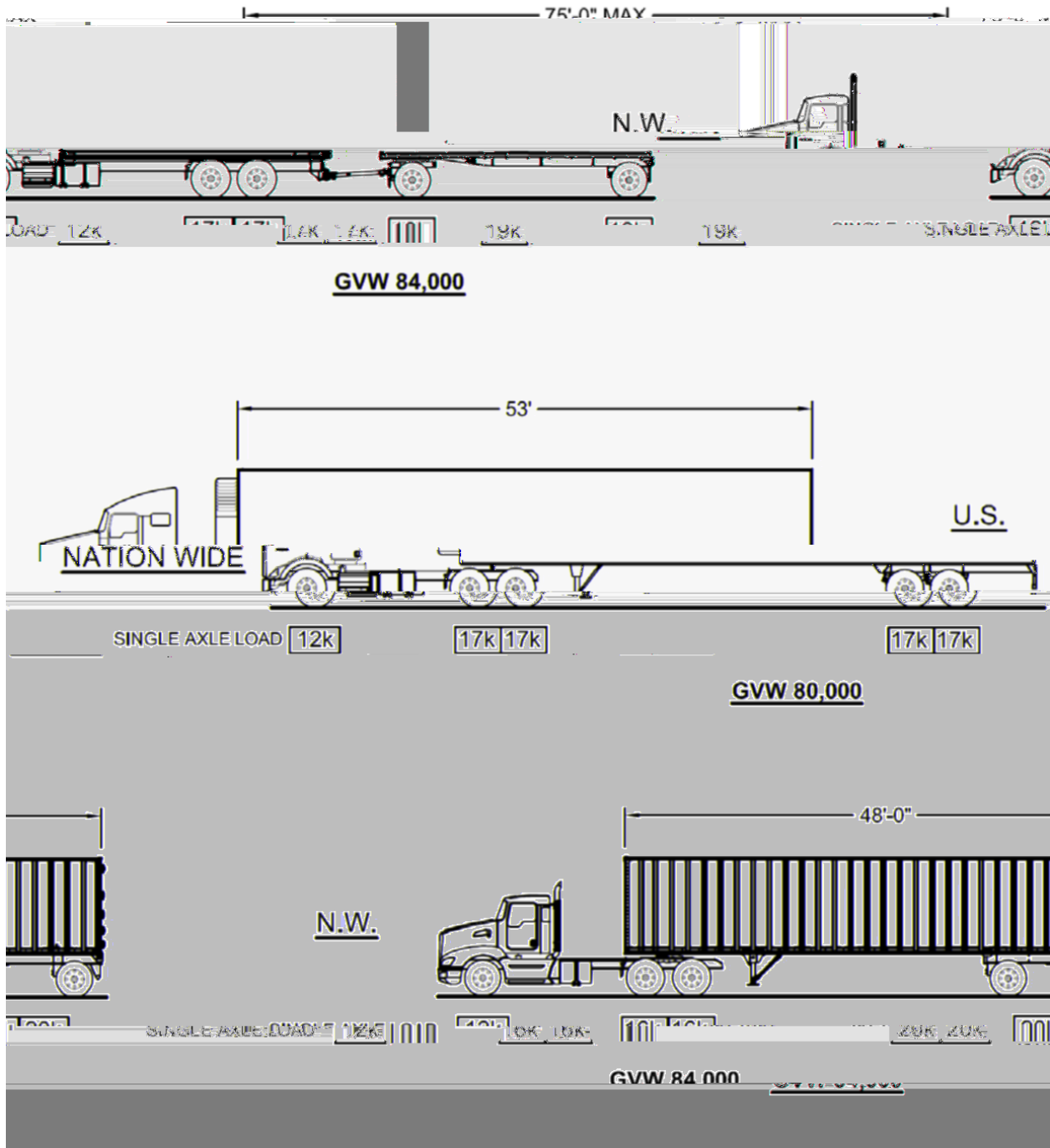
Agriculture trucks are also permitted on the Idaho highway system. As shown in figure 2.2, the exempt agriculture trucks of 57,800 and 79,500 pounds have axle loads that reach 20,000 lb., which is higher than the axle loads of standard 80,000-pounds trucks. Figure 2.3 shows various trucks with various axle loads that follow the bridge formula B.

The 129,000-pound trucks might have various lengths, but in most cases they do not exceed 115 ft. However, they can still have offtracking that is less than that of other heavy trucks, such as 105,500-pound trucks. Most 129,000-pound trucks have a more powerful braking system than conventional 80,000-pound trucks.

The primary objective of this project was to develop guidance procedures that LHJs can use to evaluate 129,000-pound route requests on Idaho local roads. The guidelines are written mainly for LHJs that have personnel with limited engineering background and limited resources. The procedures presented in this report are based on the features of the roadway. The guidelines recommend either to approve the route request or to perform engineering design and analysis for the situation under consideration.



**Figure 2.2** Examples of exempt agriculture trucks with GVWs of 57,800 and 79,000 pounds.



**Figure 2.3** Examples of exempt agriculture trucks with GVWs of 80,000 and 84,000 pounds

The LHTAC suggested has local procedures for issuing annual permits for 129,000-pound trucks on local highway road systems, as shown in figure 2.4. It is the local highway

jurisdiction’s responsibility to evaluate and issue permits on the local system if requested and warranted (Idaho code 49-1004A). The carrier should cover any costs associated with the evaluation process to receive the permit.

**The following is a suggested local procedure:**

1. The LHJ receives a request for a 129,000 Pound Route, either directly or through ITD.
2. If the LHJ has engineering staff, they will review the proposed route and make a preliminary determination on meeting engineering and safety standards, if the engineering information exists. If the information does not exist, the LHJ will prepare a cost estimate to acquire and analyze the information. The LHJ may request the applicant to deposit such sums to begin the analysis or require the applicant to prepare the analysis for local review. The jurisdiction having roadway authority shall analyze the safety and feasibility of adding such a route in accordance with Idaho Code 49-1004A(2). If the requestor declines to provide funds to study the route their request may be denied.
3. The LHJ Engineer shall present their findings and preliminary recommendation to the governing body in a public meeting. If conditions per Idaho Code 49-1004A(2) are not met, the governing body may deny the application and notify the applicant.
4. If the proposed local route meets engineering and safety standards, the LHJ shall then publish notice and schedule a public hearing in accordance with Idaho Code 49-1004A(3) including a transcript of oral testimony.
5. The LHJ's Engineer's findings and the Public Hearing testimony are presented to the LHJ's governing body for action.
6. The LHJ will issue findings and a decision in the form of a resolution.
7. The LHJ will notify the requestor of the decision and notify the ITD including a map of the route, if approved.
8. If the route is approved, the LHJ shall issue an annual permit for each truck.

**Idaho Laws Passed in 2013**

The 2013 Idaho Legislature passed bills that authorize Idaho Highway Jurisdictions to issue permits for truck carriers to operate trucks up to 129,000 pounds gross vehicle weight on designated routes. There are currently 35 such designated routes on the State Highway System which do not include the interstate freeway system that limits trucks to 105,500 pounds.

ITD has posted a map and additional information about approved routes on their homepage.  
[http://www.id.gov/transportation/129KRoutesApproval\\_031.pdf](http://www.id.gov/transportation/129KRoutesApproval_031.pdf)

Many of the origins or destinations of these trucks are located on the local roadway system which must be used to travel to the designated state route. It is the Local Highway Jurisdiction's responsibility to evaluate and issue permits on the local system if requested and warranted. LHTAC has reviewed relevant Idaho state code to identify key issues for the LHJ to consider when such a route is requested. The carrier requesting the designated route should cover any costs associated with the evaluation and/or improvements required. ITD is required to notify the LHJ if a request has been made for a state route within the boundaries of the LHJ.

**LHTAC**  
**129,000 POUND LOCAL TRUCK ROUTES**

Local Highway Technical Assistance Council  
 3330 Grace Street  
 Boise, ID 83703  
 208-344-0565 or 1-800-259-6841

Additional information on 129,000 Pound Local Truck Routes is available at [www.lhtac.org](http://www.lhtac.org)

**Figure 2.4** LHTAC suggested procedure for 129,000-pound truck permits

The following procedure is used when districts receive requests for 129,000-pound truck permits:

“1. The Highway District receives a request for a 129,000-pound route; either directly or through ITD.

“2. The Highway District will require the applicant to provide an engineering and safety standard analysis for review and will need to contact the clerk to request being added to the agenda at least 5 business days prior to the board meeting.

“If the requester declines to provide analysis the route may be denied.

“3. The board of commissioners and the director of highways will analyze the safety and feasibility of adding such route in accordance with Idaho Code 49-1004 A (2) at the monthly

board meeting. If conditions per Idaho Code 49-1004A (2) are not met, the commissioners may deny the application and notify the applicant.

“4. If the proposed local route meets engineering and safety standards, the highway district will then publish notice and schedule a public hearing in accordance with Idaho Code 49-1004 A (3) including a transcript of oral testimony.

“5. The engineering findings will be presented at the public hearing and the public will be given the opportunity for testimony to be heard by the board of commissioners; the applicant’s engineer may be required to attend the public hearing meeting.

“6. The highway district board of commissioners will issue findings and a decision in the form of a resolution.

“7. The highway district will notify the requestor of the decision and notify the ITD including a map of the route, if approved.

“8. If the route is approved, the highway district shall issue an annual \$50.00 permit per truck/per year and will also require the owner of the truck to repair the road for any damage to highway district roads due to the fault of the driver or due to the excessive weight.

“9. Highway districts reserve the right to close the road to the 129,000-pound truck route due to road conditions, weather conditions or road projects; therefore, it will be necessary that we have on file current contact information at all times.”



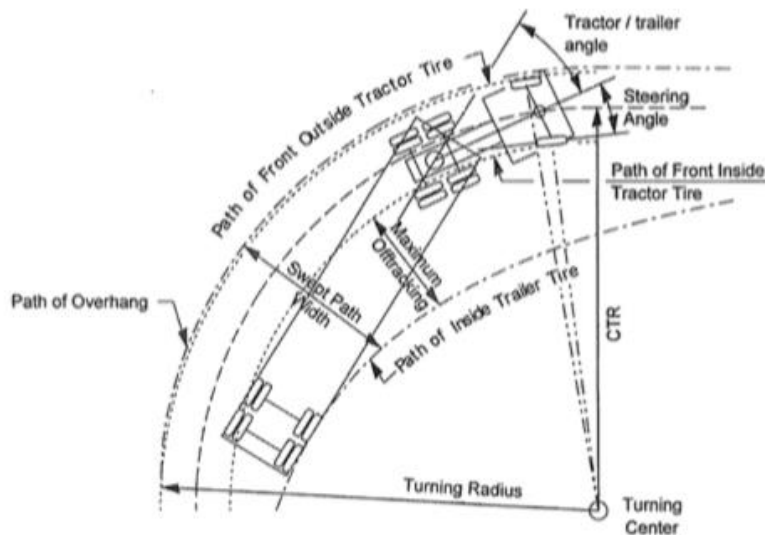
## Chapter 3 Methodology

This chapter presents the methodology of providing assistance to LHJs in four engineering-based categories to evaluate 129,000-pound truck requests: offtracking, structural safety of bridges and culverts, pavement and gravel road conditions, and crash data and safety evaluation. The route request should be approved only if the conditions in all four categories have been met and satisfied.

### 3.1 Offtracking

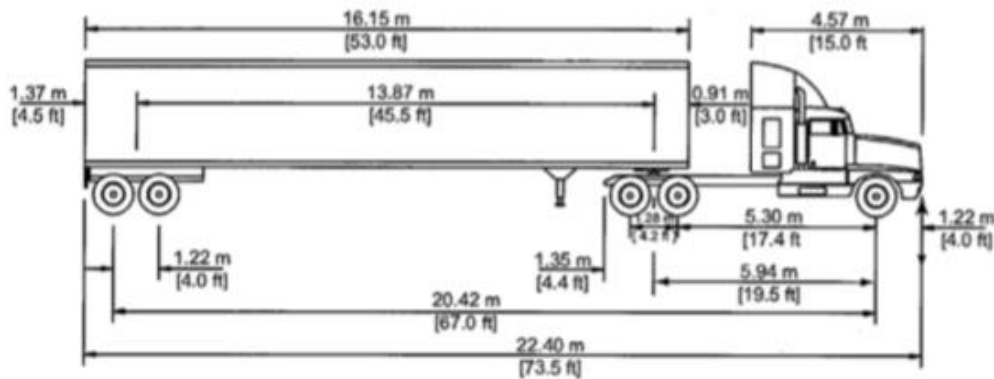
#### *3.1.1 Background*

Offtracking is defined as a characteristic, common to all trucks, in which the rear wheels do not precisely follow the same path as the front wheels when a vehicle traverses a horizontal curve or makes a turn. Offtracking in truck-trailer combinations occurs because the rear wheels of trailer trucks do not pivot and, therefore, will not follow the same path as the front wheels, as shown in figure 3.1.

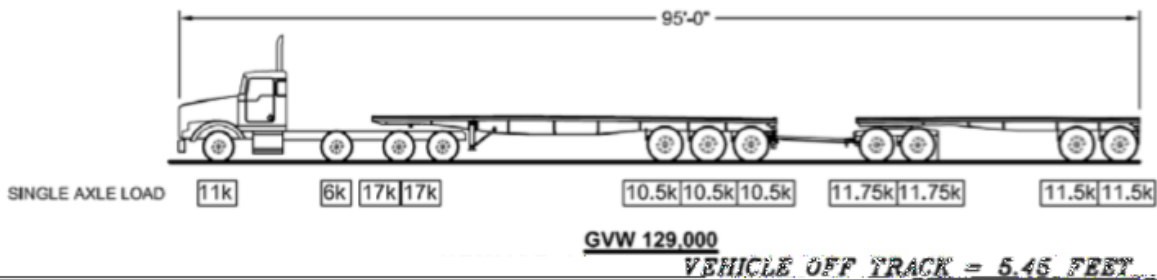


**Figure 3.1** Offtracking illustration for a typical tractor-semitrailer combination truck  
[source: AASHTO 2011 Design Controls and Criteria]

It is common that the larger the truck size, the larger the offtracking value. However, for heavy trucks such as 105,500-pound and 129,000-pound trucks, offtracking will not necessarily be more. The distance between the axles is the main factor that controls the offtracking value, regardless of the overall truck length. As an example, the offtracking of a 53-ft trailer that is being used on the Idaho interstate is 7.8 feet (figure 3.2), whereas the offtracking for a 129,000-pound truck with a total length of 98.57 feet is 5.45 feet (figure 3.3).



**Figure 3.2** AASHTO interstate semitrailer design vehicle (WB-62), offtracking = 6.53 feet



**Figure 3.3** 129,000-pound truck configuration, offtracking = 5.45 feet

The ITD designs its routes in a way that can be used by heavy trucks with various offtracking allowances (from 80,000 pounds to 129,000 pounds), represented by a color system, and they are differentiated on the basis of the following categories, as shown in table 3.1.



**Table 3.1** ITD routes for trucks between 80,000 pounds and 105,500 pounds

<b>Route</b>	<b>Maximum Truck Length (feet)</b>	<b>Maximum Offtracking (feet)</b>
<b>Routes for Trucks between 80,000-pounds and 105,500-pounds</b>		
Blue-Coded Routes	95	5.5
Red-Coded Routes	115	6.5
Black-Coded Routes	----	6.5 to 8.75
Green-Coded Routes*	85	3
<b>Routes for Trucks between 105,500-pounds and 129,000-pounds</b>		
Magenta-Coded Routes.	115	6.5
Brown-Coded Routes	95	5.5
Orange-Coded Routes	Non-state maintained highways that allow vehicle combinations to operate at the weights above.	

\*Trucks with overhang should not exceed 85 feet.

### 3.1.2 Procedure

If the offtracking engineering calculations need to be verified in the field for a 129,000-pound truck request, the next processes are recommended. If the LHJ receives a request to allow 129,000-pound trucks on a specific local road, the width of the road must be considered in the engineering calculations. The width of road considered in this report is based on a 8.50-ft maximum truck width, and the offtracking values of 5.5 feet and 6.5 feet corresponding to roadway widths of 28 feet and 30 feet, respectively. Two cases are considered as in the following:

Routes with straight alignment: The 129,000-pound request should be approved as long as the pavement satisfies the minimum road width of 8.5 feet and the roadway is straight.

Roads with horizontal curves: The horizontal curve that has the snuggest radius must be identified along the horizontal curve, and the local jurisdictions must use a tape to measure the total width at the curve. The results then should be analyzed on the basis of table 3.2:

**Table 3.2** Conditions to determine whether offtracking should be allowed on roadways

Road Width (W)	Needed Actions	Maximum Offtracking Allowed (feet)	Maximum Truck length (feet)
$W < 28$ feet	Engineering Study	Need to be calculated	No limit
$30 \text{ feet} < W < 28 \text{ feet}$	Request should be approved	5.5 feet	95 feet*
$W > 30$ feet	----	6.5 feet	115 feet*

- If the road under consideration has an intersection, a field verification should be performed.

Field verification is needed in certain situations where assurance is needed that heavier trucks, such as the 129,000-pound trucks, will be able to stay within their driving lane and their movement through curves will be safe. From a safety point of view, no 129,000-pound trucks should intrude into opposite lanes, bike routes, sidewalks, or intersections. If the LHJ needs to conduct field verifications, it should perform the following steps:

Step 1: The 129,000-pound truck requester must provide a test truck with a length and offtracking values that follow the conditions shown in table 3.2 or provide a test truck that the requestor intends to use on that specific route.

Step 2: The approval or denial of the test truck should be based on conditions such as the entire body of the test truck must be able to stay in its lane and within the pavement markers, and the body of the truck should not cross into the opposite lane at intersections. The swept path width (figure 3.1) and the truck wheels cannot be allowed to intrude onto the road shoulder unless it is in good condition. It is not allowed that the truck wheels intrude onto sidewalks, curbs, traffic signs, traffic signals, trees, poles, cut slopes, traffic control channels, rock outcrops, or meridians.

## 3.2 Bridges and Culverts

### *3.2.1 Background*

ITD personnel are responsible for inspecting the structural health and load rating of bridges and culverts with spans of greater than 20 feet every four years, while LHJs inspect bridges and culverts located on local roads in Idaho with spans less than 20 feet. All bridges and culverts are rated by using a rating factor. The rating factor is defined as the ability of the structure to carry trucks safely during their service life and is simply calculated by dividing the bridge internal capacity by the actual loads imposed on the bridge or culvert. The rating factor should be greater than 1.0. The ITD uses the nominal truck load of 121,000 pounds in its designs to produce the highest possible load on bridges and culverts; therefore, it is expected that when a bridge is able to carry 121,000-pound trucks, it should also be able to carry 129,000-pound trucks.

Four different trucks (80,000, 105,500, 121,000, and 129,000 pounds) were used as extreme loads on bridges and culverts that have spans of less than 20 feet. The four trucks were positioned on various positions along the bridge spans and the absolute maximum moments were calculated. As shown in figure 3.4, table 3.3, and table 3.4, the 129,000-pound truck generates a lower absolute moment than the standard 80,000-pound truck configurations.

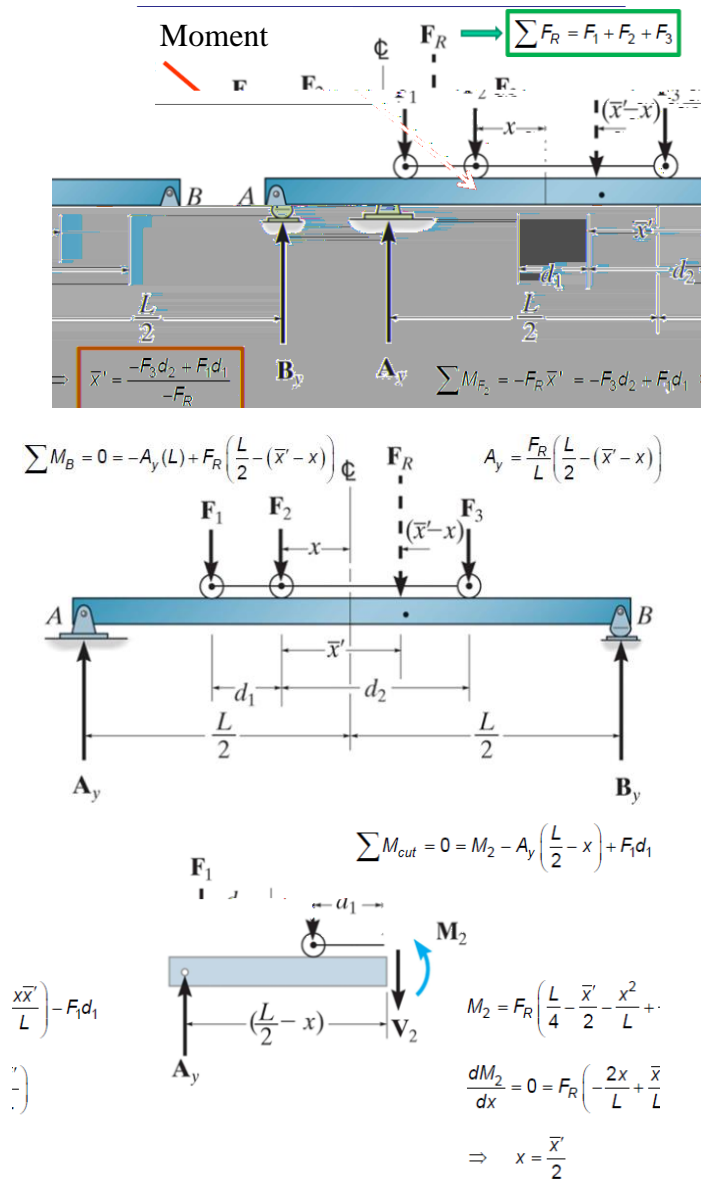


Figure 3.4 Procedure used to calculate the absolute maximum moments.

**Table 3.3** Absolute maximum moments of various trucks for bridges with spans of 20 feet.

Truck	Configuration	M1 (k.ft)	M2 (k.ft)	M3 (k.ft)	Axle Loads (F1-F2-F3-F4) (kips)	Axle Spacing (ft.)	Absolute Moment (k.ft)
<b>80 k</b>	1	101.8	104.18	25.78	17-17-12-0	4-16	170.5
	2	55.0	135.44	128.44	10-17.5-17.5-0	11-4	
	3	51.6	107.96	100.96	10-14-14-0	11-4	
		59.7	101.73	93.33	14-14-14-0	12-4	
	ITD	122.5	170.50	170.50	8-17-17-8	4-4-4	
<b>105.5 k</b>	1						112.01
		21.6	97.88	96.28	12-17-17-0	16.6-4.33	
		99.3	112.01	78.42	14-14-15	4.33-10	
<b>121 k</b>	1	119.1	137.60	119.07	12.8-12.8-12.8	4.25-4.25	137.60
		100.6	112.19	76.35	12.8-12.8-11	4.25-8	
		81.1	101.55	88.54	12.8-11-11	8-4.08	
		73.8	80.37	45.74	11-11-10.5	4.08-11.83	
		47.5	76.49	69.61	11-10.5-10.5	11.83-4.08	
<b>129 k</b>	1	35.3	100.65	96.45	12-15.5-15.5	14.5-4	143.85
		123.4	143.85	123.43	13.7-13.7-13.7	4.5-4.5	
		87.2	93.97	44.91	13.7-13.7-11.5	4.5-12.5	
		51.5	73.53	64.97	13.7-11.5-11.5	12.5-5	
		40.4	68.58	62.11	11.5-11-11	13-5	
	2	30.8	93.66	89.95	12-15.5-15.5	15-4.5	
		105.9	121.01	89.39	13.75-13.75-13.75	4.5-8	
		89.4	121.01	105.93	13.75-13.75-13.75	8-4.5	
		108.3	108.30	108.30	13.75-13.75	4.5	
	ITD	100.6	112.19	76.35	12.8-12.8-11	4.25-8	

\*M1: moment calculated at F1 position, M2: moment calculated at F2 position

\*M3: moment calculated at F3 position

**Table 3.4** Absolute maximum moments of various trucks for bridges with spans of 15 feet.

<b>Truck</b>	<b>Configuration</b>	<b>M1 (k.ft)</b>	<b>M2 (k.ft)</b>	<b>M3 (k.ft)</b>	<b>Axle Loads (F1-F2-F3- F4) (kips)</b>	<b>Axle Spacing (ft.)</b>	<b>Absolute Moment (k.ft)</b>
<b>80 k</b>	1	52.9	48.07	2.20	17-17-12-0	4-16	108.83
	2	17.9	79.34	76.68	10-17.5- 17.5-0	11-4	
	3	18.6	60.78	58.11	10-14-14-0	11-4	
		32.0	40.03	20.83	14-14-14-0	12-4	
	ITD	67.5	108.83	108.83	8-17-17-8	4-4-4	
<b>105.5 k</b>	1	1.0	41.81	48.33	12-17-17-0	16.6-4.33	59.04
		52.9	59.04	35.91	14-14-15	4.33-10	
<b>121 k</b>	1	74.0	89.60	74.0	12.8-12.8- 12.8	4.25-4.25	89.6
		59.0	66.56	38.24	12.8-12.8- 11	4.25-8	
		43.4	58.44	49.81	12.8-11-11	8-4.08	
		38.9	40.56	17.05	11-11-10.5	4.08- 11.83	
		18.6	37.48	35.79	11-10.5- 10.5	11.83- 4.08	
<b>129 k</b>	1	6.9	48.11	50.51	12-15.5- 15.5	14.5-4	104.58
		75.52	92.48	75.52	13.7-13.7- 13.7	4.5-4.5	
		45.6	46.06	13.78	13.7-13.7- 11.5	4.5-12.5	
		19.2	29.13	29.13	13.7-11.5- 11.5	12.5-5	
		13.0	27.82	28.78	11.5-11-11	13-5	
	2	4.7	41.09	45.14	12-15.5- 15.5	15-4.5	
		59.9	69.69	45.85	13.75- 13.75-13.75	4.5-8	
		45.9	69.69	59.89	13.75- 13.75-13.75	8-4.5	
		64.2	104.58	104.58	13.75-13.75	4.5	
	ITD	59.0	66.56	38.24	12.8-12.8- 11	4.25-8	

\*M1: moment calculated at F1 position

\*M2: moment calculated at F2 position

\*M3: moment calculated at F3 position

### *3.2.2 Procedure*

The following procedure is recommended for evaluating 129,000-pound truck requests for bridges and culverts with spans of less than 20 feet.

Step 1: Obtain the load rating for bridges and culverts with spans of over 20 feet from ITD. If the load rating is greater than 1.0, the request should be approved, and if the rating is less than 1.0, the request should be denied.

Step 2: For bridges and culverts that have spans of less than 20 feet, the 129,000-pound truck request should be approved. As shown in table 3.3, the impacts of a 129,000-pound truck is less than that of the 80,000-pound truck loads. However, it is recommended that the LHJ inspect the health of the structure(s) for excessive deflection; wide individual or pattern cracks; and any signs of spalling, corrosion, or other signs of deterioration before approval of the request.

## 3.3 Pavement and Gravel Roads

### *3.3.1 Pavement*

The 129,000-pound truck load is distributed over more axles than that of the 80,000-pound standard truck. Therefore, the load per axle for the 129,000-pound truck is less than the load per axle for the 80,000-pound truck. This means that the impact of the 129,000-pound truck on pavement service life is less with same truck volume. The ITD Pavement Rating Manual [5] provides a comprehensive process that ITD uses to determine the rating and health of pavement roads subjected to various truck volumes and axle loads. In addition, LHJs use the Pavement Surface and Evaluation Rating (PASER) system with a 1 to 10 rating scale to determine pavement condition and quality along road sections. Pavement stresses cannot be determined by PASER, so the procedures outlined in this section for evaluating pavement conditions for 129,000-pound truck requests are based on both PASER and ITD pavement manuals.

Special attention should be given when local jurisdictions evaluate the quality of

pavement subjected to a 129,000-pound truck in situations such as uphill grades with a slope greater than 6 percent, when the 129,000-pound truck trip is originated, and when the traction forces resulting from braking loads might be high.

#### *3.3.1.1 Procedure*

The procedures to use engineering judgment to determine whether the pavement conditions are adequate to safely carry a 129,000-pound truck load are as follows:

Step 1: Check for defects and distresses in the pavement surface, as shown in the next section. Most pavement problems are in the most traveled lane, which the majority of the time is the right-most lane

Step 2: Rate the severities of the defects or distresses based on slight, moderate, or severe for cracking, potholes/patching (low, medium, or high), raveling, and rutting. If the pavement is judged to be in moderate condition, an engineering study is required before the pavement can be approved. If the pavement is found to be in severe or high distress, then deny the request.

#### *3.3.1.2 Types of Cracking*

Longitudinal and Transverse Cracking. Cracks are in the direction of the flow of traffic, usually at the edges of wheel paths (longitudinal), and cracks are perpendicular to the centerline strip, often regularly spaced (transverse). See figures 3.5 to 3.7.



Slight Severity: Crack width is up to 1/8 in., and there are one to four cracks per 500 ft.



**Figure 3.5** Example of longitudinal and transverse cracking, slight severity.

Moderate Severity: Crack width is up to 1/8- to 1/4 in., or there is a dip 3- to 6-in. wide at the crack, and there are four to ten cracks per 500 ft.



**Figure 3.6** Example of longitudinal and transverse cracking, medium severity.

Heavy Severity: Crack width is more than 1/4 in. or there is a distinct dip of 6 to 8 in., and there are more than 10 cracks per 500 ft.



**Figure 3.7** Example of longitudinal and transverse cracking, heavy severity

Alligator Cracking. Cracks are interconnected, forming small pieces that mimic an alligator's skin (figures 3.8 to 3.10).

Slight Severity: Large alligator cracking, 3 feet or more apart.



**Figure 3.8** Example of alligator cracking, slight severity

Moderate Severity: Alligator cracking is 1 to 2 feet apart.



**Figure 3.9** Example of alligator cracking, moderate severity.

Heavy Severity: Alligator cracking is smaller than 1 foot apart.



**Figure 3.10** Example of alligator cracking, heavy severity.

Block Cracking. Interconnected longitudinal and transverse cracks form large blocks.

Blocks range in size from 1ft. to 10 ft. or more across (figures 3.11 to 3.13).

Slight Severity: Cracks are barely visible, and blocks are about 10 ft. by 10 ft. in size.



**Figure 3.11** Example of block cracking, slight severity.

Moderate Severity: Cracks begin to form “branch-like” formations, breaking off into smaller cracks. Block size is 5 ft. to 10 ft.



**Figure 3.12** Example of block cracking, moderate severity.

Heavy Severity: Crack widths are significant; block edges have begun to show alligator cracking, and potholes may be starting to form.



**Figure 3.13** Example of block cracking, high severity.

Potholes/Patching. Patches are an original surface repaired with a new asphalt surface material. Potholes are loss of pavement material caused by traffic loading, fatigue, and inadequate strength. They are often combined with poor drainage (figures 3.14 to 3.16).

Slight Severity: A pothole is noticeably present.



**Figure 3.14** Example of potholes, slight severity



Moderate Severity: The pothole needs remedial attention soon.



**Figure 3.15** Example of potholes, moderate severity

High Severity: The pothole needs immediate maintenance.



**Figure 3.16** Example of potholes, high severity

Types of Rutting: Ruts in asphalt pavements are channelized depressions in the wheel tracks (figures 3.17 to 3.19).

Low. Barely noticeable, with a depth of less than 0.25 in.



**Figure 3.17** Example of rutting, low severity

Medium: Readily noticeable, with a depth of more than 0.25 in. but less than 1 in.



**Figure 3.18** Example of rutting, medium severity

High: Affects vehicle control, with a depth of more than 1 in.



**Figure 3.19** Example of rutting, high severity

### *3.3.2 Gravel Roads*

#### *3.3.2.1 Background*

The gravel road crown should be higher than the exterior edges of the road to provide drainage capabilities. It is recommended that there should be no more than 1/2 inch of crown per foot (FHWA Gravel Roads Manual). Figure 3.20 shows a gravel road with a good shape for the entire cross-section. The road has a driving surface with an adequate crown that slopes directly to the edge of the shoulder. Figure 3.21 shows a gravel road that lacks an adequate crown, which results in potholes and irregularities along the road. Figure 3.22 shows a gravel road with an excessive crown, which causes everyone to drive in the middle of the road.





**Figure 3.20** Gravel road with adequate crown



**Figure 3.21** Gravel road with inadequate crown



**Figure 3.22** Gravel road with excessive crown

The gravel road shoulder should begin no higher or lower than the edge of the roadway. Maintaining this shape eliminates the low shoulder (or drop-off), which is a safety hazard, and improves roadway edge support. Figure 3.23 shows two examples of gravel shoulders that match the edge of the roadway very well and drain water to the ditch.



**Figure 3.23** Gravel road with good condition shoulders

The procedures to assess gravel roads are as follows:

#### *3.3.2.1 Procedure*

Step 1: Determine whether the gravel road is approved for 80,000-pound trucks. If yes, go to step 2. If no, the request should be denied.

Step 2: Inspect the road to determine the condition of the crown. If the crown is 1/2 inch or less per foot of roadway width, the crown is adequate. If there is more than 1/2 inch of crown per foot of roadway width, the request should be denied.

Step 3: Inspect the road to determine the condition of the shoulder. If the shoulder is no higher or no lower than the edge of the roadway, the condition of the shoulder is adequate. If the shoulder is higher or lower than the edge of the roadway, the request should be denied.

### 3.4 Crash Analysis

This section provides guidelines on conducting a crash analysis to approve or deny

129,000-pound truck requests. Intersection safety also needs to be determined when LHJs receive a request. The procedures are as follows:

#### *3.4.1 Crash Analysis Procedure*

Step 1: Check the Local Highway Technical Assistance Council (LHTAC) [Crash Data website](#) to obtain available crash data.

Step 2: Do the crash data show one or more fatal or severe injury crashes, or a pattern of crashes on the route in the last five years?

- If yes, an engineering study is required.
- If no, go to step3.

Step 3: Were there one or more truck-related crashes on the route during the last five years?

- If yes, an engineering study is required.
- If no, the request should be approved.

#### *3.4.2. Intersection Safety Evaluation*

Intersection safety should be assessed through the field verification procedures listed in section 3.1.2 of this report.



## **Chapter 4 Conclusions**

The purpose of this report is to provide engineering assistance to local highway jurisdictions in evaluating requests to increase weight allowances on local roadways for trucks of up to 129,000 pounds. This guide, however, is limited to providing engineering assistance for only four categories: offtracking, bridges and culverts, pavements, and crash analysis.

Additional factors beyond the scope of this report that local highway jurisdictions will need to consider include, but are not limited to, spring breakup concerns; existing and needed chain-up areas; compatibility of runaway truck escape ramps (if any); current and future roadway improvement projects (if any); shoulder width, including the condition of shoulders on paved and gravel roads; conflicts with pedestrians; adjacent land uses such schools, parks, community centers, retirement communities and other residential areas; current and future development projects; and possible impacts of truck traffic on businesses, particularly travel through a downtown area.



## References

1. 129,000 Pound Pilot Project. 2013. Idaho Transportation Department.
2. David M. Luskin, and C. Michael Walton. 2001. Effect of Truck Size and Weights on Highway Infrastructure and Operations: A Synthesis Report. Center for Transportation Research. The University of Texas at Austin.
3. Guide for Uniform Laws and Regulations Governing Truck Size and Weight Among the WASHTO States, WASHTO Committee on Highway Transport, 2009.
4. Idaho Transportation Department, 2014 Pavement Performance Report, P.O. Box 7129, Boise, ID 83707.
5. Idaho Transportation Department Pavement Rating Manual 2010
6. Design Controls and Criteria, American Association of State Highway and Transportation Officials. "A Policy on Geometric Design of Highways and Streets." AASHTO, Washington, D. C. 2011. Chapter Two.
7. Gravel Roads Maintenance and Design Manual. South Dakota Local Technical Assistance Program (LTAP) and the Federal Highway Administration (FHWA), U.S. Department of Transportation, Washington, DC. Ken Skorseth and A.A. Selim, 2000. <http://www.mnltap.umn.edu/publications/videos/gravelroadmaintenance/documents/manual.pdf>

