

A Plan to Meet the Nation's Needs for Surface Current Mapping

Updated - May 2015



Prepared for the
Interagency Working
Group on Ocean
Observations

This document is a May 2015 updated version of the National Surface Current Plan initially released in September 2009 and subsequently updated in April 2013.

Executive Summary

Ocean currents determine the movement of surface waters, providing critical information to support pollutant tracking, search and rescue, harmful algal bloom monitoring, navigation, and a number of other applications discussed in this report. Existing oceanographic monitoring systems are insufficient to provide the level of detail required by scientists and forecasters to measure surface current speed and direction. In order for coastal managers, emergency responders, and marine scientists to perform most effectively, they require access to more densely distributed, near-real-time, surface current measurements than are presently available. High frequency radar (known as “HF radar” or simply “HFR”) is recognized nationally as a cost-effective solution to augment the existing system of in situ measurements and to provide increased spatial and temporal resolution.

Requirements for ocean surface currents, derived from HF radar, have been emphasized in national and international reports, including The National Strategy for Marine Transportation System: A Framework for Action (2008), the plan for A National Water Quality Monitoring Network for U.S. Coastal Waters and their Tributaries (2006) provided to the President’s Council on Environmental Quality, the National Science and Technology Council’s Subcommittee on Water Availability and Quality, and the Joint Subcommittee on Ocean Science and Technology, as a result of recommendations in Chapter 15 of the Final Report of the U. S. Commission on Ocean Policy (COP, 2004), The Integrated Global Observing Strategy: Report of the Coastal Theme Team (2006), and the First U. S. Integrated Ocean Observing System (IOOS) Development Plan (2006). Additionally, 19 program requirements for surface current observations within the National Oceanic and Atmospheric Administration (NOAA) have been identified. The United States IOOS program recognizes the need for a robust, national, ocean current monitoring capability that addresses diverse stakeholder needs in a more deliberate manner, providing high-density, near-real-time, round-the-clock coverage of the nation’s coastal waters. As a result, multiple partners from Federal agencies, IOOS Regional Associations (RAs) of coastal ocean observing systems, universities, and industry were assembled to develop an HFR-based National Surface Current Mapping Plan that provides a blueprint for building a viable, sustainable, and reliable network that delivers timely monitoring and distribution of coastal current data to federal, state, and local governments, as well as the general public. The plan is structured to develop an initial network over a five-year period that includes maintaining existing radar sites, acquiring additional radar sites to fill high priority gaps, and improving data management, product development, and data/product delivery.

Over the past 15 years, nearly \$65M has been invested in HFR stations, data management, and product development, primarily at the state and regional levels. The resulting infrastructure provides a solid framework for a nationwide, operational, surface current monitoring network; however, many of these assets were obtained via grants and contracts that do not provide ongoing funding for sustained operations and maintenance or data management. This plan describes a way to maximize the benefit of existing investments by providing a mechanism for sustained operation and delivery of these surface current data in a consistent manner to users around the country. The plan also identifies highest priority data gaps that must be filled to achieve a national surface current monitoring capability that can characterize the often-complex flows in coastal waters and meet the needs of diverse stakeholders in each region.

The national network is designed to function as a distributed system that applies consistent data standards and best practices to achieve integration, not only among various HFR observing assets, but also with other IOOS surface current measurements. As the lead federal agency for IOOS, NOAA will lead the overall plan and coordinate requirements and efforts to ensure consistency between national and regional needs and provide for the national Data Management and Communication (DMAC) objectives. Regional Coastal Ocean Observing System (RCOOS) partners will assist the NOAA IOOS Program in planning and designing the system. The plan outlines implementation through the RCOOSes in partnership with NOAA and other federal, state, and local agencies, as well as industry.

The partners of IOOS have been engaged in the development of this capability over several years, particularly as HFR grows in use and popularity and as more State governments invest in this technology. In Summer 2008, NOAA surveyed the RCOOS partners, as well as a number of Federal agencies, to determine existing HFR capability in each region and needs for the future based on local conditions and observing requirements. Information collected through the survey effort is summarized in the plan and was used to establish the overall framework and annual targets to develop the national network. The NOAA IOOS Program will collaborate with other NOAA programs and Federal agencies whose missions intersect with the needs of the HFR network capabilities to identify specific product requirements, such as those related to ocean current forecasting, harmful algal blooms (HAB) forecasting, oil spill trajectory prediction, climate prediction, United States Coast Guard (USCG) search and rescue, and ecosystem monitoring and assessment. The USCG has already implemented real-time use of HFR data into its search and rescue operations.

The plan uses information collected from knowledgeable partners across the HFR community to deliver a collaborative approach for the design, implementation, and management of the national surface current monitoring network, including staffing and training requirements, cost, hardware and server requirements, and data management principles. The cost estimate to implement this plan, including operations and maintenance (O&M), acquisition and deployment of new radars to fill priority data gaps, and acquisition of additional replacement radars to minimize down time is provided. The buildout of the network adds 208 radars to the existing 143 for a total of 351 radars, whose total acquisition and O&M cost estimates are approximately \$20M each year for five years. In addition, approximately \$1.7M per year is estimated for national data management, product development, and server system maintenance, while an estimated \$1.5M per year provides regional HFR management staff. It is envisioned that a national HF radar network would require active participation at the federal, regional, and state levels, with distributed expertise in the regions to

operate and maintain the radar systems. Data management and operational data delivery would be the responsibility of NOAA with support from the RCOOSes. Technical workshops and groups, such as the Radiowave Operators Working Group (ROWG), and the IOOS National HFR Technical Steering Team will continue to refine the network and data management requirements over time and work with NOAA to ensure the guidelines included in this plan are updated accordingly.

Envisioned as a living document, this plan will be updated periodically to reflect the evolving landscape in HFR requirements, applications, and knowledge.

This 5-year plan presents the uses of HF radar, the requirements that drive the measurement of ocean surface currents, and the implementation design for a five-year buildout. Sections 1 through 11 comprise the higher level design, while the later sections and appendices contain technical details, as well as a tutorial on HFR.

Review Panel

Arthur Allen, USCG – Office of Search and Rescue

Don Barrick, CODAR Ocean Sensors Ltd.

P. Johannes Buermans, ASL Environmental Sciences

Pat Burke, NOAA National Ocean Service, Center for Operational Oceanographic Products & Services

Bill Burnett, NOAA National Weather Service, National Data Buoy Center

Bob Cohen, Aerospace & Marine International Corp.

Jorge Corredor, Caribbean Regional Association

Pierre Flament, School of Ocean and Earth Science and Technology, University of Hawaii

Toby Garfield, San Francisco State University & CeNCOOS

Scott Glenn, Rutgers University Institute of Marine & Coastal Science & MARCOOS

Jack Harlan, NOAA IOOS Program

Brian Haus, University of Miami & GLOS

Stephan Howden, University of Southern Mississippi & GCOOS

Ming Ji, NOAA National Weather Service, Ocean Prediction Center

Josh Kohut, Rutgers University Institute of Marine & Coastal Science & MARCOOS

Mike Kosro, Oregon State University & NANOOS

Bob Leben, University of Colorado-Boulder Colorado Center for Astrodynamics Research

Jim O'Donnell, University of Connecticut & NERACOOS

Jeffrey Paduan, Naval Postgraduate School & CeNCOOS

Neal Pettigrew, University of Maine & NERACOOS

Rachel Potter, University of Alaska-Fairbanks & AOOS

Sheila Semans, California Coastal Conservancy

Nick Shay, University of Miami & SECOORA

Ted Strub, Oregon State University & NANOOS

Mario Tamburri, University of Maryland & Alliance for Coastal Technologies

Eric Terrill, University of CA-San Diego & SCCOOS

Libe Washburn, University of California-Santa Barbara & SCCOOS

Glen Watabayashi, NOAA National Ocean Service, Office of Response & Restoration

Marcia Weeks, NOAA IOOS Program

Contents

Executive Summary	i
Review Panel	iii
1. Rationale	1
2. Background and Approach.....	4
2.1 Requirements for Surface Current Velocity Data.....	6
2.2 Estimating HF Radar Coastal Ocean Coverage	7
2.3 National Data Server Capability.....	8
3. Design and Implementation Overview.....	8
3.1 Integrate and Sustain Existing Infrastructure and Data.....	8
3.2 Transition to National Operational Network	9
3.3 Data Management and Data Products	9
4. Gap Analysis.....	10
5. Implementation.....	11
5.1 Implementation: Data Flow	11
5.2 Implementation: Radar Network Infrastructure	12
6. Technical Staff Coordination and Program Management	13
6.1 NOAA IOOS Program.....	13
6.2 Regional Workforce.....	13
6.2a. Regional POC	13
6.2b. Field Technicians.....	14
6.2c. Technician Training Strategy	14
6.2d. Radar Site Operations and Maintenance Best Practices	15
6.3. Technical Advisory Panel	15
7. Product Development	15
7.1 Data Products.....	15
7.2 Application Products	16
7.3 Valued-Added Private Sector Products.....	18
8. Modeling, Data Assimilation, and Integration	18
9. Cost Estimate – Schedule – Performance Metrics	19
9.1 Performance Metrics.....	22
10. Frequency Allocation	22
11. Additional Potential High Frequency Radar (HFR) Applications	23
11.1 Vessel Detection and Tracking.....	23
11.2 Wave Measurements	24
11.3 Freshwater Applications	24
12. Hardware and Network Design Details	25
12.1 Hardware Infrastructure.....	25
12.2 Network Software System Design Details.....	25
12.3 Network Management Details.....	25
12.4 Network Servers Details	25
12.5 Data Server Operations and Maintenance.....	26
12.6 Web Display and IOOS Data Integration Framework (DIF)	26
13. Data Management Details	27
13.1 Data Description	27
13.1a. Doppler Spectra.....	27
13.1b. Radial Velocities	27
13.1c. Total Vector Velocities	27
13.2 Data Access and Transport.....	28
13.2b. OPeNDAP and Open Geospatial Consortium (OGC)-compliant Web Services.....	28

13.3	Metadata	28
13.3a.	Gridded Total Velocity Vector Metadata.....	28
13.3b.	Radial Velocity Metadata.....	29
13.3c.	Total Vector and Radial Velocity Metadata Linkages	29
13.3d.	Doppler Spectra Metadata.....	29
13.3e.	Additional Metadata Topics.....	29
13.4	Archive.....	30
13.5	Current Velocity Data Quality Control and Processing Description	30
13.5a.	On-Site Radial Velocity QC.....	30
13.5b.	Data Portal-Resident Radial Velocity QC.....	31
13.5c.	Real-time Velocity (RTV) Surface Current Processing.....	31
13.5d.	Active Developments in Quality Control.....	32
14.	Conclusions and Next Steps	33
	Appendix A: High Frequency (HF) Radar Current Mapping Explained	A-i
	Appendix B: Regional Gap Analyses	B-i
	Appendix C: Workshops.....	C-i
	Appendix D: Regional Project Examples	D-i
	Appendix E: Total Vector Velocity Gridded Data Metadata Parameters.....	E-i
	Appendix F: Detailed Regional Maps.....	F-i
	Appendix G: References	G-i
	Appendix H: List of Acronyms.....	H-i

1. Rationale

Nearly 50% of the nation's population lives within 50 miles of the coastline (United States Census 2000), heightening the need for accurate, reliable, and detailed measurements of coastal environmental variables. Just as the winds in the atmosphere provide information about where and when weather systems occur, ocean currents determine the move-

ment of oceanic events. These two dynamic flows are used to determine where pollutants, man-made or natural, will travel. Presently, ocean current measurements are not as readily available as winds, in large part due to the expense and difficulty of measuring in situ ocean currents in many locations.



Photo 1: Oil Slick, Angel Island, San Francisco Bay, California

Consequently, these sparsely located measurements provide a partial, less detailed description of the complexity of coastal current speed and direction, which is essential for oil spill and point source pollution tracking and prediction, Search and Rescue (SAR), marine navigation, harmful algal bloom (HAB) forecasts, marine protected area and ecosystem management, effects of climate change on coastal ecosystems, and coastal zone management. As an example, the United States Coast Guard (USCG), which currently ingests surface currents data from HFR sites into its SAR operations center for the Mid-Atlantic coast, estimated that access to HFR data in all United States coastal waters would save an additional 26 to 45 lives annually and reduce the \$30M per year currently spent on rescue flights (A. Allen, USCG Office of Search and Rescue analysis, 2006; available at www.ioos.noaa.gov/library/sarops_data_sources_uncert_nov2006.pdf). Furthermore, the nation's marine transportation system accounts for more than 40% by value and 77% by weight of all United States international trade. The National Strategy for the Marine Transportation System: A Framework for Action (2008) recommends, as an action item, the need to "Deliver timely, relevant, accurate navigation safety information to mariners, including real-time information

systems, such as...High Frequency Radar." The Coast and Geodetic Survey Act and The Hydrographic Services Improvement Act of 1998 both direct NOAA to provide ocean current data for marine transportation purposes. From the plan for A National Water Quality Monitoring Network for U.S. Coastal Waters and their Tributaries (2006), surface currents are identified as a key variable that "will affect the transport of chemicals in the water" for the Great Lakes and coastal areas from shoreline out to the full extent of the Exclusive Economic Zone (EEZ), and HFR, in particular, is mentioned as a technology for their measurement. From the global ocean observing perspective of the Integrated Global Observing Strategy (IGOS) Partnership: Report of the Coastal Theme Team (2006), surface currents are "required to provide accurate vulnerability assessments" of coastal hazards; to assess "human health risks associated with increasing coastal urbanization" by tracking the "transport of contaminant sources via currents" and under the category of ecosystem health and productivity so as to track hypoxic and anoxic water masses, as well as HABs. This IGOS report also specifically identifies HFR as a means of surface current measurement and also recommends that HFR "coverage needs to be significantly expanded."



Photo 2: United States Coast Guard Rescue

From the existing network of 70 radars extending from the California/Mexico border well up into Washington State, a large-scale picture of the coastal flow can be provided (Figure 1). Although no other part of the United States presently has such a continuous HFR coverage, spanning more than 2000 km, this offers a vision and promise of what the

complete continental United States HFR current mapping capability might offer. Figure 2 illustrates the complex flow, strong southward flows interspersed with much weaker flows, that can exist along a coast and can only be captured, cost-effectively, by a network of HF radars.

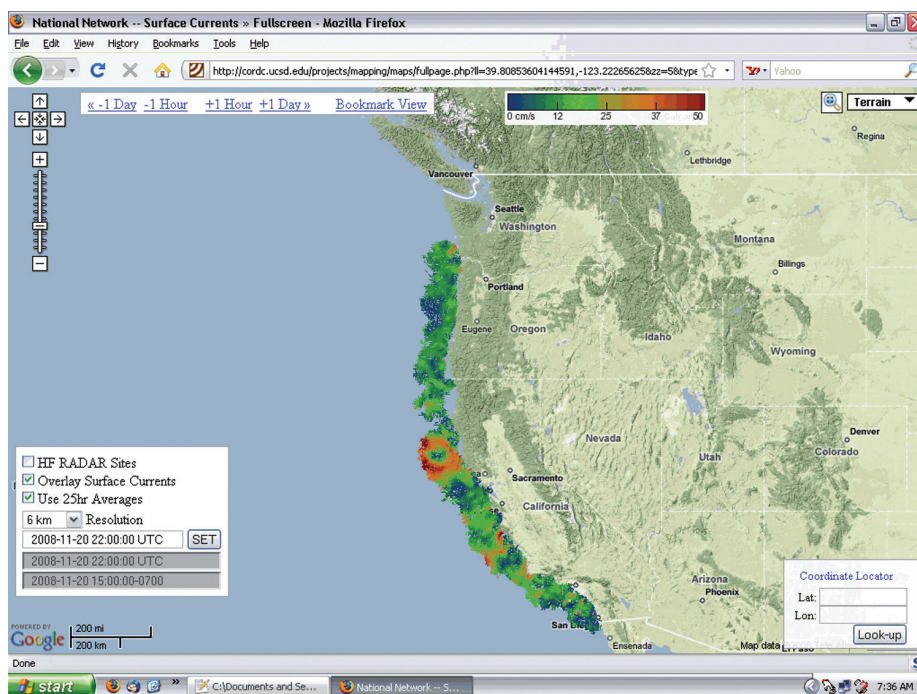

Figure 1: Real-time display from existing west coast HFR network

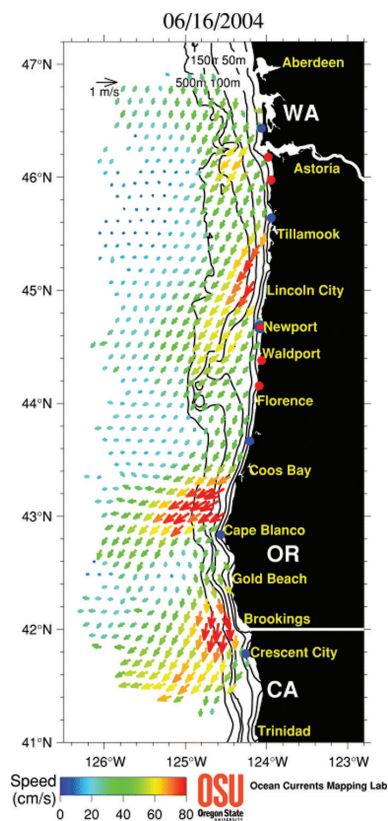

Figure 2: Complex regional coastal flows can only be captured by HFR surface current mapping networks

Recognizing the value of this technology, state, regional, and academic partners have already invested significant resources to purchase radar systems for their regions, estimated to be at least \$65 million nationwide, based on input from all the Regional Coastal Ocean Observing Systems (RCOOS) members of the Integrated Ocean Observing System (IOOS). Data from these existing radars have been

integrated and made available to the public, resulting in the total number of available surface current measurements to increase from about 100 per hour from in situ methods (e.g., moored buoys) to about 60,000 HFR observations per hour. Although this increased capacity would never have been attempted using only moored buoys, it would have cost in excess of \$10 billion if it were.



Photo 3: Present-day Coastal Ocean Dynamics Applications Radar (CODAR) having combined transmit and receive antennas in one unit. (Total height is approximately 8 meters for this particular unit).

The nation requires access to more densely distributed, near-real time surface current measurements so that existing coastal monitoring and current trajectory forecasting needs can be met. A community-wide workshop convened by Ocean.US¹ endorsed the establishment of an HF radar-based network for surface current mapping (Paduan et al, 2004). Surface current measurements have also been identified as critical for meeting many Ocean Research Interactive Observatory Networks (now known as Ocean Observatories Initiative) goals. The requirement for surface current monitoring is also detailed in NOAA's Consolidated Observation Requirements List database with 19 NOAA program-specific

requirements, spread over 10 NOAA programs, for coastal or offshore current measurement.

Surface current measurements have also been identified by the Regional Associations as the most highly desired regional observation requirement, and regionally-based HFR systems are a priority effort in all of the RCOOS conceptual designs, available at www.usnra.org/committees/HFRadar.html, and are deemed a "high" priority in eight of the 11 RCOOSes. This capability is highly valued because it has a direct impact on the social and economic needs of regional stakeholders.

* Ocean.US was formally disbanded in 2008.



Photo 4: Wellen Radar (WERA) Receive Antenna in South Florida

2. Background and Approach

To fully measure coastal ocean surface current features, data are needed throughout the coastal oceans from the shoreline to the outer continental shelf. Because of the often-complex flows in coastal waters, the data sampling must be dense enough and frequent enough to capture those flows in ways that can be delivered to the end user. Approximately 20 years of collecting HF radar-derived ocean currents within the United States have made it clear that only HF radar has the capability to cost-effectively meet the bulk of these coastal sampling needs (see Appendix D for examples of regional projects and applications that have contributed to HF radar validation and to application development). This Plan details how to augment the existing system of in situ measurements with HF radar and extend its geographic coverage.

HF radar technology provides ocean surface current velocities over hundreds of square miles simultaneously, reporting hourly, out to about 125 miles (200 km) from near shore resolving spatial scales of about 0.5 to 6 miles (about one to 10 km), unaffected by clouds, fog, or precipitation. This technology uses low-power transmitters and small stationary antennas that are relatively simple to deploy. There are presently about 130 of these radars operating throughout United States coastal waters.

While conventional in situ methods, such as moorings, only provide sparse single-point measurements, at a great distance from one another along the United States coast, HF radar provides two-dimensional maps of oceanic flow over a much larger area. Each pair of HF radars can produce a current measurement coverage area of 6,000 square miles

(about 15,750 square km), equivalent to a square of about 77 miles (125 km) on each side. Maps produced from these existing HFR observations cover a significant percentage of the Atlantic, Pacific, and Gulf coasts – more than 50 percent of the United States Exclusive Economic Zone – but these outputs are not yet fully integrated.

Before assessing the capability of HF radar to meet a requirement, some background on HF radar operation is useful (see Appendix A for the HF radar tutorial). The table below gives operating parameters of HF radars, depending on the transmit frequency that determines the typical maximum range from shore. Because of the physics of the propagation of the radio waves, lower frequencies travel further. Transmit frequency also determines the best attainable horizontal resolution, not because of physical laws but because of regulatory constraints that limit the amount of radio spectrum bandwidth available for transmission. Accuracies have been determined by comparisons with in situ sensors in dozens

of peer-reviewed journal articles over the last 30 years. A bibliography of comparison studies is given at the U.S. IOOS website, www.ioos.noaa.gov/library/technologydocs.html. For hourly data, the differences are approximately 6-12 cm/s when compared with point sensors, such as moored current meters and acoustic doppler current profilers. When comparing HF radar data with many drifters deployed within a single radar cell area producing an “integrated 2-D spatial view,” a much more meaningful comparison is produced because the HF radar measurement is also an integrated value over a spatial area. These comparisons result in root-mean-square (RMS) differences of 3-5 cm/s (Ohlmann, et al, 2007). To date, these 2-D spatial drifter comparisons have been done with standard HF radars but not with long-range HF radars, although other comparisons with long-range HF radars show similar results, e.g., Kohut et al., 2006. Table 1 is useful when referring to Table 2 later in the document.

HFR Type ¹	Maximum Typical Range from Shore	Horizontal Range Resolution	Accuracy ² (RMS Differences)	Temporal Resolution
High Res HFR Bays, Harbors	15-25 km	0.5 km	2-12 cm/s 2-4 cm/s Tidal and Sub-Tidal	1 hr
Std HFR: Bays, Coastal	30-40 km	1.0-2.0 km	2-12 cm/s 2-4 cm/s Tidal and Subtidal	1 hr
Std HFR: Coastal Only	60-90 km	1.5-3.0 km	2-12 cm/s 2-4 cm/s Tidal and Subtidal	1 hr
Long Range HFR: Coastal Only	170-200 km	6 km	5-12 cm/s 5-6 cm/s Tidal Subtidal	1 hr

Table 1: Resolutions, Range, and Accuracy of HF Radar Types

¹ HFR type is arranged, top to bottom, from higher to lower transmit frequencies

² Root-mean-square differences from numerous studies comparing HFR to in situ sensors

2.1 Requirements for Surface Current Velocity Data

The spatio-temporal resolutions identified as acceptable for coastal observing systems by the IGOS Coastal Theme Report for the EEZ are 5 km spatial and hourly temporal with an accuracy of 10 cm/s, summarized in Table 2. These resolution requirements can be met by all HFRs. (For the long-range HFRs, a resolution of 6 km is nominally obtained. Medium-range and short-range high-resolution systems have resolutions from 0.5 to 3 km. The IGOS Report delineates its requirements for resolutions in multiples of 5 km, except when 1 km or less. So, here it is reasonable to assume that 6 km is as adequate as 5 km.) The ideal spatial and temporal resolutions from that report are 0.3 km and 20 minutes, respectively. No existing sensor can meet these ideal requirements throughout the coastal zone, even within 20 km.

Three NOAA programs (1. Science & Technology Infusion-Ocean and Coastal Weather; 2. Marine Weather; 3. Environmental Modeling-Marine) have defined surface current requirements across the entire EEZ (200 nautical miles = 370 km, from shore). Long-range HFRs can routinely cover out to 170 km and often to 200 km with 6 km horizontal resolution and hourly temporal resolution, which equates to a 46 % fulfillment of the requirement. For the NOAA Ocean and

Coastal Weather requirement of 0.75 km horizontal resolution, only the high-resolution HF radar system could meet that requirement. Hence, the range to 25 km is identified. Another program, Marine Transportation System, identifies “coastal” areas needing 4 cm/s accuracy and one hour temporal resolution. Since a horizontal resolution requirement is not specified for this program, the HFR horizontal resolution is also not given in Table 2. For this program, coastal areas consist primarily of areas near major ports. The desired parameters for use of surface currents by operational marine weather forecasters is also included.

The programs that define the range of interest as “global ocean” might use HFR data for those parts of the ocean within the 170-200 km range of HFR and are also included in Table 2. Outside this range, such as in the middle of large ocean basins, HFR data would be unavailable. Each of the programs in Table 2 also has a surface current direction requirement, not shown, which is associated with the surface current speed. The fulfilling of those requirements by HFR data can be summarized as: three are met, while four require directional accuracy of less than 10 degrees that cannot be met, and two requirements are yet to be specified. It should also be noted that one NOAA program, Coastal and Marine Resources, has listed surface current speed, but not direction, as a requirement, but the details have not yet been specified.

Requiring Program	Range	HFR Range/Type ¹	Horizontal Resolution Reqmt	HFR Hor Res ²	Accuracy Reqmt	HFR Acc ³	Temporal Resolution Reqmt	HFR Temporal Res
IGOS	EEZ (370 km)	200 km	5 km	0.5-6 km	10 cm/s	2-12 cm/s	1 hr	1 hr
NOAA Science & Technology Infusion-Ocean and Coastal Weather	EEZ (370 km)	25 km	0.75 km	0.5-1 km	10 cm/s	2-12 cm/s	1 hr	1 hr
NOAA Environmental Modeling-Marine	EEZ (370 km)	50 km	1.0 km	0.5-3 km	12 cm/s	2-12 cm/s	20 min	1 hr
NOAA Environmental Modeling-Climate	Global Ocean	200 km	50 km	0.5-6 km	10 cm/s	2-12 cm/s	1 hr	1 hr
NOAA Environmental Modeling-Atmospheric	Global Ocean	200 km	50 km	0.5-6 km	10 cm/s	2-12 cm/s	1 hr	1 hr
NOAA Science & Technology Infusion-Hurricane Intensity	Global Ocean	200 km	2 km	0.5 -6 km	1 km/hr = 28 cm/s	2-12 cm/s	1 hr	1 hr
NOAA Climate Observations & Modeling	Global Ocean	200 km	600 km	0.5-6 km	5 cm/s	2-12 cm/s	1 month	1 hr
NOAA Marine Transportation System	Coastal (Ports)	25 km	N/A	N/A	4 cm/s	2-12 cm/s	1 hr	1 hr
NOAA Marine Weather	EEZ (370)	200 km	10 km	0.5-6 km	10 cm/s	2-12 cm/s	1 hr	1 hr
NOAA Local Forecasts & Warnings	Global Ocean	200 km	2 km	0.5-6 km	27 cm/s	2-12 cm/s	3 hr	1 hr

Table 2: Surface current requirements and HFR capability (Blue = requirement met; Red = requirement unmet)

1 HFR range depends on HFR type, i.e., transmit frequency. See Table 1.

2 HFR horizontal resolution depends on HFR type and licensed radar bandwidth.

3 HFR “accuracy” is actually root-mean-square difference based on comparisons with in situ current meters and drifters.

2.2 Estimating HF Radar Coastal Ocean Coverage

For some critical missions of national importance, it is necessary to have complete coastal coverage with HFR data so that two-dimensional surface current maps can be obtained throughout the coastline. To obtain a conceptual perspective

on the number of HFRs required to cover the entire United States coastline, consider the following background facts:

- The United States coastline is nearly 20,000 km in length.
- For the contiguous 48 states (CONUS), the length decreases to about 10,000 km since Alaska’s coastline, including its Arctic coast, is nearly 10,000 km.

Using a real-world example, about 85 to 90% of the Mid-Atlantic coastline from Cape Hatteras to New York Harbor is presently covered by 8 long-range DF HFRs. Expanding that network to obtain 100% coverage, only 1 to 2 more DF HFRs would be required for this 617 km long coastline for a total of about 9 to 10 long-range DF HFRs. The CONUS coastline is more than 16 times longer than this, which, by extrapolation, would lead to 144 to 160 long-range DF HFRs necessary for complete coarse-resolution coverage.

In addition to this basic coverage, nested higher-resolution HFRs are needed in certain sub-regional areas, such as major bays, critical shipping lanes, and regions of ecological significance are needed. Using a conservative estimate of four such areas for each of the seven coastal RCOOSes within CONUS leads to 28 additional areas needing higher-resolution HFR coverage. Typically, three to four HFRs are used in each nested area so that 72 to 112 additional HFRs would be needed for CONUS. Examples of this are already in place in Delaware Bay, New York/New Jersey Harbor, Chesapeake Bay, and San Francisco Bay, among others.

Based on these simple assumptions and extrapolating them for CONUS, 216 to 272 HFRs are estimated for both basic coarse-resolution coverage and higher-resolution nested coverage. It would not be reasonable to extrapolate the estimates for CONUS to the Alaska, Caribbean Islands and Pacific Islands RCOOSes because of the radically different coastal geography. These three RCOOSes presently have little HFR infrastructure, so the regional gap analyses (Section 4) serve as logical guidance to the number of HFRs necessary for a basic and nested regional network. Approximately 25 HFRs have been identified for each of these three RCOOSes as necessary to provide a useful network coverage. Alaska's Pacific coastline is as long as that of CONUS, so even these HFRs would not complete the coverage.

In summary, for the seven coastal RCOOSes within CONUS and the Alaska, Caribbean Islands, and Pacific Islands RCOOSes, using these rough estimates, 291 to 347 HFRs would comprise a basic coarse-resolution network with higher-resolution coverage in selected sub-regional areas. These estimates are in close agreement with the 351 total buildout number of radars that includes the number of existing radars plus those identified by the gap analyses. The differences are accounted for by 1) the conservative assumption of four sub-regional areas having higher-resolution radars; and 2) the extrapolation of the Mid-Atlantic coastline result to the entire CONUS coastline that cannot account for the variations in coastal geography.

2.3 National Data Server Capability

Over the past three years, IOOS efforts have made significant progress in developing a national HFR data server to integrate HFR data, providing access to these vast surface current data resources. This access enables the creation of a new suite of national, regional, and sub-regional products. Scalable server architecture has been implemented to allow the system to accept the data from additional HFRs at minimal additional server cost. To ensure the data from the existing 130+ radar systems around the country are high quality, compatible, and able to be integrated, NOAA IOOS has funded efforts to develop HFR data/metadata standards, as well as standard operating procedures and quality control methods. In addition, back-up data systems were implemented to ensure continuity in the event of a server failure, electrical power outage, or other problem. A national HFR capability serving search and rescue, oil spill response, and other real-time emergency applications must be reliable and available for continuous, around the clock operations.

3. Design and Implementation Overview

The outcomes envisioned with this Plan are predicated on a robust HFR site infrastructure; a comprehensive data handling system, including ingest, assembly, management, delivery, storage and archive, and product development. The network of radar sites necessary for some mission-critical data should be gap-free, geographically and temporally.

The five-year design detailed in this document will require an incremental approach in which the first priority is to support the existing HFR assets for sustained operation, which requires an increase in technician staffing to transition these HFRs from a loose network of research-driven radars to an operational system providing consistent and reliable surface currents. Secondly, the goal of providing a gap-free coastal coverage requires an annual increase in HFR deployments along with the appropriate technician staff increases.

3.1 Integrate and Sustain Existing Infrastructure and Data

The top priorities for advancing the development of a national current measuring capability are to integrate the data and operate and maintain the existing radar infrastructure as a cohesive network. Nearly all of the existing HFR systems are owned and operated by Regional Coastal Ocean Observing System (RCOOS) partners who provide considerable experience and technical expertise in operating HFRs. A top priority is sustained operations and maintenance (O&M) of the existing HFR systems that have been deployed during the last fifteen years, mostly in a piecemeal way for coastal ocean research.

3.2 Transition to National Operational Network

To effectively and efficiently improve coastal forecasting, maritime operations, search and rescue, spill response, and other national applications, a number of concerns must be taken into consideration: (1) gaps in the existing HFR network; (2) configuration(s) control and system type(s) must be more fully defined for guidance to radar operators (3) training and sustainment of technical expertise must be addressed and (4) end-to-end data management must be put in place.

Technical personnel for operating and maintaining the existing HFRs in a mission-oriented operational mode, as well as additional staffing for the increased number of HFRs necessary to implement this 5-year plan, will be required. Operational capacity also requires a standing inventory of spare hardware and robust data communications within the HFR network. These requirements are key for the transition from a collection of pre-operational regional networks to an operational network for the Nation.

NOAA's RCOOS partners have examined their region's needs for increased surface current observations. Requirements vary by region depending on existing capacity and monitoring priorities. For example, some regions will require long-range HFRs that provide 6,000 square miles (15750 square km) of ocean coverage with data points every 3.5 miles (6 km), while others that already have access to long-range HFR may need finer resolution from standard-range HFRs. To some extent these needs parallel NOAA needs such as higher resolution nearer to shore and in areas with large amounts of marine traffic. These gap analyses, comprising more than 200 pages, are detailed at the website, <http://usn-fra.org/committees/HFRadar.html> and synopses are given in Appendix B. Despite varying requirements across regions, the vast majority of management, operations, and data handling requirements for HFR observations are common at all locations. In this regard, the regions are greatly benefitted by nationally-coordinated HFR operations.

3.3 Data Management and Data Products

Reliable, quality-controlled delivery of surface current nowcasts and forecasts and the associated HF radar data require round-the-clock, real-time support, such as that provided by NOAA's data centers. The scalable data network architecture, already developed with NOAA IOOS funds, will be expanded and enhanced to create a fully operational capability. IOOS will collaborate with NOAA programs and other Federal agencies whose missions intersect with the HFR network capabilities to identify specific product requirements. Simultaneously, each region is developing products that fulfill their local end-user needs. These development efforts are being coordinated within IOOS, and it is envisioned that some regional products will have national application that would be implemented by NOAA and conversely, regional needs may require unique versions of national products.

Presently, the products available from national servers are 1) real-time current velocity vectors in graphical or network Common Data Form (netCDF) file format and 2) graphical time series of velocity for individual geographical points. These are accessible at <http://hfradar.ndbc.noaa.gov> and at <http://cordc.ucsd.edu/projects/mapping>. See Figure 1 for an example screenshot from the latter website.

To develop this capability for HFR, IOOS data management efforts in the first year of this Plan will focus primarily on enhanced radar data management, including storage systems and data and data product delivery, data archiving, as well as the development and implementation of quality control improvements. During the following four years, the focus will expand to include, for example, support for transitioning regional products to national application, development of new national products, operationalizing the assimilation of HFR data into nowcast/forecast models and integration of nearshore sensors and satellite-based current measurements with HFR-derived surface currents. These national efforts and their estimated costs are summarized in Table 3, Section 9.

4. Gap Analysis

The RCOOSes have demonstrated regional capability to provide pre-operational HFR-derived surface currents, but many areas of the United States coastline are not covered at all by HFR or are inadequately covered. These gaps in coverage can be geographical or functional. For example, some areas without coverage will require initial radar deployments, while others might need additional coverage to meet a particular stakeholder need. Determining the location and types of additional sensors required a close examination of the stated requirements by both the Federal agencies and our regional partners. The type of HFR (e.g., its spatial resolution and range), as well as relative priorities, were determined based on both federal and regional input.

The surface current data needs will vary dramatically across the U.S. coastal waters prompting a request to the federal partners of the Interagency Working Group on Ocean Observing (IWGOO), specific offices within NOAA and the IOOS RCOOSes for identification of needs and gap-filling prioritization for the national plan development. There are presently 143 HFRs spread unevenly throughout United States coastal regions, including radars that are not currently operating on a regular basis. As of September 2012, there are 132 (129 are supported by the US IOOS program while one is supported by an oil company and two are supported by a DHS research project) radars operating as part of the US IOOS National HF Radar Network. Because of varying levels of present investment in HFR infrastructure, some regions require substantial new investment, while others require only limited gap filling. All the individual RCOOS gap analyses, comprising more than 200 pages, can be found on this website <<http://usnfra.org/committees.html>>. Federal agency input is provided in Appendix B. The gap analyses provided by the IOOS RCOOSes were understandably more extensive as they have been the primary develop-

ers and operators of this pre-operational system. During the August 2008 workshop, all the gap analyses were reviewed to provide the 5-year buildout proposed in this Plan.

Despite some differences from region to region, all regions contribute to the HFR data stream for applications of national interest. Within regions, priorities range across many coastal interests, including water quality monitoring and management, ecosystem and fisheries management, harmful algal bloom monitoring, and renewable energy generation.

These high priority sites were chosen by considering the most critical gaps, both geographically and functionally. Filling geographic gaps in areas with existing HFRs is fairly straightforward. However, those new locations are chosen based on their functionality as well. For example, gaps are usually in areas of greatest economic and ecological importance, such as population centers, major marine transport centers, or marine protected areas.

The buildout is also composed of O&M for today's HFRs but adds the acquisition of 208 new HFRs, bringing the network to 351 HFRs. Figure 3 represents this full 5-year buildout scenario. It should be noted that Figure 3 gives approximate locations. Most of the existing sites shown are typically operating, but some may only be operating for limited periods while in a research capacity. A set of more detailed maps is given in Appendix F. The most up-to-date and accurate maps of the existing and proposed radar sites are maintained at www.ioos.noaa.gov/hfradar, which also provides an interactive method for the user to explore specific regions or particular radar sites.

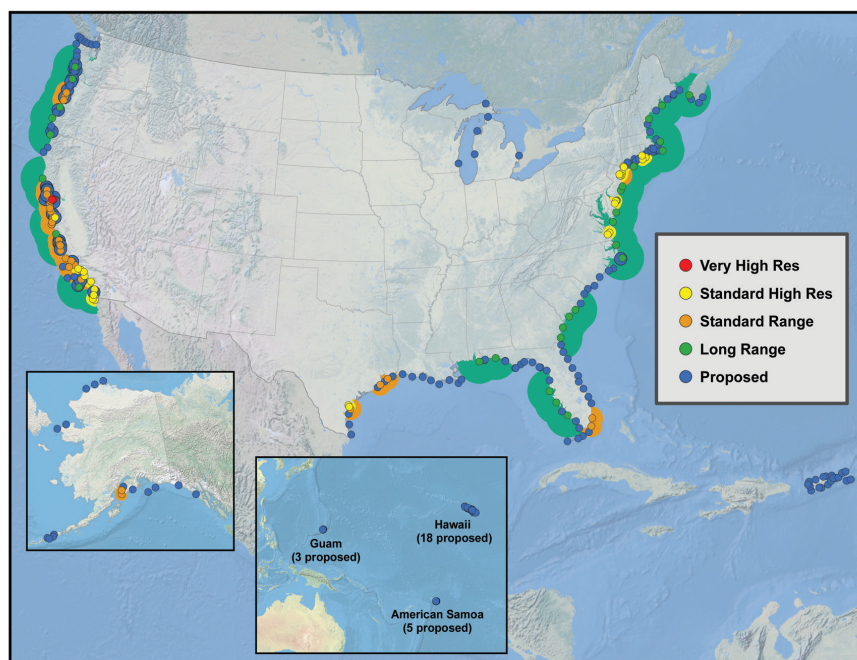

Figure 3: Existing Network & Proposed Sites for Full 5-Year Build-out.

5. Implementation

The implementation design for a national HFR surface current measuring network is based on the last 15 years of experience gained by the research community operating similar networks over smaller scales. The design builds on the present distributed system of regional HFR networks bringing them together with a national data management and delivery system. The management of the regional networks remains within the RCOOSes, although with the requisite interaction and oversight of a national HFR network as part of the national IOOS. Two different perspectives on the implementation are given below: Data Flow and Radar Network Infrastructure. While the two views are not mutually exclusive, these two perspectives highlight the unique attributes of both data flow and radar infrastructure designs. The two approaches also make it possible to explore the options as the existing network is transitioned to an operational system.

5.1 Implementation: Data Flow

From a national perspective, the HFR surface current capability is comprised of a network of HFRs of a limited number of configurations distributed throughout the United States coastal waters and large bays. Each of these radars provides its radial velocity data files in a standardized format that includes a number of metadata variables to a regional data portal that will ingest data from as many as 50 radars. These data portals are continuously monitored by processes that

detect when new radial files arrive at the data portal. The radial files are then transported to the national servers, also known as data nodes.

At the national server level, the radial velocity data are combined to form a gridded data set of total velocity vectors. These gridded data are comprised of three different grid resolutions. Far offshore, more than approximately 80 km, where only lower resolution radar data are available, the grid resolution is 6 km. From the nearshore to 80 km, the grid resolution is 3 km, while in some areas having higher resolution radars, the grid resolution is 1 km. In selected bays, where very high frequency (VHF) radars having short maximum ranges with sub-kilometer resolution are installed, the grid size is 500 m.

The gridded velocity data are then available for delivery to end-users, as input to both government and commercial product development, and as input to circulation models or other operational models (e.g., harmful algal bloom forecasting and search and rescue). The delivery methods are multifaceted and include Open-source Project for a Network Data Access Protocol (OPeNDAP), Open Geospatial Consortium-compliant web services, as well as direct file transfers. In many cases, the specific data product will deliver information to the end-user using transfer methods that are transparent to the user. Implementation of web services transfer protocols was completed in September 2008 at the NOAA National Data Buoy Center (NDBC).

At the NDBC, a Data Assembly Center (DAC) has been established that is responsible for aggregating data content from oceanographic and meteorological sensors distributed throughout the United States. The DAC also houses the NOAA National HFR Data Server, one of three national servers sponsored by the NOAA IOOS Program. The other two are at Scripps Institution of Oceanography's Coastal Observing Research and Development Center, the primary

development site, and at Rutgers University Institute of Marine and Coastal Sciences. Since all three data nodes store copies of the same data, there is ample failover redundancy.

The HFR data is archived at the National Centers for Environmental Information (NCEI). Both the gridded total velocities and radial velocities are archived. NCEI accesses the data

files monthly from NDBC. The archive contains data from 2007 forward.

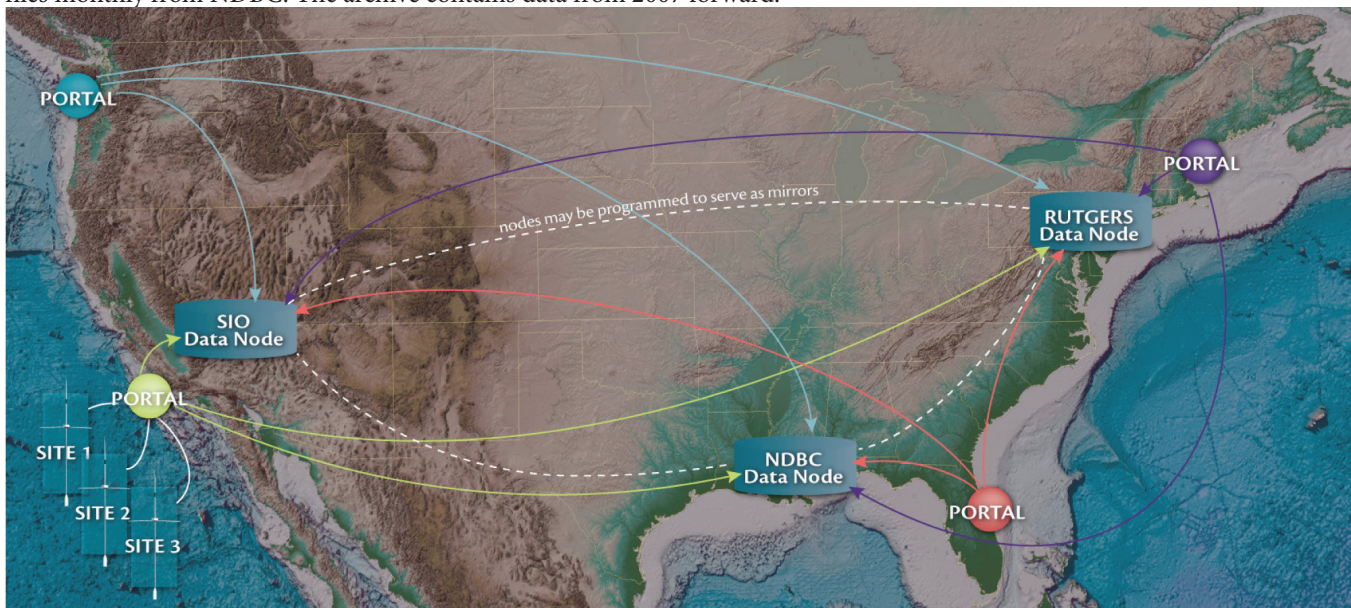

Figure 4: National Data Nodes and Regional Data Portals, Dotted lines indicate national failover capability. Data flow from four example Portals to the three National Data Nodes are indicated by arrows. As an example, data flow from three HFRs to a Regional Portal (lower left) is also shown.

5.2 Implementation: Radar Network Infrastructure

The radars will be distributed throughout the RCOOSes and will be operated and maintained by regional staff. National and regional needs and gap-filling analyses determine the location of the HFRs. Although HFRs are essentially autonomous systems designed to run unattended, a set of best practices for deployment and maintenance has been developed by the existing HF radar technician community in an online document <<http://cordc.ucsd.edu/projects/mapping/documents>>. These methods and processes are periodically reassessed by the NOAA-sponsored Radiowave Operators Working Group (ROWG) (see Appendix C) and updated per community consensus.

Each HFR can be operated independently of other HFRs. However, for most of the long-range HFR systems, radio transmission frequency is shared among multiple adjacent systems. This is accomplished by using highly accurate transmit and receive timing based on Global Positioning System (GPS) time code synchronization. Since frequency

availability is severely limited at the lower HF frequencies, lower than about 10 MHz, this allows the network, as a whole, to require fewer transmit frequencies. Note that, eventually, all HFRs, not just those operating lower than 10 MHz, will be required to share frequencies once the United States implements the frequency bands identified for oceanographic HFR by the International Telecommunications Union (Section 10)

To minimize the amount of HFR downtime, each region shall have a repository of spare parts commensurate with the number of HFRs in the region. The spare parts will typically be comprised of antenna whips, cables, transmitter and receiver electronics, power supplies for the electronics, and field site computers.

Each radar site has a computer that controls the radar operations, processes the raw data from the receiver, performs spectral processing to create real-time Doppler spectra, and runs software that creates radial velocity files from those spectra. Downtime can sometimes be associated with problems in the computer hardware or software. Methods for rapid diagnosis and remote repair of these issues are con-

tinually being evaluated and implemented among the HFR network technicians.

Data communications to and from the radar site allow the radar site's computer to be accessed by a technician remotely rather than spending valuable time traveling to the site. Resolving problems can sometimes be accomplished remotely via software changes. However, when communications to the remote site computer have failed, a site visit is required. Data communications downtime has been identified by discussions with the ROWG participants as the most significant source of data stream interruption, informally estimated to account for 30 to 40% of the interruptions.

Response to radar problems is dependent on the adequacy of staffing for both local and regional technicians. It is

envisioned that quality control diagnostics, accessible from regional network servers, will identify problems with either the radar hardware or software and that notification will then be made to field technicians.

Generally, it is expected that nearly all radar problems can be resolved back to full operation within 2 to 3 days. However, there are instances that occasionally will occur when longer times are needed (e.g., for sites that are not accessible by standard passenger vehicles, when access or electrical power to a site is restricted by the landowner, when widespread electrical grid outages occur, or when a hurricane or other catastrophic storm damages multiple HFRs within a single region). Although there will be regional parts repositories, specialized replacement parts may not always be readily available, which could also increase downtime.

6. Technical Staff Coordination and Program Management

The predominant cost driver of a national HFR network is the staffing of technical personnel for operations and maintenance. For efficiency, a tiered approach to radar network management and maintenance is envisioned. A national HF radar network would require national coordination with distributed expertise in the regions. The national project manager, within the NOAA IOOS Program, will coordinate the overall network operations. The NOAA IOOS program will coordinate with other NOAA program offices and interagency groups, such as the Interagency Working Group on Ocean Observations (IWGOO). It is recommended that each member agency of the IWGOO with an interest in HFR data have a single POC for HFR issues. This individual would provide input on HFR-related issues to that agency's IWGOO panel member. The following recommendations are based on collective operating experience of present HFR operators, as well as recommendations from the Ocean.US workshop (Paduan et al, 2004) and the Radiowave Operators Working Group (Appendix C). It is recommended that staffing of the regional managerial roles would be made up of personnel already involved in regional HFR management.

6.2 Regional Workforce

6.2a. Regional POC

Each region will identify a primary and an alternate POC for HFR. They should have HF radar experience and a working knowledge of the network needs within the region. They will direct the available resources toward operation and maintenance of the region's HFRs. The responsibilities for each POC include, but are not limited to:

- Access to the data by public entities, private citizens, or private companies
- Location of radar sites and viewshed issues
- Radio frequency interference issues
- Interaction with the NOAA IOOS Program Office

They will coordinate with the NOAA IOOS Program on data-related issues, including quality and continuity. These staff members will usually have extensive HFR field experience that will allow them to diagnose and troubleshoot problems remotely, as well as directing the Field Technicians. The technical duties include:

6.1 NOAA IOOS Program

The HFR Project Manager, within the NOAA IOOS Program, will direct the overall system management both programmatically and operationally, will serve as a point of contact for participating agencies of the IWGOO, and will coordinate communication among all the regions within the network. The office will be staffed to carry out these specific tasks:

- Program lead for the national HFR network
- National POC for the national HFR network
- Coordinate with the Regional Associations (RAs)
- Develop planning and budgeting materials for the network
- Serve as a liaison between NOAA, the RAs, and other Federal agencies

This office will have the responsibility of ensuring that the technical and programmatic needs of IOOS are being carried out at the national level and coordinating those needs with the regional efforts and goals. The Technical Steering Team (Section 6.3) will provide technical advice to the NOAA IOOS Office.

- Monitor radial file transfers from the local sites to the central site.
- Ensure radial velocity level Quality Assurance/Quality Control (QA/QC) until sufficient automated diagnostics are developed.
- Monitor radial data distribution to the national server.
- Maintain an appropriate store of spares.
- Ensure adherence to standard operating procedures.

Additionally, each regional POC will serve on a regional operations committee. The operations committee will provide network performance statistics to the NOAA IOOS Program.

6.2b. Field Technicians

To maintain a national scale system, a team of technicians distributed throughout the regions will be supported. The field technicians and engineers will serve as a first responder

to issues at the site that disrupt data flow. Specifically they would.

- Perform regular site hardware and software maintenance and calibration.
- Maintain communication lines between radar sites and data portals.
- Respond to site outages.
- Diagnose and repair hardware/software failures.
- Coordinate new site installations.

The ratio of technicians to systems has been extensively discussed in the preparation of this plan. The results below are based on past efforts within two California Regional Associations (SCCOOS and CeNCOOS), the Mid Atlantic Regional Association (MARACOOS), and the Northwest Association of Networked Ocean Observing Systems (NA-NOOS) Regional Association. This is the best estimate of the required levels of support given today's technology and knowledge base, but the NOAA IOOS office will continue to evaluate technologies that might allow for a reduction in staffing by increasing efficiencies while maintaining network reliability.

The level of system reliability will be related to the level of support for operations and maintenance. Each region should employ approximately 2 local field technicians for every 7 direction-finding (DF) HFRs or 2 technicians for every 4 linear phased array (LPA) HFRs. This approximation may vary in some regions, e.g. Alaska, where long travel times to sites requires more staff time. These staffing estimates can also be interpreted as man-months, e.g., 24 man-months per 7 DF or 4 LPA HFRs. For the network at the proposed 5-year end-state, these support estimates translate to approximately 118 full-time field staff. It will be the responsibility of the RCOOS management to ensure that national and community operations and maintenance (O&M) recommendations are being communicated through the regional POC who, in turn, communicates them to the local staff. Since each RA may have different distributions of supervisory and field staff, the Regional POC must submit their specific organization to the national management office and the operations committee.

Since the technician workforce is the largest cost driver, we will continue to evaluate other approaches to staffing for O&M. One approach is to make the system a Federal System with government employees operating and maintaining the system. Another approach is to follow the National Lightning Network model and outsource the operations to one contractor. The consensus opinion by the Review Panel indicates that currently the Regional Associations are better suited to continue operating the HF Radar network during the time frame of this Plan and could establish a useful national system much more quickly than having a competition for an industry-provided implementation.

6.2c. Technician Training Strategy

HF radar technology requires a unique blend of skills for effective operations and maintenance. For a sustainable national HFR network, a comprehensive program of HFR technician training must be established. This training program should include a combination of student and on-the-job training. Undergraduate and graduate training programs can provide much of the pool of future regional supervisory and field staff. The national education strategy identifies the critical need to enhance existing Science Technology Engineering Mathematics education programs. The needed skills are often acquired from on-the-job training of individuals possessing some core portion of the entire set of skills. HFR vendors also provide short training courses for their particular products. The implementation design includes a training program that would supplement on-the-job training with NOAA-sponsored intensive learning workshops, university course work, or a combination of the above. It is expected that technicians will receive a viable level of training to meet core competencies required for successful operation.

6.2d. Radar Site Operations and Maintenance Best Practices

A separate document <http://cordc.ucsd.edu/projects/mapping/documents/SCCOOS-BestPractices.pdf>, produced by Scripps Coastal Observing Research and Development Center, has detailed information for HFR site O&M best practices. This "Best Practices" document (45 pages) was produced with extensive input from the ROWG series of workshops and the collective experience of dozens of HFR technicians throughout the United States. It details the deployment, as well as O&M, for many different site scenarios, although some sections (e.g., site radar software) are mainly focused on the direction-finding HFR from CODAR Ocean Sensors, Ltd (COS), known as CODAR SeaSondes®, because the document was initially designed for the California HFR network, which is completely composed of that vendor's radars. However, the concepts are easily applied to other types of HFRs. Topics covered include:

- Locating an HFR
- HFR Setup
- Site HFR Software
- Site Maintenance
- HFR Data Management
- HFR Quality Assurance/Quality Control
- Alternative Off-the-Grid Power Supplies

6.3. Technical Steering Team

One of the basic goals of IOOS is to foster research and development of activities and technologies that will enhance the observing system's sensors, methods, models, and analysis. To that end, the IOOS National HFR Technical Steering Team was formed in 2010.

It is composed of six elected representatives from the RCO-

OSes as well as members from industry and academia and operational oceanography offices including NOAA and US Army Corps of Engineers. In contrast to the ROWG, which is primarily for the exchange of the latest O&M methods by field and software engineers, the Steering Team has an advisory role for the planning and continued development of the national network.

In addition to providing guidance on the direction of HFR research and development, the Steering Team will also have a role in:

- reviewing proposed algorithms for standardized data processing
- coordinating new development of products in order to maximize benefit of national expertise
- providing input to the NODC for archival planning
- assessing regional and national strategies for future deployment of HFRs
- assessing regional and national strategies for future deployment of HFRs

7. Product Development

The products derived from the HFR national network fall into two general categories: data products and applications products. Data products will be surface current velocities, although they will be represented in varying ways. Applications products usually have surface current velocities as input, which are then transformed to a final (in some cases, perhaps, an intermediate) product that has specific end-users in mind, such as, for example, a harmful algal bloom (HAB) forecast. Descriptions of the data types that serve as input to the data products are given in Section 13.1.

7.1 Data Products

The following products are termed “data products” because they have many possible applications and, hence, are not directed at one particular end-user or stakeholder. Similar to satellite data products, these are given a “Level” designation with higher number levels requiring more processing. These data types and their metadata are discussed in Section 12. Level “4” refers to application products that are addressed in Section 7.2.

- Quality controlled radial currents plus error (Level 1)

The primary use of these data are as input to various hydrodynamic and statistical models of coastal circulation. These data are also important for validating surface currents derived from these models.

- Gridded total vector velocities (Level 2)

Generally, end-users prefer Level 2 data types as input to their own applications. This data type can be delivered in near-real-time or in a delayed mode wherein corrections or improvements to the data can be rendered.

- Near-real-time velocities (presently available via national servers) (Level 2a)

- Reprocessed or delayed-mode version with best-known data (implementation design underway) (Level 2b)
- Objective analysis of gridded surface current maps (Level 3)
 - Near-real-time analysis maps (Optimal interpolation fields available from national development server at Scripps) (Level 3a)
 - Reprocessed or delayed-mode version with best-known data (under research and development) (Level 3b)

7.2 Application Products

National Applications:

Some agencies have missions that span all coastal regions, which could benefit from HFR data throughout. Examples include United States Coast Guard Search and Rescue which uses HF radar data operationally, NOAA oil and hazardous material spill response and water quality monitoring which is a component of the missions of the Environmental Protection Agency and United States Geological Survey. The NOAA Office of Response and Restoration (OR&R) Emergency Response Division (ERD) responded to over 110 hazardous spill incidents during FY07, including the release of an estimated 53,500 gallons of fuel oil into San Francisco Bay, California when the Cosco Busan struck the Bay Bridge. For the Cosco Busan incident, HFR data were used to corroborate the flow predictions offshore of San Francisco where the sensitive Gulf of Farallones National Marine Sanctuary is located. The NOAA/OR&R/ERD team used HFR data to conclude that the oil would not threaten the sanctuary that allowed responders to deploy assets more efficiently. Heightening the need for pollution tracking products is the fact that pollution has rendered 44 percent of tested United States estuaries and 12 percent of ocean shoreline waters unfit for uses such as

swimming, fishing, or supporting aquatic life. In addition, in 2001, polluted runoff caused over 16,000 beach closings and swimming advisories. On April 20, 2010, BP's Deepwater Horizon Oil Rig Platform exploded 40 miles southeast of Louisiana, unleashing the largest offshore oil spill in U.S. history. IOOS utilized HFR technology to measure surface current speed and direction in near real time for the duration of the oil spill response efforts. Crews used regionally-operated IOOS radars in the Gulf Coast and Southeast at sites along Florida's West Coast and the northern Gulf to monitor the oil's surface travels. NOAA immediately used these data to provide science-based daily oil trajectory maps. Because IOOS members in Southern California previously worked with NOAA on a five-year effort to develop usable formats for high frequency radar data, this effort proved seamless when needed most. During the period 2011-2014, NOAA/OR&R/ERD has responded to about 100 incidents per year, on average.

NOAA's Center for Operational Oceanographic Products and Services (CO-OPS) functions as an end user of processed HFR data. CO-OPS' primary constituency is the marine navigation community and many of CO-OPS' programs are driven by their requirements. In 2014 and 2015, CO-OPS released an HF radar web product which provides near real-time surface current observations and tidal current predictions in select estuarine and coastal locations. The new web product is presently available in Chesapeake Bay, San Francisco Bay and New York Harbor (<http://tidesandcurrents.noaa.gov/hfradar/>) and provides two primary sources of information to users: near real-time HF radar surface current observations, and tidal current predictions. The hourly averaged surface current observations are provided via an interactive map and plotting interface for the most recent 48 hours at regularly spaced grid points in each domain (2 km resolution for Chesapeake Bay and 1 km resolution for San Francisco Bay and New York Harbor). The tidal current predictions are calculated based on a harmonic analysis of 1 year of observations at each grid point in the domain. The predictions are calculated each hour and are provided to users for the previous and following 48 hours.

During FY2015, the NWS disseminated the HFR total vector gridded velocities as a new product within AWIPS-2. The data are distributed to AWIPS-2 in GRIB-2 format via the Satellite Broadcast Network. Forecasters at all coastal weather forecast offices (WFOs) now have access to HFR surface current velocities for supplementing their local marine forecasts.

Regional Applications:

- Wastewater and sewage spills
- Coastal inundation, storm surge
- Ecological assessment larval/ecological transport
- Harmful algal bloom transport
- Maritime Operations (including ocean routing)
- Beach closure due to pollution
- Rip currents (input to models, not a direct measurement)

Examples of a Maritime Operations application, developed by Southern California Coastal Ocean Observing System (SCCOOS) members and the Coastal Data Information Program (CDIP), are near real-time, customized websites displaying environmental conditions at the entrance to the Ports of Los Angeles and Long Beach Harbor (<http://www.sccoos.org/data/harbors/lalb/>) and San Diego (<http://www.sccoos.org/data/harbors/sd/>). Each website integrates wave data from CDIP and SCCOOS HFR-derived surface current maps, as well as NOAA nautical charts, shipping lanes, and ferry routes. This application is a decision support tool for those who manage maritime traffic and for inbound or outbound mariners from the Ports of Long Beach and Los Angeles and San Diego.

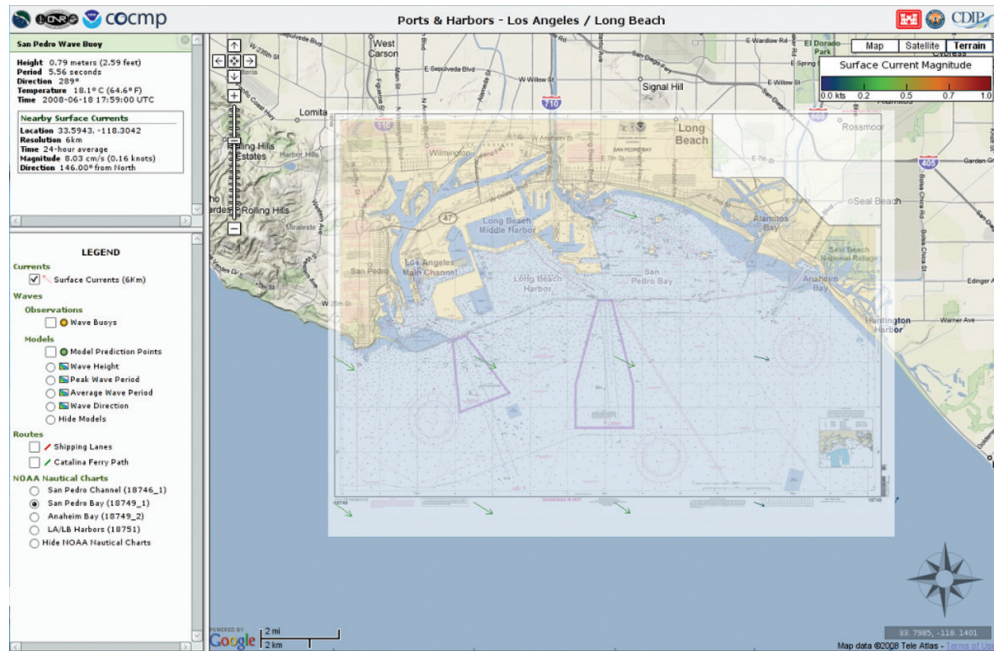

Figure 5: Maritime Operations website for Los Angeles/Long Beach Harbor integrating HFR-derived surface current maps with in situ data and NOAA nautical charts.

For monitoring wastewater or sewage spills, HFR-derived current maps can be transformed into forecast trajectories. The Central and Northern California Ocean Observing System (CeNCOOS) HFR team developed a trajectory product to assist City and County of San Francisco’s wastewater system decision managers when it was found that a defect in the system would cause a point-source discharge of secondarily-treated wastewater. The trajectory products were updated every day with forecasts based on the HFR data and provided to officials who could then decide whether closures were necessary at nearby beaches.

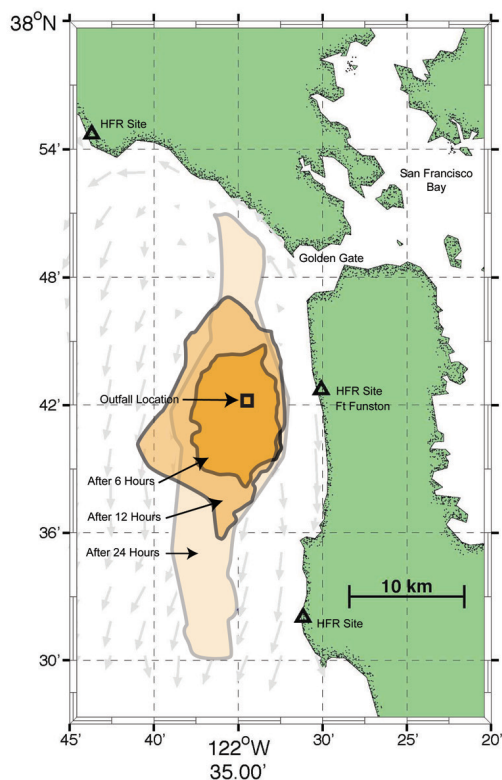

Figure 6: Trajectory forecasts during the Ocean Beach Outfall near San Francisco derived from near-real-time HFR data.

7.3 Valued-Added Private Sector Products

Just as many private weather information services exist to create and deliver enhanced products for private or public clients using NOAA and other data sources, it is envisioned that these services will also seek to use the NOAA-provided HFR data products for their own product generation. Al-

ready, private companies are accessing the pre-operational HFR gridded vector velocity data product from the national servers as input to value-added products. For example, a product that provides an integrated overlay of HFR gridded velocity data on satellite-derived sea surface temperature images has been created by Ocean Imaging (California, USA) for the California Office of Spill Prevention and Response.

8. Modeling, Data Assimilation, and Integration

The national HFR surface current mapping capability will enhance the accuracy of coastal ocean nowcast/forecast systems (for example, Gopalakrishnan et al, 2008; Oke et al, 2002; Paduan and Shulman, 2004; Wilkin et al, 2005; Kim et al, 2008; Shulman and Paduan, 2008; Paduan and Washburn, 2013). These radar measurements provide a nearly continuous time series of surface velocities that uniquely resolve the time and space scales unavailable from other observations. Ultimately, a complete nowcast/forecast system is envisioned, and toward that goal, several regions have already been engaged in assimilation of HFR data into circulation models. These endeavors have demonstrated the increased predictive ability of the models when HFR data are included (Figure 8).

The HFR data, both Level 1 (radial velocities) and 2 (total vector velocities), will be used for a variety of modeling and integration activities, including model development, data assimilation, and skill assessment. HFRs can resolve ocean features that satellites cannot resolve and can provide two-dimensional maps of ocean velocity that are not possible with moorings or drifting buoys. Nevertheless, imperfections in HFR operation or processing could lead to gaps in the two-dimensional maps of HFR-derived currents. Therefore, statistical objective analysis techniques are needed, such as open-boundary modal analysis (OMA) (for example, Kaplan and Lekien, 2007) and optimal interpolation (OI) (for example, Chu et al, 2003), to produce gap-free two-dimensional

time series of surface ocean currents. These efforts are encouraged and need to be continued.

Within NOAA National Ocean Service (NOS), it is anticipated that NOS Operational Forecast Systems, such as that for Chesapeake Bay, would use HFR data to ground-truth the nowcast as well as to help quantify the uncertainties in the nowcast. As of FY2015, there is an effort underway within the NCEP to assimilate HFR data into a West Coast Operational Forecast System model.

The OR&R General NOAA Operational Modeling Environment (GNOME), used for modeling oil spill and other trajectories, also has operationally ingested HFR data.

Integrating with other in situ data, satellite data, and large-scale model fields is also important. In situ data from moorings, gliders, and research vessels provide subsurface information. Satellite data provides surface fields (sea surface temperature, sea surface height, ocean color), complementing the surface currents from HFR. Large-scale circulation models provide the boundary conditions to the coastal models. The net result is an integrated coastal ocean observing and nowcast/forecast system that connects the United States IOOS effort to the larger Global Ocean Observing System.

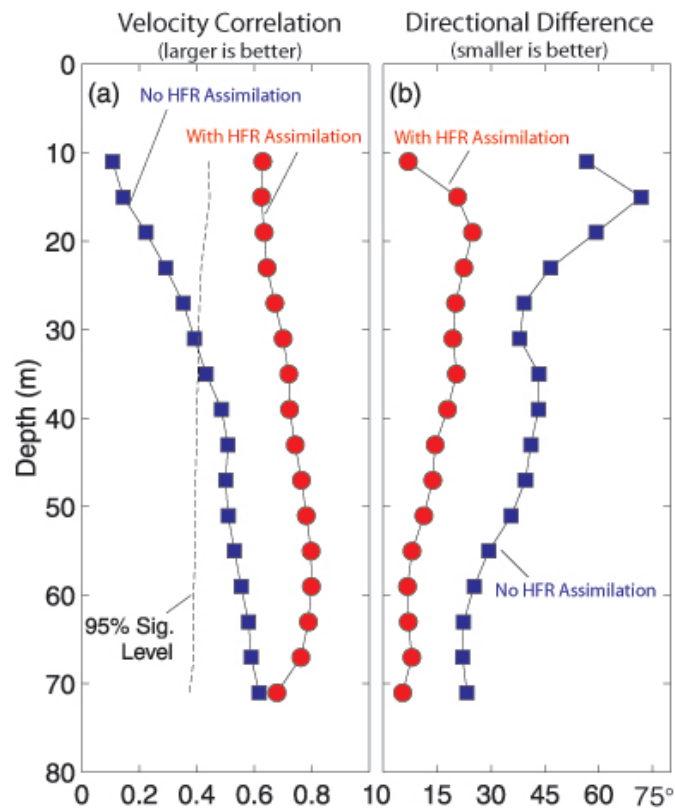

Figure 7: Improvement in model current estimation after assimilating HFR data (from Oke et al., 2002).

9. Cost Estimate – Schedule – Performance Metrics

The main cost drivers of a national HFR surface current capability are the operations and maintenance of the HFRs and the acquisition of additional HFRs to fill the existing observation gaps. Also presented here are the cost estimates for the national data management tasks listed in Section 3.3, as well as the regional POC, and supervisory staff described in Section 6. Note that the staff cost estimates may actually be slightly less in regions where the regional POC also serves as a supervisor and also note that Field Technician costs estimates and travel are included in the O&M costs estimates of Tables 4 and 5.

	Year 1 (\$K)	Year 2 (\$K)	Year 3 (\$K)	Year 4 (\$K)	Year 5 (\$K)
Data Server O&M, Data Management, Data & Radar Hardware Quality Assurance/Quality Control, Quality Control Enhancement Development	700	700	700	700	700
Transition of Regional Products to National, Develop New National Products, R&D e.g. Freshwater Applications	650	650	650	650	650
Integrate Nearshore & Satellites with HFR	0	0	150	150	100
Operationalize HFR Data Use in Models	250	250	250	250	250
Data Archiving	75	50	50	50	50
10 Regional POCs (\$150K/FTE)	1,500	1,500	1,500	1,500	1,500
Radar Technician Training	75	75	75	75	75
Annual Total (\$K)	3,250	3,225	3,375	3,375	3,325

Table 3: Cost Estimates of Tasks (Section 3.3 Data Management and Data Products and Section 6 Regional Workforce) for National Network Development and Management

Although the necessary number of technicians to sustain a regional HFR network will vary somewhat from region to region, an estimate of two technicians for every seven (2:7 ratio) direction-finding (DF) HFRs and a ratio of 2:4 for linear phased array (LPA) HFRs is assumed here.

The buildout is also composed of O&M for today's HFRs but adds the acquisition of 208 new HFRs.

The following tables represent a summary of the annual costs estimates from each RCOOS to implement their gap filling. These costs estimates include HFR acquisition, deployment, O&M, spare parts, and technician salary (x1000). Each year's new HFR acquisition will be spread out over the course of

twelve months, i.e., some will be deployed in the first month of the year and some in the last month of the year. Hence, on average, the annual estimate for new HFRs is for six-months of O&M, which is shown in row 2 of Table 5. The costs estimates for existing systems are intended to reflect existing numbers of HFRs in the region that are potentially available, not necessarily currently deployed.

Region	YR1	YR2	YR3	YR4	YR5	Total New	Total Existing	Total at 5-Yr Buildout	Total Acquisition & Deployment (\$K)*	Existing Annual Regional O&M (\$K)*	Total New Annual O&M* (\$K)
Alaska	6	3	4	2	5	20	2	22	\$3,200	\$98	\$371
Caribbean	6	6	6	6	5	29	0	29	\$4,640	\$0	\$539
Pacific Islands	5	6	5	5	5	26	2	28	\$7,800	\$154	\$845
Northeast Atlantic	6	6	3	1	1	17	8	25	\$2,720	\$393	\$316
Mid-Atlantic	10	8	5	0	0	23	29	52	\$3,680	\$1,425	\$427
Southeast Atlantic	6	6	6	6	3	27	12	39	\$8,100	\$813	\$878
Gulf of Mexico	5	4	3	3	2	17	16	33	\$5,100	\$842	\$553
Southern California	3	2	2	2	2	11	31	42	\$1,760	\$1,523	\$204
Central & N. California	4	4	4	4	2	18	32	50	\$2,880	\$1,573	\$334
Pacific Northwest	4	4	4	4	4	20	11	31	\$3,200	\$541	\$371
Totals	55	49	42	33	29	208	143	351	\$39,580	\$7,362	\$4,838

* Technician fully encumbered salary is estimated at \$130,000; purchase and deployment for DF HFRs, LPA HFRs are \$160,000 and \$250,000, respectively. Two technicians for each 7 DF HFRs, 4 LPA HFRs, respectively

Table 4: Full 5-Year Buildout. Estimated costs for new HFRs and to maintain existing HFRs

	Year 1	Year 2	Year 3	Year 4	Year 5	Total
Annual New Acquisition & Deployment	\$10,240	\$9,280	\$7,980	\$6,540	\$5,540	\$39,580
Annual New O&M	\$1,244	\$1,133	\$975	\$808	\$678	\$4,838
Annual O&M for Pre-Existing	\$7,362	\$8,606	\$9,739	\$10,714	\$11,522	\$47,942
Replacement/Spare	\$1,320	\$1,647	\$1,927	\$2,147	\$2,340	\$9,380
Total Annual Acquisition + All O&M, Spare	\$20,166	\$20,666	\$20,621	\$20,208	\$20,080	\$101,740

Table 5: Full 5-Year Buildout. Estimated annual costs for new HFRs and to maintain existing HFRs, (\$K)

9.1 Performance Metrics

Many potential metrics are available with which to gauge the performance of the buildout of the national HFR network. The intent of the HFR network is to follow the standards set by other operational networks and data providers such as those, for example, in the National Weather Service National Data Buoy Center (NDBC) and National Ocean Service's Center for Operational Oceanographic Products and Services (CO-OPS).

- Number of NOAA programs supported: This is projected to increase from four in Year 1 to eight in Year 5.
- Number of non-NOAA Federal agencies and other governmental agencies accessing the HFR data from the national servers: This is projected to grow from 2 in Year 1 to 10 in Year 5 (i.e., 2 agencies per year).
- Number of products transitioned from regional to national or new national products and models delivered: Within the 5-year period, two regional products will be transitioned to national; one national integrated satellite-HFR data product will

be developed. Two regional models will assimilate HFR data, and one will be transitioned to operations within the five years. The second regional model would be transitioned in later years.

- Number of quality-controlled surface current observations delivered by servers to publicly accessible website: The number of HFR-derived current velocities are projected to grow from 175M in Year 1 to 221M in Year 5.
- Percent availability of HFR servers.
- Number of visits to public website (both NDBC and CORDC).

The United States Coast Guard (USCG) routinely monitors the use of HFR data and STPS forecasts based on HFR data for their SAR operations.

As the Regional Coastal Ocean Observing Systems (RCO-OSes) assist local coastal zone managers in decision making, it is envisioned that the beneficial effect of HFR data on beach closing decisions and water quality monitoring will be quantified (see Section 7.2 for an actual example).

10. Frequency Allocation

As an agency of the Federal government, NOAA is required to seek radio frequency usage through the Interdepartment Radio Advisory Committee (IRAC), which is chaired by the National Telecommunications and Information Administration and is made up of representatives from agencies throughout the Federal government. All Federal Government requests for radio frequency usage must be approved by this committee. Private entities, as well as state and local governments, are required to obtain frequency licenses from the Federal Communications Commission (FCC).

Nearly all of the HFR systems in the United States are owned and operated by university research departments, with funding for the equipment obtained from federal, state, and/or municipal governments. To support the continued operation and expansion of this network, some of the radars use frequencies provided by NOAA, although the vast majority of the licenses currently in use were approved by the FCC.

All HFR licenses in the United States and most, if not all, worldwide bear the stipulation that they are used on a "not to interfere" basis. This means that a transmitting radio station with a "primary" license for that frequency can ask the HFR operator to change frequency or shut down. Because of the historical popularity of HF for communications prior to the advent of satellites, every 3 kHz slot in the HF band is occupied by a primary license holder somewhere in the world, most of which only transmit less than an hour a day or not at all. The FCC and IRAC, therefore, search for HFR frequency slots as far away as possible from other "primary" station transmitters. To mitigate the overuse of HF spec-

trum, an invention based on GPS timing synchronization allows many HFRs to operate on the same frequency, eliminating the need for a separate frequency for each. This is an attempt to minimize the HFR spectral footprint for other users of the HF bands. One potential requirement may be that all HFRs are equipped with GPS synchronization or another technique that is equally precise, to allow for frequency sharing. This may require retrofitting some older HFRs.

As part of the transition of the national HFR network to a fully operational status – and with a goal of further minimizing HFR spectral occupancy – NOAA is seeking primary frequency allocations in the 3 to 50 MHz range for HFR ocean monitoring (we note here that part of this range of frequencies, between 30 and 50 MHz, is actually part of the Very High Frequency (VHF) band). This process occurred through the World Radiocommunication Conference (WRC) and the International Telecommunications Union (ITU). The NOAA Office of Radio Frequency Management led this effort and developed a United States proposal that was submitted to the 2007 WRC (WRC-07). The proposal was added to the agenda, as agenda item 1.15, of the WRC held in January 2012 (WRC-12). The period between WRC-07 and WRC-12 was used to conduct technical studies to determine the impact of a new allocation to radio operators with existing allocations and to identify the most suitable frequency bands and bandwidths for the allocations. The outcomes of the WRC-12 were: (1) Several bands were approved for use by HF oceanographic radar, (2) HF radar operators should use frequency sharing techniques to minimize their spectrum us-

age, and (3) HF radar operators will need to broadcast a station identifier in Morse code at least once every 20 minutes.

The available frequency bands along with the usable bandwidths within those bands are given here:

4.438 - 4.488 MHz 50 kHz

5.250 - 5.275 MHz 25 kHz

13.450 - 13.550 MHz 100 kHz

16.100 - 16.200 MHz 100 kHz

24.450 - 24.650 MHz 200 kHz

26.200 - 26.420 MHz 220 kHz

41.015 - 41.665 MHz 650 kHz

43.350 - 44.000 MHz 650 kHz

Any HFR operator who needs to use a frequency band other than those given here would need to operate on an experimental license which may be granted by the FCC.

Currently, the FCC and NTIA are in the process of finalizing the allocation tables that will determine exactly which bands are available to HFR operators.

11. Additional Potential High Frequency Radar (HFR) Applications

HF radar systems, potentially, have additional capabilities to observe surface waves, winds, and to detect and track vessels. Dedicated deployments of assets to provide this information have been rare. However, opportunistic use of systems deployed primarily to observe surface currents have demonstrated the utility of HF radars for these purposes, which are undergoing research and development. Use of HF and VHF radar for freshwater current monitoring also has some interest but is still in a research and demonstration phase. These are promising capabilities, but this plan is based on HF radar delivering ocean surface currents data.

11.1 Vessel Detection and Tracking



Although ship echoes had been observed in HF sea-surface radars for 40 years and had been eliminated to optimize current mapping, after the 2001 terrorist attacks, the Office of Naval Research (ONR) initiated a three-year program with Rutgers and CODAR to develop vessel detection capability from real-time radars in the IOOS national network. This program was successful, and was followed by a number of

smaller efforts to extend this capability. None of this was at a sufficient level or intended to reach operational status.

In 2008 the Department of Homeland Security established the National Center for Secure and Resilient Maritime Commerce (CSR) and the Center for Island, Maritime, and Extreme Environmental Security (CIMES) – DHS Science & Technology (S&T) sister Centers of Excellence (CoE). Their mission includes basic research and education that develops and transitions new technologies supporting Maritime Domain Awareness (MDA) at three scales – the global scale observed via satellite, the approach scale observed by beyond-the-horizon HF radar, and the local scale observed via line-of-site microwave radars, cameras and underwater acoustics. The HF radar research focused on development of a dual-use surface-current mapping and vessel-tracking capability. This capability is designed to bridge a surveillance gap between the low update rates provided by global satellite coverage and the high update rates of local line-of-sight microwave radars and underwater acoustic sensors in ports and harbors. CSR established the first two multi-static dual-use HF radar sites that began reporting real-time surface-current mapping and vessel-detection results to an aggregation center in 2011. Two independent DHS studies indicate that: (a) a network of inexpensive compact HF radars is more effective and robust to countermeasures than large single radars; and (b) the demonstrated dual-use vessel-tracking capability indicates that a multi-static HF Radar network is a viable approach for establishing a national MDA capability.

There are three steps in the HF radar vessel surveillance process: (1) Detection of vessel peaks in the HF radar Doppler spectra. This detection process returns the range, the radial velocity component, and the bearing to each potential target. The algorithms are mature and are implemented at high-interest sites in the MARACOOS, AOOS and CaRA

regions. (2) Association of the detection peaks from multiple looks. Target peaks are seen among the various permutations of parallel signal-processing channels at a single radar, as well as multiple radars viewing the same vessel (including multi-static geometries); these may be the same or different targets. “Association” consists of sorting these candidates optimally. Those that are the same target are grouped, and a final, more accurate position and velocity are derived, along with tightened uncertainty estimates. False alarms are eliminated in this process. Research on this process is currently occurring within the CSR. (3) Track fitting to the associated peaks then provides a best-fit nowcast and short-term predicted track of each vessel. Track fitting has been demonstrated in two Department of Defense (DoD) studies to produce accurate tracks from associated detections, leading to the conclusion that existing trackers are sufficient once the detections can be aggregated through an association processes. A real-time association algorithm is being installed at a site in New Jersey, representing Step 2, for debugging and optimization.

Building a robust HFR capability to provide maritime domain surveillance has been a challenge that has remained unrealized to date because – following conventional radar practices – clutter and interference mask detection over 40% of the velocity spectra for a single radar. The way around this became obvious as the U.S. IOOS national network came on line and the multi-static augmentation within the HF radar network became mature. Overlapping coverage needed for current mapping and the introduction of multi-static operation allowed the same target to be seen simultaneously via many different geometries. This eliminates the masking problem inherent in the conventional large single-radar approach that has held back acceptance of that product for vessel surveillance.

11.2 Wave Measurements



Approximately four decades of research, supported by many peer-reviewed journal articles, suggest the promise of HF radars (WERA and CODAR) for providing information about the ocean wave field from Doppler spectra. At present, no operational capability for such wave parameter

output has been demonstrated, although research with both systems continues to make progress toward this objective. The NOAA IOOS Program has supported the development of “An Integrated Ocean Observation System Operational Wave Observation Plan” that recommended that approaches to evaluating HFR-derived wave data be developed and that “more dedicated validation is required.” That Plan provides guidance on HFR-derived wave measurements. The IOOS National HF Radar Technical Steering Team has released a position paper on the use of HF radar for wave measurement which can be found at www.ioos.noaa.gov/hfradar/use_hfr_wave_paper2012.pdf. The primary finding of the Steering Team was that only significant wave height has the near-term potential for operational use. However, to ingest and distribute HFR-derived wave data from appropriate HFR sites will require significant resources.

11.3 Freshwater Applications

There have been limited research studies of HF radar in freshwater, primarily in the 1990s. Several impediments still stand in the way of this application: 1) no commercial off-the-shelf radars have been demonstrated effectively; 2) there have been no long-term deployments; 3) in the Great Lakes, lake ice adds more uncertainty to the effectiveness of HF radar in those areas; 4) researchers have suggested that HF radars for the Great Lakes would need to be operated in a frequency-agile manner that would necessitate more radio spectrum usage. This is not compatible with the radio frequency license process presently underway and required by domestic and international regulatory agencies (see Section 10: Frequency Allocation).

The IOOS National HF Radar Technical Steering Team released a position paper in August 2012 that identifies the difficulties of freshwater-based HFR measurements. The position paper includes, as an appendix, a field study performed in May 2011 by University of Michigan and Codar Ocean Sensors using a standard Codar SeaSonde that demonstrated the performance of a commercial off-the-shelf system

12. Hardware and Network Design Details

This section discusses the existing HF radar hardware and network software systems as well as their continued expansion and enhancement over the life of this Plan.

12.1 Hardware Infrastructure

There are two types of HFRs currently in use in the United States: Compact direction-finding (DF) and linear phased array (LPA). More than 90% of the existing HFRs are of the DF type, commonly referred to as CODARs, originally known as Coastal Ocean Dynamics Applications Radars when they were developed within a NOAA Research laboratory. They are now produced by CODAR Ocean Sensors Ltd. under the tradename CODAR SeaSondes®. The most common LPA system is Wellen Radar (WERA) from Helzel Messtechnik of Hamburg, Germany. Of the 143 radars presently known to exist within the United States, most (129) are CODAR systems, while the others are WERAs.

This plan does not decide between the two types of HFR systems described above. However, as we move to an operational national system, configuration control(s) will need to be established. The plan does indicate there is a cost differential between the two systems, DF and LPA. The NOAA IOOS program will coordinate all new HFR purchases to justify HFR system type based on operational needs. This will be done in coordination with the appropriate RCOOS. Depending on the coastal application, HFR systems are acquired that transmit at frequencies that best meet the needs of the data user. The details of the use of transmit frequencies, other radar operating parameters, and a general tutorial on HFR are described in Appendix A.

12.2 Network Software System Design Details

The data system development effort focuses on building robust data communications from remote field locations (sites) for ingestion into the data system via data Portals. Portals are computer systems enabled with the Antelope Real-Time System (ARTS), allowing the acquisition, transfer, buffering, and serving of data. Once surface current data is within the ARTS framework, it is buffered and transported through Object Ring Buffers, a set of code-specific to real-time data delivery. Each Portal is designed to interact with any number of data repositories or Nodes that collect data from any number of regional Portals. A data system built around the concept of a distributed network provides redundancy by allowing multiple locations to house data, while addressing throttling issues during high usage periods. Aggregation of surface current data across regions enables integrated total vector processing on large scale national grids.

12.3 Network Management Details

Similar to the role of a system administrator for servers, the HFR network requires network administrators in order to ensure that new sites are cleanly integrated and that maintenance and upgrades are applied consistently across the network. Portals are now under exclusive control of HFR network administrators, while Nodes have shared control between network administrators and local users. The reason for differing management between Portals and Nodes is due to the fact that Portals affect data received by all Nodes, while Nodes are currently an end to themselves and don't influence other systems in the network. This enables local users to develop local products and algorithms as needed. More details about the Portals and Nodes are contained in reference guides at the Coastal Observing Research and Development Center (CORDC) documents website <<http://cordc.ucsd.edu/projects/mapping/documents>>.

Although the HFR network has reached proto-operational status, it is still in active development as metadata, quality control, and processing algorithms evolve. Development is carried out at CORDC with funding from NOAA Integrated Ocean Observing System (IOOS) and State of California. All new code is thoroughly tested on a development server before release onto the network. A deployment plan is drafted before network administrators install new code in order to minimize downtime and potential problems. In time, it is envisioned that HFR network developers will evolve as a distinct group from network administrators. This would enable developers to focus on design, while administrators can focus on operations and maintenance (O&M). Once developers have code ready for release, a deployment plan can be communicated to administrators for deployment.

Two mailing lists have been established in order to facilitate communication between local Portal and Node hosts and the HF-Radar Network administrators. The HFRNetOps mailing list is used by administrators to announce the addition of new sites or any other operational changes to the network to Portal and Node hosts. HFRNetAdm is used by local Portal and Node hosts to communicate the availability of new sites, server downtime, etc. to network administrators.

12.4 Network Servers Details

The HF Radar Network is built on a software application called Antelope, which, for x86 architectures, is currently tested on the SuSE distribution of Linux. For this reason, SuSE or RedHat Enterprise Linux (preferred) is used for operational systems in the HF Radar Network. Nodes additionally require MATLAB for total vector

processing. All servers require secure shell (SSH) services and port 6580 to be open for maintenance and data telemetry. Static IPs are required of all Nodes, while resolving hostnames are not. Mail services are required to be running on all servers so that Antelope can send mail regarding the system's health and status to network and local administrators. Network Time Protocol (NTP) services are run to keep the system clock from drifting, and the default run level is set to 3 in order to minimize services.

National Data Buoy Center (NDBC) is an autonomous data node, capable of handling data storage, data communications, and web display of quality assurance/quality control (QA/QC) HFR data for the available and participating HFR sites. Rutgers University will have the same capabilities as NDBC, serving as a backup data node together with the Scripps Institution of Oceanography in order to provide fail-safe access to real-time HF radar data. Each region in the national network stores information from HF Radar sites for future access and online distribution as needed and determined by the individual institution. At the present time, real-time data will be maintained for a period of 48 - 72 hours. The present configuration of the network nodes and some of the portals are shown in Figure 5.

In addition to the many applications of near-real-time HFR data, a number of user-applications require access to long-term data records that have been re-processed with additional quality control. These include monitoring long-term circulation trends; identifying features, such as eddies and front locations; and upwelling indices for purposes of ecosystem assessment. They also include developing tidal constituents, residual (i.e. non-tidal) current data sets and performing hindcast trajectory analyses for purposes of assessing discharge and oil spill risk and impact. Similar to re-processed remote sensing data, the HF radar national network will develop a database of historical surface current data, which will be updated monthly to provide climate quality records. The routine reprocessing performed by the system will allow for the transition of new velocity vector processing and QA/QC algorithms into reprocessing of data records, as well as the inclusion of new radial velocity data that may not have been available to the near-real-time processing stream. The development of this offline processing and storage system will build upon the existing national network's software architecture. Implementation of new processing algorithms will be vetted through the Technical Advisory Panel.

12.5 Data Server Operations and Maintenance

The redundant data servers at Scripps CORDC, NDBC, and Rutgers are managed and maintained by Scripps CORDC staff under funding from NOAA IOOS and the State of California's Coastal Ocean Current Monitoring Program (COCMP). In FY2009, NDBC will assume the maintenance and management of the servers located at Rutgers and

NDBC in coordination with the Scripps CORDC administrators. Analysis of the data load on the data servers will be of primary importance to ensure the requirements of the data do not exceed the capabilities of the servers. In conjunction with data server O&M responsibilities, NDBC shall continue to provide integration of HFR web display with the NDBC main website.

12.6 Web Display and IOOS Data Integration Framework (DIF)

The CORDC at Scripps has developed a website for viewing the near-real-time vector velocities <<http://cordc.ucsd.edu/projects/mapping/maps/>> and for prototyping new display features. Also, this site allows for web access to a number of diagnostic parameters from the individual HFRs that help to troubleshoot operating problems. These diagnostics will be expanded and enhanced with further development of the national HFR operational network. The NOAA web interface is located at the NDBC <http://hfradar.ndbc.noaa.gov> where the HFR data is integrated with other current measurements ingested by NDBC. The final configuration of the NDBC HFR website is by direct query of the data portal servers directly from the NDBC HFR server. A national grid encompassing the continental United States was created to integrate four areas of improvement have been or are near completion for the IOOS HFR website hosted at NDBC. The first area was in the visualization of the HF Radar RTVs. The rendering speed of the graphical display and clarity of information was addressed via Google technology and was implemented via the website in June 2008. The second area of enhancement was displaying additional data along with the RTVs. NDBC stations with surface deployed current meters and profiling current meters have near surface velocities displayed in conjunction with the HFR RTVs. The third area involves tracking metrics for availability and variability of data receipt and performance of the computation of HFR RTVs. There already exists fairly extensive metrics for the construction and tracking of the radial data provided to the portals, but very few statistics exist for the construction of the RTVs. The fourth area is in dissemination of metadata of the HFR measurements. This is primarily comprised of frequency, range, and resolution of the HFR sites that provide the radial measurements that feed the portals.

The data management principles adhered to by the national data server development are compliant with IOOS Data Management and Communications (DMAC) and have been coordinated with the IOOS Data Integration Framework (DIF) while ongoing HFR data management efforts ensure continued compliance. The DMAC recommendations for topics, such as data formats, metadata variables and formats, data transport, and data delivery, are each addressed.

13. Data Management Details

13.1 Data Description

For the purposes of this document, there are three levels of HFR data (Levels 0-2):

- Doppler spectra
- Radial velocities aka “radial data” or “radials”
- Total vector velocities aka “totals”

HFR surface current velocity data are somewhat unique in the oceanographic observation world since they have all the following attributes: 1) they are two-dimensional ocean surface measurements; 2) they are derived from a fixed land-based remote sensor; and 3) they are placed on a fixed grid.

The Doppler frequency spectra produced from the backscatter of the electromagnetic radio waves off the ocean surface are processed into georeferenced radial velocities. The national server ingests all available radial data files each hour to create gridded total vector velocity files.

13.1a. Doppler Spectra

The Doppler spectra are processed and stored at each radar site. The radar operating parameters that modify the output Doppler spectra are occasionally changed by the operator, but the manufacturers’ default settings are the norm.

However, the quality of radial velocity data is dependent on the quality of the Doppler spectra. A number of diagnostic parameters derived from the spectra have been, and are still being, investigated for their efficacy as performance metrics (see Section 13.5 - Quality Control).

It is expected that the primary use of the stored spectra files will be for reprocessing in a retrospective mode. They can be delivered to the regional and national servers in non-real-time for eventual storage in an archive (see Section 13.4 - Archive).

13.1b. Radial Velocities

The radial velocity data, produced by each radar site, are combined with other sites’ radial velocity data to create the total vector velocities. This data type is derived from the spectral processing of the Doppler spectra (see Section 13.5 - Quality Control). However, since these radial velocity data are at a more fundamental level, they are generally of interest only to ocean circulation modeling that can assimilate them and to researchers investigating, for example, vector-combining algorithm development or objective analysis methods development.

To promote data format interoperability, HFR data providers have been exchanging radial velocity data files in a latitude,

longitude, u-velocity component, v-velocity component self-documenting ASCII text column format for several years, commonly referred to as “LLUV format.” This format contrasts with, for example, the previous native format from the CODAR Ocean Sensors, Ltd. (COS) HFR system, which was based on a range and bearing format somewhat akin to that of a scanning radar and required external documentation in order to interpret the data values. The LLUV format has now been adopted by both COS and Wellen Radar (WERA) systems.

13.1c. Total Vector Velocities

These data are the velocities that are most needed by end-users and that are provided by the HFR data servers. Totals are produced at the servers by an algorithm that uses the radial velocities as input. The particular algorithm used has, historically, been chosen by the researcher using the HFR data. Recent analysis performed for IOOS has led to a consensus algorithm choice for the national servers. In essence, the algorithm combines radial velocities from two or more radar sites to form total vector velocities on a pre-defined latitude-longitude grid that is sparse because of the remaining gaps in geographic coverage of HFR.

Because of variable coastline geographic geometries and the availability of data from any particular HFR site, the number of radials that compose a total vector will also vary.

The grid chosen for the vector data is a constant latitude and longitude spacing on an equidistant cylindrical projection. This grid provides orthogonality at all grid vertices at the sacrifice of constant resolution and equal area for each grid cell. Grid metrics (data about vertical and horizontal grid spacing and grid areas) are based on the World Geodetic System (WGS84) ellipsoid standard.

The network Common Data Form (NetCDF) Climate and Forecast (CF) Metadata Convention Standard Name Table can accommodate the total vector surface current velocity data type.

Also of note is the capability to provide best-known vector velocities that are composed of reprocessed radial velocities and the capability, still under R&D, to create gap-filled vector velocity fields via objective analysis/optimal interpolation methods. The former capability has greatest use for applications that do not require near-real-time data, while the latter capability has use for both near-real-time and retrospective applications.

13.2 Data Access and Transport

The NOAA Data Management Integration Team has identified data transport and access standards that are desirable for IOOS. The intent of this section is to illustrate that the development of the HFR data management scheme is compliant with existing standards for data transport and access. The standards are identified here, while the implementation is being carried out by the NOAA IOOS DIF. The standards for transport and access include:

13.2a. Relational Database Management Systems (RDBMS)

For internal data transport and storage, an RDBMS provides an effective interoperable solution. Currently, the HFR radial metadata are managed by Datascope, a commercial product distributed by Boulder Real-Time Technologies (BRTT) as part of its Antelope software. Datascope was chosen for its scalability and proven ability to robustly handle real-time telemetry between data servers and hundreds of remotely located sensors. The data server administration staff continues to explore non-proprietary database options.

13.2b. OPeNDAP and Open Geospatial Consortium (OGC)-compliant Web Services

The HFR total vector gridded data files are Climate and Forecast Conventions (CF)-netCDF-compliant to allow for Open-source Project for a Network Data Access Protocol (OPeNDAP) delivery (also see Metadata section below).

Open Geospatial Consortium (OGC) Web Map Services (WMS) provide web access to data maps delivered as png, gif, or jpeg images. Web user interfaces will use WMS when images, such as Georeferenced Tagged Image File Format (GeoTIFF), of the HFR data are being delivered.

National Data Buoy Center (NDBC), working with the NOAA IOOS Program, implemented OGC Web Coverage Service (WCS) for the CF-netCDF files via an IOOS DIF-provided schema.

13.3 Metadata

13.3a. Gridded Total Velocity Vector Metadata

The metadata for gridded HFR total velocity vector data will be compliant with the standards set forth in netCDF Climate and Forecast Metadata Conventions (Version 1.0, 28 October, 2003). This metadata type is equivalent to the “granule-level” type often used in the satellite remote sensing community.

The CF Standard Name Table currently has the following names and definitions that are appropriate for gridded HFR total velocities:

- surface_eastward_sea_water_velocity

The surface called “surface” means the lower boundary of the atmosphere.

A velocity is a vector quantity. “Eastward” indicates a vector component, which is positive when directed eastward (negative westward). $m\ s^{-1}$

- surface_northward_sea_water_velocity

The surface called “surface” means the lower boundary of the atmosphere.

A velocity is a vector quantity. “Northward” indicates a vector component, which is positive when directed northward (negative southward). $m\ s^{-1}$

By using the CF ancillary_variables attribute (Section 3.4 of the netCDF Climate and Forecast Metadata Conventions document), the gridded data type’s metadata can be expanded to include data quality metadata for each grid point.

Processing-related metadata would be invariant for a particular gridded dataset and, therefore, would be included in “global” attributes or in “collection level” metadata. See Appendix E for a preliminary list.

Software development, funded by NOAA IOOS, is currently in progress to ensure CF-compliance while the metadata are being identified.

13.3b. Radial Velocity Metadata

There are numerous HFR metadata associated with the radial velocity data. Static site-specific metadata are sometimes referred to as “station level” metadata, while the quasi-static and time-varying metadata, noted below, are called “collection level” metadata.

13.3b1. CODAR Systems

For CODAR systems, metadata types are embedded in the radial velocity files. The static and quasi-static metadata are stored in the header portion of the ASCII radial data file delivered to regional and national servers. Currently, they are stored in a commercial database product, Datascope, from BRTT. Most of the static and quasi-static site-specific metadata are named using understandable text strings. However, some of the site-specific metadata and most of the diagnostic metadata currently require some external documentation available at the COS website.

The CODAR radial velocity metadata can be logically partitioned into three basic types:

CODAR Static Site-specific Metadata

These metadata are the conventional metadata associated with most stationary data sensors. These will be compliant with the Federal Geographic Data Committee (FGDC) metadata standards, and an example in Extensible Markup Language (XML) format that conforms to Content Standard for Digital (CSDGM) core requirements has also been developed. Examples of the types of parameters include site name, owner of the site, and operator of the site.

CODAR Quasi-Static Site-specific Metadata

There are approximately 40 parameters of this type of metadata. They include radar operating parameters, such as transmit frequency, transmit bandwidth, and spectral processing algorithm parameters. Generally, for an operational HFR system, these would only change because of, for example, software updates, deliberate decisions by HFR network management (e.g., changing transmit frequency in order to change the range extent of a radar), or processing enhancements. These metadata are currently stored in a proprietary database that is under review for a non-proprietary solution.

CODAR Time-Varying Metadata

There are approximately 60 parameters of this type of metadata. As for the quasi-static parameters, these are also stored in a proprietary database. These include many parameters for diagnostic monitoring of an individual HFR and, for example, intermediate values within the spectral processing stream that are useful for quality control (QC) metrics. The hardware-related parameters are recorded every 15 minutes, and the signal-processing-related parameters are recorded every 10 minutes.

Clearly, then, a database for the time-varying metadata alone is larger and more complex than the radial velocity database itself, which are a once-hourly 4-item dataset. This is noted only to illustrate that additional database development and storage capacity needs will grow.

13.3b2. WERA Systems

The radial velocity files from WERA systems, as presently configured, have a much more limited set of metadata. To some extent, this is because the processing algorithms do not require as many parameters as the CODAR systems, but also there are many other WERA metadata parameters that have yet to be ingested by the network. For WERA systems, the static metadata include all the standard items, such as station location. The time-varying metadata include the signal-to-noise ratio and total signal power for each radial velocity data point. More software development may be needed to increase the metadata for the WERA radial velocity files so as to allow for a complete characterization of the data and operation of the radar.

13.3c. Total Vector and Radial Velocity Metadata Linkages

It is envisioned that the complete metadata for each total velocity vector would be linked to the radar site names that contributed radial velocity data to the total vector. Then, the complete radar sites' metadata could be accessed for a specific time/location of the gridded totals. This is believed to be a necessary requirement for monitoring the data quality and the health of the radar network.

13.3d. Doppler Spectra Metadata

For this unique data type, substantial metadata development must still be undertaken as part of the national network. Preliminary research indicates that the International Organization for Standardization (ISO) 19115 metadata standards have possible application.

13.3e. Additional Metadata Topics

Additionally, the FGDC Remote Sensing Extensions (RSE) allow for considerable definition of instrument-specific metadata. For the HFRs, some examples might include transmit frequency, frequency bandwidth, and software version number. When appropriate, FGDC RSE will be used.

Work underway in FY09 will inform the decisions as to which HFR metadata from the radial velocity files are needed in the CF-netCDF files for total vector velocities and which should be confined to the radial velocity metadata database.

Finally, as FGDC evolves toward ISO 19115-2 standards, the HFR metadata will also evolve toward ISO-compliance.

13.4 Archive

While the NDBC Data Assembly Center (DAC) will have some limited non-real-time storage ability, the archiving of data is the responsibility of NOAA's National Oceanographic Data Center.

The data to be archived include the radial velocity data and the total vector velocity data with their associated metadata. A lower level data type, Doppler spectra, from which radial velocities are derived, will also be archived. However, existing metadata standards do not presently provide the appropriate parameters for HFR Doppler spectra. In coordination with the NOAA IOOS DIF and the IOOS DMAC process, the metadata standards for describing the Doppler spectral data will be identified and developed by NOAA IOOS-sponsored efforts. Similarly, metadata standards for HFR antenna pattern measurements will also be developed so that these measurements can be stored and archived. National products, such as Level 3 and 4 products, e.g., gap-filled velocity fields, would also be submitted for archival as they transition to operations.

Preliminary estimates for the size of the archive per RA range from about 6 terabyte/year, growing to about 25 terabytes/

year at buildout, which include the radial velocities, the gridded total velocities, and the Doppler spectra.

The archival decision making process will follow the NOAA Procedure for Scientific Records Appraisal and Archive Approval (2008). This procedure specifies a mechanism to formally document and maintain the steps NOAA takes in identifying, appraising, and approving what scientific records are preserved in a NOAA archive. Some of the input to the process are: data description, including instrument description and processing description; documents, such as user guides; metadata; transfer protocol to the archive center; file size(s); volume per day or month; user access requirements; and search criteria required. In the context of the NOAA archive, “raw” data will refer to the HFR Doppler spectral data. The archival process also allows for multiple versions of the data sets; such as reprocessed data using improved algorithms or recalibrated hardware.

13.5 Current Velocity Data Quality Control and Processing Description

QC is performed at many stages during data processing. Radial data (Sections 13.5a-c) are quality controlled during each of three main processing stages:

- At the radar site on the radar-dedicated computer during production of georeferenced radial velocities with bearing determination from raw signal voltages
- Upon acquisition of radial data by HFR network portals
- During processing for production of synoptic surface current maps (Total vector velocity data quality control are also performed at this stage)

Existing quality control and surface current processing algorithms in the HFR network are documented below, along with work in progress aimed at delivering the next generation of QC metrics.

13.5a. On-Site Radial Velocity QC

Radial velocities derived from surface ocean backscatter of HFR are dependent upon the quality of Doppler spectra formed from the reflected energy. Prior to estimating radial velocities, the manufacturers’ software performs quality control on the Doppler spectra to ensure they are of suitable quality for velocity estimates. The internal software parameters used to determine whether spectra are acceptable have been empirically derived and refined over 20 years of research, development, and user feedback. These tests include, but are not limited to:

- Noise floor detection and computation
- First order Bragg peak detection and measurement (Doppler frequency limits of first order are determined in CODAR systems)

- Second order peak detection and measurement
- Individual spectrum signal-to-noise ratio (SNR) computation for the first and second order peak
- First to second order ratio measurement
- Detection and removal of burst interference (e.g., lightning)
- Detection and removal of ionospheric echo
- Detection and removal of ship echoes

Doppler spectra are rejected, and radial velocities are not produced from them depending on the outcome of these tests. Since these processes influence the production of radial velocities, they are inherently part of the quality control process for surface currents.

13.5b. Data Portal-Resident Radial Velocity QC

Radial data QC is performed upon file acquisition by the network portals and consists of basic file integrity and consistency tests. Any given radial file must pass all QC tests before being placed in the object ring buffer (ORB) for distribution in the network. Performing basic QC on files upon acquisition prevents incomplete files from entering the network and allows downstream quality control to focus on specific tests, such as radial velocity uncertainty. The specific tests performed on radial velocity files upon acquisition by a portal are described below. Radial files failing to meet these criteria are not placed on the ORB for distribution.

File Format Independent Tests

All radial files, regardless of format, must have a timestamp consistent with the current date or a past date, not a date in the future. This test was established in order to protect against occasional files with timestamps from the far future (i.e., year 2040). Currently, all radial files acquired by HFR network portals report the data timestamp in the filename. The filename timestamp must not be any more than 72 hours in the future relative to the portals’ system time.

CODAR Range-Bin Format Tests

Range-bin format files are converted to LLUV format before distribution through the ORB. Several QC tests are performed upon converting the file including:

The file name timestamp must match the timestamp reported within the file

Files must contain radial data (bearing, velocity, and uncertainty)

As a minimum, the following metadata must be defined:

- Site code (obtained from filename)
- Timestamp (obtained from filename)
- Site coordinates (reported within file)
- Antenna pattern type (measured or idealized, obtained from filename)

- Timezone (UTC or GMT only accepted, reported within file)

LLUV Format Tests

Before placing LLUV format files on the ORB, the following tests are performed:

The file name timestamp must match the timestamp reported within the file

Radial data tables (Lat., Lon., U, V, ...) must not be empty

Radial data table columns stated must match the number of columns reported for each row (a useful test for catching partial or corrupted files)

The site location must be within range:

As a minimum, the following metadata must be defined:

- Filetype (LLUV)
- Site code
- Timestamp
- Site coordinates
- Antenna pattern type (measured or idealized)
- Timezone (UTC or GMT only accepted)

13.5c. Real-time Velocity (RTV) Surface Current Processing

Once radial data arrives at an HFR Network Node, it is available for integration with other radial velocity measurements from neighboring sites through surface current mapping. The HFR Network's primary proto-operational product is the generation of RTVs, which are ocean surface currents mapped from radial component measurements. There are three general steps in producing RTVs:

- Radial data QC
- Surface current mapping
- Resolved surface current QC

Radial Velocity QC

Questionable radial velocity measurements are removed prior to mapping surface currents in order to reduce error. Two criteria must be met in order for a radial measurement to be used in deriving RTV solutions. The radial velocity must be (a) below the maximum radial magnitude threshold and (b) located over water. The maximum radial magnitude threshold represents the maximum reasonable radial magnitude for the given domain. This maximum radial threshold is 1 m/s for the West Coast of the United States and 3 m/s for the East/Gulf Coast. These maximum thresholds will be refined as the network evolves so that special cases can be handled properly, such as e.g., the Columbia River outflow and Cook Inlet, Alaska. Landmasking of radial solutions is performed using polygons derived from the World Vector Shoreline database collected by the National Geospatial Intelligence

Agency and obtained from the National Geophysical Data Center (<http://rimmer.ngdc.noaa.gov/mgg/coast/getcoast.html>).

Surface Current Mapping

Surface currents are mapped onto regional grids based on equidistant cylindrical projections with resolutions of 500m, 1km, 2km, and 6km. Regional grids have been developed for the West Coast of the United States, the Gulf of Alaska, and the Gulf/East Coast of the United States. In order to reduce the solution space, grid points over land and near the coast (within 1/2 km) are removed.

Surface currents are derived using a least square's fit to radial velocities (following Lipa and Barrick, 1983; Gurgel, 1994) within a pre-defined distance from each grid point. Radials must come from at least two different sites, and there must be at least three radials available in order to produce a velocity estimate for a given grid point. The search radius around each gridpoint is approximately 30% greater than the grid resolution. Actual search radii for each grid resolution defined are given below:

Grid Resolution (km)	Search Radius (km)
0.5	0.75
1	1.5
2	3
6	10

The contribution of each site's radials to solutions for a given resolution are currently determined solely by the site's operating frequency. Sites operating near 25 MHz and higher contribute to solutions at 1 km resolution, 12 MHz and higher sites contribute to solutions at 2 km resolution, and all sites contribute to solutions at 6 km resolution. Site selection for each resolution will eventually be determined by the radial range resolution instead of operating frequency.

Real-time Velocity (RTV) QC

Surface currents derived from integrated radial velocity measurements must not exceed the following thresholds:

Maximum total speed threshold

Maximum Geometric Dilution of Precision (GDOP) threshold

Like the maximum radial speed threshold, the maximum total speed threshold represents the maximum reasonable surface velocity for the given domain. The maximum total speed threshold is 1 m/s for the West Coast of the United States and 3 m/s for the East/Gulf Coast domain. As mentioned above for radial velocities, these thresholds will be refined for regions of known routinely strong currents.

GDOP is a scalar representing the contribution of the radial (bearing) geometry to uncertainty in velocity at a given gridpoint. Higher GDOP values indicate larger covariances associated with the least square's fit used in obtaining the solution. The GDOP maximum threshold is 10 for all domains. However, near-real-time applications, such as web display, apply a more conservative maximum threshold of 1.25 to RTV solutions.

13.5d. Active Developments in Quality Control

A variety of Multiple Signal Classification (MUSIC) algorithm decision metrics will be collected and statistically analyzed for QC purposes. These QC metrics include (but are not limited to):

- SNR for each antenna
- Cross spectra covariance matrix eigenvalues
- Single and Dual angle solution
- Direction of Arrival (DOA) metrics (magnitude)
- Direction of Arrival (DOA) function widths (3 dB)
- Signal amplitude matrices

Statistical distributions for all QC metrics will be generated, and first and second order moments will be determined and continuously maintained. When radial solutions have QC metrics that fall below a threshold (e.g., the mean value minus three standard deviations), they will be flagged as having low quality. An overall quality metric for each radial will be computed, for example, on a scale of 0-5. A metric of 0 would indicate low values of all metrics listed above and poor quality; a score of 5 would indicate high values of all metrics and good quality. The overall quality metric for each radial solution will be displayed in conjunction with the radial output. Users will be able to view plots of radial quality metrics over the observation area of the HFR. This will indicate spatial areas with low quality solutions.

In the future, the overall quality metrics can be passed on with the radial solutions to the total current vector algorithm, and poor quality radial data can be filtered out before the total current vectors are computed.

14. Conclusions and Next Steps

Responding to clear requirements for increased and improved coastal surface current measurements throughout the United States coastal waters, NOAA, on behalf of the IW-GOO, along with the IOOS Regional partners have developed this Plan. The most cost-effective technology for meeting the present-day requirements of the 21st century is High Frequency Radar (HFR). Within the Regional Coastal Ocean Observing Systems (RCOOSes), numerous applications of HFR data have already been underway and have proven to be effective for near-real-time decision-making. Examples include hazardous spill tracking and response, wastewater pollution tracking, and marine navigation. Assimilation of HFR data into circulation models has been shown to increase model nowcast/forecast accuracy.

To fully meet the requirements for coastal surface currents data, a number of items need to be well-defined as we moved from a collection of pre-operational HFR regional networks to a fully operational network. These items include: (1) define standard configuration(s); (2) provide additional HFRs to close the identified gaps; (3) fully support the system by providing for spares and necessary technician support. The

gap analysis identifies an additional 208 additional HFRs that are needed and the support required to sustain these systems.

Providing the HFR data and products requires a national data server and management infrastructure. For the past four years, NOAA IOOS has funded the development of this infrastructure that includes a distributed server system with national and regional nodes, standardized data file formats, metadata, quality control, and delivery services.

Under the Plan, the national capability would add increased quality control, archiving, regional operational model assimilation of HFR data, transitioning regionally-developed products to national application and developing new national applications.

This Plan brings together the ideas of oceanographic experts from NOAA, other Federal agencies, academia, industry, and the RCOOSes as to how to build a sustainable, cost-effective national capability for ocean surface current observing and forecasting. Continued cooperation among these interests ensure that a viable national HFR network can be obtained.

Appendix A: High Frequency (HF) Radar Current Mapping Explained

A.1. How the Signal Scattered from Ocean Waves Leads to Currents

A.1a. The Bragg Mechanism Produces Two Distinguishable Doppler Peaks

The fundamental quantity that allows coastal HF radars to map ocean currents is the unique echo scattered from the surface waves. This was discovered experimentally and theoretically in the 1950s and 1960s. This pioneering work was done by Crombie and Barrick, who both ended up at the National Oceanic and Atmospheric Administration (NOAA) during the 1970s to advance the field through the early research and development (R&D) phases.

If one creates spectra from the radar echo time series, two large, distinct peaks are observed, nearly symmetrically

placed about the center position. The reason that peaks are displaced from the zero-frequency center is target motion: its velocity shifts the frequency from that transmitted by the well-known Doppler effect. The near-symmetric shift of these two peaks to the left (negative Doppler) and right (positive Doppler) results from the fact that the scattering waves important to the radar are those precisely half the radar wavelength. This was named “Bragg scatter,” after the 19th century scientist who related the scatter direction of X-rays from a crystal to its periodic lattice structure. Two sets are possible: one traveling toward the radar (producing the right-side peak) and one traveling away from the radar (for the left-side peak). Though waves having different lengths and traveling toward other directions are always present, these scatter to different points of space other than the radar, by the same Bragg mechanism. This is depicted in the blue spectral sketch below, which shows that for the “no current” condition, the Bragg peaks are arrayed perfectly symmetric about the center.

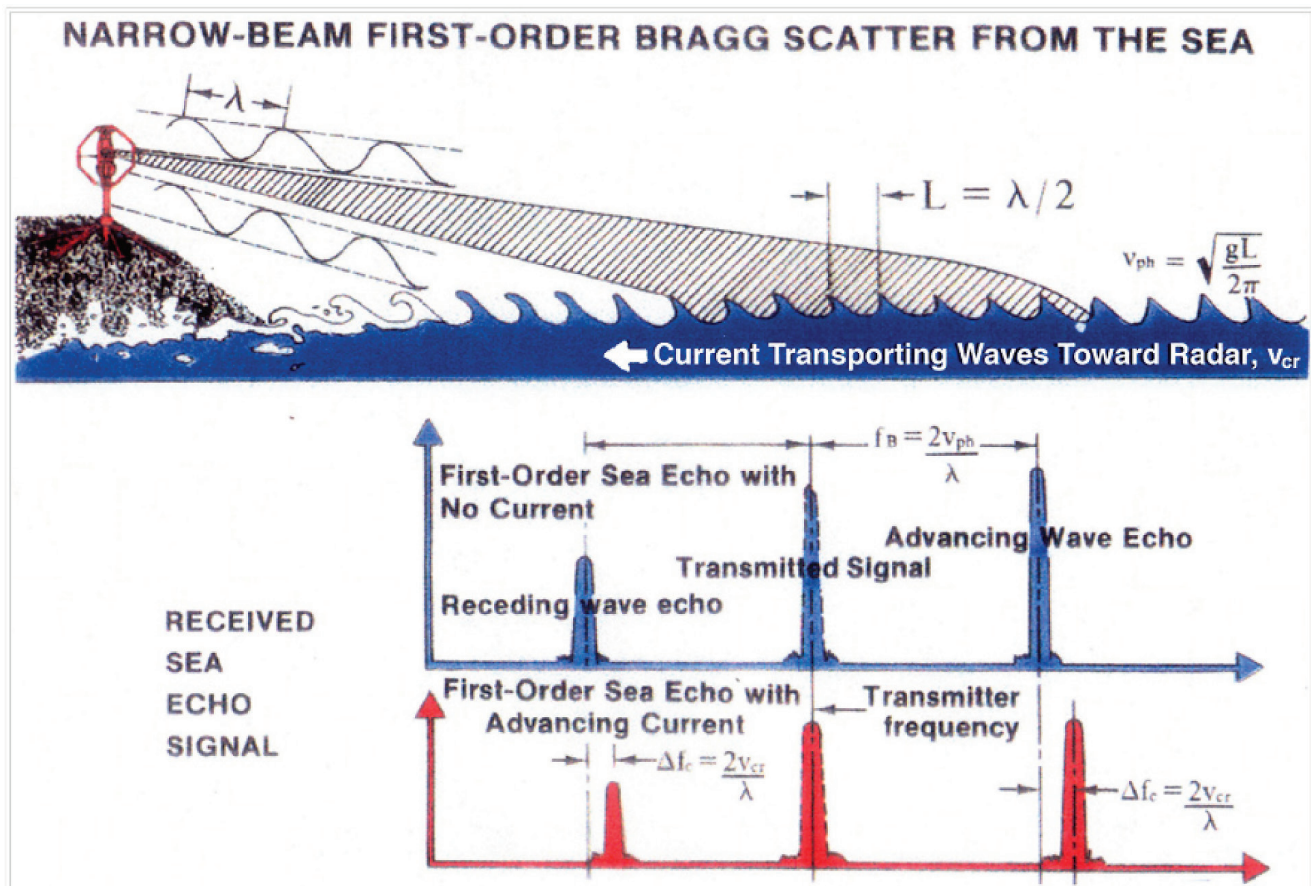

A.1b. Underlying Surface Currents Shift the Doppler Peaks

If a current is transporting the scattering waves, this adds to the overall scatterer velocity. This is illustrated in the above figure, with the white caption and arrow under the waves. If this current is moving toward the radar on shore, the Bragg peaks are both given an added positive Doppler shift, moving them to the right. This is shown in the red spectral panel. Although the shift due to currents is small compared to that from the waves, it is precisely measurable. This incremental displacement is measured and related to current velocity through the Doppler relation, whose equation is shown in the figure. However, any radar (including that used by police to measure auto speeds) can sense only motion toward or away from the radar. It is sometimes termed a “radial velocity,” or just “radial.” This component by itself is not the complete 2-D current vector that is needed to describe flows. To determine that, another radar must observe the same spot on the sea from a different direction.

A.1c. HF Sees Beyond the Horizon

HF radar is a very old, but an uncommon variety of radar. Operating at frequencies thousands of times lower than the popular, ubiquitous microwave radars, there have only been approximately 300 HF radars built and operating in the world, whereas there are perhaps 2 billion microwave radars in existence. The market and applications for HF are highly limited, with current measurement and its mapping being the principal application by far.

The main feature touted for HF radars is the ability to see beyond the horizon when propagating over conductive sea water. This is not due to the atmosphere nor ionosphere. Rather, it is a “waveguide-type” effect. The vertically polarized electromagnetic waves attaches to the mean spherical sea surface. The lower the HF frequency, the farther the signal reaches beyond the visible horizon. At 5 MHz, with modest transmit power, radar distances of 200 km are common even though the horizon for a microwave radar may be only 30 km away. Above 100 MHz, the signals become restricted to line of sight, the same as microwave and optical transmissions. HF radar requires that the transmitted radio signal be conducted across the sea surface. Since freshwater is inherently 5,000 times less conductive than seawater, HF signals do not travel nearly as far over freshwater. As an example, a standard 12MHz signal might travel 90 km in the coastal ocean, but only about 5 km over one of the Great Lakes.

A.2. The Radar System Itself (shown below)

A.2a. The Receiver Is the Heart of the System

In all of the HF radars used today, the receiver section is its core. Signals needed are generated here. This is done digitally, based on direct digital synthesis (DDS) technology that allows precise control of all aspects of the frequency and waveform. Echoes arriving into the receive antennas pass through the receiver and are digitized. Most present-day systems have one receiver channel for each antenna, giving optimal signal-to-noise ratio (SNR). USB is a commonly used communications protocol for transferring signal data to the computer/processor, while sending control commands for of all of the radar functions back to the receiver. One of the HF signals generated in the receiver subsection is passed to the transmitter. Since all signals come from a common source, they are mutually coherent – a requirement for optimal performance.

A.2b. The Transmitter Amplifies and Radiates the Signal

In most cases, the “transmitter” is merely an amplifier that boosts the power in the HF signal to a level suitable for radiation by the transmit antenna. If the signal is pulsed, then the transmitter is turned on and off, synchronized with the pulsing. The efficiency of the transmit amplifier can range between 15% and 85% for systems currently in use. Average power outputs for HF radars in use today are less than 50 watts. Although higher powers are possible that will achieve greater radar ranges, there are a number of reasons why this has been avoided: (1) It is more difficult to get frequency approvals because interference potential is greater; (2) The transmitter and system cost goes up nonlinearly with output power; (3) Air conditioning becomes a prohibitive burden.

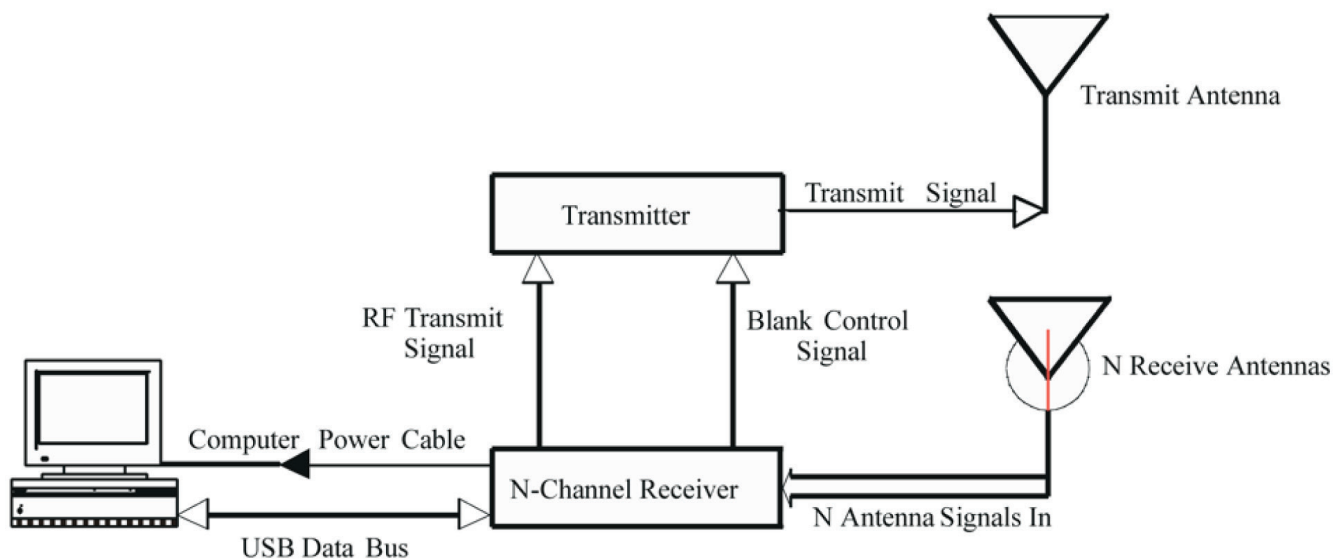

Figure A-2: Diagram of Core HFR Components and Data Flow

A.2c. The Field Computer Processor

At least one computer is included at each radar site; one is shown in the figure above. In many cases, this is a laptop PC. This computer/processor controls all aspects of the radar system operation. This same computer (in some systems, in tandem with a second unit) also processes the digitized echo signals in real time, usually going all the way through Doppler spectra (as pictured in our first figure) and, finally, to production of the radial velocities used in the current mapping. With the computing power of modern day PCs, these radar field processors are burdened at typically only a 5% capacity during continuous radiation and operation for current mapping applications.

A.2d. The Container and Air Conditioning

The size, volume, and power requirements of the radar electronics can vary quite a bit from one vendor to another. In some cases, it makes sense to house the system in a metal shipping container that sits on the beach within cable reach of the antennas. In other cases, an entire radar unit consists of two chassis and a laptop processor on a desk or inside a closet of a lighthouse or other available existing building on the coast. Power requirements for radars in operation today vary at one end from 350 watts supplied by solar/battery systems at remote sites that must operate “off the grid.” In other cases, power required exceeds 1.5 kW. These power requirements are for radar electronics only and do not include air conditioning.

Except for operations at higher, cooler latitudes, nearly all installations must include air conditioning. Both the external, ambient temperatures (and in most cases, the highly corrosive humid coastal environment), as well as heat generated by the electronics, will necessitate air conditioning to keep electronics/computer temperatures below 40° C. Often the air conditioning power requirements exceed that of the system electronics. In cases where systems operate “off the grid” from solar/battery, clever heat exchangers have been used that require minimal extra power to operate.

A.2e. The Antennas

We discuss here the transmit antenna and its pattern; the receive antennas are covered in the next section. The most compact transmit antenna in widest use today is a single vertical monopole or dipole with an omnidirectional pattern in bearing angle. However, many systems employ two or four such monopoles in an array in order to beam the energy toward the sea, while minimizing radiation back over land.

Nonetheless, in contrast to microwave radars that transmit and receive in a narrow beam, all HF systems radiate a “floodlight” field-of-view pattern. This means that they illuminate simultaneously an angle sector from $\pm 45^\circ$ through a full 360° view, the latter being necessary/useful for operation from an offshore platform or small island. This allows echoes to come back from a very wide angle sector at the same time. Some commercial systems being sold now combine the transmit and receive antennas into a single unit, comprising a post with the radiating elements up out of reach; and often, the latter are mounted on roofs of available coastal buildings.

A.3. The Radar Observables That Lead to Radial Current Maps

A.3a. The Doppler Shift Determines the Radial Current Speed

In the first section we discussed how and why Doppler shift from the moving waves and underlying currents is fundamental and essential to HF radar current mapping. The Doppler spectrum from the signal at different ranges and bearings and/or antenna channels is calculated quickly, in real time at the field processor, using a simple fast Fourier transform (FFT) algorithm. The Doppler frequency of the Bragg-peak echo is directly related to the radial current speed through the equation shown in the first figure. This important Doppler-shift/radial-velocity is the most accurate observable produced by an HF radar.

A.3b. The Signal Waveform and Its Processing Give the Radar Cell Range

Most conventional microwave radars use very short pulses to determine range to the radar target. This is done by measuring the time of flight from pulse transmission to echo reception. All HF radars in operation today (available from at least four commercial vendors) employ another signal format. The signal frequency is slowly swept linearly over a predetermined bandwidth and then repeated. The time delay (related to target range) is thereby translated to a frequency offset of the echo. This frequency offset giving the range cell distance is also calculated by FFT processing at the radar site, done before the Doppler processing described above. This waveform and its digital processing dates back to its 1972 inception at NOAA; it is referred to as frequency-modulated continuous wave (FMCW). The target range determined in this manner is the second most accurate observable with HF radars.

Some HF radars “pulse and gate” the FMCW signal. This consists of turning on and off the continuous signal at a slow rate (although it is faster than the linear sweep repetition frequency). The half-on-half-off waveform thus has a 50% duty factor. This is advantageous when transmit and receive antennas are very close or colocated, in order that the strong transmit signal does not overload the receiver.

A.3c. The Receive Antenna System Is the Basis for Echo Bearing Angle

The third – and least accurate – HF radar observable is the bearing angle to the target (or in our case, to the radar echo cell on the sea surface). The methodology used to extract it follows one of two routes, both being used in systems operating today.

A.3c.1. *Phased-Array Beam Forming and Scanning*

This technique employs a linear array of receiving antenna elements on the beach. These arrays were first used in 1960s HFR campaigns. Normally, between 8 and 16 individual array elements are spaced about 1/2 wavelength apart. Recent options use curved and randomly spaced arrays instead of uniformly spaced linear arrays. By phasing the signals from these elements in a linearly varying progression, a narrow beam is formed and pointed to a desired direction, much as a flashlight forms and directs a narrow light beam. The beamwidth depends on the ratio of the wavelength divided by the array length and on the angle toward which the beam is steered. Since this phasing is done on digital signals after reception, an overlay of beams is simultaneously formed across the field of view. Such arrays can span between 50 m and 400 m, depending on the radar frequency band and the number of array elements deployed. In some systems that do not use pulsing/gating, the transmit antenna must be separated from the receive antenna array another 200 m. Cabling from the electronics enclosure runs out to all of the transmit and receive antenna elements.

A.3c.2. *Direction Finding (DF) for Bearing Determination*

DF is based on phase and amplitude differences in the patterns of receiving antenna elements. The simplest example is a loop antenna, as is found inside hand-held AM radios; rotate the radio, and you will find a direction where the received signal is strongest and another where it is weakest. This is direction finding and was first used in World War 1 to locate enemy radio transmitters. With HF radars, DF is done without mechanically rotating the antenna but by software processing of the signals from several colocated or closely spaced, fixed, receive antennas. The first use of DF with HF current-mapping radars was done by researchers at NOAA in the 1970s – to replace the larger phased array antennas described above – with smaller, compact DF receive antenna units. Several commercial versions are available today. Often, colocated crossed-loop/dipole units are mounted on a single post and combined with the transmit antenna.

A.4. Producing 2-D Total Vector Maps from Radials (see figure below)

The 15-year old above example shows simultaneous radial vector maps at the top from HF radar systems at Santa Cruz and Monterey (40 km apart on Monterey Bay). By themselves, it is difficult to recognize the overall flow pattern. When they are combined trigonometrically, the blue-shaded total vector map below these two reveals Southward flow produced by upwelling happening further North along the coastline.

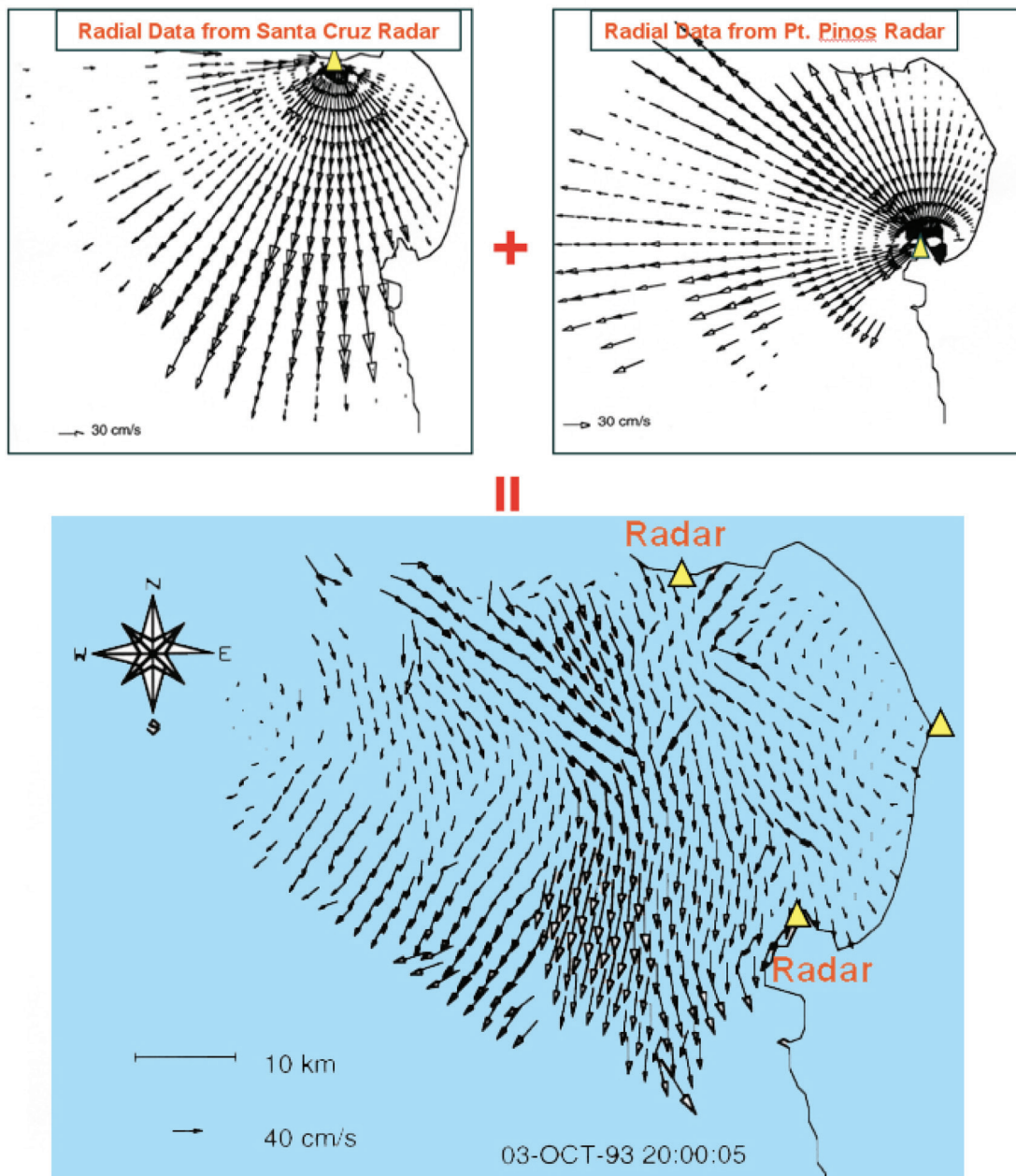

Figure A-3: Radial Velocity Maps from Two HFR Sites and Map of Combined Radials to Create Total Vector Velocity Maps

This geometry also allows us to highlight another complexity of producing total vector maps. Along the “baseline” directly along the two sites across the bay, the radials from both radars are parallel, and one theoretically cannot calculate total vectors. This is referred to as the region of baseline instability. To estimate 2-D vectors across this region, two options are available: (1) Place a third radar so that its radials cross this baseline at a different angle. This in fact is what was done to solve the problem for this case; the yellow marker to the right is the Moss Landing radar; (2) Interpolate the unstable transverse component across the baseline. There are at least three algorithms that have solved this problem successfully.

A.5. Networking Multiple Stations to Cover a Long Coastline

The final step in evolving uninterrupted coastal surface-current coverage is combining radial data from a network of dozens of HF radars. One can usually “daisy-chain” along the coast, adding a third radar to the end of a pair; then a fourth, etc. Some types of radars available can only operate in pairs, which can double the number of individual radars. In other cases, signal blocking by a complexly curving coastline may necessitate closer radar spacings in certain regions.

Software is being optimized for combining radials from multiple radars. This includes options of using optimal interpolation (OI), sometimes called objective mapping, to spatially filter the total vectors and fill in the inevitable gaps that sometimes occur. The use of OI also allows calculation of surface particle trajectories that can depict the fates of floating pollutants – such as oil spills – and/or fish larvae. Such trajectories are also an indicator of where the body of an accident victim would be carried – one of several HFR applications to search and rescue discussed in the main body of this document. Among other challenges being addressed is – how to combine data from a nested grid of radars, some with higher resolution but shorter range that focus on zones of greater human activity, such as bays, ports, and harbors. A recently solved example spanned the Golden Gate in California between the high resolution systems that operate inside San Francisco Bay, with the medium-range systems outside looking Westward into the Pacific Ocean.

One such combining algorithm produced the recent United States West Coast, zoomed-out, real-time web-based coverage map shown in Figure 1 of the main body of this Plan.

Appendix B: Regional Gap Analyses

B.1 Alaska Ocean Observing System (AOOS)

Because of the enormity of the Alaska coastline, even if all the new High Frequency Radar (HFR) sites identified in this AOOS gap analysis were to be deployed, there would still be vast areas of coastline where no ocean current monitoring would be available after the five years of this plan. However, prioritization of HFR deployments focuses on the Northern Gulf of Alaska, offshore of Prince William Sound, the Chukchi Sea, Cook Inlet, Unimak Pass, Bering Strait, and Southeast Alaska (Yakutat Bay to Cross Sound). Applications include marine transportation, commercial and recreational fishing fleets, oil and gas exploration, coastal erosion, contaminant spills, and search and rescue.

The Alaska region presents many unique challenges, including a rugged coastline that is largely without connection to a power grid, thus requiring remote power. This fact, along with difficult site access, also presents numerous logistic and permitting issues.

Present assets include two Coastal Ocean Dynamics (CODAR) HFRs. The analysis indicates that 20 more CODAR HFRs could be deployed over five years.

B.2 Caribbean Regional Association (CaRA)

The Caribbean regional observing system includes Puerto Rico and the United States Virgin Islands (USVI). Presently, there are no HFRs in the CaRA region. Several applications, including marine transportation, search & rescue, spill trajectory monitoring, and dispersal of floating eggs and larvae of many commercial species are of primary interest. Additionally, fundamental information about the currents, some of which are extremely energetic, is also needed. However, in areas near population centers, small recreational and fishing vessel activity emphasize the need for high resolution current measurements. Hence, a nested local network of high resolution CODAR systems within a larger scale network of standard resolution CODARs is envisioned to provide adequate ocean information for safety and ocean monitoring needs. Over the five year period of this Plan, CaRA proposes to add 29 HFRs.

B.3 Pacific Islands Ocean Observing System (PacIOOS)

The Pacific Islands region is by far the largest region but presently has only 2 HFRs (Wellens Radar (WERA) systems) as assets. The region includes the Hawaiian Islands, Guam,

American Samoa, the Marshall Islands, the Mariana Islands, and several other islands having political affiliations with the United States government. Maritime safety and navigation and ocean conditions are of primary concern. PacIOOS seeks to add 26 new WERA HFRs.

B.4 Northeastern Regional Association of Coastal Ocean Observing Systems (NERACOOS)

This region spans the coastline from Cape Cod northward to Nova Scotia, including the coasts of Connecticut, Rhode Island, Massachusetts, New Hampshire, and Maine. Present HFR assets include eight CODARs. The region has identified 17 sites where CODAR HFRs are to be deployed under this five-year plan. Their focus applications are fisheries management, coastal water quality, and marine security, which includes search and rescue.

B.5 Mid-Atlantic Regional Coastal Ocean Observing System (MARCOOS)

The Mid-Atlantic region encompasses the coastline from Cape Cod in the north, southward to Cape Hatteras. It already has a large, mature HFR network of 29 sites and seeks to add 23 new CODAR HFRs. The distribution of the additional sites was chosen to enhance support of shelf-wide and nearshore/estuary coverage needs. The present application areas are focused on maritime safety, including search and rescue operations and hazardous material spill tracking. The other primary focus is integrated ecosystem assessment, including commercial and recreational fishing interests. Coastal inundation and water quality monitoring are sub-regional themes.

B.6 Southeast Coastal Ocean Observing Regional Association (SECOORA)

The Southeast Atlantic region includes the Carolinas, Georgia, and the east coast of Florida. Presently, the region has four CODAR HFRs and eight WERA HFRs available. Their analysis identifies 27 HFR sites for addition to the existing 12 systems. The new HFRs would expand the geographic coverage along the Florida, Georgia, and Carolinas coasts, as well as in the vicinity of key shipping ports.

B.7 Gulf Coastal Ocean Observing System (GCOOS)

The Gulf of Mexico region presently has 14 CODAR systems. GCOOS plans to add 17 WERA systems during the Plan period. In addition to maritime transportation, natural and living resource exploitation, recreational boating and fishing, search and rescue, pollution monitoring and response, GCOOS has much interest in tracking harmful algal blooms and in coastal inundation prediction.

NOTE: At the time of version 1.0 of this Plan, significant changes are underway whereby radars in Texas are being removed. These changes will likely require an updated gap analysis for this RCOOS when the final disposition of those radars is known.

B.8 Southern California Coastal Ocean Observing System (SCCOOS)

Much of this existing regional network was developed under the California Coastal Ocean Currents Monitoring Project (COCMP), funded by the State of California, and presently is comprised of 31 CODAR systems. The SCCOOS analysis calls for the addition of 11 more CODAR HFRs over the five-year period of the Plan. The region's applications include oil spill and point-source pollution tracking, water quality monitoring and search and rescue operations.

B.9 Central and Northern California Ocean Observing System (CeNCOOS)

Through the COCMP and two long-term research sites, CeNCOOS has one of the most extensive HFR networks in the United States. Presently 32 HFR compact systems are configured to address the needs of this region. The entire coast is covered by long range systems. In the regions of high environmental impact, there is standard range coverage. San Francisco Bay is unique in that it is a large estuary with multiple commercial piers. Coverage in San Francisco Bay is best provided by the short range, high frequency systems. Model inputs, oil spill response, sewage discharge, and other source point discharge event tracking, search and rescue, safe transit of commercial traffic, Marine Protected Areas (MPA) current monitoring, fisheries restoration support, and offshore energy environmental impact monitoring are some of the priority CeNCOOS applications. The CeNCOOS gap analysis identifies 18 additional HFR systems. These include more coastline systems (13) to provide better coverage in the high impact regions and increased coverage in San Francisco Bay (5) to cover areas presently not monitored.

B.10 Northwest Association of Networked Ocean Observing Systems (NANOOS)

The Pacific Northwest regional observing system includes Oregon and Washington. There are presently 11 CODAR HFRs in place, with 9 in Oregon. The regional applications include Harmful Algal Bloom (HAB) monitoring and tracking, search and rescue, maritime transportation, and commercial fishing. The addition of 24 CODAR HFRs would extend the coastal coverage to include all of Washington's coast, as well as important locations within Puget Sound and the Strait of Juan de Fuca and coastal harbors in both states.

B.11 Federal Agency Needs for HFR-Derived Surface Currents

Many federal agencies, other than NOAA, use ocean current measurements to achieve their missions. The Interagency Working Group on Ocean Observations (IWGOO) is composed of eleven federal agencies, each of which has been requested to submit their surface current needs for the development of this document. Those needs that can be met, technically, are presented here.

B.11a. Department of Homeland Security (DHS)/United States Coast Guard (USCG)

The prediction of drift of objects on the surface of the ocean is of direct interest to the Coast Guard for its Search and Rescue (SAR), Law Enforcement, and Marine Environmental Protection missions. The drift of survivors; survivor craft; bales of contraband; safety hazards, such as oil drums, lost shipping containers, logs, and medical waste all benefit from having the high-resolution in both space and time measurements and predictions that come from HF radar measurements. As mentioned previously, the HF radar current velocities from the mid-Atlantic region are being ingested into the USCG's search and rescue operations. Search and Rescue Planning System System (SAROPS) is capable of performing the trajectory analysis for a great variety of common drift objects, including all of the above mentioned objects. The accurate prediction of the drift of these objects is critical to the successful operations of the Coast Guard.

Recent history with SAR operations shows that some coastal areas of the United States with relatively limited HFR coverage have a more immediate need than other areas for increased HFR data. These include the southeastern United States region, the Gulf of Mexico, and the Caribbean.

B.11b. Bureau of Ocean Energy Management (BOEM)

The BOEM (formerly MMS) HFR needs have been articulated for the Gulf of Mexico, Southern California, and Alaskan waters.

B.11b.1. Gulf of Mexico

Currents at 6 hourly intervals extending out to 75-100 km from shore are needed with near-real-time web products, as well as output data for GoM modelers.

B.11b.2. Southern California

A key area of interest is in the vicinity of Pt. Conception, where surface currents are needed to monitor natural oil seepage, as well as man-made oil spills. HFR has already been identified as the technology of choice for this area.

B.11b.3. Alaska

HF radar is extremely important to BOEM in Alaska, especially within the Beaufort and Chukchi seas, where ice conditions, remote access, and high operations costs limit the ability to collect surface current data. BOEM has a strong need for surface current data collection from HF radar for ongoing efforts to produce and enhance mesoscale modeling of wind fields, General Circulation Models (GCMs), for oil spill risk analysis, wind/wave forecasts, and to help define feeding habitats for marine mammals and for other marine organisms in the Arctic. HF radar surface current data collection in the Arctic is a potential platform in meeting these objectives. These real-time data could provide real-time information to the subsistence whaling communities along the Chukchi and Beaufort Sea coasts and to provide information on surface currents to the oil and gas industry.

There is a particular need for developing algorithms to be able to collect surface current data in mixed sea ice conditions

B.11c. Environmental Protection Administration (EPA)

The needs of EPA that have been presented for this Plan fall into two categories: 1) NY, NJ coastal areas; and 2) Gulf of Mexico hypoxia monitoring and assessment. The EPA is flexible as to file formats and delivery methods.

B.11c.1. NY, NJ coast

The EPA needs near-real-time data from the surf zone to 3 nmi (6 km), as well as reprocessed or delayed-mode data. This need can be partially met by HFR, but HFR cannot provide data from the surf zone to about 3 km from shore because of the modulation inherent in the radar transmit signal.

B.11c.2. Gulf of Mexico hypoxia

For this application, near-real-time data would be useful to the extent that the data are assimilated into circulation models, and the resolution inherent in HFR data (1 to 6 km) would be appropriate.

Appendix C: Workshops

Within the HF radar research and ocean observing community, there have been coordinated efforts to share knowledge and techniques that improve the application of HF radar data. Some of these have been ongoing for a number of years and have provided input to this Plan.

Radiowave Oceanography Workshop (ROW), a self-organized, independent scientific group, approximately every 18 months since 2001: The purpose of the ROW series is to gather the world's experts on high frequency (HF) radars together to discuss the development of radiowave backscatter hardware (antennas, signal waveforms, etc.), processing algorithms, and methodologies for analyzing the resulting fields. The specific goals are to (i) facilitate communication among researchers and engineers, (ii) develop a user group devoted to making HF radar a common measuring tool for the oceanographic community, (iii) achieve a better understanding of how HF radar works, including its limitations and its error and noise characteristics, (iv) develop standards for data exchange and frequency management, and (v) share results based on applications of HF radar data. In addition to these specific goals, the workshop series will serve the HF radar community by rotating its venue between the many international participants and by producing written documentation of the results presented and issues raised at each workshop, of which this volume represents the first installment. It was decided that the applications of HF radar could be further accelerated through regular interactions between the small but growing group of scientists and engineers working with radiowave (i.e., HF) backscatter in oceanography. To that end, we proposed a series of annual workshops devoted to HF applications and engineering challenges.

Surface Current Mapping Initiative (SCMI), 2003: In September 2003, Ocean.US established the SCMI. Surface current mapping is very important to the Integrated Ocean Observing System, and the availability and maturity of High-Frequency radar technology makes reliable surface current mapping now possible. Ocean.US appointed an SCMI steering committee to address critical technical issues associated with implementation of a surface current mapping system for coastal United States waters. Committee membership included people experienced with existing research based HF radar networks, operational installations, users needs, and federal agency requirements. Users and federal agency representatives were also included. Issues identified by the steering committee included governance of an integrated current mapping network, siting HF Radars, coordination of frequency allocations, development of HF Radar products, research topics, and vessel tracking. They estimated the cost for a nationwide surface current mapping (SCM) network would be about \$15 M to \$44 M for 100 to 200 sites and that the annual operating cost would be about \$5.3 M to \$13.5 M. The range in cost depends on the coverage in Alaska,

Hawaii, and the trust territories and variability in installation and maintenance costs. The committee also recommended pilot projects that would lead to operational systems.

ACT HF Radar Workshop, 2004: The Alliance for Coastal Technologies (ACT) Workshop "Radar Technologies for Surface Current Mapping" was held in St. Petersburg, Florida, March 14th and 16th, 2004, sponsored by the University of South Florida College of Marine Science, an ACT partner institution, and the Ocean.US SCMI. The workshop was designed to summarize existing radar technologies for SCM and address the impediments to their use in operational coastal ocean observing systems for the purpose of facilitating future technological advancements in these technologies. Participants were chosen to represent the research community, federal/state/local environmental managers, and industry representatives interested in the development and implementation of surface current radars for coastal ocean observation. The overall goal for the workshop was to explore present and future radar technologies as well as identify the steps necessary to incorporate them into an operational observing system. There was a strong focus on high frequency (HF) radar systems as these systems are in the most widespread use today. SCM technologies were suggested as being the most cost effective means for observing surface currents and that they have great potential for mapping surface waves. Obstacles to implementation as part of an operational observing system include restrictions on siting, radio frequency allocations, lack of human resources to operate SCM systems, and integration of data for multiple SCM operators. Recommendations include the identification and standardization of useful products from SCM observations, establishment of geographically distributed demonstration projects using multiple SCM technologies, establishing radar testbeds to evaluate and compare different SCM technologies, creation of a national frequency allocation policy, and education/training of SCM operators and technicians through workshops.

Quality Assurance of Real-Time Oceanographic Data (QARTOD), 2005: The dawn of the Integrated Ocean Observing System (IOOS) era brings with it many challenges related to the distribution and description of real-time ocean data. One of the primary challenges facing the ocean community will be the fast and accurate assessment of the quality of the data streaming from the IOOS measurement systems. Operational data merging and assimilation from multiple data sources will be essential to the ability to adequately describe and predict the physical, chemical, and biological state of the coastal ocean. These activities demand a simple, trustworthy, and consistent quality description for every observation distributed as part of the IOOS system. QARTOD is a continuing multi-agency effort to address the quality assurance and quality control issues of the Integrated Ocean Observing

System (IOOS) community. The first workshop was held at the NOAA National Data Buoy Center (NDBC) office in Bay St. Louis, MS in the winter of 2003. Over 80 participants attended with the primary task to develop minimum standards for calibration, quality assurance/quality control (QA/QC) methods and metadata. The workshop resulted in a report that summarized the recommendations on these issues and on future workshops. QARTOD II and QARTOD III both held in 2005 focused on remote currents (HF radar) among other observations and platforms. The proceedings from these workshops provide guidance on the present status of HF radar quality control and assurance and necessary next step. These workshop proceedings can be downloaded directly from the QARTOD website (<http://www.ncddc.noaa.gov/activities/qartod>).

Radiowave Operators Working Group (ROWG), approximately every 18 months since 2005: The ROWG was formed to address the growing HF radar network in the United States and around the world and to coordinate regional efforts and promote collaboration. Specifically, the group (i)

fosters collaboration between new and experienced HF radar operators, and (ii) develops procedures governing HF radar operations, including site logistics, processing to component vectors, total vector products and data management, and provide recommendations to users, developers, manufacturers, and program managers. At the present time, the Radiowave Operators Working Group community has hosted 7 workshops that have brought operators together to address hardware and software priorities as they pertain to a national network. Proceedings from these workshops along with additional HF radar information can be accessed on the web (www.rowg.org).

Appendix D: Regional Project Examples

Mid Atlantic Regional Ocean Observing System (MARCOOS): The Mid Atlantic Regional Ocean Observing System is the ocean observatory for the Mid-Atlantic (MA) regional association, MACOORA. A major component of this observatory is an HF Radar network consisting of 29 sites and distinguished by its nested coverage of important bays and sounds. The design and operation of this network is focused on the delivery of products in support of MARCOOS themes, maritime security, and resource management. Specifically, surface current maps are provided at nested resolutions to the United States Coast Guard (USCG) and regional forecast modeling groups for ocean nowcasts and forecasts in support of both USCG Search and Rescue (SAR) and fisheries resource managers. It also serves as a testbed for the (1) NOAA HFR research for bistatic operations, which will improve surface current mapping in complicated coastal regions, (2) USCG for evaluation of new products for Search and Rescue Optimal Planning System (SAROPS), and (3) Department of Homeland Security (DHS)/Counter NarcoTerrorism for development of dual-use vessel tracking capabilities. The MARCOOS HF radar network is regional in scale with distributed technicians coordinated through a central organizing body. This organization ensures that certified data is delivered to regional and national users.

In order to manage this regional network stretching along 1000km of coastline, the system has been divided into geographically separated operational clusters established in the northern, central, and southern MA. These clusters are coordinated through a regional center at Rutgers University. Several tools have been implemented to bridge this geographic divide. A monthly conference call has been setup for operators to communicate and share pressing issues. A collaborative development website was created for the sharing of documents and archive communications during the project. An advanced HF radar operator training course was conducted by the hardware vendor (CODAR Ocean Sensors). The agenda was user driven developed in collaboration with the manufacturer of the HF radar. A database was created where critical information on each site was centrally accessible and stored for a unified regional system. Best practices documents on radar antenna patterns and quality assurance and quality control of radial data were created to be shared among the HF radar operators. This is consistent with the 3-Phase implementation plan for the Ocean.US Surface Current Mapping Initiative (SCMI). The MARCOOS HF Radar regional coordinator ensures that all sites are operating by standards established at the recent NOAA coordination meeting and is delivering quality-controlled data consistent with NOAA Quality Assurance of Real-Time Oceanographic Data (QARTOD).

Northwest Association of Networked Ocean Observing Systems (NANOOS): The HFR array in the Pacific Northwest provides surface currents along 500km of coastline, from Loomis Lake, Washington to Crescent City, California, using six long-range SeaSondes installed, beginning in 2000, supplemented by higher resolution subarrays from Newport to Florence (3 systems) and off the Columbia River mouth (2 systems). Operational funding for these systems is provided by the IOOS regional association NANOOS and by the National Science Foundation (NSF) through the Center for Coastal Margin Observation and Prediction (CMOP). The system is coordinated and managed through Oregon State University, which owns the bulk of the equipment. Maps and data from these systems are provided to the public through the web and as a feed to HFRNet. A forecast system for the short-term prediction of currents in the waters has been developed and evaluated for search-and-rescue and pollution transport applications. The data have been assimilated in circulation models to improve the models fidelity.

Southern California Coastal Ocean Observing System (SCCOOS): Central to the system is the measurement of coastal currents along a wide region of the coast, the backbone of which is the installation of high-resolution transmit and receive radio antenna systems and long-range systems that are used to map ocean surface currents. The HF Radar component of SCCOOS is managed by four participating organizations divided geographically along the coast of Southern California. Each organization maintains between 6-10 HF radar sites. A central point of contact at Scripps Institution of Oceanography assists in coordination of HF radar deployments, frequency allocations, site request management, and best practices. Management and technicians coordinate activities through conference calls and e-mail. SCCOOS programmers have developed a useful, interactive site management tool for Surface Current Mapping antenna systems: www.sccoos.org/SoCal and www.sccoos.org/CeNCOOS. The site can be used for planning purposes having California Coastline, google maps, and Topozone links based on Global Positioning System (GPS) location. Users are able to view available geographic information for the site location and upload images taken at the site location for discussion and review. The site hosts publicly displayed data, as well as login required information such as maintenance notes and privately maintained images and contributed files. Programmers have also developed detailed system diagnostic utilities from the available metadata, allowing for a quick look at data transfer latencies, system health, data reliability, and error estimates. SCCOOS staff have drafted the technical document: Deployment & Maintenance of a High-Frequency Radar for Ocean Surface Current Mapping: Best Practices.

Notable applications of the growing HFR capabilities include the following examples:

Stormwater Plume Tracking – The City of San Diego, Department of Environmental Health, conducted simulation of particles tracking using near real-time HF radar derived surface currents. The city uses the Tijuana River Plume Trajectory to help guide decisions about sampling and beach closures.

Ocean Outfall Impacts – SCCOOS responds to ocean outfall diversions providing local views of near real-time surface currents, modeled surf zone waves, and currents and meteorological observations. SCCOOS is able to initiate a plume tracking simulation at the diverted inshore location for tracking surfacing discharge during the event. This information proves beneficial for city managers deciding where to conduct intense sampling for contamination and presenting to the public.

Oil Spill Prevention and Response – Fluorescing dye studies have been conducted off the coast of San Diego to evaluate transport models using data from surface currents measured by CODAR. These models are being developed for and used to predict the trajectory and dispersion of plumes during oil spill, stormwater, and water pollution events.

Advanced mapping applications – An example of an advanced mapping application of HF Radar is its use to detect spiral eddies. HF Radar measures surface currents in a coastal area over space and time, providing researchers with information about coastal eddies and other dynamic, circulation features. Improved information about eddies, which transport water-borne materials, such as nutrients and larvae, and affect the fate of pollutants and nearshore habitat, contributes to more effective management of coastal hazards and spill events.

An operational ocean circulation model presently operates in a nowcast/forecast mode using HF radar data assimilation from the network.

Appendix E: Total Vector Velocity Gridded Data Metadata Parameters

These potential metadata parameters are specific to the gridded total vector data type.

Term	Definition
MaxErr	maximum Geometric Dilution of Precision (GDOP) error allowed, higher values will be masked
MaxSpeed	maximum speed allowed, higher values will be masked
MinSites	minimum number of sites required for processing
MinRads	minimum number of radials required before processing total
AngleGap	interpolation will occur for angular gaps less than the specified value (0 = no interpolation)
RangeGap	interpolation will occur for gaps in range less than the specified value (0 = no interpolation)
RadGridAngleThreshold_Degrees	Used for gridding in interpolation
RadGridRangeThreshold_km	Used for gridding in interpolation
TotalGridFileName	Grid file used for computing totals
TotalGridPointSearchRadius_km	Radial search radius around given total gridpoint

Appendix F: Detailed Regional Maps

The most up-to-date and accurate maps of the existing and proposed radar sites are maintained at www.ioos.noaa.gov/

[hfradar](#), which also provides an interactive method for the user to explore specific regions or particular radar sites.

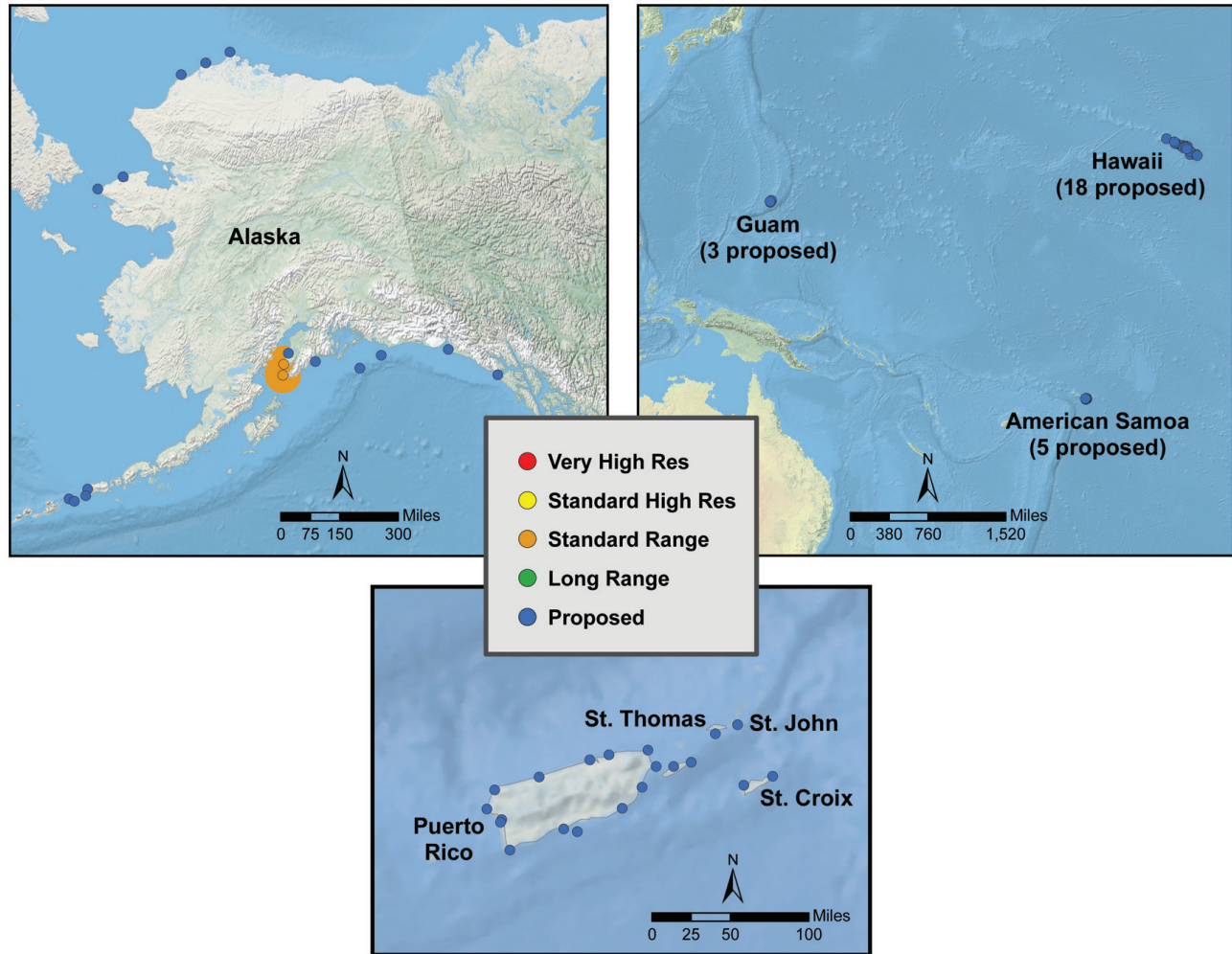

Figure F1: Full Buildout Illustrating Existing and Proposed HFR Sites for Alaska, Pacific Islands, and Caribbean Regions

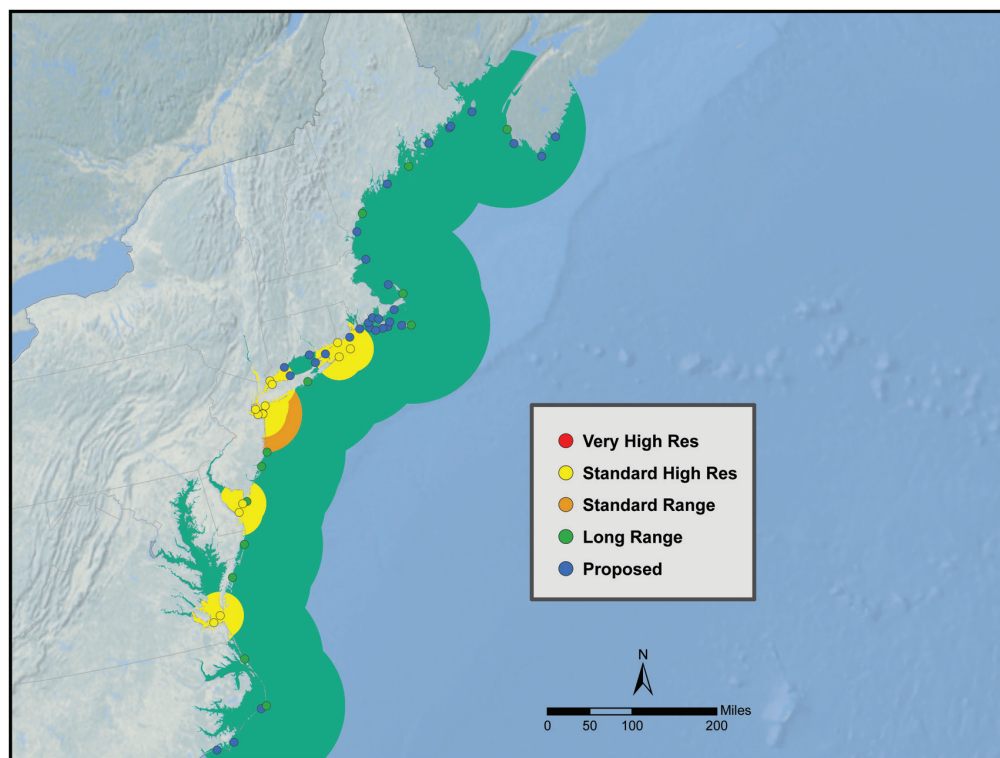

Figure F2: Full Buildout Illustrating Existing and Proposed HFR Sites for Northeast and Mid-Atlantic Regions

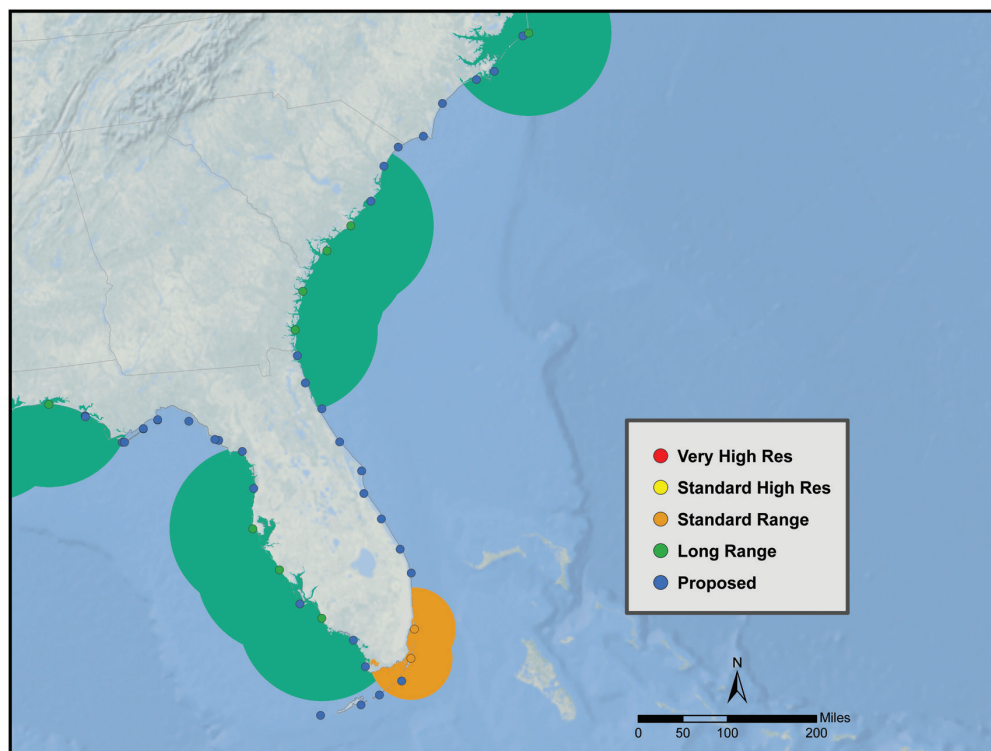

Figure F3: – Full Buildout Illustrating Existing and Proposed HFR Sites for Southeastern United States

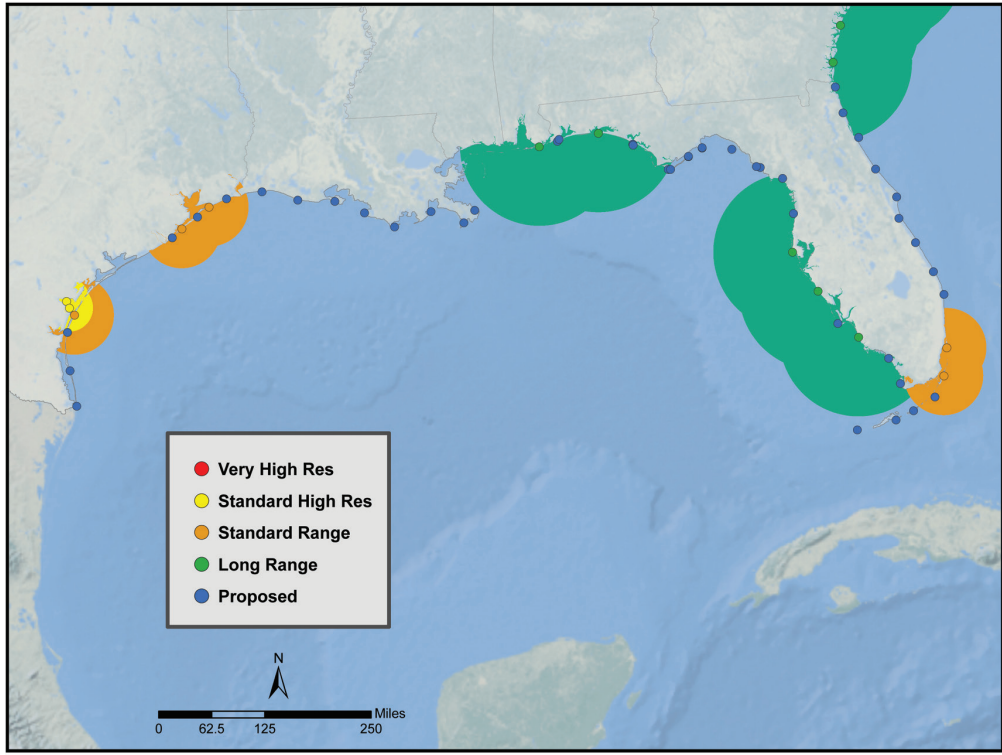

Figure F4: – Full Buildout Illustrating Existing and Proposed HFR Sites for Gulf of Mexico and Southeastern United States.
NOTE: See Section B.7 for a note on the Texas radars.

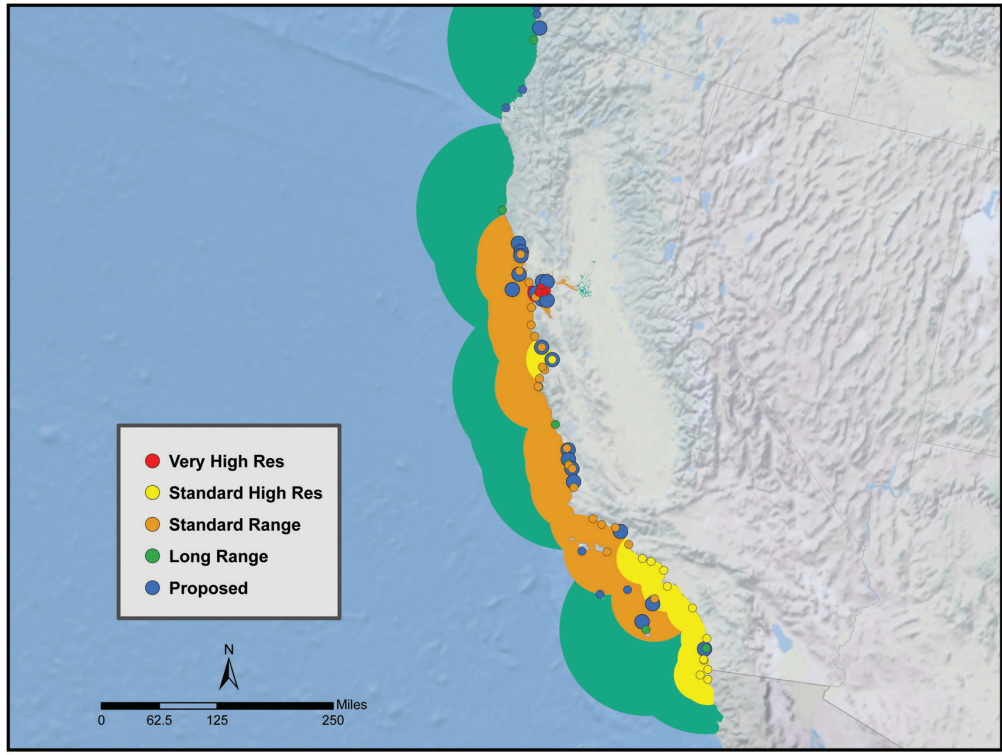

Figure F5: – Full Buildout Illustrating Existing and Proposed HFR Sites for Southwestern United States

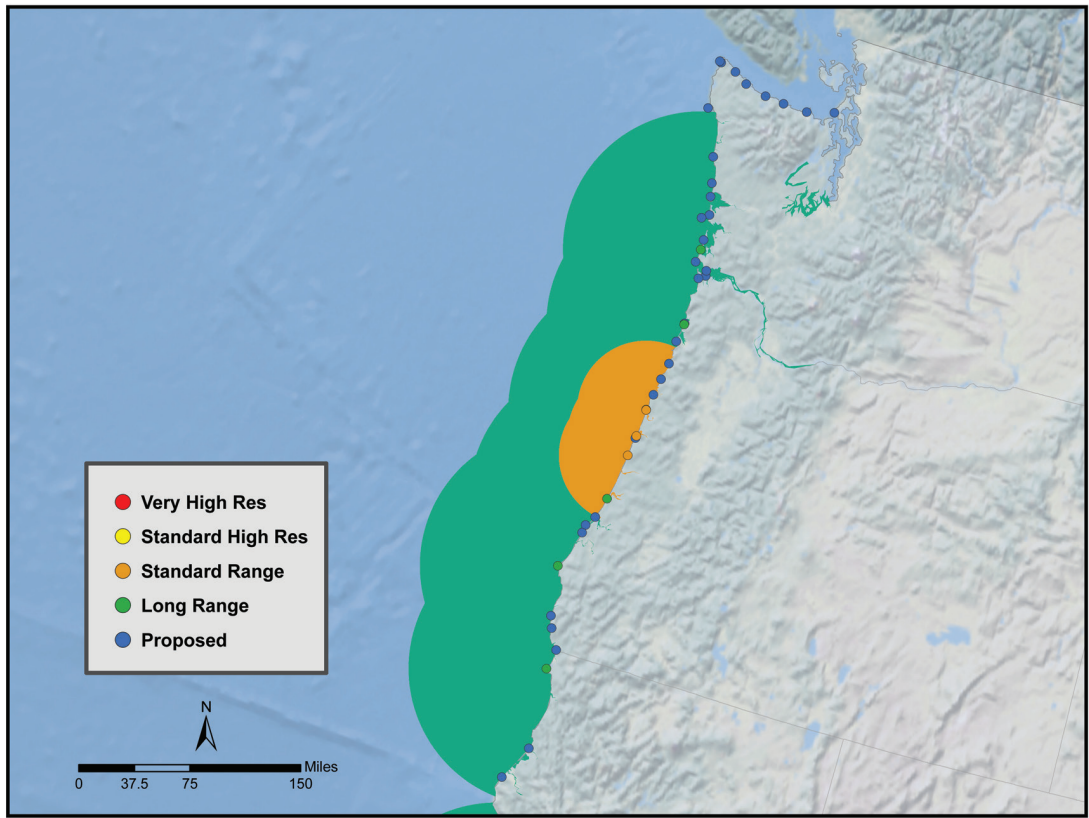

Figure F6: -- Full Buildout Illustrating Existing and Proposed HFR Sites for Northwestern United States

Appendix G: References

- Chu, P.C., L.M. Ivanov, T.P. Korzhova, T.M. Margolina, and O.M. Melnichenko, 2003: Analysis of sparse and noisy ocean current data using flow decomposition. Part 1: Theory." *J. Atmos. Oceanic Technol.*, 20 (4), 478-491.
- Committee on the Marine Transportation System (2008). *The National Strategy for Marine Transportation System: A Framework for Action.*
- Gopalakrishnan, G., A. F. Blumberg, and R. I. Hires. *Estuarine and Coastal Modeling (2008), Assimilating Data into an Estuarine Coastal and Ocean Circulation Model*, ASCE, 685 – 703.
- Gurgel, K-W. (1994), Shipborne measurement of surface current fields by HF radar (extended version). *L`Onde Electrique*. Septembre-Octobre 1994, Vol 74, no 5, pp. 54-59.
- Integrated Global Observing Strategy Partnership (2006). *The Integrated Global Observing Strategy: Report of the Coastal Theme Team.*
- Kaplan, D., and F. Lekien (2007), Spatial interpolation and filtering of surface current data based on open-boundary modal analysis. *J. Geophys. Res.*, 112, C12007, doi:10.1029/2006JC003984.
- Kim, S. Y., E. J. Terrill, and B. D. Cornuelle (2008), Mapping surface currents from HF radar radial velocity measurements using optimal interpolation, *J. Geophys. Res.*, 113, C10023, doi:10.1029/2007JC004244.
- Kohut, J.T., H.J. Roarty and S.M. Glenn (2006), Characterizing Observed Environmental Variability with HF Doppler Radar Surface Current Mappers and Acoustic Doppler Current Profilers: Environmental Variability in the Coastal Ocean, *IEEE Journal of Oceanic Engineering*, Vol. 31, No. 4, October 2006, 876-884.
- Lipa, B.J. and D.E. Barrick (1983), Least-squares methods for the extraction of surface currents from CODAR crossed-loop data: Application at ARSLOE, *IEEE J. Oceanic Engr.*, vol. OE-8, pp. 226-253.
- National Water Quality Monitoring Council (2006). *A National Water Quality Monitoring Network for U.S. Coastal Waters and their Tributaries.*
- Ocean.US (2006). *First U.S. Integrated Ocean Observing System (IOOS) Development Plan.* Ocean.US Publication No. 9.
- Ohlmann, C., P. White, L. Washburn, E. Terrill, B. Emery and M. Otero (2007), Interpretation of Coastal HF Radar Derived Surface Currents with High-Resolution Drifter Data, *Journal of Atmospheric and Oceanic Technology*, 24, 666-680, doi:10.1175/JTECH1998.1.
- Oke, P. R., J. S. Allen, R. N. Miller, G. D. Egbert, and P. M. Kosro (2002), Assimilation of surface velocity data into a primitive equation coastal ocean model, *J. Geophys. Res.*, 107(C9), doi:10.1029/2000JC000511.
- Paduan, J.D., and I. Shulman (2004), CODAR data assimilation in the Monterey Bay area. *J. Geophys. Res.*, 109, C07S09, doi: 10.1029/2003JC001949.
- Paduan, J., J. O'Donnell, A. Allen, P. M. Kosro, S. Glenn, M. Bushnell, D. Musgrave, N. Shay, L. Washburn, M. Luther (2004), *Surface Current Mapping in U.S. Coastal Waters: Implementation of a National System.* Ocean. US, Arlington, VA., 22 pp.
- Paduan, J. and L. Washburn, (2013), High-Frequency Radar Observations of Ocean Surface Currents, *Annu. Rev. Mar. Sci.* 2013. 5:115–36
- Shulman, I. and J.D. Paduan (2008), Assimilation of HF radar-derived radials and total currents in the Monterey Bay area. *Deep-Sea Res.*, 56 (3–5), 149–160.
- Wilkin, J.L., H. G. Arango, D. B. Haidvogel, C. S. Lichtenwalner, S. M. Glenn, and K. S. Hedström (2005), A Regional Ocean Modeling System for the Long-term Ecosystem Observatory, *J. Geophys. Res.*, 110, C06S91, doi:10.1029/2003JC002218.



Appendix H: List of Acronyms

ACT: Alliance for Coastal Technologies	NDBC: National Data Buoy Center
AOOS: Alaska Ocean Observing System	NERACOO: Northeastern Regional Association of Coastal Ocean Observing Systems
ARTS: Antelope Real-Time System	netCDF: network Common Data Form
BRTT: Boulder Real-Time Technologies	NOAA: National Oceanic and Atmospheric Administration
CaRA: Caribbean Regional Association	NTP: Network Time Protocol
CeNCOOS: Central and Northern California Ocean Observing System	O&M: Operations and Maintenance
CF: Climate and Forecast Conventions	OGC: Open Geospatial Consortium
COCMP: Coastal Ocean Current Monitoring Program	OPeNDAP: Open-source Project for a Network Data Access Protocol
CODAR: Coastal Ocean Dynamics Applications Radar	PacIOOS: Pacific Islands Ocean Observing System
CODAR: Coastal Ocean Dynamics Applications Radar	POC: Point of Contact
CONUS: Continental United States	QARTOD: Quality Assurance of Real-Time Oceanographic Data
CO-OPS: Center for Operational Oceanographic Products and Services	RA: Regional Association
COP: Commission on Ocean Policy	RCOOS: Regional Coastal Ocean Observing System
CORDC: Coastal Observing Research and Development Center	RDBMS: Relational Database Management Systems
COS: CODAR Ocean Sensors, Ltd.	ROW: Radiowave Oceanography Workshop
CSDGM: Content Standard for Digital Geospatial Metadata	ROWG: Radiowave Operators Working Group
DAC: Data Assembly Center	RSE: Remote Sensing Extensions
DHS: Department of Homeland Security	RTVs: Real-Time Vectors
DIF: Data Integration Framework	SAR: Search and Rescue
DMAC: Data Management and Communications	SAROPS: Search and Rescue Optimal Planning System
EEZ: Exclusive Economic Zone	SCCOOS: Southern California Coastal Ocean Observing System
EPA: Environmental Protection Agency	SCM: Surface Current Mapping
FCC: Federal Communications Commission	SCMI: Surface Current Mapping Initiative
FGDC: Federal Geographic Data Committee	SECOORA: Southeast Coastal Ocean Observing Regional Association
GCOOS: Gulf Coastal Ocean Observing System	SSH: Secure Shell
GDOP: Geometric Dilution of Precision	TAP: Technical Advisory Panel
GPS: Global Positioning System	USCG: United States Coast Guard
HAB: Harmful Algal Bloom	VD&T: Vessel Detection and Tracking
HFR: High Frequency Radar	VHF: Very High Frequency
IGOS: Integrated Global Observing Strategy	WCS: Web Coverage Services
IOOS: Integrated Ocean Observing System	WERA: Wellen Radar
IRAC: Interdepartment Radio Advisory Committee < http://www.ntia.doc.gov/osmhome/irac.html >	WMS: Web Map Services
ISO: International Organization for Standardization	WRC: World Radiocommunication Conference
IWGOO: Interagency Working Group on Ocean Observations	XML: Extensible Markup Language
LPA: Linear Phased Array	
MARCOOS: Mid-Atlantic Regional Coastal Ocean Observing System	
MACOORA: Mid-Atlantic Coastal Ocean Observing Regional Association	
MMS: Minerals Management Service	
NANOOS: Northwest Association of Networked Ocean Observing Systems	

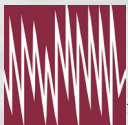

**ALLIANCE
FOR COASTAL
TECHNOLOGIES**

www.act-us.info