



SAROPS

Environmental Data Sources

Their Uncertainties

Art Allen

U.S. Coast Guard

Office of Search and Rescue

Arthur.A.Allen@uscg.mil

860-441-2747

EDS Architecture

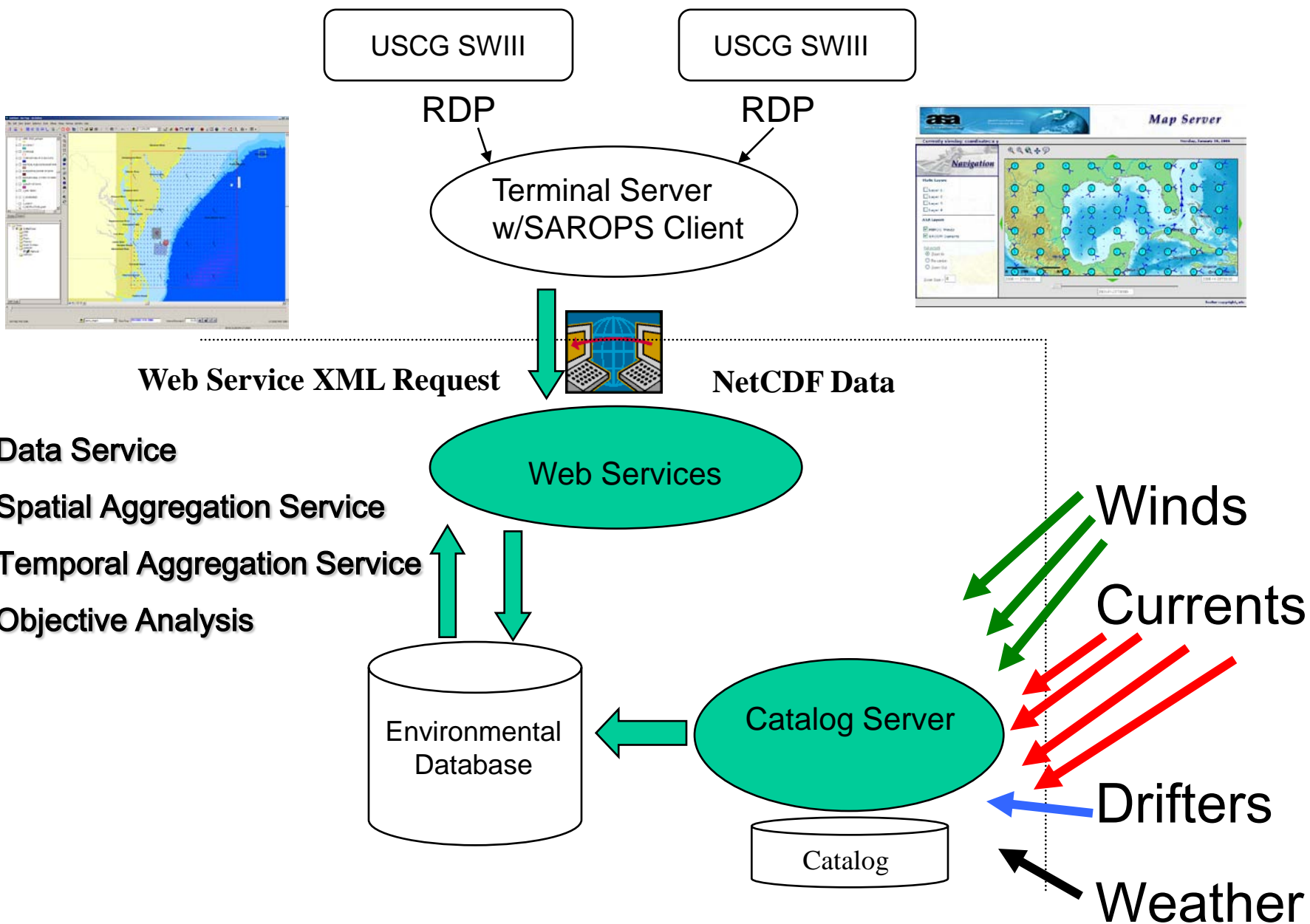



NOAA products & services used by SAROPS



- NCEP North Atlantic HYCOM currents
- Navy NAVO NCOM currents (via NCDDC)
- GLERL/NOS Great Lakes currents
- NCEP GFS winds
- NCEP NAM winds
- NDBC moored buoys / C-MAN winds
- NOS NOWCOAST shape files - weather
- Nautical Charts
- GSHHS shoreline



EDS Current Products



- Navy NAVO (via NCDDC) NCOM
- NOAA NCEP North Atlantic HYCOM
- NOAA GLERL/NOS Great Lakes currents
- ADCIRC East and West
- Navy FNMOC CASP currents
- Mariano Seasonal Ship drift
- Florida Current Data File
- USCG SLDMBs



Davis/ CODE drifter Self-Locating Datum Marker Buoys (SLDMB)

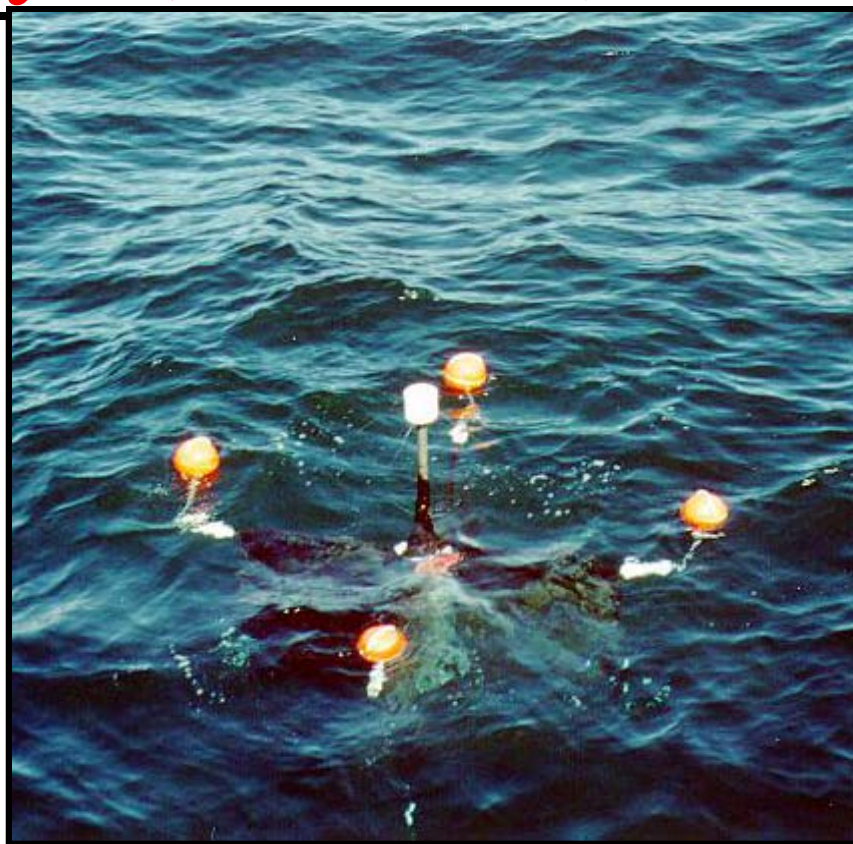
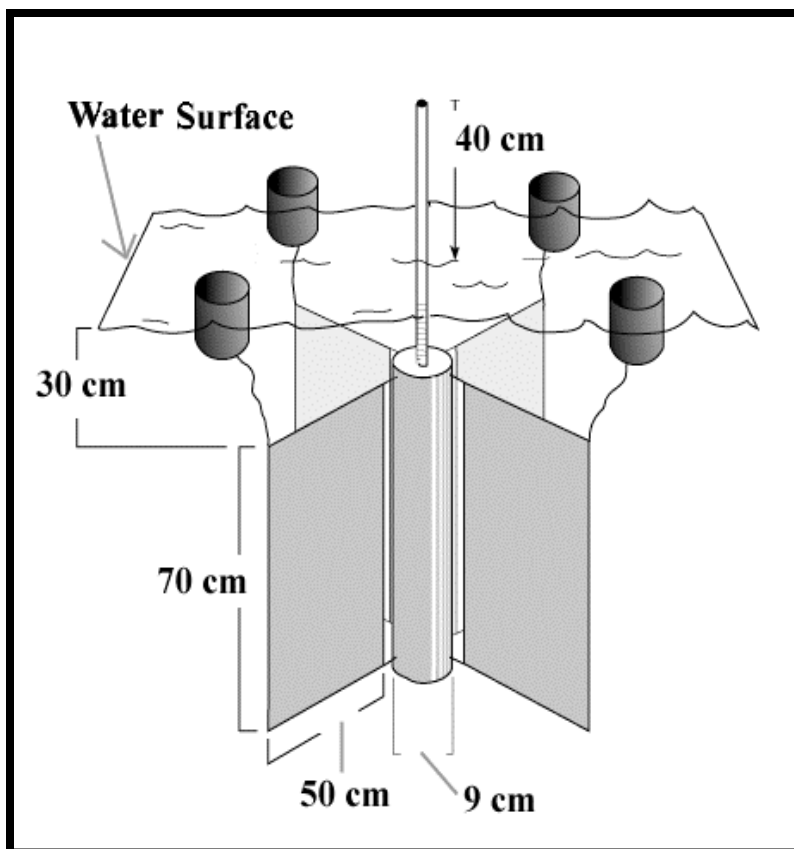



“Trajectory Prediction using HF Radar Surface Currents: Monte Carlo Simulation of Prediction Uncertainties”

- Ullman, O'Donnell, Kohut, Fake and Allen
- JGR (in press)
- Hourly drifter velocity from -30 and +30 minute positions
- $U' = \text{Drifter } U - \text{Product } U$
- Best exponential decay fit to Auto covariance U', V'



Data processing



- 1) 105 SLDMB clean records
 - 4 to 30 days
 - 1 Jan – 30 June 2006
- 2) Find 4 closest EDS vectors to SLDMB's positions at each hour
- 3) Follow Ullman et al.



SLDMB comparisons

NCOM / HYCOM

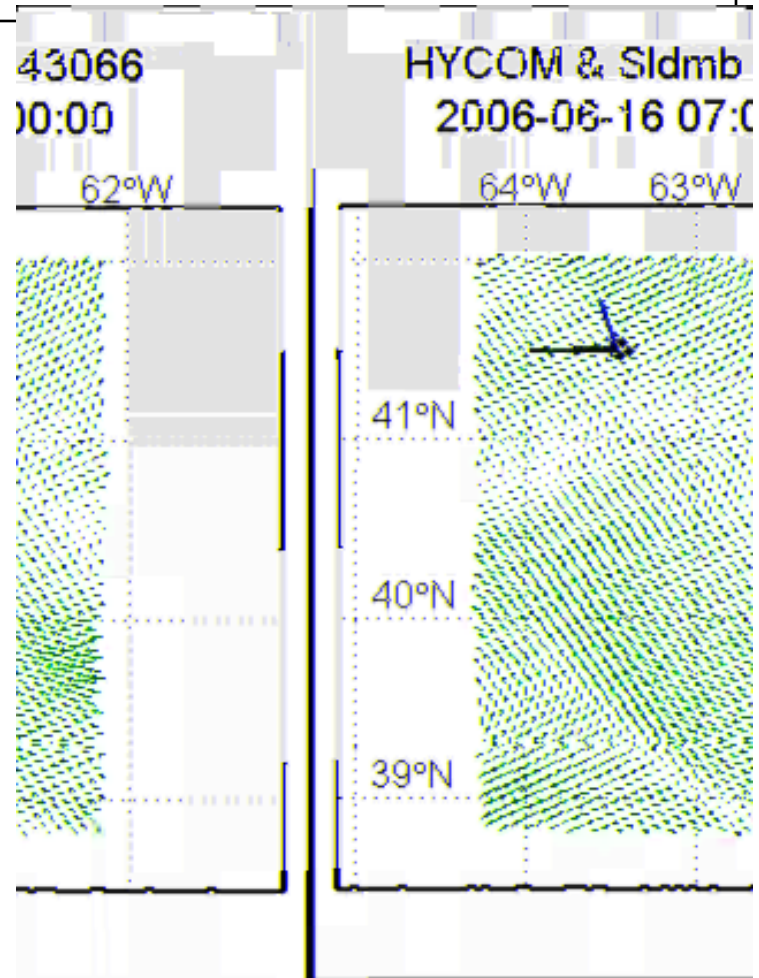
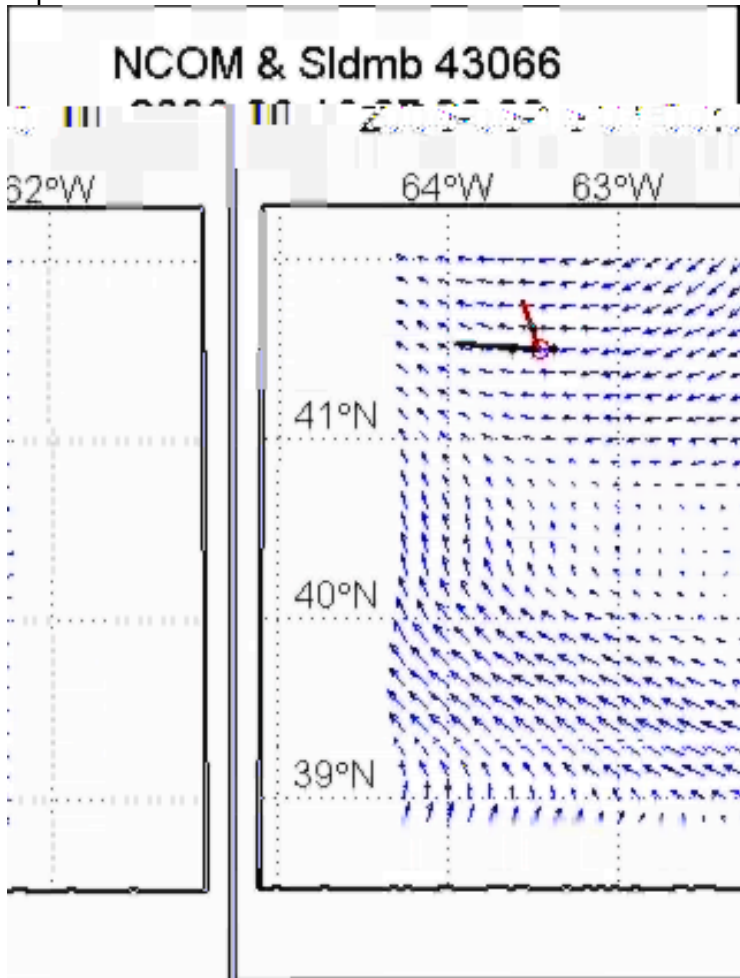



Ullman et al HF Surface Wave Radar

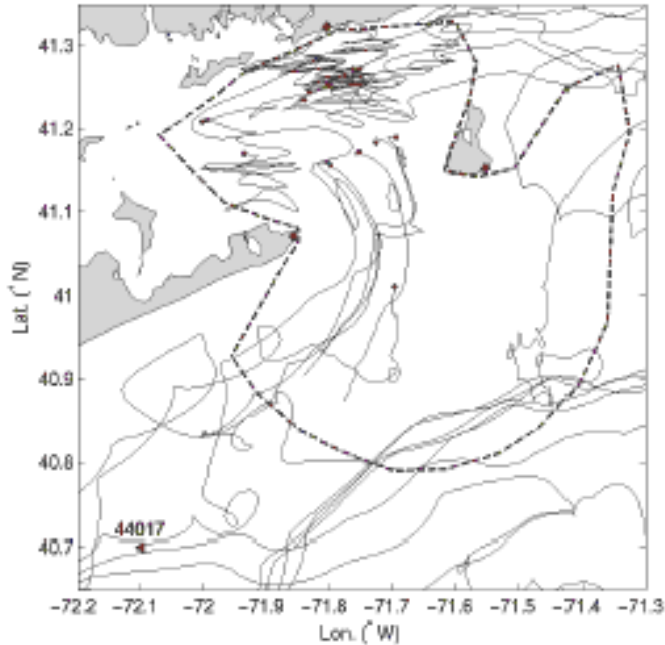

Long Range (NJ coast)

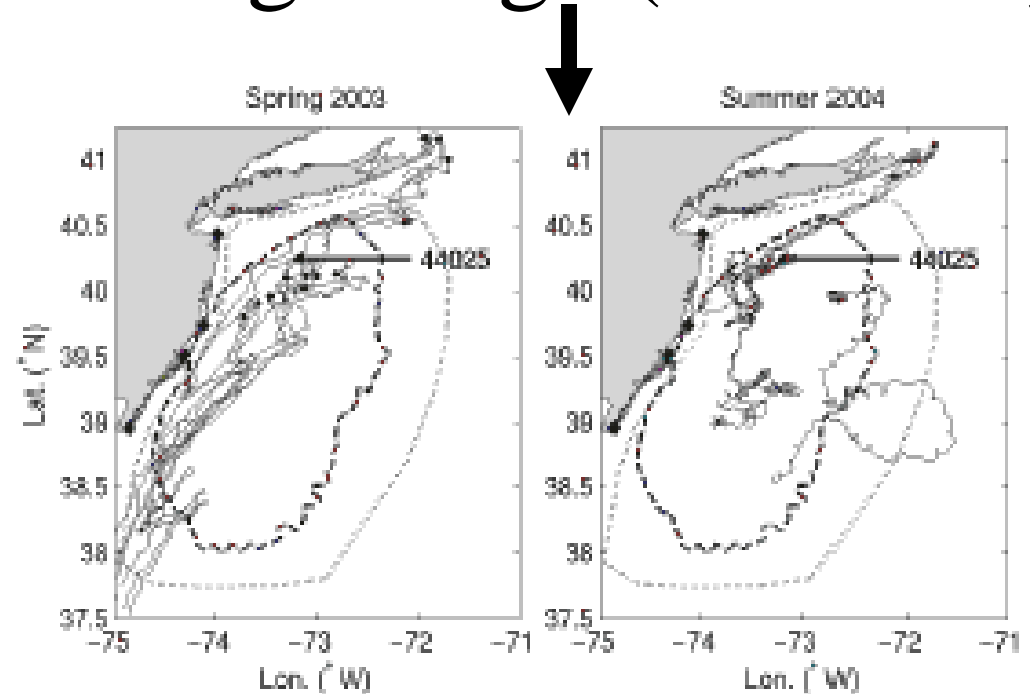

Standard (Block Island Sound)



Mariano

Seasonal ship-set & drift
82 SLDMBs 28,013 hr

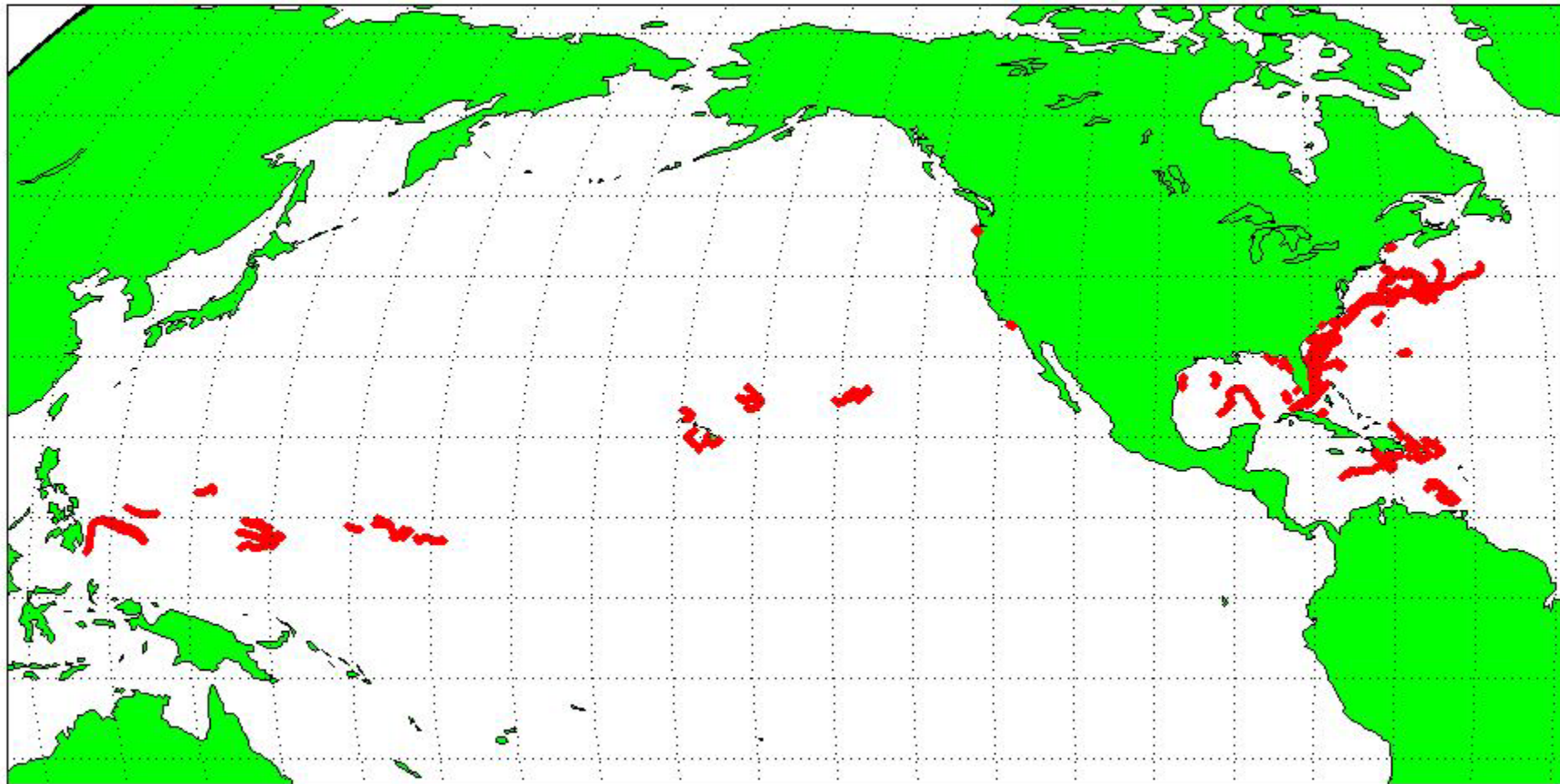



Navy's Global NCOM surface currents 61 SLDMBs 14,359 hrs

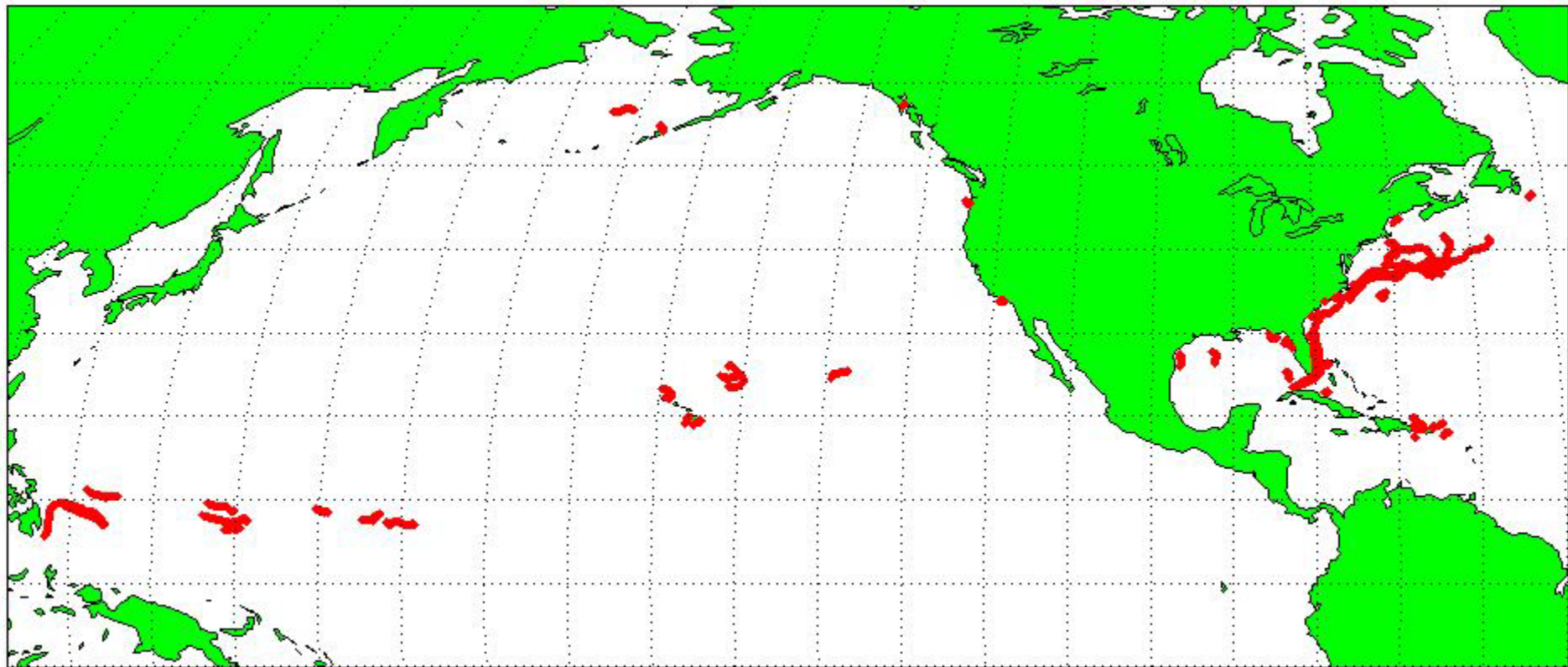



NOAA NCEP

North Atlantic HYCOM

17 SLDMBs 3,248 hrs

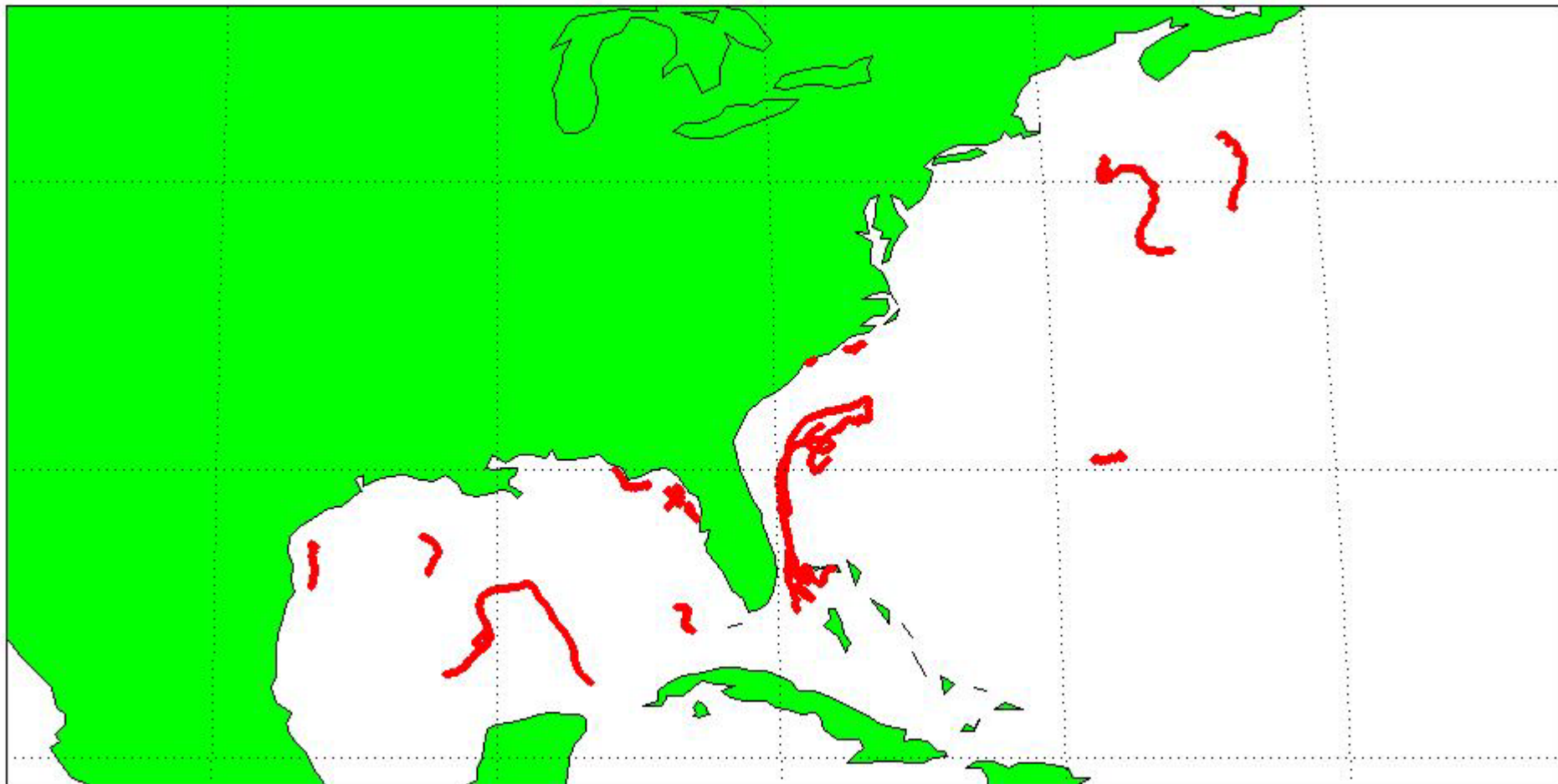



Florida Gulf Stream Data

(FLDA)

(red box)

11 SLDMBS

3,304 hrs

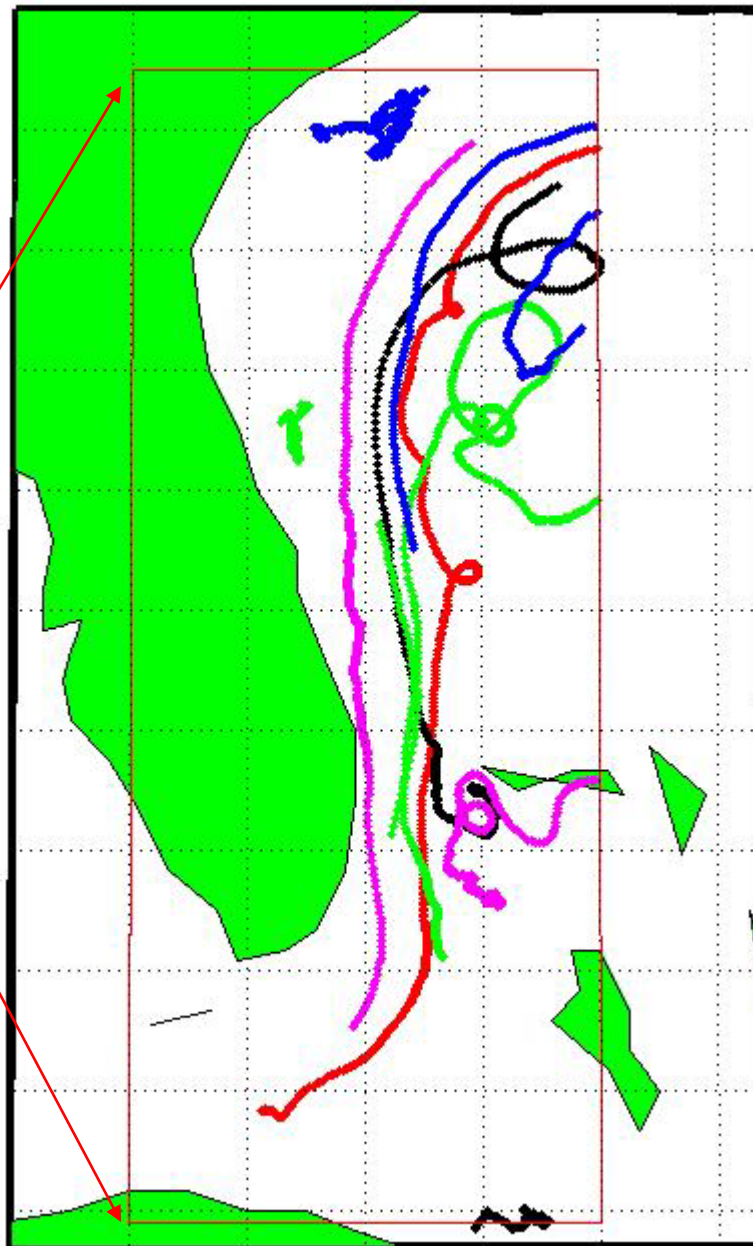



GLERL

9 SLDMBs 1,221 hrs

15 Jun – 18 Aug '06

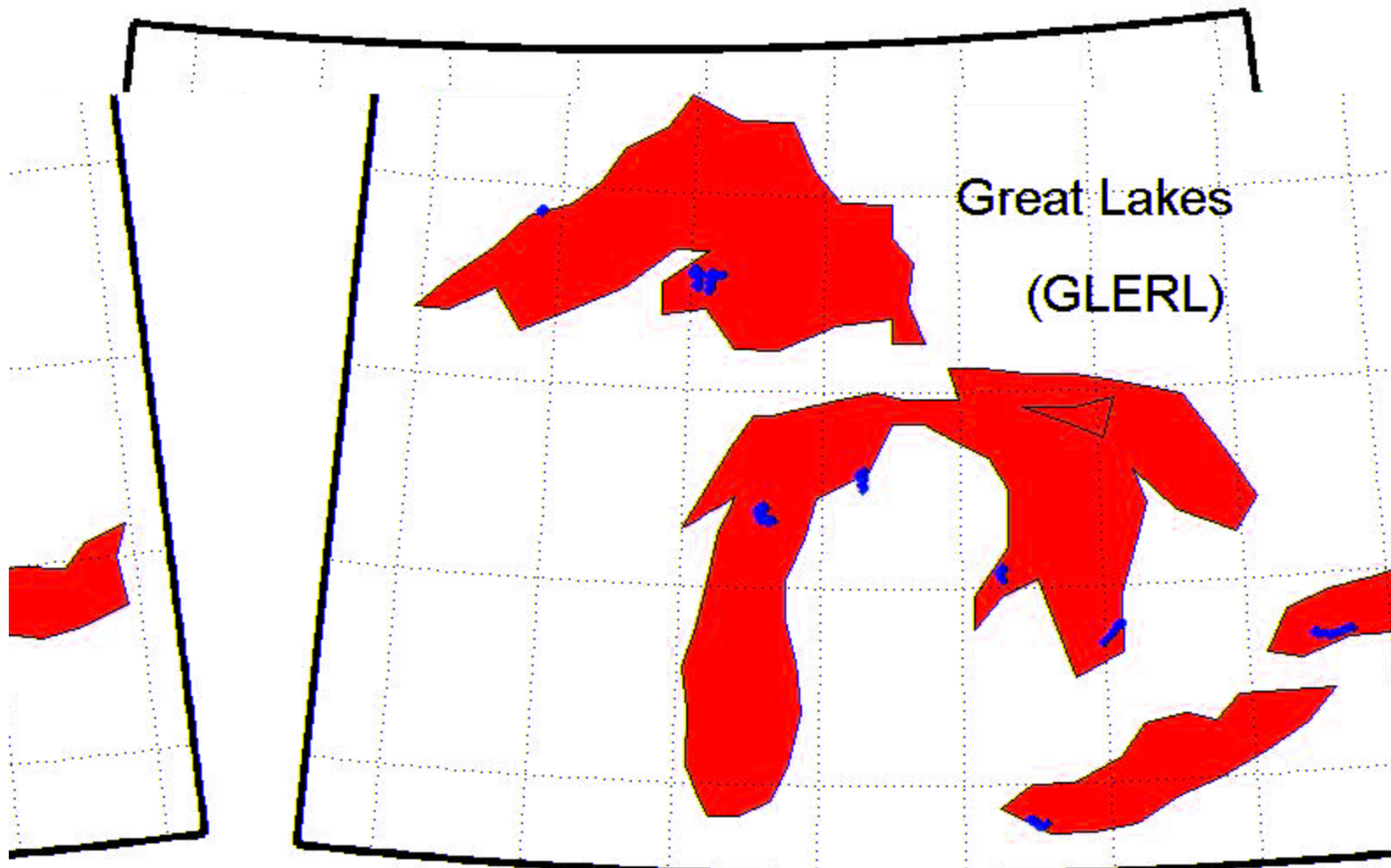



ADCIRC (Tides only)



11 SLDMBs, 3,453 hrs

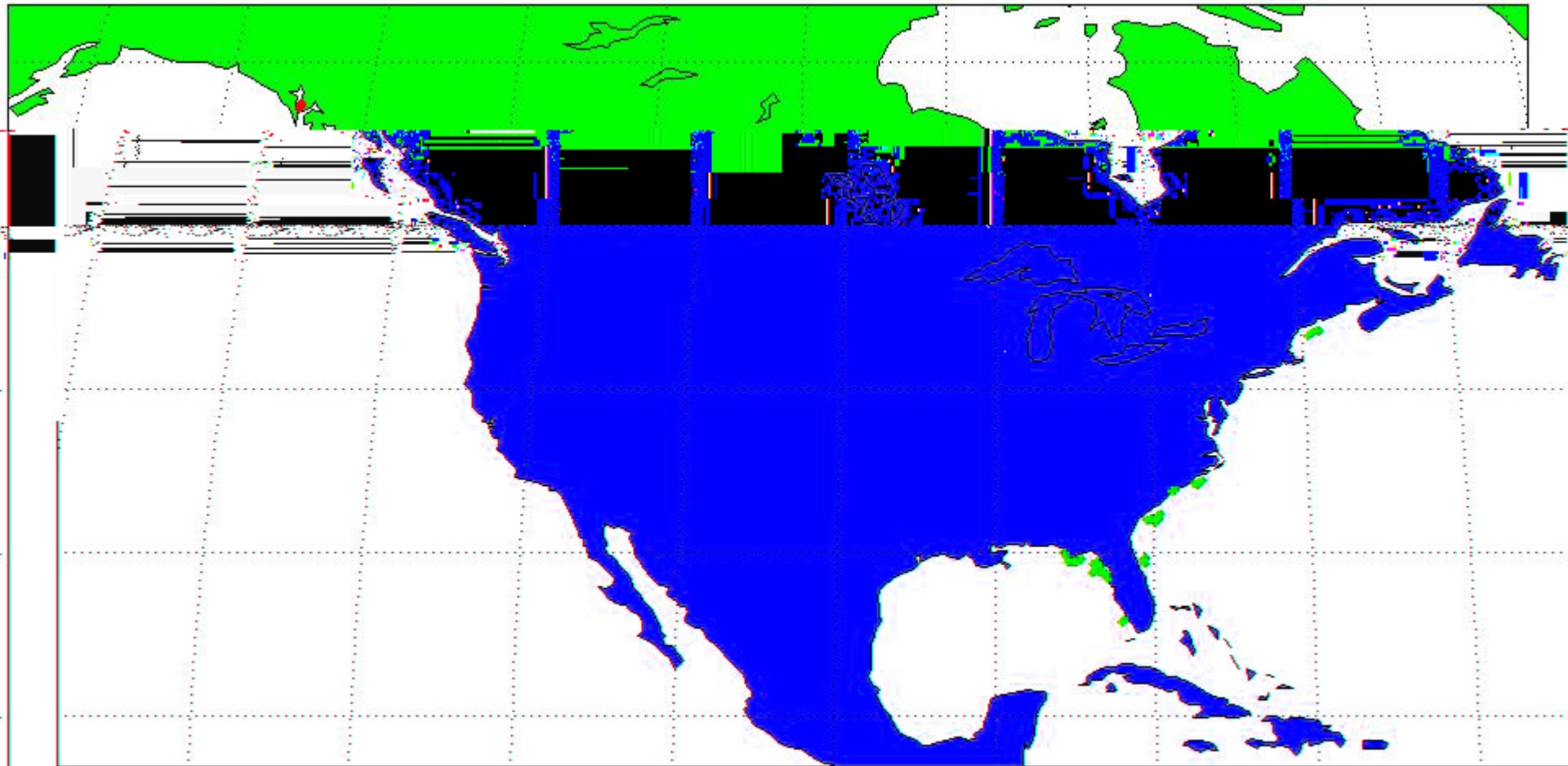

EDS Uncertainties

Product	# SLDMB / hrs	σ_u cm/s	Γ_u hrs	σ_v cm/s	Γ_v hrs
HR Radar Std	16 / 669	14	1.5	12	1.4
HR Radar LR	12 / 6,228	11	4.1	13	3.7
ADCIRC	11 / 3,453	14.3	2.6	13.8	5.1
ADC/NCOM	9 / 2,161	15.5	3.0	14.6	3.4
GLERL	9 / 1,221	27.8	2.3	27.6	2.3
FLDA	11 / 3,304	30.0	17.3	38.1	23.1
Mariano	82 / 28,013	25.2	21.8	27.4	23.1
HYCOM	17 / 3,248	51.3	12.3	43.0	7.2
NCOM	61 / 14,359	62.0	3.0	57.5	3.8

SAROPS Examples Uncertainties

Product (Examples)	σ (Std Dev) Kts	Γ (half-life) hrs (min)
Low / Low	0.25	3 (180)
Med / Low	0.5	3 (180)
High / Low	1.0	3 (180)
Med / High	0.5	20 (1200)
High / Med	1.0	10 (600)

“Currents Uncertainty Only Case”

SAROPS inputs

- 1) SLDMBs
- 2) LKP zero error, @ 09z 18 Sept
- 3) Winds 0kts N, (σ 0.0 kts, Γ 60 min)
- 4) Currents zero (**vary σ and Γ**)
- 5) 24 hour drift to 09z 19 Sept

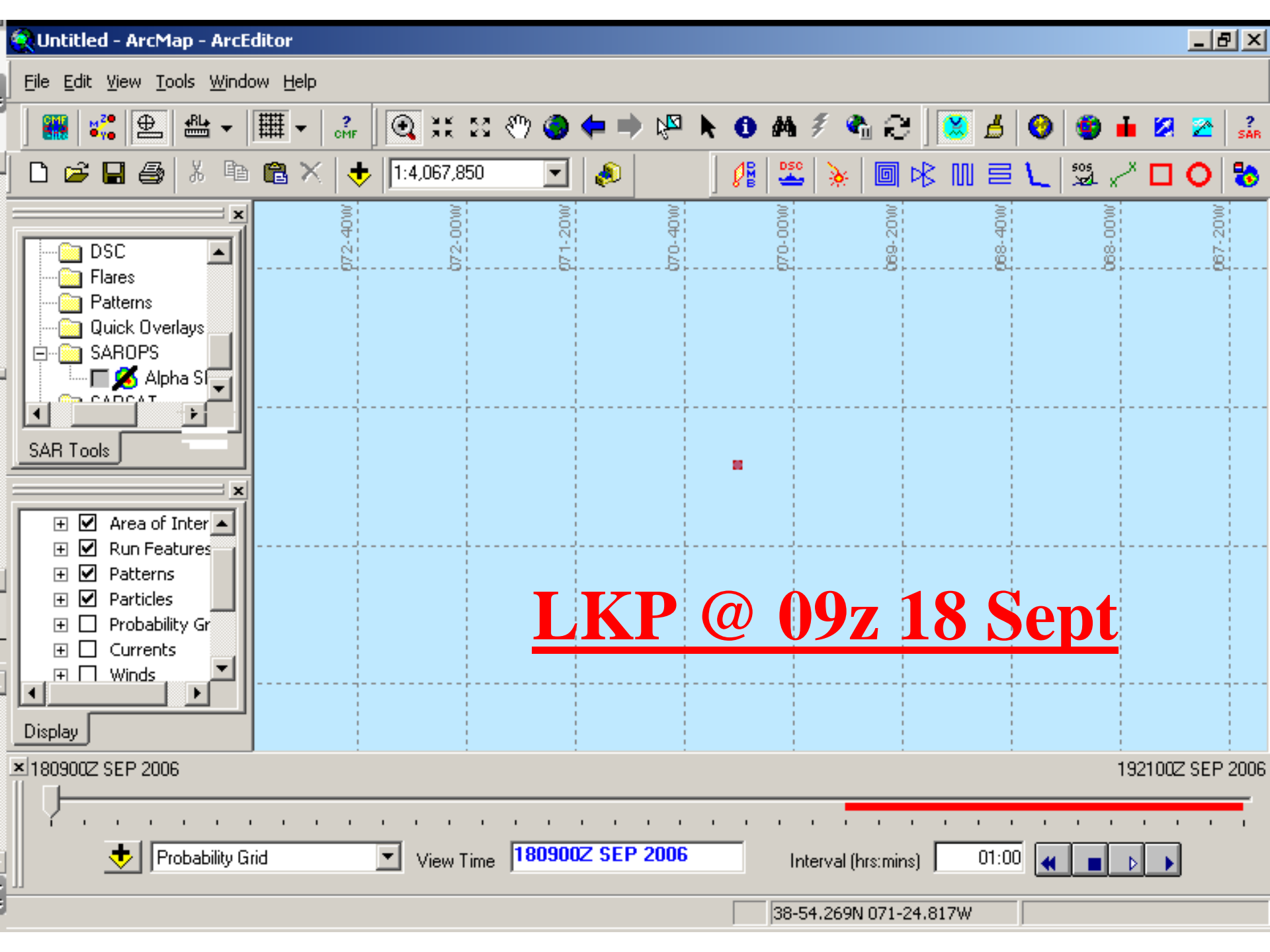

LKP @ 09z 18 Sept

Low / Low

0.25

3 (180)

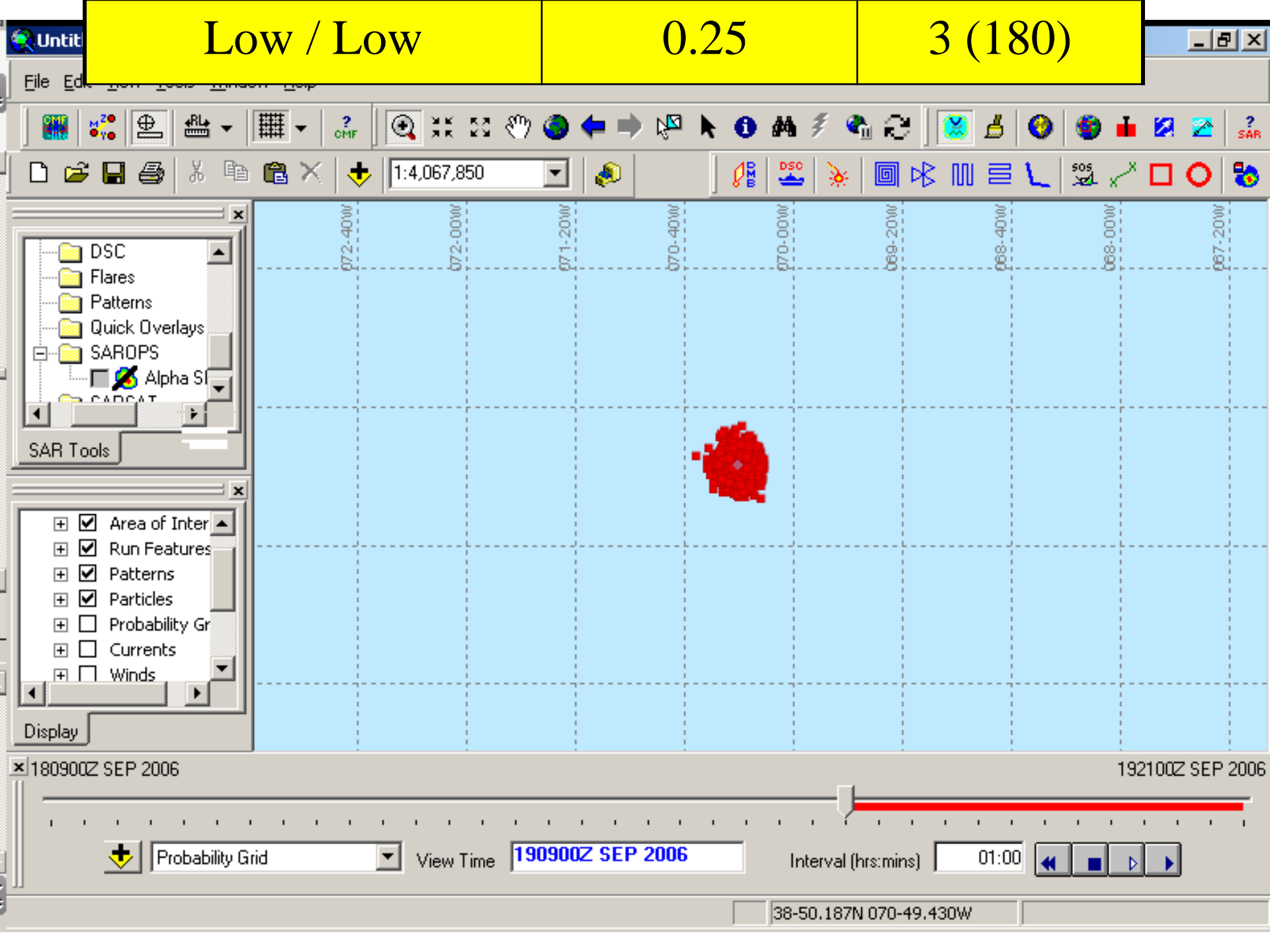

Med / Low

0.5

3 (180)

File Edit

CMF CMF ? CMF

1:4,067,850

DSC DSC SOS

SAR Tools

- DSC
- Flares
- Patterns
- Quick Overlays
- SAROPS
 - Alpha S
 - CADCAT

Display

- Area of Inter
- Run Features
- Patterns
- Particles
- Probability Gr
- Currents
- Winds

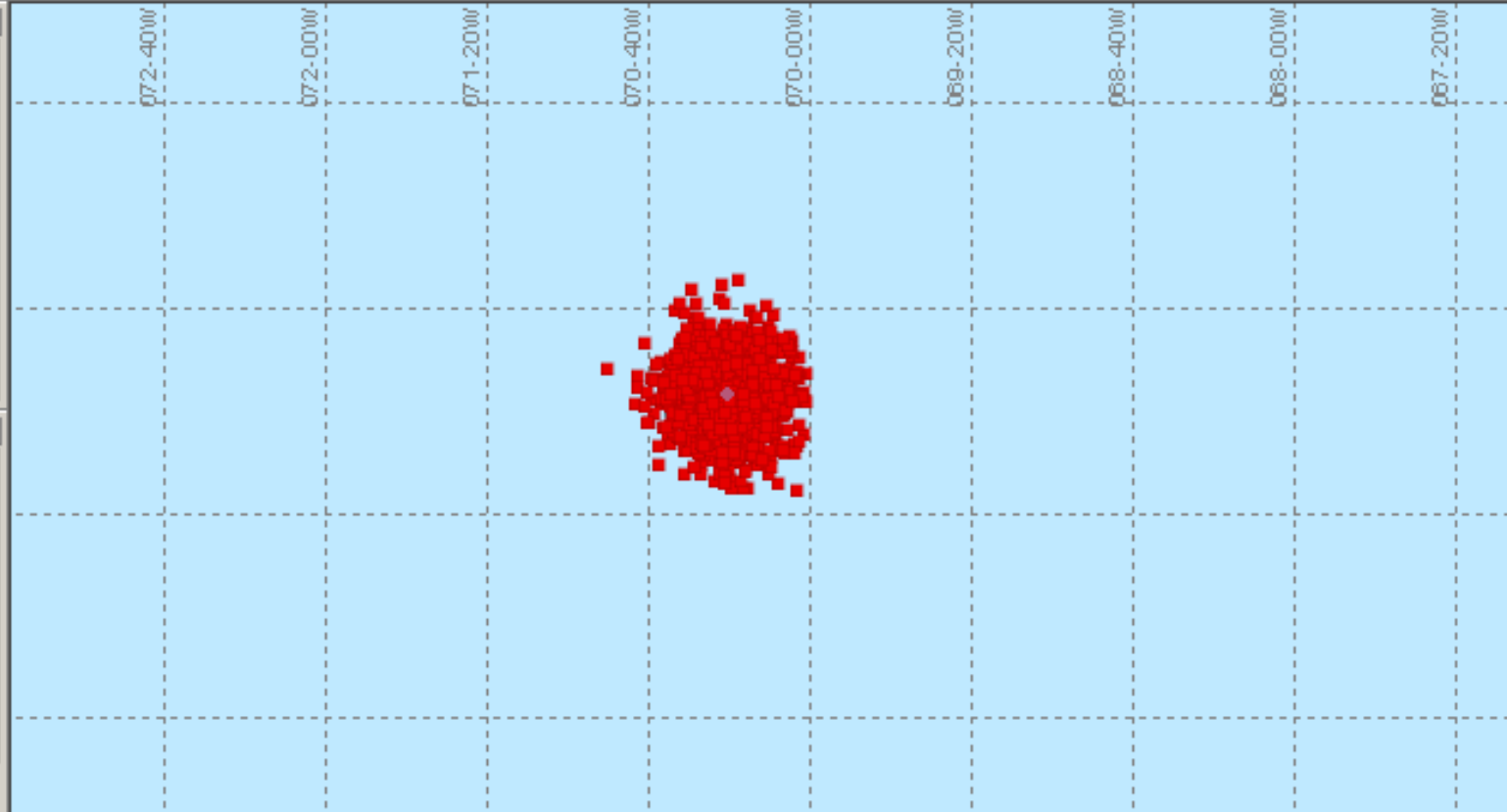

180900Z SEP 2006 192100Z SEP 2006

Probability Grid View Time 190900Z SEP 2006 Interval (hrs:mins) 01:00

38-56.082N 073-12.717W

High / Low

1.0

3 (180)

File Edit View Tools Window Help

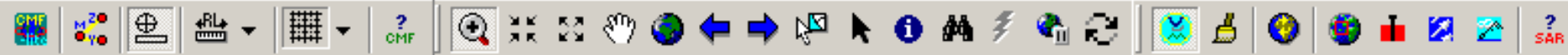

1:4,067,850

SAR Tools

- Folder: DSC
- Folder: Flares
- Folder: Patterns
- Folder: Quick Overlays
- Folder: SAROPS
 - Alpha S
 - CADCAT

Display

- Area of Inter
- Run Features
- Patterns
- Particles
- Probability Gr
- Currents
- Winds

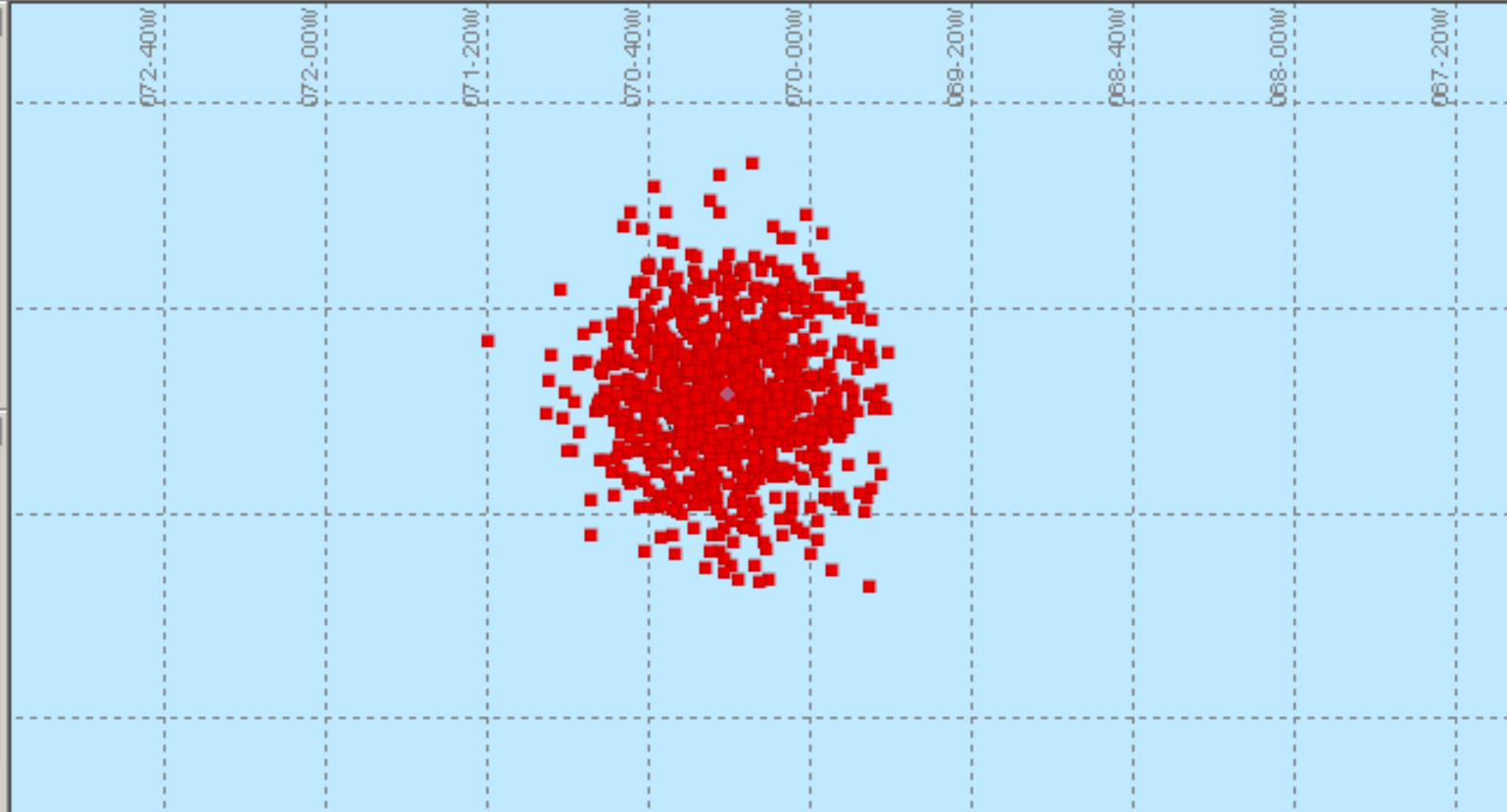

180900Z SEP 2006

192100Z SEP 2006

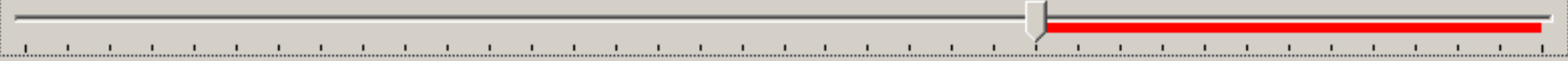

Probability Grid View Time 190900Z SEP 2006 Interval (hrs:mins) 01:00

39-25.429N 069-46.778W

“Currents Uncertainty Only Case”

SAROPS inputs

- 1) SLDMBs
- 2) LKP zero error, @ 09z 18 Sept
- 3) Winds 0kts N, (σ 0.0 kts, Γ 60 min)
- 4) **Currents zero ($\sigma = 0.5$ kts and vary Γ)**
- 5) 24 hour drift to 09z 19 Sept

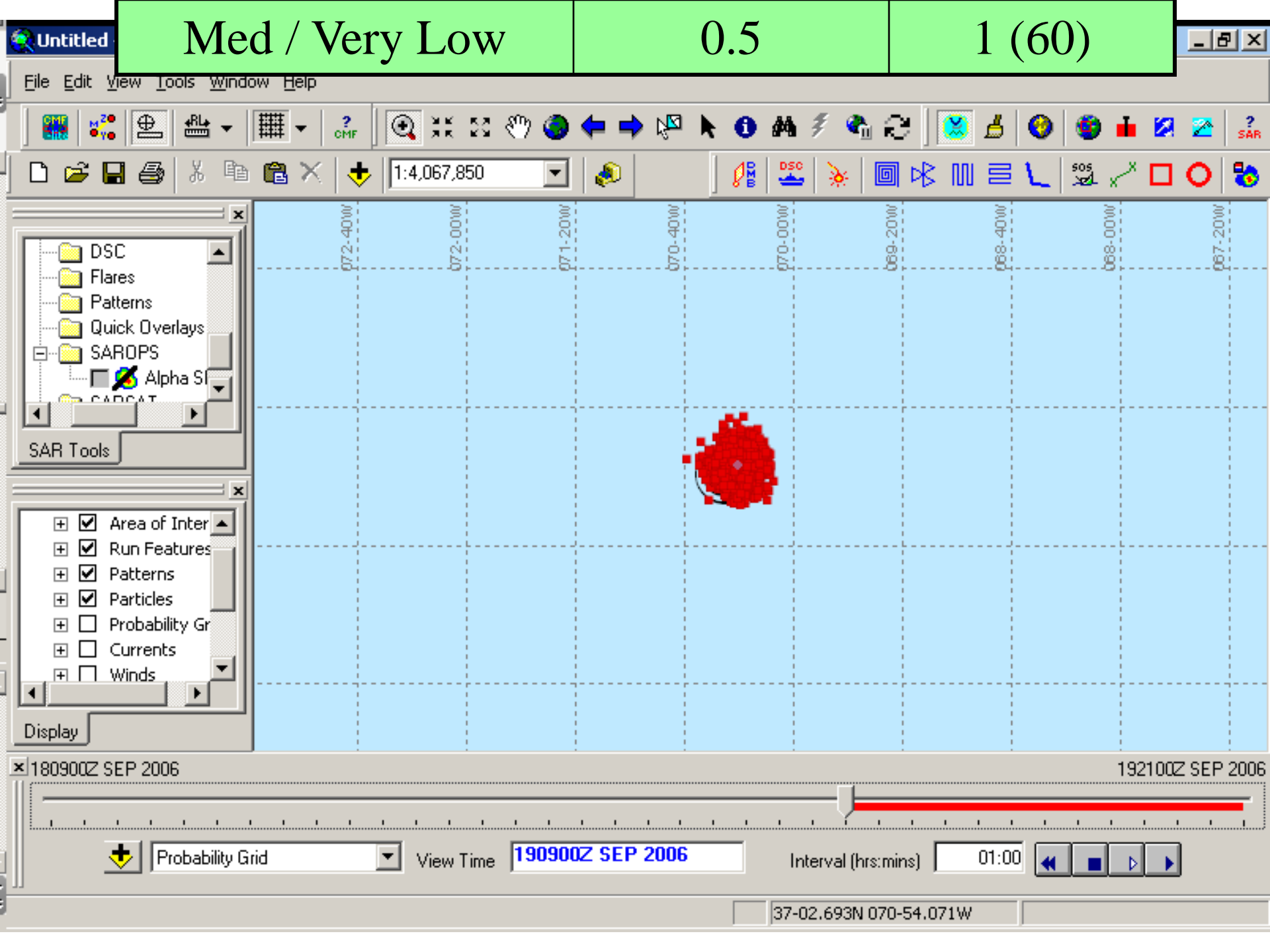

Med / Low

0.5

3 (180)

File Edit

CMF CMF ? CMF

1:4,067,850

DSC DSC SOS

SAR Tools

- DSC
- Flares
- Patterns
- Quick Overlays
- SAROPS
 - Alpha S
 - CADCAT

Display

- Area of Inter
- Run Features
- Patterns
- Particles
- Probability Gr
- Currents
- Winds

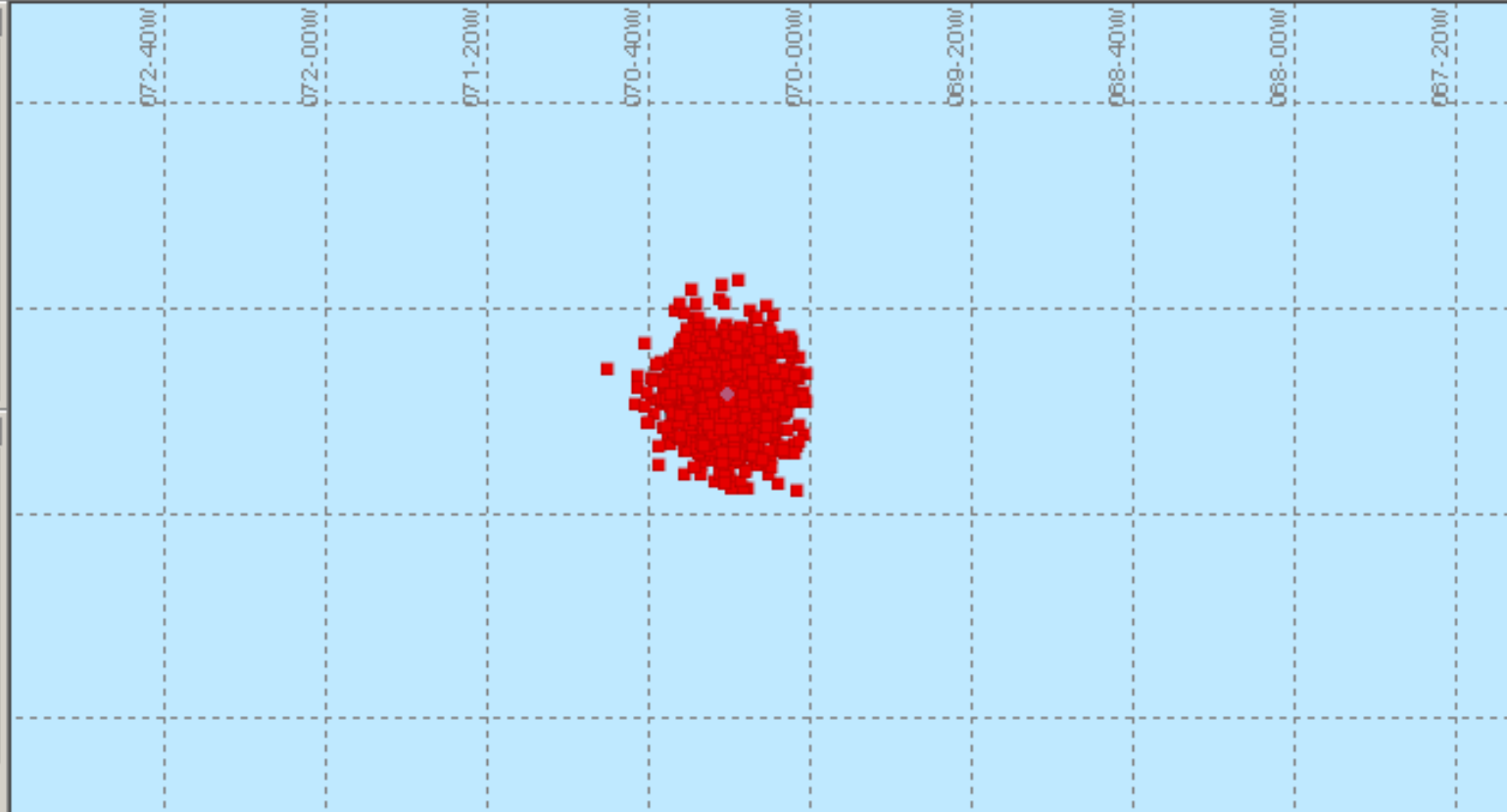

180900Z SEP 2006 192100Z SEP 2006

Probability Grid View Time 190900Z SEP 2006 Interval (hrs:mins) 01:00

38-56.082N 073-12.717W

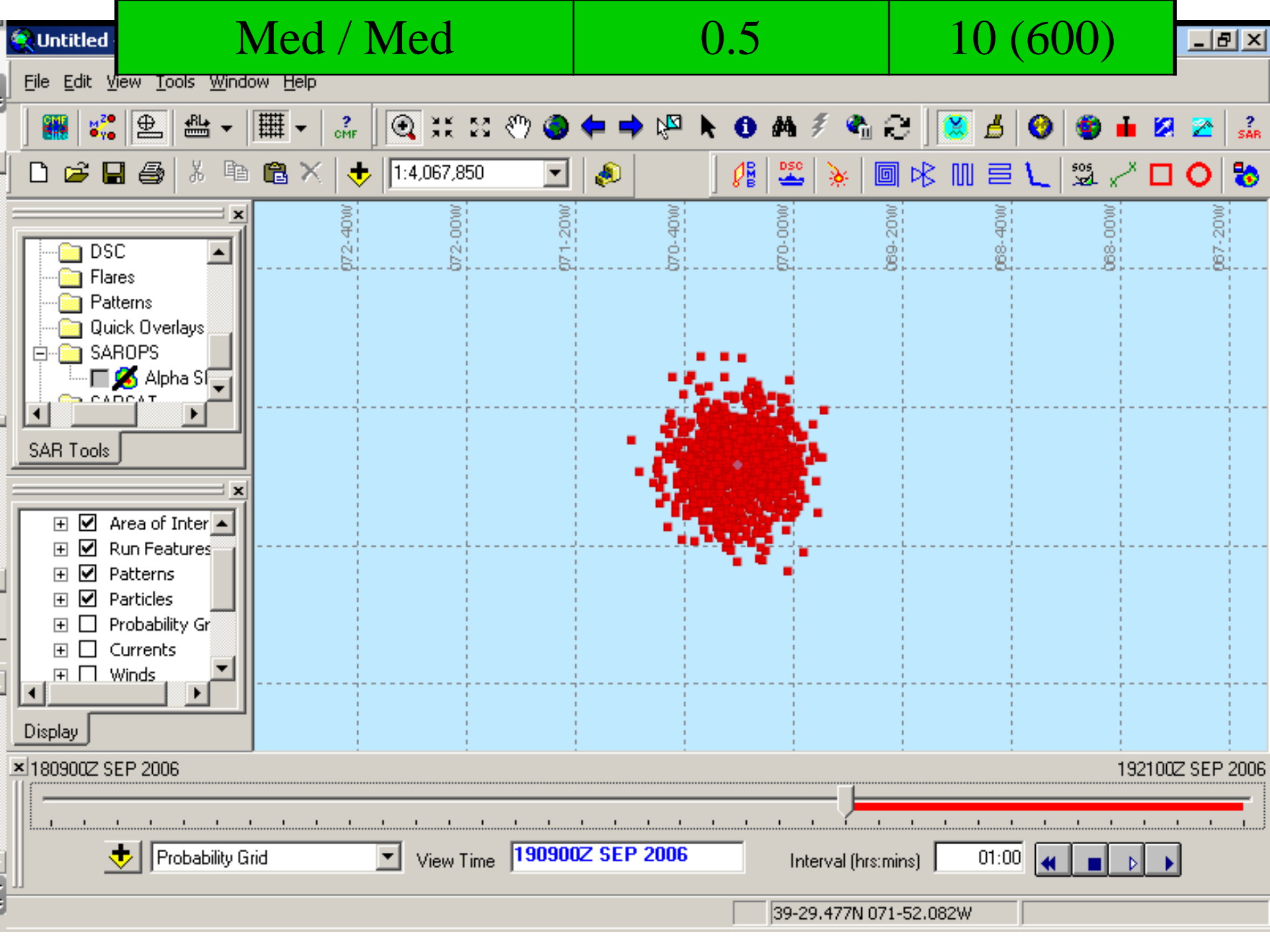

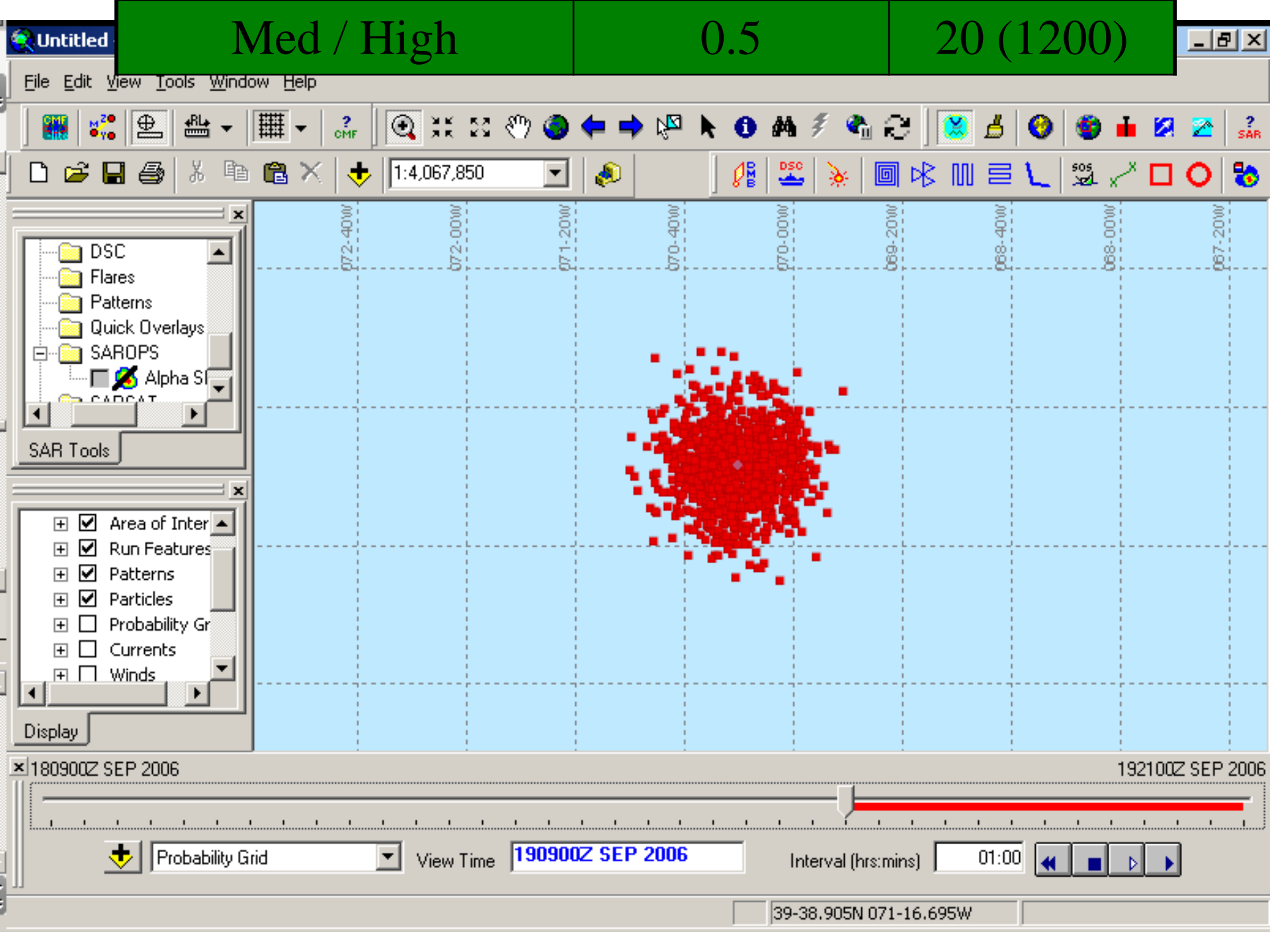

Untitled

Med / High

0.5

20 (1200)

File Edit View Tools Window Help

Toolbar containing various icons for navigation, zooming, and tool selection. Includes a search bar with the value "1:4,067,850".

File Explorer showing a directory tree with folders: DSC, Flares, Patterns, Quick Overlays, SAROPS, and SARCAT. A sub-folder "Alpha S" is expanded. Below the tree is a "SAR Tools" section.

Display Settings Panel with a list of features to be displayed or hidden:

- Area of Inter
- Run Features
- Patterns
- Particles
- Probability Gr
- Currents
- Winds

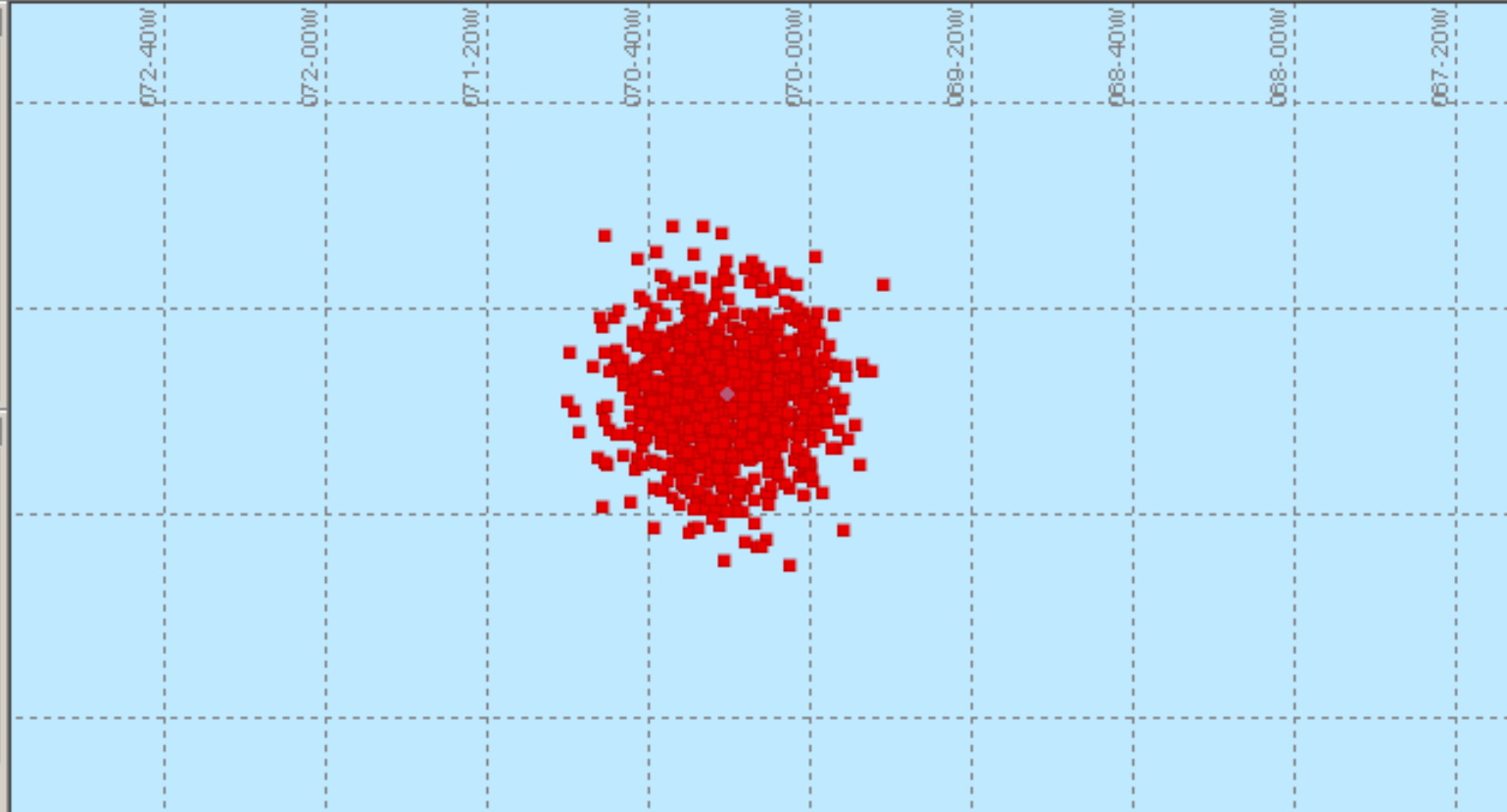

180900Z SEP 2006

192100Z SEP 2006

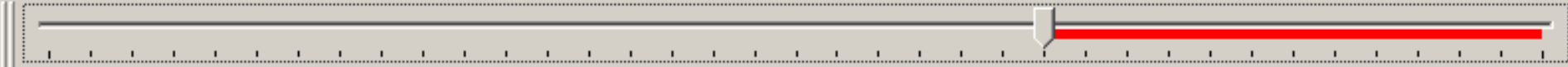

View Time: 190900Z SEP 2006 Interval (hrs:mins): 01:00

39-38.905N 071-16.695W

“Typical SAR Case”

SAROPS inputs

PIWs / Life Raft / Skiff

LKP 2 nm error, @ 00z 18 Sept (± 1 hr)

Winds 15 kts W, (σ 1.0 kts, Γ 60 min)

Currents 0.2 kts to SE (**vary σ and Γ**)

24-26 hour drift to 01z 19 Sept

1) Helo (100 kts, 300 ft, 3 hour on-scene time, visual search)

Low / Low

0.25

3 (180)

SAR Tools

- Flares
- Patterns
- Quick C
- SAROP
- SARSA

Layers

- Area of Inter
- Run Features
- Patterns
- Particles
- Probability Gr
- Currents

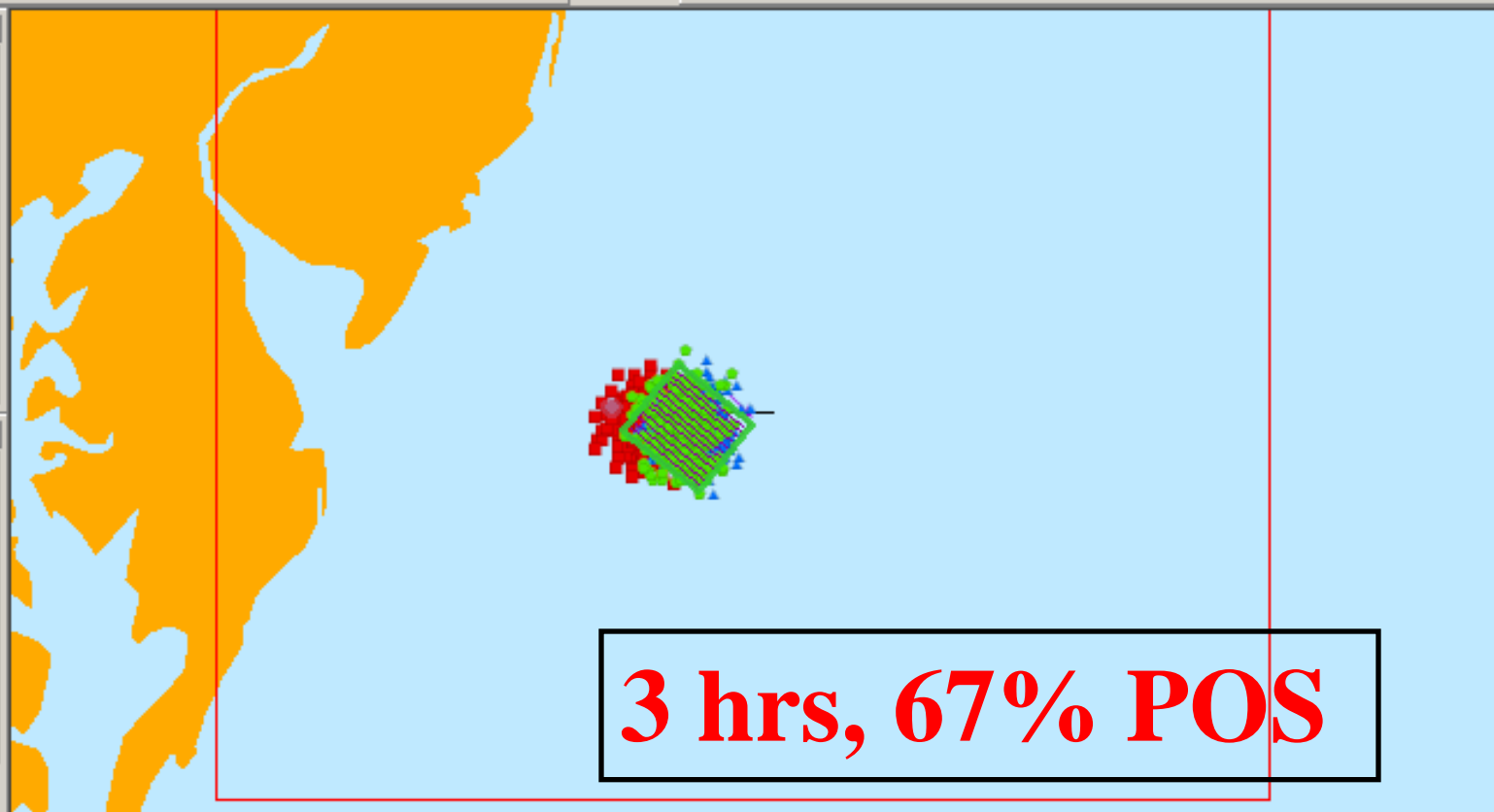

3 hrs, 67% POS

172300Z SEP 2006

191300Z SEP 2006

Probability Grid View Time **190100Z SEP 2006** Interval (hrs:mins) 01:00

39-11.919N 073-30.613W

Med / Low

0.5

3 (180)

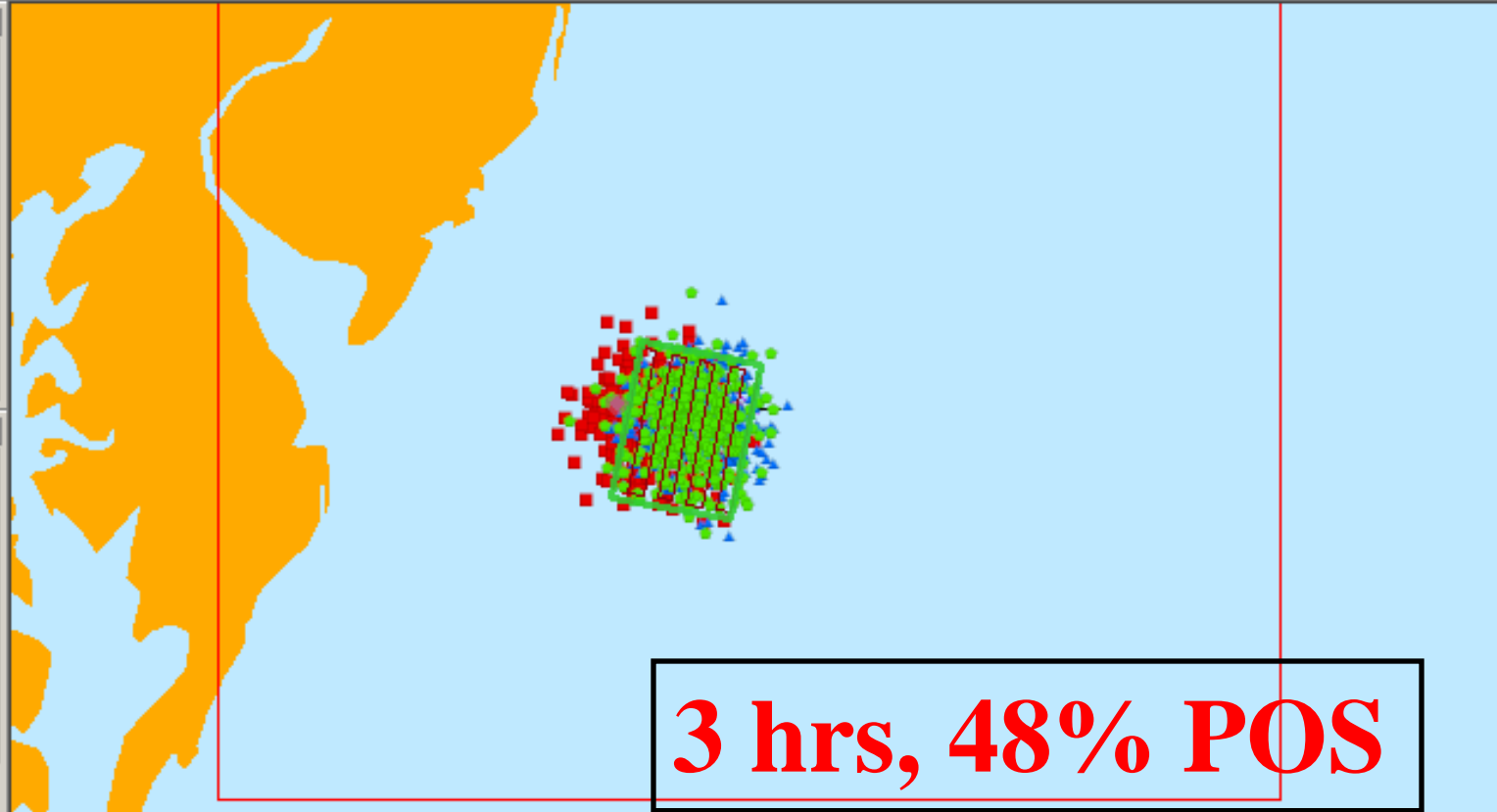
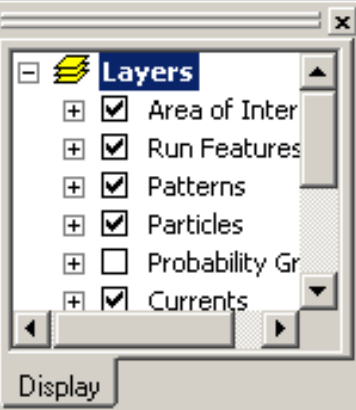
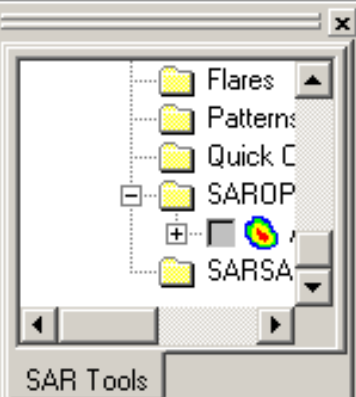

3 hrs, 48% POS

172300Z SEP 2006 191300Z SEP 2006

Probability Grid View Time **190100Z SEP 2006** Interval (hrs:mins) 01:00

39-21.716N 073-37.216W

High / Low

1.0

3 (180)

3 hrs, 22% POS

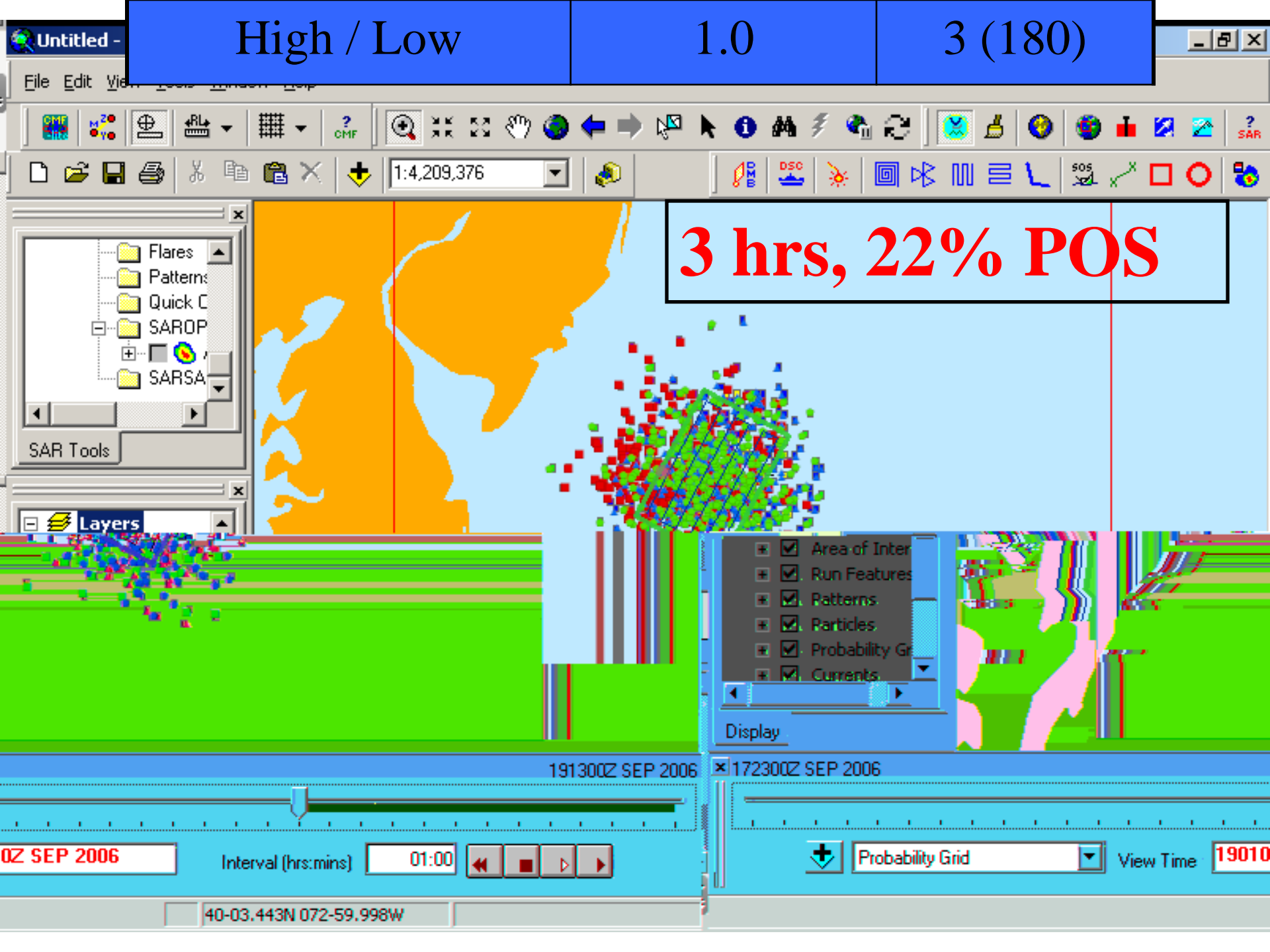

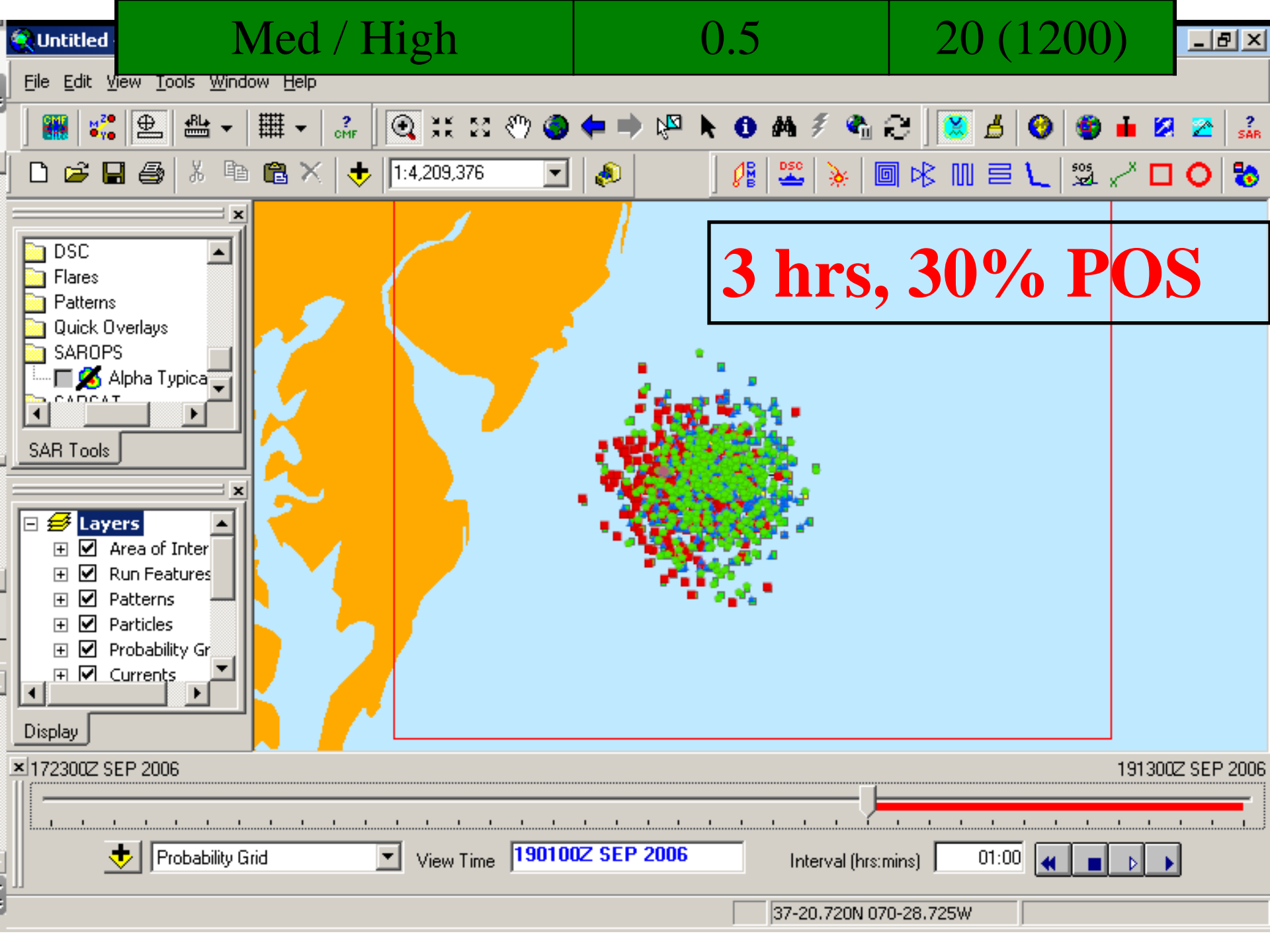

Med / High

0.5

20 (1200)

File Edit View Tools Window Help

Toolbar containing various icons for file operations, navigation, and simulation controls.

SAR Tools panel with a tree view showing folders: DSC, Flares, Patterns, Quick Overlays, SAROPS, Alpha Typica, and CARCAT.

Layers panel with a list of layers: Area of Inter, Run Features, Patterns, Particles, Probability Gr, and Currents.

3 hrs, 30% POS

Timeline slider showing the time range from 172300Z SEP 2006 to 191300Z SEP 2006.

View Time: 190100Z SEP 2006 Interval (hrs:mins): 01:00

37-20.720N 070-28.725W

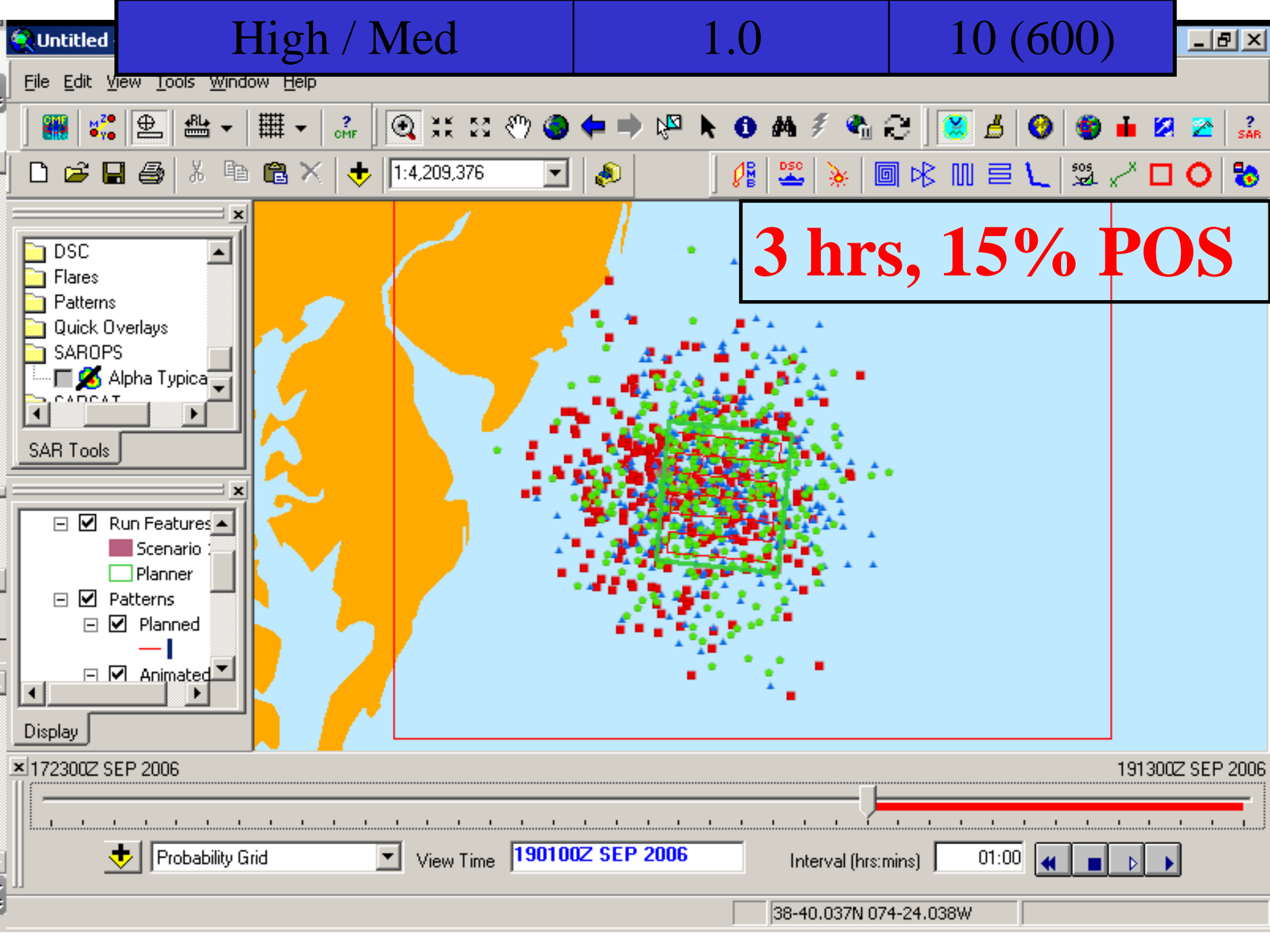

High / Med

1.0

10 (600)

File Edit View Tools Window Help

Toolbar containing various icons for navigation, zooming, and tool selection. A central dropdown menu shows the value "1:4,209,376".

3 hrs, 15% POS

File tree sidebar showing folders: DSC, Flares, Patterns, Quick Overlays, SAROPS, Alpha Typica, and SARCAT. Below the tree is a "SAR Tools" section.

Display options sidebar with checkboxes: Run Features (checked), Scenario (Planner), Patterns (checked), Planned (checked), and Animated (checked).

Timeline slider showing a red bar. Start time: 172300Z SEP 2006. End time: 191300Z SEP 2006.

View Time: 190100Z SEP 2006. Interval (hrs:mins): 01:00. Navigation buttons for back, stop, forward, and refresh.

38-40.037N 074-24.038W



CG Wide



FY	Cases (K)	Lives Saved	Lives Lost		
			Before After CG Notification	Unaccounted for	
03	31.6	5,192	260	412	499
04	32.6	5,555	277	502	676
05	29.8	5,648	320	521	606
06	28.3	5,260	310	476	667



CG Wide



- 1) 3 searches / day = ~ 1000 / yr
- 2) 3 persons lost / day = ~ 1000 / yr
- 3) Costs \$10k/hr to search
 - $\$10\text{k/hr} \times \sim 1000 \times \sim 3 \text{ hr} = \sim \30M
- 4) Value of Statistical Life = \$3M
 - $1000 \times \$3\text{M} = \sim \3B



CG Wide



- 1) Assume 100 persons involved / yr
with sub-optimal search areas
- 2) Assume 22% POS now “typical”
- 3) 22 save/100 vs. 48/100 vs. 67/100
- 4) Save 26 to 45 additional persons / yr
 - (\$ 78M – \$135M VSL)