

Congratulations, you and your MacBook
were made for each other.

Welcome to your MacBook.

www.apple.com/macbook



Built-in FaceTime camera

Make video calls to the latest iPad, iPhone, iPod touch, or Mac.

Help Center

 [facetime](#)



Multi-Touch trackpad

Use gestures like these to control your Mac.

Help Center

 [gestures](#)



Click anywhere



Pinch to zoom

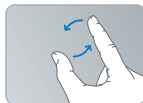

Rotate images



Scroll up or down



Swipe between full-screen apps

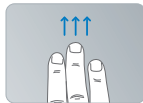

View Mission Control

OS X Lion

www.apple.com/macosex



Mission Control

A bird's-eye view of what's running on your Mac.

Help Center

 [mission control](#)



Launchpad

Instant access to all your apps in one place.

Help Center

 [launchpad](#)



Full screen

Make apps full screen with a click.

Help Center

 [full screen](#)



Mac App Store

The best way to discover and download Mac apps.

Help Center

 [mac app store](#)



Mail

Group your messages by conversations.

Help Center

 [mail](#)



iPhoto

Organize, edit, and share your photos.

iPhoto Help

 [photos](#)



iMovie

Turn home videos into home blockbusters.

iMovie Help

 [movie](#)



GarageBand

Create great-sounding songs with ease.

GarageBand Help

 [record](#)

Contents

Chapter 1: Ready, Set Up, Go

- 9 What's in the Box
- 9 Setting Up Your MacBook
- 16 Putting Your MacBook to Sleep or Shutting It Down

Chapter 2: Life with Your MacBook

- 20 Basic Features of Your MacBook
- 22 Keyboard Features of Your MacBook
- 24 Ports on Your MacBook
- 26 Using the Multi-Touch Trackpad
- 30 Using the MacBook Battery
- 31 Getting Answers

Chapter 3: Boost Your MacBook

- 37 Replacing the Hard Disk Drive
- 46 Installing Additional Memory

Chapter 4: Problem, Meet Solution

- 52 An Ounce of Prevention
- 53 Problems That Prevent You from Using Your MacBook
- 56 Repairing, Restoring, or Reinstalling Mac OS X Software
- 61 Using Apple Hardware Test
- 62 Problems with Your Internet Connection
- 64 Problems with Wi-Fi Communication
- 65 Keeping Your Software Up to Date
- 66 Learning More, Service, and Support
- 68 Locating Your Product Serial Number

Chapter 5: Last, but Not Least

- 70 Important Safety Information
- 74 Important Handling Information
- 77 Understanding Ergonomics
- 79 Apple and the Environment

Looking for Something?

- 86 Index

1

Ready, Set Up, Go

www.apple.com/macbook

[Help Center](#)  [Migration Assistant](#)

Your MacBook is designed so that you can set it up quickly and start using it right away. If you have never used a MacBook or are new to Mac computers, read this chapter for help getting started.

Important: Read all the installation instructions (and the safety information starting on page 70) carefully before you first use your computer.

If you're an experienced user, you may already know enough to get started. Make sure you look over the information in Chapter 2, "Life with Your MacBook," to find out about the new features of this MacBook.

Many answers to questions can be found on your computer in Help Center. For information about using Help Center, see "Getting Answers" on page 31. Apple may release new versions and updates to its system software, so the images shown in this book may be slightly different from what you see onscreen.

What's in the Box

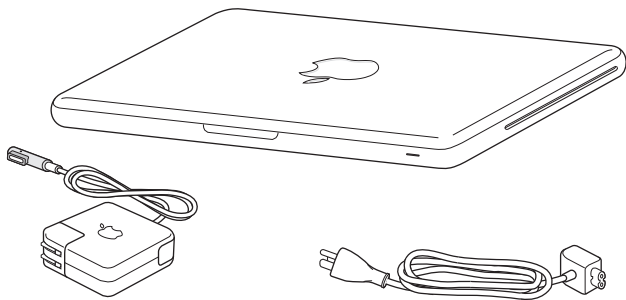

60W MagSafe Power Adapter

AC power cord

Setting Up Your MacBook

Your MacBook is designed so that you can set it up quickly and start using it right away. The following pages take you through the setup process, including these tasks:

- Plugging in the 60W MagSafe Power Adapter
- Connecting cables and accessing a network
- Turning on your MacBook and using the trackpad
- Configuring a user account and other settings using Setup Assistant
- Setting up the Mac OS X desktop and preferences

Important: Remove the protective film around the 60W MagSafe Power Adapter before setting up your MacBook.

Step 1: Plug in the 60W MagSafe Power Adapter to provide power to the MacBook and charge the battery.

Make sure the AC plug is fully inserted into the power adapter and the electrical prongs on your AC plug are in their completely extended position. Insert the AC plug of your power adapter into a power outlet and the MagSafe connector into the MagSafe power port. As the MagSafe connector gets close to the port, you'll feel a magnetic pull drawing it in.

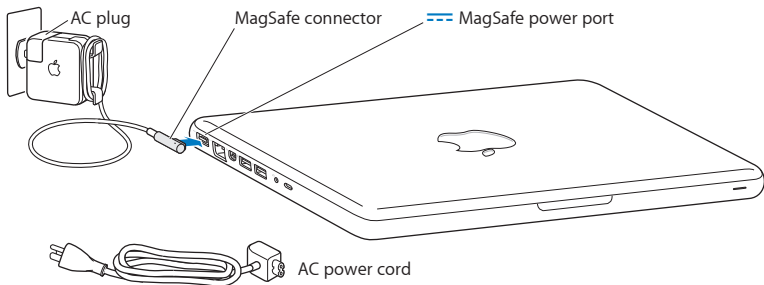

To extend the reach of your power adapter, replace the AC plug with the AC power cord. Pull the AC plug up to remove it from the adapter, and then attach the included AC power cord to the adapter, making sure it's seated firmly.

When disconnecting the power adapter from an outlet or from the computer, pull the plug, not the cord.

When you connect the power adapter to your MacBook, an indicator light on the MagSafe connector starts to glow. An amber light indicates that the battery is charging. A green light indicates that the battery is fully charged. If you don't see a light, make sure the connector is seated properly and the power adapter is plugged in.

Step 2: Connect to a wireless or wired network.

- To use a wireless network with the built-in 802.11n Wi-Fi technology, make sure that the wireless base station is turned on and that you know the name of the network. After you turn on your MacBook, Setup Assistant guides you through the connection process. For troubleshooting tips, see page 64.
- To use a wired connection, connect one end of an Ethernet cable to your MacBook and the other end to a cable modem, DSL modem, or network.

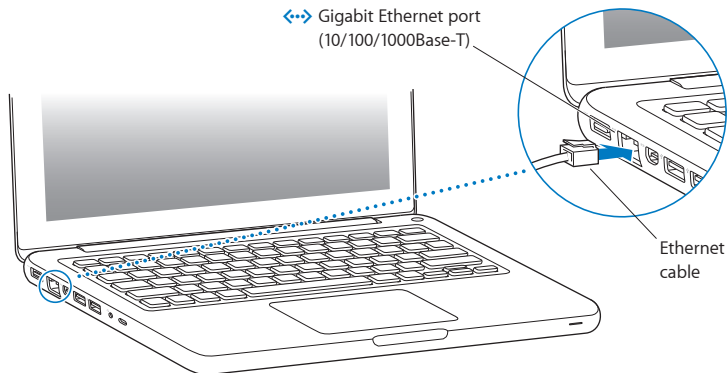

Step 3: Press the power (⏻) button briefly to turn on your MacBook.

You hear a tone when you turn on the computer.

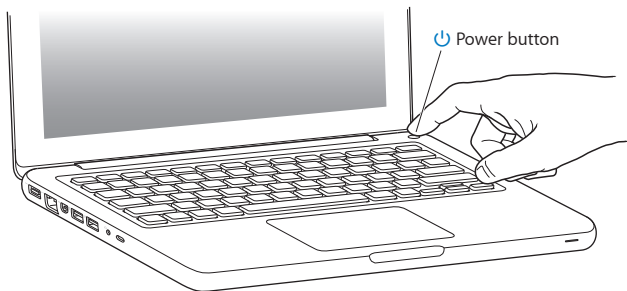

It takes the computer a few moments to start up. After it starts up, Setup Assistant opens automatically.

If your computer doesn't turn on, see "If your MacBook doesn't turn on or start up" on page 54.

Step 4: Configure your MacBook with Setup Assistant.

The first time you turn on your MacBook, Setup Assistant starts. Setup Assistant helps you specify your Wi-Fi network, set up a user account, and transfer information from another Mac or PC. You can also transfer information from a Time Machine backup or other disk.

If you're migrating from another Mac, you might have to update software if the other Mac doesn't have Mac OS X version 10.5.3 or later installed. To migrate from a PC, download the Migration Assistant from www.apple.com/migrate-to-mac, and install it on the PC you want to migrate from.

After you start Setup Assistant on your MacBook, you can leave it midprocess without quitting, move to the other computer if you need to update its software, and then return to your MacBook to complete the setup.

Note: If you don't use Setup Assistant to transfer information when you first start up your MacBook, you can do it later using Migration Assistant. Open Migration Assistant in the Utilities folder in Launchpad. For help using Migration Assistant, open Help Center and search for "Migration Assistant."

To set up your MacBook:

- 1 In Setup Assistant, follow the onscreen instructions until you get to the “Transfer Information to This Mac” screen.
- 2 Do a basic setup, do a setup with migration, or transfer information from a Time Machine backup or other disk:
 - *To do a basic setup*, select “Don’t transfer now” and click Continue. Follow the remaining prompts to select your wired or wireless network, set up an account, and exit Setup Assistant.
 - *To do a setup with migration*, select “From another Mac or PC” and click Continue. Follow the onscreen instructions to select the Mac or PC you want to migrate from. Your Mac or PC must be on the same wired or wireless network. Follow the onscreen instructions for migrating.
 - *To transfer information from a Time Machine backup or another disk*, select “From a Time Machine backup or other disk” and click Continue. Select the backup or the other disk that you want to migrate from. Follow the onscreen instructions.

If you don’t intend to keep or use your other computer, it’s best to deauthorize it from playing music, videos, or audiobooks that you’ve purchased from the iTunes Store. Deauthorizing a computer prevents any songs, videos, or audiobooks you’ve purchased from being played by someone else, and frees up another authorization for use. For information about deauthorizing, choose iTunes Help from the Help menu in iTunes.

Step 5: Customize the Mac OS X desktop and set preferences.

You can quickly make the desktop look the way you want using System Preferences, your command center for most settings on your MacBook. Choose Apple (🍏) > System Preferences from the menu bar or click the System Preferences icon in the Dock.

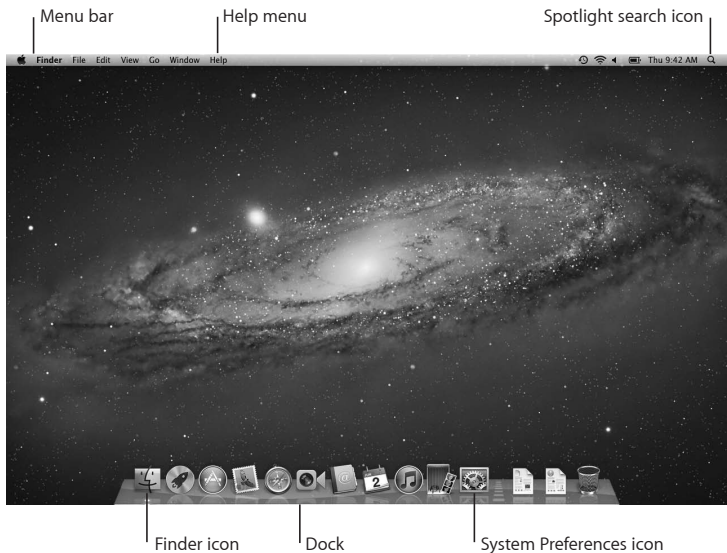

Important: You can set an option to reset your password in Users & Groups preferences, in case you forget your login password. For help with system preferences, open Help Center and search for “system preferences” or for the specific preference you want help for.

Putting Your MacBook to Sleep or Shutting It Down

When you finish working with your MacBook, you can put it to sleep or shut it down.

Putting Your MacBook to Sleep

If you'll be away from your MacBook for only a short time, put it to sleep. When the computer is in sleep, you can quickly wake it and bypass the startup process.

To put your MacBook to sleep, do one of the following:

- Close the display.
- Choose Apple () > Sleep from the menu bar.
- Press the power (⏻) button and click Sleep in the dialog that appears.
- Choose Apple () > System Preferences, click Energy Saver, and set a sleep timer.

NOTICE: Wait a few seconds until the sleep indicator light starts pulsing (indicating that the computer is in sleep and the hard disk has stopped spinning) before you move your MacBook. Moving your computer while the hard disk is spinning can damage it, causing loss of data or the inability to start up from the hard disk.

To wake your MacBook:

- *If the display is closed*, simply open it to wake your MacBook.
- *If the display is already open*, press the power (⏻) button or any key on the keyboard.

When your MacBook wakes from sleep, your applications, documents, and computer settings are exactly as you left them.

Shutting Down Your MacBook

If you aren't going to use your MacBook for a day or two, it's best to shut it down. The sleep indicator light goes on briefly during the shutdown process.

To shut down your MacBook, do one of the following:

- Choose Apple (🍏) > Shut Down from the menu bar.
- Press the power (⏻) button and click Shut Down in the dialog that appears.

If you plan to store your MacBook for an extended period of time, see page 76 for information about how to prevent the battery from draining completely.

2

Life with Your MacBook

www.apple.com/macosex

Help Center  Mac OS X

Basic Features of Your MacBook

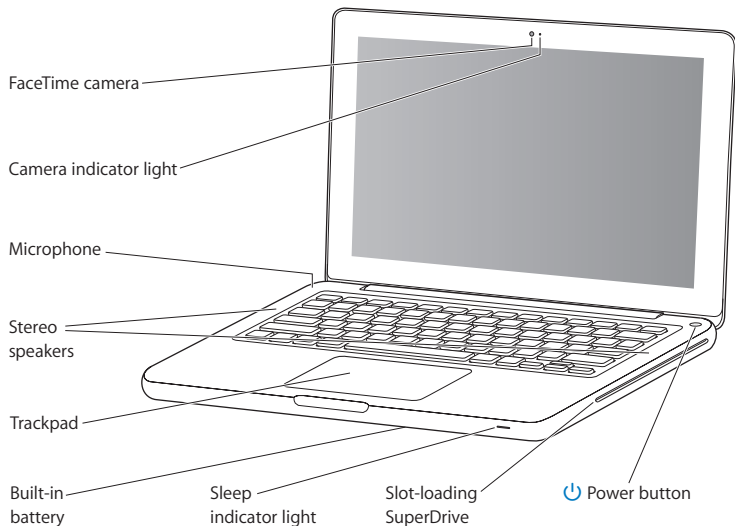

Built-in FaceTime camera and camera indicator light

Use the included FaceTime application to make video calls to other FaceTime users (on any iPhone 4, iPad 2, new iPod touch, or Mac with FaceTime), take pictures with Photo Booth, or capture video with iMovie. The indicator light glows when the FaceTime camera is operating.

Built-in microphone

Capture sounds with the microphone (located above and to the left of the Esc key on your keyboard), or talk with friends live over the Internet using the FaceTime or iChat application.

Built-in stereo speakers

Listen to music, movies, games, and other multimedia files.

Trackpad

Click or double-click anywhere on the trackpad. Touch the trackpad with one or more fingers to move the pointer and use Multi-Touch gestures (described on page 26).

Built-in battery

Use battery power when you're away from a power outlet.

Sleep indicator light

A white light pulses when the MacBook is in sleep.

Slot-loading SuperDrive

Your optical drive can read and write to standard-size CD and DVD discs.

**Power button**

Turn your MacBook on or off, or put it to sleep.

Keyboard Features of Your MacBook

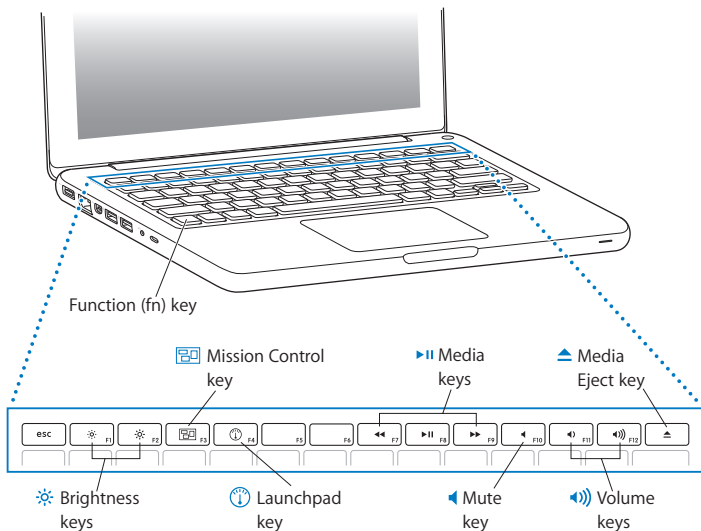

Function (fn) key

Hold down this key to activate customized actions assigned to the function keys (F1 to F12). To learn how to customize function keys, choose Help > Help Center from the menu bar and search for “function keys.”

**Brightness keys (F1, F2)**

Increase (☀) or decrease (☀) the brightness of the screen.

**Mission Control key (F3)**

Open Mission Control to get a comprehensive view of what’s running on your MacBook, including Dashboard, all your spaces, and all open windows.

**Launchpad key (F4)**

Open Launchpad to instantly see all the applications on your MacBook. Click an application to open it.

**Media keys (F7, F8, F9)**

Rewind (◀), play or pause (▶||), or fast-forward (▶▶) a song, movie, or slideshow.

**Mute key (F10)**

Mute the sound coming from the built-in speakers or audio out port.

**Volume keys (F11, F12)**

Increase (🔊) or decrease (🔊) the volume of the sound coming from the built-in speakers or audio out port.

**Media Eject key**

Hold down this key to eject a disc that’s not in use. You can also eject a disc by dragging its desktop icon to the Trash.

Ports on Your MacBook

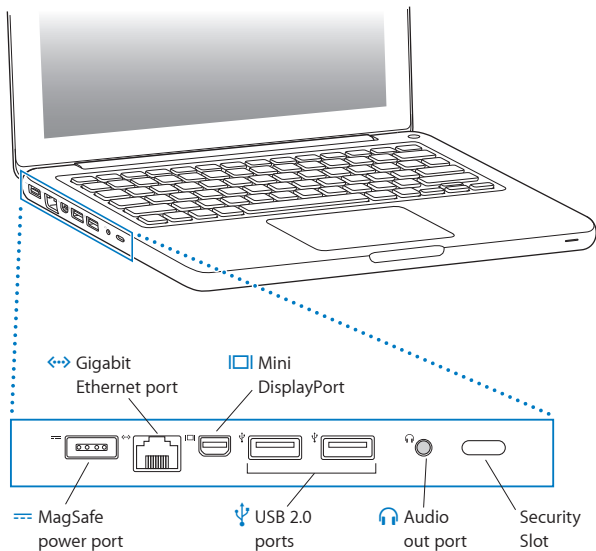

**MagSafe power port**

Plug in the included 60W MagSafe Power Adapter to recharge the MacBook battery.

**Gigabit Ethernet port**

Connect to a high-speed Ethernet network, a DSL or cable modem, or another computer. The Ethernet port automatically detects Ethernet devices and doesn't require an Ethernet crossover cable.

**Mini DisplayPort**

Connect to an external display or projection system that uses a DVI or VGA connector. You can purchase adapters for supported video formats.

**Two USB (Universal Serial Bus) 2.0 ports**

Connect an iPod, iPhone, iPad, mouse, keyboard, printer, disk drive, digital camera, joystick, modem, and more to your MacBook.

**Audio out port**

Connect external speakers, headphones (including iPhone), or digital audio equipment. To use a line-level microphone or analog audio equipment, specify audio line in functionality using Sound preferences.

Security slot

Attach a lock and cable (available separately) to prevent theft.

Note: Adapters and other accessories are sold separately at www.apple.com/store or your local Apple Retail Store.

Using the Multi-Touch Trackpad

Use the trackpad to move the cursor and to perform a variety of Multi-Touch gestures. Unlike typical trackpads, the entire MacBook trackpad is a button, and you can click anywhere on the trackpad. To enable Multi-Touch gestures, view instructional videos of the gestures, and set other trackpad options, choose Apple (🍏) > System Preferences, and then click Trackpad.

Here are ways to use your MacBook trackpad:

- *Two-finger scrolling* lets you drag to scroll quickly up, down, or sideways in the active window.

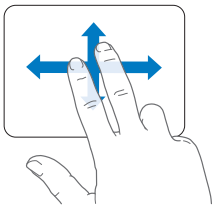

- *Secondary-clicking* or “*right-clicking*” lets you access shortcut menu commands.
 - To set up two-finger secondary-clicking anywhere on the trackpad, select “Secondary click” in the Point & Click pane of Trackpad preferences.

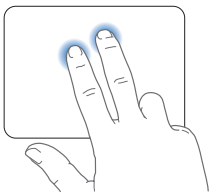

- To set up a one-finger secondary-click zone in the bottom left or right corner of the trackpad, select “Secondary click” in the Point & Click pane of Trackpad preferences, and choose an option from the pop-up menu.

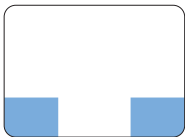

Secondary-click zone

Note: You can also secondary-click by holding down the Control key while you click.

The following trackpad gestures work in certain applications. When you perform these gestures, slide your fingers lightly on the surface of the trackpad. For more information, see Trackpad preferences or choose Help > Help Center and search for “trackpad.”

- *Two-finger pinching* lets you zoom in or out on PDFs, images, photos, and more.

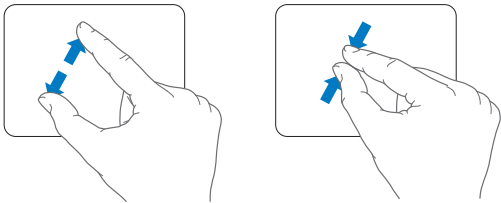

- *Two-finger rotating* lets you rotate photos, pages, and more.

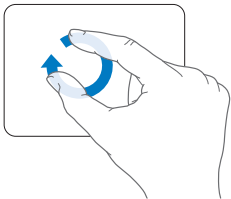

- *Three-finger swiping* works in the Finder and all applications. Swiping three fingers to the left or right lets you cycle through full-screen applications. Swiping three fingers up opens Mission Control. You can also set these options to work with four fingers.

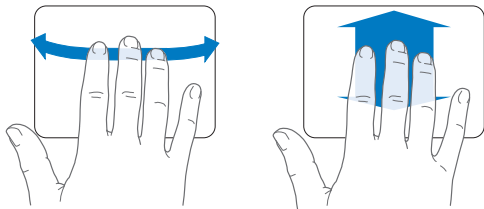

- *Four-finger pinching* displays Launchpad when you pinch your thumb and three fingers together. Spread the same fingers apart to return to the desktop.

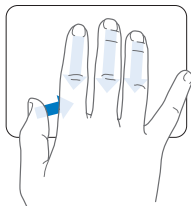

Note: You can specify other functions for many gestures. For details about all available gestures, choose Apple () > System Preferences, and then click Trackpad. Click the checkboxes to turn gestures on or off, and explore the pop-up menus to see the options for each gesture.

Using the MacBook Battery

When the MagSafe power adapter isn't connected, your MacBook draws power from its built-in battery. The length of time that you can run your MacBook varies, depending on the applications you use and the external devices connected to your MacBook.

Turning off features such as Wi-Fi or Bluetooth® wireless technology and reducing screen brightness can help conserve battery charge—for example, when you're traveling by air. Many of your system preferences are automatically set to optimize battery life.

If the battery runs low while you're working, connect your power adapter and let the battery recharge. You can check the amount of battery charge left by viewing the Battery (🔋) status icon in the menu bar. The battery charge level displayed is based on the amount of power left in the battery with the applications, peripheral devices, and system settings you're currently using. To conserve battery power, close applications and disconnect peripheral devices not in use, and adjust your Energy Saver settings.

For more information about battery conservation and performance tips, go to www.apple.com/batteries/notebooks.html.

Charging the Battery

When the power adapter that came with your MacBook is connected, the battery recharges whether the computer is on, off, or in sleep. The battery recharges more quickly, however, when the computer is off or in sleep.

The battery in your MacBook can be replaced only by an Apple Authorized Service Provider or an Apple Retail Store.

Getting Answers

Much more information about using your MacBook is available in Help Center on your computer and on the Internet at www.apple.com/support/macbook.

To open Help Center:

- 1 Click the Finder icon in the Dock (the bar of icons along the edge of the screen).



- 2 Click the Help menu in the menu bar and do one of the following:
 - a Type a question or term in the Search field, and select a topic from the list of results or select Show All Results to see all topics.
 - b Choose Help Center to open the Help Center window, where you can browse or search topics.

More Information

For more information about using your MacBook, see the following:

| To learn about | See |
|--|--|
| Installing memory | Chapter 3, “Boost Your MacBook” on page 35. |
| Troubleshooting your MacBook if you have a problem | Chapter 4, “Problem, Meet Solution” on page 51. |
| Finding service and support for your MacBook | “Learning More, Service, and Support” on page 66. Or see the Apple Support website at www.apple.com/support/macbook . |
| Using Mac OS X | The Mac OS X website at www.apple.com/macosx . Or search for “Mac OS X” in Help Center. |
| Moving from a PC to a Mac | “Why you’ll love a Mac” at www.apple.com/getamac/whymac . |
| Using iLife applications | The iLife website at www.apple.com/ilife . Or open an iLife application, open Help for the application, and then type a question or term in the search field. |
| Changing system preferences | System Preferences by choosing Apple () > System Preferences. Or search for “system preferences” in Help Center. |
| Using your trackpad | System Preferences and click Trackpad. |
| Using your keyboard | Help Center and search for “keyboard.” |
| Using the FaceTime camera | Help Center and search for “FaceTime.” |
| Using Wi-Fi technology | Help Center and search for “wi-fi.” |

| To learn about | See |
|---|---|
| Using Bluetooth wireless technology | The Bluetooth Support page at www.apple.com/support/bluetooth . Or open the Bluetooth File Exchange application (in the Utilities folder in Launchpad) and choose Help > Bluetooth Help. |
| Caring for the battery | Help Center and search for "battery." |
| Connecting a printer | Help Center and search for "printing." |
| USB connections | Help Center and search for "USB." |
| Connecting to the Internet | Help Center and search for "Internet." |
| Connecting an external display | Help Center and search for "display port." |
| Burning a CD or DVD | Help Center and search for "burn disc." |
| Specifications | The Specifications page at www.apple.com/support/specs . Or open System Information by choosing Apple (🍏) > About This Mac from the menu bar, and then click More Info. |
| Apple news | The Apple website at www.apple.com . |
| Software downloads | The Mac App Store (available in Mac OS X v10.6.6 or later). |
| Instructions, technical support, and manuals for Apple products | The Apple Support website at www.apple.com/support . |

3

Boost Your MacBook

www.apple.com/store

[Help Center](#)  [RAM](#)

This chapter provides information and instructions for upgrading the hard drive and installing additional memory in your MacBook.

WARNING: Apple recommends that you have an Apple-certified technician install replacement drives and memory. Consult the service and support information that came with your computer for information about how to contact Apple for service. If you attempt to install a replacement drive or memory and you damage your equipment, such damage is not covered by the limited warranty on your computer.

The battery in your MacBook is not user-replaceable. If you think your battery needs to be replaced, contact an Apple Retail Store or an Apple Authorized Service Provider.

Replacing the Hard Disk Drive

You can upgrade the hard disk drive in your MacBook. The hard disk drive is located next to the built-in battery when you open the back of your MacBook. The replacement drive must be a 2.5-inch drive with a Serial ATA (SATA) connector.

Important: Apple recommends that you back up the data on your hard disk drive before removing and replacing it. Apple is not responsible for any lost data.

To replace the hard disk drive in your MacBook:

- 1 Shut down your MacBook. Disconnect the power adapter, Ethernet cable, USB cables, security lock, and any other cables connected to the MacBook to prevent damaging the computer.

WARNING: The internal components of your MacBook can be warm. If you have been using your MacBook, wait 10 minutes after shutting down to let the internal components cool before continuing.

- 2 Turn over your MacBook and remove the eight (8) screws that secure the bottom case. Lift off the case from the hinged side, and place it aside.

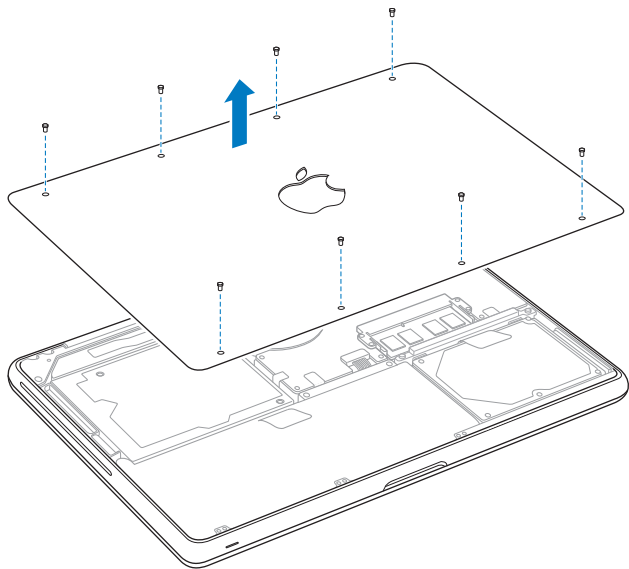

Important: When you remove the bottom case, you expose sensitive internal components. Avoid touching anything other than the hard drive assembly when you remove or add a hard disk drive.

- 3 Touch a metal surface inside the computer to discharge any static electricity from your body.

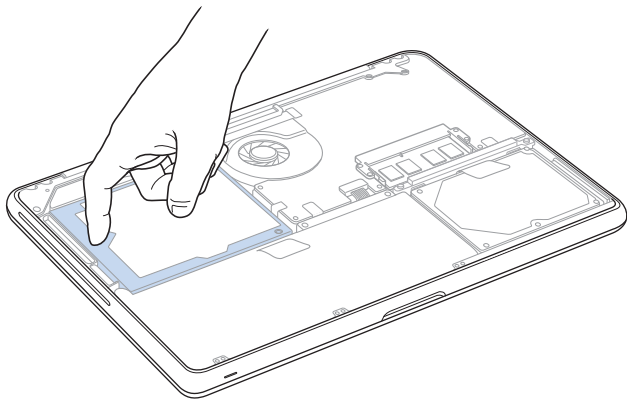

- 4 Locate the bracket at the top of the drive. Use a Phillips screwdriver to loosen the two captive screws that hold the bracket in place. Put the bracket aside in a safe place.
- 5 Using the pull tab, gently lift the drive out of the bay.

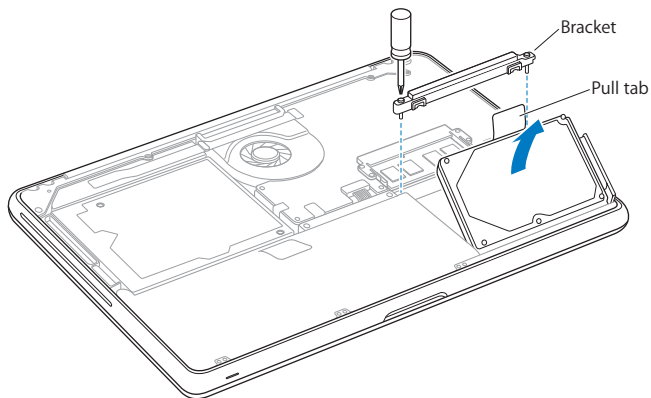

- 6 Hold the drive by its sides and gently pull the connector on the right side of the drive to disconnect it. Don't press the drive between your fingers, and avoid touching the circuitry on the underside of the drive.

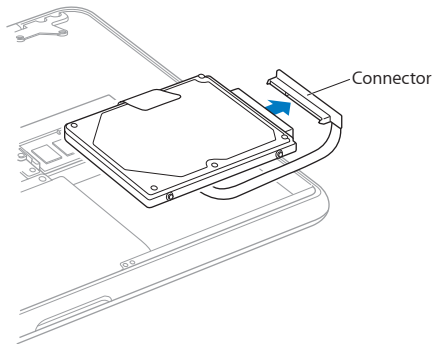

The connector is attached to a cable and remains in the hard disk drive bay.

Important: There are four (4) mounting screws on the sides of your hard disk drive. If your replacement drive doesn't include mounting screws, remove the ones from your old drive and mount them on the replacement drive before you install it.

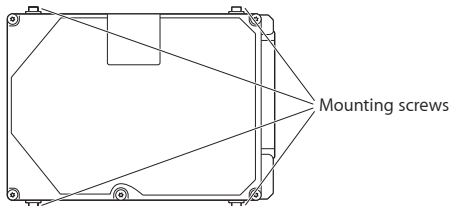

7 Attach the connector to the right side of the replacement drive.

- 8 Insert the replacement drive at an angle, making sure the mounting screws are seated properly.

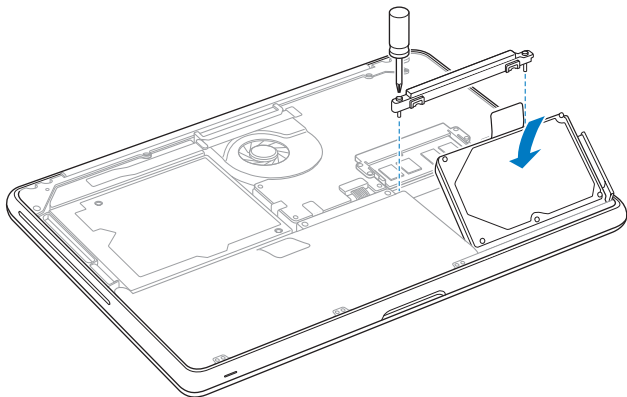

- 9 Replace the bracket and tighten the screws.

- 10 Replace the bottom case. Grasp the case in the middle of each side, and push down first with one thumb and then the other to lock the snaps on the inside of the case.

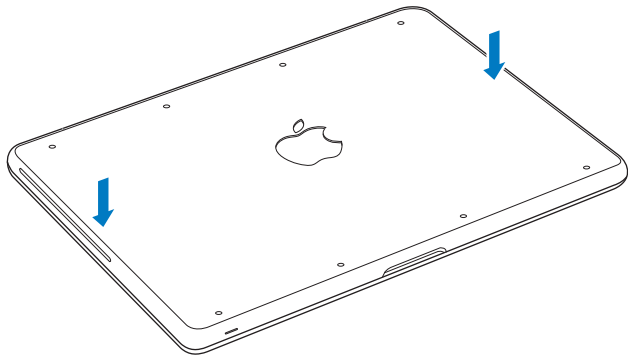

11 Replace and tighten the eight screws you removed in step 2.

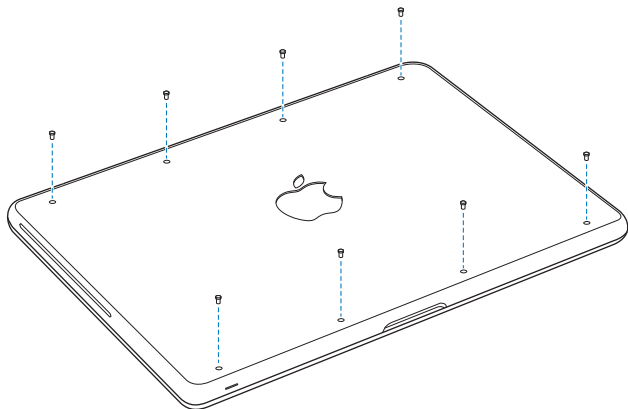

For information about installing Mac OS X and bundled applications, see “Repairing, Restoring, or Reinstalling Mac OS X Software” on page 56.

Installing Additional Memory

Your computer has two memory slots that you access by removing the bottom case. Your MacBook comes with a minimum of 2 gigabytes (GB) of 1066 MHz Double Data Rate (DDR3) Synchronous Dynamic Random-Access Memory (SDRAM) installed. Both memory slots can accept an SDRAM module that meets the following specifications:

- Double Data Rate Small Outline Dual Inline Memory Module (DDR3) format
- 30 mm (1.18 inches)
- 204-pin
- 1 GB or 2 GB
- PC3-8500 DDR3 SO-DIMM 1066 MHz Type RAM

You can add two 2 GB memory modules for a maximum of 4 GB of memory. For best performance, fill both memory slots and install an identical memory module in each slot.

To install memory in your MacBook:

- 1 Follow steps 1 through 3 beginning on page 37.

Important: When you remove the bottom case, you expose sensitive internal components. Avoid touching anything other than the memory assembly when you remove or add memory.

- 2 Push the levers on the sides of the memory module in an outward direction to release the module from the memory card slot.

The memory pops up at an angle. Before removing it, make sure you see the semicircular notches. If you don't, try pushing the levers outward again.

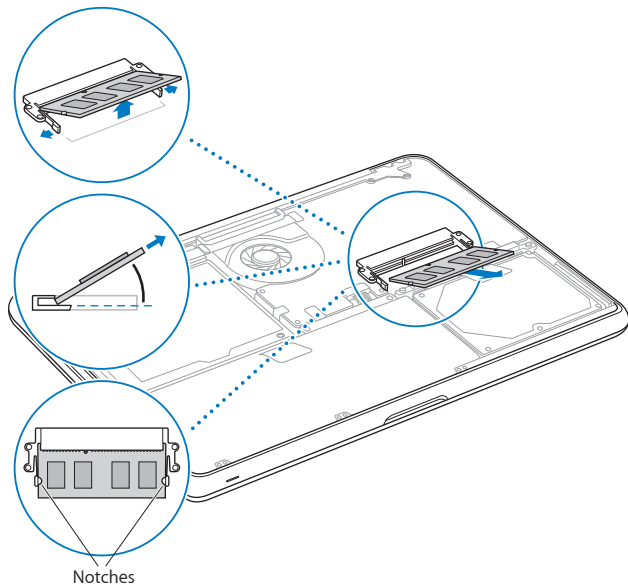

3 Hold the memory module by its notches and remove it from the slot.

4 Remove the other memory module.

Important: Hold the memory modules by their edges, and do not touch the gold connectors.

5 Insert the new memory module in the slot:

a Align the notch on the gold edge of the module with the notch in the lower memory slot.

b Tilt the card and push the memory into the slot.

c Use two fingers with firm, even pressure to push down on the memory module. You should hear a click when the memory is inserted correctly.

d Repeat to install an additional memory module in the top slot. Press down on the module to make sure it is level.

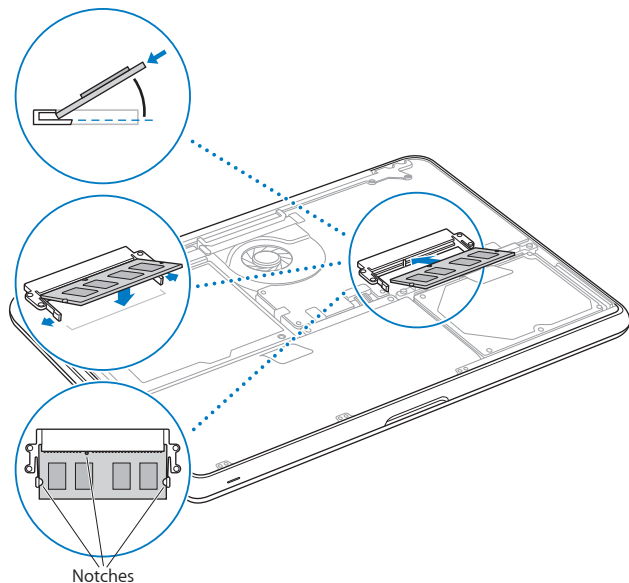

- 6 Follow the instructions for replacing the bottom case in steps 10 and 11 on page 44 and page 45.

Making Sure Your MacBook Recognizes the New Memory

After installing additional memory in your MacBook, check whether the computer recognizes the new memory.

To check the computer's memory:

- 1 Start up your MacBook.
- 2 When you see the Mac OS X desktop, choose Apple (🍏) > About This Mac. For a detailed breakdown of the memory installed in your computer, open System Information by clicking More Info, and then click Memory.

If your MacBook doesn't recognize the memory or doesn't start up correctly, confirm that the memory you installed is compatible with your MacBook and that it's installed correctly.

4

Problem, Meet Solution

www.apple.com/support

Help Center  help

Occasionally, you may have problems while working with your MacBook. Read on for troubleshooting tips to try when you have a problem. You can also find more troubleshooting information in Help Center and on the MacBook Support website at www.apple.com/support/macbook.

If you experience a problem with your MacBook, there is usually a simple and quick solution. Think about the conditions that led up to the problem. Making a note of things you did before the problem occurred will help you narrow down possible causes and find the answers you need. Things to note include:

- The applications you were using when the problem occurred. Problems that occur only with a specific application might indicate that the application is not compatible with the version of the Mac OS installed on your computer.
- Any new software that you installed, especially software that added items to the System folder.
- Any hardware that you installed, such as additional memory or a peripheral.

An Ounce of Prevention

If you have a problem with your computer or software, having kept up-to-date Time Machine backups ensures that your data won't be lost. If you make regular Time Machine backups, you can restore your software and all your data to exactly the way it was at the time of the backup. Even serious issues are of less concern when you safeguard your information with Time Machine.

Problems That Prevent You from Using Your MacBook

If your MacBook doesn't respond or the pointer doesn't move

On rare occasions, an application might “freeze” on the screen. Mac OS X provides a way to quit a frozen application without restarting your computer.

To force an application to quit:

- 1 Press Command (⌘)-Option-Esc or choose Apple () > Force Quit from the menu bar. The Force Quit Applications dialog appears with the application selected.
- 2 Click Force Quit.

The application quits, leaving all other applications open.

If you need to, you can also restart the Finder from this dialog.

Next, restart the computer to make sure the problem is entirely cleared up.

If the problem occurs frequently, choose Help > Help Center from the menu bar at the top of the screen. Search for the word “freeze” to get help for instances when the computer freezes or doesn't respond.

If the problem occurs only when you use a particular application, check with the application's manufacturer to see if the application is compatible with your computer. To get information about the software that came with your MacBook, go to www.apple.com/downloads.

If you know an application is compatible, you might need to reinstall your computer's system software. See “Repairing, Restoring, or Reinstalling Mac OS X Software” on page 56.

If your MacBook freezes during startup, or you see a flashing question mark, or the screen is dark and the sleep indicator light is glowing steadily (not in sleep)

The flashing question mark usually means that the computer can't find the system software on the hard disk or any disks attached to the computer.

- Wait a few seconds. If the computer doesn't start up soon, shut it down by pressing and holding the power (⏻) button for about 8 to 10 seconds. Disconnect all external peripherals and try restarting by pressing the power (⏻) button while holding down the Option key. When your computer starts up, click the hard disk icon, and then click the right arrow. After the computer starts up, open System Preferences and click Startup Disk. Select a local Mac OS X System folder.

If the problem occurs frequently, you might need to reinstall your computer's system software. See "Repairing, Restoring, or Reinstalling Mac OS X Software" on page 56.

If your MacBook doesn't turn on or start up

Try the following suggestions in order until your computer turns on:

- Make sure the power adapter is plugged into the computer and into a functioning power outlet. Be sure to use the 60W MagSafe Power Adapter that came with your MacBook. If the power adapter stops charging and you don't see the indicator light on the power adapter turn on when you plug in the power cord, try unplugging and replugging the power cord to reset it.
- If the indicator light on the MagSafe connector is amber, the battery might need to be recharged. Keep the power adapter connected and charge the battery with the computer off. A green light indicates that the battery is fully charged.
- If the problem persists, reset the MacBook power manager (while still preserving your files) by pressing the left Shift key, the left Option (alt) key, the left Control key, and the power (⏻) button simultaneously for five seconds until the computer restarts.

- If you recently installed additional memory, make sure that it is correctly installed and that it is compatible with your computer. See whether removing it and reinstalling the old memory allows the computer to start up (see page 46).
- Press the power (⏻) button and immediately hold down the Command (⌘), Option, P, and R keys simultaneously until you hear the startup sound a second time. This resets the parameter RAM (PRAM).
- If you still can't start up your MacBook, see “Learning More, Service, and Support” on page 66 for information about contacting Apple for service.

If the screen suddenly goes black or your MacBook freezes

Try restarting your MacBook.

- 1 Unplug any devices that are connected to your MacBook, except the power adapter.
- 2 Press the power (⏻) button to restart the system.
- 3 Let the battery charge to at least 10 percent before plugging in any external devices and resuming your work.

To see how much the battery has charged, look at the Battery (🔋) status icon in the menu bar.

The screen might also darken if you have energy saver features set for the battery.

If an audio device plugged into the audio port isn't working

Unplug the audio device. Choose Apple (🍏) > System Preferences, and open Sound preferences. In the Input pane, specify whether you want the port to be used for Sound Input or Sound Output. Plug the audio device back in.

Note: If you're running Windows on your MacBook, the port supports only audio output.

If you have trouble ejecting a disc

- Quit any applications that might be using the disc and try again.
- If this doesn't work, restart the computer while holding down the trackpad.

Repairing, Restoring, or Reinstalling Mac OS X Software

If you have a problem with your Mac software or hardware, Mac OS X provides repair and restore utilities that may eliminate problems and can even restore your software to its original factory settings. You can access these utilities from the Mac OS X Utilities application, even if your computer isn't starting up correctly.



Use the Mac OS X Utilities application to:

- Restore your software and data from a Time Machine backup.
- Reinstall Mac OS X and Apple applications.
- Restore your computer to its factory settings by erasing its disk and reinstalling Mac OS X and your Apple applications.
- Repair your computer's disk using Disk Utility.

If your computer detects a problem, it opens the Mac OS X Utilities application automatically. You can also open it manually by restarting your computer.

To open the Mac OS X Utilities application:

- Restart your computer while holding down the Command (⌘) and R keys. The Mac OS X Utilities pane appears.

Some utilities in the Mac OS X Utilities application require access to the Internet and the Mac App Store. You may need to make sure your computer is connected to the Internet by using your Ethernet or Wi-Fi network.

To connect by using a Wi-Fi network:

- 1 Choose a network from the Wi-Fi status menu in the upper-right corner of the screen.
- 2 If necessary, type the network password.

To join a closed network, choose Join Other Network. Enter the network name and password.

Repairing a Disk with Disk Utility

If you have a problem with your computer, or if you start your computer and see the Mac OS X Utilities application, you may need to repair your computer's disk.

- 1 Select Disk Utility in the Mac OS X Utilities pane and click Continue.
- 2 Select the disk or partition in the list on the left, and then click the First Aid tab.
- 3 Click Repair Disk.

If Disk Utility can't repair the disk, back up as much of your information as possible, and then follow the instructions in "Repairing, Restoring, or Reinstalling Mac OS X Software" on page 56.

For information about Disk Utility and its options, see Help Center, or open Disk Utility (in the Utilities folder in Launchpad) and choose Help > Disk Utility Help.

Restoring Information Using a Time Machine Backup

If you previously created a Time Machine backup, use the Restore utility to restore everything on your computer to its previous state.

Use your Time Machine backup to restore information only to the computer that was the source of the backup. If you want to transfer information to a new computer, use Migration Assistant (in the Utilities folder in Launchpad).

- 1 If your backup is on a Time Capsule, make sure you're connected to an Ethernet or Wi-Fi network. (To connect to a Wi-Fi network, follow the instructions on page 57.)
- 2 In the Mac OS X Utilities pane, select Restore From Time Machine Backup and click Continue.
- 3 Select the disk that contains the Time Machine backup, and then follow the onscreen instructions.

Reinstalling Mac OS X and Apple Applications

Under some circumstances, you may need to reinstall Mac OS X and Apple applications. You can reinstall while keeping your files and user settings intact.

- 1 Make sure your MacBook is connected to the Internet by using an Ethernet or Wi-Fi network. (To connect to a Wi-Fi network, follow the instructions on page 57.)
- 2 In the Mac OS X Utilities pane, select Reinstall Mac OS X and click Continue.
- 3 In the pane where you're asked to select a disk, select your current Mac OS X disk (in most cases, it is the only one available).
- 4 To select or deselect optional software, click Customize.
- 5 Click Install.

You can install Mac OS X without erasing the disk, which saves your existing files and settings, or you can erase the disk first, which erases all your data and leaves the computer ready for you to reinstall Mac OS X and Apple applications.

After installing Mac OS X, you can go to the Mac App Store and re-download your Apple applications.

Important: Apple recommends that you back up the data on the disk before restoring software. Apple is not responsible for any lost data.

Restoring Your Computer to Its Factory Settings

When you restore your computer to its factory settings, everything on your computer (your user accounts, network settings, and all of your files and folders) is deleted. Before you restore, back up any files you want to keep by copying them to another disk. Write down your network settings from Network preferences to make it easier to get connected again after reinstalling Mac OS X.

- 1 Make sure you're connected to the Internet by using an Ethernet or Wi-Fi network. (To connect to a Wi-Fi network, follow the instructions on page 57.)
- 2 In the Mac OS X Utilities pane, select Disk Utility and click Continue.
- 3 Select the disk in the list on the left, and then click the Erase tab.
- 4 Select Mac OS Extended (Journaled) from the Format pop-up menu, type a name for the disk, and then click Erase.
- 5 After the disk is erased, choose Disk Utility > Quit Disk Utility.
- 6 In the Mac OS X Utilities pane, select Reinstall Mac OS X and click Continue.
- 7 To reinstall Mac OS X and your applications, follow the instructions in the Mac OS X Installer.

After restoring Mac OS X and your Apple applications, you can selectively restore your other data and applications from a Time Machine backup.

Using Apple Hardware Test

If you suspect a problem with the MacBook hardware, you can use the Apple Hardware Test application to help determine if there is a problem with one of the computer's components, such as the memory or processor.

To use Apple Hardware Test:

- 1 Disconnect all external devices from your computer except the power adapter. If you have an Ethernet cable connected, disconnect it.
- 2 Restart your MacBook, and hold down the D key as it starts up.
- 3 When the Apple Hardware Test chooser screen appears, select the language for your location.
- 4 Press the Return key or click the right arrow button.
- 5 When the Apple Hardware Test main screen appears (after about 45 seconds), follow the onscreen instructions.
- 6 If Apple Hardware Test detects a problem, it displays an error code. Make a note of the error code before pursuing support options. If Apple Hardware Test doesn't detect a hardware failure, the problem might be software related.

Problems with Your Internet Connection

Your MacBook has the Setup Assistant application to help walk you through setting up an Internet connection. Open System Preferences and click Network. Click the “Assist me” button to open Network Setup Assistant.

If you have trouble with your Internet connection, you can try the steps in this section starting with Network Diagnostics.

To use Network Diagnostics:

- 1 Choose Apple (🍏) > System Preferences.
- 2 Click Network and then click “Assist me.”
- 3 Click Diagnostics to open Network Diagnostics.
- 4 Follow the onscreen instructions.

If Network Diagnostics can't resolve the problem, there may be a problem with the Internet service provider (ISP) you're trying to connect to, with an external device you are using to connect to your ISP, or with the server you are trying to access. You can try the following steps.

Cable Modem, DSL, and LAN Internet Connections

Make sure all modem cables are firmly plugged in, including the modem power cord, the cable from the modem to the computer, and the cable from the modem to the wall jack. Also check the cables and power supplies for Ethernet hubs and routers.

Turn off your DSL or cable modem for a few minutes, and then turn it back on. Some ISPs recommend that you unplug the modem's power cord. If your modem has a reset button, you can press it either before or after you turn the power off and on.

Important: Instructions that refer to modems do not apply to LAN users. LAN users might have hubs, switches, routers, or connection pods that DSL and cable modem users do not have. LAN users should contact their network administrator rather than an ISP.

PPPoE Connections

If you're unable to connect to your Internet service provider using PPPoE (Point to Point Protocol over Ethernet), make sure you've entered the correct information in Network preferences.

To check PPPoE settings:

- 1 Choose Apple (🍏) > System Preferences.
- 2 Click Network.
- 3 Click Add (+) at the bottom of the network connection services list, and choose PPPoE from the Interface pop-up menu.
- 4 Choose an interface for the PPPoE service from the Ethernet pop-up menu. Choose Ethernet if you're connecting to a wired network, or Wi-Fi if you're connecting to a wireless network.
- 5 Click Create.
- 6 Enter the information you received from your service provider, such as the account name, password, and PPPoE service name (if your service provider requires it).
- 7 Click Apply to make the settings active.

Network Connections

Make sure the Ethernet cable is plugged into your MacBook and into the network. Check the cables and power supplies to your Ethernet hubs and routers.

If you have two or more computers sharing an Internet connection, be sure that your network is set up properly. You need to know if your ISP provides only one IP address or if it provides multiple IP addresses, one for each computer.

If only one IP address is provided, then you must have a router capable of sharing the connection, also known as network address translation (NAT) or “IP masquerading.” For setup information, check the documentation provided with your router or ask the person who set up your network. You can use an AirPort base station to share one IP address among multiple computers. For information about using an AirPort base station, check Help Center or visit the Apple AirPort website at www.apple.com/support/airport.

If you can't resolve the issue using these steps, contact your ISP or network administrator.

Problems with Wi-Fi Communication

If you have trouble using Wi-Fi communication:

- Make sure the computer or network you're trying to connect to is running and has a wireless access point.
- Make sure you've properly configured the software according to the instructions that came with your base station or access point.

- Make sure your MacBook is within antenna range of the other computer or the network's access point. Nearby electronic devices or metal structures can interfere with wireless communication and reduce this range. Repositioning or rotating the computer might improve reception.
- Check the Wi-Fi (📶) status icon in the menu bar. Up to four bars appear, indicating signal strength. If the signal strength is weak, try changing your location.
- Get help online by choosing Help > Help Center, and then searching for "wi-fi." Also see the instructions that came with the wireless device for more information.

Keeping Your Software Up to Date

You can connect your MacBook to the Internet and automatically download and install the latest free software versions, drivers, and other enhancements from Apple.

When your MacBook is connected to the Internet, Software Update checks to see if any updates are available for your computer. You can set your MacBook to check for updates periodically, and then you can download and install updated software.

To check for updated software:

- 1 Choose Apple (🍏) > System Preferences.
- 2 Click the Software Update icon and follow the onscreen instructions.
 - For more information, search for "Software Update" in Help Center.
 - For the latest information about Mac OS X, go to www.apple.com/macosx.

Learning More, Service, and Support

Your MacBook does not have any user-serviceable parts, except the hard drive and the memory. If you need service, contact Apple or take your MacBook to an Apple Authorized Service Provider. You can find more information about the MacBook through online resources, onscreen help, System Information, or Apple Hardware Test.

Online Resources

For online service and support information, go to www.apple.com/support. Choose your country from the pop-up menu. You can search the AppleCare Knowledge Base, check for software updates, or get help from Apple's discussion forums.

Onscreen Help

You can look for answers to your questions, as well as instructions and troubleshooting information, in Help Center. Choose Help > Help Center.

System Information

To get information about your MacBook, use System Information. It shows you what hardware and software is installed, the serial number and operating system version, how much memory is installed, and more. To open System Information, choose Apple (🍏) > About This Mac from the menu bar and then click More Info.

AppleCare Service and Support

Your MacBook comes with 90 days of technical support and one year of hardware repair warranty coverage at an Apple Retail Store or an Apple-authorized repair center, such as an Apple Authorized Service Provider. You can extend your coverage by purchasing the AppleCare Protection Plan. For information, go to www.apple.com/support/products or the website for your country listed below.

If you need assistance, AppleCare telephone support representatives can help you with installing and opening applications, and basic troubleshooting. Call the support center number nearest you (the first 90 days are complimentary). Have the purchase date and your MacBook serial number ready when you call.

Note: Your 90 days of complimentary telephone support begins on the date of purchase. Telephone fees may apply.

| Country | Phone | Website |
|------------------------------|--------------------|--|
| United States | 1-800-275-2273 | www.apple.com/support |
| Australia | (61) 1-300-321-456 | www.apple.com/au/support |
| Canada (English) (French) | 1-800-263-3394 | www.apple.com/ca/support www.apple.com/ca/fr/support |
| Ireland | (353) 1850 946 191 | www.apple.com/ie/support |
| New Zealand | 00800-7666-7666 | www.apple.com/nz/support |
| United Kingdom | (44) 0844 209 0611 | www.apple.com/uk/support |

Telephone numbers are subject to change, and local and national telephone rates may apply. A complete list is available on the web:

www.apple.com/support/contact/phone_contacts.html

Locating Your Product Serial Number

Use one of these methods to find your MacBook serial number:

- Turn over your MacBook. The serial number is etched into the bottom case.

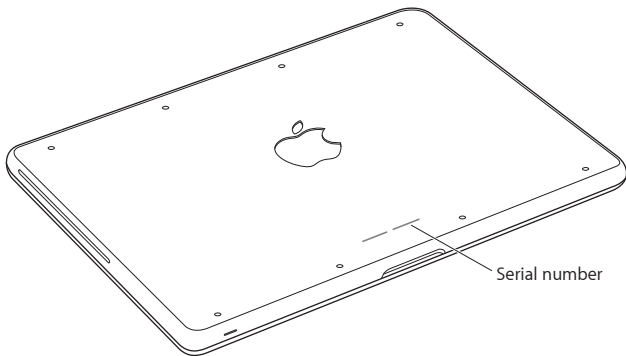

- Choose Apple () > About This Mac, and then click the version number beneath the words "Mac OS X" to cycle through the Mac OS X version number, the build version, and the serial number.
- Open System Information in the Utilities folder in Launchpad.

5

Last, but Not Least

www.apple.com/environment

Help Center  ergonomics

For your safety and that of your equipment, follow these rules for handling and cleaning your MacBook and for working more comfortably. Keep these instructions handy for reference by you and others.

WARNING: Incorrect storage or use of your computer may void the manufacturer's warranty.

Important Safety Information

WARNING: Failure to follow these safety instructions could result in fire, electric shock, or other injury or damage.

Built-in battery Do not remove the battery from your MacBook. The battery should be replaced only by an Apple Authorized Service Provider. Discontinue use of your MacBook if it is dropped or appears crushed, bent, deformed, or damaged. Do not expose the computer to temperatures above 212° F or 100° C.

Proper handling Set up your MacBook on a stable work surface that allows for adequate air circulation under and around the computer. Do not operate your MacBook on a pillow or other soft material, as the material can block the airflow vents. Never place anything over the keyboard when operating your MacBook. Never push objects into the ventilation openings.

The bottom of your MacBook may become very warm during normal use. If your MacBook is on your lap and gets uncomfortably warm, remove it from your lap and place it on a stable work surface.

Water and wet locations Keep your MacBook away from sources of liquid, such as drinks, washbasins, bathtubs, shower stalls, and so on. Protect your MacBook from dampness or wet weather, such as rain, snow, and fog.

60W MagSafe Power Adapter Use only the power adapter that came with your MacBook, or an Apple-authorized power adapter that is compatible with this product. Make sure the AC plug or AC power cord is fully inserted into the power adapter before plugging the adapter into a power outlet.

The power adapter may become very warm during normal use. The MagSafe Power Adapter complies with the user-accessible surface temperature limits defined by the International Standard for Safety of Information Technology Equipment (IEC 60950-1).

To reduce the possibility of overheating the power adapter or of heat-related injuries, do one of the following:

- Plug the power adapter directly into a power outlet.

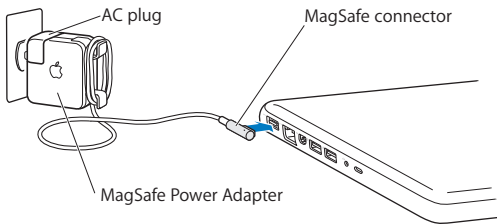

- If you're using the AC power cord, place the power adapter on a desk, table, or on the floor in a well-ventilated location.

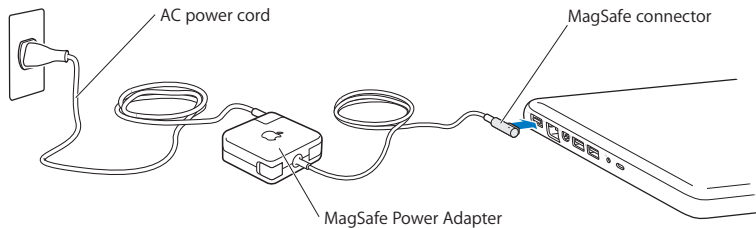

Disconnect the power adapter and disconnect any other cables if any of the following conditions exist:

- You want to add memory or upgrade the hard disk drive.
- You want to clean the case (use only the recommended procedure described on page 76).
- The power cord or plug becomes frayed or otherwise damaged.
- Your MacBook or power adapter is exposed to rain, excessive moisture, or liquid spilled into the case.
- Your MacBook or power adapter has been dropped, the case has been damaged, or you suspect that service or repair is required.

The MagSafe power port contains a magnet that can erase data on a credit card, iPod, or other device. To preserve your data, do not place these or other magnetically sensitive material or devices within 1 inch (25 mm) of this port.

If debris gets into the MagSafe power port, remove it gently with a dry cotton swab.

MagSafe power specifications:

- *Frequency:* 50 to 60 Hz, single phase
- *Line Voltage:* 100 to 240 V
- *Output Voltage:* 16.5 V DC, 3.65 A

Hearing damage Permanent hearing loss may occur if earbuds or headphones are used at high volume. You can adapt over time to a higher volume of sound that may sound normal but can be damaging to your hearing. If you experience ringing in your ears or muffled speech, stop listening and have your hearing checked. The louder the volume, the less time is required before your hearing could be affected. Hearing experts suggest that to protect your hearing:

- Limit the amount of time you use earbuds or headphones at high volume.
- Avoid turning up the volume to block out noisy surroundings.
- Turn the volume down if you can't hear people speaking near you.

High-risk activities This computer is not intended for use in the operation of nuclear facilities, aircraft navigation or communications systems, air traffic control systems, or for any other uses where the failure of the computer could lead to death, personal injury, or severe environmental damage.

Laser Information for Optical Disc Drives

WARNING: Making adjustments or performing procedures other than those specified in your equipment's manual may result in hazardous radiation exposure.

The optical disc drive in your computer contains a laser that is safe in normal use but that may be harmful to your eyes if disassembled. For your safety, have this equipment serviced only by an Apple Authorized Service Provider.

Important Handling Information

NOTICE: Failure to follow these handling instructions could result in damage to your MacBook or other property.

Operating environment Operating your MacBook outside these ranges may affect performance:

- *Operating temperature:* 50° to 95° F (10° to 35° C)
- *Storage temperature:* -4° to 113° F (-20° to 45° C)
- *Relative humidity:* 5% to 90% (noncondensing)
- *Operating altitude:* 0 to 10,000 feet (0 to 3048 meters)

Turning on your MacBook Never turn on your MacBook unless all of its internal and external parts are in place. Operating the computer when parts are missing may be dangerous and may damage your computer.

Carrying your MacBook If you carry your MacBook in a bag or briefcase, make sure that there are no loose items (such as paper clips or coins) that could accidentally get inside the computer through vent openings or the optical drive slot or get stuck inside a port. Also, keep magnetically sensitive items away from the MagSafe power port.

Using connectors and ports Never force a connector into a port. When connecting a device, make sure the port is free of debris, that the connector matches the port, and that you have positioned the connector correctly in relation to the port.

Using the optical drive The SuperDrive in your MacBook supports standard 12 cm (4.7 inch) discs. Irregularly shaped discs or discs smaller than 12 cm (4.7 inches) are not supported.

Handling glass parts Your MacBook contains glass components, including the display and trackpad. If they are damaged, don't use your MacBook until it has been repaired by an Apple Authorized Service Provider.

Storing your MacBook If you are going to store your MacBook for an extended period of time, keep it in a cool location (ideally, 71° F or 22° C) and discharge the battery to 50 percent or less. When storing your MacBook for longer than five months, discharge the battery to approximately 50 percent. To maintain the capacity of the battery, recharge the battery to 50 percent every six months or so.

Cleaning your MacBook When cleaning the outside of your MacBook and its components, first shut down your MacBook and unplug the power adapter. Then use a damp, soft, lint-free cloth to clean the computer's exterior. Avoid getting moisture in any openings. Do not spray liquid directly on the computer. Do not use aerosol sprays, solvents, or abrasives that might damage the finish.

Cleaning the MacBook screen To clean the MacBook screen, first shut down your MacBook and unplug the power adapter. Then dampen a clean cloth with just water and wipe the screen. Do not spray liquid directly on the screen.

Understanding Ergonomics

Here are some tips for setting up a healthy work environment.

Keyboard and Trackpad

When you use the keyboard and trackpad, your shoulders should be relaxed. Your upper arm and forearm should form an angle that is slightly greater than a right angle, with your wrist and hand in roughly a straight line.

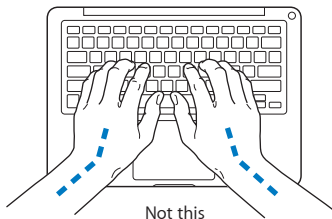
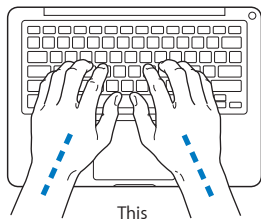

Use a light touch when typing or using the trackpad and keep your hands and fingers relaxed. Avoid rolling your thumbs under your palms.

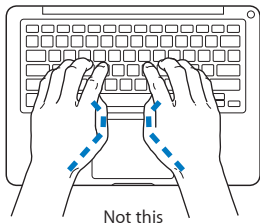
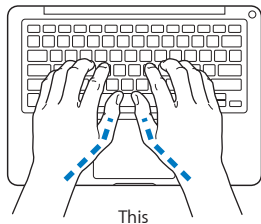

Change hand positions often to avoid fatigue. Some computer users might develop discomfort in their hands, wrists, or arms after intensive work without breaks. If you begin to develop chronic pain or discomfort in your hands, wrists, or arms, consult a qualified health specialist.

External Mouse

If you use an external mouse, position the mouse at the same height as the keyboard and within comfortable reach.

Chair

An adjustable chair that provides firm, comfortable support is best. Adjust the height of the chair so your thighs are horizontal and your feet are flat on the floor. The back of the chair should support your lower back (lumbar region). Follow the manufacturer's instructions for adjusting the backrest to fit your body properly.

You might have to raise your chair so that your forearms and hands are at the proper angle to the keyboard. If this makes it impossible to rest your feet flat on the floor, you can use a footrest with adjustable height and tilt to make up for any gap between the floor and your feet. Or you can lower the desktop to eliminate the need for a footrest. Another option is to use a desk with a keyboard tray that's lower than the regular work surface.

Built-in Display

Adjust the angle of the display to optimize viewing in your environment. Do not force the display if you meet resistance. The display is not meant to open past 135 degrees.

You can adjust the brightness of the screen when you take the computer from one work location to another, or if the lighting in your work area changes.

More information about ergonomics is available on the web:

www.apple.com/about/ergonomics

Apple and the Environment

Apple Inc. recognizes its responsibility to minimize the environmental impacts of its operations and products.

More information is available on the web:

www.apple.com/environment

Regulatory Compliance Information

FCC Compliance Statement

This device complies with part 15 of the FCC rules. Operation is subject to the following two conditions: (1) This device may not cause harmful interference, and (2) this device must accept any interference received, including interference that may cause undesired operation. See instructions if interference to radio or television reception is suspected.

Radio and Television Interference

This computer equipment generates, uses, and can radiate radio-frequency energy. If it is not installed and used properly—that is, in strict accordance with Apple's instructions—it may cause interference with radio and television reception.

This equipment has been tested and found to comply with the limits for a Class B digital device in accordance with the specifications in Part 15 of FCC rules. These specifications are designed to provide reasonable protection against such interference in a residential installation. However, there is no guarantee that interference will not occur in a particular installation.

You can determine whether your computer system is causing interference by turning it off. If the interference stops, it was probably caused by the computer or one of the peripheral devices.

If your computer system does cause interference to radio or television reception, try to correct the interference by using one or more of the following measures:

- Turn the television or radio antenna until the interference stops.
- Move the computer to one side or the other of the television or radio.
- Move the computer farther away from the television or radio.
- Plug the computer in to an outlet that is on a different circuit from the television or radio. (That is, make certain the computer and the television or radio are on circuits controlled by different circuit breakers or fuses.)

If necessary, consult an Apple Authorized Service Provider or Apple. See the service and support information in this guide. Or consult an experienced radio/television technician for additional suggestions.

Important: Changes or modifications to this product not authorized by Apple Inc. could void the EMC compliance and negate your authority to operate the product.

This product has demonstrated EMC compliance under conditions that included the use of compliant peripheral devices and shielded cables (including Ethernet network cables) between system components. It is important that you use compliant peripheral devices and shielded cables between system components to reduce the possibility of causing interference to radios, television sets, and other electronic devices.

Responsible party (contact for FCC matters only):

Apple Inc. Corporate Compliance
1 Infinite Loop, MS 26-A
Cupertino, CA 95014

Wireless Radio Use

This device is restricted to indoor use when operating in the 5.15 to 5.25 GHz frequency band.

Cet appareil doit être utilisé à l'intérieur.

この製品は、周波数帯域 5.18 ~ 5.32 GHz で動作しているときは、屋内においてのみ使用可能です。

Exposure to Radio Frequency Energy

The radiated output power of the Wi-Fi technology is below the FCC radio frequency exposure limits. Nevertheless, it is advised to use the wireless equipment in such a manner that the potential for human contact during normal operation is minimized.

FCC Bluetooth Wireless Compliance

The antenna used with this transmitter must not be colocated or operated in conjunction with any other antenna or transmitter subject to the conditions of the FCC Grant.

Canadian Compliance Statement

This device complies with Industry Canada license-exempt RSS standard(s). Operation is subject to the following two conditions: (1) this device may not cause interference, and (2) this device must accept any interference, including interference that may cause undesired operation of the device.

Cet appareil est conforme aux normes CNR exemptes de licence d'Industrie Canada. Le fonctionnement est soumis aux deux conditions suivantes : (1) cet appareil ne doit pas provoquer d'interférences et (2) cet appareil doit accepter toute interférence, y compris celles susceptibles de provoquer un fonctionnement non souhaité de l'appareil.

Bluetooth Industry Canada Statement

This Class B device meets all requirements of the Canadian interference-causing equipment regulations.

Cet appareil numérique de la Class B respecte toutes les exigences du Règlement sur le matériel brouilleur du Canada.

Industry Canada Statement

Complies with the Canadian ICES-003 Class B specifications. Cet appareil numérique de la classe B est conforme à la norme NMB-003 du Canada. This device complies with RSS 210 of Industry Canada.

Bluetooth Europe—EU Declaration of Conformity

This wireless device complies with the R&TTE Directive.

Europe—EU Declaration of Conformity



Български Apple Inc. декларира, че това MacBook е в съответствие със съществените изисквания и другите приложими правила на Директива 1999/5/EC.

Česky Společnost Apple Inc. tímto prohlašuje, že tento MacBook je ve shodě se základními požadavky a dalšími příslušnými ustanoveními směrnice 1999/5/ES.

Dansk Undertegnede Apple Inc. erklærer herved, at følgende udstyr MacBook overholder de væsentlige krav og øvrige relevante krav i direktiv 1999/5/EF.

Deutsch Hiermit erklärt Apple Inc., dass sich das MacBook in Übereinstimmung mit den grundlegenden Anforderungen und den übrigen einschlägigen Bestimmungen der Richtlinie 1999/5/EG befinden.

Eesti Käesolevaga kinnitab Apple Inc., et see MacBook vastab direktiivi 1999/5/EÜ põhinõuetele ja nimetatud direktiivist tulenevatele teistele asjakohastele sätetele.

English Hereby, Apple Inc. declares that this MacBook is in compliance with the essential requirements and other relevant provisions of Directive 1999/5/EC.

Español Por medio de la presente Apple Inc. declara que este MacBook cumple con los requisitos esenciales y cualesquiera otras disposiciones aplicables o exigibles de la Directiva 1999/5/CE.

Ελληνικά Με την παρούσα, η Apple Inc. δηλώνει ότι αυτή η συσκευή MacBook συμμορφώνεται προς τις βασικές απαιτήσεις και τις λοιπές σχετικές διατάξεις της Οδηγίας 1999/5/ΕΚ.

Français Par la présente Apple Inc. déclare que l'appareil MacBook est conforme aux exigences essentielles et aux autres dispositions pertinentes de la directive 1999/5/CE.

Islenska Apple Inc. lýsir því hér með yfir að þetta tæki MacBook fullnægir lágmarkskröfum og öðrum viðeigandi ákvæðum Evróputilskipunar 1999/5/EC.

Italiano Con la presente Apple Inc. dichiara che questo dispositivo MacBook è conforme ai requisiti essenziali ed alle altre disposizioni pertinenti stabilite dalla direttiva 1999/5/CE.

Latviski Ar šo Apple Inc. deklarē, ka MacBook ierīce atbilst Direktīvas 1999/5/EK būtiskajām prasībām un citiem ar to saistītajiem noteikumiem.

Lietuvių Šiuo „Apple Inc.“ deklaruojai, kad šis MacBook atitinka esminius reikalavimus ir kitas 1999/5/EB Direktyvos nuostatas.

Magyar Alulírott, Apple Inc. nyilatkozom, hogy a MacBook megfelel a vonatkozó alapvető követelményeknek és az 1999/5/EC irányelv egyéb előírásainak.

Malti Hawnhekk, Apple Inc., jiddikjara li dan MacBook jikkonforma mal-htigijiet essenzjali u ma provvedimenti oħrajn relevanti li hemm fid-Direttiva 1999/5/EC.

Nederlands Hierbij verklaart Apple Inc. dat het toestel MacBook in overeenstemming is met de essentiële eisen en de andere bepalingen van richtlijn 1999/5/EG.

Norsk Apple Inc. erklærer herved at dette MacBook-apparatet er i samsvar med de grunnleggende kravene og øvrige relevante krav i EU-direktivet 1999/5/EF.

Polski Niniejszym Apple Inc. oświadcza, że ten MacBook są zgodne z zasadniczymi wymogami oraz pozostałymi stosownymi postanowieniami Dyrektywy 1999/5/EC.

Português Apple Inc. declara que este dispositivo MacBook está em conformidade com os requisitos essenciais e outras disposições da Directiva 1999/5/CE.

Română Prin prezenta, Apple Inc. declară că acest aparat MacBook este în conformitate cu cerințele esențiale și cu celelalte prevederi relevante ale Directivei 1999/5/CE.

Slovensko Apple Inc. izjavlja, da je ta MacBook skladne z bistvenimi zahtevami in ostalimi ustreznimi določili direktive 1999/5/ES.

Slovensky Apple Inc. týmto vyhlasuje, že toto MacBook spĺňa základné požiadavky a všetky príslušné ustanovenia Smernice 1999/5/ES.

Suomi Apple Inc. vakuuttaa täten, että tämä MacBook tyyppinen laite on direktiivin 1999/5/EY oleellisten vaatimusten ja sitä koskevien direktiivin muiden ehtojen mukainen.

Svenska Härmed intygar Apple Inc. att denna MacBook står i överensstämmelse med de väsentliga egenskapskrav och övriga relevanta bestämmelser som framgår av direktiv 1999/5/EG.

A copy of the EU Declaration of Conformity is available at: www.apple.com/euro/compliance

This equipment can be used in the following countries:

| | | | | | | | | | | | |
|----|----|----|----|----|----|----|----|----|----|----|----|
| AT | BG | BE | CY | CZ | DK | EE | FI | FR | DE | GR | HU |
| IE | IT | LV | LT | LU | MT | NL | PL | PT | RO | SK | SL |
| ES | SE | GB | IS | LI | NO | CH | | | | | |

Korea Warning Statements

대한민국 규정 및 준수

방통위고시에 따른 고지사항

해당 무선설비는 운용 중 전파혼신 가능성이 있음.

이 기기는 인명안전과 관련된 서비스에 사용할 수 없습니다.

B급 기기(가정용 방송통신기자재)

이 기기는 가정용(B급) 전자파적합기기로서 주로

가정에서 사용하는 것을 목적으로 하며, 모든 지

역에서 사용할 수 있습니다.

Singapore Wireless Certification

Complies with
IDA Standards
DB00063

Taiwan Wireless Statements

無線設備的警告聲明

經型式認證合格之低功率射頻電機，非經許可，公司、商號或使用者均不得擅自變更頻率、加大功率或變更原設計之特性及功能。低功率射頻電機之使用不得影響飛航安全及干擾合法通信；經發現有干擾現象時，應立即停用，並改善至無干擾時方得繼續使用。前項合法通信指依電信法規定作業之無線電通信。低功率射頻電機須忍受合法通信或工業、科學及醫療用電波輻射性電機設備之干擾。

警告

本電池如果更換不正確會有爆炸的危險

請依照製造商說明書處理用過之電池

如有這頻率:

於 5.25GHz 至 5.35GHz 區域內操作之
無線設備的警告聲明

工作頻率 5.250 ~ 5.350GHz 該頻段限於室內使用。

Taiwan Class B Statement

Class B 設備的警告聲明

NL

VCCI Class B Statement

情報処理装置等電波障害自主規制について

この装置は、情報処理装置等電波障害自主規制協議会（VCCI）の基準に基づくクラス B 情報技術装置です。この装置は家庭環境で使用されることを目的としていますが、この装置がラジオやテレビジョン受信機に近接して使用されると、受信障害を引き起こすことがあります。

取扱説明書に従って正しい取扱をしてください。

Russia



ME67

External USB Modem Information

When connecting your MacBook to the phone line using an external USB modem, refer to the telecommunications agency information in the documentation that came with your modem.

ENERGY STAR® Compliance



As an ENERGY STAR® partner, Apple has determined that standard configurations of this product meet the ENERGY STAR® guidelines for energy efficiency. The ENERGY STAR® program is a partnership with electronic equipment manufacturers to promote energy-efficient products. Reducing energy consumption of products saves money and helps conserve valuable resources.

This computer is shipped with power management enabled with the computer set to sleep after 10 minutes of user inactivity. To wake your computer, click the mouse or trackpad button or press any key on the keyboard.

For more information about ENERGY STAR®, visit:
www.energystar.gov

Disposal and Recycling Information



This symbol indicates that your product must be disposed of properly according to local laws and regulations. When your product reaches its end of life, contact Apple or your local authorities to learn about recycling options.

For information about Apple's recycling program, go to:
www.apple.com/recycling

European Union—Disposal Information



The symbol above means that according to local laws and regulations your product should be disposed of separately from household waste. When this product reaches its end of life, take it to a collection point designated by local authorities. Some collection points accept products for free. The separate collection and recycling of your product at the time of disposal will help conserve natural resources and ensure that it is recycled in a manner that protects human health and the environment.

Türkiye

EEE yönetmeliğine (Elektrikli ve Elektronik Eşyalarda Bazı Zararlı Maddelerin Kullanımının Sınırlanırılmasına Dair Yönetmelik) uygundur.

Brasil: Informações sobre descarte e reciclagem



O símbolo acima indica que este produto e/ou sua bateria não devem ser descartadas no lixo doméstico. Quando decidir descartar este produto e/ou sua bateria, faça-o de acordo com as leis e diretrizes ambientais locais. Para informações sobre o programa de reciclagem da Apple, pontos de coleta e telefone de informações, visite www.apple.com/br/environment.

Battery Disposal Information

Dispose of batteries according to your local environmental laws and guidelines.

Deutschland: Dieses Gerät enthält Batterien. Bitte nicht in den Hausmüll werfen. Entsorgen Sie dieses Gerät am Ende seines Lebenszyklus entsprechend der maßgeblichen gesetzlichen Regelungen.

Nederlands: Gebruikte batterijen kunnen worden ingeleverd bij de chemokar of in een speciale batterijcontainer voor klein chemisch afval (kca) worden gedeponneerd.

台灣



廢電池請回收

China Battery Statement

警告：不要刺破或焚烧。该电池不含水银。

Taiwan Battery Statement

警告：請勿戳刺或焚燒。此電池不含汞。

中国

| 有毒或有害物质 | 零部件 | | | | |
|--------------|-----|-----|-----|----|-------|
| | 电路板 | 显示屏 | 电池组 | 附件 | 电源适配器 |
| 铅 (Pb) | X | X | X | X | X |
| 汞 (Hg) | 0 | 0 | 0 | 0 | 0 |
| 镉 (Cd) | 0 | 0 | 0 | 0 | 0 |
| 六价铬 (Cr, VI) | 0 | 0 | 0 | 0 | 0 |
| 多溴联苯 (PBB) | 0 | 0 | 0 | 0 | 0 |
| 多溴二苯醚 (PBDE) | 0 | 0 | 0 | 0 | 0 |

0: 表示该有毒有害物质在该部件所有均质材料中的含量均在 SJ/T 11363-2006 规定的限量要求以下。

X: 表示该有毒有害物质至少在该部件的某一均质材料中的含量超出 SJ/T 11363-2006 规定的限量要求。

根据中国电子行业标准 SJ/T11364-2006 和相关的中国政府法规，本产品及其某些内部或外部组件上可能带有环保使用期限标识。取决于组件和组件制造商，产品及其组件上的使用期限标识可能有所不同。组件上的使用期限标识优先于产品上任何与之相冲突的或不同的环保使用期限标识。



Looking for Something?

Index

A

- AC plug 10
- AC power adapter. *See* power adapter
- AC power cord 10
- adapter, power. *See* power adapter
- AppleCare 66
- Apple Hardware Test 61
- application freeze 53
- applications
 - FaceTime 21
 - iChat 21
 - iLife 32
 - Migration Assistant 13
 - Photo Booth 21
- audio out port 25

B

- battery
 - disposal 84
 - location 21
 - performance 30
- blinking question mark 54
- brightness controls 23
- brightness keys 23

- built-in battery. *See* battery
- built-in speakers 21
- button, power 12, 21

C

- cable modem 11
- camera 21
- camera indicator light 21
- carrying your computer 75
- changing
 - System Preferences 15
 - the desktop 15
- checking memory 50
- cleaning
 - the screen 76
 - your computer 76
- computer
 - disposal 84
 - freezes 54
 - putting to sleep 16
 - shutting down 17
 - turning on 12
 - waking 17
 - won't turn on 54
- connecting to a network 11
- Control-click 27

- controls. *See also* keys
 - media 23
 - volume 23
- cord, AC power 10

D

- desktop, customizing 15
- discs
 - ejecting 56
 - supported sizes 75
- display. *See also* screen
 - cleaning 76
 - external 25
- disposing of batteries 84
- disposing of your
 - computer 83, 84
- Dock 31
- downloading software 65
- drive, SuperDrive 21
- DSL modem 11

E

- ejecting a disc,
 - troubleshooting 56
- Energy Saver preferences 30
- environmental impact 79
- ergonomics 77

Ethernet
connecting to 11
port 25
external display port 25

F

F1 to F12 function keys 23
FaceTime
application 21
camera 21
Fast-forward key 23
flashing question mark 54
Force Quit 53
four-finger pinching 29
function (fn) key 23

G

gestures, trackpad 26

H

hand positions 77
hard disk drive
removing and replacing 37
specifications 37
headphone port. *See* audio
out port
Help Center 31
Help, finding answers 31, 52

I

iLife applications 32
installation instructions
hard disk drive 37

memory 46
overview 8
Internet, connecting to 11

K

keyboard. *See also* keys
ergonomics 77
features 22
shortcuts 27
keys
brightness 23
function 23
Launchpad 23
Media 23
Media Eject 23
Mission Control 23
mute 23
volume 23

L

Launchpad key 23
light, sleep indicator 21

M

Mac App Store 33
Mac OS X Utilities
application 13
Mac OS X website 32
MagSafe power adapter.
See power adapter
MagSafe power port 25
Media Eject key 23

media keys 23
memory
checking 50
installing 46
specifications 46
microphone 21
Migration Assistant 13
Mini DisplayPort 25
Mission Control key 23
modem 11
mouse. *See also* trackpad
connecting to USB port 25
ergonomics 78
Multi-Touch gestures 26
mute key 23

N

network connections 11, 64
Network Diagnostics 62
Network Setup Assistant 62

O

online resources 66
optical disc drive
safety 74
optical drive
location 21

P

password, resetting 16
Photo Booth application 21
pinching to zoom 28

- Play/pause key 23
- plug, AC 10
- power adapter
 - port 25
 - safety tips 71
 - using 10
- power button 12, 21
- problems. *See* troubleshooting
- putting your computer to sleep 16

Q

- question mark, flashing 54

R

- RAM. *See* memory
- resetting password 16
- Rewind key 23
- right-clicking 27
- rotating objects using trackpad 28

S

- safety
 - general instructions 70
 - handling information 74
 - power adapter 71
- screen. *See also* display
 - goes black 55
 - setting brightness 23
- scrolling with two fingers 26
- SDRAM specifications 46

- secondary-clicking 27
- security slot 25
- Serial ATA (SATA) hard drive 37
- serial number, locating 68
- service and support 66
- Setup Assistant 13
- shutting down your computer 17
- sleep mode
 - indicator light 21
 - putting computer to sleep 16
- software
 - updating 65
- Software Update
 - preferences 65
- speakers 21
- specifications
 - computer 33
 - hard disk drive 37
 - memory 46
- SSD drive. *See* hard disk drive
- Startup Disk preferences 54
- stopping
 - an application 53
 - the computer 17
- storing your computer 76
- SuperDrive
 - location 21
 - supported disc sizes 75
- support, technical 66

- swiping to move quickly through documents 29
- System Information 66
- System Preferences
 - customizing the desktop 15
 - Energy Saver 30
 - Software Update 65
 - Startup Disk 54

T

- technical support 66
- three-finger swiping 29
- trackpad
 - gestures 26
 - location 21
- troubleshooting
 - AppleCare 66
 - computer freezes 54
 - computer won't turn on 54
 - ejecting a disc 56
 - hardware problems 61
 - pointer won't move 53
 - screen goes black 55
 - service and support 66
 - using Help Center 31, 66
 - Wi-Fi 64
- turning on your computer 12
- two-finger pinching 28
- two-finger rotating 28
- two-finger scrolling 26
- typing position 77

U

updating software 65

USB

connections 33

ports 25

V

video

Mini DisplayPort 25

video camera 21

video camera indicator

light 21

volume keys 23

W

waking your computer 17

Wi-Fi

connecting wirelessly 11

troubleshooting 64

Z

zooming using the

trackpad 28

 Apple Inc.

© 2011 Apple Inc. All rights reserved.

Under the copyright laws, this manual may not be copied, in whole or in part, without the written consent of Apple.

Every effort has been made to ensure that the information in this manual is accurate. Apple is not responsible for printing or clerical errors.

Apple
1 Infinite Loop
Cupertino, CA 95014
408-996-1010
www.apple.com

The Apple logo is a trademark of Apple Inc., registered in the U.S. and other countries. Use of the “keyboard” Apple logo (Option-Shift-K) for commercial purposes without the prior written consent of Apple may constitute trademark infringement and unfair competition in violation of federal and state laws.

Apple, the Apple logo, AirPort, FaceTime, Finder, GarageBand, iChat, iLife, iMovie, iPhone, iPhoto, iPod, iPod touch, iTunes, Keynote, Mac, MacBook, Mac OS, MagSafe, Photo Booth, Safari, Spaces, Spotlight, SuperDrive, Time Capsule, and Time Machine are trademarks of Apple Inc., registered in the U.S. and other countries.

iPad and Multi-Touch are trademarks of Apple Inc.

Apple, AppleCare, Apple Store, and iTunes Store are service marks of Apple Inc., registered in the U.S. and other countries.

App Store is a service mark of Apple Inc.

ENERGY STAR® is a U.S. registered trademark.

The Bluetooth® word mark and logos are registered trademarks owned by Bluetooth SIG, Inc. and any use of such marks by Apple Inc. is under license.

Other company and product names mentioned herein are trademarks of their respective companies. Mention of third-party products is for informational purposes only and constitutes neither an endorsement nor a recommendation. Apple assumes no responsibility with regard to the performance or use of these products.

Manufactured under license from Dolby Laboratories. “Dolby,” “Pro Logic,” and the double-D symbol are trademarks of Dolby Laboratories. Confidential Unpublished Works, © 1992–1997 Dolby Laboratories, Inc. All rights reserved.

Simultaneously published in the United States and Canada.

