

ChM[®]



















7.0 ChM Locked Plating
ChLP system

LOCKING PLATES 7.0ChLP

- *IMPLANTS*
- *INSTRUMENT SET 40.5702.700*
- *SURGICAL TECHNIQUE*



SYMBOLS DESCRIPTION

	Titanium or titanium alloy		H length [mm]
	Cobalt		Angle
	Left		available lengths
	Right		Available number of holes
	Available versions: left/right		Thickness [mm]
	Length		Scale 1:1
	Torx drive		Number of threaded holes in the shaft part of the plate
	Torx drive cannulated		Number of locking holes in the plate
	Hexagonal drive		Variable angle
	Hexagonal drive cannulated		Cortical
	Cannulated		Cancellous
	Locking		Available in sterile/ non- sterile condition
	Diameter [mm]		Refer to surgical technique
	Caution - pay attention to a special procedure.		
	Perform the activity under X-Ray control.		
	Information about the next stages of a procedure.		
	Proceed to the next stage.		
	Return to the specified stage and repeat the activity.		
	Before using the product, carefully read the Instructions for Use. It contains, among others, indications, contraindications, side effects, recommendations and warnings related to the use of the product.		
	The above description is not a detailed instruction of conduct. The surgeon decides about choosing the operating procedure.		

www.chm.eu

Document No ST/48C
 Date of issue 05.09.2012
 Review date P-005-08.12.2020

The manufacturer reserves the right to introduce design changes.

Updated INSTRUCTIONS FOR USE are available at the following website: ifu.chm.eu

I. INTRODUCTION	4
II. PLATE SELECTION AND CONTOURING	5
II.1. INDICATIONS	5
III. CATALOGUE PAGES	6
III.1. PLATES	6
III.2. SCREWS	21
III.3. INSTRUMENTS FOR 7.0ChLP PLATE	30
IV. SURGICAL TECHNIQUE	32
IV.1. TEMPORARY PLATE ATTACHMENT	32
IV.2. LOCKING SCREW Ø5.0 INSERTION	33
IV.3. THE USE OF AIMING BLOCK	36
IV.4. CORTICAL SCREW Ø4.5 INSERTION	37
IV.5. CANNULATED SCREW Ø7.3 INSERTION	39
V. POSTOPERATIVE TREATMENT	40
VI. IMPLANT REMOVAL	40

I. INTRODUCTION

The main purpose of surgical treatment of bone fractures is to reconstruct the anatomical bone structure and to restore its function.

Internal stabilization with locking plates enables accurate fracture reduction, stable fixation, blood flow preservation and functional activation of injured limb.

System ChLP consists of titanium plates and screws combining locking screws technique with conventional treatment techniques using plates. This system is the improvement of existing stabilization methods. Locking screws system enables angular fixation using conventional surgical techniques. It is particularly indicated in:

- multifragmental fractures;
- non-unions or malunions;
- osteopenia;
- osteotomy stabilization;
- when applying conventional screws is insufficient or does not bring expected effects.

Locking plates are provided with holes A for conventional cortical screws with or without compression and with threaded holes B for locking screws.

Compression holes designed in ChLP System enable compression in both directions.

Plates design allows to perform classical dynamic compression.

Advantages of using locking plates system over conventional methods of fracture treatment using plates:

- enable stable fixation ensuring angular stabilization in fracture site;

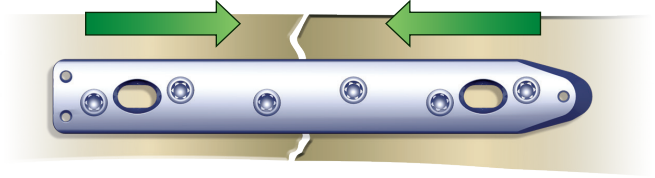

- enable compression using conventional cortical and cancellous screws, combination with conventional and locking screws is available;
- reduced bone-plate contact ensures better blood flow of perimplant tissues;
- locking screws enable uni-cortical plate position against the bone;
- plates can be contoured to match the anatomical bone shape that is particularly important in periarticular fractures.

The following instruction does not refer to particular fracture types as the locking plates system includes different plates that are relevant to many different fractures.

ChLP System was divided as follows:

- 4.0ChLP System;
- 4.5ChLP System;
- 5.0ChLP System;
- 7.0ChLP System.

Division is based on the screw head diameter; however, screws with different cortical thread diameter in one system range are available.

Additionally, systems were differentiated with colors as follows:

- 4.0ChLP System – green;
- 4.5ChLP System – gold;
- 5.0ChLP System – brown;
- 7.0ChLP System – blue.

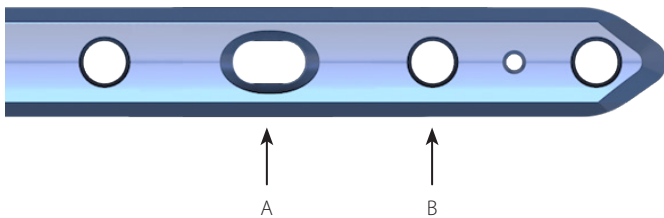

Before product usage, read the Instructions For Use carefully. The IFU is supplied with the product and attached at the end of this document. It includes, among others: the indications, contraindications, adverse effects, warnings and recommendations associated with product usage.

II. PLATE SELECTION AND CONTOURING

Wide size range of locking plates enables proper plate selection.

Locking plate contouring is not recommended due to possibility of threaded holes damaging.

Bottom surface of the plate does not have to contact with the bone if locking screws are used. There is no necessity of accurate plates contouring. Advanced shaped plates do not require additional bending in most cases.

If the plate bending is necessary, remember to not deform threaded holes excessively. It is essential to ensure that the desired shape of the implant is reached in as few bends as possible because titanium hardness increases and ductility (*bendability*) decreases. Excessive bending can lead to postoperative fracture of the plate. Due to potential risk for postoperative implant breakage, extremely acute angles together with small bending radii must be avoided. If Implant damage (*indentations, elongated screw holes, etc.*) occur, plate is to be exchanged for new one, more carefully bent one.

If the plate bending is required:

- perform it between locking holes;
- do not bend the plate more than 20° – 25°;
- do not bend the plate back and forth;
- before bending, insert the locking screws in the bending area, that decreases the threaded holes deformation degree.

II.1. INDICATIONS

7.0 locking plate system is designed to stabilize the fracture of various long bones such as:

- femoral bone,
- tibial bone

Straight wide plates are mainly used to stabilize the shafts of bone fractures. Shape plates are used for metaphyseal bone fractures as well as simple, comminuted, wedge-shaped lateral and medial fractures, condylar fractures and the ones combined with the shaft of a bone.

III. CATALOGUE PAGES

III.1. PLATES

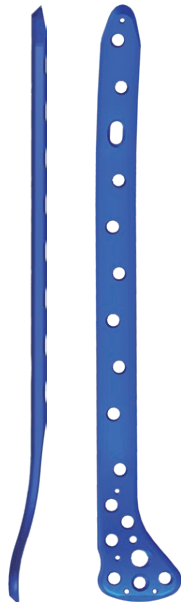

		Ti	
	Len	L	R
4	138	3.4023.604	3.4024.604
6	180	3.4023.606	3.4024.606
8	221	3.4023.608	3.4024.608
10	263	3.4023.610	3.4024.610

4-16 138-387

	Ti						
	3.5210.xxx	✓	✓	✓			5.0
	3.5232.xxx	✓	✓		✓		5.4
	3.5216.xxx	✓		✓			5.0
	3.5221.xxx	✓	✓		✓	✓	7.3
	3.5224.xxx	✓			✓	✓	7.3
	3.5228.xxx	✓	✓		✓		6.5
	3.1471.xxx	✓		✓			4.5
	3.5219.008	✓	✓				5.0
	3.1221.070		✓				

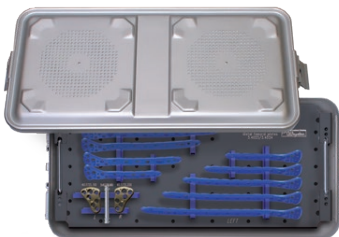

Palette for 7.0ChLP plates - 3.4023/3.4024

40.5704.510



Aiming block L [3.4023]

40.5725.100



Aiming block R [3.4024]

40.5725.200



Plate 3.4023.606 trial

43.4023.606

Plate 3.4024.606 trial

43.4024.606

Indications

- Comminuted fractures of the distal part of the femoral bone and fractures extending to the shaft of the femur.
- Supracondylar fractures.
- Articular and extra-articular condylar fractures.
- Non-union or malunions of fractured bone.

Contraindications

Absolute

- Health condition precluding surgery.
- Allergic reactions to the metal from which the implant is made.
- Active infection.

Relative

- Weakened bone (*by disease, infection or prior implantation*) making it impossible to install/stabilize the implant properly.
- Abnormal perfusion of fracture area or surgical site.
- Excessive obesity.
- Lack of adequate tissue coverage.
- Psychiatric disorders or the disorders of the musculoskeletal system which may create a risk of fusion failure or complications in the postoperative period.
- Other medical conditions that exclude the potential benefits of the treatment.

The patient's position



Surgical approach



Lateral approach: the lateral incision of about 80 mm in the proximal direction shall begin from Gerdy's tubercle. If necessary, the incision may be lengthened. The incision is recommended for extra-articular fractures and simple articular and metaphyseal fractures without displacement.

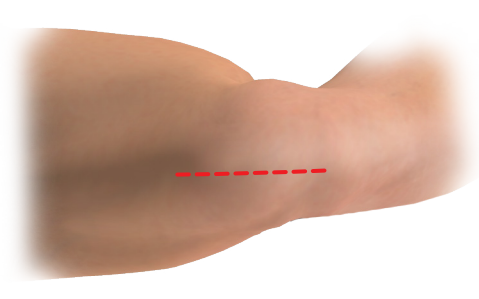

Anterior-lateral approach: perform the parapatellar incision. Perform the arthrotomy as to expose the articulation and reduce the fragments of the fractured bone; pull the patella medially and widen the cut adequately to expose the femoral condyle. The parapatellar incision is recommended for more complex articular comminuted fractures.

Procedure stages

- Reduction of fracture and stabilization of the fracture fragments with Kirschner wires.
- The choice of implants - determining the length and position of the implant.
- Insertion of the plate and its positioning.
- Temporary stabilization of the implant using Kirschner wires.
- Introduction of the screws to the distal parts of the plate.
- Stabilization of the shaft using locking or compression screws.



			Ti	
	Len	L		R
4	129	3.4013.604		3.4014.604
5	150	3.4013.605		3.4014.605
6	171	3.4013.606		3.4014.606
8	213	3.4013.608		3.4014.608
4-12	129 - 297			

	Ti					
	3.5210.xxx	✓	✓	✓		5.0
	3.5232.xxx	✓	✓		✓	5.4
	3.5216.xxx	✓		✓		5.0
	3.1471.xxx	✓		✓		4.5
	3.5219.008	✓	✓			5.0
	3.1221.070		✓			

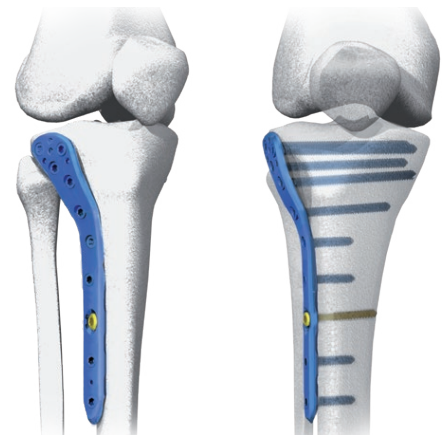

Palette for 7.0ChLP plates - 3.4013/3.4014

40.5704.520



Aiming block L [3.4013]

40.5724.100

Aiming block R [3.4014]

40.5724.200



Plate 3.4013.605 trial

43.4013.605

Plate 3.4014.605 trial

43.4014.605

Indications

- Articular and extra-articular, metaphyseal and epiphyseal comminuted fractures of the proximal part of the tibia and fractures extending to the shaft of the tibia.
- Non-union or malunions of fractured bone

Contraindications

Absolute:

- Health condition precluding surgery.
- Allergic reactions to the metal from which the implant is made.
- Active infection.

Relative:

- Weakened bone (*by disease, infection or prior implantation*) making it impossible to install/stabilize the implant properly.
- Abnormal perfusion of fracture area.
- Excessive obesity.
- Lack of adequate tissue coverage.
- Psychiatric disorders or the disorders of the musculoskeletal system which may create a risk of fusion failure or complications in the postoperative period.
- Other medical conditions that exclude the potential benefits of the treatment.

The patient's position



Surgical approach



Lateral S incision - recommended for simple articular and extra-articular fractures



Straight anterior-lateral incision - recommended for more complex articular fractures.

Anterior-lateral approach. The incision performed between the tibia and fibula bone should begin approximately 1 cm proximally from Gerdy's tubercle for a desired length of the plate. In the minimally invasive technique, a short cut and additional cuts for the access to the holes of the shaft of the plate should be performed.

Procedure stages

- Reduction of fracture and stabilization of the fracture fragments using Kirschner wires.
- The choice of implants - determining the length and position of the implant.
- Insertion of the plate and its positioning.
- Temporary stabilization of the implant using Kirschner wires.
- Introduction of the screws in the distal parts of the plate.
- Stabilization of the shaft using locking or compression screws.
- Positioning of the plate using the compression screw in the extended hole.
- Making X-Ray film in both A-P and lateral position as to make sure the plate and screws are positioned properly.
- Closing the wound.

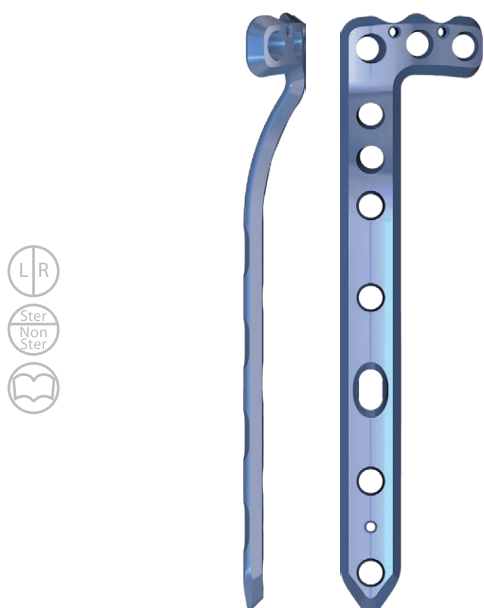

			Ti	
	Len	L		R
4	116	3.4009.604		3.4010.604
6	158	3.4009.606		3.4010.606
8	200	3.4009.608		3.4010.608
10	242	3.4009.610		3.4010.610
4-14	116 - 326			

	Ti						
	3.5210.xxx	✓	✓	✓			5.0
	3.5232.xxx	✓	✓		✓		5.4
	3.5216.xxx	✓		✓			5.0
	3.1471.xxx	✓		✓			4.5
	3.5219.008	✓	✓				5.0
	3.1221.070		✓				

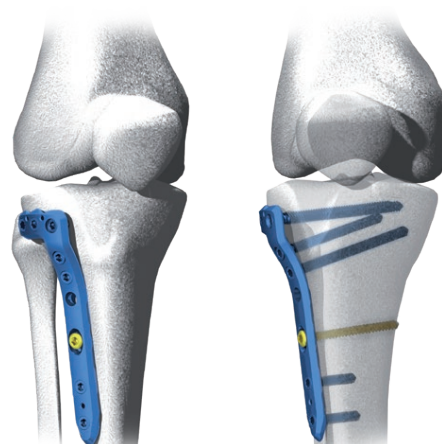

Palette for 7.0ChLP plates - 3.4009/3.4010

40.5704.540

Plate 3.4009.606 trial

43.4009.606

Plate 3.4010.606 trial

43.4010.606

Indications

- Articular and extra-articular, metaphyseal and epiphyseal comminuted fractures of the proximal part of the tibia and fractures extending to the shaft of the tibia.
- Non-union or malunions of fractured bone

Contraindications

Absolute:

- Health condition precluding surgery.
- Allergic reactions to the metal from which the implant is made.
- Active infection.

Relative:

- Weakened bone (*by disease, infection or prior implantation*) making it impossible to install/stabilize the implant properly.
- Abnormal perfusion of fracture area.
- Excessive obesity.
- Lack of adequate tissue coverage.
- Psychiatric disorders or the disorders of the musculoskeletal system which may create a risk of fusion failure or complications in the postoperative period.
- Other medical conditions that exclude the potential benefits of the treatment.

The patient's position



Surgical approach



Lateral S incision - recommended for simple articular and extra-articular fractures



Straight anterior-lateral incision - recommended for more complex articular fractures.

Anterior-lateral approach. The incision performed between the tibia and fibula bone should begin approximately 1 cm proximally from Gerdy's tubercle for a desired length of the plate. In the minimally invasive technique, a short cut and additional cuts for the access to the holes of the shaft of the plate should be performed.

Procedure stages

- Reduction of fracture and stabilization of the fracture fragments using Kirschner wires.
- The choice of implants - determining the length and position of the implant.
- Insertion of the plate and its positioning.
- Temporary stabilization of the implant using Kirschner wires.
- Introduction of the screws in the distal parts of the plate.
- Stabilization of the shaft using locking or compression screws.
- Positioning of the plate using the compression screw in the extended hole.
- Making X-Ray film in both A-P and lateral position as to make sure the plate and screws are positioned properly.
- Closing the wound.



	Len	L	Ti	R
	3	131	3.4089.603	3.4090.603
	4	152	3.4089.604	3.4090.604
	6	194	3.4089.606	3.4090.606
	8	236	3.4089.608	3.4090.608

	Ti						
	3.5210.xxx	✓	✓	✓			5.0
	3.5232.xxx	✓	✓		✓		5.4
	3.5216.xxx	✓		✓			5.0
	3.1471.xxx	✓		✓			4.5
	3.5219.008	✓	✓				5.0
	3.1221.070		✓				



Palette for 7.0ChLP plates - 3.4089/3.4090

40.5704.560



Aiming block L [3.4089]

40.5709.100

Aiming block R [3.4090]

40.5709.200



Plate 3.4089.604 trial

43.4089.604

Plate 3.4089.604 trial

43.4090.604

Indications

- Articular and extra-articular, metaphyseal and epiphyseal comminuted fractures of the proximal part of the tibia and fractures extending to the shaft of the tibia.
- Non-union or malunions of fractured bone

Contraindications

Absolute:

- Health condition precluding surgery.
- Allergic reactions to the metal from which the implant is made.
- Active infection.

Relative:

- Weakened bone (*by disease, infection or prior implantation*) making it impossible to install/stabilize the implant properly.
- Abnormal perfusion of fracture area.
- Excessive obesity.
- Lack of adequate tissue coverage.
- Psychiatric disorders or the disorders of the musculoskeletal system which may create a risk of fusion failure or complications in the postoperative period.
- Other medical conditions that exclude the potential benefits of the treatment.

The patient's position



Surgical approach



Lateral S incision - recommended for simple articular and extra-articular fractures



Straight anterior-lateral incision - recommended for more complex articular fractures.

Anterior-lateral approach. The incision performed between the tibia and fibula bone should begin approximately 1 cm proximally from Gerdy's tubercle for a desired length of the plate. In the minimally invasive technique, a short cut and additional cuts for the access to the holes of the shaft of the plate should be performed.

Procedure stages

- Reduction of fracture and stabilization of the fracture fragments using Kirschner wires.
- The choice of implants - determining the length and position of the implant.
- Insertion of the plate and its positioning.
- Temporary stabilization of the implant using Kirschner wires.
- Introduction of the screws in the distal parts of the plate.
- Stabilization of the shaft using locking or compression screws.
- Positioning of the plate using the compression screw in the extended hole.
- Making X-Ray film in both A-P and lateral position as to make sure the plate and screws are positioned properly.
- Closing the wound.



		Ti	
		Len	
		L	R
4	134	3.7055.604	3.7054.604
6	176	3.7055.606	3.7054.606
8	218	3.7055.608	3.7054.608
10	260	3.7055.610	3.7054.610
3-13	113 323		

* holes number in shaft part of the plate

	Ti						
3.5210.xxx	✓	✓	✓				5.0
3.5232.xxx	✓	✓		✓			5.4
3.5216.xxx	✓			✓			5.0
3.1471.xxx	✓			✓			4.5
3.5219.008	✓	✓					5.0
3.1221.070		✓					

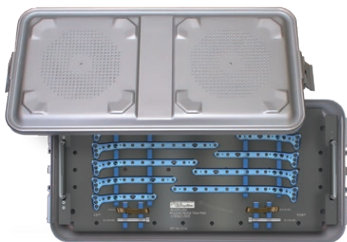
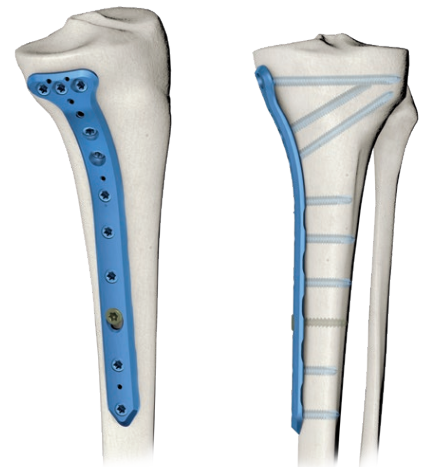

Palette for 7.0ChLP plates - 3.7054/3.7055

40.6292.000

Aiming block L [3.7055]

40.8221.000

Aiming block R [3.7054]

40.8220.000

Indications

- Articular and extra-articular, metaphyseal and epiphyseal comminuted fractures of the proximal part of the tibia and fractures extending to the shaft of the tibia.
- Non-union or malunions of fractured bone

Contraindications

Absolute:

- Health condition precluding surgery.
- Allergic reactions to the metal from which the implant is made.
- Active infection.

Relative:

- Weakened bone (*by disease, infection or prior implantation*) making it impossible to install/stabilize the implant properly.
- Abnormal perfusion of fracture area.
- Excessive obesity.
- Lack of adequate tissue coverage.
- Psychiatric disorders or the disorders of the musculoskeletal system which may create a risk of fusion failure or complications in the postoperative period.
- Other medical conditions that exclude the potential benefits of the treatment.

The patient's position

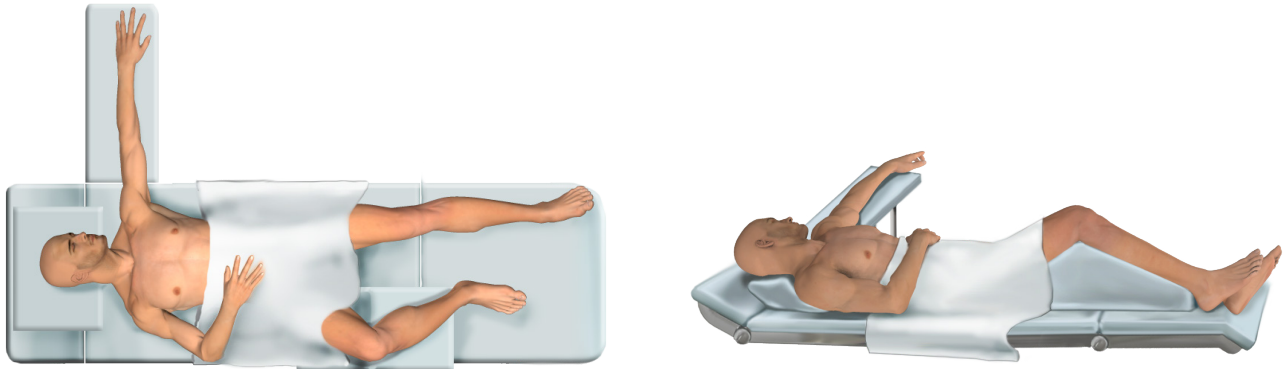

Surgical approach

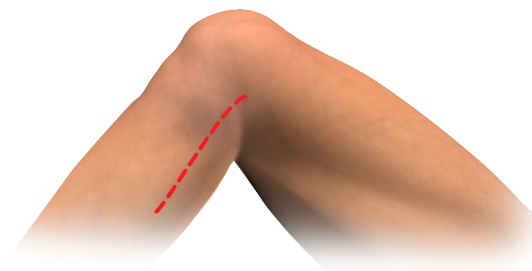

Dostęp tylnopryśrodkowy

Staw kolany ułożony w lekkim zgięciu. Wykonać proste lub lekko zakrzywione cięcie biegnące od przyśrodkowego nadkłyka kości udowej w kierunku tylnopryśrodkowej krawędzi piszczeli. W razie potrzeby cięcie może być rozszerzone zarówno proksymalnie jak i dystalnie.

Procedure stages

- Reduction of fracture and stabilization of the fracture fragments using Kirschner wires.
- The choice of implants - determining the length and position of the implant.
- Insertion of the plate and its positioning.
- Temporary stabilization of the implant using Kirschner wires.
- Introduction of the screws in the distal parts of the plate.
- Stabilization of the shaft using locking or compression screws.
- Positioning of the plate using the compression screw in the extended hole.
- Making X-Ray film in both A-P and lateral position as to make sure the plate and screws are positioned properly.
- Closing the wound.

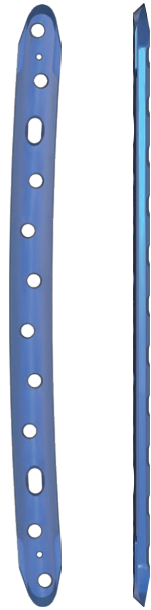

	Len	Ti
10	209	3.7062.610
12	251	3.7062.612
14	292	3.7062.614
16	333	3.7062.616

	Ti						
	3.5210.xxx	✓	✓	✓			5.0
	3.5232.xxx	✓	✓		✓		5.4
	3.5216.xxx	✓		✓			5.0
	3.1471.xxx	✓		✓			4.5
	3.5219.008	✓	✓				5.0
	3.1221.070		✓				



Indications

- Comminuted, transverse, spiral, oblique, compression fractures of the femoral shaft.
- Non-unions or malunions of the femoral shaft.
- Osteotomies.

Contraindications

Absolute:

- Health condition precluding surgery.
- Allergic reactions to the metal from which the implant is made.
- Active infection.

Relative:

- Weakened bone (*by disease, infection or prior implantation*) making it impossible to install/stabilize the implant properly.
- Abnormal perfusion of fracture area or surgical site.
- Excessive obesity.
- Lack of adequate tissue coverage.
- Psychiatric disorders or the disorders of the musculoskeletal system which may create a risk of fusion failure or complications in the postoperative period.
- Other medical conditions that exclude the potential benefits of the treatment.

The patient's position

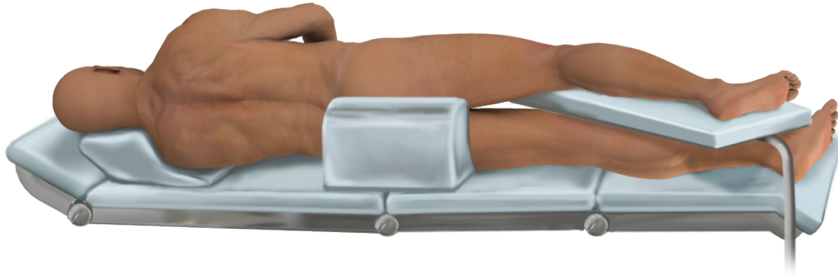

Surgical approach

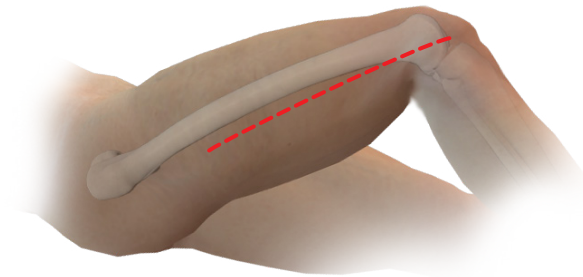

Lateral approach: length and location of the incision depends on the location and type of fracture.

Incision approx. 5 cm below the greater trochanter to approx. 5 cm above the lateral epicondyle of the femur. When minimally invasive technique is applied, the incision length of approx. 5 cm is performed on the lateral proximal or distal femur (*depending on local conditions and a surgeon's preferences*)

Procedure stages

- Reduction and initial fracture stabilization.
- The choice of implants - determining the length and position of the implant.
- Insertion of the plate and its positioning.
- Temporary stabilization of the implant using Kirschner wires.
- Stabilization of the plate using locking or compression screws.

7.0 ChM Locked Plating
ChLP system



	Len	L	R
2	132	3.7023.602	3.7022.602
4	174	3.7023.604	3.7022.604
6	216	3.7023.606	3.7022.606
8	258	3.7023.608	3.7022.608

Ti

2-16 132 / 426

	Ti	Icon 1	Icon 2	Icon 3	Icon 4	Icon 5	Icon 6
	3.5210.xxx	✓	✓	✓			5.0
	3.5232.xxx	✓	✓		✓		5.4
	3.5216.xxx	✓		✓			5.0
	3.5221.xxx	✓	✓		✓	✓	7.3
	3.5224.xxx	✓			✓	✓	7.3
	3.5228.xxx	✓	✓		✓		6.5
	3.1471.xxx	✓		✓			4.5
	3.5219.008	✓	✓				5.0
	3.1221.070		✓				

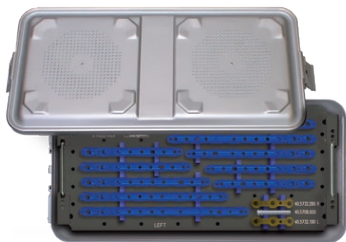

Palette for 7.0ChLP plates - 3.7022/3.7023

40.5704.590



Aiming block L [3.7023]

40.5732.100

Aiming block R [3.7022]

40.5732.200



Plate 3.7022.604/ 3.7023.604 trial

43.7022.604



	Len	Ti
6	131	3.3155.606
8	173	3.3155.608
10	215	3.3155.610
12	257	3.3155.612
14	299	3.3155.614

	Ti						
3.5210.xxx	✓	✓	✓				5.0
3.5232.xxx	✓	✓		✓			5.4
3.5216.xxx	✓		✓				5.0
3.1471.xxx	✓		✓				4.5
3.5219.008	✓	✓					5.0
3.1221.070		✓					

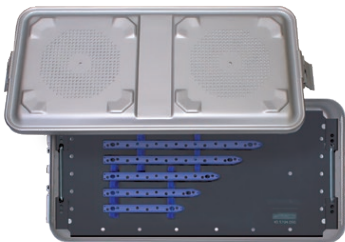

Palette for 7.0ChLP plates - straight

40.5704.550

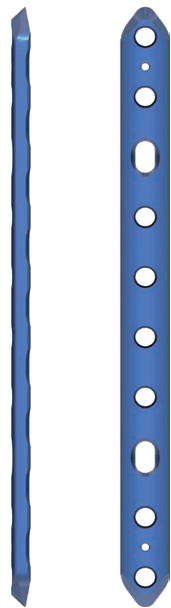

*	Len	Ti
5	90	3.7093.605
6	108	3.7093.606
8	144	3.7093.608
10	180	3.7093.610
12	216	3.7093.612
14	252	3.7093.614

* holes number in shaft part of the plate

	Ti						
3.5210.xxx	✓	✓	✓				5.0
3.5232.xxx	✓	✓		✓			5.4
3.5216.xxx	✓			✓			5.0
3.1471.xxx	✓			✓			4.5
3.5219.008	✓	✓					5.0
3.1221.070			✓				





III.2. SCREWS

	3.5210.xxx	✓		✓	✓			5.0
	3.5232.xxx	✓		✓		✓		5.4
	3.5228.xxx	✓		✓		✓		6.5
	3.5221.xxx	✓		✓		✓	✓	7.3
	3.5224.xxx	✓				✓	✓	7.3
	3.5216.xxx	✓			✓			5.0
	3.1471.xxx	✓			✓			4.5
	3.5219.008	✓		✓				5.0
	3.1448.xxx		✓	✓	✓			5.0
	3.1380.xxx		✓	✓		✓		5.4
	3.1383.xxx		✓	✓		✓		6.5
	3.1664.xxx		✓	✓		✓	✓	7.3
	3.1665.xxx		✓			✓	✓	7.3
	3.1449.xxx		✓		✓			5.0
	3.1443.xxx		✓		✓			4.5
	3.1448.008		✓	✓				5.0
	3.1221.070			✓				





7.0ChLP SELF-TAPPING SCREW 5.0

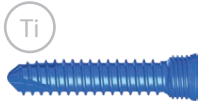

16	3.5210.016
18	3.5210.018
20	3.5210.020
22	3.5210.022
24	3.5210.024
26	3.5210.026
28	3.5210.028
30	3.5210.030
32	3.5210.032
34	3.5210.034
36	3.5210.036
38	3.5210.038
40	3.5210.040
42	3.5210.042
44	3.5210.044
46	3.5210.046
48	3.5210.048
50	3.5210.050
52	3.5210.052
54	3.5210.054
56	3.5210.056
58	3.5210.058
60	3.5210.060
65	3.5210.065
70	3.5210.070
75	3.5210.075
80	3.5210.080
85	3.5210.085
90	3.5210.090
95	3.5210.095

core diameter	4.0	
drill with scale	4.0	40.5651.212
guide sleeve	7.0/4.0	40.5705.740
screwdriver tip	T25	40.5684.200

CORTICAL SELF-TAPPING SCREW 4.5



20	3.1471.020
22	3.1471.022
24	3.1471.024
26	3.1471.026
28	3.1471.028
30	3.1471.030
32	3.1471.032
34	3.1471.034
36	3.1471.036
38	3.1471.038
40	3.1471.040
42	3.1471.042
44	3.1471.044
46	3.1471.046
48	3.1471.048
50	3.1471.050
52	3.1471.052
54	3.1471.054
56	3.1471.056
58	3.1471.058
60	3.1471.060
65	3.1471.065
70	3.1471.070
75	3.1471.075
80	3.1471.080
85	3.1471.085
90	3.1471.090
95	3.1471.095

core diameter	3.0	
drill with scale	3.2	40.5650.212
compression guide	3.2	40.4802.732
screwdriver tip	T25	40.5684.200



7.0ChLP CANCELLOUS SCREW 5.4

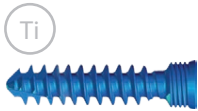

35	3.5232.035
40	3.5232.040
45	3.5232.045
50	3.5232.050
55	3.5232.055
60	3.5232.060
65	3.5232.065
70	3.5232.070
75	3.5232.075
80	3.5232.080

7.0ChLP CONICAL CANNULATED SCREW 7.3X16/30T



50	3.5224.050
55	3.5224.055
60	3.5224.060
65	3.5224.065
70	3.5224.070
75	3.5224.075
80	3.5224.080
85	3.5224.085
90	3.5224.090
95	3.5224.095

core diameter	3.2	
drill with scale	3.2	40.5650.212
guide sleeve	3.2	40.5705.732
screwdriver tip	T25	40.5684.200

core diameter	5.2	
Kirschner wire	2.0	40.4815.210
guide sleeve	5.0/2.0 9.0/5.0	40.5654.120 40.5654.750
cannulated drill with scale	5.0/2.2	40.5652.212
cannulated screwdriver tip	T30	40.5685.200



7.0ChLP CONICAL SELF - TAPPING SCREW 5.0

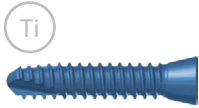

30	3.5216.030
35	3.5216.035
40	3.5216.040
45	3.5216.045
50	3.5216.050
55	3.5216.055
60	3.5216.060
65	3.5216.065
70	3.5216.070
75	3.5216.075
80	3.5216.080
85	3.5216.085
90	3.5216.090

7.0ChLP CANCELLOUS SCREW 6.5



30	3.5228.030
35	3.5228.035
40	3.5228.040
45	3.5228.045
50	3.5228.050
55	3.5228.055
60	3.5228.060
65	3.5228.065
70	3.5228.070
75	3.5228.075
80	3.5228.080
85	3.5228.085
90	3.5228.090
95	3.5228.095

core diameter	4.0	
drill with scale	4.0	40.5651.212
guide sleeve	7.0/4.0	40.5705.740
screwdriver tip	T25	40.5684.200

core diameter	3.2	
drill with scale	3.2	40.5650.212
guide sleeve	9.0/3.2	40.5707.732
cannulated screwdriver tip	T30	40.5685.200



7.0ChLP CANNULATED SCREW 7.3

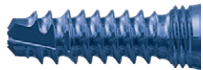

30	3.5221.030
35	3.5221.035
40	3.5221.040
45	3.5221.045
50	3.5221.050
55	3.5221.055
60	3.5221.060
65	3.5221.065
70	3.5221.070
75	3.5221.075
80	3.5221.080
85	3.5221.085
90	3.5221.090
95	3.5221.095
100	3.5221.100

7.0ChLP DISTANCE SCREW



8	3.5219.008
---	------------

7.0ChLP CERCLAGE SCREW



3.1221.070

*
Wire diameter max. 1.5 mm

screwdriver	40.4746.000
-------------	-------------



40.5749.600

Stand for screws 7.0ChLP



Stand for screws 7.0ChLP	40.5749.600	1
Container with solid bottom 1/2 306x272x135mm	12.0751.103	1
Perforated aluminum cover 1/2 306x272x15mm Gray	12.0751.200	1

40.5749.700

implants not included;

Name	Catalogue no.	Pcs.	
Palette for 7.0ChLP straight plates			
	Palette	40.5704.350	1
	Container with solid bottom 1/1 595x275x86mm	12.0750.100	1
	Perforated aluminum lid 1/1 595x275x15mm Gray	12.0750.200	1
			40.5704.550

implants not included;

Palette for 7.0ChLP plates - 3.4023/3.4024			
	Aiming block [3.4023]	40.5725.100	1
	Aiming block R [3.4024]	40.5725.200	1
	Protective guide 9/7	40.5708.000	2
	Palette	40.5704.410	1
	Container with solid bottom 1/1 595x275x86mm	12.0750.100	1
	Perforated aluminum lid 1/1 595x275x15mm Gray	12.0750.200	1
			40.5704.510

implants not included; with additional instruments

Palette for 7.0ChLP plates - 3.4013/3.4014			
	Aiming block L [3.4013]	40.5724.100	1
	Aiming block R [3.4014]	40.5724.200	1
	Protective guide 9/7	40.5708.000	2
	Palette	40.5704.420	1
	Container with solid bottom 1/1 595x275x86mm	12.0750.100	1
	Perforated aluminum lid 1/1 595x275x15mm Gray	12.0750.200	1
			40.5704.520

implants not included; with additional instruments



Palette	40.5704.340	1
Container with solid bottom 1/1 595x275x86mm	12.0750.100	1
Perforated aluminum lid 1/1 595x275x15mm Gray	12.0750.200	1

40.5704.540

implants not included;

Palette for 7.0ChLP plates - 3.4089/3.4090;



Aiming block L [3.4089]	40.5709.100	1
Aiming block R [3.4090]	40.5709.200	1
Protective guide 9/7	40.5708.000	2
Palette	40.5704.460	1
Container with solid bottom 1/1 595x275x86mm	12.0750.100	1
Perforated aluminum lid 1/1 595x275x15mm Gray	12.0750.200	1

40.5704.360

40.5704.560

implants not included; with additional instruments

Palette for 7.0ChLP plates - 3.7054/3.7055



Aiming block L [3.7055]	40.8221.000	1
Aiming block R [3.7054]	40.8220.000	1
Protective guide 9/7	40.5708.000	2
Palette	40.6293.000	1
Container with solid bottom 1/1 595x275x86mm	12.0750.100	1
Perforated aluminum lid 1/1 595x275x15mm Gray	12.0750.200	1

40.6292.000

implants not included; with additional instruments

Palette for 7.0ChLP plates - 3.7022/3.7023;



Aiming block L [3.7023]	40.5732.100	1
Aiming block R [3.7022]	40.5732.200	1
Protective guide 9/7	40.5708.000	2
Palette	40.5704.490	1
Container with solid bottom 1/1 595x275x86mm	12.0750.100	1
Perforated aluminum lid 1/1 595x275x15mm Gray	12.0750.200	1

40.5704.390

40.5704.590

implants not included; with additional instruments

Palette for 7.0ChLP plates - 3.7062;







Palette	40.5704.800	1
Container with solid bottom 1/1 595x275x86mm	12.0750.100	1
Perforated aluminum lid 1/1 595x275x15mm Gray	12.0750.200	1

40.5704.900























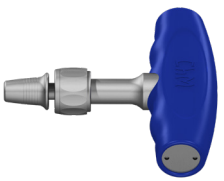

implants not included;

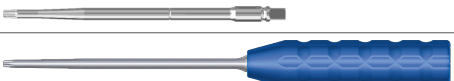

	Name	[L/R] Left/Right	Catalogue No.
	Plate 3.4009.606 trial	L	43.4009.606
	Plate 3.4010.606 trial	R	43.4010.606
	Plate 3.4013.605 trial	L	43.4013.605
	Plate 3.4014.605 trial	R	43.4014.605
	Plate 3.4023.606 trial	L	43.4023.606
	Plate 3.4024.606 trial	R	43.4024.606
	Plate 3.4089.604 trial	L	43.4089.604
	Plate 3.4090.604 trial	R	43.4090.604
	Plate 3.7022.604 trial	L/R	43.7022.604









III.3. INSTRUMENTS FOR 7.0ChLP PLATE

A. Universal instrument set 40.5702.700

	Name	Pcs	Catalogue No.
	Guide sleeve 7.0/2.0	2	40.5705.720
	Guide sleeve 7.0/3.2	2	40.5705.732
	Guide sleeve 7.0/4.0	4	40.5705.740
	Compression guide 3.2	1	40.4802.732
	Drill with scale 3.2/220	2	40.5650.222
	Drill with scale 4.0/220	2	40.5651.222
	Cannulated drill with scale 5.0/2.2/220	1	40.5652.222
	Kirschner wire 2.0/220	4	40.4815.220
	Setting-compressing screw 4.0/180	2	40.5706.740
	Screw length measure	1	40.5675.100
	Depth measure	1	40.4639.700
	Screwdriver tip S3.5-1/4	1	40.5686.000
	Screwdriver tip T 25-1/4	1	40.5684.000
	Torque limiting ratchet handle T 4Nm	1	40.6660.000
	Bender for plates 4/6	2	40.4250.000
	Guide sleeve 9/3.2	1	40.5707.732
	Guide sleeve 9/5.0	1	40.5654.750
	Guide sleeve 5.0/2.0	1	40.5654.120
	Cannulated screwdriver tip S5-1/4	1	40.5687.000
	Cannulated screwdriver tip T30-1/4	1	40.5685.000
	Star cannulated screwdriver T30	1	40.0672.000
	Star screwdriver T25	1	40.0671.000
	Hexagonal screwdriver S3.5	1	40.0320.000
	Cannulated screwdriver S5	1	40.4817.000
	Tap 7.0ChLP - 5.0	1	40.5646.000
	Cortical tap HA 4.5	1	40.5647.000
	Screwdriver	1	40.4746.000
	Stand for instrument set of 7.0ChLP plate	1	40.5703.700
	Container with solid bottom 1/1 595x275x86mm	1	12.0750.100
	Perforated aluminum lid 1/1 595x275x15mm gray	1	12.0750.200

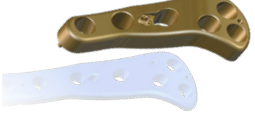
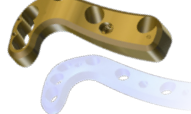
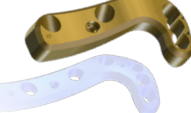
B. Additional instruments

Instruments not included in the instrument set [40.5702.700]

	Name	Pcs	Catalogue No.
	Protective guide 9.0/7.0	2	40.5708.000
	Aiming block L [3.4023]	1	40.5725.100
	Aiming block R [3.4024]	1	40.5725.200
	Aiming block L [3.4013]	1	40.5724.100
	Aiming block R [3.4014]	1	40.5724.200
	Aiming block L [3.4089]	1	40.5709.100
	Aiming block R [3.4090]	1	40.5709.200
	Aiming block L [3.7023]	1	40.5732.100
	Aiming block R [3.7022]	1	40.705.200
	Aiming block L [3.7055]	1	40.7054.000
	Aiming block R [3.7054]	1	40.8220.000

IV. SURGICAL TECHNIQUE

IV.1. TEMPORARY PLATE ATTACHMENT



When fracture is reduced and the plate position is confirmed, determine its temporary location using Kirschner wires 2.0 [40.4815.220].
Wires can be inserted in proximal holes of the plate and the most distal ones.



Confirm the plate position is correct taking X-Ray image.



The Setting-compressing screw 4.0/180 [40.5706.740] can be used to stabilize and tighten the plate up to the bone for temporary purposes. The screw is to be inserted via the Guide sleeve 7.0/4.0 [40.5705.740].

Locking screw $\varnothing 5.0$ can be inserted in the hole after removal of the Setting-compressing screw 4.0/180.

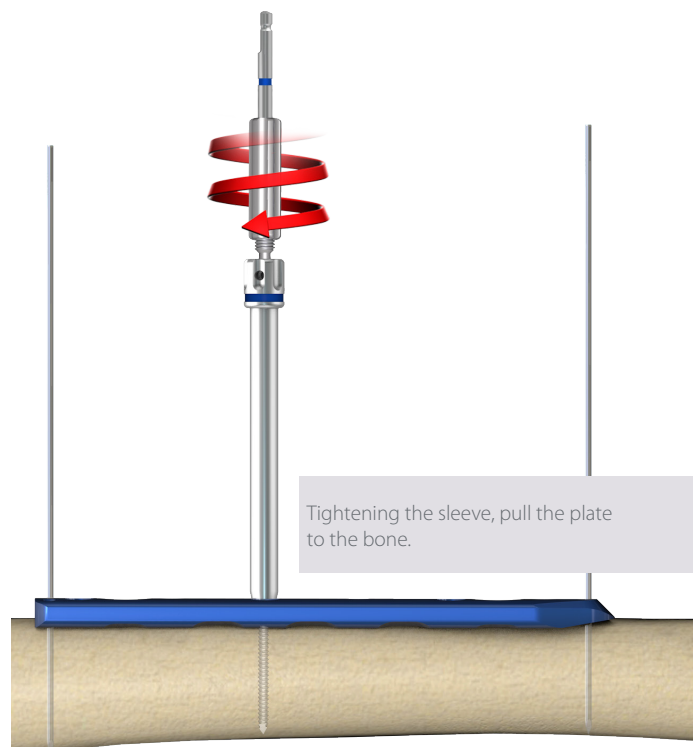
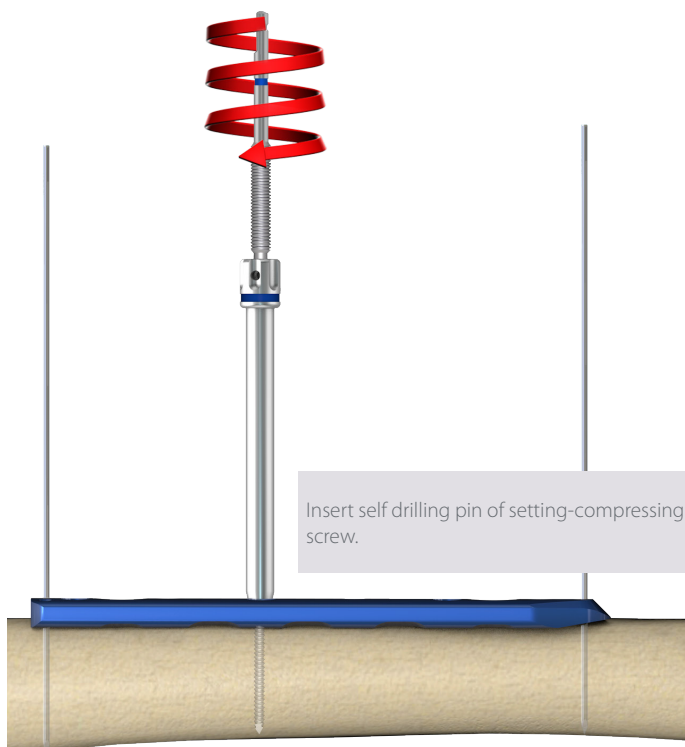
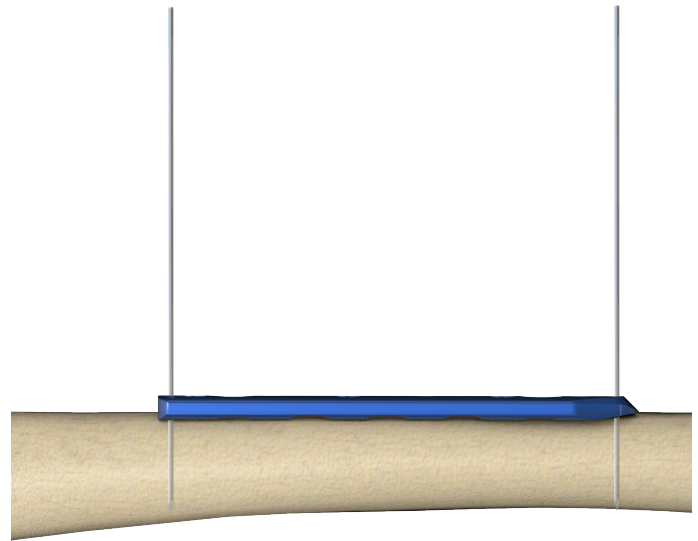

IV.2. LOCKING SCREW Ø5.0 INSERTION



It is important to drill exactly in the axis of a locking hole. Use always the appropriate guide sleeve when drilling. The guide sleeve will ensure the locking screw take an axial position towards the hole of the plate and be correctly locked in the plate. Unprepared drilling of a hole can lead to: thread skewing and jamming the screw, incorrect screw locking and problems when removing the screws (*thread seizure*).

Guide sleeve screwing



40.5705.740

Insert the Guide sleeve 7.0/4.0 [40.5705.740] into the plate

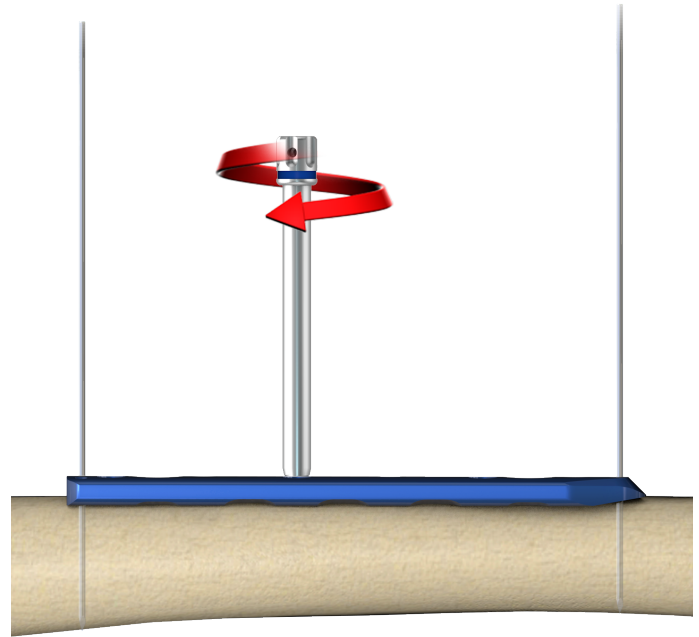

Drilling the hole



40.5651.222

Ream the hole using the Drill with scale 4.0/220 [40.5651.222] until the desired depth is reached

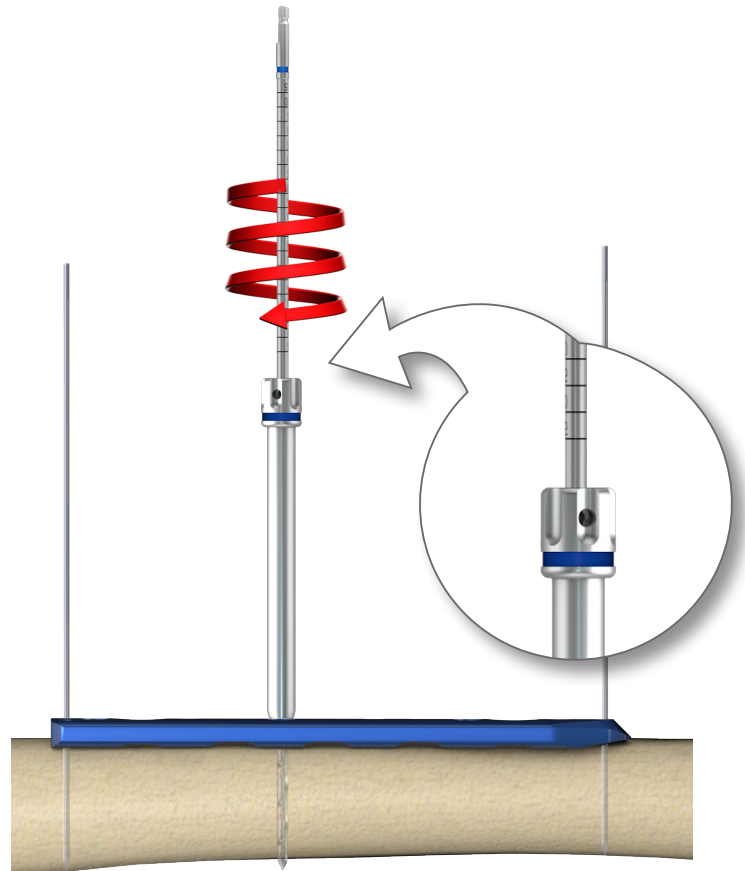

Hole depth measurement

OPTION I





40.5705.740



40.5651.222

Read the value on the Drill with scale [40.5651.222] or

OPTION II

	40.5705.740
	40.5651.222
	40.5675.100

use the Screw length measure [40.5675.100].

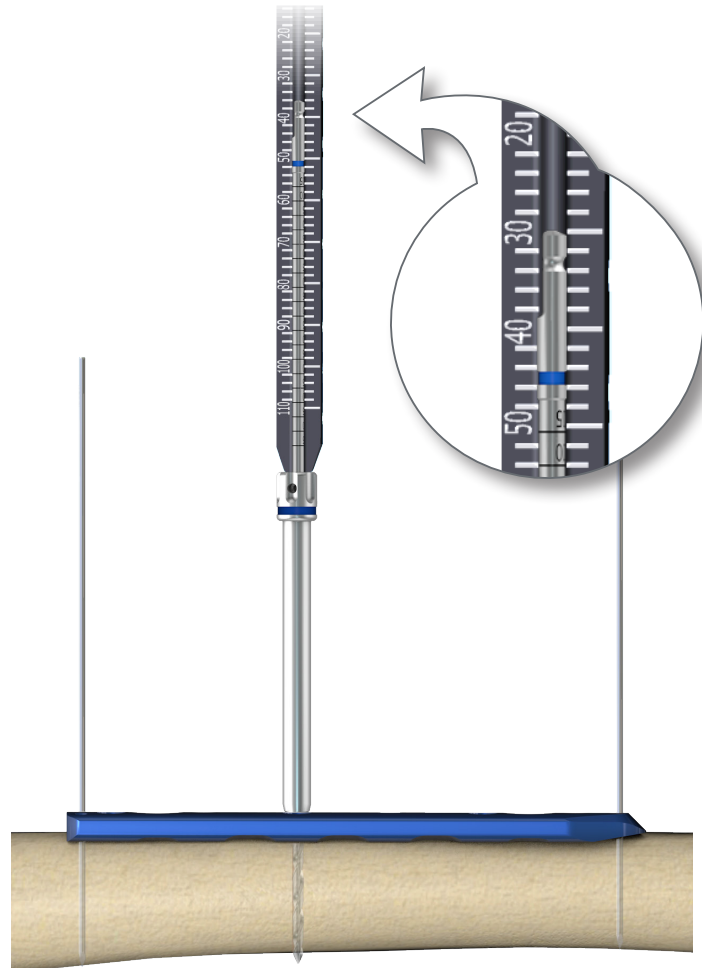

OPTION III

	40.4639.700
---	-------------

Unscrew the Guide sleeve 7.0/4.0 [40.5705.740] and define the screw length using the Depth measure [40.4639.700].

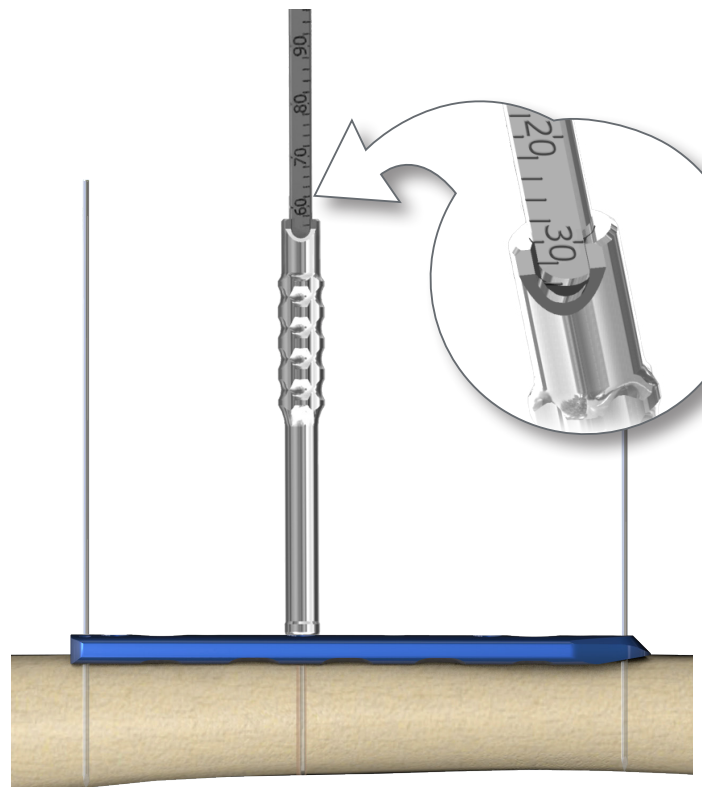

Screw insertion

Remove the Guide sleeve 7.0/4.0 [40.5705.740].

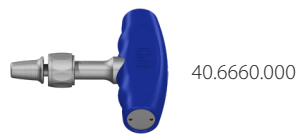
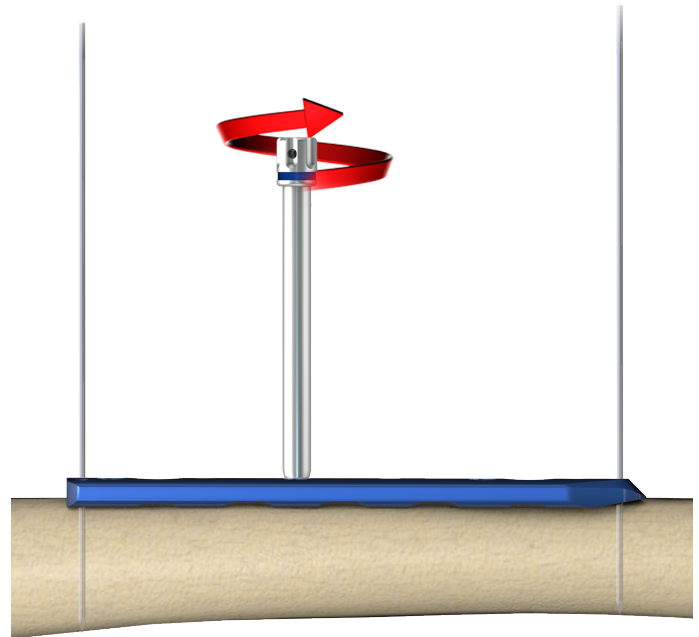

40.6660.000



40.5686.000



40.5684.000

Insert the locking screw Ø5.0 using the Torque wrench [40.6660.000] and proper screwdriver tip.

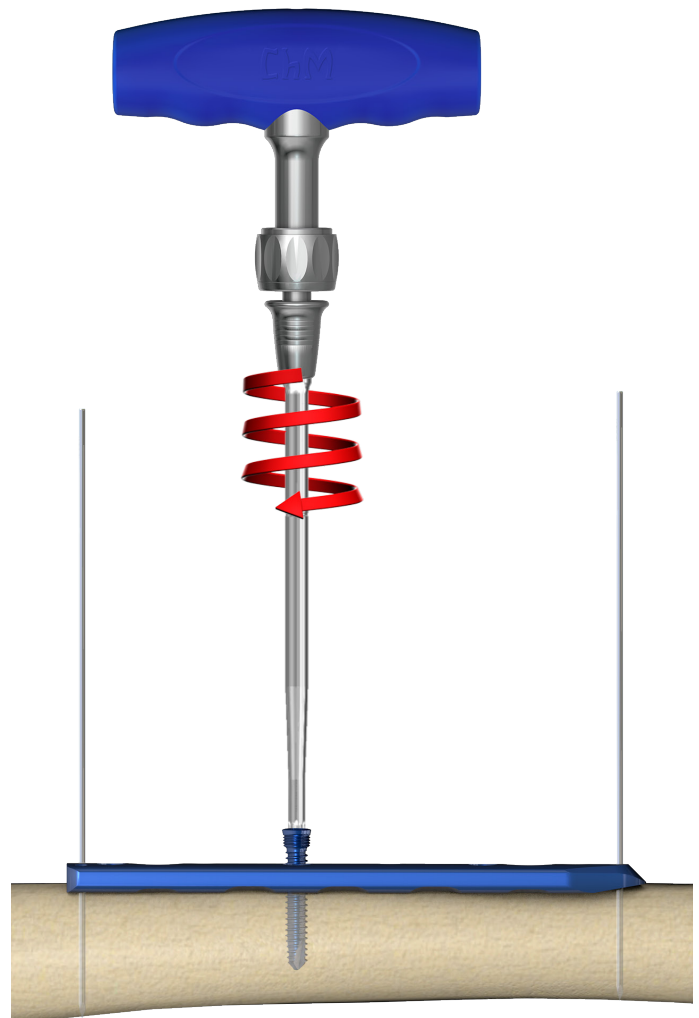

IV.3. THE USE OF AIMING BLOCK



Most locking plates ChLP are available with aiming blocks, as additional complementary instruments. Using aiming blocks ensures proper fastening of guide sleeves in the locking holes, in the epiphyseal part of the plate. It facilitates also the smooth conduct of the procedure, reduces its duration, and ensures that drilling is performed in the axis of the locking hole (*note from point IV.2*).



When aiming blocks are not used, the implantation can be incorrect, and in particular can cause: improper locking of the screws and their migration, decrease of the fixation stability, complications while implants removal.

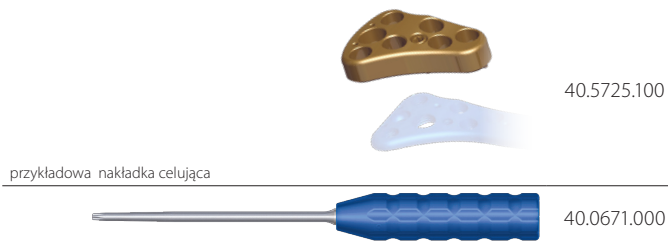

Position the aiming block on the plate.
Tighten up with Star screwdriver T25 [40.0671.000].

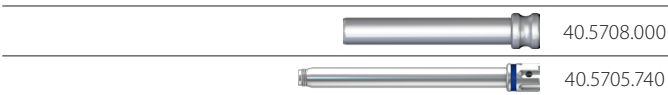

Insert Protective sleeve 9.0/7.0 [40.5708.000] in the desired hole of the aiming block.

Then screw the Guide sleeve 7.0/4.0 [40.5705.740] into the plate through the Protective sleeve 9.0/7.0.



Further proceedings in accordance with the steps described in the point IV.2 on page 25.

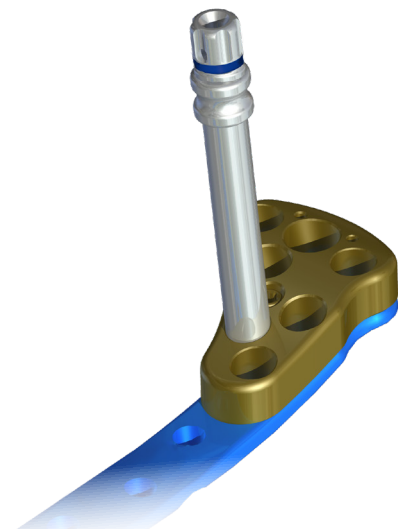
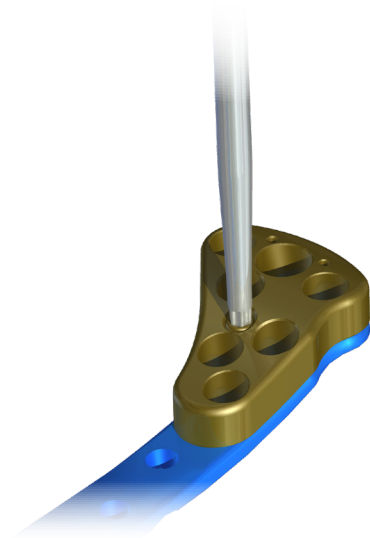
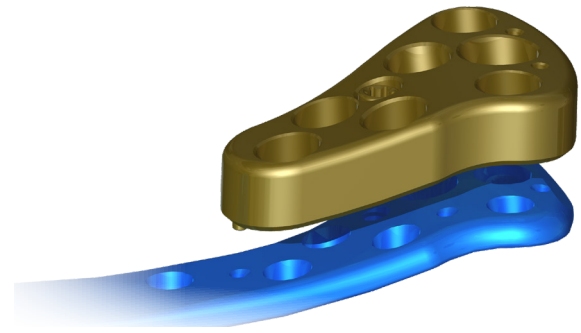

IV.4. CORTICAL SCREW Ø4.5 INSERTION

Compression guide setting



40.4802.732

Set the Compression guide 3.2 [40.4802.732] in desire position:

1. Neutral position

Press the guide to the plate to achieve the neutral position for screw insertion.

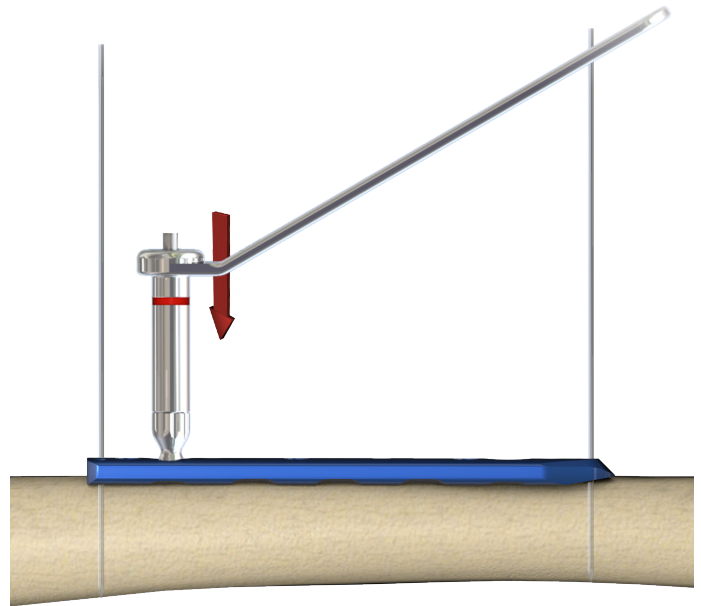
**2. Compressive position**

Move the guide without pressure to the edge of compression hole to achieve the compression position for screw insertion.

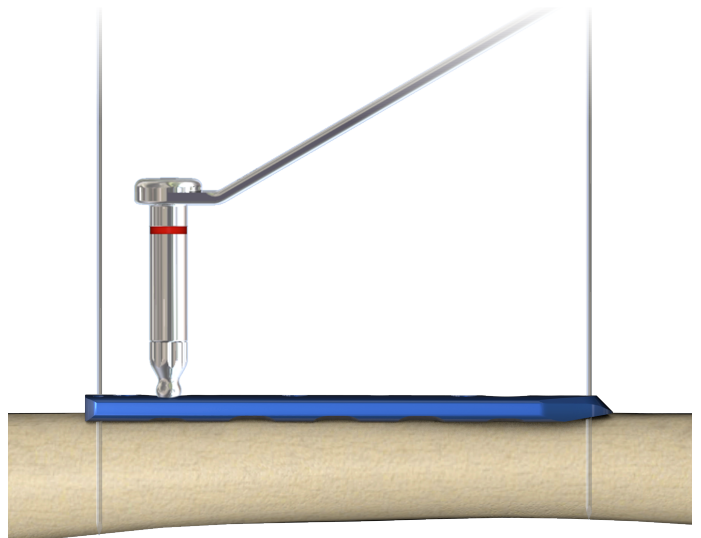
**3. Angular position**

Angular positioning of the guide is also available.

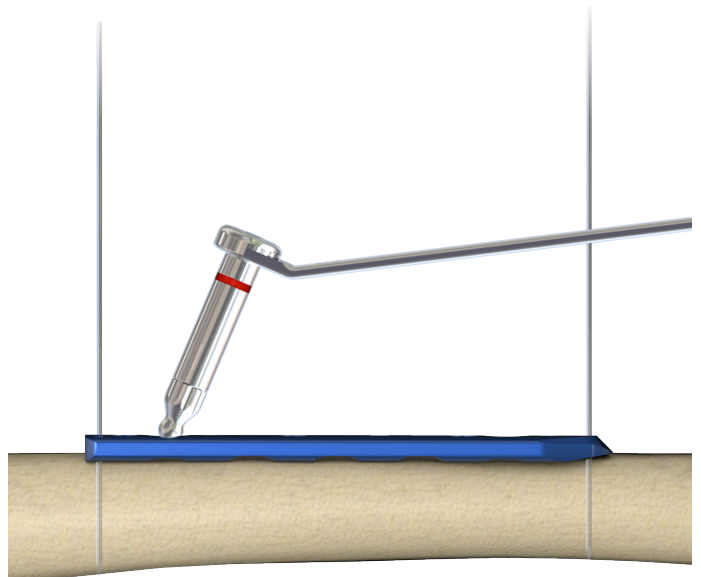

Drilling



Drill the hole through both cortices in desire position for the cortical screw Ø4.5 insertion using the Drill Ø3.2/220 [40.5650.222]

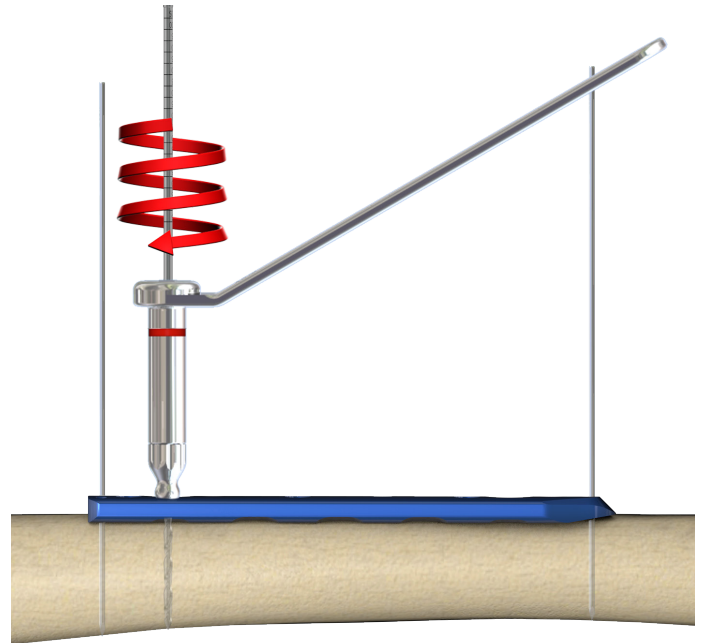

Hole depth measurement



Insert the Depth measure [40.4639.700] into the drilled hole until its hook anchors the outer surface of the opposite cortex

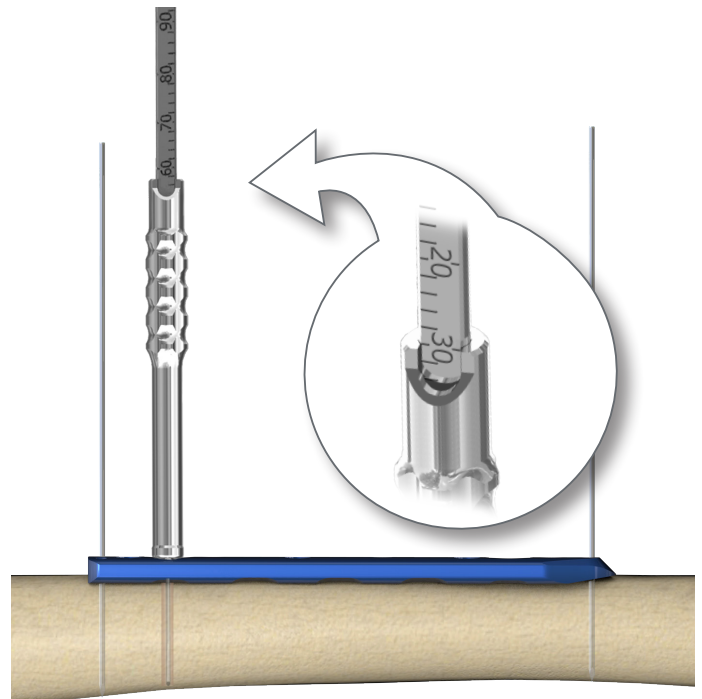

Screw insertion

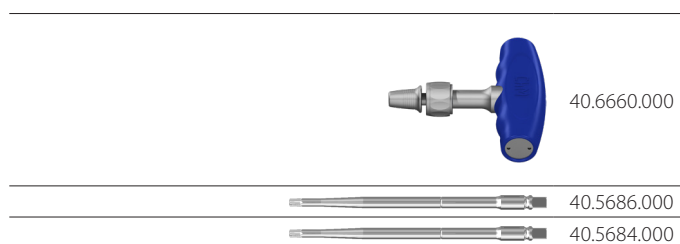

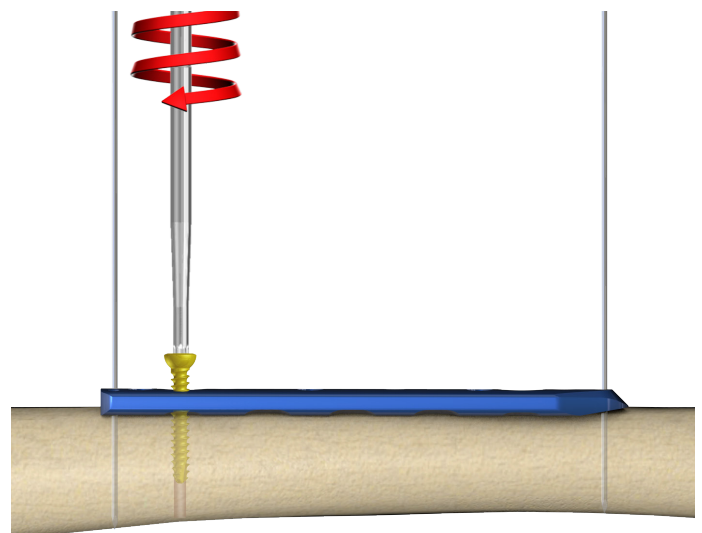

Insert cortical screw Ø4.5.



IV.5. CANNULATED SCREW Ø7.3 INSERTION

In the middle of the condylar part of the femoral plate L-[3.4023], R-[3.4024], there is provided a larger hole for insertion of cannulated screw Ø7.3mm.



Guide sleeve screwing

	40.5654.750
	40.5654.120

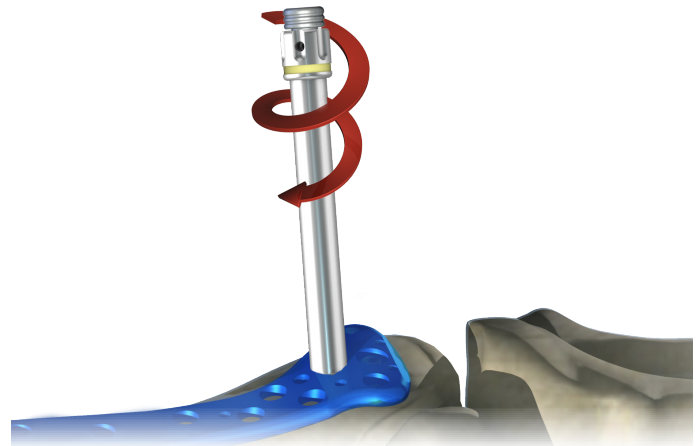
Screw in the Guide sleeve 9.0/5.0 [40.5654.750] along with the Guide sleeve 5.0/2.0 [40.5654.120] for Kirschner wire 2.0 insertion [40.4815.220].



Hole depth measurement

	40.4815.220
	40.5675.100



Insert Kirschner wire 2.0 [40.4815.220]; determine the screw length using the Screw length measure [40.5675.100].

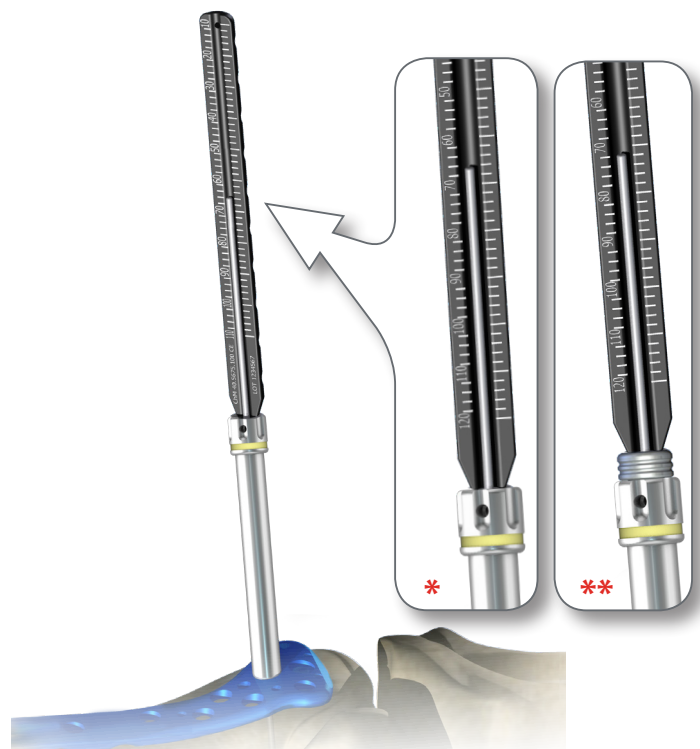

- *Remove the inner sleeve 5.0/2.0 [40.5654.120] and read the value using the Screw length measure [40.5675.100].
- **Subtract 5mm from the measured value if the sleeve 5.0/2.0 [40.5654.120] is not removed.



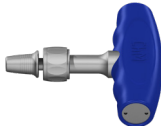

Cannulated screw Ø7.3 insertion

	40.6660.000
	40.5687.000
	40.5685.000

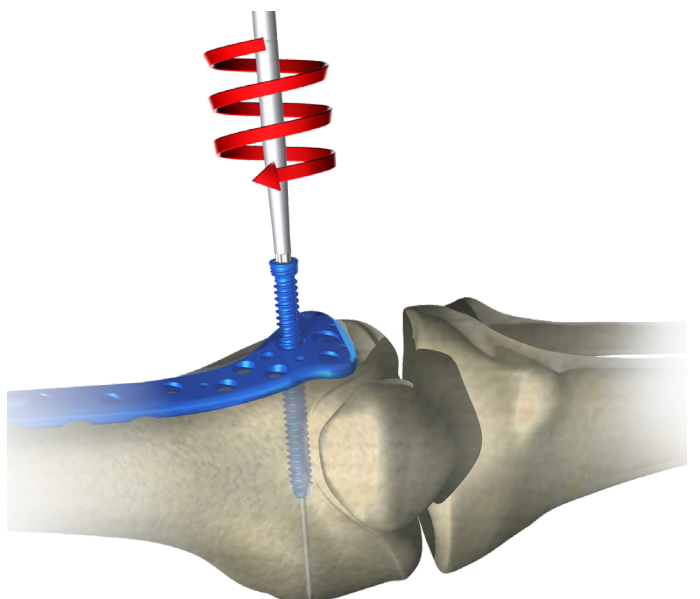
Remove the Guide sleeve.
Insert the cannulated screw Ø7.3 using the Torque wrench [40.6660.000] and relevant cannulated screwdriver tip.



	40.5654.750
	40.4815.220
	40.5652.222



Use the Cannulated drill with scale 5.0/2.2/220 [40.5652.222]

If the bone is very hard, use the Cannulated drill with scale 5.0/2.2/220 [40.5652.222]. Drill using the Guide sleeve 9.0/5.0 [40.5654.750] via Kirchner wire 2.0 [40.4815.220].

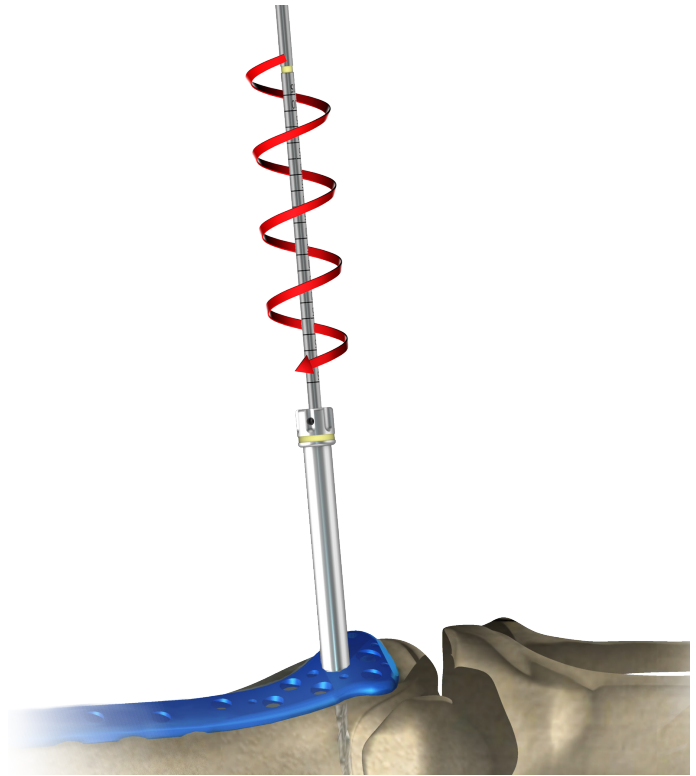

V. POSTOPERATIVE TREATMENT

Postoperative treatment after locking plates does not differ from treatment after conventional stabilization.

VI. IMPLANT REMOVAL

In order to remove the screws, first unlock all locking screws from the plate. Then remove bone screws. This prevents the rotation of the plate while removing the last locking screw.

ChM sp. z o.o.

Lewickie 3b
16-061 Juchnowiec Kościelny
Poland

tel. +48 85 86 86 100

fax +48 85 86 86 101

chm@chm.eu

www.chm.eu



CE 0197