

**Report: TR 17-1006**

**PHASE I TESTING OF PROTOTYPE U-NII-4 DEVICES**



October 22, 2018

**Prepared by:**

Laboratory Division  
Office of Engineering and Technology  
Federal Communications Commission

# Table of Contents

|  |    |
|--|----|
| References.....  | 10 |
| Acronyms.....  | 11 |
| 1. Executive Summary .....   | 13 |
| 1.1 Detect-and-Vacate Proposal.....  | 14 |
| 1.2 Re-Channelization Proposal.....  | 15 |
| 1.3 Initial Assessment of the Two Proposed Interference Mitigation Methods .....         | 17 |
| 1.4 Detect-and-Vacate Proposal Observations .....  | 17 |
| 1.5 Re-channelization Proposal Observations .....  | 18 |
| 1.6 Summary Comparison of the Two Interference Mitigation Methods.....                   | 19 |
| 2. Introduction.....   | 20 |
| 2.1 Objectives .....   | 20 |
| 2.2 System Description .....   | 21 |
| 2.2.1 Overview.....  | 21 |
| 2.2.2 DSRC Operating Channel Frequencies .....   | 21 |
| 2.2.3 DSRC Operating Channel Description:.....   | 22 |
| 2.3 Scope.....   | 23 |
| 3. RF Characterization of U-NII-4 and DSRC Devices, Assumptions and Considerations ..... | 24 |
| 4. U-NII-4 and DSRC Unmitigated Interaction Test, Assumptions and Considerations .....   | 26 |
| 4.1 Performance Metrics.....   | 26 |
| 4.2 Test Setup.....  | 27 |
| 5. Interference Mitigation Tests.....  | 29 |
| 5.1 “Detect-and-Vacate” Strategy, Assumptions and Considerations .....                   | 29 |
| 5.1.1 Performance Metrics.....   | 30 |
| 5.1.2 Test Approach.....   | 30 |
| 5.1.3 DSRC Detection Threshold .....   | 31 |
| 5.1.4 Channel-Move Time .....  | 31 |
| 5.2 “Re-Channelization” Strategy, Assumptions and Considerations .....                   | 32 |
| 5.2.1 Performance Metrics.....   | 34 |
| 5.2.2 Test Approach.....   | 34 |
| 5.2.3 DSRC Detection Threshold .....   | 34 |
| 5.2.4 Coexistence Scenarios .....  | 35 |
| 6. Results.....  | 37 |
| 6.1 RF Characterization Test Results.....  | 37 |
| 6.1.1 Conducted Occupied Bandwidth for U-NII-4 Devices.....                              | 37 |
| 6.1.2 Conducted Occupied Bandwidth for DSRC Devices .....                                | 39 |
| 6.1.3 Conducted Average Channel Power Tests for U-NII-4 Devices .....                    | 41 |
| 6.1.4 Conducted Average Channel Power Tests for DSRC Devices.....                        | 43 |
| 6.1.5 Conducted Out of Band Emissions (OOBE) Tests .....                                 | 44 |
| 6.1.6 DSRC Receiver Sensitivity Tests .....  | 45 |
| 6.2 U-NII-4 and DSRC Unmitigated Interaction Test Results .....                          | 47 |
| 6.2.1 Cisco Device to DSRC 1.....  | 47 |
| 6.2.2 Qualcomm Device to DSRC 1 .....  | 51 |
| 6.2.3 Broadcom Device to DSRC 1 .....  | 55 |
| 6.2.4 Cisco Device to DSRC 2.....  | 59 |

|   |     |
|---|-----|
| 6.2.5 Qualcomm Device to DSRC 2.....  | 63  |
| 6.2.6 Broadcom Device to DSRC 2.....  | 67  |
| 6.2.7 AWGN Signal to DSRC 2.....  | 73  |
| 6.2.8 Cisco Device to DSRC 3.....   | 77  |
| 6.2.9 Qualcomm Device to DSRC 3.....  | 80  |
| 6.2.10 Broadcom Device to DSRC 3.....   | 83  |
| 6.3 Interference Mitigation Test Results- Cisco's Detect-and-Vacate Strategy.....                   | 86  |
| 6.3.1 Detection Threshold.....  | 86  |
| 6.3.2 Channel-Move Time.....  | 87  |
| 6.3.3 Coexistence Scenarios.....  | 88  |
| 6.4 Interference Mitigation Test Results – Re-Channelization Strategy.....                          | 89  |
| 6.4.1 Detection Threshold.....  | 89  |
| 6.4.2 Coexistence Scenarios.....  | 90  |
| 7. Observations.....  | 94  |
| 7.1 Initial Assessment of the Two Proposed Interference Mitigation Methods.....                     | 94  |
| 7.2 Detect-and-Vacate Method.....   | 94  |
| 7.3 Re-Channelization Method.....   | 95  |
| 7.4 Comparison of the Two Interference Mitigation Methods.....                                      | 98  |
| Appendix A: Enhanced Distributed Channel Access (EDCA).....   | 99  |
| Appendix B: RF Characterization Test Results.....   | 101 |
| B.1 Conducted Occupied Bandwidth (OBW) Test Results.....  | 101 |
| B.2 Conducted Average Channel Power (ACP) and Out of Band Emission Test Results<br>(RBW: 1MHz)..... | 139 |
| Appendix C: Pictures of the Test Setup and Devices under Test.....                                  | 184 |

## Table of Figures

|   |    |
|---|----|
| Figure 1 – Interference Test Setup where Interference Signal is injected to DSRC Receiver.....                  | 28 |
| Figure 2 – Block Diagram of DSRC Preamble Detector Architecture, Developed by Cisco.....                        | 29 |
| Figure 3 – DSRC Detection Threshold Test Setup .....  | 31 |
| Figure 4 – Test Setup for Detect and Vacate Method (Channel-move time measurement) .....                        | 32 |
| Figure 5 – Re-Channelization Method Test Setup .....  | 36 |
| Figure 6 – DSRC 1 (Sample # 29A) Receiver Sensitivity, Channel 172.....   | 45 |
| Figure 7 – DSRC 2 (Sample # 26A) Receiver Sensitivity, Channel 172.....   | 45 |
| Figure 8 – DSRC 3 (Sample # 01) Receiver Sensitivity, Channel 172.....  | 46 |
| Figure 9 – DSRC 4 (Sample # 31) Receiver Sensitivity, Channel 172.....  | 46 |
| Figure 10 – Cisco Device to DSRC 1 Receiver, Co-channel Interaction .....                                       | 48 |
| Figure 11 – Cisco Device (60% Duty Cycle) to DSRC 1 Receiver, Adj. channel Interactions.....                    | 49 |
| Figure 12 – Cisco Device (and Simulated IEEE 802.11) to DSRC 1 Transmitter, Co- channel Interactions .....      | 50 |
| Figure 13 – Qualcomm Device to DSRC 1 Receiver, Co-channel Interaction.....                                     | 51 |
| Figure 14 – Qualcomm Device (55% Duty Cycle) to DSRC 1 Receiver, Adj. channel Interactions .....                | 52 |
| Figure 15 – Qualcomm Device (75% Duty Cycle) to DSRC 1 Receiver, Adj. channel Interactions .....                | 53 |
| Figure 16 – Broadcom Device to DSRC 1 Receiver, Co-channel Interaction.....                                     | 55 |
| Figure 17 – Broadcom Device (55% Duty Cycle) to DSRC 1 Receiver, Adj. channel Interactions .....                | 56 |
| Figure 18 – Broadcom Device (75% Duty Cycle) to DSRC 1 Receiver, Adj. channel Interactions .....                | 57 |
| Figure 19 – Cisco Device to DSRC 2 Receiver, Co-channel Interaction .....                                       | 59 |
| Figure 20 – Cisco Device (60% duty cycle) to DSRC 2 Receiver, Adj. channel Interactions .....                   | 60 |
| Figure 21 – Cisco Device (70% duty cycle) to DSRC 2, Adj. channel Interactions.....                             | 61 |
| Figure 22 – Cisco Device (85% duty cycle) to DSRC 2 Receiver, Adj. channel Interactions .....                   | 61 |
| Figure 23 – Cisco Device (and Simulated IEEE 802.11 Signal) to DSRC 2 Transmitter, Co-channel Interactions..... | 62 |
| Figure 24 – Qualcomm Device to DSRC 2 Receiver, Co-channel Interaction.....                                     | 63 |
| Figure 25 – Qualcomm Device (55% Duty Cycle) to DSRC 2 Receiver, Adjacent Channel Interactions. 64              |    |
| Figure 26 – Qualcomm Device (75% Duty Cycle) to DSRC 2 Receiver, Adjacent Channel Interactions. 65              |    |
| Figure 27 – Broadcom Device to DSRC 2 Receiver, Co-channel Interaction .....                                    | 67 |
| Figure 28 – Broadcom Device (40 MHz wide) to DSRC 2 Receiver, Co-channel Interaction .....                      | 68 |
| Figure 29 – Broadcom Device (55% Duty Cycle) to DSRC 2 Receiver, Adjacent channel Interactions... 69            |    |
| Figure 30 – Broadcom Device (75% Duty Cycle) to DSRC 2 Receiver, Adjacent channel Interactions... 70            |    |
| Figure 31 – Broadcom Device (40 MHz) to DSRC 2 Receiver, Adj. Channel Interactions.....                         | 71 |
| Figure 32 – AWGN Signal to DSRC 2 Receiver, Co-channel Interaction .....  | 73 |
| Figure 33 – AWGN Signal to DSRC 2 Receiver, 1 <sup>st</sup> Adjacent Channel Interaction .....                  | 74 |
| Figure 34 – AWGN Signal to DSRC 2 Receiver, 2nd Adjacent Channel Interaction .....                              | 75 |
| Figure 35 – AWGN Signal to DSRC 2 Receiver, 3rd Adjacent Channel Interaction.....                               | 75 |
| Figure 36 – AWGN Signal to DSRC 2 Transmitter, Co-channel Interaction.....                                      | 76 |
| Figure 37 – Cisco Device to DSRC 3, Co-channel Interaction.....   | 77 |
| Figure 38 – Cisco Device to DSRC 3, Adjacent channel Interactions.....  | 78 |
| Figure 39 – Qualcomm Device to DSRC 3 Receiver, Co-channel Interaction.....                                     | 80 |
| Figure 40 – Qualcomm Device (55% Duty Cycle) to DSRC 3 Receiver, Adjacent Channel Interactions. 81              |    |

|  |     |
|--|-----|
| Figure 41 – Qualcomm Device (75% Duty Cycle) to DSRC 3 Receiver, Adjacent Channel Interactions.            | 82  |
| Figure 42 – Broadcom Device to DSRC 3 Receiver, Co-channel Interaction .....                               | 83  |
| Figure 43 – Broadcom Device (55% Duty Cycle) to DSRC 3 Receiver, Adjacent channel Interactions...          | 84  |
| Figure 44 – Broadcom Device (75% Duty Cycle) to DSRC 3 Receiver, Adjacent channel Interactions...          | 85  |
| Figure 45 – DSRC detection threshold- lower 4 channels of DSRC band .....                                  | 86  |
| Figure 46 – DSRC detection threshold (with added noise) – 4 lower channels of DSRC band .....              | 87  |
| Figure 47 – DSRC detection threshold- Broadcom .....   | 89  |
| Figure 48 – U-NII-4 and DSRC Co-channel Interaction, PCR – DSRC BW: 20 MHz.....                            | 90  |
| Figure 49 – U-NII-4 and DSRC Co-channel Interaction, IDT – DSRC BW: 20 MHz .....                           | 91  |
| Figure 50 – U-NII-4 and DSRC 1 <sup>st</sup> Adjacent Channel Interaction – DSRC BW: 20 MHz, Channel 173.. | 92  |
| Figure 51 – U-NII-4 and DSRC 1 <sup>st</sup> Adjacent Channel Interaction – DSRC BW: 10 MHz, Channel: 180. | 93  |
| Figure 52 – Conducted OBW, Sample 05 U-NII-4, CH.177 OFDM MCS Index 0 Plot.....                            | 102 |
| Figure 53 – Conducted OBW, Sample 05 U-NII-4, CH.177 OFDM MCS Index 1 Plot.....                            | 102 |
| Figure 54 – Conducted OBW, Sample 05 U-NII-4, CH.177 OFDM MCS Index 3 Plot.....                            | 103 |
| Figure 55 – Conducted OBW, Sample 05 U-NII-4, CH. 177 OFDM MCS Index 5 Plot.....                           | 103 |
| Figure 56 – Conducted OBW, Sample 05 U-NII-4, CH. 175 OFDM MCS Index 0 Plot.....                           | 104 |
| Figure 57 – Conducted OBW, Sample 05 U-NII-4, CH.171 OFDM MCS Index 0 Plot.....                            | 104 |
| Figure 58 – Conducted OBW, Sample 06 U-NII-4, CH.177 OFDM MCS Index 0 Plot.....                            | 105 |
| Figure 59 – Conducted OBW, Sample 06 U-NII-4, CH.177 OFDM MCS Index 1 Plot.....                            | 105 |
| Figure 60 – Conducted OBW, Sample 06 U-NII-4, CH.177 OFDM MCS Index 3 Plot.....                            | 106 |
| Figure 61 – Conducted OBW, Sample 06 U-NII-4, CH.177 OFDM MCS Index 5 Plot.....                            | 106 |
| Figure 62 – Conducted OBW, Sample 06 U-NII-4, CH.175 OFDM MCS Index 0 Plot.....                            | 107 |
| Figure 63 – Conducted OBW, Sample 06 U-NII-4, CH.171 OFDM MCS Index 0 Plot.....                            | 107 |
| Figure 64 – Conducted OBW, Sample 07D U-NII-4, CH.177 OFDM MCS Index 0 Plot.....                           | 108 |
| Figure 65 – Conducted OBW, Sample 07D U-NII-4, CH.177 OFDM MCS Index 1 Plot.....                           | 108 |
| Figure 66 – Conducted OBW, Sample 07D U-NII-4, CH.177 OFDM MCS Index 3 Plot.....                           | 109 |
| Figure 67 – Conducted OBW, Sample 07D U-NII-4, CH.177 OFDM MCS Index 5 Plot.....                           | 109 |
| Figure 68 – Conducted OBW, Sample 07D U-NII-4, CH.175 OFDM MCS Index 0 Plot.....                           | 110 |
| Figure 69 – Conducted OBW, Sample 07D U-NII-4, CH.171 OFDM MCS Index 0 Plot.....                           | 110 |
| Figure 70 – Conducted OBW, Sample 08D U-NII-4, CH.177 OFDM MCS Index 0 Plot.....                           | 111 |
| Figure 71 – Conducted OBW, Sample 08D U-NII-4, CH.177 OFDM MCS Index 1 Plot.....                           | 111 |
| Figure 72 – Conducted OBW, Sample 08D U-NII-4, CH.177 OFDM MCS Index 3 Plot.....                           | 112 |
| Figure 73 – Conducted OBW, Sample 08D U-NII-4, CH.177 OFDM MCS Index 5 Plot.....                           | 112 |
| Figure 74 – Conducted OBW, Sample 08D U-NII-4, CH.175 OFDM MCS Index 0 Plot.....                           | 113 |
| Figure 75 – Conducted OBW, Sample 08D U-NII-4, CH.171 OFDM MCS Index 0 Plot.....                           | 113 |
| Figure 76 – Conducted OBW, Sample 14A U-NII-4, CH.177 OFDM MCS Index 0 Plot.....                           | 114 |
| Figure 77 – Conducted OBW, Sample 14A U-NII-4, CH.177 OFDM MCS Index 1 Plot.....                           | 114 |
| Figure 78 – Conducted OBW, Sample 14A U-NII-4, CH.177 OFDM MCS Index 3 Plot.....                           | 115 |
| Figure 79 – Conducted OBW, Sample 14A U-NII-4, CH.177 OFDM MCS Index 5 Plot.....                           | 115 |
| Figure 80 – Conducted OBW, Sample 15A U-NII-4, CH.177 OFDM MCS Index 0 Plot.....                           | 116 |
| Figure 81 – Conducted OBW, Sample 15A U-NII-4, CH.177 OFDM MCS Index 1 Plot.....                           | 116 |
| Figure 82 – Conducted OBW, Sample 15A U-NII-4, CH.177 OFDM MCS Index 3 Plot.....                           | 117 |
| Figure 83 – Conducted OBW, Sample 15A U-NII-4, CH.177 OFDM MCS Index 5 Plot.....                           | 117 |
| Figure 84 – Conducted OBW, Sample 16A U-NII-4, CH.177 OFDM MCS Index 0 Plot.....                           | 118 |

|   |     |
|---|-----|
| Figure 85 – Conducted OBW, Sample 16A U-NII-4, CH.177 OFDM MCS Index 1 Plot.....      | 118 |
| Figure 86 – Conducted OBW, Sample 16A U-NII-4, CH.177 OFDM MCS Index 3 Plot.....      | 119 |
| Figure 87 – Conducted OBW, Sample 16A U-NII-4, CH.177 OFDM MCS Index 5 Plot.....      | 119 |
| Figure 88 – Conducted OBW, Sample 16G U-NII-4, CH.177 OFDM MCS Index 0 Plot.....      | 120 |
| Figure 89 – Conducted OBW, Sample 16G U-NII-4, CH.177 OFDM MCS Index 1 Plot.....      | 120 |
| Figure 90 – Conducted OBW, Sample 16G U-NII-4, CH.177 OFDM MCS Index 3 Plot.....      | 121 |
| Figure 91 – Conducted OBW, Sample 16G U-NII-4, CH.177 OFDM MCS Index 5 Plot.....      | 121 |
| Figure 92 – Conducted OBW, Sample 01 DSRC, CH.172 OFDM MCS Index 0 Plot.....          | 122 |
| Figure 93 – Conducted OBW, Sample 01 DSRC, CH.172 OFDM MCS Index 1 Plot.....          | 122 |
| Figure 94 – Conducted OBW, Sample 01 DSRC, CH.172 OFDM MCS Index 3 Plot.....          | 123 |
| Figure 95 – Conducted OBW, Sample 01 DSRC, CH.172 OFDM MCS Index 5 Plot.....          | 123 |
| Figure 96 – Conducted OBW, Sample 01 DSRC, CH.175 OFDM MCS Index 0 Plot.....          | 124 |
| Figure 97 – Conducted OBW, Sample 02 DSRC, CH.172 OFDM MCS Index 0 Plot.....          | 124 |
| Figure 98 – Conducted OBW, Sample 02 DSRC, CH.172 OFDM MCS Index 1 Plot.....          | 125 |
| Figure 99 – Conducted OBW, Sample 02 DSRC, CH.172 OFDM MCS Index 3 Plot.....          | 125 |
| Figure 100 – Conducted OBW, Sample 02 DSRC, CH.172 OFDM MCS Index 5 Plot.....         | 126 |
| Figure 101 – Conducted OBW, Sample 02 DSRC, CH.175 OFDM MCS Index 0 Plot.....         | 126 |
| Figure 102 – Conducted OBW, Sample 03 DSRC, CH.172 OFDM MCS Index 0 Plot.....         | 127 |
| Figure 103 – Conducted OBW, Sample 03 DSRC, CH.172 OFDM MCS Index 1 Plot.....         | 127 |
| Figure 104 – Conducted OBW, Sample 03 DSRC, CH.172 OFDM MCS Index 3 Plot.....         | 128 |
| Figure 105 – Conducted OBW, Sample 03 DSRC, CH.172 OFDM MCS Index 5 Plot.....         | 128 |
| Figure 106 – Conducted OBW, Sample 03 DSRC, CH.175 OFDM MCS Index 0 Plot.....         | 129 |
| Figure 107 – Conducted OBW, Sample 04 DSRC, CH.172 OFDM MCS Index 0 Plot.....         | 129 |
| Figure 108 – Conducted OBW, Sample 04 DSRC, CH.172 OFDM MCS Index 1 Plot.....         | 130 |
| Figure 109 – Conducted OBW, Sample 04 DSRC, CH.172 OFDM MCS Index 3 Plot.....         | 130 |
| Figure 110 – Conducted OBW, Sample 04 DSRC, CH.172 OFDM MCS Index 5 Plot.....         | 131 |
| Figure 111 – Conducted OBW, Sample 04 DSRC, CH.175 OFDM MCS Index 0 Plot.....         | 131 |
| Figure 112 – Conducted OBW, Sample 13A DSRC, CH. 172 OFDM MCS Index 0 Plot.....       | 132 |
| Figure 113 – Conducted OBW, Sample 16F DSRC, CH.172 OFDM MCS Index 0 Plot.....        | 132 |
| Figure 114 – Conducted OBW, Sample 26A DSRC, CH.172 OFDM MCS Index 0 Plot.....        | 133 |
| Figure 115 – Conducted OBW, Sample 26A DSRC, CH.172 OFDM MCS Index 1 Plot.....        | 133 |
| Figure 116 – Conducted OBW, Sample 26A DSRC, CH.172 OFDM MCS Index 3 Plot.....        | 134 |
| Figure 117 – Conducted OBW, Sample 26A DSRC, CH.172 OFDM MCS Index 5 Plot.....        | 134 |
| Figure 118 – Conducted OBW, Sample 29A DSRC, CH.172 OFDM MCS Index 0 Plot.....        | 135 |
| Figure 119 – Conducted OBW, Sample 29A DSRC, CH.172 OFDM MCS Index 1 Plot.....        | 135 |
| Figure 120 – Conducted OBW, Sample 29A DSRC, CH.172 OFDM MCS Index 3 Plot.....        | 136 |
| Figure 121 – Conducted OBW, Sample 29A DSRC, CH.172 OFDM MCS Index 5 Plot.....        | 136 |
| Figure 122 – Conducted OBW, Sample 29A DSRC, CH.175 OFDM MCS Index 0 Plot.....        | 137 |
| Figure 123 – Conducted OBW, Sample 31 DSRC, CH.177 OFDM MCS Index 0 Plot.....         | 137 |
| Figure 124 – Conducted OBW, Sample 31 DSRC, CH.177 OFDM MCS Index 1 Plot.....         | 138 |
| Figure 125 – Conducted ACP/OOBE, Sample 05 U-NII-4, CH.177 OFDM MCS Index 0 Plot..... | 140 |
| Figure 126 – Conducted ACP/OOBE, Sample 05 U-NII-4, CH.177 OFDM MCS Index 1 Plot..... | 141 |
| Figure 127 – Conducted ACP/OOBE, Sample 05 U-NII-4, CH.177 OFDM MCS Index 3 Plot..... | 141 |
| Figure 128 – Conducted ACP/OOBE, Sample 05 U-NII-4, CH.177 OFDM MCS Index 5 Plot..... | 142 |



|   |     |
|---|-----|
| Figure 173 – Conducted ACP/OOBE, Sample 02 DSRC, CH.172 OFDM MCS Index 5 Plot.....                  | 164 |
| Figure 174 – Conducted ACP/OOBE, Sample 02 DSRC, CH.175 OFDM MCS Index 0 Plot.....                  | 165 |
| Figure 175 – Conducted ACP/OOBE, Sample 03 DSRC, CH.172 OFDM MCS Index 0 Plot.....                  | 165 |
| Figure 176 – Conducted ACP/OOBE, Sample 03 DSRC, CH.172 OFDM MCS Index 1 Plot.....                  | 166 |
| Figure 177 – Conducted ACP/OOBE, Sample 03 DSRC, CH.172 OFDM MCS Index 3 Plot.....                  | 166 |
| Figure 178 – Conducted ACP/OOBE, Sample 03 DSRC, CH.172 OFDM MCS Index 5 Plot.....                  | 167 |
| Figure 179 – Conducted ACP/OOBE, Sample 03 DSRC, CH.175 OFDM MCS Index 0 Plot.....                  | 167 |
| Figure 180 – Conducted ACP/OOBE, Sample 04 DSRC, CH.172 OFDM MCS Index 0 Plot.....                  | 168 |
| Figure 181 – Conducted ACP/OOBE, Sample 04 DSRC, CH.172 OFDM MCS Index 1 Plot.....                  | 168 |
| Figure 182 – Conducted ACP/OOBE, Sample 04 DSRC, CH.172 OFDM MCS Index 3 Plot.....                  | 169 |
| Figure 183 – Conducted ACP/OOBE, Sample 04 DSRC, CH.172 OFDM MCS Index 5 Plot.....                  | 169 |
| Figure 184 – Conducted ACP/OOBE, Sample 04 DSRC, CH.175 OFDM MCS Index 0 Plot.....                  | 170 |
| Figure 185 – Conducted ACP/OOBE, Sample 16F DSRC, CH.172 OFDM MCS Index 0 Plot.....                 | 170 |
| Figure 186 – Conducted ACP/OOBE, Sample 26A DSRC, CH.172 OFDM MCS Index 0 Plot.....                 | 171 |
| Figure 187 – Conducted ACP/OOBE, Sample 26A DSRC, CH.172 OFDM MCS Index 1 Plot.....                 | 171 |
| Figure 188 – Conducted ACP/OOBE, Sample 26A DSRC, CH.172 OFDM MCS Index 3 Plot.....                 | 172 |
| Figure 189 – Conducted ACP/OOBE, Sample 26A DSRC, CH.172 OFDM MCS Index 5 Plot.....                 | 172 |
| Figure 190 – Conducted ACP/OOBE, Sample 29A DSRC, CH.172 OFDM MCS Index 0 Plot.....                 | 173 |
| Figure 191 – Conducted ACP/OOBE, Sample 29A DSRC, CH.172 OFDM MCS Index 1 Plot.....                 | 173 |
| Figure 192 – Conducted ACP/OOBE, Sample 29A DSRC, CH.172 OFDM MCS Index 3 Plot.....                 | 174 |
| Figure 193 – Conducted ACP/OOBE, Sample 29A DSRC, CH. 172 OFDM MCS Index 5 Plot.....                | 174 |
| Figure 194 – Conducted ACP/OOBE, Sample 29A DSRC, CH.175 OFDM MCS Index 0 Plot.....                 | 175 |
| Figure 195 – Conducted ACP/OOBE, Sample 31 DSRC, CH.173 OFDM MCS Index 0 Plot.....                  | 175 |
| Figure 196 – Conducted ACP/OOBE, Sample 31 DSRC, CH.177 OFDM MCS Index 1 Plot.....                  | 176 |
| Figure 197 – Conducted ACP/OOBE, Sample 02 DSRC, CH.172 OFDM MCS Index 0 Plot.....                  | 177 |
| Figure 198 – Conducted ACP/OOBE, Sample 02 DSRC, CH.172 OFDM MCS Index 1 Plot.....                  | 177 |
| Figure 199 – Conducted ACP/OOBE, Sample 02 DSRC, CH.172 OFDM MCS Index 3 Plot.....                  | 178 |
| Figure 200 – Conducted ACP/OOBE, Sample 02 DSRC, CH.172 OFDM MCS Index 5 Plot.....                  | 178 |
| Figure 201 – Conducted ACP/OOBE, Sample 02 DSRC, CH.175 OFDM MCS Index 0 Plot.....                  | 179 |
| Figure 202 – Conducted ACP/OOBE, Sample 04 DSRC, CH.172 OFDM MCS Index 0 Plot.....                  | 179 |
| Figure 203 – Conducted ACP/OOBE, Sample 04 DSRC, CH.172 OFDM MCS Index 1 Plot.....                  | 180 |
| Figure 204 – Conducted ACP/OOBE, Sample 04 DSRC, CH.172 OFDM MCS Index 3 Plot.....                  | 180 |
| Figure 205 – Conducted ACP/OOBE, Sample 04 DSRC, CH.172 OFDM MCS Index 5 Plot.....                  | 181 |
| Figure 206 – Conducted ACP/OOBE, Sample 04 DSRC, CH.175 OFDM MCS Index 0 Plot.....                  | 181 |
| Figure 207 – Conducted ACP/OOBE, Sample 26A DSRC, CH.172 OFDM MCS Index 0 Plot.....                 | 182 |
| Figure 208 – Conducted ACP/OOBE, Sample 26A DSRC, CH.172 OFDM MCS Index 1 Plot.....                 | 182 |
| Figure 209 – Conducted ACP/OOBE, Sample 29A DSRC, CH.172 OFDM MCS Index 0 Plot.....                 | 183 |
| Figure 210 – DSRC devices used in the FCC laboratory tests .....                                    | 184 |
| Figure 211 – U-NII-4 Devices used in the FCC laboratory tests in conjunction with DSRC devices..... | 185 |
| Figure 212 – RF Characterization test setup .....   | 186 |
| Figure 213 – U-NII-4 and DSRC test setup with DSRC devices inside RF enclosures .....               | 187 |



## Index of Tables

|   |    |
|---|----|
| Table 1 – Comparison of the Two Mitigation Methods.....                   | 19 |
| Table 2 – DSRC Channel Plan and Allocated Frequencies .....               | 22 |
| Table 3 – List of DSRC and U-NII-4 Devices.....                           | 25 |
| Table 4 – All Combinations of U-NII-4 Devices Tested .....                | 26 |
| Table 5 – EDCA Parameter Sets Employed by Broadcom U-NII-4 Devices .....  | 33 |
| Table 6 – Conducted OBW, U-NII-4 devices, OFDM MCS Index 0 results .....  | 37 |
| Table 7 – Conducted OBW – U-NII-4 Devices, OFDM MCS Index 1 Results ..... | 38 |
| Table 8 – Conducted OBW – U-NII-4 Devices, OFDM MCS Index 3 Results ..... | 38 |
| Table 9 – Conducted OBW – U-NII-4 Devices, OFDM MCS Index 5 Results ..... | 38 |
| Table 10 – Conducted OBW, DSRC devices, OFDM MCS Index 0 results .....    | 39 |
| Table 11 – Conducted OBW, DSRC devices, OFDM MCS Index 1 results .....    | 39 |
| Table 12 – Conducted OBW, DSRC devices, OFDM MCS Index 3 results .....    | 40 |
| Table 13 – Conducted OBW, DSRC devices, OFDM MCS Index 5 results .....    | 40 |
| Table 14 – Conducted ACP, U-NII-4 devices, OFDM MCS Index 0 results ..... | 41 |
| Table 15 – Conducted ACP, U-NII-4 devices, OFDM MCS Index 1 results ..... | 41 |
| Table 16 – Conducted ACP, U-NII-4 devices, OFDM MCS Index 3 results ..... | 42 |
| Table 17 – Conducted ACP, U-NII-4 devices, OFDM MCS Index 5 results ..... | 42 |
| Table 18 – Conducted ACP, DSRC devices, OFDM MCS Index 0 results.....     | 43 |
| Table 19 – Conducted ACP, DSRC devices, OFDM MCS Index 1 results.....     | 43 |
| Table 20 – Conducted ACP, DSRC devices, OFDM MCS Index 3 results.....     | 44 |
| Table 21 – Conducted ACP, DSRC devices, OFDM MCS Index 5 results.....     | 44 |
| Table 22 – Cisco Channel-Move Time .....                                  | 87 |
| Table 23 – KEA Channel-Move Time .....                                    | 88 |
| Table 24 – Comparison of the Two Mitigation Methods.....                  | 98 |

## References

- IEEE Std 802.11-2016 IEEE Standard for Information technology–Telecommunications and information exchange between systems–Local and metropolitan area networks–Specific requirements–Part 11: Wireless LAN Medium Access Control (MAC) and Physical Layer (PHY) Specifications
- IEEE Std 802.11ac-2013 IEEE Standard for Information technology–Telecommunications and information exchange between systems–Local and metropolitan area networks–Specific requirements–Part 11: Wireless LAN Medium Access Control (MAC) and Physical Layer (PHY) Specifications–Amendment 4: Enhancements for Very High Throughput for Operation in Bands below 6 GHz
- IEEE Std 1609 IEEE family of standards for Wireless Access in Vehicular Environment (WAVE) that define an architecture and a complementary, standardized set of services and interfaces that collectively enable secure vehicle to vehicle (V2V) and vehicle to infrastructure (V2I) wireless communications
- IEEE 802.11-15/0347r0 Final Report of DSRC Coexistence Tiger Team, March 9, 2015, <https://mentor.ieee.org/802.11/dcn/15/11-15-0347-00-0reg-final-report-of-dsrc-coexistence-tiger-team-clean.pdf>
- SAE J2945\_201712 Dedicated Short Range Communication (DSRC) Systems Engineering Process Guidance for SAE J2945/X Documents and Common Design Concepts (2017)

## Acronyms

|          |   |
|----------|---|
| AC       | access category (IEEE 802.11 protocol)                        |
| ACP      | average channel power (emissions test)                        |
| ACRR     | adjacent channel rejection ratio                              |
| AIFS     | arbitration inter frame space (IEEE 802.11 protocol)          |
| AIFSN    | arbitration inter frame spacing number (IEEE 802.11 protocol) |
| AP       | access point  |
| ASD      | aftermarket safety device (DSRC)                              |
| AWGN     | additive white gaussian noise)                                |
| BE       | best effort (DSRC traffic)                                    |
| BIM      | basic infrastructure message                                  |
| BSM      | basic safety message  |
| CCA      | clear channel assessment (802.11 protocol)                    |
| CCA-CS   | clear channel assessment with carrier sense (802.11 protocol) |
| CCA-ED   | clear channel assessment with energy detect (802.11 protocol) |
| CCH      | control channel   |
| CFR      | Code of Federal Regulations                                   |
| CS       | carrier sense (IEEE 802.11 protocol)                          |
| CW       | contention window   |
| DCF      | distributed coordination function (IEEE 802.11 protocol)      |
| DIFS DCF | DCF inter-frame space (IEEE 802.11 protocol)                  |
| DSRC     | dedicated short-range communications                          |
| DSRCS    | Dedicated Short Range Communications Systems                  |
| ECU      | electronic control unit                                       |
| EDCA     | enhanced distributed channel access                           |
| EIFS     | extended inter-frame space (IEEE 802.11 protocol)             |
| EIRP     | equivalent isotropic radiated power                           |
| EMC      | electromagnetic compatibility                                 |
| FCC      | Federal Communication Commission                              |
| GHz      | gigahertz - frequency measurement                             |
| GNSS     | Global Navigation Satellite System                            |
| HPV2I    | high powered vehicle to infrastructure                        |
| HT       | high throughput signals (IEEE 802.11 protocol)                |
| VHT      | very high throughput signals (IEEE 802.11 protocol)           |
| IAT      | Inter arrival time (of communication packets)                 |
| IDT      | inter departure time (of communication packets)               |
| IEEE     | Institute of Electrical and Electronics Engineers             |
| IFS      | inter-frame spacing   |
| IPG      | inter-packet gap  |
| LAN      | local area network  |
| MAC      | Medium Access Control (IEEE 801.11 protocol)                  |
| MAP      | intersection geometry message                                 |
| MCS      | modulation and coding scheme                                  |

|          |  |
|----------|--|
| NHTSA    | National Highway Traffic Safety Administration             |
| NTIA     | National Telecommunications and Information Administration |
| OBE      | on-board equipment   |
| OBU      | on board units   |
| OBW      | occupied bandwidth   |
| OET      | Office of Engineering and Technology (FCC)                 |
| OFDM     | orthogonal frequency division multiplexing                 |
| OOBE     | out-of-band emissions                                      |
| PA       | priority access (DSRC network)                             |
| PHY      | physical layer (IEEE 802.11 protocol)                      |
| PCF      | point coordination function (IEEE 802.11 protocol)         |
| PIFS PCF | PCF inter-frame space (IEEE 802.11 protocol)               |
| PCR      | packet completion rate                                     |
| PER      | packet error rate  |
| POD      | probability of detection                                   |
| PPS      | pulse per second   |
| QAM      | quadrature amplitude modulation                            |
| QoS      | quality of service   |
| QPSK     | quadrature phase shift keying                              |
| RBW      | resolution bandwidth (emissions testing)                   |
| RF       | radio frequency  |
| RIFS     | reduced inter-frame space                                  |
| RSE      | road-side equipment  |
| RSU      | road side unit   |
| RTCM     | Radio Technical Commission for Maritime Services           |
| SAE      | Society of Automotive Engineers                            |
| SIFS     | short inter-frame space                                    |
| SPaT     | signal phase and timing                                    |
| STA      | station (client) device/mode                               |
| STS      | short training symbol                                      |
| TIM      | traveler information message                               |
| TTI      | transmit time interval                                     |
| TXOP     | transmit opportunity                                       |
| U-NII    | Unlicensed-National Information Infrastructure             |
| UP       | user priority  |
| V2I      | Vehicle to Infrastructure                                  |
| V2V      | Vehicle to Vehicle   |
| WAVE     | Wireless Access for Vehicular Environments                 |
| WLAN     | wireless local area network                                |
| WSM      | WAVE short message   |
| WSMP     | WAVE short message protocol                                |

## 1. Executive Summary

The Commission has completed the first phase of testing on the equipment prototypes submitted to demonstrate potential sharing solutions between the proposed Unlicensed National Information Infrastructure (U-NII) devices<sup>1</sup> and Dedicated Short Range Communications (DSRC)<sup>2</sup> operations in the 5850-5925 MHz (U-NII-4) frequency band. The laboratory test results provide baseline data for performing analysis of additional operational scenarios and other “real-world” empirical tests as part of the future phases of the coexistence test effort.

The Commission issued a Public Notice (PN)<sup>3</sup> on June 1, 2016 proposing three phases of a test program to assess the potential compatibility between proposed U-NII-4 and emerging DSRC networks operating in the band utilizing two sharing proposals from the IEEE 802.11 Tiger Team coexistence efforts.<sup>4</sup> These two sharing proposals have been designated the “Detect and Vacate” (*aka* “Detect and Avoid”) and the “Re-Channelization” interference mitigation strategies.

The PN invited submittal of prototype devices to the Office of Engineering and Technology (OET) Laboratory for use in the phase I testing. In response to this request, four parties provided U-NII-4 prototype devices: Broadcom, Cisco, KEA, and Qualcomm. Each of the parties submitted at least two prototypes to facilitate the implementation of a simple network involving a single Access Point (AP) and a single station/client (STA) device. Additionally, Qualcomm provided one set of DSRC devices (10 MHz) to be used in the phase I testing. Cisco and KEA, both advocates of the detect-and-vacate sharing strategy, each provided a third device that generated the DSRC preamble data for use in testing DSRC detection capabilities. To facilitate testing of one of the proposed sharing plans (the Re-channelization interference mitigation strategy), Broadcom also upgraded their AP with software to assign priority to DSRC traffic, once detected. They also provided a pair of DSRC devices modified to operate on 20 MHz

---

<sup>1</sup> U-NII devices provide short-range, high-speed unlicensed wireless connections in the 5 GHz band for, among other applications, Wi-Fi-enabled radio local networks, cordless telephones, and fixed outdoor broadband transceivers used by wireless internet providers.

<sup>2</sup> DSRC technology is a form of Wireless Access for Vehicular Environment (WAVE) communications system. The DSRC Physical (PHY) layer and Medium Access Control (MAC) layer are specified in the IEEE 802.11 and IEEE 1609.x family of standards. While DSRC technology is envisioned to offer many modes of operation and communication, one of its main applications is in Vehicle-to-Vehicle (V2V) communications. V2V communications use DSRC radios to exchange basic safety messages (BSM). Onboard safety applications use the information contained in the BSMs about the host vehicle and remote vehicles to detect potential crash threats and alert the driver. BSMs are transmitted as Wireless Access in Vehicular Environments (WAVE) short messages using the WAVE Short Message Protocol (WSMP) as defined in IEEE 1609.3.

<sup>3</sup> See The Commission Seeks to Update and Refresh the Record in the “Unlicensed National Information Infrastructure (U-NII) Devices in the 5 GHz Band” Proceeding, ET Docket No. 13-49, Public Notice, FCC 16-68 (June 1, 2016). See also, Revision of Part 15 of the Commission’s Rules to Permit Unlicensed National Information Infrastructure (U-NII) Devices in the 5 GHz Band, ET Docket No. 13-49, Notice of Proposed Rulemaking, 28 FCC Rcd 1769 (2013).

<sup>4</sup> IEEE 802.11-15/0347r0, Final Report of DSRC Coexistence Tiger Team, March 9, 2015, <https://mentor.ieee.org/802.11/dcn/15/11-15-0347-00-Oreg-final-report-of-dsrc-coexistence-tiger-team-clean.pdf>

channels instead of the standard 10 MHz DSRC channels. The Department of Transportation (DoT) also provided two sets of DSRC devices (via memoranda of agreement with multiple DSRC manufacturers) to the OET for use in the Phase I testing).

The OET undertook Phase I testing to evaluate the two proposed sharing plans under laboratory conditions. FCC staff evaluated the U-NII-4 and DSRC devices' transmission and receiver characteristics. These measurements were performed in an equivalent manner to the compliance measurements regularly performed by the FCC laboratory. The data collected from the characterization efforts confirmed that the prototype devices operate in accordance with the relevant IEEE 802.11<sup>5</sup> and DSRC standards.

The next step in testing was to evaluate the response of DSRC devices in the presence of undesired co-channel U-NII-4 transmissions, even though both of the proposed mitigation strategies are designed to preclude such interactions. The data collected from these tests were intended to aid in understanding the behavior of the DSRC components (receivers and transmitters) in a co-channel interference interaction with no emphasis placed on informing an evaluation of the proposed mitigation strategies. This data also served to facilitate a qualitative assessment of the adjacent channel rejection (ACR) capability of DSRC devices. The DSRC receiver sensitivity levels were also measured and compared to the U-NII-4 prototype device detection threshold for DSRC signals.

The final step in this effort was to test the efficacy and reliability of the two proposed interference mitigation strategies intended to facilitate spectrum sharing between proposed U-NII-4 and incumbent DSRC operations (i.e., Detect-and-Vacate and Re-Channelization).

### **1.1 Detect-and-Vacate Proposal**

Under the Detect-and-Vacate proposal, a U-NII-4 device intending to operate in the band will be required to cease transmission upon detection of DSRC activity in any of the DSRC channels (i.e., the entire DSRC band and the upper 25 MHz of the existing U-NII-3 band). There is currently no specification as to what other spectrum a U-NII-4 device would be required to move to upon DSRC signal detection, but the sample devices provided for this test campaign implement a strategy that has them relocating operation to the U-NII-1 band. The Detect-and-Vacate proposal assumes that all future U-NII-4 operation will be limited to channels below 5895 MHz, leaving the upper three DSRC channels unencumbered by potential co-channel interference interactions.

---

<sup>5</sup> IEEE 802.11 refers to a family of technical standards that contain specifications for implementing wireless local area network (WLAN) computer communication in the 900 MHz, 2.4 GHz, 3.6 GHz, 5 GHz, and 60 GHz frequency bands. In particular, the specifications for communication in the 5 GHz bands are found in IEEE 802.11ac, originally published in 2013 as an amendment to the standard. See IEEE Std 802.11ac-2013, *IEEE Standard for Information technology – Telecommunications and information exchange between systems Local and Metropolitan area networks Specific Requirements Part 11: Wireless LAN Medium Access Control (MAC) and Physical Layer (PHY) Specifications Amendment 4: Enhancements for Very High Throughput for Operation in Bands below 6 GHz* (2013). IEEE Std 802.11-2016 incorporated IEEE 802.11ac amendment (Amendment 4) in 2016. Throughout this report, legacy IEEE 802.11 signals and waveforms are simply referred to as “IEEE 802.11” signals in contrast to IEEE 802.11ac signals.

The testing involved introducing a DSRC signal to the U-NII-4 device under test, initially at a low level and recording the number of positive detections, the number of missed detections, and then determining the associated probability of detection over 50 trials. This test was repeated at incrementally lower DSRC power levels until detection was no longer possible. At each increment (DSRC received power level), the same statistics were recorded over 50 trials. These tests were initially performed under clear channel conditions but were supplemented by repeating the tests with noise injected into the channel to simulate more stressed operational conditions.

These tests were also designed to facilitate a measurement of the channel-move time (i.e., the elapsed time between detection of a DSRC signal and subsequent U-NII-4 device retransmission in an alternative U-NII band)<sup>6</sup> associated with the scheme, although it is not apparent that such a specification has yet been contemplated. In the absence of a channel-move time specification, there is no established threshold on which to base an evaluation. The channel-move time data is collected, reported, and not analyzed. It is noted that the cumulative move time will be a function of several factors such as signal detection and vacate time which are in turn dependent upon factors such as signal-to-noise ratio, and others. The objective of this effort did not include investigating or analyzing the measured channel-move time, the relationship to channel vacate time, or the observed variances.

Based on the data collected it was determined that the devices with detect and vacate capability can detect the presence of a valid 10 MHz DSRC (OFDM) transmission in any of the four lower DSRC channels simultaneously. The DSRC detectors in the tested devices were designed to detect DSRC waveforms at received power levels from -95 dBm/10 MHz to -30 dBm/10 MHz, assuming no external interferers or added noise. These tests confirmed that the DSRC detectors were in fact capable of detecting a DSRC signal as low as -95 dBm in a 10 MHz detection bandwidth under optimal conditions.

## **1.2 Re-Channelization Proposal**

The Re-Channelization proposal involves restructuring of the existing DSRC channel plan. The first part of this proposal would require relocating the two 10-MHz DSRC public safety channels (currently located at the upper and lower ends of the DSRC band) and the 10-MHz control channel (currently located at the center of the DSRC band) to the upper 30 MHz of the DSRC band (i.e., 5895 to 5925 MHz). According to the proponents, this restructuring of the channel plan would avoid sharing the spectrum with safety-related DSRC applications (i.e., the channels designated for the basic safety message, the control channel and the public safety channel would be relocated to the upper 30 MHz of the band and would not be shared).

The second part of this proposal would require that the remaining 45 MHz of the DSRC spectrum (5850 to 5895 MHz) be re-channelized from the four existing 10-MHz DSRC channels into two 20-MHz shared channels (that are aligned with IEEE 802.11 channel configurations.)

---

<sup>6</sup> For interference mitigation purposes, the time it takes the device to vacate a channel is an important parameter. To measure the channel-vacate time, the U-NII-4 devices must be equipped with a test mode to provide continuous transmission (or close to 100% duty cycle) so the channel-vacate time (relative to the appropriate DSRC signal detection) can be accurately measured. However, none of the available U-NII-4 devices were equipped with such capability. The channel-move time, as described and measured in this test report, provides a conservative upper bound of the channel-vacate time.

The existing 5-MHz guard band at the bottom end of the DSRC spectrum would be joined with U-NII-3 spectrum to make available an additional 20-MHz U-NII channel. The re-channelization of the band would facilitate contiguous 40 MHz, 80 MHz, and 160 MHz channels as per the IEEE 802.11ac standard.

Re-channelizing the existing four 10-MHz DSRC channels into two 20-MHz shared channels is intended to enable the use of existing IEEE 802.11ac clear channel assessment – carrier sense (CCA-CS) protocols for detecting and prioritizing DSRC message traffic, which requires full channel alignment between the DSRC channels and the IEEE 802.11ac channels. Upon detection of the DSRC signal (co-channel with U-NII-4), the existing IEEE 802.11ac Enhanced Distributed Channel Access (EDCA) protocol could be adapted to enable priority access to DSRC message traffic.

The ability to fully test this mitigation proposal was limited by practical considerations. Currently available DSRC devices have been designed to implement channel requirements premised on the existing DSRC band plan that specifies seven standard 10-MHz channels and provides the option to combine four of the 10-MHz channels to create two 20-MHz channels. However, since the usage of the optional 20-MHz DSRC channels has yet to be fully defined, it appears that DSRC devices generally have not yet implemented the optional 20-MHz channel capability.

To facilitate testing of this method, one set of DSRC devices were modified by Broadcom to operate in 20 MHz channel configurations in channels 173 and 177. Additionally, a U-NII-4 AP and STA (Broadcom device) were modified through a software update to detect DSRC transmissions and provide DSRC devices a higher priority by implementing the EDCA protocol. The DSRC modes of operation beyond the broadcast mode where BSMs are regularly transmitted are not yet well defined. We note that in its proposed mandate to require deployment of DSRC devices, the NHTSA only proposes to require operations on the basic safety message channel (172), leaving the use of the of the other channels to the discretion of the industry.<sup>7</sup> The devices available for this test effort did not provide for DSRC operation on channels other than the basic safety message channel. Therefore, it was difficult to directly quantify the potential impact of U-NII-4 transmissions to DSRC operations on channels other than the basic safety message channel.

Nevertheless, to examine coexistence of co-channel DSRC signals and U-NII-4 signals under the Re-channelization proposal, two EDCA parameters – Contention Window min (CW<sub>min</sub>), and Arbitration Inter Frame Spacing Number (AIFSN) – were varied throughout the tests to force assignment of a higher priority to DSRC transmissions. U-NII-4 and DSRC co-channel operation were examined with U-NII-4 devices using five discrete sets of EDCA parameters, corresponding to specific levels of interference mitigation provided to the DSRC transmission. Throughout this report, these mitigation levels are referred to as Mitigation Modes. Four out of the five mitigation modes – mode 0, mode 2, mode 5 and mode 6 – were tested. The fifth mitigation mode, mode 1, was not tested since the initial test results of modes 0 and 1 were

---

<sup>7</sup> See National Highway Transportation Safety Administration (NHTSA), Notice of Proposed Rulemaking, 82 Fed. Reg. 3854 (Jan 12, 2017).



indistinguishable. It was thus decided to simply evaluate mode 0 instead of both modes. Mode 0 is also the default mode of operation.

### 1.3 Initial Assessment of the Two Proposed Interference Mitigation Methods

Test results show that the prototype U-NII-4 devices were able to detect a co-channel DSRC signal and implement post detection steps as claimed by the submitters. All of the prototype U-NII-4 devices were found to be capable of detecting a DSRC signal at a level of approximately -95 dBm. The receiver sensitivity level of the DSRC devices tested fell in the range of -95 dBm to -93 dBm. In other words, the detection threshold of the U-NII-4 devices was similar to that of the DSRC devices detecting its own signal.

Data suggests that the two proposed interference mitigation methods, Detect-and-Vacate and Re-channelization proposals, offer a means for U-NII-4 devices to coexist with DSRC devices. For example, assuming a DSRC transmission at the maximum permissible EIRP level of 33 dBm<sup>8</sup> along a 300-meter unobstructed line-of-sight propagation path, the theoretical received power level at a U-NII-4 device will be approximately -65 dBm.<sup>9</sup> This calculation suggests that all of the prototype U-NII-4 devices tested would be capable of detecting this DSRC signal at a distance of 300 meters with significant margin (~30 dB) to account for additional signal attenuation associated with multipath and/or signal obstructions. The two proposals make different assumptions about the characteristics associated with: (1) the environment in which DSRC and U-NII-4 devices operate; (2) detection mechanisms of the U-NII-4 devices to sense the presence of a DSRC transmission; and (3) steps each U-NII-4 device will take upon detection of a DSRC signal (post detection process).

The Detect-and-Vacate proposal offers protection to DSRC operation through frequency separation, while the Re-channelization proposal affords a higher probability of transmission to DSRC devices during co-channel operation as described in the previous section. Below is a summary of main points observed during the FCC laboratory testing.

### 1.4 Detect-and-Vacate Proposal Observations

Our initial assessment of this method indicates that U-NII-4 AP and STA equipped with a 10 MHz DSRC preamble detector as proposed by Cisco and KEA – can effectively detect DSRC transmissions at thresholds of approximately -95 dBm, or higher, within the lower 4 DSRC channels. The following observations were made upon conclusion of the test:

- The detection threshold is a function of (desired) signal-to-noise ratio at the detector's receiver. A noisy channel can degrade this threshold as verified during the laboratory testing. Introducing added white Gaussian noise at -90 dBm/20 MHz power density level decreased the 90% probability of detection (POD) by approximately 2 dB.<sup>10</sup>

---

<sup>8</sup> §90.377(b).

<sup>9</sup>  $P_R = EIRP - L_P$ , where  $P_R$  = received power (dBm), EIRP = equivalent isotropic radiated power (dBm),  $L_P$  = basic free space propagation path loss (dB).

<sup>10</sup> To determine the detection threshold of the U-NII-4 device, 100 BSM packets were transmitted, at 100 ms interval, and introduced to DSRC detectors of U-NII-4 device. The transmission of 100 BSM packets at 100 ms

- Added white Gaussian noise produced false detection under certain circumstances. 10 MHz wide band-limited white Gaussian noise that was centered at the same frequency as DSRC device (co-channel with DSRC signal) introduced false detection when the added noise power level was about -92 dBm.
- Once a DSRC transmission is detected, the time it takes a U-NII-4 AP (or STA) to move and retransmit at the new backup channel (i.e., channel-move time) appeared to be a random value that was a function of DSRC signal power (desired signal), added noise power, and modulation and coding scheme of IEEE 802.11ac signal. Correlation between the power of DSRC (desired) signal and the average channel-move time was observed. The average channel-move time varied from 9.7 ms to 798.0 ms (Cisco Detector), and 0.3 ms to 385.16 ms (KEA Detector). On average, higher DSRC signal power (present in U-NII-4 DSRC detector path) corresponded with shorter channel-move times. No attempt was made to examine the observed variance in channel move time. In the event that one of these mitigation proposals were to be adopted, a minimum vacate time would be established by either regulation or standard.

### 1.5 Re-channelization Proposal Observations

Our initial assessment of this method indicates that U-NII-4 AP and STA can detect a 20-MHz-wide (co-channel) DSRC signal at approximately -96 dBm, under optimal condition, and can subsequently execute the EDCA protocol to provide higher priority to DSRC transmissions as has been proposed by Broadcom and Qualcomm Inc. The following observations were made upon conclusion of these tests:

- Detection threshold is a function of the (desired) signal-to-noise ratio at the detector's receiver. A noisy channel can degrade this threshold. To maintain a 90% probability of detection, the DSRC signal received power at the U-NII-4 detection receiver must increase by 1 dB for every 2 dB increase in additional noise power in the channel.
- Upon detection of a DSRC signal, higher order mitigation modes will provide higher priority to the detected DSRC transmission.<sup>11</sup>
- There appears to be three distinct regions of performance when DSRC and U-NII-4 devices operate simultaneously in a co-channel configuration: a) Region 1 where Packet Completion Rate (PCR) decreases as interference power level increases from -92 dBm to -82 dBm; b) Region 2 where PCR stays relatively constant as interference power level increases from -82 dBm to -70 dBm; and c) Region 3 where PCR increases as interference power level increases from -70 dBm to -44 dBm.

---

interval provided a detection opportunity of approximately 10 seconds (listening period) for the U-NII-4 device. This listening period was chosen for measurement purposes and used consistently for all tests. It is possible that a recorded missed detection could have been a successful one, had the DSRC detector had the option to listen for longer periods of time. The appropriate listening time period for U-NII-4 devices could be addressed when final requirements are established in future standards.

<sup>11</sup> DSRC network maintains its own Priority Access (PA) class and EDCA parameters. The DSRC devices under test are believed to have used EDCA parameters associated with Best Effort (BE) traffic. The DSRC EDCA parameters were not changed during the test.

- The PCR and Inter Departure Time (IDT) data indicates a direct correlation. Higher order mitigation modes improve PCR and IDT of transmitted packets. As the packet completion rate approaches 100%, the packet inter-departure time approaches the baseline value of 10 ms.

### 1.6 Summary Comparison of the Two Interference Mitigation Methods

Table 1 provides a summary of the characteristics of the two interference mitigation methods. It should be noted that our findings here are based on limited laboratory (“bench top”) testing performed during the first phase of the proposed three phase test program. All tests were performed on a conducted basis.<sup>12</sup>

**Table 1 – Comparison of the Two Mitigation Methods**

| <b>Features</b>                     | <b>Cisco Detect-and-Vacate Method</b>                | <b>Broadcom/Qualcomm Re-Channelization Method</b>  |
|-------------------------------------|--|--|
| Detection Threshold (10 MHz DSRC)   | > -95 dBm  | N/A  |
| Detection Threshold (20 MHz DSRC)   | N/A  | > -96 dBm  |
| Bandwidth of Detection              | Four lower 10 MHz channels                           | Detects DSRC signal at the channel it intends to transmit  |
| Coexistence upon detection          | Vacates entire U-NII-4 band. No co-channel operation | Provides higher priority to DSRC transmission during co-channel operation  |
| Impact to current DSRC channel plan | None   | Requires 20 MHz DSRC channels in the lower 40 MHz portion of the band, and places all BSM operations at the upper 30 MHz portion of the band |

<sup>12</sup> This means that the tests were performed by connecting the devices together by wire, to eliminate uncertainty associated with antenna effects.

## 2. Introduction

The Commission released Public Notice (PN) FCC 16-68 on June 1, 2016 to update and refresh the Record in the “Unlicensed National Infrastructure (U-NII) Devices in the 5 GHz Band” Proceeding (hereinafter, the PN).<sup>13</sup> A draft test plan was included that described a general approach for performing laboratory tests intended to collect empirical data that can be used in a technical evaluation of the electromagnetic compatibility (EMC) between proposed 5.9 GHz U-NII-4 transmitters and DSRC devices as they transmit and receive basic safety messages (BSM).

The Office of Engineering and Technology (OET) undertook Phase I testing to evaluate the two mitigation strategies that have been proposed to facilitate sharing between proposed U-NII-4 and incumbent DSRC operations (i.e., Detect-and-Vacate and Re-Channelization Methods, as elaborated *supra*) under laboratory conditions. All submitted prototype U-NII-4 and DSRC devices were characterized to ascertain their transmission and receiver characteristics.

The measurements of the transmission characteristics are similar to the compliance measurements performed by the FCC laboratory on a routine basis, such as the occupied bandwidth of the fundamental emission, the maximum power contained within the fundamental emission, and the power associated with any spurious or harmonic emissions. The data collected from the characterization efforts confirmed that the prototype devices operate in accordance with the relevant IEEE 802.11 and DSRC standards.

The next step was to evaluate the response of DSRC transmitters and receivers to the proposed introduction of U-NII-4 operations within the same frequency band, in the absence of any interference mitigation techniques. This approach also enabled us to create a baseline for measuring the effectiveness of the two proposed interference mitigation methods. In addition, these tests measured the potential for interference to the first, second and third adjacent DSRC channels.

The last step was to test the efficacy and reliability of the two proposed interference mitigation strategies.

### 2.1 Objectives

The primary objectives of this test and measurement effort was to: (1) evaluate the effectiveness of the two proposed interference mitigation methods; (2) measure the effectiveness of each mitigation method, both with DSRC and U-NII-4 devices in co-channel and adjacent channel configurations; (3) determine the U-NII-4 transmission’s effect on DSRC performance; and (4) examine the specific features of each proposed mitigation method.

---

<sup>13</sup> See *supra* note 3.

## 2.2 System Description

### 2.2.1 Overview

DSRC technology is a form of Wireless Access for Vehicular Environment (WAVE) communications system. The DSRC Physical (PHY) layer and Medium Access Control (MAC) layer are specified in the IEEE 802.11 and IEEE 1609.x family of standards. While DSRC technology is envisioned to offer many modes of operation and communication, one of its main applications is in Vehicle-to-Vehicle (V2V) communications. V2V communications use DSRC radios to exchange basic safety messages (BSM). Onboard safety applications use the information contained in the BSMs about the host vehicle and remote vehicles to detect potential crash threats and alert the driver. The V2V onboard equipment (OBE) typically consists of four subsystems: DSRC Radio Subsystem, Positioning Subsystem (that includes Global Navigation Satellite System (GNSS) receiver), OBE Control Processor Electronic Control Unit (ECU), and Antennas.

Each vehicle broadcasts BSMs to provide neighboring vehicles with trajectory and status information.<sup>14</sup> Each vehicle also receives BSMs transmitted by neighboring vehicles to create a dynamic map of its surroundings. With a sufficiently high population of DSRC radio-equipped vehicles, the number of BSMs being transmitted can congest the channel, necessitating congestion control procedures.<sup>15</sup>

### 2.2.2 DSRC Operating Channel Frequencies

FCC regulations govern the operation of DSRC devices, both On Board Units (OBUs) and Road Side Units (RSUs).

The FCC allocated seven 10-MHz channels in the 5850 MHz to 5925 MHz U-NII bands for DSRC operations. The following table indicates the channel designations of frequencies available for assignment.

---

<sup>14</sup> BSMs are transmitted as Wireless Access in Vehicular Environments (WAVE) short messages using the WAVE Short Message Protocol (WSMP) as defined in IEEE 1609.3.

<sup>15</sup> DSRC radios typically transmit BSMs at a rate of 10 Hz (1 BSM every 100 ms). However, based on quality of channel and packet collision rate (possibly due to a congested environment), DSRC radios can adapt their transmission rate (to lower than 10 Hz) to manage congestion and to avoid packet collisions.

**Table 2 – DSRC Channel Plan and Allocated Frequencies**

| <b>Channel Number</b> | <b>Channel Use</b>              | <b>Frequency Range (MHz)</b> |
|-----------------------|---------------------------------|------------------------------|
| 170                   | Reserved                        | 5850- 5855                   |
| 172                   | Service Channel (Public Safety) | 5855- 5865                   |
| 174                   | Service Channel                 | 5865- 5875                   |
| 175                   | Service Channel <sup>16</sup>   | 5865- 5885                   |
| 176                   | Service Channel                 | 5875- 5885                   |
| 178                   | Control Channel                 | 5885- 5895                   |
| 180                   | Service Channel                 | 5895- 5905                   |
| 181                   | Service Channel <sup>17</sup>   | 5895- 5915                   |
| 182                   | Service Channel                 | 5905- 5915                   |
| 184                   | Service Channel (Public Safety) | 5915- 5925                   |

**2.2.3 DSRC Operating Channel Description:**

**Channel 172** – primarily broadcasts BSMs to support V2V safety applications. Channel 172 is not subject to control by the control channel (channel 178). Channel 172 will also be used to broadcast signal and timing (SPaT) messages, MAP (an intersection geometry message), GNSS location and correction messages, a subset of radio technical commission for maritime (RTCM) messages.,

**Channels 174 and 176** – designated as medium-power service channels. Other than applications to increase work zone safety, many of the applications that will use these channels have not yet been defined.

**Channels 180 and 182** – designated as low-power service channels, considered for very short-range communications and applications. Applications that are planned to use these channels are still under development

**Channel 178** – designated as control channel (CCH). Typically used in roadside units (RSUs) to advertise services or applications on service channels, directing OBUs to service channels where data can be exchanged.

**Channel 184** – designated for higher powered vehicle to infrastructure (HPV2I) applications such as public safety, emergency vehicles. It typically has longer range of communications, up to 1,000 meters.

---

<sup>16</sup> Channels 174 and 176 may be combined to create a twenty-megahertz channel, designated as Channel 175.

<sup>17</sup> Channels 180 and 182 may be combined to create a twenty-megahertz channel, designated as Channel 181.

### 2.3 Scope

As mentioned above, the FCC Laboratory testing only considered interactions between U-NII-4 devices and DSRC OBUs that comply with SAE standard J2945, “On-Board System Requirements for Vehicle to Vehicle (V2V) Safety Communications”.<sup>18</sup> In the setup, U-NII-4 devices were set to operate as Access Points (AP) and Stations (STA). The DSRC devices were manually set to one DSRC transmitter responsible for generating BSM packets, placing them in the transmit queue, and transmitting them; and one BSM receiver responsible for receiving the transmitted BSM packets, decoding, and demodulating them. This DSRC setup represents a two-vehicle scenario when one vehicle is transmitting a DSRC signal and the other vehicle is receiving it. The BSM packets are typically transmitted at 100 ms interval.<sup>19</sup>

To eliminate uncertainty associated with antenna effects, the tests were performed by connecting the devices together by wire. Therefore, any degradation to DSRC performance was measured at the receiver. This configuration does not consider Doppler Effect, or other effects, due to mobility of transmitters and receivers<sup>20</sup>.

To the extent possible, effects of U-NII-4 network loading (also referred to as channel occupancy or duty cycle of transmission) were also considered. Using a combination of modulation and coding scheme, and varying the packet transmission rate, we were able to generate IEEE 802.11ac transmission with various loading factors. Depending on the scenario under investigation, the IEEE 802.11ac channel occupancy (loading factor) ranged from 55% to almost 95%. BSM transmission rate were also increased by a factor of 10 during testing of Re-channelization method to investigate an additional scenario.

---

<sup>18</sup> See SAE J2945\_201712, *Dedicated Short Range Communication (DSRC) Systems Engineering Process Guidance for SAE J2945/X Documents and Common Design Concepts* (2017).

<sup>19</sup> The DSRC devices available for testing had very limited control options to adjust timing. The test setup does not account for potential impact to a DSRC receiver due to loading of the channel by other neighboring DSRC transmitters.

<sup>20</sup> Testing in a laboratory setting, where devices under tests are stationary and connected by wires, provides little flexibility to simulate Doppler or multipath phenomena due to mobility of devices. However, detection capability of both mitigation methods were examined under ideal conditions as well as in noisy channel to obtain more realistic results.

### 3. RF Characterization of U-NII-4 and DSRC Devices, Assumptions and Considerations

A series of Radio Frequency (RF) characterization testing of the submitted DSRC and U-NII-4 devices were performed to evaluate RF emission profiles of the transmitting devices. The testing included measurement of transmission's occupied bandwidth, average channel power, and out-of-band (OOB) and spurious emission of the transmitting devices. To compare the emissions characteristics of the U-NII-4 and DSRC devices, various combinations of RF output power levels, channel settings, and modulation and coding schemes were evaluated. For informational purposes, the emission profile of U-NII-4 transmitting devices and DSRC devices were compared to IEEE 802.11ac and IEEE 802.11p<sup>21</sup> transmit mask specifications respectively. Additionally, the receiver sensitivity of DSRC devices were also measured while transmitting BSM packets at 100 ms interval. For this test, we defined receiver sensitivity as the level at which 90% packet completion rate is achieved while the DSRC device is transmitting 300-bytes long BSM packets.

RF transmission profile of the following U-NII-4 devices were characterized:

- Two Cisco IEEE 802.11 access point and station prototypes (Cisco Device)
- Two Qualcomm IEEE 802.11ac access point and station prototypes (Qualcomm Device)
- Two Broadcom IEEE 802.11ac access point and station prototypes (Broadcom Device)
- Two KEA IEEE 802.11ac access point and station prototypes (KEA Device)

The RF transmission profile and receiver sensitivity of four sets of DSRC devices (three 10 MHz devices and one 20 MHz device) were characterized (herein referred to as DSRC 1, 2, 3 and 4).

Since there was more than one sample of each DSRC or U-NII-4 device, all devices were identified by their name or number and assigned a sample number. Table 3 below shows a list of all devices that were tested and characterized.

---

<sup>21</sup> IEEE 802.11p is an approved amendment to the IEEE 802.11 standard to add wireless access in vehicular environments (WAVE). See *supra* note 5. IEEE 802.11p was incorporated into IEEE Standard 802.11 in 2012 that was subsequently revised in 2016. The current version of the standard, as of December 2017, is IEEE Std 802.11-2016.



**Table 3 – List of DSRC and U-NII-4 Devices**

| <b>Device Type</b>                     | <b>Sample #</b> | <b>Description</b>              | <b>Serial #</b> |
|--|-----------------|---------------------------------|-----------------|
| DSRC 3                                 | 29A             | ASD                             | N/A             |
| DSRC 2                                 | 26A             | ASD                             | N/A             |
| DSRC 1                                 | 01              | DRSC Device                     | 2               |
| DSRC 1                                 | 02              | DRSC Device                     | 3               |
| DSRC 1                                 | 03              | DRSC Device                     | 4               |
| DSRC 1                                 | 04              | DRSC Device                     | 5               |
| DSRC 4                                 | 31              | DSRC (20 MHz channels)          | NA              |
| DSRC                                   | 13A             | DSRC Preamble Generator (KEA)   | NA              |
| DSRC/ U-NII-4                          | 14A             | DSRC Detector + AP (KEA)        | KEA-DSRC-1001   |
| DSRC/ U-NII-4                          | 15A             | DSRC Detector + client (KEA)    | KEA-DSRC-1002   |
| DSRC/ U-NII-4<br>(tested U-NII-4 only) | 16A             | DSRC Detector + client (Cisco)  | WS-a-00510      |
| DSRC                                   | 16F             | DSRC Preamble Generator (Cisco) | NA              |
| DSRC/ U-NII-4<br>(tested U-NII-4only)  | 16G             | DSRC Detector + AP (Cisco)      | WS-a-00637      |
| U-NII-4 (Qualcomm)                     | 05              | CASCADE SR108 2x2 device        | 65-Y9345-202    |
| U-NII-4 (Qualcomm)                     | 06              | CASCADE SR108 2x2 device        | 65-Y9345-203    |
| U-NII-4 (Broadcom)                     | 07D             | WLAN Module                     | 2062384         |
| U-NII-4 (Broadcom)                     | 08D             | WLAN Module                     | 2062388         |

#### 4. U-NII-4 and DSRC Unmitigated Interaction Test, Assumptions and Considerations

The following U-NII-4 devices were used during this testing effort:

- Two Cisco IEEE 802.11 access point and station prototypes (Cisco Device)
- Two Qualcomm IEEE 802.11ac access point and station prototypes (Qualcomm Device)
- Two Broadcom IEEE 802.11ac access point and station prototypes (Broadcom Device)

And three sets of DSRC devices (DSRC 1, 2 and 3) were used in conjunction with the U-NII-4 devices.

Once DSRC devices’ sensitivity levels were determined, three test levels were established as follows:<sup>22</sup>

- Level 1 - DSRC received signal strength was 3-4 dB above its corresponding sensitivity.
- Level 2 - DSRC received signal strength was 15 dB above its corresponding sensitivity.
- Level 3 - DSRC received signal strength was 25 dB above its corresponding sensitivity.

Table 4 shows all combinations of U-NII-4 and DSRC devices tested.

**Table 4 – All Combinations of U-NII-4 Devices Tested**

| DSRC<br>U-NII-4 | DSRC 1 | DSRC 2 | DSRC 3 |
|-----------------|--------|--------|--------|
| Cisco Device    | ☑      | ☑      | ☑      |
| Qualcomm Device | ☑      | ☑      | ☑      |
| Broadcom Device | ☑      | ☑      | ☑      |

U-NII-4 devices were set as access points and stations as they usually are in a Wi-Fi local area network configuration. All U-NII-4 proposed mitigation techniques were disabled to examine the impact of unmitigated interference on DSRC performance due to U-NII-4 transmissions.

DSRC devices were set to only transmit and receive BSMs at a rate of 10 Hz, with one DSRC radio functioning as transmitter and one radio as DSRC receiver only. MCS 0, corresponding to longest BSM) was chosen to examine the worst-case scenario.

##### 4.1 Performance Metrics

There are well-known and established methods to assess performance of wireless network systems. Depending on the nature and characteristics of each wireless networks, some

---

<sup>22</sup> All proposed tests at level 1, and limited tests at level 2 and 3 were performed.

performance metrics are better suited than others to describe how well such networks respond to various conditions such as network loading, interference, etc. Because many DSRC applications are safety related and hence latency-sensitive<sup>23</sup> in nature, the following performance indicators are introduced to serve as metrics for the interference susceptibility test<sup>24</sup>:

- **(Received) Packet Completion Rate (PCR):** The ratio of the number of successfully received packets to number of transmitted packets.  $PCR(\%) = \left( \frac{P_{received}}{P_{transmitted}} \right) \times 100$
- **Inter Arrival Time (of Received Packets) (IAT):** The time between two successive received packets
- **Inter Departure Time (of Transmitted Packets) (IDT):** The time between two successive transmitted packets

## 4.2 Test Setup

DSRC devices are considered local area network (LAN) devices in that DSRC transmitters broadcast basic safety messages (or packets) to neighboring DSRC devices. DSRC receivers are designed to receive BSMs and take certain actions upon processing them. Unwanted signals or added noise may interfere with DSRC devices via the following mechanisms:

- A collision of unwanted packets and DSRC packets in the DSRC receiver resulting in an increase in packet error rate (PER).
- Suppression or delay in transmission of DSRC packets as DSRC receivers assess and declare the channel as busy (clear channel assessment or CCA). In this case, typically, the DSRC transmitters respond to clear channel assessment, performed by the DSRC receivers, and suppress or delay transmitting their packets.
- Added noise to the DSRC receiver, causing degradation of probability of detection, resulting in an increase in PER.

To further investigate the above-mentioned mechanisms, DSRC devices were manually set up as transmitters and receivers. An IEEE 802.11 signal (generated by the U-NII-4 devices, or an IEEE 802.11 signal simulator) was then introduced to each DSRC receive and transmit path, separately and independently. This approach enabled us to examine and observe the response of DSRC devices to IEEE 802.11 signal transmissions when:

- DSRC receivers experience interference while DSRC transmitters are not necessarily implementing any interference or congestion mitigation techniques. Additionally, this

---

<sup>23</sup> Defining DSRC safety applications is beyond the scope of this report. However, as mentioned in section 2.2, the test and measurement efforts here focused on one application of DSRC technology that is unanimously regarded as such, i.e., transmission and reception of Basic Safety Messages (BSM) in broadcast mode.

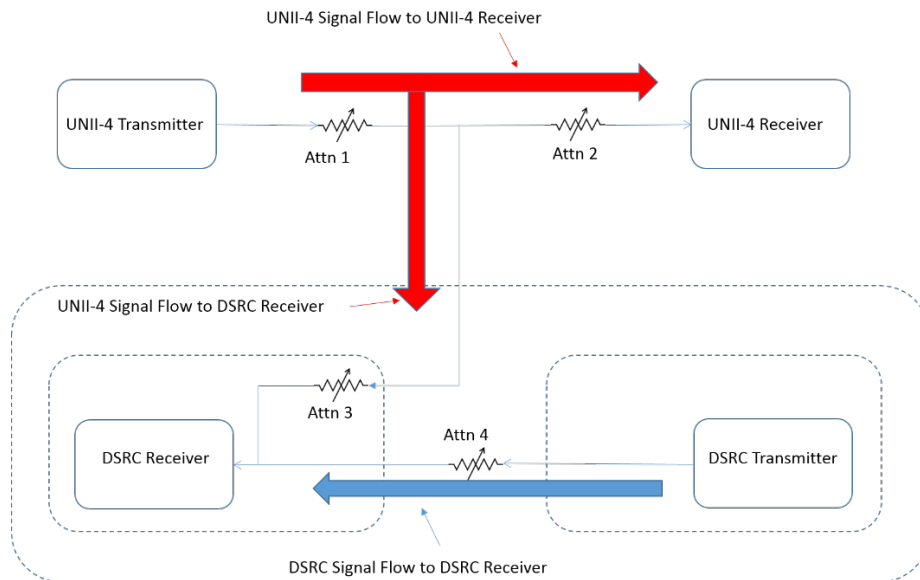
<sup>24</sup> Another performance metric commonly used in wireless communications systems is information age (IA). One definition of IA is the time that elapses between generation of packets at transmitter's application layer and successful reception of the same packet at receiver's application layer. Information age, as defined here, measures end-to-end latency. The FCC Laboratory test setup studied performance of DSRC transmitter and receiver separately and independently. Therefore, the two performance metrics, IAT and IDT, were chosen instead.

approach enabled us to study the DSRC receiver’s response to IEEE 802.11ac signal transmissions with varying modulation and coding scheme (MCS), and channel occupancy (duty cycle). This setup represented a scenario where the DSRC receivers are subject to interference, while the DSRC transmitters are unaware of the presence of an interfering signal due to physical separation, blockage, or the geometry of interference sources.

- DSRC transmitters’ response to “channel busy” statement declared by DSRC receivers due to interfering signals. We observed how DSRC transmitters would act subsequent to a Clear Channel Assessment (CCA) signal performed by DSRC receivers. Additionally, we expected degradation to DSRC transmitter performance to be a function of MCS and the duty cycle of the IEEE 802.11ac signal. To test our hypothesis, channel occupancy of the IEEE 802.11ac transmission was increased until degradation to DSRC packet transmission rate was observed.

Figure 1 illustrates where an IEEE 802.11(ac) signal was injected into the DSRC receiver. A similar setup, not shown, was also made for injecting a U-NII-4 signal into the DSRC transmitter. The dashed line in Figure 1 represents a shielded enclosure or shielded room. Note that the shielded enclosures were also placed in a shielded room to provide improved RF shielding U-NII-4 devices (source of IEEE 802.11 signal) were placed outside of the anechoic chamber for additional isolation. U-NII-4 and DSRC devices were connected through bulkhead connector. DSRC packet capturing software was used to ensure DSRC devices did not communicate via over the air emissions.

For calibration purposes, once reference measurements were made and associated losses were accounted for the setup was kept the same throughout the day in order to maintain calibration. The process was repeated in the beginning of the following test day.



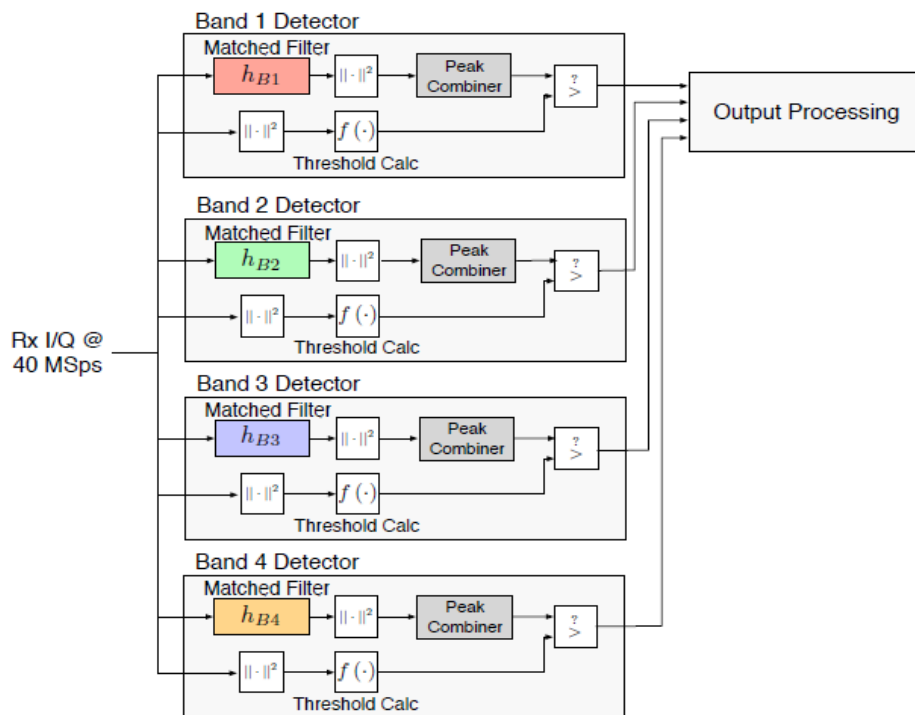
**Figure 1 – Interference Test Setup where Interference Signal is injected to DSRC Receiver**

## 5. Interference Mitigation Tests

Two mitigation methods have been proposed by the industry to enable coexistence between DSRC and U-NII-4 devices in the 5850 MHz to 5925 MHz frequency band. The two mitigation methods are: (1) a Detect and Vacate strategy proposed by Cisco; and (2) a Re-channelization strategy proposed by Qualcomm and Broadcom Inc. The following sections provide a brief description of each method, and their corresponding test approach to further evaluate each mitigation method.

### 5.1 “Detect-and-Vacate” Strategy, Assumptions and Considerations

The provided sample devices, with Detect-and-Vacate capability, are purported to be able to detect the presence of the start of a valid 10-MHz DSRC (OFDM) transmission in any of the four lower DSRC channels simultaneously. To detect the DSRC preamble, the sample device employs matched filters tuned to a Short Training Symbol (STS) in the preamble of a 10-MHz OFDM transmission. Each matched filter, along with a peak combiner and threshold calculator, makes up a detector. Four detectors are employed in the sample device to cover parallel detection of DSRC preambles in four lower DSRC channels (channels 172, 174, 176 and 178) as shown in Figure 2.<sup>25</sup>



**Figure 2 – Block Diagram of DSRC Preamble Detector Architecture, Developed by Cisco**

<sup>25</sup> IEEE 802.11\_DSRC\_Demo\_UserGuide\_v1.0 by Cisco Systems, Inc. In Cisco document, DSRC channels 172, 174, 176, and 178 are referred to as Band 1, Band 2, Band 3 and Band 4.

The DSRC detector in the sample device is specified and designed to detect DSRC waveforms at receive power levels from -95 dBm/10 MHz to -30 dBm/10 MHz, assuming no external interferers or added noise.

Upon successful detection of DSRC activity in any one of the channels, the U-NII-4 device will cease transmission anywhere in the band (i.e., the entire DSRC band and the upper 25 MHz of the existing U-NII-3 band). Currently, there is no specification as to what other spectrum a U-NII-4 device would move to upon DSRC detection, but the implementation in the sample devices has them relocating operation to the U-NII-1 band (i.e., 5150 to 5250 MHz). The Detect-and-Vacate proposal assumes all U-NII-4 operations are limited to channels below 5895 MHz, leaving the upper three DSRC channels unencumbered by potential co-channel interference interactions.

### 5.1.1 Performance Metrics

The following parameters were collected to help characterize the performance of the proposed Detect-and-Vacate method:

- **Detection Threshold** at which point probability of detecting DSRC preamble is equal to or greater than certain percentage (90<sup>th</sup> percentile)
- **Channel-Move Time** or the time between detection of DSRC preamble and start of IEEE 802.11 transmission in a backup channel
- **(Received) Packet Completion Rate (PCR):** The ratio of the number of successfully received packets to number of transmitted packets.  $PCR(\%) = \left( \frac{P_{received}}{P_{transmitted}} \right) \times 100$
- **(Transmitted) Packet Completion Rate (PCR):** The ratio of the number of packets placed in transmit queue to the number of successfully transmitted packets
- **Inter Arrival Time (of Received Packets) (IAT):** The time between two successive received packets
- **Inter Departure Time (of Transmitted Packets) (IDT):** The time between two successive transmitted packets

### 5.1.2 Test Approach

The Detect-and-Vacate method hinges on the successful detection of a DSRC signal, hence the threshold at which reliable detection occurs is of critical importance. Furthermore, to minimize interference to DSRC devices, U-NII-4 devices must be able to detect DSRC signals before the DSRC device detects U-NII-4 transmissions. Therefore, this detection threshold should ideally be below any signal level that can potentially degrade DSRC operation.

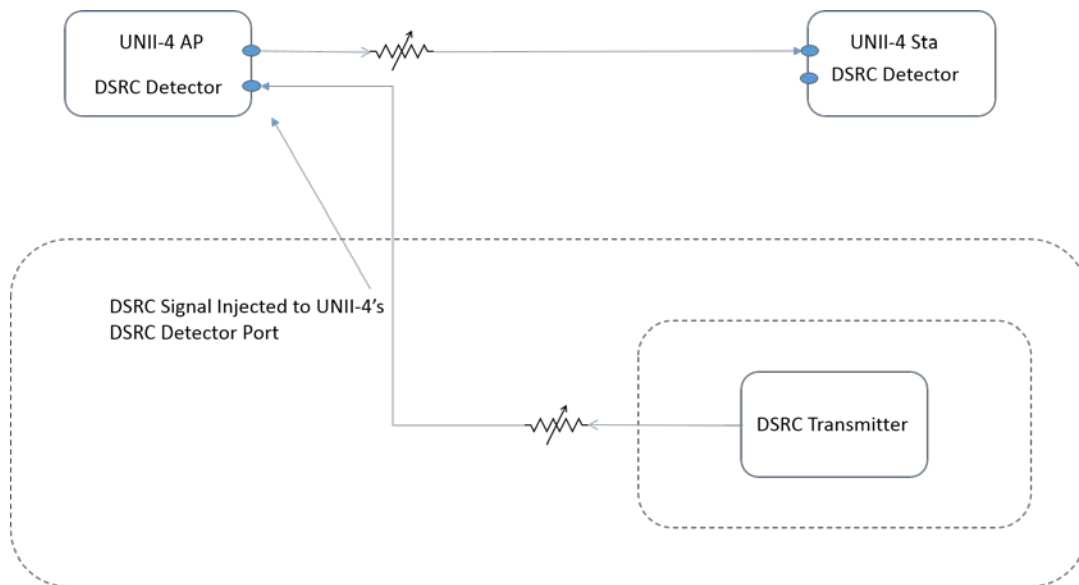
Upon successful detection of a DSRC signal, the U-NII-4 device (under Detect-and-Vacate) is designed to vacate the U-NII-4 band to minimize risk of interference due to simultaneous operation of U-NII-4 and DSRC devices. There is inevitably a delay between the two events (detection of DSRC signal and U-NII-4 retransmission in a backup U-NII band). This time delay, referred to as the Channel-Move Time in the previous section, is also a crucial factor.

The following tests were designed to measure the Detection Threshold and Channel-Move Time of U-NII-4 devices under Detect-and-Vacate Scheme.

### 5.1.3 DSRC Detection Threshold

The DSRC Detection Threshold testing involved introducing a DSRC signal to the U-NII-4 device under test, initially at a low level (just above minimum sensitivity) and recording the number of positive detections, the number of missed detections, and the associated probability of detection over 50 trials. This test was repeated at incrementally lower DSRC power levels until detection was no longer possible. At each increment (DSRC received power level), the same statistics were recorded over 50 trials. These tests were initially performed under clear channel conditions but were supplemented by repeating with noise injected into the channel to simulate more stressed operational conditions.

Figure 3 shows the setup to determine the DSRC detection threshold when a DSRC signal was injected to the DSRC detector port of the U-NII-4 Access Point (AP). A similar test was performed when the DSRC signal was injected into the DSRC detector port of the U-NII-4 Station (STA) to ensure both AP and STA devices can independently detect DSRC signals. The DSRC signal in both cases was a simulated 10-MHz Basic Safety Message (BSM) transmitted at a rate of 10 Hz (10 transmissions per second). The dashed line in Figure 3 represents a shielded enclosure or shielded room. The purpose of the shielded room was to eliminate the possible influence of other outside signals.



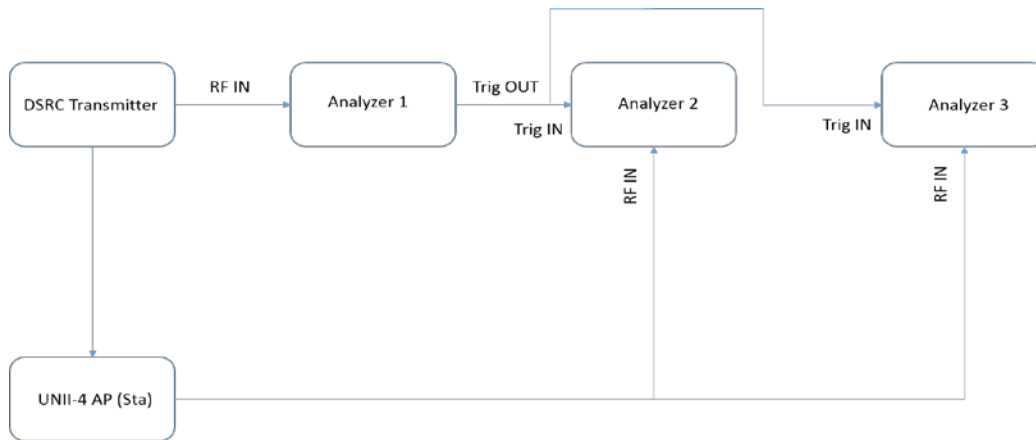
**Figure 3 – DSRC Detection Threshold Test Setup**

### 5.1.4 Channel-Move Time

These Channel-Move Time tests were designed to facilitate a measurement of the elapsed time between the detection of a DSRC signal and the U-NII-4 device retransmission in an alternative

U-NII band. It is not apparent that such a specification has yet been contemplated, but we decided to measure it due to its expected importance.

Figure 4 shows the setup for measuring the channel-move time. The DSRC transmit signal is used as a trigger to measure the start of an IEEE 802.11 transmission into a backup U-NII band relative to the DSRC signal reception by the IEEE 802.11 AP or Station. Analyzer 3 is tuned to the AP's (or Station's) frequency of operation in the alternative U-NII band (U-NII-1 band in this case), and performs this triggered measurement. For visual purposes, analyzer 2 also shows the departure of the IEEE 802.11 transmission from the U-NII-4 band as triggered by the reception of the DSRC signal.



**Figure 4 – Test Setup for Detect-and-Vacate Method (Channel-move time measurement)**

## 5.2 “Re-Channelization” Strategy, Assumptions and Considerations

The Re-Channelization proposal involves significant restructuring of the existing DSRC channel plan. The first part of this proposal would require relocating the two public-safety-designated 10-MHz DSRC channels (currently located at the upper and lower ends of the DSRC band) and the 10-MHz control channel (currently located at the center of the DSRC band) to the upper 30 MHz of the DSRC band (i.e., 5895 to 5925 MHz). According to the proponents, this restructuring of the channel plan would avoid sharing the spectrum with safety-related DSRC applications (i.e., the channels designated for the basic safety message, the control channel and the public safety channel would be relocated to the upper 30 MHz of the band and would not be shared).

The second part of this proposal would require that the remaining 45 MHz of the DSRC spectrum (5850 to 5895 MHz) be re-channelized from the four existing 10-MHz DSRC channels into two 20-MHz shared channels (that are aligned with IEEE 802.11 channel configurations). The existing 5-MHz guard band at the bottom end of the DSRC spectrum would be joined with U-NII-3 spectrum to make an additional 20-MHz U-NII channel available and to facilitate contiguous 40 MHz, 80 MHz, and 160 MHz channels as per the IEEE 802.11ac standard.

Re-channelizing the four 10-MHz DSRC channels into two 20-MHz shared channels is intended to enable the use of existing IEEE 802.11ac clear channel assessment – carrier sense (CCA-CS)



protocols for use in detecting and avoiding DSRC message traffic, which requires full channel alignment. Upon detection of DSRC signal, the existing IEEE 802.11ac Enhanced Distributed Channel Access (EDCA) protocol could be adapted to enable priority access to DSRC message traffic.

The ability to fully test this mitigation proposal was limited by practical considerations. Existing DSRC devices have been designed to implement channel requirements premised on the current DSRC band plan that specifies seven standard 10-MHz channels and two optional 20-MHz channels. However, since the usage of the optional 20-MHz DSRC channels has yet to be fully defined, DSRC devices have not implemented a 20-MHz channel capability.

To facilitate testing of this method, one set of DSRC devices were modified to operate in 20-MHz configurations in proposed channels 173 and 177. Additionally, one set of U-NII-4 access point and station (Broadcom device) were modified through a software update to detect 20-MHz DSRC transmission, and afford DSRC devices higher priority by implementing the EDCA protocol mentioned above. DSRC modes of operation beyond broadcast mode when BSMs are regularly transmitted, are not well defined yet. Therefore, it is difficult to quantify the potential impact to DSRC operations, due to U-NII-4 transmission, when DSRC devices operate in modes other than broadcast mode when BSM packets are exchanged. In other words, since this approach is based on sharing the spectrum with non-safety related DSRC applications, we were not able to fully replicate the impact of this sharing on DSRC operations.

For these test, to examine the coexistence of DSRC and U-NII-4 devices under the Re-Channelization strategy, two EDCA parameters, Contention Window min (CWmin), and Arbitration Inter Frame Spacing Number (AIFSN) were varied throughout the test to provide higher priority to DSRC transmission. Table 5 provides five sets of EDCA parameters corresponding to certain levels of interference mitigation that they provide to DSRC transmission. Throughout this report, these mitigation levels are referred to as Mitigation Modes. Four mitigation modes--mode 0, mode 2, mode 5 and mode 6--were tested. (Mitigation mode 1 was not tested because initial test results of modes 0 and 1 were too similar to have any meaningful distinction; it was thus elected to simply evaluate mode 0 instead of both modes.)

**Table 5 – EDCA Parameter Sets Employed by Broadcom U-NII-4 Devices**

| <b>Mitigation Mode</b> | <b>CWmin</b> | <b>CWmax</b> | <b>AIFSN</b> | <b>Max TXOP</b> |
|------------------------|--------------|--------------|--------------|-----------------|
| 0*                     | 15           | 1023         | 3            | 0               |
| 1                      | 15           | 1023         | 6            | 0               |
| 2                      | 31           | 1023         | 6            | 0               |
| 5                      | 31           | 1023         | 8            | 0               |
| 6                      | 31           | 1023         | 10           | 0               |

\*- U-NII-4 (Broadcom)'s Mode 0 was the default mode of operation.

### 5.2.1 Performance Metrics

The following performance indicators are introduced to serve as metrics to assess the efficacy of Re-Channelization method:

- **Detection Threshold:** at which point the probability of detecting DSRC signal is equal to or greater than certain percentages (90th percentile)
- **(Received) Packet Completion Rate (PCR):** The ratio of the number of successfully received packets to number of transmitted packets.  $PCR(\%) = \left( \frac{P_{received}}{P_{transmitted}} \right) \times 100$
- **(Transmitted) Packet Completion Rate (PCR):** The ratio of the number of packets placed in the transmit queue to the number of successfully transmitted packets
- **Inter Arrival Time (of Received Packets) (IAT):** The time between two successive received packets
- **Inter Departure Time (of Transmitted Packets) (IDT):** The time between two successive transmitted packets

### 5.2.2 Test Approach

As with the Detect-and-Vacate method, the Re-Channelization method relies on successful detection of DSRC signal, hence the threshold at which reliable detection occurs is of critical importance. However, unlike the former, the Re-Channelization method allows for co-channel operation of U-NII-4 and DSRC devices. Where U-NII-4 provides higher priority of transmission to DSRC devices. Therefore, evaluating the efficacy of this method involved:

- 1) Determining the detection threshold at which a U-NII-4 device can reliably detect the DSRC signal; and
- 2) Evaluating the coexistence of the U-NII-4 and DSRC devices during simultaneous (co-channel and adjacent channel) operations. Unlike the Detect-and-Vacate method, this method assumes 20-MHz “re-channelized” DSRC signals and detects 20-MHz DSRC signals that are centered at 5865 MHz (channel 173) or 5885 MHz (channel 177). Another major difference between the two mitigation methods is that under the Detect-and-Vacate method, U-NII-4 devices are responsible for detecting the DSRC signal, and upon detection, they must take all necessary actions to vacate the DSRC spectrum to avoid co-channel interference. On the other hand, under the Re-Channelization method, the U-NII-4 devices must detect the 20-MHz DSRC signals that are aligned with U-NII-4 channel configurations and determine the action it must take to avoid interference. As a result, both the DSRC and U-NII-4 devices will sense each other’s signals during co-channel operation (assuming signal levels are above their detection threshold).

### 5.2.3 DSRC Detection Threshold

This testing involved introducing a DSRC signal to the U-NII-4 device, initially at a low level (just above minimum sensitivity) and recording the number of positive detections, the number of missed detections, and the associated probability of detection over 50 trials. This test was repeated at incrementally lower DSRC power levels until detection was no longer possible. At

each power level, the same statistics were recorded over 50 trials. These tests were initially performed under clear channel conditions but were supplemented by repeating the tests with noise injected into the channel to simulate more stressed operational conditions.

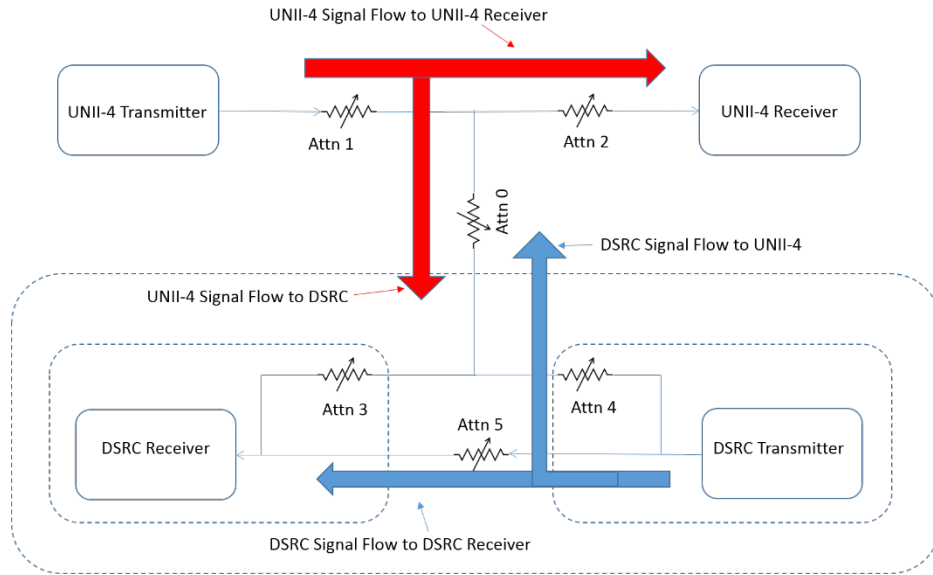
#### 5.2.4 Coexistence Scenarios

Under the Re-Channelization method, a U-NII-4 device must first detect a co-channel DSRC signal, and then provide higher priority to the DSRC transmission. To ensure that the U-NII-4 device could always detect a DSRC transmission throughout the test, the previous test setup was modified in such a way that both the DSRC and U-NII-4 devices could detect one another's signal. Figure 5 shows the test setup in which the U-NII-4 device can sense the DSRC signal, and similarly, the DSRC device can sense a IEEE 802.11 signal (generated by the U-NII-4 device) through the same RF path (when the IEEE 802.11 signal level is above the CCA-ED level). Reducing attenuation in this path (by adjusting Attenuator 0) will deliver more IEEE 802.11 (U-NII-4) signal power to both DSRC device TX and RX antenna ports. It will also result in higher DSRC signal power being present at the U-NII-4 TX and RX antenna ports. This configuration can simulate a scenario in which a DSRC transmitter and receiver are approaching each other near a stationary U-NII-4 device.<sup>26</sup> In this scenario, both the DSRC transmitter and receiver will sense monotonically increasing U-NII-4 RF power at their antenna ports. Under the Re-Channelization method, U-NII-4 devices are allowed to stay and operate simultaneously with DSRC devices.

Test setup, as shown in Figure 5, was also used to investigate the adjacent channel scenario. Since there is a potential for simultaneous operation of U-NII-4 and DSRC devices where U-NII-4 devices operate in channels adjacent to the DSRC channel. This condition will exist since there might be potential for U-NII-4 and DSRC device interaction where U-NII-4 devices do not necessarily detect DSRC signal transmitted on channels adjacent to U-NII-4's.

---

<sup>26</sup> Provided that both DSRC and U-NII-4 devices were stationary, Doppler Effect, or other effects, due to mobility of transmitters and receivers were not considered in this test. Incorporating a simulated Doppler shift into the test setup was a complex matter and was considered beyond the scope of this test effort.



**Figure 5 – Re-Channelization Method Test Setup**

## 6. Results

Section 6.1 provides a summary of the RF characterization testing of the submitted U-NII-4 and DSRC devices. The detailed test results are presented in Appendix B, due to the large volume of test data. Section 6.2 provides the results of the U-NII-4 and DSRC unmitigated interaction tests performed. All interference mitigation techniques were disabled during this phase to study the behavior of DSRC devices in the absence of any mitigation methods (unmitigated interference).

Sections 6.3 and 6.4 provide the results of the interference mitigation tests where the behavior of U-NII-4 devices were studied upon detection of a DSRC signal. Sections 6.3 and 6.4 also present our findings regarding coexistence of U-NII-4 and DSRC devices when proposed interference mitigation methods are enabled.

### 6.1 RF Characterization Test Results

#### 6.1.1 Conducted Occupied Bandwidth for U-NII-4 Devices

Tables 6 through 9 summarize the occupied bandwidth test results for each U-NII-4 device. U-NII-4 devices were tested with modulation and coding schemes (MCS) of 0, 1, 3 and 5, and bandwidths of 20 MHz, 40 MHz and 80 MHz. Tables 6 through 9 show occupied bandwidth (bandwidth containing 99% of the integrated power) test results. Corresponding plots also show the -26 dB bandwidth test results.

**Table 6 – Conducted OBW, U-NII-4 devices, OFDM MCS Index 0 results**

| MCS Index 0<br>Channel #      | Sample 05<br>(Qualcomm)<br>(OBW) | Sample 06<br>(Qualcomm)<br>(OBW) | Sample 07D<br>(Broadcom)<br>(OBW) | Sample 08D<br>(Broadcom)<br>(OBW) |
|-------------------------------|----------------------------------|----------------------------------|-----------------------------------|-----------------------------------|
| CH.177 (5885 MHz)<br>@ 20 MHz | 17.5541 MHz<br>Figure 52         | 17.4157 MHz<br>Figure 58         | 17.7250 MHz<br>Figure 64          | 17.6502 MHz<br>Figure 70          |
| CH.175 (5875 MHz)<br>@ 40 MHz | 36.0169 MHz<br>Figure 56         | 36.0385 MHz<br>Figure 62         | 36.1694 MHz<br>Figure 68          | 36.1880 MHz<br>Figure 74          |
| CH.171 (5855 MHz)<br>@ 80 MHz | 75.6554 MHz<br>Figure 57         | 75.4420 MHz<br>Figure 63         | 75.4689 MHz<br>Figure 69          | 75.5041 MHz<br>Figure 75          |
| MCS Index 0<br>Channel #      | Sample 14A<br>(KEA)<br>(OBW)     | Sample 15A<br>(KEA)<br>(OBW)     | Sample 16A<br>(Cisco)<br>(OBW)    | Sample 16G<br>(Cisco)<br>(OBW)    |
| CH.177 (5885 MHz)<br>@ 20 MHz | 17.6189 MHz<br>Figure 76         | 17.5817 MHz<br>Figure 80         | 17.5989 MHz<br>Figure 84          | 17.6145 MHz<br>Figure 88          |
| CH.175 (5875 MHz)<br>@ 40 MHz | Not Available                    | Not Available                    | Not Available                     | Not Available                     |
| CH.171 (5855 MHz)<br>@ 80 MHz | Not Available                    | Not Available                    | Not Available                     | Not Available                     |

**Table 7 – Conducted OBW – U-NII-4 Devices, OFDM MCS Index 1 Results**

| <b>MCS Index 1<br/>Channel #</b> | <b>Sample 05<br/>(Qualcomm)<br/>(OBW)</b> | <b>Sample 06<br/>(Qualcomm)<br/>(OBW)</b> | <b>Sample 07D<br/>(Broadcom)<br/>(OBW)</b> | <b>Sample 08D<br/>(Broadcom)<br/>(OBW)</b> |
|----------------------------------|---|---|--|--|
| CH.177 (5885 MHz)<br>@ 20 MHz    | 17.5290 MHz<br>Figure 53                  | 17.4781 MHz<br>Figure 59                  | 17.6404 MHz<br>Figure 65                   | 17.6354 MHz<br>Figure 71                   |
| <b>MCS Index 1<br/>Channel #</b> | <b>Sample 14A<br/>(KEA)<br/>(OBW)</b>     | <b>Sample 15A<br/>(KEA)<br/>(OBW)</b>     | <b>Sample 16A<br/>(Cisco)<br/>(OBW)</b>    | <b>Sample 16G<br/>(Cisco)<br/>(OBW)</b>    |
| CH.177 (5885 MHz)<br>@ 20 MHz    | 17.6141 MHz<br>Figure 77                  | 17.5991 MHz<br>Figure 81                  | 17.6132 MHz<br>Figure 85                   | 17.5967 MHz<br>Figure 89                   |

**Table 8 – Conducted OBW – U-NII-4 Devices, OFDM MCS Index 3 Results**

| <b>MCS Index 3<br/>Channel #</b> | <b>Sample 05<br/>(Qualcomm)<br/>(OBW)</b> | <b>Sample 06<br/>(Qualcomm)<br/>(OBW)</b> | <b>Sample 07D<br/>(Broadcom)<br/>(OBW)</b> | <b>Sample 08D<br/>(Broadcom)<br/>(OBW)</b> |
|----------------------------------|---|---|--|--|
| CH.177 (5885 MHz)<br>@ 20 MHz    | 17.5427 MHz<br>Figure 54                  | 17.4424 MHz<br>Figure 60                  | 17.6544 MHz<br>Figure 66                   | 17.6276 MHz<br>Figure 72                   |
| <b>MCS Index 3<br/>Channel #</b> | <b>Sample 14A<br/>(KEA)<br/>(OBW)</b>     | <b>Sample 15A<br/>(KEA) (OBW)</b>         | <b>Sample 16A<br/>(Cisco)<br/>(OBW)</b>    | <b>Sample 16G<br/>(Cisco)<br/>(OBW)</b>    |
| CH.177 (5885 MHz)<br>@ 20 MHz    | 17.5645 MHz<br>Figure 78                  | 17.5778 MHz<br>Figure 82                  | 17.5723 MHz<br>Figure 86                   | 17.5762 MHz<br>Figure 90                   |

**Table 9 – Conducted OBW – U-NII-4 Devices, OFDM MCS Index 5 Results**

| <b>MCS Index 5<br/>Channel #</b> | <b>Sample 05<br/>(Qualcomm)<br/>(OBW)</b> | <b>Sample 06<br/>(Qualcomm)<br/>(OBW)</b> | <b>Sample 07D<br/>(Broadcom)<br/>(OBW)</b> | <b>Sample 08D<br/>(Broadcom)<br/>(OBW)</b> |
|----------------------------------|---|---|--|--|
| CH.177 (5885 MHz)<br>@ 20 MHz    | 17.4157 MHz<br>Figure 55                  | 17.4910 MHz<br>Figure 61                  | 17.6491 MHz<br>Figure 67                   | 17.6325 MHz<br>Figure 73                   |
| <b>MCS Index 5<br/>Channel #</b> | <b>Sample 14A<br/>(KEA)<br/>(OBW)</b>     | <b>Sample 15A<br/>(KEA) (OBW)</b>         | <b>Sample 16A<br/>(Cisco)<br/>(OBW)</b>    | <b>Sample 16G<br/>(Cisco)<br/>(OBW)</b>    |
| CH.177 (5885 MHz)<br>@ 20 MHz    | 17.5879 MHz<br>Figure 79                  | 17.5788 MHz<br>Figure 83                  | 17.5905 MHz<br>Figure 87                   | 17.5908 MHz<br>Figure 91                   |

### 6.1.2 Conducted Occupied Bandwidth for DSRC Devices

Tables 10 through 13 summarize the occupied bandwidth test results for each DSRC device. DSRC devices were tested with modulation and coding schemes (MCS) of 0, 1, 3 and 5, and bandwidths of 10 MHz and 20 MHz. Tables 10 through 13 show occupied bandwidth (bandwidth containing 99% of the integrated power) test results. Corresponding plots also show the -26 dB bandwidth test results.

**Table 10 – Conducted OBW, DSRC devices, OFDM MCS Index 0 results**

| MCS Index 0<br>Channel #      | Sample 01<br>(DSRC 1)<br>(OBW) | Sample 02<br>(DSRC 1)<br>(OBW) | Sample 03<br>(DSRC 1)<br>(OBW) | Sample 04<br>(DSRC 1)<br>(OBW) |
|-------------------------------|--------------------------------|--------------------------------|--------------------------------|--------------------------------|
| CH.172 (5860 MHz)<br>@ 10 MHz | 8.1323 MHz<br>Figure 92        | 8.1311 MHz<br>Figure 97        | 8.1305 MHz<br>Figure 102       | 8.1184 MHz<br>Figure 107       |
| CH.175 (5875 MHz)<br>@ 20 MHz | 16.2756 MHz<br>Figure 96       | 16.2598 MHz<br>Figure 101      | 16.2401 MHz<br>Figure 106      | 16.2662 MHz<br>Figure 111      |
| MCS Index 0<br>Channel #      | Sample 26A<br>(OBW)            | Sample 29A<br>(OBW)            | Sample 13A<br>(KEA)<br>(OBW)   | Sample 16F<br>(Cisco)<br>(OBW) |
| CH.172 (5860 MHz)<br>@ 10 MHz | 8.0034 MHz<br>Figure 114       | 8.2723 MHz<br>Figure 118       | 8.1000 MHz<br>Figure 112       | 39.6400 MHz<br>Figure 113      |
| CH.175 (5875 MHz)<br>@ 20 MHz |                                | 16.5354 MHz<br>Figure 101      |                                |                                |
| MCS Index 0<br>Channel #      | Sample 31<br>(DSRC 4)<br>(OBW) |                                |                                |                                |
| CH.177 (5885 MHz)<br>@ 20 MHz | 16.2341 MHz<br>Figure 123      |                                |                                |                                |

**Table 11 – Conducted OBW, DSRC devices, OFDM MCS Index 1 results**

| MCS Index 1<br>Channel #      | Sample 01<br>(DSRC 1)<br>(OBW)  | Sample 02<br>(DSRC 1)<br>(OBW)  | Sample 03<br>(DSRC 1)<br>(OBW) | Sample 04<br>(DSRC 1)<br>(OBW) |
|-------------------------------|---------------------------------|---------------------------------|--------------------------------|--------------------------------|
| CH.172 (5860 MHz) @<br>10 MHz | 8.1501 MHz<br>Figure 93         | 8.1319 MHz<br>Figure 98         | 8.1323 MHz<br>Figure 103       | 8.1345 MHz<br>Figure 108       |
| MCS Index 1<br>Channel #      | Sample 26A<br>(DSRC 2)<br>(OBW) | Sample 29A<br>(DSRC 3)<br>(OBW) |                                |                                |
| CH.172 (5860 MHz) @<br>10 MHz | 8.0191 MHz<br>Figure 115        | 8.2490 MHz<br>Figure 119        |                                |                                |
| MCS Index 1<br>Channel #      | Sample 31<br>(DSRC 4)<br>(OBW)  |                                 |                                |                                |
| CH.177 (5885 MHz) @<br>20 MHz | 16.2451 MHz<br>Figure 124       |                                 |                                |                                |

**Table 12 – Conducted OBW, DSRC devices, OFDM MCS Index 3 results**

| <b>MCS Index 3<br/>Channel #</b> | <b>Sample 01<br/>(DSRC 1)<br/>(OBW)</b>  | <b>Sample 02<br/>(DSRC 1)<br/>(OBW)</b>  | <b>Sample 03<br/>(DSRC 1)<br/>(OBW)</b> | <b>Sample 04<br/>(DSRC 1)<br/>(OBW)</b> |
|----------------------------------|--|--|---|---|
| CH.172 (5860 MHz) @<br>10 MHz    | 8.1082 MHz<br>Figure 94                  | 8.1494 MHz<br>Figure 99                  | 8.1430 MHz<br>Figure 104                | 8.1509 MHz<br>Figure 109                |
| <b>MCS Index 3<br/>Channel #</b> | <b>Sample 26A<br/>(DSRC 2)<br/>(OBW)</b> | <b>Sample 29A<br/>(DSRC 3)<br/>(OBW)</b> |   |   |
| CH.172 (5860 MHz) @<br>10 MHz    | 8.0401 MHz<br>Figure 116                 | 8.2500 MHz<br>Figure 120                 |   |   |

**Table 13 – Conducted OBW, DSRC devices, OFDM MCS Index 5 results**

| <b>MCS Index 5<br/>Channel #</b> | <b>Sample 01<br/>(DSRC 1)<br/>(OBW)</b>  | <b>Sample 02<br/>(DSRC 1)<br/>(OBW)</b>  | <b>Sample 03<br/>(DSRC 1)<br/>(OBW)</b> | <b>Sample 04<br/>(DSRC 1)<br/>(OBW)</b> |
|----------------------------------|--|--|---|---|
| CH.172 (5860 MHz) @<br>10 MHz    | 8.1675 MHz<br>Figure 95                  | 8.1912 MHz<br>Figure 100                 | 8.1650 MHz<br>Figure 105                | 8.1591 MHz<br>Figure 110                |
| <b>MCS Index 5<br/>Channel #</b> | <b>Sample 26A<br/>(DSRC 2)<br/>(OBW)</b> | <b>Sample 29A<br/>(DSRC 3)<br/>(OBW)</b> |   |   |
| CH.172 (5860 MHz) @<br>10 MHz    | 8.0448 MHz<br>Figure 117                 | 8.2554 MHz<br>Figure 121                 |   |   |



### 6.1.3 Conducted Average Channel Power Tests for U-NII-4 Devices

Tables 14 through 17 summarize the average channel power test results for each U-NII-4 device. U-NII-4 devices were tested with modulation and coding schemes (MCS) of 0, 1, 3 and 5, and bandwidths of 20 MHz, 40 MHz and 80 MHz.

**Table 14 – Conducted ACP, U-NII-4 devices, OFDM MCS Index 0 results**

| MCS Index 0<br>Channel #      | Sample 05<br>(Qualcomm)<br>(ACP) | Sample 06<br>(Qualcomm)<br>(ACP) | Sample 07D<br>(Broadcom)<br>(ACP) | Sample 08D<br>(Broadcom)<br>(ACP) |
|-------------------------------|----------------------------------|----------------------------------|-----------------------------------|-----------------------------------|
| CH.177 (5885 MHz)<br>@ 20 MHz | 18.650 dBm<br>Figure 125         | 17.489 dBm<br>Figure 131         | 9.749 dBm<br>Figure 137           | 9.204 dBm<br>Figure 143           |
| CH.175 (5875 MHz)<br>@ 40 MHz | 19.219 dBm<br>Figure 129         | 18.568 dBm<br>Figure 135         | 9.116 dBm<br>Figure 141           | 8.079 dBm<br>Figure 147           |
| CH.171 (5855 MHz)<br>@ 80 MHz | 15.935 dBm<br>Figure 130         | 16.104 dBm<br>Figure 136         | 9.786 dBm<br>Figure 142           | 8.873 dBm<br>Figure 148           |
| MCS Index 0<br>Channel #      | Sample 14A<br>(KEA) (ACP)        | Sample 15A<br>(KEA)<br>(ACP)     | Sample 16A<br>(Cisco) (ACP)       | Sample 16G<br>(Cisco) (ACP)       |
| CH.177 (5885 MHz)<br>@ 20 MHz | 15.675 dBm<br>Figure 149         | 14.547 dBm<br>Figure 153         | 9.945 dBm<br>Figure 157           | 9.710 dBm<br>Figure 161           |
| CH.175 (5875 MHz)<br>@ 40 MHz | Not Available                    | Not Available                    | Not Available                     | Not Available                     |
| CH.171 (5855 MHz)<br>@ 80 MHz | Not Available                    | Not Available                    | Not Available                     | Not Available                     |

**Table 15 – Conducted ACP, U-NII-4 devices, OFDM MCS Index 1 results**

| MCS Index 1<br>Channel #      | Sample 05<br>(Qualcomm)<br>(ACP) | Sample 06<br>(Qualcomm)<br>(ACP) | Sample 07D<br>(Broadcom)<br>(ACP) | Sample 08D<br>(Broadcom)<br>(ACP) |
|-------------------------------|----------------------------------|----------------------------------|-----------------------------------|-----------------------------------|
| CH.177 (5885 MHz) @<br>20 MHz | 18.821 dBm<br>Figure 126         | 20.289 dBm<br>Figure 132         | 9.499 dBm<br>Figure 138           | 9.122 dBm<br>Figure 144           |
| MCS Index 1<br>Channel #      | Sample 14A<br>(KEA)<br>(ACP)     | Sample 15A<br>(KEA)<br>(ACP)     | Sample 16A<br>(Cisco) (ACP)       | Sample 16G<br>(Cisco) (ACP)       |
| CH.177 (5885 MHz) @<br>20 MHz | 15.212 dBm<br>Figure 150         | 14.059 dBm<br>Figure 154         | 8.808 dBm<br>Figure 158           | 9.109 dBm<br>Figure 162           |
| CH.175 (5875 MHz) @<br>40 MHz | Not Available                    | Not Available                    | Not Available                     | Not Available                     |
| CH.171 (5855 MHz) @<br>80 MHz | Not Available                    | Not Available                    | Not Available                     | Not Available                     |

**Table 16 – Conducted ACP, U-NII-4 devices, OFDM MCS Index 3 results**

| <b>MCS Index 3<br/>Channel #</b> | <b>Sample 05<br/>(Qualcomm)<br/>(ACP)</b> | <b>Sample 06<br/>(Qualcomm)<br/>(ACP)</b> | <b>Sample 07D<br/>(Broadcom)<br/>(ACP)</b> | <b>Sample 08D<br/>(Broadcom)<br/>(ACP)</b> |
|----------------------------------|---|---|--|--|
| CH.177 (5885 MHz) @<br>20 MHz    | 18.588 dBm<br>Figure 127                  | 19.993 dBm<br>Figure 133                  | 9.315 dBm<br>Figure 139                    | 8.983 dBm<br>Figure 145                    |
| <b>MCS Index 3<br/>Channel #</b> | <b>Sample 14A<br/>(KEA) (ACP)</b>         | <b>Sample 15A<br/>(KEA) (ACP)</b>         | <b>Sample 16A<br/>(Cisco)<br/>(ACP)</b>    | <b>Sample 16G<br/>(Cisco)<br/>(ACP)</b>    |
| CH.177 (5885 MHz) @<br>20 MHz    | 14.822 dBm<br>Figure 151                  | 13.358 dBm<br>Figure 155                  | 7.557 dBm<br>Figure 159                    | 7.766 dBm<br>Figure 163                    |
| CH.175 (5875 MHz) @<br>40 MHz    | Not Available                             | Not Available                             | Not Available                              | Not Available                              |
| CH.171 (5855 MHz) @<br>80 MHz    | Not Available                             | Not Available                             | Not Available                              | Not Available                              |

**Table 17 – Conducted ACP, U-NII-4 devices, OFDM MCS Index 5 results**

| <b>MCS Index 5<br/>Channel #</b> | <b>Sample 05<br/>(Qualcomm)<br/>(ACP)</b> | <b>Sample 06<br/>(Qualcomm)<br/>(ACP)</b> | <b>Sample 07D<br/>(Broadcom)<br/>(ACP)</b> | <b>Sample 08D<br/>(Broadcom)<br/>(ACP)</b> |
|----------------------------------|---|---|--|--|
| CH.177 (5885 MHz) @<br>20 MHz    | 18.499 dBm<br>Figure 128                  | 18.331 dBm<br>Figure 134                  | 9.094 dBm<br>Figure 140                    | 8.629 dBm<br>Figure 146                    |
| <b>MCS Index 5<br/>Channel #</b> | <b>Sample 14A<br/>(KEA)<br/>(ACP)</b>     | <b>Sample 15A<br/>(KEA) (ACP)</b>         | <b>Sample 16A<br/>(Cisco)<br/>(ACP)</b>    | <b>Sample 16G<br/>(Cisco)<br/>(ACP)</b>    |
| CH.177 (5885 MHz) @<br>20 MHz    | 13.879 dBm<br>Figure 152                  | 12.577 dBm<br>Figure 156                  | 6.305 dBm<br>Figure 160                    | 5.798 dBm<br>Figure 164                    |
| CH.175 (5875 MHz) @<br>40 MHz    | Not Available                             | Not Available                             | Not Available                              | Not Available                              |
| CH.171 (5855 MHz) @<br>80 MHz    | Not Available                             | Not Available                             | Not Available                              | Not Available                              |

### 6.1.4 Conducted Average Channel Power Tests for DSRC Devices

Tables 18 through 21 summarize the average channel power test results for each DSRC device. DSRC devices were tested with modulation and coding schemes (MCS) of 0, 1, 3 and 5, and bandwidths of 10 MHz and 20 MHz.

**Table 18 – Conducted ACP, DSRC devices, OFDM MCS Index 0 results**

| MCS Index 0<br>Channel #      | Sample 01<br>(DSRC 1)<br>(ACP)  | Sample 02<br>(DSRC 1)<br>(ACP)  | Sample 03<br>(DSRC 1)<br>(ACP) | Sample 04<br>(DSRC 1)<br>(ACP) |
|-------------------------------|---------------------------------|---------------------------------|--------------------------------|--------------------------------|
| CH.172 (5860 MHz) @<br>10 MHz | 17.004 dBm<br>Figure 165        | 16.077 dBm<br>Figure 170        | 15.905 dBm<br>Figure 175       | 15.984 dBm<br>Figure 180       |
| CH.175 (5875 MHz) @<br>20 MHz | 13.006 dBm<br>Figure 169        | 11.516 dBm<br>Figure 174        | 12.303 dBm<br>Figure 179       | 11.226 dBm<br>Figure 184       |
| MCS Index 0<br>Channel #      | Sample 26A<br>(DSRC 2)<br>(ACP) | Sample 29A<br>(DSRC 3)<br>(ACP) |                                |                                |
| CH.172 (5860 MHz) @<br>10 MHz | 20.066 dBm<br>Figure 186        | 8.603 dBm<br>Figure 190         |                                |                                |
| CH.175 (5875 MHz) @<br>20 MHz |                                 | 6.681 dBm<br>Figure 194         |                                |                                |

**Table 19 – Conducted ACP, DSRC devices, OFDM MCS Index 1 results**

| MCS Index 1<br>Channel #      | Sample 01<br>(DSRC 1)<br>(ACP)  | Sample 02<br>(DSRC 1)<br>(ACP)  | Sample 03<br>(DSRC 1)<br>(ACP) | Sample 04<br>(DSRC 1)<br>(ACP) |
|-------------------------------|---------------------------------|---------------------------------|--------------------------------|--------------------------------|
| CH.172 (5860 MHz) @<br>10 MHz | 15.267 dBm<br>Figure 166        | 14.456 dBm<br>Figure 171        | 14.553 dBm<br>Figure 176       | 14.500 dBm<br>Figure 181       |
| MCS Index 1<br>Channel #      | Sample 26A<br>(DSRC 2)<br>(ACP) | Sample 29A<br>(DSRC 3)<br>(ACP) |                                |                                |
| CH.172 (5860 MHz) @<br>10 MHz | 19.225 dBm<br>Figure 187        | 7.815 dBm<br>Figure 191         |                                |                                |
| MCS Index 1<br>Channel #      | Sample 31<br>(DSRC 4)<br>(ACP)  |                                 |                                |                                |
| CH.177 (5885 MHz) @<br>20 MHz | 9.410 dBm<br>Figure 196         |                                 |                                |                                |

**Table 20 – Conducted ACP, DSRC devices, OFDM MCS Index 3 results**

| MCS Index 3<br>Channel #      | Sample 01<br>(DSRC 1)<br>(ACP)  | Sample 02<br>(DSRC 1)<br>(ACP)  | Sample 03<br>(DSRC 1)<br>(ACP) | Sample 04<br>(DSRC 1)<br>(ACP) |
|-------------------------------|---------------------------------|---------------------------------|--------------------------------|--------------------------------|
| CH.172 (5860 MHz) @<br>10 MHz | 12.943 dBm<br>Figure 167        | 12.139 dBm<br>Figure 172        | 11.907 dBm<br>Figure 177       | 11.638 dBm<br>Figure 182       |
| MCS Index 3<br>Channel #      | Sample 26A<br>(DSRC 2)<br>(ACP) | Sample 29A<br>(DSRC 3)<br>(ACP) |                                |                                |
| CH.172 (5860 MHz) @<br>10 MHz | 18.712 dBm<br>Figure 188        | 4.746 dBm<br>Figure 192         |                                |                                |

**Table 21 – Conducted ACP, DSRC devices, OFDM MCS Index 5 results**

| MCS Index 5<br>Channel #      | Sample 01<br>(DSRC 1)<br>(ACP)  | Sample 02<br>(DSRC 1)<br>(ACP)  | Sample 03<br>(DSRC 1)<br>(ACP) | Sample 04<br>(DSRC 1)<br>(ACP) |
|-------------------------------|---------------------------------|---------------------------------|--------------------------------|--------------------------------|
| CH.172 (5860 MHz) @<br>10 MHz | 10.382 dBm<br>Figure 168        | 8.705 dBm<br>Figure 173         | 10.156 dBm<br>Figure 178       | 9.269 dBm<br>Figure 183        |
| MCS Index 5<br>Channel #      | Sample 26A<br>(DSRC 2)<br>(ACP) | Sample 29A<br>(DSRC 3)<br>(ACP) |                                |                                |
| CH.172 (5860 MHz) @<br>10 MHz | 14.971 dBm<br>Figure 189        | 5.062 dBm<br>Figure 193         |                                |                                |

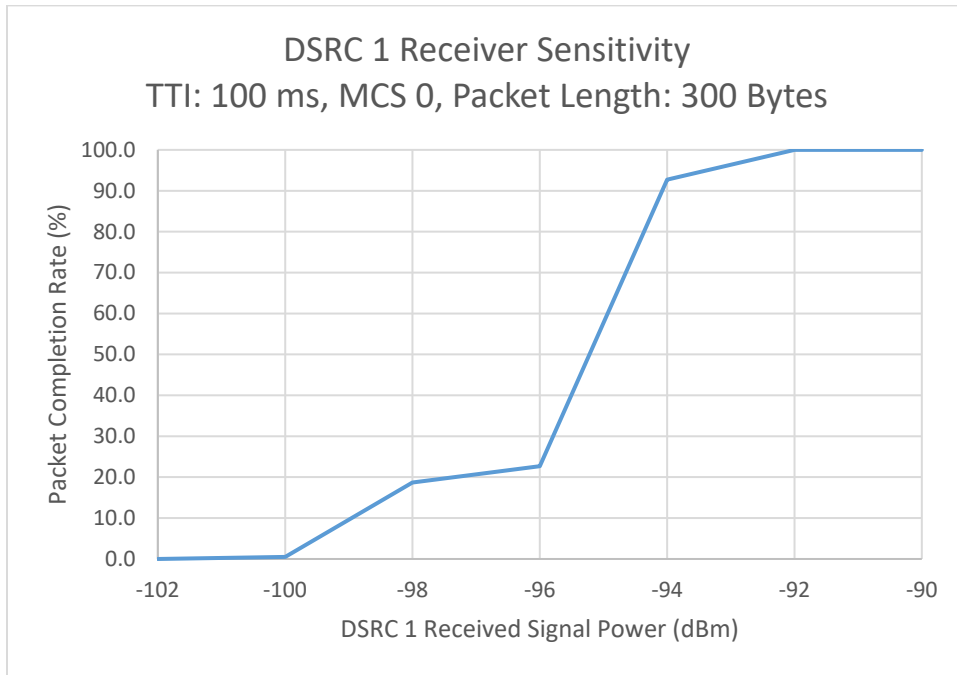
### 6.1.5 Conducted Out of Band Emissions (OOBE) Tests

See Appendix B for the conducted OOBE test plots. Using an RF Spectrum Analyzer, each of the U-NII-4 device’s antenna ports were examined for OOBE, from 5555 MHz to 6155 MHz. The OOBE scans were recorded from 5555-6155 MHz for U-NII-4 devices set to Channel 171, 5795-5935 MHz for U-NII-4 devices set to Channel 173, 5575-6175 MHz for U-NII-4 devices set to Channel 175, and 5815-5955 MHz for U-NII-4 devices set to Channel 177.

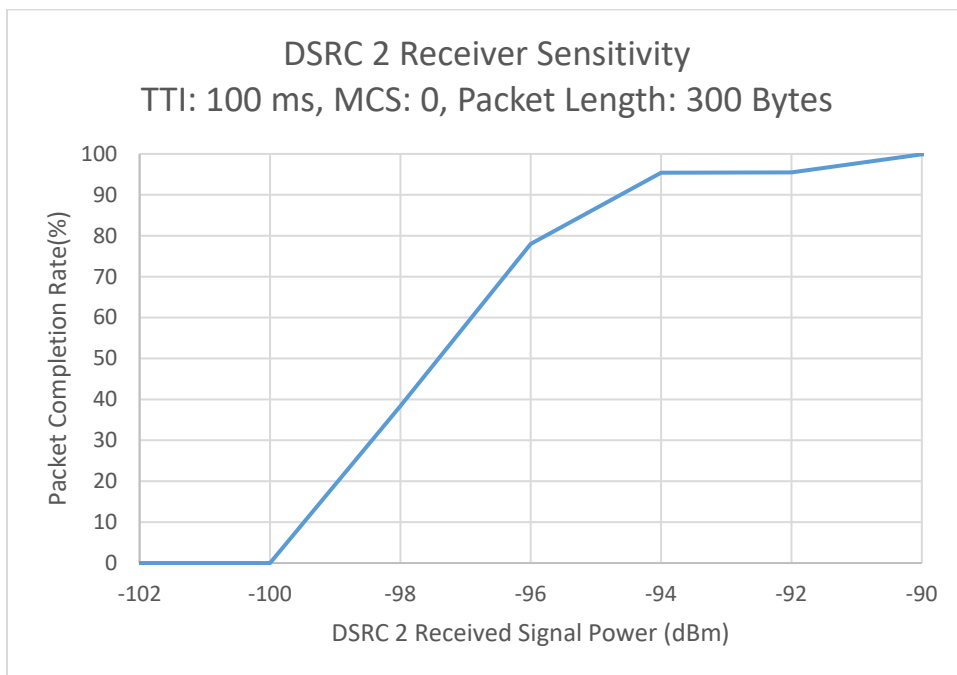
For the DSRC OOBE measurements, each device was set to Channel 172 and scanned for spurious emissions between 5790 MHz to 5930 MHz. Additionally, DSRC Channel 175 OOBE scans were recorded from 5800 to 5945 MHz, using the ‘worst-case’ MCS Index designator’s OBW reading from DSRC Channel 172.

### 6.1.6 DSRC Receiver Sensitivity Tests

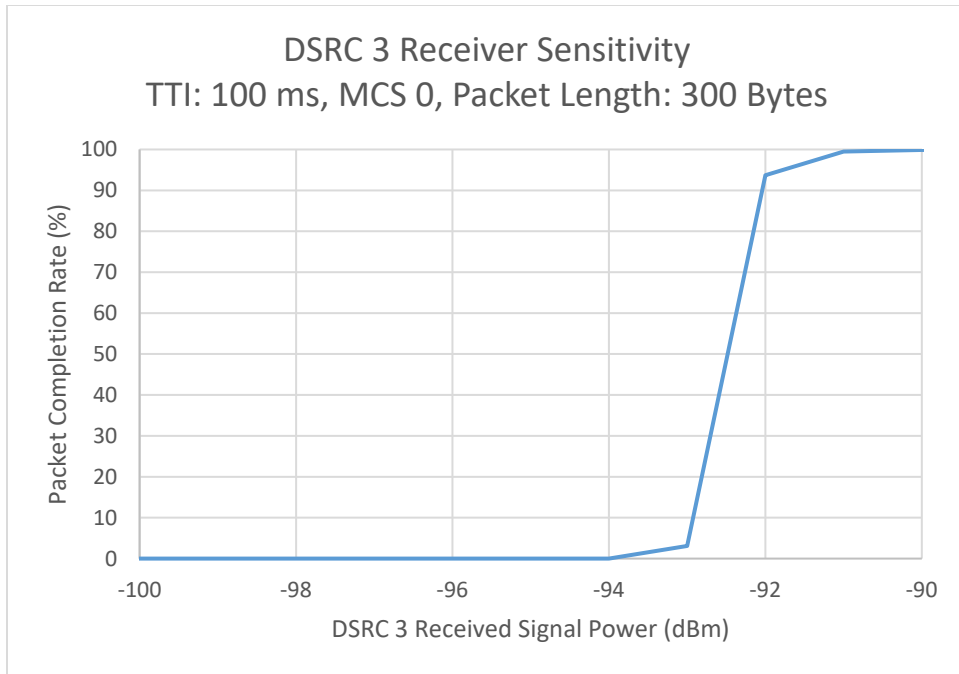
Figures 6 through 9 show the receiver sensitivity test results of the DSRC devices.



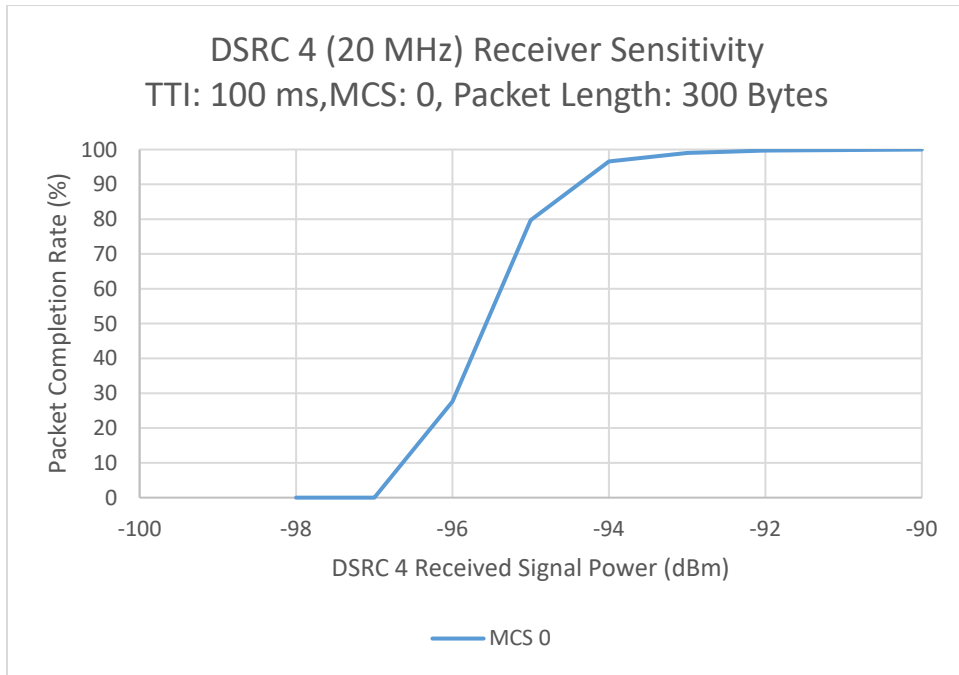
**Figure 6 – DSRC 1 (Sample # 29A) Receiver Sensitivity, Channel 172**



**Figure 7 – DSRC 2 (Sample # 26A) Receiver Sensitivity, Channel 172**



**Figure 8 – DSRC 3 (Sample # 01) Receiver Sensitivity, Channel 172**



**Figure 9 – DSRC 4 (Sample # 31) Receiver Sensitivity, Channel 172**

## **6.2 U-NII-4 and DSRC Unmitigated Interaction Test Results**

U-NII-4 and DSRC unmitigated interaction test results are presented in this section. Responses of DSRC devices have been expressed in terms of Packet Completion Rate (PCR), and plotted as a function of undesired signal (IEEE 802.11 or IEEE 802.11ac) power level. Desired signal levels have also been recorded and the PCRs could also be plotted as a function of desired signal to interference ratio (S/I).

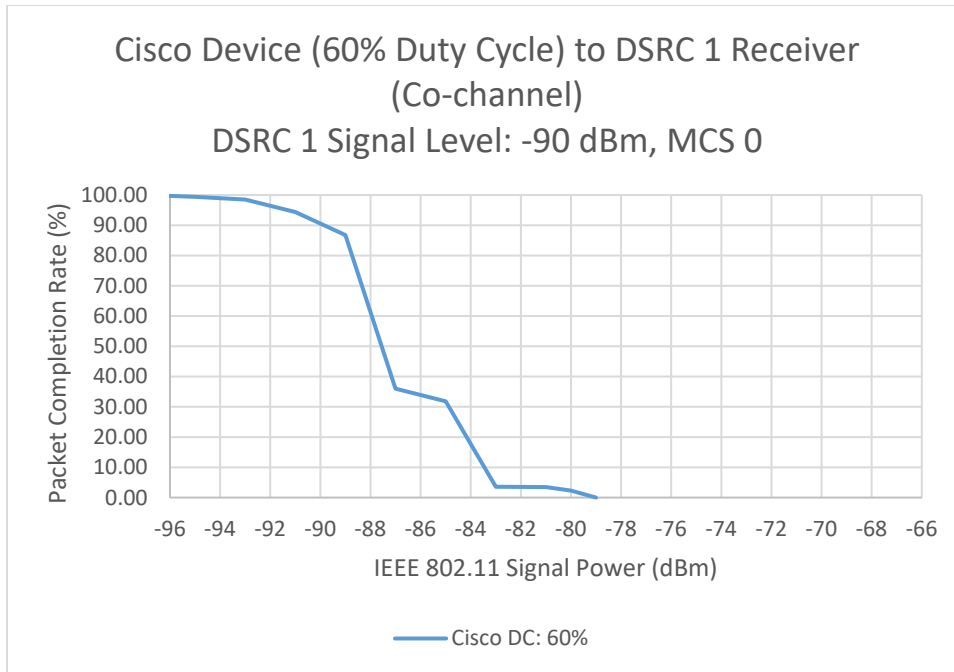
The data collected from these tests were intended to aid in understanding the behavior of the DSRC components (transmitters and receivers) in a co-channel and adjacent channel interaction rather than to inform an evaluation of the proposed mitigation strategies. The data from these tests also served to facilitate a qualitative assessment of adjacent channel rejection (ACR) capability of DSRC devices.

### **6.2.1 Cisco Device to DSRC 1**

#### **6.2.1.1 DSRC 1 Receiver Response to 20 MHz IEEE 802.11 Signal Transmission- Co-channel Interactions**

Of the three submitted U-NII-4 devices, the Cisco AP and STA were capable of only transmitting legacy IEEE 802.11 and IEEE 802.11n (HT) signals. Therefore, Cisco's signal configuration and transmission profile were not identical to Broadcom's or Qualcomm's IEEE 802.11ac (VHT) transmission. To examine co-channel and adjacent channel interactions, the IEEE 802.11 packet length was set to approximately 238 microseconds (1450 bytes using 64-QAM modulation scheme with a  $\frac{3}{4}$  rate coding) that roughly corresponded to a data rate of 58 Mbps. This configuration resulted in channel occupancy factors of 55% to 70%, with a nominal occupancy of 60%.

Figure 10 shows the impact of a co-channel IEEE 802.11 signal transmission (unmitigated) on the DSRC 1 receiver packet reception ability. The DSRC 1 receiver is tuned to channel 176 (5880 MHz) and the IEEE 802.11 signal (generated by the Cisco device) is a 20-MHz wide transmission centered at 5885 MHz (channel 177). The DSRC 1 received signal power (desired signal) is -90 dBm at the input to its receiver antenna port. The DSRC 1 BSM transmission rate is 10 Hz.

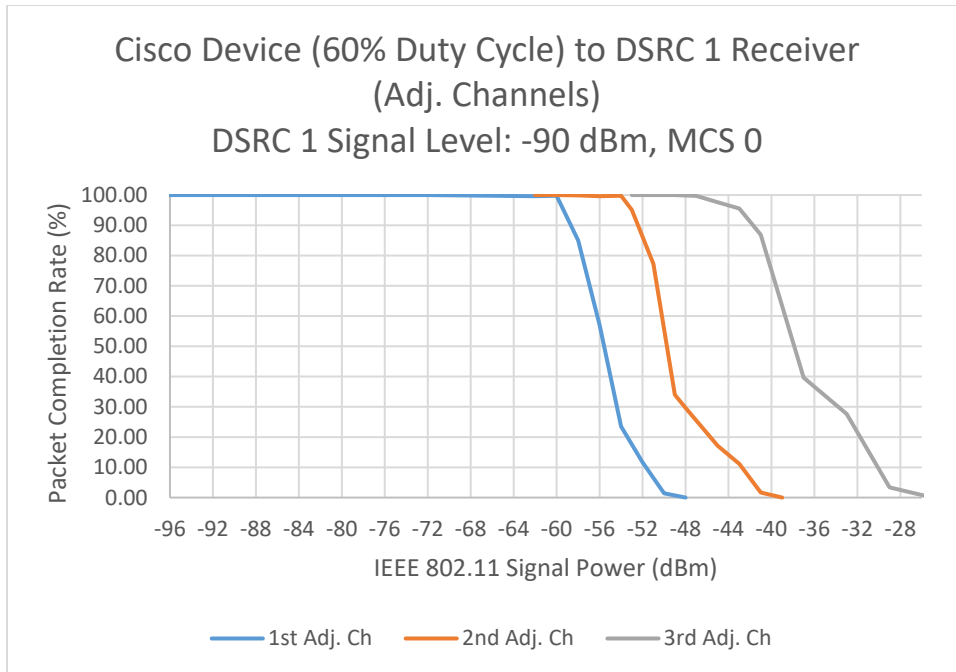


**Figure 10 – Cisco Device to DSRC 1 Receiver, Co-channel Interaction**

**6.2.1.2 DSRC 1 Receiver Response to 20 MHz IEEE 802.11 Signal Transmission - Adjacent Channel Interactions**

Figure 11 shows the impact of an off-tune (1<sup>st</sup>, 2<sup>nd</sup> and 3<sup>rd</sup> adjacent channels) IEEE 802.11 signal transmission (unmitigated) on DSRC 1 packet reception ability. DSRC 1 receiver is tuned to channels 174, 172 and 184 respectively, and the IEEE 802.11 signal (generated by Cisco device) is a 20-MHz-wide transmission centered at 5885 MHz (channel 177). The IEEE 802.11 signal is modulated as 64-QAM with a 3/4 rate coding. The IEEE 802.11 transmission occupies the channel approximately 60% of the time. The DSRC 1 received signal power (desired signal) is -90 dBm at the input to its receiver antenna port. The DSRC 1 BSM transmission rate is 10 Hz.





**Figure 11 – Cisco Device (60% Duty Cycle) to DSRC 1 Receiver, Adj. channel Interactions**

### 6.2.1.3 DSRC 1 Transmitter Response to 20 MHz IEEE 802.11 Signal Transmission- Co-channel Interactions

In an equivalent manner to the DSRC 1 receiver test, an IEEE 802.11 signal was introduced to the RF path of the DSRC 1 transmitter. In this setup, the DSRC 1 receiver, associated with the DSRC 1 transmitter under test, is responsible for sensing the channel and prompting the DSRC 1 transmitter to take necessary actions upon detection of the IEEE 802.11 signal. At the same time, the second DSRC 1 receiver, while isolated from IEEE 802.11 signal, receives DSRC packets and processes them. To examine the co-channel and adjacent channel interactions, the IEEE 802.11 packet length was set to approximately 238 microseconds (1450 bytes using 64-QAM modulation with a 3/4 rate coding) that roughly corresponded to a 58 Mbps data rate. This configuration resulted in channel occupancy factors of 55% to 70%, with a nominal occupancy of 60%.

The DSRC 1 transmitter was set to transmit at its default power level (14 dBm at the antenna port). No remarkable degradation to the DSRC 1 transmitter's performance was observed while the IEEE 802.11 signal occupied the channel 60% of the time. To increase the IEEE 802.11 channel occupancy factor, the Cisco IEEE 802.11 transmitter was replaced with a simulated IEEE 802.11 signal (generated by Signal Studio) as the interfering source. No major degradation to the DSRC 1 transmitter was observed until the simulated IEEE 802.11 signal channel occupancy reached approximately 94%. Figure 12 shows the impact of the IEEE 802.11 co channel transmission (Cisco and Signal Studio) on the DSRC 1 transmitter. Given the IEEE 802.11 signal was isolated from DSRC 1 receiver, the degradation to PCR is primarily due to actions taken by the DSRC 1 transmitter. In this case, the DSRC 1 transmitter suppressed its packet transmission responding to channel busy statement declared by its associated receiver.

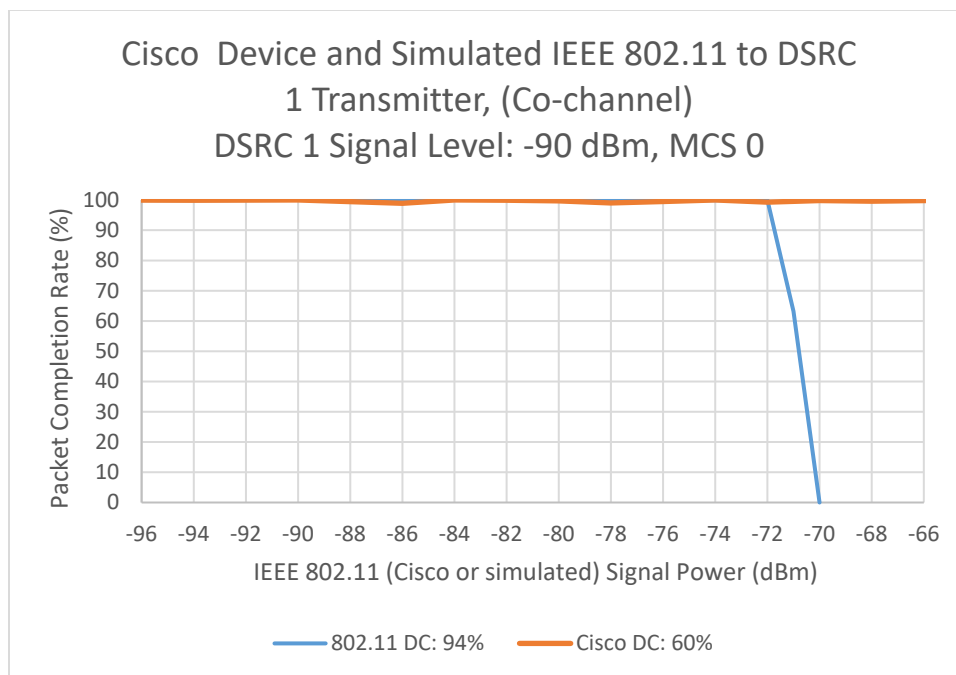


Figure 12 – Cisco Device (and Simulated IEEE 802.11) to DSRC 1 Transmitter, Co-channel Interactions

## 6.2.2 Qualcomm Device to DSRC 1

### 6.2.2.1 DSRC 1 Receiver Response to 20 MHz IEEE 802.11ac Signal Transmission- Co-channel Interactions

Figure 13 shows the impact of a co-channel IEEE 802.11 signal transmission (unmitigated) on DSRC 1 packet reception ability.

The DSRC 1 receiver is tuned to channel 176 (5880 MHz) and the IEEE 802.11ac signal (generated by the Qualcomm device) is a 20-MHz wide transmission centered at 5885 MHz (channel 177). The IEEE 802.11ac signal is modulated as 64-QAM with a  $\frac{3}{4}$  rate coding. The IEEE 802.11ac transmission channel occupancy is approximately 55% and 75%, respectively. The DSRC 1 received signal power (desired signal) is -90 dBm at the input to its receiver antenna port. The DSRC 1 BSM transmission rate is 10 Hz.

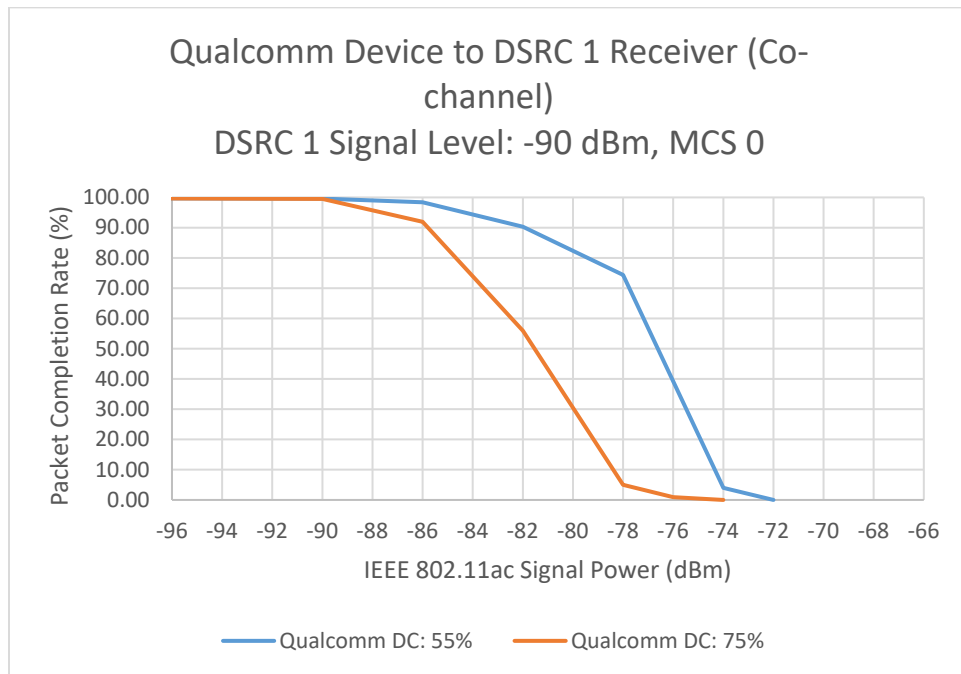


Figure 13 – Qualcomm Device to DSRC 1 Receiver, Co-channel Interaction

### 6.2.2.2 DSRC 1 Receiver Response to 20 MHz IEEE 802.11ac Signal Transmission - Adjacent Channel Interactions

Figures 14 and 15 show the impact of an off-tune (1<sup>st</sup>, 2<sup>nd</sup> and 3<sup>rd</sup> adjacent channels) IEEE 802.11ac signal transmission (unmitigated) on the DSRC 1 packet reception ability. The DSRC 1 receiver is tuned to channels 174, 172 and 184 respectively, and the IEEE 802.11ac signal (generated by Qualcomm device) is a 20-MHz wide transmission centered at 5885 MHz (channel 177). The IEEE 802.11ac signal is modulated as 64 QAM with a 3/4 rate coding. The IEEE 802.11ac transmission's channel occupancy is approximately 55% and 75%, respectively. The DSRC 1 received signal power (desired signal) is -90 dBm at the input to its receiver antenna port. The DSRC 1 BSM transmission rate is 10 Hz.

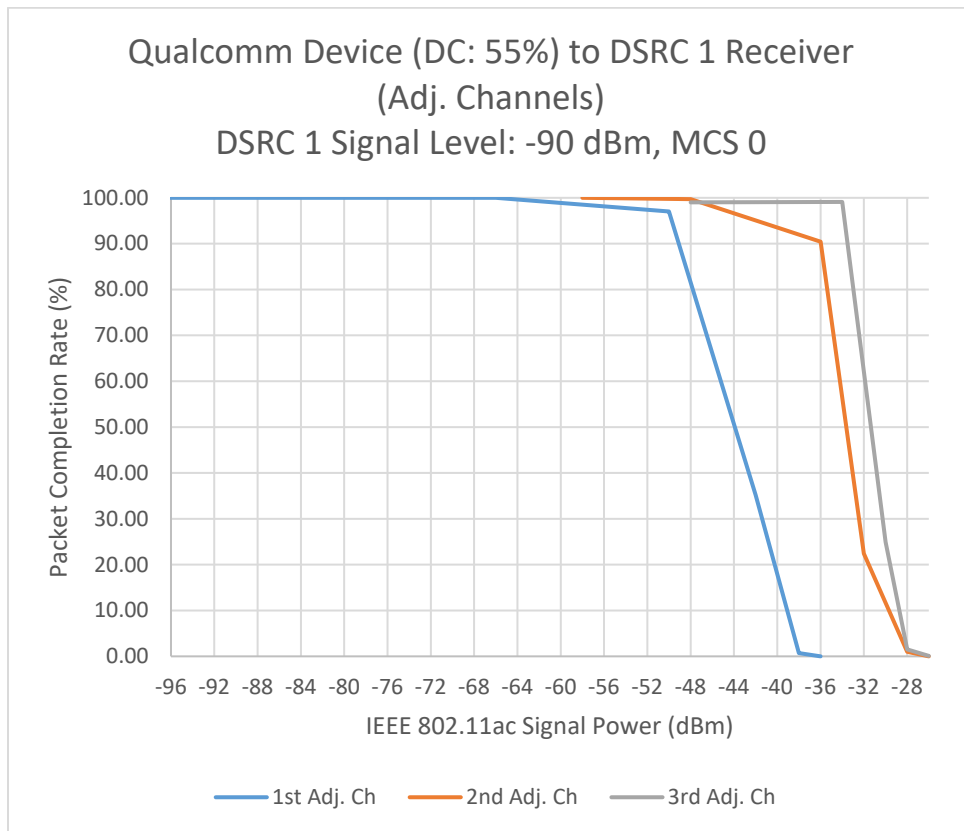
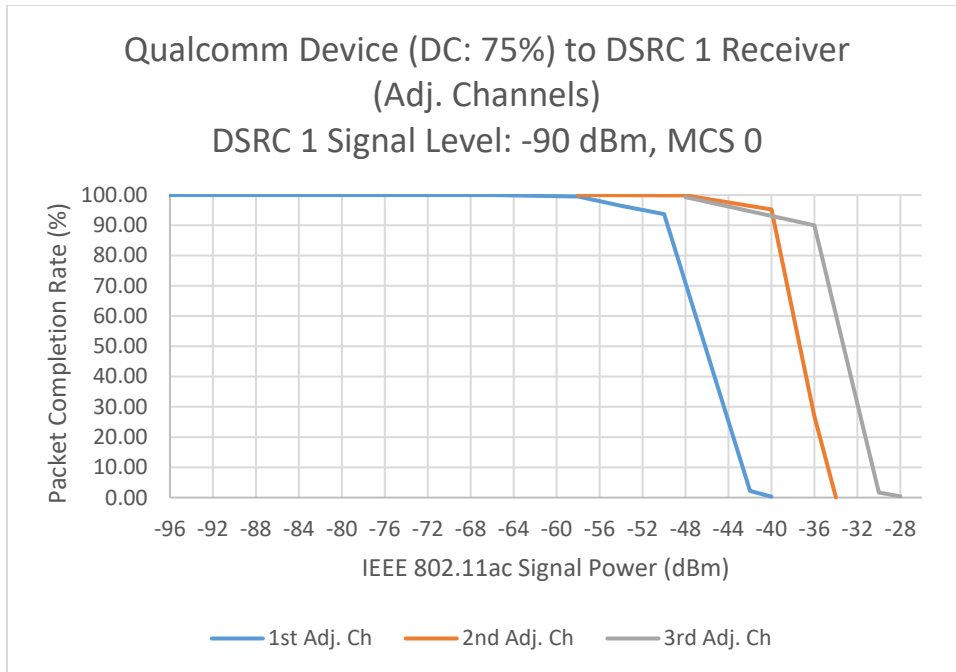


Figure 14 – Qualcomm Device (55% Duty Cycle) to DSRC 1 Receiver, Adj. channel Interactions



**Figure 15 – Qualcomm Device (75% Duty Cycle) to DSRC 1 Receiver, Adj. channel Interactions**

### **6.2.2.3 DSRC 1 Transmitter Response to 20-MHz IEEE 802.11ac Signal Transmission - Co-channel Interactions**

In an equivalent manner to the DSRC 1 receiver test, an IEEE 802.11ac signal was introduced to the RF path of the DSRC 1 transmitter. The DSRC 1 receiver was tuned to channel 176 (5880 MHz) and the IEEE 802.11ac signal (generated by Qualcomm device) was a 20-MHz-wide transmission centered at 5885 MHz (channel 177). The IEEE 802.11ac signal was modulated as 64 QAM with a  $\frac{3}{4}$  rate coding. The IEEE 802.11ac transmission's channel occupancy was approximately 55% and 75%, respectively. The DSRC 1 received signal power (desired signal) was -90 dBm at the input to its receiver antenna port. The DSRC 1 BSM transmission rate was 10 Hz. No major impact to the DSRC 1 transmitter was observed as the interference power level (IEEE 802.11ac) varied from -98 dBm to -2 dBm (measured at the DSRC antenna port). Adjacent channel interactions were not tested.

### 6.2.3 Broadcom Device to DSRC 1

#### 6.2.3.1 DSRC 1 Receiver Response to 20 MHz IEEE 802.11ac Signal Transmission - Co-channel Interactions

Figure 16 shows the impact of a co-channel IEEE 802.11ac signal transmission (unmitigated) on the DSRC 1 packet reception ability.

The DSRC 1 receiver is tuned to channel 176 (5880 MHz) and the IEEE 802.11ac signal (generated by Broadcom device) is a 20-MHz wide transmission centered at 5885 MHz (channel 177). The IEEE 802.11ac signal is modulated as 64-QAM with a  $\frac{3}{4}$  rate coding. The IEEE 802.11ac transmission's channel occupancy is approximately 55% and 75%, respectively. The DSRC 1 received signal power (desired signal) is -90 dBm at the input to its receiver antenna port. The DSRC 1 BSM transmission rate is 10 Hz.

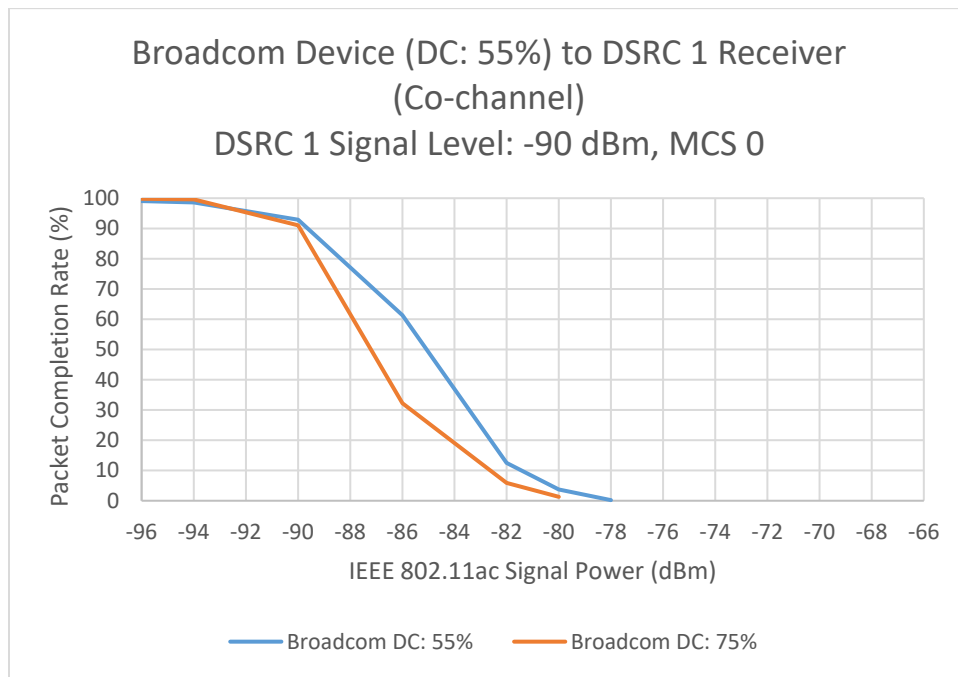
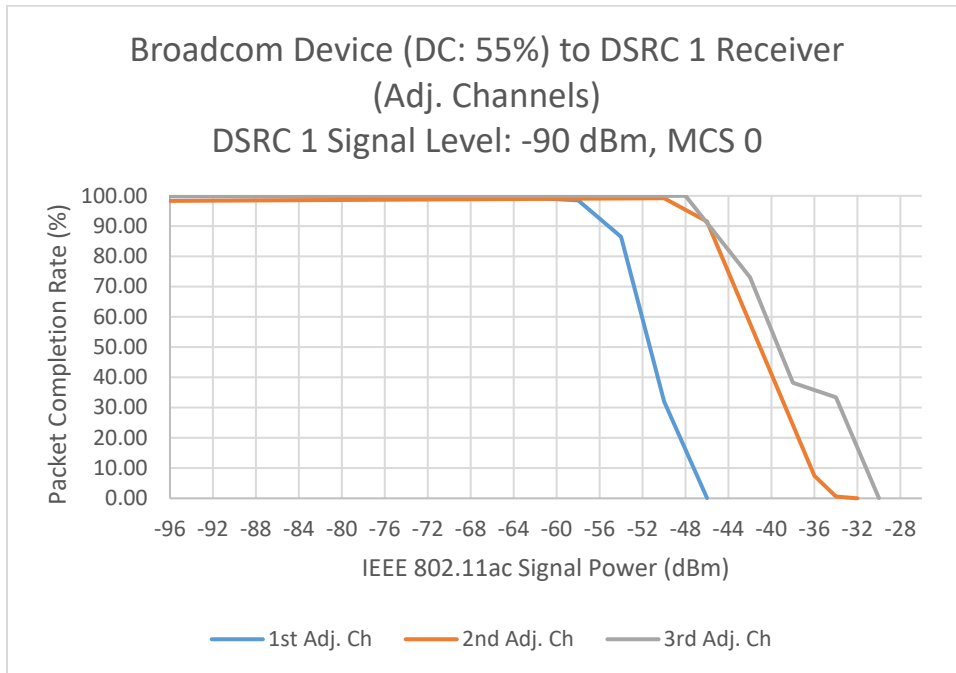


Figure 16 – Broadcom Device to DSRC 1 Receiver, Co-channel Interaction

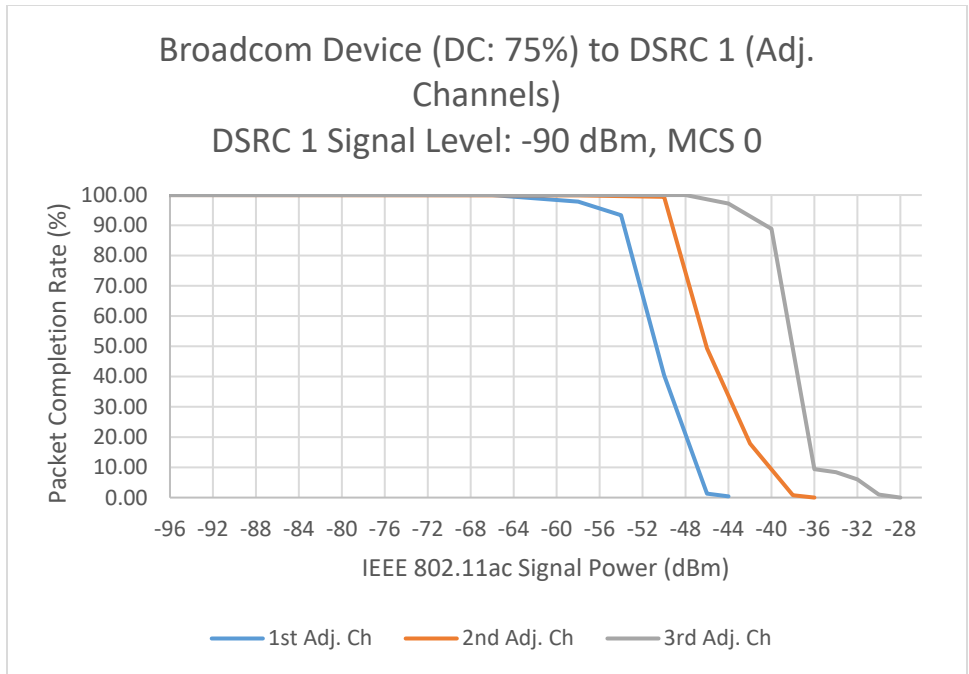
### 6.2.3.2 DSRC 1 Receiver Response to 20 MHz IEEE 802.11ac Signal Transmission - Adjacent Channel Interactions

Figures 17 and 18 show the impact of an off-tune (1<sup>st</sup>, 2<sup>nd</sup> and 3<sup>rd</sup> adjacent channels) IEEE 802.11ac signal transmission (unmitigated) on DSRC 1 packet reception ability. DSRC 1 receiver is tuned to channels 174, 172 and 184 respectively, and IEEE 802.11ac signal (generated by Broadcom device) is 20 MHz wide transmission centered at 5885 MHz (channel 177). IEEE 802.11ac signal is modulated as 64-QAM with a 3/4 rate coding. The IEEE 802.11ac transmission's channel occupancy is approximately 55% and 75%, respectively. The DSRC 1 received signal power (desired signal) is -90 dBm at the input to its receiver antenna port. The DSRC 1 BSM transmission rate is 10 Hz.



**Figure 17 – Broadcom Device (55% Duty Cycle) to DSRC 1 Receiver, Adj. channel Interactions**





**Figure 18 – Broadcom Device (75% Duty Cycle) to DSRC 1 Receiver, Adj. channel Interactions**

### **6.2.3.3 DSRC 1 Transmitter Response to 20 MHz IEEE 802.11ac Signal Transmission Co-Channel Interactions**

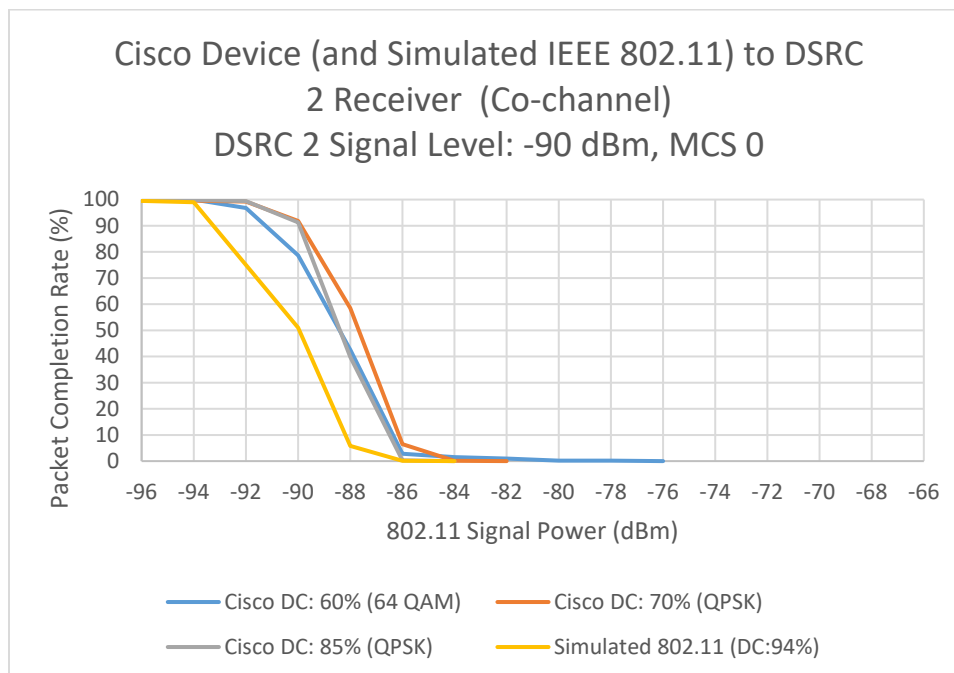
In an equivalent manner to the DSRC 1 receiver test, an IEEE 802.11ac signal was introduced to the RF path of the DSRC 1 transmitter. The DSRC 1 receiver was tuned to channel 176 (5880 MHz) and the IEEE 802.11ac signal (generated by the Broadcom device) was a 20-MHz-wide transmission centered at 5885 MHz (channel 177). The IEEE 802.11ac signal was modulated as 64 QAM with a  $\frac{3}{4}$  rate coding. The IEEE 802.11ac transmission's channel occupancy was approximately 55% and 75%, respectively. DSRC 1 received signal power (desired signal) was -90 dBm at the input to its receiver antenna port. DSRC 1 BSM transmission rate was 10 Hz. No major impact to DSRC 1 transmitter was observed as the interference power level (IEEE 802.11ac) varied from -98 dBm to -2 dBm (measured at DSRC antenna port). Adjacent channel interactions were not tested.

## 6.2.4 Cisco Device to DSRC 2

### 6.2.4.1 DSRC 2 Receiver Response to 20 MHz IEEE 802.11 Signal Transmission- Co-channel Interactions

Cisco AP and STA were capable of only transmitting legacy IEEE 802.11 signals up to IEEE 802.11n (HT). Therefore, Cisco's signal configuration and transmission profile was not identical to Broadcom's or Qualcomm's IEEE 802.11ac (VHT). To examine co-channel and adjacent channel interactions, the IEEE 802.11 packet length was set to approximately 238 microseconds (1450 bytes using 64-QAM modulation scheme with a  $\frac{3}{4}$  rate coding) that roughly corresponded to 58 Mbps data rate. This configuration resulted in channel occupancy factors of 55% to 70%, with a nominal occupancy of 60%. Additionally, the co-channel and adjacent channel interactions of DSRC 2 and Cisco devices were examined using nominal channel occupancy factors of 70% and 85% (non-HT QPSK modulation scheme with a  $\frac{1}{2}$  rate coding). Finally, the co-channel interaction of DSRC 2 and simulated IEEE 802.11ac signals was evaluated using Signal Studio. The Simulated IEEE 802.11ac transmission occupied the channel approximately 94% of the time using 16 QAM modulation scheme.

Figure 19 shows the impact of co-channel IEEE 802.11 signal transmission (unmitigated) on DSRC 2 receiver packet reception ability. DSRC 2 receiver is tuned to channel 176 (5880 MHz) and IEEE 802.11 signal (generated by Cisco device) is 20 MHz wide transmission centered at 5885 MHz (channel 177). The DSRC 2 received signal power (desired signal) is -90 dBm at the input to its receiver antenna port. The DSRC 2 BSM transmission rate is 10 Hz.



**Figure 19 – Cisco Device to DSRC 2 Receiver, Co-channel Interaction**

### 6.2.4.2 DSRC 2 Receiver Response to 20 MHz IEEE 802.11 Signal Transmission - Adjacent Channel Interactions

Figures 20 through 22 show the impact of off-tune (1<sup>st</sup>, 2<sup>nd</sup> and 3<sup>rd</sup> adjacent channels) IEEE 802.11 signal transmission (unmitigated) on DSRC 2 packet reception ability. DSRC 2 receiver is tuned to channels 174, 172 and 184 respectively, and IEEE 802.11 signal (generated by Cisco device) is a 20-MHz-wide transmission centered at 5885 MHz (channel 177). The IEEE 802.11 signal is modulated as 64-QAM with a 3/4 rate coding. The IEEE 802.11 transmission occupies the channel approximately 60%, 70% and 85% of the time, respectively. The DSRC 2 received signal power (desired signal) is -90 dBm at the input to its receiver antenna port. The DSRC 2 BSM transmission rate is 10 Hz.

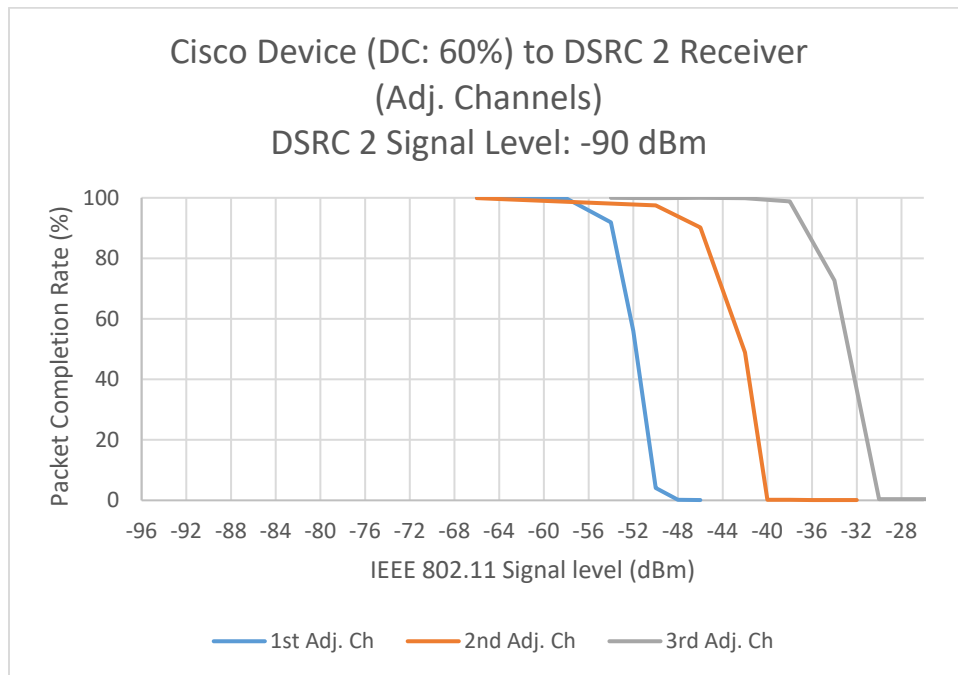
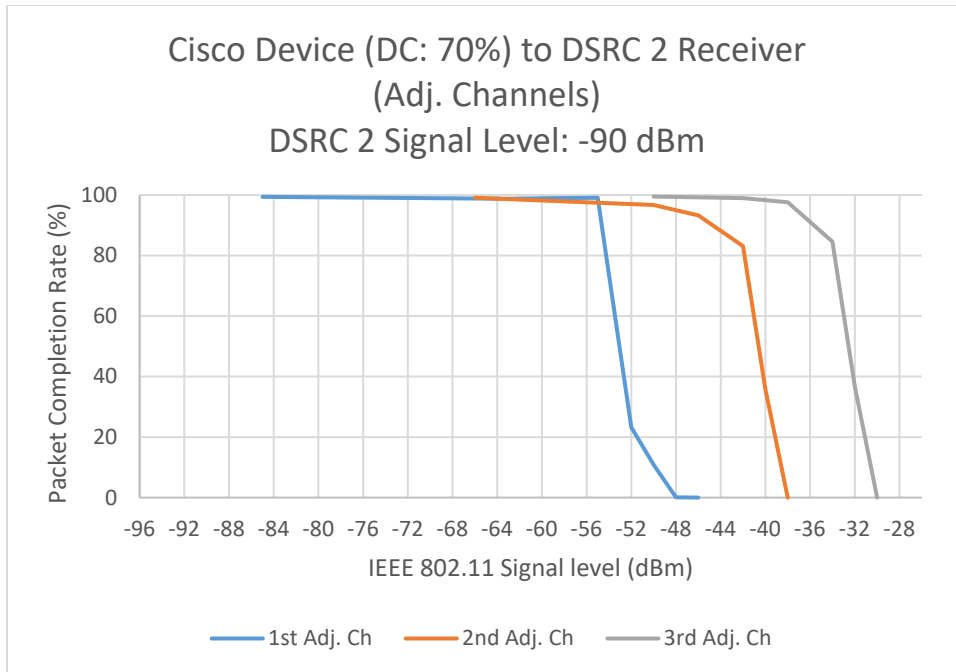
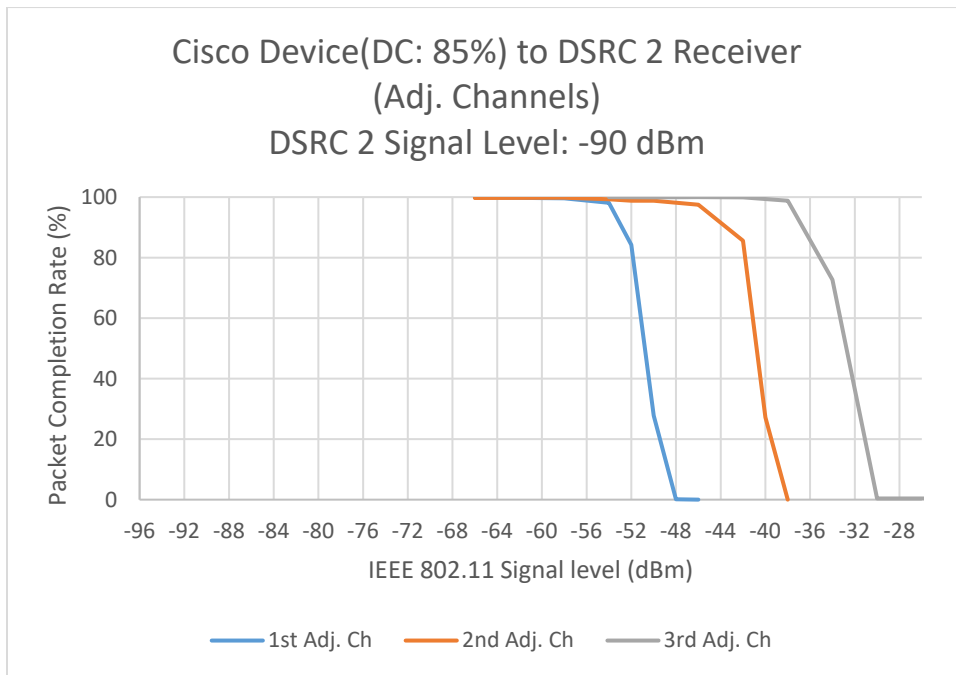


Figure 20 – Cisco Device (60% duty cycle) to DSRC 2 Receiver, Adj. channel Interactions



**Figure 21 – Cisco Device (70% duty cycle) to DSRC 2, Adj. channel Interactions**



**Figure 22 – Cisco Device (85% duty cycle) to DSRC 2 Receiver, Adj. channel Interactions**

### 6.2.4.3 DSRC 2 Transmitter Response to 20 MHz IEEE 802.11 Signal Transmission - Co-channel Interactions

In an equivalent manner to the DSRC 2 receiver test, an IEEE 802.11ac signal was introduced to the RF path of the DSRC 2 transmitter. To examine co-channel and adjacent channel interactions, the IEEE 802.11 packet length was set to approximately 238 microseconds (1450 bytes using 64-QAM modulation scheme with a  $\frac{3}{4}$  rate coding) that roughly corresponded to a data rate of 58 Mbps. This configuration resulted in channel occupancy factors of 55% to 70%, with a nominal occupancy of 60%. The DSRC 2 transmitter was set to transmit at its default power level (14 dBm referenced to antenna output). The test was repeated after increasing the IEEE 802.11 channel occupancy to 85%. No remarkable degradation to the DSRC 2 transmitter performance was observed while the IEEE 802.11 signal occupied the channel 60% or 85% of the time. To increase IEEE 802.11 channel occupancy, the Cisco IEEE 802.11 transmitter was replaced with an IEEE 802.11 signal generator (Signal Studio) as the source of interference. Degradation to DSRC 2 transmitter was observed when the simulated IEEE 802.11 signal channel occupancy reached approximately 90%. Figure 23 shows the impact of IEEE 802.11 co-channel transmission (Cisco and Signal Studio) on the DSRC 2 transmitter.

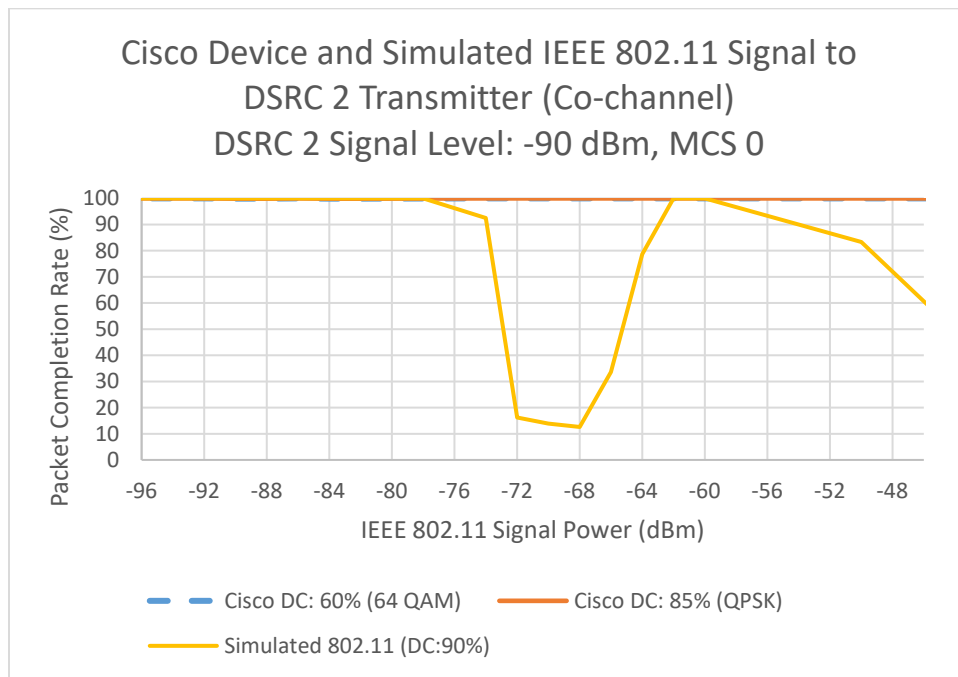


Figure 23 – Cisco Device (and Simulated IEEE 802.11 Signal) to DSRC 2 Transmitter, Co-channel Interactions

## 6.2.5 Qualcomm Device to DSRC 2

### 6.2.5.1 DSRC 2 Receiver Response to 20 MHz IEEE 802.11ac Signal Transmission - Co-channel Interactions

Figure 24 shows the impact co-channel IEEE 802.11 signal transmission (unmitigated) on DSRC 2 receiver packet reception ability. The DSRC 2 receiver is tuned to channel 176 (5880 MHz) and the IEEE 802.11ac signal (generated by Qualcomm device) is a 20-MHz-wide transmission centered at 5885 MHz (channel 177). The IEEE 802.11ac signal is modulated as 64-QAM with a  $\frac{3}{4}$  rate coding. The IEEE 802.11ac transmission's channel occupancy is approximately 55% and 75%, respectively. The DSRC 2 received signal power (desired signal) is -90 dBm at the input to its receiver antenna port. The DSRC 2 BSM transmission rate is 10 Hz.

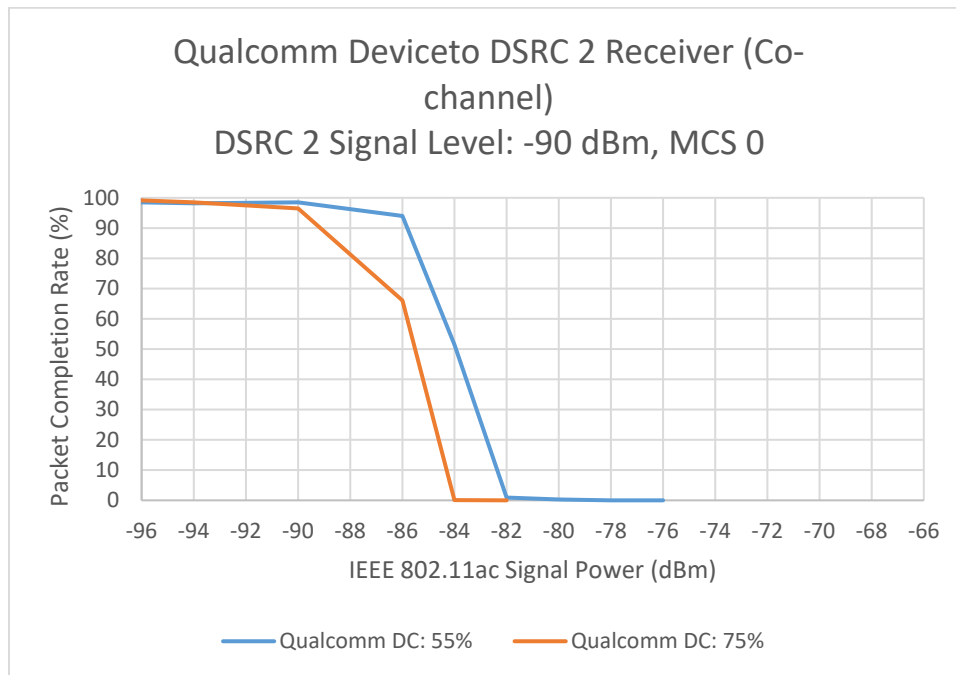
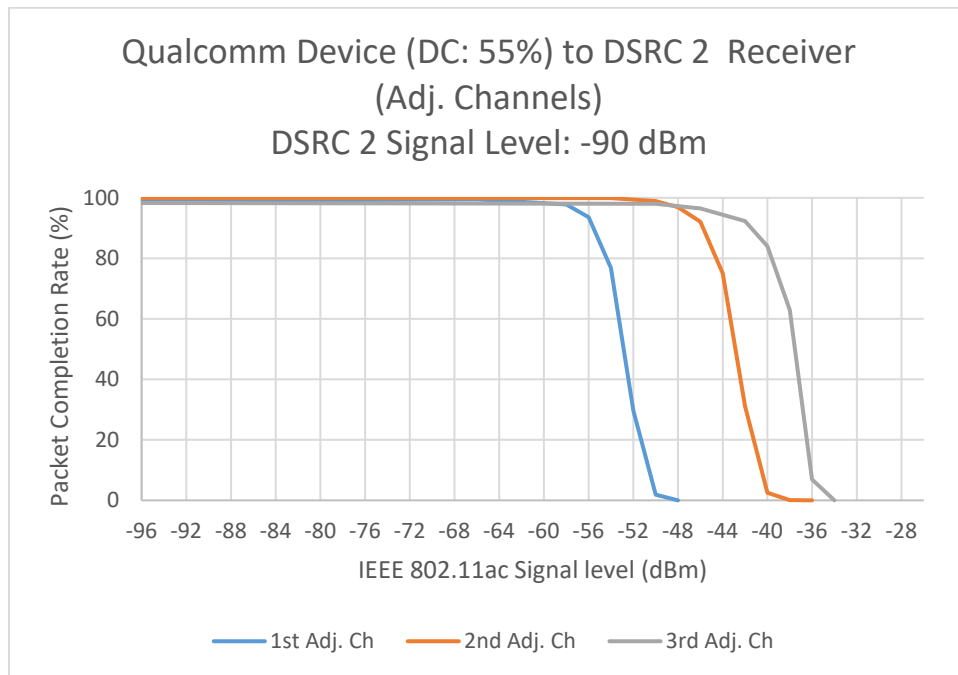


Figure 24 – Qualcomm Device to DSRC 2 Receiver, Co-channel Interaction

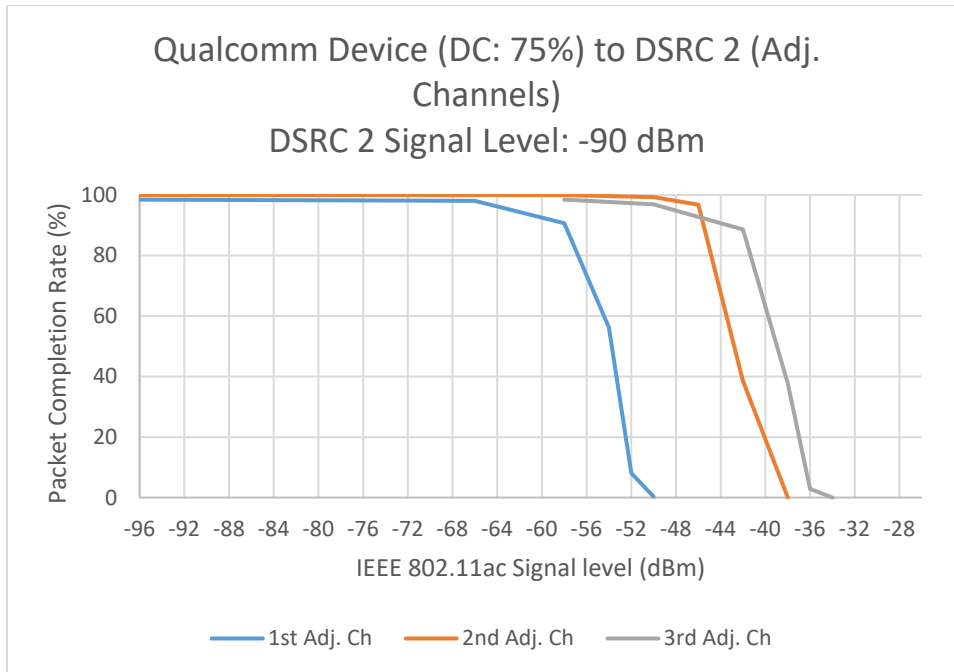
### 6.2.5.2 DSRC 2 Receiver Response to 20 MHz IEEE 802.11ac Signal Transmission - Adjacent Channel Interactions

Figures 25 and 26 show the impact of off-tune (1<sup>st</sup>, 2<sup>nd</sup> and 3<sup>rd</sup> adjacent channels) IEEE 802.11ac signal transmission on DSRC 2 packet reception ability. DSRC 2 receiver is tuned to channels 174, 172 and 184 respectively, and IEEE 802.11ac signal (generated by Qualcomm device) is a 20-MHz-wide transmission centered at 5885 MHz (channel 177). IEEE 802.11ac signal is modulated as 64 QAM with a 3/4 rate coding. The IEEE 802.11ac transmission's channel occupancy is approximately 55% and 75%, respectively. The DSRC 2 received signal power (desired signal) is -90 dBm at the input to its receiver antenna port. The DSRC 2 BSM transmission rate is 10 Hz.



**Figure 25 – Qualcomm Device (55% Duty Cycle) to DSRC 2 Receiver, Adjacent Channel Interactions**





**Figure 26 – Qualcomm Device (75% Duty Cycle) to DSRC 2 Receiver, Adjacent Channel Interactions**

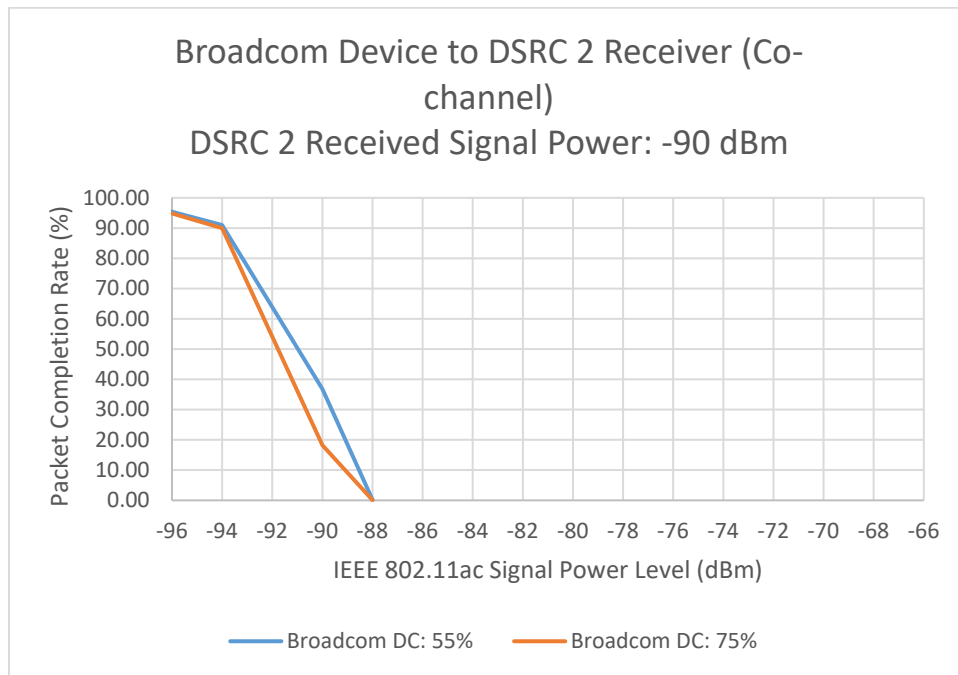
### **6.2.5.3 DSRC 2 Transmitter Response to 20 MHz IEEE 802.11ac Signal Transmission - Co-channel Interactions**

In an equivalent manner to the DSRC 2 receiver test, an IEEE 802.11ac signal was introduced to the RF path of the DSRC 2 transmitter. DSRC 2 receiver was tuned to channel 176 (5880 MHz) and IEEE 802.11ac signal (generated by Qualcomm device) was a 20-MHz-wide transmission centered at 5885 MHz (channel 177). IEEE 802.11ac signal was modulated as 64 QAM with a  $\frac{3}{4}$  rate coding. The IEEE 802.11ac transmission's channel occupancy was approximately 55% and 75%, respectively. DSRC 2 received signal power (desired signal) was -90 dBm at the input to its receiver antenna port. The DSRC 2 BSM transmission rate was 10 Hz. No major impact to DSRC 2 transmitter was observed as the interference power level (IEEE 802.11ac) varied from -98 dBm to -2 dBm (measured at DSRC antenna port). Adjacent channel interactions were not tested.

## 6.2.6 Broadcom Device to DSRC 2

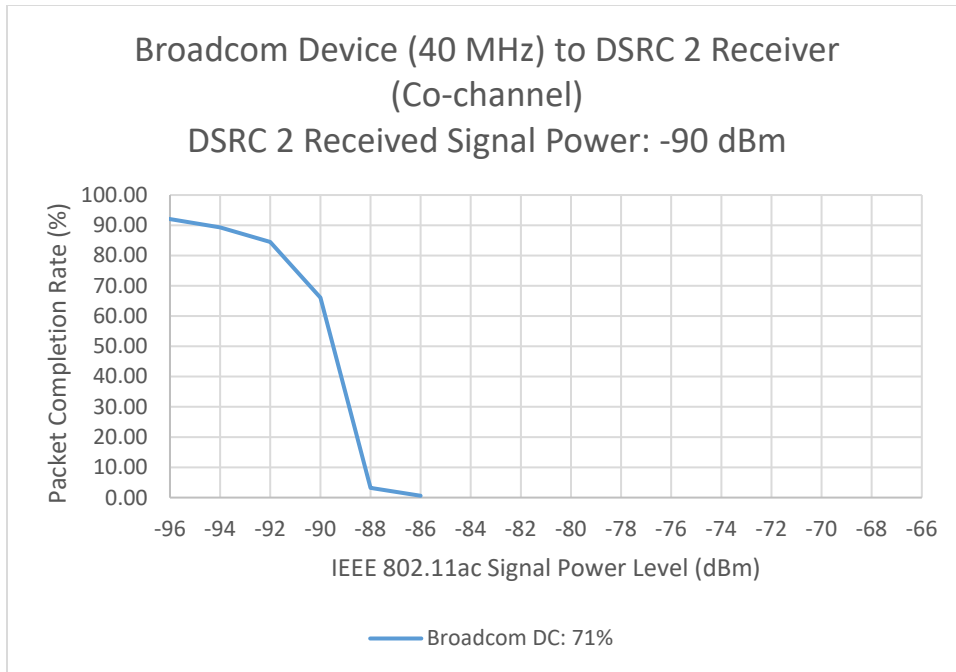
### 6.2.6.1 DSRC 2 Receiver Response to 20 MHz IEEE 802.11ac Signal Transmission- Co-channel Interactions

Figure 27 shows the impact of co-channel IEEE 802.11ac signal transmission on DSRC 2 packet reception ability. DSRC 2 receiver is tuned to channel 176 (5880 MHz) and IEEE 802.11ac signal (generated by Broadcom device) is 20 MHz wide transmission centered at 5885 MHz (channel 177). IEEE 802.11ac signal is modulated as 64 QAM with a  $\frac{3}{4}$  rate coding. The IEEE 802.11ac transmission's channel occupancy is approximately 55% and 75%, respectively. The DSRC 2 received signal power (desired signal) is -90 dBm at the input to its receiver antenna port. The DSRC 2 BSM transmission rate is 10 Hz.



**Figure 27 – Broadcom Device to DSRC 2 Receiver, Co-channel Interaction**

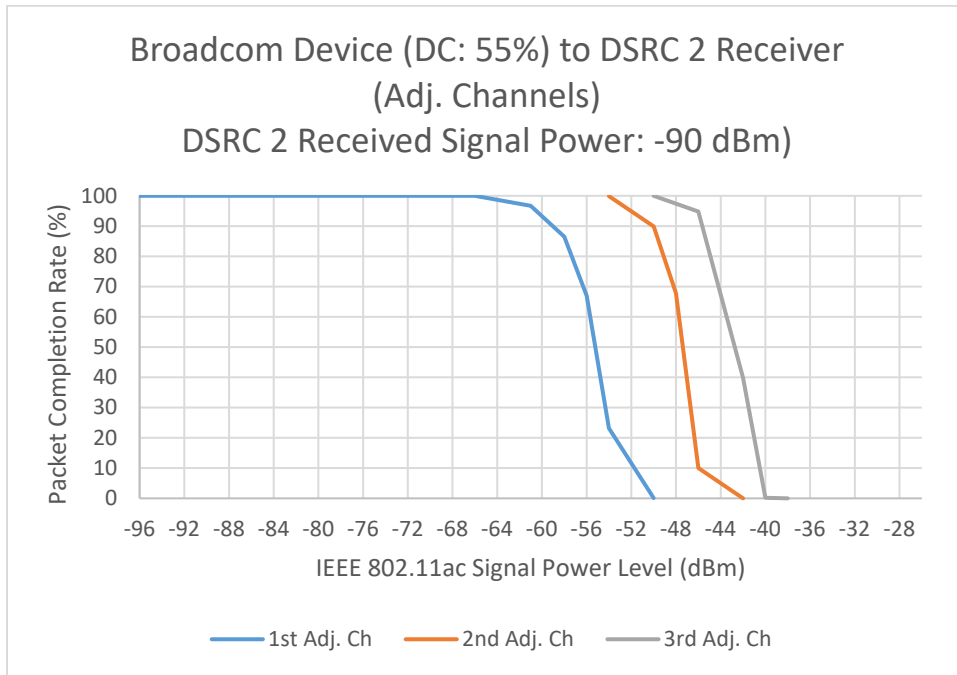
Using Broadcom AP and STA, the impact of 40 MHz wide IEEE 802.11ac transmission was investigated on DSRC packet reception capability. Figure 28 shows the impact of co-channel IEEE 802.11ac signal transmission on DSRC 2 packet reception ability due to 40 MHz IEEE 802.11ac transmission. DSRC 2 receiver is tuned to channel 176 (5880 MHz) and IEEE 802.11ac signal (generated by Broadcom device) is centered at 5875 MHz (channel 175). IEEE 802.11ac signal is modulated as 64 QAM with a  $\frac{3}{4}$  rate coding. Using this modulation and coding scheme, IEEE 802.11ac transmission occupies channel approximately 71% of the time. The DSRC 2 received signal power (desired signal) is -90 dBm at the input to its receiver antenna port. The DSRC 2 BSM transmission rate is 10 Hz.



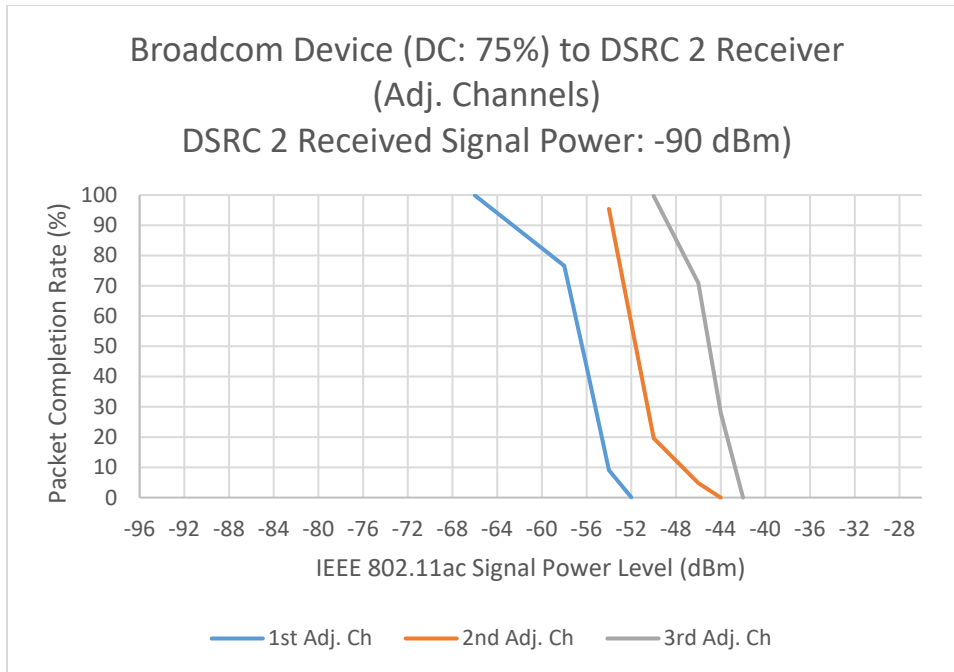
**Figure 28 – Broadcom Device (40 MHz wide) to DSRC 2 Receiver, Co-channel Interaction**

### 6.2.6.2 DSRC 2 Receiver Response to 20 MHz IEEE 802.11ac Signal Transmission - Adjacent Channel Interactions

Figures 29 and 30 show the impact of off-tune (1<sup>st</sup>, 2<sup>nd</sup> and 3<sup>rd</sup> adjacent channels) IEEE 802.11ac signal transmission on DSRC 2 packet reception ability. DSRC 2 receiver is tuned to channels 174, 172 and 184 respectively, and IEEE 802.11ac signal (generated by Broadcom device) is a 20-MHz-wide transmission centered at 5885 MHz (channel 177). IEEE 802.11ac signal is modulated as 64 QAM with a 3/4 rate coding. The IEEE 802.11ac transmission's channel occupancy is approximately 55% and 75%, respectively. The DSRC 2 received signal power (desired signal) is -90 dBm at the input to its receiver antenna port. The DSRC 2 BSM transmission rate is 10 Hz.

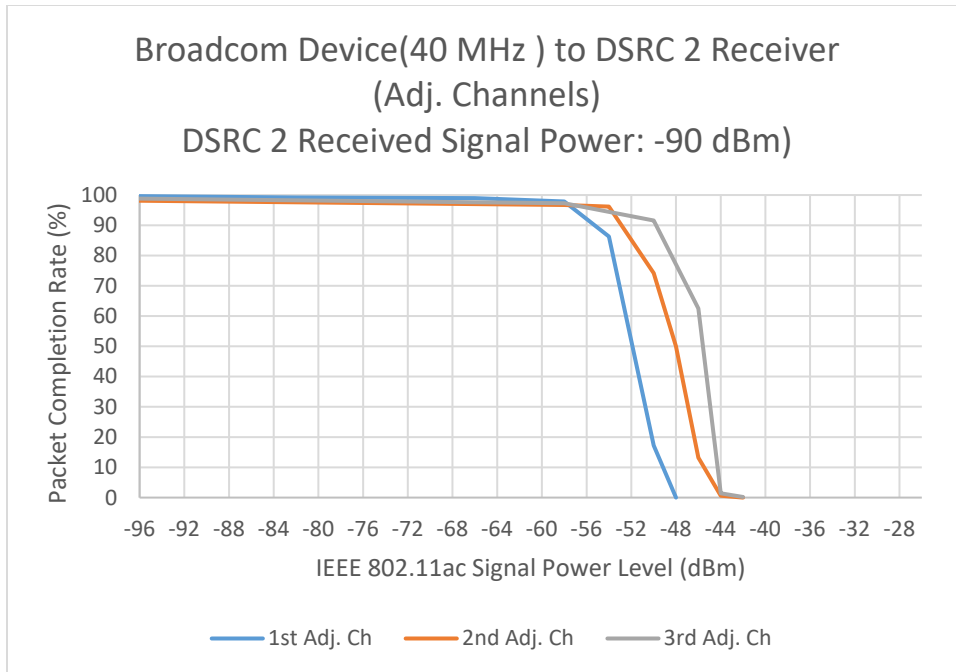


**Figure 29 – Broadcom Device (55% Duty Cycle) to DSRC 2 Receiver, Adjacent channel Interactions**



**Figure 30 – Broadcom Device (75% Duty Cycle) to DSRC 2 Receiver, Adjacent channel Interactions**

Using Broadcom AP and STA, the impact of 40 MHz wide IEEE 802.11ac transmission was investigated on DSRC 2 packet reception capability. Figure 31 shows the impact of adjacent channel IEEE 802.11ac transmission on DSRC 2 packet reception. DSRC 2 receiver is tuned to channel 180 (5900 MHz), channel 182 (5910 MHz), and channel 184 (5920 MHz) respectively. 40 MHz IEEE 802.11ac signal (generated by Broadcom device) is centered at 5875 MHz (channel 175). The IEEE 802.11ac signal is modulated as 64 QAM with a  $\frac{3}{4}$  rate coding. Using this modulation and coding scheme, the IEEE 802.11ac transmission occupies the channel approximately 71% of the time. The DSRC 2 received signal power (desired signal) is -90 dBm at the input to its receiver antenna port. The DSRC 2 BSM transmission rate is 10 Hz.



**Figure 31 – Broadcom Device (40 MHz) to DSRC 2 Receiver, Adj. Channel Interactions**

### **6.2.6.3 DSRC 2 Transmitter Response to 20 MHz IEEE 802.11ac Signal Transmission - Co-channel Interactions**

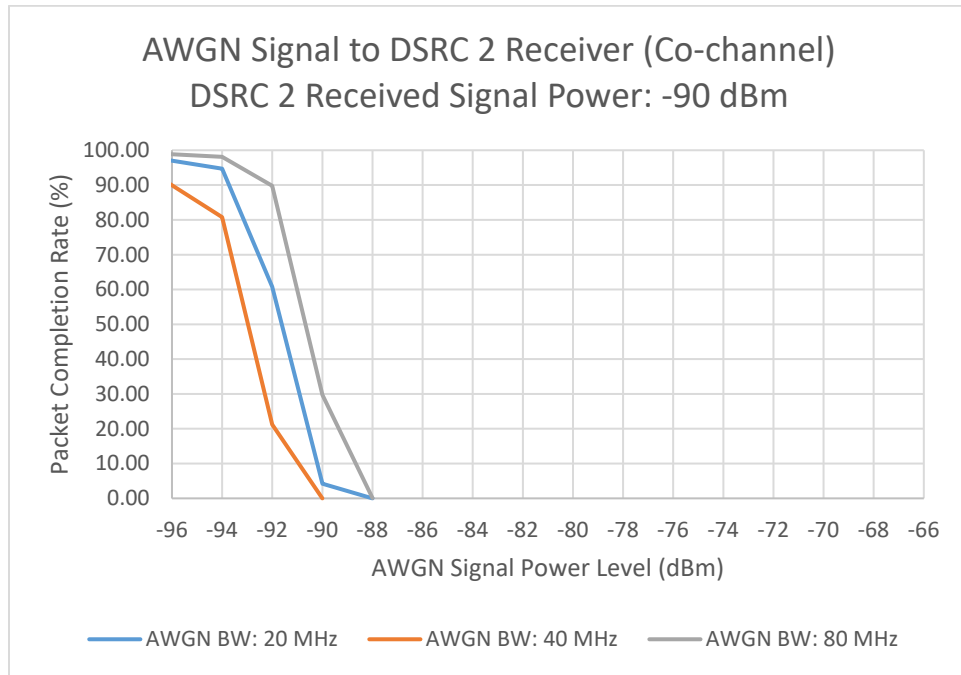
In an equivalent manner to the DSRC 2 receiver test, an IEEE 802.11ac signal was introduced to the RF path of the DSRC 2 transmitter. The DSRC 2 receiver was tuned to channel 176 (5880 MHz) and the IEEE 802.11ac signal (generated by Broadcom device) is a 20-MHz-wide transmission centered at 5885 MHz (channel 177). The IEEE 802.11ac signal was modulated as 64 QAM with a  $\frac{3}{4}$  rate coding. The IEEE 802.11ac transmission's channel occupancy was approximately 55% and 75%, respectively. The DSRC 2 received signal power (desired signal) was -90 dBm at the input to its receiver antenna port. The DSRC 2 BSM transmission rate was 10 Hz. No major impact to the DSRC 2 transmitter was observed as the interference power level (IEEE 802.11ac) was varied from -98 dBm to -2 dBm (measured at the DSRC antenna port). Adjacent channel interactions were not tested.



## 6.2.7 AWGN Signal to DSRC 2

### 6.2.7.1 DSRC 2 Receiver Response to AWGN Signal- Co-channel Interactions

Figure 32 shows the impact of band-limited additive white Gaussian noise (AWGN) (20 MHz, 40 MHz and 80 MHz wide signals) on the DSRC 2 receiver's packet completion rate during co-channel operation.



**Figure 32 – AWGN Signal to DSRC 2 Receiver, Co-channel Interaction**

### 6.2.7.2 DSRC 2 Receiver Response to AWGN Signal - Adjacent Channel Interactions

Figures 33 through 35 show the impact of band-limited additive white gaussian noise signals (20 MHz, 40 MHz, and 80 MHz wide signals) on the DSRC 2 receiver's packet completion rate during adjacent-channel operation.

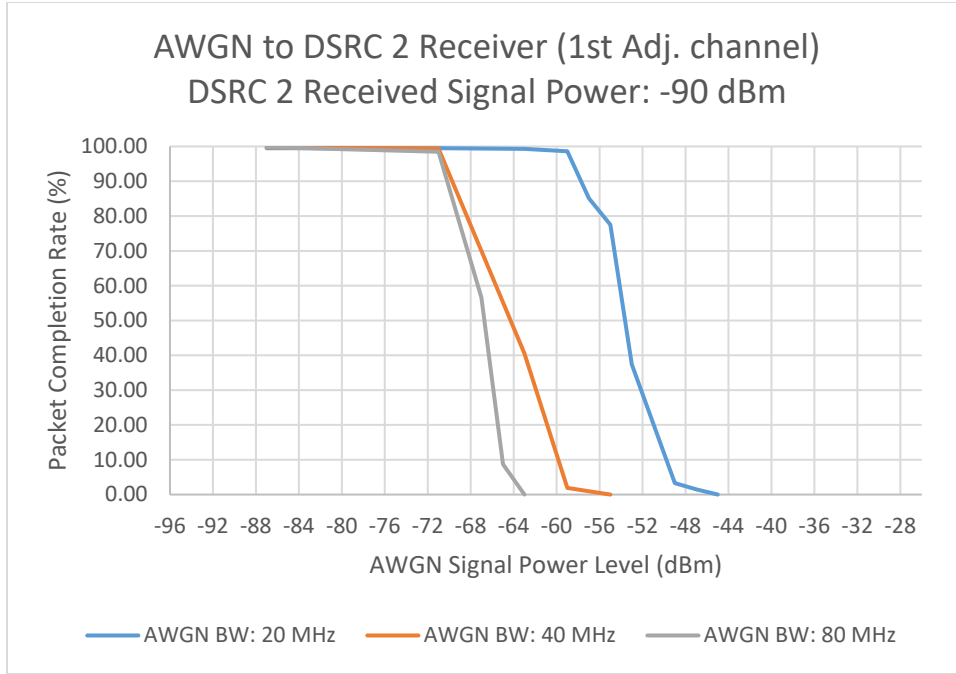
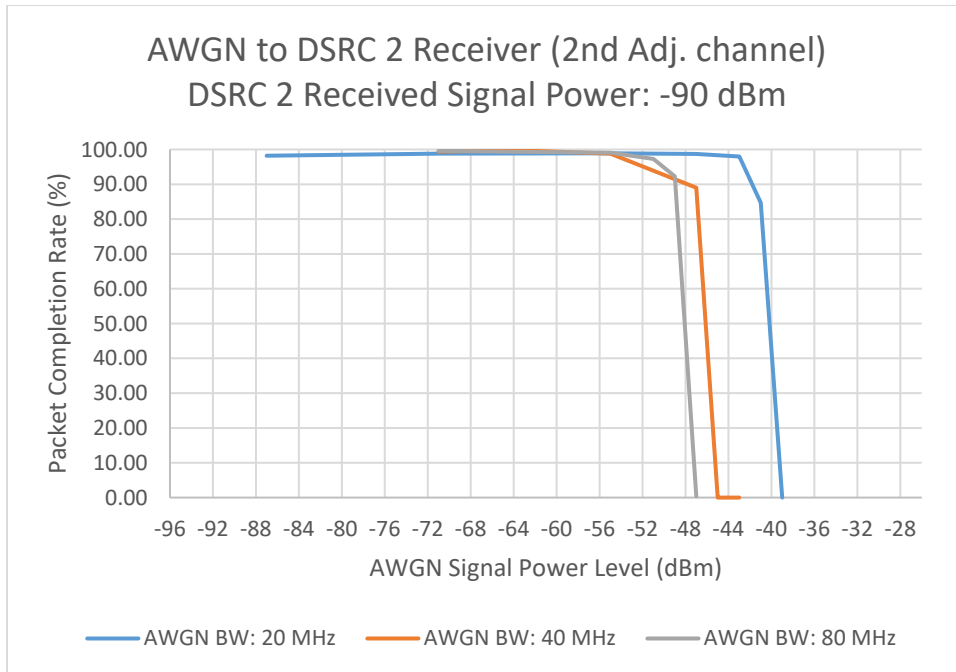
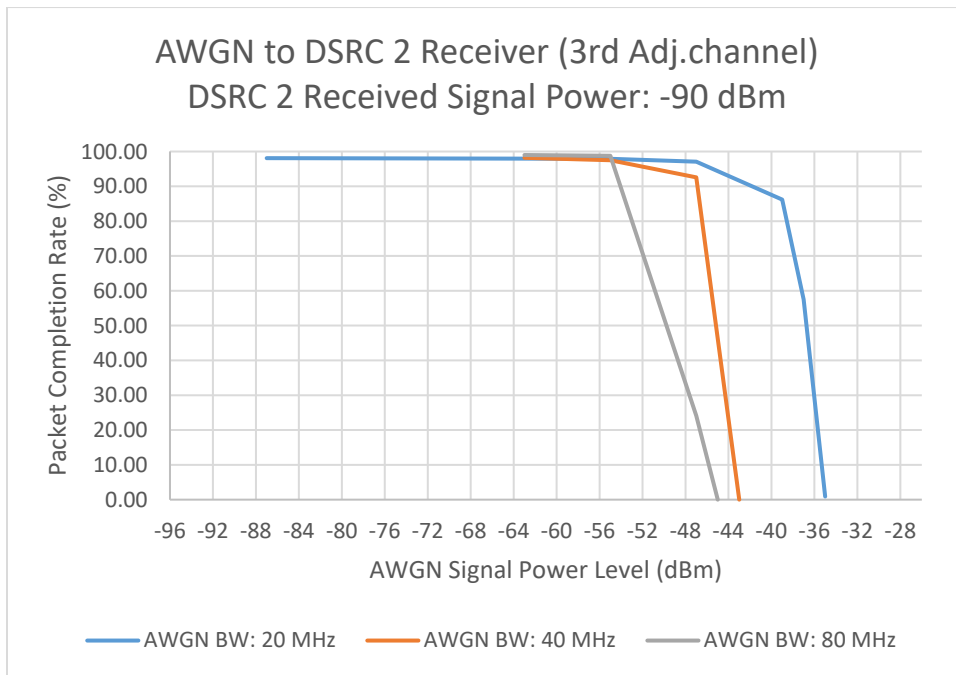


Figure 33 – AWGN Signal to DSRC 2 Receiver, 1<sup>st</sup> Adjacent Channel Interaction



**Figure 34 – AWGN Signal to DSRC 2 Receiver, 2nd Adjacent Channel Interaction**



**Figure 35 – AWGN Signal to DSRC 2 Receiver, 3rd Adjacent Channel Interaction**

### 6.2.7.3 DSRC 2 Transmitter Response to AWGN Signal Co-channel Interactions

The DSRC 2 transmitter/receiver performance was evaluated against band-limited additive white gaussian noise signals. Using the same IEEE 802.11 channel configuration, a 20-MHz AWGN signal was injected into the DSRC 2 transmitter, and the DSRC 2 transmitter performance was observed. Figure 36 shows a plot of the DSRC 2 packet completion rate as a function of noise power (injected to the DSRC 2 transmit antenna port). The DSRC 2 transmitter was configured to transmit 1000 packets at a rate of 10 Hz (100 ms interval). The number of packets that were transmitted (and subsequently received) was recorded as a function of injected noise signal power. The AWGN signal was initially injected to the DSRC 2 at level of -98 dBm, and was incrementally increased to -70 dBm. One-way delay of transmission was recorded each time. Here, one-way delay is defined as the lapsed time between event 1 (when a packet was placed in transmit queue) and event 2 (when the same packet was successfully received by DSRC 2 receiver). This delay was recorded as 2.01 ms when the noise power was at -98 dBm. However, the delay was increased to approximately 5 ms at the noise power of -72 dBm at which point only 994 packets were received. The DSRC 2 transmitter was shut down at interference power level of -70 dBm.

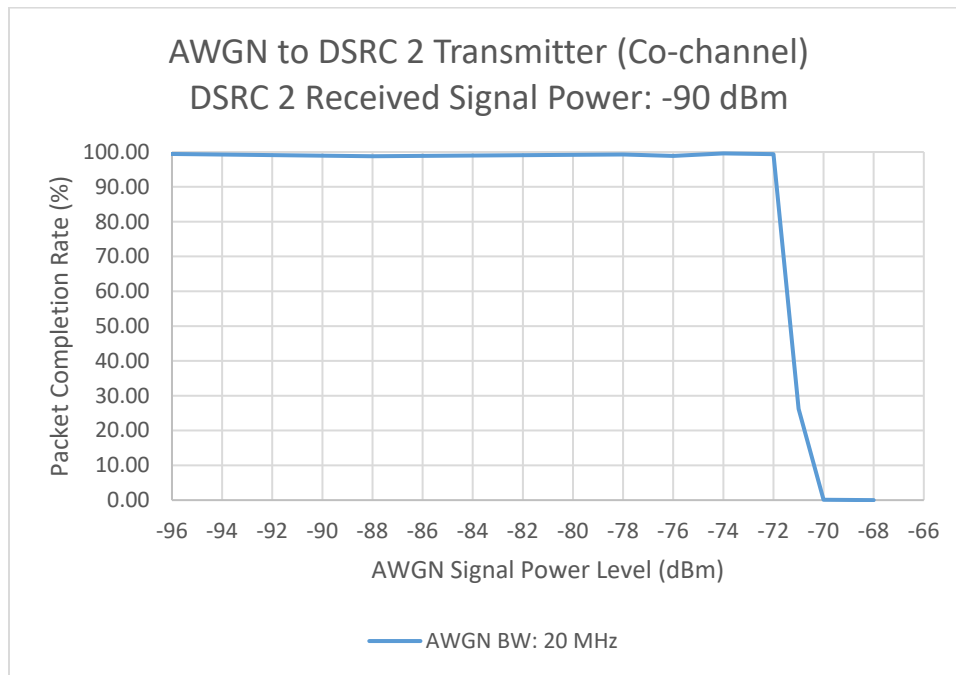


Figure 36 – AWGN Signal to DSRC 2 Transmitter, Co-channel Interaction

## 6.2.8 Cisco Device to DSRC 3

### 6.2.8.1 DSRC 3 Receiver Response to 20 MHz IEEE 802.11 Signal Transmission- Co-channel Interactions

Cisco AP and STA were capable of only transmitting legacy IEEE 802.11 signal and up to IEEE 802.11n (HT) signals. Therefore, the Cisco's signal configuration and transmission profile was not identical to Broadcom's or Qualcomm's. To examine co-channel or adjacent channel interactions, the IEEE 802.11 packet length was set to approximately 238 microseconds (1450 bytes using 64 QAM modulation scheme with a  $\frac{3}{4}$  rate coding) that roughly corresponded to 58 Mbps data rate. This configuration resulted in channel occupancy factors of 55% to 70%, with a nominal occupancy of 60%.

Figure 37 shows the impact of co-channel IEEE 802.11 signal transmission on the DSRC 3 packet reception ability. The DSRC 3 receiver is tuned to channel 176 (5880 MHz) and the IEEE 802.11 signal (generated by Cisco device) is a 20-MHz-wide transmission centered at 5885 MHz (channel 177). The IEEE 802.11 signal is modulated as 64 QAM with a  $\frac{3}{4}$  rate coding. The IEEE 802.11ac transmission's channel occupancy is approximately 60%. The DSRC 3 received signal power (desired signal) is -86 dBm at the input to its receiver antenna port. The DSRC 3 BSM transmission rate is 10 Hz.

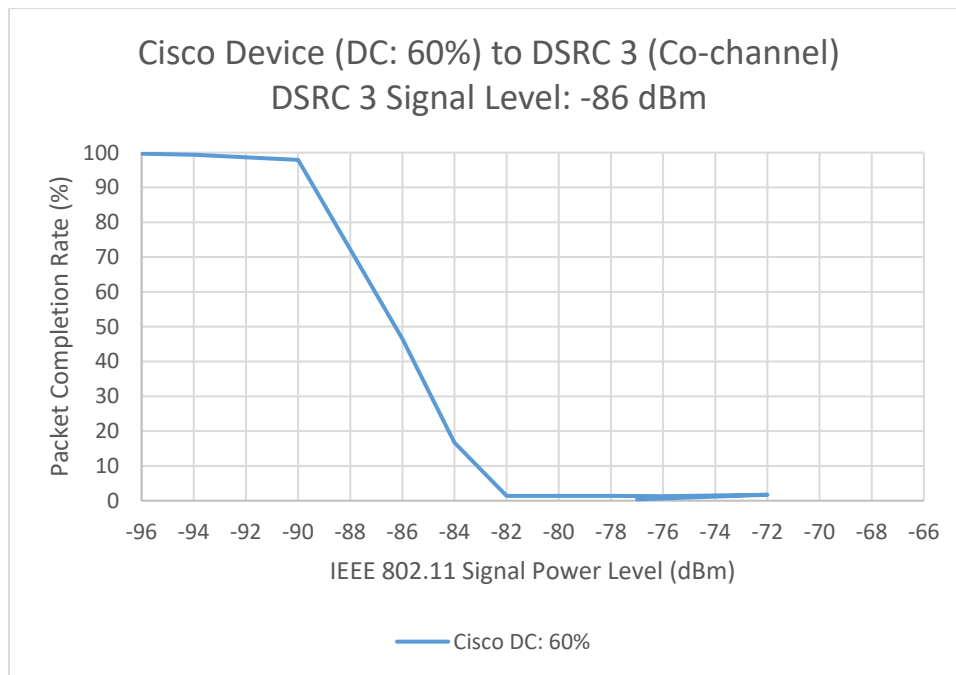


Figure 37 – Cisco Device to DSRC 3, Co-channel Interaction

### 6.2.8.2 DSRC 3 Receiver Response to 20 MHz IEEE 802.11 Signal Transmission - Adjacent Channel Interactions

Figure 38 shows the impact of off-tune (1<sup>st</sup>, 2<sup>nd</sup> and 3<sup>rd</sup> adjacent channels) IEEE 802.11 signal transmission on DSRC 3 packet reception ability. The DSRC 3 receiver is tuned to channels 174, 172 and 184 respectively, and the IEEE 802.11 signal (generated by Cisco device) is a 20-MHz-wide transmission centered at 5885 MHz (channel 177). The IEEE 802.11 signal is modulated as 64 QAM with a 3/4 rate coding. The IEEE 802.11ac transmission's channel occupancy is approximately 60%. The DSRC 3 received signal power (desired signal) is -86 dBm at the input to its receiver antenna port. The DSRC 3 BSM transmission rate is 10 Hz.

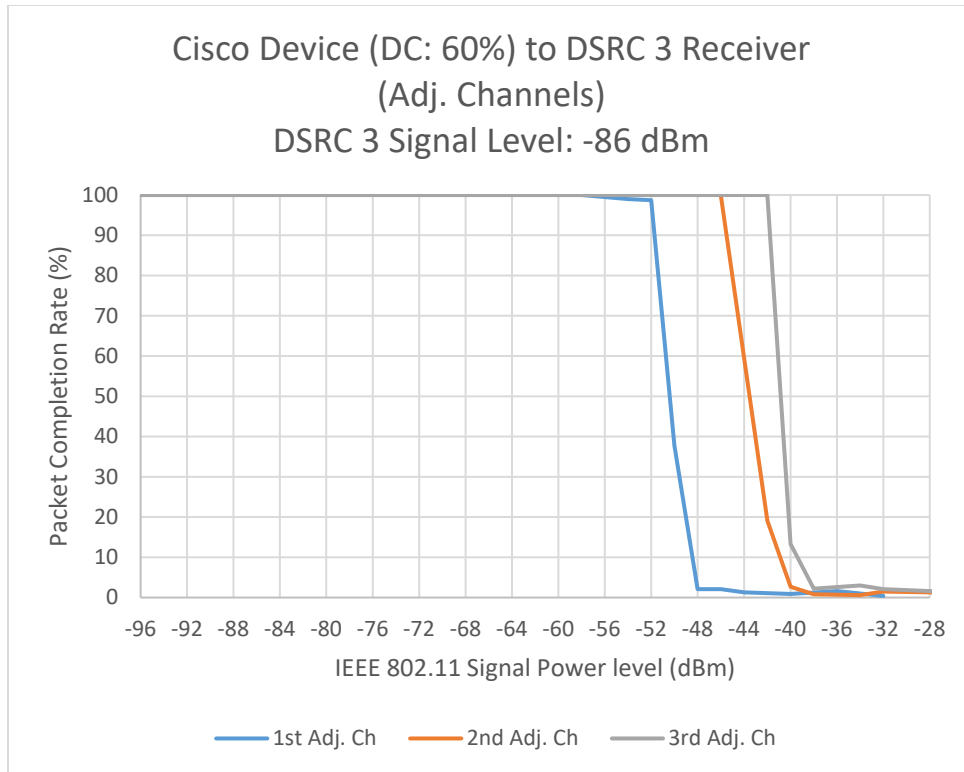


Figure 38 – Cisco Device to DSRC 3, Adjacent channel Interactions

### **6.2.8.3 DSRC 3 Transmitter Response to 20 MHz IEEE 802.11 Signal Transmission - Co-channel Interactions**

In an equivalent manner to the DSRC 3 receiver test, an IEEE 802.11ac signal was introduced to the RF path of the DSRC 3 transmitter. DSRC 3 receiver was tuned to channel 176 (5880 MHz) and IEEE 802.11ac signal (generated by Broadcom device) is a 20-MHz-wide transmission centered at 5885 MHz (channel 177). To examine co-channel and adjacent channel interactions, the IEEE 802.11 packet length was set to approximately 238 microseconds (1450 bytes using a 64 QAM modulation scheme with a  $\frac{3}{4}$  rate coding) that roughly corresponded to a 58 Mbps data rate. This configuration resulted in channel occupancy factors of 55% to 70%, with a nominal occupancy of 60%. The DSRC 2 transmitter was set to transmit at its default power level (14 dBm referenced to antenna output). No remarkable degradation to the DSRC 2 transmitter performance was observed while the IEEE 802.11 signal occupied the channel 60% of the time.

## 6.2.9 Qualcomm Device to DSRC 3

### 6.2.9.1 DSRC 3 Receiver Response to 20 MHz IEEE 802.11ac Signal Transmission - Co-channel Interactions

Figure 39 shows the impact of the co-channel IEEE 802.11ac signal transmission on the DSRC 3 packet reception ability. The DSRC 3 receiver is tuned to channel 176 (5880 MHz) and the IEEE 802.11ac signal (generated by the Qualcomm device) is a 20 MHz wide transmission centered at 5885 MHz (channel 177). The IEEE 802.11ac signal is modulated as 64 QAM with a  $\frac{3}{4}$  rate coding. The IEEE 802.11ac transmission occupies channel approximately 55%, and 75%, respectively. The DSRC 3 received signal power (desired signal) is -86 dBm at the input to its receiver antenna port. The DSRC 3 BSM transmission rate is 10 Hz.

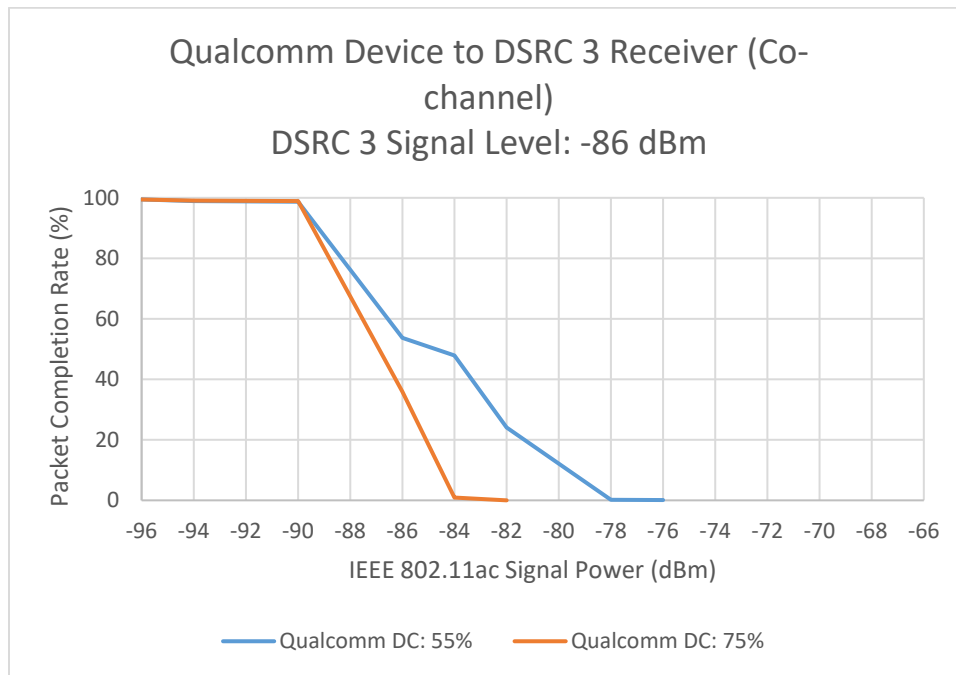
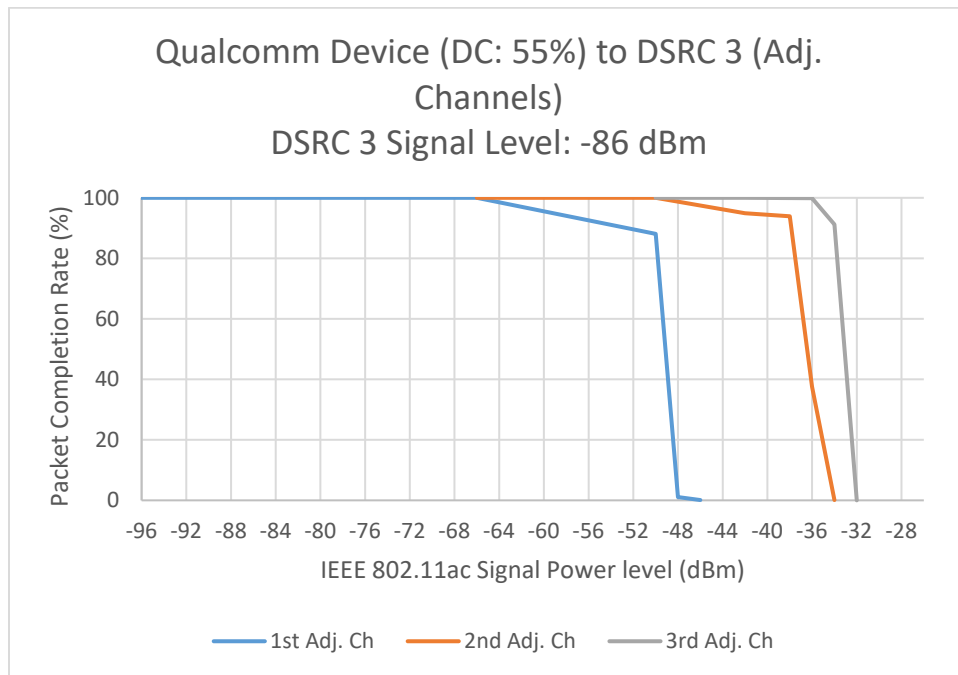


Figure 39 – Qualcomm Device to DSRC 3 Receiver, Co-channel Interaction

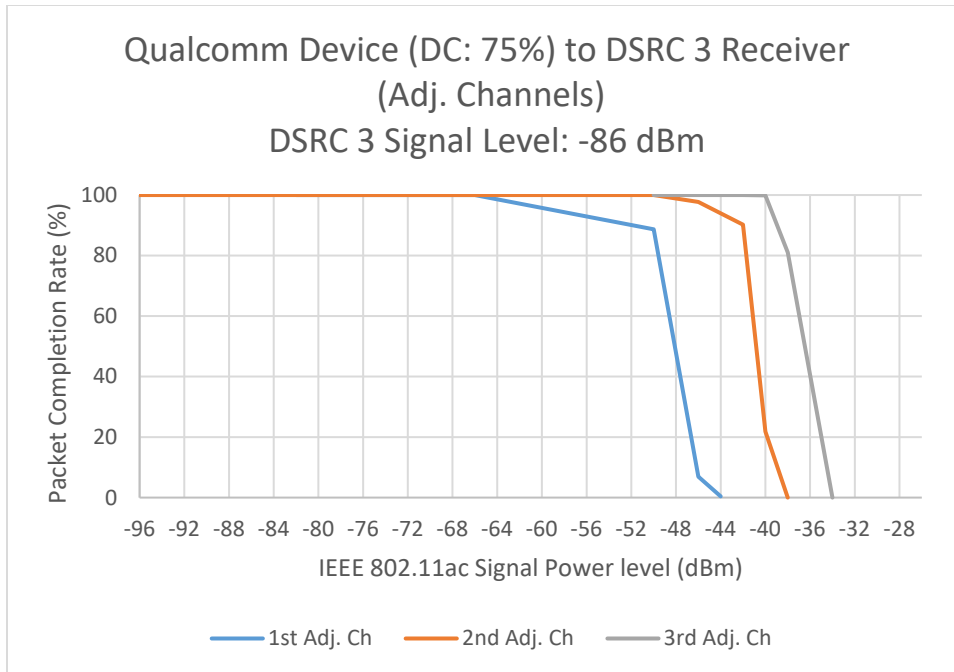


### 6.2.9.2 DSRC 3 Receiver Response to 20 MHz IEEE 802.11ac Signal Transmission- Adjacent Channel Interactions

Figures 40 and 41 show the impact of an off-tune (1<sup>st</sup>, 2<sup>nd</sup> and 3<sup>rd</sup> adjacent channels) IEEE 802.11ac signal transmission on the DSRC 3 packet reception ability. The DSRC 3 receiver is tuned to channels 174, 172 and 184 respectively, and the IEEE 802.11ac signal (generated by the Qualcomm device) is a 20-MHz-wide transmission centered at 5885 MHz (channel 177). The IEEE 802.11ac signal is modulated as 64 QAM with a 3/4 rate coding. The IEEE 802.11ac transmission's channel occupancy is approximately 55% and 75%, respectively. The DSRC 3 received signal power (desired signal) is -86 dBm at the input to its receiver antenna port. The DSRC 3 BSM transmission rate is 10 Hz.



**Figure 40 – Qualcomm Device (55% Duty Cycle) to DSRC 3 Receiver, Adjacent Channel Interactions**



**Figure 41 – Qualcomm Device (75% Duty Cycle) to DSRC 3 Receiver, Adjacent Channel Interactions**

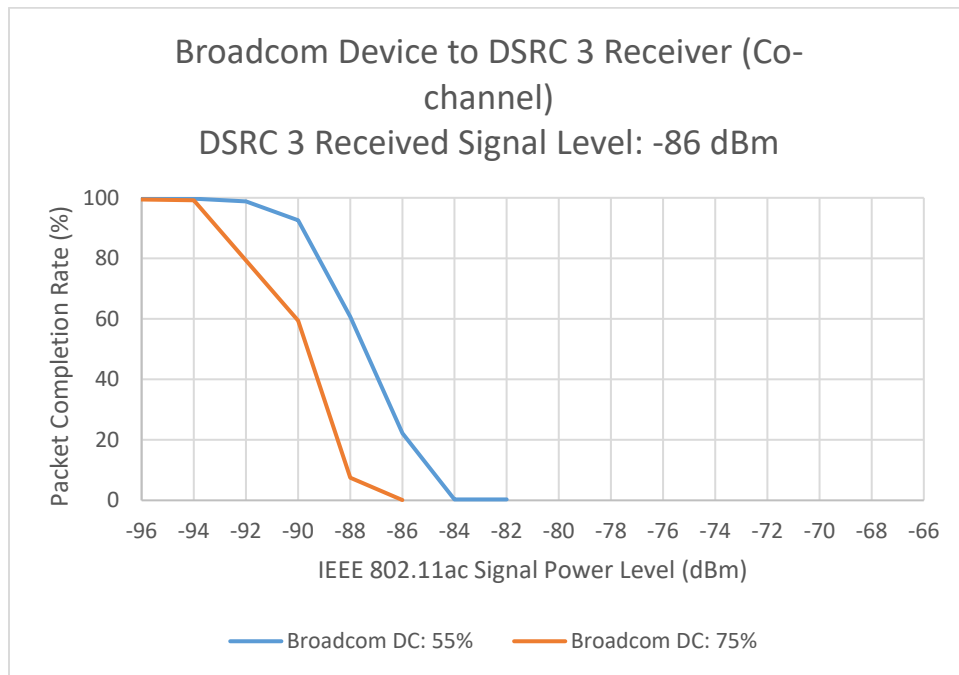
**6.2.9.3 DSRC 3 Transmitter Response to 20 MHz IEEE 802.11ac Signal Transmission - Co-channel Interactions**

In an equivalent manner to the DSRC 3 receiver test, an IEEE 802.11ac signal was introduced to the RF path of the DSRC 3 transmitter. The DSRC 3 transmitter was tuned to channel 176 (5880 MHz) and the IEEE 802.11ac signal (generated by Qualcomm device) is a 20-MHz-wide transmission centered at 5885 MHz (channel 177). IEEE 802.11ac signal was modulated as 64 QAM with a 3/4 rate coding. The IEEE 802.11ac transmission’s channel occupancy was approximately 55% and 75%, respectively. The DSRC 3 received signal power (desired signal) was -86 dBm at the input to its receiver antenna port. The DSRC 3 BSM transmission rate was 10 Hz. No major impact to the DSRC 3 transmitter was observed as the interference power level (IEEE 802.11ac) varied from -98 dBm to -2 dBm (measured at DSRC antenna port). The adjacent channel interactions were not tested.

## 6.2.10 Broadcom Device to DSRC 3

### 6.2.10.1 DSRC 3 Receiver Response to 20 MHz IEEE 802.11ac Signal Transmission – Co-channel Interactions

Figure 42 shows the impact of a co-channel IEEE 802.11ac signal transmission on the DSRC 3 packet reception ability. The DSRC 3 receiver is tuned to channel 176 (5880 MHz) and the IEEE 802.11ac signal (generated by Broadcom device) is a 20-MHz-wide transmission centered at 5885 MHz (channel 177). The IEEE 802.11ac signal is modulated as 64 QAM with a  $\frac{3}{4}$  rate coding. The IEEE 802.11ac transmission's channel occupancy is approximately 55% and 75%, respectively. The DSRC 3 received signal power (desired signal) is -86 dBm at the input to its receiver antenna port. The DSRC 3 BSM transmission rate is 10 Hz.



**Figure 42 – Broadcom Device to DSRC 3 Receiver, Co-channel Interaction**

### 6.2.10.2 DSRC 3 Receiver Response to 20 MHz IEEE 802.11ac Signal Transmission - Adjacent Channel Interactions

Figures 43 and 44 show the impact of an off-tune (1<sup>st</sup>, 2<sup>nd</sup> and 3<sup>rd</sup> adjacent channels) IEEE 802.11ac signal transmission on the DSRC 3 packet reception ability. The DSRC 3 receiver is tuned to channels 174, 172 and 184 respectively, and the IEEE 802.11ac signal (generated by Broadcom device) is a 20-MHz-wide transmission centered at 5885 MHz (channel 177). The IEEE 802.11ac signal is modulated as 64 QAM with a 3/4 rate coding. The IEEE 802.11ac transmission's channel occupancy is approximately 55% and 75%, respectively. The DSRC 3 received signal power (desired signal) is -86 dBm at the input to its receiver antenna port. The DSRC 3 BSM transmission rate is 10 Hz.

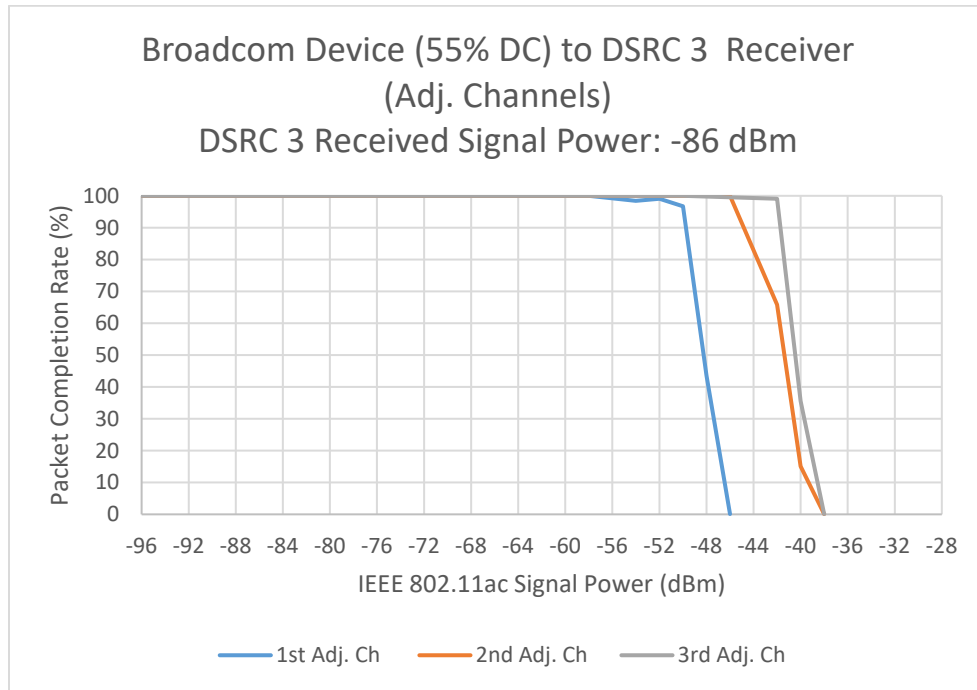
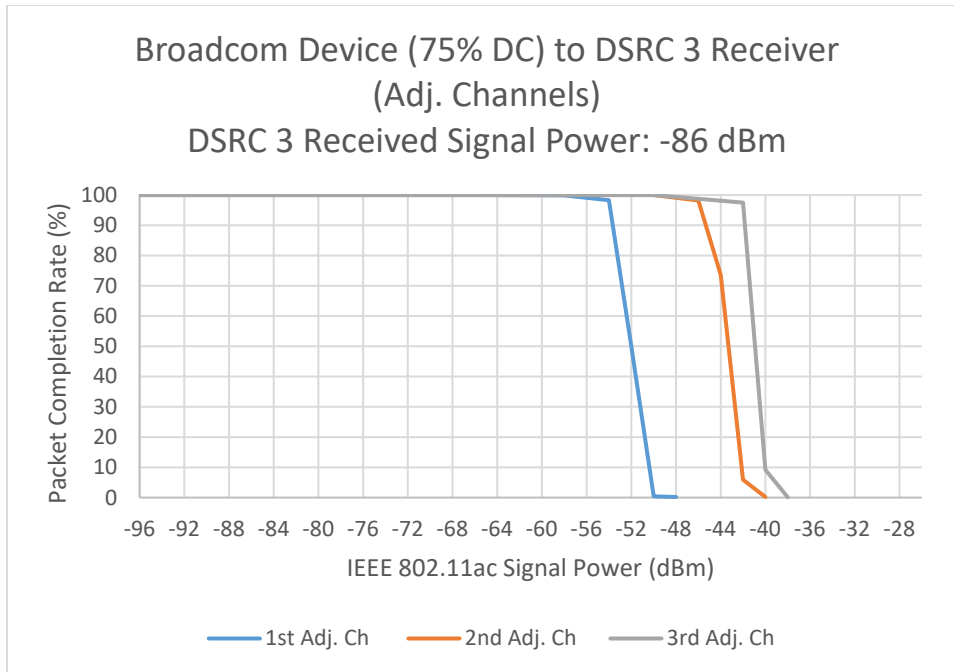


Figure 43 – Broadcom Device (55% Duty Cycle) to DSRC 3 Receiver, Adjacent channel Interactions



**Figure 44 – Broadcom Device (75% Duty Cycle) to DSRC 3 Receiver, Adjacent channel Interactions**

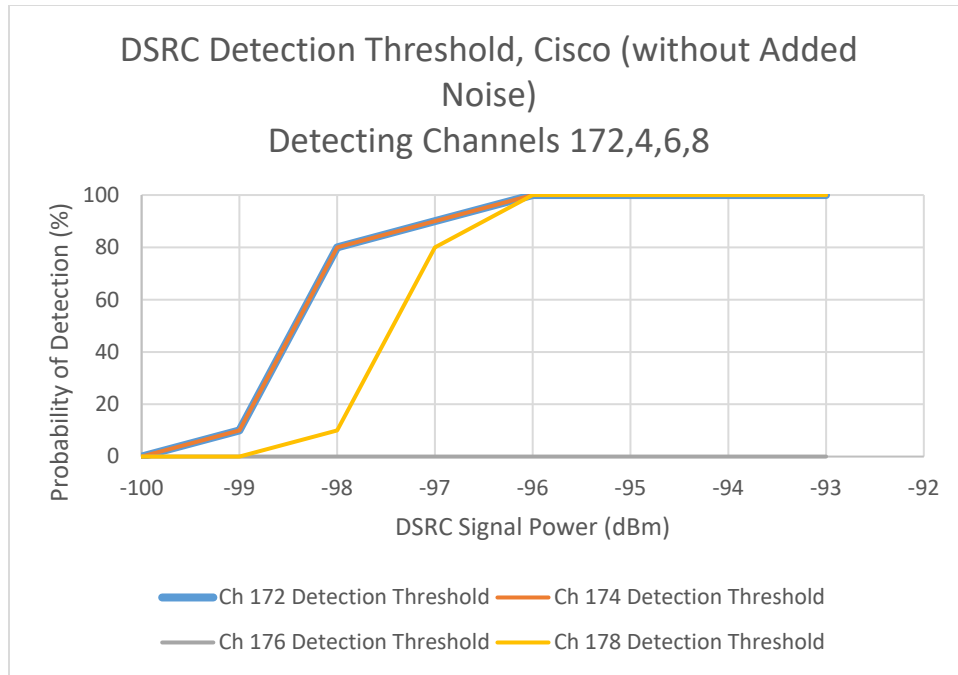
**6.2.10.3 DSRC 3 Transmitter Response to 20 MHz IEEE 802.11ac Signal Transmission – Co-channel Interactions**

In an equivalent manner to the DSRC 3 receiver test, an IEEE 802.11ac signal was introduced to the RF path of the DSRC 3 transmitter. The DSRC 3 transmitter was tuned to channel 176 (5880 MHz) and the IEEE 802.11ac signal (generated by Broadcom device) was a 20-MHz-wide transmission centered at 5885 MHz (channel 177). The IEEE 802.11ac signal was modulated as 64 QAM with a 3/4 rate coding. The IEEE 802.11ac transmission’s channel occupancy was approximately 55% and 75%, respectively. The DSRC 3 received signal power (desired signal) was -86 dBm at the input to its receiver antenna port. The DSRC 3 BSM transmission rate was 10 Hz. No major impact to DSRC 3 transmitter was observed as the interference power level (IEEE 802.11ac) varied from -98 dBm to -2 dBm (measured at DSRC antenna port). Adjacent channel interactions were not tested.

### 6.3 Interference Mitigation Test Results- Cisco's Detect-and-Vacate Strategy

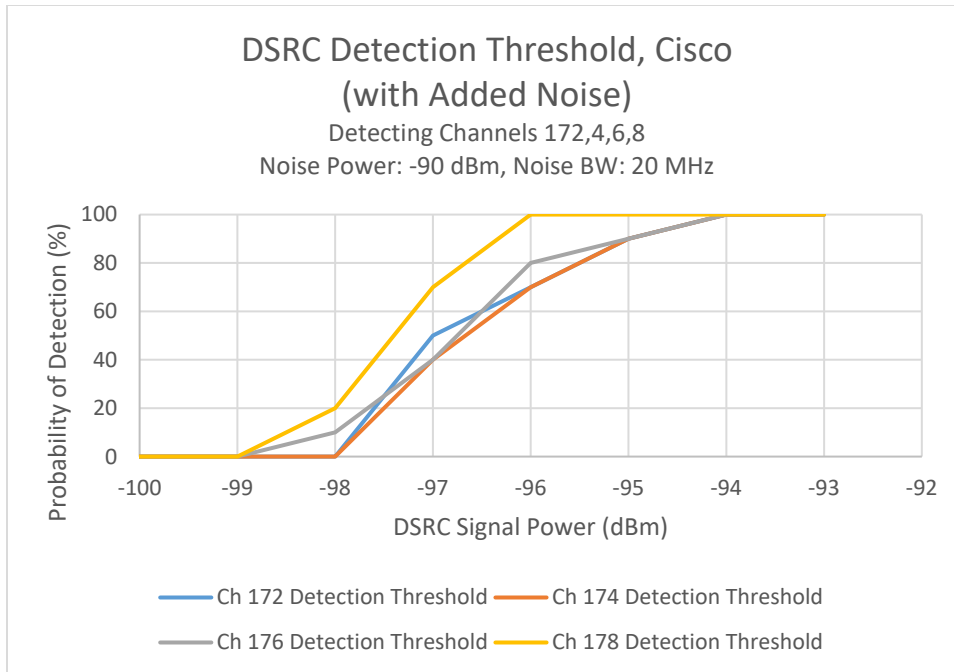
#### 6.3.1 Detection Threshold

Figure 45 shows the probability of DSRC signal detection as a function of DSRC transmit power with no added noise.



**Figure 45 – DSRC detection threshold- lower 4 channels of DSRC band**

Figure 46 shows the probability of DSRC signal detection as a function of DSRC transmit power with added noise.



**Figure 46 – DSRC detection threshold (with added noise) – 4 lower channels of DSRC band**

### 6.3.2 Channel-Move Time

**Cisco AP/ STA:** Table 22 shows the average channel-move time of the Cisco U-NII-4 device. The channel-move time was measured as the DSRC signal was injected to the Cisco AP (or Sta) at a power level of -64 dBm (with and without added noise). The test was repeated with a DSRC signal level of -94 dBm.

**Table 22 – Cisco Channel-Move Time**

| U-NII-4 Modulation      | No Added Noise |       |        |     | With Added Noise |      |        |      |
|-------------------------|----------------|-------|--------|-----|------------------|------|--------|------|
|                         | BPSK           |       | 64 QAM |     | BPSK             |      | 64 QAM |      |
| DSRC Signal Power (dBm) | -94            | -64   | -94    | -64 | -94              | -64  | -94    | -64  |
| $t_{avg}(ms)$           | 562.1          | 25.17 | 26.5   | 9.7 | 798.0            | 72.3 | 205.5  | 13.0 |

**KEA AP/STA:** Table 23 shows the average channel-move time of the KEA U-NII-4 device. The channel-move time was measured as the DSRC signal was injected to the Cisco AP (or Sta) at a power level of -64 dBm (with and without added noise). The test was repeated with the DSRC signal level of -94 dBm.

**Table 23 – KEA Channel-Move Time**

|                         | No Added Noise |      |        |      | With Added Noise |      |        |      |
|-------------------------|----------------|------|--------|------|------------------|------|--------|------|
| U-NII-4 Modulation      | BPSK           |      | 64 QAM |      | BPSK             |      | 64 QAM |      |
| DSRC Signal Power (dBm) | -94            | -64  | -94    | -64  | -94              | -64  | -94    | -64  |
| $t_{avg}$ (ms)          | 227.92         | 0.75 | 138.46 | 0.30 | 385.16           | 0.70 | 148.71 | 0.30 |

**6.3.3 Coexistence Scenarios**

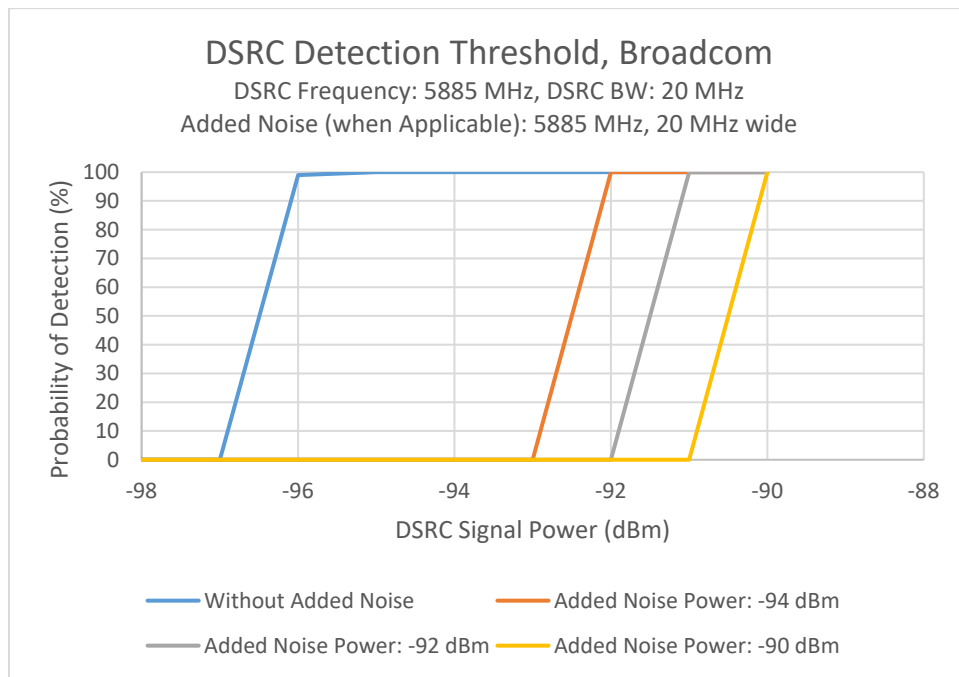
The Detect-and-Vacate strategy is primarily designed to minimize risk of interference (from U-NII-4 transmission to DSRC device) by vacating the whole DSRC band as well as upper 25 MHz of the U-NII-3 band upon detection of a DSRC signal. The detection mechanism is designed to detect DSRC transmissions anywhere in the lower 40 MHz of the DSRC band. Assuming this method is successful in detecting a DSRC signal, the only possible scenario for simultaneous operation in the U-NII-4 band is when the U-NII-4 device operates in the lower 40 MHz of the band (channel 173 or 177) while the DSRC device operates in the upper 30 MHz of the band (channel 180, 182, 184), or when the U-NII-4 devices operates in bands other than the DSRC band. U-NII-4 and DSRC device interaction in adjacent channel configurations could occur regardless of any interference mitigation method is in place. However, the probability of interference is reduced by a factor equal to the Adjacent Channel Rejection Ratio (ACRR) of the DSRC device.



## 6.4 Interference Mitigation Test Results – Re-Channelization Strategy

### 6.4.1 Detection Threshold

As mentioned above, DSRC 4 devices (upgraded DSRC 3 device) were capable of transmitting and receiving 20-MHz signals while aligned with IEEE standard's recommended channel configurations. To activate their mitigation mode, the IEEE 802.11ac devices (Broadcom AP or STA) had to first detect the DSRC signal. To determine this detection threshold, a pair of DSRC 4 devices were set up to transmit and receive a 20-MHz-wide signal on channel 173 (and 177). The DSRC signal was simultaneously fed back to Broadcom AP and STA to trigger and activate its mitigation mode. The DSRC signal power was incrementally lowered until the Broadcom AP (or STA) was not able to detect DSRC signal. Detection threshold test was repeated with added noise to the IEEE 802.11ac RF path. Figure 47 shows the Broadcom IEEE 802.11ac device's detection threshold of the DSRC signal as a function of the DSRC signal power (at Broadcom AP or STA antenna port) with and without added gaussian noise.



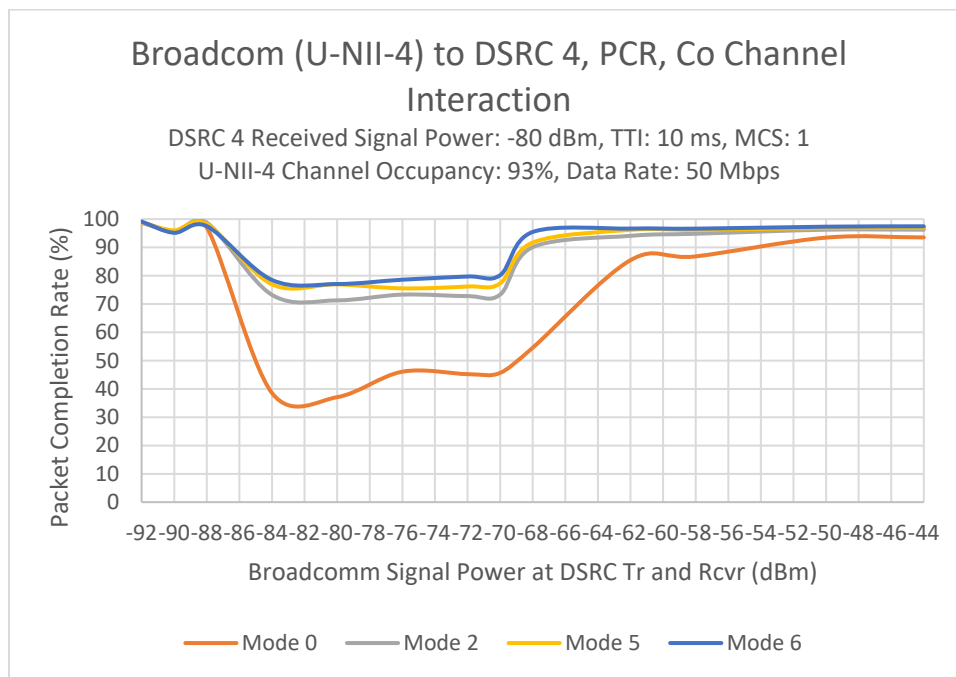
**Figure 47 – DSRC detection threshold- Broadcom**

### 6.4.2 Coexistence Scenarios

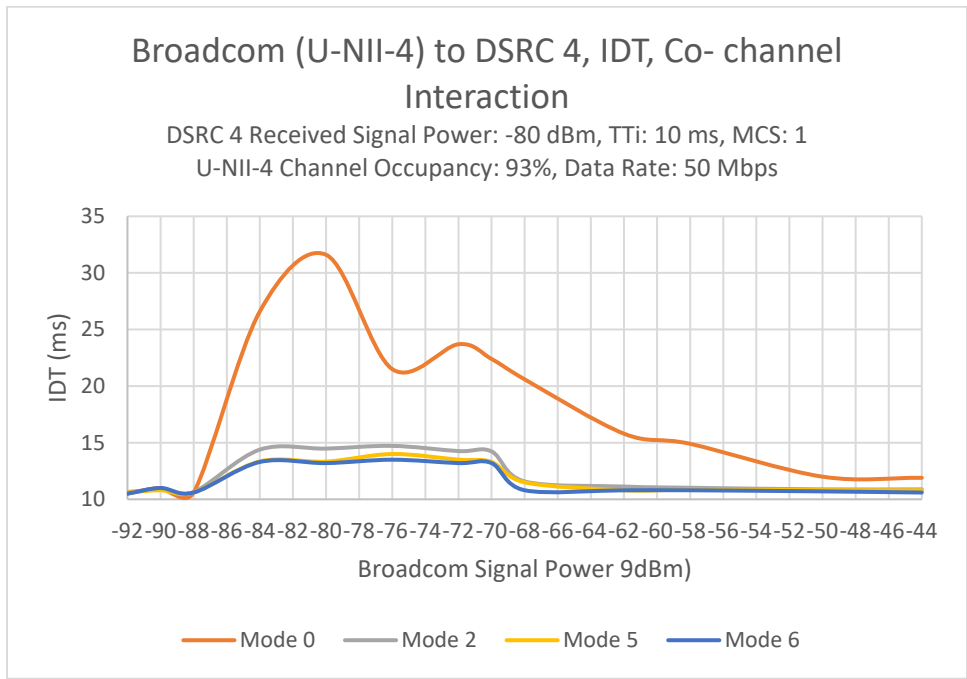
Under the Re-channelization strategy, there are two scenarios where U-NII-4 and DSRC devices may interact, i.e., co-channel and adjacent channel interactions. This section briefly describes each scenario and presents the results of each corresponding test.

#### 6.4.2.1 Co-channel Interaction

The Re-channelization mitigation method is primarily designed to minimize risk of interference from U-NII-4 to DSRC devices while the U-NII-4 and DSRC devices both operate on the same primary 20-MHz channels (co-channel). Figures 48 and 49 show the impact of U-NII-4 (co-channel) transmission on DSRC packet completion rate and its corresponding Inter-Departure Time (IDT) of the transmitted packets. Both DSRC and U-NII-4 (Broadcom AP and Station) devices operate on channel 177 (5885 MHz).



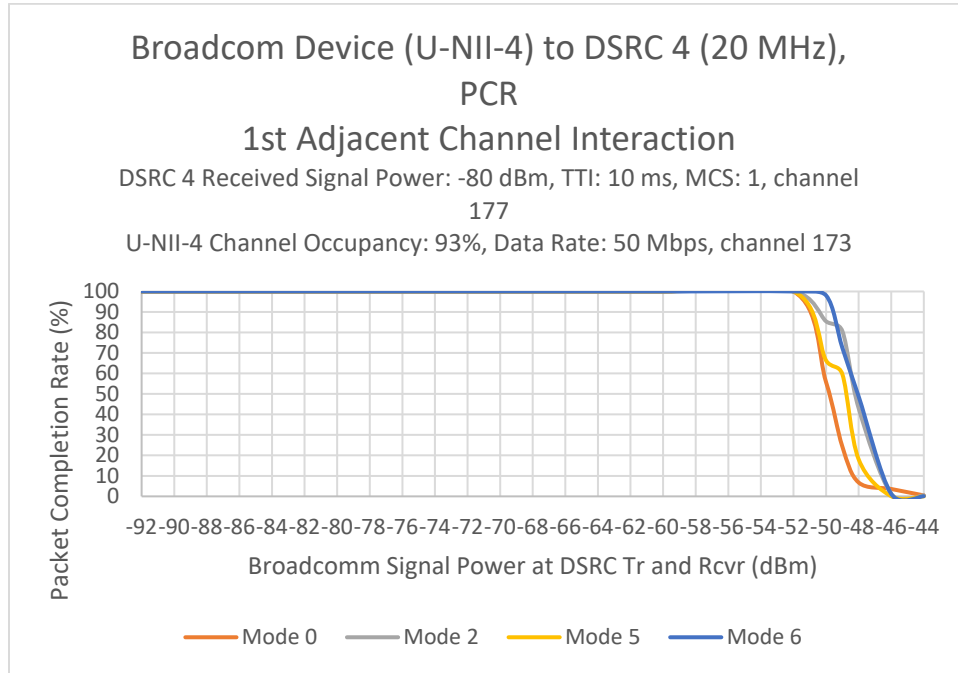
**Figure 48 – U-NII-4 and DSRC Co-channel Interaction, PCR – DSRC BW: 20 MHz**



**Figure 49 – U-NII-4 and DSRC Co-channel Interaction, IDT – DSRC BW: 20 MHz**

### 6.4.2.2 Adjacent-channel Interaction- 20 MHz DSRC operation

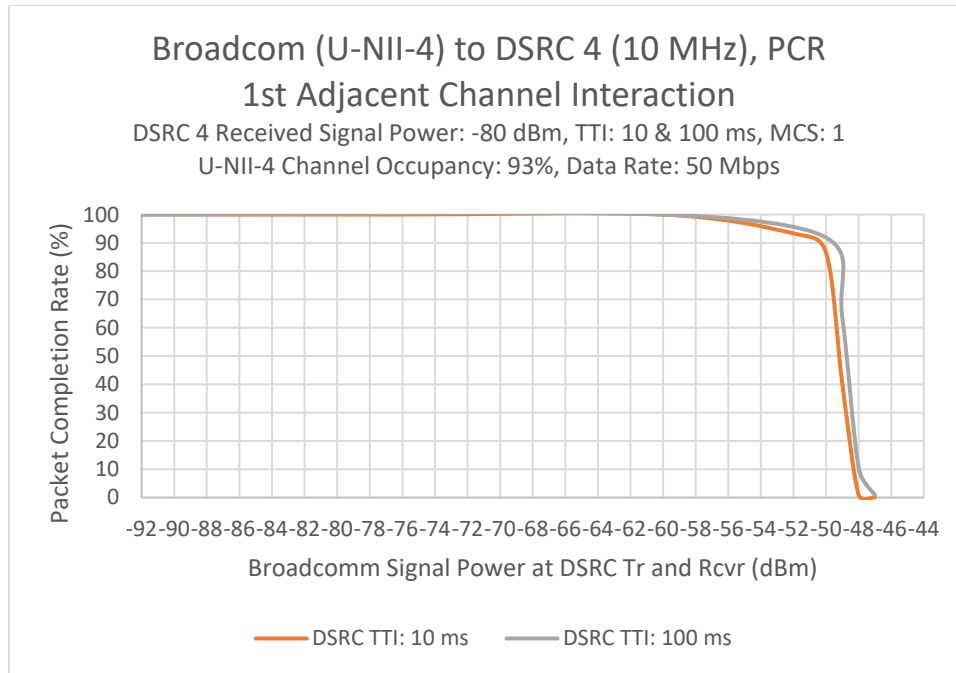
It is also possible for U-NII-4 and DSRC devices to operate on two primary 20-MHz channels immediately adjacent to one another. Figure 50 shows the impact of U-NII-4 transmission on DSRC packet completion rate when the DSRC device operates on channel 177, and the U-NII-4 (Broadcom) device operates on channel 173 simultaneously.



**Figure 50 – U-NII-4 and DSRC 1<sup>st</sup> Adjacent Channel Interaction – DSRC BW: 20 MHz, Channel 173**

### 6.4.2.3 Adjacent-channel Interaction- 10-MHz DSRC Operation

Another possibility for simultaneous DSRC and U-NII-4 device interaction maybe realized when a U-NII-4 device operates on a primary 20-MHz channel (channel 173 or 177) while the DSRC device is operating on a 10-MHz channel in the upper 30 MHz of the DSRC band (channels 180, 182 or 184). An example of such interaction is shown in Figure 51. Figure 51 shows the impact of U-NII-4 transmission on DSRC packet completion rate when a (10-MHz) DSRC device operates on channel 180, and the U-NII-4 (Broadcom) device operates on channel 177 simultaneously. DSRC TTIs of 10 ms and 100 ms were tested. The U-NII-4 mitigation mode was set to mode 0.



**Figure 51 – U-NII-4 and DSRC 1<sup>st</sup> Adjacent Channel Interaction – DSRC BW: 10 MHz, Channel: 180**

## 7. Observations

### 7.1 Initial Assessment of the Two Proposed Interference Mitigation Methods

The two proposed interference mitigation methods – Detect-and-Vacate and Re-Channelization – both offer means for U-NII-4 devices to coexist with DSRC devices in the 5.9 GHz band. For example, assuming a DSRC transmission at the maximum permissible EIRP level of 33 dBm<sup>27</sup> along a 300-meter unobstructed line-of-sight propagation path, the theoretical received power level at a U-NII-4 device will be approximately -65 dBm.<sup>28</sup> This calculation suggests that all of the prototype U-NII-4 devices tested would be capable of detecting this DSRC signal at a distance of 300 meters with significant margin (~30 dB) to account for additional signal attenuation associated with multipath and/or signal obstructions. Each method assumes certain characteristics associated with: (1) the environment in which DSRC and U-NII-4 devices are to operate; (2) detection mechanisms by which U-NII-4 devices detect the presence of DSRC devices; and (3) steps each U-NII-4 device will take upon detection of a DSRC signal (post-detection process).

With the said assumptions in place, the testing<sup>29</sup> showed that both methods were able to successfully detect a DSRC signal and implement post detection steps as they initially proposed. Both mitigation methods could detect a DSRC signal at approximately -95 dBm under optimal condition.

The Detect-and-Vacate method offers protection to DSRC operation through frequency separation, however, the Re-Channelization method affords a higher probability of transmission to DSRC devices during co-channel operation as described in the previous section. Below is a summary of the main points observed, as pertained to each proposed method, during the FCC laboratory testing.

### 7.2 Detect-and-Vacate Method

Our initial assessment of this method indicates that the U-NII-4 AP and STA – equipped with 10-MHz DSRC preamble detectors as proposed by Cisco and KEA – can effectively detect a DSRC transmission at thresholds of approximately -95 dBm, or higher, within the lower 4 DSRC channels. The following observations were made upon conclusion of the test:

- The detection threshold is a function of (desired) signal-to-noise ratio at a detector's receiver. A noisy channel can degrade this threshold as shown in Figures 45 and 46. Introducing added white Gaussian noise at a -90 dBm/20 MHz power density level

---

<sup>27</sup> §90.377(b).

<sup>28</sup>  $P_R = EIRP - L_P$ , where  $P_R$  = received power (dBm), EIRP = equivalent isotropic radiated power (dBm),  $L_P$  = basic free space propagation path loss (dB).

<sup>29</sup> It should be noted that phase I testing investigated the feasibility of two proposed interference mitigation strategies in a controlled laboratory environment and not in an outdoor setup representing real life scenarios. Two proof of concept prototypes' capability, to detect DSRC signal and execute their corresponding post detection processes, were examined with only one set of DSRC transmitter and receiver and one set of U-NII-4 access point and station present.

degraded the 90% probability of detection by approximately 2 dB as shown in Figures 45 and 46.

- Additionally, added white Gaussian noise produced false detections under certain circumstances. A 10-MHz-wide band-limited white Gaussian noise that was centered at the same frequency as a DSRC signal (co-channel) did introduce false detections when the added noise power level was about -92 dBm.
- Once a DSRC transmission is detected, the time it takes a U-NII-4 AP (or STA) to move and retransmit at the new backup channel (i.e., channel-move time) appeared to be a random number that was a function of the DSRC signal power, added noise power, and the modulation and coding scheme of a IEEE 802.11ac signal. Tables 22 and 23 show correlation between the power of the desired (DSRC) signal and the average channel-move time. The Average Channel-move time varied from 9.7 ms to 798.0 ms (Cisco Detector), and 0.3 ms to 385.16 ms (KEA Detector). On average, a higher DSRC signal power corresponded with a shorter channel-move time. No exhaustive attempt was made to explain the observed variance in channel-move time under the premise that if one of these mitigation proposals were to be adopted then a minimum vacate time would be established by either regulation or standard.
- Successful detection of a DSRC transmission, and the subsequent departure of a IEEE 802.11 transmission to a backup U-NII band, minimizes the risk of co-channel interference due to the IEEE 802.11 operation in U-NII-4 band. Risk of adjacent channel interference, on the other hand, remains unmitigated as shown in Figure 46. However, the probability of interference due to adjacent channel operations is considerably less. This probability, comparing to the probability of interference due to unmitigated co-channel operation, is reduced by a factor equal to the Adjacent Channel Rejection Ratio (ACRR) of a DSRC device. DSRC devices that were tested in the FCC Laboratory showed a ACRR of 31 dB to 41 dB (for first adjacent channel operation) as shown throughout section 6.1.
- Risk of adjacent channel interference is even further reduced under Detect-and-Vacate method. As mentioned above, this method can detect a DSRC signal at the threshold of approximately -95 dBm, or higher, anywhere in the lower 40 MHz of the 5.9 GHz band. While this method, as currently presented, may not detect DSRC signals in the upper 30 MHz of the band at such low levels, it should be noted that in almost all DSRC operational scenarios, at least one of the lower four DSRC channels (channel 172, 174, 176 and 178) is planned to be used in addition to channels 180, 182 and 184. Therefore, a DSRC signal is theoretically detectable in almost all DSRC operational scenarios if at least one of the four lower channels is used.

### **7.3 Re-Channelization Method**

Our initial assessment of this method indicates that the U-NII-4 AP and STA can detect a 20-MHz-wide (co-channel) DSRC signal at approximately -96 dBm, under optimal condition, and can subsequently execute the EDCA protocol to provide a higher priority to the DSRC transmission as has been proposed by Broadcom and Qualcomm Inc. The following observations were made upon conclusion of the test:

- Detection threshold is a function of the (desired) signal-to-noise ratio at the detector's receiver. A noisy channel can degrade this threshold as observed in Figure 47. To maintain a 90% probability of detection, the DSRC signal power must increase by 1 dB for every 2 dB increase in additional noise power in the channel as seen in Figure 47.
- Upon detection of a DSRC signal, higher order mitigation modes provide higher priority to a DSRC transmission as expected. Figure 48 depicts this trend by plotting the DSRC packet completion rate as a function of the U-NII-4 device signal power.<sup>30</sup>
- There appears to be three distinct regions of performance in Figure 48. Region 1 where PCR decreases as interference power level increases from -92 dBm to -82 dBm; Region 2 where PCR stays relatively constant as the interference power level increases from -82 dBm to -70 dBm; and Region 3 where PCR increases as the interference power level increases from -70 dBm to -44 dBm. This phenomenon is believed to be the result of the interaction between DSRC and U-NII-4 signal detection mechanisms at different power levels. As the received signals at the devices increase, it is likely that the signal detection becomes more robust and the random back-off algorithms are operating more efficiently in favor of the DSRC devices by allowing them to increase their packet completion rates. Since both the U-NII-4 and DSRC devices implement the IEEE 802.11 MAC priority access protocol and clear channel assessment, the signal detection is likely to be mutual, i.e., both the DSRC and U-NII-4 devices can detect other transmitted signals and execute sharing protocol based on their assigned EDCA parameters. The improvement in PCR shown in Figure 44 may be the result of this mutual detection mechanism, however, it's very difficult to isolate this interaction of back-off algorithms exercised by the DSRC and U-NII-4 devices.
- In the third region mentioned above, an additional detection mechanism – Clear Channel Assessment-Energy Detect (CCA-ED) capability – may have also contributed to the PCR improvement. Unlike a signal detection mechanism that can determine the exact length of time that the channel will be busy, the energy-detect scheme must sample the medium every slot time. However, CCA-ED requires a predefined threshold which determines if energy in the medium is enough to declare the channel busy or idle. It is likely that when the interference power level reaches this ED threshold (interference power levels of -70 dBm and above in Figure 50), the ED capability of U-NII-4 and DSRC devices may be enabled and subsequently boost DSRC packet completion rate.
  - The CCA-ED capability was also observed in at least one other DSRC device tested.<sup>31</sup> The DSRC 2 transmitter, for instance, responded to the AWGN signal as shown in Figure 36. The CCA-ED capability of the DSRC 2 device likely detected added noise in its receiver and declared channel busy when the AWGN power level reached approximately -72 dBm. This was evident as both the DSRC 2 TTI and one-way delay started to increase at AWGN signal power level of -72

---

<sup>30</sup> DSRC network maintains its own Priority Access (PA) class and EDCA parameters. The DSRC devices under test are believed to have used EDCA parameters associated with Best Effort (BE) traffic. The DSRC EDCA parameters were not changed during the test.

<sup>31</sup> While CCA-ED capability is recommended, by IEEE 802.11 standards, for implementation in IEEE 802.11 LAN devices it is not a mandated requirement by any U.S. regulatory bodies. It is not known if all IEEE 802.11 devices including Wi-Fi or DSRC devices are equipped with such capability.



dBm. Here, one-way delay is defined as the lapsed time between event 1 (when a packet was placed in the transmit queue) and event 2 (when the same packet was successfully received by the DSRC 2 receiver). This delay was recorded as 2.01 ms when the noise power was at -98 dBm. However, the delay was increased to approximately 5 ms at the noise power of -72 dBm, at which point only 994 packets were received. The DSRC 2 transmitter was shut down at an interference power level of -70 dBm.

- The DSRC 2 transmitter response to actual and simulated IEEE 802.11ac signal was also observed. No degradation to the DSRC 2 packet transmission rate was observed until the IEEE 802.11ac channel occupancy reached 90% (as shown in Figure 18) at which point PCR started to degrade. However, PCR was improved when the IEEE 802.11ac signal power reached -72 dBm, and the trend continued until the IEEE 802.11ac signal power level reached approximately -60 dBm. PCR improvement in this region can be attributed to the CCA-ED capability of the DSRC 2.
- The PCR and IDT data indicates a direct correlation, as shown in Figures 48 and 49. Higher order mitigation modes improve PCR and IDT. As the packet completion rate approaches 100%, the packet inter-departure time approaches the baseline value of 10 ms.
- The Re-Channelization method also leaves potential for interference due to adjacent channel unmitigated operation. However, as mentioned above, the probability of interference due to adjacent channel operation is considerably less. This probability, as compared to the probability of interference due to unmitigated co-channel operation, is reduced by a factor equal to the Adjacent Channel Rejection Ratio (ACRR) of a DSRC device. DSRC devices that were tested have an ACRR of 31 dB to 41 dB (for first adjacent channel operation), as shown throughout section 6.2.

## 7.4 Comparison of the Two Interference Mitigation Methods

Table 24 provides a summary of the characteristics of the two interference mitigation methods. It should be noted that our findings here are based on limited laboratory (“bench top”) testing performed during phase one of the three-phase test program. All tests were performed on a conducted basis.

**Table 24 – Comparison of the Two Mitigation Methods**

| <b>Features</b>                     | <b>Cisco Detect-and-Vacate Method</b>                | <b>Broadcom/Qualcomm Re-Channelization Method</b>  |
|-------------------------------------|--|--|
| Detection Threshold (10 MHz DSRC)   | ~ -95 dBm  | N/A  |
| Detection Threshold (20 MHz DSRC)   | N/A  | ~ -96 dBm  |
| Bandwidth of Detection              | Four lower 10 MHz channels                           | Detects DSRC signal at the channel it intends to transmit  |
| Coexistence upon detection          | Vacates entire U-NII-4 band. No co-channel operation | Provides higher priority to DSRC transmission during co-channel operation  |
| Impact to current DSRC channel plan | None   | Requires 20 MHz DSRC channels in the lower 40 MHz portion of the band, and places all BSM operations at the upper 30 MHz portion of the band |

## Appendix A: Enhanced Distributed Channel Access (EDCA)<sup>32</sup>

EDCA is the first (of two) mechanism, recommended by IEEE 802.11 standard that provides Media Access Control (MAC) enhancements to support IEEE 802.11 applications with Quality of Service (QoS) requirements. EDCA delivers traffic based on differentiating user priorities (UP). This differentiation is achieved by varying the following for different UP values:

- Amount of time an IEEE 802.11 device senses the channel to be idle before back-off of transmission, or
- The length of the contention window (CW) to be used for the back-off, or
- The duration an IEEE 802.11 device may transmit after it acquires the channel Transmit Opportunity (TXOP).

The time interval between IEEE 802.11 frames is called the inter-frame spacing (IFS). An IEEE 802.11 device shall determine that the medium is idle through the use of the Carrier Sense (CS) function for the interval specified. Six different IFSs are defined in IEEE 802.11 standards to provide priority levels for access to the wireless medium. The IFSs are:

- RIFS reduced inter-frame space
- SIFS short inter-frame space
- PIFS PCF inter-frame space
- DIFS DCF inter-frame space
- AIFS arbitration inter-frame space (used by the networks that provide Quality of Service (QoS))
- EIFS extended inter-frame space

Of specific interest to this test and measurement efforts is AIFS which is a time interval between frames being transmitted. AIFS depends on the access category (AC) and AIFSN or AIFS Number. AIFS is defined by the following formula  $AIFS = AIFSN * (Slot\ Time) + SIFS$ . Slot time (usually in the range of microseconds) is dependent on the physical layer (PHY) defined in each IEEE 802.11 standard, and SIFS is the time interval between a data packet and the Acknowledgement (Ack) frame.

Another parameter of interest as expressed above is the term Contention Window (CW). Once the IEEE 802.11 device has waited the appropriate AIFS time, it randomly selects a value for its random back-off timer. The timer value must be within the Contention Window values defined for the user priority (UP) queue. Each UP has a defined Contention Window range, initially defined as ranging from 0 to CW<sub>min</sub>, where CW<sub>min</sub> varies between each of the UP sets. If a collision occurs where two IEEE 802.11 devices transmit at the same time, no acknowledgment

---

<sup>32</sup> IEEE Standard IEEE 802.11-2012 IEEE Standard for Information technology, Telecommunications and information exchange between systems, Local and metropolitan area networks, Specific requirements (Part 11: Wireless LAN Medium Access Control (MAC) and Physical Layer (PHY) Specifications),

of the frame will be received and the IEEE 802.11 device will increment its retry counter and increase its contention window according to the binary exponential back-off algorithm, up to a maximum contention window size of  $CW_{max}$ . The stations must then wait the appropriate AIFS time, select a new random back-off timer using the new contention window range, and proceed as before.

As with AIFS, the differences in the contention window values serve to prioritize traffic in higher priority queues by allowing them to wait shorter time intervals before being allowed to transmit over the air. The  $CW_{min}$  and  $CW_{max}$  values vary based on the physical layer (PHY) and the UP queue in use.

## **Appendix B: RF Characterization Test Results**

### **B.1 Conducted Occupied Bandwidth (OBW) Test Results**

The U-NII-4 and DSRC devices were examined for OBW. U-NII-4 devices were set on 3 channels (Channels 177 for 20 MHz, Channel 175 for 40 MHz, and Channel 171 for 80 MHz), under maximum output power level setting, and using four MCS indexes (OFDM MCS Index 0, 1, 3 and 5) for Channel 177, and worst-case MCS for Channel 175 and 171. DSRC devices were set on 2 channels (Channels 172 for 10 MHz and 175 for 20 MHz), under maximum output power level setting, using four MCS indexes (OFDM MCS Index 0, 1, 3 and 5) for DSRC Channel 172 and worst-case MCS for DSRC Channel 175.

An RF Spectrum Analyzer was used to measure the OBW at 99% of the power, -26 dB down (each side of center) from the highest amplitude signal observed at the fundamental frequency, or located at the first order modulation products, on one of the modulated sample device's antenna coaxial port.

During the conducted antenna port OBW measurement, the Spectrum Analyzer settings were:

- RBW  $\geq$  100 kHz
- VBW  $\geq$  3x RBW
- SPAN  $\geq$  3x RBW
- SWEEP AUTO
- DETECTOR = PEAK
- TRACE = Max Hold
- MEAS = internal OBW measurement personality

Figures 52 through 124 show the conducted OBW test results for U-NII-4 and DSRC devices.

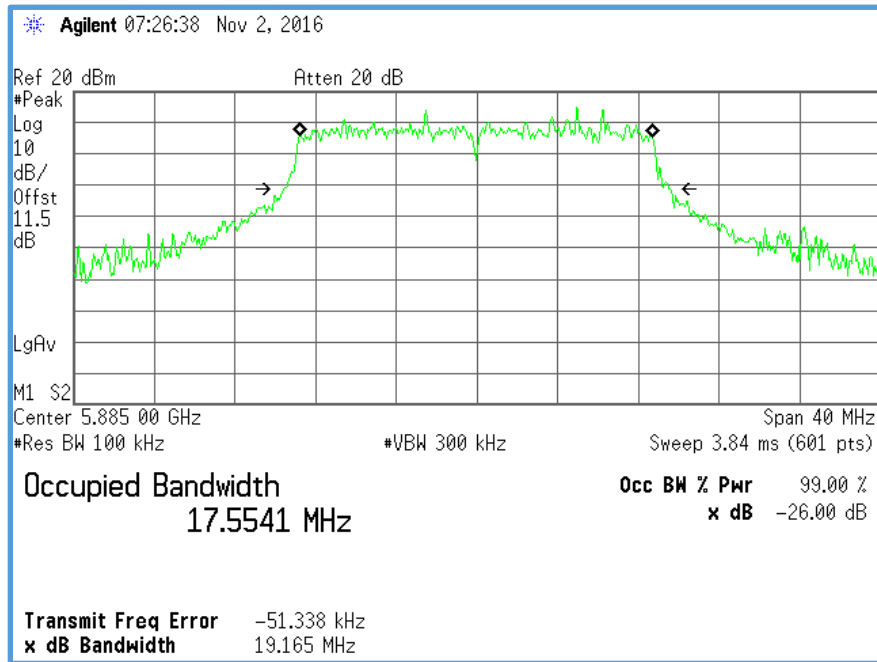


Figure 52 – Conducted OBW, Sample 05 U-NII-4, CH.177 OFDM MCS Index 0 Plot

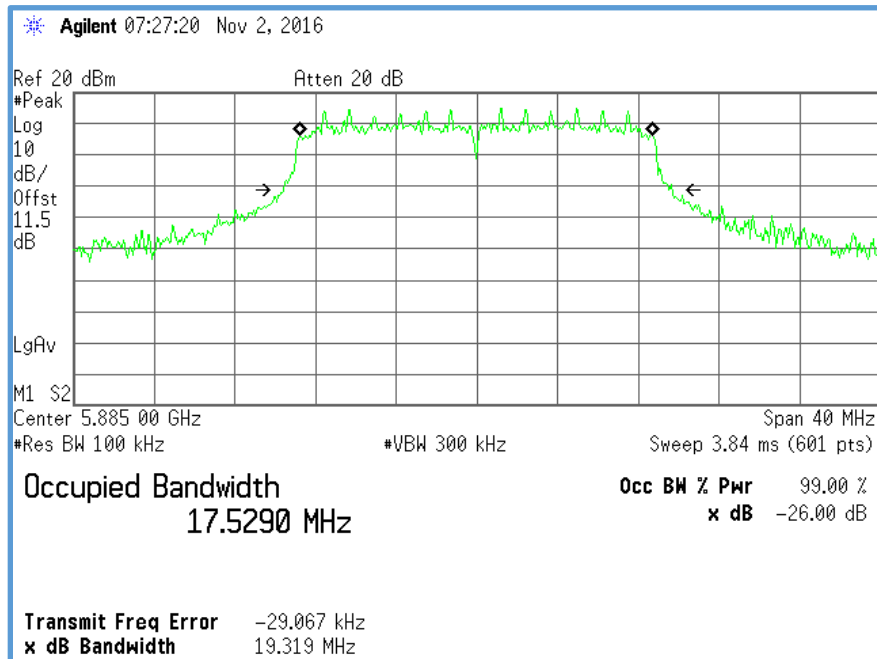


Figure 53 – Conducted OBW, Sample 05 U-NII-4, CH.177 OFDM MCS Index 1 Plot

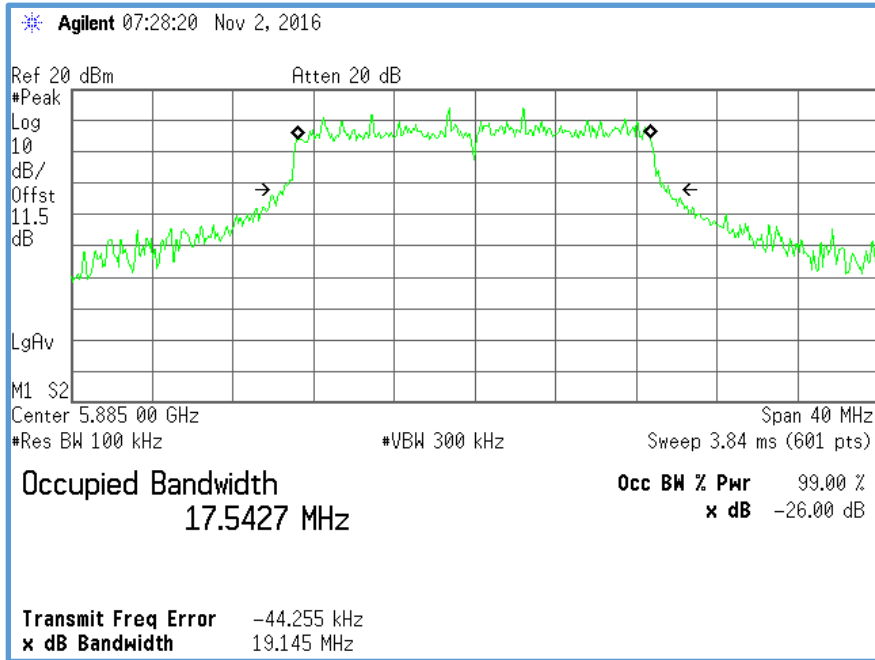


Figure 54 – Conducted OBW, Sample 05 U-NII-4, CH.177 OFDM MCS Index 3 Plot

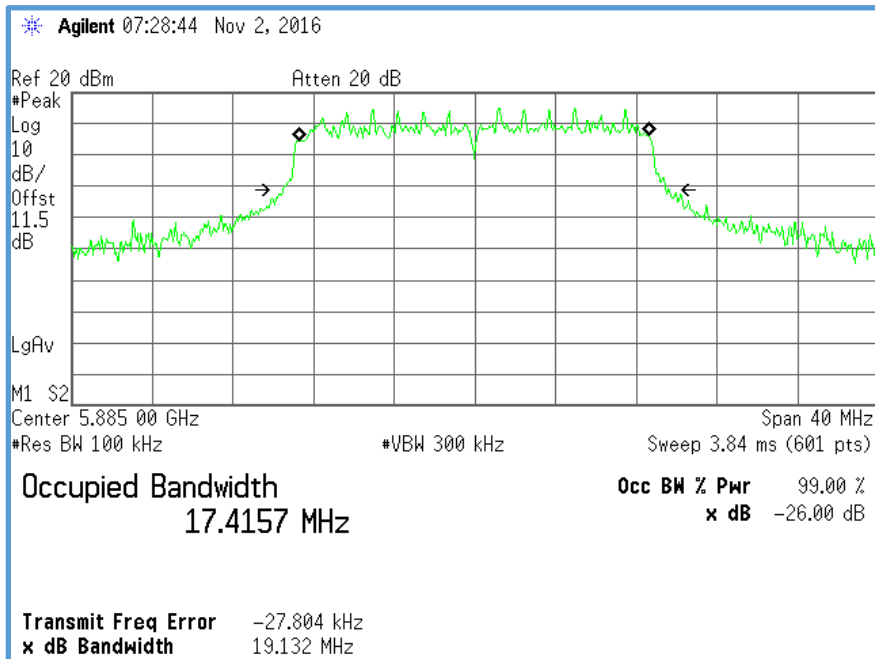


Figure 55 – Conducted OBW, Sample 05 U-NII-4, CH. 177 OFDM MCS Index 5 Plot

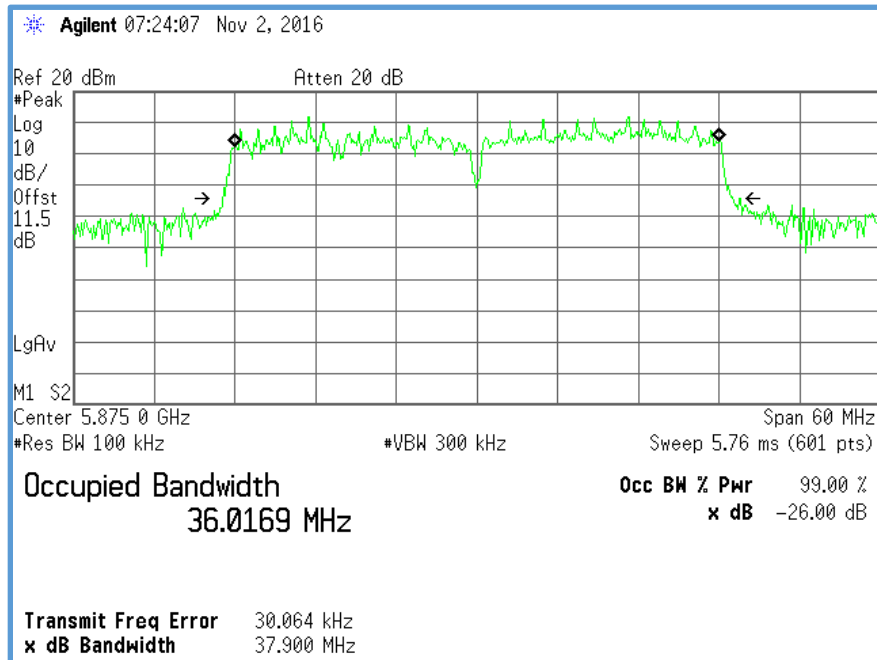


Figure 56 – Conducted OBW, Sample 05 U-NII-4, CH. 175 OFDM MCS Index 0 Plot

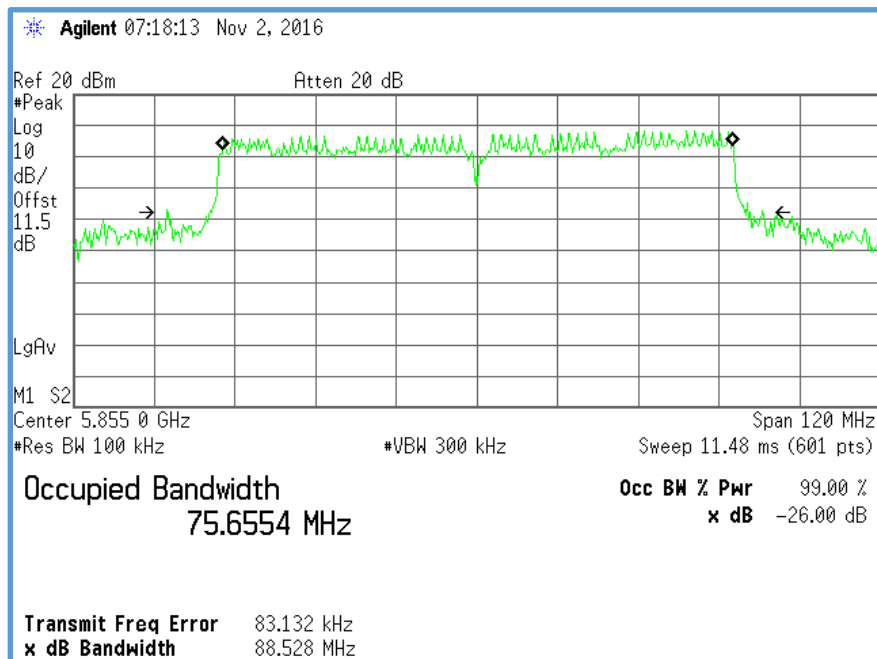


Figure 57 – Conducted OBW, Sample 05 U-NII-4, CH.171 OFDM MCS Index 0 Plot



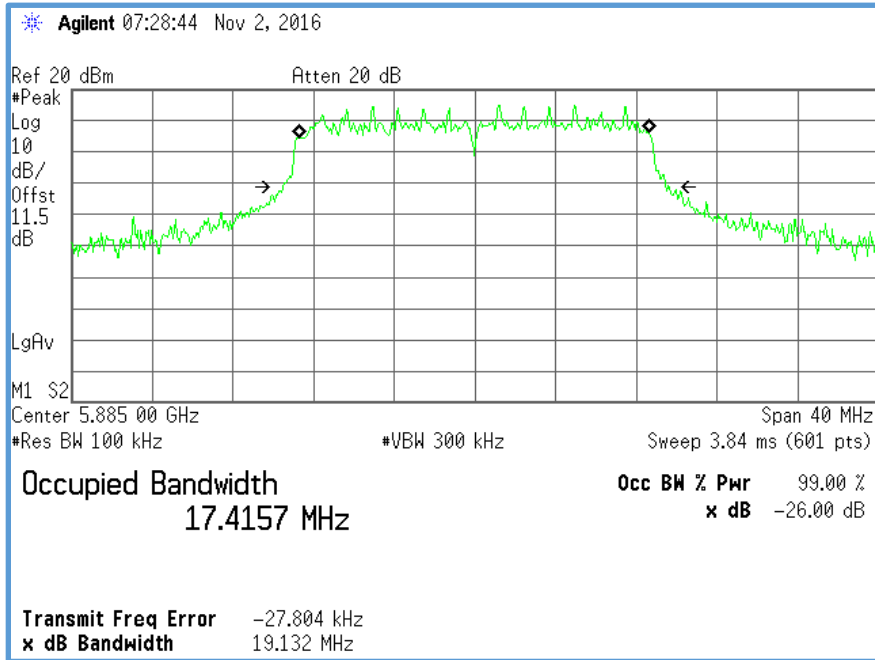


Figure 58 – Conducted OBW, Sample 06 U-NII-4, CH.177 OFDM MCS Index 0 Plot

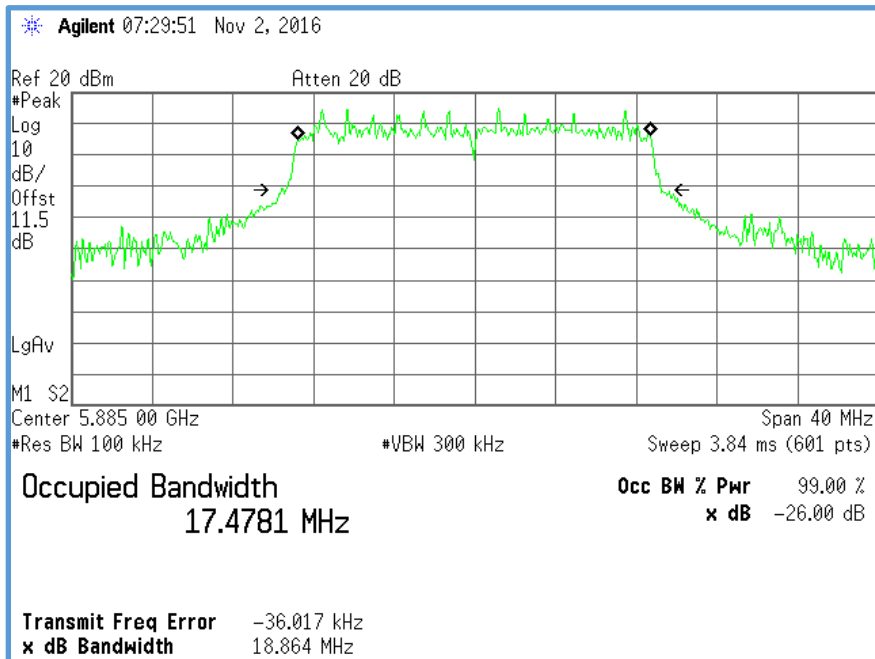


Figure 59 – Conducted OBW, Sample 06 U-NII-4, CH.177 OFDM MCS Index 1 Plot

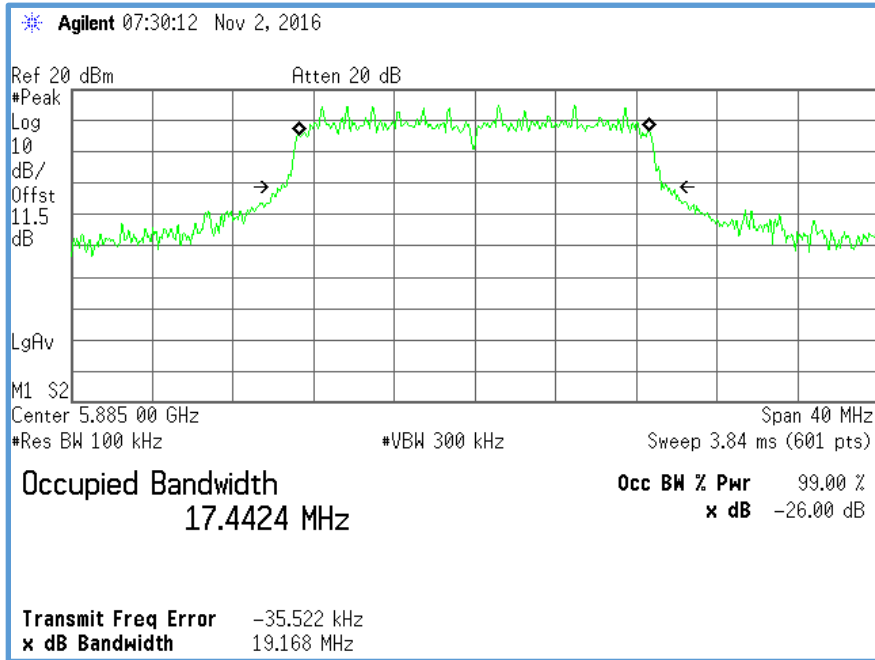


Figure 60 – Conducted OBW, Sample 06 U-NII-4, CH.177 OFDM MCS Index 3 Plot

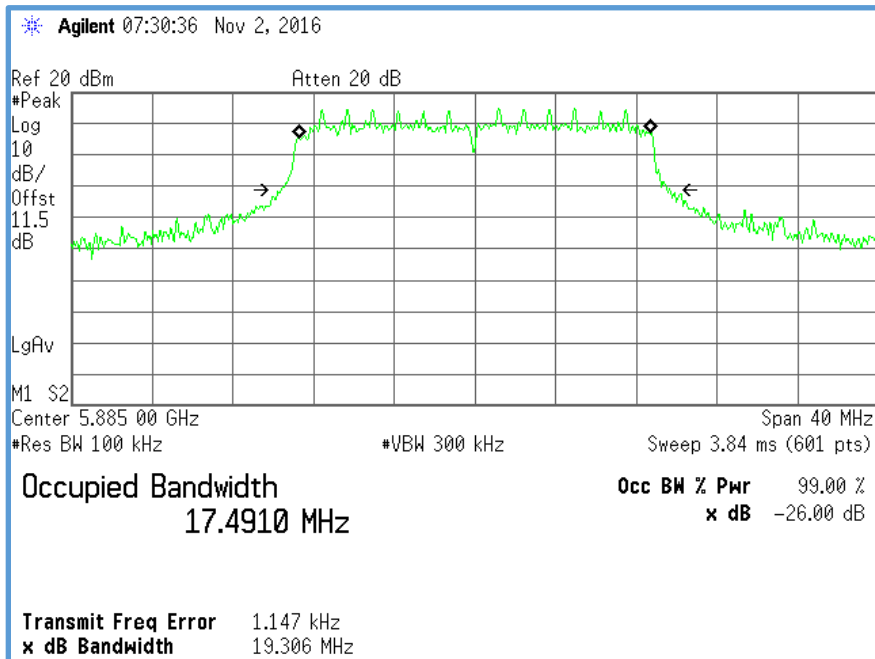


Figure 61 – Conducted OBW, Sample 06 U-NII-4, CH.177 OFDM MCS Index 5 Plot

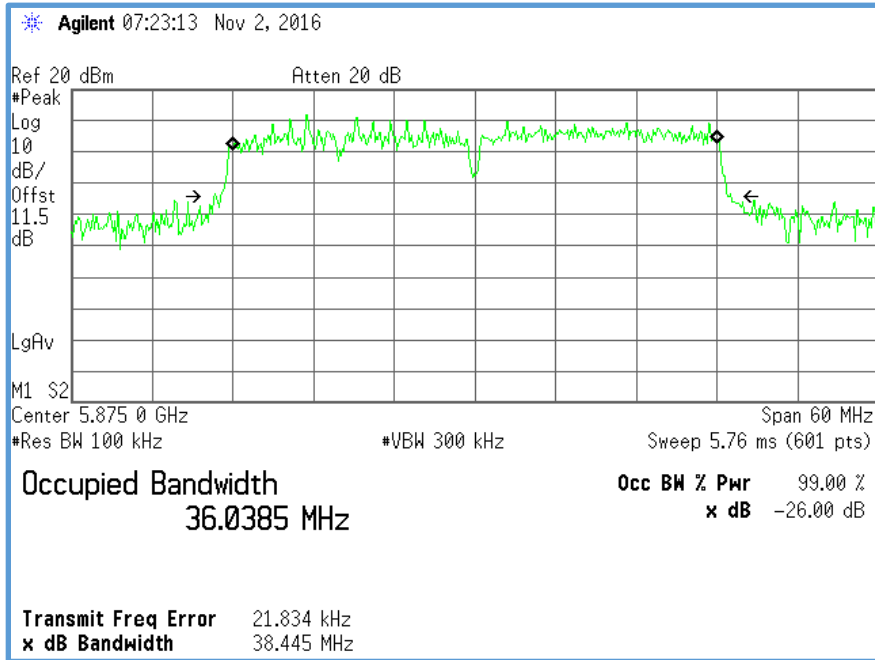


Figure 62 – Conducted OBW, Sample 06 U-NII-4, CH.175 OFDM MCS Index 0 Plot

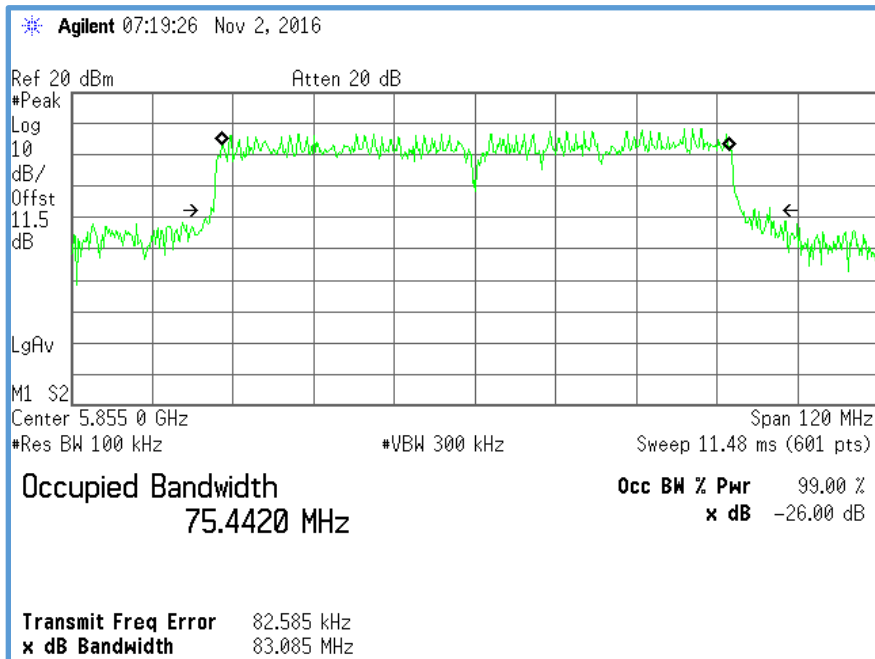


Figure 63 – Conducted OBW, Sample 06 U-NII-4, CH.171 OFDM MCS Index 0 Plot

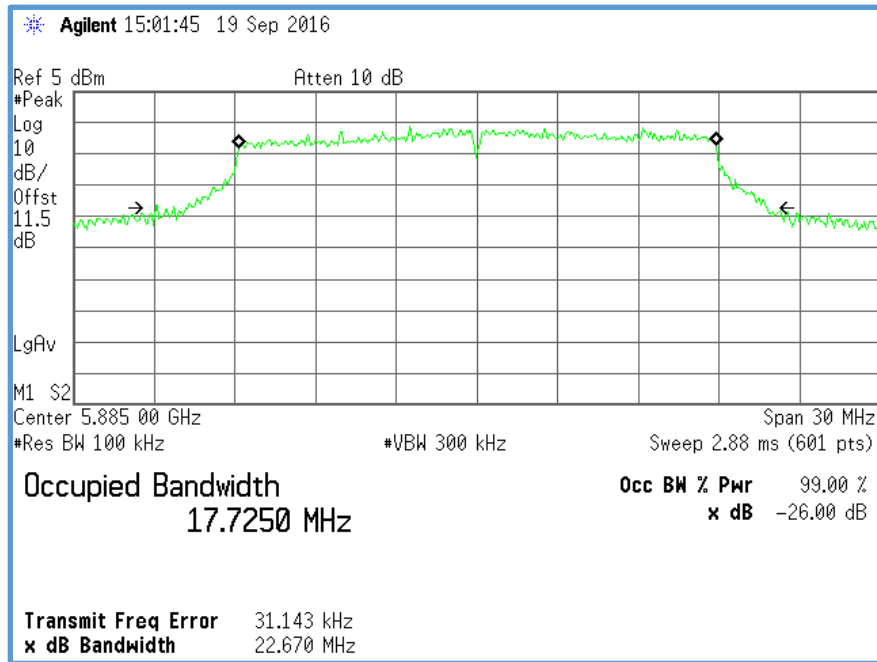


Figure 64 – Conducted OBW, Sample 07D U-NII-4, CH.177 OFDM MCS Index 0 Plot

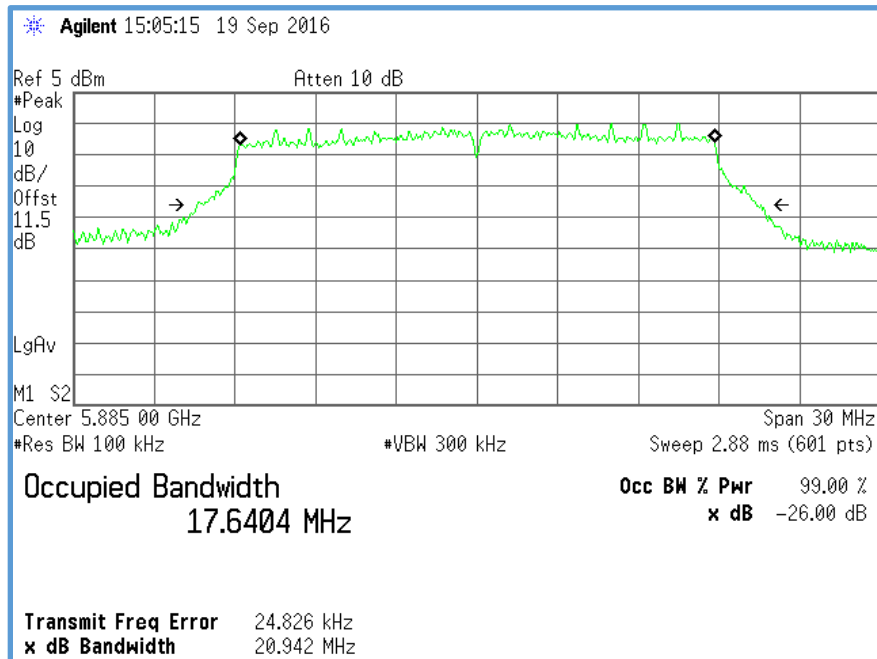


Figure 65 – Conducted OBW, Sample 07D U-NII-4, CH.177 OFDM MCS Index 1 Plot

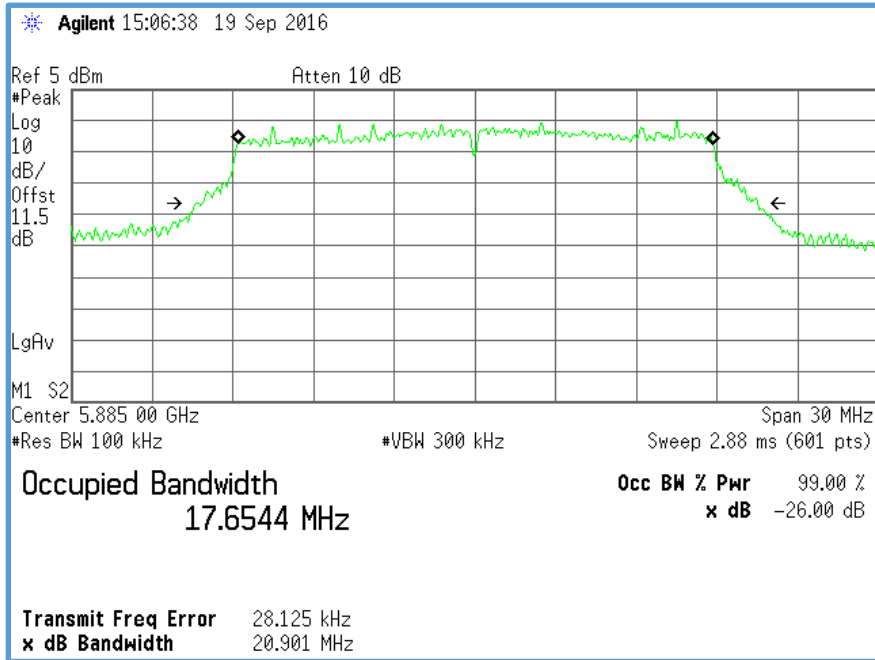


Figure 66 – Conducted OBW, Sample 07D U-NII-4, CH.177 OFDM MCS Index 3 Plot

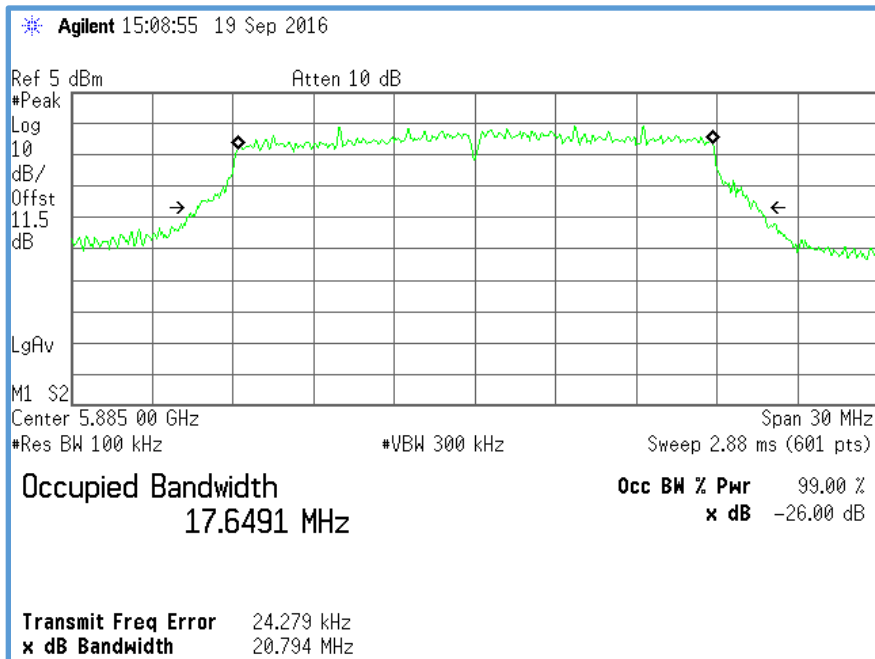


Figure 67 – Conducted OBW, Sample 07D U-NII-4, CH.177 OFDM MCS Index 5 Plot

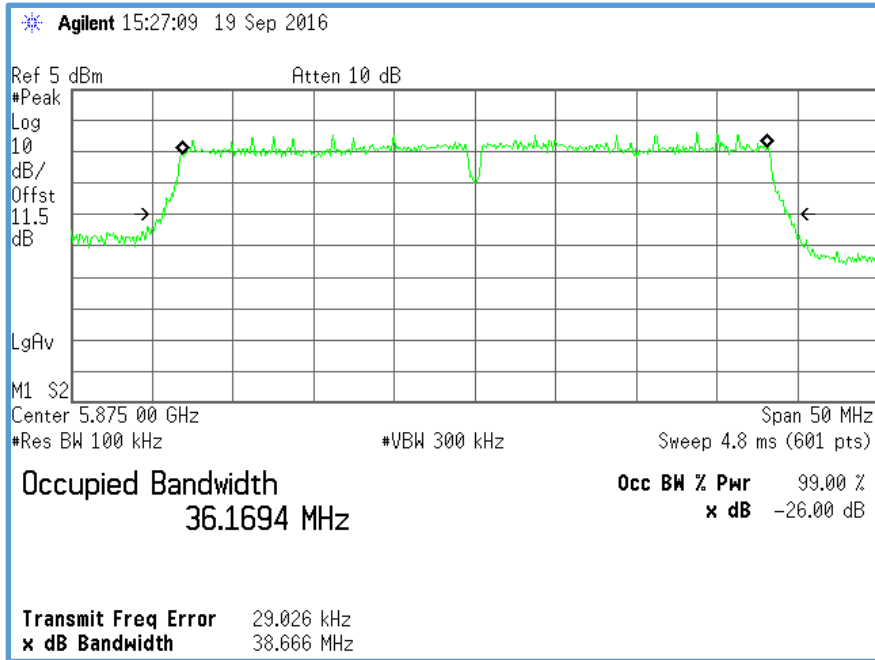


Figure 68 – Conducted OBW, Sample 07D U-NII-4, CH.175 OFDM MCS Index 0 Plot

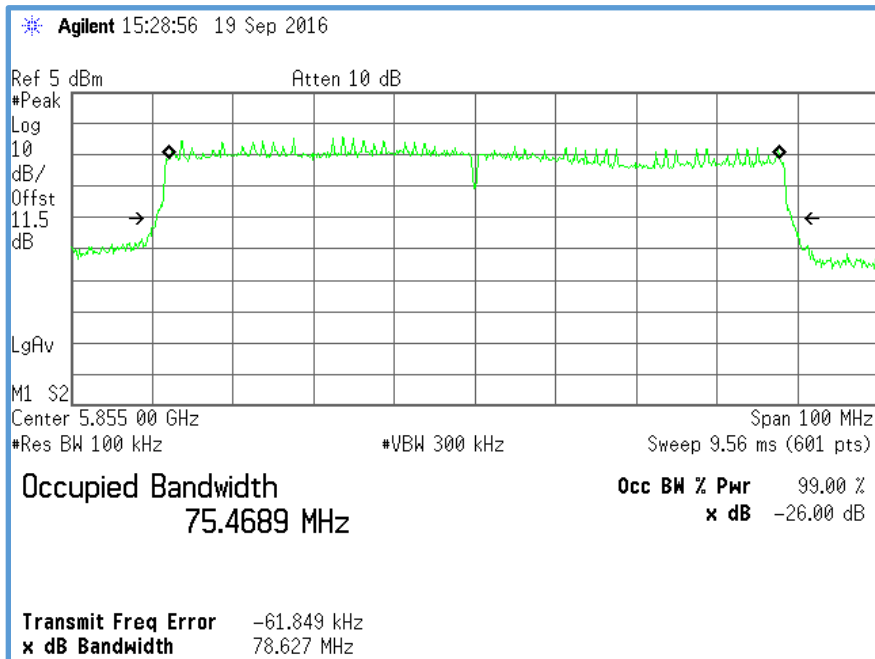


Figure 69 – Conducted OBW, Sample 07D U-NII-4, CH.171 OFDM MCS Index 0 Plot

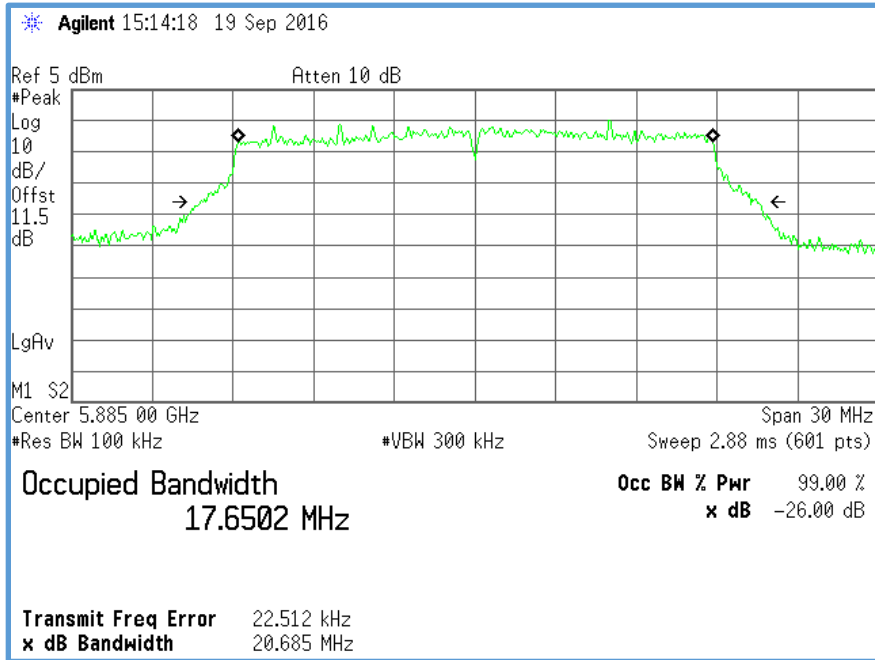


Figure 70 – Conducted OBW, Sample 08D U-NII-4, CH.177 OFDM MCS Index 0 Plot

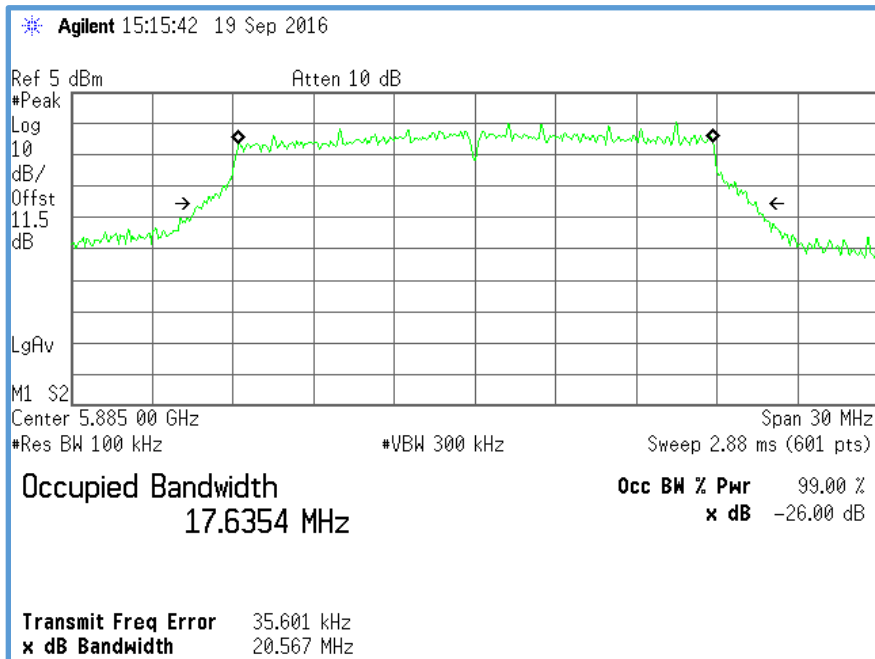


Figure 71 – Conducted OBW, Sample 08D U-NII-4, CH.177 OFDM MCS Index 1 Plot

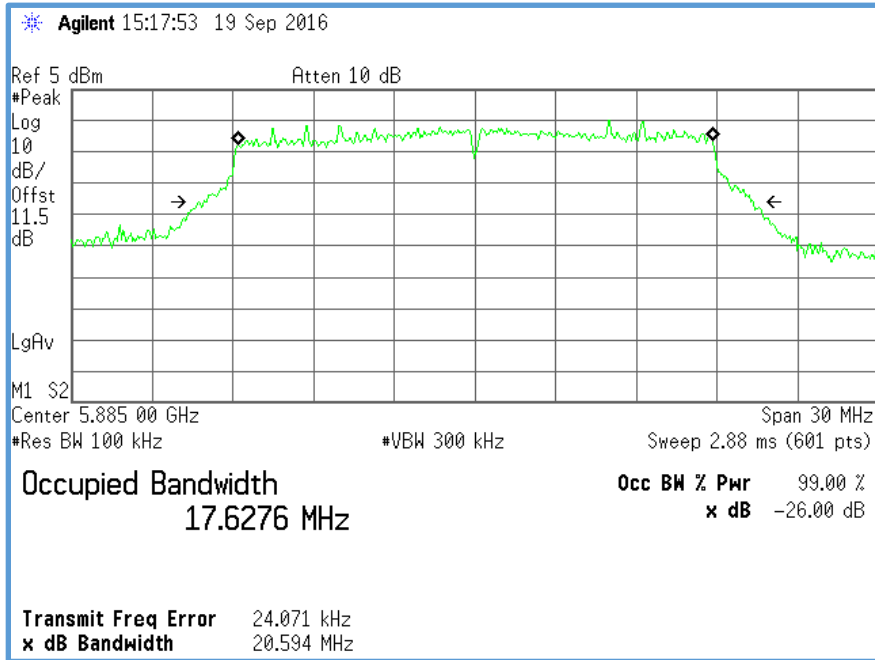


Figure 72 – Conducted OBW, Sample 08D U-NII-4, CH.177 OFDM MCS Index 3 Plot

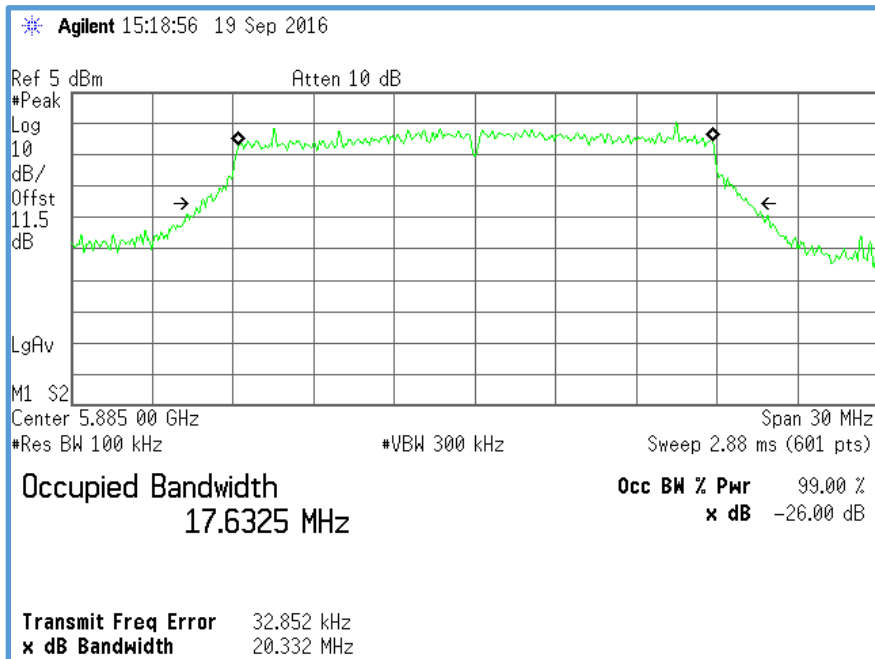


Figure 73 – Conducted OBW, Sample 08D U-NII-4, CH.177 OFDM MCS Index 5 Plot



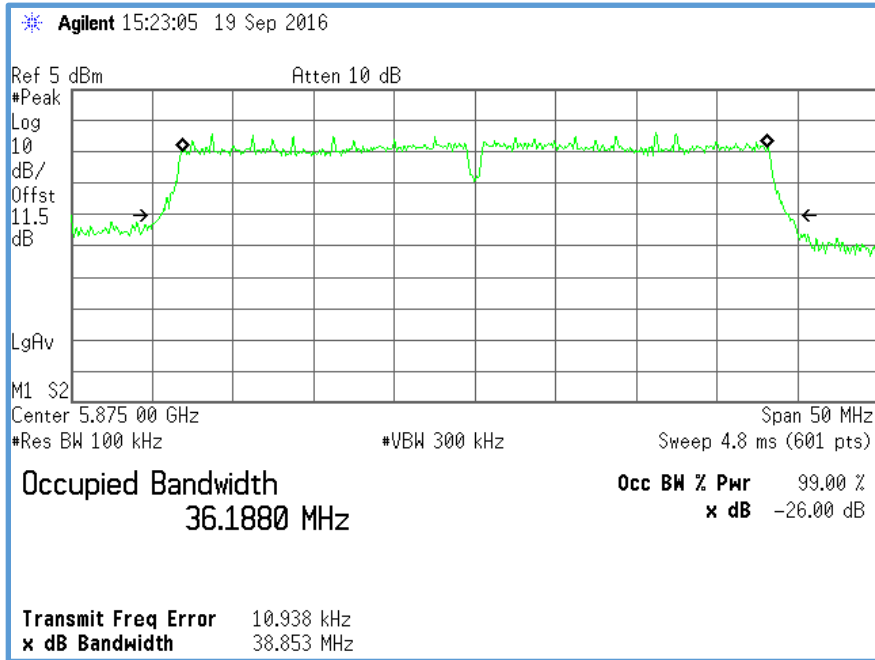


Figure 74 – Conducted OBW, Sample 08D U-NII-4, CH.175 OFDM MCS Index 0 Plot

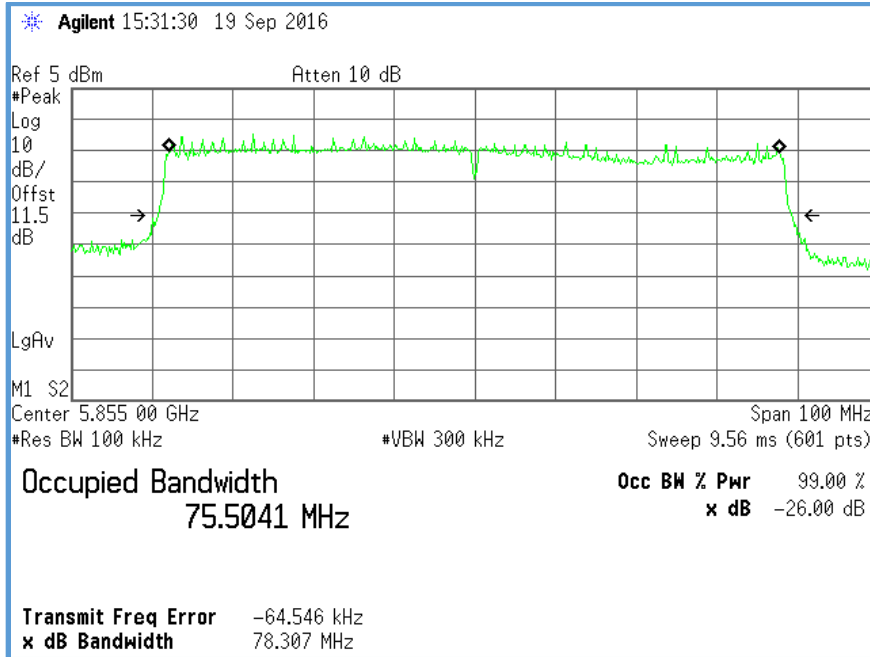


Figure 75 – Conducted OBW, Sample 08D U-NII-4, CH.171 OFDM MCS Index 0 Plot

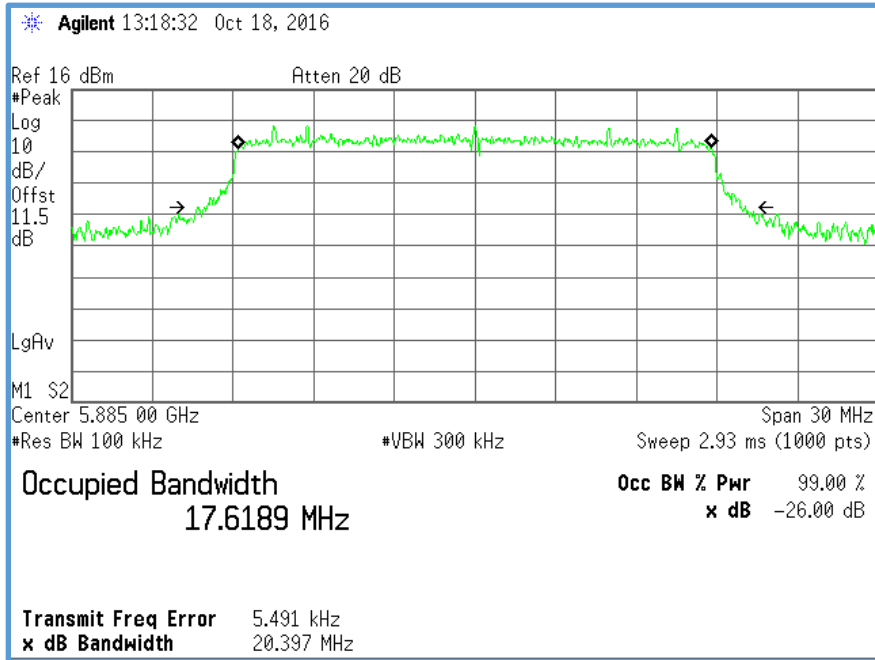


Figure 76 – Conducted OBW, Sample 14A U-NII-4, CH.177 OFDM MCS Index 0 Plot

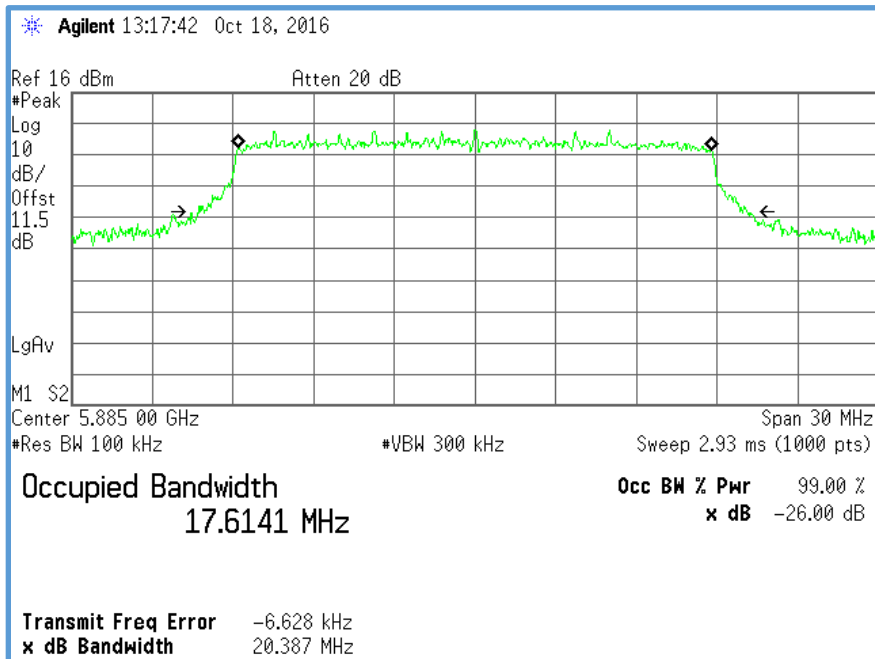


Figure 77 – Conducted OBW, Sample 14A U-NII-4, CH.177 OFDM MCS Index 1 Plot

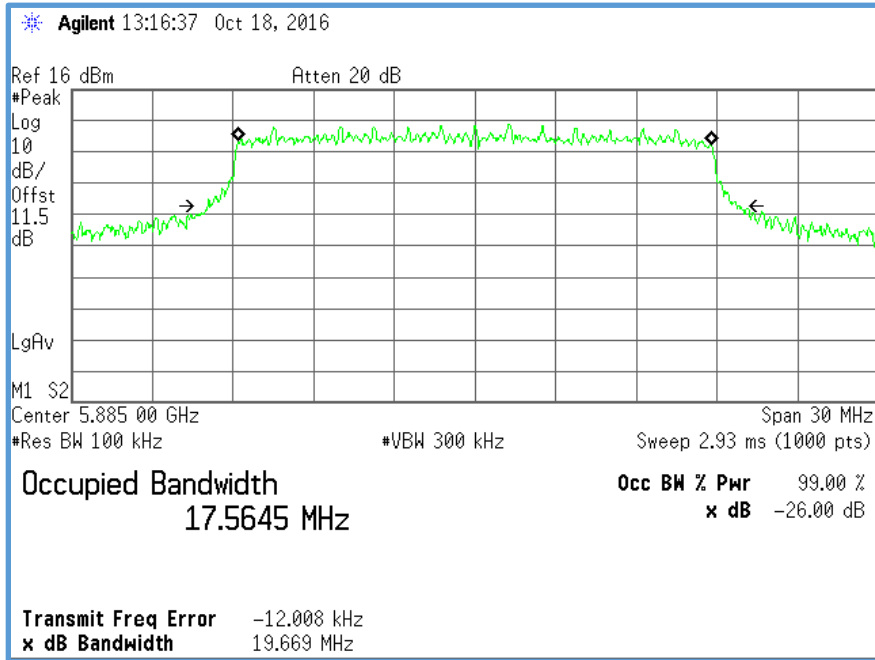


Figure 78 – Conducted OBW, Sample 14A U-NII-4, CH.177 OFDM MCS Index 3 Plot

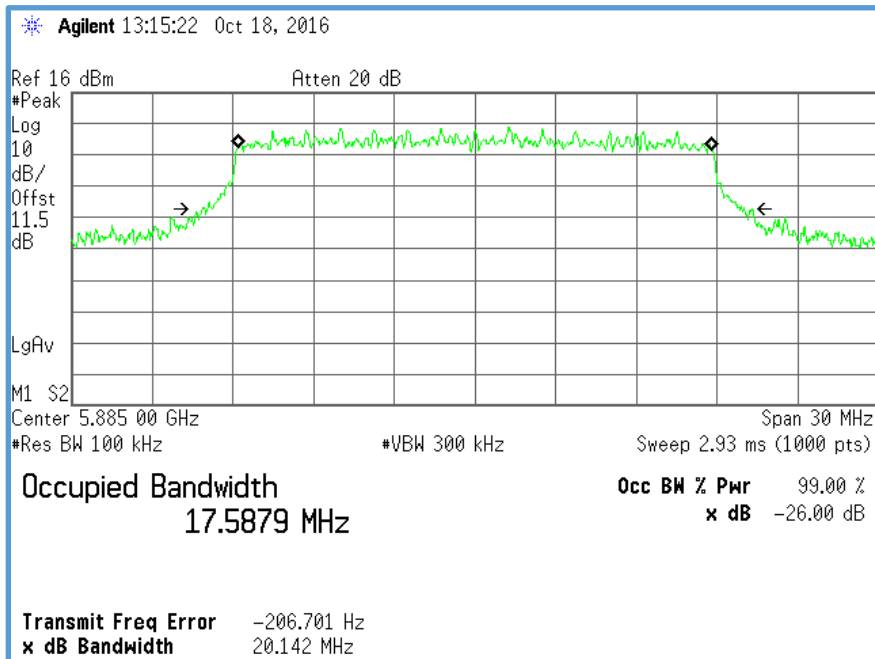


Figure 79 – Conducted OBW, Sample 14A U-NII-4, CH.177 OFDM MCS Index 5 Plot

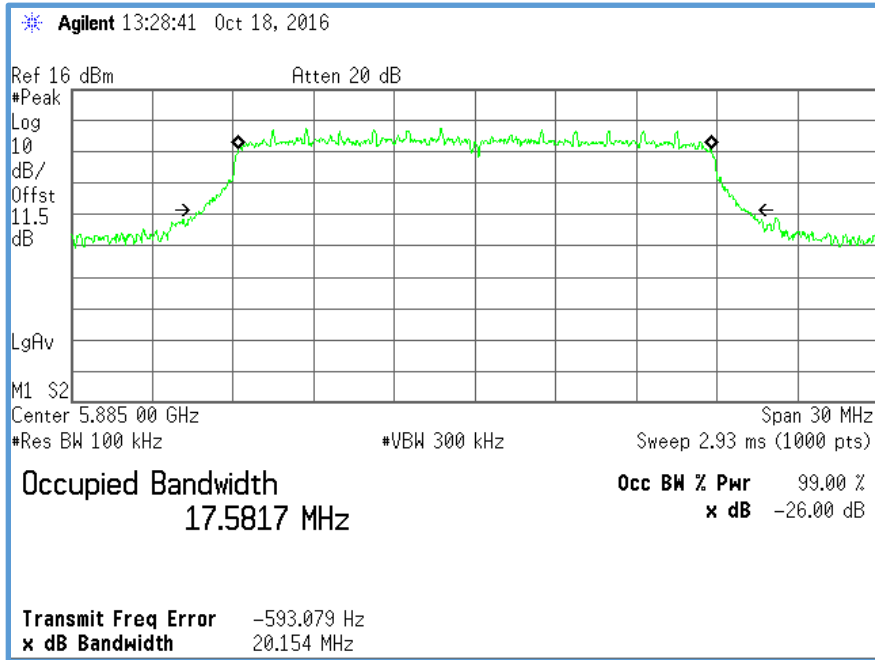


Figure 80 – Conducted OBW, Sample 15A U-NII-4, CH.177 OFDM MCS Index 0 Plot

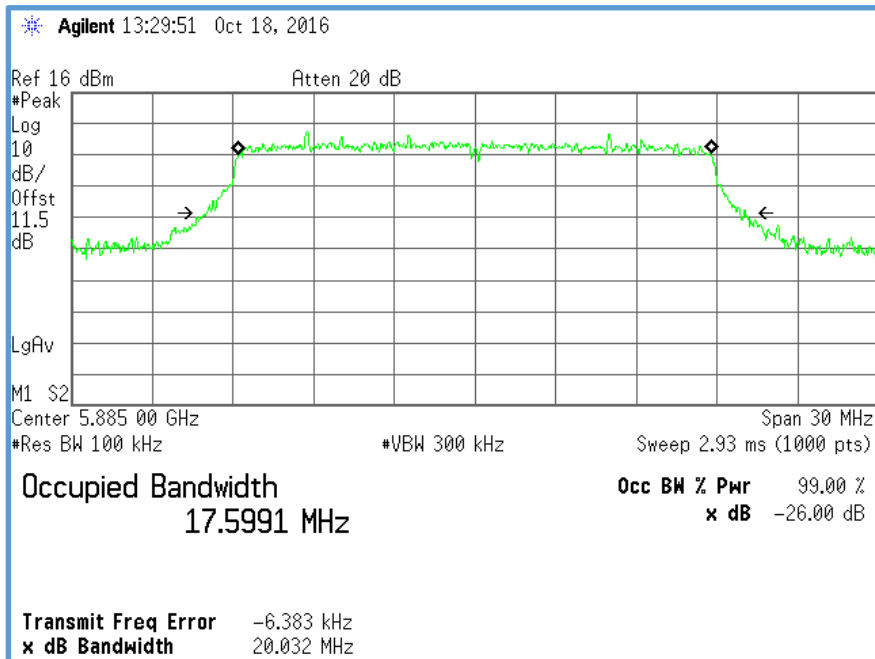


Figure 81 – Conducted OBW, Sample 15A U-NII-4, CH.177 OFDM MCS Index 1 Plot

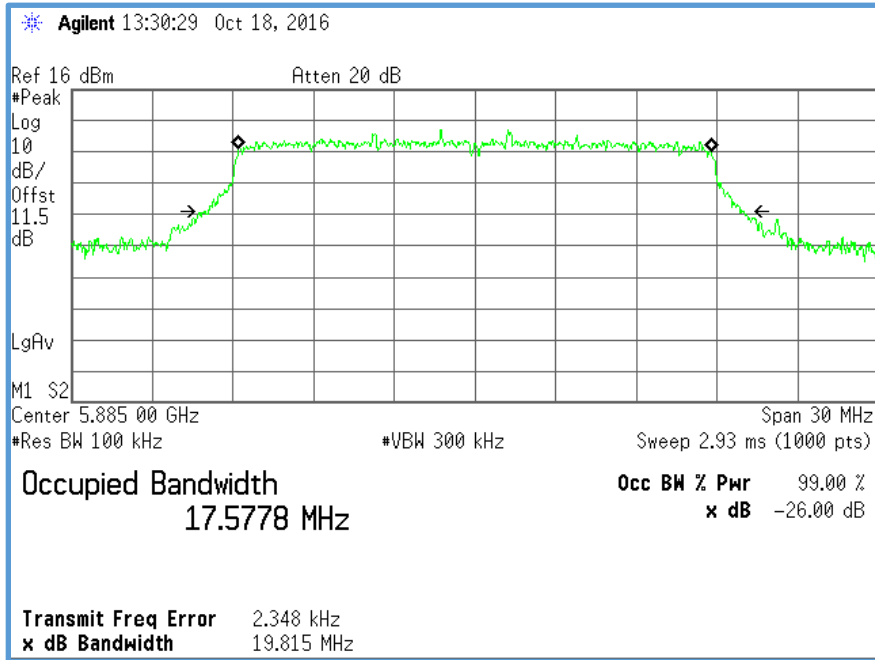


Figure 82 – Conducted OBW, Sample 15A U-NII-4, CH.177 OFDM MCS Index 3 Plot

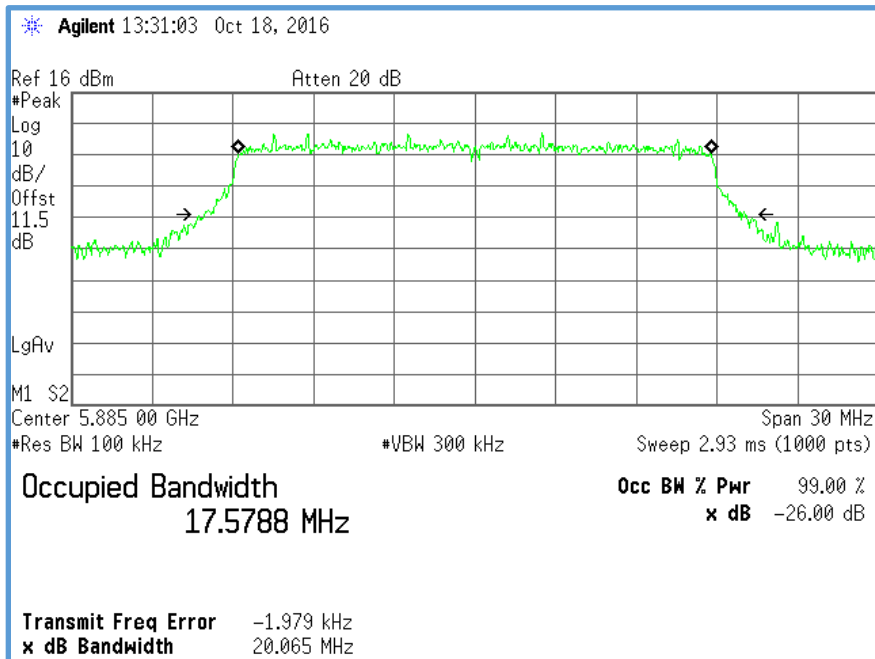


Figure 83 – Conducted OBW, Sample 15A U-NII-4, CH.177 OFDM MCS Index 5 Plot

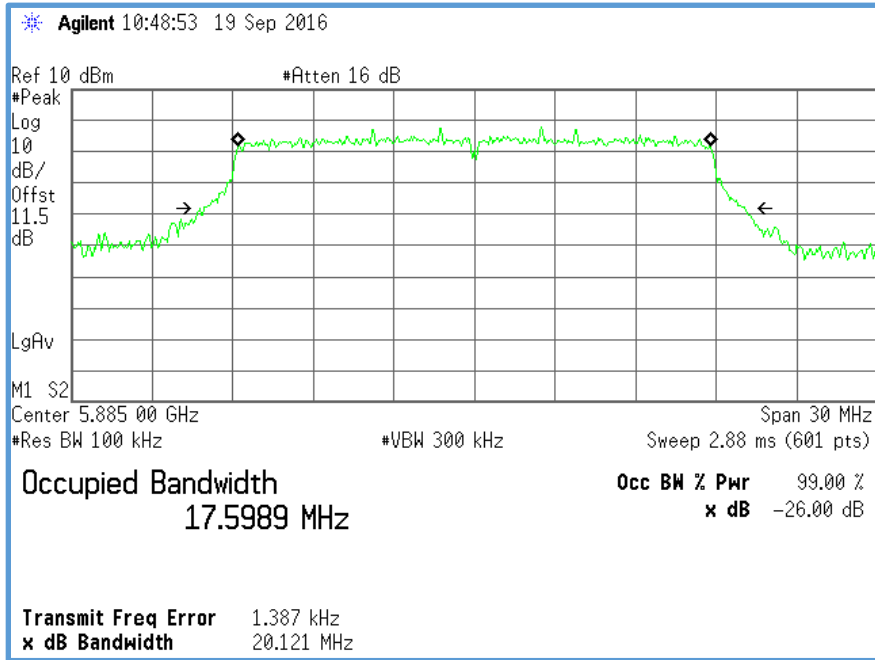


Figure 84 – Conducted OBW, Sample 16A U-NII-4, CH.177 OFDM MCS Index 0 Plot

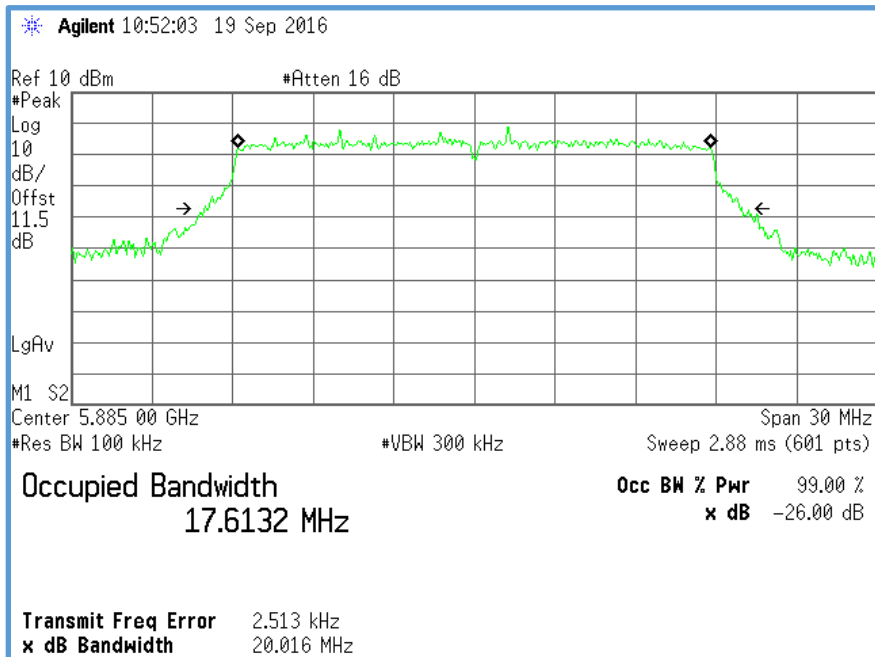


Figure 85 – Conducted OBW, Sample 16A U-NII-4, CH.177 OFDM MCS Index 1 Plot

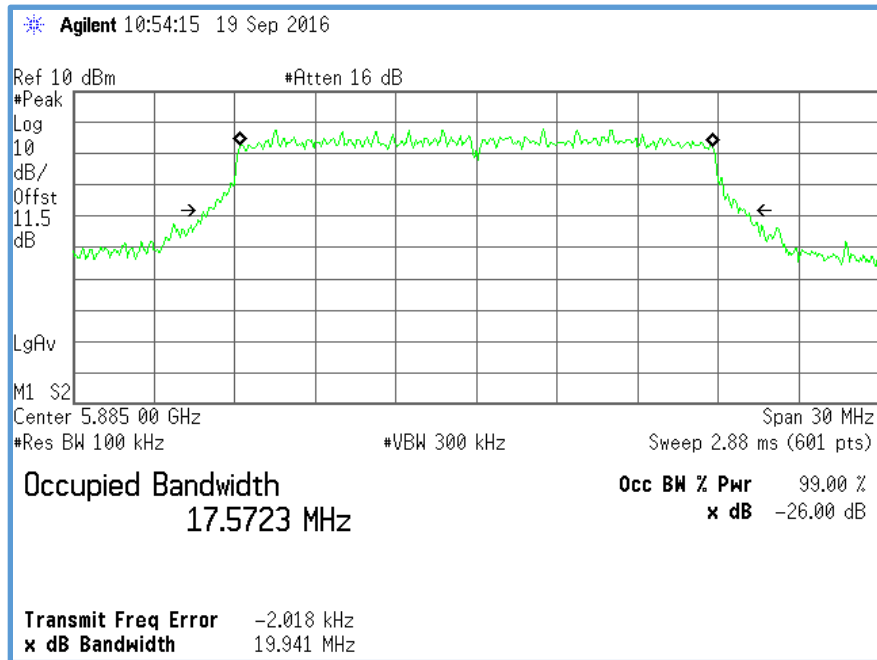


Figure 86 – Conducted OBW, Sample 16A U-NII-4, CH.177 OFDM MCS Index 3 Plot

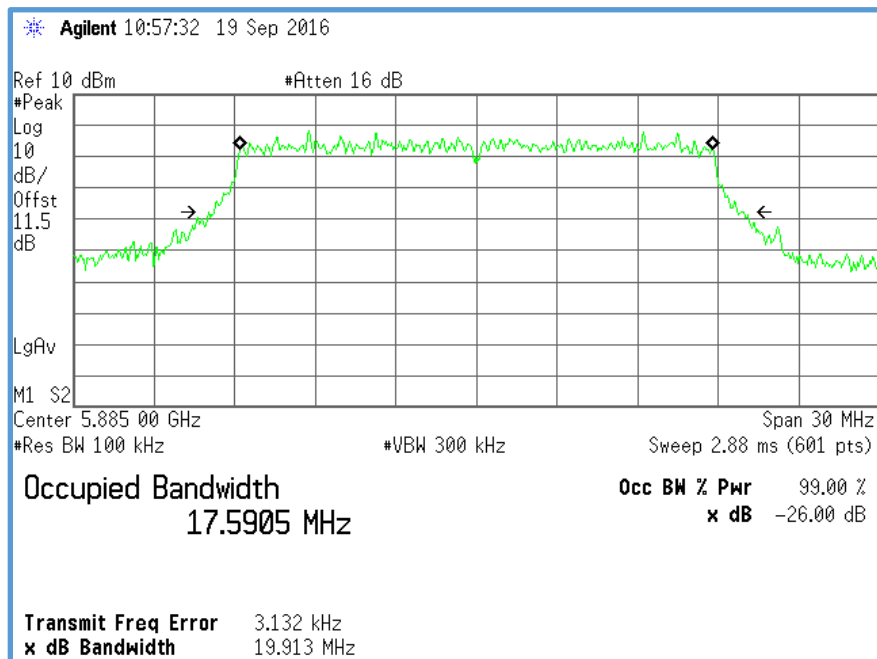


Figure 87 – Conducted OBW, Sample 16A U-NII-4, CH.177 OFDM MCS Index 5 Plot

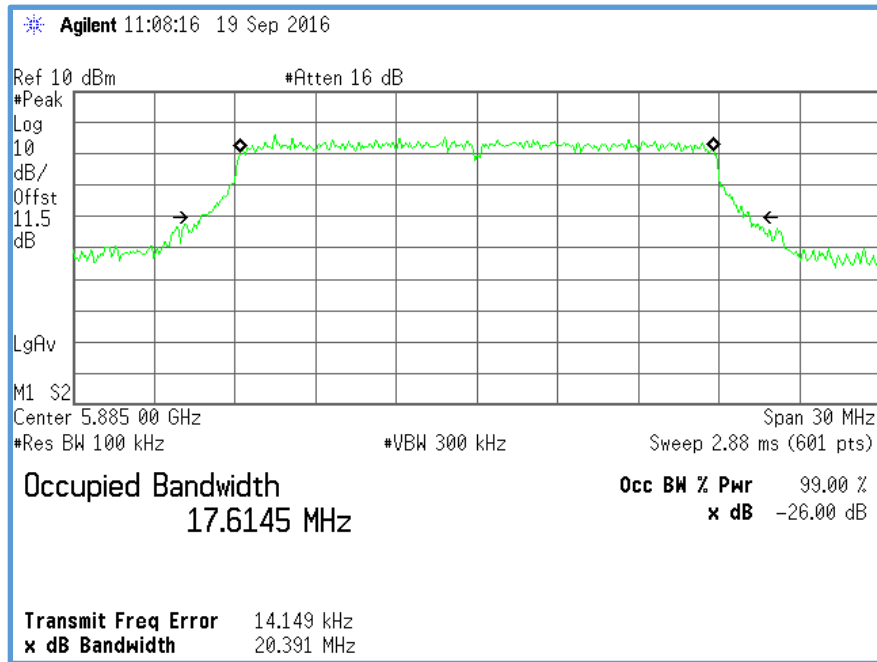


Figure 88 – Conducted OBW, Sample 16G U-NII-4, CH.177 OFDM MCS Index 0 Plot

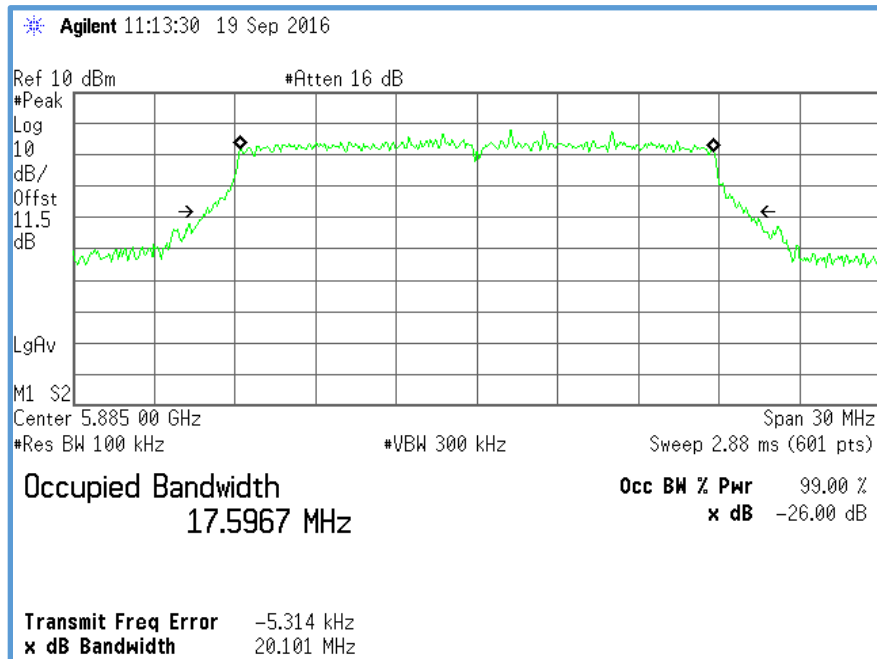


Figure 89 – Conducted OBW, Sample 16G U-NII-4, CH.177 OFDM MCS Index 1 Plot



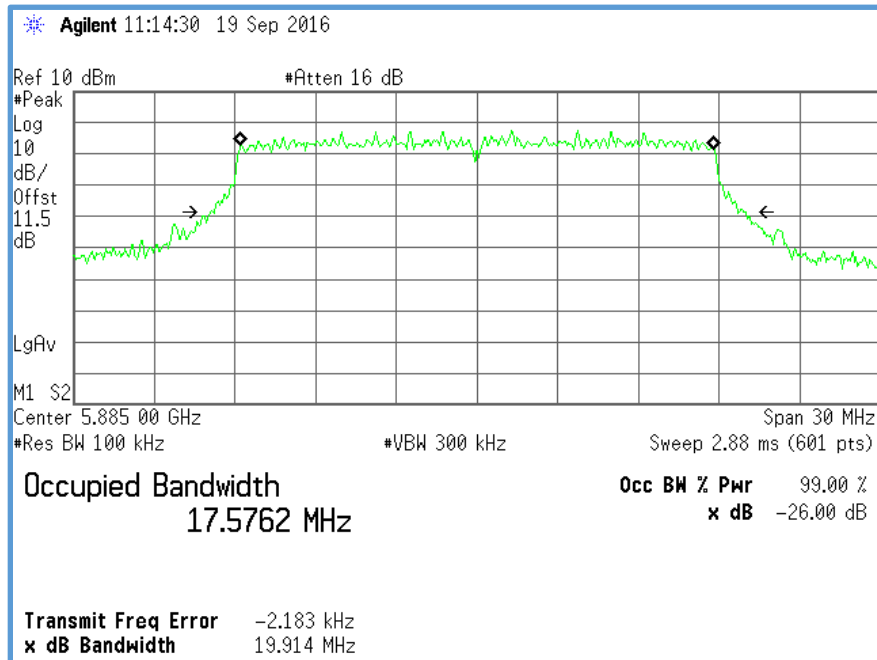


Figure 90 – Conducted OBW, Sample 16G U-NII-4, CH.177 OFDM MCS Index 3 Plot

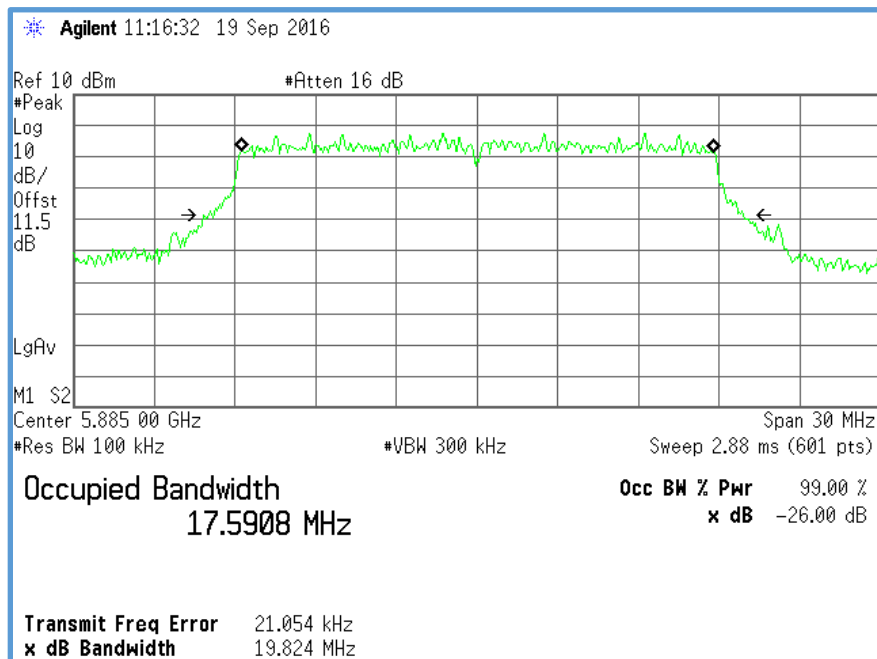


Figure 91 – Conducted OBW, Sample 16G U-NII-4, CH.177 OFDM MCS Index 5 Plot

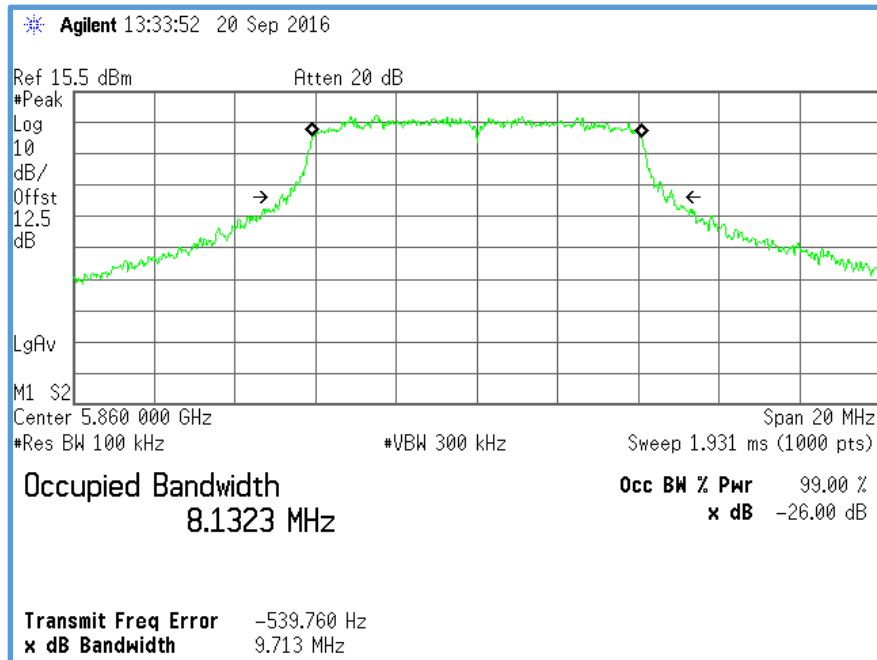


Figure 92 – Conducted OBW, Sample 01 DSRC, CH.172 OFDM MCS Index 0 Plot

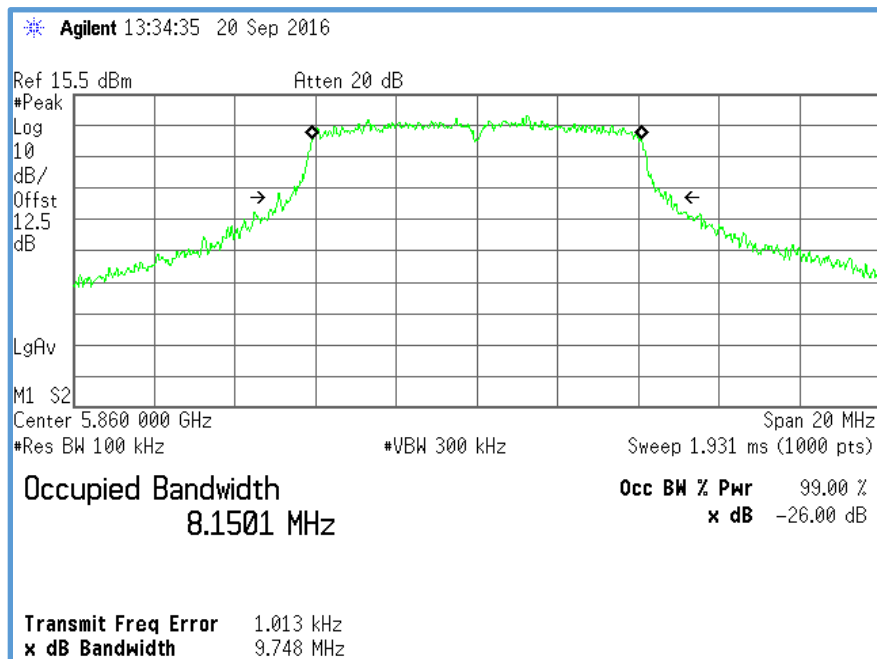


Figure 93 – Conducted OBW, Sample 01 DSRC, CH.172 OFDM MCS Index 1 Plot

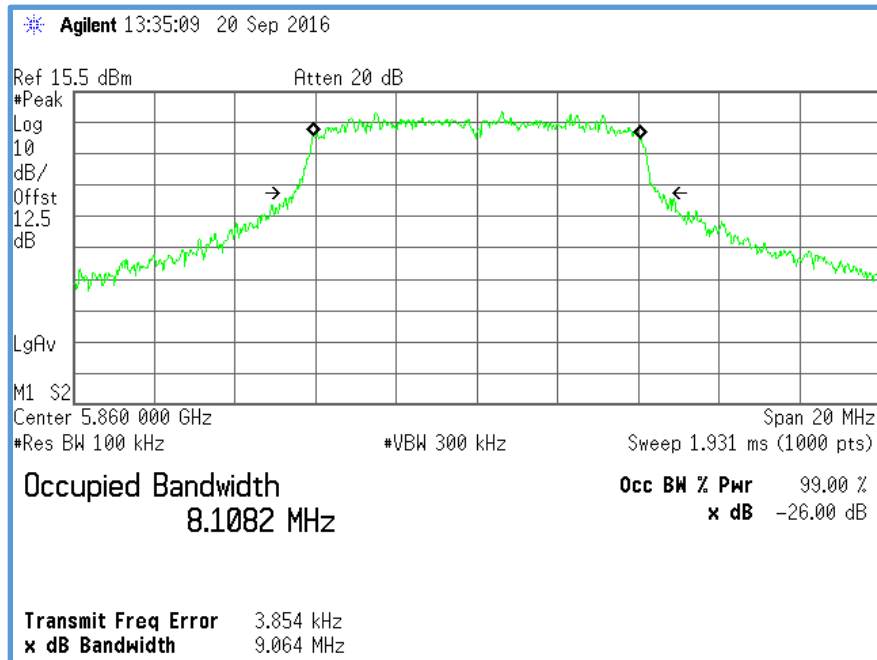


Figure 94 – Conducted OBW, Sample 01 DSRC, CH.172 OFDM MCS Index 3 Plot

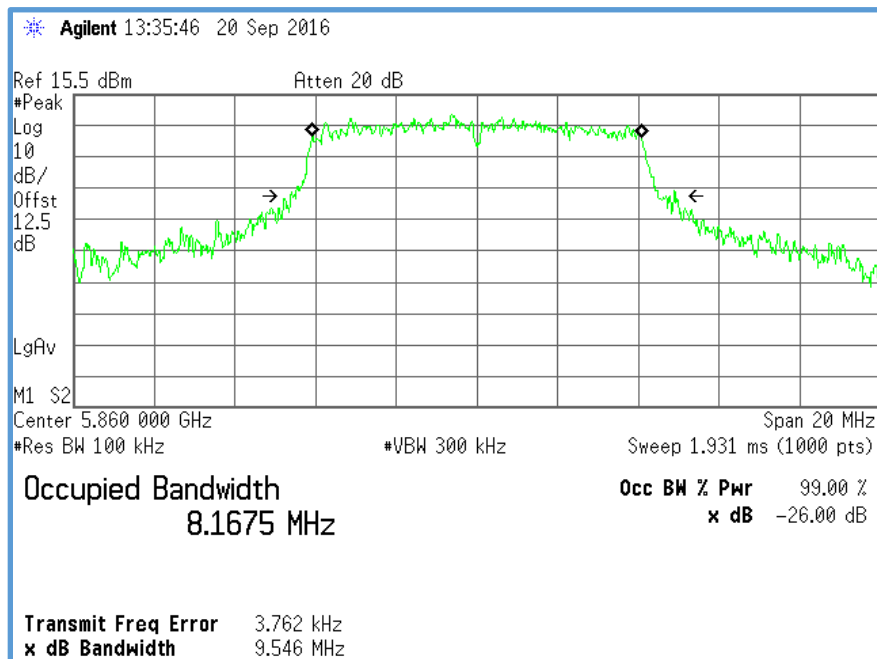


Figure 95 – Conducted OBW, Sample 01 DSRC, CH.172 OFDM MCS Index 5 Plot

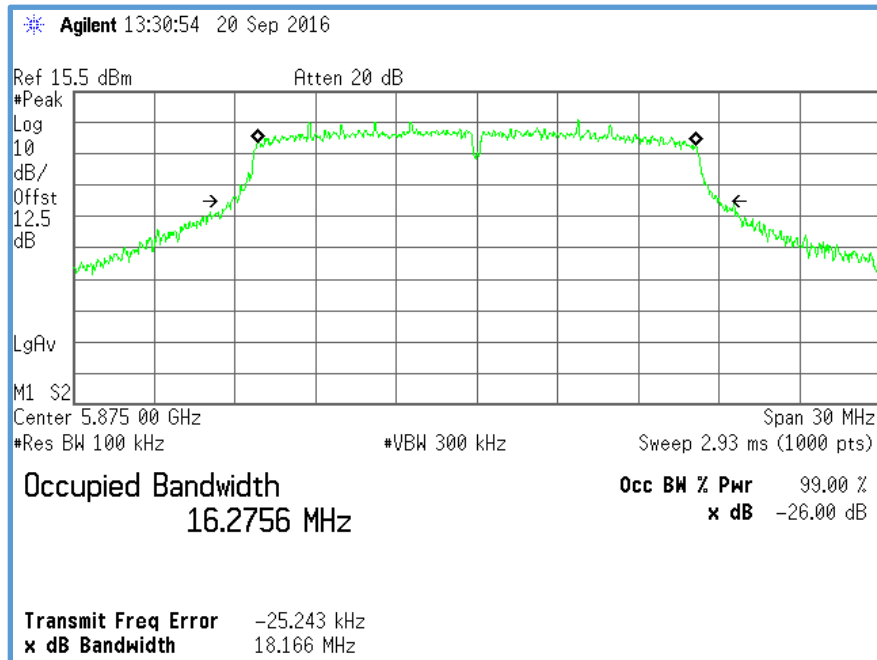


Figure 96 – Conducted OBW, Sample 01 DSRC, CH.175 OFDM MCS Index 0 Plot

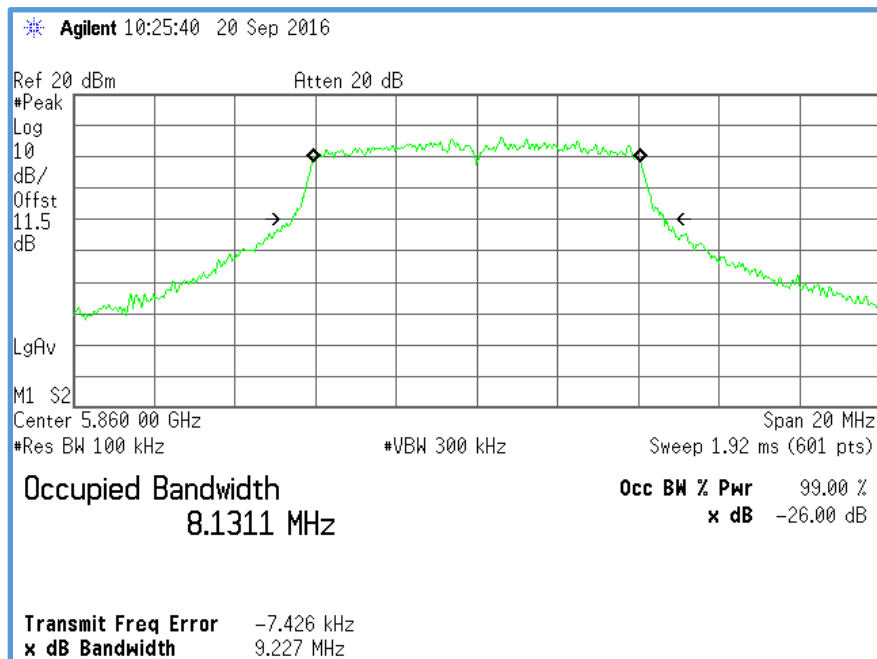


Figure 97 – Conducted OBW, Sample 02 DSRC, CH.172 OFDM MCS Index 0 Plot

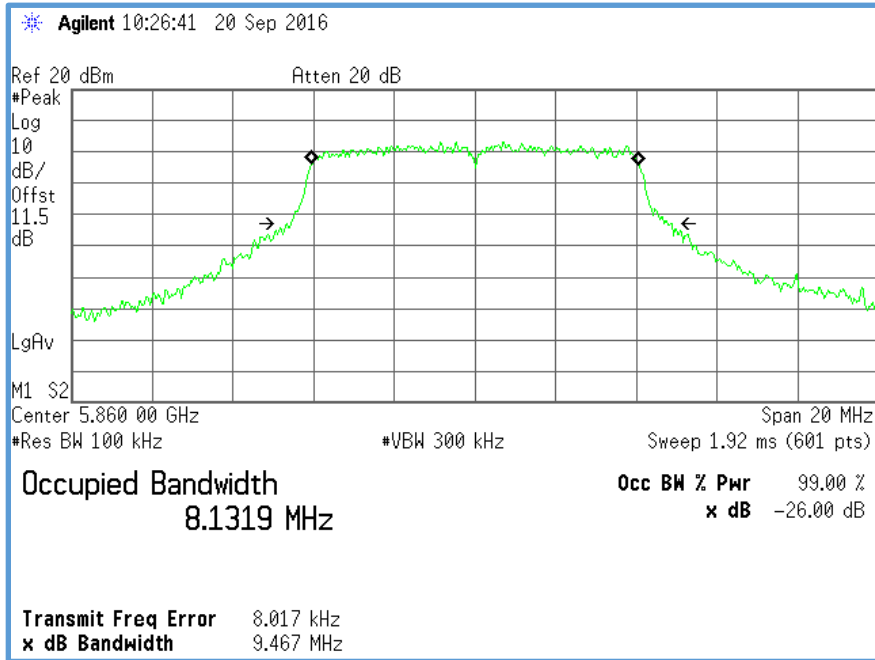


Figure 98 – Conducted OBW, Sample 02 DSRC, CH.172 OFDM MCS Index 1 Plot

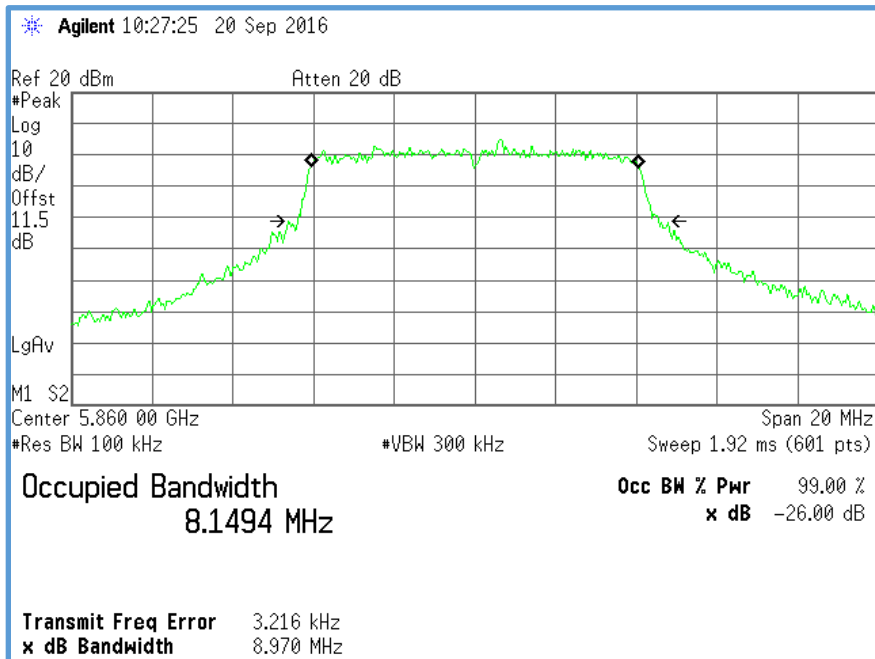


Figure 99 – Conducted OBW, Sample 02 DSRC, CH.172 OFDM MCS Index 3 Plot

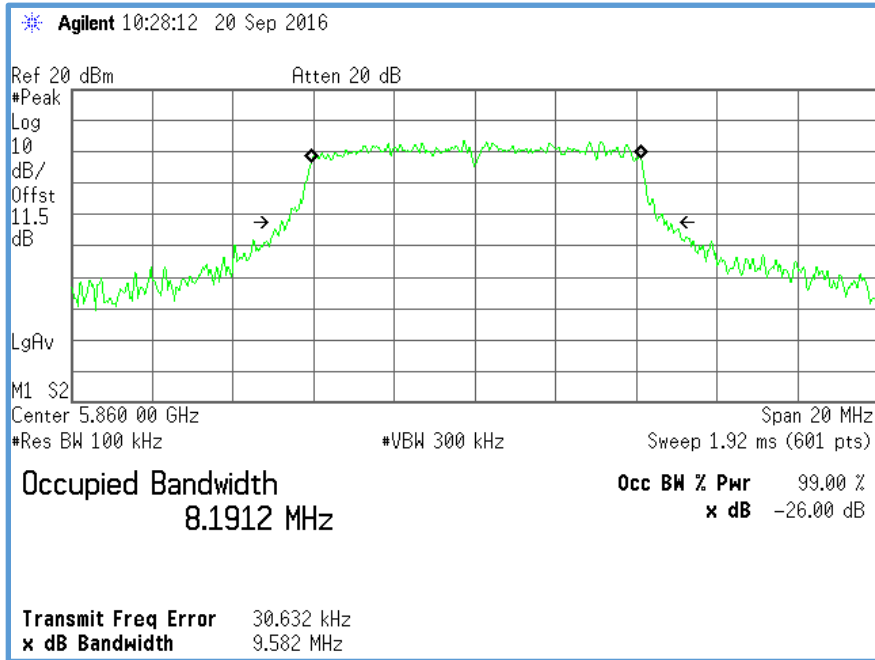


Figure 100 – Conducted OBW, Sample 02 DSRC, CH.172 OFDM MCS Index 5 Plot

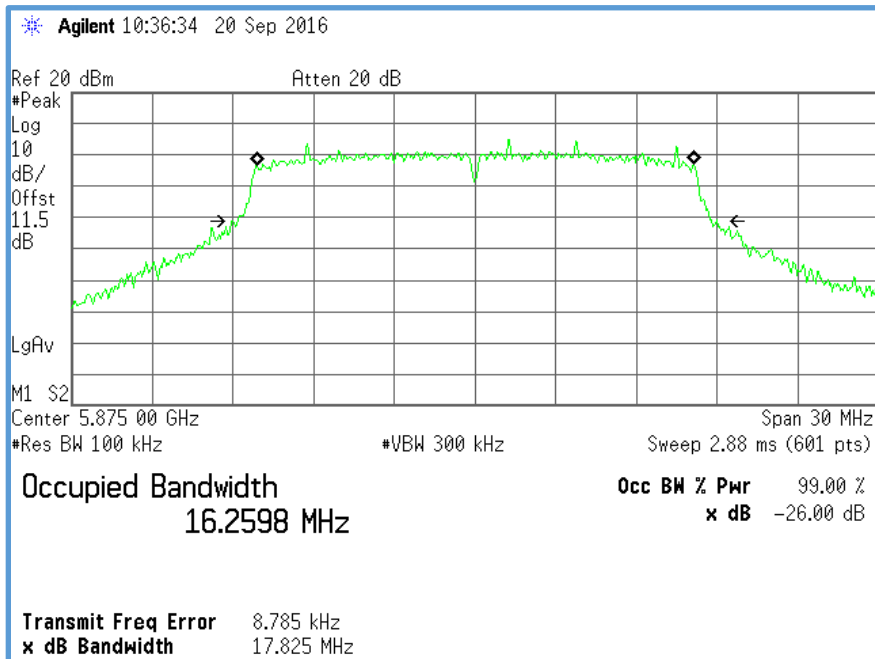


Figure 101 – Conducted OBW, Sample 02 DSRC, CH.175 OFDM MCS Index 0 Plot

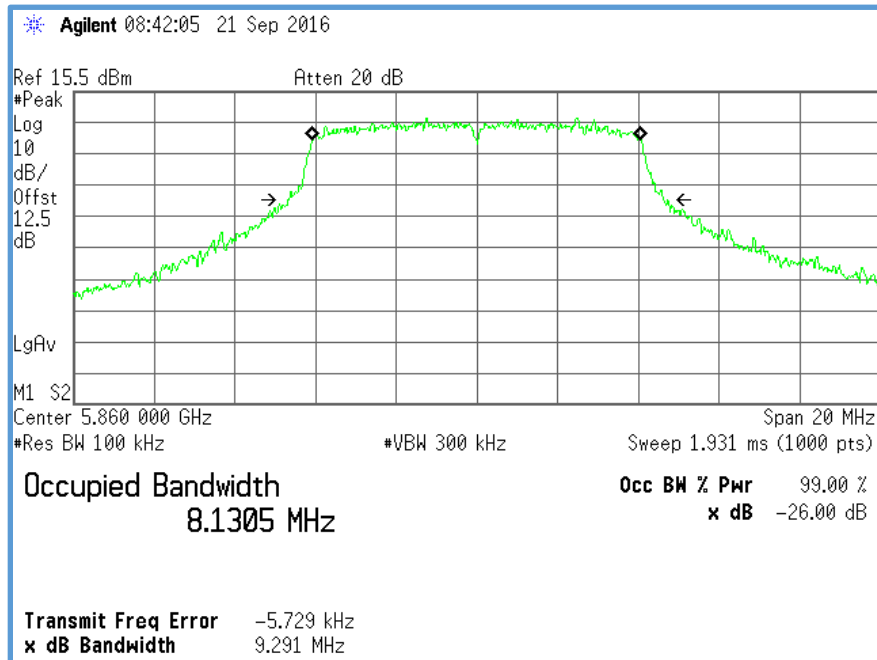


Figure 102 – Conducted OBW, Sample 03 DSRC, CH.172 OFDM MCS Index 0 Plot

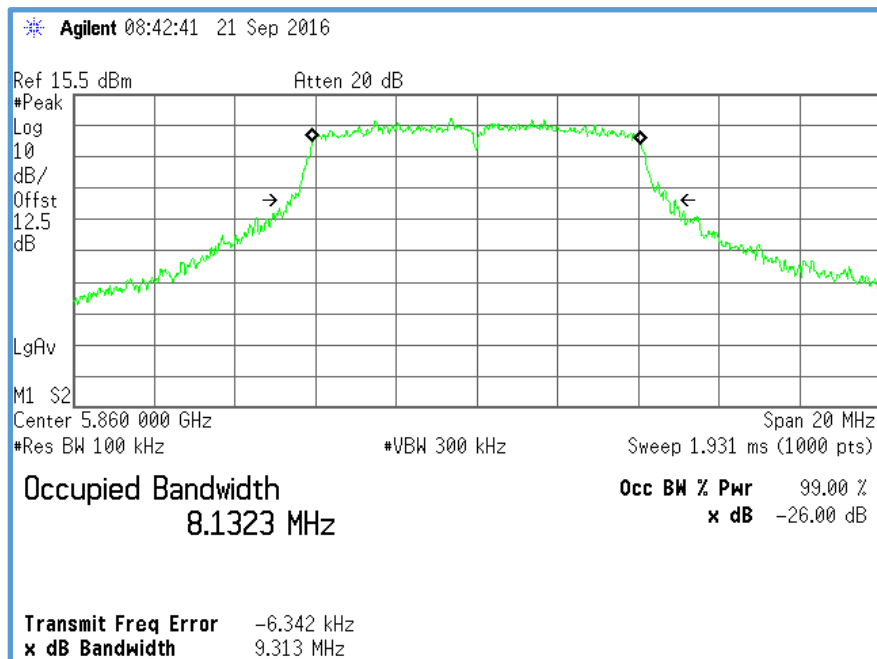


Figure 103 – Conducted OBW, Sample 03 DSRC, CH.172 OFDM MCS Index 1 Plot

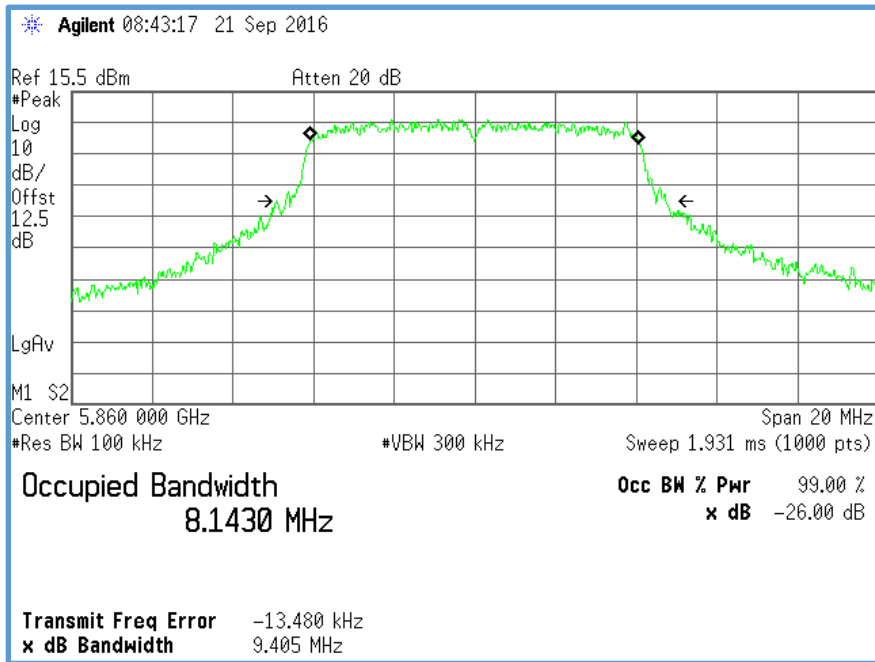


Figure 104 – Conducted OBW, Sample 03 DSRC, CH.172 OFDM MCS Index 3 Plot

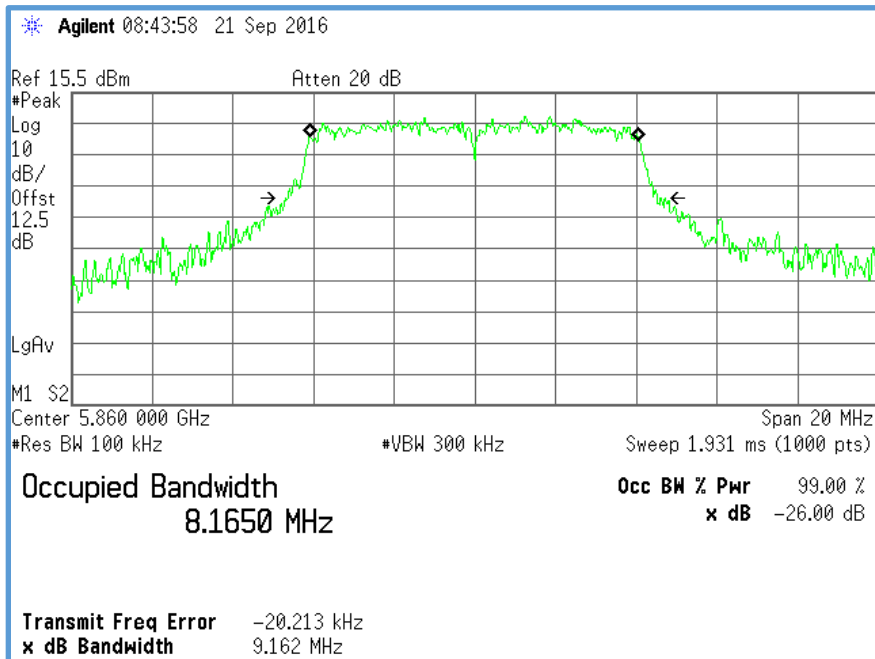


Figure 105 – Conducted OBW, Sample 03 DSRC, CH.172 OFDM MCS Index 5 Plot



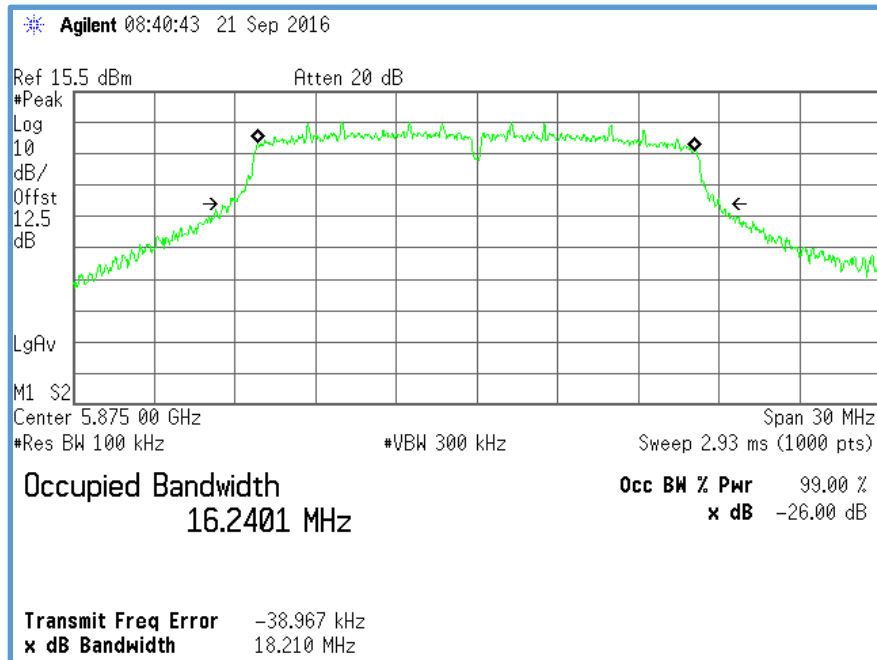


Figure 106 – Conducted OBW, Sample 03 DSRC, CH.175 OFDM MCS Index 0 Plot

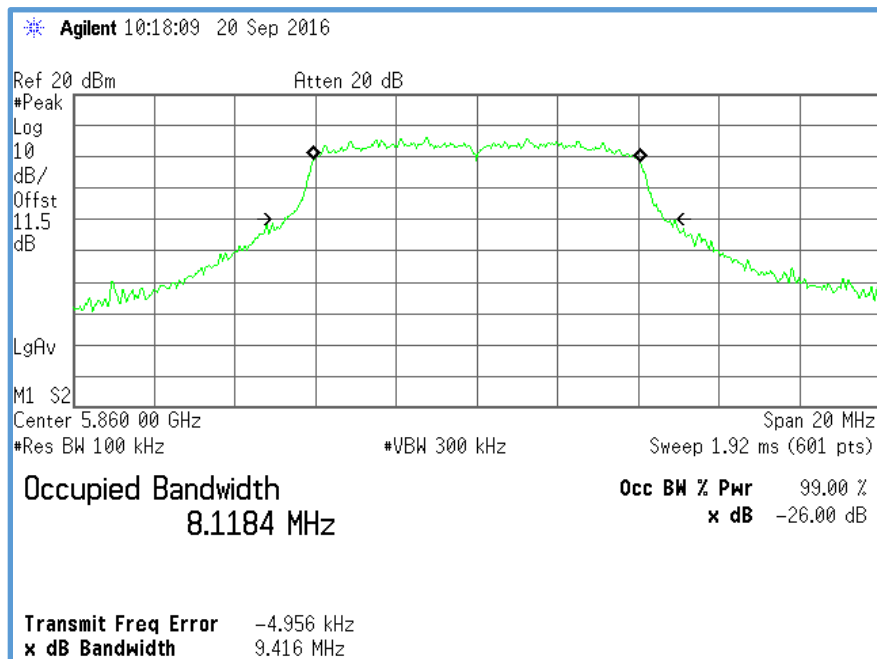


Figure 107 – Conducted OBW, Sample 04 DSRC, CH.172 OFDM MCS Index 0 Plot

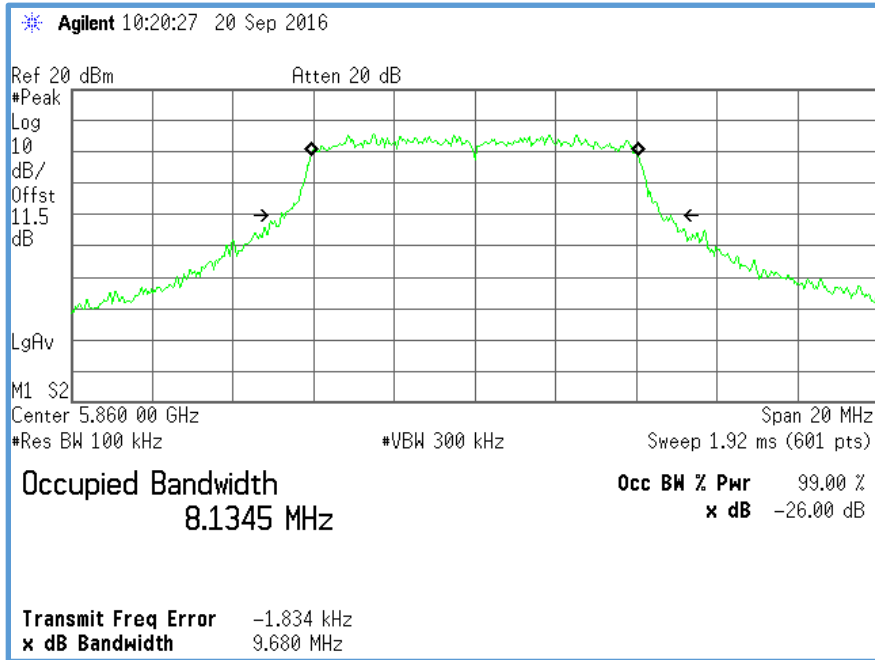


Figure 108 – Conducted OBW, Sample 04 DSRC, CH.172 OFDM MCS Index 1 Plot

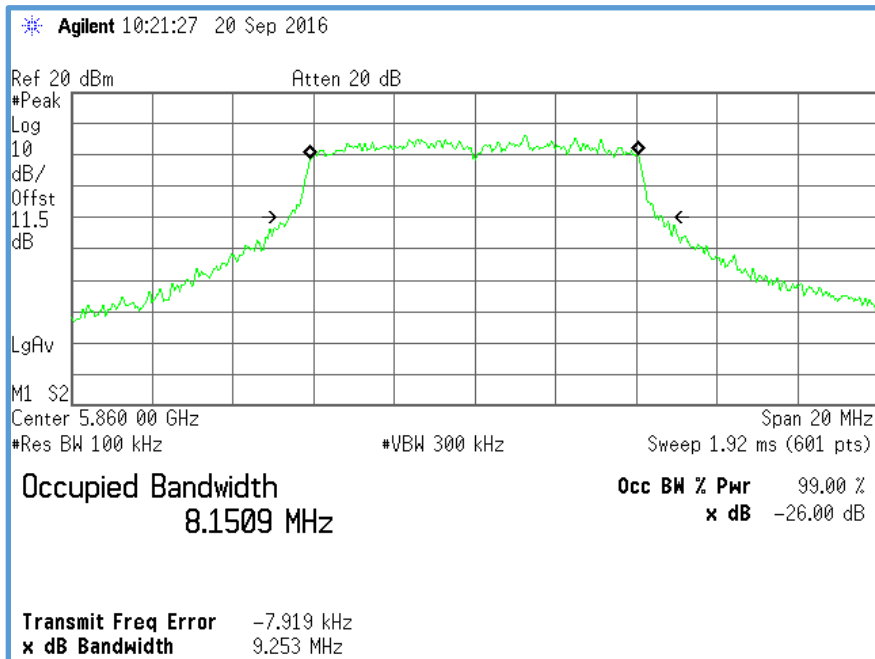


Figure 109 – Conducted OBW, Sample 04 DSRC, CH.172 OFDM MCS Index 3 Plot

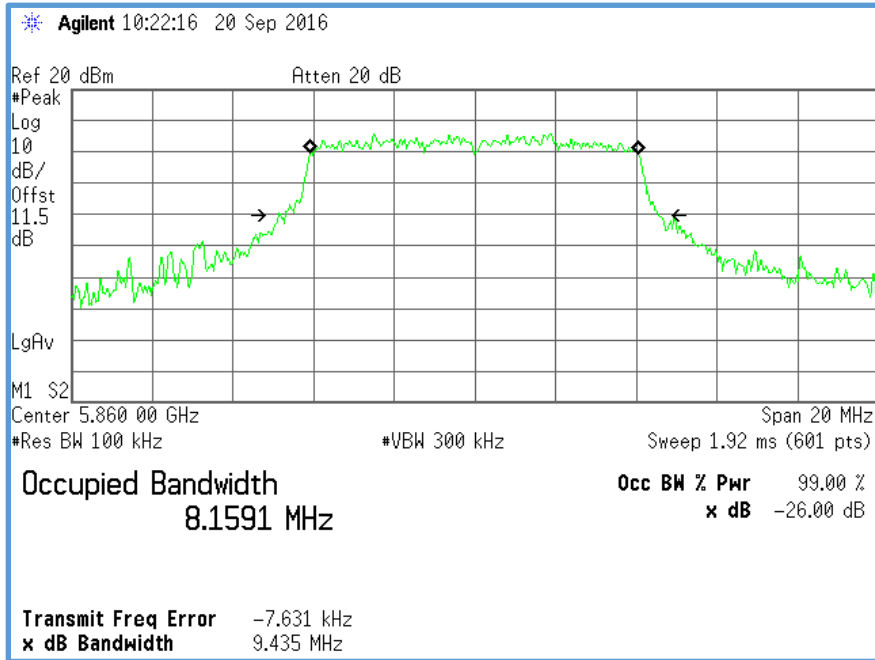


Figure 110 – Conducted OBW, Sample 04 DSRC, CH.172 OFDM MCS Index 5 Plot

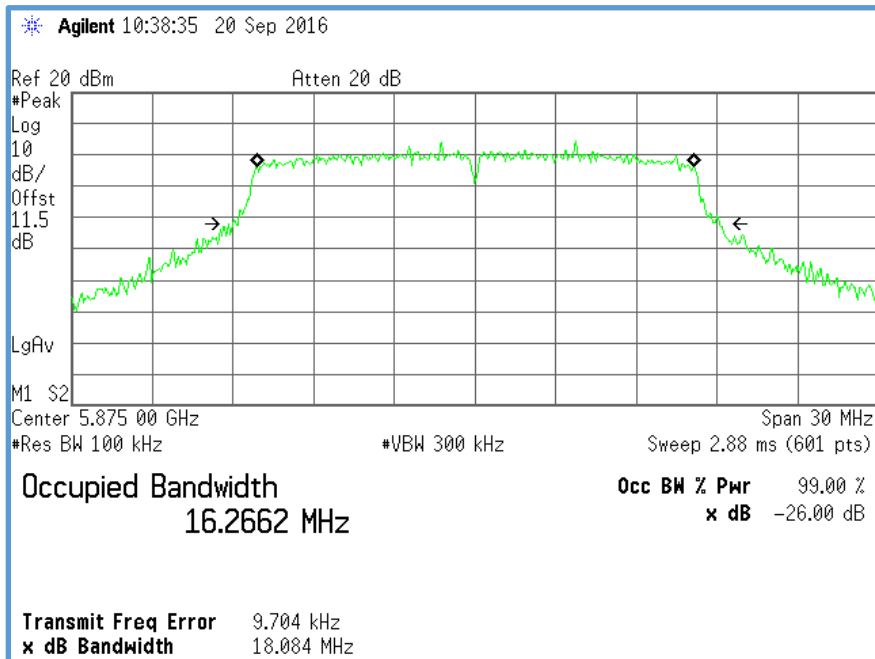


Figure 111 – Conducted OBW, Sample 04 DSRC, CH.175 OFDM MCS Index 0 Plot

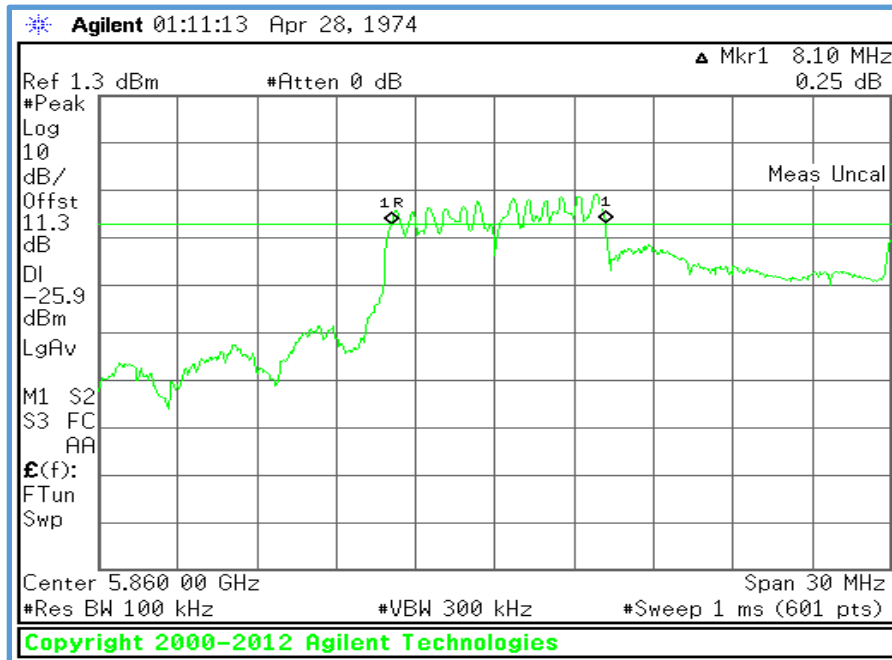


Figure 112 – Conducted OBW, Sample 13A DSRC, CH. 172 OFDM MCS Index 0 Plot

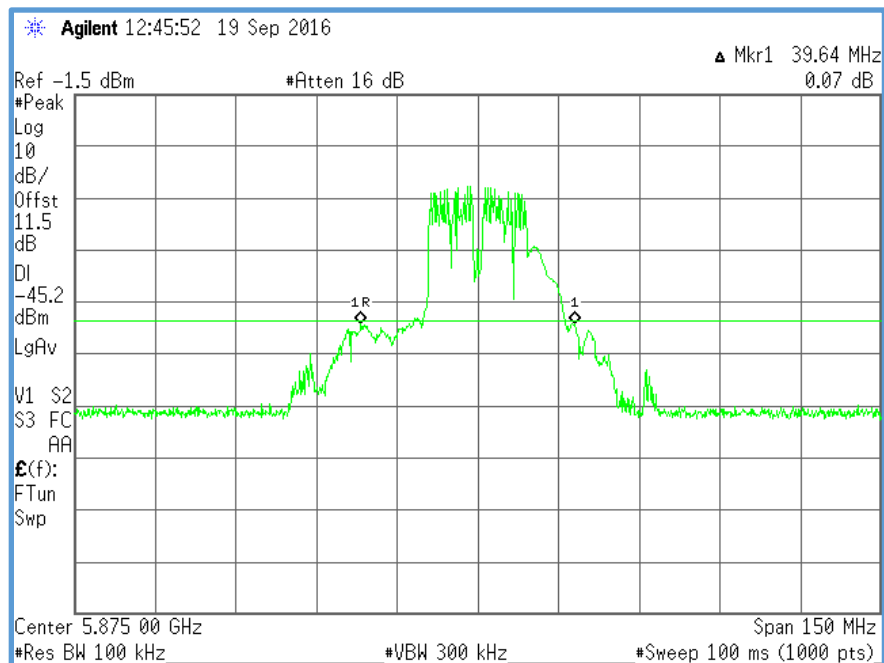


Figure 113 – Conducted OBW, Sample 16F DSRC, CH. 172 OFDM MCS Index 0 Plot

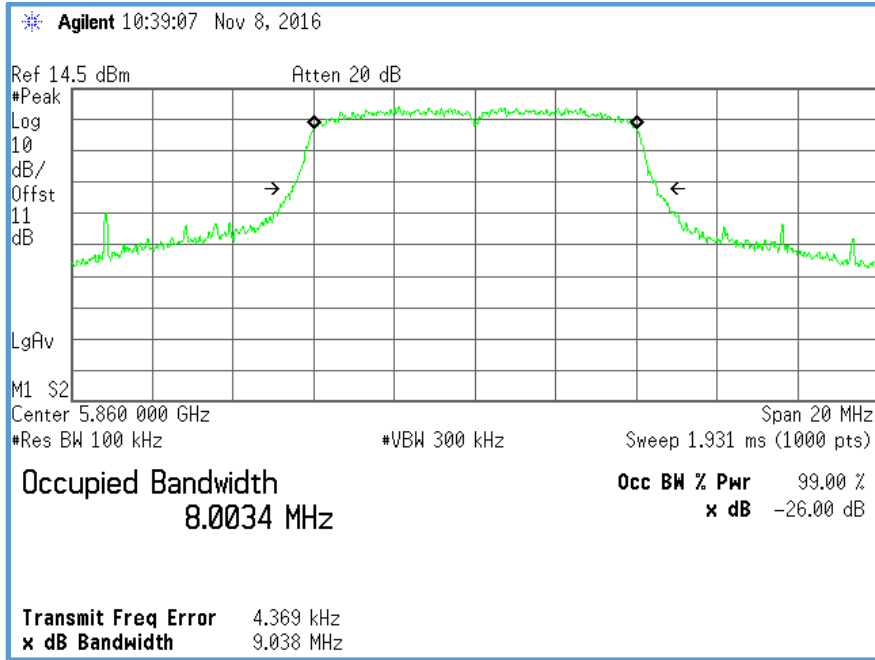


Figure 114 – Conducted OBW, Sample 26A DSRC, CH.172 OFDM MCS Index 0 Plot

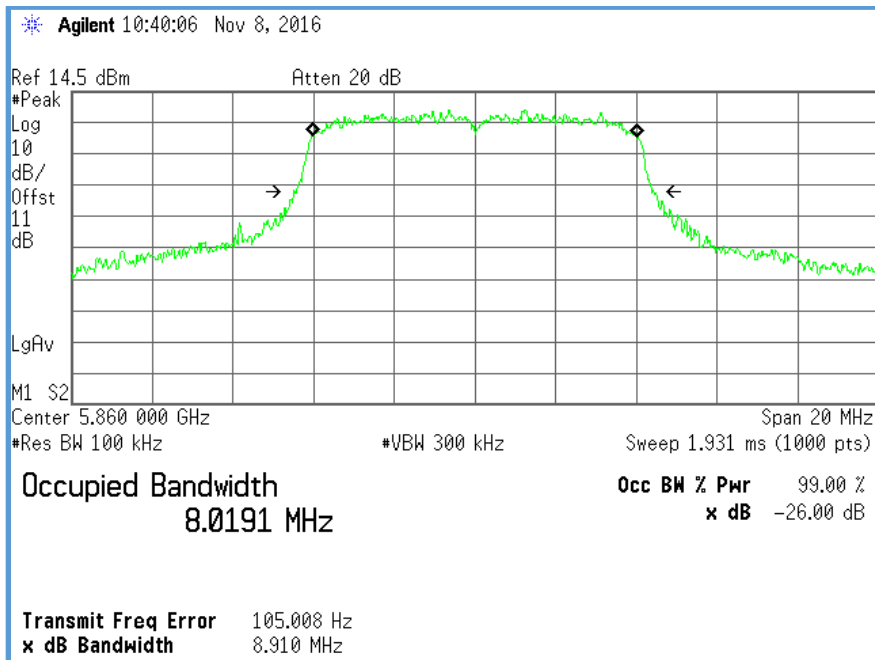


Figure 115 – Conducted OBW, Sample 26A DSRC, CH.172 OFDM MCS Index 1 Plot

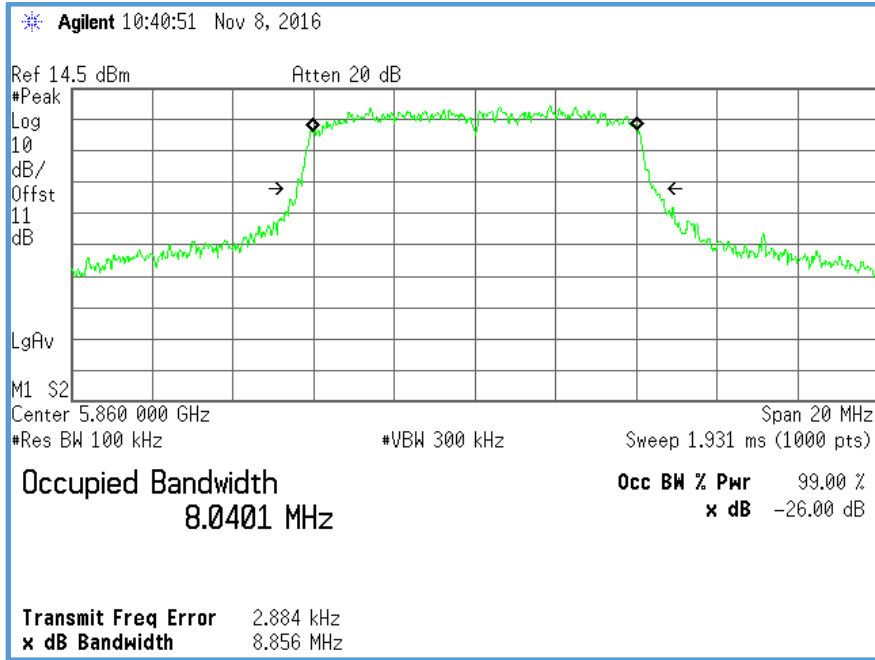


Figure 116 – Conducted OBW, Sample 26A DSRC, CH.172 OFDM MCS Index 3 Plot

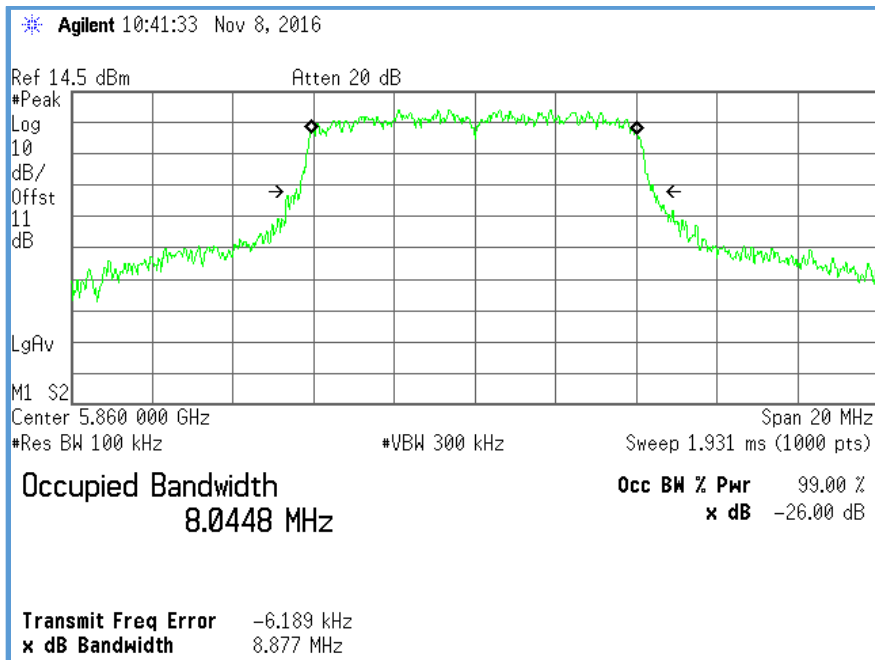


Figure 117 – Conducted OBW, Sample 26A DSRC, CH.172 OFDM MCS Index 5 Plot

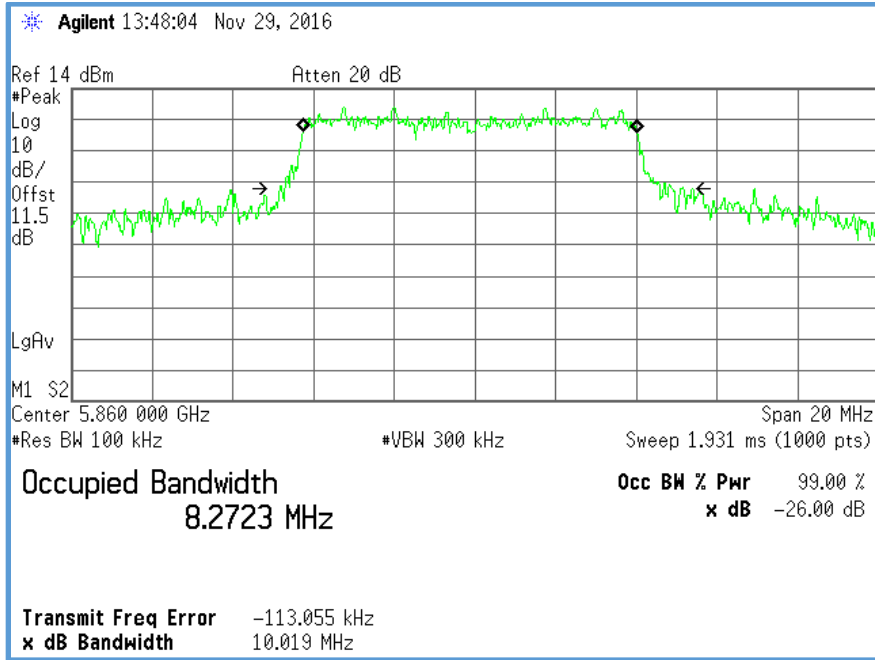


Figure 118 – Conducted OBW, Sample 29A DSRC, CH.172 OFDM MCS Index 0 Plot

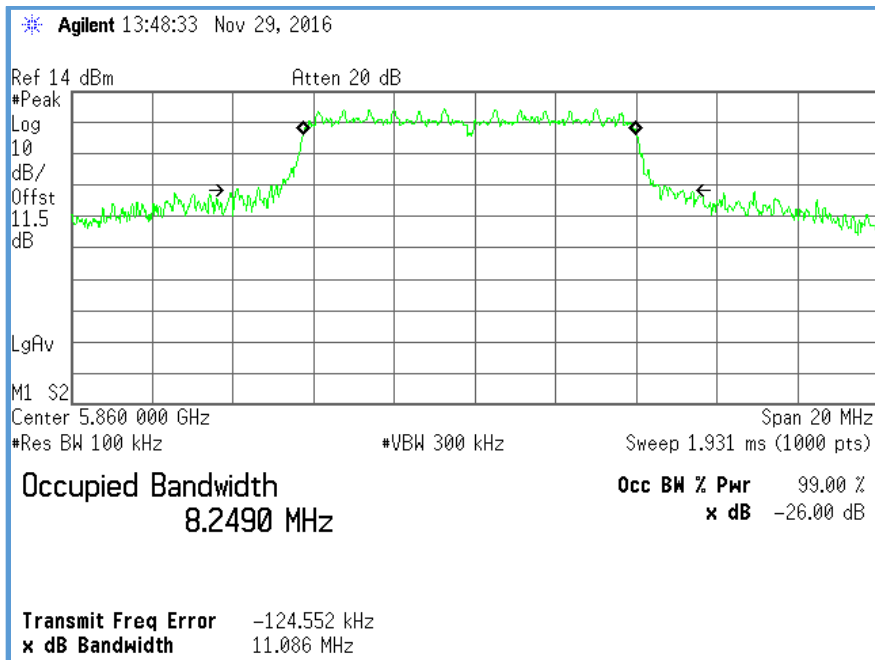
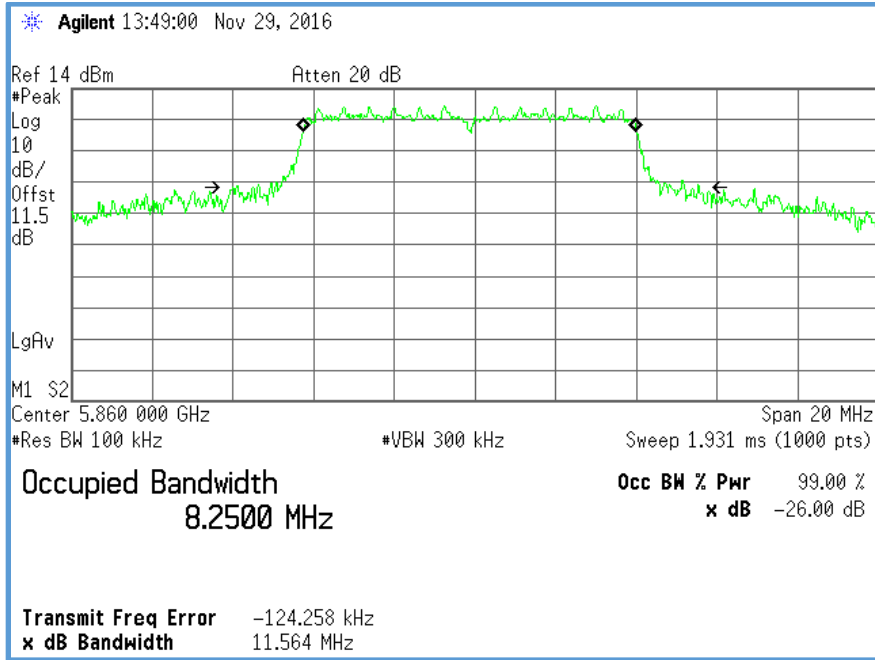
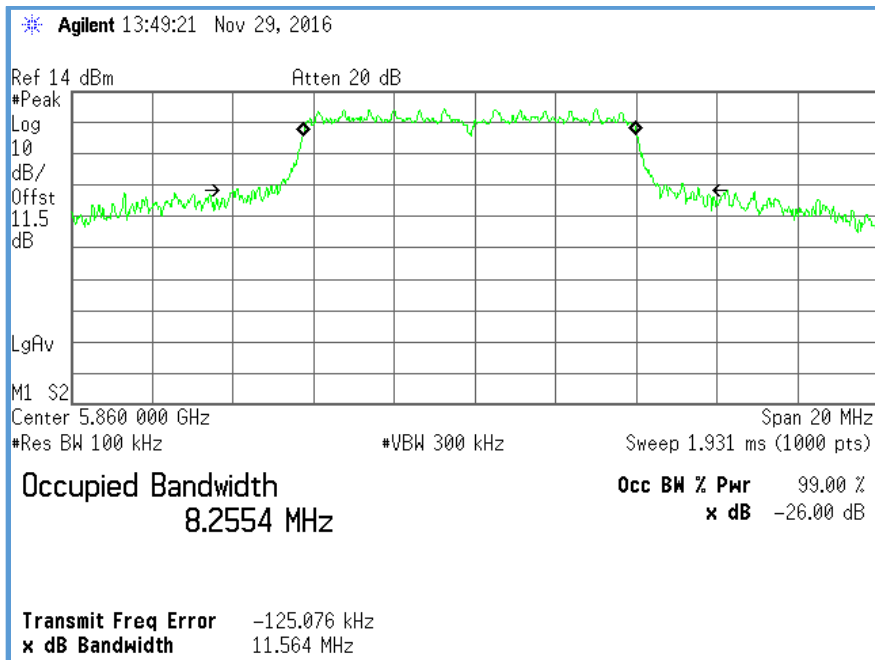


Figure 119 – Conducted OBW, Sample 29A DSRC, CH.172 OFDM MCS Index 1 Plot



**Figure 120 – Conducted OBW, Sample 29A DSRC, CH.172 OFDM MCS Index 3 Plot**



**Figure 121 – Conducted OBW, Sample 29A DSRC, CH.172 OFDM MCS Index 5 Plot**



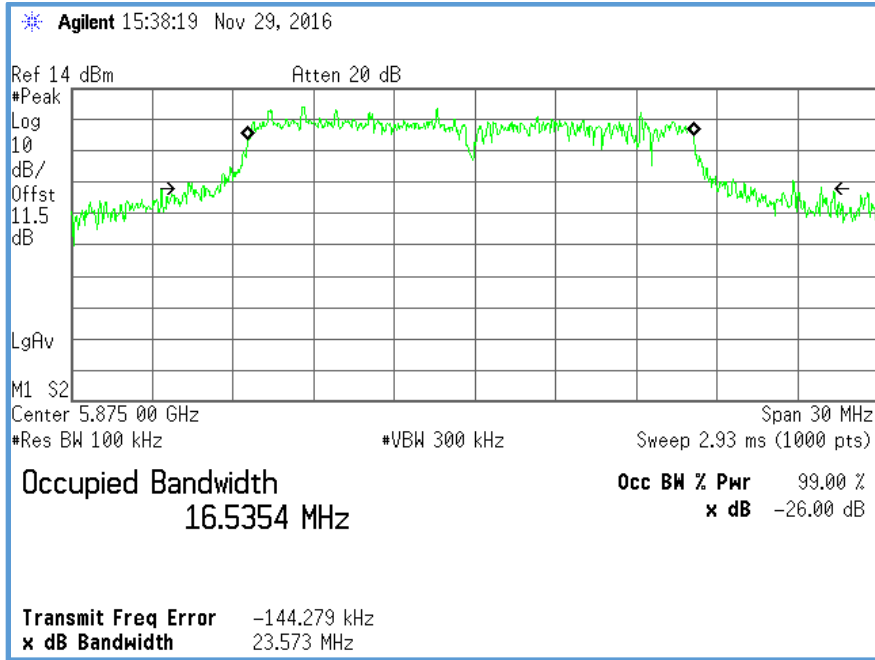


Figure 122 – Conducted OBW, Sample 29A DSRC, CH.175 OFDM MCS Index 0 Plot

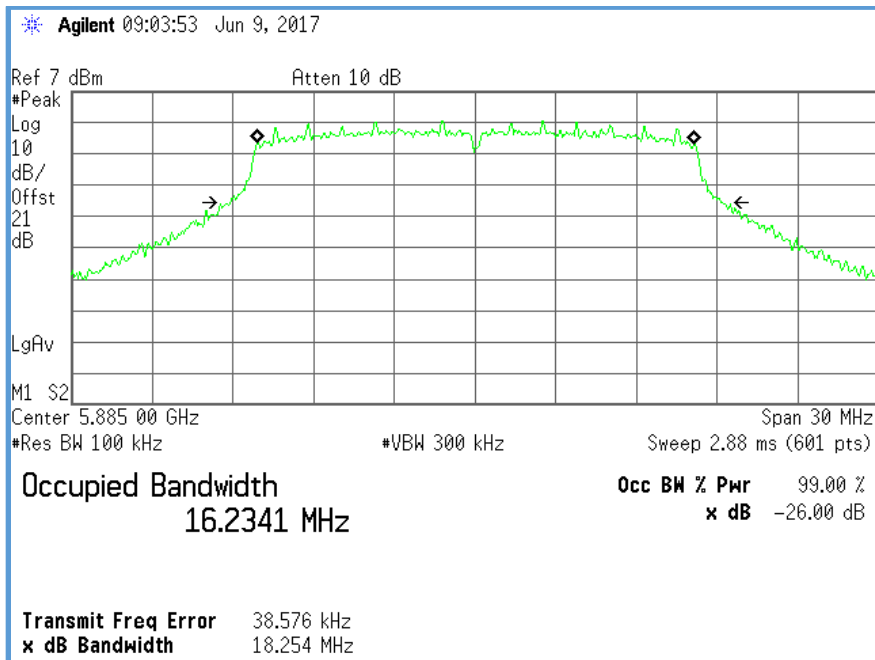
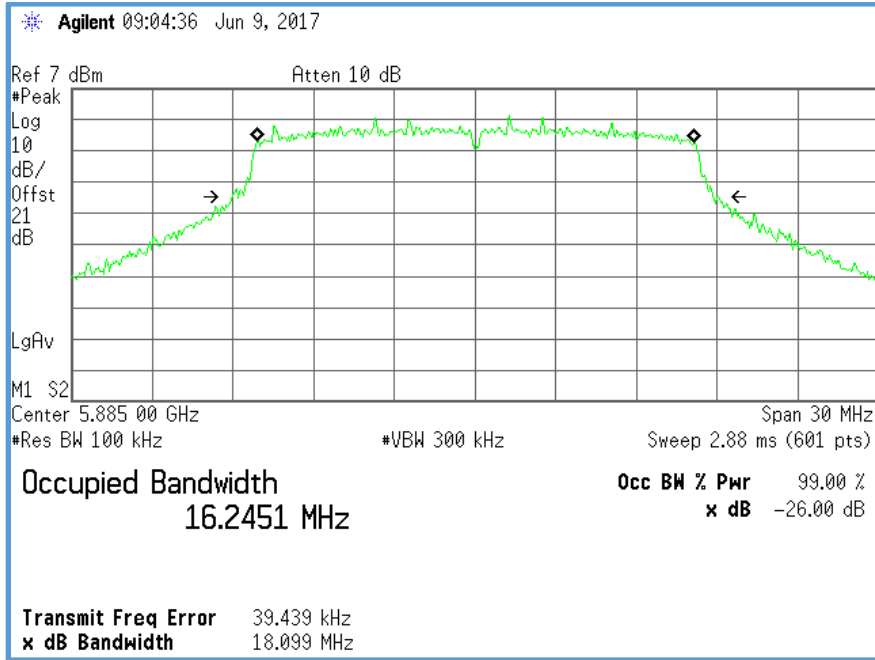


Figure 123 – Conducted OBW, Sample 31 DSRC, CH.177 OFDM MCS Index 0 Plot



**Figure 124 – Conducted OBW, Sample 31 DSRC, CH.177 OFDM MCS Index 1 Plot**

## **B.2 Conducted Average Channel Power (ACP) and Out of Band Emission Test Results (RBW: 1MHz)**

From an RF Spectrum Analyzer, the Average Channel Power (ACP) was measured for the fundamental as well as the two adjacent channels on either side (two adjacent channels measured for U-NII-4 devices only).

During the ACP measurement, the Spectrum Analyzer settings were:

RBW  $\geq$  1000 kHz  
VBW  $\geq$  3x RBW  
SPAN  $\geq$  3x RBW  
SWEEP AUTO  
DETECTOR = RMS AVE  
TRACE = Trace AVE (100 traces)  
MEAS = Marker Channel Power measurement

**Note:** The two DSRC ASD devices did not support continuous transmission, therefore, trace averaging across 100 traces was not possible. Instead, the max hold functionality of the spectrum analyzer was used.

Using an RF Spectrum Analyzer, each of the U-NII-4 device's conducted antenna port's OOB, from 5555 MHz to 6155 MHz, were examined. In particular, OOB scans were recorded from 5555-6155 MHz for U-NII-4 devices set to Channel 171, 5795-5935 MHz for U-NII-4 devices set to Channel 173, 5575-6175 MHz for U-NII-4 devices set to Channel 175, and 5815-5955 MHz for U-NII-4 devices set to Channel 177.

For the DSRC OOB measurements, each device was set to Channel 172 and scanned for spurious emissions between 5790 MHz to 5930 MHz. Additionally, DSRC Channel 175 OOB scans were recorded from 5800 to 5945 MHz, using the 'worst-case' MCS Index designator's OBW reading from DSRC Channel 172.

For the OOB measurement, the Spectrum Analyzer settings were:

RBW  $\geq$  1 MHz  
VBW  $\geq$  3 MHz  
SPAN  $\geq$  140, 300, 600 MHz (depending on OBW of fundamental)  
SWEEP AUTO  
DETECTOR = RMS AVE  
TRACE = Trace AVE (100 traces)  
MEAS = observe OOB above Spectrum Analyzers noise floor

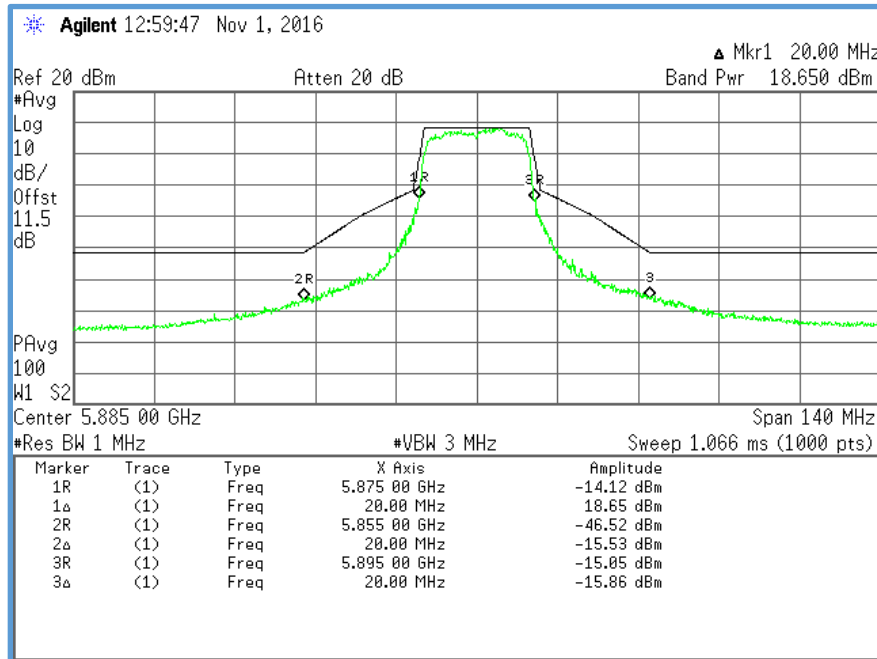
**Note:** The two DSRC ASD devices did not support continuous transmission, therefore, trace averaging across 100 traces was not possible. Instead, the max hold functionality of the spectrum analyzer was used.

Resulting plot data were examined with applicable IEEE 802.11ac and IEEE 802.11p Class C transmission mask specifications to confirm compliance or quantify deviations to the standard

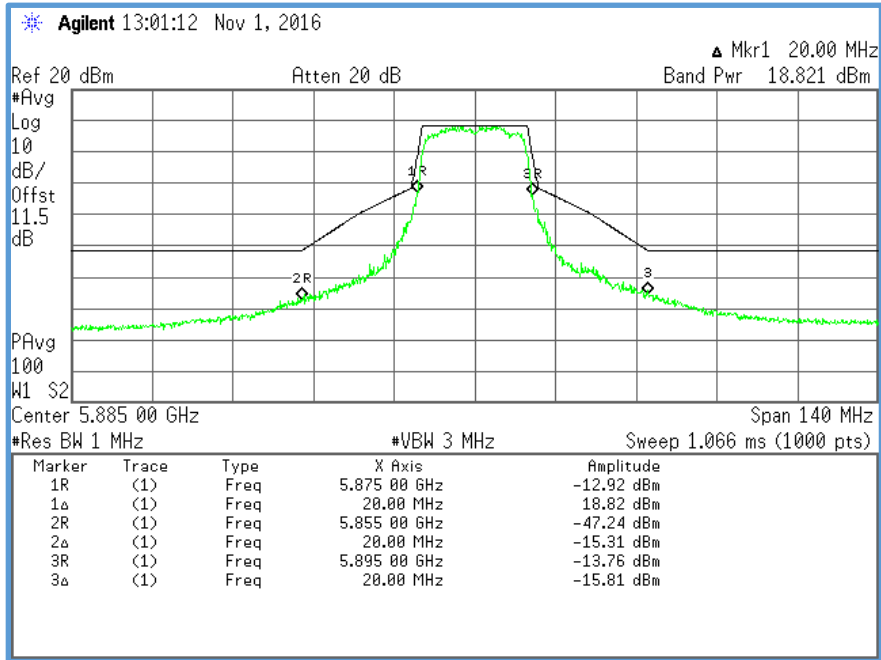
transmission mask requirements. For DSRC devices, additional data was taken with spectrum analyzer resolution bandwidth (RBW) settings adjusted per IEEE 802.11p standard (RBW: 100 kHz) to show compliance to Mask C.

Figures 125 to 196 show the DSRC and U-NII-4 devices' ACP and OOB test results using RBW of 1MHz.

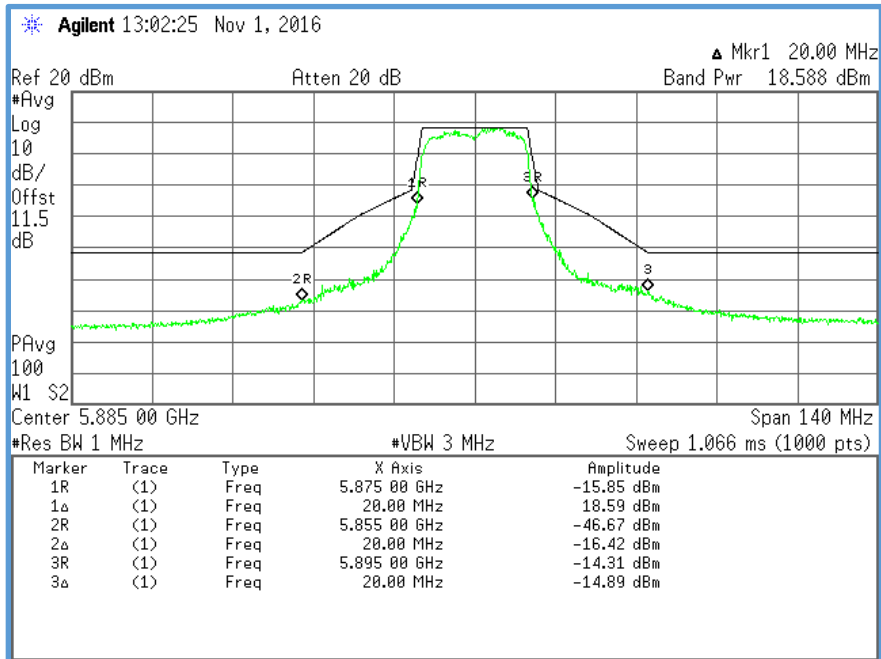
Figures 197 to 209 show the DSRC devices' ACP and OOB test results using RBW of 100 kHz.



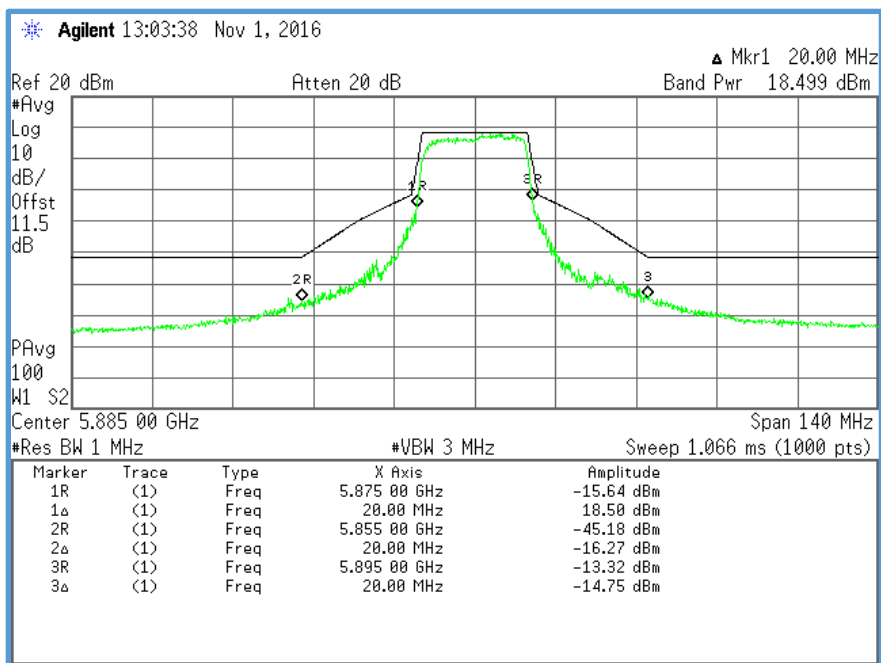
**Figure 125 – Conducted ACP/OOBE, Sample 05 U-NII-4, CH.177 OFDM MCS Index 0 Plot**



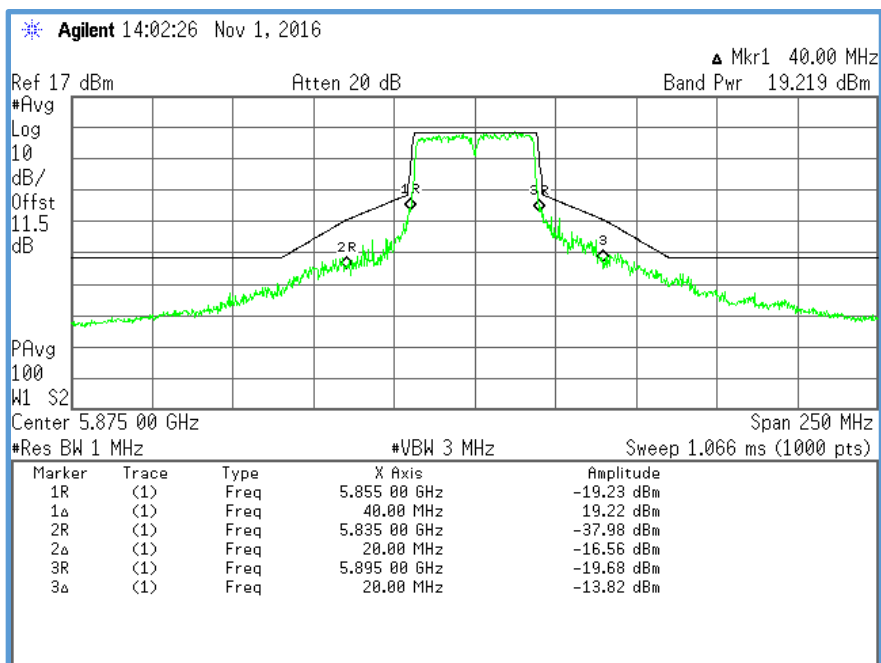
**Figure 126 – Conducted ACP/OOBE, Sample 05 U-NII-4, CH.177 OFDM MCS Index 1 Plot**



**Figure 127 – Conducted ACP/OOBE, Sample 05 U-NII-4, CH.177 OFDM MCS Index 3 Plot**



**Figure 128 – Conducted ACP/OOBE, Sample 05 U-NII-4, CH.177 OFDM MCS Index 5 Plot**



**Figure 129 – Conducted ACP/OOBE, Sample 05 U-NII-4, CH.175 OFDM MCS Index 0 Plot**

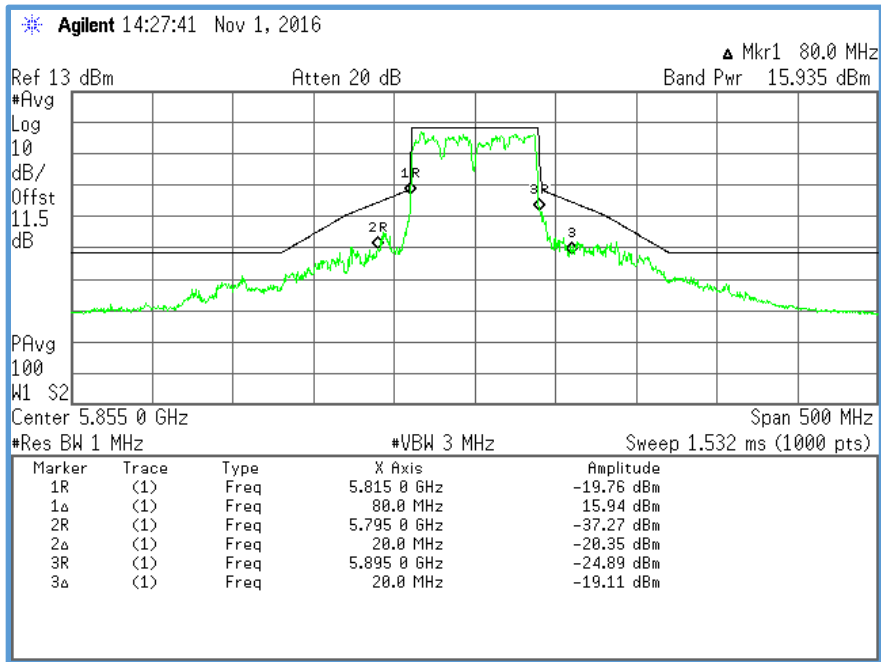


Figure 130 – Conducted ACP/OOBE, Sample 05 U-NII-4, CH.171 OFDM MCS Index 0 Plot

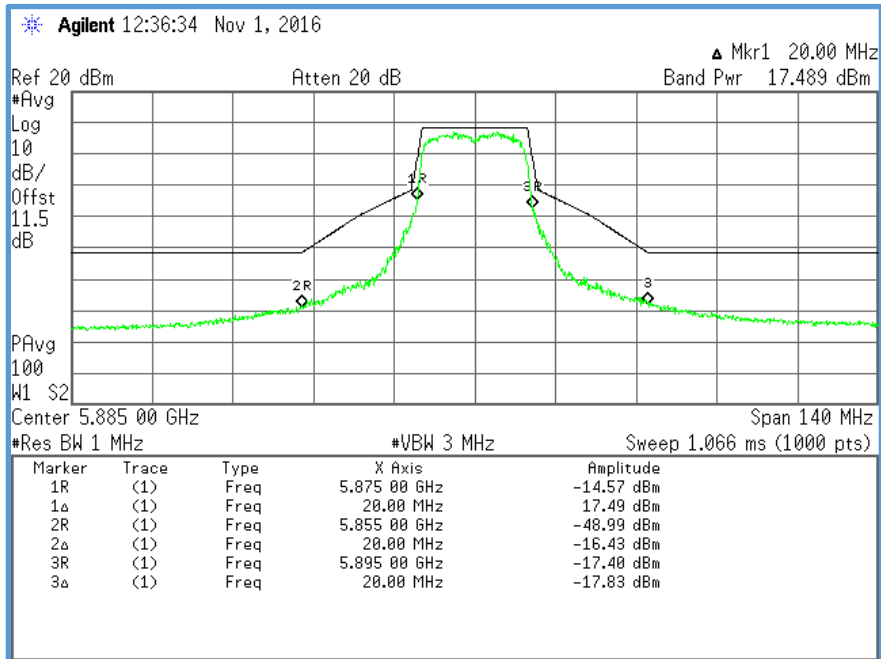


Figure 131 – Conducted ACP/OOBE, Sample 06 U-NII-4, CH.177 OFDM MCS Index 0 Plot

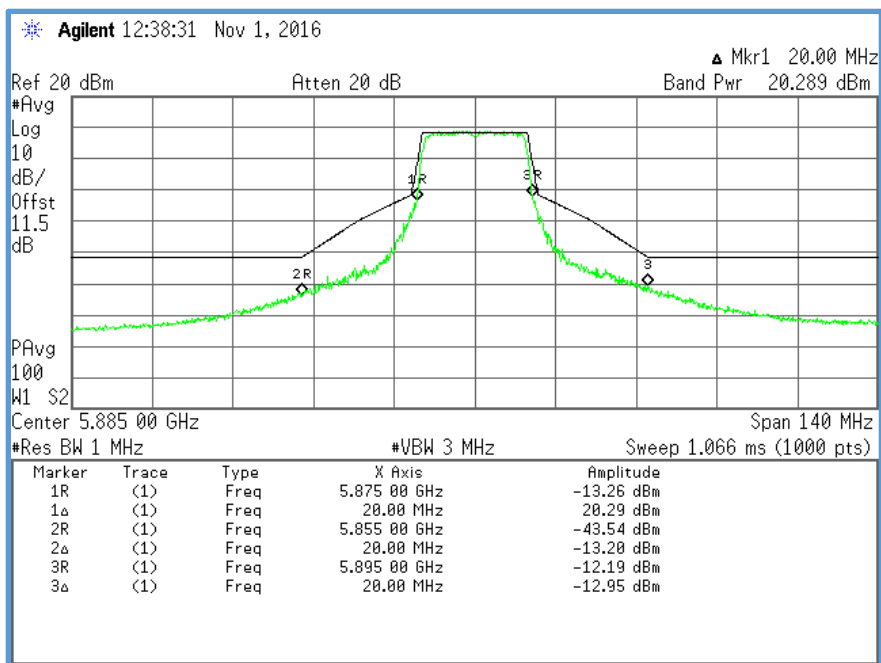


Figure 132 – Conducted ACP/OOBE, Sample 06 U-NII-4, CH.177 OFDM MCS Index 1 Plot

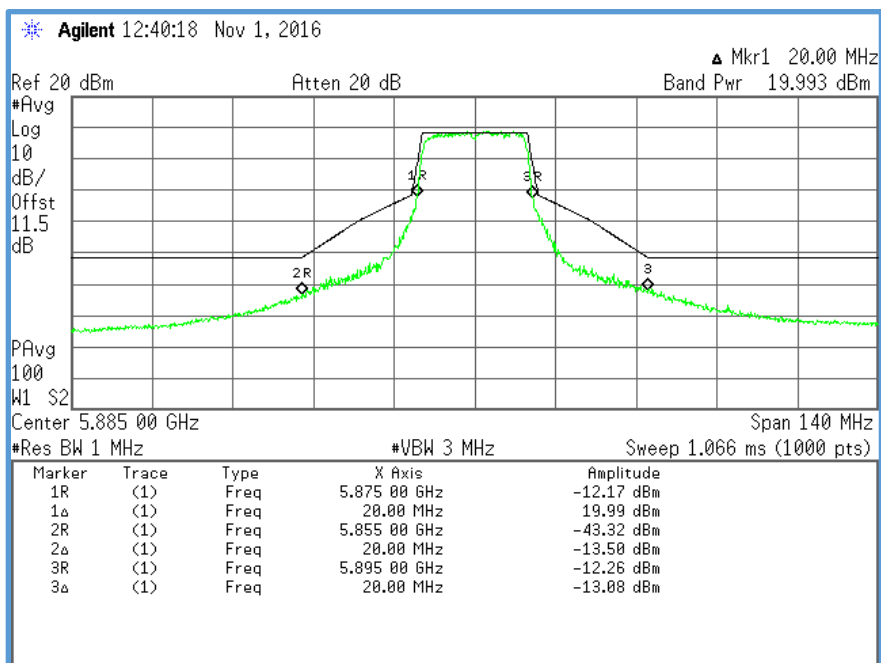


Figure 133 – Conducted ACP/OOBE, Sample 06 U-NII-4, CH. 177 OFDM MCS Index 3 Plot



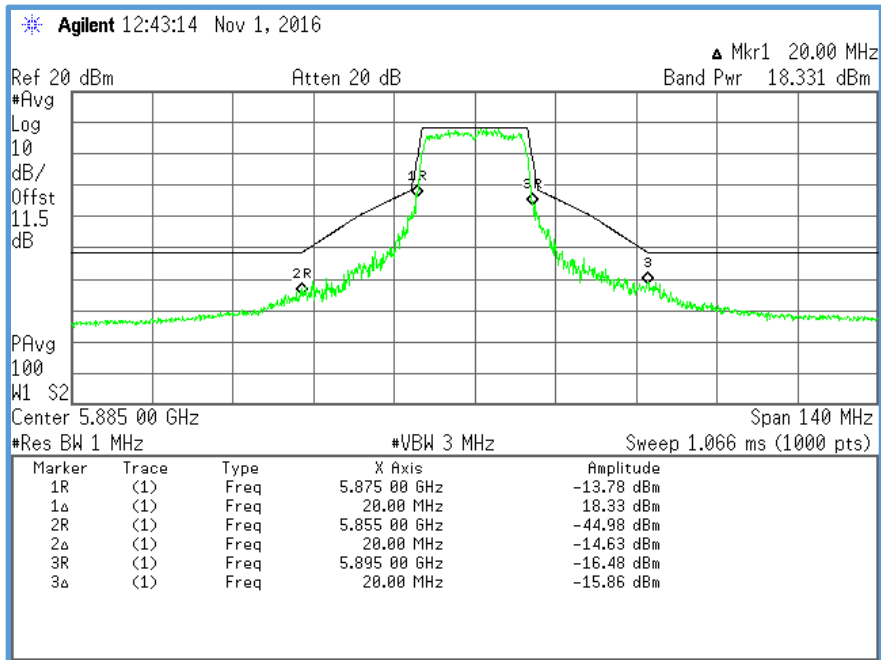


Figure 134 – Conducted ACP/OOBE, Sample 06 U-NII-4, CH.177 OFDM MCS Index 5 Plot

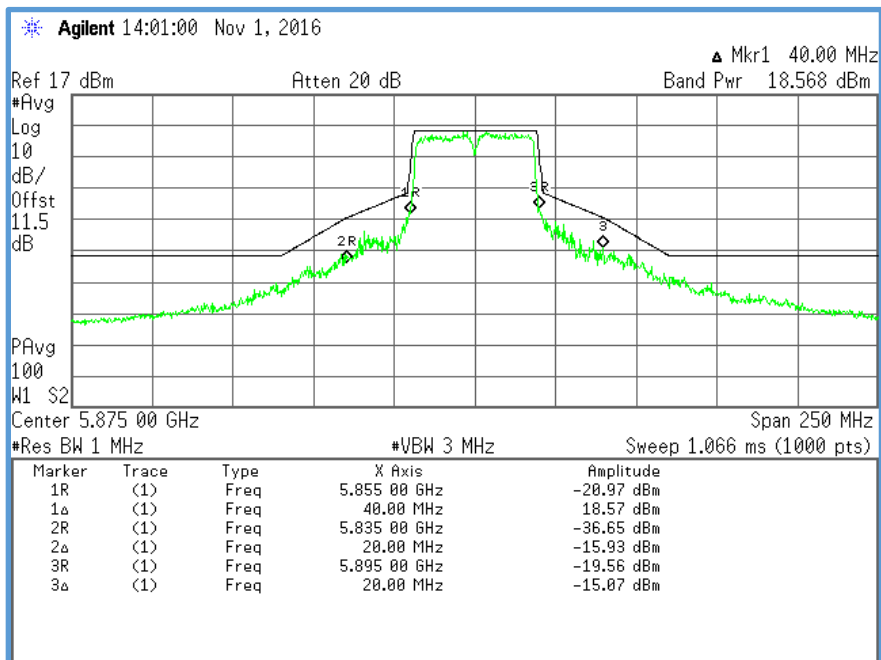


Figure 135 – Conducted ACP/OOBE, Sample 06 U-NII-4, CH.175 OFDM MCS Index 0 Plot

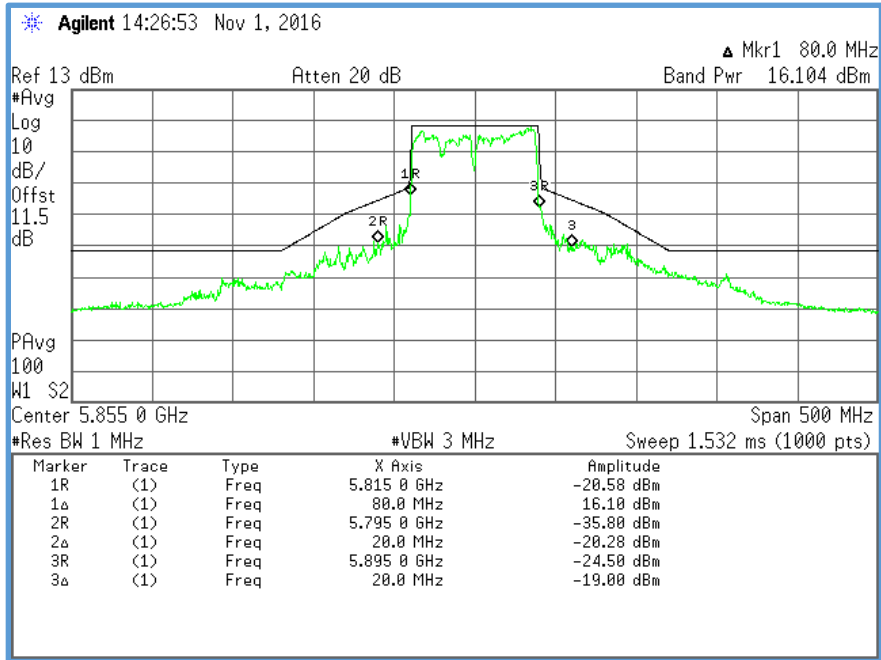


Figure 136 – Conducted ACP/OOBE, Sample 06 U-NII-4, CH.171 OFDM MCS Index 0 Plot

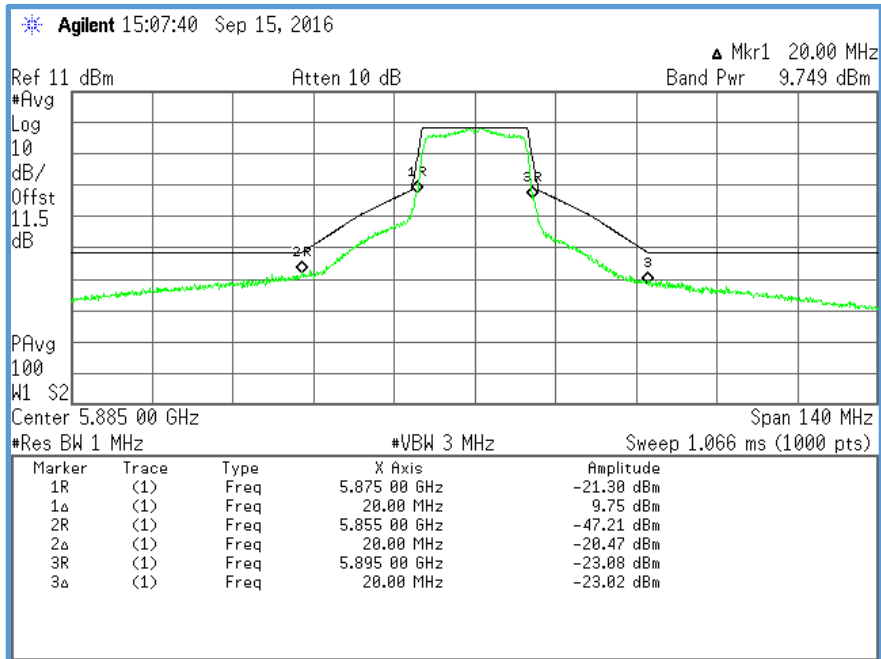


Figure 137 – Conducted ACP/OOBE, Sample 07D U-NII-4, CH.177 OFDM MCS Index 0 Plot

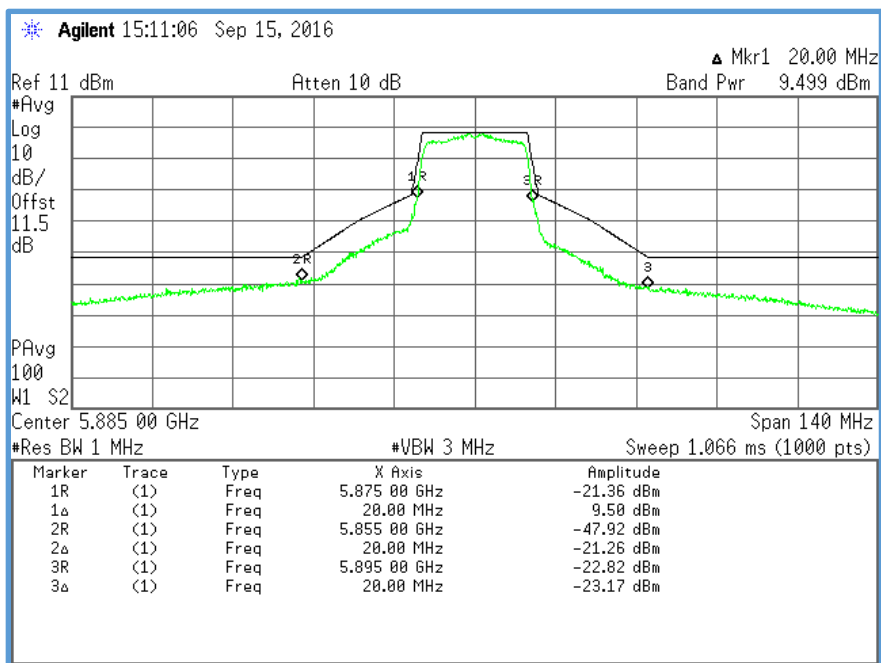


Figure 138 – Conducted ACP/OOBE, Sample 07D U-NII-4, CH.177 OFDM MCS Index 1 Plot

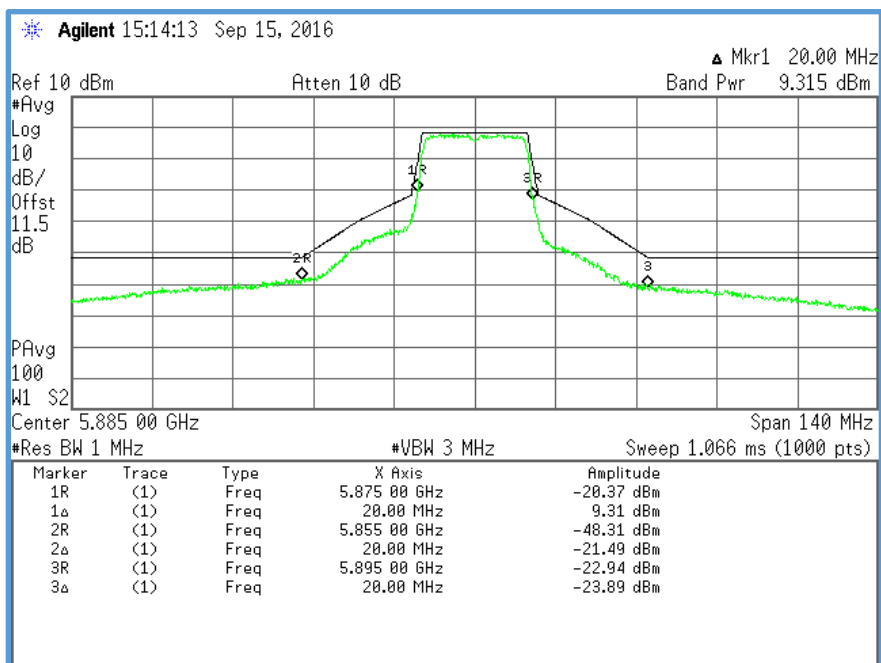


Figure 139 – Conducted ACP/OOBE, Sample 07D U-NII-4, CH.177 OFDM MCS Index 3 Plot

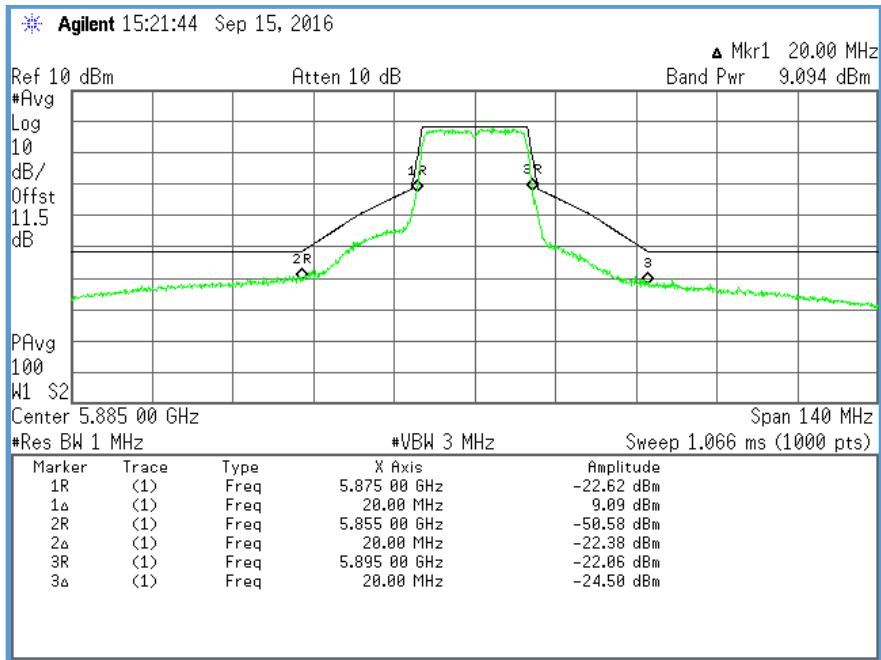


Figure 140 – Conducted ACP/OOBE, Sample 07D U-NII-4, CH.177 OFDM MCS Index 5 Plot

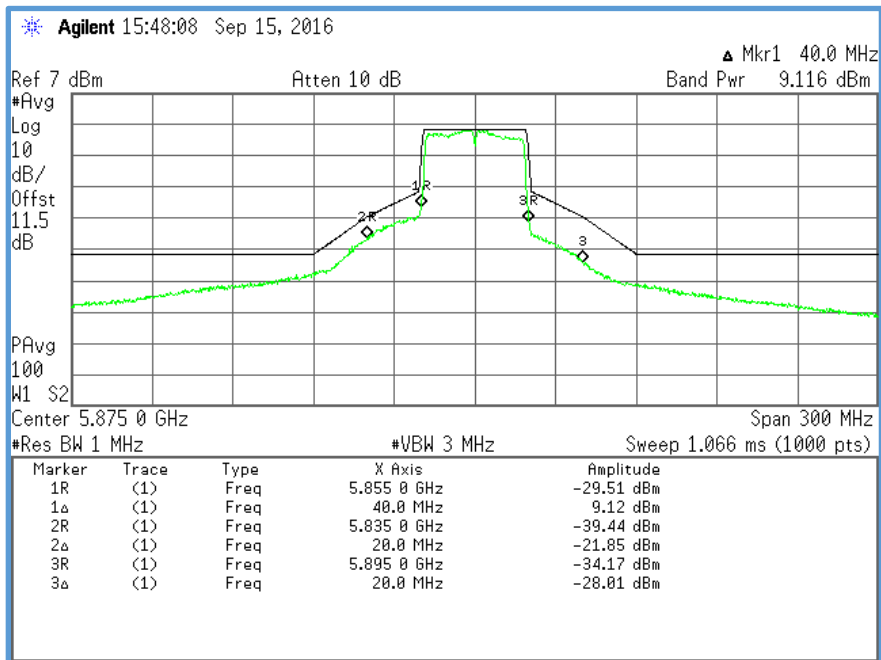


Figure 141 – Conducted ACP/OOBE, Sample 07D U-NII-4, CH.175 OFDM MCS Index 0 Plot

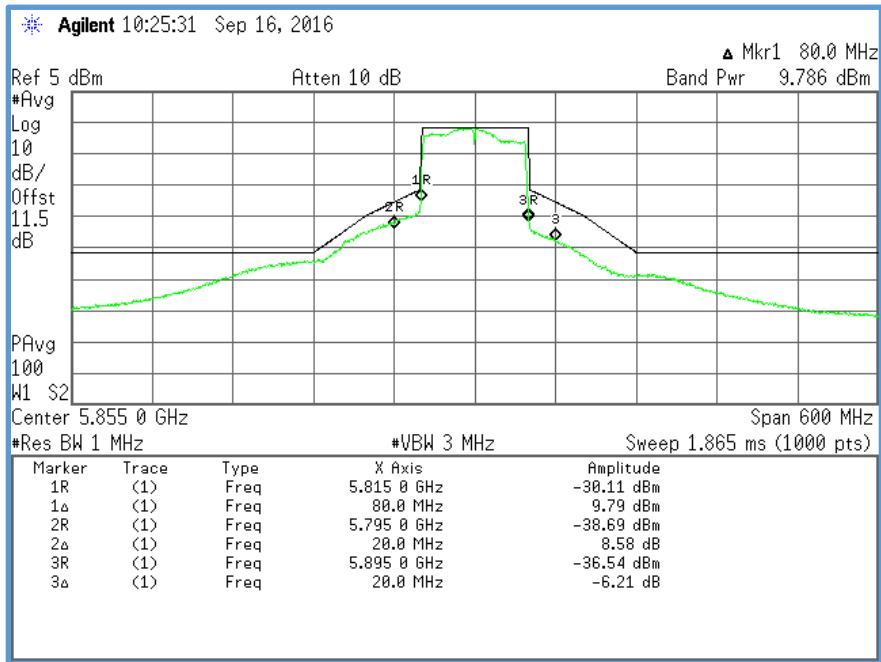


Figure 142 – Conducted ACP/OOBE, Sample 07D U-NII-4, CH.171 OFDM MCS Index 0 Plot

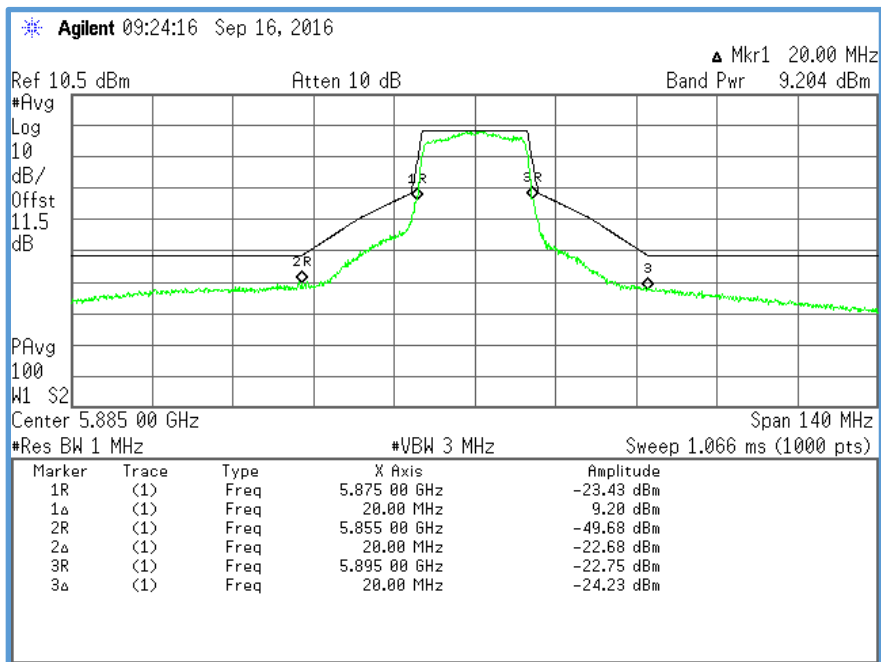


Figure 143 – Conducted ACP/OOBE, Sample 08D U-NII-4, CH.177 OFDM MCS Index 0 Plot

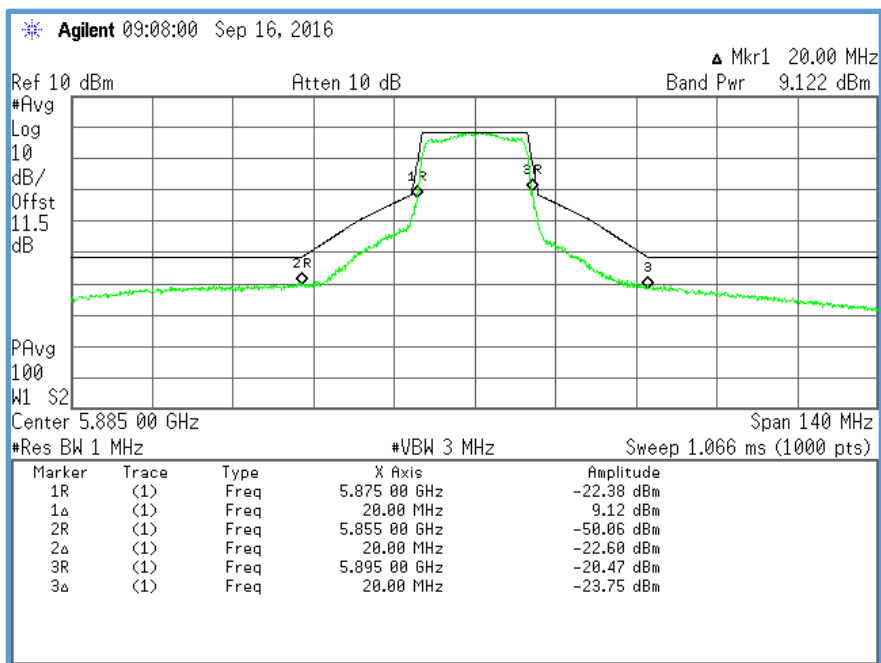


Figure 144 – Conducted ACP/OOBE, Sample 08D U-NII-4, CH.177 OFDM MCS Index 1 Plot

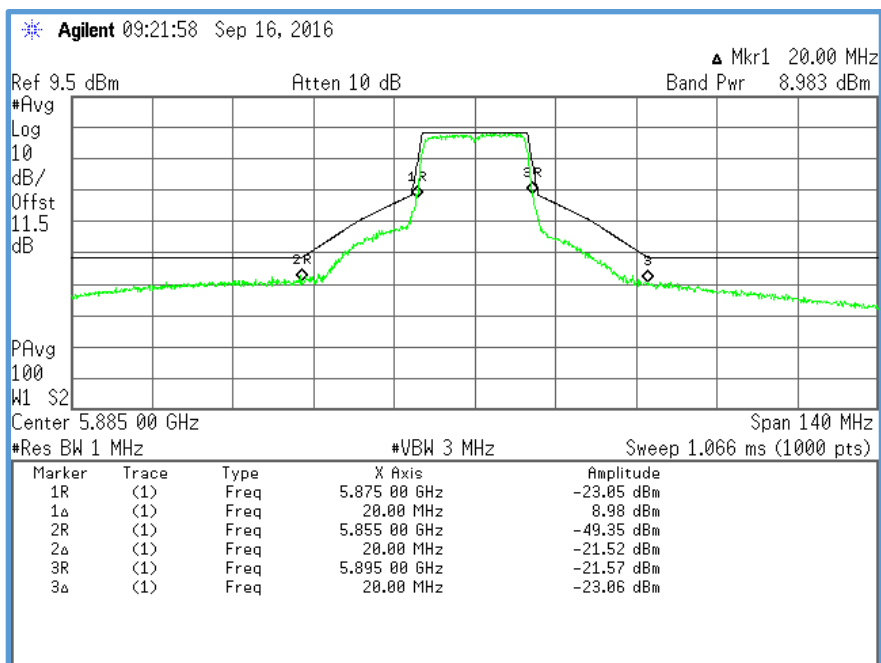


Figure 145 – Conducted ACP/OOBE, Sample 08D U-NII-4, CH.177 OFDM MCS Index 3 Plot

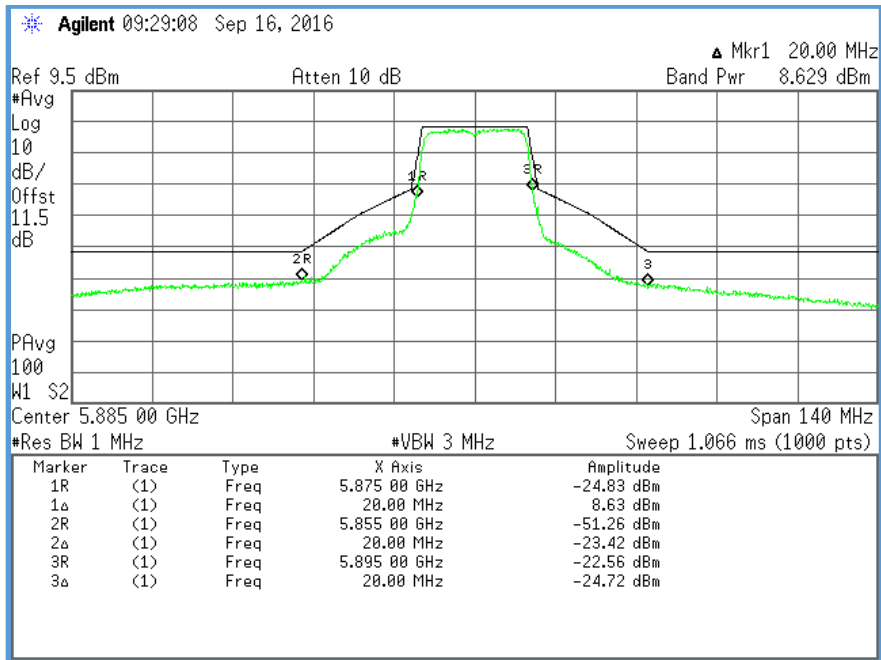


Figure 146 – Conducted ACP/OOBE, Sample 08D U-NII-4, CH.177 OFDM MCS Index 5 Plot

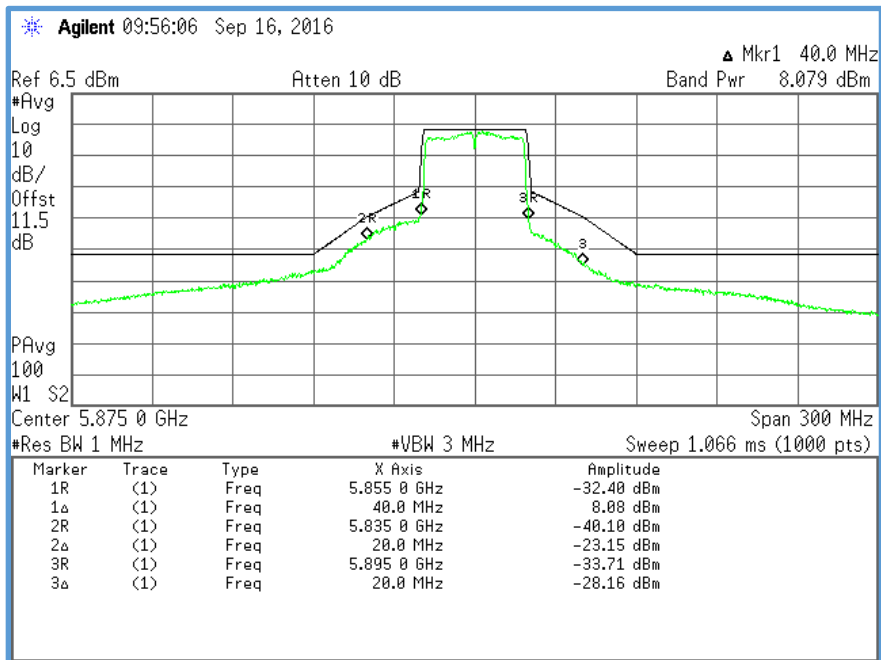


Figure 147 – Conducted ACP/OOBE, Sample 08D U-NII-4, CH.175 OFDM MCS Index 0 Plot

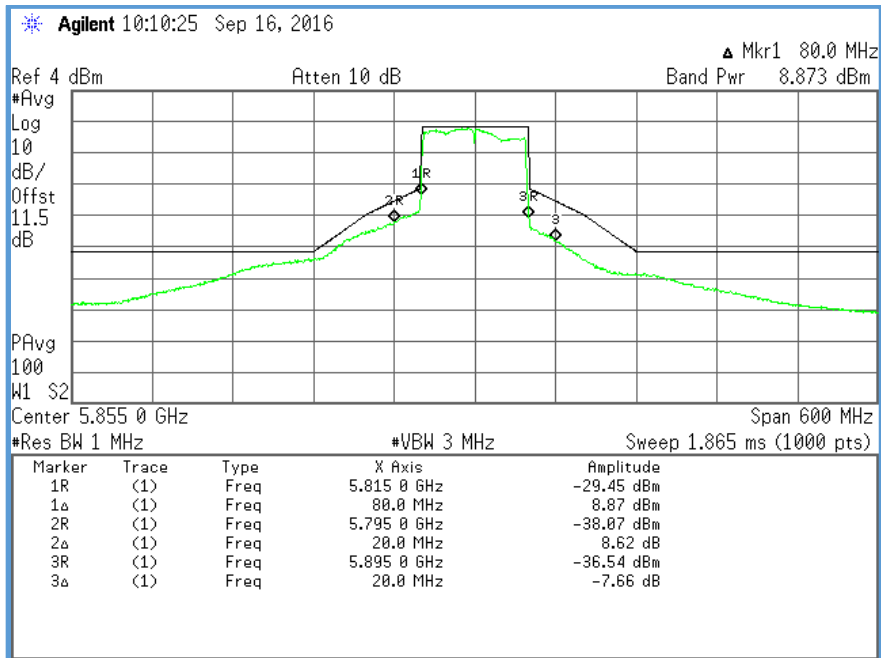


Figure 148 – Conducted ACP/OOBE, Sample 08D U-NII-4, CH.171 OFDM MCS Index 0 Plot

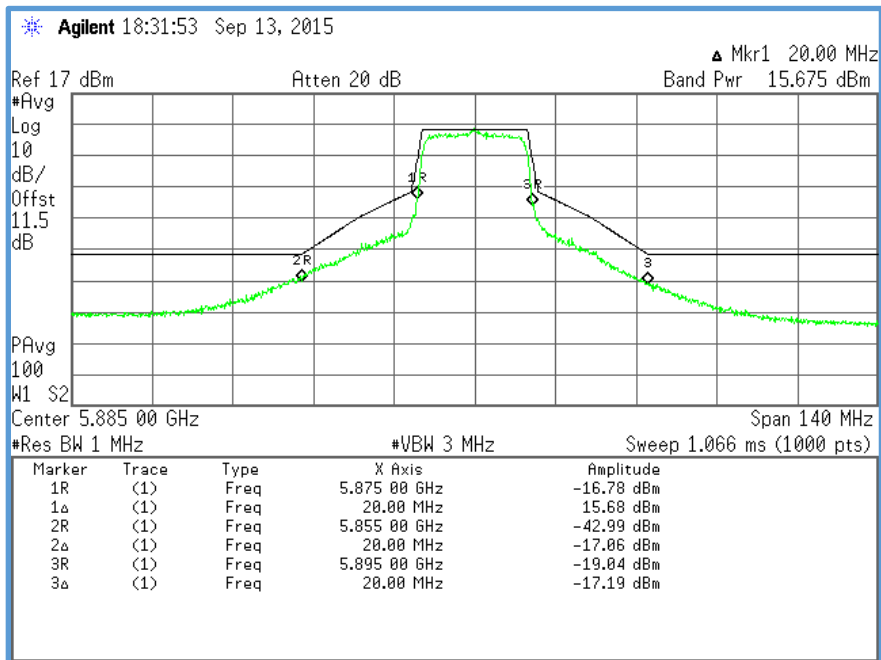


Figure 149 – Conducted ACP/OOBE, Sample 14A U-NII-4, CH.177 OFDM MCS Index 0 Plot



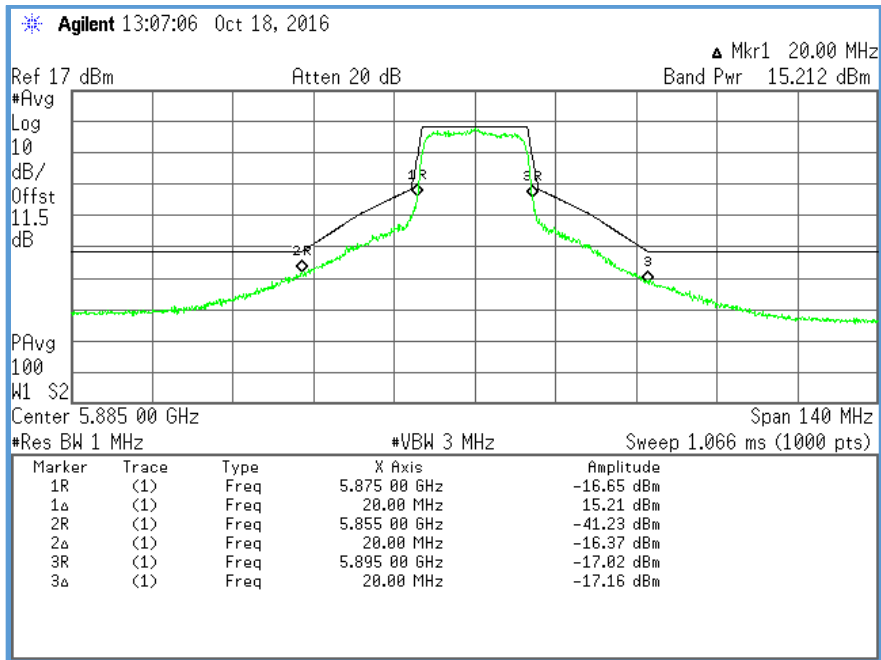


Figure 150 – Conducted ACP/OOBE, Sample 14A U-NII-4, CH.177 OFDM MCS Index 1 Plot

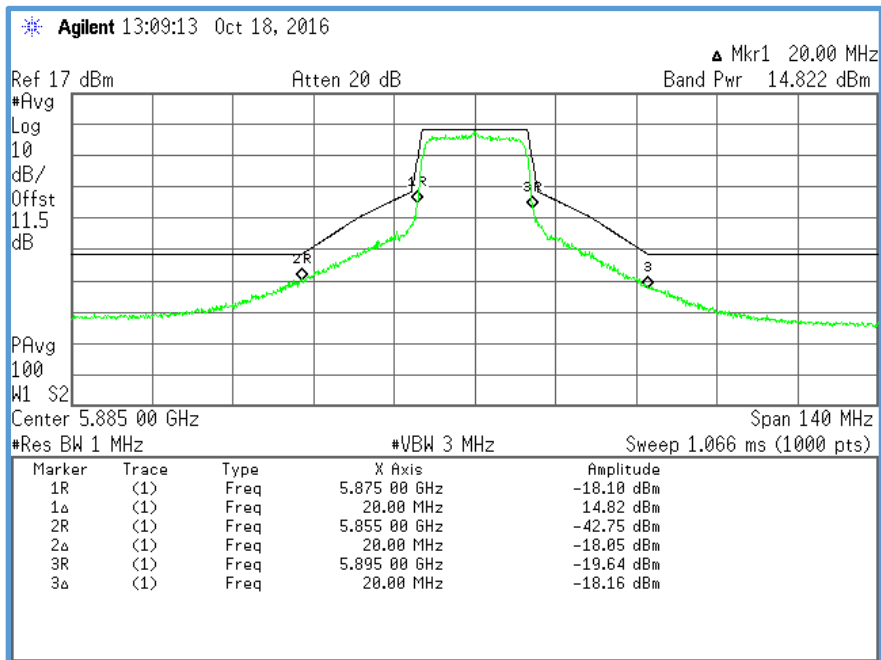


Figure 151 – Conducted ACP/OOBE, Sample 14A U-NII-4, CH.177 OFDM MCS Index 3 Plot

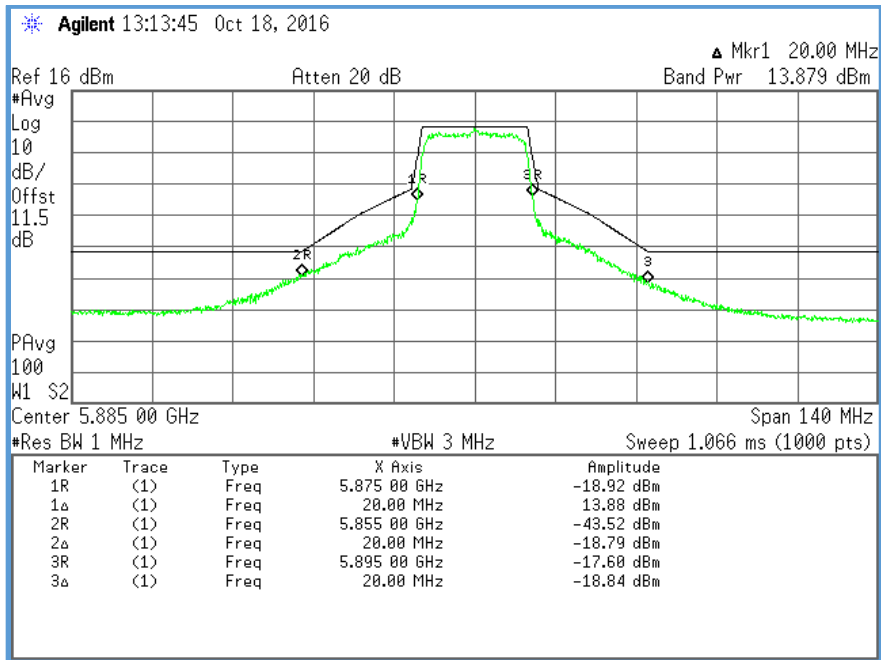


Figure 152 – Conducted ACP/OOBE, Sample 14A U-NII-4, CH.177 OFDM MCS Index 5 Plot

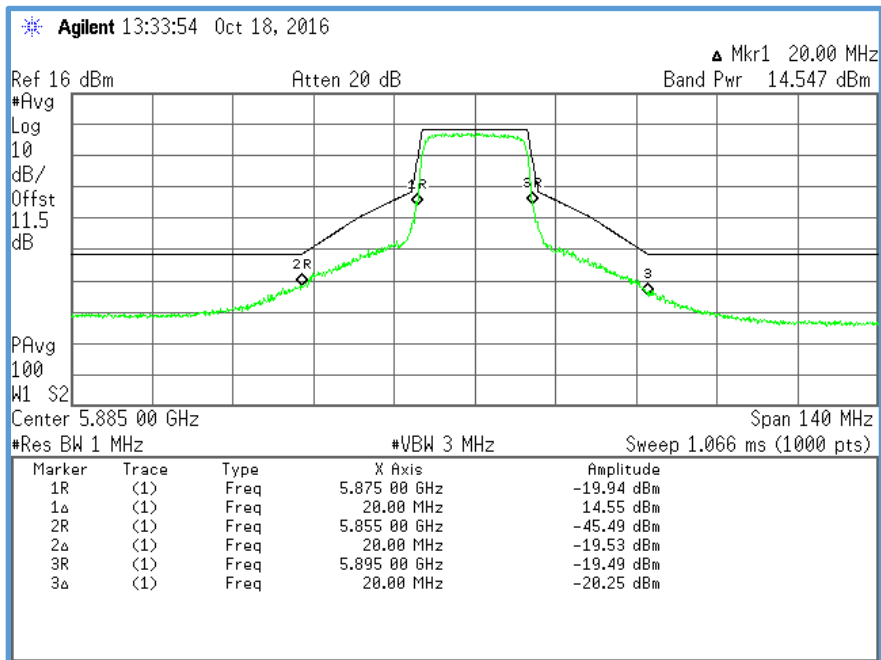


Figure 153 – Conducted ACP/OOBE, Sample 15A U-NII-4, CH.177 OFDM MCS Index 0 Plot

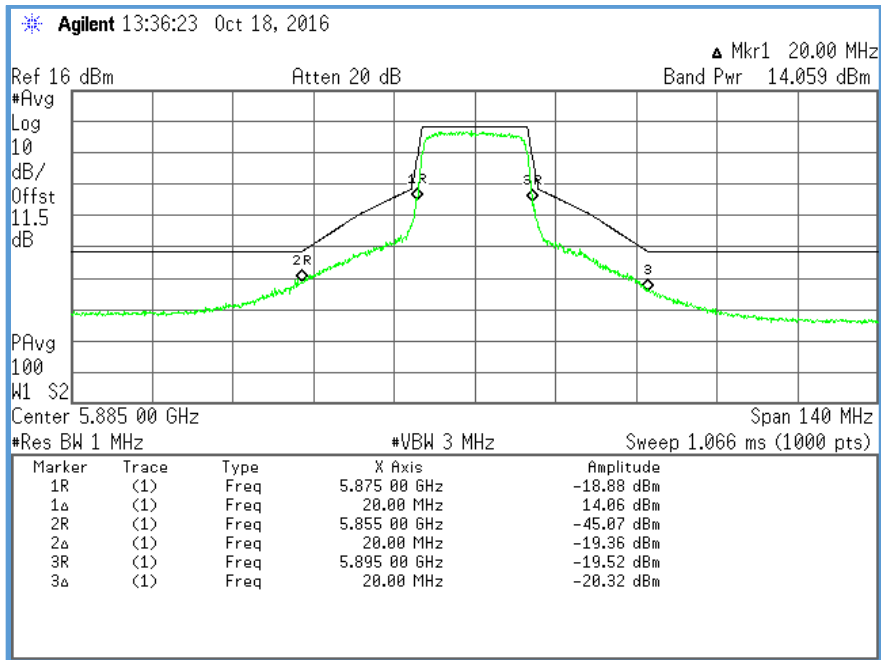


Figure 154 – Conducted ACP/OOBE, Sample 15A U-NII-4, CH.177 OFDM MCS Index 1 Plot

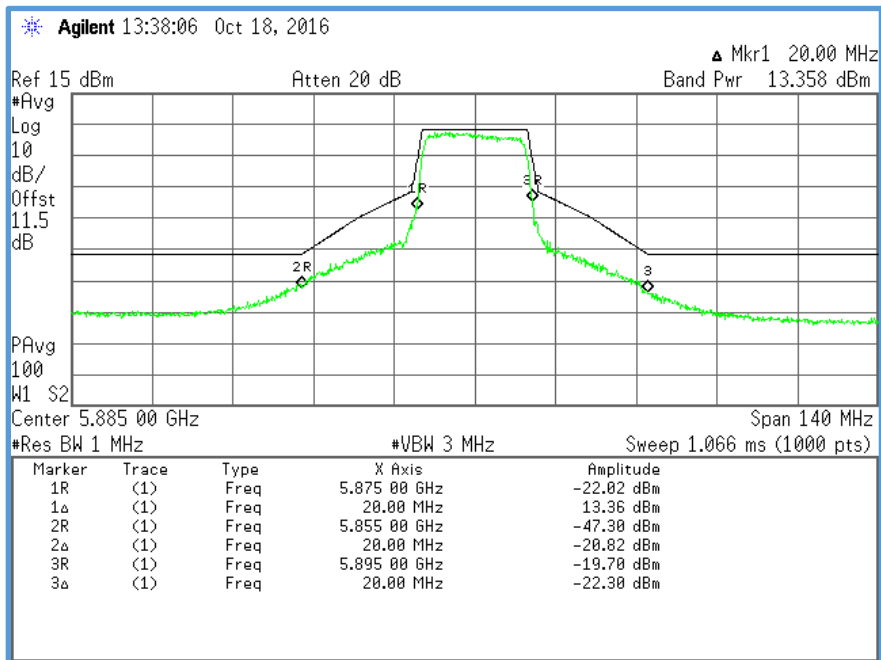


Figure 155 – Conducted ACP/OOBE, Sample 15A U-NII-4, CH.177 OFDM MCS Index 3 Plot

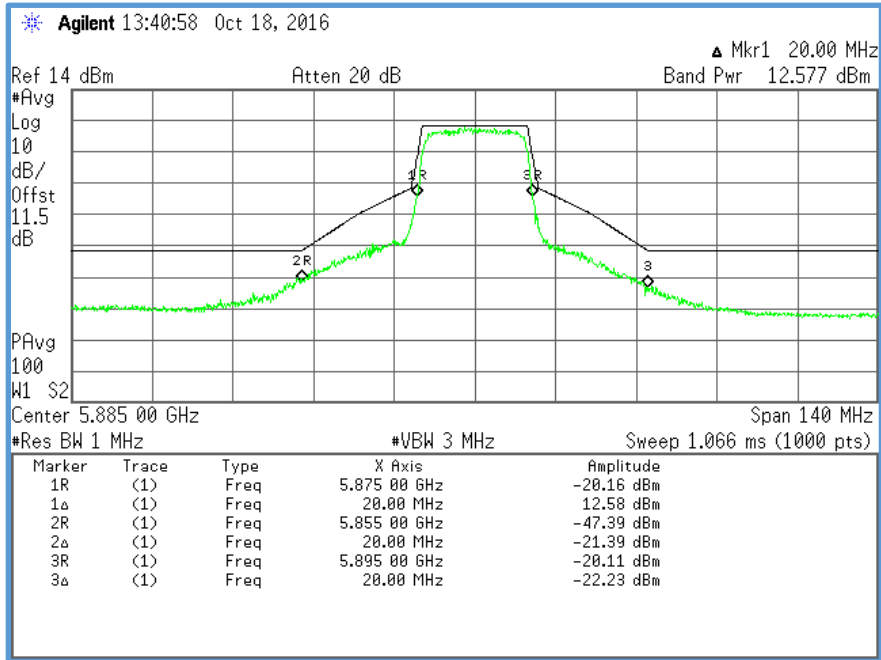


Figure 156 – Conducted ACP/OOBE, Sample 15A U-NII-4, CH.177 OFDM MCS Index 5 Plot

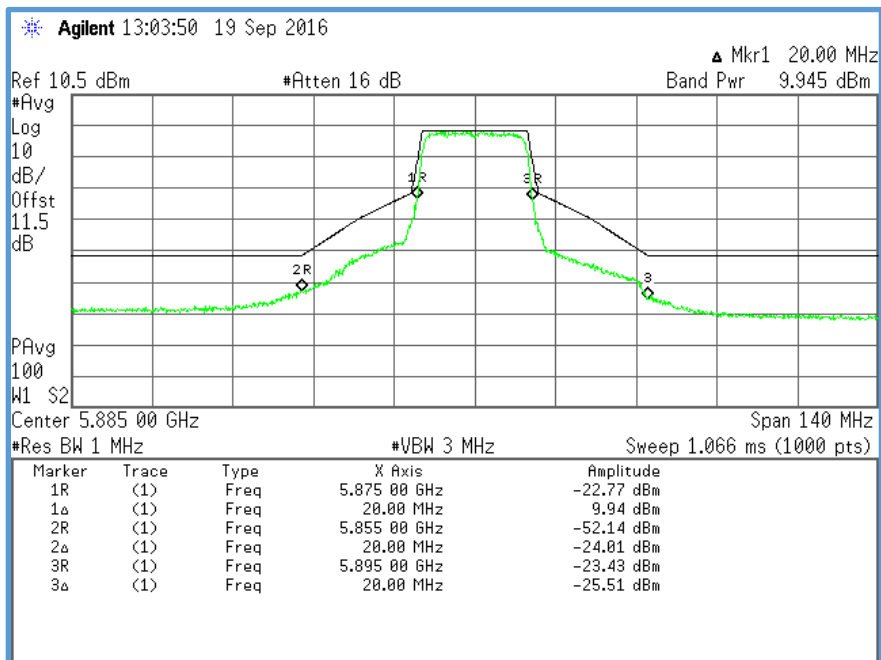


Figure 157 – Conducted ACP/OOBE, Sample 16A U-NII-4, CH.177 OFDM MCS Index 0 Plot

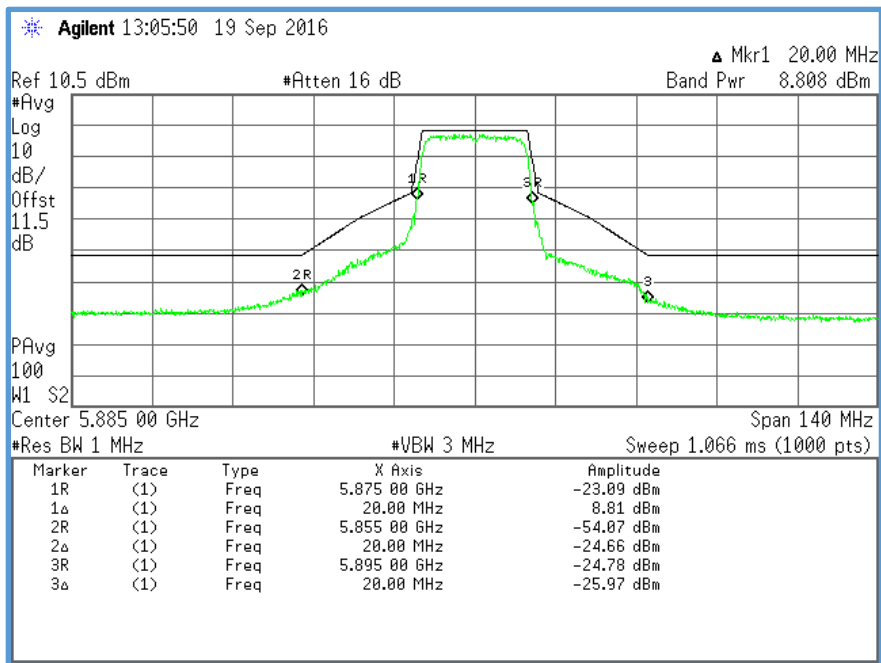


Figure 158 – Conducted ACP/OOBE, Sample 16A U-NII-4, CH.177 OFDM MCS Index 1 Plot

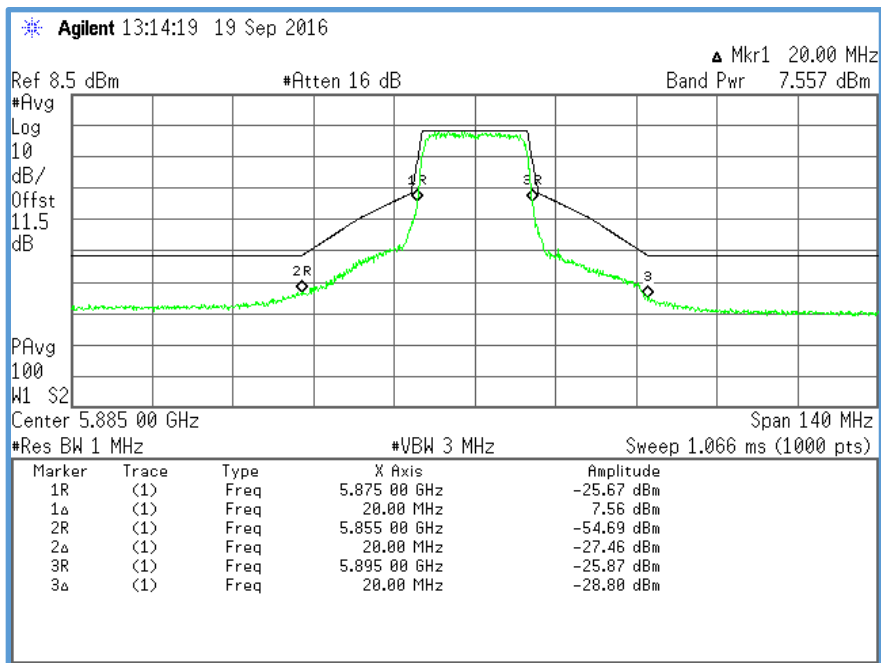


Figure 159 – Conducted ACP/OOBE, Sample 16A U-NII-4, CH.177 OFDM MCS Index 3 Plot

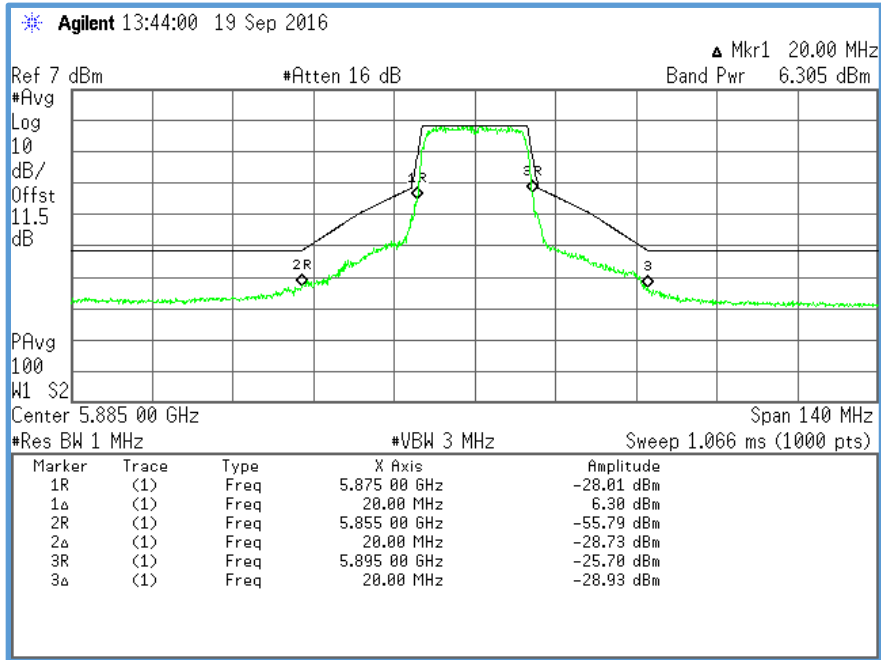


Figure 160 – Conducted ACP/OOBE, Sample 16A U-NII-4, CH.177 OFDM MCS Index 5 Plot

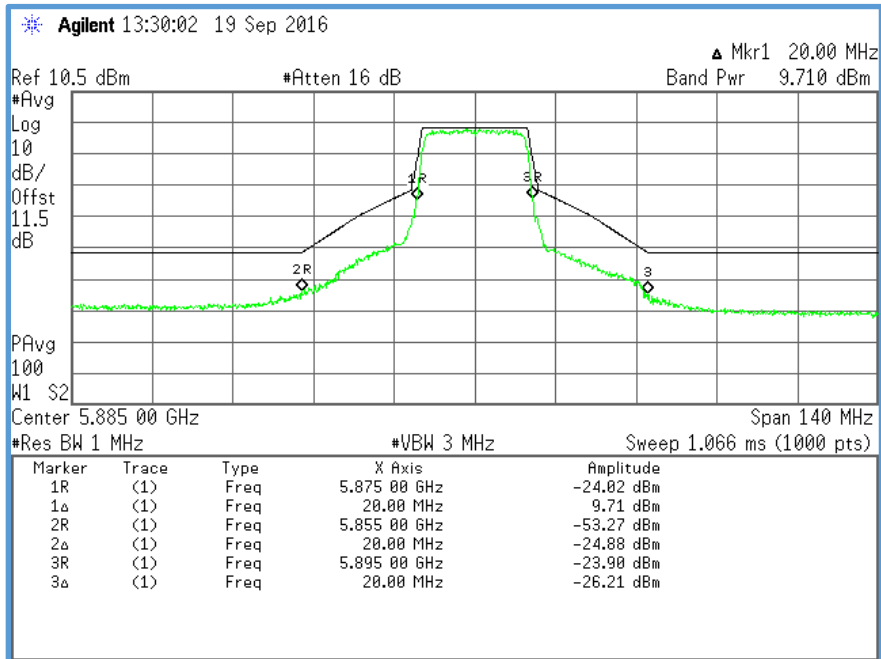


Figure 161 – Conducted ACP/OOBE, Sample 16G U-NII-4, CH.177 OFDM MCS Index 0 Plot

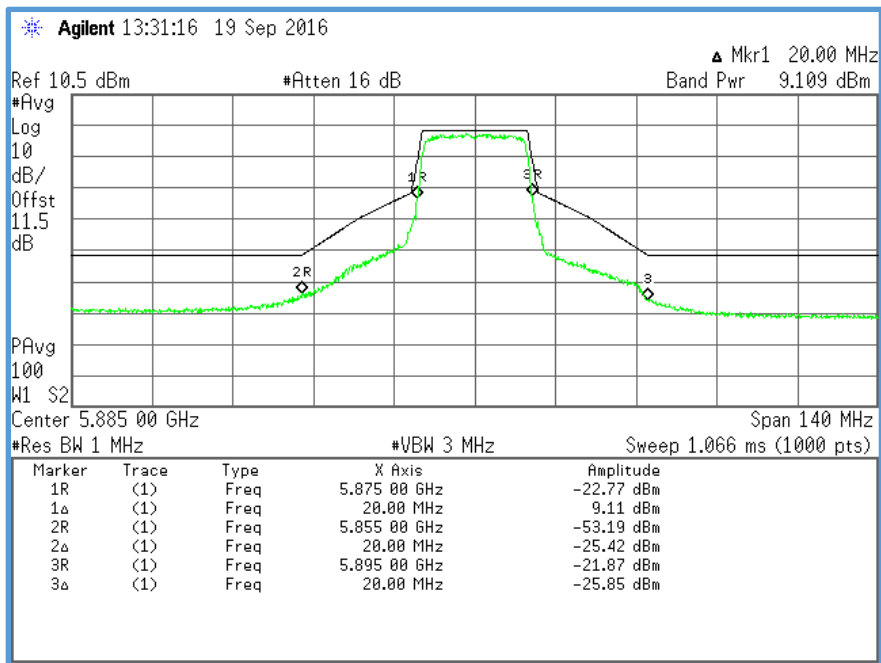


Figure 162 – Conducted ACP/OOBE, Sample 16G U-NII-4, CH.177 OFDM MCS Index 1 Plot

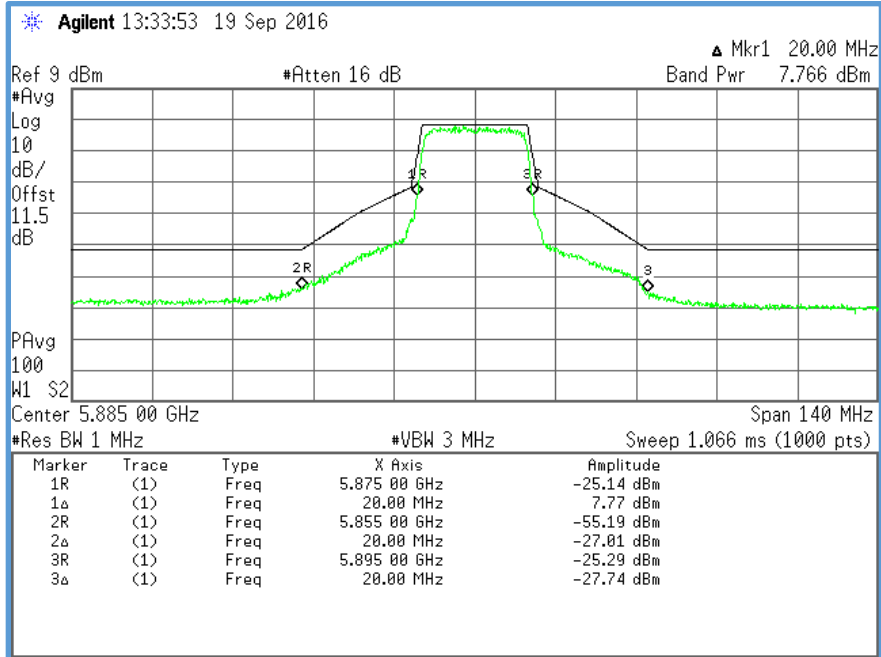


Figure 163 – Conducted ACP/OOBE, Sample 16G U-NII-4, CH.177 OFDM MCS Index 3 Plot

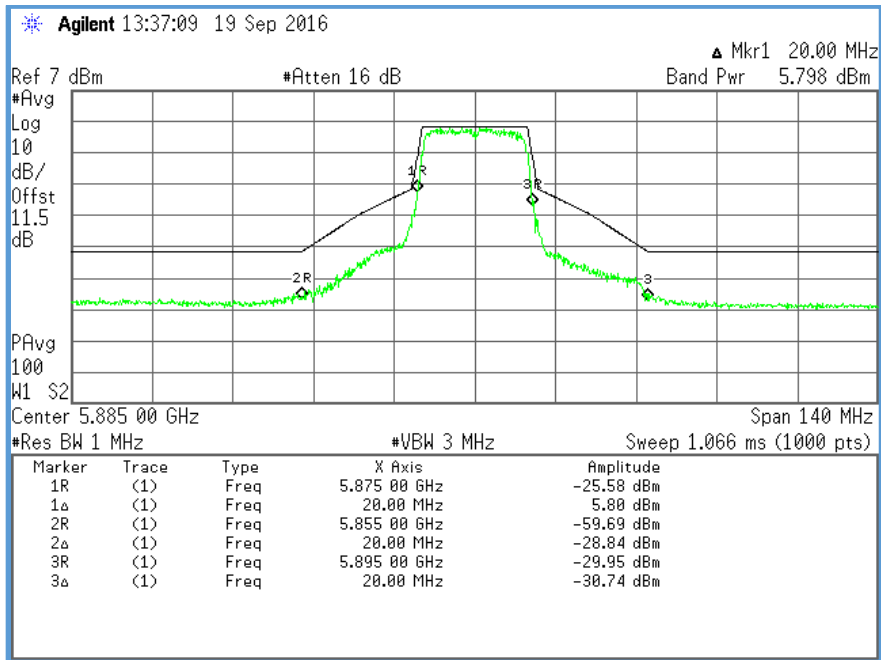


Figure 164 – Conducted ACP/OOBE, Sample 16G U-NII-4, CH.177 OFDM MCS Index 5 Plot

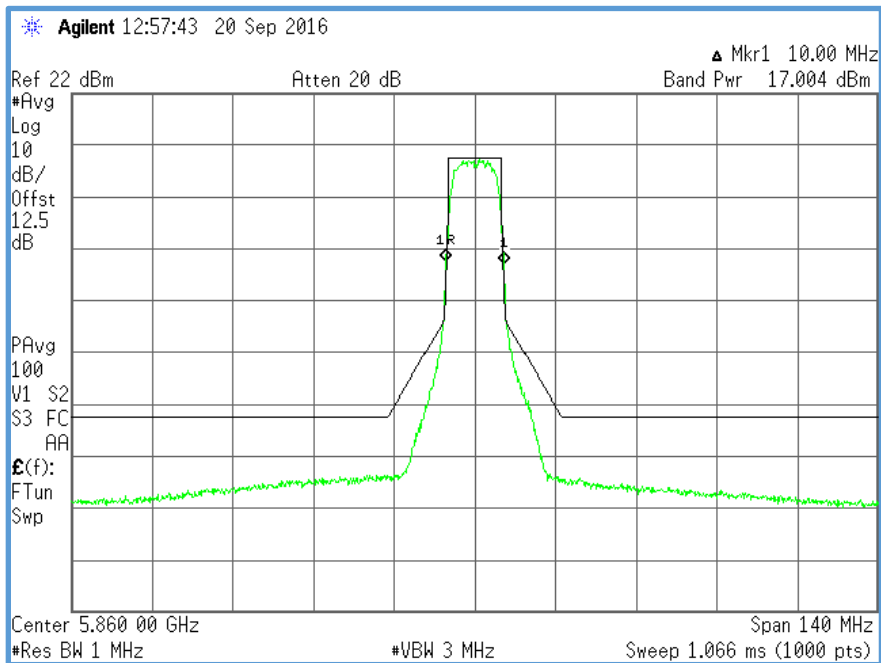
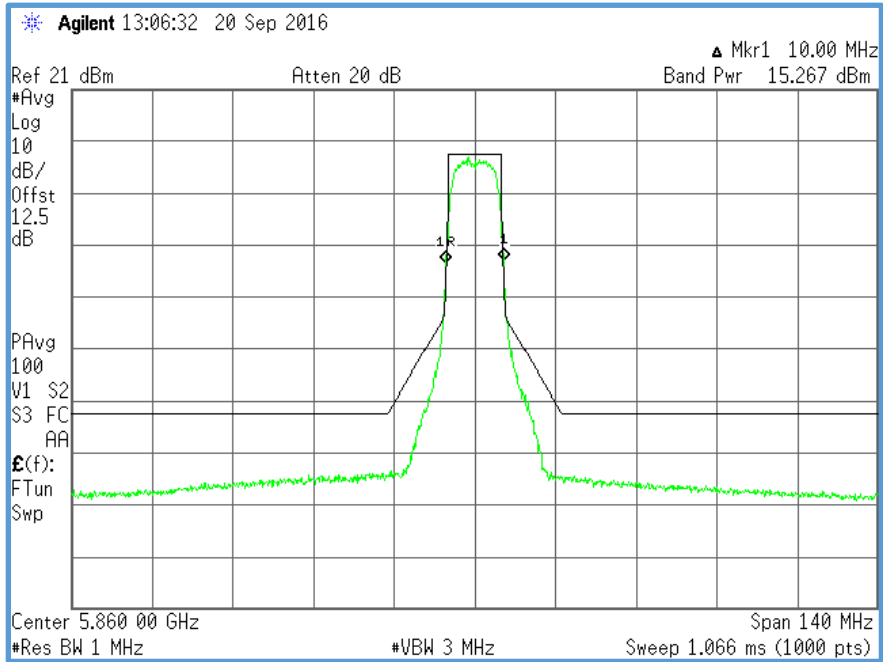
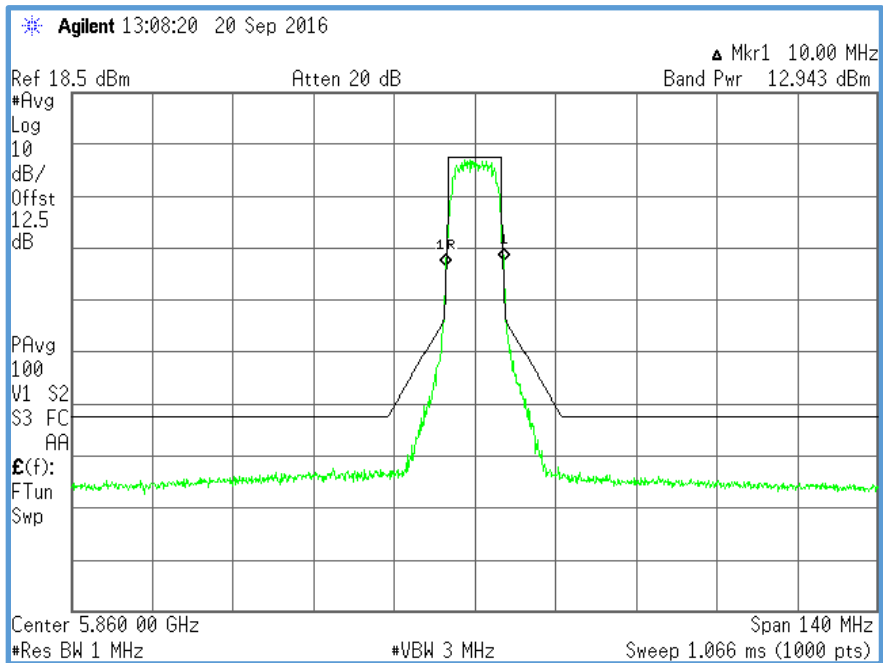


Figure 165 – Conducted ACP/OOBE, Sample 01 DSRC, CH.172 OFDM MCS Index 0 Plot

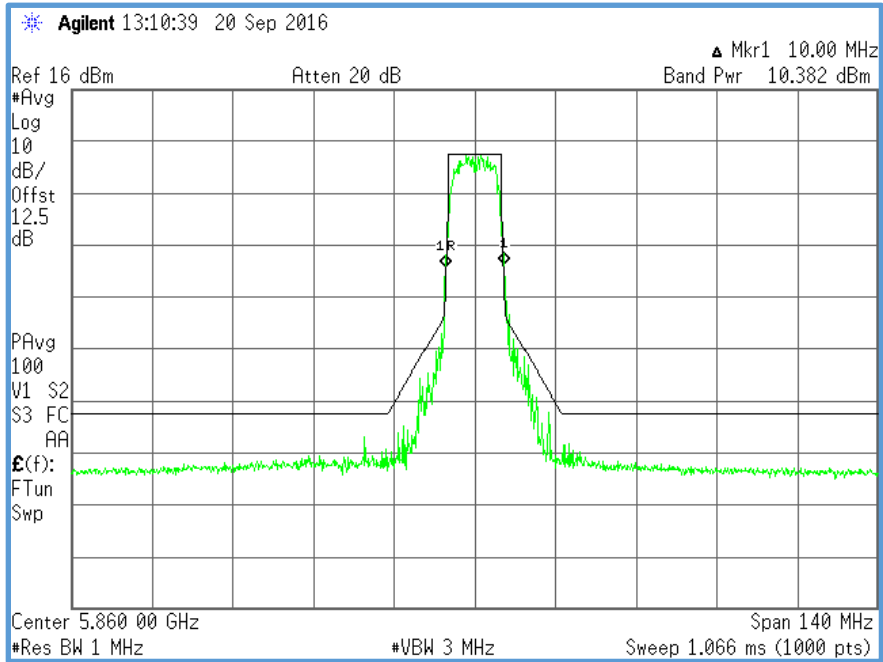




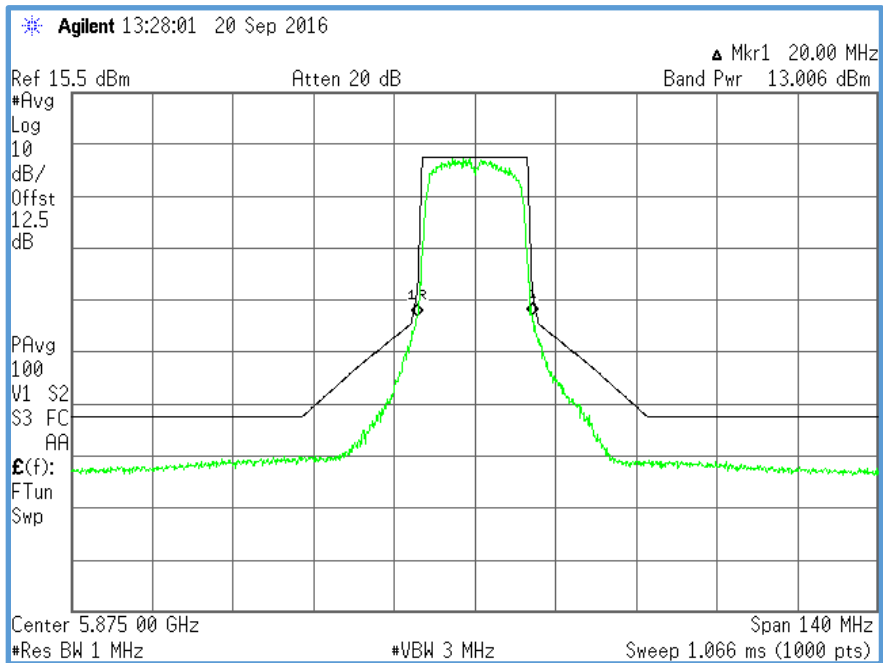
**Figure 166 – Conducted ACP/OOBE, Sample 01 DSRC, CH.172 OFDM MCS Index 1 Plot**



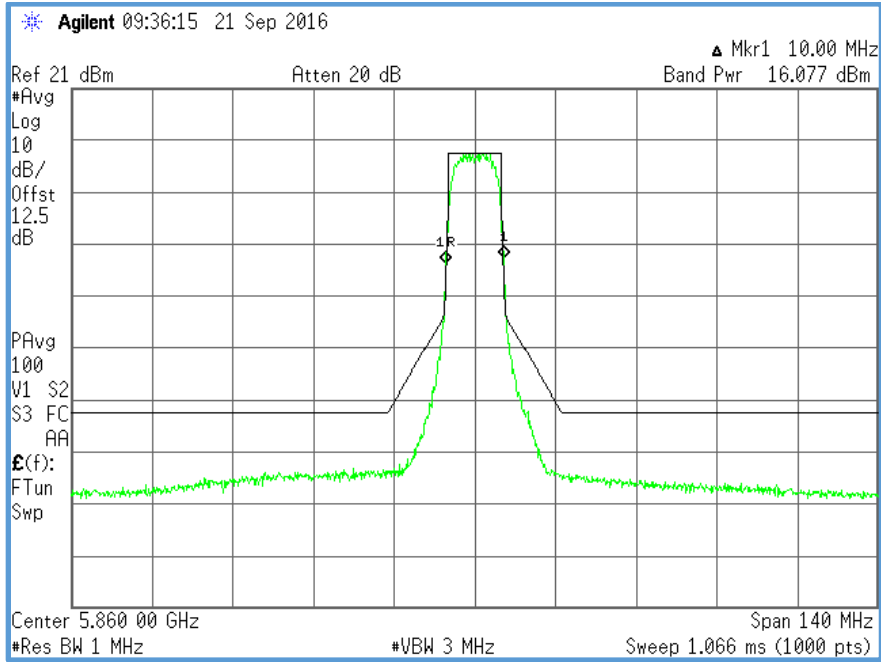
**Figure 167 – Conducted ACP/OOBE, Sample 01 DSRC, CH.172 OFDM MCS Index 3 Plot**



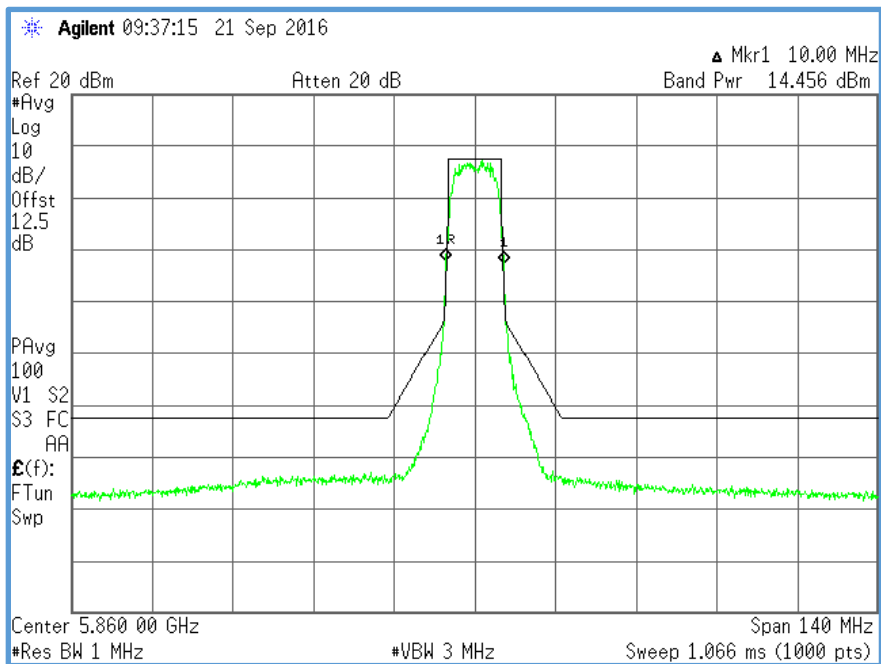
**Figure 168 – Conducted ACP/OOBE, Sample 01 DSRC, CH.172 OFDM MCS Index 5 Plot**



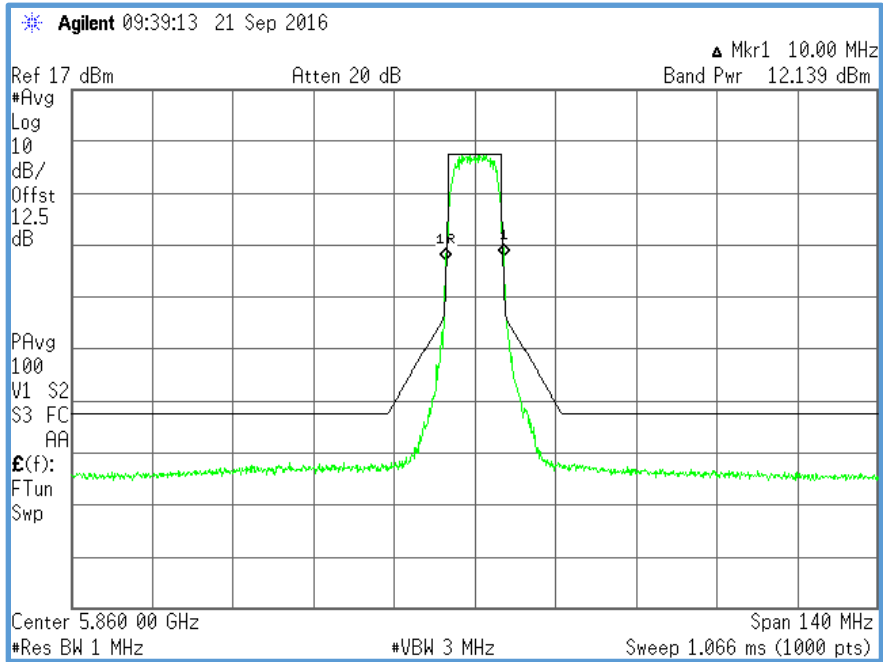
**Figure 169 – Conducted ACP/OOBE, Sample 01 DSRC, CH.175 OFDM MCS Index 0 Plot**



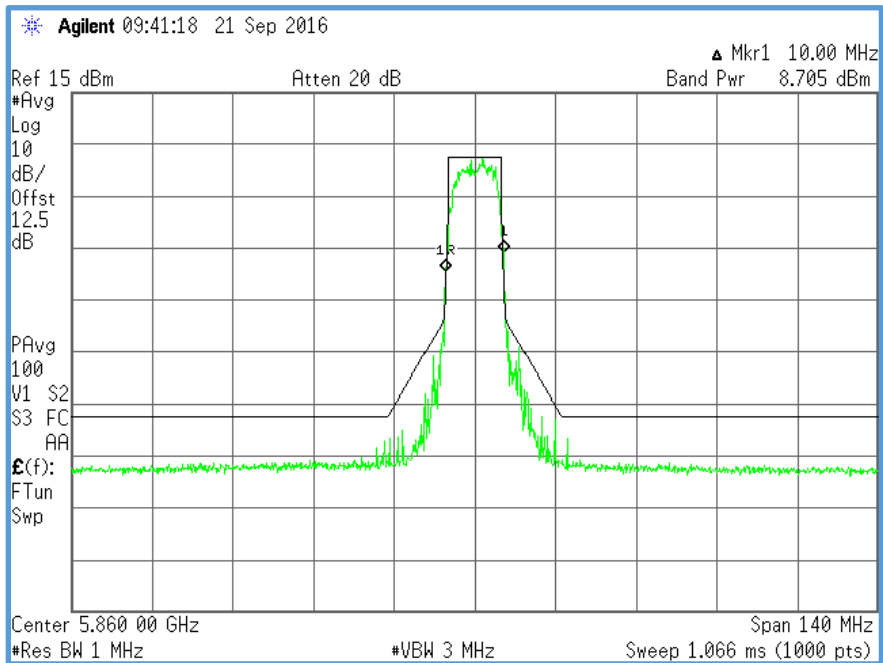
**Figure 170 – Conducted ACP/OOBE, Sample 02 DSRC, CH.172 OFDM MCS Index 0 Plot**



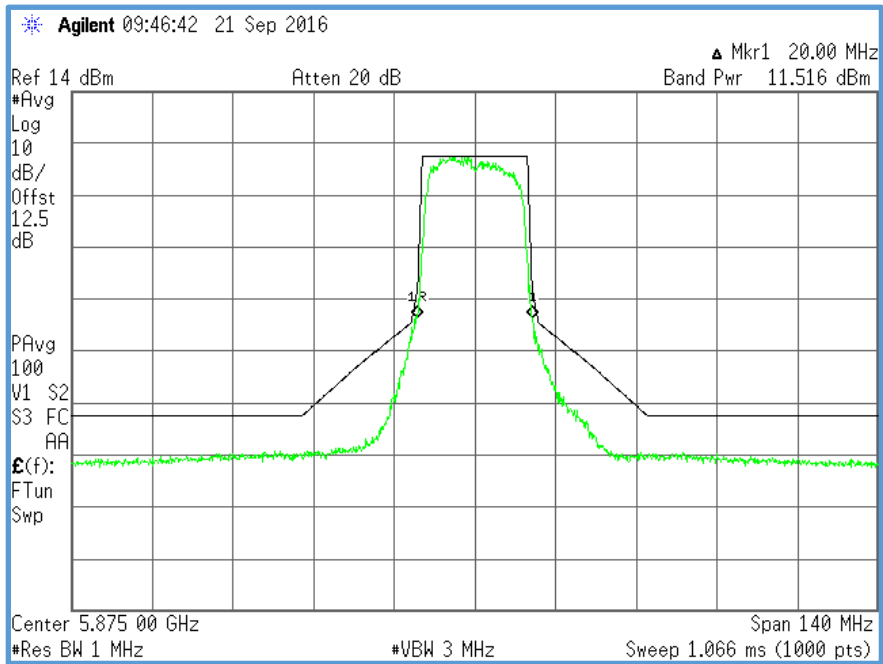
**Figure 171 – Conducted ACP/OOBE, Sample 02 DSRC, CH.172 OFDM MCS Index 1 Plot**



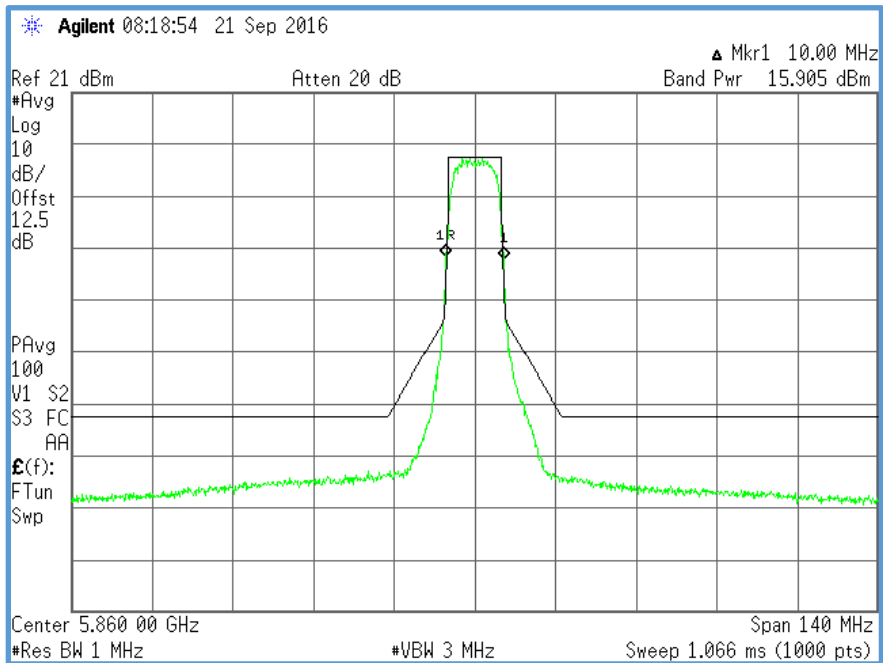
**Figure 172 – Conducted ACP/OOBE, Sample 02 DSRC, CH.172 OFDM MCS Index 3 Plot**



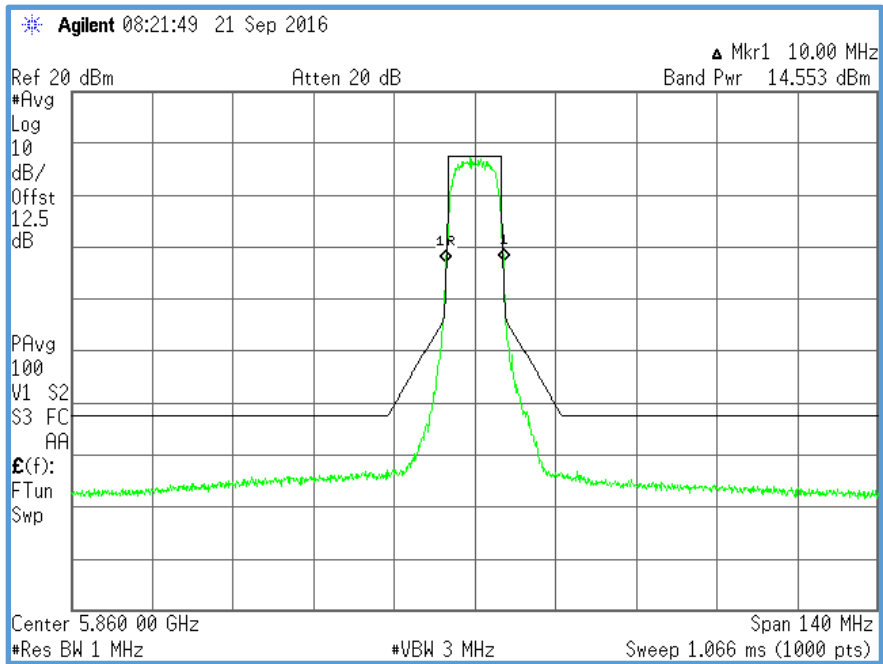
**Figure 173 – Conducted ACP/OOBE, Sample 02 DSRC, CH.172 OFDM MCS Index 5 Plot**



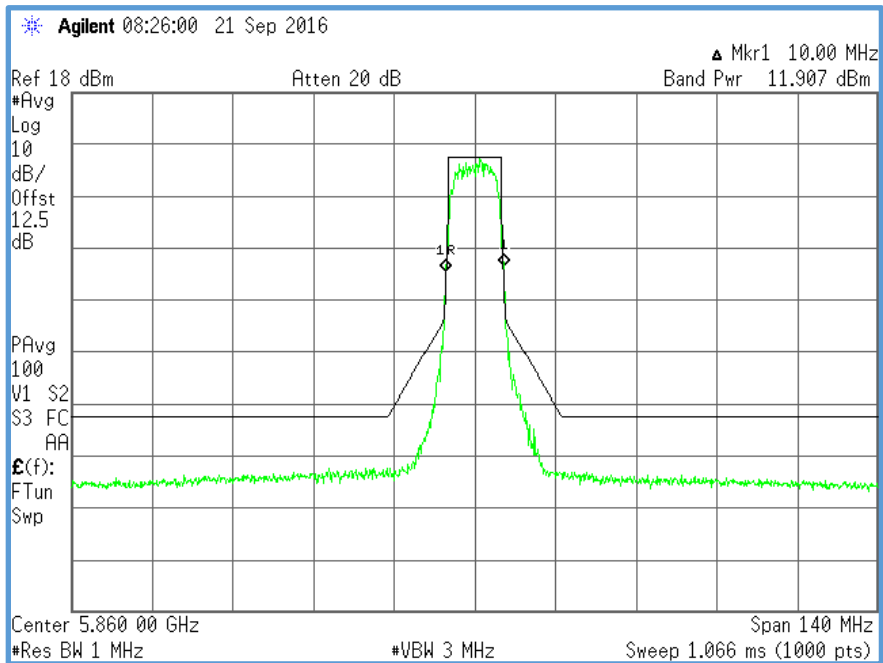
**Figure 174 – Conducted ACP/OOBE, Sample 02 DSRC, CH.175 OFDM MCS Index 0 Plot**



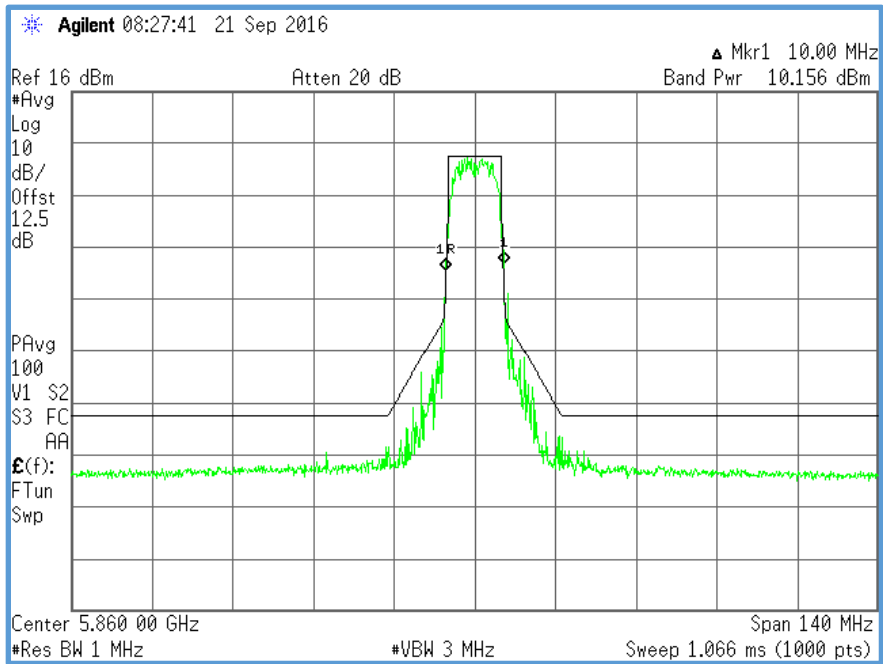
**Figure 175 – Conducted ACP/OOBE, Sample 03 DSRC, CH.172 OFDM MCS Index 0 Plot**



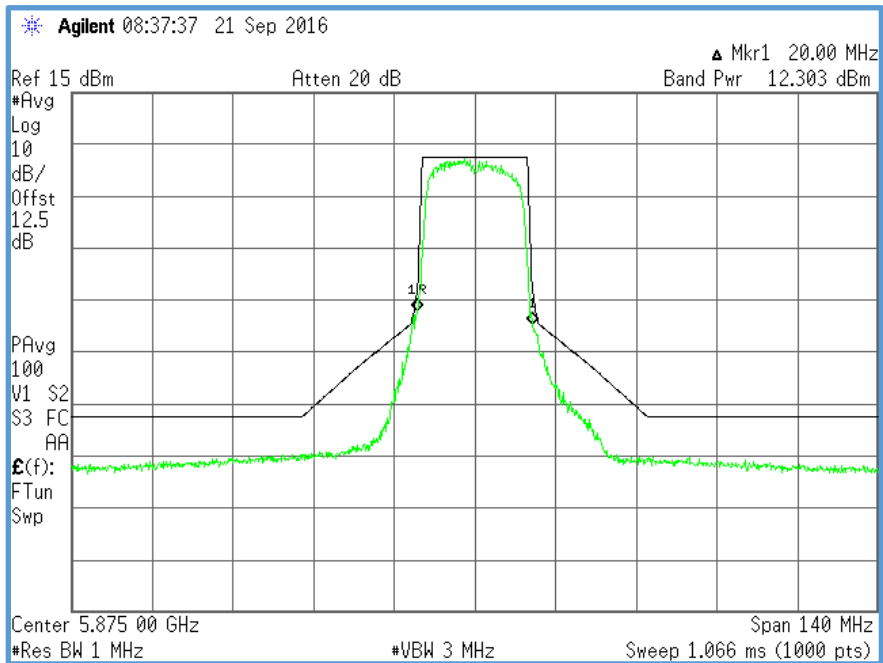
**Figure 176 – Conducted ACP/OOBE, Sample 03 DSRC, CH.172 OFDM MCS Index 1 Plot**



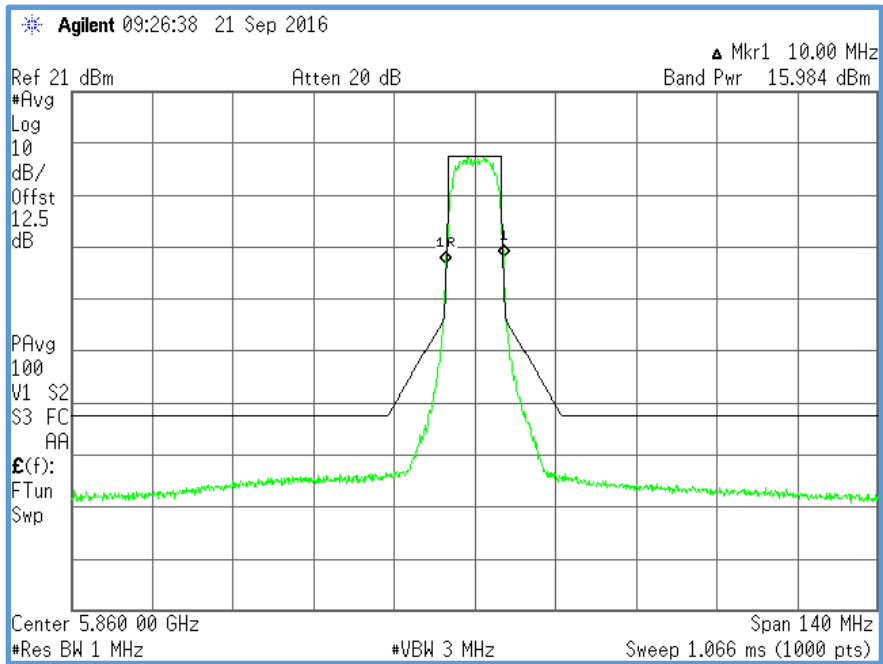
**Figure 177 – Conducted ACP/OOBE, Sample 03 DSRC, CH.172 OFDM MCS Index 3 Plot**



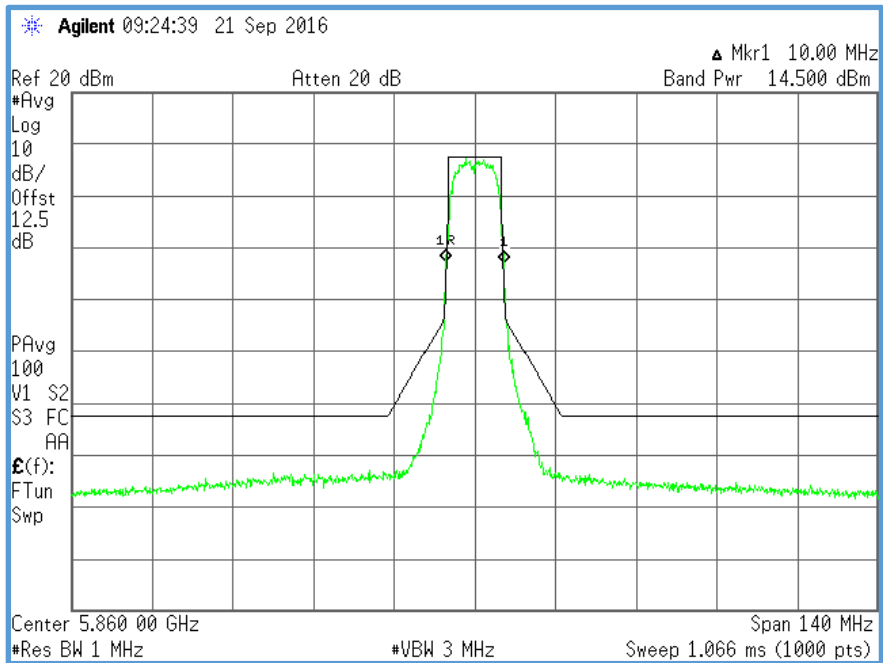
**Figure 178 – Conducted ACP/OOBE, Sample 03 DSRC, CH.172 OFDM MCS Index 5 Plot**



**Figure 179 – Conducted ACP/OOBE, Sample 03 DSRC, CH.175 OFDM MCS Index 0 Plot**

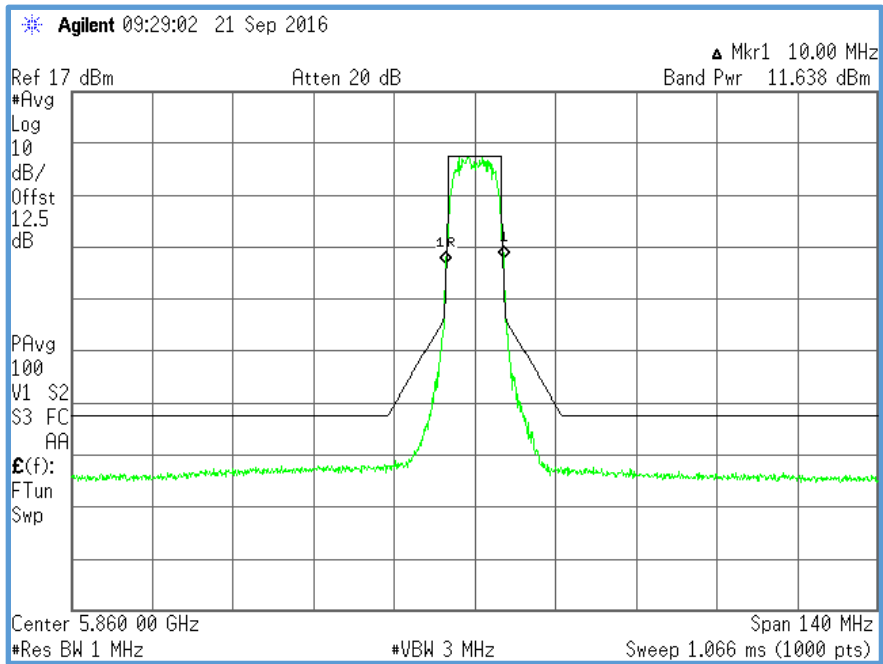


**Figure 180 – Conducted ACP/OOBE, Sample 04 DSRC, CH.172 OFDM MCS Index 0 Plot**

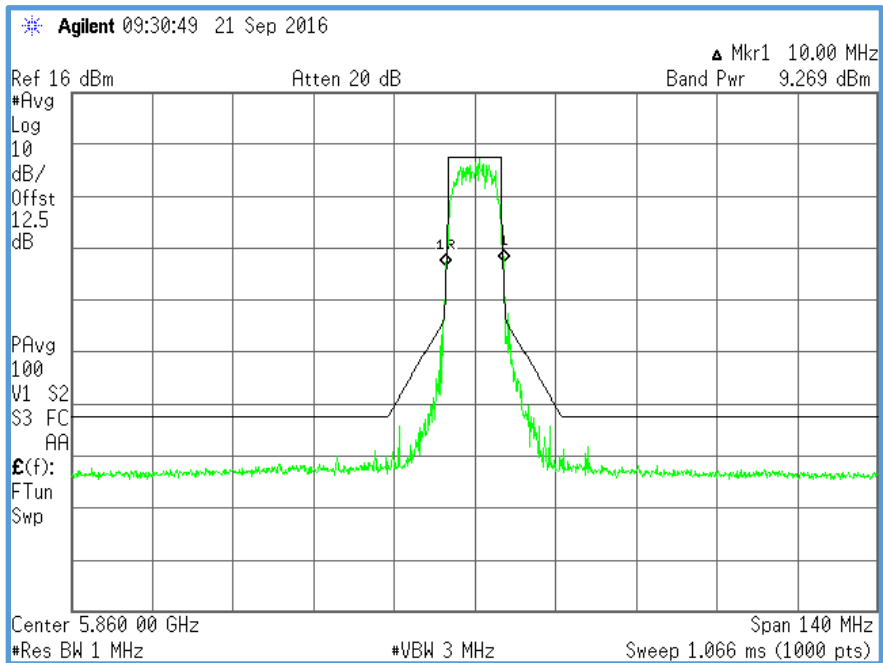


**Figure 181 – Conducted ACP/OOBE, Sample 04 DSRC, CH.172 OFDM MCS Index 1 Plot**





**Figure 182 – Conducted ACP/OOBE, Sample 04 DSRC, CH.172 OFDM MCS Index 3 Plot**



**Figure 183 – Conducted ACP/OOBE, Sample 04 DSRC, CH.172 OFDM MCS Index 5 Plot**

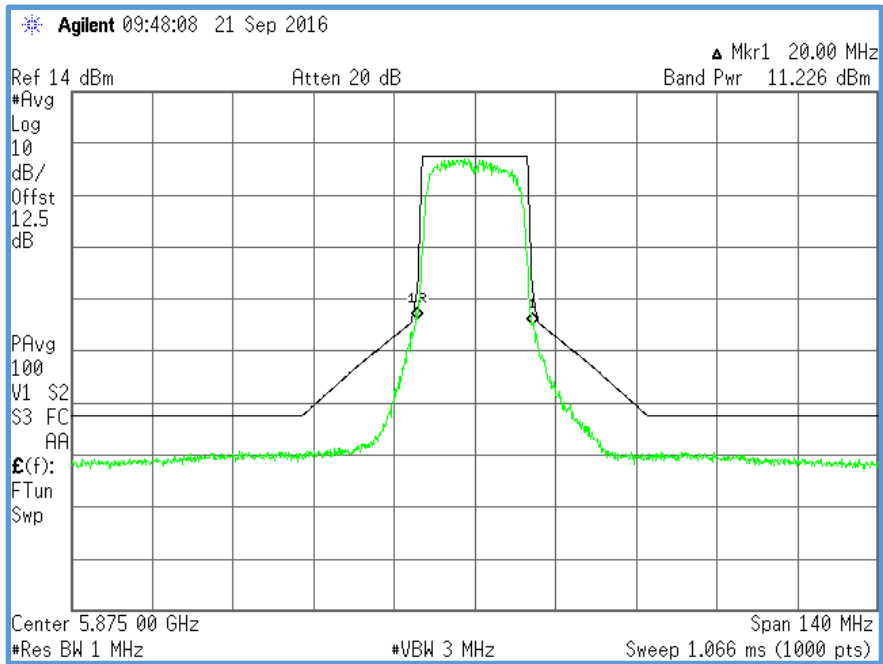


Figure 184 – Conducted ACP/OOBE, Sample 04 DSRC, CH.175 OFDM MCS Index 0 Plot

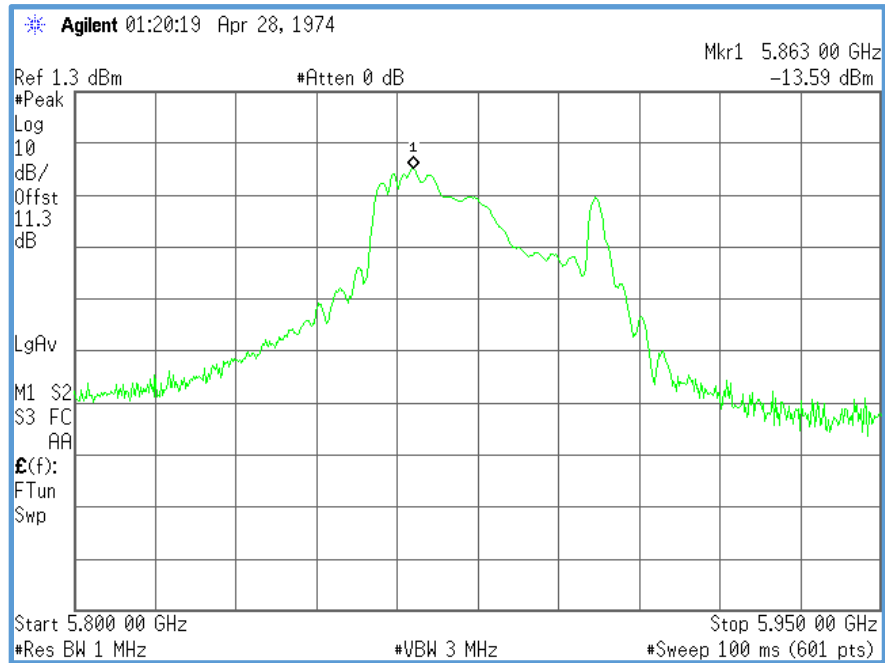
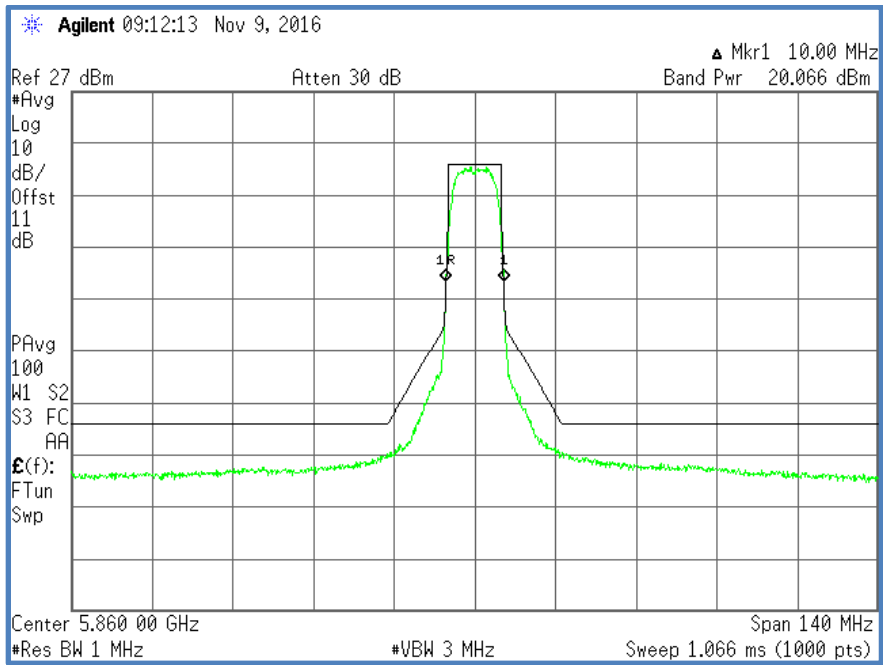
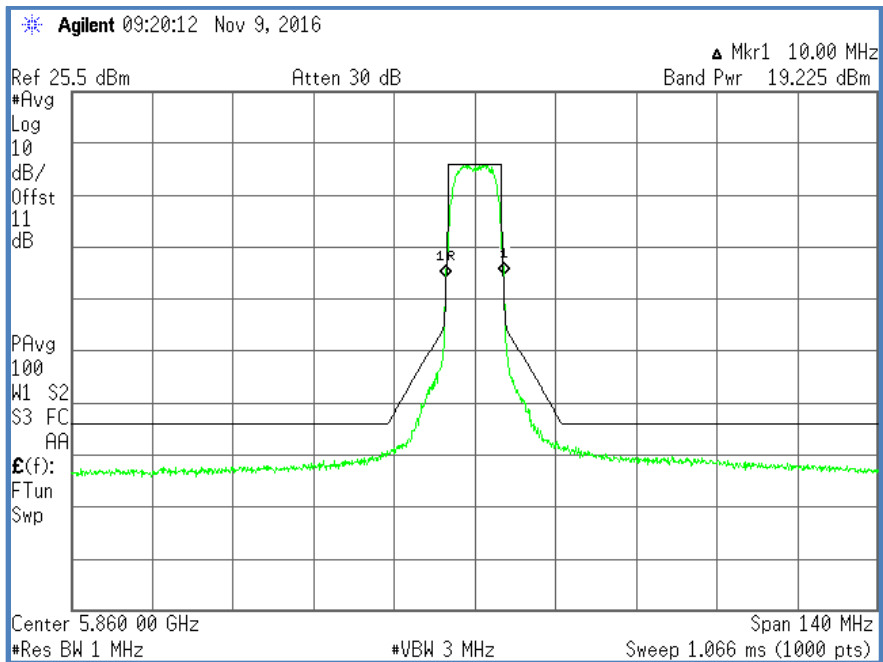


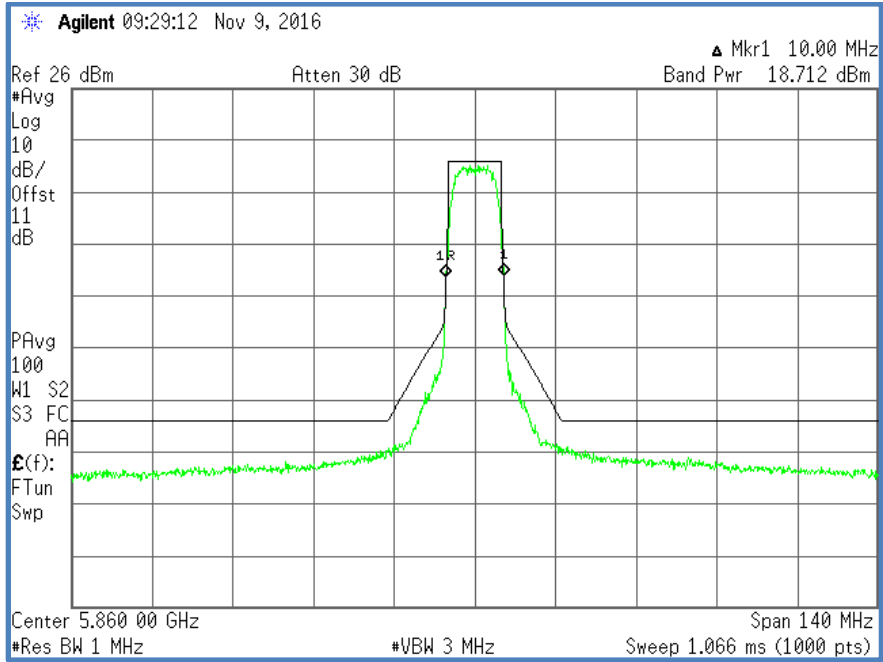
Figure 185 – Conducted ACP/OOBE, Sample 16F DSRC, CH.172 OFDM MCS Index 0 Plot



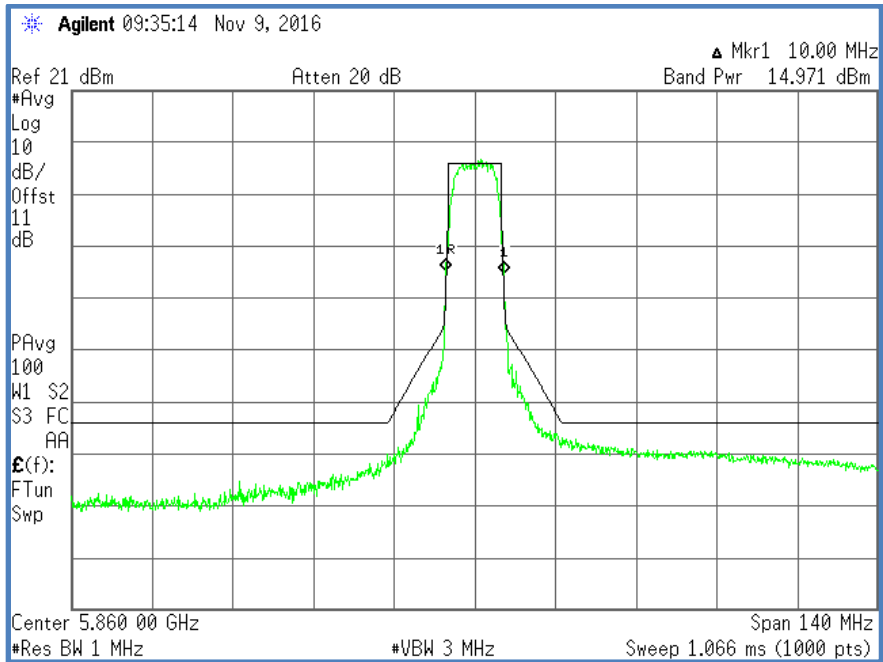
**Figure 186 – Conducted ACP/OOBE, Sample 26A DSRC, CH.172 OFDM MCS Index 0 Plot**



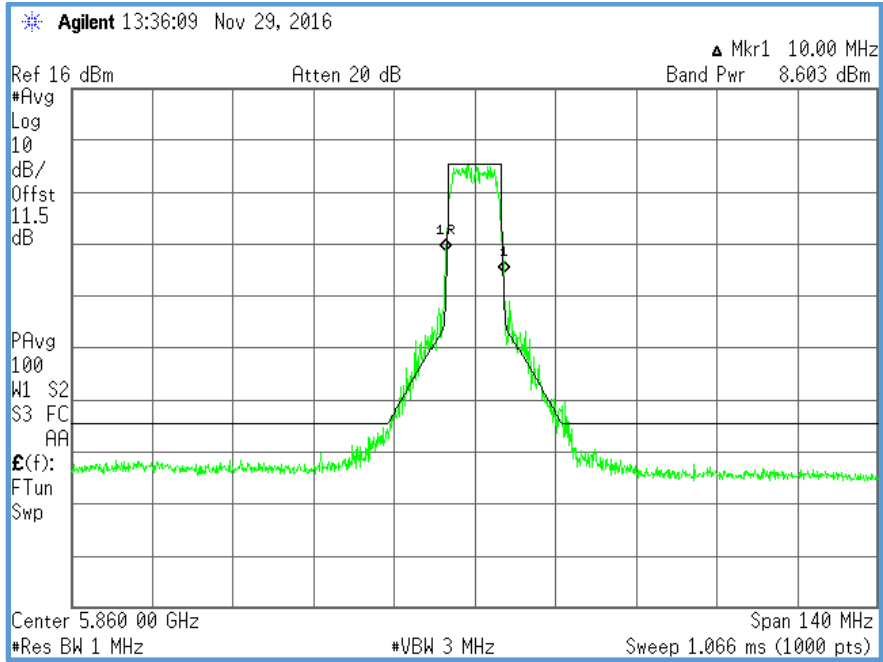
**Figure 187 – Conducted ACP/OOBE, Sample 26A DSRC, CH.172 OFDM MCS Index 1 Plot**



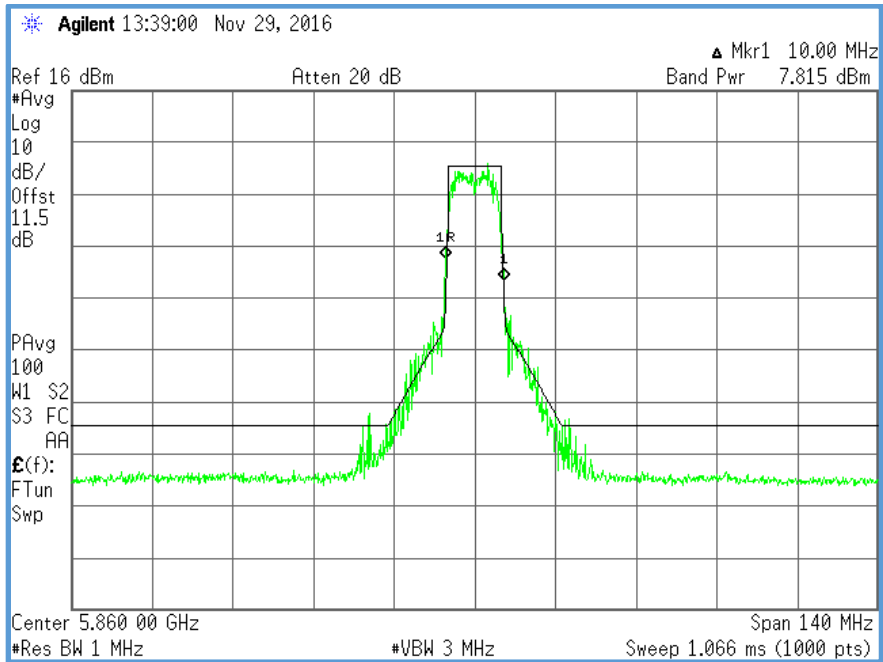
**Figure 188 – Conducted ACP/OOBE, Sample 26A DSRC, CH.172 OFDM MCS Index 3 Plot**



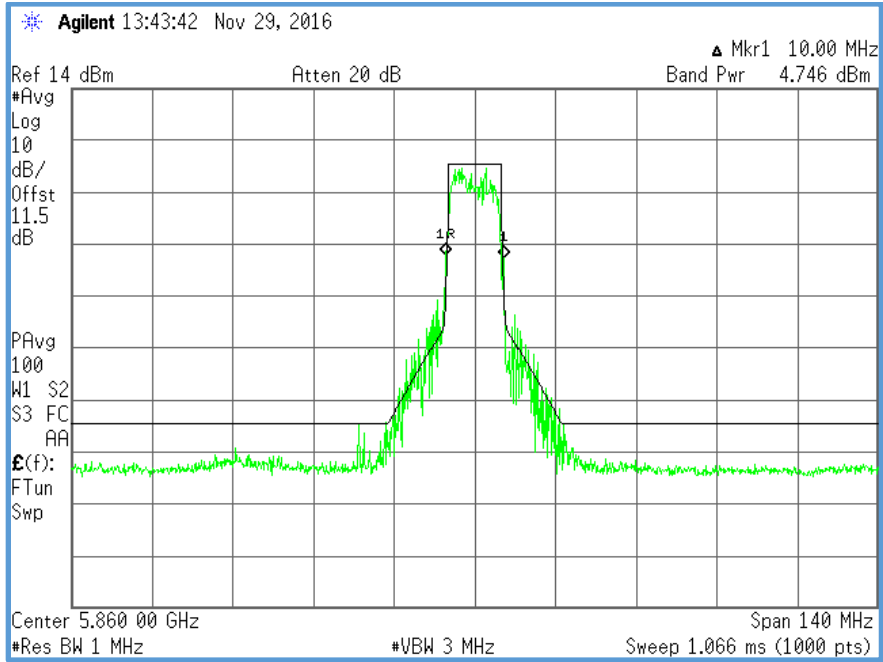
**Figure 189 – Conducted ACP/OOBE, Sample 26A DSRC, CH.172 OFDM MCS Index 5 Plot**



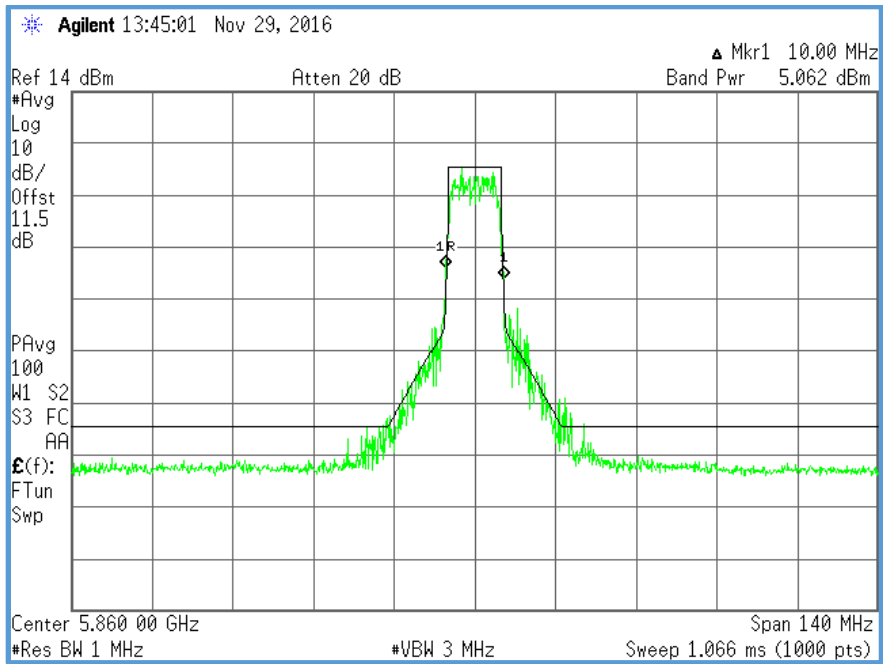
**Figure 190 – Conducted ACP/OOBE, Sample 29A DSRC, CH.172 OFDM MCS Index 0 Plot**



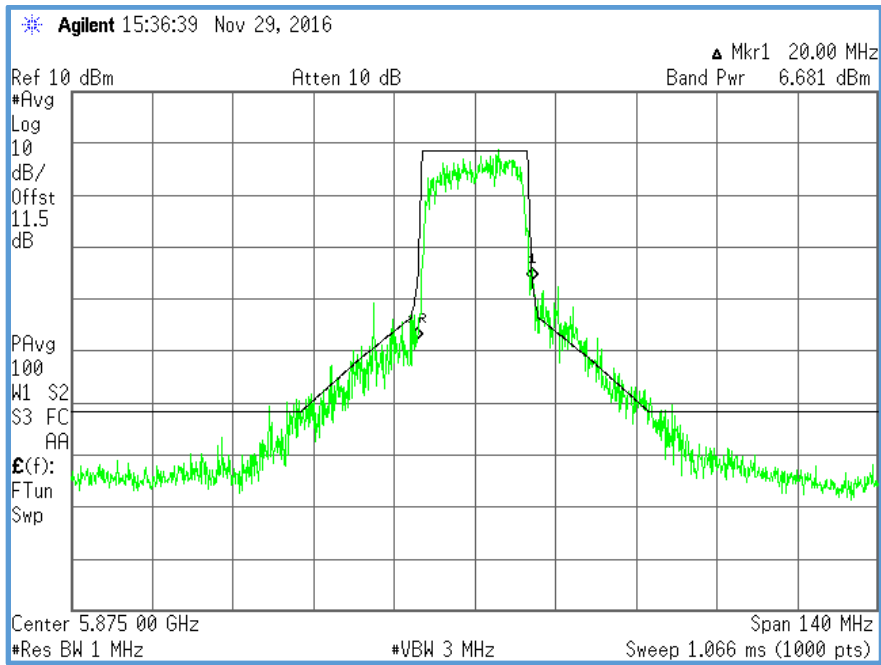
**Figure 191 – Conducted ACP/OOBE, Sample 29A DSRC, CH.172 OFDM MCS Index 1 Plot**



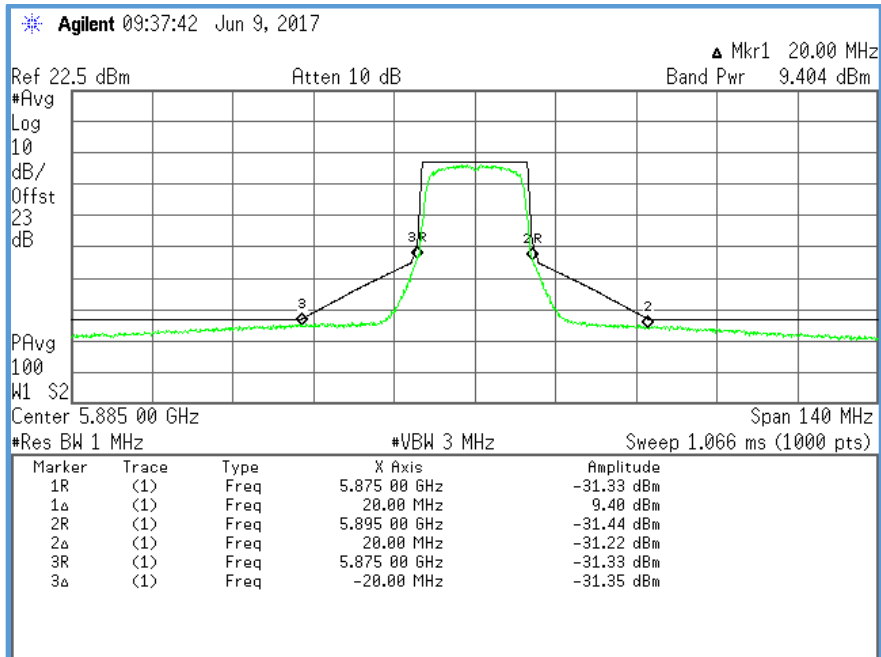
**Figure 192 – Conducted ACP/OOBE, Sample 29A DSRC, CH.172 OFDM MCS Index 3 Plot**



**Figure 193 – Conducted ACP/OOBE, Sample 29A DSRC, CH. 172 OFDM MCS Index 5 Plot**



**Figure 194 – Conducted ACP/OOBE, Sample 29A DSRC, CH.175 OFDM MCS Index 0 Plot**



**Figure 195 – Conducted ACP/OOBE, Sample 31 DSRC, CH.173 OFDM MCS Index 0 Plot**

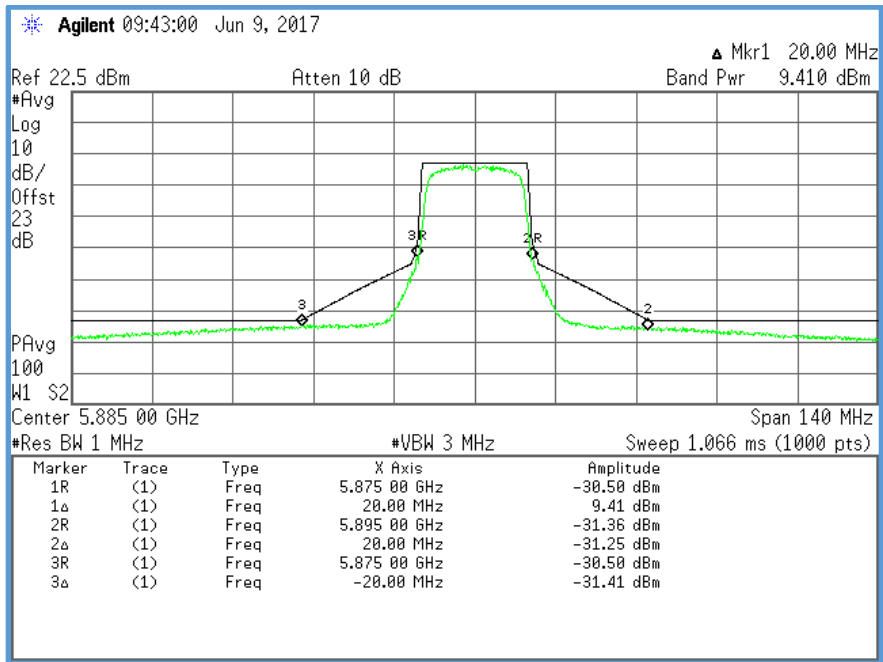
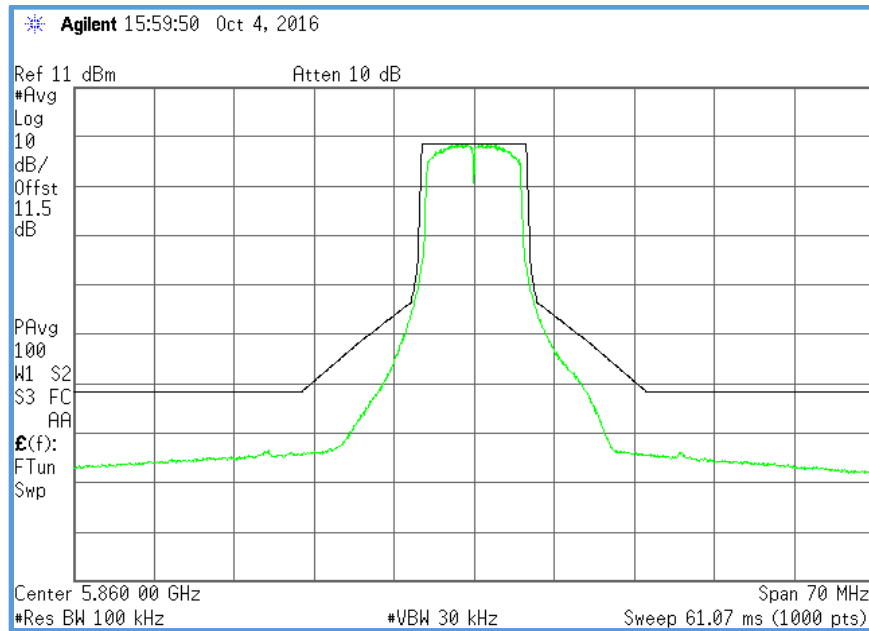


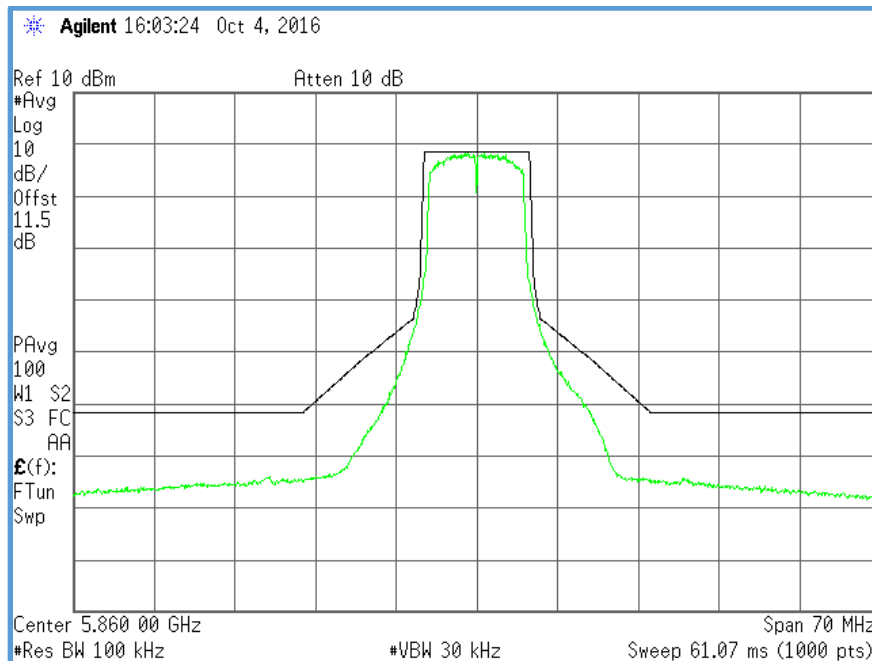
Figure 196 – Conducted ACP/OOBE, Sample 31 DSRC, CH.177 OFDM MCS Index 1 Plot



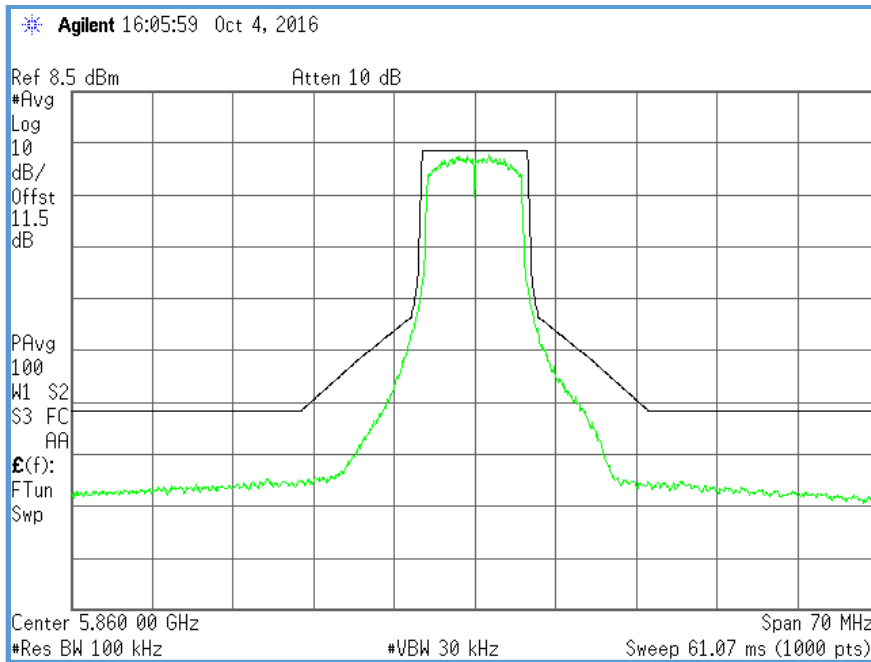
**DSRC Conducted Average Channel Power (ACP) and Out of Band Emission Test Results (RBW: 100 kHz)**



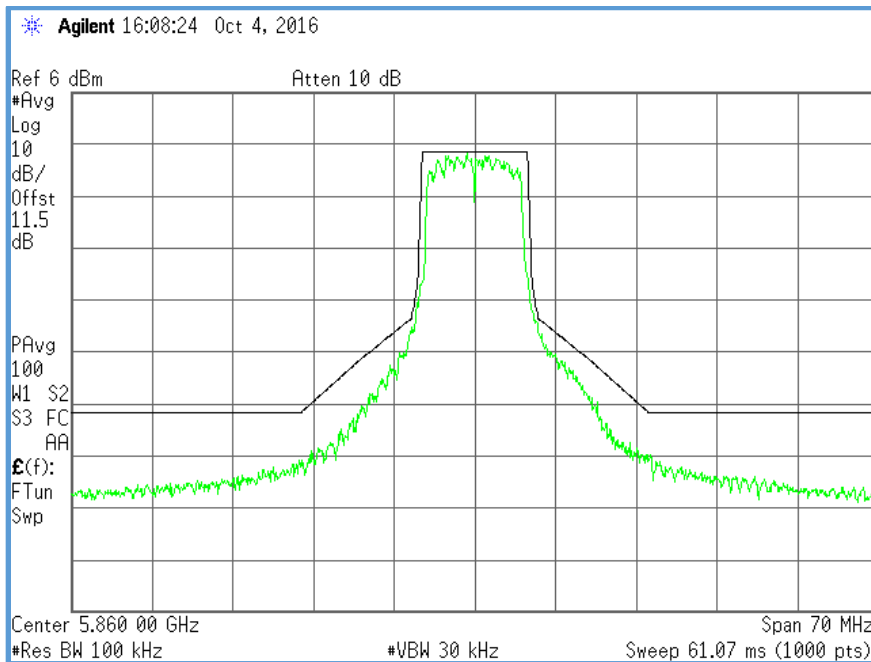
**Figure 197 – Conducted ACP/OOBE, Sample 02 DSRC, CH.172 OFDM MCS Index 0 Plot**



**Figure 198 – Conducted ACP/OOBE, Sample 02 DSRC, CH.172 OFDM MCS Index 1 Plot**



**Figure 199 – Conducted ACP/OOBE, Sample 02 DSRC, CH.172 OFDM MCS Index 3 Plot**



**Figure 200 – Conducted ACP/OOBE, Sample 02 DSRC, CH.172 OFDM MCS Index 5 Plot**

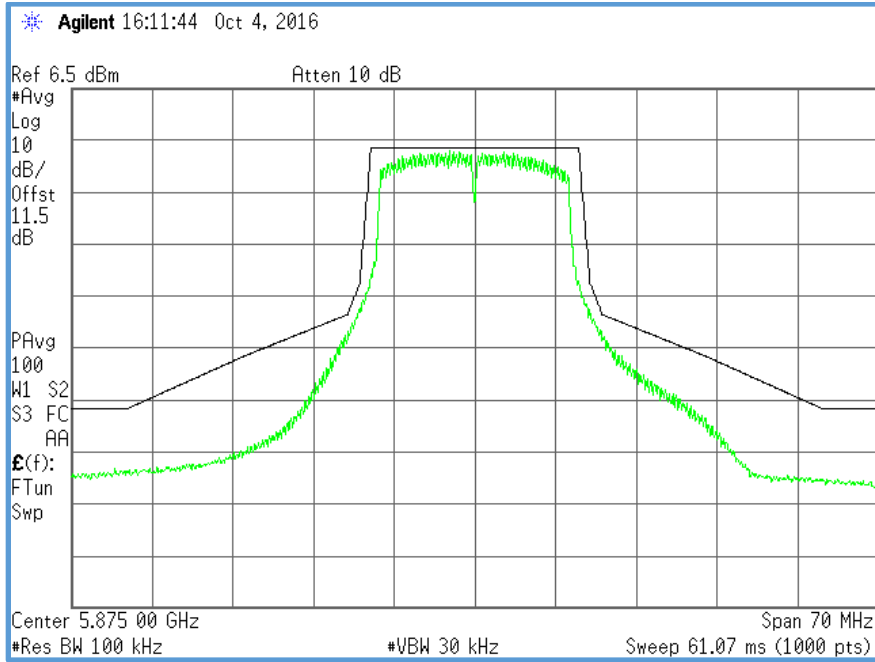


Figure 201 – Conducted ACP/OOBE, Sample 02 DSRC, CH.175 OFDM MCS Index 0 Plot

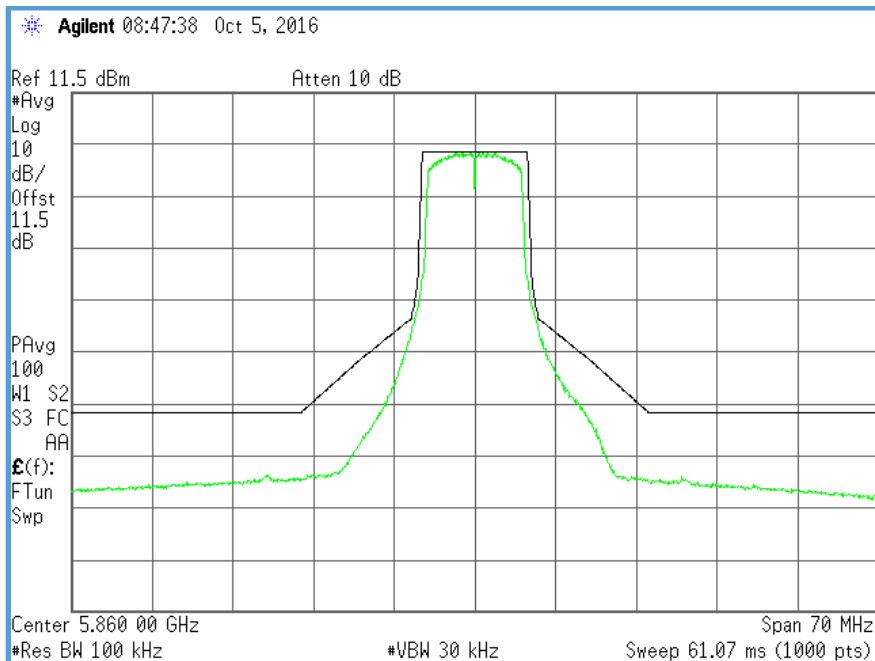
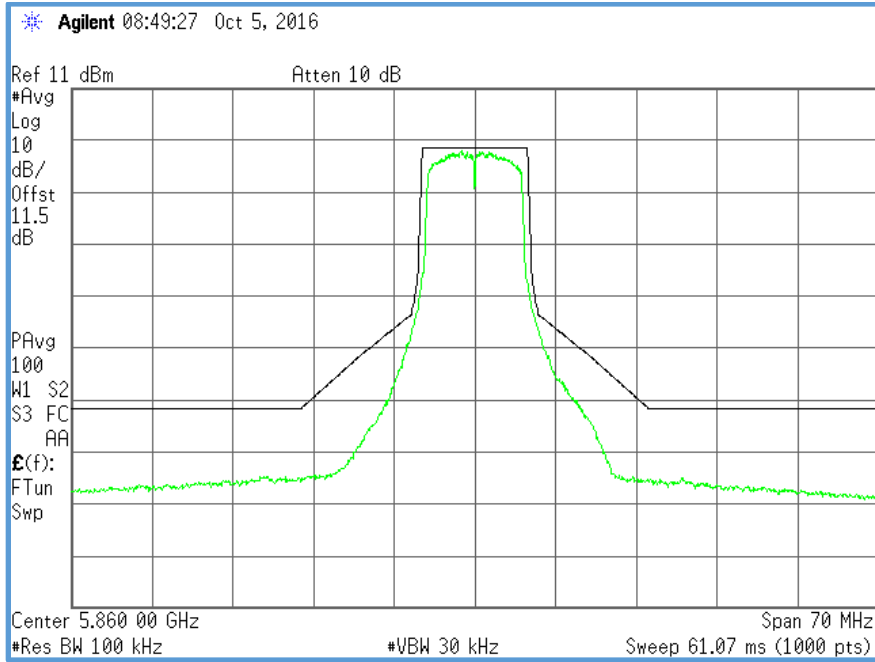
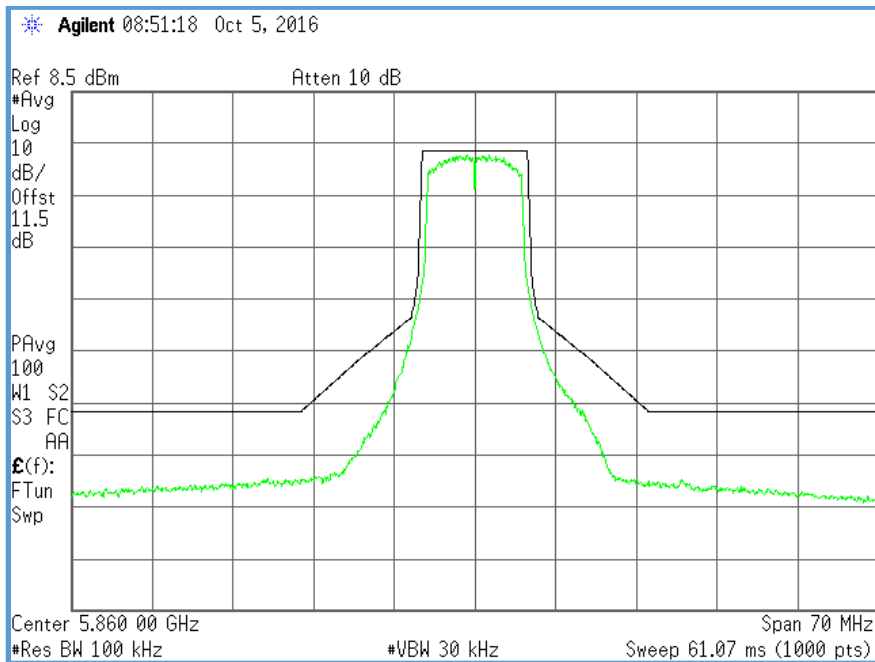


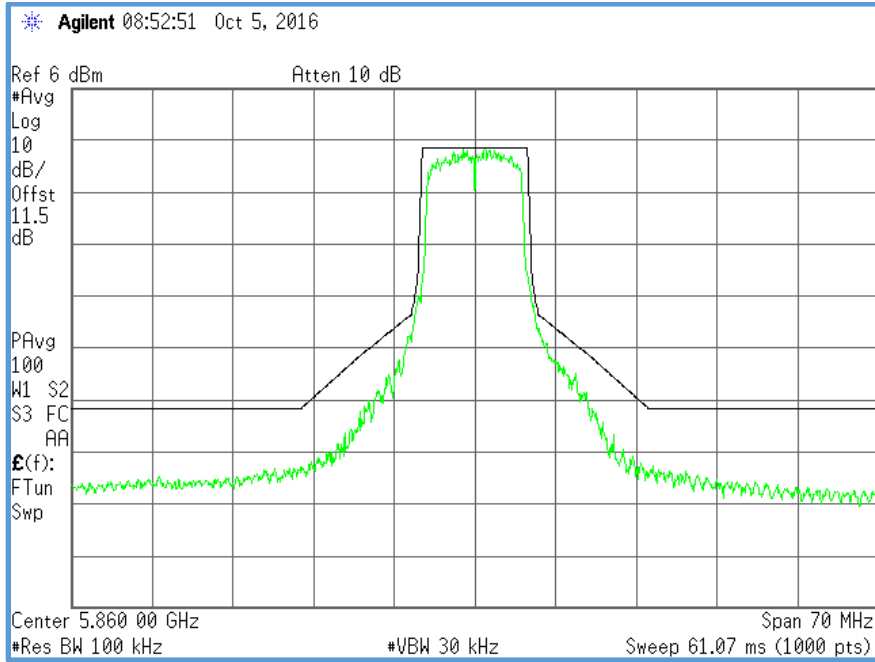
Figure 202 – Conducted ACP/OOBE, Sample 04 DSRC, CH.172 OFDM MCS Index 0 Plot



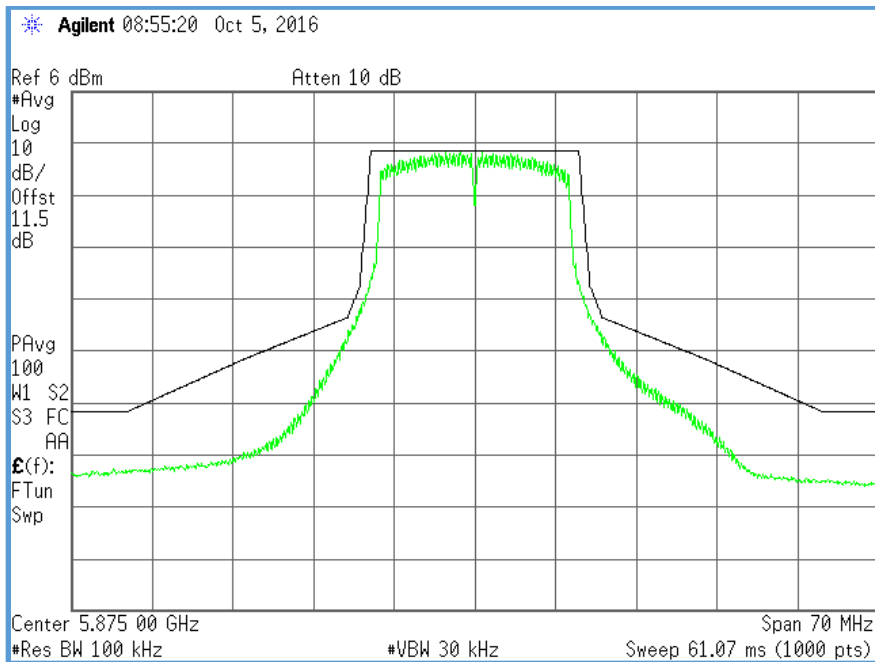
**Figure 203 – Conducted ACP/OOBE, Sample 04 DSRC, CH.172 OFDM MCS Index 1 Plot**



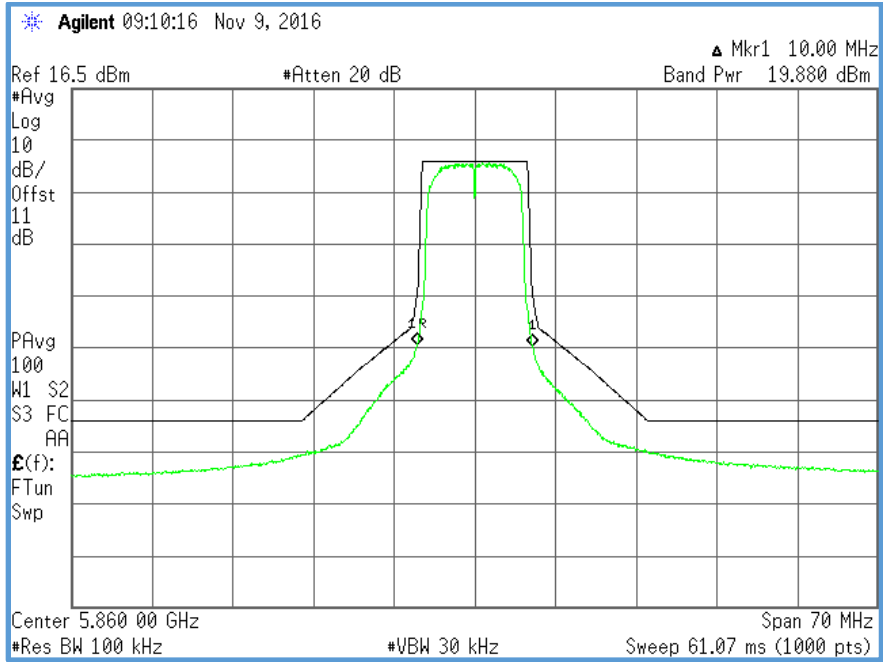
**Figure 204 – Conducted ACP/OOBE, Sample 04 DSRC, CH.172 OFDM MCS Index 3 Plot**



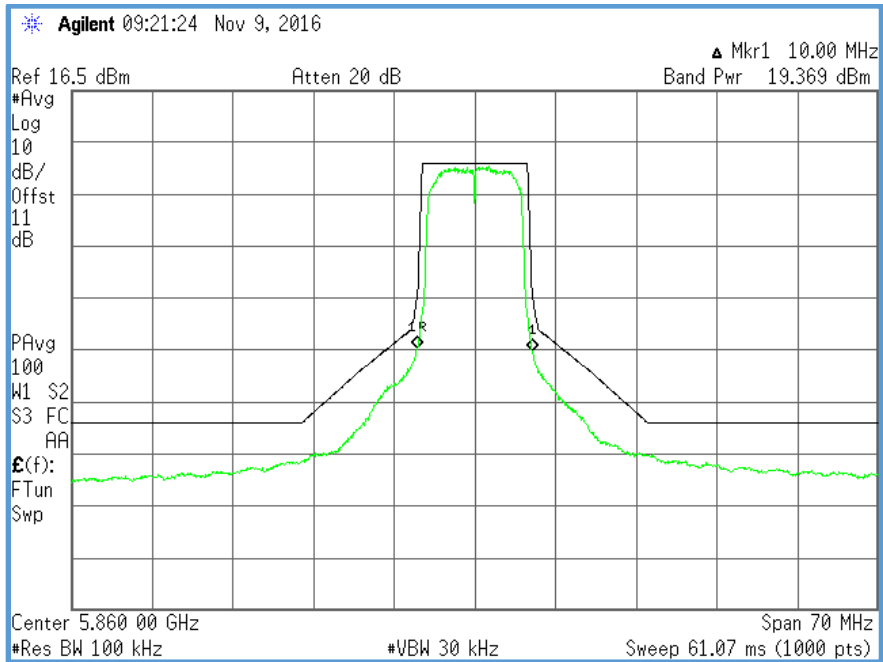
**Figure 205 – Conducted ACP/OOBE, Sample 04 DSRC, CH.172 OFDM MCS Index 5 Plot**



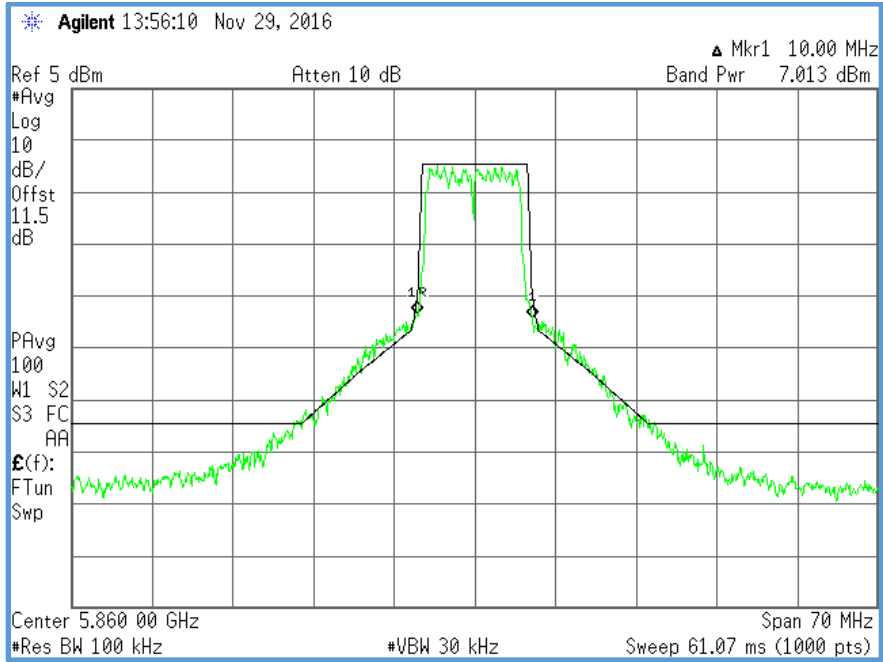
**Figure 206 – Conducted ACP/OOBE, Sample 04 DSRC, CH.175 OFDM MCS Index 0 Plot**



**Figure 207 – Conducted ACP/OOBE, Sample 26A DSRC, CH.172 OFDM MCS Index 0 Plot**



**Figure 208 – Conducted ACP/OOBE, Sample 26A DSRC, CH.172 OFDM MCS Index 1 Plot**



**Figure 209 – Conducted ACP/OOBE, Sample 29A DSRC, CH.172 OFDM MCS Index 0 Plot**

## **Appendix C: Pictures of the Test Setup and Devices under Test**

Figures 210 and 211 show pictures of DSRC and U-NII-4 devices used in phase I laboratory testing.

**Figure 210 – DSRC devices used in the FCC laboratory tests**



**Figure 211 – U-NII-4 Devices used in the FCC laboratory tests in conjunction with DSRC devices**

A series of Radio Frequency (RF) characterization testing of the submitted DSRC and U-NII-4 devices were performed to evaluate RF emission profiles of the transmitting devices. The testing included measurement of transmission's occupied bandwidth, average channel power, and out-of-band (OOB) and spurious emission of the transmitting devices. Figure 212 shows a typical setup where a U-NII-4 device (Broadcom) is being characterized.



**Figure 212 – RF Characterization test setup**

Upon completion of RF characterization testing, U-NII-4 and DSRC unmitigated interactions and interference mitigation testing were subsequently performed, as explained in sections 4 and 5. Figure 213 illustrates one setup where IEEE 802.11 signal is injected into DSRC receiver during interference mitigation testing.

During all tests, DSRC devices were placed inside of small shielded RF enclosures. DSRC packet capturing software was used to ensure DSRC devices did not communicate via over the air emissions. Small RF enclosures were placed inside a large anechoic chamber, and U-NII-4 devices (source of IEEE 802.11 signal not shown) were placed outside of the anechoic chamber for additional isolation. U-NII-4 and DSRC devices were connected through bulkhead connector.

For calibration purposes, once reference measurements were made and associated losses were accounted for the setup was kept the same throughout the day in order to maintain calibration. The process was repeated in the beginning of the following test day.



**Figure 213 – U-NII-4 and DSRC test setup with DSRC devices inside RF enclosures**