

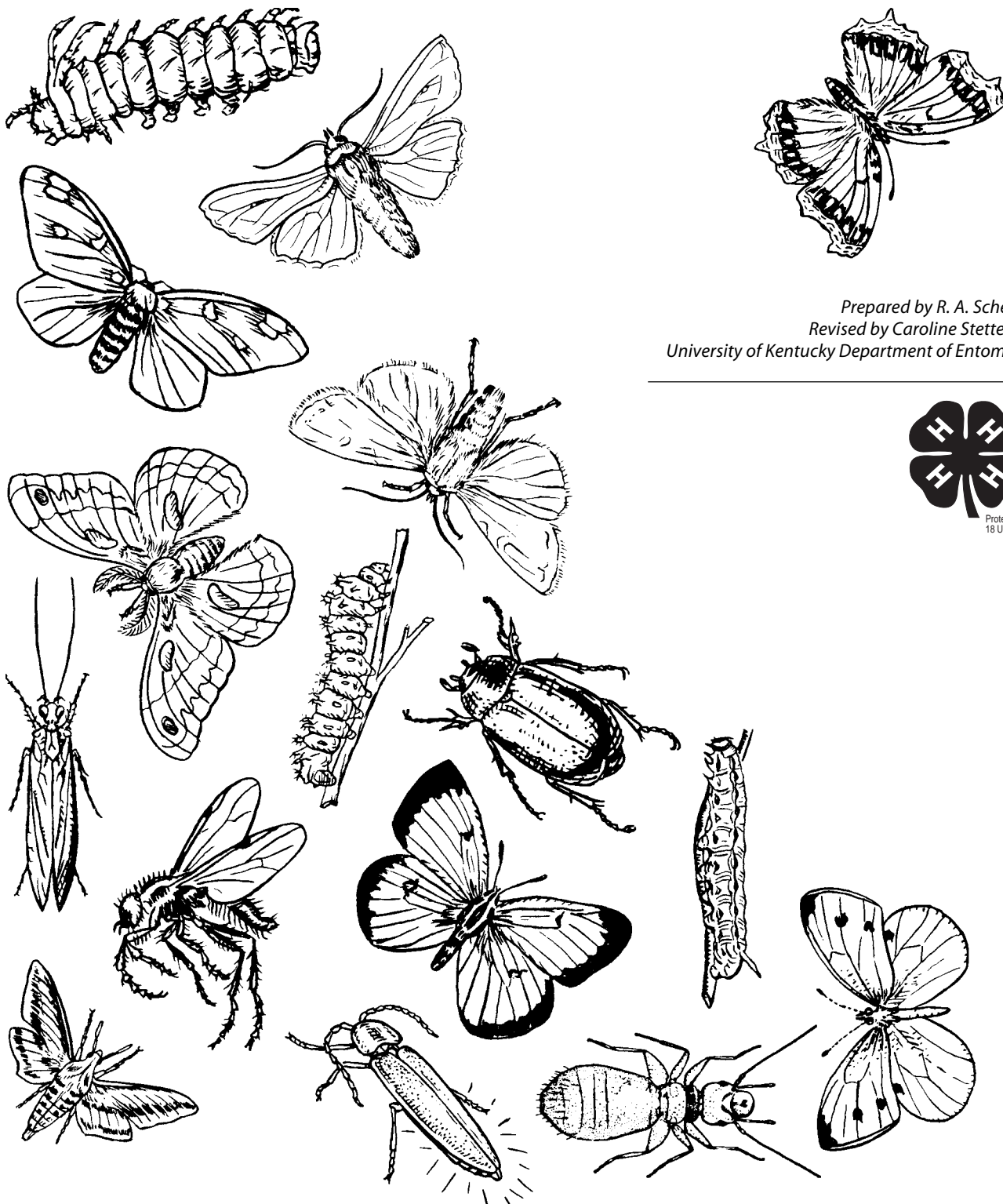

4-H Entomology: Unit II



Prepared by R. A. Scheibner
Revised by Caroline Stetter Neel
University of Kentucky Department of Entomology



Protected Under
18 U. S. C. 707

Objectives

Welcome to Unit II of 4-H Entomology. Your enrollment in Unit II indicates your interest in insects and a desire to learn more about these fascinating members of the animal kingdom.

By completing Unit I, you learned what insects are and how they differ from their close relatives. You also learned a great deal about insects in general and discovered many interesting facts about the individual insects you collected or studied.

In Unit II you will broaden your knowledge of insects by expanding and improving your insect collection. By examining individual insects more closely, you will increase your knowledge of them and better understand why insects are placed in their respective orders. The objectives of 4-H Entomology Unit II are to:

- Learn some of the characteristics that make insect orders different from each other
- Learn that insects differ in how they eat
- Learn some differences in insect wings
- Learn how different insects develop from eggs to the adult stage



- Learn some ways to improve your collecting, pinning, and displaying of insects
- Develop your leadership qualities.

There are several things you will do to meet the objectives of this unit:

- Increase and improve your insect display collection to include at least 50 insects representing at least eight orders
- Use a spreading board to position the wings of moths and butterflies
- Do the exercises on the true bug and the beetle
- Keep records of your 4-H Entomology activities
- Do at least three optional activities such as:
 - Make a pinning block
 - Make a spreading board
 - Make an aspirator
 - Make an insect display box (instructions in Unit I)
 - Make a relaxing jar
 - Make an aquatic collecting net
 - Make a light trap
 - Rear an insect
- Give a talk on collecting, pinning, or labeling insects or any other entomology topic.

Insect Body Parts

Insects all have the same general structure. They have segmented bodies divided into three regions: **head**, **thorax**, and **abdomen**. They have segmented legs and usually have wings attached to the thorax. There are also other body structures that are typical of insects. However, there are variations in body structures, and each order* of insect has variations that are characteristic for that order. In the following exercises you will learn some of the characteristic variations that are typical for two orders of insects. Doing the exercises will help you understand why insects are placed in a particular order even though some of them may, at first glance, look like insects in other orders.

Before doing the exercises on the true bug (Order Homoptera) and the beetle (Order Coleoptera), study the two illustrations to review the general structure for all insects.

*Refer to Unit 1, page 4, for classification system definitions and descriptions.

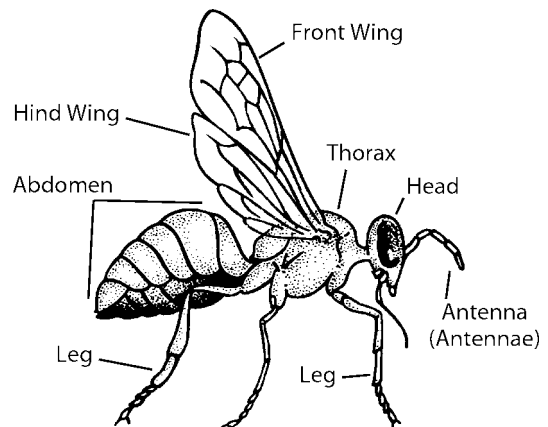
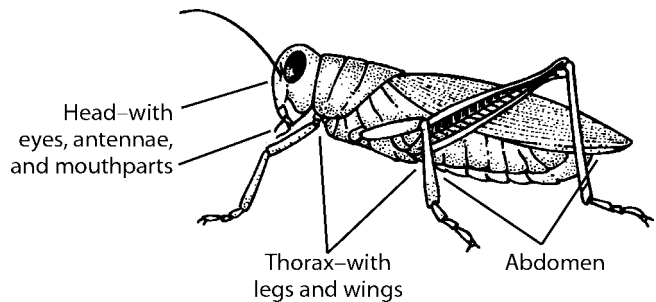

Parts of a True Bug

Although many people call all insects “bugs,” entomologists use the name “bug” to refer only to insects in the Order Hemiptera.

True bugs have all the general characteristics of typical insects. They are divided into three regions: **head, thorax, and abdomen**. The thorax bears **legs** and wings; the head bears **eyes, antennae,** and mouthparts. However, a true bug (Order Hemiptera) is very different from a grasshopper (Order Orthoptera), which you studied in Unit I.

Notice that in the true bug, the mouthparts are formed into a **beak** extending from the bottom side of the head. It is adapted for taking in liquid food. The grasshopper has chewing mouthparts adapted for

eating solid food. In the bug illustrated in this exercise, the **pronotum** is large and flat and not saddle-shaped like that on the grasshopper. (In other orders of insects, behind the pronotum is a triangular-shaped piece, called the scutellum.) On true bugs, the **scutellum** is easy to see, but in the grasshopper it is hidden under the pronotum. The front wing of a typical true bug is different from that of other insect orders. The area of the front wing next to the body is thickened or leathery, and the end area of the wing is membranous. The **front wing** of a bug is also called a hemelytron (meaning half wing). When a bug is not flying, its front wings lie flat over its back, and the membranous parts overlap each other. The **hind wings** are hidden under the front wings.

Labeling the True Bug Exercise

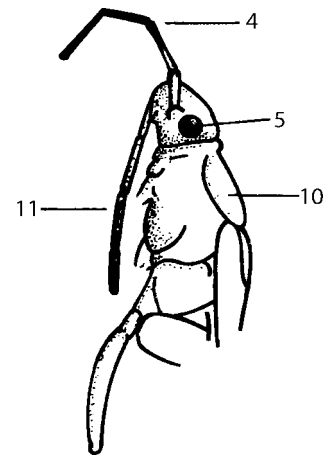
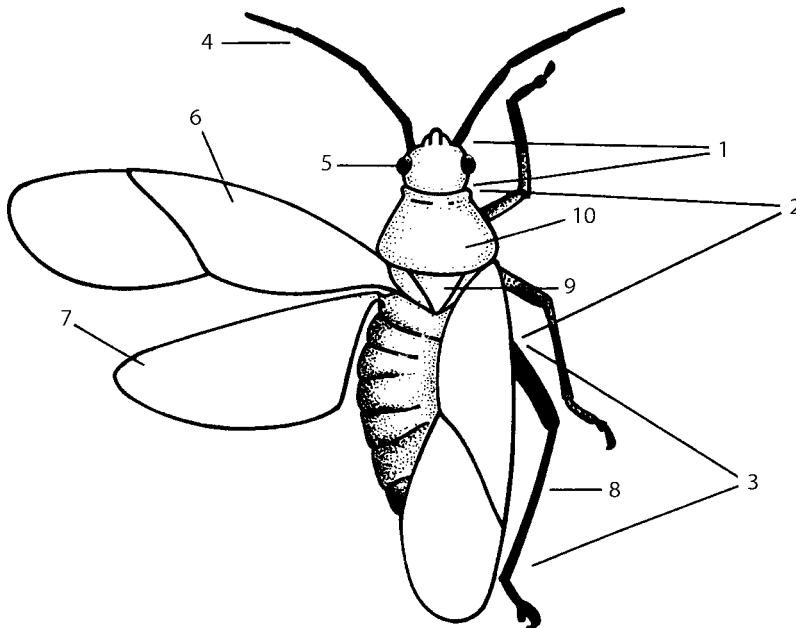

1. _____
2. _____
3. _____
4. _____
5. _____
6. _____

7. _____
8. _____
9. _____
10. _____
11. _____

Would you say this bug’s legs are best suited for walking, hopping, digging, or grasping prey? (You can find the answers on page 17, but do not look at them until you have completed the exercise for yourself.)

Parts of a Beetle



Beetles belong to the Order Coleoptera. The most noticeable way that Coleoptera differ from most other orders is the form and texture of their front wings, but there are also other characteristics that are typical for beetles.

Various parts of a beetle are described and highlighted in the following paragraphs. The descriptions include a little more detail than was given in the previous exercises. Locate and label the highlighted parts on the beetle drawings. It would be helpful to have a large beetle to look at while you do this exercise.

Like other insects, beetles have three body regions: **head, thorax, and abdomen**, but the regions are not clearly seen in the top view of a beetle. Remember that wings and legs of insects are always attached to the thorax. In the bottom view of the beetle, you can see the full length of the thorax, which extends from the head to where the hind legs are attached. The abdomen is the section after the hind legs. The entire thorax is much longer than the part you can see in the top view. The only part of the thorax visible in the top view is the **pronotum**, or top of the first thoracic segment.

Typical beetles have two pairs of wings, but the front pair, called **elytra** (plural of elytron) are stiff and not used for flying. When a beetle is not flying, the elytra meet each other in a straight line as they lie over the back, and the **hind wings** are folded and hidden under the elytra. In most beetles, the elytra are long and cover the abdomen. In some beetles, the elytra are short, and most of the abdomen can be seen when viewed from the top. These beetles resemble earwigs (Order Dermaptera) in appearance except that earwigs have pincers at the end of their bodies.

The jointed legs of insects are composed of five main segments. Beginning with the segment nearest to the body they are: **coxa, trochanter, femur, tibia, and tarsus**. The femur is usually the biggest segment. The trochanter is often very small and hard to see. The tarsus is divided into a series of subsegments, and the last tarsal subsegment bears claws. The number and shape of tarsal subsegments are important characteristics for identifying different beetles.

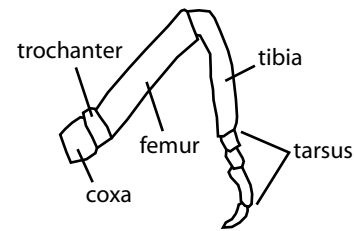

On the head of a beetle, the compound **eyes** and **antennae** (feelers) are usually easy to see. There are many forms of antennae among the beetles. Some antennae are short, clubbed, comb-like, or even hidden in pockets. The **mouthparts** of beetles are jaws adapted for chewing or biting. They never have sucking beaks such as you have seen with the true bugs (Order Hemiptera). However, some beetles have long slender snouts with small jaws at the end of the snout. Attached to the beetle's mouthparts are short feeler-like **palps**. The palps act like fingers to handle the beetle's food while it is eating it. Most other types of insects with chewing mouthparts also have palps.

Antennae

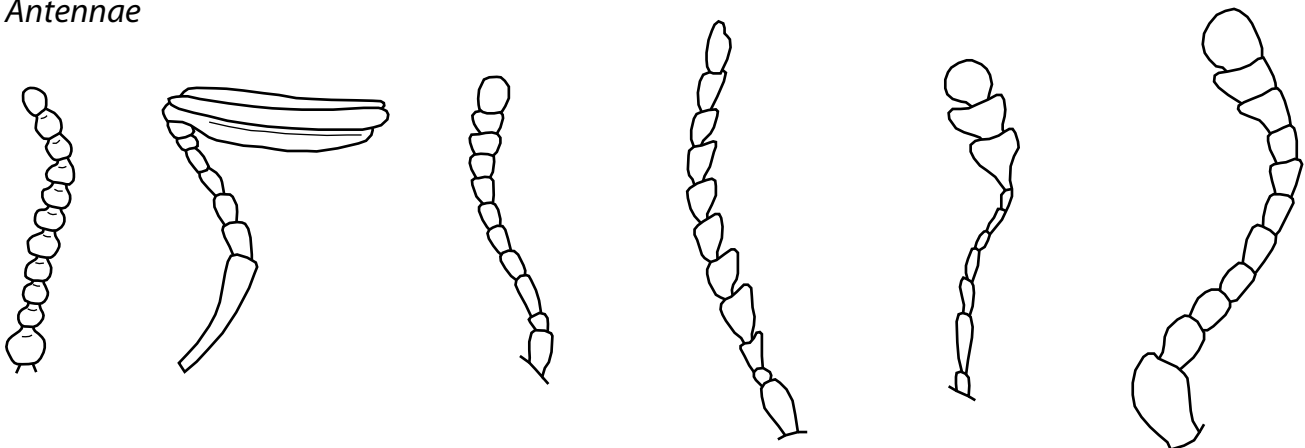

Labeling the Beetle Exercise

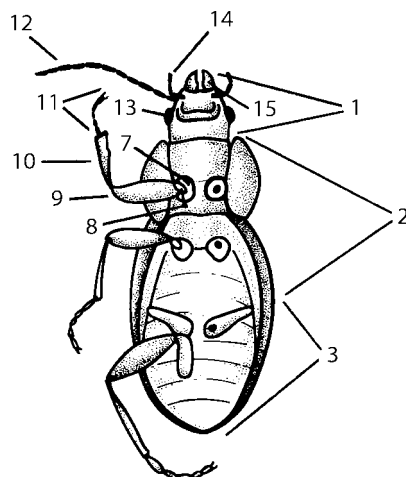
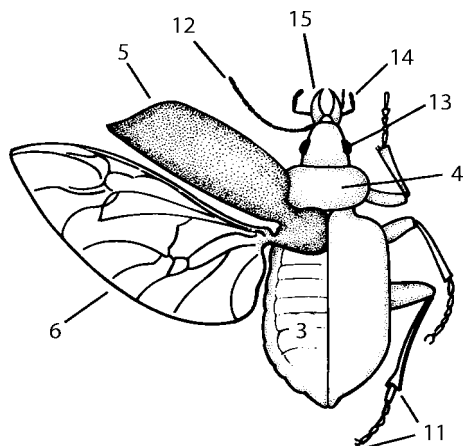

- 1. _____
- 2. _____
- 3. _____
- 4. _____
- 5. _____
- 6. _____
- 7. _____
- 8. _____

- 9. _____
- 10. _____
- 11. _____
- 12. _____
- 13. _____
- 14. _____
- 15. _____

Answers are on page 17.

How Insects Grow and Change Form

When a bird hatches from an egg, it gradually grows and changes day by day until it becomes an adult bird. However, when an insect hatches from an egg, it grows and changes by distinct stages. Each time an insect makes a change into the next growth stage, it has to molt (shed) its skin. After each molt, the insect becomes a little larger and somewhat different in form until it reaches the adult stage. After it reaches the adult stage, it does not molt or grow any more. The change in form as an insect grows is called **metamorphosis**. The exact style of metamorphosis is not the same for all insects, but insects in the same order have the same style of metamorphosis. You can't look at an adult insect and see metamorphosis, but it is one of the characteristics used for putting insects in their orders.

Although there is variation in the metamorphosis of different orders, they can be grouped into two types, **simple metamorphosis** and **complete metamorphosis**. With simple metamorphosis, wings (if any) develop on the outside during immature stages, and there is no pupal or inactive stage before the last molt. With complete metamorphosis, the wings develop internally, and the last molt is preceded by a pupal or inactive stage.

Simple metamorphosis typically exhibits three life stages including *egg*, *nymph*, and *adult*. The nymphs look very similar to the adults. If the adult has compound eyes, so will the nymph. There will be wing buds on the nymphs if the adult will be winged. With each molt, the nymphs gradually develop wings and take on the body proportions of an adult.

The kind and amount of change varies among insects that exhibit simple metamorphosis. These can

be classified into three types: *no metamorphosis*, *gradual metamorphosis*, and *incomplete metamorphosis*. With no metamorphosis, there is little or no change in appearance between the young stages and the adult except for size. Insects without metamorphosis all belong to wingless orders of insects. With gradual metamorphosis, the young and adults live in the same habitat, and adults typically are winged. Incomplete metamorphosis is somewhat like gradual metamorphosis. In this type of simple metamorphosis, the adult insect lays its eggs in or near water, and the nymph stage, referred to as naiads, develop in the water. The adults are flying insects that live out of the water. Naiads and adults therefore do not eat the same kind of food.

The most complex type of metamorphosis is called **complete metamorphosis**. It has four distinct form stages: *egg*, *larvae*, *pupa*, and *adult*. The larval stages do not look like the adult at all, and they are often worm-like. Larvae often have different mouthparts and food habits from the adult, and they often live in places different from the adult. Larvae molt several times and get a little larger with each molt, but there is no gradual development of wings or other adult characteristics. When a fully grown larva molts, it changes into a pupa. The pupa usually does not eat or move around much, but a lot of internal changes take place. When the pupa has made all its internal changes, its skin splits and the fully formed adult emerges. Most insects with complete metamorphosis are winged in the adult stage. The adults do not molt or grow any more. Little flies or beetles, for instance, do not grow to become larger.

Getting More Variety in Your Collection

If you collect in only a few different places during the day and use the same collecting techniques, it may be hard to find enough variety of the insects you want for your collection. Many types of insects that cannot be found during the day are attracted to lights at night. Some insects will come to lights early in the evening, and others may come very late. The color of the light also affects the attraction of insects. A black light (ultraviolet) is more attractive to a greater variety of

insects than lights of other types. You can also devise traps to collect insects when you are not at the light. See the *Optional Exercises* section for making and using light traps. You can use your own imagination for designing or modifying some of the light traps suggested in the *Optional Exercises*.

Simple Metamorphosis

Without Metamorphosis

Examples

Silverfish
Springtail

Orders

Thysanura
Collembola

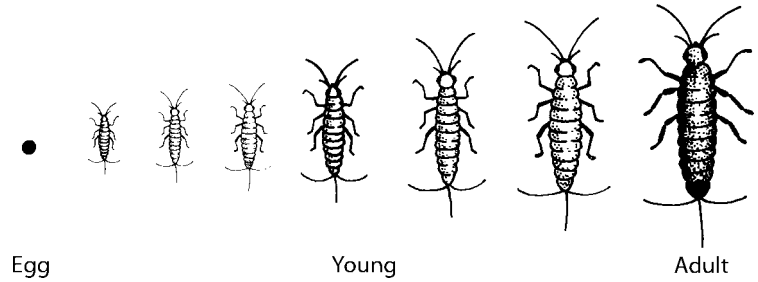

Gradual Metamorphosis

Examples

Grasshoppers
Termites
Booklice
Thrips
True Bugs
Aphids
Earwigs
Chewing Lice
Sucking Lice

Orders

Orthoptera
Isoptera
Psocoptera (Corrodentia)
Thysanoptera
Hemiptera
Homoptera
Dermaptera
Mallophaga
Anoplura

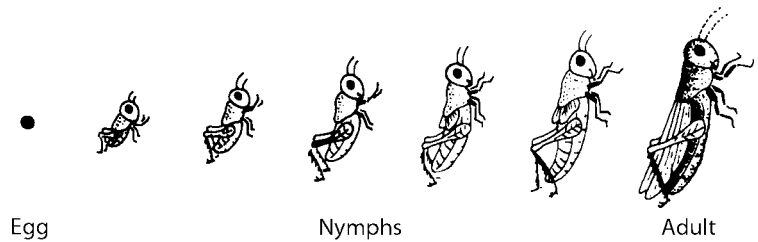

Incomplete Metamorphosis

Examples

Mayflies
Dragonflies
Stoneflies

Orders

Ephemeroptera
Odonata
Plecoptera

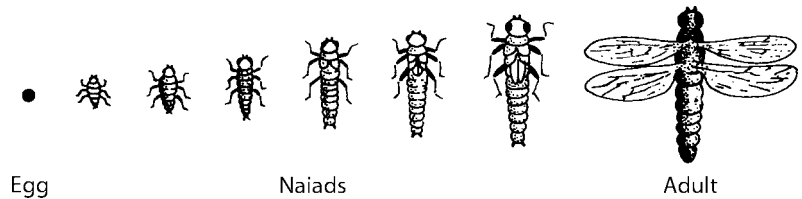

Complete Metamorphosis

Examples

Lacewing
Beetles
Scorpionfly
Caddisfly
Moths, Butterflies
Flies
Fleas
Wasps, Bees

Orders

Neuroptera
Coleoptera
Mecoptera
Trichoptera
Lepidoptera
Diptera
Siphonaptera
Hymenoptera

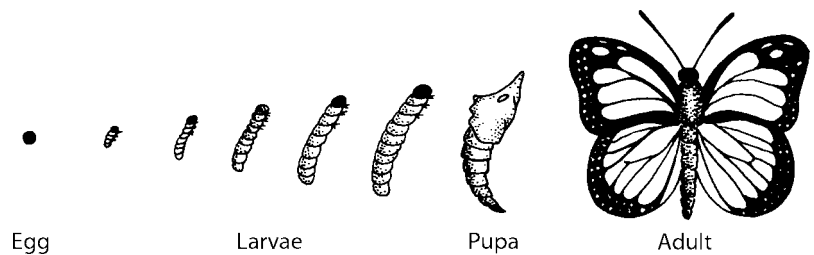

Improving Your Display Collection

Your insect collection will be judged on certain specifications in competition. The illustration on page 18 is an example for you to follow. The information below will help you in preparing your display.

1. Either the standard 18 x 24-inch **display box** or the special entomology boxes obtained from the Entomology Department must be used for exhibiting insects in competition at fairs. (Directions for making the standard box are given in 4-H Entomology Unit I.) The special entomology boxes can be obtained from the Entomology Department, S-225 Agricultural Science Center-North, University of Kentucky, Lexington, KY 40546-0091.
2. **Insects must be arranged** in the box so that the short sides of the box are the right and left sides.
3. Insects must be in **vertical columns** with the head of each insect toward the front (top) of the box.
4. Insects on **card points** must be pointed in the same direction as the other insects, with the card point jutting to the left from the pin.
5. All insects of the **same order must be grouped** together into one series, but they may continue into more than one column. In other words, insects in the same order should not be scattered in the box and separated from each other by insects of other orders.
6. The **largest insect** of an order must be placed first in that order series; the rest should be placed according to decreasing size.
7. **For Unit II**, the display should consist of one or two boxes with a minimum of eight orders and not less than 50 insects. Do not exceed the minimum requirements to the extent that insects are jammed in a messy way in the box. If you have a lot of insects, it is best to choose only the best specimens to make a good-looking, uncrowded display. (For more advanced projects that require more insects, additional boxes are allowed so the insects are not crowded.)
8. Half of the insects should be identified with a **common name** more precise than the common name of the order. For instance, "beetles" is the common name for Order Coleoptera, so when identifying a beetle you should try to identify what kind it is, such as Colorado potato beetle.



9. Use only the **labels** printed for and provided by the 4-H project. Use a pen with **black ink** and a fine tip.
10. See that the **order labels** lie flat on the bottom of the box in front of the first insect in the order series. It should be held in place with two common straight pins. If the series continues into the next column, label the continued column also. If an order series ends in the middle of a column, you may start the next order series right after it.
11. A **"date-locality" label** must be on the pin of each specimen. The pin should go through the dot at the center of the label. The label should be aligned parallel to the insect's body so it can be read from the left side of the collection. Keep the labels at a uniform height on the pins. (See the *Optional Exercises* for making and using a pinning block.)
12. If the **wing length** of moths or butterflies is one inch or more, the wings should be spread. (See page 11 for directions on spreading butterfly wings.)
13. The **"common name" labels** rest on the bottom of the box and are held in place by the specimen pins. The pin should go through the dot on the right side of the label, causing the label to jut to the left from the pin. If the insect is large and blocks the view of the common name label, the label may be placed on a separate pin close after the insect.
14. **Every insect** in the collection should be different—either a different species or a different form of the same species. (Males and females of the same species often look slightly different, so you can use a male and a female as different insects.)
15. **Damaged** or poorly pinned insects detract from the appearance of your collection and will count against your display score. Replace such specimens if you can. However, if a damaged insect is your only representative of that order, or if you need the insect to meet the minimum number of insects, then you should include it in your display collection.



Pinning Insects

In Unit I, you were given some general instructions for pinning insects, and you were shown some typical examples. You probably learned a lot about what you can and cannot do without damaging insects when you pin them. Now you are going to learn techniques for dealing with some more special situations such as pinning insects that

have become dry and brittle and spreading the wings of butterflies and moths. The illustrations below are for review of the special spots for pinning some common insects. Notice that even though the pin appears to go through a different spot on different insects, the pin always goes through the thorax a little to the right of the mid line.

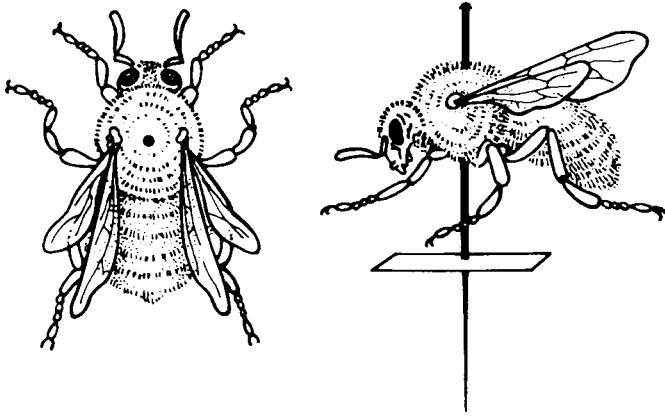

BEE—Pin bees, wasps, flies, dragonflies, and other insects with similar wings through the **thorax** between the bases of the wings.

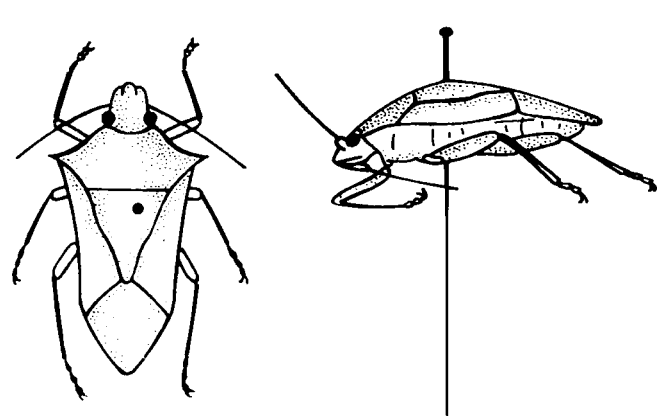

TRUE BUGS—Pin true bugs through the right corner of the **scutellum**. The scutellum is a triangular area with the point of the triangle pointing to the rear. In stink bugs the scutellum is large, but in other bugs it may be quite small.

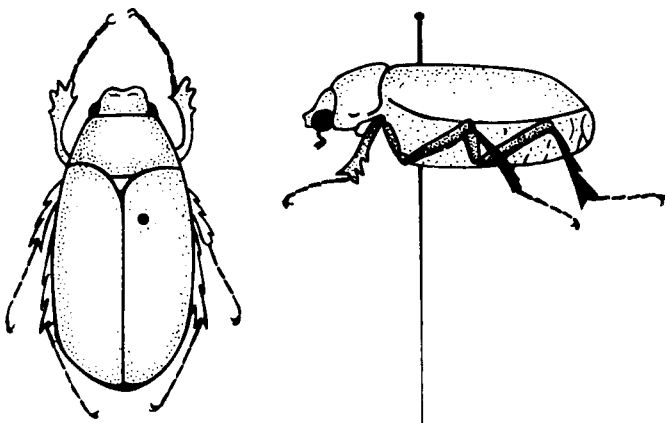

BETLES—Pin beetles to the **right of the center line** so that the pin emerges from the underside of the insect between the middle and hind legs of the right side. Do not pin so far back that the pin comes through the abdomen.

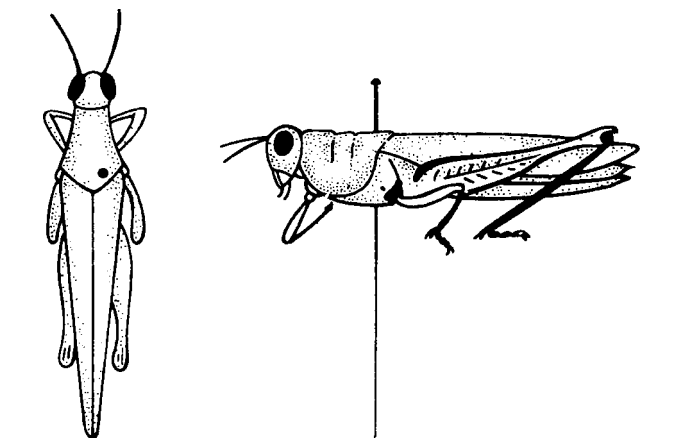

GRASSHOPPERS—Pin grasshoppers so that the pin emerges between the middle and hind legs of the right side. Insert the pin near the right hind margin of the **pronotum**. The pronotum is the saddle-shaped structure of the thorax just behind the head.

How To Card Point Small Insects

Small, delicate insects may be impossible to pin in the conventional way with standard-sized insect pins. You can solve this problem by using the card point pinning technique explained below. Prepare several card points on pins in advance so they are ready when you want to mount a small insect.

1. Select some heavy paper, such as a file card, and cut triangular card points to the dimensions as shown in Figure A.
2. Put an insect pin through the base of the card point. Use a pinning block as shown in Figure B to position the card point on the pin. (Instructions for making and using a pinning block are given on page 15.)
3. With a pair of tweezers, bend down the tip of the card point as shown in Figure C.
4. Put a tiny drop of glue on the bent-down tip of the card point, and touch the glue drop to the right side of the insect as shown in Figure D. Do not use so much glue that the insect becomes totally embedded in it. When you lift up the pin, the insect should be level and topside up as shown in Figure E.

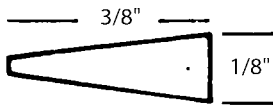

A. Cut card point to this shape and size.

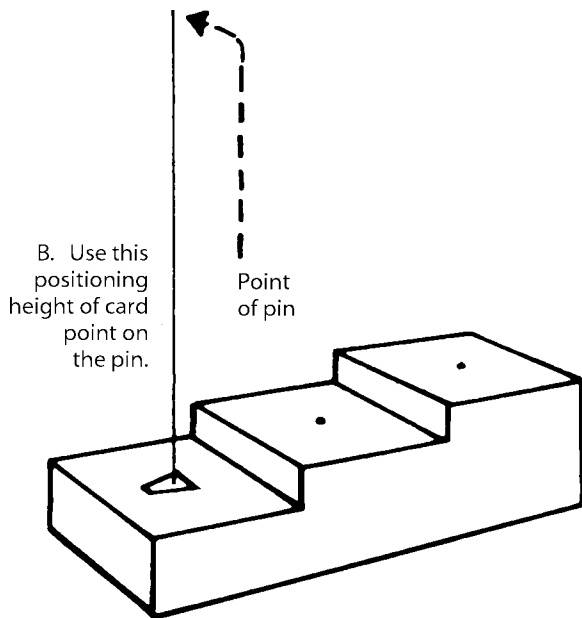

C. Put a small drop of glue on bent-down tip of card point.

Put glue here.

D. This illustration shows how to attach insect to the card point.

Attach bug to card point here.

E. This shows correct position of insect and date locality label on a card-pointed insect.



Spreading Butterflies and Moths

Moths and butterflies look better and are easier to identify if their wings are spread properly. A spreading board is used to do this. Adjustable spreading boards for use with different-sized butterflies can be bought from biological supply houses or similar versions made of plastic foam can be obtained from the Entomology Department. If you don't have either of these, you can make a spreading board according to the instructions given in the *Optional Exercises*.

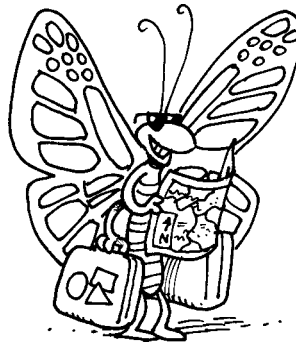

- A. **Put an insect pin** through the center of the thorax of a freshly killed butterfly. If the insect has dried, use a relaxing jar to soften it. (See *Optional Exercises* for instructions on making a relaxing jar.) One-fourth inch of the pin should be exposed above the thorax. Make sure the insect does not tip from side to side or from front to back on the pin.

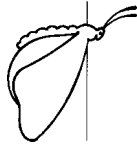

- B. Push the pin straight down in the center of the slot of your pinning board until the outstretched wings are **just level** with the surface of the pinning board.

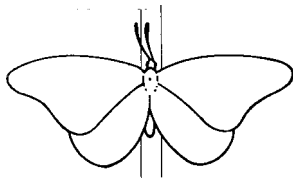

- C. Insert an insect pin lightly in each front wing near the front margin and **just behind one of the heavy wing veins**. Move the front wings forward gently until the hind margins of the front wings are in a straight line, at right angles to the body.

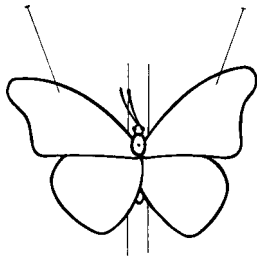

- D. With a pin placed behind a heavy vein in the **hind wing**, move each hind wing forward until the gap between the front wing and hind wing is closed to just a notch, as shown on the right side of the illustration below.

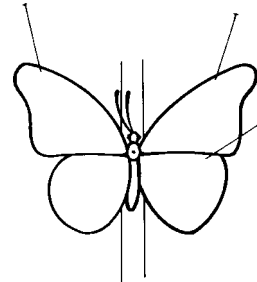

- E. Cut some narrow **strips of paper** and lay them over the wings. Pin them in place as shown. Remove the other pins that are through the wings. The pins holding the paper strips in place should not go through the wings but should be close to them to keep enough pressure on the wings to prevent their slipping out of place. **If the abdomen tends to sag**, it can be propped up with pins until it dries. You can also use pins to keep the antennae in place while the specimen dries. Depending on the moisture in the air, the specimen should remain on the board from four to eight days.

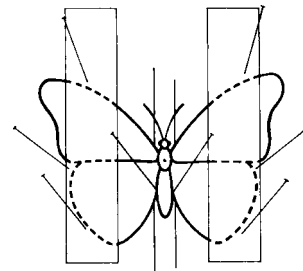

Insect Collection Catalog

The Insect Collection Catalog should accompany your collection when it is being exhibited. The example shows how the catalog should be filled out. It also shows the kinds of comments the judge might make about the insects in your collection. Blank catalog pages are supplied with the project. If you don't have them, order them from the 4-H Entomologist, Department of Entomology, University of Kentucky, Lexington, KY 40546-0091. The catalog list should be placed in an envelope and taped to the back of the box.

No.	Order	Common Name	Judge's Remarks
1	LEPIDOPTERA	Swallowtail	No condition of this is so poor it would be better to leave it out.
2	"	Zebra Swallowtail	
3	"	Monarch	Excellent spreading job.
4	"	Viceroy	
5	"	Alfalfa Butterfly	
6	"	Alfalfa Butterfly	This is the same species as No. 5, it is a different color form, as is O.K.
7	"	Cabbage Butterfly	
8	"	Cabbage Butterfly	A duplicate of No. 7. Not accepted as a different insect.
9	"	Spotted Purple	
10	"	Underwing Moth	
11	"	Underwing Moth	A moth this size should be spread.
12	"	Butterfly	Not well spread. Front wings should have been brought forward more.
13	"	Hairstreak	
14	"	Ermine Moth	Excellent job of spreading a small specimen.
15	"	Angoumois Grain Moth	Unidentified - Indian Meal Moth
16	NEUROPTERA	Owl Fly	Spelling - See note at end of catalogue. Specimen crooked.
17	"	Ant Lion	Same as above for spelling. See note.
18	"	Brown Lacewing	
19	COLEOPTERA	Stag Beetle	
20	"	Horn Beetle	Horn Beetle appears in some books, but Horned Passalus is the right name.
21	"	Stag Beetle	

You forgot the Wax Moth →

Optional Exercises

How To Make a Light Trap

A simple light trap can be made from a **funnel**, a **round gallon can**, and a **light**. You can buy a large funnel or make one by cutting the bottom out of a gallon milk or detergent container. Place the funnel on the can as shown in the illustration, and suspend the light slightly above the funnel. Insects that fly into the light bulb fall down the funnel and are trapped in the can. The spout of the funnel should be large enough to let the insects drop through it easily, but not so large as to let the insects fly out again. A few strips of 1-inch-wide newspaper in the can will give insects a place to hide so they are less likely to try to escape. When getting the insects out of the trap, put the can and funnel together into your collection net before removing the funnel. This will prevent active insects from escaping.

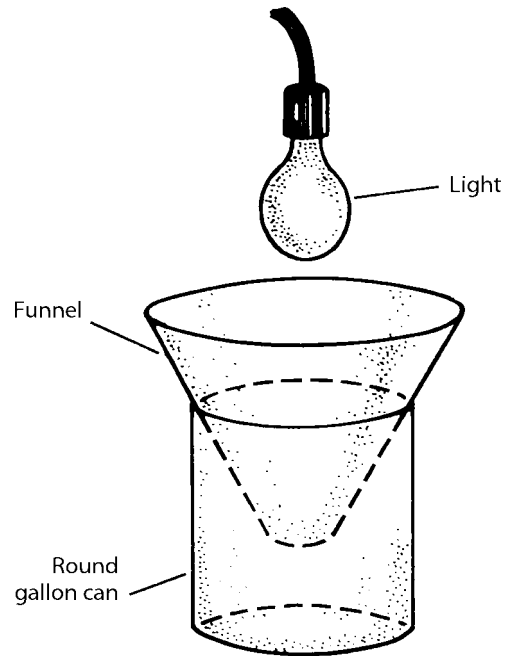

Using a Black Light

Black lights, or ultraviolet lights, are more attractive to insects than lights of other colors (wave lengths). Black lights are made like fluorescent tube lights and require the same kind of fixture. The only thing that is different is the light tube itself, which you may have to special order from a light fixture store. Black light tubes come in different sizes, but some may be more available than others. Get the black light tube first and then get the proper light fixture for it. Mount the light fixture on a board with an extension cord so you can use the light in different places. Use a white sheet as a backdrop for the light so you can easily spot the insects as they come to the light. Drape the sheet over a clothesline, stretch it between poles, or hang it on a fence or wall. Collect the insects as soon as they land on the sheet because some kinds of insects will soon run away and hide.

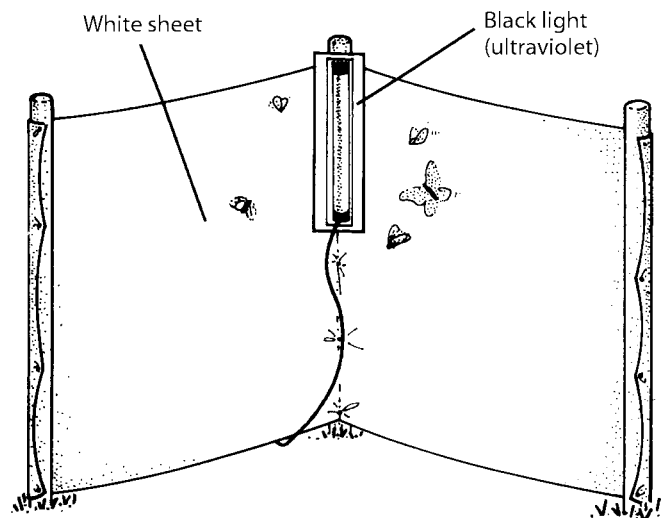

WARNING!

Never look directly at an operating black light. The ultraviolet rays may injure your eyes.

How To Make and Use an Underwater Light Trap

Materials needed:

- a length of stove pipe about 15 inches long
- a 1-inch board as wide as the diameter of the stove pipe
- a square foot of window screen
- a flashlight
- a screw-cap jar big enough to hold the flashlight
- a weight
- three small screws
- an eye hook.

How To Make:

1. Make the funnel for the trap by cutting out a 1-foot diameter circle from the piece of window screen and then cut the circle in half.
2. Next, fold one of the half circles in half and sew its two straight edges together. You now have a flattened cone.
3. Open the cone and cut off its tip to make a funnel.
4. Put the funnel into one end of the stove pipe, and fold the lip of the funnel back over the stove pipe. Use hot glue or waterproof tape to hold the funnel in place on the stove pipe.
5. To close the other end of the stove pipe, make a snug plug from the 1-inch thick piece of board. Fasten the jar lid to the center of the plug using 1-inch screws. The screws must be screwed in snugly so the jar will not leak.
6. Then drill one or two 1-inch holes in the plug and cover them with screen.
7. On the opposite face of the wooden plug, screw in an eye screw. Use three screws to hold the plug in the stove pipe as shown in the drawing, or else the plug may pull out when you retrieve the trap from the water.

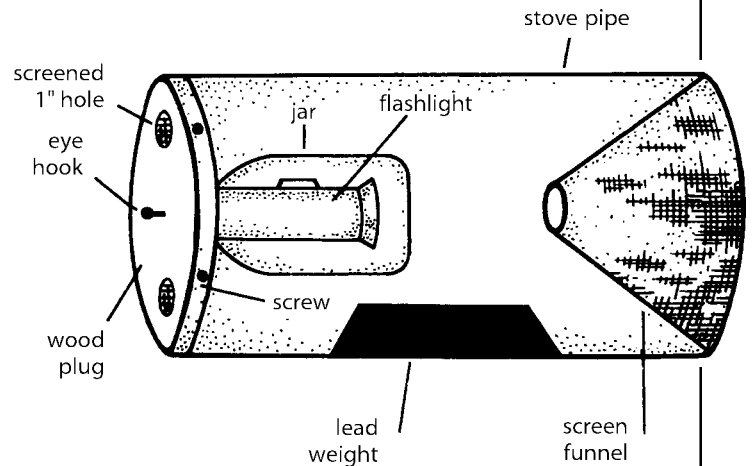

How To Use:

1. When you want to use the trap, remove the wooden plug, and put the weight and the turned-on flashlight in the jar.
2. Replace the wooden plug, and attach a long string to the eye-hook.
3. Lower the trap gently into a pond or stream, and tie the string to some solid object on the shore.
4. After leaving the trap in the water for several hours, retrieve it, using the string to find it. Lift the trap slowly from the water, funnel end first, letting the water drain out of the trap through the holes in the wooden plug.
5. Remove the wooden plug to get the insects out of the trap. Do this over a large shallow cake pan to keep insects from crawling away. The trap may also have small fish in it which should be returned to the pond or stream.

How To Make and Use a Relaxing Jar

Sometimes insects you collect may get too dry and brittle before you have time to pin them. Their body parts are easily broken when you try to pin them or spread their wings. Butterflies and moths are good examples of this. Dry specimens should be relaxed before they are pinned or their wings spread. A relaxing jar is used to put moisture back into dry insects so they will be more flexible. You can make one easily according to the following directions.

Materials needed:

- wide-mouth canning jar or peanut butter jar with a tight lid
- clean sand (sand used for mixing mortar is better than garden soil)
- disinfectant (Lysol or similar products, but not bleach)
- cardboard.

How To Make:

1. Pour 1 inch of sand in the bottom of the jar.
2. Make 1/2 cup solution of water and disinfectant. (Follow the label directions of the disinfectant for making the solution.)
3. Pour enough of the solution on the sand in the jar to wet the sand.
4. Cut a piece of cardboard to fit tightly in the jar over the sand.

How To Use:

1. Place only a few dry insects in the relaxing jar at one time. Do not allow the insects to be piled on one another or touching each other.
2. Place the lid on the jar, and let it stand for a few days to let the humidity build up in the jar.
3. Check the jar every day to see that mold does not develop on the insects or that the insects do not get too soft and soggy. The disinfectant solution

helps prevent some mold from developing, but if the insects are in the relaxer too long they may rot or mold anyway. Keep the insects spaced in the jar to reduce the risk of mold spreading from one insect to another.

4. As soon as the insect is relaxed enough, pin or spread it immediately. Relaxed insects dry out again faster than freshly killed insects.

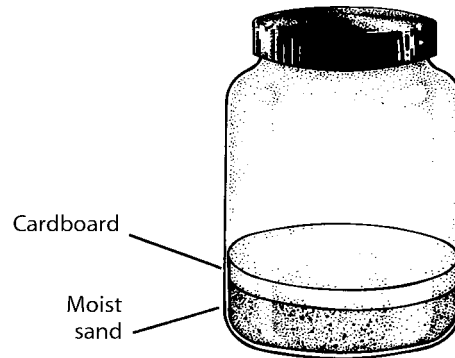

How To Make and Use a Pinning Block

A display collection will look better if the insects and labels on the pins are at a uniform height. A pinning block is used as a gauge to position insects and labels at uniform heights on the insect pins.

How To Make:

1. Make the block from strips of wood 1-inch wide by 1/4-inch thick.
2. Cut three lengths (a 3-inch piece, a 2-inch piece, and a 1-inch piece) from your wood strip, and glue them together in step fashion as shown below.
3. Next, drill three small holes as shown all the way through the block. You can use a small-sized finishing nail for the drill bit.
4. Then glue another 3-inch strip to the bottom of the block to cover the bottom of the drilled holes.

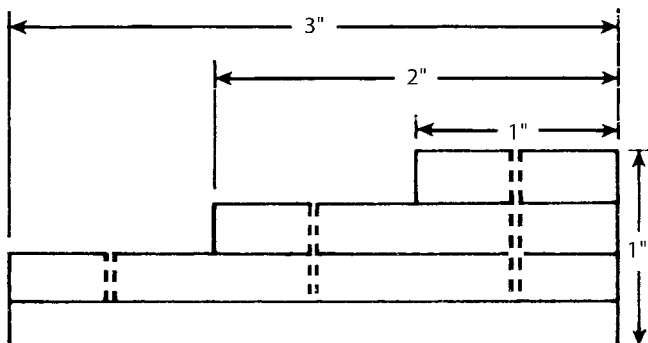

How To Use:

To use the pinning block, put the head of the pin bearing a freshly pinned insect into the shallowest hole of the pinning block. Push on the pin until its head is at the bottom of the hole. This will force the insect into a position 1/4-inch down on the pin. If the back of the insect is not resting on the block, that means the insect is too low. (Remember, the insect pin is upside down in the hole.) Push the insect downward on the pin until the insect's back is in contact with the block.

To position labels on the pin, put the label on the pin. Then put the point of the pin in either of the other two holes. Use the same hole for all the insects in your display collection. You can later change your mind about positioning labels, but not about positioning insects after they have dried on the pin.

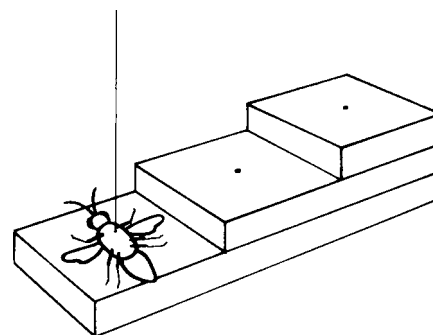

How To Make a Spreading Board

The wings of moths and butterflies look better and are easier to identify if their wings are spread. This is done with a spreading board. In the past, spreading boards were made from a soft wood such as balsa, with a one-third inch groove running down the center. The insect was pinned around this groove. An easier method is to use a piece of plastic foam, such as **Styrofoam**, from a broken cooler or purchased from a craft store. Any piece of material with a flat surface that a pin may go through will work for spreading the wings of insects. The material should be at least 1-inch thick. It is important that the plastic foam is thick enough so the pin does not come through on the other side.

Cut a groove in the piece of plastic foam slightly larger than the width and longer than the length of the body of the insect. Directions for using a spreading board are given on page 11.

Balsa block spreading board—This is merely a block of balsa wood 6 x 6 x 2 inches with a slot cut in one face of the block. The slot should be 1/2 to 1 inch deep and just a little wider than the body of the insect whose wings you want to spread.

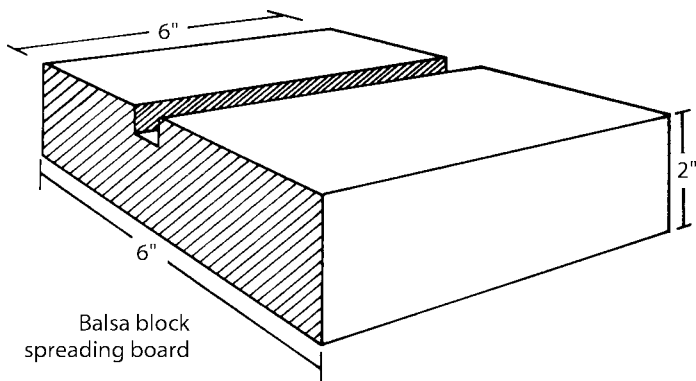

Platform-type spreading board—This board is a little harder to make, but it does not require so much balsa wood. Also you can taper the width of the slot to do the job of an adjustable purchased board. When spreading an insect, you just pick the proper place along the slot that best fits your insect.

The exact length and width of the board is a matter of choice, but 12 to 15 inches long by about 4 inches wide is a convenient size. However, the distance from the top of the board to the top of the bottom piece should be 1 1/4 inch or more. If you make this dimension too short, the bottom piece will stop the insect pin and hold the insect above the spreading surface of the board.

To assemble the board, place the top pieces on the legs so the width of the slot between the top pieces is 1/8 inch at one end and 1/2 inch at the other end. Nail the top pieces in place, and then turn the board over so the legs are up. Glue a length of balsa wood strip about 2 inches wide and 1/4-inch thick over the slot. The balsa strip should be long enough to cover the entire length of the slot. Then nail on the bottom piece. The bottom piece makes the board sturdier and protects the pins that poke through the balsa strip when there are insects on the board.

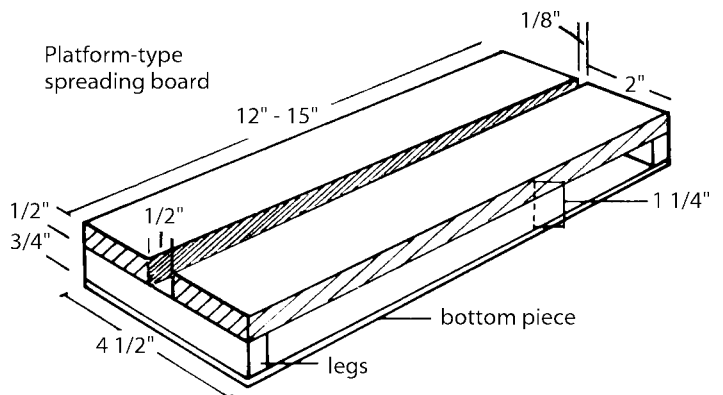

How To Make and Use an Aspirator

An aspirator is a handy device for collecting small, delicate or active insects from under rocks or bark or for removing them from your collecting net. To use the aspirator, place the end of the tubing, indicated by "A" in the drawing, close to an insect. Then give a quick suck on the end of the tubing indicated by "B." This will draw the insect into the vial. The fine screen keeps the insect from being drawn into your mouth.

The construction of the aspirator is rather simple and needs little discussion. A spice bottle, 3 or 4 inches long, can be substituted for the vial. Each piece of tubing should be about 12 inches long, and a small piece of nylon stocking can be used for the fine screen.

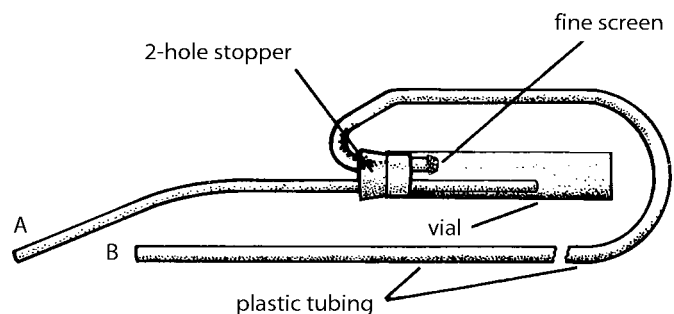

Giving Entomology Talks and Demonstrations

Now that you have learned more about how insects develop and grow and have improved your collecting, pinning, and displaying of insects, you should share your knowledge with others. You can do this by giving a talk or a demonstration to other 4-H members or other interested groups. Some suggestions for talks and demonstrations include:

- How insect orders differ from each other
- How different insects develop and grow
- How to collect, pin, and display insects
- How to make and use a spreading board
- How to make and use a pinning block
- What is a “true bug”?
- How to make an insect trap
- How to relax dry specimens.

A trip to your school library or public library will help you collect information for your presentation. Besides the books listed in the Unit I project, the following books may also be helpful:

- *Insects*. Yearbook of Agriculture. 1952.
- Farb, Peter and the Editors of Life. *The Insects*. Time Inc., Life Nature Library.
- Scheibner, R. and L.H. Townsend. *Beginning Beekeeping for Kentuckians*. Lexington: UK publication ENT-41, UK Cooperative Extension Service.
- Sterling, D. *Insects and the Homes They Build*. Garden City, NY: Doubleday and Co.

Records

The recognition you get for your work in 4-H depends on what you do. To help keep track of your project-related activities, record them as you do them. Then, when you are ready to complete your project record, you will have the information you need.

Part of your entomology record includes project-related activities you participated in during the year. There is a place to record these activities on your project record. Examples of activities you might want to record are given below.

4-H Club meeting participation:

- Number of club meetings attended
- Committees served on (clean-up, membership drive, fund raising, etc.)
- Committee reports given
- Demonstrations or talks given
- Offices held (president, treasurer, secretary, committee chairman, etc.).

Other activities not at club meeting:

- Helped another club member with his or her project
- Exhibited project in competition at local, county, or state fair
- Exhibited project at school, store, civic club, etc.
- Gave demonstration at school or at an adult organization
- Went on a group field trip
- Enrolled in an adult entomology club or society (Lepidopterists' Club, for example)
- Took photographs of entomology activities.

Awards and recognition for entomology participation include:

- Ribbons received at fairs
- Pins, trophies, or certificates of accomplishment received
- Newspaper articles in which you are mentioned (save the clippings)
- Radio or television appearances.

Answers to Labeling the True Bug Exercise

1. Head, 2. Thorax, 3. Abdomen, 4. Antennae, 5. Eye, 6. Front wing, 7. Hind wing, 8. Leg, 9. Scutellum, 10. Pronotum, 11. Beak

Answers to Labeling the Beetle Exercise

1. Head, 2. Thorax, 3. Abdomen, 4. Pronotum, 5. Elytron, 6. Hind wing, 7. Coxa, 8. Trochanter, 9. Femur, 10. Tibia, 11. Tarsus, 12. Antennae, 13. Eyes, 14. Palps, 15. Mouthparts

Example of Entomology Project Exhibit

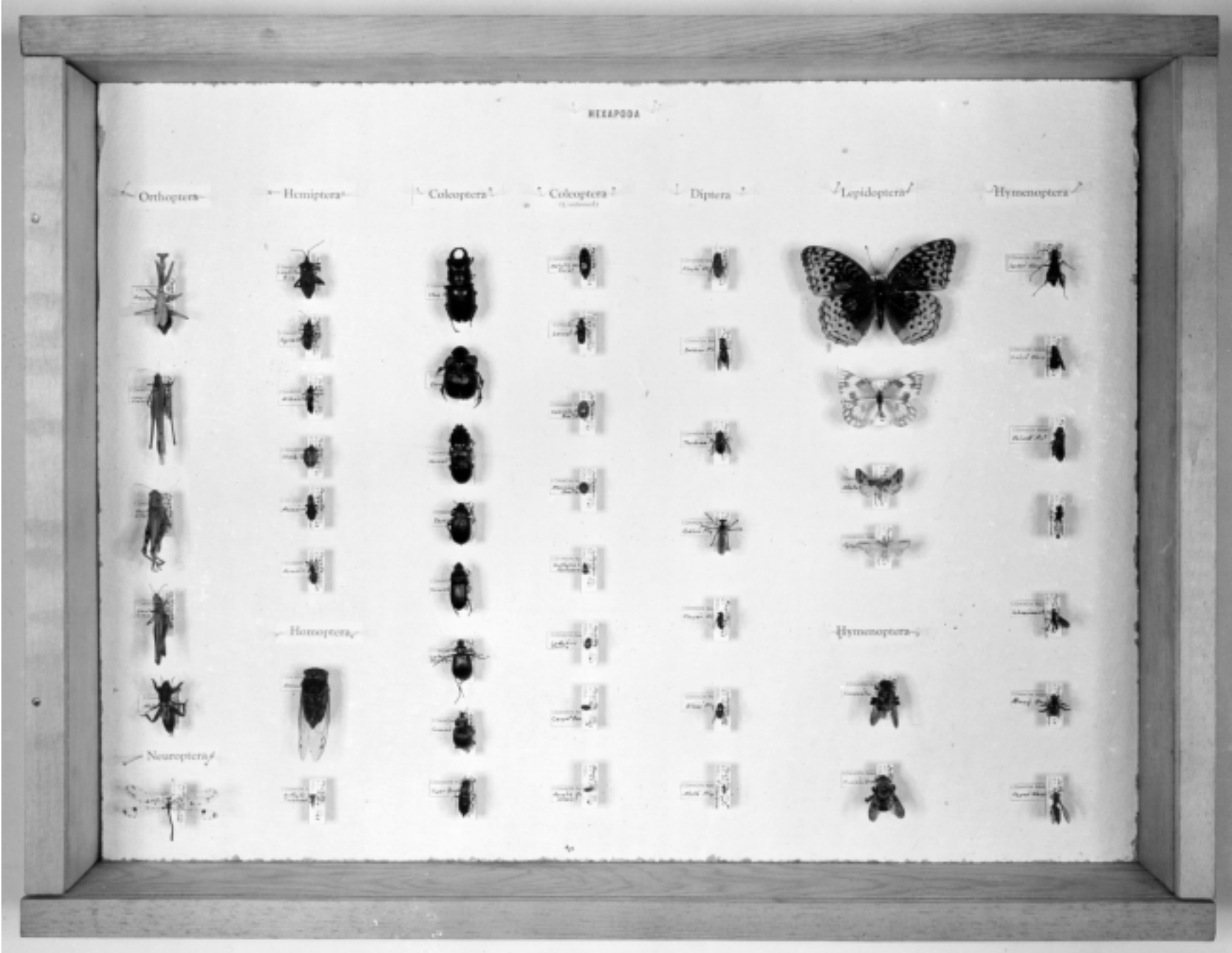

4-H Entomology Project Record: Unit II

Name of Member _____ Year _____

Parent or Guardian _____

Mailing Address _____ Zip _____

County _____ Name of Club _____

Grade in School _____ Name of School _____

Birth Date _____ Years in this Project _____ Years in 4-H _____

1. I participated in the following entomology activities. (If the activity relates to club participation, record "club" in the "where" column. Otherwise, record the place where the activity occurred.)

Date	Kind of Activity (Title)	Where
_____	_____	_____
_____	_____	_____
_____	_____	_____
_____	_____	_____
_____	_____	_____
_____	_____	_____
_____	_____	_____
_____	_____	_____
_____	_____	_____
_____	_____	_____

2. I helped _____ other 4-H'ers with their entomology project. I helped them by:

3. I participated in the following community service activities through my 4-H club:

4. I read the following articles, pamphlets, or books to prepare for my demonstrations or to help me to learn more about entomology (list titles, authors, and, if available, dates):

5. I used the following equipment in completing my project this year (list each item, whether you bought or made the item, and how much it cost):

6. I received the following awards and recognition (list activity, date of activity, where it took place, and award or recognition received):

7. I completed the following Optional Exercises for Unit II:

8. In your own words, write a summary of your entomology project. Tell what you did, what you learned from the project, and how you could have improved your project. Write your story on a separate sheet of paper, and attach it to this record sheet.

Cartoon drawings by Chris Ware, Lexington, Kentucky

Where trade names are used, no endorsement is intended, nor criticism implied of similar products not named.