



ESA

ACHIEVEMENTS

more than thirty years of pioneering space activity



BR-250
June 2005



ESA **ACHIEVEMENTS**

more than thirty years of pioneering space activity

Andrew Wilson

European Space Agency
Agence spatiale européenne



Foreword	4	Envisat	220
Introduction	8	MSG	230
		Integral	236
Europa	46	Mars Express	244
ESRO-2	50	SMART-1	254
ESRO-1	52	Rosetta	260
HEOS	54	Sloshsat	272
TD-1	58		
ESRO-4	60	Coming Launches	
Cos-B	62	CryoSat	274
Geos	66	Venus Express	278
OTS	70	Galileo	284
ISEE-2	74	Metop	292
Meteosat	76	ATV	298
IUE	82	GOCE	304
Ariane-1/2/3/4	86	Columbus	310
Marecs	94	SMOS	324
Sirio-2	98	Proba-2	330
Exosat	100	Planck	332
ECS	104	Herschel	338
Spacelab	108	Vega	344
Giotto	114	ERA	348
Olympus	120	ADM-Aeolus	352
Hipparcos	124	LISA Pathfinder	356
FOC/HST	128	Swarm	358
Ulysses	134	JWST	362
ERS	144	Gaia	366
Eureca	152	BepiColombo	372
ISO	156	EarthCARE	378
SOHO	160	LISA	380
Ariane-5	168	Solar Orbiter	384
Cluster	182		
Huygens	188	Chronologies	388
TeamSat	200	Acronyms & Abbreviations	398
ARD	202		
XMM-Newton	206	Index	400
Artemis	210		
Proba-1	216		

BR-250 "ESA Achievements (3rd edition)"

ISBN 92-9092-493-4

ISSN 0250-1589

Compiled/
written by:

Andrew Wilson,
ESA Publications Division

Published by:

ESA Publications Division,
ESTEC, Noordwijk,
The Netherlands

Design by:

Leigh Edwards &
Andrew Wilson

Price:

€30

© European Space Agency 2005

It is a privilege to be part of an organisation with such a rich heritage and exciting potential as the European Space Agency (ESA). The Agency is at a turning point in its history, so it is an appropriate moment to document and reflect on the many successes of the past and those still under way, while preparing to head in new directions for the future.

The remarkable record stretches from humble beginnings in the 1960s to ESA's leading position today among the front rank of space organisations, generating enormous benefits for its Member States and their citizens. The Agency has been responsible for developing systems that are now accepted as everyday – and profitable – parts of our lives, leading to the creation of new entities and companies responding to our needs.

The Ariane rocket alone has provided an impressive return on investment. It has long dominated the world's commercial launch market, operated by the Arianespace company. The new heavy-lift Ariane-5 is already building a significant reputation as the latest addition to the Ariane family. The Meteosat weather satellite system developed by ESA similarly led to the creation of Eumetsat. The ECS communications satellites led to Eutelsat, and the Marecs maritime satellites were vitally important to Inmarsat. These are all now enterprises of global importance. Likewise, ESA's science programme is second-to-none, and our Earth-observation satellites continue to return torrents of data. Our expertise is such that we are welcomed as a major Partner in the International Space Station. These missions are all included in this volume. Individual entries cover past, current and approved future missions beyond this decade.

Despite this superb record, the Agency cannot afford to stand still. We have thus set three main priorities for the future. The first is Global Monitoring for Environment and Security, or GMES. The environment and security are two of the biggest concerns of Europe's citizens, and ESA has been working with the European Commission over the past few years to build a plan for future activities. The time has now come to implement that plan, based on the concrete results that we have already achieved in Earth observation, especially with ERS and Envisat.



The second priority is Exploration. It is a very important priority for our future, creating the basis for increasing scientific benefits and for robust European participation in future large international cooperative space programmes beyond the lifetime of the International Space Station. Europe has always been highly successful in this domain, as our scientific missions have proved time and again, and it now has a new momentum created in part by the Vision for Space Exploration of President George W. Bush. European spacecraft are now orbiting the Moon and Mars and one recently made the first-ever landing on Titan, so we are building our future on concrete results.

The third priority groups together market technologies, essentially telecommunications, technologies preparing for the long-term, and dual-use technologies. Technology programmes are a key element of an industrial policy that serve to consolidate the capabilities and competitiveness of European industry.

Together, the GMES and technology initiatives provide the foundation for responding to the demands of European security policies.

The three new initiatives build on the priorities defined by the Space Council, a joint meeting of the ESA Council and the European Union Council. ESA's relationship with the European Union has been strengthened substantially by a Framework Agreement essential for joint activities. The joint Space Council set up by this Framework Agreement held its inaugural meeting in November 2004, the first time that the EU and ESA Councils have met to discuss space policy and the future of space in Europe. Close cooperation between our two organisations lies at the heart of European space policy. The pioneering Galileo satellite navigation system is but the first joint venture that will put space at the service of European citizens.

The Agency is preparing programme proposals on the basis of this strategy and will submit them to the ESA Ministerial meeting scheduled for December 2005. With these new directions, we can expect that the Agency has an equally productive future and a crucial role in the success of Europe.

Jean-Jacques Dordain
Director-General, European Space Agency



Launches of ESA, ESRO, ELDO and related missions

	Launch date	Mission
Europa-I F1	5 Jun 1964	Launcher: test of stage-1
ESRO-2A*	29 May 1967	Science: cosmic rays, solar X-rays
ESRO-2B	17 May 1968	Science: cosmic rays, solar X-rays
ESRO-1A	3 Oct 1968	Science: Earth auroral and polar-cap phenomena, ionosphere
Europa-I F7*	30 Nov 1968	Launcher: first orbital attempt
HEOS-1	5 Dec 1968	Science: interplanetary medium, bow shock
ESRO-1B	1 Oct 1969	Science: as ESRO-1A
Europa-II F11*	5 Nov 1971	Launcher: orbital demonstration
HEOS-2	31 Jan 1972	Science: Earth polar magnetosphere, interplanetary medium
TD-1	12 Mar 1972	Science: UV, X-ray and gamma-ray astronomy
ESRO-4	26 Nov 1972	Science: Earth neutral atmosphere, ionosphere, auroral particles
Cos-B	9 Aug 1975	Science: gamma-ray astronomy
Geos-1	20 Apr 1977	Science: dynamics of Earth magnetosphere
OTS-1*	14 Sep 1977	Telecommunications: demonstrate European technologies
ISEE-2	22 Oct 1977	Science: Sun/Earth relations and magnetosphere
Meteosat-1	23 Nov 1977	Meteorology: pre-operational meteorological services
IUE	26 Jan 1978	Science: ultraviolet astronomy
OTS-2	12 May 1978	Telecommunications: demonstrated European technologies
Geos-2	24 July 1978	Science: Earth magnetospheric fields, waves and particles
Ariane-1	24 Dec 1979	Commercial launcher: first of 11 Ariane-1 launches
Meteosat-2	19 Jun 1981	Meteorology: pre-operational meteorological services
Marecs-A	20 Dec 1981	Telecommunications: maritime communications
Marecs-B*	10 Sep 1982	Telecommunications: maritime communications
Sirio-2*	10 Sep 1982	Meteorological data distribution & clock synchronisation
Exosat	26 May 1983	Science: X-ray astronomy
ECS-1	16 Jun 1983	Telecommunications: operational European Communications Satellite
Spacelab-1	28 Nov 1983	First of 22 manned Spacelab missions, plus multi-disciplinary First Spacelab Payload (FSLP)
Ariane-2/3	4 Aug 1984	Commercial launcher: first of 17 Ariane-2/3 launches
ECS-2	4 Aug 1984	Telecommunications: operational European Communications Satellite
Marecs-B2	10 Nov 1984	Telecommunications: maritime communications
Giotto	2 Jul 1985	Science: Comet Halley and Comet Grigg-Skjellerup encounters
ECS-3*	12 Sep 1985	Telecommunications: operational European Communications Satellite
ECS-4	16 Sep 1987	Telecommunications: operational European Communications Satellite
Ariane-4	15 Jun 1988	Commercial launcher: first of 116 Ariane-4 launches
Meteosat-3	15 Jun 1988	Meteorology: pre-operational meteorological services
ECS-5	21 Jul 1988	Telecommunications: operational European Communications Satellite
Meteosat-4	6 Mar 1989	Meteorology: operational meteorological services
Olympus	12 Jul 1989	Telecommunications: technology demonstration
Hipparcos	8 Aug 1989	Science: astrometry
HST/FOC	24 Apr 1990	Science: astronomy (Hubble Space Telescope/Faint Object Camera)
Ulysses	6 Oct 1990	Science: probing heliosphere above/below ecliptic up to solar poles
Meteosat-5	2 Mar 1991	Meteorology: operational meteorological services
ERS-1	17 Jul 1991	Earth observation: pre-operational radar
Eureca	31 Jul 1992	Science: multi-disciplinary, reusable platform
Meteosat-6	20 Nov 1993	Meteorology: operational meteorological services
ERS-2	21 Apr 1995	Earth observation: pre-operational radar
ISO	17 Nov 1995	Science: infrared astronomy
SOHO	2 Dec 1995	Science: Sun, from core to beyond Earth orbit
Ariane-5*	4 Jun 1996	Commercial launcher: new generation of heavy launchers
Cluster*	4 Jun 1996	Science: space plasma physics in 3D (FM1-FM4)
Meteosat-7	2 Sep 1997	Meteorology: operational meteorological services
Huygens	15 Oct 1997	Science: Titan atmosphere/surface probe
TeamSat	30 Oct 1997	Science/technology: experiments on Ariane-502 demonstration launch
ARD	21 Oct 1998	Technology: demonstration of Earth-return technologies
XMM-Newton	10 Dec 1999	Science: X-ray astronomy
Cluster	16 Jul 2000	Science: space plasma physics in 3D (first pair: FM6 & FM7)
Cluster	9 Aug 2000	Science: space plasma physics in 3D (second pair: FM5 & FM8)
Artemis	12 Jul 2001	Telecommunications: demonstration

/continued next page

	Launch date	Mission
Proba-1	22 Oct 2001	Technology/Earth observation
Envisat	1 Mar 2002	Earth observation
Meteosat-8	28 Aug 2002	Meteorology: Meteosat Second Generation
Integral	17 Oct 2002	Science: gamma-ray astronomy
Ariane-5ECA*	11 Dec 2002	Launcher: 9 t GTO-capacity, A5ECA debut
Mars Express	2 Jun 2003	Science: Mars orbiter & lander
SMART-1	27 Sep 2003	Technology/science: lunar orbiter
Rosetta	2 Mar 2004	Science: Comet rendezvous (2014-2015)
Sloshsat	12 Feb 2005	Technology

*launch failure

Only the debut launches of Ariane-1/2/3/4/5/5ECA, Europa, Vega, Spacelab and ATV are shown.



Planned launches of ESA and related missions

	PLANNED	Launch date	Mission
MSG-2		Aug 2005	Meteorology: Meteosat Second Generation
CryoSat		Sep 2005	Earth observation: polar ice thickness
Venus Express		Oct 2005	Science: Venus orbiter
GSTB-V2		Dec 2005	Navigation: Galileo System Test Bed
Metop-2		Apr 2006	Meteorology: polar meteorological services
ATV		2006	Space station: Automated Transfer Vehicle debut
GOCE		Sep 2006	Earth observation: Earth's gravity field and geoid
Columbus		2006	Space station: research laboratory
SMOS		Mar 2007	Earth observation: soil moisture and ocean salinity
Proba-2		Mar 2007	Technology/solar observation
Planck		Aug 2007	Science: map Cosmic Microwave Background
Herschel		Aug 2007	Science: far-IR/sub-mm astronomy
Vega		Nov 2007	Launcher: debut of small solid-propellant launcher
ERA		Nov 2007	Space station: European Robotic Arm
ADM-Aeolus		Sep 2008	Earth observation: global wind measurements
Galileo IOV		2008	Navigation: Galileo in-orbit validation
LISA Pathfinder		2008	Technology/science: demonstration for LISA
Proba-3 ¹		2008	Technology
MSG-3		2008-2009	Meteorology: Meteosat Second Generation
Swarm		2009	Earth observation: Earth's magnetic field
Metop-1		2010	Meteorology: polar meteorological services
MSG-4		2010-2011	Meteorology: Meteosat Second Generation
JWST		Aug 2011	Science: James Webb Space Telescope
Gaia		2011	Science: astrometry
BepiColombo		May 2012	Science: two Mercury orbiters
EarthCARE		2012	Earth observation: clouds and aerosols
LISA		2012	Science: gravitational wave detection
Solar Orbiter ¹		Oct 2013	Science: solar observations
Metop-3		2014	Meteorology: polar meteorological services
MTG ¹		2015	Meteorology: Meteosat Third Generation

¹awaiting full approval

ESA

Achievements

The impetus for creating an independent space power in Europe began in the early 1960s. Belgium, France, Germany, Italy, the Netherlands and the United Kingdom (associated with Australia) signed the Convention in March 1962 to create the European Launcher Development Organisation (ELDO), with the goal of developing a satellite launch vehicle independent of the two great space powers, the USA and USSR.

Similarly, Belgium, Denmark, France, Germany, Italy, the Netherlands, Spain, Sweden, Switzerland and the UK in June 1962 signed the Convention to create the European Space Research Organisation (ESRO), for undertaking scientific satellite programmes.

These partners subsequently decided to merge the activities of ELDO and ESRO into a single body, and in July 1973 a ministerial conference of the 10 European countries met in Brussels and laid down the principles for creating the European Space Agency (ESA). The Agency began operating on 31 May 1975, and on 30 October 1980 the final signature ratifying the Convention gave legal existence to ESA.

While ELDO had dramatic difficulties developing the Europa launcher, ESRO was becoming a mature organisation. Seven scientific satellites reached orbit by the end of

1972, proving that ESRO could compete with the major space powers and could manage important industrial contracts. By this time, there had been a fundamental change in ESRO's aims. Its Council resolved in December 1971 to include applications satellites, namely the Orbital Test Satellite for telecommunications, Meteosat for meteorology and Aerosat for aeronautical communications. While these would dominate the science element financially, they were optional, allowing Member States the choice of participating or not. The Science Programme became

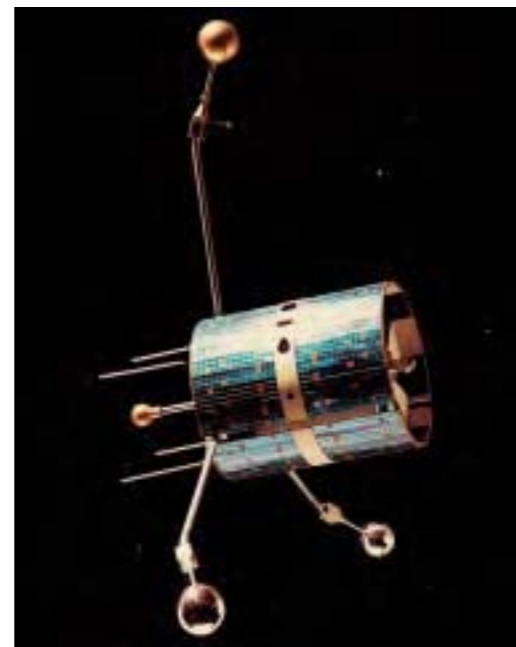

From humble beginnings: the ESRO scientific satellites (ESRO-4 is shown here) were small by comparison with today's sophisticated spacecraft, but they laid a firm foundation for the future.

mandatory, so that long-term planning was possible for the first time. Three more optional programmes were added in 1973: Spacelab, Europe's contribution to the US Space Shuttle programme; the Ariane launcher; and the Marots (later Marecs) maritime communications satellite.

All of these programmes were underway in May 1975 when ESA assumed *de facto* responsibility.

ESA and Science

The Science Programme is one of the Agency's mandatory activities, in which all Member States participate. Much of the advanced technology used today stems from the scientific programme: over the years it has been the driving force behind many other ESA activities.

The origins of the Science Programme, the oldest in the Agency, hark back to the days of ESRO. ESRO's seven successful scientific satellites paved the way for ESA's remarkable series of pioneering missions that have placed Europe at the vanguard of disciplines such as X-ray, gamma-ray and infrared astronomy; astrometry; Solar System sciences (especially cometary), solar and heliospheric physics, as well as space plasma physics. Driven by the limited available means, ESA's Science Programme has consistently focused on missions with strong innovative contents. All of the missions launched or approved so far are covered in separate entries in this volume.

1985 was an important milestone in the history of ESA's Science Programme. It saw the approval of

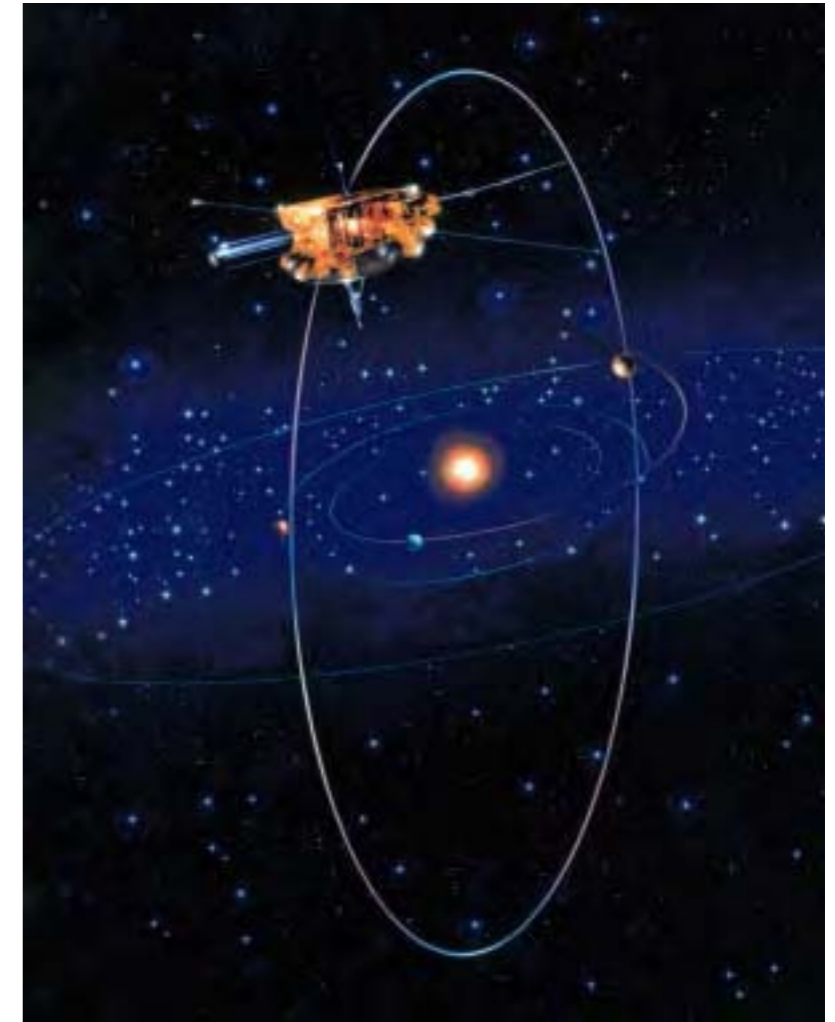

the long-term Horizon 2000 programme of scientific research in space, designed to ensure that Europe would play a key and balanced role beyond the end of the century. Executing Horizon 2000 required a special financial effort from the Member States, amounting to a progressive budgetary increase of 5% per year from 1985 to a steady plateau in 1994 of about €470 million in 2004 terms. Horizon 2000 encompassed the missions already approved (Hubble Space Telescope, Ulysses, Hipparcos and ISO) and added four Cornerstone missions, plus Medium-size ('M') missions

Ulysses completed its original mission of probing the heliosphere at all latitudes and is now swinging around on a third passage

SOHO observes a Coronal Mass Ejection – billions of tonnes of magnetised plasma erupting from the Sun's corona at up to 2000 km/s.

selected competitively. Cornerstone-1 combined two missions into the Solar-Terrestrial Science Programme: Cluster and SOHO. The CS-2 High-Throughput X-ray Spectroscopy Cornerstone is XMM-Newton; the CS-3 Cometary Cornerstone is Rosetta; the CS-4 Far-Infrared and Submillimetre Spectroscopy Cornerstone is Herschel. The selected Medium missions are: M-1 Huygens Probe; M-2 Integral; M-3 Planck.

Preparatory work began in 1993 on the follow-up Horizon 2000 Plus programme to cover new missions for 2007-2016, including three new Cornerstones. The Ministerial Meeting in September 1995 approved the long-term programme but imposed a 3% annual reduction in purchasing power on the Scientific Directorate. Then, when the four Cluster satellites were destroyed by the Ariane-501 failure in June 1996, it became inevitable that the Science Programme had to be revised.

The Cornerstones were maintained, but the medium M-missions were replaced by smaller missions in order to regain programme flexibility. These were 'F' (Flexible) missions with purely scientific goals, and 'SMART' (Small Missions for Advanced Research in Technology), which can provide in-orbit proof of technologies, particularly for Cornerstones, and carry, as a secondary goal, scientific experiments. Mars Express was conditionally approved in November 1998 as the first Flexi mission (F1) and confirmed following the May 1999 Ministerial Council meeting. SMART-1 (2002) is demonstrating technologies for the Mercury Cornerstone, and SMART-2 (now called LISA Pathfinder; 2008) for LISA. On 1 October 1999, ESA requested proposals for F2 and

F3, selecting five of the 50 for assessment studies March-May 2000: Eddington, Hyper, MASTER, Solar Orbiter and Storms; the James Webb Space Telescope was already part of the process.

In October 2000, the Science Programme Committee (SPC) approved a package of missions for 2008-2013. BepiColombo became CS-5 (2012, Mercury Cornerstone) and Gaia CS-6 (2012). LISA is also a Cornerstone (Fundamental Physics) but to fly in collaboration with NASA at a cost to ESA of a Flexi mission. F2 and F3 are JWST and Solar Orbiter, respectively. A reserve Flexi mission, Eddington (to map stellar evolution and find habitable planets), was also selected in case the JWST and LISA schedules of NASA slipped beyond 2013 (see later for Eddington's fate).

The Cornerstone Darwin Infrared Space Interferometer, to search for Earth-like planets around other stars, falls beyond the horizon but work on it continues towards future funding.

Following the Ministerial Council of November 2001 (Edinburgh, UK), where there was no increase in real terms of the level of resources allocated to science, ESA undertook a complete reassessment of the science programme in close collaboration with the science community. The resulting 'Cosmic Vision' was approved by the SPC on 23 May 2002. It not only maintained the missions approved in October 2000, but added the Eddington mission:

Astrophysics

Group 1: XMM-Newton, Integral
Group 2: Herschel, Planck, Eddington
Group 3: Gaia.

Solar System

Group 1: Rosetta, Mars Express
Group 2: SMART-1, BepiColombo,
Solar Orbiter

Fundamental Physics

STEP (Satellite Test of the Equivalence Principle, cancelled by NASA in 2002)
SMART-2 (became LISA Pathfinder)
LISA (joint mission with NASA).

In addition, the Agency was committed to cooperation with NASA on JWST.

The 'production groups' are more than scientific groupings. Missions within each are sharing technologies and engineering teams wherever possible. For example, Herschel, Planck and Eddington were to use not only the same bus but also the same engineering team. BepiColombo and

Solar Orbiter were teamed, and international collaboration sought. The philosophy saw Venus Express added in November 2002 to reuse the Mars Express bus, expertise and most of the instruments. At the same time, major technical changes reduced the cost of Gaia with no loss of science.

The high ambitions combined with the slow decline in funding meant there was little flexibility left to cope with adverse events. A major blow was dealt when the failure of the new Ariane-5 design in December 2002 grounded the whole fleet and forced major delays on Rosetta (13 months) and SMART-1 (6 months) costing about €100 million. Faced with this and other financial demands, the SPC on 6 November 2003 was forced for the first time ever to cancel a

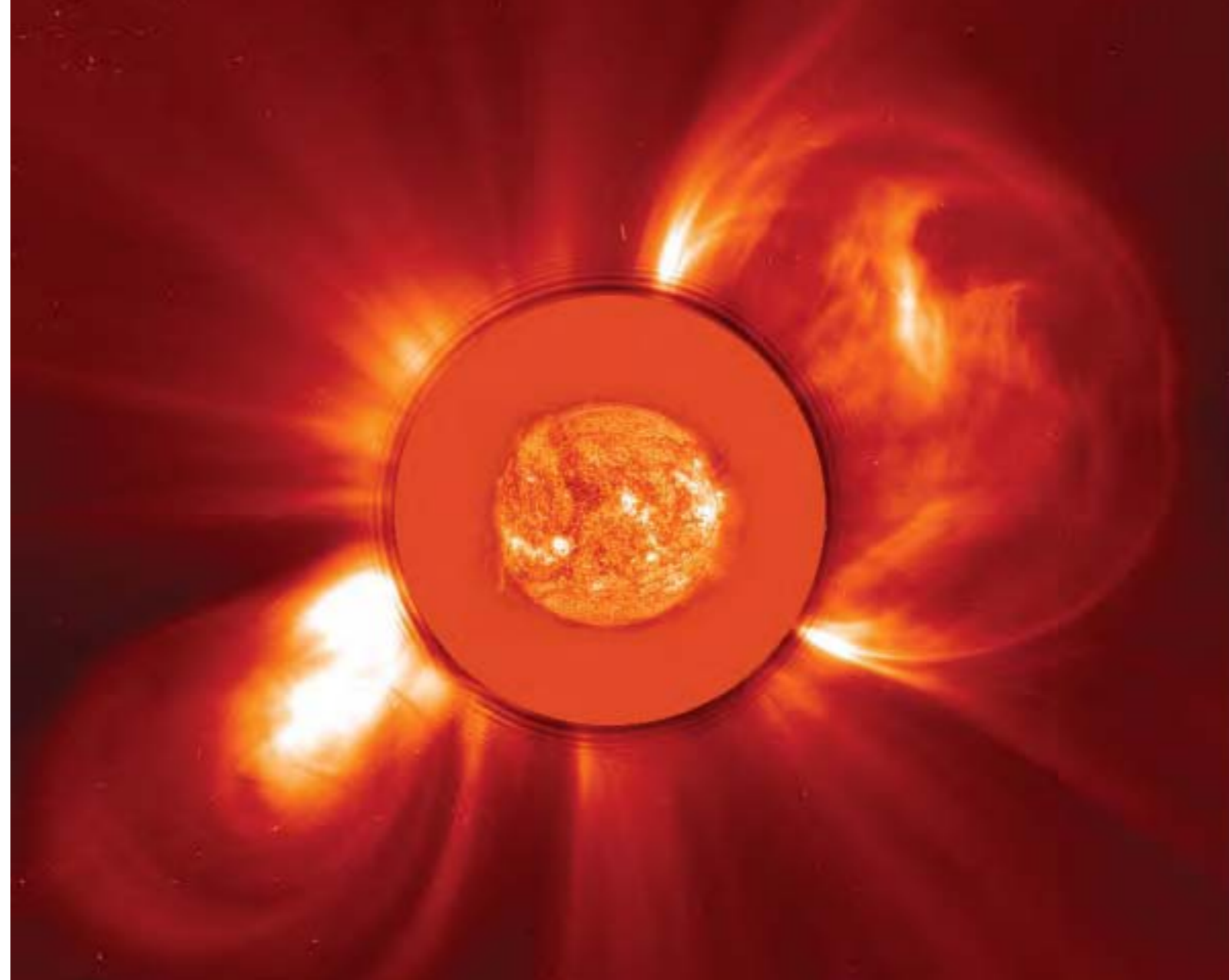

*The Grand Canyon of Mars: Valles Marineris
imaged by the High Resolution Stereo Camera of
Mars Express on 14 January 2004.
(ESA/DLR/FU Berlin, G. Neukum)*



XMM-Newton is helping to solve a number of cosmic mysteries, ranging from the enigma of black holes to the origin of the Universe itself. Inset: soft X-ray image of Comet McNaught-Hartley, January 2001.

The first four Cluster satellites were destroyed in 1996, but a replacement set was launched successfully in pairs in 2000.



ESA's Huygens Probe parachuted through the atmosphere of Saturn's moon Titan in January 2005. Inset: the first colour image from the surface of the mysterious moon.

Phobos: the martian moon imaged by Mars Express at a resolution of about 7 m per pixel on 22 August 2004. (ESA/DLR/FU Berlin, G. Neukum)

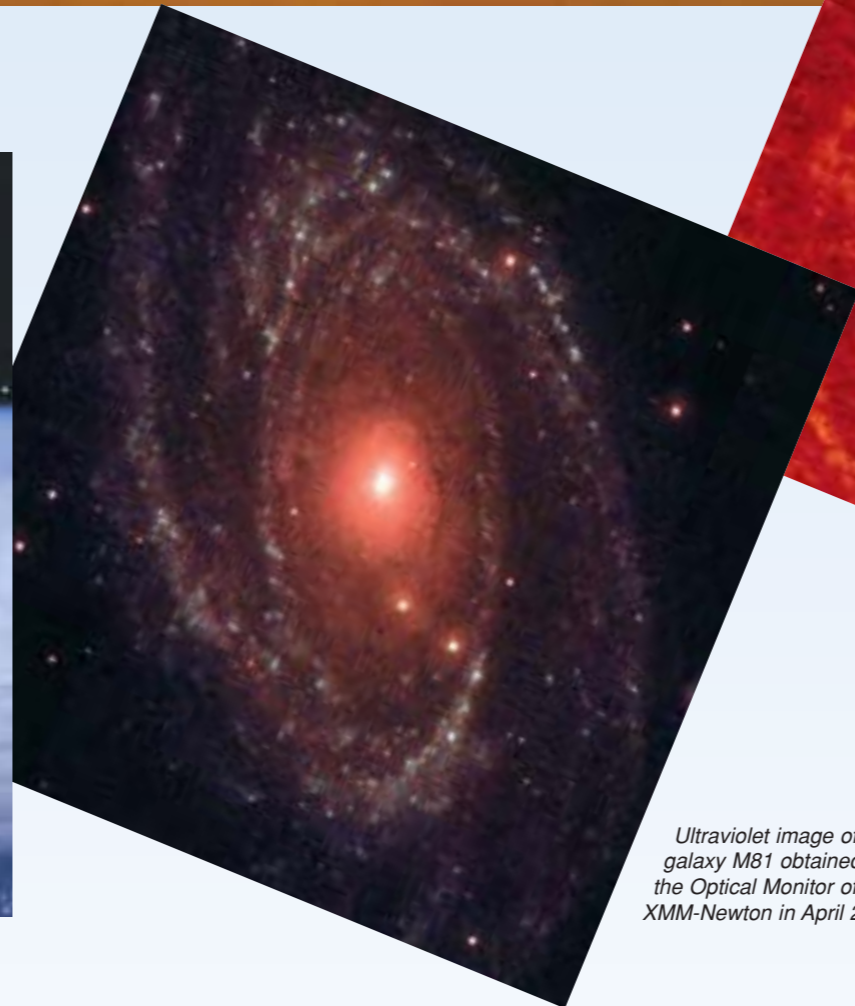

Ultraviolet image of galaxy M81 obtained by the Optical Monitor of XMM-Newton in April 2001.



ISO's infrared view of the Helix Nebula, showing the shells of gas and dust ejected as a Sun-like star collapsed. The resulting central white dwarf star is too hot to show up in the infrared. (ESA/ISOCAM/P. Cox et al)

mission. The choice came down to Eddington and LISA Pathfinder. Eddington was riding on the coat-tails of Herschel/Planck and could not be delayed without major cost increase, whereas LISA Pathfinder was already agreed with NASA on a strict schedule. Eddington was cancelled. In addition, the Mercury lander of BepiColombo was cancelled.

Cosmic Vision is a living programme, having to adapt to the available funding at the same time as responding to the expectations of the scientific community. The goal of the SPC is to maximise the outcome of Cosmic Vision across disciplines, keeping it challenging but affordable.

The current Cosmic Vision runs until 2015 but the Agency, supported by its advisory

structure, developed a new plan during 2004 for approval in 2005. This will be the culmination of the third major planning exercises that have framed European space science over the past two decades since the Horizon 2000 exercise of 1983-1984.

ESA issued a call for themes in spring 2004. Nine major themes were condensed from the 151 proposals:

- Other worlds and life in the Universe;
- The early Universe;
- The evolving violent Universe;
- Towards quantum gravity;
- Beyond the standard model;
- The gravitational-wave Universe;
- From the Sun to the Earth and beyond;
- Tracing the origin of the Solar System;
- Life and habitability in the Solar System and beyond.

The Agency then focused on developing mission scenarios and technology requirements to satisfy these themes within the envisaged timescale. Following endorsement by the SPC in May 2005, the 'Cosmic Vision 2015-2025' document will be produced, laying out the targets for European space science for that decade. Subsequently, once the financial framework is known, the European scientific community will be called upon to produce a plan, including concrete missions and mission scenarios, to capture the range of scientific themes targeted.

Past, current and approved science missions are:

ESRO-2 (1968): studied cosmic rays and solar X-rays.

ESRO-1A/B (1968/69): aurora and ionosphere.

HEOS-1/2 (1968/72): first European satellites beyond near-Earth space, to study magnetosphere and interplanetary medium.

TD-1 (1972): UV, X-ray and gamma-ray astronomy.

ESRO-4 (1972): upper atmosphere and ionosphere.

Cos-B (1975): ESA's first satellite mapped the little-explored gamma-ray sky.

Geos (1977/78): two satellites studied the particles, fields and plasma of Earth's magnetosphere.

ISEE-2 (1977): worked in tandem with NASA's ISEE-1 studying Earth's magnetosphere.

IUE (1978): the International Ultraviolet Explorer was the world's longest serving and most prolific astronomy satellite, returning UV spectra on celestial objects ranging from comets to quasars until 1996.

Exosat (1983): studied the X-ray emissions and their variations over

time of most classes of astronomical objects in 1780 observing sessions.

Giotto (1985): first close flyby of a comet (Comet Halley, March 1986), followed by a bonus encounter with Comet Grigg-Skjellerup in July 1992.

Hipparcos (1989): produced the most accurate positional survey of more than 100 000 stars, fundamentally affecting every branch of astronomy.

Hubble Space Telescope (1990): 15% contribution, including the Faint Object Camera, to this premier international space telescope.

Ulysses (1990): continuing the fields and particles investigation of the inner heliosphere at all solar latitudes, including the solar poles.

ISO (1995): world's first infrared astronomical observatory provided a fresh perspective on the Universe.

SOHO (1995): first Horizon 2000 Cornerstone, studying the Sun's interior, as well as the corona and its expansion into the solar wind.

Cluster (1996): part of the first Horizon 2000 Cornerstone, to investigate plasma processes in Earth's magnetosphere using four satellites. Lost in first Ariane-5 launch failure; replacements successful in mid-2000.

Huygens (1997): the first probe designed to descend through the atmosphere of Saturn's moon Titan, January 2005.

XMM-Newton (1999): the X-ray Multi-Mirror mission is the most sensitive X-ray astronomy satellite yet, finding millions of new objects.

Cluster (2000): duplicate replacements of the four Cluster satellites, observing plasma processes in Earth's magnetosphere.

Integral (2002): the International



*Integral is observing the most energetic events in the Universe. (ESA/D. Ducros)
Inset: a gamma-ray burst like this, Integral's first, may signal the birth of a black hole.*

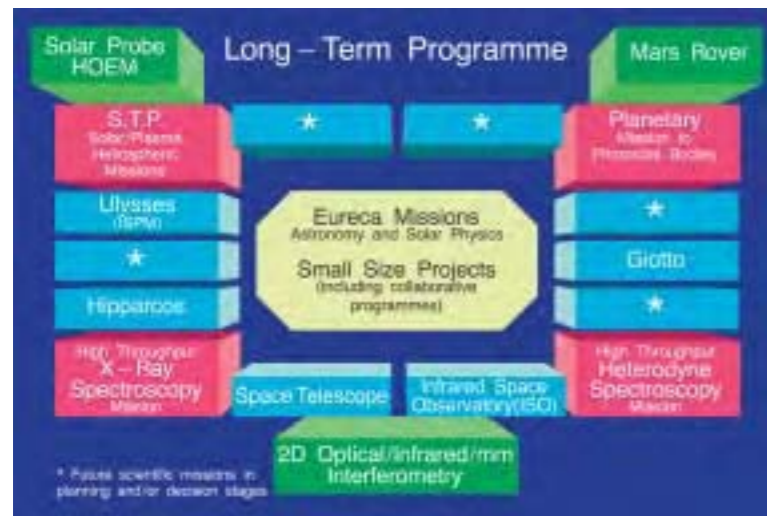

Above: the Horizon 2000 space science plan was formulated in 1985. Right: it was extended by Horizon 2000 Plus 10 years later, and jointly termed Horizons 2000. Financial constraints and the Cluster launch failure led to the later Medium (blue) missions being replaced by Flexi and SMART missions.

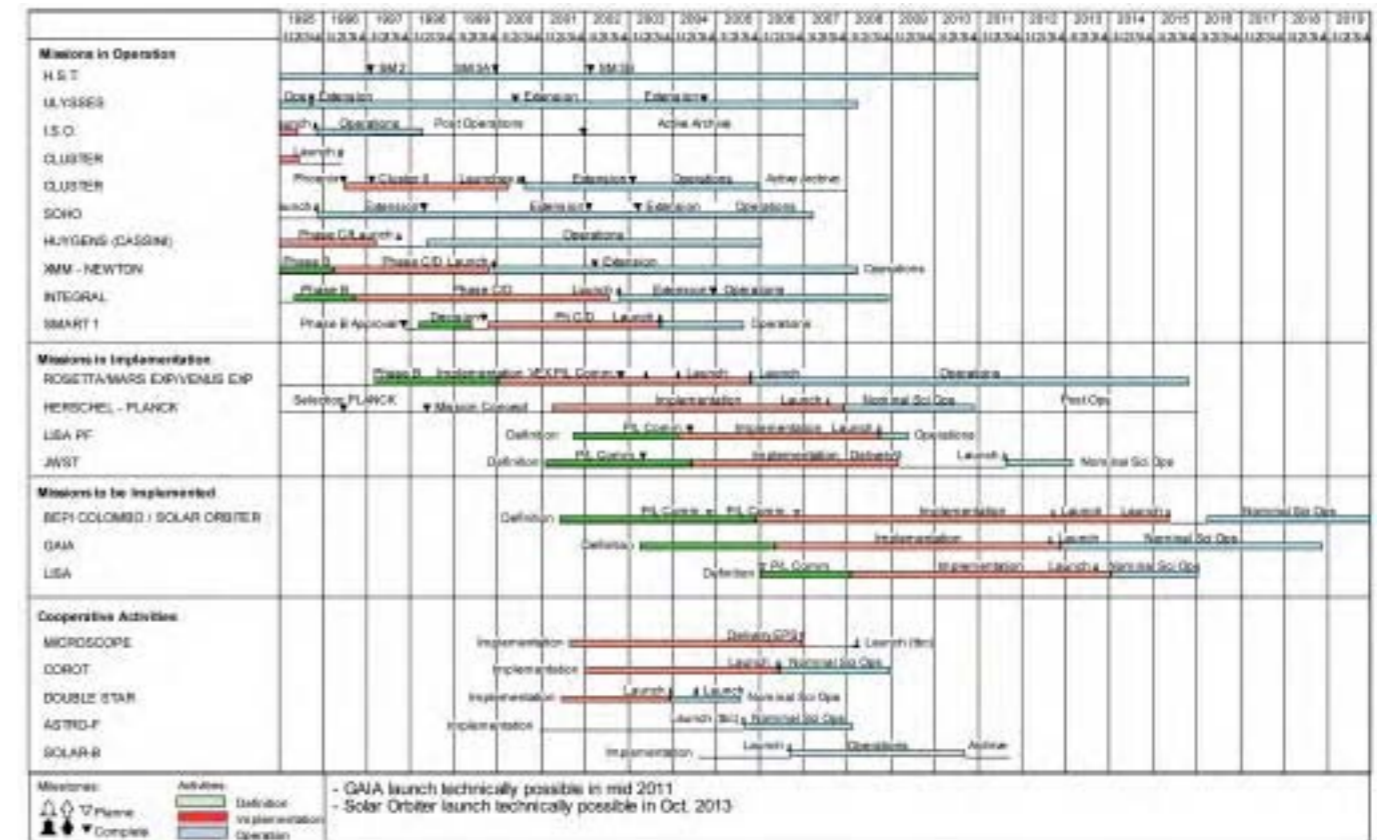

ESA Science Programme funding is currently about €370 million annually. The annual budgets have been converted into 2004 €, highlighting the gradual reduction in real terms. (Status November 2004.)

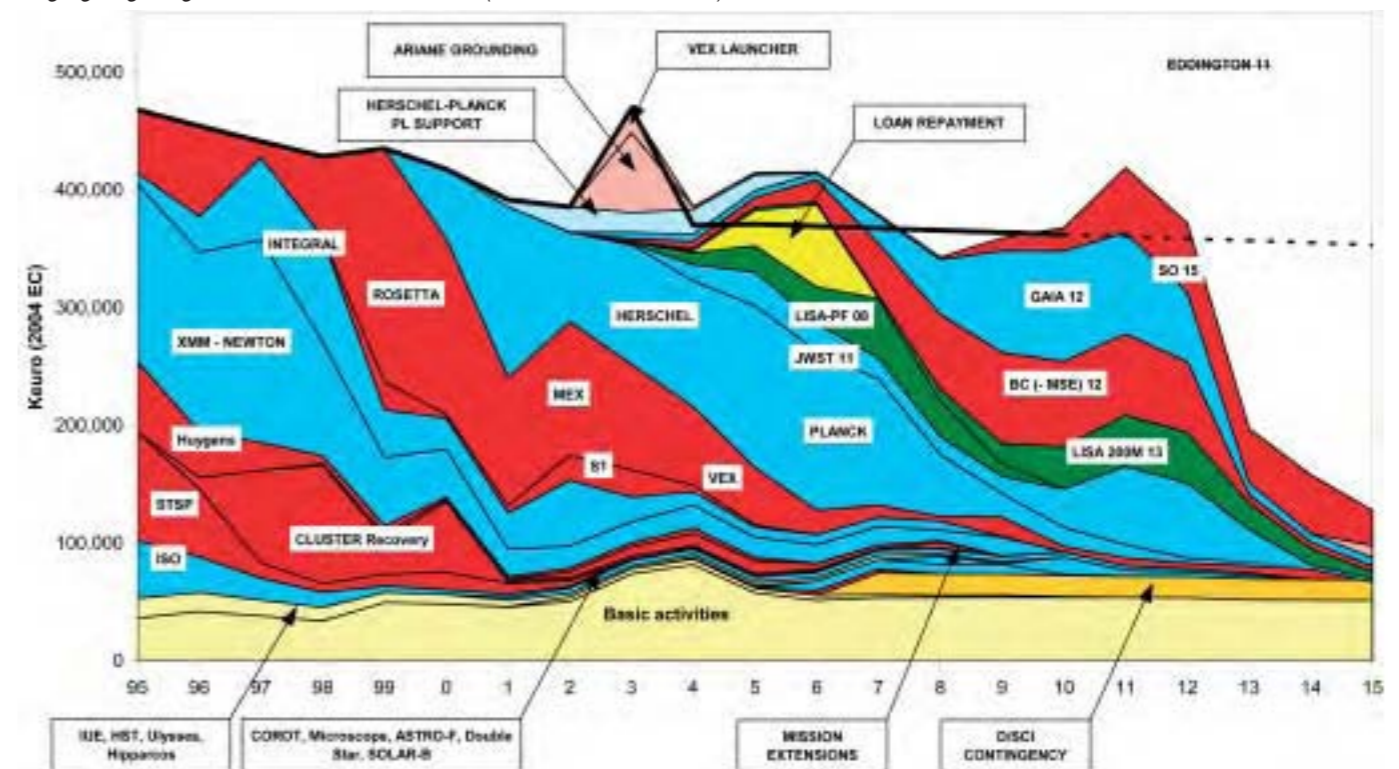

Gamma-Ray Astrophysics Lab is observing gamma-ray sources within our Galaxy and beyond, including exploding stars, black holes, gamma-ray bursts and pulsars.

SMART-1 (2002): demonstrating key technologies, including primary propulsion by a solar electric thruster, critical for BepiColombo.

Mars Express (2003): this orbiter is intensively studying Mars.

Rosetta (2004): arriving at Comet Churyumov-Gerasimenko in 2014, Rosetta will orbit the nucleus for 2 years of intensive studies, depositing a lander.

Venus Express (2005): reuse of Mars Express bus and instruments.

Planck (2007): the mission to map the structure of the Cosmic Microwave Background, in unprecedented detail. Launch in tandem with Herschel.

Herschel (2007): using one of the least explored windows on the Universe, it will observe the births

of stars and galaxies throughout the history of the Universe. Launch in tandem with Planck.

LISA Pathfinder (2008): to demonstrate key technologies for LISA.

JWST (2011): 15% contribution to NASA's infrared observatory for probing back to the time of the very first stars.

Gaia (2011): building on Hipparcos to create a high-precision 3-D map of 1000 million stars in our Galaxy and beyond.

BepiColombo (2012): two Mercury orbiters, arriving 2017, in collaboration with Japan.

Solar Orbiter (2013): SOHO successor to study the Sun to within 45 solar radii.

LISA (2013): three satellites in formation to detect gravitational waves for the first time, in collaboration with NASA.

ESA and Earth Observation

It has become increasingly recognised over the past three decades that many key aspects of monitoring and managing our planet can be adequately addressed only by observing the Earth from space. In this respect, ESA's role has been critically important.

The Earth's environment and climate are determined not only by complex interactions between the atmosphere, oceans, land and ice regions, but also by mankind's ability to affect them. Our future depends on the careful management of resources and on an improved understanding of the interactions creating our ecosphere.

The first of seven first-generation Meteosat meteorological satellites, originating under ESA's auspices, appeared in 1977 to monitor the weather of Europe and Africa from a vantage point over the Equator. The success of that first satellite led to the formation of the European Organisation for the Exploitation of Meteorological Satellites (Eumetsat) in 1986, which took over direct operational control in December 1995.

It has been estimated that the total benefits from improved weather forecasts due to Meteosat alone equate to about €125 million annually in cost savings for all industries and €137 million in saving of life and reduction in environmental damage. Agriculture alone saves €30 million and civil aviation €11 million each year. In addition, the capacity of weather satellites to gather long-term measurements from space in support of climate-change studies is of growing importance.

The Meteosat Second Generation (MSG) entered service in 2004. Jointly funded by ESA Member States and Eumetsat, the programme began in 1994 to enhance the performance of today's satellites, incorporating a much-improved imager and the first instrument capable of observing the Earth's radiation balance from geostationary orbit. MSG provides the most advanced capabilities available from geostationary orbit. It is not only a major advance in monitoring changing weather patterns over an entire hemisphere, but it is also improving storm warnings and long-term forecasts, while contributing significantly to global climate research. MSG sees much more clearly and frequently than its predecessors, revealing features like thunderstorms, encroaching storm fronts, fog banks and other hazardous weather conditions. By monitoring ozone in the upper atmosphere, MSG is improving forecasts of harmful ultraviolet light levels and thereby reducing the threat of skin cancer.

The Meteosat Third Generation (MTG) is already under study, with the aim of entering service in 2015.

Polar-orbiting meteorological satellites will be added in 2006 with the first of three Metop (Meteorological Operational) spacecraft developed by ESA and Eumetsat. This will not only continue and improve meteorological observations previously provided by US NOAA satellites in the 'morning' polar orbit, but it will also endow Europe with an enhanced capability for routine climate monitoring. Notable improvements include routine observations of sea-surface

The Meteosat Second Generation entered service in 2004 to extend services to Europe's meteorological agencies. MSG-1/Meteosat-8 final inspection. (Alcatel Space Industries)



The series of eight Meteosats has returned hundreds of thousands of Earth images from geostationary orbit. (Meteosat-8 image, 19 May 2003; Eumetsat)

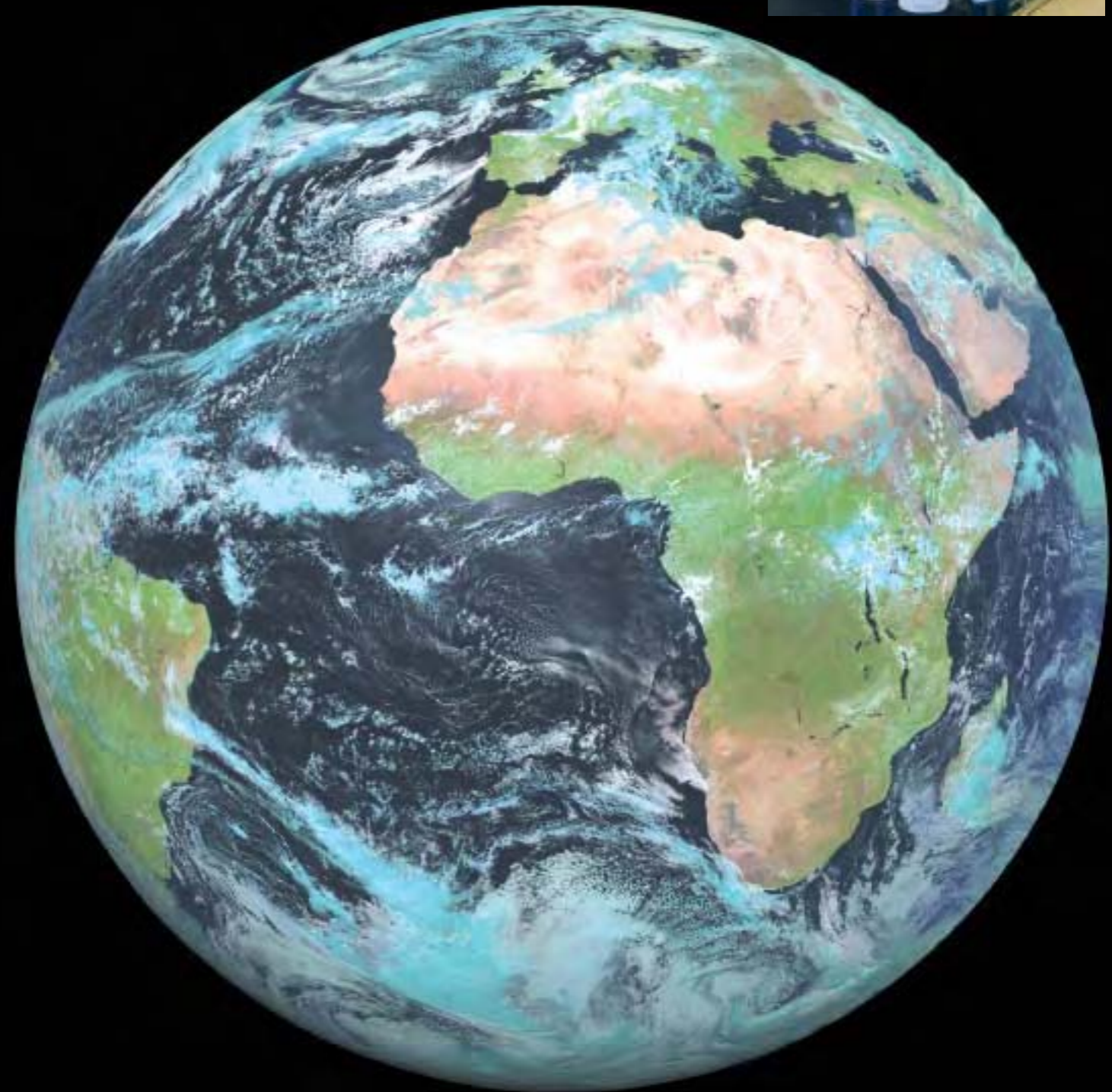

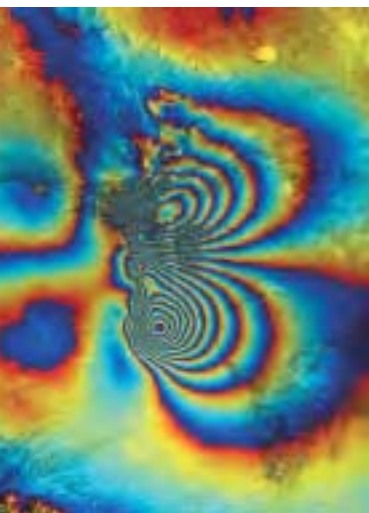

wind fields, ozone levels and much higher-resolution temperature and humidity profiles.

ESA's first remote-sensing satellite series, ERS, continues to make major contributions in areas as diverse as global and regional ocean and atmospheric science, sea ice, glaciological and snow cover investigations, land surface studies and the dynamics of the Earth's crust. For example, global maps of sea-surface winds are routinely provided as inputs to numerical weather forecasting. The 1991 launch of ERS-1 was followed in 1995 by

ERS-2, which added the Global Ozone Monitoring Experiment to address an area of growing concern, namely atmospheric chemistry, and in particular to generate global ozone maps every 3 days.

ESA's large Envisat second generation remote-sensing satellite appeared in orbit in 2002. It not only ensures continuity of many ERS observations but adds important new capabilities for understanding and monitoring our environment, particularly in the areas of atmospheric chemistry and ocean biological processes.

Envisat is carrying the three most advanced instruments to date to study atmospheric chemistry: MIPAS, GOMOS and SCIAMACHY. They are helping us to understand the complex processes behind the growing greenhouse effect.

The MERIS instrument is recognised as providing unprecedented spectral resolution for land and ocean research and applications. In addition, the ATSR instrument on ERS and Envisat is the most accurate source of sea-surface temperature measurements from space, and the only one able to study long-term

The global reach of the Envisat environmental satellite is revealed by this portrait of Planet Earth in 2004. Envisat's MERIS imaging spectrometer reveals a wide variety of land covering, from ice to forest, grassland to desert. For this true-colour mosaic, a total of 1561 orbits during May, July, October and November 2004 were used to screen out the clouds.

Inset: ASAR interferogram of the Bam (Iran) earthquake of 26 December 2003. Combining images taken shortly before and after the level-6.3 quake shows the 5-30 cm ground movement, revealing a fault previously unsuspected.

climate change by virtue of its accuracy and continuity over up to 18 years in orbit.

The Agency's strategy for Earth observation beyond 2000 was endorsed by ESA's Council in March 1998 after being approved in principle by the Ministerial Council of October 1995 in Toulouse. ESA's 'Living Planet' programme follows on from Envisat, and is designed to cover the whole spectrum of user interests ranging from scientific research to applications. Research-driven Earth Explorer missions are paralleled by Earth Watch missions, designed to focus on specific applications and service provision to satisfy operational user needs.

Member States subscribe to the overall Explorer financial envelope, so that each project no longer has to be approved separately. As has long been the case in ESA's Science Programme, this allows a coherent, long-term set of missions to be developed.

The Earth's environment is a highly complex system coupling the atmosphere, oceans, biosphere and cryosphere. Despite its importance, many aspects of this Earth system are still poorly understood and we are struggling to assess global threats such as climate change, stratospheric ozone depletion and tropospheric pollution, as well as more localised events such as the 1998 El Niño event, fires in South East Asia and devastating earthquakes in Turkey. Observations from space can provide the required globally coherent data.

Explorer offers two mission types: Core and Opportunity. The larger

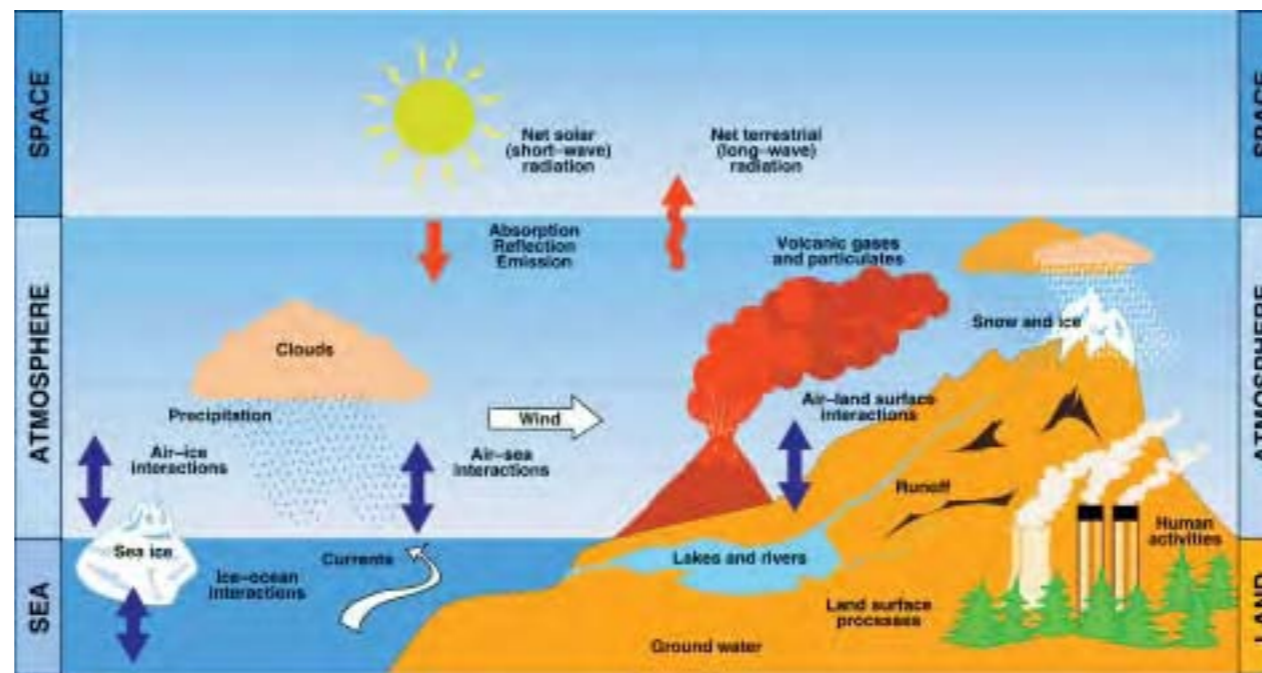

Core missions are selected through a traditional process involving extensive consultation with the user community. Opportunity missions are intended to respond quickly to flight opportunities or to user requirements, and are not necessarily ESA-led. In this way, the programme combines stability with flexibility, notably the ability to respond quickly to an evolving situation. Core missions cost the Agency no more than €425 million (2004 conditions), while Opportunity missions cost an average €110 million (€170 million maximum in 2004 terms). The goal is to fly a Core mission about every 2 years, interspersed with Opportunity missions.

Explorer Core Missions

An Earth Observation User Consultation Meeting at ESTEC in October 1994, followed by other consultations, identified nine candidate Core missions. These were assessed by ESA working groups and four were selected in November 1996 for June 1998 to June 1999 Phase-A studies: Earth Radiation Mission (ERM), Gravity Field and Steady-State Ocean Circulation Mission (GOCE), Land Surface Processes and Interactions Mission (LSPIM) and

Atmospheric Dynamics Mission (ADM-Aeolus). GOCE and ADM were selected in order of priority in November 1999. GOCE immediately began Phase-B for launch in 2006, while ADM-Aeolus began Phase-B in 2002 for launch in 2007.

GOCE will measure the Earth's gravity field and geoid with unprecedented accuracy and resolution using a 3-axis gradiometer. This will improve our understanding of the Earth's internal structure and provide a much better reference for ocean and climate studies.

ADM-Aeolus will make the first direct observations on a global scale of wind profiles over the depth of the atmosphere, a notable deficiency in current observing methods. This is important for understanding atmospheric processes – particularly in the tropics – as well as improving the numerical modelling used in weather forecasting.

The second Call for Ideas for Core missions was issued on 1 June 2000, receiving ten proposals by the 1 September 2000 closing date. On 20 November 2000, ESA selected five for assessment studies:

The Earth's environment is a highly complex, coupled system. Understanding it requires observations from space.

ACECHEM: Atmospheric Composition Explorer for Chemistry and Climate Interaction to study climate-chemistry interactions and man-made effects;

EarthCARE: Earth Clouds Aerosol and Radiation Explorer (encompassing ERM) to measure the physical properties of clouds and aerosols to improve climate modelling and our understanding of Earth's radiation balance; joint mission with JAXA;

SPECTRA: Surface Processes and Ecosystems Changes Through Response Analysis to measure vegetation parameters for studying the carbon cycle and the effects of climate variability on ecosystems (builds on LSPIM);

WALES: Water Vapour Lidar Experiment in Space to measure water vapour and aerosol distribution in the troposphere;

WATS: Water Vapour and Wind in Atmospheric Troposphere and Stratosphere to monitor water distribution for assessing climate change (encompassing the ACE hot standby from the Opportunity missions).

Three were selected on 29 November 2001 for 12-month Phase-A studies: EarthCARE, SPECTRA and WALES. On 28 May 2004, the Programme Board announced the choice would be between EarthCARE and SPECTRA, although EarthCARE was ranked first. The Board of 24 November 2004 voted for EarthCARE, with launch in 2012.

Explorer Opportunity Missions

The AO for Opportunity missions was released on 30 June 1998 and 27 proposals were received by closure on 2 December 1998. On 27 May 1999, ESA approved CryoSat as the first for

GOCE



ADM-Aeolus



EarthCARE

CryoSat



SMOS



Swarm

Phase-A/B, with an extended Phase-A for SMOS. CryoSat will measure the variations in the thickness of the polar ice sheets and the thickness of floating sea ice. SMOS will measure soil moisture and ocean salinity – two key variables in the Earth system. Launches are expected in 2005 and 2007, respectively.

Work continued on ACE (Atmospheric Climate Explorer) as a hot backup should the first two suffer problems. It would monitor GPS signals refracted through the upper atmosphere to measure temperature and humidity. ACE+ competed again for the third Opportunity slot in 2004. Swarm and SWIFT were held in reserve. Multiple Swarm satellites would measure the geomagnetic field at high resolution, providing new insights into the Earth's structure. SWIFT (Stratospheric Wind Interferometer for Transport studies) would map winds and ozone in the stratosphere.

In fact, SWIFT (largely funded by Canada) was approved in October 2000 by Japan's NASDA (now JAXA) space agency to fly on Gosat (Greenhouse Gas Observing Satellite) in 2007. It remains part of Earth Explorer but flying cooperatively leaves the funding intact for further full ESA missions.

The next Opportunity AO was made on 1 June 2001 and 25 full proposals were received by closure in January

2002. The Programme Board selected three on 16 May 2002 for Phase-A studies: Swarm, ACE+ and EGPM (European contribution to the Global Precipitation Mission). Swarm was selected by the Programme Board on 28 May 2004 for launch in 2009. EGPM was recommended for consideration as part of Earth Watch.

GOCE, ADM-Aeolus, Cryosat, SMOS, Swarm and EarthCARE are covered in separate entries.

The next Call for Ideas for Earth Explorer Core missions was issued on 15 March 2005, with a deadline of 15 July 2005. Up to six candidate missions will be announced on 30 December 2005 for further studies.

Further information on Earth Explorer can be found at <http://www.esa.int/livingplanet>

Earth Watch

Earth Watch missions are the prototypes for future operational systems, focusing on specific applications and service provision to satisfy user needs in partnership with industry and operational entities. Driven by the operational user communities, Earth Watch missions are being implemented with partners who will eventually take responsibility for service continuity. The long-term guaranteed provision of services is essential, which means they must be sustained outside of ESA's research budgets. The

collaboration with Eumetsat on meteorological satellites is the first example of Earth Watch mission implementation.

Central to Earth Watch is the initiative for **Global Monitoring for Environment and Security (GMES)**. Institutional needs include the emerging requirements of GMES, defined as part of the European strategy for space jointly established with the European Commission. GMES centres on three major environmental themes: global changes, including management of treaty commitments; natural and manmade hazards; and environmental stress. In addition, peacekeeping and security require all-weather high-resolution imagery. GMES itself is not a satellite programme, but is the link between Europe's political requirements and the capabilities provided by observation satellites, ensuring that the integrated information required at the political level is available. It is expected to be a major new arena for ESA; full implementation of GMES will be decided at the next Ministerial Council in December 2005. Following Galileo, it will be the second major joint activity with the EC.

GMES means optimising the use of current and future Earth observation systems, whose unique perspectives provide a whole new dimension of information about the Earth. As a first step, ESA is supporting a pilot suite of operational observation-

based services. This 5-year €84 million first GMES programme, known as the GMES Services Element (GSE), was approved at the Ministerial Council of November 2001 for 2002-2006. For example, 'Coastwatch' is providing information in support of coastal management. Data from GSE supports the work of scientists, policymakers and implementers within government agencies, non-governmental organisations and key international scientific bodies. The needs of GSE users are also influencing the design of future European satellite systems. Already, initial studies are under way on the five 'Sentinel' satellites that would form the backbone of the European system to monitor the environment:

Sentinel-1 A SAR family, continuing established applications, especially interferometry. Begin operating end-2008.

Sentinel-2 Superspectral terrestrial imaging, continuing Landsat and Spot. Begin operating 2009.

Sentinel-3 Ocean monitoring. Begin operating 2010-2011.

Sentinel-4 A GEO family for atmospheric composition and trans-border pollution monitoring. Begin operating end-2012.

Sentinel-5 A LEO family for atmospheric composition monitoring. Begin operating end-2012.

Further information GMES can be found at <http://earth.esa.int/gmes>

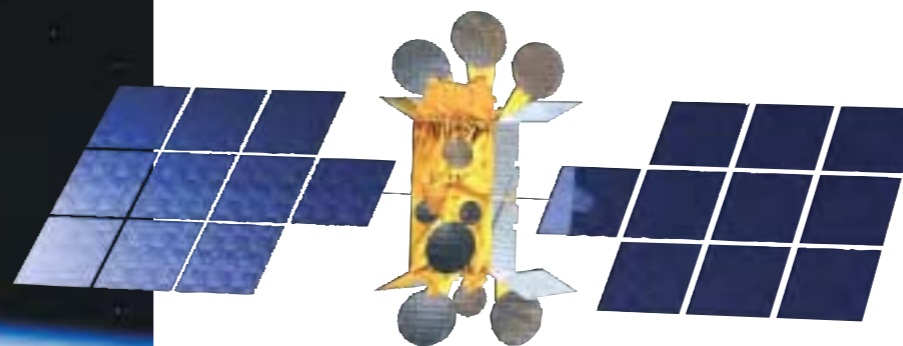

Far left: Artemis is successfully demonstrating new technologies such as mobile communications and inter-satellite laser links. Left: AlphaBus will provide Europe with a competitive powerful commercial satellite.

ESA and Telecommunications

ESA has played the lead role in developing space communications for Europe, with the Orbital Test Satellite (OTS), European Communications Satellite (ECS), Maritime ECS (Marecs) and the direct-broadcasting Olympus. Public telecommunications services have made full use of ESA satellites, through Eutelsat and Inmarsat; some satellites served for more than 15 years. Artemis, launched in 2001, is demonstrating further innovative techniques.

After a relatively late start, European space industry has achieved a high level of technical competence. In 2000, its provision of commercial telecommunications satellites exceeded that of US industry for the first time. ESA's long-term telecommunications plan is to help European industry maintain and improve its competitiveness. The Agency's programme accounts for a cumulative expenditure in excess of €1 billion, but it is estimated that more than €2.7 billion has been generated in service revenues and about €3 billion in industry turnover.

OTS was the first-ever Ku-band satellite with 3-axis stabilisation, a concept that has since become the standard for telecommunications satellites worldwide. Some 30 satellites built in Europe were derived from the original OTS design. ESA's second technology demonstration mission, Olympus, began in 1989. Its four advanced payloads helped to

push back the frontiers of new telecommunications services such as direct-to-home TV, business networks, narrowcasting and videoconferencing. ESA continues to help European industry gain a foothold in the market for second-generation satellite systems for personal and mobile communications. Artemis is demonstrating the next generation of European services: voice and data links between mobile terminals, mainly on cars, trucks, trains and boats; accurate navigation information broadcast as part of the European Geostationary Navigation Overlay Service (EGNOS), to augment the US Global Positioning System (GPS) and Russia's similar Glonass system; and high-rate data links directly between satellites are helping Europe to reap the benefits of its investment in Earth observation from space by bringing data directly to the user where it is needed most. The combined use of GPS positioning data and the pan-European mobile communications capabilities of Artemis promise improved transport management.

Commercial satellites are growing inexorably larger and more powerful, and Europe cannot afford to be left behind. Around 100 in-orbit satellites will need replacement during 2006-2011, so the commercial potential is huge. European satellites are so far limited to 10 kW payload power, which meant that the €4 billion market of 1998-2003 for larger satellites was left entirely to US manufacturers. In response, ESA and CNES are working

with EADS Astrium and Alcatel Space to develop the 12-18 kW AlphaBus platform. It will accommodate 100-250 transponders, and antennas up to 7.5 m diameter will handle high-power mobile missions such as future 3G-type handsets. The payload will be powered by the 15-25 kW solar array. Launch mass will be 5.5-8 t, sized to fit in the 5 m-dia fairing of Ariane-5. Technology developments include electric propulsion, deployable radiator panels, active fluid loops and heat pipes for heat dissipation, new solar-array technology, a 500 N apogee boost motor, Li-ion batteries, fibre-optic gyroscopes, accelerometers and a new generation of star trackers. These developments will give AlphaBus growth potential up to 25 kW payload power.

ESA and Navigation

For the first time, the Agency has taken a lead role in the navigation segment. ESA and the European Commission have joined forces to design and develop Europe's own satellite navigation system, Galileo. Whereas GPS and Glonass were developed for military purposes, the civil Galileo will offer a guaranteed service. It will be interoperable with GPS and Glonass, so that a receiver can use any satellite in any system. However, Galileo will deliver positioning accuracy down to 5 m, which is unprecedented for a public system.

The European Commission, ESA and private industry are meeting the €3.55 billion cost (2001 conditions) through a public/private partnership. Studies suggest that Galileo will repay its investment handsomely – at a ratio of 4.6 – estimating that equipment sales and value-added services will earn €90 billion over 20 years.

The fully-fledged service will be operating from about 2010 when 30 Galileo satellites are in position in circular orbits 23 222 km above the Earth. The first will be launched in 2008 and by 2009 sufficient should be in place to begin an initial service.

This is the Agency's first major joint venture with the European Commission, laying the foundations for expanding together into global monitoring and communications.

Europe's first venture into satellite navigation is EGNOS, a system to improve the reliability of GPS and Glonass to the point where they can be used for safety-critical applications, such as landing aircraft. Working in close cooperation with the EC and the European Organisation for the Safety of Air Navigation (Eurocontrol), ESA will begin EGNOS operations in 2005 using payloads on Artemis and two Inmarsat satellites working with a network of ground stations to increase navigation receiver accuracy (2 m instead of 20 m) and reliability.



The first Galileo navigation satellite is expected to be launched in 2008.

Ariane-5 entered commercial service in 1999 as Europe's new heavy-lift launcher. (ESA/CNES/CSG)

ESA and Launchers

Through the Ariane launcher programme, ESA has provided Europe with autonomous access to space – the strategic key to the development of all space applications. Moreover, having been developed initially for the sake of European independence, the Ariane launcher has become Europe's most spectacular commercial space success by virtue of the volume of business and the share of the world market it has achieved. It is one of the most important factors in Europe's credibility as a space power.

The space ministers of 10 countries decided in Brussels in July 1973 to develop a competitive satellite launch vehicle that would capture a significant share of the expected market for launching applications satellites. Arianespace was established in 1980 to contract, manage production, finance, market and conduct the launches.

Ariane proved to be a resounding technical and commercial success. In 1998 alone, the profit reported by Arianespace was €12.6 million on revenues of €1.07 billion from 11 launches involving 14 satellites. Taxpayers' investment of €6 billion between 1974-2000 was handsomely rewarded by the more than €18 billion generated by launch contracts.

Beginning with the maiden Ariane in December 1979, there was a total of 144 launches, successfully delivering 196 main satellites and 25 auxiliary payloads into orbit. The 1.85 t capacity into geostationary transfer orbit (GTO) by the initial Ariane-1 model grew into more than 4.95 t for the Ariane-4.



Ariane-1 scored a remarkable success on its first launch (shown). Ariane-4 then more than doubled the original capacity and was long the world's most successful commercial launch vehicle. (ESA/CNES/CSG)

First launched in 1996, the radically new Ariane-5 completely assumed the mantle of Europe's main launcher in 2003. The ESA Ministerial Council meeting in November 1987 endorsed the development of this first European heavy-lift launch vehicle. Although Ariane-1 to -4 were outstandingly successful, it was clear that a larger vehicle would be required to handle the ever-growing telecommunications satellites dominating the payload market. Ariane-5's goal is to reduce the payload cost/kg by more than 40%.

The maiden launch, in June 1996, was unsuccessful, but two further launches by the end of 1998 proved



*The Vega small launcher
will make its debut in late
2007.*

*Soyuz launches are
planned from the
Guiana Space Centre
beginning in 2008.
(ESA/D. Ducros)*



the vehicle's capabilities. Ariane-5 is now in the hands of Arianespace for commercial exploitation. But the market does not stand still and the initial target capacity of 5.95 t into GTO is now unable to handle many paired satellites – essential for profitability. The October 1995 ESA Ministerial Council meeting therefore approved the Ariane-5 Evolution programme to expand capacity to 7.4 t. But even that is now insufficient to satisfy the market. ESA's Council in June 1998 approved the Ariane-5 Plus programme to offer 9 t into GTO using a cryogenic upper stage. The

maiden launch proved to be a failure, on 11 December 2002, but the second flight, on 12 February 2005, was a resounding success. Earlier that year, Arianespace had already placed an order worth around €3 billion for 30 vehicles to satisfy demand into 2009. By then, a larger cryogenic upper stage delivering 12 t into GTO may become a necessity.

At the end of 2000, ESA approved the development of the Vega solid-propellant launcher for smaller payloads – up to 1.5 t into a 700 km polar orbit from the Ariane launch site at Kourou, French Guiana. The cost to users will be held to €18.5 million by synergy with Ariane-5 production and operations. The qualification first launch, being offered to potential customers at a reduced price, is planned for November 2007.

In 2008, the payload capabilities of Ariane-5 and Vega will be extended by a pioneering collaboration with Russia. ESA on 4 February 2004 approved €223 million funding, in addition to €121 million from Arianespace, to build a complex at the Guiana Space Centre for commercial Soyuz launches.

This Soyuz version is based on the upgraded Soyuz-2 vehicle that first flew on 8 November 2004. Its GTO capacity will be 3 t, in contrast to the 1.7 t from Baikonur.

The new ELS (Ensemble de Lancement Soyuz) site is being built in freshly-cleared jungle 10 km northwest of the Ariane site and includes the launch pad and, 700 m away, the satellite preparation building. A rail track will take Soyuz



to the pad horizontally, as at Baikonur. The site has been designed so that it can be adapted for manned missions.

To prepare for the next launcher generation after Ariane-5, and aiming at drastically reducing the cost of access to space, ESA is carrying out a technology programme to prepare the best options for decisions on major developments around 2010. The FESTIP Future European Space Transportation Investigation Programme studied several concepts from 1994 to 2000, with more than 30 companies pooling their efforts towards the goal of a Reusable Launch Vehicle (RLV) capable of placing 7 t into a low equatorial orbit and 2 t into polar. This was equivalent to 4 t in geostationary transfer orbit – now clearly well short of today's market needs as satellites grow larger, showing how difficult market prediction can be. So the FLTP Future Launchers Technologies Programme, approved at the May 1999 Ministerial Council, increased the target to 7.5 t into GEO.

Meanwhile, ESA gathered valuable data from the 1998 flight of the Atmospheric Reentry Demonstrator and collaborated with Germany to assist NASA in developing the X-38 prototype of the Crew Return Vehicle for the International Space Station. The Hermes spaceplane project in the early 1990s added considerable expertise.

Building on that FESTIP experience and on results from national programmes, ESA began preliminary work on its new Future Launcher Preparatory Programme (FLPP) in 2004 following approval of €37 million funding from the Ministerial Council

meeting in May 2003. The next period of FLPP will be put forward for approval at the next Ministerial meeting, in Berlin in late 2005.

Under FLPP, Europe will look at different launcher concepts, develop key technologies and test-fly experimental vehicles. Particular emphasis in the early stages is on reusable propulsion and advanced structures. Progress in these areas will allow ESA to select the preferred reusable launch vehicle system concept by 2007 and to complete comparative system studies of expendable and reusable concepts for the next-generation launcher by 2010.

Two-stage and multi-stage semi-reusable vehicles are already within our grasp, and they may be a step on the road to building fully reusable successors. A Two-Stage-To-Orbit design would typically involve a reusable, large spaceplane releasing a second, smaller reusable vehicle at high altitude to make its own way to orbit. The first stage would return to base for a fast turnaround, like an aircraft, before its next trip.

After further detailed studies of the most promising concepts and demonstration flights of experimental vehicles by the FLPP, a decision to proceed with the full development of the next-generation launcher could be taken around 2012. However, major advances will have to be made in many areas, including engines, guidance and navigation, and lightweight reusable structures, before this becomes a reality. The goal is to have a new-generation vehicle operational by 2020 that reduces today's €15 000/kg cost into orbit by around two-thirds.

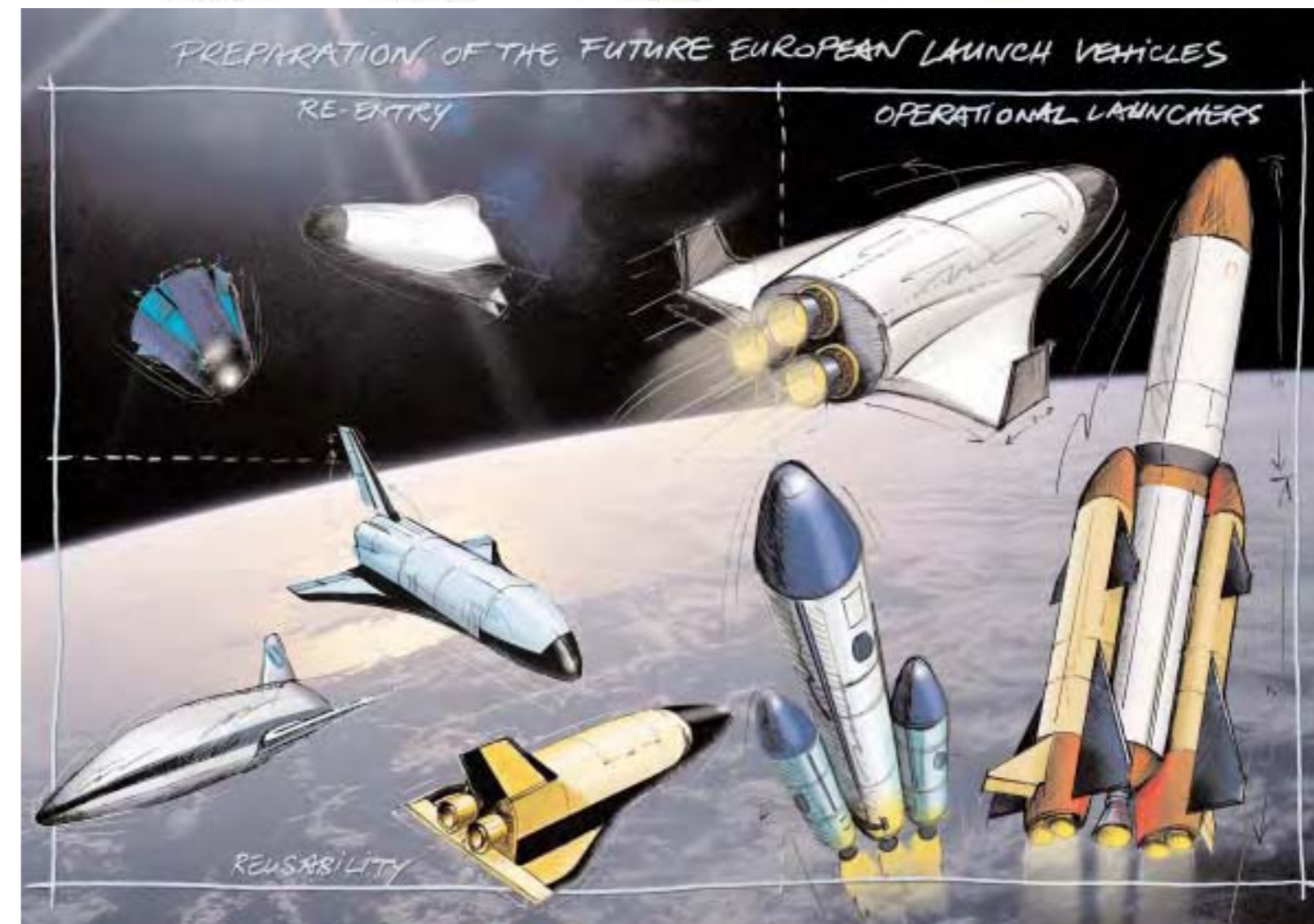

ESA and Manned Spaceflight

European involvement in manned spaceflight stretches back to 1969, when NASA issued an invitation to participate in the post-Apollo programme. Europe opted in December 1972 to develop the modular Spacelab as an integral element of the Space Shuttle. Spacelab's 22 missions between November 1983 and April 1998 made outstanding contributions to astronomy, life sciences, atmospheric physics, Earth observation and materials science.

Spacelab's debut also saw the first ESA astronaut, Ulf Merbold, venturing into space. By the end of 2004, ESA astronauts had made a total of 22 flights, comprising 14 aboard the Space Shuttle, three long-duration stays aboard Russia's Mir space station, and five Soyuz visits to the International Space Station. The Agency's first three astronauts were selected in 1977, six were added in 1992 and in 1998 a Single European Astronaut Corps was formed, creating a cadre of 16 astronauts by 2000.

ESA astronaut missions for the foreseeable future will, of course, centre on the International Space Station. This is the largest project of international cooperation ever undertaken. For the first time, almost half a century after the dawn of the Space Age, scientists and engineers have a permanent international presence in space. While orbiting at an average altitude of 400 km, they are performing scientific and technological tests using laboratories comparable with the best on Earth. The Station will be a research base like those built in the Antarctic or on the ocean floor, but it uniquely involves five international Partners

(USA, Europe, Japan, Russia and Canada) and embraces almost all fields of science and technology.

Physicists, engineers, technicians, physicians and biologists are working together to pursue fundamental research and to seek commercially-oriented applications. Research will extend far beyond basic goals such as puzzling over the mysteries of life: the Station is a test centre for developing innovative technologies and processes, speeding their introduction into all areas of our lives.

Despite significant budget reductions in space activities, Europe in March 1995 committed itself to full partnership in the International Space Station and to providing elements on a strict schedule. This major multi-year investment immediately boosted Europe's aerospace industry, hard hit since the late 1980s by budget cuts in defence and aviation. Opting for this new space policy ensured that established teams of engineers and scientists could remain intact, assuring the future of European high technology.

Fully assembled, the International Space Station will total about 450 t in orbit and offer 1200 m³ of habitable volume – equivalent to the passenger cabins of two Airbus aircraft. With a length of 108 m, span of 80 m and vast solar panels, it is sheltering a permanent crew of two during the assembly phase – expanding to six from 2007 – as it builds towards completion in 2010. There will be six laboratories, including Europe's Columbus. The Russian Zvezda module provides the crew's living quarters. There will be European, Japanese and Russian research

Claude Nicollier works on servicing the Hubble Space Telescope, December 1999.

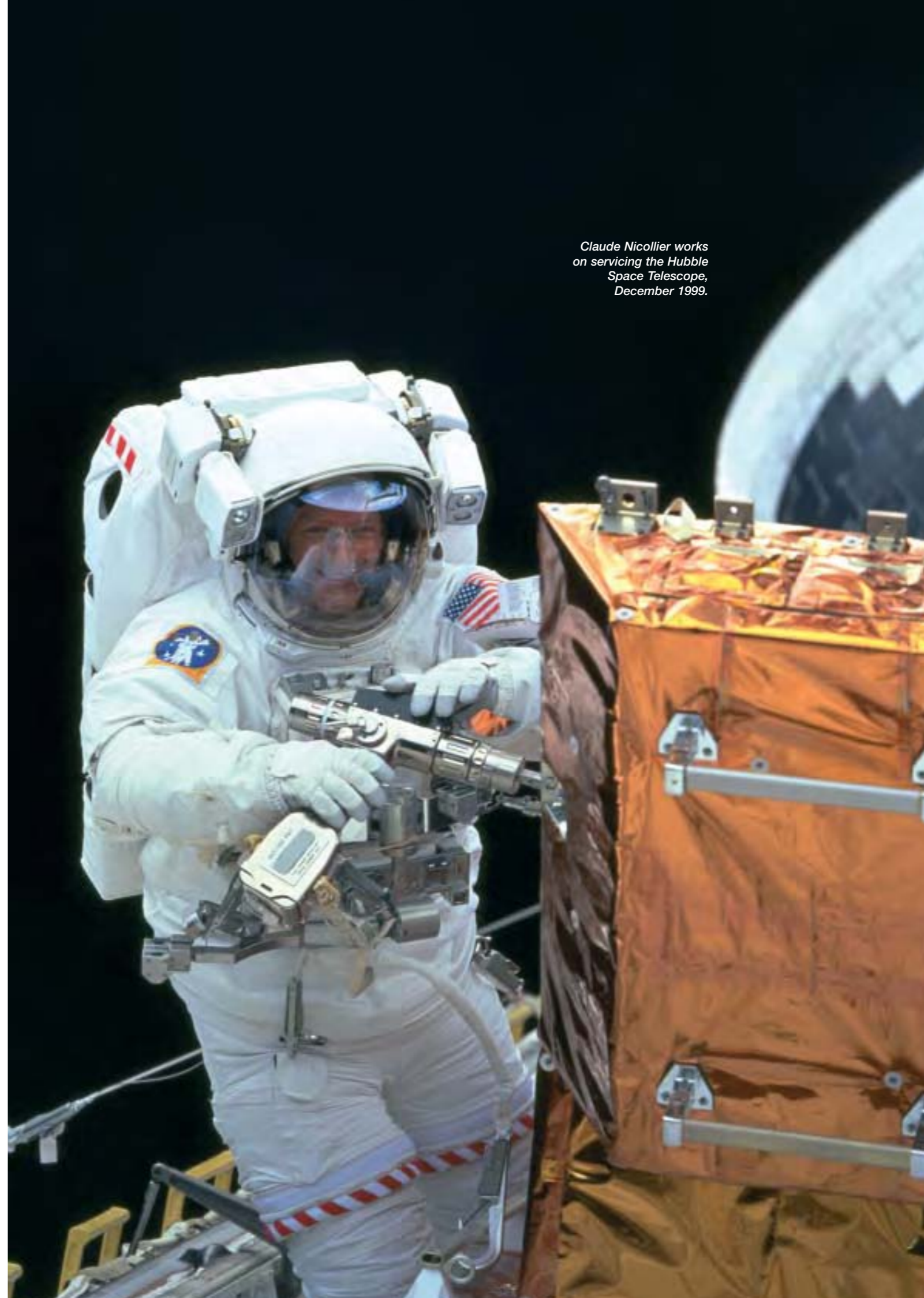

ESA's Automated Transfer Vehicle will deliver 7.4 t of supplies to the International Space Station on each mission. (ESA/D. Ducros)

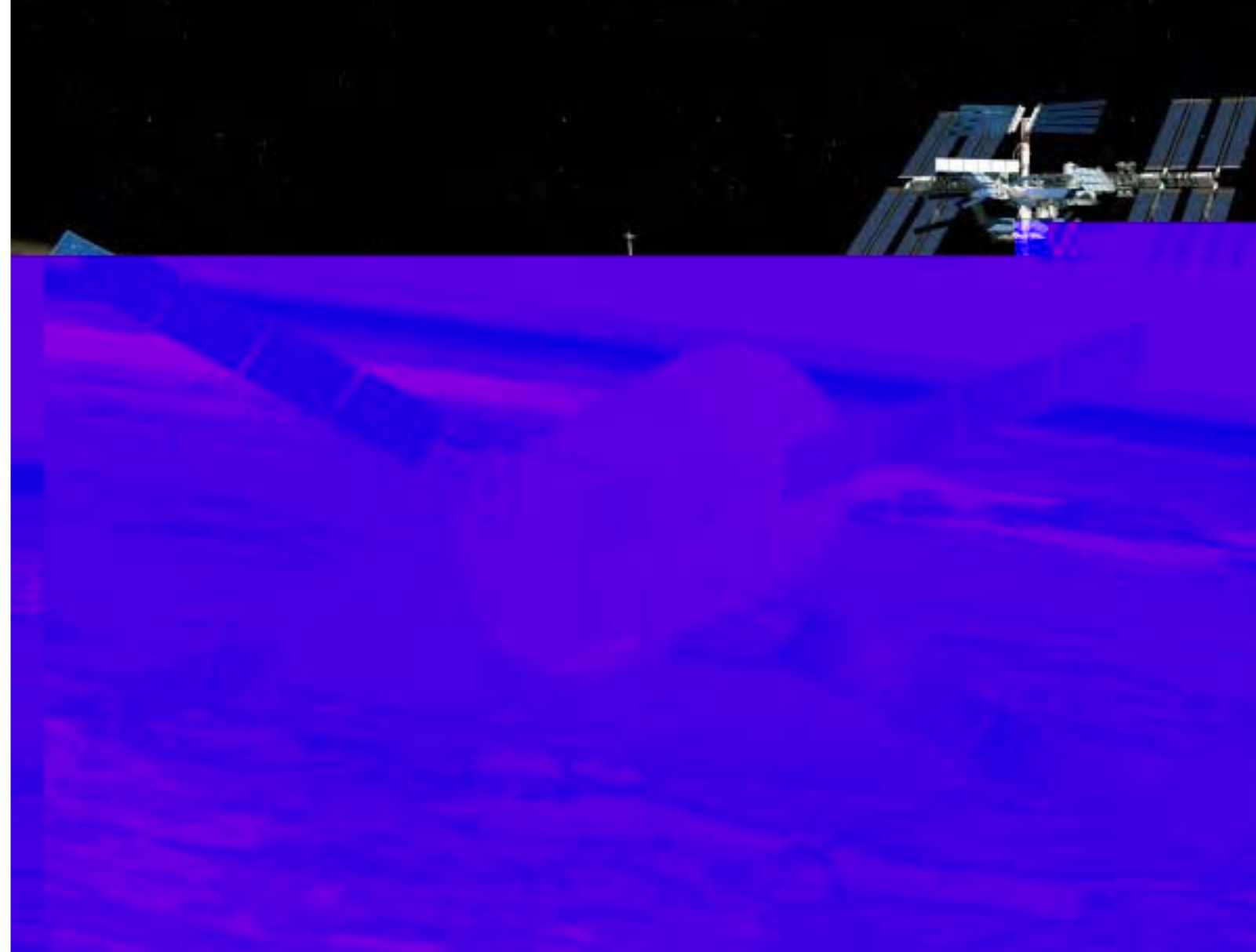

modules, all maintained with Earth-like atmospheres. Additional research facilities will be available in the connecting Nodes. The central 90 m 'truss' girder connecting the modules and the main solar power arrays will also carry Canada's 17 m-long robotic arm on a mobile base to perform assembly and maintenance work. A lifeboat Soyuz descent vehicle has always been attached since permanent occupation began in October 2000.

ESA's major contribution to the Station is the Columbus laboratory. Columbus provides Europe with the possibility for continuous exploitation of an orbital facility. In this pressurised laboratory, European astronauts and their international counterparts can work in a comfortable shirtsleeve environment. This state-of-the-art workplace, launched in late 2006, will support the most sophisticated research in weightlessness for at least 10 years. Columbus is a general-purpose laboratory, accommodating astronauts and experiments studying life sciences, materials science, technology development, fluid sciences, fundamental physics, biology and other disciplines.

In combination with the Ariane-5 launcher, the Automated Transfer Vehicle (ATV) will enable Europe to transport supplies to the International Space Station. Its 7.4 t payload will include scientific equipment, general supplies, water, oxygen and propellant. Up to 4.6 t can be propellant for ATV's own engines to reboost the Station at regular intervals to combat the atmospheric drag that pulls the Station towards Earth at around 200 m each day. Up to 860 kg of refuelling propellant can

be transferred for Station attitude and orbit control. Up to 5.5 t of dry cargo can be carried in the pressurised compartment.

ATV offers about four times the payload capability of Russia's Progress ferry. Without ATV, only Progress can significantly reboost the Station. Both technically and politically, it is essential that the Station can call on at least two independent systems.

An ATV will be launched on average every 15 months, beginning in early 2006, paying Europe's 8.3% contribution in kind towards the Station's common operating costs. It can remain docked for up to 6 months, during which time it will be loaded with waste before undocking and flying into Earth's atmosphere to burn up.

Another major ESA contribution to the Station is the European Robotic Arm (ERA). Mounted on the Russian Multipurpose Laboratory Module, the 11.3 m-long ERA manipulator arm will be launched in 2007. By replacing or supporting spacewalking astronauts, it reduces the risks and time spent on dangerous work in the harsh conditions of space. ERA has a reach of 10 m and strength to move around 8 t. While one 'hand' grasps one of the many base points on the Russian modules, the other is free to carry astronauts or large pieces of hardware. It can travel around the Russian part of the Station by moving hand-over-hand from one base point to the next.

Unusually, the main computer is mounted on ERA itself so that the versatile arm can be operated from inside or outside the Station.

ESA's principal contributions to the International Space Station.

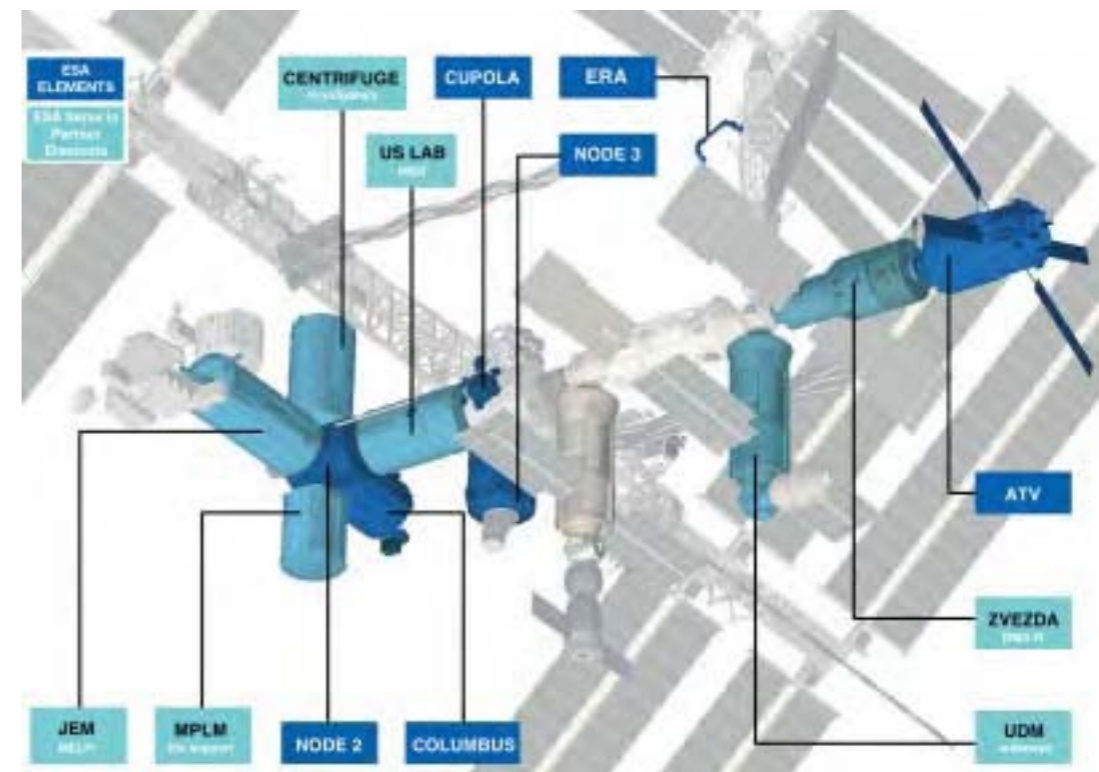

Pedro Duque floats through the Zvezda module of the ISS.



The ESA Astronaut Corps, May 2003. From left, front: Duque, Thiele, Clervoy, Guidoni, Eyharts, Ewald, Vittori, Nicollier; back: Nespoli, Reiter, Fugelsang, De Winne, Tognini, Schlegel, Perrin, Kuipers.

ESA astronaut missions		
Astronaut	Launch	Mission
Ulf Merbold	November 1983	STS-9/Spacelab-1
Wubbo Ockels	October 1985	STS-22/Spacelab-D1
Ulf Merbold	January 1992	STS-42/Spacelab IML-1
Claude Nicollier	July 1992	STS-46/TSS-1 + Eureca-1
Claude Nicollier	December 1993	STS-61/Hubble servicing
Ulf Merbold	October 1994	Euromir-94
J.-F. Clervoy	November 1994	STS-66/Atlas-3
Thomas Reiter	September 1995	Euromir-95
Maurizio Cheli	February 1996	STS-75/TSS-1R
Claude Nicollier	February 1996	STS-75/TSS-1R
J.-F. Clervoy	May 1997	STS-84/Mir
Pedro Duque	October 1998	STS-95
J.-P. Haigneré*	February 1999	Soyuz-TM27/Mir
Claude Nicollier	December 1999	STS-103/Hubble servicing
J.-F. Clervoy	December 1999	STS-103/Hubble servicing
Gerhard Thiele*	February 2000	STS-99/SRTM
Umberto Guidoni*	April 2001	STS-100/ISS + MPLM
Claudie Haigneré*	October 2001	Soyuz-TM33/ISS
Roberto Vittori	April 2002	Soyuz-TMA1/ISS
Frank De Winne	October 2002	Soyuz-TMA2/ISS
Pedro Duque	October 2003	Soyuz-TMA3/ISS
André Kuipers	April 2004	Soyuz-TMA4/ISS
Roberto Vittori	April 2005	Soyuz-TMA6/ISS
Planned		
Thomas Reiter	September 2005	STS-121/ISS
Christer Fuglesang	April 2006	STS-116/ISS

*mission flown under national agency while member of ESA Corps

The European Astronaut Corps

ESA began its manned flight programme with Spacelab, providing the opportunity for the selection of the first ESA astronauts in 1978: Ulf Merbold (D), Wubbo Ockels (NL) and Claude Nicollier (CH). Merbold was the first to fly in 1983 (STS-9) and Ockels flew 2 years later. Nicollier had to wait 14 years for his first flight (STS-46, 1992), but now leads the pack with four flights.

The second selection came in 1992 to prepare for the major Hermes and Columbus projects. More than 22 000 Europeans expressed interest in becoming astronauts, including 5500 serious candidates. Six were selected, including an existing national astronaut: Jean-Francois Clervoy (F). Also selected were Thomas Reiter (D), Maurizio Cheli (I; left in 1996), Pedro Duque (E), Christer Fuglesang (S) and the first woman, Marianne Merchez (B), who left before flying.

On 25 March 1998, the ESA Council agreed to build the single European Astronaut Corps of 16 astronauts (four for Germany, France and Italy, and four for all the other Member States). Member States could still call on their astronauts for missions

organised at the national level. The first group of seven joined the Corps in 1998: Gerhard Thiele (D), Hans Schlegel (D), Umberto Guidoni (I), Paolo Nespoli (I), Roberto Vittori (I), Léopold Eyharts (F) and Jean-Pierre Haigneré (F). Haigneré left the Corps in November 1999, after his second flight, to become Head of the Astronaut Division at the European Astronaut Centre (Cologne, D). Since 2004, he has been in charge of studying manned Soyuz flights from Kourou. A second group of four joined in 1999: Reinhold Ewald (D), André Kuipers (NL), Claudie Haigneré (F; formerly André-Deshays) and Michel Tognini (F). Frank De Winne (B) joined at the beginning of 2000. In June 2002, Claudie Haigneré took up the post of Minister for Research and New Technologies in the French government. In May 2003, Tognini left to head the Astronaut Division; he became head of EAC in January 2005.

Philippe Perrin (F) joined in December 2002 (after flying on the Shuttle in June 2002 as a CNES astronaut) and left in May 2004 to become a test pilot with Airbus Industrie in Toulouse. Guidoni left the Corps in June 2004, leaving a total of 13.



The goal of Aurora: Europeans on Mars by 2030.

Astronauts may assume control from the safety of Russia's Zvezda module, working via a laptop computer and detailed video images from ERA. Alternatively, ERA can be operated by a spacewalker via a sturdy external control panel.

As part of the barter agreement with NASA for launching Columbus aboard the Space Shuttle, ESA is providing two of the Station's three Nodes, the connecting elements between various laboratory and habitation modules. These Nodes-2

and -3 use the same structural concept as Columbus.

Major experiment facilities being developed by ESA include Biolab, the Fluid Science Laboratory, the Material Science Laboratory and the European Physiology Modules. ESA is also supplying -180°C and -80°C freezers for storing biological samples, the Microgravity Science Glovebox (installed in NASA's Destiny laboratory module in June 2002), and the 6-degrees-of-freedom Hexapod positioning and pointing

unit for external payloads. ESA is also providing the Cupola – a domed element with windows for the crew to control and directly view remote manipulator operations – in exchange for Shuttle launch/return services for five European external payloads.

ESA's philosophy in all of these barter arrangements is to pay in kind for services and responsibilities rather than through hard cash. Once Columbus is operational, ESA will have the right, on average, for a 3-month stay aboard the Station by an astronaut every 8 months.

Further information about ESA's contributions to the International Space Station, and its other manned spaceflight activities, can be found at <http://www.esa.int/spaceflight>

ISS operations will continue to at least 2016, so ESA is already considering further activities. The cargo carrier of ATV could be replaced with a recoverable capsule to return experiment results from the Station. This will become a pressing need if NASA carries out its declared intention of retiring the Shuttle fleet in 2010 when ISS assembly is completed. Manned Soyuz missions could be launched from Kourou, and Europe could cooperate in the development of the 'Clipper' new generation of Russian manned craft. The ISS could be used to demonstrate inflatable modules, regenerative life-support systems and 'intelligent' robots for future deep-space exploration.

The future direction of manned activities is reflected in the addition of 'Exploration' on 1 November 2004 to the name of the Agency's

Directorate of Human Spaceflight and Microgravity. Work is under way on creating a proposal for the European Space Exploration Programme to be placed before the next Ministerial Council meeting in December 2005. When US President G.W. Bush announced on 14 January 2004 a radical change of direction for US space activities – human exploration of the Moon and Mars – he provided a boost for European studies that began in 2002 with the ultimate goal of landing people on Mars by 2030 as part of an international endeavour. These first steps of the 'Aurora' programme were approved by the Ministerial Council meeting in Edinburgh (UK) in November 2001. If approved, Aurora would feature robotic missions to the Moon and Mars in preparation for human missions. Included would be the search for extraterrestrial life. There are two categories of Aurora missions: Flagship and Arrow. The first are major missions that serve as milestones on the road to Mars, building the knowledge and capabilities to achieve the final goal, while offering opportunities to a wide range of scientific disciplines. Arrow missions are smaller and designed to prove new technologies. Phase-A studies are under way on four missions:

- reentry vehicle demonstrator, 2007 (Arrow);
- aerocapture demonstrator at Mars, 2010 (Arrow);
- ExoMars, 2013 (Flagship). A Mars orbiter and rover with a 40 kg exobiology payload;
- Mars Sample Return, 2016 (Flagship), featuring an orbiter, lander and Earth-return module to deliver a martian soil sample.

Europa

Achievements: first European satellite launcher development programme

Launch dates: 11 launches 1964-1971

Launch site: Woomera (Australia) and Kourou (French Guiana)

Launch mass: 104 t Europa 1; 112 t Europa 2

Performance: 1150 kg LEO, 170 kg GEO from Kourou

The impetus for creating an independent space power in Europe began in the early 1960s. Belgium, France, Germany, Italy, the Netherlands and the United Kingdom (associated with Australia) signed the Convention in 1962 to create the European Launcher Development Organisation (ELDO), with the goal of developing a satellite launch vehicle independently of the two great space powers. The UK began development of the medium-range Blue Streak nuclear missile in 1955 under prime contractor de Havilland. The 2500 km range was increased to 4000 km in 1958 but the concept was overtaken by changes in the political and military landscapes – Blue Streak was cancelled as a missile on 13 April 1960. Rather than cancel it altogether, the UK government took up the idea of recycling it as a satellite launcher, using the UK Black Knight research rocket as stage 2. A 3-day conference in Strasbourg beginning 30 January 1961 produced an Anglo-French memorandum declaring that an organisation should be set up to develop a launcher using a Blue Streak first stage and a French second. Germany declared its intention in June 1961 to provide the third stage. The Lancaster House,



London meeting of 30 October - 3 November 1961 agreed on the guiding principles of the ELDO Convention, which was signed on 30 April 1962 and came into force on 29 February 1964. Italy was to provide the fairing and test satellites, Belgium the downrange guidance station and The Netherlands the long-

range telemetry links. Australia's contribution was the Woomera launch site.

ELDO A (later renamed Europa 1) was to be capable of delivering 500-1000 kg satellites into LEO orbits. The first three tests (see table) were promising but by now it was clear that Europe would need a vehicle capable of delivering telecommunications satellites into GEO by the early 1970s. In July 1966, the participants agreed to develop the ELDO PAS (Europa 2) version. The Perigee-Apogee System would use a solid-propellant motor at perigee and the satellite's own apogee motor to deliver 170 kg into GEO. The UK replaced the radio guidance system with inertial guidance, Italy provided the perigee motor and STV and France the operational launches from its Kourou base. There were also proposals to



replace the second and third stages successively with hydrogen-oxygen stages, to deliver 1 t into GEO.

Spiralling costs and disappointing tests of the upper stages increasingly threatened the whole organisation. With hindsight, there were two major problems: ELDO did not have genuine technical and management authority (which belonged to the Member States) and there was no overall prime contractor. The UK, under a different government since 1964, became lukewarm towards a European heavy launcher. In April 1969, the UK and Italy withdrew from Europa 2, while the other ELDO states resolved to begin studies of a Europa 3 to deliver 400-700 kg into GEO, indicative of French determination in particular to develop a heavy launcher that did not depend on Blue Streak.

The 5th European Space Conference (ESC) in December 1972 agreed to Europeanise the French L3S project (which became Ariane) and cancel Europa 3. ELDO's Council on 27 April 1973 decided to close the Europa 2 programme and to wind down the organisation. The 6th ESC in July 1973 paved the way for ESA's creation to merge the activities of ELDO and ESRO.

Europa 1 Characteristics

Launch mass: 104 t

Length: 31.7 m

Principal diameter: 3.05 m

Guidance: radio

Performance: 850 kg into 500 km circular orbit launched northwards from Woomera, 1150 kg launched eastwards from equatorial site.
800 km: 700 kg & 950 kg;
400x5000 km: 350 kg & 550 kg

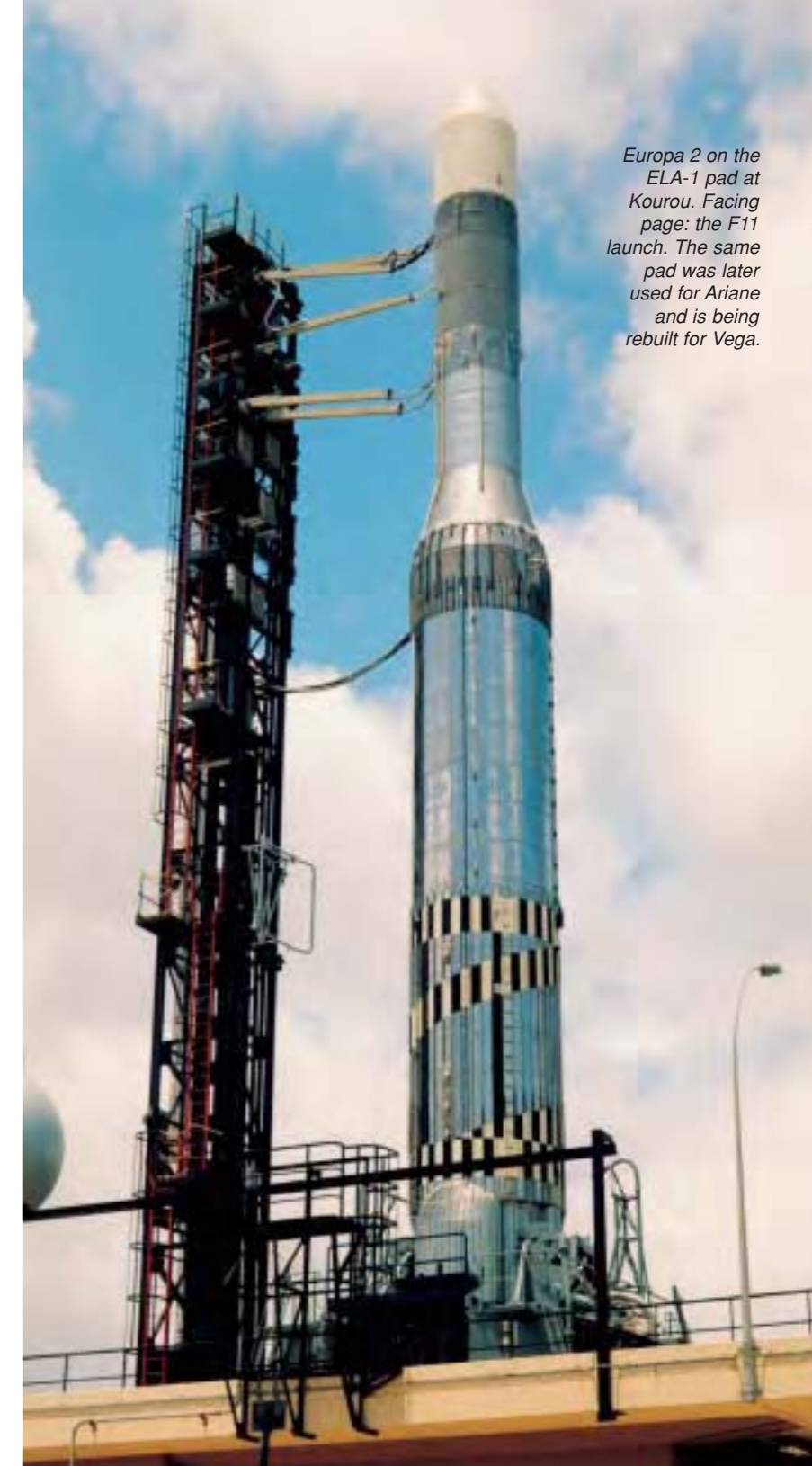

Europa 2 on the ELA-1 pad at Kourou. Facing page: the F11 launch. The same pad was later used for Ariane and is being rebuilt for Vega.

Stage 1 (Blue Streak)

Principal contractor: Hawker Siddeley Dynamics

Propulsion: 2x Rolls-Royce RZ-2 (US Rocketdyne S3 under licence), total 1334.4 kN sea-level thrust

Propellants: 84950 kg LOX/kerosene
Length: 18.7 m

Principal diameter: 3.05 m

Mass: 95025 kg (dry 6168 kg)

Burn duration: 160 s



Europa 1 at Woomera.

Stage 2 of Europa 2 F11 at Kourou.

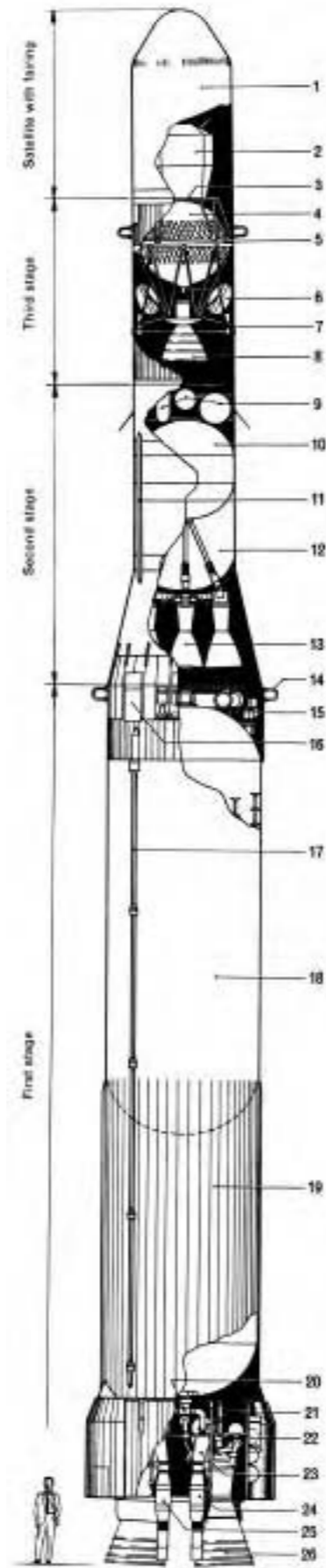

Europa Launch Record

	Date	Vehicle	Comments
F1	5 Jun 1964	Europa 1	Blue Streak-only. Success. Altitude 177 km, downrange 965 km. Engines shut down 6 s early (147 s) because of lateral oscillations induced by propellant sloshing (planned downrange 1500 km)
F2	20 Oct 1964	Europa 1	Blue Streak-only. Success. Altitude 241 km, downrange 1609 km
F3	22 Mar 1965	Europa 1	Blue Streak-only. Success
F4	24 May 1966	Europa 1	BS/inert upper stages/STV. Success
F5	15 Nov 1966	Europa 1	BS/inert upper stages/STV. Success
F6-1	4 Aug 1967	Europa 1	BS/stage 2/inert stage 3/STV. Success. Stage 2 failed to ignite
F6-2	6 Dec 1967	Europa 1	BS/stage 2/inert stage 3/STV. Stage 2 sequencer did not start; stage did not separate
F7	30 Nov 1968	Europa 1	All live + STV. Stage 3 burned 6 s. First orbital attempt
F8	3 Jul 1969	Europa 1	All live + STV. Stage 3 failed to ignite. Second orbital attempt
F9	12 Jun 1970	Europa 1	All live + 260 kg STV. Fairing failed to separate and stage 3 under-performed. Third orbital attempt
F11	5 Nov 1971	Europa 2	Europa 1/stage 4/360 kg STV. Inertial guidance failed at 105 s, vehicle broke up at 150 s. Fourth orbital attempt (GTO)

All launches from Woomera, except F11 (Kourou). BS = Blue Streak; STV = Satellite Test Vehicle. F12 was ready at Kourou when the programme was cancelled (before F11 failure, F12 launch was scheduled for Apr 1972). F13 is at the Deutsches Museum, Munich (D); F14 at East Fortune Field, Edinburgh Science Museum (UK); F15 at Redu (B). F13/F14 were earmarked for the Franco-German Symphonie telecommunications satellites, launched instead by US Deltas in Dec 1974/Aug 1975; F15 was planned for Cos-B.

Stage 2 (Coralie)

Principal contractors: SNIAS, Lab de Recherches Balistiques et Aérodynamiques (engines)

Propulsion: 4 engines providing total 265 kN vac; SI 280 s

Propellants: NTO/UDMH

Length: 5.50 m

Principal diameter: 2.00 m

Mass: 12186 kg (dry 2263 kg)

Burn duration: 96.5 s

Propellants: NTO/Aerozine 50

Length: 3.82 m

Principal diameter: 2.00 m

Mass: 4007 kg (dry 885 kg)

Burn duration: 36 s

Fairing

Length: 4.00 m

Diameter: 2.00 m

Mass: 300 kg

Stage 3 (Astris)

Principal contractors: Bölkow, ERNO

Propulsion: 22.5 kN vac + 2x0.4 kN verniers

Europa 2 Characteristics (where different from Europa 1)

Launch mass: 111.6 t

Guidance: inertial (Marconi Space & Defence Systems)

Performance: 400/170 kg into GTO/GEO from Kourou

Stage 4

Principal contractors: AERFER

Pomigliano d'Arco Napoli, Matra

Propulsion: 41.2 kN vac, solid propellant. Spun-up to 120 rpm by 4x1250 N solids

Length: 2.02 m

Principal diameter: 73 cm

Mass: 790 kg (dry 105 kg)

Burn duration: 45 s

Left: principal characteristics of Europa 1 (Europa 2 was identical but the satellite perched on a perigee kick stage). 1: fairing. 2: Satellite Test Vehicle. 3: payload adapter. 4: Aerozine tank (NTO tank is lower half). 5: support ring. 6: He tank (x2). 7: vernier (x2). 8: main engine. 9: pressurant tanks. 10: NTO tank. 11: interbay ducting. 12: UDMH tank. 13: main engines (x4). 14: telemetry antenna. 15: equipment bay. 16: access door. 17: LOX tank pressurisation pipe. 18: LOX tank. 19: kerosene tank. 20: low-pressure feed pipes. 21: turbopumps. 22: GN₂. 23: turbine exhaust. 24: LN₂-GN₂ heat exchanger. 25: LOX-GOX heat exchanger. 26: expansion bell.

ESRO-2



Achievements: first ESRO satellite; significant contributions to understanding near-Earth space
Launch dates: ESRO-2A 29 May 1967 (launch failure); ESRO-2B (Iris) 17 May 1968
Mission end: ESRO-2A 29 May 1967 (launch failure); ESRO-2B 9 May 1971 (reentry; 12-month design life)
Launch vehicle/site: NASA Scout from Western Test Range, California
Launch mass: 74 kg (21.3 kg scientific payload)
Orbit: 334x1085 km, 98.9° Sun-synchronous
Principal contractor: Hawker Siddeley Dynamics (UK)

ESRO's first satellites concentrated on solar and cosmic radiation and its interaction with the Earth. ESRO-2 looked at solar X-rays, cosmic radiation and Earth's radiation belts, while ESRO-1A simultaneously examined how the auroral zones responded to geomagnetic and solar activity. Direct measurements were made as high-energy charged particles plunged from the outer magnetosphere into the atmosphere.

ESRO's HEOS-1 also played its part through simultaneous measurements of the interplanetary magnetic field and the particles en route to Earth. This meant the particles could be used to trace out the magnetosphere's structure and how it connected with the interplanetary field. ESRO-2 and -1 contributed significant pieces to this puzzle. ESRO-2 was particularly fruitful on the arrival of solar particles over the polar caps, highlighting striking intensity variations between the two regions, when uniformity had been expected.

ESRO-2A was lost when the fourth stage of its Scout launcher failed to ignite, leaving the satellite to burn up on reentry. The prototype was refurbished as a replacement, carrying the same seven experiments (see table) and renamed 'Iris' once in orbit. Although its design life was only 1 year, most of the subsystems

worked well throughout and four experiments were still returning data by the time atmospheric drag precipitated reentry after 16 282 orbits. The tape recorder failed after 6.5 months, reducing average data recovery from more than 90% to around 20%.

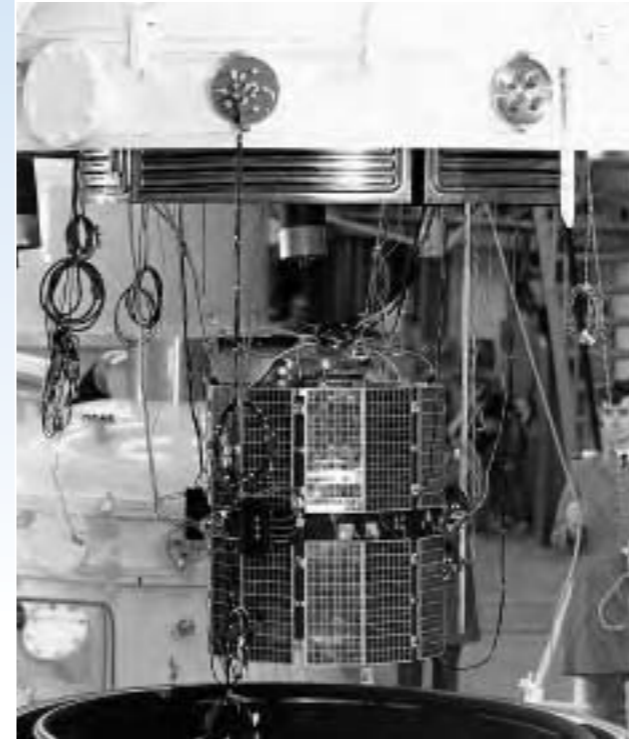
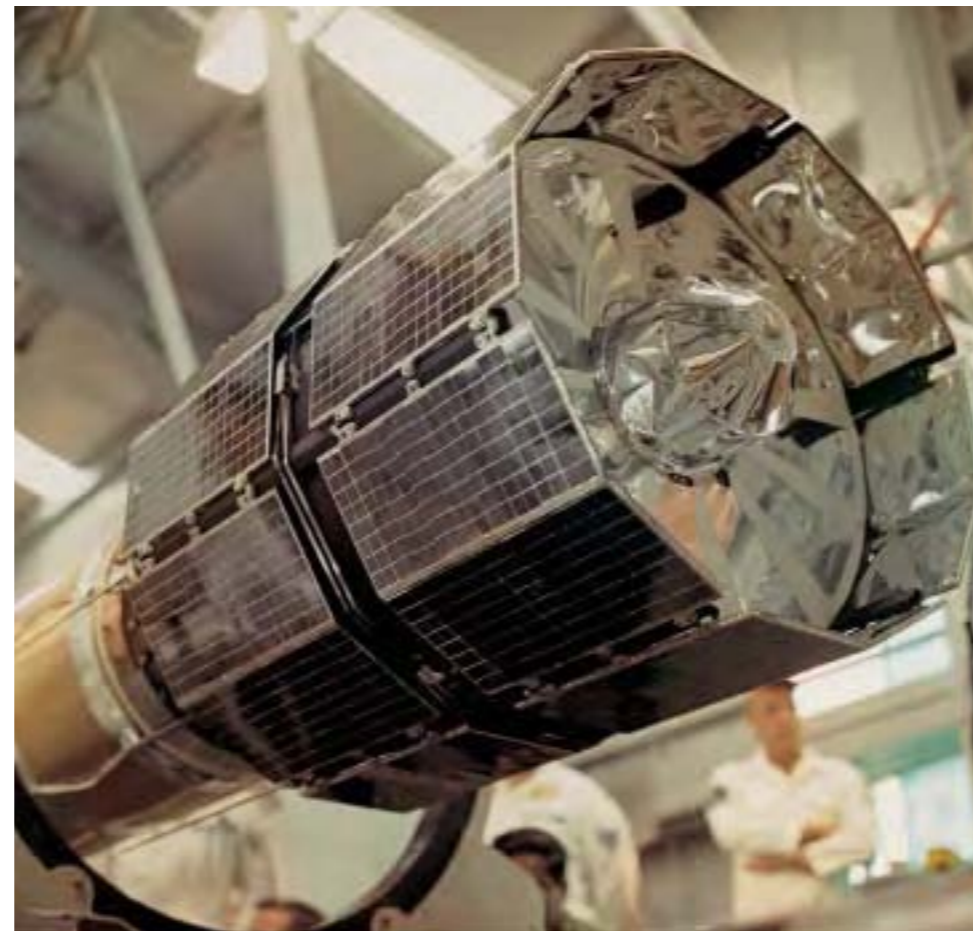

ESRO-2 thermal-vacuum testing at ESTEC.

ESRO-2 attached to the final stage of its Scout launcher at the Western Test Range in California.

Satellite configuration: 12-sided cylinder, 86 cm long, 78 cm diameter. Six aluminium panels (carrying the solar array) were attached to six magnesium alloy longerons, bolted to two honeycomb floors and stabilised by end frames. Central thrust tube.

Attitude/orbit control: spin stabilised at 40 rpm along main axis, 90° to Sun direction. Spin-up by gas jets; spin axis controlled by magnetorquer.

Power system: 3456 20.5 mm² Si cells on body panels. Supported by 3 Ah nickel cadmium battery.

Communications: 128 bit/s realtime telemetry on 137 MHz. Tape recorder stored 128 bit/s for 110 min; playback at 4096 bit/s on 136 MHz. TC at 148 MHz. Controlled from ESOC.



Right: ESRO-2 and its Scout stage 4 undergoing spin-balancing at the Western Test Range.

ESRO-2 Scientific Instruments

S25	Two Geiger-Müller counters measured time variations in Van Allen belt population. Imperial College London (UK)
S27	Four solid-state detectors measured solar and Van Allen protons (1-100 MeV) and α -particles. Imperial College London (UK)
S28	Scintillator, proportional counters and Cerenkov detectors measured 0.4-0.8 GeV solar protons/ α -particles. Imperial College London (UK)
S29	Scintillator/Cerenkov detector for flux/energy spectrum of 1-13 GeV electrons. Univ of Leeds (UK)
S36	Proportional counters measured 1-20 Å solar X-rays. University College London/Leicester Univ (UK)
S37	Proportional counters measured 44-60 Å solar X-rays. Lab voor Ruimteonderzoek, Utrecht (NL)
S72	Two solid-state detectors measured solar and galactic protons (0.035-1 GeV) and α -particles (140-1200 MeV). Centre d'Etudes Nucleaires de Saclay (F)

ESRO-1

Achievements: significant contributions to understanding near-Earth space
Launch dates: ESRO-1A (Aurora) 3 October 1968; ESRO-1B (Boreas) 1 October 1969
Mission end: ESRO-1A 26 June 1970; ESRO-1B 23 November 1969 (reentry; 6-month design lives)
Launch vehicle/site: NASA Scout from Western Test Range, California
Launch mass: 74 kg (22 kg scientific payload)
Orbit: ESRO-1A 258x1538 km, 93.7° Sun-synchronous; ESRO-1B 291x389 km, 86.0°
Principal contractors: Laboratoire Central de Telecommunications (Paris), with Contraves (CH) and Bell Telephone Manufacturing (B) as main associates

ESRO's first satellites concentrated on solar and cosmic radiation and its interaction with the Earth. ESRO-2 looked at solar X-rays, cosmic radiation and Earth's radiation belts, while ESRO-1A simultaneously examined how the auroral zones responded to geomagnetic and solar activity. Direct measurements were

ESRO-1 was built, unusually, around a conical thrust tube and four vertical walls.



made as high-energy charged particles plunged from the outer magnetosphere into the atmosphere.

ESRO's HEOS-1 also played its part through simultaneous measurements of the interplanetary magnetic field and the particles en route to Earth. This meant the particles could be used to trace out the magnetosphere's structure and how it connected with the interplanetary field. ESRO-2 and -1 contributed significant pieces to this puzzle. ESRO-1B aimed at a lower circular orbit to provide complementary measurements, but it was lower than planned and reentry was inevitable after a few weeks.

The satellites were stabilised so that, over the North Pole, the particle experiments looked up or across the magnetic field, while two photometers looked down to measure absolute auroral luminosity. This was one of the first dual-satellite arrangements tried in the magnetosphere, preceding the more sophisticated ISEE mission by 8 years. Two satellites made it possible to distinguish spatial from temporal variations.

Both satellites continued transmitting data until reentry. ESRO-1A's tape recorder failed on 29 April 1969, reducing the data take from 80% to 20%, but those data (over the North Pole) were the most important.

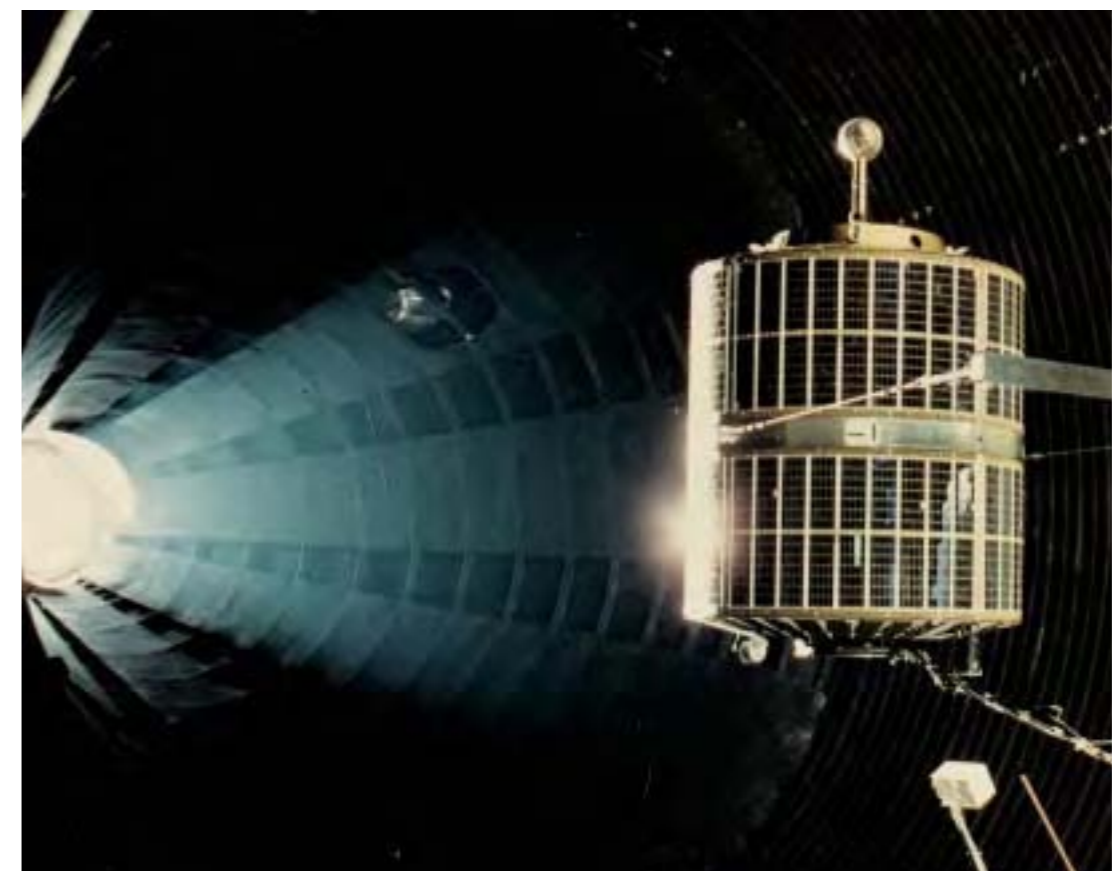

Installation of ESRO-1B on its Scout launcher at the Western Test Range, California.

ESRO-1 solar simulation testing at ESTEC.

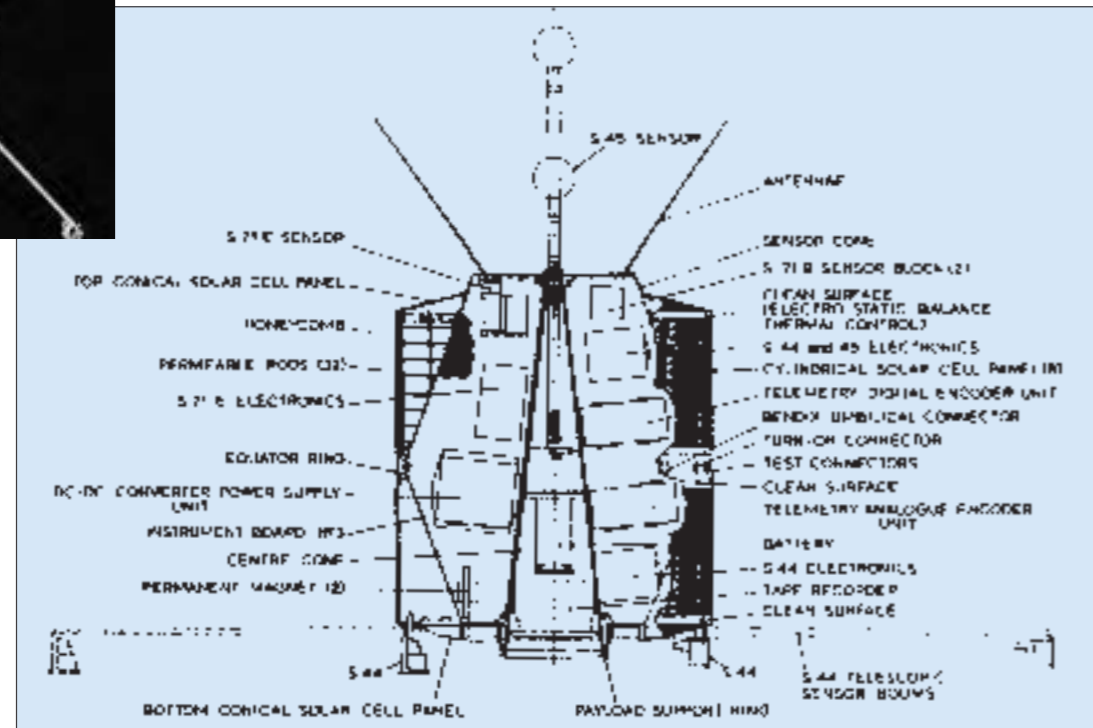
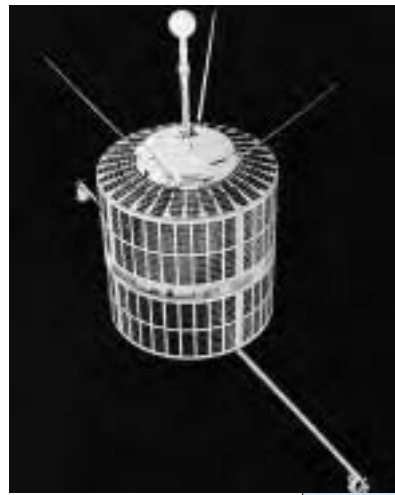

ESRO-1 principal features.

Satellite configuration: 90 cm-high, 76 cm-diameter cylindrical bus. Conical magnesium thrust tube supported four vertical aluminium honeycomb walls for attaching experiments and subsystems. Total height 153 cm. Forward axial boom extended to 50 cm in orbit; two 99 cm booms released from base.

Attitude/orbit control: injection spin of 150 rpm removed by yo-yo masses, for satellite to stabilise itself to within 5° along the magnetic field lines using two 25.2 Am² bar magnets.

Power system: 6990 2 cm² Si cells on body panels provided 23 W orbit average. Supported by 3 Ah nickel cadmium battery.

Communications: 5120 bit/s realtime telemetry on 1.2 W/137 MHz, or 320 bit/s on 0.2 W/136 MHz. Tape recorder stored 320 bit/s for playback at 10.24 kbit/s on 137 MHz. Telecommand at 148 MHz. Controlled from ESOC.

ESRO-1 Scientific Instruments	
S32	Two photometers registered northern auroral brightness. Norwegian Institute of Cosmic Physics (N)
S44	Two boom-mounted Langmuir probes for ionosphere electron temperature/density. University College London (UK)
S45	Boom-mounted Langmuir probe for ionosphere ion composition/temperature. University College London (UK)
S71A	Scintillator for electron flux/energy spectra (50-400 keV). Radio & Space Research Station (UK)
S71B	Electrostatic analysers + channeltrons for electrons and protons (1-13 keV) with high time resolution. Kiruna Geophysical Observatory (S)
S71C	Three solid-state detectors for 0.01-6 MeV protons. Univ of Bergen/Danish Space Research Institute (N/DK)
S71D	Four Geiger counters for pitch angles of electrons (>40 keV) and protons (>500 keV) with high time resolution. Norwegian Defence Research Establishment/Danish Space Research Institute (N/DK)
Ratemeter	Geiger counter for trapped electrons (>40 keV) and protons (>500 keV). ESLAB (Space Science Dept) of ESRO
S71E	Solid-state detector and scintillator telescope for flux/energy spectra of 1-30 MeV solar protons. Radio & Space Research Station (UK)

HEOS

Achievements: first European probe into cislunar space; first magnetically clean European satellite; first highly-eccentric polar orbit

Launch dates: HEOS-1 5 December 1968; HEOS-2 31 January 1972

Mission end: HEOS-1 reentered 18 October 1975; HEOS-2 reentered 2 August 1974

Launch vehicle/sites: HEOS-1 Delta from Cape Canaveral, Florida; HEOS-2 Delta from Western Test Range, California

Launch mass: HEOS-1 108 kg; HEOS-2 117 kg

Orbits: HEOS-1 injected into 424x223 428 km, 28.3°; HEOS-2 injected into 405x240 164 km, 89.9°

Principal contractors: Junkers Flugzeug- und Motorenwerke GmbH (prime)

HEOS-1 (Highly Eccentric Orbit Satellite-1) was the first European spacecraft to venture beyond near-Earth space, in order to study the magnetic fields, radiation and the solar wind outside of the Earth's magnetosphere. This required an orbit stretching two-thirds of the way to the Moon and launch during a period of high solar activity. The scientific experiments also demanded a magnetically clean vehicle, another first for Europe and requiring a new facility at ESTEC for testing the integrated satellite.

HEOS-1 performed admirably for 7 years, for the first time providing scientists with continuous observations of interplanetary conditions over most of a solar cycle. Precise calibration of the magnetometer meant that these data have been used ever since as a fundamental reference. Another feature – novel at the time – was the magnetometer's memory, which allowed measurements with very high time resolution. HEOS-1 also released a canister of barium and copper oxide on 18 March 1969 some 75 000 km out from Earth – igniting it 40 km from HEOS – in order to trace distant magnetic field lines.

HEOS-2 was equally successful, this time investigating northern polar regions by climbing into a high-inclination orbit. It discovered a layer

of plasma flow ('plasma mantle') inside the tail magnetosphere. In addition, it observed interplanetary conditions during most of its orbit. In August 1972 it was ideally placed to study some of the most dramatic interplanetary and magnetospheric events ever recorded following major solar activity.

HEOS' 1.7 m boom held the magnetometer away from the body's magnetic influence. HEOS-2 (seen here) was similar to its predecessor but notably carried a loop antenna just above its main body for solar radio observations.



HEOS-1 Scientific Instruments	
S24A	Triaxial fluxgate magnetometer on 1.70 m tripod boom. Measured ± 64 -gamma magnetic fields with 0.5-gamma accuracy. 3.8 kg. Imperial College London (UK)
S24B	Cerenkov and scintillation counters detected high-energy cosmic ray protons of >350 MeV and their anisotropies. 2.9 kg. Imperial College London (UK)
S24C	Solid-state detector telescopes detected 0.9-20 MeV solar protons and their anisotropies. 2.1 kg. Imperial College London (UK)
S58/S73	Measured the energy and angular distributions of solar wind protons. 0.7/2.2 kg. Universities of Rome, Florence and Brussels
S72	Solid-state telescope measured electrons, protons and α -particles over wide energy ranges. 1.8 kg. Centre d'Etudes Nucleaires de Saclay (F)
S79	Measured 50-600 MeV cosmic ray electrons. 5.0 kg. Centre d'Etudes Nucleaires de Saclay (F) & University of Milan (F/I)
S16	Released barium canister to highlight magnetic field lines. 8.2 kg (capsule 7.7 kg). Max-Planck-Institut für Extraterrestrische Physik, Garching (D)

HEOS-2 Scientific Instruments	
S201	As S24A on HEOS-1 but range/accuracy improved to ± 144 -gamma with 0.25-gamma accuracy in lower range
S202	Measurement of 20 eV-50 keV electrons and protons. Univ of Rome (I)
S203	Solar VLF observations at 20-236 Hz by a 1.4 m ² loop antenna and two spherical wire-cage antennas. Danish Space Research Institute
S204	Particle telescopes to measure 0.5-3 MeV electrons, 9-36 MeV protons and 36-142 MeV α -particles. Space Science Dept of ESRO/ESTEC
S209	As S79 on HEOS-1
S210	Solar wind's velocity and angular distributions. Max-Planck-Institut für Extraterrestrische Physik, Garching (D)
S215	Mass/velocity determination of 10^{-17} - 10^{-9} g micrometeoroids. Max-Planck-Institut für Kernphysik, Heidelberg (D)

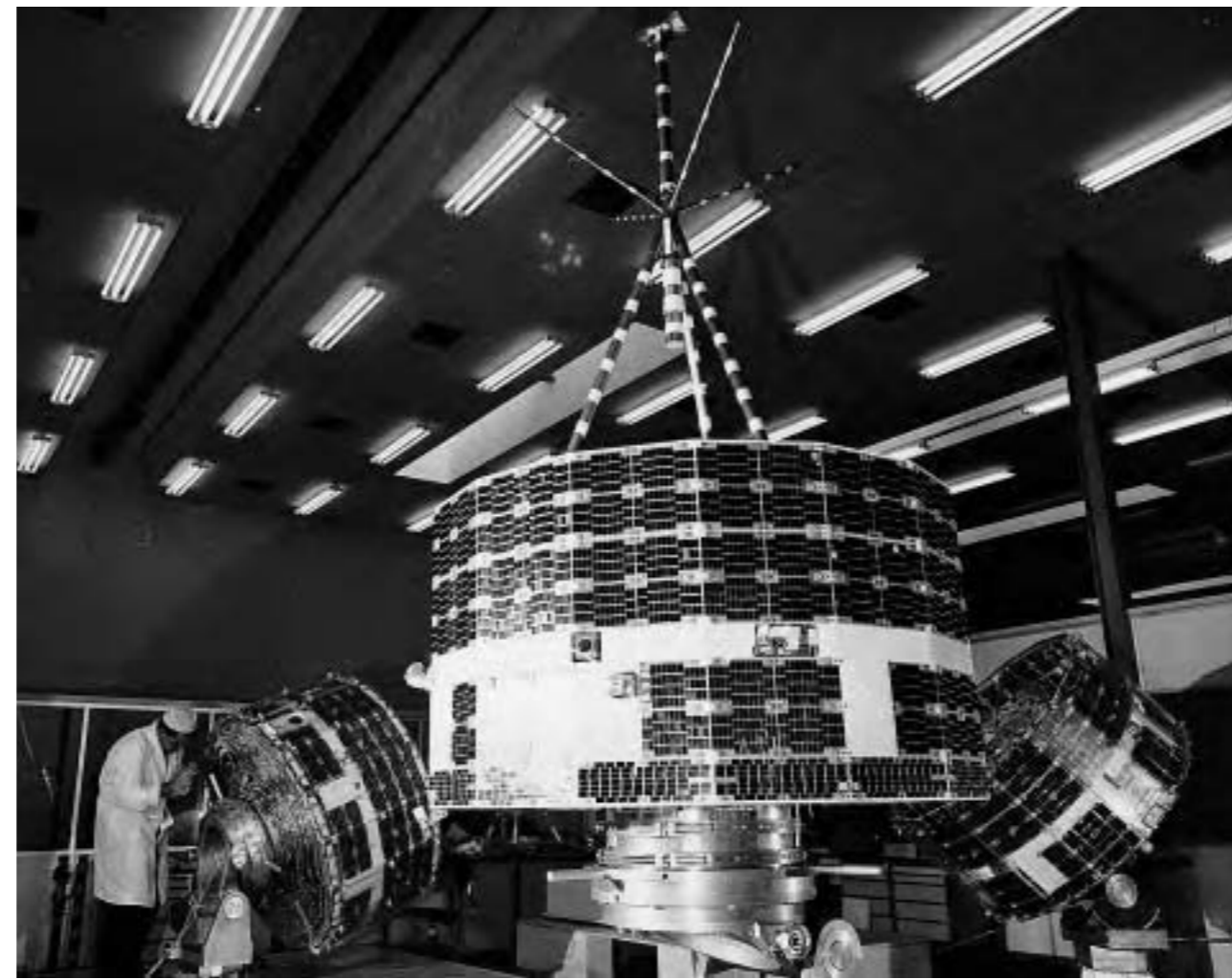
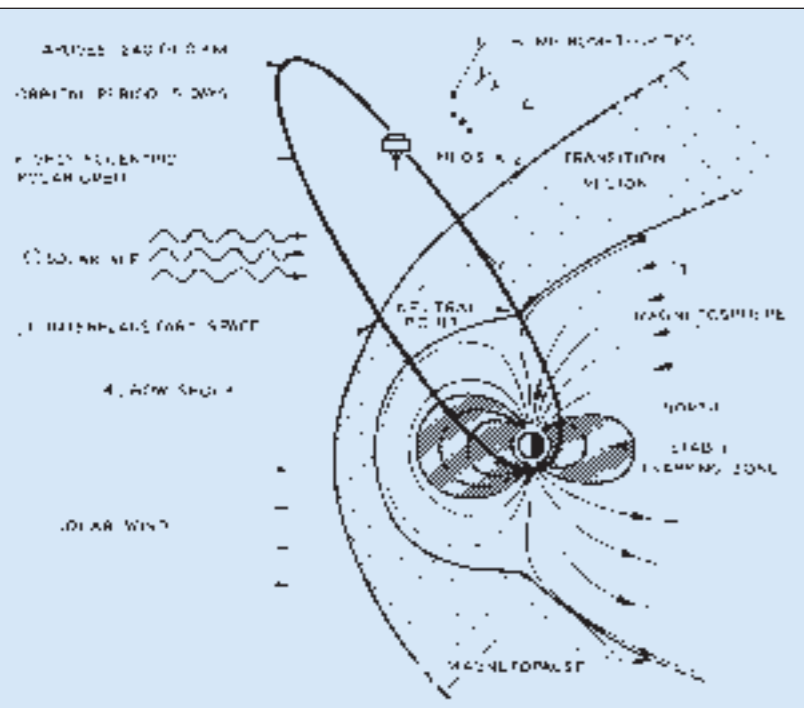

The prototype and two flight models of HEOS-1 in the integration hall at ESTEC.

Satellite configuration: 16-sided bus, 75 cm high, 130 cm diameter across faces. 1.70 m-high fixed boom along spin axis for magnetometer and antennas. Equatorial belt reserved for experiments, attitude sensors and spin nozzles. Central aluminium honeycomb octagonal thrust tube, with outrigger structures on alternating panels supporting four solar array panels. Electronic boxes bolted on thrust tube, with sensors on cantilever supports. HEOS-1's S16 experiment and its ejection mechanism was on lower adapter (on HEOS-2, this space housed the S215 micrometeoroid impact detector); the upper part housed the nitrogen bottle near the centre of gravity.

The orbits of both HEOS were designed to slice through Earth's magnetosphere and penetrate deep into interplanetary space. The high inclination of HEOS-2 made it the first spacecraft to explore the outer polar cusp, searching for a neutral point.

Attitude/orbit control: spin-stabilised at 10 rpm around axis perpendicular to Sun direction. Spin axis determined to $\pm 2^\circ$ by Sun/Earth sensors. Spin axis adjusted by pulsing single 0.2 N thruster on bottom skirt; spin-up/down by paired 0.2 N equatorial belt thrusters; 1.9 kg of nitrogen stored at 250 bar in single central titanium sphere.

Power system: four solar panels formed HEOS outer surface. 8576 Si cells provided 60 W BOL (42 W after 1 year) at 16 V. Supported by 5 Ah silver cadmium battery.

Communications payload: 12 bit/s data (32 bit/s on HEOS-2) returned at 136 MHz by 6 W transmitter in realtime (no onboard storage). Primary stations Redu (Belgium) and Fairbanks (Alaska, US), controlled from ESOC. Telecommand at 145.25/148.25 MHz HEOS-1/2.



HEOS-2 was the first to probe the Earth's northern polar region from a highly-eccentric orbit. Right: HEOS-1 released a barium canister to create an artificial ion cloud tracing the Earth's magnetic field lines.

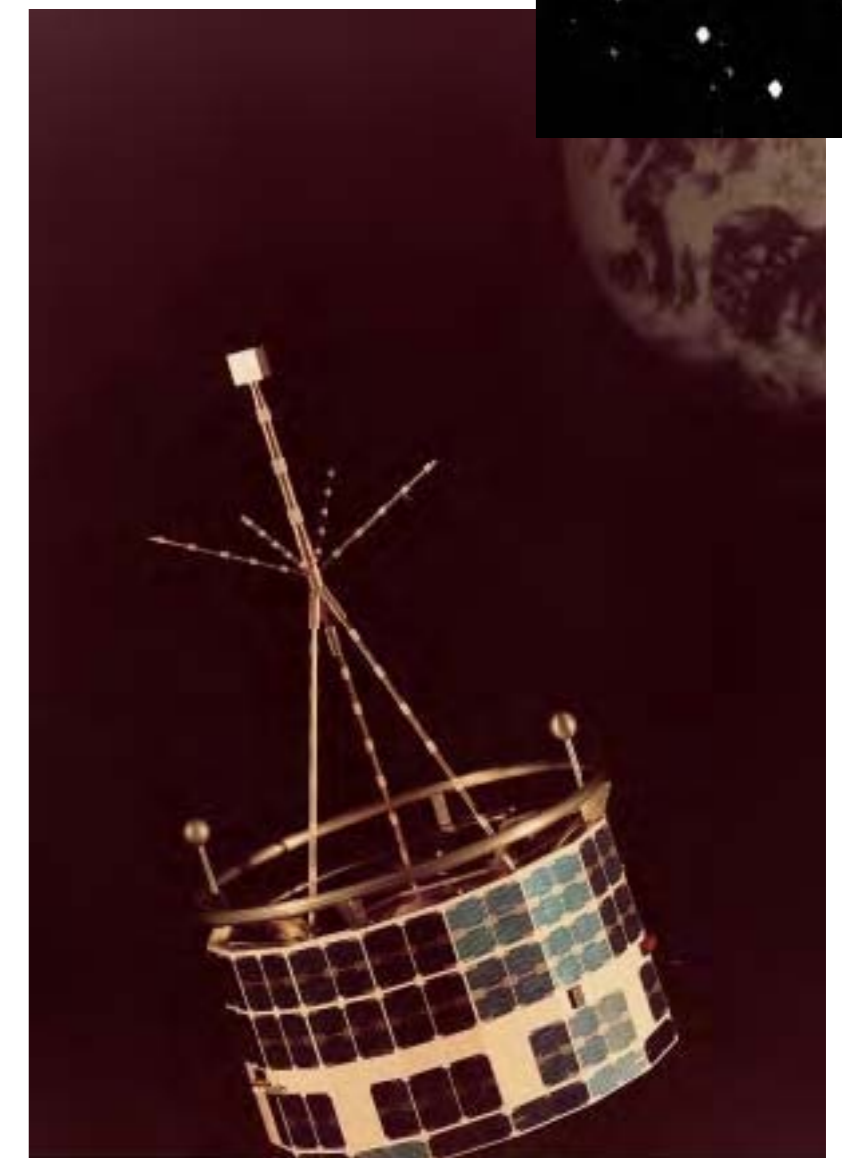

TD-1

Achievements: ESRO's first astronomy satellite; important advances in UV astronomy (all-sky UV survey not superseded until US GALEX mission of 2003)
Launch date: 12 March 1972
Mission end: 4 May 1974 (design life 6 months; reentered 9 January 1980)
Launch vehicle/site: Thor Delta (hence name of satellite) from Western Test Range, California
Launch mass: 473 kg (scientific payload 120 kg)
Orbit: 531x539 km, 95.3° (Sun-synchronous)
Principal contractors: Engins Matra (prime), ERNO (structure, thermal control, housekeeping subsystems), Saab (communications), HSD (power supply, gyros)

TD-1 was ESRO's most ambitious satellite project of that era, carrying a large and complex scientific payload to survey the whole sky in ultraviolet, X-rays and gamma-rays, monitor heavy cosmic ray nuclei and measure X/gamma-rays from the Sun.

It was the organisation's first satellite to carry astronomical telescopes, with heavy emphasis on UV observations of stars. One telescope used a wide aperture for scanning the whole sky in this little-studied section of the spectrum, while another made high-resolution measurements of UV spectral lines from individual stars. The resolution of 1.8 Å was a major advance over anything flown previously.

The mission was seriously jeopardised soon after launch, when both onboard tape recorders failed after only 2 months. A dramatic rescue operation by ESRO set up 40 ground stations around the world in collaboration with other space agencies to capture most of the realtime data.

As a result of the rescue, 95% of the celestial sphere was scanned, and spectral measurements on more than 30 000 stars were catalogued and published. The measurement of UV spectral line shapes and positions revealed, for example, that some stars are rapidly shedding their atmospheres. Significant advances were also made in identifying interstellar dust and plotting its distribution throughout the Galaxy.

The mission had been planned to end in October 1972 when the orbit had shifted such that the Earth began eclipsing the attitude system's Sun sensors. In view of the data lost from the recorder failures and TD-1's otherwise good health, it was decided to try a manoeuvre for which the satellite had not been designed. As the eclipses began, TD-1 was spun faster around its Sun-pointing axis for stability and placed in hibernation. The reverse operation was successful in February 1973, to the delight of its controllers and scientists. 70% data coverage was

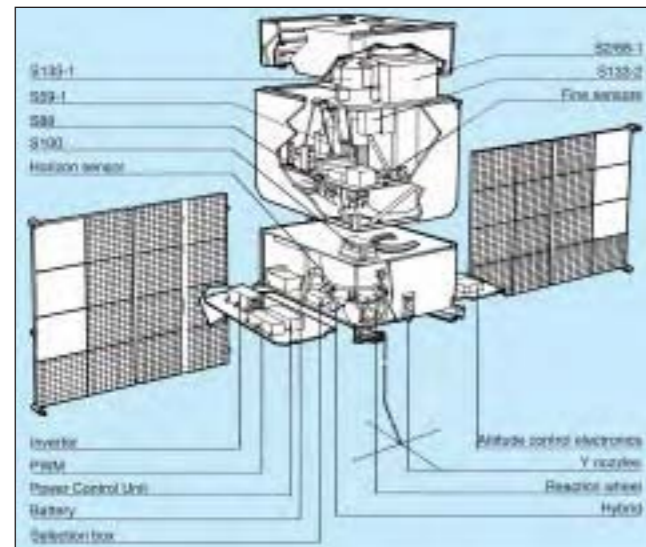

TD-1 in the integration hall at ESTEC, July 1971. The attitude control system held this side square on to the Sun.

achieved in the second scan period of March-October 1973, the most productive phase of the mission. One tape recorder even began working again, in October 1973.

Hibernation was successful again October 1973-March 1974. All of the instruments were still working in May 1974 when attitude control was lost following exhaustion of the onboard gas supply, and the mission ended. By that time, TD-1 had achieved 2.5 celestial scans and the mission was declared a total success.

Satellite configuration: box-shaped bus, 0.9x1 m, 2.2 m high. Experiments housed in upper box; subsystems in lower box.

Attitude/orbit control: X-axis (solar

array face) Sun-pointing with 1 arcmin accuracy, while TD rotated at 1 rev/orbit about X-axis for the four instruments pointing along the +Z-axis (anti-Earth) to scan the whole sky in 6 months. Sun/Earth sensors, momentum wheels and cold-gas jets (11 kg gas supply).

Power system: two deployed solar wings continuously faced Sun (Sun-synchronous orbit) to provide power from 9360 2x2 cm Si cells; supported by nickel cadmium battery.

Communications: 1700 bit/s realtime on 0.3 W transmitter, with simultaneous recording on tape recorders for playback at 30.6 kbit/s on 3 W transmitter. Both recorders failed by 23 May 1972, but one resumed working in October 1973.

This internal view highlights the complexity of TD-1. Compare it with the photographs of its ESRO contemporaries on other pages.



TD-1 Scientific Instruments

S2/68	Telescope/spectrometer: whole-sky scan at 1350-3000 Å. Inst d'Astrophysique, Liège (B)/Royal Obs Edinburgh (UK)
S59	Telescope/spectrometer gimballed for star-tracking: UV stellar spectroscopy 2000-3000 Å (1.8 Å resolution). Space Research Lab, Utrecht (NL)
S67	Two solid-state detectors/Cerenkov detector: spectrometry of primary charged particles. Centre d'Etudes Nucléaires, Saclay (F)
S77	Proportional counter: spectrometry of 2-30 keV celestial X-rays. Centre d'Etudes Nucleaires de Saclay (F)
S88	Solar gamma-rays (50-500 MeV). Univ of Milan (I)
S100	CsI scintillation crystal: solar X-rays (20-700 keV). Space Research Lab, Utrecht (NL)
S133	Spark chamber, vidicon camera, particle counters and Cerenkov counter: celestial gamma-rays (70-300 MeV). CENS/Univ of Milan/MPI Garching (F/I/D)

ESRO-4

Achievements: significant contributions to upper atmosphere, ionosphere and magnetosphere research

Launch date: 22 November 1972

Mission end: 15 April 1974 (reentry; 18-month design life)

Launch vehicle/site: NASA Scout from Western Test Range, California

Launch mass: 114 kg

Orbit: 245x1087 km, 99.2°

Principal contractor: Hawker Siddeley Dynamics (UK)

ESRO-4 was based on the proven ESRO-2 design and carried five experiments concentrating on the Earth's ionosphere, atmosphere, radiation belts and penetration of solar particle radiation into the magnetosphere. Achievements included unique high-quality measurements of the atmosphere's constituents between 240 km and 320 km altitude. Detailed global maps were produced for the concentrations of nitrogen, oxygen, helium and argon and their seasonal variations. Their movement following ionosphere and geomagnetic

disturbances was plotted, and their variations with longitude were established.

ESRO-4's results feature prominently in the world's scientific literature on the upper atmosphere. This small satellite significantly advanced our basic understanding of the relationships between solar radiation and the Earth's atmosphere and magnetic environment.

A total of 3×10^{10} data bits were returned before reentry in 1974, and even the tape recorder was still

ESRO-4 flew some of the experiments planned for TD-2, cancelled in 1968 on cost grounds. It used the ESRO-2 bus, whereas the alternative ESRO-3 proposal would have been derived from ESRO-1.

running – a European record. NASA's launcher placed ESRO-4 in a low orbit (perigee 245 km instead of 280 km), which reduced its orbital life from the planned 3 years to 17 months but which also allowed it to sample a deeper slice of atmosphere.

Satellite configuration: 90 cm-high, 76 cm-diameter cylindrical bus. Central thrust tube supported two equipment floors, enclosed by outer shell of solar array. Four booms deployed for experiment S45: one axial and three 130 cm-long radial.

Attitude/orbit control: magnetorquers could precess the spin axis to different geomagnetic attitudes.

Power system: Si cells on body panels provided 60 W orbit average.

Communications: 640 bit/s or 10.24 kbit/s realtime data or 20.48 kbit/s tape recorder playback, at 137.2 MHz using 0.3 W or 2.8 W transmitters. Controlled from ESOC.

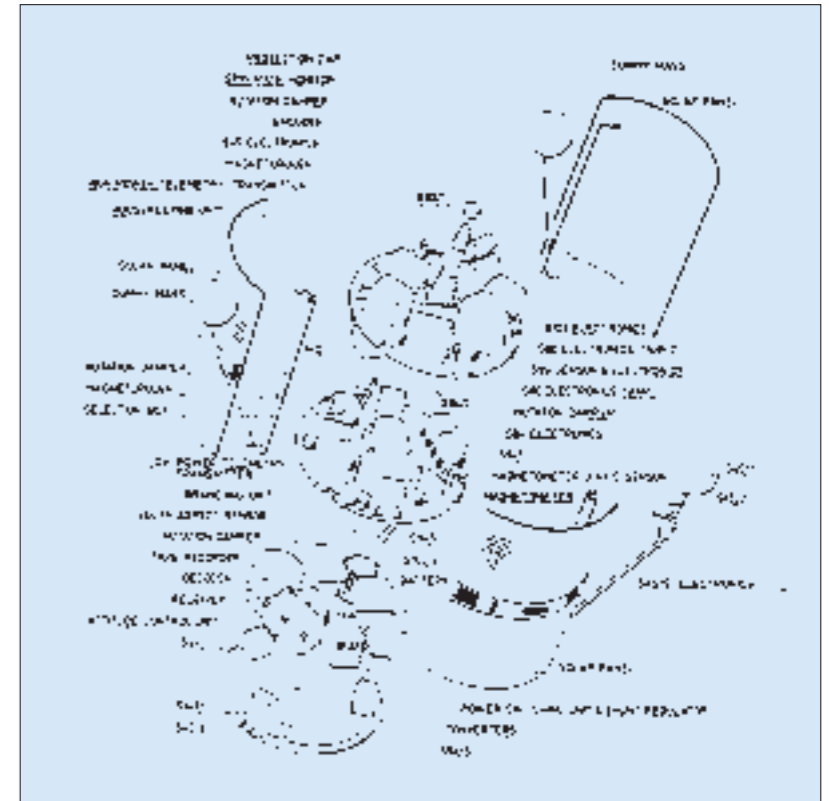

ESRO-4 Scientific Instruments	
S45	Boom-mounted spherical probes: density, temperature and composition of positive ions. University College London (UK)
S80	Monopole mass spectrometer: density and composition of 1-44 amu atmosphere constituents. University of Bonn (D)
S94	Electrostatic analysers, Geiger counters and solid-state detectors: angle/energy spectra of 0.5-150 keV electrons and protons. Geophysical Observatory Kiruna (S)
S99	Two solid-state detector telescopes: solar protons (2-100 MeV) and α -particles (4-240 MeV) over poles. Space Research Lab, Utrecht (NL)
S103	Solid-state detectors: solar protons (0.2-90 MeV) and α -particles (2.5-360 MeV), mainly over poles. MPI Garching (D)

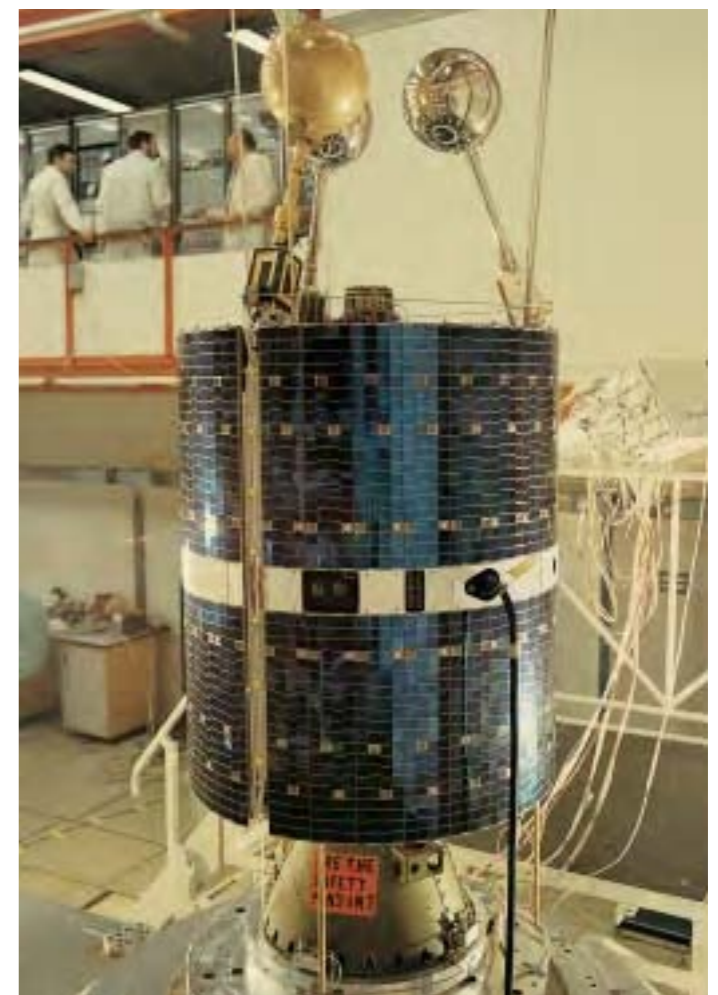
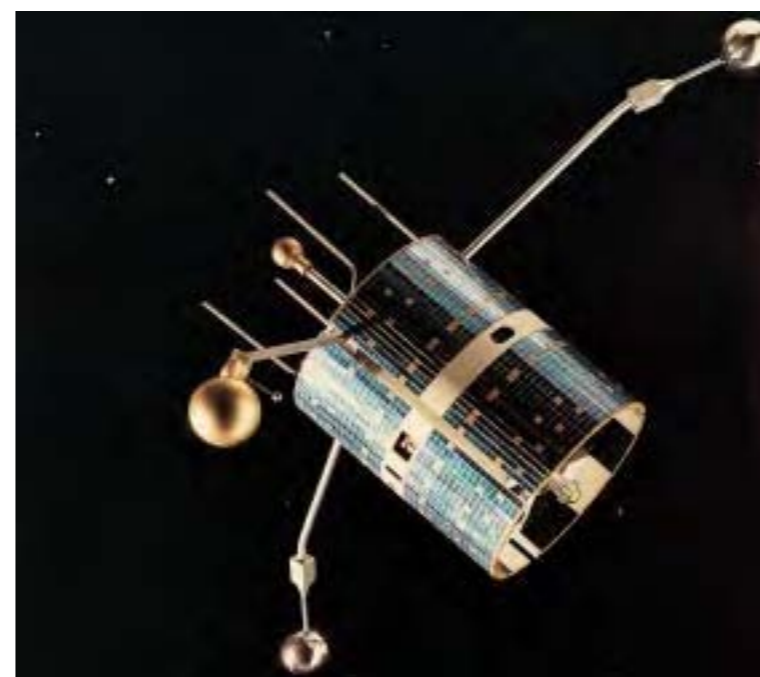

Cos-B

Achievements: first complete galactic survey in high-energy gamma-rays
Launch date: 9 August 1975 (1-year design life; 2-years' consumables)
Science operations began/ended: first data returned 12 August 1975, routine science operations began 17 August 1975, Cos-B deactivated 25 April 1982
Launch vehicle/site: Delta 2913 from Western Test Range, California
Launch mass: 278 kg (including 118 kg scientific payload)
Orbit: initially 337x99 067 km, 90.2°; evolved to 12 155x87 265 km, 98.4° by mission-end. Orbit maximised time above interfering radiation belts, on average allowing observations for 25 h on each 37 h orbit
Principal contractors: MBB (prime, spacecraft), Aerospatiale (structure, thermal), BAC (AOCS, solar array), ETCA/TERMA (power supply), Selenia (data handling, telecommunications)

Cos-B was the first ESA/ESRO satellite devoted to a single payload: a gamma-ray telescope designed to perform an extensive, pioneering survey of the Galaxy at energies of 50 MeV to 5 GeV. Before Cos-B, this high-energy range had been only partially explored. Major achievements included observations of the Crab and Vela pulsars, discovery of numerous point sources in the galactic disc, pinpointing the mysterious Geminga object to within 0.5°, and the first observation of gamma-rays from an extragalactic source (quasar 3C273).

The satellite operated in a pointing mode with its spin axis directed towards fixed points in the sky for periods of 4-5 weeks early in the mission and up to 3 months in later observations. In total, 64 pointings were carried out: a broad band along the galactic equator was studied deeply by repeated and overlapping observations. About 50% of the celestial sphere was covered. The database was formally released to the scientific community on 27 September 1985.

The telescope performed well throughout the mission, the only complication being occasional erratic performance of the spark chamber and the inevitable reduction in

performance as the chamber gas aged. This ageing was minimised by emptying and refilling the neon, and, as the rate of gas deterioration slowed, the intervals between flushings rose from the initial 6 weeks to about 36 weeks before the last in November 1981. The payload was still working when the attitude control gas was exhausted in April 1982.

Cos-B (and, simultaneously, Geos) was formally approved by the ESRO Council in July 1969 in competition with other science missions because it placed Europe at the forefront of a new field. The proposed Cos-A included an X-ray detector, but it was felt that Europe should leapfrog to the next generation in order to compete with NASA; this led directly to Exosat.

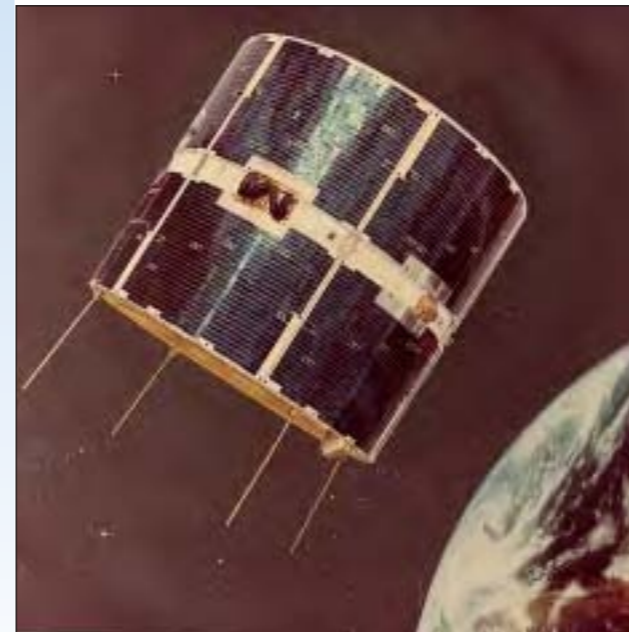

Artist's impression of Cos-B in operational configuration.

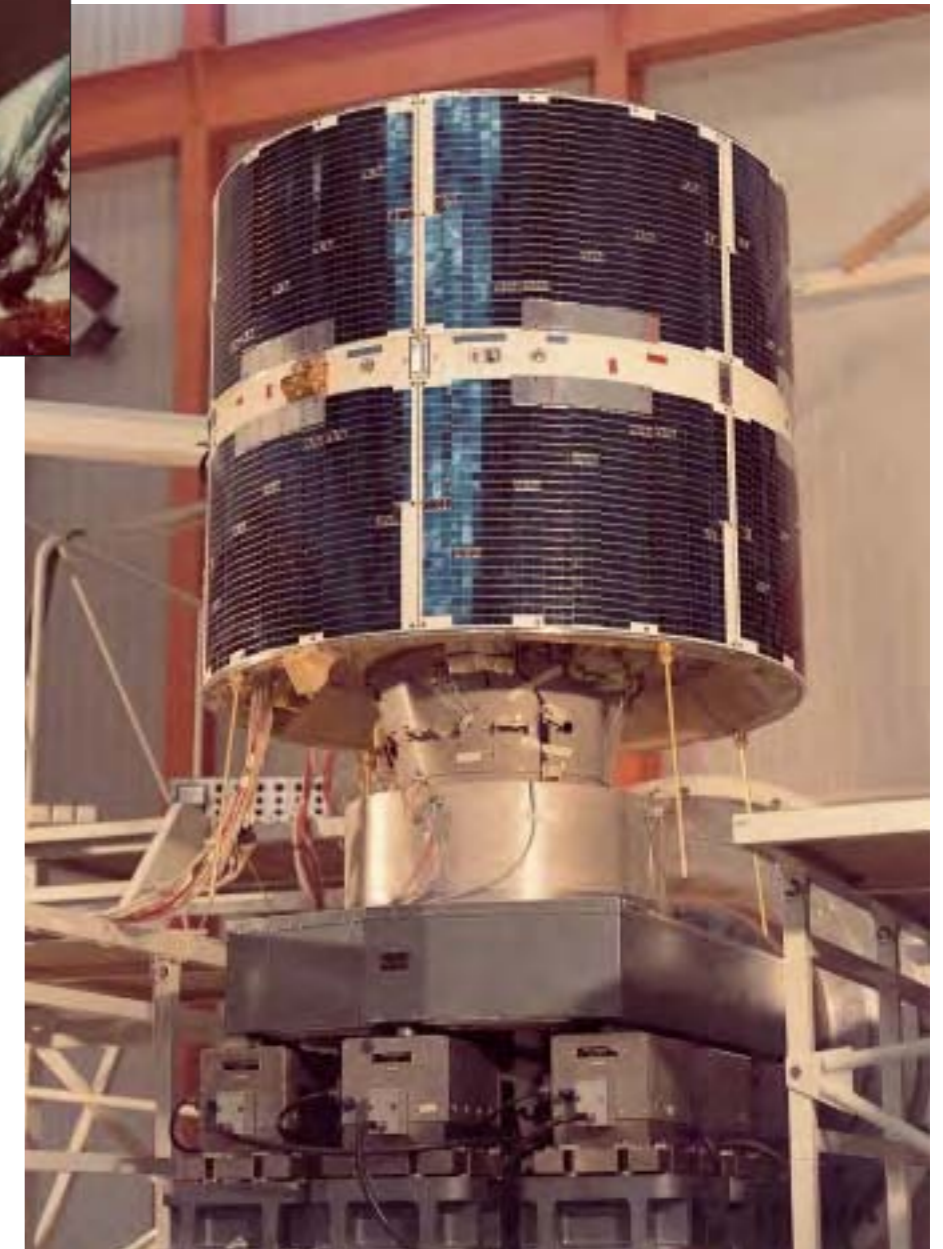

Cos-B prototype vibration testing at ESTEC.

The Galaxy's gamma-ray emission as observed by Cos-B.

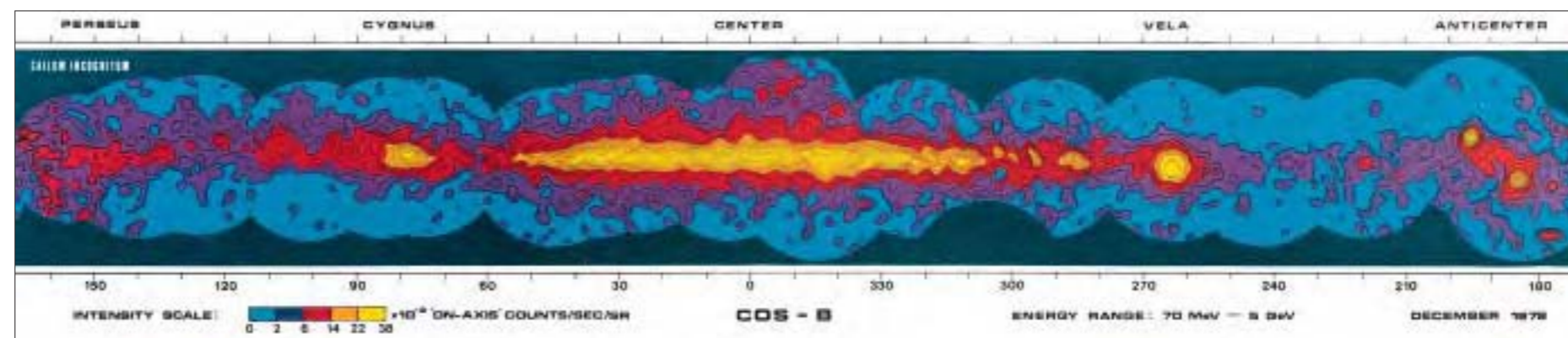

Integration of the Cos-B detector package and spacecraft prototypes at MBB.

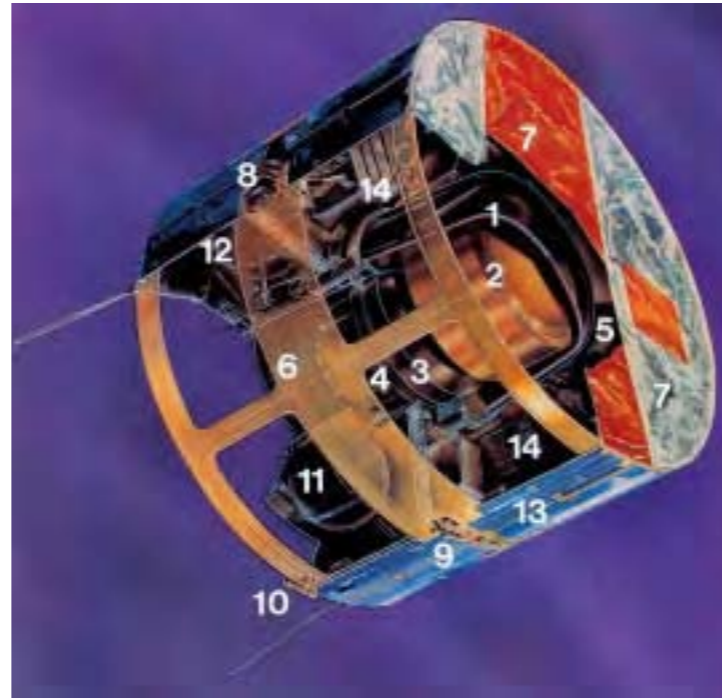

Cos-B principal features. 1: Anti-coincidence Counter. 2: Spark Chamber. 3: Triggering Telescope. 4: Energy Calorimeter. 5: Pulsar Synchroniser. 6: structure. 7: super-insulation. 8: Sun/Earth attitude sensors. 9: spin thruster. 10: precession thruster. 11: nitrogen tank. 12: neon tank. 13: solar array. 14: electronics. (MBB)

Bottom right: schematic of Cos-B's gamma-ray detector package. See the text for a description.

Satellite configuration: 1200 mm-high, 1488 mm-diameter cylinder with science payload in centre. 1712 mm total height, including antennas. Aluminium central cone, platform, struts and outer cylinder.

Attitude/orbit control: spin-stabilised at 10 rpm about main axis, maintained and pointed by simple cold gas attitude control system: 2 spin-up/down + 2 precession jets; 9.9 kg nitrogen at initial 250 bar. Sun/Earth sensors provided attitude determination to 0.5° .

Power system: 12 solar panels on cylindrical surface designed to provide 83 W at 16 V after 2 years; 9480 Si cells. Supported by 6 Ah nickel cadmium battery. Experiment required 25 W.

Communications/data: 6.5 W 137 MHz transmitter provided 80/160/320 bit/s, 8 Kbit buffer (typical gamma event 1100 bit). Telecommand at 148 MHz. Primary ground stations Redu (B) & Fairbanks (Alaska, USA).

Science payload: the gamma-ray detector's effective sensitive area peaked at 50 cm^2 at 400 MeV. Angular resolution 2° at high energies; energy resolution peaked ($\sim 40\%$ FWHM) at 150 MeV, and was

$>100\%$ up to at least 3 GeV. It featured a $24 \times 24 \times 24 \text{ cm}$ spark chamber (SC, see labelled diagram) with 16 paired wire grids. Tungsten sheets between the grids converted some gamma-rays into electron pairs. The particles' ionisation trail through the 2-bar neon gas was located and timed by applying a high voltage across the grids. The field of view was defined by the Triggering Telescope, which triggered the voltage when its scintillation (B1/B2) and Cerenkov (C) counters, with their photomultiplier tubes (PMTs), generated simultaneous signals. Cosmic rays ($\sim 1000/\text{s}$) were rejected when the surrounding anti-coincidence scintillation counter (A) and its nine PMTs produced a signal simultaneous with the Triggering Telescope. Below, the caesium iodide scintillator Energy Calorimeter (E/D) absorbed the electron pairs, PMTs recording the light pulse strength as a direct measure of the original energy. A 2-12 keV 1° FOV 'Pulsar Synchroniser' argon proportional counter monitored X-rays for correlation with gamma variations. For the SC, 1.1 kg of neon was stored at 13 bar to flush/refill the chamber at 2 bar up to 13 times.

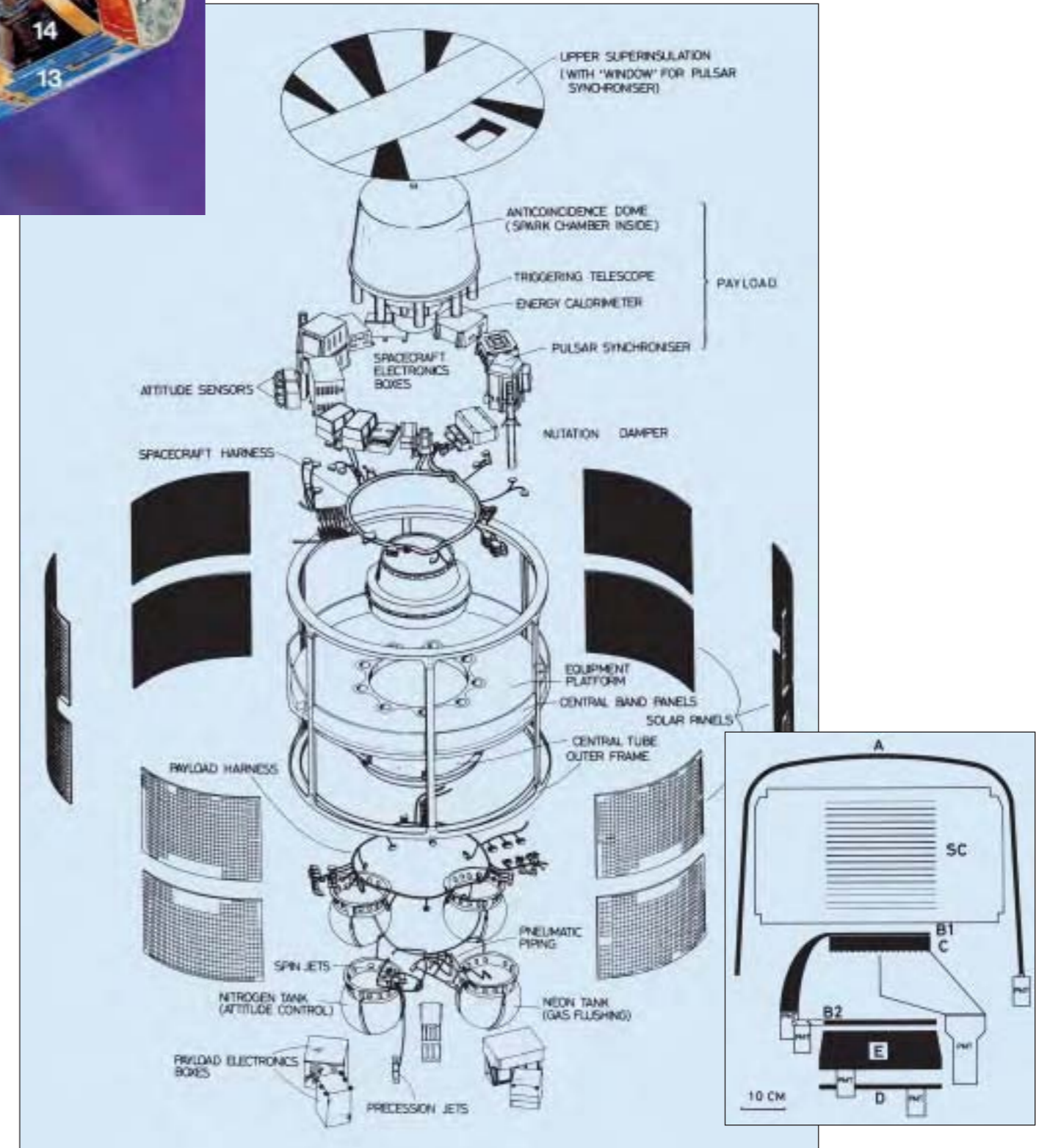

Geos

Achievements: major contributions to magnetospheric research

Launch dates: Geos-1 20 April 1977; Geos-2 14 July 1978

Mission end: Geos-1 April 1980; Geos-2 October 1985 (24-month goal)

Launch vehicle/sites: Geos-1 Delta from Cape Canaveral, Florida; Geos-2 Delta from Cape Canaveral

Launch mass: Geos-1 573 kg; Geos-2 573 kg

Orbits: Geos-1 injected into 2682x38 475 km, 26.6°; Geos-2 initial science operations over 37°E geostationary

Principal contractors: British Aircraft Corp heading Star consortium of Dornier, Sener, Ericsson, Thomson-CSF, Contraves, CGE-FIAR, Montedel

Geos was designed for geostationary (GEO) orbit to study the particles, fields and plasmas of the Earth's magnetosphere using seven instruments provided by ten European laboratories. Because of its unique orbit and the sophistication of its payload, Geos was selected as the reference spacecraft for the worldwide 'International Magnetospheric Study'. Unfortunately, Geos-1 was left in a low transfer orbit because of a stage-2/3 separation problem on its US Delta launcher. As a result, the Qualification Model was launched with an identical payload and successfully reached GEO.

In spite of its orbit, Geos-1 made a significant contribution to IMS,

ending its mission formally on 23 June 1978, when the ground system had to be handed over to prepare for Geos-2. That second craft was highly successful, creating a huge database for magnetospheric studies and plasma research in general.

Geos was the first ever spacecraft to carry a totally conductive coating – even over its solar cells. An electron beam experiment and a pair of probes 40 m apart provided independent measurements of the electric field at GEO altitude, yielding not only excellent science but also confirming the surface-treatment technology. The lessons proved extremely valuable for designing commercial satellites operating in this regime.

Geos-1/2 Scientific Instruments	
S300	AC-magnetic fields to 30 kHz; DC/AC electric fields & plasma resonances to 80 kHz; mutual/self-impedance. CRPE (F)
S302	Thermal plasma to 500 eV by 2 electrostatic analysers. Mullard Space Science Laboratory (UK)
S303	Ion composition (1-140 amu) and energy spectra to 16 keV by combined electrostatic and magnetic analyser. University of Bern/MPI Garching (CH/D)
S310	Pitch-angles of 0.2-20 keV electrons/protons by 10 electrostatic analysers. Kiruna Geophysical Observatory (S)
S321	Pitch-angles for 20-300 keV electrons & 0.020-3 MeV protons by magnetic deflection system followed by solid-state detectors. Max-Planck-Institut Lindau (D)
S329	DC electric field by tracing electron beam over one or more gyrations. Max-Planck-Institut Garching (D)
S331	DC & ULF magnetic field by fluxgate magnetometer. CNR/NASA Goddard Space Flight Center (I/US)



Geos in the Integration Hall at ESTEC. In front of Geos-1 is the Apogee Boost Motor. In the background is the Geos Qualification Model, later modified as Geos-2.



The Geos Qualification Model (which became Geos-2) on the moment-of-inertia measurement machine in the Dynamic Test Chamber at ESTEC.

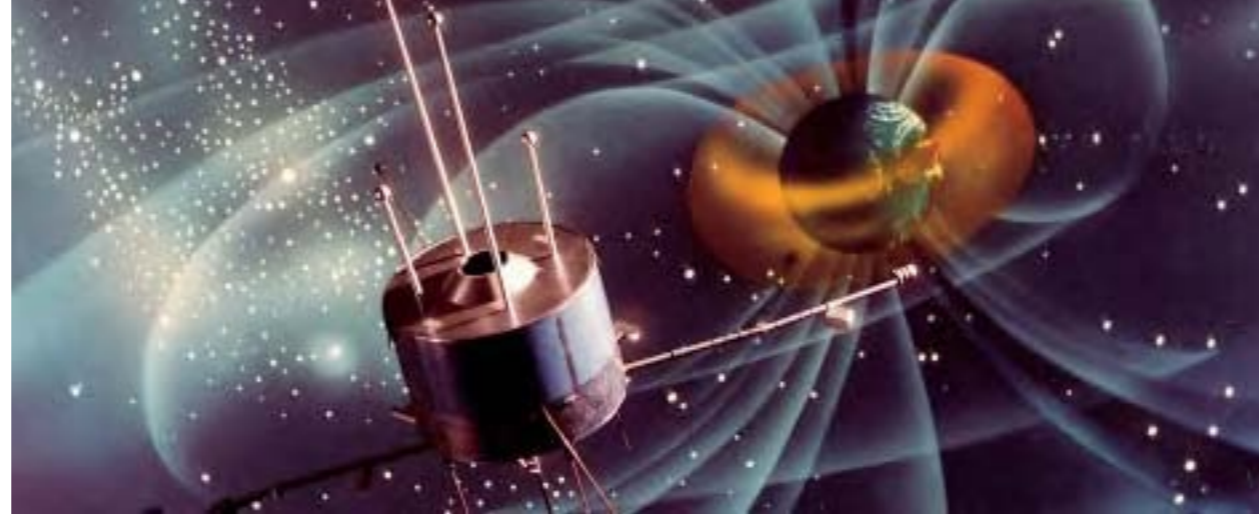

Geos-1 being prepared for boom deployment tests in the Dynamic Test Chamber at ESTEC.

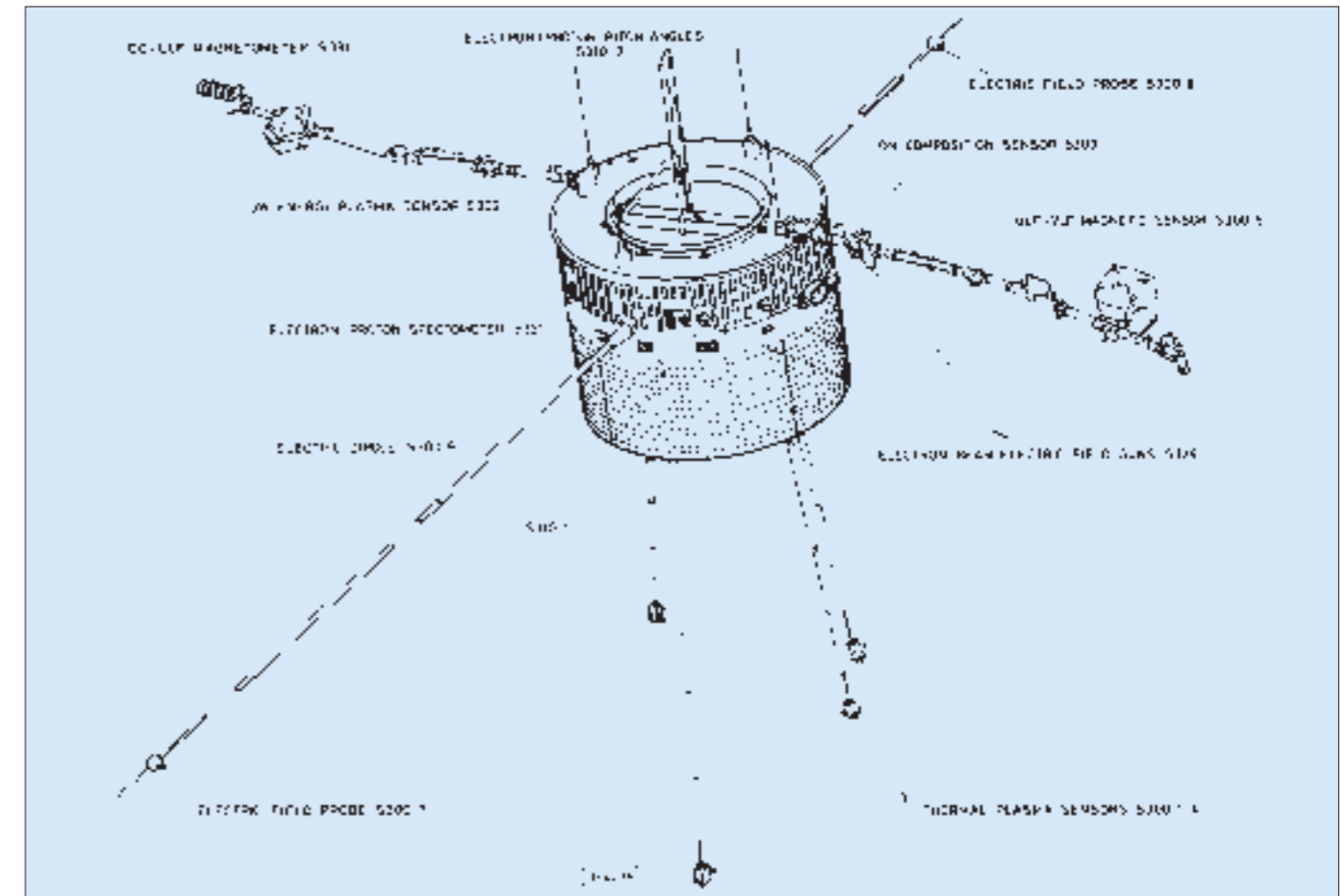

Satellite configuration: cylindrical bus, 132 cm high, 164.5 cm diameter. Maximum dimensions 477 cm from UHF antenna tip to S300 long axial boom tip; 42.6 m tip-to-tip of long radial booms.

Attitude/orbit control: apogee kick motor (269 kg solid propellant) for injection into GEO. Six 15 N thrusters provided reaction control (30.6 kg hydrazine): 2 axial thrusters (tilt/precess), 2 radial (orbit adjust) + spinup/down; 2 fluid nutation

dampers. Attitude measurement by Sun and Earth sensors plus accelerometer.

Power system: >110 W BOL provided from 7200 solar cells on cylindrical bus.

Communications payload: data 100 kbit/s continuous at 2299.5 MHz (no onboard storage). Telecommand at 149.48 MHz.

OTS

Achievements: first ESA telecommunications satellite; first European 3-axis Ku-band satellite; far exceeded design life
Launch dates: OTS-1 14 September 1977 (launch failure); OTS-2 12 May 1978
Mission end: OTS-2 retired operationally end-1983; deactivated January 1991
Launch vehicle/site: Delta 3914 from Cape Canaveral
Launch mass: 865 kg (444 kg on-station BOL); including 432 kg apogee boost motor
Orbit: geostationary, over 10°E
Principal contractors: British Aerospace, heading MESH consortium (Matra AIT, EGSE, AOCS; ERNO structure, RCS; Saab-Scania TT&C; AEG-Telefunken repeater payload)

The Orbital Test Satellite (OTS) was ESA's first communications satellite programme, and was crucial in demonstrating the technology for the European Communications Satellite (ECS) and Marecs maritime derivatives. It was instrumental in the creation of the European Telecommunications Organization (Eutelsat). Although the programme suffered the worst of all beginnings – its US Delta launcher exploded only 54 s after launch from Cape Canaveral – OTS ultimately went on to become one of the world's most successful telecommunications projects. Eight months later, the second flight model was launched successfully and placed in a geostationary orbit over 10°E, its three transmit antennas covering Western Europe, the Middle East, North Africa and Iceland.

OTS was the first satellite under 3-axis control to demonstrate use of the Ku-band (11-14 GHz) for the next generation of satellites, seeking to ease the growing congestion at C-band (4-6 GHz). It offered four wideband channels with a total capacity of 7200 telephone circuits or eight TV transmissions. OTS demonstrated the commercial potential of the Ku-band within its first year of operations, including telephone, data transmission and TV exchanges between Europe and North Africa. An important element of the

utilisation programme was the development and testing of the Time Division Multiple Access (TDMA) system for use later in the operational ECS telephony network. The first videoconferencing experiments using small ground antennas between Germany and the UK were successful by 1980, and using small terminals suitable for community TV reception aroused the interest of cable distribution companies. OTS' TV distribution



OTS-2 is installed on its Delta launcher at complex 17, Cape Canaveral.

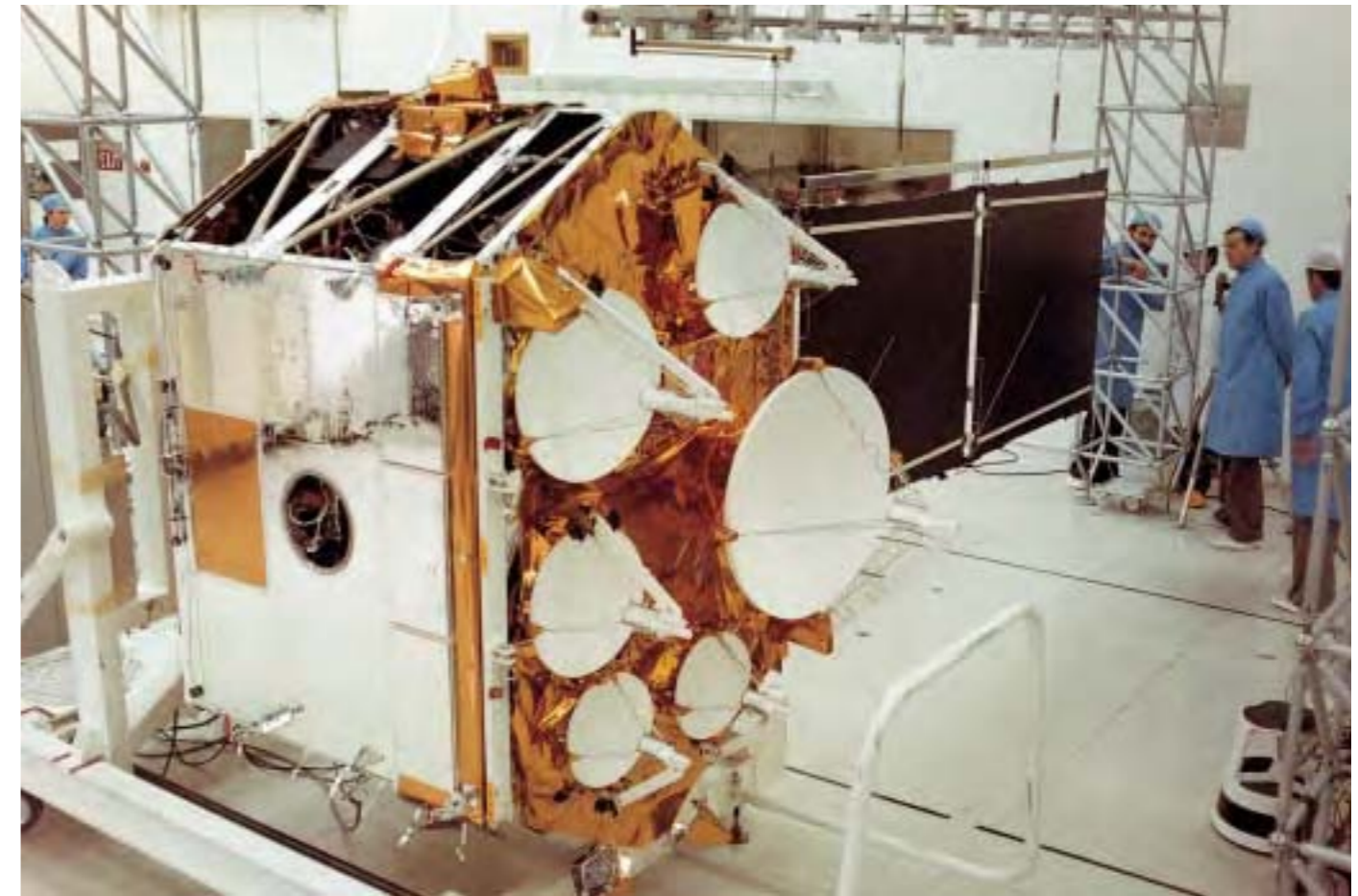

OTS-2 final tests.

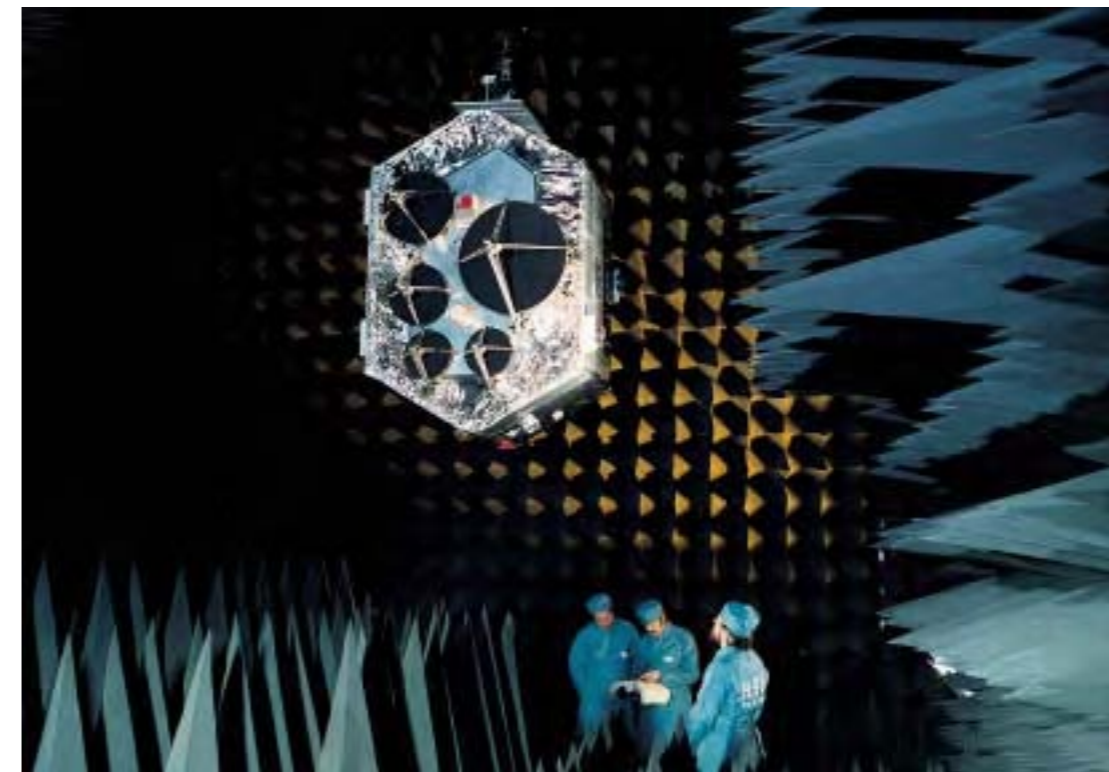

OTS-2 in the anechoic test chamber at British Aerospace, Stevenage, UK.

OTS was instrumental in ushering Europe into regional satellite telecommunications.

OTS pioneered the coverage of Europe planned for ECS.



TELEX

Thursday, 20 May 1978

from: OTS / TUCIND - STOLE

to: air-mobility station / STAC - FOLLOWING

subject: air service observed

this is the first time in history a message is sent via an air service via a communications satellite.

We hope this exciting event will be followed by many others, finally leading to an improvement of inter-continental communication.

XXXXXXXXXXXXXXXXXXXX

TELEX

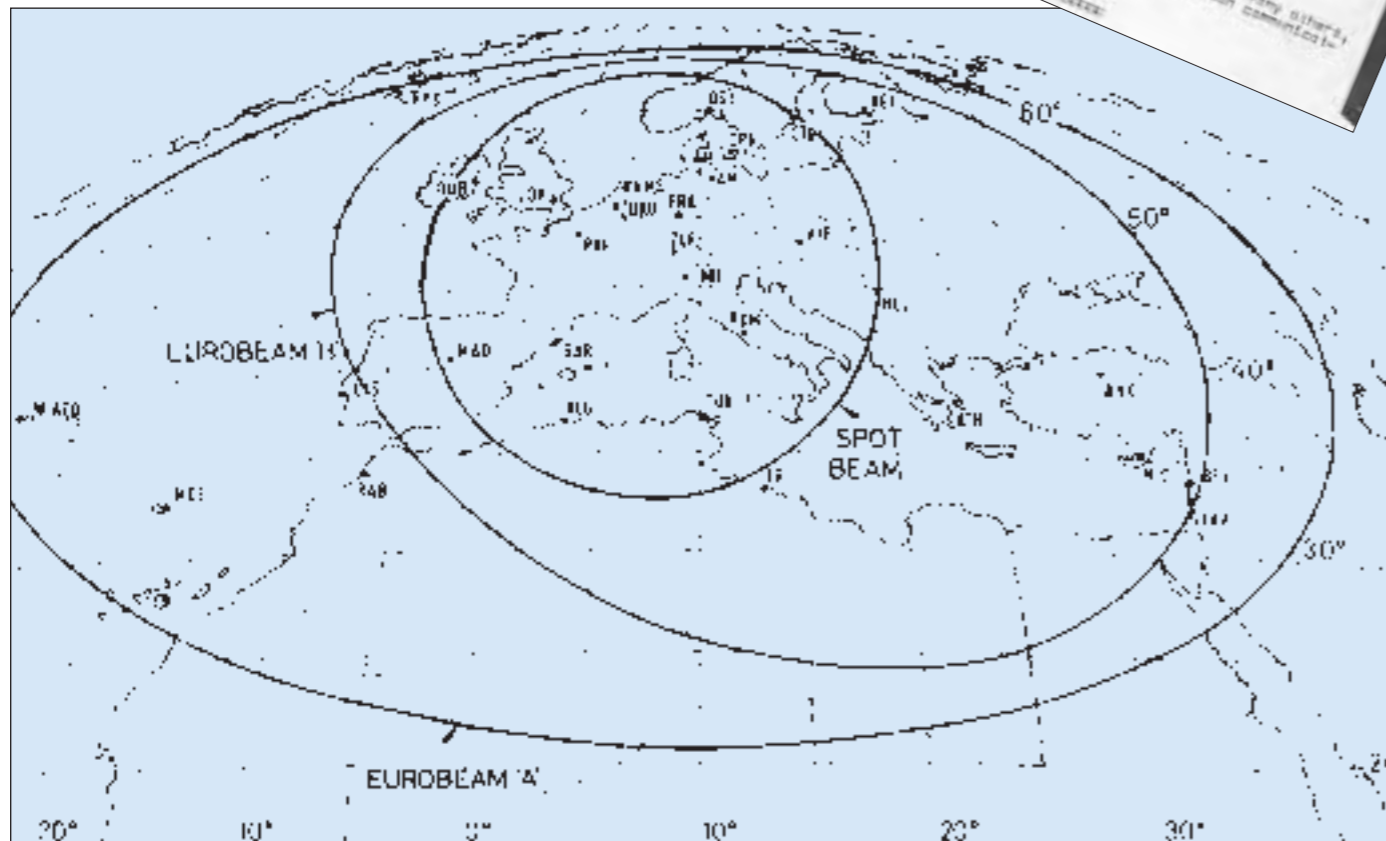

ESA's first telecommunications satellite, OTS-1, was lost in September 1977 when its US launch vehicle exploded.

experiments were so successful that ECS-1 was almost entirely dedicated to this function. The rapid response of satellite systems for coping with emergencies was demonstrated in November 1981 when the French PTT system at Lyons was destroyed by fire. Within hours, OTS and a transportable station had been brought into use to handle priority telephone traffic.

OTS more than doubled its target operational life of 3 years and was used by Eutelsat for commercial operations until the end of 1983. Before it was retired, ESA experimented with some risky manoeuvres, including recovery from a flat spin, a first for a 3-axis geostationary satellite. ESA also pioneered a new method of 'solar sailing' that tightened stationkeeping without consuming significantly more propellant. Solar sailing was also used operationally for more than 2 years for attitude control during normal mode control. OTS was placed in hibernation from late 1984 for final studies of long-term subsystem degradation, but in May 1988 it was reactivated to broadcast celebrations marking its 10th anniversary. The last of its channels failed in late 1990, so ESOC in January 1991 boosted it above the geostationary arc and into a well-earned retirement.

Satellite configuration: hexagonal-prism bus, 2.39 m high and 2.13 m wide; span 9.26 m across solar array. Service module (43 kg

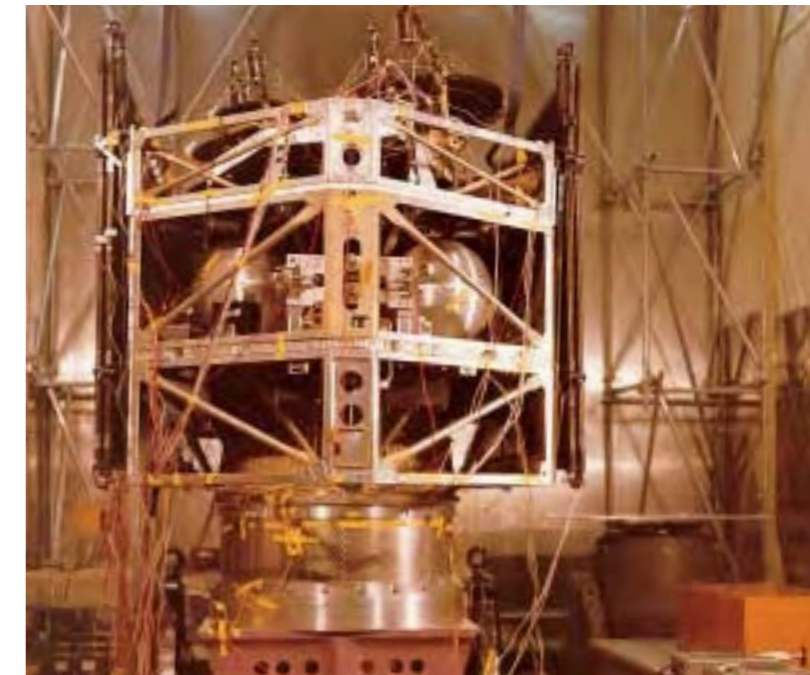

ECS and Marecs adopted the general design proved by OTS.

structure) based around central conical tube housing ABM; the module carried the propellant tanks, momentum wheels, gyros, most of the electronic units and the solar wing mounts. The communications module (20 kg structure) housed the repeater package and, on a separate panel, the six Ku-band antennas and Earth sensors.

Attitude/orbit control: fixed momentum wheel in conjunction with hydrazine thrusters provided normal Earth-pointing, using 2-axis Earth sensor (pitch/roll); rate gyro provided yaw error. Antenna Earth accuracy $\pm 0.2^\circ$. Aerojet SVM-7 solid-propellant ABM provided transfer from GTO into GEO.

Power system: twin 2-panel Si-cell solar wings powered the 50 V bus. Nickel cadmium battery sized to continue operating two channels through 72-min eclipse.

Communications payload: two 11.5 GHz 20 W 40 MHz-bandwidth with $4.25 \times 7.5^\circ$ Eurobeam-A coverage; two 11.6 GHz 20 W 120 MHz-bandwidth with 2.5° Spotbeam coverage; two 11.8 GHz 20 W 5 MHz-bandwidth with $3.5 \times 5^\circ$ Eurobeam-B coverage.

ISEE-2

Achievements: unprecedented observations, with ISEE-1, of Earth's magnetosphere

Launch date: 22 October 1977

Mission end: reentered 26 September 1987 (design life 3 years)

Launch vehicle/site: US Delta from Cape Canaveral complex 17

Launch mass: 165 kg (27.7 kg science payload)

Orbit: operational 2400x135 830 km, 23.0°

Principal contractors: Dornier-System GmbH, heading the STAR consortium

The International Sun-Earth Explorer (ISEE) was a joint ESA/NASA 3-spacecraft mission designed to study the dynamic properties of the Earth's magnetosphere and the solar wind in front of the magnetosphere. ESA's 'daughter' ISEE-2 was launched in tandem with NASA's 'mother' ISEE-1 and released into almost the same highly-elliptical orbit that provided good coverage of all the magnetosphere features over the period of a year. The separation between the spacecraft could be varied between 50 km and 5000 km, according to the scale of the feature being studied. The pairing allowed

differentiation between spatial and temporal phenomena.

NASA's ISEE-3 was launched in August 1978 to monitor the solar wind, fields and cosmic rays before they arrived at Earth. More than 100 investigators, representing most of the magnetospheric community, from 33 institutes were involved in the ISEE mission and its 28 instruments. The satellites were planned with 3-year lives but the ISEE-1/2 pair both operated for almost 10 years until their reentries in 1987. It is remarkable that no ISEE-2 units failed, apart from the expected loss of its battery.

Mission objectives included quantifying the picture of the magnetosphere known at the time, identifying how the solar wind affects the near-Earth environment, exploiting the plasmasphere and bow shock magnetosheath for plasma and particle physics studies, and measuring the isotopic composition of solar and galactic cosmic rays. For example, the satellites provided the first reliable measurement of the thickness of the magnetopause, the boundary between the Earth's magnetic field and the solar wind.

Satellite configuration: spin-stabilised cylindrical bus with three deployed instrument booms. Strict measures were followed to eliminate interference from the spacecraft to some of the experiments: the entire

ISEE-2 installation in the HBF 3 facility at ESTEC for thermal-vacuum testing.



Only two ISEE-2 models were built: the vibration-test version (later converted to engineering/prototype standard) and the flight model.

exterior was made conductive to reduce potential difference to 1 V, the use of non-magnetic materials restricted ISEE's DC field to <0.25-gamma at the magnetometer, and stringent limits were imposed on the electromagnetic radiation emitted by ISEE's interior.

Attitude/orbit control: 20 rpm spin-stabilised about longitudinal axis, perpendicular to ecliptic plane; 4 spin nozzles, 2 precession nozzles, also used for separation manoeuvres from ISEE-1. Cold gas propellant: 10.7 kg Freon-14. Attitude determined by two Earth albedo and solar aspect sensors.

Power system: Si cells on cylindrical panels generated >100 W (65 W after 10 years; 27 W required by science payload), supported by nickel cadmium battery (failed, as predicted, after 2 years).

Communications payload: S-band data returned at 8192 bit/s (high) or 2048 bit/s (low). Controlled from NASA Goddard.

ISEE-2 Scientific Instruments

AND	8-380 keV protons & 8-200 keV electrons at high time resolution. K.A. Anderson, Univ. California at Berkeley (US)
EGD	0.001-10 keV/N solar wind ions. G. Moreno, CNR Frascati (I)
FRD	0.001-50 keV protons & 0.001-250 keV electrons at high angular resolution. L. Frank, Iowa Univ. (US)
GUD	10 Hz-2 MHz electric waves & 10 Hz-10 kHz magnetic waves. D. Gurnett, Iowa Univ. (US)
HAD	Total electron density between ISEE-1/2. C.C. Harvey, Meudon (F)
KED	0.025-2 MeV protons & 20-250 keV electrons at high angular resolution. D. Williams, NOAA Boulder (US)
PAD	0.005-40 keV protons & 0.005-20 keV electrons at high time resolution. G. Paschmann, MPI Garching (D)
RUD	Magnetometer, range 8192-gamma sensitivity 0.008-gamma. C. Russell, Univ. California at Los Angeles (US)



ISEE-2 in the Dynamic Test Chamber at ESTEC.

Meteosat

Achievements: first European meteorological satellite; first European geostationary satellite; creation of Eumetsat
Launch dates: Meteosat-1 23 November 1977; Meteosat-2 19 June 1981; Meteosat-3 15 June 1988; Meteosat-4 6 March 1989; Meteosat-5 2 March 1991; Meteosat-6 20 November 1993; Meteosat-7 2 September 1997
Mission end: Meteosat-1 end-1984; Meteosat-2 end-1991; Meteosat-3 end-1995; Meteosat-4 end-1995; Meteosat-5 end-2005; Meteosat-6/7 still in service (5-year design lives)
Launch vehicles/sites: Meteosat-1 Delta from Cape Canaveral; Meteosat-2/3/4/5/6/7 Ariane from Kourou, French Guiana
Launch mass: about 680 kg (320 kg on-station BOL)
Orbit: geostationary over 0°
Principal contractors: Aerospatiale (prime), Matra (radiometer)

ESRO approved development of Europe's first applications-satellite project in 1972, creating the system that is now an integral and indispensable part of the world's network of meteorological satellites. The success of the first three pre-operational satellites paved the way for the Meteosat Operational Programme in 1983 (Meteosat-4/5/6) and the current Meteosat Transition Programme (Meteosat-7).

ESA was responsible for developing and operating the system on behalf of the newly-created European Meteorological Satellite Organisation (Eumetsat), which took direct operational control on 1 December 1995 as MTP began. Eumetsat's Convention was ratified in June 1986 and the organisation assumed overall and financial responsibility for MOP in January 1987. MOP began life as an ESA 'optional programme' – as did the original programme – but Eumetsat then took over all obligations from the Agency and it became a 'third party-financed programme' (as is MTP). For the one new satellite of MTP – identical to its three predecessors – ESA managed satellite procurement but Eumetsat was responsible for the ground segment, launch and operations.

The Meteosat Second Generation was introduced in 2002, although Meteosat-7 will remain at the prime 0° location until end-2005. ESA continues responsibility for developing and procuring these new satellites.

Meteosat-1 was on-station over the prime meridian from 7 December 1977 – as Europe's first geostationary satellite – and returned its first image soon after. Its planned 3-year life was cut short on 24 November 1979 when a design fault in an under-voltage protection unit knocked the imaging and data-dissemination systems out of action. Nevertheless, Meteosat-1 had returned more than 40 000 images and admirably fulfilled its promise. It continued in its data-collection role until the end of 1984, when its hydrazine neared exhaustion.

Meteosat-2 arrived on station 20 July 1981 and began routine operations 12 August 1981. It performed the primary role far beyond its design life, until Meteosat-3 took over on 11 August 1988. The original

programme called for two satellites, but the P2 prototype was upgraded to ensure continuity until the MOP was ready. Meteosat-2 was boosted above GEO in December 1991 and shut down after returning 284 000 Earth images. Meteosat-3 also proved to be a great success. Once it was replaced as the prime satellite by Meteosat-4, it spent several spells covering the eastern United States from 50°W on loan to the US because of problems in the GOES system. It was removed from GEO and retired in November 1995.

Meteosat-4 entered service as the prime satellite over 0° on 19 June 1989. Although interference between power supplies caused striping in some images, it served as prime from April 1990 to February 1994, when it was replaced by Meteosat-5. It was removed from GEO and deactivated in November 1995. Its two successors took over the prime roles in February 1994 and February 1997, respectively. Meteosat-5 began moving from storage at 10°W in January 1998 and halted at 63°E on 19 May 1998 to begin 18 months



Merged images from Meteosats-3/4 on 16 May 1993. At the time, Meteosat-4 was at Europe's prime longitude of 0°, while Meteosat-3 was at 50°W on loan to the US weather service. (ESA/Eumetsat)

Meteosats 1-7 look identical. The second generation is a similar configuration, but larger.

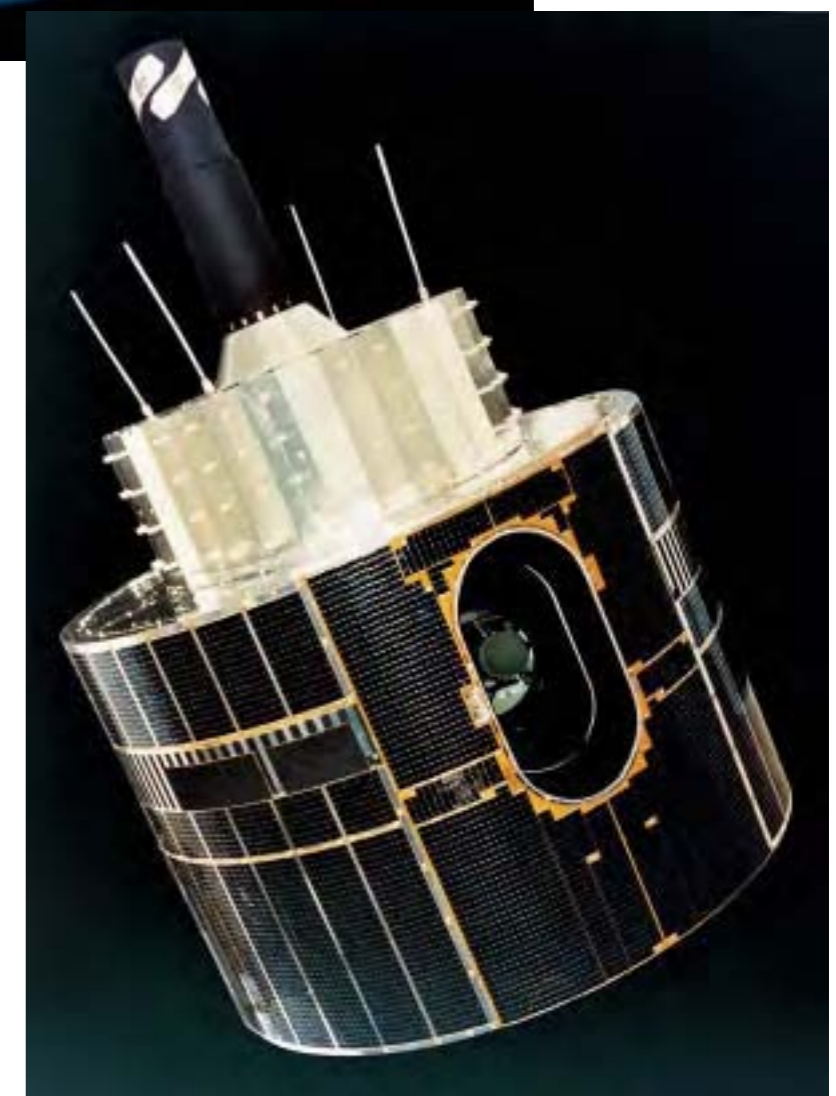

Meteosat-7 image of 20 October 1998. (Eumetsat)

covering the Indian Ocean from 1 July 1998, providing meteorologists with a complete orbital ring of satellites. After the Indian Ocean Experiment ended in May 1999, Eumetsat decided to continue coverage there until the end of 2003. The goal now is for it to retire from there at end-2005, replaced by Meteosat-7, which will continue the service to end-2008. Meteosat-7 took over the system's prime role in June 1998 (and will continue it to end-2005), before Meteosat-6 moved later that month to 10°W as backup. Meteosat-6 has been used to support the Rapid Scanning Service since 18 September 2001. When MSG-1 appeared at 10.5°W, Meteosat-6 moved to 10°E, arriving 14 October 2002. It is planned to remain there beyond 2005 as backup.

Satellite configuration: 2.1 m-diameter, 3.195 m-high stepped cylinder, with imaging radiometer field of view at 90° to spin axis for scanning across Earth disc.

Attitude/orbit control: operationally held within $\pm 1^\circ$ at 0° longitude by thrusters. Spin-stabilised at 100 rpm around main axis parallel to Earth's axis. Six thrusters: 2x10 N parallel to spin axis (NSSK & attitude control); 2x10 N in spin plane, offset 12° from spin axis (E-W control; spin-up/down); 2x2 N (as previous, plus also 12° below spin plane for attitude control). Typically 40 kg hydrazine loaded in 3 tanks pressurised by nitrogen. Propellant remaining as of May 2005: 9.4 kg M7; 6.3 kg M6; 4.5 kg M5. Attitude information from pairs of Earth horizon and Sun sensors. Injection into GEO by solid-propellant apogee boost motor.

Power system: six Si-cell panels on cylindrical body provide 300 W BOL.

Radiometer payload: Meteosat's scanning imaging radiometer returns three visible/IR full-disc Earth images every 25 min, followed by a 5 min reset period. The pivoted



Examples of Meteosat imagery from Meteosat-3.
 Top left: visible full-disc; top right: visible-light Europe; bottom left: thermal-IR; bottom right: water vapour-IR. The colouring has been added. During the Meteosat Operational Programme (1983-1995), ESA's European Space Operations Centre (ESOC) in Germany processed more than 1.1 million Meteosat images. (ESA/Eumetsat)

Far right: Meteosat-5 view from 63°E, 4 September 2001. (Eumetsat).



Meteosat Radiometer Payload

Meteosat's scanning imaging radiometer returns three visible/IR full-disc Earth images every 25 min, followed by a 5 min reset period. The pivoted Ritchey-Chrétien 40 cm-aperture, 365 cm-focal length telescope, is stepped 0.125 mrad by a motor every 100 rpm Meteosat rotation to scan Earth's disc at 5 km intervals south to north. The two visible (0.4-0.9 μm) Si photodiode detectors return images of 5000 scan lines, for 2.5 km resolution. The thermal-IR (10.5-12.5 μm) and the water vapour-IR (5.7-7.1 μm) mercury-cadmium-telluride detectors assemble images of 2500 lines (each 2500 pixels), yielding 5 km resolution. The water vapour channel was experimental on the first three satellites, but was included operationally beginning with Meteosat-4.

Meteosat-3 added the Laser Synchronisation from Stationary Orbit (LASSO) package of laser reflectors to demonstrate time standard synchronisation over large distances with 10^{-9} s accuracy. The laser pulses could also measure Meteosat's distance to within 10 cm.

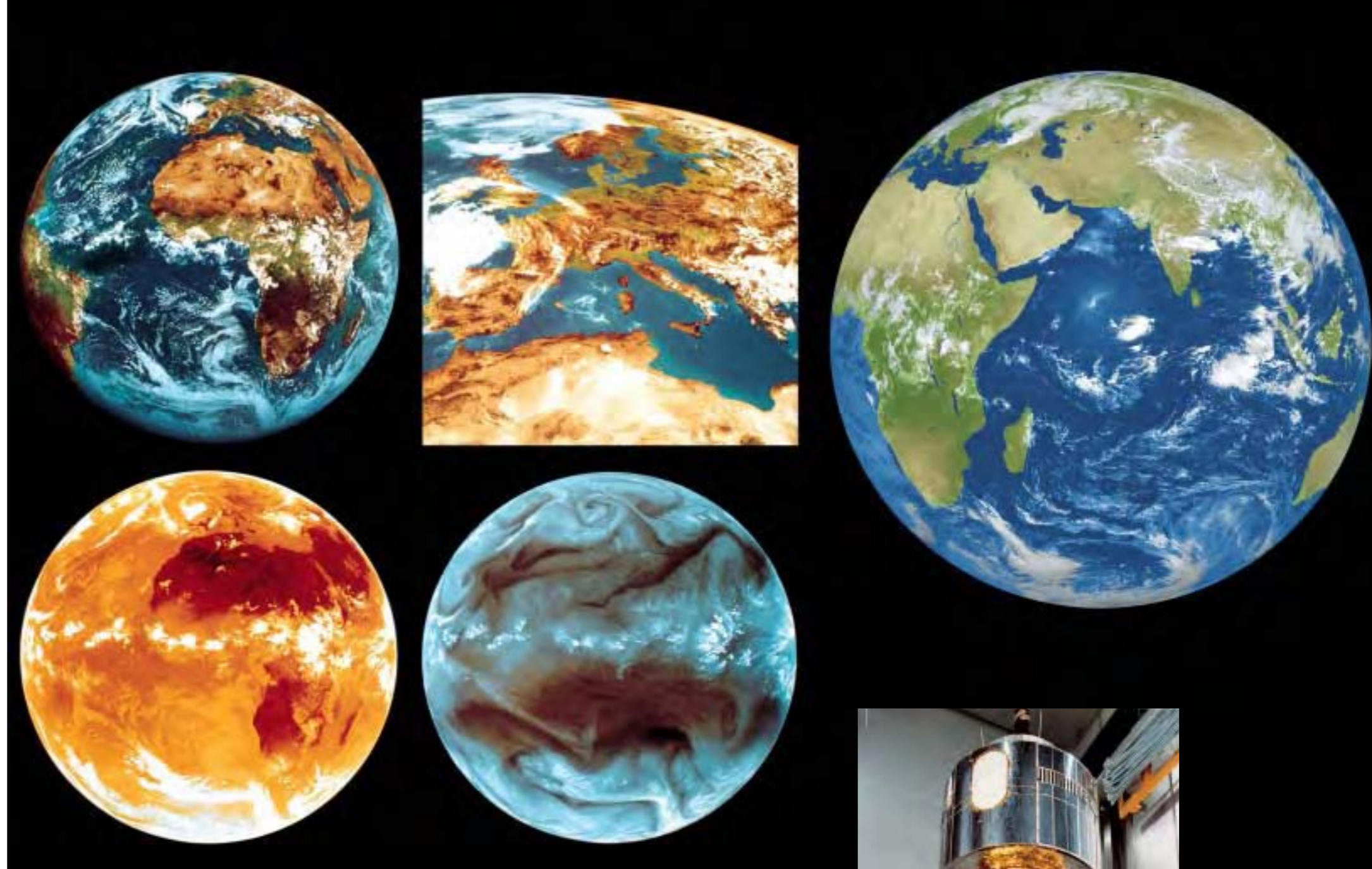

Ritchey-Chrétien 40 cm-aperture, 365 cm-focal length telescope, is stepped 0.125 mrad by a motor every 100 rpm Meteosat rotation to scan Earth's disc at 5 km intervals south to north. The two visible (0.4-0.9 μm) Si photodiode detectors return images of 5000 scan lines, for 2.5 km resolution. The thermal-IR (10.5-12.5 μm) and the water vapour-IR (5.7-7.1 μm) mercury-cadmium-telluride detectors assemble images of 2500 lines (each 2500 pixels), yielding 5 km resolution. The water vapour channel was experimental on the first three satellites, but was included operationally beginning with Meteosat-4.

Meteosat-3 added the Laser Synchronisation from Stationary

Orbit (LASSO) package of laser reflectors to demonstrate time standard synchronisation over large distances with 10^{-9} s accuracy. The laser pulses could also measure Meteosat's distance to within 10 cm.

Communications payload: top cylinder carries radiating dipole antenna elements activated sequentially (electronically despun) for 333 kbit/s S-band image transmissions and TT&C operations. The imagery were received and processed at ESOC (by Eumetsat in Darmstadt from 1 December 1995) and disseminated to users at L-band through Meteosat itself. The satellite also relays data from international Data Collection Platforms (to transfer to MSG-1 end-2005).



Meteosat-2 (top) is prepared for launch by Ariane in 1981. (CSG/Arianespace)

IUE

Achievements: longest spaceborne astronomy mission (18.7 years); first astronomical satellite at geostationary altitude
Launch date: 17:36 UT 26 January 1978
Mission end: 30 September 1996, terminated 18:44 UT on ground command (design life 3 years; consumables sized for 5 years)
Launch vehicle/site: Delta 2914, from Cape Canaveral, Florida
Launch mass: 671 kg (122 kg science, 237 kg apogee boost motor)
Orbit: geosynchronous over Atlantic: initially 32050x52254 km, 28.6°, 23.93 h, mission-end 36360x48003 km, 35.9°; Jan 2004 29191x42490 km, 40°

The International Ultraviolet Explorer (IUE) remains the longest-serving and most prolific astronomical satellite yet launched: its 18.7 years of operations returned 104 468 high- (~0.1 Å) and low-resolution (~6 Å) spectra from 9600 celestial sources in the 1150-3200 Å UV band. IUE provided astronomers with a unique tool, and requests for observing time even towards the end of its career remained two-three times greater than could be satisfied. Despite the appearance of the Hubble Space Telescope in 1990, IUE continued to prosper because it covered an entire spectral region not accessible in one sweep to HST's high-resolution spectrographs. It was the first

scientific satellite that allowed 'visiting' astronomers to make realtime observations of UV spectra: the impressive response time of <1 h provided an unparalleled flexibility in scheduling targets of opportunity.

IUE was a trilateral project, based on the 1974 Memorandum of Understanding specifying that NASA would provide the spacecraft, telescope, spectrographs and one ground observatory, ESA the solar panels and the second observatory, and the UK the four spectrograph detectors. In addition to controlling the satellite, the ground sites acted as typical astronomical observatories, except that their telescope hovered far out in space. ESA's 'IUE Observatory' was established in 1977 at the Villafranca Satellite Tracking Station, Madrid, Spain. During IUE's life, >1000 European observing programmes were conducted from Villafranca, returning >30 000 spectra from about 9000 targets.

In March 2000, ESA delivered the IUE Archive to the scientific community. Spain's Laboratory for Space Astrophysics and Theoretical Physics (LAEFF, part of the National Institute for Aerospace Technology, INTA) assumed responsibility for the Archive and INES (IUE Newly Extracted Spectra), a system for rapid and simple global access. This principal centre is mirrored by the Canadian Astronomical Data Centre and supported through 18 National Hosts that offer local access to the data. From 2000 to 2003, the INES system had 30 000 queries from 1400 nodes in 30 countries, resulting in the download of 227 000 files (29 Gbytes).

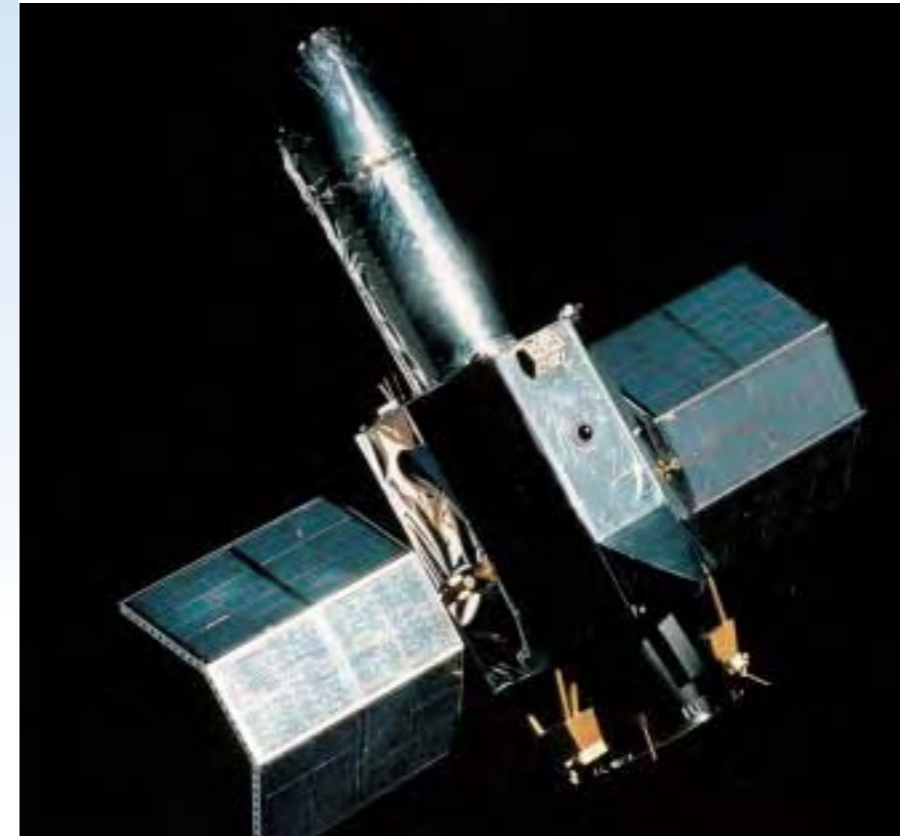

IUE was the first astronomical observatory based around geostationary altitude, hovering over the Atlantic Ocean in constant view of its users at Villafranca and NASA Goddard. Below: a section of IUE's high-resolution spectrum of supernova SN 1987A. The narrow lines are caused by the gas in our Galaxy, the Large Magellanic Cloud and in between.

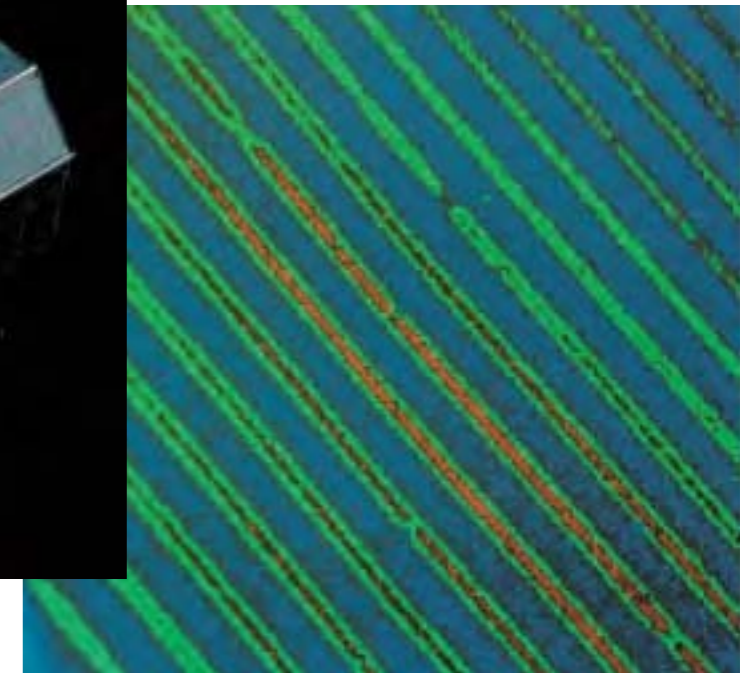

These spectra were processed and deposited in a public domain archive together with the data collected by the IUE Observatory at NASA's Goddard Space Flight Center. The IUE Data Archive remains the most heavily used astronomical archive in existence: each IUE spectrum had been used almost nine times by 2004. During 2000-2003, 15% of papers using HST data referred to IUE data in the abstract.

IUE's only serious problems stemmed from the failures (1979, 2x1982, 1985, 1991) of five of the six gyros in its attitude control system, although only one succumbed within the 3-year design life. When the fourth failed in 1985, IUE continued operations thanks to an innovative reworking of its attitude control system by using the fine Sun sensor as a substitute. Even with another lost in the last year, IUE could still be stabilised in 3-axes by adding star tracker measurements.

Until October 1995, IUE was in continuous operation, run 16 h daily from Goddard and 8 h from Villafranca. After that, as the two agency's budgets tightened, observations were made only during the 16 h low-radiation part of the orbit, controlled from Villafranca

IUE identified the star that exploded into SN 1987A – the first supernova visible to the naked eye in 383 years. The diagram below shows how the brightness at each UV wavelength changed, beginning a few hours after the supernova's discovery. The emission shifts towards longer wavelengths as the supernova rapidly cools from 13 500 K on 25 February 1987 to 5200 K by 14 March 1987.

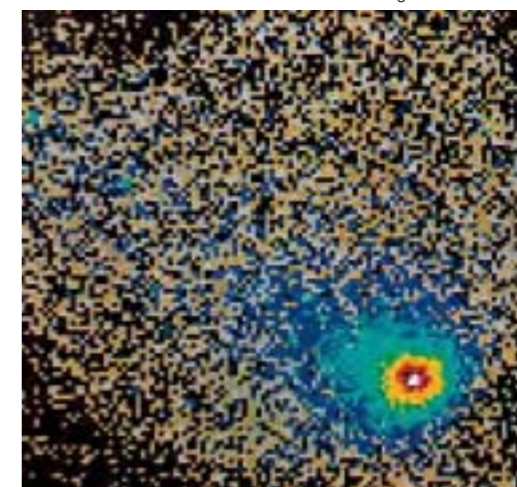
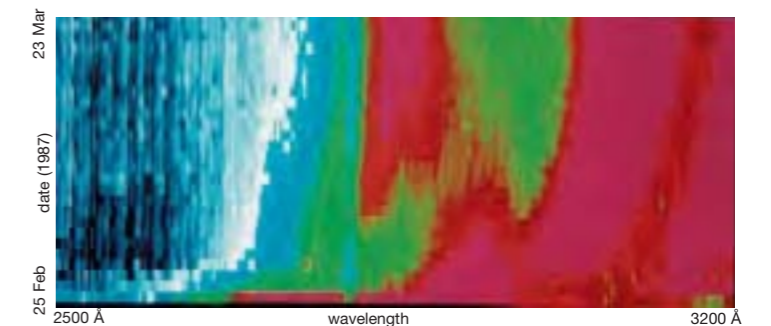

IUE carried two star trackers (Fine Error Sensors) viewing through the main telescope to provide precise positioning information. This FES image shows Halley's Comet during its closest approach to Earth in 1985.

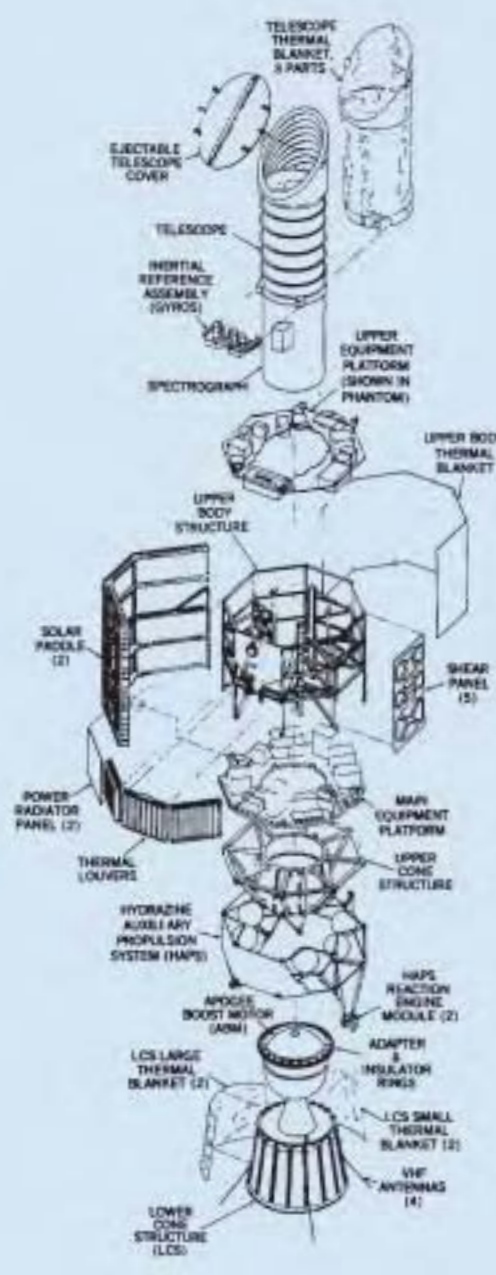

Right: The IUE Flight Model being prepared for a fine-pointing test.
Below: IUE ready for launch.
(NASA)

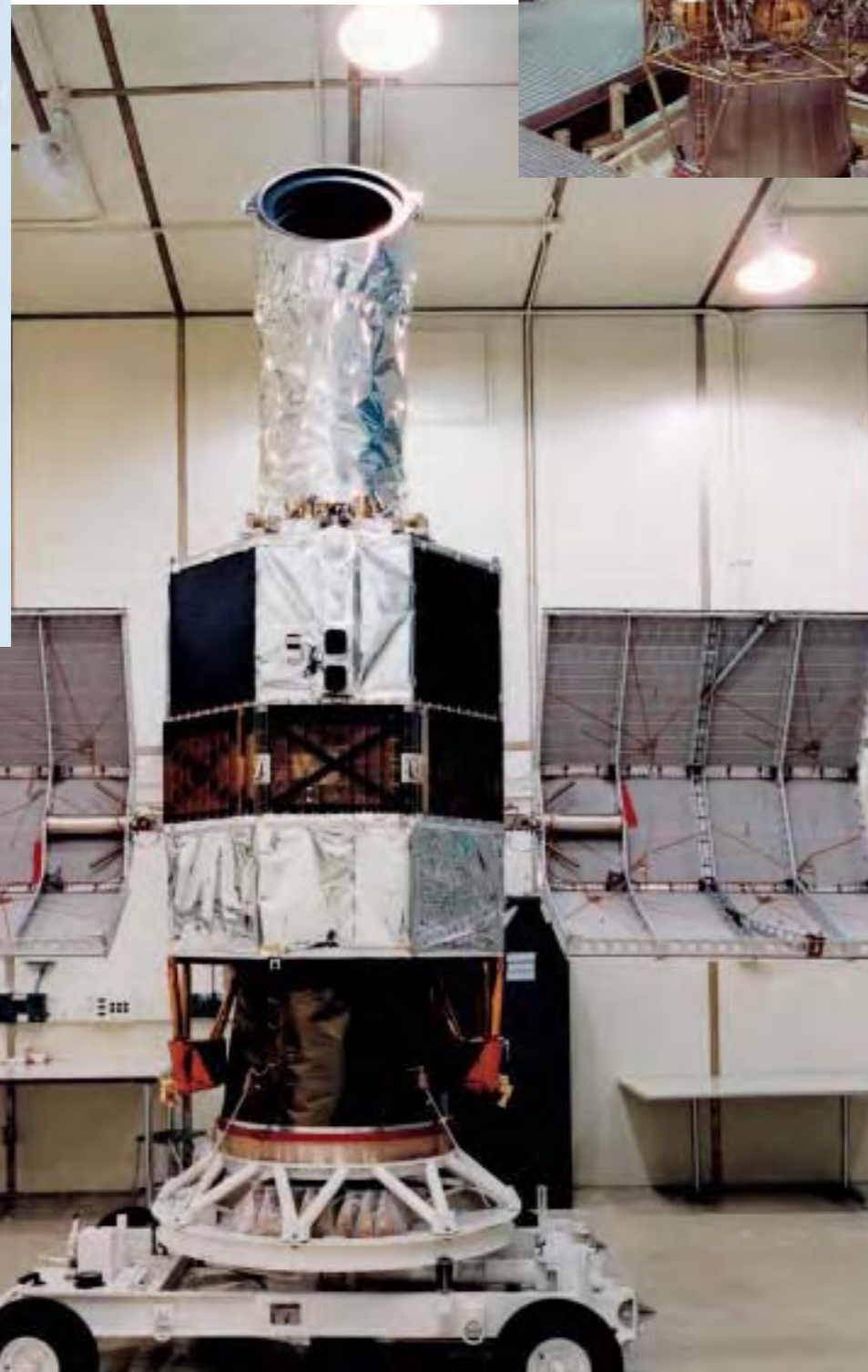

while NASA concentrated on creating the IUE Final Archive. IUE remained operational until its hydrazine was deliberately vented, its batteries drained and its transmitter turned off.

Satellite configuration: 1.45 m-dia octagonal-prism bus with telescope assembly along main axis, and fixed solar wings extending from opposing faces. Most of the higher-power electronics were mounted on the main equipment panel at the base, near the thermal louvres, while the experiment electronics and attitude control elements were on the upper equipment platform.

Attitude/orbit control: 3-axis control by four reaction wheels, Fine Error Sensors (2-axis star trackers using the telescope optics for 0.27 arcsec angular resolution in 16 arcmin FOV), fine/coarse Sun sensors and 8x9 N + 4x22 N hydrazine thrusters (27.3 kg hydrazine in 6 tanks) for momentum dumping and orbit adjust. The control system had to hold a 1 arcsec-dia star image within a 3 arcsec-dia spectrograph entrance for a 1 h integration by the camera.

Power system: 424 W BOL/28 Vdc (170 W after 18 yr; 210 W required) provided by two fixed 3-panel wings carrying 4980 2x2 cm Si cells; 2x6 Ah nickel cadmium batteries.

Communications/data: 1.25-40 kbit/s 2.25 GHz 6 W S-band downlink with fixed + reprogrammable formats. 139 MHz VHF for telecommand.

Science payload: 45 cm-diameter f/15 Ritchey-Chrétien telescope with two Fine Error Sensors, echelle spectrographs (1150-1980 Å; 1800-3200 Å), resolutions 270 at 1500 Å & 400 at 2700 Å. Redundant 1150-1970 Å and 1750-3300 Å vidicon cameras, 768x768 pixels.

The Goals and Highlights of IUE

IUE's original scientific objectives were to:

- obtain high-resolution spectra of stars of all spectral types to determine their physical characteristics
- study gas streams in and around binary star systems
- observe faint stars, galaxies and quasars at low resolution, interpreting these spectra by reference to high-resolution spectra
- observe the spectra of planets and comets
- make repeated observations of objects with variable spectra
- study the modification of starlight caused by interstellar dust and gas.

Scientific highlights were the:

- first detection of aurorae on Jupiter
- first detection of sulphur in a comet
- first measurement of water loss in a comet (10 t/s)
- first evidence for strong magnetic fields in chemically peculiar stars
- first orbital radial velocity curve for a Wolf-Rayet star, allowing its mass determination
- first detection of hot dwarf companions to Cepheid variables
- first observational evidence for semi-periodic mass-loss in high-mass stars
- discovery of high-velocity winds in stars other than the Sun
- first identification of a supernova progenitor (SN 1987A)
- discovery of starspots on late-type stars through Doppler mapping
- discovery of large-scale motions in the transition regions of low-gravity stars
- discovery of high-temperature effects in stars in the early stages of formation
- discovery of high-velocity winds in cataclysmic variables
- discovery of the effect of chemical abundance on the mass-loss rate of stars
- first determination of a temperature and density gradient in a stellar corona beyond the Sun
- first detection of gas streams within and outflowing from close binary stars.
- determination that no nova ejects material with solar abundance
- discovery of 'O-Ne-Mg' novae, where the excess of these elements can be directly traced to the chemical composition of the most massive white dwarfs
- discovery of a ring around SN 1987A, a leftover from previous evolutionary stages
- first direct detection of galactic haloes
- first observations of extragalactic symbiotic stars
- first uninterrupted lightcurves of stars for more than 24 h continuously
- first detection of photons below 50 nm from any astronomical source other than the Sun
- first direct determination of the size of the active regions in the nuclei of Seyfert galaxies (mini-quasars)
- first detection of a transparent sightline to a quasar at high redshift, allowing the first abundance determination of the intergalactic medium in the early Universe
- first astronomical and satellite facility to deliver fully reduced data within 48 h to scientists

Ariane-4 Ariane-3 Ariane-2 Ariane-1

Achievements: first successful European satellite launcher; launched half of world's commercial satellites into GTO; 144 flights (116 Ar-4); 100th launch 23 Sep 1997; 100th Ar-4 launch 29 Oct 2000 (Ar-4 total 337 t orbited in 163 payloads); Ariane carried its 100th telecommunications satellite (Astra 1E) on 19 Oct 1995; heaviest payload is Anik-F1 (4711 kg, 21 Nov 2000); world record 74 consecutive successes Mar 1995 to Feb 2003 (programme end; Ar-4 overall success rate 97.4%, orbiting 182 satellites totalling 404.1 t)

Launch dates: 24 Dec 1979 for first of 11 Ar-1; 4 Aug 1984 for first of 17 Ar-2/3; 15 Jun 1988 for first of 116 Ar-4

Launch site: Ar-1/2/3 from ELA-1 pad, Ar-2/3/4 from ELA-2 pad; Kourou, French Guiana

Launch mass: 484 t for heaviest Ariane-4 version (Ar-44L), 245 t for lightest Ariane-4 version (Ar-40)

Performance: optimised for GTO. Up to 4950 kg into 7°-inclined GTO for Ar-44L from Kourou; Ar-1 1850 kg; Ar-2 2175 kg; Ar-3 2700 kg

Principal contractor: EADS Launch Vehicles (industrial architect)



Launch of the first Ariane-4 (V22), in August 1984. Note the two liquid-propellant and two solid-propellant strap-ons. (ESA/CNES/CSG)

The Ministers responsible for space affairs in 10 European countries decided in Brussels on 31 July 1973 to develop a competitive vehicle that would win a significant share of the launch market for applications satellites. All the signs were that 1980-90 would see the setting up of a myriad of operational and commercial space systems for telecommunications, direct TV broadcasting, meteorology and Earth observation. Several contemporary studies estimated that 180 satellites would require launches into geosynchronous orbits.

The highly successful and profitable Ariane programme more than vindicated that original agreement of the 10 countries: France (63.9%), Germany (20.1%), Belgium (5.0%),

UK (2.5%), The Netherlands (2.0%), Spain (2.0%), Italy (1.7%), Switzerland (1.2%), Sweden (1.1%) and Denmark (0.5%). The vehicle captured half of the world's commercial launch contracts annually. In 1998 alone, the profit reported by Arianespace – established by CNES in 1980 to contract, manage production, finance, market and conduct the launches – was €12.6 million on sales of €1.07 billion from 11 launches involving 14 satellites.

A study of the direct economic effects of the Ariane-1 to -4 programmes showed a financial return of slightly more than a factor of 3. In other words, the revenues generated for Arianespace and European industry were more than three times the initial

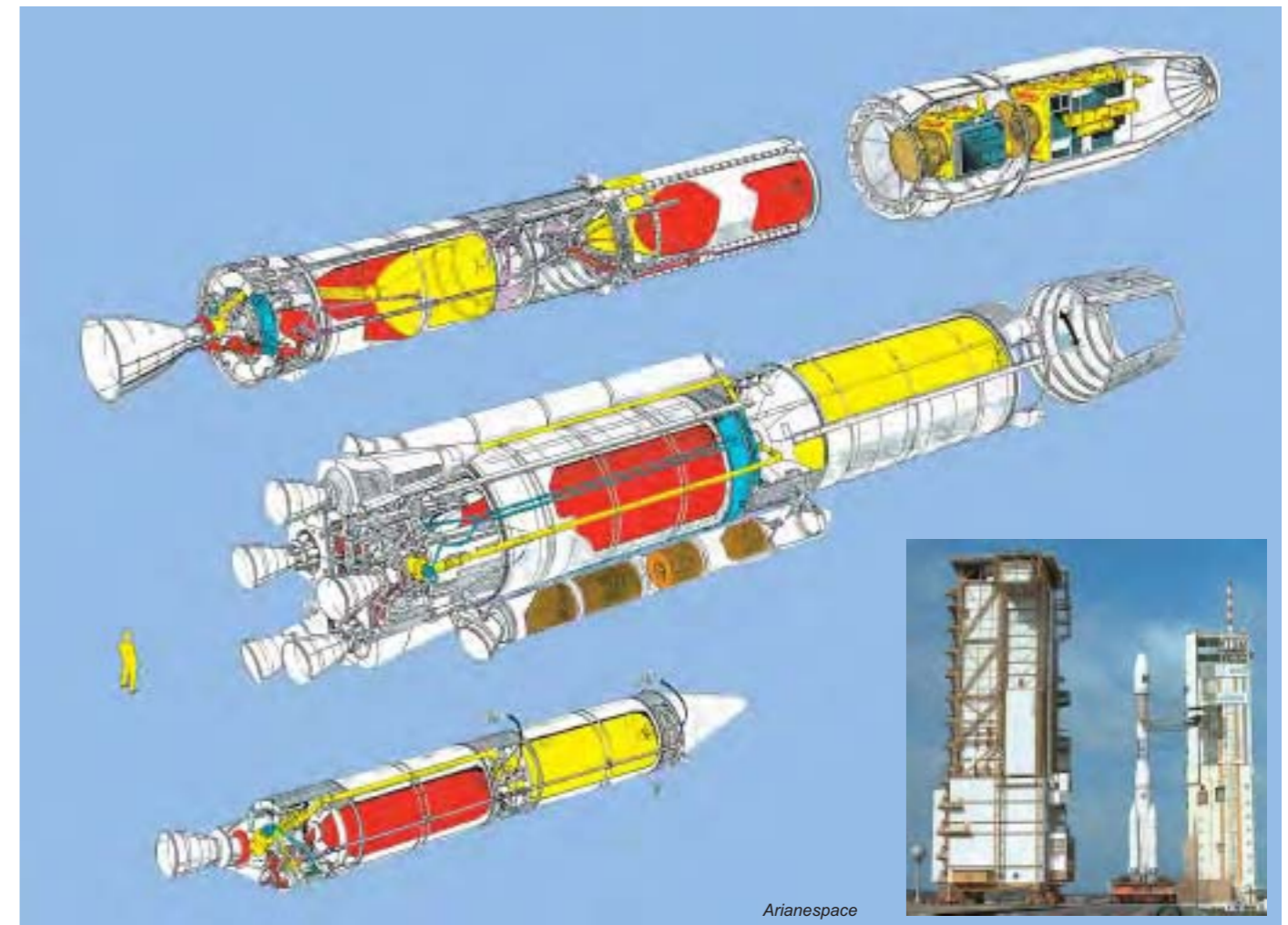

Arianespace

public investment in Ariane, taking into account the €6 billion invested by ESA and national institutions between 1974 and 2000 and the more than €18 billion generated by launch contracts. These figures also covered the public expenditure related to the Kourou launch site.

ESA was responsible (as design authority) for Ariane development work, owning all the assets produced. It entrusted technical direction and financial management to CNES, which wrote the programme specifications and placed the industrial contracts on its behalf. EADS Launch Vehicles (the former Aerospatiale) acted as industrial architect. ESA/CNES were directly responsible for the L01-L04 development launches and the L5-L8 promotional launches, before Arianespace assumed responsibility beginning with flight 9. The 3-stage launcher was optimised for direct

Ariane-4 Variants				
		Launch thrust	Launch mass	7° GTO capacity
Ar-40	no strap-ons	2720 kN	245 t	2130 kg
Ar-42P	2 solids	3945 kN	324 t	2970 kg
Ar-44P	4 solids	5140 kN	356 t	3530 kg
Ar-42L	2 liquids	4060 kN	363 t	3560 kg
Ar-44LP	2 solids/2 liquids	5270 kN	421 t	4310 kg
Ar-44L	4 liquids	5400 kN	484 t	4950 kg

ascent into GTO, beginning with Ariane-1's capacity of 1850 kg. The 47.4 m-high, 210 t Ariane-1 was powered by four Viking 5 engines on stage-1, a single Viking 4 on stage-2 and the cryogenic liquid oxygen/liquid hydrogen HM-7 engine of stage-3. The Ariane-1 vehicle flew 11 times during 1979-86, with its nine successes a remarkable achievement for a new design.

Overpage: preparing for Ariane-44P V144, launched 25 September 2001 carrying Atlantic Bird-2 for Eutelsat (left); Ariane-44L V156 with NSS-6 on 17 December 2002. (ESA/CNES/CSG)



Ariane-4 V34 included four liquid-propellant strapons to help deliver the Intelsat 6 telecommunications satellite into GTO. Forty of these Ar-44L versions had been launched when the programme ended in February 2003. (ESA/CNES/CSG)



Ariane's first launch, on 24 December 1979, was a complete success. (ESA/CNES/CSG)



Ariane V10 in August 1984 saw the first use of solid-propellant strapons to increase performance. On this occasion, the boosters carried recoverable cameras to film the separation sequence 4.8 km high. The other booster can be seen as Ariane accelerates away with its four Viking engine bells glowing red hot. (ESA/MAN)



Ariane-4 Principal Characteristics

Stage-1

Principal contractor: EADS-LV (Aerospatiale)

Size: 28.39 m (including 3.31 m interstage) long; 3.80 m diameter, 17.5 t dry mass

Powered by: four Snecma Moteurs Viking 5 engines providing total of 2720 kN at launch for up to 205 s (qualified to 300 s), gimballed for attitude control, drawing on up to 227 t of nitrogen tetroxide (NTO) and UH25 (unsymmetrical dimethyl hydrazine + 25% hydrazine hydrate)

Design: propellants were carried in two identical 10.1 m-long, 3.80 m-diameter steel tanks, separated by a 2.69 m-long interstage. An 8200-litre toroidal water tank sat on top of the lower tank, used for engine cooling

Solid-propellant strapons: 0, 2 or 4 carried, ignited at launch, 4.2 s after main engines. Each 650 kN thrust, 33 s burn (ejected >1 min after launch), 1205 cm long, 107 cm diameter, 12 660 kg (9500 kg propellant). EADS-LV prime contractor

Liquid-propellant strapons: 0, 2 or 4 carried, ignited with stage-1 engines. Each 670 kN thrust, 142 s burn (ejected 149 s after launch), 1860 cm long, 222 cm diameter, 43 550 kg (39 000 kg propellant). Powered by single, fixed Viking 6; design similar to stage-2. Astrium GmbH prime contractor

Stage-2

Principal contractor: Astrium GmbH

Size: 11.61 m long; 2.60 m diameter, 3.4 t dry mass

Powered by: Snecma Moteurs Viking 4 engine providing 798 kN for 125 s, drawing on up to 35 t of NTO/UH25

Design: propellants were carried in aluminium cylinder, 652 cm long, divided into two vessels by an internal bulkhead. Rear conical skirt, 157 cm long, connected with stage-1 interstage and housed Viking's toroidal water coolant tank. 125 cm-long front skirt connected with stage-3's interstage

Stage-3

Principal contractor: EADS-LV (Aerospatiale)

Size: 11.05 m long; 2.60 m diameter, 1.24 t dry mass

Powered by: gimballed Snecma Moteurs HM-7B cryogenic engine providing 64.8 kN for 780 s, drawing on 11.9 t of liquid oxygen/liquid hydrogen

Design: propellants are housed in an aluminium cylinder, with tanks separated by an internal bulkhead. 45 cm-long front skirt connects to Ariane's equipment bay; 273 cm-long rear skirt connects with stage-2.

Vehicle Equipment Bay (VEB)

Principal contractor: Astrium SA

Purpose: carried equipment for vehicle guidance, data processing, sequencing, telemetry and tracking

Size: 104 cm high; 4.0 m diameter, 520 kg

Design: internal cone provided 1920 mm-diameter attachment to payload; external cone connected with payload fairing/carrier; annular platform carried the electronics

Payload Fairing and Carriers

Payloads were protected by a 2-piece aluminium fairing until it was jettisoned after about 285 s during the stage-2 burn. Prime contractor was Oerlikon Contraves. Three basic lengths are available: 8.6 m, 9.6 m and 11.1 m; diameter was 4 m. The main payload carrier was the Spelda, which sat between the fairing and stage-3, housing one satellite internally and a second on its top face, under the fairing. A range of sizes for matching payload requirements was available. Some missions could also carry up to six 50 kg satellites as passengers.

But each Ariane-1 could carry only two GTO satellites of up to 700 kg each, when it was clear that the market would soon demand greater capacities. The Ariane-3 design thus made its debut in 1984, capable of delivering two 1195 kg satellites (or one of 2700 kg) into GTO. This was achieved mainly by uprating the engines, stretching stage-3 by 1.3 m, adding two solid-propellant strapons

to stage-1 and enlarging the payload fairing. Ariane-2, capable of placing 2175 kg in GTO, was identical but flew without the strapons. Ten of the 11 Ariane-3s were successful 1984-89 and 5 out of 6 Ariane-2s during 1986-89.

The development of a more powerful variant to become the standard vehicle through the 1990s was



The engine bay of Ariane's first stage carried four Viking 5 engines. (Sneema Moteurs)



The night launch of Ariane-4 V48 in December 1991 carried the Inmarsat-2 F3 and Telecom-2A telecommunications satellites. (ESA/CNES/CSG)

Stage-2 was powered by a single Viking engine. (ESA/CNES/CSG)



The Giotto Halley's Comet probe installed on top of its Ariane-1 launcher. The Vehicle Equipment Bay carried the rocket's control electronics. Behind, to the left, is one half of the fairing. (ESA/CNES/CSG)

formally approved by ESA's Council in January 1982 and management responsibility assigned to CNES. A total of 116 vehicles was launched (the last in February 2003) before the new-generation Ariane-5 completely replaced it. Its 113 successes (97.4%) delivered 182 satellites into orbit (139 telecommunications, 9 Earth observation, 5 meteorological, 2 scientific, 27 auxiliary), totalling 404.1 t. Six Ariane-4 variants were created by mixing pairs of solid and/or liquid strapon boosters; in order of increasing performance, they are shown in the earlier table.

Ariane-4 was not merely an upgrading but a significant redesign to meet the increasing needs of the commercial market. From Ariane-3, stage-1 was stretched by 6.7 m to increase propellant capacity from 144 t to 227 t, and the Viking 5 engines increased their burn times from 138 s to 205 s. Stage-1 could also carry up to four liquid-propellant strapons comparable in size and performance with stage-2; a stretched version of Ariane-3's solid-propellant strapons was also available. Initially, stage-3 was similar to that on Ariane-3, but it was stretched by

32 cm in April 1992 to add another 340 kg of cryogenic propellants, and then another redesign was introduced in December 1994 that increased capacity from 4460 kg to 4720 kg into GTO. In January 1996, other adjustments produced 4820 kg. The record is 4947 kg, for the launch of 28 October 1998; 5000 kg was attainable. In addition, Ariane-4 offered a range of payload fairings and carriers to handle mixes of up to two major satellites and six 50 kg payloads on each launch.

Marecs

Achievements: first European maritime communications satellites; inaugurated Inmarsat; greatly exceeded 7-year design lives
Launch dates: Marecs-A 20 December 1981; Marecs-B 10 September 1982 (launch failure); Marecs-B2 10 November 1984
Mission end: Marecs-A retired from Inmarsat service in 1991, ESA deactivated it in August 1996; Marecs-B2 retired from Inmarsat service in December 1996, ESA deactivated it in January 2002
Launch vehicle/site: Ariane from Kourou, French Guiana
Launch mass: 1060 kg (562 kg on-station BOL; communications payload 96 kg)
Orbit: geostationary, Marecs-A initially 26°W (retired from 22.5°E), Marecs-B2 initially 177.5°W (retired from 26°W)
Principal contractors: British Aerospace (prime); Marconi Space Systems (payload)
ESA cost-to-completion (MAU): Marecs-A 161 (1982 e.c.), Marecs-B/B2 107 (1984 e.c.)

Conceived as an experimental project, Marecs evolved to provide Europe with a major breakthrough in mobile telecommunications expertise. Several ESA Member States undertook in 1973 to fund a satellite programme that would demonstrate communications between ships and land stations linking into the public networks, at a time when vessels could call only via unpredictable short-wave radio. In fact, Marecs (so named because it adapted ESA's ECS design for a maritime application) became the agency's first venture into the commercial satellite business. The two successfully-launched satellites were leased initially for 10 satellite-years to the Inmarsat (International Maritime Satellite Organisation), which formally inaugurated its service on 1 February 1982. Marecs was designed to provide high-quality voice, data and telex services for maritime users. This included about 60 telephone channels linked into the public system (including fax and data transmissions), 1200 telex channels working through the international telex system, priority relay of distress signals, and the broadcasting of material such as weather forecasts to whole groups of users simultaneously.

With Marecs-A and -B2 providing coverage over the Atlantic and Pacific



Oceans, 130 ships carried Inmarsat transceivers on inauguration day. More than 100 000 terminals have been commissioned, today including systems on aircraft and land vehicles, and even briefcase sets for business travellers. Inmarsat has now changed the 'Maritime' in its name to 'Mobile' to better reflect its growing business.

Developing Marecs placed Europe at the forefront of mobile communications technology, so that when Inmarsat requested bids for



Marecs-A in orbital configuration.

Marecs-A assembly at British Aerospace in Stevenage, UK.

building its first generation of dedicated satellites a consortium headed by British Aerospace won the prime contract, drawing on the Marecs heritage. These four satellites were launched 1990-1992, and are now augmented by third-generation satellites carrying payloads provided by Astrium.

Despite the advent of the new satellites, the two Marecs continued in service with Inmarsat far beyond their 7-year design lives. Marecs-A was removed from service in 1991 because of its ageing solar arrays, but ESA continued to use it for experiments at 22.5°E until it was boosted above GEO in August 1996 and deactivated. Inmarsat's Marecs-B2 lease expired at the end of 1996 and the veteran satellite was moved to 26°W, where it was leased by Nuovo Telespazio (Italy) from August 1997 to January 2000. A Nuovo Telespazio customer, Fugro, disseminated GPS navigation system updates to users primarily in South America. It was expected to be leased to Comsat General Corp to provide links with the US National Science Foundation at the South Pole, from where its 10° orbital inclination made it visible for 2 h each day, but the



opportunity was lost in the aftermath of 11 September 2001. It was raised into an elliptical orbit 752-1778 km above GEO and deactivated on 25 January 2002.

One of the two L-band Solid State Power Amplifier (SSPA) clusters for transmitting to maritime users. Three of the five SSPAs in both clusters were grouped to generate a 75 W output.

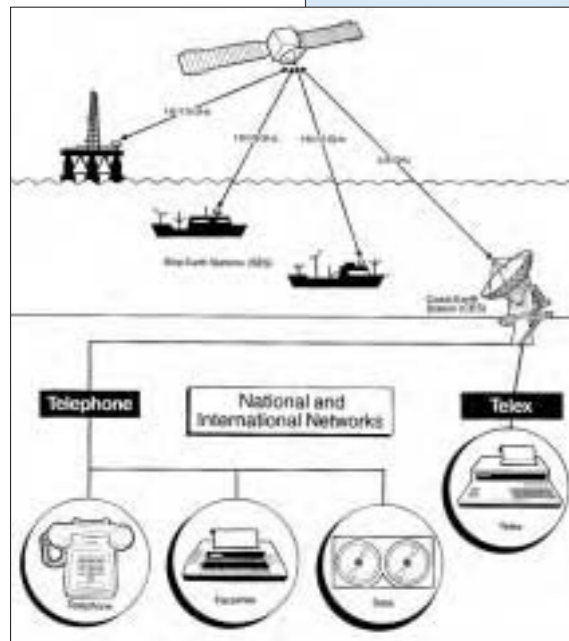
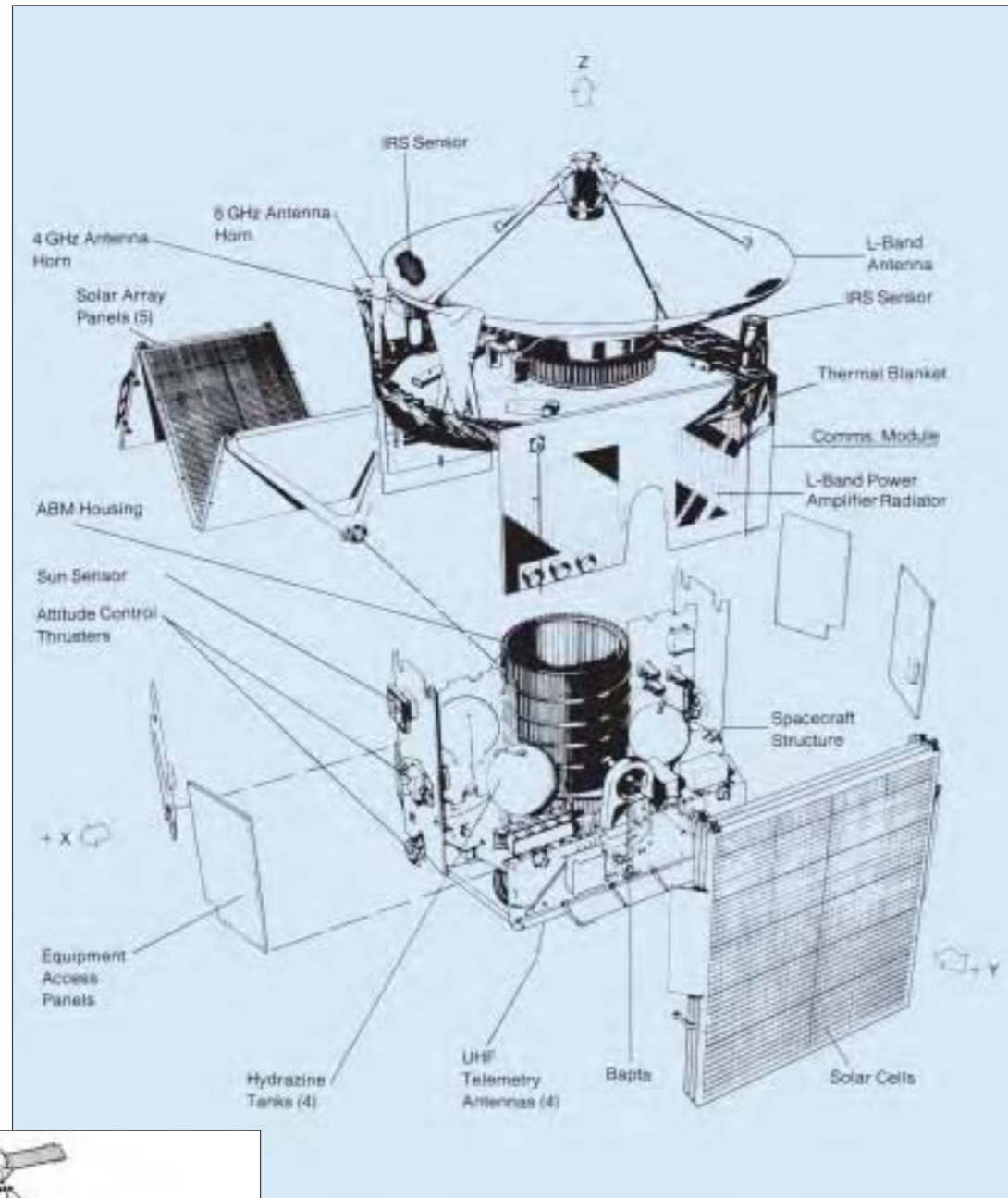

Marecs principal features. The service module was directly derived from the ECS satellite.

Marecs-A is prepared for launch from Kourou on an Ariane vehicle.

Marecs pioneered maritime satellite communications, providing reliable links with the land-based public networks.

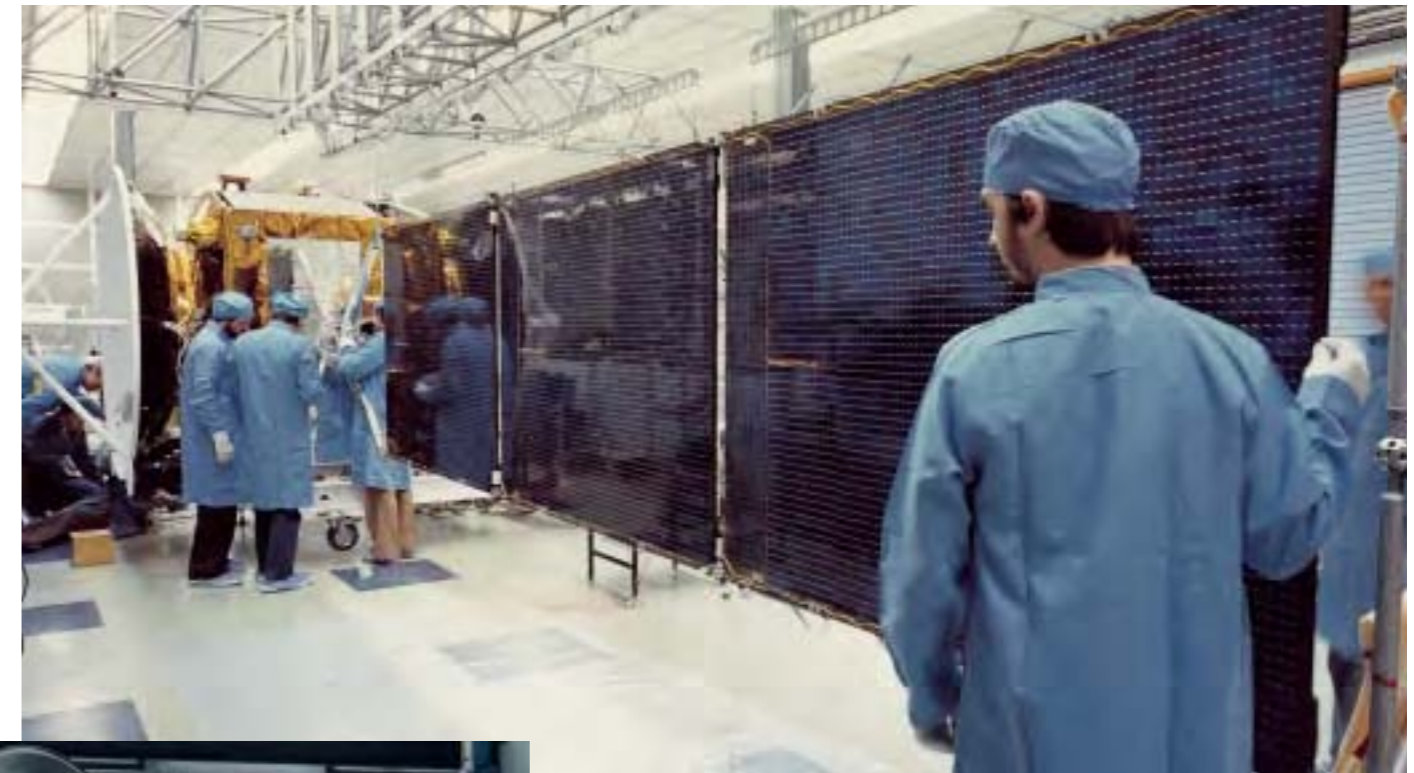

Satellite configuration: maritime version of ECS satellite, 2.2x3.1x1.8 m at launch, solar array deployed span 13.8 m.

Marecs-A undergoes a solar array deployment test at British Aerospace.

Attitude/orbit control: 3-axis stabilisation and maintained in GEO by momentum wheels and redundant 0.5 N and 2 N hydrazine thrusters (90 kg hydrazine in four tanks; 26 kg remained in B2 as of Feb 2001). Earth and Sun sensors provide Earth pointing with 0.04° accuracy. Transfer from GTO to GEO by solid-propellant apogee boost motor.

Power system: two 3-panel Si solar wings generated 1050 W; 425 W required by communications payload. Powered by 2x21 Ah nickel cadmium batteries during eclipse.

Communications payload: up to six L-band SSPAs (out of 10) with total 75 W output (EIRP 33.1 dBW hemispherical beam edge) relayed >35 voice channels at 1.54 GHz to ships, and could receive >50 at 1.64 GHz. One C-band 1 W 6.4 GHz TWTA provides link to land station. Flight Control Centre at ESOC (Redu from March 1997), working via C-band station at Villafranca.

Sirio

Launch date: 10 September 1982 (launch failure)
Mission end: launch failure; 2-year nominal mission planned
Launch vehicle/site: Ariane from Kourou, French Guiana
Launch mass: 420 kg (on-station BOL 237 kg; payload 50.0 kg, apogee motor 203 kg, hydrazine/nitrogen 34 kg)
Orbit: orbit not achieved, planned to be geostationary over 25°W
Principal contractor: Compagnia Nazionale Satelliti per Telecomunicazione SpA

Italy expressed an interest in 1977 in using the spare flight model of its successful domestic Sirio-1 telecommunications satellite for applications on a broader European basis. ESA's proposal, after consulting national meteorological services and the World Meteorological Organisation, was accepted by the Agency's Council in December 1978 and spacecraft development (Phase-C/D) began in January 1979.

One payload was for the **Meteorological Data Distribution (MDD)** mission. Sirio-2 was to be positioned in geostationary orbit over Africa, so that its MDD transponder would allow meteorological centres on

that continent to relay weather data using simple receive/transmit stations. Sirio provided 24x100 bit/s and 12x2.4 kbit/s 2105/1695 MHz up/down channels working to <40 dBw EIRP stations. On Sirio, the despun 70x99 cm 45° planar reflector directed incoming signals to the fixed 70 cm parabolic reflector and its antenna feed.

The other payload was **Laser Synchronisation from Stationary Orbit (Lasso)** for synchronising high-precision clocks at widely-separated locations with 1 ns accuracy at low cost. Lasso consisted of a 155x340 mm panel of 98 20 mm-diameter laser retro-reflectors mounted on the Ariane interface adapter, photodetectors for sensing ruby and neodyme laser pulses, and an ultrastable oscillator/counter to time-tag the pulse arrivals. Different ground stations could thus observe the reflected pulses and use the time-tagging to compare their clocks.

Satellite configuration: total height 2.400 m, diameter 1.438 m, based on cylindrical body 9.954 m high, 1.438 m diameter. Four principal elements: main structure; solar array structure; payload platform; interface adapter. Main structure was aluminium honeycomb thrust cone supporting apogee motor at one end, the main load platform on its mid-section, and payload platform on top end. The main load platform accommodated the four propellant

Sirio-2 complete, with the solar array panels removed.

Facing page: Sirio's main platform carried most of the spacecraft systems. Prominent at top is the launcher interface adapter, carrying the panel of 98 laser reflectors.



Sirio-2 ready at Kourou for encapsulation in the Ariane payload fairing. The despun antenna is covered by a protective cylinder (top). (ESA/CNES/CSG)

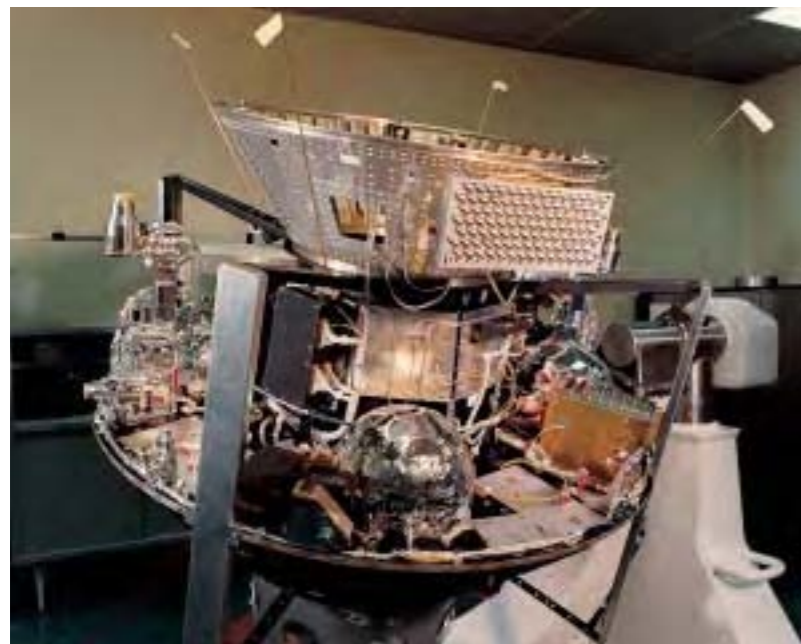

tanks, thrusters, attitude detection units and main services such as power, telemetry & command. Solar array cylindrical structure of four 90° sections attached to main load platform at mid-height and to thrust cone by struts at both ends.

Attitude/orbit control: Auxiliary Propulsion Subsystem of two radial and two axial 22 N hydrazine thrusters; spin-stabilised at 90 rpm. Attitude determination by four 2 kg Earth/Sun IR sensor packages.

Insertion into GEO by solid-propellant apogee motor.

Power system: 8496 2x2 cm Si cells on cylindrical body main array, supported by 300 2x2 cm Si cells for battery charging. Total output 133 W BOL at summer solstice.

Communications payload: telemetry & command at 148/136 MHz up/down VHF using redundant 8 W transponders; 512 bit/s telemetry. Controlled from Fucino, Italy.

Exosat

Achievements: detailed observations of celestial X-ray sources

Launch date: 26 May 1983

Mission end: reentered 6 May 1986 (designed for 2-year life, science operations began August 1983)

Launch vehicle/site: Delta from Vandenberg Air Force Base, California

Launch mass: 510 kg (science instruments 120 kg)

Orbit: 2919x189 000 km, 71.4°

Principal contractors: MBB headed the Cosmos consortium: SNIAS-Cannes (F)/CASA (E)/Contraves (CH)/BADG (UK) (structure/thermal/mechanisms/solar array mechanical); MBB (D)/SNIAS-LM (F)/MSDS (UK)/Sodern (F)/Ferranti (UK)/SEP(F)/TPD-TNO (NL)/NLR (NL) (AOCS); Selenia (I)/Laben (I)/Saab (S)/Crouzet (F)/LM-Ericsson (S) (data handling/RF); ETCA (B)/Terma (DK)/Saft (F)/AEG (D) (power/solar array electrical)

ESA's X-ray Observatory Satellite (Exosat) studied the X-ray emission from most classes of astronomical objects, including active galactic nuclei, white dwarfs, stars, supernova remnants, clusters of galaxies, cataclysmic variables and X-ray binaries. In 1780 observations, it measured the locations of cosmic X-ray sources, their structural features and spectral, as well as temporal, characteristics in the wavelength range from extreme-UV to hard X-rays. Its primary mission was to study sources already detected by earlier satellites, although it did discover many new ones serendipitously as it slewed from one target to the next or focused on specific areas.

Exosat was the first ESA/ESRO science satellite totally funded by the Agency. Its observations and data were not restricted to the groups that had built the three instruments, but were made available to a wider community. The satellite was operated as a true astronomical observatory. A unique feature was the highly eccentric orbit which, although it subjected Exosat to higher background radiation dependent on solar activity, provided up to several days at a time for uninterrupted viewing of a source. More than 450 publications of

Exosat results in leading scientific journals have been made. Notable discoveries include:

- 'quasi-periodic oscillations' (QPOs). Exosat searched for the spin rates of neutron stars in low-mass X-ray binaries but, instead, discovered periods wandering back and forth. QPOs are thought to be caused by instabilities in the accretion discs surrounding the neutron stars.
- Exosat discovered two stars orbiting each other every 11 min – the shortest period known at the time. XB 1820-30 emits X-rays 10^{11} more intense than from the Sun as material falls onto its neutron star.
- The X-ray binary SS433 is probably a massive star feeding a black hole 10 times the mass of the Sun. Two giant jets near the black hole are ejecting material at a quarter the speed of light. The X-ray jets wave back and forth every 167 days, which Exosat discovered is the same period as variations in the optical lines. This is helping to explain the enigmatic nature of jets from black holes – still one of the hot topics in astrophysics.
- Exosat surveyed 48 Seyfert galaxies, which have giant black



Exosat Mission Objectives

Precise location of sources: within 10 arcsec at 0.04-2 keV, 2 arcmin for 1.5-50 keV.

Mapping diffuse extended objects: at low energies using imaging telescopes.

Broadband spectroscopy of sources: with all instruments between 0.04 keV & 80 keV.

Dispersive spectroscopy: of point sources using gratings with imaging telescopes.

Time variability of sources: from days to sub-millisecond.

New sources: detection.

Exosat in operating configuration. On the front, from left to right, are two startrackers, the two low-energy imaging telescopes and the four quadrants of the medium-energy instrument. The gas scintillation proportional counter is visible to the right of the medium energy instrument.



Inside Exosat. The two low-energy imaging telescopes are prominent, with their apertures at left and their detectors at right.

- holes at their centres and are strong X-ray emitters. Exosat discovered a soft X-ray component, now thought to be emission from matter swirling into an accretion disc before disappearing into a black hole.
- observations of the pulsing X-ray nova EXO 2030+375 provided new insights into how material from a companion is captured by the intense magnetic field of a pulsing neutron star.

Exosat was approved in 1973, when the intention was to take simple readings of X-ray sources – only a small number of positions were known at that time. This HELOS (Highly Eccentric Lunar Occultation Satellite) would map the positions

and shapes of X-ray sources by observing as they were covered by the Moon. By 1977, when Exosat was funded, missions such as Uhuru, Copernicus, Ariel-5, ANS, SAS-3 and HEAO-1 had changed the priority, because positions were now being determined much more accurately. It was therefore decided to include X-ray imaging, making Exosat a forerunner of XMM-Newton and Chandra.

Exosat was ESA's first satellite to carry an onboard computer (OBC), a 16-bit parallel machine for experiment control and data processing. It was reprogrammed in flight in response to lessons-learned to allow, for example, better study of the newly-discovered QPOs.

Exosat being prepared for launch from Vandenberg Air Force Base, California. The medium-energy and low-energy instruments are protected by their shutters on the left-hand face. These shutters were opened in orbit to act as sun shades for the telescopes.

Inset: Exosat image of the black hole candidate Cygnus X-1.



A low-energy X-ray image of the bright supernova remnant Cas-A. X-rays are generated by interaction between the interstellar medium and stellar material ejected in the supernova event.

Exosat Scientific Instruments

Low-Energy Imaging Telescope (LE)

Two grazing incidence telescopes, 0.04-2 keV, 1 m focal length, 1° FOV to provide X-ray images using channel-multiplier arrays. Passband filters provided coarse spectral information; diffraction gratings for high-resolution spectroscopy (mechanical failure limited grating use to first few months of operations). Each telescope 30 kg, 5 W.

Medium Energy Experiment (ME)

Array of eight proportional counters, total area 1600 cm², 1.5° FOV, for moderate spectral resolution over 1-50 keV. Four detectors could be offset by up to 2° for simultaneous off-target background monitoring. 48 kg, 17 W.

Gas Scintillation Proportional Counter (GSPC)

Higher-resolution spectrophotometry, collecting area 100 cm², 2-20 keV, 1.5° FOV. 8 kg, 1.5 W.

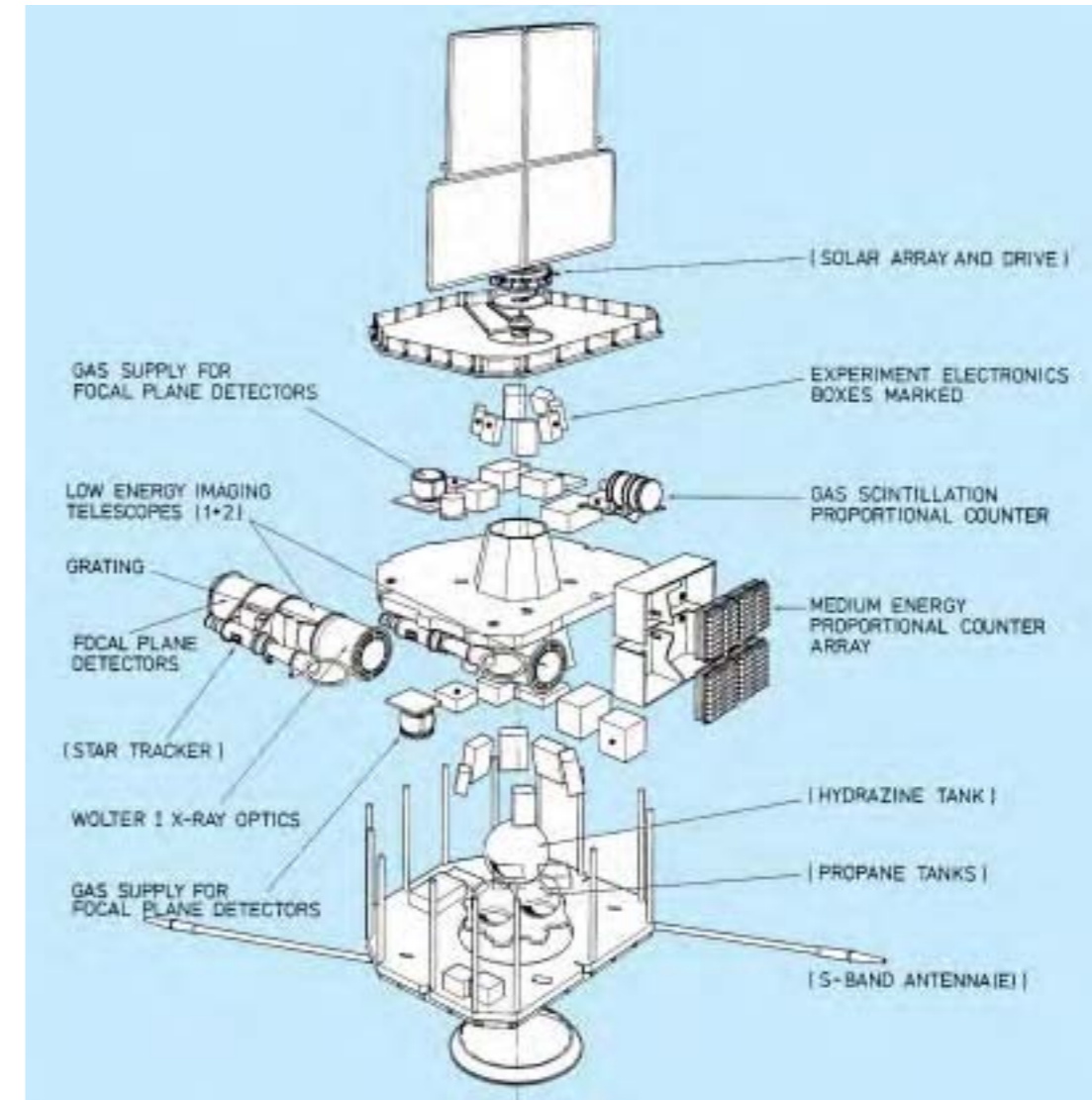
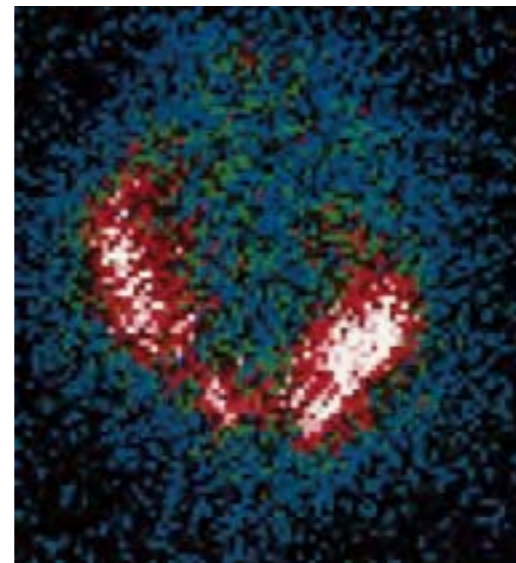

Satellite configuration: box-shaped bus, 2.1 m square, 1.35 m high, topped by 1.85 m-high solar array. The science instruments viewed through one wall, covered by flaps during launch that opened in orbit to act as thermal and stray-light shields. Primary structure comprised central cone supporting one main and two secondary platforms. All alignment-sensitive units (science instruments and fine attitude-measurement units) were mounted on the highly-stable carbon fibre main platform.

Attitude/orbit control: 3-axis control by redundant sets of six 0.05-0.2 N propane thrusters. Attitude determination by gyros, Sun sensors and star trackers to 10 arcsec for Y/Z-axes and few arcmin for X-axis. Orbit adjust by 14.7 N hydrazine thrusters; delta-V measured by

redundant accelerometers. AOCS equipment housed in central cone, with thrusters mounted on edges of platforms.

Power system: 260 W provided by 1-degree-of-freedom solar sail, following Sun to within 3°. Supported by two 7 Ah NiCd batteries.

Communications: the orbit was designed for Exosat to be in continuous realtime contact with Villafranca in Spain for the scientifically significant part of the orbit – the 76 h out of the 90 h orbital period when it was beyond the disturbing influence of Earth's radiation belts. Spacecraft control and science operations were conducted from ESOC. Science/engineering data returned at 8 kbit/s (no onboard recorder) via 6 W S-band transmitter.

ECS

Achievements: first European regional satellite communications system; far exceeded design lives; 348 channel-years of communications service
Launch dates: ECS-1 16 June 1983; ECS-2 4 August 1984; ECS-3 12 September 1985 (launch failure); ECS-4 16 September 1987; ECS-5 21 July 1988
Mission end: ECS-1 December 1996; ECS-2 November 1993; ECS-3 launch failure; ECS-4 December 2002; ECS-5 May 2000 (7-year design lives)
Launch vehicle/site: Ariane, from Kourou, French Guiana
Launch mass: about 1185 kg (about 700 kg on-station BOL)
Orbit: geostationary; initially ECS-1 10°E, ECS-2 10°E, ECS-4 10°E, ECS-5 16°E
Principal contractors: Hawker Siddeley Dynamics (UK, prime) heading MESH consortium of Matra (F), ERNO (D), Saab (S), AEG (D), Selenia (I), Aeritalia (I)
ESA cost-to-completion: ECS-1/2 154.3 MAU; ECS-3/4/5 115.1 MAU (1977 rates)



ECS-1 undergoing solar array deployment tests at Matra.

The success of ESA's first communications satellite programme, OTS, led directly to the development of the European Communications Satellite (ECS) and the creation of the European Telecommunications Satellite Organization (Eutelsat) in 1977 as an inter-governmental entity to operate Europe's first regional satellite system on behalf of, at the time of privatisation in July 2001, 48 member states. Under a 10-year agreement, ESA provided the first-generation space segment for Eutelsat, which became the owner of each satellite after in-orbit testing. The last was handed over in 1988, and operated for almost 12 years. ESA controlled the satellites from its Redu (B) site.

Apart from the Ariane launch loss of ECS-3, the satellites proved remarkably successful and served well beyond their 7-year design goals. Each operated up to nine Ku-band transponders working simultaneously through five beams around Europe, with an equivalent capacity of 12 000 telephone circuits or 10 TV channels. They provided all types of telecommunications and audiovisual services, such as telephony, European Broadcasting Union TV and radio distribution, business TV and communications, satellite newsgathering and, from 1991, the

Euteltracs two-way messaging and position-reporting service for small mobile terminals. The antenna module generated three adjacent spot beams for the telecommunications services, a lower-intensity broad 'Eurobeam' and (after ECS-3) the Satellite Multiservice System (SMS) beam dedicated to business data transmissions.

ECS-1 was handed over to Eutelsat by ESA on 12 October 1983 to begin



Europe's new phase of satellite-based communications. It served at a number of GEO positions and, after the Eutelsat-procured second generation was well established, it was moved to 48°E in December 1993 to provide services to the newly-independent ex-Soviet countries. It retired in December 1996 at 36°E, almost doubling its design life and

having accumulated 710 562 channel-hours of communications service.

Successor satellites added SMS to provide companies with a European network of dedicated links for 2.4-2000 kbit/s data transmission, video conferencing, facsimile and remote printing. ECS-2 retired from service at 1°E on 13 September 1993 and was boosted by its hydrazine thrusters 400 km above GEO in November 1993, the first Eutelsat retirement. It had provided 634 576 channel-hours. ECS-5 was last used at 12°W (arriving March 1999) for Internet traffic between Canada and Turkey, with two transponders available. In March 2000, it arrived at 4°E, from where it was retired in May 2000, after 779 727 channel-hours.

Inset: The end of an era. Benoit Demelonne at ESA's Redu ground station sends the final command to shut down ECS-4 at 17:22 UT 1 December 2002. The satellite's last 4.6 kg of propellant had raised it 414 km above GEO in a series of burns starting 26 November 2002.

Despite Eutelsat completing its second-generation network of six satellites and beginning its third, ECS-4 remained in service with four operational transponders, held at 33°E with its four usable transponders leased until mid-2002 to a state communications agency in Georgia for Internet links. Until 2000, it was at 25.5°E for Euteltracs, TV and news gathering. It was last used for ad hoc data links between Europe and the Middle East, bringing it to 932 400 channel-hours.

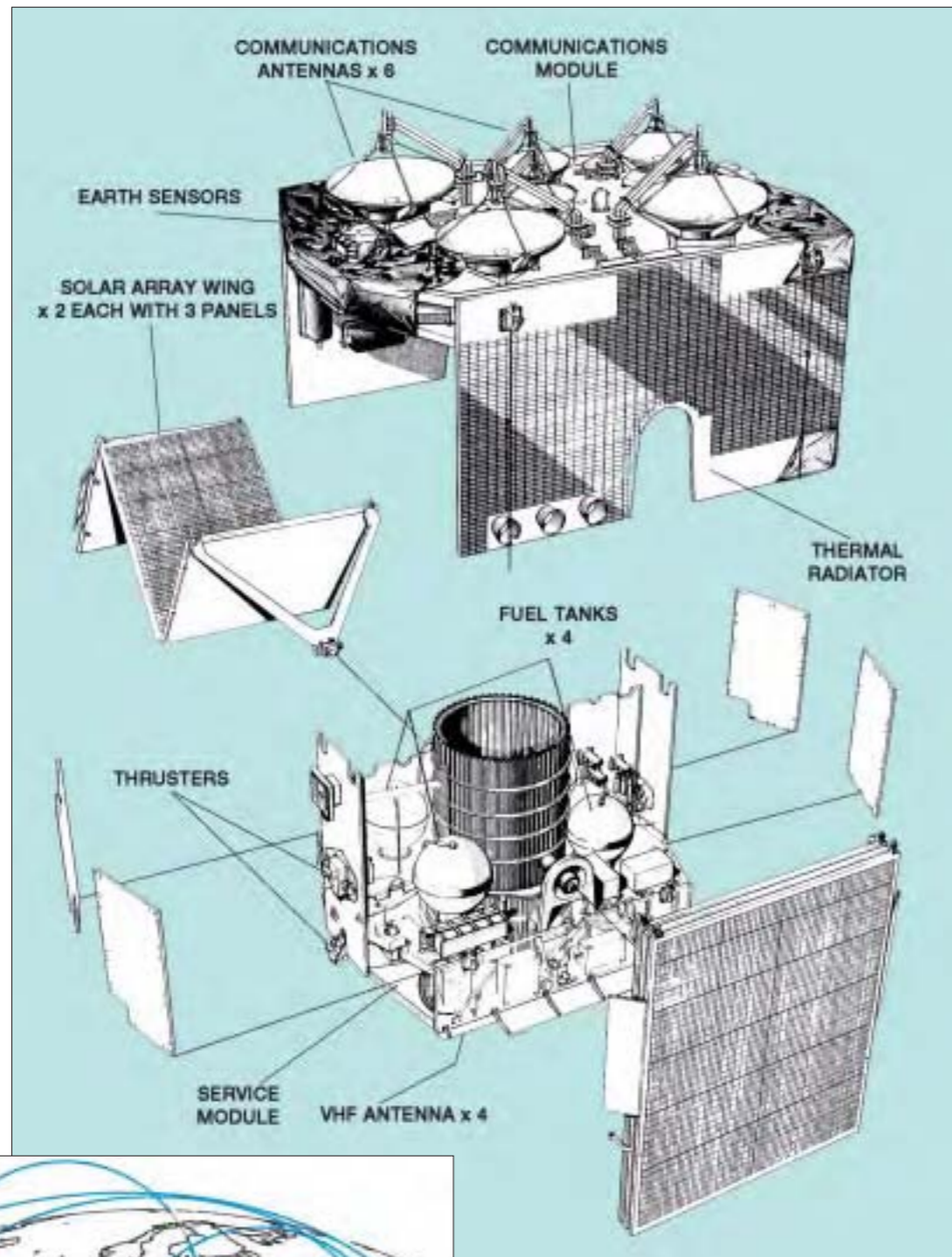

ECS-1 provided services to Europe and north Africa via three spot beams and a single Eurobeam. Its successors added the Satellite Multiservice System for business users.



ECS-2 and subsequent satellites reconfigured the antenna platform, adding the Satellite Multiservice System for business data transmissions.

ECS-1 ready for launch. The black Sylda canister carried a second satellite. (CSG/Arianespace)

Satellite configuration: 1.91 m-length, 1.46 m-width, 1.42 m-height (1.95 m with antennas) hexagonal bus, derived from OTS, using service and communications modules of aluminium construction. Built around central cylindrical thrust cone housing apogee boost motor. Span across solar array 13.8 m.

Attitude/orbit control: 3-axis control by two momentum wheels + one reaction wheel, and 8x2 N + 12x0.5 N thrusters (4 yaw backup on later models) drawing on 117-122 kg hydrazine in four spheres. Injection into GEO by solid-propellant apogee boost motor.

Power system: two 1.3x5.2 m 3-panel wings of Si cells generated 1.26 kW BOL. 2x24 Ah NiCd batteries provided power during eclipses.

Communications payload: 9 of 14 (ECS-1 9 of 12) 20 W Ku-band (10.95-11.2/11.45-11.7 GHz) TWTAs active simultaneously providing three spot beams (EIRP 46 dBw), one Eurobeam (41 dBw) and (after ECS-1) SMS 12.5-12.75 GHz beam (43.5 dBw).



Spacelab

Achievements: principal scientific manned module for US Space Shuttle; major contributions to space sciences research and applications; first European manned space project; 22 missions

Launch dates: see table

Launch vehicle/site: US Space Shuttle, Kennedy Space Center, Florida

Launch mass: typically 10 t (Spacelab-1 totalled 8145 kg Pressure Module and 3386 kg Pallet; including experiments totalling 1392 kg)

Orbits: typically 300 km altitude, inclinations 28-57°

Principal contractors: VFW-Fokker/ERNO (later MBB/ERNO; prime), Aeritalia (PM structure, Igloo, thermal control), Matra (command/data management), Dornier (IPS, ECLSS), British Aerospace (Pallet)

Spacelab was an integral element of NASA's Space Shuttle programme and provided ESA/ESRO with a unique opportunity for developing a manned space capability. The 22 missions made outstanding contributions to astronomy, life sciences, atmospheric physics, Earth observation and materials science under microgravity – advances that stemmed from this crucial European contribution. Spacelab essentially comprised two types of payload carrier: a pressurised manned laboratory module and unpressurised external pallets. Its flexibility allowed it to accommodate both multi-disciplinary experiments and complements devoted to a single scientific or applications theme. The Pressure Module (PM) hosted the experiments equipment, data processing and electrical power equipment, an environmental control system and crew control stations. The crew of up to six researchers relied on the Shuttle Orbiter for living quarters, communications and data transmissions.

Europe was invited in 1969 to participate in the post-Apollo programme, ultimately deciding at the Ministerial Meeting of the European Space Conference in Brussels on 20 December 1972 to entrust ESRO with developing a modular, general-purpose laboratory.

Spacelab was an integral part of the Space Transportation System. Shown is the Spacelab-1 configuration, flown in 1983.

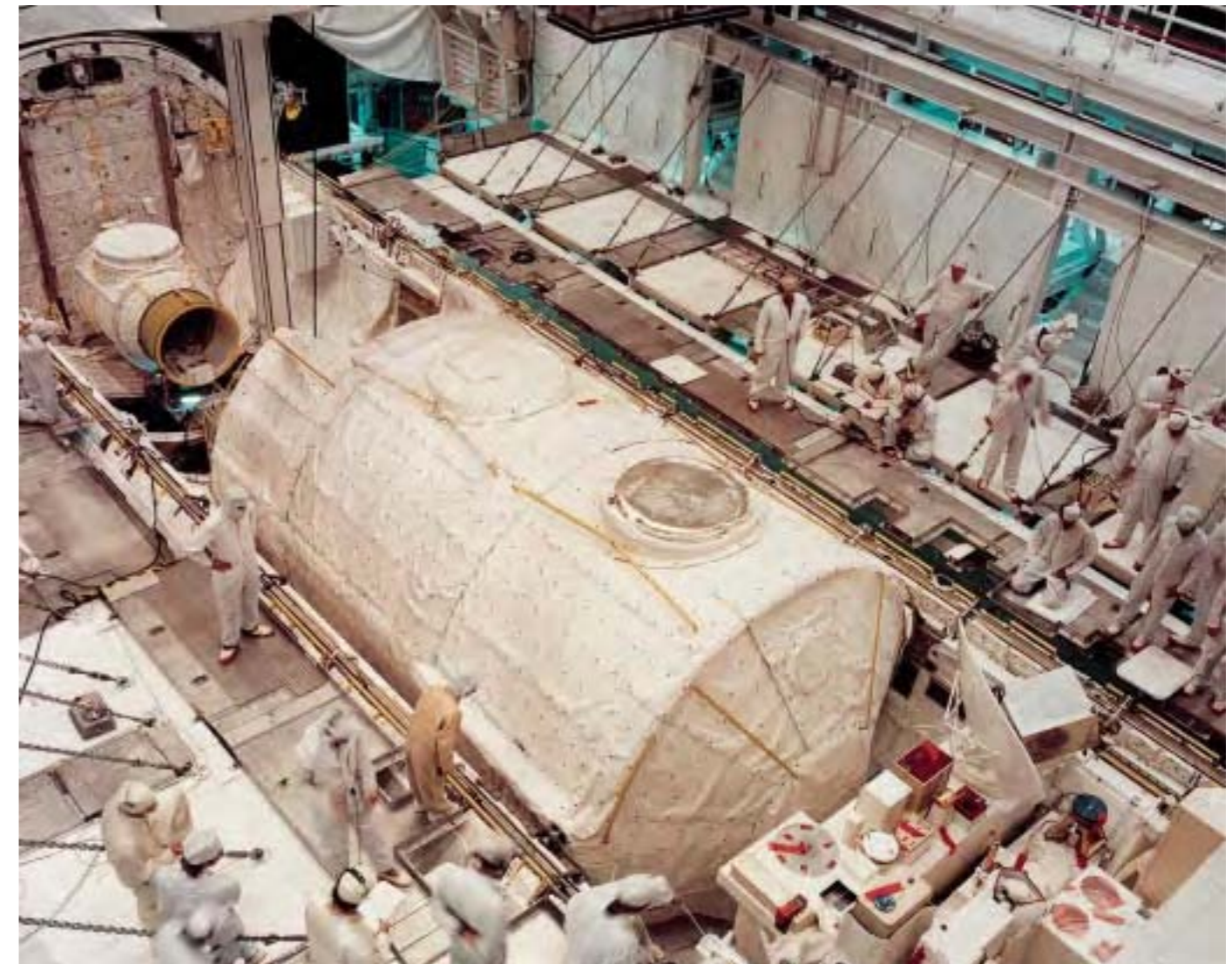

The Memorandum of Understanding was signed with NASA on 24 September 1973, giving Europe the responsibility for funding, designing and building Spacelab. Europe agreed to deliver free of charge the Engineering Model and the first Flight Unit, plus ground support equipment, in return for a shared first mission. NASA would purchase any further equipment. The consortium headed by VFW-Fokker/ERNO (later MBB/ERNO) was awarded the 6-year ECU180 million Phase C/D contract in June 1974. Spacelab Flight Unit I, in Spacelab-1 configuration, was formally accepted by NASA in February 1982, comprising a Pressure Module, five Pallets, an Igloo, an Instrument

Pointing System, plus support equipment. NASA bought a second set from ESA for about ECU200 million.

The maiden mission was designed to prove Spacelab's capabilities across numerous disciplines. Half the payload was allocated to ESA's First Spacelab Payload (FSLP). The representative configuration was the PM plus one Pallet with a total of 70 experiments. The mission required not only more experiment hardware than any previous ESA flight, but also more experimenters: 100 investigators interested in atmospheric physics, Earth observation, space plasma physics,

Inserting Spacelab-1 into the Shuttle Orbiter's cargo bay. The tunnel from the Orbiter's cabin has yet to be connected (top left).



Spacelab-1 in orbit: the debut of Europe's manned space laboratory. (NASA)



ESA astronaut Wubbo Ockels at work during the Spacelab-D1 mission.

life sciences, materials science, astronomy, solar physics and technology. It also included the first European astronaut, Ulf Merbold, selected by ESA in 1977 along with Wubbo Ockels and Claude Nicollier as the agency's first astronaut corps. The mission was a resounding success, demonstrating Spacelab's far-reaching capabilities. Spacelab

went on to prove itself as an unsurpassed asset. In the first eight PM missions alone, 387 experiments involved 323 Principal Investigators from 148 institutes in 26 countries. Spacelab flew its last mission in 1998 – a quarter of a century after Europe began the project – as scientists prepared for the advent of the International Space Station.

Spacelab Missions						
STS Orbiter	Launch Duration	Orbit Inc Altitude	Mission	Configuration	Discipline	European Astronaut
STS-9 Columbia	28 Nov 83 10 d	57° 250 km	SL-01 FSLP	LM + 1P	Multi-discipline	U. Merbold
STS-51B Challenger	29 Apr 85 7 d	57° 360 km	SL-03	LM + MPESS	Materials Science	
STS-51F Challenger	29 Jul 85 8 d	50° 320 km	SL-02	IG + 3P + IPS	Solar Astronomy	
STS-61A Challenger	30 Oct 85 7 d	57° 330 km	SL-D1	LM + MPESS	Materials/ Life Sciences	W. Ockels E. Messerschmid R. Furrer
STS-35 Columbia	2 Dec 90 9 d	28° 350 km	Astro-1	IG + 2P + IPS	Astronomy	
STS-40 Columbia	5 Jun 91 9 d	39° 300 km	SLS-01	LM	Life Sciences	
STS-42 Discovery	22 Jan 92 8 d	57° 300 km	IML-01	LM	Materials/ Life Sciences	U. Merbold
STS-45 Atlantis	24 Mar 92 9 d	57° 300 km	Atlas-1	IG + 2P	Atmos. Physics Solar Astron.	D. Frimout
STS-50 Columbia	25 Jun 92 14 d	28° 300 km	USML-01	LM/EDO	Materials Science	
STS-47 Endeavour	12 Sep 92 8 d	57° 300 km	SL-J	LM	Materials/ Life Sciences	
STS-56 Discovery	8 Apr 93 9 d	57° 300 km	Atlas-2	IG + 1P	Atmospheric Physics	
STS-55 Columbia	26 Apr 93 10 d	28° 300 km	SL-D2	LM + USS	Multi-discipline	M. Schlegel U. Walter
STS-58 Columbia	18 Oct 93 14 d	39° 280 km	SLS-02	LM/EDO	Life Sciences	
STS-65 Columbia	8 Jul 94 15 d	28° 300 km	IML-02	LM/EDO	Materials/ Life Sciences	
STS-66 Atlantis	3 Nov 94 11 d	57° 300 km	Atlas-3	IG + 1P	Atmospheric Physics	J-F. Clervoy
STS-67 Endeavour	2 Mar 95 17 d	28° 350 km	Astro-2	IG + 2P EDO	Astronomy	
STS-71 Atlantis	27 Jun 95 10 d	52° 300 km	SL-Mir	LM		
STS-73 Columbia	20 Oct 95 16 d	39° 300 km	USML-02	LM/EDO	Materials Science	
STS-78 Columbia	20 Jun 96 17 d	39° 280 km	LMS	LM/EDO	Materials/ Life Sciences	J-J. Favier
STS-83 Columbia	4 Apr 97 4 d	28° 300 km	MSL-01	LM/EDO	Materials Science	
STS-94 Columbia	1 Jul 97 16 d	28° 300 km	MSL-01R	LM/EDO	Materials Science	
STS-90 Columbia	17 Apr 98 16 d	39° 280 km	Neurolab	LM/EDO	Life Sciences	

Atlas: Atmospheric Laboratory for Applications and Science. EDO: Extended Duration Orbiter. IG: Igloo. IML: International Microgravity Laboratory. LM: Long Module. LMS: Life and Microgravity Spacelab. MPESS: Mission Peculiar Experiment Support Structure. MSL: Microgravity Sciences Laboratory. P: Pallet. SL: Spacelab. SLS: Spacelab Life Sciences. USML: US Microgravity Laboratory.



The Atlas Spacelab missions did not include a Pressure Module, but instead housed the avionics in an Igloo (foreground) for controlling the payloads on the two Pallets. (NASA)

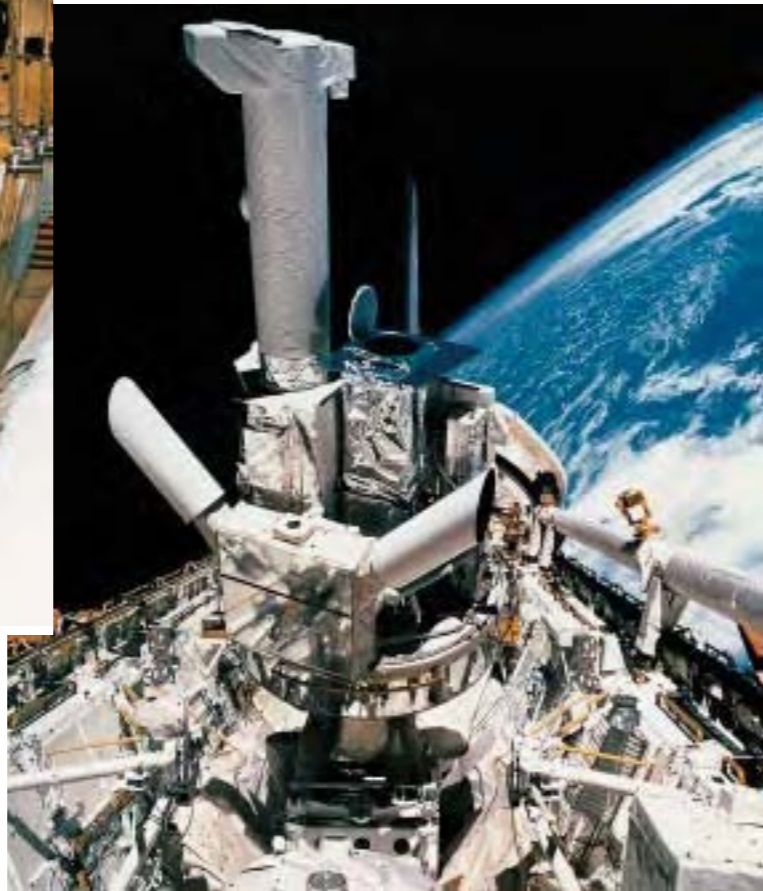

The Astro-1 mission was the first to employ the Instrument Pointing System, using the high-precision pointing capabilities for detailed observations of the Sun.

Pressure Module (PM)

The 75 m³ PM was Spacelab's principal element, providing scientist-astronauts with a comfortable working environment. The 4.1 m-diameter, 7 m-long module was basically a 1.6-3.5 mm-thick aluminium cylinder with conical end pieces. The main segments could be unbolted for ground processing. The experiment racks were integrated outside the PM and then rolled with the floor into place along the PM side support beams. The racks held standard 48.3 cm-wide laboratory trays; the Double Rack had a 1.75 m³/580 kg capacity. The PM could carry the equivalent of 20 Single Racks, although two DRs were reserved each mission for avionics and equipment storage. The roof and floor offered storage space. The roof included two 1.3 m-diameter apertures: a window in the forward one and a scientific airlock aft for exposing experiments to space.

Pallets and Igloo

Experiments requiring direct exposure to space were carried on U-shaped

Pallets that could be fully integrated before being inserted into the Shuttle's cargo bay. These proved to be so useful that non-Spacelab missions also used the Pallets; indeed, they continued in service for the International Space Station. Each 725 kg, 3 m-long 4 m-wide aluminium Pallet could hold a 3 t payload. Experiments were normally controlled via the PM, but on non-PM missions the pressurised 640 kg, 2.4 m-high 1.1 m-diameter cylindrical Igloo accommodated the avionics.

Instrument Pointing System (IPS)

Three Spacelab missions carried IPS to provide precision control and pointing of astronomical telescopes: the arcsec accuracy for a 2 t payload was 0.4 lateral/11.2 roll under star tracker control, and 0.5/41.0 in Sun mode. The 1.18 t IPS carried all inertial sensors, data and power electronics and the dedicated software for control via the Spacelab computers. It could route 1.25 kW to the payload and provided a 16 Mbit/s data rate.



Transferring the assembled Spacelab-1 to Space Shuttle Columbia. This assembly has been displayed in the Udvar-Hazy Center annex of the National Air & Space Museum at Dulles International Airport, Washington DC, since December 2003 (<http://www.nasm.si.edu/udvarhazy/>). The second set, flown on the final mission, can be seen at Bremen Airport (D).

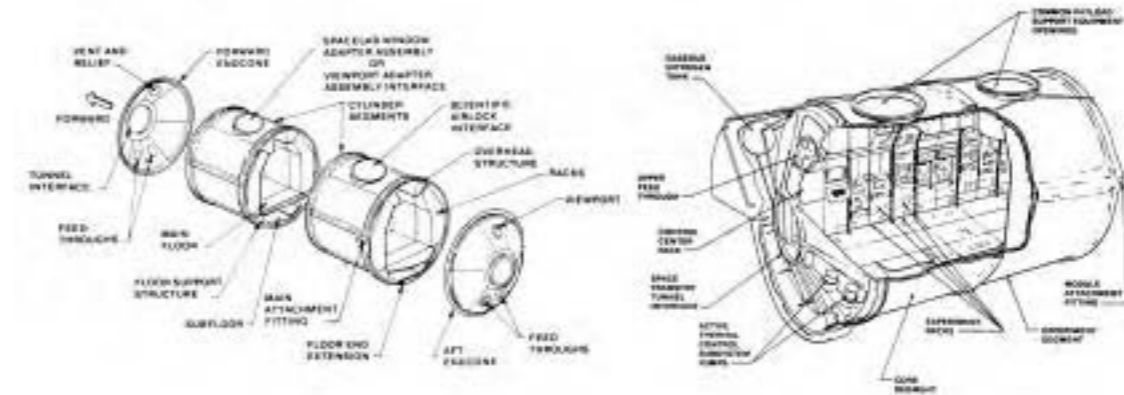

Configuration: Spacelab comprised several elements that could be mixed-and-matched according to mission requirements. The Pressure Module accommodated experiments in a shirtsleeve environment, external experiments were mounted on Pallets, the Instrument Pointing System provided precision pointing for large telescopes, and the Igloo housed avionics when the PM was absent (6 out of 22 missions). See the separate sections for descriptions of each.

Attitude/orbit control: provided by Space Shuttle Orbiter.

Life support: a joint effort with the Orbiter to maintain a 1-bar atmosphere at 18-27°C and 30-70% humidity. Orbiter cabin air was drawn in through the linking tunnel, cleaned with lithium hydroxide and charcoal, cooled by heat exchangers and blown into the module through roof diffusers.

Power/thermal system: Spacelab was powered by the Space Shuttle's fuel cells at 28 Vdc, limited to 8 kW by the thermal control system. Experiments and avionics were mounted on cold plates linked to the Orbiter's cooling system. Cooling air was also forced up inside the experiment racks and drawn off. The whole module carried an external jacket of 39 layers of Dacron and goldised Kapton completed by an outer layer of Teflon-coated beta cloth.

Communications/data: data were usually transmitted in realtime through NASA's relay satellite system at up to 50 Mbit/s via the Orbiter's Ku-band system. When the realtime link was unavailable, a High Data Rate Recorder provided 32 Mbit/s storage. Spacelab's systems and experiments were controlled by three IBM AP-101SL computers (originally Matra 125/MS 64 kbit).

Giotto

Achievements: first cometary close flyby; first dual-comet mission; first European deep space mission; first European gravity-assist mission; first reactivation of an ESA spacecraft

Launch date: 2 July 1985

Mission end: 2 April 1986 (Halley flyby); 23 July 1992 Giotto Extended Mission

Launch vehicle/site: Ariane-1 from Kourou, French Guiana

Launch mass: 960 kg (574 kg at time of Halley flyby)

Orbit: injected into 199x36 000 km, 7° GTO; Mage boosted Giotto on 3 July 1985 into heliocentric orbit with 120 000 km Halley miss-distance

Principal contractors: British Aerospace (prime), Alcatel Thomson Espace (telecommunications), SEP (antenna despin, kick motor), FIAR (power), Fokker (thermal), TPD (starmapper), Dornier (structure)

Giotto's flyby of Comet Halley in March 1986 was the culmination of the international effort to investigate the most famous of all comets. Halley was selected because, of all the >1000 comets then known, it was unique in being young, active and with a well-defined path – essential for an intercept mission. ESA's probe was also unique: of all the worldwide scientific instrumentation focused on the comet, Giotto was the only platform that could take a payload close in to the nucleus. It was the first (and until Stardust in 2004, the only) spacecraft to do this.

Observations from the two Soviet Vega probes were crucial for pin-pointing Halley's nucleus, reducing the Earth-based error from 1500 km to 75 km. At 21:00 UT on 12 March 1986, the JPA instrument signalled the beginning of the encounter, detecting the first Halley hydrogen ions 7.8 million km from the nucleus. At 19:40 UT on 13 March, and still 1 064 000 km out, Giotto crossed the bowshock in the solar wind. The formal 4 h encounter began 35 min later. The first of 12 000 dust impacts came 122 min before closest approach. At 23:58 UT, at a distance of 20 100 km, Giotto passed through the contact surface where the solar

wind was turned away by cometary material. The closest approach of 596 km occurred at 00:03:02 UT on 14 March over the sunlit hemisphere.

The best of Giotto's 2112 images, from 18 270 km, showed a lumpy nucleus 15 km long and 7-10 km wide, the full width being obscured by two large jets of dust and gas on the active sunward side. The dark



Giotto during the solar simulation test at Intespace in Toulouse, France. Visible are the Halley Multicolour Camera (white baffle, two horns for balancing during camera rotation) and the starmapper (red cover).



Giotto depicted a few days before closest approach to Halley's Comet. The diameter of Halley's visible dust coma at the time of encounter was about 100 000 km.

Giotto with the cylindrical solar cell array removed. Shown on the payload platform are (from left to right) the Halley Multicolour Camera (HMC), the electronics box of the Dust Impact Detection System (DIDS), the Rème Plasma Analyser (RPA) with its red cover on, and the dust mass spectrometer (PIA). Seen on the upper platform are two of the four hydrazine fuel tanks for attitude and orbit control.

side, with an unexpectedly low albedo of 2-4%, was quiescent but image enhancement revealed circular structures, valleys and hills over the entire surface. The jets broke through the dark crust that insulated the underlying ice from solar radiation.

Images continued to within 1372 km, 18 s before closest approach. The rate of dust impacts rose sharply in the final few minutes, and in the last seconds there were 230 strikes as Giotto apparently penetrated one of the jets. Only 7.6 s before closest approach, it was hit by a particle large enough to break Earth lock, although data for the following 30 min were later recovered from the degraded signal.

Giotto confirmed that Halley had formed 4500 million years ago from ices condensing onto grains of interstellar dust, and had then remained almost unaltered in the cold, outer regions of the Solar System. Analysis of the dust particles provided some surprises. Comets are not dirty snowballs, as previously believed, but largely dust with embedded ice. Tiny grains the size of smoke particles were much more abundant than expected, and – unlike most space dust – they were

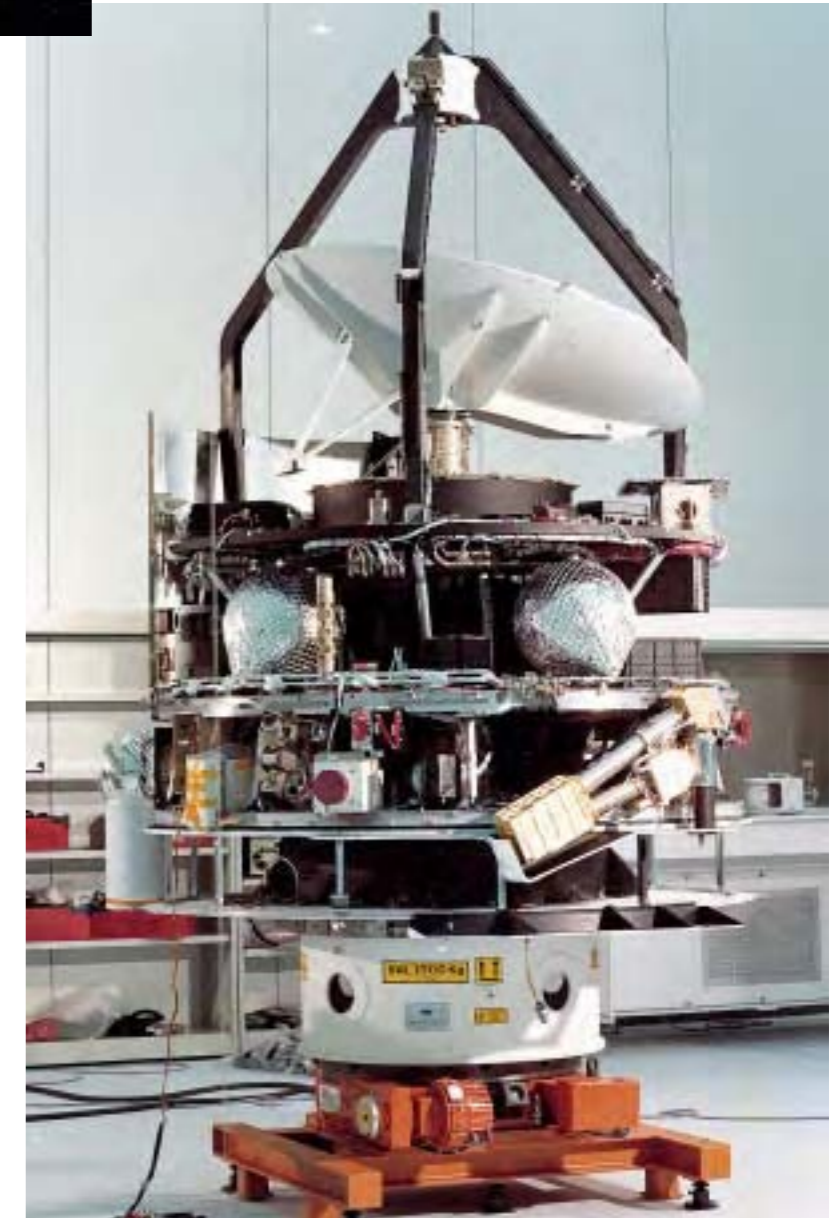

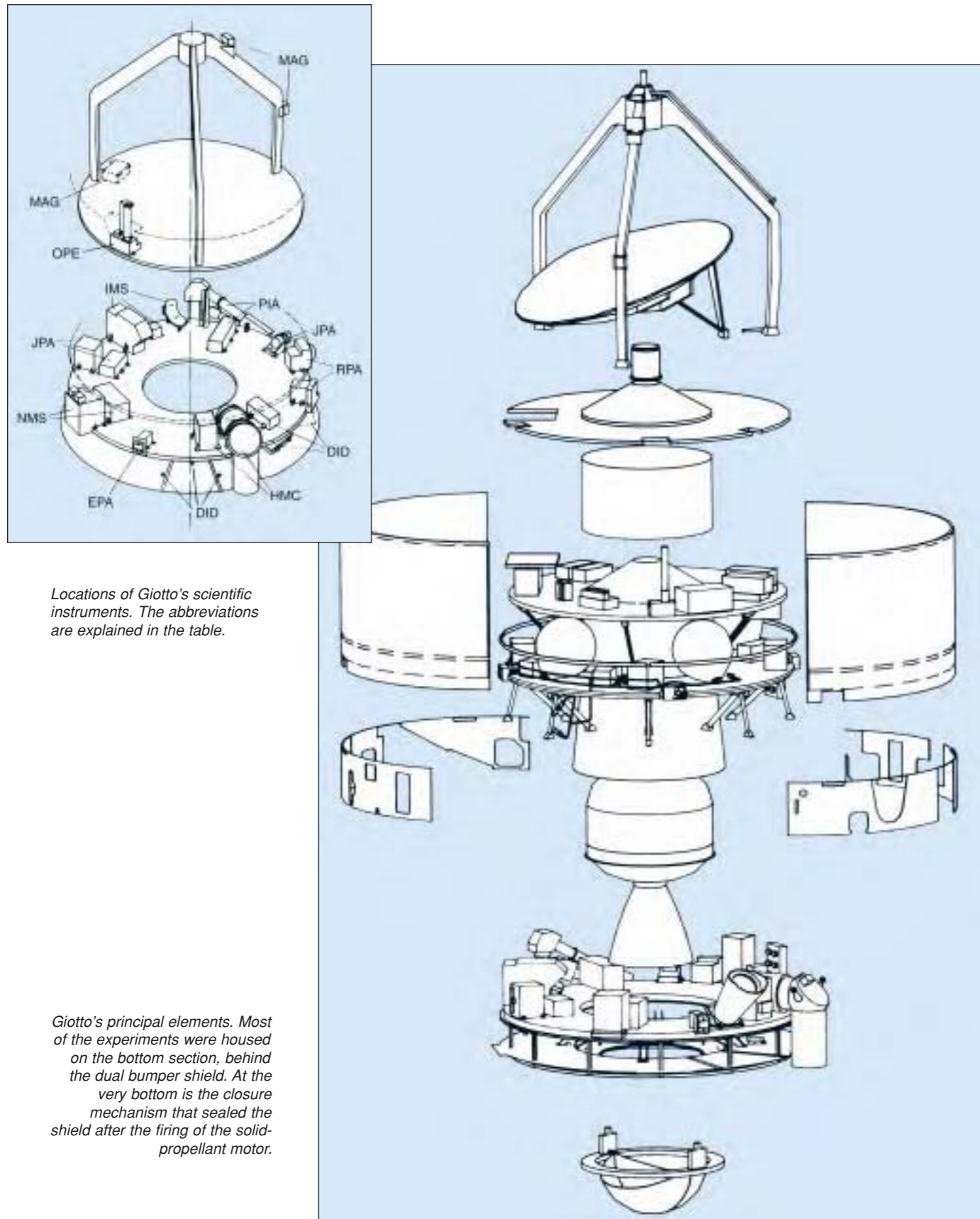

Locations of Giotto's scientific instruments. The abbreviations are explained in the table.

Giotto's principal elements. Most of the experiments were housed on the bottom section, behind the dual bumper shield. At the very bottom is the closure mechanism that sealed the shield after the firing of the solid-propellant motor.

not stony but organic. Giotto discovered particles rich in carbon, hydrogen, oxygen and nitrogen – elements essential for life. Dust from comets could have fertilised Earth, supplying the raw materials for nucleic acids and proteins to form.

Giotto's encounter with Halley proved to be a magnificent success, providing unprecedented information on the solar system's most active but least known class of object. Although its primary mission was successfully completed, Giotto was placed in

Installation of Giotto on its Ariane launcher at Kourou. The dome cover of Ariane's third stage liquid hydrogen tank can be seen protruding through the centre of the Vehicle Equipment Bay. (CSG/CNES/Arianespace)

The Giotto mission begins. (CSG/CNES/Arianespace)

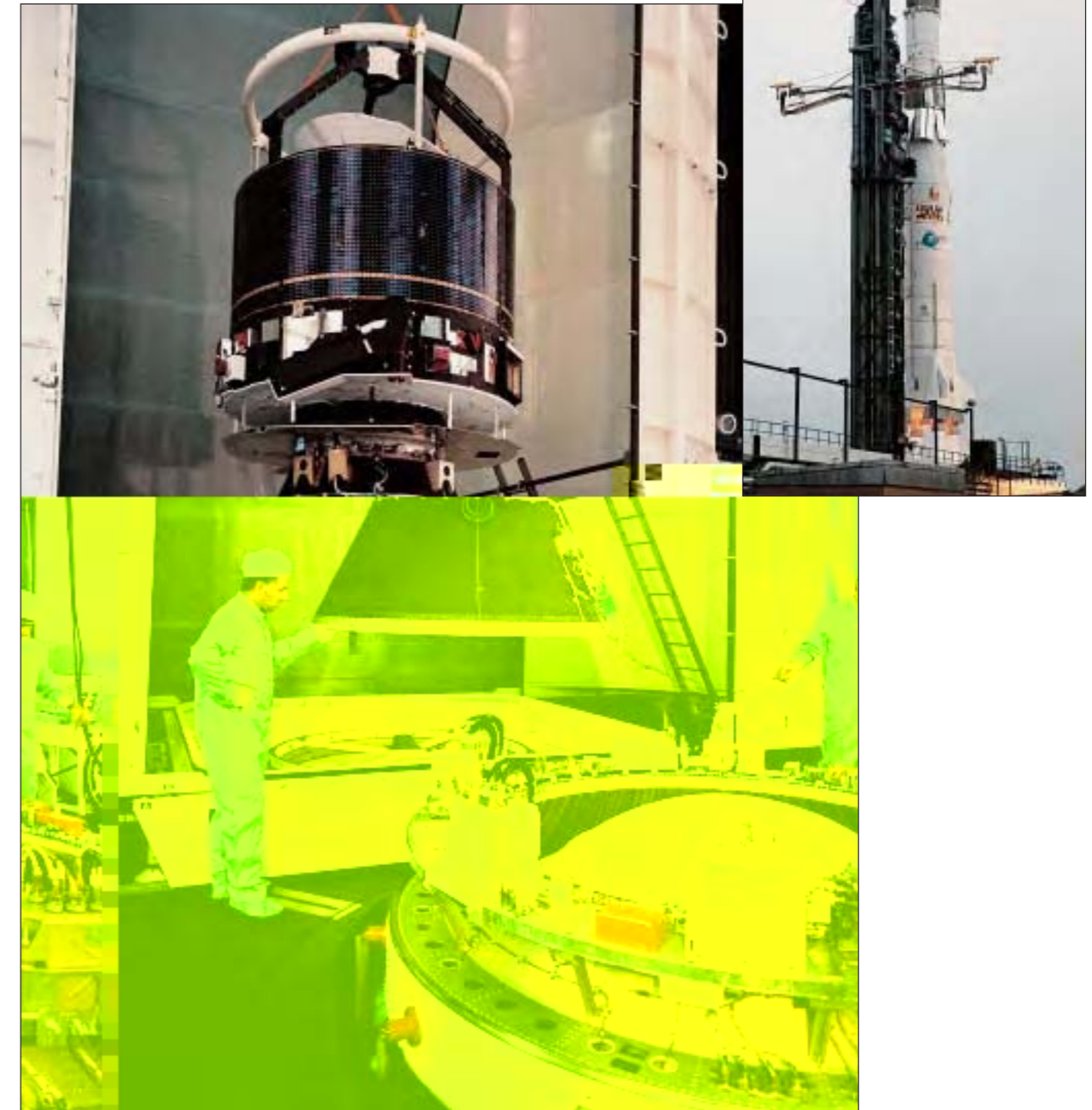

hibernation on 2 April 1986 in the hope that another mission could be attempted.

ESOC reactivated Giotto in 1990 after 1419 days in hibernation to assess its condition for the Giotto Extended

Mission (GEM). This time, a flyby of Comet Grigg-Skjellerup complemented the Halley observations by studying a far less active comet. The camera proved to be unusable because it was blocked by its Halley-damaged baffle, but



Giotto returned more than 2000 images during its close flyby of Comet Halley. The six shown here range from #3416 375 s before closest approach to #3496 only 55 s before closest approach. (MPAE, courtesy Dr. H.U. Keller)

This composite of seven Halley images highlights details on the nucleus and the dust jets emanating from the sunlit side. (MPAE, courtesy Dr. H.U. Keller)

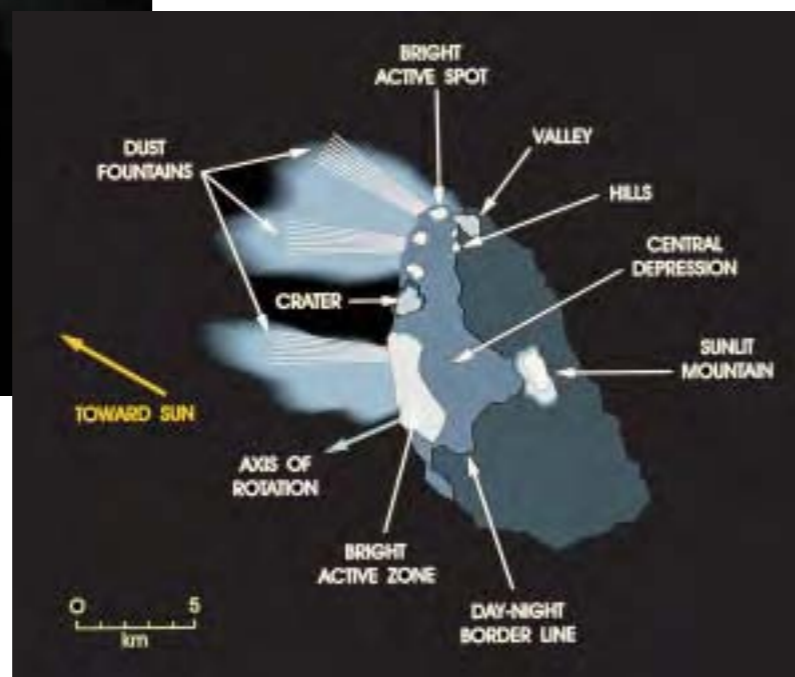

Principal features identified on Giotto's images of Comet Halley.

eight scientific instruments were still active. JPA detected the first cometary ions 440 000 km from the nucleus, and MAG found exciting wave phenomena not previously seen in a natural plasma. EPA saw surprising differences in the structures compared with Halley. OPE provided the first indication of entering the dust coma at 17 000 km; combined with MAG data, it showed that Giotto passed by on the dark tail side. Closest approach was about 100 km at 15:30:43 UT on 10 July 1992.

Spacecraft configuration: 1.867 m diameter, 2.848 m high, cylindrical bus (derived from Geos design). Central aluminium thrust tube supported three aluminium sandwich platforms: the top one carried the despun antenna and telecommunications equipment; the central one housed the four propellant tanks; the bottom one carried most of the experiments behind the bumper shield. Because of the 68 km/s Halley encounter speed, Giotto ventured into the coma protected by a dual bumper shield capable of stopping of a 1 g particle: a 1 mm-thick aluminium alloy outer shield 23 cm in front of a 13.5 mm-thick Kevlar sandwich.

Attitude/orbit control: spin-stabilised at 15 rpm about main axis. Redundant sets of four 2 N thrusters (69 kg hydrazine loaded) provided spin control and orbit adjust. Mage 1SB solid-propellant motor provided 1.4 km/s boost from GTO into Halley intercept orbit. Mage was housed in the thrust tube, firing through a central hole in the bumper shield, which was then closed by two quadrispherical aluminium shells. Attitude reference by Earth and Sun sensors for near-Earth, then Sun and star mapper.

Power system: 5032 Si cells on the cylindrical body were sized to provide 190 W at Halley encounter, supported by four 16 Ah silver cadmium batteries for peak demands.

Communications: the 1.47 m-diameter 20 W S/X-band antenna was canted 44.3° to the spin axis to point at Earth during the Halley flyby. The 8.4 GHz X-band provided 40 kbit/s realtime data to ESOC – there was no onboard storage as Giotto might not have survived encounter. Two low-gain antennas were used for near-Earth operations.

Giotto Science Instruments	
Halley Multicolour Camera (HMC)	
CCD camera with f/7.68 Ritchey-Chretien telescope, 22 m resolution from 1000 km. 13.5 kg, 11.5 W. PI: H.U. Keller, MPI für Aeronomie (D)	
Neutral Mass Spectrometer (NMS)	
Energy/mass of neutral atomic particles: 1-36 amu, 20-2110 eV. 12.7 kg, 11.3 W. PI: D. Krankowsky, MPI für Kernphysik (D)	
Ion Mass Spectrometer (IMS)	
Energy/mass of ions. 9.0 kg, 6.3 W. PI: H. Balsiger, Univ. of Bern (CH)	
Dust Mass Spectrometer (PIA)	
Mass (3×10^{-16} - 5×10^{-10} g) and composition (1-110 amu) of dust particles. 9.9 kg, 9.1 W. PI: J. Kissel, MPI für Kernphysik (D)	
Dust Impact Detector (DID)	
Mass spectrum of dust particles: 10^{-17} - 10^{-3} g. 2.3 kg, 1.9 W. PI: J.A.M. McDonnell, Univ of Kent (UK)	
Johnstone Plasma Analyser (JPA)	
Solar wind and cometary ions 10 eV-20 keV, cometary ions 100 eV-70 keV/1-40 amu. 4.7 kg, 4.4 W. PI: A. Johnstone, Mullard Space Science Laboratory (UK)	
Rème Plasma Analyser (RPA)	
Solar wind and cometary ions 10 eV-30 keV, cometary ions 1-200 amu. 3.2 kg, 3.4 W. PI: H. Rème, Centre d'Etude Spatiale des Rayonnements (F)	
Energetic Particles Analyser (EPA)	
3-D measurements of protons (15 keV-20 MeV), electrons (15-140 keV), α -particles (140 keV-12.5 MeV). 1.0 kg, 0.7 W. PI: S. McKenna-Lawlor, St Patrick's College (IRL)	
Magnetometer (MAG)	
0.004-65 536 nT. 1.4 kg, 0.8 W. PI: F.M. Neubauer, Institut für Geophysik und Meteorologie (D)	
Optical Probe Experiment (OPE)	
Coma brightness in dust and gas bands. PI: A.C. Levasseur-Regourd, Service d'Aeronomie du CNRS (F)	
Radio Science (GRE)	
Cometary electron content and mass fluence. PI: P. Edenhofer, Institut für Hoch- und Höchstfrequenztechnik (D)	

Olympus

Achievements: demonstrated new communications services; largest civil telecommunications satellite

Launch date: 12 July 1989

Mission end: 30 August 1993 (5-year target)

Launch vehicle/site: Ariane from Kourou, French Guiana

Launch mass: 2612 kg (359 kg communications payload; 1328 kg propellant)

Orbit: geostationary, at 19°W

Principal contractors: British Aerospace (prime), Alenia Spazio, Marconi Space and Alcatel-Bell (payloads)

ESA's Olympus telecommunications project was aimed at demonstrating new market applications using state-of-the-art payloads and a new-generation satellite platform. It also helped to establish the requirements for future Data Relay Satellites. The demonstrations covered TV and radio broadcasting direct to users' dishes, inter-city telephone routing, business communications and ground-breaking mm-wave links. For example, the In-Orbit Communications (IOC) experiment tested the first Ka-band data relay between two spacecraft, working with ESA's Eureka satellite during August 1992 to June 1993. Users of the direct-broadcast beam included Eurostep, an association of institutions interested in exploiting satellites for education, training and distance-learning projects. More than 100 organisations in 12 countries employed the facility. Technical institutes across Europe took measurements of the Ku/Ka-band propagation beacons and coordinated their results on how these frequencies behaved under different conditions to help plan for future satellite systems. Phase-C/D cost was 465.3 MAU (1980 e.c.; 119.8% envelope). Phase-A/B envelope ~35 MAU.

Olympus achieved most of its objectives but control was lost in 1991 and it drifted from its operational position at 19°W. A

complex recovery programme that in itself broke new ground brought it back after 77 days, on 13 August 1991. The rescue drew heavily on the propellant reserves, but it was still hoped that Olympus would complete its nominal 5-year mission. However, control was lost again 2 years later and the remaining propellant was almost exhausted; Olympus was thus lowered from GEO and deactivated.

Satellite configuration: 257 cm-high, 210x175 cm cross-section box-shaped bus centred on cylindrical propulsion unit, with base service module.

Attitude/orbit control: 3-axis control in GTO/GEO by reaction wheels and 16x22 N N₂O₄/MMH thrusters (first ESA satellite under 3-axis control in GTO). GEO insertion by Marquardt R-4D 490 N liquid apogee engine.

Power system: two solar wings spanning 27.5 m delivered 3.6 kW (payload required 2.3 kW). Batteries: 24 Ah nickel cadmium + 35 Ah nickel hydrogen.



Olympus deployed in its orbital configuration. Inset: launch by Ariane-4 V32.

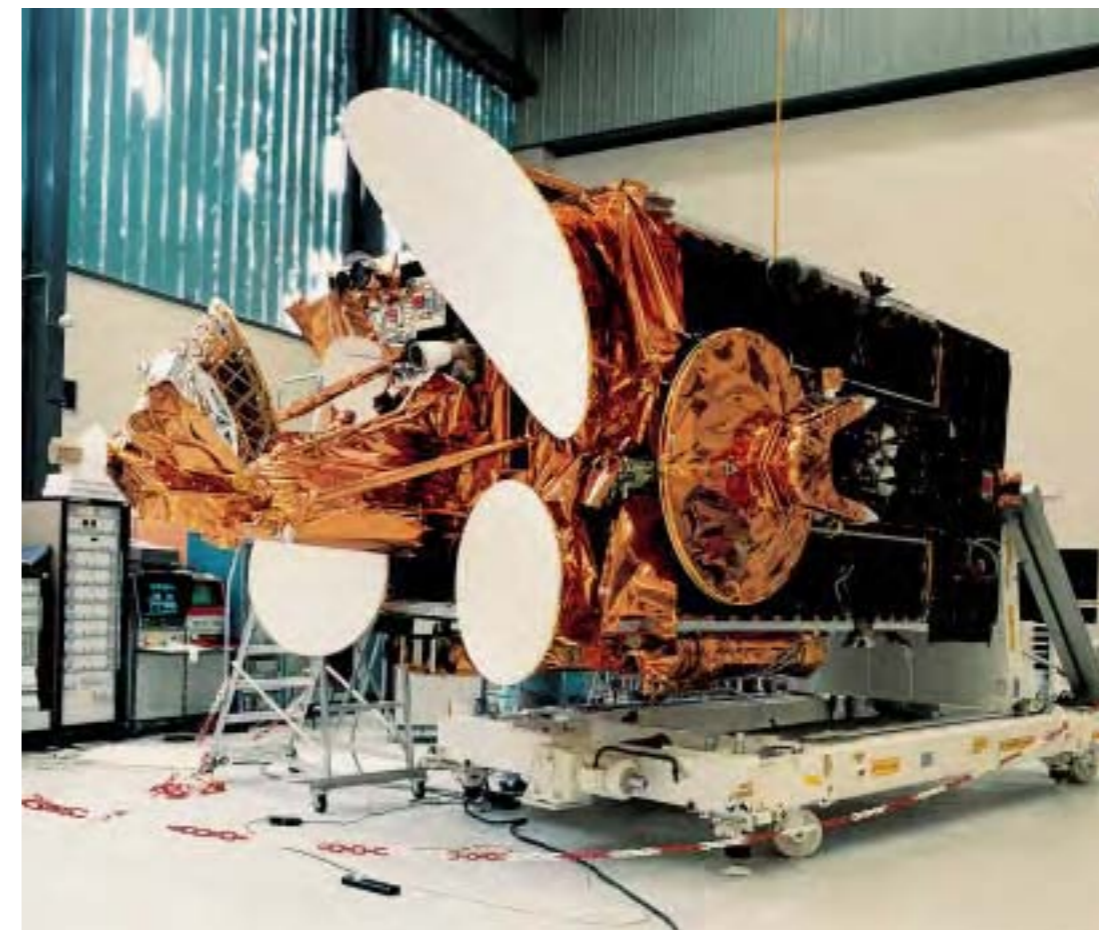

Olympus launch preparations at Kourou.



Integration of Olympus with its Ariane carrier at the Kourou launch site. (CSG/Arianespace)



Olympus undergoing electromagnetic compatibility testing at the David Florida Laboratory in Canada.

Communications payload:

- two 230 W 12.2 GHz TWTAs for delivering TV/radio direct to users with 45 cm and 90 cm dishes: one for Italy (1.0x2.4° elliptical beam), one Europe-wide (1.5° circular beam). Both antennas fully steerable.
- four 30 W 12.5 GHz TWTAs Specialised Services Payload working through steerable beams for high-speed data transmission, video conferencing and TV delivery.
- two 30 W 19 GHz TWTAs providing two steerable 0.6°-diameter spot beams for experimental video conferencing, business applications, VSAT and SNG.
- 20 GHz and 30 GHz beacons for propagation research.

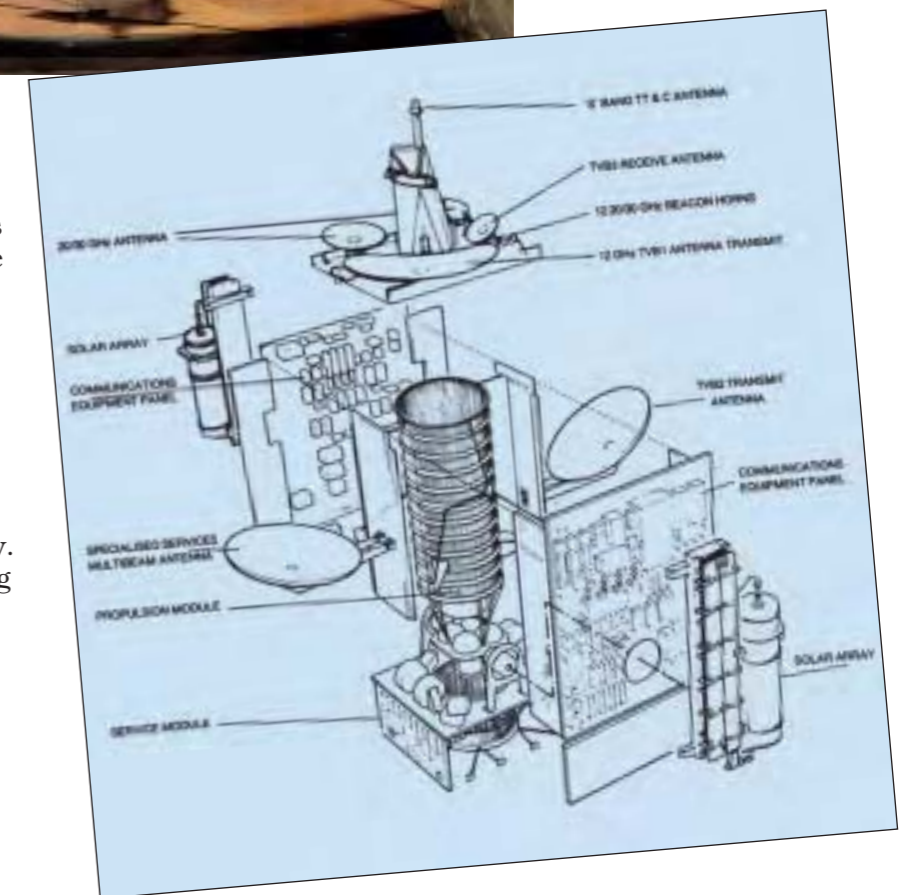

Hipparcos

Achievements: first space-based astrometric survey
Launch date: 8 August 1989 (design life 30 months)
Science operations began/ended: November 1989/March 1993. Communications ended 15 August 1993
Launch vehicle/site: Ariane-44LP from ELA-2, Kourou, French Guiana
Launch mass: 1140 kg (including 215 kg science payload)
Orbit: boost motor failure left Hipparcos in 200x35 896 km, 6.9° instead of placing it in geostationary orbit at 12°W. Thrusters raised it to 526x35 900 km for revised science operations
Principal contractors: Matra Marconi Space (satellite prime, payload development), Alenia Spazio (co-prime: spacecraft procurement & AIT)

Hipparcos ('High Precision Parallax Collecting Satellite') had the single goal of producing the most accurate positional survey of more than 100 000 stars, in the process determining their distances, their motions and other characteristics such as their variability and binary nature. Improving on ground-based accuracies by a factor of 10-100, Hipparcos is fundamentally affecting every branch of astronomy, from the Solar System to the history of the Universe, and especially theories of stars and their evolution.

The mission was a major technical challenge for European industry in building the satellite, and the European astronomical community in generating the resulting star catalogues. The satellite design required extreme thermal stability to maintain optical precision, smooth jitter-free motion, realtime attitude determination to within 1 arcsec, and fast realtime data downlinking to handle the information generated by the scanning. 1000 Gbit were returned during the 4 years of operations, making the production of the catalogues the largest data analysis problem ever undertaken in astronomy. The approach was simple: measure the angles between selected pairs of stars as Hipparcos' rotation scanned its telescope across the sky. Covering the whole celestial sphere

allowed these 118 000 target stars to be precisely located to within about 0.001 arcsec. Simultaneously, redundant star mappers of the satellite's attitude determination system performed the less accurate 'Tycho' survey of 1 million stars. The Hipparcos Catalogue (118 218 entries) and the Tycho Catalogue (1 058 332 entries) were both declared final on 8 August 1996, and the 17-volume set was published by ESA in 1997.

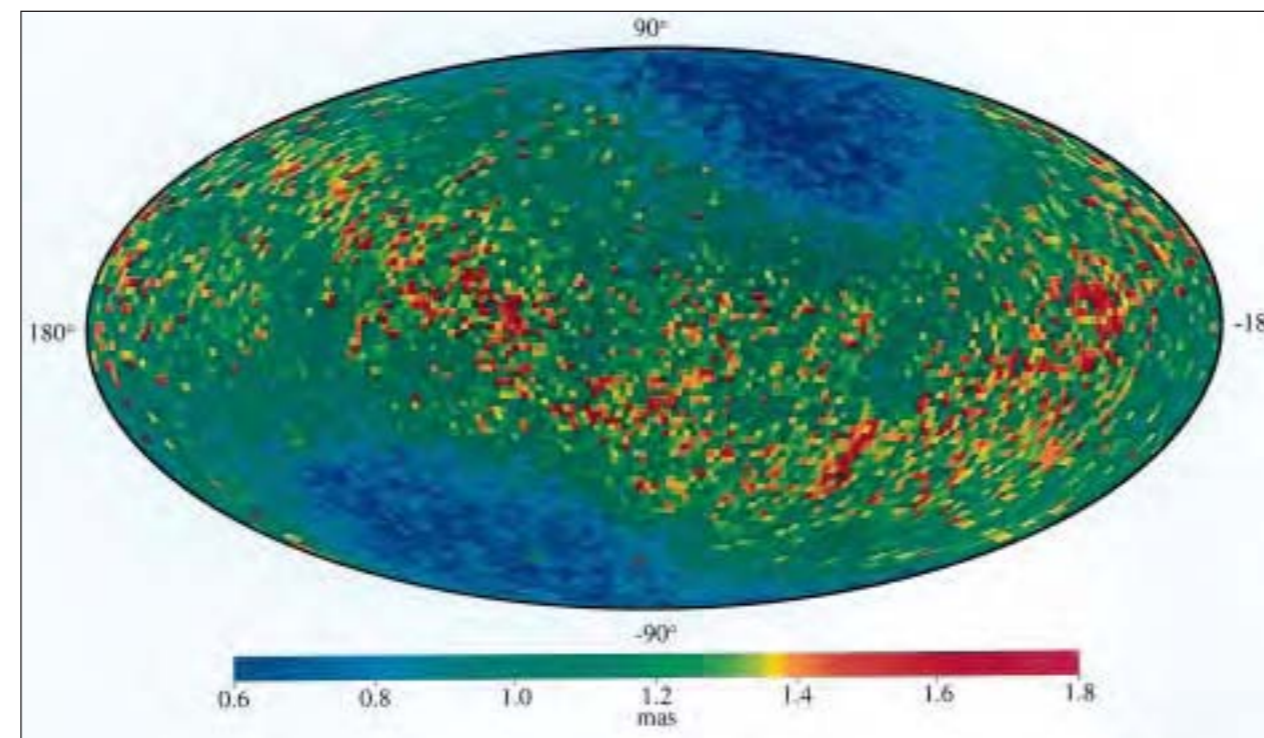

Astronomers continue to analyse the data: the Tycho-2 catalogue covering 2 539 913 stars (99% of all stars down to 11th magnitude) was issued in 2000. Hipparcos pioneered techniques that will be used by ESA's Gaia mission (see separate entry) to analyse the composition, formation and evolution of our Galaxy by mapping 1000 million stars.

The resounding success of Hipparcos is even more remarkable considering its dramatic problems soon after

Accuracy of Hipparcos stellar distances. The data obtained by Hipparcos is of unprecedented accuracy and is being used to tackle many issues in astronomy, such as the structure of the Galaxy, the evolution of stars, and the age the Universe. The map is in equatorial coordinates; mas = milliarcsecond. (From the Hipparcos and Tycho Catalogues, ESA SP-1200, Vol. 1.)



Hipparcos final qualification testing in the Large Space Simulator at ESTEC. One of the telescope's two semi-circular apertures is seen closed; the other is side-on at far right.

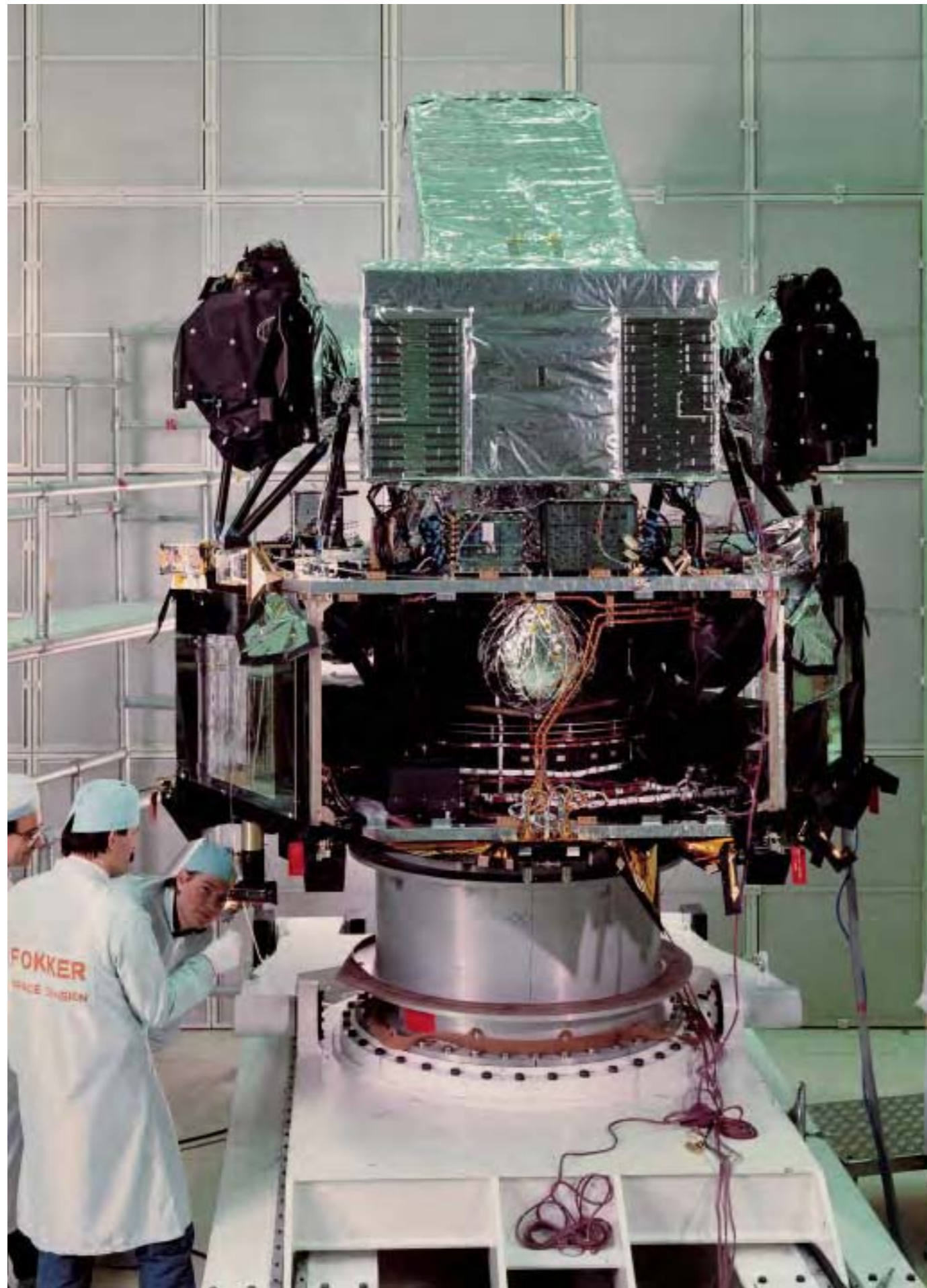

The Hipparcos flight model being prepared for testing in the Large Space Simulator at ESTEC, April 1988. The payload module is mounted on the bus before installation of the sunshield. The two telescope apertures are covered at top.

Hipparcos' optical system measured the angular separations of stars by timing their passages over a modulating grid, combining fields of view 58° apart on the sky. Processing the voluminous data required a very accurate knowledge of the satellite's orientation at all times. These data, along with data for the million-star Tycho Catalogue, came from separate detectors and a star-mapper grid on one side of the main grating.

launch. The satellite was destined for geostationary orbit, but it was stranded in the transfer orbit when its solid-propellant boost motor failed to fire. Using 26 kg of its 32 kg hydrazine supply allowed its small thrusters to lift the 200 km perigee away from atmospheric drag, but that still left severe operational problems. The solar panels and spacecraft electronics were not designed for repeated passage through the harsh Van Allen radiation belts, and unexpected periods in Earth's shadow threatened battery breakdown. Also, the torrent of realtime data could no longer be collected by the single Odenwald station in Germany as Hipparcos swung around the Earth – stations in Kourou, Perth and Goldstone had to be added, increasing costs. Despite these problems, the goal of 30 months' observations was comfortably achieved before the electronics succumbed to the bombarding radiation in 1993.

The mission's scientific aspects were conducted by four consortia, altogether comprising some 200 scientists, responsible for constructing, documenting and publishing the final catalogues.

Satellite configuration: bus was an irregular hexagonal prism of conventional aluminium design with

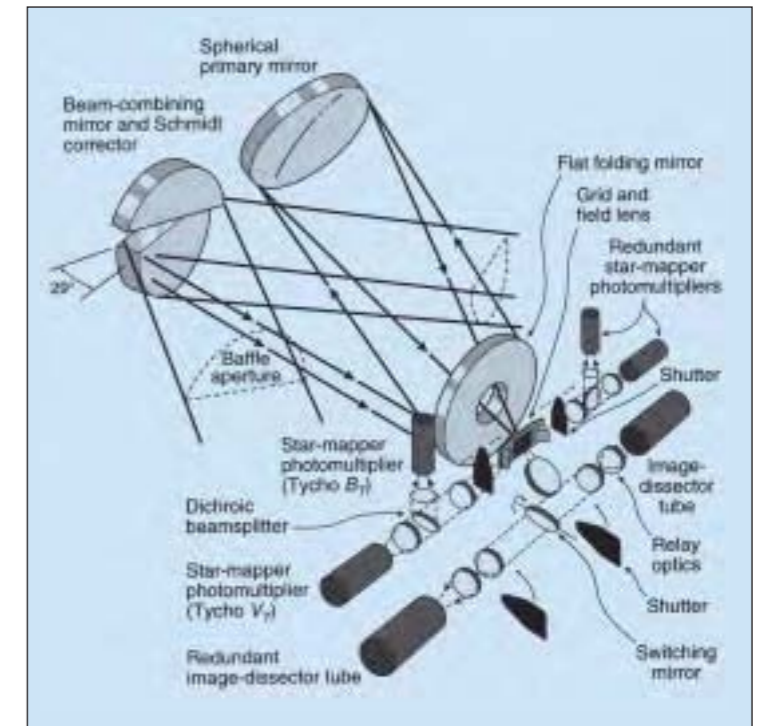

central thrust tube. Payload module mounted on top; CFRP structure required for thermal stability. Topped by sunshield. Total height 3 m; body diameter 1.8 m.

Attitude/orbit control: 6x20 mN nitrogen thrusters (9.3 kg supply in two tanks, 285 bar) maintained smooth spin stabilisation at 11.25 revolutions daily for scanning. Supported by 4x5 N hydrazine thrusters (32 kg supply in two tanks, 22-5.5 bar blowdown). Mage-2 Apogee Boost Motor to circularise GTO into GEO (failed).

Power system: three 119x169 cm deployed Si solar panels generated 380 W at 50 Vdc (payload requirement 110 W); 2x10 Ah nickel cadmium batteries.

Communications/data: 2.5 W 2.24 GHz S-band omni transmitter provided 24 kbit/s realtime science data downlink.

Hipparcos Scientific Payload

1.400 m-focal length 29.0 cm-diameter Schmidt telescope simultaneously observed two 0.9° star fields separated by 58° . Combining mirror focused the two fields on a 2.5×2.5 cm detector carrying 2688 3.2 mm-wide parallel slits 8.2 mm apart for the modulated light over a 38 arcsec field to be sampled by a redundant image dissector tube at 1200 Hz. As Hipparcos' spin axis changed by 4.415° daily, the whole sky was scanned several times. An average star crossed the detector in 20 s and was observed 80 times during the mission. This allowed the positions, proper motions and parallaxes of 118 000 programmed stars to be measured with 0.001 arcsec accuracy. Also, two star mappers used primarily for attitude determination produced the Tycho catalogue of position (0.015 arcsec) and photometric (0.01m) data on 1 million other stars, followed by the Tycho-2 catalogue of 2.54 million stars.

Hubble Space Telescope Faint Object Camera

Achievements: first photon-counting high-resolution camera for Hubble Space Telescope

Launch date: 24 April 1990

Mission end: returned to Earth 12 March 2002 by Space Shuttle mission STS-109

Launch vehicle/site: NASA Space Shuttle mission STS-31, Kennedy Space Center, Florida

Launch mass: 320 kg (Hubble Space Telescope 10 843 kg)

Orbit: about 600 km, 28.5°

Principal contractors: Dornier/Matra Espace (co-contractors), British Aerospace (photon-counting assembly)

The objective of the Hubble Space Telescope (HST) mission is to operate a 2 m-class astronomical telescope in orbit for at least 15 years as an international observatory. HST's advantages over a ground-based observatory include the diffraction-limited angular resolution and access to the UV and near-IR ranges. ESA's 15% contribution consists of three main elements:

- the Faint Object Camera (FOC), a prime focal plane instruments;
- two pairs of solar wings (the original pair was replaced by the second, improved, pair during the first Servicing Mission in December 1993);
- scientific and technical personnel seconded to the Space Telescope Science Institute (STScI) in Baltimore, Maryland, US.

In return, European astronomers from ESA Member States are guaranteed a minimum of 15% of HST observing time. However, in open competition, Europe averages about 20%. European astronomers are also supported by the ESA/ESO Space Telescope - European Coordinating Facility (ST-ECF), located within the European Southern Observatory at Garching (D). ST-ECF's main functions are to provide a regional source of information on instrument status, analysis software and access to the HST data archives.

The most important change in HST's status after SM1 was correction of the spherical aberration discovered in the primary mirror after launch. That mission substituted the least-used High Speed Photometer with the COSTAR device to deploy pairs of corrective mirrors in front of the remaining axial instruments. The FOC optics performed flawlessly, showing text-book diffraction-limited images of stars.

Almost 7000 images were recorded with the FOC and archived, providing unique close-up views of almost every type of astronomical object known – from the asteroids and planets of our solar system to the most remote quasars and galaxies. FOC's first image, of NGC 188, came on 17 June

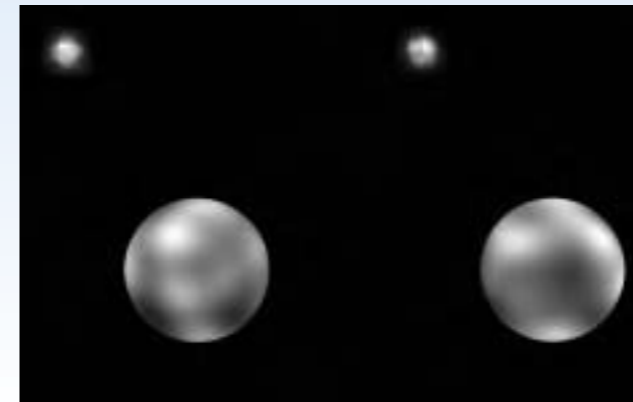

1990. It was last used scientifically 3 July 1999 to image quasar Q1157+317, but it continued to be operated for calibration purposes until shortly before it was removed. FOC's major achievements include:

- first direct image of the surface of the red giant star Betelgeuse;
- first high-resolution image of the circumstellar ring and ejecta of Supernova 1987A;
- first detection of white dwarfs and stellar mass segregation in a globular cluster;
- first image of an 'exposed' black hole;
- first detection of intergalactic helium in the early Universe.

SM3A in December 1999 renewed Hubble's gyros. SM3B in March 2002 replaced FOC with NASA's own Advanced Camera for Surveys (ACS), and ESA's flexible solar wings with rigid US versions. The FOC was removed on 7 March 2002 and returned for storage at ESTEC. The SM4 fifth servicing mission was planned to replace COSTAR with the Cosmic Origins Spectrograph (COS) and WFPC2 by Wide Field Camera 3 (WFC3) in 2005. Lacking a propulsion system, Hubble would then have been deorbited robotically in about 2010.



Above: ESA provided HST's solar array and one of the five original scientific instruments. The Faint Object Camera is one of the four box-like units in the base section.

Above left: the first surface maps of Pluto constructed from a long series of FOC images taken in 1994. The two smaller inset pictures give samples of the actual raw FOC images. Pluto is only two-thirds the size of the Moon and is 12000 times farther away.

Bottom left: FOC is removed from HST by Jim Newman and Mike Massimino.

However, following the loss of Shuttle Columbia, NASA on 16 January 2004 announced cancellation of SM4 because of the risks. The two remaining gyros are expected to fail 2007-2008 and the batteries by 2010. The Space Telescope Imaging Spectrometer (STIS, installed during SM2 in February 1997) failed on 3 August 2004, leaving astronomers without a UV-spectrometer. COS is designed to replace it. Scientific and political support has resulted in studies of a robotic servicing mission in late 2007 or 2008. HST could then continue operations possibly beyond 2011 when its successor, the James Webb Space Telescope (JWST), is scheduled for launch. The ESA/NASA HST MoU of October 1977 expired in April 2001 but has been extended by 5 years.

The collaboration with NASA on HST dates to the mid-1970s. It was clear that an instrument was needed that could fully exploit the telescope's high resolving power, and at the same time image the very faintest objects. This was to be achieved with the FOC's primary f/96 camera, operating in photon-counting mode. The limitations of storage technology in the 1970s meant that this came at the expense of viewing area. In order to alleviate this restriction, a fully independent f/48 mode was added, which included a long-slit spectrograph. The technical heart of the FOC was its unique 2-D photon-counting detector, with a pedigree stretching back to Alec Boksenberg's Imaging Photon Counting System (IPCS) developed at University College London in the early 1970s. With its 36 kV image intensifier and complex video camera readout, it was notoriously finicky. By substituting a B52 bomb sight for the camera section and paying meticulous care in packaging the delicate high-voltage image tube, this considerable engineering challenge was overcome. In spite of its complexity, the FOC performed extremely well in orbit. The only

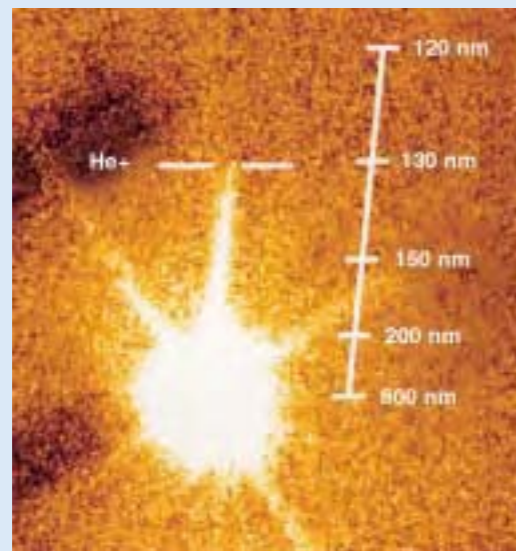

significant problem was a high-voltage discharge in one of the f/48 detectors. Because of its particular 'go for broke' scientific niche, the FOC was hit hard by HST's spherical aberration. It became COSTAR's most demanding and key customer. The spectacularly successful SM1 servicing mission in 1993 led to the complete recovery of the f/96 imaging camera and its associated objective prism and polarimetry modes. The f/48 camera and its long-slit spectrograph was also recovered optically, but its widespread use was hampered by the detector problem. The only observing mode never used scientifically was the f/288 coronagraphic mode, the apodising mask of which was rendered useless, first by the spherical aberration, and later by the shift in pupil position introduced by the COSTAR optics. Starting in late 1998, the FOC was no longer offered as a general observing facility. While it was still fully functional and being maintained as a backup, the point had now been reached where most of its capabilities had been superseded by various observing modes of STIS and WFPC2. The FOC's foremost scientific capability was its very high angular resolution, a feature evident even in the central image cores of the early aberrated HST images. With the COSTAR corrected optics in place, the FOC

The long-sought 'fossil' helium found at last. The first big find with the refurbished HST came early in 1994. Helium was a key product of the Big Bang and influenced the development of the Universe. The helium should reveal its presence in deep space by blocking much of the UV light from quasars in extremely active and distant galaxies. Hydrogen in intervening clouds usually frustrates the attempts to see distant helium, but a chink was found in the clouds in front of Quasar 0302-003. The FOC's prism created a simple spectrum, revealing the long-sought helium by the abrupt cut-off in the spectrum at 130 nm. The discovery of this singly-ionised helium-II was a breakthrough in cosmology.



This FOC image of the red giant star Betelgeuse in ultraviolet light is the first direct image ever taken of a star beyond the Sun. It reveals a huge tenuous atmosphere with a mysterious hot spot on its surface.

This FOC image reveals one of the smallest stars in our Galaxy, Gliese 623b. The diminutive star is ten times less massive and 60 000 times fainter than the Sun, and appears as the smaller component (arrowed) of a double star system in which the separation between the two members is only twice the distance between the Earth and the Sun.

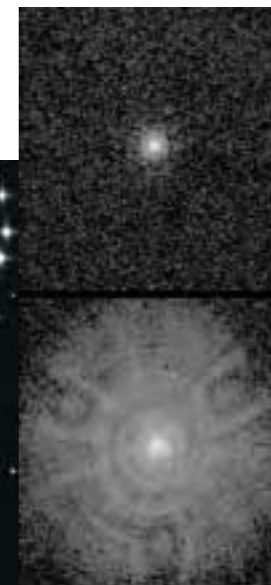

FOC images of a single star before (bottom) and after COSTAR. The halo of poorly focused light is completely rectified by COSTAR.

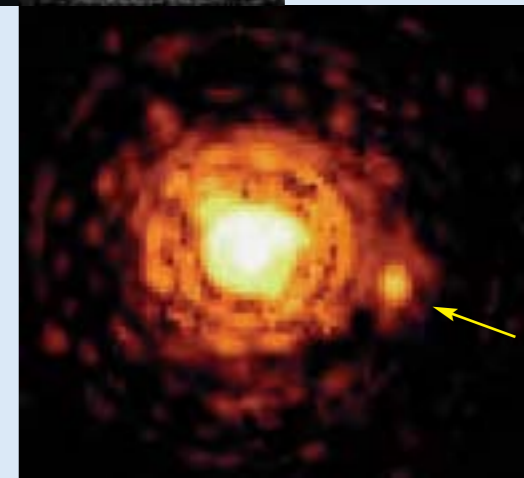

achieved essentially diffraction-limited image quality at visible wavelengths: 43 μ arcsec FWHM at 5000 Å. The superb image quality provided unique close-up views of most classes of objects, revealing Pluto's surface features and the first direct images of the atmospheres of the giant stars Betelgeuse and Mira-A. A major theme was the study of Active Galactic Nuclei, where high-resolution, narrowband and polarisation images proved invaluable for probing the complex geometry of their innermost regions. The FOC polarisation images of AGN jets were also spectacular, M87 especially.

The second key feature of the FOC was its sensitivity down into the far-UV. The simple, but versatile, far- and near-UV objective prism modes were, until the installation of STIS, the only 2-D modes on HST capable of detecting the very

faintest UV sources. This capability was extensively used to search for rare examples of very high-redshift quasars, an effort that ultimately resulted in the first detection of singly-ionised helium between the galaxies.

The FOC's unique combination of high spatial resolution and UV sensitivity was perhaps most dramatically used to study globular clusters, where it was able to 'shoot straight through' the dense cores of these objects and reveal their contents and structure. FOC UV imaging enabled the ready identification of the more exotic denizens of clusters, including novae, cataclysmic variables and X-ray binaries. A highlight of these efforts was the first detection of white dwarf stars in globular clusters.

Rudolf Albrecht (ST-ECF) & Peter Jakobsen (FOC Project Scientist)

FOC awaits installation in the Hubble Space Telescope.

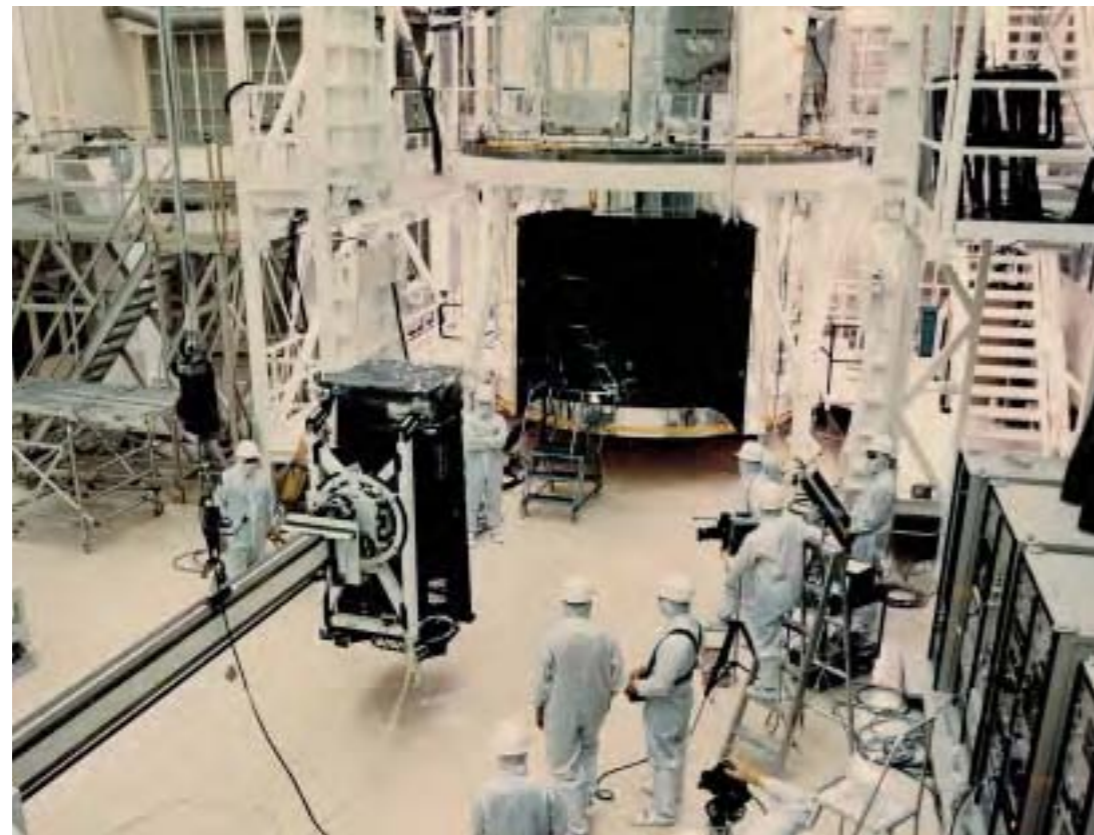
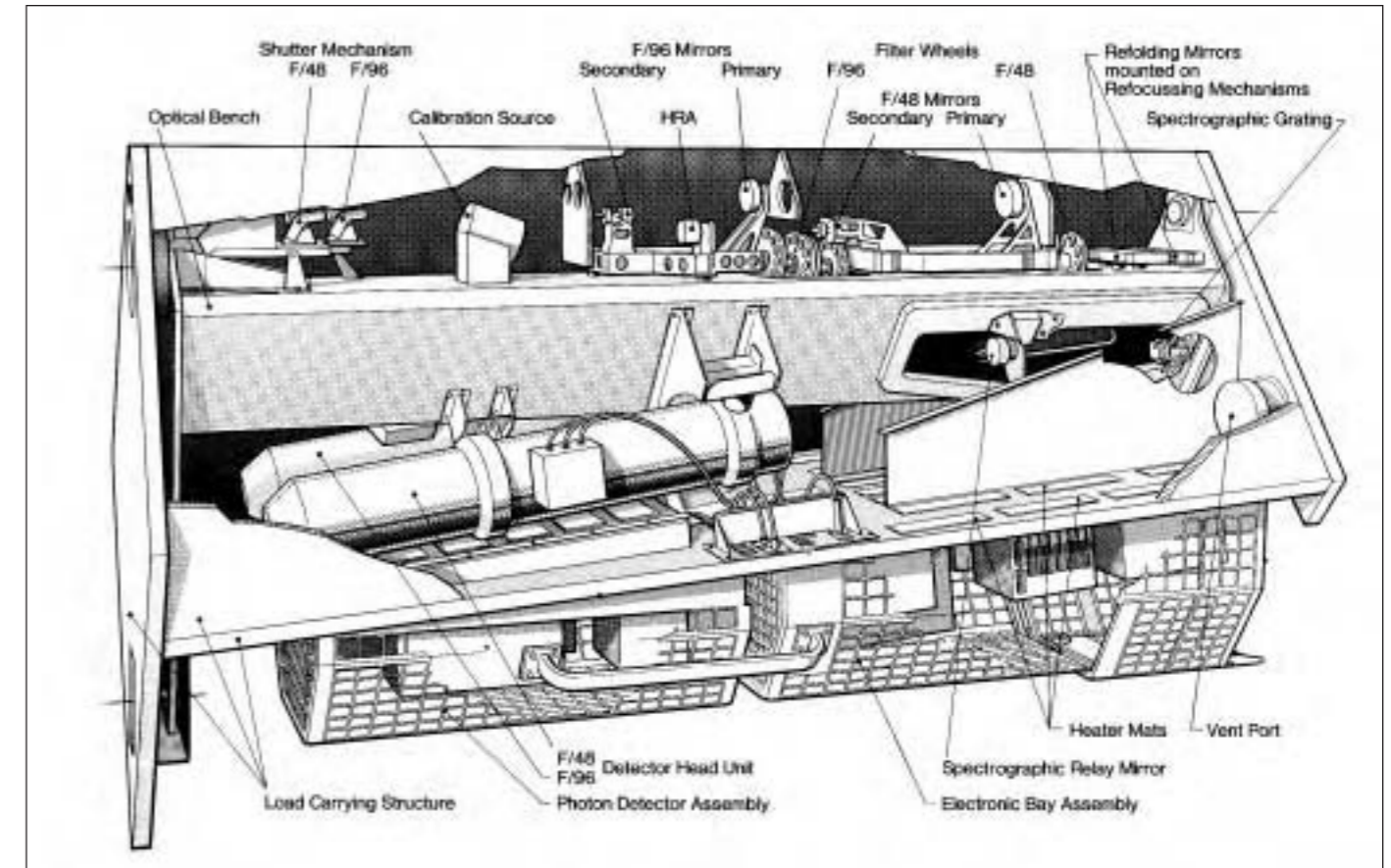

The Faint Object Camera is installed in the base of Hubble, behind the main mirror. The camera was returned to Earth aboard the Space Shuttle in March 2002.

HST configuration: HST, 13.1 m long and 4.27-4.7 m diameter, employs a 2.40 m-diameter primary mirror and optical relaying light to five (four after SM1) aft-mounted focal plane instruments. The f/24 Ritchey-Chrétien Cassegrain optical system comprises an 830 kg primary mirror of ultra-low expansion titanium silicate glass and a 30 cm-diameter Zerodur secondary. Effective focal length is 57.6 m. The 5 m-distant secondary directs the light cone through the primary's 60 cm-diameter central aperture to a focus 1.5 m behind the face plate for dispersion to the scientific instruments.

Power system: FOC requires 150 W when operating, 75 W in standby. HST was powered by twin ESA/British Aerospace solar wings providing 5.0 kW BOL and 4.3 kW after 5-year design life. Each 150 kg, 2.83x11.8 m wing carried 24 380 Si

cells. First pair replaced by SM1 in December 1993; inspection found > 80 000 micrometeoroid impacts. Second pair replaced by SM3B in March 2002.

FOC: 2 m long, 1x1 m cross section, optimised to exploit HST's full resolution capabilities for faint objects of magnitude +24 to +29 using long exposures. Covering 1150-6500 Å, it operated in four principal modes: direct imaging at f/48 (22x22 arcsec FOV, 2x magnification), f/96 (11x11 arcsec, 4x) and f/288 (4x4 arcsec, 12x), and as a 20x0.1 arcsec R=1000 long-slit spectrograph. Four wheels provided banks of filters, polarisers and objective prisms. Two photon-counting intensified cameras acted as detectors. Following SM1, FOC's optical chains were fed corrected but magnified images: f/96 became f/150 (7 arcsec FOV), f/48 became f/75 (14 arcsec) and f/288 became f/450.

Principal features of the Faint Object Camera.

Ulysses

Achievements: first in situ investigation of the inner heliosphere from the solar equator to the poles; first exploration of the dusk sector of Jupiter's magnetosphere; fastest spacecraft at launch (15.4 km/s)

Launch date: 6 October 1990

Mission end: planned March 2008

Launch vehicle/site: NASA Space Shuttle Discovery from Kennedy Space Center, USA

Launch mass: 370 kg (including 55 kg scientific payload)

Orbit: heliocentric, 1.34x5.4 AU, inclined 79.1° to ecliptic, 6.2 year period

Principal contractors: Dornier (prime), British Aerospace (AOCS, HGA), Fokker (thermal, nutation damper), FIAR (power), Officine Galileo (Sun sensors), Laben (data handling), Thomson-CSF (telecommand), MBB (thrusters)]

Ulysses is making the first-ever study of the particles and fields in the inner heliosphere at all solar latitudes, including the polar regions. A Jupiter flyby in February 1992 deflected Ulysses out of the ecliptic plane into a high-inclination solar orbit, bringing it over the Sun's south pole for the first time in September 1994 and its north pole 10.5 months later. Ulysses spent a total of 234 days at latitudes >70°, reaching a maximum 80.2° in both hemispheres. The mission was originally to end in September 1995, but Ulysses' excellent health and the prospect of important new science resulted in operations being extended for two more solar orbits. Ulysses passed over the south pole for a second time in November 2000, and the north pole in October 2001. In contrast to the passes in 1994/95, which took place near solar minimum, the return to high latitudes was under much more active conditions. In 2007/08, Ulysses will return to the poles during quiet conditions again, but this time with the Sun's magnetic polarity reversed.

The unique data from Ulysses have added a new dimension to our knowledge of the Sun's environment – the heliosphere. Important accomplishments include the characterisation of two distinctly different solar-wind states (fast wind

from the poles filling a large fraction of the heliosphere, and slow wind confined to the equatorial regions), the discovery that high- and low-latitude regions of the heliosphere are connected in a much more systematic way than previously thought, the first direct measurement of interstellar gas (both in neutral and ionised states) and dust particles, and the precise measurement of cosmic-ray isotopes. These, together with numerous other important findings, have resulted in more than 1100 publications to date in the scientific literature.

ESA and NASA signed the MoU 29 March 1978 for the International Solar Polar Mission (ISPM) as a 2-craft mission launched by a single

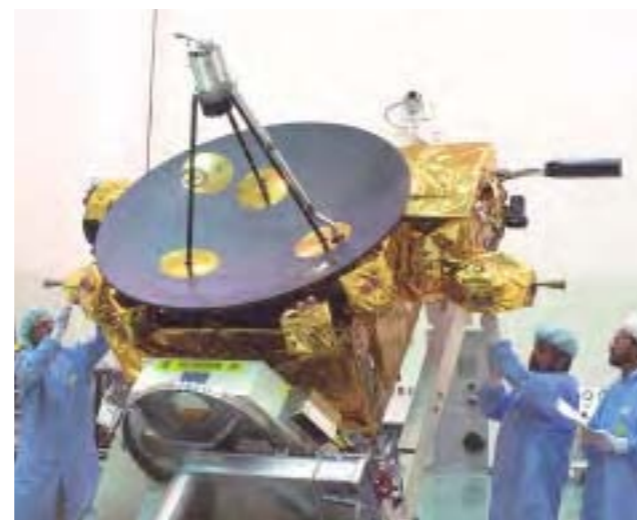

Preparing Ulysses for launch, in Hangar AO at Cape Canaveral.



Ulysses' high-gain antenna points continuously towards Earth, returning 8 h of realtime and 16 h of recorded data every day on the Sun's domain

Shuttle and 3-stage Inertial Upper Stage (IUS) in February 1983. Jupiter gravity assists would have thrown them into opposing solar orbits. NASA awarded TRW the contract for the US spacecraft in July 1979; Dornier was selected in September 1979 as leader of the STAR consortium for ESA's spacecraft. US budget cuts in February 1981 saw NASA unilaterally cancelling its spacecraft to save \$250-300 million. NASA would still provide launch, tracking and the RTG. Shuttle and other problems delayed the launch to May 1986 – now using a cryogenic Centaur upper stage – but the *Challenger* accident of January 1986 postponed all flights. Safety concerns prompted the final switch to an all-solid 3-tier IUS/Payload Assist Module (PAM) upper stage.

Ulysses' record 15.4 km/s speed took it across the Moon's orbit in only 8 h. The deployment of the 5.55 m radial boom on 7 October 1990 reduced the spin to 4.7 rpm. Beginning with

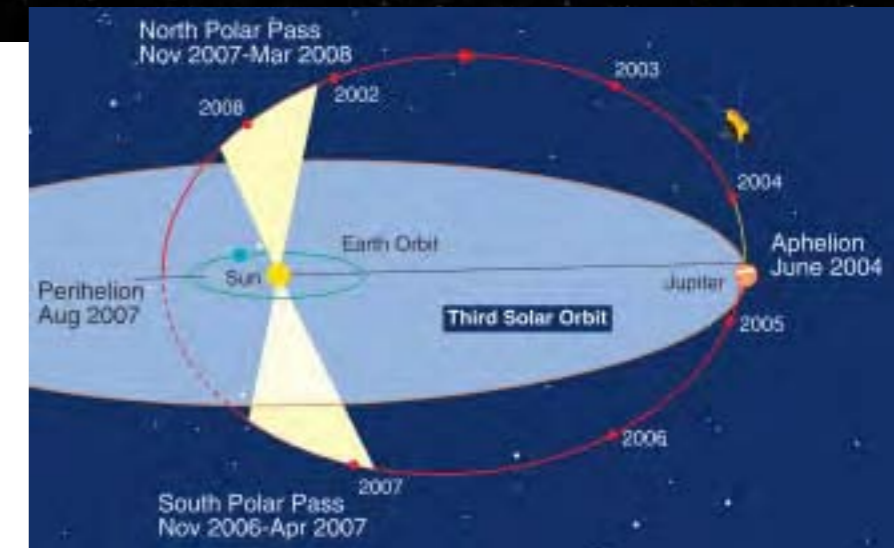

EPAC, the science instruments were turned on starting 19 October and checked out over several weeks. The 7.5 m axial boom was deployed on 4 November.

After travelling 993 million km and already collecting important information on the interplanetary medium, Ulysses began the Jupiter encounter by detecting the bowshock crossing at 17.33 GMT 2 February



Ulysses was launched on an IUS topped by a PAM final kick stage. (Boeing)

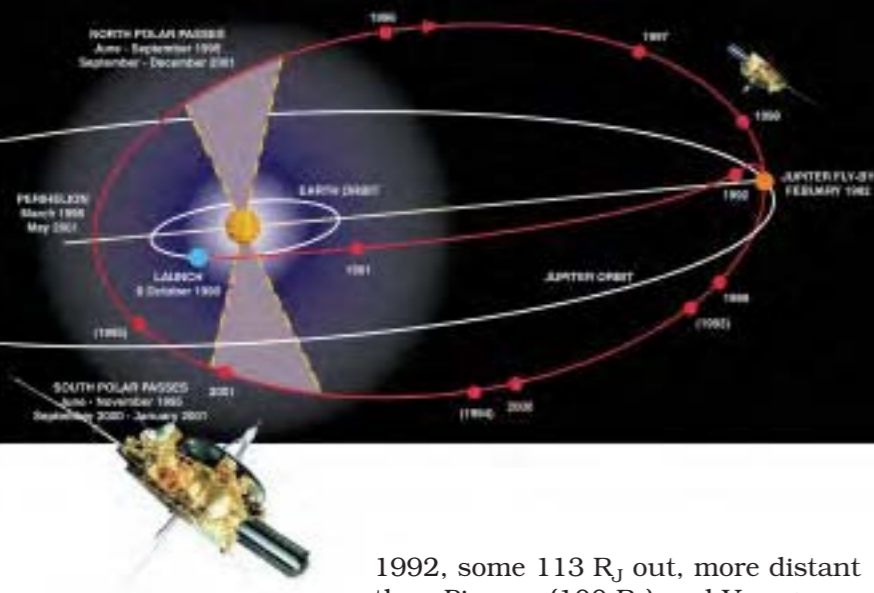

1992, some 113 R_J out, more distant than Pioneer (100 R_J) and Voyager (60 R_J). It approached through the late morning region of the magnetosphere at about $30^\circ N$, came within 378 400 km of the cloudtops (5.3 R_J) at 12.02 GMT 8 February 1992, and then exited unscathed on the previously unexplored evening side, at high southern latitudes, having spent more than a week in the magnetosphere. Just before closest approach, Ulysses entered the magnetosphere's polar cap. The close 13.5 km/s flyby produced the high ecliptic inclination – IUS/PAM could have reached only 23° without the assist. A major finding was that the solar wind affects the magnetosphere much more than expected. The magnetic field in the dusk sector is not rotating with the planet and is swept down into the magnetotail. Also, Jupiter's intense radiation belts reach only to 40° latitude, whereas Earth's extend to 70° . Ulysses passed directly through the Io plasma torus (only Voyager 1 preceded it), which plays a key role in refuelling the magnetosphere with plasma.

At the end of February 1992, the Sun, Earth and Ulysses were in direct opposition, the best time to detect gravitational waves by observing an arcmin shift in the craft's position. Although they were not positively identified by this radio science experiment, new upper limits were set with a factor of 20 improvement in sensitivity. Important observations include the first direct detection of ionised O, N and He (and neutral He) atoms arriving from interstellar space, and the measurement of micron-sized dust grains from interstellar space. This first-ever measurement of the interstellar $^3\text{He}/^4\text{He}$ ratio suggests that the amount of dark matter created in the Big Bang was greater than previously believed.

By mid-1993, Ulysses was permanently immersed in the region of space dominated by the Sun's southern pole. This could be seen in the consistently negative polarity measured by the magnetometer from April 1993. Increasing latitude also reduced the intensity of charged particles.

Passage over the Sun's south pole provided the first long-term in situ observations of high-speed solar wind flowing from the large coronal hole that covers that polar cap at solar minimum. Measurements of ionised interstellar neutral gas ('interstellar pickup ions') led to a major advance in understanding the processes affecting this component of the heliospheric particle population.

Unexpectedly, the magnetometers detected a wide variety of fluctuations at many spatial scales in the Sun's high-latitude field. They are believed to represent relatively unevolved turbulence originating at the southern

Ulysses is sampling the Sun's sphere of influence in 3-D for the first time.

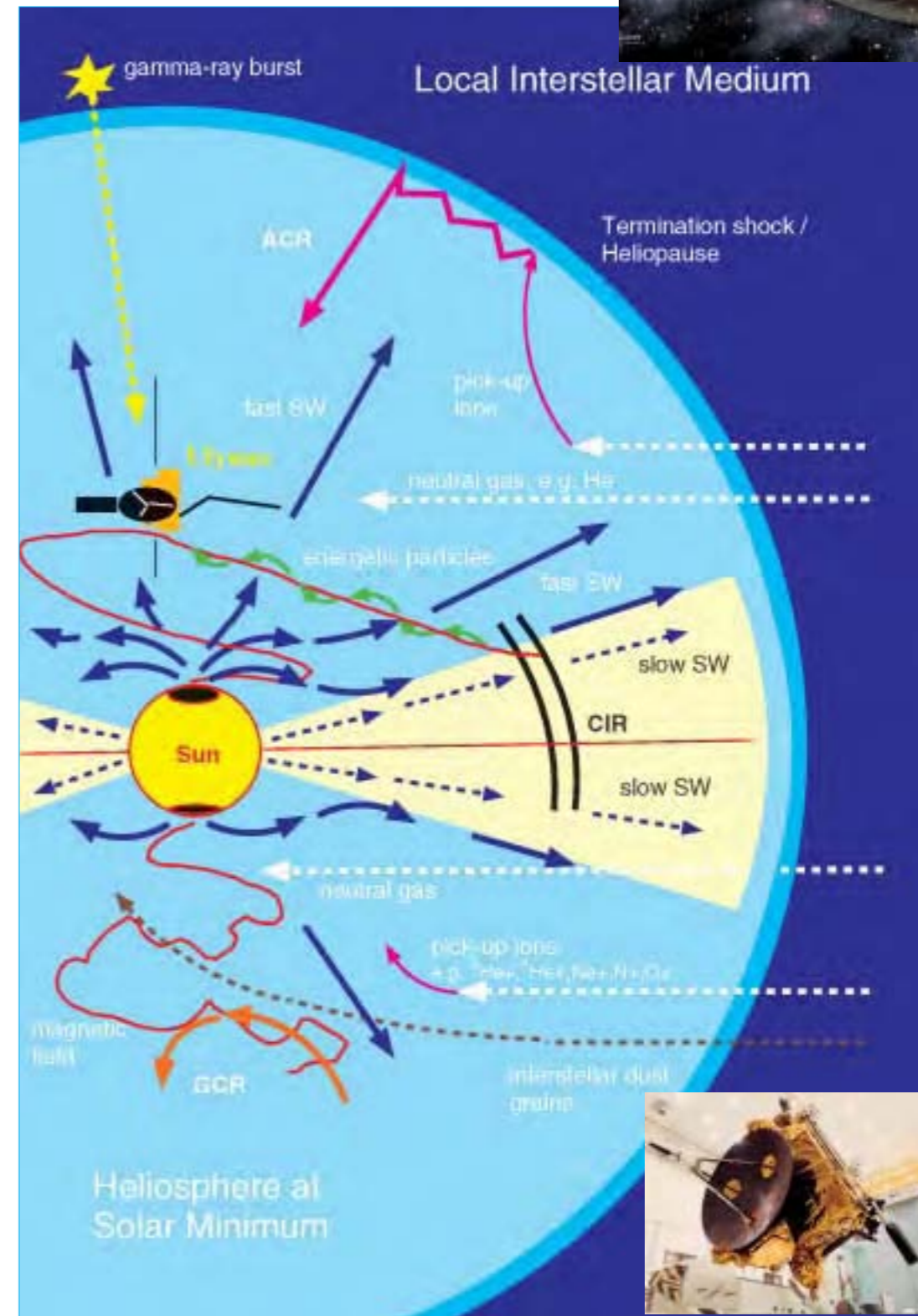
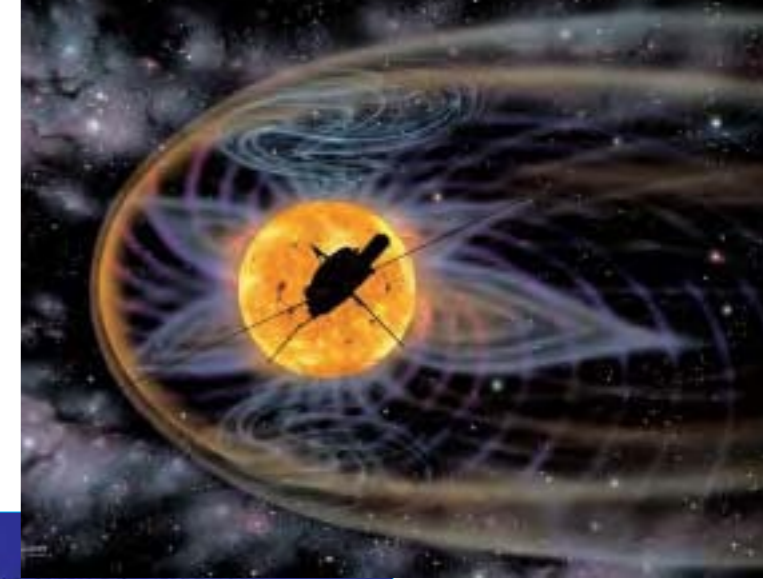

Measurements made by Ulysses during one complete orbit of the Sun, in the form of a polar diagram. The traces show (from the inside moving out) the solar wind speed increasing from 400 km/s near the equator to 750 km/s at latitudes >20-30°, the magnetic field polarity, the intensity of accelerated interplanetary particles, and the intensity of incoming cosmic rays.

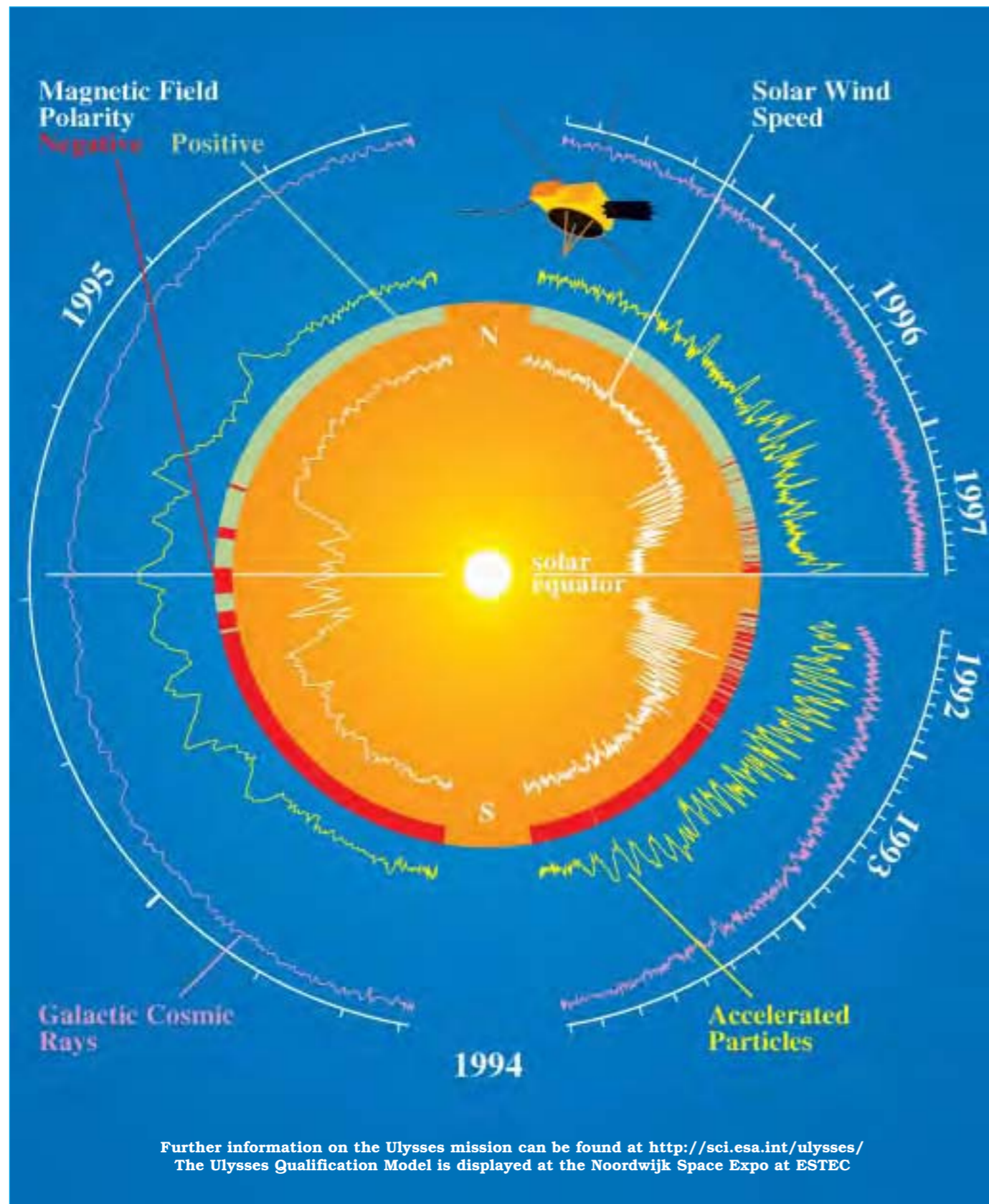

Installed on its kick stages at Cape Canaveral, Ulysses is ready for installation aboard the Space Shuttle. (NASA)

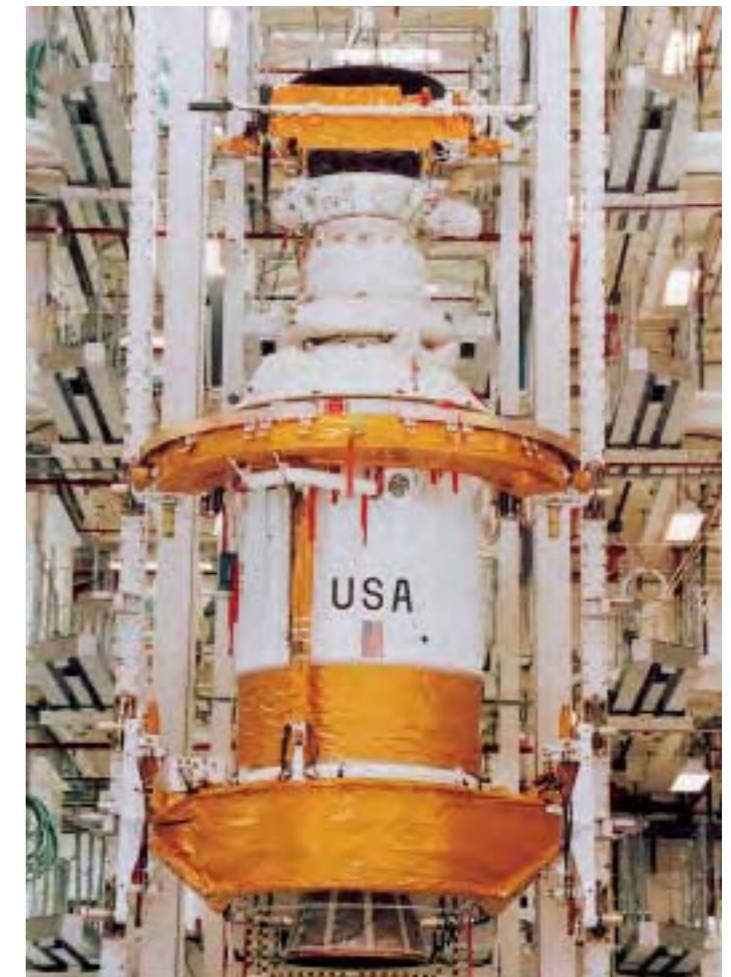

polar coronal hole. Another important finding was that the magnetic field radial component varies relatively little with latitude. This is contrary to the expectation that the imprint of the underlying dipole-like magnetic field at the Sun's surface, showing an increase in the radial field at the poles, would be detected at Ulysses' position. Simply, there was no south magnetic pole at high latitudes. Undoubtedly related to the large-scale fluctuations in the polar magnetic field was the detection of an unexpectedly small increase in the influx of cosmic rays over the poles. It was hoped that the much-reduced effects of solar rotation over the pole would result in a smooth near-radial magnetic field, providing easy access to low-energy cosmic rays.

Moving back towards the equator, Ulysses left the fast solar wind (750 km/s) in which it had been immersed for more than 18 months, crossed briefly into the equatorial region dominated by slow wind (400 km/s) and once again became immersed in the fast wind, this time from the north pole. The boundaries were strikingly symmetric: 22°S/21°N. The magnetic field changed from negative (directed inwards) to positive (outwards), reflecting the configuration of the Sun's dipole-like surface field. The radial component's strength continued to show no change with latitude. With the exception of the N-S solar wind asymmetry and cosmic-ray intensity, the north pass was generally similar to the south pass.

An unexpected result was the finding that Ulysses crossed the distant tail of Comet Hyakutake in 1996. Not well understood at the time, the signature in the magnetic field, solar wind and low-energy ion data was recognised in

1999 to be cometary in origin. With this result, Ulysses set a record for the observation of the longest (3.8 AU) comet tail.

In June 2000, ESA's Science Programme Committee approved additional funding to continue operations until September 2004. A key argument for the extension was to observe the effects of the Sun's magnetic polarity reversal on the heliosphere's structure. From May 2002, however, the RTG has not been able to power the full payload. The power-sharing strategy guarantees a set of core measurements covering fundamental solar wind and magnetic field parameters, as well as a number

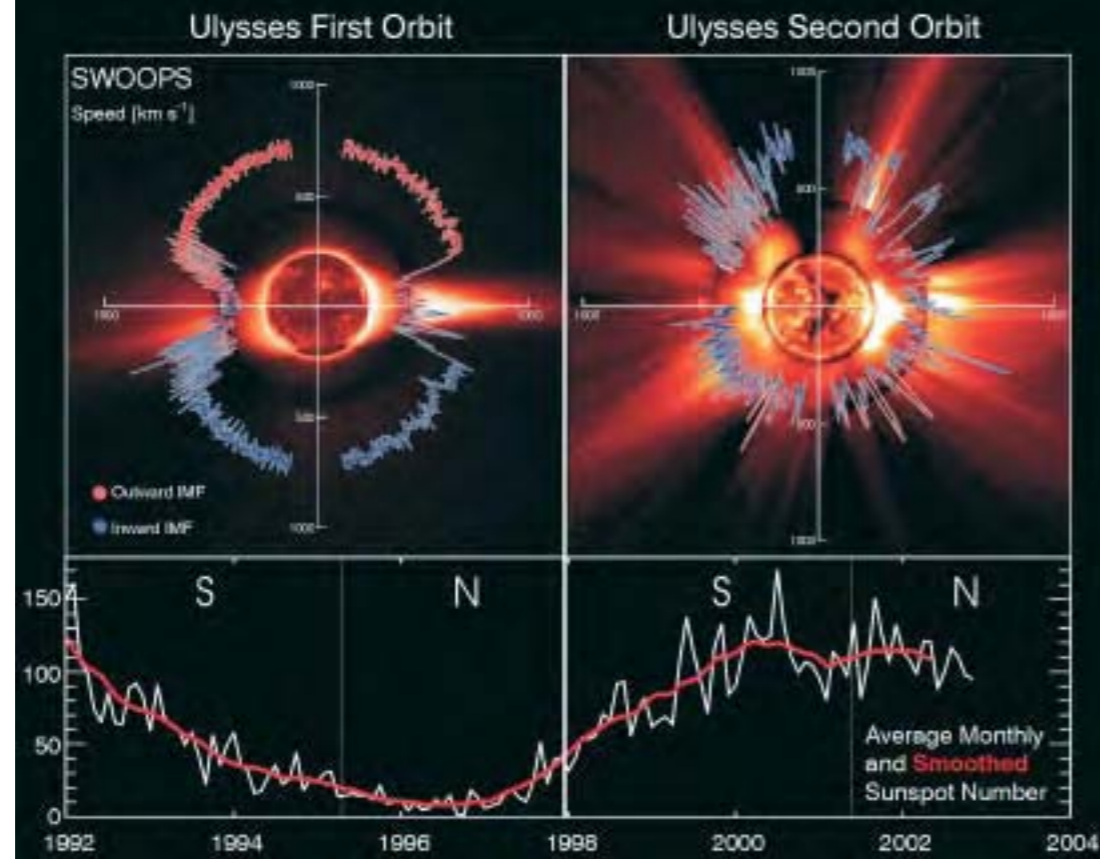

A comparison of solar wind observations from the solar minimum (left panel) and around solar maximum (right panel) phases of the mission. (D.J. McComas)

of energetic particle and cosmic ray channels.

After crossing the ecliptic at a distance of 5.4 AU in April 1998 (thus completing the first out-of-the-ecliptic orbit), Ulysses headed back towards the increasingly active Sun, passing over the south pole for a second time in November 2000, and the north pole in October 2001. The solar wind structure was fundamentally different; the speed measured during 1998-2000 was persistently variable. There were no signs of the stable stream structure seen earlier, and the wind speed rarely exceeded 600 km/s. Although magnetic field compressions related to stream interactions were seen, these showed no persistent recurrence and extended to the highest latitudes covered.

The spacecraft spent the last 3 months of 2001 fully immersed in the fast (~750 km/s) solar wind from the newly-formed north polar coronal hole, followed by regular excursions back into the slow wind, skimming the boundary of the hole. Observations from SWOOPS and SWICS were combined for the first-ever study of solar wind flows from high-latitude coronal holes near solar maximum. By

2004, Ulysses was sampling the edges of coronal holes in detail as it returned slowly to lower latitudes. From October 2002, there were no more excursions into the high-speed wind from the northern polar coronal hole, and Ulysses spent most of the time since in more variable, lower-speed flows.

In line with the decreasing level of solar activity, the Sun's magnetic dipole began to dominate the global magnetic field configuration again. The angle between the dipole and rotational axes, nearly 90° at solar maximum, also decreased. As a consequence, the heliospheric current sheet that separates inward (negative) magnetic fields from outward (positive) magnetic fields became less inclined to the solar equator. These large-scale changes had a significant effect on the energetic particles measured at Ulysses. For most of the period, only modest increases in particle fluxes were observed, with very few transient-related events.

Starting at the end of October 2003, however, the Sun underwent a major surge in activity. Strong outbursts in the form of solar flares and coronal mass ejections are often seen during the declining phase of a solar cycle

(sunspot maximum of cycle 23 was in mid-2000), but that surge was unusual in its intensity and lateness. The largest flare of the series, rated at X28, came on 4 November 2003. Although 5.3 AU from the Sun, Ulysses was well-placed to observe the effects of this violent outburst. A fast CME from the same region swept over Ulysses, driving a significant interplanetary shock wave. Impressive enhancements in the flux of energetic particles, modulated by the passage of CME-related solar wind transients – and the passage of high-speed solar wind streams originating in a large, persistent, trans-equatorial coronal hole – were seen at Ulysses throughout this increased activity. The study of the precise mechanisms whereby solar energetic particles are distributed throughout large volumes of the heliosphere, and under which conditions efficient re-acceleration of these particles occurs, remains an important area of research by Ulysses. This unusual activity period appears to have been the Sun's final outburst before settling into a more stable configuration leading to the next solar minimum.

Ulysses 'encountered' Jupiter for the second time in February 2004, although only to within 0.8 AU. This time, though, it observed previously unexplored regions of the jovian magnetosphere. A bonus was the availability of 24 h/day real-time coverage for a 50-day period that allowed the tape recorders to be switched off, freeing sufficient power to run the full payload suite instead of power-sharing. As it approached from high northern latitudes, the difference from 1992's encounter was apparent in the URAP radio data as far back as February 2003. URAP detected intense radio emission, at levels well above

Key Dates in the Ulysses Mission.

Events	Date
Launch	1990 10 06
Jupiter flyby	1992 02 08
start	1994 06 26
maximum latitude (80.2°, 2.3 AU)	1994 09 13
end	1994 11 05
1st Perihelion (1.34 AU)	1995 03 12
2nd Polar Pass (north)	
start	1995 06 19
maximum latitude (80.2°, 2.0 AU)	1995 07 31
end	1995 09 29
Start of Solar Maximum Mission	1995 10 01
Aphelion (5.40 AU)	1998 04 17
3rd Polar Pass (south)	
start	2000 09 06
maximum latitude (80.2°, 2.3 AU)	2000 11 27
end	2001 01 16
2nd Perihelion (1.34 AU)	2001 05 23
4th Polar Pass (north)	
start	2001 08 31
maximum latitude (80.2°, 2.0 AU)	2001 10 13
end	2001 12 12
Jupiter approach (0.8 AU)	2004 02 04
Aphelion	2004 06 30
5th Polar Pass (south)	
start	2006 11 17
maximum latitude	2007 02 07
end	2007 04 03
3rd Perihelion	2007 08 18
6th Polar Pass (north)	
start	2007 11 30
maximum latitude	2008 01 11
end	2008 03 15
End of Mission	2008 03 31

those seen in 1993 when Ulysses was at a comparable 2.8 AU. The unusual approach geometry was well-suited to studying periodic auroral phenomena that produce both radio and X-ray bursts. For example, URAP detected numerous quasi-periodic (averaging 40-min period) radio bursts. Also seen in 1992/93, they are thought to be triggered by solar wind transients impacting Jupiter's magnetosphere. The encounter brought more information on jovian dust streams. Thought to originate in the volcanos of moon Io, they were discovered by Ulysses, and have also been observed by Galileo and Cassini. This time, the streams recurred about every 28 days, and showed a fine structure.

On 1 October 2004, Ulysses began what is likely to be the final phase of its unique mission of exploration. This third extension, to March 2008, was approved by the SPC in February 2004, and allows Ulysses to cover a major part of the Sun's 22-year magnetic cycle.

ESA named the project after Homer's mythological hero and in reference to Dante's description in the *Inferno* of Ulysses' urge to explore 'an uninhabited world behind the Sun'.

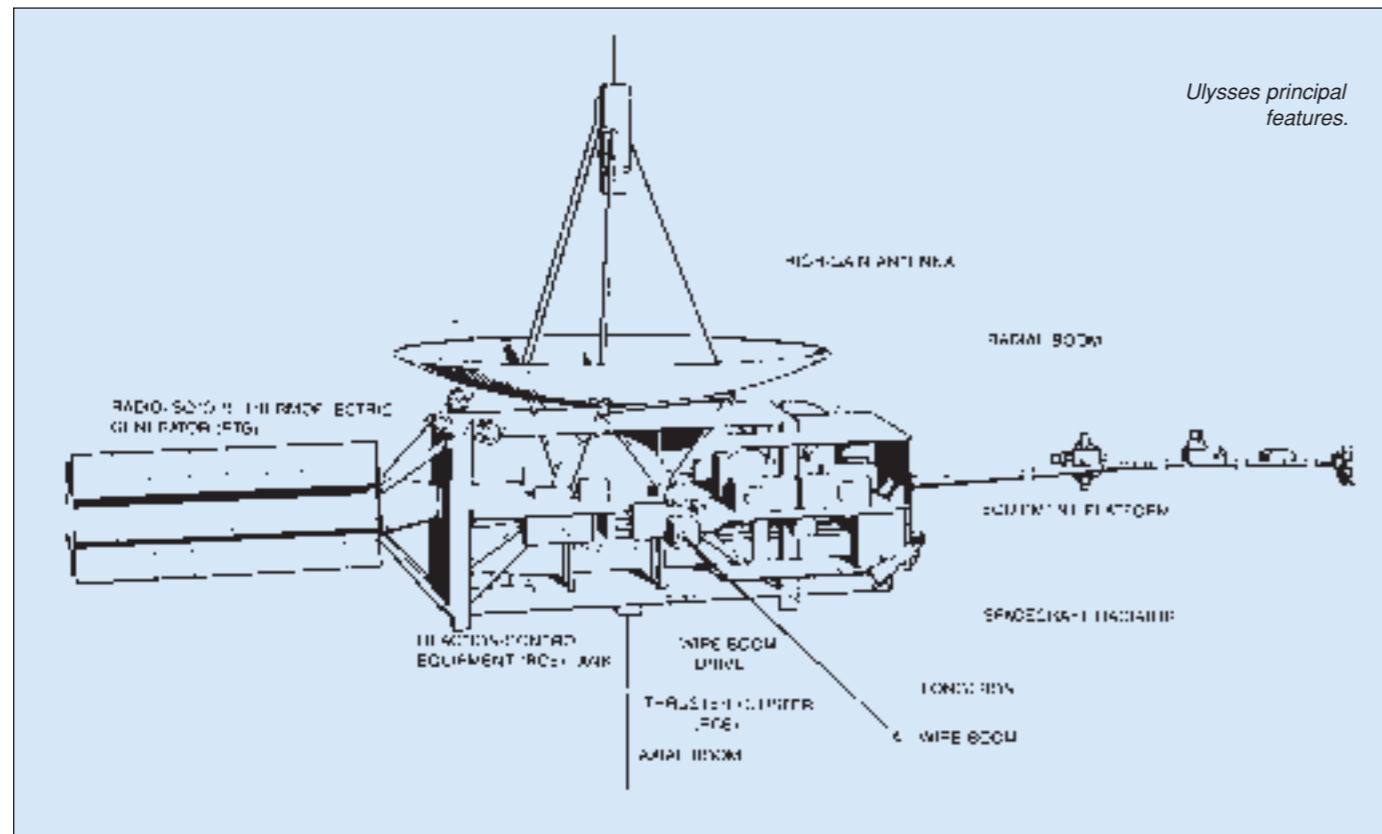

Ulysses principal features.

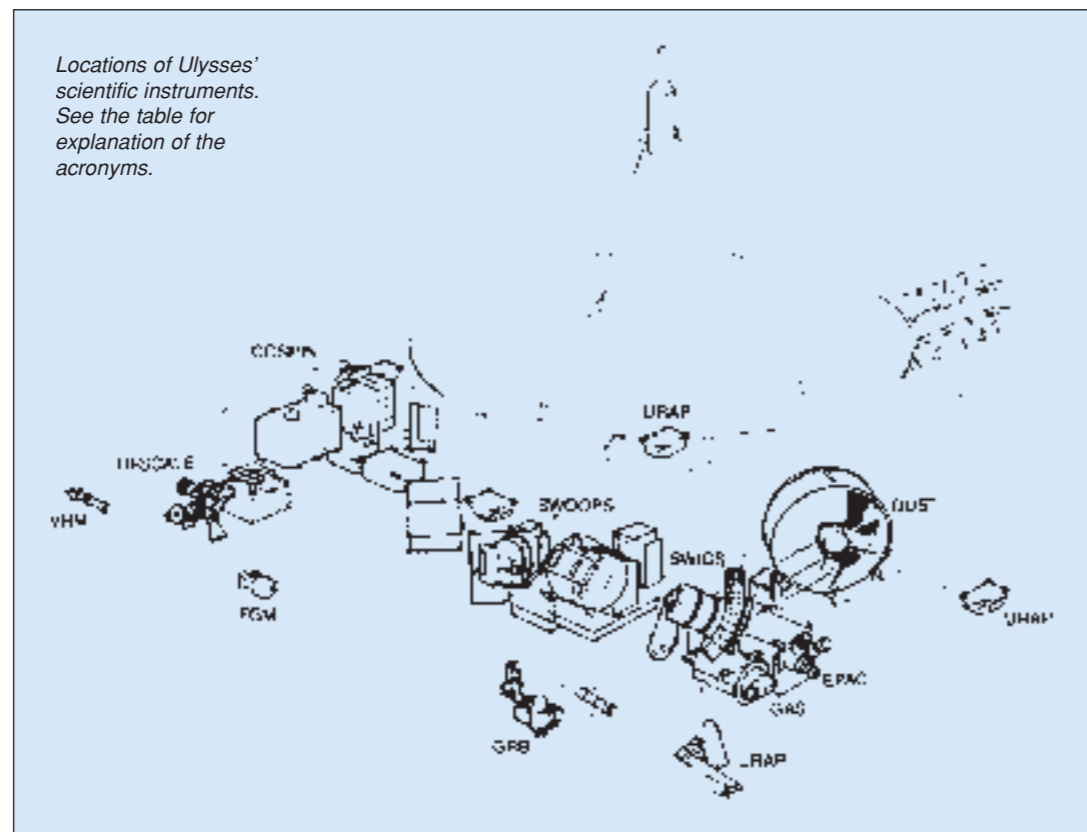

Locations of Ulysses' scientific instruments. See the table for explanation of the acronyms.

Ulysses Scientific Instruments						
Instrument		Measurements	Instrumentation	Mass (kg)	Power (W)	Data (bit/s)
SWOOPS	Solar Wind Plasma	ions 0.257-35 keV/Q; electrons 1-903 eV	2 electrostatic analysers + channel electron multipliers	6.7	5.5	160
SWICS	Solar Wind Ion Composition	elemental & ion charge composition, T & speed of 145 km/s (H ⁺)-1352 km/s (Fe ¹⁶⁺) solar wind ions	electrostatic analyser time-of-flight/ energy measurement	5.6	4.0	88
DUST	Cosmic Dust	2x10 ⁻⁹ -2x10 ⁻¹⁵ g	multi-coincidence impact detector with channeltron	3.8	2.2	8
MAG	Magnetic Field	±0.01-44 000 nT	triaxial vector helium and fluxgate magnetometers	4.8	5.1	80
GRB	Solar X-rays/ Cosmic Gamma Bursts	5-150 keV	2 Si solid-state + 2 CsI scintillation detectors	2.0	2.6	40
EPAC/ GAS	Energetic Particle Composition/ Interstellar Gas	0.080-15 MeV/nucleon composition Interstellar Neutral Helium	4 solid-state detectors LiF-coated conversion plates with channel electron multipliers	4.3	4.0	160
HISCALE	Low-Energy Ions & Electrons	0.050-5 MeV ions; 30-300 keV electrons	2 sensor heads with 5 solid-state detectors	5.8	4.0	160
COSPIN	Cosmic Rays/ Solar Particles	0.3-600 MeV/nucleon; 4-2000 MeV electrons	5 solid-state detectors + double Cerenkov and semiconductor telescope for electrons	14.8	14.8	160
URAP	Radio & Plasma Waves	0-60 kHz plasma waves 1-940 kHz 10-500 Hz magnetic fields	72.5 m radial dipole antenna 7.5 m axial monopole antenna 2-axis search coil	7.4	10.0	232

Radio Science investigations (Coronal Sounding and Gravitational Wave Experiments) were conducted during the primary mission phase.

Satellite configuration: box-shaped aluminium bus supports body-mounted aluminium/CFRP HGA, RTG boom and several science booms: 5.55 m radial boom carries four sensors for VHM/FGM (MAG), URAP & GRB experiments (see table), 7.5 m axial boom acts as monopole for URAP and two wire booms 72.5 m tip-to-tip as dipole for URAP.

Attitude/orbit control: spin-stabilised at 5 rpm, with fixed HGA pointing continuously at Earth. Two sets of 4x2 N catalytic thrusters (33.5 kg hydrazine in single sphere pressurised by nitrogen at 22 bar; 7.9 kg hydrazine remained June 2004) provide spin control and trajectory corrections. Attitude determined by Sun sensors and HGA X-band signal angle.

Power system: RTG provided 284 W initially, decreasing to 221 W by 2001 and 206 W by October 2004; power-saving measures since May 2002.

Communications/data: Ulysses is tracked 10 h/day by the 34 m antennas of NASA's Deep Space Network. Operations are controlled by a joint ESA/NASA team at NASA's Jet Propulsion Lab in California. 1.65 m-diameter HGA downlinks realtime data at 1024 kbit/s interleaved with playback of stored data at 20 W 8.4 GHz X-band (primary TWTA failed February 2003). 5 W S-band 2112/2293 MHz up/down is used for dual-frequency radio science investigations. Two redundant tape recorders each store 45.8 Mbit at 128/256/512 bit/s.

ERS

Achievements: first European radar satellites, first long-duration civil radar satellites
Launch dates: ERS-1 17 July 1991; ERS-2 21 April 1995
Mission end: ERS-1 10 March 2000; ERS-2 continues full operations (2006 projected retirement to overlap with Metop). 3-year projected lives
Launch vehicle/site: Ariane-4 from ELA-2, Kourou, French Guiana
Launch mass: ERS-1 2384 kg on-station BOL (888 kg payload, 318 kg hydrazine; 2269 kg EOL); ERS-2 2516 kg on-station BOL (2398 kg at 27 October 2004)
Orbit: ERS-1 782x785 km, 98.5° Sun-synchronous with 35-day repeat cycle during most of operational phase; ERS-2 784x785 km, 98.6° Sun-synchronous
Principal contractors: Dornier (prime), Matra (bus), Marconi Space Systems (AMI), Alenia Spazio (RA), British Aerospace (ATSR); ERS-2 added Officine Galileo (GOME)

The European Remote Sensing (ERS) satellite was the forerunner of a new generation of environmental monitoring satellites, employing advanced microwave techniques to acquire measurements and images regardless of cloud and lighting conditions. Such techniques had been used previously only by NASA's short-lived Seasat mission in 1978, and during brief Space Shuttle experiments.

Before Envisat, ERS was unique in its systematic and repetitive global coverage of the Earth's oceans, coastal zones and polar ice caps, monitoring wave heights and wavelengths, wind speeds and directions, precise altitude, ice parameters, sea-surface temperatures, cloud-top temperatures, cloud cover and atmospheric water vapour content. Until ERS appeared, such information was sparse over the polar regions and the southern oceans, for example.

ERS is both an experimental and a pre-operational system, since it has had to demonstrate that the concept and the technology had matured sufficiently for successors such as Envisat, and that the system could routinely deliver to end users some data products such as sea-ice distribution charts and wind maps

within a few hours of the satellite observations.

ESA launched ERS-2 to ensure continuity of service until Envisat's appearance in 2001, and the pairing with ERS-1 made new demonstrations possible. The two satellites operated simultaneously from August 1995 to May 1996 – the first time that two identical civil Synthetic Aperture Radars (SARs) had worked in tandem. The orbits were carefully phased for 1-day revisits, allowing the collection of 'interferometric' image pairs revealing minute changes.

ERS-1 was held in hibernation as a backup from June 1996, while ERS-2 continued full operations. Its SAR Image mode was activated daily for battery conditioning. On 8 March 2000 a computer failure was followed the next day by an unrelated gyro control failure, leading to battery depletion on 10 March. During its remarkable career, major progress was made in environmental and geophysical applications such as disaster monitoring and risk management. It is hoped that ERS-2 will continue operations until at least Metop is commissioned in 2006.

ERS radar imagery is unhindered by cloud cover. Shown here is The Netherlands.





A composite of products from the ERS satellites. They were the first European missions to provide detailed information on a wide range of important factors for understanding our planet and the impact we are having on it. As well as highly detailed images and accurate height measurements, they also recorded wave and wind patterns over the oceans, sea, land and cloud-top temperatures, and vegetation cover – information that has found a wide range of scientific and commercial applications. Regular global measurements of the oceans and ice cover are feeding into climate studies. Ozone measurements are helping scientists to monitor the health of the ozone layer and understand how pollution affects it. Images and measurements of land surfaces are helping oil prospectors to identify new deposits, authorities to monitor changes in land use, and emergency services to monitor natural disasters.



ERS in orbital configuration. During its remarkable career, ERS-1 generated about 1.5 million SAR scenes. ERS-2 had reached 1.37 million by end-2002. More than 5000 scientists have published more than 50 000 scientific papers based on ERS data. (Dornier)

GOME clearly showed a deep ozone hole over the South Pole in October 1996. (ESA/DLR)



ERS view of flooding in Northern Europe in January 1995. This image was created by superimposing two Synthetic Aperture Radar images and assigning different colours to each. The first image was acquired on 21 September 1994 and the second on 30 January 1995. Flooded areas appear in blue.



ERS-2 undergoing final launch preparations at Kourou, French Guiana. (ESA/CSG/Arianespace)

El Niño is a disruption of the ocean-atmosphere in the tropical Pacific that affects weather around the globe. The 1997-98 El Niño was one of the strongest last century, with increased rainfall causing destructive flooding in the US and Peru, and drought in the western Pacific, also associated with devastating fires. The phenomenon is characterised by a rise of up to 40 cm in sea level and up to 8°C in sea-surface temperature in the eastern equatorial Pacific and falls of up to 40 cm/6°C in the western equatorial Pacific. They are closely monitored by the ERS Radar Altimeter and Along-Track Scanning Radiometer. The image above shows the state of the Pacific Ocean in November 1997. The height of this 3D image represents sea-level anomalies, ranging from -40 cm to +40 cm; the colours indicate sea-surface temperature anomalies ranging from -6°C (blue) to 8°C (red).

The 'normal' state of the ocean is such that the sea level on the western side is higher than on the eastern side. This difference is due to the Trade Winds blowing constantly from east to west, causing the waters to pile up at the western side. Also due to the Trade Winds, the surface water on the eastern side is constantly transported westward, and replaced by cold, nutritious water rising from deeper layers. So generally along the South American coast, cold and nutritious waters prevail, while on the western side there is warm surface water. During an El Niño event the Trade Winds relax, and become very weak (and may even reverse). This causes the warm surface waters to flow back eastward, and stops the upwelling on the eastern side. No more upwelling means that the sea-surface temperatures rise, implying a sea level rise.



ERS-2 in the Large European Acoustic Facility at ESTEC.

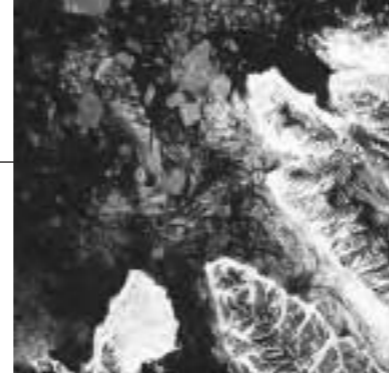
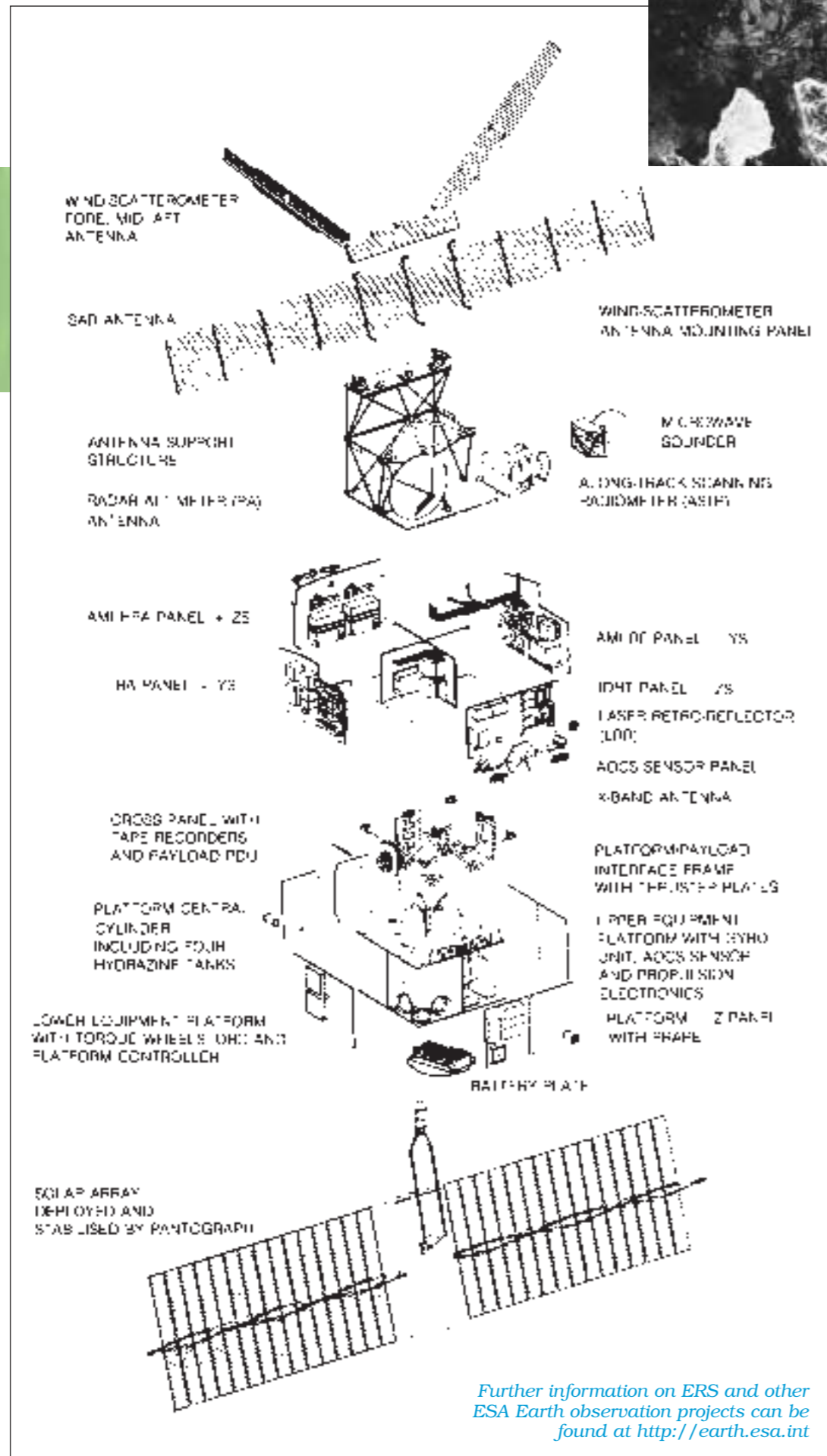

ERS principal features (ESA). Inset far left: ERS-1 imaged from 41 km above by France's Spot-4 Earth observation satellite on 6 May 1998 over the Tenere Desert of Niger, Africa (CNES). Inset near-left: the first recorded SAR image (at Kiruna) from ERS-1, taken at 11:50:32 UT 27 July 1991 and centred on 79.99°N/15.01°E (ESA).

Satellite configuration: payload support module, 2x2 m, 3 m high, above a platform derived from Matra's 3-axis Spot platform providing power, AOCs and overall operational management. Total 11.8 m high, 11.7 m deployed span.

Attitude/orbit control: primary attitude control by reaction wheels, unloaded by magnetorquers. Hydrazine thrusters provide orbit adjust and further attitude control. Pitch/roll information from Digital Earth Sensor, yaw reference from Sun sensor; supported by 6 gyros. ERS-2 began 1-gyro control in Feb 2000, and switched to gyroless control (using DES and X-axis RW) after last gyro failed 13 January 2001.

Power system: twin 2.4x5.8 m Si-cell solar wings sized for 2.2 kW after 2 years, supported by four 24 Ah nickel cadmium batteries.

Communications: controlled from ESOC at Darmstadt, Germany with ESA ground receiving stations at Salmijärvi, near Kiruna (Sweden, primary station, also for TT&C), Fucino (I), Gatineau (CDN), Maspalomas (E), Prince Albert (CDN), plus national & foreign stations e.g. at Fairbanks (Alaska, US), Neustrelitz (D), West Freugh (UK), Alice Springs (Australia). SAR's 105 Mbit/s image data returned in realtime only, available only when the wave/wind modes are inactive. All other data (LBR: Low Bit Rate) recorded onboard for global coverage, but *all* data realtime-only since mid-2003, after tape recorder B failed 20 Dec 2002 & A 22 Jun 2003. So LBR station network is being expanded (Miami, McMurdo, Beijing & Hobart added by end-2004); this new LBR scenario provides data within 15-45 min of sensing. ESRIN ERS Central Facility (EECF) facility at Frascati (I) is the user service and data management centre and prepares the mission operation plan for ESOC, with

ERS Earth Observation Payload	
Active Microwave Instrument (AMI)	
Incorporates two separate 5.3 GHz C-band 4.8 kW-peak power radars: a Synthetic Aperture Radar using a 1x10 m antenna for the image and wave modes; a 3-beam scatterometer for the wind mode. <i>SAR imaging:</i> 30 m resolution, linear-vertical polarisation, 37.1 μ s transmit pulse width, 105 Mbit/s data rate, 100 km swath width, with 23° incident angle at mid-swath (up to 35° using experimental roll-tilt attitude control system mode). <i>SAR wave mode:</i> operates at 200 km intervals along-track for 5x5 km images to provide ocean wave speed and directions. <i>AMI Wind Scatterometer:</i> three antennas (fore/aft 360x25 cm, mid 230x35 cm) providing fore/mid/aft beams sweep 500 km swath in 50 km cells for surface wind vectors: 4-24 m/s, 0-360±20°.	
Radar Altimeter (RA)	
The 120 cm-diameter nadir-viewing, 13.8 GHz, 1.3°-beamwidth altimeter measures, in Ocean Mode, wind speed (2 m/s accuracy), 1-20 m wave heights (50 cm accuracy, 2 km footprint), and altitude to 5 cm. Ice Mode operates with a coarser resolution to determine ice sheet topography, ice type and sea/ice boundaries.	
Along-Track Scanning Radiometer and Microwave Sounder (ATSR-M)	
An experimental 4-channel IR radiometer for temperature measurements and a 2-channel nadir-viewing microwave sounder for water vapour measurements. <i>IR Radiometer:</i> scanning at 1.6/3.7/10.8/12 μ m, 0.5 K resolution over 50x50 km, 1 km spatial resolution; 500 km swath. ERS-2 added 0.55/0.67/0.78 μ m visible channels to improve monitoring of land applications, such as vegetation moisture. <i>Microwave Sounder:</i> 23.8/36.5 GHz channels measuring the vertical column water vapour content within a 20 km footprint, providing corrective data for ATSR sea-surface temperature and RA measurements.	
Global Ozone Monitoring Experiment (GOME, ERS-2 only)	
Near-UV/visible scanning spectrometer measuring backscattered Earth radiance in 3584 pixels over four channels, 240-316/311-405/405-611/595-793 nm, to determine ozone and trace gases in troposphere and stratosphere.	
Precise Range/Range Rate Experiment (PRARE)	
For precise orbit determination with ranging accuracy of 3-7 cm using 8.5 GHz signals transmitted to a network of mobile ground transponders. ERS-1 PRARE failed within 3 weeks because of radiation damage, but ERS-2's improved design remains operational.	
Laser Retroreflector	
Also permits precise range/orbit determination, but less frequently than PRARE, and RA calibration.	

processing/archiving facilities at Brest (F), Farnborough (UK), DLR Oberpfaffenhofen (D) and Matera (I). Some products, such as from the wind scatterometer, are available within 3 h of observation.

Eureca

Achievements: world's first dedicated microgravity free-flyer; Europe's first reusable satellite

Launch date: 31 July 1992

Mission end: 24 June 1993

Launch vehicle/site: NASA Space Shuttle from Kennedy Space Center, Florida

Launch mass: 4490 kg (payload capacity up to 1000 kg)

Orbit: released from Shuttle into 425 km, 28.5°, raised to 508 km for experiment operations, lowered to 476 km for retrieval by Shuttle

Principal contractors: MBB-ERNO (prime)

ESA began studying the European Retrieivable Carrier (Eureca) in 1978 as a follow-on to the manned Spacelab programme; the ESA Council approved it in December 1981. Eureca was designed to carry a mix of experiments totalling up to 1 t for 6-9 months in orbit, released and retrieved by NASA's Space Shuttle. It was the world's first free-flyer designed specifically to satisfy microgravity experiments, providing $10^{-5}g$ conditions for long periods. Although Eureca was controlled from ESOC in Germany, it could operate autonomously for up to 48 h. An important feature was reusability: Eureca was capable of making five flights over a 10-year period.

Eureca-1 and its 15 experiments (see separate box) were launched aboard Shuttle mission STS-46 in July 1992 and released from the Shuttle's robot arm by ESA Mission Specialist Claude Nicollier on 2 August. Eureca's thrusters raised its orbit by 83 km within a week and the 6 months of operations began on 18 August. Most of the microgravity experiments were completed by January 1993, but others continued even as it Eureca waited for recovery during Shuttle mission STS-57 in June 1993. By that time, its orbit had decayed through atmospheric drag to 490 km and its thrusters lowered it further to 476 km for NASA astronaut George Low to capture it during 24 June.

The Eureca-1 mission was rated as highly successful, and a 1995 Eureca-2 mission was planned before ESA Ministerial meetings rejected further funding. The carrier was stored at DASA (ex-MBB/ERNO) in Bremen, where it was hoped that a DASA-led consortium could provide commercial flights.

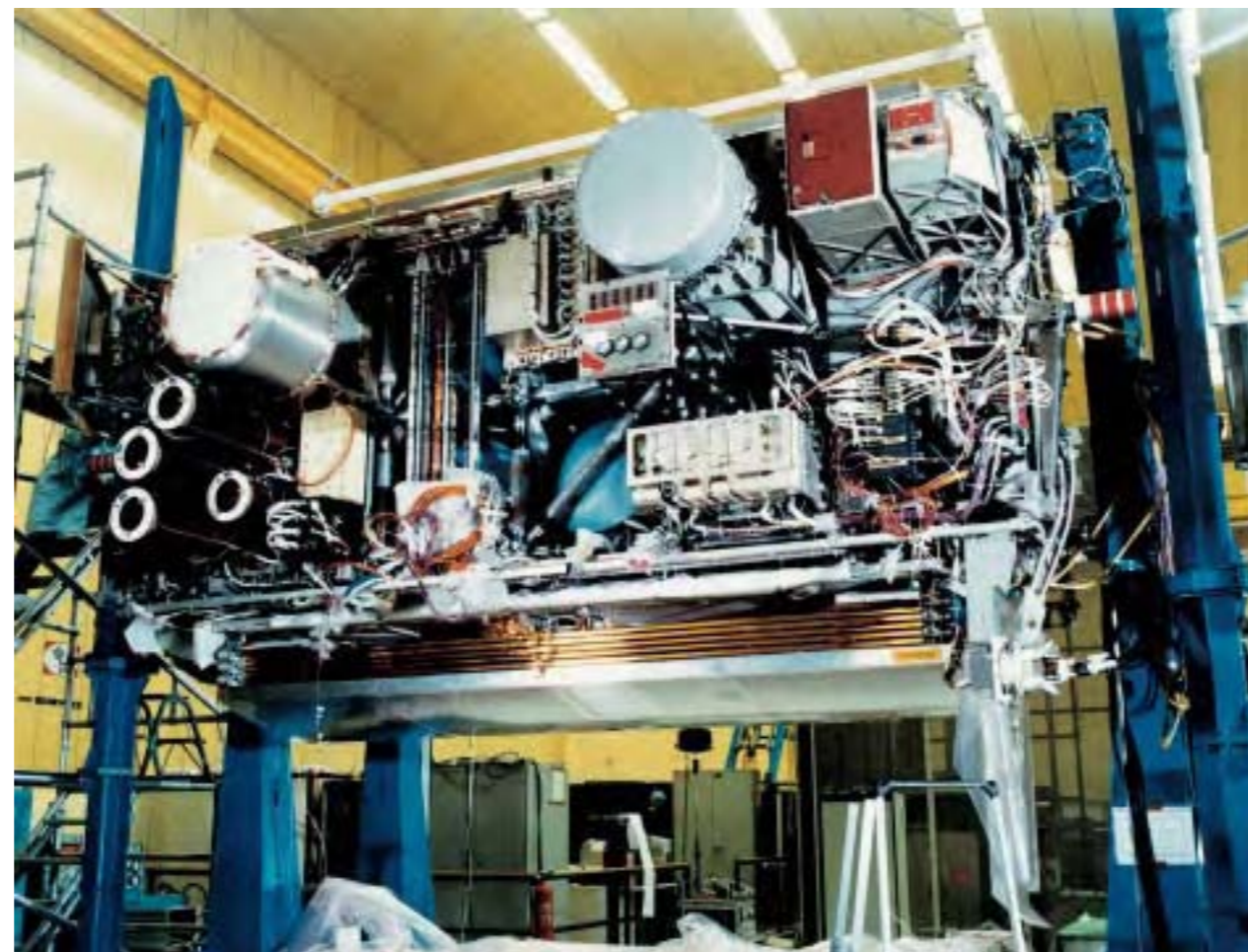

Eureca's solar wings were safely deployed before the free-flyer was released. (NASA)

Eureca-1 Payload

ESA's five microgravity core multi-user facilities:

- Automatic Mono-ellipsoid Mirror Furnace (AMF)
- Solution Growth Facility (SGF)
- Protein Crystallisation Facility (PCF)
- Multi Furnace Assembly (MFA)
- Exobiological Radiation Assembly (ERA).

Two further microgravity elements were:

- High Precision Thermostat (HPT, Germany)
- Surface Forces Adhesion Experiment (SFA, Italy).

The five space science experiments were:

- Solar Spectrum Experiment (SOSP)
- Solar Variation Experiment (SOVA)
- Occultation Radiometer (ORA)
- Wide Angle Telescope for Cosmic and X-ray Transients (WATCH)
- Timeband Capture Cell Experiment (TICC).

The three technology demonstrations were:

- Radio Frequency Ionization Thruster Assembly (RITA)
- Advanced Solar Gallium Arsenide Array (ASGA)
- Inter Orbit Communication Experiment (IOC, working with Olympus).

Integration of Eureca at DASA in Bremen. (DASA)



Eureka – with its solar wings already folded against its sides – was recaptured in June 1993 after almost a year in orbit. ESA cost-at-completion for the project was €296.3 million (1983 conditions). (NASA)



Processing Eureka at the Kennedy Space Center for insertion into the Space Shuttle cargo bay. (NASA)

Satellite configuration: total width 4.6 m, total height about 2.6 m. Bus structure consisted of carbon fibre struts connected by titanium nodal joints. The nodes carried larger hardware loads, while smaller assemblies were fastened to standard Equipment Support Panels. Supported in Shuttle cargo bay by two longeron and one keel fitting. Grapple fixture allowed deployment/retrieval by Shuttle Remote Manipulator System.

Attitude/orbit control: 3-axis control (normally Sun-pointing) by magnetorquers, supported by Reaction Control Assembly of 6x21 mN nitrogen thrusters. Orbit transfers between about 400-500 km by Orbit Transfer Assembly of redundant 4x21 N hydrazine thrusters (supply sized for two transfers plus 9-month on-orbit stay). Attitude/rate determination by accelerometer package, gyros and IR Earth and Sun sensors.

Power system: twin deployable/retractable 5-panel Si-cell wings



Eureka has been displayed since November 2000 at the Swiss Museum of Transport and Communication in Lucerne. (Courtesy of the Museum)

generated 5 kW at 28 Vdc, providing 1 kW average for payload operations (1.5 kW peak). Supported by 4x40 Ah nickel cadmium batteries.

Communications: controlled from ESOC in Darmstadt, Germany. S-band link provided up to 256 kbit/s downlink for payloads, with 128 Mbit onboard memory.

ISO

Achievements: world's first space infrared observatory; fundamental discoveries on the nature of the Universe; far-exceeded design life

Launch date: 19 November 1995 (routine science operations began 4 February 1996)

Mission end: deactivated 12:00 UT 16 May 1998; last science observation 10 May 1998; cryogen exhausted 8 April 1998

Launch vehicle/site: Ariane-44P from ELA-2, Kourou, French Guiana

Launch mass: 2498 kg (2418 kg BOL)

Orbit: initially 500x71 850 km, 5.25°; raised to operational 1038x70 578 km, 5.2°, 24 h; by 10 January 2004 521x70 202 km, 3.0°

Cost to ESA: €977 million (2004 conditions; €503 million 1987)

Principal contractors: Aerospatiale (prime), DASA (cryostat payload module)

The spectacular success of the Infrared Space Observatory (ISO) as the world's first spaceborne observatory working in the cool light of the infrared has provided an entirely fresh perspective on the Universe. It has proved a major boost to most areas of astrophysics, reaching from the nearby planets to the most distant quasars, taking in star formation, dark matter and superluminous galaxies. Even now, 6 years after it was shut down, its data continue to deliver ground-breaking results.

The cryogenically-cooled ISO studied the Universe's 2.5-240 μm IR radiation as a follow-up to the all-sky survey undertaken by IRAS (8-120 μm) in 1983. However, ISO's sensitivity at 12 μm was about 1000 times greater and spatial resolution 100 times higher, and it was operated from ESA's station in Villafranca, Spain as an *observatory*, studying specific targets for up to 10 h at a time, with more than half of its observing time available to the general astronomical community.

Newborn stars in the Rho Ophiuchi cloud. In 2001, continuing analysis discovered 30 rare brown dwarf 'failed' stars in the cloud. At 50 Jupiter-masses, they fall short of the 80 M_J lower limit to ignite as stars. The bright fuzzy object at top is a new star much larger than the Sun, still wrapped in its birth cloud. (ESA/ISO, CEA Saclay, ISOCAM)

Very deep camera and photometer images were recorded to study the early evolution of galaxies and to help determine the history of star formation. All the instruments observed many star-forming regions to study how clouds of dust and gas collapse to form young stars. Many observations looked at stars with discs of matter to unravel the mysteries of planet formation. The spectrometers found abundant water in many different places: Comet Hale-Bopp, Mars, Titan and the giant planets in our own Solar System, around young and old stars and even in external galaxies. ISO looked hard at the mysterious 'ULIRGs' (ultra-



ISO's payload module was supported by the service module below. (Aerospatiale)

The Antennae: the collision of two galaxies has triggered star formation within dense IR-bright dust clouds.

luminous IR galaxies) and shed new light on whether their prodigious power comes mainly from bursts of star formation (the 'baby' theory) or from stars being swallowed by black holes (the 'monster' theory). ISO found the characteristic chemical signatures of starbursts.

ISO found clear links between stars, comets and Earth's origin. It found the spectral signature of the mineral olivine – a major constituent of Earth's interior – in Comet Hale-Bopp and in dusty discs encircling young stars where planetary systems are forming. Many molecular species were detected in interstellar space for the first time, including carbon-bearing molecules such as the methyl radical and benzene, providing

insight into the complex organic chemistry necessary to produce the molecules of life.

ISO made more than 26 000 separate observations and, by the time orbital

operations ended, the work of detailed analysis was only just starting. The flood of results shows no sign of abating: 1200 refereed papers were published between late 1996 and end-2004, and about 50 astronomers every month retrieve data from the ISO archive in Villafranca (E). The ISO Legacy Archive was released in February 2002. The Active Archive Phase of January 2002 - December 2006 will bequeath an enriched archive for future astronomers.

Working at these thermal wavelengths meant that ISO's



telescope and detectors had to be encased in a cryostat filled with >2100 litres of superfluid helium chilled to only 1.8 K above absolute zero. A pre-mission life of about 18 months was required before the helium completely boiled away, leaving the instruments to warm up, but the supply lasted for 10 months longer, until 8 April 1998. This allowed, for example, two series of observations of the Taurus-Orion region, an important cradle of star birth. Even after the cryogen was exhausted, a few of the short-wavelength detectors in a spectrometer could be used for a special scientific programme interleaved with final calibrations and technology tests. Some extra 150 h were used to measure almost 300 stars at 2.4-4 μm . ISO's 'last light' observation, late on 10 May 1998, was of the Canis Majoris hot supergiant star. The remaining propellant was then used to lower the perigee in order to speed up the orbit's decay: ISO is expected to reenter within 20-30 years.

Seen in the far-IR, the Andromeda Galaxy (M31) sports multiple rings rather than the classical spiral form seen in visible light.

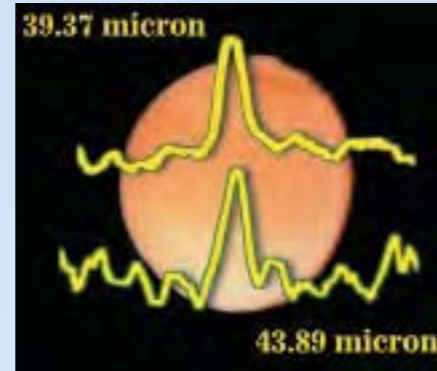
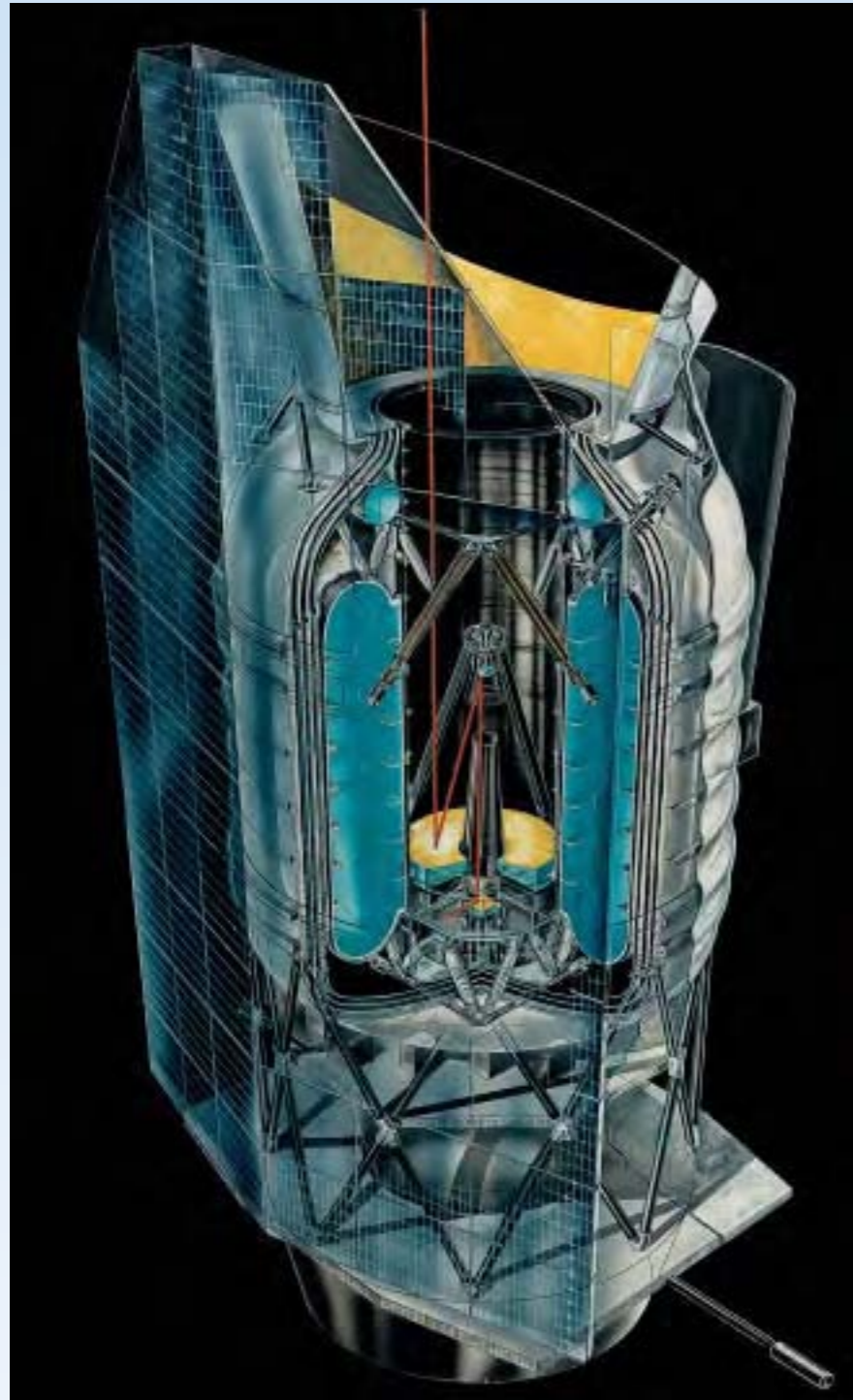

ISO found water throughout the Universe, increasing expectations of life beyond Earth. Particularly exciting was finding water on Titan – Saturn's largest moon and the target of ESA's Huygens probe. Titan will help us to understand the organic chemistry of the young Earth, with its mix of elaborate organic molecules resembling the chemical soup out of which life emerged. Thanks to ISO, the cosmic history of water was traced for the first time. During the violent early stages of starbirth, a young star spews out high-speed gas, generating a shock wave that heats and compresses the surrounding hydrogen and oxygen, creating the right conditions for water to form. ISO saw the process at work in the Orion and Sagittarius nebulae. ISO also unexpectedly found large amounts of water in the higher atmospheres of the Solar System's giant planets. The water must be coming from cometary grains. (ESA/ISO SWS)

Left: ISO's telescope and detectors were encased in a cryostat filled with superfluid helium at 1.8 K. Incoming infrared radiation was fed to the four science instruments below the main mirror.

The Birth of Stars

ISO peered into clouds of dust and gas where stars are being born, seeing for the first time the earliest steps of star formation. It discovered that stars begin to form at temperatures of -250°C or even lower. Astronomers were able to follow the evolution of dust from its creation in massive old stars, to the regions where it forms new planetary systems. ISO analysed the chemical composition of the dust, thereby opening up a new field of research: astromineralogy. It also found that most young stars have dust discs that could harbour planets.

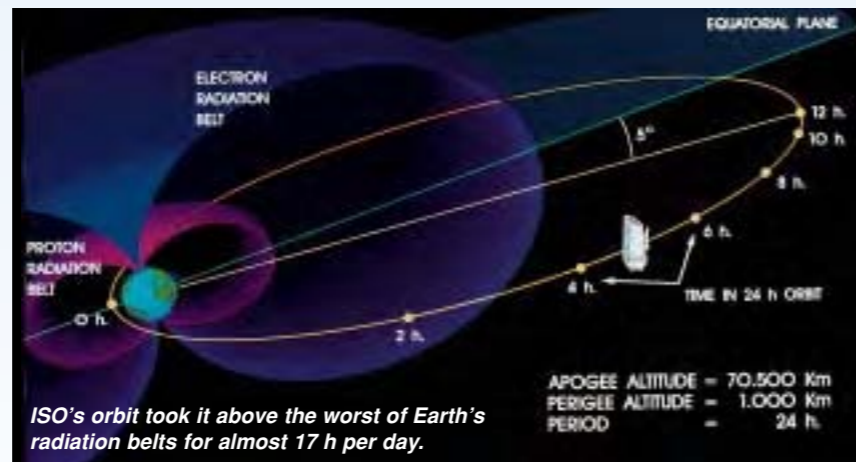

ISOCAM image of Comet Hale-Bopp in October 1996, revealing the comet's dust coma 100 000 km across. Inset: ISOCAM.

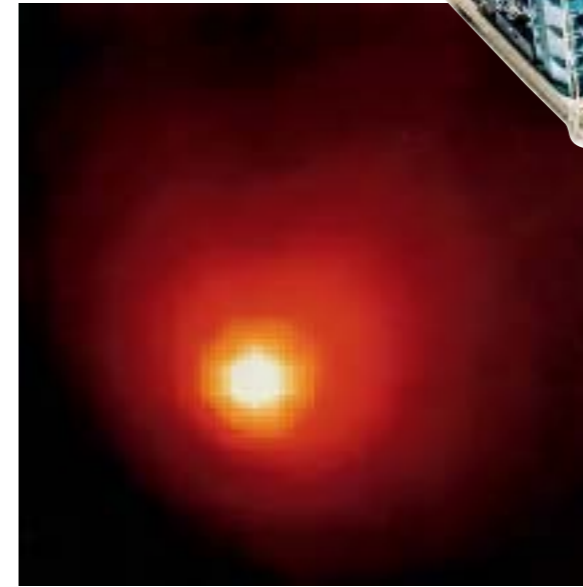

The Whirlpool Galaxy was ISO's 'first light' target on 28 November 1995, when the telescope was opened to the sky. The ISOCAM image shows regions of star formations along the spiral arms and on either side of the nucleus.

Satellite configuration: cylindrical payload module with conical sunshade and two star trackers, supported by service module providing basic spacecraft functions. Overall size: 5.3 m high, 2.3 m wide. The payload module was a cryostat enveloping the telescope and detectors, cooled by a toroidal tank holding 2250 litres of 1.8 K superfluid helium for at least 18 months' observations. Some detectors were cooled to 2 K by copper links to the tank; other elements were cooled to 3-4 K by the boiloff gas. A toroidal tank with 60 litres of normal liquid helium provided cooling on the pad for the last 100 h before launch.

Attitude/orbit control: 3-axis arcsec-control for stable observations of up to 10 h incorporated Earth/Sun sensors, star trackers, four rate integrating gyros, four skewed reaction wheels and redundant sets of 8x2 N hydrazine thrusters.

Power system: 600 W provided from two fixed Si-cell body panels (which also acted as thermal shields).

Communications: realtime downlink (no onboard recorders) at 33 kbit/s (24 kbit/s for science data) to ISO Control Centre at Villafranca, Spain, allowing about 13 h of contact daily. NASA's Goldstone station in California extended coverage to almost 24 h daily. ISO was used scientifically while outside the radiation belts, i.e. about 16.75 h per day.

ISO Scientific Instruments

The 60 cm-diameter Ritchey-Chrétien telescope fed four focal-plane instruments behind the main mirror for photometry and imaging at 2.5-240 μm and medium/high-resolution spectroscopy at 2.5-196 μm .

ISOCAM

2.5-17 μm camera/polarimeter, 1.5/3/6/12 arcsec resolutions, two channels each with 32x32-element arrays. PI: Catherine Cesarsky, CEN-Saclay, France.

ISOPHOT

2.5-240 μm imaging photopolarimeter, operating in three separate modes as 30-240 μm far-IR camera, 2.5-12 μm spectro-photometer, and 3-110 μm multi-band multi-aperture photopolarimeter. PI: Dietrich Lemke, MPI für Astronomie, Germany.

SWS

2.5-45 μm Short Wavelength Spectrometer (two gratings and two Fabry-Perot interferometers), 7.5x20 and 12x30 arcsec resolutions, 1000 and 20 000 spectral resolution. PI: Thijs de Graauw, SRON, Netherlands.

LWS

45-196 μm Long Wavelength Spectrometer (grating and two Fabry-Perot interferometers), 1.65 arcmin resolution, 200 & 10 000 spectral resolution. PI: Peter Clegg, Queen Mary & Westfield College, UK.

SOHO

Achievements: unique studies of Sun's interior; the heating and dynamics of the corona and transition region; the acceleration and composition of the solar wind and coronal mass ejections; comets, the heliosphere and the interstellar wind

Launch date: 08:08 UT 2 December 1995

Mission end: operations approved to March 2007 (2-year design life)

Launch vehicle/site: Atlas 2AS from Complex 36, Cape Canaveral Air Station

Launch mass: 1864 kg (655 kg payload, 251 kg hydrazine)

Orbit: halo orbit around Sun-Earth L1 libration point (1.5 million km from Earth); arrived 14 February 1996

Principal contractors: Matra Marconi Space (prime, payload module, propulsion subsystem), British Aerospace (AOCS), Alenia (structure, harness), CASA (thermal control), Saab Ericsson (communications, data handling)

The Solar and Heliospheric Observatory (SOHO) is a cooperative project between ESA and NASA studying the Sun, from its deep core, through its outer atmosphere and the solar wind, into the heliosphere. It has revolutionised our understanding of the Sun, particularly the 'big three' questions: what are the structure and dynamics of the interior, how is the corona heated, and how is the solar wind accelerated? SOHO is providing solar physicists with their first long-term, uninterrupted view of the Sun, helping us to understand the interactions between the Sun and the Earth's environment with unprecedented clarity.

Three helioseismology instruments are providing unique data on the structure and dynamics of the Sun's interior, from the very deep core to the outermost layers of the convection zone. Five complementary imagers, spectrographs and coronagraphs observing in EUV, UV and visible-light are providing our first comprehensive view of the outer solar atmosphere and corona, helping to solve some of the Sun's most perplexing riddles, including the heating of the corona and the acceleration of the solar wind.

Three particle instruments explore the detailed composition, state and

variability of the Earth's environment in space, as influenced by the solar wind, coronal mass ejections and extragalactic sources. The outward-looking SWAN scans the sky for clues to the changing large-scale structure of the solar wind and its interaction with the intergalactic medium, as well as giving unique measurements of comet properties.

SOHO recorded its first solar image on 19 December 1995, en route to its orbit around the L1 Lagrangian point. Halo-orbit insertion occurred on 14 February 1996, 6 weeks ahead of schedule following a launch so precise it retained enough hydrazine for 100 years of operations. Routine science operations began after commissioning was formally completed on 16 April 1996. Since then, SOHO has generated a torrent of data that place it centre stage in solar physics. Scientific highlights include:

- unprecedented accuracy in modelling the solar interior, and in measuring solar irradiance variations;
- detecting plasma rivers beneath the surface;

EIT extreme-UV image of a huge eruption. The prominence is 60 000-80 000K, much cooler than the 1 million K and more of the surrounding corona. (He II line at 304 Å; 14 September 1997)

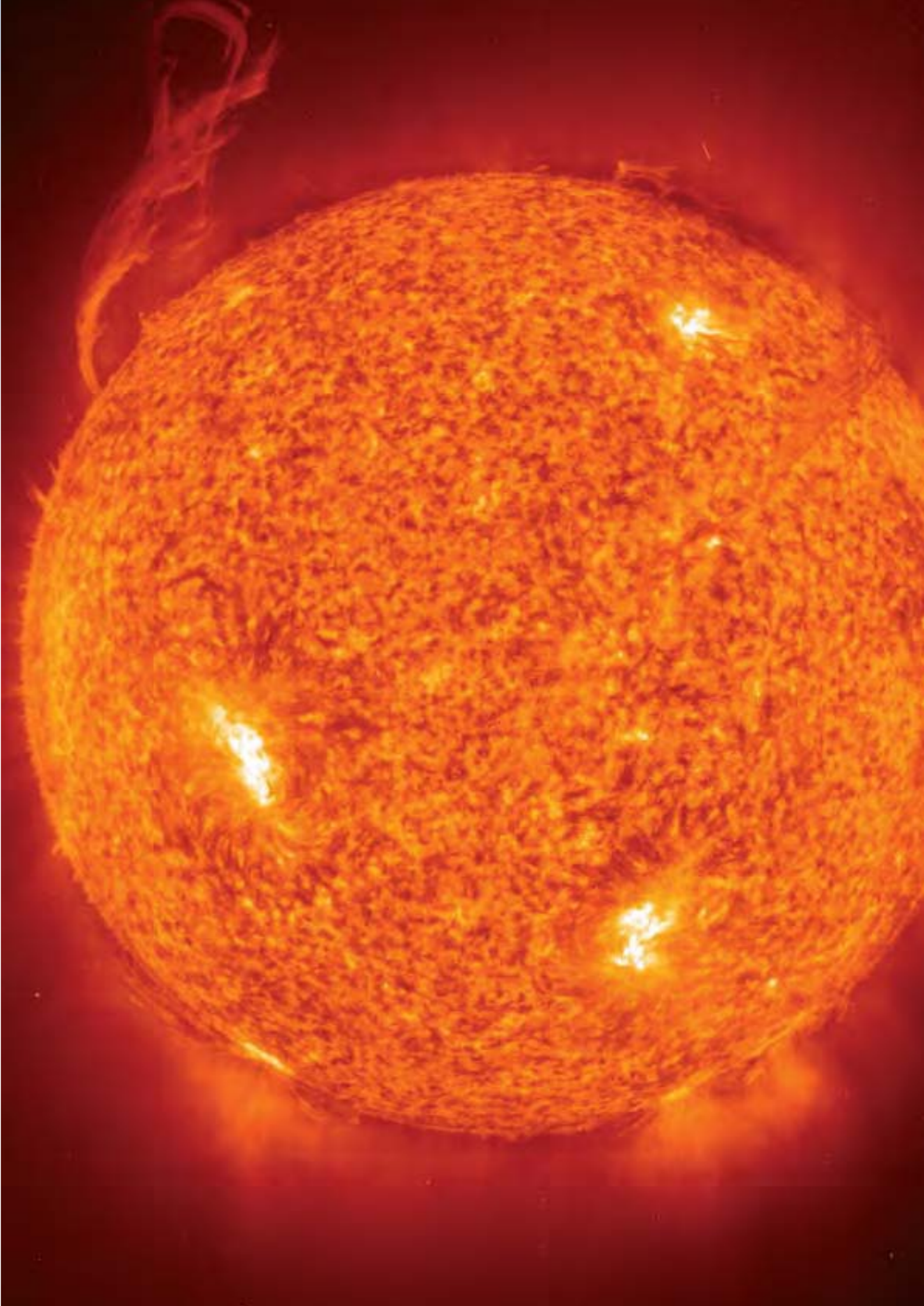



SOHO's Payload Module
at Matra Marconi Space.

- discovering a quasi-periodic oscillation in the rotational shear near the base of the solar convection zone;
- discovering a magnetic surface 'carpet', subducted and replaced every 1.5-3 days, that may be the energy source for coronal heating;
- the first detection of a flare-induced 'Sunquake';
- holographic imaging of the Sun's far side - the Sun made transparent;
- identifying the source regions of the fast solar wind;
- revealing the highly dynamic nature of the transition region even in 'quiet Sun' areas;
- detecting polar plume oscillations of 11-25 min indicative of compressive waves;
- discovering 'EIT waves' and their relation to CMEs, dramatically improving space weather forecasting reliability;
- possibly the first direct observations of a post-CME current sheet;
- providing invaluable statistics on,

- and spectacular images and movies of coronal mass ejections;
- measuring ion temperatures in coronal holes up to 200 million K;
- significantly contributing to understanding the acceleration of the solar wind;
- discovering large differences between the heating and acceleration mechanisms at play in polar versus equatorial coronal holes;
- discovering falling coronal structures;
- initial acceleration of >10 MeV particles seem to occur when an 'EIT wave' propagates to the Earth-connected field lines;
- measuring ion freeze-in temperatures and their variations with element and time;
- discovering >850 Sun-grazing comets (nearly half of all comet discoveries since 1761!), about 70% by amateurs via the Web;
- uniquely measuring cometary outgassing rates and nucleus sizes;
- detecting active regions on the Sun's far side through their 'lighthouse' effect;
- the first 3-D view of CMEs;
- discovery of oscillations in hot loops, opening a new area of 'coronal seismology'.

SOHO had returned about 2 million images when, on 25 June 1998, control was lost during routine maintenance operations. Contact was re-established on 3 August, allowing the batteries to be charged, and the propulsion system and its hydrazine to be thawed. Sun-pointing was restored on 16 September and SOHO was finally returned to normal mode on 25 September. The first instrument (SUMER) was switched on 5 October and all 12 science instruments were back to normal on 4 November. SOHO's mission continued.

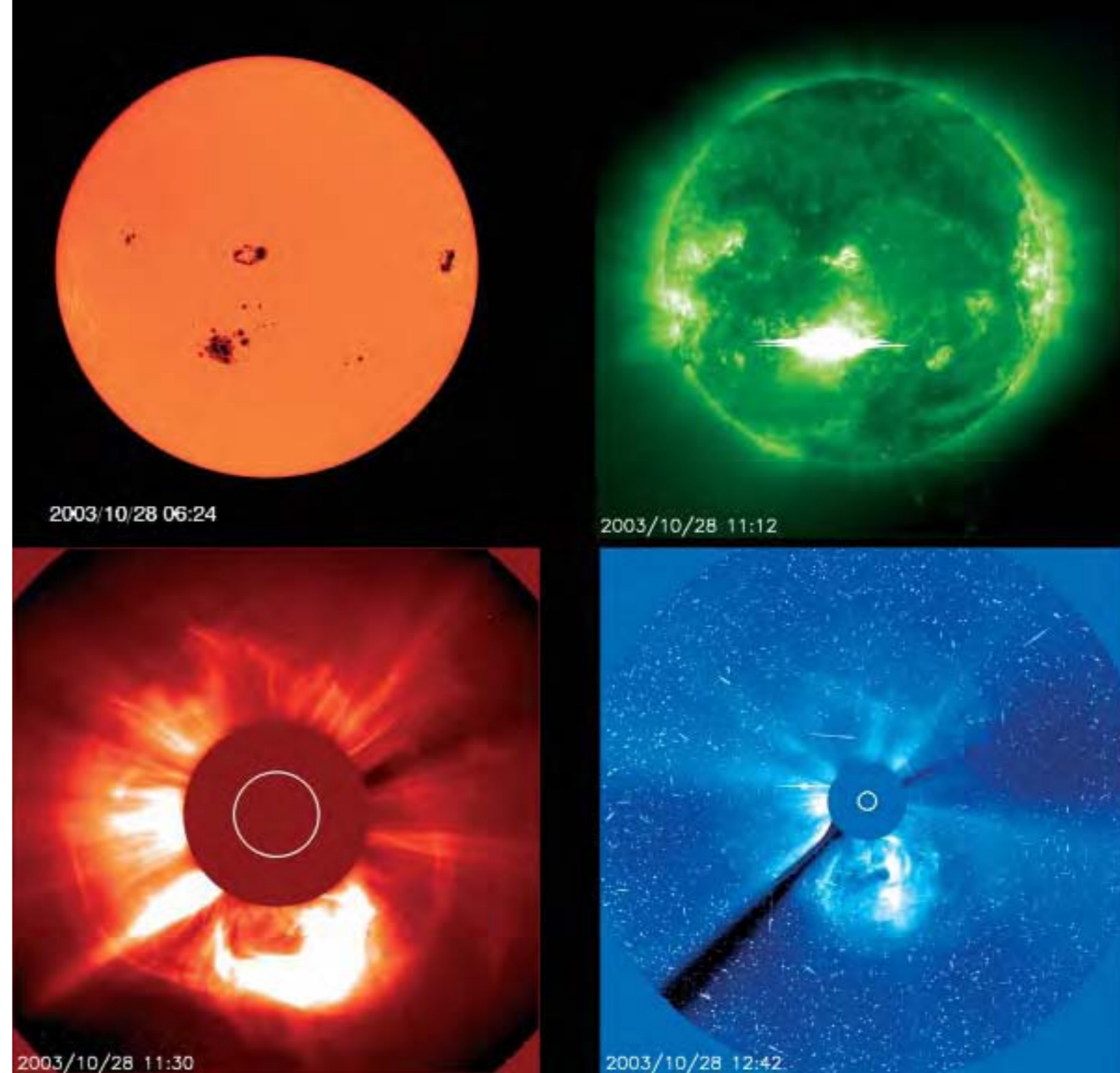

During 2 weeks in October-November 2003, the Sun featured three unusually large sunspot groups (including the largest one of this solar cycle), 11 X-class flares (including the strongest ever recorded), numerous halo coronal mass ejections (two with near-record speeds) and two proton storms. Satellites, power grids, radio communications and navigation systems were affected. The events, among the best observed ever, with data from multiple spacecraft and ground observatories, will be analysed for years to come. They generated unprecedented attention from the media and the public; SOHO images appeared in most major news outlets. All existing SOHO web traffic records were rewritten, including monthly (31 million requests, 4.3 TB data), weekly (16 million/2.6 TB) and daily. The daily and hourly volumes were bandwidth-limited.

From top left: giant sunspot regions 10484, 10486 and 10488 seen by MDI in white light; the X 17.2 flare as seen by EIT at 195 Å; the 2200 km/s CME in the LASCO C2 coronagraph; then in the LASCO C3 coronagraph (with particle shower becoming visible as 'snow' in the image). The cloud impacted Earth's magnetosphere a mere 19 h later, almost a record speed.

The range of SOHO's scientific research. The interior image from MDI illustrates the rivers of plasma discovered flowing under the surface. The surface image is from EIT at 304 Å. They are superimposed on a LASCO C2 image of the corona.

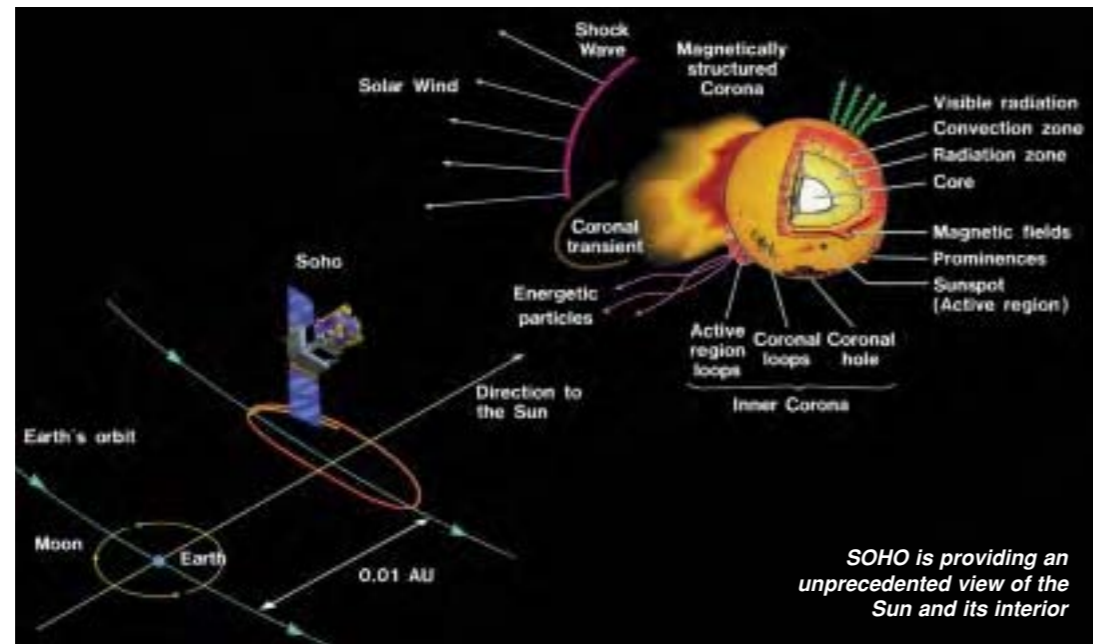

SOHO is providing an unprecedented view of the Sun and its interior

The Origins of SOHO

SOHO was first proposed in 1982 but its roots were laid in the earlier studies of GRIST (Grazing Incidence Solar Telescope) and DISCO (Dual Spectral Irradiance and Solar Constant Orbited). The combined objectives of these two missions formed the core of SOHO's mission.

In June 1976, GRIST competed with Solar Probe and proposals from other disciplines for further study. Solar Probe envisaged a set of instruments on a craft close to the Sun, but it was GRIST that proceeded to the feasibility stage because its wavelength range was particularly useful for studying the hot outer solar atmosphere. GRIST was intended for flights on the manned Spacelab. As a collaboration with NASA, GRIST fell victim in 1981 to the unilateral cancellation of the US twin probe for what became Ulysses. GRIST was 'parked', but restricted studies on its main spectrometers were supported by ESA.

In 1980, a group of French and American physicists observed the Sun

continuously from Antarctica for 6 days. These historic global velocity oscillation measurements led to the decision to include the same sort of experiments on the proposed DISCO mission. DISCO would sit at the L1 Lagrange point between the Sun and the Earth, an ideal observing site. The Antarctic experiment could be used as part of DISCO's payload, provided its weight could be reduced. DISCO was conceived as a fairly small and cheap spin-stabilised spacecraft of no more than 520 kg, similar to Cluster. A first assessment was made in 1981. ESA's Solar System Working Group preferred DISCO to the competing Kepler Mars mission, but it lost out to ISO in 1983.

SOHO itself developed as a mission in 1983, combining many aspects of the earlier proposals. It became important because it developed momentum, together with Cluster, as part of the International Solar-Terrestrial Physics Programme. In May 1984, ESA identified SOHO as part of a Cornerstone of the Horizon 2000 science programme.

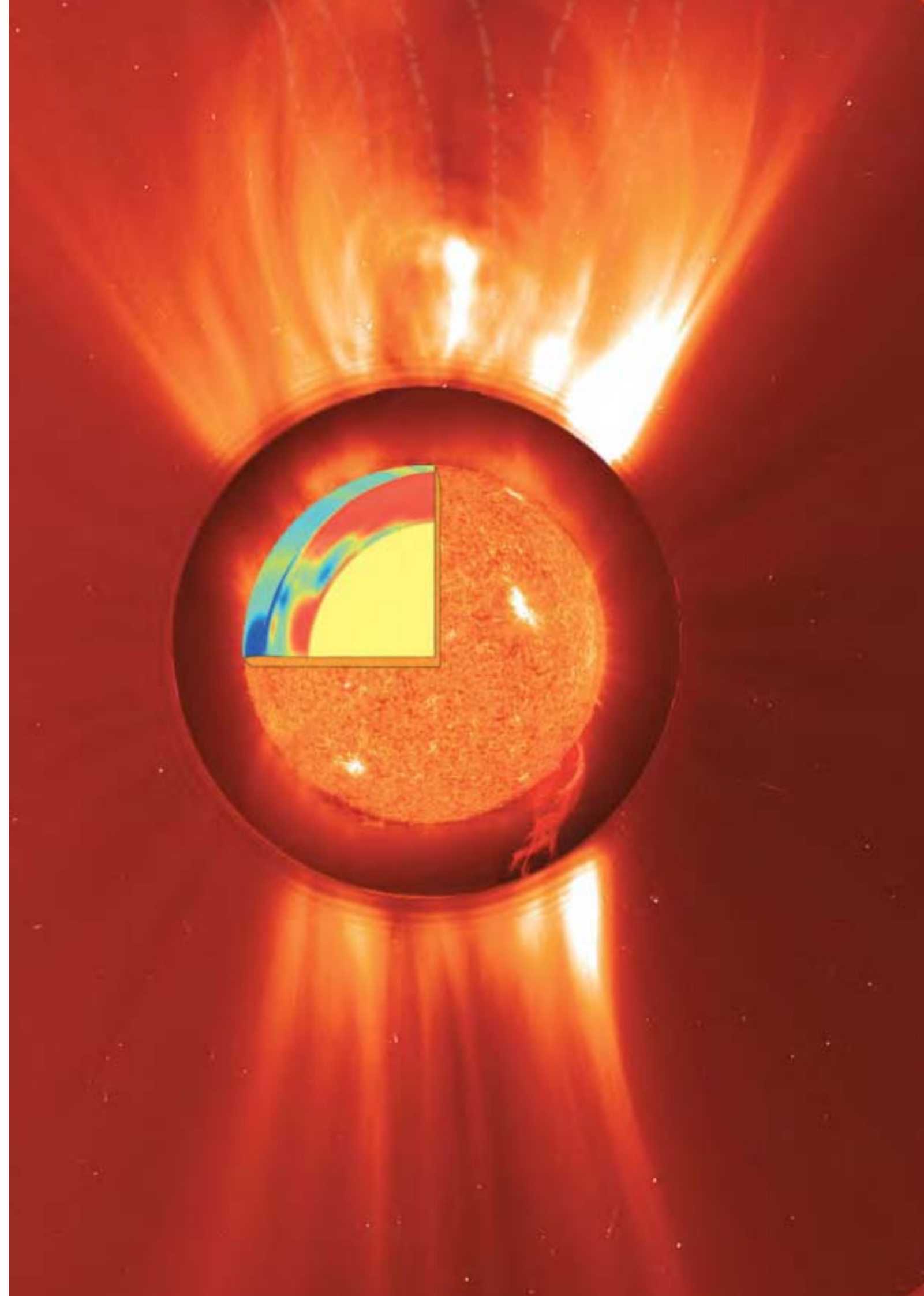

Most SOHO instruments are operational, but: SUMER: both detectors are near the end of their calibrated lifetimes, so the instrument is used only during selected campaigns. LASCO: C1 has not operated since 1998's recovery. CELIAS: one of 4 sensors is impaired. COSTEP: one of 2 sensors is impaired.

SOHO Scientific Payload

Investigation	Principal Investigator	Collaborating Countries	Measurements	Technique
<i>Helioseismology</i>				
Global Oscillations at Low Frequencies (GOLF)	A. Gabriel, IAS, Orsay, F	F, ESA, DK, D, CH, UK, NL, E, USA	Global Sun velocity oscillations ($l = 0-3$)	Na-vapour resonant scattering cell, Doppler shift and circular polarisation
Variability of solar IRradiance and Gravity Oscillations (VIRGO)	C. Fröhlich, PMOD/WRC, Davos, CH	CH, N, F, B, ESA, E	Low-degree ($l = 0-7$) irradiance oscillations and solar constant	Global Sun and low-resolution (12-pixel) imaging and active cavity radiometers
Michelson Doppler Imager (MDI)	P.H. Scherrer, Stanford Univ, California, USA	USA, DK, UK	Velocity oscillations high-degree modes (up to $l = 4500$)	Doppler shift with Fourier tachometer, 4 and 1.3 arcsec resolution
<i>Solar Atmosphere Remote Sensing</i>				
Solar UV Measurements of Emitted Radiation (SUMER)	W. Curdt, MP Ae, Lindau, D	D, F, CH, USA	Plasma flow characteristics (temperature, density, velocity); chromosphere through corona	Normal-incidence spectrometer, 50-160 nm, spectral resolution 20000-40000, angular resolution 1.2-1.5 arcsec
Coronal Diagnostic Spectrometer (CDS)	A. Fludra, RAL, Chilton, UK	UK, CH, D, USA, N, I	Temperature and density: transition region and corona	Normal and grazing-incidence spectrometers, 15-80 nm, spectral resolution 1000-10000, angular resolution 3 arcsec
Extreme-ultraviolet Imaging Telescope (EIT)	J-P Delaboudinière, IAS, Orsay, F	F, USA, B	Evolution of chromospheric and coronal structures	Full-disc images (1024×1024 pixels in 42×42 arcmin) at lines of HeII, FeIX, FeXII, FeXV
Ultraviolet Coronagraph Spectrometer (UVCS)	J.L. Kohl, SAO, Cambridge, MA, USA	USA, I, CH, D	Electron and ion temperature densities, velocities in corona (1.3-10 R_{\odot})	Profiles and/or intensity of selected EUV lines 1.3-10 R_{\odot}
Large Angle and Spectrometric COronagraph (LASCO)	R. Howard, NRL, Washington DC, USA	USA, D, F, UK	Structures' evolution, mass, momentum and energy transport in corona (1.1-30 R_{\odot})	One (C1) internally and two (C2 & C3) externally occulted coronagraphs. Spectrometer for 1.1-3 R_{\odot}
Solar Wind ANisotropies (SWAN)	J.L. Bertaux, SA Verrières-le-Buisson, F	F, FIN, USA	Solar wind mass flux anisotropies. Temporal variations	Scanning telescopes with hydrogen absorption cell for Lyman-alpha
<i>Solar Wind 'in situ'</i>				
Charge, ELeMent and Isotope Analysis System (CELIAS)	P. Bochsler, Univ. Bern, CH	CH, D, USA, Russia	Energy distribution and composition. (mass, charge, charge state) (0.1-1000 keV/e)	Electrostatic deflection, time-of-flight measurements and solid-state detectors
Comprehensive SupraThermal Energetic Particle analyser (COSTEP)	H. Kunow, Univ. Kiel, D	D, USA, J, F, E, ESA, IRL	Energy distribution of ions (p, He) 0.04-53 MeV/n and electrons 0.04-5 MeV	Solid-state detector telescopes and electrostatic analysers
Energetic and Relativistic Nuclei and Electron experiment (ERNE)	J. Torsti, Univ. Turku, FIN	FIN, UK	Energy distribution and isotopic composition of ions (p-Ni) 1.4-540 MeV/n and electrons 5-60 MeV	Solid-state and plastic scintillation detectors

IAS: Institut d'Astrophysique. PMOD: Physikalisch-Meteorologisches Observatorium Davos. MP Ae: Max-Planck-Institut für Aeronomie. RAL: Rutherford Appleton Laboratory. SAO: Smithsonian Astrophysical Observatory. NRL: Naval Research Laboratory. SA: Service d'Aeronomie

SOHO ready for mounting on the launch vehicle.



Although the freezing had not seriously affected the instruments, two of SOHO's three gyros were damaged by the cold. Then, on 21 December 1998, the surviving gyro failed and SOHO began firing its thrusters to maintain Sun-pointing. To halt the rapid depletion of hydrazine, engineers devised software to ignore faulty gyro data, making SOHO the first 3-axis spacecraft to operate without gyros. Science operations resumed 2 February 1999.

In order to fulfil its high promise, SOHO observations were planned to continue at least through the period of maximum sunspot activity in 2000. The two agencies then agreed to extend the mission to 2003, operating SOHO as the flagship of a multi-national fleet of solar spacecraft that includes Ulysses and Cluster. In February 2002, ESA approved an extension to March 2007, allowing SOHO to cover a full solar cycle.

The satellite's age began to show when, in May 2003, the drive mechanism of the high-gain antenna began missing steps. It was prudently parked and SOHO is instead rotated every 6 months to minimise the data loss. The mission continues to deliver its unique results; by the end of 2004, it had returned 25 million images and spectra: EIT 450 000; MDI 9 million; UVCS 1.35 million; LASCO 450 000; CDS 7.91 million; SUMER 5.23 million.

Satellite configuration: 2.5x2.9 m, total height 3.9 m, 9.5 m span across solar array. Instruments accommodated in Payload Module, highly decoupled from Service Module, which forms the lower portion of the spacecraft and provides power, thermal control, AOCS, pointing and telecommunications for the whole spacecraft and support for the solar panels.

Attitude/orbit control: 3-axis stabilisation, Sun-pointing with nominal 10 arcsec accuracy, pointing stability 1 arcsec per 15 min (10 arcsec per 6 months), using 4 reaction wheels and two sets (redundant) of eight (2xpitch, 2xyaw, 4xroll) thrusters: 4.2 N (blowdown BOL, 22.4 bar; 2.2 N @ 6.6 bar; 3 N @ Dec 1998, 15.8 bar), 251 kg hydrazine loaded (122 kg @ Feb 2002) in single He-pressurised tank. Total delta-V 318 m/s (43 m/s reserved for attitude control). Attitude data from two fine-pointing Sun sensors, two star trackers and three gyros (no-gyro operations since February 1999).

Power system: 1400 W from twin 2.3x3.66 m Si-cell solar wings (payload requires 440 W); two 20 Ah NiCd batteries used soon after launch and in recovery operations (1 dead).

Communications: science instruments normally return 40 kbit/s (+160 kbit/s when MDI in high-rate mode) at 2.245 GHz S-band to NASA's Deep Space Network for 12 h daily; supported by 1 Gbit tape recorder and 2 Gbit solid-state recorder. Instrument operations are controlled from the Experiment Operations Facility at NASA's Goddard Space Flight Center.

Ariane-5

Achievements: first European heavy-lift satellite launcher; 20 launches by end-2004; planned launches 6 in 2005

Launch dates: debut A501 4 Jun 1996 (failed), first success A502 30 Oct 1997, first operational flight A504 10 Dec 1999; debut A5ECA 11 December 2002 (failed), first success 12 February 2005; debut A5ES planned 2006

Launch site: ELA-3 complex, Kourou

Launch mass: 747 t (A5G), 746 t (A5GS), 767 t (A5ES), 780 t (A5ECA)

Length: depending on fairing configuration 46.27-53.93 m (A5G/GS), 46.27-53.43 m (A5ES), 50.56-57.72 m (A5ECA)

Performance: optimised for geostationary transfer orbit (GTO); see separate table

Principal contractor: EADS Space Transportation (industrial architect)

The ESA Ministerial Council meeting in The Hague, The Netherlands in November 1987 approved development of the first European heavy-lift launch vehicle. Although Ariane-1 to -4 proved to be remarkably successful, it was clear that a new, larger vehicle was required to handle the ever-growing sizes of commercial telecommunications satellites. The goal was to offer 60% additional GTO capacity for only 90% the cost of an Ariane-44L, equivalent to reducing the cost/kg by 44%. From 2005, the cost is expected to be €13 000/kg for eight launches annually.

At the time of approval, it was intended that Ariane-5 would also be tailored to carry the Hermes manned spaceplane. Although Hermes was later shelved, the design can still be man-rated if required. The standard 'lower composite' of stage-1 plus boosters is aiming for a reliability of 99%. Ariane-5's overall reliability target is 98.5%. Like Ariane-4, it is optimised for dual-satellite launches into GTO.

ESA is responsible (as design authority) for Ariane development work, owning all the assets produced. Until 2003, it entrusted technical direction and financial management to the French space agency, CNES, which wrote the programme specifications and placed the

industrial contracts on its behalf. EADS Launch Vehicles (the merged Aerospatiale and DASA) acted as industrial architect. As part of a reorganisation of Europe's launcher industry, ESA in 2003 took over management of the programme and EADS Space Transportation became prime contractor, responsible for delivering the integrated vehicle to Arianespace. ESA/CNES were directly responsible for the first three Ariane-5 launches, before Arianespace assumed responsibility for commercial operations. The new vehicle completely replaced Ariane-4 in 2003.

Kourou's ELA-3 and associated processing areas were constructed as dedicated Ariane-5 facilities to permit up to 10 launches annually (8 is the current target). Unlike Ariane-4, the payload assembly is integrated with the vehicle before they are transported to the pad only 8 h before launch, in order to minimise pad operations. A launch campaign covers 21 days; the payload is mated 6 days before launch. The simplified pad concept allows filling of the cryogenic propellants for the core stage from below the mobile launch table; it also reduces vulnerability to launch accidents. There are four principal buildings in the preparation zone:

The launch of A516/V162, with the triple payload that included ESA's SMART-1 lunar orbiter. (ESA/Arianespace/CSG)



A513 on the pad, carrying MSG-1. This is the second mobile platform, equipped to load the A5ECA cryogenic upper stage. (ESA/Arianespace/CSG)

- Bâtiment d'Intégration Propulseur (BIP) integration hall for the solid-propellant boosters to be assembled and checked out;
- Bâtiment d'Intégration Lanceur (BIL) launcher integration building where the complete launcher is erected on the mobile platform, with boosters added;
- Bâtiment d'Assemblage Final (BAF) assembly building where the payload composite is assembled and erected, the upper stage tanks filled (for A5G; the A5ECA cryogenic upper stage is filled on the pad) and the final electrical checkout conducted;
- Launch Centre (CDL-3) for launch operations with up to two vehicles simultaneously.

The new 3000 m² S5 payload processing facility came on line in 2001, designed to handle four large payloads simultaneously, including the Automated Transfer Vehicle. Envisat was the first satellite to use it. A second mobile launch table was added in 2000.

Ariane-5E The mass of commercial telecommunications satellites destined for geostationary orbit – Ariane's principal market – have been growing continuously. Ariane-5's initial target capacity of 5.97 t into GTO will no longer be able to accommodate the two satellites per launch that are essential for profitability. The October 1995 ESA Ministerial Council in Toulouse therefore approved the Ariane-5E (E=Evolution) programme to increase dual-payload GTO capacity to 7.4 t by improvements to the lower composite. Most of the improvement (800 kg) in the performance comes from upgrading the main engine to the Vulcain-2

Ariane-5 Batches

The first two Ariane-5s were funded as part of the development programme. Arianespace ordered its first P1 batch of 14 Ariane-5G (G = generic) vehicles in June 1995. The contracts for the P2.1 batch were signed in 2000: the first three (A518-A520) were A5G (and termed A5G+ to show they were from a later batch) and the rest were to be A5ECA. Post-A517, the six A5ECA were changed to A521-ECA (to qualify A5ECA), A522-ES (to qualify A5ES) and the rest to a generic A5GS (S = star, as in A5G*) as a gapfiller until A5ECA becomes the standard. A5GS differs from A5G mainly in the reinforced Vulcain-1 bell as a result of the A517 Vulcain-2 failure. The P2.1 cost reduction in comparison with P1 is 35%.

Arianespace signed a contract worth about €3 billion on 10 May 2004 with prime EADS Space Transportation for 30 vehicles – 25 A5ECA + 5 A5ES – for deliveries to begin mid-2005. This 'PA' (Production-A) batch is expected to satisfy requirements to 2009. The goal for batch PA is a 50% cost reduction with respect to P1.

model: increasing thrust to 1350 kN by widening the throat 10%, increasing chamber pressure 10%, extending the nozzle and raising the LH₂/LOX mixture ratio from 5.3 to 6.2. That last element requires the tank bulkhead to be lowered by 65 cm, raising propellant mass to 175 t. Welding the booster casings instead of bolting them together saves 2 t and will allow 2430 kg more propellant, increasing GTO capacity by 300 kg (to be introduced on A536 in 2006). A new composite structure for the VEB saved 160 kg. Replacing the Speltra carrier by the lighter Sylدا-5 adds



Cutaway of the Ariane-5G vehicle on the ELA-3 launch pad. (ESA/D. Ducros)



Ariane-5ECA vehicle on the ELA-3 launch pad. (ESA/D. Ducros)



380 kg capacity. Roll control during burns is provided by a thruster package on the EPC core, simplifying the control system.

But even these improvements are not enough to remain competitive, as market projections predict launches of paired 6 t satellites will be required by 2006. ESA's Council in June 1998 therefore approved the Ariane-5 Plus programme to meet this challenge by adding upper-stage improvements to Ariane-5E.

Ariane-5ECA (Evolution Cryogénique A) provides 9 t into GTO using the ESC-A cryogenic upper stage (Etage Supérieure Cryogénique) powered by the 64.8 kN HM7B engine from Ariane-4. Propellant mass is 14.5 t, diameter 5.4 m; single ignition. It uses the Ariane-4 LOX tank and thrust frame, plus the Ariane-5 EPC tank bulkhead. The first flight (A517) on 11 December 2002 (which was also the maiden Ariane-5E) ended with failure of the Vulcain-2 nozzle extension, now reinforced. ESC-A did not have the opportunity to ignite. The second test flight, of A521, on 12 February 2005, was fully successful, and A5ECA entered service in 2005 as the standard model.

Ariane-5ES (Evolution Stockables) will allow multiple EPS Aestus engine reignitions to accommodate a wider range of missions. Stretched EPS tanks add 250 kg of propellant. Coasting between burns requires a longer life, provided by improving thermal protection and larger batteries. The first customer is ATV, which

requires three ignitions, including the deorbit burn of the spent upper stage.

Ariane-5ECB (Evolution Cryogénique B) was approved by the Ministerial Council in November 2001 as the final phase of Ariane-5 Plus. However, efforts were reduced to a minimum post-A517 in order to focus on bringing the A5ECA back to flight. The intention was to offer 12 t GTO capacity by 2006 (now 2010 at the earliest) by using the ESC-B stage, derived from ESC-A. The Ariane-5 Plus programme would have achieved 11.6 t, with further effort required for the full 12 t. The new 178 kN Snecma Moteurs Vinci engine offers multiple ignitions. Vinci uses the expander cycle, in which the turbines are driven by hydrogen heated through the walls of the combustion chamber before being injected. SI 464 s, combustion pressure 61 bar, expansion ratio 240, mixture ratio 5.8 (LOX/LH₂), flow rates 39 kg/s, burn time 610 s, mass 510 kg, height 5.6 m, exit diameter 2.10 m. A5ECB launch mass would be about 790 t, length (depending on fairing) 51.51-58.67 m; ESC-B dry mass 6 t.

The successful first hot-firing test, lasting 1 s, of the Vinci engine took place on 20 May 2005 at the DLR Lampoldshausen P4.1 test stand in Germany.

Current and future versions of Ariane-5. Left: A5G. Right: Ariane-5E lower composite (note the Vulcain-2) supporting ESC-A (left), ES (centre, with ATV payload) and ESC-B. (ESA/D. Ducros)





Preparing to install the Vulcain-1 main engine on Ariane-5. (ESA/CNES/CSG)

The EPS upper stage is designed for compactness, nestling the engine among clustered propellant tanks. (ESA/CNES/CSG)

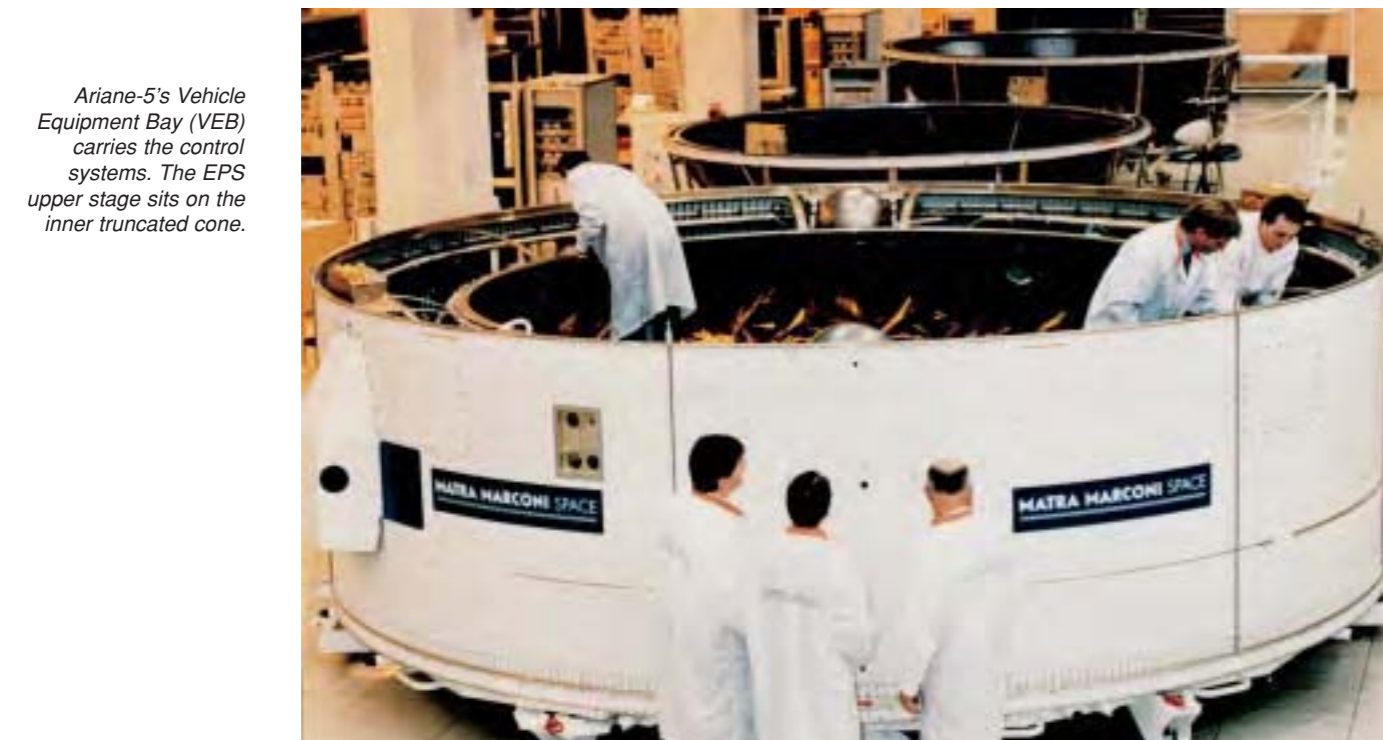

Ariane-5's Vehicle Equipment Bay (VEB) carries the control systems. The EPS upper stage sits on the inner truncated cone.

Ariane-5G/G+/GS

Boosters

(EAP: Etage d'Accélération à Poudre)

Principal contractors: EADS Space Transportation (stage integrator), Europropulsion (motors)

Size: 31.2 m long, 3.05 m diameter, 40 t empty mass

Powered by: 238 t of solid propellant generates 5250 kN each at launch; 132 s burn time

Design: motor is assembled in Kourou from three sections, each of 8 mm-thick steel. The two lower sections each comprise three 3.35 m-long cylinders. HTPB solid propellant of 68% ammonium perchlorate, 18% aluminium and 14% liner produced and cast in casings in Kourou; 3.4 m-long forward section shipped already loaded by Avio from Italy. Nozzle expansion ratio 11; steering by two hydraulic actuators using flexbearing for 6° deflection. Recovery option for inspection of two booster sets every 2 years using parachutes carried in nosecone.

Core Stage

(EPC: Etage Principal Cryotechnique)

Principal contractors: EADS Space Transportation (stage integrator), Snecma-Safran Moteurs (main engine), Cryospace (tanks)

Size: 30.7 m long; 5.40 m diameter, 12.6 t dry mass

Powered by: one Snecma Moteurs Vulcain cryogenic engine providing 900 kN at launch, increasing to 1145 kN (vacuum thrust) for 580 s, gimballed for attitude control, drawing on 157 t LOX/LH₂

Design: the aluminium tank is divided into two sections by a common bulkhead, creating a 120 m³ LOX forward tank (pressurised to 3.5 bar by helium) and a 390 m³ LH₂ aft tank (pressurised to 2.5 bar by gaseous H₂). The tank's external surface carries a

Ariane-5 Performance (kg)

	A5G	A5GS	A5ES	A5ECA	A5ECB
GTO ¹	5950 ²	6130 ²	–	8300 ^{2,5}	12 000 ²
SSO ³	9216	9940	–	–	13 300
LEO	–	–	19 670 ⁴	–	–

1: dual payloads, 600x36 000 km, 7°, short fairing. 2: Sylta-5. 3: Sun-synchronous 800x800 km, 98.6°, long fairing. 4: 260x260 km, 51.6° for ATV, long fairing; increase to 20 700 kg in 300x300 km for ATV-2 in 2006 when welded joints introduced on boosters. 5: increase to 9400 kg with introduction of boosters using welded joints.

2 cm-thick insulation layer to help maintain the cryogenic temperatures

Upper Stage

(EPS: Etage à Propergols Stockables)

Principal contractor: EADS Space Transportation

Size: 3.3 m long; 3.94 m diameter, 1.2 t dry mass

Powered by: Astrium Aestus gimballed engine with delayed or reignition capability providing 27.5 kN for 1100 s, drawing on up to 9.7 t of NTO/MMH

Design: this orbit injection stage also ensures payload orientation and separation. Required to nestle inside the VEB under the payload fairing, it is designed for compactness: the engine is embedded within the four propellant spheres (each 1.41 m-diameter, pressurised to 18.8 bar by helium). Main structural element is frustum continuing VEB's frustum at 3936 mm-diameter lower face and supporting payload adapters on 1920 mm-diameter forward face

Vehicle Equipment Bay (VEB)

Principal contractor: EADS Space Transportation

Purpose: carries equipment for vehicle guidance, data processing, sequencing, telemetry and tracking

Size: 104 cm high; 4.0 m diameter, 520 kg

Design: internal frustum of a CFRP sandwich supports upper stage at its

The first three launches employed a Speltra carrier.
(ESA/D. Ducros)

3936 mm-dia forward end; external aluminium cylinder supports payload fairing/carrier; annular platform carries the electronics. Hydrazine thrusters provide roll control during stage-1/2 burns, and 3-axis control after stage firings

Payload Fairing and Carriers

Payloads are protected by a 2-piece aluminium fairing until it is jettisoned after about 278 s during the core stage burn. Prime contractor is Contraves. Three basic lengths are available: 12.7, 13.8 and 17 m; dia 5.4 m. The initial main payload carrier was the Speltra, which sits between the fairing and upper stage/VEB, housing one satellite internally and a second on its top face, under the fairing. Two models: 5.5 m (704 kg) & 7 m (820 kg) heights. Sylda-5 added in 2002, sitting inside standard fairings: 6 versions, 420 kg smallest, 4.9-6.4 m heights (extension rings 30 cm high), 4.6 m inner dia. Four extension rings available for fairing, increase heights by 0.50-2.0 m. Some missions can also carry up to six 50 kg satellites as passengers on ASAP-5 adapter.

Ariane-5ECA Characteristics

Boosters

(EAP: Etage d'Accélération à Poudre)

Principal contractors: EADS Space Transportation

(stage integrator), Europropulsion (motors)

Size: 31.2 m long, 3.05 m diameter, 38 t empty mass

Powered by: 241 t of solid propellant generates 5250 kN each at launch; 132 s burn time

Design: as A5G/G+/GS

Core Stage

(EPC: Etage Principal Cryotechnique)

Principal contractors: EADS Space Transportation

(stage integrator), Snecma Moteurs (main engine), Cryospace (tanks)

Size: 30.7 m long; 5.40 m diameter, 12.6 t dry mass

Powered by: one Snecma Moteurs Vulcain-2

cryogenic engine providing 960 kN at sea level, increasing to 1355 kN (vacuum), 590 s, SI 434 s, expansion ratio 60, 2040 kg, 115 bar chamber pressure, gimballed for attitude control, drawing on 175 t LOX/LH₂

Design: as A5G/G+/GS but tank bulkhead lowered 65 cm



Ariane-5 Launch Log

Flight		Date	Type	Mission	Capacity*	Carriers**	Payload
V88 ¹	A501	04 Jun 1996	-	GTO	5759 kg	02001	Cluster
V101 ²	A502	30 Oct 1997	-	GTO	5728 kg	02001	dummy/Teamsat
V112	A503	21 Oct 1998	A5G	sub/GTO	6543 kg	02001	ARD/dummy
V119	A504	10 Dec 1999	A5G	HEO	3954 kg	00001	XMM
V128	A505	21 Mar 2000	A5G	GTO	5811 kg	00101	AsiaStar/Insat-3B
V130	A506	14 Sep 2000	A5G	GTO	5963 kg	00101	Astra-2B/GE-7
V135	A507	16 Nov 2000	A5G	GTO+	6317 kg	00001	PAS-1R ³
V138	A508	20 Dec 2000	A5G	GTO	4803 kg	00411	Astra-2D/GE-8/LDREX
V140	A509	08 Mar 2001	A5G	GTO	5304 kg	00421	Eurobird/BSat-2a
V142 ⁴	A510	12 Jul 2001	A5G	GTO	5317 kg	00421	Artemis/BSat-2b
V145	A511 ⁵	01 Mar 2002	A5G	SSO	8605 kg	00003	Envisat
V153	A512	05 Jul 2002	A5G	GTO	6632 kg	00121	Stellat-5/NStar-c
V155	A513	28 Aug 2002	A5G	GTO	6586 kg	00422	MSG-1/Atlantic Bird
V157 ⁶	A517	11 Dec 2002	A5ECA	GTO	8353 kg	00603	Hot Bird-7/Stentor
V160	A514	09 Apr 2003	A5G	GTO	5443 kg	00402	Insat-3A/Galaxy-12
V161	A515	11 Jun 2003	A5G	GTO	6883 kg	00212	Optus-C1/BSat-2c
V162	A516	27 Sep 2003	A5G	GTO	6137 kg	00641	Insat-3E/eBird/SMART-1
V158	A518	02 Mar 2004	A5G+ ⁷	escape	3188 kg	00001	Rosetta
V163	A519	18 Jul 2004	A5G+	GTO	6246 kg	00002	Anik-F2 ⁸
V165	A520	18 Dec 2004	A5G+	SSO	6038 kg	00021	Helios-2A ⁹
V164	A521	12 Feb 2005	A5ECA	GTO	8312 kg	00442	XTAR/Sloshsat/dummy
V166	A523	Aug 2005	A5GS ¹⁰	GTO			iPSTAR
V167	A522	Aug 2005	A5ECA	GTO			Spaceway-2/Telkom-2

1: failure; guidance system software error. 2: partial success; unpredicted roll torque from Vulcain led to early shut down of stg-1, lowering final orbit; allowed for on future flights. 3: + auxiliary payloads Amsat-P3D & STRV-1c/1D; first ASAP-5. 4: Aestus combustion instability ended stg-3 burn 90 s early, leaving payloads in sub-GTO. 5: A5G upgraded beginning A511 - Vulcain could change mix ratio in flight (added 150 kg GTO) and EAP nozzle lengthened/exit ratio increased from 10.3 to 11 (adding 70 kg GTO). EPC forward skirt strengthened. 6: failure; Vulcain-2 nozzle extension required strengthening; first A5ECA. 7: EPS further upgraded for the three A5G+; carried 300 kg more propellant and ignition optimised by delay. 8: heaviest-ever telecom satellite (5965 kg). 9: + auxiliary payloads Essaim (x4), Parasol & Nanosat on ASAP-5. 10: A5GS introduced by A523 as gapfiller until A5ECA qualified. Reinforced Vulcain-1 bell.

Welded booster joints will be introduced on A536 in late 2006, adding 300 kg GTO.

* total vehicle performance into orbit indicated (thus greater than payload carried).

** identifies type of fairing & carrier used in 'abcde' code. 'a': ACY 5400 extension ring beneath Speltra/Sylda (0 = none; 1 = 0.5 m; 2 = 1 m; 3 = 1.5 m; 4 = 2 m). 'b': Speltra (0 = none; 1 = short/5.5 m; 2 = long/7 m). 'c': Sylda-5 (0 = none; 1 = short/4.9 m; 2 = 5.2 m; 3 = 5.5 m; 4 = 5.8 m; 5 = 6.1 m; 6 = long/6.4 m; 7 = ultra-short/4.3 m). 'd': as 'a', but beneath fairing. 'e': fairing (1 = short/12.7 m; 2 = medium/13.8 m; 3 = long/17 m).

A515/V161 carried two commercial telecommunication satellites. (ESA/Arianespace/CSG)

Upper Stage

(ESC-A: Etage Supérieure Cryogénique)

Principal contractor: EADS Space

Transportation

Size: 4.750 m long; 5.435 m diameter, 3.450 t dry mass

Powered by: Ariane-4 HM7B engine providing 64.8 kN for 950 s. SI 445.6 s, 162 kg, mix ratio 5.04, expansion ratio 62.5, chamber pressure 36 bar, drawing on 11952/2582 kg LOX/LH₂ at 14.8 kg/s

Design: adapts the Ariane-4 third stage HM7B engine, thrust frame and LOX tank to 5.435 m dia. Tank volumes 39.41/11.36 m³ LOX/LH₂. Attitude control during burn: pitch/yaw by gimbaled nozzle; roll by 4 GH₂ thrusters. Control during coast: 3-axis by 4 clusters of 3 GH₂ thrusters.

Vehicle Equipment Bay (VEB)

Principal contractor: Astrium SAS

Purpose: carries equipment for vehicle guidance, data processing, sequencing, telemetry and tracking

Size: 104 cm high; 4.0 m dia, 950 kg

Design: internal frustum of a CFRP sandwich supports upper stage at its 3936 mm-dia forward end; external aluminium cylinder supports payload fairing/carrier; annular platform carries the electronics.

Payload Fairing and Carriers

Payloads are protected by a 2-piece aluminium fairing until it is jettisoned after about 180 s during the stage-2 burn. Prime contractor is Contraves. Three basic lengths are available: 12.7, 13.8 and 17 m; dia 5.4 m. The main payload carrier is Sylva-5, sitting inside standard fairings: 6 versions, 420 kg smallest, 4.9-6.4 m heights (extension rings 30 cm high), 4.6 m inner dia. Four extension rings available for fairing, increase heights by 0.50-2.0 m. Some missions can also carry up to six 50 kg satellites as passengers on ASAP-5 adapter.

Typical launch sequence (GTO, dual payload)

Event	(min:s)	alt. (km)
Vulcain ignition	-0.65	0
Booster ignition	-0.25	0
Lift-off	0	0
Begin pitch	5.03	0.08
Begin roll	9.75	0.35
End pitch	24.75	2.5
Mach 1	41.3	6.8
Max. dyn. pressure	57.7	12.6
Boosters sep	2:15.7	68.9
Fairing sep	3:0.7	113.3
Natal acquire	6:45.7	211
Vulcain shutdown	8:40.7	215
EPC sep	8:46.7	215
ESC-A ignite	9:50.7	215
Ascension acquire	13:2.7	201
Libreville acquire	18:4.7	229
ESC-A shutdown	24:24.7	646
Sat-1 sep	27:17.7	1089
Sylva-5 sep	31:18.7	1887
Sat-2 sep	35:34.7	2879
ESC-A passivation	48:53.7	6275

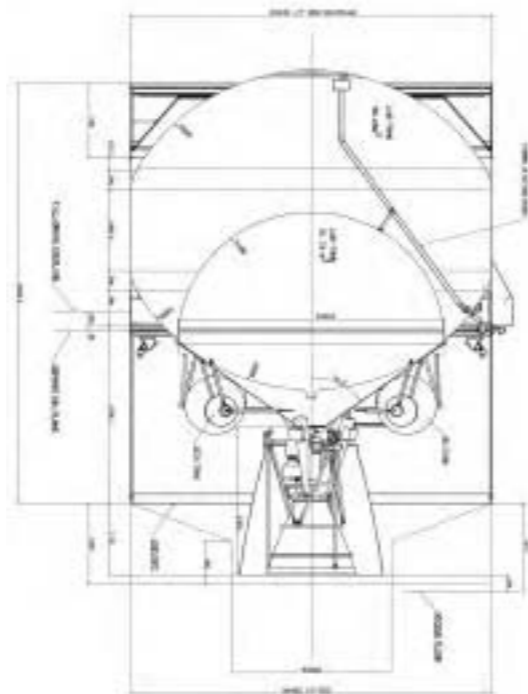

The baseline ESC-B cryogenic stage.



Cluster

Achievements: most comprehensive and detailed observations of Earth's magnetosphere and its environment

Launch dates: FM1-FM4 4 June 1996 (launch failure); FM6/FM7 16 July 2000; FM5/FM8 9 August 2000

Mission end: planned December 2009

Launch vehicle/site: FM1-FM4 Ariane-501 from ELA-3, Kourou, French Guiana; FM5-FM8 in pairs on Soyuz-Fregats from Baikonur Cosmodrome, Kazakhstan

Launch masses: FM1 1183 kg; FM2 1169 kg; FM3 1171 kg; FM4 1184 kg; FM5 1183 kg; FM6 1193 kg; FM7 1181 kg; FM8 1195 kg. 650 kg propellant, 72 kg science payload

Orbits: FM1-FM4 planned 25 500x125 000 km, 90° (via 10° GTO); FM5-FM8 delivered into 250x18 050 km, 64.8°, used onboard propulsion in 5 burns to attain 23 600x127 000 km, 90.5°, formation-flying began 16 August 2000

Principal contractors: Dornier (prime), MBB (solar array, thrusters), British Aerospace (AOCS, RCS), FIAR (power), Contraves (structure), Alcatel (TT&C), Laben (OBDH), Sener (booms)

The Cluster mission was proposed to the Agency in late 1982 and selected, with SOHO, as the Solar Terrestrial Science Programme, the first Cornerstone of ESA's Horizon 2000 Programme. The mission is investigating plasma processes in the Earth's magnetosphere using four identical spacecraft simultaneously. It is accurately measuring 3-D and time-variable phenomena, making it possible to distinguish clearly between spatial and temporal variations for the first time.

The four Cluster spacecraft are in almost identical, highly eccentric polar orbits, essentially fixed inertially so that in the course of the nominal 2-year mission a detailed examination was made of all the significant regions of the magnetosphere. With summer launches, the plane of this orbit bisects the geomagnetic tail at apogee during the summer, and passes through the northern cusp region of the magnetosphere 6 months later. Thrusters are being used to change the in-orbit constellation of the satellites periodically by modifying their separations to between 200 km and 18 000 km to match the scale lengths of the plasma phenomena

under investigation. For example, 600 km was established for the February 2001 cusp crossings. As the original Cluster mission took advantage of a cheap Ariane-5 GTO demonstration launch, the satellites carried high propellant loads to attain their required orbits. Unfortunately, the spacecraft were lost in the launch failure. ESA's Science Programme Committee on 3 April 1997 approved the replacement mission. Only three new satellites required ordering from Dornier in November 1997; the first

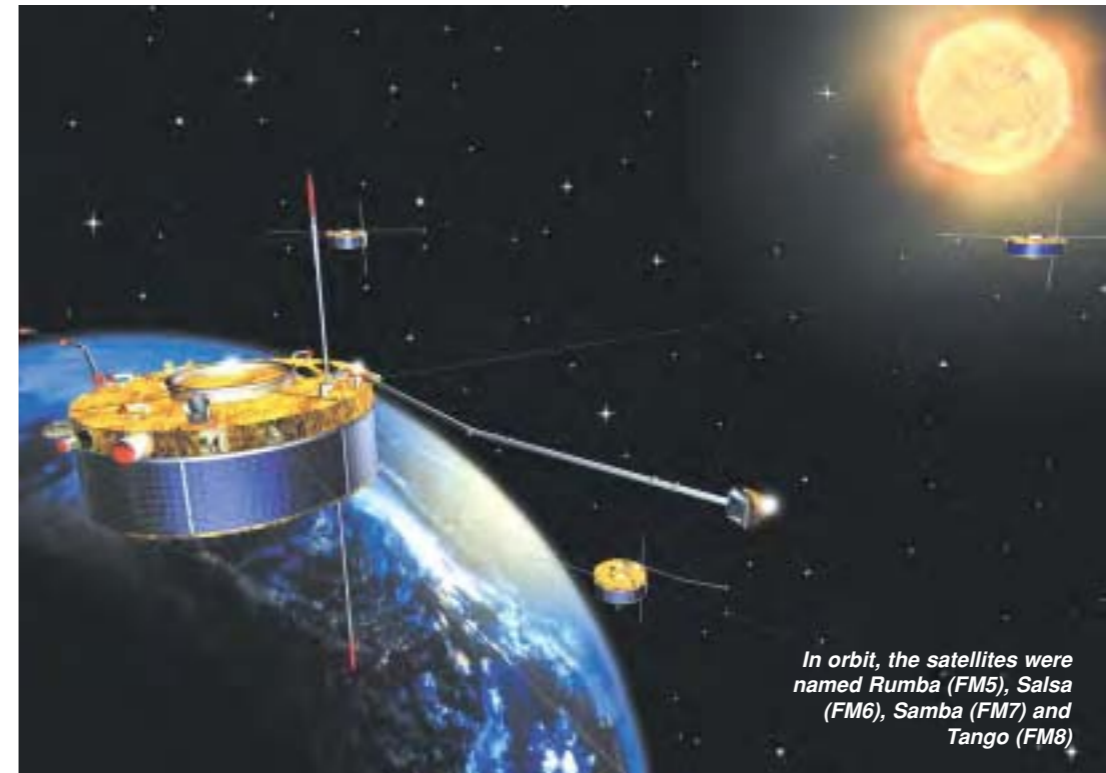

In orbit, the satellites were named Rumba (FM5), Salsa (FM6), Samba (FM7) and Tango (FM8)

(FM5) was quickly assembled from spares. The spacecraft are essentially identical to their predecessors, but some electronic components were no longer available. The solid-state recorders are new designs, with increased capacities. The high-power amplifiers, previously provided by NASA, were procured in Europe. Minor modifications shortened the experiment-carrying radial booms to fit the spacecraft inside the Soyuz payload fairing. Also, the main ground antenna at Odenwald (D) was replaced by Villafranca (E).

Cluster commissioning began 16 August 2000 when they had rendezvoused in the planned orbit. First, the ASPOC and CIS covers were opened and all rigid booms were deployed. The magnetometers on all four craft were then commissioned. The instruments were split into two groups: the wave instruments were commissioned on two spacecraft while the particle instruments were commissioned on the other pair. This avoided conflict between deploying the 44 m-long wire booms (four on each craft) and commissioning the particle instruments. This took about 1.5 months; work then began on the other half. During commissioning,

ASPOC failed on FM5 (high-voltage control) and CIS on FM6 (power supply). Formally, science operations began 1 February 2001.

The first glimpse of the fluctuating magnetic battleground came on 9 November 2000 when the quartet made their first crossings of the magnetopause. Data clearly showed that gusts in the solar wind were causing the magnetosphere to balloon in and out, meaning the satellites were alternately inside and outside Earth's magnetic field. For the first time, simultaneous measurements were made on both sides of the magnetopause. An early achievement was the first observational proof by STAFF and FGM of waves along this shifting boundary. Cluster found waves rippling along it like waves on a lake – but at 145 km/s.

By late December 2000, the quartet moved close to the bow shock – 100 000 km on Earth's sunward side – where solar wind particles are slowed to subsonic speeds after slamming into Earth's magnetic shield at more than 1 million km/h. Cluster's instruments began to record in great detail what happens at this turbulent barrier. Again, the buffeting

solar wind shifted the bow shock back and forth across the spacecraft at irregular intervals. The bow shock had never been seen before in such detail.

The first observations of the north polar cusp were made on 14 January 2001, when shifts in the solar wind caused the spacecraft to pass right through this narrow 'window' in the magnetic envelope at an altitude of about 64 000 km. The EISCAT ground-based radar in Svalbard, which lay beneath the Cluster spacecraft at that time, confirmed the abrupt change in the cusp's position.

The different data sets are providing valuable new insights into the physical processes in these key regions above the Earth's magnetic poles. This very dynamic region had been studied previously only by single satellites.

During 10 May - 3 June 2001, 28 burns (consuming 2.7 kg propellant) increased the satellite separations to 2000 km for 6 months of magnetotail observations. By August, the apogee was centred in the tail.

In January 2002, the separation was reduced to 100 km (consuming 3.1 kg propellant) to study the cusp and bow shock in great detail. This will be the smallest separation of the whole mission. On 18 March 2002, Cluster made a breakthrough in understanding a puzzling type of aurora. It observed protons leaking through the magnetosheath during a magnetic reconnection event, just as NASA's IMAGE satellite witnessed a 'dayside proton auroral spot' in the ionosphere. This first direct link between the two has opened a new area of research: these aurorae show where and for how long cracks appear in the magnetic shield.

In February 2002, the SPC approved extension of the mission from January 2003 to December 2005, plus a second ground station (Maspalomas, Canary Islands, began 15 September 2002) to double the data return, along the whole orbit. In February 2005, the mission was extended to December 2009.

In June-July 2002 separation was increased (6 kg propellant) to 4000 km for tail measurements. During 4 June - 7 July 2003, each satellite made about 10 burns (7.3 kg propellant) to achieve 250 km in order to study the tail in the greatest detail of the mission, followed 6 months later by further cusp measurements. During June-July 2004, the line of apsides was changed and separation increased (10.1 kg propellant) to 1100 km for more tail measurements. By 14 July 2005, C3 & C4 were paired at 1000 km while the others remained at 10 000 km for the first-ever multi-scale measurements. In later 2005, a 10 000 km separation for all will allow



The mating of the ring-shaped main equipment platform of FM6 with its cylindrical central section took place on 2 November 1998 at prime contractor Dornier Satellitensysteme in Friedrichshafen, Germany. A team of about 30 spent the next 2 months attaching the 11 scientific experiments to the aluminium structure and completing assembly. Several more months of testing followed before the spacecraft was delivered to IABG in Munich for further trials. Facing page: at Baikonur preparing for launch.

Double Star: Two More Cluster-type Satellites

Cluster has been joined by China's two Double Star (DSP) satellites carrying some Cluster flight spare instruments to provide complementary observations from equatorial and polar orbits, respectively. The eight European instruments are ASPOC, FGM, PEACE, STAFF-DWP, Hot Ion Analyser and Neutral Atom Imager. The 350 kg Tan Ce 1 ('Explorer') was launched 29 December 2003 on a CZ-2C vehicle from Xichang into 555x78 051 km, 28.5°. Science operations began February 2004; planned life was 18 months but extended in May 2005 to December 2006. The STAFF boom failed to deploy but data are still being returned. The 343 kg TC 2 was launched 25 July 2004 on a CZ-2C from Taiyuan into 666x38 566 km, 90.1°. Science operations began October 2004; planned life is 12 months (both attitude-control computers failed within 2 weeks of launch; 1-yr life can be achieved despite slow drift of spin axis).

The agreement with the Chinese National Space Administration was signed at ESA HQ on 9 July 2001; the ESA cost of €8 million includes 4 h/day data reception.

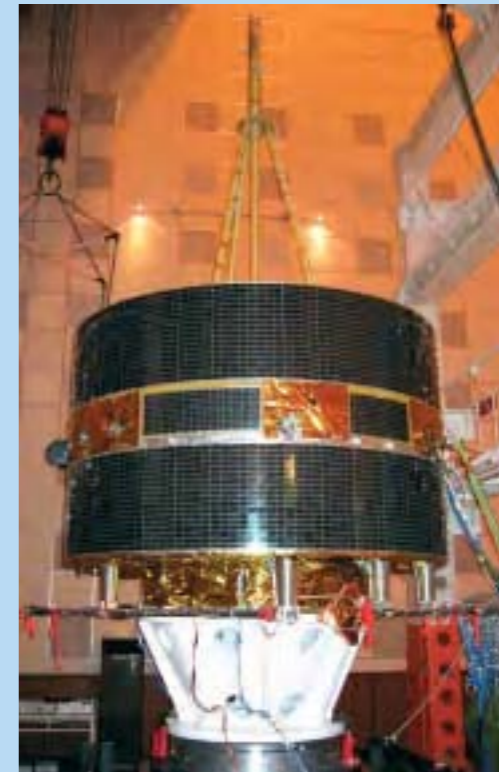

large-scale observations in the dayside magnetosphere and solar wind. The apogee will be allowed to drift naturally to the southern hemisphere to probe regions for the first time with multiple satellites. For

example, Cluster will cross the low-altitude auroral zone where electrons are accelerated to high energies before pouring into the atmosphere, causing intense auroras and transmitting strong radio waves.





FM1-FM4 at IABG in Ottobrun, Germany. (DASA)

Satellite configuration: spin-stabilised 2.9 m-dia cylinder, 1.3 m high, with conductive surfaces, solar array mounted on body, two 5 m-long radial booms carry magnetic field instruments, two pairs of 100 m tip-to-tip wire antennas for electric field measurements. The structure is based around a central CFRP cylinder supporting the main equipment platform (MEP), an aluminium-skinned honeycomb panel reinforced by an outer aluminium ring, supported by CFRP struts connected to the cylinder. Six cylindrical titanium propellant tanks with hemispherical ends are each mounted to the central cylinder via four CRFP struts and a boss. Six curved solar-array panels together form the outer cylindrical shape of the spacecraft body and are attached to the MEP. The MEP provides the mounting area for most of the spacecraft units, the payload units being accommodated on the upper surface and the subsystems, in general, on the lower surface. The five batteries and their regulator units that power the spacecraft during eclipse are mounted directly on the central cylinder.

Attitude/orbit control: spin-stabilised at 15 rpm in orbit; attitude

determination better than 0.25° by star mapper and Sun sensor. RCS of eight 10 N MON/MMH thrusters. Single 400 N MON/MMH motor raised parking orbit into operational orbit in five firings consuming 500 kg propellant (~63 kg left for constellation and other manoeuvres).

Power system: silicon-cell solar array on cylindrical body sized to provide 224 W (payload requires 47 W); five silver-cadmium batteries totalling 80 Ah provide eclipse power

Communications: science data rate transmitted at 16.9 kbit/s realtime (105 kbit/s burst mode) or stored on two 3.7 Gbit (2.25 Gbit FM1-FM4) SSRs for later replay. Telemetry downlink 2-262 kbit/s at S-band (2025-2110/2200-2290 MHz up/down) at 10 W. Data from four satellites synchronised via highly stable onboard clock and time stamping at ground stations. Operated from ESOC via Villafranca & Maspalomas (E). Science operations coordinated through a Joint Science Operations Centre in the UK; data distributed via Cluster Science Data System (CSDS), using internet to transfer to centres in Austria, France, Germany, Hungary, Scandinavia, Netherlands, UK, China and US.



Cluster FM3 at prime contractor Dornier. (DASA)



The five Wave Experiment Consortium instruments on Cluster-II. 1: Spatio-Temporal Analysis of Field Fluctuations (STAFF). 2: Electrical Field & Wave (EFW). 3: Digital Wave Processing (DWP). 4: Waves of High Frequency and Sounder for Probing of Density by Relaxation (WHISPER). 5: Wideband Data (WBD). (ESA/VisuLab)

Cluster Scientific Instruments (identical on each satellite)	
FGM	Fluxgate Magnetometer (2 on 5 m boom; DC to ~10 Hz). PI: A. Balogh, Imperial College, UK
STAFF	Spatio-Temporal Analysis of Field Fluctuations (3-axis search coil on 5 m boom; wave form to 10 Hz). PI: N. Cornilleau-Wehrin, CETP, F
EFW	Electric Fields & Waves (paired 88 m wire booms; wave form to 10 Hz). PI: M. Andre, IRFU, S
WHISPER	Waves of High Frequency and Sounder for Probing of Density by Relaxation (total electron density, natural plasma waves to 400 kHz). PI: P.M.E. Décréau, LPCE, F
WBD	Wide Band Data (high frequency electric fields of several 100 kHz). PI: D.A. Gurnett, Iowa Univ., USA
DWP	Digital Wave Processor (controls STAFF, EFW, WHISPER, WBD wave consortium experiments). PI: H. Alleyne, Sheffield Univ., UK
EDI	Electron Drift Instrument (measurement of electric field by firing electron beam in circular path for many tens of km around satellite, detector on other side picks up return beam; 0.1-10 mV/m, 5-1000 nT). PI: G. Paschmann, MPE, D
CIS	Cluster Ion Spectrometry (composition/dynamics of slowest ions, 0-40 keV/q). PI: H. Rème, CESR, F
PEACE	Plasma Electron/Current Analyser (distribution, direction, flow and energy distribution of low/medium-energy electrons; 0-30 keV). PI: A. Fazakerley, MSSL, UK
RAPID	Research with Active Particle Imaging Detectors (energy distribution of 20-400 keV electrons & 2-1500 keV/nucleon ions). PI: P. Daly, MP Ae, D
ASPOC	Active Spacecraft Potential Control (removal of satellite excess charge by emitting indium ions, current up to 50 mA). PI: K. Torkar, IWF, A

Huygens

Achievements: most distant lander, first probe to Titan, first ESA lander and planetary mission

Launch: 08.43 UT 15 October 1997 by Titan-4B from Cape Canaveral Air Force Station, Florida

Mission end: 14 January 2005 (Titan entry/descent/landing); Cassini 1 July 2008

Launch mass: 348.3 kg total (318.3 kg entry Probe; 30.0 kg Orbiter attachment).

Cassini/Huygens total launch mass 5548 kg

Orbit: interplanetary, using gravity assists at Venus (26 April 1998; 24 June 1999), Earth (18 August 1999) and Jupiter (30 December 2000)

Principal contractors: Aerospaziale (prime, thermal protection, aerothermodynamics); DASA (system integration & test; thermal control)

The Huygens Probe was ESA's element of the joint Cassini/Huygens mission with NASA/ASI to the Saturnian system. Huygens was carried by NASA's Orbiter to Saturn, where it was released to enter the atmosphere of Titan, the planet's largest satellite and the only moon in the Solar System with a thick atmosphere. The Probe's primary scientific phase came during the 148 min parachute descent, when the six sophisticated instruments studied the complex atmosphere's chemical and physical properties. Although Titan is too cold (-180°C at the surface) for life to have evolved, it offers the unique opportunity for studying pre-biotic chemistry on a planetary scale in a cold environment with no liquid water.

ESA cost-at-completion was €363.8 million (2004 conditions).

The Cassini/Huygens spacecraft arrived at Saturn in late June 2004, and fired its main engine as it crossed the ring plane on 1 July 2004, setting up an initial 117-day orbit. A second burn, on 23 August, shifted the trajectory towards Titan; a final correction on 17 December during the third orbit around Saturn set up the entry trajectory. On 25 December 2004, Cassini turned to orient Huygens to its entry attitude, spun it up to 7.5 rpm (confirmed by Cassini's magnetometer detecting

Huygens' rotating weak magnetic field) and released it at 0.35 m/s. Huygens hit the atmosphere at 6 km/s at an entry angle of -65.2° , aiming for a dayside landing at $10.2^{\circ}\text{S}/190.7^{\circ}\text{W}$.

The entry configuration consisted of the 2.75 m-diameter 79 kg 60° half-angle conical front heatshield and the aluminium back cover, providing thermal protection as Huygens decelerated to 400 m/s (Mach 1.5) within 4.7 min as it reached 155 km altitude. At this point, the parachute deployment sequence began as a mortar extracted the 2.59 m-diameter pilot chute which, in turn, pulled away the back cover. After inflation of the 8.30 m-diameter main parachute to decelerate and stabilise Huygens through the transonic region, the front shield was released at Mach 0.6 to fall from the Descent Module (DM). Then, after a 30 s delay to ensure that the shield was sufficiently far below the DM to avoid instrument contamination, the GCMS and ACP inlet ports were opened and the HASI booms deployed. The main chute was sized to pull the DM safely from the front shield; it was jettisoned after 15 min to avoid a lengthy descent and a smaller 3.03 m-diameter parachute was deployed. Resources were sized, with a comfortable margin, for a maximum descent of 150 min and at least 3 min on the

captions overpage

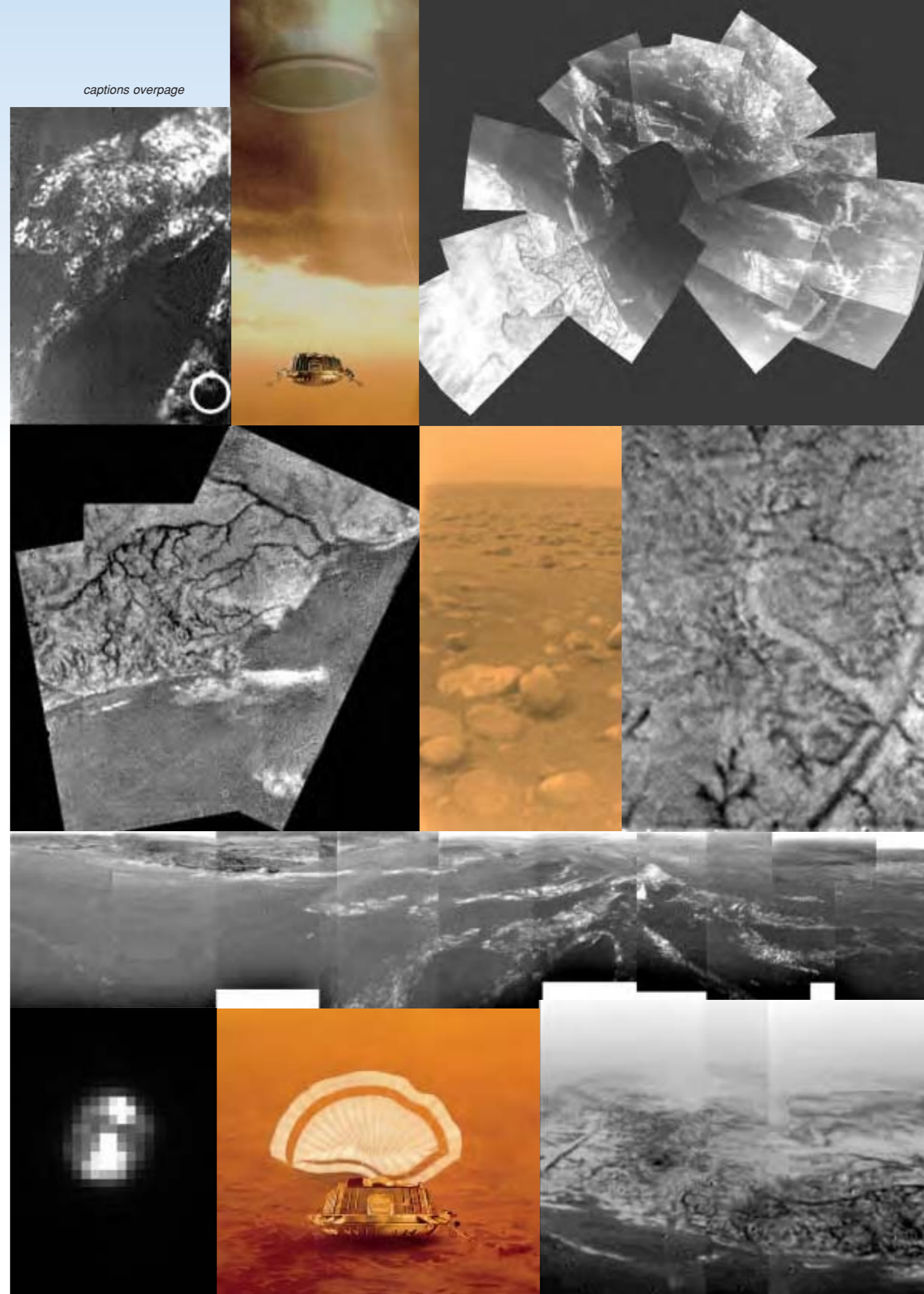

surface. After separation from the Orbiter, Huygens' only power was from five lithium batteries. Instrument operations followed either a time sequence in the higher descent or the radar-measured altitude further down. Huygens operated autonomously after Orbiter separation, the radio link being one-way for telemetry only. Until separation, telecommands could be sent via an umbilical from the Orbiter (which also provided power), but this was used only during cruise for Huygens' biannual check-outs. There were no scientific measurements before Titan arrival and Huygens was dormant for most of the 4 billion km cruise. During the 21-day coast after Orbiter separation, only the triple timer was active, waking up Huygens 264 min before entry, giving time for the probe to warm up. Setting the timer and conditioning the batteries were the last commands sent from ESOC.

Huygens was designed to make a detailed in situ study of Titan's atmosphere and to characterise the surface along the descent ground track and near the landing site. After parachute deployment, all of the instruments had direct access to the atmosphere to make detailed measurements of structure, composition and dynamics. Images and other surface remote sensing measurements were also made. Before the mission, it was hoped that Huygens would survive the 5 m/s impact for at least 3 min, allowing direct characterisation of the surface for 30-45 min before the batteries expired.

At launch, Huygens was scheduled to arrive at Titan on 27 November 2004. But the approach following

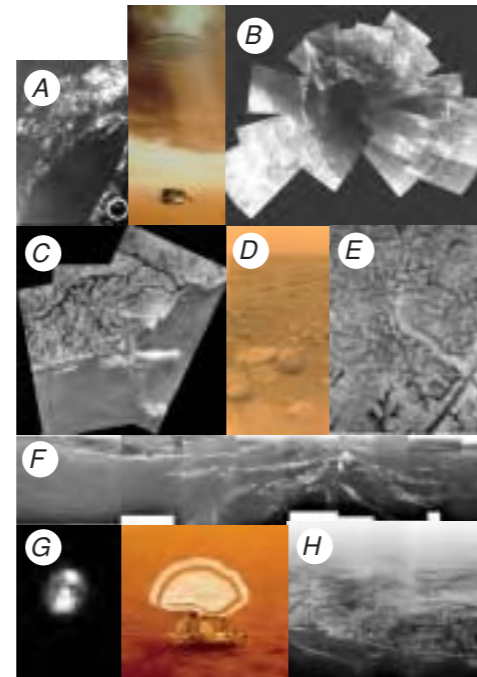

A: The first best-guess of Huygens' landing site.
 B: A 30-image composite varying in altitude from 13 km to 8 km. Resolution is 20 m/pixel, covering an area extending to 30 km. Descent speed at this time was 6 m/s.
 C: Methane rain seems to have washed the water-ice highlands clean of the 'tarry gunk' settling down from the atmosphere. Drainage channels take it into the now-dry major river channel.
 D: The first colour view of the surface, created using DISR's reflection spectra data. The nearby water-ice 'rocks' are about 15 cm across and show evidence of erosion at their bases, suggesting fluvial activity.
 E: Water ice and methane springs. A bright linear feature suggests water ice extruded onto the surface. Stubby dark channels might have been formed by springs of liquid methane.
 F: A full panorama from Huygens at 8 km altitude and 20 m/pixel resolution. The white streaks near the light/dark boundary at left could be a ground fog of methane or ethane vapour. As Huygens descended, it drifted over a plateau (centre) and headed towards its landing site in a dark area (right of centre). This dark area is possibly a drainage channel.
 G: Cassini imaged Huygens from 18 km about 12 h after release, confirming the probe was on target.
 H: A composite view from about 8 km altitude, with 20 m/pixel resolution. The brighter higher ground is linked to the darker low ground by what appear to be drainage channels.
 (ESA/NASA/JPL/U. Arizona)

arrival at Saturn had to be redesigned in 2001 in order to reduce the Doppler shift of the radio signal received by the Orbiter because of a design flaw discovered in the Huygens radio receiver during inflight testing in 2000. Twice a year, Huygens was activated for 3 h and checked out, allowing regular calibration of the instruments and subsystems. An end-to-end test of the radio relay

Huygens Events at Saturn/Titan

1 Jul 2004: Cassini/Huygens enters orbit around Saturn. One of two redundant 445 N engines fired beginning 02:36 for 96 min to brake by 626 m/s for Saturn Orbit Insertion (SOI), entering an 80731 x 9091186 km, 117-day, 11.5° initial orbit (distances from Saturn centre), consuming 830 kg of the 3000 kg main propellant supply. Mission's closest approach was 19 980 km above the cloud tops at 04:03.

14 Jul: Huygens checkout 14.

23 Aug: 51-min, 393 m/s Periapse Raise Maneuver (PRM) raises periapsis to 498 970 km to set up the first Titan encounter.

14 Sep: Huygens checkout 15.

19 Sep: Huygens batteries activated for first time since launch, to remove 'passivation' chemical layer from electrodes.

26 Oct: 1st Titan flyby, 1174 km altitude at 16:44.

23 Nov: Huygens checkout 16.

3 Dec: 'go' given for Huygens baseline mission.

5 Dec: 2nd battery depassivation sequence.

13 Dec: 2nd Titan flyby, 1200 km altitude at 11:38.

17 Dec: 11.9 m/s 84.9 s Probe Targeting Manoeuvre (PTM) burn by Cassini sets up Titan impact.

17 Dec: 'go' given for Huygens release activities.

21 Dec: triple timers activated.

23 Dec: final PTM clean-up tweak by Cassini.

25 Dec: Huygens separation, at 02:00, at 7.5 rpm & 0.35 m/s.

27 Dec: 23.7 m/s 153.4 s Orbiter Deflection Maneuver (ODM) burn moves Cassini path away from Titan impact, and sets up the flyby trajectory for Huygens' descent.

14 Jan 2005:
 04:41:33 Huygens wake-up by triple timers.

07:02 Cassini turns main antenna towards Titan (closest approach 60000 km).

09:05:56 Huygens reaches entry reference altitude at 1270 km.

09:10:21 entry ends with pilot 'chute release at ~155 km & 400 m/s (Mach 1.5), followed 2.5 s later by aft cover release and 8.30 m 'chute deployment.

09:10:52 heat shield is released at ~150 km.

09:11:11 GCMS inlet/outlet ports opened; HASI booms deployed.

09:11:28 DISR cover ejected.

09:12:51 ACP cover ejected.

09:25:21 3.03 m 'chute deploys at ~115 km altitude.

~10.25 Green Bank (USA) radio telescope detects carrier signal; first indication that Huygens has survived entry and is active.

11:36:05 DISR lamp activates at 700 m altitude to illuminate surface.

11:38:11 Huygens lands on Titan at ~5 m/s, 10.5-11.0°S/192-193°W (final analysis awaited).

12:50:24 Cassini reception ends when it dips below Huygens' horizon.

13:59 Cassini turns to Earth to begin transmitting stored 474 Mbit Huygens data.

15:24 first Cassini data arrive on Earth; Huygens data begin arriving ~45 min later; first assessment of Huygens housekeeping data at 16:15 shows probe has operated correctly.

15:55 Parkes (Australia) radio telescope is still detecting Huygens transmission (14:48 tx time) when it has to stop listening.

18:00 reception of first dataset is completed.

15 Feb: 3rd Titan flyby, 1577 km altitude. 41 more flybys planned for 2005-2008.

All times UT actual.

Huygens' Descent Module is attached to the rear of the front shield, which protected it from the intense heat of entry. The central canister contained the mortar that began the 148-min parachute descent phase by firing a small deployment parachute through a membrane in the centre of the back cover (at left), which then itself was detached by the parachute's drag. The main and stabiliser 'chutes were stored in the large box. Also visible on the DM's top face are the two redundant (black conical) antennas that transmitted the data back to the Cassini Orbiter. At top left is the CD carrying more than 100 000 signatures and messages.

Cassini/Huygens required several planetary swingbys to gain sufficient speed to reach Saturn within 7 years.

Bottom view of Huygens' Experiment Platform. The red cylinder is part of the SSP; the black cylinder is the GCMS; the black box is the ACP. The silver boxes are the batteries, connected to the power distribution unit (green box).

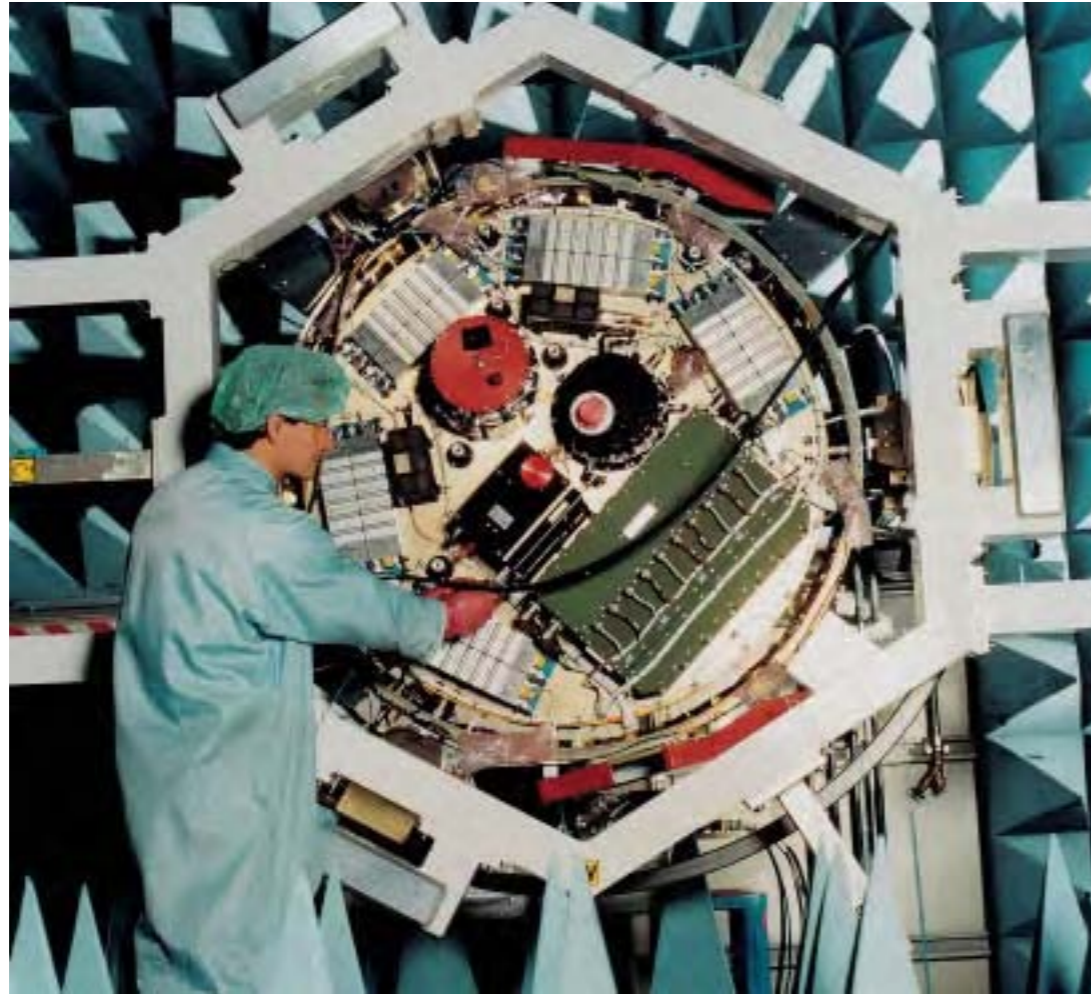

Cassini/Huygens path after Saturn Orbit Insertion (SOI). ODM: Orbiter Deflection Maneuver; PRM: Perigee Raise Maneuver; PTM: Probe Target Maneuver.

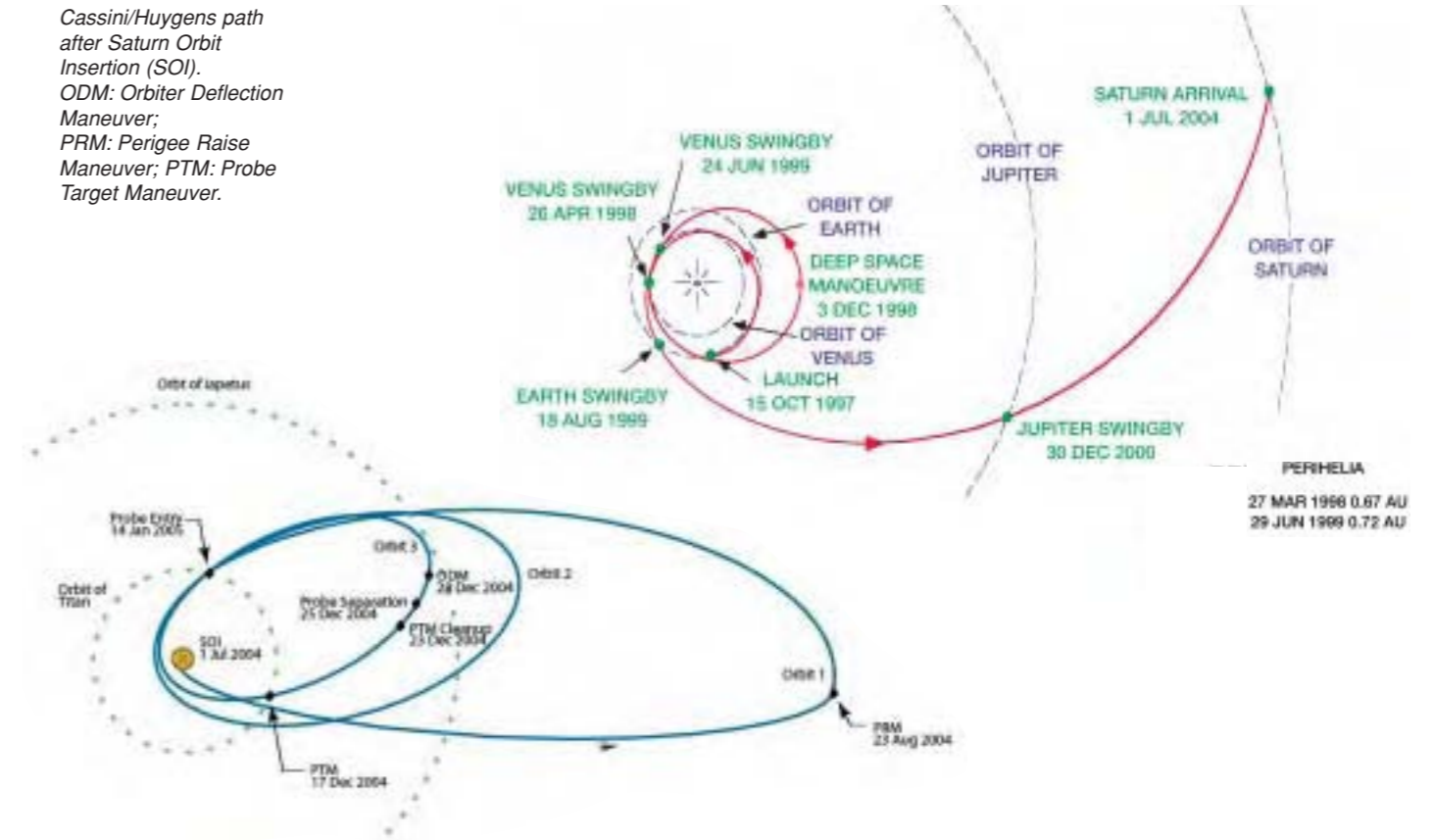

link during the 5th checkout, in February 2000 (supported by further tests using the Probe Engineering Model at ESOC in September-December 2000) revealed that the bandwidth of the Huygens receiver on Cassini was too narrow to cope with the expected Doppler shift during descent. As a result, Cassini's flyby was moved much further out from Titan to reduce the Doppler shift. Huygens' onboard software and that of several instruments was also modified in December 2003 to optimise the signal.

The descent proved to be bumpier than expected, with Huygens swinging up to 20° before stabilising; there may have been an unexpected change in wind profile at about 25 km. After 10 min under the main parachute, Huygens' spin reversed for reasons yet to be explained. The atmosphere was probed and sampled all the way from 145 km altitude to ground level, revealing a uniform mix of methane with nitrogen in the stratosphere. The methane concentration increased steadily in the troposphere and down to the surface. A cloud layer was found at about 20 km, and perhaps fog near the surface. Unexpectedly, GCMS found only argon of the inert gases, perhaps implying that Titan went through a hot phase that drove such gases from the atmosphere. During the descent, HASI's microphone provided the sound backdrop. It listened for thunder in a search for

More than 474 Mbit were received from Huygens, including some 350 images collected during the descent and on the surface, which revealed a landscape apparently modelled by erosion, with drainage channels, shoreline-like features and even pebble-shaped objects.

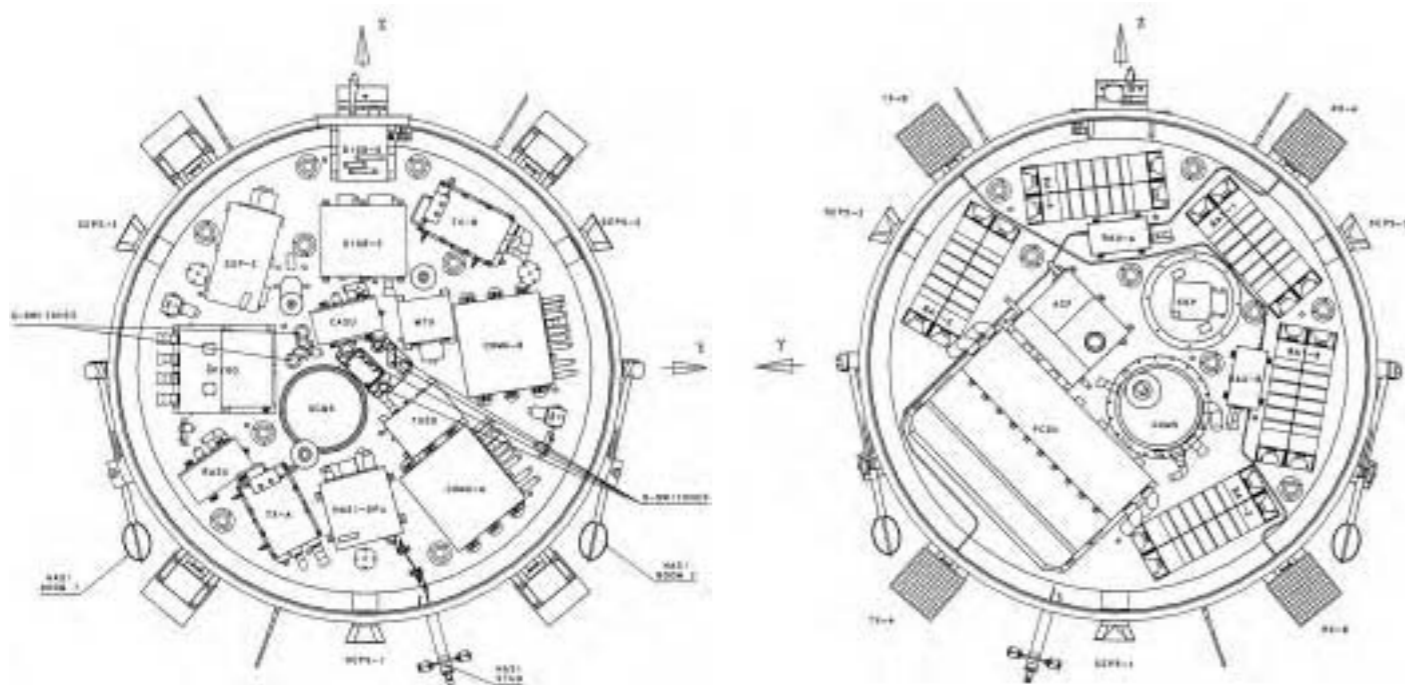

lightning; although none was immediately apparent, the analysis continues.

Spectacular images from DISR reveal that Titan has extraordinarily Earth-like meteorology and geology. A complex network of narrow drainage channels run from brighter highlands to lower, flatter, dark regions. These channels merge into river systems running into lakebeds featuring offshore 'islands' and 'shoals' remarkably similar to those on Earth. We now have the key to understanding what shapes Titan's landscape; geological evidence for precipitation, erosion, mechanical abrasion and other fluvial activity says that the physical processes shaping Titan are much the same as those on Earth. Huygens' data show strong evidence for liquids flowing on Titan. However, the fluid is methane, a simple organic compound that can exist as a liquid or gas at Titan's very low temperatures, rather than water as on Earth. Titan's rivers and lakes appear to be dry at the moment, although the landing site was wet with methane, so it may have rained not long ago.

As Huygens touched down, SSP provided a large amount of deceleration and penetration data on the texture of the surface, which resembles wet sand or clay with a thin solid crust. DISR measurements showed mainly a mix of dirty water ice and hydrocarbon ice, producing a darker 'soil' than expected. The temperature measured at ground level was 94K. Huygens settled 10-15 cm into the surface.

Heat generated by Huygens warmed the soil beneath the probe and both GCMS and SSP detected bursts of methane gas boiled out of surface

material. DISR surface images show small rounded pebbles in a dry riverbed. DISR colour spectra measurements are consistent with dirty water ice rather than silicate rocks. However, water-ice is rock-like in Titan's climate. The soil consists at least in part of precipitated deposits of the organic haze that shrouds the planet. This dark tarry gunk' settles out of the atmosphere. When washed off high elevations by methane rain, it concentrates at the bottom of the drainage channels and riverbeds, contributing to the dark areas seen in DISR images.

Thus, while many of Earth's familiar geophysical processes occur on Titan, the chemistry involved is quite different. Instead of liquid water, Titan has liquid methane. Instead of silicate rocks, Titan has hard water-ice. Instead of dirt, Titan has hydrocarbon particles settling out of the atmosphere, and instead of lava, perhaps there are Titanian volcanoes spewing very cold ice. Titan is therefore an extraordinary world, having Earth-like geophysical processes operating on exotic materials in very alien conditions.

Generation of the wind profiles accurate to 1 m/s took longer because human error meant that data channel A, the only one with the ultra-stable receiver required by DWE, was never activated aboard Cassini. It was expected, though, that DWE's objectives would be fully satisfied by the Earth network of 17 radio telescopes using VLBI (Very Long Baseline Interferometry) on Huygens' carrier signal. A bonus set of 350 DISR images interpolated between the received images was also lost, as was some HASI data; the other instruments duplicated their data on the two channels.

Further information can be found at <http://sci.esa.int/huygens> and in Huygens: Science, Payload and Mission, ESA SP-1177, August 1997.

The Principal Characteristics of the Huygens Payload.

Instrument/ Principal Investigator	Science objectives	Sensors/measurements	Mass (kg)	Power (typical/ peak, W)	Participating countries
Huygens Atmospheric Structure Instrument (HASI) M. Fulchignoni, University Paris 7/ Obs. Paris-Meudon (France)	Atmospheric temperature and pressure profile, winds and turbulence Atmospheric conductivity. Search for lightning. Surface permittivity and radar reflectivity.	T: 50-300K, P: 0-2000 mbar γ : 1 μ g-20 mg AC E-field: 0-10 kHz , 80 dB at 2 μ V/m Hz DC E-field: 50 dB at 40 mV/m Conductivity 10 ⁻¹⁵ Ω /m to ∞ Relative permittivity: 1 to ∞ Acoustic: 0-5 kHz, 90 dB at 5 mPa	6.3	15/85	I, A, D, E, F, N, SF, USA, UK, ESA/RSSD, IS
Gas Chromatograph Mass Spectrometer (GCMS) H.B. Niemann, NASA/GSFC, Greenbelt (USA)	Atmospheric composition profile. Aerosol pyrolysis products analysis.	Mass range: 2-146 dalton Dynamic range: >10 ⁸ Sensitivity: 10 ⁻¹⁰ mixing ratio Mass resolution: 10 ⁻⁶ at 60 dalton GC: 3 parallel columns, H ₂ carrier gas Quadropole mass filter 5 electron impact sources Enrichment cells (\times 100- \times 1000)	17.3	28/79	USA, A, F
Aerosol Collector and Pyrolyser (ACP) G.M. Israel, SA/CNRS Verrières-le-Buisson (France)	Aerosol sampling in two layers – pyrolysis and injection to GCMS	2 samples: 150-40 km; 23-17 km 3-step pyrolysis: 20°C, 250°C, 600°C	6.3	3/85	F, A, USA
Descent Imager/Spectral Radiometer (DISR) M.G. Tomasko, University of Arizona, Tucson (USA)	Atmospheric composition and cloud structure. Aerosol properties. Atmospheric energy budget. Surface imaging.	Upward and downward (480-960 nm) and IR (0.87-1.64 μ m) spectrometers, res. 2.4/6.3 nm. Downward and side imagers. (0.660-1 μ m), res. 0.06-0.20° Solar Aureole measurements: 550 \pm 5 nm, 939 \pm 6 nm. Surface spectral reflectance with 25 W surface lamp.	8.1	13/70	USA, D, F
Doppler Wind Experiment (DWE) M.K. Bird, University of Bonn (Germany)	Probe Doppler tracking from the Orbiter for zonal wind profile measurement.	(Allan Variance) : 10 ⁻¹¹ (1 s); 5 \times 10 ⁻¹² (10 s); 10 ⁻¹² (100 s) Wind measurements 2-200 m/s Probe spin, signal attenuation	1.9	10/18	D, I, USA
Surface Science Package (SSP) J.C. Zarnecki, Open University, Milton Keynes (UK)	Titan surface state and composition at landing site. Atmospheric measurements.	γ : 0-100 g; tilt \pm 60°; T: 65-110K; T _{th} : 0-400 mW m ⁻¹ K ⁻¹ Speed of sound: 150-2000 m s ⁻¹ , Liquid density: 400-700 kg m ⁻³ Refractive index: 1.25-1.45 Acoustic sounding, liquid relative permittivity	3.9	10/11	UK, F, USA, ESA/RSSD, PL



Cassini/Huygens installed on their launch vehicle.

for release. 36 peripheral DM vanes ensured slow spin (1-2 rpm < 20 km altitude) during descent for azimuthal coverage of some instruments.

Power system: five LiSO₂ batteries to provide total of 2060 Wh, beginning shortly before release: 0.3 W for 21-day coast (to power wake-up timers), 90 W for pre-heating, 210-330 W for descent and ~260 W after landing.

Thermal protection/control: tiles of AQ60 ablative material, a felt of silica fibres reinforced by phenolic resin, glued to the front shield's CFRP honeycomb shell to protect against the 1 MW/m² entry flux. Prosiol, a suspension of hollow silica spheres in silicon elastomer, was sprayed directly on to the shield's rear aluminium structure, where fluxes were ten times lower. The back cover was protected by 5 kg of Prosiol. In space, Huygens was insulated from the Orbiter and protected against variations in solar heating (3800 W/m² near Venus, reducing to 17 W/m² near Titan) by: multi-layer insulation on all external areas (except for a 0.17 m² white-painted thin aluminium sheet on the front shield's outer face as a controlled heat leak – about 8 W during cruise); 35 radioisotope heaters on the Experiment and Top Platforms provided continuous 1 W each.

Communications payload: two hot-redundant S-band 10 W transmitters and two circular-polarisation antennas (LHCP 2040 MHz; RHCP 2098 MHz) on Huygens broadcast data at 8 kbit/s 41.7 dBm EIRP beginning shortly before entry. No onboard storage. Received by Cassini HGA, recorded and later relayed to Earth (command error failed to activate LHCP receiver).

Huygens configuration: the Probe consisted of the Entry Assembly (ENA) cocooning the Descent Module (DM). ENA provided Orbiter attachment, umbilical separation and ejection, cruise and entry thermal protection, and entry deceleration control. It was jettisoned after entry, releasing the DM. The DM comprised an aluminium shell and inner structure containing all the experiments and support equipment, including the parachutes. The DM was sealed except for a 6 cm² vent hole on the top, and comprised: 73 mm-thick aluminium honeycomb sandwich Experiment Platform (supporting most experiments and subsystems); 25 mm-thick aluminium honeycomb sandwich Top Platform, forming the DM's top surface (descent system and RF antennas); After Cone and Fore Dome aluminium shells, linked by a central ring.

Attitude/orbit control: provided by Cassini orbiter; spun up to 7.5 rpm

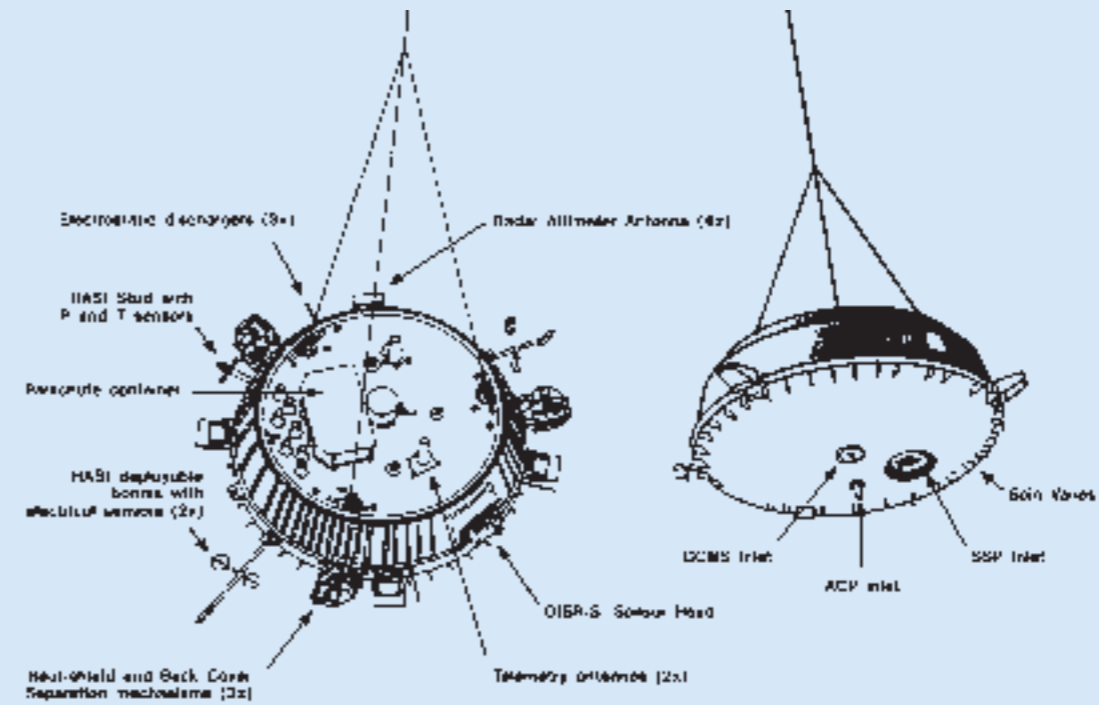

The Descent Module under its parachute. The HASI booms are deployed and the DISR sensor head can be seen. At right, the GCMS, ACP and SSP view through the fore dome.

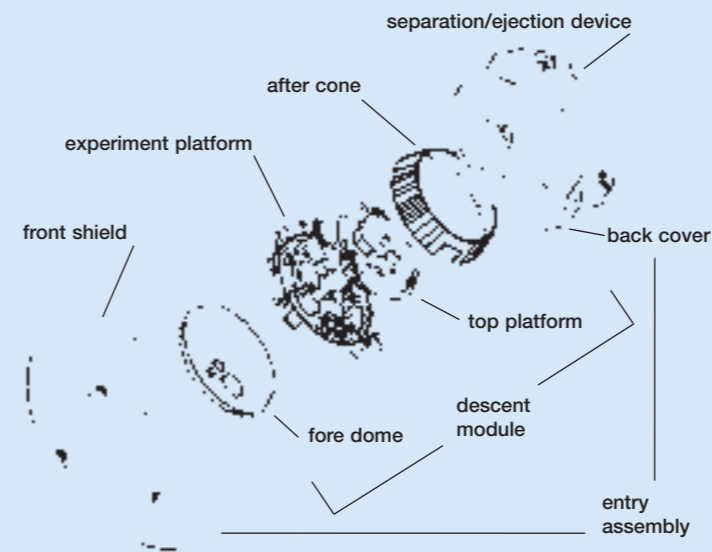

Cassini, with Huygens mounted on the side, is lowered on to its launch vehicle adapter in the Payload Hazardous Servicing Facility at the Kennedy Space Center. The Huygens Engineering Model is in the Huygens Probe Operations Centre (HPOC) at ESOC, used as a testbed during the cruise to Saturn. (NASA)



TeamSat

Achievements: developed in record time and cost; demonstrated new technologies
Launch date: 30 October 1997
Mission end: 2 November 1997 (after 3 days when battery expired)
Launch vehicle/site: Ariane-502 from ELA-3, Kourou, French Guiana
Launch mass: 350 kg
Orbit: 540x26 635 km, 8°
Principal contractor: ESTEC

TeamSat (Technology, Science and Education Experiments Added to Maqsat) was an initiative of ESTEC's Automation and Informatics Department in response to an invitation from ESA's Launchers Directorate to add experiments to one of the Maqsat instrumented mockups on the Ariane-502 test flight. A principal objective was hands-on involvement of young trainee engineers at ESTEC. The payload was produced in the unprecedented short time of only 7 months from start (December 1996) to readiness (July 1997). Furthermore, costs were kept to a bare minimum (<ECU1 million) through the use of in-house equipment and spares, support from ESTEC staff and the free launch.

TeamSat was not an independent satellite – most of it remained attached to Ariane's Maqsat-H monitoring payload. The five experiments were (in order of increasing complexity):

Orbiting Debris Device (ODD): Maqsat-H was painted 75% white/25% black for optical tracking of the spinning object to help calibrate ground-based telescopes and radars for space debris tracking. Other studies included paint degradation;

Autonomous Vision System (AVS): a camera that automatically recognised a non-stellar object and could be used to determine attitude

accurately; it could thus be used for navigation and imaging purposes (Technical University of Denmark);

Visual Telemetry System (VTS): a system of three cameras with an image compression and storage unit that recorded images of the fairing and satellite separation after launch (Catholic University of Leuven);

Flux Probe Experiment (FIPEX): measured the concentration of atomic oxygen up to altitudes of 1000 km. Atomic oxygen is known for its erosion of optical surfaces and lenses;

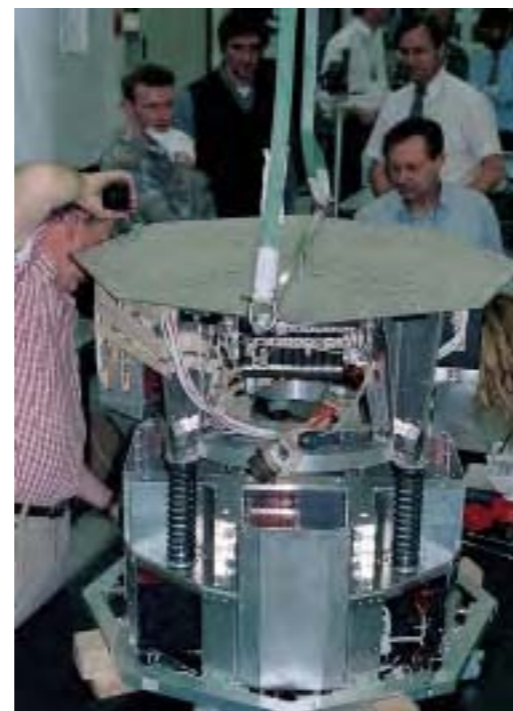

TeamSat's first fit-check in the High Bay of ESTEC's Erasmus building of the Team (top) and YES (Young Engineers' Satellite, bottom) systems with the ejection springs in place. (ESA/Andy Bradford)

Preparing Maqsat-H, with TeamSat attached at bottom, in the Batiment d'Assemblage Final building at Kourou, French Guiana ready for the Ariane-502 launch. (ESA/CNES/CSG)

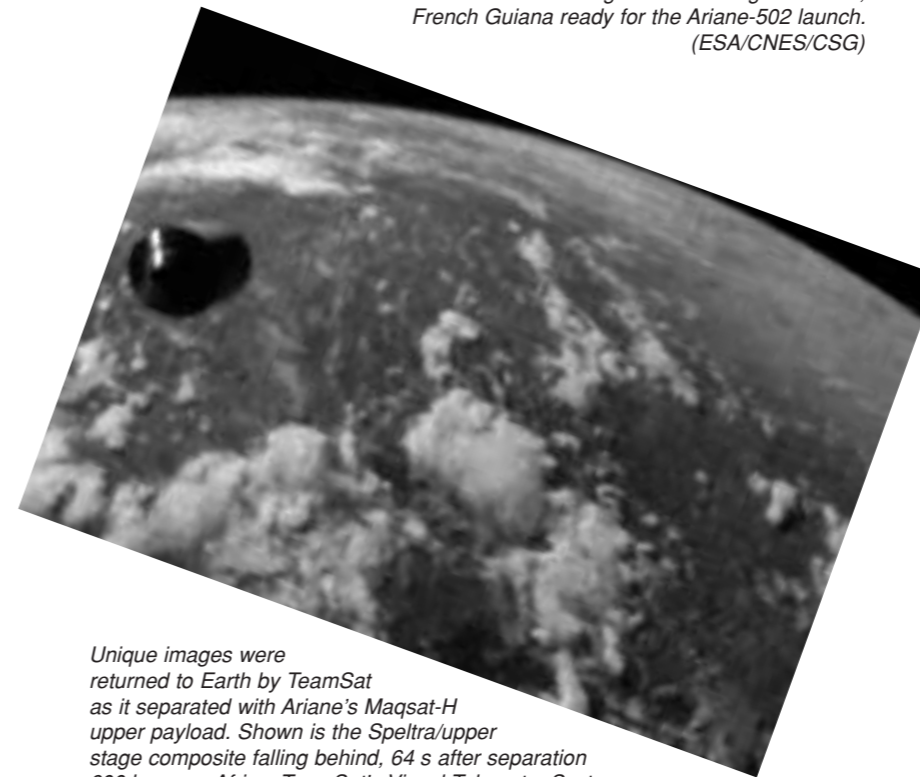

Unique images were returned to Earth by TeamSat as it separated with Ariane's Maqsat-H upper payload. Shown is the Speltra/upper stage composite falling behind, 64 s after separation 600 km over Africa. TeamSat's Visual Telemetry System was designed to acquire image sequences of critical operations. (ESA)



Young Engineers' Satellite (YES): designed, assembled and integrated in record time by young graduates at ESTEC, YES was planned as a tethered subsatellite to be deployed on a 35 km tether. It also contained some additional small experiments, to measure radiation, the solar angle and acceleration in autonomous mode after separation from Maqsat-H. A GPS receiver was also installed, demonstrating the first reception from above the GPS satellite constellation. Unfortunately, the tether was not used because the launch window requirements were changed, resulting in the tether posing a high collision and debris risk. Nevertheless, YES was separated from Maqsat-H (without any tether), and a rehearsal of the tether operations was performed in preparation for a possible future flight.

The whole project, particularly YES, evolved for Young Graduate Trainees and Spanish Trainees to gain valuable experience in designing,

building and integrating a satellite and its payload. Some 43 young engineers from these schemes, as well as from the Technical University of Delft, were involved at different stages during the satellite production.

From the technology point of view, TeamSat's achievements included:

- use of a quadrifilar helix antenna for 100 MHz to 3 GHz links (to be flown on the Metop weather satellite);
- first fully asynchronous ESA CCSDS-standard packet telemetry system, using new chips for telemetry transfer frame generation;
- provision of telemetry dynamic bandwidth allocation without the use of an onboard computer;
- first ESA spacecraft to use the standard packet-telecommand protocols;
- first demonstration of GPS reception from above the GPS satellite constellation.

ARD

Achievements: ESA's first Earth-return craft, first complete space mission (launch to landing) by Europe

Launch date: 16:37 UT, 21 October 1998

Mission end: flight duration 101 min, splashing down at 19:28 UT, 21 October 1998

Launch vehicle/site: Ariane-503 from ELA-3 complex, Kourou, French Guiana

Launch mass: 2716 kg

Orbit: suborbital, apogee 830 km above Indian Ocean (5.40°S/78.5°E)

Principal contractors: Aerospatiale (prime; contract signed 30 September 1994), Alenia (descent & landing system), DASA (RCS), MMS-France (electronics), SABCA & SONACA (structure)



Principal stages in the mission of ARD. (ESA/D. Ducros)

ESA's Atmospheric Reentry Demonstrator (ARD) was a major step towards developing and operating space transportation vehicles capable of returning to Earth, whether carrying payloads or people. For the first time, Europe flew a complete space mission – launching a vehicle into space and recovering it safely.

ARD was an unmanned, 3-axis stabilised automatic capsule launched by an Ariane-5 into a suborbital ballistic path that took it to a height of 830 km before bringing it back into the atmosphere at 27 000 km/h. Atmospheric friction and a series of parachutes slowed it down for a relatively soft landing in the Pacific Ocean, 101 min after launch and three-quarters of the way around the world from its starting point.

ARD's recorded and transmitted telemetry allowed Europe to study the physical environment to which future space transportation systems will be

exposed when they reenter the Earth's atmosphere. It tested and qualified reentry technologies and flight control algorithms under actual flight conditions. In particular, it: validated theoretical aerothermodynamic predictions; qualified the design of the thermal protection system and of thermal protection materials; assessed navigation, guidance and control system performances; assessed the parachute and recovery system; and studied radio communications during reentry. ARD provided Europe with key expertise in developing future space transportation and launch vehicles.

One objective was to validate the flight control algorithms developed as part of the former Hermes spaceplane programme. The guidance algorithm was similar to that used by NASA's Space Shuttle, based on a reference

deceleration profile and also used by Apollo. This approach provided good final guidance accuracy (5 km; achieved 4.9 km) with limited real-time calculation complexity. In order to reach the target and to hold deceleration levels to 3.7 g and thermal flux within acceptable limits, ARD snaked left and right of the direct flight path with the help of the reaction control system (RCS) thrusters.

Another objective was to study communications possibilities during reentry and, in particular, to analyse blackout phenomena and their effects on radio links. Radio blackout was expected between 90 km and 42 km altitude (actual: 90-43 km) as ionisation of the super-heated atmosphere interfered with signals. As soon as ARD reached 200 km, it was in telemetry contact with two US Air Force KC-135 aircraft.

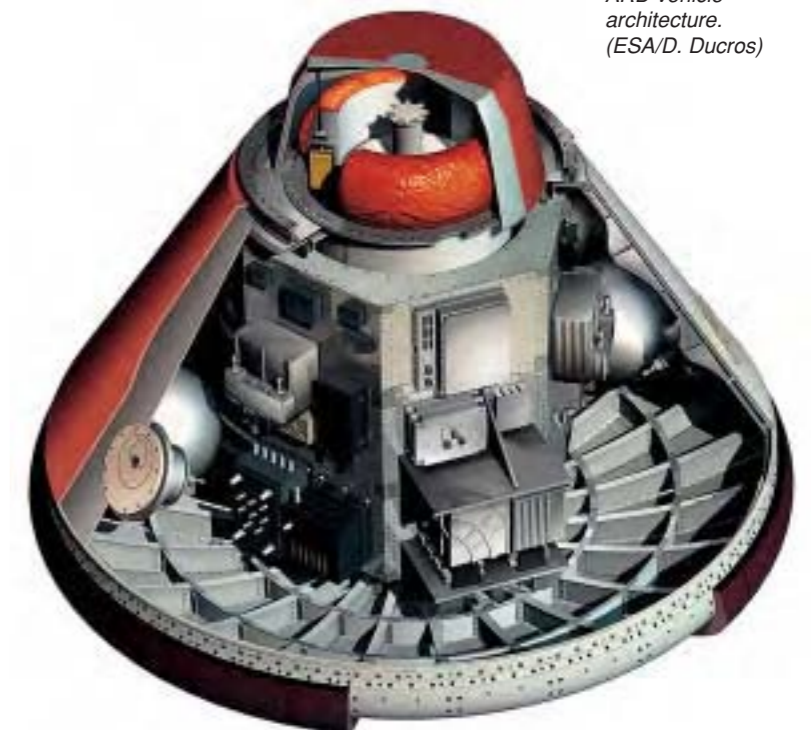

ARD vehicle architecture. (ESA/D. Ducros)



Main image: ARD integrated at Aerospatiale, Bordeaux. The heatshield included samples of new materials. Inset: post-flight measurements showed that the main shield was eroded by only 0.1-0.3 mm.

allowed the capsule's location to be determined within 1500 m. The French naval recovery ship approached within 100 m and then stood off for 6 h so that the capsule's interior could cool below 47°C, the explosive temperature for the remaining RCS hydrazine. The ship delivered ARD to Papeete in Tahiti, from where it was transported by a commercial ship to Europe and returned to Aerospatiale in Bordeaux for inspection and testing.

Vehicle configuration: conical capsule (70%-scale of Apollo Command Module), height 2.04 m, base diameter 2.80 m. Four main elements creating air- and water-tight pressurised structure: bulkhead structure with heatshield; conical section carrying RCS and internal secondary structure; secondary structure holding electrical equipment; back cover protecting descent & recovery systems. All structural elements made of mechanical-fastened aluminium alloy parts.

Thermal protection: heatshield exposed to 2000°C/1000 kW/m², conical surface to 1000°C/90-125 kW/m². Internal temperature within 40°C. 600 kg heatshield composed of 93 Aleastrasil tiles (randomly-oriented silica fibres impregnated with phenolic resin) arranged as one central tile and six circumferential rings. Conical surface coated with Norcoat 622-50FI (cork powder and phenolic resin). Samples of new materials tested: four Ceramic Matrix Composite heatshield tiles and two Flexible External Insulation panels on conical surface.

Control: automatic navigation, guidance and control system

The automatic parachute deployment sequence began at 87 min 56 s at 13.89 km above the Pacific Ocean. In order to avoid tearing the parachutes, the deployment sequence did not begin until the speed fell below Mach 0.7; maximum allowable dynamic pressure was 5000 Pa. The 91 cm-diameter extraction parachute was ejected by a mortar from under the back cover; this then extracted a 5.80 m drogue. That was jettisoned 78 s later at 6.7 km altitude, and a set of three 22.9 m-diameter main parachutes was released. They were reefed and opened in three steps in order to avoid over-stressing the system. They slowed the descent rate to 20 km/h at impact (7.3 g) at 134.0°E/3.90°N, south-east of Hawaii and north-east of the French Marquesa Islands. After landing, these parachutes were separated and two balloons inflated to ensure upright flotation.

Analysis of the telemetry received at the ARD Control Centre in Toulouse

ARD recovery from the Pacific Ocean.



Installation of ARD on its Ariane adapter in the final assembly building at the launch site. The combination was then hoisted on to the launch vehicle. (ESA/CNES/CSG)

ARD has been displayed since June 2002 at the Cité de l'Espace space park in Toulouse: www.cite-espace.com

consisted of Global Positioning System (GPS) receiver, inertial navigation system, computer, data bus and power supply & distribution system, and RCS. RCS was derived from Ariane-5's attitude control system, using seven 400 N thrusters (3 pitch, 2 roll, 2 yaw) drawing on hydrazine carried in two 58-litre tanks pressurised by nitrogen.

Power system: two 40 Ah NiCd Spot-4-type batteries.

Communications: >200 parameters recorded during flight and transmitted to TDRS and USAF aircraft at up to 250 kbit/s during descent below 200 km: 121 temperature channels, 38 pressure, 14 accelerometer and gyro, 8 reflectometer, 5 force measurement, 1 acoustic and functional parameters such as mission sequences.

XMM-Newton

Achievements: high-throughput, broadband (0.1-10 keV), medium resolution (20-30 arcsec) X-ray spectrophotometry and imaging of sources, ranging from nearby stars to quasars

Launch date: 10 December 1999, routine science operations began 1 July 2000

Mission end: 31 March 2008 (nominally 2 yr); 10-yr extended mission possible

Launch vehicle/site: Ariane-504 from ELA-3, Kourou, French Guiana

Launch mass: 3764 kg

Orbit: Ariane delivered it into 838x112 473 km, 40.0°; six apogee burns 10-16 December produced 7365x113 774 km, 38.9°, 48 h

Principal contractors: Dornier Satellitensysteme (prime), Carl Zeiss (mirror mandrels), Media Lario (mirror manufacture/assembly), MMS Bristol (AOCS), BPD Difesa e Spazio (RCS), Fokker Space BV (solar array)

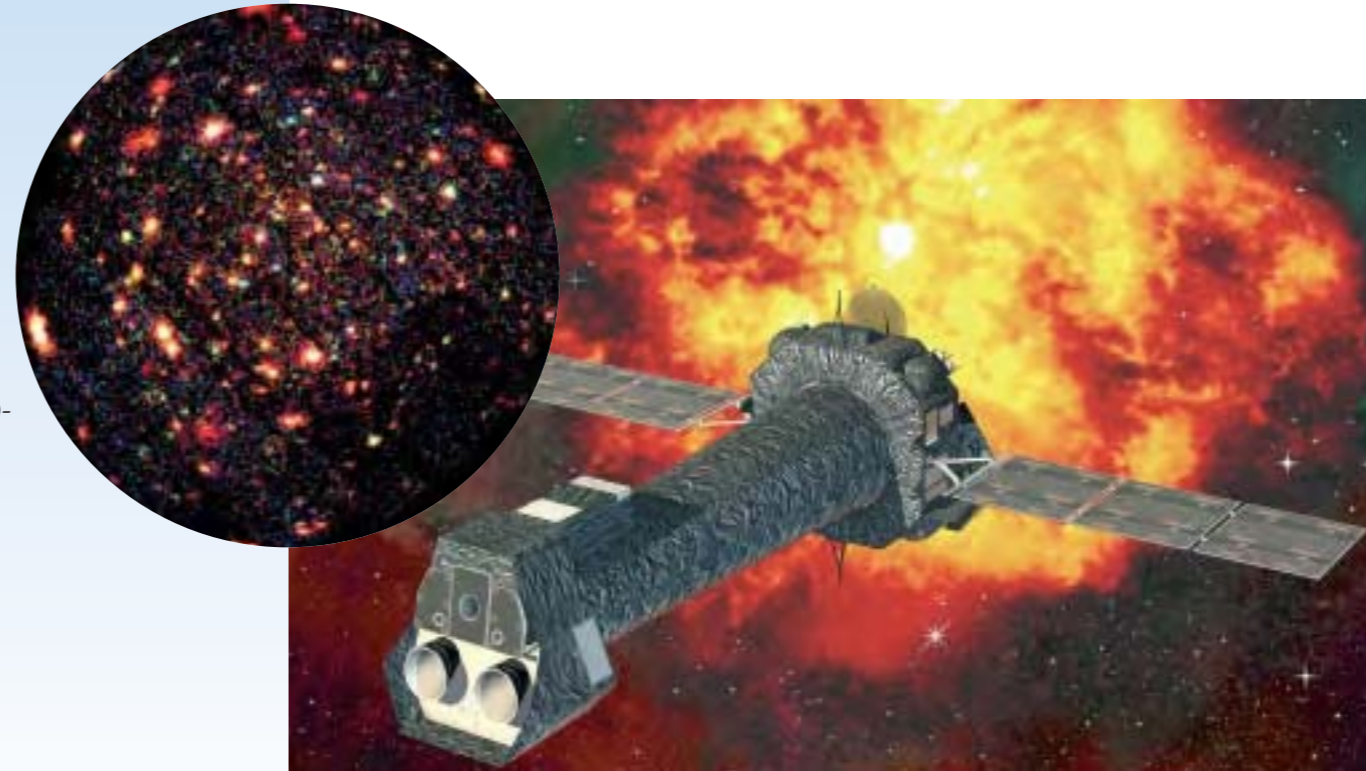

Far left: combined 30 h exposures from the EPIC-PN and EPIC-MOS cameras of the Lockman Hole, where a 'window' in our Galaxy provides a view into the distant Universe. Red (low-energy) objects were previously observed by Rosat, but green and blue objects are much more energetic and are being seen clearly for the first time. It is evident that XMM is detecting vast number of previously unknown X-ray sources.

The X-ray Multi-Mirror (XMM) observatory (renamed XMM-Newton in February 2000) forms the second, High-Throughput X-ray Spectroscopy, cornerstone mission of ESA's Horizons 2000 space science plan, concentrating on the soft X-ray portion of the electromagnetic spectrum (100 eV to 12 keV). By virtue of its large collecting area and highly eccentric orbit, it is making long observations of X-ray sources with unprecedented sensitivity. Most of the 50-200 sources in every image are being seen for the first time. Whereas the German/US/UK Rosat mission, launched in 1990, pushed the number of known X-ray sources to 120 000, XMM-Newton is seeing millions.

The heart of the mission is the X-ray telescope. It consists of three large mirror modules and associated focal plane instruments held together by the telescope's central tube. Each module carries 58 nested gold-coated nickel mirrors using their shallow incidence angles to guide the incoming X-rays to a common focus for imaging by the scientific instruments.

One module uses an advanced PN-CCD camera (EPIC) capable of detecting rapid intensity variations down to a thousandth of a second or less – important for tracking down

black holes. All three EPIC cameras measure the proportions of different X-ray wavelengths to give a broad impression of each source's spectrum. For a more thorough analysis, two telescopes divert about 40% of their beams with grating stacks to diffract the X-rays, fanning out the various wavelengths on to a CCD strip (RGS). Spikes stand out at specific wavelengths, corresponding to individual chemical elements.

Besides its X-ray telescopes, XMM carries a sensitive conventional telescope (OM) to observe the same sections of sky by UV and visible light so that astronomers know exactly what the satellite is observing.

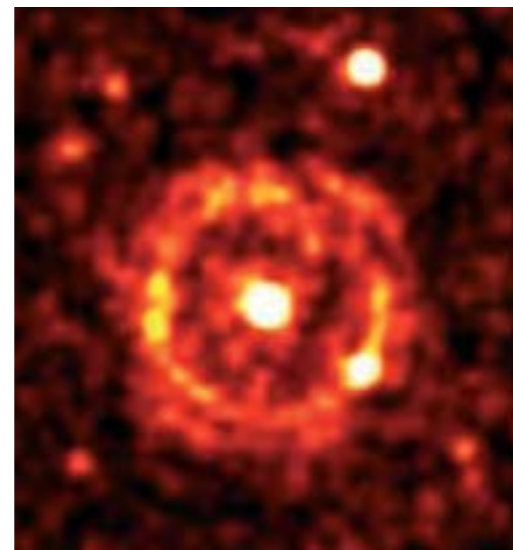

EPIC shows the expanding ring of X-rays from a powerful gamma-burster (GRB 031203) on 3 December 2003. The slowly fading afterglow of the gamma burst is at the centre. (ESA/S. Vaughn, Univ. Leicester)

XMM confirms Europe's position at the forefront of X-ray astronomy by providing unprecedented observations of, for example, star coronas; accretion-driven binary systems containing compact objects; supernova remnants (SNRs); normal galaxies containing hot interstellar medium as well as point-like accretion-driven sources and SNRs; Active Galactic Nuclei, which may well be accretion-driven; clusters of galaxies with hot inter-cluster medium.

Activation of the science instruments began on 4 January 2000, after the mirror module and OM doors had been opened on 17/18 December 1999. After engineering images were returned, the first science images from all three EPIC cameras and OM were taken 19-24 January 2000. The first RGS spectrum was produced 25 January. The Calibration & Performance Validation phase began 3 March 2000; routine science operations began 1 July 2000.

An exciting result is that XMM can track simultaneously the X-ray and optical afterglows of gamma-ray bursts. It has identified the chemical elements thrown out and confirmed it as the death of a massive star in a supernova explosion. In another discovery, XMM has found more iron than expected in an early galaxy on

the edge of the Universe. As iron levels build with age, is the Universe older than we thought?

Highlights from the first 5 years of the mission include:

- the first detection of an X-ray cycle in a Sun-like star;
- observations of several gamma-ray bursters and supernovas, and the first detection of their expanding haloes of X-rays;
- observations of supernovae remnants, and the movement of the neutron star Geminga in one;
- the detection of four regularly spaced absorption features in the spectrum of the neutron star

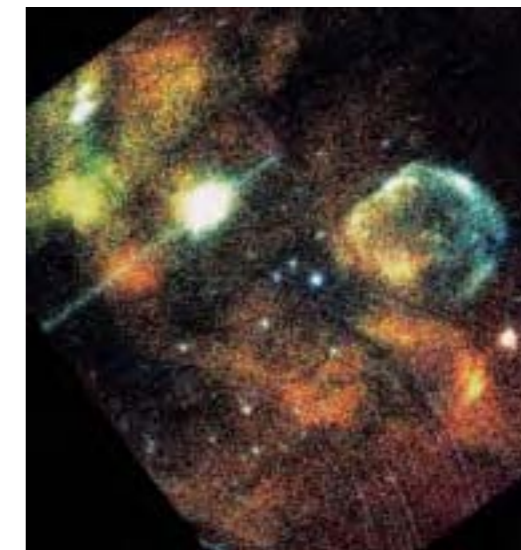

One of the first science images: an EPIC-PN view of the 30 Doradus region of the Large Magellanic Cloud. In this region, supernovae are seeding the creation of new stars. At right centre is the blue-white arc of a supernova shockwave heating the interstellar gas. At lower right is the remains of the star that exploded as Supernova 1987A – the first naked-eye supernova since 1604. The brightest object (left centre) is also a supernova remnant star. (EPIC Consortium)

Right: clusters of galaxies can contain thousands of galaxies. They are favourite targets of X-ray astronomers because the hot gas between the galaxies can be seen only in the X-ray energy band. This temperature map of Abell 754 shows, at left, a shock wave from a collision with smaller clusters 300 million years ago. (ESA/P. Henry et al.)

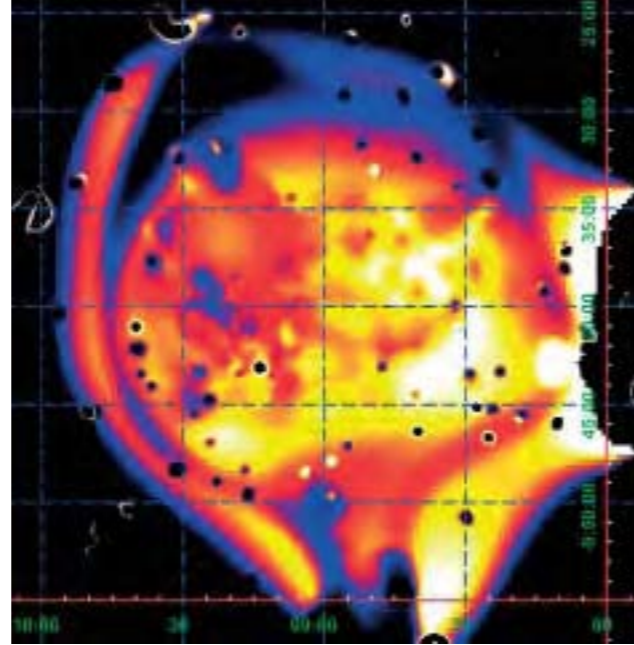

Left: this supernovae exploded in 1006 and was observed in Europe, Egypt, Iraq, China and Japan. The two images of the supernova remnant in two energy bands indicate different radiation mechanisms. (CEA/DSM/DAPNIA/SAP & ESA)

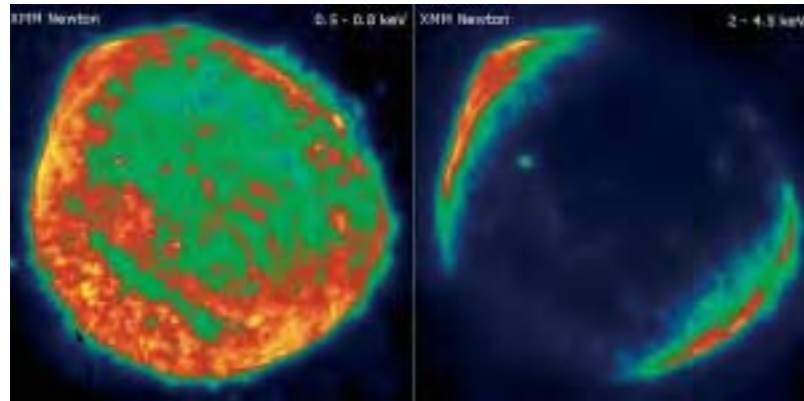

Right: each of XMM's mirror modules houses 58 nested mirrors to reflect the incoming X-rays to a focus. Two modules also have a grating stack for spectroscopy.

Left: the gold-plated mandrel for one of XMM's mirrors. Mirror manufacturing was based on a replication process, which transferred a gold layer deposited on the highly polished master mandrel to the electrolytic nickel shell that was electroformed on to the gold.

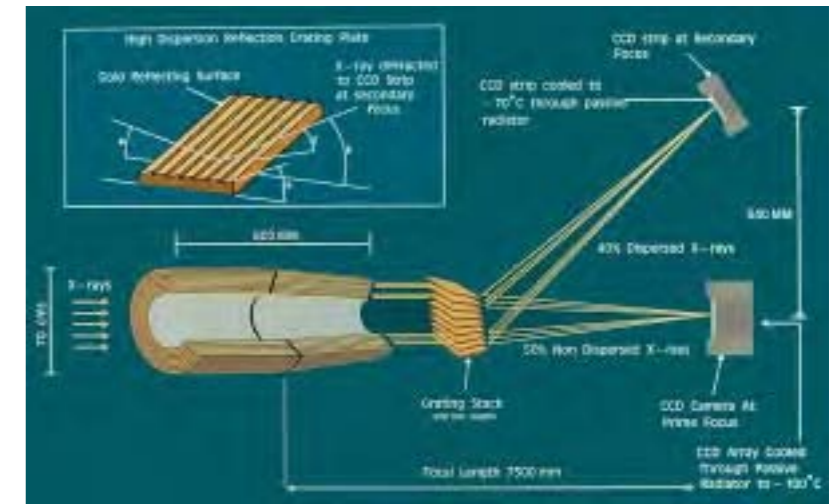

The lower module Flight Model in the Large Space Simulator at ESTEC. ESA still has a spare mirror assembly, which in 2001 was part of two proposals for NASA Explorer missions.

- 1E1207.4-5209, caused by resonant cyclotron absorption;
- the detection of a hot spot only 60 m across on the surface of the neutron star Geminga;
- iron lines distorted and broadened by the strong gravitational fields of nearby black holes;
- the final emission from stars falling into a supermassive black hole;
- collisions between clusters of galaxy
 - objects containing thousand of galaxies;
- spectra of the oldest objects in the Universe, from 12.7 billion years ago, when the Universe was only 1 billion years old.

Satellite configuration: 10.05 m total length in launch configuration; 10.80 m deployed in orbit, 16.16 m span across solar wings. XMM's shape is dominated by the telescope's 7.5 m focal length and the need to fit inside Ariane-5's fairing. The mirror modules are grouped at one end in the Mirror Support Platform (MSP) and connected rigidly by the 6.7 m-long CFRP telescope tube to the scientific instruments in the Focal Plane Array (FPA). Launch was with the mirror end attached to Ariane's adapter because

of centre-of-mass considerations. Subsystems are positioned around the external circumference at this end in the separate Service Module (SVM), including solar arrays, data handling and AOCs. ESA's Integral gamma-ray observatory uses the same SVM to reduce cost. The FPA is protected by a Sun shield incorporating passive radiators for instruments' detector cooling.

Attitude/orbit control: four Reaction Wheels, two Star Trackers, four Inertial Measurements Units, three Fine Sun Sensors and three Sun Acquisition Sensors provide 3-axis control. Pointing accuracy better than 1 arcmin, with a drift of 5 arcsec/h and 45 arcsec/16 h. Hydrazine thrusters provide orbit maintenance, attitude control and wheel desaturation: four sets of two thrusters (primary + redundant) 20 N blowdown (24-5.5 bar) thrusters sit on each of four inter-connected 177 litre titanium propellant tanks. Hydrazine loading 530 kg.

Power system: two fixed solar wings, each of three 1.81x1.94 m rigid panels with Si cells totalling 21 m², sized to provide 1600 W after 10 years. 28 V main bus. Eclipse power from two 24 Ah 41 kg NiCd batteries.

Communications: data rate 70 kbit/s in realtime (no onboard storage) to stations at Perth (Australia), Kourou

XMM-Newton Scientific Instruments

Three Wolter 1-type mirror modules provide the photon-collecting area (1475 cm² at 1.5 keV; 580 cm² at 8 keV EOL) for three CCD imaging array cameras and two reflection grating spectrometers; complemented by a separate optical monitor. Each 420 kg mirror module contains 58 paraboloid/hyperboloid mirrors 60 cm-long with a gold coating providing the reflective surface at 0.5° grazing incidence. Outermost mirror 70.0 cm diameter, innermost 30.6 cm; mirror thickness reduces from 1.07 mm to 0.47 mm and separation from 4 mm to 1.5 mm. Focal length 7500 mm.

European Photon Imaging Camera (EPIC)

A CCD camera at the prime focus of each mirror module performs broadband (0.1-10 keV) imaging/spectrophotometry. Two cameras based on MOS-CCD technology share the mirrors with the RGS; one camera using PN-CCD has its own dedicated mirror module. EPIC consortium led by University of Leicester, UK (PI: M. Turner)

Reflection Grating Spectrometer (RGS)

Half of the exit beams from two mirror modules are intercepted by a 20 cm-deep gold-coated reflection grating stack for dispersion to a CCD strip at the secondary focus. E/ΔE of 300-700 (1st order) for 0.35-2.5 keV; resolving power >500 at 0.5 keV. RGS consortium led by SRON, The Netherlands (PI: A.C. Brinkman)

Optical Monitor (OM)

A separate 30 cm-aperture Cassegrain telescope provides simultaneous coverage at 160-550 nm for coordination with X-ray observations and pointing calibration. Photon-counting detectors provide 17x17 arcmin FOV at 1 arcsec resolution down to magnitude +24.5. A 10-position filter/prism wheel permits spectroscopy. The OM group is led by the Mullard Space Science Laboratory, UK (PI: K.O. Mason)

(French Guiana) and - added in Feb 2001 - Santiago (Chile). Controlled from ESOC; science data returned to Villafranca, Spain. Observations possible for up to 40 h out of each 48 h orbit, when above Earth's radiation belts.

Artemis

Achievements: first European data relay mission, including first optical intersatellite link; first European operational use of ion propulsion

Launch: 21:58 UT 12 July 2001

Mission end: design life 10 years

Launch vehicle/site: Ariane-510 from ELA-3, Kourou, French Guiana

Launch mass: 3105 kg (550 kg payload, 1559 kg propellant)

Orbit: geostationary, above 21.5°E

Principal contractors: Alenia Spazio (prime, thermal control, RF data relay payload), FiatAvio (propulsion), CASA (structure), Fiar (power), Fokker (solar array), Bosch/Alcatel (RD data relay payload elements), Astrium SAS (SILEX), Astrium UK (Portsmouth; Electro-bombardment Thruster), Astrium GmbH (Ottobrun; RF Ion Thruster), Telespazio (ground segment)

ESA's Advanced Relay and Technology Mission Satellite is demonstrating new telecommunications techniques, principally for data relay and mobile services. Before Artemis, users of Earth observation satellites such as ERS in low orbit relied on global networks of ground stations to receive their vital data. But, as information requirements and the number of missions grow, this approach is becoming too slow and expensive and sometimes technically unfeasible.

Two Artemis payloads are exploring data relay directly between satellites, receiving data from low Earth-orbiting satellites and relaying them to Europe: the SILEX laser terminal and the SKDR S/Ka-band terminal. Spot-4 and Envisat are already major users.

The 'L-band Land Mobile' (LLM) provides 2-way links between fixed Earth stations and land mobiles in Europe, North Africa and the Near East. LLM is fully compatible with the European Mobile System (EMS) payload already developed by ESA and flying aboard Italsat-2.

Artemis also carries a transponder providing part of the European Geostationary Navigation Overlay Service (EGNOS) for enhancing the

GPS/Glonass navigation satellite constellations.

Artemis is the first ESA satellite to fly electric propulsion technology operationally: UK and German xenon ion thrusters were included to control the north-south drift in geostationary orbit (NSSK: north-south stationkeeping). The attractions of this technology are its high specific impulse (3000 s) and low thrust (about 20 mN) in contrast with chemical propulsion. For Artemis, the result was a mass saving of about 400 kg.

Artemis also differs from the traditional approach by combining onboard data handling and AOCS into a centralised processing architecture.

The programme cost-to-completion is €827 million (2004 conditions).

Artemis was released into a low transfer orbit because of a malfunction in Ariane-5's upper stage: instead of the planned 858x35 853 km, 2° GTO, the underburn resulted in 590x17 487 km, 2.94°. As scheduled, the solar wings were partially deployed some 2 h after launch and began delivering power while controllers formulated a recovery strategy. The Liquid Apogee Engine (LAE) was fired during five

Artemis is dominated by the two 2.85 m-diameter reflectors for inter-orbit links and the LLM payload.

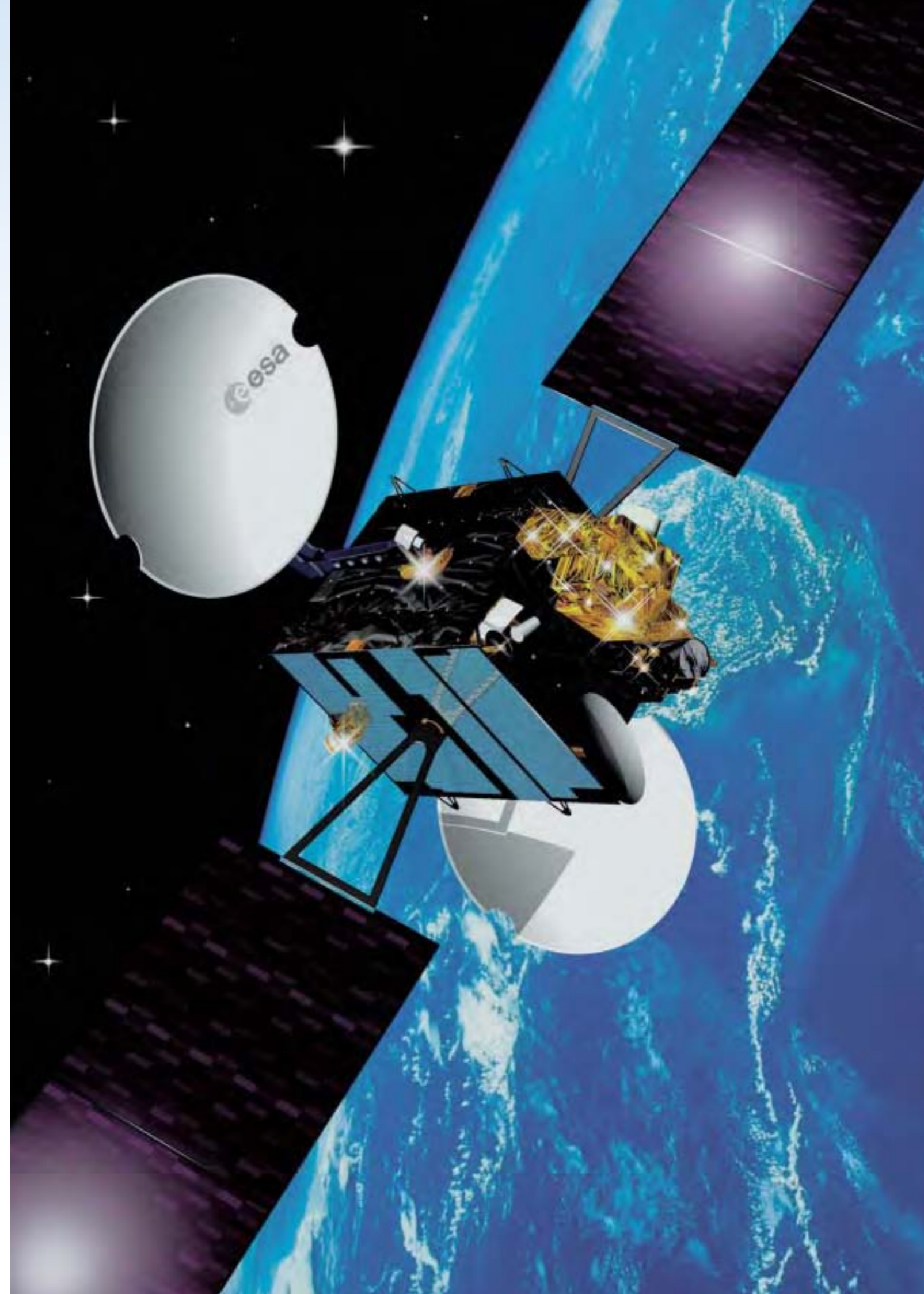



Above: unpacking the Flight Model after its arrival at ESTEC to begin systems-level testing in July 1998. The SILEX terminal is at bottom right; the telescope is pointing down. Above it is the Ku-band feeder link for the LLM land mobile package. At top left is the Ka-band feeder for the SKDR and SILEX packages. Bottom left is the L-band horn for the EGNOS navigation package.

perigee passes on 18-20 July to raise apogee to about 31 000 km. The LAE raised perigee in three burns on 22-24 July to produce a circular orbit at about 31 000 km, 0.8°, 20 h. The solar arrays were then fully deployed, as were the two antenna reflectors. In escaping the deadly Van Allen belts, Artemis had used 1449 kg (1885 m/s) of the available 1519 kg chemical propellant.

Artemis could then use its ion thrusters to climb slowly to operational altitude. They were originally designed only to control orbit inclination by thrusting at 90° to the orbital plane, now Artemis had to turn through 90° for them to push along the orbit. Steering the engines included entirely new control modes never before used on a telecom satellite, as well as new telecommand and telemetry and other data-handling functions. In all, some 20% of the original onboard control software had to be modified by uplinking patches totalling 15 000 words, the largest reprogramming of flight software ever done on a telecom satellite. By the end of December 2001, the new software was completed and on 19 February 2002 the orbit-raising began. The 15 mN

thrust produced a climb of 15 km per day. In all, the thrusters operated for about 6000 h, equivalent to 4 yr of conventional GEO NSSK. Almost all of the work was done by RITA-2 on the north side because of operating difficulties with the other three.

The final adjustments were made using the 10 N chemical thrusters, activated for the first time. A burn in December 2002 and two more in January 2003 slowed the drift rate to a few degrees/day. The last burn on 31 January halted Artemis at the planned 21.5°E. Despite the extensive manoeuvres, the remaining 40±10 kg of MMH/N₂O₄ and 25 kg of Xe are sufficient for 7-10 years of operations. To conserve propellant, no NSSK is being performed. Artemis arrived in GEO with 1.6° inclination, which will

be allowed to grow to 4° after 3 yr and 10° after 10 yr. The ion thruster will be used to remove Artemis from GEO at the end of its life.

The gap of several months before orbit-raising began in February 2002 was used to commission the communications payload. Payload tests during November/December 2001 could be done only every 5th day, when the Artemis feeder link antenna beam illuminated ESA's Redu station. All payloads met specifications. The most spectacular event came with SILEX. Following initial commissioning via ESA's optical ground station on Tenerife, the optical link was established between Artemis and Spot-4. On 30 November 2001, for the first time ever, image data collected by a LEO

satellite were transmitted by laser to a quasi-GEO satellite, and from there to the data processing centre in Toulouse. All 26 attempts were successful. Link quality was almost perfect: a bit error rate of better than 1 in 10⁹ was measured. Since 1 April 2003, Artemis has been routinely providing the SILEX link for Spot-4; by 30 January 2005, the total link time was 140 h (765 links).

In 2005, a SILEX test programme is planned with Japan's OICETS satellite and with an aircraft optical terminal. SILEX can also point at neighbouring GEO satellites, so a demonstration might be made.

Since 1 April 2003, Artemis has provided routine links for ESA's Envisat using Ka-band SKDR. Envisat is using up to 14 links per day on two channels for ASAR and MERIS data, which Artemis transmits directly to the Envisat Processing Centre at ESRIN. By 30 January 2005, the total link time reached 2400 h (5025 links).

In the future, ATV will use the S-band SKDR service, and Columbus plans to use the S/Ka-bands.

Artemis ready to be installed on its launcher. Note the south-face ion thruster package below the solar wing.

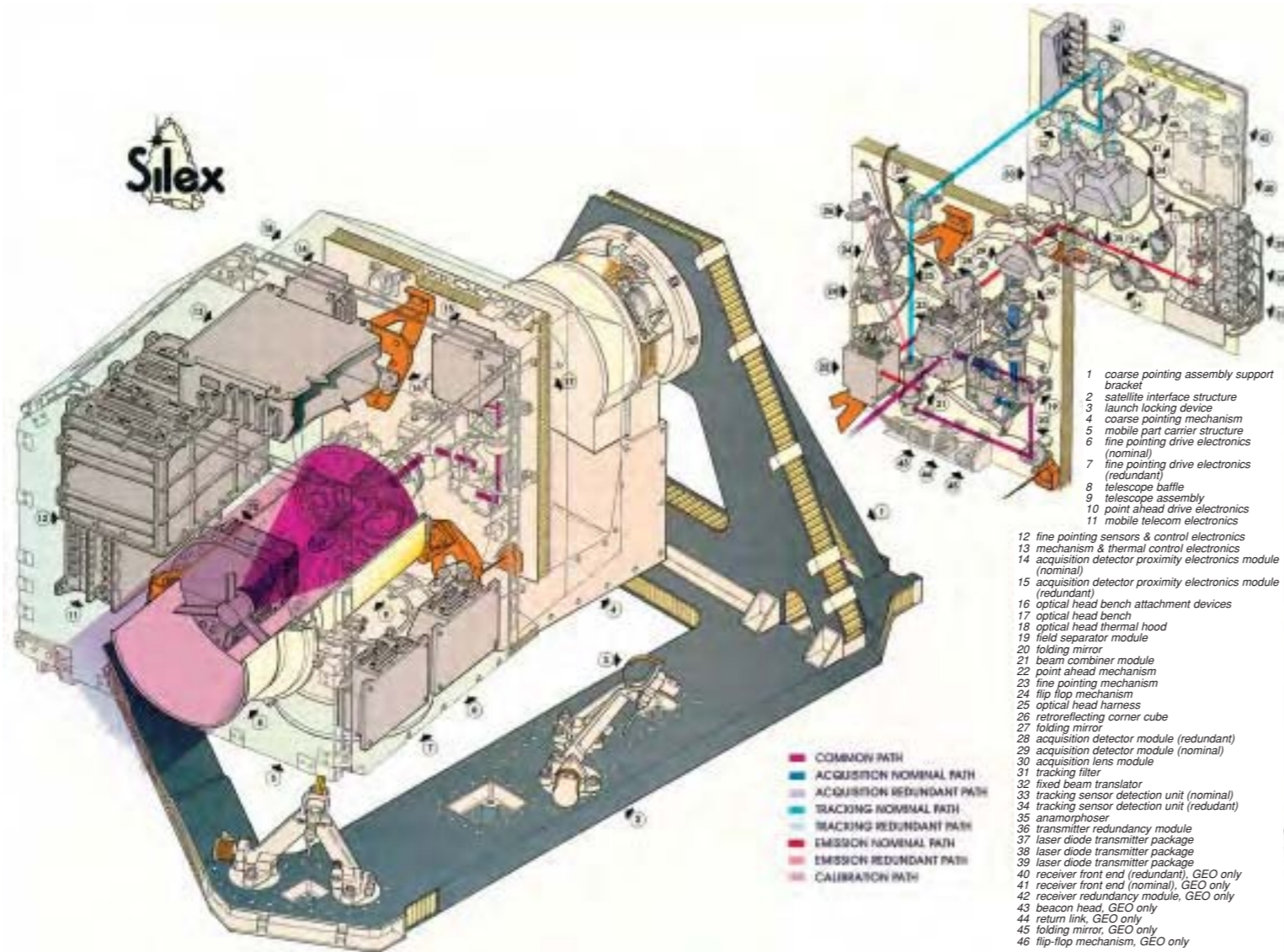

Since March 2003, the LLM L-band payload has been providing operational 2-way links between fixed Earth stations and land mobiles in Europe, North Africa and the Near East. LLM is fully compatible with the European Mobile System (EMS) payload developed by ESA and initiated aboard Italsat-2. LLM is highly reconfigurable, with spot beams allowing traffic to be directed straight to the area of interest. Mobile service operators, including Telespazio and Eutelsat are leasing capacity to complement their existing systems.

The NAV payload was commissioned in February 2003 and demonstrated with the EGNOS testbed in November 2003. The EGNOS system will become operational in 2005.

Satellite configuration: classical box-shaped 3-axis bus derived from Italsat

and other European predecessors. 25 m span across solar wings. Primary structure of central cylinder (aluminium honeycomb skinned by carbon fibre), main platform, propulsion platform and four shear panels. The secondary structure is principally the N/S radiators, E/W panels and Earth-facing panel. The central propulsion module houses the propellant tanks, LAE, pressurant tanks and RCS pipes. E panel: L-band antenna/feed. W panel: IOL antenna. N/S panels: host most of the electronic components requiring heat dissipation. Earth panel: other antennas and AOCSS sensors.

Attitude/orbit control: Earth/Sun sensors & gyros for attitude determination, reaction wheels for attitude control (RCS thrusters for wheel offloading). Unified Propulsion

Artemis Communication and Navigation Payload

Semiconductor Laser Intersatellite Link Experiment (SILEX)

SILEX is the world's first civil laser-based intersatellite data relay system. The transmitter terminal on Spot-4 in LEO beams data at 50 Mbit/s (bit error rate $<10^{-9}$) to the receiver on Artemis for relay via the feeder link to Spot's Earth station near Toulouse (F). Japan's OICETS satellite will also be used in experiments (including 2 Mbit/s from ground via Artemis to OICETS). Each terminal has a 25 cm-diameter telescope mounted on a coarse pointing mechanism; pointing accuracy 0.8 mrad. Optical power source: 830 nm GaAlAs semiconductor laser diode, peak output 160 mW (60 mW continuous), beamwidth 0.0004° (400 m-diameter circle at the distance of receiver). Receiver: silicon avalanche photodiode (SI-APD), followed by a low-noise trans-impedance amplifier; 1.5 nW useful received power. CCD acquisition/tracking sensors direct fine-pointing mechanism of orthogonal mirrors. A 1 m telescope at the Teide Observatory on Tenerife acts as a test station.

S/Ka-band Data Relay (SKDR)

The 2.85 m antenna tracks a LEO user satellite via either loaded pointing table values and/or error signals to receive up to 450 Mbit/s Ka-band or up to 3 Mbit/s S-band for relay via the feeder link to Earth. Up to 10 Mbit/s Ka-band and 300 kbit/s S-band can be transmitted by Artemis to LEO satellite. Single Ka-band transponder (plus one backup) 25.25-27.5/23.2-23.5 GHz rx/tx, adjustable EIRP 45-61 dBW, G/T 22.3 dB/K, up to 150 Mbit/s each of three channels LEO to Artemis and up to 10 Mbit/s Artemis to LEO. RH/LHCP on command. One S-band transponder (plus one backup) 2.200-2.290/2.025-2.110 GHz rx/tx, adjustable EIRP 25-45 dBW, G/T 6.8 dB/K, 15 MHz bandwidth, up to 3 Mbit/s single channel LEO to Artemis and up to 300 kbit/s Artemis to LEO. RH/LHCP on command. Artemis broadcasts 23.540 GHz beacon to help the LEO satellite track it.

SILEX and SKDR feeder link

Three transponders (plus one backup, 4-for-3) act as Artemis-ground links for SILEX and SKDR. 27.5-30/18.1-20.2 GHz rx/tx, EIRP 43 dBW, G/T 0 dB/K, 234 MHz bandwidth, linear vertical polarisation.

L-band Land Mobile (LLM)

Designed principally for mobile users such as trains and trucks. Artemis carries 2.85 m antenna and multiple element feed for pan-European coverage and three European spot beams. Three 1 MHz plus three 4 MHz SSPA channels, providing up to 650 2-way circuits with EIRP >19 dBW 1550 MHz L-band transmitting to terminals (1650 MHz receiving) and 14.2/12.75 GHz Ku-band rx/tx for the feeder links to the home stations. All channels fully tunable and most commandable LH/RHCP. LLM provides an operational service in conjunction with Italsat-2's European Mobile System package (also funded through ESA).

Navigation Payload (NAV)

As part of the European Geostationary Navigation Overlay System (EGNOS), NAV broadcasts L-band navigation signals from the EGNOS Master Control Centre, adding accuracy and integrity for GPS/Glonass users. Tx 1575.42 MHz, 4 MHz bandwidth, EIRP >27 dBW (1 of 3 SSPAs has failed), 45 cm-dia horn. Uses LLM Ku-band package for feeder: 13.875/12.748 GHz rx/tx. 25 kg, 110 W.

System: conventional bipropellant (MMH/N₂O₄; 1519 kg at launch) system of a single 400 N Liquid Apogee Engine (LAE, for insertion into GEO) and two redundant branches of eight 10 N RCS thrusters each. Propellants in two Cassini-type 700-litre tanks; helium pressurant in three spheres. LAE operates at regulated 15.7 bar, then isolated once in GEO for RCS to operate in blowdown mode. E/W positioning maintained by RCS; N/S by ion thrusters (planned). Ion Propulsion Subsystem (IPS) comprises two thruster assemblies, one each on N/S faces: a 15 mN RF Ion Thruster Assembly (RITA) and an 18 mN

Electro-bombardment Thruster Assembly (EITA). Each is powered and monitored separately, but with common propellant supply (40 kg Xe). 600 W required in operation.

Power: twin 4-panel solar wings provide 2.8 kW at equinox after 10 years to 42.5 Vdc bus; eclipse protection by two 60 Ah nickel-hydrogen batteries.

Communications: satellite control from Control Centre and TT&C station in Fucino Mission Control; In-Orbit Testing from ESA Redu. See separate box for Artemis communications payload.

Proba-1

Achievements: ESA's first small satellite for technology demonstration, highest-performance computing system flown by ESA, first flight of new type of Earth-observation instrument

Launch date: 04:53 UT 22 October 2001

Mission end: 2-year nominal mission; extension to end-2005 (funded since 1 Jan 2005 as Earth Observation third-party mission; ESA cost-at-completion €13.5 million)

Launch vehicle/site: auxiliary passenger on PSLV-C3 from Sriharikota, India

Launch mass: 94 kg (payload 25 kg)

Orbit: 561x681 km, 97.9° Sun-synchronous

Principal contractors: Verhaert Design & Development (B; prime), Spacebel (B; software), Verhaert/SIL/Netronics (B/UK/NL; RF, power & avionics), SAS (B; ground segment), Université de Sherbrooke/NGC Aerospace (Canada; attitude control and navigation), Space Systems Finland (FIN; software validation tool), Officine Galileo (I; solar array). Ph-A June 1997 - February 1998; Ph-B June-October 1998; Ph-C/D October 1998 - October 2001

ESA's small, low-cost Proba (Project for On-Board Autonomy) satellite validated new spacecraft autonomy and 3-axis control and data system technology as part of the Agency's In-orbit Technology Demonstration Programme. Provided as an ESA Announcement of Opportunity instrument, Proba's main payload is the novel CHRIS imaging spectrometer.

First contact with Proba-1 was made at 06:16 UT 22 October 2001 via Kiruna, ready to complete platform commissioning in May 2002. The first year was allocated to technology demonstrations; since then, Proba-1 has operated as an Earth observation mission. Proba's autonomy requires only the coordinates of a target to be provided and its onboard computer navigates to the correct location, tilts, shoots and delivers the image. The nominal mission was completed with full success; Verhaert & Spacebel now offer the platform as a commercial turnkey satellite system. Proba-2 is planned for early 2007.

Proba is ESA's first fully autonomous spacecraft, specifically aimed at reducing the cost of space-mission operations and including some of the most advanced technology yet flown. It carries the highest-performance

computing system yet flown by ESA, with 50 times the processing power of Soho. It relies on radiation-hard SPARC (ERC-32) and DSP processors, the latter resulting from an ESA-European Union co-funded technology development effort.

Proba's high-performance attitude control and pointing system supports the complex multispectral measurements of CHRIS. The GPS-based position and attitude determination and autonomous star sensor technology make it one of the best-performing small satellites in production.

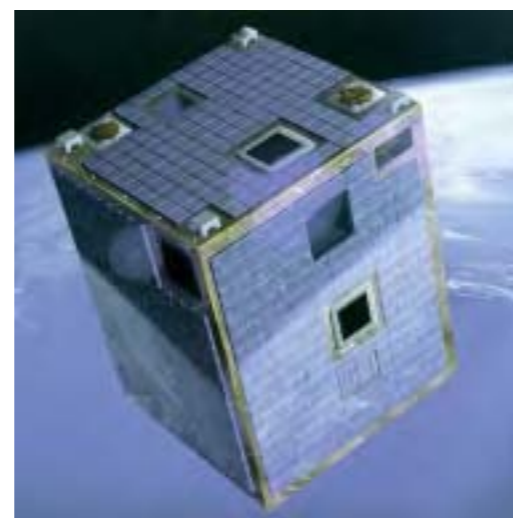

Proba offers the opportunity for rapid flight-testing of technologies such as miniature digital cameras and distributed sensing, all of which are of strategic importance for future ESA missions and European industrial competitiveness. In particular, the following functions are autonomous:

- commanding for management of onboard resource and housekeeping functions;
- scheduling, preparation and execution of scientific observations (eg slew, attitude pointing, instrument settings);
- scientific data collection, storage, processing and distribution;
- data communications management between Proba, scientific users and the ground station;
- performance evaluation and estimation of drifts, trends;
- failure detection, reconfigurations and software exchanges.

A core of technologies to demonstrate autonomy was accommodated in the attitude control and avionics subsystems:

- autonomous double-head star tracker, all-sky coverage, high-accuracy for Earth observation and astronomy. Can autonomously reconstruct inertial attitude from 'lost in space' attitude (Space Instrumentation Group, Technical Univ. Denmark);
- GPS L1 C/A receiver and four antennas for position and medium-accuracy attitude determination. It provides all essential AOCS measurements without ground intervention, plus all onboard timing for autonomous operations (Surrey Satellite Technology Ltd, UK);
- ERC-32 onboard computer performs guidance, navigation, control, housekeeping, onboard scheduling and resource management. It supports all processing normally performed on ground. It is a space version of a standard commercial processor, intended by ESA to validate a computing core for future spacecraft such as SMART-1 and ATV. >80 Krad SPARC V7 processor, 10 MIPS & 2 MFLOPS with floating-point unit;

Proba's view of the Mauna Kea volcano, Hawaii. Inset: first image from Proba, taken over snowy Bruggen (B) on 4 January 2002 by CHRIS. In its first 3 years, Proba has returned more than 10 000 CHRIS & HRC images, adding 300 every month.

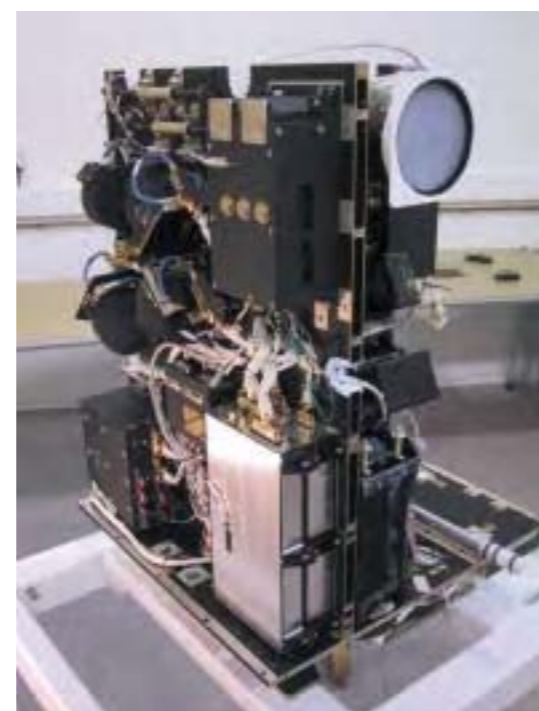
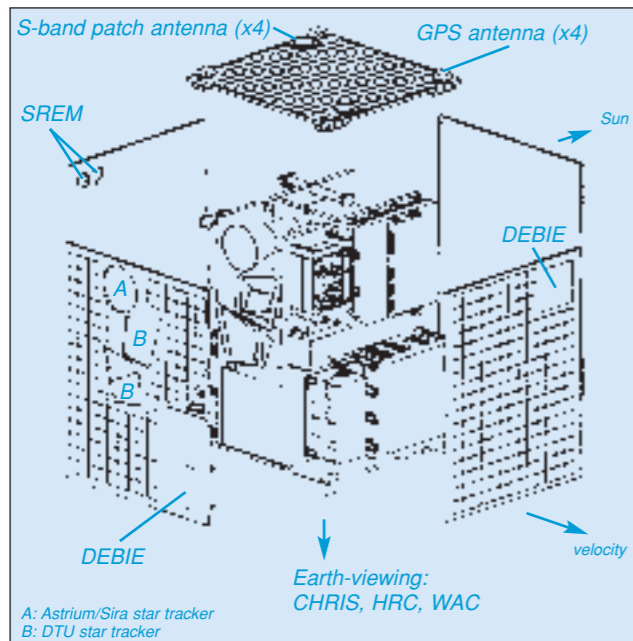

Top right and centre right: the flight model at prime contractor Verhaert D&D. Centre left: ready for launch. Bottom left: the smoking Etna, viewed 30 October 2002 by CHRIS. Bottom right: the flight model during integration.

- Digital Signal Processor (DSP), TCS21020, for payload data processing;
- Memory Management Unit, 1 Gbit, as part of Payload Processor Unit, to support autonomous data transmissions (Astrium UK).

Satellite configuration:
600x600x800 mm box-shaped structure of conventional aluminium honeycomb design. Load-carrying structure is of three panels in 'H' configuration. Top panel: 4 GPS antennas, 2 S-band patch antennas, solar cells. Ram panel: DEBIE sensor, solar cells. Anti-ram panel: SREM sensor hole, solar cells. Deep-space panel: star sensor (2 holes), solar cells. Earth panel: CHRIS aperture, 3 S-band patch antennas, launcher interface.

Attitude/orbit control: 3-axis stabilisation by four 5 mN-m Teldix reaction wheels (unloaded by three 5 Am² Fokker magnetotorquers); attitude determination by autonomous high-accuracy (<10 arcsec) 2-head star tracker (7.5 W, 2.7 kg), GPS sensor & 3-axis magnetometer. Nadir pointing to 150 arcsec accuracy; off-nadir inertial pointing to 100 arcsec. A second star tracker (Astrium UK/Sira) validated a new star-pattern recognition algorithm. Autonomous navigation via GPS and orbit propagation. No onboard propulsion.

Power/thermal system: 4x4 cm 200 µm-thick GaAs cells on a Ge substrate body-mounted on five faces provide 90 W peak (72 W max. required; 17 W in safe mode), supported by 9 Ah 1.9 kg Li-ion battery (AEA Technology, UK). 28 Vdc bus. Passive thermal control.

Proba Scientific Payload

Compact High Resolution Imaging Spectrometer (CHRIS)

Targeted at directional spectral reflectance of land areas; Proba slewing allows multiple imaging (typically 6) of same Earth scene under different viewing & illumination geometries. This permits new land surface biophysical & biochemical information to be derived. For example, it is now possible for the first time to distinguish between variations in leaf biochemistry and leaf/canopy structure (such as wilting due to water stress), which both affect the spectral reflectance of vegetation canopies. Range 415-1050 nm, spectral resolution 5-12 nm, spatial resolution 25 m at nadir, swath width 19 km, area CCD. The spectral bands are fully programmable over whole range; up to 19 can be acquired simultaneously at full resolution. Contractor: Sira Electro-optics (UK).

Standard Radiation Environment Monitoring (SREM)

Measures electron (0.3-6 MeV) & proton (8-300 MeV) fluxes using three Si-diode detectors (two stacked) and total dose (RadFET). Box 10x12x22 cm; 2.5 kg; 2.5 W. Contractor: Contraves (CH). 10 SREMS built to provide radiation-environment data to satellite operators; also carried by Integral, Rosetta, Herschel, Planck, Galileo GSTP-V2 & Gaia. Proba-1 is also testing a trial version of a second-generation, miniaturised, SREM using crystal scintillation: 3x10x10 cm; 0.325 kg; 0.5 W.

Debris In-orbit Evaluator (DEBIE)

Measures mass (>10⁻¹⁴ g), speed and penetration power using impact ionisation, momentum & foil penetration detection of Proba's sub-mm meteoroid & debris environment. Two 10x10 cm impact detectors, on ram side and deep space face, plus processing unit. Standard detector designed for different missions with little modification; see <http://gate.etamax.de/edid>. DEBIE-2 planned for International Space Station EuTEF in 2007. Contractor: Patria Finnavitec (FIN).

Cameras

High-level imaging requests handled by Proba's planning capability to predict ground target visibility. High Resolution Camera (HRC) is a black & white camera to demonstrate high-res (10 m) imaging using a miniaturised telescope (Cassegrain, 115 mm aperture dia, focal length 2296 mm) and steerable spacecraft; also complements CHRIS multispectral imaging. 1024x1024 CCD detector using 3D packaging technology. FOV 0.504° across diagonal. Wide Angle Camera (WAC) is a miniaturised (7x7x6 cm) black & white camera using a 640x480 CMOS Active Panel Sensor. FOV 40x31°. WAC (already carried by XMM-Newton and Cluster) is for public relations and educational purposes; 40 Belgian schools in the EduProba project perform WAC & HRC experiments via the Internet. Contractor: OIP (B).

Smart Instrumentation Point (SIP)

SIP sensors provide measurements of total radiation dose and temperature around the spacecraft, using smart sensor and 3D technology. Contractors: Xensor (NL), 3D plus (F).

Communications: S-band link to ESA Redu (B) control centre (2.4 m dish); 4 kbit/s packet TC uplink, 1 Mbit/s packet TM down (2 W redundant transmitter). (Kiruna for LEOP.) 1 Gbit Memory Management Unit, orbit allows complete dump at least every 12 h if required.

Operations: controlled from a dedicated ground station at ESA Redu (B; 2.4 m dish). Scientific data distributed from Redu via a webserver. Contractors: SAS (B), Enerotec (F), Gigacomp (CH).

Envisat

Achievements: Europe's largest and most complex satellite; Europe's most ambitious Earth-observation mission and a key tool in understanding the Earth system; daily generating 77 product types totalling 140 GB data

Launch date: 01:08 UT 1 March 2002

Mission end: 5-year nominal mission

Launch vehicle/site: Ariane-5 from ELA-3, Kourou, French Guiana

Launch mass: 8111 kg (2145 kg payload; 318 kg hydrazine)

Orbit: 783x785 km circular, 98.54° Sun-synchronous, 35-day repeat cycle with same ground track as ERS-2, 10:00am descending node mean local time

Principal contractors: Dornier (mission prime), Matra Marconi Space-Bristol (satellite & Polar Platform prime; MMS-Toulouse: Service Module; Dornier: Payload Equipment Bay), Dornier (payload; MMS-Portsmouth: ASAR; MMS-Toulouse: GOMOS; Alcatel Espace Cannes: MERIS & LRR; Dornier: MIPAS; Alenia Aerospazio: MWR & RA-2), Alcatel Espace (Payload Data Segment)

ESA's second generation remote-sensing satellite not only provides continuity of many ERS observations – notably the ice and ocean elements – but adds important new capabilities for understanding and monitoring our environment, particularly in the areas of atmospheric chemistry and ocean biological processes.

Envisat is the largest and most complex satellite ever built in Europe. Its package of 10 instruments is making major contributions to the global study and monitoring of the Earth and its environment, including global warming, climate change, ozone depletion and ocean and ice monitoring. Secondary objectives are more effective monitoring and management of the Earth's resources, and a better understanding of the solid Earth processes.

As a total package, Envisat's capabilities exceed those of any previous or planned Earth observation satellite. The payload includes three new atmospheric

sounding instruments designed primarily for atmospheric chemistry, including measurement of ozone in the stratosphere. The advanced synthetic aperture radar collects high-resolution images with a variable viewing geometry, with new wide swath and selectable dual-polarisation capabilities. A new imaging spectrometer is included for ocean colour and vegetation monitoring, and there are improved versions of the ERS radar altimeter, microwave radiometer and visible/near-IR radiometers, together with a new very precise orbit measurement system.

Envisat is observing many of the factors related to changes in atmospheric composition. The results of these changes include the enhanced greenhouse effect, increases in levels of UV-B radiation reaching the ground and changes in atmospheric composition. Understanding the processes involved and the ability to observe the key parameters are both currently lacking.



The oceans exert a major influence on the Earth's meteorology and climate through their interaction with the atmosphere. Understanding the transfer of moisture and energy between ocean and atmosphere, as well as the transfers of energy by the oceans themselves, are matters of scientific priority. Envisat is contributing to this area by providing information on ocean topography and circulation, winds and waves, ocean waves and internal waves,

atmospheric effects on the sea surface, sea-surface temperatures, coastal bathymetry and sediment movements, as well as the biophysical properties of oceans.

The Earth's land surface is a critical component of the Earth system because it carries more than 90% of the biosphere. It is the location of most human activity and it is therefore on land that human impact on the Earth is most visible. Within

This MERIS view of 24 January 2004 stretches from the southern tip of Florida (top left) to the southern coast of Cuba, with the islands of the Bahamas and their shallow blue waters to the right.



Inset: radar image of Envisat in orbit by the FGAN system in Wachtberg (D), March 2002.

Envisat flight model during integration and alignment tests at ESTEC, April 2000.

the biosphere, vegetation is of fundamental importance because it supports the bulk of human and animal life and largely controls the exchanges of water and carbon between the land and the atmosphere. Yet our understanding of the many processes involved is limited. Envisat observations are characterising and measuring vegetation parameters, surface water and soil wetness, surface temperature, elevation and topography. These are critical data sets for improving climate models.

Last, but not least, the cryosphere is a key component of the climate system. It includes the ice sheets, sea-ice and snow cover. Here, Envisat's all-weather capabilities are being exploited to the full as the remoteness, winter darkness, hostile weather conditions and frequent cloud cover of high-latitude ice/snow-covered regions make the use of remote sensing mandatory. Envisat is providing important information on seasonal and long-term variations in sea-ice extent and thickness, evolution in the ice sheets and snow cover. All affect the climate system; several are very sensitive indicators of climate change. Here again, our knowledge of many of the processes involved is lacking.

The satellite comprises the payload complement mounted on the Polar Platform. Some of the instruments focus on ensuring data continuity with the ERS satellite: ASAR, AATSR and RA-2 with the MWR, DORIS and LRR supporting instruments (see the box for instrument details). Observation of the ocean and coastal waters – with the retrieval of marine biology constituent information – is the primary objective of MERIS. The ability to observe the atmosphere,



Envisat and Metop use the multi-mission capability of the Polar Platform (PPF) that originated in the Columbus programme. PPF, in turn, draws heavily on the hardware and technologies from Spot. The Columbus programme approved at the ESA Ministerial Council Meeting in The Hague (NL) in 1987 included the development of a multi-mission PPF as part of the International Space Station. Following a series of studies and iterations with potential users, reuse of the Spot-4 bus design, albeit significantly enlarged, was decided upon. The main development phase (Phase-C/D) for PPF was awarded to British Aerospace in Bristol (UK; now EADS Astrium) in late 1990.

As the ERS-1 launch drew closer, ESA was considering how to continue and extend its services. In 1988, these elements were drawn together in a proposal to Member States for an overall 'Strategy for Earth Observation'. These considerations led to the adoption of the POEM-1 (Polar

Orbit Earth-observation Mission) programme, using the PPF, at the Ministerial Council Meeting in Munich (D) in November 1991. Evolution of POEM-1's payload culminated in splitting it between separate Envisat and Metop satellites, which was finally approved at the next Ministerial Council, in Granada (E) in November 1992. The Phase-C/D contract for the Envisat payload (the 'Mission Prime Contract') was awarded to Dornier Satellitensystem in July 1992.

The two large PPF and Mission Prime contracts, interfacing at some of the technically most critical onboard locations, caused a number of problems during development. Satellite integration was largely carried out at ESTEC following closure of the Bristol site. As a result, many of the technical personnel were collocated with ESA at ESTEC. This, and the grouping of both contractors within Astrium, ensured a much smoother technical path in the final phase.

following on from GOME on ERS-2, is significantly enhanced by three complementary instruments: SCIAMACHY, GOMOS and MIPAS. They can detect a large number of atmosphere trace constituents by analysing absorption lines, and characterise atmospheric layers by complementary limb and nadir observations.

The observations will be continued and extended by the series of smaller satellites being developed within the Agency's Earth Observation and Earth Watch Programmes.

Envisat's launch campaign began on 3 January 2002 in the new S5 integration/fuelling building at Kourou. It was fuelled 6-9 February and transferred to the Batiment d'Assemblage Final launcher final assembly building on 20 February, where it was mated with Ariane-511 on 21 February; the fairing was added



China's longest river and its second largest lake feature in this 230 km-wide ASAR image of 16 August 2003. Dongting Lake is the large L-shaped body of water at lower right. Its size varies considerably as flood waters pour from the famous Yangtze River (from top left and exiting at right) into the lake between July and September. The Yangtze is the longest river in Asia and the third in the world, snaking for 6300 km across China and draining 1.8 million km² of territory. Note the oxbow lakes formed on its right bank. Also feeding into Dongting Lake are the Yuan (from left) and the Yiang (from bottom). The heart-shaped water body above the Yangtze to the right is Lake Hong, known for its beauty and significant as a site for fishing and crab breeding.



Earth's newest desert. Once the fourth largest lake in the world, the Aral Sea has lost three-quarters of its volume over the last 40 years, leaving 40 000 km² of dry white salt terrain now called the Aralkum Desert. The Sea began shrinking in the 1960s when the USSR diverted the Amu Darya and Syr Darya rivers to irrigate the cotton crops of Kazakhstan and Uzbekistan. During the 1980s, little water reached the Sea, and evaporation eventually split it into two sections. MERIS, 9 July 2003, 300 m full resolution; orbit 7088.

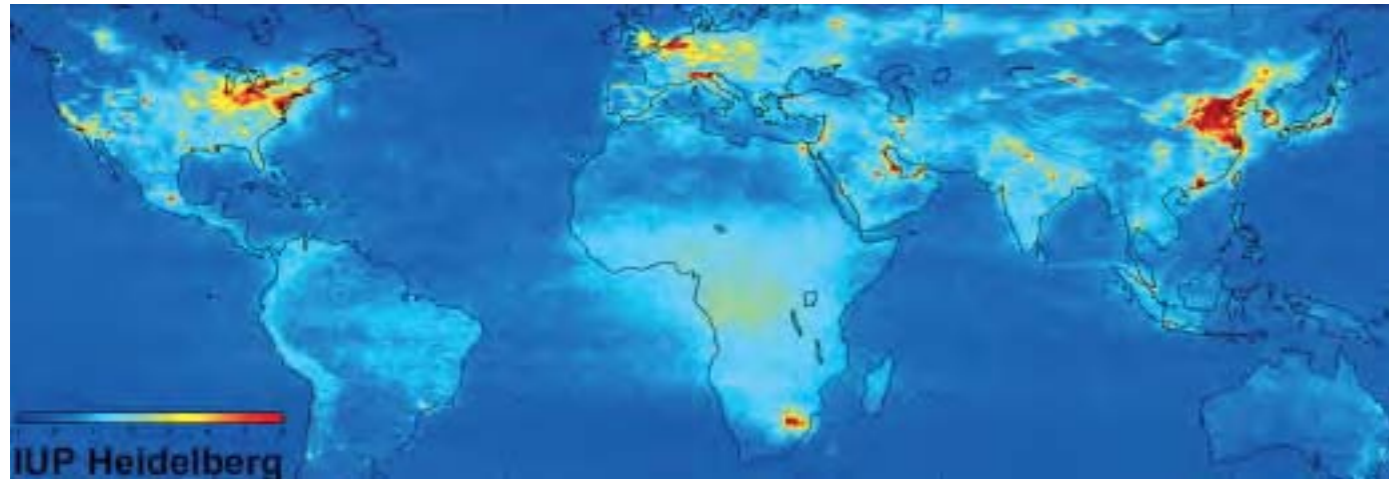

Above: 18 months of SCIAMACHY data on nitrogen dioxide makes clear just how much human activities pollute air quality. NO₂ is mainly man-made, from power plants, heavy industry and road transport, along with biomass burning. SCIAMACHY's 30x60 km resolution shows individual cities in N. America and Europe, a very high concentration above NE China, and biomass burning across SE Asia and Africa. Even ship tracks are visible in the Red Sea and from the tip of India to Indonesia.

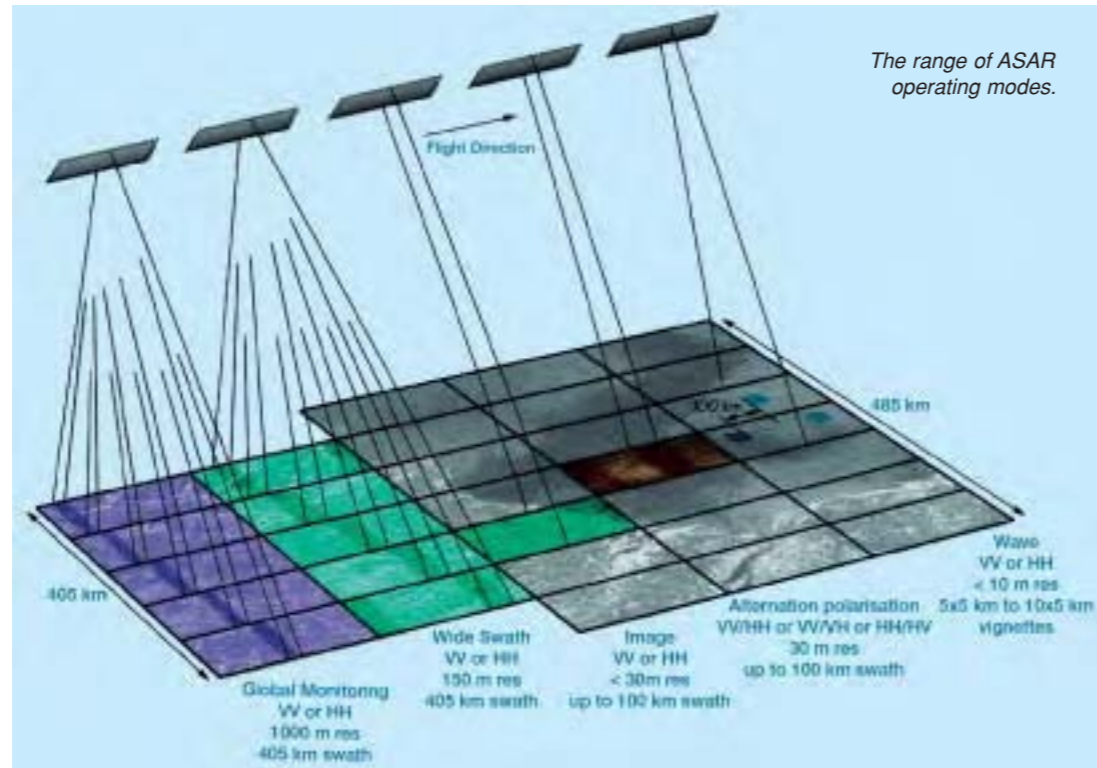

Envisat installed on its launcher. (ESA/CSG/Arianespace)

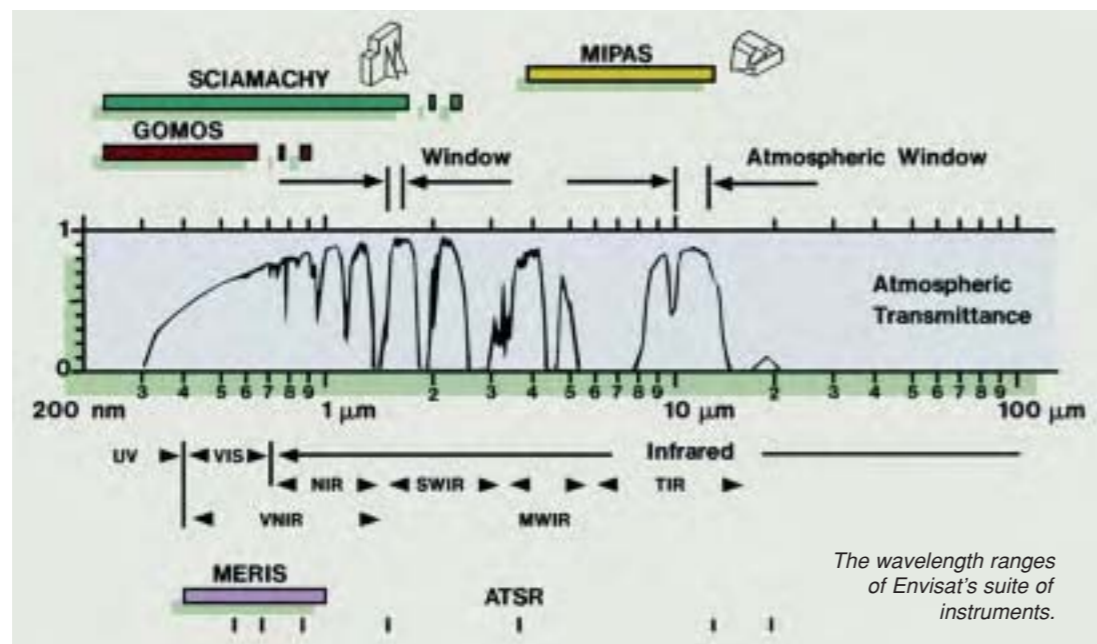

22 February. The stack was transported to the pad on 27 February, but two ventilation hoses became disconnected in windy conditions and the assembly returned to BAF for reconnection; it returned to the pad 28 February. Envisat separated from Ariane 26 min after launch. The solar array was deployed and stable attitude achieved within 90 min of leaving Kourou. Within 2 days, orbital adjustments using 29 kg of hydrazine moved it towards the same ground track as ERS-2, although 30 min ahead, by 3 April. The ASAR antenna was deployed in stages 2-4 March; the Artemis Ka-band antenna 7 March. ASAR was activated 8 March; the first image (of the Amazonian forest) was received 13 March. The Wide Swath

Mode (405 km) was successfully tested 14 March. RA2 was commanded into its main measurement mode 12 March. MWR measurements began 15 March; MERIS 21 March; AATSR 14 March (visible channels only; IR channel 11 April); GOMOS observed its first occultation 20 March; the first MIPAS interferogram was acquired 24 March after cooling down; SCIAMACHY was activated and healthy but the first atmospheric spectra were not returned until April because the optical covers remained closed to avoid pollution from satellite outgassing. The Commissioning Phase ended in December 2002; the official transition from 'initial operations' to 'routine operations' came on 1 September 2003.

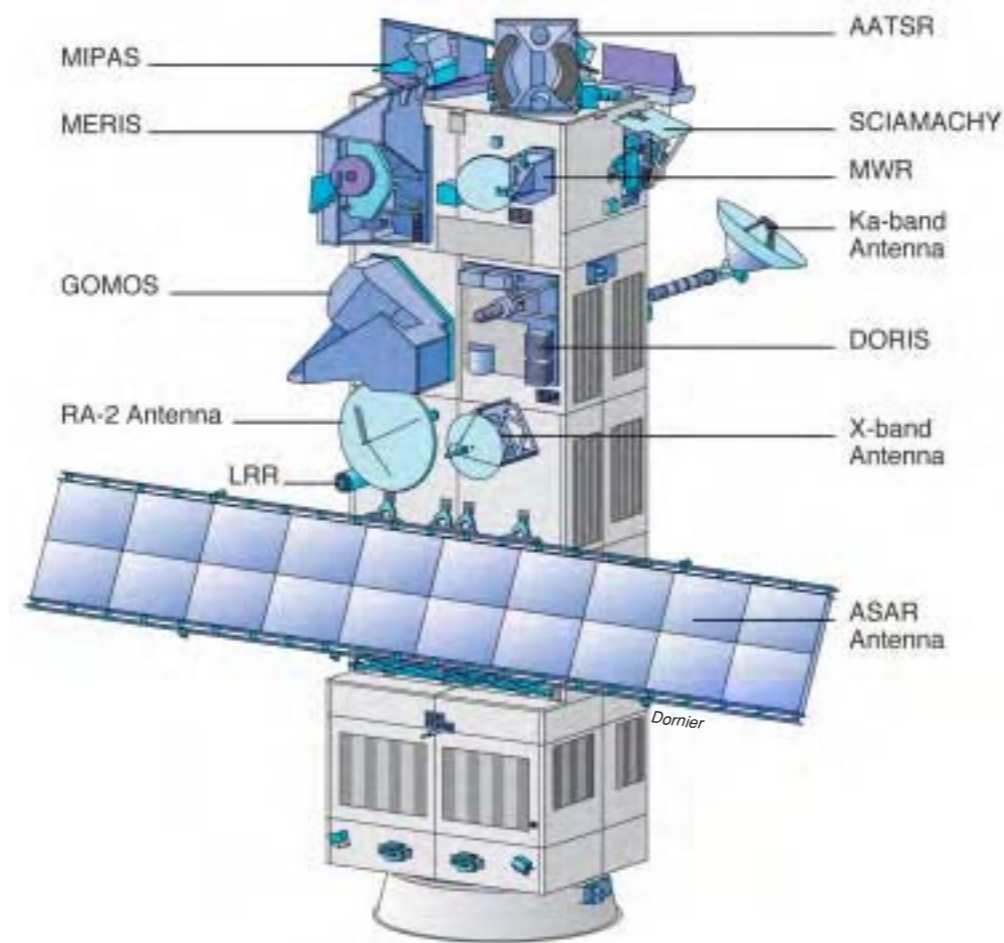

Satellite configuration: 10.5 m long, 4.57 m diameter envelope in launch configuration; 26x10x5 m deployed in orbit. The satellite comprises the bus (Polar Platform; PPF) and the payload. The PPF is divided into the Service Module (derived from Spot-4's SM and providing power, AOCS and S-band communications) and the Payload Module providing data handling, power and communications for the payload.

Attitude/orbit control: primary 3-axis attitude control by five 40 Nms reaction wheels, magnetorquers for fine control ($0.1^\circ 3\sigma$). Hydrazine thrusters provide orbit adjust and attitude control. Attitude determination by Earth, Sun and star sensors, with gyros. 289 kg hydrazine remained on reaching the operational orbit; 257 kg @ October 2003; 226 kg @ September 2004.

Power system: single 5x14 m 14-panel Si solar wing generates 6.5 kW after 5 years (1.9/4.1 kW average/peak to payload); eclipse power provided by eight 40 Ah NiCd batteries.

Communications: Flight Operations Segment including Flight Operations Control Centre at ESOC working via the primary S-band TT&C station (2/4 kbit/s up/down) at Kiruna-Salmijärvi (S). Payload Data Segment including Payload Data Control Centre at ESRIN, Payload Data Handling Stations at Kiruna-Salmijärvi (X-band data) and ESRIN (Ka-band data via Artemis), Payload Data Acquisition Station at Matera (I, X-band data) and 6 Processing Archiving Centres in F, UK, D, I, E & S. Data transmission by 100 Mbit/s channel for ASAR and one 0-32 Mbit/s and nine 0-10 Mbit/s channels for others. Two 70 GB SSRs for Low Bit Rate (LBR) recording at 4.6 Mbit/s, dump 50 Mbit/s; plus High Bit Rate (HBR) 100 Mbit/s record/dump for ASAR high-rate & MERIS full-resolution. Backup tape recorder for LBR. Realtime/recorded data via three 8.1-8.3 GHz X-band TWTA direct links and three 26-27 GHz Ka-band via Artemis (steerable 90 cm-diameter antenna on 2 m-long mast) at 50 & 100 Mbit/s. Artemis link increases coverage by more than 30 min per orbit.

Envisat Payload	
Advanced Synthetic Aperture Radar (ASAR)	ESA
Improved version of ERS SAR. 5.331 GHz, 1.3x10 m array of twenty 66.4x99.5 cm radiating panels (each 16 rows of 24 microstrip patches). <i>Imaging mode:</i> HH or VV polarisation, 29x30 m/2.5 dB resolution, 7 selectable swaths 100-56 km wide at 15-45° incidence angles, 96.3 Mbit/s, 1365 W power consumption. <i>Alternating polarisation mode:</i> HH + VV, 29x30 m/3.5 dB, 7 selectable swaths 100-56 km at 15-45°, 96.3 Mbit/s, 1395 W. <i>Wide swath mode:</i> HH or VV, 150x150 m/2.5 dB, 405 km swath width in 5 subswaths at 17-42°, 96.8 Mbit/s, 1200 W. <i>Global monitoring mode:</i> HH or VV, 1000x1000 m/1.5 dB, 405 km swath width in 5 subswaths at 17-42°, 0.9 Mbit/s (allowing onboard storage), 713 W. <i>Wave mode:</i> HH or VV, 30 m/2.0 dB, two vignettes of 5x5 km every 100 km in any swath at 20-45°, 0.9 Mbit/s, 647 W. Up to 30 min of high-resolution imagery can be returned on each orbit. 830 kg.	
Radar Altimeter (RA-2)	ESA
Fully-redundant nadir-pointing pulse-limited radar using 1.2 m-diameter dish at 13.575 & 3.3 GHz. Derived from ERS RA; 3.3 GHz channel added to correct for ionosphere propagation effects. Fixed pulse repetition frequencies of 1800/450 Hz are used respectively by the two channels. Onboard autonomous selection of transmitted bandwidth (20, 80 or 320 MHz) makes possible continuous operation over ocean, ice and land. Altitude accuracy after ionospheric correction improved to < 4.5 cm for Significant Wave Height up to 8 m. 110 kg, 100 kbit/s, 161 W.	
Advanced Along-Track Scanning Radiometer (AATSR)	UK/Australia
Continues data from ERS-1/2 ATSR on sea-surface temperatures (accurate to 0.5 K) for climate research and operational users. AATSR adds land and cloud measurements for vegetation biomass, moisture, health and growth stage, and cloud parameters such as water/ice discrimination and particle size distribution. Seven channels: 0.555, 0.67, 0.865, 1.6, 3.7, 10.85 & 12 μ m, spatial resolution 1x1 km, swath width 500 km. 101 kg, 625 kbit/s, 100 W.	
Scanning Imaging Absorption Spectrometer for Atmospheric Chartography (SCIAMACHY)	D/NL
240-2380 nm grating spectrometer (limb/nadir viewing) for detrimental trace gas measurement in troposphere/stratosphere. Resolution 2.4 Å UV and 2.2-14.8 Å visible/IR. Swath 1000 km wide in nadir mode. 198 kg, 400 kbit/s (1867 kbit/s realtime), 122 W.	
Medium Resolution Imaging Spectrometer (MERIS)	ESA
MERIS is the first programmable imaging spectrometer. 400-1050 nm, 250 m spatial/12.5 nm spectral resolution (adjustable as required), swath width 1130 km. Water quality measurements, such as phytoplankton content, depth and bottom-type classification and monitoring of extended pollution. Secondary goals: atmospheric monitoring and land surfaces processes. 207 kg, 24/1.6 Mbit/s (full/reduced resolution), 148 W average.	
Michelson Interferometer for Passive Atmospheric Sounding (MIPAS)	ESA
A Fourier transform spectrometer observing mid-IR 4.15-14.6 μ m limb emissions with high spectral resolution (< 0.03 cm^{-1}), allowing day/night measurement of trace gases (including the complete nitrogen-oxygen family and several chlorofluorocarbons) in stratosphere and cloud-free troposphere. Global coverage, including poles. 320 kg, 533 kbit/s (8 Mbit/s raw), 195 W.	
Global Ozone Monitor by Occultation of Stars (GOMOS)	ESA
Two UV to near-IR spectrometers observe setting stars through the atmosphere for 50 m vertical resolution and 0.1% annual variation sensitivity of ozone/related gases. Occultation method is self-calibrating and avoids the long-term instrumental drift problems of previous sensors. Spectrometer A: 2500-6750 Å, resolution 0.3 nm/pixel; B: 9260-9520 Å (H_2O) and 7560-7730 Å (O_2), resolution 0.05 nm/pixel. The Fast Photometer Detection Module provides 1 kHz 2-band scintillation monitoring of the star image. 163 kg, 222 kbit/s, 146 W. Switched to redundant side 15 July 2003 because of reduction in FOV.	
Microwave Radiometer (MWR)	ESA
A nadir-viewing 23.8/36.5 GHz Dicke radiometer with 600 MHz bandwidth. ERS MWR design modified mainly in the mechanical layout and antenna configuration. Radiometric stability < 0.5 K over 1 year. Periodic onboard calibration by switching receiver input between two references: a horn pointing at the cold sky and a hot radiator at ambient. MWR determines tropospheric column water vapour content by measuring the radiation received from Earth's surface to correct RA-2 altitude measurements. 25 kg, 16.7 kbit/s, 23 W.	
Doppler Orbitography & Radio-positioning Integrated by Satellite (DORIS)	France
DORIS determines orbit with cm-accuracy. It receives 2.03625 GHz & 401.25 MHz signals from ground beacons and measures the Doppler shift every 7-10 s. 91 kg, 16.7 kbit/s, 42 W. Switched to backup June 2004.	
Laser Retroreflector (LRR)	ESA
Precise orbit determination using cluster of laser reflectors mounted close to RA-2.	

MSG

Achievements: continues and extends Europe's geostationary meteorological satellite system

Launch dates: Meteosat-8/MSG-1 22.45 UT 28 August 2002;

planned MSG-2 August 2005; MSG-3 2008-2009; MSG-4 2010-2011

Mission end: 2018 (7-year design lives)

Launch vehicle/site: Ariane-5 from Kourou, French Guiana

Launch mass: MSG-1 2032 kg (dry 1063 kg; 1220 kg BOL GEO)

Orbit: geostationary over 0° (MSG-1 3.4°W)

Principal contractors: Alcatel Space Industries (Cannes, prime), Astrium SAS (radiometer), Astrium GmbH (power system, AOCS, propulsion system), Alenia Spazio (Mission Communication Package), Saab-Ericsson Space (Data Handling Subsystem)

ESRO approved development of Europe's first applications-satellite project in 1972, creating the Meteosat system that is now an integral and indispensable part of the world's network of meteorological satellites. The success of the first three pre-operational satellites paved the way for the Meteosat Operational Programme in 1983 (Meteosat-4/5/6) and the current Meteosat Transition Programme (Meteosat-7).

ESA was responsible for developing and operating the system on behalf of the newly-created European Organisation for the Exploitation of Meteorological Satellites (Eumetsat), which took direct operational control on 1 December 1995. The Meteosat Second Generation (MSG) was introduced in 2002 to provide services until at least 2018. ESA continues responsibility for developing and procuring these satellites; MSG-1/Meteosat-8 funding was shared by ESA (two-thirds) and Eumetsat, while MSG-2/3/4 are funded solely by Eumetsat.

MSG is a significantly enhanced follow-on system, designed in response to user needs for 'nowcasting' applications and Numerical Weather Prediction (NWP), in addition to providing important data for climate monitoring and research.

MSG carries the new Spinning Enhanced Visible and Infrared Imager (SEVIRI), improving on its predecessors:

- 12 spectral channels, instead of three, to provide more precise data about the atmosphere, improving the quality of the starting conditions for NWP models,
- 15-min imaging cycle, instead of 30-min, to provide more timely data for nowcasting, helping in the forecasting of severe weather such as thunderstorms, snow and fog,
- better horizontal image resolution: 3 km (*vs* 5 km) for 11 channels and 1 km (*vs* 2.5 km) for high-resolution visible, the latter to help forecasters in detecting small-scale weather phenomena,
- the all-digital data transmission increases performance and data rates.

The Global Earth Radiation Budget (GERB) instrument was selected by ESA as an Announcement of Opportunity payload for MSG-1. Eumetsat decided to fund further instruments for MSG-2/3/4. GERB is providing critical data on the Earth's reflected solar and thermal radiation for climate research.

ESA/ESOC delivered MSG-1 to 10.5°W, where it was formally handed over to Eumetsat on 25 September 2002 to begin commissioning. On 17 October 2002, SSPA-C in the communication

Right: the first image from MSG-1/Meteosat-8: recorded in the visible channel at 12.15 UT on 28 November 2002. (Eumetsat)

Right below: GERB images on 1 February 2003. The left view shows radiances in the shortwave channel, at right in the total channel.

Below: MSG-1/Meteosat-8 in final configuration at Alcatel Space Industries.

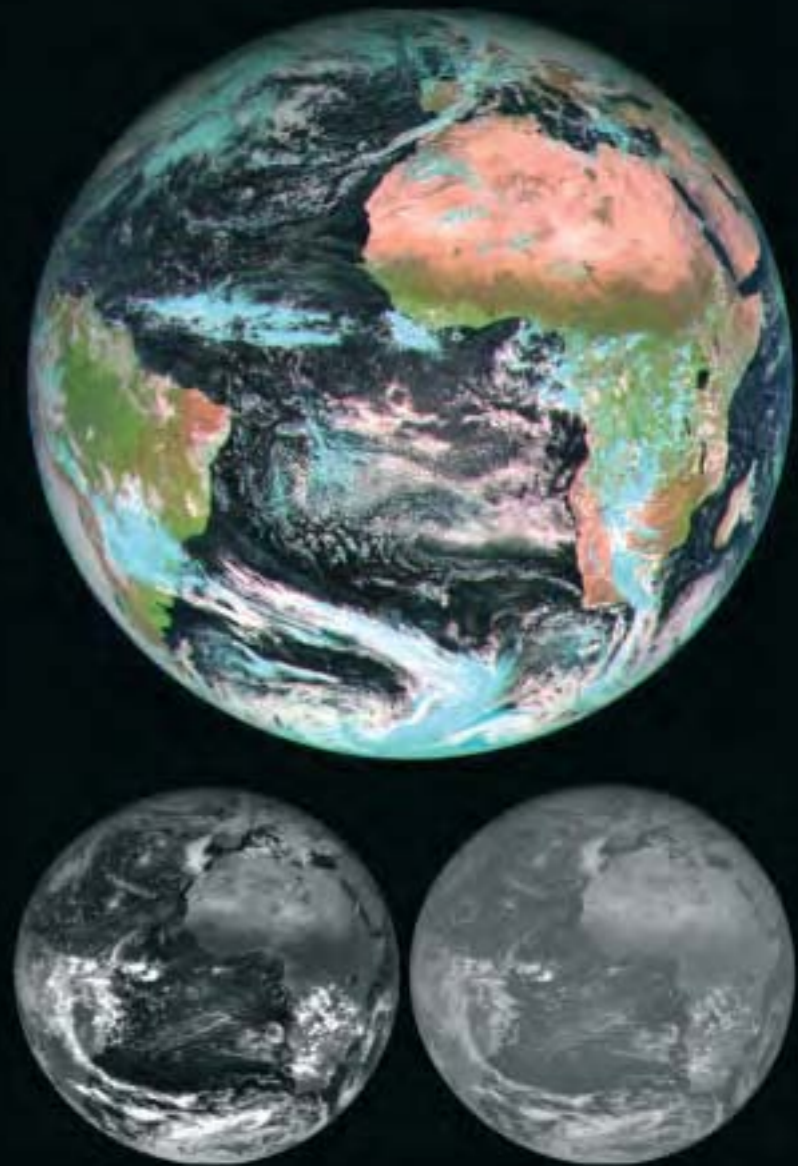

system failed. Although there is a spare SSPA, it was deemed prudent to disseminate processed images to users instead through commercial satellites (EUMETCast); MSG-1 continues downlinking raw images and its search & rescue and data platform functions. As a result, Meteosat-7 will remain at 0° until replaced by MSG-2 at end-2005. The full dissemination service will not be implemented until about 2009 via MSG-3, with MSG-2 as backup. EUMETCast will be available for the whole mission.

MSG-1 commissioning resumed on 26 November 2002, and the first SEVIRI image was returned on 28 November. Commissioning was completed 19 Dec 2003. MSG-1 began moving from 10.5°W on 14 January 2004, and arrived at its new operational slot over 3.4°W 13 days

later. It was declared operational on 29 January 2004 and renamed Meteosat-8. It will continue to work in parallel with Meteosat-7 until MSG-2 arrives to assume the prime role at end-2005.

The original design – but now beginning with MSG-3 – was for digital image data and meteorological products to be disseminated via two distinct channels: High-Rate Image Transmission for the full volume of processed image data in compressed form; Low-Rate Image Transmission for a reduced set of processed image data and other data in compressed form. Different levels of access to HRIT and LRIT data are provided through encryption. The Eumetsat central processing facility in Darmstadt generates a range of meteorological products, including:

The Applications of Meteosat Second Generation

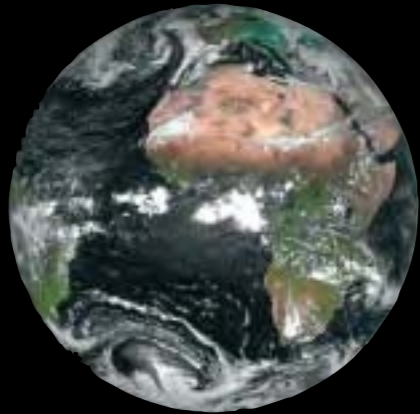

CHANNEL 1: VISIBLE 0.6
(0.56-0.71 μm)

These channels are essential for cloud detection, cloud tracking, scene identification and the monitoring of land surfaces and aerosols. Together with channel 3, they can be used to generate vegetation indices.

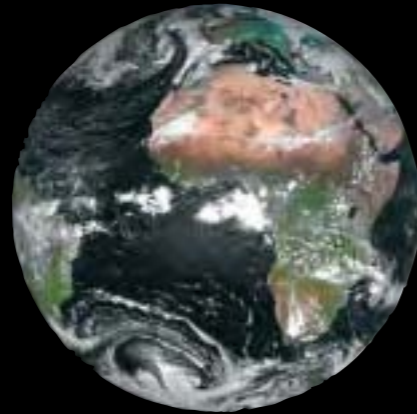

CHANNEL 2: VISIBLE 0.8
(0.74-0.88 μm)

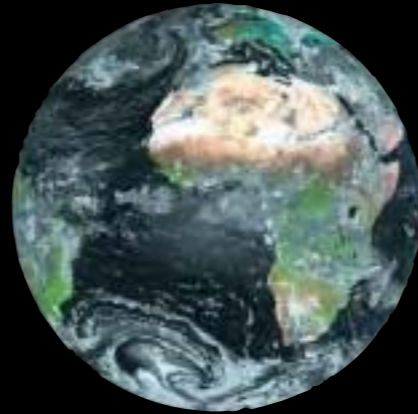

CHANNEL 3: NEAR-INFRARED 1.6
(1.50-1.78 μm)

Helps to discriminate between snow and cloud, and between ice and water clouds. Also provides aerosol information.

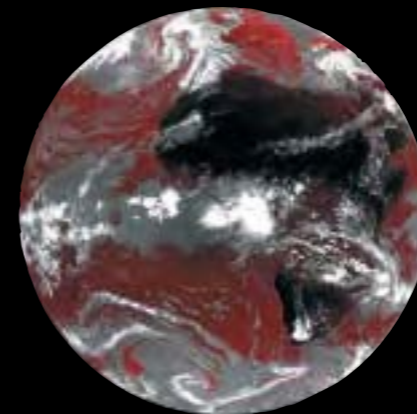

CHANNEL 4: INFRARED 3.9
(3.48-4.36 μm)

Primarily for detection of low cloud and fog at night, but also useful for measurement of land and sea temperatures at night and the detection of forest fires.

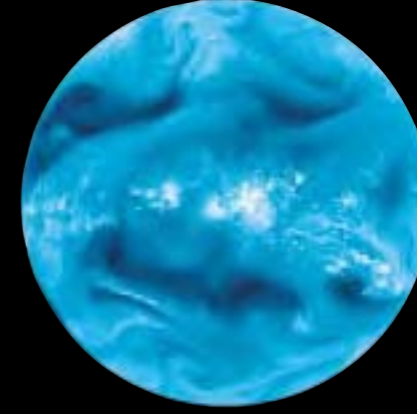

CHANNEL 5: WATER VAPOUR 6.2
(5.35-7.15 μm)

Provides continuity of the Meteosat first-generation broadband water vapour channel to measure mid-atmospheric water vapour and to produce tracers for atmospheric winds. Also supports height assignment for semi-transparent clouds. Two separate channels representing different atmospheric layers instead of the single channel on Meteosat-7.

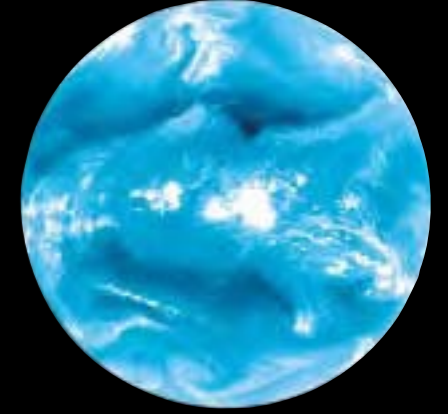

CHANNEL 6: WATER VAPOUR 7.3
(6.85-7.85 μm)

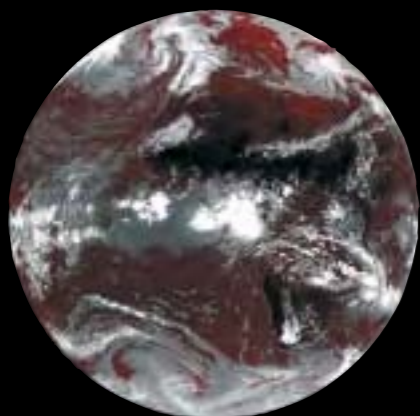

CHANNEL 7: INFRARED 8.7
(8.3-9.1 μm)

Used mainly to provide quantitative information on thin cirrus clouds and to support the discrimination between ice and water clouds.

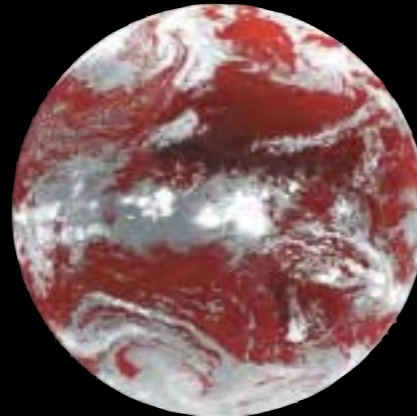

CHANNEL 8: INFRARED 9.7
(9.38-9.94 μm)

Responsive to ozone concentration in the lower stratosphere. It is used to monitor total ozone and diurnal variability. Potential for tracking ozone patterns as an indicator of wind fields at that level.

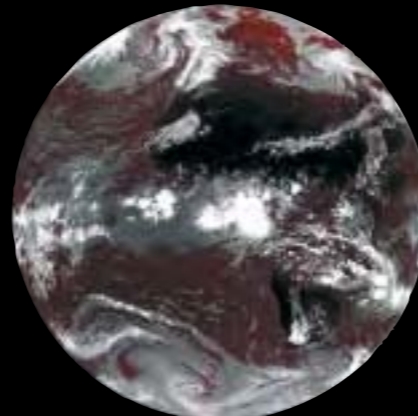

CHANNEL 9: INFRARED 10.8
(9.8-11.8 μm)

The 'split-window' thermal-IR channels. They have slightly different responses to the temperatures of clouds and the surface. Together, they reduce

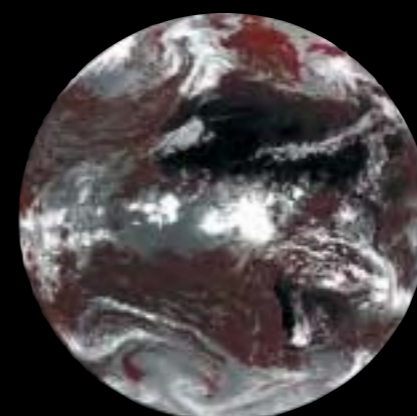

CHANNEL 10: INFRARED 12.1
(11-13 μm)

atmospheric effects when measuring surface and cloud-top temperatures. Also cloud tracking for atmospheric winds and estimates of atmospheric instability.

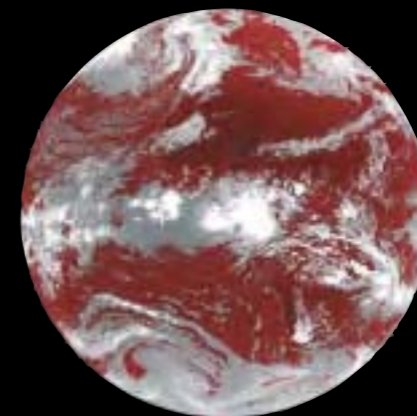

CHANNEL 11: INFRARED 13.4
(12.4-14.4 μm)

CO₂ absorption channel, used for estimating atmospheric instability, as well as contributing temperature information on the lower troposphere.



CHANNEL 12: HIGH-RES VISIBLE
(0.6-0.9 μm)

Broadband visible channel, as the previous Meteosat VIS channel, but with an improved sampling interval of 1 km (Meteosat-7: 2.5 km).



Integration of the SEVIRI Engineering Model at Astrium SAS. The telescope stands 1.3 m high, plus the 1.2 m-high passive cooler for the infrared detectors.



MSG-1 minus its solar array.

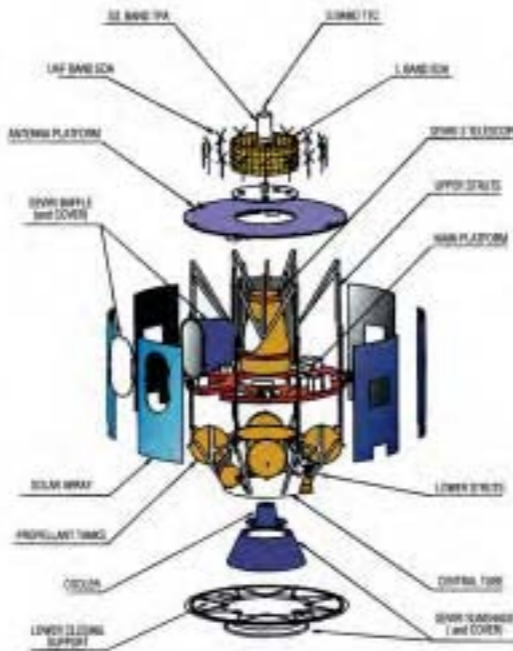

- atmospheric wind vectors at various altitudes,
- cloud analysis providing identification of cloud layers with coverage, height and type,
- tropospheric humidity at medium and upper levels,
- high-resolution precipitation index,
- cloud-top height images for aviation meteorology,
- clear-sky radiances
- global airmass instability,
- total ozone product.

In addition to these instruments, MSG receives 100 bit/s Data Collection Platform information for distribution in near-realtime, and the GEOSAR Search & Rescue transponder relays 406 MHz distress signals from ships, aircraft and other vehicles to the COSPAS-SARSAT system.

Satellite configuration: 3.218 m-dia, 3.742 m-high (2.4 m body) stepped cylinder, with SEVIRI field of view at 90° to axis for scanning Earth disc.

Attitude/orbit control: operationally held within $\pm 1^\circ$ at 0° longitude (3.4°W MSG-1) by thrusters. Spin-stabilised (by thrusters) at 100 rpm anti-clockwise around main axis parallel to Earth's axis. Attitude information from Earth horizon and Sun sensors. Bipropellant (MMH/MON-1) Unified Propulsion System (94 kg dry) of two 400 N apogee engines for 3-burn insertion into GEO and six 10 N thrusters. Four 75 cm-dia spheres hold up to 976 kg propellant (MSG-1: 61.9 kg MMH, 100.4 kg MON-1 remained as of May 2005).

Power system: eight panels 2.4 m high, 1.25 m wide on cylindrical body carry 7854 32x60 mm high- ϵ Si cells, supported by two 29 Ah 27.5 kg

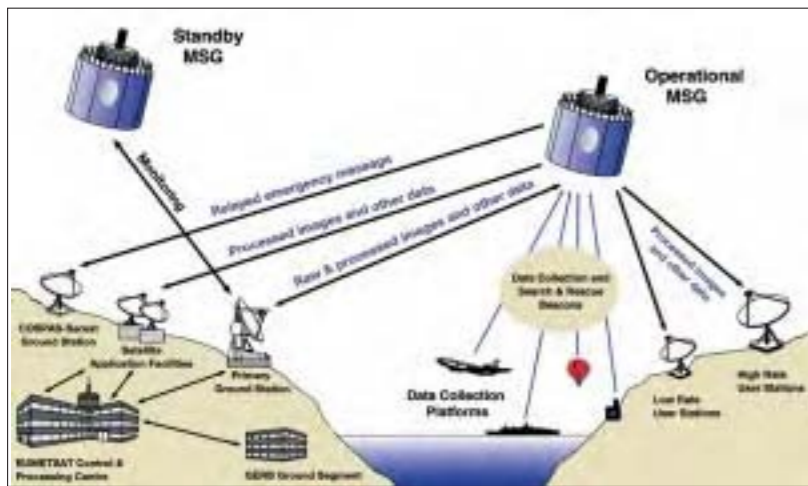

MSG Earth Observation Payload

Spinning Enhanced Visible and Infrared Imager (SEVIRI)

SEVIRI returns 12 visible/IR full-disc Earth images every 12 min, followed by a 3 min reset period. The 5367 mm-focal length telescope uses three lightweight Zerodur mirrors. The 51 cm diameter circular main mirror is combined with a 512x812 mm elliptical scanning mirror, stepped with MSG's rotation to scan Earth's disc at 9 km intervals south to north. There are 42 detector elements: 9 for High-Resolution Visible (HRV, 0.5-0.9 μm) and 3 each for the other 11 channels: 0.56-0.71, 0.74-0.88, 1.50-1.78, 3.48-4.36, 8.30-9.10, 9.80-11.80 & 11.00-13.00 μm (enhanced imaging); 5.35-7.15, 6.85-7.85, 9.38-9.94 & 12.40-14.40 μm (air-mass, pseudo-sounding). Data sampling intervals 3 km, except 1 km for HRV. 270 kg, 153 W nominal power consumption. First image 28 Nov 2003.

Global Earth Radiation Budget (GERB)

Together with SEVIRI, GERB enables study of water vapour and cloud forcing feedback, two of the most important (and poorly understood) processes in climate prediction. It measures Earth's long- and shortwave radiation to within 1%; a full scan takes 5 min. Bands: 0.35-4.0 and 0.35-30 μm (4.0-30 μm by subtraction). 45x50 km nadir pixel size. Instrument 26 kg, 36 W power consumption, 55 kbit/s data rate. Cooperative project by UK, Italy & Belgium; developed by consortium led by Rutherford Appleton Laboratory, UK. Data sent from Darmstadt to RAL in near-realtime, processed and forwarded 20 min later to Royal Meteorological Inst. Belgium for further processing and release to science team in 2 h. Activated 9 Dec 2002; first image 12 Dec 2002.

NiCd batteries, deliver 700 W at equinox after 7 years. Solar array mass 76 kg.

Communications payload: raw data downlinked at 3.27 Mbit/s 1686.8 MHz L-band using one of three (4:3 redundancy) 10 W SSPA solid-state power amplifiers, together with relayed Data Collection Platform data, to Eumetsat in Darmstadt, Germany. L-band retransmits processed imagery received at S-band and other data to users in high/low rate data streams (up to 1 Mbit/s without compression). Data volume is a magnitude greater than previous generation. (Service not available via MSG-1.) Telecommand/telemetry at S-band.

Meteosat Third Generation (MTG)

Even as MSG-1 was being prepared for launch, preliminary work was already under way on the mission requirements and observation concepts for the third generation, projected to enter service in 2015. MTG will significantly improve Europe's short-range weather forecasting, including extreme events, and the monitoring of air quality and pollution. Consultations with users, beginning with a workshop in November 2001, have yielded five candidate observation goals for MTG: high-resolution fast imagery; full-disc spectral imagery; IR sounding; lightning imagery; UV-visible sounding. Pre-Phase-A studies have been conducted 2002-2005; parallel ESA & Eumetsat Ph-A studies are planned 2005-2007; Ph-B 2007-2009; Ph-C/D 2009-2014.

Integral

Achievements: detailed spectroscopy and imaging of celestial gamma-ray sources; largest ESA science satellite

Launch date: 04:41 UT 17 October 2002

Mission end: 2.2-year nominal, extended to December 2008; satellite design life minimum 5 years

Launch vehicle/site: Proton from Baikonur Cosmodrome, Kazakhstan

Launch mass: 3958 kg (dry 3414 kg, 2013 kg payload, 544 kg propellant)

Orbit: BOL 9050x153 657 km, 52.25°, 72 h (evolving after 5 yr to: 12 500x153 650 km, 87°)

Principal contractor: Alenia Spazio

ESA's International Gamma-Ray Astrophysics Laboratory (Integral) is providing an unprecedented combination of celestial imaging and spectroscopy over a wide range of X-ray and gamma-ray energies, including optical monitoring. For the first time, astronomers are making simultaneous observations over seven orders of magnitude in photon energy (from visible light to gamma-rays) of some of the most energetic objects in the Universe.

Integral was selected by the Agency's Science Programme Committee in 1993 as the M2 medium-size scientific mission. It was conceived as an observatory, with contributions from Russia (launch) and NASA (Deep Space Network ground stations).

Gamma-ray astronomy explores nature's most energetic phenomena and addresses some of the most fundamental problems in physics and astrophysics. It embraces a great variety of processes: nuclear excitation, radioactivity, positron annihilation, Compton scattering, and an even greater diversity of astrophysical objects and phenomena: nucleosynthesis, nova and supernova explosions, the interstellar medium, cosmic ray interactions and sources, neutron stars, black holes, gamma-ray bursts, active galactic nuclei and the cosmic gamma-ray background. Not only do

gamma-rays allow us to see deeper into these objects, but the bulk of the power radiated by them is often at gamma-ray energies.

Understanding the nature and properties of black holes is a key objective. Their masses range up to many millions of times that of the Sun. Such giant black holes may lie at the centre of many galaxies, including our own. IBIS has detected a new source within 0.9 arcmin of Sgr A* at the Galactic Centre at energies up to about 100 keV. This is the first report of persistent hard X-ray emission from the Galaxy's central 10 arcmin. Although other sources within this region might be contributors, there is a distinct possibility that we are seeing hard X-rays from the supermassive black hole at the centre of our Galaxy for the first time.

SPI has produced its first all-sky map of the 511 keV line emission produced when electrons and their anti-matter equivalents, positrons, meet and annihilate. The exact energy, shape and width of this line provide information on the medium where this annihilation is occurring, and the distribution around the sky provides clue to the source(s) of the

Inset: Integral's first gamma-ray burst, seen 25 November 2002 by IBIS. Such a burst may signal the birth of a black hole.

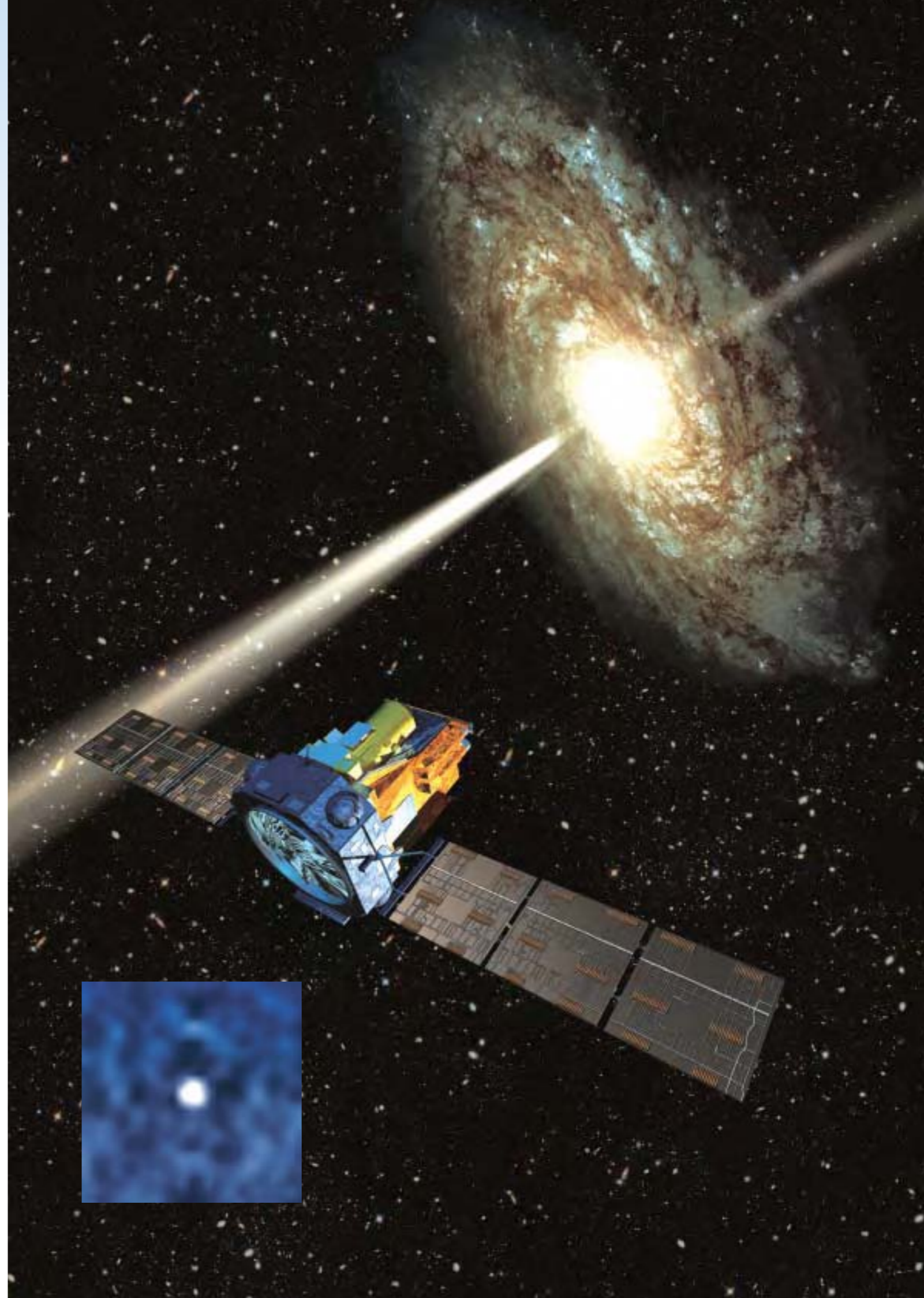

Are we seeing the supermassive black hole at the centre of our Galaxy for the first time? IBIS has found a new source (arrowed cross) close to the Sgr A* galactic nucleus. (G. Belanger/CEA-Saclay et al.)

The 511 keV gamma-rays from the Galactic Centre are created by the annihilation of electrons with their anti-matter twins (J. Knoedseder/CESR Toulouse). The inset spectrum, the best ever obtained, provides information on the conditions where the gamma-rays are generated. (E. Churazov/IKI/MPI)

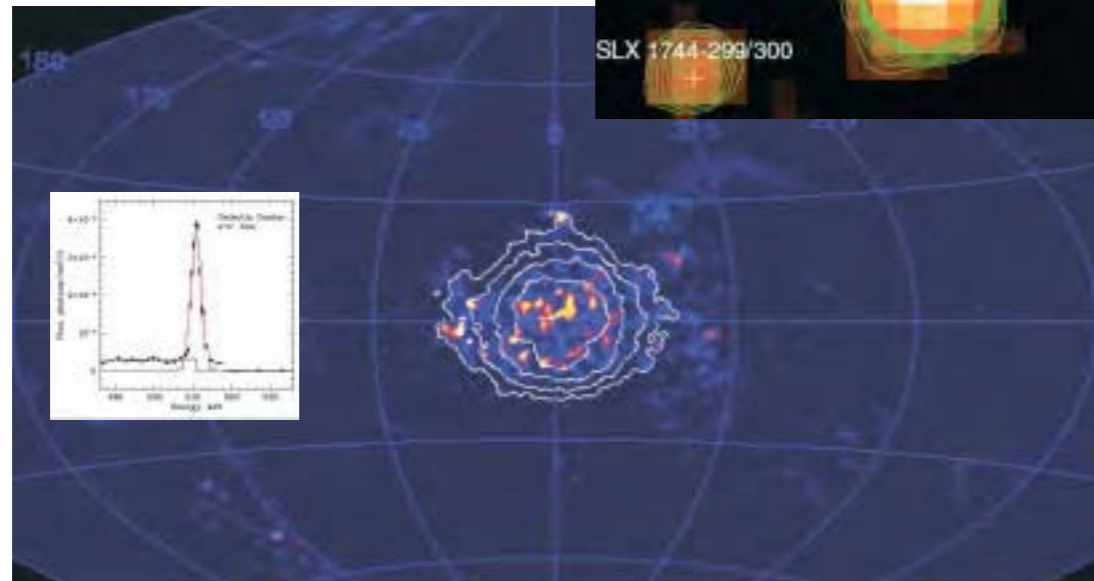

anti-matter – one of the mysteries that Integral is hoping to solve. What is producing the positrons is being hotly debated. SPI shows the emission is so far seen only towards the Galactic Centre, with a spread that could be from a galactic bulge or halo, a bulge and disc, or a combination of point sources. Such distributions are expected if the anti-matter is created in X-ray binary stars, novae, Type-Ia supernovae or, more excitingly, by light Dark Matter. Integral has measured the shape of the 511 keV line with unprecedented precision; it suggests the annihilation is happening in a region with a temperature of at least 7000 K.

Another new high-energy source recently discovered by Integral coincides with the giant molecular cloud Sgr B2 towards the Galactic Centre. Integral and other

observatories strongly support the idea that the hard X-ray emission of Sgr B2 is Compton scattered and reprocessed radiation emitted 300 years ago by Sgr A*, the supermassive black hole candidate in the centre of our Galaxy.

A key puzzle solved by Integral is the contribution of point sources to the diffuse soft gamma-ray background. With its superior ability to see faint and fine details, Integral reveals the individual sources that comprise the foggy, soft gamma-ray background seen by previous observatories. The brightest 91 objects mapped by Integral as individual sources almost entirely account for that diffuse emission.

A surprise was the unexpected discovery by Integral of a new type of highly absorbed X-ray binary stars that had escaped detection by other

One of Integral's most important objectives is to study compact objects such as neutron stars and black holes. IBIS is imaging them in unprecedented detail and SPI is allowing the first detailed physical analysis at gamma-ray energies. Early observations included simultaneous views by all four instruments of Cygnus X-1, believed to be a black hole consuming its giant star companion.

missions. These objects have hard spectra at high energies and strong photoelectric absorption, most likely caused by the stellar wind and accreting material of the companion stars below a few keV. From spectroscopic observations, these objects are likely to be high-mass X-ray binaries, many of them in the spiral arms Scutum and Norma.

The high-energy sky is highly variable and many objects appear only briefly. Integral has observed many of these unusual 'Targets of Opportunity'. The massive X-ray binary V0332+53 (discovered in 1973 by Vela-5B) was observed by Integral during an outburst in early 2005. The binary system X0115+63 was observed during an outburst in September 2004. Again, it is a transient pulsar and Integral provided the highest resolution observation ever of cyclotron lines – radiation from charged particles oscillating in a star's strong magnetic field. The line energy varies during the pulse phase, suggesting that the magnetic field is changing. Another surprise was the detection by Integral of very hard emission from anomalous X-ray pulsars. These systems were known until Integral as young pulsars, with soft spectra and very strong magnetic fields. Integral showed for the first time that the spectra are very hard above 10-20 keV.

Observation of gamma-ray lines produced during nucleosynthesis is the main objective for SPI. The 511 keV observations of the Galactic Centre revealed a weak disc emission from the positrons produced during the radioactive decay of ^{26}Al and ^{44}Ti , two radioactive species produced during explosive nucleosynthesis in supernova explosions. ^{26}Al is thereby

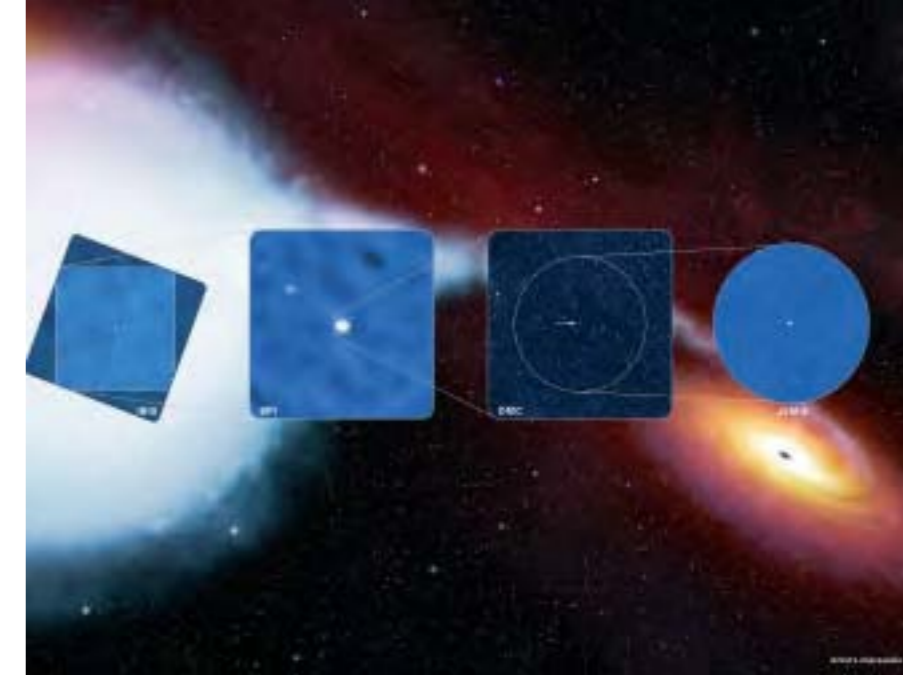

a key tracer of star formation. The line has been detected in the Cygnus region of active star formation. ^{44}Ti emission has been detected from the supernova remnant Cas A; work is under way to measure the line width to help explain the explosion mechanism. Recently, an important discovery was the line emission from the decay of ^{60}Fe , another product of nucleosynthesis at the end of a star's life. Future mapping should separate the different stars responsible for creating ^{26}Al and ^{60}Fe , believed to occur at different stages of a star's life cycle.

Active galactic nuclei are important targets for Integral. At the centres of each AGN is an accreting supermassive black hole. Depending on the angle of the surrounding torus, it can hide the black hole and hot accretion disc from us. Such galaxies are known as 'Seyfert 2' types and are usually faint to optical telescopes. Another theory is that they are faint because the black hole is not actively accreting gas and the disc is therefore weak. But Integral and XMM-Newton have found more evidence that massive black holes are surrounded by a toroidal gas cloud that sometimes blocks our view. Looking edge-on into this doughnut for NGC 4388, features were revealed in unprecedented clarity. Some of the gamma-rays produced close to the black hole are absorbed by iron atoms in the torus and re-emitted at a lower energy.

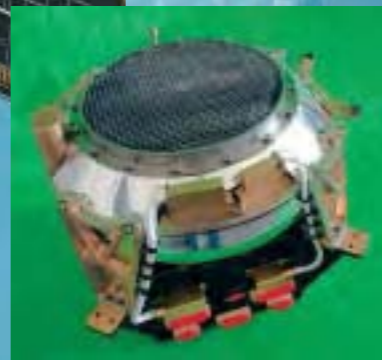
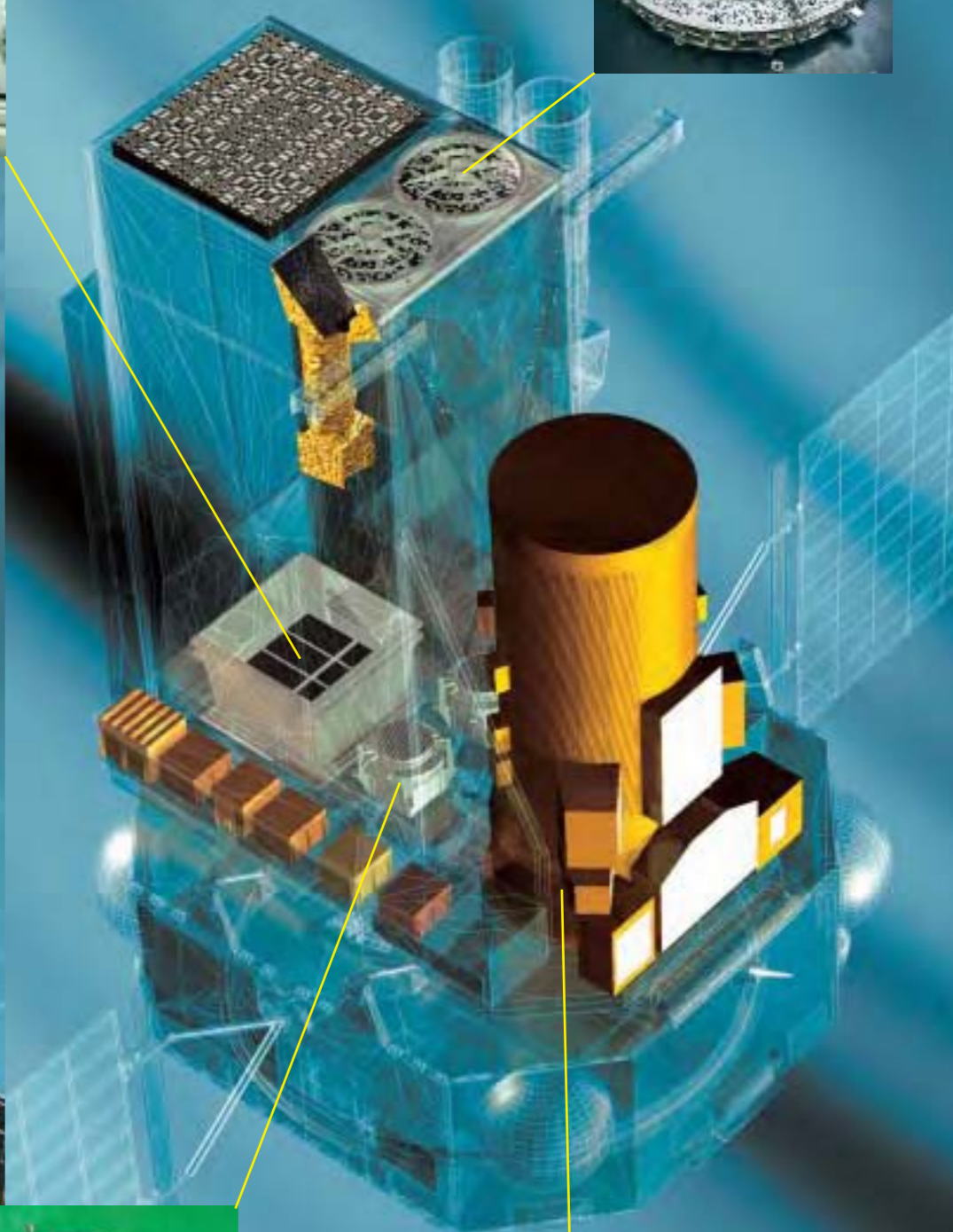
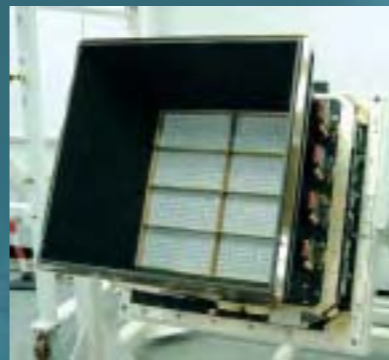
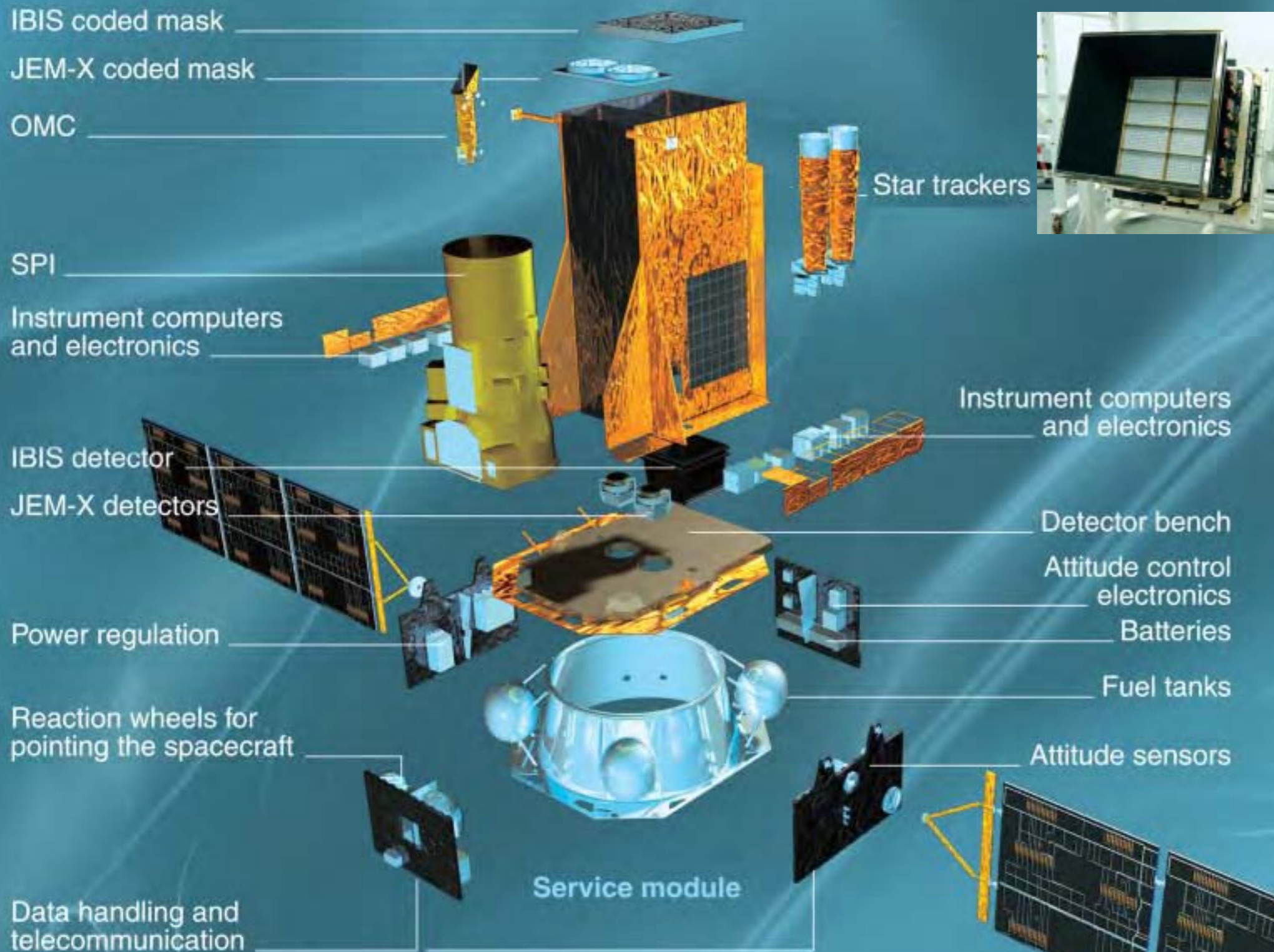

Integral's two main instruments are SPI and IBIS. The fine spectroscopy by SPI permits spectral features to be uniquely identified and line profiles to be determined. The fine imaging capability of IBIS within a large field of view accurately locates the gamma-emitting objects with counterparts seen at other wavelengths, enabling extended regions to be distinguished from point sources. These instruments are complemented by two monitors in the X-ray (JEM-X) and optical (OMC) bands. SPI, IBIS and JEM-X have a common principle of operation: they are all coded-aperture mask telescopes. This is the key that allows imaging at these high energies, which is all-important in separating and locating sources. The instruments were activated in order and made their first-light observations: IBIS 20 Oct 2002 (fully operational 7 Nov), OMC 21 October, JEM-X & SPI 27 Oct (first JEM-X image 29 Oct). Integral's early observations included Cygnus X-1, one of the brightest gamma emitters, and thought to be a black hole ripping apart a blue-supergiant star. The operational science programme began 30 Dec 2002.



Left: the Integral Flight Model ready for payload integration at Alenia Spazio. Right: Integral's Structural and Thermal Model (STM) at ESTEC in 1998. The patterned coded-aperture mask for IBIS is visible at top right. SPI is the cylindrical unit at left.

Integral regularly sees Gamma-ray Bursts (GRBs) as serendipitous sources in its large field of view. An automatic ground system detects the GRBs and instantly alerts astronomers worldwide to perform crucial follow-up observations at other wavelengths. Thanks to this service, a GRB seen on 3 December 2003 was thoroughly studied by Integral and an armada of space and ground observatories. GRB 031203 proved to be the closest gamma-ray burst on record, and the faintest. It suggests that an entirely new family of weaker bursts was going unnoticed until Integral.

Satellite configuration: 5 m high, body diameter 3.7 m, 16 m span across solar wings. The Service Module (SVM) design, including power, data handling and attitude/RCS, is reused from the XMM mission, with minor modifications. The science instruments are accommodated in the Payload Module (PLM), designed to be tested separately and then attached to the SVM via simple interfaces.

Attitude/orbit control: four Reaction Wheels, two Star Trackers, four Inertial Measurements Units, a Rate Measurement Unit, three Fine Sun Sensors and three Sun Acquisition Sensors provide 3-axis control. Pointing accuracy better than 15 arcmin, with a

drift of 4 arcsec/h. Hydrazine thrusters provide orbit adjust, attitude control and wheel desaturation: four pairs (primary + redundant) of 20 N blowdown (24-5.5 bar) thrusters sit on the SVM base, supplied by four interconnected 177-litre titanium propellant tanks. Hydrazine loading 543.7 kg (+4.2 kg pressurant); reached operational orbit with 182.7 kg, sufficient for >15 yr. Released by Proton into 643.3x152 094 km, 51.71°, Raised perigee at 3-5th apogees + 5th perigee passes to attain final 9050x153 657 km, 52.25° (target: 9000x153 600 km, 51.6°) by 1 Nov.

Power system: two fixed solar wings, each of three 1.81x1.94 m rigid panels of Si cells totalling 21 m², sized to provide 1600 W after 10 years. 28 V main bus; provided 2380 W BOL. Eclipse power from two 24 Ah 41 kg NiCd batteries.

Communications: science data rate 112 kbit/s in realtime (no onboard storage) to ESA Redu & NASA Goldstone ground stations. Controlled from ESOC; science data routed by ESOC to the Integral Science Data Centre (provided by the user community) in Geneva, Switzerland. The Integral Science Operations Centre (initially at ESTEC but moved to ESAC in February 2005) plans the observations for uplinking by ESOC.

Integral Scientific Instruments				
	<i>SPI Spectrometer</i>	<i>IBIS Imager</i>	<i>JEM-X X-ray Monitor</i>	<i>OMC Optical Monitor</i>
Energy range	0.018-8 MeV	0.015-10 MeV	3-35 keV	500-850 nm
Detector	19 6x7 cm Ge cooled to 85 K	16384 CdTe (4x4x2 mm) 4096 CsI (9x9x30 mm)	Microstrip Xe-gas (1.5 bar)	CCD + V-filter
Detector area (cm ²)	500	2600 CdTe; 3100 CsI	2x500	2048x1024 pixel
Spectral resolution	2.2 keV at 1.33 MeV	8 keV at 100 keV	1.3 keV at 10 keV	-
Field of View (fully coded, degrees)	16	8x8	4.8	5x5
Angular res. (FWHM)	2.5°	12 arcmin	3 arcmin	23 arcsec/pixel
10σ source location	< 60 arcmin	< 1 arcmin	< 20 arcsec	6 arcsec
Continuum sensitivity*	8x10 ⁻⁷ at 1 MeV	7x10 ⁻⁷ at 100 keV	1.2x10 ⁻⁴ at 6 keV	18.1 ^m (2000 s)
Line sensitivity*	2x10 ⁻⁵ at 1 MeV	2x10 ⁻⁵ at 100 keV	1.6x10 ⁻⁴ at 6 keV	-
Timing accuracy (3σ)	129 μs	61 μs - 1 h	122 μs	>3 s
Mass (kg)	1273	731	76	23
Power (W)	384	234	68	26

*sensitivities are 3σ in 10⁶ s, units photons/(cm² s keV) continuum, photons/(cm² s) line

SPI
The spectrometer performs spectral analysis of gamma-ray sources and regions with unprecedented energy resolution using 19 hexagonal high-purity germanium detectors (2 now failed) cooled by active Stirling coolers to 85 K. A hexagonal coded-aperture mask 1.7 m above the detection plane images large regions of the sky. To reduce background radiation, the detector assembly is shielded by an active scintillator veto system around the bottom and side of the detectors almost up to the coded mask. Co-PIs J.-P. Roques (CESR Toulouse, France) & R. Diehl (MPE Garching, Germany).
IBIS
The imager provides fine imaging and spectral sensitivity to continuum and broad lines over a wide energy range, achieved by two layers of detector elements: a front layer of CdTe backed by CsI elements. A tungsten coded-aperture mask 3.2 m above the detection plane is optimised for high angular resolution. The two layers of detectors allow the photons to be tracked in 3D as they scatter and interact with elements. The aperture is restricted by a lead tube system and shielded in all other directions by an active scintillator veto system. PI: P. Ubertini (IASF Rome, Italy).
JEM-X
The X-ray monitor is crucial for identifying gamma sources by making observations simultaneously with the main gamma-ray instruments. Two identical imaging microstrip gas chambers each view the sky through a coded-aperture mask positioned 3.2 m above the detection plane. PI: N. Lund (Danish Space Research Institute, Denmark).
OMC
The optical monitor consists of a passively cooled CCD in the focal plane of a 50 mm lens. It offers the first opportunity for making long-duration V-band optical observations simultaneously with those at X/gamma-rays. Variability patterns from tens of seconds up to years are monitored. PI: M. Mas-Hesse (INTA Madrid, Spain).
IREM (Integral Radiation Environment Monitor): provides electron (> 0.5 MeV) & proton (> 20 MeV) counts to instruments so they can turn off their detectors to avoid damage from particle radiation.

Mars Express

Achievements: first European Mars orbiter & lander

Launch date: 17:45 UT 2 June 2003 (start of 11-day window), Mars arrival 25 December 2003 (lander released 08:31 UT 19 December 2003)

Mission end: orbiter after 1 martian year (687 Earth days), 1-year extension possible; lander goal 180 Earth days

Launch vehicle/site: Soyuz-Fregat from Baikonur Cosmodrome, Kazakhstan

Launch mass: 1186 kg (science payload 116 kg, lander 69 kg)

Orbit: 1.014x1.531 AU, 0.2° heliocentric; initial Mars orbit 390x183 000 km, 10° 25 December 2003; 258x11 560 km, 86.6°, 7.5 h Mars mapping orbit from 28 January 2004 for first 103 days, followed by 298x10 107 km, 86.35°, 6.7 h

Principal contractors: Astrium SAS (orbiter), Astrium UK (lander), Martin-Baker Aircraft Co (EDLS). Phase-B January-November 1999, Phase-C/D January 2000 - November 2002

Mars Express has a key role in the international exploration programme planned for the Red Planet this decade, focusing on global coverage and the search for water and life. Some of the orbiter's instruments were originally developed for Russia's ill-fated Mars-96 mission. Upgraded, they are providing remote sensing of the atmosphere, ground and up to 5 km below the surface. The information will help to answer many outstanding questions about Mars, such as what happened to the water that once flowed freely, and did life ever evolve?

The Beagle 2 lander was designed as the first lander since NASA's two Viking probes in 1976 to look specifically for evidence of past or present life.

Mars Express was conceived in 1997, to recover the science goals of the lost Mars-96 mission, as the first Flexible low-cost mission in the Horizons 2000 programme. It is costing the Agency no more than €150 million (1996 rates; €175 million 2003) – only about a third of the cost of similar previous missions. Despite that modest level, however, its future hung in the balance because of the steady erosion of ESA's science budget since 1995. In November 1998, the Science Programme

Committee approved it on the basis that it did not affect missions already selected, particularly Herschel and Planck. After the Ministerial Council of 11/12 May 1999 approved the funding, the SPC gave the final go-ahead on 19 May 1999.

ESA funded the orbiter, launch and operations. The science instruments were provided separately by their home institutes; the lander was a cooperative venture by the UK Beagle 2 consortium and ESA. The science Announcement of Opportunity was released in December 1997 and 29 proposals were received by the 24 February 1998 deadline, including three for a lander, which was treated as an instrument. The SPC endorsed the selection at the end of May 1998.

The spacecraft was built unusually quickly to meet the tight 11-day launch window during the particularly favourable Mars opportunity of 2003. Savings were made by reusing existing hardware, adopting new management practices,

HRSC image of 9 June 2004, showing fluvial surface features at Mangala Valles. The image was taken during orbit 299 at a resolution of 28 m per pixel; image centre is at 209°E longitude and 5°S latitude. (ESA/DLR/FU Berlin; G. Neukum)

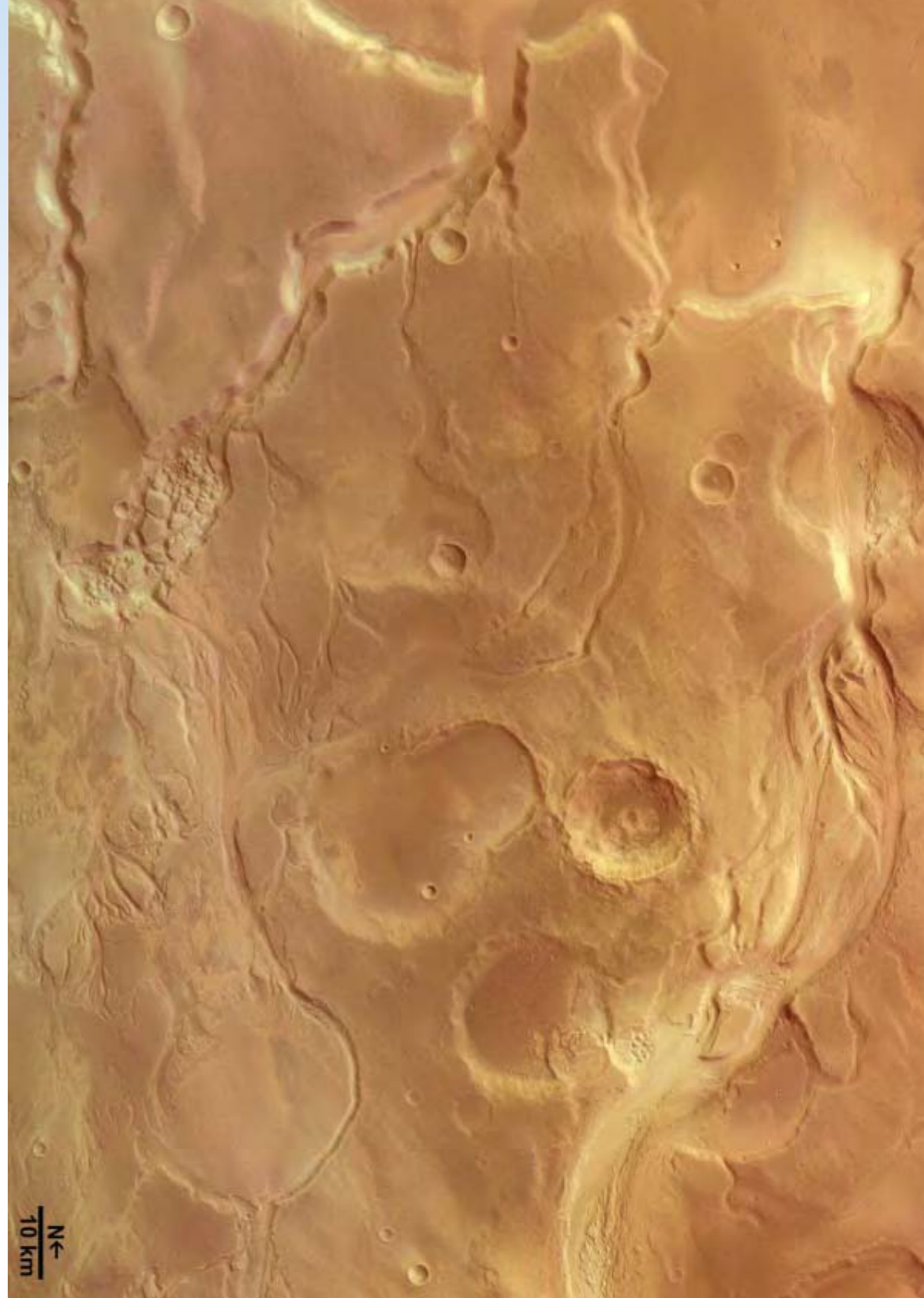

OMEGA was activated on 18 January 2004 and observed the southern polar cap of Mars. At right is the visible image; in the middle is carbon dioxide ice; at left is water ice. The two types of ice are mixed in some areas but distinct in others. (ESA/IAS, Orsay; J-P. Bibring)

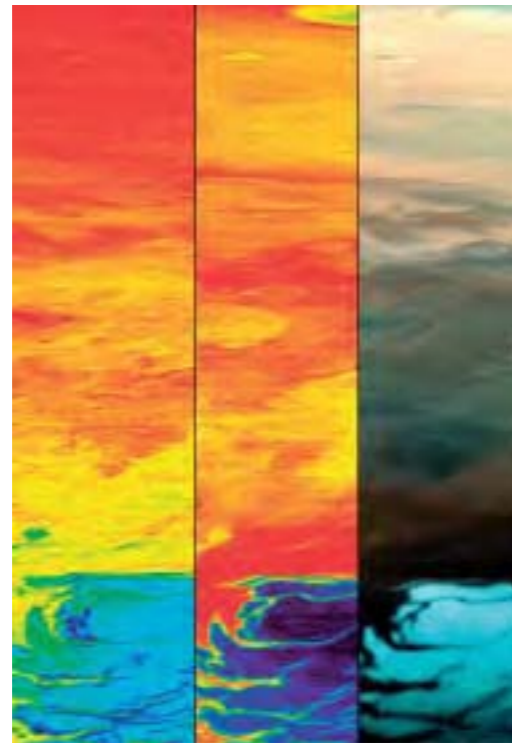

shortening the time from original concept to launch, and procuring the most cost-effective launcher available. Maximum use was made of off-the-shelf and Rosetta technology – 65% of the hardware was at least partially derived from the Rosetta cometary mission. ESA delegated tasks to Astrium SAS in Toulouse (F) that previously would have been performed by the project team at ESTEC. In particular, Astrium managed the orbiter/payload and orbiter/launcher technical interfaces. The period from concept to awarding the design and development contract was cut from about 5 years to little more than 1 year. Astrium SAS won the €60 million fixed-price prime contract in December 1998 in

This HRSC vertical view shows the complex caldera at the summit of Olympus Mons, the highest volcano in the Solar System. The average elevation is 22 km; the caldera has a depth of about 3 km. This is the first high-resolution colour image of the complete caldera, taken from a height of 273 km during revolution 37 on 21 January 2004. Centred at 18.3°N/227°E, the image is 102 km across with a resolution of 12 m/pixel; south is at the top. (ESA/DLR/FU Berlin; G. Neukum)

Mars Express Science Goals

- image the entire surface at high resolution (10 m/pixel) and selected areas at super-high resolution (2.3 m/pixel from 250 km)
- map the mineral composition of the surface at 100 m resolution
- map the composition of the atmosphere and determine its global circulation
- determine the structure of the subsurface down to a few kilometres
- determine the effect of the atmosphere on the surface
- determine the interaction of the atmosphere with the solar wind
- Beagle 2 lander:*
- determine the geology and mineral composition of the landing site
- search for life signatures (exobiology)
- study the weather and climate

competition with consortia led by Alenia/Aerospatiale and Dornier. The Phase-B/C/D design and development phase took less than 4 years, compared with up to 6 years for previous similar missions.

Previous missions raised many questions about Mars. What forces created the spectacular landscape features? When did they stop – or are they still active? Was early Mars really warm and wet? If so, where did the water and atmosphere go? Did life evolve there? And is primitive life still thriving, perhaps in underground aquifers? Mars Express is helping to provide answers by mapping the subsurface, surface, atmosphere and ionosphere from orbit, and planned to

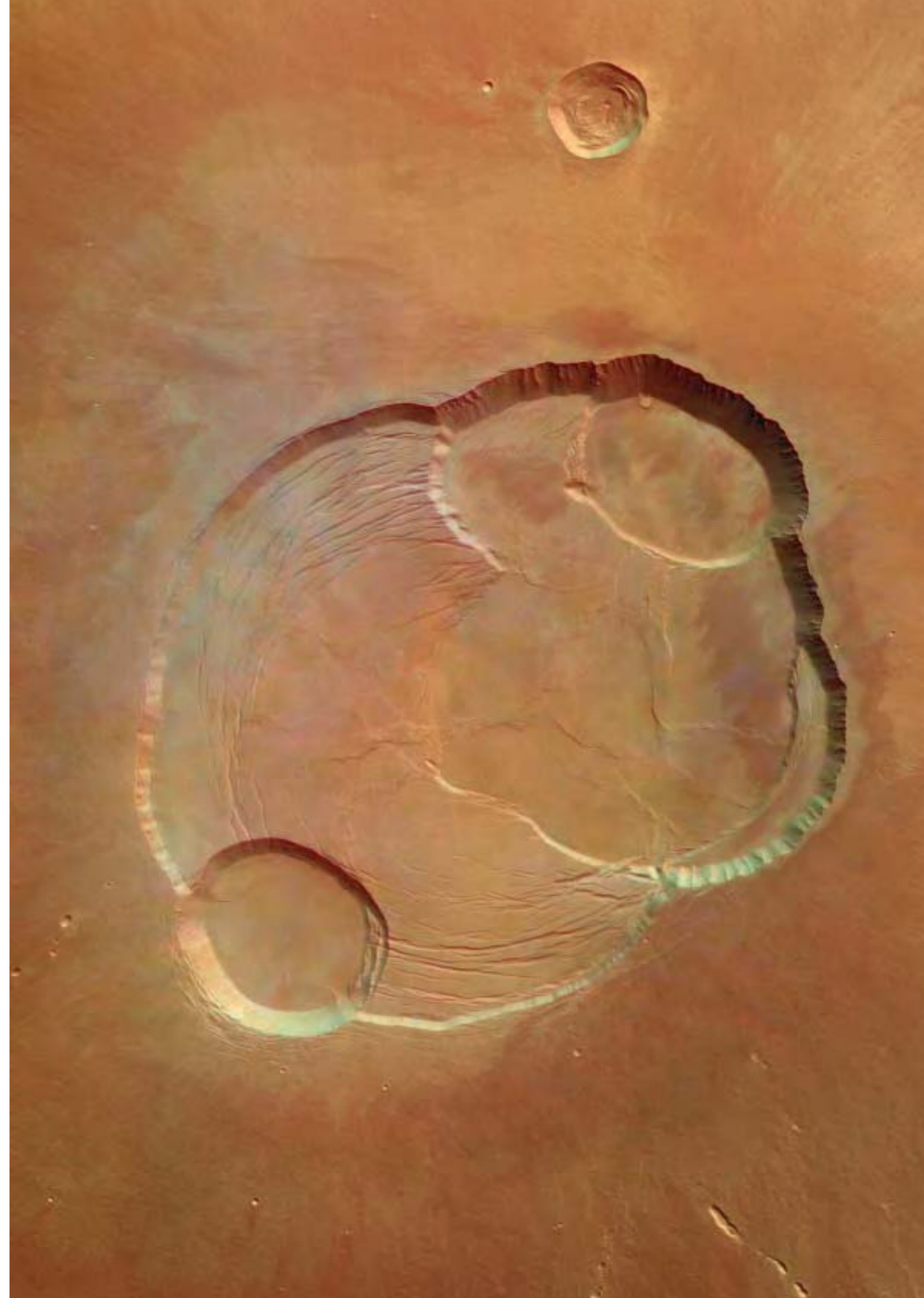



Water ice in a 35 km-diameter crater on the Vastitas Borealis plain, which covers much of Mars' far northern latitudes. HRSC obtained this perspective view on 2 February 2005 at a resolution of 15 m per pixel. (ESA/DLR/FU Berlin; G. Neukum)

conduct observations and experiments on the surface. Investigations are also providing clues as to why the north is so smooth while the south is so rugged, how the Tharsis and Elysium bulges were raised and whether there are still active volcanoes. Not only does Mars have the largest volcanoes and deepest canyons in the Solar System, it also shows evidence for the most catastrophic floods. Large channels carved by these floods drain into the northern plains, lending support for the existence of an ancient ocean over most of the northern hemisphere. Valley networks that criss-cross the southern highlands were also probably formed by water. And many craters, especially at high latitudes, are surrounded by fluidised ejecta. This suggests there was underground water or ice at the time of impact, and possibly more recently. Water is the unifying theme of the mission.

If water was largely responsible for these features, however, it has long since disappeared: most of the evidence is more than 3.8 billion years old. Today, atmospheric pressure at ground level is only about 1% that on Earth. So where did the gases and water go and why? Each of the orbiter's seven instruments will contribute towards the answer.

The water could have been lost to space and/or trapped underground. Four orbiter experiments (ASPERA, SPICAM, PFS, MaRS) are observing the atmosphere and revealing processes by which water vapour and other atmospheric gases could have escaped into space. Two (HRSC, OMEGA) are examining the surface and in the process adding to knowledge about where water may once have existed and where it could still lie underground. One (MARSIS)



will look for underground water and ice. This will be the first time that a ground-penetrating radar has been used in space.

A precise inventory of existing water on the planet (ice or liquid, mostly below ground) is important given its implications for the potential evolution of life on Mars; the 3.8 billion-year age is precisely when life appeared on Earth, which harboured similar conditions to Mars at that time. Thus, it is not unreasonable to imagine that life may also have emerged on Mars and possibly survived the intense UV solar radiation by remaining underground. The confirmation of methane in the atmosphere by PFS indicates just that or the presence of active volcanism.

Following a 34 min burn ending at 03:21 UT 25 December 2003, Mars

Express entered an initial orbit of 390x183 000 km, 10°. An apogee burn on 30 December made the inclination the final 86.6°. The first pericentre was reached at 13:05 UT 4 January. The mapping orbit of 258x11 560 km, 86.6° was reached on 28 January 2004 after a series of apogee-reduction manoeuvres.

Following completion of orbiter commissioning in mid-January 2004, most instruments began their own calibration and testing, in the process acquiring scientific data. PFS was the first to make observations, on 4 January, even before the first pericentre. OMEGA followed on 8 January, HRSC & SPICAM on 9 January and ASPERA on 14 January. MaRS performed its first bistatic radar experiment on 21 January using the 70 m DSN dish in Australia; the first direct tracking was performed 21 January.

Inset: Beagle 2 drifts slowly from Mars Express. This image, taken at 08:33 UT 19 December 2003 by a small engineering camera aboard the orbiter, shows the entry capsule when it was about 20 m away.

Commissioning lasted until 3 June 2004, when all the instruments except MARSIS began routine operations. The deployment of the MARSIS radar antennas, however, was postponed. It was initially planned to begin after 20 April to allow the other instruments to take advantage of the good lighting conditions before the pericentre naturally drifted to southern latitudes, which coincides with the nighttime conditions required for subsurface sounding by MARSIS. However, new studies by JPL of the US-supplied MARSIS booms showed the potential for the two 20 m-long booms to strike the orbiter during the 10 min deployment; the decision was taken 25 April to postpone release until later in the mission when the other instruments had achieved their primary objectives. The ESA review board gave its approval 25 January 2005, and deployment was successful in May-June 2005.

HRSC is providing breathtaking views of the planet, particularly in regions near the Valles Marineris canyon (pointing to liquid water as responsible for modifying tectonic and impact features in the area) and of several large volcanoes (the Olympus Mons caldera and glaciation features surrounding Hecates Tholus). OMEGA has provided unprecedented maps of water-ice and carbon dioxide-ice at the south pole. PFS has confirmed the presence of methane for the first time, which would indicate current volcanic activity and/or biological processes. SPICAM has provided the first complete vertical profile of carbon dioxide density and temperature, and has simultaneously measured the distribution of water vapour and ozone. ASPERA has identified the

solar wind interaction with the upper atmosphere, and has measured the properties of the planetary wind in Mars' magnetic tail. MaRS has measured surface roughness for the first time by pointing the high-gain antenna towards the planet and reflecting the signal to Earth. Also, the martian interior is being probed by studying the gravity anomalies affecting the orbit owing to mass variations of the crust.

Beagle 2 was released at 08:31 UT 19 December 2003 to enter the atmosphere at more than 20 000 km/h on its way to landing at 02:52 UT 25 December. Contact was attempted by the NASA Mars Odyssey orbiter, several Earth-based radio telescopes and later by the Mars Express orbiter itself, but no signal was ever received. It was declared lost 6 February 2004; it is unknown if Beagle 2 arrived on the surface intact. An ESA investigation was unable to pinpoint a single cause for the failure.

Orbiter configuration: box-shaped bus 1.5x1.8x1.4 m of conventional aluminium construction. Dry mass 637 kg.

Attitude/orbit control: orbit correction & Mars insertion by single 400 N NTO/MMH thruster, attitude control by 8x10 N hydrazine thrusters (457 kg in 2 tanks totalling 580 litres) and 4x12 Nms reaction wheels. Pointing accuracy 0.15° supported by 2 star trackers, 6 laser gyros, 2 coarse Sun sensors.

Power system: twin 4-panel Si solar wings derived from Globalstar totalling 11.42 m² to provide 650 W at Mars (500 W required). Post-launch testing showed up to 30% lost owing

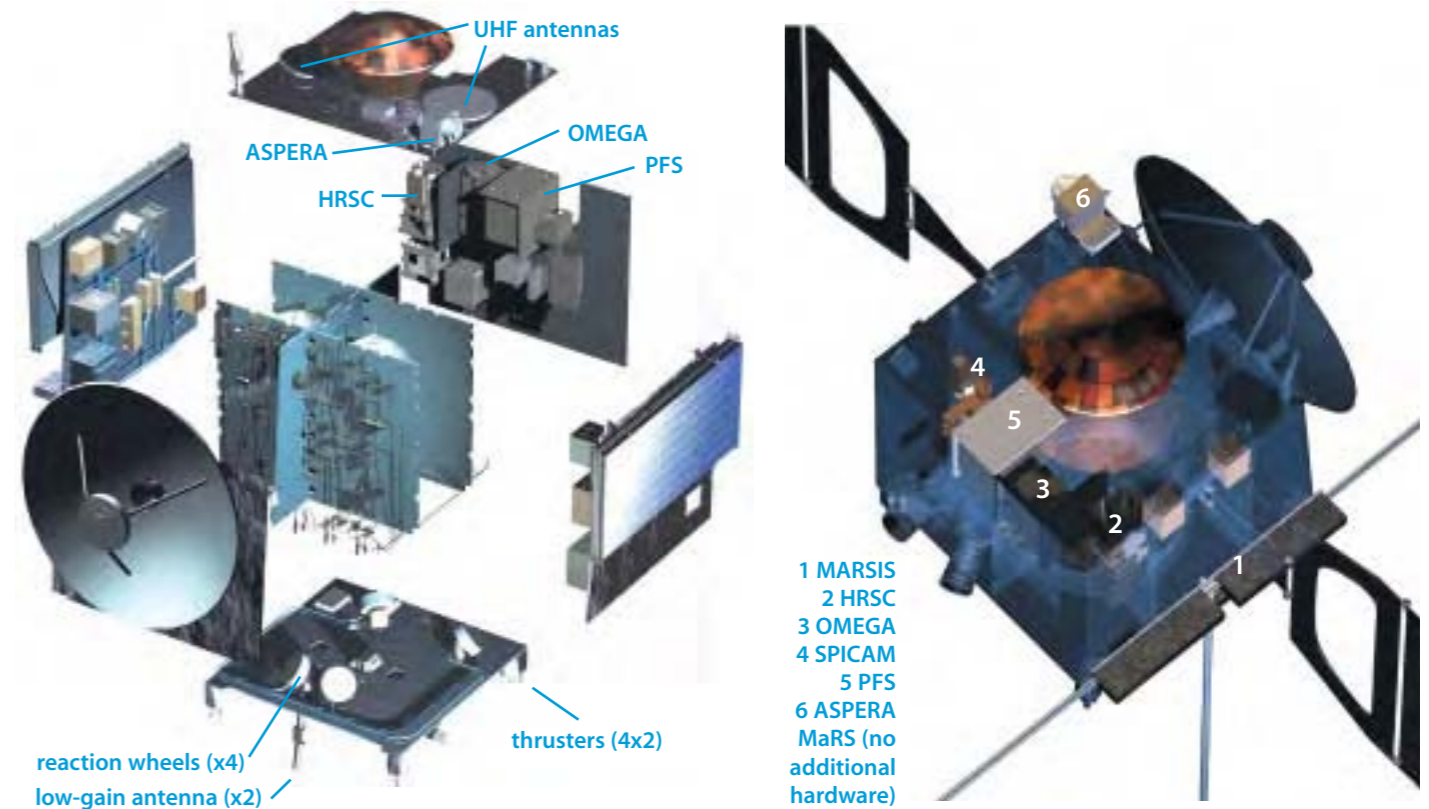

Mars Express ready for installation on its launcher at Baikonur.



Beagle 2 as it would have appeared on the surface of Mars.

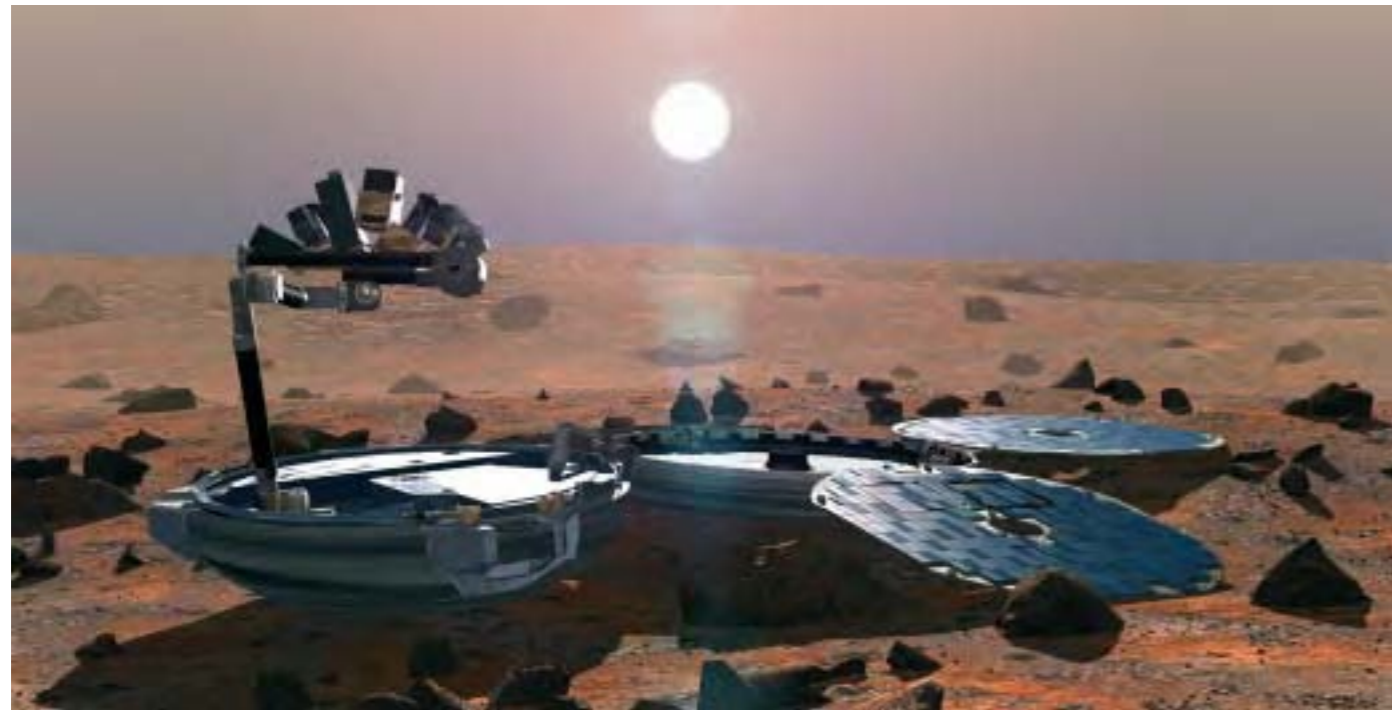

to faulty connection between solar array and power conditioning unit. Supported by 3x22.5 Ah Li-ion batteries.

Thermal control: aluminium/tin alloy blankets keep interior at 10-20°C.

Communications: via 1.6 m-dia 65 W X-band HGA to 34 m New Norcia, Perth ground station and NASA DSN at up to 230 kbit/s from 12 Gbit SSR. Daily download 0.5-6 Gbit, depending on Earth-Mars geometry. UHF antenna to receive Beagle 2 data (commands were relayed to NASA's *Spirit* Mars rover for the first time 6 February 2004, and images received from it). Processed data are placed in public archive at ESTEC after 6 months. Controlled from Mission Operations Centre, ESOC.

Beagle 2 configuration: lander 66 cm-dia, 22 cm-high, primary structure carbon-fibre skin on aluminium honeycomb; 69 kg (33 kg

on surface, 8.90 kg science instruments). Powered up shortly before ejection from orbiter. Comprised lander and Entry, Descent & Landing System (EDLS), drawing heavily on Huygens heritage. EDLS provided a front shield/aeroshell and back cover/bioshield. Mortar fired through patch in back shield to deploy 3.2 m-dia drogue 'chute and then 7.5 m-dia main 'chute; front shield released pyrotechnically. Three 2 m-dia gas-bags inflated. On contact, 'chute released for lander to bounce away. Coming to rest, the lacing was cut for the bags to open. Beagle's clam-shell lid opened to begin the science phase. Most science instruments mounted on arm with 75 cm reach: stereo camera, microscope, two spectrometers (Mössbauer and X-ray), lamp, mole and corer/grinder.

DLR's Pluto (planetary undersurface tool) mole could crawl 1 cm in 6 s by using spring compression to propel a

Mars Express Scientific Instruments

HRSC	Super/High-Resolution Stereo Colour Imager. Push-broom scanning camera, 9 CCDs. 10 m global res, 2 m res selected areas. 20 kg, 40 W, 25 Mbit/s. PI: Gerhard Neukum, Freie Universität Berlin (D). Participating countries: D, F, RU, US, FIN, I, UK
OMEGA	Visible/IR Mineralogical Mapping Spectrometer. Mineral mapping at 100 m res, Specific surface mineral and molecular phases, mapping photometric units, atmospheric particles. 0.5-5.2 μm . 30 kg, 42 W, 500 kbit/s. PI: Jean-Pierre Bibring, Institut d'Astrophysique Spatiale (Orsay, F). Participating countries: F, I, RU
PFS	Planetary Fourier Spectrometer. Atmospheric composition & circulation, surface mineralogy, surface-atmosphere interactions. 1.2-45 μm . 32 kg, 35 W, 33 kbit/s. PI: Vittorio Formisano, Istituto Fisica Spazio Interplanetario (Frascati, I). Participating countries: I, RU, PL, D, F, E, US
MARSIS	Subsurface Sounding Radar/Altimeter. Subsurface structure from 200 m to few km, distribution of water in upper crust, surface roughness and topography, ionosphere. 40 m-long antenna, 11.3-5.5 MHz RF waves, 17 kg, 60 W, 30 kbit/s. PI: Giovanni Picardi, Universita di Roma La Sapienza (Rome, I). Participating countries: I, US, D, CH, UK, DK
ASPERA	Energetic Neutral Atoms Analyser. Upper atmosphere interaction with interplanetary medium & solar wind (lack of a magnetic field is believed to have allowed the solar wind to sweep away most of Mars' atmosphere); near-Mars plasma and neutral gas environment. 9 kg, 12 W, 6 kbit/s. PI: Rickard Lundin, Swedish Institute of Space Physics (Kiruna, S). Participating countries: S, D, UK, F, FIN, I, US, RU
SPICAM	UV and IR Atmospheric Spectrometer. Water (1.30 μm), ozone (250 nm UV) & dust profiles of atmosphere by stellar occultation. 6 kg, 12 W, 6 kbit/s. PI: Jean-Loup Bertaux, Service d'Aeronomie du CNRS (Verrieres-le-Buisson, F). Participating countries: F, B, RU, US
MaRS	Radio Science Experiment. Atmospheric density, P & T profiles, ionospheric electron density profiles (passage of radio waves through atmosphere), surface dielectric and scattering properties (reflection of radio waves) and gravity anomalies (orbital tracking). PI: Martin Paetzold, Köln University (D). Participating countries: D, F, US, A
Beagle 2	360° panoramic stereo camera & microscope (surface textures, 4 μm res; Mullard Space Science Lab.), X-ray spectrometer (in situ chemical composition; Leicester Univ.), Mössbauer spectrometer (Fe minerals, inc. carbonates, sulphates, nitrates; MPI für Chemie), Gas Analyser Package (GAP; carbon, gas isotopes, trace constituents; Open Univ.), Environmental Sensor Suite (T, P, wind speed/direction, 200-400 nm UV flux, solar protons/cosmic rays, dust impacts; 0.180 kg; Leicester Univ./Open Univ.), mole & corer/grinder (DLR Inst. Space Simulation & Polytechnic Univ. of Hong Kong). Lander surface mass 33 kg (instruments 9 kg, 40 W, 128 Kbit/s). PI: Colin Pillinger, Open Univ. (Milton Keynes, UK). Participating countries: UK, D, F, HK, CH

drive mass. Collects sample in tip cavity, wound back in from up to 3 m by power cable for sample delivery to instruments. Grinder/corer to expose fresh rock surfaces and could drill 1 cm deep for 2 mm-dia 60 mg sample.

Power provided by GaAs array totalling 1 m² on 5 panels, supported by 200 Wh Li-ion battery. 128 Kbit/s data link by 400 MHz UHF 5 W transmitter via patch antennas to orbiter. Goal for surface operations was 180 Earth days.

SMART-1

Achievements: first European lunar orbiter, first global map of lunar elements, new technologies tested, first electric thruster-powered gravity assist

Launch date: 23:14 UT 27 September 2003

Mission end: nominally August 2006

Launch vehicle/site: Ariane-5 from Kourou, French Guiana

Launch mass: 367 kg (19 kg science payload)

Orbit: initial 656x35 881 km, 7.0° GTO; operational lunar orbit 471x2880 km, 90.1°, 4.97 h from 28 February 2005, with perilune over South Pole

Principal contractors: Swedish Space Corp (prime), SNECMA (plasma thruster), APCO (bus structure), Saab Ericsson Space (integration, test, thermal, RTUs, harness), Fokker Space (solar array), CRISA (battery management electronics), Primex (hydrazine system); Phase-A May – September 1997, Phase-B April 1998 – June 1999, Phase-C/D October 1999 – September 2003

SMART-1 is the first of the Small Missions for Advanced Research in Technology of ESA's Horizons 2000 science plan. Its principal mission is to demonstrate innovative and key technologies for deep-space science missions. Its primary objective is to flight test Solar Electric Primary Propulsion (SEPP) for future large missions; the BepiColombo Mercury mission will be the first to benefit, followed by Solar Orbiter and LISA.

ESA's Science Programme Committee (SPC) in November 1998 approved a lunar-orbiting mission as the baseline, with the possibility of extending it to a flyby of a near-Earth asteroid. The SPC approved the €84 million (1999 rates) science funding in September 1999; the prime and launch contracts were signed in November 1999. Total cost to ESA is €110 million (2004 rate). The low budget meant that a low-cost launch and a new procurement and management approach had to be adopted. SMART-1 was therefore launched as an auxiliary payload on a commercial Ariane-5 launch into GTO. The SEPP used its 70 mN Hall-effect xenon plasma thruster to spiral out from GTO over 10 months for lunar capture before spiralling down to a polar lunar orbit.

The SPC confirmed the selected science payload in November 1999 following AOs in March 1998 (science) and April 1998 (technology). It includes a 5° field-of-view multicolour micro-camera (AMIE) with high resolution and sensitivity even for lunar polar areas. The compact IR spectrometer (SIR) is mapping lunar minerals and looking for water ice in eternally shadowed craters. The X-ray mapping spectrometer (D-CIXS) is generating the first global map of the major rock-forming elements, following its X-ray monitoring of very bright cosmic sources during the cruise. The absence so far of global maps of



SMART-1 in the final assembly building at Kourou, 18 September 2003, ready for encapsulation on its launcher. (ESA/CSG)



SMART-1 approaches the Moon over the north pole (north is to right). AMIE recorded this view on 12 November 2004 at a distance of 60 000 km, shortly before SMART-1 was captured into lunar orbit. (ESA/Space-X)



magnesium, aluminium and silicon abundances is a serious hurdle to understanding the Moon. The XSM solar X-ray monitor also performed spectrometric observations of the Sun during the cruise. The lightweight SPEDE characterised the natural and induced plasma environment around the spacecraft. The complementary EPDP technology package monitored the plasma and contamination created by the SEPP thruster. The RSIS radio science investigation is using the KATE X-Ka radio transponder technology payload to perform several experiments. One, in conjunction with AMIE, is measuring lunar libration as a demonstration of the crucial BepiColombo investigation of Mercury's internal structure.

AMIE has helped to validate deep-space optical communications (LaserLink Experiment) using ESA's Optical Ground Station at the Teide Observatory in Tenerife. The camera also validated the OBAN autonomous navigation experiment based on image processing. For the spacecraft bus, a combination of off-the-shelf hardware and innovative application were used. For example, the communications bus was inherited from the automotive industry.

In synergy with its technology objectives, SMART-1 provides an opportunity for lunar science investigations. These include studies of the chemical composition and evolution of the Moon, of geophysical processes (volcanism, tectonics, cratering, erosion, deposition of ices and volatiles) for comparative planetology, and high-resolution studies in preparation for future steps in lunar exploration. The mission is also addressing several topics such as the accretional

processes that led to the formation of planets, and the origin of the Earth-Moon system. SMART-1 is also preparing the scientific community for the BepiColombo mission.

SMART-1 was released by its Ariane-5 42 min after liftoff, into a 656x35 881 km, 7.0° GTO. The electric thruster was fired for the first time for an hour beginning 12:25 UT on 30 September. By the end of January 2004, SMART-1 had completed more than 200 orbits of Earth, with all functions normal. It had accumulated more than 1700 h of thrusting, using 27.1 kg of Xe for a delta-V of 1.22 km/s to reach a highly elliptic orbit of 14 312x59 491 km, period of 24 h 53 min, optimised to limit the length of the eclipses in March 2004. After 4 months of repeated passages through the near-Earth radiation belts and suffering heavily from energetic particle events, SMART-1 reached a much gentler environment on 7 January when perigee rose above 20 000 km. With the ion engine switched off on 30 January 2004, the next 3 weeks were used to commission the payload. A first test image of the Moon was obtained by AMIE on



SMART-1 is hoisted towards installation on its Ariane-5 launch vehicle. (ESA/CSG)

SMART-1 Technology and Science Goals

- test SEPP and characterise the induced environment
- test new spacecraft and payload technology for Cornerstone missions (Li-ion modular battery package, X-Ka deep-space transponder with turbo-codes, deep-space laser link, Swept Charge Device X-ray detector, onboard software auto-code generation & autonomy)
- Moon elemental geochemistry and mineralogy
- Moon geology, morphology & topography at medium- & high-resolution
- Moon exospheric and polar environment
- cruise observations of X-ray cosmic sources

18 January. The efficiency of the electric propulsion system and the higher level of electric power available (resulting from low solar cell degradation and lower power consumption) meant that SMART-1 was expected to arrive at the Moon earlier than the Spring 2005 anticipated at launch, and would not require lunar swingbys. The fuel efficiency meant that operators could aim for an operational orbit of only 300 km altitude over the South Pole and 3000 km over the North Pole (pre-launch goal of 300-2000 x 10 000 km), and then raise the orbit to a more stable altitude after 6 months of science investigations.

Instead, three 'lunar resonant approaches', on 19 August, 15 September & 12 October 2004, used the Moon's gravity to raise the perigee and change the inclination. After the third, SMART-1's orbit was a geocentric 173 339x298 835 km, 20.6°. SMART-1 passed through the weak stability boundary region at the Earth-Moon L1 point on 11 November and passed into the Moon's sphere of influence. The ion thruster was reignited at 05:24 UT on 15 November

as SMART-1 headed towards capture by the Moon and its first perilune at 17:48 UT over the South Pole, establishing a stable lunar orbit of 4962 x 51 477 km, 81°, 89 h. To reach the Moon, it had orbited the Earth 332 times, travelling 84 million km, while firing its ion thruster 289 times for a total of 3700 h, consuming 59 kg of the 82 kg of xenon.

By the 9th apolune passage on 4 December 2004, the orbit had been reduced to 5455 x 20 713 km, 83.0°, 37.30 h. By the 12th perilune passage on 9 December, the 20 periods of thrusting totalling 333 h beginning 15 November had reduced the period to 29 h. The science operational orbit of 471 x 2880 km, 90.06°, 4.97 h was reached on 28 February 2005, allowing 6 months of science observations to begin at the end of March. By the end of this phase, Earth-gravity perturbations will threaten to crash SMART-1 into the Moon, so 4 kg of Xe are reserved to raise the orbit. The SPC on 10 February 2005 approved a 1-year mission extension to August 2006 to complete measurements in contribution to future international missions.

SMART-1 payload experiments.				
Expt. Code	Investigation Type	Main Investigator	Team Co-Is	Description of Experiment
AMIE	Principal Investigator	J.L. Josset (Space-X, CH)	F, NL, FIN, I, ESA	Asteroid Moon Imaging Experiment. miniaturised CCD (1024x1024-pixel) camera, 27 m res from 300 km, 4 fixed filters (750, 847, 900, 950 nm), 5.3° FOV, 16.5 mm-dia aperture, 154 mm f.l., micro-Data Processing Unit. Also supports LaserLink, OBAN & RSIS. 1.8 kg (camera 0.45 kg), 9 W
LaserLink	Guest Technology Investigator	Z. Sodnik (ESA)		Demonstration of a deep-space laser link with ESA Optical Ground Station: OGS aims 6 W 847 nm laser with < 10 μrad accuracy for detection by AMIE.
OBAN	Guest Technology Investigator	F. Ankersen (ESA)		Validation of On-Board Autonomous Navigation algorithm. AMIE stares at planet/asteroid, ground software uses star tracker data to remove spacecraft attitude motions to reveal relative velocity vector. Ground demonstration only.
SPEDE	Principal Investigator	A. Malkki (FMI, FIN)	FIN, S, ESA, USA	Spacecraft Potential, Electron & Dust Experiment. 2 Langmuir Probes on 60 cm-long CFRP booms measure spacecraft potential and plasma environment created by EP. 0-40 eV, 0.7 kg, 2 W
EPDP	Technology Investigator	G. Noci (Laben Proel, I)	I, ESA, FIN, A	Electric Propulsion Diagnostics Package for monitoring the EP; plasma environment characterisation. Plasma (0-400 eV): Langmuir Probe and Retarding Potential Analyser. Quartz-Crystal Microbalance measures mass of deposited contamination; dedicated solar cell monitors neutral ion deposition. 2.3 kg, 18 W
RSIS	Guest Science Investigator	L. Iess (Univ. Rome, I)	USA, D, UK, F, ESA, S	Radio-Science Investigation System monitors the Electric Propulsion, using KATE and AMIE.
SIR	Technology Investigator	U. Keller (MPAe, D)	D, UK, CH, I, IRL	SMART-1 IR Spectrometer. Miniaturised 256-channel near-IR (0.9-2.4 μm) grating spectrometer for lunar surface mineralogy studies. 1.1 mrad FOV, 6 nm spectral res, 330 m spot size at 300 km. Passively cooled InGaAs array. Good discrimination between pyroxenes, olivines & feldspar; possible detection of H ₂ O, CO ₂ & CO ices/frosts. 1.7 kg, 2.0 W
D-CIXS/XSM	Technology Investigator	M. Grande (RAL, UK) J. Huovelin (Univ. Helsinki, FIN)	S, E, I, F, ESA, USA	Demonstration Compact Imaging X-ray Spectrometer for mapping main lunar rock-forming minerals (Si, Mg, Fe, Na, O, C; 30 km res) via X-ray fluorescence. 24 Swept Charge Detectors plus micro-collimators. 0.5-10 keV. X-ray Solar Monitor using Peltier-cooled Si diode measures the solar X-rays that excite the Moon's fluorescence. 0.8-20 keV. Total D-CIXS/XSM: 3.3 kg, 10 W
KATE	Technology Investigator	R. Kohl (Dornier, D) P. McManamon (ESA)	ESA, UK, I	Ka-band TT&C Experiment, demonstrates X-band (8 GHz) + Ka-band (32-34 GHz) telecommunications (up to 500 kbit/s from lunar orbit) & tracking (X/Ka-band Doppler improves accuracy) and tests turbo-codes (2-3 dB increase) and VLBI operation. 5.2 kg, 18 W



The glow of ionised Xe from the PPS-1350 thruster.

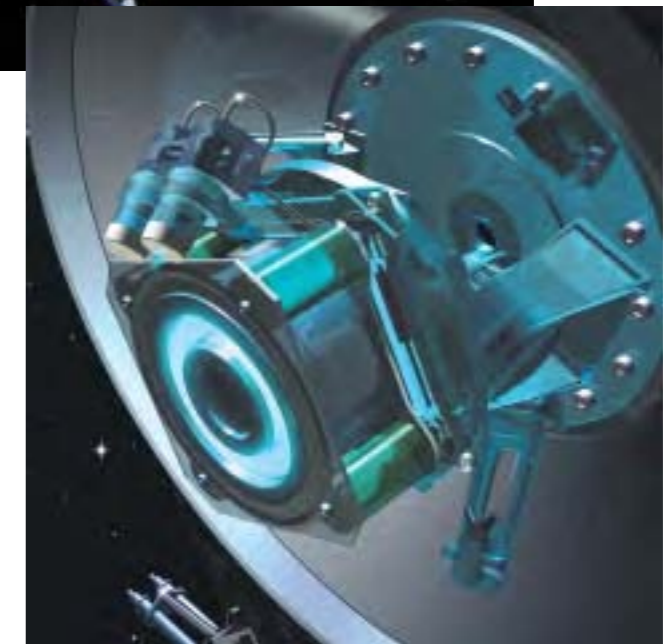

Satellite configuration: box-shaped 115x115x94.5 cm 45 kg bus of conventional aluminium construction, with twin solar wings spanning 14 m. Thin-walled riveted thrust cone carries main loads (top, equipment and bottom platforms) and houses Xe tank.

Primary propulsion: PPS-1350 Hall-effect Stationary Plasma Thruster, 70 mN at 1350 W inlet power, 10 cm-dia chamber, SI 1500 s, 82 kg Xe propellant, mounted in 2-degree-of-freedom gimbals, pointing accuracy 0.02°.

Attitude/orbit control: 3-axis zero momentum by 4x2.5 Nms Teldix reaction wheels, 10 arcsec accuracy for 10 s required; 8x1 N hydrazine thrusters (4 kg hydrazine) for RW unloading and high-rate recovery. Attitude determination to 4 arcsec by two autonomous star trackers.

Power system: twin 3-panel (each 800x1778 mm) solar wings, adapted from Globalstar design, GaAs/InP multi-junction cells, 1850 W at 1 AU BOL. Supported by 5 Li-ion batteries totalling 600 Wh capacity.

Communications: no realtime science or operations, planned ground contact of < 8 h every 4 d via 15 m ESA station network, but thruster, startracker and thermal anomalies required continuous coverage. Experimental mobile XKaT laboratory based at ESTEC as backup (S-band 62 kbit/s, X-band 2 kbit/s from lunar orbit, Ka-band 120 kbit/s). Redundant 4 Gbit solid-state mass memory. SIMOC Mission Operations Centre at ESOC, STOC Science & Technology Operations Centre at ESTEC.

Rosetta

Planned achievements: first comet orbiter, first comet lander, first solar-powered deep space probe, first European probe beyond Mars

Launch date: 07:17:51 UT 2 March 2004 (window 26 February - 17 March)

Mission end: December 2015

Launch vehicle/site: Ariane-5G+ from ELA-3 Kourou, French Guiana

Launch mass: 3064.8 kg (dry 1335 kg, propellant 1719 kg, 165 kg Orbiter science payload, 108 kg Lander)

Orbit: heliocentric (initially 0.885x1.094 AU, 0.4°, target 1.29x5.72 AU, 7.1°); cometocentric

Principal contractors: Astrium GmbH (prime), Astrium UK (bus), Astrium SAS (avionics), Alenia Spazio (AIV), DLR (Lander). Mission Definition 1993-1996, Phase-B March 1997 - September 1998, Phase-C/D 12 April 1999 - May 2002

Rosetta's main goal is mankind's first rendezvous with a comet: 67P/Churyumov-Gerasimenko. Comets are the most primitive objects in the Solar System so they hold many clues to the evolution of the Sun and planets. On its way to 67P/C-G, Rosetta will inspect two asteroids, Steins and Lutetia, at close quarters.

Launch came more than a year later than scheduled. In January 2003, Rosetta was ready to depart to Comet 46P/Wirtanen when the failure of the new Ariane-5ECA on its maiden flight on 11 December 2002 grounded the vehicle family and Wirtanen moved out of range. The Project Team, in close cooperation with the Flight Dynamics Team at ESOC, studied possible options for a new mission. 67P/C-G was the only target that could be reached using the original Ariane-5G+, did not require modifications to the spacecraft or payload, and did not extend the mission duration by more than 2 years.

Intensive observations of the new target began immediately. Hubble Space Telescope observations showed a nucleus radius of 2 km. A major concern was whether the Lander could cope with the higher

touchdown speed of about 1 m/s, in contrast to the 0.5 m/s for the 600 m radius of Wirtanen. Studies and tests demonstrated that only a minor modification was required to stiffen the landing gear. In April 2003, the Rosetta Science Working Team approved the new mission scenario, which provides the same potential scientific return as the original baseline.

The mission faces a number of unique features and challenges, including a flight of 10 years in deep space while relying on electrical power from solar arrays. The considerable variations in the distances from the Sun (0.9-5.7 AU) and the Earth have major effects on thermal control, solar array design and telecommunications. Onboard autonomous operations are particularly important because the round-trip light time for radio signals exceeds 90 min for a significant part of the mission.

Orbiting the comet for more than a year, Rosetta will observe changes in surface activity as the nucleus is warmed by the Sun. Instruments will analyse the effusions of dust and gas and determine the chemical, mineralogical and isotopic composition of the volatiles. The





67P/Churyumov-Gerasimenko photographed by the European Southern Observatory.

Inset: Comet LINEAR imaged by OSIRIS in blue light, 30 April 2004. (ESA/MPG/H.U. Keller)

Lander will provide ground truth data by analysing in situ samples. The material has changed little since it was part of the early solar nebula 4600 million years ago.

The comet was discovered on 20 September 1969 by Klim Churyumov on plates of 32P/Comas Solá taken by Svetlana Gerasimenko. The comet has an unusual history. Up to 1840, its perihelion was 4.0 AU, so it was invisible from Earth. That year, an encounter with Jupiter reduced the perihelion to 3.0 AU. Over the next century, perihelion gradually decreased to 2.77 AU. Then, in 1959, a Jupiter encounter reduced it to only 1.29 AU. 67P/C-G has now been observed from Earth on six approaches to the Sun: 1969, 1976, 1982, 1989, 1996 and 2002. It is unusually active for a short-period object and has a coma and often a tail at perihelion. Although it is classed as a dusty comet, its peak dust production rate (60 kg/s) is some 40 times lower than for 1P/Halley (although up to 220 kg/s was reported in 1982/83). Twice as much gas is emitted.

The Mission

Ariane's main stage provided an Earth 'orbit' of 45x3849 km, 5.7°; the EPS upper stage began a 17 min burn at 09:14 UT to inject Rosetta into a hyperbolic Earth escape orbit with a perigee of 392 km, departing at a relative 3.4 km/s; they separated at 09:32 UT. Rosetta entered a heliocentric orbit of 0.885x1.094 AU, 0.4° with perihelion on 25 May.

COSIMA was the first instrument to begin commissioning, on 8 Mar, followed by CONSERT (including antenna deployment) 11 Mar, OSIRIS 11-12 Mar & 25 Apr - 1 May, Lander 12-17 Mar, 9-15 Apr & 13-21 May, RPC 17-19 Mar (including MIP/LAP boom deployment) & 7-10 May, ROSINA 19-21 Mar & 21-27 May, ALICE 22-24 Mar & 15-23 Apr, VIRTIS 24-26 Mar, RSI 26-29 Mar, MIRO 30 Mar - 3 Apr, GIADA 4 Apr, MIDAS 4-9 Apr, and SREM 11-13 May. OSIRIS, during commissioning, on 30 April 2004 returned the mission's first scientific results by observing Comet C/2002 T7 (LINEAR). Although parallel operation was not planned until later in the year, ALICE, MIRO



and VIRTIS were then used the same day to observe the comet, from a distance of 95 million km.

The propulsion system was pressurised to 17 bar on 6 May 2004 by firing the 12 pyro valves, in preparation for the first trajectory adjustment, Deep Space Manoeuvre 1 (DSM-1), made on 10 May (152.8 m/s, 3.5 h burn by 4 axial thrusters) and the touch-up burn on 16 May (5.0 m/s, 17 min), before the first phase of commissioning ended on 7 June 2004. Rosetta then went into quiet cruise mode until 6 September 2004, when it began the final commissioning phase, completed 15 October.

Four planetary gravity-assists will set up the rendezvous (see box). Rosetta will twice fly through the main asteroid belt, fulfilling the secondary mission objective, and fly close to asteroids Steins and Lutetia. These flybys were baselined only after launch, when the propellant situation became clear.

These primordial rocks are very dissimilar. Lutetia will be the largest

asteroid yet encountered by a spacecraft, while Steins will be one of the smallest. Both are scientifically important. The spectrum of 100 km-diameter Lutetia resembles that of carbonaceous chondrites in the near-IR but is closer to that of an iron meteorite at shorter wavelengths. Steins, with a diameter of a few km, does not fit any known type – it has a featureless spectrum with a very steep UV slope – but it might be a primitive C-type asteroid. Rosetta will approach to within 1700 km of Steins on 5 September 2008, and to 3000 km of Lutetia on 10 July 2010.

Rosetta will rendezvous with 67P on the inward leg to the Sun so that it can study the nucleus and its environment as solar radiation increases. When Rosetta closes in to about 100 000 km, the navigation cameras will image the comet to optimise the approach trajectory. On arrival, Rosetta will manoeuvre into an orbit at an altitude of about 25 km, depending on the comet's actual size, shape and mass. The comet's radius is 3-5 km, while the Orbiter's relative velocity will be < 1 km/h much of the time. A

Rosetta Scientific Goals

The primary scientific objectives are to study the origin of comets, the relationship between cometary and interstellar material, and the implications for theories on the origin of the Solar System. The measurements will provide:

- global characterisation of the nucleus, determination of dynamic properties, surface morphology and composition;
- determination of the chemical, mineralogical and isotopic compositions of volatiles and refractories in a cometary nucleus;
- determination of the physical properties and interrelation of volatiles and refractories in a cometary nucleus;
- study of the development of cometary activity and the processes in the surface layer of the nucleus and the inner coma (dust/gas interaction);
- global characterisation of an asteroid, including determination of dynamic properties, surface morphology and composition.

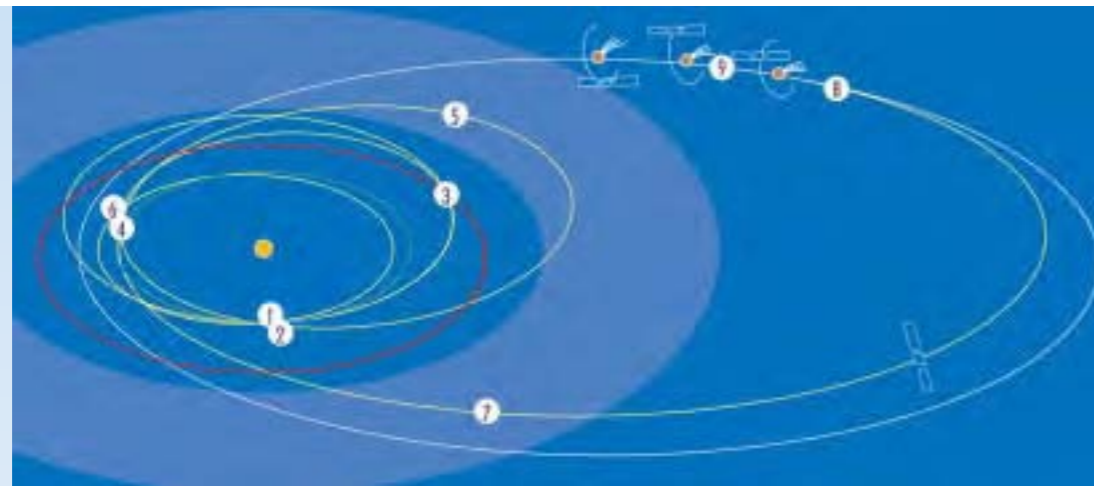

Launch (2 Mar 2004): injected into Earth-escape trajectory.

Earth flybys (4 Mar 2005, 13 Nov 2007 & 13 Nov 2009): Rosetta remains active during the cruise to Earth. Flyby distance is 300-14 000 km (2005 = 1955 km). Operations mainly involve tracking, orbit determination and payload checkout. Orbit corrections before and after each.

Mars flyby (25 Feb 2007): Rosetta flies past Mars at 200 km, obtaining some science. Earth is eclipsed by Mars for 37 min, causing a communications blackout.

Steins flyby (5 Sep 2008): Rosetta hibernates on the way to the asteroid belt. Flypast at 1700 km, 9 km/s; science data downlinked after flyby.

Lutetia flyby (10 Jul 2010): Rosetta hibernates during the cruise to

Lutetia. Flypast at 3000 km, 15 km/s; science data downlinked after flyby.

Deep-space hibernation (Jul 2011 - Jan 2014): after a 526 m/s deep-space manoeuvre, Rosetta enters hibernation. During this phase, it records its maximum distances from the Sun (800 million km) and Earth (930 million km).

Comet approach (Jan-May 2014): Rosetta is reactivated for the 777 m/s rendezvous manoeuvre, during which the thrusters fire for several hours to slow the relative drift rate with the comet to 25 m/s. As Rosetta drifts towards the nucleus, the mission team will avoid dust and aim for good illumination. The first images will dramatically improve calculations of the nucleus position, orbit, size, shape and rotation. The relative speed will gradually be reduced to 2 m/s after 90 days.

Comet mapping/characterisation (Aug-Oct 2014): within 200 km of the nucleus, images show the spin-axis orientation, angular velocity, major landmarks and other basic characteristics. Eventually, Rosetta is inserted into orbit at a height of 25 km; relative speed is a few cm/s. The orbiter begins mapping in great detail. Five potential landing sites are selected for closer observation.

Landing (Nov 2014): Philae is released from 1 km for touchdown at < 1.5 m/s. Once anchored, Philae transmits high-resolution images and other data on the ices and organic crust. The orbiter downlinks them to Earth during the next ground station contact.

Escorting the nucleus (Nov 2014 - Dec 2015): Rosetta observes events as perihelion (Aug 2014) approaches. The mission ends in Dec 2015 after 4000 days.

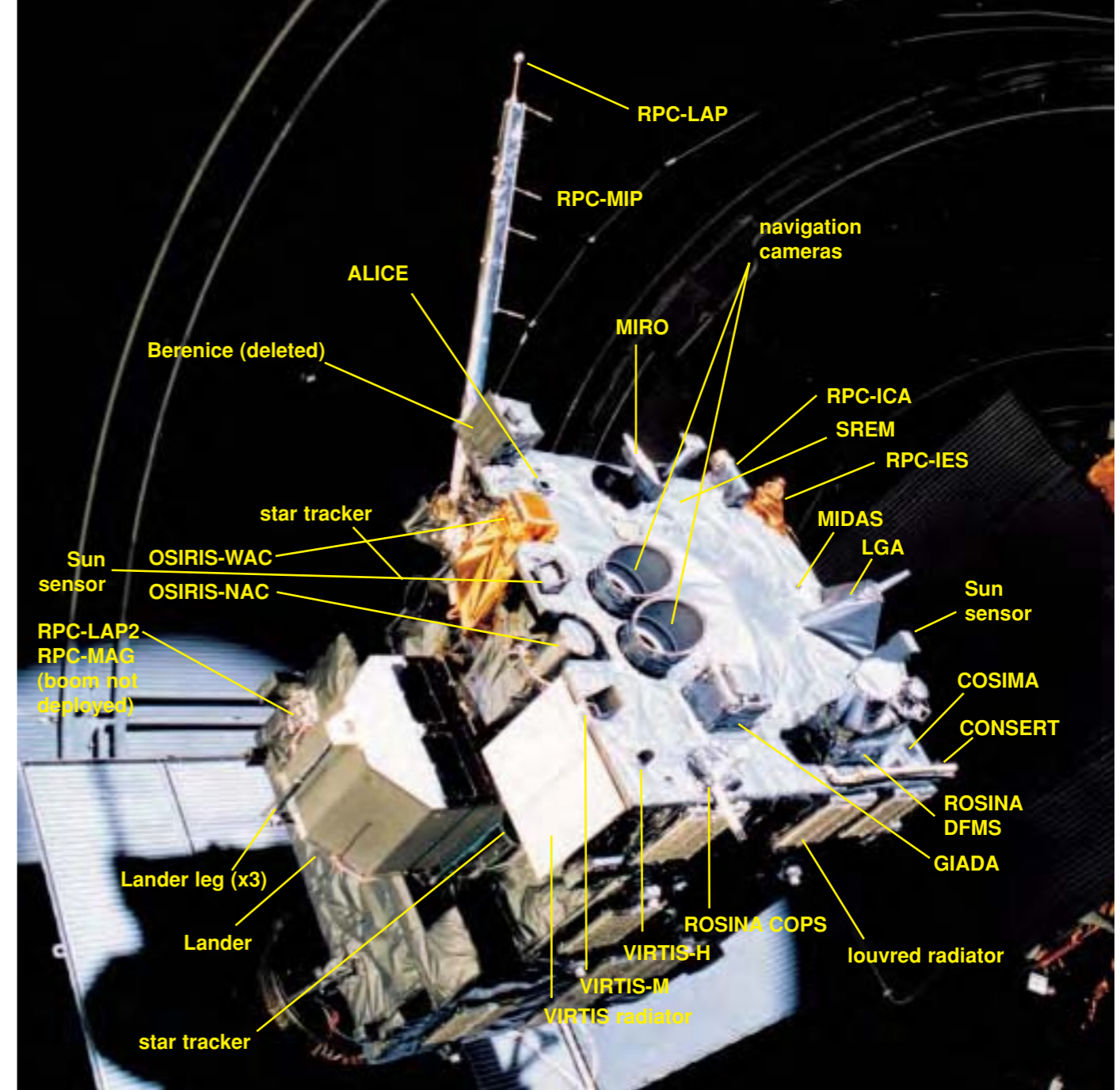

Comet 67P/Churyumov-Gerasimenko

Nucleus diameter (km)	3x5
Rotation period (h)	~12
Orbital period (yr)	6.57
Aphelion (million km/AU)	858/5.74
Perihelion (million km/AU)	194/1.29
Orbital eccentricity	0.632
Orbital inclination (deg)	7.12

Asteroids 2867 Steins & 21 Lutetia

	Steins	Lutetia
Perihelion (AU)	2.019	2.036
Aphelion (AU)	2.709	2.834
Orbital period (yr)	3.7	3.8
Size (km)	~10	~96
Rotation period (min)	?	490
Orbital inc (deg)	9.9	3.06
Orbital eccentricity	0.146	0.168
Asteroid type	C	CV
Discovered	Nov 1969	Nov 1852

The Names: Rosetta and Philae

The Rosetta Stone was the key to understanding ancient Egypt, so it is appropriate to adopt the name for a mission that will unlock the mysteries of the Solar System's oldest building blocks. The Stone's hieroglyphics were duplicated in Greek, so historians were able to begin deciphering the mysterious carved figures.

Three weeks before launch, the Lander was named 'Philae' after the Nile island where an obelisk was found with a bilingual inscription that included the names of Cleopatra and Ptolemy in hieroglyphs. This provided French scholar Jean-François Champollion with the final clues that enabled him to decipher the Rosetta Stone. The main contributors to the Lander held national competitions to select an appropriate name; Philae was proposed by 15-year-old Serena Olga Vismara from Arluno (I).

The Rosetta Structural & Thermal Model during thermal balance tests in the Large Space Simulator at ESTEC.

dedicated 1-month global mapping programme will help to select a landing site, while other instruments simultaneously measure the comet's environment.

The Lander ejection, descent and landing operation is a complex autonomous sequence of events. The Orbiter navigation must be precise to within 10 cm and 1 mm/s at the time of ejection, at an altitude of 1 km for a touchdown speed of up to 1.5 m/s (10° slope). For this comet, a bracket was added to stiffen the legs, allowing only up to 5° flex. Local gravity is only $30 \times 10^{-4} g$, so the Lander will anchor itself to the dusty snowball by firing two harpoons from under the body on contact. The minimum goal for surface operations is a week, but it is hoped that several months will be achieved.

As the Lander carries out its experiments, the data will be relayed to Earth via the Orbiter. Thereafter, the Orbiter will follow the comet for another year. Throughout the cometary phase, there are severe technical, operational and navigational challenges because Rosetta will fly at low altitude around an irregular celestial body with a weak, asymmetric and rotating gravity field, enveloped by dust and gas jets.

The Orbiter payload comprises 11 investigations. Four instruments (ALICE, OSIRIS, VIRTIS, MIRO) provide remote sensing of the nucleus, covering the wavelength range from UV to sub-mm. Three (ROSINA, COSIMA, MIDAS) provide compositional and morphological analysis of the volatile and refractory components of the

nucleus. They are complemented by a suite of instruments that describe the near-nucleus gas and dust environments and the coma interaction with the solar wind (GIADA, RPC). CONSERT, on both craft, investigates the large-scale structure of the nucleus. RSI uses the telecommunications system to study the mass distribution in the nucleus. The Lander focuses on the in situ composition and physical properties of nucleus material. It carries cameras (CIVA and ROLIS) and instruments for compositional analysis (APXS, COSAC, Ptolemy) and for the study of physical properties (SESAME, MUPUS, ROMAP, CONSERT).

Spacecraft configuration: 2.0x2.1x2.8 m box-shaped bus of conventional aluminium construction, with solar array spanning 32 m. Central thrust cylinder of corrugated Al honeycomb with shear panels connecting the side panels. Solar wings on Y panels, HGA +X, Lander -X, science instruments +Z.

Control: up to 90-min round-trip light-time means that realtime control is not possible, so autonomous management system executes pre-loaded sequences and ensures immediate corrective actions in case of anomalies. Implemented on 4 MA31750 processors (any 2 for data management & AOCS).

Attitude/orbit control: 2 sets of 12x10 N Mars Express thrusters using 1060 kg NTO / 659.6 kg MON1 in 2x1108-litre Spacebus tanks, 310 bar MEOP. 4 axial thrusters only for delta-V; Rosetta capacity 2300 m/s, 2114 m/s required to complete rendezvous.



The Rosetta Flight Model at ESTEC, 2002.

Rosetta: a History

ESA's Horizon 2000 long-term programme was established in 1984 with 'A Mission to Primordial Bodies including Return of Pristine Materials' as one of the four Cornerstones. A returned drill core from a comet was of the highest scientific interest. The Rosetta Comet Nucleus Sample Return mission was studied in partnership with NASA for launch in 2002 to deliver 10 kg of samples in 2010 to Earth. The main craft was based on NASA's Cassini design, with ESA providing the lander and return capsule. NASA decided in 1991 that the project could not begin until about 2000, departing in 2005 at the earliest. ESA's new baseline thus became a Europe-only mission focusing on comet rendezvous and asteroid flyby. The International Rosetta Mission was approved in November 1993 by the SPC as the Planetary Cornerstone Mission of Horizon 2000. The reference mission was originally Comet Schwassmann-Wachmann 3 and asteroid Brita but studies showed there to be insufficient margins. Comet 46P/Wirtanen and asteroids 3840 Mimistobell & 2530 Shipka were adopted in 1994. 2703 Rodari replaced Shipka in 1996; Otawara and Siwa were baselined in 1998 after further studies showed them to be more interesting objects.

The AO for Orbiter investigations and Interdisciplinary Scientists was issued in March 1995, and the selection was endorsed by the SPC in February 1996. It included two Surface Science Packages: Champollion by NASA/JPL/CNES and RoLand by DLR/MPAe. During the 1-year science verification phase, the payload was consolidated and, for programmatic and budget reasons, NASA

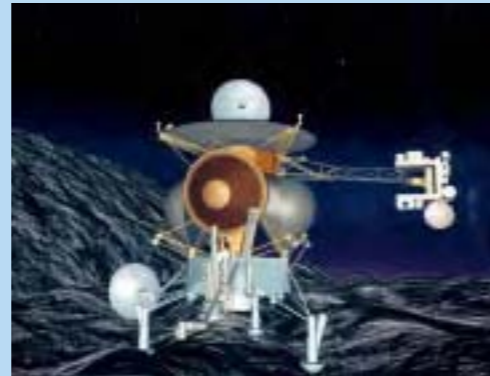

The proposed Comet Nucleus Sample Return mission.

withdrew from Champollion in September 1996. CNES and the RoLand team then merged their efforts into the Rosetta Lander. The prime contract was awarded to what was then Dornier Satellitensysteme in February 1997.

The launch contract with Arianespace was signed 19 June 2001. Launch was scheduled for 13 January 2003, but the failure of a new Ariane-5 version (ECA) on 11 December 2003 led to cancellation on 14 January 2003 of the Wirtanen mission. Of the eight alternative mission scenarios studied by the Rosetta Science Working Team, three were presented to the SPC on 25/26 February 2003. The February 2004 (Ar-5G+) and February 2005 (Ariane-5ECA or Proton) proposals would take Rosetta to 67P/C-G, while that of January 2004 (Proton) returned to Wirtanen. The SPC on 14 May 2003 approved selection of 67P/C-G, with launch on 26 February 2004. The delay cost about €80 million.

Blowdown mode (22 bar max), can be pressurised twice (4x35-litre He tanks): first on 6 May 2004 to 17 bar. Attitude determination to 40 arcsec by 2 star trackers (16.8x16.8° FOV), 3 laser gyros, Sun sensors.

Power system: twin 5-panel steerable solar wings provide 850/395 W at 3.4/5.25 AU. 249 W required during

hibernation, 401 W active cruise, 660 W at comet. 62 m² of Si LILT cells optimised for low-intensity (40 W/m²) & low-T (-130°C). 4x10 Ah NiCd batteries. In hibernation, totalling 2.5 yr, almost all electrical systems are off: Rosetta spins at Sun-pointing 1 rpm, with only radio receivers, command decoders and power supply active (these units are

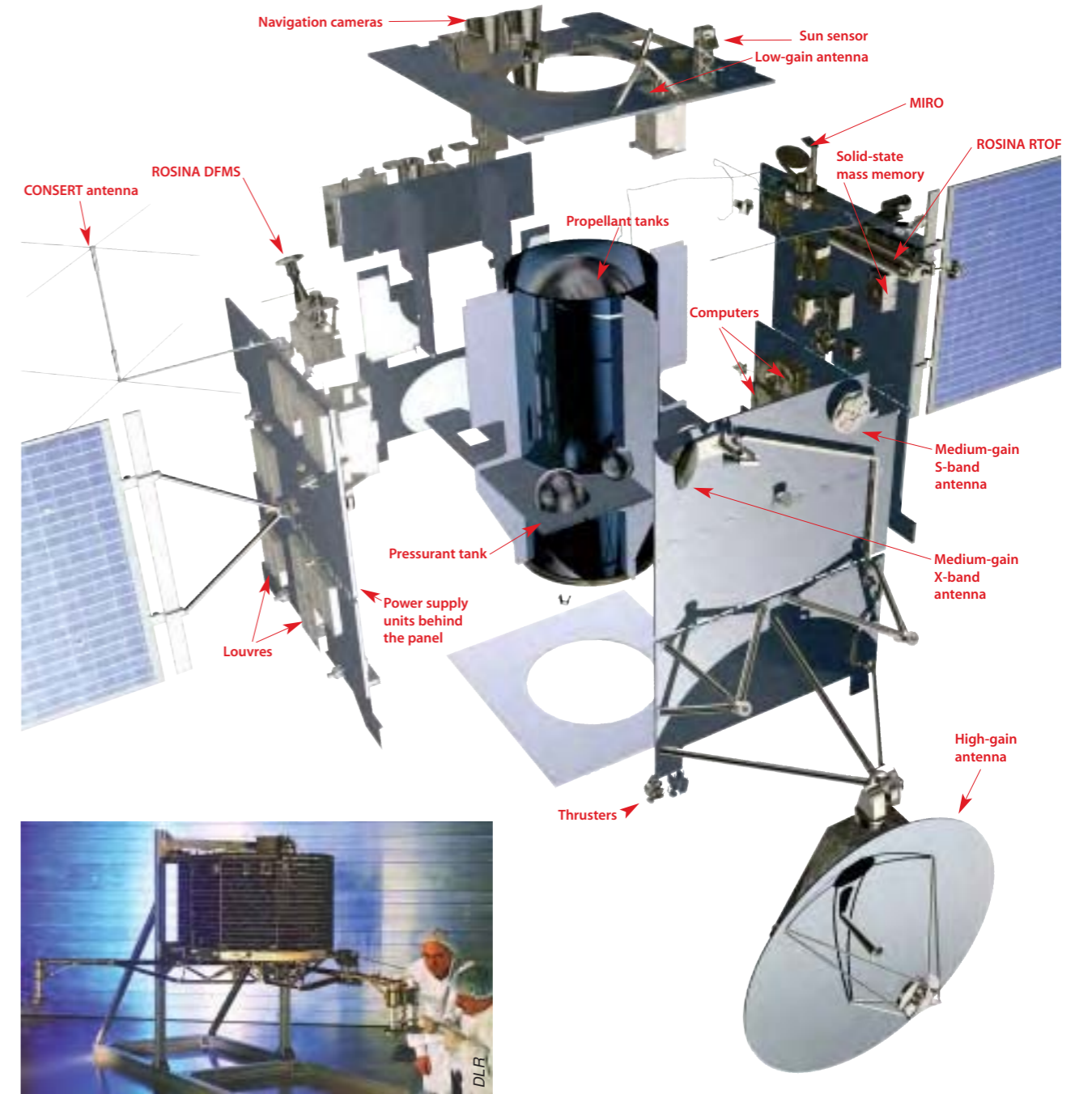

hot redundant, so autonomous fault-management system not required active).

Thermal control: to cope with x25 variation in solar heating. 132 W of heaters for cold operations. MLI of 2 sets of 10-layers; external foil is 1-mil carbon-filled black Kapton. Cooling by 14x0.17 m² louvre radiators.

Communications: 2.2 m-dia 2-axis HGA S/X-band up/down (28 W X-band), 1° beam, up to 64 kbit/s down (5 kbit/s min during main science phases). Coding & modulation optimised for power-limited system (Turbo Code demonstrated by SMART-1). Fixed 80 cm-dia MGA, 9° X-band, 30° S-band. 2 LGAs for emergency

Rosetta Orbiter Scientific Instruments
ALICE . UV (70-205 nm) imaging spectrometer. Coma/tail gas composition, production rates of H ₂ O & CO ₂ /CO, nucleus surface composition. Spectral res 3-13 Å; spatial res 0.05x0.6°. PI: S.A. Stern, SouthWest Research Inst., USA. 3.1 kg, 2.9 W, Participating: F.
CONSERT (Comet Nucleus Sounding Expt by Radiowave Transmission). Nucleus deep structure. Lander transponds 90 MHz radio waves back to Orbiter after propagation through nucleus. PI: W. Kofman, CEPHAG, F. 3.1 kg, 2.5 W, 24 Mbit/orbit. Participating: D, I, NL, UK, USA.
COSIMA (Cometary Secondary Ion Mass Analyser). Characteristics of dust grains. Time-of-flight mass spectrometer, m/Δm 2000. PI: J. Kissel, MPI für Sonnensystemforschung, D. 19.1 kg, 19.5 W. Participating: A, CH, F, FIN, I, NL, USA.
GIADA (Grain Impact Analyser & Dust Accumulator). Number, mass, momentum & speed distribution of dust grains. PI: L. Colangeli, Obs. di Capodimonte, I. 6.2 kg, 3.9 W. Participating: D, E, F, UK, USA.
MIDAS (Micro-Imaging Dust Analysis System). Dust environment: particle population, size, volume & shape. Atomic Force Microscope with nm-res. PI: W. Riedler, Space Research Inst., A. 8.0 kg, 7.4 W. Participating: D, F, N, NL, UK, USA.
MIRO (Microwave Instrument for the Rosetta Orbiter). Abundances of major gases, surface outgassing rate, nucleus subsurface T. 30 cm-dia dish radiometer & spectrometer, 1.6 & 0.5 mm wavelengths. Spatial res 15 m & 5 m at 2 km, respectively. PI: S. Gulkis, JPL, USA. 19.5 kg, 43 W, 2.53 kbit/s. Participating: D, F.
OSIRIS (Optical, Spectroscopic & IR Remote Imaging System). High-resolution imaging. WAC wide-angle camera (10.1 m res at 100 km, 12x12°, 245-800 nm, f.l. 767 mm) & NAC narrow-angle camera (1.9 m res at 100 km, 2.18x2.18°, 250-1000 nm, f.l. 132 mm). PI: H.U. Keller, MPI für Aeronomie, D. 30.9 kg, 22 W. Participating: E, F, I, NL, S, TWN, UK, USA.
ROSINA (Rosetta Orbiter Spectrometer for Ion & Neutral Analysis). Atmosphere/ionosphere composition, velocities of electrified gas particles and their reactions. Double-focusing spectrometer: 12-200 amu, m/Δm 3000; time-of-flight spectrometer 12-350 amu, m/Δm 2900. PI: H. Balsiger, Univ. Bern, CH. 34.8 kg, 27.5 W. Participating: B, D, F, USA.
RPC (Rosetta Plasma Consortium). Nucleus physical properties, inner coma structure, cometary activity, cometary interaction with solar wind. Five particle/field sensors: Langmuir probe, ion & electron sensor, fluxgate magnetometer, ion composition analyser, mutual impedance probe. PI: A. Eriksen & R. Lundin, Swedish Inst. Space Physics, S; J. Burch, Southwest Research Inst., USA; K-H. Glassmeier, TU Braunschweig, D; J.G. Trotignon, LPCE/CNRS, F. 8.0 kg, 10.6 W. Participating: HUN, S, UK.
RSI (Radio Science Investigation). Nucleus mass, density, gravity, orbit, inner coma by Doppler tracking of X-band signal. PI: M. Pätzold, Univ. Köln, D. Uses spacecraft telemetry. Participating: CHL, F, N, S, UK, USA.
VIRTIS (Visible/IR Thermal Imaging Spectrometer). Maps nature & T of nucleus solids, identifies gases, characterises coma conditions, identifies landing sites. 0.25-5 μm. PI: A. Coradini, IFSI-CNR, I. 30.0 kg, 28 W, 3 Mbit/s. Participating: F, G.
Rosetta also carries an ESA Standard Radiation Environment Monitor (SREM). See the Proba-1 entry for further information.



Rosetta Lander Scientific Instruments
APXS (Alpha Proton X-ray Spectrometer). Surface elemental composition (C-Ni) by α-particle backscattering and X-ray fluorescence. PI: R. Rieder, MPI für Chemie, D. 1.2 kg, 1.5 W.
ÇIVA (Comet IR & Visible Analyser). 6 identical ÇIVA-P micro-cameras return panoramic surface images (1 mm res under Lander); 7th camera adds stereo. ÇIVA-M 1-4 μm spectrometer studies composition, texture & albedo of samples collected by SD2. 40 μm res. ÇIVA-M microscope 7 μm res, 3-colour images. PI: J.P. Bibring, IAS, F. 4.4 kg (with ROLIS). Participating: D. Imaging Main Electronics shared with ROLIS.
ROLIS (Rosetta Lander Imaging System). CCD camera obtains high-res images during descent and stereo panoramic images of areas sampled by SD2. PI: S. Mottola, DLR Berlin, D. 0.94 kg, 4 W. Participating: F.
CONSERT See Orbiter entry. 1.9 kg, 2 W, 1.5 Mbit/orbit.
COSAC (Cometary Sampling & Composition Expt). Evolved gas analyser identifies complex organic molecules from their elemental & molecular composition. PI: H. Rosenbauer, MPI für Aeronomie, D. 4.85 kg, 8 W, typically 3 Mbyte from 1 sample. Participating: F.
MUPUS (Multi-Purpose Sensors for Surface & Subsurface Science). Sensors on anchor, probe & exterior measure density, thermal & mechanical properties of upper 32 cm of surface. PI: T. Spohn Univ. Münster, D. 2.0 kg, 1.3 W, 3 Mbit/first science sequence. Participating: A, F, POL, UK, USA.
Ptolemy . Evolved gas analyser focuses on isotopic ratios of light elements. Gas chromatograph & mass spectrometer. PI: I. Wright, Open Univ., UK. 4.3 kg.
ROMAP (Rosetta Lander Magnetometer & Plasma Monitor). Local magnetic field (fluxgate magnetometer) and comet/solar wind interaction (Simple Plasma Monitor). Ions to 8 MeV, electrons to 4.2 MeV. PI: U. Auster, TU Braunschweig, D. 0.7 kg, 0.9 W, 4.4 kbit/s. Participating: A, HUN, RU, USA.
SD2 (Sampling & Distribution Device). Drills up to 23 cm deep, collects samples and delivers to ÇIVA-M microscope and COSAC/Ptolemy ovens. PI: A. Finzi, Politecnico di Milano, I. 4.6 kg, 6 W.
SESAME (Surface Electrical, Seismic & Acoustic Monitoring Expts). 3 instruments measure properties of nucleus outer layers to 2 m depth: Cometary Acoustic Sounding Surface Expt (CASSE, propagation of sound); Permittivity Probe (PP, electrical properties); Dust Impact Monitor (DIM, dust falling back to surface). PI: D. Möhlmann, DLR Köln, D; W. Schmidt, FMI, FIN; I. Apathy, KFKI, HUN. 1.9 kg. Participating: F, NL.

S-band. 25 Gbit mass memory. Up to 12 h/day coverage by 35 m-dia ground station at New Norcia, Perth, Australia. Mission Control Centre at ESOC, Science Operations Centre at ESTEC & ESOC; Lander Control Centre at DLR Cologne, supported by Lander Science Centre at CNES Toulouse.

Lander: carbon-fibre structure consists of a baseplate and a 5-panel

instrument platform under a polygonal hood covered by solar cells. The 'balcony' area is exposed, with SD2 sampling system and MUPUS & APX deployable sensors. Nine experiments total 21 kg, plus SD2. On command, Lander self-ejects 1 km above surface by 3 rotating lead screws, providing ejection speed selectable 0.05-0.5 m/s (±1%). Descent stabilised by 5 Nms flywheel. Single 17.5 N GN2

thruster provides up to 1 m/s increase to reduce 1 h descent time and minimise atmospheric effects. Tripod legs deploy and damp out impact energy. Microswitches on footpads trigger two harpoons from under body to anchor Lander to surface (GN2 thruster also fires). Orbiter provides power before release; at release, 700 Wh primary non-rechargeable battery +68 Wh rechargeable. At 3 AU, Si LILT cells

covering 1.4 m² provide 9-10 W during comet's 'day'; average 5 W projected. Primary battery allows complete measurement cycle in 60 h irrespective of solar power. 16 kbit/s data rate to Orbiter, allowing 13 Mbit in 15 min after touchdown. At 3-2 AU, electronics are kept warm inside two 20-layer MLI tents aided by two absorbers on hood. At 2 AU, overheating becomes the problem.

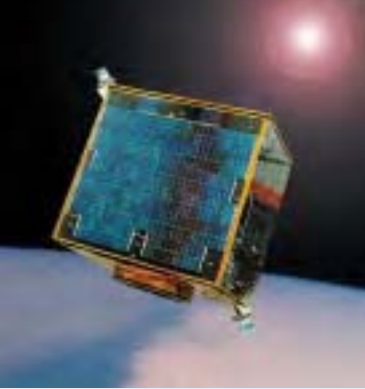

Sloshtsat-FLEVO

Achievements: first satellite dedicated to studying fluid behaviour in weightlessness
Launch date: 21.03 UT 12 February 2005
Mission end: last contact 18:30 UT 19 February 2005; reentry projected after about 20 years
Launch vehicle/site: Ariane-5ECA A521 from Kourou, French Guiana
Launch mass: satellite 128.5 kg
Orbit: geostationary transfer orbit of 250x35 821 km, 6.98°
Contractors: National Aerospace Laboratory (NL; prime), Dutch Space (NL; structure, power), Verhaert (B; ejection system, ground support equipment), Newtec (B; Hitchhiker Communication System, Sloshtsat radio subsystem), Rafael (IS; reaction control system), Kvant (RU; solar cells). Phase-A/B September 1993 - September 1995, Phase-C/D September 1995 - August 2000

Sloshtsat-FLEVO was a small satellite designed to investigate the dynamics of fluids in microgravity. The behaviour of water in an instrumented tank was monitored to help understand how sloshing affects the control of launchers and space vehicles. As a joint programme between ESA and the Netherlands Agency for Aerospace Programmes (NIVR), satellite development was performed within ESA's Technology Development Programme Phase 2 and NIVR's Research & Technology programme. FLEVO is the acronym Facility for Liquid Experimentation and Verification in Orbit; it is also the region of The Netherlands where NLR is located. Indeed, the word means 'water'. Total cost was about €9 million, including the €7 million Dutch contribution.

For 7 days, Sloshtsat transmitted data on the behaviour of the water in its experiment tank. The thickness of the water near the tank wall was measured at 270 locations, as well as the temperature, pressure and fluid velocity at 17 locations. The influence of the sloshing water on the spacecraft's dynamics was measured by gyroscopes and accelerometers. Total experiment time was 55 h 36 min; quiescent periods between experiment runs allowed the water to settle and the battery to charge.

The data are being used to validate a new generation of fluid-motion simulation models. These models will better predict sloshing behaviour in microgravity, yielding more accurate control of satellites carrying large quantities of fluids. For example, docking supply vessels to the International Space Station, controlling launch vehicles and accurately pointing astronomical satellites will all benefit from the new models.

The mission's main objectives were to:

- design and develop Sloshtsat and perform the experiment;
- obtain experiment data to verify/validate existing fluid dynamic models;
- develop and qualify a low-cost, small spacecraft bus that complied



Above: completion of Sloshtsat. The 'spots' on the tank are some of the 270 platinum capacitors for measuring the thickness of water on the wall. Right: Sloshtsat being prepared for thermal-vacuum testing.



with Ariane-5 and Shuttle safety requirements.

The data obtained are being used for several main scientific objectives:

- to verify the adequacy of existing analytical fluid dynamics models;
- to verify the existing Computational Fluid Dynamics (CFD) software;
- to allow the development of new CFD numerical models;
- to provide information for designing microgravity liquid management systems.

The effect of sloshing on spacecraft control has so far been difficult to predict for real situations.

Sloshtsat was designed to be released from the Space Shuttle into an orbit of about 225 km, 51.6°. However, the loss of Shuttle *Columbia* in February 2003 postponed it indefinitely, and made it available for the second test flight of Ariane-5 ECA. Additional efforts required to fly on Ariane-5 were:

- structural qualification tests at Ariane-5 levels;
- separation shock test;
- communications via ESA's Diane station in Kourou.

Configuration: box-shaped bus, 91.6x74.8x96.5 cm. 86.9-litre experiment tank, cylindrical with hemispherical ends, contained 33.5-litres of deionised water

and nitrogen at 1 bar. The aluminium outer tank, 736 mm long, 498 mm diameter, protected the inner tank of an aramid fibre reinforced epoxy and 2.3 mm-thick polyethylene liner. Sensors: 270 capacitors (coarse water thickness on wall); fine liquid thickness (3 locations); liquid velocity (10); liquid pressure (1); liquid temperature (3). The tank was mounted on the equipment platform, which hosts power, data handling, control, etc systems. Sloshtsat's structure was aluminium. Released from Ariane by ESAEJECT mechanism, designed for 50-150 kg satellites.

Power/thermal control: body-mounted Si solar cells on five sides provided 35-55 W, supported by 5.1 Ah/143 Wh NiCd battery for eclipses. Internal 0-70°C maintained by multi-layers insulation blankets, heaters & coatings.

Motion control: 12x1.1 N blowdown thrusters fed by four nitrogen tanks (1.6 kg N₂ at 600 bar) provided linear/rotational movement to excite fluid motion. (Corresponds to maximum linear acceleration capability of 0.0186 m/s² for 432 s.) Three Litton-Litef fibre-optic gyros (±98°/s) and six AlliedSignal QA-3000-10 accelerometers (±0.030 & ±1.5 g) monitored Sloshtsat movements. No attitude or orbit control.

Communications: when available, 2205 MHz used for realtime data downlink and 2075 MHz for TC uplink. Sloshtsat was controlled by operators at the Diane ground station in Kourou, using real-time orbit predictions provided by ESOC from tracking of Sloshtsat using the NORAD radar system (US Space Command).

Installing Sloshtsat on top of the Maqsat-B2 dummy payload on Ariane-5 in the BAF final assembly building in Kourou.

CryoSat

Planned achievements: definitive measurements of thickness changes in polar ice

Launch date: planned for September 2005

Mission end: after 3.5 years

Launch vehicle/site: Rockot from Plesetsk, Russia

Launch mass: 684 kg (70 kg SIRAL: SAR & Interferometric Radar Altimeter)

Orbit: planned 717 km circular, 92°, 369-day repeat, 30-day subcycle

Principal contractors: EADS Astrium GmbH (prime, system, platform, AIV, mass memory), Alcatel Space Industries (SIRAL), Thales (DORIS), Contraves (structure), Terma (startracker), Laben (CDMU), Emcore (US, solar array); Phase-A February - July 2000; Phase-B July 2000 - January 2001; System Design Review February 2001; Phase-C/D July 2001 - February 2005; Critical Design Review Pt 1 June 2003, Pt 2 May 2004

CryoSat will monitor changes in the thickness of the polar ice sheets and of floating sea ice. The Announcement of Opportunity for the first Earth Explorer Opportunity mission in ESA's Living Planet programme was released on 30 June 1998; 27 proposals were received by closure on 2 December 1998. On 27 May 1999, ESA approved CryoSat. As an Opportunity mission, it is dedicated to research. Lead Investigator (LI) is Prof. Duncan Wingham of University College London (UK); ESA has overall mission responsibility. ESA projected cost-at-completion is €134 million (2004 conditions; level-2 products excluded).

Rising temperatures mean that we face the widespread disappearance over the next 80 years of the year-round ice covering the Arctic Ocean. The effects will be profound not only in the Arctic. Warm winter temperatures in Europe result from ocean currents that are affected by fresh water from precipitation and Arctic ice meltwater, and both may increase in a warming climate.

CryoSat will measure variations in the thickness of the Arctic sea ice and the ice sheet, ice caps and glaciers that ring the Arctic Ocean. The team has adapted the French

Poseidon-2 altimeter from the French/US Jason mission to use synthetic aperture and interferometric techniques. In the Synthetic Aperture Radar (SAR) mode, CryoSat's radar beam footprint is divided into 64 strips, each about 250 m in the along-track direction. When the satellite has advanced 250 m, the process is repeated. All the measurements for each 250 m strip can then be combined to give a single height. Later measurements will show if there has been a change in height. Of course, this requires that CryoSat's orbit is known accurately. To cope with sloping terrain, as found around the edges of ice sheets, the second radar receiver provides the 'SARin' (SAR interferometer) mode across-track.

Sea-ice thickness plays a central role in Arctic climate: it limits how much the winter Arctic atmosphere benefits from heat stored in the ocean the previous summer. Heat flux of more than 1.5 kW/m² from the open ocean may be reduced by a factor of 10-100 by ice. Secondly, fluctuations in sea-ice mass affect how ocean circulation is modified by fresh water. Presently, half of the fresh water flowing into the Greenland Sea - some 2000 Gt/yr - comes from the wind-driven ice floes from the Arctic Ocean. Finally, sea-ice thickness is very

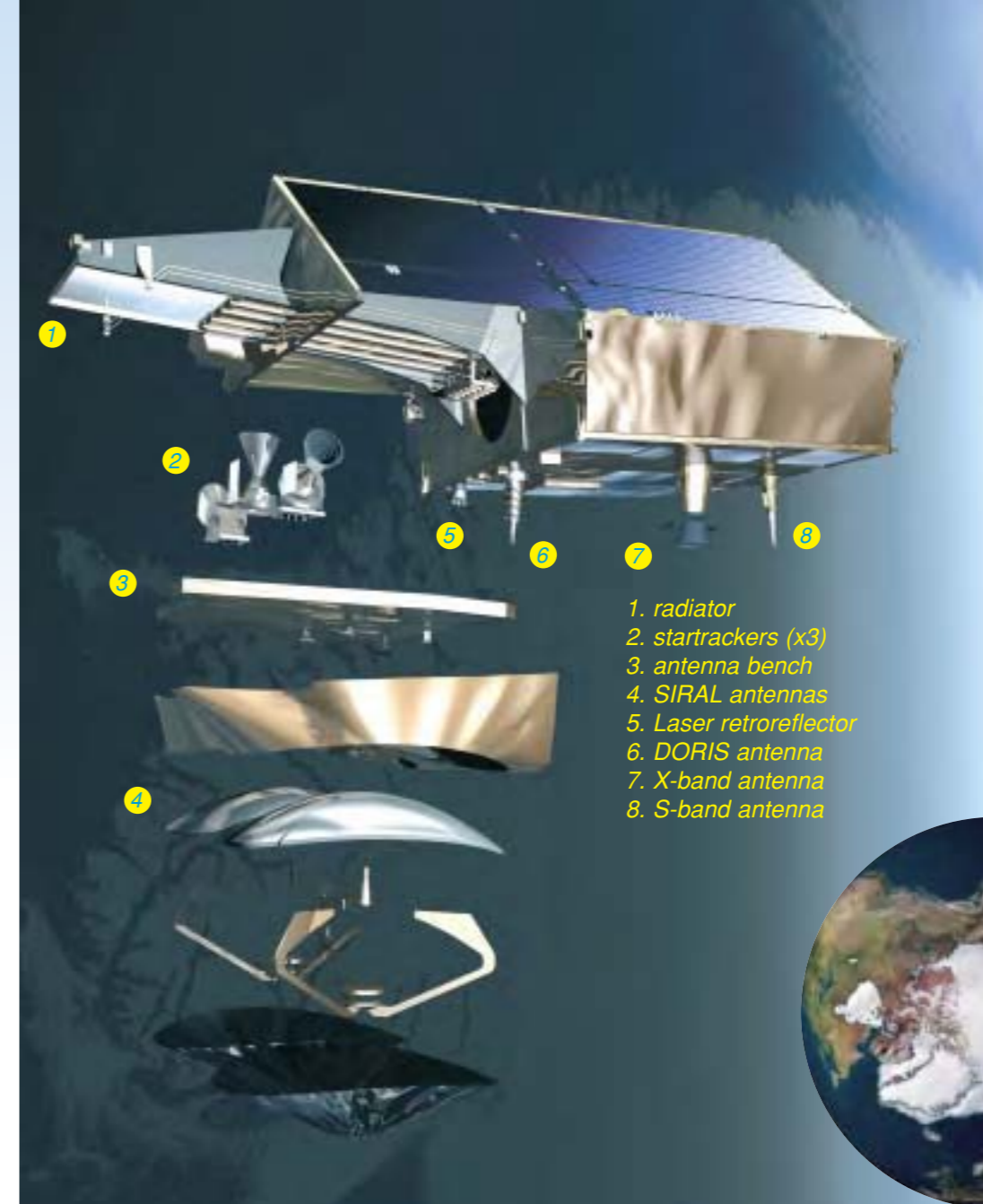

1. radiator
2. startrackers (x3)
3. antenna bench
4. SIRAL antennas
5. Laser retroreflector
6. DORIS antenna
7. X-band antenna
8. S-band antenna



CryoSat at prime contractor EADS Astrium (Friedrichshafen, D), 16 July 2004.

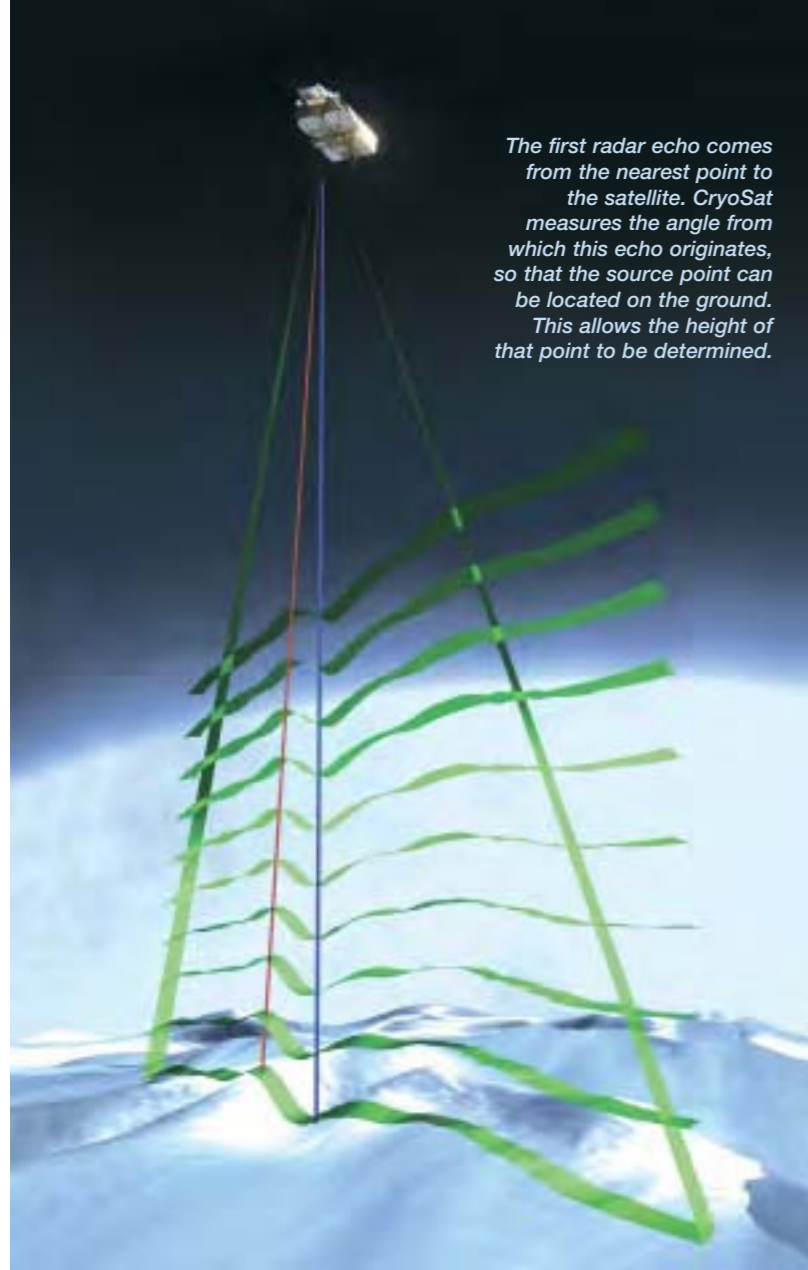

The first radar echo comes from the nearest point to the satellite. CryoSat measures the angle from which this echo originates, so that the source point can be located on the ground. This allows the height of that point to be determined.

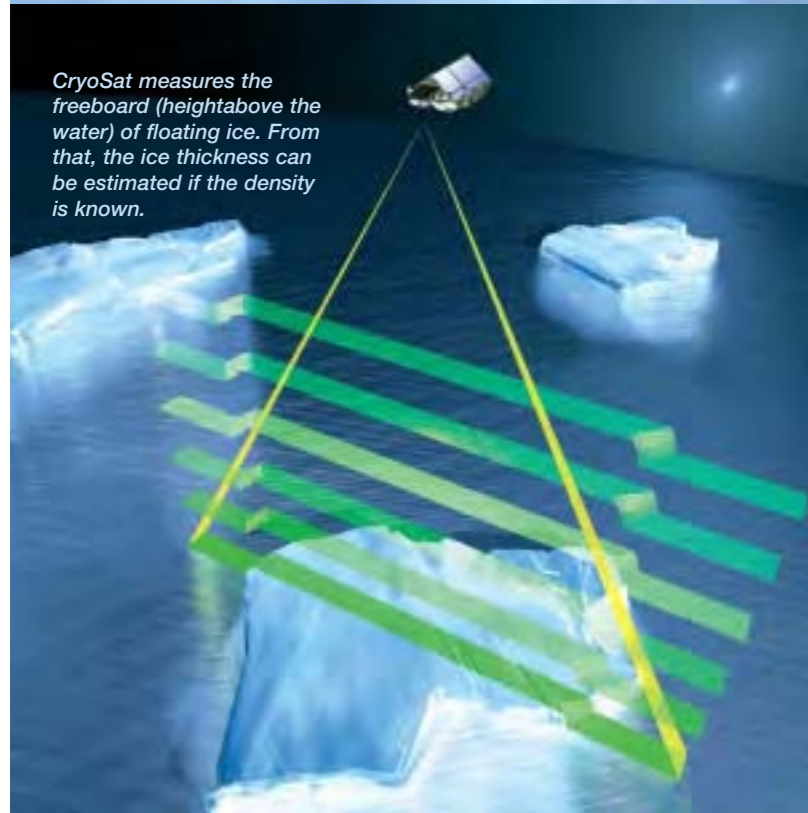

CryoSat measures the freeboard (height above the water) of floating ice. From that, the ice thickness can be estimated if the density is known.



CryoSat Payload	
SIRAL	Cassegrain antenna emits 44.8 μ s Ku-band pulses, bandwidth 320 MHz. Three operating modes: <i>Low-Resolution Mode (LRM)</i> 1 pulse in 44.8 μ s burst, 51 kbit/s; <i>SAR mode</i> 64 pulses in 3.8 ms burst, 12 Mbit/s, for ice floes & ice sheet interiors at < 1 km res; <i>SARin mode</i> 64 pulses in 3.8 ms burst, received by both antennas, 2x12 Mbit/s, for ice sheet edges at 250-300 m res.
DORIS	Doppler Orbitography & Radio-positioning Integrated by Satellite determines the orbit with 5 cm accuracy. It receives 2.03625 GHz & 401.25 MHz signals from ground beacons and measures the Doppler shift every 7-10 s. 91 kg, 16.7 kbit/s, 42 W.
LRR	Cluster of 7 laser reflectors provides orbit determination with cm-accuracy using laser ground stations. Backup to DORIS.

The UK Hadley Centre predicts a thinning of Arctic ice from 5 m (left) to 1 m (right) if the carbon dioxide level quadruples.

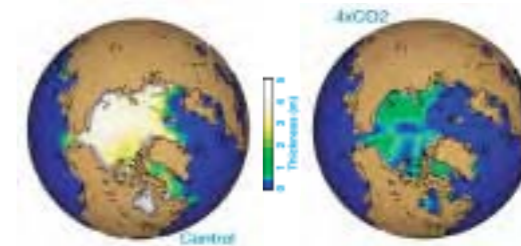

sensitive to ice thermodynamics, how ice deforms under stress, and heat from the air and ocean – 10 W/m² will melt around 1 m of ice in a year.

It is possible that an irreversible change in Arctic sea-ice mass is already underway. Existing thickness measurements already suggest an important trend in Arctic climate – but it is equally possible that this is merely an unremarkable local change. The measurements are still scattered too thinly in space and time to tell. Sea-ice thickness has previously been measured by drilling, by sonar observations of ice draught from submarines operating beneath the pack ice, or in one case, from a moored sonar array across the Fram Strait. Measurements have accumulated over the years, but are rarely of the same locations. CryoSat, by repeatedly sampling 70% of ice floes, will provide an authoritative view of the fluctuations.

CryoSat will do more than observe the floating ice of the Arctic Ocean. Obvious sources for the water causing the 18 cm rise in sea level last century are the ice sheets and glaciers on land. Observations from ERS, Seasat and Geosat indicate that the great central plateaus of the Antarctic and Greenland ice sheets are stable so, if these ice sheets are contributing to the rising sea level, the changes must be happening at their edges. The improvement in resolution from CryoSat's radar, coupled with its interferometric capability, will make continuous measurements of the ice sheet margins and smaller ice caps possible for the first time.

These measurements translate into the need to measure thickness changes in Arctic sea ice of 10⁵ km²

with an accuracy of 3.5 cm/yr (1.2 cm/yr will be achieved); in ice sheets covering 10⁴ km² of 8.3 cm/yr (3.3 cm/yr will be achieved); and in ice sheets the size of Antarctica (13.8x10⁶ km²) of 0.76 cm/yr (equivalent to a loss of 92 Gt of water each year; 0.12 cm/yr will be achieved).

Satellite configuration: total length 4.6 m, width 2.34 m. Box-shaped aluminium bus with extended nose for SIRAL. End/side plates complete main body and support solar array; nadir face as radiator. Controlled by ERC-32 single-chip processor via MIL-1553B bus.

Attitude/orbit control: 3-axis nadir pointing to 0.2/0.2/0.25° roll/pitch/yaw by three 30 Am² magnetorquers supported by redundant sets of eight 10 mN cold-gas nitrogen blowdown thrusters (plus four 40 mN for orbit adjust); 37 kg nitrogen at 250 bar in single central sphere. Attitude determination by 3 star trackers, 3 fluxgate magnetometers, and Earth/Sun sensors. Precise orbit determination by DORIS (5 cm radial accuracy; 30 cm realtime), Laser Retroreflectors (cm accuracy) and S-band transponder.

Power system: two GaAs panels totalling 9.4 m² on upper bus provide 525 Wh (SIRAL requires 132 W; 99 W in low-res mode). Supported by 60 Ah Li-ion battery.

Communications: controlled from ESOC via Kiruna (S). 320 Gbit downlink each day from 2x128 Gbit solid-state mass recorder at 100 Mbit/s QSPK 25 W 8.100 GHz. 2 kbit/s TC at 2026.7542 MHz. 4 kbit/s TM at 2201 MHz.

Venus Express

Planned achievements: first European Venus orbiter

Launch date: planned for 26 October 2005 (window to 25 November), Venus arrival mid-April 2006

Mission end: after 2 Venus sidereal days (486 Earth days), 2-day extension possible

Launch vehicle/site: Soyuz-Fregat from Baikonur Cosmodrome, Kazakhstan

Launch mass: 1270 kg (science payload 88 kg, 570 kg propellant)

Orbit: 250x350 000 km, ~90°, 10 d Venus capture orbit; 250x66 000 km, 90°, 24 h operational Venus orbit

Principal contractors: Astrium-EADS (prime, Toulouse, F), Alenia Spazio (AIV, Turin, I). Phase-B August 2002 - January 2003, Phase-C/D February 2003 - June 2005; PDR January 2003, CDR March 2004, Flight Acceptance Review July 2005

Although it comes closer to Earth than any other planet, Venus remains a mystery. After more than three decades of intense scrutiny by numerous Russian and US space probes, the cloud-shrouded world refuses to unveil many of its secrets. Remarkably similar in size to Earth, Venus could hardly be more different in other respects – and we do not really know why. We still do not understand the details of the greenhouse effect on Venus, which keeps the surface at a sizzling 460°C, hot enough to melt lead. The crushing atmosphere is 90 times thicker than Earth's.

Venus and Earth have evolved quite differently. In the absence of continents, Venus is covered in vast, smooth volcanic plains. Planet-wide volcanism is believed to feed the sulphur-rich cloud layers and sulphuric acid rain. Instead of crustal plates that slide past each other to generate earthquakes and volcanoes, Venus seems to have one all-embracing slab of crust perforated by hot spots where molten magma erupts onto the surface.

Most puzzling of all is how the atmosphere circulates – high-level, hurricane-force winds sweep around Venus in just four days at 360 km/h, remarkably rapid for a planet that

rotates only once every 243 Earth days. Yet the surface atmosphere is a stagnant syrup. By explaining these startling differences between sister worlds, we will gain a better understanding of Earth's weather and changing climate.

Despite its impressive goals, Venus Express is a low-cost spacecraft built and launched in only three years. This is made possible by basing it on ESA's Mars Express, with modifications to cope with the hotter environment at Venus, and the seven instruments including five developed for previous missions. Such instruments have never flown to Venus before, so the planet will be viewed through new eyes.

Some instruments, directly derived from Mars Express and Rosetta, will look at the composition, temperature and density of the atmosphere to an altitude of 200 km. One innovative instrument will picture the energetic atoms escaping from the atmosphere. Unlike Earth, Venus has no protective magnetic field so the powerful wind of electrified atomic particles streaming in from the Sun is continuously stripping away the top of the atmosphere. A wide-angle camera will monitor the whole planet. From its operational polar orbit, it will study the atmosphere, surface and

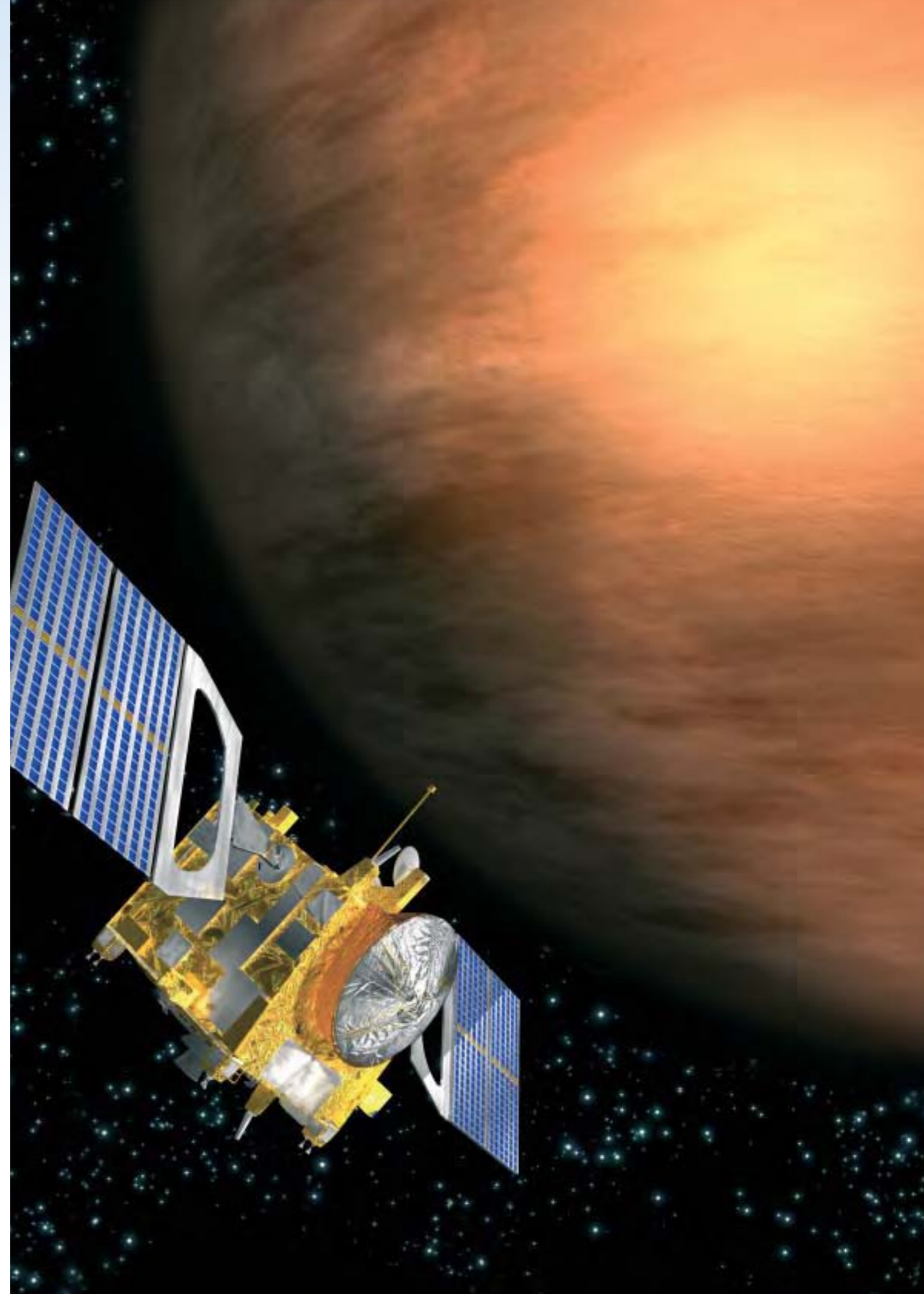

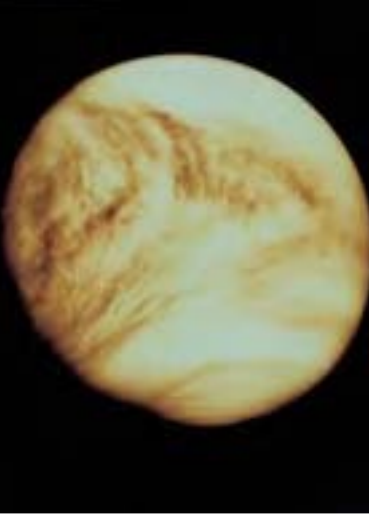

electrified particles for at least 2 Venus 'days' of 243 Earth days each.

Venus Express was proposed to ESA in response to the March 2001 Call for Ideas for reuse of the Mars Express platform. A strict schedule was imposed, aiming at a launch date in 2005, with a strong recommendation to include instruments already available, in particular as flight-spare units from Mars Express and Rosetta. Three missions were studied by EADS Astrium in parallel from mid-July to mid-October 2001: Venus Express, Cosmic Dune (interplanetary & interstellar dust) and Sport Express (polarisation of cosmic microwave background). Venus Express was unanimously recommended by ESA's Solar System Working Group and then by the Space Science Advisory Committee in November 2001. After the Science Programme Committee meeting in December 2001, Venus Express was included in the list of missions to be considered in the replanning exercise of ESA's Science Programme that was conducted in early 2002. In order to maintain the 2005 launch schedule, pre-Phase-B activities were carried out in February-May 2002. Venus Express, originally included in the 'Cosmic Vision 2020' programme put forward for SPC approval in May 2002, was withdrawn from the programme by ESA's executive because the payload funding was not secured. Following the recommendation formulated by ESA's Council of 16-17 June, further negotiations on payload funding were successfully concluded in late June with the funding authorities of the instruments' home countries. On 11 July 2002, although the payload funding was still not fully in place,

Venus Express Science Goals

Scientific observations are divided between the pericentre region, where high-resolution studies of small-scale features will be carried out, and near-apocentre and intermediate observations, where global features will be studied. The main goal is a comprehensive study of the atmosphere and to study in some detail the plasma environment and the interaction between the upper atmosphere and the solar wind. Surface and surface-atmosphere interactions will also be studied. Seven Science Themes have been defined, each with its own detailed set of objectives:

- atmospheric dynamics;
- atmospheric structure;
- atmospheric composition and chemistry;
- cloud layers and hazes;
- radiative balance;
- surface properties and geology;
- plasma environment and escape processes.

The fundamental questions to be answered include:

- what is the mechanism of the global atmospheric circulation?
- what are the mechanisms and the driving force behind the atmospheric super-rotation?
- what are the chemical composition and its spatial and temporal variations at the short- and long-term?
- what is the role of the cloud layers and the trace gases in the thermal balance of the planet?
- what is the importance of the greenhouse effect?
- how can the origin and the evolution of the atmosphere be described?
- what has been and what is the role of atmospheric escape for the present state of the atmosphere?
- what role does the solar wind play in the evolution of the atmosphere?
- is there still active volcanism and seismic activity on Venus?

Resolving these issues is of crucial importance for understanding the long-term evolution of climatic processes on the sister planets of Venus, Earth and Mars, and will significantly contribute to general comparative planetology.

the SPC unanimously approved the start of work. On 5 November 2002, ESA made its final decision on the payload complement and therefore to proceed with the mission. Industrial and payload activities started in mid-July.

Venus Express will be by far the fastest developed scientific project implemented by ESA. The Phase-C/D contract for €82.4 million was signed with EADS Astrium on 28 January



2003. The projected ESA cost-at-completion is €220 million (2004 conditions).

Venus Express will provide a breakthrough by fully exploiting the near-IR atmospheric windows over the planet's night side, discovered in the 1980s, through which radiation from the lower atmosphere and even the surface escapes to space.

As there were strict requirements on the instruments – they had to be available to match the challenging schedule of the mission – the list of candidates was restricted. The obvious candidates were the spare models from the Mars Express and Rosetta projects. After detailed assessment, three Mars Express and two Rosetta instruments were chosen, enhanced with a new miniaturised 4-band camera and a new magnetometer (with heritage from the Rosetta lander). In addition,

a very high-resolution solar occultation spectrometer was added to the SPICAM Mars Express instrument. This resulted in an instrument complement able to sound the entire atmosphere from the surface to 200 km altitude by combining different spectrometers, an imaging spectrometer and a camera, covering the UV to thermal-IR range, along with a plasma analyser and a magnetometer. Radio science will use the communication link to Earth enhanced with an ultra-stable oscillator, for high-resolution vertical investigations. As it turns out, despite the limitations in choice, the payload is close to optimised for the mission.

The spacecraft is derived from Mars Express, using most subsystems without modification. The major differences are in the thermal control system, which was redesigned to cope with the much higher heat input from

Venus Express Scientific Instruments	
PFS	Planetary Fourier Spectrometer (from Mars Express). Atmospheric composition & circulation, surface mineralogy, surface-atmosphere interactions. 1.2-45 μm . 32 kg, 35 W, up to 300 Mbit/orbit. PI: V. Formisano, Istituto Fisica Spazio Interplanetario (Rome, I). Participating countries: I, RU, PL, D, F, E, US
ASPERA	Energetic Neutral Atoms Analyser (from Mars Express). Upper atmosphere interaction with interplanetary medium & solar wind; near-Venus plasma and neutral gas environment. 9 kg, 12 W, up to 400 Mbit/orbit. PI: S. Barabash, Swedish Institute of Space Physics (Kiruna, S). Participating countries: S, D, UK, F, FIN, I, US, RU, CH, IRL
SPICAV	UV and IR Atmospheric Spectrometer (from Mars Express with added SOIR high-res IR solar occultation channel). O_3 content of atmosphere and vertical profiles of CO_2 , O_3 and dust. SOIR channel will detect chemical species such as H_2O , CO , H_2S and trace gases such as methane & ethane. 9 kg, 21 W, up to 250 Mbit/orbit. PI: J.-L. Bertaux, Service d'Aeronomie du CNRS (Verrieres-le-Buisson, F). Participating countries: F, B, RU, US
VeRa	Radio Science Experiment (from Rosetta). Atmospheric density, P & T profiles, ionospheric electron density profiles (passage of radio waves through atmosphere), surface dielectric and scattering properties (reflection of radio waves) and gravity anomalies (orbital tracking). 1.5 kg, 5 W. PI: B. Häusler (Universität der Bundeswehr, München, D). Participating countries: D, F, US, B, JPN
MAG	Magnetometer (partly from Rosetta Lander). Identify boundaries between plasma regions, interaction of solar wind with atmosphere, support data for other instruments. Two tri-axial fluxgate magnetometers, one body-mounted and one on a 1 m deployed boom. Default range ± 262.1 nT (res 8 pT); range commandable to between ± 32.8 nT (res 1 pT) and ± 8388.6 nT (res 128 pT). 2.2 kg, 4.25 W, up to 50 Mbit/orbit. PI: T. Zhang (IFW, Graz, A). Participating countries: A, D, UK, S, ESA, US
VIRTIS	Visible/IR Imaging Spectrometer (from Rosetta). Composition of atmosphere below clouds, cloud structure & composition, cloud tracking, T/wind speed at 60-100 km altitude, T of surface (volcanoes?), lightning. Spectral res 0.25-5 μm . R~200 at 0.25-1 & 1-5 μm , and R~1200 at 2-5 μm . PI: P. Drossart (Obs. de Paris, Meudon, F) & G. Piccioni (IASF, Rome, I). 31 kg, 66 W, up to 5 Gbit/orbit. Participating countries: F, D, I, US, PL, NL, UK
VMC	Wide-angle Venus Monitoring Camera. 1032 x 1024-pixel CCD with four 13 mm f.l. F/5 optics for imaging in UV (0.365 μm), visible (0.513 μm) & near-IR (1.01 & 0.915 μm), 17.5° FOV for global spatial & temporal coverage of Venus disc. 1.1 kg, 4 W, up to 1.5 Gbit/orbit. PI: W. Markiewicz (MPAe, Katlenburg-Lindau, D). Participating countries: D, F, US, JPN, RU

the Sun (2600 W/m² at Venus vs 600 W/m² at Mars) and the higher albedo of the planet itself. For the same reason, the solar panels have been completely redesigned: they are based on high-temperature GaAs cells and cover about half the area of the Mars Express panels.

Configuration: box-shaped bus 1.5x1.8x1.4 m of conventional aluminium honeycomb construction. Dry mass 680 kg.

Attitude/orbit control: orbit correction & Venus insertion by single 400 N MON-3/MMH thruster, attitude

control by 8x10 N hydrazine thrusters (570 kg in 2 267-litre tanks) and 4x12 Nms reaction wheels. Pointing accuracy 0.15° supported by 2 star trackers, 2 inertial measurement units (each 3 ring laser gyros + 3 accelerometers), 2 coarse Sun sensors.

Power system: twin 2-panel GaAs solar wings totalling 5.8 m² to provide 1450 W at Venus (160 W for science). Supported by 3x24 Ah Li-ion batteries.

Thermal control: 24-layer MLI derived from Rosetta on the 2 hot walls

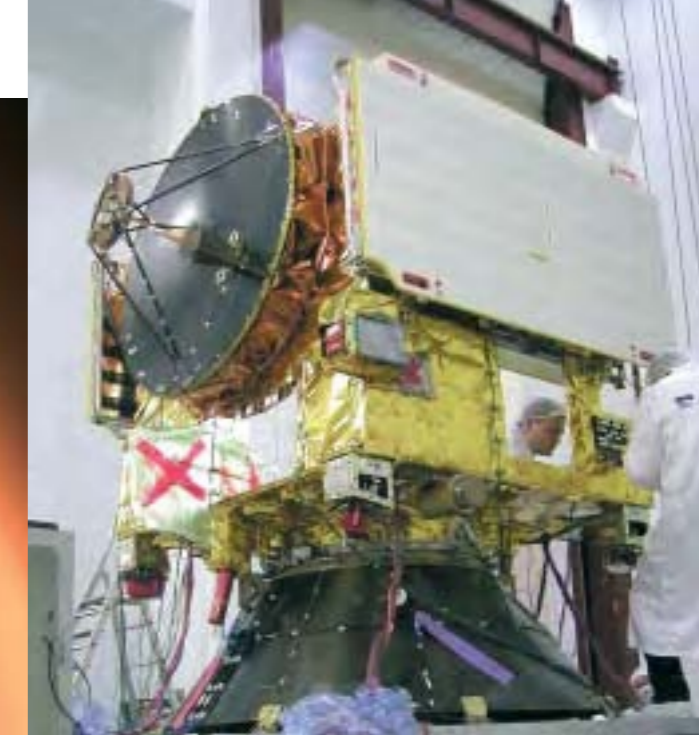
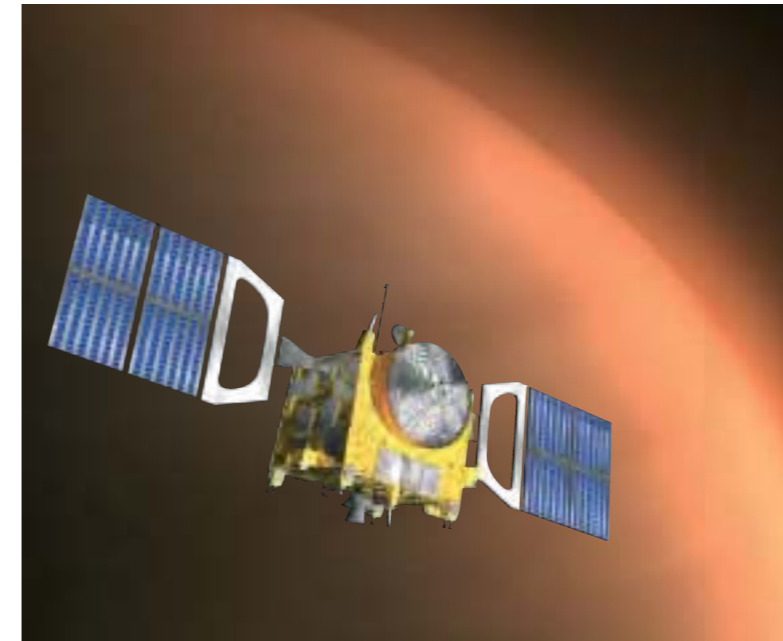

The Venus Express flight model being prepared for vibration at Intespace.

(+X/+Z) keep interior at 10-20°C. Radiators on -X wall (opposite HGA) for PFS & VIRTIS. ASPERA moved (from Mars Express) to side wall to avoid Sun illumination; VIRTIS occupies OMEGA/HRSC locations of Mars Express.

Communications: transmitted from 12 Gbit SSR to ground during the 8 h following the pericentre pass each orbit via 1.3 m-dia X/S-band HGA to 35 m Cebreros (E). Plus 30 cm-dia X-band HGA2 on top (+Z) derived from Rosetta MGA. Rate will vary according to Earth distance, with 26-228 kbit/s giving at least 500 Mbit

(2 Gbit average) of science data per orbit via the 65 W X-band link. ESA's other 35 m station, at New Norcia, Australia, will be used during mission-critical operations and for radio science support during dedicated campaigns. The 5 W S-band channel is included for near-Earth communications and radio science. Processed data will be placed in ESA's publicly accessible Planetary Science Archive (PSA) after 6 months. Mission control is handled by the Mission Operations Centre at ESOC; the science planning and coordination is handled by the Science Operations Centre at ESTEC.

Galileo

Planned achievements: first European global navigation satellite system; civil position accuracy to 5 m

Launch date: experimental satellite planned December 2005, demonstration satellites 2008, operational satellites 2008-2010

Mission end: no mission end; each operational satellite nominal lifetime of 15 years

Launch vehicle/site: operationally in clusters of 6 on Ariane-5 from Kourou, and Soyuz-Fregat, replacements by vehicles such as Soyuz-Fregat

Launch mass: GSTB-V2/A 600 kg; GSTB-V2/B 525 kg; IOV/operational satellites 650 kg

Orbit: 23 222 km circular, 56°, 14.4 h, in 3 orbital planes

Principal contractors: Galileo Industries (GSTB-V2/B; IOV), SSTL (GSTB-V2/A), contractor for operational satellites to be selected. Development & Validation Phase 2001-2007; Deployment Phase 2008-2010; Operations Phase from 2010



For the first time, the Agency has taken a lead role in the navigation segment. ESA and the European Commission have joined forces to design and develop Europe's own satellite navigation system, Galileo. Whereas the US GPS and Russian Glonass systems were developed for military purposes, Galileo is a civil system that will offer, inter alia, a guaranteed service, allowing Europe to develop an integrated transport system. It will also allow the European economy to benefit from the enormous growth expected in value-added services and equipment for navigation systems.

Europe's first venture into satellite navigation is EGNOS (European Geostationary Navigation Overlay Service), a system to improve the reliability and accuracy (2 m) of GPS and Glonass to the point where they can be used for safety-critical applications, such as landing aircraft and navigating ships through narrow channels. ESA engineers first developed plans for a GPS and Glonass augmentation system in the late 1980s. Working in close cooperation with the EC and the European Organisation for the Safety of Air Navigation (Eurocontrol), the Agency later adopted the plans as the EGNOS programme. When EGNOS becomes

operational in 2005, using payloads on Artemis and Inmarsat satellites, it will be Europe's contribution to the first stage of the Global Navigation Satellite System (GNSS-1), complementing similar enhancements in the US and Japan.

In addition, the European Union recognised the need for its own independent global satellite navigation system. Consultations began in 1994 and 4 years later plans for a fully European system were drawn up. Early in 1999, the EC



announced Galileo. It will be interoperable with GPS and Glonass, so that a user can take a position with the same receiver from any of the satellites in any system. By offering dual frequencies as standard, however, Galileo will deliver positioning accuracy down to 5 m, which is unprecedented for a civil system. It will also guarantee availability of the service under all but the most extreme circumstances and will inform users within 6 s of the failure of any satellite. This will make it suitable for safety-critical applications.

The fully-fledged service will be operating by about 2010 when 30 Galileo satellites are in position in circular orbits 23 222 km above the Earth. The first will be launched in 2008 and by 2009 sufficient should be in place to begin an initial service. The orbits will be inclined at 56° to the equator, giving good coverage at all latitudes. A total of 27 satellites will be operational and three will be active spares, ensuring that the loss of one has no discernible effect on the user. Ground stations spread around the globe will monitor the satellites' positions and the accuracies of their onboard clocks. The stations will be connected to central control facilities in Europe via

a dedicated network. The control facilities will monitor and control the constellation and compute navigation messages to transmit to the satellites via the ground stations. The control facilities will also keep service providers, such as providers of traffic management services, informed about the operating status of the satellites.

ESA approved the initial studies in May 1999 at its Ministerial Council in Brussels; the EC decided on its own go-ahead in June 1999. The EC is responsible for the political dimension: undertaking studies into the overall system architecture, the economic benefits and the needs of users. ESA defined the Galileo space and ground segments under its GalileoSat programme. ESA placed contracts with European industry to develop critical technologies, such as navigation signal generators, power amplifiers, antennas and highly accurate atomic clocks, and to provide tools to simulate the performance of the whole constellation.

Europe's traditional space industry undertook Galileo definition studies from November 1999 to February 2001 under two contracts financed separately by the EC and ESA. Industries not usually associated

with space, such as mobile phone manufacturers and service providers, are, in addition to their involvement in the EC-funded definition study, undertaking their own studies of services and applications.

The European Commission, ESA and the eventual commercial operator will meet the €3550 million (2001 conditions) estimated cost of Galileo through a public/private partnership. Public money will fund the project through to the end of the validation phase, followed by majority private funding from the concession-winner for launching and operating the final system.

Studies suggest that Galileo will repay its investment handsomely, estimating that equipment sales and value-added services will earn an extra €90 billion over 20 years. More recent studies yielded higher estimates by considering potential earnings from value-added services that combine Galileo positioning with other services provided by the new generation of mobile phones, such as internet services. Around 140 000 jobs are expected to be created, with a return ratio on the system cost of 4.6.

Initial funding on the EC side came from the European Union's 5th Framework programme of research and development and on the ESA side from the Agency's GalileoSat definition programme (November 1999 to 2002, costing €97.6 million, including technology development).

The development and in-orbit validation (IOV) phase was projected in 2000 to cost €1.1 billion, financed equally by ESA and the EU from

public money. It aims to have in orbit by 2008 a handful of satellites for validating the Galileo system.

At its meeting on 30 January 2001, ESA's Navigation Programme Board approved the release of €53 million for funding critical technology development, the Galileo Phase-B2 study, the mission consolidation studies and the support studies on the Galileo services to begin. ESA released the second and main tranche of €547 million at its Council Meeting of May 2003.

On the EU side, the Transport Ministers on 5 April 2001 approved the release of €100 million to start development. The ministers approved the release of a further €450 million on 26 March 2002, when they also approved the setting up of an entity to manage the programme. The EC/ESA Galileo Joint Undertaking (GJU) formally assumed responsibility on 1 September 2003 for the development, validation and commercial phases. ESA's approval to set up GJU came at its May 2003 Council Meeting; the GJU founding act was signed by the EC and ESA on 25 May 2003.

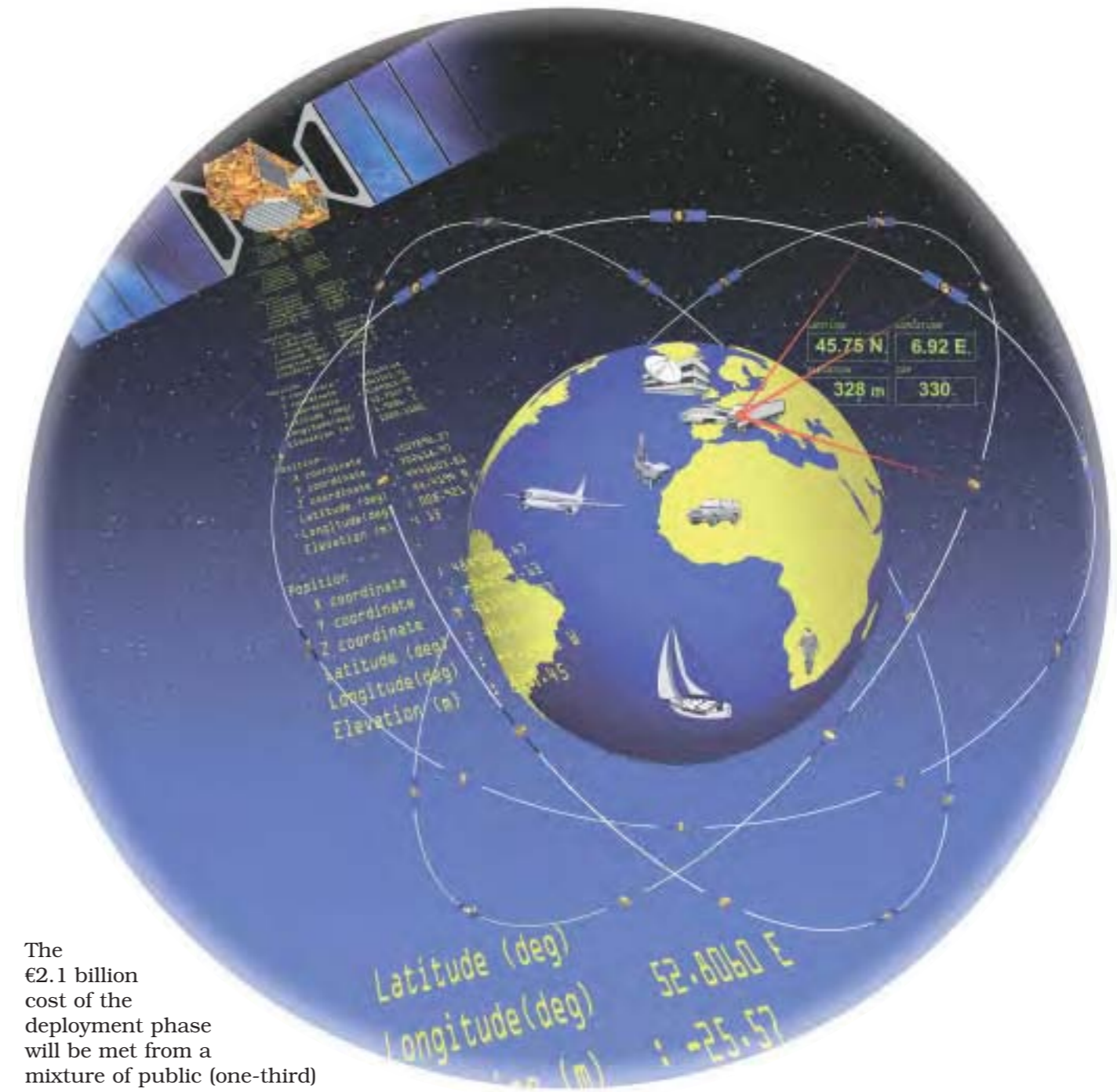
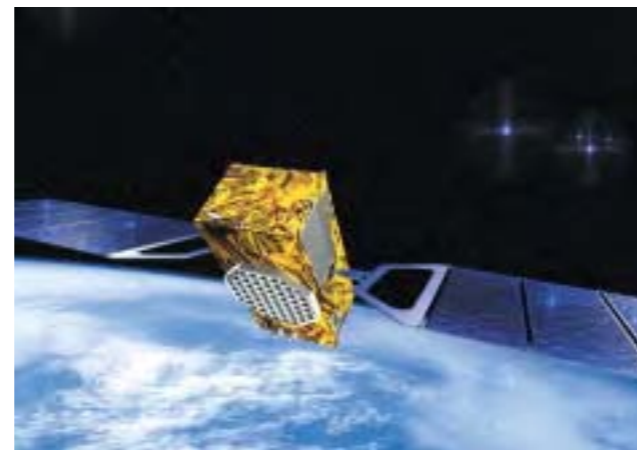

The €2.1 billion cost of the deployment phase will be met from a mixture of public (one-third) and private funding (two-thirds). ESA and the EU will share the public slice equally (i.e. €350 million each). The EC on 10 December 2004 approved the move to the deployment and operational phases. During the deployment phase, which will end around 2010 when all the satellites are launched, industry and service providers will be able to develop commercial opportunities. Once operational, the system will cost around €220 million annually to maintain, including satellite replacements. The Public sector intends to provide financial support for the first years of the operational phase; €500 million is earmarked for that purpose. After that initial period,

the cost should be borne entirely by the concessionaire. By this time, the system will be fully operational and available for a wide variety of commercial and public service users.

The total cost for the design, development, in-orbit validation and deployment of the first full constellation, including the ground segment, is €3550 million (2001 conditions).

On 17 October 2003, the GJU began the process to find a concessionaire, the commercial operator for the system. Two bids were submitted by

The Galileo navigation and S&R payload, carried by the IOV and operational satellites.

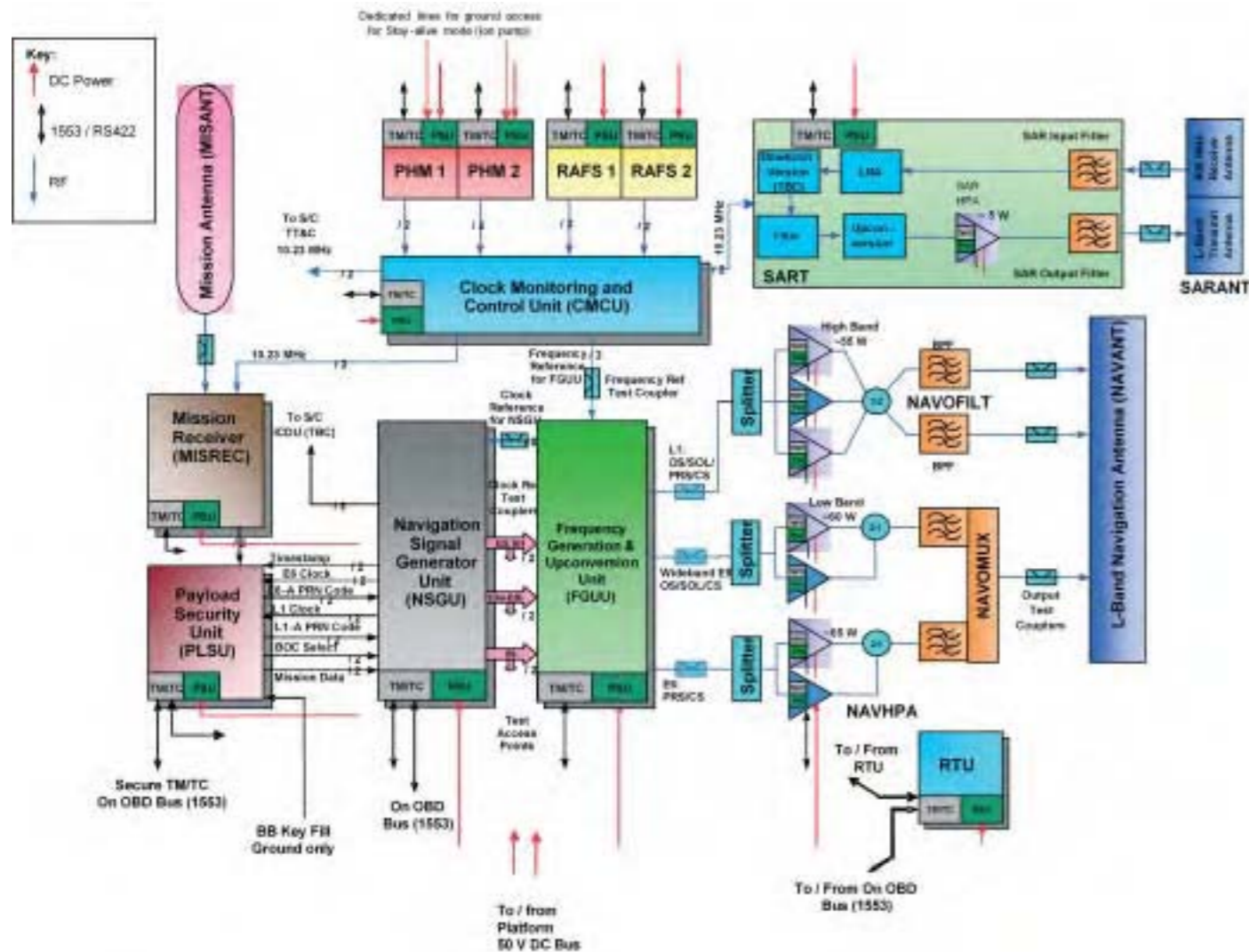

the deadline of 1 September 2004 (and the final bids on 25 January 2005): from the iNavsat consortium led by EADS Space, Thales and Inmarsat, and the Eurely consortium headed by Vinci Concessions, Alcatel Space and Finmeccanica. The selection is due to be made in March 2005, and the 20-year concession contract to be signed in December 2005. The concessionaire will be responsible for awarding the contract for the 26-27 satellites to come after IOV.

Navigation payload: the navigation signals are modulated with 500-1000 bit/s data messages received from ground stations through the TT&C subsystem and stored, formatted and encoded onboard. Galileo will use up to four 50 W carriers at 1164-1215, 1260-1300 & 1559-1591 MHz. A highly stable onboard reference frequency of 10.23 MHz is generated from rubidium atomic frequency standards and passive hydrogen masers

Galileo Services

Galileo will provide five levels of service:

The **Open Service (OS)** is for mass-market applications, free of direct user charge. Up to three separate frequencies are available, but cheap single-frequency receivers can provide reduced accuracy. In general, OS applications will use a combination of Galileo and GPS signals, which will improve performance in severe environments such as urban areas. OS does not offer integrity information, and determining the quality of signals will be left entirely to the users.

The certified **Safety-of-Life Service (SoL)** will provide the same position and timing accuracy as OS, but it offers a worldwide high level of integrity for safety-critical applications, such as maritime, aviation and rail, where guaranteed accuracy is essential. EGNOS will be integrated with it for GPS integrity information.

The **Commercial Service (CS)** aims at market applications requiring higher performance than from OS. It provides added value services on payment of a fee. CS is based on adding two signals to the open access signals, protected via commercial encryption.

The encrypted **Public Regulated Service (PRS)** will be used by groups such as the police, coastguard and customs. It will be operational at all times and under all circumstances, including periods of crisis. A major feature is the signal robustness, protected against jamming and spoofing.

The **Search & Rescue Service (SAR)** is Europe's contribution to the international search and rescue. Improvements on the existing system include near real-time reception of distress messages from anywhere on Earth (the average waiting time is currently an hour) and the precise location of alerts (a few metres, instead of the current 5 km).

operating in hot redundant, parallel configuration. Solid-state amplifiers generate some 50 W output per signal carrier. The navigation antenna uses twin beam-forming networks (one for each band) and an array of radiating elements to provide global coverage with a single beam. High data rates

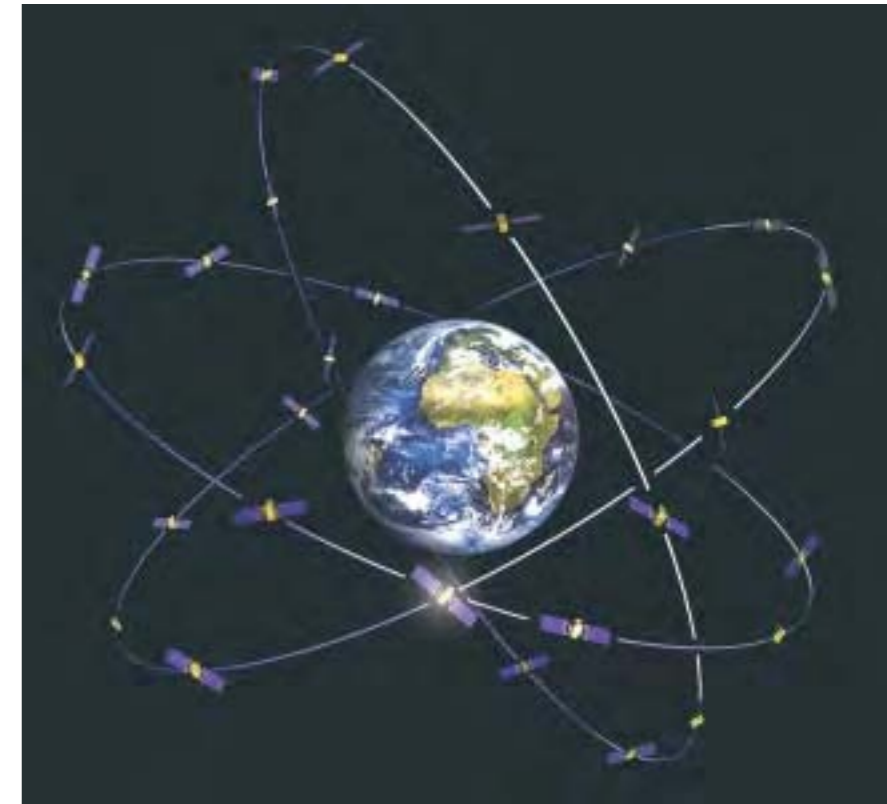

maximise the potential for value-added services such as weather alerts, accident warnings, traffic information and map updates.

Two Galileo Control Centres (GCCs) will be built in Europe to control the satellites and manage the navigation mission. The data provided by a global network of some 30 Galileo Sensor Stations (GSSs) will be used by the GCCs to compute the integrity information and to synchronise the time signal of all satellites and of the ground station clocks. The exchange of data between the GCCs and the satellites will be via five S-band and 10 C-band stations around the globe.

Search & Rescue (SAR) payload: the SAR payload, being defined in cooperation with COSPAS-SARSAT,

receives signals from standard 406 MHz distress beacons through a dedicated antenna. The signals are amplified and transmitted at 1544 MHz to SAR Control Centres using the navigation antenna. Acknowledgement messages are relayed back to the beacon by integrating them in the navigation data stream.

IOV & GSTB-V2

The Galileo Development and Validation phase began in December 2003, aiming for 3-4 satellites to prove the system concept before full deployment begins. On 14 June 2004, ESA released the Request for Quotation for Phase-C/D/E1 to the Galileo Industries consortium of Alcatel Space Industries (F), Alenia Spazio (I), Astrium GmbH (D), Astrium Ltd (UK), Galileo Sistemas y Servicios (E) and Thales (F), formed in May 2000, with the response due mid-October; a €150 million initial contract was signed 21 December 2004 with Galileo Industries. The first IOV launch is planned for mid-2008. The whole phase was projected in December 2000 to cost €1.1 billion, with €645 million for the space/ground segment, but the overall costs have risen to €1.5 billion, largely because a second experimental satellite has been added, the total now includes the cost of security elements, and the change in economic conditions from 2000 to 2005.

The Galileo System Test Bed is composed of an experimental satellite 'GSTB-V2' and a network of GPS stations and processing facilities to verify the Galileo algorithms (GSTB-V1). A purpose of GSTB-V2 is to ensure that the International

Telecommunications Union legal requirement of representative Galileo signals being received from a representative Galileo orbit was met before the deadline of June 2006. GSTB-V2 is also designed to measure the radiation environment in this orbit (instruments include the ESA Standard Radiation Environment Monitor; see Proba-1 entry), demonstrate key technologies and provide test signals for coordination with other systems. Which of the two GSTB-V2 satellites will be launched first, in late 2005 aboard a Soyuz from Baikonur Cosmodrome, will be decided in mid-2005.

Contracts for both satellites were signed 11 July 2003: €27.9 million with Surrey Satellite Technology Ltd (UK) for GSTB-V2/A; and €72.3 million with Galileo Industries for GSTB-V2/B. The smaller V2/A carries a rubidium clock and two different signal generators to cover various signal options, while V2/B adds a passive hydrogen maser and will allow the contemporary transmission of signals over three navigation bands. The maser stability of better than 1 ns per day will make it the best clock ever flown in space.

GSTB-V2/A

Schedule: PDR December 2003; CDR February 2005

Principal contractors: SSTL

Design life: 27 months

Key technologies: rubidium clock, dual signal generators, 70 W TWTA, navigation antenna

Launch mass: 600 kg

Satellite configuration: bus 1.3x1.8x1.65 m; space across deployed solar array 9.6 m

Attitude/orbit control: 3-axis nadir-pointing by 4 reaction wheels; 3-axis magnetorquers for wheel



GSTB-V2/B

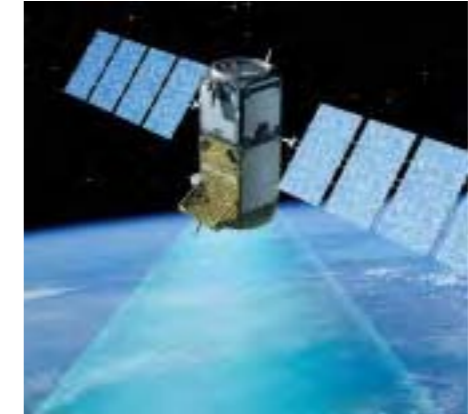

offloading; attitude determination by Earth/Sun sensors. 8 thrusters, 75 kg butane in 2 tanks
Power system: 700 W required, 2-panel wings (each panel 0.98x1.74 m) of Si cells, Li-ion battery.

Communications: 9.6 kbit/s S-band with control centre at SSTL (Guildford), ground stations in UK (Guildford & RAL-Oxfordshire) & Malaysia; in-orbit testing facility at Chilbolton (UK).

GSTB-V2/B

Schedule: PDR December 2003; CDR-1 July 2004, CDR-2 December 2004

Principal contractors: Galileo Industries

Design life: 27 months

Key technologies: rubidium clock, passive hydrogen maser, 50 W SSPA, navigation antenna

Launch mass: 525 kg

Satellite configuration: bus 1.6x1.8x2.7 m

Attitude/orbit control: 3-axis nadir-pointing by 4 12 Nms reaction wheels; 3 one-axis magnetorquers for wheel offloading; attitude determination by Earth sensor + 3 fine Sun sensors; 2 3-axis gyros used when no Earth reference. 18 N thrusters, 28 kg hydrazine in 1 tank

Power system: 940 W required, 4-panel Si wings (each panel 0.8x1.49 m), 78 Ah Li-ion battery
Communications: S-band (TC

2 kbit/s, TM 31.25 kbit/s) with control centre in Fucino (I). ground stations in Fucino (I) & Kiruna (S) (LEOP adds Santiago/Chile & Dongara/Australia); in-orbit testing facility in Redu (B).

IOV Satellites

Schedule: PDR June 2005; CDR September 2007

Principal contractors: Galileo Industries

Design life: 12 years (reliability 0.832 over 12 years)

Launch mass: 690 kg

Satellite configuration: bus 1.10x1.20x2.50 m, aluminium panels; span across deployed solar array 13 m

Attitude/orbit control: 3-axis nadir-pointing by 4 reaction wheels; 3-axis magnetorquers for wheel offloading; attitude determination by Earth sensor + 3 fine Sun sensors; 2 3-axis gyros used when no Earth reference. 8 N thrusters, 75 kg hydrazine in 1 tank

Power system: 1700 W EOL required, 24-panel GaAs wings, Li-ion battery

Communications: S-band, with control centre and ground stations to be decided

Navigation and S&R payload: 146 kg, 940 W, 2 paired rubidium & hydrogen maser clocks, 1.32x1.48 m L-band navigation antenna, 35.2 cm C-band rx antenna; L-band S&R 1544 MHz tx & 406 MHz rx antennas.

Metop

Planned achievements: first European meteorological satellite in polar orbit

Launch dates: Metop-2 planned for April 2006, Metop-1 2010, Metop-3 2014

Mission end: nominally after 5 years

Launch vehicle/site: Soyuz-ST from Baikonur Cosmodrome, Kazakhstan (also compatible with Ariane-5 from Kourou, French Guiana)

Launch mass: 4093 kg (2128 kg payload module, 1397 kg service module, 252 kg solar array, 316 kg propellant)

Orbit: planned 817 km circular, 98.7° Sun-synchronous (09:30 local time descending node), 29-day/412-rev repeat cycle

Principal contractors: Astrium SAS (prime, service module), Astrium GmbH (payload module, ASCAT, GRAS with Saab-Ericsson Space), Galileo Avionica (GOME-2), Dutch Space (solar generator); all other instruments are customer-provided

Metop will provide Europe's first meteorological satellites in polar orbit. They were originally part of a much larger satellite concept, called POEM, which was to have been the successor to ERS, based on the Columbus Polar Platform. This very large satellite would have carried the payloads of both Envisat and Metop and would have been serviceable in-orbit. At the ESA Ministerial Council in Granada, Spain in 1992, this approach was abandoned and Envisat and Metop were born. Metop is a joint undertaking by ESA and Eumetsat as part of the Eumetsat Polar System (EPS). In addition to the satellites, EPS comprises the ground segment development and operations, the launches and various infrastructure elements. ESA is funding 64% (€480 million in 2004 terms) of Metop-1, while Eumetsat covers the rest (€264.2 million) and the two follow-on satellites. The cooperative agreement between the two agencies was signed on 9 December 1999, at the same time as the industrial contract with Matra Marconi Space (now EADS Astrium). EPS will provide an operational service for 14 years, which requires three satellites with nominal lifetimes of 5 years.

synchronous planes: mid-morning and afternoon. Following launch of the first Metop, the mid-morning service will be provided by EPS as part of the 'Interim Joint Polar System'. During the transitional phase, the older generation of instruments will continue to fly as the newer instruments are introduced; Metop will carry older instruments from NOAA as well as more advanced, European, ones. The present NOAA satellites and the military DMSP satellites will be replaced by the end of the decade by a new integrated system (NPOESS) operating in three planes: early



The engineering model of Metop's payload module being prepared for testing in ESTEC's Large Space Simulator, June 2001.

The US National Oceanic & Atmospheric Administration (NOAA) currently operates polar meteorological satellites for civil use in two Sun-



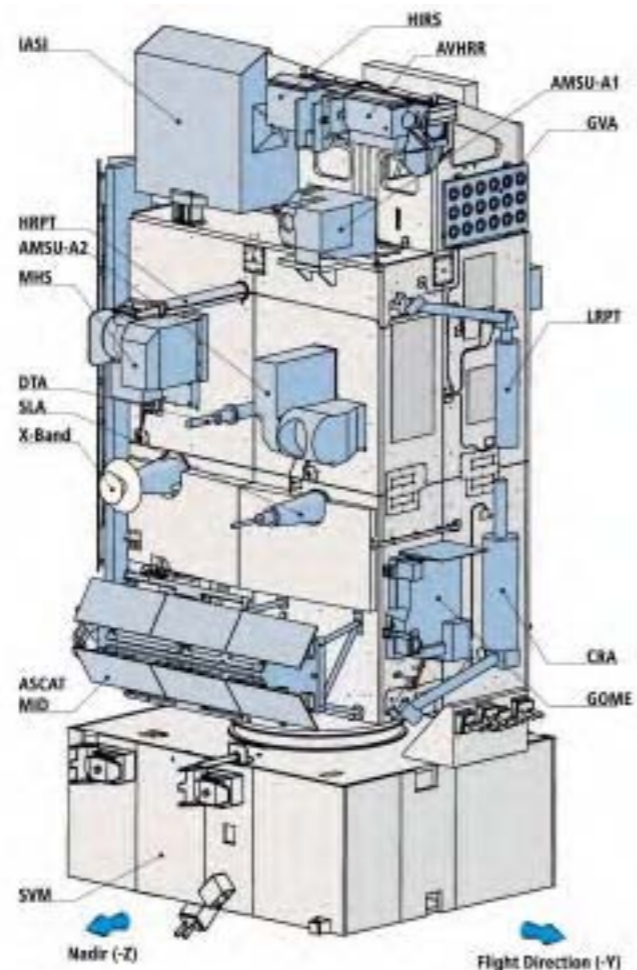
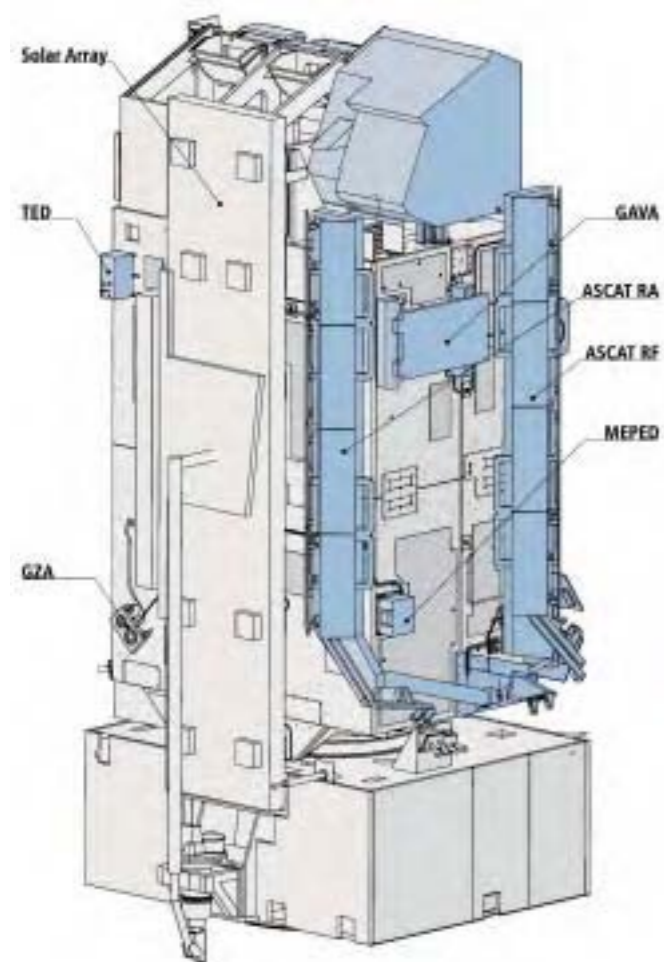

Right: radio-frequency compatibility tests were conducted on the engineering model payload module at ESTEC in mid-2001.

Facing page, bottom right: the Metop-2 payload module in ESTEC's Large Space Simulator, February 2004.

Facing page, top: principal Metop features. acronyms (in addition to instruments): CRA: Combined Receive Antenna (ADCS, SARR, SARP-2); DTA: DCS-2 Transmit Antenna; GAVA: GRAS Anti-Velocity Antenna; GVA: GRAS Velocity Antenna; GZA: GRAS Zenith Antenna; HRPT: High-Resolution Picture Transmission; LRPT: Low-Resolution Picture Transmission; MEPED: Medium-Energy Proton & Electron Detector; SARP: S&R Processor; SARR: S&R Receiver; SLA: S&R L-band transmit Antenna (SARR); SVM: service vehicle module; TED: Total Energy Detector



morning, mid-morning and afternoon. Under the Joint Polar System agreement, EPS/Metop will continue to provide the main sounding mission for the mid-morning service.

Metop stores its data for downlinking each orbit, but it also provides continuous direct data-broadcast services to users. The channels can be selectively encrypted for decoding by commercial customers. The High-Resolution Picture Transmission (HRPT) broadcasts the full data set at L-band for regional meteorological organisations to receive relevant data in realtime. The Low-Resolution Picture Transmission (LRPT) service at VHF provides a subset of the HRPT data. It is comparable to the existing NOAA automatic picture transmission (APT) service, with the objective of providing inexpensive access to low-resolution AVHRR images by local users.

Notable improvements for Metop are:

- new instruments: ASCAT, IASI, GOME-2 and GRAS;
- an innovative onboard compression scheme that is a considerable improvement over the existing APT service and provides LRPT user access to three channels of AVHRR data at full instrument spatial and radiometric resolution;
- continuous onboard recording of the

global data set for dumping every orbit to a high-latitude ground station, with the global processed data available to users within 2.25 h of the measurements;

- high pointing and orbital stability to ensure that data may be geo-located without reference to ground-control points in imagery;
- a selective encryption system to ensure the commercial and data-denial needs of Eumetsat and the US Government, respectively.

The three Metops will carry heritage instruments from the current NOAA satellites:

- Advanced Very High Resolution Radiometer (AVHRR), an optical/infrared imager for global coverage of clouds, ocean and land;
- High-resolution Infra-Red Sounder (HIRS), a spectrometer with a relatively coarse spatial resolution and a mechanical scan over a wide swath, from which height profiles of atmospheric pressure and temperature may be derived (not on Metop-3 because IASI by then will be a proven instrument);
- Advanced Microwave Sounding Unit-A (AMSU-A), a mechanically scanned multi-channel microwave radiometer for pressure and temperature profiles;

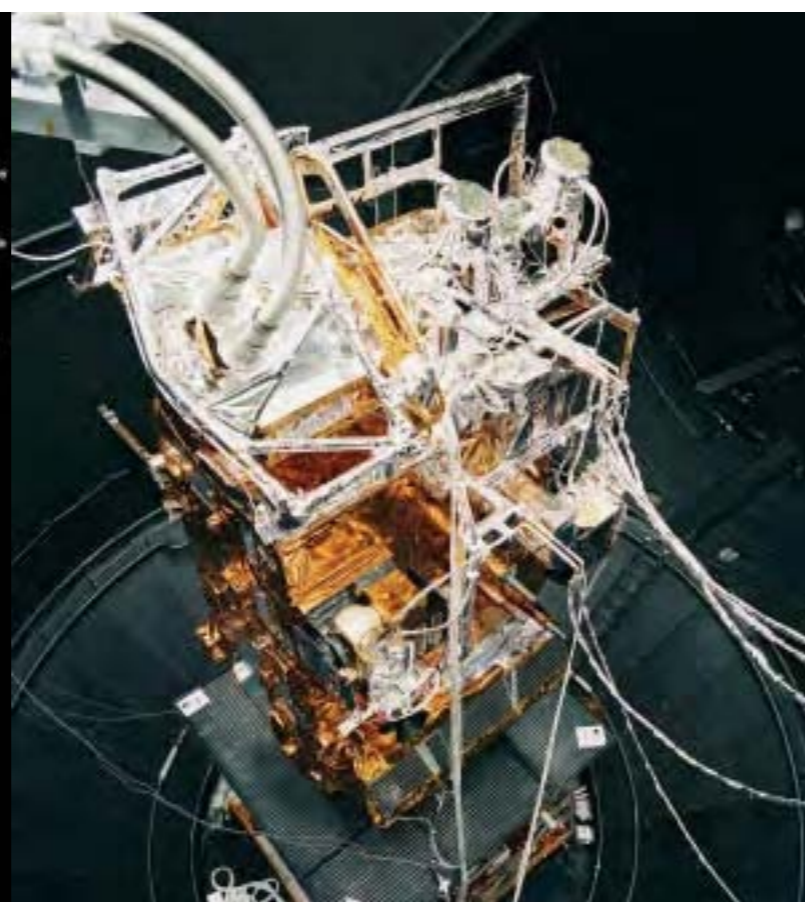
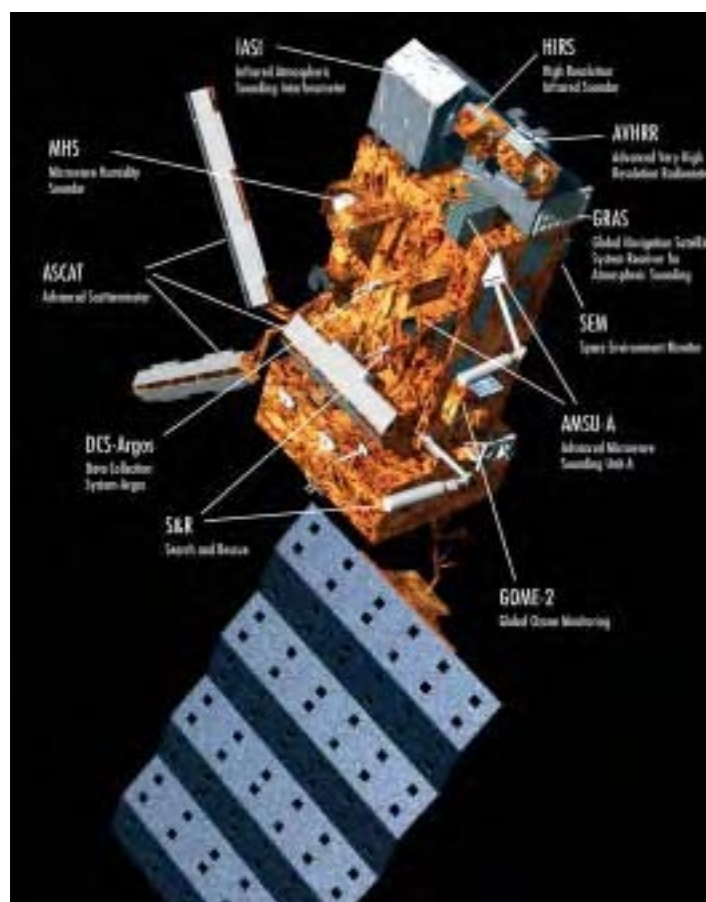

Metop payload	
Advanced Very High Resolution Radiometer (AVHRR/3)	NOAA
6-channel visible/IR (0.6-12µm) imager, 2000 km swath, 1x1 km resolution. Global imagery of clouds, ocean and land. 35 kg, 622/39.9 kbit/s (high/low rate), 27 W.	
High-resolution Infra-Red Sounder (HIRS/4)	NOAA
20-channel optical/IR filter-wheel radiometer, 2000 km swath, IFOV 17.4 km (nadir). 35 kg, 2.9 kbit/s, 21 W. Not on Metop-3.	
Advanced Microwave Sounding Unit (AMSU-A1/A2)	NOAA
Step-scan 15-channel microwave radiometers for 50 GHz oxygen absorption line, 2000 km swath, IFOV 30 km (nadir). A1/A2: 54/50 kg, 2.1/1.1 kbit/s, 79/37 W.	
Microwave Humidity Sounder (MHS)	Eumetsat
5-channel quasi-optical heterodyne radiometer, 190 GHz (water vapour absorption line), 89 GHz (surface emissivity), 2000 km swath, IFOV 30 km (nadir). 63 kg, 3.9 kbit/s, 95 W.	
Infrared Atmospheric Sounding Interferometer (IASI)	CNES/Eumetsat
Fourier-transform spectrometer, 3.62-15.5 µm in 3 bands. 4 IFOVs of 20 km at nadir in a square 50x50 km, step-scanned across track (30 steps), synchronised with AMSU-A. 2000 km swath. Resolution 0.35 cm ⁻¹ . Radiometric accuracy 0.25-0.58 K. Integrated near-IR imager for cloud discrimination. Water vapour sounding, NO ₂ & CO ₂ , temperature sounding, surface & cloud properties. 251 kg, 1.5 Mbit/s, 240 W.	
Advanced Scatterometer (ASCAT)	ESA
5.255 GHz C-band radar scatterometer with 3 dual-swath (2x500 km width, offset 384 km left/right of groundtrack) antennas (fore/mid/aft) for measurement of radar backscatter at three azimuth angles to provide surface wind vectors of 4-24 m/s with accuracy ±2 m/s & ±20°, spatial resolution 50 km (25 km experimental), 0.57 dB radiometric accuracy. Incidence angle range 25-65°, 10 ms pulses of 120 W peak power. Additional products such as sea-ice cover, snow cover and vegetation density. 263 kg, 60 kbit/s, 251 W.	
Global Ozone Monitoring Experiment (GOME-2)	ESA/Eumetsat
Scanning spectrometer, 250-790 nm, resolution 0.2-0.4 nm, 960 km or 1920 km swath, resolution 80x40 km or 160x40 km. Double monochromator design: first stage of quartz prism with physical separation of 4 channels (240-315, 311-403, 401-600, 590-790 nm); second stage of blazed grating in each channel. Detector: 1024-pixel random-access Si-diode arrays. Ozone total column & profiles in stratosphere & troposphere; NO ₂ BrO OClO ClO. Albedo and aerosol; cloud fraction, cloud-top altitude, cloud phase. 67 kg, 400 kbit/s, 45 W.	
GNSS Receiver for Atmospheric Sounding (GRAS)	ESA/Eumetsat
GPS satellite occultation (up to 500/day) receiver for bending angle measurement better than 1 µrad, fitting data to stratospheric model for temperature profile (vertical sounding of ±1 K with vertical resolution of 150 m in troposphere (5-30 km altitude) and 1.5 km in stratosphere), retrieval of refractive index vs. altitude profile. 27 kg, 60 kbit/s, 42 W.	
Advanced Data Collection System (ADCS)	CNES
Collection of oceanographic, atmospheric and/or meteorological 400 bit/s or 4800 bit/s data on 401.65 MHz from platform transmitters (PTT) on buoys, ships, land sites and balloons worldwide for later relay to ground via X-band and HRPT. Determines PTT location by Doppler. Can transmit to PTTs on 466 MHz at 200 bit/s or 400 bit/s. 22 kg, 7.5 kbit/s, 60 W.	
Space Environment Monitor (SEM-2)	NOAA
Multi-channel charged particle spectrometer as part of NOAA's 'Space Weather' activities. Total energy of electron & proton fluxes 0.05-1 keV and 1-20 keV; directional & omni measurements in 6 bands 30-6900 keV for protons and three bands 30-300 keV for electrons. 16 kg, 166 bit/s, 9 W.	
Search & Rescue (S&R; SARP, SARR)	CNES/NOAA
Relay of distress beacon signals; 121.5/243.0/406.05 MHz uplink from EPIRB (Emergency Position Indicating Rescue Beacon), 1544.5 GHz 2.4 kbit/s downlink. 33 kg, 75 W. Not on Metop-3.	

- Microwave Humidity Sounder (MHS), a new instrument on the last of the NOAA satellites: global sounding, cloud and Earth radiation budget, sea ice;
- Space Environment Monitor (SEM), to measure the charged-particle radiation environment;
- Data Collection System (DCS/Argos), which receives brief telemetry signals from a global network of remote stations. As well as delivering these messages to a central processing site, this new version can also send messages to the terminals;
- Search & Rescue (S&R), for reception and rebroadcast of signals from emergency transmitters typically carried on ships and aircraft. Not on Metop-3.

The new generation of instruments offers improved sensing capabilities:

- Infrared Atmospheric Sounding Interferometer (IASI), an important development providing a significant improvement in determining the vertical temperature and humidity profiles in the atmosphere;
- Advanced Scatterometer (ASCAT), developed within the Metop-1 contract, uses multiple radar beams to measure the small-scale roughness of the ocean surface from three directions, over a wide swath on each side of the satellite, to determine the wind speed and direction;
- Global Ozone Measurement Experiment-2 (GOME-2), an improved successor to GOME-1 of ERS-2, is a high-resolution visible/UV spectrometer for measurements over a wide swath and wide spectral range to determine ozone profiles and total

column amounts of many other trace gases;

- GNSS Receiver for Atmospheric Sounding (GRAS), developed within the Metop-1 contract, is a geodetic-quality GPS receiver equipped with three antennas to measure the signals from GPS satellites in occultation by Earth's atmosphere, revealing temperature and humidity profiles.

Satellite configuration: payload module supported by box-shaped service module derived from Envisat and Spot-5 service modules. Launch configuration 3.4x3.4x16.5 m; in-orbit 5x5.2x17.6 m.

Attitude/orbit control: 3-axis (pointing knowledge 0.07° X /0.11° Y/ 0.15° Z) by 3x0.45 Nm/40 Nms (at max 2400 rpm) reaction wheels; orbit adjust by redundant 8x22.7 N thrusters in blowdown mode (22 bar BOL), max. 316 kg hydrazine in 4 tanks.

Power system: single 8-panel flatpack solar array provides 1835 W orbit average EOL (1398 W for payload). Each panel 1x5 m. Total area 40 m² carrying 32.4x73.7 mm Si BSR cells, supported by five 40 Ah batteries.

Communications: data downlinked at 70 Mbit/s 7750-7900 MHz X-band from 24 Gbit solid-state recorder to 2 ground stations within one orbit of recording. Realtime broadcasting of data for HRPT (3.5 Mbit/s 1701.3 MHz L-band) and LRPT (72 kbit/s 137.1 MHz VHF). Spacecraft controlled by Eumetsat via Kiruna (S) S-band 2053/2230 MHz up/down ground station at 2.0/4.096 kbit/s up/down. Metop autonomy for 36 h without ground contact.

ATV

Planned achievements: ISS resupply/reboost

Launch date: ATV-1 planned for early 2006, ATV-2 July 2007, ATV-3 mid-2009; then annually

Mission end: nominally after 6 months

Launch vehicle/site: Ariane-5ES from ELA-3, Kourou, French Guiana

Launch mass: 20 750 kg (7667 kg payload)

Orbit: as ISS (typically 400 km, 51.6°)

Principal contractors: EADS-Space Transportation (Les Mureaux, F; prime contractor, software), EADS Astrium GmbH (Bremen, D; integration, Propulsion & Reboost Subsystem), Alenia Spazio (Torino, I; Cargo Carrier), EADS Astrium (avionics), Oerlikon Contraves (structure), Alcatel Bell Telephon (EGSE), Dutch Space) solar array)

In combination with the Ariane-5 launcher, the Automated Transfer Vehicle (ATV) will enable Europe to transport supplies to the International Space Station. It will dock with Russia's Zvezda module after a 2-day autonomous flight using its own guidance, propulsion and docking systems. Its 7.4 t payload will include scientific equipment, general supplies, water, oxygen and propellant. Up to 4.6 t can be propellant for ATV's own engines to provide propulsive support including reboost of the Station at regular intervals to combat atmospheric drag. Up to 860 kg of refuelling propellant can be transferred via Zvezda to Zarya for Station attitude and orbit control. Up to 5.5 t of dry cargo can be carried in the pressurised compartment.

ATV offers about four times the payload capability of Russia's Progress ferry. Without ATV, only Progress could reboost the Station. Both technically and politically, it is essential that the Station can call on at least two independent systems.

An ATV will be launched on average every 15 months, paying Europe's 8.3% contribution in kind to the Station's common operating costs. It can remain docked for up to 6 months, during which time it will be loaded with Station waste before

undocking and flying into Earth's atmosphere to burn up.

Following launch from the Ariane-5 complex, the mission will be controlled from the ATV Control Centre in Toulouse (F). Docking manoeuvres will be coordinated with NASA's Space Station Control Center



in Houston and with Russia's control centre near Moscow, which oversees all the Station's Russian modules.

ATV's docking mechanism is being provided by Russia in exchange for ESA's Data Management System (DMS-R) for Zvezda (ESA will buy them after the first two). A similar DMS is being used in ATV. The docking system has long been used on Russia's stations and Soyuz and Progress craft. A probe engages the receptacle on Zvezda and is slowly retracted until the 1.3 m-dia faces and their electrical and hydraulic connectors mate. Eight hooks on each face are closed to complete hard docking. Zvezda's 80 cm-dia hatch is opened by the crew and a long tool is used to unlock ATV's hatch. Finally, 16 clamps are installed for rigidity across the docking collars.

ATV development was confirmed at the October 1995 ESA Ministerial Council meeting in Toulouse. Phase-B2 began in July 1996. The €408.3 million (1997 conditions) Phase-C/D fixed-price contract was signed with EADS Launch Vehicles (now EADS Space Transportation) on 25 November 1998. PDR was completed in December 2000 and CDR in June 2003. The System Qualification Review starting in May 2005 is the final hurdle before flight. ESA and Arianespace in June 2000 signed a €1 billion contract to launch nine ATVs over a period of 10 years. With design changes and cost increases, revised contracts were signed in 2004: €925 million on 12 May for the Phase-C/D and delivery of ATV-1, and a stepped €835 million contract on 13 July to build ATV-2 to -7.

Ariane-5 injects ATV into a 260x260 km, 51.6° circular orbit.

ATV's four 490 N main engines fire to boost the Station's altitude. (ESA/D. Ducros)



To ensure proper capture and acceptable docking loads, ATV's docking probe has to meet Zvezda's docking cone within 10 cm and a lateral velocity of less than 2 cm/s. To meet these conditions, the relative navigation during final approach from 3.5 km is based on ATV's optical sensors, with corresponding passive target patterns close to Zvezda's port. While measurements from the Videometer primary sensor are used in the active GNC loops to control ATV's motion, the information provided by the Telegoniometer secondary sensor is provided to the Flight Control Monitoring (FCM) system that supervises the performance of the active loop.

The Videometer delivers range and line-of-sight angles to the GNC system, and, from within 30 m, relative attitude angles, based on triangulation. A diverging laser beam emitted by diodes on the ATV front cone towards Zvezda is returned by a pattern of reflectors, imaged by a CCD. The pattern size provides the range, its position on the CCD yields the line-of-sight angles, and its apparent shape gives information about the relative attitude angles.

The Telegoniometer delivers range and line-of-sight angles to the FCM. Collimated laser pulses from a diode scan the ISS vicinity and are returned by three reflectors on Zvezda. The light-pulse travel time provides the distance, and the positions of two beam steering mirrors give the two line-of-sight angles.

The crew closely monitors this last part of the approach using information independent of ATV's onboard systems: Zvezda video camera visual image, and range and range-rate readings from the Russian Kurs rendezvous system on Zvezda.



The Station crew will closely monitor the ATV approach and can abort it at any time. Inset above: the laser reflectors installed on Zvezda.

Right/top: the Integrated Cargo Carrier of ATV-1 'Jules Verne' in the ESTEC Test Centre, September 2004. The red covers protect the Russian docking system. The Videometers can be seen in the 8 & 10 o'clock positions. Right/bottom: the spacecraft section ready for mating with the cargo carrier. Below: the ATV Structural & Thermal Model in ESTEC's acoustic test chamber.



A series of reconfiguration and check-out operations is then performed, notably deployment of the solar array. Altitude raising and phasing with the Station then take about 50 h. All ATV operations are monitored from Toulouse via NASA's Tracking & Data Relay Satellite (TDRS) system and Europe's own Artemis satellite.

About 90 min before it enters the approach ellipsoid, integrated operations begin and mission authority is transferred to the Mission Control Center in Moscow. Beginning at about 30 km, ATV performs final approach and docking manoeuvres automatically over a period of 5 h, with either automatic or manual capability

from the Station crew to trigger a collision avoidance manoeuvre. On first contact, ATV thrusts to ensure capture and to trigger the automatic docking sequence.

After docking, the hatch remains open unless it is closed to minimise the power required from the Station. The crew manually unloads cargo from the pressurised compartment while ATV is dormant. Dry cargo is carried in a shirtsleeve environment.

Station refuelling is powered and controlled (integrity checks, line venting, fluid transfer and line purging) by the Station through connectors in the docking face. ATV is reactivated during the attitude control and reboost.

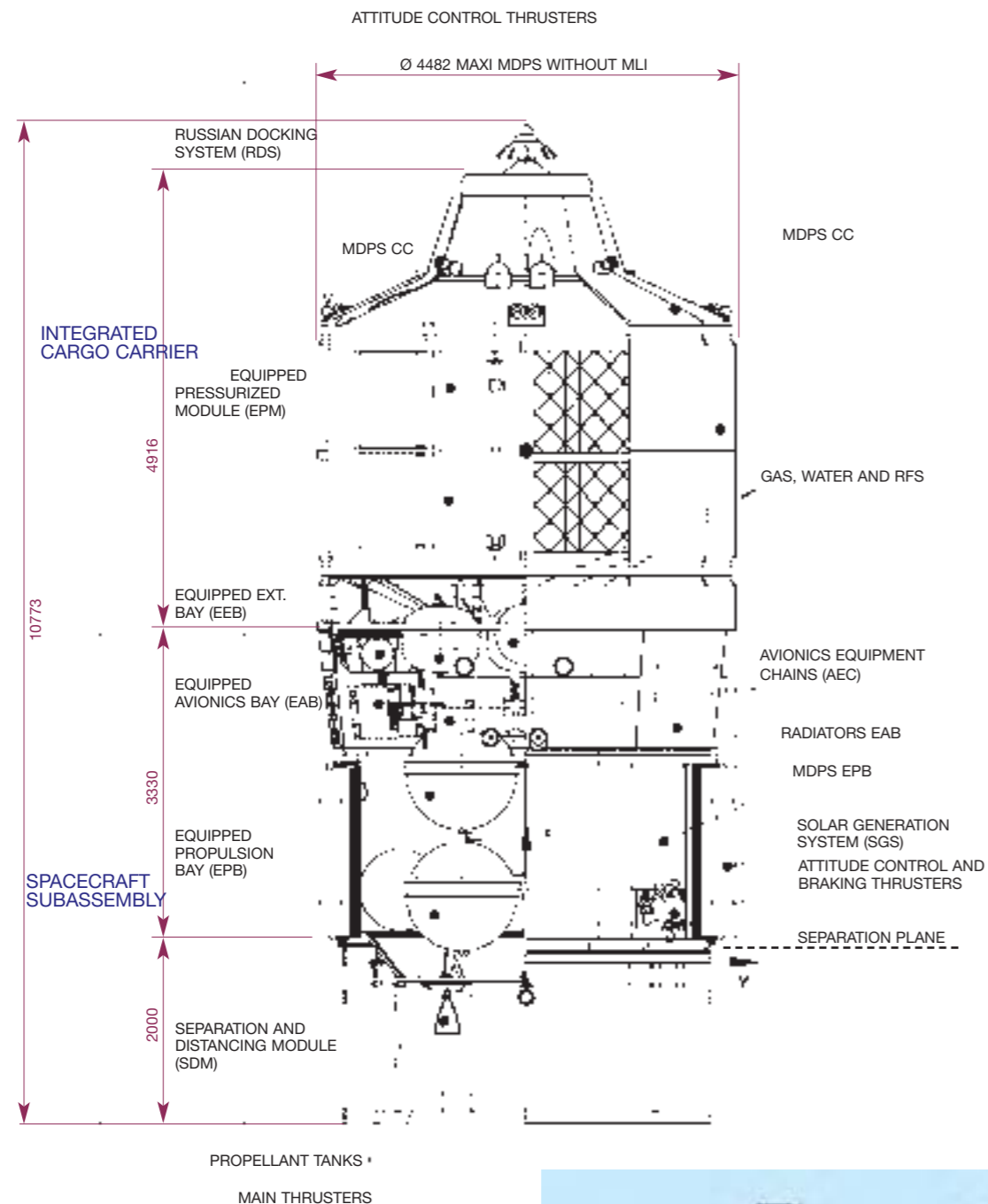

After undocking, ATV automatically manoeuvres for deorbiting and controlled reentry in the Earth's atmosphere. Carrying up to 5.5 t of dry waste (plus 840 kg wet) from the Station, ATV will be safely consumed during reentry.

high-pressure tanks regulated to 20 bar. Tanks can hold up to 6760 kg of propellant for main navigation and ISS propulsive support. GNC calculations are based on two GPS receivers for position, four gyros and two Earth sensors for attitude, and two rendezvous sensors for final approach and docking.

Configuration: flared cylinder, 10.27 m long, max 4.48 m dia, 22.281 m across solar wings. Propulsion Module, Avionics Module and Separation and Distancing Module, all of Al-2219 aluminium alloy, with a Meteoroid and Debris Protection System (Al-6061-T6 covered by Nextel/Kevlar blankets) mounted on the primary structure.

Power system: four wings (each of four 1.158x1.820 m panels) in X-configuration, using mix of GaAs and high-efficiency Si cells. 3860 W BOL in Sun-pointing mode; 3800 W EOL (6 months). Supported by 40 Ah NiCd batteries during eclipse periods; non-rechargeable batteries are used during some flight phases. Attached to ISS, ATV in dormant mode requires up to 400 W (900 W active) from the Station.

Attitude/orbit control: Propulsion & Reboost Subsystem uses four 490 N main engines (SI >310 s) and 28 220 N attitude thrusters (minimum impulse bit < 5 Ns). Mixed oxides of nitrogen (MON, oxidiser) and monomethyl hydrazine (MMH, fuel) stored in eight identical 1 m-dia titanium tanks, pressurised with helium stored in two

Communications: via two redundant S-band systems – a TDRS link to ground control and a proximity link to the Station.

ATV Capacities

Launch mass: 20750 kg (ATV-1: 19670 kg)
 Cargo: 7667 kg
 dry cargo: 1500-5500 kg
 water: 0-840 kg
 gas (O₂, N₂, air): 0-100 kg
 Refuelling propellant: 0-860 kg
 (306/554 kg MMH/MON)
 Reboost propellant: 0-4600 kg
 Dry mass: 10470 kg
 Spacecraft dry: 5320 kg
 Cargo Carrier dry: 5150 kg (cargo hardware 1437 kg)
 Consumables (propellant/He): 2613 kg
 Download: 6340 kg (5500 dry + 840 wet)

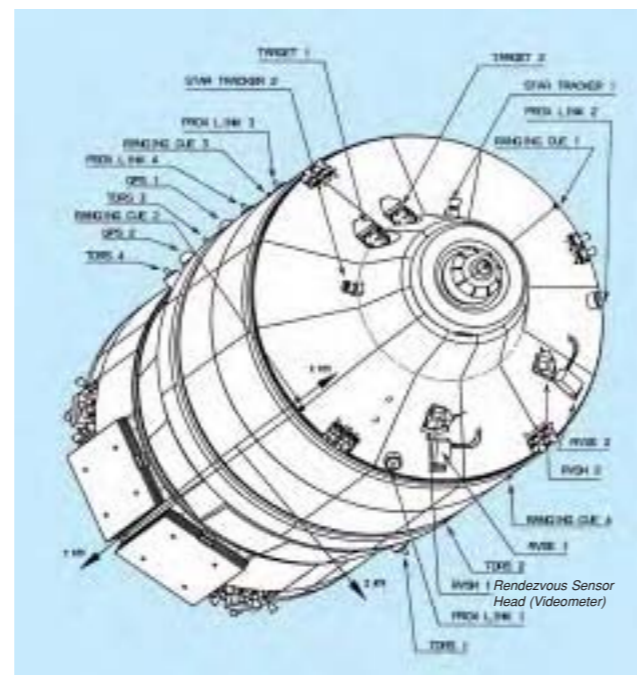

GOCE

Planned achievements: major improvement in measurement of Earth's gravity field and geoid; first use of gradiometry in space

Launch date: planned for 31 August 2006

Mission end: nominal 20 months, extended 30 months

Launch vehicle/site: Rockot from Plesetsk, Russia

Launch mass: 1100 kg (200 kg payload)

Orbit: planned operational 250 km circular, 96.5° Sun-synchronous; initial 285 km for 1.5 month commissioning, then 250 km for 1.5 month payload commissioning, 6 months measurements; 240 km 6 months measurements

Principal contractors: Alenia Spazio (prime), EADS Astrium (platform), EADS Casa (structure), Alcatel Space Industries (gradiometer), ONERA (gradiometer accelerometers); Phase-A June 1998 - June 1999; Phase-B December 2000 - 9 April 2002; Phase-C/D April 2003 - June 2006

The Gravity Field and Steady-State Ocean Circulation Mission (GOCE) will measure the Earth's gravity field and geoid with unprecedented accuracy and resolution using a 3-axis gradiometer. This will improve our understanding of the Earth's internal structure and provide a much better reference for ocean and climate studies, including sea-level changes and ice-sheet dynamics.

GOCE was selected in 1999 as the first Earth Explorer Core mission in the Living Planet programme. Four candidate Core missions were selected in November 1996 for 12-month Phase-A studies, completed in June 1999. GOCE and ADM were selected in November 1999 in order of priority. Alenia Spazio was selected as GOCE prime contractor in January 2001; the €149 million Ph-B/C/D/E1 contract was signed 23 November 2001. The launch contract was awarded in December 2003 to Eurockot. The GOCE cost-at-completion to ESA is €289 million (2004 conditions).

The Earth's gravity field is the fundamental physical force for every dynamic process on the surface and below. Since the beginning of the space age, mapping the global gravity field has been a high-priority task. The first era lasted for about 40

Why Measure the Gravity Field?

The gravity field plays a dual role in Earth sciences. Gravity anomalies reflect mass variations inside the Earth, offering a rare window on the interior. The geoid is the shape of an ideal global ocean at rest, and it is used as the reference surface for mapping all topographic features, whether they are on land, ice or ocean. The geoid's shape depends solely on Earth's gravity field, so its accuracy benefits from improved gravity mapping. Measuring sea-level changes, ocean circulation and ice movements, for example, need an accurate geoid as a starting point. Heat and mass transport by oceans are important elements of climate change, but they are still poorly known and await measurement of ocean surface circulation.

years, with Europe playing a leading role. The research was characterised by a combination of satellite geodetic (optical, laser, Doppler) and terrestrial gravity methods. It produced significantly improved measurements at the scale of several thousand km. The new era is using dedicated satellite missions to determine the global gravity field with consistent accuracy and higher resolution. GOCE puts European science and technology in a leading position. The GOCE-derived gravity field and

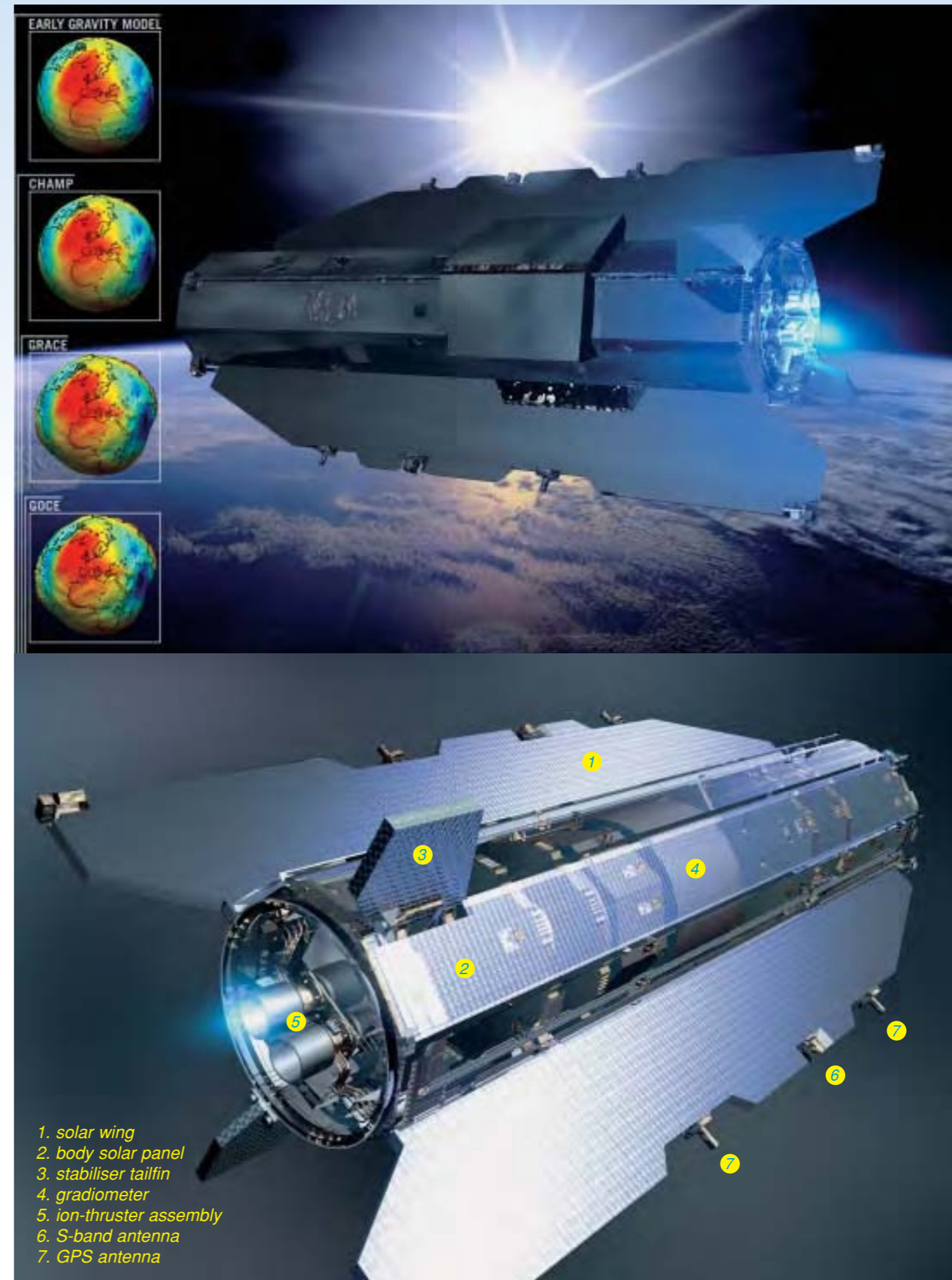

The Benefits from GOCE

Geodesy

Geodesy is concerned with mapping the Earth's shape, to the benefit of all branches of the Earth sciences. Whereas positions on the Earth's surface can be measured purely geometrically, height determination requires knowledge of the gravity field. Geodetic levelling provides mm-precision over short distances, but has systematic distortions on a continental scale that severely limit the comparison and linking of height systems used in neighbouring countries or, for example, of tide gauges on distant coasts. Separation of land areas by sea inevitably leads to large discontinuities between height systems. GOCE data will serve to control or even replace traditional levelling methods, making feasible levelling with a global spaceborne reference system such as GPS and Galileo. This will help towards worldwide unification of height systems, allowing, for example, comparison of the sea-level and its changes in the North Sea with those in the Mediterranean.

Absolute Ocean Circulation

With ocean topography measured by altimeter satellites using GOCE's geoid as the reference surface, almost all ocean current systems from the strongest (Gulf Stream, Kuroshio, Antarctic Circumpolar Current) through to weaker deep-ocean and coastal current systems will be determined in terms of location and amplitude. Uncertainties in mass and heat transport will be halved in the upper layers, with significant reductions throughout the ocean depths. Clear benefits are expected in high-resolution ocean forecasting.

Solid Earth

Detailed 3-D mapping of density variations in the lithosphere and upper mantle, derived from a combination of gravity, seismic tomography, lithospheric magnetic-anomaly information and topographic models, will allow accurate modelling of sedimentary basins, rifts, tectonic movement and sea/land vertical changes. It will contribute significantly to understanding sub-crustal earthquakes – a long-standing objective.

Ice Sheets

GOCE will improve our knowledge of the bedrock landscape under the Greenland and Antarctic ice sheets, especially undulations at scales of 50-100 km. A precise geoid will be a major benefit to modern geodetic surveys of the ice sheets, while improved gravity maps in polar regions will help satellites to measure their orbits using altimeters.

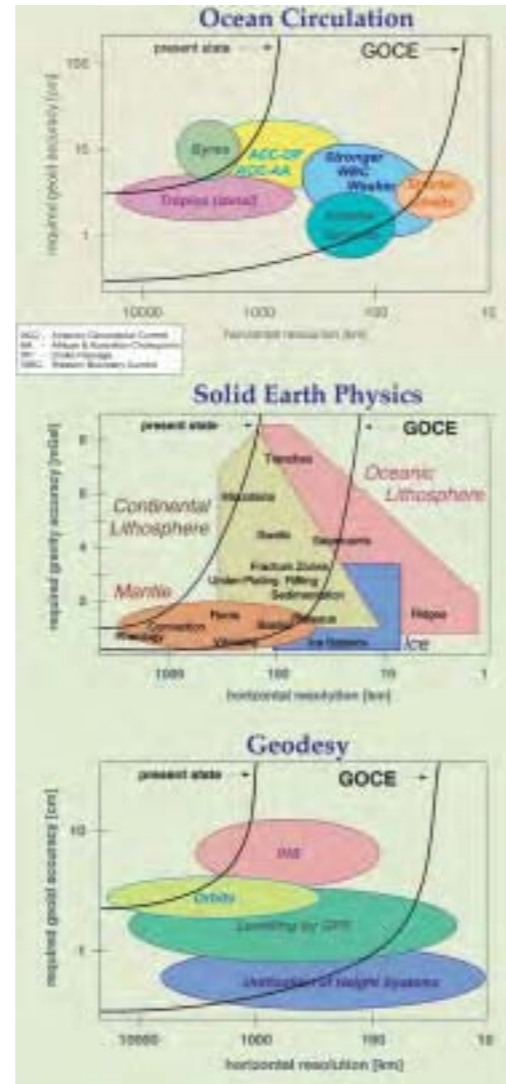

The accuracies necessary to resolve the noted phenomena and processes. The curves show current accuracies and what can be expected from GOCE. (INS: Inertial Navigation System, uncertainties in the geoid introduce errors in inertial navigation.)



The 3 axes of the GOCE gradiometer simultaneously measure six independent but complementary components of the gravity field. Shown here are global maps of residual gradients referring to an ellipsoidal model. $1 \text{ E (Eötvös)} = 10^{-9} \text{ s}^{-2}$

ESA's Quiet Mission

GOCE's goal is to map Earth's gravity field with unprecedented precision, so it is crucial that the measurements are of true gravity and not influenced by movements of the satellite itself. There are strict requirements on the structure's dimensional stability and any micro disturbances caused by moving parts, sudden stress releases from differential thermal expansions, inductive electromagnetic forces, gas and liquid flows, etc. are eliminated or minimised. A comprehensive test programme covering structural items, electronic units and the multi-layer insulation blankets will verify potential noise sources that could affect the gradiometric measurements.





associated geoid will be the dominant reference for the following decades of geophysical research.

GOCE's gradiometer will for the first time measure gravity gradients in all directions. It is specifically designed for the stationary gravity field – measuring the geoid and gravity anomalies with high accuracy (1-2 cm and 1 mgal, respectively) and high spatial resolution (100 km). In particular, it will provide:

- new understanding of the physics of the Earth's interior such as geodynamics associated with the lithosphere, mantle composition and flow, uplifting and subduction processes,
- a precise estimate of the marine geoid for the first time, which is needed in combination with satellite altimetry for measuring ocean circulation and transport of mass,
- estimates of the thickness of the polar ice sheets through the combination of bedrock topography derived from space gravity and ice surface height measured by altimeter satellites.
- a high-accuracy global height reference system for datum point linking, which can serve as a reference surface for studying topographic processes, including the evolution of ice sheets and land topography.

Space gradiometry is the measurement of acceleration differences, ideally in all three

GOCE Payload
Gradiometer
The Electrostatic Gravity Gradiometer (EGG) is a set of six 3-axis capacitive accelerometers mounted in a diamond configuration in an ultra-stable carbon/carbon structure. Each accelerometer pair forms a 'gradiometer arm' 50 cm long, with the difference in gravitational pull measured between the two ends. Each accelerometer measures the voltage needed to hold the proof mass (4x4x1 cm, 320 g platinum-rhodium) centred between electrodes, controlled by monitoring the capacitance between the mass and the cage. Three arms are mounted orthogonally: along-track, cross-track and vertically.
Laser Retroreflector (LRR)
As used on ERS and Envisat: 9 corner cubes in hemispherical configuration, Earth-facing for orbit determination by laser ranging.
Satellite-to-Satellite Tracking (SST)
Real-time position (100 m), speed (30 cm/s) and time data using GPS C/A signal. 1-2 cm each axis post-processing position accuracy.

dimensions, between separated proof masses inside a satellite. The differences reflect the various attracting masses of the Earth, ranging from mountains and valleys, via ocean ridges, subduction zones and mantle inhomogeneities down to the topography of the core-mantle-boundary. The technique can resolve all these features imprinted in the gravity field. Non-gravitational forces on the satellite, such as air drag, affect all the accelerometers in the same manner and so are cancelled out by looking at the *differences* in accelerations. The satellite's rotation does affect the measured differences, but can be separated from the gravitational signal in the analysis. The gravitational signal is stronger closer to Earth, so an orbit as low as possible is chosen, although that then requires thrusters to combat the air drag. GOCE's cross-section is as small as possible in order to minimise that drag.

The gradiometer measurements are supplemented by a GPS receiver that can 'see' up to 12 satellites simultaneously. The gravity field's long-wavelength effects on the orbit

GOCE's gradiometer uses six paired proof masses to measure variations in the gravitational field to within 10^{-13} g. The accelerometers are 100 times more sensitive than any previously flown.

will be detected by this technique. Laser-ranging will independently monitor GOCE's orbit to cm-precision to validate the GPS-based orbit.

Satellite configuration: CFRP bus is an octagonal prism of 5.02 m total length, 90 cm dia, of sandwich side panels connected by longerons. Span 2.20 m across fixed solar wings. Small cross-section of 0.8 m² and symmetry minimises atmospheric perturbations. Seven transverse platforms (two for gradiometer).

Attitude/orbit control: paired Xe ion thrusters operate continuously along the main axis to counteract atmospheric drag. Thrust controllable 1-20 mN; 40 kg Xe. Magnetorquers for attitude control. GPS receiver, gradiometer and star trackers provide attitude/orbit data. Nitrogen cold-gas thrusters selectable 0-1 mN for gradiometer calibration.

Thermal: MLI, paint pattern, OSRs, heaters, thermistors. GOCE flies in Sun-synchronous orbit with one side always facing the Sun. High-dissipation units such as the battery and transponders are mounted on the 'cold' side.

Power system: >1.3 kW EOL (950 W required) from two fixed wings + four body panels of GaAs cells, supported by 78 Ah Li-ion battery.

Communications: controlled from ESOC via Kiruna 4 kbit/s uplink. 14 kbit/s data stored on 4 Gbit SSR for S-band downlinking to Kiruna or Svalbard at maximum 1 Mbit/s.

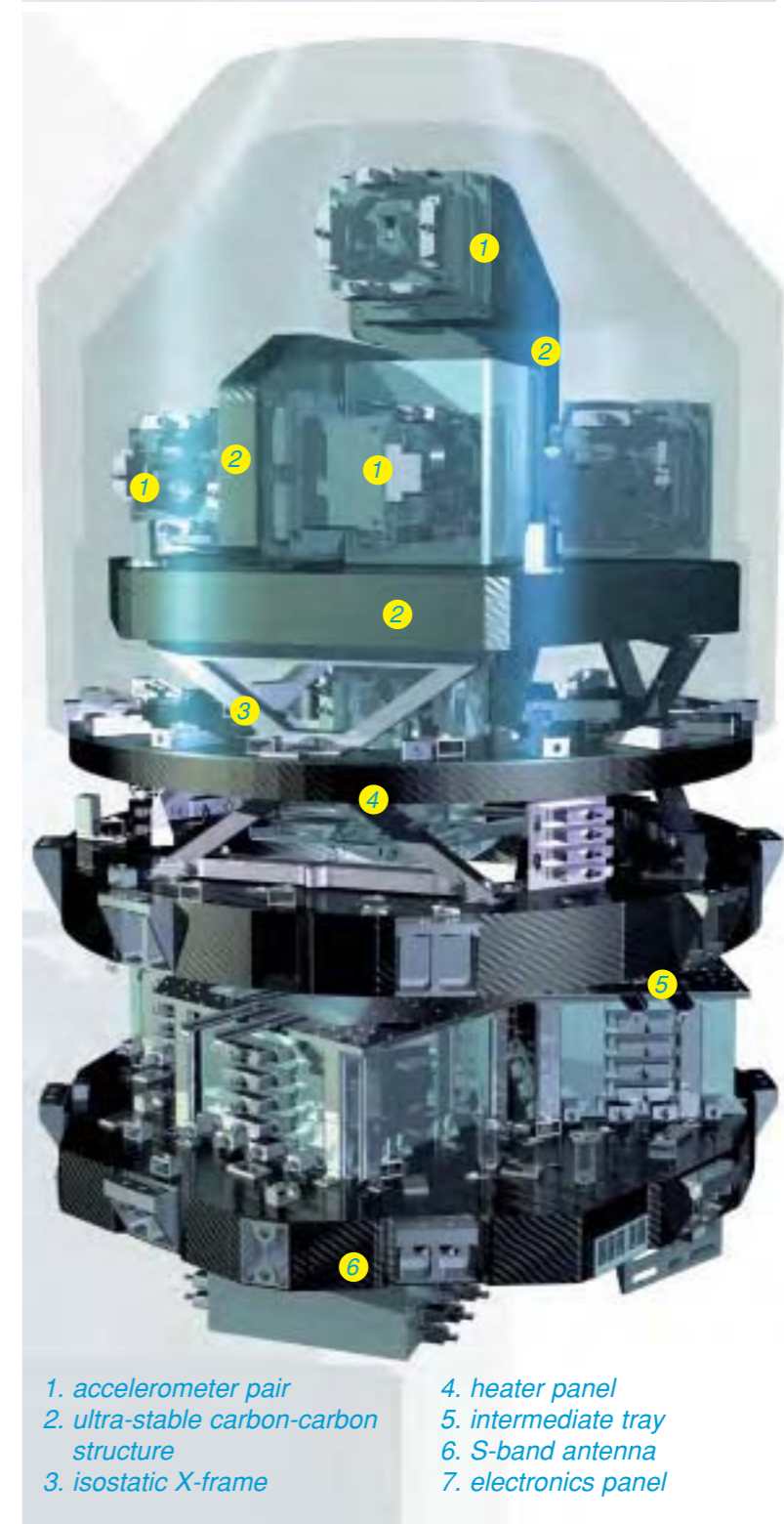
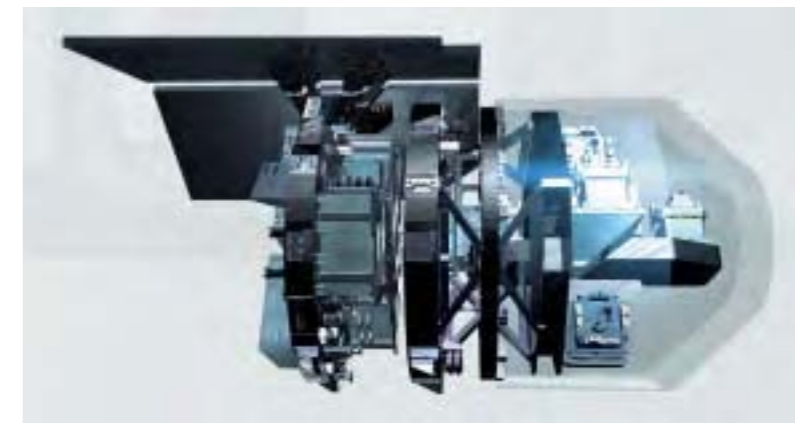

1. accelerometer pair
2. ultra-stable carbon-carbon structure
3. isostatic X-frame
4. heater panel
5. intermediate tray
6. S-band antenna
7. electronics panel

Columbus

Planned achievements: key Space Station laboratory

Launch date: planned for late 2006

Mission end: nominally after 10 years

Launch vehicle/site: NASA Space Shuttle from Kennedy Space Center, Florida

Launch mass: 12 800 kg (including 2500 kg payload)

Orbit: as ISS (about 400 km, 51.6°)

Principal contractors: EADS Space Transportation (Bremen, D; prime; ECLS, MDPS), Alenia Spazio (Torino, I; structure, ECLS, thermal control, pre-integration), EADS Astrium SAS (Toulouse, F; DMS). Phase-C/D began January 1996; PDR December 1997; CDR October-December 2000

The Columbus laboratory is the cornerstone of Europe's participation in the International Space Station (ISS). Columbus will provide Europe with experience of continuous exploitation of an orbital facility, operated from its own ground control facility in Oberpfaffenhofen (D). In this pressurised laboratory, European astronauts and their international counterparts will work in a comfortable shirtsleeve environment. This state-of-the-art workplace will support the most sophisticated research in weightlessness for 10 years or more. Columbus is a general-purpose laboratory, accommodating astronauts and experiments studying life sciences, materials processes, technology development, fluid sciences, fundamental physics and other disciplines.

In October 1995, the ESA Ministerial Council meeting in Toulouse approved the programme 'European Participation in the International Space Station Alpha' - 10 years after the authorisation of studies and Phase-B work by the Ministerial Council in Rome in 1985. During that period, a variety of space elements was studied in parallel with the Ariane-5 launcher and Hermes shuttle programmes, which all led to integrated European scenarios that were clearly unaffordable. In late 1994, a series of dramatic cutbacks

When the programme was approved in 1994, the launch target for Columbus was 2002. Before the loss of Shuttle *Columbia* in February 2003, the goal was October 2004. Columbus development formally ended on 4 November 2004 with Qualification Review-2; it then remained in hibernation at prime contractor EADS Space Transportation in Bremen (D). The final integration will begin 13 months before launch, followed 6 months later by shipping to the Kennedy Space Center ready for launch.

ESA is entitled to an astronaut on the Columbus launch and then a member of the resident crew for 3 months every 8 months.

began, which underwent frequent iterations with ESA Member States and the ISS Partners. The process culminated in a package worth some €2.6 billion being approved in Toulouse, including what was then called the Columbus Orbital Facility.

Soon after that Toulouse conference, a contract was signed with prime contractor Daimler Benz Aerospace (which then became DaimlerChrysler Aerospace or DASA, then Astrium GmbH), in March 1996, at a fixed price of €658 million, the largest single contract ever awarded by the Agency at the time. The cost of module development has not increased since then.

ESA's ISS Exploitation Programme for 2000-2013 was presented at the Ministerial Council in Brussels in



May 1999, where the overall programme approach and the initial phase of activities were approved. The programme is being carried out in 5-year phases, each with a 3-year firm commitment and a 2-year provisional commitment. The programme covers the System Operations costs in Europe, the ESA share (8.3%) of the overall Station Common Operations costs and the European Utilisation-related costs. The average yearly cost over the whole period will be about €300 million (2004 rates).

Under an agreement with the Italian Space Agency (ASI), ESA provided the Columbus-derived ECLS for ASI's three Multi-Purpose Logistics Modules (MPLMs, first flown March 2001) in exchange for the Columbus primary structure, derived from that of MPLM. The estimated saving to each partner was €25 million.

Although it is the Station's smallest laboratory module, Columbus offers the same payload volume, power,

data retrieval etc. as the others. This is achieved by careful use of the available volume and sometimes by compromising crew access and maintainability in favour of payload accommodation. A significant benefit of this cost-saving design is that Columbus can be launched already outfitted with 2500 kg of payload racks, together with two external payloads. Once Columbus is operational, an ESA astronaut will work on average aboard the Station for 3 months every 8 months.

Columbus will be delivered to the ISS by the Space Shuttle Orbiter, carried in the spaceplane's cargo bay via its trunnions and keel fitting. A Station-common grapple fixture will allow the Space Station Remote Manipulator System (SSRMS) to lift it out of the Orbiter and transport it to its final destination on Node-2.

In exchange for NASA launching Columbus aboard the Space Shuttle, ESA is providing two of the Station's three Nodes, the Cryosystem freezer

Columbus will be attached to Node-2 on the Station's starboard forward position. (ESA/D. Ducros)

The Columbus assembly arrives in Bremen, September 2001.



and other miscellaneous elements (the Crew Refrigerator/Freezer was cancelled by NASA). ESA entrusted responsibility for developing Nodes-2 and -3, which use the same structural concept as Columbus, to ASI, but then assumed control of the Nodes programme in 2004.

Inside Columbus, the International Standard Payload Racks (ISPRs) are arranged around the circumference of the cylindrical section, in a 1 g configuration, to provide a working environment for up to three astronauts. A total of 16 racks can be carried in four segments of four racks each. Three in the floor contain systems; D1 contains environmental equipment (water pumps, condensing heat exchanger, water separator, sensors); D2/D3 are devoted to avionics. Ten racks are fully outfitted with resources for payloads and three are for stowage. NASA has the rights to five of the payload racks. ISPRs have standardised interfaces that allow operation in any non-Russian ISS module.

The External Payload Facility is installed on Columbus. Note the bolted cover over the module opening used during assembly.



Columbus will be launched with an internal payload of up to 2500 kg in five racks: ESA's Biolab, Fluid Science Lab (FSL), European Physiology Modules (EPM), European Drawer Rack (EDR) and the European Transport Container (ETC) stowage rack. The other five are being delivered by MPLM, the only carrier that can deliver and return whole racks.

European rack payloads are connected to dedicated busses for data to be routed, via the ISS data transfer system, directly to the Columbus Control Centre in Oberpfaffenhofen (D) and thence to the individual users. For NASA rack payloads, interfaces to the NASA Data Management System are provided.

Columbus also offers an External Payload Facility (EPF), added in 1997 when it became clear that leasing US locations would be too expensive and that Japan's sites were full. External payloads will be installed on the four positions on-orbit by EVA (the first two during the 1E mission). EPF

The layers of Columbus. From top: complete with Meteoroid & Debris Protection System; the primary pressure vessel; the secondary structure; the payload racks. (ESA/D. Ducros)



The External Payload Facility, featuring (from bottom) ACES, Export, EuTEF and Solar. (ESA/D. Ducros)
Bottom image: the Columbus interior after delivery from Alenia Spazio, before outfitting.

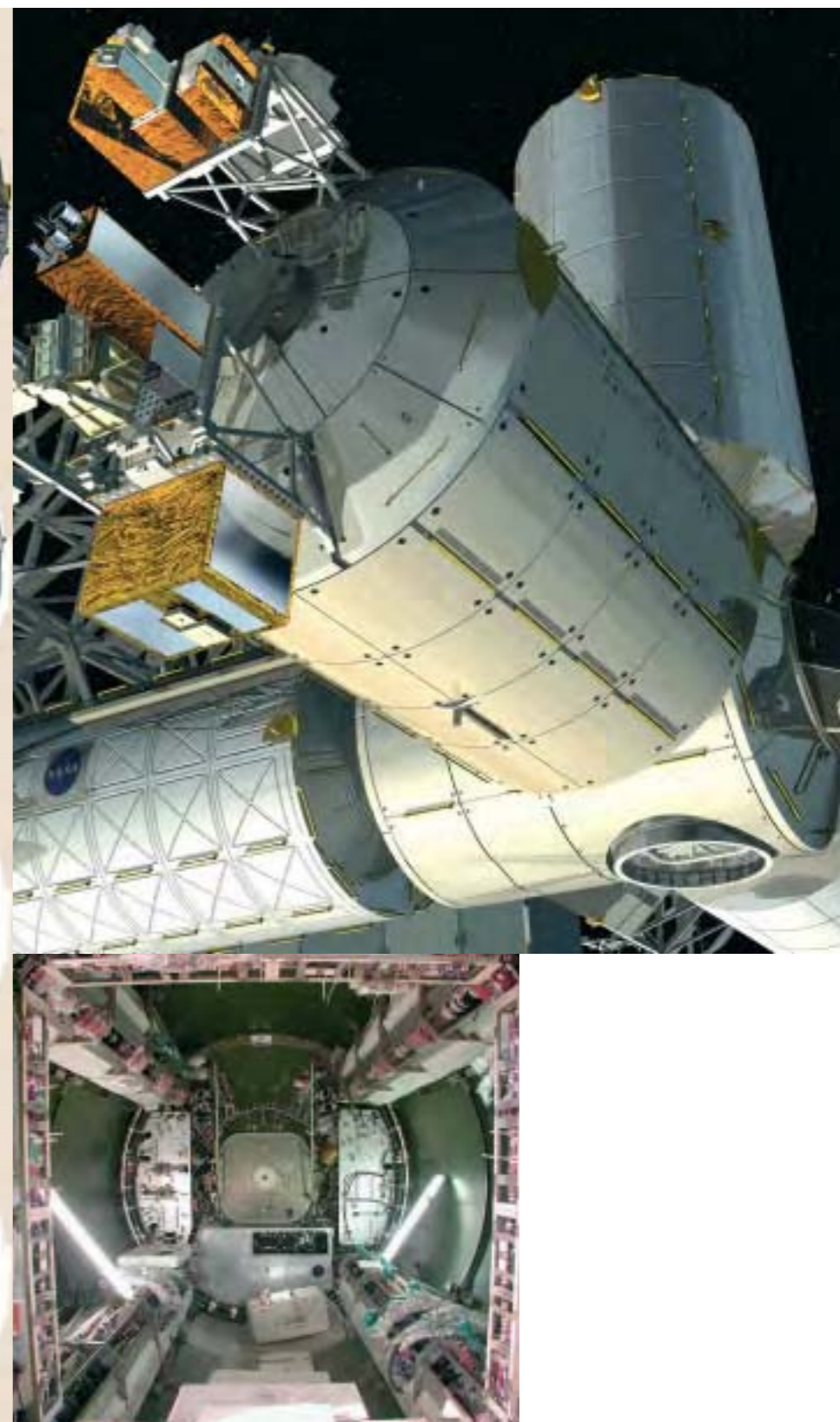

The layout of Columbus racks at launch (left) and fully outfitted in orbit (right).

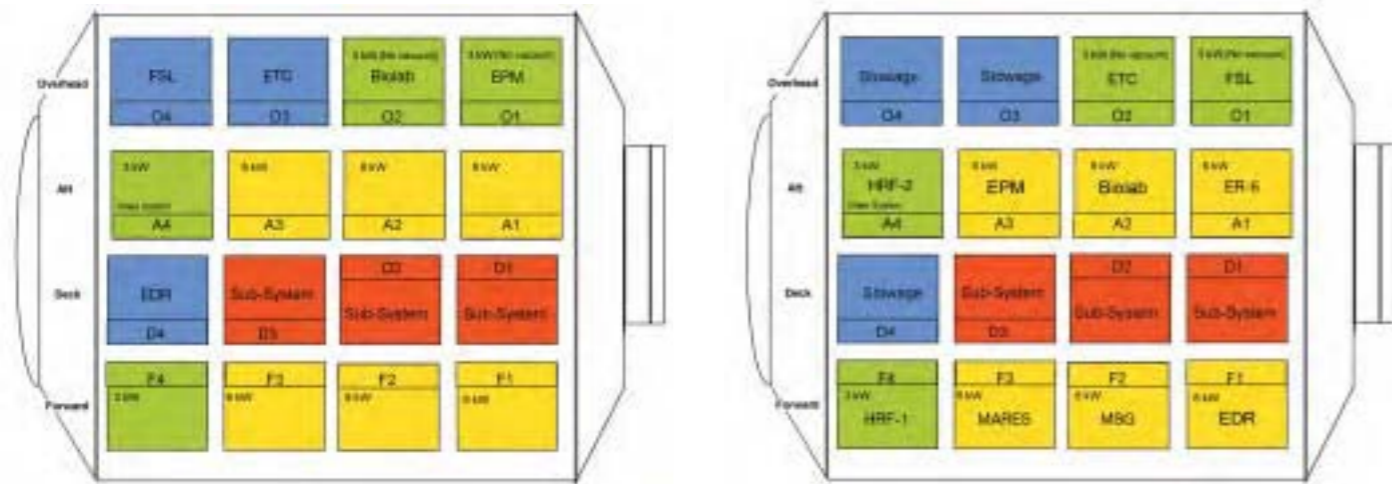

provides the same mechanical interfaces as NASA's standard Express Pallets for external payloads on the ISS Truss.

The central area of the starboard cone carries system equipment that requires direct crew viewing and handling access, such as video monitors and cameras, switching panels, audio terminals and fire extinguishers.

Although Columbus is not autonomous – it has no power generation or attitude control, for example – it is a manned laboratory and as such carries its own Environmental Control and Life Support Subsystem (ECLSS), largely in system rack D1.

Configuration: 10.3 t without research equipment, 12.8 t at launch, 20.1 t fully outfitted. 4.2 m-dia cylinder closed with welded endcones. 3004 kg primary structure is 2219-aluminium alloy, 3.8 mm thick, increasing to 7 mm for the endcones. Length 6.2 m. Total volume 75 m³, reducing to 50 m³ with full rack load. Passive

NASA-designed Common Berthing Mechanism (CBM) attaches it to active CBM of Node-2. Other endcone has 2.5 m-dia opening used on ground to install large items such as system racks. On completion, the hole was permanently closed off by a bolted plate.

Power: Columbus is sized to receive 20 kW total (13.5 kW for payloads). The Station's 120 Vdc system goes through the Columbus Power Distribution Unit and then, as 120 Vdc, to all payload racks, EPF locations, centre aisle standard utility panels and subsystems.

Thermal control: 22 kW-capacity active control via a water loop serving all payload rack locations. Connected to the ISS centralised heat rejection system via interloop heat exchangers. In addition, there is an air/water heat exchanger to remove condensation from cabin air. The module is wrapped in goldised Kapton Multi Layer Insulation to minimise overall heat leaks. A system of electrical heaters combats the extreme cold possible at some Station attitudes. These heaters

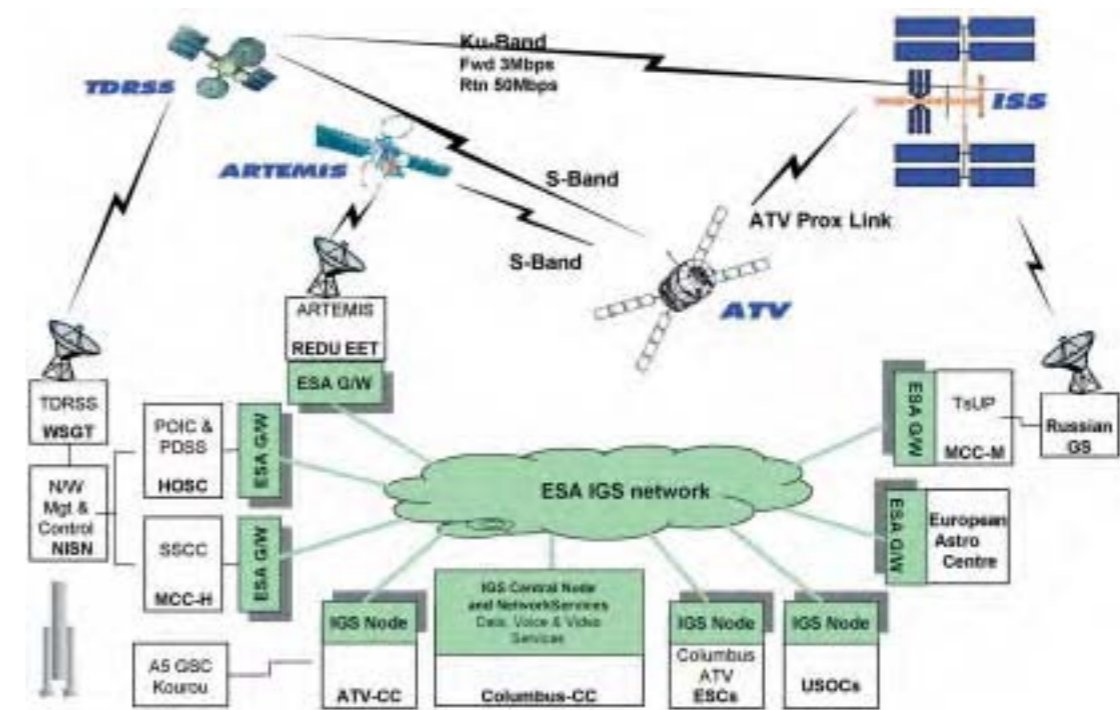

The communications infrastructure for Columbus and ATV. ATV-CC: Automated Transfer Vehicle Control Centre (Toulouse, F), EAC: European Astronaut Centre (ESA), EET: ESA Earth Terminal, ESC: Engineering Support Centre, FRC: Facility-Responsible Centre, GS: ground station, GSC: Guiana Space Centre, G/W: ground network, IGS: Interconnected Ground Subnet, JSC: Johnson Space Center (NASA), MCC-H: Mission Control Center-Houston, MSFC: Marshall Space Flight Center (NASA), NISN: NASA Integrated Services Network, N/W: network, PDSS: Payload Data Service System, POIC: Payload Operations Integration Center (NASA), SSCC: Space Station Control Center, TsUP: Russian Flight Control Centre, USOC: User Support Operations Centre, WSGT: White Sands Ground Terminal.

will be activated shortly after reaching orbit, and during the transfer from the Shuttle bay, drawing on the SSRMS power supply.

Atmosphere: the cabin is ventilated by a continuous airflow entering via adjustable air diffusers on the upper stand-offs, sucked in from Node-2 by a fan centred below the hatch in the port cone. The air returns to the Node for refreshing and carbon dioxide removal. The crew can control temperature (16-30°C) and humidity, and air content is monitored for contamination.

Communications: data rate up to 43 Mbit/s available (ESA has access right of 8.3%) through NASA Ku-band TDRS/White Sands system; also possible via Japan's JEM to Artemis

to Redu ground station. System/payload control by Data Management System (DMS) using MIL-STD-1553 bus and Ethernet LAN; crew access via laptops. Columbus Control Centre is at DLR Oberpfaffenhofen (D; inaugurated 19 October 2004).

MDPS: Columbus is protected by the 2 t Meteoroid and Debris Protection System of bumper panels. There are two general panel types: single (1.6 mm-thick Al 6061-T6), double (2.5 mm-thick Al 6061-T6 with a separate internal bumper of Nextel & Kevlar). The cylinder carries 48 panels: double on the side along the velocity vector (+Y), and single on the anti-velocity face (-Y). The port cone has 16 singles; the starboard cone has 16 doubles plus a single on the central disc.



Inset: NASA astronaut Peggy Whitson working with the Microgravity Science Glovebox.

Columbus will be launched with four ESA research facilities, and a fifth (MSL-EML) will be added later.

Biolab: biological experiments on micro-organisms, animal cells, tissue cultures, small plants and small invertebrates in zero gravity. This is an extension – as for so many other payloads – of pioneering work conducted on the Spacelab missions.

European Physiology Modules (EPM): body functions such as bone loss, circulation, respiration, organ and immune system behaviour, and their comparison with 1 g performance to determine how the results can be applied to Earth-bound atrophy and age-related problems.

Fluid Science Laboratory (FSL): the complex behaviour of

fluids, the coupling between heat and mass transfer in fluids, along with research into combustion phenomena that should lead to improvements in energy production, propulsion efficiency and environmental issues.

Material Science Laboratory-Electromagnetic Levitator (MSL-EML): solidification physics, crystal growth with semiconductors, measurement of thermophysical properties and the physics of liquid states. For example, crystal growth processes aimed at improving ground-based production methods can be studied. In metal physics, the influences of magnetic fields on microstructure can be determined. Microstructure control during solidification could lead to new materials with industrial applications.

EML allows containerless process, which avoids contamination of the samples.

The first pair of external payloads will be installed via EVA on the Columbus mission: *Solar* (on Coarse Pointing Device), to measure the Sun's total and spectral irradiance; *European Technology Exposure Facility* (EuTEF), a wide range of on-orbit technology investigations. Two others will be added later: *Atomic Clock Ensemble in Space* (ACES), providing an ultra-accurate global time-scale, supporting precise evaluations of relativity; *Export*, comprising *Expose*, on a CPD, for long-term studies of microbes in artificial meteorites and different ecosystems, and *Sport*, to measure polarisation of the sky's diffuse background at 20-90 GHz.

Schedule of European Hardware and Research Facility Contributions to the ISS

	Launch	Mission	Comments
DMS-R	12 Jul 00	Proton	Data Management System-Russian, Zvezda and initial ISS control
MPLM	08 Mar 01	STS-102/5A.2	Debut of 3 reusable MultiPurpose Logistics Modules
MSG	05 Jun 02	STS-111/UF-2	Microgravity Science Glovebox. Installed in Destiny; transfer to Columbus planned
Matroshka	29 Jan 04	Progress-13P	Measurement of EVA radiation dose using 'human phantom', installed outside Zvezda 26 Feb 2004 by EVA
MELFI	Sep 2005	STS-121/ULF-1.1	Debut of 'Minus-Eighty degrees Lab for the ISS' to deliver/return cold/frozen cargo in MPLM (MPLM not configured for active cooling on first ascent). To be installed in Destiny. MELFI-2 for JAXA; MELFI-3 NASA
EMCS	Sep 2005	STS-121/ULF-1.1	European Modular Cultivation System, to be installed in Destiny for plant research
PFS	Sep 2005	STS-121/ULF-1.1	Pulmonary Function System, part of NASA HRF-2 Human Research Facility in Destiny
ATV-1	early 2006	Ariane-5ES	Debut of cargo ferry
Node-2	Oct 2006	STS-120/10A	
Columbus	late 2006	STS-122/1E	Launched with Biolab, FSL, EPM, EDR (carrying PCDF Protein Crystallisation Diagnostics Facility), ETC and external EuTEF & Solar
MSL-USLab	May 2007	STS-123/ULF-2	Half of US Materials Science Research Rack (MSSR-1) in Destiny
ATV-2	mid-2007	Ariane-5ES	Cargo ferry
ERA	Nov 2007	Proton	Attached to Russian Multipurpose Laboratory Module
PEMS	Jan 2008	STS-127/UF-3	Percutaneous Electrical Muscle Stimulator for muscle research, with HRF-1/2 & EPM in Columbus
MARES	Jan 2008	STS-127/UF-3	Muscle Atrophy Research & Exercise System, with HRF-1/2 & EPM in Columbus
Hexapod	Mar 2008	STS-128/UF-4	Pointing unit carrying NASA SAGE-III atmosphere instrument
MSL-EML	Jul 2008	STS-130/UF-5	To be installed in Columbus
Node-3	Oct 2008	STS-131/20A	
Cupola	Mar 2009	STS-133/14A	To be installed on Node-3
ACES	Mar 2009	STS-133/14A	Atomic Clock Ensemble in Space; installation on Columbus EPF
Export	Mar 2009	STS-133/14A	Expose exobiology and Sport astronomy payloads; installation on Columbus EPF
ATV-3	mid-2009	Ariane-5ES	Cargo ferry
Cryosystem	Jul 2009	STS-134/UF-7	Launched with CAM Centrifuge Accommodation Module to store biological samples and protein crystals at -180°C
ATV-4	mid-2010	Ariane-5ES	Cargo ferry
ATV-5	mid-2011	Ariane-5ES	Cargo ferry
ATV-6	mid-2012	Ariane-5ES	Cargo ferry
ATV-7	mid-2013	Ariane-5ES	Cargo ferry

UF: Utilization Flight; ULF: Utilization & Logistics Flight



The Space Shuttle delivers an MPLM.



Nodes

Nodes-2 & 3 will provide important on-orbit resources for operating other ISS elements. In particular, Node-3 will provide water processing and oxygen generation for the US segment, avoiding dependence on the Russian segment. Node-2 was delivered to the Kennedy Space Center in June 2002, and will be launched in October 2006. Node-3 delivery is scheduled for December 2006, and its launch October 2008. The Nodes have the same basic geometry of a cylindrical pressure shell capped by two end-cones with axial ports. The cylinder is a 2-bay section for housing eight racks plus a section with four radial ports.

Columbus internal payload accommodation: payloads carried in 10 ISPRs supplied with services via Columbus. ISPR (2013 mm ht, 1046 mm width, 858 mm max depth, empty mass 99 kg) supports 704 kg in 1.2 m³. 3 kW & 6 kW versions, located in six 6 kW & four 3 kW slots, with water cooling loop sized to match. 13.5 kW total to payloads. GN2 supply, vacuum (except rack positions O2/O1), 32 Mbit/s (Columbus max 43 Mbit/s), video system (A4 only), MIL-STD-1553 Columbus & Destiny payload bus & LAN. Payloads also carried in centre aisle, which provides only data & power (500 W) links.

EPF Accommodation: 4 positions each offer payload envelope of 981x1194 mm, 1393 mm ht, 227 kg, 2x1.25 kW @ 120 Vdc, 32 Mbit/s, interface to Columbus/Destiny payload bus & LAN. No thermal control GN2, venting. Payload carries integrated standard Express Pallet Adapter (EPA) on active Flight Releasable Attachment Mechanism (FRAM). SSRMS positions payload on EPF's passive FRAM.

The initial NASA concept design for Nodes-2/3 was the same as that of Node-1. However, NASA wanted longer Nodes from Europe. Stretching provided additional locations for stowage. Node-3 was a Node-2 copy for future Station use. NASA then decided to make the stowage area configurable for Crew Quarters, so that Node-2 could provide early Station habitation, and most of the former US Habitation module functions such as air revitalisation and water processing were moved into Node-3. Eventually, Node-3 was configured with resources for other attached elements: Cupola, Crew Return Vehicle and a future Habitation module, in addition to providing redundant ports with growth utilities for docking of MPLMs, Shuttle or another laboratory module.

Each Node is 7.19 m long overall and 4.48 m in diameter. Node-2 carries four avionics racks and four rack locations for either stowage or crew quarters. Node-3 has two avionics racks, four for environmental control and one Waste & Hygiene



Top: the locations of Nodes-2/3. (CRV was the Crew Return Vehicle, cancelled by NASA in 2001.)
Bottom: Node-2 arrives in the Space Station Integration Facility at KSC, June 2002.



Node-2 views (from top):
aft, forward, starboard
and zenith.
(ESA/D. Ducros)

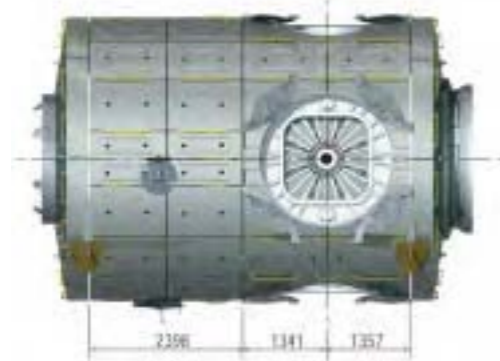
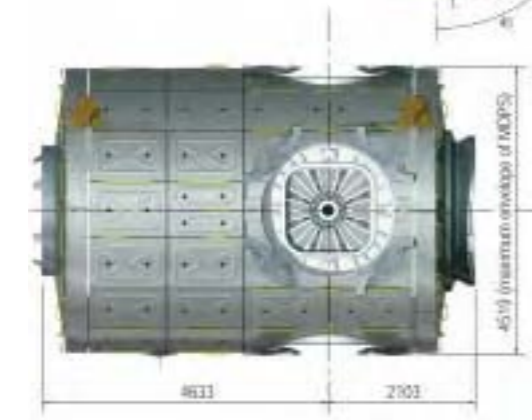
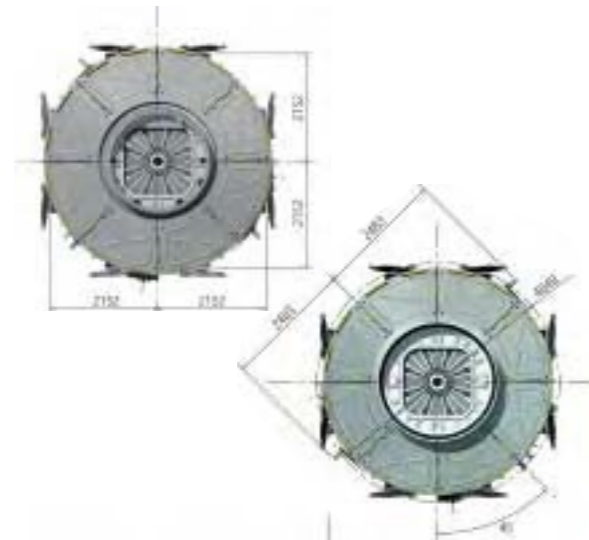

Compartment packaged in two rack locations. Externally, the layout includes 98 MDPS panels with thermal blankets underneath, to minimise heat flux across the shell and to protect against meteoroids and debris. Heat exchangers between the external panels and the pressure shell reject heat from Node internal equipment and attached modules.



Node-2 internal
configuration.
(Alenia Spazio)

Node-2 will be attached in front of Destiny, with its longitudinal axis along the Station's velocity vector. The forward port supports Shuttle docking, via a Pressurized Mating Adapter (PMA). The starboard side provides resources for Columbus, and the port side for JEM. At the zenith position, Node-2 will initially accommodate Japan's Experimental Logistics Module-Pressurized Section (ELM-PS), before JEM appears, and later the Centrifuge Accommodation

Node-2 Major Capabilities

- regulation and distribution of power to elements and Node equipment (sized for 56 kW);
- active thermal control of coolant water for heat rejection from internal Node equipment and from attached elements;
- temperature, humidity and revitalisation control of cabin air and air exchanged with attached elements;
- distribution lines for cabin air sampling, oxygen, nitrogen, waste water and fuel cell water;
- data acquisition and processing to support power distribution, thermal control and environmental control functions inside the Node, as well as data exchange between the US Lab and Node-attached elements;
- audio and video links.

Node-3 Major Capabilities

- Featuring the same basic Node-2 capabilities, Node-3 manages less power (23 kW) but adds:
- on-orbit air pressure and composition control, including carbon dioxide removal;
 - oxygen generation, a dedicated rack also scarred for future water generation;
 - waste and hygiene compartment;
 - urine and water processing;
 - controlled venting of byproducts from environmental control;
 - drinking water distribution;
 - audio and video recording;
 - on-orbit reconfiguration of utilities provided to Cupola, MPLM and Habitation Module.

Module (CAM). Finally, the nadir port will allow temporary docking of MPLM or Japan's HII Transfer Vehicle (HTV).

When Node-2 is delivered to the Station, its aft port will be docked first to Node-1's port side. After the Shuttle departs, the SSRMS will move the docking adapter to Node-2's forward port, and then move the whole module to Destiny's forward port.

Node-3 will be attached to Node-1's nadir, with its radial ports closer to Earth. To starboard, Node-3 can accommodate a lifeboat, while the port side is outfitted for a future Habitation module. The forward position includes utilities for berthing the Cupola and is also a backup location for the MPLM. The aft port can be used for temporary parking of Cupola. Nadir offers a redundant location for Shuttle docking, via a PMA.

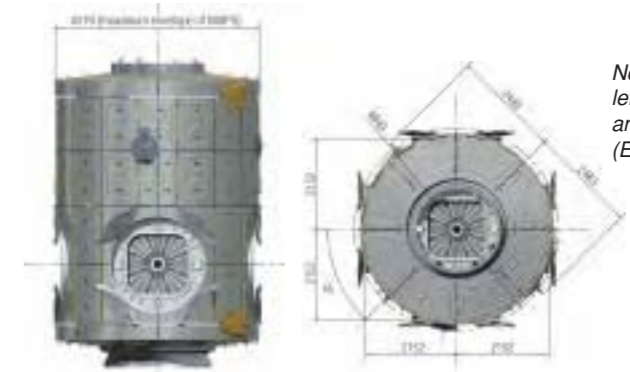

Node-3 views (from top left): forward, zenith, port
and starboard.
(ESA/D. Ducros)



Node-3 internal
configuration.
(Alenia Spazio)

Cupola

Initially being developed by Boeing as part of the US segment of the Space Station, the Cupola was cancelled by NASA in 1993 as a financial measure. NASA and ESA in 1997 began discussing a barter, in which ESA would deliver the Cupola in exchange for the Shuttle launch and return of five external payloads and 70 kg of Columbus internal payloads. The signature of the agreement in October 1998 brought the Cupola back into the ISS configuration. Following the €20 million contract award in December 1998, Alenia improved and matured the Boeing design.

Cupola will be installed on Node-3's radial forward port to provide external views for controlling the robotic operations of the SSRMS, and monitoring crew spacewalks and the berthings of Japan's HTV. In addition, it will allow scientific observations of the Earth and celestial bodies, and offer a prime location for the crew to relax. Its role in maintaining the psychological health of astronauts on long mission will be priceless.

The Cupola is a truncated hexagonal pyramid – the closest shape to a spherical dome given the technical constraint of flat window panes. The one circular and six trapezoidal windows (totalling 15 m²) offer a full hemispherical view on the Station, Earth and Universe. At 80 cm diameter, the circular window will be the largest ever flown in space. The window design is highly sophisticated, incorporating two 2.5 cm-thick glass pressure panes to maintain the cabin pressure and resist the internal pressure load. Normally, only the inner pane takes the pressure load, with the outer



pane redundant. A glass scratch pane protects the inner pressure pane from damage by crew activities, while a glass debris pane protects the outer pressure pane from EVA activities and micrometeoroid and orbital debris impacts. When not in use, the windows are further protected from meteoroids and orbital debris by external shutters, manually operated from inside the Cupola.

Internally, the Cupola provides all the mechanical, electrical, video and audio interfaces for the Robotic Work Station and Audio Terminal Unit that controls the SSRMS arm and communications with the rest of the Station, the ground, the Shuttle and

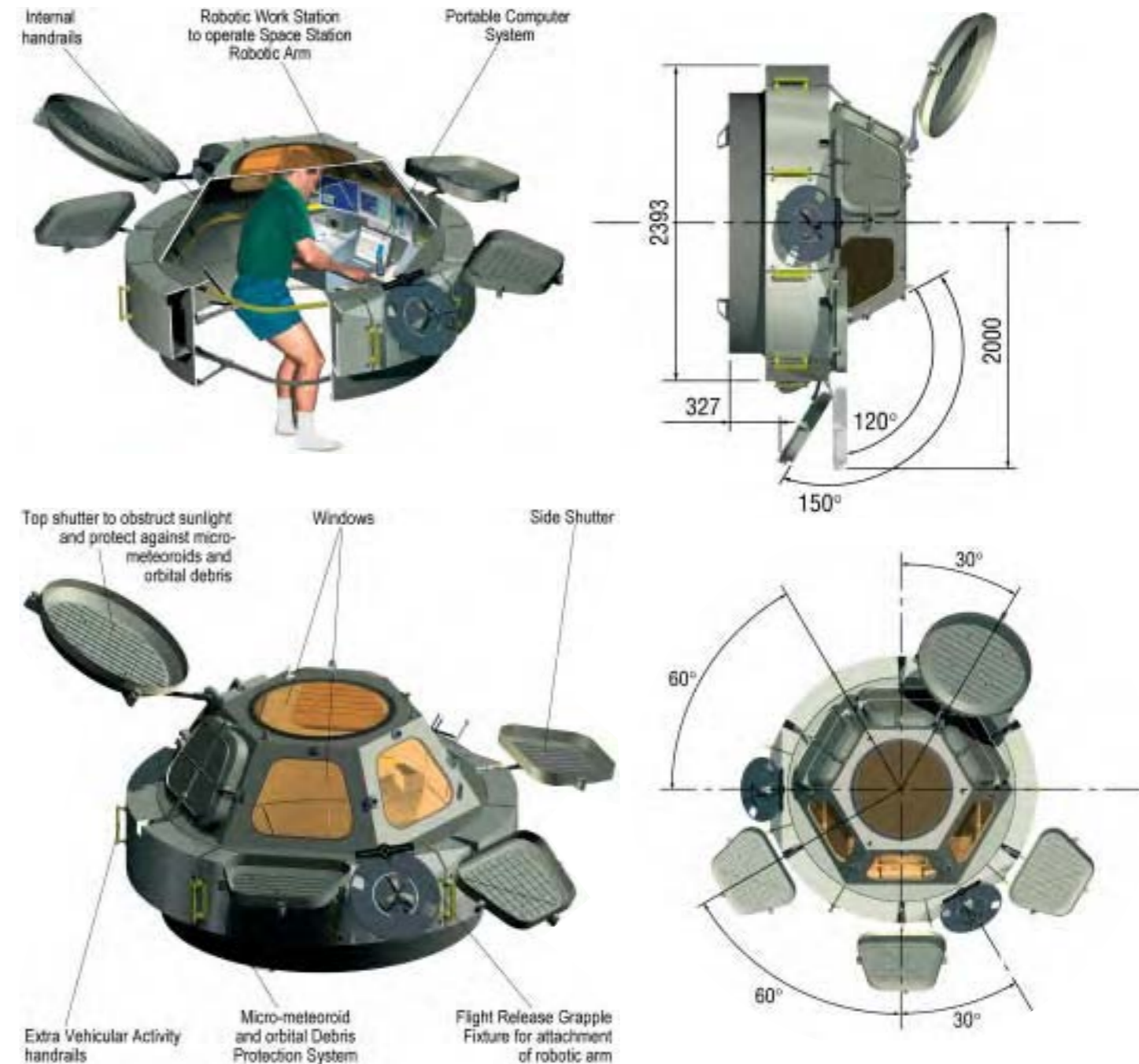

spacewalkers. It provides a shirtsleeve environment for up to two astronauts, using water cooling and air circulation from Node-3.

The Cupola's stringent leak limit is 3.6 g of air per day; testing showed the actual level was 10 times better.

Cupola arrived at KSC on 8 October 2004 and ownership was formally transferred to NASA on 7 July 2005. By the end of the year, Cupola was in storage, with a launch goal of 2009.

Mass: 1805 kg launch, 1880 kg outfitted in orbit

Size: 1500 mm height, 2955 mm dia

Construction: dome forged Al 2219-T851, machined to 50 mm thickness; Al 2219-T851 skirt. Windows (provided by NASA) fused silica & borosilicate glass

Environmental control: via Node-3, manual T adjustment (water loop from Node-3), passive MLI, window heaters

Power: 120 Vdc from Node-3

Communications: Audio Terminal Unit; 1553B bus to Node-3

Outfitting: Robotic Work Station, Portable Computer System, portable light system

SMOS

Planned achievements: the first global measurements of soil moisture and ocean salinity; first passive L-band interferometer in space

Launch date: planned for February/March 2007

Mission end: after minimum 3 years (2-year extension expected)

Launch vehicle/site: Rockot from Plesetsk, Russia

Launch mass: 670 kg (370 kg payload; 282 kg dry platform; 28 kg propellant)

Orbit: planned 756 km circular, 98.42° Sun-synchronous (06:00 local time ascending node), revisit time 3 days at the equator

Principal contractors (Phase-A): Alcatel Space Industries platform prime, EADS-CASA Espacio payload prime; Payload Extended Phase-A September 2000 - December 2001; Bridging Phase April-December 2002, Phase-B December 2002 - December 2003, Phase-C/D December 2003 - May 2006

The Soil Moisture and Ocean Salinity (SMOS) mission will use an L-band passive interferometer to measure two crucial elements of Earth's climate: soil moisture and ocean salinity. It will also monitor the vegetation water content, snow cover and ice structure. SMOS was selected as the second Earth Explorer Opportunity mission in ESA's Living Planet programme. The AO was released on 30 June 1998 and 27 proposals were received by closure on 2 December 1998. On 27 May 1999, ESA approved CryoSat as the first for Phase-A/B, with an extended Phase-A for SMOS as the second. The projected ESA cost-at-completion is about €158 million (2003 conditions, including 7% contingency). Total cost to ESA, CNES and CDTI (Centro para el Desarrollo Tecnológico Industrial, E) is projected at about €222 million. The €62 million payload Phase-C/D contract was signed with EADS-CASA on 11 June 2004; it is Spain's first major satellite payload for ESA.

Human activities appear to be influencing our climate. The most pressing questions are: is the climate actually changing and, if so, how fast and what are the consequences, particularly for the frequency of extreme events? Answering these questions requires reliable models to

predict the climate's evolution and to forecast extreme events. Significant progress has been made in weather forecasting, climate monitoring and extreme-event forecasting in recent years, using sophisticated models fed with data from operational satellites such as Meteosat. However, further improvements now depend to a large extent on the global observation of a number of key variables, including soil moisture and sea-surface salinity. No such long-duration space mission has yet been attempted.

The RAMSES mission (Radiométrie Appliquée à la Mesure de la Salinité et de l'Eau dans le Sol) was proposed in 1997 to CNES as a French national mission and studied to Phase-A. Further work produced the SMOS proposal to ESA by a team of scientists from 10 European countries and the USA, bringing together most of the available expertise in the related fields. As an Explorer Opportunity mission, it is dedicated to research and headed by Lead Investigators (LIs): Yann H. Kerr of the Centre d'Etudes Spatiales de la Biosphère (CESBIO, F); and Jordi Font, Institut de Ciències del Mar (E). ESA has overall mission responsibility, CNES is managing the satellite bus, and CDTI the Payload Mission and Data Centre at Villafranca (E). A joint team is in



Simulated seasonal soil moisture maps (starting with winter at the top). The units are 'cubic metre of water per cubic metre of soil'.

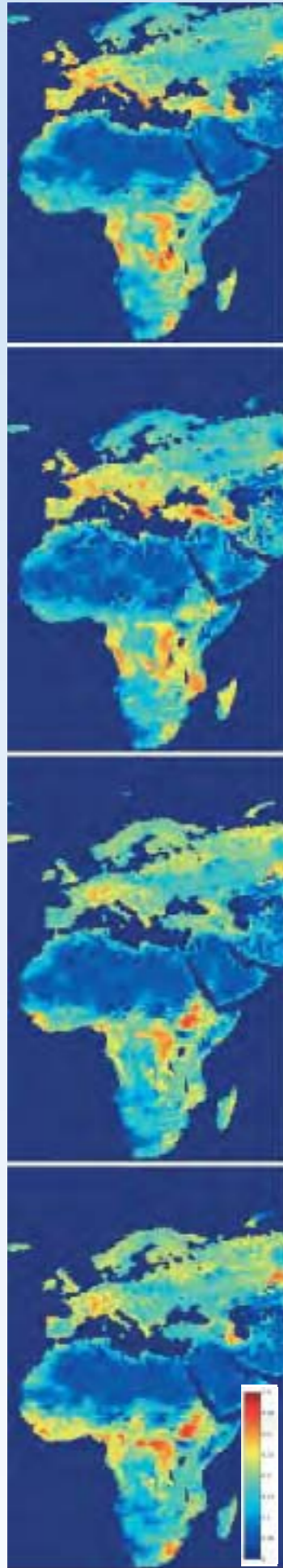

The roughly hexagonal field of view 1000 km wide will cover the globe in 3 days.

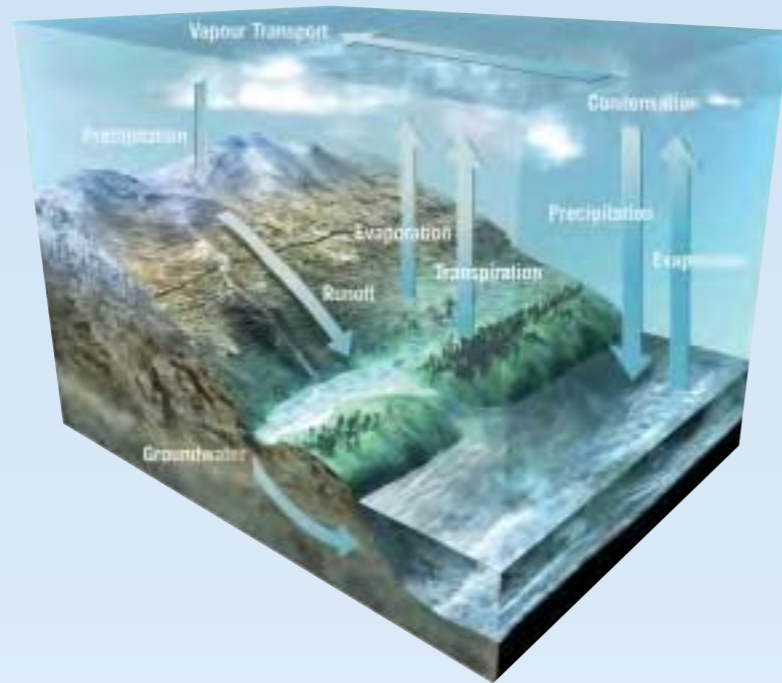

Water is the source of all life on Earth. The total amount is fixed and does not change but, powered by the Sun, water is continuously circulated between the oceans, atmosphere and land. This 'water cycle' is a crucial component of our weather and climate. More than 96% of the water is stored in the oceans. Evaporation from the oceans is thus the primary driver of the surface-to-atmosphere portion of the cycle. The atmosphere holds less than 0.001% of the Earth's water, which seems remarkably low since water plays such an important role in the weather. While around 90% of this atmospheric water vapour comes from the oceans, the remaining 10% is provided by plant transpiration and evaporation from soil.



charge of technical definition and development of the mission components.

The microwave emission of soil depends on its moisture content to a depth of a few cm. At 1.4 GHz, the signal is strong and has minimal contributions from vegetation and the atmosphere. Water and energy exchange between land and the atmosphere strongly depend on soil moisture. Evaporation, infiltration and runoff are driven by it. It regulates the rate of water uptake by vegetation in the unsaturated zone above the water table. Soil moisture is thus critical for understanding the water cycle, weather, climate and vegetation.

At sea, the 1.4 GHz microwave emission depends on salinity, but is affected by temperature and sea-state. Those factors must be accounted for.

The global distribution of salt in the oceans and its variability are crucial factors in the oceans' role in the climate system. Ocean circulation is driven mainly by the momentum and heat exchanges with the atmosphere, which can be traced by observing sea-surface salinity. In high-latitude ocean regions such as the Arctic, salinity is the most important variable because it controls processes such as deep water formation by controlling the density. This is a key process in the ocean thermohaline circulation 'conveyor belt'. Salinity is also important for the carbon cycle in oceans, as it determines ocean circulation and plays a part in establishing the chemical equilibrium that, in turn, regulates the carbon dioxide uptake and release – important for global warming.

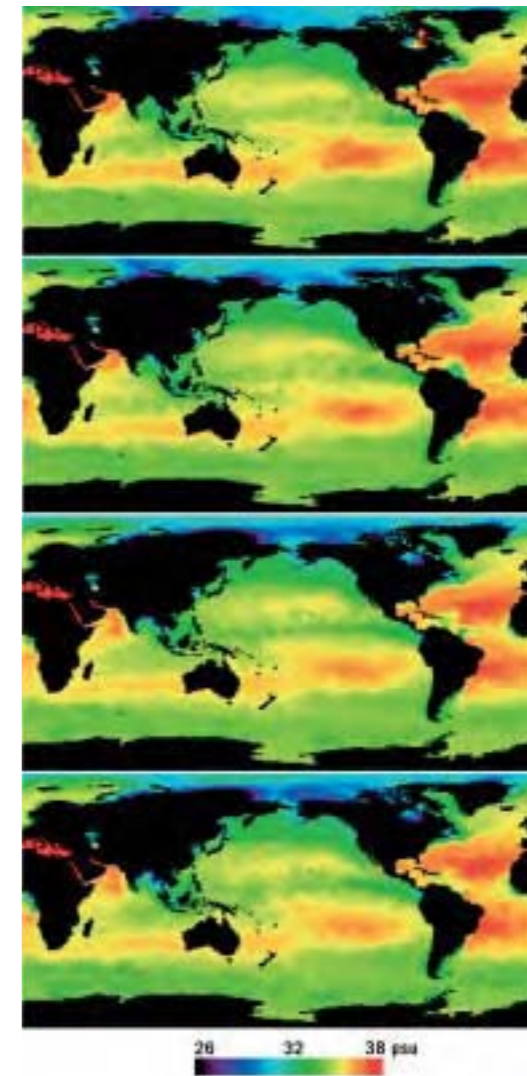

Simulated seasonal sea-surface salinity maps, highlighting how the Atlantic is saltier than the Pacific. In-situ sampling is difficult, so the only current way of estimating global ocean salinity is to simulate the data using complex computer models. (psu = practical salinity unit, equivalent to 1 g of salt in 1 litre of water.)

Monitoring sea-surface salinity could also improve the quality of the El Niño-Southern Oscillation prediction by computer models. The lack of salinity measurements creates major discrepancies with the observed near-surface currents.

Satellite configuration: CNES Proteus platform (first launched as Jason, December 2001), 1 m cube, hardware on four side walls. Flight software in

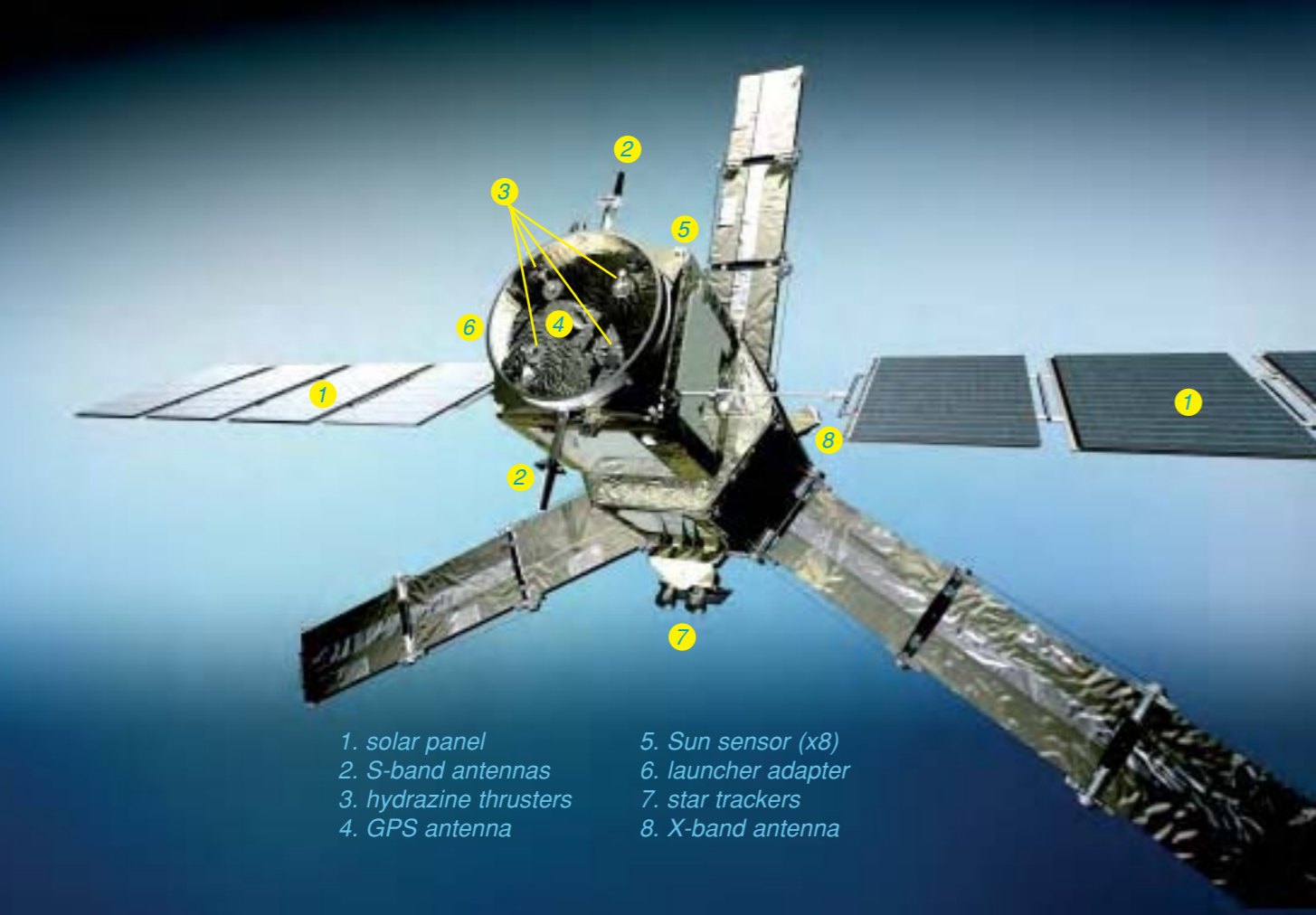

- 1. solar panel
- 2. S-band antennas
- 3. hydrazine thrusters
- 4. GPS antenna
- 5. Sun sensor (x8)
- 6. launcher adapter
- 7. star trackers
- 8. X-band antenna

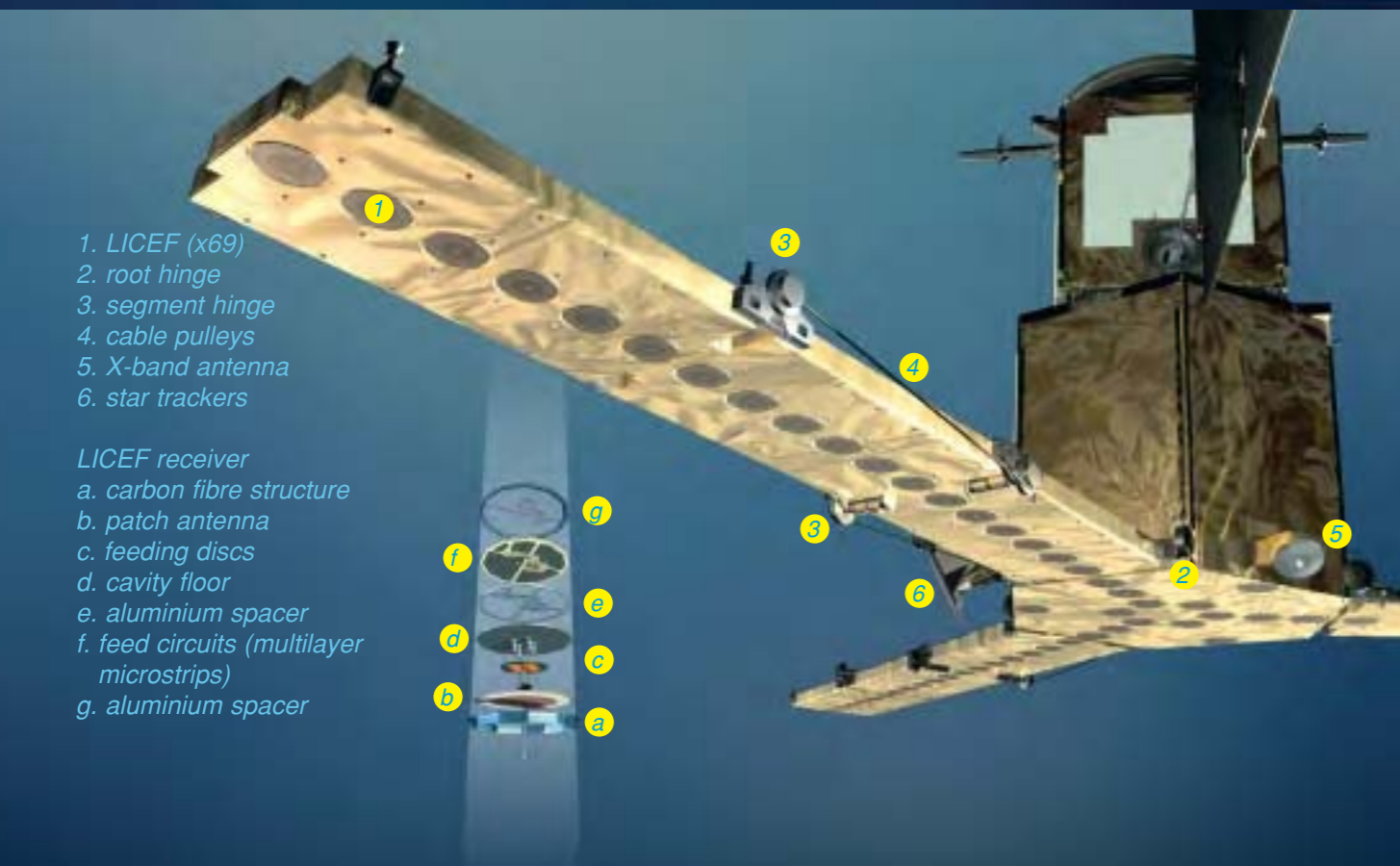

- 1. LICEF (x69)
- 2. root hinge
- 3. segment hinge
- 4. cable pulleys
- 5. X-band antenna
- 6. star trackers

- LICEF receiver
- a. carbon fibre structure
 - b. patch antenna
 - c. feeding discs
 - d. cavity floor
 - e. aluminium spacer
 - f. feed circuits (multilayer microstrips)
 - g. aluminium spacer

Unable to carry a single large antenna, SMOS achieves the required resolution by synthesising together a multitude of small antennas. It employs the 'Microwave Imaging Radiometer using Aperture Synthesis' (MIRAS) instrument, developed since 1993 within ESA's Technology Research Programme and General Support & Technology Programme. MIRAS has a hub and three 3-panel deployable arms carrying 66 Lightweight Cost-Effective Front-end (LICEF) receivers separated by 18.4 cm (0.875 times the L-band wavelength of 21 cm). A central correlator unit then performs interferometry cross-correlations of the signals between all possible combinations of receiver pairs, dramatically reducing the amount of data that has to be transmitted to the ground. MIRAS can operate in two measurement modes: dual-polarisation or polarimetry. The

baseline is dual-polarisation, where all the LICEF antennas are switched between horizontal and vertical measurements. The polarimetric mode acquires both polarisations simultaneously, adding scientific value but doubling the data requiring transmission. Only flight experience will show if the baseline mode alone satisfies the mission's objectives. The receivers are sensitive to temperature and ageing, so they will be calibrated several times per orbit by injecting a known signal into them. In addition, an absolute calibration every 14 days will require attitude manoeuvres to view deep space or a celestial target. To avoid electromagnetic disturbance, the LICEF measurements are routed via fibre optics to the control and correlator unit.

MA-31750 microprocessor; dual redundant MIL-STD-1553B bus. Payload module 130 cm-dia hexagonal prism, 124 cm high. Span across antenna array 8.03 m; span across solar array 9.64 m.

Attitude/orbit control: 3-axis control to 32.5° in pitch by 4 reaction wheels desaturated by magnetotorquers, measured to 0.05° using 2 star trackers, 8 coarse Sun sensors, 3 gyros and 2 magnetometers. Orbit control by four 1 N thrusters (28 kg hydrazine in 40-litre tank; including safe mode and SMOS disposal EOL). GPS provides 100 m position accuracy.

Power system: up to 900 W (619 W EOL orbit average) from two solar wings of four 80x150 cm Si panels each; 375/300 W required for payload/bus. Supported by 78 Ah Li-ion battery.

Communications: controlled from Spacecraft Operations Control Centre at Toulouse (F) via generic Proteus

system, commands uplinked typically weekly at 4 kbit/s S-band via Kiruna. Science data downlink by 8.2 GHz X-band at 16.8 Mbit/s to 15 m dish at Payload Mission and Data Centre, Villafranca (E). Onboard storage at 180 kbit/s on redundant 20 GBit solid-state recorders.

SMOS Payload

The accuracies required are: soil moisture 4% every 3 days (to track land drying after rainfall) at 50x50 km resolution; *salinity* 0.1 psu every 10-30 days at 200x200 km resolution (psu = practical salinity unit, equates to 0.1% mass; oceans typically 32-37 psu); *vegetation moisture* 0.3 kg/m² every 7 days at 50x50 km resolution.

MIRAS Interferometric Radiometer

A passive interferometer using three 4 m-long CFRP arms in Y-shaped configuration. 69 receiver elements, including 18 on each arm, 19 cm-dia, 1 kg each. 1404-1423 MHz L-band, H/V polarisation. Records emission every 1.2 s within irregular-hexagonal FOV instantaneously and at several incidences (0-50°) as SMOS moves along orbit. Swath width ~1000 km, spatial resolution < 35 km in centre FOV, radiometric resolution 0.8-2.2 K.

Proba-2

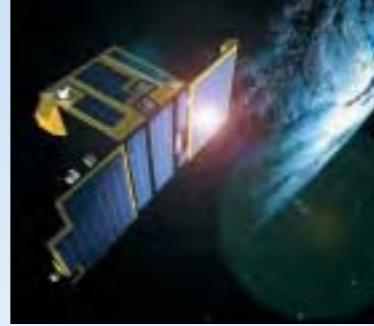

Achievements: ESA's second small satellite for technology demonstration
Launch date: planned for February/March 2007
Mission end: 2-year nominal mission; 3-month in-orbit commissioning
Launch vehicle/site: auxiliary passenger on Rockot (with SMOS)
Launch mass: 120 kg (85 kg platform, 35 kg payload)
Orbit: planned polar LEO
Principal contractors: Verhaert Design & Development (B; prime), Spacebel (B; software). Ph-A/B November 2003 - May 2004, Ph-C/D May 2004 - July 2006

ESA's series of small, low-cost Proba (Project for On-Board Autonomy) satellites is being used to validate new spacecraft autonomy and 3-axis control and data system technologies as part of the Agency's In-orbit Technology Demonstration Programme funded through the General Support Technology Programme. Proba-1 (q.v.) continues to operate after more than 3 years.

Proba-2 will use the same platform to demonstrate yet more advanced bus technologies:

- miniaturised and highly integrated avionics bus (computer, telemetry & telecommand, power) based on the new LEON processor;
- all-startracker attitude control system;
- agility using advanced startrackers (Active Pixel Sensor, high slew rate);
- high pointing accuracy suitable for Earth observation and scientific missions;
- autonomous orbit control;
- advanced software development and tools using automated software generation, and simulation-based development and testing;
- commercial-off-the-shelf products and commercial parts.

A Call for Ideas for platform elements was issued in March 2002 and 84 were submitted by the deadline in July 2002. A total of 23 were announced in November 2002. Of these, 12 remained at the end of Ph-B in May 2004 for

firm inclusion. Two (PALAMGI & X-CAM) were transferred to the payload element (see box).

- onboard software (Spacebel, B);
- payload software (Spacebel, B);
- Software Validation Facility (Spacebel, B);
- advanced stellar compass: new miniaturised and high tracking-rate autonomous star sensor (DTU, DK);
- AOCS design & software (NGC, CAN);
- reaction wheels (Dynacon, CAN);
- solar array assembly (Galileo Avionica, I);
- Li-ion battery (SAFT, F);
- resistojet propulsion system (SSTL, UK);
- solid gas-generator: new technology for tank repressurisation (Bradford Engineering, NL).

In addition, ESA is providing other platform elements:

- dual-frequency GPS sensor (Alcatel, F);
- miniaturised commercial GPS sensor (DLR, D);
- new digital Sun sensor (TNO, NL);
- BepiColombo startracker: APS-based (Galileo Avionica, I);
- solar panel concentrator (CSL, B);
- Fibre Sensor technology Demonstrator (FSD): (MPB, CAN).

For the payload, the Announcement of Opportunity was issued on 3 June 2002 and 14 proposals were submitted by the deadline of 26 July 2002. Five



were announced in October 2002, in order of priority: SWAP, LYRA, DSLP, TPMU and SGVM (see box for details). This package of two solar (SWAP & LYRA) and plasma instruments will exercise the platform's full capabilities, demonstrate payload technologies (e.g. the APS detectors) for future missions and deliver valuable scientific data.

The €13.5 million Proba-2 prime contract was signed with Verhaert D&D on 15 July 2004. The ESA cost-at-completion is projected to be €20 million (€13.84 million from the General Support Technology Programme).

Satellite configuration: 600x600x800 mm box-shaped structure of conventional aluminium honeycomb design. Load-carrying structure is of three panels in 'H' configuration.

Attitude/orbit control: 3-axis stabilisation by four 30 mN-m Dynacon reaction wheels (unloaded by magnetorquers); attitude determination by autonomous high-accuracy (5 arcsec over 10 s) 2-head star tracker, GPS sensors & 3-axis magnetometer. Sun pointing to 100 arcsec accuracy. Autonomous navigation via GPS and orbit propagation. Single 20 mN resistojet for orbit adjust, using xenon or nitrogen (nitrogen from solid cartridge).

Power/thermal system: 4x4 cm 200 µm-thick GaAs cells on a Ge

Proba-2 Payload

Sun Watcher using APS (SWAP)

EUV telescope for coronal imaging using APS detector with scintillator coating (1024x1024-pixel phosphor-coated CMOS detector). Off-axis Ritchey-Chrétien telescope, FOV 45x45 arcmin, 14Å spectral range centred on 195Å, exposure 1-15 s. Investigator: Centre Spatial de Liège (B).

Lyman α-Radiometer (LYRA)

Solar irradiance in 4 channels: 121.6 (Lyman alpha), 120-200, 200-220, 1-200 nm using new (diamond) detector. Investigator: Royal Observatory of Belgium.

Dual Segmented Langmuir Probe (DSLPL)

To measure plasma properties (electron density & T; ion density) in Proba orbit and the satellite's interaction with it (Proba potential; low-frequency E-field & Proba potential fluctuations) using two 4 cm-dia electrodes (already flying on CNES Demeter). Investigator: Inst. Atmospheric Physics (CZ).

Thermal Plasma Measurement Unit (TPMU)

To measure total ion density (2x10⁷-8x10¹² m³), electron T (800-20000K), ion composition & T (800-10000K) and floating potential (±12 V). Investigator: Inst. Atmospheric Physics (CZ).

Science Grade Vector Magnetometer (SGVM)

To measure Earth 3-axis magnetic field 20 times/s; sensor noise < 15 pT rms, vector accuracy ~2 arcsec. Derived from instrument flown on Champ. Investigator: Danish Technical Univ. (DK).

PALAMGI & X-CAM

Miniature camera provides 360° annular view for attitude sensing. The refraction & reflection optics (PALAMGI = Panoramic Annular Lens Attitude Measurement sensor combined with Ground Imager) is combined with 3D camera (X-CAM), which includes CCD detector, analogue-digital converter & mass memory. PALAMGI Investigator: OPTOPAL (HUN); X-CAM Investigator: Space-X (CH).

substrate body-mounted on 2 deployed/fixed panels provide 90 W peak (88 W max. required; 17 W in safe mode), supported by 16.5 Ah Li-ion SAFT battery. 28 Vdc bus. Passive thermal control.

Communications: S-band link to ESA Redu (B) control centre (2.4 m dish); 16 kbit/s packet TC uplink, 1 Mbit/s packet TM down (2 W redundant transmitter). (Kiruna for LEOP.) SPARC V8 processor (100 MHz, 100 MIPS, 2 MFLOPS). 3 Gbit Memory Management Unit, orbit allows complete dump at least every 12 h if required.

Operations: controlled from a dedicated ground station at ESA Redu (B; 2.4 m dish). Scientific data distributed from Redu via a webserver. Contractors: SAS (B), Enertec (F), Gigacom (CH).

Planck

Planned achievements: most detailed observations to date of Cosmic Microwave Background

Launch date: planned for February 2007 (with Herschel)

Mission end: after 15 months of observations

Launch vehicle/site: Ariane-5 from Kourou, French Guiana

Launch mass: about 1430 kg (445 kg science payload)

Orbit: planned Lissajous orbit around L2 Lagrangian point, 1.5 million km from Earth in anti-Sun direction. 4-month transfer from Earth

Principal contractors: Alcatel Space Industries (Cannes, F; prime, Payload Module, AIV), Alenia Spazio (Torino, I; Service Module). Phase-B April 2001 - June 2002; Phase-C/D July 2002 - September 2006, PDR September 2002, CDR October 2004

Planck is designed to help answer key questions: how did the Universe come to be and how will it evolve? To do this, it will map with the highest accuracy yet the first light that filled the Universe after the Big Bang. Its telescope will focus radiation from the sky onto two arrays of highly sensitive radio detectors. Together, they will measure the temperature of the Cosmic Microwave Background (CMB) radiation over the whole sky, searching for regions slightly warmer or colder than the average 2.73 K.

300 000 years after the Big Bang, the Universe was 1000 times smaller than now and had cooled to 3000 K. This was cold enough for hydrogen atoms to form, so light and matter now existed independently and light could travel freely for the first time. CMB radiation is that 'first light', a fossil light carrying information both about the past and the future of the Universe. This background glow was discovered in 1964. A thousand million years after the Big Bang, the Universe was a fifth of its present size and stars and galaxies already existed. They formed as matter accreted around primaeval dense 'clots' that were present in the early Universe and that left their imprint in the radiation, at the period when light and matter were still closely coupled. Today, the fingerprints of these clots are detected as very slight

differences – sometimes as small as one in a million – in the apparent temperature of the CMB. All of the valuable information lies in the precise shape and intensity of these temperature variations. In 1992, NASA's COBE satellite made the first blurry maps of these anisotropies in the CMB. Planck will map these features as fully and accurately as possible.

The anisotropies hold the answers to many key questions in cosmology. Some refer to the past of the Universe, such as what triggered the Big Bang, and how long ago it happened. Others look deep into the future. What is the density of matter in the Universe and what is the true nature of this matter? These parameters will tell us if the Universe will continue its expansion forever or if it will eventually collapse on itself.

Another question is the existence of a 'dark energy' that might exist in large quantities in our Universe, as indicated by recent experiments. Is it really there? If so, what are its effects? Planck will shed light on these issues, because it will be the most powerful tool yet for analysing the CMB anisotropies.

Planck's instruments will focus on microwaves with wavelengths of 0.3 mm to 1 cm. This wide coverage

Planck will provide a window back to the early Universe.

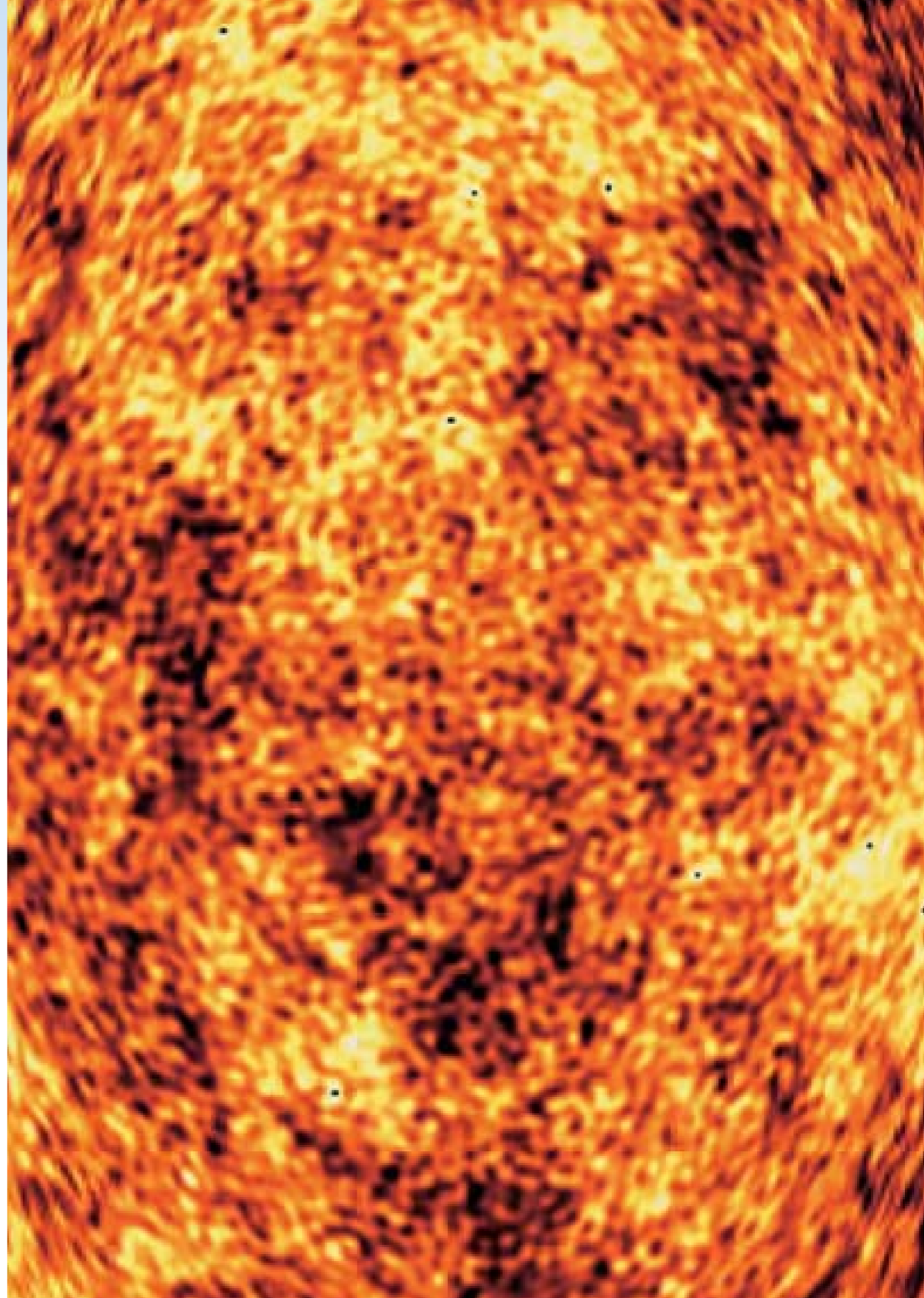

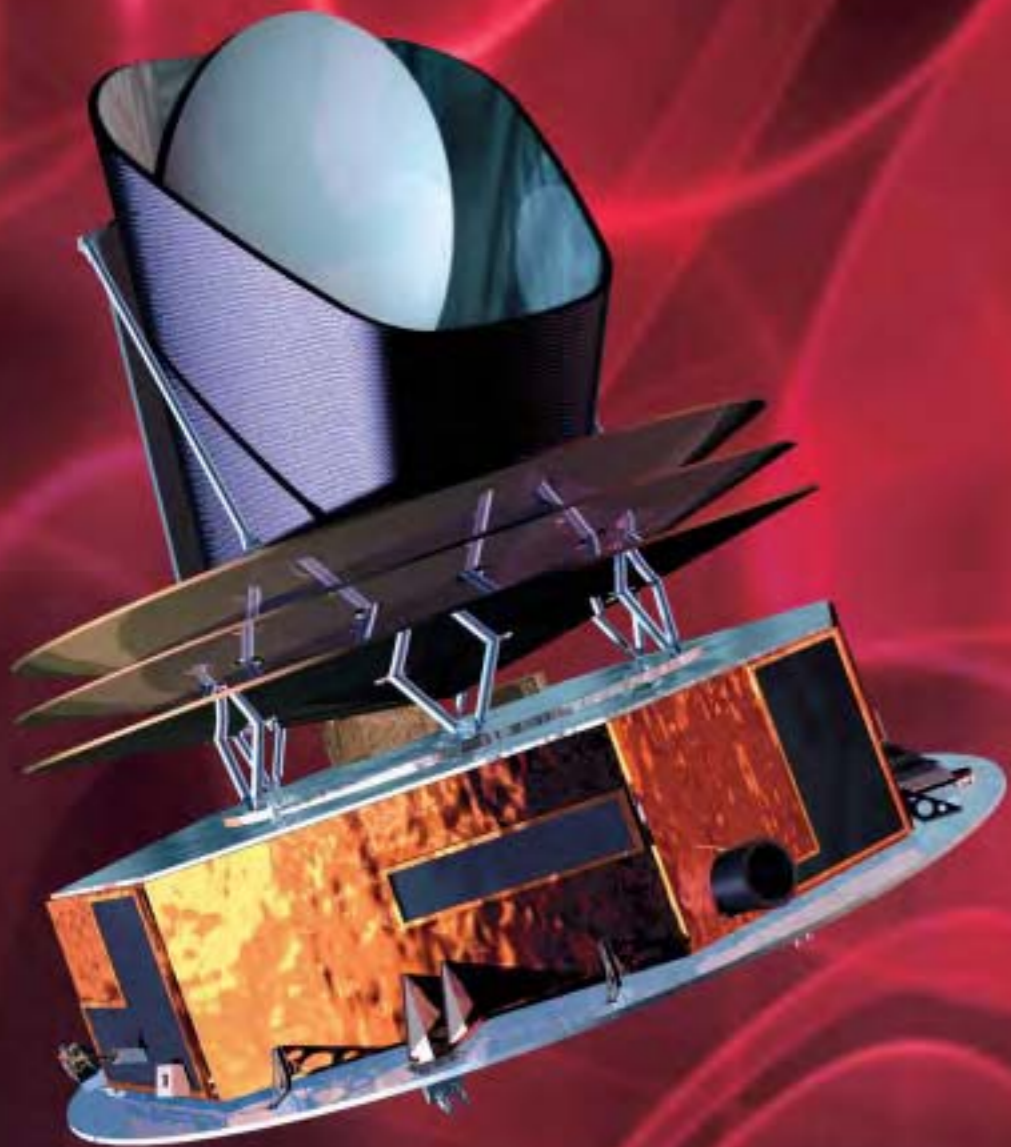

solves a major challenge: to distinguish between the actual CMB and the many other undesired signals that introduce spurious noise. Many other objects, such as our own Galaxy, radiate at the same wavelengths as the CMB itself. These confusing signals have to be mapped and finally removed from the measurements. This means that many of Planck's wavelength channels are dedicated to measuring signals other than the CMB. These measurements in turn will generate a wealth of information on the dust and gas in our Galaxy and the properties of other galaxies. The Sunyaev-Zeldovich effect (a distortion of the CMB by the hot gas in galactic clusters) will be measured for thousands of clusters.

The detectors must be very cold so that their own emissions do not swamp the signal from the sky. Some will be cooled to about 20 K and some to 0.1 K. Planck will rotate slowly and sweep a large swath of the sky each minute. In about 15 months, it will have covered the sky fully, twice over. It will operate completely autonomously and dump the stored data each day to Earth.

A call for ideas for ESA's M3 third Medium-class science mission for launch in 2003 was issued to the scientific community in November 1992. Assessment studies began in October 1993 on six, including what was then called COBRAS/SAMBA (Cosmic Background Radiation Anisotropy Satellite/Satellite for Measurement of Background Anisotropies, originally two separate proposals). The studies were completed in April 1994 for four to continue with Phase-A studies until April 1996. COBRAS/SAMBA was

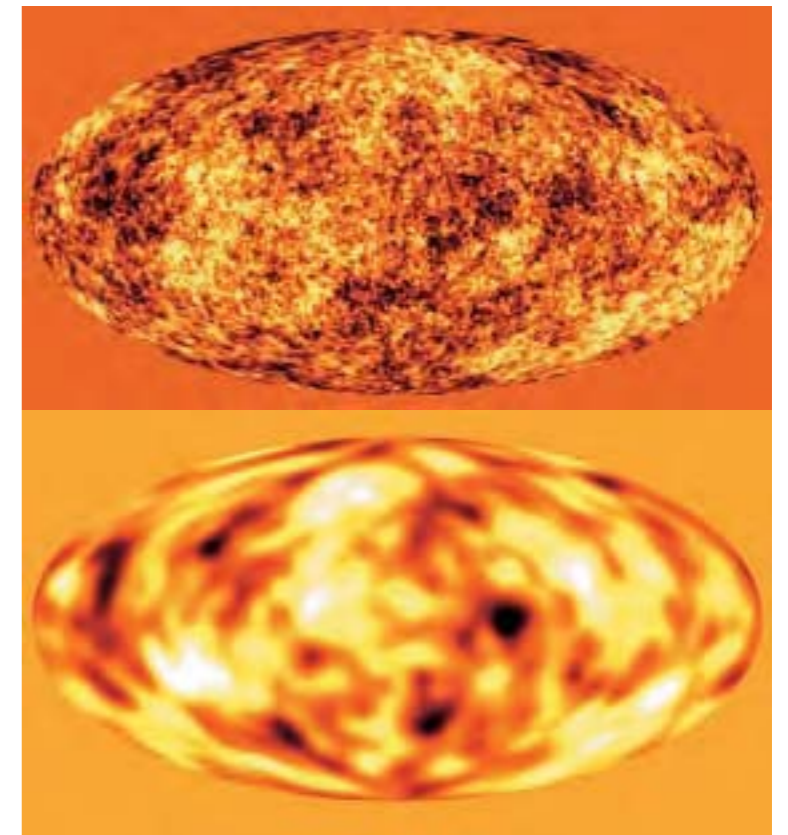

Simulations of observations of the CMB show the dramatic improvement that can be achieved by increasing the angular resolution from the level of the COBE satellite (bottom) to the 5-10 arcmin of Planck (top). On scales of larger than 10° , the CMB temperature varies by about one part in 100 000 from the average 2.73 K.

selected as M3 by ESA's Science Programme Committee in June 1996. However, the SPC in February 1996 had already ordered a reduction in the cost of new missions, so starting in 1997 several studies looked at how M3 could be implemented more cheaply. Three scenarios were considered: a dedicated satellite; a merged mission with Herschel, operating the instruments in turn; a dedicated satellite launched in tandem with Herschel. The last,

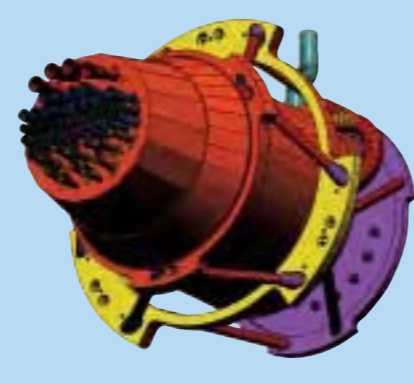
Planck's scientific payload						
Low Frequency Instrument (LFI)						
LFI's 56 High Electron Mobility Detectors (HEMTs), fed by a ring of corrugated horns, are cooled to 20 K by H ₂ sorption cooler. PI: Reno Mandolesi, Istituto di Tecnologie e Studio delle Radiazioni Extraterrestri (CNR), Bologna (I).						
Centre Frequency (GHz)	30	44	70			
Number of Detectors	4	6	12			
Bandwidth ($\Delta\nu/\nu$)	0.2	0.2	0.2			
Angular Resolution (arcmin)	33	23	14			
Average $\Delta T/T$ per pixel (14 months, 1σ , 10^{-6} units)	2.0	2.7	4.7			
Average $\Delta T/T$ polarisation per pixel (14 months, 1σ , 10^{-6} units)	2.8	3.9	6.7			
High Frequency Instrument (HFI)						
HFI's 50 bolometers, fed by corrugated horns and filters, are cooled to 0.1 K by a combination of a 20 K sorption cooler, a 4 K Joule-Thompson mechanical cooler and an open-cycle dilution refrigerator. PI: Jean-Loup Puget, Institut d'Astrophysique Spatiale (CNRS), Orsay (F).						
Centre Frequency (GHz)	100	143	217	353	545	857
Number of Detectors	8	12	12	12	4	4
Bandwidth ($\Delta\nu/\nu$)	0.25	0.25	0.25	0.25	0.25	0.25
Angular Resolution (arcmin)	9.5	7.1	5.0	5.0	5.0	5.0
Average $\Delta T/T$ per pixel (14 months, 1σ , 10^{-6} units)	2.5	2.2	4.8	14.7	147.0	6700
Average $\Delta T/T$ polarisation per pixel (14 months, 1σ , 10^{-6} units)	4.0	4.2	9.8	29.8	-	-
Telescope						
1.5 m-diameter telescope, 8°-FOV, 1.8 m focal length, is offset by 85° from Planck's spin axis to scan the sky. Both reflectors are CFRP. LFI/HFI occupy the focal plane, with HFI's detectors in the centre surrounded by LFI's in a ring. PI: Hans Ulrik Nørgaard-Nielsen, Danish Space Research Institute. Copenhagen (DK).						
						
LFI is an array of 56 tuned radio receivers using High Electron Mobility Transistors (HEMTs) cooled to 20 K to map at three wavelengths of 4 mm to 1 cm. HFI is also visible, inserted in the centre of the LFI ring of horns.			HFI is an array of 48 bolometers cooled to 0.1 K to map at six wavelengths of 0.3-3 mm.			



'carrier', option was selected by the SPC in May 1998 for a 2007 launch.

The Announcement of Opportunity for the instruments was made in October 1997; the flight models are due to be delivered in mid-2005. In September 2000, ESA issued a joint Herschel-Planck Invitation to Tender to industry for building both spacecraft. The responses were submitted by early December 2000 and Alcatel Space Industries was selected 14 March 2001 as the prime contractor for the largest space science contract yet awarded by ESA: €369 million, signed in June 2001. Phase-B began early April 2001.

Satellite configuration: octagonal service module with a sunshield carrying solar array. CFRP central cone, 8 CFRP shear webs, CFRP upper/lower platforms. Payload module houses telescope, two science instruments and their coolers.

Attitude/orbit control: spin-stabilised at 1 rpm about longitudinal axis to scan telescope across sky. Pointing error 16.9 arcsec. ERC 32-based attitude control computer; star mapper, 3x2-axis Sun sensors, 2x3-axis quartz rate sensors. Redundant sets of 6x10 N + 2x1 N thrusters; 3x135 kg hydrazine tanks.

Power system: solar array mounted on Earth/Sun-facing thermal shield, GaAs cells provide 1664 W EOL, supported by 2x36 Ah Li-ion batteries.

Communications: data rate 100 kbit/s 30 W X-band from single 25 Gbit solid-state recorder to ESA's Perth (Australia) station; 3-hour data dump daily. Controlled from Mission Operations Centre (MOC) at ESOC; science data provided to the two PI Data Processing Centres.

Herschel

Planned achievements: first spaceborne observatory for 100-600 μm ; largest imaging telescope ever launched (3.5 m diameter mirror)
Launch date: planned for August 2007 (with Planck)
Mission end: minimum of 3 years of routine science operations
Launch vehicle/site: Ariane-5ECA from ELA-3, Kourou, French Guiana
Launch mass: about 3200 kg (science payload 415 kg)
Orbit: planned halo orbit around L2 Lagrangian point, 1.2-1.8 million km satellite distance from Earth in anti-Sun direction. 4-month transfer from Earth
Principal contractors: Alcatel Space Industries (Cannes, F; prime), EADS Astrium (Friedrichshafen, D; AIV, cryostat), Alenia Spazio (Torino, I; Service Module), EADS Astrium (Toulouse, F; mirror). Phase-B April 2001 - June 2002; Phase-C/D July 2002 - September 2006, satellite PDR October 2002, satellite CDR October 2004

ESA's Herschel Space Observatory will be the first astronomical satellite to study the cold Universe at far-infrared and submillimetre wavelengths. Its main goal is to look at the origins of stars and galaxies, reaching back to when the Universe was only a third of its present age. When and how did galaxies form? Did they all form at about the same time? Were the first galaxies like those we see now? Did the stars form first and then congregate as galaxies? As well as peering at the distant past, Herschel will also see into the hearts of today's dust clouds as they collapse to create stars and planets.

Objects at 5-50 K radiate mostly in Herschel's wavelength range of 60-670 μm , and gases between 10 K and a few hundred K have their brightest molecular and emission lines there. Broadband thermal radiation from small dust grains is the commonest continuum emission process across this band.

The Universe was probably already dusty as the first galaxies formed and other telescopes cannot penetrate the veil. That epoch has therefore so far remained a 'dark age' for astronomers, although pioneering infrared satellites, such as ESA's Infrared Space Observatory (ISO),

have helped to outline a general scenario. Sometime after the Big Bang, the first stars formed, possibly in small clusters. With time, they merged and grew, and the accumulation of matter triggered the formation of more stars. These stars produced dust, which was recycled to make more stars. By then, the first galaxies were already in place, and they also merged to form larger systems. These galactic collisions triggered an intense formation of stars in the Universe. Herschel will see the emission from dust illuminated by the first big starbursts in the history of the Universe.

Herschel will also show us new stars forming within their thick cocoons of dust. Gravity squeezes gas and dust towards the centre, while cooling mechanisms keep the system at very low temperatures to avoid a quick collapse and a premature death of the embryonic star. The dust cocoons and the 13 K temperatures make the pre-star cores invisible to all but radio and infrared telescopes. The earliest stages of star-birth are thus poorly known, even though ISO unveiled more than a dozen cocoons.

After starbirth, leftover gas and dust remain swirling around the young



Infrared-bright regions in the M16 Eagle Nebula reveal dense clouds of cool dust that harbour forming stars. (ESA/ISO & G. Pilbratt et al.)

Herschel: the main science goals

Deep extragalactic broadband photometric surveys in Herschel's 100-600 μm prime wavelength band for detailed investigation of the formation and evolution of galaxy bulges and elliptical galaxies in the first third of the age of the Universe

Follow-up spectroscopy of interesting objects discovered in the survey. The far-IR/sub-mm band contains the brightest cooling lines of interstellar gas, which provides very important information on the physical processes and energy production in galaxies

Detailed studies of the physics and chemistry of the interstellar medium in galaxies, both in our own Galaxy as well as in external galaxies, by photometric & spectroscopic surveys and detailed observations. Includes the important question of how stars form out of molecular clouds

The chemistry of gas and dust to understand the stellar/interstellar lifecycle and to investigate the physical and chemical processes involved in star formation and early stellar evolution in our Galaxy. Herschel will provide unique information on most phases of this lifecycle

High-resolution spectroscopy of comets and the atmospheres of the cold outer planets and their moons

star, forming a protoplanetary disc. The dust grains are the seeds of future planets. Once the new planetary system is formed, only a thin ring of debris remains. The discs and debris rings are favourite targets for infrared space telescopes. ISO showed that planets beyond our Solar System are common. Almost all young stars are surrounded by a thin disc of debris, in which the planet-making process is not completely finished, and small bodies like comets are still very conspicuous. Herschel will shed light on all of these theories.

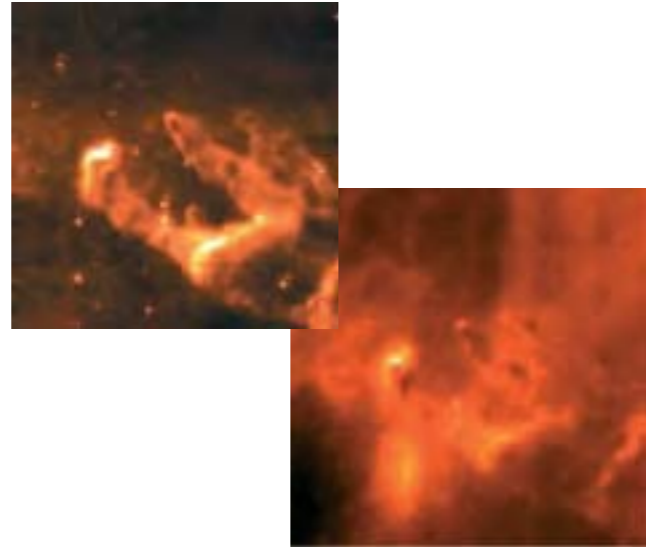

The Solar System was formed 4500 million years ago, out of the same raw material that about 500 million years earlier had served to build the Sun itself. To help reconstruct that formation, Herschel will study in detail the chemical composition of the planets' atmospheres and surfaces, and especially the chemical composition of comets. Comets are the best 'fossils' of the earliest Solar System. They are made of pristine material from that primaeval cloud, including water-ice. They may also solve the question of the origin of Earth's oceans. Most of Earth's water may have come from impacting comets during the early Solar System. Herschel's spectrographs have unprecedented sensitivity to analyse the chemical composition of Solar System bodies, especially with respect to water. If cometary water has the same signature as Earth's, then the link is confirmed.

Huge amounts of water, and very complex molecules of carbon – the most basic building blocks for life –

have been detected in the material surrounding stars. All living systems, including humans, are literally 'stardust'. Stars are the chemical factories of the Universe: most chemical elements are made in their cores, and many chemical compounds are produced in the stars' environments. Most molecules show their unmistakable signatures at infrared and submillimetre wavelengths, which makes Herschel an ideal tool to detect them. It will study the chemistry of many regions in the Universe, from the stars and their environments to other galaxies. It will observe objects as chemically rich as the molecular clouds in the interstellar medium, where nearly a hundred different molecules – many of which were detected in space even before they were ever seen in laboratories – have been discovered. Herschel will provide a much better understanding of the chemistry of the Universe.

With a diameter of 3.5 m, Herschel's silicon carbide primary mirror is the largest ever built for a space telescope. It is a technological challenge: it must be very light, withstand the extreme cold of space and have a surface accurate to 10^{-6} m. The infrared detectors of the three instruments must be cooler than the radiation they are to measure. The telescope itself is cooled passively to 80 K, and parts



of all three instruments will be kept at 1.65 K in a 2160-litre cryostat filled with superfluid helium. The SPIRE and PACS bolometer detectors will be cooled to 0.3 K. Herschel's observations will end when the cryogen is exhausted.

FIRST was one of the original four Cornerstone missions of the Horizon 2000 science plan; it was confirmed as Cornerstone 4 in November 1993 by the Agency's Science Programme Committee. The Announcement of Opportunity for the science instruments was released in October 1997; the SPC made its

selection in May 1998. About 40 institutes are involved in developing the three instruments. In September 2000, ESA issued a joint Herschel-Planck Invitation to Tender to industry for building both spacecraft. The responses were submitted by early December 2000 and Alcatel Space Industries was selected 14 March 2001 as the prime contractor for the largest space science contract yet awarded by ESA: €369 million, signed in June 2001. Phase-B began early April 2001.

The observatory's name, announced in December 2000, commemorates Anglo-German astronomer William Herschel, who discovered infrared light in 1800. The mission was previously known as the Far Infrared and Submillimetre Telescope (FIRST).

Herschel (upper) in launch configuration with Planck (lower). (Alcatel Space)

Herschel's 3.5 m-diameter SiC primary mirror is the largest ever made for a space observatory, but weighs only 300 kg. Top: assembling the 12 petals. Centre: before machining the stiffeners off the inner face and reducing the shell thickness to 2.5 mm (February 2004). Bottom: after machining, ultrasonic inspection of the petals' brazed joints (May 2004). (EADS Astrium)

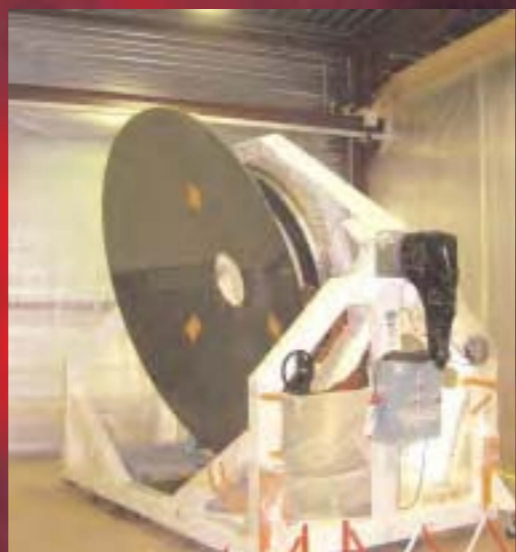

Herschel's scientific payload

Photodetector Array Camera & Spectrometer (PACS)

PACS is a camera and low- to medium-resolution spectrometer for 60-210 μm . Two 16×25 Ge:Ga and two bolometer detector arrays cover: 60-90 & 90-130 μm ('blue'; 3.4 arcsec pixels) and 130-210 μm ('red'; 6.8 arcsec pixels). As a photometer, images a 1.75×3.5 arcmin FOV simultaneously in 'red' and one 'blue' band. As a spectrometer, covers all three bands with 50×50 arcsec FOV, with $150\text{-}200 \text{ km}^{-1}$ velocity resolution and instantaneous coverage of 1500 km^{-1} .
PI: Albrecht Poglitsch, MPE Garching (D).

Spectral & Photometric Imaging Receiver (SPIRE)

SPIRE is an imaging photometer and low- to medium-resolution imaging Fourier Transform Spectrometer (FTS) for 200-610 μm . Both use bolometer detector arrays: three dedicated to photometry and two for spectroscopy. As a photometer, it covers a large 4×8 arcmin field of view that is imaged in three bands (centred on 250, 350, 500 μm) simultaneously.
PI: M. Griffin, Queen Mary & Westfield College, London (UK).

Heterodyne Instrument for the Far-Infrared

HIFI is a heterodyne spectrometer offering very high velocity-resolution ($0.3\text{-}300 \text{ km}^{-1}$), combined with low-noise detection using superconductor-insulator-superconductor (SIS; bands 1-5 500-1250 GHz) and hot electron bolometer (HEB; bands 6-7, 1410-1910 & 2400-2700 GHz) mixers, for a single pixel on the sky (imaging by raster mapping or continuous slow scanning).
PI: Th. de Graauw, Space Research Organisation Netherlands, Groningen (NL).

Satellite configuration: 7.5 m high, 4.0 m wide. Payload module (PLM), based on ISO's superfluid helium cryostat technology, houses the optical bench with the instrument focal plane units (SPIRE and PACS each carry an internal ^3He sorption cooler for 0.3 K bolometer operating temperature) and supports the telescope and some payload-associated equipment. The service module (SVM; partial commonality with Planck) below provides the infrastructure and houses the 'warm' payload equipment. Cassegrain telescope with 3.5 m-diameter SiC 12-segment primary mirror with wavefront error of 6 μm , feeding SiC secondary. Sunshade allows mirror to cool to 80 K.

Attitude/orbit control: 3-axis pointing to 2.12 arcsec. ERC 32-based attitude control; 2 star trackers, 4-axis gyro,

2x2-axis Sun sensors, 2x3-axis quartz rate sensors, 4 skewed RWs. Redundant sets of 6x10 N thrusters; 2x135 kg hydrazine tanks.

Power system: solar array mounted on thermal shield, GaAs cells provide 1450 W EOL, supported by 2x36 Ah Li-ion batteries.

Communications: downlink data rate max. 1.5 Mbit/s (25 Gbit solid-state memory) to Perth (Australia). Controlled from Mission Operations Centre (MOC) at ESOC; science data returned to Herschel Science Centre (HSC) at Villafranca (Spain) for distribution to users. The NASA Herschel Science Center at the Infrared Processing & Analysis Center (IPAC/Caltech) serves US astronomers. The L2 orbit allows continuous observations and operations (3 h daily downlink).

Vega

Achievements: cost-effective small launcher

Launch dates: planned debut November 2007

Launch site: Kourou, French Guiana (Vega pad 5°14'9"N/52°46'29"W)

Launch mass: 138 t

Performance: optimised for LEO. 1500 kg into 700 km 90° polar, 1200 kg into 1200 km Sun-synchronous

Principal contractors: *vehicle:* ELV, Avio, EADS-ST, EADS Espacio, Dutch Space, TNO-Stork, Contraves, CRISA, Sabca, SES, Officine Galileo, Vitrociset, OCI, Arianespace, Pyroalliance; *P80:* Avio, Europropulsion, Snecma (nozzle), TNO-Stork (igniter), Sabca; *ground segment:* Vitrociset, Carlo Gavazzi, Nofrayane, Peyrani, OCI, Cegelec, Dataspazio, GTD, Laben

Vega's primary role is to fill a gap in Europe's line of launchers. While the market segment initially targeted was science satellites of 1000-1200 kg into LEO, later forecasts prompted a focus on polar-orbiting Earth observation satellites of 400-2500 kg. In addition, the need for microsatellite (50-200 kg) services increased significantly in recent market assessments. The launch service price will be €18.5 million, assisted by synergy with Ariane-5 production and operations and based on only 2-4 government and 1-2 commercial missions annually. Once operational, the service will be offered by Arianespace.

Vega began as a national Italian concept in the 1980s. BPD Difesa e Spazio in 1988 proposed a vehicle to the Italian space agency (ASI) to replace the retired US Scout launcher based around the Zefiro (Zephyr) motor developed from the company's Ariane expertise. The design was significantly reworked in 1994 towards the current configuration. Over the same period, CNES was studying a European Small Launcher drawing on Ariane-5 technology and facilities. Spain was also studying its own smaller Capricornio to operate from the Canary Islands.

In February 1998, ASI proposed Vega as a European project. In April 1998, ESA's Council approved a Resolution authorising programme start in June;

but this was only a limited declaration, approving the first step of pre-development activities, notably on solid-booster design. Step-1, running from June 1998 to September 1999, studied a Vega using a P85 first stage derived from Ariane-5's existing strap-on. At the October 1999 Council, France declined to support that approach. In November 2000, after a further trade-off between different vehicle configurations and options for the first and third stages, it was agreed to proceed with two strands: an advanced booster that could serve as both an improved Ariane-5 strap-on and as Vega's first stage, and the Vega programme itself.

The Vega Programme was approved by ESA's Ariane Programme Board on 27-28 November 2000, and the project officially started on 15 December 2000 when seven countries subscribed to the Declaration. ESA signed the €221 million development contract with ELV (European Launch Vehicle: 70/30% Avio/ASI) on 25 February 2003, at the same time as CNES on ESA's behalf signed the €40.7 million P80 development contract with Avio (then FiatAvio). Industry's own investment of P80 is €63 million. ELV is funding the qualification first launch, worth about €30 million.

The ESA cost-to-completion for Vega is €335 million (1997 conditions; 2004: €367 million), including the €44 million



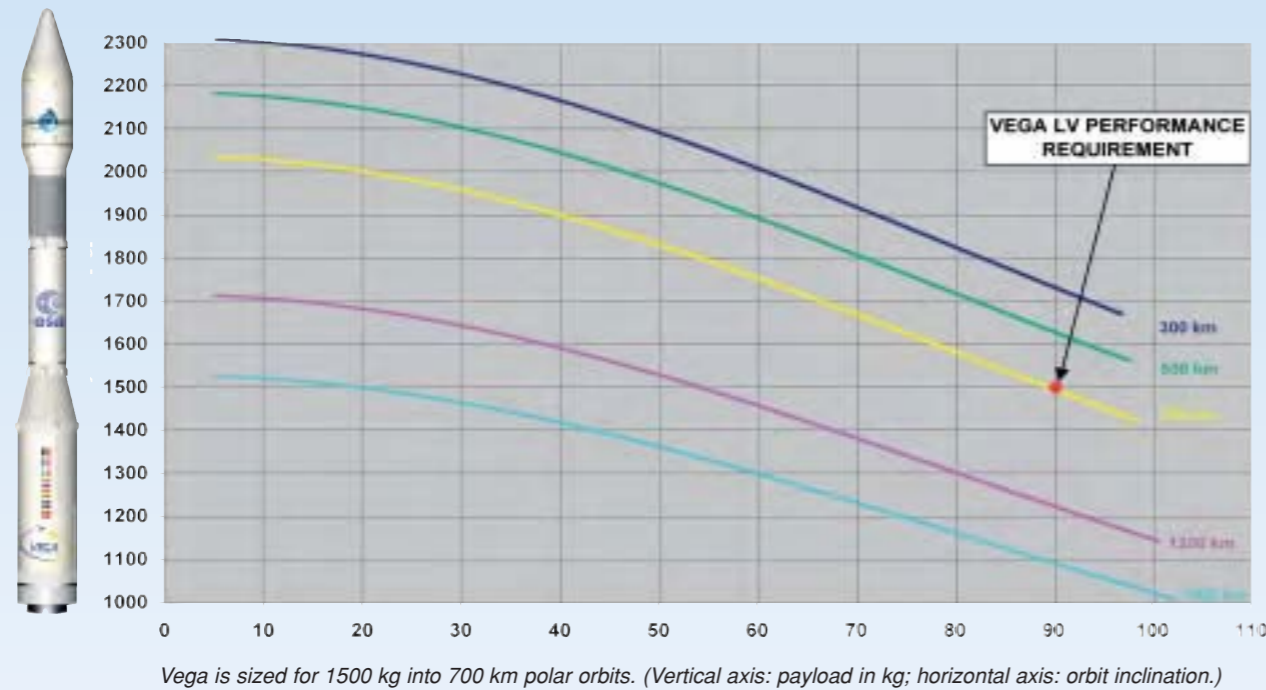

Stg 1 ignition/launch
 T (mission time) = 0 s
 z (altitude) = 0 km
 V (relative speed) = 0 m/s
 R (downrange) = 0 km

**Stg 1 burnout/sep,
 Stg 2 ignition**
 T = 107 s
 z = 44 km
 V = 1825 m/s
 R = 64 km

Stg 2 burnout
 T = 179 s
 z = 95 km
 V = 4120 m/s
 R = 271 km

**Stg 2 separation/
 Stg 3 ignition**
 T = 217 s
 z = 116 km
 V = 4072 m/s
 R = 423 km

Fairing separation
 T = 223 s
 z = 118 km
 V = 4162 m/s
 R = 445 km

**Stg 3 burnout/sep
 AVUM ignition 1**
 T = 329 s
 z = 146 km
 V = 7645 m/s
 R = 1205 km

**AVUM cut-off
 (transfer orbit)**
 T = 725 s
 z = 216 km
 V = 7912 m/s
 R = 4031 km

AVUM ignition 2
 T = 2870 s
 z = 698 km
 V = 7376 m/s
 R = 18553 km

**AVUM cut-off,
 circularisation**
 T = 3013 s
 z = 700 km
 V = 7522 m/s

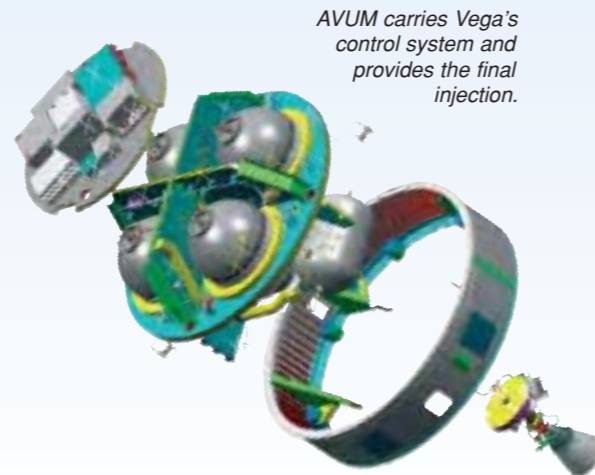

of Step-1. The national contributions are: Belgium 5.63%, France 15%, Italy 65%, Netherlands 3.5%, Spain 6%, Sweden 0.8%, Switzerland 1.34%.

The separate P80 Solid Propulsion Stage Demonstrator programme will cost a total of €123 million (2000 conditions), with €54 million from ESA, €63 million from Italy via the prime contractor and €6.6 million from Belgium via ESA's General Support & Technology Programme. The overall contributions are therefore (€ million): Belgium 6.6, France 45.1, Italy 68.6, Netherlands 2.7.

Vega's PDR was held Jun-Jul 2001, and the System Design Review Apr-May 2004. The System CDR is planned for Sep 2006 and the Qualification Flight in Nov 2007. P80's

PDR was held in Mar 2001; the CDR is planned for May 2006 after the development firing test of Jan 2006. P80's QM1 qualification firing test is planned for Jul 2006.

Vega will make maximum use of the existing Ariane infrastructure at Kourou. It was decided in Nov 2001 that it would reuse the old ELA-1 Ariane-1 pad. Launcher assembly and integration will be performed on the pad within the new Mobile Gantry (MG). Launch will be conducted from a dedicated room in the Ariane-5 CDL-3 control centre. Satellites will be processed in Kourou's existing EPCU payload facilities. The €48.7 million (2004 conditions) ground segment contract will be signed in 2005 with prime contractor Vitrociset (I).

Vega Characteristics

Total length: 30.22 m
 Principal diameter: 3.005 m
 Launch mass: 136.7 t (excluding payload)
 Launch thrust: 2700 kN sea level
 Capability: reference mission is 1500 kg into 700 km 90° orbit from Kourou.
 Injection accuracy: ±10 km altitude, ±0.1° inclination
 Reliability goal: 0.98
 Guidance: avionics mounted on AVUM

Stage-1

Principal contractor: Avio/Europropulsion
 Length: 11.713 m (aft skirt 70 cm; interstage 2138 mm, 14.5° slope)
 Principal diameter: 3.005 m
 Motor: P80, filament-wound graphite-epoxy casing, 88.4 t HTPB 1912, SI 279.5 s vac, 95 bar operating pressure, nozzle (carbon phenolic) expansion ratio 16 (3D carbon-carbon throat 468 mm dia), length 10.555 m, mass fraction 0.92
 Thrust: 2260/3050 kN avg/max vacuum
 Burn time: 106.7 s
 Steering: TVC by ±6.58° deflection of flexible nozzle joint by electromechanical actuators provides vehicle pitch/yaw control

Stage-2

Principal contractor: Avio
 Length: 5.790 m
 Principal diameter: 1.905 m
 Motor: Zefiro 23, filament-wound carbon-epoxy casing, 23.9 t HTPB 1912, finocyl grain, SI 288.6 s vac, 106 bar maximum operating pressure, nozzle expansion ratio 25 (throat 294 mm dia), mass fraction 0.92, EPDM insulation. Scaled up from Zefiro 16 (length 7.3 m); tested 18 Jun 1998, 17 Jun 1999, 15 Dec 2000 (QM1); planned: Dec 2005 & Dec 2006
 Thrust: 900/1200 kN avg/max vacuum
 Burn time: 72 s
 Steering: TVC by ±6.5° deflection of submerged flexible nozzle joint by electromechanical actuators provides vehicle pitch/yaw control, 3D carbon-carbon throat

Stage-3

Principal contractor: Avio
 Length: 3.767 m (aft interstage 163 mm, aluminium)
 Principal diameter: 1.905 m
 Motor: Z9 derived from Zefiro 16, filament-wound carbon-epoxy casing, 10 t HTPB 1912, finocyl grain, SI 294 s vac, 83 bar maximum operating pressure, nozzle expansion ratio 56 (throat 164 mm dia), mass fraction 0.925, EPDM insulation
 Thrust: 235/330 kN avg/max vacuum
 Burn time: 110 s
 Steering: as stage-2 except TVC ±6°

AVUM Attitude & Vernier Upper Module

AVUM provides the final injection accuracy, orbit circularisation, deorbit, roll control during stage-3 burn and 3-axis control during all coasts. Lower section is APM (AVUM Propulsion Module), upper is AAM (AVUM Avionics Module).
 Principal contractor: Avio (engine: Yuzhnoye, Ukraine)
 Length: 1.285 m (820 mm aft interstage)
 Principal diameter: 1.90 m
 Dry mass: 440 kg
 Propulsion: single 2450 N NTO/UDMH RD-869 engine for delta-V, SI 315.5 s, nozzle expansion ratio 102.5, chamber pressure 20 bar; 5-ignition capability; up to 550 kg propellant depending on mission: up to 367/183 kg NTO/UDMH in 4x142-litre tanks, pressurised to max 36 bar by He in 87-litre tank (310 bar). Two sets 3x50 N GN2 (310 bar in 87-litre tank) thrusters for attitude control
 Burn time: typically 400 s #1 + 143 s #2

Payload Fairing and Accommodation

Can carry a main payload and up to 6 microsats, or two payloads of 300-1000 kg each. Protected by Contraves 2-piece 500 kg fairing until it is jettisoned after about 223 s after stage-2 separation when heating <1135 w/m². Carbon skin on aluminium honeycomb. Total length 7.88 m, diameter 2.6 m; payload envelope 5.5 m high, 2.38 m diameter. Payload adaptor Ariane ACU 937B.
 Acceleration load (static): 5.5 g max longitudinal, 1 g lateral
 Acoustic: max 142 dB overall



ERA

Planned achievements: first European robot arm in space

Launch date: about November 2007

Mission end: 10 years

Launch vehicle/site: Proton from Baikonur Cosmodrome, Kazakhstan

Launch mass: 630 kg

Orbit: attached to International Space Station (altitude about 400 km)

Principal contractors: Dutch Space (prime), SABCA (MJS), NLR (MPTE), Spacebel/Trasys (IMMI, MPTE), EADS Astrium (EES, MJS, OBC), OG (CLU), Fiar (EMMI), HTS (MLS), Saab (OBC), Technospacio/Terma (software)

ESA's European Robotic Arm (ERA) will play an important role in assembling and servicing the International Space Station (ISS). It is a cooperative venture between ESA and Roskosmos, the Russian space agency. The project began as the Hermes Robot Arm (HERA) for ESA's Hermes mini-shuttle. When Hermes was discontinued, studies for the arm to fly on Russia's proposed Mir-2 second generation space station were conducted between Fokker (now Dutch Space) and RSC-Energia. These studies highlighted the value of a robotic manipulator in reducing the time needed for expensive manned activities in a hazardous environment.

Following Russia joining the ISS programme in 1993, the arm was formally incorporated into the station's Russian Segment in July 1996. It was to be mounted on Russia's Science and Power Platform (SPP), launched together on the US Shuttle in 1999. Among its first tasks

was installing the SPP's solar arrays. Russian funding problems indefinitely postponing work on the SPP and Shuttle difficulties stretching out the ISS assembly sequence pushed ERA's launch beyond 2005 even though ESA could have had it flight-ready in 2002. The goal now is to launch it in 2007 as part of Russia's Multipurpose Laboratory Module (MLM), built using the Zarya backup vehicle. ERA passed its Qualification & Acceptance Review in October 2003, certifying it flightworthy. Cost to ESA by end-2003 was €188 million (2003 conditions).

ERA is functionally symmetrical, with each end sporting an 'End-Effector' that works either as a hand or as a base from which the arm can operate. There are seven joints (in order: roll, yaw, pitch, pitch, pitch, yaw, roll), of which six can operate at any one time. This configuration allows ERA to relocate itself on to different basepoints, using a camera on the End-Effector to locate a basepoint accurately.

Each End-Effector includes a special fixture to grapple and carry payloads of up to 8 t. Through this fixture, the arm can supply power and exchange data and video signals. In addition, it features a built-in Integrated Service Tool that can activate small mechanisms in the grappled payload. Equipped with a foot restraint, ERA can carry spacewalking cosmonauts,

ERA Characteristics

Total length:	11.30 m
Reach:	9.70 m
Mass:	630kg
Payload positioning accuracy:	5 mm
Payload capability:	8000 kg
Maximum tip speed:	20 cm/s
Stiffness (fully stretched):	>0.4 N/mm
Operating power:	475/800 W avg/peak
Arm booms:	carbon fibre, 25 cm dia

Preparing for thermal-vacuum testing of the Engineering Qualification Model at ESTEC, November 1999.



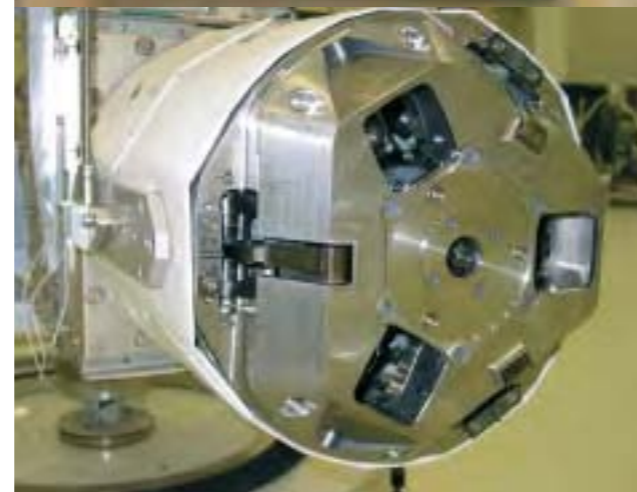
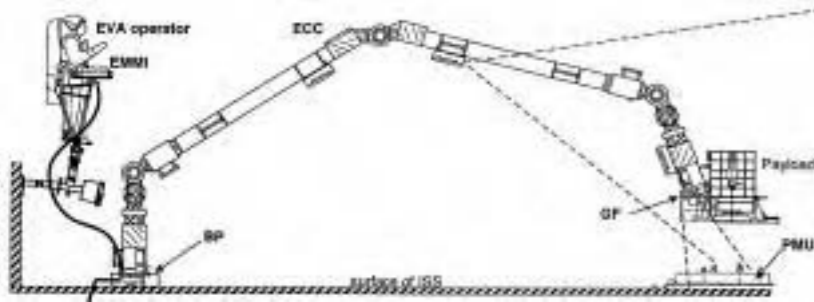

The EMMI control panel (upper left) is used by a spacewalking cosmonaut (upper far left). Cosmonauts inside the Space Station control ERA via IMMI's computer-generated views (lower far left). Lower left: the End-Effector. The hardware shown in both cases is the Flight Model at Dutch Space, February 2002.

ERA principal features. CLU: Camera & Lighting Unit; ECC: ERA Control Computer; EES: End-Effector System; GF: Grapple Fixture; MJS: Manipulator Joint System; MLS: Manipulator Limb System. Should there be a serious failure, it is divided at the ends of the limbs into three ERA (Orbit) Replaceable Units (ERUs). There are spares of the elbow section and one wrist section, making two-thirds of a flightworthy arm.

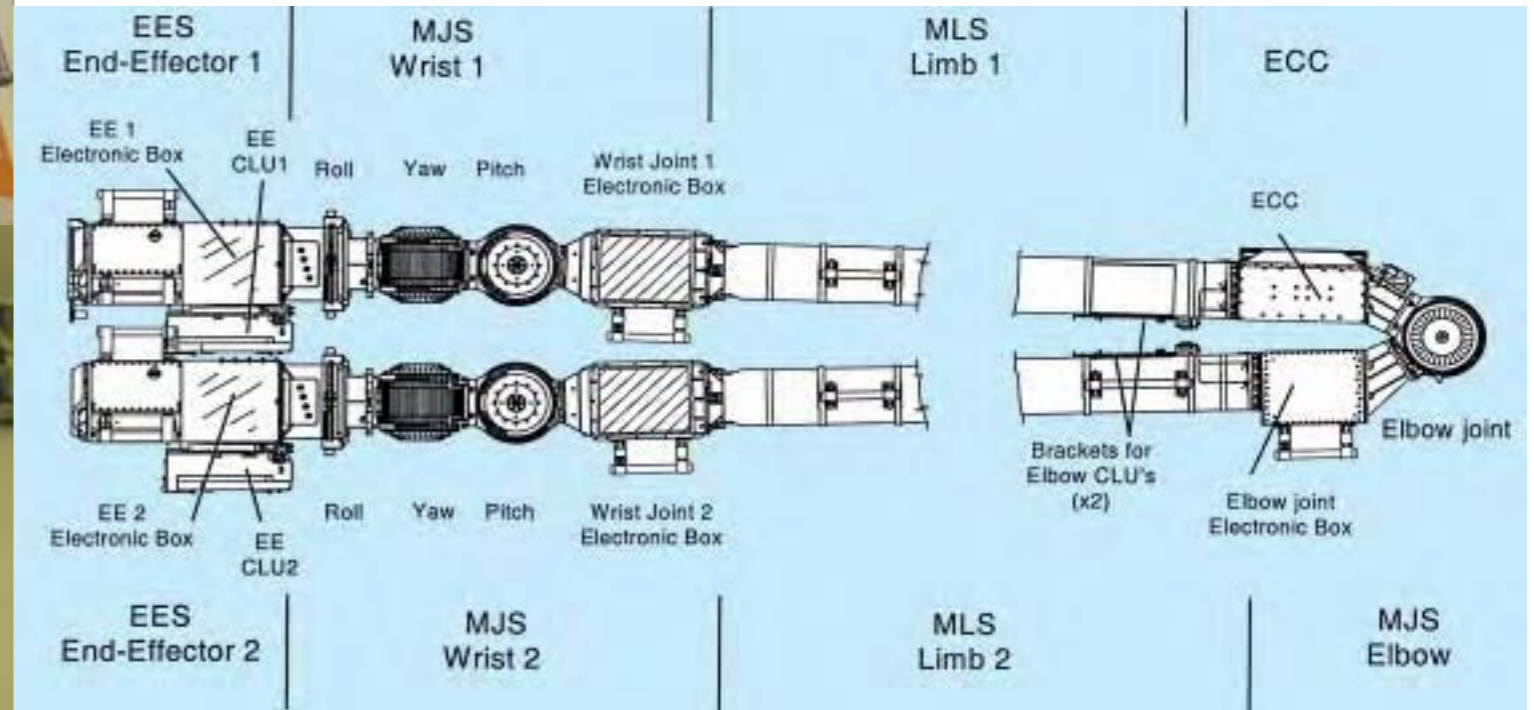

providing them with a platform as they work in weightlessness.

Unusually, ERA's main computer is mounted on the arm itself, providing a simpler control interface. It can be controlled from inside the Station, using the Internal Man-Machine Interface (IMMI) at the Zvezda module's central control post. IMMI's synoptic display provides computer-generated detailed and overview pictures of ERA and its surroundings. In addition, monitors display video images from ERA and the Station's external cameras. ERA can also be operated by a spacewalker via the External Man-Machine Interface (EMMI) control panel. Commands are entered via toggle switches, while LEDs display arm status and operations progress. Both approaches offer an automatic mode (using

prepared mission plans), semi-automatic mode (standard autosequences) and manual mode (controlling the individual joints).

Cosmonauts train on the Mission Planning and Training Equipment (MPTE), a realistic simulator of the arm and its environment. At its core is a fully flight-representative ERA onboard computer using the full flight software. The MPTE, including fully functional models of IMMI and EMMI and using their flight software, is located in Russia at RSC-Energia and the Gagarin Cosmonaut Training Centre, and at ESTEC in the ERA Support Centre. The ESTEC MPTE additionally includes the ERA Software Maintenance Facility (SMF). The Russian MPTEs are used to train ERA's cosmonaut operators and generate ERA flight procedures for

transmission to the Space Station. The MPTE can also provide on-line support during ERA operations, and play back and analyse actual operations. ESTEC's MPTE support these activities.

Crews aboard the Station will maintain their expertise via a special 'Refresher Trainer'. This is a reduced ERA simulation built into a standalone laptop. They can practise an entire ERA operation before it is done for real.

There are three main development models. The Engineering/Qualification Model (EQM) was tested in November 1999 in the Large Space Simulator at ESTEC to check its thermal balance. The Flight Model underwent EMC and vibration testing at ESTEC at the end of 2000. The



ERA will be launched on the Multipurpose Laboratory Module in 2007.

Flight Spare consists of a wrist and elbow ERUs, making two-thirds of a flightworthy arm.

Under the July 1996 agreement, Russia takes ownership of the flight hardware once it is launched, in exchange for which ESA will participate in robotics activities aboard the Station and Agency astronauts will train at the Gagarin centre.

ADM-Aeolus

Planned achievements: the first direct global wind profile measurements throughout the atmosphere

Launch date: planned for September 2008

Mission end: after 3 years (1-year extension possible)

Launch vehicle/site: to be selected (Vega/Dnepr/Rocket-class)

Launch mass: 1200-1400 kg (650 kg platform; 450 kg payload)

Orbit: planned 408 km circular, 97.06° Sun-synchronous (18:00 local time ascending node)

Principal contractors: EADS-Astrium (UK); Phase-A June 1998 - June 1999; Phase-B July 2002 - September 2003; Phase-C/D October 2003 - September 2008, CDR September 2005

Aeolus, the Atmospheric Dynamics Explorer (ADM), will be the first space mission to measure directly wind speeds throughout the depth of the atmosphere. It is expected to provide an improvement in weather prediction. At the moment, wind measurements are taken from the ground with instruments such as anemometers, and higher in the atmosphere using weather balloons and radar profilers. There are large portions of the atmosphere that are not regularly observed – a major deficiency. The Aeolus wind profiles will be invaluable for weather forecasting and climate studies, improving the accuracy of numerical weather forecasting, advancing our understanding of tropical dynamics and processes involved in climate variability and climate modelling. In particular, it will also improve our predictions of severe storms. It is envisaged that Aeolus will be the forerunner of a series of similar operational meteorological satellites.

Aeolus was selected in 1999 as the second Earth Explorer Core mission in the Living Planet programme. Four candidate Core missions were selected in May 1996 for 12-month Phase-A studies, completed in June 1999. GOCE and Aeolus were selected in November 1999 for Phase-B. The €157.9 million

Phase-C/D/E1 contract was signed 22 October 2003 with EADS Astrium (UK). The ESA projected cost-at-completion is €319.9 million (2004 conditions).

The heart of Aeolus is the ALADIN (Atmospheric Laser Doppler Instrument) lidar emitting ultraviolet pulses. The backscatter from the atmosphere and the Earth's surface will be analysed to measure cross-track wind speeds in slices up to 30 km altitude. The lidar exploits the Doppler shifts from the reflecting aerosols (Mie scattering) and molecules (Rayleigh scattering) transported by the wind. In addition, information can be extracted on cloud cover and aerosol content. UV radiation is heavily attenuated by

Mission Objectives

- to measure global wind profiles up to altitudes of 30 km;
- to measure wind to an accuracy of 1 m/s in the planetary boundary layer (up to altitudes of 2 km);
- to measure wind to an accuracy of 2 m/s in the free troposphere (up to altitudes of 16 km);
- to determine the average wind speed across 50 km tracks;
- to measure 120 wind profiles per hour.



ADM-Aeolus Payload

ALADIN

The Atmospheric Laser Doppler Instrument (ALADIN) uses a 1.5 m-dia main Cassegrain SiC mirror. Diode-pumped Nd:YAG laser generates 355 nm 150 mJ 100 Hz pulses for 7 s (+1 s warm-up) every 28 s. ALADIN aims 35° off-nadir and at 90° to the flight direction to avoid Doppler shift from its own velocity. A measurement is made every 200 km over a length of 50 km (integrated from 3.5 km steps; 1 km steps possible) in 7 s. A wind accuracy of 2-3 m/s is required, for vertical steps selectable 0.5-2 km. Two optical analysers measure respectively the Doppler shift of the molecular scattering (Rayleigh) and scattering from aerosols and water droplets (Mie).

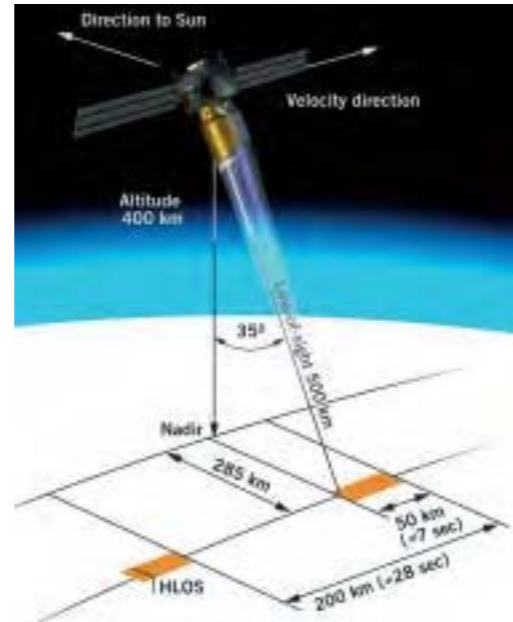

Thermal: instrument dissipation of 500 W via heat pipes to +Y face to deep space. 215 W from electronics boxes mounted on ±X walls.

Power system: two 3-panel wings (total 13.4 m²) of GaAs cells providing 2200 W EOL (1.4 kW required), supported by 84 Ah Li-ion battery. System design driven by laser pulse power.

Communications: raw data downlinked at 10 Mbit/s on 5.6 W SSPA 8.040 GHz X-band to Svalbard (N) ground station. 2 kbit/s TC & 8 kbit/s TM S-band. X-band antenna mounted on lidar baffle. Aeolus controlled from ESOC via Kiruna. ESRIN will process & calibrate the data before sending it to the European Centre for Medium-Range Weather Forecasts (UK), which will be responsible for quality control and dissemination within 3 h of observation to meteorological centres and other users.

cloud, so a complete wind profile can be derived only in a clear or partly cloud-free atmosphere through cloud gaps. In an overcast sky, wind profiles can be derived for the layers above the clouds.

Satellite configuration: conventional box-shaped bus with four side walls attached to central thrust cone by flat shear walls. Electronics mounted on ±X walls (acting as radiators) that also carry the solar wings. Lidar mounted on cone by three bipods.

Attitude/orbit control: the dawn-dusk orbit means that the +Y axis always faces away from the Sun, and the solar wings can be fixed ±X aft/forward along the line of flight. Attitude control to 50 μrad by four 40 Nms reaction wheels & three 400 Am² magnetorquers. Pointing knowledge 30 μrad from two star trackers, gyros, GPS receiver, two 3-axis magnetometers & coarse Earth/Sun sensors. Four 5 N hydrazine thrusters for orbit adjust; 116-266 kg propellant in two tanks.



1. X-band antenna
2. coarse Earth/Sun sensor
3. orbit-adjust thruster
4. startracker
5. inertial measurement unit
6. hydrazine tanks
7. reaction wheels (x4)
8. laser cooling radiator
9. S-band antenna
10. power control & distribution unit
11. Li-ion battery
12. ALADIN control & data management

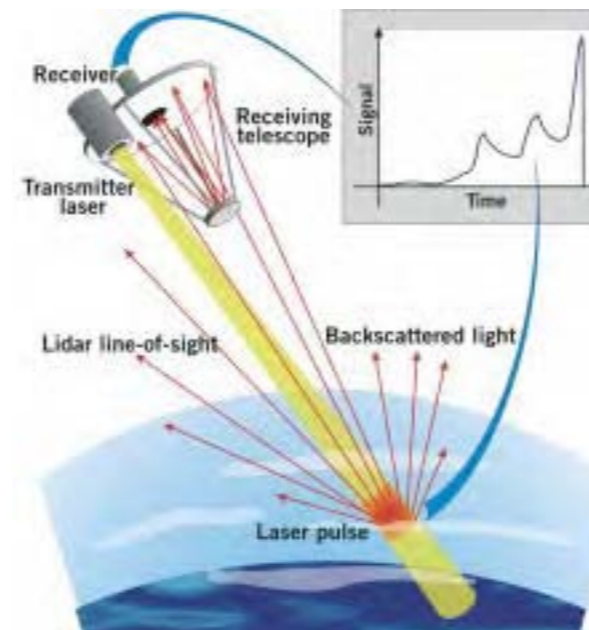

The centre frequency of the backscattered light is shifted by the wind speed in the measurement direction, and the random motion of the air molecules broadens the frequency width of the backscattered Rayleigh signal. Time corresponds to altitude.

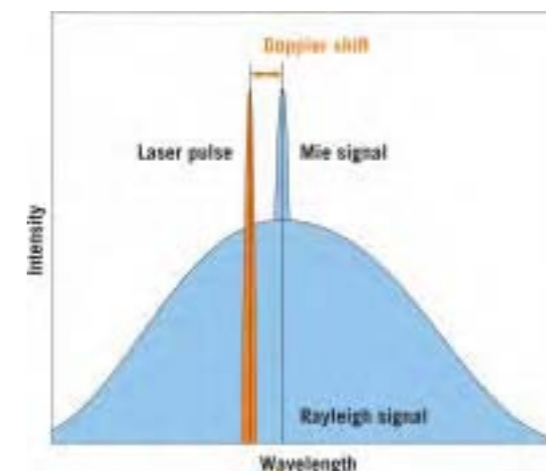

LISA Pathfinder

Planned achievements: demonstrate technologies for ground-breaking LISA mission

Launch date: planned for February 2008

Mission end: nominally end-2008

Launch vehicle/site: to be selected, but Rockot/Dnepr-class

Launch mass: 1820 kg (on-station 470 kg, payload 200 kg)

Orbit: halo orbit around L1

Principal contractors: EADS Astrium Ltd (UK; prime, platform), EADS Astrium GmbH (LTP, DFACS), SciSys Ltd (software); System & Technology Study June 1999 - February 2000; Ph-A/B1 September 2001 - July 2002, parallel studies EADS Astrium Ltd & CASA; Extended Definition Phase November 2002 - January 2004; Implementation Phase (Ph-B2/C/D) 4 February 2004 - January 2008

LISA Pathfinder was formally approved by ESA in 2004 in order to demonstrate the demanding technologies required for the LISA mission; see the separate LISA entry for details.

Despite the simplicity of the LISA concept, the challenges are enormous. The main difficulty is keeping the test masses in a near-perfect free-fall trajectory via the drag-free system. This means keeping each proof mass within an enclosure that suppresses disturbances from external forces, such as aerodynamic and radiation pressures, and internal forces, such as electromagnetic. This protection is achieved by a combination of extremely accurate construction of the entire spacecraft and the use of the Drag-Free Attitude Control System (DFACS). DFACS is based on measuring the displacement

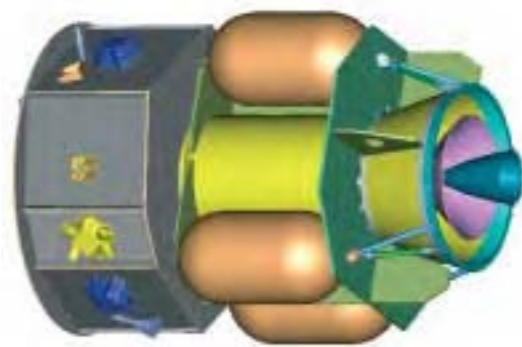

LISA Pathfinder uses a propulsion module (right) to carry it to the L1 halo orbit.

of the test masses inside their enclosures using capacitive sensors and laser metrology, and controlling the motion of the spacecraft surrounding the masses via ultra-precise micro-thrusters.

The free-fall conditions required to prove DFACS cannot be reproduced on Earth so, to demonstrate this and the other key technologies for LISA, ESA decided to undertake the LISA Pathfinder precursor project (formerly SMART-2). LISA Pathfinder will carry the LISA Technology Package (LTP), provided and funded by European institutes, and a Disturbance Reduction System (DRS) that is very similar to LTP and has the same goals, but comes from NASA. LTP represents one arm of the LISA interferometer, in which the separation of two proof masses is reduced from 5 million km to 30 cm. LTP will:

- demonstrate DFACS using two proof masses with a performance of $10^{-14} \text{ ms}^{-2}/\sqrt{\text{Hz}}$ in the bandwidth 10^{-3} - 10^{-1} Hz (LISA requirement is $10^{-15} \text{ ms}^{-2}/\sqrt{\text{Hz}}$);
- demonstrate laser interferometry in the required low-frequency regime with a performance as close as possible to that required for LISA ($10^{-11} \text{ m}/\sqrt{\text{Hz}}$ in the frequency band 10^{-3} - 10^{-1} Hz)

- assess the longevity and reliability of the LISA sensors, thrusters, lasers and optics in space.

The environment on the LISA Pathfinder spacecraft will be comparatively noisy in terms of temperature fluctuations and residual forces, so the specifications are about a factor of 10 more relaxed than those for LISA itself.

The orbital transfer, initial set-up and calibration are followed by the LTP demonstration (90 days), DRS (70 days) and 20 days of joint operations, providing timely feedback for the development of LISA itself.

LISA Pathfinder was confirmed by the SPC in November 2003 (in favour of the Eddington mission), and received its final formal approval 7 June 2004; Multilateral Agreements are being signed with national agencies. The projected cost-at-completion to ESA is €160million (2004 conditions). The €80 million prime contract (ITT released April 2003) with EADS Astrium was signed 23 June 2004. LTP Co-PIs are S. Vitale (Trento Univ., I) and K. Danzmann (Albert Einstein Inst., Hannover, D); LTP is funded by ASI, DLR, Max Planck Inst. and other national contributions.

Previously, SMART-2 was proposed to include a second satellite, to demonstrate the formation-flying and inter-satellite metrology required for the Darwin mission, but this approach was dropped in 2002.

Satellite configuration: octagonal bus 2.1 m dia, 1.0 m high, CFRP (low thermal expansion).

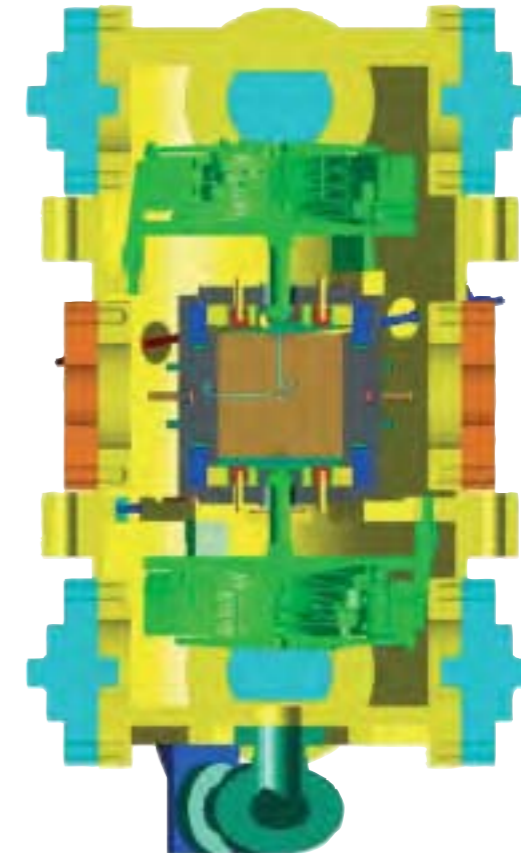

The LTP inertial sensor. The 46 mm proof mass cube is surrounded by the electrode housing in a vacuum enclosure. Optical windows allow the laser beam to be reflected by the cube faces. UV optical fibres illuminate the cubes to discharge any charging produced by cosmic rays. The proof mass is held in a safe position during launch by a 'caging' mechanism.

Attitude control: as LISA. Chemical propulsion module (1400 kg, 2.0 m-dia, 1.8 m-high, CFRP, single 400 N NTO/MMH engine) jettisoned after 5-week transfer from Earth; 8x10 N hydrazine thrusters provide 3-axis control and orbit adjust. Attitude from star trackers, Sun sensors.

Power system: 650 W on-station, provided from GaAs cells on circular top face, supported by single 36 Ah Li-ion battery.

Communications: 10 cm-dia X-band antenna transmits payload and housekeeping data at 16 kbit/s to the 15 m ESA dish, 4 kbit/s TC. Mission operations at ESOC.

Swarm

Planned achievements: most detailed measurements ever of Earth's magnetic field and its environment

Launch date: planned for 2009

Mission end: after about 4.5 years

Launch vehicle/site: Dnepr/Vega/Rocket-class

Launch mass: each identical Swarm satellite 300-400 kg

Orbit: planned Swarm-A/B 450 km (separated east-west by 150 km at equator);

Swarm-C 530 km; inclinations between 86-88°. Swarm-C drifts relative to Swarm-A/B with time

Principal contractors: Phase-A Astrium GmbH and OHB System, Phase-A May 2003 - March 2004; Phase-B (prime to be selected) 2005, Phase-C/D 2006 - 2009

Swarm will provide the most detailed survey of the Earth's magnetic field and its changes over time, providing new insights into our planet's interior and climate. Swarm was selected as the third Earth Explorer Opportunity mission in ESA's Living Planet programme. Like its predecessors, it is being developed quickly in response to a pressing environmental concern. The AO was released on 1 June 2001 and 25 full proposals were received by closure in January 2002. The ESA Programme Board for Earth Observation selected three on 16 May 2002 for Phase-A studies: Swarm, ACE+ (Atmospheric Climate Explorer) and EGPM (European Global Precipitation Mission). The parallel 10-month studies on Swarm were completed by Astrium GmbH and OHB System in March 2004. Swarm was selected by the Programme Board on 28 May 2004 for full development. As an Opportunity mission, it is dedicated to research. Drs Eigil Friis-Christensen (Danish National Space Centre), Hermann Lühr (GeoForschungsZentrum, Potsdam, D) and Gauthier Hulot (Inst. Physique du Globe de Paris, F) led the science team that proposed the mission to ESA; the Agency has overall mission responsibility. ESA projected cost-at-

Swarm, with the closest satellite in a higher orbit. The booms trail behind the satellites.

completion is €170 million (2004 conditions).

The powerful and complicated magnetic field created deep inside the Earth protects us from the continuous flow of charged particles, the solar wind, before it reaches the atmosphere. The field is generated by the turbulent motions of molten iron in the planet's outer core acting like a dynamo. The dominant axial dipole component, however, is weakening ten times faster than it would naturally decay if the dynamo were switched off. It has fallen by almost 8% over the last 150 years, a rate comparable to that seen at times of magnetic reversals. However, in regions like the South Atlantic Anomaly the field has weakened by up to 10% in the last 20 years alone.

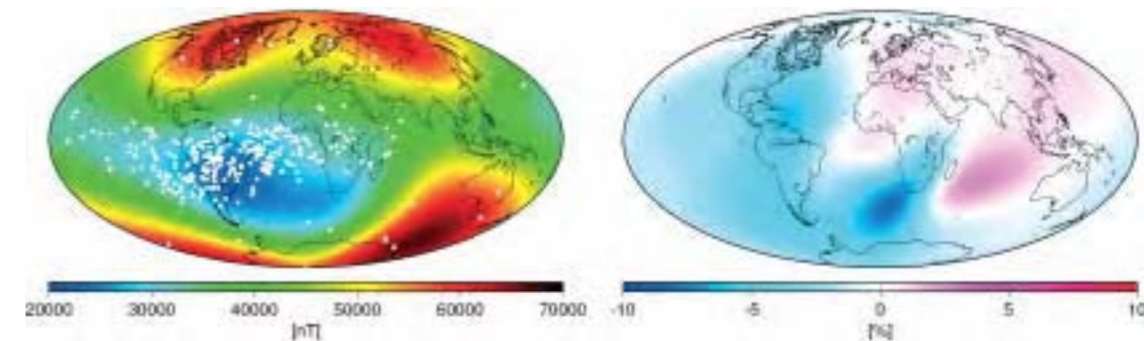
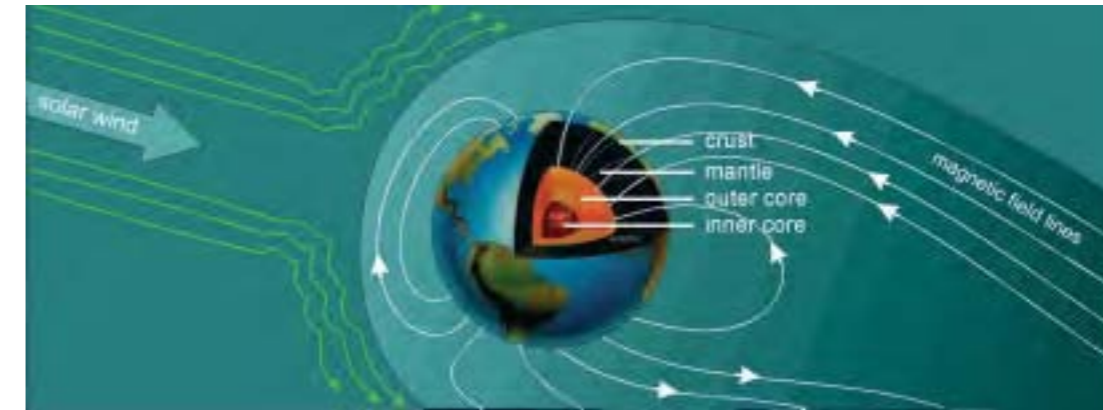

The magnetic field strength at the Earth's surface. The South Atlantic Anomaly is evident from the weak field. The white dots show where the Topex/Poseidon satellite suffered radiation upsets. The change in field strength over 20 years (from Magsat to Ørsted) is shown in percentage terms. (right).

Understanding how this thinning shield will change in the future is so important that new and unique satellite measurements are required.

Swarm will use a constellation of three satellites in polar orbits at initial altitudes of 450 km and 530 km for high-precision and high-resolution measurements of the strength and direction of the magnetic field. Swarm will take full advantage of a new generation of magnetometers for measurements over different regions of the Earth simultaneously. GPS receivers, an accelerometer and an electric field instrument will provide supplementary information for studying the interaction of the magnetic field with other terrestrial features; for example, Swarm could

provide independent data on ocean circulation.

In parallel, other issues could also be addressed:

- in conjunction with recent advances in numerical and experimental dynamos, better mapping of the geomagnetic field with time will provide new insights into field generation and diffusion, and mass and wave motions in Earth's fluid core. Progress in geomagnetic research calls for moving beyond simple extrapolation of the field with time to forecasting that field via a better understanding of the underlying physics.
- the magnetism of the lithosphere, which tells us about the history of

Simulated results from Swarm at 400 km altitude. After progressive elimination of each dominant field effect, weaker sources are revealed. From left: core; magnetosphere; ionosphere; crust; ocean currents.

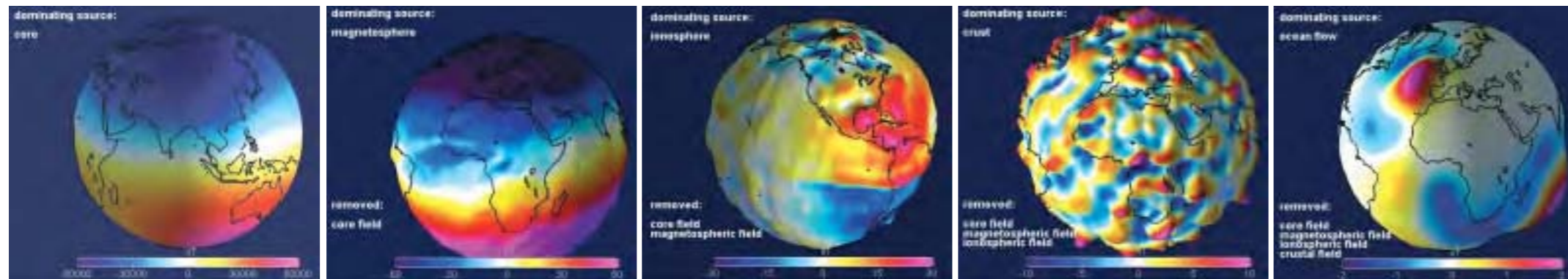

the global field and geological activity, could be determined with much higher resolution. This will be a bridge between knowledge of the lower crust from previous satellite missions, and knowledge of the upper crust from aeromagnetic surveys. The changing field might also have affected the climate over history by affecting the escape to space of atmospheric gases.

- global 3-D images of the mantle's electrical conductivity would be possible for the first time. These would provide clues to the chemical composition and temperature, fundamentally important for understanding mantle properties and dynamics.
- the magnetic field is of primary importance for the Earth's external environment, providing information about the connected Sun-Earth system.

Magnetic sensors on or near the Earth's surface measure a combination of the core field tangled with others from magnetised rocks in the crust, electrical currents flowing in the ionosphere, magnetosphere and oceans, and currents induced in the Earth by external fields. The challenge is to separate the magnetic field from all these other sources, each with its own spatial and time characteristics.

The core field and, in particular, how it changes with time are among the very few means available for probing the

On 25 October 2003, Japan's Midori-2 ceased operation above the Pacific, a little westward of Peru, possibly as a result of the huge geomagnetic storm under way at that time. This region in the southern hemisphere is known to be the place of many spacecraft failures owing to the reduced magnetic field intensity allowing damaging particle radiation to leak through the Earth's magnetic shield. This was the latest in a series of radiation-induced satellite failures in recent years, mainly in the South Atlantic Anomaly, where the field is particularly weak.

Earth's liquid core. Variations with time directly reflect the fluid flows in the outermost core and provide a unique experimental constraint on geodynamo theory. But a serious limitation on investigating internal processes over months to years is the effect of external magnetic sources that contribute on time-scales up to the 11-year solar cycle. All this clearly shows the need for a comprehensive separation and understanding of external and internal processes.

Recent studies have greatly improved our global and regional knowledge of the magnetisation of the crust and uppermost mantle. However, fundamental unresolved questions remain about the magnetic field of the lithosphere and the electrical conductivity of the mantle. The key to answering these questions is high-resolution measurements in space

and time on global and regional scales.

The geomagnetic field is not only important for learning about the origin and the evolution of our planet. While it is well-known that the air density in the thermosphere is statistically related to geomagnetic activity, recent results suggest that it is also locally affected by geomagnetic activity in a way that is still poorly understood. Furthermore, the magnetic field is a shield against high-energy particles from the Sun and deeper space. It controls the location of the radiation belts, and also the paths of incoming cosmic ray particles, which reflect the physical state of the heliosphere. The interplanetary medium controls the energy input into the Earth's magnetosphere and the development of magnetic storms, in short: Space Weather. Numerously reported, but still poorly understood, correlations between solar activity and climate variations have recently been related to the flux of high-energy cosmic ray particles from space and the Sun.

No other single physical quantity can be used for such a variety of studies related to our planet. Highly accurate and frequent measurements of the magnetic field will provide new insights into the Earth's formation, dynamics and environment, stretching all the way from the Earth's core to the Sun.

Swarm Payload	
Absolute Scalar Magnetometer (ASM)	To measure magnetic field strength and to calibrate VFM to maintain the absolute accuracy during the multi-year mission. On the boom.
Vector Field Magnetometer (VFM)	To measure the magnetic field vector, on the boom, together with startracker for precise attitude measurement.
Electrical Field Instrument (EFI)	To measure local ion density, drift velocity and electric field. Also for plasma density mapping in conjunction with GPS.
Accelerometer (ACC)	To measure non-gravity accelerations, such as air drag and solar radiation.
GPS Receiver (GPS)	To determine precise position, speed and time.
Laser Retroreflector (LRR)	Orbit determination to cm-accuracy by laser ranging.

Satellite configuration: magnetically clean, with VFM & ASM on deployed boom (~4-6 m). Size: 6-8 m long (boom deployed behind), 1.5-2 m wide, 0.8-1.1 m high.

Attitude/orbit control: attitude determination by startracker, magnetometer, coarse Sun/Earth sensors; 3-axis control by 1 N cold-gas thrusters & magnetorquers. Propellant about 50 kg in 2 tanks.

Power system: two panels (4.4-4.7 m²) of GaAs cells provide 105-160 W, supported by 36 Ah Li-ion battery.

Communications: Mission Control at ESOC, via Kiruna. Data processing & archiving at ESRIN. Science data downlink 1-5 Mbit/s S- or X-band; 125 Mbyte/day; onboard storage S-band for satellite TM/TC.

JWST

Planned achievements: observe the Universe back to the time of the first stars;
extend the NASA/ESA Hubble Space Telescope collaboration

Launch date: about August 2011

Mission end: after 5 years (consumables sized for 10 years)

Launch vehicle/site: Ariane-5 ECA from ELA-3, Kourou, French Guiana

Launch mass: about 5400 kg (1400 kg science module)

Orbit: planned 250 000-800 000 km 6-month halo orbit around L2 Lagrangian point, 1.5 million km from Earth

Principal contractors: Northrop Grumman (spacecraft). ESA

Assessment/Pre-Definition November 2000 - June 2003, Definition (Ph-A/B1) September 2003 - May 2004, Implementation (Ph-B2/C/D) July 2004 - March 2009, for ESA hardware delivery to NASA in March 2009

The NASA/ESA Hubble Space Telescope (HST) is one of the most successful astronomical space projects ever undertaken. The equal access to the observatory gained through ESA's active participation in the mission from the very beginning is hugely beneficial to European astronomers.

Since 1996, NASA, ESA and the Canadian Space Agency (CSA) have been collaborating on a worthy successor to HST – the James Webb Space Telescope (JWST; Next Generation Space Telescope until September 2002). By participating at the financial level of a Flexi-mission, ESA has a partnership of about 15% in the observatory as well as continued access to HST. In October 2000, ESA's Science Programme Committee approved a package of missions for 2008-2013, including JWST as the F2 Flexi mission. ESA's projected cost-at-completion is €130 million (2004 conditions, excluding launch); NASA \$1.6 billion.

JWST is a 6.5 m-class telescope, optimised for the near-IR (0.6-5 μm) region, but with extensions into the visible (0.6-1 μm) and mid-IR (5-27 μm). The large aperture and shift to the infrared is driven by the desire of astronomers to probe the Universe back in time and redshift to the epoch of 'First Light', when the very first stars began to shine,

perhaps less than 1000 million years after the Big Bang. Nonetheless, like HST, JWST is a general-purpose observatory, with a set of instruments to address a broad spectrum of outstanding problems in galactic and extragalactic astronomy. In contrast with its predecessor, JWST will be placed in a halo orbit around the L2 Lagrangian point, so will not be accessible for servicing after launch.

The Design Reference Mission covers the first 2.5 years of observations, with 23 programmes touching almost all areas of modern astrophysics:

- cosmology and structure of the Universe,
- origin and evolution of galaxies,
- history of the Milky Way and its neighbours,
- the birth and evolution of stars,
- origins and evolution of planetary systems.

Following the bid submission in October 2001, NASA awarded the \$825 million contract for building the observatory to Northrop Grumman Space Technology (formerly TRW) in 2002.

Detailed assessment studies of a wide range of instrument concepts for JWST were funded by the three agencies and carried out by their scientific communities and industries. Based on these studies,

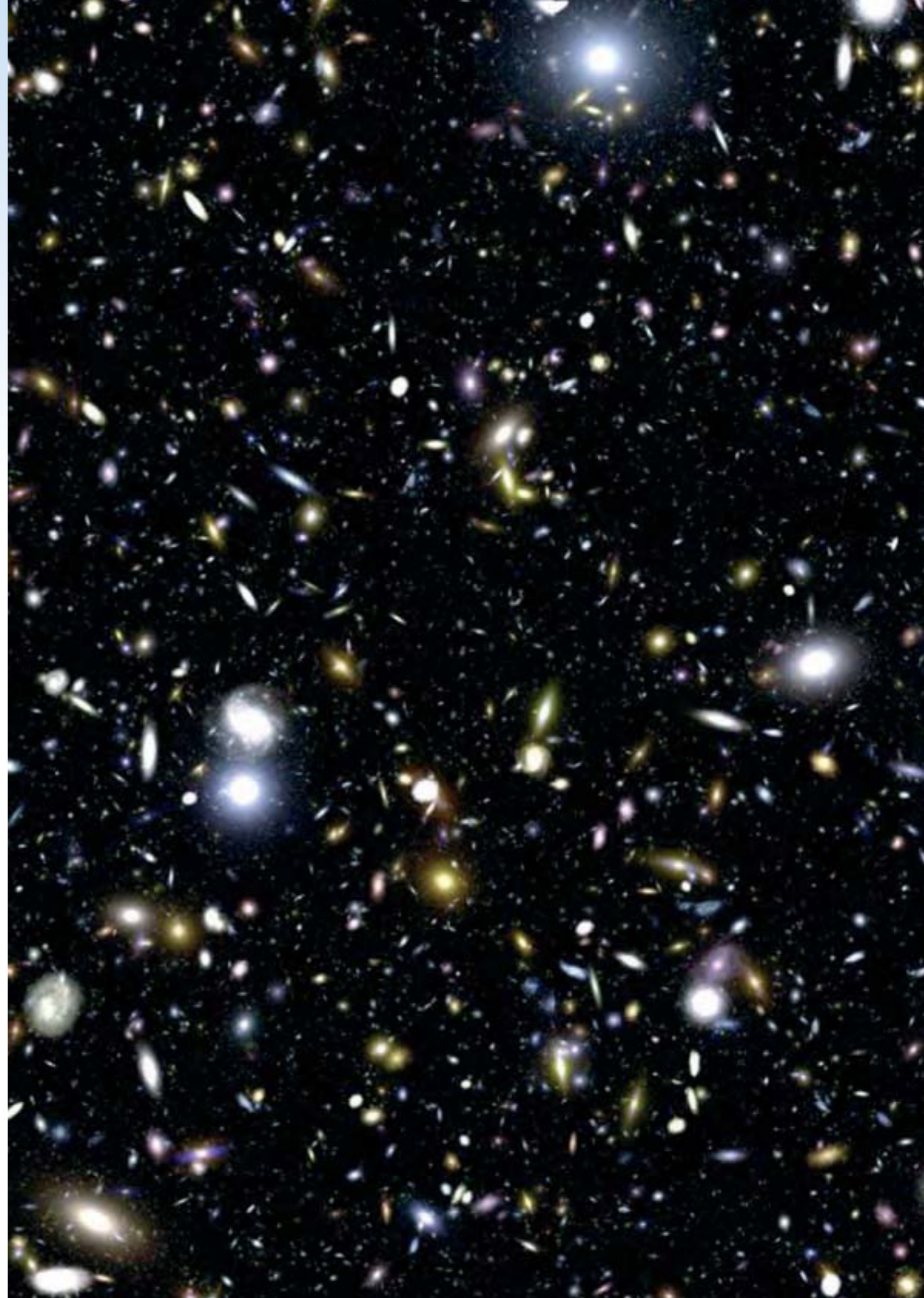

JWST Science Goals

- Formation and evolution of galaxies (imaging & spectra).
- Mapping dark matter
- Searching for the reionisation epoch.
- Measuring cosmological parameters.
- Formation and evolution of galaxies – obscured stars and Active Galactic Nuclei.
- Physics of star formation: protostars.
- Age of the oldest stars.
- Detection of jovian planets.
- Evolution of circumstellar discs.
- Measure supernovae rates.
- Origins of substellar-mass objects.
- Formation and evolution of galaxies: clusters.
- Formation and evolution of galaxies near AGN.
- Cool-field brown dwarf neighbours.
- Survey of trans-neptunian objects.
- Properties of Kuiper Belt Objects.
- Evolution of organic matter in the interstellar medium (astrobiology).
- Microlensing in the Virgo cluster.
- Ages and chemistry of halo populations.
- Cosmic recycling in the interstellar medium.
- IR transients from gamma-ray bursts and hosts.
- Initial Mass Function of old stellar populations.



The winning 2002 design for the JWST spacecraft, from Northrop Grumman.

Simulated JWST image with redshifts marked. JWST could detect some 100 galaxies with redshifts > 5 in this small fraction (< 1%) of the camera field of view. (STSci)

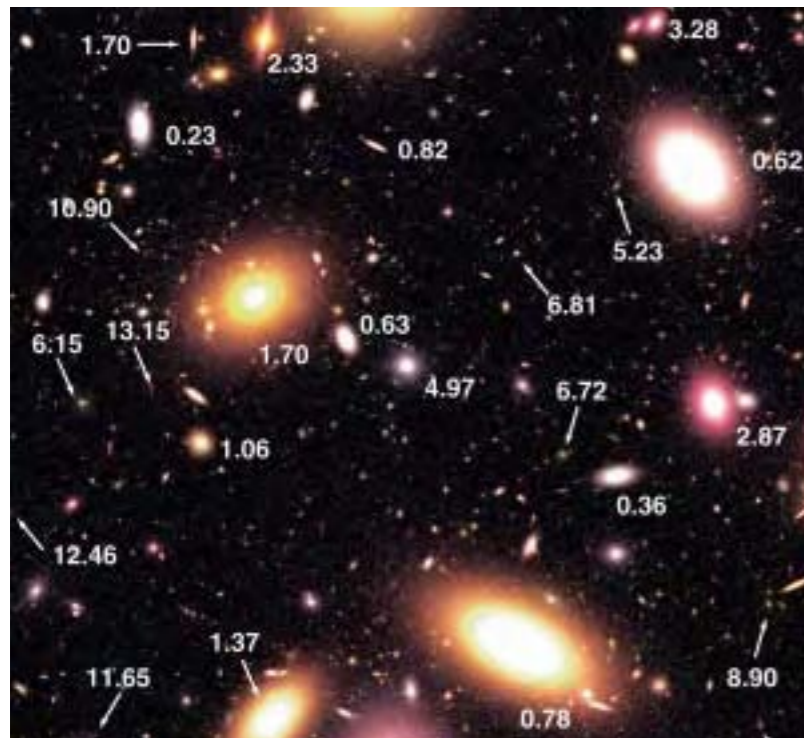

the suite consists of three core instruments:

- NIRCam: a near-IR Wide-Field Camera covering 0.6-5 μm ;
- NIRSpec: a near-IR Multi-Object Spectrograph covering 0.6-5 μm ;
- MIRI: a mid-IR combined Camera/Spectrograph covering 5-27 μm .

In addition, the Fine Guidance Sensor (Canada) provides near-IR 0.6-5 μm imaging.

Guided by this recommendation, the three agencies agreed in July 2000 on their contributions. ESA's closely follows the HST model, with three main elements:

Scientific instrumentation: ESA is procuring about half of the core payload, principally providing

NIRSpec and, through special contributions from its Member States, 50% of MIRI (optics, structure and mechanisms), being developed jointly by NASA/ESA/CSA.

Non-instrument flight hardware: ESA will provide the Ariane-5 launch (alternatively considered were the Service Module, derived from the Herschel bus, or SM subsystems plus some optical figuring and polishing of the telescope mirrors).

Contributions to operations: ESA will participate in operations at a similar level to HST.

Through these contributions, ESA will secure for astronomers from its Member States full access to the JWST observatory on identical terms to those enjoyed today on HST – representation on all project advisory bodies, and observing time allocated via a joint peer-review process, backed by a guaranteed 15% minimum.

The telescope and instruments are passively cooled behind a 420 m², 360 kg deployable sunshade (5 layers of 1 mm-thick Kapton) to 37 K, a level determined by the operating temperature of the HgCdTe 1-5 μm detector arrays. The Si:As detectors to reach beyond 5 μm require MIRI to be cooled to 7 K by a cryostat. The 0.6 μm lower wavelength limit allows a gold coating to be used as the reflecting surface in the telescope and instrument optics.

Science configuration: 3-mirror anastigmat telescope, 6.55 m-dia (25 m² equivalent aperture) 340 kg primary (folded for launch) of 18 hexagonal beryllium segments, f/20, diffraction-limited at 2 μm . Image

JWST scientific payload

NIRCam (Near-IR Wide-Field Camera)

Shortwave 0.6-2.3 μm , fixed filters (R-4/10/100) & coronagraphic spots, 2.2x4.4 arcmin FOV, two 2x2 mosaics 2048x2048 HgCdTe detectors. Longwave 2.4-5.0 μm , fixed filters (R-4/10/100) & coronagraphic spots, 2.2x4.4 arcmin FOV, two 2048x2048 HgCdTe detector arrays. 62 W, 161 kg. (PI: Marcia Rieke, Univ. Arizona). Dedicated to detecting light from the first stars, star clusters and galaxy cores; study of very distant galaxies in process of formation; detection of light distortion by dark matter; supernovae in remote galaxies; stellar population in nearby galaxies; young stars in our Galaxy; Kuiper Belt objects in Solar System.

NIRSpec (Near-IR Multi-Object Spectrograph)

Prism R-100, 0.6-5 μm , 3.1x3.4 arcmin FOV; grating R-1000 & R-3000, 1.0-5.0 μm , 3.1x3.4 arcmin FOV; integral field unit R-3000, 1.0-5.0 μm , FOV 3x3 arcsec; two 2048x2048 HgCdTe detectors. 38 W, 220 kg. (Lead: Peter Jakobsen, ESA). Prime EADS Astrium GmbH (D), Ph-C/D began 2 July 2004. Can obtain spectra for >100 objects simultaneously. Key objectives: studies of star formation and chemical abundances of young distant galaxies; tracing creation of chemical elements back in time; exploring history of intergalactic medium.

MIRI (Mid-IR Camera/Spectrograph)

Imaging 5-27 μm , broadband filters, coronagraphic spots & phase masks, R-100 prism spectroscopy, 1024x1024 CCD, 1.4x1.9 arcmin FOV (26x26 arcmin coronagraphic). Spectroscopy 5-27 μm in 4 bands, R-3000 using 2 1024x1024 CCDs, 3.6x3.6-7.5x7.5 arcsec FOV. Cooled to 7 K in cryostat; Si:As detectors. 35 W, 103 kg (+208 kg dewar). (PIs: George Rieke, Univ. Arizona & Gillian Wright, Royal Observatory Edinburgh; project management JPL & ESA). Key objectives: old and distant stellar population; regions of obscured star formation; distant hydrogen emission; physics of protostars; sizes of Kuiper Belt objects and faint comets.

FGS (Fine Guidance Sensor)

1.2-2.4 & 2.5-5.0 μm tunable filter imaging capability, CCD 2048x2048, FOV 2.3x2.3 arcmin, R-100.

stability 10 mas using fast-steering mirror controlled by FGS in the focal plane. Instrument module 2.5x2.5x3.0 m, 1400 kg.

Bus: Pointing accuracy 2 arcsec rms. < 1000 W required from solar array. 1.6 Mbit/s from science instruments, stored on 100 Gbit SSR, downlinked at X-band.

Gaia

Planned achievements: map 1000 million stars at 10-200 microarcsec accuracy to discover how and when our Galaxy formed, how it evolved and its current distribution of dark matter; fundamental importance for all branches of astronomy; maintain Europe's lead in astrometry

Launch date: planned for 2011

Mission end: 5-year mission planned (5-year observation period); 1-year extension possible

Launch vehicle/site: Soyuz-Fregat from Kourou, French Guiana

Launch mass: 2000 kg (900 kg payload)

Orbit: planned Lissajous orbit around L2 point 1.5 million km from Earth

Principal contractors: Alcatel (Cannes, F: definition studies), Alenia (I: definition studies), EADS-Astrium (F: definition studies, focal plane assembly, optical bench, SiC mirror), e2v (UK: CCD). Ph-B1 April 2004 - April 2005, Ph-B2 begins mid-2005; Phase-C/D 2006-2011

Gaia aims to solve one of the most difficult but fundamental challenges in modern astronomy: to determine the composition, creation and evolution of our Galaxy, in the process creating an extraordinarily precise 3-D map of more than 1000 million stars throughout the Galaxy and beyond.

When ESA's Horizon 2000 science programme was extended in 1994 with Horizon 2000 Plus, the three new Cornerstones included an interferometry mission. Two options were proposed. Gaia aimed at 10 microarcsec-level astrometry, while Darwin would look for life on planets discovered around other stars. Following studies, Gaia's interferometric approach was replaced in 1997 by measurements using simpler monolithic mirrors (and Gaia became a name instead of an acronym for Global Astrometric Interferometer for Astrophysics). Gaia competed in 2000 with BepiColombo for the fifth Cornerstone slot. In October 2000, the Science Programme Committee approved a package of missions for 2008-2013: BepiColombo was selected as CS-5 (2009) and Gaia as CS-6. Following the Ministerial Council of November 2001, the revised science programme funding indicated that the costs of

new Cornerstone missions (€586 million for Gaia in 2002 terms) could not be supported, so a major review of the overall ESA science programme was undertaken by the Agency's advisory bodies. The Gaia project began a 6-month technical reassessment study in December 2001. The constraint to use a shared Ariane-5 was relaxed, and the payload was resized for the smaller and cheaper Soyuz vehicle, while maintaining all of the primary scientific goals. The accuracy goal of 10 μ arcsec at 15 mag, was relaxed to 15-20 μ arcsec, primarily because the primary mirror was reduced from 1.7x0.7 m² to 1.4x0.5 m² for Soyuz. The service module is now adapted from Herschel/Planck. Gaia was confirmed by the SPC in June 2002, and reconfirmed following another reevaluation of the programme in November 2003. The expected cost-at-completion for the revised mission is about €460 million (2004 conditions).

By combining positions with radial velocities, Gaia will map the stellar motions that encode the origin and evolution of the Galaxy. It will identify the detailed physical properties of each observed star: brightness, temperature, gravity and elemental composition.

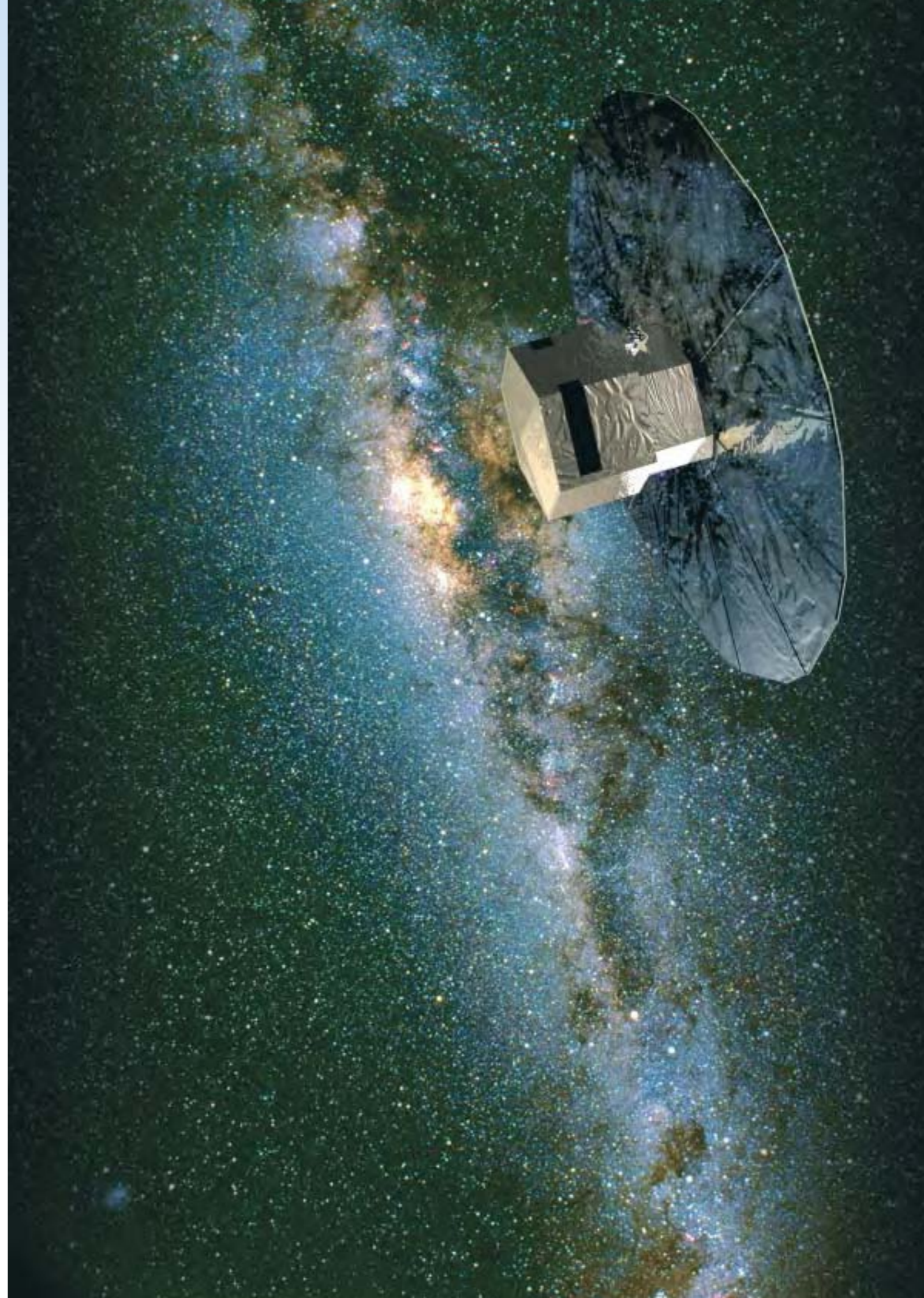

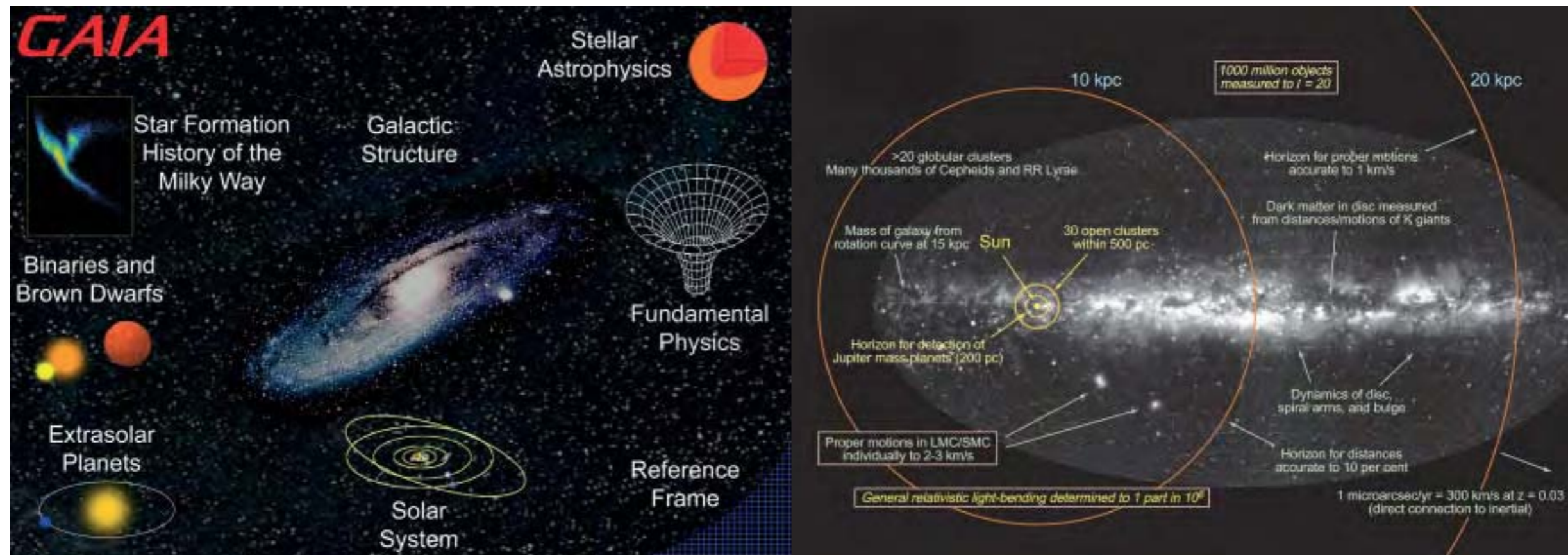

Overview of Gaia's performance, superimposed on the Lund Observatory map of the sky.

Gaia will achieve all this by repeatedly measuring the positions and multi-colour brightnesses of all objects down to magnitude +20. Variable stars, supernovae, transient sources, micro-lensed events and asteroids will be catalogued to this faint limit. Final accuracies of 10 microarcsec (the diameter of a human hair viewed from a distance of 1000 km) at magnitude +15, will provide distances accurate to 10% as far as the Galactic Centre, 30 000 light-years away. Stellar motions will be measured even in the Andromeda Galaxy.

Gaia will provide the raw data to test our theories of how galaxies and stars form and evolve. This is possible because low-mass stars live for much longer than the present age of the Universe, and retain in their atmospheres a fossil record of the chemical elements in the interstellar medium when they formed. Their

current orbits are the result of their dynamical histories, so Gaia will identify where they formed and probe the distribution of dark matter. Gaia will establish the luminosity function for pre-main sequence stars, detect and categorise rapid evolutionary stellar phases, place unprecedented constraints on the age, internal structure and evolution of all star types, establish a rigorous distance scale framework throughout the Galaxy and beyond, and classify star formation and movements across the Local Group of galaxies.

Gaia will pinpoint exotic objects in colossal numbers: many thousands of extrasolar planets will be discovered, and their detailed orbits and masses determined; brown dwarfs and white dwarfs will be identified in their tens of thousands; some 100 000 extragalactic supernovae will be discovered in time for ground-based follow-up observations; Solar System

studies will receive a massive impetus through the discovery of many tens of thousands of minor planets; inner Trojans and even new trans-Neptunian objects, including Plutinos, will be discovered.

Gaia will also contribute to fundamental physics. It will quantify the bending of starlight by the Sun and major planets over the entire celestial sphere, and therefore directly observe the structure of space-time. Gaia's accuracy will allow the long-sought scalar correction to the tensor form to be determined. The Parameterised Post-Newtonian (PPN) parameters γ and β , and the solar quadrupole moment J_2 will be determined with unprecedented precision. New constraints on the rate of change of the gravitational constant, \dot{G} , and possibly on gravitational wave energy over a certain frequency range will be obtained.

Like Hipparcos, Gaia will measure the angles between targets as its rotation scans two telescopes (separated by 99°) around the sky. Processing on the ground will link these targets in a grid with 10 microarcsec accuracy. Distances and proper motions will 'fall out' of the processing, as will information on double and multiple star systems, photometry, variability and planetary systems.

The two moderate-size telescopes use large CCD focal plane assemblies, with passive thermal control. A Lissajous orbit around Lagrange point L2 is preferred, from where an average of 1 Mbit/s will return to the single ground station throughout the 5-year mission (totalling 20 Tbytes of raw data). Every one of the 10^9 targets will be observed typically 100 times, each time in a complementary set of photometric filters, and a large fraction also with the radial velocity spectrograph.

Progress in astrometric accuracy. Two periods of dramatic increase in astrometric accuracy are evident between the Hipparchus and Hipparcos catalogues: Tycho Brahe in the early 17th Century and ESA's Hipparcos astrometry mission. Gaia pushes space-based astrometric measurements to the limits; its catalogue will be available 3 years after the mission is completed. (E. Høg)

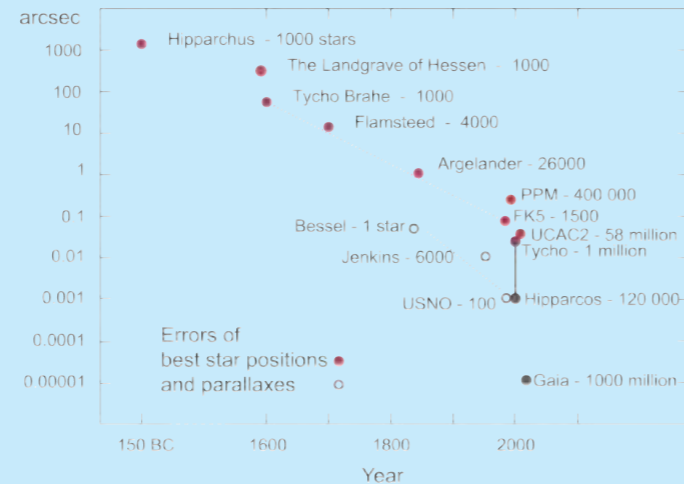

Gaia Measurement Capabilities

Median parallax errors

4 μ as at +10 mag
11 μ as at +15 mag
160 μ as at +20 mag

Distance accuracies

2 million better than 1%
50 million better than 2%
110 million better than 5%
220 million better than 10%

Radial velocity accuracies

1-10 km/s to $V = +16-17$ mag,
depending on spectral type

Catalogue

~1000 million stars
26 million to $V = +15$ mag
250 million to $V = +18$ mag
1000 million to $V = +20$ mag
completeness to about +20 mag

Photometry

to $V = +20$ mag in 4 broad and 11 medium bands

Gaia Science Goals

Galaxy

origin and history of Galaxy
tests of hierarchical structure formation theories
star-formation history
chemical evolution
inner bulge/bar dynamics
disc/halo interactions
dynamical evolution

nature of the warp
star cluster disruption
dynamics of spiral structure
distribution of dust
distribution of invisible mass
detection of tidally-disrupted debris
Galaxy rotation curve
disc mass profile

Star formation and evolution

in situ luminosity function
dynamics of star-forming regions
luminosity function for pre-main sequence stars
detection/categorisation of rapid evolutionary phases
complete local census to single brown dwarfs
identification/dating of oldest halo white dwarfs
age census
census of binaries/multiple stars

Distance scale and reference frame

parallax calibration of all distance scale indicators
absolute luminosities of Cepheids
distance to the Magellanic Clouds
definition of the local, kinematically non-rotating metric

Local Group and beyond

rotational parallaxes for Local Group galaxies
kinematical separation of stellar populations
galaxy orbits and cosmological history
zero proper motion quasar survey

cosmological acceleration of Solar System
photometry of galaxies
detection of supernovae

Solar System

deep and uniform detection of minor planets
taxonomy and evolution
inner Trojans
Kuiper Belt Objects
disruption of Oort Cloud
near-Earth objects

Extrasolar planetary systems

complete census of large planets to 200-500 pc
orbital characteristics of several thousand systems

Fundamental physics

γ to $\sim 5 \times 10^{-7}$
 β to $3 \times 10^{-4} - 3 \times 10^{-5}$
solar J_2 to $10^{-7} - 10^{-8}$
 \dot{G}/G to $10^{-12} - 10^{-13} \text{ yr}^{-1}$
constraints on gravitational wave energy for $10^{-12} < f < 4 \times 10^9 \text{ Hz}$
constraints on Ω_M and Ω_Λ from quasar microlensing

Specific objects

$10^6 - 10^7$ resolved galaxies
 10^5 extragalactic supernovae
500 000 quasars
 $10^5 - 10^6$ (new) Solar System objects
50 000 brown dwarfs
30 000 extrasolar planets
200 000 disc white dwarfs
200 microlensed events
 10^7 resolved binaries within 250 pc

Many analyses will be possible even during operations, while some will require the whole mission calibration information or even the final data reduction. Gaia will provide exciting scientific data to a very wide community, beginning with the first photometric observations, and rapidly increasing until the fully reduced data become available 2-3 years after mission-end. The resulting analyses will provide a vast scientific legacy, generating a wealth of quantitative data on which all of astrophysics will build.

Satellite configuration: payload module (PLM) 3.8 m diameter, 2.1 m high; service module (SVM) 3.8/9.0 m diameter (stowed/deployed), PLM/SVM mechanically- and thermally-decoupled, separated by 9.0 m-diameter solar array/sunshield (the only deployable element), SVM interfaces with Soyuz adapter; structure is aluminium with CFRP shear walls. Lateral panels used as radiators and covered with optical solar reflectors. SVM is at 200°C, PLM at 200K (stability tens of μ K). 6 solar wings stowed during launch; insulated from PLM with MLI on rear face. Additional insulation sheets, reinforced with kevlar cables, are spread between the wings.

Attitude/orbit control: FEEP electric or cold-gas thrusters maintain 60 arcsec/s spin; 3-axis control by 10 N thrusters during 220-240 day transfer orbit to L2 point. Lissajous eclipse-free orbit around L2 provides stable thermal environment and high observing efficiency (Sun and Earth always out of fields of view).

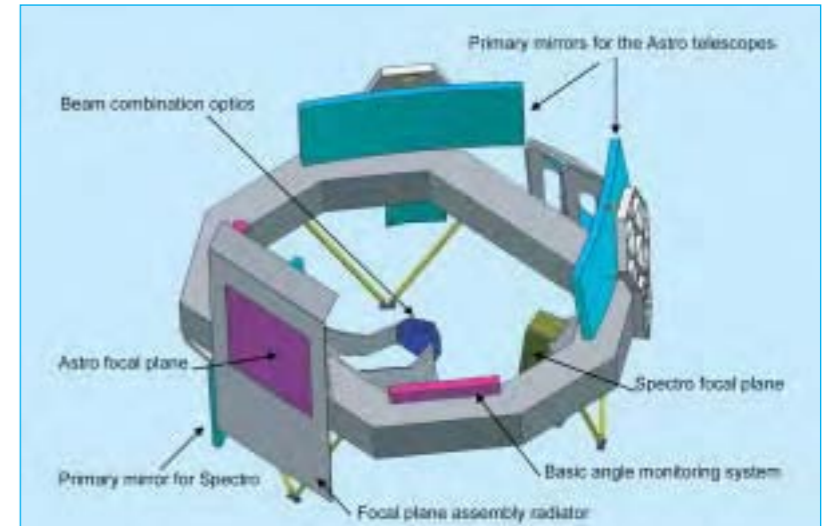

The payload is mounted on a silicon carbide optical bench. Two telescopes separated by 99° are scanned by Gaia's 1 rev/6 h spin rate, for the simultaneous measurement of the angular separations of thousands of star images as they pass through the 1° FOV. The precise angular separation ('basic angle') of the primary 1.4x0.5 m rectangular mirrors (50 m f.l.), is continuously measured. Secondary mirrors are adjustable to within 1 μ m. The focal plane has an array of 170 CCDs (each 4500x1966 pixels) forming a 45x58 mm detector. FOV divided into: Astrometric Sky Mapper of 2 CCD strips to identify entering objects; Astrometric Field (0.5x0.66°) for the actual position measurements; 4-band photometer. The third telescope (entrance pupil 50x50 cm) is a spectrometer, for radial velocity (from Doppler shift) measurements using 20 CCDs and medium-band photometry using 20 CCDs with 11 filters.

Power system: 2200 W required, including 1100 W payload, 700 W SVM. Two panels of GaAs cells on each of 6 CFRP solar wings, totalling 20 m².

Communications: 17 W X-band high-gain, electronically-steered phased-array antenna provides 3 Mbit/s (minimum 1 Mbit/s) to ESA's 35 m-diameter Cebreros ground station 8 h daily. SSR ≥ 200 Gbit, sized to hold full day's data. Controlled from ESOC. Low-gain omni antenna for TC and housekeeping TM.

BepiColombo

Planned achievements: first dual Mercury orbiters; third mission to Mercury; first European deep-space probe using electric propulsion
Launch date: planned May 2012 (arriving January 2017)
Mission end: nominally after 1 year in orbit around Mercury
Launch vehicle/site: Soyuz-Fregat 2-1B from Kourou, French Guiana
Launch mass: ~2100 kg; MPO 400-500 kg; MMO ~230 kg
Orbit: heliocentric transfer to 400x12 000 km (MMO) and 400x1500 km (MPO) polar Mercury orbits
Principal contractors: definition studies Alenia Spazio (I) & Astrium GmbH (D); Assessment March 1998 - May 2000, Definition May 2001 - November 2005, Implementation December 2005 - August 2012

As the nearest planet to the Sun, Mercury has an important role in teaching us how planets form. Mercury, Venus, Earth and Mars are the family of terrestrial planets, each carrying information that is essential for tracing the history of the whole group. Knowledge about their origin and evolution is a key to understanding how conditions supporting life arose in the Solar System, and possibly elsewhere. As long as Earth-like planets orbiting other stars remain inaccessible to astronomers, the Solar System is the only laboratory where we can test models applicable to other planetary systems. The exploration of Mercury is therefore of fundamental importance for answering questions of astrophysical and philosophical significance, such as 'Are Earth-like planets common in the Galaxy?'

A Mercury mission was proposed in May 1993 for ESA's M3 selection (eventually won by Planck). Although the assessment study showed it to be too costly for a medium-class mission, it was viewed so positively that, when the Horizon 2000 science programme was extended in 1994 with Horizon 2000 Plus, the three new Cornerstones included a Mercury orbiter. Gaia competed in 2000 with BepiColombo for the fifth Cornerstone slot. In October 2000, the Science Programme Committee approved a package of missions for 2008-2013:

BepiColombo was selected as CS-5 (2009) and Gaia as CS-6 (2012). The SPC in September 1999 named the mission in honour of Giuseppe (Bepi) Colombo (1920-1984). The Italian scientist explained Mercury's peculiar rotation - it turns three times for every two circuits around the Sun - and suggested to NASA that an appropriate orbit for Mariner-10 would allow several flybys in 1974-75.

That US probe remains the only visitor to Mercury, so there are many questions to be answered, including:

- what will be found on the unseen hemisphere?
- how did the planet evolve geologically?
- why is Mercury's density so high?
- what is its internal structure and is there a liquid outer core?
- what is the origin of Mercury's magnetic field?
- what is the chemical composition of the surface?
- is there any water ice in the polar regions?
- which volatile materials form the vestigial atmosphere (exosphere)?
- how does the planet's magnetic field interact with the solar wind?

BepiColombo's other objective goes beyond the exploration of the planet and its environment, to take



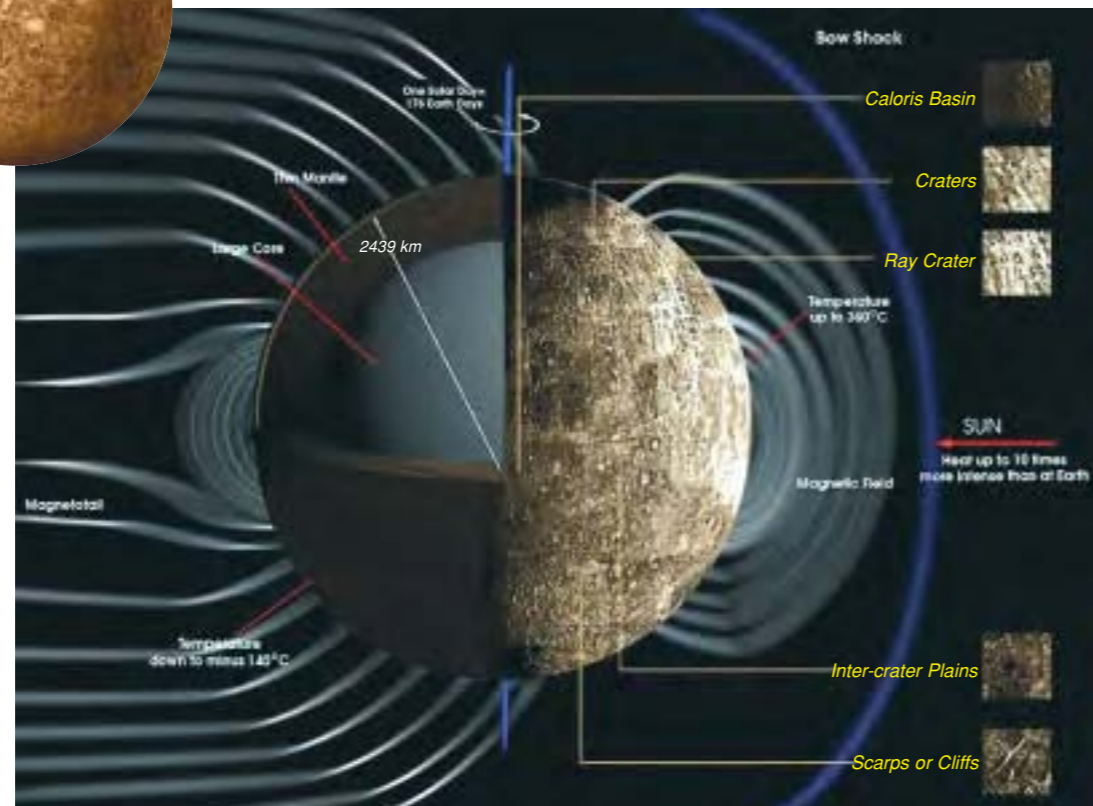

advantage of Mercury's proximity to the Sun:

- fundamental science: is Einstein's theory of gravity correct?

A 1-year System and Technology Study completed in April 1999 revealed that the best way to fulfil the scientific goals was to fly two Orbiters and a Lander:

- the Mercury Planetary Orbiter (MPO), a 3-axis stabilised and nadir-pointing module in a low orbit for planet-wide remote sensing and radio science;
- the Mercury Magnetospheric Orbiter (MMO), a spinner in an eccentric orbit, accommodating mostly the field, wave and

particle instruments. Provided by Japan's JAXA space agency; - the Mercury Surface Element (MSE) lander, for in situ physical, optical, chemical and mineralogical observations that would also provide ground-truth for the remote-sensing measurements.

How to deliver these elements to their destinations emerged from a trade-off between mission cost and launch flexibility. It combined electrical propulsion, chemical propulsion and planetary gravity assists. Interplanetary transfer is performed by a Solar Electric Propulsion Module (SEPM), jettisoned upon arrival. The orbit injection manoeuvres then use a Chemical Propulsion Module (CPM), which is also jettisoned once the satellites are deployed.



A two-launch scenario, with the spacecraft elements divided into two composites using near-identical propulsion elements, was considered as the baseline: the MPO and MMO-MSE composites were launched by two Soyuz-Fregats. Two competing industrial definition studies began in May 2001 to run to late 2002 to prepare for the 1-year Phase-B to begin by mid-2003 and Phase-C/D in 2004. However, this study showed that a *third* launcher was required for MSE. The severe reduction in the science budget after the Ministerial Council of November 2001 ultimately meant that MSE had to be dropped from the mission baseline. From 1 October 2002 to 30 June 2003, BepiColombo went through a reassessment with the aim of maximising the scientific performance by optimising the

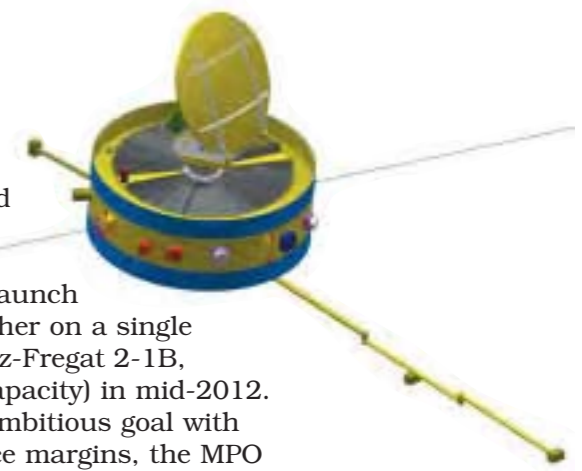

MPO (left) and MMO (right) in operational configuration.

payload, while reducing cost and risk. The scenario that emerged was to launch MPO/MMO together on a single launcher (a Soyuz-Fregat 2-1B, offering higher capacity) in mid-2012. To achieve this ambitious goal with adequate resource margins, the MPO payload resources, particularly mass, had to be significantly reduced (to ~50 kg) while ensuring the mission's scientific competitiveness was improved. This was achieved by defining, from analysis of the science objectives, the corresponding payload complement and resulting instrument requirements (these normally result from scientists' proposals for experiments). An optimised reference payload suite was defined in which instruments share common functions and resources, producing improved science performance at significantly lower cost.

On 6 November 2003 the SPC approved the BepiColombo mission with MPO/MMO but cancelled MSE as part of the reconstructed Cosmic Vision programme. The cost is projected at €456 million (mixed 2004 conditions), having saved €275 million on the lander.

ESA issued its MPO payload request for proposals on 26 February 2004, with a closing date of 15 May. The selection was made by the SPC on 10 November 2004. Japan's Space Activities Commission approved participation in BepiColombo in July 2003. JAXA issued its own MMO AO on 15 April 2004, with a closing date of 15 July 2004.

Key technologies are being developed 2001-2004: high-temperature

MMO will emphasise fields & particles measurements. (JAXA)

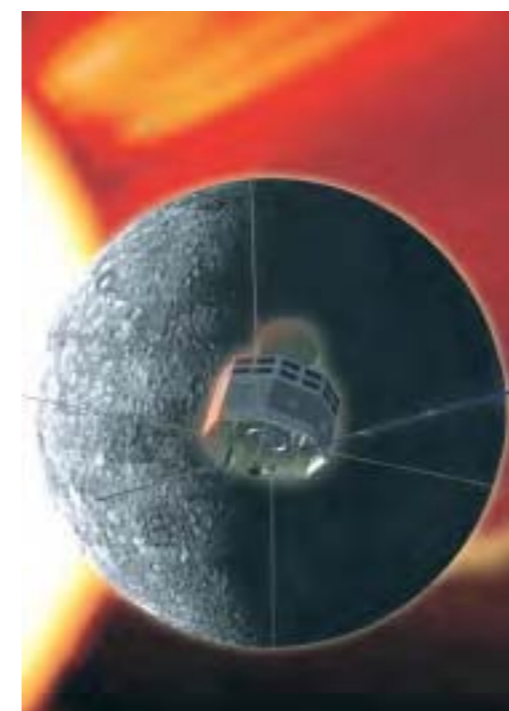

thermal control (materials, louvres, heat pipes embedded in structural panels); high-temperature solar arrays (GaAs cells, arrays, drive mechanisms); high-temperature high-gain antennas (reflector materials, feed and pointing/despin mechanisms); miniaturised integrated avionics. SMART-1 has already demonstrate the use of an electric thruster for primary propulsion.

Mission profile: the composite is launched into Earth orbit with a high apogee (312 500 km), leading to a lunar swingby to set up one Earth, 2 Venus and 2 Mercury gravity assists during the 4.2-year cruise. At Mercury, the CPM's 4 kN engine burns to enter a 400x12 000 km polar orbit, where MMO can be released. For MPO, CPM reignites to set up a 400x1500 km orbit and is then jettisoned. MPO/MMO are both designed for 1 year of observations (4 Mercury years).

MPO: configuration driven by thermal constraints, requiring high-efficiency insulation and 1.5 m² (200 W rejection) radiator. Bus is a flat prism with 3 sides slanting 20° as solar arrays, providing 420 W at perihelion (30% cells, 70% optical solar reflectors). 1.5 m dia Ka-band HGA delivers 1550 Gbit in 1 year. 3-axis control, nadir-pointing. Mass 400-500 kg (including ~50 kg science payload).

MMO: cylindrical bus (1.80 m-dia, 90 cm-high) spinning at 15 rpm (axis perpendicular to Mercury equator). CFRP thrust cone houses tanks for cold-gas nitrogen thrusters. Hardware mounted on walls and 2 platforms; top/bottom

BepiColombo Science Goals

- exploration of Mercury's unknown hemisphere;
- investigation of the geological evolution of the planet;
- understanding the origin of Mercury's high density;
- analysis of the planet's internal structure and search for the possible liquid outer core;
- investigation of the origin of Mercury's magnetic field;
- study of the planet's magnetic field interaction with the solar wind;
- characterisation of the surface composition;
- identification of the composition of the radar bright spots in the polar regions;
- determination of the global surface temperature;
- determination of the composition of Mercury's vestigial atmosphere (exosphere);
- determination of the source/sink processes of the exosphere;
- determination of the exosphere and magnetosphere structures;
- study of particle energisation mechanisms in Mercury's environment;
- fundamental physics: verification of Einstein's theory of gravity.

faces are radiators. Despun X-band 20 W HGA delivers 160 Gbit in 1 year; 2 MGAs. Mass ~230 kg (including 30 kg science payload).

Solar Electric Propulsion Module: provides cruise propulsion and is jettisoned before Mercury insertion. 150-200 mN-class Xe ion thrusters powered by 2 wings of GaAs cells delivering ~5.5 kW at 1 AU. Wings tilt to maintain T < 150°C.

Chemical Propulsion Module: provides Mercury capture and orbit manoeuvres. Classical bipropellant engine with redundant attitude thrusters.

BepiColombo Scientific Instruments				
Instrument		Measurements	Mass (kg)	Power (W)
MPO				
BepiColombo Laser Altimeter	BELA*	topographic mapping	10	50
Italian Spring Accelerometer	ISA	non-gravity acceleration of spacecraft	5.0	6.2
Magnetic Field Investigation	MERMAG	magnetic field, interaction with solar wind	1.9	4.7
Mercury Radiometer & Thermal Imaging Spectrometer	MERTIS	global mineral mapping (7-14 μm), surface T	2.8	7.0
Mercury Gamma-ray & Neutron Spectrometer	MGNS** or MANGA**	elemental surface/subsurface composition, volatile deposits in polar areas	5.2	3.5
Mercury Imaging X-ray Spectrometer	MIXS	elemental surface composition, global mapping & composition of surface features	4.6	12.4
Mercury Orbiter Radio Science Experiment	MORE	core & mantle structure, orbit, gravity field, fundamental science	3.5	15
Probing of Hermean Exosphere by UV Spectroscopy	PHEBUS	UV spectral mapping of the exosphere	4.5	4.1
Search for Exospheric Refilling & Emitted Natural Substances	SERENA	in situ study of composition, vertical structure and source & sink processes of the exosphere	4.1	20.8
Solar Intensity X-ray & Particle Spectrometer	SIXS	monitor solar X-ray intensity & particles to support MIXS	1.4	1.8
Spectrometers & Imagers for MPO BepiColombo Integrated Observatory	SIMBIO-SYS: HIRC, STC, VIHI	optical high-res & stereo imaging, near-IR (<2.0 μm) imaging spectroscopy for global mineralogical mapping	7.1	31.6
MMO				
Mercury Magnetometer	MERMAG	magnetosphere, interaction with solar wind	1.7	2.8
Mercury Plasma Particle Expt	MPPE	low/high-energy particles in magnetosphere	15.1	19.5
Plasma Wave Instrument	PWI	structure & dynamics of magnetosphere	8.2	9.7
Mercury Sodium Atmosphere Spectral Imager	MSASI	abundance, distribution & dynamics of sodium in exosphere	4.2	7.1
Mercury Dust Monitor	MDM	distribution of interplanetary dust in Mercury orbit	0.5	2.7

*feasibility still to be demonstrated; **feasibility still to be demonstrated, MGNS is preferred solution¶

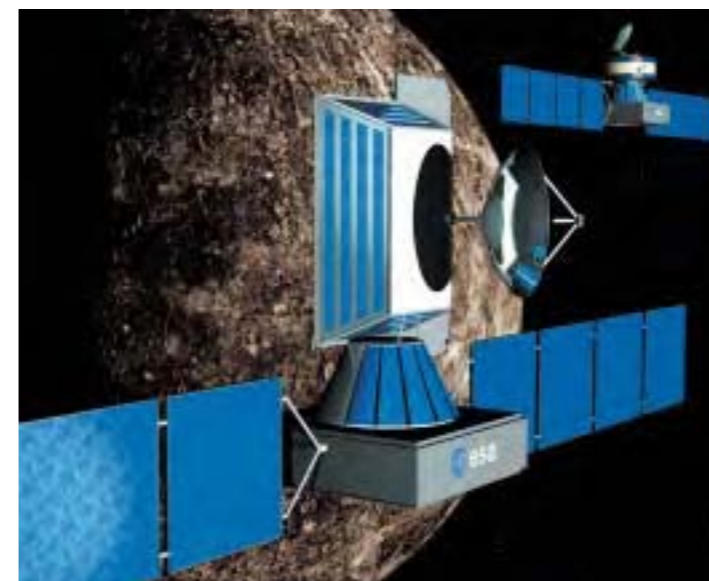

The pre-definition study design for BepiColombo. In the foreground is MPO, with the Solar Electric Propulsion Module still attached via the conical interface that houses the Chemical Propulsion Module. In the background is the MMO/MSE composite.

EarthCARE

Planned achievements: global cloud & aerosol measurements

Launch date: planned for 2012

Mission end: nominally after 2 years (potential 1-year extension)

Launch vehicle/site: to be selected, but Soyuz/Rockot/Dnepr-class

Launch mass: ~1300 kg

Orbit: 451 km or 444 km, Sun-synchronous polar

Principal contractors: to be selected (Phase-A EADS Astrium GmbH & Alcatel Space Industries). Phase-A November 2002 - April 2004, Phase-B 2006-2007, Phase-C/D 2007-2012

EarthCARE (Earth Clouds, Aerosols & Radiation Explorer), a joint ESA/Japan mission, was selected in 2004 as the third Earth Explorer Core mission in the Living Planet programme. It is designed to measure the physical properties of clouds and aerosols to improve climate modelling and our understanding of Earth's radiation balance.

The second Call for Ideas for Explorer Core missions was issued on 1 June 2000, receiving ten proposals by the 1 September 2000 closing date. On 20 November 2000, ESA selected five for assessment studies: ACECHEM, EarthCARE, SPECTRA, WALES & WATS.

EarthCARE, SPECTRA and WALES were selected on 29 November 2001 for 12-month Phase-A studies, for launch in about 2008. On 28 May 2004, the Earth Observation Programme Board announced the choice would be between EarthCARE and SPECTRA, although EarthCARE was ranked first. The Board of 24 November 2004 voted in favour of EarthCARE as the next Earth Explorer Core mission.

Aerosols, clouds and convection are not easily included in numerical models of the atmosphere, seriously limiting our ability to forecast the weather accurately and to predict the future climate reliably. They govern the radiation balance (hence

the Earth's temperature) and are directly responsible for precipitation (thus controlling the water cycle).

Aerosols reflect solar radiation back to space, which leads to cooling. Absorbing aerosols, such as man-made carbon, can produce local heating. Aerosols also control the radiative properties of clouds and their precipitation. The low concentration of aerosols in marine air creates water clouds with a small number of relatively large droplets. In contrast, the high concentration of aerosols in continental and polluted air creates a much higher concentration of smaller droplets. Continental clouds therefore not only reflect more sunlight back to space, but also are much more stable and long-lived and less likely to produce precipitation. Aerosols also control glaciation, yet their effect on ice clouds is essentially unknown. We need to measure how much aerosols are responsible for the rapid drop in the albedo of fresh snow. Today's observations of global aerosol properties are limited to optical depth and a crude estimate of particle size. This is very unsatisfactory, because we need to know their chemical composition, whether they scatter or absorb, and their vertical and geographical distribution.

Clouds are the principal modulators of the Earth's radiation balance. Currently, there are global estimates



of cloud cover, but little information on their vertical extent or the condensed mass of ice or liquid cloud water. Low clouds cool the climate by reflecting short-wave solar radiation back to space, whereas high clouds warm the climate because they are cold and emit less IR radiation to space. In the present climate, these two effects are large and opposite. Any changes in the vertical distribution of clouds in a future warmer climate could lead to large changes in the net radiation. Climate models disagree whether this would attenuate or amplify the effect of the original direct greenhouse gas warming. Uncertainties in the vertical profiles of clouds strongly affect predictions of future global warming, and also limit the accuracy of numerical weather prediction. Models can reproduce the observed top-of-the-atmosphere radiation but with very different vertical profiles of clouds and water content. Observations of cloud profiles are urgently required, so that the ability of models to provide reliable weather forecasts and predictions of future global warming can be improved.

Clouds are the source of all precipitation, but the process is poorly understood. Major difficulties include the large spread in model

EarthCARE Payload	
Cloud Profiling Radar (CPR)	JAXA
Vertical profiles of cloud structures, penetrating deeply into lower cloud layers unseen by MSI or ATLID. Sensitivity detects almost all ice clouds. Doppler shift measurements of vertical motion of cloud & rain particles overlaid on vertical wind to identify cloud types, drizzle & cloud droplet fall speed. 2.5 m-dia main reflector with high surface accuracy & pointing. 94.05 GHz, pulse repetition >6 Hz, footprint 750 m dia nadir. 216 kg, 300 W, 120 kbit/s.	
Backscatter Lidar (ATLID)	ESA
Vertical profiles of thin cloud & aerosol layers, particle shapes and altitude of cloud boundaries. 355 nm Nd-YAG laser, ~20 mJ pulses at 70-100 Hz. Res 100 m vertical from ground to 20 km. Three channels: Mie co-polar & cross-polar; Rayleigh co-polar. Footprint 5-12 m, 2° forward along-track.	
Multispectral Imager (MSI)	ESA
Complementary data for other instruments, to determine cloud type, texture & top T. 7 channels 0.659-12.0 µm, swath 150 km, 500x500 m pixels.	
Broadband Radiometer (BBR)	ESA
Reflected 0.2-4 µm & emitted 4-50 µm radiation at top of atmosphere. 10x10 km FOV. 3 simultaneous views: nadir, ±50° along-track.	

One of the satellite concepts emerging from the two Phase-A studies. EarthCARE is dominated by the 2.5 m-dia radar dish.

predictions of cloud condensate, the efficiency with which this is converted to precipitation, and the convective motions. The extent to which vigorous tropical convection introduces moisture into the stratosphere is uncertain. It is also known that the modelled daily cycle of convection is wrong. Understanding these processes is crucial for accurate precipitation forecasting. For example, we could predict flash flooding with far greater certainty.

LISA Pathfinder

LISA

Planned achievements: first detection of gravitational waves, first direct measurements of massive black holes at centres of galaxies

Launch date: planned for 2012-2013

Mission end: nominally after 5 years in operational orbit

Launch vehicle/site: Delta-IV from Cape Canaveral, Florida

Launch mass: total 1380 kg (on-station 274 kg each, science payload 70 kg each)

Orbit: heliocentric, trailing Earth by 20°

Principal contractors: to be selected; System & Technology Study June 1999 - February 2000; Phase-A January 2005 - January 2007, Phase-B 2007 - 2008, Phase-C/D 2008 - 2012

The ambitious Laser Interferometer Space Antenna (LISA) aims to make the first detection of gravitational waves – ripples in space-time. According to Einstein's Theory of General Relativity, these waves are generated by exotic objects such as binary black holes, which distort space and time as they orbit closely. To detect the elusive gravitational waves, the three LISA satellites will carry state-of-the-art inertial sensors, a laser-interferometry telescope system and highly sensitive ion thrusters.

In October 2000, the Science Programme Committee approved a package of missions for 2008-2013. LISA will fly as Cornerstone 7 (Fundamental Physics), but in collaboration with NASA at a cost to ESA of a Flexi mission. The demanding technologies will be tested by the dedicated LISA Pathfinder in 2008; see the separate entry.

Massive bodies produce indentations in the elastic fabric of spacetime, like billiard balls on a springy surface. If a mass distribution moves aspherically, then the spacetime ripples spread outwards as gravitational waves. A perfectly symmetrical collapse of a supernova will produce no waves, while a non-spherical one will emit gravitational radiation. A binary system always radiates.

As gravitational waves distort spacetime, they change the distances between free bodies. Gravitational waves passing through the Solar System changes the distances between all bodies in it. This could be the distance between a spacecraft and Earth, as in the cases of Ulysses and Cassini (attempts continue to measure these distance fluctuations), or the distances between shielded proof masses inside well-spaced satellites, as in LISA. The main problem is that the distance changes are exceedingly small. For example, the periodic change between two proof masses owing to a typical white dwarf binary at a distance of 50 pc is only 10^{-10} m. Gravitational waves are not weak (a supernova in a not too-distant galaxy drenches every square metre on Earth with kilowatts of gravitational radiation), but the resulting length changes are small because spacetime is so stiff that it takes huge energies to produce even minute distortions.

If LISA does not detect the gravitational waves from known binaries with the intensity and frequency predicted by Einstein's General Relativity, it will shake the very foundations of gravitational physics.

LISA's main objective is to learn about the formation, growth, space density and surroundings of massive

LISA will fly a troika of identical satellites in an equilateral triangle formation to detect distance changes as they surf gravitational waves passing through the Solar System.

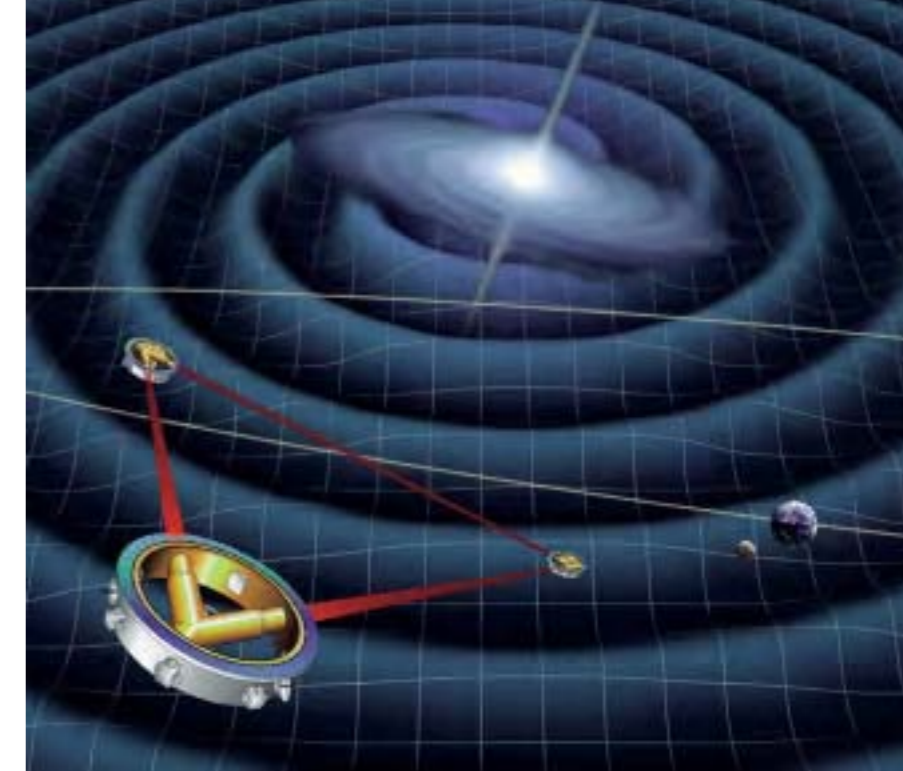

black holes (MBHs). There is now compelling indirect evidence for the existence of MBHs with masses of 10^6 - 10^8 Suns in the centres of most galaxies, including our own. The most powerful sources are the mergers of MBHs in distant galaxies. Observations of these waves would test General Relativity and, particularly, black-hole theory to unprecedented accuracy. Not much is known about black holes of masses 10^2 - 10^6 Suns. LISA can provide unique new information throughout this mass range.

LISA uses identical satellites 5 million km apart in an equilateral triangle. It is a giant Michelson interferometer, with a third arm added for redundancy and independent information on the

LISA is a NASA/ESA collaboration: NASA provides the satellites, launch, X-band communications, mission and science operations, and about 50% of the payload; Europe provides the other 50% of the payload (funded nationally), with ESA responsible for payload integration & testing. The formal agreement with NASA was signed in 2004. ESA projected cost-at-completion is €204 million (2004 conditions).

A 4-satellite version of LISA was proposed to ESA in May 1993 for the M3 competition (won by Planck), but that version clearly exceeded the cost limit for a medium-class mission. A 6-spacecraft version was proposed in December 1993 as a Cornerstone for the Horizon 2000 Plus programme, and selected, earmarked for launch after 2017. By early 1997, the cost had been drastically reduced by halving the number of satellites and through collaboration with NASA (until August 2004, it was expected that ESA would provide the satellites).



waves' two polarisations. Their separations (the interferometer arm length) determine LISA's wave frequency range (10^{-4} - 10^{-1} Hz), carefully chosen to cover the most interesting sources of gravitational radiation.

ESA-studied LISA satellite configuration. The Y-shaped twin-telescope assembly is supported by a carbon-epoxy ring. The top solar array is not shown, nor the bottom propulsion module.

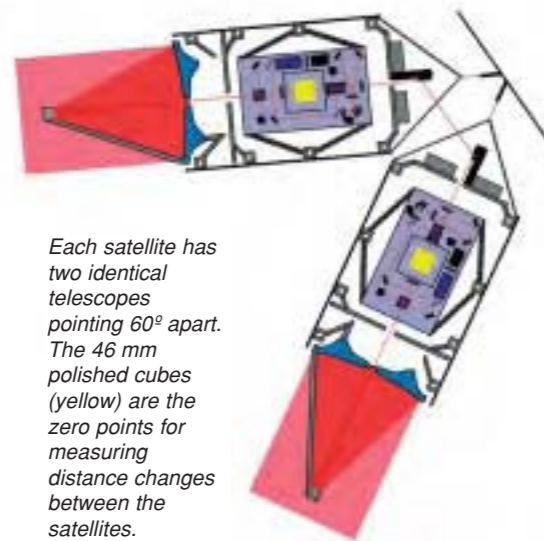

The centre of the triangular formation is in the ecliptic plane 1 AU from the Sun and 20° behind the Earth. The plane of the triangle is inclined 60° to the ecliptic. This configuration means that the formation is maintained throughout the year, and appears to rotate around its centre annually.

Each satellite contains two optical assemblies, each pointing to an identical assembly on each of the other satellites. A 1 W 1.064 μm IR Nd:YAG laser beam is transmitted via a 30 cm-aperture f/1 Cassegrain telescope. The other satellite's own laser is phase-locked to the incoming light, providing a return beam with full intensity. The first telescope focuses the very weak beam (a few pW) from the distant spacecraft and directs it to a sensitive photodetector, where it is superimposed with a fraction of the original local light, serving as a local oscillator in a heterodyne detection. The distance fluctuations are

measured to 40 pm (4×10^{-11} m) precision which, combined with the 5 million km separations, allows LISA to detect gravitational-wave strains down to one part in 10^{-23} in a year of observation with a signal-to-noise ratio of 5.

At the heart of each assembly is a vacuum enclosure housing a free-flying polished platinum-gold 46 mm cubic proof mass, which serves as the optical reference mirror for the lasers. The spacecraft serve mainly to shield the proof masses from solar radiation pressure, and the spacecraft's actual position does not directly enter into the measurement. It is nevertheless necessary to keep them moderately centred (10^{-8} m/√Hz in the measurement band) on their proof masses to reduce spurious local noise forces. This is done by a drag-free control system consisting of an accelerometer (or inertial sensor) and a system of μN thrusters. 3-D capacitive sensing measures the displacements of the proof masses relative to the spacecraft. These position signals are used to command Field-Emission Electric Propulsion (FEEP) thrusters to enable the spacecraft to follow its proof masses precisely. The thrusters also control the attitude of the spacecraft relative to the incoming optical wave fronts using signals derived from quadrant photodiodes. As the constellation orbits the Sun in the course of a year, the observed gravitational waves are Doppler-shifted by the orbital motion. For periodic waves with sufficient signal-to-noise ratio, this allows the direction of the source to be determined to arcminute or degree precision, depending on source strength.

LISA's sensitivity to binary stars in our Galaxy and black holes in distant galaxies. The heavy black curve shows LISA's detection threshold after a year's observations. The vertical scale is the distance change detected (one part in 10^{23} is the goal). At frequencies below 10^3 Hz, binary stars in the Galaxy are so numerous that LISA will not resolve them (marked 'Binary confusion noise'). In lighter green is the region where LISA should resolve thousands of binaries closer to the Sun or radiating at higher frequencies. The signals expected from two known binaries are indicated by the green triangles. The blue area covers waves expected from massive black holes merging in other galaxies (redshift $z = 1$). The red spots mark the mergings of two million-solar-mass black holes, and two 10 000-solar-mass black holes. The bottom red spot shows the expected wave from a 10-solar-mass black hole falling into one of a million solar masses, at a distance of $z = 1$.

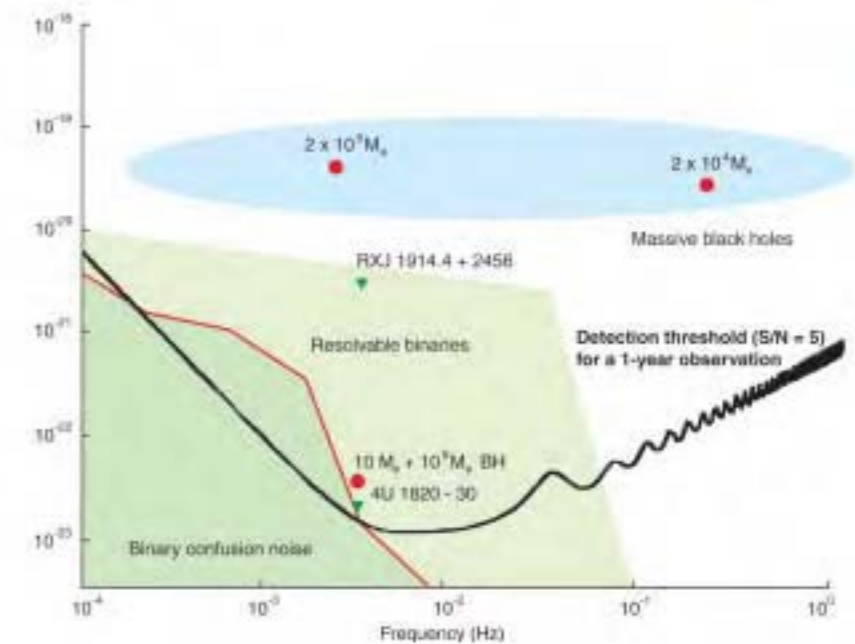

Satellite configuration (ESA study): total diameter 2.2 m across solar array. Main structure is a 1.80 m-dia, 48 cm-height ring of graphite-epoxy (low thermal expansion). Each satellite houses two identical telescopes and optical benches in a Y-shaped configuration.

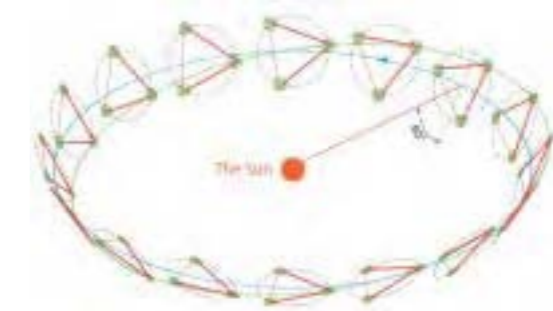

LISA consists of a constellation of three spacecraft flying in formation at the corners of an equilateral triangle, inclined at 60° with respect to the ecliptic plane, in a heliocentric orbit. The equilateral triangle performs a complete rotation around its centre during one year, while rotating around the Sun.

Attitude control: drag-free attitude control system (DFACS) of 6 clusters of four FEEP thrusters (to be decided if caesium or indium), controlled by feedback loop using capacitive position sensing of proof masses. Performance: 3×10^{-15} m/s² in the band 10^{-4} - 10^{-3} Hz. Solar-electric propulsion module (142 kg, 1.80 m-dia, 40 cm-high, CFRP, redundant 20 mN Xe ion thrusters) jettisoned after 13-month transfer from Earth; 4x4.45 N + 4x0.9 N hydrazine thrusters provide 3-axis control and orbit adjust. Attitude from 4 star trackers, Sun sensors.

Power system: 315 W on-station (72 W science), provided from GaAs cells on circular top face, supported

by Li-ion batteries. 940 W required during ion-powered cruise, from similar propulsion module array.

Communications: two 30 cm-dia 5 W X-band steerable antennas transmit science and engineering data (stored onboard for 2 days in 1 GB solid-state memory) 8 h/day at 7 kbit/s to the 34 m network of NASA's Deep Space Network. Total science rate 672 bit/s.

Solar Orbiter

Planned achievements: closest-ever solar approach; first images of the Sun's polar regions; highest-resolution solar observations

Launch date: planned for October 2013 (Venus window every 19 months)

Mission end: after 4.5 years (nominal science phase; 2.5-year extension possible)

Launch vehicle/site: Soyuz-Fregat from Baikonur or Kourou

Launch mass: about 1495 kg (150 kg science payload)

Orbit: planned operational 149-day heliocentric, minimum perihelion 0.22 AU, up to 35° solar latitude

Principal contractors: to be selected

On 1 October 1999, ESA requested proposals for the F2 and F3 Flexi science missions, selecting five of the 50 for assessment studies March-May 2000: Eddington, Hyper, MASTER, Solar Orbiter and Storms; the Next Generation Space Telescope was already part of the process. In October 2000, the Science Programme Committee approved a package of missions for implementation in 2008-2013, including Solar Orbiter as the F3 Flexi mission. It was reconfirmed in June 2004, to be implemented as a common development with BepiColombo. However, final go-ahead is still required. Two parallel industrial Assessment Studies were conducted April-December 2004.

The Sun's atmosphere and the heliosphere are unique regions of space, where fundamental physical processes common to solar, astrophysical and laboratory plasmas can be studied in detail and under conditions impossible to reproduce on Earth. The results from missions such as Helios, Ulysses, Yohkoh, Soho, TRACE and RHESSI have significantly advanced our understanding of the solar corona, the associated solar wind and the 3-D heliosphere. Further progress will be made with STEREO, Solar-B and the first of NASA's Living With a Star (LWS) missions, the Solar Dynamics Observatory (SDO). Each mission has a focus, being part of an overall strategy of coordinated solar and

heliospheric research. An important element of this strategy, however, has yet to be implemented. We have reached the point where further in situ measurements, now much closer to the Sun, together with high-resolution imaging and spectroscopy from a near-Sun and out-of-ecliptic perspective, promise major breakthroughs in solar and heliospheric physics. The Solar Orbiter will, through a novel orbital design and an advanced suite of instruments, provide the required observations.

The unique mission profile of Solar Orbiter will, for the first time, make it possible to:

- explore the uncharted innermost regions of our Solar System,
- study the Sun from close-up: 48 solar radii (0.22 AU/ 33.2 million km),
- hover over the surface for long-duration, detailed observations by

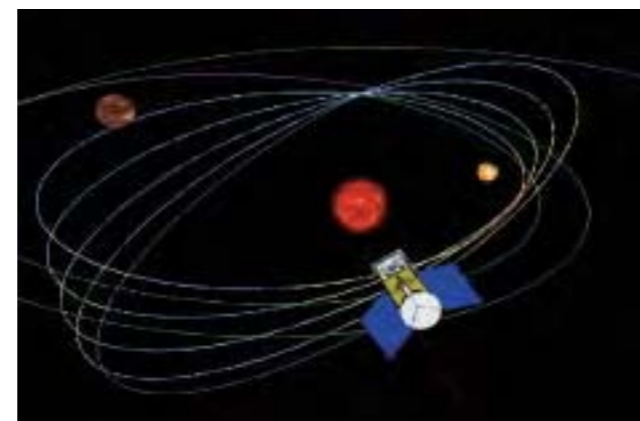

- tuning its orbit for its perihelion speed to match the Sun's 27-day rotation rate;
- provide images of the Sun's polar regions from latitudes higher than 30°.

The principal scientific goals of the Solar Orbiter are to:

- determine the properties, dynamics and interactions of plasma, fields and particles in the near-Sun heliosphere;
- investigate the links between the solar surface, corona and inner heliosphere;
- explore, at all latitudes, the energetics, dynamics and fine-scale structure of the Sun's magnetised atmosphere;
- probe the solar dynamo by observing the Sun's high-latitude field, flows and seismic waves.

These specific goals are directly related to more general questions of relevance to astrophysics in general. For example:

- why does the Sun vary and how does the solar dynamo work?
- what are the fundamental processes at work in the solar atmosphere and heliosphere?
- what are the links between the magnetic field-dominated regime in the solar corona and the particle-dominated regime in the heliosphere?

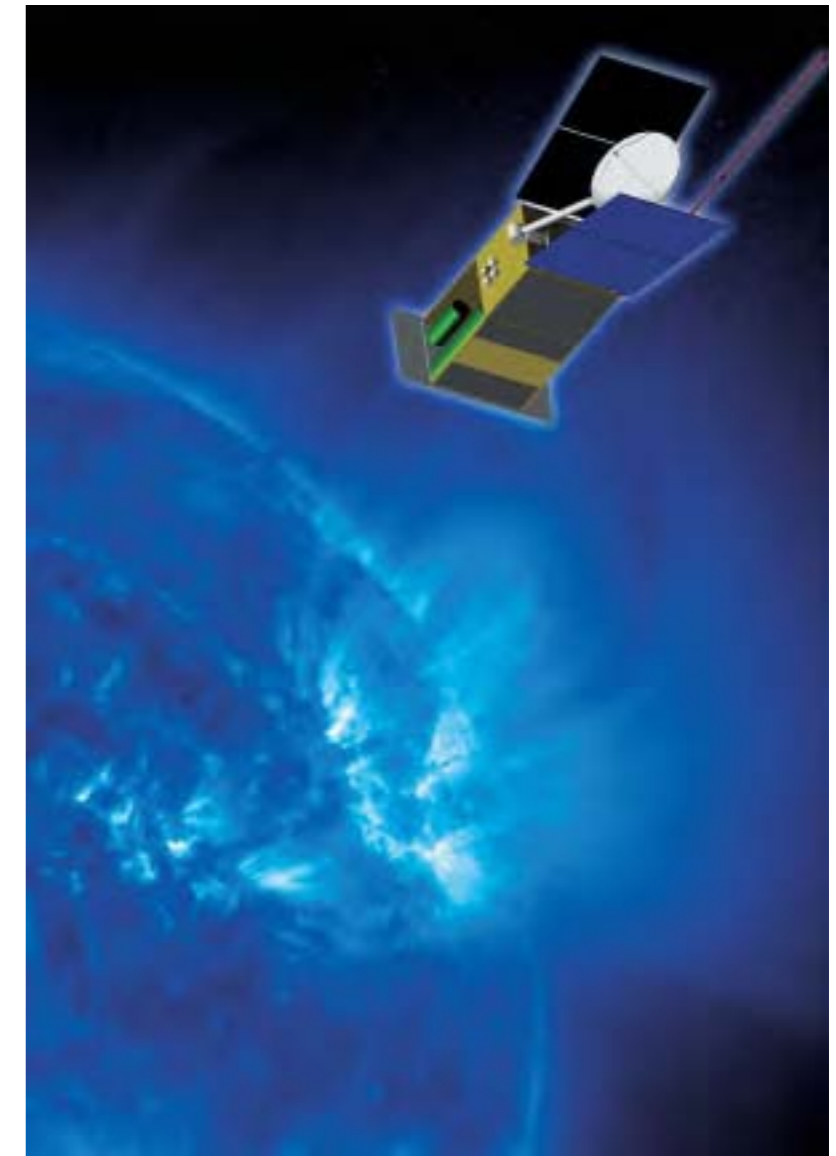

The near-Sun interplanetary measurements together with simultaneous remote sensing of the Sun will permit us to disentangle spatial and temporal variations during the corotational phases. They will allow us to understand the characteristics of the solar wind and energetic particles in close linkage with the plasma conditions in their source regions on the Sun. By approaching to within 48 solar radii, the Solar Orbiter will view the atmosphere with unprecedented spatial resolution (70 km pixel size, equivalent to 0.1 arcsec from Earth). Over extended periods, it will deliver images and data of the polar region and the side of the Sun not visible from Earth. This latter aspect is a key factor in Solar Orbiter's potential role as a Sentinel within the framework of the International Living With a Star (ILWS) initiative.

Solar Orbiter Model Payload		
Instrument		Science Goals
SWA	Solar Wind Plasma Analyser	Kinetic properties and composition (mass & charge states) of solar wind plasma
RPW	Radio & Plasma Analyser	Radio and plasma waves, including coronal and interplanetary emissions
MAG	Magnetometer	Solar wind magnetic field
EPD	Energetic Particle Detector	The origin, acceleration and propagation of solar energetic particles
DPD	Dust Detector	The flux, mass and major elemental composition of near-Sun dust
NGD	Neutron Gamma-ray Detector	The characteristics of low-energy solar neutrons, and solar flare processes
VIM	Visible Imager & Magnetograph	Magnetic and velocity fields in the photosphere
EUS	EUV Spectrometer	Properties of the solar atmosphere
EUI	EUV Imager	High-res UV imaging of the solar atmosphere
COR	VIS-EUV Coronagraph	Polarised brightness measurements in EUV of coronal structures
STIX	Spectrometer Telescope Imaging X-ray	Energetic electrons near the Sun, and solar X-ray emission

Solar Orbiter will achieve its wide-ranging aims with a suite of sophisticated instruments that perform remote sensing of the Sun with high spatial and temporal resolution, and also measure the properties of the particles and fields at the location of the spacecraft.

In order to reduce costs, the spacecraft design will benefit from technology developed for BepiColombo (such as Solar Electric Propulsion). SEP in conjunction with multiple planetary swingbys at Earth and Venus will deliver Solar Orbiter into a solar orbit with a period of 149 days, exactly two-thirds that of

Venus. The initial operational orbit will have a perihelion of 0.22 AU (48 solar radii) and an aphelion of 0.88 AU. Subsequent Venus swingbys will increase the inclination of the orbit, allowing Solar Orbiter to reach latitudes in excess of 30°, while increasing the perihelion distance. A mission extension of about 2 years would allow a maximum latitude of 35° to be reached.

The spacecraft will be 3-axis stabilised and Sun-pointed. Given the extreme thermal conditions – up to 20 times harsher than at Earth's distance – the craft's thermal design is the subject of detailed study.

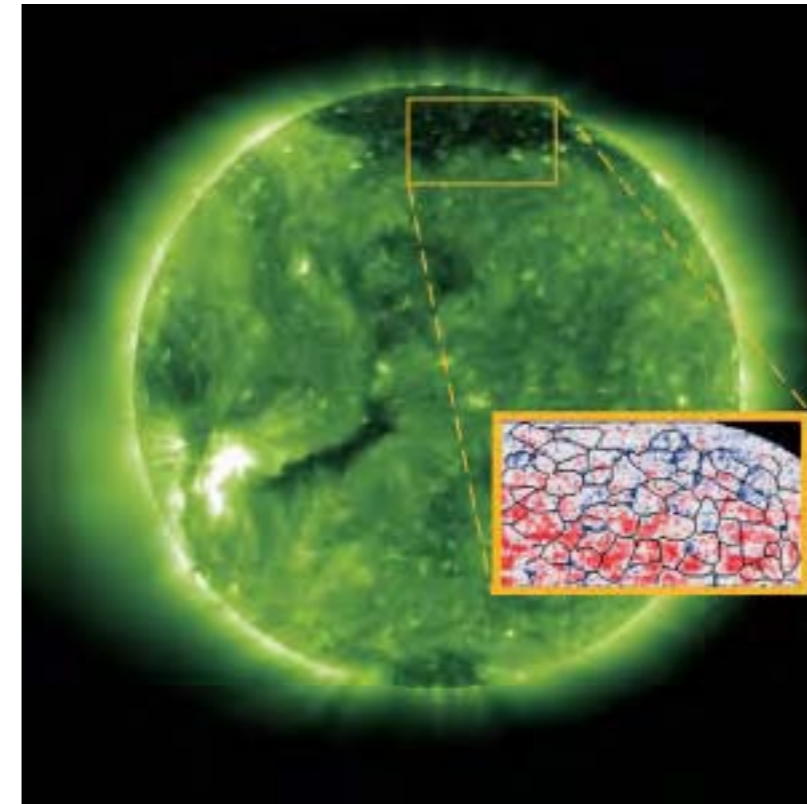

Soho observations of the regions where the solar wind is created illustrate the need for high-latitude observations and the potential for linking remote-sensing and in situ measurements of the surface and solar wind. The green image shows the extreme-UV Sun (Soho/EIT) with the polar coronal holes clearly visible. The inset Soho/SUMER Doppler images (Ne VIII) show blue- and red-shifted plasma flows; black lanes mark the supergranular network boundaries. The outflowing solar wind (blue-shifts) clearly originate in the network cell boundaries and junctions. This is an intriguing result, but as Doppler shifts can be measured only close to the line-of-sight, instruments need to fly well above the ecliptic plane to obtain a thorough understanding of the polar outflow of the high-speed solar wind. In addition, the distribution of the solar-wind outflow regions should be imprinted on the higher solar wind, which can be confirmed only by in situ measurements.

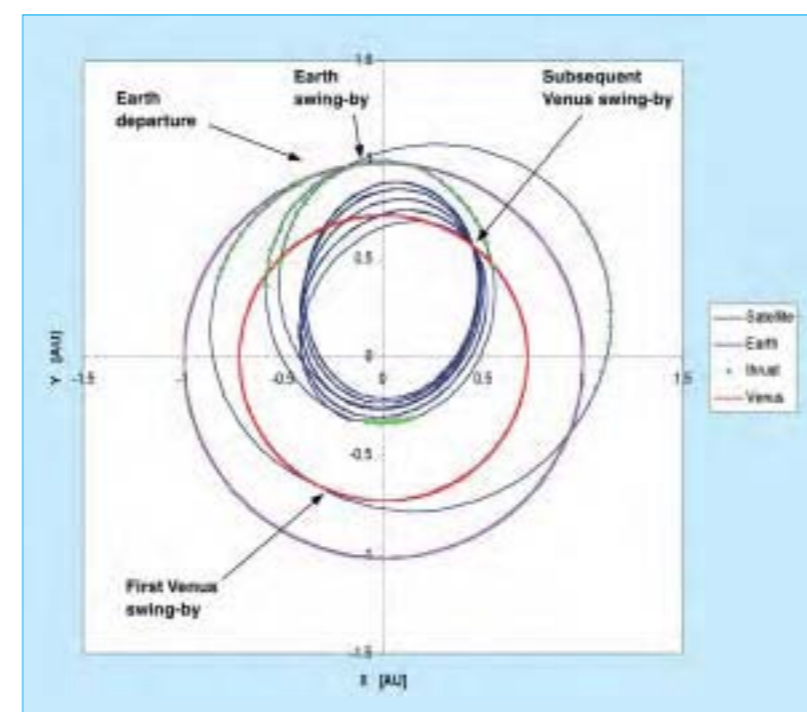

Representative trajectory of Solar Orbiter. The 22-month cruise phase uses Venus flybys and SEP thrusters firings to establish the initial 0.22x0.88 AU operational orbit. During the 7-orbit prime operational phase, Venus encounters increase the inclination to achieve a maximum solar latitude of 30.8°. In the extended phase, two further Venus swingbys increase the maximum latitude to 35°.

ESA Milestones (1997-2005)

1997

- 5 Mar: ESA and NASA sign an agreement in principle for the Columbus module to be launched by the Shuttle in exchange for two Nodes and other hardware.
- 20 Mar: Council appoints Antonio Rodotà as the next Director General, Hans Kappler as Director of Industrial Matters and Technology Programmes, Daniel Sacotte as Director of Administration, and David Dale as Director of Technology and Operational Support.
- 3 Apr: the SPC approves the reflight of Cluster.
- 18 Apr: ESA and NASDA sign an MoU on the launch and use of Artemis.
- 15-24 May: ESA astronaut Jean-Francois Clervoy flies Shuttle mission STS-84.
- 1 Jul: Mr Rodotà takes over from his predecessor, Jean-Marie Luton (F).
- 3 Sep: launch of Meteosat-7, last of the first-generation meteorological satellites.

- 23 Sep: 100th flight of Ariane, carrying Intelsat 803.
- 15 Oct: launch of the NASA/ESA Cassini/Huygens mission by Titan-4B/Centaur from Cape Canaveral.
- 30 Oct: second test flight of Ariane-5 (502).
- 24 Nov: Meteosat celebrates 20 years.
- 12 Dec: signature of the ESA/ASI Arrangement for Node-2/ Node-3.

1998

- 29 Jan: signature of the Intergovernmental Agreement (IGA) on Space Station Cooperation by 15 countries and of the MoU between ESA and NASA in Washington DC.
- 2 Feb: Matra Marconi Space receives the green light from ESA and Eumetsat to begin the development and production of three Metop meteorological satellites.
- 25 Mar: Council approves the proposal to set up a single European Astronaut Corps by merging existing national

- astronaut programmes with the ESA programme.
- 16 May: completion of the ISO mission, which made more than 26 000 observations since launch in 1995.
- 22 Jun: ceremony in Brussels to mark the 25th anniversary of the 1973 European Space Conference that laid the foundation for ESA.
- 23-24 Jun: 136th ESA Council meets in Brussels and approves funding for the: first step of the Global Navigation Satellite System (GNSS-2); definition and start-up of activities for the 'Living Planet Programme' of Earth Observation; first step in the development of a more powerful version of Ariane-5 (Ariane-5 Plus); preliminary work to develop the Vega small launcher. In addition, Council adopts a Resolution on the Reinforcement of the Synergy between ESA and the European Union. This document was adopted in parallel by the EU Research Ministers on 22 Jun.

- 20 Oct: successful launch of Ariane-503 allows the vehicle to be declared operational. Atmospheric Reentry Demonstrator was carried and successfully recovered.
- 21 Oct: Council appoints Claudio Mastracci (I) as Director of Application Programmes. He takes up duties in Dec.
- 29 Oct: ESA Astronaut Pedro Duque is launched on 9-day Shuttle mission STS-95.
- 2-3 Nov: the SPC approves the Mars Express mission.
- 20 Nov: launch of Zarya, the first element of the International Space Station, by Proton rocket from Baikonur.
- 25 Nov: signature with

- Aerospatiale of the ATV development contract.
- 4 Dec: launch of Node-1 (Unity), the second ISS element, aboard the Shuttle.
- 16 Dec: Council decides to locate Columbus control centre at DLR Oberpfaffenhofen (D) and ATV control centre at CNES Toulouse (F).
- 20 Dec: celebration of the 20th anniversary of the ESA/Canada Cooperation Agreement.

1999

- 21 Jan: ESA signs eight bilateral Agreements with Air Traffic Service Providers for European Geostationary Navigation Overlay Service (EGNOS).
- 8 Feb: Alenia Aerospazio and ESA sign Cupola contract for ISS; see 6 Sep 2004.
- 20 Feb: Jean-Pierre Haigueré departs for his 188-day flight to the Mir space station (until 28 Aug); it is the longest stay in space for a non-Russian.
- 30 Mar: signature of Mars Express contract with Matra Marconi Space.
- 7-9 Apr: the 139th Council meeting is held in Longyearbyen, Spitzbergen (N).
- May 1999: Jean-Jacques Dordain is appointed Director of the new Directorate of Strategy and Technical Assessment.
- 11-12 May: Council meeting at ministerial level in Brussels approves investments in major new programmes in telecommunications, navigation (including the Galileo definition phase) and Earth observation.
- 17 May: creation of Astrium by Aerospatiale Matra, DASA and Marconi.
- 23-24 Jun: Council elects Alain Bensoussan (F) as new



The main control room in ESOC.

- Chairman from 1 Jul, taking over from Hugo Parr (N).
- 28 Jun: the ISS User Centre formally opens at ESTEC.
- 9 Sep: launch of Foton-12 from Plesetsk carrying 240 kg of European experiments.
- 14 Oct: creation of the European Aeronautic, Defense and Space Co. (EADS).
- 7 Dec: ESA and the European Commission sign the contract for the GalileoSat study, the ESA contribution to the definition phase of the Galileo programme.
- 10 Dec: first operational flight of Ariane-5 (504) carrying ESA's XMM-Newton X-ray observatory.
- 15 Dec: signature of accession agreement of Portugal, which becomes 15th ESA member state.
- 19-27 Dec: ESA Astronauts Claude Nicollier and Jean-François Clervoy fly on the STS-103 third servicing mission to the Hubble Space Telescope.
- 2000
- 11-22 Feb: ESA Astronaut Gerhard Thiele flies the STS-99 Shuttle Radar Topography Mission (SRTM).
- 13 Mar: the ERS-1 mission ends after 9 years of service.
- 4 May: inauguration of the joint ESA/EC Galileo Programme Office in Brussels.
- 17 May: 10th anniversary of the European Astronaut Centre (EAC).
- 7 Jun: ESA contract award to Arianespace for nine Ariane-5 launchers for ATV. The total value of more than €1 billion is the largest contract ever placed by ESA.
- 20 Jun: signature of International Charter on disaster management between ESA and CNES.
- 21 Jun: CNES/ESA Agreement on constitution of EAC team.
- 21 Jun: ESA and Canada renew cooperation agreement in Paris in the presence of the Canadian Prime Minister, Jean Chrétien.
- 10 Jul: ESA and UNESCO present their joint report on the social and ethical implications of space activities.
- 12 Jul: launch of the Zvezda module to the ISS. ESA provided the module's Data Management System.
- 15 Jul: the first pair of Cluster-II satellites is launched by Soyuz from Baikonur.
- 9 Aug: the second pair of Cluster-II satellites is launched by Soyuz from Baikonur.
- 12 Sep: signature of Agreement between Luxembourg and ESA on participation in ARTES.
- 14 Sep: third commercial flight of Ariane-5 (506).
- 30 Oct: 100th Ariane-4 flight.



ESTEC: the principal technical site of ESA.

31 Oct: launch of first ISS habitation crew, aboard Soyuz from Baikonur.

16 Nov: adoption of a common Resolution on a European strategy for space by the ESA and EU Research Councils, a first in the ESA/EU relationship.

19 Nov: the three Wise Men (C. Bildt, J. Peyrelevede, L. Späth) present their report on the evolution of ESA.

19 Dec: Council appoints Jean-Jacques Dordain to the post of Director of Launchers; he takes up duties on 15 Feb 2001.

2001

17 Jan: signature of framework cooperation agreement with Greece.

8 Mar: 'Leonardo' makes the first flight of Europe's MPLM multi purpose logistics module to the ISS, aboard STS-102.

21 Mar: Council nominates Pieter Gaele Winters as Director of Technical and Operational Support; he takes up duties on 1 Jun 2001.

19 Apr: ESA Astronaut Umberto Guidoni is launched on Shuttle STS-100 and becomes the first European aboard the ISS.

1 May: the new Director of Science, David Southwood, takes up office. He succeeds Roger Bonnet, who managed the Science Programme for 17 years.

17 May: inauguration of the new building for INTA-Spasolab, ESA's external laboratory for solar-cell qualification and testing in Madrid (E).

21 Jun: Council appoints Jean-Pol Poncelet as Director of Strategy and External Relations; he takes up duties on 16 Aug 2001.

22 Jun: ESA announces the award of its largest contract to date, totalling about €370 million to a consortium led by Alcatel Space to build both Herschel and Planck.

9 Jul: ESA and the Chinese National Space Administration (CNSA) sign an agreement to fly Cluster instruments on China's Double Star satellites. See 29 Dec 2003.

12 Jul: Ariane-5 (V142) places Artemis and Japan's BSAT-2b in lower-than-planned orbits. ESOC controllers rescue Artemis using its own chemical and ion thrusters, delivering it to its final GEO position 31 Jan 2003.

21 Oct: ESA Astronaut Claudie Haigneré is launched aboard Soyuz-TM33 to the ISS on an 8-day visit.

22 Oct: ESA's first microsatellite, Proba-1, is launched by PSLV.

26 Oct: ISS receives Prince of Asturias Award of International Cooperation.

14-15 Nov: Council meeting at ministerial level in Edinburgh (UK) approves investments in new programmes amounting to almost €8 billion, including about €500 million for Galileo.

21 Nov: Artemis and Spot-4 become the first satellites to communicate with each other via laser.

18 Dec: CNES celebrates its 40th anniversary.

20 Dec: Council appoints José Achache (F) as the Director of Earth Observation Programmes; he takes up duties on 1 Jan 2002.

2002

25 Jan: Marecs-B2, launched in 1984, is retired..

28 Feb: launch of Envisat from Kourou by Ariane-5.

26 Mar: the EU Transport Council approves the Galileo development phase and releases €450 million for its funding.

25 Apr: ESA Astronaut Roberto Vittori is launched aboard Soyuz-TMA1 for an 8-day mission aboard the ISS.

2 May: ESA and CNES sign a contract on funding the fixed costs of CNES/CSG facilities 2002-2006.

27 May: the Director of Science presents the 'Cosmic Vision 2020' restructured long-term plan for space science to the SPC.

12 Jun: Council elects Per Tegnér as its new Chairman as from 1 Jul 2002. He takes over from Alain Bensoussan (F).

17 Jun: Claudie Haigneré is appointed as Minister for Research and New Technologies in the French government.

28 Aug: MSG-1 is by Ariane-5 (V155) and returns its first image 28 Nov.

6 Sep: 35th anniversary of ESOC.

8 Oct: signature of agreement on AmerHis project (onboard switching telecommunications) between CDTI, Hispasat and ESA.

15 Oct: Foton-M1, carrying 44 ESA experiments, is destroyed soon after launch from Plesetsk.

17 Oct: Integral is launched by Proton from Baikonur. Science operations begin 30 Dec.

30 Oct: ESA Astronaut Frank De Winne is launched aboard Soyuz-TMA2 for an 8-day mission aboard the ISS.

5 Nov: the SPC approves the Venus Express for launch in 2005.

12 Nov: EIROforum is formally

established with the signature of a common Charter by the DGs of seven European intergovernmental research organisations (CERN, EMBL, ESA, ESO, ESRF, ILL, EFDA).

1 Dec: the ECS programme ends with deactivation of the last satellite.

11 Dec: failure of the first flight of the new Ariane-5 ECA model (V157). See 12 Feb 2005.

11-12 Dec: Council appoints Jean-Jacques Dordain as new Director General as from 1 Jul 2003. It approves a Resolution on introducing 3-year budget planning and the creation of the European Space Policy Institute (ESPI), in Vienna (A).

2003

15 Jan: presentation of the Bonnet report on French space policy.

21 Jan: the European Commission publishes the Green Paper on European space policy.

28 Jan: signature of contract with EADS Astrium for the design & development (Phase-C/D) of Venus Express.

31 Jan: Artemis reaches its final orbital position after the 18-month recovery operations, becoming operational on 1 Apr.

1 Feb: loss of Space Shuttle *Columbia*.

6 Feb: EU Convention: the Presidium presents drafts of Articles 1 to 16 of the Constitutional Treaty. Reference to space is made in Art. 3 (the Union's objectives) and in Art. 12.2 (Shared competences).

11 Feb: signature of the Agreement between ESA and Russia on Cooperation and Partnership in the Exploration and Use of Outer Space for



ESA's Villafranca tracking station near Madrid, Spain.

Peaceful Purposes in Paris in the presence of the Russian Foreign Minister, Igor Ivanov.

15 Feb: 116th and last flight of a Ariane-4. The 73rd consecutive success.

25 Feb: signature of contracts for full development of Vega and P80.

5 Mar: ESA's first deep-space ground station opens, in New Norcia, West Australia.

31 Mar: signature with DLR of contract for the Columbus Control Centre.

1 Apr: Maxus-5 is launched from Kiruna (S), providing 740 s of µg to five experiments.

7 Apr: signature of European Cooperating State Agreement between ESA and Hungary (see 5 Nov 2003).

9 Apr: Ariane-5 (514/V160) is launched carrying Insat-3A and Galaxy-12. It is the first Ariane-5 since the ECA failure of 11 Dec 2002.

17 Apr: signature with CNES of the contract for the ATV Control Centre.

12 May: 25th anniversary of VILSPA.

25 Apr: Council appoints Antonio Fabrizi (I) as Director of Launchers.

27 May: Council at delegate level

in Paris takes important decisions on the European launcher sector, ISS and ESA-EU relations.

May: the 1000th refereed paper based on ISO data is published.

1 Jun: ISS Node-2 arrives at the Kennedy Space Center from Alenia in Turin (I). Ownership is formally transferred from ESA to NASA 18 Jun.

2 Jun: launch of Mars Express by Soyuz from Baikonur.

11 Jun: ESTEC celebrates its 35th anniversary.

11 Jun: Ariane-5 (V161) is launched carrying Optus-C1 and BSAT-2c.

17 Jun: the contract to launch Venus Express on Soyuz from Baikonur is signed with Starsem.

1 Jul: Jean-Jacques Dordain takes up duties as Director General.

10 Jul: ESA and the Netherlands Government sign the bilateral agreement for the DELTA Dutch Soyuz Mission. The ISS Flight Order Contract is signed with Rosaviakosmos/RSC Energia 23 Jul.

11 Jul: contracts for the first Galileo satellites are signed at ESTEC: €27.9 million with SSTL

- Ltd (UK) and €72.3 million with Galileo Industries.
- 11 Jul: the Phase-C/D contract for ACES (Atomic Clock Assembly in Space) is signed with EADS.
- 15 Jul: ESA signs the Transfer of Ownership for the Microgravity Science Glovebox to NASA; the US agency signs 14 Aug.
- 22 Jul: ESA and Spain sign an agreement for a new high-performance deep-space tracking station in Cebreros (E), to become operational Sep 2005.
- 27 Sep: SMART-1, Europe's first lunar mission, is launched by Ariane-5 V162 from Kourou, French Guiana, at 23:14 UT. See 30 Sep.
- 29 Sep: three industrial teams are announced to carry out Phase-A mission designs for Aurora ExoMars under 10-month €600k contracts, headed by Alenia Spazio (I), Alcatel Space (F) and EADS Astrium (F). See Feb 2004. Two teams were selected for the Entry Vehicle Demonstrator mission pre-Phase-A 5-month €150k studies, led by EADS Launch Vehicles (F) and SSTL (UK).
- 30 Sep: SMART-1's ion thruster is fired for the first time at 12:25 UT for 1 h. This is the first European mission to use electric primary propulsion and the first European Hall-effect thruster.
- 17 Oct: the Galileo Joint Undertaking issues the invitation to tender for the Galileo Concession. The Joint Undertaking will shortlist bidders to become the Concession-holder for Galileo's deployment and operations phases.
- 18 Oct: ESA Astronaut Pedro Duque is launched to the ISS aboard Soyuz-TMA3/75, returning 28 Oct.
- 21 Oct: ESA and Rosaviakosmos sign the agreement for Foton flights M2 (2005) & M3 (2006), to carry 660 kg of ESA payloads.
- 22 Oct: the €157.9 million Phase-C/D/E1 contract to build Aeolus is signed with EADS Astrium (UK).
- Oct: two €600k Phase-A study winners for Aurora's Mars Sample Return Mission were announced: Astrium Ltd (UK) and Alenia (I).
- 5 Nov: signature of the PECS document (Plan of space collaboration activities for European Cooperating State) between ESA and Hungary (see 7 Apr 2003).
- 6 Nov: the Science Programme Committee approves the LISA Pathfinder mission, but cancels Eddington and the BepiColombo lander because of financial constraints.
- 11 Nov: the European Commission adopts the White Paper on European Space Policy. It presents an action plan for implementing an enlarged European space policy, including proposals for joint ESA-EU space programmes.
- 20 Nov: 5th anniversary of launch of the first ISS element, Zarya.
- 24 Nov: signature of European Cooperating State Agreement between ESA and Czech Republic (see 24 Nov 2004).
- 25 Nov: signature of the ESA-EU Framework Agreement to facilitate new joint projects.
- 25 Dec: Mars Express enters Mars orbit. Beagle-2 (released 19 Dec) fails in landing attempt.
- 29 Dec: Double Star-1 is launched by China, including eight ESA instruments to study the interaction between the solar wind and Earth's magnetic field in conjunction with Cluster. DS-2 followed 25 Jul 2004.
- 2004**
- 4 Feb: Council approves funding for European Guaranteed Access to Space (EGAS; see 9 Mar), Soyuz launches from Kourou and the Future Launcher Preparatory Programme (FLPP).
- Feb: two industrial teams are announced to carry out Phase-A designs for Aurora's ExoMars rover and Pasteur payload under 12-month €900k contracts, headed by EADS Astrium (UK) & MD Robotics (CDN). See 29 Sep 2003.
- 2 Mar: launch of Rosetta by Ariane-5 from Kourou.
- 5 Mar: Soyuz launch contract is signed for the two Galileo System Test Bed satellites.
- 9 Mar: ESA and Arianespace sign the €950 million European Guaranteed Access to Space (EGAS) contract.
- 25 Mar: Council approves the accession of Greece and Luxembourg (see 6 May & 19 Jul) to the ESA Convention.
- 19 Apr: ESA Astronaut André Kuipers is launched to the ISS aboard Soyuz-TMA4/8S, returning 30 Apr.
- Apr: Gaelle Winters takes up duty as Director of Operations and Infrastructure (D/OPS).
- 1 May: Michel Courtois is appointed Director of Technical & Quality Management, and head of ESTEC.
- 6 May: Mrs Erna Hennicot-Schoepges, Minister for Culture, Higher Education and Research of the Grand Duchy of Luxembourg, and Jean-Jacques Dordain sign the Agreement on Luxembourg's accession to the ESA Convention. Under this agreement, Luxembourg becomes a full Member State of ESA by Dec 2005 at the latest, after a transition period.
- 28 May: the Swarm geomagnetic survey mission is selected by the Earth Observation Programme Board as the next Earth Explorer Opportunity mission, for launch in 2009.
- 23 Jun: signature of €80 million contract with EADS Astrium Ltd (Stevenage, UK) for LISA Pathfinder Phase-B2/C/D. Launch is planned for 2008.
- Jun: Giuseppe Viriglio is appointed Director of European Union and Industrial Programmes (D/EUI).
- 1 Jul: Cassini/Huygens enters orbit around Saturn.
- 13 Jul: signature of €1.046 billion contract with EADS Space Transportation (Bremen, D) for ISS exploitation activities, including six ATVs (€835 million) and Columbus.
- 15 Jul: signature of the Framework Cooperation Agreement between ESA and Turkey on Cooperation in the Exploration and Use of Outer Space for Peaceful Purposes.
- 15 Jul: signature of the €13.5 million prime contract with Verhaert D&D for Proba-2.
- 19 Jul: signature of Agreement on Greece's accession to the ESA Convention. See 9 Mar 2005.
- 25 Jul: Double Star-2 is launched by China; see 29 Dec 2003.
- 6 Sep: ceremony at Alenia Spazio, Torino (I) marks end of Cupola development. Delivered to Kennedy Space Center 8 Oct; launch is planned for Jan 2009.
- 19 Oct: inauguration of the Columbus Control Centre, Oberpfaffenhofen (D).
- 22 Oct: Proba-1 marks 3 years of operations.
- 26 Oct: Cassini/Huygens makes its first close approach to Titan (1200 km).
- 1 Nov: Daniel Sacotte takes up duty as Director of Human Spaceflight, Microgravity & Exploration (D/HME). Volker Liebig takes up duty as Director of Earth Observation (D/EOP).
- 2 Nov: signature of €135 million contract with Alcatel Space for MSG-4.
- 15 Nov: SMART-1 enters orbit around the Moon.
- 22 Nov: Maxus-6 is launched from Kiruna (S), providing 12 min of μ g to 8 experiments.
- 24 Nov: signature of the PECS document (Plan of space collaboration activities for European Cooperating State) between ESA and the Czech Republic (see 24 Nov 2003).
- 25 Nov: the first Space Council is held, in Brussels, the first joint meeting of the EU Council and of the ESA Council at ministerial level.
- 10 Dec: EC approves Galileo deployment and operation phases.
- 21 Dec: ESA signs a €150 million contract with Galileo Industries for the Galileo In-Orbit Validation phase as a step towards a €950 million contract covering the overall IOV phase.
- 25 Dec: Huygens is released at 02:00 UT by Cassini; see 14 Jan 2005.
- 2005**
- 14 Jan: Huygens successfully probes the atmosphere and surface of Titan.
- 19 Jan: signature in Moscow by Jean-Jacques Dordain and the Head of the Russian Federal Space Agency, Anatoly Perminov, of an agreement for long-term cooperation and partnership in the development, implementation and use of launchers.
- 10 Feb: the Science Programme Committee approves a 4-year extension of the Cluster mission, to Dec 2009.
- 12 Feb: success of the second flight of the new Ariane-5 ECA model (V164).
- 4 Mar: Rosetta flies past Earth, closing to 1900 km at 22:10 UT.
- 9 Mar: Greece formally becomes the 16th member state of ESA.
- 17 Mar: the Council approves a cooperation agreement between ESA and ISRO for India's first Moon mission, Chandrayaan-1, planned for launch 2007/2008.
- 15 Apr: ESA Astronaut Roberto Vittori is launched to the ISS aboard Soyuz-TMA6/10S, returning 25 Apr.
- 21 Apr: ERS-2 and all its instruments continue operations 10 yr and 52 289 orbits after launch.
- 2 May: Maser-10 is launched from Kiruna (S), providing 6 min of μ g to 5 experiments and reaching 252 km altitude.
- 31 May: ESA marks its 30th birthday.
- 31 May: launch of Foton-M2 from Baikonur carrying 385 kg of European experiments, landing 16 Jun.
- 31 May: ESA and the European Centre for Medium-Range Weather Forecasts (ECMWF) sign a long-term agreement to exchange information and expertise.
- 1 Jun: René Oosterlinck takes up duties as Director of External Relations (D/EXR).
- 7 Jun: the second Space Council is held in Luxembourg.
- 16 Jun: the contract for AlphaBus development is signed by ESA, CNES, EADS Astrium & Alcatel Space.
- 22 Jun: Council elects Sigmar Wittig as its new Chairman as from 1 Jul 2005. He takes over from Per Tegnér (S).

ISS Mission Milestones

1998

20 Nov 1998: Zarya launch, first ISS element.

4 Dec 1998: STS-88/2A launch, docks Unity Node-1 with Zarya 7 Dec. First crew aboard ISS 10 Dec. 3 Shuttle EVAs make external connections.

1999

27 May 1999: STS-96/2A.1 launch, docks with Unity/PMA-2 29 May carrying logistics in Spacehab module. Shuttle EVA installs 2 external cranes. Undocks 3 Jun.

2000

19 May: STS-101/2A.2a Atlantis launch, docks with Unity/PMA-2 21 May carrying supplies and to perform maintenance (including EVA 22 May from Shuttle). Undocks 26 May.

12 Jul: Zvezda launch, incorporating ESA **DMS-R**; Zarya/Unity docks 26 Jul.

6 Aug: Progress-M1-3/1P launch, docks with Zvezda aft port 8 Aug carrying cargo/propellant. Undocks 1 Nov.

8 Sep: STS-106/2A.2b Atlantis launch, docks with Unity/PMA-2 10 Sep carrying logistics in Spacehab module. Shuttle EVA makes Zvezda/Zarya external connections. Undocks 17 Sep.

11 Oct: STS-92/3A Discovery launch, docks with Unity/PMA-2 13 Oct. Attaches first Truss section (Z1, with CMGs and Ku-band comms system) to Unity zenith port 14 Oct. 4 Shuttle EVAs make Z1/Unity connections, attach PMA-3 to Unity nadir, and prepare for future attachments. Undocks 20 Oct.

31 Oct: Soyuz-TM31 launch, Expedition-1 crew (Gidzenko, Shepherd, Krikalev) docks with Zvezda aft port 2 Nov. Beginning of ISS continuous occupation.

16 Nov: Progress-M1-4/2P launch, docks with Zarya nadir port 18 Nov carrying cargo/propellant. Undocks 1 Dec; redocks 26 Dec; undocks 8 Feb 2001.

30 Nov: STS-97/4A Endeavour

launch, docks with Unity PMA-3 2 Dec. P6 Truss segment with solar arrays installed in 3 EVAs. Undocks 9 Dec.

2001

7 Feb 2001: STS-98/5A Atlantis launch, docks with Unity PMA-3 9 Feb. US Destiny lab attached 10 Feb; PMA-2 moved from Unity nadir to Destiny forward. ISS attitude control transferred from Zvezda to Destiny. Undocks 16 Feb.

24 Feb: Soyuz-TM31 moves from Zvezda aft port to Zarya nadir port.

26 Feb: Progress-M44/3P launch, docks with Zvezda aft port 28 Feb carrying cargo/propellant. Undocks 16 Apr.

8 Mar: STS-102/5A.1 Discovery launch, docks with Destiny/PMA-2 10 Mar. First **MPLM** (Leonardo) attached/detached Unity/PMA-3 nadir. Expedition-2 crew swaps with #1 crew. Undocks 19 Mar.

18 Apr: Soyuz-TM31 moves from Zarya nadir port to Zvezda aft port.

19 Apr: STS-100/6A Endeavour launch, docks 21 Apr with Destiny/PMA-2. Crew includes ESA astronaut **Umberto Guidoni**, first European aboard the ISS. Second **MPLM** (Raffaello) attached/detached Unity/PMA-3 nadir, with racks/equipment for Destiny outfitting. UHF antenna and Canadarm2 SSRMS Station robot arm installed in 2 EVAs. Undocks 29 Apr.

28 Apr: Soyuz-TM32/2S taxi flight launch, docks 30 Apr with Zarya nadir port. Crew returns in TM31 5 May from Zvezda aft port, leaving TM32 as fresh return craft.

20 May: Progress-M1-6/4P launch, docks with Zvezda aft

port 23 May carrying cargo/propellant. Undocks 22 Aug.

8 Jun: Usachev & Voss make 19 min internal 'spacewalk' in Zvezda's node, replacing nadir hatch with docking cone. DC-1 docking compartment will be attached to this third Russian docking port.

12 Jul: STS-104/7A Atlantis launch, docks with Destiny/PMA-2 03:08 UT 14 Jul. Berths 'Quest' Joint Airlock 07:34 UT 15 Jul to Unity's starboard position assisted by 359 min Gernhardt/Reilly EVA. 389 min EVA-2 by Gernhardt/Reilly on 18 Jul adds O₂/N₂ tanks. 242 min EVA-3 by Gernhardt/Reilly on 21 Jul is first to use Quest. Undocks 04:54 UT 22 Jul.

10 Aug: STS-105/7A.1 Discovery launch, docks with Destiny/PMA-2 18:42 UT 12 Aug. **MPLM** (Leonardo) attached/detached Unity/PMA-3 nadir 13/19 Aug, with racks/equipment for Destiny outfitting (3300/1700 kg up/down). Barry/Forrester 376 min EVA-1 16 Aug adds ammonia coolant supply; 329 min EVA-2 18 Aug installs handrails and heater cables on Destiny to prepare for S0 truss. Expedition-3 crew (Culbertson, Dezhurov, Tyurin) swaps with Expedition-2. Undocks 14:52 UT 20 Aug.

22 Aug: Progress-M45/5P launch, docks with Zvezda aft port 23 Aug carrying cargo/propellant. Undocks 22 Nov.

14 Sep: Russian Pirs module launch, docks with Zvezda nadir port 01:05 UT 17 Sep for EVAs and Soyuz dockings.

8 Oct: Dezhurov & Tyurin make 298 min first EVA from Pirs, installing equipment for future EVAs and dockings.



STS-100 approaches carrying MPLM Raffaello, April 2001. (NASA)

15 Oct: Dezhurov & Tyurin make 352 min second EVA from Pirs, installing experiments on Zvezda.

19 Oct: Soyuz-TM32 moves from Zarya nadir port to Pirs (first use).

21 Oct: Soyuz-TM33/3S taxi flight launch with Afanasyev, Kozev & ESA astronaut **Claudie Haigneré**, docks 23 Oct with Zarya nadir port. Crew returns in TM32 31 Oct from Pirs, leaving TM33 as fresh return craft.

12 Nov: Dezhurov & Culbertson make 304 min EVA from Pirs, completing module's external outfitting.

26 Nov: Progress-M1-7/6P launch, soft docks with Zvezda aft port 28 Nov carrying cargo/propellant (see 3 Dec). Undocks 19 Mar 2002.

3 Dec: Dezhurov & Tyurin make 166 min EVA from Pirs, clearing debris from Zvezda aft port, allowing Progress-M1-7/6P to hard dock.

5 Dec: STS-108/UF-1 Endeavour launch, docks with Destiny/PMA-2 20.03 UT

7 Dec. **MPLM** (Raffaello) attached/detached Unity/PMA-3 nadir 8/14 Dec, with supplies. Godwin/Tani 252 min EVA 10 Dec adds thermal blankets to P6 bearing assembly. Expedition-4 crew (Onufrienko, Walz, Bursch) swaps 8 Dec with #3. Undocks 17:28 UT 15 Dec.

2002

14 Jan: Onufrienko & Walz make 363 min EVA from Pirs, using its Strela arm to install second Strela, previously stored on PMA-1.

25 Jan: Onufrienko & Bursch make 359 min EVA from Pirs, installing thruster deflectors on Zvezda and replacing materials experiments.

20 Feb: Walz & Bursch make 347 min EVA from Quest to prepare for arrival of S0 Truss segment.

21 Mar: Progress-M1-8/7P launch, docks with Zvezda aft port 24 Mar carrying cargo/propellant. Undocks 25 Jun.

8 Apr: STS-110/8A Atlantis launch, docks with



Umberto Guidoni was the first European aboard the ISS. (NASA)



The Soyuz carrying Frank De Winne approaches docking with the ISS. (NASA)

Destiny/PMA-2 16:04 UT 10 Apr. 12 t S0 truss attached to Destiny 11 Apr, accompanied by 468-min Smith/Walheim EVA to connect struts and cabling. Ross/Morin 450-min EVA 13 Apr completes strut installation. Smith/Walheim 387-min EVA 14 Apr reroutes Canadarm2 power/control links via S0 and unclamps Mobile Transporter, which moves for first time 15 Apr. Ross/Morin 397-min EVA 16 Apr completes S0 installation. All EVAs from Quest. Undocks 18:31 UT 17 Apr.

20 Apr: Soyuz-TM33 moves from Zarya nadir port to Pirs.

25 Apr: Soyuz-TM34/4S taxi flight launch with Gidzenko, Shuttleworth & ESA astronaut **Roberto Vittori**, docks 27 Apr with Zarya nadir port. Crew returns in TM33 5 May from Pirs, leaving TM34 as fresh return craft.

5 Jun: STS-111/UF-2 Endeavour launch, docks with Destiny/PMA-2 16:25 UT 7 Jun. **MPLM** Leonardo attached/detached

Unity/PMA-3 nadir 8/14 Jun, with supplies (2540/2110 kg up/down); **Microgravity Science Glovebox**, first ESA facility aboard, transferred to Destiny 9 Jun. 434-min EVA-1 9 Jun adds Power & Data Grapple Fixture to P6 truss. Mobile Remote Servicer Base System added to Mobile Transporter 10 Jun. 300-min EVA-2 11 Jun makes Base/Transporter connections. 437-min EVA-3 13 Jun replaces Canadarm2 wrist roll joint. All EVAs by Chang-Díaz/Perrin from Quest. Expedition-5 crew (Korzun, Treschev, Whitson) swaps with #4. Undocks 14:32 UT 15 Jun.

26 Jun: Progress-M46/8P launch, docks with Zvezda aft port 29 Jun carrying cargo/propellant. Undocks 24 Sep.

16 Aug: Korzun & Whitson make 265 min EVA from Pirs, installing 6 debris protection shields on Zvezda.

26 Aug: Korzun & Treschev make 321 min EVA from Pirs, swapping NASDA exposure experiments on Zvezda and installing Russian sensor to measure thruster pollution.

25 Sep: Progress-M1-9/9P launch, docks with Zvezda aft port 29 Sep carrying cargo/propellant. Undocks 1 Feb 2003.

7 Oct: STS-112/9A Atlantis launch, docks with Destiny/PMA-2 15:17 UT 9 Oct. S1 truss attached to S0 by Canadarm2. 3 EVAs totalling 19:41 by Wolf/Sellers from Quest completes installation. Undocks 13:13 UT 16 Oct.

30 Oct: Soyuz-TMA1/5S taxi flight launch with Zalyotin, Lonchakov & ESA astronaut **Frank De Winne**, docks 1 Nov with Pirs. Crew returns in TM34 9 Nov from Zarya nadir port, leaving TMA1 as fresh return craft. TMA1 undocks 3 May 2003 with Expedition-6 crew.

24 Nov: STS-113/11A Endeavour launch, docks with Destiny/PMA-2 21:59 UT 25 Nov. P1 truss attached to S0 26 Nov. 3 EVAs by Lopez-Alegria/Herrington from Quest finalised P1: 405 min 26-27 Nov; 370 min 28-29 Nov; 420 min 30 Nov-1 Dec. Expedition-6 crew (Bowersox, Budarin, Pettit) swaps with #5. Undocks 20:05 UT 2 Dec.

2003

15 Jan: 411 min EVA by Bowersox & Pettit from Quest to deploy P1's radiator.

2 Feb: Progress-M47/10P launch, docks with Zvezda aft port 4 Feb carrying cargo/propellant. Undocks 27 Aug.

8 Apr: 386 min EVA by Bowersox & Pettit from Quest to perform multiple small tasks.

26 Apr: Soyuz-TMA2/6S launch with Expedition-7 crew Malenchenko & Lu, docks 28 Apr with Zarya nadir port. Undocks 28 Oct with Malenchenko, Lu & Duque.

8 Jun: Progress-M1-10/11P launch, makes first unmanned

docking with Pirs 11 Jun carrying cargo/propellant. Undocks 4 Sep.

29 Jul: 1000th day of continuous habitation (Expedition-1 crew boarded 2 Nov 2000).

29 Aug: Progress-M48/12P launch, docks with Zvezda aft port 31 Aug carrying cargo/propellant. Undocks 28 Jan 2004.

18 Oct: Soyuz-TMA3/7S launch with Expedition-8 crew Foale & Kaleri and ESA astronaut **Pedro Duque**, docks 20 Oct with Pirs. Undocks 30 Apr 2004 with Foale, Kaleri & Kuipers.

2004

29 Jan: Progress-M1-11/13P launch, docks with Zvezda aft port 31 Jan carrying cargo/propellant, including **Matroshka**. Undocks 24 May.

26 Feb: 235 min EVA by Foale & Kaleri from Pirs mounts **Matroshka** outside Zvezda. **ATV** laser targets left untouched because planned 5.5 h EVA curtailed by humidity problem in Kaleri's suit.

19 Apr: Soyuz-TMA4/8S launch with Expedition-9 crew Padalka & Fincke and ESA astronaut **André Kuipers**, docks 21 Apr with Zarya nadir port. Undocks 23 Oct with Padalka, Fincke & Shargin.

25 May: Progress-M49/14P launch, docks with Zvezda aft port 27 May carrying cargo/propellant. Undocks 30 Jul.

24 Jun: Padalka & Fincke EVA cancelled after a few min because of oxygen control problem on Fincke's suit. EVA successful 30 Jun.

30 Jun: Padalka & Fincke make 340 min EVA from Pirs to replace a power controller on Control Moment Gyro 2.

3 Aug: Padalka & Fincke make



The ISS configuration as STS-112 departed in October 2002. (NASA)

270 min EVA from Pirs to install **ATV** hardware on Zvezda.

11 Aug: Progress-M50/15P launch, docks with Zvezda aft port 14 Aug carrying cargo/propellant. Undocks 22 Dec.

3 Sep: Padalka & Fincke make 321 min EVA from Pirs to install **ATV** hardware on Zvezda.

14 Oct: Soyuz-TMA5/9S launch with Expedition-10 crew Chiao & Sharipov and test cosmonaut Yuri Shargin, docks 16 Oct with Pirs. Transfers 29 Nov to Zarya nadir; undocks 24 Apr 2005 with Chiao, Sharipov & Vittori.

23 Dec: Progress-M51/16P launch, docks with Zvezda aft port 25 Dec carrying cargo/propellant. Undocks 27 Feb 2005.

2005

26 Jan: Chiao & Sharipov make 328 min EVA from Pirs to mount experiments on Zvezda, including DLR's Rokviss test robotic arm.

28 Feb: Progress-M52/17P launch, docks with Zvezda aft

port 2 Mar carrying cargo/propellant, including experiments for Vittori mission and Proximity Communications Equipment (see 28 Mar) for **ATV**. Undocks 15 Jun.

28 Mar: Chiao & Sharipov make 270 min EVA from Pirs to install remaining **ATV** hardware (3 S-band antennas & GPS antenna) on Zvezda.

15 Apr: Soyuz-TMA6/10S launch with Expedition-11 crew Krikalev & Phillips and ESA astronaut **Roberto Vittori**, docks 17 Apr with Pirs. Vittori returns to Earth 25 Apr with Expedition-10 crew Chiao & Sharipov in Soyuz-TMA5.

16 Jun: Progress-M53/18P launch, docks with Zvezda aft port 19 Jun carrying cargo/propellant.

19 Jul: Krikalev & Phillips move Soyuz-TMA6 from Pirs to Zarya nadir port to clear Pirs for EVAs.

26 Jul: STS-114/LF-1 Discovery launch, docks with Destiny/PMA-2 11:18 UT 28 Jul. **MPLM** Raffaello attached Unity/PMA-3 nadir 29 Jul.

Acronyms & Abbreviations

ACE: Atmospheric Composition Explorer	CSG: Centre Spatial Guyanais	FESTIP: Future European Space Transportation Investigation Programme	IUE: International Ultraviolet Observatory	MSL: Material Science Laboratory	RW: reaction wheel
ACES: Atomic Clock Ensemble in Space	DLR: Deutsches Zentrum für Luft- und Raumfahrt (D)	FIR: far-infrared	IWF: Institut für Weltraumforschung (A)	MSSL: Mullard Space Science Laboratory (UK)	Rx: receive
ADM: Atmospheric Dynamics Mission	DMS-R: Data Management System-Russian	f.l.: focal length	JAXA: Japan Aerospace & Exploration Agency	MW: momentum wheel	SA/CNRS: Service d'Aeronomie du Centre National de la Recherche Scientifique (F)
Ah: amp-hour	DSP: digital signal processor	FLPP: Future Launcher Preparatory Programme	JEM: Japanese Experiment Module (ISS)	N ₂ O ₄ : nitrogen tetroxide	SAO: Smithsonian Astrophysical Observatory (USA)
AIT: assembly, integration & test	EAC: European Astronaut Centre (ESA)	FM: flight model	JWST: James Webb Space Telescope	NASA: National Aeronautics and Space Administration (USA)	Si: silicon
AOCS: attitude and orbit control system	ECLSS: environmental control and life support system	FOV: field of view	LEO: low Earth orbit	NASDA: National Space Development Agency of Japan (now JAXA)	SILEX: Semiconductor Laser Intersatellite Link Experiment
APS: Advanced Pixel Sensor	ECU: European Currency Unit	FSL: Fluid Science Laboratory	LHCP: left-hand circular polarisation	NIR: near-infrared	SMART: Small Missions for Advanced Research in Technology
ARD: Atmospheric Reentry Demonstrator	EGNOS: European Geostationary Navigation Overlay Service	FWHM: full width at half maximum	LISA: Laser Interferometer Space Antenna	NOAA: National Oceanographic & Atmospheric Administration (USA)	SMOS: Soil Moisture and Ocean Salinity
ASI: Agenzia Spaziale Italiana	EDR: European Drawer Rack	GaAs: gallium arsenide	LN ₂ : liquid nitrogen	NRL: Naval Research Lab (USA)	SNG: satellite news gathering
ATV: Automated Transfer Vehicle	EGPM: European contribution to the Global Precipitation Mission	GEO: geostationary	LOX: liquid oxygen	NTO: nitrogen tetroxide	SOHO: Solar and Heliospheric Observatory
AU: Astronomical Unit (149.5 million km)	EIRP: equivalent isotropically radiated power	GMES: Global Monitoring for Environment and Security	LPCE: Laboratoire de Physique et Chimie, de l'Environnement (F)	OBDH: onboard data handling	SPC: Science Programme Committee (ESA)
BOL/EOL: beginning of life/end of life	ELDO: European Launcher Development Organisation	GN ₂ : gaseous nitrogen	Marecs: Maritime European Communications Satellite	OSR: optical solar reflector	SRON: Space Research Organisation Netherlands
BSR: back scatter reflector	EMCS: European Modular Cultivation System	GOCE: Gravity Field and Steady-State Ocean Circulation Mission	MARES: Muscle Atrophy Research & Exercise System	OTS: Orbital Test Satellite	SSPA: solid-state power amplifier
CCD: charge coupled device	EOL/BOL: end/beginning of life	GOX: gaseous oxygen	mas: milliarcsec	PCDF: Protein Crystallisation Diagnostics Facility	SSR: solid-state recorder
CCSDS: Consultative Committee on Space Data Systems	EPM: European Physiology Modules	GPS: Global Positioning System	MDM: multiplexer-demultiplexer	PEMS: Percutaneous Electrical Muscle Stimulator	STEP: Satellite Test of the Equivalence Principle
CEA: Commissariat à l'Energie Atomique (F)	ERA: European Robotic Arm	GSTP: General Support & Technology Programme	MELFI: Minus-Eighty degrees Laboratory for the ISS	PFS: Pulmonary Function System	STM: structural and thermal model
CEN: Centre d'Etudes Nucleaires (F)	ERS: European Remote Sensing satellite	GTO: geostationary transfer orbit	MGSE: mechanical ground support equipment	PI: Principal Investigator	SWIFT: Stratospheric Wind Interferometer for Transport Studies
CESR: Centre d'Etude Spatiale des Rayonnements (F)	ESA: European Space Agency	HEOS: Highly Eccentric Orbit Satellite	MMH: monomethyl hydrazine	PMOD: Physikalisch-Meteorologisches Observatorium Davos (CH)	TC: telecommand
CETP: Centre d'étude des Environnements Terrestre et Planétaires (F)	ESOC: European Space Operations Centre (ESA)	HGA: high-gain antenna	MON: mixed oxides of nitrogen	PMT: photomultiplier tube	TD: Thor-Delta
CFD: computational fluid dynamics	ESRO: European Space Research Organisation	HRF: Human Research Facility	MOS: metal oxide semiconductor	PN: positive-negative	TDP: Technology Development Programme
CFRP: carbon-fibre reinforced plastic	ESTEC: European Space Research and Technology Centre (ESA)	IABG: Industrieranlagenbetriebsgesellschaft GmbH	MPAe: Max-Planck-Institut für Aeronomie (Germany)	POEM: Polar Orbit Earth-observation Mission	TT&C: telemetry, tracking and control
CMG: control moment gyro	ETC: European Transport Container	IAS: Istituto di Astrofisica Spaziale (I)	MPE: Max-Planck-Institut für Extraterrestrische Physik (D)	Prodex: Programme de Développement d'EXpériences scientifiques	TWTA: travelling wave tube amplifier
CNES: Centre National d'Etudes Spatiales (F)	EuTEF: European Technology Exposure Facility	IFOV: instantaneous FOV	MPI: Max-Planck-Institut (D)	RAL: Rutherford Appleton Laboratory (UK)	Tx: transmit
CNRS: Centre National de la Recherche Scientifique (F)	EUV: extreme ultraviolet	INTA: Instituto Nacional de Tecnica Aeroespacial (E)	MPK: Max-Planck-Institut für Kernphysik (D)	RCS: reaction control system	UV: ultraviolet
COROT: Convection, ROTation and planetary Transits (CNES)		IR: infrared	MPLM: MultiPurpose Logistics Module	RHCP: right-hand circular polarisation	VSAT: very small aperture terminal
CPD: Coarse Pointing Device		IRFU: Swedish Institute of Space Physics	msg: milliradian	RLV: Reusable Launch Vehicle	XMM: X-ray Multi-Mirror
CRPE: Centre de Recherche en Physique de l'Environnement terrestre et planétaire (F)		ISEE: International Sun-Earth Explorer	MSG: Meteosat Second Generation; Microgravity Science Glovebox	RTG: radioisotope thermoelectric generator	

Index

- ACE: 25, 26
ACES: 316, 317
Alphabus/Alphasat: 28-29
ADM-Aeolus: 25, 352-355
ARD: 202-205
Ariane: 30-32, 35, 86-93,
168-181, 202-205, 272-
273, 298
Arrow: 45
Artemis: 210-215
Astro-F: 19
Astronauts: 36-37, 42-43
ATV: 298-303, 317
Aurora: 44, 45
- Beagle-2: 244-253
BepiColombo: 10, 16, 18,
19, 372-377
Biolab: 314, 316, 317
Blue Streak: 46-49
- Cassini: 19, 188-199
Clipper: 45
Cluster: 10, 14, 17, 19,
182-187
Columbus: 36, 39, 310-318
Comet: 114-119, 260-271
Cornerstone: 10
COROT: 19
Cos-B: 17, 62-65
Cosmic Vision: 10-11, 16-17
CryoSat: 25-26, 274-277
Cryosystem: 311, 317
Cupola: 39, 317-323
- Darwin: 10
DMS-R: 319
Double Star: 19, 185
- Earth Explorer: 24-26
Earth Watch: 26-27
EarthCARE: 25, 378-379
ECS: 28, 104-107
Eddington: 16
EDR: 314, 316, 317
EGNOS: 29, 284
EGPM: 26, 27
ELDO: 8, 46-49
EMCS: 317
Envisat: 22-24, 220-229
EPM: 316, 317
ERA: 38, 39, 348-351
ERS: 22, 144-151, 220
ESRO-1: 17, 52-54
ESRO-2: 17, 50-51
ESRO-4: 8, 17, 60-61
ETC: 316
Eureca: 152-155
Europa: 46-49
- European Astronaut Corps:
36-37
EuTEF: 316, 317
ExoMars: 45
Exosat: 17, 62, 100-103
Export: 316, 317
- Faint Object Camera: 128-
133
FESTIP: 34
Flagship: 45
Flexi missions: 10
FLPP: 34-35
FSL: 312, 316, 317
- Gaia: 10, 18, 19, 366-371
Galileo: 5, 29, 284-291
Geos: 17, 66-69
Giotto: 17, 114-119
GMES: 4, 5, 27
GOCE: 25, 304-309
- HEOS: 17, 55-57
Herschel: 9, 18, 19, 338-343
Hexapod: 44, 317
Hipparcos: 17, 124-127
Hubble Space Telescope: 17,
19, 37, 128-133, 362
Huygens: 9, 14-15, 17, 19,
188-199
- Integral: 17-18, 19, 236-243
International Space Station:
36-45, 298-303, 310-323,
348-351
ISEE-2: 17, 74-75
ISO: 15, 17, 19, 156-159
IUE: 17, 82-85
- JWST: 10, 18, 362-365
- LISA/LISA Pathfinder: 10,
18, 19, 356-357, 380-381
- Marecs: 28, 94-97
MARES: 317
Mars Express: 10, 12-13,
15, 18, 19, 244-253, 278
Matroshka: 316, 317
MELFI: 317
Metop: 144, 292-297
Meteosat: 20, 21, 76-81,
230-235
Meteosat Second
Generation: 20, 21, 230-
235
Microgravity Science
Glovebox: 316, 317
MPLM: 311, 312, 316, 317
- MSG: see Meteosat Second
Generation; Microgravity
Science Glovebox
MSL: 316, 317
- Newton: see XMM-Newton
Node: 38, 39, 317-321
- Olympus: 28, 120-123
OTS: 28, 70-73
- PEMS: 317
PFS: 317
Philae: see Rosetta
Planck: 9, 18, 19, 332-337
POEM: 222
Proba: 216-219, 330-331
- Rosetta: 11, 18, 19, 260-271
- Sentinel: 27
SILEX: 210-215
Sirio: 98-99
Sloshsat: 272-273
SMART-1: 10, 11, 18, 19,
254-259
SMART-2: see LISA
Pathfinder
SMOS: 26, 324-329
SOHO: 10, 11, 17, 19, 160-
167
Solar: 316, 317
Solar-B: 19
Solar Orbiter: 384-385
Soyuz: 32, 35, 45
Spacelab: 108-113
STEP: 11
Sun: 134-143, 160-167,
384-385
Swarm: 358-361
SWIFT: 25, 26
- TD-1: 17, 58-59
Teamsat: 200-201
Titan: 188-189
- Ulysses: 9, 17, 19, 134-143
- Vega: 32-33, 35, 344-347
Venus Express: 11, 18, 19,
278-283
- XMM-Newton: 10, 14, 15,
17, 19, 206-209