



ELSEVIER

Palaeogeography, Palaeoclimatology, Palaeoecology 124 (1996) 107–136

PALAEO GEOGRAPHY
CLIMATOLOGY
ECOLOGY

Integrated taphonomy of an avian death assemblage in marine sediments from the late Pliocene of Florida

Steven D. Emslie ^a, Warren D. Allmon ^b, Fredrick J. Rich ^c, John H. Wrenn ^d,
Susan D. de France ^e

^a Department of Sciences, Western State College, Gunnison, CO 81231, USA

^b Paleontological Research Institution, 1259 Trumansburg Road, Ithaca, NY 14850, USA

^c Department of Geology, Landrum Box 8149, Georgia Southern University, Statesboro, GA 30458, USA

^d Center for Excellence in Palynology, Louisiana State University, Baton Rouge, LA 70803, USA

^e Department of Anthropology, University of Montana, Missoula, MT 59812, USA

Received 19 April 1995; revised and accepted 22 January 1996

Abstract

We integrate taphonomic data on vertebrate and invertebrate paleontology, micropaleontology and palynology to explain the formation of a late Pliocene death assemblage of marine birds and fish in the “Pinecrest Sand”, Gulf Coastal Florida. Stereonet plots of orientation data on over 1500 cormorant (*Phalacrocoracidae*: *Phalacrocorax*) bones indicate that this fossil assemblage formed first from gradual accumulation of bone, shell and sediments on a barrier island beach, and second by rapid sedimentation in a quiet, back-beach setting associated with multiple episodes of breaching of the barrier. This latter event resulted in the preservation of 137 partial and complete cormorant skeletons and thousands of isolated bones that show a high angle of dip and a preferred orientation to the northeast. Invertebrate fossils exhibit taphonomic signatures characteristic of high-energy reworking with a large percentage of abraded shell fragments similar to beach deposits. Moreover, these data indicate that more than a single depositional episode caused the formation of the deposits referred to as the bird layers. Palynological evidence supports this conclusion. The pollen recovered from the deposits is highly abraded and broken and does not represent an in situ vegetational environment as compared to other deposits of this age in Florida and Georgia. The large number of cormorant and other seabird and fish remains in the bird layers appears to have been caused by a series of toxic red tides that occurred on the Gulf Coast of Florida. These events today cause die offs of large flocks of cormorants and bottom-dwelling fish similar to those recovered from the site. Palynological analysis of the sediments revealed abundant cysts of a dinoflagellate species known to produce toxic red tides. The most likely cause of the death of the cormorants and other vertebrates at this site is a toxic bloom of a variety of *Pyrodinium bahamense*, the thecate form of the dinoflagellate cyst *Polysphaeridium zoharyi*, which has a stratigraphic range from the lower Eocene to the Holocene.

1. Introduction

The marine “Pinecrest Sand” (late Pliocene, 3.5–2.0 Ma; see Allmon, 1993 for a discussion on the nomenclature of these beds) on the Gulf Coast of Florida is well known for its diverse molluscan faunas (Petuch, 1982; Stanley, 1986; Allmon, 1993; Allmon et al., 1993). Fossils of marine and terrestrial vertebrates also are known from these beds (Hulbert, 1987; Morgan and Ridgway, 1987; Jones et al., 1991; Emslie, 1992; Morgan, 1994), but those of seabirds are relatively rare. A new exposure of the upper units of these beds in Sarasota County has produced a highly localized section of shell, sand and clay layers containing thousands of bones of a single species of extinct cormorant (*Phalacrocoracidae*, *Phalacrocorax filyawi* Emslie, 1995a), and thousands of bones, scales and otoliths of marine fish. Excavations of fossils from this new locality resulted in the collection of over 5000 bones and 137 associated partial and complete skeletons of the cormorant (Emslie and Morgan, 1994; Emslie, 1995a). Forty-one bones from at least 10 other taxa of birds, and 11 bones of an extinct species of seal (*Callophoca obscura*), also were recovered. The entire vertebrate fauna reflects a beach or shoreline environment that rarely is preserved in the fossil record of Florida. This fauna, and other Pliocene marine faunas from Florida, provide vertebrate evidence for cold-water upwelling in the Gulf of Mexico in correlation with submergence of the Panamanian isthmus (Emslie and Morgan, 1994; Allmon et al., 1995).

Taphonomic data also were collected from this new exposure including in situ orientation on over 1500 cormorant bones, quantified samples of sediments and invertebrate fossils, and palynologic samples. Systematic identification of fish remains and pollen from the site also were completed to supplement that of the avifauna reported elsewhere (Emslie, 1995a). Here, we integrate these taphonomic and systematic data to interpret the paleoecology and depositional environment of this site. Specifically, we examine the hypothesis that the deposit formed first from a gradual accumulation of bone on or near a barrier beach followed by rapid sedimentation in a back-beach area associ-

ated with breaching of the barrier. These data provide compelling evidence that the unusual accumulation of cormorant and other vertebrate bones and skeletons resulted in part from a series of toxic red tides on the Gulf Coast of Florida. The localized nature of the deposits in the “Pinecrest Sand” also is examined.

2. Stratigraphy and age

The site is located at the Richardson Road Shell Pits (Phase 6) of Quality Aggregates, Inc., Sarasota County, Florida (Fig. 1). It was discovered in 1989 after mining operations exposed the shell beds and bones in one portion of the mine. Fossils were collected at the site by a field crew from the Florida Museum of Natural History (FLMNH) in 1989 and 1990, though subsequent mining operations removed much of the deposit before systematic excavations began in 1991. These excavations were conducted in an undisturbed section of the shell beds in 1991 and 1992 by a crew from FLMNH and the University of California, Santa Cruz (UCSC). In 1995, mining operations in the Phase 6 pit ceased, the pit filled with water and the site is no longer accessible.

Examination of the stratigraphy of the site during initial excavations in 1989 indicated that the bone-bearing horizon extended for at least 200 m east–west, and probably at least 50 m north–south (Emslie, 1995a). Density of bone throughout the bone layers varied, decreasing to the east and west from a center of concentration. In 1991, two sections in the center of this concentration were gridded for excavations in 1 × 1 m squares aligned to true north (Fig. 1). These areas were designated Pits 2 and 4 with most excavations occurring in the latter.

Each square was excavated in three layers collectively known as the bird layers: upper shell, lower shell, and lower sand/clay (Fig. 1; see Emslie, 1995a for a description including orientation and dip of these layers). The upper and lower shell layers consist of cross-bedded and high-angled sediments of shell (some pyritized or encrusted with siderite), shell hash and sand (Fig. 2). The

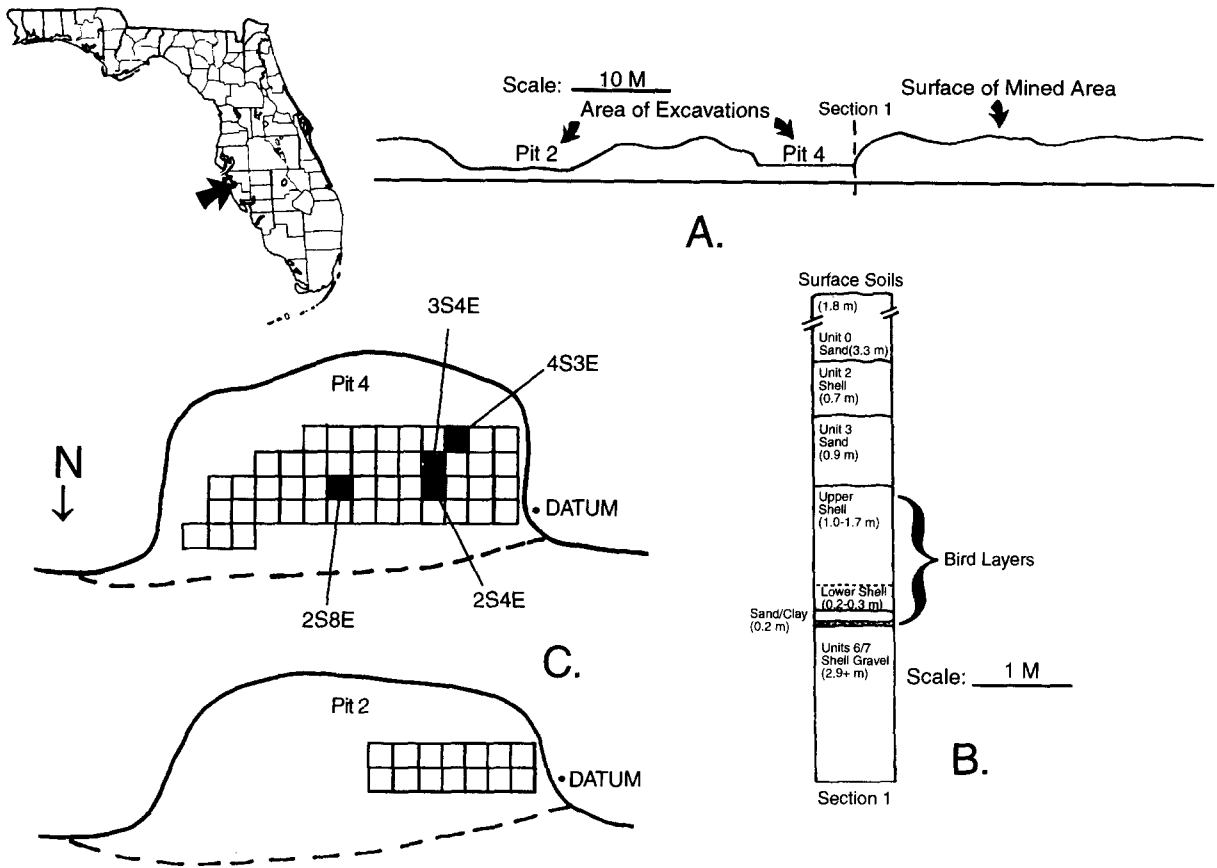

Fig. 1. Location and stratigraphy of the fossil deposits at Richardson Road Shell Pit, Sarasota County, Florida. A. Map with arrow pointing to location of the site, and cross-section of the south wall of the canal in which the site was discovered showing the extent of the deposits in the upper "Pinecrest Sand". The vertical dashed line locates the stratigraphic section shown in B and corresponds with section 1 in Fig. 3. B. Stratigraphic section of the units exposed in the upper Pinecrest "Sand" showing the location of the bird layers. C. Plan views extracted from the south wall of the canal in A of Pits 2 and 4 to show the grids and excavated 1×1 m squares. The grid outline for Pit 4 is repeated in Fig. 5 to illustrate variations in bone density throughout the excavated squares. The shaded squares are labeled by location from the datum and correspond with peak concentrations of bone as shown in Fig. 5.

lower sand/clay layer forms the lower boundary of the bird layers and is characterized by a distinct horizon of greenish clay and sand that is not present in other exposures of the Pinecrest (see below). The clay increases from 1 cm in thickness at the west edge of the site, to about 30 cm thickness at the east end. This clay marks a distinct unconformity with the shell beds below identified as units 6/7 of Petuch (1982; see Fig. 1) and as unit 3? by Emslie and Morgan (1994). The sand in the lower sand/clay begins as a small lens 1–2 cm

thick above the clay at the west end of the pit. It thickens to the east to almost 1 m, but contains few bones or shells.

Petuch (1982) proposed a generalized stratigraphic scheme for the "Pinecrest Sand" exposed at the APAC (Macasphalt, Newburn or Warren Brothers) shell mine (a private mine where shells were removed and sold for construction and road bedding) 2 km west of Richardson Road, near Sarasota. The precise correlation of the Richardson Road bird layers within the upper

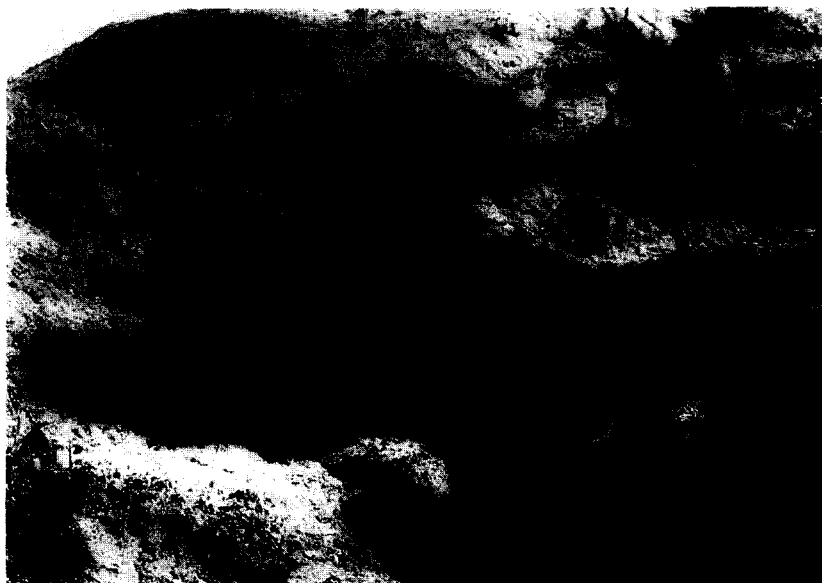

Fig. 2. View of the cross-bedded and angled sediments in the bird layers at Richardson Road Shell Pit. This photo was taken near the excavations at Pit 4 (see Fig. 1). The pick is approximately 1 m long for scale.

units of the “Pinecrest Sand” remains unclear. They may be roughly time-equivalent to unit 4 at APAC which dates to the late Blancan (2.4–2.0 Ma) based on mammalian and invertebrate biochronology, strontium isotope chronostratigraphy, and paleomagnetism (Morgan and Ridgway, 1987; Hulbert, 1987; Jones et al., 1991; Allmon, 1992, 1993). Taphonomically, unit 4 represents a different depositional environment than that of the bird layers as shown by its diverse molluscan, avian, and mammalian faunas (Petuch, 1982; Emslie, 1992; Morgan and Ridgway, 1987). This unit probably formed in an organic-rich, brackish-water environment.

The bird layers at Richardson Road reflect a markedly different paleoecology and taphonomy than those of unit 4 at APAC. The localized lower sand/clay layer is suggestive of a lagoonal deposit while the upper and lower shell layers reflect one or more high-energy and rapid sedimentary events. These depositional events may have occurred near the same time as those that caused the formation of unit 4 at APAC, but under differing sea-level and coastal conditions perhaps related to local geographic features that existed in this region during

the late Pliocene. Moreover, the lower sand/clay at Richardson Road is approximately 0.6 m below modern mean sea level, whereas unit 4 at APAC is 0.4–0.9 m above, based on measured stratigraphic sections (Petuch, 1982; Emslie, 1995a).

Additional evidence that suggests unit 4 is roughly equivalent in age to the bird layers is the observation that the latter appear to sit in the same stratigraphic position above a horizon apparently correlative to unit 6/7 (faunally and lithologically) and below horizons recognizable as units 3 and 2 at APAC (Fig. 1). The horizon immediately above the bird layers is very similar to unit 3 at APAC: a well-sorted, sparsely shelly quartz sand with abundant, large, articulated specimens of the mytilid bivalve *Perna conradina*. The horizon overlying this layer at Richardson Road is a very shelly, relatively high diversity unit that is taxonomically and lithologically similar to unit 2 at APAC, but with many fewer specimens of the large oyster *Hyotissa haitensis* and many more individuals of the gastropod *Turritella apicalis* (many more than unit 2 at APAC; Allmon et al., 1996). This layer was referred to unit 2? by Emslie and Morgan (1994).

3. Methods

The grid for systematic excavations was placed at the top of the upper shell layer in Pits 2 and 4 after removing an overburden of over 3 m of sands and shell that extended up to present ground surface. Each grid was oriented to true north and measured from datum points placed at the west ends of the pits (Fig. 1). Each 1 × 1 m square was labeled by its directional placement from the datum, beginning with square 1S1E, 1S2E, 2S1E, etc. Forty-nine squares were excavated in Pit 4, where bones were most concentrated, and an additional 14 squares in Pit 2.

Matrix was removed from each square by a trowel and washed through 1/4-inch (6.35 mm) and window (2 mm) screens to separate the size fractions of shell fragments, and sorted in the field for bone. Samples of matrix from each layer were collected from Pits 2 and 4 to quantify horizontal and vertical density of fossils in the site. These samples were dried, weighed and screen-washed in the laboratory at FLMNH and sorted using a binocular microscope to recover all fish remains, including otoliths. Palynologic, sediment and bulk invertebrate samples also were collected from each layer by scraping an exposed section and removing samples with a clean trowel and placing them in sterile plastic bags.

All vertebrate fossils collected at the site are cataloged with University of Florida (UF) numbers and are housed at FLMNH, Gainesville. Analyzed invertebrate samples are housed at the Paleontological Research Institution (PRI), Ithaca, New York; duplicate sediment samples are archived at FLMNH. Excavations and stratigraphy of the site were documented with a video camera; a copy of this video is archived with the collections at FLMNH.

3.1. Vertebrate taphonomy

Over 1500 isolated bones of cormorant were measured in situ from all the bird layers in the site using a Brunton compass to obtain direction (bearing from true north) and angle of dip for each bone. Bone position also was recorded by noting the side that faced upward in the sediments and

the end (proximal or distal) that was oriented towards the direction of dip. These data were analyzed using Stereo-PC, Rockware Inc. Stereonets (Schmidt projection) of bone data were generated with this program for each layer and by major skeletal elements to identify patterns in bone orientation and dip. Data were rotated by the average direction and dip of the layer in which they were found.

Orientation also was recorded on associated skeletal material, but these data were excluded from the stereonet analysis so that patterns of orientation could be evaluated on isolated bones only. This associated material was recognized by articulation, or near articulation, of elements in situ. Although some bones that were found in close proximity may have been associated at one time, we did not record them as such unless they were still in life position and clearly from one individual. Bone density and element distribution by square were analyzed using Z-Con, a contour mapping program designed by Rockware Inc.

Minimum number of individuals (MNI's) was calculated by counting the number of complete and partial skeletal elements of the same side. MNI's of the fossil cormorant (*Phalacrocorax fily-awi*) were determined for cranial and all major limb elements using bones recovered from the excavated squares; vertebrae and fossils recovered from areas outside the grid system were not included in these calculations. Percent representations of skeletal elements in the fossil sample were determined by calculating the MNI represented by each element and dividing this by the total MNI for all elements. Age of cormorant bones could not be determined other than as adult versus juvenile based on bone porosity present in the latter. Cormorant bones become fully ossified within 2–3 months after the chick hatches, as with most birds, and cannot be used for age-structure analyses of the fossil population. Sex may be estimated by relative size of bones, but extensive overlap in measurements between each sex in cormorants precluded analysis of this variable as well.

Fish remains were abundant throughout the bird layers and were quantified by collecting five volumetric samples of matrix from specific layers in

Pits 2 and 4 at Richardson Road (Table 1). Each sample was dried and weighed prior to screen-washing through 1/4" and window screen at FLMNH. Processed samples were weighed and sorted for bone, scales and otoliths of fish using a microscope. The fish remains were identified using the comparative collection of modern fishes in the Environmental Archaeology Laboratory at FLMNH. Fish remains were quantified using number of identified fragments and estimates of the MNI. MNI estimates were determined by the number of elements and size of the specimens. The number of bones for each taxon of fish identified per dry weight of these samples was used to assess relative abundance of fishes between layers in the site. Estimates of individual size (including mean, range and standard deviation) were determined for the pigfish (*Orthopristis chrysopterus*), one of the most common fish species in the site. These estimates were derived from measurements (using digital calipers) of the greatest length of the otolith, and by comparisons with modern skeletons for which size information is known in the Environmental Archaeology Lab, FLMNH. All of the specimens were cataloged with University of Florida (UF) numbers and curated in the Vertebrate Paleontology collection.

Statistical analyses were completed with SPSS/PC+. Data on cormorant bone density and position were analyzed using Chi-square goodness

of fit and ANOVA. Statistics generated in the Stereo-PC program for data on bone orientation included eigenvalues and *Rbar* calculations. Best-fit great circles also were plotted with mean lineation vector.

3.2. Invertebrate taphonomy

Invertebrate samples (IS) of about 2 liters each were taken from the three layers within the bird layers as well as from the upper section of units 6/7 at the Richardson Road Pit. Twenty-two samples were collected (Fig. 3 gives stratigraphic locations for each sample) of which data from eight (IS 6, 11, 23–28) are presented here. After a small archival subsample was removed, each sample was washed through coarse (5 mm) wire mesh. After drying, every shell fragment ≥ 1 cm was recovered and identified to genus and species, if possible. A total of 9738 specimens representing 88 nominal taxa from the samples was analyzed. Each of these larger shell fragments was scored for a number of taphonomic attributes (Table 2). Discriminant function analysis of these data was performed using BMDP/PC (see Reyment, 1991).

3.3. Palynology and micropaleontology

Spore/pollen studies

Twelve palynologic samples (identified here as PS 1–12) were collected below, within and above the bird layers in Pits 2 and 4 at Richardson Road (Table 3). These samples contained varying amounts of dispersed organic matter (kerogen) and were processed according to their appearances. All of them were initially sieved to remove coarse shell fragments, and were then placed in 10% HCl to remove carbonates. Without exception, the samples produced a very strong odor of petroleum as the carbonates dissolved and the kerogen was liberated from the matrix. Samples 5–8 had so much kerogen in them that they were mixed with 10% KOH and boiled in a water bath for 10 minutes to remove organic substances. After the HCl or KOH was washed from the samples, the residues were mixed with concentrated HF to remove silicates. Following the HF treatment, the insoluble residues were mixed with a 50:50 blend

Table 1
Analyzed volumetric samples for fish remains from the Richardson Road Shell Pit, Sarasota County, Florida, giving their location (Pit, square and strata), dry weight after washing through window (2 mm) screen, and number of bones per kg

Location	Processed matrix dry weight (kg)	Number of bones/kg
Pit 2, 2S7E, Lower Sand/Clay	1.25	410
Pit 2, 2S7E, Upper Shell	12.58	22
Pit 4, 1S2E, Lower Sand/Clay	1.24	857
Pit 4, 1S2E, Upper Shell	8.78	59
Pit 4, 1S2E, Lower Shell	5.46	83

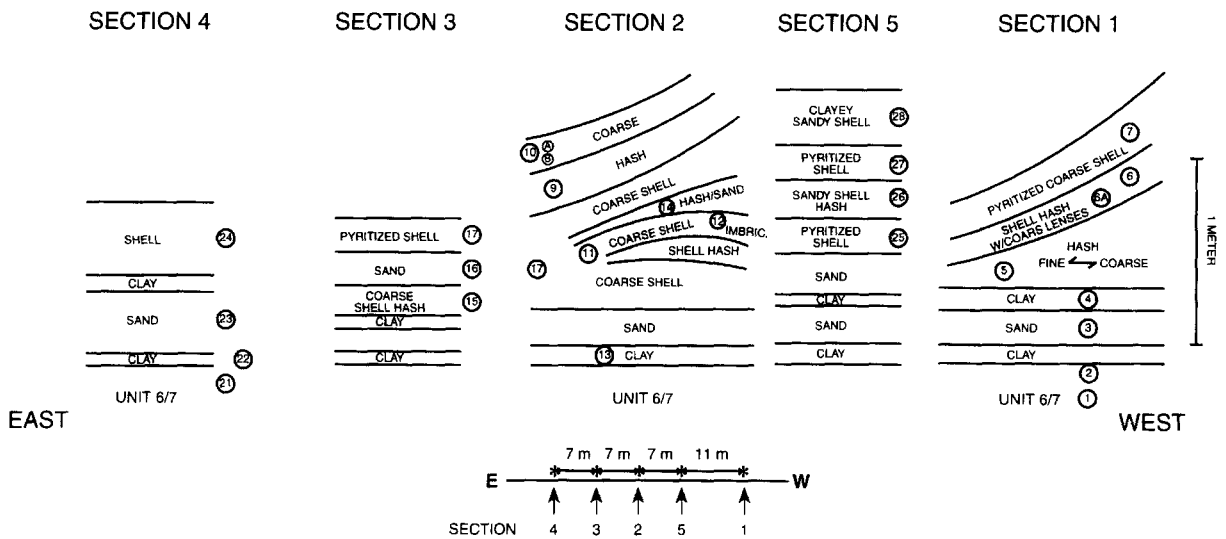

Fig. 3. Schematic cross-section of exposures of the bird layers from which invertebrate samples (IS) for taphonomic analysis were collected. Circled numbers refer to IS numbers; only 8 of the 22 samples taken are discussed here. Cormorant bones and partial skeletons were found throughout all of the layers illustrated here except units 6/7.

of water and glycerine jelly. Slides were prepared and point counts were made to determine the relative abundances of the pollen in the samples (no spores were seen in any of the samples).

Dinocyst studies

Four sediment samples (SS 1–SS 4; Table 3) were collected from the three bird layers and from unit 6/7 below the layers. These samples were examined for dinoflagellate cysts (dinocysts) and were screened through a 300 μm sieve to remove coarse shell fragments and concentrate the fine fraction for palynological sample processing. The less than 300 μm fraction was processed using the sample preparation techniques described by Barss and Williams (1973). Subsequent to acid digestion of the samples, organic residues were examined with a microscope after each processing step to determine the next appropriate processing procedure. The final organic residues were sieved and strewn slides were prepared from the +45 μm and the 20–45 μm size fractions using silicone oil for the mounting medium. A total of 600 dinocysts, 300 in both size fractions, was counted.

4. Results

4.1. Vertebrate paleontology and taphonomy

The avifauna from Richardson Road is dominated by a single species of extinct cormorant (*Phalacrocorax filyawi*) that is represented by 5000 isolated bones and 137 partial skeletons (Emslie, 1995a). Detailed measurements of cranial and limb elements also indicated that both sexes are represented in this sample. Only 41 bones of 10 other taxa of bird were recovered, including two grebes (*Podilymbus podiceps* and *Podiceps* sp.), an egret (cf. *Egretta* sp.), the extinct pygmy goose (*Anabernicula* cf. *A. minuscula*), an avocet (*Recurvirostra* sp.), two shorebirds that closely resemble the extant Red Knot (*Calidris* cf. *C. canutus*) and Sanderling (*Calidris* cf. *C. alba*), a jaeger (*Stercorarius* sp.), and two extinct species of gull (*Larus lacus* and *L. perpetuus*). The mammalian fauna is limited to 11 bones of an adult and juvenile seal (*Callophoca obscura*).

Stereonet plots of data on cormorant bones (Fig. 4, rotated and non-rotated) indicate that skeletal elements in the lower sand/clay and lower

Table 2

Outline and hierarchy of taphonomic attributes recorded for all shell fragments ≥ 1 cm in bulk samples. Modified from Staff and Powell (1990). Attributes marked with asterisks were graded on a numerical scale based on proportion of the shell affected as follows: 1=0–20%; 2=20–40%; 3=40–60%; 4=60–80%; 5=80–100%

Breakage	whole (>75%) fragment		
Articulation (bivalves)		articulated	disarticulated
			right left
Size	max length (mm) max width (mm)		
*Dissolution (% shell surface with chalky appearance, no shine)			
*Abrasion (% shell surface with worn sculpture; edge condition ignored)			
*Bioerosion	Sponges	interior	
	(clionids) (very small \pm circular holes)	exterior	
	Worms (larger, more elongate holes)	interior	exterior
	Bivalves (lithophagids) (shell still in hole or clearly cylindrical, smooth hole)	interior	exterior
*Encrustation	Other (algae) (irregular holes)	interior	exterior
	Barnacles	interior	exterior
	Coral	interior	exterior
	Worm tubes	interior	exterior
	Bryozoans	interior	exterior
	Bivalves (oysters)	interior	exterior

shell layers are oriented towards the northwest after rotation. This orientation varies significantly from a uniform distribution ($Rbar > 0.17$,

Table 3

Stratigraphic locations of pollen (PS) and sediment (SS) samples from Richardson Road Shell Pit, Sarasota County, Florida

Sample no.	Location
PS 1	Pit 4, Lower Sand/Clay
PS 2	Pit 2, Lower Sand/Clay
PS 3	Between Pits 1 and 2, Lower Sand/Clay
PS 4	Pit 1, Lower Sand/Clay
PS 5	Pit 4, 4S2E, Upper Shell
PS 6	Pit 4, 4S2E, Lower Shell
PS 7	Pit 4, 4S2E, Lower Sand/Clay
PS 8	Pit 4, unit 6/7
PS 9	Pit 4, unit 2
PS 10	Pit 2, Upper Shell
PS 11	Pit 2, Lower Sand
PS 12	Pit 2, Lower Sand
SS 1	Pit 4, 4S10E, Upper Shell
SS 2	Pit 4, 5S2E, Lower Shell
SS 3	Pit 4, East End, Lower Sand/Clay
SS 4	Pit 4, East End, unit 6/7

$p < 0.001$). Eigenvalues for these plots, with the first two nearly equal and much larger than the third, indicate a girdle distribution that describes bone within the layers (plane) in which they were found. Bone in the upper shell layer is oriented towards the northeast after rotation ($Rbar = 0.38$, $p < 0.001$). The average angle of dip before rotation ($18.95^\circ \pm 12.85$, $n = 454$) also was significantly higher (ANOVA, $F = 42.27$, $p < 0.000$) in this layer, as shown by the greater number of points toward the center of the plot in Fig. 4, than in the lower shell layer ($x = 12.60^\circ \pm 10.25$, $n = 322$) or lower sand/clay layer ($x = 11.12^\circ \pm 9.7$, $n = 654$).

Stereonet plots of data on selected skeletal elements were generated to determine if certain bones had a greater chance of orienting towards a particular direction than others. Wing elements (humeri, ulnae and radii) showed significant orientation to the northeast in the upper shell layer ($N = 191$, $Rbar = 0.41$, $p < 0.01$), but not in the lower shell layer ($N = 126$, $Rbar = 0.15$, $p < 0.1$). Leg elements

Fig. 4. Stereonet plots of cormorant bones measured in situ in the bird layers at Richardson Road. Plots on the left show non-rotated data; those on the right are rotated by the average orientation and dip of each bed (see text). The data indicate bone direction and dip for the upper shell (top), lower shell (middle), and lower sand/clay (bottom) layers. Note the relatively greater dispersion of points toward the center and the tendency towards a preferred orientation of bone in the upper shell layer, reflecting high-angle dips and current-related deposition, than in the lower shell or lower sand/clay layers.

CORMORANT BONES

Projection	Schmidt
Number of Sample Points	454
Mean Lincation Azimuth	131.8
Mean Lincation Plunge	5.6
Great Circle Azimuth	333.9
Great Circle Plunge	14.5
Rotational Axis Azimuth	85.0
Rotational Axis Plunge	0.0
Angle of Rotation	-20.0
1st Eigenvalue	0.510
2nd Eigenvalue	0.432
3rd Eigenvalue	0.088
LN (E1 / E2)	0.238
LN (E2 / E3)	1.519
(LN(E1/E2)) / (LN(E2/E3))	0.157
Spherical variance	0.6174
Rbar	0.3826

• UPPER SHELL

Projection	Schmidt
Number of Sample Points	322
Mean Lincation Azimuth	330.4
Mean Lincation Plunge	0.7
Great Circle Azimuth	190.0
Great Circle Plunge	1.1
Rotational Axis Azimuth	41.0
Rotational Axis Plunge	0.0
Angle of Rotation	-12.0
1st Eigenvalue	0.512
2nd Eigenvalue	0.432
3rd Eigenvalue	0.056
LN (E1 / E2)	0.169
LN (E2 / E3)	2.095
(LN(E1/E2)) / (LN(E2/E3))	0.080
Spherical variance	0.8225
Rbar	0.1775

• LOWER SHELL

Projection	Schmidt
Number of Sample Points	654
Mean Lincation Azimuth	226.1
Mean Lincation Plunge	0.4
Great Circle Azimuth	221.1
Great Circle Plunge	4.9
Rotational Axis Azimuth	30.0
Rotational Axis Plunge	0.0
Angle of Rotation	-8.0
1st Eigenvalue	0.497
2nd Eigenvalue	0.415
3rd Eigenvalue	0.068
LN (E1 / E2)	0.112
LN (E2 / E3)	2.034
(LN(E1/E2)) / (LN(E2/E3))	0.055
Spherical variance	0.7740
Rbar	0.2260

• LOWER SAND/CLAY

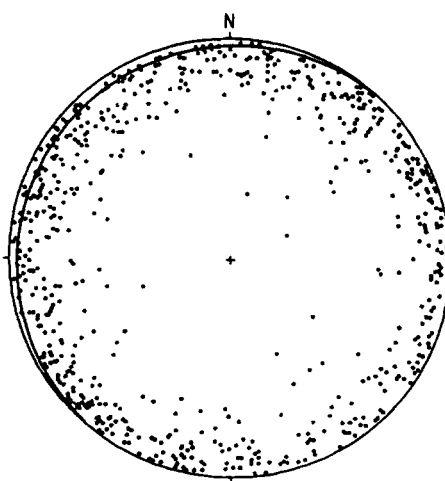
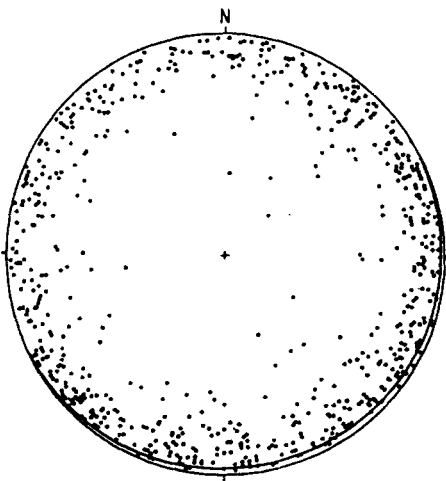
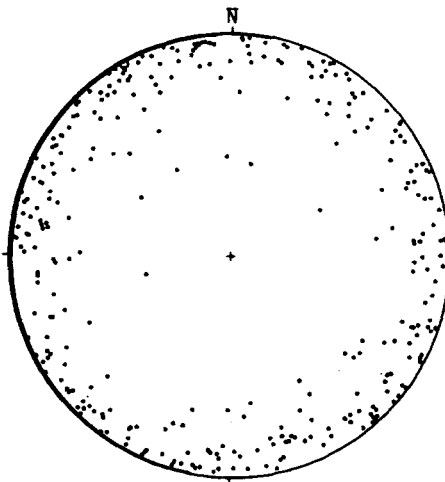
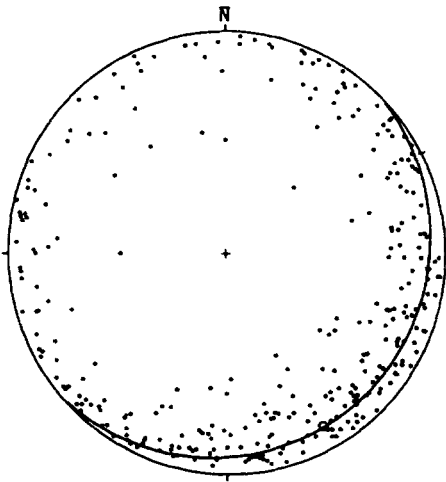
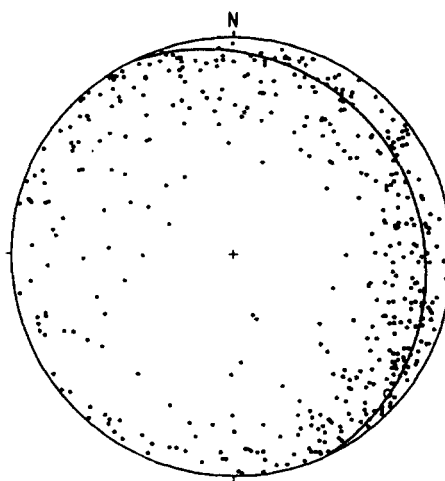
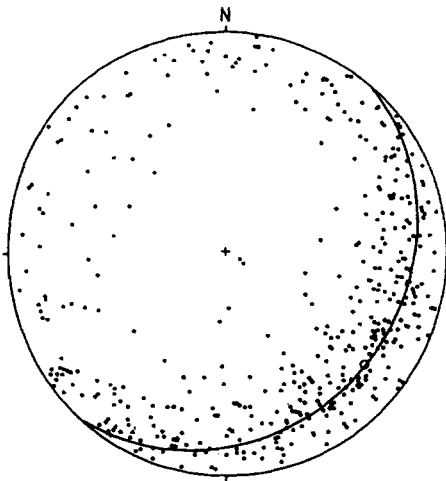

(femora, tibiotarsi and tarsometatarsi) showed significant orientation to the northeast in the upper shell layer ($N=194$, $Rbar=0.36$, $p<0.01$), and to the southwest in the lower shell layer ($N=105$, $Rbar=0.20$, $p<0.01$). In the lower sand/clay layer, wing and leg elements were oriented significantly to the northwest ($N=311$ and 95 , respectively; $Rbar>0.19$, $p<0.01$). Bone position did not show a directional bias in any layer. For all major limb elements, distal or proximal ends had an equal chance of orienting with the direction of dip ($X^2<5.3$, $df=2$, $p<0.1$).

Bone density and skeletal-element distribution varied significantly by square ($X^2>446$, $df=45$, $p<0.001$). For example, bones were significantly more concentrated in squares 2S4E, 3S4E and 4S3E (see Fig. 1), and included a higher number of humeri, ulnae, femora, tibiotarsi and tarsometatarsi representing a minimum of 54 individuals, than in surrounding squares. When plotted by contour intervals based on bone density, peaks and ridges of bone concentrations are apparent (Fig. 5). When plotted for leg or wing elements only, the data suggest taphonomic sorting of these skeletal elements within the deposits. For example, squares 2S4E, 3S4E and 4S3E collectively contained 99 ulnae, 66 humeri, and 111 tibiotarsi (MNI=54) to produce a peak or ridge of high concentration (Fig. 5, all diagrams). However, another peak in square 2S8E that is noticeable when all elements are plotted (Fig. 5, top) is based in part on 11 mandibles and 9 pelvi. Bone with orientation data from these concentrations, of which over 80% occurred in the upper and lower shell layers, were plotted separately on a stereonet and show a strong and significant directional bias towards the east (Fig. 6; $Rbar=0.64$, $p<0.001$) more so than data for the entire sample of bones in the upper shell layer.

The cormorant bones were found either as isolated elements or as partial or complete articulated skeletons. Bone from these samples showed differences in preservation and percent representation. Most associated skeletons (85.5%) were well preserved and dark brown or black. This preservation contrasted with that of the isolated bone, which included complete and well preserved elements similar to the skeletons, but also bone that was

fragmentary and abraded. The coloration of most of this bone varied from light brown to mottled brown and black. A sample of 104 complete left humeri (to ensure no duplication of elements from fragments) indicated that only 15.4% were solid brown or black, a pattern opposite that of the associated skeletons. Of 77 complete left tarsometatarsi, only 10.4% were solid brown or black. These differences in bone coloration were not restricted to any one layer and all variations occurred in each level at approximately the same frequency. Less than 1% of these elements were pyritized; those with small barnacles and oysters attached to their surface could not be quantified as most of these invertebrates fell off the bones after washing and drying. With few exceptions, all bones were from adult individuals at time of death; unossified and porous bones of chicks or juveniles were rare (<0.1% of total sample).

The associated skeletal material is biased towards pectoral and wing elements. Of 83 partial skeletons (MNI=33) recovered from the excavated squares, 65 (78.3%) are from this region of the body whereas the remainder are pelvic and leg parts (no crania are represented). Percent representation of MNI's by element also shows this bias (Fig. 7) with articulated wings having a significantly greater chance of being preserved than legs ($X^2=12.75$, $df=1$, $p<0.005$). Isolated bone from the excavated grids (MNI=225) displayed a different pattern. While wing elements were abundant, pelvi and tibiotarsi also were well represented (Fig. 7). The ulna was the most frequently encountered element in the site.

The fishes identified in the site include five species of sharks (3 sharks, 2 rays) and at least 34 species of bony fishes (Table 4). Fishes identified in each of the five volumetric, fine-screened samples are not presented here, but these data are available from the senior author upon request. Eighteen of the identified fish taxa (genera or species) are new to the fossil record of Florida. At least 300 individuals are represented in the samples. The relative abundance of fish bones by squares is significantly greater in all bird layers in Pit 4 compared to Pit 2, and in the lower sand/clay than in the upper layers in both Pits 2 and 4 ($X^2>16.9$, $df=2$; $p<0.005$).

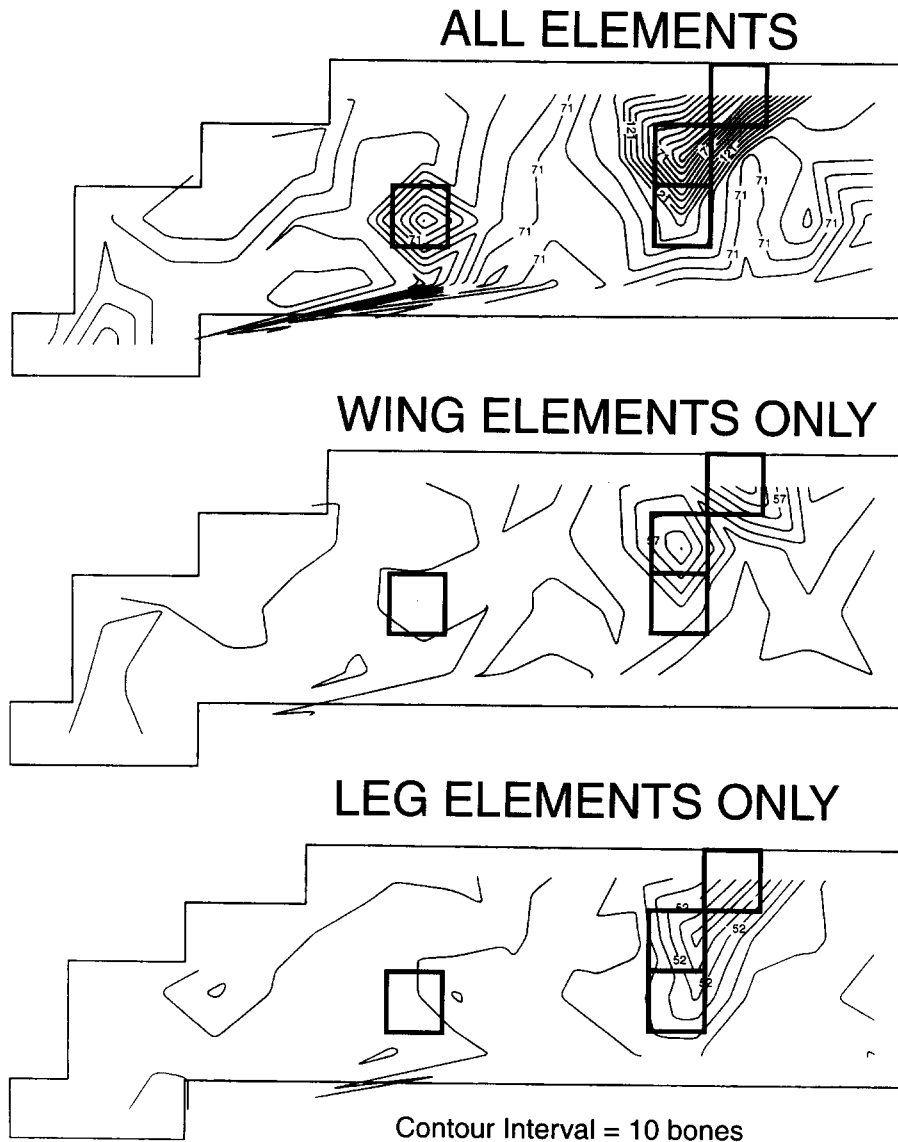

Fig. 5. Plan views of the grid in Pit 4 (see Fig. 1) indicating relative density of bone using contour intervals of 10 from all three of the bird layers for the total sample (top, base contour = 7), wing elements only (coracoid, humerus and ulna; middle, base contour = 17) and leg elements only (femur, tibiotarsus and tarsometatarsus; bottom, base contour = 12). Peak concentrations (highest contours) occur in squares 3S4E and 4S3E (see Fig. 1) outlined in each diagram.

Three species, pigfish (*Orthopristis chrysopterus*), star drum (*Bairdiella chrysoura*), and spot (*Leiostomus xanthurus*), are represented almost exclusively by otoliths that were recovered only in the fine-screened samples. These species also were the most common fish in each of the bird layers (pigfish, 10.6–44.3%; star drum, 4.9–14.6%; and

spot, 6.6–15.1% of total MNI's, respectively). When only the coarse-screened (1/4" mesh) material was considered, the dominant fishes were sea robin (*Prionotus* sp.), mullet (*Mugil* sp.), lizardfish (*Synodus* sp.), and eagle rays (*Myliobatis* sp.) (Emslie and Morgan, 1994).

A measurable sample of 23 right otoliths of

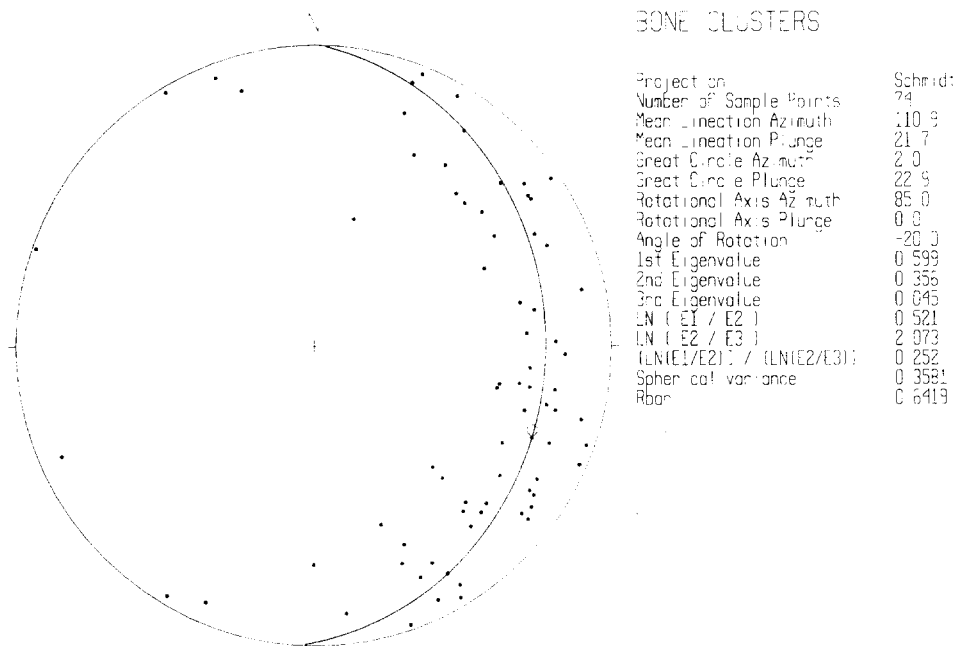

Fig. 6. Stereonet plot of rotated data on cormorant bones found in bone clusters in squares 2S4E, 3S4E and 4S3E illustrated in peaks of Fig. 5; only bones from the upper and lower shell are plotted. Note the strong directional orientation to the east for most bones in these clusters.

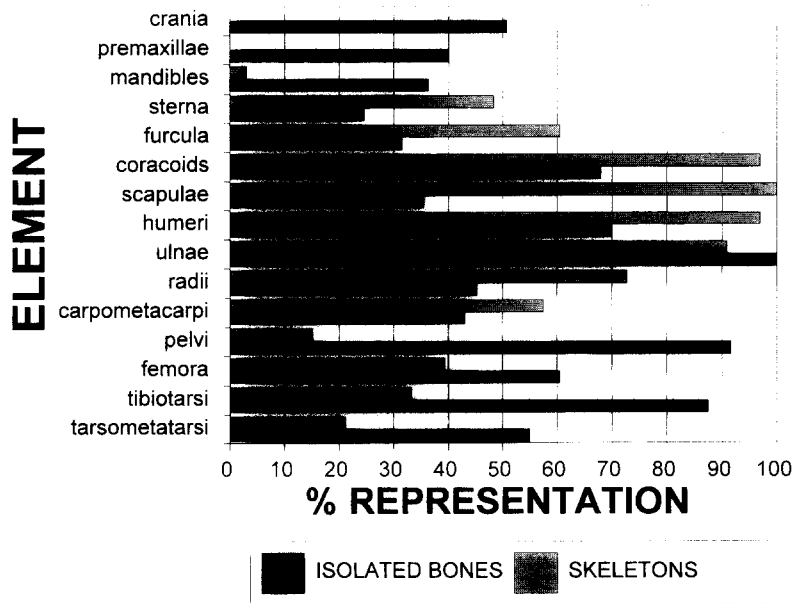

Fig. 7. Percent representation of isolated skeletal elements from the total minimum number of individuals (MNI, solid bars; 225 individuals based on ulnae) and bones in 83 associated skeletons (hatched bars; MNI=33 based on scapulae) from the excavated grids (Pits 2 and 4) at Richardson Road Shell Pit, Sarasota County, Florida. A clear distinction is apparent in the associated skeletons, which are biased towards wing elements, versus the isolated bones that show high numbers of wing and leg elements. Vertebrae were not included in these analyses.

Table 4

Sharks, rays, and bony fish identified from the Richardson Road Shell Pit, Sarasota County, Florida, identified from the volumetric samples¹. An asterisk (*) indicates those taxa new to the fossil record of Florida. Arrangement of orders and families follows the American Fisheries Society (1991) and Nelson (1984)

Taxon	Habitat ²	Taxon	Habitat ²
Elasmobranchiomorphi		Scorpaeniformes	
Lamniformes		TRIGLIDAE (searobins)	
CARCHARHINIDAE (requiem sharks)		<i>Prionotus</i> sp.	bay, inshore, shelf
<i>Carcharhinus brevipinna</i> *	pelagic, rare inshore	Perciformes	
<i>Carcharhinus limbatus</i>	temperate, tropical waters	SERRANIDAE (sea basses)	
<i>Negaprion brevirostris</i> ³	marsh channels	genus and species indet.	
		<i>Diplectrum formosum</i> *	course sand bottoms
Rajiformes		<i>Epinephalus</i> sp.*	deeper offshore, inshore to feed
Family indet.		CARANGIDAE (jacks)	
MYLIOBATIDAE		<i>Caranx</i> sp.	inshore, esp. for young
<i>Myliobatis</i> sp. ³	bays, inshore waters	GERREIDAE (mojarras)	
<i>Rhinoptera bonasus</i> ³	bays, inshore waters	<i>Eucinostomus gula</i> *	shallow waters, near shore
		<i>Eucinostomus</i> sp.*	shallow waters
Osteichthyes		HAEMULIDAE (grunts)	
Clupeiformes		genus and species indet.	
CLUPEIDAE (herrings)		<i>Haemulon</i> sp.*	offshore reefs, inshore to feed
genus and species indet.			shallow bays, young in grass beds
<i>Alosa</i> sp.*	bays, spawn in rivers	<i>Orthopristis chrysopterus</i> *	
<i>Harengula</i> sp.*	bays, inshore waters		
cf. <i>Jenkinsia</i> sp.	bays, inshore waters	SPARIDAE (porgies)	
<i>Opisthomena oglinum</i> *	bays, inshore waters	genus and species indet.	
<i>Sardinella</i> sp.*	bays, inshore waters	<i>Archosargus probatocephalus</i>	inshore waters
		SCIAENIDAE (drums)	
Siluriformes		genus and species indet.	
ARIIDAE (sea catfishes)		<i>Bairdiella chrysoura</i>	bays, young in grass flats
genus and species indet.		<i>Cynoscion</i> sp.	bays, young near grass beds
<i>Arius felis</i>	bays and shallow waters	<i>Equetus</i> sp.*	young inshore rocky, adults-reef
		<i>Leiostomus xanthurus</i> *	bays, shallow waters
Aulopiformes		<i>Menticirrhus</i> sp.*	inshore waters
SYNODONTIDAE		<i>Micropogonias cromis</i>	bottom dwelling in estuaries
(lizardfishes)		<i>Pogonias cromis</i>	bay waters
<i>Synodus</i> cf. <i>foetens</i> *	bays, inshore to brackish	<i>Sciaenops ocellatus</i>	shallow bays
<i>Synodus</i> sp.*	bays, inshore waters	<i>Stellifer lanceolatus</i> *	mud bottoms in bays
		MUGILIDAE (mulletts)	
Gadiformes		<i>Mugil</i> sp.	common inshore
OPHIDIIDAE (cusk-eels)		LABRIDAE (wrasses)	
<i>Ophidion</i> sp.*	shallow, burrows in mud	<i>Halichoeres</i> sp.*	inshore waters and reefs
		<i>Lachnolaimus maximus</i> ³	offshore reefs, pelagic waters
Batrachoidiformes		Pleuronectiformes	
BATRACOIDIDAE (toadfishes)		BOTHIDAE (lefteye flounders)	bottom dwellers, inshore waters
genus and species indet.		genus and species indet.	
<i>Opsanus</i> sp.	bays, oyster reefs		
		Tetraodontiformes	
Atheriniformes		OSTRACIIDAE (boxfishes)	
BELONIDAE (needlefishes)		<i>Lactophrys</i> sp.	over reefs, shelf, and bays
genus and species indet.	bays, inshore waters	TETRAODONTIDAE (puffers)	
ATHERINIDAE (silversides)		genus and species indet.	bays, offshore reefs
genus and species indet.	shallow waters, bay margins		
Gasterosteiformes			
SYNGNATHIDAE (pipefishes)*	grass flats in bays		
genus and species indet.			

¹Volumetric samples of 7 gallons (26.5 l) were analyzed from five deposits. The faunal material was recovered with window screen (1/16", 2.0 mm).

²Habitat information obtained from Hoese and Moore (1977).

³Specimens identified from non-volumetric samples with 1/4" (6.35 mm) mesh screen.

pigfish was recovered from Pit 4, square 1S2E, upper shell, with an additional 23 from the lower shell and upper shell of Pit 2. These otoliths ranged in size from 2.6–7.7 mm (greatest length, mean 4.57 ± 1.38 mm). The largest percentage of otoliths (13, 28.3%) fall between 3.0–3.9 mm in length and represent live fish with an estimated total length of 7.2 cm and weight of 5.2 g.

4.2. Invertebrate paleontology and taphonomy

The Pinecrest mollusk fauna contains approximately 1000 species; the Pinecrest exposed at APAC shell mine probably contains 70–80% of this number (Allmon et al., 1993). The invertebrate samples (IS) analyzed for this study contained only about 10% of the total mollusk taxa present in the entire unit at this site. The sample from unit 6/7 has much higher abundance and diversity of mollusks than any sample from the bird layers. Bivalves outnumber gastropods in both number of species and number of individuals, and also show lower species:specimen ratios, in all samples studied (data on frequencies of taxa identified in each IS sample are available from the authors upon request). In total species number in the bird layer samples, IS 24 is most similar to unit 6/7 in having the highest diversity. Although whole/fragment ratios are not substantially different among the samples (Table 5) unit 6/7 shell fragments are significantly larger than any bird layer sample taken separately or all samples combined (t-tests, p 's < 0.01).

Approximately 68% of all shell fragments analyzed are assignable to two species: the mytilid bivalve *Perna conradina* and the limpetiform gastropod *Crepidula* cf. *C. fornicata*. The co-occurrence and abundance of these two taxa is highly correlated ($R^2=0.71$, $p=0.05$). The abundance of *Perna* in the upper and lower shell layers is not significantly different (IS 24, 27, 28 compared to IS 6, 25, 11, 23; t-test, $p=0.16$), whereas the abundance of *Crepidula* in these layers is significantly different (IS's as for *Perna*; $p=0.03$).

Discriminant function analysis of the entire data set, and of each of these two most abundant species separately (Fig. 8), shows that unit 6/7 is distinct from the bird layer samples. For each

species independently and all shells together, the first two functions account for more than 65% or more of the total variance in the data (Table 6). The first canonical variable in a Discriminant function analysis is the linear combination of variables that best discriminates among the groups; the second canonical variable is the next best combination orthogonal to the first one, etc. Coefficients for the canonical variables (standardized by pooled within-group variances) indicate what input variables are most responsible for discrimination along that axis. In the case of *Crepidula* and *Perna*, abrasion and size respectively have the highest coefficients on the first canonical variable, whereas sponge bioerosion (exterior) and other bioerosion have the highest coefficients on the second canonical variable (data available from the authors upon request).

Discriminant function analysis of *Perna* and *Crepidula* separately show what at first appear to be conflicting patterns of difference between unit 6/7 and the bird layers. These patterns may, however, support similar conclusions (Fig. 8). *Perna* from the bird layers are more fragmented (i.e., of smaller size) and with somewhat less dissolution and bioerosion than those from unit 6/7. *Crepidula* from the bird layers also are more fragmented and show less bioerosion and abrasion. Within the bird layers, samples of *Perna* show some variation; *Perna* from IS 24 and 26 appear most similar to those from unit 6/7, while *Perna* from IS 11, 15 and 27 are very similar to each other. In *Crepidula*, all bird layer samples show relatively high variation along the first canonical variable (which implies variation in abrasion), with IS 24 and 25 being most similar to unit 6/7.

4.3. Palynology and micropaleontology

Several characteristics were common to the palynologic samples (PS): (1) the insoluble organic matter consisted largely of flocculent, amorphous material, with very limited amounts of woody tissue fragments, charcoal, and cuticles; (2) the residues all contained abundant, minute particles of pyrite, usually cubic crystals or framboids; (3) most of the samples contained numerous dinoflagellate cysts (PS 5 had none and PS 6 had only

Table 5

Mean and standard deviation (s.d.) of analyzed variables for invertebrate samples (IS) from Richardson Road Shell Pit, Sarasota County, Florida

	All samples		IS 6/7		IS 11		IS 23			
	Mean	s.d.	Mean	s.d.	Mean	s.d.	Mean	s.d.	Mean	s.d.
Whole/Frag	1.769	0.422	1.6096	0.4879	1.8461	0.3611	1.7464	0.4357		
RLA	0.7382	1.13	1.42	1.2016	0.3625	0.8977	0.3343	0.835		
Size	472.9	793.2	876.07	1239.61	286.48	317.48	282.88	428.06		
Diss	4.175	0.6956	4.3879	0.6607	3.8312	0.7115	3.7349	0.8111		
Abrasion	4.305	0.6989	3.9438	0.7718	4.3207	0.6654	3.876	0.7558		
Sponge I	1.492	0.7884	1.5145	0.9394	1.5948	0.7439	1.634	0.861		
Sponge E	1.648	0.7915	2.0025	0.8676	1.4926	0.6963	1.5504	0.7676		
Worm I	0.9084	0.3067	0.7401	0.4574	0.996	0.08909	0.9366	0.2556		
Worm E	0.9829	0.2639	0.9125	0.3397	1.0218	0.2432	0.9914	0.2462		
Other I	1.965	0.9829	1.7149	1.1385	2.5064	0.8196	2.1585	0.9621		
Other E	2.305	0.84	2.1679	0.9703	2.571	0.718	2.4179	0.8906		
Bivalve I	0.07289	0.2681	0.0626	0.2553	0.1887	0.1361	0.02305	0.1503		
Bivalve E	0.1442	0.36	0.207	0.4193	0.03476	0.1833	0.05476	0.2278		
Barnacle I	0.002048	0.06554	0.005489	0.1121	0	0	0.005763	0.07581		
Barnacle E	0.003276	0.07961	0.01033	0.1411	0	0	0	0		
Coral I	0.001843	0.04521	0.005812	0.08016	0	0	0	0		
Coral E	0.01607	0.2277	0.04714	0.3817	0	0	0	0		
Worm I	0.124	0.3427	0.227	0.4266	0	0	0.01729	0.1305		
Worm E	0.1281	0.35	0.2619	0.4528	0.001986	0.06303	0.005764	0.07581		
Bryozoan I	0.01935	0.1526	0.05586	0.255	0	0	0.005764	0.07581		
Bryozoan E	0.02836	0.1891	0.0846	0.3204	0	0	0.002882	0.05368		
Bivalve I	0.03829	0.216	0.1056	0.3524	0	0	0.008646	0.1199		
Bivalve E	0.07361	0.2992	0.2212	0.4867	0	0	0	0		
	IS 24		IS 25		IS 26		IS 27		IS 28	
	Mean	s.d.	Mean	s.d.	Mean	s.d.	Mean	s.d.	Mean	s.d.
Whole/Frag	1.8604	0.3467	1.8304	0.3753	1.881	0.3242	1.8438	0.3666	1.8725	0.3339
RLA	0.5412	1.019	0.3474	0.8764	0.7878	1.1556	0.3235	0.8552	0.4854	0.9929
Size	279.7	300.2	279.06	279.77	280.67	302.87	258.68	283.64	393.35	409.48
Diss	4.2229	0.6596	4.1562	0.6527	3.9743	0.7866	4.0271	0.5991	4.1365	0.64
Abrasion	4.5558	0.5304	4.5618	0.5208	4.3248	0.5908	4.4625	0.5483	0.02477	0.5237
Sponge I	1.4936	0.7198	1.3991	0.6514	1.8939	0.7481	1.2915	0.5722	1.519	0.7143
Sponge E	1.5425	0.7247	1.3571	0.6194	1.9711	0.6927	1.3592	0.621	1.6868	0.7519
Worm I	0.9854	0.1395	0.9949	0.1374	1.0064	0.139	0.9865	0.1602	0.962	0.2136
Worm E	1.0044	0.1652	1.0207	0.206	0.9936	0.2124	1.0381	0.2668	1.00671	0.1706
Other I	2.2221	0.8546	1.9212	0.832	1.9035	0.8213	1.77	0.8094	2.02461	0.9312
Other E	2.4406	0.7013	2.3281	0.7556	2.0675	0.8064	2.1697	0.7531	2.3758	0.8402
Bivalve I	0.08629	0.2809	0.06175	0.2464	0.1318	0.3388	0.1255	0.36	0.1812	0.4027
Bivalve E	0.1478	0.3586	0.1055	0.3132	0.2443	0.4378	0.1242	0.3374	0.1655	0.3897
Barnacle I	0	0	0	0	0	0	0.00123	0.03507	0	0
Barnacle E	0	0	0	0	0	0	0	0	0	0
Coral I	0	0	0	0	0	0	0	0	0	0
Coral E	0.00698	0.1798	0	0	0	0	0	0	0	0
Worm I	0.224	0.4577	0.01106	0.1046	0.1125	0.3165	0.05289	0.2294	0.1051	0.335
Worm E	0.2094	0.4471	0.01382	0.1244	0.04502	0.2077	0.04551	0.22	0.05593	0.2576
Bryozoan I	0.006345	0.08706	0	0	0	0	0	0	0.008948	0.1156
Bryozoan E	0.005711	0.08338	0	0	0.003215	0.0567	0.00123	0.03507	0.006711	0.08174
Bivalve I	0.0165	0.1323	0.002304	0.04795	0.006431	0.08006	0.00123	0.03507	0.02237	0.1481
Bivalve E	0.01269	0.1175	0.002765	0.06784	0.009646	0.0979	0.00123	0.03507	0.008948	0.1156

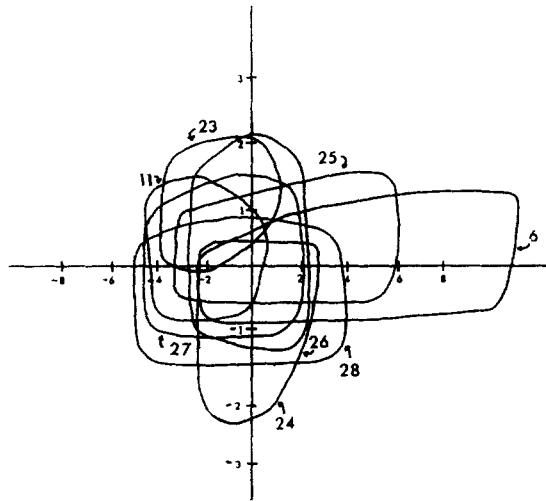

A

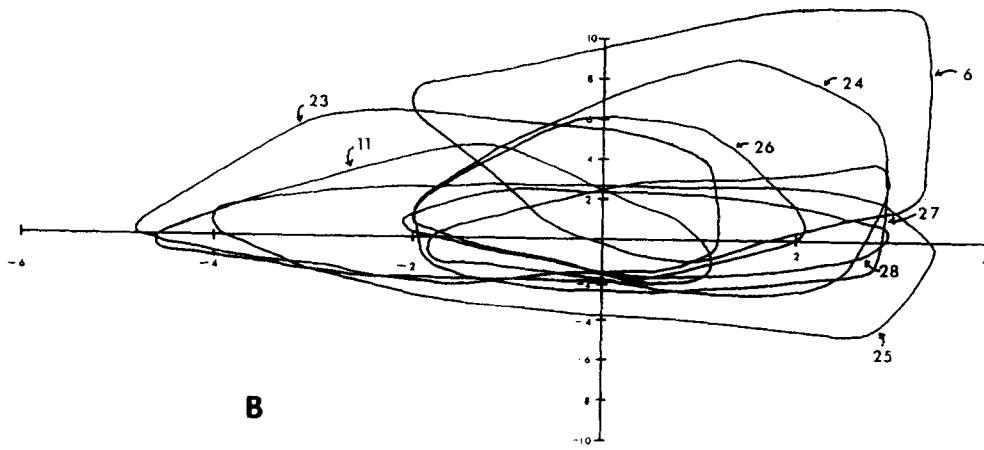

B

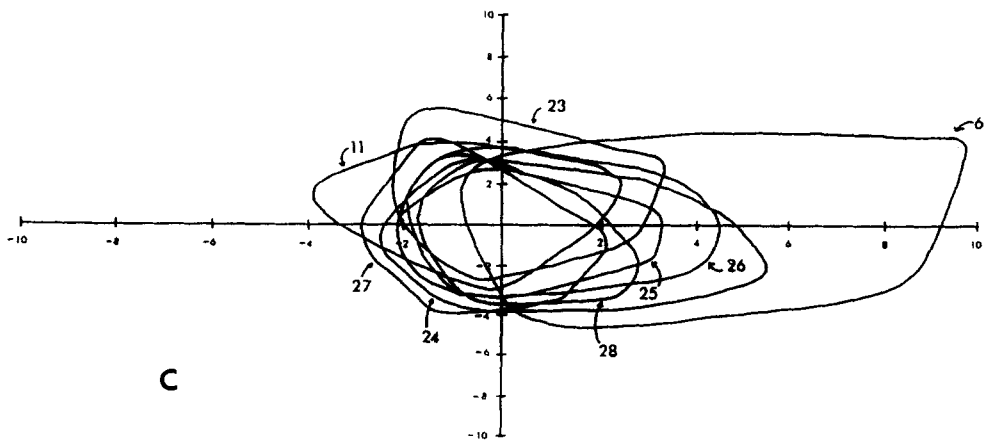

C

Table 6
Summary statistics for discriminant function analysis of invertebrate fossils

Canonical variable	Eigenvalue	% of variance	Cumulative %	Canonical correl.
<i>Crepidula</i>				
1	0.66053	0.41623	0.41623	0.63070
2	0.40755	0.25682	0.67305	0.53809
3	0.24072	0.15169	0.82474	0.44048
4	0.13950	0.08791	0.91265	0.34989
5	0.07791	0.04910	0.96175	0.26885
<i>Perna</i>				
1	1.86565	0.79719	0.79719	0.80687
2	0.21069	0.09003	0.88722	0.41716
3	0.11518	0.04922	0.93644	0.32138
4	0.08048	0.03438	0.97082	0.27292
5	0.03452	0.01475	0.98557	0.18267
<i>All taxa</i>				
1	1.34837	0.80582	0.80582	0.75774
2	0.16941	0.10124	0.90706	0.38061
3	0.07541	0.04507	0.95213	0.26480
4	0.05057	0.03022	0.98235	0.21939
5	0.01603	0.00958	0.99193	0.21562

one), and PS 2, 3, and 8 also contained foraminifera remains; (4) although each of the productive samples had abundant *Pinus* (pine) pollen, almost every specimen was broken in half. Some samples, i.e., PS 5, 6, 9, and 12, had so few pollen grains that they were of little use for palynological analysis. The remaining samples all had sufficient pollen to produce at least 200 identifiable grains per sample.

Twenty-one taxa constitute the pollen flora for the 12 samples (Fig. 9; samples are presented in stratigraphic order, top to bottom, on the *Y* axis). These include taxa which can be attributed to 14 genera and six families, all of which currently live in the southeastern United States. Two genera, *Pterocarya* and *Sciadopitys*, were present in three samples and were the only taxa which are now extinct in the Western Hemisphere. Among the 22 taxa, only nine are present in amounts greater

than or equal to 1% of the pollen count in at least one sample. Those nine taxa include *Carya* (hickory/pecan), the Chenopodiaceae/Amaranthaceae (known collectively as the cheno-ams, and represented by *Chenopodium*, *Amaranthus*, *Salsola*, etc.), the Compositae (asters, daisies, and their kin), *Corylus* (hazel), the Gramineae (grasses), *Myrica* (wax myrtle), *Pinus*, *Quercus* (oak), and *Taxodium* (cypress). Among the nine relatively abundant pollen types, three (*Pinus*, *Quercus*, and *Taxodium*) are clearly dominant, with relative abundances as high as 69%, 22%, and 39%, respectively.

A total of 600 dinocysts were counted in each of the four sediment samples (SS). Dinocyst recovery was too sparse to reach a count of 600 in only two samples (Table 7). Approximately 30 dinocyst taxa were recovered from the four samples, of which 13 were identifiable to species (Table 7). The dinocysts of three of the 13 identifiable species are known to be produced by the thecate form of dinoflagellates responsible for red tides in modern seas. These species are *Pyrophacus vancampoae* (the thecate form of *Tuberculodinium vancampoae*; Fig. 10c), *Lingulodinium polyedra* (the thecate form of *L. machaerophorum*; Fig. 10b,d) and *Pyrodinium bahamense* (Fig. 10e,f; the thecate form of *Polysphaeridium zoharyi*; Fig. 10a).

5. Discussion

5.1. Paleoecology

The vertebrate fauna at Richardson Road is dominated by marine and coastal species of birds and fish. Modern counterparts of these taxa inhabit beach and coastal areas, or marshes and lagoons. The birds, including grebes, pygmy goose, and wading and shorebirds, are indicative of wetland habitats as well (Emslie, 1995a). The single species of extinct seal also reflects a shoreline or beach environment, the preferred habitat of many living

Fig. 8. Results of discriminant function analysis of taphonomic data (Table 2) on invertebrate shells and shell fragments from the bird layers at the Richardson Road Shell Pit (see Tables 6–7). Axes are the first (*x*) and second (*y*) canonical variables. A. Total data set for all 88 nominal taxa from all 8 samples examined. B. Values for all specimens of *Crepidula fornicata* in all 8 samples. C. Values for all specimens of *Perna conradina* in all 8 samples.

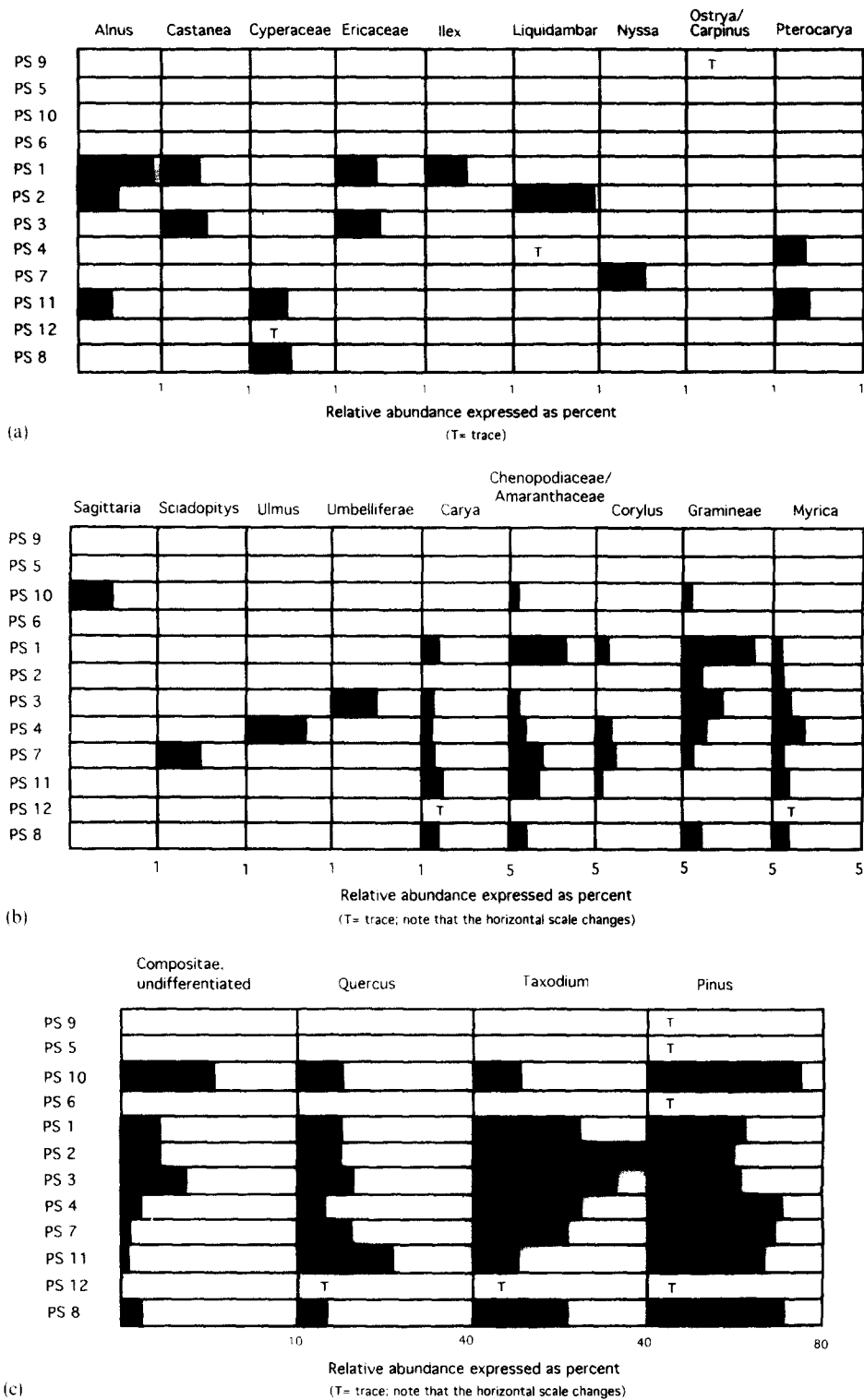

Fig. 9. Relative abundances of pollen in 12 samples (PS 1–12) from Richardson Road Shell Pit, Sarasota County, Florida. Samples are arranged on the vertical axis in stratigraphic order, top to bottom, with PS 9 from the highest unit (unit 2) and PS 8 from the lowest (unit 6/7; see Table 3). Trace means grains were seen in preliminary scans but were not observed during point counts.

Table 7
Dinocysts recovered from the sediment samples (SS) at Richardson Road Shell Pit, Sarasota County, Florida

Taxon	SS 1 Upper Shell	SS 2 Lower Shell	SS 3 Sand/Clay	SS 4 Unit 6/7
<i>Ataxiodinium choane</i>	0	0	1	0
<i>Cleistosphaeridium</i> sp.	3	0	3	0
<i>Cyclopsiella</i> ? sp.	0	0	21	0
Dinocyst A	9	1	26	11
Dinocyst B	1	0	0	0
Dinocyst C	6	1	6	1
<i>Hystrichokolpoma</i> sp.	1	0	0	2
<i>Kallosphaeridium</i> sp. A	6	0	33	38
<i>Lingulodinium</i> <i>machaerophorum</i>	2	0	14	3
<i>Melitasphaeridium</i> <i>choanophorum</i>	1	0	0	2
<i>Operculodinium</i> <i>centrocarpum</i>	0	0	3	6
<i>Operculodinium</i> <i>israelianum</i>	5	1	51	38
<i>Operculodinium</i> sp.	1	0	5	0
<i>Polysphaeridium</i> <i>zoharyi</i>	497	11	124	293
<i>Polysphaeridium</i> sp.	1	0	68	0
<i>Protoperidinium</i> sp.	0	0	1	0
<i>Selenopemphix</i> <i>brevispinosa</i>	0	0	1	0
<i>Spiniferites</i> <i>hyperacanthus</i>	1	0	17	3
<i>Spiniferites</i> <i>membranaceus</i>	0	0	10	3
<i>Spiniferites mirabilis</i>	5	1	15	22
<i>Spiniferites ramosus</i>	7	1	9	0
<i>Spiniferites</i> sp. A	6	1	0	21
<i>Spiniferites</i> sp. B	0	0	1	0
<i>Spiniferites</i> sp. C	0	0	2	0
<i>Spiniferites</i> sp. D	1	0	2	0
<i>Spiniferites</i> spp.	47	3	102	157
<i>Tuberculodinium</i> <i>vancampoeae</i>	0	0	6	0
Total count	600	20	521	600

species where they haul out to breed or molt (ibid.; Emslie and Morgan, 1994).

The coastal environment represented at Richardson Road is one that rarely is preserved in the fossil record of Florida. This rarity is reflected by the vertebrate taxa that occur in the site. The cormorant is a marine species unknown

from other localities. Fossils of gulls and jaeger are uncommon in North America where only four species of the former, and one of the latter, have been described (Olson, 1985). Only two other Pliocene localities in eastern North America have produced comparable vertebrate faunas that include cormorant, gull and jaeger (Brodkorb, 1955; Becker, 1987). These localities are marine deposits from the Yorktown Formation (early Pliocene, 4.8–3.7 Ma) at Lee Creek, North Carolina, and the Bone Valley Formation (early Pliocene, 5.2–4.5 Ma), Florida. The seal (*Callophoca obscura*) is known from the upper Bone Valley Formation, but is rare in the Tamiami Formation and is reported from only two localities at APAC and Richardson Road Shell Pits (Morgan, 1994).

The high number of new records (18) of fish also indicate the rarity of this coastal environment in the fossil record of Florida. The fish assemblage is one of the most diverse fossil collections for Florida. The majority of the fishes are shallow marine species including several bottom-dwelling varieties (Table 4). Species that inhabit near-shore grass beds include the pigfish, spot, and the star drum. Other species that are common in shallow, near-shore waters are the rays (Rajiformes), sea catfishes (Ariidae), toadfishes (*Opsanus* sp.), searobins (*Prionotus* sp.), the drums (Sciaenidae), mullet, (*Mugil* sp.), and the flounder (Bothidae). Some herrings (*Alosa* sp.) enter rivers to spawn with adults eventually returning to the ocean. Habitat information on the other taxa is summarized in Table 4.

These data also are examined in light of the hypothesis that the Gulf Coast of Florida experienced upwelling currents during the Pliocene perhaps as a result of the submergence of the Panamanian isthmus (see Emslie and Morgan, 1994; Allmon et al., 1995). Although none of the identified fishes are exclusively oceanic or cold water species as would be expected in an upwelling environment, the fish fauna suggest that in the Pliocene it was less tropical than today. Only two of the fishes (*Haemulon* sp. and *Lachnolaimus maximus*) recovered in the samples generally inhabit tropical reefs, but neither are abundant. *Haemulon* today is represented by a diverse range

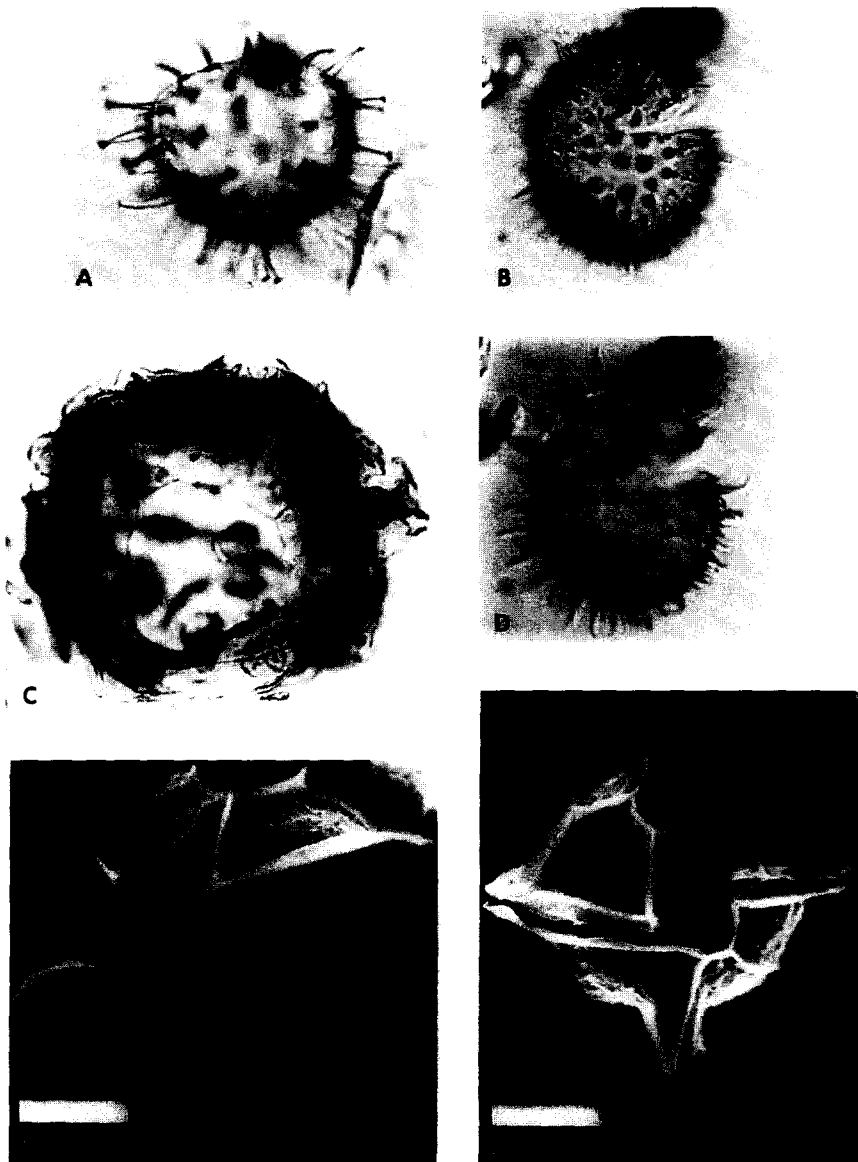

Fig. 10. Fossil dinocysts (a–d) recovered from the “Pinecrest Sand” at Richardson Road Shell Pit and thecate specimens (e–f) of *Pyrodinium bahamense*. (a) *Polysphaeridium zoharyi* (Rossignol) Bujak et al. Slide 3 (+45 μm); coordinates 121.5 \times 12.9; magnification 400 \times ; (b,d) *Lingulodinium machaerophorum* (Deflandre and Cookson) Wall. Slide 2 (+45 μm); coordinates 110.1 \times 4.9; magnification 400 \times ; (c) *Tuberculodinium vancampoae* (Rossignol) Wall. Slide 2 (+45 μm); coordinates 102.9 \times 10.0; magnification 400 \times ; (e) *Pyrodinium bahamense* var. *compressum* (Bohm) Steidinger, Tester and Taylor 1980; scale bar = 20 μm ; (f) *Pyrodinium bahamense* var. *bahamense* Steidinger, Tester and Taylor 1980; scale bar = 20 μm (photos e and f courtesy of K. Steidinger, Florida Marine Research Institute).

of species some of which are more tolerate of temperate and subtropical waters.

The taxonomic composition of the mollusk fauna in the bird layers is distinct from that of

unit 6/7. It is not unusual for bulk samples in high-diversity shell beds to contain only a small subset of the entire fauna (CoBabe and Allmon, 1994). Although bed-by-bed mollusk diversities

have not been compiled for the Pinecrest at Sarasota, the species richness in the bulk (IS) samples considered here are consistent with observations from faunal surveys that unit 4 at APAC contains fewer species than units immediately above or below (Petuch, 1982; Allmon, 1993).

The dominance of *Perna* and *Crepidula* in the mollusk assemblage in the bird layers is consistent with an environment of more-or-less normal marine salinity, shallow subtidal depths, and moderate wave action and turbidity. It also is indicative of substantial transport from environments of life into a somewhat different environment of deposition. *Crepidula fornicata* today occurs most commonly and abundantly in shallow water (<3 m) with brackish to near-normal marine salinities (20–30‰) and moderate but not high turbidity, and in fine sediments with relatively high organic content; the species is highly gregarious in life, forming stacks of up to a dozen individuals, with the bottom individual usually secured to some sort of solid substrate (rock, shell, etc.; Johnson, 1972; Hoagland, 1979; Loomis and Van Nieuwenhuyze, 1985; Miller and DuBar, 1988). The ecology of Recent *Perna* is poorly known. In Hong Kong, *P. viridis* is a fouling species, and is prolific on hard substrates such as piers and ship bottoms; it occurs in high abundance in depths of up to 10 m, brackish to normal marine salinities (apparently preferring higher values), moderate wave/current energy and relatively low turbidity (Huang et al., 1985). On Margarita Island, Venezuela, *P. perna* occurs in clusters in the splash zone of rocks exposed to ocean waves (Rodríguez, 1959; Beaupérthuy, 1967; see also Siddall, 1980). In contrast, paired valves of *P. conradina* in apparent life position are common in the clean sands of unit 3 that are stratigraphically above unit 4 at APAC and the bird layers at Richardson Road.

These observations suggest that the mollusk assemblage in the bird layers originated from more than a single community. The *Perna* may have been living in a clean sand bed (similar to unit 3) and/or a rocky zone (similar to the indurated zone noted at Richardson Road by Harris and Scott [in prep.]), but not in the unstable shell gravels of the bird layers. *Crepidula* may have been living in somewhat quieter waters, in which were being

deposited relatively fine sediments with high organic content, as well as at least some sizeable shell fragments. Shells from these two near-shore environments were evidently mixed and swept into a near-shore depositional setting.

The interpretations which can be drawn from the pollen analyses (Fig. 9) are limited, principally because species abundance and taxonomic diversity are seriously limited. Without adequate representation of herbaceous species, shrubs, vines, and trees, it is difficult to properly reconstruct a flora. Investigations by Rich (1979, 1985) elsewhere in the Southeast suggest that as many as 50 or 60 taxa might have been expected in the bird layer samples, based upon species composition in some of the plant communities in coastal Georgia and Florida. The lack of diversity and the dominance of three genera may be due either to lack of diversity in the communities which produced the pollen, or to winnowing of pollen taxa as a result of differential pollen production, sorting of pollen by wind and water, and consumption of pollen by detritus feeders.

Given the limitations which depositional and diagenetic processes have imposed upon the pollen flora, it is still possible to construct a generalized picture of the vegetation which existed near the site of deposition. Most of the pollen could have been derived from inland sites, for which the abundance of *Taxodium* is good evidence as this genus currently is most common in Florida in freshwater swamps and other inland environments (Ewel, 1990). Even the less abundant taxa, such as *Sagittaria* (arrowhead), *Nyssa* (black gum), *Liquidambar* (sweet gum), and *Ulmus* (elm) are more typical of inland sites than coastal areas. Inland, freshwater derivation of the pollen in PS 10 is supported by the presence in that sample of colonies of *Botryococcus*, a minute alga which is most common in freshwater environments. Halophytic (salt-tolerant) taxa might be represented by the cheno-ams or, perhaps, the Compositae in the cormorant site samples, but there are no mangrove pollen (e.g., *Rhizophora* or *Avicennia*) or similar indications of significant halophytic input. Even the grasses show only modest representation (a maximum of 4% in PS 1), and it is difficult to imagine expansive marshes of

Spartina (salt marsh cord grass) anywhere near the fossil site (Fig. 9).

Taxa that, in all likelihood, represent both air- and water-borne pollen derived from inland, terrestrial communities include *Pinus* and *Quercus*. It is difficult to distinguish pollen of different southeastern species of these genera, so they have all been combined. Fortunately, such lumping does not necessarily obscure the usefulness of the genera in paleoenvironmental reconstructions. Although there are species of pine and oak which prefer to live in swamps, the plants are, by and large, inhabitants of sand ridges and other upland sites which are edaphically dry. This is especially true in Florida, where subtle changes in topography result in marshes and swamps occurring in low areas, and pine-oak woodland occupying topographically high sites.

Of the dinoflagellates represented in the sediment samples from the site, *Pyrodinium bahamense* favors a tropical to subtropical climate and a neritic to estuarine environment. It is in such settings that in situ dinocysts of *P. bahamense* (i.e., *Polysphaeridium zoharyi*) are most abundant (Wall and Dale, 1969). General environmental parameters for the motile stage reported from field studies of the motile and cyst stages include temperature ranges of 25–35°C and salinities of 14–40‰ (Buchanan, 1971; Wall et al., 1977; Azanza-Corrales and Hall, 1991). These data provide a suggested range of environmental conditions that may have prevailed in the area of the Richardson Road Shell Pit during the Pliocene when units 6/7 and 3 of Petuch (1982) were deposited. Ostracod studies indicate a cooler temperature range of 15–25°C during the Pliocene for units 2, 3 and 6/7 (Willard et al., 1993). However, the temperature ranges overlap at the lower extreme (25°C) reported for *P. bahamense*.

5.2. The depositional environment

Large number of cormorant bones and carcasses may accumulate at breeding colonies, where these birds congregate. However, non-systematic observations at several modern colonies by one of us (SDE) indicate that bones on these breeding areas are nearly 100% from chicks and juveniles that

died in or near their nests; adults rarely die at the colony. Moreover, systematic survey at other seabird colonies show similar biases in bone accumulation and preservation at these sites (Emslie, 1995b). The nearly complete absence of bones from juvenile cormorants at Richardson Road indicates that this accumulation did not form at a breeding colony.

The sample of associated skeletons from the site represents dozens (or hundreds if extrapolated across the entire site) of birds that died at one time. This catastrophic death assemblage is evinced by the bias towards articulated wing elements (78.3% of carcasses in the 63 squares) and their differences in coloration from the isolated bones. Wing and pectoral skeletal elements tend to disarticulate last when a bird carcass decomposes (Schäfer, 1972; Bickart, 1984; Oliver and Graham, 1994). The high representation of articulated wing elements in the fossil assemblage suggests that these birds died and decayed at the same time and rate, prior to rapid burial in the sediments (Emslie and Morgan, 1994; Emslie, 1995a). The precise articulation of many of the associated cormorant bones in the sediments also indicates that soft tissue was present on them at time of burial. Furthermore, that the bias towards articulated wing elements is not an artifact of preservation is shown by the percent representation of isolated bones. In this latter sample, leg elements are equally represented as those from the wing (Fig. 7), as would be expected after carcasses completely decompose and disarticulate over a long period of time.

An alternate explanation for the formation of this site and the avian death assemblage is provided by the taphonomic evidence presented here. Sedimentological and taphonomic evidence is consistent with a relatively complex scenario for the deposition of the bird layers. We believe that the layers formed through multiple episodes of breaching of a barrier-island sand bar. Through the resulting pass, large amounts of shell and bone that had accumulated over fairly long periods on the seaward side of the barrier were transported relatively quickly. Hurricanes and associated “hurricane passes” are common on the barrier islands

along the west coast of Florida today (e.g., Wright and O'Donnell, 1973; Brand, 1990; Cuffe, 1991).

The relatively restricted lateral extent of the bird layers is consistent with the filling of a small, back-barrier lagoon or inlet. The physical stratigraphy of at least some areas of the unit (e.g., Fig. 2) is marked by well-developed trough or channel-fill cross-bedding (cf., Reineck and Singh, 1980: p. 98, 104), such as might form through the scouring and filling of a tidal channel. The complex stratigraphy itself is indicative of more than a single depositional event. Moreover, bone in the upper shell layer is oriented differently, with a stronger angle of dip that is characteristic of high-energy deposition (Voorhies, 1969), than bone in the lower shell and sand/clay layers. Bone clusters with their strong directional bias add further support to this interpretation and may be a result of eddies, debris dams or other factors that operated during the deposition of the upper shell layer. These taphonomic differences in the isolated bones, in conjunction with data presented on articulation patterns of associated skeletons, provide further evidence for multiple depositional events.

Long-term accumulation of the cormorant bones is indicated by the thousands of isolated bones, of which some (approximately 1%) show evidence for apparently having lain in shallow marine pools where invertebrates (barnacles and oysters) attached and grew on their surface prior to burial in the sediments. In addition, an unusually large number of cormorants are represented in this fossil assemblage. At least 225 individuals are represented by the total sample of bones from the excavated grid and this number increases to 255 when associated material is considered as well (based on number of ulnae). We estimate that the excavated portion of the site represents at most 10% of the total area of bone concentration in the sediments. Extrapolating from this figure, a conservative estimate for the total number of cormorants once represented in this site would be at least 2550, and perhaps as many as 10,000, individuals. Bones from these birds probably accumulated in the sediments over many years, perhaps from periodic die offs that occurred in this region.

Taphonomic analysis of the molluscs is consistent with the results for the vertebrates. Unit 6/7

was clearly deposited in a full-marine setting, probably in 10–30 m depth, over a considerable time span (i.e., 10^3 – 10^5 years) with a combination of high biological productivity and hard-part concentration by sediment winnowing (Allmon, 1993; Allmon et al., 1995). This produced a somewhat time-averaged, but probably not significantly habitat-averaged (i.e., parautochthonous) assemblage (sensu Kidwell et al., 1986; Staff and Powell, 1990). Taphonomic attributes of shells in the bird layers, in contrast, point to a different history. The shells in the bird layers are more fragmented, less bioeroded and, in some cases, more abraded, than shells in unit 6/7. The bird layer shells clearly underwent extensive physical transport before final deposition, probably in a high-energy environment such as a beach swash zone or tidal channel. Such transport would break and wear the shells, and also discourage bioerosion. After accumulating and being reworked in such environments, the shells (and associated bones) were deposited relatively quickly, and in multiple events, by relatively high-energy currents (as indicated by the cross-beds). The currents responsible for final deposition of the shells and bones probably had little effect on their taphonomic signature, however; in general, shells' environment of origin exerts more effect on their condition than their environment of deposition (Davies et al., 1989; Powell et al., 1989; Albertzart and Wilkins, 1990).

The differing taphonomic signals evident in *Perna* and *Crepidula* are consistent with the physical stratigraphy in pointing to more than a single such event. The bird bed contains several distinct shell layers (Figs. 2, 8). The samples analyzed from these layers vary considerably in character, suggesting a varied depositional history. IS 24 is the most similar to the sample analyzed from unit 6/7 (Fig. 8; Tables 2, 6). Its species richness is higher, its *Perna* shell fragments are larger and its *Crepidula* fragments show similar physical abrasion and bioerosion patterns. Within the bird layers, however, the different samples analyzed do not show consistent patterns of difference in the most common taxa (Fig. 8). With respect to *Perna*, IS 11, 25, and 27 are most similar, whereas with respect to *Crepidula*, IS 11 is most similar to IS 23. Comparing these results to the lateral and

vertical distribution of the samples (Fig. 8) suggests first that more than a single depositional episode was involved; characteristic faunas and taphofacies are not distributed homogeneously across the bird bed. It also suggests that either a single area with a changing environment was “sampled” by the depositional currents over a long period, or that a wider geographic area characterized by a variety of environments was sampled over a shorter period. Given the similarity of the vertebrate fauna in the different layers, the latter explanation would seem the more likely.

The pollen flora in the site also is a result of some degree of reworking. Research recently completed at several other sites in Georgia and Florida (Rich and Pirkle, 1993, 1994; Rich and Newsom, 1995) supports the contention that the impoverished state of the flora appears to have been caused by transportation by water, including streams, coastal currents, and waves which results in patterns in pollen occurrence similar to those at Richardson Road. Some plants (e.g., *Alnus* and *Nyssa*) typically grow in inland, freshwater swamps and produce pollen that, though abundant where the plants grow, may not survive long-distance transport in water. The bird layers clearly represent shallow marine sediments and the pollen present within them must have experienced a considerable amount of transport. The fine-grained, flocculent organic matter that dominates the residues, and the lack of structured plant matter such as wood fragments, charcoal, or cuticle, indicate long-distance transport of the sediment, during which sorting of particles took place. The pollen of some plants simply may not travel far because of their size and shape, or they may be mechanically battered or attacked chemically/biologically to the extent that they do not survive long enough to be deposited, buried, and preserved. The abundance of broken pine pollen at the site also supports the notion that the pollen all were carried long distances, or were repeatedly transported, deposited, and transported again until they finally came to rest in the bird layers.

What could have caused the high mortality of birds and fishes at this site? At least two scenarios are possible. First, it is possible that an upwelling environment in the Gulf waters experienced an El

Niño event accompanied by an influx of warmer waters, particularly in the near surface zones. As warmer waters entered the Gulf, the photosynthetic pathways generally associated with upwelling currents were disrupted. The fishes (e.g., anchovies) that normally feed on the phytoplankton produced in the shallower waters would have retreated to deeper waters and been inaccessible to both birds, such as cormorants, and other fishes that feed upon them leading to their starvation; such events occur regularly in eastern Pacific upwelling zones (e.g., Ainley and Boekelheide, 1990). Warmer waters would have allowed new fish species to populate the area. The majority of the fish individuals represented in the fine-screened samples are small-sized individuals that would have been suitable food for the abundant cormorants in the samples. If this scenario is correct, the fishes may represent a death assemblage since there is no change in species representation through time.

A second hypothesis is that the death of the cormorants and the fishes reflect a toxic red tide event or events in the late Pliocene. Modern bird kills resulting from toxic red tides are well known from many areas of the world (e.g., Adnan, 1991; Coulson et al., 1968; Todd et al., 1991). The numerous bottom-dwelling herbivorous fishes at the site may have initiated a die off of various animals in the food chain by ingesting the red tide promoting algae (dinoflagellate). Cormorants or carnivorous fishes that consumed the smaller fishes would have experienced the greatest death rates as the poisonous effects became magnified in the food chain (Anderson, 1994, 1995). Because of their tendency to feed in flocks and their high susceptibility to PSP, cormorants may die in large numbers during red tide events (Coulson et al., 1968); bottom-dwelling fish also frequently die in these events (R. Pierce, pers. comm., 1993). Because these taxa are abundant in the fossil assemblage at Richardson Road, we hypothesize that a succession of red tide events in the Sarasota area may have contributed to the accumulation of skeletal material at this site. These events are common in the Gulf of Mexico and the Sarasota region today (Forrester et al., 1977; Culotta, 1992), as well as on the Atlantic Coast (Anderson, 1994).

Moreover, other studies have indicated that red tides may have caused die offs of marine organisms as early as the Jurassic (Noe-Nygaard et al., 1987).

5.3. Bloom-forming dinoflagellates

Three of the dinocyst species recovered from the site are known to be produced by thecate dinoflagellates that are responsible for red tides in modern seas. The blooms of *Pyrophacus vancamptoeae* are non-toxic, whereas those of *Lingulodinium polyedra* can be toxic. The toxicity of *Pyrodinium bahamense*, the third red tide dinoflagellate, is more equivocal. Two proposed varieties of *P. bahamense*, *P. bahamense* var. *bahamense* (Fig. 10f) and *P. bahamense* var. *compressum* (Fig. 10e; Steidinger et al., 1980) are not easily differentiated and may represent only one quite variable species (Balech, 1985). Additional statistical studies of the cysts and thecae of both varieties are needed to confirm their existence (Matsuoka et al., 1989). Here, we follow the recent literature on red tides (e.g., Smayda and Shimizu, 1991) and adhere to the proposal of Steidinger et al. (1980) until the issue is resolved. This approach also facilitates the discussion of the toxic and non-toxic populations.

Of the two varieties, blooms of *Pyrodinium bahamense* var. *bahamense* are apparently non-toxic. This variety is common today in the Caribbean Sea, the Gulf of Mexico and the tropical waters of the Atlantic Ocean (Buchanan, 1968; Wall and Dale, 1969; Steidinger et al., 1980). It apparently does not co-occur in the Pacific or Indian Oceans with *P. bahamense* var. *compressum*, but does overlap with that variety off the west coast of Mexico (Tafall, 1942; Taylor and Pollinger, 1987). *Pyrodinium bahamense* var. *compressum* also has been reported from the Persian Gulf (Böhm, 1931), the Red Sea (Matzeuner, 1933), Papua New Guinea (MacLean, 1973, 1977; Worth et al., 1975), the Andaman Sea (Taylor, 1976), Brunei and Sabah on Borneo (Beales, 1976), and the Philippine Islands (Hermes and Villosa, 1983).

Cysts of *Pyrodinium bahamense* (i.e., *Polysphaeridium zoharyi*) have a stratigraphic range of lower Eocene to Holocene (Williams and Bujak, 1985). *P. zoharyi* occurs in the uppermost

Tallahatta Formation (latest early Eocene) in the Little Stave Creek section outside Jackson, Alabama (Wrenn, unpubl. data). Its presence in sediments of this formation indicates that *P. bahamense* has been a member of the phytoplankton community in the Gulf of Mexico for at least 54 million years. *Polysphaeridium zoharyi* is the dominant dinocyst species recovered from all samples of the Pinecrest Beds (Table 7). It also has been recovered from Oligocene deposits of the Murray Basin of southeast Australia (Truswell et al., 1985) indicating that *P. bahamense* has been present in the southeast Pacific for at least 24 million years.

Since the early 1970's, *Pyrodinium bahamense* var. *compressum* blooms have caused outbreaks of paralytic shellfish poisoning (PSP) in the Indo-Pacific area, including Papua New Guinea (MacLean, 1973, 1977; Worth et al., 1975), Brunei Darussalam and Sabah (Beales, 1976; Steidinger et al., 1980) and the Philippine Islands (Hermes and Villosa, 1983; Azanza-Corrales and Hall, 1991). More recently, outbreaks of PSP in Indonesia have sickened or killed fish, dogs, chickens and humans (Adnan, 1991). MacLean (1979) notes that *P. bahamense* var. *compressum* is the major toxic dinoflagellate in the Indo-Pacific area. The neurotoxins produced by *Pyrodinium bahamense* var. *compressum* paralyze the neuromuscular system and on occasion result in death by respiratory paralysis with no known antidote (Shimizu, 1987).

A variety of organisms, including shellfish, crustaceans, plankton-grazing fish, cormorants and other birds are affected by PSP (Sommer, 1932; Coulson et al., 1968; Todd et al., 1991) when they consume toxic motile cells and dinocysts. The PSP toxins accumulate in their tissues (Anderson and Wall, 1978; Hsu et al., 1979) and are passed up the food chain to birds, marine mammals and humans when they eat the contaminated primary consumers. Most seabirds contract PSP and die by eating contaminated fish (McKernan and Scheffer, 1942; Coulson et al., 1968; Forrester et al., 1977). Large die offs of fish, cormorants and other birds, and marine mammals caused by toxic red tides from the dinoflagellate *Gymnodinium breve* currently occur on the Gulf Coast of Florida and on the Atlantic seaboard

(Forrester et al., 1977; Anderson, 1994). Our data suggest that *Pyrodinium bahamense* had a similar effect in Florida during the late Pliocene. Toxic blooms of this species may have contributed to the long-term deposition of thousands of cormorant and fish bones in the site; the partial skeletons of cormorant probably represent the most recent die off caused by red tide prior to the rapid sedimentary event that buried and the decomposed carcasses. Continued decay of these carcasses after burial, in a reducing environment, also may have contributed to the formation of pyrite on many of the bones and shells.

The present day toxicity and distribution of the two varieties of *Pyrodinium bahamense* creates a problem for ascribing our purported Florida Pliocene bird kill to a toxic bloom of that species: the modern Caribbean variety is non-toxic, whereas the modern toxic variety lives only in the Pacific. However, it is possible that toxicity of the non-toxic variety of *Pyrodinium bahamense* may be induced by environmental pressures, such as high bacterial concentrations in the water column or within the dinoflagellate cell (Steidinger et al., 1973; Silva, 1979; Steidinger and Baden, 1984; Balech, 1985), or that it was toxic in the Pliocene but no longer is today. Modern blooms of *P. bahamense* var. *compressum* are not consistently toxic or of equal virulence (MacLean, 1979).

It is also possible that the Pliocene distribution of *P. bahamense* var. *compressum* may have differed from its modern range. This variety could have gained access to the Gulf of Mexico from the Pacific Ocean by way of the Panamanian seaway, prior to the final emergence of the Central American Isthmus. Formation of the Isthmus was occurring during the time of deposition of units 10 through 2 of the "Pinecrest Sands" (i.e., 3.5–2.0 Ma; Keigwin, 1978; Coates et al., 1992). Because both varieties of *P. bahamense* are most abundant in shallow coastal waters, a shallow seaway would have sufficed to permit a continuous exchange across the submerged isthmus. Such a shallow seaway may have existed as late as 2.0 Ma (Willard et al., 1993; Cronin and Dowsett, in press; Allmon et al., 1995). The subsequent disappearance of *P. bahamense* var. *compressum* may have resulted from the Pleistocene cooling of the Gulf of Mexico.

We believe that this exchange best explains the situation at Richardson Road and is particularly compelling as the cormorant at this site is an extinct species most closely related to taxa currently restricted to the eastern Pacific. A common ancestor for the extinct species of cormorant at Richardson Road and the Pacific species probably entered the Gulf of Mexico in the early Pliocene (or earlier) also via the Panamanian seaway (Emslie, 1995a). Thus, this Pliocene seaway presumably allowed biological exchange of organisms between the Pacific Ocean and the Gulf of Mexico that included higher vertebrates as well as invertebrates and plants. Extinctions of local populations on either side of the Central American Isthmus since its formation in the late Pliocene have resulted in peculiar biogeographic distributions such as those for the dinoflagellates, cormorants and other taxa.

6. Conclusion

We have integrated taphonomic data on vertebrate and invertebrate paleontology, micropaleontology and palynology to explain an avian death assemblage in late Pliocene marine deposits on the Gulf Coast of Florida. Our data indicate that these deposits formed in a highly localized section of the "Pinecrest Sands", first by gradual accumulation of sediments and fossils on or near an exposed barrier beach, and second by a series of rapid sedimentation events associated with breaching of this barrier and deposition in a quiet back-beach setting. The large number of partial and complete skeletons of cormorant, and the thousands of isolated bones of these, other seabirds, and fish, probably accumulated in these deposits due to periodic toxic red tides that occurred during the Late Pliocene. The death of large numbers of cormorants or other aquatic birds is known to occur as a result of modern toxic red tides (McKernan and Scheffer, 1942; Coulson et al., 1968; Forrester et al. 1977) or other unusual circumstances (e.g., Oliver and Graham, 1994). In addition, repeat occurrence of toxic red tides in the same region is not unusual and these events occur periodically off western Florida today

(Steidinger, 1975; Pierce et al., 1990; Anderson, 1994). Periodic fish and cormorant kills in this region, combined with local coastal features, tides and currents, probably resulted in continuous and punctuated deposition of carcasses, shell and sediments at this location.

The great abundance of *Polysphaeridium zoharyi*, the cyst of *Pyrodinium bahamense*, in the bird layers is interpreted to indicate that *P. bahamense* toxic red tides caused the massive bird and fish kills recorded in the Pinecrest at Richardson Road. The toxic variety of this species, *P. bahamense* var. *compressum*, no longer occurs in the Gulf of Mexico, but may have extended into this region from the Pacific Ocean during the Pliocene, prior to the emergence of the Central American Isthmus. If so, the bird layers at Richardson Road Shell Pit provide an example of biological exchange and extinctions that resulted from climatic changes and the submergence/emergence of the Central American Isthmus.

Acknowledgments

This research was funded by NSF Grants EAR-9116330 and EAR-9218583 to S. Emslie. We thank Wayne Filyaw for bringing the site at Richardson Road to the attention of personnel at FLMNH. H. Cannon, Quality Aggregates, Inc., generously allowed access to the site and provided the use of heavy equipment. Thanks also are due to J. Carter, B. Harris, and W. Lyons for discussion and sharing unpublished data, and to M. Stiger for assistance with graphics. F.L. Pirkle, E.I. DuPont de Nemours and Co., Trail Ridge Plant, provided support for extraction and analysis of the pollen samples. Assistance in the field and/or lab was provided by P. Bruner, C. Carr, N. Karnovsky, Xu Li, G. Morgan, D. Munn, P. Neuhs, M. Noel, R. Portell, A. Poyer, A. Pratt, C. Rado, J. Romo, B. Shockey, E. Simons, E. Taylor, J. Tegan, B. and R. Toomey, S. Watts, D. Whidden and P. Whisler. Kerry Lyle assisted with the printing of Fig. 10. We thank Graham Williams and one anonymous reviewer for their helpful comments and suggestions that improved this paper.

References

- Adnan, Q., 1991. PSP and red tide status in Indonesia. In: T.J. Smayda and Y. Shimizu (Editors), *Toxic Phytoplankton Blooms in the Sea*. Elsevier, Amsterdam, pp. 199–202.
- Ainley, D.G. and Boekelheide, R.J., 1990. Seabirds of the Farallon Islands. Stanford Univ. Press.
- Albertzart, L.S. and Wilkinson, B.H., 1990. Barrier backbeach shell assemblages from the central Texas Gulf coast. *Palaios*, 5: 346–355.
- Allmon, W.D., 1992. Whence southern Florida's Pliocene shell beds? *Fla. Geol. Surv. Spec. Publ.*, 36: 1–20.
- Allmon, W.D., 1993. Age, environment and mode of deposition of the densely fossiliferous Pinecrest Sand (Pliocene of Florida): implications for the role of biological productivity in shell bed formation. *Palaios*, 8: 183–201.
- Allmon, W.D., Rosenberg, G., Portell, R.W. and Schindler, K.S., 1993. Diversity of Atlantic Coastal Plain mollusks since the Pliocene. *Science*, 260: 1626–1629.
- Allmon, W.D., Spizuc, M.P. and Jones, D.S., 1995. Taphonomy and paleoenvironment of two turritellid gastropod-rich beds, Pliocene of Florida. *Lethaia*, 28: 75–83.
- Allmon, W.D., Emslie, S.D., Jones, D.S. and Morgan, G.S., 1996. Late Neogene oceanographic change along Florida's west coast: evidence and mechanisms. *J. Geol.*, 104: 143–162.
- American Fisheries Society, 1991. *Common and Scientific Names of Fishes from the United States and Canada*. Am. Fish. Soc. Spec. Publ., 20, 5th ed.
- Anderson, D.M., 1994. Red tides. *Sci. Am.*, 271: 62–68.
- Anderson, D.M., 1995. Toxic red tides and harmful algal blooms—a practical challenge in coastal oceanography. *Rev. Geophys.*, 33 (2, Suppl.): 1189–1200.
- Anderson, D.M. and Wall, D., 1978. Potential importance of benthic cysts of *Gonyaulax tamarensis* and *G. excavata* in initiating toxic dinoflagellate blooms. *J. Phycol.*, 14: 224–234.
- Azanza-Corrales, R. and Hall, S., 1991. Isolation and culture of *Pyrodinium bahamense* var. *compressum* from the Philippines. In: T.J. Smayda and Y. Shimizu (Editors), *Toxic Phytoplankton Blooms in the Sea*. Elsevier, Amsterdam, pp. 725–730.
- Balech, E., 1985. A Revision of *Pyrodinium bahamense* Plate (Dinoflagellata). *Rev. Palaeobot. Palynol.*, 45: 1734.
- Barss, S.D. and Williams, G.L., 1973. Palynology and nannofossil processing techniques. *Geol. Surv. Can. Pap.*, 73-26: 1–25.
- Beales, R.W., 1976. A red tide in Brunei's coastal waters. *Brunei Mus. J.*, 3: 167–182.
- Beauperthuy, I., 1967. Los mitilidos de Venezuela (Mollusca, Bivalvia). *Bol. Inst. Oceanogr. Univ. Oriente*, 6: 7–115.
- Becker, J., 1987. *Neogene Avian Localities of North America*. Smithsonian. Inst. Press, Washington, DC.
- Bickart, J., 1984. A field experiment in avian taphonomy. *J. Vertebr. Paleontol.*, 4: 525–535.
- Böhm, A., 1931. Peridineen aus dem Persischen Golf und dem Golf von Oman. *Arch. Protistenkd.*, 74: 188–197.
- Brand, S., 1990. Tampa Bay as a hurricane haven. *NOAA Mar. Weather Log*, 34: 48–51.

- Brodkorb, P., 1955. The avifauna of the Bone Valley Formation. Fla. Geol. Surv. Rep. Invest., 14: 1–57.
- Buchanan, R.J., 1968. Studies at Oyster Bay in Jamaica, West Indies. IV. Observations on the morphology and asexual cycle of *Pyrodinium bahamense* Plate. J. Phycol., 4: 272–277.
- Buchanan, R.J., 1971. Studies at Oyster Bay in Jamaica, West Indies. V. Qualitative observations on the planktonic algae and protozoa. Bull. Mar. Sci., 21(4): 914–937.
- Coates, A.G. et al., 1992. Closure of the Isthmus of Panama: the near-shore marine record of Costa Rica and western Panama. Geol. Soc. Am. Bull., 104: 814–828.
- CoBabe, E.A. and Allmon, W.D., 1994. Effects of sampling on paleoecologic and taphonomic analyses in high-diversity fossil accumulations: an example from the Eocene Gosport Sand, Alabama. Lethaia, 27: 167–178.
- Coulson, J.C., Potts, G.R., Deans, I.R. and Fraser, S.M., 1968. Exceptional mortality of shags and other seabirds caused by paralytic shellfish poison. Br. Birds, 61: 381–404.
- Cronin, T.M. and Dowsett, H.J., in press. Biotic and oceanographic response to the Pliocene closing of the Isthmus of Panama. In: J.B.C. Jackson et al. (Editors), Neogene Tropical America. Univ. Chicago Press.
- Cuffe, C.K., 1991. Development and stratigraphy of ebb- and flood-tidal deltas at Hurricane Pass, Pinellas County, Florida. Thesis. Univ. South Florida, Tampa (unpublished).
- Culotta, E., 1992. Red menace in the world's oceans. Science, 257: 1476–1477.
- Davies, D.J., Powell, E.N. and Stanton Jr., R.J., 1989. Taphonomic signature as a function of environmental process: shells and shell beds in a hurricane-influenced inlet on the Texas coast. Palaeogeogr. Palaeoclimatol. Palaeoecol., 72: 317–356.
- Emslie, S.D., 1992. Two new late Blancan avifaunas from Florida and the extinction of wetland birds in the Pliocene. Nat. Hist. Mus. Los Angeles Co. Sci. Ser., 36: 249–269.
- Emslie, S.D., 1995a. A catastrophic death assemblage of a new species of cormorant and other seabirds from the late Pliocene of Florida. J. Vertebr. Paleontol., 15: 313–330.
- Emslie, S.D., 1995b. Age and taphonomy of abandoned penguin rookeries in the Antarctic Peninsula region. Polar Rec., 31: 409–418.
- Emslie, S.D. and Morgan, G.S., 1994. A catastrophic death assemblage and paleoclimatic implications of Pliocene seabirds of Florida. Science, 264: 684–685.
- Ewel, K.C., 1990. Swamps. In: R.L. Myers and J.J. Ewel (Editors), Ecosystems of Florida. Univ. Central Fla. Press, Orlando, pp. 281–323.
- Forrester, D.J. et al., 1977. An epizootic of waterfowl associated with a red tide episode in Florida. J. Wildlife Diseases, 13: 160–167.
- Hermes, R. and Viloso, E.P., 1983. A recent bloom of the toxic dinoflagellate *Pyrodinium bahamense* var. *bahamense* in the central Philippine waters. Fish. Res. J. Philippines, 8(2): 1–8.
- Hoagland, K.E., 1979. The behavior of the sympatric species of *Crepidula* (Gastropoda: Prosobranchia) from the Atlantic with implications for evolutionary ecology. Nautilus, 94: 143–149.
- Hoese, H.D. and Moore, R.M., 1977. Fishes of the Gulf of Mexico: Texas, Louisiana, and Adjacent Waters. Texas A and M Univ. Press.
- Hsu, C.P. et al., 1979. Paralytic shellfish toxins in the sea scallop, *Placopecten magellanicus* in the Bay of Fundy. J. Fish. Res. Board Can., 36: 32–36.
- Hulbert Jr., R.C., 1987. A new *Cormohipparian* (Mammalia, Equidae) from the Pliocene (latest Hemphillian and Blancan) of Florida. J. Vertebr. Paleontol., 7: 451–468.
- Huang, Z.G., Lee, S.Y. and Mak, P.M.S., 1985. The distribution and population structure of *Perna viridis* (Bivalvia: Mytilacea) in Hong Kong waters. In: B. Morton and D. Dudgeon (Editors), Proc. 2nd Int. Workshop Malacofuna of Hong Kong and southern China, Hong Kong, 1983. Hong Kong Univ. Press, pp. 465–471.
- Johnson, J.K., 1972. Effect of turbidity on the rate of filtration and growth of the slipper limpet, *Crepidula fornicata* Lamarck, 1799. Veliger, 14: 315–320.
- Jones, D.S., MacFadden, B.J., Webb, S.D., Mueller, P.A., Hodell, D. and Cronin, T., 1991. Integrated geochronology of a classic Pliocene fossil site in Florida: linking marine and terrestrial biochronologies. J. Geol., 99: 637–648.
- Keigwin Jr., L.D., 1978. Pliocene closing of the Isthmus of Panama, based on biostratigraphic evidence from nearby Pacific Ocean and Caribbean Sea cores. Geology, 6: 630–634.
- Kidwell, S.M., Fürsich, F.T. and Aigner, T., 1986. Conceptual framework for the analysis and classification of fossil concentrations. Palaios, 1: 228–238.
- Loomis, S.H. and Van Nieuwenhuyze, W., 1985. Sediment correlates to density of *Crepidula fornicata* Linnaeus in the Pataguanset River, Connecticut. Veliger, 27: 266–272.
- MacLean, J.L., 1973. Red tide and paralytic shellfish poisoning in Papua New Guinea. Papua New Guinea Agric. J., 24: 131–138. (distr. 1975).
- MacLean, J.L., 1977. Observations on *Pyrodinium bahamense*, a toxic dinoflagellate, in Papua New Guinea. Limnol. Oceanogr., 22: 234–254.
- MacLean, J.L., 1979. Indo-Pacific red tides. In: D.L. Taylor and H.H. Seliger (Editors), Toxic Dinoflagellate Blooms (Devel. Mar. Biol.). Elsevier, Amsterdam, pp. 173–178.
- Matsuoka, K., Fukuyo, Y. and Gonzales, C.L., 1989. A new discovery of cysts of *Pyrodinium bahamense* var. *compressum* from the Samar Sea, Philippines. In: T. Okaichi et al. (Editors), Red Tides: Biology, Environmental Science, and Toxicology. Elsevier, Amsterdam, pp. 301–304.
- Matzeuner, L., 1933. Die Dinoflagellaten des Indischen Ozeans (mit Ausnahme der Gattung *Ceratim*). Bot. Arch., 35: 437–510.
- McKernan, D.L. and Scheffer, V.B., 1942. Unusual numbers of dead birds on the Washington coast. Condor, 44: 264–266.
- Miller III, W. and DuBar, J.R., 1988. Community replacement of a Pleistocene *Crepidula* biostrome. Lethaia, 21: 67–78.
- Morgan, G.S., 1994. Miocene and Pliocene marine mammal faunas from the Bone Valley Formation of central Florida. Proc. San Diego Soc. Nat. Hist., 29: 239–268.

- Morgan, G.S. and Ridgway, R.B., 1987. Late Pliocene (late Blancan) vertebrates from the St. Petersburg Times Site, Pinellas County, Florida, with a brief review of Florida Blancan faunas. *Pap. Fla. Paleontol.*, 1: 1–22.
- Nelson, J.S., 1984. *Fishes of the World*. Wiley, New York.
- Noe-Nygaard, N., Surlyk, F. and Piasecki, S. 1987. Bivalve mass mortality caused by toxic dinoflagellate blooms in a Berriasian–Valanginian lagoon, Bornholm, Denmark. *Palaaios*, 2: 263–273.
- Oliver, J.S. and Graham, R.W., 1994. A catastrophic kill of ice-trapped coots: time-averaged versus scavenger-specific disarticulation patterns. *Paleobiology*, 20: 229–244.
- Olson, S., 1985. The fossil record of birds. In: D. Farner et al. (Editors), *Avian Biology*. Academic Press, New York, 8, pp. 79–238.
- Petuch, E.J., 1982. Notes on the molluscan paleoecology of the Pinecrest Beds at Sarasota, Florida, with the description of *Pyruella*, a stratigraphically important new genus (Gastropoda: Melongenidae). *Proc. Acad. Nat. Sci. Phila.*, 134: 12–30.
- Pierce, R.H., Henry, M.S., Proffitt, L.S. and Hasbrouck, P.A., 1990. Red tide toxin (Brevetoxin) enrichment in marine aerosol. In: E. Graneli et al. (Editors), *Toxic Marine Phytoplankton*. Elsevier, Amsterdam, pp. 397–402.
- Powell, E.N., Staff, G.M., Davies, D.J. and Callender, W.R., 1989. Macrobenthic death assemblages in modern marine environments: formation, interpretation, and application. *Rev. Aquat. Sci.*, 1: 555–589.
- Reineck, H.E. and Singh, I.B., 1980. *Depositional Sedimentary Environments*. Springer, Berlin, 2nd ed..
- Reyment, R.A., 1991. *Multidimensional Palaeobiology*. Pergamon Press, New York.
- Rich, F.J., 1979. The origin and development of tree islands in the Okefenokee Swamp, as determined by peat petrography and pollen stratigraphy. Thesis. Penn. State Univ. (unpublished).
- Rich, F.J., 1985. Palynology and paleoecology of a lignitic peat from Trail Ridge, Florida. *Fla. Geol. Surv. Inf. Circ.*, 100: 1–15.
- Rich, F.J. and Newsom, L., 1995. Preliminary palynological and macrobotanical report for the Leisey Shell Pits, Hillsborough County, Florida. *Bull. Fla. Mus. Nat. Hist.*, 37: 117–126.
- Rich, F.J. and Pirkle, F.L., 1993. Palynology and paleoecology of Reids Bluff. In: K.M. Farrell et al. (Editors), *Geomorphology and Facies Relationships of Quaternary Barrier Island Complexes Near St. Marys, Georgia*. *Ga. Geol. Soc. Guidebook*, 13(1): 74–81.
- Rich, F.J. and Pirkle, F.L., 1994. Paleoecological interpretation of the Trail Ridge sequence, and related deposits in Georgia and Florida, based on pollen sedimentation and clastic sedimentology. In: A. Traverse (Editor), *Sedimentation of Organic Particles*. Cambridge Univ. Press, pp. 287–310.
- Rodriguez, G., 1959. The marine communities of Margarita Island, Venezuela. *Bull. Mar. Sci. Gulf Carib.*, 9: 237–280.
- Schäfer, W., 1972. Ecology and Paleoecology of Marine Environments. Oliver and Boyd, Edinburgh.
- Shimizu, Y., 1987. Dinoflagellate toxins. In: T.J. Smayda and Y. Shimizu (Editors), *Toxic Phytoplankton Blooms in the Sea* (Devel. Mar. Biol., 3). Elsevier, Amsterdam, pp. 282–315.
- Siddall, S.E., 1980. A clarification of the genus *Perna* (Mytilidae). *Bull. Mar. Sci.*, 30(4): 858–870.
- Silva, E.S., 1979. Intracellular bacteria, the origin of the dinoflagellates toxicity. Proc. 4th IUPAC Symp. Mycotoxins and Phycotoxins, Lausanne. *Pahotox Publ.*
- Smayda, T.J. and Shimizu, Y. (Editors), 1991. *Toxic Phytoplankton Blooms in the Sea*. (Devel. Mar. Biol., 3). Elsevier, Amsterdam.
- Sommer, H., 1932. The occurrence of paralytic shellfish poisoning in the common sand crab. *Science*, 76: 574–575.
- Staff, G.M. and Powell, E.N., 1990. Local variability of taphonomic attributes in a parautochthonous assemblage: can taphonomic signature distinguish a heterogeneous environment? *J. Paleontol.*, 64 (4): 648–658.
- Stanley, S.M., 1986. Anatomy of a regional mass extinction: Plio-Pleistocene decimation of the western Atlantic bivalve fauna. *Palaaios*, 1: 17–36.
- Steidinger, K.A., 1975. Origin of Florida red tides. *Fla. Mar. Res. Publ.*, 8: 4–5.
- Steidinger, K.A. and Baden, D.G., 1984. Toxic marine dinoflagellates. In: D.L. Spector (Editor), *Dinoflagellates*. Academic Press, New York, pp. 201–261.
- Steidinger, K.A., Burklew, M.A. and Ingle, R.M., 1973. The effect of *Gymnodinium breve* toxin on estuarine animals. In: D.F. Martin and G.M. Pallida (Editors), *Marine Pharmacognosy*. Academic Press, New York, pp. 179–202.
- Steidinger, K.A., Tester, L.S. and Taylor, F.J.R., 1980. A redescription of *Pyrodinium bahamense* var. *compressum* (Böhm) stat. nov. from Pacific red tides. *Phycologia*, 19(4): 329–337.
- Tafall, B.F.O., 1942. Notas sobre algunos dinoflagelados planctónicos marinos de Mexico, con descripción de nuevas especies. *Ann. E.N. Cienc. Biol.*, 2: 435–447.
- Taylor, F.J.R., 1976. Dinoflagellates from the International Indian Ocean Expedition. *Bibl. Bot.*, 132: 1–234.
- Taylor, F.J.R. and Pollinger, U., 1987. Ecology of dinoflagellates. In: F.J.R. Taylor (Editor), *The Biology of Dinoflagellates* (Bot. Monogr., 21). Blackwell, pp. 398–502.
- Todd, C.D. et al., 1991. Recent illnesses from seafood toxins in Canada: Paralytic, amnesic and diarrhetic shellfish poisoning. In: T.J. Smayda and Y. Shimizu (Editors), *Toxic Phytoplankton in the Sea* (Devel. Mar. Biol. 3). Elsevier, Amsterdam, pp. 335–339.
- Truswell, E.M., Sluiter, I.R. and Harris, W.K., 1985. Palynology of the Oligocene–Miocene sequence in the Oakvale-1 corehole, western Murray Basin, South Australia. *BMR J. Aust. Geol. Geophys.*, 9: 267–295.
- Voorhies, M.R., 1969. Taphonomy and population dynamics of an early Pliocene vertebrate fauna, Knox County, Nebraska. *Univ. Wyo. Contrib. Geol. Spec. Pap.*, 1: 1–69.
- Wall, D. and Dale, B., 1969. The “hystrichosphaerid” resting spore of the dinoflagellate *Pyrodinium bahamense* Plate 1906. *J. Phycol.*, 5: 140–149.

- Wall, D., Dale, B., Lohman, G.P. and Smith, W.K., 1977. The environmental and climatic distribution of dinoflagellate cysts in modern marine sediments from regions in the North and South Atlantic Oceans and adjacent seas. *Mar. Micropaleontol.*, 2: 121–200.
- Willard, D.A. et al., 1993. Terrestrial and marine records of climatic and environmental changes during the Pliocene in subtropical Florida. *Geology*, 21: 679–682.
- Williams, G.L. and Bujak, J.P., 1985. Mesozoic and Cenozoic dinoflagellates. In: H.M. Bolli et al. (Editors), *Plankton Stratigraphy*. Cambridge Univ. Press, pp. 849–964.
- Worth, G.K., MacLean, J.L. and Price, M.J., 1975. Paralytic shellfish poisoning in Papua New Guinea. *Pac. Sci.*, 29: 1–5.
- Wright, A.P. and O'Donnell, E., 1973. Shoreline and beach changes on Honeymoon Island, Pinellas County, Florida, 1967–1971. *Trans. Gulf Coast Assoc. Geol. Soc.*, 23: 341–350.