



2012

Guidelines for Water Reuse



Cover Photo Credits:

Clockwise from top: greenhouse trial of lettuce grown with Washington State Class A reclaimed water, courtesy of Dana Devin Clarke; The E.L. Huie Constructed Wetlands in Clayton County, Georgia, courtesy of Aerial Innovations of Georgia, Inc.; and an aerial view of the Occoquan Reservoir, which is recharged with reclaimed water, courtesy of Roger Snyder, Manassas, Virginia.

Guidelines for Water Reuse

U.S. Environmental Protection Agency

Office of Wastewater Management

Office of Water

Washington, D.C.

National Risk Management Research Laboratory

Office of Research and Development

Cincinnati, Ohio

U.S. Agency for International Development

Washington, D.C.

Notice

This document was produced by CDM Smith Inc. (CDM Smith) under a Cooperative Research and Development Agreement (CRADA) with the U.S. Environmental Protection Agency (EPA). It has been subjected to EPA's peer and administrative review and has been approved for publication. Mention of trade names or commercial products does not constitute endorsement or recommendation for use.

The statutes and regulations described in this document may contain legally binding requirements. Neither the summaries of those laws provided here nor the approaches suggested in this document substitute for those statutes or regulations, nor are these guidelines themselves any kind of regulation. This document is intended to be solely informational and does not impose legally binding requirements on EPA; U.S. Agency for International Development (USAID); other U.S. federal agencies, states, local, or tribal governments; or members of the public. Any EPA decisions regarding a particular water reuse project will be made based on the applicable statutes and regulations. EPA will continue to review and update these guidelines as necessary and appropriate.

Foreword

For decades, communities have been reusing valuable reclaimed water to recharge groundwater aquifers, irrigate landscapes and agricultural fields, provide critical stream flows, and provide industries and facilities with an alternative to potable water for a range of uses. While water reuse is not new, population increases and land use changes, combined with changes in the intensity and dynamics of local climatic weather patterns, have exacerbated water supply challenges in many areas of the world. Furthermore, treated wastewater is increasingly being seen as a resource rather than simply ‘waste.’ In this context, water reclamation and reuse have taken on increased importance in the water supply of communities in the United States and around the world in order to achieve efficient resource use, ensure protection of environmental and human health, and improve water management. Strict effluent discharge limits have spurred effective and reliable improvements in treatment technologies. Along with a growing interest in more sustainable water supplies, these improvements have led an increasing number of communities to use reclaimed water as an alternative source to conventional water supplies for a range of applications. In some areas of the United States, water reuse and dual water systems for distribution of reclaimed water for nonpotable uses have become fully integrated into local water supplies. Alternative and efficient water supply options, including reclaimed water, are necessary components of holistic and sustainable water management.

As a collaborative effort between EPA and USAID, this document’s primary purpose is to facilitate further development of water reuse by serving as an authoritative reference on water reuse practices. In the United States, water reuse regulation is primarily under the jurisdiction of states, tribal nations, and territories. This document includes an updated overview of regulations or guidelines addressing water reuse that are promulgated by these authorities. Regulations vary from state to state, and some states have yet to develop water reuse guidelines or regulations. This document meets a critical need: it informs and supplements state regulations and guidelines by providing technical information and outlining key implementation considerations. It also presents frameworks should states, tribes, or other authorities decide to develop new regulations or guidelines.

This document updates and builds on the *2004 Guidelines for Water Reuse* by incorporating information on water reuse that has been developed since the 2004 document was issued. This document includes updated discussion of regional variations of water reuse in the United States, advances in wastewater treatment technologies relevant to reuse, best practices for involving communities in planning projects, international water reuse practices, and factors that will allow expansion of safe and sustainable water reuse throughout the world. The 2012 guidelines also provide more than 100 new case studies from around the world that highlight how reuse applications can and do work in the real world.

Over 300 reuse experts, practitioners, and regulators contributed text, technical reviews, regulatory information, and case studies. This breadth of experience provides a broad and blended perspective of the scientific, technical, and programmatic principles for implementing decisions about water reuse in a safe and sustainable manner.

Nancy Stoner
Acting Assistant Administrator
Office of Water
U.S. EPA

Eric Postel
Assistant Administrator
Bureau for Economic Growth, Education & Environment
USAID

Lek Kadeli
Acting Assistant Administrator
Office of Research & Development
U.S. EPA

Updating the Guidelines

The *Guidelines for Water Reuse* debuted in 1980 and was updated in 1992 and 2004. EPA contracted with CDM Smith through a CRADA to update the EPA guidelines for this 2012 release. Building on the work of previous versions, the CDM Smith project management team has involved a wide range of stakeholders in the development process. Beginning in 2009, EPA, USAID, and CDM Smith began facilitating workshops and informational sessions at water events and conferences around the world to solicit feedback on what information should be repeated, updated, added, or removed from the 2004 document. In addition, a committee of national and international experts in the field of water reclamation and related subjects was established to approve the document outline, develop new text and case studies, and review interim drafts of the document.

Ten stakeholder consultations were carried out in 2009 to 2011. (Unless otherwise noted, the consultations were held in the United States.) The consultations included:

- September and October 2009: Stakeholder workshops at the Annual WaterReuse Symposium in Seattle, Wash., and Water Environment Federation Technical Exhibition and Conference (WEFTEC) in Orlando, Fla., were conducted to collect feedback on the format and scope of the update.
- November 2010: Brainstorming sessions at the American Water Works Association (AWWA) Water Quality Technology conference in Savannah, Ga., were held to identify major focus areas in the 2004 document and to identify potential authors and contributors.
- March, July, and September 2011: The International Water Association (IWA) Efficient 2011 conference in Jordan and the Singapore International Water Week (SIWW) in Singapore were used to collect input on international water reuse practices that encompass a range of treatment technologies, market-based mechanisms for implementation of reuse, and strategies for reducing water reuse-related health risks in developing countries. A status report was presented at the IWA International Conference on Water Reclamation and Reuse in Barcelona, Spain.
- January to October 2011: Status reports were presented at the New England Water Environment Association conference in Boston, Mass.; the WaterReuse California conference in Dana Point, Calif.; the Annual WaterReuse Symposium in Phoenix, Ariz.; and in a special session at the WEFTEC in Los Angeles, Calif.

The workshops held in Jordan, Singapore, and Spain provided an opportunity for input from a diverse group of international participants. Professionals from the private sector also attended these events, as did representatives from government and state agencies, universities, and nonprofit water-advocacy organizations. Non-governmental organizations, including the World Bank, World Health Organization (WHO), and International Water Management Institute (IWMI), were also represented.

The stakeholder input process identified a number of themes to update or emphasize in the updated guidelines, including:

- The role of reuse in integrated water resources management
- Energy use and sustainability associated with water reuse
- Agricultural reuse
- Wetlands polishing and stream augmentation
- Expanding opportunities for industrial reuse

- Groundwater augmentation and managed aquifer recharge
- Individual on-site and graywater reuse systems
- New information on direct and indirect potable reuse practices
- International trends in water reuse

In addition to the stakeholder input, the final document was researched, written, and reviewed by more than 300 experts in the field, including authors who contributed to case studies or chapters and reviewers. The contributors included participants from other consulting firms, state and federal agencies, local water and wastewater authorities, and academic institutions. The project management team compiled and integrated the contributions.

The formal review process included a two-stage technical review. The first stage of review was conducted by additional technical experts who were not involved in writing the document, who identified gaps or edits for further development. The project management team edited the text based on these recommendations and wrote or solicited additional text. The second stage of review was conducted by the peer review team; a group of reviewers who are experts in various areas of water reuse. The peer review team provided a written technical review and in-person comments during a meeting in June 2012. The project management team carefully evaluated and documented all technical comments/recommendations and the decision-making regarding the incorporation of the recommendations into the document.

The final draft and review record was presented to EPA and USAID for final approval in August 2012.

Table of Contents

| | |
|--|------------|
| Chapter 1 Introduction | 1-1 |
| 1.1 Objectives of the Guidelines | 1-1 |
| 1.2 Overview of the Guidelines | 1-2 |
| 1.3 Guidelines Terminology | 1-2 |
| 1.4 Motivation for Reuse | 1-5 |
| 1.4.1 Urbanization and Water Scarcity | 1-5 |
| 1.4.2 Water-Energy Nexus | 1-5 |
| 1.4.3 Environmental Protection | 1-6 |
| 1.5 "Fit for Purpose" | 1-7 |
| 1.6 References | 1-8 |
| Chapter 2 Planning and Management Considerations..... | 2-1 |
| 2.1 Integrated Water Management | 2-1 |
| 2.2 Planning Municipal Reclaimed Water Systems | 2-3 |
| 2.2.1 Identifying Users and Types of Reuse Demands | 2-4 |
| 2.2.2 Land Use and Local Reuse Policy | 2-4 |
| 2.2.3 Distribution System Considerations | 2-6 |
| 2.2.3.1 Distribution System Pumping and Piping | 2-7 |
| 2.2.3.2 Reclaimed Water Appurtenances | 2-8 |
| 2.2.3.3 On-Site Construction Considerations..... | 2-9 |
| 2.2.4 Institutional Considerations | 2-10 |
| 2.3 Managing Reclaimed Water Supplies | 2-11 |
| 2.3.1 Operational Storage | 2-12 |
| 2.3.2 Surface Water Storage and Augmentation | 2-13 |
| 2.3.3 Managed Aquifer Recharge | 2-14 |
| 2.3.3.1 Water Quality Considerations | 2-15 |
| 2.3.3.2 Surface Spreading | 2-16 |
| 2.3.3.3 Injection Wells..... | 2-17 |
| 2.3.3.4 Recovery of Reclaimed Water through ASR | 2-20 |
| 2.3.3.5 Supplementing Reclaimed Water Supplies | 2-22 |
| 2.3.4 Operating a Reclaimed Water System..... | 2-23 |
| 2.3.4.1 Quality Control in Production of Reclaimed Water | 2-23 |
| 2.3.4.2 Distribution System Safeguards for Public Health Protection in Nonpotable Reuse | 2-23 |
| 2.3.4.3 Preventing Improper Use and Backflow | 2-25 |
| 2.3.4.4 Maintenance..... | 2-25 |
| 2.3.4.5 Quality Assurance: Monitoring Programs | 2-26 |
| 2.3.4.6 Response to Failures | 2-27 |
| 2.3.5 Lessons Learned from Large, Medium, and Small Systems | 2-28 |
| 2.4 Water Supply Conservation and Alternative Water Resources | 2-31 |
| 2.4.1 Water Conservation | 2-31 |
| 2.4.2 Alternative Water Resources | 2-32 |
| 2.4.2.1 Individual On-site Reuse Systems and Graywater Reuse..... | 2-32 |
| 2.4.2.2 LEED-Driven On-site Treatment | 2-35 |
| 2.4.2.3 Stormwater Harvesting and Use | 2-37 |
| 2.5 Environmental Considerations | 2-37 |

| | |
|-----------------------------------|------|
| 2.5.1 Land Use Impacts | 2-38 |
| 2.5.2 Water Quantity Impacts..... | 2-38 |
| 2.5.3 Water Quality Impacts..... | 2-39 |
| 2.6 References | 2-40 |

Chapter 3 Types of Reuse Applications.....3-1

| | |
|---|------|
| 3.1 Urban Reuse | 3-2 |
| 3.1.1 Golf Courses and Recreational Field Irrigation | 3-2 |
| 3.2 Agricultural Reuse..... | 3-4 |
| 3.2.1 Agricultural Reuse Standards | 3-6 |
| 3.2.2 Agricultural Reuse Water Quality..... | 3-6 |
| 3.2.2.1 Salinity and Chlorine Residual | 3-8 |
| 3.2.2.2 Trace Elements and Nutrients | 3-8 |
| 3.2.2.3 Operational Considerations for Agricultural Reuse..... | 3-10 |
| 3.2.3 Irrigation of Food Crops | 3-10 |
| 3.2.4 Irrigation of Processed Food Crops and Non-Food Crops | 3-11 |
| 3.2.5 Reclaimed Water for Livestock Watering..... | 3-13 |
| 3.3 Impoundments..... | 3-13 |
| 3.3.1 Recreational and Landscape Impoundments | 3-14 |
| 3.3.2 Snowmaking..... | 3-14 |
| 3.4 Environmental Reuse | 3-16 |
| 3.4.1 Wetlands | 3-16 |
| 3.4.1.1 Wildlife Habitat and Fisheries | 3-18 |
| 3.4.1.2 Flood Attenuation and Hydrologic Balance..... | 3-18 |
| 3.4.1.3 Recreation and Educational Benefits..... | 3-18 |
| 3.4.2 River or Stream Flow Augmentation | 3-19 |
| 3.4.3 Ecological Impacts of Environmental Reuse..... | 3-19 |
| 3.5 Industrial Reuse | 3-20 |
| 3.5.1 Cooling Towers | 3-20 |
| 3.5.2 Boiler Water Makeup..... | 3-22 |
| 3.5.3 Produced Water from Oil and Natural Gas Production..... | 3-23 |
| 3.5.4 High-Technology Water Reuse | 3-24 |
| 3.5.5 Prepared Food Manufacturing | 3-24 |
| 3.6 Groundwater Recharge – Nonpotable Reuse..... | 3-26 |
| 3.7 Potable Reuse..... | 3-26 |
| 3.7.1 Planned Indirect Potable Reuse (IPR) | 3-28 |
| 3.7.2 Direct Potable Reuse (DPR) | 3-30 |
| 3.7.2.1 Planning for DPR | 3-30 |
| 3.7.2.2 Future Research Needs | 3-32 |
| 3.8 References | 3-33 |

Chapter 4 State Regulatory Programs for Water Reuse4-1

| | |
|--|-----|
| 4.1 Reuse Program Framework..... | 4-1 |
| 4.2 Regulatory Framework..... | 4-1 |
| 4.3 Relationship of State Regulatory Programs for Water Reuse to Other Regulatory Programs..... | 4-1 |
| 4.3.1 Water Rights | 4-4 |
| 4.3.2 Water Supply and Use Regulations | 4-5 |
| 4.3.3 Wastewater Regulations and Related Environmental Regulations | 4-5 |

| | |
|---|------|
| 4.3.4 Drinking Water Source Protection..... | 4-6 |
| 4.3.5 Land Use | 4-6 |
| 4.4 Suggested Regulatory Guidelines for Water Reuse Categories..... | 4-6 |
| 4.4.1 Water Reuse Categories..... | 4-7 |
| 4.4.2 Suggested Regulatory Guidelines | 4-7 |
| 4.4.3 Rationale for Suggested Regulatory Guidelines | 4-7 |
| 4.4.3.1 Combining Treatment Process Requirements with Water Quality Limits..... | 4-12 |
| 4.4.3.2 Water Quality Requirements for Disinfection..... | 4-12 |
| 4.4.3.3 Indicators of Disinfection | 4-13 |
| 4.4.3.4 Water Quality Requirements for Suspended and Particulate Matter..... | 4-14 |
| 4.4.3.5 Water Quality Requirements for Organic Matter..... | 4-14 |
| 4.4.3.6 Setback Distances | 4-14 |
| 4.4.3.7 Specific Considerations for IPR | 4-15 |
| 4.4.4 Additional Requirements | 4-16 |
| 4.4.4.1 Reclaimed Water Monitoring Requirements | 4-16 |
| 4.4.4.2 Treatment Facility Reliability | 4-16 |
| 4.4.4.3 Reclaimed Water Storage | 4-17 |
| 4.5 Inventory of State Regulations and Guidelines..... | 4-17 |
| 4.5.1 Overall Summary of States' Regulations | 4-17 |
| 4.5.1.1 Case-By-Case Considerations..... | 4-17 |
| 4.5.1.2 Reuse or Treatment and Disposal Perspective | 4-21 |
| 4.5.2 Summary of Ten States' Reclaimed Water Quality and Treatment Requirements..... | 4-22 |
| 4.5.2.1 Urban Reuse – Unrestricted | 4-23 |
| 4.5.2.2 Urban Reuse – Restricted..... | 4-23 |
| 4.5.2.3 Agricultural Reuse – Food Crops..... | 4-23 |
| 4.5.2.4 Agricultural Reuse – Processed Food Crops and Non-food Crops | 4-24 |
| 4.5.2.5 Impoundments – Unrestricted..... | 4-24 |
| 4.5.2.6 Impoundments – Restricted..... | 4-24 |
| 4.5.2.7 Environmental Reuse..... | 4-24 |
| 4.5.2.8 Industrial Reuse | 4-24 |
| 4.5.2.9 Groundwater Recharge – Nonpotable Reuse..... | 4-25 |
| 4.5.2.10 Indirect Potable Reuse (IPR) | 4-25 |
| 4.6 References..... | 4-37 |

Chapter 5 Regional Variations in Water Reuse.....5-1

| | |
|---|------|
| 5.1 Overview of Water Use and Regional Reuse Considerations | 5-1 |
| 5.1.1 National Water Use | 5-1 |
| 5.1.2 Examples of Reuse in the United States | 5-2 |
| 5.2 Regional Considerations | 5-2 |
| 5.2.1 Northeast..... | 5-6 |
| 5.2.1.1 Population and Land Use..... | 5-9 |
| 5.2.1.2 Precipitation and Climate | 5-9 |
| 5.2.1.3 Water Use by Sector..... | 5-9 |
| 5.2.1.4 States' and Territories' Regulatory Context | 5-10 |
| 5.2.1.5 Context and Drivers of Water Reuse | 5-11 |
| 5.2.2 Mid-Atlantic | 5-12 |
| 5.2.2.1 Population and Land Use..... | 5-12 |
| 5.2.2.2 Precipitation and Climate | 5-13 |

| | |
|--|------|
| 5.2.2.3 Water Use by Sector | 5-13 |
| 5.2.2.4. States' Regulatory Context | 5-13 |
| 5.2.2.5 Context and Drivers of Water Reuse | 5-14 |
| 5.2.3 Southeast | 5-15 |
| 5.2.3.1 Population and Land Use | 5-15 |
| 5.2.3.2 Precipitation and Climate | 5-16 |
| 5.2.3.3 Water Use by Sector | 5-16 |
| 5.2.3.4. States' Regulatory Context | 5-18 |
| 5.2.3.5 Context and Drivers of Water Reuse | 5-19 |
| 5.2.4 Midwest and Great Lakes | 5-23 |
| 5.2.4.1 Population and Land Use | 5-23 |
| 5.2.4.2 Precipitation and Climate | 5-24 |
| 5.2.4.3 Water Use by Sector | 5-24 |
| 5.2.4.4. States' Regulatory Context | 5-25 |
| 5.2.4.5 Context and Drivers of Water Reuse | 5-26 |
| 5.2.5 South Central | 5-29 |
| 5.2.5.1 Population and Land Use | 5-29 |
| 5.2.5.2 Precipitation and Climate | 5-29 |
| 5.2.5.3 Water Use by Sector | 5-30 |
| 5.2.5.4. States' Regulatory Context | 5-30 |
| 5.2.5.5 Context and Drivers of Water Reuse | 5-31 |
| 5.2.6 Mountains and Plains | 5-35 |
| 5.2.6.1 Population and Land Use | 5-35 |
| 5.2.6.2 Precipitation | 5-35 |
| 5.2.6.3 Water Use by Sector | 5-35 |
| 5.2.6.4. States' Regulatory Context | 5-36 |
| 5.2.6.5 Context and Drivers of Water Reuse | 5-36 |
| 5.2.7 Pacific Southwest | 5-37 |
| 5.2.7.1 Population and Land Use | 5-37 |
| 5.2.7.2 Precipitation and Climate | 5-38 |
| 5.2.7.3 Water Use by Sector | 5-39 |
| 5.2.7.4. States' Regulatory Context | 5-39 |
| 5.2.7.5 Context and Drivers of Water Reuse | 5-41 |
| 5.2.8 Pacific Northwest | 5-44 |
| 5.2.8.1 Population and Land Use | 5-45 |
| 5.2.8.2 Precipitation and Climate | 5-45 |
| 5.2.8.3 Water Use by Sector | 5-46 |
| 5.2.8.4. States' Regulatory Context | 5-46 |
| 5.2.8.5 Context and Drivers of Water Reuse | 5-47 |
| 5.3 References | 5-48 |

Chapter 6 Treatment Technologies for Protecting Public and Environmental Health...6-1

| | |
|---|-----|
| 6.1 Public Health Considerations | 6-2 |
| 6.1.1 What is the Intended Use of the Reclaimed Water? | 6-2 |
| 6.1.2 What Constituents are Present in a Wastewater Source, and What Level of Treatment is Applicable for Reducing Constituents to Levels that Achieve the Desired Reclaimed Water Quality? | 6-3 |
| 6.1.3 Which Sampling/Monitoring Protocols Are Required to Ensure that Water Quality Objectives Are Being Met? | 6-3 |
| 6.2 Wastewater Constituents and Assessing Their Risks | 6-4 |

| | |
|---|------|
| 6.2.1 Microorganisms in Wastewater | 6-4 |
| 6.2.1.1 Protozoa and Helminths | 6-6 |
| 6.2.1.2 Bacteria | 6-6 |
| 6.2.1.3 Viruses | 6-7 |
| 6.2.1.4 Aerosols | 6-7 |
| 6.2.1.5 Indicator Organisms | 6-7 |
| 6.2.1.6 Removal of Microorganisms | 6-8 |
| 6.2.1.7 Risk Assessment of Microbial Contaminants | 6-9 |
| 6.2.2 Chemicals in Wastewater | 6-10 |
| 6.2.2.1 Inorganic Chemicals | 6-10 |
| 6.2.2.2 Organics | 6-11 |
| 6.2.2.3 Trace Chemical Constituents | 6-12 |
| 6.3 Regulatory Approaches to Establishing Treatment Goals for Reclaimed Water | 6-17 |
| 6.3.1 Microbial Inactivation | 6-18 |
| 6.3.2 Constituents of Emerging Concern | 6-19 |
| 6.3.2.1 Example of California’s Regulatory Approach to CECs | 6-20 |
| 6.3.2.2 Example of Australia’s Regulatory Approach to Pharmaceuticals | 6-21 |
| 6.4 Wastewater Treatment for Reuse | 6-21 |
| 6.4.1 Source Control | 6-22 |
| 6.4.2 Filtration | 6-23 |
| 6.4.2.1 Depth Filtration | 6-24 |
| 6.4.2.2 Surface Filtration | 6-24 |
| 6.4.2.3 Membrane Filtration | 6-24 |
| 6.4.2.4 Biofiltration | 6-25 |
| 6.4.3 Disinfection | 6-26 |
| 6.4.3.1 Chlorination | 6-27 |
| 6.4.3.2 Ultraviolet Disinfection | 6-28 |
| 6.4.3.3 Ozone | 6-30 |
| 6.4.3.4 Pasteurization | 6-31 |
| 6.4.3.5 Ferrate | 6-32 |
| 6.4.4 Advanced Oxidation | 6-32 |
| 6.4.5 Natural Systems | 6-34 |
| 6.4.5.1 Treatment Mechanisms in Natural Systems | 6-34 |
| 6.4.5.2 Wetlands | 6-36 |
| 6.4.5.3 Soil Aquifer Treatment Systems | 6-37 |
| 6.4.6 Monitoring for Treatment Performance | 6-37 |
| 6.4.7 Energy Considerations in Reclaimed Water Treatment | 6-38 |
| 6.5 References | 6-39 |

Chapter 7 Funding Water Reuse Systems7-1

| | |
|---|-----|
| 7.1 Integrating Reclaimed Water into a Water Resource Portfolio | 7-1 |
| 7.2 Internal and Debt Funding Alternatives | 7-2 |
| 7.2.1 State and Federal Financial Assistance | 7-2 |
| 7.2.1.1 Federal Funding Sources | 7-3 |
| 7.2.1.2 State, Regional, and Local Grant and Loan Support | 7-4 |
| 7.3 Phasing and Participation Incentives | 7-5 |
| 7.4 Sample Rate and Fee Structures | 7-6 |
| 7.4.1 Service Fees | 7-6 |
| 7.4.2 Special Assessments | 7-8 |
| 7.4.3 Impact Fees | 7-8 |

| | |
|--|------|
| 7.4.4 Fixed Monthly Fee..... | 7-8 |
| 7.4.5 Volumetric Rates | 7-8 |
| 7.5 Developing Rates..... | 7-8 |
| 7.5.1 Market Rates Driven by Potable Water..... | 7-10 |
| 7.5.2 Service Agreements Based on Take or Pay Charges | 7-11 |
| 7.5.3 Reuse Systems for New Development | 7-12 |
| 7.5.4 Connection Fees for Wastewater Treatment versus Distribution | 7-12 |
| 7.6 References..... | 7-13 |

Chapter 8 Public Outreach, Participation, and Consultation.....8-1

| | |
|--|------|
| 8.1 Defining Public Involvement..... | 8-1 |
| 8.1.1 Public Opinion Shift: Reuse as an Option in the Water Management Toolbox | 8-1 |
| 8.1.2 Framing the Benefits | 8-2 |
| 8.2 Why Public Participation is Critical..... | 8-3 |
| 8.2.1 Project Success | 8-3 |
| 8.2.2 The Importance of an Informed Constituency..... | 8-3 |
| 8.2.3 Building Trust | 8-3 |
| 8.3 Identifying the “Public”..... | 8-4 |
| 8.4 Steps to Successful Public Participation..... | 8-4 |
| 8.4.1 Situational Analysis..... | 8-5 |
| 8.4.1.1 Environmental Justice..... | 8-6 |
| 8.4.2 Levels of Involvement | 8-7 |
| 8.4.3 Communication Plan..... | 8-7 |
| 8.4.3.1 The Role of Information in Changing Opinion..... | 8-7 |
| 8.4.3.2 Words Count | 8-8 |
| 8.4.3.3 Slogans and Branding..... | 8-11 |
| 8.4.3.4 Reclaimed Water Signage | 8-11 |
| 8.4.4 Public Understanding..... | 8-12 |
| 8.4.4.1 Perception of Risk..... | 8-12 |
| 8.4.4.2 Trusted Information Sources..... | 8-12 |
| 8.4.5 Community Leaders | 8-13 |
| 8.4.6 Independent Experts..... | 8-13 |
| 8.4.6.1 Advisory Groups..... | 8-13 |
| 8.4.6.2 Independent Advisory Panels | 8-14 |
| 8.4.6.3 Independent Monitoring and Certification | 8-14 |
| 8.4.7 Media Outreach..... | 8-15 |
| 8.4.7.1 New Media Outreach Methods – Social Networking | 8-15 |
| 8.4.8 Involving Employees | 8-16 |
| 8.4.9 Direct Stakeholder Engagement | 8-16 |
| 8.4.9.1 Dialogue with Stakeholders | 8-16 |
| 8.4.9.2 Addressing Opposition..... | 8-16 |
| 8.5 Variations in Public Outreach..... | 8-17 |
| 8.6 References..... | 8-18 |

Chapter 9 Global Experiences in Water Reuse.....9-1

| | |
|--|-----|
| 9.1 Introduction..... | 9-1 |
| 9.1.1 Defining the Resources Context | 9-1 |
| 9.1.2 Planned Water Reuse and Wastewater Use | 9-1 |
| 9.1.3 International Case Studies..... | 9-2 |

| | |
|---|------|
| 9.2 Overview of Global Water Reuse..... | 9-6 |
| 9.2.1 Types of Water Reuse | 9-6 |
| 9.2.1.1 Agricultural Applications..... | 9-6 |
| 9.2.1.2 Urban and Industrial Applications | 9-6 |
| 9.2.1.3 Aquifer Recharge | 9-7 |
| 9.2.2 Magnitude of Global Water Reuse..... | 9-7 |
| 9.3 Opportunities and Challenges for Expanding the Scale of Global Water Reuse..... | 9-8 |
| 9.3.1 Global Drivers | 9-9 |
| 9.3.2 Regional Variation in Water Reuse..... | 9-10 |
| 9.3.3 Global Barriers to Expanding Planned Reuse | 9-11 |
| 9.3.3.1 Institutional Barriers | 9-11 |
| 9.3.3.2 Public Perception/Educational Barriers | 9-12 |
| 9.3.3.3 Economic Barriers..... | 9-12 |
| 9.3.3.4 Organizational Barriers | 9-12 |
| 9.3.4 Benefits of Expanding the Scale of Water Reuse | 9-13 |
| 9.4 Improving Safe and Sustainable Water Reuse for Optimal Benefits | 9-13 |
| 9.4.1 Reducing Risks of Unplanned Reuse: The WHO Approach..... | 9-13 |
| 9.4.2 Expanding and Optimizing Planned Water Reuse..... | 9-16 |
| 9.5 Factors Enabling Successful Implementation of Safe and Sustainable Water Reuse | 9-20 |
| 9.6 Global Lessons Learned About Water Reuse..... | 9-21 |
| 9.7 References | 9-22 |

| | |
|--|------------|
| Appendix A Funding for Water Reuse Research..... | A-1 |
| Appendix B Inventory of Recent Water Reuse Research Projects and Reports | B-1 |
| Appendix C Websites of U.S. State Regulations and Guidance on Water Reuse | C-1 |
| Appendix D U.S. Case Studies..... | D-1 |
| Appendix E International Case Studies and International Regulations | E-1 |
| Appendix F List of Case Studies in 2004 <i>Guidelines for Water Reuse</i> | F-1 |
| Appendix G Abbreviations..... | G-1 |

List of Tables

Chapter 1

| | |
|--|-----|
| Table 1-1 Organization of 2012 <i>Guidelines for Water Reuse</i> | 1-3 |
| Table 1-2 Categories of water reuse applications..... | 1-4 |

Chapter 2

| | |
|--|------|
| Table 2-1 Common institutional arrangements for water reuse..... | 2-10 |
| Table 2-2 Comparison of vadose zone and direct injection recharge wells | 2-18 |
| Table 2-3 Operational status and source water treatment for reclaimed water ASR projects | 2-22 |
| Table 2-4 Quality monitoring requirements in Texas | 2-26 |
| Table 2-5 Summary of NSF Standard 350 Effluent Criteria for individual classifications | 2-34 |
| Table 2-6 Summary of ANSI/NSF Standard 350-1 for subsurface discharges | 2-34 |

Chapter 3

| | |
|---|------|
| Table 3-1 Distribution of reclaimed water in California and Florida | 3-2 |
| Table 3-2 Interpretation of reclaimed water quality | 3-3 |
| Table 3-3 Nationwide reuse summaries of reclaimed water use in agricultural irrigation..... | 3-5 |
| Table 3-4 Guidelines for interpretation of water quality for irrigation | 3-7 |
| Table 3-5 Recommended water quality criteria for irrigation | 3-9 |
| Table 3-6 Examples of global water quality standards for non-food crop irrigation..... | 3-13 |
| Table 3-7 Guidelines for concentrations of substances in livestock drinking water..... | 3-13 |
| Table 3-8 Recommended boiler water limits..... | 3-22 |
| Table 3-9 Overview of selected planned indirect and direct potable reuse installations worldwide (not intended to be a complete survey) | 3-28 |

Chapter 4

| | |
|---|------|
| Table 4-1 Key elements of a water reuse program..... | 4-2 |
| Table 4-2 Fundamental components of a water reuse regulatory framework for states | 4-3 |
| Table 4-3 Water reuse categories and number of states with rules, regulations or guidelines addressing these reuse categories | 4-8 |
| Table 4-4 Suggested guidelines for water reuse | 4-9 |
| Table 4-5 Summary of State and U.S. Territory reuse regulations and guidelines | 4-18 |
| Table 4-6 Abbreviations of terms for state reuse rules descriptions..... | 4-23 |
| Table 4-7 Urban reuse – unrestricted | 4-26 |
| Table 4-8 Urban reuse – restricted | 4-27 |
| Table 4-9 Agricultural reuse - food crops..... | 4-28 |
| Table 4-10 Agricultural reuse – non-food crops and processed food crops (where permitted)..... | 4-29 |
| Table 4-11 Impoundments – unrestricted | 4-30 |
| Table 4-12 Impoundments – restricted | 4-31 |
| Table 4-13 Environmental reuse | 4-32 |
| Table 4-14 Industrial reuse | 4-33 |
| Table 4-15 Groundwater recharge - nonpotable reuse..... | 4-34 |
| Table 4-16 Indirect potable reuse (IPR)..... | 4-35 |

Chapter 5

| | |
|---|-----|
| Table 5-1 Percent change in resident population in each region during the periods 1990-2000, 2000-2010, and 1990-2010 | 5-7 |
|---|-----|

Chapter 6

| | |
|---|------|
| Table 6-1 Types of reuse appropriate for increasing levels of treatment..... | 6-2 |
| Table 6-2 Infectious agents potentially present in untreated (raw) wastewater..... | 6-5 |
| Table 6-3 Indicative log removals of indicator microorganisms and enteric pathogens during various stages of wastewater treatment..... | 6-9 |
| Table 6-4 Categories of trace chemical constituents (natural and synthetic) potentially detectable in reclaimed water and illustrative example chemicals..... | 6-13 |
| Table 6-5 Indicative percent removals of organic chemicals during various stages of wastewater treatment..... | 6-16 |
| Table 6-6 Summary of filter type characteristics..... | 6-25 |
| Table 6-7 California and Florida disinfection treatment-based standards for tertiary recycled water and high level disinfection | 6-27 |
| Table 6-8 Electrochemical oxidation potential (EOP) for several disinfectants | 6-33 |

Chapter 7

| | |
|---|------|
| Table 7-1 Comparison of reclaimed water rates | 7-7 |
| Table 7-2 Utility distribution of the reclaimed water rate as a percent of the potable water rate for single-family homes in Florida..... | 7-11 |

Chapter 8

| | |
|--|------|
| Table 8-1 Focus group participant responses—most trusted sources | 8-13 |
|--|------|

Chapter 9

| | |
|---|------|
| Table 9-1 Global domestic wastewater generated and treated | 9-7 |
| Table 9-2 Projected reuse capacity in selected countries | 9-8 |
| Table 9-3 Percent of urban populations connected to piped sewer systems in 2003-2006..... | 9-11 |
| Table 9-4 Selected health-protection measures and associated pathogen reductions for wastewater reuse in agriculture..... | 9-15 |
| Table 9-5 Challenges and solutions for reuse standards development and implementation..... | 9-17 |

List of Figures

Chapter 1

| | |
|--|-----|
| Figure 1-1 The 2004 EPA <i>Guidelines for Water Reuse</i> has had global influence | 1-1 |
| Figure 1-2 Purple pipe is widely used for reclaimed water distribution systems | 1-6 |
| Figure 1-3 Treatment technologies are available to achieve any desired level of water quality..... | 1-7 |

Chapter 2

| | |
|---|------|
| Figure 2-1 Traditional versus Integrated Water Management | 2-1 |
| Figure 2-2 36-inch CSC 301 purple mortar pipe, San Antonio Water System..... | 2-7 |
| Figure 2-3 Appropriate separation of potable, reclaimed water, and sanitary sewer pipes...2-8 | |
| Figure 2-4 Purple snap-on reclaimed water identification cap..... | 2-9 |
| Figure 2-5 Commonly used methods in managed aquifer recharge..... | 2-15 |
| Figure 2-6 Sample decision tree for selection of groundwater recharge method | 2-15 |
| Figure 2-7 Typical sign complying with FDEP signage requirements..... | 2-24 |
| Figure 2-8 Reclaimed water pumping station, San Antonio, Texas..... | 2-25 |
| Figure 2-9 Upper Occoquan schematic | 2-29 |

Chapter 3

| | |
|--|------|
| Figure 3-1 Reclaimed water use in the United States..... | 3-1 |
| Figure 3-2 Nationwide reuse summaries of reclaimed water use in agricultural irrigation ... | 3-5 |
| Figure 3-3 Monterey County vegetable fields irrigated with disinfected tertiary recycled water | 3-12 |
| Figure 3-4 Alfalfa irrigated with secondary effluent, Wadi Mousa (near Petra), Jordan | 3-12 |
| Figure 3-5 Large hyperbolic cooling towers | 3-21 |
| Figure 3-6 Estimates of produced water by state | 3-23 |
| Figure 3-7 Planned IPR scenarios and examples..... | 3-29 |
| Figure 3-8 Planned DPR and specific examples of implementation..... | 3-31 |

Chapter 5

| | |
|---|------|
| Figure 5-1 Freshwater use by category in the United States..... | 5-1 |
| Figure 5-2 Geographic display of United States reuse case studies categorized by application..... | 5-3 |
| Figure 5-3 Percent change in population (2000-2010) and developed land (1997-2007) in the Northeast Region, compared to the United States | 5-9 |
| Figure 5-4 Average monthly precipitation (1971-2000) for states in the Northeast Region...5-9 | |
| Figure 5-5 Freshwater use by sector for the Northeast region | 5-9 |
| Figure 5-6 Change in population (2000-2010) and developed land (1997-2007) in the Mid-Atlantic region, compared to the United States. | 5-12 |
| Figure 5-7 Average monthly precipitation in the Mid-Atlantic region | 5-13 |
| Figure 5-8 Freshwater use by sector for the Mid-Atlantic region | 5-13 |
| Figure 5-9 Change in population (2000-2010) and developed land (1997-2007) in the Southeast region, compared to the United States..... | 5-16 |
| Figure 5-10 Average monthly precipitation in the Southeast region | 5-16 |
| Figure 5-11 Freshwater use by sector for the Southeast region..... | 5-17 |
| Figure 5-12 Water reuse in Florida by type | 5-20 |

| | |
|---|------|
| Figure 5-13 Map of per capita reuse flow by county in Florida | 5-21 |
| Figure 5-14 Cary, N.C., bulk fill station allows approved contractors, landscapers, and town staff to use reclaimed water | 5-22 |
| Figure 5-15 Change in population (2000-2010) and developed land (1997-2007) in the Midwest and Great Lakes Regions, compared to the United States | 5-24 |
| Figure 5-16 Average monthly precipitation in the Midwest | 5-24 |
| Figure 5-17 Freshwater use by sector for the Midwest and Great Lakes Regions..... | 5-24 |
| Figure 5-18 Water use in Minnesota, 2007 | 5-25 |
| Figure 5-19 Water use in Minnesota by source, 2007 | 5-25 |
| Figure 5-20 The SMSC WRF and wetlands..... | 5-27 |
| Figure 5-21 Mankato Water Reclamation Facility | 5-28 |
| Figure 5-22 Change in population (2000-2010) and developed land (1997-2007) in the South Central Region, compared to the United States. | 5-29 |
| Figure 5-23 Average monthly precipitation in the South Central region | 5-30 |
| Figure 5-24 Freshwater use by sector for the South Central region | 5-30 |
| Figure 5-25 Water consumption in El Paso, Texas..... | 5-34 |
| Figure 5-26 Wastewater flows in El Paso, Texas | 5-34 |
| Figure 5-27 Wastewater influent strength, BOD ₅ | 5-34 |
| Figure 5-28 Wastewater influent strength, NH ₃ -N | 5-34 |
| Figure 5-29 Wastewater influent strength, TSS | 5-34 |
| Figure 5-30 Change in population (2000-2010) and developed land (1997-2007) in the Mountain and Plains region, compared to the United States | 5-35 |
| Figure 5-31 Average monthly precipitation in the Mountains and Plains Regions | 5-35 |
| Figure 5-32 Freshwater use by sector for the Mountains and Plains regions | 5-36 |
| Figure 5-33 Change in population (2000-2010) and developed land (1997-2007) Pacific Southwest Region, compared to the United States | 5-38 |
| Figure 5-34 Average monthly precipitation in the Pacific Southwest region..... | 5-38 |
| Figure 5-35 Freshwater use by sector for the Pacific Southwest Region | 5-39 |
| Figure 5-36 2010 Reclaimed water use in Tucson, Ariz. | 5-42 |
| Figure 5-37 Uses of recycled water in California | 5-42 |
| Figure 5-38 Change in population (2000-2010) and developed land (1997-2007) in the Pacific Northwest region, compared to the United States. | 5-45 |
| Figure 5-39 Average monthly precipitation in the Pacific Northwest region | 5-45 |
| Figure 5-40 Freshwater use by sector for the Pacific Northwest region | 5-46 |

Chapter 6

| | |
|---|------|
| Figure 6-1 Potable reuse treatment scenarios..... | 6-1 |
| Figure 6-2 Pasteurization demonstration system in Ventura, Calif..... | 6-31 |
| Figure 6-3 Example WRF treatment train that includes UV/H ₂ O ₂ AOP | 6-32 |

Chapter 8

| | |
|--|-----|
| Figure 8-1 Survey results from San Diego: opinion about using advanced treated recycled water as an addition to drinking water supply..... | 8-2 |
| Figure 8-2 Focus group participant responses: before and after viewing information..... | 8-8 |
| Figure 8-3 Water reclamation terms most used by the water industry are the least reassuring to the public | 8-9 |
| Figure 8-4 Focus group participants preferred “direct potable use” over “business as usual,” “blended reservoir,” or “upstream discharge” IPR options..... | 8-9 |

| | |
|--|------|
| Figure 8-5 CVWD encourages its wholesale customers to promote the notification of reuse water benefits | 8-12 |
| Figure 8-6 A luncheon was held in King County, Wash. to present data on reclaimed water used for irrigation, along with lunch featuring crops and flowers from the reuse irrigation study..... | 8-17 |

Chapter 9

| | |
|--|------|
| Figure 9-1 Geographic display of international water reuse case studies categorized by application | 9-3 |
| Figure 9-2 Global water reuse after advanced (tertiary) treatment: market share by application..... | 9-6 |
| Figure 9-3 Countries with greatest irrigated areas using treated and untreated wastewater..... | 9-9 |
| Figure 9-4 Reducing the pathogenic health risks from unsafe use of diluted wastewater.... | 9-16 |
| Figure 9-5 Multi-barrier approach to safeguard public health where wastewater treatment is limited | 9-17 |

Dedication

Daniel James Deely
(1944-2012)

This document is dedicated to Daniel James Deely, for his tireless dedication to a decades-long collaboration between EPA and USAID and to the *Guidelines for Water Reuse*. It is because of Dan's vision that this collaboration came about and was sustained. Dan served more than 40 years with USAID working on environmental and development projects worldwide. Dan was a walking reference for the history of the agency's water programming. His wisdom, patience, strong dedication to the human development mission of USAID, and expertise are dearly missed by his colleagues and his extended network of professional contacts.

Acknowledgements

The *Guidelines for Water Reuse* was first published in 1980 and was updated in 1992 and 2004. Since then, water reuse practices have continued to develop and evolve. This edition of the *Guidelines* offers new information and greater detail about a wide range of reuse applications and introduces new concepts and treatment technologies supporting water reuse operations. It includes an updated inventory of state reuse regulations and expanded coverage of water reuse practices in countries outside of the United States. More than 300 reuse experts contributed text and case studies to highlight how reuse applications can and do work in the real world.

The 2012 *Guidelines for Water Reuse* stands on the foundation of information generated by the substantial research and development efforts and extensive demonstration projects on water reuse practices throughout the world. Some of the most useful sources consulted in developing this update include conference proceedings, reports, and journal articles published by a range of organizations, including: the WaterReuse Association (WRA), WaterReuse Research Foundation (WRRF), Water Environment Federation (WEF), Water Environment Research Foundation (WERF), and AWWA. The National Research Council's *Water Reuse: Potential for Expanding the Nation's Water Supply Through Reuse of Municipal Wastewater* 2012 report was a timely and key contribution to the information contained in this document. This study takes a comprehensive look at the potential for reclamation and reuse of municipal wastewater to expand and enhance water supply alternatives.

The 2012 *Guidelines for Water Reuse* was developed by CDM Smith Inc. through a CRADA with EPA and USAID. Partial funding to support preparation of the updated document was provided by EPA and USAID. IWMI also provided technical, financial, and in-kind support for the development of Chapter 9 and the international case studies. We wish to acknowledge the direction, advice, and suggestions of the EPA Project Manager for this document, Robert K. Bastian of the Office of Wastewater Management; Dan Deely and Emilie Stander, PhD of USAID; and Jonathan Lautze, PhD and Pay Drechsel, PhD of IWMI. The CDM Smith project management team also reached out to the U.S. Department of Agriculture for input through James Dobrowolski and the U.S. Centers for Disease Control through Maxwell Zarate-Bermudez. The CDM Smith project management team was led by Project Director Robert L. Matthews, P.E., DEE and included Project Manager Katherine Y. Bell, PhD, P.E., BCEE; Technical Director Don Vandertulip, P.E., BCEE; and Technical Editors Allegra da Silva, PhD and Jillian Jack, P.E. Additional support was provided by Stacie Cohen, Alex Lumb, and Marcia Rinker of CDM Smith.

The process to create this document is outlined in **Updating the Guidelines**. We would like to express gratitude to the technical review committee who so painstakingly reviewed this document. The technical review committee included:

- Marc Andreini, PhD, P.E., University of Nebraska Robert B. Daugherty Water for Food Institute
- Robert B. Brobst, P.E., EPA, Region 8
- James Crook, PhD, P.E., BCEE, Environmental Engineering Consultant
- Shivaji Deshmukh, P.E., West Basin Municipal Water District
- Julie Minton, WRRF
- James Dobrowolski, USDA/NIFA
- Mark E. Elsner, P.E., South Florida Water Management District
- Wm. Bart Hines, P.E., Trinity River Authority of Texas

- Carrie Miller, EPA, Office of Ground Water and Drinking Water
- Craig Riley, Washington State Department of Health
- Joan B. Rose, PhD, Michigan State University
- Valerie Rourke, CPSS, CNMP, Virginia Department of Environmental Quality

Special thanks go to our colleagues who took their time to share professional experiences and technical knowledge in reuse to make these guidelines relevant and interesting. These contributors provided text or case studies; contributors who compiled and/or edited major sections of text are indicated with an asterisk (*). In addition, some members of the technical review committee contributed significant contributions of text. Please note that the listing of these contributors does not necessarily identify them as supporters of this document or represent their ideas or opinions on the subject. These persons are leaders in the field of water reuse, and their expertise has added to the depth and breadth of the document.

Solomon Abel, P.E.
CDM Smith
San Juan, Puerto Rico

Robert Angelotti
Upper Occoquan Sewage Authority (UOSA)
Centreville, VA

Constantia Achileos, MSc
Sewerage Board of Limassol Amathus
Limassol, Cyprus

David Arseneau, P.Eng, MEPP
AECOM
Kitchener, Ontario, Canada

Robert Adamski, P.E., BCEE
Gannett Fleming
Woodbury, NY

Shelly Badger
City of Yelm
Yelm, WA

Pruk Aggarangsi, PhD
Energy Research and Development Institute-
Nakornping, Chiang Mai University
Chaing Mai, Thailand

Kathy Bahadoorsingh, PhD, R.Eng
AECOM
Trinidad

Sohahn Akhtar
CDM Smith
Atlanta, GA

K. Balakrishnan
United Tech Corporation
Delhi, India

Priyanie Amerasinghe, PhD
International Water Management Institute
Andhra Pradesh, India

Jeff Bandy, PhD
Carollo Engineers
Boise, ID

David Ammerman, P.E.
AECOM
Orlando, FL

Randy Barnard, P.E.
California Department of Public Health
San Diego, CA

Bobby Anastasov, MBA
City of Aurora
Aurora, CO

Carl Bartone
Environmental Engineering Consultant
Bonita Springs, FL

Daniel T. Anderson, P.E., BCEE
CDM Smith
West Palm Beach, FL

Somnath Basu, PhD, P.E., BCEE
Shell Oil Co.
Houston, TX

Rolf Anderson
USAID

Jim Bays, P.W.S.
CH2M Hill

*Katherine Bell, PhD, P.E., BCEE
CDM Smith
Nashville, TN

Ignacio Benavente, Eng, PhD
University of Piura
Piura, Peru

Alon Ben-Gal, PhD
Agricultural Research Organization, Gilat Research
Center
Negev, Israel

Nan Bennett, P.E.
City of Clearwater
Clearwater, FL

Jay Bhagwan
Water Research Commission
Johannesburg, South Africa

Rajendra Bhardwaj
Central Pollution Control Board
Delhi, India

Heather N. Bischel, PhD
Engineering Research Center (ERC) for Re-
inventing the Nation's Urban Water Infrastructure
(ReNUWIT), Stanford University
Stanford, CA

Jacob Boomhouwer, P.E.
CDM Smith
Portland, OR

Lucas Botero, P.E., BCEE
CDM Smith
West Palm Beach, FL

Keith Bourgeois, PhD
Carollo Engineers
Sacramento, CA

Paul Bowen, PhD
The Coca-Cola Company
Atlanta, GA

Andrew Brown, P.E.
City of Phoenix
Phoenix, AZ

Randolph Brown
City of Pompano Beach
Pompano Beach, FL

Sally Brown, PhD
University of Washington
Seattle, WA

Tom Bruursema
NSF International
Ann Arbor, MI

Laura Burton
CDM Smith
Cambridge, MA

Laura Cameron, BSBM
City of Clearwater
Clearwater, FL

Celeste Cantú
Santa Ana Watershed Project Authority
Riverside, CA

*Guy Carpenter, P.E.
Carollo Engineers
Phoenix, AZ

Edward Carr
ICF International
San Rafael, CA

*Bruce Chalmers, P.E.
CDM Smith
Irvine, CA

Peter Chapman
Sydney Water Corporation
Penrith, New South Wales, Australia

Cody Charnas
CDM Smith
Denver, CO

Ana Maria Chavez, Eng, MSc
University of Piura
Piura, Peru

Rocky Chen, P.E.
Oklahoma Department of Environmental Quality
Oklahoma City, OK

Henry Chin, PhD
The Coca-Cola Company
Atlanta, GA, US

Richard Cisterna
Natural Systems Utilities, Inc.
Hillsborough, NJ

Joseph Cleary, P.E., BCEE
HDR/HydroQual
Mahwah, NJ

Tracy Clinton, P.E.
Carollo Engineers
Walnut Creek, CA

Stacie Cohen
CDM Smith
Cambridge, MA

Octavia Conerly
EPA Office of Science and Technology
Washington, D.C.

Teren Correnti
CDM Smith
Carlsbad, CA

*Joseph Cotruvo, PhD
Joseph Cotruvo and Associates
Washington, D.C.

Jim Coughenour
City of Phoenix
Phoenix, AZ

*Patti Craddock, P.E.
Short Elliott Hendrickson Inc.
St. Paul, MN

Donald Cutler, P.E.
CDM Smith
Carlsbad, CA

*Allegra K. da Silva, PhD
CDM Smith
Wethersfield, CT

Walter Daesslé-Heuser, PhD
Autonomous University of Baja California (UABC)
Ensenada, Baja California, Mexico

Arnon Dag, PhD
Agricultural Research Organization, Gilat Research
Center
Gilat, Israel

Liese Dallbauman, PhD
PepsiCo
Chicago, IL

Marla Dalton
City of Raleigh, NC
Raleigh, NC

Dnyanesh V Darshane, PhD, MBA
The Coca-Cola Company
Atlanta, GA

William Davis
CDM Smith
Denver, CO

Gary Dechant
Laboratory Quality Systems
Grand Junction, CO

Gina DePinto
Orange County Water District
Fountain Valley, CA

Clint Dolsby
City of Meridian
Meridian, ID

Amy Dorman, P.E.
City of San Diego
San Diego, CA

Karen Dotson, Retired
Tucson Water
Tucson, AZ

*Pay Drechsel, PhD
International Water Management Institute (IWMI)
Colombo, Sri Lanka

Jörg Drewes, PhD
Colorado School of Mines
Golden, CO

William Dunivin
Orange County Water District
Fountain Valley, CA

Yamaji Eiji
University of Tokyo
Tokyo, Japan

Mark Elbag
Town of Holden
Holden, MA

Jeroen H. J. Ensink, PhD
London School of Hygiene and Tropical Medicine
London, England

Lucina Equihua
Degremont, S.A. de C.V.
Mexico City, Mexico

Kraig Erickson, P.E.
RMC Water and Environment
Los Angeles, CA

Ramiro Etchepare, MSc
Universidade Federal do Rio Grande do Sul
Port Alegre, Brazil

Patrick J. Evans, PhD
CDM Smith
Bellevue, WA

Rob Fahey, P.E.
City of Clearwater
Clearwater, FL

Johnathan Farmer
Jones Hawkins & Farmer, PLC
Nashville, TN

MerriBeth Farnham
HD PR Group
Fort Myers, FL

James Ferguson, P.E.
Miami Dade Water and Sewer Department
Miami, FL

Diana Lila Ferrando, Eng, MSc
University of Piura
Piura, Peru

Colin Fischer
Aquacell
Leura, New South Wales, Australia

*Peter Fox, PhD
Arizona State University
Tempe, AZ

Mary Fralish
City of Mankato
Mankato, MN

Tim Francis, P.E., BCEE
ARCADIS
Phoenix, AZ

Steven A. Friedman, P.E., PMP
HDR Engineering
Riverside, CA

Paul Fu , PhD, P.E.
Water Replenishment District
Lakewood, CA

Naoyuki Funamizu , Dr. Eng.
Hokkaido University
Sapporo, Japan

Jocelyn L. Cheeks Gadson, PMP
The Coca-Cola Company
Atlanta, GA

Elliott Gall
University of Texas
Austin, TX

Patrick Gallagher, JD
CDM Smith
Cambridge, MA

*Monica Gasca, P.E.
Los Angeles County Sanitation Districts
Whittier, CA

Daniel Gerrity, PhD
UNLV
Las Vegas, NV

Patrick Girvin
GE
Boston, MA

Victor Godlewski
City of Orlando
Orlando, FL

Scott Goldman, P.E., BCEE
RMC Water and Environment
Irvine, CA

Fernando Gonzalez
Degremont, S.A. de C.V.
Mexico City, Mexico

Albert Goodman, P.E.
CDM Smith
Louisville, KY

Leila Goodwin, P.E.
Town of Cary
Cary, NC

Charles G. Graf, R.G.
Arizona Department of Environment Quality
Phoenix, AZ

Thomas Grizzard, PhD, P.E.
Virginia Tech
Manassas, VA

Amit Gross, PhD
Ben Gurion University of the Negev
Sede Boqer, Midreshet Ben Gurion, Israel

*Eelson Gushiken
ITC Water Management, Inc.
Haleiwa, Hawaii

Juan M. Gutierrez, MS
Javeriana University
Bogota, Colombia

Brent Haddad, MBA, PhD
UC Santa Cruz
Santa Cruz, CA

Josef Hagin, PhD
Grand Water Research Institute Technion – Israel
Institute of Technology
Haifa, Israel

*Ken C. Hall, P.E.
CH2M HILL
Fort Worth, TX

Laura Hansplant, RLA, ASLA, LEED AP
Andropogon Associates (formerly) and Roofmeadow
Philadelphia, PA

Earle Hartling
Los Angeles County Sanitation Districts
Whittier, CA

Damian Higham
Denver Water
Denver, CO

Mark Hilty, P.E.
City of Franklin TN
Franklin, TN

Grant Hoag, P.E.
Black and Veatch
Irvine, CA

Rita Hochstrat, MTechn.
University of Applied Sciences Northwestern
Switzerland
Muttentz, Switzerland

Abigail Holmquist, P.E.
Honeywell
Des Plaines, IL

Robert Hultquist
California Department of Public Health
El Cerrito, CA

Christopher Impellitteri, PhD
US Environmental Protection Agency
Cincinnati, OH

Ioanna Ioannidou, MSc, MBA
Larnaca Sewerage and Drainage Board
Larnaca, Cyprus

Kevin Irby, P.E.
CDM Smith
Raleigh, NC

*Jillian Jack, P.E.
CDM Smith
Atlanta, GA

JoAnn Jackson, P.E.
Brown and Caldwell
Orlando, FL

Afsaneh Janbakhsh, MSc, Cchem, MRSC, Csci
Northumbrian Water Ltd
Chelmsford, Essex, United Kingdom

Veronica Jarrin, P.E.
CH2M HILL
Atlanta, GA

Raymond Jay
Metropolitan Water District
Los Angeles, CA

Blanca Jiménez-Cisneros, PhD
Universidad Nacional Autónoma de México
Mexico City, Mexico

Mohammad Jitan, PhD
National Center for Agricultural Research and
Extension
Baq'a, Jordan

Patrick Jjemba, PhD
American Water

Mary Joy Jochico
USAID
Manilla, Philippines

Rony Joel, P.E., DEE
AEC Water
Marco Island, FL

Grace Johns, PhD
Hazen and Sawyer
Hollywood, FL

Daniel Johnson, P.E.
CDM Smith
Atlanta, GA

Jason Johnson, P.E.
CDM Smith
Miami, FL

Geoff Jones
Barwon Water
Geelong, Victoria, Australia

Jayne Joy, P.E.
Eastern Municipal Water District
Perris, CA

Graham Juby, PhD, P.E.
Carollo Engineers
Riverside, CA

Bader Kassab, MSc
USAID
Baq'a, Jordan

Sara Katz
Katz & Associates, Inc.
San Diego, CA

Andrew Kaye, P.E.
CDM Smith
Orlando, FL

Christian Kazner, Dr.-Ing.
University of Technology Sydney
Sydney, Australia

Uday Kelkar, PhD, P.E., BCEE
NJS Consultants Co. Ltd
Pune, India

Diane Kemp
CDM Smith
Tampa, FL

Bernard Keraita, PhD
International Water Management Institute (IWMI)
and Copenhagen School of Global Health
Kumasi, Ghana

Zohar Kerem, PhD
The Hebrew University of Jerusalem
Rehovot, Israel

Stuart Khan, PhD
University of South Wales
Sydney, New South Wales, Australia

Robert Kimball, P.E., BCEE
CDM Smith
Helena, MT

Katsuki Kimura, Dr.Eng.
Hokkaido University
Sapporo, Japan

Kenneth Klinko, P.E.
CDM Smith
Carlsbad, CA

*Nicole Kolankowsky, P.E.
Black and Veatch
Orlando, FL

Ariel Lapus
USAID-PWRF Project
Manilla, Philippines

Cory Larsen, P.E.
North Carolina Department of Environment and
Natural Resources
Raleigh, NC

Roberta Larson, JD
California Association of Sanitation Agencies
Sacramento, CA

James Laurenson
Health & Environmental Assessment Consulting
Bethesda, MD

*Jonathan Lautze, PhD
International Water Management Institute (IWMI)
Pretoria, South Africa

Jamie Lefkowitz, P.E.
CDM Smith
Cambridge, MA

Richard Leger, CWP
City of Aurora
Aurora, CO

Elizabeth Lemonds
Colorado Department of Public Health and
Environment
Denver, CO

Liping Lin
GE Water and Power
Beijing, China

Enrique López Calva
CDM Smith
San Diego, CA

Maria Loucraft
City of Pompano Beach
Pompano Beach, FL

Karen Lowe, P.E.
CDM Smith
Tampa, FL

Alex Lumb
CDM Smith
Cambridge, MA

Linda Macpherson
CH2M HILL
Portland, OR

Peter Macy, P.E.
CDM Smith
Pretoria, South Africa

Ben Manhas
New Jersey Department of Environmental Protection
Trenton, NJ

Mike Markus, P.E., D.WRE
Orange County Water District
Fountain Valley, CA

W. Kirk Martin, P.G.
CDM Smith
Ft. Myers, FL

Pablo Martinez
SAWS
San Antonio, TX

Ignacio Martinez
Texas A&M AgriLife Research Center at El Paso
El Paso, TX

Jim Marx, MSc, P.E.
AECOM
Washington, D.C.

*Robert Matthews, P.E., DEE
CDM Smith
Rancho Cucamongo, CA

Naeem Mazahreh, PhD
National Center for Agricultural Research and
Extension
Baq'a, Jordan

Peter McCornick
International Water Management Institute (IWMI)
Colombo, Sri Lanka

J. Torin McCoy
NASA
Houston, TX

Karen McCullen, P.E., BCEE
CDM Smith
Orlando, FL

Ellen T. McDonald, PhD, P.E.
Alan Plummer Associates, Inc.
Fort Worth, TX

Rachael McDonnell, PhD
International Center for Biosaline Agriculture
Dubai, United Arab Emirates

Ted McKim, P.E., BCEE
Reedy Creek Energy Services
Lake Buena Vista, FL

Jean E.T. McLain, PhD
University of Arizona
Tucson, AZ

Kevin S. McLeary, P.E.
Pennsylvania Department of Environmental
Protection

Matt McTaggart, P.Eng, R.Eng
AECOM

Sharon Megdal, PhD
University of Arizona
Tucson, AZ

Leopoldo Mendoza-Espinosa, PhD
Autonomous University of Baja California (UABC)
Ensenada, Baja California, Mexico

Tracy Mercer, MBA
City of Clearwater
Clearwater, FL

Mark Millan
Data Instincts
Windsor, CA

Wade Miller
WaterReuse Association
Alexandria, VA

*Dianne Mills
CDM Smith
Charlotte, NC

Seiichi Miyamoto, PhD
Texas A&M AgriLife Research Center at El Paso
El Paso, TX

Jeff Moyer
Rodale Institute
Kutztown, PA

Rafael Mujeriego, PhD
Universidad Politécnic de Cataluña
Barcelona, Spain

Richard Nagel, P.E.
West Basin Municipal Water Districts
Carson, CA

Sirenn Naoum, PhD
National Center for Agricultural Research and
Extension
Amman, Jordan

Eileen Navarrete, P.E.
City of Raleigh Public Utilities Department
Raleigh, NC

Margaret Nellor
Nellor Environmental Associates
Austin, TX

Chad Newton, P.E.
Gray & Osborne, Inc.
Seattle, WA

My-Linh Nguyen, PhD, P.E.
Nevada Division of Environmental Protection
Carson City, NV

Viet-Anh Nguyen, PhD
National University of Civil Engineering
Hanoi, Vietnam

Lan Huong Nguyen, MSc
National University of Civil Engineering
Hanoi, Vietnam

Seydou Niang, PhD
Cheikh Anta Diop University of Dakar
Dakar, Senegal

Tressa Nicholas
Idaho Department of Environmental Quality
Boise, ID

Joan Oppenheimer, BCES
MWH
Arcadia, CA

Kerri Jean Ormerod
University of Arizona
Tucson, AZ

David Ornelas
El Paso Water Utilities
El Paso, TX

Alysia Orrel
CDM Smith
Newport News, VA

John Emmanuel T. Pabilonia
USAID

Alexia Panayi, MBA
Water Development Department
Nicosia, Cyprus

Lynne Pantano
Consultant
Orange County, CA

Iacovos Papaioacovou
Sewerage Board of Limassol Amathus
Limassol, Cyprus

James M. Parks, P.E.
North Texas Municipal Water District
Wylie, TX

Carl Parrott
Oklahoma Department of Environmental Quality
Oklahoma City, OK

Meha Patel, P.E.
CDM Smith
Los Angeles, CA

Mehul Patel, P.E.
Orange County Water District
Fountain Valley, CA

Thomas Pedersen
CDM Smith
Cambridge, MA

Harold Perry
King County, WA
Seattle, WA

Danielle Pieranunzi, LEED AP BD+C
Sustainable Sites Initiative
Austin, TX

Belinda Platts, MSc
Monterey Regional Water Pollution Control Agency
Monterey, CA

Megan H. Plumlee, PhD, P.E.
Kennedy/Jenks Consultants
San Francisco, CA

H. Plummer, Jr., P.E., BCEE
Alan Plummer Associates, Inc.
Fort Worth, TX

Jim Poff
Clayton County Water Authority
Morrow, GA

Arlene Post
CDM Smith
Los Angeles, CA

Steve Price, P.E.
Denver Water
Denver, CO

Lisa Prieto, P.E., BCEE
Cater Verplanck
Orlando, FL

Muien Qaryouti, PhD
National Center for Agricultural Research and
Extension
Baq'a, Jordan

Joseph Quicho
City of San Diego
San Diego, CA

Daphne Rajenthiram
CDM Smith
Austin, TX

Alison Ramoy
SWFWMD
Brooksville, FL

Laura Read
Tufts University
Medford, MA

Eugene Reahl
GE

David Requa, P.E.
Dublin San Ramon Services District
Dublin, CA

*Alan Rimer, PhD, P.E., DEE
Black and Veatch
Cary, NC

Marcia Rinker
CDM Smith
Denver, CO

Jon Risgaard
North Carolina Department of Environment and
Natural Resources
Raleigh, NC

Channah Rock, PhD
Soil Water and Environmental Science, University of
Arizona
Tucson, AZ

Steve Rohrer, P.E.
ARCADIS
Phoenix, AZ

Alberto Rojas
Comisión Estatal del Agua
San Luis Potosí, Mexico

Irazema Rojas, P.E.
El Paso Water Utilities
El Paso, TX

C. Donald Rome, Retired
Southwest Florida Water Management District
Brooksville, FL

Joel A. Rosenfield
The Coca-Cola Company
Atlanta, GA

Debra Ross
King County Wastewater Treatment Division
Seattle, WA

Jonathan Rossi
Western Municipal Water District
Riverside, CA

Suzanne Rowe, P.G., C.HG.
CDM Smith
Irvine, CA

A. Robert Rubin, PhD
Professor Emeritus, NC State University
Raleigh, NC

Jorge Rubio, PhD, DIC
Universidade Federal do Rio Grande do Sul
Porto Alegre, Brazil

Lluís Sala
Consorti Costa Brava
Girona, Spain

Fernando Salas
Tufts University
Medford, MA

Steve Salg
Denver Zoo
Denver, CO

*Andrew Salvesson, P.E.
Carollo Engineers
Walnut Creek, CA

Mike Savage, P.E.
Brown and Caldwell
Irvine, CA

Roger Schenk
CDM Smith
Austin, TX

Michael Schmidt, P.E., BCEE
CDM Smith
Jacksonville, FL

Larry Schwartz, PhD, P.W.S.
South Florida Water Management District
West Palm Beach, FL

Christopher Scott, PhD
University of Arizona
Tucson, AZ

Harry Seah, MSc
Singapore Public Utilities Board
Singapore

Mark Sees
City of Orlando
Orlando, FL

Eran Segal, PhD
Agricultural Research Organization, Gilat Research
Center
Gilat, Israel

Raphael Semiat, PhD
Grand Water Research Institute Technion – Israel
Institute of Technology
Haifa, Israel

*Bahman Sheikh, PhD, P.E.
Water Reuse Consultant
San Francisco, CA

*Eliot Sherman
EPA
Washington, D.C.

Arun Shukla
NJS Engineers India Pvt. Ltd.
Bangalore, India

Menachem Yair Sklarz, PhD
Ben Gurion University of the Negev
Sede Boqer, Midreshet Ben Gurion, Israel

Theresa R. Slifko, PhD
Sanitation Districts of Los Angeles County
Whittier, CA

David Sloan, P.E., BCEE
Freese and Nichols
Fort Worth, TX

David Smith, PhD
WaterReuse California
Sacramento, CA

Erin Snyder, PhD
University of Arizona
Tucson, AZ

Shane Snyder, PhD
University of Arizona
Tucson, AZ

Maria Ines Mancebo Soares, PhD
Ben Gurion University of the Negev
Sede Boqer, Midreshet Ben Gurion, Israel

*Shanin Speas-Frost, P.E.
Florida Department of Environmental Protection
Tallahassee, FL

Rebecca Stack
District Department of the Environment
Washington, D.C.

Christopher Stacklin, P.E.
Orange County Sanitation District
Fountain Valley, CA

Mary Stahl, P.E.
Olsson Associates
Golden, CO

*Emilie Stander, PhD
USAID
Washington, D.C.

Benjamin Stanford, PhD
Hazen and Sawyer
Raleigh, NC

Bill Steele
USB
Temecula, CA

Marsi Steirer
City of San Diego
San Diego, CA

Jo Sullivan
King County, WA
Seattle, WA

Greg Taylor, P.E.
CDM Smith
Maitland, FL

*Patricia Tennyson
Katz and Associates
San Diego, CA

Michael Thomas
CCWA
Morrow, GA

Donald Thompson, PhD, P.E.
CDM Smith
Jacksonville, FL

Ching-Tzone Tien, PhD, P.E.
Maryland Department of the Environment
Baltimore, MD

Jennifer Troy
CDM Smith
Cambridge, MA

Ryujiro Tsuchihashi, PhD
AECOM
Burnaby, BC, Canada

Anthony Van
City of San Diego
San Diego, CA

Emmanuel Van Houtte
IWVA, 'Intercommunale Waterleidingsmaatschappij
van Veurne-Ambacht' translated 'Intermunicipal
Water Company of the Veurne Region'
Doornpannestraat, Koksijde, Belgium

*Don Vandertulip, P.E., BCEE
CDM Smith
San Antonio, TX

Milind Wable, PhD, P.E., BCEE
NJS Consultants Co. Ltd
San Diego, CA

Kenny Waldrup, P.E.
City of Raleigh, NC
Raleigh, NC

Michael Walters
Lake Simcoe Region Conservation Authority
Newmarket, Ontario, Canada

Elizabeth Watson, P.E., LEED AP
CDM Smith
Cambridge, MA

Jennifer Watt, P.E.
GE
Oakville, Ontario, Canada

Michael P. Wehner
Orange County Water District
Fountain Valley, CA

Kirk Westphal, P.E.
CDM Smith
Cambridge, MA

Gregory D Wetterau, P.E., BCEE
CDM Smith
Raleigh, NC

Carolyn Ahrens Wieland
Booth, Ahrens & Werkenthin, PC
Austin, TX

Michael Wilson, P.E.
CH2M HILL
Boston, MA

Anna Wingard
CDM Smith
New York, NY

*Lee Wiseman, P.E., BCEE
CDM Smith
Orlando, FL

Chester J. Wojna
The Coca-Cola Company
Atlanta, GA

Steven Wolosoff
CDM Smith
Rancho Cucamonga, CA

Chee Hoe Woo, MSc
Singapore Public Utilities Board
Singapore

Mauri L. Wood
CDM Smith
Franklin, TN

Tim Woody
City of Raleigh
Raleigh, NC

Elizabeth Ya'ari
Friends of the Earth Middle East
Bethlehem, Palestinian Territories

Alexander Yakirevich, PhD
Ben Gurion University of the Negev
Sede Boqer, Midreshet Ben Gurion, Israel

Eiji Yamaji, PhD
University of Tokyo
Chiba Prefecture, Japan

Uri Yermiyahu, PhD
Agricultural Research Organization, Gilat Research
Center
Gilat, Israel

David Young, P.E., BCEE, FACEC
CDM Smith
Cambridge, MA

Ronald Young, P.E., DEE
Elsinore Valley Municipal Water District
Lake Elsinore, CA

Rafael Zaneti, MSc
Universidade Federal do Rio Grande do Sul
Porto Alegre, Brazil

Maribel Zapater, MSc
University of Piura
Piura, Peru

Max Zarate-Bermudez, MSc, MPH, PhD
CDC/NCEH
Atlanta, GA

Meiyang Zhou, MSc
Ben Gurion University of the Negev
Sede Boqer, Midreshet Ben Gurion, Israel

Christine Ziegler
Rodale Institute
Kutztown, PA

The following individuals also provided special assistance or review comments on behalf of EPA:

Robert K. Bastian
EPA Office of Wastewater Management
Washington, D.C.

Phil Berger, PhD
EPA Office of Ground Water and Drinking Water
Washington, D.C.

Veronica Blette
EPA Office of Wastewater Management
Washington, D.C.

Octavia Conerly
EPA Office of Science and Technology
Washington, D.C.

Michael J. Finn
EPA Office of Ground Water and Drinking Water
Washington, D.C.

Ellen Gilinsky, PhD
EPA Office of Water
Washington, D.C.

Bonnie Gitlin
EPA Office of Wastewater Management
Washington, D.C.

Robert Goo
EPA Office of Wetlands Oceans and Watersheds
Washington, D.C.

James Goodrich, PhD
EPA Office of Research and Development
Cincinnati, OH

Roger Gorke
EPA Office of Water
Washington, D.C.

Audrey Levine, PhD
Battelle Memorial Institute
Washington, D.C.

Cheryl McGovern
EPA Region 9
San Francisco, CA

George Moore
EPA Office of Research and Development
Cincinnati, OH

Dan Murray, P.E., BCEE
EPA Office of Research and Development
Cincinnati, OH

Joseph Morris
Tinker AFB
Midwest City, OK

Tressa Nicholas, MSCE
Idaho Department of Environmental Quality Water
Quality Division
Boise, ID

Charles Noss, PhD
EPA Office of Research and Development
Research Triangle Park, NC

George O'Connor, PhD
University of Florida
Gainesville, FL

Phil Oshida
EPA Office of Ground Water and Drinking Water
Washington, D.C.

Nancy Yoshikawa
EPA Office of Wetlands Oceans and Watersheds
Washington, D.C.

Carrie Wehling
EPA Office of General Council
Washington, D.C.

J. E. Smith, Jr, D.Sc, MASCE, BCEEM (Retired)
EPA Office of Research and Development
Cincinnati, OH

Frequently Used Abbreviations and Acronyms

| | |
|-------|---|
| ANSI | American National Standards Institute |
| AOP | advanced oxidation processes |
| ASR | aquifer storage and recovery |
| BOD | biochemical oxygen demand |
| CBOD | carbonaceous biochemical oxygen demand |
| COD | chemical oxygen demand |
| CWA | Clean Water Act |
| DBP | disinfection by-product |
| DO | dissolved oxygen |
| DOC | dissolved organic carbon |
| DPR | direct potable reuse |
| EDC | endocrine disrupting compounds |
| EPA | U.S. Environmental Protection Agency |
| FDEP | Florida Department of Environmental Protection |
| GAC | granular activated carbon |
| HACCP | Hazard Analysis and Critical Control Points |
| IPR | indirect potable reuse |
| IRP | integrated resources plan |
| LEED | Leadership in Energy and Environmental Design |
| MBR | membrane bioreactor |
| MCL | maximum contaminant level |
| MF | microfiltration |
| NDMA | <i>N</i> -nitrosodimethylamine |
| NPDES | National Pollutant Discharge Elimination System |
| PPCP | pharmaceuticals and personal care product |
| PCR | polymerase chain reaction |
| POC | particulate organic carbon |
| RO | reverse osmosis |
| SAT | soil-aquifer treatment |
| SDWA | Safe Drinking Water Act |
| SRT | solids retention time |
| TDS | total dissolved solids |
| TMDL | total maximum daily load |
| TOC | total organic carbon |
| TrO | trace organic compounds |
| TSS | total suspended solids |
| TWM | total water management |
| UF | ultrafiltration |
| USACE | U.S. Army Corps of Engineers |

| | |
|-------|---|
| USAID | U.S. Agency for International Development |
| USDA | U.S. Department of Agriculture |
| WHO | World Health Organization |
| WPCF | water pollution control facility |
| WRF | water reclamation facility |
| WRA | WaterReuse Association |
| WRRF | WaterReuse Research Foundation |
| WWTF | wastewater treatment facility |
| WWTP | wastewater treatment plant |

CHAPTER 1

Introduction

Recognizing the need to provide national guidance on water reuse regulations and program planning, the U.S. Environmental Protection Agency (EPA) has developed comprehensive, up-to-date water reuse guidelines in support of regulations and guidelines developed by states, tribes, and other authorities. Water reclamation and reuse standards in the United States are the responsibility of state and local agencies—there are no federal regulations for reuse. The first EPA *Guidelines for Water Reuse* was developed in 1980 as a technical research report for the EPA Office of Research and Development (EPA, 1980). It was updated in 1992 to support both project planners and state regulatory officials seeking EPA guidance on appropriate water quality, uses, and regulatory requirements for development of reclaimed water systems in the various states (EPA, 1992). The primary purpose of the update issued in 2004 was to summarize water reuse guidelines, with supporting research and information, for the benefit of utilities and regulatory agencies, particularly in the United States (EPA, 2004). As of the publication of the 2012 updated document, 30 states and one U.S. territory have adopted regulations and 15 states have guidelines or design standards that govern water reuse. The updated guidelines serve as a national overview of the status of reuse regulations and clarify some of the variations in the regulatory frameworks that support reuse in different states and regions of the United States.

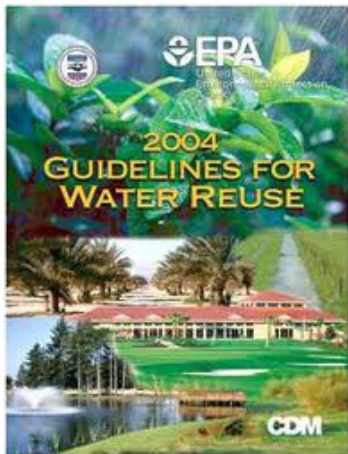

Figure 1-1
The 2004 EPA *Guidelines for Water Reuse* has had global influence.

in the regulatory frameworks that support reuse in different states and regions of the United States.

Globally, the EPA *Guidelines for Water Reuse* has also had far-reaching influence. In fact, some countries either reference the document or adopt the guiding principles outlined in the 2004 guidelines. Many countries of the world also reference the World Health

Organization (WHO) *Guidelines for the Safe Use of Wastewater, Excreta and Greywater*.

Over the last decade there has been significant growth in the application of reuse, important advances in reuse technologies, and an increase in the number of states that have implemented either rules or guidelines for reuse. In addition, growing worldwide water supply demands have forced planners to consider nontraditional water sources while maintaining environmental stewardship. In response to these changes and advances in reuse, EPA has developed the 2012 *Guidelines for Water Reuse* to incorporate this information through a Cooperative Research and Development Agreement (CRADA) with CDM Smith and an Interagency Agreement with U.S. Agency for International Development (USAID).

1.1 Objectives of the Guidelines

There were several key reasons to update the guidelines in 2012. As the field of reuse has expanded greatly over the past decade, there is a need to address new applications and advances in technologies, as well as update state regulatory information. As technologies are now advanced enough to treat wastewater to the water quality required for the intended use, the concept of “fit for purpose” is highlighted to emphasize the efficiencies realized by designing reuse for specific end applications. Second, EPA has committed to work with communities to incorporate the approach of integrated water management, where nonconventional water sources are incorporated as part of holistic water management planning, a theme that is emphasized in this update (Rodrigo et al., 2012). Third, there was interest in incorporating findings and recommendations from the National Research Council’s (NRC) Water Science & Technology Board report, *Water Reuse: Potential for Expanding the Nation’s Water Supply Through Reuse of Municipal Wastewater* (NRC, 2012).

Globally, the WHO has also updated its guidelines, which were under revision at the time of publication of the 2004 EPA guidelines document. In response to these changes and other advances in reuse technologies, EPA deemed it appropriate and

necessary to revise its guidelines document to include updated information. As a result, facilitated workshops and informational sessions were initiated in 2009 at water events around the world to generate feedback about concepts that should be repeated, updated, added, or removed from the document; the current version of the *Guidelines for Water Reuse* incorporates this information.

In states and nations where standards do not exist or are being revised or expanded, the EPA guidelines can assist in developing reuse programs and appropriate regulations. The guidelines also will be useful to engineers and others involved in the evaluation, planning, design, operation, or management of water reclamation and reuse facilities. Because the number of reuse applications has expanded so significantly since publication of the 2004 document, this revision has modified the format and scope of case studies to provide readers with examples of best practices and lessons learned. Additionally, the chapter on international reuse has been expanded to include a discussion of principles for mitigating risks associated with wastewater use where treatment does not exist and enabling factors for expanding wastewater treatment to promote the increase of water reuse. The chapter also provides case studies of global experiences that can inform approaches to reuse in the United States.

1.2 Overview of the Guidelines

Stakeholder input was gathered from a wide range of contributors in order to identify key themes to emphasize in this update. The stakeholder involvement process is described in further detail in **Updating the Guidelines**. This input has been integrated throughout the document, which has been arranged by topic and devotes separate chapters to each of the key technical, financial, legal and institutional, and public involvement issues. While the document generally follows the outline of the 2004 guidelines, integration of some of the new materials resulted in expanded chapters that required minor reorganization. The document is organized into nine chapters and six appendices, as outlined in **Table 1-1**.

Throughout the text, **case studies** are introduced and referenced by a **[code name]** in brackets. In the compiled pdf version of this document, hyperlinks will direct the reader to the case studies in the appendices. The U.S. case studies are listed and contained in Appendix D. International case studies are listed and contained in Appendix E.

1.3 Guidelines Terminology

The terminology associated with treating municipal wastewater and reusing it varies both within the United States and globally. For instance, although the terms are synonymous, some states and countries use the term *reclaimed water* while others use the term *recycled water*. Similarly, the terms *water recycling* and *water reuse* have the same meaning. In this document, the terms *reclaimed water* and *water reuse* are used. Definitions of terms used in this document, with the exception of their use in case studies, which may contain site-specific terminology, are provided below.

De facto reuse: A situation where reuse of treated wastewater is, in fact, practiced but is not officially recognized (e.g., a drinking water supply intake located downstream from a wastewater treatment plant [WWTP] discharge point).

Direct potable reuse (DPR): The introduction of reclaimed water (with or without retention in an engineered storage buffer) directly into a drinking water treatment plant, either collocated or remote from the advanced wastewater treatment system.

Indirect potable reuse (IPR): Augmentation of a drinking water source (surface or groundwater) with reclaimed water followed by an environmental buffer that precedes drinking water treatment.

Nonpotable reuse: All water reuse applications that do not involve potable reuse.

Potable reuse: Planned augmentation of a drinking water supply with reclaimed water.

Table 1-1 Organization of 2012 *Guidelines for Water Reuse*

| Chapter | Overview of Contents |
|--|--|
| Chapter 2—Planning and Management Considerations | EPA's Total Water Management (TWM) approach to water resources planning is described as a framework within which water reuse is integrated into a holistic water management approach. The steps that should be considered in the planning stage as part of an integrated water resources plan are then presented, followed by an overview of key considerations for managing reclaimed water supplies. These discussions cover management of supplies as well as managed aquifer recharge, which has progressed substantially since publication of the previous guidelines. |
| Chapter 3—Types of Reuse Applications | A discussion of reuse for agricultural, industrial, environmental, recreational, and potable supplies is presented. An expanded discussion of indirect potable reuse (IPR) and direct potable reuse (DPR) is also provided with references to new research and literature. Urban reuse practices such as fire protection, landscape irrigation, and toilet flushing were described in great detail in the 2004 guidelines and are not repeated here; however, general information regarding planning and management of reclaimed water supplies and systems that include urban reuse is provided in Chapter 2. |
| Chapter 4—State Regulatory Programs for Water Reuse | An overview of legal and institutional considerations for reuse is provided in this chapter. The chapter also gives an updated summary of existing state standards and regulations. At the end of this chapter are suggested minimum guidelines for water reuse in areas where such guidance or rules have not yet been established. |
| Chapter 5—Regional Variations in Water Reuse | This new chapter summarizes current water use in the United States and discusses expansion of water reuse nationally to meet water needs. The chapter discusses variations in regional drivers for water reuse, including population and land use, water usage by sector, water rates, and the states' regulatory contexts. Representative water reuse practices are described for each region, and U.S. water reuse case studies are introduced. |
| Chapter 6—Treatment Technologies for Protecting Public and Environmental Health | This chapter provides an overview of the treatment objectives for reclaimed water and discusses the major treatment processes that are fundamental to production of reclaimed water. And, while this chapter is not intended to be a design manual or provide comprehensive information about wastewater treatment, which can be found in other industry references, an overview of these processes and citations for updated industry standards is provided. |
| Chapter 7—Funding Water Reuse Systems | Assuring adequate funding for water reuse systems is similar to funding other water services. Because of increased interest in using reclaimed water as an alternate water source, this chapter provides a discussion of how to develop and operate a sustainable water system using sound financial decision-making processes that are tied to the system's strategic planning process. |
| Chapter 8—Public Outreach, Participation, and Consultation | This chapter presents an outline of strategies for informing and involving the public in water reuse system planning and reclaimed water use and reflects a significant shift in thinking toward a higher level of public engagement since publication of the last guidelines. This chapter also describes some of the new social networking tools that can be tapped to aid with this process. |
| Chapter 9—Global Experiences in Water Reuse | With significant input from USAID and the International Water Management Institute (IWMI), the chapter on international reuse has been expanded to include a description of the growth of advanced reuse globally. In addition, this chapter provides information on principles for mitigating risks associated with the use of untreated or partially treated wastewater, enabling factors for expanding water reuse, and new case studies that can provide informed approaches to reuse in the United States. |
| APPENDIX A | Federal and nonfederal agencies that fund research in water reuse |
| APPENDIX B | Inventory of water reuse research projects |
| APPENDIX C | State regulatory websites |
| APPENDIX D | Case studies on water reuse in the United States |
| APPENDIX E | Case studies on water reuse outside the United States |
| APPENDIX F | List of case studies that were included in the 2004 EPA guidelines |
| APPENDIX G | Abbreviations for names of states and units of measure |

Reclaimed water: Municipal wastewater that has been treated to meet specific water quality criteria with the intent of being used for a range of purposes. The term *recycled water* is synonymous with *reclaimed water*.

Water reclamation: The act of treating municipal wastewater to make it acceptable for reuse.

Water reuse: The use of treated municipal wastewater (reclaimed water). Other alternate sources of water,

including graywater and stormwater, are discussed in Chapter 2.

Wastewater: Used water discharged from homes, business, industry, and agricultural facilities.

In addition to the general terms defined above, the following terminology is used in this document to delineate between categories of water reuse applications (**Table 1-2**).

Table 1-2 Categories of water reuse applications

| Category of reuse | | Description |
|---|---|---|
| Urban Reuse | Unrestricted | The use of reclaimed water for nonpotable applications in municipal settings where public access is not restricted |
| | Restricted | The use of reclaimed water for nonpotable applications in municipal settings where public access is controlled or restricted by physical or institutional barriers, such as fencing, advisory signage, or temporal access restriction |
| Agricultural Reuse | Food Crops | The use of reclaimed water to irrigate food crops that are intended for human consumption |
| | Processed Food Crops and Non-food Crops | The use of reclaimed water to irrigate crops that are either processed before human consumption or not consumed by humans |
| Impoundments | Unrestricted | The use of reclaimed water in an impoundment in which no limitations are imposed on body-contact water recreation activities |
| | Restricted | The use of reclaimed water in an impoundment where body contact is restricted |
| Environmental Reuse | | The use of reclaimed water to create, enhance, sustain, or augment water bodies including wetlands, aquatic habitats, or stream flow |
| Industrial Reuse | | The use of reclaimed water in industrial applications and facilities, power production, and extraction of fossil fuels |
| Groundwater Recharge – Nonpotable Reuse | | The use of reclaimed water to recharge aquifers that are not used as a potable water source |
| Potable Reuse | IPR | Augmentation of a drinking water source (surface or groundwater) with reclaimed water followed by an environmental buffer that precedes normal drinking water treatment |
| | DPR | The introduction of reclaimed water (with or without retention in an engineered storage buffer) directly into a water treatment plant, either collocated or remote from the advanced wastewater treatment system |

1.4 Motivation for Reuse

The ability to reuse water, regardless of whether the intent is to augment water supplies or manage nutrients in treated effluent, has positive benefits that are also the key motivators for implementing reuse programs. These benefits include improved agricultural production; reduced energy consumption associated with production, treatment, and distribution of water; and significant environmental benefits, such as reduced nutrient loads to receiving waters due to reuse of the treated wastewater. As such, in 2012, the drivers for reuse are similar to those presented in the 2004 guidelines and center around three categories: 1) addressing urbanization and water supply scarcity, 2) achieving efficient resource use, and 3) environmental and public health protection.

1.4.1 Urbanization and Water Scarcity

The present world population of 7 billion is expected to reach 9.5 billion by 2050 (USCB, n.d.).

In addition to the increasing need to meet potable water supply demands and other urban demands (e.g., landscape irrigation, commercial, and industrial needs), increased agricultural demands due to greater incorporation of animal and dairy products into the diet also increase demands on water for food production (Pimentel and Pimentel, 2003). These increases in population and a dependency on high-water-demand agriculture are coupled with increasing urbanization; all of these factors and others are effecting land use changes that exacerbate water supply challenges. Likewise, sea level rise and increasing intensity and variability of local climate patterns are predicted to alter hydrologic and ecosystem dynamics and composition (Bates et al., 2008). For example, the western United States, including the Colorado River Basin, which provides water to 35 million people, is projected to experience seasonal and annual temperature increases, resulting in increased evaporation (Garfin et al., 2007; Cohen, 2011).

Reuse projects must factor in climate predictions, both for demand projections and for ecological impacts. Municipal wastewater generation in the United States averages approximately 75 gpcd (284 Lpcd) and is relatively constant throughout the year. Where collection systems are in poor condition, the wastewater generation rate may be considerably higher or lower due to infiltration/inflow or exfiltration, respectively. Thus, according to Schroeder et al.

(2012), the potential municipal water supply offset by reuse for a community of 1 million people will be approximately 75 mgd (3,950 L/s) or 27,400 million gallons (125 MCM) per year. Given losses at various points in the overall system and potential downstream water rights, the actual available water would most likely be about 50 percent of the potential value, but the resulting impact on the available water supply would still be impressive.

As urban areas continue to grow, pressure on local water supplies will continue to increase. Already, groundwater aquifers used by over half of the world population are being overdrafted (Brown, 2011). As a result, it is no longer advisable to use water once and dispose of it; it is important to identify ways to reuse water. Reuse will continue to increase as the world's population becomes increasingly urbanized and concentrated near coastlines, where local freshwater supplies are limited or are available only with large capital expenditure (Creel, 2003).

1.4.2 Water-Energy Nexus

Energy efficiency and sustainability are key drivers of water reuse, which is why water reuse is so integral to sustainable water management. The water-energy nexus recognizes that water and energy are mutually dependent—energy production requires large volumes of water, and water infrastructure requires large amounts of energy (NCSL, 2009). Water reuse is a critical factor in slowing the compound loop of increased water and energy use witnessed in the water-energy nexus. A frequently-cited definition of sustainability comes from a 1987 report by the Bruntland Commission: “Sustainable development is development that meets the needs of the present without compromising the ability of future generations to meet their own needs” (WCED, 1987). Therefore, sustainable water management can be defined as water resource management that meets the needs of present and future generations.

Water reuse is integral to sustainable water management because it allows water to remain in the environment and be preserved for future uses while meeting the water requirements of the present. Water and energy are interconnected, and sustainable management of either resource requires consideration of the other. Water reuse reduces energy use by eliminating additional potable water treatment and associated water conveyance because reclaimed

water typically offsets potable water use and is used locally. For example, about 20 percent of California's electricity is consumed by water-related energy use, including potable water conveyance, storage, treatment, and distribution and wastewater collection, treatment, and discharge (California Energy Commission, 2005). Although additional energy is required to treat wastewater for reclamation, the amount of energy required for treatment and transport of potable water is generally much greater in southern California. And the estimated net energy savings could range from 0.7 to 1 TWh/yr, or 3,000 to 5,000 kWh/Mgal. At a power cost of \$0.075/kWh, the savings would be on the order of \$50 to \$87 million per year (Schroeder et al., 2012).



Figure 1-2
Purple pipe is widely used for reclaimed water distribution systems (Photo credit: CDM Smith)

The energy required for capturing, treating, and distributing water and the water required to produce energy are inextricably linked. Water reuse can achieve two benefits: offsetting water demands and providing water for energy production. As described in Chapters 3 and 5, thermoelectric energy generation currently uses about half of the water resources consumed in the United States and is a major potential user of reclaimed water (Kenny et al., 2005). On-site energy and resource efficiency is also driving the installation of decentralized reuse applications in industrial applications and establishments seeking Leadership in Energy and Environmental Design (LEED) certification.

EPA has developed principles for an Energy-Water Future that incorporate familiar concepts of: efficiency, a water-wise energy sector as well as an energy-wise water sector, consideration of wastewater as a resource, and integrated resource planning and recognition of the societal benefits (EPA, 2012).

Understanding that reuse is one of the tools that urban water/wastewater/stormwater managers have at their disposal to improve their existing systems' energy efficiency, EPA is currently developing a handbook titled *Leveraging the Water-Energy Connection—An Integrated Resource Management Handbook for Community Planners and Decision-Makers*, envisioned to be an integrated water management-planning support document. The manual will address water conservation and efficiency (which is discussed in these guidelines with respect to its role in TWM), as well as alternative water sources (reclaimed water, graywater, harvested stormwater, etc.) as part of capacity development, building codes for improved water and energy-use efficiency, and renewable energy sources from/for both water and wastewater systems.

1.4.3 Environmental Protection

Water scarcity and water supply demands in arid and semi-arid regions drive reuse as an alternate water supply; however, there are still many water reuse programs in the United States that have been initiated in response to rigorous and costly requirements to remove nutrients (mainly nitrogen and phosphorus) from effluent discharge to surface waters. Environmental concerns over negative impacts from increasing nutrient discharges to coastal waters are resulting in mandatory reductions in the number of ocean discharges in Florida and California. By eliminating effluent discharges for all or even a portion of the year through water reuse, a municipality may be able to avoid or reduce the need for costly nutrient removal treatment processes or maintain wasteload allocations while expanding capacity. Avoiding costly advanced wastewater treatment facilities was the key driver for St. Petersburg, Fla., to initiate reclaimed water distribution to residential, municipal, commercial, and industrial demands when the state legislature enacted the Wilson-Grizzle Act in 1972, significantly restricting nutrient discharge into Tampa Bay. Today, St. Petersburg serves more than 10,250 residential connections in addition to parks, schools, golf courses, and commercial/industrial applications, including 13 cooling towers. Another current example is King County, Wash., which is implementing reuse to reduce the discharge of nutrients into Puget Sound to address the health of this marine water [[US-WA-King County](#)].

Under some National Pollutant Discharge Elimination System (NPDES) programs, water reuse may have evolved from initial land treatment system or zero discharge system concepts. The reuse program in this circumstance may serve dual objectives. First, the system could treat as much effluent on as little land as possible (thus, application rates are often greater than irrigation demands), with subsequent “disposal” of the remaining fraction. And second, the evolution of this treatment process could provide an alternate water supply when water reuse practices are implemented.

Many communities are also turning to water reuse to achieve environmental goals of maintaining flows to sensitive ecosystems, such as in Sierra Vista, Ariz.; San Antonio, Texas; and Sydney, Australia [US-AZ-Sierra Vista, US-TX-San Antonio, and Australia-Replacement Flows].

1.5 "Fit for Purpose"

While the increased use of reclaimed water typically poses greater financial, technical, and institutional challenges than traditional sources, a range of treatment options are available such that any level of water quality can be achieved depending upon the use of the reclaimed water. This is also reflective of the evolution of reclaimed water from its origins as land application and treatment for disposal of treated wastewater effluent for groundwater recharge and crop production to the advanced treatment processes that are applied today to meet potable water quality for indirect potable reuse. Indeed, the NRC’s Water Science & Technology Board recently acknowledged this continuum of reuse practices in its 2012 report, *Water Reuse: Potential for Expanding the Nation’s Water Supply Through Reuse of Municipal Wastewater* (NRC, 2012), with the following statement:

“A portfolio of treatment options, including engineered and managed natural treatment processes, exists to mitigate microbial and chemical contaminants in reclaimed water, facilitating a multitude of process combinations that can be tailored to meet specific water quality objectives. Advanced treatment processes are also capable of addressing contemporary water quality issues related to potable reuse involving emerging pathogens or trace organic chemicals. Advances in membrane filtration have made membrane-based processes particularly attractive for water reuse applications. However, limited cost-effective concentrate disposal alternatives hinder the application of membrane technologies for water reuse in inland communities” (NRC, 2012).

This concept is represented graphically in **Figure 1-3**, which illustrates that water treatment technologies (combined with disinfection) offer a ladder of increasing water quality, and choosing the right level of treatment should be dictated by the end application of the reclaimed water for achieving economic efficiency and environmental sustainability.

There are numerous case studies that demonstrate the balance of treatment costs along with the intended use of the reclaimed water. Many of these develop reuse in the interest of replacing the use of drinking water for nonpotable applications and meeting the future water demands. As such, the treatment level required for reclaimed water production depends on the end use. A number of states, such as Washington, California, Florida, Arizona, and others, prescribe the level of treatment depending on the end use. This recognition of “Fit for Purpose” provides a framework for cost-effective treatment to be applied to a water

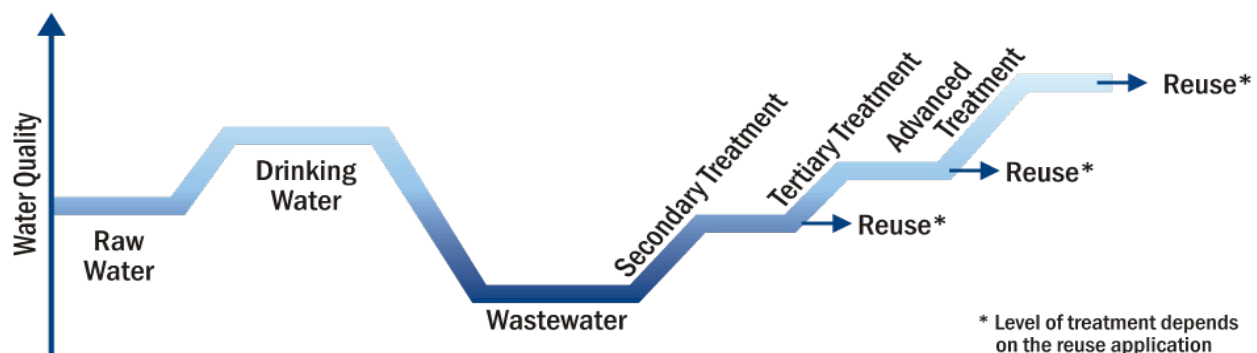

Figure 1-3
Treatment technologies are available to achieve any desired level of water quality

source sufficient to meet the quality appropriate for the intended use. By selecting appropriate treatment for specific applications, water supply costs can be controlled and the costs for improved wastewater treatment technologies delayed until they are balanced by the benefits. Consideration must also be balanced with the potential for future reuse of higher reclaimed water quality such that these uses are not limited.

1.6 References

Bates, B. C., Z. W. Kundzewicz, S. Wu, and J. P. Palutikof. 2008. *Climate Change and Water*. Technical paper. Intergovernmental Panel on Climate Change. Geneva.

Brown, L. R. 2011. "The New Geopolitics of Food," *Foreign Policy*, 4, 1 – 11. *California Department of Water Resources (2011). Notice to State Water Project Contractors*. State Water Project Analyst's Office. Retrieved August 2012 from <http://www.water.ca.gov/swpao/notices.cfm>.

California Energy Commission. 2005. *Final Staff Report, California's Water-Energy Relationship, CEC-700-2005-011-SF*. Retrieved August 2012 from <http://www.energy.ca.gov/2005publications/CEC-700-2005-011/CEC-700-2005-011-SF.PDF>.

Cohen, M. 2011. *Municipal Deliveries of Colorado River Basin Water*. Pacific Institute. Oakland, CA.

Creel, L. 2003. "Ripple Effects: Population and Coastal Regions," *Population Reference Bureau*. Washington, D.C.

Garfin, G., M. A. Crimmins, and K. L. Jacobs. 2007. "Drought, Climate Variability, and Implications for Water Supply." In Colby, B.G. and K.L. Jacobs, (eds.) *Arizona Water Policy: Management Innovations in an Urbanizing Arid Region*. Resources for the Future. Washington, D.C.

Kenny, J. F., N. L. Barber, S. S. Hutson, K. S. Linsey, J. K. Lovelace, and M. A. Maupin. 2005. *Estimated Use of Water in the United States in 2005*. United States Geological Survey (USGS). Retrieved April 5, 2012, from <http://pubs.usgs.gov/circ/1344/>.

National Conference of State Legislatures (NCSL). 2009. *Overview of the Water-Energy Nexus in the U.S.* Retrieved August 2012 from <http://www.ncsl.org/issues-research/env/res/overviewofthewaterenergyintheus.aspx>.

National Research Council (NRC). 2012. *Water Reuse: Potential for Expanding the Nation's Water Supply Through Reuse of Municipal Wastewater*. The National Academies Press: Washington, D.C.

Pimentel, D., and M. Pimentel. 2003. "Sustainability of Meat-based and Plant-based Diets and the Environment." *American Journal of Clinical Nutrition*. 78(3):660S-663S.

Rodrigo, D., E. J. López Calva, and A. Cannan. 2012. *Total Water Management*. EPA 600/R-12/551. U.S. Environmental Protection Agency. Washington, D.C.

Schroeder, E., G. Tchobanoglous, H. L. Leverenz, and T. Asano. 2012. *Direct Potable Reuse: Benefits for Public Water Supplies, Agriculture, the Environment, and Energy Conservation, National Water Research Institute (NWRRI) White Paper, Publication Number NWRRI-2012-01*. Fountain Valley, CA.

United States Census Bureau (USCB). n.d. World Population. Accessed on September 17, 2012 from http://www.census.gov/population/international/data/worldpop/table_population.php.

U.S. Environmental Protection Agency (EPA). 1980. *Protocol Development: Criteria and Standards for Potable Reuse and Feasible Alternatives*. 570/9-82-005. Environmental Protection Agency. Washington, D.C.

U.S. Environmental Protection Agency (EPA). 1992. *Guidelines for Water Reuse*. 625/R92004. Environmental Protection Agency. Washington, D.C.

U.S. Environmental Protection Agency (EPA). 2004. *Guidelines for Water Reuse*. 625/R-04/108. Environmental Protection Agency. Washington, D.C.

U.S. Environmental Protection Agency (EPA). 2012. *Energy/Water*. Retrieved August 2012 from <http://water.epa.gov/action/energywater.cfm>.

World Commission on Environment and Development (WCED). 1987. *Our Common Future: The Brundtland Report*. United Nations World Commission on Environment and Development. Oxford University Press. New York, NY.

CHAPTER 2

Planning and Management Considerations

With increasing restrictions on conventional water resource development and wastewater discharges, reuse has become an essential tool in addressing both water supply and wastewater disposal needs in many areas. This growing dependence on reuse makes it critical to integrate reuse programs into broader planning initiatives. Since publication of the 2004 guidelines, some excellent materials on planning, developing, and managing reuse systems have been published and are referenced in this chapter. A summary of overarching management themes and discussion of some important management practices and tools are provided in this chapter.

2.1 Integrated Water Management

Beyond the need to address water supply challenges, many utility systems are under increasing pressures to save costs and demonstrate environmental stewardship. Under this scenario, weaknesses in the traditional practices of water management, which typically focus on individual resources or utilities, have become apparent. Recognizing these challenges, application of adaptive management approaches, such as integrated water management, is a means of improving water resource management and reducing waste streams (Rodrigo et al., 2012). This approach is the result of a focus on broader water resources management options that encompass all of the water resource systems within a community, and reuse is a key factor in this more holistic planning method. **Figure 2-1** illustrates the difference between integrated and nonintegrated water resources management approaches.

As described in the document *Total Water Management* (Rodrigo et al., 2012), receiving waters (**Figure 2-1**) represent surface and groundwater resources that provide both water supply sources and points of wastewater discharge. Dry weather stormwater represents low flows that may end up in the wastewater collection system, and wet weather stormwater represents higher flow periods that generally end up as discharge to receiving waters (Rodrigo et al., 2012). In the non-integrated approach, urban watersheds use more receiving waters for their water supplies and

heavily discharge wastewater and stormwater into receiving waters.

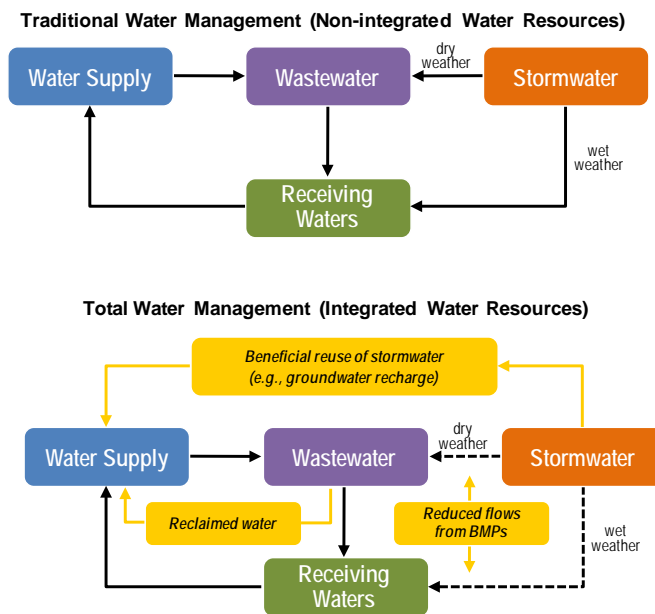

Figure 2-1
Traditional versus Integrated Water Management
 (adapted from O'Connor et al., 2010)

This approach can result in detrimental environmental impacts and lead to inefficiencies in the use of water. Integrated water management significantly improves the opportunities to obtain benefits from water, regardless of the stage in the water cycle. Concepts such as integrating water conservation practices to reduce the demand for freshwater are part of this comprehensive management approach. Also, rather than viewing stormwater as a nuisance, it should be considered an asset that is allowed to recharge groundwater through best management practices (BMPs), such as the use of swales, porous pavement, or cisterns. Additionally, wastewater can be reused, providing both environmental and water supply benefits.

The end result of integrated water management is reduced discharges to receiving waters and reduced reliance on surface and groundwater supplies to meet water demands. The following set of management

strategies and alternative resources are typically considered in an integrated water management plan:

- Water conservation
- Reuse of wastewater
- Reuse of graywater
- Stormwater BMPs
- Rainwater harvesting
- Enhanced groundwater recharge
- Increased surface water detention
- Dry weather urban runoff treatment
- Dual plumbing for potable and nonpotable uses
- Separate distribution systems for fire protection
- Multi-purpose infrastructure
- Use of the right water quality for intended use
- Green roofs
- Low impact development (LID)

An example of this new approach to water resources planning is the Integrated Resources Plan (IRP) of Los Angeles, Calif. In 1999, Los Angeles embarked on an entirely new approach for managing its water resources. The IRP took a holistic, watershed approach by developing a partnership among different city departments that managed water supply, wastewater, and stormwater (CDM, 2005; López Calva et al., 2001). The goal was to develop multi-purpose, multi-benefit strategies to address chronic droughts, achieve compliance with water quality laws (e.g., total maximum daily loads [TMDLs]), provide additional wastewater system capacity, increase open space, reduce energy consumption, manage costs, and improve quality of life for its citizens. Completed in 2006, the IRP won numerous awards and was well-supported by the city's diverse stakeholders (CH:CDM, 2006a, 2006b, and 2006c). Projects identified in the IRP will be implemented over the next 20 years. When the strategies that were evaluated as part of the IRP development were compared to traditional water management practices, integrated water management scenarios demonstrated greater benefits at lower total present value costs than the baseline traditional approach scenario.

While the results in the city of Los Angeles IRP were largely driven by the higher cost for imported water,

which is very susceptible to droughts, there are other motives for integrated planning. The city of San Diego [[US-CA-San Diego](#)] is conducting an 18-month demonstration project in 2012 to demonstrate the potential of IPR. Pending the results of the demonstration project, the city would mine treated wastewater effluent from the outfall serving the Point Loma Primary Treatment Plant to provide water higher in quality than drinking water standards and augment the supply of the San Vicente Reservoir. Drivers for this project include an expanded water supply, reduction of coastal discharges, and lower energy consumption compared to importation of new supplies or ocean desalination. In other areas of the country, this integrated management approach may also produce greater benefits for water management, and not necessarily for water supply alone. Even smaller communities can benefit from examining water resources in a more interconnected and integrated manner. Franklin, Tenn. [[US-TN-Franklin](#)] has proactively adopted this management approach through the integrated water resources planning process. The city has reached beyond the typical application of this management tool to improve the overall services of the drinking water, wastewater, stormwater, and reclaimed water systems. The end result is that the city of Franklin, through a stakeholder participation process, has developed a long-term plan that will ultimately protect the Harpeth River—a source of water supply, a receiving body for treated effluent, a recreational waterway, and one of the community's most prized recreational resources.

Under the umbrella of an integrated plan, the development and management of facilities and policies for water, wastewater, stormwater, reclaimed water, and energy can be evaluated concurrently. Not only does this process bring together resources that share a common environment, it brings together the people who manage or are affected by these resources and their infrastructure, which is one of the reasons the integrated planning process is gaining in appeal. In this process, elected officials rely on the consensus backing of stakeholders, and the IRP process inherently strives to achieve goals that are common to all participating stakeholders (discussed further in Chapter 8). Specific guidance and examples of how water planners and managers can use the IRP process as an objective and balanced means of exploring the relative merits of considering reuse options alongside traditional water supply and demand

management alternatives is provided in the research report titled, *Extending the Integrated Resource Planning Process to Include Water Reuse and Other Nontraditional Water Sources* (WRRF, 2007a). The report provides an extensive description of each of the elements of the IRP process, the issues and opportunities related to incorporating reuse into integrated plans, and the tools and models that can be used for facilitating appropriate reuse applications into an integrated management plan. Additional information is also provided in the document, *Total Water Management* (Rodrigo et al., 2012).

Integral to the successful implementation of integrated water management is a regulatory framework that facilitates rather than obstructs this approach. The various managed components of an integrated water resources plan, which may include water, wastewater, stormwater, reclaimed water, and energy, may be regulated by different state agencies and, in some cases, one component may be regulated by more than one state agency. Some state agencies, particularly those that have been delegated Clean Water Act (CWA), NPDES, and Safe Drinking Water Act (SDWA) federal programs, have deliberately elected to establish clear boundaries to avoid any potential for redundancy and confusion for the public. In the case of an IPR proposal, however, aspects of the project might require involvement and possibly permitting by multiple agencies. The degree of coordination and cooperation that can be achieved may vary from project to project and from state to state. Therefore, states committed to achieving integrated water resources planning goals may choose to adopt laws that consolidate regulatory programs to the extent possible or improve the coordination and cooperation among programs of different state agencies for the purpose of facilitating this planning framework. Subsequently, regulatory programs developed on the basis of these laws should provide greater focus and details on implementation of more integrated solutions.

2.2 Planning Municipal Reclaimed Water Systems

Regardless of the size and type of a reclaimed water system, there are planning steps that should be considered (although an industrial process recycle system may have different process control drivers). Planning should be consistent with the overall water resources management objectives, which should be defined through an integrated planning process

(Section 2.1). As part of an integrated water resources plan, a reclaimed water master plan can identify acceptable community uses for reclaimed water, potential customers and their demands, and the quality of water required. Planners must also determine the volume of reclaimed water available for distribution, paying attention to the diurnal discharge curve at the community WWTP. This is an important consideration that can drive many other planning decisions as water conservation practices often require evening or early morning irrigation when low flows to the WWTP occur. If irrigation will occur during low influent wastewater periods, the supply of reclaimed water may not be adequate to meet the instantaneous demands, unless the reclaimed water demand rate is low compared to current treatment plant capacity. Storage is one option to resolve this supply/demand imbalance.

As part of the initial viability assessment, it is critical to examine federal and state laws, regulations, rules, and policies. Frameworks of state regulations are described in Chapter 4. In addition to the state regulatory context, certain overarching federal and state natural resource and environmental impact laws apply at the planning stage. The National Environmental Policy Act (NEPA) requires an assessment of environmental impacts for all projects receiving federal funds and subsequent mitigation of all significant impacts. Many states also have equivalent rules that mandate environmental impact assessment and mitigation planning for all projects prior to construction. These requirements often stipulate terms of public review. Even in cases where it is not legally required, stakeholder involvement in the planning of a water-reuse system is important and can help to achieve a successful outcome, as described in Chapter 8.

Other laws protect biological, scenic, and cultural resources. These laws can result in a *de facto* moratorium on the construction of large-scale water diversions (by dams) that flood the habitat of protected species or inundate pristine canyons or areas of historical significance. These laws are of particular relevance where new water supply is under consideration. In some cases these laws make reuse more attractive than new source development, but they may impact seasonal storage options for reclaimed water.

To further examine project viability, the following project-planning steps taken from the *WateReuse Association Manual of Practice* serve as a guide (WRA, 2009):

- A. Identify quantity of reclaimed water available
- B. Screen all existing and potential future uses and users
- C. Identify potential users
- D. Determine if users will accept reclaimed water
- E. Compare supply to potential demand
- F. Prepare distribution system layout
- G. Finalize customer list
- H. Determine economic feasibility
- I. Compile final user list and distribution
- J. Prepare point-of-sale facilities
- K. Obtain regulatory approval
- L. Perform on-site retrofits
- M. Perform cross-connection test
- N. Begin delivering water

While the *WateReuse Association Manual of Practice* provides details on each of these steps, a number of considerations are worth further exploration.

2.2.1 Identifying Users and Types of Reuse Demands

Because permitted uses vary greatly between states, a review of individual state regulations is important so the utility has a thorough understanding of how reclaimed water is regulated and what uses are allowed. Once regulations and allowed uses are fully understood, a utility may review water usage records to identify and locate some of its largest users. Focusing first on the largest water users helps the utility get the best possible return on investment, as well as maximize its benefits to the potable water system. In addition to water records, aerial photographs can be useful in identifying users who could utilize reclaimed water for irrigation purposes (such as golf courses and other recreational facilities).

Variables such as an area's climate, state regulations, and common industries will determine the best potential reclaimed water customers. Irrigation of golf courses and recreational facilities may be the most

well-known application of reclaimed water, but there are a number of less-traditional applications that can provide a utility with significant potable water savings:

- Irrigation and toilet flushing in large government facilities, such as capital complexes, schools, hospitals, colleges, and prisons
- Irrigation and toilet flushing in sports franchises, large arenas, and planned community centers
- Brownfield redevelopment
- Various uses in commercial and manufacturing processes
- Industrial fire protection
- Stream restoration/augmentation (where regulations allow)

The most reliable customers will be those who can utilize nonpotable water daily and throughout the year, such as in boilers and chillers or in a manufacturing process. These potential customers with a consistent usage rate will provide the utility with a baseline usage and will not be affected by wet or dry weather. A utility can count on these customers to provide turnover in pipelines during cool and/or wet periods and to provide a certain amount of consistent revenue. Additionally, within an integrated management approach, a utility may want to consider where the application of reuse provides the most value to the overall water supply system. Providing reclaimed water to commercial or industrial customers using a potable system nearing its capacity or to any users competing for the same limited resources as the utility may be more advantageous than supplying irrigation water to the local golf course, even if the latter is provided at a higher cost. Similarly, supplying reclaimed water to hydrate an impacted wetland or to control saline water movement within a critical aquifer system may allow continued or expanded use of a limited conventional water resource. Once initial potential users are identified, information should be gathered about the best way to get reclaimed water to them.

2.2.2 Land Use and Local Reuse Policy

Most communities in the United States engage in some type of structured planning process whereby the local jurisdiction regulates land use development according to a general plan, sometimes reinforced with

zoning regulations and similar restrictions. Developers of approved areas for new development may be required to prepare specific plans that demonstrate sufficient water supply or wastewater treatment capacity. In these contexts, dual-piped systems may be developed at the outset of development. It is important that any reuse project conforms to requirements under the general plan to ensure the project does not face legal challenges on a land use basis. Local planning processes often include public notice and hearings. As the public may have many misconceptions about reclaimed water, it is important for planners to address public concerns or opposition, as described in depth in Chapter 8.

Chapter 5 of the 2004 guidelines identified land use and environmental regulation controls used by local government entities to implement and manage reclaimed water systems; this chapter also identified mandatory use requirements in California. Since publication of the 2004 guidelines, many communities and states have implemented more formal water planning processes to meet public health needs for adequate water, wastewater, and reclaimed water services. There are several reasons a utility might create a local policy to require connection to a reclaimed water system, with parallel logic used in many communities to require connection to municipal utilities when reasonably available. The most common reason to require connection is to assure use of the new system, adequate to shift some of the water demand and to pay for the new system or defer new potable main construction. In an integrated water management program, potable water supplies may be limited and require construction of a reclaimed water/dual water system to meet the total demand. Even if reclaimed water is priced lower than the potable supply, the public may not have been adequately informed to understand the benefits of a diversified water system and may resist conversion to reclaimed water.

Mandatory connection to reclaimed water systems is becoming more common. Planning for future use of reclaimed water allows communities to require certain uses to utilize reclaimed water if reasonably available. Because construction cost for retrofit with a dual water system is higher and disruption of other infrastructure is unavoidable, dual water piping can be installed initially with the nonpotable distribution system dedicated to irrigation, cooling towers, or industrial

processes. When reclaimed water is available to the development area, a connection to the supply is the only local construction required.

Utilities may also need to secure bonds used for construction with an ordinance requiring connection to a reclaimed water system, thus providing a guarantee of future cash flow to meet bond payments. In addition to state legislative action in California (identified in Chapter 5 of the previous guidelines), many utilities have included mandatory connection language. Water Recycling Funding Program Guidelines initially issued in 2004 and amended in July 2008 require loan/grant applicants to include a draft mandatory use ordinance in their application packet (SWRCB, 2009). Text in the Marina Coast Water District Ordinance, Title 4, 4.28.030 Recycled water service availability, includes:

- A. When recycled water is available to a particular property, as described in Section 1.04.010, the owner must connect to the recycled water system. The owner must bear the cost of completing this connection to the recycled water system.
- B. New water users who are not required to connect to recycled water because the distance to the nearest recycled water line is greater than the distance provided in Section 1.04.010, shall be required to construct isolated plumbing infrastructure for landscape irrigation or other anticipated nonpotable uses, with a temporary connection to the potable water supply.
- C. All new private or public irrigation water systems, whether currently anticipating connection to the recycled system or that shall be connected to the potable water system temporarily while awaiting availability of recycled water, shall be constructed of purple polyvinyl chloride (PVC) pipe to the existing district standard specification” (Marina Coast Water District, 2002).

Examples of other California utilities with mandatory connection requirements include Dublin San Ramon Services District (DSRSD); Inland Empire Utility Agency; San Luis Obispo Rowland Heights; Cucamonga Valley Water District; and Elsinore Valley Municipal Water District. Florida is another state with mandatory connection requirements; 78 counties, cities, and private utilities responded on their 2011

annual reuse reports that they either require construction of reclaimed water piping in new residential or other developments or require connection to reuse systems when they become available. The Florida communities of Altamonte Springs; Boca Raton; Brevard, Charlotte, Polk, Colombia, Palm Beach, and Seminole Counties; Marco Island; and Tampa are examples. There are no communities in Texas with mandatory connections, but requirements were also found in Yelm, Wash.; Cary, N.C.; and Westminster, Md.

Along with the mandatory connection requirement, there are also ordinances that promote use of reclaimed water through incentives. The St. Johns River Water Management District, Fla., provides a model water conservation ordinance to cities within the district to promote more water efficient landscape irrigation. The model ordinance includes time-of-day/day-of-week restrictions based on odd-even street address as well as daily irrigation limits of 0.75 in/day (1.9 cm/d). Exemptions may be granted to these limitations. Possible exemptions include using a micro-spray, micro-jet, drip, or bubbler irrigation system; establishing new landscape; or watering in lawn treatment chemicals. The use of water from a reclaimed water system is allowed anytime.

The capacity of a reclaimed water system can be strained if customers continue to use reclaimed water beyond the utility capacity to supply it. In Cape Coral, Fla., the city council is considering an ordinance to re-establish an emergency water conservation plan due to a persistent drought since 2007 (Ballaro, 2012). The dry-season water demand—and the abuse of reclaimed water—has increased. As much as 42 million gallons (160,000 m³) of reclaimed water are being used each scheduled watering day, and 19 million gallons (72,000 m³) were being used on a day when no watering is allowed. The council is taking a proactive approach to protect the city's water resources, including reclaimed water.

2.2.3 Distribution System Considerations

It is important to keep in mind that reclaimed water distribution systems require many of the same planning and design considerations as potable water systems. And, because public water utilities are ultimately responsible for protecting the integrity of their water systems, safety programs addressing the potential for cross-connections must involve the public

water authorities from inception. If a dual water system is being considered, planning for a new potable water system may be concurrent. Retrofits into existing developed areas, however, may require more effort as designers must identify all existing utilities to meet separation distances and avoid impacts to other utilities during construction. In any case, design of a reclaimed water distribution system should follow design standards required in the state where the project is implemented.

Where reclaimed water criteria are not available, designers should apply the general engineering design standards applicable to potable water or irrigation systems, as appropriate. General guidelines will be provided in this section, and users of these guidelines are referred to other current design documents that can provide guidance for reclaimed water systems. The *WaterReuse Association Manual of Practice* identifies the basic steps in developing a water reuse program, including system engineering criteria (WRA, 2009). American Water Works Association (AWWA) published the third edition of its *Manual of Water Supply Practices M-24*, which discusses planning, design, construction, operation, regulatory framework, and management of community dual water systems (AWWA, 2009). AWWA also is preparing a new Reclaimed Water Management Standard that will be the first in a planned series of management standards. Additional information on cross-connection control is also provided in the *Cross-Connection Control Manual*. EPA 816-R-03-002 (EPA, 2003).

To develop a robust reclaimed water distribution system, it is important to provide an initial “backbone,” or primary transmission main, of sufficient size to allow the system to carry reclaimed water away from the source. The primary transmission main should be constructed in a location that will allow for connections to future lines as well as easy connection to previously identified large potable water users. Several items should be considered when evaluating potential routes for the primary transmission main of a reclaimed water distribution system, including:

- The location of previously identified potential users
- The total amount of potable water to be saved by connecting these potential users to the reclaimed water distribution system

- The amount of potable water to be saved that is not dependent on weather or climate conditions
- Other potential future users along each alternate route
- Other utility or roadway projects that may be taking place around the same time as construction of the primary transmission main, which may help reduce initial capital costs

Coordination with other potential projects can help save a large amount of money in capital investment, and acquiring additional users (or positioning the utility to acquire additional users in the future) will help offset the capital investment and provide future revenue.

With a new reclaimed water distribution system, especially in a state or region where reclaimed water is not yet common, customer and public education are critical components for making the project successful. Potential customers must be informed of the benefits of using reclaimed water instead of potable water for their nonpotable water needs. There may be a financial incentive for the first customers in a new system. In addition, any myths or misconceptions about reclaimed water need to be dispelled immediately and replaced with accurate information about the safety and quality of reclaimed water. Providing water quality data on reclaimed water may help ease customer concerns. As the distribution system grows, new users will be identified more easily. During periods of dry weather or drought, potential users will often identify themselves and help expand the system.

Reuse systems often have different peak hours than potable water systems. Peak usage of a reclaimed water distribution system often occurs at night when large users are irrigating. To help shave the peaks from the system, a utility can set an irrigation schedule for large irrigation users. This will prevent too many large irrigation users from irrigating simultaneously and taxing the system. Requiring large users to maintain their own on-site storage can also control peak delivery rates and equalize flow within the system.

2.2.3.1 Distribution System Pumping and Piping

To meet initial and projected demands, a hydraulic model using real data from potable water records can provide a realistic view of how much reclaimed water

could be used at both average and peak times. This will help determine the size of the primary transmission main, as well as initial or future storage. Hydraulic modeling can also identify optimum pipe diameters and routing for initial and expanded distribution systems. Integral to the choice of pipe diameters based on anticipated flow rates are decisions on utility and customer storage, time-of-day watering restrictions, and rate of delivery to the customer. Large irrigation customers, especially golf courses, may already have water features that are filled daily from existing water sources and that serve as storage for on-site irrigation systems. Automated irrigation systems are quite common at golf courses and are typically programmed to apply controlled amounts of water to meet course demands based on weather conditions and evapotranspiration data. A component of the user agreement may include limits on rate of delivery to fill an existing storage feature at a flat rate during a 24-hour period to maximize delivery capacity for the utility. The blend of large customers that have available storage and small customers that simply are willing to replace potable water at line pressure with reclaimed water at line pressure will influence system storage, pumping, and delivery main sizing.

Most states require reclaimed water distribution piping to be purple, with the color integral to the pipe; Pantone 512 or 522 is often specified for this purpose (**Figure 2-2**). Reclaimed water piping should be identified in a manner consistent with state design criteria, which may include labeling or tags as well as signage along the piping alignment. Pipe material is often PVC, as color is readily incorporated into the pipe during manufacturing. For larger systems that use concrete steel cylinder pipe for transmission mains, purple dye can be added to the mortar during manufacture of the pipe, as is the practice for most of the large diameter pipes in the transmission lines in the San Antonio Water System (SAWS).



Figure 2-2
36-inch CSC 301 purple mortar pipe, San Antonio Water System (SAWS).
(Photo credit: Don Vandertulip)

Where utility preference or construction conditions dictate the use of other pipe material, such as ductile iron pipe, purple plastic sleeves can be used to provide corrosion control and identify the water main as a reclaimed water main. Likewise, steel pipe can be painted and high density polyethylene (HDPE) pipe can be ordered with purple stripes integral to the pipe.

Separation distances are required between reclaimed water pipes and water and sewer pipes, typically identified as 9 or 10 ft (3 m) pipe-to-pipe horizontal separation between reclaimed water and potable water piping. The same provision typically applies to separation distance between a reclaimed water pipe and a sanitary sewer main. Where a crossing occurs, the pipe with the highest quality product should be located above the other two, with 1 ft (0.3 m) vertical separation between any two pipes. Specifically, potable pipe should be above reclaimed water pipe, and reclaimed water pipe should be above the sanitary sewer main, as shown in **Figure 2-3**.

2.2.3.2 Reclaimed Water Appurtenances

Reclaimed water distribution systems will have all of the appurtenances typical of a potable water system. Most of the typical system components are now available in purple to support increased installation of purple color-coded reclaimed water systems. Valve riser covers are often triangular or square to distinguish them from potable water covers; reclaimed water system valves can be ordered as plant valves with opposite open and close positions from potable valves. Backflow prevention devices, air relief valves, meter boxes, and sprinkler heads are all available in purple. All components and appurtenances of a nonpotable system should be clearly and consistently identified throughout the system. Identification should be through color coding and marking so that the nonpotable system (i.e., pipes, pumps, outlets, and valve boxes) is distinctly set apart from the potable system. The methods most commonly used are unique colorings, labeling, and markings.

Location of Public Water System Mains in Accordance with F.A.C. Rule 62-555.314

Figure 2-3

Appropriate separation of potable, reclaimed water, and sanitary sewer pipes (FDEP, n.d.)

A reclaimed water distribution system typically requires signage at facilities (e.g., pump stations, storage, etc.), and some states require marking of utility pipelines along the alignment. For irrigation components that incorporate hose bibs, most state regulations require a locking hose vault or quick connection assembly to preclude unauthorized connection and use of the reclaimed water. Purple asset identification tags can be attached to valve box lids, valve handles, backflow preventers, and other appurtenances to readily identify these system components. All major irrigation system suppliers have snap-on components (rings) in purple that can be added to existing sprinkler heads, as shown in **Figure 2-4**. Purple Mylar pre-printed stickers are also popular and can be wrapped around pop-up sprinkler heads to identify the system as providing reclaimed water.

2.2.3.3 On-site Construction Considerations

Many reclaimed water providers provide guidance and instructions to property owners connecting to the reclaimed water system. This can include user manuals and training classes for on-site supervisors of commercial properties. These manuals and instructions typically cover state and local regulations related to reclaimed water, proper use, cross-connection control, and on-site construction standards and materials. Good examples of user manuals are those provided by SAWS and DSRSD (SAWS, 2006 and DSRSD, 2005). Tucson has developed an extensive cross-connection control program and a manual for its cross-connection control specialist; more information on the Tucson Site Inspection Program is available in a case study [[US-AZ-Tucson](#)].

Typically, utility design criteria apply within the public right-of-way, and locally-adopted plumbing code controls, construction practices, permits, and construction inspections apply for work on private property. There are two plumbing codes in general use within the United States: the Uniform Plumbing Code produced by the International Association of Plumbing and Mechanical Officials (IAPMO) and the International Plumbing Code produced by the International Code Council (ICC). Beginning in 2008, several professional organizations (WaterReuse Association [WRA], Water Environment Federation [WEF], AWWA) serving reclaimed water utilities began a dialogue with IAPMO, and eventually also with ICC, attempting to change plumbing code pipe color requirements adopted in 2009. The proposal requires

all pipe conveying alternate waters to be purple; alternate waters includes reclaimed water provided by the off-site municipal utility provider but also would include any other nonpotable water generated on the private property. The issue for many utilities is the significant water quality difference between municipally produced, tested, and distributed reclaimed water and other on-site water, including graywater, which is by definition “wastewater.” The second issue that surfaced was the plumbing code’s use of green pipe to designate potable water. In the municipal utility business, blue is the color used to designate potable water piping while green is used to designate wastewater. This identified a potential cross-connection problem that, to date, is unresolved.



Figure 2-4
Purple snap-on reclaimed water identification cap
(Photo credit: Rain Bird)

Color coding of utility piping systems has been practiced for decades, and the roots of the current American National Standard Institute (ANSI) Standard Z-535 color standard in the United States can be traced back to the July 16, 1945 American Standard Association (ASA) approval of safety color standards at the request of the War Department (ANSI, 2007).

The American Public Works Association (APWA) Uniform Color Standard was initially adopted in 1980 (Precaution Blue for water systems and Safety Green for sewer systems), and an updated policy that added purple for reclaimed water pipes was adopted in 2003. The use of purple pipe to designate reclaimed or recycled water was first adopted by the AWWA California-Nevada Section in 1997. The California Department of Health Services and Nevada Division of

Environmental Protection reviewed and accepted the guidelines (AWWA, 1997). More recently, the Common Ground Alliance (CGA) was formed by the Department of Transportation in 1998, and in 2009 the CGA adopted the APWA Uniform Color Standard. The CGA Uniform Color Code and Marking Guideline, Appendix B (CGA, 2011) is the basis of color-code marking for the national One-Call System used to locate and mark underground utilities prior to construction (Vandertulip, 2011a).

Three states have addressed the issue of on-site purple pipe application for conveyance of alternative waters. California adopted final rules for graywater systems that became effective January 27, 2010, as Title 5, Part 24, Chapter 16A Nonpotable Water Reuse Systems. Purple pipe requirements in California's state code for recycled water (Title 22) were maintained for reclaimed water piping in a building, and Universal Product Code (UPC) 1610.2 state adoption of the plumbing code excludes reference to pipe color for alternate waters. In similar fashion, Florida adopted the International Plumbing Code (IPC) without adopting the pipe color code sections, while maintaining Section 602 requirements that reclaimed water be distributed in purple pipe. Washington state modified the base UPC in WAC 51-56-1600 Chapter 16—Gray water systems 1617.2.2 Other Nonpotable Reused Water to maintain yellow pipe with black text designating the type of nonpotable water while 1617.2.1 maintained purple pipe for reclaimed water (Vandertulip, 2011b).

2.2.4 Institutional Considerations

The rules and regulations governing design, construction, and implementation of reuse systems are described in Section 2.2.3, and the practical implications of these rules can be found in Chapter 4. In addition to rules specifically aimed at water reuse projects, regulations governing utility construction in

general also apply. The details of such rules are beyond the scope of this document but can be promulgated by state agencies (including health departments) and local jurisdictions or can be established by federal grant or loan programs.

Once facilities have been constructed, state and local regulations often require monitoring and reporting of performance, as described in Chapter 4. To provide production, distribution, and delivery of reclaimed water, as well as payment for it, a range of institutional arrangements can be utilized, as listed in **Table 2-1**.

It is necessary to conduct an institutional inventory to develop a thorough understanding of the institutions with jurisdiction over various aspects of a proposed reuse system. On occasion there is an overlap of agency jurisdiction, which may cause conflict unless steps are taken early in the planning stages to obtain support and delineate roles. The following institutions should be involved or, at a minimum, contacted: federal and state regulatory agencies, administrative and operating organizations, and general units of local (city, town, and county) government.

In developing a viable arrangement, it is critical that both public and private organizations be considered. As access to public funds decrease, the potential for private capital investment increases. It is vital that the agency or entity responsible for financing the project be able to assume bonded or collateralized indebtedness, if such financing is likely, and have accounting and fiscal management structures to facilitate financing (see Chapter 7). Likewise, the arrangement must designate an agency or entity with contracting power so that agreements can be authorized with other entities in the overall service structure. Additional responsibilities may be assigned to different groups depending on their historical roles and technical and managerial expertise. Close internal coordination between departments and branches of

Table 2-1 Common institutional arrangements for water reuse

| Type of Institutional Arrangement | Production | Wholesale Distribution | Retail Distribution |
|---|-----------------------------|-----------------------------|----------------------------|
| Separate Authorities | Wastewater Treatment Agency | Wholesale Water Agency | Retail Water Entity |
| Wholesaler/Retailer System | Wastewater Treatment Agency | Wastewater Treatment Agency | Retail Water Entity |
| Joint Powers Authority (for Production and Distribution only) | Joint Powers Authority | Joint Powers Authority | Retail Water Entity |
| Integrated Production and Distribution | Water/Wastewater Authority | Water/Wastewater Authority | Water/Wastewater Authority |

local government, along with a range of legal agreements, will be required to ensure a successful reuse program. Examples of institutional agreements developed for water reuse projects are provided in the 2004 guidelines in Chapter 5 and in a case study [US-CA-San Ramon].

Finally, the relationship between the water purveyor and the water customer must be established, with requirements on both sides to ensure reclaimed water is used safely. Agreements on rates, terms of service, financing for new or retrofitted systems, educational requirements, system reliability or scheduling (for demand management), and other conditions of supply and use reflect the specific circumstances of the individual projects and the customers served. (See Chapter 7 for a discussion of the development of the financial aspects of water reuse fees and rates.) In addition, state laws, agency guidelines, and local ordinances may require customers to meet certain standards of performance, operation, and inspection as a condition of receiving reclaimed water. However, where a system supplies a limited number of users, development of a reclaimed water ordinance may be unnecessary; instead, a negotiated reclaimed water user agreement would suffice. It is worth noting that in some cases, where reclaimed water is still statutorily considered effluent, the agency's permit to discharge wastewater—along with the concomitant responsibilities—may be delegated by the agency to customers whose reuse sites are legally considered to be distributed outfalls of the reclaimed water.

2.3 Managing Reclaimed Water Supplies

Managing and allocating reclaimed water supplies may be significantly different from the management of traditional water sources. Traditionally, a water utility drawing from groundwater or surface impoundments uses the resource as both a source and a storage facility. If the entire yield of the source is not required, the water is simply left for use at a later date. Yet in the case of reuse, reclaimed water is continuously generated, and what cannot be used immediately must be stored or disposed of in some manner. As a traditional reclaimed water system expands, an increasing volume of water may need to be stored. Depending on the volume and pattern of projected reuse demands, in addition to operational storage considerations, seasonal storage requirements may become a significant design consideration and have a

substantial impact on the capital cost of the system. While some systems continue to rely on conventional disposal alternatives, the increasing value of reclaimed water is also resulting in more research into practices that provide for increased storage volumes, supplemental water supplies that allow an increased customer base, and improved seasonal management, which together reduce the need for discharges to streams or ocean outfalls.

Where water reuse is being implemented to reduce or eliminate wastewater discharges to surface waters, state or local regulations usually require that adequate seasonal storage be provided to retain excess wastewater under a specific return period of low demand. In some cold climate states, storage volumes may be specified according to projected nonapplication days due to freezing temperatures. Failure to retain reclaimed water under the prescribed weather conditions may constitute a violation of an NPDES permit and result in penalties. A method for preparing storage calculations under low-demand conditions is provided in the *EPA Process Design Manual: Land Treatment of Municipal Wastewater* (EPA, 2006). In many cases, state regulations will also include a discussion about the methods to be used for calculating the storage required to retain water under a given rainfall or low demand return interval. In almost all cases, these methods will be aimed at demonstrating sites with hydrogeologic storage capacity to receive treated effluent for the purposes of disposal. In this regard, significant attention is paid to subsurface conditions as they apply to the percolation of effluent into the groundwater with specific concerns as to how the groundwater mound will respond to effluent loading. Because seasonal storage is such an important factor in maximizing use of reclaimed water, this section provides a discussion of considerations for seasonal storage systems, including surface water storage as well as managed aquifer recharge practices.

Another option to maximize the use of reclaimed water is to supplement reclaimed water flows with another water source, such as groundwater or surface water. Supplemental sources, where permitted, can bridge the gap during periods when reclaimed water flows are not sufficient to meet the demands. This practice allows connection of additional users and increases reuse versus disposing of excess reclaimed water. Additionally, operational strategies can be

implemented to meet peak demands while maximizing the use of reclaimed water during other times of the year. One such strategy is the use of curtailable customers. Brevard County, Fla., has a group of reclaimed water users referred to as “curtailable customers”—customers that maintain an alternative water source (e.g., golf courses that still have irrigation wells as back-up supplies) that can be used during peak demand periods to release reclaimed water demand to meet seasonal peak demands in other areas of their reuse system.

2.3.1 Operational Storage

In many cases, a reclaimed water distribution system will provide reclaimed water to a diverse customer base. Urban reuse customers typically include golf courses and parks and may also include commercial and industrial customers. Such is the case in the city of St. Petersburg, Fla., and Irvine Ranch Water District, Calif. These reuse programs, which were previously described in the 2004 guidelines, provide water for cooling, wash-down, toilet flushing, and irrigation (EPA, 2004). Each water use has a distinctive demand pattern and, thereby, impacts the need for storage. While there are systems that operate without seasonal storage, thus limiting their ability to maximize beneficial reuse of the available reclaimed water, the increasing value of reclaimed water is driving better use of operational storage facilities. As a supplement to engineered storage systems, as discussed in Section 2.3.2.4, aquifer storage and recovery (ASR) has tremendous potential to better align reclaimed water availability and with demand, particularly for long periods of time. The potential storage volumes for ASR and the land requirements may be much greater than for conventional engineered systems such as above-ground storage tanks and surface reservoirs.

Planners are referred to text in the 2004 guidelines for additional discussion on planning seasonal system storage (EPA, 2004). When considering reclaimed water distribution system storage, planners and engineers should consider the types of users, potential peak demands (daily and seasonal), potential for concurrent peaks, time-of-day restrictions for irrigation, and whether the reclaimed water system will be designed to meet fire protection requirements. Retrofitted dual water systems usually do not include fire protection as the existing potable water system has usually been designed to meet domestic

requirements, irrigation demands, and concurrent fire flow requirements. By transferring the irrigation demands from the potable water system to the reclaimed water system, the capability of the existing potable water system is extended, and system components for the reclaimed water system can focus on the irrigation and industrial demands. Because there are different peaking factors and time-of-day demands on industrial demands compared to irrigation demands, extended-period simulation models can be used to assist designers in selecting appropriate storage volumes. As discussed in Section 2.2.3, large system users may be required to provide their own on-site storage, allowing multiple large users to be supplied at a constant flow rate over the full 24-hour day. This can decrease pumping and system storage requirements. Some utilities, such as the Loxahatchee River District in Florida, have the ability to curtail deliveries of reclaimed water to large users through telemetry-controlled valves once contractual volumes are met or during periods of extremely high demand.

From an operational perspective, maintaining a chlorine residual in the reclaimed water system is as important as maintaining a residual in the potable water system. Public health decisions should control design decisions; maintaining good bacteriological quality in a reclaimed water system where occasional contact with the public is likely dictates monitoring and control measures. This could include chlorine residual analyzers at system storage and booster pump stations to confirm adequate chlorine residuals and systems to add incremental amounts of disinfectant to maintain high water quality. Operational practices that decrease water age by keeping the reclaimed water moving through the system can also improve the quality of the delivered water and decrease system maintenance efforts. Maintaining positive water movement during low-flow/low-demand periods of the year can be accomplished by operating tanks at lower elevations or by having a discharge point at the far ends of the reclaimed water distribution system. In an ideal design, a large customer with continuous demands would be located at the end of the system, ensuring continuous flow through the piping. If there is an opportunity to include discharge to a creek or other water feature near the end of the distribution system, this environmental augmentation can provide a base flow that will assist in maintaining reclaimed water quality in the distribution system. Another alternative is to install air-gap discharges to a sanitary sewer that

will provide a continuous flow in the reclaimed water transmission main even during periods of low demand.

Tank material selection should be based on the material selection criteria applied to the local water system. This guidance is based on the delivery of reclaimed water that is stabilized and meeting state-defined water quality goals. For advanced purification systems that include reverse osmosis (RO), reclaimed water product should be stabilized prior to pumping into the distribution system and storage.

Reclaimed water storage tanks are likely to encounter the same public scrutiny as potable storage tanks. When retrofitting an existing system, consider the tank locations already controlled by the utility, and determine if these sites can accommodate a reclaimed water tank. If the potable water tank is located on a high tract of land to minimize tank elevation or pumping head, that same advantage would apply to the reclaimed water system. Tank color may be another common issue to consider. Many states will have labeling requirements, but color choices for the tank structure may not be specified. Maintaining one tank bowl color can provide for a consistent appearance and reduce maintenance cost while reducing customer questions. As with potable storage systems, tank sites should be secure and often are connected into the utility supervisory control and data acquisition (SCADA) system, with water system operators monitoring and controlling the two parallel systems.

2.3.2 Surface Water Storage and Augmentation

The reuse of water after discharge into surface water often results in augmentation of potable water supplies where surface water is used for potable water supply. While there are other uses that benefit from surface water storage and augmentation, this section focuses on surface discharge as it relates to unplanned or planned indirect potable reuse, which are also discussed in greater detail in Section 3.7. Unplanned or incidental indirect potable reuse has occurred for decades as utilities pursued the most plentiful, appropriate, and cost-effective options for water supplies. The recent National Academy of Science report, *Water Reuse: Potential for Expanding the Nation's Water Supply through Reuse of Municipal Wastewater* described *de facto* reuse (discussed further in Chapter 3), which is the unplanned reuse of

treated wastewater that has been discharged to the environment as source water (NRC, 2012). In most cases, the decision to intentionally use or not use a surface water source that included some water that originated as treated wastewater was based on availability and yield of the source water, cost, public acceptance, and public confidence in water treatment processes. The balance of these factors is different for each utility and the communities it serves. In most cases, discharges upstream of surface water sources are designed to meet permit limits and corresponding water quality standards that are protective of beneficial uses downstream of the discharge, including withdrawals for public water supply.

In some cases, the incremental addition of various advanced treatment processes to a reclaimed water treatment process will allow the reclaimed water to meet surface water quality standards, thereby making it a viable option to augment water supplies, e.g., the SDWA. The incentive to provide this additional treatment for surface water augmentation may be driven by regulations intended to protect water supplies, but in most cases it is linked to the benefits derived by the discharger or a downstream community seeking to increase the yield of water supplies on which they depend either directly or indirectly.

While satisfying the decision factors noted above may be necessary to pursue indirect potable reuse, there are two additional factors that typically control viability of implementation. First, although existing water supplies may be of limited availability and yield, there still must be a means to reap the benefits of withdrawing the additional yield of the augmented water supply via water rights, permits, storage contracts, etc. In other words, a utility can rarely be expected to expend funds in excess of what is required by regulation or law unless there is a recognized benefit to its ratepayers. Second, the public acceptance of indirect potable reuse is of paramount importance but must be based on the specifics of the project and the local community. The following examples illustrate how these key components can play out in project planning and implementation.

An often-cited example of surface water augmentation is the Upper Occoquan Service Authority's (UOSA) discharge into the Occoquan Reservoir in northern Virginia [[US-VA-Occoquan](#)]. In this particular case,

serious water quality issues were caused by multiple small effluent discharges into the reservoir. The Fairfax County Water Authority withdraws water from the Occoquan Reservoir to meet the water supply needs of a large portion of northern Virginia. UOSA was formed in 1971 to address the water quality problem by the same local government entities that relied on the reservoir for their water supply. Therefore, these local governments, and by proxy their residents, received the benefits of the investments in additional wastewater treatment, satisfying the first key component that their water supply was now both protected and augmented. Regarding the second key component, the improvements made a dramatic improvement in the water quality of the reservoir that was readily visible to the general public. Algae blooms, foul odors, low dissolved oxygen (DO) for fish, and other factors were addressed by the regionalization and additional treatment processes, which provided the public with a tangible example of a system that resulted in improved water quality over past practices.

Another example is the Gwinnett County, Ga., discharge to Lake Lanier. Lake Lanier is formed by Buford Dam, which is operated by the U.S. Army Corps of Engineers (USACE) on the Chattahoochee River north of Atlanta. Gwinnett County withdraws all of its water from Lake Lanier, as do several other communities around the lake. Given the linkage between water withdrawal from the lake and the desire to return reclaimed water to the lake, the first key component was satisfied by the issuance of a revised state withdrawal permit and amended USACE storage contract that provided credit for the water returned. In this case, the key issues were permitting the discharge and the multiple administrative and legal challenges raised by stakeholders with interests in the lake. Because the focus of these stakeholders was primarily lake quality, discharge limits were made significantly more stringent using anti-degradation regulations as the rationale. In a federal court decision in September 2011, it was determined that Georgia could not use the lake for water supply. Georgia's neighbors, Alabama and Florida, have argued that Congress never gave Georgia permission to use the federal reservoir as a water source (Henry, 2011 and Section 5.2.3.5).

2.3.3 Managed Aquifer Recharge

As our population continues to grow and the associated demand for water increases, alternative water resources may play a greater role in meeting

water demands. Reclaimed water is a safe and reliable source of supply for replenishing groundwater basins, creating salt water intrusion barriers, and mitigating the negative impacts of subsidence caused by over withdrawal of groundwater. Aquifer recharge has a long history, and there are abundant examples of successfully managed programs. Managed aquifer recharge (MAR) has been successfully applied in California for almost 50 years; the Montebello Forebay Groundwater Recharge Project uses recycled water to recharge the Central Groundwater Basin and provides 40 percent of the total water supply for the metropolitan area of Los Angeles County, Calif. [[US-CA-Los Angeles County](#)].

Other MAR projects have been implemented to aid in maintaining a salt balance in water supply aquifers, as demonstrated in a case study on the Santa Ana River Basin [[US-CA-Santa Ana River](#)]. In Arizona, the Groundwater Management Act allows users to store recharged water and sell the associated water rights. This led to the first-ever auction of reclaimed water rights in Prescott Valley. The ability to bank recharged reclaimed water provided the versatility necessary for the auction [[US-AZ-Prescott Valley](#)]. In Mexico City, reclaimed water is being used to recharge the local aquifer, which is overdrawn by 120 percent, leading to the subsidence of the soil in some places at a rate of up to 16 in/yr (40 cm/yr) [[Mexico-Mexico City](#)]. (National Water Commission of Mexico, 2010).

MAR systems may be described in terms of their five major components: a source of reclaimed water, a method to recharge, sub-surface storage, recovery of the water, and the final use of the water. One of the key considerations in MAR is managing the travel time of reclaimed water before it is recovered for use. As a result, the identification, selection, and testing of environmentally-acceptable tracers for measuring travel times of reclaimed water and its constituents in recharge systems has been the subject of recent research. In the research report *Selection and Testing of Tracers for Measuring Travel Times in Natural Systems Augmented with Treated Wastewater Effluent* (WRRF, 2009), a summary of literature related to conservative and surrogate tracers for reclaimed water constituent transport in the subsurface is provided along with the materials and results from tracer experiments on three common recharge systems augmented with reclaimed water, information on the

process for regulatory approval of the use of tracers for reclaimed water recharge systems, and field methods for conducting tracer tests. Reclaimed water can be directly or indirectly used after sub-surface storage. Some systems both directly and indirectly use reclaimed water when demand for irrigation is high and recharge water for future indirect use when demand for irrigation is low.

The two primary types of groundwater recharge are surface spreading and direct injection. Vadose zone injection wells have been increasing in use as this technology has become established in recent years. **Figure 2-5** illustrates these recharge methods. Direct injection wells may also be used as dual-purpose ASR wells for both recharging and recovering stored water. The recharge method will depend on the aquifer type and depth and on the aquifer characteristics, which impact the ability to recharge water into the storage zone and later recover that water. The use of recharge basins and vadose zone injection wells is restricted to unconfined aquifers, while direct injection systems may be used in both unconfined and deeper confined aquifer systems.

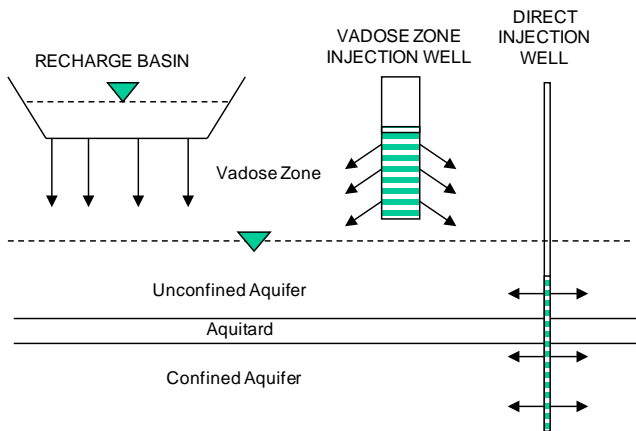

Figure 2-5
Commonly used methods in managed aquifer recharge

There are many site-specific variables that affect the design and selection of the most appropriate MAR system for a specific application. As shown in **Figure 2-6**, the first critical question is “what aquifer is being considered for use in the MAR system?” If a confined aquifer is being considered, then direct injection is the only feasible alternative; direct injection may include either single-use injection wells or the dual-purpose wells used in ASR systems. If the goal of a groundwater recharge project is to provide short-term

storage and the water must be recovered quickly, then ASR systems might be the only feasible alternative. If an existing distribution and well system may be utilized as part of an ASR system, then dual-purpose direct injection wells might be the best choice. If an unconfined aquifer is being considered, there are no constraints on the choice of recharge method.

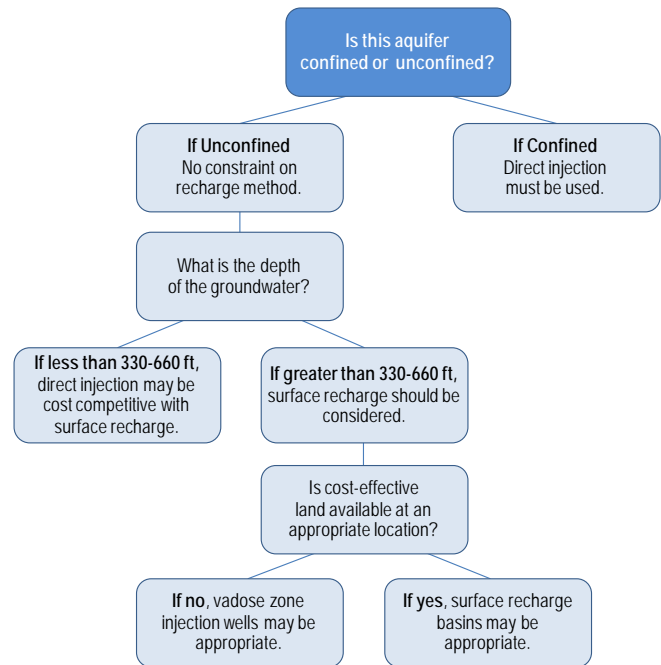

Figure 2-6
Sample decision tree for selection of groundwater recharge method

For unconfined aquifers, as the depth to groundwater increases, the cost of direct injection wells increases; therefore, the effect of depth should be evaluated for each situation. Land price, location, and availability are also key considerations. Potential negative impacts from rising groundwater levels, including groundwater mounding, must also be considered.

2.3.3.1 Water Quality Considerations

Depending on the method and purpose of groundwater recharge, most states require either a minimum of secondary treatment with or without additional filtration for groundwater recharge. State Underground Injection Control programs and Sole Source Aquifer Protection are included under Sections 1422 of the SDWA, which provides safeguards so that aquifer recharge and ASR

wells do not endanger current and future underground sources of drinking water. There is currently no specific requirement for nutrient removal, but lower effluent nutrient concentrations required for point-source discharges could meet strict nutrient groundwater recharge requirements, such as the 0.5 mg/L ammonia limit in Miami-Dade County for the South District Water Reclamation Plant (SDWRP), without additional treatment. Additionally, the California *Draft Regulations for Groundwater Replenishment with Recycled Water* proposes a 10 mg/L total nitrogen limit for recycled water (California Department of Public Health [CDPH], 2011). Nutrient removal at the wastewater plant is also thought to remove *N*-nitrosodimethylamine (NDMA) precursors, reducing the potential formation of NDMA. Generally, direct injection requires water of higher quality than is required for surface spreading because of the absence of a vadose zone and/or shallow soil matrix treatment afforded by surface spreading, as discussed in Chapter 6. In addition, higher-quality water is needed to maintain the hydraulic capacity of the injection wells, which can be affected by physical, biological, and chemical clogging. Water quality parameters are typically measured at the end of the treatment plant, but some agencies, such as Florida's Miami-Dade Department of Environmental Resources Management (DERM), allow projects to meet the requirements at the nearest ecological receptor.

In many cases, wells used for injection and recovery of reclaimed water are classified by EPA as Class V injection wells, and some states, including California and Florida, require that the injected water must meet drinking water standards prior to injection, depending on the native quality of water in the aquifer being recharged. Typical water quality parameters used for regulating recharge include total nitrogen, nitrate, nitrite, total organic carbon (TOC), pH, iron, total coliform bacteria, and others, depending on the use of the aquifer. Other water quality parameters can be used to estimate potential well corrosion or fouling, including calculated values such as the Langelier Saturation Index (LSI), the Silt Density Index (SDI), and the Membrane Fouling Index (MFI). Information and global case studies on specific treatment technologies to address microbial and chemical contaminants for MAR applications are available in *Water Reclamation Technologies for Safe Managed Aquifer Recharge* (Kazner et al., 2012).

Other criteria specific to the quality of the reclaimed water, groundwater, and aquifer matrix must also be taken into consideration. These include possible undesirable chemical reactions between the injected reclaimed water and groundwater, iron precipitation, arsenic leaching, ionic reactions, biochemical changes, temperature differences, and viscosity changes. Most clogging problems are avoided by proper pretreatment, well construction, and operation (Stuyfzand, 1998). Hydrogeochemical modeling should be performed to confirm compatibility of the recharge water and the aquifer matrix. In some areas, such as South Florida and Southern California, naturally-occurring arsenic-containing minerals in the aquifer matrix may leach into the groundwater due to changes in oxidation-reduction potential (ORP) during injection, storage, and recovery. Arsenic in recovered water has been detected or is a significant concern based on area ASR projects. Approaches to minimizing arsenic levels and other trace inorganic leaching/transport can include controlling the pH and matching the ORP of the recharge water with the ORP of the ambient groundwater. For direct injection to a highly permeable aquifer, such as the Biscayne Aquifer in South Florida, additional nutrient limits that are stricter than those required for typical direct injection may be set. The nutrient requirements address the potential impacts to nearby surface waters, such as rivers, lakes, canals, and wetlands that are hydrologically connected and supported by the aquifer. For the SDWRP, DERM has a very low ammonia requirement (0.5 mg/L) and includes phosphorus removal in its antidegradation water quality requirements.

2.3.3.2 Surface Spreading

Surface spreading is the most widely-used method of groundwater recharge due to its high loading rates with relatively low maintenance requirements. At the spreading basin, the reclaimed water percolates into the soil, consisting of layers of loam, sand, gravel, silt, and clay. As the reclaimed water filters through the soil, these layers allow it to undergo further physical, biological, and chemical purification through a process called Soil Aquifer Treatment (SAT); ultimately, this water becomes part of the groundwater supply. SAT systems require unconfined aquifers, vadose zones free of restricting layers, and soils that are coarse enough to allow for sufficient infiltration rates but fine enough to provide adequate filtration. A summary and discussion of the removal mechanisms for pathogens, organic carbon, contaminants of concern, and nitrogen

during SAT are provided in Chapter 6. These mechanisms are important when spreading basins and analogous systems, such as bank filtration, are used; this treatment also occurs to a varying extent during ASR, vadose zone injection, and direct injection. Though management techniques are site-specific and vary accordingly, some common principles are practiced in most spreading systems. The three main engineering factors that can affect the performance of surface spreading systems are reclaimed water pretreatment, site characteristics, and operating conditions (Fox, 2002).

Reclaimed Water Pretreatment. Municipal wastewater typically receives a minimum of conventional secondary treatment, but may also receive filtration followed by disinfection (e.g., chlorination) prior to groundwater recharge. Some utilities are beginning to further treat the reclaimed water with microfiltration, RO, and ultraviolet (UV) disinfection prior to recharge into potable water aquifers. For reclaimed water that is spread in groundwater basins, the soil itself provides additional treatment to purify the water through SAT. Reclaimed water pretreatment directly impacts the performance of a SAT system. While RO processes provide high reclaimed water quality, the reject brine waste streams from this process may be difficult to dispose.

Site Characteristics. Local geology and hydrogeology determine the site characteristics for a surface-spreading operation. Site selection is dependent on a number of factors, including suitability for percolation, proximity to conveyance channels and/or water reclamation facilities, and land availability. Design options for spreading grounds are limited to the size and depth of the basins and the location of production wells. The subsurface flow travel time is affected by the well locations.

System Operation. For surface spreading to be effective, the wetted surfaces of the soil must remain unclogged to maximize infiltration, and the quality of the reclaimed water should not inhibit infiltration. Spreading basins are typically operated under a wetting/drying cycle designed to optimize inflow and percolation and discourage the presence of vectors. Spreading basins can be subdivided into an organized system of smaller basins that can be filled or dried alternately to allow maintenance in some basins while others are being used.

Spreading basins should be managed to avoid nuisance conditions, such as algae growth and insect breeding in the basins. This is typically accomplished by rotating a number of basins through wetting, draining, and drying cycles. Cycle length is dependent on soil conditions, the development of a clogging layer, and the distance to the groundwater table. Algae can clog the bottom of basins and reduce infiltration rates. Algal growth can be minimized by upstream nutrient removal or by reducing the detention time of the reclaimed water within the basins, particularly during summer periods when algal growth rates increase due to solar intensity and increased temperature.

Periodic maintenance, which involves cleaning the basin bottom by scraping the top layer of soil, is used to prevent clogging. Disking of the basin to break up surface clogging is generally not used as it forces finer clay particles deeper into the soil column. When a clogging layer develops during a wetting cycle, infiltration rates can decrease to unacceptable levels. The drying cycle allows for the aeration and drying of the clogging layer and the recovery of infiltration rates during the next wetting cycle.

2.3.3.3 Injection Wells

Methods for recharging groundwater using injection wells can include injection either into the vadose zone or directly into the aquifer. Each injection method has its own unique applicability and requirements, which vary with location, quantity and quality of source water, and hydrogeology of the vadose zone and target aquifers. While direct injection wells are more expensive than vadose zone wells, the control of where the water is injected minimizes risks associated with lost water. Direct injection wells can also be cleaned and redeveloped, which reduces fouling and lengthens the life of the wells. A summary of vadose zone and direct-injection well construction and operation is presented in **Table 2-2**, including the main advantages and disadvantages for each of the recharge methods. Vadose zone wells are the least expensive injection method, but they have a limited life and must be replaced periodically. Direct injection wells are more costly, can be maintained for a longer life, and allow water to be directly and quickly recharged into the targeted aquifer.

Table 2-2 Comparison of vadose zone and direct injection recharge wells

| Recharge Method | Main Advantages | Main Disadvantages |
|-----------------------------|--|---|
| Vadose Zone Wells | <ul style="list-style-type: none"> - Suitable for unconfined aquifers - Bypass low permeability layers - Decreased travel time to aquifers versus surface spreading - Lower cost - SAT benefits to water quality - May allow smaller setback from extraction wells | <ul style="list-style-type: none"> - Inability to rehabilitate clogged wells - Decreased certainty of migration pathways - Requires operation to avoid air entrainment - Deeper wells needed to penetrate deep clay layers - New wells required periodically - Greater risk of water loss |
| Groundwater Injection Wells | <ul style="list-style-type: none"> - Can target specific aquifers and locations - Benefits groundwater levels immediately - Wells can be cleaned and redeveloped - Can be maintained for a longer life | <ul style="list-style-type: none"> - Wells can be costly to install and maintain - Periodic pumping required to maintain capacity - Foot valves may be required to minimize air entrainment |

Vadose Zone Injection. Vadose zone injection wells for groundwater recharge with reclaimed water were developed in the 1900s and have been used primarily where aquifers are very deep and construction of a direct-injection well is difficult and expensive. A vadose zone well is essentially a dry well, installed in the unsaturated zone above the permanent water table. These wells typically consist of a large-diameter borehole, sometimes with a casing or screen assembly, installed with a filter pack. The well is used to transmit recharge water into the ground, allowing water to enter the vadose zone through the well screen and filter pack and percolate into the underlying water table. Creating this conduit into the ground can be advantageous where surficial soils or the shallow subsurface contain clay layers or other low-permeability soils that impede percolation deep into the ground. Vadose zone wells allow recharge water to bypass these layers, reaching the water table faster and along more direct pathways. Typical vadose zone injection wells vary in width from about 2 ft (0.5 m) up to 6 ft (2 m) in diameter and are drilled 100 to 150 ft (30 to 46 m) deep. A vadose zone injection well is backfilled with porous media, and a riser pipe is used to allow water to enter at the bottom of the wells to prevent air entrainment. An advantage of vadose zone injection wells is significant cost savings when compared to direct-injection wells.

Although the infiltration rates of vadose zone wells are often similar or slightly better as compared to direct-injection wells, they cannot be backwashed, and a severely clogged well may be permanently destroyed. Therefore, reliable pretreatment is considered essential to maintaining performance of a vadose zone

injection well. Maintenance of a disinfection residual is critical if the water has not been treated by RO. Because of the considerable cost savings associated with vadose wells as compared to direct injection wells, the estimated 5-year life cycle for a vadose injection well can still make it an economical choice. And, because vadose zone injection wells allow for percolation of water through the vadose zone and flow into the saturated zone, it should be expected that some water quality improvements similar to soil aquifer treatment would be achieved (see Chapter 6 for further discussion).

The number of vadose zone injection wells is dependent on the recharge capacity of the soil matrix. Recharge capacities can be estimated from test wells and infiltration tests. The head required to drive the water into the ground is influenced by the lithology and hydraulic conductivity (permeability) of the soil in the vadose zone. Because the movement of the water is highly dependent on localized features, such as clay layers or low-permeability lenses, movement is difficult to predict. Capture of the recharge water within the aquifer for extraction is also less certain than with direct injection, and vadose zone projects are at greater risk of water loss.

Vadose zone injection facilities were constructed as part of the city of Scottsdale’s Water Campus project northeast of downtown Phoenix, Ariz. The project has 35 active injection wells (with 27 back-up wells) with a capacity of about 400 gpm each. The wells were constructed to a depth of 180 to 200 ft with the aquifer water level approximately 1,200 ft below ground surface (bgs). Vadose zone injection wells of similar

design are also used by the cities of Gilbert and Chandler, Ariz. Reuse projects in other areas, such as the Seaside Basin in the Monterey Bay area of California, have also considered the use of vadose zone wells because of the depth to groundwater (300+ ft bgs). According to groundwater modeling estimates, it would take almost 300 days for the water recharged in the vadose zone to reach the top of the aquifer. Because of clay layers and other low-permeability soil lenses, there is minimal control of where the recharged water enters the underlying aquifer and at what rate.

Rapid Infiltration Trenches. Rapid infiltration trenches (RITs) are not vadose zone wells, but are similar in that recharge water is discharged into a media-filled “hole” or trench. Unlike the vertically-constructed vadose zone well, however, RITs are long, horizontal trenches excavated into the soil and filled with media. A horizontal, perforated pipe conveys the water into the RIT where it percolates into the underlying soil. RITs can be excavated into the vadose zone where the groundwater is deep, or into the aquifer where groundwater levels are close to the surface. Because RITs are not true wells, specialty contractors are not required, and the costs can be less than either vadose zone or direct-injection wells.

Direct Injection. Direct-injection systems involve pumping recharge water directly into either a confined or unconfined aquifer. Direct injection is used where space or hydrogeological conditions are not conducive to surface spreading; such conditions might include unsuitable surface/near-surface soils of low permeability, unfavorable topography for construction of basins, the desire to recharge confined aquifers, or scarcity of land. Direct injection is also an effective method for creating barriers against saltwater intrusion in coastal areas and for development of ASR systems using dual-purpose wells. In designing a direct-injection well system, it is critical to fully characterize the target aquifer and surrounding confinement hydraulics that will affect migration of the reclaimed water. Additionally, water quality within the reuse system and the target aquifer must be balanced along with the needs of the end user in development of a direct-injection system.

A direct-injection well is drilled into the targeted aquifer, discharging recharge water at a specific depth within the aquifer. Direct-injection wells are similar to extraction wells in that they have a borehole and

casing and may have screens, granular media around the well, and a drop pipe into the well. The diameter of the well depends on required flow and the ability of the aquifer to move the water. Screened wells are required in unconsolidated formations whereas open-hole construction is typically used in rock formations. The injection well can be designed to target specific aquifers or specific portions of an aquifer that are most suitable for injection. Typical direct-injection wells vary in diameter from about 12 to 30 in (30 to 76 cm), and depths vary from less than 100 ft to more than 1,500 ft (30 to 470 m) in certain applications. Ideally, an injection well will recharge water at the same rate as it can pump yield water; however, conditions are rarely ideal. Injection/withdrawal rates tend to decrease over time, and although clogging can easily be remedied in a surface spreading system by scraping, drying, and other methods, remediation in a direct-injection system can be costly and time consuming, depending on the nature and severity of clogging. The most frequent causes of clogging are accumulation of organic and inorganic solids, biological and chemical precipitates, and dissolved air and gases from turbulence. Low concentrations of suspended solids (1 mg/L) can clog an injection well. Even low concentrations of organic contaminants can cause clogging due to bacteriological growth near the point of injection. Typical remediation of a clogged well is by mechanical means or chemical injection of acids and/or disinfectants.

Treatment of organics can occur in the groundwater system with time, especially in aerobic or anoxic conditions (Gordon et al., 2002; Toze and Hanna, 2002). Therefore, the location of the direct injection wells in relation to the extraction well is critical to determining the flow-path length and residence time in the aquifer, as well as the mixing of recharge water with native groundwater. When recharge water has been treated by RO, improvements in water quality are not expected. There have been several cases where direct-injection systems with wells providing significant travel time have allowed for the passage of NDMA and 1,4-dioxane into recovery wells, even though treatment processes included RO. Additional treatment of reclaimed water is now required to control these contaminants. These trace organic compounds (TrOCs) have not been observed in soil aquifer treatment systems using spreading basins where microbial activity in the subsurface is stimulated. It is uncertain whether RO water discharged into a vadose

zone well will support biological activity and additional treatment; at the Scottsdale Water Campus, attenuation of NDMA during sub-surface transport has been limited with RO-treated water and vadose zone injection wells.

Direct-injection wells have been used for Orange County Water District's (OCWD) Talbert Gap Barrier with water supplied by the Groundwater Replenishment System (GWRS), for the Dominguez Gap Barrier with water supplied by the West Basin Municipal Water District's El Segundo facilities, and for the Alamitos Barrier with water supplied in part by the Water Replenishment District's Leo J. Vander Lans Water Treatment Facility (LVLWTF) [US-CA-Vander Lans]. Direct-injection wells were also proposed for Miami-Dade Water and Sewer Department's SDWRP [US-FL-Miami So District Plant].

2.3.3.4 Recovery of Reclaimed Water through ASR

ASR allows direct recovery of reclaimed water that has been injected into a subsurface formation for storage. ASR can be an effective management tool to provide reclaimed water storage, minimizing seasonal fluctuations in supply and demand, by allowing storage during the wet season when demand is low and recovery of water during dry periods when demand is high. Because the potential storage volume of an ASR system is essentially unlimited, it is expected that these systems will offer a solution to the shortcomings of the traditional, engineered storage techniques. ASR was considered as part of the Monterey County, Calif., reuse program to overcome seasonal storage issues associated with an irrigation-based project. In the United States, reclaimed water ASR projects are currently operating in Arizona, Florida, and Texas (Pyne, 2005; Shrier 2010). Internationally, the only operating ASR systems identified in literature are located in Australia.

While ASR is gaining interest, there are considerations for operation of these systems. Federal Underground Injection Control (UIC) rules do not allow the injection of any fluid other than water meeting drinking water standards into an underground source of drinking water (USDW), which is defined as having a total dissolved solids concentration of less than 10,000 mg/L (EPA, 2001). Section 1453 of the 1996 amendments to the SDWA outlines a Source Water Quality Assessment to achieve maximum public health

protection. This could require reclaimed water to be treated with advanced treatment and disinfection processes, such as RO and UV light with ozone or peroxide, to not only meet drinking water standards but also to address state-specific regulations for trace organics and pathogens. Therefore, many existing reclaimed water ASR projects inject into portions of aquifers beneath the USDW (i.e., into brackish water aquifers). However, there still must be good vertical confinement between the injection zone and the base of the USDW to prevent upward vertical migration of the injected reclaimed water into the USDW. For reclaimed water ASR projects injecting into nonpotable aquifers (total dissolved solids [TDS] >10,000 mg/L), the recovery efficiencies are usually less than for other ASR projects injecting into the USDW.

In addition, potentially undesirable geochemical reactions between the injected fluid and the aquifer matrix must be considered. Unlike other MAR systems, there is a buffer zone where reclaimed water and native groundwater blend in a manner that is distinctly different from other systems. Pathogens and organic contaminants in reclaimed water complicate the use of ASR for reclaimed water storage and recovery, and high levels of treatment and disinfection are needed to implement reclaimed water ASR.

ASR Water Quality Considerations. The primary contaminants in reclaimed water that affect ASR projects include nutrients and metals, pesticides, endocrine disruptor compounds, pharmaceuticals and personal care products, and microbes (WRRF, 2007b). SDWA describes the essential steps for every community to inventory known and potential sources of contamination within their drinking water sources. Nutrients and most bacteria are usually removed in advanced biological wastewater treatment processes. While most large pathogens are not a concern in most MAR systems, the reversal of flow in ASR systems can release materials that are normally removed. These same treatment processes are also typically used to remove the other recalcitrant groups of contaminants listed above. If the TOC concentrations are elevated and chlorine is used for disinfection, disinfection by-products (DBPs) such as trihalomethanes, haloacetic acids, and NDMA can be of concern. A more in-depth discussion of these source water quality concerns is presented in *Prospects for Managed Underground Storage of Recoverable Water and Reclaimed Water Aquifer*

Storage and Recovery: Potential Changes in Water Quality (NRC, 2008 and WRRF, 2007b).

According to the 2007 WaterReuse Research Foundation (WRRF) study referenced above, 13 U.S.-based reclaimed water ASR projects and three international reclaimed water ASR projects were identified in various phases of development and implementation (**Table 2-3**). Two additional projects in Florida were being tested as of 2012; the Collier County and Naples projects are also shown in **Table 2-3**. The reclaimed water source for all 18 ASR projects will meet advanced wastewater treatment levels with disinfection. Additionally, two of the facilities in the United States (Fountain Hills and Scottsdale, Ariz.) and one project in Kuwait (Sulaibiya) are/will be using advanced filtration technologies, such as microfiltration (MF) or MF/RO, to improve water quality prior to injection.

While there are specific water quality requirements for ASR, regulatory agencies also may limit the quantity of reclaimed water used for a groundwater recharge project, also referred to as the reclaimed water contribution (RWC). The RWC is calculated by dividing the volume of reclaimed water recharge by the total volume of water recharge. Other sources of water recharge, which serve to dilute the reclaimed water, must not be of wastewater origin and can include imported water, local water supply, and, potentially, subsurface flow. The inclusion of subsurface flow in the basin recharged by the Inland Empire Utilities Agency in Chino, Calif. has virtually eliminated the need for other sources of water recharge. The RWC may be set by the regulatory agency and can vary depending on the level of effluent treatment, the type of recharge, and project history.

Monitoring. Recharge projects are strictly regulated and subject to complex water quality monitoring and compliance programs that assess all the waters used for recharge of the groundwater system to ensure the protection of human health and the environment. Additionally, water reclamation plant performance reliability is ensured through various in-plant control parameters, redundancy capabilities, and emergency operation plans. This is discussed in greater detail in Section 2.3.4.

The use of recycled water to recharge groundwater via surface spreading or direct injection has been successfully applied in California for almost 50 years [[US-CA-Los Angeles County](#)]. As the future supply of surface water continues to diminish and our population continues to grow, alternative water resources must increase to meet water demands.

Subsurface Geochemical Processes. Adverse geochemical reactions can occur in the storage zone due to differences in water quality between the injected fluid and native water quality (Mirecki, 2004; NRC, 2008). Although relatively uncommon in ASR projects, geochemical reactions can occur that result in dissolution and clogging of the aquifer matrix in the storage zone. The most notable reaction is the oxidation of arsenopyrite, a naturally-occurring mineral in aquifers. When this mineral is oxidized, arsenic is released into the stored water (at concentration in excess of the drinking water maximum contaminant level (MCL) of 10 µg/L) due to differences in ORP between the injected fluid and native groundwater.

Many source waters (potable, surface, and reclaimed water) have an elevated ORP (+millivolts) and DO (>2 to 3 mg/L) concentrations relative to confined aquifers and deep portions of unconfined aquifers (-millivolts and <0.5 mg/L). The oxidized source waters can react with the aquifer matrix, which is in equilibrium under reduced conditions, changing the hydrogeochemistry of the stored and recovered water. Different technologies that can adjust the ORP and DO of the recharge waters closer to that of the native water before injection into confined aquifers have been developed (Bell et al., 2009; Entrix, 2010). Recent research by USACE suggests that treated surface water initially causes arsenic in the aquifer matrix to leach into the stored and recovered water, but it is later reabsorbed in the presence of naturally high iron and TOC concentrations in the source water (Mirecki, 2010). The conclusions in this study suggest that similar water quality conditions that can lead to the precipitation of arsenic occur in reclaimed water. Additional information on the state of the practice of ASR using reclaimed water is provided in the WRRF report, *Reclaimed Water Aquifer Storage and Recovery: Potential Changes in Water Quality* (WRRF, 2007b).

Table 2-3 Operational status and source water treatment for reclaimed water ASR projects

| State or Country | City or County | Operation Status | Reclaimed Water Treatment Level |
|------------------|---------------------|----------------------|--|
| Arizona | Chandler | Full Operation | Advanced treatment with UV disinfection |
| Arizona | Fountain Hills | Full Operation | Conventional secondary treatment /microfiltration/unknown method of disinfection |
| Arizona | Scottsdale | Full Operation | Advanced treatment/microfiltration/RO/Cl ₂ disinfection |
| Florida | Cocoa | Testing | Advanced treatment with Cl ₂ disinfection |
| Florida | Englewood | Full Operation | Advanced treatment with Cl ₂ disinfection |
| Florida | Hillsborough County | Terminated | NA |
| Florida | Clearwater | Terminated | NA |
| Florida | Lehigh Acres | Testing | Advanced treatment with Cl ₂ disinfection |
| Florida | Manatee County | Testing | Advanced treatment with Cl ₂ disinfection |
| Florida | Collier County | Testing | Advanced treatment with Cl ₂ disinfection |
| Florida | Naples | Testing | Advanced treatment with Cl ₂ disinfection |
| Florida | Oldsmar | Permitting | Advanced treatment with Cl ₂ disinfection |
| Florida | Pinellas County | Feasibility/Planning | Advanced treatment with Cl ₂ disinfection |
| Florida | St. Petersburg | Testing | Advanced treatment with Cl ₂ disinfection |
| Florida | Tarpon Springs | Feasibility/Planning | Advanced treatment with Cl ₂ disinfection |
| Florida | Sarasota County | Construction | Advanced treatment with Cl ₂ disinfection |
| Texas | El Paso | Full Operation | Advanced treatment/ozone disinfection |
| Australia | Adelaide (Bolivar) | Full Operation | Advanced treatment with Cl ₂ disinfection |
| Australia | Willunga | Testing | Advanced treatment with Cl ₂ disinfection |
| Kuwait | Sulaibiya | Feasibility/Planning | Advanced treatment/RO/unknown method of disinfection |

(Source: Updated data from WRRF, 2007b)

Cl₂ means chlorine

NA means not applicable

2.3.3.5 Supplementing Reclaimed Water Supplies

Another option to maximize the use of reclaimed water for irrigation is to supplement reclaimed water flows with other sources, such as groundwater or surface water. Supplemental sources, where permitted, can bridge the gap during periods when reclaimed water flows are not sufficient to meet the demands. Supplementing reclaimed water flows allows connection of additional users and increases reuse overall versus disposing of excess reclaimed water. Incremental use of supplemental supplies can result in a significant return in terms of reclaimed water usage versus supplemental volumes.

An example of a utility that developed supplemental supplies is the city of Cape Coral, Fla. There are approximately 400 mi of canal systems within the city. Of these, approximately 295 mi are considered freshwater and about 105 mi are brackish water. In addition, within these canals, approximately 27 water-control structures (weirs) have been designed and placed to control canal flows. Supplemental water from

this canal system has been used since the early 1990s to bridge the gap between reclaimed water supply and demands. Today, Cape Coral's reclaimed water program ("Water Independence for Cape Coral" or WICC) provides supplemented reclaimed water to almost 38,000 residences for irrigation. The city has implemented a major initiative over the last decade to install automated flow controls on all existing weirs, allowing the city to control freshwater canal levels and optimize the hydro period to mimic more natural flow patterns. These upgrades allow the city to store considerably more water in the existing canals. ASR is also planned to store excess surface water. Upon completion of the project, the city will be able to store an additional 1 billion gallons (3.8 MCM) of freshwater in the canals during dry periods and in ASR wells during wet periods.

In addition to supplementing reclaimed water supplies, alternative source waters can be used to replace the demands for reclaimed water. Discussion of alternative water sources as part of an integrated water management approach is provided in Section 2.4

2.3.4 Operating a Reclaimed Water System

In order to protect public health and enhance customer satisfaction and confidence, water of a quality that is safe and suitable for the intended end uses must be reliably produced and distributed, regardless of the source water. AWWA published the third edition of its *Manual of Water Supply Practices M-24*, which discusses planning, design, construction, operation, regulatory framework, and management of community dual-water systems (AWWA, 2009). In addition to the materials discussion in that manual, a brief discussion of the importance and considerations for well-designed quality assurance/quality control (QA/QC) and monitoring programs is provided here.

2.3.4.1 Quality Control in Production of Reclaimed Water

A high standard of reliability, similar to water treatment plants, is required at wastewater reclamation plants. An array of design features and non-design provisions can be employed to improve the reliability of the separate elements of a water reclamation system and the system as a whole. Backup systems are important in maintaining reliability in the event of failure of vital components, including the power supply, individual treatment units, mechanical equipment, the maintenance program, and the operating personnel. Federal guidelines identify the following factors that are appropriate to consider for treatment operations (EPA, 1974):

Design Factors:

- Duplicate dual feed sources of electric power
- Standby on-site power for essential plant elements
- Multiple process units and equipment
- Holding tanks or basins to provide for emergency storage of overflow and adequate pump-back facilities
- Flexibility of piping and pumping facilities to permit rerouting of flows under emergency conditions
- Dual chlorination systems
- Automatic residual control

- Instrumentation and control systems for online monitoring of treatment process performance and alarms for process malfunctions
- Supplemental storage and/or water supply to ensure that the supply can match user demands

Other Factors:

- Preliminary project planning and engineering report to indicate reliability compliance
- Effective monitoring program
- Effective maintenance and process control program
- Operator certification to ensure that qualified personnel operate the water reclamation and reclaimed water distribution systems
- A comprehensive QA program to ensure accurate sampling and laboratory analysis protocol
- A comprehensive operating protocol that defines the responsibilities and duties of the operations staff to ensure reliable production and delivery of reclaimed water
- A strict industrial pretreatment program and strong enforcement of sewer-use ordinances to prevent illicit dumping of hazardous materials—or other materials that may interfere with the intended use of the reclaimed water—into the collection system

Additional discussion of many of these reliability features is discussed in Section 3.4.3 of the 2004 EPA *Guidelines for Water Reuse*. Many states have incorporated procedures and practices into their reuse rules and guidelines to enhance the reliability of reclaimed water systems, including inline automatic diversion valves when reclaimed water quality does not meet monitoring requirements for chlorine residual and turbidity.

2.3.4.2 Distribution System Safeguards for Public Health Protection in Nonpotable Reuse

As described in Chapters 3 and 4, the level of treatment required for reclaimed water depends on the intended use. Where water reuse applications are designed for indirect or direct potable reuse, treatment is designed to achieve the level of purity required for

potable reuse. Where reclaimed water is to be used in nonpotable applications, water quality must be protective of public health, but need not be treated to the quality required for potable reuse. In addition to appropriate water quality requirements, other safeguards must be employed to protect public health in nonpotable reuse.

Where reclaimed water is intended for nonpotable reuse, the major priority in design, construction, and operation of a reclaimed water distribution system is the prevention of cross-connections. A cross-connection is a physical connection between a potable water system used to supply water for drinking purposes and any source containing nonpotable water through which potable water could be contaminated. Another major objective is to prevent improper or inadvertent use of reclaimed water as potable water. To protect public health from the outset, a reclaimed water distribution system should be accompanied by the following protection measures:

- Establish that public health is the overriding concern
- Devise procedures and regulations to prevent cross-connections and misuse, including design and construction standards, inspections, and operation and maintenance staffing
- Ensure the physical separation of the potable water, reclaimed water, sewer lines, and appurtenances in design and construction
- Develop a uniform system to mark all nonpotable components of the system
- Devise procedures for approval (and disconnection) of service
- Establish and train special staff members to be responsible for operations, maintenance, inspection, and approval of reuse connections
- Provide for routine monitoring and surveillance of the nonpotable system
- Prevent improper or unintended use of nonpotable water through a proactive public information program

Some states specify the type of identification required. For example, the Florida Department of Environmental

Protection (FDEP) requires all components to be tagged or labeled (bearing the words “Do not drink” in English and “No beber” in Spanish, together with the equivalent standard international symbol) to warn the public and employees that the water is not intended for drinking (FDEP, 2009). **Figure 2-7** shows a typical reclaimed water advisory sign and pipe coloring.



Figure 2-7
Typical sign complying with FDEP signage requirements (Photo credit: Lisa Prieto)

The type of messaging on advisory signs must comply with state guidelines and regulations and be chosen carefully to support public awareness. Chapter 8 discusses some of the issues surrounding messaging about water reuse. One specific issue for signage that includes the message “do not drink” is the potential long-term public perception that reclaimed water *cannot* be safe for drinking. If a city may want to introduce potable reuse in the future, the choice of messaging for signage of nonpotable reuse applications is all the more critical.

In addition to advisory signs and coloring, the valve covers for nonpotable transmission lines should not be interchangeable with potable water covers. For example, the city of Altamonte Springs, Fla., uses square valve covers for reclaimed water and round valve covers for potable water. Blow-off valves should be painted and carry markings similar to other system piping. Irrigation and other control devices should be marked both inside and outside. Any constraints or special instructions should be clearly noted and placed in a suitable cabinet. If fire hydrants are part of the system, they should be painted or marked, and the stem should require a special wrench for opening.

All piping, pipelines, valves, and outlets must be color-coded, or otherwise marked, to differentiate reclaimed water from domestic or other water (FDEP, 2009). FDEP requires color coding with Pantone Purple 522C using different methods, depending on the size of the pipe (FDEP, 2009). Pipe coloring can be integrated into the material or added externally with a polyethylene vinyl wrap, vinyl adhesive tape, plastic marking tape (with or without metallic tracer), or stenciling, as shown in **Figure 2-8**. The IAPMO publishes the *Uniform Plumbing Code*, a document that many state and local governments use as a model when they approve their own plumbing codes. An alternate code is the IPC distributed by the ICC.



Figure 2-8
Reclaimed water pumping station, San Antonio, Texas (Photo credit: Don Vandertulip)

Permitting and Inspection. The process to permit water reclamation and reuse projects differs from state to state; however, the basic procedures generally include plan and field reviews followed by periodic inspections of facilities. This oversight includes inspection of reclaimed water generators, distributors and, in some cases, end users. Additional guidance on permitting and inspection is provided in the *Manual of Water Supply Practices M-24* (AWWA, 2009). Piping at the site of reclaimed water use may be controlled by local plumbing code, and advance coordination between utility and local plumbing departments is advised.

2.3.4.3 Preventing Improper Use and Backflow

Several methods can be used to prevent inadvertent or unauthorized connection to a reclaimed water system. The Irvine Ranch Water District, Calif., mandates the use of special quick-coupling valves with

an Acme thread key for on-site irrigation connections. This type of valve is not used in potable water systems, and the cover on the reclaimed water coupler is different in color and material from that used on the potable system. Hose bibs are generally not permitted on nonpotable systems because of the potential for incidental use and possible human contact with the reclaimed water. Florida regulations (FDEP, 2009) allow below-ground bibs that are either placed in a locking box or require a special tool to operate.

Where the possibility of cross-connection between potable and reclaimed water lines exists, backflow prevention devices should be installed on-site when both potable and reclaimed water services are provided to a user. The backflow prevention device is placed on the potable water service line to prevent potential backflow from the reclaimed water system into the potable water system if the two systems are illegally interconnected. Accepted methods of backflow prevention vary by state, but may include:

- Air gap
- Reduced-pressure principal backflow prevention assembly
- Double-check valve assembly
- Pressure vacuum breaker
- Atmospheric vacuum breaker

In addition to discussion of backflow prevention in Section 3.6.1 of the 2004 EPA *Guidelines for Water Reuse*, additional guidance is provided in the 2003 EPA *Cross-Connection Control Manual* which has been designed as a tool for health officials, waterworks personnel, plumbers, and any others involved directly or indirectly in water supply distribution systems, with more recent information in the *AWWA Manual of Water Supply Practices M-24* (AWWA, 2009).

2.3.4.4 Maintenance

Maintenance requirements for nonpotable components of the reclaimed water distribution system should be the same as for potable systems. From the outset, items such as isolation valves, which allow for repair to parts of the system without affecting a large area, should be designed into the system. Flushing the line after construction should be mandatory to prevent sediment from accumulating, hardening, and

becoming a serious future maintenance problem. New systems should confirm whether discharge of reclaimed water from the initial construction activity is allowed or considered an unauthorized discharge. The flush water may need to be returned to a sanitary sewer, or use of potable water may be considered for initial flushing. A reclaimed water supplier should

reserve the right to withdraw service for any offending condition, subject to correction of the problem. Such rights are often established as part of a user agreement or reuse ordinance.

2.3.4.5 Quality Assurance: Monitoring Programs

The purpose of monitoring is to demonstrate that the management system and treatment train are functioning according to design and operating expectations. Expectations should be specified in management systems, such as a Hazard Analysis and Critical Control Points (HACCP) or water safety plan (WSP). While the monitoring program will be based on the regulatory and permit requirements established for the system, the program not only must address those elements needed to verify the product water but also must support overall production efficiency and effectiveness. Having performance standards and metrics along with policies describing organizational goals and responsibilities for the execution of a water quality management program will reinforce a strong public perception of the overall water quality being produced. See Chapter 8 for additional discussion of public education and communication tools.

Monitoring programs must establish goals for reclaimed water treatment performance and distribution system water quality, provide monitoring to

verify conformance with the goals, and establish appropriate actions if goals are not achieved. An example of water quality monitoring requirements for Texas is provided in **Table 2-4**.

The Texas Commission on Environmental Quality (TCEQ) regulates wastewater reclamation and reuse in Texas. Under Chapter 210 of Texas Administrative Code, Volume 30, TCEQ prescribes the quality and use requirements as well as the responsibilities of producers and users. In addition to regulatory requirements, specific uses of reclaimed water, such as some industrial uses or even irrigation when it is for particular golf courses, may require additional testing and/or increased monitoring frequency. Monitoring requirements for reclaimed water are based on the intended use and not on the treatment process utilized to produce reclaimed water (TCEQ, 1997). Two reclaimed water use types are recognized by the TCEQ: Type I use is where contact with humans is likely, such as irrigation, recreational water impoundments, firefighting, and toilet flush water, and Type II use is where contact with humans is unlikely, such as in restricted or remote areas [[US-TX-San Antonio](#)].

Three to four parameters must be monitored in accordance with the intended use of the reclaimed water in Texas: *E. coli* or fecal coliform (cfu/100 mL), 5-day biochemical oxygen demand (BOD₅) or 5-day carbonaceous biochemical oxygen demand (CBOD₅) (mg/L), Turbidity (NTU) and *Enterococci* (cfu/100mL) (**Table 2-4**). Use type also affects monitoring frequency. Type I uses require a twice-weekly monitoring protocol while Type II uses require weekly monitoring.

Table 2-4 Quality monitoring requirements in Texas

| Texas Category | Is human contact likely? | Examples | Monitoring frequency | <i>Enterococci</i> (MPN/100mL) | Fecal Coliforms or <i>E. coli</i> (MPN/100mL) | CBOD ₅ or BOD ₅ (mg/L) | Turbidity (NTU) |
|----------------|--------------------------|---|----------------------|--------------------------------|---|--|-----------------|
| Type I | Yes | Irrigation, recreational impoundments, firefighting, toilet flush water | Twice weekly | 9/4 ¹ | 75/20 ¹ | 5 | 3 |
| Type II | No | Restricted or remote reuse | Once weekly | 35 | 800/200 ¹ | 15 or 20 ² | N/A |

¹ The first value represents a single sample maximum value and the next value refers to a 30-day average (BOD₅ and Turbidity) or 30-day geometric mean (fecal coliform or *E. coli*).

² In Type II uses, the CBOD₅ maximum 30-day average value is 15 mg/L while the BOD₅ value is 20 mg/l for the same period.

The first element of a system monitoring program is choosing appropriate, quantifiable measurement parameters that relate to operational and regulatory decision-making. At a minimum, state-required regulatory parameters should be included for analysis. Parameters such as flow rates, distribution system water quality (measured by chlorine residual and bacteriological quality), and TDS are commonly included, but the final choice will depend on the individual system. Detailed monitoring lists may not be necessary once relationships between types of chemicals, treatment train performance, and surrogate measures have been established with definitive data generated from statistically robust experiments. For example, the city of San Diego's water purification demonstration project monitors several water quality parameters, including contaminants regulated by the SDWA [US-CA-San Diego]. Online monitoring methods are preferred because they provide real-time data on system performance. Further, well-defined criteria must be set for each measurement parameter to support the facility's water quality and productivity goals. These may be established by regulatory drivers or self-imposed as part of the overall quality or operational goals.

As noted, in many instances the use of real-time remote measuring devices is required to maintain process and product quality control. Well-defined procedures for the care, calibration, calibration verification, and data collection for any remote or inline measurement devices should be established.

For parameters that cannot be measured online, a routine sampling plan must be developed to select representative sampling sites that adequately cover all key elements (Critical Control Points [CCP]) in the process at a frequency sufficient to anticipate potential problems and respond before problems become critical. In addition to daily, weekly, or monthly analyses, periodic (quarterly or annually) analyses that are more comprehensive can further validate that the routine process performance indicators are adequate to detect potential problems. Locations where high failures are occurring may require more frequent sampling as part of the corrective action.

Sampling methods should focus on obtaining data where the resulting accuracy is adequate for the intended purpose. Samples that are not immediately analyzed must be handled in a way that maintains

sample integrity. The validity of the sampling process can significantly impact the validity and usability of the data from those samples. Sampling procedures for required regulatory reporting should follow well-accepted practices, such as Standard Methods for the Examination of Water and Wastewater.

Because regulatory and public perception of the monitoring program will rely heavily on the confidence in the quality and validity of the data collected, certifications or accreditations for laboratories doing analytical work supporting the water industries may be required. These can include state programs, such as Arizona Department of Health Services (ADHS), or national accreditation programs, such as The National Environmental Laboratory Accreditation Conference (NELAC) Institute (TNI, n.d.), which is used by states like Texas and Florida. The NELAC Institute (TNI) was formed in 2006 by combining the boards of the NELAC and the Institute for National Environmental Laboratory Accreditation. Accreditation may be required for both internal and commercial laboratories. These programs require laboratories that produce data to support water quality programs to have established basic quality requirements incorporated into their data collection processes. These requirements should include the analytical procedures, instrument calibration requirements, quality control practices and documentation, and reporting protocol sufficient to document the traceability and quality of the result.

The city of Tucson, Ariz., has a well-established Reclaimed Water Site Inspection Program that accomplishes many of these goals [US-AZ-Tucson]. The program provides for periodic inspection of all sites having reclaimed water service, along with training and certification of reclaimed water site testers.

2.3.4.6 Response to Failures

The final and probably most important element is a well-defined and rigorously-enforced procedure for responding to system failures within the defined criteria. Obviously, this will include procedures for returning to normal operation as quickly as reasonably possible, but it should also include root-cause analysis or other investigative techniques to determine if systematic problems exist. In addition to water quality monitoring, the system as a whole requires monitoring and maintenance. A number of best practices to monitor the system include:

- Contractor training requirements on the regulations governing reclaimed water installations
- Requirements to submit all modifications to approved facilities to the responsible agencies
- Detection and documentation of any breaks in the transmission main
- Random inspections of user sites to detect any faulty equipment or unauthorized use
- Installation of monitoring stations throughout the system to test pressure, chlorine residual, and other water quality parameters
- Accurate recording of system flow to confirm total system use and spatial distribution of water supplied

2.3.5 Lessons Learned from Large, Medium, and Small Systems

Regardless of the size of a reclaimed water system, there are lessons learned that can be applied to other systems, and several case study examples are highlighted below by system size. Large reclaimed water systems (large systems) are defined as systems with a capacity larger than 10 mgd (440 L/s). In general, large systems have matured from smaller, initial start-up or backbone facilities that were implemented to meet smaller demands in prior years. As illustrated by several current large systems in the United States, however, this may not always be the case. Medium reclaimed water systems (medium systems) are defined as systems with a capacity ranging from 1 to 10 mgd (44 to 440 L/s). And small systems are defined as facilities treating flows ranging between 1,500 and 100,000 gpd (5.6 to 380 m³/d), while small community systems may treat flows of up to 1 mgd (44 L/s) (Crites and Tchobanoglous, 1998).

Large Systems. The scale of the delivery system for the case study examples varies from gravity plant discharge to delivery through 130 mi (210 km) of pipeline. Three of these systems started at near their

current capacities by providing alternative water sources to mature markets with significant drivers to meet water supply needs under time constraints. The UOSA, for example, developed from regional concerns over water quality issues from small and individual systems draining to the Occoquan Reservoir [US-VA-Occoquan]. What emerged from regional planning are key examples of planned IPR as a means of augmenting the raw water reservoir with high-quality source water, as depicted in **Figure 2-9**. Common themes throughout all of these large system case studies are the importance of public education and public information programs to educate staff, elected officials, the business community, and customers, which is discussed further in Chapter 8.

These large projects include significant design challenges that have led to state-of-the-science technical applications to meet the project constraints. However, the successful application of technology for projects such as the Occoquan Reservoir has been documented in research by Rose et al. (2001). Application of the lessons learned from these large reclaimed water projects provides valuable information for all systems in technology application and proven results for public acceptance.

Further, large reclaimed water system projects will typically involve more than one agency. In the case of OCWD and Orange County Sanitation District (OCSD), two boards worked together over many years to collectively solve problems and serve their individual system needs [US-CA-Orange County]. In the case of the Upper Occoquan project [US-VA-Occoquan], the UOSA was created by the state of Virginia and took over service obligations from numerous small providers. Supply to the Palo Verde Nuclear Generating Station (PVNGS) and USACE wetlands project in Arizona required public involvement and public hearings through state and two federal agencies [US-AZ-Phoenix]. San Antonio's project [US-TX-San Antonio] was driven by endangered species lawsuits limiting future water withdrawals, which required multiple local, state, and federal agencies to work together.

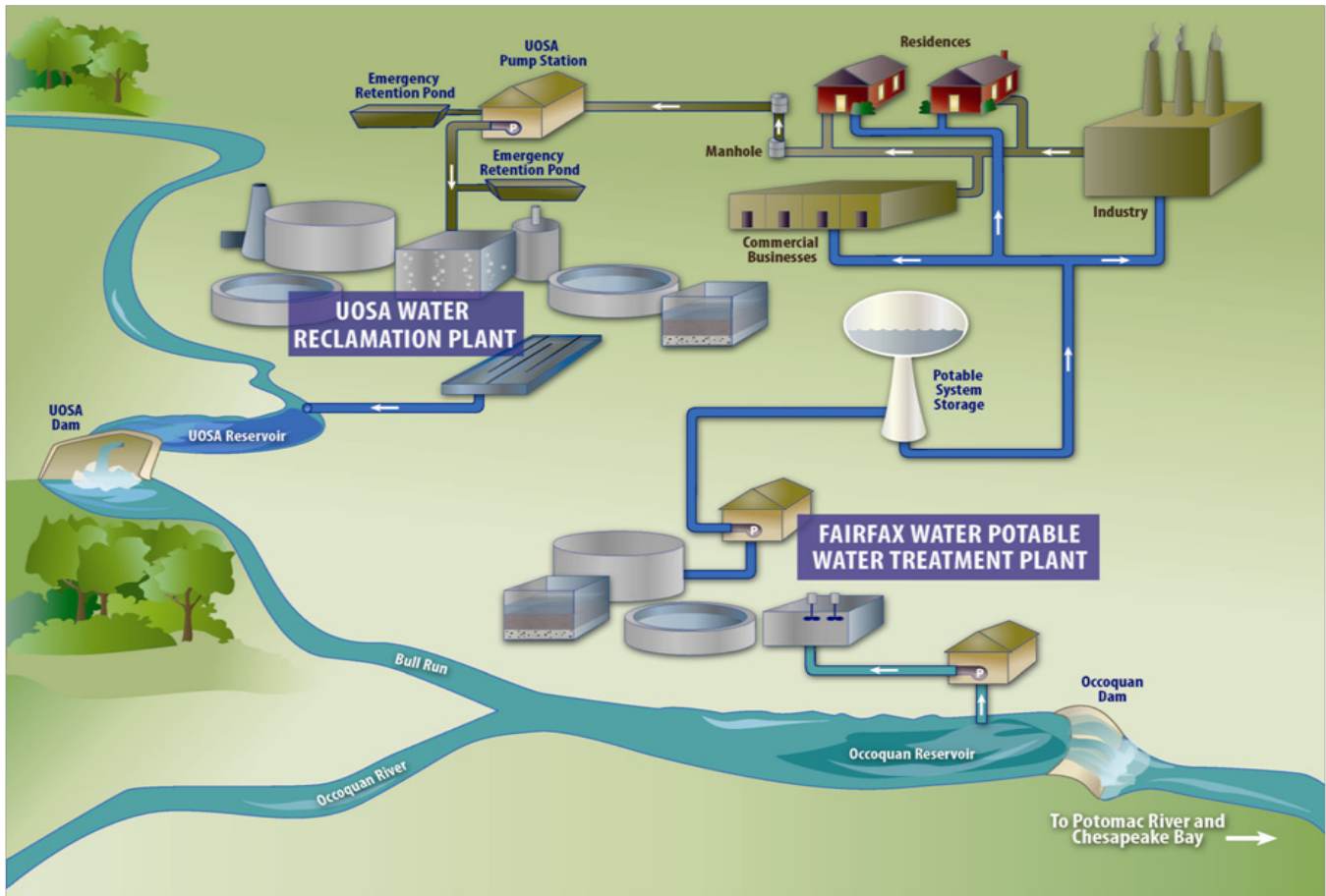

Figure 2-9
Upper Occoquan schematic

Each of these projects is an example of leaders and planners recognizing the importance of providing timely and accurate information to decision-makers and the public. These projects also provide valuable resource recovery and reuse to support the local water supply. In doing so, various permits required for the projects were issued because of community support.

Medium Systems. Existing medium-sized facilities can benefit from the experience of larger systems as well as from the development of their existing systems. Medium-sized systems have typically worked through many of the same operational considerations and, in most cases, the community is aware of the benefits of reusing local resources. For medium systems in particular, identifying potential reclaimed water customers is one of the most important phases of planning the reuse system and ensuring that the system can be sustained. Unlike large systems with capacities of greater than 10 mgd (438 L/s), which generally have a set reclaimed water user baseline,

and smaller systems, which generally rely on a pre-identified (and consistent) source of reclaimed water, medium systems are largely dependent on the needs of their customer bases. This need can greatly vary depending on the type of reclaimed water customer, the end use for the reclaimed water, and the time of year (i.e., decreased demands in wet weather months). Identifying potential customers will help evaluate the financial viability of a reuse system as well as provide an estimate of how much potable water can be saved by connecting customers to a new reclaimed water system. A more accurate estimate may be provided by contacting identified potential customers to determine their willingness to participate in converting a portion of their demands to reclaimed water.

An excellent case study example of a medium system expanding its customer base is the city of Pompano Beach, Fla. [[US-FL-Pompano Beach](#)]. The city's OASIS (Our Alternative Supply Irrigation System)

program is taking a systematic approach to increase existing and future reuse capacity to achieve the region's reuse requirements. Current plant capacity is 7.5 mgd (329 L/s), of which only 1.8 mgd (79 L/s) are produced because of a lack of demand. The city's greatest reuse challenge has been convincing single-family residential customers to hook up to the system. While connection is mandatory for commercial and multi-family customers, the city did not mandate connection for single-family residences. Even though construction of the reuse mains required working in existing neighborhoods and placing a reuse meter box at each home, and even though each home pays a monthly available charge, single-family residential customers have been slow to connect to the system. Reasons range from connection cost to permitting issues. Residents also complained about the annual backflow preventer assembly certifications and the resulting payback time.

In 2010, the city manager and the city commissioner approved a connection program to target single-family residential customers. The new program allows the city, working through a contractor, to perform the necessary plumbing on the customer's property to connect to the reuse system and eliminates the annual certification requirement for the customer. Installation cost is covered by the city's utilities department, which also retains ownership of the dual-check valve and meter. These costs are recovered through reclaimed water use rate (\$0.85/1,000 gallons [$\$0.22/\text{m}^3$] for the smallest meter size) that is slightly higher than existing reclaimed water use rates (\$0.61/1,000 gallons [$\$0.16/\text{m}^3$]). The program includes a public outreach campaign "I Can Water," which launched in July 2011 with meetings, media outreach, mailers, cable TV, a Web page, and a hotline. To reward the existing 73 customers, the city will replace and take over their backflow devices and keep them at the current lower rate. Customer response to this campaign has been positive.

Small Systems and Small Community Systems.

Small systems and small community systems differ in both size and scope. Small systems typically serve a small development or project, while small community systems serve an entire community. Small systems can generally be classified according to the following categories:

- Point-of-use systems for a specific user

- A satellite facility within a medium or large system that is remote from the main WWTP or reclaimed water source
- A decentralized system in an area without community collection and treatment
- An internal industrial process reuse system
- A start-up system in initial phases of development that is intended to progress to a medium or large system
- A community reclaimed water system for a community generating less than 1 mgd (44 L/s) of plant flow

The scale of effort required in planning a small system is proportional to the system size. For example, the planning area for a small town may not be as large as a system for a population of 4 million, but small communities typically have fewer resources, so the effort can still be significant. Most of the systems will have similar regulatory hurdles, and all of the users in the categories above will need to address potential plant improvements to provide a water quality that will be acceptable to potential customers (sometimes in excess of the regulatory quality).

There is often an overlap in the above categories. For example, in order to conserve water and money, a small community with an existing WWTP decides to start a reclaimed water system by providing reclaimed water to its golf course. In this case, the planning process may initially be truncated by having one customer that can use a large volume of water. During the summer in the arid south, an 18-hole golf course can use 2 ac-ft (2,500 MCM) of reclaimed water per night. For many small communities, this may exceed their capacity, and as a result during peak summer use the reclaimed water may only supplement the previous source water. If a small community is a little larger, success with the first customer may lead to another planning process to identify other customers and explore the possibility of extending the small reclaimed water system.

An excellent case study example of this evolution is in Yelm, Wash. [[US-WA-Yelm](#)], where the community embraced reclaimed water as the best solution to safeguard public health, protect the Nisqually River, and provide an alternate water supply. While the city

faced challenges, an intensive community outreach program helped the city successfully expanded its system into one of the first Class “A” Reclaimed Water Facilities in the state of Washington. Yelm constructed a wetlands park to have a highly visible and attractive focal point promoting reclaimed water use, and a local reclaimed water ordinance was adopted, establishing the conditions of reclaimed water use. The ordinance includes a “mandatory use” clause allowing Yelm to require construction of reclaimed water distribution facilities as a condition of development approval. Yelm continues to plan expansion of storage, distribution, and reuse facilities, and in 2002 the city received the Washington State Department of Ecology’s Environmental Excellence Award for successfully implementing Class “A” reclaimed water into its community.

Additional information on low-cost treatment technologies for small-scale water reuse projects is provided in a recent WRRF report on *Low-Cost Treatment Technologies for Small-Scale Water Reclamation Plants*, which identifies and evaluates established and innovative technologies that provide treatment of flows of less than 1 mgd (44 L/s) (WRRF, 2012). A range of conventional treatment processes, innovative treatment processes, and package systems was evaluated with the primary value of this work including an extensive cost database in which cost and operation data from existing small-scale water reclamation facilities have been gathered and synthesized.

2.4 Water Supply Conservation and Alternative Water Resources

Water scarcity is one of the key drivers for developing reclaimed water supplies and systems. As part of the overall management of water resources, it is critical to evaluate alternative management strategies for making the most of the existing supplies. Water conservation is an important management consideration for managing the water demand side. On the supply side, the use of alternative water resources, such as reuse of graywater, rainwater harvesting (where applicable), produced water, and other reuse practices, should also be considered as part of an overall plan.

2.4.1 Water Conservation

Integrating water conservation goals and programs into utility water planning is emerging as a priority for

communities outside of the traditional water-short regions of the United States. Catalysts for implementing water conservation programs include growing competition for limited supplies, increasing costs and difficulties with developing new supplies, increasing demands that stress existing infrastructure, and growing public support for resource protection and environmental stewardship. As a result of the growing interest in water conservation, one of EPA’s most successful partnership programs is WaterSense®, which supports water efficiency by developing specifications for water-efficient products and services (EPA, 2012). The program also provides resources for utilities to help promote their water conservation programs.

In addition to using conservation as a means to utilities to help meet growing water demands, many utilities are also beginning to understand the value of water conservation as a way of saving on costs for both the utility and its customers. Throughout the United States, utilities have experienced quantifiable benefits associated with long-term water conservation programs, including:

- Reduction in operation and maintenance costs resulting from lower use of energy for pumping and less chemical use in treatment and disposal
- Less expensive than developing new sources
- Reduced purchases from wholesalers
- Reduce, defer, or eliminate need for capacity expansions and capital facilities projects

Selecting the appropriate conservation program components includes understanding water use habits of customers, service area demographics, and the water efficiency goals of the utility; some of the most effective practices that encourage conservation include:

- Customer education
- Metering
- Rate structures with a volumetric component with rate increases with increased use (tiered rate structure)
- Irrigation efficiency measures

- Time-of-day and day-of-week water limitations
- Seasonal limitations and/or rate structures
- High-efficiency device distribution and rebates

Since 1991, for example, the Los Angeles Department of Water and Power has installed more than one million ultra-low-flush toilets and hundreds of thousands of low-flow showerheads and has provided rebates for high-efficiency washing machines and smart irrigation devices. The city used less water in 2010 than it did in 1990, despite adding more than 700,000 new residents to its service area (Rodrigo et al., 2012).

While it is clear that potable water resources should be conserved for the reasons above, reclaimed water in some regions of the country is not considered a resource; rather, it is sometimes viewed as a waste that must be disposed of. With this mindset, customers are sometimes encouraged to use as much reclaimed water as they want, whenever they want. In areas where there are fresh water supply shortfalls or where reclaimed water has become valued as a commodity, however, conservation has also become an important element of reclaimed water management. As a result, reclaimed water is recognized by many states as a resource too valuable to be wasted. The 1995 Substitute Senate Bill 5605 Reclaimed Water Act, passed in the state of Washington, stated that reclaimed water is no longer considered wastewater (Van Riper et al., 1998). The California legislature has declared, “Recycled water is a valuable resource and significant component of California’s water supply” (California State Water Resources Control Board, 2009). These recent declarations are part of broad statewide objectives to achieve sustainable water resource management. Chapter 8 describes how water conservation and water reuse public outreach can be synergistic.

Efficient and effective use can be critical to ensure that the reclaimed water supply is available when there is a demand for it. In addition, storage of reclaimed water can focus on periods of low demand for later use during high-demand periods, thereby stretching available supplies of reclaimed water and maximizing its use. While this practice is sometimes a challenge, it is gaining interest because of recent advances in management practices, such as ASR, which is discussed in Section 2.3.

Several conservation methods that are used in potable water supply systems are applicable to reclaimed water systems, including volume-based rate structures, limiting irrigation to specific days and hours, incorporation of soil moisture sensors or other controllers that apply reclaimed water when conditions dictate irrigation, and metering. Examples of reclaimed water conservation are prevalent in Florida. Many utilities’ reclaimed water availability is limited by seasonal demands that can exceed supply, making conservation and management strategies a necessity. To promote conservation, several utilities have implemented conservation rate structures to encourage efficient use of reclaimed water. In addition, utilities that provide reclaimed water for landscape irrigation, including irrigation for residential lots, medians, parks, and other green space, are promoting efficient use of reclaimed water by limiting the days and hours that users can irrigate. The Loxahatchee River District in Palm Beach County, Fla., has designated irrigation days for residential landscape irrigation reuse customers and can shut off portions of its system on designated non-irrigation days. Port Orange, Fla., retrofitted its entire reuse system with meters so that customers could be charged according to a tiered volumetric rate rather than a flat rate that encouraged excessive use. And the Southwest Florida Water Management District has recognized the importance of conserving reclaimed water to ensure more customers can be served by providing grant funding for reuse programs where efficient use is a criterion for receiving funds.

2.4.2 Alternative Water Resources

While these guidelines are intended to highlight the reuse of reclaimed water derived from treated municipal effluent, there are a number of other alternative water sources that are often considered and managed in a manner similar to reclaimed water. Some of the most important alternative water resources include individual and on-site graywater and stormwater.

2.4.2.1 Individual On-site Reuse Systems and Graywater Reuse

Graywater is untreated wastewater, excluding toilet and—in most cases—dishwasher and kitchen sink wastewaters. Wastewater from the toilet and bidet is “blackwater,” and while the exclusion of toilet waste is a key design factor in on-site and graywater systems, this does not necessarily prevent fecal matter and

other human waste from entering the graywater system—albeit in small quantities. Examples of routes for such contamination include shower water and bathwater and washing machine discharge after cleaning of soiled underwear and/or diapers (Sheikh, 2010). In fact, California's latest graywater standards define graywater as untreated wastewater that has not been contaminated by any toilet discharge; has not been affected by infectious, contaminated, or unhealthy bodily wastes; and does not present a threat from contamination by unhealthful processing, manufacturing, or operating wastes. Graywater does include wastewater from bathtubs, showers, bathroom washbasins, clothes washing machines, and laundry tubs, but does not include wastewater from kitchen sinks or dishwashers (California Building Standards Commission, 2009). Thus, for a graywater system, it is assumed that a building or homeowner would take extraordinary care in source control of contaminants and ensure pathogen-free graywater, an assumption that could be questionable in a certain percentage of cases.

For these reasons, use of graywater has been a controversial practice. While viewed by some as the panacea for water shortages, groundwater depletion, surface water contamination, and climate change, use of graywater can also be seen as a threat to the health and safety of the users and their neighbors. While the reality of graywater lies somewhere between these two perceptions, the installation of a graywater system may save a significant amount of potable water (and its costs) for the homeowner or business, even though the payback period for the more complex systems may exceed the useful life of the system. Graywater use does not always reduce total water use, as shown in a study in Southern Nevada (Rimer, 2009). Because all wastewater in the region is collected, treated, and returned to Lake Mead, all water is already reused. Using untreated or partially treated graywater had higher public health risk than continued use of reclaimed water, and graywater users felt less constrained in using potable water, actually increasing total metered water use. There are no documented cases in the United States of any disease that has been caused by exposure to graywater—although systematic research on this public health issue is virtually nonexistent. And, while the absence of documentation does not prove that there has never been such a case, graywater is, in fact, wastewater with microbial concentrations far in excess of levels

established in drinking, bathing, and irrigation water standards for reclaimed water (Sheikh, 2010).

Graywater Policy and Permitting. Key to the viability of small or on-site graywater systems is an effective policy, permitting, and regulatory process to provide adequate treatment of graywater for the intended end use. In many states the regulatory system is still designed for large-scale systems; the permitting process for small systems is complex because small systems cross into the purview of various regulatory agencies, which can cause hurdles in the approval process. There are a number of states and local agencies that provide specific regulations or guidance for graywater use, including Arizona, California, Connecticut, Colorado, Georgia, Montana, Nevada, New Mexico, New York, Massachusetts, Oregon, Texas, Utah, Washington, and Wyoming. In addition to the states that have specific policies on graywater use, there are other institutional policies, such as the UPC and the IPC, that are applicable to the implementation of graywater systems. A comprehensive compilation of graywater laws, suggested improvements to graywater regulations, legality and graywater policy, sample permits, public health considerations, studies, and other considerations has been assembled by Oasis Design, a firm with vested interest in promoting use of graywater. Links to numerous resources targeted at regulators, inspectors, elected officials, building departments, health departments, builders, and homeowners have been posted by Oasis Design (Oasis Design, 2012).

Graywater Quality Criteria. For any size and type of system, proper consideration for public health begins with risk management, which puts in place mechanisms to minimize or eliminate the risk of contaminated water entering the water supply. Thus, from a policy perspective, the first step in risk management is establishing transparent criteria for water quality; the NSF Standard 350 establishes water quality criteria for on-site systems.

In 2011, NSF/ANSI Standard 350 *Onsite Residential and Commercial Water Reuse Treatment Systems* and NSF/ANSI Standard 350-1 *Onsite Residential and Commercial Graywater Treatment Systems for Subsurface Discharge* were adopted (NSF, 2011a and 2011b). The standards provide detailed methods of evaluation; product specifications; and criteria related to materials, design and construction, product

literature, wastewater treatment performance, and effluent quality for on-site treatment systems. Graywater treatment to NSF 350 levels also requires certified operators, reliability, and public water supply protection. The NSF/ANSI Standard 350 is for graywater treatment systems with flows up to 1,500 gpd (5.7 m³/d) or larger. The standards apply to graywater treatment systems having a rated treatment capacity of up to 1,500 gpd (5.7 m³/d), residential wastewater treatment systems with treatment capacities up to 1,500 gpd (5.7 m³/d), and commercial treatment systems with capacities exceeding 1,500 gpd (5.7 m³/d) for commercial wastewater and commercial laundry facilities. End uses appropriate for reclaimed water from these systems include indoor restricted urban water use, such as toilet flushing, and outdoor unrestricted urban use, such as surface irrigation.

The Standard 350 effluent criteria (**Table 2-5**) are applied consistently to all treatment systems regardless of size, application, or influent quality. Effluent criteria in **Table 2-5** must be met for a system to be classified as either a residential treatment system for restricted indoor and unrestricted outdoor use (Class R) or a multi-family and commercial facility water treatment system for restricted indoor and unrestricted outdoor use (Class C).

The NSF/ANSI Standard 350-1 is for graywater treatment systems with flows up to 1,500 gpd (5.7 m³/d). For systems above 1,500 gpd (5.7 m³/d), a multiple-component system should be performance tested for at least 6 months at the proposed site of use

following the field evaluation protocol in Annex A of NSF-350. Annex A prescribes testing sequence, frequency of sampling and testing, and test protocol acceptance and review procedures. End uses appropriate for these systems include only subsurface discharges to the environment. The effluent requirements of graywater systems seeking certification through the ANSI/NSF Standard 350-1 for subsurface discharge are provided in **Table 2-6**.

Table 2-6 Summary of ANSI/NSF Standard 350-1 for subsurface discharges

| Parameter | Test Average |
|--------------------------|-----------------|
| CBOD ₅ (mg/L) | 25 mg/L |
| TSS (mg/L) | 30 mg/L |
| pH (SU) | 6.0 – 9.0 |
| Color | MR ¹ |
| Odor | Non-offensive |
| Oily film and foam | Non-detectable |
| Energy consumption | MR |

¹ MR: Measured reported only.

It is important to note that while the NSF/ANSI Standards provide detailed information for graywater use, individual state statutes and regulations and local building codes, which generally take precedence, may not allow graywater use in a given locale.

Implementation of Residential and Commercial On-site and Graywater Treatment Systems. Treatment technologies that can be used for meeting the stringent standards of ANSI/NSF 350 and 350-1

Table 2-5 Summary of NSF Standard 350 Effluent Criteria for individual classifications

| Parameter | Class R | | Class C | |
|---|-----------------|-----------------------|---------------|-----------------------|
| | Test Average | Single Sample Maximum | Test Average | Single Sample Maximum |
| CBOD ₅ (mg/L) | 10 | 25 | 10 | 25 |
| TSS (mg/L) | 10 | 30 | 10 | 30 |
| Turbidity (NTU) | 5 | 10 | 2 | 5 |
| E. coli ² (MPN/100 mL) | 14 | 240 | 2.2 | 200 |
| pH (SU) | 6.0 – 9.0 | NA ¹ | 6.0 – 9.0 | NA |
| Storage vessel disinfection (mg/L) ³ | ≥ 0.5 – ≤ 2.5 | NA | ≥ 0.5 – ≤ 2.5 | NA |
| Color | MR ⁴ | NA | MR | NA |
| Odor | Nonoffensive | NA | Nonoffensive | NA |
| Oily film and foam | Nondetectable | Nondetectable | Nondetectable | Nondetectable |
| Energy consumption | MR | NA | MR | NA |

¹ NA: not applicable

² Calculated as geometric mean

³ As total chlorine; other disinfectants can be used

⁴ MR: Measured reported only

include suspended media treatment, fixed media treatment systems, and constructed wetland systems. All of these technologies must be followed by advanced filtration and disinfection. On-site applications of membrane bioreactor (MBR) technology have also been utilized effectively in commercial and residential properties for outdoor irrigation and indoor nonpotable uses. Design standards for treatment systems are enforced through local health and environmental agencies, and permits to operate on-site treatment systems often include requirements for increased levels of monitoring.

Because increased monitoring can be burdensome for small systems, operational monitoring can be used to determine if the system is performing as expected. By using instrumentation and remote monitoring technologies, small schemes can produce real-time data to ensure the system is functioning according to water quality objectives. This operational monitoring strategy is a risk management methodology borrowed from the food and beverage industry; the HACCP is a preventive approach that identifies points of risk throughout the treatment process and assigns corrective actions should data reveal heightened risk (Natural Resource Management Ministerial Council, Environment Protection and Heritage Council and Australian Health Ministers' Conference, 2006). Water quality parameters are set at different CCPs and monitored in real-time online; if data reveal water quality is outside the set parameters, a corrective action will be triggered automatically in real time. With an operational monitoring model in place, ongoing sampling serves only as confirmation of the operational data, and frequency of regulatory sampling could be reduced. In the case where indoor uses are allowed, turbidity meters are often employed as a measure of system performance.

While the quantitative impact of increased graywater use is expected to be modest, even under the most aggressive growth assumptions, much of the growth in graywater use is expected to take place in areas where municipal water reuse will likely not be practiced—unsewered urban areas and rural and remote areas, as exemplified in several case studies [[Australia-Sydney](#)]. Further, there are growing possibilities for increased on-site treatment systems in urban buildings that are LEED certified.

2.4.2.2 LEED-Driven On-site Treatment

A recent development in on-site treatment systems in urban development has been driven largely by the private sector's desire to create more highly sustainable developments through the LEED program. This program area remains small compared to the municipal reuse market. However, it has a growing role for improving water efficiency in new buildings and developments and also for major modifications to existing facilities. A primary driver that compels land developers to consider the implementation of on-site treatment systems is the sustainability accreditation that is promoted and earned through the LEED program. The LEED program was developed by the U.S. Green Building Council (USGBC) in 2000 and represents an internationally-recognized green building certification system. At the time of preparation of this document, the current version of the Rating System Selection Guidance was LEED 2009, originally released in January 2010 and updated in September 2011. The guidance is currently under revision with the new LEED v4 focusing on increasing technical stringency from past versions and developing new requirements for project types such as data centers, warehouses and distribution centers, hotels/motels, existing schools, existing retail, and mid-rise residential buildings. More information is available on the USGBC website (USGBC, n.d.).

LEED provides building owners/operators with a framework for the selection and implementation of practical, measurable, and sustainable green building design, construction, and operations and maintenance solutions. LEED promotes sustainable building and site development practices through a tiered certification rating system that recognizes projects that implement green strategies for better overall environmental and health performance. The LEED system evaluates new developments, as well as significant modifications to existing buildings, based on a certification point system where applicants may earn up to a maximum of 110 points. LEED promotes a whole-building approach to energy and water sustainability by observance of these seven key areas of the LEED evaluation criteria: 1) sustainable sites, 2) water efficiency, 3) energy and atmosphere, 4) materials and resources, 5) indoor air quality, 6) innovation and design process, and 7) regional-specific priority credits. Developments may qualify for LEED certification designation and points, according to the following qualified certification categories:

- LEED Certified – 40 to 49 points
- LEED Silver – 50 to 59 points
- LEED Gold – 60 to 79 points
- LEED Platinum - 80+ points

On-site treatment systems can comprise a substantial fraction of the certification points with these systems qualifying for up to a maximum number of 11 points through the water efficiency and innovation and design processes in combination with water conservation practices. On-site water treatment systems may qualify for up to 10 points in the water efficiency category through water efficient design, construction, and long-term operation and maintenance features that promote water conservation and efficiency as follows:

- Water Efficient Landscaping, 2 to 4 points
- Innovative Wastewater Technologies, 2 points
- Water Use Reduction, 2 to 4 points

The on-site treatment system must provide water use reductions in conjunction with an associated water conservation program to secure a maximum number of LEED water efficiency points. An on-site treatment system may also help qualify for an Innovation in Design Process maximum credit of one point.

A major sub-category under the Water Efficiency section of the LEED criteria is water use reduction. The water use reduction subcategory determines how much water use can be reduced in and around a LEED-certified development. One item that can receive a score under water reuse is a rainwater (rooftop) harvesting system. The harvested rainwater resource may then be combined with an on-site graywater treatment system, a high-quality wastewater treatment system, or with the use of a municipal reclaimed water system source. The combination of the rainwater harvesting system with either a graywater treatment system, an on-site wastewater treatment system, or a municipal reuse system can together account for a total of up to seven LEED points. While this practice is contrary to the conventional practice of avoiding dilution of biologically degradable material in the sewage that is used by municipal wastewater treatment processes, the on-site treatment system allows multiple objectives of reducing effluent discharges and reducing stormwater

runoff while providing water that can be used for nonpotable purposes. The Fay School, located in Southborough, Mass., achieved LEED Gold Certification from the USGBC. The Fay School students now monitor building energy and building water consumption from a digital readout in each new dormitory building. The entire project was developed from the Fay School's interest in sustainable design principles and educates the students on the importance of water efficiency [[US-MA-Southborough](#)].

Battery Park City in lower Manhattan, New York City, is a collection of eight high-rise structures with 10 million ft² of floor area that serves 10,000 residents plus 35,000 daily transient workers. Water for toilet flushing, cooling, laundry, and irrigation comes from six on-site treatment systems. On-site systems use MBR technology for biological treatment and UV and ozone for disinfection. Potable water is supplied by New York City and the on-site treatment systems overflow to a combined wastewater/stormwater outfall. All buildings in Battery Park City are LEED certified Gold or Platinum (WERF, n.d.).

In an industrial setting, the Frito-Lay manufacturing facility in Casa Grande, Ariz., received a LEED Gold EB (Existing Building) certification with modification to the manufacturing process to incorporate an on-site process water treatment system and addition of 5 MW of on-site photovoltaic power generation [[US-AZ-Frito Lay](#)].

Reclaimed water, along with other major alternative water sources, such as harvested rainwater and collected stormwater runoff, offer the opportunity to maximize landscape irrigation and reduce potable water use at many industrial and commercial institutions and at multi-family residential developments. In the south and southwest United States, air conditioning condensate collection and reuse may represent another significant alternate water resource. On-site treatment systems can be designed to treat municipal wastewater, graywater, harvested rainwater, and stormwater. Regardless of water source selected for use, care must be taken to differentiate pipes on the private side of the municipal utility boxes, appropriately color code on-site pipes, and adopt a cross-connection control program for the different water sources.

2.4.2.3 Stormwater Harvesting and Use

Comprehensive and sustainable integrated water management programs should also consider multiple goals, including those that are related to stormwater, such as cost-effectively controlling flooding and erosion; improving water quality; conserving, sustaining, and recharging water supply; and preserving and restoring the health of wetlands and aquatic ecosystems. Because rainfall is generally the most significant factor in managing stormwater, capture and harvesting of rainfall and associated runoff present opportunities for stormwater use benefits. These include direct use of runoff for urban and agricultural irrigation, alternative water supply, aquifer recharge and saltwater intrusion barriers, wetlands enhancement, low (minimum) flow augmentation, feed lot cleaning, heating ventilation and air conditioning (HVAC) and power plant cooling, firefighting, and toilet flushing. However, stormwater harvesting requires an effective means of stormwater capture and retention that also supports the concurrent need for flood control. A good example of this practice is Cape Coral, Fla., which has maintained a very effective stormwater harvesting program since the 1980s primarily because of its extensive network of canals throughout the city. Within Cape Coral's integrated water management system, stormwater makes up as much as 75 percent of the irrigation water demand in the city, which allows for 100 percent reuse of the city's wastewater flows. Another case study that highlights these benefits is from the Water Purification Eco-Center (WPEC) at the Rodale Institute in Kutztown, Pa. [[US-PA-Kutztown](#)]; the WPEC project captures rainwater for public septic use and treats the septic water to be returned to the surrounding environment.

While the benefits of stormwater harvesting are clear, there are currently no federal regulations governing rainwater harvesting for nonpotable use, and the policies and regulations enacted at the state and local levels vary widely from one location to another. Regulations are particularly fragmented with regard to water conservation, as the permissible uses for harvested water tend to vary depending on the climate and reliability of the water supply. There are local plumbing codes, and some states, including Georgia, have published *Rainwater Harvesting Guidelines*, but not all states have formally defined rainwater harvesting as a practice distinct from water recycling (Georgia Department of Community Affairs, 2009). In

recent years, cities and counties looking to promote water conservation have begun issuing policies that better define harvested water and its acceptable uses. The city of Portland, Ore., for example, provides explicit guidance on the accepted uses of harvested water both indoors and outdoors. In January 2010, Los Angeles County issued a policy providing a clear, regulatory definition of "rainfall/nonpotable cistern water" and drawing a specific distinction between harvested water and graywater or recycled water.

In 2010, IAPMO published the *Green Plumbing and Mechanical Code Supplement (GPMCS)*. The supplement is a separate document from the Uniform Plumbing and Mechanical Codes and establishes requirements for green building and water efficiency applicable to plumbing and mechanical systems. The purpose of the GPMCS is to "provide a set of technically sound provisions that encourage sustainable practices and works towards enhancing the design and construction of plumbing and mechanical systems that result in a positive long-term environmental impact" (IAPMO, 2010). In addressing "Non-potable Rainwater Catchment Systems," the GPMCS specifically identifies provisions for collection surfaces, storage structures, drainage, pipe labeling, use of potable water as a back-up supply (provided by air-gap only), and a wide array of other design and construction criteria. It also refers to and incorporates information from the *ARCSA/ASPE Rainwater Catchment Design and Installation Standard (2008)*, a joint effort by the American Rainwater Catchment Systems Association (ARCSA) and the American Association of Plumbing Engineers (ASPE) (ARCSA/ASPE, 2008).

2.5 Environmental Considerations

Increasing water withdrawals, coupled with effluent discharges from WWTPs and agricultural runoff, can dramatically alter the hydrological cycles and nutrient cycling capacity of aquatic ecosystems. Water reuse can have both positive and adverse impacts on surrounding and downstream ecosystems. Elimination or reduction of a surface water discharge by reclamation and reuse generally reduces adverse water quality impacts to the receiving water. However, development of water reuse systems may have unintended environmental impacts related to land use, stream flow, and groundwater quality.

An environmental assessment may be required to meet state regulations or local ordinances and is required whenever federal funds are used. Formal guidelines for the development of an environmental impact statement (EIS) have been established by EPA. Such studies are generally associated with projects receiving federal funding or new NPDES permits and are not specifically associated with reuse programs. Where an investigation of environmental impacts is required, it may be subject to state policies. The following conditions could induce an EIS in a federally-funded project:

- The project may significantly alter land use.
- The project is in conflict with land use plans or policies.
- Wetlands will be adversely impacted.
- Endangered species or their habitat will be affected.
- The project is expected to displace populations or alter existing residential areas.
- The project may adversely affect a floodplain or important farmlands.
- The project may adversely affect parklands, preserves, or other public lands designated to be of scenic, recreational, archaeological, or historical value.
- The project may have a significant adverse impact upon ambient air quality, noise levels, or surface or groundwater quality or quantity.
- The project may have adverse impacts on water supply, fish, shellfish, wildlife, and their actual habitats.

These types of activities associated with federal EIS requirements are described below. Many of the same requirements are incorporated into environmental assessments required under state laws.

2.5.1 Land Use Impacts

Water reuse can induce significant land use changes, either directly or indirectly. Direct changes include shifts in vegetation or ecosystem characteristics induced by alterations in water balance in an area, such as wetland restoration or creation. Indirect

changes include land use alterations associated with industrial, residential, or other development made possible by the added supply of water from reuse. Other examples of changes in land use as a result of available reclaimed water include the potential for urban or industrial development in areas where natural water availability limits the potential for growth. For example, if the supply of potable water can be increased through recharge using reclaimed water, then restrictions to development might be reduced or eliminated. Even nonpotable supplies, made available for uses such as residential irrigation, can affect the character and desirability of developed land in an area. Similar effects can also happen on a larger scale, as municipalities in areas where development options are constrained by water supply might find that nonpotable reuse enables the development of parks or other amenities that were previously considered to be too costly or difficult to implement. Commercial users, such as golf courses, garden parks, or plant nurseries, have similar potential for development given the presence of reclaimed water supplies.

2.5.2 Water Quantity Impacts

Instream flows and levels in lakes and reservoirs can either increase or decrease as a consequence of reuse projects. In each situation where reuse is considered, there is the potential to shift water balances and effectively alter the prevailing hydrologic regime in an area, with the potential to damage or improve impacted ecosystems. Where wastewater discharges have occurred over an extended period of time, the flora and fauna can adapt and even become dependent on that water. A new or altered ecosystem can arise, and a reuse program implemented without consideration of this fact could have an adverse impact on such a community. Examples of how flows can increase as a result of a reuse project include:

- In streams where dry weather base flows are groundwater dependent, land application of reclaimed water for irrigation or other purposes can cause an increase in base flows, if the prevailing groundwater elevation is raised.
- Increases in stream flows during wet periods can result from pervasive use of recharge on the land surface during dry periods. In such a case, antecedent conditions are wetter, and less water moves into the ground, thereby increasing

runoff during a rainstorm. The instream system bears the consequences of this change.

- Instream flow reduction is also possible and can impact actual or perceived water rights. For example, the Trinity River in Texas, near the Dallas-Fort Worth Metroplex, maintains a continuous flow of several hundred cubic feet per second during dry periods due to return flows (discharges) from multiple WWTPs. If extensive reuse programs were to be implemented at the upstream facilities, dry weather flows in the Trinity River would be reduced, and plans for urban development downstream could potentially be impacted due to water restriction. Houston-area interest near the downstream end of the Trinity River stalled TCEQ issuance of Metroplex discharge and bed and banks transfer permits for several years until agreements were reached with individual large discharges in the Metroplex to maintain minimum flow to Lake Livingston, a primary source of drinking water for Houston.

In southern Arizona, the San Pedro River is distinct as the last free-flowing undammed river in Arizona, which supports a unique desert riparian ecosystem. Population growth around Sierra Vista has caused a significant drop in the groundwater table, which in turn reduces the stream flow in the river. Ecological considerations, including the protection of endangered species, prompted the decision to recharge the underlying aquifer with reclaimed water. Environmental Operations Park (EOP) in Sierra Vista includes a reclamation facility that polishes reclaimed water in constructed wetlands. The reclaimed water is then used to recharge the local aquifer in order to mitigate the adverse impacts of continued groundwater pumping in the San Pedro River system. The Sierra Vista EOP was established as a multi-use center, combining recharge basins, constructed wetlands, native grasslands, and a wildlife viewing facility [US-AZ-Sierra Vista].

An example from Sydney, Australia provides a rather unusual case where water reclamation was designed explicitly for environmental flows. Drinking water supplies in Sydney's main storage reservoir (Warragamba Dam) were rapidly declining between 2000 and 2006 due to severe drought. By law, Warragamba Dam was also required to continue to

provide satisfactory environmental flows (4.8 billion gallons [18 MCM] released annually) in the downstream Hawkesbury Nepean River system. A massive water reclamation project was implemented [Australia-Replacement Flows] to replace the Warragamba Dam's discharge with an alternative high-quality water source that met the required downstream environmental flows.

The SAWS in Texas defined the historic spring flow at the San Antonio River headwaters during development of its reclaimed water system. In cooperation with downstream users and the San Antonio River Authority, SAWS agreed to maintain release of 55,000 ac-ft/yr (68 MCM/yr) from its water reclamation facilities. This policy protects and enhances downstream water quality and provides 35,000 ac-ft/yr (43 MCM/yr) of reclaimed water for local use [US-TX-San Antonio]. The implication of these examples is that a careful analysis of the entire hydrologic system is an appropriate consideration in a reuse project, particularly where reuse flows are large, relative to the hydrologic system that will be directly impacted. Likewise, analysis of the effects from the chemical, physical, and biological constituents in discharges of reclaimed water must be considered where the end use is environmental flows; this is the same or similar to what is required for discharges of wastewater effluent.

2.5.3 Water Quality Impacts

There are potential water quality impacts from introducing reclaimed water back into the environment. The ecological risks associated with environmental reuse applications can be assessed relative to existing wastewater discharge practices (NRC, 2012); additional discussion on this topic is provided in Chapter 3. The report concludes that the ecological risks in reuse projects for ecological enhancement are not expected to exceed those encountered with the normal surface water discharge of treated municipal wastewater. Indeed, risks from reuse could be lower if additional levels of treatment are applied. The report cautions that current limited knowledge about the ecological effects of trace chemical constituents requires research to link population-level effects in natural aquatic systems to initial concerning laboratory observations. In reuse applications targeted for ecological enhancement of sensitive aquatic systems, careful assessment of risks from these constituents is warranted because aquatic organisms can be more

sensitive to certain constituents than humans (NRC, 2012).

In addition to potential impacts on surface water quality, groundwater quality can be significantly impacted by recharge with reclaimed water. Recharging groundwater with reclaimed water may change the water quality in the receiving aquifer. Conditions must be evaluated on a case-by-case basis, depending on potential constituents present in reclaimed water and the underlying site hydrogeology; additional discussion is provided in Section 2.3.3.

2.6 References

ARCASA/ASPE, 2008, *Rainwater Catchment Design and Installation Standard*. Retrieved August 23, 2012 from <http://scienceinteractive.net/files/ProposedRainwaterCatchmentDesignStandard.pdf>.

American Water Works Association (AWWA). 2009. *Manual of Water Supply Practices M-24: Planning for the Distribution of Reclaimed Water*. 3rd edition. American Water Works Association. Denver, CO.

American National Standard Institute (ANSI), 2007. *Standard Z535.1- 2006, For Safety Colors*, Rosslyn, VA.

AWWA California-Nevada Section (1997) *Guidelines for the On-Site Retrofit of Facilities Using Disinfected Tertiary Recycled Water*. Orange County, CA.

Ballaro, C. 2012. "Need for Water Conservation Stressed, Water Management Plan Laid Out for Cape Council." *Cape Coral (FL) Daily Breeze*, April 16, 2012. Retrieved April 2012 from <http://www.cape-coral-daily-breeze.com/page/content.detail/id/529796/Need-for-water-conservation-stre---.html>.

Bell, K.Y; L.P. Wiseman; and L. Turner. 2009. "Designing Pretreatment to Control Arsenic Leaching in ASR Facilities." *Journal of the American Water Works Association*. 101(6): 74-84.

California Building Standards Commission. 2009. *Express Terms for Proposed Emergency Building Standards of the Department of Housing and Community Development Regarding the 2007 California Plumbing Code (CPC), California Code of Regulations, Title 24, Part 5, Chapter 16A, Part I (Graywater Standards)*. Retrieved January 2010, from http://www.hcd.ca.gov/codes/shl/ET_Emerg_Ch16A_Pt1_R_EV7-1-09.pdf.

California Department of Public Health (CDPH). 2011. *Draft Regulations for Groundwater Replenishment with Recycled Water*. November 21, 2011. Retrieved August 2012, from

<http://www.cdph.ca.gov/certlic/drinkingwater/Documents/Recharge/DraftRechargeReg-2011-11-21.pdf>.

California State Water Resources Control Board (SWRCB). 2009. *Recycled Water Policy*. Retrieved July 2012, from http://www.swrcb.ca.gov/water_issues/programs/water_recycling_policy/.

CDM. 2005. *Urban Water Management Plan*. Report prepared for City of Los Angeles. CDM. Los Angeles, CA.

CH:CDM. 2006a. *Integrated Resources Plan, Facilities Plan, Volume 2*. Report prepared for City of Los Angeles. CDM. Los Angeles, CA.

CH:CDM. 2006b. *Integrated Resources Plan, Facilities Plan, Volume 3*. Report prepared for City of Los Angeles. CDM. Los Angeles, CA.

CH:CDM. 2006c. *Integrated Resources Plan, Facilities Plan, Volume 4*. Report prepared for City of Los Angeles. CDM. Los Angeles, CA.

Common Ground Alliance (CGA). 2011. *Best Practices Version 8.0*, Washington, DC. Retrieved August 2012 from http://www.commongroundalliance.com/Content/NavigationMenu/Best_Practices/Best_Practices_2011/BP_8.0_Web.pdf.

Crites, R. W., and G. Tchobanoglous. 1998. *Small and Decentralized Wastewater Management Systems*. McGraw-Hill. New York.

Dublin San Ramon Services District (DSRSD). 2005. *Recycled Water Use Guidelines and Requirements*. Retrieved July 2012 from http://www.dsrdsd.com/img_doing_business/Recycled%20Water%20Use%20Guidelines/RW%20Guidelines.pdf.

Enrix. 2010. "ASR Using Sodium Bisulfide Treatment for Deoxidation to Prevent Arsenic Mobilization." *Proceedings of the Aquifer Recharge Conference*. Orlando, FL.

Florida Department of Environmental Protection (FDEP). n.d. Retrieved July 2012 from http://www.dep.state.fl.us/water/wastewater/dom/docs/separations_diagram.pdf.

Florida Department of Environmental Protection (FDEP). 2009. *Florida Section Resources*. Retrieved August 2012, from <http://www.watereuse.org/sections/florida/resources>.

Fox, P. 2002. "Soil Aquifer Treatment: An Assessment of Sustainability." In *Management of Aquifer Recharge for Sustainability*. A. A. Balkema Publishers. Australia.

- Georgia Department of Community Affairs. 2009. *Georgia Rainwater Harvesting Guidelines*. Retrieved August 2012, from http://www.dca.state.ga.us/development/constructioncodes/programs/downloads/GeorgiaRainWaterHarvestingGuidelines_2009.pdf.
- Gordon, H. B., L. D. Rotstain, J. L. McGregor, M. R. Dix, E. A. Kowalczyk, S. P. O'Farrell, L. J. Waterman, A. C. Hirst, S. G. Wilson, M. A. Collier, I. G. Watterson, and T. I. Elliott. 2002. "The CSIRO Mk3 Climate System Model." In *CSIRO Atmospheric Research Technical Paper*, no. 60. Commonwealth Scientific and Industrial Research Organisation. Australia.
- Henry, R. 2011. "Lake Lanier Water Dispute: Court Won't Rehear Ruling." *Huffington Post*. Retrieved August 2012, from http://www.huffingtonpost.com/2011/09/19/georgia-lake-lanier-water-dispute-court-hearing_n_970328.html.
- International Association of Plumbing and Mechanical Officials. 2010. *Green Plumbing and Mechanical Code Supplement*. IAPMO. Ontario, Canada.
- Kazner, C.; T. Wintgens; and P. Dillon. 2012. *Water Reclamation Technologies for Safe Managed Aquifer Recharge*. IWA Publishing. London, UK.
- López Calva, E., A. Magallanes, and D. Cannon. 2001. "Systems Modeling for Integrated Planning in the City of Los Angeles: Using Simulation as a Tool for Decision Making." WEFTEC 2001. Water Environment Federation 74th Annual Conference and Exhibition. Atlanta, GA.
- Marina Coast Water District, CA. 2002. Title 4. Recycled Water Chapter 4.28 Recycled Water, Supplement 3-02 to Ordinance 29 § 4, 5, and 6, 1995; and Ordinance 27 § 5, 1994, Retrieved April 2012 from http://www.mcwd.org/code_4_recycled_water.html.
- Mirecki, J. E. 2010. "Dynamics of Sulfate Reduction in the Floridian Aquifer System with Implications for Arsenic Sequestration at Reclaimed and Treated Surface Water ASR Systems." *Proceedings of the Aquifer Recharge Conference*. Orlando, FL.
- Mirecki, J. E. 2004. *Water-Quality Changes During Cycle Tests at Aquifer Storage Recovery (ASR) Systems of South Florida*. ERDC/EL TR-04-8. U.S. Army Corps of Engineers. Vicksburg, MS.
- National Research Council. 2012. *Water Reuse: Potential for Expanding the Nation's Water Supply Through Reuse of Municipal Wastewater*. The National Academies Press: Washington, D.C.
- National Research Council. 2008. *Prospects for Managed Underground Storage of Recoverable Water*. The National Academies Press. Washington, D.C.
- The NELAC Institute (TNI). n.d. Retrieved August 23, 2012 from <http://www.nelac-institute.org/>.
- NSF/ANSI 350-2011 (NSF). 2011a. *Onsite Residential and Commercial Water Reuse Treatment Systems*. National Sanitation Foundation, Ann Arbor, Michigan, July 2011.
- NSF/ANSI 350-1-2011 (NSF) 2011b. *Onsite Residential and Commercial Graywater Treatment Systems for Subsurface Discharge*. National Sanitation Foundation, Ann Arbor, Michigan, June 2011.
- National Water Commission of Mexico. 2010. *Statistics on Water in Mexico*. CONAGUA. Mexico.
- Natural Resource Management Ministerial Council, Environment Protection and Heritage Council, and Australian Health Ministers' Conference. 2006. *Australian Guidelines for Water Recycling: Managing Health and Environmental Risks*. Environment Protection Heritage Council. Canberra, Australia.
- Oasis Design. 2012. *Graywater Policy Center*. Retrieved July 2012 from <http://www.oasisdesign.net/greywater/law/>.
- O'Connor, T. P., D. Rodrigo, and A. Cannan. 2010. "Total Water Management: The New Paradigm for Urban Water Resources Planning." *Proceedings of World Environmental and Water Resources Congress 2010*. Providence, R.I.
- Pyne, R. D. G. 2005. *Aquifer Storage Recovery: A Guide to Groundwater Recharge through Wells*. 2nd edition. ASR Systems Publishing, Gainesville, FL.
- Rimer, A. 2009. "Graywater 'Blues' – The Perils of Its Use." *WateReuse Symposium*, Seattle, WA.
- Rodrigo, D., E. J. López Calva, and A. Cannan. 2012. *Total Water Management*. EPA 600/R-12/551. U.S. Environmental Protection Agency. Washington, D.C.
- Rose, J. B., D. E. Huffman, K. Riley, S. Farrah, J. Lukasik, and C. L. Hamann. (2001). "Reduction of Enteric Microorganisms at the Upper Occoquan Sewage Authority Water Reclamation Plant." *Water Environment Research*. 73:711–720.
- San Antonio Water System (SAWS). 2006. *Recycled Water Users' Handbook*. Retrieved July 2012 from http://www.saws.org/your_water/recycling/handbook/docs/recycled_water_hb_rev20080620.pdf
- Sheikh, B. 2010. White Paper on Graywater. WateReuse Association. Alexandria, VA.

- Shrier, C. 2010. "Reclaimed Water ASR for Potable Re-Use: The Next Frontier." *Proceedings of the Aquifer Recharge Conference*. Orlando, FL.
- Stuyfzand, P. J. 1998. "Quality Changes upon Injection into Anoxic Aquifers in the Netherlands: Evaluation of 11 Experiments." In J. H. Peters (Ed.), *Artificial Recharge of Groundwater*. A.A. Balkema. Rotterdam, Netherlands.
- Texas Commission on Environmental Quality (TCEQ). 1997. *Texas Administrative Code*. Retrieved August, 2012, from [http://info.sos.state.tx.us/pls/pub/readtac\\$ext.ViewTAC?tac_view=4&ti=30&pt=1&ch=210](http://info.sos.state.tx.us/pls/pub/readtac$ext.ViewTAC?tac_view=4&ti=30&pt=1&ch=210).
- Toze, S., and J. Hanna. 2002. "The Survival Potential of Enteric Microbial Pathogens in a Treated Effluent ASR Project." In *Management of Aquifer Recharge for Sustainability*. Balkema Publishers. Australia.
- U.S. Environmental Protection Agency (EPA). 2012. *WaterSense: An EPA Partnership Program*. Retrieved September 6, 2012 from www.epa.gov/watersense.
- U.S. Environmental Protection Agency (EPA). 2006. *Process Design Manual Land Treatment of Municipal Wastewater Effluents*. EPA/625/R-06/016. Environmental Protection Agency, Office of Research and Development. Cincinnati, OH.
- U.S. Environmental Protection Agency (EPA). 2004. *Guidelines for Water Reuse*. EPA. 625/R04/108. Environmental Protection Agency. Washington, D.C.
- U.S. Environmental Protection Agency (EPA). 2003. *Cross-Connection Control Manual*. EPA 816-R-03-002. Environmental Protection Agency, Office of Water, Washington, D.C.
- U.S. Environmental Protection Agency (EPA). 2001. *Safe Drinking Water Act, Underground Injection Control (UIC) Program, Protecting Public Health and Drinking Water Resources*. EPA. 816-H-01-003. Environmental Protection Agency. Washington, D.C.
- U.S. Environmental Protection Agency (EPA). 1974. *Design Criteria for Mechanical, Electrical, and Fluid System and Component Reliability – Supplement to Federal Guidelines for Design, Operation, and Maintenance of Waste Water Treatment Facilities*. EPA 430/99-74-001. Environmental Protection Agency. Washington, D.C.
- U.S. Green Building Council (USGBC). n.d. Accessed July 2012 from <http://www.usgbc.org/>.
- Van Riper, C., G. Schlender, and M. Walther. 1998. "Evolution of Water Reuse Regulations in Washington State." *WaterReuse Conference Proceedings*. Denver, CO.
- Vandertulip, W. D. 2011a. "Are We Color Blind?" *WEFTEC Proceedings*. Los Angeles, CA.
- Vandertulip, W. D. 2011b. "Can We Support a National Water Utility Pipe Color Code?" *WaterReuse Symposium Proceeding*. Phoenix, AZ.
- WaterReuse Association (WRA). 2009. *Manual of Practice, How to Develop a Water Reuse Program*. WaterReuse Association. Alexandria, VA.
- Water Environment Research Foundation (WERF). n.d. *Case Study: Battery Park Urban Water Reuse*. Water Environment Research Foundation. Alexandria, VA.
- WaterReuse Research Foundation (WRRF). 2009. *Selection and Testing of Tracers for Measuring Travel Times in Natural Systems Augmented with Treated Wastewater Effluent*. WRF-05-007. WaterReuse Research Foundation. Alexandria, VA.
- WaterReuse Research Foundation (WRRF). 2007a. *Extending the Integrated Resource Planning Process to Include Water Reuse and Other Nontraditional Water Sources*. WRF-04-010. WaterReuse Research Foundation. Alexandria, VA.
- WaterReuse Research Foundation (WRRF). 2007b. *Reclaimed Water Aquifer Storage and Recovery: Potential Changes in Water Quality*. WRF-03-009-01. WaterReuse Foundation. Alexandria, VA.

CHAPTER 3

Types of Reuse Applications

The United States has achieved numerous accomplishments toward expanding the use of reclaimed water and extending water resources for many communities. Yet, there is room for improvement in terms of the total amount of water reused, distribution of reclaimed water use throughout the country, and the adoption of new, higher quality uses. A report by the NRC Water Science & Technology Board titled *Water Reuse: Potential for Expanding the Nation's Water Supply Through Reuse of Municipal Wastewater* estimates that as much as 12 bgd (45 MCM/d) of the 32 bgd (121 MCM/d) produced in the United States can be beneficially reclaimed and reused (NRC, 2012). Recent estimates indicate that approximately 7 to 8 percent of wastewater is reused in the United States (Miller, 2006 and GWI, 2009) (**Figure 3-1**). Therefore, there is tremendous potential for expanding the use of reclaimed water in the future.

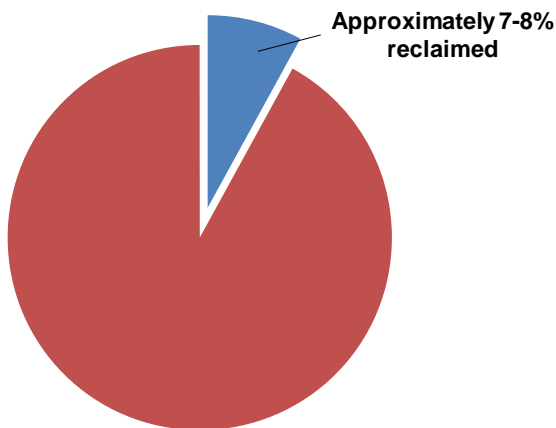

The United States produces approximately 32 billion gallons of municipal effluent per day.

Figure 3-1
Reclaimed water use in the United States

Outside of the United States, there are examples of countries with different water resource demands that greatly exceed this percentage. Several countries, including Australia and Singapore, have established goals for reuse, expressed in terms of the percentage of municipal wastewater effluent that is treated to a higher quality and beneficially reused. Australia currently reuses approximately 8 percent of its treated

wastewater with a goal of reusing 30 percent by 2015. Saudi Arabia currently reuses 16 percent with a goal to increase reuse to 65 percent by 2016. Singapore reuses 30 percent and has long-term planning in place to diversify its raw water supplies and reduce dependence on supplies from outside sources (i.e., Malaysia). Israel has attained the highest national percentage by beneficially reusing 70 percent of the generated domestic wastewater.

The last comprehensive survey of water reuse in the United States was conducted in 1995 by the U.S. Geological Survey (USGS); more recently, the USGS compiled water use data from 2005 (Solley et al., 1998). Estimates of wastewater reuse were compiled by some states for the industrial, thermoelectric, and irrigation categories but were not reported because of the small volumes of water compared to the totals (Kenny et al., 2009). The study revealed that 95 percent of water reuse occurred in just four states: Arizona, California, Florida, and Texas. This is now estimated to be less than 90 percent due to increased water reuse in several other states, especially Nevada, Colorado, New Mexico, Virginia, Washington, and Oregon. In addition, reuse is now practiced in the Mid-Atlantic and Northeast regions of the United States, with a number of water reuse facilities in New Jersey, Pennsylvania, New York, and Massachusetts. Production and distribution of reclaimed water varies regionally by categories of use and depends on historical and emerging drivers, as described in Chapter 5.

Table 3-1 shows the distribution of reclaimed water use for California and Florida—the two largest users of reclaimed water in the United States. Although California reused 669,000 ac-ft (825 MCM) of water in 2009, coastal communities were an untapped source of reclaimed water by discharging 3.5 million ac-ft (4,300 MCM) of highly-treated wastewater to the Pacific Ocean. The challenge for coastal communities then shifts from adequate supply to an ability to distribute the new source water from the coast through a highly-developed urbanized area to points of use.

Table 3-1 Distribution of reclaimed water in California (Baydal, 2009) and Florida (FDEP, 2011)

| Reuse Category | | California (% Use in 2009) | Florida (% Use in 2010) |
|--------------------------------|--|-------------------------------|----------------------------|
| Irrigation | Agricultural | 29 | 11 |
| | Urban reuse (landscape irrigation, golf courses) | 19 | 55 |
| Groundwater Recharge | | 5 | 14 |
| Seawater Intrusion Barrier | | 8 | - |
| Industrial Reuse | | 7 | 13 |
| Natural Systems and Other Uses | | 23 | 9 |
| Recreational Impoundments | | 7 | - |
| Geothermal Energy | | 2 | - |

The distribution of reclaimed water use in the United States is a reflection of regional characteristics, and these differences are explored in greater detail in Chapter 5. Understanding the planning considerations and requirements for reuse types is critical to developing a successful program. Thus, this chapter highlights major types of reuse, including agricultural, industrial, environmental, recreational, and potable reuse; examples of these applications across the United States and internationally are provided for these applications.

3.1 Urban Reuse

While there are several major categories of reuse, in the United States urban reuse is one of the highest volume uses. Applications such as recreational field and golf course irrigation, landscape irrigation, and other applications, including fire protection and toilet flushing, are important components of the reclaimed water portfolio of many urban reuse programs. Urban reuse is often divided into applications that are either accessible to the public or have restricted access, in settings where public access is controlled or restricted by physical or institutional barriers, such as fences or temporal access restriction. Additional information on the treatment and monitoring requirements for both types of urban reuse is provided in Chapter 6. Additionally, because urban reuse comprises such a large fraction of the total reclaimed water use, detailed information regarding planning and management of reclaimed water supplies and systems that include urban reuse is provided in Chapter 2.

3.1.1 Golf Courses and Recreational Field Irrigation

In order to maximize the use of potable water in resource-limited systems, communities are working to identify alternatives for minimizing nonpotable

consumption by supplying reclaimed water for reuse. When used to irrigate residential areas, golf courses, public school yards, and parks, reclaimed water receives treatment and high-level disinfection and is not considered a threat to public health. However, the water quality of reclaimed water differs from that of drinking quality water or rainfall and should be considered when used for irrigation and other industrial reuse applications. Of particular importance are the salts and nutrients in reclaimed water, and special management practices for both end uses may be required depending on the concentrations in the reclaimed water. For example, in some areas where landscaping is irrigated, the salt sensitivity of the irrigated plants should be considered.

The 2004 *Guidelines for Water Reuse* (EPA, 2004) identified irrigation of golf courses as one of several typical urban water reuse practices. While this was and still is an attractive use for reclaimed water as large quantities can be beneficially used by one user, there are operational practices and cautions that planners should consider. Between September 2000 and December 2004, AWWA conducted a survey of reclaimed water use practices on golf courses (Grinnell and Janga, 2004). Results of this survey were compiled from 180 responses from seven states, Canada, and Mexico. Two-thirds of the responses were from Florida, California, and Arizona. Combined with data from the Golf Course Superintendents Association of America (GCSAA), AWWA estimated in 2004 that 2,900 of the 18,100 golf courses surveyed were using reclaimed water, a 600 percent increase from 1994 data. Although most comments were positive, some respondents expressed concern regarding algal problems in ponds, changes in course treatment, and increased turf management.

A more recent survey in 2006 by the GCSAA and the Environmental Institute for Golf (EIFG) requested input from superintendents at 16,797 courses and received response from 2,548 (GCSSA and EIFG, 2009). Based on this survey, an estimated 12 percent of golf courses in the United States use reclaimed water, with more courses in the southwest (37 percent) and southeast (24 percent) practicing reuse. In fact, the most recent state survey for Florida in 2010 (FDEP, 2011) listed 525 golf courses using nearly 118 mgd (5170 L/s) of reclaimed water, representing about 17.9 percent of the daily reuse within the state. This continued application of reuse to golf courses is exemplified in the following case studies:

- US-FL-Pompano Beach
- US-FL-Marco Island
- US-TX-Landscape Study
- Australia-Victoria

The most common reason identified by golf courses for not using reclaimed water for irrigation was the lack of a source for reclaimed water (53 percent of respondents) (FDEP, 2011). It was also not a surprise that the poorest water quality identified by respondents was in the southwest where there was typically higher TDS and salinity concerns. With lower water quality, systems in the southwest and southeast were most likely to use wetting agents and fertigation systems. To address some of the water quality concerns, turfgrass research has been conducted to determine the most salt-tolerant species for a geographic area and soil type.

In San Antonio, SAWS and Texas A&M University conducted a 2-year test (2003 to 2004) that compared the application rates of potable (control) water and reclaimed water on 18 plots of Tifway Bermuda grass and Jamur zoysia grass (Thomas et al., 2006). The study evaluated leachate quality, soil ion retention, and grass quality. Of particular concern was the potential transport through the root zone of nitrate, which could potentially percolate in the local karst geology to the sole source Edwards Aquifer. Results indicated both grasses were well adapted to using the SAWS reclaimed water; the grasses maintained high quality but did not uptake all of the nitrogen applied during the December to February dormant period. Soil

ions concentrations increased, indicating a need for long-term monitoring, scheduled leaching, and/or supplemental treatment to maintain good soil conditions. During the dormant season for the two grasses, the study recommended applications of reclaimed water at no more than the evapotranspiration rate to preclude nitrate transport below the root zone.

Golf course turf studies have been conducted for over 30 years and there are several publications that have been developed for the USGA and GCSAA related to use of reclaimed water for golf course irrigation. Reclaimed water for this purpose has been referred to as “purple gold,” especially in the southwestern United States where golf course turf depends on irrigation (Harivandi, 2011). Recommendations for use of reclaimed water for turfgrass irrigation focus on quality limits of reclaimed water and monitoring. For reclaimed water that exceeds the recommended criteria presented in **Table 3-2**, slight to moderate use restrictions would apply (Harivandi, 2011).

Even though the poorest quality reclaimed water with respect to TDS is produced in the southwest, it is there where the greatest golf course reuse occurs. In addition to selecting salt-tolerant grasses such as Alkali, Bermuda, Fineleaf, St. Augustine, Zoysia, Saltgrass, Seashore, or Paspalum, many facilities have implemented solutions to mitigate adverse impacts of challenging water quality. Some of these practices include:

- Applying extra water to leach excess salts below the turfgrass root zone
- Providing adequate drainage

Table 3-2 Interpretation of reclaimed water quality

| Parameter | Units | Degree of Restriction on Use | | |
|-------------------|--------------------|------------------------------|--------------------|---------|
| | | None | Slight to Moderate | Severe |
| Salinity | | | | |
| Ecw | dS m ⁻¹ | < 0.7 | 0.7 - 3.0 | > 3.0 |
| TDS | mg/L | < 450 | 450 - 2,000 | > 2,000 |
| Ion Toxicity | SAR | < 3 | 3-9 | > 9 |
| Sodium (Na) | meq/L | < 3 | > 3 | |
| Root Absorption | mg/L | < 70 | > 70 | |
| Foliar Absorption | meq/L | < 2 | 2 - 10 | > 10 |
| Chloride (Cl) | mg/L | < 70 | 70 - 355 | > 355 |
| Root Absorption | meq/L | < 3 | > 3 | |
| Foliar Absorption | mg/L | < 100 | > 100 | |
| Boron | mg/L | < 1.0 | 1.0 - 2.0 | > 2.0 |
| pH | | | 6.5 - 8.4 | |

- Modifying turf management practices
- Modifying the root zone mixture
- Blending irrigation waters
- Using amendments

A study by Virginia Polytechnic Institute and State University investigated nutrient management practices and application rates of nitrogen to turf and crops in Virginia (Hall et al., 2009). This study found that 50 percent of responding golf course superintendents were applying nitrogen to greens at rates in excess of turfgrass needs (> 5.1 lbs of water soluble nitrogen per 1,000 ft²). With only 16 percent of respondents providing supplemental irrigation, no significant problems were detected, but the study did suggest education programs to reduce nitrogen application rates in several turf management areas to minimize potential for transport of nutrients off-site.

In addition to managing water quality, many facilities are required to implement special management practices where reuse is implemented to minimize the potential of cross-connection of water sources. For example, golf courses in San Antonio are required to include a double-check valve on the reclaimed water supply to the property to prevent backflow of reclaimed water into the SAWS potable water distribution system. Golf courses are also required to include a reduced pressure principal backflow preventer on the potable water supply to the property.

Irrigation of public parks and recreation centers, athletic fields, school yards and playing fields, and landscaped areas surrounding public buildings and facilities plays an important role in reuse. The considerations for irrigating these areas are much like those for golf courses. However, as discussed in Chapter 4, many states have regulations that specifically address urban use of reclaimed water.

3.2 Agricultural Reuse

Water availability is central to the success of agricultural enterprises domestically and globally and cuts across multiple disciplines related to human health, food safety, economics, sociology, behavioral studies, and environmental sciences (O'Neill and Dobrowolski, 2011). As such, almost 60 percent of all the world's freshwater withdrawals go towards irrigation uses. Farming could not provide food for the

world's current populations without adequate irrigation (Kenny et al., 2009). By 2050, rising population and incomes are expected to demand 70 percent more production, compared to 2009 levels. Increased production is projected to come primarily from intensification on existing cultivated land, with irrigation playing an important role (FAO, 2011).

In the United States, agricultural irrigation totals about 128,000 mgd (5.6 M L/s) (Kenny et al., 2009), which represents approximately 37 percent of all freshwater withdrawals. Confounding the agricultural water supply issue are the recent increases in midwestern and southeastern inter-annual climate variability that has led to more severe droughts, making issues of agricultural water reliability a greater national challenge. In many regions of the United States, expanding urban populations and rising demands for water from municipal and industrial sectors now compete for water supplies traditionally reserved for irrigated agriculture. In other areas, irrigation water supplies are being depleted by agricultural use. These shifts in the availability and quality of traditional water resources could have dramatic impacts on the long-term supply of food and fiber in the United States (Dobrowolski et al., 2004, 2008).

Agricultural use of reclaimed water has a long history and currently represents a significant percentage of the reclaimed water used in the United States. Therefore, the U.S. Department of Agriculture/National Institute of Food and Agriculture (USDA/NIFA) has made funding for water reuse one of its key priorities; additional discussion of the USDA/NIFA research is provided in Appendix A. Reclaimed water from municipal and agricultural sources provides many advantages, including:

- The supply of reclaimed water is highly reliable and typically increases with population growth.
- The cost of treating wastewater to secondary (and sometimes even higher) standards is generally lower than the cost of potable water from unconventional water sources (e.g., desalination).
- The option of allocating reclaimed water to irrigation is often the preferred and least expensive management alternative for municipalities.

- Reclaimed water is an alternative to supplement and extend freshwater sources for irrigation.
- In many locales, reclaimed water might be the highest quality water available to farmers, and could represent an inexpensive source of fertilizer. However, this advantage is conditional on proper quantities and timing of water and nutrients. Depending on the stage of growth, excess nutrients can negatively affect yields (Dobrowolski et al., 2008).

Use of reclaimed water for agriculture has been widely supported by regulatory and institutional policies. In 2009, for example, California adopted both the *Recycled Water Policy* and “Water Recycling Criteria.” Both policies promote the use of recycled water in agriculture (SWRCB, 2009 and CDPH, 2009). In response to an unprecedented water crisis brought about by the collapse of the Bay-Delta ecosystem, climate change, continuing population growth, and a severe drought on the Colorado River, the California State Water Resources Control Board (SWRCB) was prompted to “exercise the authority granted to them by the Legislature to the fullest extent possible to encourage the use of recycled water, consistent with state and federal water quality laws.” As a result, future recycled water use in California is estimated to reach 2 million ac-ft/yr (2,500 MCM/yr) by 2020, and 3 million ac-ft/yr (3,700 MCM/yr) by 2030 (SWRCB, 2009). As a result, California presently recycles about 650,000 ac-ft/yr (800 MCM/yr), an amount that has doubled in the last 20 years (SWRCB, 2010) with agriculture as the top recycled water user. Other

reclaimed water uses are shown in **Figure 3-2**.

In Florida, promotion of reclaimed water began in 1966; currently, 63 of 67 counties have utilities with reclaimed water systems. One of the largest and most visible reclaimed water projects is known as WATER CONSERV II in Orange County, Fla., where farmers have used reclaimed water for citrus irrigation since 1986. Another long-serving example of reclaimed water use in the United States is the city of Lubbock, Texas, where reclaimed water has been used to irrigate cotton, grain sorghum, and wheat since 1938. In addition, reclaimed water is a significant part of the agricultural water sustainability portfolio in Arizona, Colorado, and Nevada (**Table 3-3**).

Table 3-3. Nationwide reuse summaries of reclaimed water use in agricultural irrigation (adapted from Bryk et al., 2011)

| State | Annual Agricultural Reuse Volume | |
|----------------|----------------------------------|---------------|
| | mgd | 1000 ac-ft/yr |
| Arizona | 23 | 26 |
| California | 270 | 303 |
| Colorado | 2.97 | 3 |
| Florida | 256 | 287 |
| Idaho | 0.27 | 0.3 |
| North Carolina | 1.0 | 1 |
| Nevada | 13.4 | 15 |
| Texas | 19.4 | 22 |
| Utah | 0.81 | 1 |
| Washington | 0.02 | 0.03 |
| Wyoming | 0.89 | 1 |

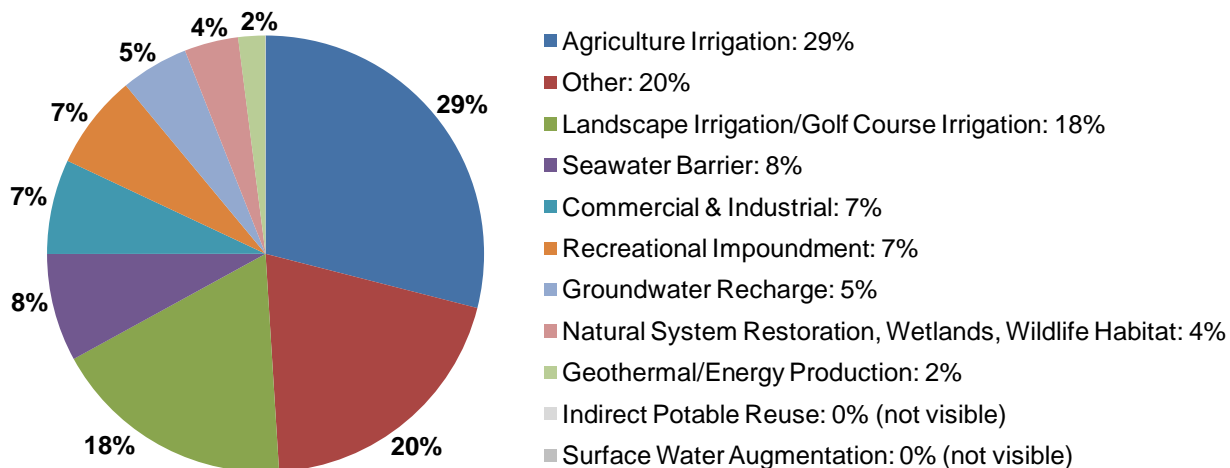

Figure 3-2 Nationwide reuse summaries of reclaimed water use in agricultural irrigation (adapted from Bryk, et al., 2011)

3.2.1 Agricultural Reuse Standards

Different regions and governmental agencies, both in the United States and globally, have adopted a variety of standards for use of reclaimed water for irrigation of crops. These rules and regulations have been developed primarily to protect public health and water resources; specific crop water quality requirements must be developed with the end users. The standards that have been adopted in the United States have proven protective of public health in spite of the vast differences in their stringency.

The WHO guidelines (WHO, 2006) for irrigation with reclaimed water, widely adopted in Europe and other regions, is a science-based standard that has been successfully applied to irrigation reuse applications throughout the world. And, the California Water Recycling Criteria (Title 22 of the state Code of Regulations) require the most stringent water quality standards with respect to microbial inactivation (total coliform < 2.2 cfu/100 mL). California Water Recycling Criteria requires a specific treatment process train for production of recycled water for unrestricted food crop irrigation that includes, at a minimum, filtration and disinfection that meets the state process requirements.

Irrigation of crops (both food and non-food) with untreated wastewater is widely practiced in many parts of the developing world with accompanying adverse public health outcomes. Nonetheless, this practice represents an economic necessity for many farming communities and for the rapidly expanding population at large, much of which is dependent on locally grown crops. Various international aid organizations have mobilized to improve upon these irrigation practices and provide barriers against transmission of disease-carrying agents (Scott et al., 2004). Regulated and well-managed irrigation under WHO guidelines (or similar standards) can be protective of public health and the health of farm workers. More restrictive regulations, such as those in California and Italy, while amply protective, are potentially prohibitively expensive in some economic contexts without necessarily improving the public health outcome. Additional discussion of the implications of stringent regulations in economically challenged contexts is provided in Chapter 9. The regulations, guidelines, and standards that are relevant to agricultural reuse applications in the United States, as well as a summary of standards by reuse type, are provided in Chapter 4.

3.2.2 Agricultural Reuse Water Quality

Because agricultural reuse is one of the most significant uses of reclaimed water globally, it is critical to understand the factors that determine success or failure of a farming operation dependent upon reclaimed water for irrigation. The same concerns for chemical constituents are applicable to all sources of irrigation water, and reclaimed water is no exception. Several factors, including soil-plant-water interactions (irrigation water quality, plant sensitivity and tolerance, soil characteristics, irrigation management practices, and drainage) are important in crop production. For example, under poor drainage conditions, even the most generally suitable water quality used for irrigation may lead to crop failure. On the other hand, well-drained soils, combined with a proper leaching fraction in the irrigation regime, can tolerate relatively high salinity in the irrigation water, whether it is reclaimed water or brackish groundwater.

Thus, when considering the use of reclaimed water in agriculture, it is important to identify the key constituents of concern for agricultural irrigation. Plant sensitivity is generally a function of a plant's tolerance to constituents encountered in the root zone or deposited on the foliage, and reclaimed water tends to have higher concentrations of some of these constituents than the groundwater or surface water sources from which the water supply is drawn. The types and concentrations of constituents in reclaimed water depend on the municipal water supply, the influent waste streams (i.e., domestic and industrial contributions), the amount and composition of infiltration in the wastewater collection system, the treatment processes, and the type of storage facilities. Determining the suitability of a given reclaimed water supply for use as a supply of agricultural irrigation is, in part, site-specific, and agronomic investigations are recommended before implementing an agricultural reuse program.

To assess quality of reclaimed water with respect to salinity, the Food and Agriculture Organization (FAO) (1985) has published recommendations for agricultural irrigation with degraded water; this information provides a guide to making an initial assessment for application of reclaimed water in an agricultural setting. A summary of these recommendations is provided in **Table 3-4**. There are a number of assumptions in these guidelines, which are intended to cover the wide range of conditions that may be

encountered in irrigated agriculture practices; where sufficient experience, field trials, research, or observations are available, the guidelines may be modified to address local conditions more closely.

- **Yield Potential:** Full production capability of all crops, without the use of special practices, is assumed when the guidelines indicate no restrictions on use. A “restriction on use” indicates that choice of crop may be limited or that special management may be needed to maintain full production capability; it does not indicate that the water is unsuitable for use.
- **Site Conditions:** Soil texture ranges from sandy-loam to clay-loam with good internal drainage; the climate is semi-arid to arid, and rainfall is low. Rainfall does not play a significant role in meeting crop water demand or leaching requirement. Drainage is assumed to be good, with no uncontrolled shallow water table present within 6 ft (2 m) of the surface.
- **Method of Irrigation:** Normal surface or sprinkler irrigation methods are used; water is applied infrequently, as needed; and the crop utilizes a considerable portion of the available stored soil-water (50 percent or more) before the next irrigation. At least 15 percent of the applied water percolates below the root zone. The guidelines are too restrictive for specialized irrigation methods, such as localized drip irrigation, which results in near daily or frequent irrigations, but are applicable for subsurface irrigation if surface-applied leaching satisfies the leaching requirements.

Table 3-4 Guidelines for interpretation of water quality for irrigation¹

| Potential Irrigation Problem | | Units | Degree of Restriction on Irrigation | | |
|--|--------------------------------------|-----------------------------|-------------------------------------|--------------------|--------|
| | | | None | Slight to Moderate | Severe |
| Salinity (<i>affects crop water availability</i>) ² | | | | | |
| | EC_w | dS/m | < 0.7 | 0.7 – 3.0 | > 3.0 |
| | TDS | mg/L | < 450 | 450 – 2000 | > 2000 |
| Infiltration (<i>affects infiltration rate of water into the soil; evaluate using EC_w and SAR together</i>) ³ | | | | | |
| SAR | 0 – 3 | and EC_w = | > 0.7 | 0.7 – 0.2 | < 0.2 |
| | 3 – 6 | | > 1.2 | 1.2 – 0.3 | < 0.3 |
| | 6 – 12 | | > 1.9 | 1.9 – 0.5 | < 0.5 |
| | 12 – 20 | | > 2.9 | 2.9 – 1.3 | < 1.3 |
| | 20 – 40 | | > 5.0 | 5.0 – 2.9 | < 2.9 |
| Specific Ion Toxicity (<i>affects sensitive crops</i>) | | | | | |
| | Sodium (Na) ⁴ | | | | |
| | surface irrigation | SAR | < 3 | 3 – 9 | > 9 |
| | sprinkler irrigation | meq/l | < 3 | > 3 | |
| | Chloride (Cl) ⁴ | | | | |
| | surface irrigation | meq/l | < 4 | 4 – 10 | > 10 |
| | sprinkler irrigation | meq/l | < 3 | > 3 | |
| | Boron (B) | mg/L | < 0.7 | 0.7 – 3.0 | > 3.0 |
| Miscellaneous Effects (<i>affects susceptible crops</i>) | | | | | |
| | Nitrate (NO₃-N) | mg/L | < 5 | 5 – 30 | > 30 |
| | Bicarbonate (HCO₃) | meq/L | < 1.5 | 1.5 – 8.5 | > 8.5 |
| | pH | | Normal Range 6.5 – 8.4 | | |

¹ Adapted from FAO (1985)

² EC_w means electrical conductivity, a measure of the water salinity, reported in deciSiemens per meter at 25°C (dS/m) or in millimhos per centimeter (mmho/cm); both are equivalent.

³ SAR is the sodium adsorption ratio; at a given SAR, infiltration rate increases as water salinity increases.

⁴ For surface irrigation, most tree crops and woody plants are sensitive to sodium and chloride; most annual crops are not sensitive. With overhead sprinkler irrigation and low humidity (< 30 percent), sodium and chloride may be absorbed through the leaves of sensitive crops.

- Restriction on Use:** The “Restriction on Use” shown in **Table 3-4** is divided into three degrees of severity: none, slight to moderate, and severe. The divisions are somewhat arbitrary because changes occur gradually, and there is no clear-cut breaking point. A change of 10 to 20 percent above or below a guideline value has little significance if considered in proper perspective with other factors affecting yield. Field studies, research trials, and observations have led to these divisions, but management skill of the water user can alter the way in which the divisions are interpreted for a particular application. Values shown are applicable under normal field conditions prevailing in most irrigated areas in the arid and semi-arid regions of the world.

3.2.2.1 Salinity and Chlorine Residual

As noted in **Table 3-4**, salinity is a key parameter in determining the suitability of the water to be used for irrigation, and the wide variability of salinity tolerance in plants can confound the issue of establishing salinity criteria. All waters used for irrigation contain salt to some degree; therefore, salts (both cations and anions) will build up without proper drainage. *Agricultural Salinity Assessment and Management*, which is the second edition of ASCE MOP 71 (American Society of Civil Engineers [ASCE], 2012) provides additional information on worldwide salinity and trace element management in irrigated agriculture and water supplies. This updated edition provides a reference to help sustain irrigated agriculture and integrates contemporary concepts and management practices. It covers technical and scientific aspects of agricultural salinity management as well as environmental, economic, and legal concerns. However, because salinity management is such an important consideration in agricultural reuse, a brief discussion of the topic is provided here.

Salinity is determined by measuring the electrical conductivity (EC) and/or the TDS in the water; however, for most agricultural measurements, TDS is reported as EC. The use of high TDS water for irrigation will tend to increase the salinity of the groundwater if not properly managed. The extent of salt accumulation in the soil depends on the concentration of salts in the irrigation water and the rate at which salts are removed by leaching. Using

TDS as a measure of salinity, no detrimental effects are usually noticed below 500 mg/L. Between 500 and 1,000 mg/L, TDS in irrigation water can affect sensitive plants; at concentrations above 1,000 to 2,000 mg/L, TDS levels can affect many crops, so careful management practices should be followed. Several case study examples demonstrate the importance and implementation of TDS management for use of reclaimed water for irrigation [[US-TX-Landscape Study](#); [US-CO-Denver Soil](#); [US-CA-Monterey](#); and [Israel/Jordan-AWT Crop Irrigation](#)]. At TDS concentrations greater than 2,000 mg/L, water can be used regularly only for salt-tolerant plants on highly permeable soils. A study was conducted in Israel to address the impact of reclaimed water containing high levels of salts, including ions specifically toxic to plants, such as sodium (Na) and boron (B); results are provided in a case study summary from Israel and Jordan [[Israel and Jordan - Brackish Irrigation](#)].

With respect to chlorine residuals, which may be present as a disinfection residual, free chlorine at concentrations less than 1 mg/L usually poses no problem to plants; chlorine at concentrations greater than 5 mg/L can cause severe damage to most plants. However, some sensitive crops may be damaged at levels as low as 0.05 mg/L. For example, some woody crops may accumulate chlorine in the tissue up to toxic levels; further, excessive chlorine residuals can have a similar leaf-burning effect that is caused by sodium and chloride when reclaimed water is sprayed directly onto foliage. Low-angle spray heads or surface irrigation options can reduce the leaf-burning impact.

3.2.2.2 Trace Elements and Nutrients

Thirteen mineral nutrients are required for plant growth, and fertilizers are added to soils with inadequate concentrations of these nutrients. Mineral nutrients are divided into two groups: macronutrients (primary and secondary) and micronutrients. Primary macronutrients, which include nitrogen, phosphorus, and potassium, are often lacking from the soil because plants use large amounts for growth and survival. The secondary macronutrients include calcium, magnesium, and sulfur. Micronutrients—boron, copper, iron, chloride, manganese, molybdenum, and zinc—are elements essential for plant growth in small quantities and are often referred to as trace elements. While these trace elements are necessary for plant growth, excessive concentrations can be toxic.

The recommended maximum concentrations of constituents in reclaimed water for “long-term continuous use on all soils” are set conservatively based on application to sandy soils that have adsorption capacity. These values have been established below the concentrations that produce toxicity when the most sensitive plants are grown in nutrient solutions or sand cultures to which the constituent has been added. Thus, if the suggested limit is exceeded, phytotoxicity will not necessarily occur; however, most of the elements are readily fixed or tied up in soil and accumulate with time such that repeated application in excess of suggested levels is likely to induce phytotoxicity. The trace element and nutrients criteria recommended for fine-textured neutral and alkaline soils with high capacities to remove the different pollutant elements are provided in

Table 3-5. These criteria, were previously presented in 2004, however, based on maintaining sustainable application of reclaimed water for irrigation, recommendations have included removal of increased concentrations for short-term use, which is also consistent with recommendations of the FAO in *Water Quality for Agriculture* (FAO, 1985). There are also related effects of pH on plant growth, which are primarily related to its influence on metal toxicity, as shown in **Table 3-5**; as a result, a pH range of 6-8 is recommended for reclaimed water used for irrigation.

Of the macronutrients, nitrogen is the most widely applied as a fertilizer. Nitrogen is important in helping plants with rapid growth, increasing seed and fruit production, and improving the quality of leaf and forage crops. Like nitrogen, phosphorus effects rapid

Table 3-5 Recommended water quality criteria for irrigation

| Constituent | Maximum Concentrations for Irrigation (mg/L) | Remarks |
|-----------------------------|--|--|
| Aluminum | 5.0 | Can cause nonproductiveness in acid soils, but soils at pH 5.5 to 8.0 will precipitate the ion and eliminate toxicity |
| Arsenic | 0.10 | Toxicity to plants varies widely, ranging from 12 mg/L for Sudan grass to less than 0.05 mg/L for rice |
| Beryllium | 0.10 | Toxicity to plants varies widely, ranging from 5 mg/L for kale to 0.5 mg/L for bush beans |
| Boron | 0.75 | Essential to plant growth; sufficient quantities in reclaimed water to correct soil deficiencies. Optimum yields obtained at few-tenths mg/L; toxic to sensitive plants (e.g., citrus) at 1 mg/L. Most grasses are tolerant at 2.0 - 10 mg/L |
| Cadmium | 0.01 | Toxic to beans, beets, and turnips at concentrations as low as 0.1 mg/L; conservative limits are recommended |
| Chromium | 0.1 | Not generally recognized as an essential element; due to lack of toxicity data, conservative limits are recommended |
| Cobalt | 0.05 | Toxic to tomatoes at 0.1 mg/L; tends to be inactivated by neutral and alkaline soils |
| Copper | 0.2 | Toxic to a number of plants at 0.1 to 1.0 mg/L |
| Fluoride | 1.0 | Inactivated by neutral and alkaline soils |
| Iron | 5.0 | Not toxic in aerated soils, but can contribute to soil acidification and loss of phosphorus and molybdenum |
| Lead | 5.0 | Can inhibit plant cell growth at very high concentrations |
| Lithium | 2.5 | Tolerated by most crops up to 5 mg/L; mobile in soil. Toxic to citrus at low doses—recommended limit is 0.075 mg/L |
| Manganese | 0.2 | Toxic to a number of crops at few-tenths to few mg/L in acidic soils |
| Molybdenum | 0.01 | Nontoxic to plants; can be toxic to livestock if forage is grown in soils with high molybdenum |
| Nickel | 0.2 | Toxic to a number of plants at 0.5 to 1.0 mg/L; reduced toxicity at neutral or alkaline pH |
| Selenium | 0.02 | Toxic to plants at low concentrations and to livestock if forage is grown in soils with low levels of selenium |
| Tin, Tungsten, and Titanium | - | Excluded by plants; specific tolerance levels unknown |
| Vanadium | 0.1 | Toxic to many plants at relatively low concentrations |
| Zinc | 2.0 | Toxic to many plants at widely varying concentrations; reduced toxicity at increased pH (6 or above) and in fine-textured or organic soils |

growth of plants and is important for blooming and root growth. Potassium is absorbed by plants in larger amounts than any other mineral element except nitrogen and, in some cases, calcium; the role of this nutrient is key in fruit quality and reduction of diseases. All of these nutrients can be obtained from application of reclaimed water, so there is added value in using reclaimed water. However, in light of ever-increasing regulatory requirements for nutrient removal to address loads to receiving streams, nitrogen and/or phosphorus are often removed in municipal WWTPs.

As a result of nutrient removal, even if reclaimed water is applied in adequate quantities to provide trace nutrients, fertilizer application may still be required. Where appropriate for crop use, increased supply of reclaimed water for irrigation could provide needed nutrients for crops while concurrently reducing nutrient load to the receiving stream.

Nutrients, such as nitrogen and phosphorus, may contain beneficial qualities for irrigation. In a Canadian case study, the authors provided insight into cost-effective advantages of diverting these nutrients from Lake Simcoe [[Canada-Nutrient Transfer](#)].

3.2.2.3 Operational Considerations for Agricultural Reuse

A municipal wastewater treatment facility and an agricultural operation have little in common, except that one entity supplies the water and the other uses it. Understanding how these two enterprises function is critical to developing a successful agricultural reuse system. First, operators of the municipal facility must understand that the demand for irrigation water will vary throughout the year as a function of rainfall and normal seasonal agricultural operations. Experience has shown that attempts to deliver a fixed volume of water for agricultural applications, independent of the actual need for irrigation water, rarely survive the first rainy season. Experience also suggests that asking the municipal or agricultural entity to take on the duties of the other party can cause problems. For example, farmers are typically not well suited to navigate the regulatory requirements to obtain a permit for use of reclaimed water. Likewise, a municipality is not set up to respond to changes in the agricultural market.

There are many differences between municipal and agricultural operations that may not be apparent until the water reclamation system goes into operation. Consideration of these differences is needed at the

preliminary design stage of a project to ensure the proposed water reclamation system is feasible. A recommended list of considerations for agricultural reuse projects is provided below:

- Compatibility of agricultural operations with reclaimed water may warrant site-specific investigations to reveal compatibility issues that may arise when switching from traditional water supplies to reclaimed water. For example, reclaimed water treated to secondary standards may not be suitable for use in drip irrigation systems as the suspended solids in the reclaimed water can increase clogging.
- There are differences in agricultural and municipal system reliability requirements. For example, distribution pipe pressure ratings for agriculture are close to that of the expected working pressure. Additionally, pump capacity redundancy in municipal systems is installed in the event of a failure; however, this is not common practice in agricultural operations.
- Because reclaimed water quality is directly linked to crops that may be produced with that water, there may be additional regulatory controls that dictate when irrigation is applied and who is allowed on the property being irrigated. Examples of regulatory controls include modifications to irrigation systems to prevent contact with edible crops as required in Florida, Texas, and other states.
- It also may be undesirable to use secondary quality reclaimed water where irrigation equipment results in aerosols, particularly where the area under irrigation is adjacent to the property boundary.
- Regular communication between the end user and reclaimed water supplier is critical to a successful program, as it allows issues to be addressed as they arise.

3.2.3 Irrigation of Food Crops

Irrigation of food crops with reclaimed water is common both in the United States and globally. However, there are “resource constrained” regions where untreated wastewater and inadequately-treated reclaimed water, sometimes mixed with river water, is used for irrigation of food crops—with devastating

gastrointestinal disease consequences for consumers of the crops. As a result, the WHO guidelines provide specific procedures for minimizing these risks in most regions of the world (WHO, 2006). These regulations for food crop irrigation with reclaimed water are intended to minimize risks of microbial contamination of the crops, especially those grown for raw consumption, such as lettuce, cucumbers, and various fruits. The regulations specify treatment processes, water quality standards, and monitoring regimes that minimize risks for use of reclaimed water for irrigation of crops that are ingested by humans. Further discussion on global water reuse is provided in Chapter 9. Additional discussion of state regulatory guidelines and requirements for irrigation of food crops with reclaimed water is also provided in Section 4.5.2.3.

An example of large-scale recycled water irrigation for raw-eaten food crops is in Monterey County, Calif. [US-CA-Monterey]. More than 5,000 ha of lettuce, broccoli, cauliflower, fennel, celery, strawberries, and artichokes have been irrigated with recycled water for more than a decade (**Figure 3-3**). This large-scale use of recycled water was preceded by an intensive, 11-year pilot study to determine whether or not the use of disinfected filtered recycled water for irrigation of raw-eaten food crops would be safe for the consumer, the farmer, and the environment (Sheikh et al., 1990). Results of this project have shown that food crops are protected against pathogenic organisms, such as *Giardia* and *Cryptosporidium* (Sheikh et al., 1999).

Marketing of produce from farms in northern Monterey County has been successful and profitable, although the local farmers initially feared customer backlash and rejection of produce irrigated with “sewer water.” As a result, farmers insisted that the produce not be labeled as having been irrigated with recycled water. The Monterey Regional Water Pollution Control Agency—producer/supplier of the recycled water—works closely with the farming community and has a contingency plan in place to address claims arising from an epidemic that might be traced to or associated with the fields using recycled water. Over the 13 years of irrigation (as of December 2011), there have been no such associations.

The success of this exemplary and pioneering project in Monterey County—from both technical and public acceptance points of view—has encouraged similar

projects in other parts of the United States, and throughout the world [US-CA-Temecula, US-WA-King County, Argentina-Mendoza, Israel/Palestinian Territories/Jordan-Olive Irrigation, Senegal-Dakar, Vietnam-Hanoi]. In eastern Sicily (Italy), Cirelli et al. (2012) showed that reclaimed water treated at constructed wetlands could be used for edible food crops in Mediterranean countries and other arid and semi-arid regions that are confronting increasing water shortages. In addition to demonstrating that food crops were safe for human consumption, some crops showed higher yields (by approximately 20 percent) using reclaimed water when compared with controls supplied with freshwater.

3.2.4 Irrigation of Processed Food Crops and Non-Food Crops

Irrigation of non-food crops (seed crops, industrial crops, processed food crops, fodder crops, orchard crops, etc.) with reclaimed water is far less complicated and more readily accepted by the agricultural community. Many countries use the WHO guidelines, which are risk-based and designed to provide a reasonable level of safety, assuming conservative levels of exposure by the public, the consumer, and farm workers. An example of reclaimed water use for non-food production is in Jordan, where reclaimed water is used on alfalfa plants, as shown in **Figure 3-4** [Jordan-Irrigation].

In the United States, various states have adopted regulations for use of reclaimed water for non-food crop irrigation that are generally more relaxed than for food crops, allowing disinfected secondary effluent to be used in many cases. In any case, these are generally far more restrictive than the WHO guidelines. For example, California Water Recycling Criteria (Title 22) requires total coliform bacteria to be less than 23 MPN/100 mL for irrigation of non-food crops. This standard can be related to the concern for exposure of farm workers to the recycled water, although this level of water quality can be reliably achieved with well-operated secondary treatment processes with disinfection.



Figure 3-3
Monterey County vegetable fields irrigated with disinfected tertiary recycled water



Figure 3-4
Alfalfa irrigated with secondary effluent, Wadi Mousa (near Petra), Jordan

Between the standards of California and WHO, there is a wide range of treatment standards throughout the world, as shown in **Table 3-6**. Additional discussion of state regulatory guidelines and requirements for irrigation of food crops with reclaimed water in the United States is also provided in Section 4.5.2.3.

Table 3-6 Examples of global water quality standards for non-food crop irrigation

| Microbial Standards or Guidelines by State, Country, Region | Total Coliform per 100 mL | Fecal Coliform or <i>E. coli</i> per 100 mL |
|---|---------------------------|---|
| Puglia (S. Italia) | ≤ 10 | |
| California, Italy | ≤ 23 | |
| Australia | | ≤ 10 |
| Germany | ≤ 100 | ≤ 10 |
| Washington State | ≤ 240 | |
| Florida, Utah, Texas, EPA (Guidelines) | | ≤ 200 |
| Arizona, New Mexico, Australia, Victoria, Mexico | | ≤ 1,000 |
| Austria | | ≤ 2,000 |
| Sicily | ≤ 3,000 | ≤ 1,000 |
| Cyprus | | ≤ 3,000 |
| WHO, Greece, Spain | | ≤ 10,000 |

3.2.5 Reclaimed Water for Livestock Watering

Generally in the United States, reclaimed water is not utilized for direct consumption by livestock; however, *de facto* reuse often occurs. In this case, **Table 3-7** is provided as a guide to acceptable water quality for livestock consumption. It should be noted that the information in **Table 3-7** was developed from FAO 29 Water Quality in Agriculture, with more recent updates from Raisbeck et al. (2011) for molybdenum, sodium, and sulfate (FAO, 1985). These values are based on amounts of constituents normally found in surface and groundwater and are not necessarily the limits of animal tolerance. Additional sources of these substances may need to be considered along with drinking water, such as additional animal intake of these substances through feedstuffs. If concerns persist about safety for livestock, the local land-grant university should be consulted for additional information.

3.3 Impoundments

Uses of reclaimed water for maintenance of impoundments range from water hazards on golf courses to full-scale development of water-based recreational impoundments involving incidental contact

(fishing and boating) and full body contact (swimming and wading). With respect to water quality for recreational reuse that involves body contact, EPA has had recreational water quality criteria since 1986 for surface water that receives treated effluent regulated through the NPDES program. The criteria were developed to protect swimmers from illnesses from exposure to pathogens in recreational waters, as described in Section 6.3.1. EPA has also recently proposed new draft recreational water quality criteria in response to research findings in the fields of molecular biology, virology, and analytical chemistry (EPA, 2011).

Table 3-7 Guidelines for concentrations of substances in livestock drinking water¹

| Constituent (Symbol) | Concentration (mg/L) |
|---|----------------------|
| Aluminium (Al) | 5.0 |
| Arsenic (As) | 0.2 |
| Beryllium (Be) ² | 0.1 |
| Boron (B) | 5.0 |
| Cadmium (Cd) | 0.05 |
| Chromium (Cr) | 1.0 |
| Cobalt (Co) | 1.0 |
| Copper (Cu) | 0.5 |
| Fluoride (F) | 2.0 |
| Iron (Fe) | not needed |
| Lead (Pb) ³ | 0.1 |
| Manganese (Mn) ⁴ | 0.05 |
| Mercury (Hg) | 0.01 |
| Molybdenum (Mo) | 0.3 |
| Nitrate + Nitrite (NO ₃ -N + NO ₂ -N) | 100 |
| Nitrite (NO ₂ -N) | 10.0 |
| Selenium (Se) | 0.05 |
| Sodium (Na) | 1000 ⁵ |
| Sulfate (as SO ₄) | 1000 ⁶ |
| Vanadium (V) | 0.10 |
| Zinc (Zn) | 24.0 |

¹ Adapted from FAO (1985) with updates for Mo, Na, and SO₄ from Raisbeck et al. (2011).

² Insufficient data for livestock; value for marine aquatic life is used.

³ Lead is accumulative, and problems may begin at a threshold value of 0.05 mg/L.

⁴ Insufficient data for livestock; value for human drinking water used.

⁵ Short-term exposure (days/weeks) can be up to 4000 mg/L, assuming normal feedstuff Na concentrations.

⁶ Short-term exposure (days/weeks) can be up to 1.8 mg/L, assuming normal feedstuff SO₄ concentrations.

3.3.1 Recreational and Landscape Impoundments

One example of reclaimed water use for recreational impoundments is the Santee Lakes Recreation Preserve (Park), which is a recreational facility owned and operated by Padre Dam Municipal Water District. It is located strategically within San Diego County, Calif. Its seven lakes, which contain approximately 82 ac (33 ha) of water, were formed by sand and gravel mining in the dry stream bed of Sycamore Canyon as part of the district's original water reclamation program. In the early 1960s, the district converted the lakes to recreational use to demonstrate the concept of water reuse. Its purpose was also to gain public acceptance of reclaimed water for recreational, agricultural, irrigation, and industrial applications.

As with any form of reuse, the development of water reuse projects that include impoundments will be a function of water demand coupled with a cost-effective source of suitable quality reclaimed water. Regulation of impoundments that are maintained using reclaimed water typically is according to the potential for contact for that use. For example, in Arizona, reclaimed water that is used for recreational impoundments where boating or fishing is an intended use of the impoundment must meet Class A requirements, which includes secondary treatment, filtration, and disinfection so that no detectable fecal coliform organisms are present in four of the last seven daily reclaimed water samples taken, and no single sample maximum concentration of fecal coliform organisms exceeds 23/100 mL. Even though NPDES permits may allow discharge of treated effluent into a water body with higher bacterial concentrations, swimming and other full-body recreation activities are prohibited where reclaimed water is used to maintain the "recreational" impoundment. This is consistent with goals to protect public health, particularly in light of evidence provided by Wade et al. (2010) who have shown a relationship between gastrointestinal illness and estimates of fecal indicator organisms and that children less than 11 years old are at greater risk from exposure (Wade et al., 2008).

In impoundments where body contact is prohibited, such as a manmade facility that is created for storage, landscaping, or for aesthetic purposes only, less stringent requirements may apply.

3.3.2 Snowmaking

The benefits of installing a reclaimed water distribution system to help meet peak irrigation demands during growing season has to be weighed carefully with the costs associated with managing the reclaimed water in the winter months when temperature and climate conditions render the system useless for irrigation. When water demands from customers that require consistent flow (such as industrial or cooling system customers) cannot be secured as part of a reclaimed water customer base in winter months, one option to manage reclaimed water in the winter months may be to make snow. While snowmaking is sometimes regulated as an urban reuse, some states consider snowmaking for recreational purposes to have body contact that requires water quality similar to that used in recreational impoundments, which is why this reuse application is discussed in this section.

Making snow from reclaimed water for the purpose of prolonging and avoiding interruption of the recreation season of sledding and skiing areas is becoming more popular, particularly in water-scarce areas. However, given the difficulty of otherwise making use of reclaimed water during the winter months, it is hard to ignore the resource as a water supply for snowmaking. This is particularly the case in areas where the temperatures are low enough to maintain water in the form of snow but natural precipitation will not otherwise support a longer recreation season. In most states, use of reclaimed water for snowmaking is either regulated or managed as a winter-time disposal option or as a reuse option, but seldom both.

Snowmaking with reclaimed water is being done in the United States, Canada, and Australia (e.g., Victoria's Mount Buller Alpine Resort installed in 2008 and Mount Hotham Resort installed in 2009). Snowmaking using reclaimed water in the United States is occurring in Maine, Pennsylvania, and California. The details of these facilities are shown in a case study [[US-ME-Snow](#)]. Some states have rules or regulations pertaining to snowmaking with reclaimed water. There do not appear to be any human health effects studies associated with exposure to snow made with reclaimed water. The highlights of the regulations from a few select states are provided to exemplify how different states implement snowmaking with reclaimed water.

Storing or stockpiling reclaimed water in the form of snow avoids the cost of building large surface water reservoirs or additional lagoon treatment modules. Depending on the quality of the originating reclaimed water, precautions may need to be taken regarding the fate of snowmelt. It may be necessary to prevent snowmelt from frozen reclaimed water with a relatively high content of phosphorus from entering a sensitive water body. Conversely, if reclaimed water can be sprayed onto a seasonally dormant agricultural field, the phosphorus may be a benefit to the farmer who will plant the field in the spring.

Care must also be taken to quantify the volume of snowmelt runoff that will occur according to a range of spring thaw scenarios to manage the runoff. Planners should consider downstream and groundwater rights to the water diverted for snowmaking and to the snowmelt. An ac-ft (1,200 m³) of medium-density snow (1 ac with 1 ft of snow on it) has an equivalent water volume of approximately 146,000 gallons (550 m³). It is necessary to consider the density of the accumulated snow and its depth to avoid overflowing the reservoir with snowmelt. Note also that snow will sublime (convert from the solid phase of water to the gaseous phase without going through the liquid phase) during storage.

Captured snowmelt from snow made from reclaimed water of a particular quality may not reflect the original water quality. Snowmelt may pick up contaminants from the soil, including microbiological and chemical constituents; further, sublimation has the effect of concentrating whatever constituents are present into higher concentrations. In addition, some constituents that were present in the original reclaimed water may degrade over time, or be “lost” (as in the case of nutrients) to the soil when the snow melts. Therefore, if snowmelt is to be introduced into the reclaimed water distribution system, it may be necessary to treat it to achieve the same level of quality as the reclaimed water produced by the reclamation facility.

Arizona

The Arizona Department of Environmental Quality (ADEQ) regulates reclaimed water quality for prescribed uses allowing for snowmaking with Class A reclaimed water, which is wastewater that has undergone secondary treatment, filtration, and disinfection to achieve a 24-hour average turbidity of 2 NTU or less (instantaneous turbidity of 5 NTU or less)

and no detectable fecal coliform organism in four of the last seven daily reclaimed water samples (single sample maximum of 23 fecal coliform organism per 100 mL). As of 2012, there were no ADEQ-permitted uses of reclaimed water for snowmaking in Arizona. However, the Sunrise Park Resort, owned and operated by the White Mountain Apache Tribe (WMAT), makes use of WWTP effluent blended with another source of water for snowmaking. ADEQ does not regulate the WMAT, as they are a sovereign nation; thus, it is not known what water quality is used, to what extent, or with what frequency.

A service agreement between the city of Flagstaff and owners of the Snowbowl Ski Resort allowed Flagstaff to sell reclaimed water for snowmaking. Planning started in 2000, and approval from the U.S. Forest Service was granted in 2004 (Snowbowl operates on federal land). In 2004, opponents to snowmaking with reclaimed water, led by the Navajo Nation, filed suit against Snowbowl and the city of Flagstaff. Following several court cases, in 2009 the full U.S. 9th Circuit Court refused to reject lower court decisions supporting the Snowbowl/Flagstaff agreement, and the U.S. Supreme Court refused to hear the case. In September 2009 a new suit was filed by Save the Peaks Coalition, and on February 9, 2012, a three-judge panel of the 9th U.S. Circuit Court of Appeals rejected the current suit as it was “virtually identical” to the previous suit (Associated Press, 2012).

California

CDPH regulates recycled water use and allows for snowmaking with disinfected filtered reclaimed water meeting specific turbidity criteria. However, it is noted that in some cases (such as for the Donner Summit Public Utilities District), snowmaking may also be permitted under an NPDES permit.

Colorado

The Colorado Department of Public Health and Environment’s Regulation No. 84—Reclaimed Water Control Regulation does not mention snowmaking. Regulators in Colorado view snowmaking with reclaimed water as inevitable discharge to surface waters during snowmelt and runoff. Therefore, use of reclaimed water to make snow would be permitted under the NPDES discharge framework rather than under Regulation No. 84. Further, because water rights regulations in Colorado limit the amount of water that can be reused to the volume imported from west

of the Continental Divide, reclaimed water is first applied to highest use at lowest cost.

Maine

The Maine Department of Environmental Protection (MDEP) does not have reclaimed water quality or water reuse rules, let alone regulations for snowmaking. However, the MDEP issues wastewater discharge permits for making snow with reclaimed water under the Maine Pollution Discharge Elimination System program. Snowmaking is used to reduce the volume of water in lagoons or to otherwise manage treatment plant effluent. There are currently systems in operation in three Maine communities (town of Rangeley; Carrabassett Valley Sanitary District, which serves Sugarloaf Mountain Ski Resort; and Mapleton Sewer District).

New Hampshire

New Hampshire's rules regarding snowmaking provide more discussion about snowmaking than any other state. Snow can be made using disinfected, filtered secondary effluent, depending on the end use of the manufactured snow. It can be used to recharge aquifers or for recreation purposes, such as skiing. Snow made from reclaimed water is referenced as "E-Snow" (for Effluent Snow) in New Hampshire's *Land Treatment and Disposal of Reclaimed Wastewater: Guidance for Groundwater Discharge Permitting* revised July 30, 2010.

Before reclaimed water is considered for recreational snowmaking, it must first be filtered with site-specific nutrient removal depending on snowmelt and runoff to surface streams. Treatment beyond secondary quality is commonly achieved using a variety of biological nutrient removal technologies, and the processed wastewater is filtered using advanced (ultra) filtration to achieve 4-log reduction of viral pathogens; disinfection is also included as the final treatment process. It is noteworthy that higher quality reclaimed water is required for golf course irrigation than for snowmaking.

Pennsylvania

Although the Pennsylvania Department of Environmental Protection does not have water reuse regulations, it does have guidelines that allow water reuse through the issuance of a Water Quality Management permit from the agency. The guidelines, titled *Reuse of Treated Wastewater Guidance Manual*

362-0300-009 sets forth minimum treatment goals for snowmaking. Snowmaking is allowed with Class B water, which is water that has undergone secondary treatment, filtration, and disinfection. Where chlorine is utilized for disinfection, a total chlorine residual of at least 1.0 mg/L should be maintained for a minimum contact time of 30 minutes at design average flow, and there should be a detectable chlorine residual (>0.02 mg/L) at the point of reuse application.

Where UV light is used for disinfection, a design dose of 100 mJ/cm² under maximum daily flow should be used. The design dose may be reduced to 80 mJ/cm² for porous membrane filtration and 50 mJ/cm² for semi-permeable membrane filtration. This dose should also be based on continuous monitoring of lamp intensity, UV transmittance, and flow rate. Reclaimed water is being used for snowmaking at Seven Springs Mountain Resort, and planning for use at Bear Creek Mountain Resort is underway.

3.4 Environmental Reuse

Environmental reuse primarily includes the use of reclaimed water to support wetlands and to supplemental stream and river flows. Aquifer recharge also may be considered environmental reuse, but because this practice is integral to management of many reuse systems, an expanded discussion of this topic is provided in Section 2.3. A more detailed discussion of using wetlands and other natural systems for treatment to enhance water quality is provided in Chapter 6 with regulatory requirements for this reuse type described in Section 4.5.2.7.

3.4.1 Wetlands

Over the past 200 years, substantial acreage of wetlands in the continental United States have been destroyed for such diverse uses as agriculture, mining, forestry, and urbanization. Wetlands provide many important functions, including flood attenuation, wildlife and waterfowl habitat, food chain support, aquifer recharge, and water quality enhancement. In addition, maintenance of wetlands in the landscape mosaic is important for regional hydrologic balance. Wetlands naturally provide water conservation by regulating the rate of evapotranspiration and, in some cases, by providing aquifer recharge. Wetlands are also natural systems that can be used to treat a wide range of pollution sources, and they are particularly attractive for rural areas in developed countries and for general use in developing countries.

Development has altered the landscape, including changing the timing and quantities of stormwater and surface water flows and lowering of the groundwater tables, which affect environmental systems that have adapted and depend on these for their existence. Reclaimed water could be used to mitigate some of these impacts. Application of reclaimed water serves to restore and enhance wetlands that have been hydrologically altered. New wetlands can be created through application of reclaimed water, resulting in a net gain in wetland acreage and function. In addition, constructed and restored wetlands can be designed and managed to maximize habitat diversity within the landscape.

While the focus of this section is to highlight applications of wetlands, it is worth noting that some states, including Florida, South Dakota, and Washington, do provide regulations to specifically address use of reclaimed water in wetlands systems. In addition to state requirements, natural wetlands, which are considered waters of the United States, are protected under EPA's NPDES Permit and Water Quality Standards programs. The quality of reclaimed water entering natural wetlands is regulated by federal, state, and local agencies and must be treated to secondary treatment levels or greater. On the other hand, constructed wetlands, which are built and operated for the purpose of treatment, are not considered waters of the United States. Several case studies focused on wetlands are highlighted in this document and briefly summarized below:

- **US-AZ-Phoenix:** The 91st Avenue WWTP reuses approximately 60 percent of the current plant production (by a nuclear generating station for cooling tower makeup water, new constructed wetlands, and an irrigation company for agricultural reuse), with the remaining effluent discharged to the dry Salt River riverbed that bisects the nearby communities.
- **US-GA-Clayton County:** The Clayton County Water Authority (CCWA) began water reuse in the 1970s when a land application system (LAS) was selected as a way to increase water supplies for its growing population while minimizing the stream impact of wastewater discharges. Over the past decade, the LAS was converted into a series of treatment wetlands,

and the existing treatment plant was upgraded to an advanced biological treatment plant. This system, along with additional constructed wetlands, provides some aquifer infiltration, but the vast majority flows into two of CCWA's water supply reservoirs—Shoal Creek and Blalock reservoirs. Water typically takes 2 years under normal conditions to filter through wetlands and reservoirs before being reused and takes less than a year under drought conditions. The Panhandle Road Constructed Wetlands and the E.L. Huie Constructed Wetlands have treatment capacities of 4.4 mgd (193 L/s) and 17.4 mgd (762 L/s), respectively. The transition from LAS to wetlands has saved energy costs through reduced pumping. The wetlands system is less expensive to maintain and operate and has allowed CCWA to reduce maintenance staff, equipment, and materials. The wetlands treatment system and indirect reuse program have lowered CCWA's need for additional reservoir storage and water withdrawals.

- **US-FL-Orlando Wetlands:** The Orlando Easterly Wetlands enhances the environment with highly-treated reclaimed water. The project began in the mid-1980s when the city, faced with the need to expand its permitted treatment capacity, was unable to increase the amount of nutrients being discharged into sensitive area waterways. The constituents of concern in the effluent consist primarily of nitrogen and phosphorus, which can promote algae blooms that deplete oxygen in a water body and result in fish kills and other undesirable conditions. Florida water bodies are particularly susceptible to these problems due to periods of very low flows that occur in the summer. This project has seen great success throughout its two decades of performance. The Orlando Wetlands Park consists of 1,650 ac (670 ha) of hardwood hammocks, marshes, and lakes, and is a great location for bird-watching, nature photography, jogging, and bicycling.
- **Israel-Vertical Wetlands:** Compact vertical-flow constructed wetlands are being used in Israel for decentralized treatment of domestic wastewater. When treated with the UV disinfection unit, the effluent of the recirculating

vertical flow constructed wetland (RVFCW) consistently met the stringent Israeli *E. coli* standards for reclaimed water irrigation of less than 10 cfu/100 mL (Inbar, 2007). The treated wastewater will be used for unrestricted landscape and, possibly, fodder irrigation.

3.4.1.1 Wildlife Habitat and Fisheries

Diverse species of mammals, plants, insects, amphibians, reptiles, birds, and fish rely on wetlands for food, habitat, and/or shelter. Wetlands are some of the most biologically productive natural ecosystems in the world, comparable to tropical rain forests or coral reefs in the number and variety of species they support. Migrating waterfowl rely on wetlands for resting, eating, and breeding, leading to increased populations. Wetlands are also vital to fish health and, thus, to the multibillion dollar fishing industry in the United States. Wetlands also provide an essential link in the life cycle of 75 percent of the commercially-harvested fish and shellfish in the United States, and up to 90 percent of the recreational fish catch. Wetlands provide a consistent food supply, shelter, and nursery grounds for both marine and freshwater species. The city of Sequim, Wash., constructed its water reclamation facility and upland reuse system to protect shellfish beds and conserve freshwater supplies. Due to the location of Sequim, it was vital for the community to make conservation and marine protection a priority [[US-WA-Sequim](#)].

Another case study, the Sierra Vista EOP, Ariz. [[US-AZ-Sierra Vista](#)] spans 640 ac (260 ha) and includes 30 open basins that recharge nearly 2,000 ac-ft/yr (2.5 MCM/yr) of reclaimed water to the aquifer, 50 ac (20 ha) of constructed wetlands, nearly 200 ac of native grasslands, and 1,800 ft² (170 m²) of wildlife viewing facility. The constructed wetlands provide numerous beneficial services, including filtering and improving water quality as plants take up available nutrients. In the EOP wetlands, secondary treated effluent is filtered naturally. The primary purpose of EOP is to offset the effects of continued groundwater pumping that negatively impacts the river and to protect the habitat for native and endangered species.

3.4.1.2 Flood Attenuation and Hydrologic Balance

Flood damages in the United States average \$2 billion each year, causing significant loss of life and property (EPA, 2006a). One of the most valuable benefits of

wetlands is their ability to store flood waters; maintaining only 15 percent of the land area of a watershed in wetlands can reduce flooding peaks by as much as 60 percent. In addition to reducing the frequency and intensity of floods by acting as natural buffers that soak up and store a significant amount of flood water, coastal wetlands serve as storm-surge protectors when hurricanes or tropical storms come ashore. And, according to Hey et al. (2004), the damage sustained by the Gulf Coast during Hurricane Katrina could have been less severe if more wetlands had been in place along the coast and Mississippi delta. As a result, with the encouragement of the Louisiana Department of Environmental Quality and a \$400,000 grant from the Delta Regional Authority, the Sewerage and Water Board of New Orleans identified a plan to use highly-treated reclaimed water from the WWTP to restore the damaged marsh lands. The multi-disciplinary project also includes proof of a new technology, ferrate (discussed further in Chapter 6), that is intended to scrub treated effluent of emerging pollutants of concern and set new standards for use of biosolids in wetlands assimilation (AWWA, 2010).

3.4.1.3 Recreation and Educational Benefits

Wetlands such as the Orlando Wetlands Park [[US-FL-Orlando Wetlands](#)] are also inviting places for popular recreational activities, including hiking, fishing, bird-watching, photography, and hunting. In addition to the many ways wetlands provide recreational benefits, they also offer numerous less-tangible benefits. These include providing aesthetic value to residential communities, reducing streambank erosion, and providing educational opportunities as an ideal “outdoor classroom,” as demonstrated at the Sidwell Friends School case study [[US-DC-Sidwell Friends](#)]. The school, in Washington, D.C., incorporated a constructed wetland into its middle school building renovation. This water reuse system was part of an overall transformation of a 50-year-old facility into an exterior and interior teaching landscape that seeks to foster an ethic of social and environmental responsibility in each student. With a focus on smart water management, a central courtyard was developed with a rain garden, pond, and constructed wetland that uses stormwater and wastewater for both ecological and educational purposes. More than 50 plant species, all native to the Chesapeake Bay region, were included in the landscape.

3.4.2 River or Stream Flow Augmentation

Among the numerous water industry challenges are high demand and inadequate supplies. Water conservation and reuse can reduce the demand on aquifers, as can river or stream flow augmentation. River and stream augmentation differs from a surface water discharge in several ways. Augmentation seeks to accomplish a benefit, such as aesthetic purposes or enhancement of aquatic or riparian habitat, whereas discharge is primarily for disposal. River or stream flow augmentation may provide an economical method of ensuring water quality, as well as having other benefits. It can minimize the challenge of locating a reservoir site, the additional water can improve the overall water quality of the receiving water body, and it can ameliorate the effect of low flow drought conditions, providing high quality water at the time of test need. River and stream augmentation may also reduce or eliminate water quality impairment and may be desirable to maintain stream flows and to enhance the aquatic and wildlife habitat, as well as to maintain the aesthetic value of the water courses. This may be necessary in locations where a significant volume of water is drawn for potable or other uses, largely reducing the downstream volume of water in the river or stream.

As with impoundments, water quality requirements for river or stream augmentation will be based on the designated use of the water course and the aim to enhance an acceptable appearance. In addition, there should be an emphasis on creating a product that can promote native aquatic life. The quality of the reclaimed water discharged to the receiving water body is critical to evaluating its benefits to the stream. Currently, there are limited data available to assess such water augmentation schemes a priori, and detailed, site-specific evaluations are needed (WRRF, 2011a). Water reclamation for stream augmentation applications requires consideration of a complex set of benefits and risks. For example, wastewater is known to contain microbiological contaminants as well as other trace levels of organic contaminants, some of which may be carcinogens, toxins, or endocrine disruptors (Lazorchak and Smith, 2004). These contaminants may be present in the reclaimed water at varying concentrations, depending upon the treatment process used (Barber et al., 2012), and the presence of these types of compounds in a receiving water body may have ecotoxicological consequences.

While some states have guidelines or regulations that provide requirements for reclaimed water quality and monitoring to protect wetlands (Section 4.5.2.7), which may even be considered part of the treatment system, requirements for reclaimed water quality for augmenting rivers or streams are often covered under a discharge permit. And, while the whole effluent toxicity (WET) testing and biomonitoring required in some NPDES permits may provide an indication of the overall ecological effect of the reclaimed water, this approach still presents a regulatory challenge because the current science on compounds of emerging concern is not fully defined (Section 6.2.2.3). Thus, evaluation and design for river or stream flow augmentation must address the site-specific water quality and habitat needs of the water course and any downstream use of the reclaimed water. And, in an appropriately designed river or stream augmentation project where treatment is provided to be protective of the end use of the receiving water, there are opportunities for public education regarding the value of reclaimed water as a resource and its potential to provide environmental benefits.

One case study example illustrates the potential for positive impacts of water reuse on downstream ecosystems. In the city of Sequim, Wash., in addition to municipal uses, reaerated reclaimed water is discharged into Bell Creek to improve stream flows for fisheries and habitat restoration, keeping the benthic layer wet for small species that live in the streambed [[US-WA-Sequim](#)].

3.4.3 Ecological Impacts of Environmental Reuse

The NRC report describes how ecological risks in environmental reuse applications should be assessed relative to existing wastewater discharge practices (NRC, 2012). The report concludes that the ecological risks in reuse projects for ecological enhancement are not expected to exceed those encountered with the normal surface water discharge of reclaimed water, although risks from reuse could be lower if additional levels of treatment are applied. The report cautions that current limited knowledge about the ecological effects of trace chemical constituents requires research to link population level effects in natural aquatic systems to initial concerning laboratory observations. In reuse applications targeted for ecological enhancement of sensitive aquatic systems, careful assessment of risks from these constituents is

warranted, because aquatic organisms can be more sensitive to certain constituents than humans (NRC, 2012).

Lake Elsinore, southern California's largest natural lake, is fed only by rain and natural runoff, with an annual evaporation rate of 4.5 ft. Because of these characteristics, the lake has been plagued for decades by low water levels and high concentrations of nutrients. The Elsinore Valley Municipal Water District (EVMWD) implemented a project to transfer 5 million gallons of reclaimed water per day to the lake to help with the low water levels [[US-CA-Elsinore Valley](#)].

3.5 Industrial Reuse

Traditionally, pulp and paper facilities, textile facilities, and other facilities using reclaimed water for cooling tower purposes, have been the primary industrial users of reclaimed water. Since the publication of the 2004 *Guidelines for Water Reuse*, the industrial use of reclaimed water has grown in a variety of industries ranging from electronics to food processing, as well as a broader adoption by the power-generation industry. Over the past few years, these industries have embraced the use of reclaimed water for purposes ranging from process water, boiler feed water, and cooling tower use to flushing toilets and site irrigation. Additionally, industries and commercial establishments seeking LEED certification are driven to reclaimed water to enhance their green profile. In addition, these facilities recognize that reclaimed water is a resource that can replace more expensive potable water with no degradation in performance for the intended uses.

When reclaimed water was first used for industrial purposes (dating back to the first pulp and paper industries), it was generally treated and reused on-site. As water resources in the arid states have become increasingly stressed (Arizona, California, and Texas) and availability of groundwater sources are becoming extremely limited (Florida), municipal facilities have started to produce reclaimed water for irrigation, industrial, and power company users. This section examines water reuse in traditional industrial settings (cooling towers and boiler water feed) and discusses emerging industries, such as electronics and produced waters from natural gas operations. Additional discussion on state guidelines and regulations for industrial reuse is provided in Section 4.5.2.8.

Case study examples of industrial water reuse to address energy and sustainability goals include reuse projects by companies such as Coca-Cola, Frito-Lay, and Intel [[US-AZ-Frito Lay](#)]. Coca-Cola has installed recycle-and-reclaim loops in 12 of its water treatment systems in North America and Europe, with goals of equipping up to 30 facilities with these systems by the end of 2012. These loops allow facilities to reuse processed water in cooling towers, boilers, or cleaning, saving an average of 57 million gallons (220 million liters) of water per system annually.

3.5.1 Cooling Towers

Cooling towers are recirculating evaporative cooling systems that use the reclaimed water to absorb process heat and then transfer the heat by evaporation. As the cooling water is recirculated, makeup water (reclaimed water) is required to replace water lost through evaporation. Water must also be periodically removed from the cooling water system to prevent a buildup of dissolved solids in the cooling water. There are two common types of evaporative cooling water systems—cooling towers and spray ponds. Spray ponds are not widely used and generally do not utilize reclaimed water. Cooling towers have become very efficient, with only 1.5 to 1.75 percent of the recirculated water being evaporated for every 10°F (6°C) drop in process water temperature, reducing the need to supplement the system flow with makeup water. Because water is evaporated, dissolved solids and minerals remain in the recirculated water, and these solids must be removed or treated to prevent accumulation on equipment. Removal of these solids is accomplished by discharging a portion of the cooling water, referred to as blow-down water, which is usually treated by a chemical process and/or a filtration/softening/clarification process before disposal to a local WWTP. Cooling tower designs vary widely. Large hyperbolic concrete structures can range from 250 to 400 ft (76 to 122 m) tall and 150 to 200 ft (46 to 61 m) in diameter and are common at utility power plants, as shown in **Figure 3-5**.

These cooling towers can recirculate (cool) approximately 200,000 to 500,000 gpm (12,600 to 31,500 L/s) and evaporate approximately 6,000 to 15,000 gpm (380 to 950 L/s) of water. Smaller cooling towers, which may be used at a variety of industries, can be rectangular boxes constructed of wood, concrete, plastic, and/or fiberglass-reinforced plastic with circular fan housings for each cell. Each cell can



Figure 3-5
Large hyperbolic cooling towers (Photo Courtesy of International Cooling Towers)

recirculate (cool) approximately 3,000 to 5,000 gpm (190 to 315 L/s). Commercial air conditioning cooling tower systems can recirculate as little as 100 gpm (6 L/s) to as much as 40,000 gpm (2,500 L/s).

Any contamination of the cooling water through process in-leakage, atmospheric deposition, or treatment chemicals will also impact the water quality. While reclaimed water generally has very low concentrations of microorganisms due to the high level of treatment, one of the major issues with reclaimed water use in cooling towers relates to occurrence of biological growth when nutrients are present. Biological growth can produce undesirable biofilm deposits, which can interfere with heat transfer and cause microbiologically-induced corrosion from acid or corrosive by-products and may shield metal surfaces from water treatment corrosion inhibitors and establish under-deposit corrosion. Biological films can grow rapidly and plug heat exchangers, create film on the cooling tower media, or plug cooling tower water distribution nozzles/sprays.

Scaling can also be a problem in cooling towers. The primary constituents resulting in scale potential from reclaimed water are calcium, magnesium, sulfate, alkalinity, phosphate, silica, and fluoride. Minerals that

form scale in concentrated cooling water generally include calcium phosphate (most common), silica (fairly common), and calcium sulfate (fairly common); other minerals that are less commonly found include calcium carbonate, calcium fluoride, and magnesium silicate. Constituents with the potential to form scale must be evaluated and controlled by chemical treatment and/or by adjusting the cycles of concentration. Therefore, reclaimed water quality must be evaluated, along with the scaling potential to establish the use of specific scale inhibitors, as demonstrated by the Southwest Florida Water Management District through its Regional Reclaimed Water Partnership Initiative [[US-FL-SWFWMD Partnership](#)] illustrating the use of reclaimed water for cooling water at a major utility in Florida. Another power plant, located in Colorado, [[US-CO-Denver Energy](#)] utilizes reclaimed water for cooling towers.

3.5.2 Boiler Water Makeup

The use of reclaimed water for boiler make-up water differs little from the use of conventional potable water—both require extensive pretreatment. Water quality requirements for boiler make-up water depend on the pressure at which the boiler is operated; in general, higher pressures require higher-quality water. The primary concern is scale buildup and corrosion of equipment. Control or removal of hardness from either potable water or reclaimed water is required for use as boiler make-up; additionally, control of insoluble scales of calcium and magnesium, and control of silica and alumina, are also required. Alkalinity of the reclaimed water, as determined by its bicarbonate, carbonate, and hydroxyl content, is also of concern because excessive alkalinity concentrations in boiler feed water may contribute to foaming and other forms of carryover, resulting in deposits in superheater, reheater, and turbine units. Bicarbonate alkalinity in feed water breaks down under the influence of boiler heat to release carbon dioxide, a major source of

localized corrosion in steam-using equipment and condensate-return systems. Organics in reclaimed water can also cause foaming in boilers, which can be controlled by carbon adsorption or ion exchange. The American Boiler Manufacturers Association (ABMA) maximum recommended concentration limits for water quality parameters for boiler operations is presented in **Table 3-8**. For steam generation, TDS levels are recommended to be less than 0.2 part per million (ppm) and less than 0.05 ppm for once through steam generation (OTSG).

Since 2000, several refineries in southern Los Angeles, Calif., have turned to using recycled water as their primary source of boiler make-up water. Using clarification, filtration, and RO, high-quality boiler make-up water is produced that provides water supply, chemical, and energy savings. The West Basin Municipal Water District (WBMWD) supplies recycled water for both low-pressure and high-pressure boiler feed water; because high-quality water is required for high-pressure boiler feed, some of the water (after the

Table 3-8 Recommended boiler water limits

| Drum Operating Pressure (psig) | 0-300 | 301-450 | 451-600 | 601-750 | 751-900 | 901-1000 | 1001-1500 | 1501-2000 | OTSG |
|--|-----------|----------|----------|----------|----------|----------|-----------|-----------|-----------|
| Steam | | | | | | | | | |
| TDS max (ppm) | 0.2-1.0 | 0.2-1.0 | 0.2-1.0 | 0.1-0.5 | 0.1-0.5 | 0.1-0.5 | 0.1 | 0.1 | 0.05 |
| Boiler Water | | | | | | | | | |
| TDS max (ppm) | 700-3500 | 600-3000 | 500-2500 | 200-1000 | 150-750 | 125-625 | 100 | 50 | 0.05 |
| Alkalinity max (ppm) | 350 | 300 | 250 | 200 | 150 | 100 | n/a | n/a | n/a |
| TSS Max (ppm) | 15 | 10 | 8 | 3 | 2 | 1 | 1 | n/a | n/a |
| Conductivity max (µmho/cm) | 1100-5400 | 900-4600 | 800-3800 | 300-1500 | 200-1200 | 200-1000 | 150 | 80 | 0.15-0.25 |
| Silica max (ppm SiO ₂) | 150 | 90 | 40 | 30 | 20 | 8 | 2 | 1 | 0.02 |
| Feed Water (Condensate and Makeup, After Deaerator) | | | | | | | | | |
| Dissolved Oxygen (ppm O ₂) | 0.007 | 0.007 | 0.007 | 0.007 | 0.007 | 0.007 | 0.007 | 0.007 | n/a |
| Total Iron (ppm Fe) | 0.1 | 0.05 | 0.03 | 0.025 | 0.02 | 0.02 | 0.01 | 0.01 | 0.01 |
| Total Copper (ppm Cu) | 0.05 | 0.025 | 0.02 | 0.02 | 0.015 | 0.01 | 0.01 | 0.01 | 0.002 |
| Total Hardness (ppm CaCO ₃) | 0.3 | 0.3 | 0.2 | 0.2 | 0.1 | 0.05 | ND | ND | ND |
| pH @ 25° C | 8.3-10.0 | 8.3-10.0 | 8.3-10.0 | 8.3-10.0 | 8.3-10.0 | 8.8-9.6 | 8.8-9.6 | 8.8-9.6 | n/a |
| Nonvolatile TOC (ppm C) | 1 | 1 | 0.5 | 0.5 | 0.5 | 0.2 | 0.2 | 0.2 | ND |
| Oily Matter (ppm) | 1 | 1 | 0.5 | 0.5 | 0.5 | 0.2 | 0.2 | 0.2 | ND |

Source: Boiler Water Quality Requirements and Associated Steam Quality for Industrial/Commercial and Institutional Boilers (American Boiler Manufacturers Association, 2005)

first-pass RO treatment and disinfection) passes through RO a second time (second pass) to remove additional dissolved solids from the water. For water fed to the Chevron refinery in El Segundo, Calif., about 5.8 mgd (254.1 L/s) receives single-pass RO treatment low-pressure boiler feed, while an additional 2.4 mgd (105 L/s) receives second-pass RO treatment for high-pressure boiler feed. The product water is pumped to a storage tank at the nearby Chevron refinery. Boiler water is also produced at the WBMWD's satellite MF/RO plant in Torrance, Calif.; the 2,200 gpm (3,500 ac-ft/yr or 4.3 MCM/yr) satellite treatment plant located on-site at the Exxon Mobil refinery produces water for their boiler feed operations. Another WBMWD facility in Carson also provides recycled water to the BP refinery.

3.5.3 Produced Water from Oil and Natural Gas Production

While not specifically reuse of treated municipal effluent, the reuse of produced water that is generated as a by-product resulting from the extraction of crude oil or natural gas from the subsurface warrants discussion. Produced water, for the purposes of this discussion, is defined as any water present in a reservoir with a hydrocarbon resource that is produced to the surface with the crude oil or natural gas. There are three types of water associated with subsurface hydrocarbon reservoirs and production operations:

- Formation water is water that flows from the hydrocarbon zone or from production activities when injected fluids and additives are introduced to the formation.
- Produced water is generated when the hydrocarbon reservoir is produced and formation water is brought to the surface.
- Flowback is water that returns to the surface within a few days or weeks following hydraulic fracturing performed on a natural hydrocarbon reservoir; this practice involves injection of large volumes of fracturing fluid into the hydrocarbon reservoir.

Recent advances in drilling techniques have led to an increase in production water from unconventional gas formations, including coal seams, tight sand, and shale deposits. These new techniques result in approximately eight barrels of water brought to the surface for every barrel of oil. This produced water is often highly saline and contaminated by hydrocarbons; it is a waste that requires treatment, disposal, and, potentially, recycling. Handling this produced water is an integral part of the oil and gas industry, and according to estimates by Clark and Veil (2009), the United States generates around 20.7 bbl/yr out of a worldwide total 69.8 bbl/yr (or 2.4 mgd of 8 mgd total; 9 ML/d of 30 ML/d total). The breakdown by state of produced water is shown in **Figure 3-6**. As might be expected, the quality of produced waters varies widely, ranging from water that meets state and federal drinking water standards to water having very high TDS concentrations. The properties can vary considerably depending on geographic location, the source geological formation, and the type of hydrocarbon being extracted. When produced water contains certain constituents at high concentrations, it can threaten aquatic life if discharged to streams or other water bodies or used as irrigation water without treatment. As a result, produced water management is subject to applicable federal and state regulatory requirements, which are further described by the U.S. Department of Energy in an online resource, The Produced Water Management System (DOE, n.d.).

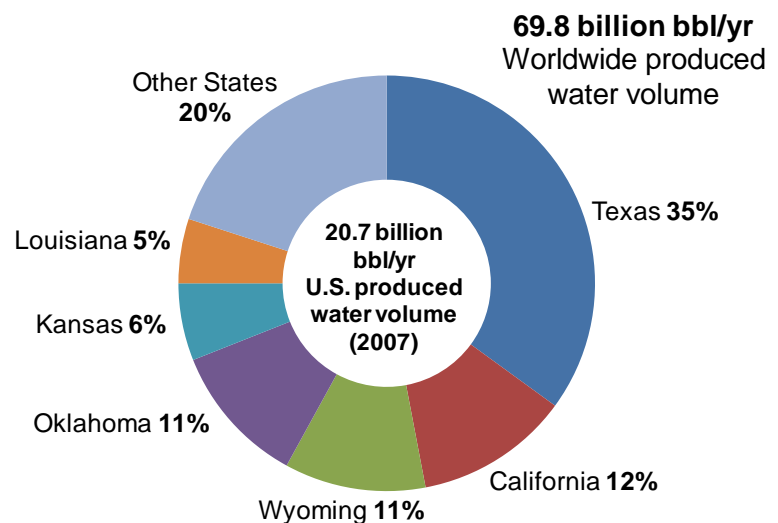

Figure 3-6
Estimates of produced water by state (GW, 2011)

It is of interest to note that under current regulations, produced water can only be utilized west of the 99 meridian and the practice is most contentious. Where produced water can be used, as with reclaimed water produced from treated municipal effluent, there are a variety of uses depending on the produced water quality and the level of treatment provided. Low TDS water sources, such as those common with coalbed methane production, may be reused with very little treatment (NRC, 2010). Higher TDS sources usually require a much higher level of treatment and may be limited in their end uses. End uses of treated, produced water include surface water flow augmentation, aquifer recharge, storage and recovery, crop irrigation, and livestock watering. Produced water may also be used for a variety of industrial purposes, especially in areas where freshwater resources are scarce. It is important to note that produced waters associated with hydraulic fracturing operations cannot be used as reclaimed water for alternative uses without extensive and expensive treatment operations, and reuse is limited to development of additional wells, with appropriate treatment.

Treatment of produced water is often required before the water can be put to beneficial reuse. The degree of treatment and the type of treatment technology used is based on a number of factors, including the produced water quality, volume, treated water quality objectives, options available for disposal of residual waste (such as concentrated brine), and cost. In oil and gas operations, it is sometimes necessary to use modular technologies that can be mobilized for localized treatment in the field versus building a fixed-based treatment facility in a central location. The overall objective is to develop a simple, cost-effective treatment solution capable of consistently meeting effluent treatment objectives. Because of the wide variation in produced water quality and treatment objectives in oil and gas fields across the United States, development of the best solution is challenging and often requires a combination of treatment technologies to meet the individual needs of each operator. Treatment technologies commonly used for produced water prior to reuse include oil-water separators, dissolved gas flotation or coalescing media separators, adsorption, and filtration targeted for removal of specific constituents from the produced water. As a result, the best approach must balance produced water quality, simplicity of operations, treatment objectives, and cost.

3.5.4 High-Technology Water Reuse

The use of reclaimed water in high-technology manufacturing, such as the semiconductor industry, is a relatively new practice. Within the semiconductor industry, there are two major processes that use water: microchip manufacturing, which has rarely utilized reclaimed water, and the manufacture of circuit boards. In circuit board manufacturing, water is used primarily for rinse operations; similar to production of boiler feed water, reclaimed water for circuit board manufacturing requires extensive treatment. While only circuit board manufacturing uses reclaimed water in the actual production process, both semiconductor and circuit board manufacturing facilities do use reclaimed water for cooling water and site irrigation.

Examples of reuse in high-technology industries include projects by companies such as Intel, that improved the efficiency of the process used to create the ultra-pure water (UPW) required to clean silicon wafers during fabrication. Previously, almost 2 gallons of water were needed to make 1 gallon of UPW. Today, Intel generates 1 gallon of UPW from between 1.25 and 1.5 gallons. After using UPW to clean wafers, the water is suitable for industrial purposes, irrigation, and many other needs. Intel's factories are equipped with complex rinse-water collection systems with separate drains for collecting lightly contaminated wastewater for reuse. This reuse strategy enables Intel to harvest as much water from its manufacturing processes as possible and then direct it to equipment such as cooling towers and scrubbers. In addition, several of Intel's locations take back graywater from local municipal water treatment operations for municipal use. In 2010, Intel internally recycled approximately 2 billion gallons (7.6 MCM) of water, equivalent to 25 percent of its total water withdrawals for the year.

3.5.5 Prepared Food Manufacturing

The food and beverage manufacturing industry was initially reluctant to use—and publicize the use of—reclaimed water because of public perception concerns. As knowledge of water reuse principles has increased, so has the reuse of highly-treated process waters that meet water quality criteria and address public health concerns. In many cases, not only is reuse of water at a manufacturing site “green,” but it also can reduce operating costs and an industry's water footprint and, in some cases, provide better water quality than the public water supply.

Because of the interest in reuse for the food and beverage industry, the International Life Sciences Institute Research Foundation (ILSIRF) was requested to develop guidelines for water recovery for multiple uses in beverage production facilities. Many beverage producers and food processors are experiencing multiple pressures to find ways to minimize the total volume of water they use in the production of product. Producers need to secure adequate, predictable, and sustainable supplies of water for all uses at reasonable costs, and with efficient usage to maximize product output. Reducing the “water footprint” of a facility that is feeling these pressures allows for greater production of product and less waste, as well as realizing possible economic advantages, and possibly better relations with local citizens and governments. Companies such as Coca-Cola and PepsiCo are implementing practices to improve their water use in their operations as further described in case study examples of water recovery practices at beverage processing facilities [[US-GA-Coca-Cola](#) and [US-NY-PepsiCo](#)].

In response to this request, ILSIRF convened an international expert committee to carry out the guideline development process that has been underway since the summer of 2011; the expected completion and release date is the end of 2012. Beverage production processes covered by these guidelines include sodas, beer, juices, milk, and still or carbonated waters. The technologies being considered are typically used in current bottling or public drinking water and applicable water reclamation (ILSIRF, 2012).

An award-winning example of integrated water reuse and sustainable practices is represented in the 2011 WaterReuse Association Project of the Year award to PepsiCo/Frito-Lay Corporation Casa Grande, Ariz., facility [[US-AZ-Frito Lay](#)]. A new process water recovery treatment plant eliminated the previous land application system and currently recycles 75 percent of plant process water, saving 100 million gallons of water per year. Elimination of the land application site allowed for the installation of 5 MW of solar photovoltaic and Sterling dish technology, reducing impact on the local power grid.

There are numerous water-demanding processes in the food and beverage industry, in addition to the potable water that may be incorporated into the product. These include cleaning and sanitation, steam

and hot water generation for processing, transport and cleaning of food products, equipment cleaning, container (bottles, cans, cartons, etc.) cleaning, can and bottle conveyor belt lubrication, can and bottle warming, and cooling. Water use for cleaning varies by industry segment from 22 percent of water use in jam production to 70 percent in the bakery segment (East Bay Municipal Utility Division, 2008).

The transport of some food products, such as potatoes and other canned goods, through the processing facility may be accomplished via water flumes. While conveyor systems with water sprays or counter-flow wash systems are gaining in use as a water conservation measure, flume water and spray water from these processes are often collected and reused following filtration and disinfection, if appropriate. Conserving water through the use of dry cleaning methods is often integrated with other water reuse practices such as using internally recycled water from equipment cleaning for other uses or for irrigation. These practices can reduce operating costs and flows to the wastewater treatment process.

Container cleaning (bottles, cans, kettles, other containers) is performed both before and after the filling process, as some overflow or spillage typically occurs. Wash water can be filtered through nanofiltration to recover both the sugars and product for use as animal feed or for growing yeast, while the cleaned water is available for additional reuse, such as crate or pallet cleaning or conveyor lubrication. Water, including reclaimed water, can be used for both heating and cooling, with water as the heat transfer medium. In canning, heating of cold ingredients after can filling prevents formation of condensation on the can and allows shorter drying cycles.

The Coca-Cola Company has developed and is implementing its Rainmaker® beverage process water recovery system for clean-in-place and bottle washing. Following conventional treatment, the recovered water is further treated using MBR ultrafiltration, RO, ozonation, and UV disinfection. This process was bench tested then implemented in facilities in Ahmedabad, India, and Hermosillo, Mexico, with reduction in water use up to 35 percent. Based on the full-scale application, the Hermosillo facility has approval to continue use of the Rainmaker® system, and approval is anticipated in 2012 for Ahmedabad (Gadson et al., 2012).

Reuse and waste load reduction combined in a new facility in Spartanburg, S.C., with expansion of New United Resource Recovery Corporation, LLC. (NURRC), a joint venture formed in 2007 between Coca-Cola Company and United Resource Recovery Corporation (URRC). NURRC recycles discarded plastic beverage bottles and other food product containers into NSF-certified reclaimed plastic for the bottling and beverage industry. When proposing a ten-fold expansion of its facility, NURRC realized that this would also increase the wastewater load to the Spartanburg Sanitary Sewer District (SSSD), with a population equivalent load of 30,000 people and concurrent increase in water use. A high-strength treatment process relying on ultrafiltration and RO was installed to produce reclaimed water with BOD less than 1 mg/L and TDS less than 100 mg/L; the reclaimed water is now used in multiple nonpotable processes throughout the facility. On-site pre-treatment of waste streams from the UF/RO process has resulted in a reduction of the waste load to SSSD to only 20 percent of the pre-expansion loads (Cooper et al., 2011).

3.6 Groundwater Recharge – Nonpotable Reuse

Groundwater recharge to aquifers not used for potable water has been practiced for many years, but has often been viewed as a disposal method for treated wastewater effluent. In addition to providing a method of treated effluent disposal, groundwater recharge of reclaimed water can provide a number of other benefits including

- Recovery of treated water for subsequent reuse or discharge
- Recharge of adjacent surface streams
- Seasonal storage of treated water beneath the site with seasonal recovery for agriculture

In many cases, groundwater can be recharged in a manner that also utilizes the soil or aquifer system where reclaimed water is applied as an additional treatment step to improve the reclaimed water quality. SAT, further discussed in Chapter 2, is particularly attractive in dry areas in arid regions and studies in Arizona, California, and Israel (Idelovich, 1981) have demonstrated that the recovery of the treated water may be suitable for unrestricted irrigation on many types of crops. Additional discussion on groundwater

recharge using land treatment and SAT are provided in the 2006 *Process Design Manual - Land Treatment of Municipal Wastewater Effluents* (EPA, 2006b) and Chapter 2 of this document.

The Talking Water Gardens project in Oregon is a case study example of a public-private partnership that has helped Albany and Millersburg meet the newly established temperature total maximum daily limits (TMDL) for the Willamette River along with providing ecological services including groundwater recharge. The objective of the TMDL is to enhance the fish passage through that area, protecting a threatened salmonid species. The Talking Water Gardens serve as the final treatment step for wastewater effluent through natural hydrological processes in the wetlands. The project includes 37 ac (15 ha) of constructed wetlands that serve as an environmentally beneficial alternative to more traditional wastewater treatment methods. Project developers estimate that the wetlands treatment alternative will provide approximately 2.5 times more value in ecological services than a conventional treatment alternative when project attributes such as habitat disturbance, groundwater recharge, and habitat diversity are considered (EPA, n.d.).

3.7 Potable Reuse

In 1980, EPA sponsored a workshop on “Protocol Development: Criteria and Standards for Potable Reuse and Feasible Alternatives” (EPA, 1982). In the Executive Summary of that document, the chairman of the planning committee noted that “*A repeated thesis for the last 10 to 20 years has been that advanced wastewater treatment provides a water of such high quality that it should not be discharged but put to further use. This thesis when joined to increasing problems of water shortage, provides a realistic atmosphere for considering the reuse of wastewater. However, at this time, there is no way to determine the acceptability of renovated wastewater for potable purposes.*” This demonstrates that more than 30 years ago there was recognition of the importance of reuse for potable purposes as well as acknowledgement that what was known about the quality of the treated wastewater was a limitation to this practice.

Since that time, a great deal has changed with respect to our understanding of this concept. The 2012 NRC report presents a brief summary of the nation’s recent history in water use and shows that although reuse is

not a panacea, the amount of wastewater discharged to the environment is of such quantity that it could play a significant role in the overall water resource picture and complement other strategies, such as water conservation (NRC, 2012). One of the most important themes throughout the report is water reuse for potable reuse applications, including a discussion of both DPR and IPR and unplanned or *de facto* reuse.

Water reclamation for nonpotable applications is well established, as discussed in the previous sections of this chapter, with system designs and treatment technologies that are generally well accepted by communities, practitioners, and regulatory authorities. The use of reclaimed water to augment potable water supplies has significant potential for helping to meet future needs, but planned potable water reuse only accounts for a small fraction of the volume of water currently being reused. However, if *de facto* (or unplanned) water reuse is considered, potable reuse is certainly significant to the nation's current water supply portfolio. The unplanned reuse of wastewater effluent as a water supply is common, with some drinking water treatment plants using waters from which a large fraction originated as wastewater effluent from upstream communities, especially under low-flow conditions. Thus, the term *de facto* reuse will be used to describe unplanned IPR, which has been identified in the NRC report (2012), and is becoming recognized by professionals and the general public. Examples of *de facto* potable reuse abound, including such large cities as Philadelphia, Nashville, Cincinnati, and New Orleans, which draw their drinking water from the Delaware, Cumberland, Ohio, and Mississippi Rivers, respectively. These communities, and most others using unplanned IPR sources, do provide their customers with potable water from these rivers that meet current drinking water regulations by virtue of the drinking water treatment technologies used.

This practice of discharging treated wastewater effluent to a natural environmental buffer, such as a stream or aquifer, has historically been deemed as an appropriate practice for IPR. However, research during the past decade on the performance of several full-scale advanced water treatment operations indicates

that some engineered systems can perform equally well or better than some existing environmental buffers in attenuating contaminants, and the proper use of indicators and surrogates in the design of reuse systems offers the potential to address many concerns regarding quality assurance. A number of these planned IPR projects have been in use for many years, demonstrating successful operation and treatment.

Several examples of IPR and DPR projects are summarized in **Table 3-9** to illustrate that this practice occurs worldwide at both very small and very large scales. And there are countless other planned IPR applications, where treated wastewater is deliberately recharged to a groundwater aquifer using rapid infiltration basins or injection wells, or to a drinking water reservoir. Additional information for the examples described in **Table 3-9** are provided in case studies; in addition to the case studies provided in the table, more information on specific IPR projects in the United States is available in case studies for successful IPR projects [[US-CA-Los Angeles County](#), [US-CA-San Diego](#), [US-AZ-Prescott Valley](#), [US-CA-Vander Lans](#)].

Implementation of technologies for increasingly higher levels of treatment for many of these IPR projects has led to questions about why reclaimed water would be treated to produce water with higher quality than drinking water standards, and then discharged to an aquifer or lake. This realization has led to new interest in DPR, utilizing the various multiple-barrier treatment technologies. However, even with the numerous successful IPR projects, such as cited in **Table 3-9**, and technology advances, Windhoek, Namibia, was the first city to implement long-term DPR without use of an environmental buffer. This is an example of the distinction between IPR and DPR: a reuse practice in which purified municipal wastewater is introduced into a water treatment plant intake (after treatment to at least near drinking water quality) for the purposes of this document, or directly into the water distribution system after meeting drinking water standards which has been proposed by others (Tchobanoglous et al., 2011).

Table 3-9 Overview of selected planned indirect and direct potable reuse installations worldwide (not intended to be a complete survey)

| Country | City | Project Capacity (mgd) | Description of Advanced System for Potable Reuse | Case Study |
|----------------|---------------------------|------------------------|--|--------------------------------|
| Belgium | Wulpen | 1.9 | Reclaimed water is returned to the aquifer before being reused as a potable water source | [Belgium-Recharge] |
| India | Bangalore (planned) | 36 | Reclaimed water will be blended in the reservoir, which is a major drinking water source | [India-Bangalore] |
| Namibia | Windhoek | 5.5 | Reclaimed water is blended with conventionally-treated surface water for potable reuse | (NAS, 2012) |
| United States | Big Spring, Texas | 3 | Reclaimed water is blended with raw surface water for potable reuse | [US-TX-Big Spring] |
| United States | Upper Occoquan, Virginia | 54 | Reclaimed water is blended in the reservoir, which is a major drinking water source | [US-VA-Occoquan] |
| United States | Orange County, California | 40 | Reclaimed water is returned to the aquifer before being reused as a potable water source | [US-CA-Orange County] |
| United Kingdom | Langford | 10.5 | Reclaimed water is returned upstream to a river, which is the potable water source | [United Kingdom-Langford] |
| Singapore | Singapore | 122 | Reclaimed water is blended in the reservoir, which is a major drinking water source | [Singapore-NEWater] |
| South Africa | Malahleni | 4.2 | Reclaimed water from a mine is supplied as drinking water to the municipality | [South Africa-eMalahleni Mine] |

Source: Adapted from Von Sperling and Chernicharo (2002)

The rationale for DPR is based on the technical ability to reliably produce purified water that meets all drinking water standards and the need to secure dependable water supplies in areas that have, or are expected to have, limited and/or highly variable sources. A unique DPR project has been successful aboard the International Space Station [US-TX-NASA]. However, although reclaimed water can be treated to meet all applicable standards, DPR still raises a number of issues and requires a careful examination of regulatory requirements, health concerns, project management and operation, and public perception. Many of these issues have been discussed in greater detail with respect to how regulatory agencies and utilities in California would pursue DPR as a viable option in the future (Crook, 2010).

3.7.1 Planned Indirect Potable Reuse (IPR)

Planned IPR involves a proactive decision by a utility to discharge or encourage discharge of reclaimed water into surface water or groundwater supplies for the specific purpose of augmenting the yield of the supply. For the purposes of the discussion related to planned IPR, it is useful to examine **Figure 3-7**, which

provides a graphical representation of IPR with specific examples. There are specific regulatory programs that may be referenced for this practice, and additional discussion on regulatory approaches to planned IPR is provided in Section 4.5.2.10.

In either case, the decision to pursue planned IPR typically involves the following factors.

- Limited availability and yield of alternate sources
- High cost of developing alternate water sources
- Conscious or unconscious public acceptance
- Confidence in, and some level of control over, both advanced reclaimed water treatment processes and water treatment processes

In some cases, the level of reclaimed water treatment required to meet water quality standards is considerable. The incentive to provide additional treatment may be driven by regulations intent on protecting water supplies but in most cases is also

Figure 3-7
Planned IPR scenarios and examples

linked to benefits to the discharger or community in increasing the yield of water supplies that they depend on either directly or indirectly. While satisfying these four factors may be necessary to pursue IPR, they are not sufficient. Two specific components of these factors typically control the viability of implementation. First, even though existing water supplies may be of limited availability and yield, the means via water rights, permits, and storage contracts must exist to reap the benefits of withdrawing the additional yield of the augmented water supply. Second, public acceptance of IPR is of paramount importance but sometimes takes counterintuitive turns based on the specifics of the project and the local community. The following examples illustrate how these key components can play out in project planning and implementation.

An often-cited example of IPR is the UOSA discharge into Occoquan Reservoir in Northern Virginia. In this particular case, serious water quality issues were caused by multiple small effluent discharges into the reservoir. The Fairfax County Water Authority withdraws water from the reservoir to meet the water supply needs of a large portion of Northern Virginia. In

1971, the UOSA was formed to address the water quality problem by the same local government entities that relied on the reservoir for their water supply. Therefore, these local governments, and by proxy their residents, received the benefits of the investments of additional wastewater treatment, satisfying the first key component that their water supply was now both protected and augmented. Regarding the second key component, the improvements made a dramatic improvement in the water quality of the reservoir that was readily visible to the general public. Algae blooms, foul odors, low DO for fish, etc., were addressed by the regionalization and advanced treatment and provided the public with a tangible example showing improved water quality over past practices. See [[US-VA-Occoquan](#)] for further information.

Another example is the Gwinnett County, Ga., where treated effluent is discharged to Lake Lanier. Operated by the USACE, Lake Lanier is formed by Buford Dam on the Chattahoochee River north of Atlanta. Gwinnett County, along with several other communities around the lake, withdraws all of its water for potable supply from Lake Lanier. Given the linkage between the water withdrawal from the lake and the desire to return

reclaimed water to the lake, the first key component was satisfied by the issuance of a revised state withdrawal permit and amended USACE storage contract that provided credit for the water returned. In this case, the key issue focused on permitting the discharge and on the multiple administrative and legal challenges identified by stakeholders with interest in the lake. Because the focus of the stakeholders was primarily lake quality, discharge limits were significantly reduced from already-low proposed levels. For example, the proposed 0.13 mg/L total phosphorus limit based on detailed lake modeling was eventually reduced through the legal and permitting process to 0.08 mg/L using anti-degradation regulations as the rationale. Interestingly, plaintiffs also successfully pushed for the outfall to be closer to the county's raw water intake to ensure that the reclaimed water discharge would be as reliable as possible.

In other example IPR projects, including San Diego and Tampa, the issue of supply and demand was not a significant concern, as the ability of the dischargers to utilize the reclaimed water to augment their yields was confirmed early in the planning process. However, unlike Gwinnett County, the primary opposition to IPR was related to the perceived health risks to the public from drinking the treated drinking water from the blended source. Public opposition of this type has significantly delayed or tabled many IPR plans. In many cases the opposition appears to be rooted, in part, to the public's perception of the quality of the existing water source and that it will be degraded by the addition of reclaimed water. San Diego was able to provide new educational communication materials to the public and interest groups and is operating an IPR demonstration facility to provide specific data for permitting to augment the San Vicente Reservoir with recycled water [US-CA-San Diego]. Additional information on public information campaigns is provided in Chapter 8.

3.7.2 Direct Potable Reuse (DPR)

To date, no regulations or criteria have been developed or proposed specifically for DPR in the United States. Past regulatory evaluations of this practice generally have been deemed unacceptable due to a lack of definitive information related to public health protection. Still, the *de facto* reuse of treated wastewater effluent as a water supply is common in many of the nation's water systems, with some drinking water treatment plants using water with a

large fraction originating as wastewater effluent from upstream communities, especially under low-flow conditions (NRC, 2012). Considering that unplanned reuse is already widely practiced, DPR may be a reasonable option based on significant advances in treatment technology and monitoring methodology in the last decade and health effects data from IPR projects and DPR demonstration facilities. For example, the water quality and treatment performance data generated at operational IPR projects such as Montebello Forebay [US-CA-Los Angeles County] (WRRF, 2011b), Water Factory 21/Orange County Groundwater Replenishment Project [US-CA-Orange County], Occoquan Reservoir [US-VA-Occoquan], Scottsdale Water Campus, and El Paso Water Utility Hueco Bolson augmentation indicate that the advanced wastewater treatment processes in place in these projects can meet the required purification level. In addition to addressing the technical challenges of potable reuse, these projects, as well as San Diego, Calif., CA IPR Demonstration Project [US-CA-San Diego] and Big Spring, Texas, direct blending project [US-TX-Big Spring], demonstrate recent public acceptance of these kinds of water supply projects.

3.7.2.1 Planning for DPR

A number of recent publications have focused on identifying the role that DPR will have in the management of water resources in the future (Tchobanoglous et al., 2011; NRC, 2012; Crook, 2010; Leverenz et al., 2011; Schroeder et al., 2012). For the purposes of the discussion related to planned DPR in this section, it is useful to examine **Figure 3-8**, which provides a graphical representation of DPR, according to the definitions provided in this document, with specific examples.

As defined herein, DPR refers to the introduction of purified water, derived from municipal wastewater after extensive treatment and monitoring to assure that strict water quality requirements are met at all times, directly into a municipal water supply system. The resultant purified water could be blended with source water for further water treatment or could be used in direct pipe-to-pipe blending, providing a significant advantage of utilizing existing water distribution infrastructure. Tchobanoglous et al. (2011) proposed a general process flow for alternative potable reuse strategies, which is the basis for **Figure 3-8** and in which two DPR options are available.

Figure 3-8
Planned DPR and specific examples of implementation

In the first option, purified water is first placed in an engineered storage buffer; from there, purified water is blended with the water supply prior to water treatment. In the second option, purified water, without the use of an engineered storage buffer, can be blended back into the distribution system for delivery to water users. An in-depth discussion of implementation of these options is provided by Tchobanoglous et al. (2011) and Levernez et al. (2011), along with the concept and role of the engineered storage buffer, which is a mechanism for detention to provide response time for any off-specification product water.

Multiple additional process configurations may be available, such as the configuration in Big Spring, Texas, where direct blending of highly-treated reclaimed water with quality higher than drinking water standards is provided in a raw, surface water transmission main supplying six different community surface water treatment plants. In this particular project, the low TDS DPR water blends in the

transmission main with significantly higher TDS lake water, improving the blended source water quality [[US-TX-Big Spring](#)].

In many parts of the world, DPR may be the most economical and reliable method of meeting future water supply needs. While DPR is still an emerging practice, it should be evaluated in water management planning, particularly for alternative solutions to meet urban water supply requirements that are energy intensive and ecologically unfavorable. This is consistent with the established engineering practice of selecting the highest quality source water available for drinking water production. Specific examples of energy-intensive or ecologically-challenging projects include interbasin water transfer systems, which can limit availability of local water sources for food production, and source area ecosystems, which are often impacted by reduced stream flow and downstream water rights holders who could exercise legal recourse to regain lost water. In some

circumstances, in addition to the high energy cost related to long-distance transmission of water, long transmission systems could be subject to damage from earthquakes, floods, and other natural and human-made disasters. Desalination is another practice for which DPR could serve as an alternative, because energy requirements are comparatively large, and brine disposal is a serious environmental issue. By comparison, DPR using similar technology will have relatively modest energy requirements and provide a stable local source of water. It is important to note, however, that DPR will not be a stand-alone water supply. Therefore, in managing water supplies, other local sources will need to be combined with DPR to create reliable, robust, sustainable water supplies.

While the technical issues of DPR can be easily addressed through advanced treatment, there lies the significant task of developing public education and outreach programs to achieve public acceptance of this practice. The San Diego Phase II demonstration project is a key example of the level of effort that is required to achieve support for DPR, with nearly half of the project funding being dedicated to the purpose of education and outreach [US-CA-San Diego]. Successful operation of the Orange County Groundwater Replenishment Project for more than 3 years has accommodated innumerable tours and hosted many national reporters with positive education and feedback from most participants [US-CA-Orange County].

3.7.2.2 Future Research Needs

There are several existing potable reuse projects in the United States and abroad. Past research and operational data from existing IPR facilities indicate that available technology can reduce chemical and microbial contaminants to levels comparable to or lower than those present in many current drinking water supplies. Notwithstanding the demonstrated safety of using highly-treated reclaimed water for IPR, there are areas of research that could further advance the safety, reliability, and cost-effectiveness of IPR and more clearly determine the acceptability of DPR as it relates to public health protection. Other future research needs may be related to new or alternative treatment unit processes or treatment trains that are proposed, regulatory requirements (e.g., constituent limits, monitoring, and analytical techniques), public acceptance, and other factors.

The NRC report identified several key research needs related to both nonpotable and potable reuse, which are summarized below (NRC, 2012):

- Quantify the extent of *de facto* (unplanned) potable reuse in the United States
- Address critical gaps in the understanding of health impacts of human exposure to constituents in reclaimed water
- Enhance methods for assessing the human health effects of chemical mixtures and unknowns
- Strengthen waterborne disease surveillance, investigation methods, governmental response infrastructure, and epidemiological research tools and capacity
- Quantify the nonmonetized costs and benefits of potable and nonpotable water reuse compared with other water supply sources to enhance water management decision-making
- Examine the public acceptability of engineered multiple barriers compared with environmental buffers for potable reuse
- Develop a better understanding of contaminant attenuation in environmental buffers and wetlands
- Develop a better understanding of the formation of hazardous transformation products during water treatment for reuse and ways to minimize or remove them
- Develop a better understanding of pathogen removal efficiencies and the variability of performance in various unit processes and multi-barrier treatment, and develop ways to optimize these processes
- Quantify the relationship between polymerase chain reaction detections and infectious organisms in samples at intermediate and final stages
- Develop improved techniques and data to consider hazardous events or system failure in risk assessment of water reuse

- Identify better indicators and surrogates that can be used to monitor process performance in reuse scenarios and develop online real-time or near real-time monitoring techniques for their measurement
- Analyze the need for new reuse approaches and technology in future water management

3.8 References

American Boiler Manufacturers Association. 2005. *Boiler Water Quality Requirements and Associated Steam Quality for Industrial/Commercial and Institutional Boilers*. ABMA. Vienna, VA.

American Water Works Association (AWWA). 2010. "New Orleans Plans to Restore Wetlands Using Effluent Have 'Wow' Factors." *Streamlines*. 2(24).

American Society of Civil Engineers (ASCE). 2012. *Agricultural Salinity Assessment and Management, Manuals of Practice (MOP) 71*. ASCE Press. Reston, VA.

Associated Press. 2012. "Federal Court Rejects Challenge to Arizona Snowbowl's Mountain Snow-making Plan," *Arizona Capital Times*, February 10, 2012.

Barber, L. B., A. M. Vajda, C. Douville, D. O. Norris, and J. H. Writer. 2012. Fish Endocrine Disruption Responses to a Major Wastewater Treatment Facility Upgrade. *Environmental Science & Technology*. 46(4):2121-2131.

Baydal, D. 2009. "Municipal Wastewater Recycling Survey." *California Water Recycling Funding Program (WRFP)*. Retrieved on August 23, 2012 from http://www.swrcb.ca.gov/water_issues/programs/grants_loans/water_recycling/munirec.shtml

Bryk, J., R. Prasad, T. Lindley, S. Davis, and G. Carpenter. 2011. *National Database of Water Reuse Facilities: Summary Report*. WateReuse Foundation. Alexandria, VA.

California Department of Public Health. 2009. Water Recycling Criteria. *California Code of Regulations*. Retrieved on August 23, 2012 from <http://www.cdph.ca.gov/certlic/drinkingwater/Documents/Lawbook/RWregulations-01-2009.pdf>.

California State Water Resources Control Board (California SWRCB). 2009. *Recycled Water Policy*. Retrieved July 2012, from http://www.swrcb.ca.gov/water_issues/programs/water_recycling_policy/

Cirelli, G. L., S. Consoli, F. Licciardello, R. Aiello, F. Giuffrida, and C. Leonardi. 2012. Treated Municipal

Wastewater Reuse in Vegetable Production. *Agricultural Water Management*. 104:163.

Clark, C. E., and J. A. Veil. 2009. Produced Water Volumes and Management Practices in the United States. Argonne, Illinois: Argonne National Laboratory. Retrieved August 23, 2012 from http://www.evs.anl.gov/pub/dsp_detail.cfm?PubID=2437.

Cooper, N. B., A. G. Fishbeck, and T. Barker. 2011. "Extreme Water Reuse – Water Recycling in a Food Products Industry." WateReuse Association Symposium, October 19, 2011.

Crook, J. 2010. Regulatory Aspects of Direct Potable Reuse in California. National Water Research Institute. Fountain Valley, CA.

Dobrowolski, J., M. O'Neill, L. Duriancik, and J. Throwe (eds.). 2008. Opportunities and Challenges in Agricultural Water Reuse: Final report. USDA-CSREES.

Dobrowolski, J. P., M. P. O'Neill, and L. F. Duriancik. 2004. Agricultural Water Security Listening Session: Final Report, September 9-10, 2004, Park City, UT. USDA Research, Education, and Economics.

East Bay Municipal Utility District. 2008. *Watersmart Guidebook: A Water-Use Efficiency Plan-Review Guide For New Businesses*. EBMUD. Oakland, CA.

Florida Department of Environmental Protection (FDEP). 2011. 2010 Reuse Inventory. Florida Department of Environmental Protection. Tallahassee, FL. Retrieved January 2012 from <http://www.dep.state.fl.us/water/reuse/inventory.htm>.

Food and Agriculture Organization of the United Nations (FAO). 2011. Executive Summary. Thirty-seventh Session Rome 25 June – 2 July 2011. The State of the World's Land and Water Resources for Food and Agriculture (SOLAW).

Food and Agriculture Organization of the United Nations (FAO). 1985. FAO Irrigation and Drainage Paper, 29 Rev. 1. Food and Agriculture Organization of the United Nations: Rome, Italy.

Gadson, J. C., D. V. Darshane, C. J. Wojna, and H. Chin. 2012. "Safe and Sustainable Water for the Future through Recovery and Reuse of Beverage Process Water." WateReuse Association Symposium, September 10, 2012.

Global Water Intelligence (GWI). 2011. Produced Water Market: Opportunities in the Oil, Shale and Gas Sectors in North America. Media Analytics Ltd. Oxford, UK.

Global Water Intelligence (GWI). 2009. Municipal Water Reuse Markets 2010. Media Analytics Ltd. Oxford, UK.

- Golf Course Superintendents Association of America (GCSAA) and The Environmental Institute for Golf (GCSSA and EIFG). 2009. *Golf Course Environmental Profile, Volume II, Water Use and Conservation Practices on U.S. Golf Courses*. GCSAA. Lawrence, KS. Retrieved on August 23, 2012 from <http://www.gcsaa.org/Course/Environment/default.aspx>.
- Grinnell, G. K., and R. G. Janga. 2004. *Golf Course Reclaimed Water Marketing Survey*. American Water Works Association. Denver, CO.
- Hall, J. R., III; D. R. Chalmers; D. W. McKissack; P. R. Carry; and M. M. Monnettand. 2009. *Characterization of Turfgrass Nutrient Management Practices in Virginia*. Virginia Cooperative Extension. Virginia Polytechnic Institute and State University.
- Harivandi, A. 2011. "Purple Gold - A Contemporary View of Recycled Water Irrigation." *Green Section Record*. 49.
- Hey, D. L.; D. L. Montgomery, and L. S. Urban. 2004. "Flood Damage Reduction in the Upper Mississippi River Basin – An Ecological Alternative." *The Wetlands Initiative*. Chicago, IL.
- Idelovitch, E. (1981) Unrestricted Irrigation with Municipal Wastewater, in: Proceedings, National Conference on Environmental Engineering, ASCE, Atlanta GA.
- Inbar Y. 2007. "New standards for treated wastewater reuse in Israel." In: Zaidi M. (Ed.). *Wastewater Reuse – Risk Assessment, Decision-Making and Environmental Security* Springer, Dordrecht, Netherlands.
- International Life Sciences Research Institute Research Foundation (ILSRIF). 2012. *Guidelines for Water Recovery in Beverage Production Facilities*. Washington, D.C., USA. In press.
- Kenny, J. F., N. L. Barber, S. S. Hutson, K. S. Linsey, J. K. Lovelace, and M. A. Maupin. 2009. Estimated Use of Water in the United States in 2005. United States Geological Survey (USGS). Retrieved August 2012 from <http://pubs.usgs.gov/circ/1344/pdf/c1344.pdf>.
- Leverenz, H. L., G. Tchobanoglous, and T. Asano. 2011. Direct Potable Reuse: A Future Imperative. *Journal of Water Reuse and Desalination*. 1(1):2-10.
- Lazorchak and Smith. 2004. *National Screening Survey of EDCs in Municipal Wastewater Treatment Effluents*. EPA/600/R-04/171. Environmental Protection Agency. Washington, D.C.
- Miller, W. G. 2006. *Integrated Concepts in Water Reuse: Managing Global Water Needs, Desalination* (187: 65-75).
- National Research Council (NRC). 2012. *Water Reuse: Potential for Expanding the Nation's Water Supply Through Reuse of Municipal Wastewater*. The National Academies Press: Washington, D.C.
- National Research Council (NRC). 2010. *Management and Effects of Coalbed Methane Produced Water in the United States*. The National Academies Press: Washington, D.C.
- O'Neill, M. P. and J. P. Dobrowolski. 2011. "Water and Agriculture in a Changing Climate." *HortScience*. 46:155.
- Raisbeck, M. F., S. L. Riker, C. M. Tate, R. Jackson, M. A. Smith, K. J. Reddy, and J. R. Zygmunt. 2011. *Water Quality for Wyoming Livestock & Wildlife, A Review of the Literature Pertaining to Health Effects of Inorganic Contaminants*. B-1183. University of Wyoming Department of Veterinary Sciences, UW Department of Renewable Resources, Wyoming Game and Fish Department, and Wyoming Department of Environmental Quality.
- Rowe, D. R., and I. M. Abdel-Magid. 1995. *Handbook of Wastewater Reclamation and Reuse*. CRC Press. Boca Raton, FL.
- Schroeder, E.; G. Tchobanoglous; H. L. Leverenz; and T. Asano. 2012. "Direct Potable Reuse: Benefits for Public Water Supplies, Agriculture, the Environment, and Energy Conservation." *National Water Research Institute (NWRI) White Paper*, NWRI-2012-01. National Water Research Institute. Fountain Valley, CA.
- Scott, C. A., N. I. Faruqui, and L. Raschid-Sally. 2004. *Wastewater Use in Irrigated Agriculture: Confronting the Livelihood and Environmental Realities*. IWMI, IRDC-CRDI, CABI Publishing. Trowbridge, UK.
- Sheikh, B., R. C. Cooper, and K. E. Israel. 1999. "Hygienic Evaluation of Reclaimed Water Used To Irrigate Food Crops—A Case Study." *Water Science Technology*. ,40(4-5):261.
- Sheikh, B., R. P. Cort, W.R. Kirkpatrick, R. S. Jaques, and T. Asano. 1990. "Monterey Wastewater Reclamation Study for Agriculture." *Research Journal of the Water Pollution Control Federation*. 62(3):216.
- Solley, W. B.; R. R. Pierce; and H. A. Perlman. 1998. "Estimated Use of Water in the United States in 1995." *U.S. Geological Survey Circular*, 1200.
- Tchobanoglous, G.; H. L. Leverenz; M. H. Nellor; and J. Crook. 2011. *Direct Potable Reuse: The Path Forward*. WaterReuse Research Foundation and Water Reuse California. Washington, D.C.

- Thomas, J. C., R. H. White, J. T. Vorheis, H. G. Harris, and K. Diehl. 2006. "Environmental Impact of Irrigating Turf With Type I Recycled Water." *Agronomy Journal Online*.
- U.S. Department of Energy (DOE). n.d. *Produced Water Management Information System*. Retrieved on September 5, 2012, from <http://www.netl.doe.gov/technologies/pwmis/>.
- U.S. Environmental Protection Agency (EPA). n.d. Clean Water State Revolving Fund Green Project Reserve - Case Study: Albany-Millersburg Talking Water Gardens, A Value-Focused Approach to Improving Water Quality. EPA-832-F-12-022. Retrieved August 2012, from http://water.epa.gov/grants_funding/cwsrf/upload/Albany-Millersburg-Case-Study.pdf.
- U.S. Environmental Protection Agency (EPA). 2011. Draft Recreational Water Quality Criteria 820-D-11-002. Retrieved August 2012, from http://water.epa.gov/scitech/swguidance/standards/criteria/health/recreation/upload/recreation_document_draft.pdf.
- U.S. Environmental Protection Agency (EPA). 2006a. *Economic Benefits of Wetlands*. EPA 843-F-06-004. Environmental Protection Agency, Office of Water. Washington, D.C.
- U.S. Environmental Protection Agency (EPA). 2006b. *Process Design Manual - Land Treatment of Municipal Wastewater Effluents*. EPA/625/R-06/016 EPA Environmental Protection Agency. Cincinnati, OH.
- U.S. Environmental Protection Agency (EPA). 2004. *Guidelines for Water Reuse*. EPA/625/R-04/108. Environmental Protection Agency. Washington, D.C.
- U.S. Environmental Protection Agency (EPA). 1982. *Report of Workshop Proceedings, Protocol Development: Criteria and Standards for Potable Reuse and Feasible Alternatives*. EPA 570/9-82-005. Environmental Protection Agency. Washington, D.C.
- Von Sperling, M. and C. A. L. Chernicharo. 2002. "Urban Wastewater Treatment Technologies and the Implementation of Discharge Standards in Developing Countries." *Urban Water*. 4(1): 105.
- Wade, T. J.; R. L Calderon; K. P. Brenner; E. Sams; M. Beach; R. Haugland; L. Wymer; and A. P. Dufour. 2008. "High sensitivity of children to swimming-associated gastrointestinal illness." *Epidemiology*. 19(3):375.
- Wade, T. J., E. Sams, K. P. Brenner, R. Haugland, E. Chern, M. Beach, L. Wymer, C. C. Rankin, D. Love, Q. Li, R. Noble, and A. P. Dufour. 2010. "Rapidly Measured Indicators of Recreational Water Quality and Swimming-associated Illness at Marine Beaches: a Prospective Cohort Study." *Environmental Health* 9(66):1.
- WateReuse Research Foundation. (WRRF) 2011a. Attenuation of Emerging Contaminants in Stream Augmentation with Recycled Water. *WRF Report 06-20-1*. WateReuse Foundation. Alexandria, VA.
- WateReuse Research Foundation (WRRF). 2011b. *Development and Application of Tools to Assess and Understand the Relative Risks of Regulated Chemicals in Indirect Potable Reuse Projects – The Montebello Forebay Groundwater Recharge Project. Tools to Assess and Understand the Relative Risks of Indirect Potable Reuse and Aquifer Storage & Recovery Projects, Volume 1A*. WRF-06-018-1A. WateReuse Research Foundation, Alexandria, VA.
- World Health Organization (WHO). 2006. *WHO Guidelines For The Safe Use Of Wastewater, Excreta and Greywater*. United Nations Environment Program. Paris.

This page intentionally left blank

CHAPTER 4

State Regulatory Programs for Water Reuse

This chapter presents an overview of the overarching approach to developing a reuse program at the state level, a regulatory framework outlining fundamental components for states considering developing or revising regulations, and a summary of which states have regulations and guidelines governing reuse. This chapter also provides a listing of the existing state water reuse regulations or guidelines in 10 sample states (Arizona, California, Florida, Hawaii, Nevada, New Jersey, North Carolina, Texas, Virginia, and Washington) for a comparison of approaches governing different types of reuse applications. Finally, the chapter provides suggested regulatory guidelines for water reuse.

4.1 Reuse Program Framework

Since publication of the 2004 guidelines, several states have developed state water reuse programs, building on the examples of other states with well-established water reuse programs, such as Florida, California, Texas, and Arizona. Establishing an effective state water reuse program involves a number of complex factors beyond establishing guidelines or regulations. There are 15 key elements to an effective state water reuse program, as presented in **Table 4-1**.

4.2 Regulatory Framework

Reuse programs operate within a framework of regulations that must be addressed in the earliest stages of planning. A thorough understanding of all applicable regulations is required to plan the most effective design and operation of a water reuse program and to streamline implementation. Currently, there are no federal regulations directly governing water reuse practices in the United States. In the absence of federal standards and regulations, each state may choose to adopt rules and develop

programs for water reuse to meet its specific resource needs, and to ensure that water reuse projects are designed, constructed, and operated in a manner protective of the environment, other beneficial uses, and human health. Water reuse regulations and guidelines have been developed by many states, as described in Section 4.5. Regulations refer to actual rules that have been enacted and are enforceable by governmental agencies. Guidelines, on the other hand, are generally not enforceable, but can be used in the development of a reuse program. In some states, however, guidelines are, by reference, included in the regulations, and thus are enforceable. In addition to providing treatment and water quality requirements, comprehensive rules or guidelines also promote reuse by providing the playing field for which projects must comply. They provide the certainty that if a project meets the requirements, it will be permitted.

Table 4-2 provides fundamental components of a regulatory framework that states may want to consider when developing or amending rules or regulations for water reuse.

4.3 Relationship of State Regulatory Programs for Water Reuse to Other Regulatory Programs

States' regulatory programs for water reuse must be consistent with and, in some cases, function within the limitations imposed by other federal and state laws, regulations, rules, and policies. The following subsections describe some of the more common laws and regulations that can affect states' regulatory programs for water reuse. Laws, policies, rules, and regulations that affect state water reuse regulatory programs include water rights laws, water use, and wastewater discharge regulations, as well as laws that restrict land use and protect the environment.

Table 4-1 Key elements of a water reuse program (Adapted from WateReuse Association, 2009)

| | Factor | Description |
|----|---|--|
| 1 | Establish the objectives | Objectives that encourage and promote reuse should be clear and concise. |
| 2 | Commit to the long run | A water reuse program should be considered a permanent, high-priority program within the state. |
| 3 | Identify the lead agency or agencies | The lead agencies should be able to issue permits for the production, distribution, and use of the reclaimed water. These permits are issued under state authority and are separate from the federal requirements for wastewater discharges to surface waters under the NPDES permit program. Preference to the lead agency determination should be given to the public health agency since the intent of the use of reclaimed water is for public contact and/or consumption following adequate and reliable treatment. |
| 4 | Identify water reuse leader | A knowledgeable and dedicated leader of the water reuse program who develops and maintains relationships with all water programs and other agencies should be designated. |
| 5 | Enact needed legislation | Initial legislation generally should be limited to a clear statement of the state objectives, a clear statement of authorization for the program, and other authorizations needed for implementation of specific program components. States also will want to review and evaluate existing state water law to determine what constraints, if any, it will impose on water reuse and what statutory refinements may be needed. |
| 6 | Adopt and implement rules or guidelines governing water reuse | With stakeholder involvement, a comprehensive and detailed set of reuse regulations or guidelines that are fully protective of environmental quality and public health should be developed and adopted in one location of the regulations. Formal regulations are not a necessity—they may be difficult and costly to develop and change and therefore overly rigid. Frameworks that have an ability to adapt to industry changes are most effective. |
| 7 | Be proactive | The water reuse program leader should be visible within the state and water reuse community while permitting staff of the lead agency must have a positive attitude in reviewing and permitting quality water reuse projects. |
| 8 | Develop and cultivate needed partnerships | Partnerships between the agency responsible for permitting the reclaimed water facilities (usually the lead agency) and the agency(ies) responsible for permitting water resources as well as the agency responsible for protection of public health are critical. Other agency partnerships, such as with potential major users of reclaimed water such as the department of transportation, are also helpful in fostering state-wide coordination and promotion of water reclamation. |
| 9 | Ensure the safety of water reuse | Ensuring the protection of public health and safety can be accomplished by placing reliance on production of high-quality reclaimed water with minimal end use controls, or allowing lower levels of treatment with additional controls on the use of reclaimed water (setback distances, time of day restrictions, limits on types of use, etc.), or by a combination of both types of regulations. A formal reliability assessment to assure a minimum level of redundancy and reliability to review and detail operating standards, maintainability, critical operating conditions, spare parts requirements and availability, and other issues that affect the ability of the plant to continuously produce reclaimed water. A critical component to ensuring the safety of reclaimed water for public access and contact-type reuse is defining requirements for achieving a high level of disinfection and the monitoring program necessary to ensure compliance (this is described further in Chapter 6). |
| 10 | Develop specific program components | Program components are going to differ from state to state and maturity of the reuse program. |
| 11 | Focus on quality, integrity, and service | Not only should the reclaimed water utilities implement high-quality reuse systems that are operated effectively, but the lead agency should also model this commitment to quality and prompt service to the regulated and general public regarding reuse inquiries and permitting issues. In effect, the lead agency should focus on building same level of trust public potable water systems develop and re-establish daily. |
| 12 | Be consistent | A comprehensive and detailed set of state regulations, as well as having a lead reuse role, help keep the permitting of reuse systems consistent. If there are multiple branches around the state involved in permitting, training and other measures of retaining consistency must be taken. |
| 13 | Promote a water reuse community | The lead agency should be proactive in developing and maintaining the state's water reuse community—reuse utilities, consulting engineers, state agencies, water managers, health departments, universities, researchers, users of reclaimed water, and others—in an effort to disseminate information and obtain feedback related to possible impediments, issues, and future needs. Active participation in the national and local reuse organizations is valuable. |
| 14 | Maintain a reuse inventory | Maintenance of a periodical (e.g., annual) reuse inventory is essential in tracking success of a state's water reuse program. Facilities in Florida that provide reclaimed water are required by their permits to submit an annual reuse report form every year. That data not only is used in the states annual reuse inventory report and reuse statistics but is also shared with the WateReuse Association's National Reuse Database. |
| 15 | Address cross-connection control issues | Coordination and joint activity between agencies and within agencies (drinking water program, wastewater program, water reuse program, etc.) must be taken to address cross-connection control issues (this is described further in Chapter 2). |

Table 4-2 Fundamental components of a water reuse regulatory framework for states

| Category | Comment |
|--|--|
| Purpose and/or goal statement | <ul style="list-style-type: none"> Frame the state's purpose for developing the rule or regulation (e.g., to satisfy a need or fulfill a statutory requirement), and describe the ultimate vision for the water reuse program. The process to authorize, develop, and implement rules or changes to rules is time consuming and costly. After adoption, rules are difficult to change, which limits the ability to accommodate new technologies and information. |
| Definitions | <ul style="list-style-type: none"> Define type of use and other water reuse-related terms used within the body of the rule or regulation. |
| Scope and applicability | <ul style="list-style-type: none"> Define the scope and applicability of the rules or regulations that delineates what facilities, systems, and activities are subject to the requirements of the rules or regulations. Include grandfathering or transitioning provisions for existing facilities, systems, or activities not regulated prior to the adoption of the rules or regulations. |
| Exclusions and prohibitions | <ul style="list-style-type: none"> Describe facilities, systems and activities that are 1) not subject to the requirements of the rules or regulations, and 2) specifically prohibited by the rules or regulations. |
| Variances | <ul style="list-style-type: none"> Describe procedures for variances to design, construction, operation, and/or maintenance requirements of the regulation for hardships that outweigh the benefit of a project, and the variance, if granted, would not adversely impact human health, other beneficial uses, or the environment. These variance procedures give regulators flexibility to consider projects that may deviate only minimally from the requirements with no significant adverse impact or opportunities that are not anticipated during initial development of a regulation. Since variances need to be based on sound, justifiable reasons for change, regulatory programs should develop guidance on how to develop adequate justification that can be relied upon as precedence setting for future regulatory decisions and actions. |
| Permitting requirements | <ul style="list-style-type: none"> Describe the permitting framework for water reuse. Indicate whether the water reuse rule or regulation will serve as the permitting mechanism for water reuse projects or identify other regulations through which the water reuse rule or regulation will be implemented and projects permitted. Describe if or how end users of reclaimed water will be permitted, and rights of end user to refuse reclaimed water if not demanded. Describe permit application requirements and procedures. Specify all information that the applicant must provide in order to appropriately evaluate and permit the water reuse projects. |
| Define or refine control and access to reclaimed water | <ul style="list-style-type: none"> Determine the rights to and limits of access and control over reclaimed water for subsequent use and the relationship between the underlying water right, wastewater collection system ownership, reclamation plant ownership, and downstream water users who have demonstrated good-faith reliance on the return of the wastewater effluent into a receiving stream within the limits and requirements of the state's water rights statutory and regulatory requirements. |
| Relationship to other rules | <ul style="list-style-type: none"> Describe relationship between water reuse rule or regulation and, for example, water and wastewater regulations, environmental flow requirements, solid waste or hazardous waste rules, groundwater protection, required water management plans, and relevant health and safety codes for housing, plumbing, and building. |
| Relationship to stakeholders | <ul style="list-style-type: none"> Identify regulatory or non-regulatory stakeholders from various sectors (e.g., water, wastewater, housing, planning, irrigation, parks, ecology, public health, etc.) that have a role or duty in the statewide reuse program. |
| Relationship to regulations or guidelines for uses of other non-conventional water sources | <ul style="list-style-type: none"> Describe other rules or regulations that exist for graywater recycle and stormwater or rainwater harvesting and use. Some states may choose to develop a more comprehensive approach that encompasses rules or regulations for all non-conventional water sources, including water reuse, within one set of rules or regulations. |
| Reclaimed water standards | <ul style="list-style-type: none"> See Tables 4-6 to 4-15 for standards that are either defined by end use or by degree of human contact. Include a provision to evaluate and allow standards to be developed on a case-by-case basis for less common uses of reclaimed water that are not listed. Require points of compliance to be established to verify compliance with standards. Describe response and corrective action for occurrence of substandard reclaimed water (a component of the Contingency Plan, below). |
| Treatment technology requirements | <ul style="list-style-type: none"> In addition to reclaimed water standards, some states specify treatment technologies for specific reuse applications. |
| Monitoring requirements | <ul style="list-style-type: none"> Describe methods and frequency for monitoring all standards listed in the rules or regulations. |
| Criteria or standards for design, siting, and construction | <ul style="list-style-type: none"> Describe criteria or standards of engineering design, siting, and construction for water reuse facilities and systems that typically include, but are not limited to, facilities or systems to treat/reclaim, distribute, and store water for reuse. Develop requirements for dual plumbed distributions systems (separate distribution of potable and nonpotable water) that are co-located. Describe requirements for the transfer of reclaimed water and its alternative disposal if unsuitable or not required by target user (e.g., during wet seasons). |

Table 4-2 Fundamental components of a water reuse regulatory framework for states (cont.)

| Category | Comment |
|---|--|
| Construction requirements | <ul style="list-style-type: none"> Describe requirements for engineering reports, pilot studies, and certificates required to construct and to operate. |
| Operations and maintenance (O&M) | <ul style="list-style-type: none"> Describe minimum requirements for the submission and content of O&M manual. The scope and content of an O&M manual will be determined by the type and complexity of the system(s) described by the manual. |
| Management of pollutants from significant industrial users as source water protection | <ul style="list-style-type: none"> Where facilities or systems with inputs from significant industrial users are proposing to generate reclaimed water suitable for human contact or potable reuse, describe programs that must be implemented to manage pollutant of concern from significant industrial users. Pretreatment programs of combined publicly owned treatment works and reclamation systems may satisfy program requirements. Develop program requirements for satellite reclamation systems also affected by inputs from significant industrial users. Such pretreatment programs should develop discharge limits that are intended to protect source water, rather than wastewater treatment and sewer system integrity. |
| Access control and use area requirements | <ul style="list-style-type: none"> Describe requirements to control access to sites where reclaimed water will be generated, or in some cases, stored or utilized. Describe requirements for advisory sign placement, message, and size. Describe requirements for proper use of reclaimed water by end users to ensure protection of the environment and human health (.e.g., setbacks, physical barriers or practices to prevent reclaimed water from leaving the site of use, etc.). |
| Education and notification | <ul style="list-style-type: none"> Include requirements for generators or providers of reclaimed water to educate end users of appropriate handling and use of the water, and to provide notification to end users regarding the discharges of substandard water to reuse and loss of service for planned or unplanned cause. |
| Operational flow requirements | <ul style="list-style-type: none"> Requirements for maintaining flow within design capacity of treatment system or planning for additional treatment capacity as needed. |
| Contingency plan | <ul style="list-style-type: none"> Include a requirement for a contingency plan that describes how system failures, unauthorized discharges, or upsets will be remedied or addressed. |
| Recordkeeping | <ul style="list-style-type: none"> Describe what operating records must be maintained, the location where they are retained, and the minimum period of retention. |
| Reporting | <ul style="list-style-type: none"> Describe what items must be reported, the frequency of reporting, and to whom they are reported. |
| Stakeholder participation | <ul style="list-style-type: none"> Requirements on public notice, involvement, and decision-making. This will apply where the water reuse rule or regulation is used as the vehicle to permit water reuse projects. |
| Financial assistance | <ul style="list-style-type: none"> Describe state, local, or federal funding or financing sources. |

4.3.1 Water Rights

Water reuse regulatory programs must work within the prevailing water rights laws of the state. Each state in the United States was granted ownership and control over all waters within their boundaries at statehood. “Water rights” provide the legal right for an entity to divert, capture, and use water within the boundaries of each individual state. In the United States, there are two main approaches to water rights law—appropriative doctrines (common in historically water-scarce areas) and riparian doctrines (common in historically water-abundant areas). Appropriative water rights are assigned or delegated to consumers, generally based on seniority of which users laid first claim to that water and not from the property’s proximity to the water source. In contrast, riparian water rights are based on the proximity to water and are acquired by the purchase of the land. In the West, reuse can be the target of legal challenges, depending

on how the local system of water rights regards the use and return of reclaimed water.

Access to or control over reclaimed water, like formal water rights, is unique to each individual state. Some states manage access to and use of reclaimed water under their water rights permitting program; others, like the state of Washington, incorporate this management directly with the reclaimed water permit. In this instance, the use of reclaimed water is not granted a separate and new water rights certificate or license, although the use of the reclaimed water cannot harm or impair existing rights that can demonstrate dependence on the return flows.

While most owners of water reclamation facilities generally have first rights to the use of the reclaimed water, there are scenarios where the facility is obligated to discharge effluents to receiving water

bodies rather than using the reclaimed water for other beneficial uses. These scenarios include: 1) where reduction in effluent discharge flows could be challenged by downstream users, 2) where laws require that place-of-use be located within the watershed from which the water was originally drawn (in the case that reclaimed water might be distributed outside the watershed), 3) where “beneficial uses” of higher priority can make a claim for the reclaimed water (over, for example, industrial reuse), or 4) where reductions in water withdrawals from water supply because of reclamation might change customer rights or allocations in future periods of shortage (where rights or allocations are based on historic usage).

The most significant constraint affecting use of reclaimed water is the need to assure minimum instream flows sufficient to protect aquatic habitat. This is especially necessary in locations where instream flows are necessary to protect the habitat of threatened and endangered fisheries. There are also cases where federal water laws may affect or supersede state regulatory programs for water reuse, particularly where water reuse would impact international boundaries (e.g., the Great Lakes, the Tijuana River, the Colorado River), Native American water rights, multiple states with a claim on limited water supplies, water rights on federal property (or on non-reserved lands), instream flow requirements to support threatened and endangered fisheries under the Endangered Species Act (ESA), and other federal reserved water rights. Additional information is available in the 2004 EPA *Guidelines for Water Reuse* Chapter 5 and *Potential for Expanding the Nation’s Water Supply Through Reuse of Municipal Wastewater* Chapter 10 (EPA, 2004 and NRC, 2012).

4.3.2 Water Supply and Use Regulations

Federal, state, and local entities may set standards for how water may be used as a condition for supply, and these standards can include water use restrictions, water efficiency goals, or water supply reductions. Some of these include criteria for substitution and offset credits associated with use of reclaimed water, and the resulting benefit to the utility provider.

Water use restrictions may serve to promote reuse when water users are required to use potable or reclaimed water for only certain uses under specific conditions. Penalties or consequences for non-compliance may include disconnection of service,

fees, fines, or jail time for major infractions. However, other regulations designed to protect water customers from service termination may mitigate or neutralize such penalties. There are generally provisions to allow prohibited or “unreasonable” uses of potable water when reclaimed water is unavailable, unsuitable for a specific use, uneconomical, or would cause negative environmental impacts. An example of California’s statutory mandate to utilize reclaimed water is provided in Chapter 5 of the 2004 guidelines.

Mandatory or voluntary water efficiency goals may be promulgated as part of a holistic water management program, often stimulated by public outreach campaigns and incentives. Mandatory goals may carry penalties as described above for water use restrictions. State-wide efficiency requirements may include incentives for localities to meet targets as a prerequisite for grants, loans, allocations, or other benefits. Water reuse may qualify or be required as water efficiency measures such as allowed under Washington State Department of Health’s Water Use Efficiency program. Water efficiency is discussed further in Chapter 2.

Water supply reductions are most often imposed during periods of drought and can trigger the invocation of seniority-based water allocations that can result in reduced allocations for those with more junior rights. Water agencies may adopt tiered pricing and allocation strategies. Water shortages often provide an opportunity to increase public awareness of the costs associated with water supply and may provide a powerful basis to develop a state regulatory program for water reuse, particularly where other methods to augment supply are more costly or have been exhausted.

4.3.3 Wastewater Regulations and Related Environmental Regulations

Both the federal government and state agencies exercise jurisdiction over the quality and quantity of wastewater discharge into public waterways of the United States. The primary authority for the regulation of wastewater is the Federal Water Pollution Control Act, commonly referred to as the Clean Water Act (Public Law 92-500). The 1972 CWA assigned the federal government and states specific responsibilities for water quality management designed to make all surface waters “fishable and swimmable.” The CWA requires states to set water quality standards, thus

establishing the right to control pollution from WWTPs, as long as such regulations are at least as stringent as federal rules. Major objectives of the CWA are to eliminate all pollutant discharges into navigable waters, stop discharges of toxic pollutants in toxic amounts, develop waste treatment management plans to control sources of pollutants, and to encourage (but not require) water reclamation and reuse through delegation agreements. Primary jurisdiction under the CWA is with EPA, but in most states many provisions of the CWA are administered and enforced by the state water pollution control agencies.

Wastewater discharge regulations mostly address treated effluent quality, but can indirectly restrict the quantity of effluent discharged to a receiving body by limiting the pollutant loads resulting from the discharge. Treated wastewater discharge permits are issued pursuant to the NPDES program under the CWA. In addition to limits on the concentration of specific contaminants, discharge permits may also include limits on the total mass of a pollutant discharged to the receiving stream—known as TMDL limits—and on the quality of the water in the receiving stream itself (e.g., minimum DO limits). For reuses that involve a discharge to surface waters, such as IPR or stream augmentation, states may choose to regulate them through the NPDES permit program. In this case, the discharge for the reuse would need to comply, at a minimum, with state surface water quality standards and any TMDLs that would apply to the particular receiving water. Though not specifically addressed, water reuse is encouraged by the CWA.

Discharged water quantity may also be regulated locally by terms of the ESA or specific water rights law as described in Section 4.3.1. The ESA has been applied to require water users to maintain minimum flows in western rivers to protect the habitat of various species of fish whose survival is threatened by increases in water demand. Such regulations may be continuous or seasonal, and may or may not correspond to periods associated with reclaimed water demand as required by the NPDES permit. To ensure compliance with the ESA, state regulatory programs for water reuse should establish a process by which projects that will divert all or a portion of a wastewater treatment facility's effluent from a surface water discharge to consumptive reuse will be coordinated with appropriate federal (i.e., U.S. Fish & Wildlife Service) and state agencies. Consumptive reuse

refers to reuse that does not return wastewater back to the wastewater treatment facility or reclamation system from which it received reclaimed water.

4.3.4 Drinking Water Source Protection

Where reclaimed water may impact drinking water sources, the SDWA comes into play. The SDWA is the main federal law that ensures the quality of Americans' drinking water. Under SDWA, EPA sets national health-based standards, or MCLs, for drinking water quality and oversees the states, localities, and water suppliers that implement those standards. SDWA was originally passed by Congress in 1974 and amended in 1986 and 1996. While the original law focused primarily on treatment standards, the 1996 amendments greatly enhanced the existing law by setting requirements for source water protection. The SDWA's Source Water Assessment program requires each state to conduct an assessment of its sources of drinking water (rivers, lakes, reservoirs, springs, and groundwater wells) to identify significant potential sources of water quality contamination. State regulatory programs for water reuse must be compatible and consistent with federal and state SDWA regulatory programs to ensure the protection of drinking water sources (surface and ground).

4.3.5 Land Use

Several western states have adopted laws that require new developments to adopt sustainable water management plans, which may encourage water reuse [[US-AZ-Sierra Vista](#)]. In chronically water-short or environmentally-sensitive areas, use of reclaimed water may even be a prerequisite for new developments.

4.4 Suggested Regulatory Guidelines for Water Reuse Categories

As defined in Chapter 1, water reuse for the purposes of these guidelines refers to the use of treated municipal wastewater (reclaimed water). Many states have rules, regulations or guidelines for a wide range of reclaimed water end uses (or reuses), and prescribe different requirements for different reuses. This subsection examines categories of water reuses and suggested regulatory guideline for the water reuses in these categories.

4.4.1 Water Reuse Categories

For the purposes of this chapter, the most common water reuses regulated by states have been inventoried and divided into water reuse categories as described in **Table 4-3**. Minimum suggested regulatory guidelines are presented in **Table 4-4**. Although reuse categories and their descriptions included in an individual state, territory, or tribe's rules, regulations or guidelines may differ from the reuse categories and descriptions presented in **Table 4-3**, the purpose of the information provided therein is to facilitate the comparison of existing rules, regulations and guidelines adopted by states, territories, and tribes and suggest minimum regulatory guidelines using common categories.

4.4.2 Suggested Regulatory Guidelines

Table 4-4 presents suggested treatment processes, reclaimed water quality, monitoring frequency, and setback distances for water reuses in various categories. These guidelines apply to domestic wastewater from municipal or other wastewater treatment facilities having a limited input of industrial waste. The suggested regulatory guidelines are predicated principally on water reclamation and reuse information from the United States and are intended to apply to reclamation and reuse facilities in the United States. These guidelines may also be used by tribal nations in establishing water reuse programs. Local social, economic, regulatory, technological, and other conditions may limit the applicability of these guidelines in some countries (see Chapter 9).

4.4.3 Rationale for Suggested Regulatory Guidelines

The rationale for the suggested treatment processes, reclaimed water quality, monitoring frequency, and setback distances in porous media is based on:

- Water reuse experience in the United States and elsewhere
- Research and pilot plant or demonstration study data
- Technical material from the literature
- Various states' reuse rules, regulations, policies, or guidelines
- Attainability
- Sound engineering practice
- Use with a multiple barrier approach

These guidelines are not intended to be used as definitive water reclamation and reuse criteria. They are intended to provide reasonable guidance for water reuse opportunities, particularly in states that have not developed their own criteria or guidelines.

Adverse health consequences associated with the use of raw or improperly treated wastewater are well documented. As a consequence, water reuse regulations and guidelines are principally directed at public health protection and generally are based on the control of pathogenic microorganisms for nonpotable reuse applications and control of both health-significant microorganisms and chemical contaminants for IPR applications.

Table 4-3 Water reuse categories and number of states with rules, regulations or guidelines addressing these reuse categories¹

| Category of reuse | | Description | Number of States or Territories with Rules, Regulations, or Guidelines Addressing Reuse Category |
|---|---|---|--|
| Urban Reuse | Unrestricted | The use of reclaimed water for nonpotable applications in municipal settings where public access is not restricted | 32 |
| | Restricted | The use of reclaimed water for nonpotable applications in municipal settings where public access is controlled or restricted by physical or institutional barriers, such as fencing, advisory signage, or temporal access restriction | 40 |
| Agricultural Reuse | Food Crops | The use of reclaimed water to irrigate food crops that are intended for human consumption | 27 |
| | Processed Food Crops and Non-food Crops | The use of reclaimed water to irrigate crops that are either processed before human consumption or not consumed by humans | 43 |
| Impoundments | Unrestricted | The use of reclaimed water in an impoundment in which no limitations are imposed on body-contact water recreation activities (some states categorize snowmaking in this category) | 13 |
| | Restricted | The use of reclaimed water in an impoundment where body contact is restricted (some states include fishing and boating in this category) | 17 |
| Environmental Reuse | | The use of reclaimed water to create, enhance, sustain, or augment water bodies, including wetlands, aquatic habitats, or stream flow | 17 |
| Industrial Reuse | | The use of reclaimed water in industrial applications and facilities, power production, and extraction of fossil fuels | 31 |
| Groundwater Recharge – Nonpotable Reuse | | The use of reclaimed water to recharge aquifers that are not used as a potable water source | 16 |
| Potable Reuse | Indirect Potable Reuse (IPR) | Augmentation of a drinking water source (surface or groundwater) with reclaimed water followed by an environmental buffer that precedes normal drinking water treatment | 9 |
| | Direct Potable Reuse (DPR) | The introduction of reclaimed water (with or without retention in an engineered storage buffer) directly into a water treatment plant, either collocated or remote from the advanced wastewater treatment system | 0 |

¹ Individual state reuse programs often incorporate different terminology so the reader should exercise caution in comparing the categories in these tables directly to state regulatory definitions

Table 4-4 Suggested guidelines for water reuse

| Reuse Category and Description | Treatment | Reclaimed Water Quality ² | Reclaimed Water Monitoring | Setback Distances ³ | Comments |
|---|--|---|---|--|---|
| Urban Reuse | | | | | |
| <p>Unrestricted The use of reclaimed water in nonpotable applications in municipal settings where public access is not restricted.</p> | <ul style="list-style-type: none"> Secondary⁽⁴⁾ Filtration⁽⁵⁾ Disinfection⁽⁶⁾ | <ul style="list-style-type: none"> pH = 6.0-9.0 ≤ 10 mg/l BOD ⁽⁷⁾ ≤ 2 NTU ⁽⁸⁾ No detectable fecal coliform /100 ml ^(9,10) 1 mg/l Cl₂ residual (min.) ⁽¹¹⁾ | <ul style="list-style-type: none"> pH – weekly BOD - weekly Turbidity - continuous Fecal coliform - daily Cl₂ residual – continuous | <ul style="list-style-type: none"> 50 ft (15 m) to potable water supply wells; increased to 100 ft (30 m) when located in porous media ⁽¹⁸⁾ | <ul style="list-style-type: none"> At controlled-access irrigation sites where design and operational measures significantly reduce the potential of public contact with reclaimed water, a lower level of treatment, e.g., secondary treatment and disinfection to achieve < 14 fecal coli/100 ml may be appropriate. Chemical (coagulant and/or polymer) addition prior to filtration may be necessary to meet water quality recommendations. The reclaimed water should not contain measurable levels of pathogens. ⁽¹²⁾ Reclaimed water should be clear and odorless. Higher chlorine residual and/or a longer contact time may be necessary to assure that viruses and parasites are inactivated or destroyed. Chlorine residual > 0.5 mg/l in the distribution system is recommended to reduce odors, slime, and bacterial regrowth. See Section 3.4.3 in the 2004 guidelines for recommended treatment reliability requirements. |
| <p>Restricted The use of reclaimed water in nonpotable applications in municipal settings where public access is controlled or restricted by physical or institutional barriers, such as fencing, advisory signage, or temporal access restriction</p> | <ul style="list-style-type: none"> Secondary ⁽⁴⁾ Disinfection ⁽⁶⁾ | <ul style="list-style-type: none"> pH = 6.0-9.0 ≤ 30 mg/l BOD ⁽⁷⁾ ≤ 30 mg/l TSS ≤ 200 fecal coliform /100 ml ^(9, 13, 14) 1 mg/l Cl₂ residual (min.) ⁽¹¹⁾ | <ul style="list-style-type: none"> pH – weekly BOD – weekly TSS – daily Fecal coliform - daily Cl₂ residual – continuous | <ul style="list-style-type: none"> 300 ft (90 m) to potable water supply wells 100 ft (30 m) to areas accessible to the public (if spray irrigation) | <ul style="list-style-type: none"> If spray irrigation, TSS less than 30 mg/l may be necessary to avoid clogging of sprinkler heads. See Section 3.4.3 in the 2004 guidelines for recommended treatment reliability requirements. For use in construction activities including soil compaction, dust control, washing aggregate, making concrete, worker contact with reclaimed water should be minimized and a higher level of disinfection (e.g. < 14 fecal coli/100 ml) should be provided when frequent worker contact with reclaimed water is likely. |
| Agricultural Reuse | | | | | |
| <p>Food Crops ¹⁵ The use of reclaimed water for surface or spray irrigation of food crops which are intended for human consumption, consumed raw.</p> | <ul style="list-style-type: none"> Secondary ⁽⁴⁾ Filtration ⁽⁵⁾ Disinfection ⁽⁶⁾ | <ul style="list-style-type: none"> pH = 6.0-9.0 ≤ 10 mg/l BOD ⁽⁷⁾ ≤ 2 NTU ⁽⁸⁾ No detectable fecal coliform/100 ml ^(9,10) 1 mg/l Cl₂ residual (min.) ⁽¹¹⁾ | <ul style="list-style-type: none"> pH – weekly BOD - weekly Turbidity - continuous Fecal coliform - daily Cl₂ residual – continuous | <ul style="list-style-type: none"> 50 ft (15 m) to potable water supply wells; increased to 100 ft (30 m) when located in porous media ⁽¹⁸⁾ | <ul style="list-style-type: none"> See Table 3-5 for other recommended chemical constituent limits for irrigation. Chemical (coagulant and/or polymer) addition prior to filtration may be necessary to meet water quality recommendations. The reclaimed water should not contain measurable levels of pathogens. ⁽¹²⁾ Higher chlorine residual and/or a longer contact time may be necessary to assure that viruses and parasites are inactivated or destroyed. High nutrient levels may adversely affect some crops during certain growth stages. See Section 3.4.3 in the 2004 guidelines for recommended treatment reliability requirements. |
| <p>Processed Food Crops ¹⁵ The use of reclaimed water for surface irrigation of food crops which are intended for human consumption, commercially processed.</p> <p>Non-Food Crops The use of reclaimed water for irrigation of crops which are not consumed by humans, including fodder, fiber, and seed crops, or to irrigate pasture land, commercial nurseries, and sod farms.</p> | <ul style="list-style-type: none"> Secondary ⁽⁴⁾ Disinfection ⁽⁶⁾ | <ul style="list-style-type: none"> pH = 6.0-9.0 ≤ 30 mg/l BOD ⁽⁷⁾ ≤ 30 mg/l TSS ≤ 200 fecal coli/100 ml ^(9,13, 14) 1 mg/l Cl₂ residual (min.) ⁽¹¹⁾ | <ul style="list-style-type: none"> pH – weekly BOD - weekly TSS - daily Fecal coliform - daily Cl₂ residual – continuous | <ul style="list-style-type: none"> 300 ft (90 m) to potable water supply wells 100 ft (30 m) to areas accessible to the public (if spray irrigation) | <ul style="list-style-type: none"> See Table 3-5 for other recommended chemical constituent limits for irrigation. If spray irrigation, TSS less than 30 mg/l may be necessary to avoid clogging of sprinkler heads. High nutrient levels may adversely affect some crops during certain growth stages. See Section 3.4.3 in the 2004 guidelines for recommended treatment reliability requirements. Milking animals should be prohibited from grazing for 15 days after irrigation ceases. A higher level of disinfection, e.g., to achieve < 14 fecal coli/100 ml, should be provided if this waiting period is not adhered to. |

Table 4-4 Suggested guidelines for water reuse

| Reuse Category and Description | Treatment | Reclaimed Water Quality ² | Reclaimed Water Monitoring | Setback Distances ³ | Comments |
|---|--|---|---|--|--|
| Impoundments | | | | | |
| <p><u>Unrestricted</u> The use of reclaimed water in an impoundment in which no limitations are imposed on body-contact.</p> | <ul style="list-style-type: none"> Secondary ⁽⁴⁾ Filtration ⁽⁵⁾ Disinfection ⁽⁶⁾ | <ul style="list-style-type: none"> pH = 6.0-9.0 ≤ 10 mg/l BOD ⁽⁷⁾ ≤ 2 NTU ⁽⁸⁾ No detectable fecal coliform/100 ml ^(9,10) 1 mg/l Cl₂ residual (min.) ⁽¹¹⁾ | <ul style="list-style-type: none"> pH – weekly BOD – weekly Turbidity – continuous Fecal coliform - daily Cl₂ residual – continuous | <ul style="list-style-type: none"> 500 ft (150 m) to potable water supply wells (min.) if bottom not sealed | <ul style="list-style-type: none"> Dechlorination may be necessary to protect aquatic species of flora and fauna. Reclaimed water should be non-irritating to skin and eyes. Reclaimed water should be clear and odorless. Nutrient removal may be necessary to avoid algae growth in impoundments. Chemical (coagulant and/or polymer) addition prior to filtration may be necessary to meet water quality recommendations. Reclaimed water should not contain measurable levels of pathogens. ⁽¹²⁾ Higher chlorine residual and/or a longer contact time may be necessary to assure that viruses and parasites are inactivated or destroyed. Fish caught in impoundments can be consumed. See Section 3.4.3 in the 2004 guidelines for recommended treatment reliability requirements. |
| <p><u>Restricted</u> The use of reclaimed water in an impoundment where body-contact is restricted.</p> | <ul style="list-style-type: none"> Secondary ⁽⁴⁾ Disinfection ⁽⁶⁾ | <ul style="list-style-type: none"> ≤ 30 mg/l BOD ⁽⁷⁾ ≤ 30 mg/l TSS ≤ 200 fecal coliform/100 ml ^(9,13, 14) 1 mg/l Cl₂ residual (min.) ⁽¹¹⁾ | <ul style="list-style-type: none"> pH – weekly TSS – daily Fecal coliform - daily Cl₂ residual – continuous | <ul style="list-style-type: none"> 500 ft (150 m) to potable water supply wells (min.) if bottom not sealed | <ul style="list-style-type: none"> Nutrient removal may be necessary to avoid algae growth in impoundments. Dechlorination may be necessary to protect aquatic species of flora and fauna. See Section 3.4.3 in the 2004 guidelines for recommended treatment reliability requirements. |
| Environmental Reuse | | | | | |
| <p><u>Environmental Reuse</u> The use of reclaimed water to create wetlands, enhance natural wetlands, or sustain stream flows.</p> | <ul style="list-style-type: none"> Variable Secondary ⁽⁴⁾ and disinfection ⁽⁶⁾ (min.) | Variable, but not to exceed: <ul style="list-style-type: none"> ≤ 30 mg/l BOD ⁽⁷⁾ ≤ 30 mg/l TSS ≤ 200 fecal coliform/100 ml ^(9,13, 14) 1 mg/l Cl₂ residual (min.) ⁽¹¹⁾ | <ul style="list-style-type: none"> BOD – weekly SS – daily Fecal coliform - daily Cl₂ residual – continuous | | <ul style="list-style-type: none"> Dechlorination may be necessary to protect aquatic species of flora and fauna. Possible effects on groundwater should be evaluated. Receiving water quality requirements may necessitate additional treatment. Temperature of the reclaimed water should not adversely affect ecosystem. See Section 3.4.3 in the 2004 guidelines for recommended treatment reliability requirements. |
| Industrial Reuse | | | | | |
| <p><u>Once-through Cooling</u></p> | <ul style="list-style-type: none"> Secondary ⁽⁴⁾ | <ul style="list-style-type: none"> pH = 6.0-9.0 ≤ 30 mg/l BOD ⁽⁷⁾ ≤ 30 mg/l TSS ≤ 200 fecal coliform/100 ml ^(9,13, 14) 1 mg/l Cl₂ residual (min.) ⁽¹¹⁾ | <ul style="list-style-type: none"> pH – weekly BOD – weekly TSS – weekly Fecal coliform - daily Cl₂ residual – continuous | <ul style="list-style-type: none"> 300 ft (90 m) to areas accessible to the public | <ul style="list-style-type: none"> Windblown spray should not reach areas accessible to workers or the public. |
| <p><u>Recirculating Cooling Towers</u></p> | <ul style="list-style-type: none"> Secondary ⁽⁴⁾ Disinfection ⁽⁶⁾ (chemical coagulation and filtration ⁽⁵⁾ may be needed) | Variable, depends on recirculation ratio: <ul style="list-style-type: none"> pH = 6.0-9.0 ≤ 30 mg/l BOD ⁽⁷⁾ ≤ 30 mg/l TSS ≤ 200 fecal coliform/100 ml ^(9,13, 14) 1 mg/l Cl₂ residual (min.) ⁽¹¹⁾ | <ul style="list-style-type: none"> Fecal coliform - daily Cl₂ residual – continuous | <ul style="list-style-type: none"> 300 ft (90 m) to areas accessible to the public. May be reduced if high level of disinfection is provided. | <ul style="list-style-type: none"> Windblown spray should not reach areas accessible to workers or the public. Additional treatment by user is usually provided to prevent scaling, corrosion, biological growths, fouling and foaming. See Section 3.4.3 in the 2004 guidelines for recommended treatment reliability requirements. |
| <p>Other Industrial uses – e.g. boiler feed, equipment washdown, processing, power generation, and in the oil and natural gas production market (including hydraulic fracturing) have requirements that depends on site specific end use (See Chapter 3)</p> | | | | | |
| Groundwater Recharge – Nonpotable Reuse | | | | | |
| <p>The use of reclaimed water to recharge aquifers which are not used as a potable drinking water source.</p> | <ul style="list-style-type: none"> Site specific and use dependent Primary (min.) for spreading Secondary ⁽⁴⁾ (min.) for injection | <ul style="list-style-type: none"> Site specific and use dependent | <ul style="list-style-type: none"> Depends on treatment and use | <ul style="list-style-type: none"> Site specific | <ul style="list-style-type: none"> Facility should be designed to ensure that no reclaimed water reaches potable water supply aquifers. See Chapter 3 of this document and Section 2.5 of the 2004 guidelines for more information. For injection projects, filtration and disinfection may be needed to prevent clogging. For spreading projects, secondary treatment may be needed to prevent clogging. See Section 3.4.3 in the 2004 guidelines for recommended treatment reliability requirements. |

Table 4-4 Suggested guidelines for water reuse

| Reuse Category and Description | Treatment | Reclaimed Water Quality ² | Reclaimed Water Monitoring | Setback Distances ³ | Comments |
|--|---|---|--|---|---|
| Indirect Potable Reuse | | | | | |
| <u>Groundwater Recharge by Spreading into Potable Aquifers</u> | <ul style="list-style-type: none"> Secondary⁽⁴⁾ Filtration⁽⁵⁾ Disinfection⁽⁶⁾ Soil aquifer treatment | Includes, but not limited to, the following: <ul style="list-style-type: none"> No detectable total coliform/100 ml^(9, 10) 1 mg/l Cl₂ residual (min.)⁽¹¹⁾ pH = 6.5 – 8.5 ≤ 2 NTU⁽⁸⁾ ≤ 2 mg/l TOC of wastewater origin Meet drinking water standards after percolation through vadose zone | Includes, but not limited to, the following: <ul style="list-style-type: none"> pH – daily Total coliform – daily Cl₂ residual – continuous Drinking water standards – quarterly Other⁽¹⁷⁾ – depends on constituent TOC – weekly Turbidity – continuous Monitoring is not required for viruses and parasites: their removal rates are prescribed by treatment requirements | <ul style="list-style-type: none"> Distance to nearest potable water extraction well that provides a minimum of 2 months retention time in the underground. | <ul style="list-style-type: none"> Depth to groundwater (i.e., thickness to the vadose zone) should be at least 6 feet (2m) at the maximum groundwater mounding point. The reclaimed water should be retained underground for at least 2 months prior to withdrawal. Recommended treatment is site-specific and depends on factors such as type of soil, percolation rate, thickness of vadose zone, native groundwater quality, and dilution. Monitoring wells are necessary to detect the influence of the recharge operation on the groundwater. Reclaimed water should not contain measurable levels of pathogens after percolation through the vadose zone.⁽¹²⁾ See Section 3.4.3 in the 2004 Guidelines for recommended treatment reliability requirements. Recommended log-reductions of viruses, <i>Giardia</i>, and <i>Cryptosporidium</i> can be based on challenge tests or the sum of log-removal credits allowed for individual treatment processes. Monitoring for these pathogens is not required. Dilution of reclaimed water with waters of non-wastewater origin can be used to help meet the suggested TOC limit. |
| <u>Groundwater Recharge by Injection into Potable Aquifers</u> | <ul style="list-style-type: none"> Secondary⁽⁴⁾ Filtration⁽⁵⁾ Disinfection⁽⁶⁾ Advanced wastewater treatment⁽¹⁶⁾ | Includes, but not limited to, the following: <ul style="list-style-type: none"> No detectable total coliform/100 ml^(9, 10) 1 mg/l Cl₂ residual (min.)⁽¹¹⁾ pH = 6.5 – 8.5 ≤ 2 NTU⁽⁸⁾ ≤ 2 mg/l TOC of wastewater origin Meet drinking water standards | Includes, but not limited to, the following: <ul style="list-style-type: none"> pH – daily Turbidity – continuous Total coliform – daily Cl₂ residual – continuous TOC – weekly Drinking water standards – quarterly Other⁽¹⁷⁾ – depends on constituent Monitoring is not required for viruses and parasites: their removal rates are prescribed by treatment requirements | <ul style="list-style-type: none"> Distance to nearest potable water extraction well that provides a minimum of 2 months retention time in the underground. | <ul style="list-style-type: none"> The reclaimed water should be retained underground for at least 2 months prior to withdrawal. Monitoring wells are necessary to detect the influence of the recharge operation on the groundwater. Recommended quality limits should be met at the point of injection. The reclaimed water should not contain measurable levels of pathogens at the point of injection. Higher chlorine residual and/or a longer contact time may be necessary to assure virus inactivation. See Section 3.4.3 in the 2004 Guidelines for recommended treatment reliability requirements. Recommended log-reductions of viruses, <i>Giardia</i>, and <i>Cryptosporidium</i> can be based on challenge tests or the sum of log-removal credits allowed for individual treatment processes. Monitoring for these pathogens is not required. Dilution of reclaimed water with waters of non-wastewater origin can be used to help meet the suggested TOC limit. |
| <u>Augmentation of Surface Water Supply Reservoirs</u> | <ul style="list-style-type: none"> Secondary⁽⁴⁾ Filtration⁽⁵⁾ Disinfection⁽⁶⁾ Advanced wastewater treatment⁽¹⁶⁾ | Includes, but not limited to, the following: <ul style="list-style-type: none"> No detectable total coliform/100 ml^(9, 10) 1 mg/l Cl₂ residual (min.)⁽¹¹⁾ pH = 6.5 – 8.5 ≤ 2 NTU⁽⁸⁾ ≤ 2 mg/l TOC of wastewater origin Meet drinking water standards | <ul style="list-style-type: none"> Drinking water standards – quarterly Other⁽¹⁷⁾ – depends on constituent Monitoring is not required for viruses and parasites: their removal rates are prescribed by treatment requirements | <ul style="list-style-type: none"> Site specific – based on providing 2 months retention time between introduction of reclaimed water into a raw water supply reservoir and the intake to a potable water treatment plant. | <ul style="list-style-type: none"> The reclaimed water should not contain measurable levels of pathogens.⁽¹²⁾ Recommended level of treatment is site-specific and depends on factor such as receiving water quality, time and distance to point of withdrawal, dilution and subsequent treatment prior to distribution for potable uses. Higher chlorine residual and/or a longer contact time may be necessary to assure virus and protozoa inactivation. See Section 3.4.3 in the 2004 Guidelines for recommended treatment reliability requirements. Recommended log-reductions of viruses, <i>Giardia</i>, and <i>Cryptosporidium</i> can be based on challenge tests or the sum of log-removal credits allowed for individual treatment processes. Monitoring for these pathogens is not required. Dilution of reclaimed water with water of non-wastewater origin can be used to help meet the suggested TOC limit. |

Footnotes

- ⁽¹⁾ These guidelines are based on water reclamation and reuse practices in the U.S., and are specifically directed at states that have not developed their own regulations or guidelines. While the guidelines should be useful in many areas outside the U.S., local conditions may limit the applicability of the guidelines in some countries (see Chapter 9). It is explicitly stated that the direct application of these suggested guidelines will not be used by USAID as strict criteria for funding.
- ⁽²⁾ Unless otherwise noted, recommended quality limits apply to the reclaimed water at the point of discharge from the treatment facility.
- ⁽³⁾ Setback distances are recommended to protect potable water supply sources from contamination and to protect humans from unreasonable health risks due to exposure to reclaimed water.
- ⁽⁴⁾ Secondary treatment process include activated sludge processes, trickling filters, rotating biological contractors, and may stabilization pond systems. Secondary treatment should produce effluent in which both the BOD and SS do not exceed 30 mg/l.
- ⁽⁵⁾ Filtration means; the passing of wastewater through natural undisturbed soils or filter media such as sand and/or anthracite; or the passing of wastewater through microfilters or other membrane processes.
- ⁽⁶⁾ Disinfection means the destruction, inactivation, or removal of pathogenic microorganisms by chemical, physical, or biological means. Disinfection may be accomplished by chlorination, ozonation, other chemical disinfectants, UV, membrane processes, or other processes.
- ⁽⁷⁾ As determined from the 5-day BOD test.
- ⁽⁸⁾ The recommended turbidity should be met prior to disinfection. The average turbidity should be based on a 24-hour time period. The turbidity should not exceed 5 NTU at any time. If SS is used in lieu of turbidity, the average SS should not exceed 5 mg/l. If membranes are used as the filtration process, the turbidity should not exceed 0.2 NTU and the average SS should not exceed 0.5 mg/l.
- ⁽⁹⁾ Unless otherwise noted, recommended coliform limits are median values determined from the bacteriological results of the last 7 days for which analyses have been completed. Either the membrane filter or fermentation tube technique may be used.
- ⁽¹⁰⁾ The number of total or fecal coliform organisms (whichever one is recommended for monitoring in the table) should not exceed 14/100 ml in any sample.
- ⁽¹¹⁾ This recommendation applies only when chlorine is used as the primary disinfectant. The total chlorine residual should be met after a minimum actual modal contact time of at least 90 minutes unless a lesser contact time has been demonstrated to provide indicator organism and pathogen reduction equivalent to those suggested in these guidelines. In no case should the actual contact time be less than 30 minutes.
- ⁽¹²⁾ It is advisable to fully characterize the microbiological quality of the reclaimed water prior to implementation of a reuse program.
- ⁽¹³⁾ The number of fecal coliform organisms should not exceed 800/100 ml in any sample.
- ⁽¹⁴⁾ Some stabilization pond systems may be able to meet this coliform limit without disinfection.
- ⁽¹⁵⁾ Commercially processed food crops are those that, prior to sale to the public or others, have undergone chemical or physical processing sufficient to destroy pathogens.
- ⁽¹⁶⁾ Advanced wastewater treatment processes include chemical clarification, carbon adsorption, reverse osmosis and other membrane processes, advanced oxidation, air stripping, ultrafiltration, and ion exchange.
- ⁽¹⁷⁾ Monitoring should include inorganic and organic compounds, or classes of compounds, that are known or suspected to be toxic, carcinogenic, teratogenic, or mutagenic and are not included in the drinking water standards.
- ⁽¹⁸⁾ See Section 4.4.3.7 for additional precautions that can be taken when a setback distance of 100 ft (30 m) to potable water supply wells in porous media is not feasible.

The suggested regulatory guidelines presented in **Table 4-4** are essentially those contained in the 2004 guidelines (EPA, 2004), with some minor modifications that include the following:

1. Two categories of agricultural reuse (non-food crops and commercially processed food crops) have been combined because the reuse water quality and monitoring recommendations include identical criteria.
2. Information included for IPR guidelines have changed and include changes to TOC and TOX monitoring requirements.

The minimum recommended guideline for TOC monitoring has been reduced from 3 mg/L to 2 mg/L. Measurement of TOC in reclaimed water is a gross measure of the organic constituents of wastewater origin; due to increasing interest in addressing trace organic compounds in reclaimed water for potable reuses, the minimum recommended TOC has been modified. This is consistent with the move toward using reduced TOC concentrations for monitoring in the new California draft groundwater replenishment regulations (CDPH, 2011), which would require TOC concentrations less than 0.5 mg/L. However, due to the limit of quantitation for analytical instrumentation commonly used for TOC measurements, these guidelines provide a recommendation of 2.0 mg/L, which is more conservative than the 2004 guidelines.

Because the guidelines already provide recommendations that reclaimed water for IPR uses meet drinking water standards, TOX has been removed. TOX is a gross measurement of halogenated compounds, intended to be an indicator disinfection by-products formed during chlorine disinfection. Primary drinking water standards already include a comprehensive list of halogenated organic compounds. While the list is certainly not comprehensive, it provides a good indication of the presence of disinfection by-products. TOX measurements can have a high level of variability and without additional information on specific compounds does not provide additional information over that provided by TOC and total residual chlorine data.

3. There have been minor changes to the names of the reuse categories as follows:

- a. "Urban reuse" is now "Urban Reuse – Unrestricted"
- b. "Restricted access irrigation" is now "Urban Reuse – Restricted"
- c. "Recreational impoundments" is now "Impoundments – Unrestricted"
- d. "Landscape impoundments" is now "Impoundments – Restricted"

4.4.3.1 Combining Treatment Process Requirements with Water Quality Limits

The combination of both treatment process requirements and water quality limits are recommended for the following reasons:

- Water quality criteria that include the use of surrogate parameters may not adequately characterize reclaimed water quality.
- A combination of treatment and quality requirements known to produce reclaimed water of acceptable quality obviates the need to routinely monitor the finished water for certain constituents, e.g., some health-significant chemical constituents or pathogenic microorganisms.
- Monitoring of real-time surrogates of key treatment processes for their performance now allows assurances of removal of pathogens. (While new methods are emerging for monitoring of pathogenic microorganisms and chemical constituents that can produce information that may be valuable to the public, routine monitoring is not recommended at this time.)
- Treatment reliability is enhanced.

4.4.3.2 Water Quality Requirements for Disinfection

The guidelines suggest that, regardless of the type of reclaimed water use, some level of disinfection should be provided to avoid adverse health consequences from inadvertent contact or accidental or intentional misuse of a water reuse system. For nonpotable uses of reclaimed water, two disinfection threshold levels are recommended, depending on the probability of

human contact. Reclaimed water used for applications where no direct public or worker contact with the water is expected should be disinfected to achieve an average fecal coliform concentration not exceeding 200/100 mL because, at this indicator bacteria concentration:

- Most pathogens will be reduced to low levels
- Disinfection of secondary effluent to this coliform level is readily achievable at minimal cost
- Disinfection to lower levels may not further decrease human health risk, because there is no direct contact with the reclaimed water

For uses where direct or indirect contact with reclaimed water is likely or expected, and for dual water systems where there is a potential for cross-connections with potable water lines, disinfection to produce reclaimed water with no detectable fecal coliform organisms per 100 mL is recommended as a minimum treatment goal. In order to meet this disinfection objective, filtration is generally required. Treatment performance has been shown to produce reclaimed water that is essentially free of measurable levels of bacterial and viral pathogens in volumes of about 10 to 100 L using current culture methods.

For indirect potable uses of reclaimed water, where reclaimed water is intentionally introduced into the raw water supply for the purposes of increasing the total volume of water available for potable use, disinfection to produce reclaimed water having no detectable total coliform organisms per 100 mL is recommended. Total coliform is recommended, in lieu of fecal coliform, to be consistent with the SDWA National Primary Drinking Water Regulations (NPDWR) that regulate drinking water standards for producing potable drinking water.

4.4.3.3 Indicators of Disinfection

It would be impractical to routinely monitor reclaimed water for all of the chemical constituents and pathogenic organisms of concern, and surrogate parameters are universally accepted. In the United States, total and fecal coliforms are the most commonly used indicator organisms in reclaimed water as a measure of disinfection efficiency. While coliforms are used as indicator organisms for many bacterial pathogens, they are, by themselves, poor indicators of parasites and viruses. The total coliform

analysis includes enumeration of organisms of both fecal and nonfecal origin, while the fecal coliform analysis is specific for coliform organisms of fecal origin. Therefore, fecal coliforms are better indicators of fecal contamination than total coliforms, and these suggested guidelines use fecal coliform as the indicator organism. Either the multiple-tube fermentation technique or the membrane filter technique may be used to quantify the coliform levels in the reclaimed water. Due to the limitations of the total and fecal bacteria indicators, significant research has gone into determining better indicator species. Alternative indicator organisms that may be adopted in the future for water quality monitoring include *Enterococci* (a genus of bacteria capable of forming spores); *Bacteroides* (fecal bacteria that have a high degree of host specificity and low potential to proliferate in the environment, allowing for source tracking of fecal contamination); and new choices of bacteriophages (viruses that infect bacteria).

These guidelines do not include suggested specific parasite or virus limits. There has been considerable interest in recent years regarding the occurrence and significance of *Giardia* and *Cryptosporidium* in reclaimed water (Huffman et al., 2006). However, parasite levels, where they have been monitored for at water reuse operations in the United States, and at the treatment and quality limits recommended in these guidelines have been deemed acceptable (e.g., Florida).

Viruses are of concern in reclaimed water, but virus limits are not recommended in these guidelines for the following reasons:

- A significant body of information exists indicating that the enteroviruses are reduced or inactivated to low or non-culturable levels in about 10 to 100 L via appropriate wastewater treatment with disinfection. Adenoviruses, however, are beginning to receive some attention, as they are resistant to UV disinfection.
- The identification and enumeration of viruses in wastewater are hampered by relatively low virus recovery rates, the complexity and high cost of current cell culture laboratory procedures, and the limited number of facilities having the personnel and equipment necessary to perform the analyses.

- The laboratory culturing procedures to determine the presence or absence of pathogenic viruses in a water sample takes about 14 days, and an additional 14 days are required to identify the viruses. In addition, some enteric viruses do not have permissive cell cultures and therefore cannot be monitored using cell culture techniques.
- Molecular and genomic technology is providing new tools to rapidly detect and quantify viruses in water (e.g., nucleic acid probes and polymerase chain reaction technology), including viruses that are non-culturable. However, molecular and genomic methods currently in use are not able to differentiate between infective and non-infective virus particles. Therefore, these methods are useful in examining physical removal (by filtration, including membranes) but currently cannot fully determine degree of inactivation through disinfection steps. Methods that combine cell culture with molecular and genomic techniques may be able to improve quantification, while also giving an indication of infectivity.
- The value of bacteriophages as indicators for pathogenic viruses is currently an area of debate and ongoing research.
- There have been no documented cases based on limited epidemiological studies of viral disease resulting from water reuse operations in the United States.

4.4.3.4 Water Quality Requirements for Suspended and Particulate Matter

The removal of suspended matter is related to virus removal. Many pathogens are particulate-associated, and that particulate matter can shield both bacteria and viruses from disinfectants such as chlorine and UV. Also, organic matter consumes chlorine, thus making less of the disinfectant available for disinfection. There is general agreement that particulate matter should be reduced to low levels, e.g., 2 NTU or 5 mg/L total suspended solids (TSS), prior to disinfection to ensure reliable destruction of pathogenic microorganisms during the disinfection process. TSS limits are suggested as a measure of organic and inorganic particulate matter in reclaimed water that has received secondary treatment. Suspended solids measurements are typically performed daily on a composite sample and only

reflect an average value. Continuously monitored turbidity is superior to daily suspended solids measurements as it provides immediate results that can be used to adjust treatment operations.

4.4.3.5 Water Quality Requirements for Organic Matter

The need to remove suspended organic matter is related to the type of reuse. Some of the adverse effects associated with organic substances are that they are aesthetically displeasing (may be malodorous and impart color), provide food for microorganisms, adversely affect disinfection processes, and consume oxygen. The recommended BOD limit is intended to indicate that the organic matter has been stabilized, is non-putrescible, and has been lowered to levels commensurate with anticipated types of reuse. The recommended BOD and TSS limits are readily achievable at well-operated water reclamation plants.

4.4.3.6 Setback Distances

Many states have established setback distances or buffer zones between wastewater outfalls, reuse irrigation sites, and various facilities such as potable water supply wells, drinking fountains, property lines, residential areas, and roadways. Requirements for setback distances vary depending on the quality of reclaimed water introduced to the environment, and the method of application. Although the suggested setback distances are somewhat subjective, they are intended to protect drinking water supplies from contamination and, where appropriate, to protect humans from exposure to the reclaimed water. In irrigation, the general practice is to limit, through design or operational controls, exposure to aerosols and windblown spray produced from reclaimed water that is not, or only minimally, disinfected.

Setback distances from potable wells are intended to maintain a zone immediately around a well that is not subject to irrigation. Overall the imperative is to control sources of reuse water and its possible contaminant content, and minimize infiltration (movement of water from the surface into the soil), and any vertical or horizontal component of transport of potential contaminants through the subsurface soils. Once the water has infiltrated into the soil formation, the zone of saturation may also encounter zones of preferential flow that can lead to more rapid transport of any contaminant or solute. In media that has highly-variable porosity or transmissivity (e.g., sensitive

hydrogeological areas such as karst or fractured bedrock), the ground water residence time is often too uncertain to be useful; or protective. Overall a larger setback distance should be considered in porous soils compared to lower permeability soils. This is because most soils are not well-classified or mapped. In the absence of such information (usually gleaned from geotechnical evaluations), a more conservative setback distance is recommended. These setback distances are often applied also to physical separation between the well and any other nonpotable source in another buried conveyance, such as sewer pipes. In addition, most states also have parallel drinking water regulations for well-head protection that identify separation distances from various operations that may introduce water into or onto sensitive areas. Where these separation distances are not achievable, designers/regulators should consider additional precautions (e.g., use area controls or design components) to maintain an adequate margin of public health protection through the potable water system.

The recommended setback distances outlined in Table 4-4 are greater for the Restricted Urban category than the Unrestricted Urban category and greater for the Agricultural Reuse for Processed Food Crops and Non-Food Crops category than for the Agricultural Reuse for Food Crop category. These increased recommended setback distances are to maintain protection of public health, given that the suggested level of treatment and resulting water quality are less stringent than for Unrestricted Urban reuse or Agricultural Reuse for Food Crops.

4.4.3.7 Specific Considerations for IPR

Only a limited number of states have IPR reuse regulations, some of which are implemented through groundwater recharge rules. In states where IPR regulations or guidelines exist, these include requirements for treatment processes and reclaimed water quality and monitoring. States may specify the requirement of a pretreatment program, pilot plant studies, and public hearings. Water quality requirements for IPR typically include limits for TSS, nitrogen, TOC, turbidity, and total coliform. California draft IPR regulations also require limits for specific organics and design requirements for pathogen removal. Most states also specify a minimum time the reclaimed water must be retained in an environmental buffer (e.g., bioretention cells, properly-designed rain gardens, etc.) prior to being withdrawn as a source of

drinking water, or the separation distance between a point of recharge and a point of withdrawal. As noted in Table 4-4, it is appropriate to consider increasing the separation distance when the project is located in porous soils. In this context, the definition of porous media includes soils that are sandy (sand, sandy loam, sandy clay loam, loam), gravels, or interbedding thereof; soil formations wherein clay lenses are not predominant. Other sources of high-transmissivity may be found in rural or urban areas, and call for special consideration of well fields that border construction landfills (where buried construction debris can exhibit high transmissivity), and vacant lots. In addition to IPR regulations, drinking water standards also apply to public water supplies, since the reclaimed water will be processed through a drinking water treatment plant prior to potable reuse.

As needs for alternative water supplies grow, reclaimed water is anticipated to be intentionally used more in potable supply applications, and while no illnesses have been directly connected to the use of properly treated and managed reclaimed water, it is well recognized that the understanding of the risks from constituents of emerging concern is a rapidly evolving field, and that regulatory requirements need to be based on best available science. By example, in California, the SWRCB included a provision in their Recycled Water Policy to establish a Science Advisory Panel to provide guidance for developing monitoring programs that assess potential threats from chemicals of emerging concern (CECs) and pathogens in landscape irrigation and IPR applications.

The Science Advisory Panel's study made the following conclusion about pathogen monitoring in irrigation and IPR:

“Given the multiple barrier concept and water treatment process redundancy requirements in place, the Panel believes that the potential public health risk associated with exposure to pathogens in recycled water used for landscape irrigation or groundwater recharge is very small. However, the Panel acknowledges that some uncertainties exist regarding the occurrence of emerging waterborne microbial pathogens and encourages additional research into their fate in water reuse systems.” (Anderson et al., 2010)

Regarding CECs, the panel provided a conceptual framework for determining which CECs should be monitored out of thousands of potential targets and applied the framework to identify a list of chemicals that should be monitored presently, as described in Chapter 6 (Anderson et al., 2010). The Panel also urged California to reapply this prioritization process on at least a triennial basis and establish a state independent review panel that can provide a periodic review to the CEC monitoring efforts. The most recent draft regulations for Groundwater Replenishment Reuse in California would require annual monitoring of an indicator compound with the ability to characterize the presence of pharmaceuticals, endocrine disrupting chemicals, personal care products, and other indicators of the presence of municipal wastewater (CDPH, 2011). In general, as states adopt or update guidelines and regulations for water reuse, an adaptive, risk-based approach to addressing reclaimed water quality monitoring is appropriate (NRC, 2012).

When considering projects that may impact potable aquifers, use of multiple barriers is prudent and designers and regulators may consider the incorporation of additional precautions for public health protection, including:

- Multiple, independent barriers for removing and or transforming microbiological and chemical contaminants. Some emphasis should be placed on gaining a better understanding of soils via focused geotechnical site investigation or review of geotechnical reports for the area of interest.
- Advanced technologies that address a broader variety of contaminants with greater reliability;
- An operational plan with documented retention time and its effectiveness in attenuation of contaminants for a given barrier measure; and a monitoring program tailored to specific barriers and local conditions with appropriate systems to respond to potential system malfunctions.

4.4.4 Additional Requirements

In addition to reclaimed water quality and treatment requirements, states also adopt requirements governing monitoring, reliability, storage, and irrigation application rates. Appendix A of the 2004 guidelines illustrates the difference in state requirements for many of these requirements (EPA, 2004). However, as

these requirements are often updated, refer to the state regulatory websites contained in Appendix C for the most current state rules, regulations or guidelines related to water reuse.

4.4.4.1 Reclaimed Water Monitoring Requirements

Water quality monitoring is an important component of reclaimed water projects to ensure that public health and the environment are protected. Monitoring requirements vary greatly from state to state and again depend on the type of reuse. Typical monitoring programs focus on parameters with numeric water reuse criteria, including many of those included in **Table 4-4**, such as BOD, TSS, turbidity, and pathogens or pathogen indicators. Depending on the project and state permitting procedures, monitoring can also include parameters such as salts, minerals, and constituents with MCLs, to determine if the designated uses of receiving waters, both groundwater and surface water, are being protected. Real-time online process monitoring of surrogate parameters is sometimes specified.

Typically, reclaimed water monitoring requirements specify that monitoring be conducted at the water reclamation plant before reclaimed water is distributed for use. However, several states specifically require monitoring of groundwater where reclaimed water is used for irrigation. For groundwater recharge projects, including those to provide saltwater intrusion barriers, monitoring may be required using lysimeters, monitoring wells, or groundwater production wells. For reservoir augmentation projects, monitoring may be required for surface water and treated drinking water. For IPR projects, additional monitoring locations may be required (Crook, 2010).

4.4.4.2 Treatment Facility Reliability

Some states have adopted facility reliability regulations or guidelines in place of, or in addition to, water quality requirements. Generally, these requirements consist of alarms warning of power failure or failure of essential unit processes, automatic standby power sources, emergency storage, and the provision that each treatment process be equipped with multiple units or a back-up unit. These processes are described in Section 2.3.4. Section 4 of the 2004 guidelines describes some of the regulatory approaches with respect to reliability, which generally include

specifications for engineered redundancy, system capacity, and backup systems (EPA, 2004).

4.4.4.3 Reclaimed Water Storage

Storage is discussed in Chapter 2. Current regulations and guidelines regarding storage requirements are primarily based upon the need to limit or prevent surface water discharge and are not related to storage required to meet diurnal or seasonal variations in supply and demand for water reuse. Reclaimed water storage requirements vary from state to state and are generally dependent on geographic location, site conditions, and the existence of alternative disposal options. A comparison of regulatory approaches to storage is included in Section 4 of the 2004 guidelines (EPA, 2004).

4.5 Inventory of State Regulations and Guidelines

A survey was conducted to inventory the reuse regulations and guidelines promulgated by U.S. states, tribal communities, and territories for this document. Regulatory agencies in all 50 states and the District of Columbia were contacted to obtain information concerning their current regulations or guidelines governing water reuse. EPA's liaison offices for tribal communities, Guam, Puerto Rico, the U.S. Virgin Islands, American Samoa, and Commonwealth of the Northern Mariana Islands were likewise contacted.

4.5.1 Overall Summary of States' Regulations

Table 4-5 provides a summary of the current regulations and guidelines governing water reuse by state and by reuse category. The table identifies those states that have regulations, those with guidelines and those states that currently do not have either. The table also distinguishes between states where the intent of the regulations or guidelines is oversight of water reuse from states where the intent of the regulations or guidelines is to facilitate disposal and water reuse is considered incidental. This distinction of intent among states' regulations and guidelines can be quite subjective and open to interpretation, but is provided here to capture some of the nuance in interpreting a state's regulatory context.

As of August 2012, 22 states have adopted regulations and 11 states have guidelines or design standards with water reuse as the primary intent. Additionally, eight states and CNMI, a U.S. Pacific Insular Area

Territory, have regulations and four have guidelines that implicate water reuse primarily from a disposal perspective. Lastly, 27 states have undergone or just completed revisions to their current reuse regulations or guidelines as shown in **Table 4-5**.

To date, no states have developed or proposed regulations or guidelines specifically governing DPR. However, some states may issue project-specific permits for this reuse with detailed treatment, reclaimed water quality and monitoring requirements. DPR is discussed further in Chapter 3.

A table with links to state regulatory websites is provided in Appendix C. The WaterReuse Association will maintain links of the state regulatory sites containing water reuse regulations as links and current regulations are subject to change by the states. Readers may access the state regulations link at <https://www.watereuse.org/government-affairs/usepa-guidelines>.

4.5.1.1 Case-By-Case Considerations

In states with no specific regulations or guidelines for water reclamation and reuse, projects may still be permitted on a case-by-case basis, such as in Connecticut and Wisconsin. Likewise, some states that do have rules enable consideration of reuse options that are not specifically addressed within their existing rules or regulations. For example, Florida's rules and Virginia's regulations governing water reuse enable these states to permit other uses if the applicant demonstrates that public health will be protected. Several other activities (including use in laundries, vehicle washing, mixing of concrete, and making ice for ice rinks) are specifically identified as being allowable within Florida's reuse rules.

Table 4-5 Summary of State and U.S. Territory water reuse regulations and guidelines*

- The intent of the state’s regulations or guidelines is oversight of water reuse
- The intent of the state’s regulations or guidelines is oversight of disposal and water reuse is considered incidental
- The state does not have water reuse regulations or guidelines but may permit reuse on a case-by-case basis.

| State | Regulations | Guidelines | No Regulations or Guidelines (1) | Change from 2004 Edition | Urban Reuse – Unrestricted | Urban Reuse – Restricted | Agricultural Reuse – Food Crops | Agricultural Reuse – Processed Food Crops and Non-Food Crops | Impoundments – Unrestricted | Impoundments – Restricted | Environmental Reuse | Industrial Reuse | Groundwater Recharge – Nonpotable Reuse | Indirect Potable Reuse |
|---|-------------|------------|----------------------------------|--------------------------|----------------------------|--------------------------|---------------------------------|--|-----------------------------|---------------------------|---------------------|------------------|---|------------------------|
| Alabama | | □ | | | | □ | | □ | | | | | | |
| Alaska | □ | | | | | | | □ | | | | | | |
| Arizona | ● | | | Update | ● | ● | ● | ● | | ● | ● | ● | ● | ● |
| Arkansas | □ | | | New (2) | | | □ | | | | | | | |
| California | ● | | | Update | ● | ● | ● | ● | ● | ● | | ● | ● | ● |
| Colorado | ● | | | | ● | ● | | | | | | ● | | |
| Commonwealth of the Northern Mariana Islands (CNMI) | □ | | | (3) | | □ | | □ | | | | | | |
| Connecticut | | | -- | | | | | | | | | | | |
| Delaware | ● | | | Update | ● | ● | ● | ● | ● | ● | | ● | □ | |
| District of Columbia | | | -- | | | | | | | | | | | |
| Florida | ● | | | Update | ● | ● | ● | ● | | | ● | ● | ● | ● |
| Georgia | | ● | | Update | ● | ● | | ● | | | | | | |
| Guam | | | | (4) | | | | | | | | | | |
| Hawaii | | ● | | | ● | ● | ● | ● | | ● | | ● | ● | ● |
| Idaho | ● | | | Update | ● | ● | ● | ● | | | | ● | ● | |
| Illinois | ● | | | | ● | ● | | ● | | | | | | |
| Indiana | □ | | | Update | □ | □ | □ | □ | | | | | | |
| Iowa | ● | | | | | ● | | ● | | | | | | |
| Kansas | | □ | | | □ | □ | □ | □ | | | | □ | | |
| Kentucky | | | -- | | | | | | | | | | | |
| Louisiana | | | -- | | | | | | | | ● | | | |

Table 4-5 Summary of State and U.S. Territory reuse regulations and guidelines*

- The state's regulations or guidelines intent is for the oversight of water reuse
- The state's regulations or guidelines intent is for the oversight of disposal and water reuse is incidental
- The state does not have water reuse regulations or guidelines but may permit reuse on a case-by-case basis.

| State | Regulations | Guidelines | No Regulations or Guidelines (1) | Change from 2004 Edition | Urban Reuse – Unrestricted | Urban Reuse – Restricted | Agricultural Reuse – Food Crops | Agricultural Reuse – Processed Food Crops and Non-Food Crops | Impoundments – Unrestricted | Impoundments – Restricted | Environmental Reuse | Industrial Reuse | Groundwater Recharge – Nonpotable Reuse | Indirect Potable Reuse |
|---------------|-------------|------------|----------------------------------|--------------------------|----------------------------|--------------------------|---------------------------------|--|-----------------------------|---------------------------|---------------------|------------------|---|------------------------|
| Maine | | | -- | | | | | | | | | | | |
| Maryland | | ● | | Update | ● | ● | | ● | | | ● | ● | ● | |
| Massachusetts | ● | | | New (2) | ● | ● | ● | ● | ● | ● | ● | ● | ● | ● |
| Michigan | □ | | | | | | □ | □ | | | | | | |
| Minnesota | | ● | | (5) | ● | ● | ● | ● | □ | | | ● | | |
| Mississippi | □ | | | | | □ | | □ | | | | □ | | |
| Missouri | ● | | | | | ● | | ● | | □ | □ | □ | | |
| Montana | ● | | | Update (6) | ● | ● | ● | ● | ● | ● | | ● | ● | |
| Nebraska | □ | | | Update | □ | □ | □ | □ | ● | ● | | □ | ● | |
| Nevada | ● | | | Update | ● | ● | | ● | | ● | ● | ● | | |
| New Hampshire | | | -- | | | | | | | | | | | |
| New Jersey | ● | ● | | New (7) | ● | ● | ● | ● | | | | ● | | |
| New Mexico | | ● | | Update (8) | ● | ● | ● | ● | | ● | ● | ● | | |

Table 4-5 Summary of State and U.S. Territory reuse regulations and guidelines*

- The state's regulations or guidelines intent is for the oversight of water reuse
- The state's regulations or guidelines intent is for the oversight of disposal and water reuse is incidental
- The state does not have water reuse regulations or guidelines but may permit reuse on a case-by-case basis.

| State | Regulations | Guidelines | No Regulations or Guidelines (1) | Change from 2004 Edition | Urban Reuse – Unrestricted | Urban Reuse – Restricted | Agricultural Reuse – Food Crops | Agricultural Reuse – Processed Food Crops and Non-Food Crops | Impoundments – Unrestricted | Impoundments – Restricted | Environmental Reuse | Industrial Reuse | Groundwater Recharge – Nonpotable Reuse | Indirect Potable Reuse |
|---------------|-------------|------------|----------------------------------|--------------------------|----------------------------|--------------------------|---------------------------------|--|-----------------------------|---------------------------|---------------------|------------------|---|------------------------|
| Tennessee | | □ | | Update (12) | □ | □ | | □ | □ | □ | □ | □ | | |
| Texas | ● | | | Update | ● | ● | ● | ● | ● | ● | ● | ● | | |
| Utah | ● | | | | | ● | ● | ● | | ● | ● | ● | | ● |
| Vermont | ● | | | | | ● | | □ | | | | | | |
| Virginia | ● | | | New (13) | ● | ● | ● | ● | ● | ● | ● | ● | □ | ● |
| Washington | | ● | | Update (14) | ● | ● | ● | ● | ● | ● | ● | ● | ● | ● |
| West Virginia | □ | | | (15) | | | □ | □ | | | | | | |
| Wisconsin | □ | | | Update | | | □ | □ | | | | □ | □ | |
| Wyoming | ● | | | Update | ● | ● | ● | ● | | | | ● | | |

- (1) Specific regulations or guidelines on reuse not adopted; however, reuse may be approved on a case-by-case basis
- (2) The state had guidelines prior, and now has adopted regulations.
- (3) CNMI regulations were not listed in the 2004 guidelines.
- (4) Guam has regulations pertaining to Urban Restricted Reuse and Indirect Potable Reuse but they are not regulated by reuse or disposal regulations.
- (5) Minnesota has been using the California rules as their Municipal Wastewater Reuse guidance since the mid 90's. This was not reflected in the 2004 guidelines, which indicated that Minnesota had no guidance.
- (6) Montana is in the midst of promulgating new reuse regulations, which are anticipated to be finalized by the time of this publication.
- (7) The state had guidelines prior, and now has adopted reuse regulations as well as guidelines.
- (8) Reclaimed water projects in New Mexico are permitted under either a Ground Water Discharge Permit (which also controls use above ground) or a Construction Industries Permit if use in a building is included.
- (9) Current interpretation is that New York has no regulations or guidelines.
- (10) Groundwater recharge was added to Oregon's reuse regulations in 2008.
- (11) The state previously had no guidelines or regulations and has adopted guidelines.
- (12) Tennessee was listed as having regulations in the 2004 Guidelines; however, these were later deemed to be guidelines not regulations.
- (13) The state previously had no guidelines or regulations and has adopted regulations.
- (14) The Washington State currently has no regulations governing the use of reclaimed water. Draft regulations have been developed by the Department of Ecology in coordination with Department of Health and formal rules advisory committee. The draft rules are incomplete. Adoption of the rules has been delayed until after June 30, 2013. The reclaimed water use statute and formal standards, guidance and procedures adopted in 1997 remain in effect.
- (15) In the 2004 guidelines West Virginia was listed as having regulations; however, these appear to be wastewater treatment regulations and do not specifically govern reuse.

* No information is available at this time on regulations or guidelines on water reuse promulgated by federally recognized tribal nations, Puerto Rico, the U.S. Virgin Islands, and American Samoa.

Four case studies specifically focus on policy and regulatory processes in states around the U.S.

Arizona [US-AZ-Blue Ribbon Panel]

This case study describes the special Blue Ribbon Panel on Water Sustainability (BRP) formed by the Governor of Arizona in 2009. The BRP's charge was to focus on water conservation and recycling as strategies to improve water sustainability in Arizona. The BRP was jointly chaired by officials from the ADEQ, Arizona Department of Water Resources (ADWR) and Arizona Corporation Commission (ACC), Arizona's constitutionally established regulatory body for privately owned utilities. The case study describes the participatory process the BRP went through and some of the key recommendations.

California [US-CA-Regulations]

This case study chronicles the evolution of water reuse laws in California, from the first water quality guidance for the use of raw or settled sewage for agricultural irrigation as far back as 1906 through the 2011 draft regulations for IPR.

Virginia [US-VA-Regulations]

Virginia recently completed the process of creating a water reuse regulation and adopted the Virginia Water Reclamation and Reuse Regulation in 2008. This case study describes the multiple state agencies that play a role in regulating water reuse in Virginia and the unique aspects of water reuse in the state.

Washington [US-WA-Regulations]

Washington State has a reclaimed water program governed by comprehensive guidelines that define water quality standards and a variety of allowed beneficial uses. This case study describes how the State Departments of Ecology and Health jointly administer the reclaimed water program and the process since 2006 to develop regulations.

4.5.1.2 Reuse or Treatment and Disposal Perspective

The underlying objectives of regulations and guidelines vary considerably from state to state. States such as Arizona, California, Colorado, Florida, Georgia, Hawaii, Massachusetts, Nevada, New Jersey, New Mexico, North Carolina, Ohio, Oregon, Pennsylvania, Rhode Island, Texas, Utah, Virginia, Washington, and Wyoming have developed regulations or guidelines and standards that strongly encourage water reuse as a water resources conservation strategy. These states have developed comprehensive regulations or guidelines specifying water quality requirements, treatment processes, or both, for the full spectrum of reuse applications. The objective in these states is to derive the maximum resource benefits of the reclaimed water while protecting the environment and public health.

Other states have regulations or guidelines that focus on land treatment of wastewater-derived effluent, emphasizing additional treatment or effluent disposal rather than reuse, even though the effluent may be used for irrigation of agricultural sites, golf courses, or public access lands. When regulations specify application or hydraulic loading rates, the regulations generally pertain to land application systems that are used primarily for additional wastewater treatment for disposal rather than reuse. When systems are developed chiefly for the purpose of land treatment or disposal, the objective is often to dispose of as much effluent on as little land as possible; thus, application rates are often far greater than irrigation demands and limits are set for the maximum hydraulic loading. On the other hand, when the reclaimed water is managed as a valuable resource, the objective is to apply the water according to irrigation needs rather than maximum hydraulic loading, and application limits are rarely specified. Optimal irrigation application rates are based on site conditions (FAO, 1985).

There are many differences in the definition and approach to water reuse between states. Due to these differences, the same practice that may be considered reuse in one state may be considered primarily a means of disposal or additional "land treatment" in another. The primary reuse of reclaimed wastewater in South Dakota is by land application to non-food crops. Although South Dakota has some guidelines on land application to food crops, no one is currently doing this. South Dakota also has a few facilities that are

using infiltration or evaporation/ percolation basins as a component of their wastewater treatment facility, rather than a disposal activity. Nevada reports similar use of percolation basins as a disposal activity. Florida, however, would consider this activity reuse by surficial groundwater recharge if the percolation basins were allowed to be loaded and rested alternately.

In most states, the release of reclaimed water to a stream or other water body is still considered and permitted as a point source discharge despite the fact that it may create, enhance or sustain the water bodies receiving that water. In Texas, reuse for stream environmental enhancement or recreational reuse requires a discharge permit if the supplemental discharge point for these reuses will be at a location different from that of the primary discharge location of the treatment facility. For example, SAWS has a discharge permit for the Dos Rios Water Reclamation Facility (into the confluence of the San Antonio and Medina Rivers), one permitted discharge upstream in Salado Creek to maintain creek water quality, and three permitted discharge points into the San Antonio River to maintain flow and water quality in the San Antonio River through the River Walk entertainment area.

4.5.2 Summary of Ten States' Reclaimed Water Quality and Treatment Requirements

Reclaimed water quality and treatment requirements are a significant part of each state's regulations and guidelines for water reuse and may vary among the different reuse categories listed in **Table 4-5** above. Generally, where water reuse involves unrestricted public exposure, reclaimed water must be more highly treated for the protection of public health. Where public exposure is not likely, however, a lower level of treatment is usually acceptable.

Many states include design requirements based on a certain removal of bacterial, viral, or protozoa pathogens for public health protection. Total and fecal coliform counts are generally used as indicator organisms for many bacterial pathogens and provide a measure of disinfection process efficacy. Monitoring of viral indicators is generally not required, though virus removal rates are often prescribed by treatment requirements for system design. A limit on turbidity is usually specified as a real-time monitoring tool to verify the performance of filtration in advanced treatment

facilities. The performance of disinfection processes is monitored in real time using chlorine residual or UV intensity, depending on the disinfection method. Disinfection is also verified using bacteria cell culture methods. In addition, water quality limits are generally imposed for BOD and TSS. Water quality parameters are discussed in greater detail in Chapter 6 and monitoring protocols are discussed in Chapter 2.

A summary of the reclaimed water quality and treatment requirements follows of the following 10 states: Arizona, California, Florida, Hawaii, Nevada, New Jersey, North Carolina, Texas, Virginia, and Washington. These states' regulations and guidelines were chosen because these states provide a collective wisdom of successful reuse programs and, in most cases, long-term experience. In addition to water quality and treatment requirements, states provide requirements or guidance on a wide range of other aspects of reuse, such as but not limited to, monitoring, reliability, storage, loading rates, and setback distances. For additional details of state regulations, readers are referred to the state regulatory websites contained in Appendix C of this document.

The following sections generally describe reuse categories that were presented in **Table 4-3**. It is of note that the 10 states, discussed herein, have all established types or levels of reclaimed water based on water quality. States including North Carolina, Virginia, and Texas have established only two types of reclaimed water, while others like Arizona and Washington have a greater number of categories. In any case, the regulatory framework has been established to ensure that the water quality is appropriate for the end use. Information for these 10 representative states is presented in **Tables 4-7** through **4-16**. The reclaimed water quality type or level that applies to the specific reuse category is noted, where applicable, in the header of the table. Additional details on each of the states' reclaimed water types and quality can be found in the links provided in Appendix C.

As a matter of brevity for tabular presentation of information, several abbreviations have been used throughout the tables as noted in **Table 4-6**.

Table 4-6 Abbreviations of terms for state reuse rules descriptions

| Term | Abbreviation |
|---|---------------------|
| Annual | ann |
| Average | avg |
| Corrective action threshold | CAT |
| Day | d |
| Geometric mean | geom |
| Hour | hr |
| Maximum | max |
| Median | med |
| Minimum | min |
| Month | mon |
| UV dose requirements including: <ul style="list-style-type: none"> • 100 mJ/cm² for media filtration • 80 mJ/cm² for membrane filtration • 50 mJ/cm² for RO treatment There are additional requirements for bioassay validation and UV system design considerations | NWRI UV Guidelines* |
| Product of the total residual chlorine and contact time | C _t T** |
| Total residual chlorine | TRC |
| Week | wk |
| Year | yr |

* Most states reference either the 2000, 2003, or 2012 NWRI Ultraviolet Disinfection Guidelines for Drinking Water and Water Reuse (NWRI, 2000; NWRI, 2003; NWRI, 2012). A description of the updates to the 2012 NWRI guidelines is provided in Section 6.4.3.2.

** Also abbreviated as CT.

In addition, where TRC is listed in the tables, it is measured after the indicated contact time.

4.5.2.1 Urban Reuse – Unrestricted

Unrestricted urban reuse involves the use of reclaimed water where public exposure is likely in the reuse application, thereby requiring a high degree of treatment. In general, all states that specify a treatment process require a minimum of secondary treatment and disinfection prior to unrestricted urban reuse. However, the majority of states require additional levels of treatment that may include oxidation, coagulation, and filtration. Texas does not specify the type of treatment processes required but sets limits on the reclaimed water quality. At this time, no states have set limits on specific pathogenic organisms for unrestricted urban reuse. However, Florida does require monitoring of *Giardia* and *Cryptosporidium* with sampling frequency based on treatment plant capacity. **Table 4-7** shows the

reclaimed water quality and treatment requirements for unrestricted urban reuse for the selected states.

4.5.2.2 Urban Reuse – Restricted

Restricted urban reuse involves the use of reclaimed water where public exposure to the reclaimed water is controlled; therefore, treatment requirements may not be as strict as those for unrestricted urban reuse. Florida imposes the same requirements on both unrestricted and restricted urban access reuse. In general, the states require a minimum of secondary or biological treatment followed by disinfection prior to restricted urban reuse. Florida requires additional levels of treatment with filtration and possibly coagulation prior to restricted urban reuse. As in unrestricted urban reuse, Texas does not specify the type of treatment processes required but sets limits on the reclaimed water quality. At this time, no states have set limits on specific pathogenic organisms for restricted urban reuse. Florida does not require monitoring of *Giardia* and *Cryptosporidium* for Restricted Urban Reuse. **Table 4-8** shows the reclaimed water quality and treatment requirements for restricted urban reuse.

4.5.2.3 Agricultural Reuse – Food Crops

The use of reclaimed water for irrigation of food crops is prohibited in some states, while others allow irrigation of food crops with reclaimed water only if the crop is to be processed and not eaten raw. For example, some of the states that allow for irrigation of food crops, such as Florida, Nevada, and Virginia, require that the reclaimed water does not come in contact with the crop to be eaten or that the crop is peeled or thermally process prior to being eaten, with a few exceptions. Nevada allows only surface irrigation of fruit or nut bearing trees. In Florida, direct contact (spray) irrigation of edible crops that will not be peeled, skinned, cooked, or thermally-processed before consumption is not allowed except for tobacco and citrus. Indirect contact methods (ridge and furrow, drip, subsurface application system) can be used on any type of edible crop. However, other states, such as California, do not have this stipulation but have more stringent quality standards at or near potable quality. Depending on the type of crop or type of irrigation, states' treatment requirements range from secondary treatment and disinfection, to oxidation, coagulation, filtration, and high-level disinfection. North Carolina has specific limits for *Clostridium* and coliphage for indirect contact irrigation for crops that will not be

peeled, skinned, or thermally processed. Florida requires monitoring of *Giardia* and *Cryptosporidium* with sampling frequency, reclaimed water quality and treatment requirements as shown in **Table 4-9** for irrigation of food crops.

4.5.2.4 Agricultural Reuse – Processed Food Crops and Non-food Crops

The use of reclaimed water for agricultural irrigation of non-food crops or for food crops intended for human consumption that will be commercially processed presents a reduced opportunity of human exposure to the water, resulting in less stringent treatment and water quality requirements than other forms of reuse. However, in cases where milking animals would graze on fodder crops irrigated with reclaimed water, there are additional requirements for waiting periods for grazing and a higher level of disinfection is recommended, if a waiting period is not adhered to. In the majority of the states, secondary treatment followed by disinfection is required. There are several states that do not require disinfection if certain buffer requirements are met. At this time, no states have set limits on specific pathogenic organisms for agricultural reuse on non-food crops. **Table 4-10** shows the reclaimed water quality and treatment requirements for irrigation of non-food crops.

4.5.2.5 Impoundments – Unrestricted

As with unrestricted urban reuse, unrestricted reuse for impoundments involves the use of reclaimed water where public exposure is likely, thereby requiring a high degree of treatment. Only half of the 10 states (Arizona, California, Nevada, Texas, and Washington) have regulations or guidelines pertaining specifically to unrestricted impoundments. Of these states, only Texas does not specify treatment requirements. It is also of note that neither Arizona nor Nevada allow full-body contact (e.g., wading) in unrestricted impoundments. **Table 4-11** shows reclaimed water quality and treatment requirements for unrestricted impoundments.

4.5.2.6 Impoundments – Restricted

State regulations and guidelines regarding treatment and water quality requirements for restricted reuse for impoundments are generally less stringent than for unrestricted reuse for impoundments because the public exposure to the reclaimed water is less likely. Six of the 10 states (Arizona, California, Hawaii, Nevada, Texas, and Washington) have regulations

specifically pertaining to this category of reuse. Texas does not specify treatment process requirements. The remaining states require secondary treatment with disinfection, with some of the states requiring oxidation and filtration. At this time, no states have set limits on specific pathogenic organisms for restricted impoundments reuse. **Table 4-12** shows the reclaimed water quality and treatment requirements for restricted recreational reuse.

4.5.2.7 Environmental Reuse

Florida, Nevada, North Carolina, and Washington have regulations pertaining to the use of reclaimed water to create, enhance, sustain, or augment wetlands, other aquatic habitats, or streamflows. Florida has comprehensive and complex rules governing the discharge of reclaimed water to wetlands. Treatment and disinfection levels are established for different types of wetlands, different types of uses, and the degree of public access. Most wetland systems in Florida are used for tertiary wastewater treatment, and wetland creation, restoration, and enhancement projects can be considered reuse. Washington also specifies different treatment requirements for different types of wetlands and based on the degree of public access. **Table 4-13** shows the reclaimed water quality and treatment requirements for environmental reuse.

4.5.2.8 Industrial Reuse

Eight of the 10 states (California, Florida, Hawaii, Nevada, North Carolina, Texas, Virginia, and Washington) have regulations or guidelines pertaining to industrial reuse of reclaimed water. Arizona and New Jersey review industrial reuse on a case-by-case basis and determine regulations accordingly. Reclaimed water quality and treatment requirements vary based on the final use of the reclaimed water and exposure potential. For example, California has different requirements for the use of reclaimed water as cooling water, based on whether or not a mist is created. In North Carolina, reclaimed water produced by industrial facilities is not required to meet the reuse criteria if the reclaimed water is used in a process that has no public access. Use in toilets and urinals or fire suppression systems will be approved on a case-by-case basis if no risk to public health is demonstrated. **Table 4-14** shows the reclaimed water quality and treatment requirements for industrial reuse.

4.5.2.9 Groundwater Recharge – Nonpotable Reuse

Spreading basins, percolation ponds, and infiltration basins have a long history of providing both effluent disposal and groundwater recharge. Most state regulations allow for the use of relatively low quality water (i.e., secondary treatment with basic disinfection) based on the fact that these systems have a proven ability to provide additional treatment. Traditionally, potable water supplies have been protected by requiring a minimum separation between the point of application and any potable supply wells. These groundwater systems are also typically located so that their impacts to potable water withdrawal points are minimized. While such groundwater recharge systems may ultimately augment potable aquifers, that is not their primary intent and experience suggests current practices are protective of raw water supplies.

California, Florida, Hawaii, and Washington have regulations or guidelines for reuse with the specific intent of groundwater recharge of nonpotable aquifers. Hawaii does not specify required treatment processes, determining requirements on a case-by-case basis. The Hawaii Department of Health Services bases the evaluation on all relevant aspects of each project, including treatment provided, effluent quality and quantity, effluent or application spreading area operation, soil characteristics, hydrogeology, residence time, and distance to withdrawal. Hawaii requires a groundwater monitoring program. Arizona regulates groundwater recharge through their Aquifer Protection Permit process. Washington has extensive guidelines for the use of reclaimed water for direct groundwater recharge of nonpotable aquifers although all aquifers in the state are considered to be potable. Recharge of nonpotable aquifers in Washington first requires the redesignation of the aquifer to nonpotable. **Table 4-15** shows reclaimed water quality and treatment requirements for groundwater recharge via rapid-rate (surface spreading) application systems.

4.5.2.10 Indirect Potable Reuse (IPR)

IPR involves use of reclaimed water to augment surface or groundwater sources that are used or will be used for public water supplies or to recharge groundwater used as a source of public water supply. Unplanned (*de facto*) IPR is occurring in many river systems today. Additionally, many types of reuse projects inadvertently contribute to groundwater as an unintended result of the primary activity. For example,

irrigation can replenish groundwater sources that will eventually be withdrawn for use as a potable water supply. IPR systems, as defined here, are distinguished from typical groundwater recharge systems and surface water discharges by both intent and proximity to subsequent withdrawal points for potable water use. IPR involves intentional introduction of reclaimed water into the raw water supply for the purposes of increasing the volume of water available for potable use. In order to accomplish this objective, the point at which reclaimed water is introduced into the environment must be selected to ensure it will flow to the point of withdrawal. Typically the design of these systems assumes there will be little additional treatment in the environment after discharge, and all applicable water quality requirements are met at the point of release of the reclaimed water.

Four of the 10 states (California, Florida, Hawaii, and Washington) have regulations or guidelines specifically pertaining to IPR. For groundwater recharge of potable aquifers, most of the states require a pretreatment program, public hearing requirements prior to project approval, and a groundwater monitoring program. Florida and Washington require pilot plant studies to be performed. In general, all the states that specify treatment processes require secondary treatment with filtration and disinfection. Washington has different requirements for surface percolation, direct groundwater recharge, and streamflow augmentation. Hawaii does not specify the type of treatment processes required, determining requirements on a case-by-case basis. Texas and Virginia do not have specific IPR regulations but review specific projects on a case-by-case basis.

Most states specify a minimum time the reclaimed water must be retained underground prior to being withdrawn as a source of drinking water. Several states also specify minimum separation distances between a point of recharge and the point of withdrawal as a source of drinking water. **Table 4-16** shows the reclaimed water quality and treatment requirements for IPR.

Table 4-7 Urban reuse – unrestricted

| | | Arizona Class A | California Disinfected Tertiary | Florida | Hawaii R1 Water | Nevada Category A | New Jersey Type I RWBR | North Carolina Type 1 | Texas Type I | Virginia Level 1 | Washington Class A |
|--|---|--|---|--|---|--|--|---|--|--|---|
| Treatment (System Design) Requirements | Unit processes | Secondary treatment, filtration, disinfection | Oxidized, coagulated, filtered, disinfected | Secondary treatment, filtration, high-level disinfection | Oxidized, filtered, disinfected | Secondary treatment, disinfection | Filtration, high-level disinfection | Filtration (or equivalent) | NS | Secondary treatment, filtration, high-level disinfection | Oxidized, coagulated, filtered, disinfected |
| | UV dose, if UV disinfection used | NS | NWRI UV Guidelines | NWRI UV Guidelines enforced, variance allowed | NWRI UV Guidelines | NS | 100 mJ/cm ² at max day flow | NS | NS | NS | NWRI UV Guidelines |
| | Chlorine disinfection requirements, if used | NS | C _r T > 450 mg·min/L; 90 minutes modal contact time at peak dry weather flow | TRC > 1 mg/L; 15 minutes contact time at peak hr flow ¹ | Min residual > 5 mg/L; 90 minutes modal contact time | NS | Min residual > 1 mg/L; 15 minutes contact time at peak hr flow | NS | NS | TRC CAT < 1 mg/L; 30 minutes contact time at avg flow or 20 minutes at peak flow | Chlorine residual > 1 mg/L; 30 minutes contact time (C _r T > 30 may be required) |
| Monitored Reclaimed Water Quality Requirements | BOD ₅ (or CBOD ₅) | NS | NS | CBOD ₅ : -20 mg/L (ann avg) -30 mg/L (mon avg) -45 mg/L (wk avg) -60 mg/L (max) | 30 mg/L or 60 mg/L depending on design flow | 30 mg/L (30-d avg) | NS | -10 mg/L (mon avg) -15 mg/L (daily max) | 5 mg/L | 10 mg/L (mon avg) or CBOD ₅ : 8 mg/L (mon avg) | 30 mg/L |
| | TSS | NS | NS | 5 mg/l (max) | 30 mg/L or 60 mg/L depending on design flow | 30 mg/L (30-d avg) | 5 mg/l | -5 mg/l (mon avg) -10 mg/l (daily max) | NS | NS | 30 mg/L; this limit is superseded by turbidity |
| | Turbidity | -2 NTU (24-hr avg) -5 NTU (max) | -2 NTU (avg) for media filters -10 NTU (max) for media filters -0.2 NTU (avg) for membrane filters -0.5 NTU (max) for membrane filters | Case-by-case (generally 2 to 2.5 NTU) Florida requires continuous on-line monitoring of turbidity as indicator for TSS | -2 NTU (95-percentile) -0.5 NTU (max) | NS | 2 NTU (max) for UV | 10 NTU (max) | 3 NTU | -2 NTU (daily avg), CAT > 5 NTU | -2 NTU (avg) -5 NTU (max) |
| | Bacterial indicators | Fecal coliform: -none detectable in last 4 of 7 samples -23/100mL (max) | Total coliform: -2.2/100mL (7-day med) -23/100mL (not more than one sample exceeds this value in 30 d) -240/100mL (max) | Fecal coliform: -75% of samples below detection -25/100mL (max) | Fecal coliform: -2.2/100mL (7-day med) -23/100mL (not more than one sample exceeds this value in 30 d) -200/100mL (max) | Total coliform: -2.2/100mL (30-d geom) -23/100mL (max) | Fecal coliform: -2.2/100mL (wk med) -14/100mL (max) | Fecal coliform or <i>E. coli</i> : -14/100mL (mon mean) -25/100mL (max) | Fecal coliform or <i>E. coli</i> : -20/100mL (30-d geom) -75/100mL (max) <i>Enterococci</i> : -4/100mL (30-d geom) -9/100mL (max) | Fecal coliform: -14/100mL (mon geom), CAT > 49/100mL <i>E. coli</i> : -11/100mL (mon geom), CAT > 35/100mL <i>Enterococci</i> : -11/100mL (mon geom), CAT > 24/100mL | Total coliform -2.2/100mL (7-d med) -23/100mL (max) |
| | Pathogens | NS | NS | <i>Giardia</i> and <i>Cryptosporidium</i> sampling once each 2-yr period for plants ≥1 mgd; once each 5-yr period for plants ≤ 1 mgd | TR | TR | NS | NS | NS | NS | NS |
| | Other | If nitrogen > 10 mg/L, special requirements may be mandated to protect groundwater | - | - | - | - | (NH ₃ -N + NO ₃ -N) < 10 mg/L (max) | Ammonia as NH ₃ -N: -4 mg/L (mon avg) -6 mg/L (daily max) | - | - | Specific reliability or redundancy requirements based on formal reliability assessment |

NS = not specified by the state's reuse regulation; TR = monitoring is not required but virus removal rates are prescribed by treatment requirements

¹ In Florida when chlorine disinfection is used, the product of the total chlorine residual and contact time (CrT) at peak hour flow is specified for three levels of fecal coliform as measured prior to disinfection. (See Section 6.4.3.1 for further discussion of CrT.) If the concentration of fecal coliform prior to disinfection: is ≤ 1,000 cfu per 100 mL, the CrT shall be 25 mg·min/L; is 1,000 to 10,000 cfu per 100 mL the CrT shall be 40 mg·min/L; and is ≥ 10,000 cfu per 100 mL the CrT shall be 120 mg·min/L.

Table 4-8 Urban reuse – restricted

| | Arizona Class B | California Disinfected Secondary-23 | Florida ¹ | Hawaii R2 Water | Nevada Category B | New Jersey Type II RWBR | North Carolina ² Type 1 | Texas Type II | Virginia Level 2 | Washington Class C | |
|--|--|--|--|-----------------|--|---|--|---|--|---|--|
| Treatment (System Design) Requirements | Unit processes | Secondary treatment, disinfection | Oxidized, disinfected | NS | Oxidized, disinfected | Secondary treatment, disinfection | Case-by-case | Filtration (or equivalent) | NS | Secondary treatment, disinfection | Oxidized, disinfected |
| | UV dose, if UV disinfection used | NS | NS | NS | NS | NS | 75 mJ/cm ² at max day flow | NS | NS | NS | NWRI UV Guidelines |
| | Chlorine disinfection requirements, if used | NS | NS | NS | Chlorine residual > 5 mg/L, actual modal contact time of 10 minutes | NS | Chlorine residual > 1 mg/L; 15 minute contact time at peak hr flow | NS | NS | TRC CAT < 1 mg/L 30 minutes contact time at avg flow or 20 minutes at peak flow | Chlorine residual > 1 mg/L; 30 minutes contact time |
| Monitored Reclaimed Water Quality Requirements | BOD ₅ (CBOD for Florida) | NS | NS | NS | 30 mg/L or 60 mg/L depending on design flow | 30 mg/L (30-d avg) | NS | -10 mg/L (mon avg) -15 mg/L (daily max) | Without pond system: 20 mg/L (or CBOD 15 mg/L) With pond: 30 mg/L | -30 mg/L (mon avg) -45 mg/L (max wk) or CBOD ₅ -25 mg/L (mon avg) -40 mg/L (max wk) | 30 mg/L |
| | TSS | NS | NS | NS | 30 mg/L or 60 mg/L depending on design flow | 30 mg/L (30-d avg) | 30 mg/L | -5 mg/L (mon avg) -10 mg/L (daily max) | NS | -30 mg/L (mon avg) -45 mg/L (max wk) | 30 mg/L |
| | Turbidity | NS | NS | NS | NS | NS | NS | 10 NTU (max) | NS | NS | NS |
| | Bacterial indicators | Fecal coliform: -less than 200/100mL in last 4 of 7 samples -800/100mL (max) | Total coliform: -23/100mL (7-d med) -240/100 (not more than one sample exceeds this value in 30 d) | NS | Fecal coliform: -23/100mL (7-day med) -200/100mL (not more than one sample exceeds this value in 30 d) | Fecal coliform: -2.2/100mL (30-d geom) -23/100mL (max) | Fecal coliform: -200/100mL (mon geom) -400/100mL (wk geom) | Fecal coliform or <i>E. coli</i> : -14/100mL (mon mean) -25/100mL (daily max) | Fecal coliform or <i>E. coli</i> : -200/100mL (30-d geom) -800/100mL (max) <i>Enterococci</i> : -35/100mL (30-day geom) -89/100mL (max) | Fecal coliform: -200/100mL (mon geom), CAT > 800/100mL <i>E. coli</i> : -126/100mL (mon geom), CAT > 235/100mL <i>Enterococci</i> : -35/100mL (mon geom), CAT > 104/100mL | Total coliform: -23/100mL (7-d med) -240/100mL (max) |
| Other | If nitrogen > 10 mg/L, special requirements may be mandated to protect groundwater | - | - | - | - | (NH ₃ -N + NO ₃ -N): < 10 mg/L (max) | Ammonia as NH ₃ -N: -4 mg/L (mon avg) -6 mg/L (daily max) | - | - | - | |

NS = not specified by the state reuse regulation

¹ Florida does not specifically include urban reuses in its regulations for restricted public access under F.A.C. 62-610-400; requirements for restricted public access reuse are provided in Agricultural Reuse – Non-food Crops, Table 4-9.

² There is no expressed designation between unrestricted and restricted urban reuse in North Carolina regulations.

Table 4-9 Agricultural reuse - food crops

| | | Arizona Class A | California Disinfected Tertiary | Florida ¹ | Hawaii R1 Water | Nevada | New Jersey Type III RWBR | North Carolina | | Texas ¹ Type I Reclaimed Water | Virginia ³ Level 1 | Washington Class A |
|--|---|--|---|---|--|--------|--|---|---|--|---|---|
| | | | | | | | | Processed Type 1 | NOT processed Type 2 | | | |
| Treatment (System Design) Requirements | Unit processes | Secondary treatment, filtration, disinfection | Oxidized, coagulated, filtered, disinfected | Secondary treatment, filtration, high-level disinfection | Oxidized, filtered, disinfected | NP | Filtration, high-level disinfection | Filtration (or equivalent) | Filtration, dual UV/chlorination (or equivalent) | NS | Secondary treatment, filtration, high-level disinfection | Oxidized, coagulated, filtered, disinfected |
| | UV dose, if UV disinfection used | NS | NWRI UV Guidelines | NWRI UV Guidelines enforced, variance allowed | NWRI UV Guidelines | NP | 100 mJ/cm ² at max day flow | NS | dual UV/chlorination (or equivalent) | NS | NS | NWRI UV Guidelines |
| | Chlorine disinfection requirements, if used | NS | CrT > 450 mg·min/L; 90 minutes modal contact time at peak dry weather flow | TRC > 1 mg/L; 15 minutes contact time at peak hr flow ² | Min residual > 5 mg/L, actual modal contact time of 90 minutes | NP | Min residual > 1 mg/L; 15 minutes contact at peak hr flow | NS | dual UV/chlorination (or equivalent) | NS | TRC CAT > 1 mg/L; 30 minutes contact time at avg flow or 20 minutes at peak flow | Chlorine residual > 1; 30 minutes contact time |
| Monitored Reclaimed Water Quality Requirements | BOD ₅ (or CBOD ₅) | NS | NS | CBOD ₅ : -20 mg/L (ann avg) -30 mg/L (mon avg) -45 mg/L (wk avg) -60 mg/L (max) | 30 mg/L or 60 mg/L depending on design flow | NP | NS | -10 mg/L (mon avg) -15 mg/L (daily max) | -5 mg/L (mon avg) -10 mg/L (daily max) | 5 mg/L | 10 mg/L (mon avg) or CBOD ₅ 8 mg/L (mon avg) | 30 mg/L |
| | TSS | NS | NS | 5 mg/L (max) | 30 mg/L or 60 mg/L depending on design flow | NP | 5 mg/L | -5 mg/L (mon avg) -10 mg/L (daily max) | -5 mg/L (mon avg) -10 mg/L (daily max) | NS | NS | 30 mg/L |
| | Turbidity | -2 NTU (24-hr avg) -5 NTU (max) | -2 NTU (avg) for media filters -10 NTU (max) for media filters -0.2 NTU (avg) for membrane filters -0.5 NTU (max) for membrane filters | Case-by-case (generally 2 to 2.5 NTU) Florida requires continuous on-line monitoring of turbidity as indicator for TSS | -2 NTU (95-percentile) -0.5 NTU (max) | NP | 2 NTU (max) for UV | 10 NTU (max) | 5 NTU (max) | 3 NTU | 2 NTU (daily avg) CAT > 5 NTU | -2 NTU (avg) -5 NTU (max) |
| | Bacterial indicators | Fecal coliform: -none detectable in last 4 of 7 samples -23/100mL (max) | Total coliform: -2.2/100mL (7-day med) -23/100mL (not more than one sample exceeds this value in 30 d) -240/100mL (max) | Fecal coliform: -75% of samples below detection -25/100mL (max) | Fecal coliform: -2.2/100mL (7-day med) -23/100mL (not more than one sample exceeds this value in 30 d) -200/100mL (max) | NP | Fecal coliform: -2.2/100mL (wk med) -14/100mL (max) | Fecal coliform or <i>E. coli</i> : -14/100mL (mon mean) -25/100mL (daily max) | Fecal coliform or <i>E. coli</i> : -3/100mL (mon mean) -25/100mL (mon mean) | Fecal coliform or <i>E. coli</i> : -20/100mL (30-d geom) -75/100mL (max) <i>Enterococci</i> : -4/100mL (30-d geom) -9/100mL (max) | Fecal coliform: -14/100mL (mon geom), CAT > 49/100mL <i>E. coli</i> : -11/100mL (mon geom), CAT > 35/100mL <i>Enterococci</i> : -11/100mL (mon geom), CAT > 24/100mL | Total coliform: -2.2/100mL (7-d med) -23/100mL (max) |
| | Viral indicators | NS | NS | NS | TR | NP | NS | NS | Coliphage: -5/100mL (mon mean) -25/100mL (daily max) | NS | NS | NS |
| | Pathogens | NS | NS | <i>Giardia</i> , <i>Cryptosporidium</i> sampling once per 2-yr period for plants ≥ 1 mgd; once per 5-yr period for plants ≤ 1 mgd | - | NP | NS | NS | Clostridium: -5/100mL (mon mean) -25/100mL (daily max) | NS | NS | NS |
| | Other | If nitrogen > 10 mg/L, special requirements may be mandated to protect groundwater | - | - | Oxidized, filtered, disinfected | - | (NH ₃ -N + NO ₃ -N): < 10mg/L (max) <i>Special information, crop tests may be required</i> | Ammonia as NH ₃ -N: -4 mg/L (mon avg) -6 mg/L (daily max) | Ammonia as NH ₃ -N: -1 mg/L (mon avg) -2 mg/L (daily max) | - | - | Specific reliability and redundancy requirements based on formal assessment |

NS = not specified by the state's reuse regulation; TR = monitoring is not required but virus removal rates are prescribed by treatment requirement; NP = not permitted by the state

¹ In Texas and Florida, spray irrigation (i.e., direct contact) is not permitted on foods that may be consumed raw (except Florida makes an exception for citrus and tobacco), and only irrigation types that avoid reclaimed water contact with edible portions of food crops (such as drip irrigation) are acceptable.

² In Florida when chlorine disinfection is used, the product of the total chlorine residual and contact time (CrT) at peak hour flow is specified for three levels of fecal coliform as measured prior to disinfection. (See Section 6.4.3.1 for further discussion of CrT.) If the concentration of fecal coliform prior to disinfection: is ≤ 1,000 cfu per 100 mL, the CrT shall be 25 mg·min/L; is 1,000 to 10,000 cfu per 100 mL the CrT shall be 40 mg·min/L; and is ≥ 10,000 cfu per 100 mL the CrT shall be 120 mg·min/L.

³ The requirements presented for Virginia are for food crops eaten raw. There are different requirements for food crops that are processed, which are presented in Table 4-10.

Table 4-10 Agricultural reuse – non-food crops and processed food crops (where permitted)

| | Arizona | | California | Florida | Hawaii R2 Water | Nevada ² Category E | New Jersey Type II RWBR | North Carolina Type 1 | Texas Type II | Virginia Level 2 | Washington Class C | |
|---|--|--|--|----------|--|--|---|--|---|---|---|--|
| | Class B | Class C | Undisinfected Secondary | | | | | | | | | |
| Treatment (System Design) Requirements | Unit processes | Secondary treatment, disinfection | Secondary treatment, with or without disinfection | Oxidized | Secondary treatment, basic disinfection | Secondary-23: oxidized, disinfected | Secondary treatment ¹ | Case-by-case | Filtration (or equivalent) | NS | Secondary treatment, disinfection | Oxidized, disinfected |
| | UV dose, if UV disinfection used | NS | NS | NS | NS | NS | NS | 75 mJ/cm ² at max day flow | NS | NS | NS | NWRI UV Guidelines |
| | Chlorine disinfection requirements, if used | NS | NS | NS | TRC > 0.5 mg/L; 15 minutes contact time at peak hr flow ¹ | Chlorine residual > 5 mg/L; 10 minutes actual modal contact time | NS | Chlorine residual > 1 mg/L; 15 minute contact time at peak hr flow | NS | NS | TRC CAT < 1 mg/L; 30 minutes contact time at avg flow or 20 minutes at peak flow | Chlorine residual > 1 mg/L; 30 minutes contact time |
| Monitored Reclaimed Water Quality Requirements | BOD ₅ (or CBOD ₅) | NS | NS | NS | CBOD ₅ : -20 mg/L (ann avg) -30 mg/L (mon avg) -45 mg/L (wk avg) -60 mg/L (max) | 30 mg/L (30-d avg) | NS | NS | -10 mg/L (mon avg) -15 mg/L (daily max) | Without pond: 20 mg/L (or CBOD ₅ 15 mg/L) With pond: 30 mg/L | -30 mg/L (mon avg) -45 mg/L (max wk) or CBOD ₅ -25 mg/L (mon avg) -40 mg/L (max wk) | 30 mg/L |
| | TSS | NS | NS | NS | -20 mg/L (ann avg) -30 mg/L (mon avg) -45 mg/L (wk avg) -60 mg/L (max) | 30 mg/L (30-d avg) | 30 mg/L | 30 mg/L | -5 mg/L (mon avg) -10 mg/L (daily max) | NS | -30 mg/L (mon avg) -45 mg/L (max wk) | 30 mg/L |
| | Turbidity | NS | NS | NS | NS | NS | NS | NS | 10 NTU (max) | NS | NS | NS |
| | Bacterial indicators | Fecal coliform: -200/100mL in last 4 of 7 samples -800/100mL (max) | Fecal coliform: -1000/100mL in last 4 of 7 samples -4000/100mL (max) | NS | Fecal coliform: -200/100mL (avg) -800/100mL (max) | Fecal coliform: -23/100mL (7-day med) -200/100mL (not more than one sample exceeds this value in 30 d) | NS | Fecal coliform: -200/100mL (mon geom) -400/100mL (wk geom) | Fecal coliform or <i>E. coli</i> : -14/100mL (mon mean) -25/100mL (daily max) | :Fecal coliform or <i>E. coli</i> : -200/100mL (30-d geom) -800/100mL (max) <i>Enterococci</i> : -35/100mL (30-d geom) -89/100mL (max) | Fecal coliform: -200/100mL (mon geom), CAT > 800/100mL <i>E. coli</i> : -126/100mL (mon geom), CAT > 235/100mL <i>Enterococci</i> : -35/100mL (mon geom), CAT > 104/100mL | Total coliform: -23/100mL (7-d med) -240/100mL (max) |
| Other | If nitrogen > 10 mg/L, special requirements may be mandated to protect groundwater | If nitrogen > 10 mg/L, special requirements may be mandated to protect groundwater | - | - | - | - | (NH ₃ -N + NO ₃ -N): < 10 mg/L (max) | Ammonia as NH ₃ -N: -4 mg/L (mon avg) -6 mg/L (daily max) | - | - | - | |

NS = not specified by the state's reuse regulation

¹ In Florida when chlorine disinfection is used, the product of the total chlorine residual and contact time (CrT) at peak hour flow is specified for three levels of fecal coliform as measured prior to disinfection. (See Section 6.4.3.1 for further discussion of CrT.) If the concentration of fecal coliform prior to disinfection: is ≤ 1,000 cfu per 100 mL, the CrT shall be 25 mg-min/L; is 1,000 to 10,000 cfu per 100 mL the CrT shall be 40 mg-min/L; and is ≥ 10,000 cfu per 100 mL the CrT shall be 120 mg-min/L.

² Nevada prohibits public access and requires a minimum buffer zone of 800 feet for spray irrigation of non-food crops. (Category E, NAC 445A.2771).

Table 4-11 Impoundments – unrestricted

| | Arizona ¹ Class A | California Disinfected Tertiary | Florida | Hawaii | Nevada | New Jersey | North Carolina | Texas Type I | Virginia Level 1 | Washington Class A | |
|--|---|--|---|--------|--------|------------|----------------|-----------------|--|--|---|
| Treatment (System Design) Requirements | Unit processes | Secondary treatment, disinfection | Oxidized, coagulated, filtered, disinfected ² | NR | NR | NP | NR | NS | NS | Secondary treatment, filtration, high-level disinfection | Oxidized, coagulated, filtered and disinfected |
| | UV dose, if UV disinfection used | NS | NWRI UV Guidelines | NR | NR | NP | NR | NS | NS | NS | NWRI UV Guidelines |
| | Chlorine disinfection requirements, if used | NS | C _r T > 450 mg·min/L; 90 minutes modal contact time at peak dry weather flow | NR | NR | NP | NR | NS | NS | TRC CAT < 1 mg/L after minimum contact time of 30 mins at avg flow or 20 mins at peak flow | Chlorine residual > 1 mg/L; 30 minutes contact time |
| Monitored Reclaimed Water Quality Requirements | BOD ₅ | NS | NS | NR | NR | NP | NR | NS | 5 mg/L | 10 mg/L (mon avg) or CBOD ₅ : 8 mg/L (mon avg) | 30 mg/L |
| | TSS | NS | NS | NR | NR | NP | NR | NS | NS | NS | 30 mg/L |
| | Turbidity | NS | -2 NTU (avg) for media filters -10 NTU (max) for media filters -0.2 NTU (avg) for membrane filters -0.5 NTU (max) for membrane filters | NR | NR | NP | NR | NS | 3 NTU | 2 NTU (daily avg), CAT > 5 NTU | -2 NTU (avg) -5 NTU (max) |
| | Bacterial indicators | Fecal coliform: -none detectable in last 4 of 7 samples -23/100mL (max) | Total coliform: -2.2/100mL (7-day med) -23/100mL (not more than one sample exceeds this value in 30 d) -240/100mL (max) | NR | NR | NP | NR | NS | Fecal coliform or <i>E. coli</i> : -20/100mL (avg) -75/100mL (max) <i>Enterococci</i> : -4/100mL (avg) -9/100mL (max) | Fecal coliform: -14/100mL (mon geom), CAT > 49/100mL <i>E. coli</i> : -11/100mL (mon geom), CAT > 35/100mL <i>Enterococci</i> : -11/100mL (mon geom), CAT > 24/100mL | Total coliform: -2.2/100mL (7-day med) -23/100mL (max) |
| | Other | If nitrogen > 10 mg/L, special requirements may be mandated to protect groundwater | Supplemental pathogen monitoring | - | - | NP | NR | - | - | - | Specific reliability and redundancy requirements based on formal assessment |

NS = not specified by the state's reuse regulation; NR = not regulated by the state under the reuse program; NP = not permitted by the state

¹ Arizona does not allow reuse for swimming or "other full-immersion water activity with a potential of ingestion" [AAC R18-9-704(G)(1)(b)]. Arizona also allows "Class A" and "A+" waters to be used for snowmaking, which is included in this definition.

² Disinfected tertiary recycled water that has not received conventional treatment shall be sampled/analyzed monthly for *Giardia*, enteric viruses, and *Cryptosporidium* during first 12 months of operation and use. Following the first 12 months, samples will be collected quarterly and ongoing monitoring may be discontinued after the first two years, with approval.

Table 4-12 Impoundments – restricted

| | Arizona Class B | California Disinfected Secondary-2.2 | Florida | Hawaii R-2 Water | Nevada Category A | New Jersey | North Carolina | Texas Type II | Virginia Level 2 | Washington Class B | |
|--|---|--|--|------------------|--|--|----------------|---------------|--|--|---|
| Treatment (System Design) Requirements | Unit processes | Secondary treatment, disinfection | Oxidized, disinfected | NR | Oxidized, disinfected | Secondary treatment, disinfection | NR | NS | NS | Secondary treatment, disinfection | Oxidized, disinfected |
| | UV dose, if UV disinfection used | NS | NS | NR | NS | NS | NR | NS | NS | NS | NWRI UV Guidelines |
| | Chlorine disinfection requirements, if used | NS | NS | NR | Chlorine residual > 5 mg/L; actual modal contact time of 10 minutes | NS | NR | NS | NS | TRC CAT < 1 mg/L after minimum contact time of 30 mins at avg flow or 20 mins at peak flow | Chlorine residual > 1 mg/L; 30 minutes contact time |
| Monitored Reclaimed Water Quality Requirements | BOD ₅ | NS | NS | NR | 30 mg/L or 60 mg/L depending on design flow | 30 mg/L (30-d avg) | NR | NS | Without pond: 20 mg/L (or CBOD ₅ 15 mg/L) With pond: 30 mg/L | 30 mg/L (mon avg) 45 mg/L (max wk) or CBOD ₅ : 25 mg/L (mon avg) 40 mg/L (max wk) | 30 mg/L |
| | TSS | NS | NS | NR | 30 mg/L or 60 mg/L depending on design flow | 30 mg/L (30-d avg) | NR | NS | NS | 30 mg/L (mon avg) 45 mg/L (max wk) | 30 mg/L |
| | Turbidity | NS | NS | NR | NS | NS | NR | NS | NS | NS | NS |
| | Bacterial indicators | Fecal coliform: -200/100mL in last 4 of 7 samples -800/100mL (max) | Total coliform: -2.2/100mL (7-d med) -23/100 (not more than one sample exceeds this value in 30 d) | NR | Fecal coliform: -23/100mL (7-day med) -200/100mL (not more than one sample exceeds this value in 30 d) | Total coliform: -2.2/100mL (30-d geom) -23/100mL (max) | NR | NS | Fecal coliform or <i>E. coli</i> : -200/100mL (30-d geom) -800/100mL (max) <i>Enterococci</i> : -35/100mL (30-d geom) -89/100mL (max) | Fecal coliform: -200/100mL (mon geom), CAT > 800/100mL <i>E. coli</i> : -126/100mL (mon geom), CAT > 235/100mL Enterococci: -35/100mL (mon geom), CAT > 104/100mL | Total coliform: -2.2/100mL (7-d med) -23/100mL (max) |
| | Other | If nitrogen > 10 mg/L, special requirements may be mandated to protect groundwater | - | - | - | - | NR | - | - | - | Specific reliability and redundancy requirements based on formal assessment |

NS = not specified by the state's reuse regulation; NR = not regulated by the state under the reuse program; TR = monitoring is not required but virus removal rates are prescribed by treatment requirements

Table 4-13 Environmental reuse

| | Arizona ¹ | California | Florida ² | Hawaii | Nevada Category C | New Jersey | North Carolina Type 1 | Texas | Virginia ⁴ | Washington Class A | |
|--|---|------------|----------------------|--|-------------------|--|-----------------------|--|-----------------------|--------------------|--|
| Treatment (System Design) Requirements | Unit processes | NR | NR | Secondary treatment, nitrification, basic disinfection | NR | Secondary treatment, disinfection | NR | Filtration (or equivalent) | NR | NS | Oxidized, coagulated, filtered, disinfected |
| | UV dose, if UV disinfection used | NR | NR | NS | NR | NS | NR | NS | NR | NS | NWRI UV Guidelines |
| | Chlorine disinfection requirements, if used | NR | NR | TRC > 0.5 mg/L; 15 minutes contact time at peak hr flow ³ | NR | NS | NR | NS | NR | NS | Chlorine residual > 1 mg/L; 30 minutes contact time |
| Monitored Reclaimed Water Quality Requirements | BOD ₅ (or CBOD ₅) | NR | NR | CBOD ₅ : -5 mg/L (ann avg) -6.25 mg/L (mon avg) -7.5 mg/L (wk avg) -10 mg/L (max) | NR | 30 mg/L (30-d avg) | NR | -10 mg/L (mon avg) -15 mg/L (daily max) | NR | NS | 20 mg/L |
| | TSS | NR | NR | -5 mg/L (ann avg) -6.25 mg/L (mon avg) -7.5 mg/L (wk avg) -10 mg/L (max) | NR | 30 mg/L (30-d avg) | NR | -5 mg/L (mon avg) -10 mg/L (daily max) | NR | NS | 20 mg/L |
| | Bacterial indicators | NR | NR | Fecal coliform: -200/100mL (avg) -800/100mL (max) | NR | Fecal coliform: -23/100mL (30-d geom) -240/100mL (max) | NR | Fecal coliform or <i>E. coli</i> : -14/100mL (mon mean) -25/100mL (daily max) | NR | NS | Total coliform: -2.2/100mL (7-d med) -23/100mL (max) |
| | Total Ammonia | NR | NR | -2 mg/L (ann avg) -2 mg/L (mon avg) -3 mg/L (wk avg) -4 mg/L (max) | NR | NS | NR | Ammonia as NH ₃ -N: -4 mg/L (mon avg) -6 mg/L (daily max) | NR | NS | Not to exceed chronic standards for freshwater |
| | Nutrients | NR | NR | Phosphorus: -1 mg/L (ann avg) -1.25 mg/L (mon avg) -1.5 mg/L (wk avg) -2 mg/L (max) Nitrogen: -3 mg/L (ann avg) -3.75 mg/L (mon avg) -4.5 mg/L (wk avg) -6 mg/L (max) | NR | NS | NR | Phosphorus: 1 mg/L (max) ⁵ Nitrogen: 4 mg/L (max) ⁵ | NR | NS | Phosphorus: 1 mg/L (ann avg) ⁶ |

NS = not specified by the state's reuse regulation; NR = not regulated by the state under the reuse program

¹ Though Arizona reuse regulations do not specifically cover environmental reuse, treated wastewater effluent meeting Arizona's reclaimed water classes is discharged to waters of the U.S. and creates incidental environmental benefits. Arizona's NPDES Surface Water Quality Standards includes a designation for this type of water, "Effluent Dependent Waters."

² Florida requirements are for a natural receiving wetland regulated under Florida Administrative Code Chapter 62-611 for Wetlands Application.

³ In Florida when chlorine disinfection is used, the product of the total chlorine residual and contact time (CrT) at peak hour flow is specified for three levels of fecal coliform as measured prior to disinfection. (See Section 6.4.3.1 for further discussion of CrT.) If the concentration of fecal coliform prior to disinfection: is ≤ 1,000 cfu per 100 mL, the CrT shall be 25 mg·min/L; is 1,000 to 10,000 cfu per 100 mL the CrT shall be 40 mg·min/L; and is ≥ 10,000 cfu per 100 mL the CrT shall be 120 mg·min/L.

⁴ Wetlands in Virginia, whether natural or created as mitigation for impacts to existing wetlands, are considered state surface waters; release of reclaimed water into a wetland is regulated as a point source discharge and subject to applicable surface water quality standards of the state.

⁵ These limits are not to be exceeded unless net environmental benefits are provided by exceeding these limits.

⁶ The phosphorous limit is as an annual average for wetland augmentation/restoration while for stream flow augmentation is the same as that required to NPDES discharge limits, or in other words variable.

Table 4-14 Industrial reuse¹

| | Arizona ² | California ³ Disinfected Tertiary | Florida ³ | Hawaii ¹ R-2 Water | Nevada Category E | New Jersey Type IV RWBR | North Carolina Type 1 | Texas ^{1,5} Type II | Virginia ⁶ Level 2 | Washington ⁵ Class A | | |
|--|---|---|---|---|--|--|--------------------------|---|--|--|--|------------------------------|
| Treatment (System Design) Requirements | Unit processes | Individual Reclaimed Water Permit, case-specific ² | Oxidized, coagulated, filtered, disinfected | Secondary treatment, filtration, high-level disinfection | Oxidized, disinfected | Secondary treatment, disinfection | Case-by-case | Filtration (or equivalent), unless there is no public access or employee exposure | NS | Secondary treatment, disinfection | Oxidized, coagulated, filtered and disinfected | |
| | UV dose, if UV disinfection used | NS | NWRI UV Guidelines | NWRI UV Guidelines enforced, variance allowed | NS | NS | NS | NS | NS | NS | NWRI UV Guidelines | |
| | Chlorine disinfection requirements, if used | NS | C _T > 450 mg·min/L; 90 minutes modal contact time at peak dry weather flow | TRC > 1 mg/L; 15 minutes contact time at peak hr flow ⁴ | Chlorine residual > 5 mg/L, actual modal contact time of 10 minutes | NS | NS | NS | NS | TRC CAT < 1 mg/L; 30 minutes contact time at avg flow or 20 minutes at peak flow | Chlorine residual > 1 mg/L; 30 minutes contact time | |
| Monitored Reclaimed Water Quality Requirements | BOD ₅ (or CBOD ₅) | NS | NS | CBOD ₅ : -20 mg/L (ann avg) -30 mg/L (mon avg) -45 mg/L (wk avg) -60 mg/L (max) | 30 mg/L or 60 mg/L depending on design flow | 30 mg/L (30-d avg) | NS | -10 mg/L (mon avg) -15 mg/L (daily max) | Without pond: 20 mg/L (or CBOD ₅ 15 mg/L) With pond: 30 mg/L | -30 mg/L (mon avg) -45 mg/L (max wk) or CBOD ₅ -25 mg/L (mon avg) -40 mg/L (max wk) | 30 mg/L | |
| | TSS | NS | NS | 5 mg/L (max) | 30 mg/L or 60 mg/L depending on design flow | 30 mg/L (30-d avg) | Case-by-case | -5 mg/ (mon avg) -10 mg/L (daily max) | NS | -30 mg/L (mon avg) -45 mg/L (max wk) | 30 mg/L | |
| | Turbidity | NS | -2 NTU (avg) for media filters -10 NTU (max) for media filters -0.2 NTU (avg) for membrane filters -0.5 NTU (max) for membrane filters | Case-by-case (generally 2 to 2.5 NTU) Florida requires continuous on-line monitoring of turbidity as indicator for TSS | NS | NS | NS | NS | 10 NTU (max) | NS | NS | -2 NTU (avg) -5 NTU (max) |
| | Bacterial indicators | NS | Total coliform: -2.2/100mL (7-day med) -23/100mL (not more than one sample exceeds this value in 30 d) -240/100mL (max) | Fecal coliform: -75% of samples below detection -25/100mL (max) | Fecal coliform: -23/100mL (7-day med) -200/100mL (not more than one sample exceeds this value in 30 d) | Fecal coliform: -2.2/100mL (30-d geom) -23/100mL (max) | NS | Fecal coliform or <i>E. coli</i> : -14/100mL (mon mean) -25/100mL (daily max) | Fecal coliform or <i>E. coli</i> : -200/100mL (30-d geom) -800/100mL (max) <i>Enterococci</i> : -35/100mL (30-d geom) -89/100mL (max) | Fecal coliform: -200/100mL (mon geom), CAT > 800/100mL <i>E. coli</i> : 126/100mL (mon geom), CAT > 235/100mL <i>Enterococci</i> : -35/100mL (mon geom) -CAT > 104/100mL | Total coliform: -2.2/100mL (7-d med) -23/100mL (max) | |
| | Pathogens | NS | NS | <i>Giardia</i> , <i>Cryptosporidium</i> sampling once each 2-yr period if high-level disinfection is required | NS | TR | NS | NS | NS | NS | NS | NS |

NS = not specified by the state's reuse regulation; NR = not regulated by the state under the reuse program; TR = monitoring is not required but virus removal rates are prescribed by treatment requirements

¹ All state requirements are for cooling water that creates a mist or with exposure to workers, except for Texas and Hawaii. Texas requirements are for cooling tower makeup water and Hawaii includes industrial processes that do not generate mist, do not involve facial contact with recycled water, and do not involve incorporation into food or drink for humans or contact with anything that will contact food or drink for humans. Additional regulations for other industrial systems are in Appendix A of the 2004 Guidelines.

² Arizona regulates industrial reuse through issuance of an Individual Reclaimed Water Permit (Arizona Administrative Code [A.A.C.] R18-9-705 and 706), which provides case-specific reporting, monitoring, record keeping, and water quality requirements.

³ For industrial uses in Florida, such as once-through cooling, open cooling towers with minimal aerosol drift and at least a 300 ft setback to the property line, wash water at wastewater treatment plants, or process water at industrial facilities that does not involve incorporation of reclaimed water into food or drink for humans or contact with anything that will contact food or drink for humans, that do not create a mist or have potential for worker exposure, less stringent requirements, such as basic disinfection (e.g., TRC > 0.5 mg/L, no continuous on-line monitoring of turbidity, fecal coliform < 200/100 mL, etc.), secondary treatment standards (e.g., TSS < 20 mg/L annual average, etc.), no sampling for pathogens (except in the case of open cooling towers regardless of setbacks), may apply.

⁴ In Florida when chlorine disinfection is used, the product of the total chlorine residual and contact time (CrT) at peak hour flow is specified for three levels of fecal coliform as measured prior to disinfection. (See Section 6.4.3.1 for further discussion of CrT.) If the concentration of fecal coliform prior to disinfection: is ≤ 1,000 cfu per 100 mL, the CrT shall be 25 mg·min/L; is 1,000 to 10,000 cfu per 100 mL the CrT shall be 40 mg·min/L; and is ≥ 10,000 cfu per 100 mL the CrT shall be 120 mg·min/L.

⁵ For industrial uses, that do not create a mist or have potential for worker exposure, less stringent requirements may apply.

⁶ In Virginia, these are the minimum reclaimed water standards for most industrial reuses of reclaimed water; more stringent standards may apply as specified in the regulation. For industrial reuses not listed in the regulation, reclaimed water standards may be developed on a case-by-case basis relative to the proposed industrial reuse.

Table 4-15 Groundwater recharge - nonpotable reuse¹

| | | Arizona ² | California | Florida ³ | Hawaii | Nevada | New Jersey ⁵ | North Carolina | Texas | Virginia ⁶ | Washington Class A |
|--|--|---|--------------|--|--------------|--------|-------------------------|---|-------|-----------------------|--|
| Treatment (System Design) Requirements | Unit processes | Regulated by Aquifer Protection Permit ² | Case-by-case | Secondary treatment, basic disinfection | Case-by-case | ND | NR | Aquifer Storage and Recovery in accordance with G.S. 143-214.2. | NR | NS | Oxidized, coagulated, filtered, nitrogen reduced, disinfected |
| | UV dose, if UV disinfection used | NS | NS | NS | NS | ND | NR | NR | NR | NS | NWRI UV Guidelines |
| | Chlorine disinfection requirements, if used | NS | NS | TRC > 0.5 mg/L; 15 minutes contact time at peak hr flow ⁴ | NS | ND | NR | NR | NR | NS | Chlorine residual > 1 mg/L 30 minutes contact time at peak hr flow |
| Monitored Reclaimed Water Quality Requirements | BOD ₅ (or CBOD ₅) | NS | NS | CBOD ₅ : -20 mg/L (ann avg) -30 mg/L (mon avg) -45 mg/L (wk avg) -60 mg/L (max) | NS | ND | NR | NR | NR | NS | 5 mg/L |
| | TSS | NS | NS | -20 mg/L (ann avg) -30 mg/L (mon avg) -45 mg/L (wk avg) -60 mg/L (max) | NS | ND | NR | NR | NR | NS | 5 mg/L |
| | Turbidity | NS | NS | NS | NS | ND | NR | NR | NR | NS | -2 NTU (avg) -5 NTU (max) |
| | Bacterial indicators | NS | NS | Fecal coliform: -200/100mL (avg) -800/100mL (max) | NS | ND | NR | NR | NR | NS | Total coliform: -2.2/100mL (7-d med) -23/100mL (max day) |
| | Total Nitrogen | NS | NS | NS (nitrate < 12 mg/L) | NS | ND | NR | NR | NR | NS | Case-by-case |
| | TOC | NS | NS | NS | NS | ND | NR | NR | NR | NS | Case-by-case |
| | Primary and Secondary Drinking Water Standards | NS | NS | NS | NS | ND | NR | NR | NR | NS | Case-by-case |

NR = not regulated by the state under the reuse program; ND = regulations have not been developed for this type of reuse; NS = not specified by the state's reuse regulation

¹ All state requirements are for groundwater recharge of a nonpotable aquifer.

² Groundwater recharge using reclaimed water is pervasive in Arizona but is not considered part of the reclaimed water program; Arizona Department of Environmental Quality (ADEQ) regulates quality under the Department's Aquifer Protection Permit Program (which governs all discharges that might impact groundwater). The Arizona Department of Water Resources (ADWR) oversees a program to limit withdrawals of groundwater to prevent groundwater depletion; municipalities and other entities can offset these pumping limitations by recharging reclaimed water through detailed permits under its Recharge Program.

³ Higher treatment standards may be require, such as filtration, high level disinfection, total nitrogen below 10 mg/L, and meeting primary and secondary drinking water standards, if there may be a connection to a potable aquifer or other conditions such as groundwater recharge overlying the Biscayne Aquifer in Southeast Florida.

⁴ In Florida when chlorine disinfection is used, the product of the total chlorine residual and contact time (CrT) at peak hour flow is specified for three levels of fecal coliform as measured prior to disinfection. (See Section 6.4.3.1 for further discussion of CrT.) If the concentration of fecal coliform prior to disinfection: is ≤ 1,000 cfu per 100 mL, the CrT shall be 25 mg·min/L; is 1,000 to 10,000 cfu per 100 mL the CrT shall be 40 mg·min/L; and is ≥ 10,000 cfu per 100 mL the CrT shall be 120 mg·min/L.

⁵ All discharges to groundwater for nonpotable reuse are regulated via a New Jersey Pollutant Discharge Elimination System Permit in accordance with N.J.A.C. 7:14A-1 et seq. and must comply with applicable Groundwater Quality Standards (N.J.A.C. 7:9C).

⁶ In Virginia, groundwater recharge of a nonpotable aquifer may be regulated in accordance with regulations unrelated to the Water Reclamation and Reuse Regulation (9VAC25-740).

Table 4-16 Indirect potable reuse (IPR)

| | | Arizona ¹ | California ² | Florida ⁴ | Hawaii | Nevada | New Jersey ⁷ | North Carolina | Texas | Virginia | Washington | | | |
|--|--|----------------------|---|--|--------------|--------|-------------------------|----------------|---|--------------|---|---|---|---|
| | | | | | | | | | | | Surface Percolation Class A | Direct Groundwater Recharge ⁸ Class A | Streamflow Augmentation Case-by-case | |
| Treatment (System Design) Requirements | Unit processes | NR | Oxidized, coagulated, filtered, disinfected, multiple barriers for pathogen and organics removal | Secondary treatment, filtration, high-level disinfection, multiple barriers for pathogen and organics removal | Case-by-case | ND | NR | NR | Case-by-case | Case-by-case | Oxidized with nitrogen reduction, filtered, disinfected | Oxidized, coagulated, filtered, RO-treated, disinfected | Oxidized, clarified, disinfected | |
| | UV dose, if UV disinfection used | NR | NWRI Guidelines ³ | NWRI UV Guidelines enforced, variance allowed | NS | ND | NR | NR | NS | NS | NWRI Guidelines | NWRI Guidelines | NWRI Guidelines | |
| | Chlorine disinfection requirements, if used | NR | C _T > 450 mg·min/L; 90 minutes modal contact time at peak dry weather flow ³ | TRC > 1 mg/L; 15 minutes contact time at peak hr flow ⁵ | NS | ND | NR | NR | NS | NS | NS | Chlorine residual > 1 mg/L; 30 minutes contact time at peak hr flow | Chlorine residual > 1 mg/L; 30 minutes contact time at peak hr flow | Chlorine residual to comply with NPDES permit |
| Monitored Reclaimed Water Quality Requirements | BOD ₅ (or CBOD ₅) | NR | NS | CBOD ₅ : -20 mg/L (ann avg) -30 mg/L (mon avg) -45 mg/L (wk avg) -60 mg/L (max) | NS | ND | NR | NR | 5 mg/L | NS | 30 mg/L | 5 mg/L | 30 mg/L | |
| | TSS | NR | NS | 5 mg/L (max) | NS | ND | NR | NR | NS | NS | 30 mg/L | 5 mg/L | 30 mg/L | |
| | Turbidity | NR | -2 NTU (avg) for media filters -10 NTU (max) for media filters -0.2 NTU (avg) for membrane filters -0.5 NTU (max) for membrane filters | Case-by-case (generally 2 to 2.5 NTU) Florida requires continuous on-line monitoring of turbidity as indicator for TSS | NS | ND | NR | NR | 3 NTU | NS | -2 NTU (avg) -5 NTU (max) | -0.1 NTU (avg) -0.5 NTU (max) | NS | |
| | Bacterial indicators | NR | Total coliform: -2.2/100mL (7-day med) -23/100mL (not more than one sample exceeds this value in 30 d) -240/100mL (max) | Total coliform: -4/100mL (max) | NS | ND | NR | NR | Fecal coliform or <i>E. coli</i> -20/100mL (30-d geom) -75/100mL (max) Enterococci -4/100mL (30-d geom) -9/100mL (max) | NS | Total coliform: -2.2/100 (7-d med) -23/100 (max) | Total coliform: -1/100mL (avg) -5/100mL (max) | Fecal coliform: -200/100mL (avg) -400/100mL (max wk) | |
| | Total Nitrogen | NR | 10 mg/l (avg of 4 consecutive samples) | 10 mg/L (ann avg) | NS | ND | NR | NR | NS | NS | NA | 10 mg/L | NPDES requirements to receiving stream | |
| | TOC | NR | 0.5 mg/L | -3 mg/L (mon avg) -5 mg/L (max); TOX ⁶ : < 0.2 (mon avg) or 0.3 mg/L (max); alternate limits allowed | NS | ND | NR | NR | NS | NS | NS | NA | 1 mg/L | NS |
| | Primary and Secondary Drinking Water Standards | NR | Compliance with most primary and secondary | Compliance with most primary and secondary | NS | ND | NR | NR | NS | NS | NS | Compliance with SDWA MCLs | Compliance with most primary and secondary | NPDES requirements to receiving stream |
| | Pathogens | NR | TR | <i>Giardia</i> , <i>Cryptosporidium</i> sampling quarterly | NS | ND | NR | NR | NS | NS | NS | NS | NS | NS |

NS = not specified by the state's reuse regulation; NR = not regulated by the state under the reuse program; ND = regulations have not been developed for this type of reuse; TR = monitoring is not required but virus removal rates are prescribed by treatment requirements

- ¹ Arizona currently does not have IPR regulations; however, ADEQ regulates recharge facilities where mixed groundwater-reclaimed water may be recovered by a drinking water well through its Aquifer Protection Permit program (see Groundwater Recharge). The Governor's Blue Ribbon Panel on Water Sustainability issued a Report including a recommendation to develop a more robust regulatory/policy program to address IPR [US-AZ-Blue Ribbon Panel].
- ² These requirements are DRAFT and were taken from CDPH *Draft Regulations for Groundwater Replenishment with Recycled Water* (CDPH, 2011).
- ³ Additional pathogen removal is required for groundwater recharge through other treatment processes in order to achieve 12 log enteric virus reduction, 10 log *Giardia* cyst reduction, and 10 log *Cryptosporidium* oocysts reduction.
- ⁴ Florida requirements are for the planned use of reclaimed water to augment Class F-I, G-I or G-II groundwaters (US drinking water sources) with a background TDS of 3,000 mg/L or less. For G-II groundwaters greater than 3,000 mg/L TDS, the TOC and TOX limits do not apply. Florida also includes discharges to Class I surface waters (public water supplies) or discharges less than 24 hours travel time upstream from Class I surface waters as IPR. For discharge to Class I surface waters or water contiguous to or tributary to Class I waters (defined as a discharge located less than or equal to 4 hours travel time from the point of discharge to arrival at the boundary of the Class I water), secondary treatment with filtration, high-level disinfection, and any additional treatment required to meet TOC and applicable surface water quality limits is required. The reclaimed water must meet primary and secondary drinking water standards, except for asbestos, prior to discharge. The TOX limit does not apply and a total nitrogen limit is based on the surface water quality. Outfalls for surface water discharges are not to be located within 500 feet (150 m) of existing or approved potable water intakes within Class I surface waters. Pathogen monitoring for Class I surface water augmentation is the same, except that if discharge is 24 to 48 hr travel time from domestic water supply, *Giardia*, *Cryptosporidium* sampling is once every 2 years.
- ⁵ In Florida when chlorine disinfection is used, the product of the total chlorine residual and contact time (CrT) at peak hour flow is specified for three levels of fecal coliform as measured prior to disinfection. (See Section 6.4.3.1 for further discussion of CrT.) If the concentration of fecal coliform prior to disinfection: is $\leq 1,000$ cfu per 100 mL, the CrT shall be 25 mg·min/L; is 1,000 to 10,000 cfu per 100 mL the CrT shall be 40 mg·min/L; and is $\geq 10,000$ cfu per 100 mL the CrT shall be 120 mg·min/L.
- ⁶ Total organic halides (TOX) are regulated in Florida.
- ⁷ For groundwater recharge reuse is on a case-by-case basis, State Groundwater Quality Standards must be met.
- ⁸ Washington requires the minimum horizontal separation distance between the point of direct recharge and point of withdrawal as a source of drinking water supply to be 2,000 feet (610 meters) and must be retained underground for a minimum of 12 months prior to being withdrawn as a drinking water supply.

4.6 References

- Anderson, P., N. Denslow, J. E. Drewes, A. Olivieri, D. Schlenk, and S. Snyder. 2010. *Final Report Monitoring Strategies for Chemicals of Emerging Concern (CECs) in Recycled Water Recommendations of a Science Advisory Panel*. SWRCB. Sacramento, CA.
- California Department of Public Health (CDPH), 2011. *Draft Regulations for Groundwater Replenishment with Recycled Water*, November 21, 2011. Retrieved August, 2012 from <http://www.cdph.ca.gov/certlic/drinkingwater/Documents/Recharge/DraftRechargeReg-2011-11-21.pdf>.
- Crook, J. 2010. *NWRI White Paper: Regulatory Aspects of Direct Potable Reuse in California*. National Water Research
- Food and Agriculture Organization of the United Nations (FAO). 1985. *FAO Irrigation and Drainage Paper, 29 Rev. 1*. Food and Agriculture Organization of the United Nations: Rome, Italy.
- Huffman, D.E., A. L. Gennaccaro, T. L. Berg, G. Batzer, and G. Widmer. 2006. "Detection of infectious parasites in reclaimed water." *Water Environment Research*. 78(12):2297-302.
- National Research Council (NRC). 2012. *Water Reuse: Potential for Expanding the Nation's Water Supply Through Reuse of Municipal Wastewater*. The National Academies Press: Washington, D.C.
- National Water Research Institute (NWRI). 2012. *Ultraviolet Disinfection Guidelines for Drinking Water and Water Reuse, 3rd Edition*. National Water Research Institute. Fountain Valley, CA.
- National Water Research Institute (NWRI). 2003. *Ultraviolet Disinfection Guidelines for Drinking Water and Water Reuse, 2nd Edition*. National Water Research Institute. Fountain Valley, CA.
- National Water Research Institute (NWRI). 2000. *Ultraviolet Disinfection Guidelines for Drinking Water and Water Reuse*. National Water Research Institute. Fountain Valley, CA.
- U.S. Environmental Protection Agency (EPA). 2004. *Guidelines for Water Reuse*. EPA. 625/R04/108. Environmental Protection Agency. Washington, D.C.
- WaterReuse Association. 2009. *How to Develop a Water Reuse Program: Manual of Practice, WRA-105*. WaterReuse Association. Alexandria, VA.

This page intentionally left blank.

CHAPTER 5

Regional Variations in Water Reuse

This chapter summarizes current water use in the United States, discusses expansion of water reuse nationally to meet water needs, provides an overview of numerous water reuse case studies within the United States compiled for this document, and discusses variations pertaining to water reuse among different regions across the country. Representative water reuse practices are also described for each region.

5.1 Overview of Water Use and Regional Reuse Considerations

This section describes the sources, volumes, and uses of freshwater in the United States.

5.1.1 National Water Use

According to the USGS, total U.S. water use in 2005 was 410,000 mgd (1.55 billion m³/d), up from 402,000 mgd (1.52 billion m³/d) in 1995 (Kenny et al., 2009). Freshwater withdrawals made up 85 percent of the total, with the remaining 15 percent saline water withdrawals, mostly where seawater and brackish coastal water is used to cool thermoelectric power plants. About 80 percent of the total withdrawals were from surface water sources, with the remaining 20 percent of withdrawals sourcing groundwater (mostly freshwater as opposed to saline groundwater).

As illustrated in **Figure 5-1**, the largest freshwater demands were associated with thermoelectric power and agriculture (irrigation, aquaculture, and livestock). Thermoelectric power plant cooling uses freshwater (34 percent of total withdrawals) and nearly all of the saline water withdrawals (15 percent of total withdrawals), totaling 49 percent of the demand. Agriculture requires freshwater for irrigation (31 percent of total withdrawals), aquaculture (2 percent), and livestock (1 percent), for a total of 34 percent of total withdrawals in the United States. Public supply and domestic self-supply water uses constitute 12 percent of the total demand. The remaining categories of industrial and mining water uses together were less than 5 percent of total water withdrawals estimated in this report (Kenny et al., 2009). Even though reclaimed water can be a significant source of cooling water for power plants (particularly in Arizona, California,

Florida, and Texas), the 2005 USGS report did not include specific volumes of reclaimed water in the reference tables and figures (Kenny et al., 2009). The report tabulated water withdrawals from fresh surface water and groundwater and saline groundwater. The freshwater volumes did not recognize contributions from reclaimed water augmentation or wastewater plant discharges that contributed to the source water.

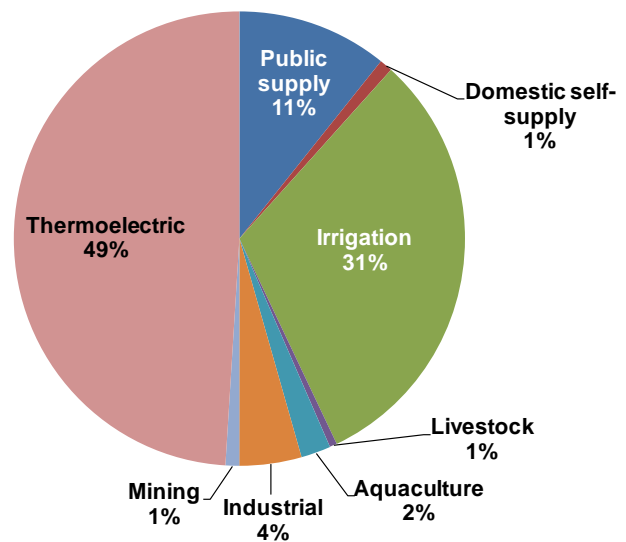

Figure 5-1
Freshwater use by category in the United States
(Source: Kenny et al., 2009)

Treated municipal wastewater represents a significant potential source of reclaimed water. As a result of the Federal Water Pollution Control Act Amendments of 1972, the CWA of 1977 and its subsequent amendments, centralized wastewater treatment has become commonplace in urban areas of the United States. Within the United States, the population generates an estimated 32 bgd (121 million m³/d) of municipal wastewater. The NRC Water Science & Technology Board estimates that a third of this could be reused (GWI, 2010; Miller, 2011; and NRC, 2012). Currently only about 7 to 8 percent of this water is reused, leaving a large area for potential expansion of the use of reclaimed water in the future (GWI, 2010 and Miller, 2012). As the world population continues to shift from rural to urban, the number of centralized

wastewater collection and treatment systems will also increase, creating significant opportunities to implement reclaimed water systems to augment water supplies and, in many cases, improve the quality of surface waters.

A key issue nationally in water reuse is the existing potable water rates. Low potable water rates typically make water reuse less favorable. A comparison of potable and reclaimed water rates is provided in **Table 7-1**.

5.1.2 Examples of Reuse in the United States

High water demand areas might benefit by augmenting existing water supplies with reclaimed water. Arid regions of the United States (such as the Southwest) are natural candidates for water reclamation, and significant reclamation projects are underway throughout this region. Yet, arid regions are not the only viable candidates for water reuse. As shown in **Figure 5-2**, water reuse is practiced widely throughout much of the United States, according to a survey conducted for this document. While the survey of reuse locations is not exhaustive, the information collected is meant to illustrate how widespread water reuse is in the United States. Data sources consulted for this survey included:

- WRA database of water reuse installations
- California SWRCB inventory of reuse projects in California, available online (SWRCB, 2011)
- FDEP inventory of reuse projects in Florida, available online (FDEP, 2012a)
- Tennessee water reuse survey provided online by Tennessee Tech University (TTU) for years 2006 to 2011 (TTU, 2012)
- TCEQ list of reuse installations
- North Carolina Department of Environment and Natural Resources Division of Water Quality inventory of reuse installations

- Georgia Environmental Protection Division inventory of reuse installations
- Case studies discussed in the 2004 EPA *Guidelines for Water Reuse*
- Locations mentioned by other state regulators and experts in the review of this chapter

Figure 5-2 also shows the location of United States case studies on reclaimed water projects that were collected for this document to show the wide variety of types of applications. The case studies can be found in Appendix D. The map legend indicates the full title and authors of the case study, and provides a link to the location of the case study in the Appendix.

5.2 Regional Considerations

This section provides an overview of the context for water reuse in the United States. For the purposes of this document, states have been combined into eight regions corresponding with EPA's regional division of the nation. The regions and states within each region are as follows:

Northeast: (EPA Regions 1 and 2) Connecticut, Maine, Massachusetts, New Hampshire, New Jersey, New York, Rhode Island, Vermont, Puerto Rico, the U.S. Virgin Islands (USVI), and eight federally recognized tribal nations.

Mid-Atlantic: (EPA Region 3) Delaware, District of Columbia, Maryland, Pennsylvania, Virginia, and West Virginia.

Southeast: (EPA Region 4) Alabama, Florida, Georgia, Kentucky, Mississippi, North Carolina, South Carolina, and Tennessee.

Midwest and Great Lakes: (EPA Regions 5 and 7) Illinois, Indiana, Iowa, Kansas, Michigan, Minnesota, Missouri, Nebraska, Ohio, and Wisconsin.

South Central: (EPA Region 6) Arkansas, Louisiana, New Mexico, Oklahoma, and Texas.

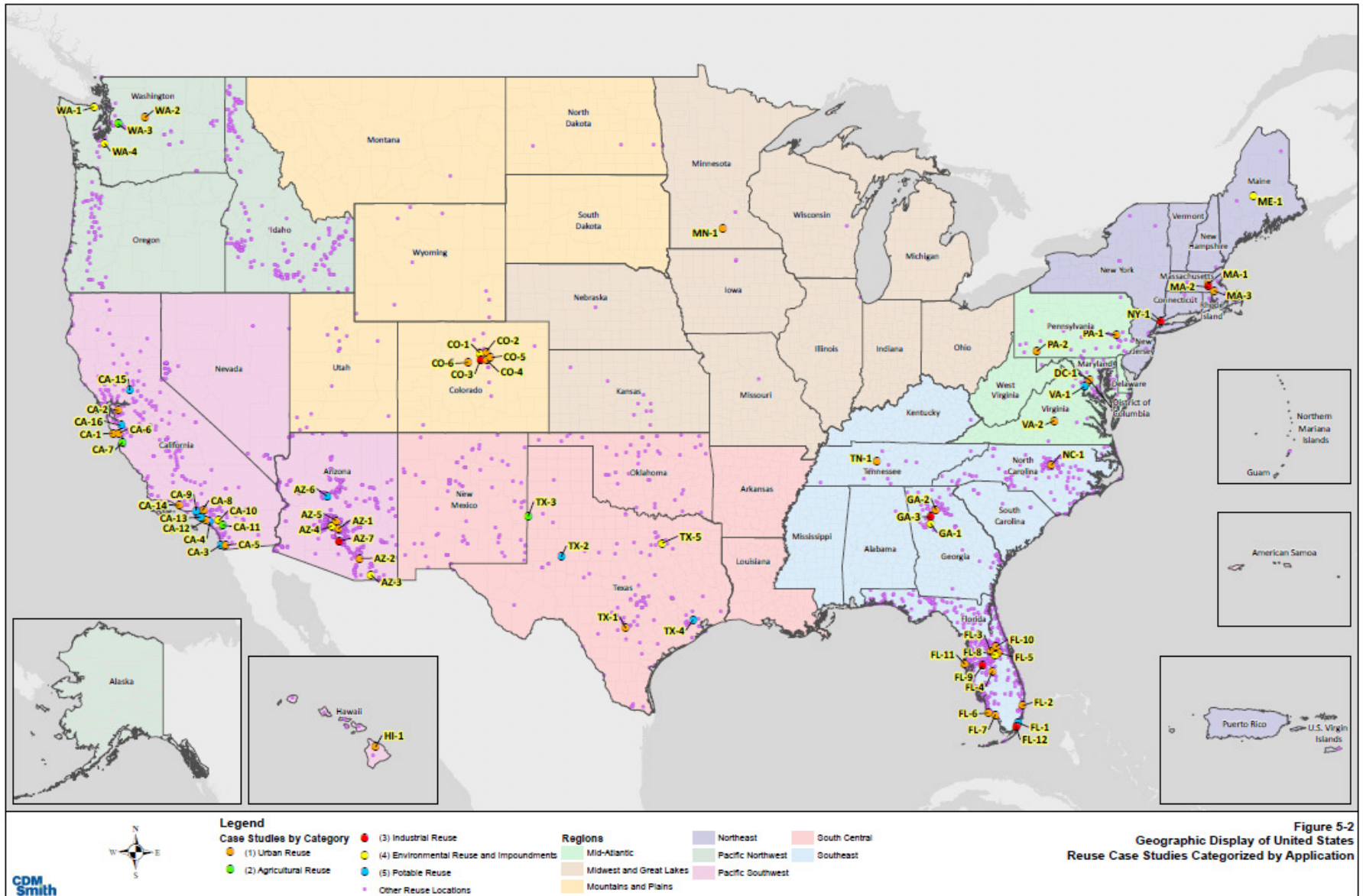

Figure 5-2 Legend

| Map Code | Text code | Case Study Name |
|----------|-------------------------------|---|
| AZ-1 | US-AZ-Gilbert | Town of Gilbert Experiences Growing Pains in Expanding the Reclaimed Water System |
| AZ-2 | US-AZ-Tucson | Tucson Water: Developing a Reclaimed Water Site Inspection Program |
| AZ-3 | US-AZ-Sierra Vista | Environmental Operations Park |
| AZ-4 | US-AZ-Phoenix | 91st Avenue Unified Wastewater Treatment Plant Targets 100 Percent Reuse |
| AZ-5 | US-AZ-Blue Ribbon Panel | Arizona Blue Ribbon Panel on Water Sustainability |
| AZ-6 | US-AZ-Prescott Valley | Effluent Auction in Prescott Valley, Arizona |
| AZ-7 | US-AZ-Frito Lay | Frito-Lay Process Water Recovery Treatment Plant, Casa Grande, Arizona |
| CA-1 | US-CA-Psychology | The Psychology of Water Reclamation and Reuse: Survey Findings and Research Roadmap |
| CA-2 | US-CA-San Ramon | Managing a Recycled Water System through a Joint Powers Authority: San Ramon Valley |
| CA-3 | US-CA-San Diego | City of San Diego – Water Purification Demonstration Project |
| CA-4 | US-CA-Orange County | Groundwater Replenishment System, Orange County, California |
| CA-5 | US-CA-North City | EDR at North City Water Reclamation Plant |
| CA-6 | US-CA-Santa Cruz | Water Reuse Study at the University of California Santa Cruz Campus |
| CA-7 | US-CA-Monterey | Long-term Effects of the Use of Recycled Water on Soil Salinity Levels in Monterey County |
| CA-8 | US-CA-Southern California MWD | Metropolitan Water District of Southern California's Local Resource Program |
| CA-9 | US-CA-Los Angeles County | Montebello Forebay Groundwater Recharge Project using Reclaimed Water, Los Angeles County, California |
| CA-10 | US-CA-Elsinore Valley | Recycled Water Supplements Lake Elsinore |
| CA-11 | US-CA-Temecula | Replacing Potable Water with Recycled Water for Sustainable Agricultural Use |
| CA-12 | US-CA-Santa Ana River | Water Reuse in the Santa Ana River Watershed |
| CA-13 | US-CA-VanderLans | Leo J. Vander Lans Water Treatment Facility |
| CA-14 | US-CA-Pasteurization | Use of Pasteurization for Pathogen Inactivation for Ventura Water, California |
| CA-15 | US-CA-Regulations | California State Regulations |
| CA-16 | US-CA-West Basin | West Basin Municipal Water District: Five Designer Waters |
| CO-1 | US-CO-Denver Zoo | Denver Zoo |
| CO-2 | US-CO-Denver | Denver Water |
| CO-3 | US-CO-Denver Energy | Xcel Energy's Cherokee Station |
| CO-4 | US-CO-Denver Soil | Effects of Recycled Water on Soil Chemistry |
| CO-5 | US-CO-Sand Creek | Sand Creek Reuse Facility Reuse Master Plan |
| CO-6 | US-CO-Water Rights | Water Reuse Barriers in Colorado |
| DC-1 | US-DC-Sidwell Friends | Smart Water Management at Sidwell Friends School |
| FL-1 | US-FL-Miami So District Plant | South District Water Reclamation Plant |
| FL-2 | US-FL-Pompano Beach | City of Pompano Beach OASIS |
| FL-3 | US-FL-Orlando E. Regional | Eastern Regional Reclaimed Water Distribution System |
| FL-4 | US-FL-Economic Feasibility | Economic Feasibility of Reclaimed Water to Users |
| FL-5 | US-FL-Reedy Creek | Reuse at Reedy Creek Improvement District |
| FL-6 | US-FL-Marco Island | Marco Island, Florida, Wastewater Treatment Plant |
| FL-7 | US-FL-Everglade City | Everglade City, Florida |
| FL-8 | US-FL-Orlando Wetlands | City of Orlando Manmade Wetlands System |

Figure 5-2 Legend

| Map Code | Text code | Case Study Name |
|----------|-------------------------|---|
| FL-9 | US-FL-SFWMD Partnership | Regional Reclaimed Water Partnership Initiative of the Southwest Florida Water Management District |
| FL-10 | US-FL-Altamonte Springs | The City of Altamonte Springs: Quantifying the Benefits of Water Reuse |
| FL-11 | US-FL-Clearwater | Evolution of the City of Clearwater's Integrated Water Management Strategy |
| FL-12 | US-FL-Turkey Point | Assessing Contaminants of Emerging Concern (CECs) in Cooling Tower Drift |
| GA-1 | US-GA-Clayton County | Sustainable Water Reclamation Using Constructed Wetlands: The Clayton County Water Authority Success Story |
| GA-2 | US-GA-Forsyth County | On the Front Lines of a Water War, Reclaimed Water Plays a Big Role in Forsyth County, Georgia |
| GA-3 | US-GA-Coca Cola | Recovery and Reuse of Beverage Process Water |
| HI-1 | US-HI-Reuse | Reclaimed Water Use in Hawaii |
| MA-1 | US-MA-Southborough | Sustainability and LEED Certification as Drivers for Reuse: Toilet Flushing at The Fay School |
| MA-2 | US-MA-Hopkinton | Decentralized Wastewater Treatment and Reclamation for an Industrial Facility, EMC Corporation Inc., Hopkinton, Massachusetts |
| MA-3 | US-MA-Gillette Stadium | Sustainability and Potable Water Savings as Drivers for Reuse: Toilet Flushing at Gillette Stadium |
| ME-1 | US-ME-Snow | Snowmaking with Reclaimed Water |
| MN-1 | US-MN-Mankato | Reclaimed Water for Peaking Power Plant: Mankato, Minnesota |
| NC-1 | US-NC-Cary | Town of Cary, North Carolina, Reclaimed Water System |
| NY-1 | US-NY-PepsiCo | Identifying Water Streams for Reuse in Beverage Facilities: PepsiCo ReCon Tool |
| PA-1 | US-PA-Kutztown | The Water Purification Eco-Center |
| PA-2 | US-PA-Mill Run | Zero-Discharge, Reuse, and Irrigation at Fallingwater, Western Pennsylvania Conservancy |
| TN-1 | US-TN-Franklin | Franklin, Tennessee Integrated Water Resources Plan |
| TX-1 | US-TX-San Antonio | San Antonio Water System Water Recycling Program |
| TX-2 | US-TX-Big Spring | Raw Water Production Facility: Big Spring Plant |
| TX-3 | US-TX-Landscape Study | Site Suitability for Landscape Use of Reclaimed Water in the Southwest |
| TX-4 | US-TX-NASA | U.S. Water Recovery System on the International Space Station |
| TX-5 | US-TX-Wetlands | East Fork Raw Water Supply Project: A Natural Treatment System Success Story |
| VA-1 | US-VA-Occoquan | Potable Water Reuse in the Occoquan Watershed |
| VA-2 | US-VA-Regulation | Water Reuse Policy and Regulation in Virginia |
| WA-1 | US-WA-Sequim | City of Sequim's Expanded Water Reclamation Facility and Upland Reuse System |
| WA-2 | US-WA-Regulations | Washington State Regulations |
| WA-3 | US-WA-King County | Demonstrating the Safety of Reclaimed Water for Garden Vegetables |
| WA-4 | US-WA-Yelm | City of Yelm, Washington |

Mountains and Plains: (EPA Region 8) Colorado, Montana, South Dakota, North Dakota, Utah, and Wyoming.

Pacific Southwest: (EPA Region 9) Arizona, California, Hawaii, Nevada, U.S. Pacific Insular Area Territories (Territory of Guam, Territory of American Samoa, and the Commonwealth of the Northern Mariana Islands (CNMI), and 147 federally recognized tribal nations.

Pacific Northwest: (EPA Region 10) Oregon, Washington, Idaho, and Alaska.

In this section, five areas of variation are discussed for each region related to water reuse. These include:

- Population and land use
- Precipitation and climate
- Water use by sector
- States' regulatory context
- Context and drivers of water reuse

The following are the sources of data cited for these discussions:

- **Population:** U.S. Census Bureau (USCB) – percent change in 2000 and 2010 resident population data in each region (USCB, n.d.)
- **Land Use:** National Resources Inventory – percent change from 1997 to 2007 in developed, non-federal land in each region, as a percentage of total region land area (USDA, 2009)
- **Precipitation:** National Oceanic and Atmospheric Administration (NOAA) 30-year annual rainfall data for each state (1971 to 2000). City precipitation figures were averaged for each state, except where noted for New Hampshire (NOAA, n.d.)
- **Water use:** *Estimated Use of Water in the United States in 2005*, USGS. Water use by sector was first calculated for each state, after which a regional average was calculated (Kenny et al, 2009)

States and territories were surveyed to obtain information on regulations and guidelines governing water reuse. An overall summary of the states and territories that have water reuse regulations and guidelines is provided in **Table 4-5**. Links to regulatory websites are provided in Appendix C.

As population growth is a key driver for infrastructure development, including water reuse facilities, the changes in population and developed land are presented for each region in the sections that follow. As an overview, the population change since 1990 is also provided in **Table 5-1** for all of the regions.

5.2.1 Northeast: Connecticut, Maine, Massachusetts, New Hampshire, New Jersey, New York, Rhode Island, Vermont, Puerto Rico, the U.S. Virgin Islands, and Eight Federally Recognized Tribal Nations

While EPA Regions 1 and 2 comprise Connecticut, Maine, Massachusetts, New Hampshire, New Jersey, New York, Rhode Island, Vermont, Puerto Rico, the U.S. Virgin Islands, and eight federally recognized tribal nations, this section focuses only on the regulatory context and drivers for water reuse in the seven states in the Northeast region of the United States and the USVI, a U.S. territory. Information is not available at this time for Puerto Rico and the eight federally recognized tribal nations in Region 2.

There are both challenges and opportunities to wastewater reclamation and reuse in the Northeast. The major drivers include state regulatory changes, urban hydrology, precipitation, seasonal use, water rates, and water use by sector. Generally speaking, wastewater reclamation is growing at a very slow rate, with an estimated reuse of approximately 8 to 10 mgd (350 to 438 L/s) of reclaimed water. Reuse in the Northeast is still a novel concept. Where reuse has been implemented, it has been used by municipalities to augment and buffer stressed potable water supplies, landscape irrigation, or on-site installations (e.g., LEED certified facilities). Often, private developers, industry, and in some cases public-private partnerships collaborate to go beyond the standards of basic environmental compliance and create a vision for integrated and sustainable water resources. Water reuse then becomes a key element in their water supply plans.

Table 5-1 Percent change in resident population in each region during the periods 1990-2000, 2000-2010, and 1990-2010 (USCB, n.d.)

| State or Region | % change 1990-2000 | % change 2000-2010 | % change 1990-2010 |
|---------------------------------------|-----------------------|-----------------------|-----------------------|
| United States | 13.2 | 9.7 | 24.1 |
| NORTHEAST REGION | 6.1 | 3.2 | 9.5 |
| Connecticut | 3.6 | 4.9 | 8.7 |
| Maine | 3.8 | 4.2 | 8.2 |
| Massachusetts | 5.5 | 3.1 | 8.8 |
| New Hampshire | 11.4 | 6.5 | 18.7 |
| Rhode Island | 4.5 | 0.4 | 4.9 |
| Vermont | 8.2 | 2.8 | 11.2 |
| New Jersey | 8.9 | 4.5 | 13.7 |
| New York | 5.5 | 2.1 | 7.7 |
| MID-ATLANTIC REGION | 7.3 | 7.2 | 15.1 |
| Delaware | 17.6 | 14.6 | 34.8 |
| District of Columbia | -5.7 | 5.2 | -0.9 |
| Maryland | 10.8 | 9.0 | 20.7 |
| Pennsylvania | 3.4 | 3.4 | 6.9 |
| Virginia | 14.4 | 13.0 | 29.3 |
| West Virginia | 0.8 | 2.5 | 3.3 |
| SOUTHEAST REGION | 19.1 | 14.7 | 36.6 |
| Alabama | 10.1 | 7.5 | 18.3 |
| Florida | 23.5 | 17.6 | 45.3 |
| Georgia | 26.4 | 18.3 | 49.5 |
| Kentucky | 9.7 | 7.4 | 17.7 |
| Mississippi | 10.5 | 4.3 | 15.3 |
| North Carolina | 21.4 | 18.5 | 43.9 |
| South Carolina | 15.1 | 15.3 | 32.7 |
| Tennessee | 16.7 | 11.5 | 30.1 |
| MIDWEST AND GREAT LAKES REGION | 8.0 | 3.9 | 12.2 |
| Illinois | 8.6 | 3.3 | 12.2 |
| Indiana | 9.7 | 6.6 | 16.9 |
| Michigan | 6.9 | -0.6 | 6.3 |
| Minnesota | 12.4 | 7.8 | 21.2 |
| Ohio | 4.7 | 1.6 | 6.4 |
| Wisconsin | 9.6 | 6.0 | 16.3 |
| Iowa | 5.4 | 4.1 | 9.7 |
| Kansas | 8.5 | 6.1 | 15.2 |
| Missouri | 9.3 | 7.0 | 17.0 |
| Nebraska | 8.4 | 6.7 | 15.7 |

Table 5-1 Percent change in resident population in each region during the periods 1990-2000, 2000-2010, and 1990-2010 (USCB, n.d.)

| State or Region | % change 1990-2000 | % change 2000-2010 | % change 1990-2010 |
|------------------------------------|-----------------------|-----------------------|-----------------------|
| SOUTH CENTRAL REGION | 17.9 | 15.5 | 36.1 |
| Arkansas | 13.7 | 9.1 | 24.0 |
| Louisiana | 5.9 | 1.4 | 7.4 |
| New Mexico | 20.1 | 13.2 | 35.9 |
| Oklahoma | 9.7 | 8.7 | 19.3 |
| Texas | 22.8 | 20.6 | 48.0 |
| MOUNTAINS AND PLAINS REGION | 22.7 | 16.1 | 42.4 |
| Colorado | 30.6 | 16.9 | 52.7 |
| Montana | 12.9 | 9.7 | 23.8 |
| North Dakota | 0.5 | 4.7 | 5.3 |
| South Dakota | 8.5 | 7.9 | 17.0 |
| Utah | 29.6 | 23.8 | 60.4 |
| Wyoming | 8.9 | 14.1 | 24.3 |
| PACIFIC SOUTHWEST REGION | 18.1 | 13.0 | 33.5 |
| Arizona | 40.0 | 24.6 | 74.4 |
| California | 13.8 | 10.0 | 25.2 |
| Hawaii | 9.3 | 12.3 | 22.7 |
| Nevada | 66.3 | 35.1 | 124.7 |
| PACIFIC NORTHWEST REGION | 21.3 | 14.2 | 38.5 |
| Alaska | 14.0 | 13.3 | 29.1 |
| Idaho | 28.5 | 21.1 | 55.7 |
| Oregon | 20.4 | 12.0 | 34.8 |
| Washington | 21.1 | 14.1 | 38.2 |

5.2.1.1 Population and Land Use

Another factor in the development of reuse programs in the Northeast is the significant change in urbanization of major population centers and in the land use surrounding those centers. As population increases, water resources are stressed and water reuse can become an attractive option. **Figure 5-3** compares the percent change in the overall population of the Northeast region to the population change of the entire United States over the past decade, along with the change in the percentage of developed land.

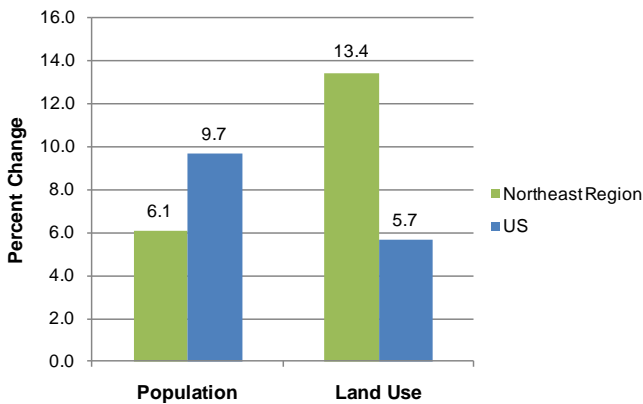

Figure 5-3
Percent change in population (2000-2010) and developed land (1997-2007) in the Northeast Region, compared to the United States

While the percent population change in the Northeast has lagged behind other regions, the developed land percent change in the Northeast has outpaced the United States average.

5.2.1.2 Precipitation and Climate

The most significant impediment to reuse is the prolific amount of annual precipitation in the Northeast. The annual average precipitation is approximately 42 in (106.5 cm), with monthly precipitation between 3 in (7.5 cm) and 4 in (10 cm). The annual average temperature in the region is approximately 53 degrees F (11.6 degrees C). The region's high precipitation and low annual temperature, combined with a lower than average water evaporation rate, results in an abundance of water for recharge of water resources on a regional basis. **Figure 5-4** depicts typical monthly precipitation by state.

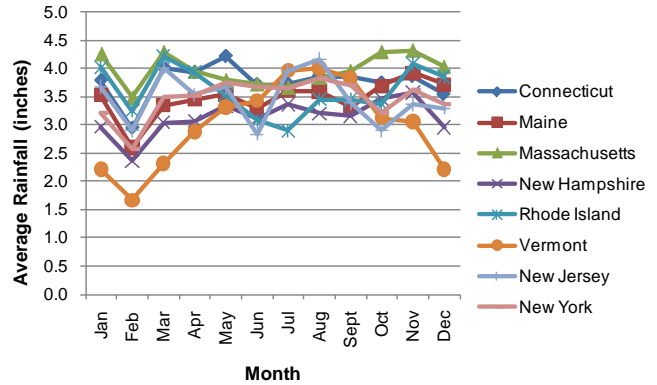

Figure 5-4
Average monthly precipitation (1971-2000) for states in the Northeast region

5.2.1.3 Water Use by Sector

Figure 5-5 shows freshwater use by sector in the Northeast.

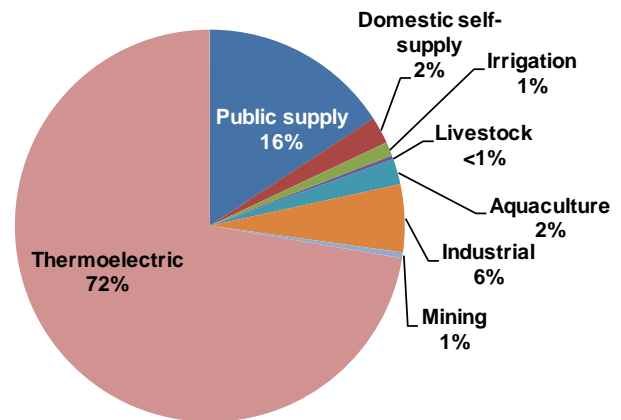

Figure 5-5
Freshwater use by sector for the Northeast region

The opportunities for water reuse are similar among the Northeast states. The greatest benefit resides in the energy sector, followed by irrigation and the industrial sector. These sectors define the future for reclamation in the Northeast and highlight the importance of the energy-water nexus. Sustainable water management requires balancing these potable demands through source substitution with reclaimed water, which can reduce stress on potable water supplies.

The energy sector in Connecticut is second only to Massachusetts energy water demands. Recently, the University of Connecticut developed a plan for using

reclaimed water at its power plant on campus. Another industrial facility in Connecticut uses reclaimed water where it's feasible to meet a zero-discharge wastewater permit. Maine has significant potable water resources and, as illustrated in **Figure 5-5**, has the greatest opportunity for water reclamation within the energy and industrial sector. Because the manufacturing of paper and wood products demands large amounts of water, it is likely that water reuse projects will develop in these sectors as potable water resources are seasonally and locally stressed.

The energy sector in Massachusetts has already provided water reclamation opportunities at power plants like Dominion Power's Brayton Point Power Plant in Somerset, Mass. Industrial wastewater reclamation is also a growing market sector. An excellent example of industrial wastewater reclamation is the EMC Headquarters in Hopkinton [[US-MA-Hopkinton](#)]. Additionally, the use of reclaimed wastewater for golf course irrigation is also a market sector that has growth potential.

Similar to the opportunities described above, New Hampshire has looked at development of water reuse at industrial parks. Rhode Island reuse projects include the irrigation of the Jamestown Golf Course, as well as a private golf course in Portsmouth, both of which are island communities in Narragansett Bay. Also in Rhode Island, there is a planned reuse project in a mixed-use community in Kingston. A power plant based at the Central Landfill in Johnston, R.I., is the largest reclaimed water project in the Northeast. In Vermont, the energy sector provides the greatest opportunity for water reuse, followed by industrial reuse. There is limited water reuse in New York with one case study in Chapter 5.7.7 of the 2004 guidelines discussing the Oneida Indian Nation (EPA, 2004). In this document, Section 2.4.2 Alternative Water Resources includes a discussion of on-site reuse in Battery Park, New York City, N.Y.

An additional potential driver for reuse in the Northeast is increasingly strict nutrient removal requirements in NPDES permits. In locations with new nutrient limits, water reuse may be a favorable alternative to enhanced treatment purely for discharge, as has been demonstrated in other parts of the United States, including Florida, Oregon, and Washington.

5.2.1.4 States' and Territories' Regulatory Context

Based on the limited number of water reuse projects undertaken in the Northeast, regulatory requirements or guidelines for reuse projects have not been implemented in most states. Massachusetts, New Jersey, and Vermont are the only states in the Northeast with water reuse regulations.

There are no comprehensive inventories of reuse projects by state, nor is there a data warehouse on the guidelines or permitted water quality criteria applied to each project.

Massachusetts

The Commonwealth of Massachusetts promulgated water reuse regulations in March 2009. The regulations were developed within 314 Code of Massachusetts Regulations (CMR) 20.00 entitled "Reclaimed Water Permit Program and Standards" and 314 CMR 5.00 regulations entitled "Groundwater Discharge." The key elements of the regulations were to protect public groundwater supplies by requiring a TOC limit when there is a discharge to the groundwater as a surrogate for endocrine disrupting compounds and contaminants within a specified travel time in the aquifer.

New Hampshire

New Hampshire does not have regulations governing water reuse but encourages it and has developed a position statement recognizing that water reuse can both reduce stress on groundwater resources as well as decrease surface water quality degradation. The New Hampshire Department of Environmental Services developed a guidance document identifying design criteria for reuse of reclaimed wastewater. Water reclamation projects are approved on a case-by-case basis.

Rhode Island

Rhode Island developed water reuse guidelines in 2007 for four allowable water reuse categories, including restricted irrigation, unrestricted irrigation, non-contact cooling water, and agricultural reuse for non-food crops. The Department of Environmental Management's Office of Water Resources has established water quality criteria, signage, and set-back distances for these four categories of reuse.

Vermont

Vermont has adopted rules for indirect discharge that require that land-based discharge (including forested spray fields) be considered prior to approval of surface water discharge.

New York

There are no formal guidelines or regulations in New York, and initial work on guidelines was suspended due to budget constraints. In highly developed areas such as Manhattan, the cost to extend dual piping systems from central wastewater reclamation facilities is cost prohibitive. There are isolated uses of reclaimed water in the state for cooling purposes with supply and quality parameters agreed to in site specific contracts. The 2004 guidelines (Chapter 5.7.7) recounts development of an intergovernmental agreement between the Oneida Indian Nation and the city of Oneida. The city's reclaimed water was supplied to the Indian Nation to enable development of a casino and golf complex by allowing the irrigation demands of the complex to be met without stressing water resources.

New Jersey

In January 2005, the New Jersey Department of Environmental Protection issued a draft "Technical Manual for Reclaimed Water for Beneficial Reuse," and proposed regulation in 2008. These regulations were codified on January 5, 2009 as New Jersey Administrative Code 7:14A-2.15. Section 2.15 establishes application requirements for Reclaimed Water for Beneficial Reuse (RWBR) and states that any feasibility studies conducted shall be performed in accordance with the Technical Manual. The regulations define two main categories of RWBR—public access and restricted access. The Technical Manual provides detailed information to applicants on the procedure for developing and implementing an RWBR program.

Connecticut and Maine

There are no formal regulations regarding water reuse in Connecticut or Maine. Installations are approved on a case-by-case basis.

USVI

Currently, there are no water reuse regulations promulgated by the USVI. Water reuse for irrigation is limited to small, on-site installations and no large scale or public projects have been undertaken. Discharges

to above ground irrigation systems are regulated under the USVI Territorial Pollutant Discharge Elimination System Permitting and Compliance permit program, while below ground dispersal systems are reviewed on a case-by-case basis. At the time of publication, USVI is reviewing draft regulations for small scale water reuse systems for groundwater recharge and irrigation. Water reuse for IPR, industrial, or recreational applications have not been proposed in the USVI, but if proposed, they would be approved on a case-by-case basis.

5.2.1.5 Context and Drivers of Water Reuse

Potable water rates vary fairly dramatically by state and regionally within each state in the Northeast, depending on whether the source is a surface water or groundwater resource. Several aquifers are stressed on a seasonal basis; there are even instances of surface waters being depleted within coastal river basins in recent years, driving up potable water rates. Obviously, the high cost of the potable water supply provides an incentive for wastewater reclamation. For example, in Massachusetts the Ipswich River Basin ran dry during the peak summer demands of 2006 and 2007. Currently, potable water rates in the Northeast range from a low of less than \$1.00/1,000 gallons (\$0.26/1000 L) to a high of over \$9.00/1,000 gallons (\$2.38/1000 L) regionally.

Since adequate potable water supply is not always available for large industrial projects regardless of the water rate, industrial facilities such as power plants have developed the largest water reclamation projects in the region. Rhode Island has the distinction of having the largest reclaimed water project in the Northeast at a power plant at the Central Landfill in Johnston, R.I. that pumps 5 mgd (219 L/s) of reclaimed water 12 mi (19.3 km) from the Cranston, R.I., WWTP for use in the on-site cooling towers. In Connecticut there are two active reuse projects (for golf course irrigation and an industrial manufacturing facility) and one facility near start-up at the University of Connecticut.

Reclaimed water is used for snowmaking in several states in New England as a means to allow for continued discharge of treated effluent from zero discharge lagoon and LAS during the winter. Several ski resorts in Maine utilize reclaimed water for snowmaking, as described in a case study (US-ME-Snow). In Vermont, one ski area, one highway rest

area, and one building at the University of Vermont are currently using reclaimed water for toilet and urinal flushing. In addition, forested spray fields are used for disposal of treated wastewater in areas of Vermont.

Several water reclamation systems from Massachusetts are highlighted in the case studies. In Southborough, a private school has installed a small wastewater treatment system to reclaim water for toilet flushing as part of a campus expansion that included LEED certification of buildings [US-MA-Southborough]. In Hopkinton, a manufacturer of electronic data storage systems has installed a wastewater treatment and reclamation plant to reuse water for toilet flushing and irrigation, which recharges groundwater. As Hopkinton has faced water shortages during summer peak seasonal demand, the project has reduced the potable water demand on a seasonally limited aquifer and has provided needed groundwater recharge [US-MA-Hopkinton]. In the town of Foxborough, when the new Gillette Stadium was being built, the New England Patriots management worked with the town and the Massachusetts Department of Environmental Protection to construct a new wastewater reclamation system for toilet flushing and groundwater recharge. The increase in wastewater generated during home games would have otherwise overwhelmed the town's wastewater treatment system, as well as severely stressed the town's groundwater supplies [US-MA-Gillette Stadium]. The Metropolitan Area Planning Council (MAPC) published a guide for expanding water reuse in Massachusetts that includes several other case studies on water reuse in the state (MAPC, 2005).

The objective of the RWBR program in the state of New Jersey is to incorporate RWBR language into all sanitary sewerage treatment plant permits. As of 2011, 118 facilities have been permitted to utilize RWBR. Of these facilities, 27 are utilizing RWBR for a variety of uses ranging from cooling water, WWTP wash down, and golf course irrigation to cage/pen washing at a county zoo.

USVI

Public potable water supply serves approximately 30 percent of the USVI, while the remaining 70 percent collect rainwater or use wells to draw groundwater for drinking. Of that 70 percent, approximately 15 percent use wells, with the remaining population relying on rainwater cisterns. While the annual rainfall is

significant, there is a dry season, and the eastern end of the island of St. Croix is particularly dry year round, providing a drive to conserve water. There also have been recent shortages of public water supply on the island of St. Thomas. Overall, however, provided conservation practices are used, water demands are generally met by supply. Thus, scarcity is not a driver for large-scale water reuse. Nonetheless, small-scale water reuse for irrigation of small plots, primarily for landscaping, does occur in the USVI, particularly in the drier areas (e.g., the eastern end of St. Croix). Commercial agriculture, primarily located on St. Croix, currently does not employ water reuse.

5.2.2 Mid-Atlantic: Delaware, District of Columbia, Maryland, Pennsylvania, Virginia, and West Virginia

This section focuses on the regulatory context and drivers for water reuse in five states and the District of Columbia in the Mid-Atlantic region.

5.2.2.1 Population and Land Use

According to the 2010 U.S. Census, the population in the Mid-Atlantic states totals around 30 million with the largest population density being the Washington, D.C.-Baltimore-Northern Virginia metropolitan area. The coastal areas of the upper Mid-Atlantic region have been thoroughly urbanized, with little to no areas of rural farmland. However, West Virginia and parts of Virginia remain largely rural with pockets of urbanization. **Figure 5-6** compares the percent change population in the Mid-Atlantic to the entire United States from 2000-2010 and percent change in developed land coverage from 1997-2007.

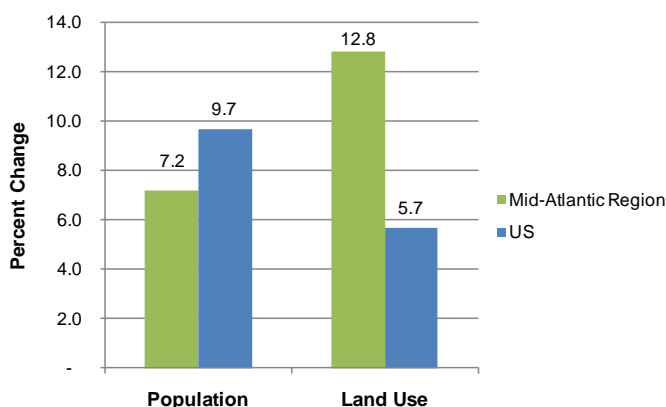

Figure 5-6
Change in population (2000-2010) and developed land (1997-2007) in the Mid-Atlantic region, compared to the United States

5.2.2.2 Precipitation and Climate

The climate in the Mid-Atlantic region is largely classified as humid subtropical. Spring and fall are warm, while winter is cool with annual snowfall averaging 14.6 in (37 cm). Winter temperatures average around 38 degrees F (3.3 degrees C) from mid-December to mid-February. Summers are hot and humid with a July daily average of 79.2 degrees F (26.2 degrees C). The combination of heat and humidity in the summer brings very frequent thunderstorms and, therefore, abundant precipitation during the warmest months. **Figure 5-7** depicts average monthly precipitation in the Mid-Atlantic region by state.

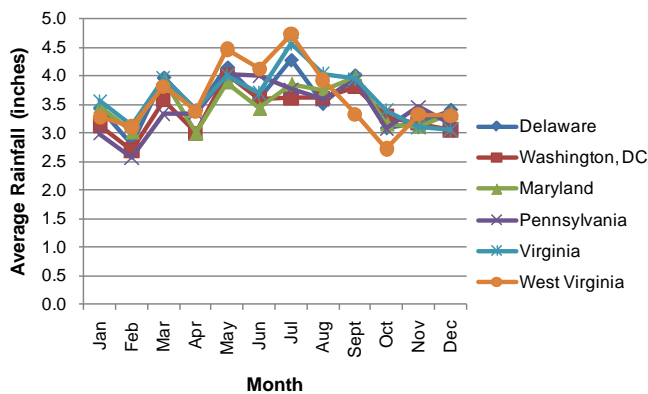

Figure 5-7
Average monthly precipitation in the Mid-Atlantic region

5.2.2.3 Water Use by Sector

Figure 5-8 shows freshwater use by sector in the Mid-Atlantic Region.

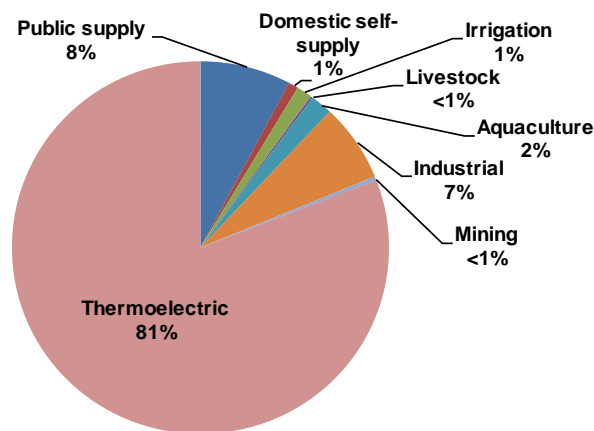

Figure 5-8
Freshwater use by sector for the Mid-Atlantic region

As for the Northeast region, the greatest possible opportunity for water reuse in the Mid-Atlantic region is in the energy sector.

5.2.2.4. States' Regulatory Context

Delaware

The Delaware Division of Water administers the state's reclaimed water permits, which are primarily for agricultural irrigation, a reuse that has been practiced since the 1970s. There are 23 permitted agricultural operations covering more than 2,200 acres, plus two golf courses and several wooded tracks. State regulations require advanced treatment for unrestricted access use; specify water quality limitations, including bacteriological standards; and require set back distances. Agricultural application rates are limited both hydraulically and by nutrient loading limits. Reclaimed water irrigation of crops intended for human consumption without processing is not allowed.

District of Columbia

The District of Columbia currently does not have any regulations or guidelines addressing water reuse but considers projects on a case-by-case basis. The city is currently developing rules and water quality requirements for stormwater use.

Pennsylvania and Maryland

Pennsylvania and Maryland have guidelines for water reuse. The Maryland Department of Environment has Guidelines for Land Application/Reuse of Treated Municipal Wastewaters, last revised in 2010. There are two quality levels (Class I and II). The guidelines provide buffer zone requirements and requirements for zero nitrogen addition to groundwaters in new permits. The 2010 amendments added a Class III water for non-restricted urban irrigation use and regulations proposed for reuse with a Class IV water allowing use in commercial settings (laundries, car wash, snowmaking, air conditioning, closed loop cooling, window washing, and pressure cleaning), irrigation for food crops (with no contact with the edible portion of the crop), and industrial facilities (washing aggregate, cooling waters, concrete manufacture, parts washing, and equipment operations).

Virginia

Virginia adopted new regulations for water reuse in 2008 under the Department of Environmental Quality (DEQ). In addition to the DEQ regulations, which

govern the centralized reclamation of domestic, municipal, or industrial wastewater and subsequent reuse, other Virginia state agencies have regulations or guidelines that affect water reuse, determined in most cases by the type of wastewater to be reclaimed. The Virginia Department of Health has regulations that allow the on-site treatment and reuse of reclaimed water in conjunction with a permitted on-site system for toilet flushing, and provides guidelines for the use of harvested rainwater and graywater. The Virginia Department of Housing and Community Development has regulations for the indoor treatment and plumbing of graywater and harvested rainwater, and for the indoor plumbing of reclaimed water meeting appropriate regulatory standards administered by the DEQ for indoor uses. The Virginia Department of Conservation and Recreation has limited regulations for the use of stormwater and evaluates such proposals on a case-by-case basis. A discussion of the development of the Virginia water reuse regulations is provided in a case study [[US-VA-Regulations](#)].

Water rights in Virginia adhere to the Riparian Doctrine, which protects the beneficial water uses of downstream riparian owners. A more detailed discussion of water rights and how they may affect the reclamation and reuse of wastewater is provided in Chapter 4. As a result of the Riparian Doctrine and Virginia's water withdrawal permit program, communities that do not have downstream riparian owners or permitted withdrawals to contend with may have a greater range of water reclamation and reuse options, including IPR and nonpotable uses. In contrast, communities with downstream riparian owners may implement IPR in lieu of nonpotable reuse of reclaimed water in order to avoid water rights conflicts. Where IPR is proposed, generators and distributors of reclaimed water will need to work more closely with downstream users within a larger regulatory context to protect water supply quantity and quality.

West Virginia

No information was available from West Virginia at the time of publication.

5.2.2.5 Context and Drivers of Water Reuse Virginia

One of the longest operating and successful reclamation projects in the country was initiated in

1978 by the UOSA. UOSA was created to provide regional collection and advanced treatment of wastewater generated from multiple small communities, many with inadequate wastewater treatment facilities and failing individual septic systems. Project details are described in a case study [[US-VA-Occoquan](#)]. The UOSA discharge provides significant contributions to the Occoquan Reservoir, which is the raw water supply for Fairfax Water, a utility that provides potable water to northern Virginia. The UOSA system is also the longest operating planned surface water IPR project in the United States.

Subsequent to the effective date of Virginia's Water Reclamation and Reuse Regulation in October 2008, several new water reclamation and reuse projects were authorized. These included, among others, the following projects:

- The Broad Run WRF in Loudoun County is permitted to produce 11 mgd (482 L/s) of Level 1 reclaimed water (secondary treatment, filtration, and higher level disinfection) for a variety of uses including turf and landscape irrigation; toilet flushing; fire fighting and protection; and evaporative cooling, primarily at data centers.
- The Noman Cole, Jr. Pollution Control Plant in Fairfax County is permitted to produce 6.6 mgd (289 L/s) of Level 1 reclaimed water. A portion of this water is delivered to an energy resource recovery facility for cooling, boiler blowdown and washdown and to the Fairfax County Park Authority for irrigation of a golf course, recreation area, and park.
- The Parham Landing WWTP in New Kent County is permitted to produce 2.0 mgd (88 L/s) of Level 1 reclaimed water. A portion of this water is delivered to two golf courses for irrigation and to a horse racing track for irrigation and dust suppression.
- The Bedford City WWTP in Bedford County is permitted to produce 2.0 mgd (88 L/s) of Level 2 reclaimed water (secondary treatment and standard disinfection). A portion of this water is delivered to a food packaging facility for cooling.

- The Maple Avenue WWTP in Halifax County is permitted to produce 1.0 mgd (43 L/s) of Level 2 reclaimed water. Most of this water will be delivered to a wood-burning power producer for cooling and boiler feed.

Other projects that have been grandfathered until they expand their reclaimed water production or distribution capacity include the Proctors Creek Wastewater Treatment Facility (WWTF) and the Remington WWTF in Chesterfield and Fauquier Counties, respectively. Both facilities provide treated effluent of quality better than or equal to Level 2 reclaimed water to coal-burning power generation facilities for cooling or stack scrubbing (Bennett, 2010).

Delaware

Delaware has a long history of promoting reuse of reclaimed water. Some fields in Delaware have been receiving reclaimed water since the 1970s with no adverse effects to the fields, crop yields, or the water table beneath the field. As previously mentioned, there are 23 facilities permitted in Delaware that use reclaimed water largely for agricultural irrigation as well as to irrigate two golf courses and several tracks of wooded land.

District of Columbia

While many facilities in the District of Columbia are practicing graywater use, only one water reuse project has been implemented to date. The Sidwell Friends Middle School campus was recently renovated for LEED Platinum certification, including on-site water reuse, as described in the associated case study [US-DC-Sidwell Friends]. The University of the District of Columbia is similarly considering on-site water reuse for its campus and is working with District of Columbia Water and Sewer Authority (D.C. Water), the District Department of the Environment, and the Department of Health to develop the potential project.

Pennsylvania

In Pennsylvania, an advanced treatment facility provides reclaimed water for Pennsylvania State University and the surrounding area from the Spring Creek Pollution Control Facility. Treatment includes activated sludge with biological nutrient removal (BNR) followed by diversion to the reclamation facilities consisting of MF/RO and UV disinfection with sodium hypochlorite added to a 1.5 million gallon storage tank serving the distribution system (Smith and Wert,

2007). Other projects include dust control and toilet/urinal flushing (Grantville and Pittsburg Convention Center) and the Falling Water garden in Mill Run, Pa. (Vandertulip and Pype, 2009 and [US-PA-Mill Run]. In Kutztown, the Rodale Institute has installed a water reclamation system as part of its Water Purification Eco-Center. The project highlights water reuse as an alternative to traditional sewage management for a broad audience, including elementary school children, municipal officials, land developers, watershed management groups, planning commissioners, policy makers, and environmental enforcement officers [US-PA-Kutztown]. Although interior residential reuse would not be permitted under current guidelines, Hundredfold Farm in Adams County was the first rural cohousing community in Pennsylvania and uses their treated wastewater for toilet flushing as well as irrigation. There are also 11 industrial establishments and 14 municipal treatment plants that use their treated wastewater for irrigation purposes.

Maryland

Maryland has 35 spray irrigation systems using reclaimed water, with the largest being 0.75 mgd (32 L/s). The majority of the systems are for agricultural irrigation. Nine of the spray irrigation systems are for golf course irrigation. Other reuse systems included four rapid infiltration systems, two overland flow, and three drip irrigation systems (Tien, 2010).

5.2.3 Southeast: Alabama, Florida, Georgia, Kentucky, Mississippi, North Carolina, South Carolina, and Tennessee

This section focuses on the regulatory context and drivers for water reuse in eight states in the Southeast.

5.2.3.1 Population and Land Use

The Southeast is one of the most populous and fastest growing regions in the United States. With nearly 19 million people, Florida is the most populous of the southeastern states. It is followed by Georgia and North Carolina, each with approximately 10 million residents, and then Tennessee with over 6 million people. Historically, the Southeast states have relied heavily on agriculture. However, in the last few decades, the region has become more urban and industrialized. Despite this development, some southeastern states still have not implemented sophisticated reuse programs. Florida, however, has one of the largest reuse programs in the country. A factor that has contributed greatly to the significant

development of reuse in Florida and the Southeast is the significant increase in urbanization of the states' major population centers and in the land use surrounding those centers. As population increases, particularly in coastal areas, water resources are stressed, and water reuse becomes an integral part of meeting the projected future water demand. **Figure 5-9** compares the percent change in population in the Southeast region to the entire United States from 2000 to 2010 and percent change in developed land coverage from 1997 to 2007.

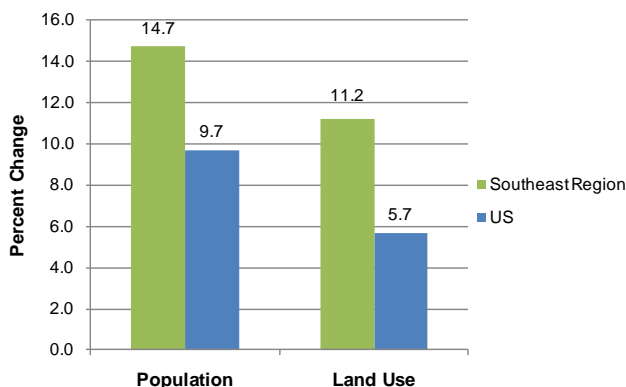

Figure 5-9
Change in population (2000-2010) and developed land (1997-2007) in the Southeast region, compared to the United States

Florida experienced huge growth in population from 1980 to 2010 (93 percent increase), and with that came a dramatic increase in developed land at nearly 100 percent over what it was in 1982. Georgia, North Carolina, South Carolina, and Tennessee likewise saw population growth exceeding the national average. In these states, population growth likewise corresponded to an increase in developed land exceeding the national rate. Because of this stress from growth and development, Florida and some of the other southeastern states, particularly in the large urban centers, present huge opportunities for reuse.

5.2.3.2 Precipitation and Climate

The predominate climate in the Southeast is humid subtropical with a small area of wet/dry-season tropical zone in South Florida. Compared to the rest of the country, states in the Southeast get the most average rainfall, with close to or above 50 in (127 cm) per year. Yet, it may be surprising that Florida has probably the most reuse flow going to landscape irrigation at 360 million gallons per day (403,200 ac-ft/yr) (15.8 m³/s) than any other state. Part of the explanation lies in an initial regulatory driver to reuse instead of increasing

deep well disposal. **Figure 5-10** depicts typical monthly precipitation in the Southeast by state.

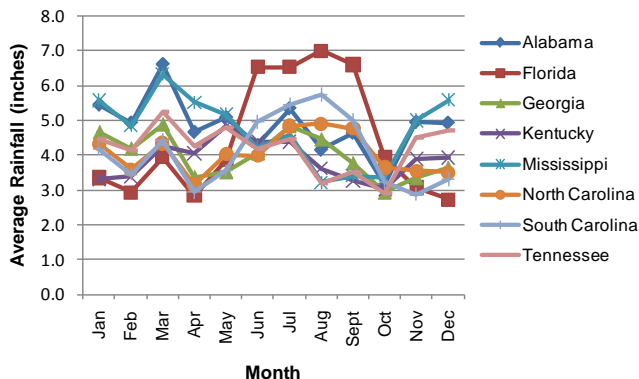

Figure 5-10
Average monthly precipitation in the Southeast region

It is clear that the springtime rainy season in the Southeast occurs in March, which is the wettest time for most of the southeast states. However, Florida's wettest season is during the summer months. For irrigation uses, this rainy cycle during the best growing months creates a disconnect between the supply and demand rates of reclaimed water for urban and agriculture reuse programs. This must be solved through the use of seasonal storage (tanks, lakes, aquifer storage, and recovery wells), diversification of the reuse program (bulk interruptible users, large industrial users, aquifer recharge, etc.), development of supplemental water sources, by permitting a limited wet-weather discharge, or by having a permitted back-up disposal option such as deep well injection or surface water discharge.

5.2.3.3 Water Use by Sector

The opportunities for water reuse differ somewhat among the Southeast states. All of the states have large opportunities for water reuse in the energy sector. In Florida and Mississippi, irrigation demand also provides a large opportunity for reuse. **Figure 5-11** shows freshwater use by sector in the Southeast.

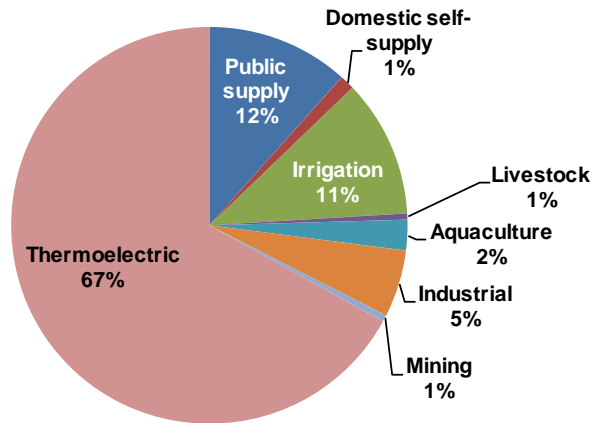

Figure 5-11
Freshwater use by sector for the Southeast region

While irrigation does not seem to present a huge opportunity for reuse in Alabama, South Carolina, and Tennessee, the use of reclaimed water for irrigation in certain circumstances (e.g., where irrigated hayfields or golf courses are located next to a domestic WWTF) in these states should not be overlooked. Likewise, in Florida and Mississippi, where the use of freshwater in the energy sector is largely overshadowed by reuse for irrigation, the use of reclaimed water in cooling towers and other uses at thermolectric power plants can be a huge local opportunity for reuse in areas where those plants are located. In Florida, power plants can be a reuse utility's largest bulk customer.

In many parts of Florida, reclaimed water is an integral part of the water supply portfolio, and this trend is expected to continue. With limited freshwater in many areas, reclaimed water has allowed communities to grow and has reduced the need for development of other alternatives. Irrigation demands in Florida are second only to Arkansas. This may partly explain why Florida's most popular use of reclaimed water (68 percent of the total reuse flow) is irrigation (public access areas, 58 percent, and agricultural irrigation 10 percent) (FDEP, 2012a). Farming is the largest industry in Florida, and the use of surface water and groundwater sources for irrigation remain significant withdrawals of the freshwater supply in the state. There are two main impeding factors to expanding the use of reclaimed water for agricultural activities: negative perception of reclaimed water by farmers and their customers, and the rural nature of farmland, which means that there are high financial and energy

costs to supply reclaimed water to these areas. The public use of water is also huge and indicates a big opportunity for aquifer recharge and potable reuse; however, this represents the most stringent level of treatment and most potential for public resistance.

Florida is not a center of heavy industry, and as a result, industry is the smallest of the water uses in Florida. Leading industries include food processing, electric and electronic equipment, transportation equipment, and chemicals. While the industrial and energy sectors are not huge parts of the total water use in Florida, the opportunities presented by these industries, particularly in the towns where large industrial facilities and power plants are located, are desirable to reclaimed water providers. Alabama, Georgia, Mississippi, South Carolina, and Tennessee all have higher industrial water use demands that are in the range of 5 to 10 percent.

Potable Water Availability and Rates

With the exception of Florida, Arkansas, and Mississippi, the majority of freshwater withdrawn in the Southeast comes from surface water sources. In Florida, nearly 90 percent of the potable water is supplied by groundwater. Potable water rates are still relatively cheap due to the low cost of production (very little treatment required). However, in some parts of the state, particularly in the Tampa Bay area and Southeast parts of the state and along the coastline in the Northeast and parts of the Panhandle, the aquifers are stressed. In these stressed areas, called Water Resource Caution Areas by state statutes, potable water rates may be higher and may be a better reflection of the real cost of providing water. Within these Water Resource Caution areas, investigating the feasibility of reuse programs is mandated, and utilities (water supply and wastewater management) as well as water users must implement reuse to the extent that is determined to be feasible.

Potable water rates in several municipalities surveyed in Florida in 2003 ranged from a low of \$0.50/1,000 gallons (\$0.13/1000 L) to a high of more than \$10.00/1,000 gallons (\$2.64/1000 L), depending on the gallon usage (tiered rate); however, for most residential uses the average potable water rate was around \$1.50/1,000 gallons (\$0.40/1,000 L) (Whitcomb, 2005). (See also **Table 7-1** for sample rates.) Note that as utilities in Florida adopt conservation rate structures, potable water rates have

increased above these 2003 values. Reclaimed water rates in the same year in Florida were very competitive, ranging from \$0.19 to \$5.42/1,000 gallons (\$0.05 to \$1.43/1,000 L) for residential customers and from \$0.05 to \$18.30/1,000 gallons (\$0.01 to \$4.83/1,000 L) for non-residential customers (FDEP, 2012a). Except for a few isolated instances, water in the southeastern states is generally undervalued, therefore inhibiting the perceived need for water reuse.

5.2.3.4. States' Regulatory Context

Alabama, Georgia, Kentucky, Mississippi, South Carolina, and Tennessee

Alabama and Georgia each have guidelines governing various aspects of reuse. Kentucky does not have regulations or guidelines governing reuse. Mississippi has regulations that cover the potential for reclaimed water to be reused for restricted urban reuse, agricultural reuse for non-food crops, and industrial reuse. South Carolina has regulations governing reuse that stipulate that wastewater facilities that apply to discharge to surface waters must conduct an alternatives analysis to demonstrate that water reuse is not economically or technologically reasonable. Tennessee allows reclaimed water to be distributed for land application reuse by industrial customers, commercial developments, golf courses, recreational areas, residential developments, and other nonpotable uses. Implementation of reuse programs are through the NPDES or state operating permit programs with additional requirements for reuse that are specified in the permits. Tennessee guidelines for reuse include the *Design Guidelines for Wastewater Treatment Systems Using Spray Irrigation*.

Florida

Florida has one of the more mature water reuse programs that continues to evolve with new environmental and regulatory drivers. Florida leads the United States with 49 percent of treated wastewater reclaimed and reused (FDEP, 2012a). The reuse capacity in the state is higher—up to 64 percent of the state's permitted domestic wastewater capacity is dedicated to reuse. In 2006, FDEP's Water Reuse Program was the first recipient of the EPA Water Efficiency Leader Award. However, Florida realizes only a fraction of reuse opportunities. In 2011, a total of 57 large domestic wastewater treatment facilities did not provide reuse of any kind. This unused capacity presents a potential to expand the availability of reclaimed water in the state. The 2008 Legislature

enacted laws that prohibit ocean discharge of treated wastewater by 2025 except as a backup to a reuse system. Sixty percent of the water currently discharged in ocean outfalls will have to be reused for a beneficial purpose, increasing reclaimed water use by at least 180 mgd (7.9 m³/s) by 2025.

The 2007 to 2008 droughts highlighted the need to use all sources of water efficiently. In lieu of new legislation considered in 2008, FDEP initiated three workshops to gather input on water reuse issues and goals for Florida. Meeting attendees included representatives from the FDEP, the five water management districts, local government, utilities, and other parties with an interest in reuse. Issues discussed included regulatory authority, offsets, irrigation, supplementation (augmentation), funding, optimization of reclaimed water resources; mandatory reuse zones, communication and coordination, and reuse feasibility study preparation. The regulatory authority may be the result of increased value seen in reclaimed water with utilities believing that they should control the resource that they spend money to create, cities wanting some control, and water management districts believing reclaimed water falls under the legislative grant of jurisdiction to regulate the consumptive use of water.

Another interesting issue is the discussion on supplementation, which is also referred to as augmentation. In most instances, augmentation is the addition of highly treated reclaimed water to a surface water body or aquifer for IPR. In Florida, for some utilities, the opportunity to supplement reclaimed water with other water sources helps promote a higher percentage use of reclaimed water because it makes availability to a larger number of users more reliable. However, some environmental organizations and other local governments have expressed concern over this practice. For more information, consult the FDEP *Connecting Reuse and Water Use: A Report of the Reuse Stakeholders Meetings* (FDEP, 2009). An outcome of these workshops was the establishment of a reclaimed water workgroup consisting of representatives from the same stakeholders. After the first three workshops, the workgroup continued to meet almost monthly for three years, coming to some kind of consensus on these issues. The workgroup's efforts resulted in statutory changes, rule changes, and increased coordination among stakeholders. The workgroup's final report was published in May 2012.

North Carolina

Reclaimed water systems are classified in North Carolina as either conjunctive or non-conjunctive systems. A conjunctive reclaimed water system refers to a system where beneficial use of reclaimed water is an option and reuse is not necessary to meet the wastewater disposal needs of the facility. In this case, other wastewater utilization or disposal methods (i.e., NPDES permit) are available to the facility at all times. A non-conjunctive reclaimed water system typically has evolved from land disposal system permits and refers to a system where the reclaimed water utilization option is required (or dedicated) to meet the wastewater disposal needs of the facility and no other disposal or utilization options are available. Of the 128 active reclaimed water permits in North Carolina, approximately 48 percent are for conjunctive use systems and approximately 64 percent of those are from municipalities. Changes in the North Carolina regulations now allow more flexibility for utilities to expand use beyond dedicated land disposal in the remaining non-conjunctive permits. The projected increase in reclaimed water demand due to the rule changes were estimated based on newly approved uses of food crop irrigation, wetlands augmentation, residential conjunctive drip irrigation systems, and the estimated increase in residential irrigation demand (NCAC, 2011).

5.2.3.5 Context and Drivers of Water Reuse

Alabama

In Foley, Ala., model studies and a constructed wetland/percolation pond were studied at 20,000 gpd (0.9 L/ s) flow rate using secondary treatment effluent as feed to confirm application for groundwater recharge in the future.

Georgia

Water reuse in Georgia varies from constructed wetlands to augment shallow aquifers and spring flow to creeks, to landscape irrigation, and even flushing urinals and toilets in permitted buildings. Two case studies [[US-GA-Clayton County](#)] and [[US-GA-Forsyth County](#)] highlight the state's success in augmenting surface water supplies and offsetting potable water demands within the state.

Historically, water reuse has been limited in Georgia due to perceived adequate rainfall and water resources. This perception began to change during an intense drought period in 2007 and 2008, after which

many communities re-evaluated how they would meet future water supply needs if a lack of rainfall persisted.

In Coastal Georgia specifically, the 2007 and 2008 drought period only compounded the already occurring issue of overproduction of drinking wells in the area, which was resulting in saltwater intrusion of coastal aquifers. In fact, the Georgia Environmental Protection Division (GEPD) had already developed a Coastal Georgia Water and Wastewater Permitting Plan for Managing Salt Water Intrusion (2006 Coastal Plan) that required a non-agricultural groundwater permittee to develop a Water Reuse Feasibility Plan. The primary focus of the plan is halting the intrusion of salt water into the Upper Floridan aquifer (GEPD, 2007).

The recommended uses for reuse water in Georgia were further expanded when on January 1, 2011; the Georgia Plumbing Code was amended to allow reclaimed water to be used for toilet and urinal flushing and for other approved uses in buildings where occupants do not have access to plumbing. This amendment to the plumbing code helped provide the framework to facilitate the use of reclaimed water in buildings in LEED-certification endeavors.

Another driver for increasing water reuse in Georgia was a federal court decision affecting the use of Lake Lanier, a reservoir in the northern portion of the state that supplies water to many metro-Atlanta communities and other nearby communities. Lake Lanier is the uppermost of four major water bodies along the Chattahoochee River system that runs from the North Georgia Mountains, through Atlanta, Ga., Columbus, Ga., and the Florida Panhandle, and eventually discharges to the Gulf of Mexico. Lake Lanier has been the subject of water rights disputes among Georgia, Alabama, and Florida for more than two decades. A federal court decision on July 17, 2009, ruled that Lake Lanier was not authorized as a water supply reservoir, which meant that metro Atlanta would have to find another source of drinking water unless a political solution could be achieved. In response, the governor created a Water Contingency Planning Task Force that included elected officials, consultants, and representatives from several communities to conduct feasibility planning to determine the impact of the ruling and discuss methods of managing water resources in North Georgia if the ruling stood (Georgia Governor's Office, 2009).

As part of the response, the Metropolitan North Georgia Water Planning District developed a water management plan identifying options and concluded that alternative sources could not be developed by the 2012 deadline in the ruling. The plan acknowledged that unplanned indirect potable reuse was already occurring by augmenting the supply of Lake Lanier and Lake Allatoona with high quality reclaimed water and capture of upstream discharges comingled in the river. The Clayton County Water Authority [US-GA-Clayton County] project was identified as a planned indirect potable reuse project. Several established nonpotable reuse projects were also acknowledged.

On June 28, 2011, the 11th Circuit Court of Appeals overturned the July 2009 court decision, finding that Lake Lanier was created as a water supply reservoir and directed the USACE to prepare a water allocation plan for Lake Lanier, after which both Alabama and Florida appealed. On June 25, 2012 the U.S. Supreme Court denied a request by Alabama and Florida for a review of the water case. While there will likely be more to this issue, it is serving as a driver for Georgia's communities to integrate water reuse options into their regional water planning.

Florida

According to Florida's 2011 Annual Reuse Inventory, the state has a total of 487 domestic wastewater treatment facilities with permitted capacities of 0.1 mgd (4.4 L/ s) or above that make reclaimed water available for reuse. These treatment facilities serve 434 reuse systems, where 722 mgd (31.6 m³/ s) of reclaimed water from these facilities is reused for beneficial purposes. The total reuse capacity associated with these systems is 2,336 mgd (102.3 m³/ s), which is 64 percent of the total capacity of domestic wastewater treatment facilities in the state and more than three times larger than the state's reuse capacity in 1986 (FDEP, 2012a). **Figure 5-12** shows the type of reuse that is occurring in Florida. To date, percentage of reuse by category of application is only available for Florida and California, states that compile the information.

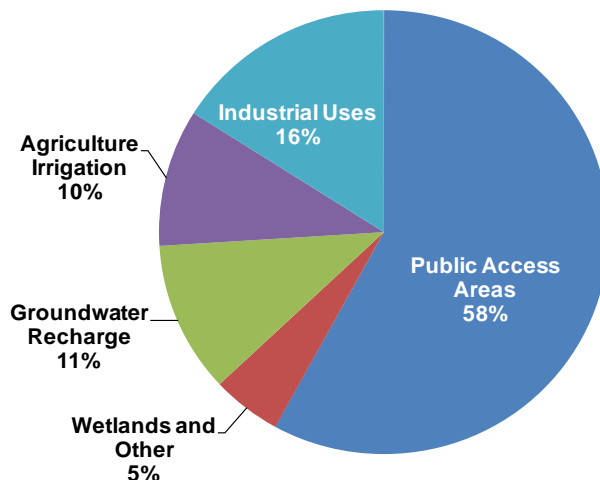

Figure 5-12
Water reuse in Florida by type (FDEP, 2012)

Figure 5-13 depicts the large population centers in Florida where reuse has the largest opportunity for growth. The statewide per capita usage based on 2011 population estimates and total reclaimed water utilization in 2011 was 38 gpd (143.8 L/day) of reuse per person in Florida. The Orlando-Tampa metropolitan area averages well over 50 gpd (189 L/day) per person, while Miami-Dade and Jacksonville Metropolitan areas average 7 and 10 gpd (26.5 and 37.9 L/day) per person, respectively (FDEP, 2011).

A future water quality issue that numerous stakeholder groups, including water resources utilities, have been watching in the state of Florida is the development of Numeric Nutrient Criteria (NNC). The national NNC dialogue began in 1998 with EPA's National Nutrient Strategy that detailed the approach EPA envisioned "in developing nutrient information and working with states and tribes to adopt nutrient criteria as part of their water quality standards." (EPA, 2007)

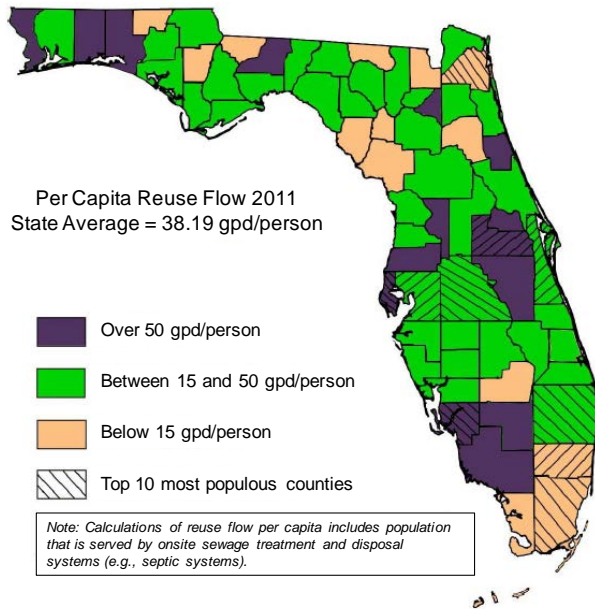

Figure 5-13
Map of per capita reuse flow by county in Florida (FDEP, 2012)

Working in partnership with EPA, FDEP established a Technical Advisory Committee in January 2003 and began development of state criteria. In 2008, a federal legal and rulemaking process ensued, which led to EPA developing their own freshwater NNC in 2010 and working towards proposing rules for primarily marine waters in 2012. Additionally in 2012, the FDEP NNC passed through the state rulemaking and legal process, and that rule has been submitted to EPA for review. It is still uncertain whether the federal or state led NNC rulemaking process will eventually evolve into the NNC rule that will be implemented in the state of Florida. Interested parties should stay tuned to both the federal and state processes to track important milestones over the coming year (EPA, n.d.; FDEP, 2012b; FR 77, 2012:13496-13499).

Unrelated to NNC, the 2008 legislature enacted laws that prohibit ocean discharge of treated wastewater by 2025 except as a backup to a reuse system. Sixty percent of the water currently discharged in ocean outfalls will have to be reused for a beneficial purpose, increasing reclaimed water use by at least 180 mgd (7.9 m³/s) by 2025. These requirements are based in part on reducing nutrient load to the coastal waters (Goldenberg et al., 2009).

North Carolina

North Carolina is the sixth fastest growing state in the United States, especially in the Research Triangle area, because of the benefits and popularity of the area. This growth increases the need for planning and timely response to meet growing resource demands. Recognition of this growth allows planners to consider an integrated water management approach to their water, wastewater, and reclaimed water utilities.

Climate change, recurring drought cycles, and increasing local temperatures result in an increase in irrigation demand to meet crop evaporation rates. At the same time, changes in precipitation patterns are causing planners to reassess previous plans. Even if the annual rainfall remains relatively constant, higher intensity rainfall can result in more runoff that is not as beneficial as multiple, less intense events. Shifts in time of year for rainfall events can significantly impact soil moisture during critical planting and harvesting periods. This can lead to an increase in supplemental irrigation for predictable crop yields. Recent changes in the North Carolina Reclaimed Water Regulations treat reclaimed water as a resource, allow many uses of reclaimed water by regulation, and increase the potential to use reclaimed water in agricultural applications, especially with Type 2 reclaimed water, the higher of two defined reuse qualities (NCAC, 2011). This higher quality reclaimed water has few agricultural restrictions (one being a 24-hour waiting period following application of reclaimed water prior to harvest). These new rules allow utilities to now consider wholesale supply of reclaimed water to agricultural interest, assuming both parties can come to agreement regarding the value of this water.

Although there may not yet be large power generating needs for reclaimed water in North Carolina, cooling water and industrial process water are attractive to industries and can be supportive of economic development for a community. New residential developments in communities facing water shortages are often able to develop and provide a benefit to residents if reclaimed water is included in a dual water system, allowing homeowners to establish landscape without water restrictions increasing their water bills or use restrictions negating their landscape investments.

In North Carolina today, nutrient reduction requirements and TMDLs resulting in new or re-issued discharge permits that will require installation of

advanced wastewater treatment to meet limit of technology nutrient removal are much like events in 1972 that led to the creation of the dual-piped reclaimed water system for St. Petersburg, Fla. The Wilson-Grizzle Act was passed by the Florida legislature in 1972. It required all utilities to cease discharge into Tampa Bay unless they installed advanced wastewater treatment equipment to meet nutrient reduction requirements. Today, St. Petersburg is known as the largest residential reclaimed water service provider in the United States (Crook, 2005). This same opportunity to develop dual piped water systems for new developments could increase use of reclaimed water for residential irrigation over time, minimize increased demands on the potable water system, and delay or eliminate costly nutrient removal improvements at WWTPs.

Going green (or, in some cases, gray) is sometimes driven by new development decisions to create a LEED-certified development or building. In the certification process, up to 10 points can be obtained through use of reclaimed water or on-site use of alternate waters. Currently in North Carolina, the use of graywater without treatment is not allowed (15A NCAC 18A); however, 2011 Session law has called for the development of graywater reuse rules to facilitate its safe and beneficial use. Currently, state/local plumbing authorities allow for the use of graywater for toilet flushing. Both national plumbing codes (Uniform Plumbing Code and International Plumbing Code) require use of purple pipe for all alternate water on-site. Alternate water is defined as reclaimed water, harvested rainwater, graywater, stormwater, and air conditioning condensate. This can create some confusion if a utility provides reclaimed water to a new development that also has alternate waters with some or no treatment.

The town of Cary has one of the more established reclaimed water systems in North Carolina, starting in 2001 with 9 mi of distribution pipeline from the North Cary WRF serving 350 customers (Miles, et al., 2003; The Town of Cary, n.d.; and [US-NC-Cary]). The town also provided a central bulk fill station at the North Cary WRF as shown in **Figure 5-14**. Since system inception, town staff members have trained over 800 bulk water users, mainly landscape and irrigation contractors, in the proper use of reclaimed water. This training is required in order to obtain and apply bulk reclaimed water from the WRF. A recent industry

article identified the Cary reclaimed water as “Purple...the new Gold” by serving as a resource during the drought to maintain landscape (Westmiller, 2010).



Figure 5-14
Cary, N.C., bulk fill station allows approved contractors, landscapers, and town staff to use reclaimed water

Durham County, N.C., expanded its reclaimed water program with storage, plant improvements, and a new distribution and metering system to supply supplemental reclaimed water to the town of Cary to begin service to the Cary West Reclaimed Water Service Area. Improvements at the County's Triangle WWTP included a 400,000-gallon ground storage tank, a new high-service reclaimed water distribution pump station, a bulk liquid chlorine feed system, a 24/20/16-in distribution system to serve the town of Cary and other county demands, and a town of Cary metering station.

The city of Raleigh Public Utilities Department currently manages two reclaimed water distribution systems (City of Raleigh, 2012). One is located in the Zebulon service area and currently serves seven customers, totaling approximately 36 million gallons (1.6 m³/s) annually. The larger Southeast Raleigh reclaimed water distribution system from the Neuse River WWTP is being extended to serve the Walnut Creek Environmental Education Center and the North Carolina State NCSU Centennial Campus and Poole Golf Course.

Raleigh has four bulk reclaimed water stations located throughout the service area at the Neuse River WWTP (southeast Raleigh), E. M. Johnson Water Treatment Plant (North Raleigh), Little Creek WWTP (Zebulon), and Smith Creek WWTP (Wake Forest). Bulk

reclaimed water is free of charge after a user completes certification training by the Public Utilities Department. Uses for bulk reclaimed water include irrigation, hydro-seeding, pesticide and herbicide application, concrete production, power/pressure washing, and dust control.

There is also a small on-site reclaimed water system in Wilkerson Park in the city of Raleigh. Wastewater is collected, treated, and reused on-site under a permit issued by the local health department.

The University of North Carolina (UNC) at Chapel Hill began addressing high water use a decade ago with traditional water conservation efforts (low flow showerheads, faucet aerators, and dual flush toilets) and by creating closed loop water service to research laboratories resulting in a 27 percent reduction in water use per square foot. More stringent stormwater regulations in the town of Chapel Hill and Jordan Lake nutrient reductions imposed by the state led to rainwater harvesting on the UNC campus. Harvested rainwater and stormwater is stored in cisterns (constructed under playing fields) and used for irrigating the soccer/intramural fields and baseball stadium, landscaping, and toilet flushing. Two 100-year drought events within 7 years led to the addition of reclaimed water to support campus activities in 2009. Five interconnected chilled water plants (50,000 ton capacity) on campus use 0.5 mgd (21.9 L/s). The UNC Hospital chiller plant uses an additional 0.2 mgd (8.8 L/s). The football and baseball fields are supplied with 0.03 mgd (1.3 L/s) of reclaimed water. Utilization of reclaimed water for uses previously provided potable water reduced potable water use by 37 percent. Finally, to increase system reliability and diversify supply, the rainwater/stormwater cistern system was provided with supply connections from the reclaimed water system (Elfland, 2010).

South Carolina

Water reuse is governed under the state land application rules and is most common along the coast via golf course irrigation. Where controlled access is part of the program, secondary treatment is acceptable. If a more publicly-accessible site is to be used, higher levels of treatment would be required. Some small towns use land application in lieu of surface water discharge in areas where land is inexpensive to purchase. A primary focus of land application permitting is groundwater protection.

Therefore, the higher the level of treatment and the greater the depth to groundwater, the more flexible a permit can be written.

Tennessee

Water reuse occurs throughout the state of Tennessee, including in Cumberland, Fayette, Franklin, Lawrence, Maury, Moore, Rutherford, Washington, Williamson, and White counties. Most reuse is for irrigation of golf courses, followed by irrigation for pasture land, residential areas, and parks. Reuse systems in Tennessee operate under a State Operation Permit issued by the Tennessee Department of Environment and Conservation's Division of Water Pollution Control. None of the existing facilities, however, use the reclaimed water for edible crop irrigation, groundwater recharge, or IPR applications. One case study in Tennessee highlights the importance of reuse in integrated planning as a means to address nutrient loading limits to a receiving stream as a result of urban growth [US-TN-Franklin].

5.2.4 Midwest and Great Lakes: Illinois, Indiana, Iowa, Kansas, Michigan, Minnesota, Missouri, Nebraska, Ohio, and Wisconsin

This section focuses on the regulatory context and drivers for water reuse in 10 states in the Midwest and Great Lakes region.

5.2.4.1 Population and Land Use

According to the 2010 United States Census, the population in the Midwest and Great Lakes Regions is around 65 million. The geographic center of the contiguous United States is found in Kansas. Chicago, Ill. and its suburbs form the largest metropolitan area in the Midwest, followed by Detroit, Mich.; the Twin Cities (Minneapolis and St. Paul, Minn.); Cleveland, Ohio; St. Louis, Mo. and the Kansas City, Mo. area. **Figure 5-15** shows change in population in the Midwest in the past decade, relative to the United States. The figure also shows the percent change in developed land coverage from 1997-2007.

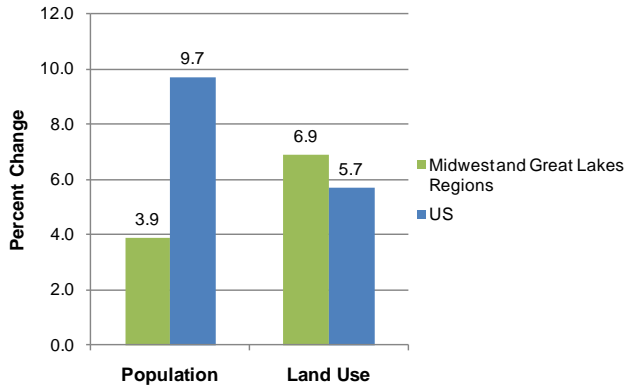

Figure 5-15
Change in population (2000-2010) and developed land (1997-2007) in the Midwest and Great Lakes region, compared to the United States

5.2.4.2 Precipitation and Climate

The Midwest states have varying hydrologic and climatic conditions that impact water use. The differences in population and land use in each state also affect consideration of reclaimed water over traditional water supplies. Common to most of the Midwest is a larger proportion of agricultural land and related agricultural processing industries. There are also heavy industrial areas that include mining, auto manufacturing, refining, and metal finishing.

The vast central area of the United States, located between the Central Atlantic coastal states and the Interior Plains states just east of the Rockies, is a landscape of low, flat to rolling terrain typified by vast acres of farmland largely affected by the Mississippi River Drainage System, as well as by the Missouri and Ohio Rivers and the Great Lakes. Rainfall decreases from east to west across the region. Much of the Midwest experiences a humid continental climate, which is typified by large seasonal temperature differences—warm to hot (and often humid) summers and cold (sometimes severely cold) winters. This region of the country is known for extreme weather events: floods in the winter and spring and droughts in the summer months. **Figure 5-16** depicts average monthly precipitation in the Midwest region by state.

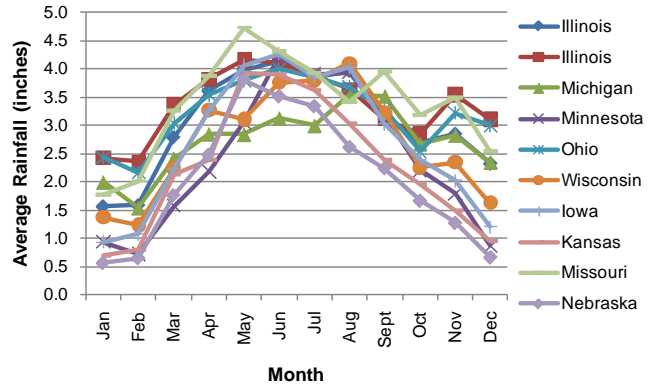

Figure 5-16
Average monthly precipitation in the Midwest

5.2.4.3 Water Use by Sector

Figure 5-17 shows freshwater use by sector in the Midwest and Great Lakes Region.

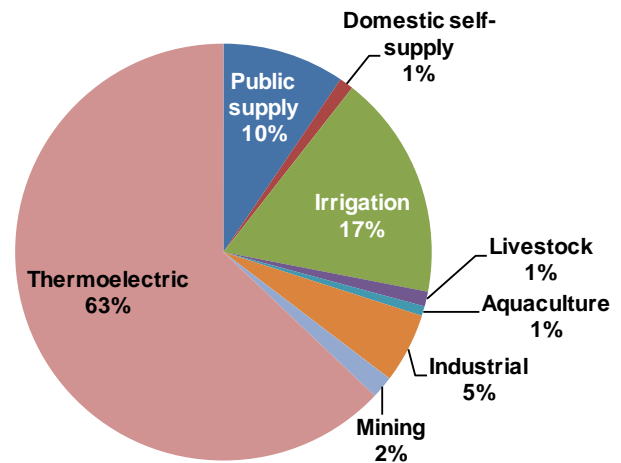

Figure 5-17
Freshwater use by sector for the Midwest and Great Lakes region

Given the different climatic regions and types of industry in the Midwest, water use varies among states. One common use for states with larger river sources such as the Mississippi, Missouri, and Ohio Rivers is the non-consumptive use for once-through cooling water at power generation facilities. This water use is not the optimum candidate for reclaimed water since it does not replace a consumed supply of groundwater or surface water, as would be the case for power plants with recirculated cooling systems. Lower effluent limit requirements being set for some municipal dischargers is expected to result in more

municipal wastewater facilities considering water reuse for future improvements projects.

An analysis of one state, Minnesota, is provided as a perspective on water use in other Midwest states.

More than 60 percent of the water used in Minnesota is for power generation facilities, mainly for once-through cooling, as depicted in **Figure 5-18**. Power generation facilities are supplied mostly by surface waters.

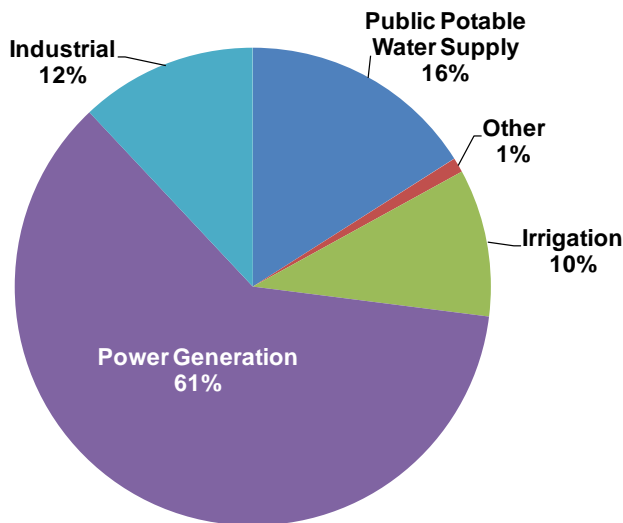

Figure 5-18
Water use in Minnesota, 2007 (Source: MDNR 2008)

The next largest use of water, around 16 percent of the total, is for potable water supply (water utilities), distributed by municipalities for domestic, commercial and industrial uses. Nearly two-thirds of the potable water in Minnesota is supplied by groundwater, as shown in **Figure 5-19**.

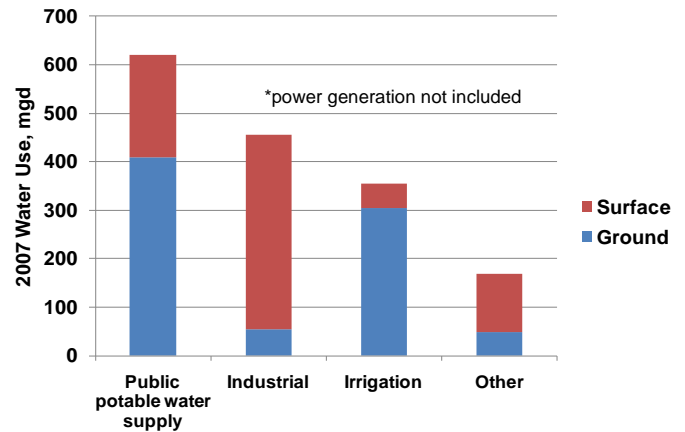

Figure 5-19
Water use in Minnesota by source*, 2007 (Source: MDNR 2008)

Water withdrawn by industries (those not served by water utilities) for various processing needs accounts for about 12 percent of the total water used in Minnesota. The majority of this is surface water used by the pulp and paper and mining industries. Agricultural processing accounts for the largest use of groundwater by industry. Irrigation accounts for about 9 percent of the total water used, and all other water uses comprise about 4 percent of the total water use.

Like many Midwest states, the larger users of groundwater in Minnesota are not always in proximity to populated areas with a sufficient reclaimed water supply, notably for agricultural irrigation and processing facilities. In 2005, the total industrial water use in Minnesota, excluding surface water supplies for power facilities, was estimated to be 445 mgd (19.5 m³/s), of which 75 mgd (3.3 m³/s) was used by industries in the Twin Cities area. The total WWTF discharge for the state is 425 mgd (18.6 m³/s), and 255 mgd (11.2 m³/s) is from WWTFs in the Twin Cities (Metropolitan Council Environmental Services, 2007).

5.2.4.4. States' Regulatory Context

The Midwest states are beginning to develop regulations and guidelines for water reuse, prompted by recent water reuse installations motivated by shrinking water supplies and other factors. Illinois, Indiana, Iowa, Michigan, Missouri, and Nebraska have water reuse regulations whereas Kansas, Minnesota, and Ohio have guidelines. Wisconsin currently does not have regulations or guidelines governing reuse.

5.2.4.5 Context and Drivers of Water Reuse

This section identifies drivers and characteristics that broadly apply to Midwest states with examples of current reuse practices and develops a range of considerations using Minnesota as an example. There are a variety of opportunities for broader implementation of water reuse practices in the Midwest. There are also a host of factors that affect the feasibility of reuse implementation. Water reuse practices in the Midwest are site-specific and based on a variety of drivers. The drivers can be grouped into four categories: water quality, water quantity, sustainable economic growth, and environmental stewardship (MCES, 2007).

Water Quality

A safe, cost-effective, and adequate water supply generally has been readily attained for most Midwest communities and industries. Historic water reuse applications have been water quality driven. Agricultural irrigation using treated wastewater effluent has been practiced in the Midwest's rural areas in lieu of summer pond discharges for facilities a significant distance from an acceptable receiving stream. More recent water reuse applications driven by discharge limitations include golf course irrigation in urban and resort areas and toilet flush water for buildings.

Water quality issues will drive future water reuse in the Midwest. As growing communities generate additional wastewater, there will be a need to provide higher levels of wastewater treatment to maintain or decrease discharge loads to the region's waterways. The development of TMDLs in the Mississippi River basin's sub watersheds will result in reduced effluent limits for phosphorus, solids, and total nitrogen for many municipal dischargers. Water reuse may become a cost-effective practice for communities where advanced treatment processes are required to meet new receiving stream discharge limits. If these communities are experiencing or forecasting water supply limitations, the benefits of a water reuse option could be even more pronounced. A new advanced WWTF in East Bethel, Minn. in the Twin Cities metro area will discharge high quality reclaimed water to rapid infiltration basins rather than discharging to the river.

Water Quantity

While water quality discharge limitations will increasingly be a factor in the Midwest, it is anticipated

that water supply limitations will be a driver in the near future. There are regions and areas specific to each state with an insufficient quantity of ground or surface water and/or impaired quality from various pollution sources.

In terms of water demand for crop irrigation, the northern plains states use 64 percent of total water withdrawals for agricultural irrigation, versus 14 percent for states to the east (Wu et al., 2009). This significant difference in water use is related to less precipitation in the northern plains states as well as a proportionately smaller population with a demand for municipal and power supply uses.

The mid-2000s surge in the biofuel industry prompted investigations for water supply options other than local groundwater in the Midwest's water supply limited regions. Ethanol facilities in North Dakota and Iowa are currently using reclaimed water.

Limited groundwater supply was also the driver for using reclaimed water for a sand washing operation in Marshfield, Wis., and several power generation facilities, such as those supplied by the Heart of the Valley Metropolitan Sewerage District, Wis.; Clear Lake Sanitary District, Iowa; and Mankato, Minn.

Sustainable Economic Growth

Water has historically been undervalued in the Midwest. With the exception of local or sub-regional areas with limited supplies of adequate quality, residents of the Midwest typically pay less for their water supply than areas of the United States with higher levels of water reuse.

While the past decades have focused on protecting the aquatic habitat of the Great Lakes resource and regional watersheds of the Mississippi River basin, future decades will increase efforts to protect ground and surface waters used for potable water supply. As observed with the surge of the biofuel industry, water demand for irrigation and industrial use already has exceeded or may at some point exceed the available groundwater supply in some areas. Communities that want to share in the economic gains of the industry need to be able to provide a sustainable water supply, and there may be more incentive to consider reclaimed water.

Environmental Stewardship

Conservation has been a part of many states' water protection programs, along with more stringent regulations for surface water dischargers. This stewardship ethic can drive reuse projects even when other drivers are not present and when economics would not point to reuse.

For example, the Shakopee Mdewakanton Sioux (Dakota) Community's (SMSC) 0.96 mgd (42 L/s) WRF, constructed in 2006, was initiated as part of SMSC's ongoing activities toward self-sufficiency and natural resources protection. The community's commitment to environmental stewardship is explained as follows: "The Dakota way is to plan for the Seventh Generation, to make sure that resources will be available in the future to sustain life for seven generations to come" (SMSC, n.d.). The facility, located in Prior Lake, Minn., is permitted to discharge to one of two wetlands, shown in **Figure 5-20**, with downstream ponded areas that provide water for SMSC's golf course irrigation system. State and federal agencies are working with the SMSC to explore aquifer recharge to be used primarily in the winter when irrigation is not needed.



Figure 5-20
The SMSC WRF and wetlands

Reclaimed water from Columbia, Mo., is directed to a series of managed wetlands operated by the Missouri Department of Conservation. The wastewater is fed through a series of channels and gates, largely by gravity, offsetting water that would have to be pumped from the ground or the nearby Missouri River for the wetlands. This saves on electrical costs, allowing the scarce public money to be spent instead on habitat

work, while preserving freshwater for additional uses. These 1,100 ac of wetlands provide habitat for migratory waterfowl and other wildlife. They are a very popular destination for bird watching and, in the fall, for duck hunting.

Emerging Water Reuse Practices

In some areas of the Midwest, additional emerging drivers may include augmenting or preserving both surface water supplies and groundwater supplies, power generation, and recreational/aesthetic reuse.

In the Chicago metro area, significant flows from regional wastewater treatment pass through the Lockport Powerhouse. Built in 1907, the powerhouse is used by the Metropolitan Water Reclamation District of Greater Chicago to control the flow of the Sanitary and Ship Canal and limit the diversion of water from the Lake Michigan Watershed. The district received approximately \$3 million of credit from Commonwealth Edison for transferring approximately 60 million kWhs of power safely generated through hydropower.

On Chicago's west side, a water reuse feasibility study was conducted for service in the vicinity of the Kirie WWTP. Three business/industrial parks in three separate villages are located near the plant, and O'Hare International Airport is to the southeast. Potential uses for reclaimed water to replace potable water use range from 1.3 to 1.9 mgd (57 to 83 L/s) based on the time of year. Potential uses include irrigation, cooling towers, industrial process water, stormwater basin cleaning, municipal solid waste truck washout, and wetland augmentation.

In some Midwest communities, recreational or aesthetic reuse occurs in the form of using reclaimed water to augment golf course ponds, both landscape ponds and water hazard features. This may be indirectly augmenting golf course irrigation needs.

The Village of Richmond, Ill., a small rural community west of Chicago, recently developed an ordinance to promote the preservation of rapidly shrinking groundwater supplies when other sources of water exist for specific uses. The ordinance describes specific instances where municipal water supply users would be required to use reclaimed water. The ordinance encourages water reuse in general. For example, industries are encouraged to use reclaimed water for nonpotable industrial processes. There are

both mandated and recommended applications. The following applications are mandated uses:

- Landscape watering except in playgrounds
- Landscape water features except in playgrounds frequented by children 10 years of age or under
- Industrial cooling water
- Toilet flushing at commercial, industrial, and public facilities
- Commercial car wash facilities
- Commercial, industrial, and public boiler feed water

The ordinance encourages other industrial users to consider reclaimed water for appropriate nonpotable industrial processes, specifically mentioning water for construction practices, commercial uses, enhancement of wildlife habitat, and recreation impoundments.

Recently, the state of Missouri was approached about the reuse of treated wastewater in intensive agriculture. The proposals would use wastewater to grow cellulosic biofuel crops in fields specifically constructed with wastewater reuse in mind to maximize production. In instances where all of the wastewater generated by a small town can be used during the summer recreation season, rather than discharged to a water body, it may enable that town to avoid costly upgrades due to new water quality regulations.

Water Reuse Practices in Minnesota

Current Minnesota reuse projects include five for golf course irrigation, one for building toilet flush water, one for wetland enhancement, one for energy plant cooling water, and 32 for agricultural irrigation (non-food crops; main discharge for seasonal stabilization ponds).

Limited water supply was the key driver for the largest water reuse application in Minnesota. The city of Mankato expanded its WWTF in 2006, shown in **Figure 5-21**, to provide the Mankato Energy Center, a 365-MW facility (ultimate capacity of 630 MW), with cooling water. The city provides up to 6.2 mgd (272 L/s) of reclaimed water to the Mankato Energy Center,

which returns its cooling water discharge to the WWTF (approximately 25 percent of the volume supplied) as a permitted industrial discharger. The cooling water is commingled with the WWTF process stream prior to dechlorination. Refer to [US-MN-Mankato] for more details.



Figure 5-21
Mankato Water Reclamation Facility

Water supply scarcity in Minnesota's southwest region affected the siting of ethanol facilities during the biofuel industry expansion of the mid-2000s. In conjunction with other planning activities, state agencies increased inventory research on groundwater resources and streamlined permitting practices. In addition, the state legislature became involved by supporting initiatives for water reuse, emphasizing the economic sustainability goals tied to water (MPCA, 2010a).

Legislation under H.F. 1231 introduced in 2009 provided in-kind matching grants for capital projects incorporating water reuse, including specific funds targeting ethanol facilities. Water conservation legislation passed in 2008, based on environmental stewardship and conservation drivers, could affect how municipalities plan for their water supplies. Public water suppliers serving more than 1,000 people (85 percent of Twin Cities metro suppliers) must implement a water conservation rate structure. The rate structure was required by Twin Cities metro area suppliers by 2010, and all remaining water suppliers are to implement the conservation rate structure by 2013 (MPCA 2010b).

Long-term planning for water reuse in Minnesota and other Midwest communities will be influenced by the

development of TMDL programs. For example, the Lake Pepin TMDL is projected to require a reduction of one-half the phosphorus and solids loads to Lake Pepin (Mississippi River segment), which will affect nearly two-thirds of Minnesota.

Implementation Considerations in Minnesota

Minnesota is one of several states that have not developed state water reuse criteria. Currently, Minnesota uses California's *Water Recycling Criteria* to evaluate water reuse projects on a case-by-case basis. In Minnesota, water reuse requirements are included in NPDES permits administered by the Minnesota Pollution Control Agency. This model has served well for the permits issued to date, but there is limited information available for those seeking to explore water reuse, and questions have surfaced regarding the applicability of the California criteria for cold-winter climates and specific issues for the Midwest region.

The modifications for reclaimed water production must continue to meet existing NPDES and other permit requirements and consider future permit conditions. Some treatment technologies result in concentrated waste streams, and there is concern that pollutant concentration discharge limits (i.e., TDS, chloride, sulfate, boron, and specific conductance) may exceed the water quality standards for some receiving streams. There are existing industries that cannot expand operations because they cannot cost effectively reduce salt concentrations in the discharge and meet their NPDES permit. Recent requirements for monitoring salty discharges at municipal WWTFs in Minnesota indicate that permit limits may be forthcoming for parameters that some WWTFs cannot currently achieve. The incorporation of reclaimed water practices may increase salt concentrations in the WWTF effluent and become a deterrent to water reuse at some facilities (MPCA 2011).

Most reclaimed water uses will require higher quality water than is currently produced by a WWTP, as with cooling water. Many Midwest communities have hard and high salt waters, which lead to more concentrated salts in the wastewater, particularly for areas relying on home softening systems. Removal of hardness and high salt levels significantly adds to the cost.

Reclaimed water is an emerging water supply for Minnesota communities and industries. Economic development, water supply limitations, and

environmental regulations and stewardship will increasingly drive the need to find alternative water supplies. Looking to balance income from water supply and the need to build more infrastructure, communities can partner with local industries and businesses to provide conditions where water reuse can provide environmental benefits and economic advantages for all partners.

5.2.5 South Central: Arkansas, Louisiana, New Mexico, Oklahoma, and Texas

This section focuses on the regulatory context and drivers for water reuse in five states in the South Central region.

5.2.5.1 Population and Land Use

Figure 5-22 compares the change in population in the South Central region to the United States over the past decade. The figure also compares the percent change in developed land between the region and the United States.

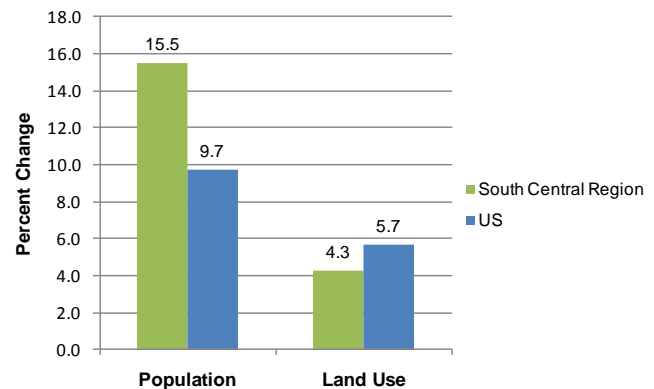

Figure 5-22
Change in population (2000-2010) and developed land (1997-2007) in the South Central region, compared to the United States

Compared to other regions, the South Central region is second only to the Mountain and Plains region in percent population growth. In the Southwest, the greatest population growth over the past decade has occurred in Texas (20.9 percent) and New Mexico (13.2 percent).

5.2.5.2 Precipitation and Climate

Figure 5-23 depicts average monthly precipitation in the South Central region by state.

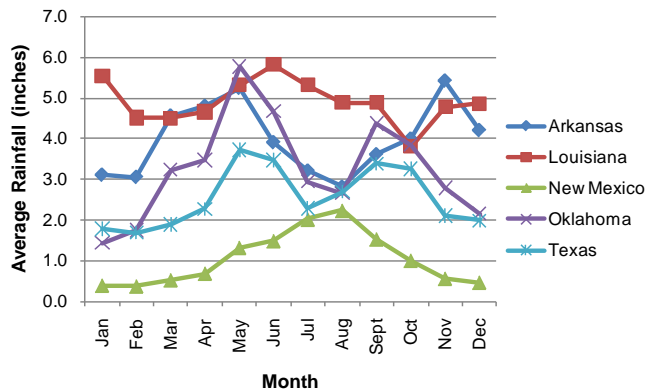

Figure 5-23
Average monthly precipitation in the South Central region

The graphs above present long-term average precipitation. Drought conditions for the last three years in the region have depleted surface water reservoirs and reduced recharge to groundwater aquifers. According to the U.S. Drought Monitor, as of May 1, 2012, over 83 percent of Texas was still in severe (D-3) to exceptional (D-5) drought conditions (Rosencrans, 2012). Southeastern New Mexico shares the fate of West Texas with severe to exceptional drought over most of the state, with relieve to abnormally dry (D-0) conditions in the northwest corner of New Mexico.

With reservoir and aquifer levels dropping, many communities are increasing their conversion to or use of reclaimed water. In West Texas, the Colorado River Municipal Water District is constructing a 2.3 mgd (101 L/s) IPR project that will convert Big Spring wastewater into higher than potable quality and blend the product water with raw water from one of three reservoirs that still has some water. The blended water is then treated at surface water treatment plants in six different communities [US-TX-Big Spring]. The community of Brownwood is in design/construction of a direct potable augmentation plant to supplement supply from a reservoir that may be depleted by the end of 2012 without significant rainfall.

5.2.5.3 Water Use by Sector

Figure 5-24 shows freshwater use by sector in the South Central region.

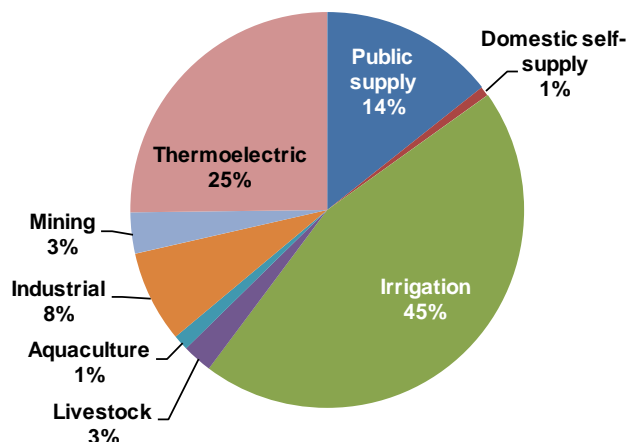

Figure 5-24
Freshwater use by sector for the South Central region

Irrigation is the largest water user in the region, and reclaimed water is commonly used for irrigation. However, the cost of incremental treatment and distribution for irrigation is a barrier to significant expansion in this sector. Thermoelectric power generation is another large potential use sector for expanding reuse.

5.2.5.4. States’ Regulatory Context

Arkansas and Louisiana

At this time, Louisiana does not have regulations or guidelines specifically addressing water reuse. Arkansas had guidelines prior and now has adopted land disposal regulations with a provision for irrigation of forage and non-contact crops.

New Mexico

In 2007, New Mexico Environment Department (NMED) created an updated reclaimed water guidance document “NMED Ground Water Quality Bureau Guidance: Above Ground Use of Reclaimed Domestic Wastewater” that supersedes 1985 and 2003 policy statements. Current guidance identifies four different qualities of reclaimed water, with Class 1A being the highest quality for unrestricted urban uses. Class 1A is based on treatment processes that remove colloidal material and color that can interfere with disinfection. Classes 1B, 2, and 3 are based on secondary treatment processes. Spray irrigation of food crops is not allowed, although surface irrigation with Class 1B or 1A is allowed without contact with edible portions of crops.

Oklahoma

Oklahoma has proposed and adopted new water reuse regulations in Chapter 627 Water Reuse and Chapter 656 Water Pollution Control Facility Construction Standards, which became effective July 1, 2012. The new rules create four categories of reclaimed water (Categories 2 through 5). Each category has a different level of treatment and permitted uses. Regulations for Category 2 for unrestricted access irrigation exclude application on food crops that could be eaten unprocessed and on processed food crops within 30 days of harvest. For Category 3 reclaimed water, the regulations also exclude use on athletic fields with potential for skin to ground contact.

Current reuse applications in Oklahoma have been primarily small community irrigation systems. Uses have expanded into higher intensity agricultural irrigation, unrestricted golf course irrigation, livestock watering, dust control and soil compaction, concrete mixing, cooling towers and chilled water cooling, industrial process water, boiler feed, and land vehicle and equipment washing, excluding self-service car washes.

Texas

Reclaimed water use in Texas is regulated by TCEQ based on Chapter 210 Regulations in the state code. Chapter 210 was first created in 1997 with additions in 2002 to add sub-chapter E specifically addressing industrial process water reuse; in 2005 with sections added at 210, 281, and 285 to describe conditions for graywater use; and in 2009 to amend section 210.33 related to bacterial limitation revisions. Monitoring for *Enterococci* with a limit of 4 CFU/100 mL as a monthly geometric mean and no single sample greater than 9 CFU/100 mL was added for Type I Reclaimed Water (unrestricted use) with a limit of 35 CFU/100 mL added for Type II Reclaimed Water (restricted use). Many stakeholders participated in a three-year review of the 210 rules with changes proposed to TCEQ in 2003 (Vandertulip, et al., 2004). Some of the proposed revisions were incorporated into a revised WWTP design rule when Chapter 317 was revised to Chapter 217 by TCEQ, effective August 28, 2008.

Reclaimed water use in Texas is by authorization from the TCEQ Executive Director upon application by a reclaimed water producer. The producer must have a permitted WWTP and provide reclaimed water of the

quality (Type I or II) required for the intended use and meet all Chapter 210 requirements. In 2007, the city of Midland petitioned TCEQ for new rulemaking relative to siting, permitting, and construction of satellite reclamation facilities. Chapter 321 P was created and effective November 28, 2008. Chapter 321 extends the executive director authorization process by allowing construction and operation of a satellite WRF upstream of an existing permitted WWTP. If special siting requirements are met, the facility can be constructed by authorization without additional hearings or permits. The buffer zone requirement doubles to 300 ft (91 m) from any treatment unit unless the reclamation facility is in a building with odor control, then the buffer zone drops to 50 ft (15 m). All screenings and waste biosolids must be returned to the wastewater collection system, and no increase in permitted treatment capacity is included (Vandertulip and Pype, 2009).

For larger systems serving a population of more than 1 million, the state legislature passed House Bill 1922 in 2009, allowing larger systems to commingle reclaimed water supplies in a common distribution system and to discharge from the reclaimed water system at any permitted discharge point. This legislation was proposed based on supply reliability and balancing system capacity, specifically to address the transmission loop for SAWS. With three water reclamation facilities feeding into the reclaimed water distribution system and seven discharge points, portions of the system were isolated by valves as TCEQ determined that discharge from one plant could not supply a system with a discharge point permitted to another WRF. HB 1922 clarified that a looped system operated by one entity could operate with multiple feeds and multiple discharge points. If a permit violation were to exist and the offending WRC could not be identified, any permit violations would apply to the largest WRF in service (Schenk and Vandertulip, 2009).

5.2.5.5 Context and Drivers of Water Reuse

In arid regions from Texas west through Arizona (including Oklahoma and New Mexico), reuse is becoming a vital component of water management. These communities have embraced the use of alternative sources of water to meet the growing need for the vital element. Drought conditions in the Southwest and many parts of Texas have driven municipalities to exploit the use of reclaimed water for

nonpotable uses as well as for stream and aquifer augmentation.

Texas

El Paso Water Utility (EPWU) began pilot testing for IPR to augment the Hueco Bolson aquifer in 1978 with operation of an 8 mgd (351 L/s) facility beginning in 1985. They have expanded their portfolio of water reuse by conventional distribution of reclaimed water for irrigation, doubling the aquifer augmentation system and implementation of the largest inland brackish desalination project in the United States with 27.5 mgd (1.2 m³/s) of supply added to the municipal water system. This integrated resource approach is being followed by the Colorado River Municipal Utility District (CRMUD) direct blending project in Big Spring, Texas [[US-TX-Big Spring](#)], where CRMUD is constructing a 2.3 mgd (101 L/s) water purification plant to treat Big Spring secondary filtered wastewater effluent through an MF/RO/advanced oxidation process (AOP) treatment process resulting in a product water with quality superior to potable quality. This product water will be blended in a raw water transmission main with water from Lake Spence and delivered as raw water to six existing surface water treatment plants operated by CRMUD member communities.

Reclaimed water is marketed as having significant advantages, both for the consumer as well as for the supplier. The ability to have a reliable source of water during drought and at a lower rate than potable water provides the greatest advantages to the consumer. However, in the supplier's standpoint, meeting contractual agreements whether based on quantity, redundancy, or even quality may become costly in the short or long term.

Water Quality and Soil Conditions

In some areas of the West, as is the case of El Paso, the source water has higher levels of salts than many water sources in other water rich communities. This creates a domino effect as it impacts the quality of reclaimed water, which has about twice the levels of salts than its source water. The reuse projects extend to areas within proximity of the treatment facilities. The soils in these areas are clay, caliche, or a combination of the two. Clay and caliche soils prevent the percolation or leaching of salts, creating a surface accumulation of salts, which hinders the proper development of plants. The areas where optimal soil

conditions are found are limited and might be far from the treatment facility. Thus, application of reclaimed water must be carefully managed to prevent detrimental effects on soil quality and performance of the vegetative landscape due to unfavorable soil characteristics (Miyamoto, 2000, 2001, and 2003) [[US-TX-Landscape Study](#)].

To offset impact of saline water supplies, EPWU has incorporated into its project planning a protocol to perform a soil suitability assessment to determine the preliminary condition of the soil that will be subjected to reclaimed water application and the vegetative landscape to set a benchmark condition of the plants and assess any potential to damages after exposure to reclaimed water (Miyamoto, 2004). This tool has been significantly important, as it ranks the suitability of all potential customer sites in order of suitable, suitable with some modification requirements, or non-suitable, prior to finalizing the project and selecting those customers that will be allowed to connect. Customers that are categorized as non-suitable or suitable with some modification are offered the opportunity to explore the level of retrofitting required for reuse. Customers who do not wish to invest in any amendment, are withdrawn from the project, thus minimizing, in most cases, the need to extend pipelines to areas where there are not a high number of customers and where it may not be financially feasible to recuperate the investment.

In the El Paso scenario, mitigation of seasonal spikes in salinity of reclaimed water has been addressed in a more rudimentary fashion. Although concentration of salts in reclaimed water above the maximum limits required by a specific customer may not happen every year, the utility has learned that these fluctuations in TDS can be mitigated by the ability to blend with potable water at a localized point, thus preventing claims for plant damage. To dilute reclaimed water with elevated salinity, reservoirs are fitted with piping that can be manually operated to add potable water to the reservoir to blend with the reclaimed water. The cost to the customer is not modified when potable water is added to the system; it does, however, increase the operational costs to the utility.

In addition to the ability to blend with potable water, the reservoirs have been equipped with recirculating and chlorine injection systems that allow for chemical addition and water mixing, thereby preventing

pathogen regrowth by maintaining a minimum chlorine residual level.

Careful consideration of soil composition and existing plant material in selection of potential irrigation customers and impacts of aggressive conservation programs are all aspects of balancing water that have reshaped the planning and phasing of reuse programs in the United States.

In-depth evaluation of soils subjected to irrigation with reclaimed water has been one of the most important considerations in planning a reuse program in El Paso. These studies have been instrumental in the effective use of reclaimed water and prevention of further soil degradation. Costs for biennial soil monitoring have also been budgeted by the utility, with no cost assessed to the customer. Customers do absorb the cost for any plant loss and soil amendments necessary.

Conservation Impact on RW Quality

Other conservation measures, such as use of low and ultra-low flow showerheads, toilets, sinks, washers, etc., continue to increase throughout the United States, so wastewater flows to the treatment facilities may be decreasing. Added to this is the increased use of *in-situ* graywater systems and increased tendencies for achieving sustainability for “green buildings” energy and conservation credits, where applicable. All combined, these factors may, in some instances, impact not only the quantity but also the quality of wastewater available for reclamation.

A study performed by EPWU in 2007 reflected the fact that increased conservation measures contributed to a decline of flows into WWTPs (**Figures 5-25 and 5-26**). In a period from 1994 to 2006, the strength of the wastewater inflow increased in terms of BOD₅ (**Figure 5-27**) and ammonia nitrogen (NH₃-N) (**Figure 5-28**) at three of the WWTPs studied. Total suspended solids (TSS) concentration also increased at one of the WWTPs (**Figure 5-29**) (Ornelas and Rojas, 2007).

Impacts from water conservation must also be considered during a reuse project planning phase, including reductions in flow where no population increases are expected to overcome decreases in flow. Similar impacts to reduced wastewater influent flows and higher strength wastewater influents have been found in San Antonio and San Diego.

Oklahoma

Reclaimed water has been used in some portions of Oklahoma (Oklahoma University golf course, Norman, Okla.) since 1996. More recently, the city of Norman conducted public forums on Sustainable Water Resources in 2010 and included water reuse as one of the available options to conserve and extend the regional water resources (Clinton, 2010).

On May 9, 2011, the Bureau of Reclamation (USBR) announced the selection of nine feasibility studies for funding under WaterSMART’s Title XVI Water Reclamation and Reuse Program in California, Oklahoma, and Texas. The Central Oklahoma Water Conservancy District will conduct a feasibility study in collaboration with surrounding entities to assess alternatives to augment the supply of Lake Thunderbird in Central Oklahoma through the treatment of effluent or surface water. The study will assess alternatives to help postpone or eliminate withdrawals from the local aquifer and alleviate pressure to secure inter-basin water transfers (WRA News, 2011).

Title XVI of P.L. 102-575 provides authority for the USBR water reuse program. WaterSMART is a program of the U.S. Department of the Interior that focuses on improving water conservation and sustainability (USBR, 2012).

New Mexico

New Mexico also is beginning to use more reclaimed water to augment limited natural resources. Projects are in place in many communities (Las Cruces, Alamogordo, Hobbs, Gallup, Santa Fe, and Clovis), and larger projects are expanding in Albuquerque and the surrounding area. The Albuquerque Bernalillo County Water Utility Authority operates the Southeast Water Reclamation plant, which provides reclaimed water to several golf courses, city parks, and a power plant under a simplified regulatory framework. Irrigation of park green space replaces 12 percent of the city’s water demand (Stomp, 2004). Including reclaimed water to reduce aquifer withdrawals is critical to slowing aquifer decline and subsidence in Albuquerque.

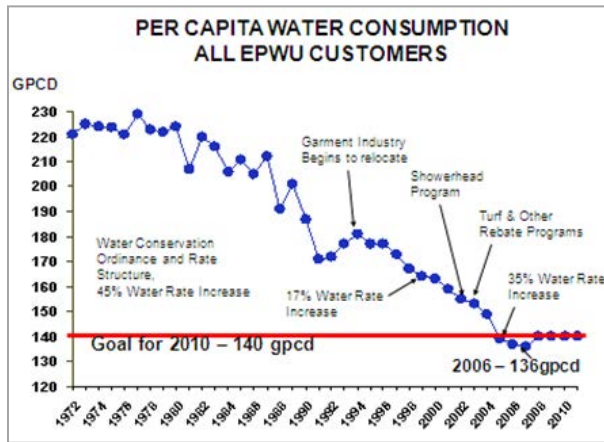

Figure 5-25
Water consumption in El Paso, Texas

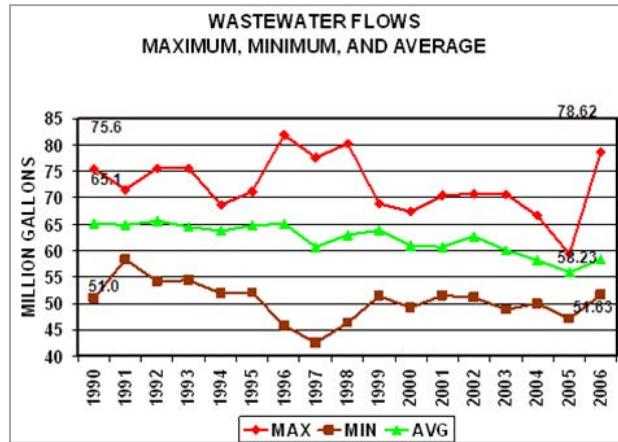

Figure 5-26
Wastewater flows in El Paso, Texas

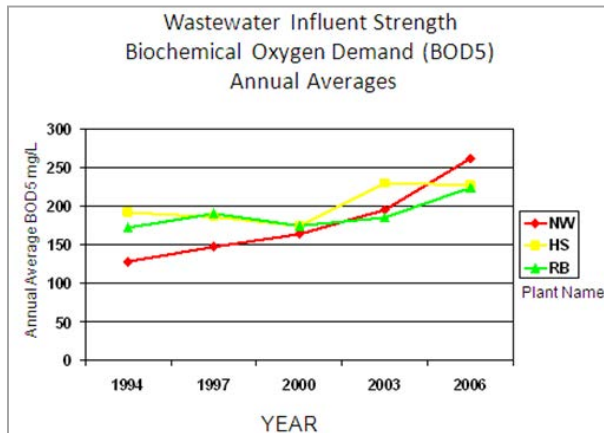

Figure 5-27
Wastewater influent strength, BOD₅

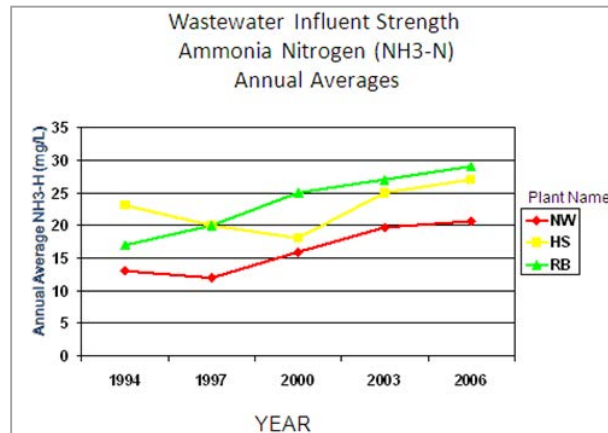

Figure 5-28
Wastewater influent strength, NH₃-N

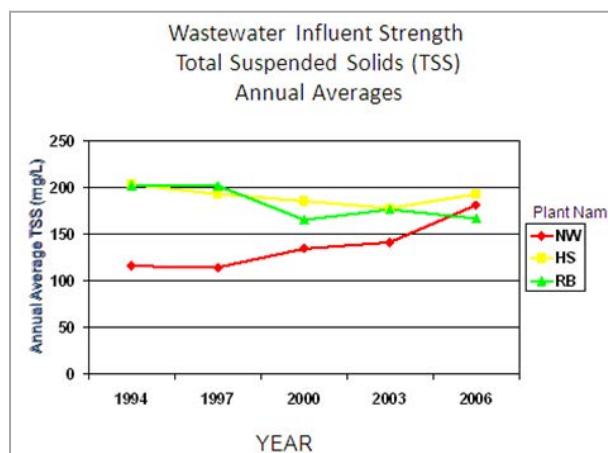

Figure 5-29
Wastewater influent strength, TSS

The state’s fastest-growing community, Rio Rancho (located to the northwest of Albuquerque) could not obtain adequate potable water without meeting some of its needs with reclaimed water. One design-build project constructed two 0.6 mgd (26.3 L/s) MBR reclamation plants (Mariposa WRF and Cabezon WRF) that provide high quality reclaimed water for landscape and golf course irrigation. The Cabezon WRF design provides for future addition of increased treatment for indirect potable applications under a direct injection aquifer recharge project (Ryan, 2006).

North of Albuquerque at the Tamaya Resort, Santa Ana Pueblo built a WRF in conjunction with a Native American Casino/Resort and began using reclaimed water to irrigate the Pueblo’s golf course in the late 1990s. The facility was further upgraded in 2007 (WaterWorld, n.d.).

5.2.6 Mountain and Plains: Colorado, Montana, South Dakota, North Dakota, Utah, and Wyoming

This section focuses on the regulatory context and drivers for water reuse in six states in the Mountain and Plains region.

5.2.6.1 Population and Land Use

Figure 5-30 compares the percent change in population and in developed land coverage in the Mountain and Plains Regions to the entire United States over the past decade.

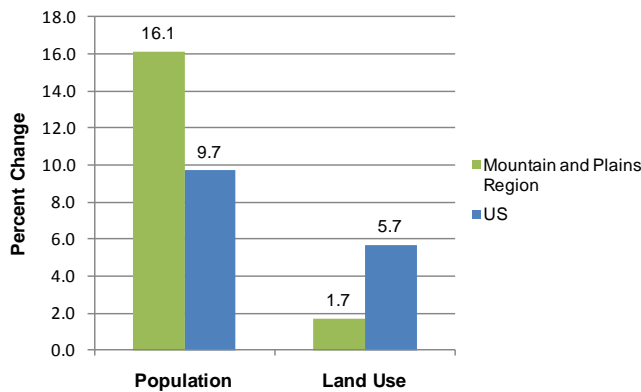

Figure 5-30 Change in population (2000-2010) and developed land (1997-2007) in the Mountain and Plains region, compared to the United States

While Montana, North Dakota, and South Dakota have seen less than 10 percent population growth over the past decade, other states in the region have had more rapid growth. Population growth in Wyoming (14.1 percent), Utah (23.8 percent), and Colorado (16.9 percent) bring the regional population growth above the national average. In fact, on a percentage basis, this region has seen the largest population growth in the nation over this period.

5.2.6.2 Precipitation

Figure 5-31 depicts average monthly precipitation in the Mountain and Plains region by state.

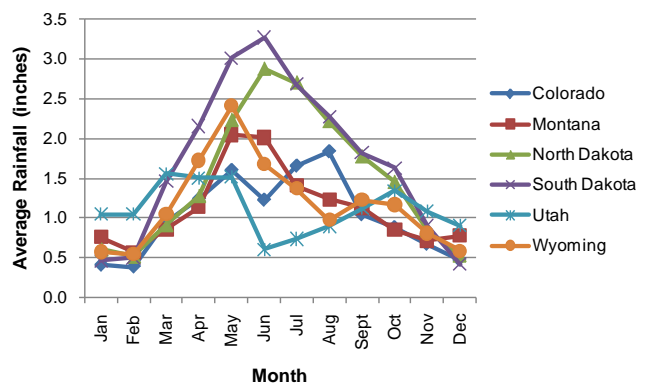

Figure 5-31 Average monthly precipitation in the Mountain and Plains region

Rainfall in this region typically peaks during the summer growing months. Combined with low density development (on average), this weakens some demand for reclaimed water use. As noted previously for Colorado, due to water rights conflicts, rainfall capture is not allowed to supplement local water demands.

5.2.6.3 Water Use by Sector

Figure 5-32 shows freshwater use by sector in the Mountain and Plains region.

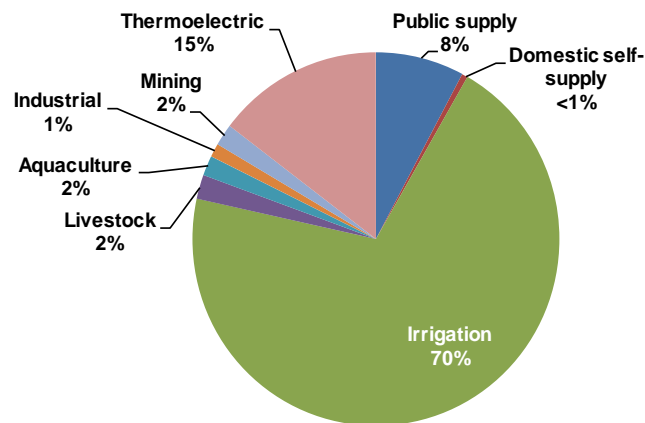

Figure 5-32
Freshwater use by sector for the Mountain and Plains region

Although irrigation is the largest water user in the region and reclaimed water is commonly used for irrigation, cost of incremental treatment and distribution to is an impediment to expansion of reclaimed water integration.

5.2.6.4. States' Regulatory Context

Colorado

The Colorado Water Quality Control commission administers four reclaimed water regulations in the Code of Colorado Regulations 1002-84 Reclaimed Water Control Regulations. The regulation identifies three qualities of reclaimed water: Classes 1, 2, and 3, with Class 3 being the highest quality. Class 3 requires secondary treatment filtration and disinfection for use in unrestricted urban applications. Colorado water rights limit the amount of reclaimed water that can be used, with quantities limited to water quantities imported from western Colorado to the east side of the Rocky Mountains [[US-CO-Water Rights](#)].

Montana

Montana established graywater rules in 2007 and updated those rules in 2009 as one step in providing higher quality on-site treatment and reducing water demands. Over the last three years, Montana DEQ staffs have been developing new wastewater design and treatment regulations, including a guidance document on reclaimed water. As of the time of publication, the new rules and standards are currently under review and public hearings.

South Dakota

South Dakota has guidelines on the reuse of reclaimed water for irrigation of food and non-food crops (including restricted urban reuse). Environmental reuse (in this case, releasing treated wastewater back to a water body) and groundwater recharge are covered by rules governing surface water quality standards and wastewater discharge permits.

North Dakota

North Dakota has guidance on water reuse for a number of categories (urban, agriculture, industrial, environmental, and groundwater recharge). While other categories of reuse are not explicitly covered at this time, guidance would allow it on a case-by-case basis.

Utah

Utah Division of Water Quality rules appear in Chapter R317-1, Utah Administrative Code. The rules provide for on-site use of reclaimed water inside a treatment plant boundary for landscape irrigation, washdown, and chlorination system feed water. Chapter R317-3-11 provides for alternate disposal methods of land application and reuse of either Type I (potential human contact) or Type II (human contact unlikely). Type I reuse is allowed for residential irrigation, urban uses, food crop irrigation, pastures, and recreational impoundments where human contact is likely. As of 2005, 10 projects were reusing over 8,500 ac-ft (7.6 mgd or 333 L/s) of reclaimed water, primarily for agricultural, golf course, and landscape irrigation (The Utah Division of Water Resources, 2005).

Wyoming

Wyoming does not have specific regulations or guidelines for water reuse; however, surface water discharge (environmental reuse) and groundwater recharge are covered through the discharge permitting rules. Any other uses, such as restricted and unrestricted urban reuse, agriculture irrigation, and both food and non-food crops are addressed on a case-by-case basis using the construction permitting regulations.

5.2.6.5 Context and Drivers of Water Reuse

Colorado

Prior to the inception of the Code of Colorado Regulations 1002-84 Reclaimed Water Control Regulations, several communities had been using reclaimed water for irrigation for many years.

Currently, 28 facilities in Colorado treat and distribute reclaimed water for beneficial uses, including irrigation, animal exhibit cleaning at the Denver Zoo, and cooling water for the Xcel Energy Plant [US-CO-Denver, US-CO-Denver Zoo, US-CO-Denver Energy, and US-CO-Sand Creek]. Several communities depend on reclaimed water in order to meet their irrigation needs. There are now more than 400 approved sites for the use of reclaimed water in Colorado. With current demands for water and expanding drought conditions, the use of reclaimed water in Colorado is moving not only to include new facilities, but possibly new uses, as well.

Montana

One of the earliest water reuse projects in Montana was at Colstrip, Mont. (Vandertulip and Prieto, 2008), which was originally a company mining town providing coal for locomotives. The mine and town were later sold to a power company, and reclaimed water was used for cooling and other industrial applications. Industrial applications, being less seasonal, are still considered a viable opportunity for reclaimed water.

South Dakota

The primary reuse of reclaimed water in South Dakota is irrigation of non-food crops.

North Dakota

Tharaldson Ethanol recognized the opportunity to provide reclaimed water for a 120 million gallon ethanol facility in Casselton, N.D. A 1.4 mgd (61 L/s) advanced membrane facility was constructed to treat city of Fargo WWTF effluent and transport it 26 miles to the ethanol facility by Cass Rural Water District. Waste streams from the ethanol facility are conveyed back to the Fargo WWTF and treated as part of the discharge to the Red River. In addition, reclaimed water is used in Jamestown, Fargo, and Dickinson for hydraulic fracturing.

Utah

Agricultural reuse, primarily for disposal purposes, has been the primary use of reclaimed water in Utah. To date, there has not been significant demand for alternative water sources, such as reclaimed water, for other uses. One agricultural project for the Heber Valley Special Service District uses 1.4 mgd (61 L/s) in agricultural applications to comply with a zero discharge requirement to the Provo River. There are several golf course irrigation projects and planning for

future uses in areas where population growth will likely exceed zero discharge capacity (Utah Division of Water Resources, 2005).

Wyoming

Until recently, water reuse projects in Wyoming were few and relatively small. Cheyenne launched the first major water recycling program in Wyoming, winning the WRA Education Program of the Year Award in 2008. Water reuse is regulated through issuance of construction permits, and up to nine facilities have been identified as using nearly 1,000 ac-ft (0.9 mgd or 39 L/s) of reclaimed water per year (0.3 billion gallons per year), primarily for irrigation. Recently, the Red Desert treatment facility opened in Rawlins, Wyo., treating up to 0.9 mgd (39 L/s) of water from hydraulic fracturing operations for reuse in subsequent hydraulic fracturing operations. Marathon Oil's Adams Ranch treatment facility in Sheridan, Wyo., is treating up to 1.5 mgd (66 L/s) of "produced water" through an innovative green sand, ion exchange softening, and RO process. This project, which returns water to the ranch for irrigation and stream flow augmentation, was recognized by the American Academy of Environmental Engineers with its 2012 Honor Award for Industrial Waste Practice.

5.2.7 Pacific Southwest: Arizona, California, Hawaii, Nevada, U.S. Pacific Insular Area Territories (Territory of Guam, Territory of American Samoa, and the Commonwealth of the Northern Mariana Islands), and 147 Federally Recognized Tribal Nations

This section focuses on the regulatory context and drivers for water reuse in the Pacific Southwest region of the United States, which includes Arizona, California, Hawaii, Nevada, the U.S. Pacific Insular Area Territories, and 147 federally recognized tribal nations.

5.2.7.1 Population and Land Use

Figure 5-33 compares the percent change in population for the Pacific Southwest states of Arizona, California, Hawaii, and Nevada to the entire United States over the past decade. The figure also compares the percent change in coverage of developed land in the region and the United States over the past decade.

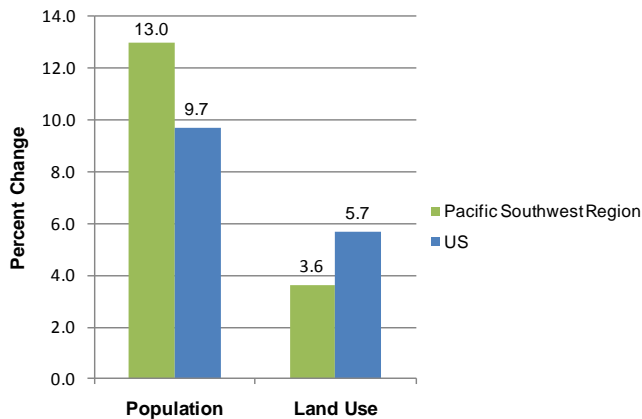

Figure 5-33
Change in population (2000-2010) and developed land (1997-2007) in the Pacific Southwest region, compared to the United States

The Pacific Southwest states have seen significant population growth over the past decade, particularly in Arizona (24.6 percent) and Nevada (35 percent). Looking back at two decades, Arizona and Nevada have experienced truly staggering growth, with 74.4 percent and 124.7 percent growth, respectively, since 1990. These two states experienced the greatest growth rates in the nation since 1990. California’s growth rate over the past decade was similar to the national average, at 10.0 percent, but has grown by 25.2 percent since 1990. With California being the most populous state in the nation, home to 37.3 million residents, the growth rate is nonetheless quite significant from a standpoint of natural resources, since the state added 3.4 million residents in 10 years. In terms of absolute numbers, this represents the largest population increase in the country during this period.

Hawaii has exceeded the national average, with a growth rate of 12.3 percent. Hawaii has a resident population of 1.36 million people and annual visitor arrivals of 9.13 million. It is the only state not located on the North American continent and the only state located within the tropics. Lying 2,100 mi west and south of California, Hawaii shares the same general north latitude as Mexico City, Calcutta, Hong Kong, Mecca, and the Sahara Desert. Six major islands (Hawaii, Maui, Oahu, Kauai, Molokai and Lanai) and two smaller islands (Niihau and Kahoolawe) totaling 6,463 mi² comprise an island chain stretching northwest to southeast over a zone 430 mi long.

5.2.7.2 Precipitation and Climate

Figure 5-34 depicts average monthly precipitation in the states of the Pacific Southwest—Arizona, California, Hawaii, and Nevada.

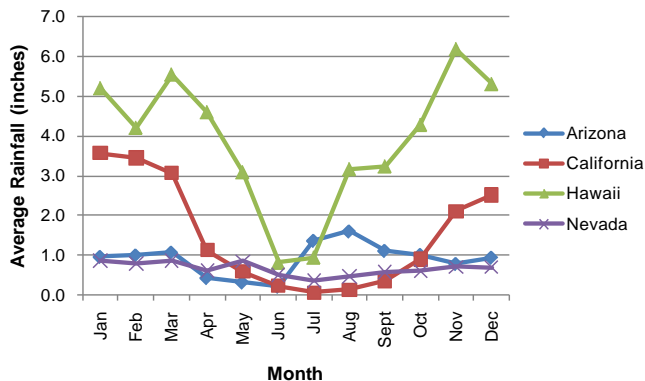

Figure 5-34
Average monthly precipitation in the Pacific Southwest region

There is obvious variance in annual rainfall between Hawaii and the three contiguous states. Within California, the average condition shown in the graph is potentially misleading, with an annual average low rainfall of 1.6 in (4 cm) at Cow Creek in Death Valley and 104.18 in (264.6 cm) at Honeydew in northern California. With a statewide average of 22.2 in (56.3 cm), California ranks 40 in the list of wettest states (Coolweather, n.d.). Arizona averages 13.61 in (34.6 cm) per year with an annual range from 3.01 in (7.6 cm) in Yuma to 22.91 in (58.2 cm) in Flagstaff. Arizona is ranked the 47th wettest state (Coolweather, n.d.). Nevada is the driest state in the United States. Annual rainfall varies from 4.49 in (11.4 cm) per year in Las Vegas to 9.97 in (25.4 cm) in Ely (NOAA, n.d.). With the largest population and driest climate in the state, Las Vegas faces a significant challenge in meeting its water resource needs.

Hawaii’s extreme geographical variations are manifest in extreme geographical rainfall variations. Although almost half the state is within 5 mi (8 km) of the seashore, 50 percent of the state is above 2,000 ft (609.6 m) in elevation and 10 percent is above 7,000 ft (2,133.6 m). Three mountain masses rise over 10,000 ft (3,048) above mean sea level, with Mauna Loa and Mauna Kea rising over 13,000 ft (3,962.4 m).

It is not unusual for snow to cap the summits of Mauna Loa, Mauna Kea, and Haleakala when winter storm

events are combined with below freezing temperatures.

Dominant trade winds blowing in a general east to west direction and the influence of the islands' terrain provide special climatic character to the islands.

Constant flow of fresh ocean air across the islands and small variation in solar energy are principal reasons for the slight seasonal temperature variations through much of Hawaii. Lowland daytime temperatures are commonly 70 to 80 degrees F (21.1 to 26.6 degrees C), and nighttime temperatures commonly range from 60 to 70 degrees F (15.5 to 21.1 degrees C).

Hawaii's steep rainfall gradients are reflected in the significant variations in precipitation throughout the islands and across individual islands. The lowest annual average precipitation is 5.7 in (14.5 cm) at Puako, Hawaii Island, and the highest average annual precipitation of 460.00 in (11.7 m) is at Mount Waialeale, Kauai. Overall, however, Hawaii's actual average annual rainfall is about 70 in (178 cm). **Figure 5-34** depicts average monthly precipitation in Hawaii.

5.2.7.3 Water Use by Sector

Figure 5-35 shows freshwater use by sector in the Pacific Southwest region states of Arizona, California, Hawaii, and Nevada.

The Pacific Southwest includes several of the driest states in the continental United States and Hawaii, with equally dry areas contrasted by areas with high rainfall. California has a long history of water reuse, while Hawaii's experience is more recent.

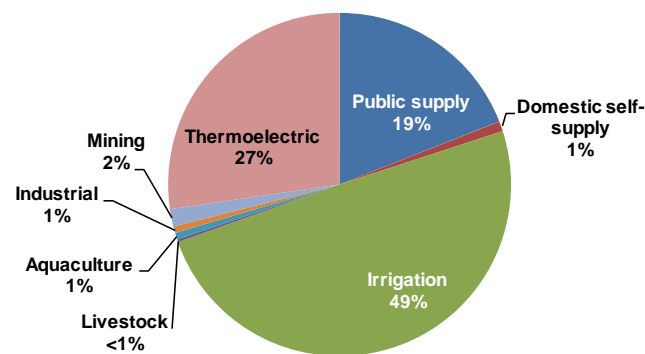

Figure 5-35
Freshwater use by sector for the Pacific Southwest region

Irrigation use is common among the four states with California's use for agricultural and landscape irrigation accounting for 54 percent of the reuse. Arizona has significant water reuse in the power industry with over 80 mgd (3.5 m³/s) devoted to supporting power generation at Palo Verde Nuclear Generation Station. One trend in each of the states is increased interest in IPR to support sustainable potable water supplies to meet growing populations.

5.2.7.4. States' Regulatory Context

Arizona

Reclaimed water regulations in Arizona have evolved since initial adoption in January 1972. The current regulations, adopted in January 2001, address reclaimed water permitting, requirements for reclaimed water conveyances, reclaimed water quality standards, and allowable end uses. These rules are codified in Arizona Administrative Code Title 18, Chapter 9, Articles 6 and 7 (Reclaimed Water Quality Conveyances and Direct Reuse of Reclaimed Water, respectively), and Title 18, Chapter 11, Article 3 (Reclaimed Water Quality Standards). Under the Chapter 11 provisions regarding reclaimed water quality standards, Arizona established five qualities of reclaimed water from A+ to C, with A+ being the highest quality. Class A+ reclaimed water in Arizona receives secondary treatment followed by filtration, disinfection, and nitrogen reduction to less than 10 mg/L total nitrogen. Table A in the regulation identifies the appropriate minimum quality for 27 categories of approved uses. Quality required for industrial reuse is industry specific and will be determined on a case-by-case basis by the ADEQ.

In August 2009, the Governor formed a Blue Ribbon Panel on Water Sustainability consisting of 40 panelists representing a cross-section of state interest [[US-AZ-Blue Ribbon Panel](#)]. The purpose of the panel was "To advance statewide sustainability of water by increasing the reuse, recycling and conservation of water to support continued economic development in the state of Arizona while protecting Arizona's water supplies and natural environment." To accomplish this, the panel developed five goals and five working groups to address: 1) Increasing the volume of reclaimed water used for beneficial purposes in place of raw or potable water; 2) Advancing water conservation; 3) Reducing the amount of energy needed to produce, deliver, treat, reclaim, and reuse water; 4) Reducing the amount of water required to

produce and provide energy by Arizona power generators; and 5) Increasing public awareness and acceptance of reclaimed water uses. The Panel's 18 recommendations were released in a final report on November 30, 2010. The panel concluded that no new regulatory programs or major reconstruction of existing programs were needed and that current programs "constitute an exceptional framework within which water sustainability can be pursued." The panel's recommendations focused on improving existing capabilities in water management, education, and research.

Significant research is being conducted in Arizona in support of the Blue Ribbon Panel recommendations, including chemical water quality; microbial water quality; optimization and life cycle analysis; and societal, legal, and institutional issues.

California

Current regulations in California related to water reuse are complex and have been in a state of continual flux as water districts and utilities look to expand their use of reclaimed water. California statutes governing water use and the protection of water quality are contained in the California Water Code, which includes varying degrees of permitting authority by nine Regional Water Quality Control Boards (RWQCB), the SWRCB, and the CDPH. Each RWQCB is given authority to regulate specific reclaimed water discharges through the establishment of Water Quality Control Plans (Basin Plans), which include water quality objectives to protect beneficial uses of surface waters and groundwaters within the region. The SWRCB is authorized to adopt statewide policies for water quality control, which are then implemented by each RWQCB. The RWQCB issues the permits based on CDPH Title 22 requirements and comments on the specific project. Finally, CDPH is required to establish uniform statewide water reuse criteria for each type of reclaimed water, wherever the uses are related to public health.

In 2009, the SWRCB adopted a Recycled Water Policy to provide uniformity in the interpretation and implementation of a 1968 anti-degradation policy by each RWQCB for water reuse projects. The policy includes specific requirements for salt/nutrient management plans, special provisions for groundwater recharge projects, anti-degradation, and monitoring for constituents of emerging concern.

Salt/nutrient management plans are a critical component of the new Recycled Water Policy, as the accumulation of salts within soils and groundwater basins has been a long-term challenge in a state with little rainfall, high evaporation rates, and large agricultural and irrigation demands. The salt/nutrient management plans are being adopted by individual RWQCBs as amendments to their current basin plans and will include sources and loadings of salts, nutrients, and other pollutants of concern for each basin; implementation measures to manage pollutant loadings on a sustainable basis; and anti-degradation analysis demonstrating that all reclaimed water projects identified in the plan will collectively satisfy the state's anti-degradation policy and applicable water-quality objectives in the basin plans.

The special provisions for groundwater recharge projects in the Recycled Water Policy require site-specific, project-by-project review and establish criteria for RWQCB approval, including a one year, expedited permit process for projects that use RO treatment for surface spreading.

CDPH regulations are codified within the California Code of Regulations, with specific provisions related to reclaimed water within California Code of Regulations Title 22 and 17. Regulations governing nonpotable reuse include specific water quality, treatment, and monitoring requirements identified in California Code of Regulations Title 22 and enforced by the various RWQCBs. These regulations have remained relatively static over the last 10 years, with recent changes related primarily to laboratory and operator certification requirements.

In addition, CDPH has developed a series of draft groundwater recharge regulations that are used as a basis for the case-by-case approval of individual groundwater replenishment projects. Current codified regulations in California Code of Regulations Title 22 include only narrative requirements for IPR, without specific provisions for treatment or water quality. Amendments to the California Water Code (CWC) made in 2010 require CDPH to adopt formal groundwater recharge regulations by December 31, 2013, while developing surface water augmentation regulations and a policy on direct potable reuse by December 31, 2016 (CWC 13350, 13521, and 13560 to 13569).

The current draft of the groundwater recharge regulations was published in November 2011 and defines separate requirements for direct injection, surface spreading, and surface spreading without advanced treatment. Full advanced treatment, defined as RO followed by advanced oxidation, is required for direct injection or for surface spreading projects where strict TOC limits cannot be met and reclaimed water contribution to the groundwater exceeds 20 percent. The draft regulations include specific limits for TOC, total nitrogen, and other regulated and previously unregulated water quality parameters, as well as pathogen reduction requirements that include a 12-log reduction for enteric virus, 10-log for *Giardia* cyst, and 10-log for *Cryptosporidium* oocyst. Recharged water must be retained underground for a minimum of two months. The regulations also allow for alternative treatment approaches evaluated on a case-by-case basis and give credit for soil aquifer treatment when surface spreading is employed.

Hawaii

All water reuse projects in the state of Hawaii are subject to the review and approval by the Hawaii State Department of Health Wastewater Branch. The Hawaii State Department of Health issued the “Guidelines for the Treatment and Use of Reclaimed Water” in November 1993. The guidelines were adopted into Hawaii Administrative Rules Title 11, Chapter 62, Wastewater Systems updated in May 2002 and re-titled, “Guidelines for the Treatment and Use of Recycled Water.”

The guidelines define three classes of reclaimed water as R-1, R-2, and R-3 water:

1. **R-1 Water** is the highest quality reclaimed water. It is treated effluent that has undergone filtration and disinfection and can be utilized for spray irrigation without restrictions on use.
2. **R-2 Water** is disinfected secondary (biologically) treated effluent. Its uses are subjected to specific restrictions and controls.
3. **R-3 Water** is the lowest quality reclaimed water. It is undisinfected, secondary treated effluent whose uses are severely limited.

Nevada

In addition to regulations, Nevada has guidelines for reuse in the form of Water Technical Sheets: WTS-1A

(General Design Criteria for Reclaimed Water Irrigation Use) and WTS-1B (General Criteria for Preparing an Effluent Management Plan). These documents describe criteria to be included in the required engineering plan for irrigation reuse projects and information to be evaluated in preparing a management plan for reclaimed water use.

U.S. Pacific Insular Area Territories (Territory of Guam, Territory of American Samoa, and CNMI), and 147 federally recognized tribal nations

CNMI has regulations that allow the reuse of wastewater. The regulations include defined treatment standards for land application, including limited types of irrigation. Use of reclaimed water for food crops, parks, playgrounds, schoolyards, residential/commercial garden landscaping, or fountains is specifically prohibited. The CNMI regulations require other safety measures for reuse, including contingency planning, reporting requirements, design requirements, and signage requirements in the Chamorro, Carolinian, and English languages. No information was located on regulations or guidelines promulgated by the territories of Guam and American Samoa or by federally recognized tribal nations.

5.2.7.5 Context and Drivers of Water Reuse

Arizona

Water reuse has become critical to many communities in Arizona as a means of ensuring a stable alternative water supply. In Gilbert, reclaimed water is an important element of the town’s ability to demonstrate a 100-year assured water supply (a requirement of the Arizona Groundwater Management Act’s stringent water conservation requirements). Without water reuse, the town would be subject to a state imposed growth moratorium [[US-AZ-Gilbert](#)]. Further north in the town of Prescott Valley, a national precedent was set in 2006 when the town held an auction for its effluent, creating marketable rights for effluent as a commodity for the first time in Arizona and in the United States as a whole [[US-AZ-Prescott Valley](#)].

Significant reclaimed water is used in Arizona for energy production and building cooling needs. The Palo Verde Nuclear Generating Station operated by Arizona Public Service has been receiving reclaimed water from the 91st Avenue Water Reclamation Plant in Phoenix for 25 years. Recent use has been 67,000 ac-ft/yr (6.0 mgd or 263 L/s), and a new contract was signed in 2010 allocating 80,000 ac-ft (7.2 mgd or 314 L/s) of reclaimed water per year for cooling water

demand [US-AZ-Phoenix]. Other significant programs in Arizona include the city of Tucson water reuse program; the Scottsdale Water Campus; the city of Peoria Butler Drive WRF; the Cave Creek Water Reclamation Plant; and the City of Surprise, with a 6.6 mgd (289 L/s) distribution of Class A+ reclaimed water for direct reuse (35 percent) and aquifer recharge.

The city of Tucson’s reclaimed water use in 2010 is shown in **Figure 5-36**. The city’s program includes an established delivery system and model cross-connection control and site inspection program [US-AZ-Tucson].

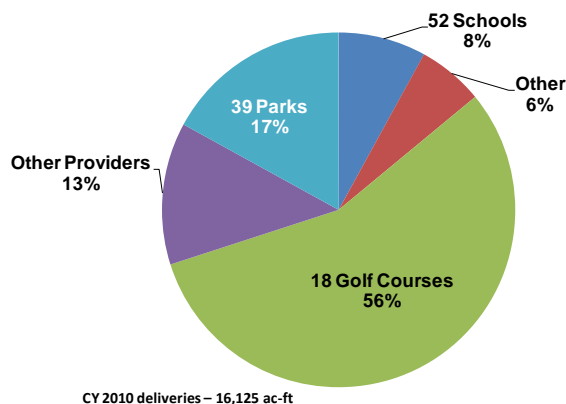

Figure 5-36
2010 Reclaimed water use in Tucson, Ariz.

A prominent addition to industrial water reclamation is represented by the expansion of the Frito-Lay production facility in Casa Grande with a 0.65 mgd (29 L/s) industrial Process Water Recovery Treatment Plant (PWRT) that saves 100 million gallons of water per year. This facility and other environmental achievements are described in a case study [US-AZ-Frito-Lay].

The EOP is operated by the city of Sierra Vista, Arizona, in Cochise County in the southeastern corner of the state to polish 2.5 mgd (110 L/s) of current flow through constructed wetlands and to recharge the local aquifer in order to mitigate the adverse impacts of continued groundwater pumping in the San Pedro River system. This project is detailed in a case study [US-AZ-Sierra Vista].

Overall, the ADEQ estimates that 65 percent of the WWTPs in Arizona now distribute treated wastewater for reuse, including 10 of the 12 largest plants.

California

Due to low seasonal rainfall, large population centers, and strong agricultural demands, reclaimed water has been utilized within the state of California for almost a century to meet irrigation and other nonpotable water needs. Initiated in 1960 with spreading basin recharge at the Montebello Forebay, IPR has been employed to supplement over-stressed potable water supplies, both through surface water spreading and through direct injection into potable water aquifers [US-CA-Los Angeles County]. A 2009 Municipal Wastewater Recycling Survey released by the SWRCB identified 669,000 ac-ft/yr (600 mgd) of reclaimed water being used in California, with 37 percent of this used for agricultural irrigation, 24 percent for landscape and golf course irrigation, and 19 percent for groundwater recharge and injection into seawater intrusion barriers (SWRCB, 2011). **Figure 5-37** identifies the uses of reclaimed water from the 2009 survey.

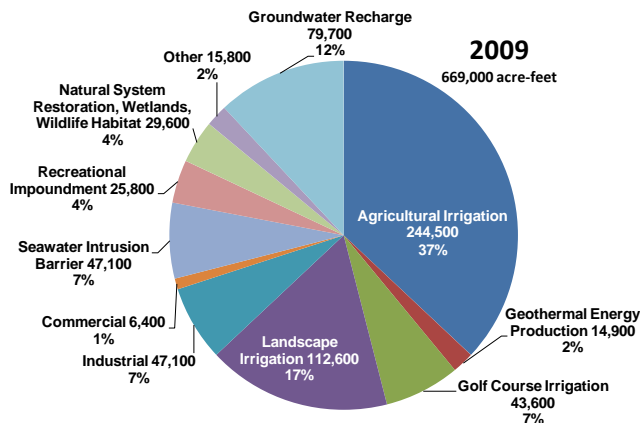

Figure 5-37
Uses of recycled water in Calif. (SWRCB 2011)

Agricultural reuse is the largest user of reclaimed water in California. In Monterey, reclaimed water has been used since 1998 on prime farmland to grow cool season vegetables as part of an effort to reduce groundwater extraction [US-CA-Monterey]. Long-term (10-year) studies of soil salinity have been implemented to understand how different soil types in the region respond to the salt content of reclaimed water. In San Diego, the North City Reclamation Plant uses an electro dialysis reversal (EDR) system to desalinate advanced treated reclaimed water to provide a new source of high quality irrigation water,

thereby reducing demand on the freshwater supply [US-CA-North City]. The desalinated reclaimed water is used to irrigate golf courses, plant nurseries, parks, highway green belts, and residential areas. In the city of Temecula, north of San Diego, local avocado, citrus, and grape farmers currently use fully treated drinking water for irrigation. Faced with rising potable water costs, farmers may go out of business. Recognizing the un-sustainability of the current system, the Rancho California Water District recently conducted a feasibility study to replace part of the irrigation water with reclaimed water [US-CA-Temecula].

An example of reuse for ecological purposes comes from Lake Elsinore, a recreational lake [US-CA-Elsinore Valley]. Lake Elsinore was plagued for decades by low water levels and high concentrations of nutrients, causing algal blooms. To improve lake levels while addressing nutrient concentrations, 5 mgd (219 L/s) of reclaimed water is now sent to the lake.

An example of two utility districts teaming together as a cost-effective solution to distribute reclaimed water comes from the San Ramon Valley Reclaimed Water Program [US-CA-San Ramon]. DSRSD and the East Bay Municipal Utility District (EBMUD) formed a joint powers authority to develop and manage the San Ramon Valley Reclaimed Water Program. Despite differences in size, structure, and culture, the two agencies have successfully joined to plan a system that serves both newly built and retrofitted neighborhoods with reclaimed water for landscape irrigation.

While the majority of water reuse in the state remains nonpotable, indirect potable uses have been growing rapidly, forcing adaptation and development of recycled water regulations to address the changing demands. In the 1970s, RO began being utilized in Orange County to treat wastewater before injecting it into barrier wells, preventing seawater intrusion into the potable water supply aquifer [US-CA-Orange County]. San Diego has identified IPR through reservoir augmentation as the preferred strategy to reduce reliance on imported water [US-CA-San Diego]. The Water Purification Demonstration Project currently underway is evaluating the feasibility of using advanced treatment technology to produce water that can be sent to the city's San Vicente Reservoir, to be later treated for distribution as potable water.

Today there are four large-scale facilities in southern California utilizing membrane filtration, RO, and varying levels of UV disinfection and advanced oxidation to produce high quality purified water for direct injection into potable water aquifers. The four facilities are the Orange County Groundwater Replenishment System [US-CA-Orange County], West Basin Municipal Water District Edward C. Little Water Recycling Facility [US-CA-West Basin], Los Angeles Bureau of Sanitation Terminal Island Water Reclamation Plant, and the Water Replenishment District of Southern California Leo J. Vander Lans Water Treatment Facility [US-CA-Vander Lans].

Other facilities are also utilizing infiltration basins for surface spreading to recharge previously over-drafted aquifers with advanced treated wastewater, including the Montebello Forebay [US-CA-Los Angeles County] and the Inland Empire Utility Agency [US-CA-Santa Ana River]. The Water Replenishment District of Southern California operates a program to artificially replenish groundwater basins by spreading and injecting replenishment water, which includes imported water and reclaimed water [US-CA-Vander Lans].

Some regional entities in water scarce parts of California are providing support and incentives for new water reuse projects. The Santa Ana River watershed encompasses parts of four large counties in Southern California. The Santa Ana Watershed Project Authority has a comprehensive, integrated planning process called "One Water One Watershed," to increase reuse from 10 to 17 percent by 2030. Reclaimed water uses include municipal use, agricultural irrigation, groundwater recharge, habitat and environmental protection, industrial use, and lake stabilization. A 40-year salinity management program is a key aspect of the integrated planning.

The Metropolitan Water District of Southern California is a regional water wholesaler serving approximately 19 million people across six counties [US-CA-Southern California MWD]. To meet long-term water demands, Metropolitan provides a regional financial incentive program to encourage development of reclaimed water and groundwater recovery projects that reduce demand on imported water supplies. To date, Metropolitan has provided incentives to 64 water reuse projects throughout Metropolitan's service area, which are expected to produce an ultimate yield of about

323,000 ac-ft (105 billion gallons) per year when fully implemented.

Hawaii

Each Hawaiian island has wet areas and dry areas with great surpluses in some areas and great deficiencies in others. Historically, there has been an overall abundance of water, but the challenge has been one of distribution rather than a general water shortage. The majority of Hawaii's potable water sources are groundwater. A growing population is increasing stress on the sustainability of these limited groundwater resources.

Almost 70 percent of Hawaii's potable water is used to irrigate agricultural crops, golf courses, and residential and commercial landscaping. The state of Hawaii, the city and county of Honolulu (Oahu), the county of Maui (Maui, Lanai, and Molokai), the county of Kauai, and the county of Hawaii are increasing water conservation and water reuse efforts to manage and preserve potable water resources.

The Hawaii State Department of Land and Natural Resources Commission on Water Resource Management in partnership with USACE have determined that a water conservation plan for the state of Hawaii should be established. Water reuse is anticipated to be a significant component of the plan's policy and program development.

Although all six major Hawaiian Islands have reclaimed water projects, the existence or nonexistence of reclaimed water programs varies by county.

The county of Maui and city and county of Honolulu have committed significant resources to promote and develop their respective reclaimed water programs. The county of Kauai does not have a stated reclaimed water program. The county of Hawaii does not have a reclaimed water program. Please see the case study [[US-HI-Reuse](#)] for more detail on reuse applications in Hawaii and a timeline of implementation.

Nevada

As the driest state whose largest population base is located in Las Vegas, Nevada is faced with a significant potable water supply challenge. Lake Mead serves as the primary water supply for the city, along with some groundwater resources. Within the Las Vegas area drainage, all reclaimed water and

stormwater return to Lake Mead, which results in a continuous water reuse cycle, fed by new river inflows. With this knowledge, high levels of treatment are provided and high technology water quality monitoring is applied to meet potable water quality for utility customers. Individual on-site graywater reuse is not allowed in Nevada, as little treatment is provided in the graywater systems compared to the municipal treatment systems, and water rights accounting does not recognize graywater, even if used in place of potable water.

CNMI

One of the golf courses on Saipan—the main inhabited island of the CNMI—uses land application of reclaimed water on non-accessible areas of the grounds (not on the playing greens).

Federally Recognized Tribal Nations

In Region 9, several tribal nations practice water reuse, particularly at facilities with transient populations in arid areas. For example, in rural Capay Valley, Calif., the Yoche Dehe Wintun Nation's Cache Creek Casino Resort has on-site water reclamation and reuse for golf course irrigation, toilet flushing, and decorative water features (S. Roberts Co., 2009). To manage salinity for irrigation, the system includes desalination. In Alpine, Calif. the Viejas Band of Kumeyaay Indians have incorporated water reuse for landscape irrigation on their reservation, which has 400 non-transient residents and an average of 5,000 transient residents who are visitors to the Viejas Casino, an Outlet Mall and Recreational Vehicle Park (Bassyouni et al., 2006).

5.2.8 Pacific Northwest: Alaska, Idaho, Oregon, and Washington

This section focuses on the regulatory context and drivers for water reuse in four states in the Pacific Northwest region.

5.2.8.1 Population and Land Use

Figure 5-38 compares the percent change in population and developed land coverage in the Pacific Northwest compared to the entire United States over the past decade.

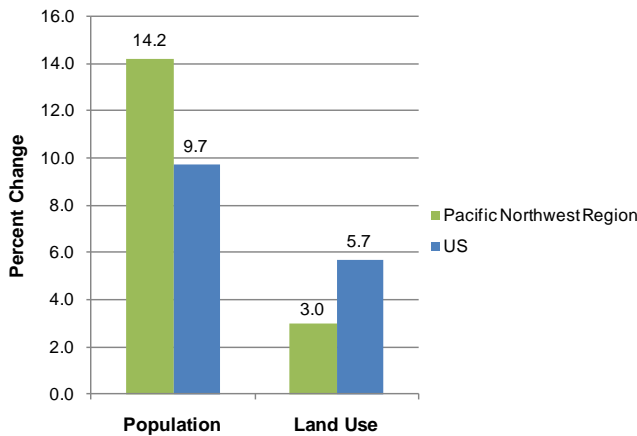

Figure 5-38
Change in population (2000-2010) and developed land (1997-2007) in the Pacific Northwest region, compared to the United States

The Pacific Northwest region’s population grew at 14.2 percent over the past decade, with significant population increases in Alaska (13.3 percent), Idaho (21.1 percent), Oregon (12.0 percent), and Washington (14.1 percent).

Alaska has a population of 0.7 million residents, adding about 80,000 residents over the past decade. Idaho is the 39th most populous state with 1.6 million residents and the 14th largest state by land area.

Oregon has 3.8 million residents. Washington State is the 13th most populous state with 6.7 million residents. The Cascade Range runs north-south, bisecting the state.

5.2.8.2 Precipitation and Climate

Figure 5-39 depicts average monthly precipitation in the Pacific Northwest region by state.

Western Washington, from the Cascades westward, has a mostly marine west coast climate with mild temperatures and wet winters, autumns, and springs, and relatively dry summers. Eastern Washington, east of the Cascades, has a relatively dry climate. Summers are warmer, winters are colder and precipitation is less than half of western Washington.

Eastern Washington has roughly twice the land area and one-third the population of western Washington.

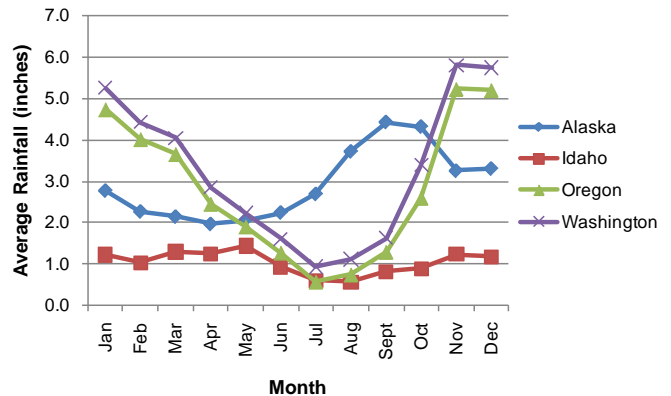

Figure 5-39
Average monthly precipitation in the Pacific Northwest region

The climate in Oregon varies greatly between the western and eastern regions of the state. The Columbia and Snake rivers delineate much of Oregon’s northern and eastern boundaries, respectively. The landscape in Oregon is diverse and varies from rain forest in the Coast Range in the western region to barren desert in the southeast. An oceanic climate predominates in Western Oregon, and a much drier semi-arid climate prevails east of the Cascade Range in Eastern Oregon. Population centers lie mostly in the western part of the state, which is generally moist and mild, while the lightly populated high deserts of Central and Eastern Oregon are much drier.

The four seasons are distinct in all parts of Idaho, but different parts of the state experience them differently. Spring comes earlier and winter later to Boise and Lewiston, which are protected from severe weather by nearby mountains and call themselves “banana belts.” Eastern Idaho has a more continental climate, with more extreme temperatures; climatic conditions there and elsewhere vary with the elevation. Humidity is low throughout the state. Precipitation in southern Idaho averages 13 in (33 cm) per year; in the north, precipitation averages over 30 in (76 cm) per year. Average annual precipitation (1971 to 2000) at Boise was 12.2 in (31 cm), with more than 21 in (53 cm) of snow. Much greater accumulations of snow are experienced in the mountains.

Though possibly perceived as a state with high precipitation, Alaska actually ranks as the 39th wettest

state (22.70 in or 57.7 cm annually) with an annual rainfall range from 4.16 in (10.6 cm) in Barrow on the north coast to 75.35 in (191 cm) in Kodiak in the south. Due to a colder climate, snowfall ranges from 30.3 in (77 cm) per year in Barrow to 322.9 in (8.2 m) in Valdez. The colder weather conditions limit agricultural applications, one of the historically high uses for reclaimed water.

5.2.8.3 Water Use by Sector

Figure 5-40 shows freshwater use by sector in the Pacific Northwest.

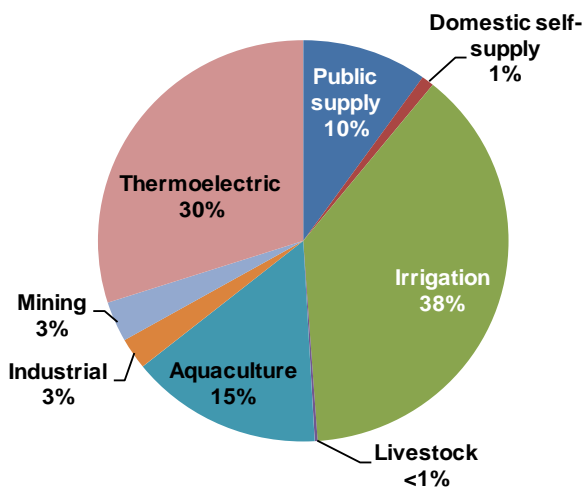

Figure 5-40
Freshwater use by sector for the Pacific Northwest region

Idaho, Oregon, and Washington have well developed regulations and standards. Idaho's continuing efforts to support reuse, considering the different types of land application and treatment systems and end uses, have led to updates in state regulations and guidance over the years. With emphasis on in-stream water quality, focused on nutrients and sediment, all of the sectors in Idaho, Oregon, and Washington could anticipate increased interest in water reuse.

5.2.8.4. States' Regulatory Context

Alaska

Alaska does not have regulations that specifically address water reuse.

Idaho

Idaho has both reuse regulations and guidelines whose scope includes treatment and beneficial reuse of municipal and industrial wastewater. Water reuse by different types of land application facilities is allowed

by state regulations. In 1988, Idaho's Wastewater Land Application permitting rules were promulgated and guidance was developed. Idaho has a public advisory working group that meets periodically to advise guidance development and review existing and future reuse guidance. In 2011 reuse regulations were updated, and the name of the rules changed to Recycled Water Rules (IDAPA 58.01.17). Idaho DEQ is the state agency tasked with issuing both industrial and municipal reuse permits. In Idaho, the NPDES permit program, which includes discharge of reclaimed water to surface waters, is administered by EPA, which means EPA is responsible for issuing and enforcing all NPDES permits in Idaho.

Oregon

The Oregon Administrative Rules, Chapter 340, Division 55 (OAR 340-055), "Recycled Water Use," prescribe the requirements for the use of reclaimed water for beneficial purposes while protecting public health and the environment. The Oregon DEQ is responsible for implementing these rules. The department coordinates closely with other state agencies to ensure consistency; in particular, the Oregon Department of Human Services and the Oregon Water Resources Department also play key roles in implementing these rules. Facilities are required to manage and operate reclaimed water projects under a water reuse management plan. These plans are specific to each facility and are considered part of a facility's NPDES or water pollution control facility (WPCF) water quality permit. Site-specific conditions, such as application rates and setbacks, may be established to ensure the protection of public health and the environment.

Washington

In 1992 the Washington State Legislature passed the Reclaimed Water Act, Chapter 90.46 RCW. The Reclaimed Water Act and Chapters 90.48 and 90.82 RCW encourage the development and use of reclaimed water, require consideration of reclaimed water in wastewater and water supply planning, and recognize the importance of reclaimed water as a strategy within water resource management statewide. Reclaimed water is recognized as a resource that can be integrated into state, regional, and local strategies to respond to population growth and climate change. The state also recognizes reclaimed water as an important mechanism for reducing discharge of treated wastewater into Puget Sound and other sensitive

areas for improving water quality in the Sound. For more history on the regulatory context in Washington state, refer to the case study [[US-WA-Regulations](#)].

5.2.8.5 Context and Drivers of Water Reuse

Alaska

Water reuse in Alaska is not regularly implemented.

Idaho

Idaho has been supporting reuse since 1988, and 2011 Idaho DEQ data indicate that 8.5 billion gallons of wastewater were reused by municipal and industrial sites. The drivers for the use of reclaimed water include more stringent discharge regulations, water supply demands, the need to offset potable water use, and a need to reduce pollutant loads and discharge volumes in receiving waters. There are 136 reuse permits in the state, and the number of permits is expected to grow due to strict TMDL limits for pollutants such as phosphorus. The first municipal land application/reuse permit was issued to the city of Rupert in 1989, and the first industrial reuse permit was issued in 1990 to Lamb Weston, a potato processor.

Although municipal reuse has been permitted for many years, the city of Meridian is the first municipal system in the state with a city-wide Class A permit. Several years ago the city had a desire to explore the use of reclaimed water at the city park, located one and a-half miles north of the WWTP. The city was able to convert a seldom used outfall line to transport reclaimed water from the plant to the park for irrigation. Additionally, this outfall line provided the chlorine contact time required to meet the city's site-specific permit. The elevated chlorine levels at the park and nutrients in the reclaimed water presented challenges with the clarity of the holding pond that the city discharged into prior to irrigation. This and other factors led to the city moving to a pressurized reclaimed water system that is currently going through startup testing. This system, coupled with a citywide reuse permit, will allow the city to use reclaimed water at a new interchange, the city park, the WWTP, and a car wash.

Since 2004 the Idaho DEQ has hosted an annual water reuse conference designed to enable water and wastewater professionals to continue their education, network, and discuss key issues related to water reuse in Idaho and the West.

Oregon

Water reuse has been practiced in Oregon for several decades. There are more than two dozen facilities that implement water reuse programs throughout the state. Many people may think of water reuse in terms of crop or pasture irrigation. While this is a valuable use, there are many other uses practiced in Oregon, including irrigation of golf courses, playing fields, poplar tree plantations, and commercial landscapes; cooling in the production of electricity; and for wetland habitats. The drivers for water reuse in Oregon include limitations imposed by new surface water discharge regulations, impaired water bodies with TMDLs, opportunities due to upgrades with advanced treatment technologies, and water supply needs.

The following are a few examples of how reclaimed water is used in Oregon:

- City of Prineville—golf course and pasture. Several years ago, the city of Prineville needed to look at non-discharge alternatives to the Crooked River during the summer months. An EPA construction grant assisted the city in developing a golf course irrigation system in which reclaimed water is used. The city owns and operates the golf course, thus generating revenue through playing fees. The city recently expanded the use of reclaimed water to irrigate nearby pasture land.
- Clean Water Services (Washington County)—golf courses, playing fields, plant nursery. This public utility serving nearly 500,000 customers operates four major WWTFs and works with 12 member cities to provide reclaimed water for a variety of uses. Reclaimed water is used for irrigation of three golf courses, two school playing fields, and a plant nursery.
- Metropolitan Wastewater Management Commission—poplar tree plantation. Serving the cities of Eugene and Springfield, this regional WWTF provides reclaimed water to its Biocycle Farm for a 596-ac poplar tree plantation. The irrigation system is designed to minimize overspray, wind drift, surface runoff, and ponding. Fences, buffers, and signage restrict unauthorized access to the site.
- Albany Talking Water Gardens Projects—wetlands. A 37-ac integrated wetland treatment

system enhances wildlife habitat while reducing the temperature, TDS, and nutrients in reclaimed water (CH2MHill, 2011). In addition, 13 ac of perimeter landscaping provides the opportunity to reuse effluent for irrigation to support more diverse habitat. The system is first in the nation designed to treat a unique combination of municipal and industrial WWTP effluents.

- City of Silverton Oregon Garden Project—wetlands. Similar to the system in Albany, the city of Silverton’s reclaimed water is used to create a thriving habitat through 17 acres of terraced ponds with cascading water, pools, and wetlands plants to a holding tank where it then flows into an irrigation system used to irrigate a garden (Oregon Garden, n.d.). The system lowers the temperature and removes nitrate and phosphorous prior to discharge in Brush Creek. The wetlands also play an active role in the education programs at The Garden.

Washington

There are more than 25 reclaimed water facilities operating in Washington State—about one-third are located in eastern Washington and two-thirds are located in western Washington. The design capacity for these facilities range from less than 1 mgd (43.8 L/s) to 21 mgd (920 L/s). Approximately 35 reclaimed water facilities are in the planning or design phase.

The drivers for reclaimed water facilities in Washington vary by facility and include discharge regulations, impaired water bodies with TMDLs, efforts to restore Puget Sound, opportunities due to upgrades or new facilities with advanced treatment technologies, and water supply needs.

Water reuse in Washington includes golf course irrigation; urban uses, such as street sweeping; agricultural irrigation; forest irrigation; groundwater recharge; ASR; wetlands enhancement; stream-flow augmentation; and commercial and industrial processes. King County and the University of Washington collaborated in a study to demonstrate the safety of using Class A reclaimed water in a vegetable garden, as detailed in a case study [US-WA-King County]. In Sequim, a reclaimed water distribution system uses reclaimed water for toilet flushing, irrigation, stream augmentation, vehicle washing, street cleaning, fire truck water, and dust control [US-

WA-Sequim], relying on a marine outfall to discharge wastewater when the reclamation process fails and seasonally when reclaimed water demand drops. In Yelm, reclaimed water is used in a wetlands park to have a highly visible and attractive focal point promoting reclaimed water use [US-WA-Yelm]. In addition, as part of planning for expansion of the reclaimed water system, a local ordinance was adopted establishing the conditions of reclaimed water use, which includes a “mandatory use” clause requiring construction of reclaimed water distribution facilities as a condition of development approval.

5.3 References

Bassyouni, A., M. Sudame, and D. McDermott. 2006. “Model Water Recycling Program.” WEFTEC Conference 2006. Water Environment Federation.

Bennett, L. 2010. “Wastewater Reclamation and Reuse Projects in the State of Virginia, What’s Happening Around the State, VWEA/VA.” *AWWA Water Reuse Committee Seminar, June 8, 2010*.

City of Raleigh. 2012. *Reuse Water System*. Retrieved on August 23, 2012 from <http://www.raleighnc.gov/home/content/PubUtilAdmin/Articles/ReuseWaterSystem.html>.

CH2MHill. 2011. *Talking Water Gardens Natural Water Treatment and Reuse Project: Innovative Approach to Complex Water Quality Issues*. Retrieved on August 23, 2012 from http://www.ch2m.com/corporate/services/sustainable_solutions/assets/projects/WBG_Talking-Water-Gardens.pdf.

Clinton, T. A. 2010. “Reclaimed Water.” City of Norman Public Forum Series On Sustainable Water Resources, February 4, 2010.

Crook, J. 2005. “St. Petersburg, Florida, Dual Water System: A Case Study,” In *Water Conservation, Reuse, and Recycling: Proceedings of an Iranian-American Workshop*, National Academy Press. Retrieved on August 23, 2012 from http://www.nap.edu/openbook.php?record_id=11241&page=175.

Coolweather. n.d. *State Rainfall*. Retrieved on August 23, 2012 from <http://coolweather.net/staterainfall/>.

Efland, C. 2010. “UNC Chapel Hill’s Sustainable Water Infrastructure: A Ten Year Journey.” AWWA Sustainable Water Management Conference, April 12, 2010.

Federal Register 77 (FR 77 2012):13496-13499, “Effective Date for the Water Quality Standards for the State of

- Florida's Lakes and Flowing Waters." 2012. Florida Department of Environmental Protection (FDEP). 2011. *2010 Reuse Inventory*. Florida Department of Environmental Protection. Tallahassee, FL.
- Florida Department of Environmental Protection (FDEP). 2009. *Connecting Reuse and Water Use: A Report of the Reuse Stakeholders Meetings*. Florida Department of Environmental Protection. Tallahassee, FL. Retrieved on August 23, 2012 from http://www.dep.state.fl.us/water/reuse/docs/reuse-stake-rpt_0209.pdf.
- Florida Department of Environmental Protection (FDEP). 2012a. *2011 Reuse Inventory*. Tallahassee, Florida. Retrieved on August 23, 2012 from http://www.dep.state.fl.us/water/reuse/docs/inventory/2011_reuse-report.pdf.
- Florida Department of Environmental Protection. 2012b. *Development of Numeric Nutrient Criteria for Florida's Waters*. Retrieved on August 23, 2012 from <http://www.dep.state.fl.us/water/wqssp/nutrients/>.
- Georgia Environmental Protection Division (GEPD). 2007. *Reuse Feasibility Analysis, EPD Guidance Document*. Atlanta, GA.
- Georgia Governor's Office. 2009. *Water Contingency Planning Task Force, Findings and Recommendations*. Governor's Task Force. Atlanta, GA.
- Global Water Intelligence (GWI). 2010. *Municipal Water Reuse Markets 2010*. Media Analytics Ltd. Oxford, UK.
- Goldenberg, B., C. Helfrich, A. Perez, A. Garcia, R. Chalmers, and P. Gleason. 2009. "The Impact of Legislation Eliminating the Use of Ocean Outfalls on Reuse in Southeast Florida." WateReuse Symposium, Seattle, WA, October 2009.
- Kenny, J. F., N. L. Barber, S. S. Hutson, K. S. Linsey, J. K. Lovelace, and M. A. Maupin. 2009. "Estimated Use of Water in the United States in 2005." United States Geological Survey (USGS). Retrieved on August 23, 2012 from <http://pubs.usgs.gov/circ/1344/pdf/c1344.pdf>.
- Metropolitan Area Planning Council (MAPC). 2005. "Once is Not Enough: A Guide to Water Reuse in Massachusetts." Retrieved on August 23, 2012 from <http://www.495partnership.org/assets/Water/3-1%20Once%20is%20Not%20Enough%20-%20Guide%20to%20Water%20Reuse%2010-05.pdf>.
- Metropolitan Council Environmental Services (MCES). 2007. *Recycling Treated Municipal Wastewater for Industrial Water Use*. A report prepared for the Legislative Commission on Minnesota Resources, August 2007. Metropolitan Council Environmental Services. St. Paul, MN. Retrieved August 23, 2012 from <http://www.metrocouncil.org/planning/environment/RTMW1WU/RecyclingWastewater.htm>.
- Miles, W., R. Bonné, and A. Russell. 2003. "Startup and Operation of Cary, North Carolina's Residential/Commercial Reclaimed Water System." Virginia Water Environment Association. Glen Allen, VA.
- Miller, W. G. 2011. "Water Reuse in the U.S.A.: Current Challenges and New Initiatives." 8th IWA International Conference on Water Reclamation and Reuse, Barcelona, Spain.
- Miller, W. G. 2012. Personal communication by document editors on extent of water reuse in the United States.
- Minnesota Department of Natural Resources (MDNR). 2008. *Minnesota Water Appropriations Permit Program, State Water Use Data System*. Data summarized through 2007 were obtained from the MDNR. Retrieved on August 23, 2012 from http://www.dnr.state.mn.us/waters/watermgmt_section/appropriations/wateruse.html.
- Minnesota Pollution Control Agency (MPCA). 2011. "Salty Discharge" Monitoring at NPDES/SDS Permitted Facilities. Retrieved on August 23, 2012 from <http://www.pca.state.mn.us/index.php/view-document.html?gid=16079>.
- Minnesota Pollution Control Agency (MPCA). 2010a. *Biofuels: Reusing Municipal Wastewater*. Retrieved on August 23, 2012 from <http://www.pca.state.mn.us/index.php/view-document.html?gid=13494>.
- Minnesota Pollution Control Agency (MPCA). 2010b. *Municipal Wastewater Reuse*. Retrieved on August 23, 2012 from <http://www.pca.state.mn.us/index.php/view-document.html?gid=13496>.
- Miyamoto, S. 2004. *Landscape Plant Lists for Salt Tolerance Assessment*. Texas A&M University Agricultural Research and Extension Center. El Paso, TX.
- Miyamoto, S. 2003. "Managing Salt Problems in Landscape Use of Reclaimed Water in the Southwest." *Waterreuse Symposium*. Alexandria, VA.

- Miyamoto, S. 2001. *El Paso Guidelines for Landscape Uses of Reclaimed Water with Elevated Salinity*. Texas A&M University Agricultural Research and Extension Center. El Paso, TX.
- Miyamoto, S. 2000. *Soil Resources of El Paso: Characteristics, Distribution and Management Guidelines*. Texas A&M University Agricultural Research and Extension Center. El Paso, TX.
- National Oceanic and Atmospheric Administration (NOAA). n.d. *National Climatic Data Center. Thirty-year annual precipitation data*. Retrieved on August 23, 2012 from <http://www1.ncdc.noaa.gov/pub/data/ccd-data/nrmppc.txt>.
- National Research Council (NRC) 2012. *Water Reuse: Potential for Expanding the Nation's Water Supply Through Reuse of Municipal Wastewater*. National Academy Press. Washington, D. C.
- North Carolina Administrative Code (NCAC). 2011. North Carolina Reclaimed Water Regulations. 15A NCAC 02U. Retrieved on August 23, 2012 from <http://ncrules.state.nc.us/ncac/title%2015a%20-%20environment%20and%20natural%20resources/chapter%2002%20-%20environmental%20management/subchapter%20u/subchapter%20u%20rules.html>.
- Oregon Garden. n.d. "Wetlands" Retrieved on August 23, 2012 from <http://www.oregongarden.org/Wetlands.htm>.
- Ornelas, D. and I. S. Rojas. 2007. "Managing Reclaimed Water Concerns Attributed to Declining Water Usage." 11th Annual WaterReuse Research Conference. WaterReuse Association: Alexandria, VA.
- Rosencrans, M. 2012. *U.S. Drought Monitor*. Retrieved on August 31, 2012 from <http://droughtmonitor.unl.edu/>.
- Ryan, M. D. 2006. "Design-Build of Rio Rancho's MBR Plants-A Win-Win-Win Success." *Design-Build Institute of America, January 26, 2006*. Albuquerque, NM,
- S. Roberts Co. 2009. *Cache Creek Desalination Facility*. Retrieved on August 23, 2012 from http://www.srobertsco.com/files/docs/631_HSe-WaterReuse-Award.pdf.
- Schenk, R. E. and D. Vandertulip. 2009. "The Next Step in Improving Texas Reclaimed Water Projects – Proposed Update of Chapter 210." *Texas Water*, April 11, 2009. Galveston, TX.
- Shakopee Mdewakanton Sioux Community (SMSC), n.d. Shakopee Mdewakanton Sioux Community Department of Land and Natural Resources. Retrieved on August 31, 2012 from <http://www.shakopeedakota.org/enviro/land.html>.
- Smith, D. A. and J. D. Wert. 2007. "University Area Joint Authority Beneficial Reuse Project-20 Months of Operation." WEFTEC 2007. San Diego, CA.
- State Water Resources Control Board (SWRCB). 2011. *Water Recycling Funding Program: Municipal Wastewater Recycling Survey*. Retrieved on August 23, 2012 from http://www.waterboards.ca.gov/water_issues/programs/grants_loans/water_recycling/munirec.shtml.
- Stomp, J. 2004. *Water Desalination And Reuse Strategies For New Mexico*. New Mexico Water Resources Institute, Las Cruces, NM.
- Tennessee Tech University (TTU). 2012. *Water Reuse Survey*. Retrieved on August 23, 2012 from <http://www.tntech.edu/wrc/water-reuse-survey/>.
- Texas Commission on Environmental Quality (TCEQ). n.d. *General Permits for Waste Discharges*. Retrieved on August 23, 2012 from <http://www.tceq.texas.gov/rules/indxpdf.html>.
- Tien, C. 2010. "Maryland Water Reuse Regulations." *19th Maryland Ground Water Symposium, September 29, 2010*.
- Town of Cary. n.d. *Reclaimed Water System*. Retrieved on December 27, 2012 from http://www.townofcary.org/Departments/Public_Works_and_Uilities/Reclaimed_Water_System.htm.
- United States Census Bureau (USCB). n.d. *Resident Population Data: 2000 and 2010*. Retrieved on August 23, 2012 from <http://2010.census.gov/2010census/data/apportionment-dens-text.php>.
- U.S. Department of Agriculture (USDA). 2009. *Summary Report: 2007 National Resources Inventory*. Natural Resources Conservation Service and Center for Survey Statistics and Methodology, Iowa State University. Retrieved on August 31, 2012 from http://www.nrcs.usda.gov/Internet/FSE_DOCUMENTS/stelprdb1041379.pdf.
- U.S. Department of the Interior, Bureau of Reclamation (USBR). 2012. *WaterSMART (Sustain and Manage America's Resources for Tomorrow)*. Retrieved on August 23, 2012 from <http://www.usbr.gov/WaterSMART/>.
- U.S. Environmental Protection Agency (EPA). 2004. *Guidelines for Water Reuse*. 625/R-04/108. Environmental Protection Agency. Washington, D.C.
- U.S. Environmental Protection Agency (EPA). 2007. *National Nutrient Strategy*. Retrieved on August 23, 2012 from <http://water.epa.gov/scitech/swguidance/standards/criteria/nutrients/strategy/#strategy>.

- U.S. Environmental Protection Agency (EPA). n.d. *Federal Water Quality Standards for the State of Florida*. Retrieved on August 23, 2012 from http://water.epa.gov/lawsregs/rulesregs/florida_index.cfm.
- The Utah Division of Water Resources. 2005. *Water Reuse In Utah*. Retrieved on August 23, 2012 from <http://www.water.utah.gov/WaterReuse/WaterReuseAA.pdf>.
- Vandertulip, D. and L. Pype. 2009. "Water Reuse Practices – Current Uses and Future Trends." Pennsylvania Water Environment Association PENNTEC 2009, June 9, 2009.
- Vandertulip, D. and L. Prieto. 2008. "Irrigation to Industrial: A Whole New World of Reuse Opportunities." Montana Section AWWAWEA Annual Conference, May 15, 2008. Great Falls, MT.
- Vandertulip, D., R. E. Schenk, and A. Plummer. 2004. "Texas 2003 Reuse Rule Revisions." AWWAWEF Water Sources Conference, January 2004.
- WaterWorld. n.d. *Water Reuse: Experiences from the Santa Ana Pueblo*. Retrieved on August 23, 2012 from <http://www.waterworld.com/articles/print/volume-24/issue-9/weftec-exhibitors/water-reuse-experiences-from-the-santa-ana-pueblo.html>.
- Westmiller, R. 2010. "Purple, the New Gold." *Irrigation and Green Industry*. October 2010(10):26-32.
- Whitcomb, J. B. 2005. *Florida Water Rates Evaluation of Single-Family Homes*. Prepared for Southwest Florida Water Management District, St. Johns River Water Management District, South Florida Water Management District, and Northwest Florida Water Management District. Retrieved on August 23, 2012 from http://www.swfwmd.state.fl.us/documents/reports/water_rate_report.pdf.
- WRA News. 2011. *Bureau of Reclamation Awards \$1.2 Million for Water Reuse Studies in Three States*. Retrieved on August 23, 2012 from <http://www.watereuse.org/node/1389>.
- Wu, M., M. Mintz, M. Wang, and S. Arora. 2009. *Consumptive Water Use in the Production of Ethanol and Petroleum Gasoline*. Center for Transportation Research, Energy Systems Division, Argonne National Laboratory.

This page intentionally left blank.

CHAPTER 6

Treatment Technologies for Protecting Public and Environmental Health

When discussing treatment for reuse, the key objective is to achieve a quality of reclaimed water that is appropriate for the intended use and is protective of human health and the environment. Secondary objectives for reclaimed water treatment are directly tied to the end application, and can include aesthetic goals (e.g., additional treatment for color or odor reduction) or specific user requirements (e.g., salt reduction for irrigation or industrial reuse). As described in Section 1.5 “Fit for Purpose,” treatment for reclaimed water is and should be tailored to a specific purpose so that treatment objectives can be appropriately set for public health and environmental protection, while being cost effective. Additionally, the appropriate treatment for reuse will vary depending upon state-specific requirements. Some states require specific treatment processes, others impose reclaimed water quality criteria, and some require both. Many states also include requirements for treatment reliability and resilience to process upsets, power outages, or equipment failure (see Chapter 4 for additional regulatory discussion).

There have been hundreds of reuse projects implemented in the United States for various end uses and these projects, cumulatively, have demonstrated that use of properly treated reclaimed water meeting cross connection controls and use area requirements is protective of human health and the environment. While specifically proving the negative is difficult, i.e.,

that there have not been human health or environmental impacts associated with use of reclaimed water, at least one report notes that, “There have not been any confirmed cases of infectious disease that have been documented in the U.S. as having been caused by contact, ingestion, or inhalation of pathogenic microorganisms at any landscape irrigation site subject to reclaimed water criteria” (WRRF, 2005). Further, with respect to chemical hazards and risks, the NRC reports that, “To date, epidemiological analyses of adverse health effects likely to be associated with use of reclaimed water have not identified any patterns from water reuse projects in the United States” (NRC, 2012).

There is a continuum of possible scenarios for nonpotable and potable reuse, ranging from distributed nonpotable reclaimed water, to long-term storage in an environmental buffer prior to reuse, to direct replenishment of potable water sources (prior to additional drinking water treatment). As an example, **Figure 6-1** depicts a variety of treatment scenarios that have been developed for indirect or direct potable end use applications. There are other treatment technologies, not reflected in **Figure 6-1**, such as conventional secondary followed by natural treatment systems (wetlands or soil aquifer treatment prior to augmentation of drinking water supplies, which is described further in Section 6.4.5).

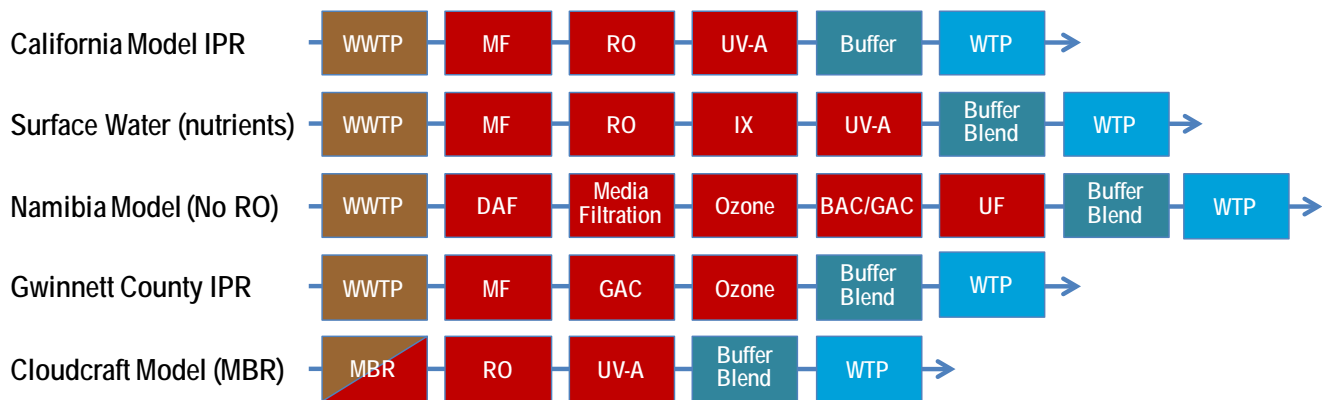

Figure 6-1
Potable reuse treatment scenarios (Chalmers et al., 2011)

The important lesson is that now, regardless of the end use and desired reclaimed water quality there are technologies available to treat water to whatever level is required for the targeted end use. In addition to successful implementation of current advanced treatment technologies for producing reclaimed water, there is ongoing research into optimizing these processes and investigating emerging technologies to meet treatment objectives for both pathogens and chemical constituents (WRRF, 2007a; 2012a).



6.1 Public Health Considerations

The most critical objective in any reuse program is to protect public health and a portfolio of treatment options exists to mitigate microbial and chemical contaminants in reclaimed water and meet specific water quality goals (NRC, 2012). Other objectives, such as preventing environmental degradation, avoiding public nuisance, and meeting user requirements, must also be satisfied, but the starting point remains the safe delivery and use of properly treated reclaimed water. In order to put concerns about protecting public health and the environment into perspective with respect to water reclamation, it is important to consider several key questions.

6.1.1 What is the Intended Use of the Reclaimed Water?

Protection of public health is achieved by 1) reducing or eliminating concentrations of pathogenic bacteria, parasites, and enteric viruses in reclaimed water; 2) controlling chemical constituents in reclaimed water; and 3) limiting public exposure (contact, inhalation, or ingestion) to reclaimed water. Reclaimed water projects may vary significantly in the level of human exposure incurred, with a corresponding variation in the potential for health risks. Where human exposure is likely, reclaimed water should be treated to a high degree prior to its use (**Table 6-1**). Reclaimed water used for irrigation of non-food crops on a restricted agricultural site may be of lesser quality than water for landscape irrigation at a public park or school, which may be of a lesser quality than reclaimed water intended to augment potable supplies. To make reuse cost-effective, the level of treatment must be “fit for purpose.” Secondary effluent can become reclaimed water nonpotable reuse by addition of filtration and enhanced disinfection. Higher level uses (e.g., potable reuse) may include additional processes, such as membranes, advanced oxidation, or soil aquifer treatment to remove chemical and biological constituents.

Table 6-1 Types of reuse appropriate for increasing levels of treatment

| Treatment Level | Increasing Levels of Treatment  | | | |
|-----------------|--|---|---|---|
| | Primary | Secondary | Filtration and Disinfection | Advanced |
| Processes | Sedimentation | Biological oxidation and disinfection | Chemical coagulation, biological or chemical nutrient removal, filtration, and disinfection | Activated carbon, reverse osmosis, advanced oxidation processes, soil aquifer treatment, etc. |
| End Use | No Uses Recommended | Surface irrigation of orchards and vineyards | Landscape and golf course irrigation | Indirect potable reuse including groundwater recharge of potable aquifer and surface water reservoir augmentation and potable reuse |
| | | Non-food crop irrigation | Toilet flushing | |
| | | Restricted landscape impoundments | Vehicle washing | |
| | | Groundwater recharge of nonpotable aquifer | Food crop irrigation | |
| | | Wetlands, wildlife habitat, stream augmentation | Unrestricted recreational impoundment | |
| | | Industrial cooling processes | Industrial systems | |
| Human Exposure | Increasing Acceptable Levels of Human Exposure  | | | |
| Cost | Increasing Levels of Cost  | | | |

Regardless of the reclaimed water use, whether irrigation, IPR, potable reuse, or car washing, the most critical treatment objective is pathogen inactivation. The reclaimed water must not pose an unreasonable risk due to infectious agents if there is human contact, which could occur by whole body contact or ingestion. EPA has established risk assessment methods and criteria that have been used in developing standards and criteria for microbial risks for both drinking water and whole body contact.

These risk assessment methods and acceptable levels of risks are described in the *Use of Microbial Risk Assessment in Setting U.S. Drinking Water Standards* and the draft *Recreational Water Quality Criteria* (EPA, 1992; 2011). While the potential human health impacts of reclaimed water is the subject of ongoing research, (e.g., WRRF project 10-07, *Bio-analytical Techniques to Assess the Potential Human Health Impacts of Reclaimed Water*, currently in preparation), additional discussion specific to risk assessment methods and tools specific to water reuse and exposure to reclaimed water are provided in other recent research reports (WRRF, 2007b; 2010a).

6.1.2 What Constituents are Present in a Wastewater Source, and What Level of Treatment is Applicable for Reducing Constituents to Levels That Achieve the Desired Reclaimed Water Quality?

Constituents that may be present in wastewater are described in Section 6.2. Numerous studies and full-scale projects have demonstrated that combining several treatment processes in sequence provides multiple barriers to remove almost all constituents to currently-accepted analytical detection levels and does not allow microbial and chemical contaminants to reach finished water at levels of potential concern. In addition, the effective use of pretreatment requirements can prevent introduction of refractory or difficult to treat contaminants to the incoming wastewater in the first place. Section 6.4 discusses the state of treatment technologies to provide extensive control of microbial and chemical contaminants for reuse projects. It is important to note that the NRC's recent survey of epidemiological studies of reuse concluded that "adverse health effects likely to be associated with use of reclaimed water have not identified any patterns from water reuse projects in the United States" (NRC, 2012).

The successful record of water reuse installations in the United States and around the world is the result of highly-engineered redundant treatment processes, which assure the safety of human health and the environment based on current standards. However, based on the last two decades of intensive experience in reuse, numerous studies, technology advances, and monitoring of successful projects, it may not always be necessary to provide such high levels of redundancy in the treatment train given the effectiveness and reliability of available technologies. For example, AOP may not be generally necessary when additional treatment will be applied at a drinking water plant, and UV alone can provide removal of the disinfection by-product NDMA, if needed; UV/AOP prior to discharge to a surface water storage reservoir may also be unnecessary. Excellent reduction of nitrogen and phosphorus nutrients may be essential for reclaimed water discharge to a storage reservoir, whereas these nutrients represent an advantage for certain irrigation applications and might not need to be removed.

The allowable concentrations of microbial and chemical constituents in reclaimed water are a function of the specific reuse application or category of reuse. And while these requirements may vary slightly from state to state, they have been designed to be protective of human health given some of the current thinking. Reclaimed water quality standards and practices have evolved, based on both scientific studies and practical experience. In particular, reclamation for potable reuse will meet drinking water standards; thus, it is not necessary to create a national list of concentration limits for specific chemical constituents for indirect or direct potable reuse projects (similar to drinking water MCLs), regardless of whether reclaimed water is part of the supply. Treatment guidelines and drinking water health advisory-type benchmarks for emerging chemicals of potential interest (pharmaceuticals, pesticides, and other "chemicals of emerging concern") are useful for assisting engineers in design of the multiple barriers that continue to protect the public from health risks.

6.1.3 Which Sampling/Monitoring Protocols are Required to Ensure that Water Quality Objectives are Being Met?

The successful record of water reuse installations is also the result of programs that ensure treatment reliability, establish cross-connection controls, manage conveyance and distribution system controls, display

user area controls (such as signage, color-coded pipes and appurtenances, and setback distances), and monitor water quality to ensure safety, as described in Chapter 4. It is also essential to have an appropriate HACCP-type management system; to employ appropriate, reliable, and multi-barrier redundant treatments; and to utilize as much as possible real-time monitoring of surrogates to assure continuous performance. While a number of online methods for performance monitoring are currently being used (e.g., turbidity and chlorine residual), the WRRF has funded additional research on monitoring for reliability and process control for potable reuse projects under project number WRF-11-01, which is anticipated for publication in 2015.

6.2 Wastewater Constituents and Assessing Their Risks

Before a particular treatment process train design can be selected for implementation in a reuse project, it is important to understand which constituents are of concern and in what concentrations. Untreated municipal wastewater contains a range of constituents, from dissolved metals and trace organic compounds to large solids such as rags, sticks, floating objects, grit, and grease. All reuse systems require a minimum of secondary treatment, which addresses large objects and particles, most dissolved organic matter, some nutrients, and other inorganics. However, there are some particles, including microorganisms and dissolved organic and inorganic constituents that remain in the secondary-treated wastewater, and further treatment is most often required before it can be reused. This section provides an overview of the key wastewater constituents that are addressed in reclaimed water treatment systems.

6.2.1 Microorganisms in Wastewater

Microorganisms are ubiquitous in nature, and most are not pathogenic to humans. Microorganisms, also called microbes, are diverse and are critical to nutrient recycling in ecosystems. In wastewater treatment systems, which are effectively engineered ecosystems, they act as beneficial decomposers of nutrients and organic matter. Concentrations of microorganisms are typically reported on a logarithmic scale (e.g., 1 million = 10^6 microorganisms) because they can be present in very high concentrations. Likewise, they can be removed to significant extents, and logarithmic scales help capture these huge ranges

in concentrations. Removal of microorganisms is typically reported logarithmically, where 1-log indicates 90 percent removal, 2-log is 99 percent removal, 3-log is 99.9 percent removal, 4-log is 99.99 percent removal, and so forth.

In addition to beneficial microorganisms, raw domestic wastewater can contain a large variety of pathogenic microorganisms that are derived principally from the feces of infected humans and primarily transmitted by the “fecal-oral” route. A pathogen is a microorganism that causes disease in its host. Most pathogens found in untreated wastewater are known as ‘enteric’ microorganisms; they inhabit the intestinal tract where they can cause disease, such as diarrhea. The source of human pathogens in wastewater is the feces of infected individuals who exhibit disease symptoms, as well as carriers with inapparent infections. Pathogens may also be present in urine, including pathogens that can cause urinary schistosomiasis, typhoid fever, leptospirosis, and some sexually transmitted infections. However, the first three diseases represent very low disease incidence in the United States, and the latter cannot survive for long in wastewater conditions. Thus, pathogens from urine are of low public health risk in water reuse.

Table 6-2 lists many of the infectious agents potentially present in raw domestic wastewater. These are classified into three broad groups: bacteria, parasites (parasitic protozoa and helminths), and viruses. **Table 6-2** also lists some of the diseases associated with each pathogen. The concentration of pathogens in wastewater varies greatly depending on the health of the general population, as well as the season. Concentrations of some organisms observed in the research are reported in **Table 6-2** to provide a general comparison, but available data are sparse due to lack of funding for these types of testing.

Water bodies, such as rivers, lakes, streams, landscape impoundments, engineered stormwater channels, groundwater, and swimming pools, can become contaminated from exposure to untreated or inadequately treated domestic sewage and agricultural runoff. Pathogen survival in the aquatic environment is governed by distance of travel, rate of transport, temperature, soil moisture content, humidity, exposure to sunlight, water chemistry (pH, salinity, etc.), and predation by other organisms, but varies greatly from pathogen to pathogen.

Table 6-2 Infectious agents potentially present in untreated (raw) wastewater

| Pathogen | Disease | Numbers in Raw Wastewater (per liter) |
|---|---|---------------------------------------|
| Bacteria | | |
| <i>Shigella</i> | Shigellosis (bacillary dysentery) | Up to 10 ⁴ |
| <i>Salmonella</i> | Salmonellosis, gastroenteritis (diarrhea, vomiting, fever), reactive arthritis, typhoid fever | Up to 10 ⁵ |
| <i>Vibrio cholera</i> | Cholera | Up to 10 ⁵ |
| Enteropathogenic <i>Escherichia coli</i> (many other types of <i>E. coli</i> are not harmful) | Gastroenteritis and septicemia, hemolytic uremic syndrome (HUS) | |
| <i>Yersinia</i> | Yersiniosis, gastroenteritis, and septicemia | |
| <i>Leptospira</i> | Leptospirosis | |
| <i>Campylobacter</i> | Gastroenteritis, reactive arthritis, Guillain-Barré syndrome | Up to 10 ⁴ |
| Atypical mycobacteria | Respiratory illness (hypersensitivity pneumonitis) | |
| <i>Legionella</i> | Respiratory illness (pneumonia, Pontiac fever) | |
| <i>Staphylococcus</i> | Skin, eye, ear infections, septicemia | |
| <i>Pseudomonas</i> | Skin, eye, ear infections | |
| <i>Helicobacter</i> | Chronic gastritis, ulcers, gastric cancer | |
| Protozoa | | |
| <i>Entamoeba</i> | Amebiasis (amebic dysentery) | Up to 10 ² |
| <i>Giardia</i> | Giardiasis (gastroenteritis) | Up to 10 ⁵ |
| <i>Cryptosporidium</i> | Cryptosporidiosis, diarrhea, fever | Up to 10 ⁴ |
| Microsporidia | Diarrhea | |
| <i>Cyclospora</i> | Cyclosporiasis (diarrhea, bloating, fever, stomach cramps, and muscle aches) | |
| <i>Toxoplasma</i> | Toxoplasmosis | |
| Helminths | | |
| <i>Ascaris</i> | Ascariasis (roundworm infection) | Up to 10 ³ |
| <i>Ancylostoma</i> | Ancylostomiasis (hookworm infection) | Up to 10 ³ |
| <i>Necator</i> | Necatoriasis (roundworm infection) | |
| <i>Ancylostoma</i> | Cutaneous larva migrans (hookworm infection) | |
| <i>Strongyloides</i> | Strongyloidiasis (threadworm infection) | |
| <i>Trichuris</i> | Trichuriasis (whipworm infection) | Up to 10 ² |
| <i>Taenia</i> | Taeniasis (tapeworm infection), neurocysticercosis | |
| <i>Enterobius</i> | Enterobiasis (pinworm infection) | |
| <i>Echinococcus</i> | Hydatidosis (tapeworm infection) | |
| Viruses | | |
| Enteroviruses (polio, echo, coxsackie, new enteroviruses, serotype 68 to 71) | Gastroenteritis, heart anomalies, meningitis, respiratory illness, nervous disorders, others | Up to 10 ⁶ |
| Hepatitis A and E virus | Infectious hepatitis | |
| Adenovirus | Respiratory disease, eye infections, gastroenteritis (serotype 40 and 41) | Up to 10 ⁶ |
| Rotavirus | Gastroenteritis | Up to 10 ⁵ |
| Parvovirus | Gastroenteritis | |

Table 6-2 Infectious agents potentially present in untreated (raw) wastewater

| Pathogen | Disease | Numbers in Raw Wastewater (per liter) |
|---|-----------------|---------------------------------------|
| Viruses | | |
| Astrovirus | Gastroenteritis | |
| Caliciviruses (including Norovirus and Sapovirus) | Gastroenteritis | Up to 10 ⁹ |
| Coronavirus | Gastroenteritis | |

(Sources: NRC, 1996; Sagik et al., 1978; Hurst et al., 1989; WHO, 2006; Feachem et al., 1983, Mara and Silva, 1986; Oragui et al., 1987, Yates and Gerba, 1998, da Silva et al., 2007, Haramoto et al., 2007, Geldreich, 1990; Bitton, 1999; Blanch and Jofre, 2004; and EPHC, 2008)

The main potential routes of waterborne disease transmission, in the context of water reclamation, include ingestion or consumption of contaminated water or foods from vectors via hand-to-mouth contact, or by inhalation from breathing in a mist or aerosolized water containing suspended pathogens. The potential transmission of infectious disease by pathogenic agents is the most common concern associated with reuse of treated municipal wastewater.

Fortunately, treatment technologies are capable of removing pathogens from water to below detection limits. However, it is still useful to understand what pathogenic microorganisms are potentially present in wastewater so that appropriate treatment can be applied. The following sections provide information on the major classes of microorganisms in wastewater.

6.2.1.1 Protozoa and Helminths

Parasites can be excreted in feces as spores, cysts, oocysts, or eggs, which are robust and resistant to environmental stresses such as desiccation, heat, freezing, and sunlight. Most parasite spores, cysts, oocysts, and eggs range in size from 1 µm to over 60 µm (larger than bacteria). Helminths can be present as the adult organism, larvae, eggs, or ova. The eggs and larvae, which range in size from about 10 µm to more than 100 µm, are resistant to environmental stresses. The occurrence of these microorganisms in reclaimed water has been the subject of recent research (WRRF, 2012b), which confirms that eliminating protozoa and helminths from wastewater can be achieved through either a “removal” or an “inactivation” process (WRRF, 2012b). In reclaimed water, protozoa and helminths can be physically removed by sedimentation or filtration (Section 6.4) because of their relatively large size. Protozoa and helminths may be resistant to disinfection by chlorination or other chemical

disinfectants, but may be inactivated using UV disinfection (Section 6.4.3.2) by inducing mutations in their DNA. Recent research on development of molecular assays that can rapidly discriminate between infectious cysts and cysts unable to cause an infection in reclaimed water have confirmed this mode of disinfection (WRRF, 2012c).

6.2.1.2 Bacteria

Bacteria are microscopic organisms ranging from approximately 0.2 to 10 µm in length. Many types of harmless bacteria colonize in the human intestinal tract and are routinely shed in the feces. Pathogenic bacteria are also present in the feces of infected individuals; therefore, municipal wastewater can contain a wide variety and concentration range of bacteria, including those pathogenic to humans. The numbers and types of these agents are a function of their prevalence in the animal and human community from which the wastewater is derived.

Bacterial levels in wastewater can be significantly lowered through removal or inactivation processes, which typically involve the physical separation of the bacteria from the wastewater through sedimentation and/or filtration. Due to density considerations, bacteria do not settle as individual cells or even colonies. Bacteria can adsorb to particulate matter or floc particles, and these particles settle during sedimentation, secondary clarification, or during an advanced treatment process such as coagulation/flocculation/sedimentation. Bacteria can also be removed by using a filtration process that includes sand filters, disk (cloth) filters, or membrane processes. Bacteria can also be inactivated by disinfection. Both filtration and disinfection are discussed further in Section 6.4.

6.2.1.3 Viruses

Viruses occur in various shapes and range in size from 0.01 to 0.3 μm , a fraction of the size of bacteria. Bacteriophages are viruses that infect bacteria; they have not been implicated in human infections and are often used as indicators. Coliphages are host-specific viruses that infect coliform bacteria. Enteric viruses multiply in the intestinal tract and are released in fecal matter of infected persons. Not all types of enteric viruses have been determined to cause waterborne disease, but more than 100 different enteric viruses are capable of producing infections or disease.

In general, viruses are more resistant to environmental stresses than many bacteria, and some viruses persist for only a short time in wastewater. Similar to bacteria and protozoan parasites, viruses can be physically removed or inactivated (Myrmet et al., 2006). However, due to the relatively small size of typical viruses, sedimentation and filtration processes are less effective at removal. Significant virus removal can be achieved with ultrafiltration membranes, possibly in the 3- to 4-log range. However, for viruses, inactivation is generally considered the more important of the two main reduction methods and is often accomplished by UV disinfection. Interestingly, disinfection of viruses requires relatively higher doses of UV compared to inactivation of bacteria and protozoa.

While monitoring specific virus pathogens in wastewater samples would provide more reliable information for risk assessments of waterborne viral infections, direct monitoring of several viral pathogens in water is challenging and impractical, despite the recent development of real-time quantitative polymerase chain reaction (PCR) analyses (LeCann et al. 2004; Van den Berg et al. 2005). Until more data regarding the detection of active, infectious viruses is available, data generated from seeded studies to evaluate the efficacy of wastewater treatment processes should be carefully evaluated to provide treatment designs that remove infectious viruses.

6.2.1.4 Aerosols

Aerosols are particles less than 50 μm in diameter that are suspended in air. Viruses, most pathogenic bacteria, and pathogenic protozoa are in the respirable size range; hence, inhalation of aerosols is a possible direct means of human infection. Aerosols are most often a concern where improperly-treated reclaimed water is applied to urban or agricultural sites with

sprinkler irrigation systems or where it is used for cooling water make-up. Infection or disease may be contracted directly through inhalation or indirectly from aerosols deposited on surfaces, such as food, vegetation, and clothes. The infective dose of some pathogens is lower for respiratory infections than for infections via the gastrointestinal tract; thus, for some pathogens, inhalation may be a more likely route for disease transmission than either contact or ingestion.

Thus, for intermittent spraying of disinfected reclaimed water, occasional inadvertent contact should pose little health hazard from inhalation. Cooling towers issue aerosols continuously and may present a greater concern if the water is not properly disinfected. In either case, aerosol exposure is limited through design or operational controls that are discussed in detail in the 2004 guidelines (EPA, 2004).

6.2.1.5 Indicator Organisms

It is important to distinguish between the actual pathogens versus indicator microorganisms that are used to measure treatment performance of a particular treatment system with respect to addressing pathogenic organisms from fecal contamination. Indicators are not themselves dangerous to human health, but are used to indicate the likelihood of occurrence of a health risk. The variety and often lower concentrations of pathogenic microorganisms in environmental waters, necessitating concentration combined with specialized analytical methodologies for pathogen detection, makes it difficult for the typical wastewater laboratory to run such tests. Regulatory agencies have historically required routine monitoring of other more abundant and more easily detected fecal bacteria as indicators of the presence of fecal contamination. In some states, total coliform bacteria are used as an indicator; however, in most states that have specific regulations, the microbiological safety of reclaimed water is evaluated by daily monitoring of fecal coliform bacteria in disinfected effluent based on a single, 100-mL grab sample.

Some states do require monitoring of certain pathogens, such as *Giardia* and *Cryptosporidium* requirements in Florida, Arizona, and California. Monitoring for viruses is also required for reclaimed water used for irrigation of food-crops in North Carolina. The specific monitoring requirements for these states are provided in Section 4.5.2. In addition, pathogen analyses are sometimes conducted as part

of special studies or by proactive utilities that wish to confirm the treatment reliability of the process used to produce reclaimed water. More often, indicators including total coliforms; fecal coliforms, a subset of total coliforms; *Escherichia coli* (*E. coli*); *enterococci*; and coliphage are used to validate performance of treatment and the quality of the final reclaimed water quality. The main drawback to using microbial indicators is that they are somewhat limited in their ability to predict the presence of pathogens. Also, all current uses of microbial indicators employ cultivation methods that delay results for at least 24 hours. For example, nonpathogenic coliforms, such as those that may be found in soil, can grow in water under certain conditions, leading to positive results that may not be indicative of wastewater impact. Additionally, coliform bacteria do not adequately reflect the occurrence of pathogens in disinfected reclaimed water due to their relatively high susceptibility to chemical disinfection and failure to correlate with protozoan parasites such as *Cryptosporidium* and enteric viruses (Bonadonna, et al., 2002; Havelaar et al., 1993).

Alternative microbiological indicators have been suggested for evaluation of wastewater, drinking water, and environmental waters, including *Enterococcus*, *Clostridium*, and coliphages. But there have been only a few studies of reclaimed water in which the levels of indicator organisms have been directly compared to those of viral, bacterial, or protozoan pathogens at each stage of treatment, and additional research on this topic is needed (Harwood et al., 2005). Analytical methods for actual pathogen monitoring continue to evolve, and recent studies have not relied solely on the traditional standard culture methods (Fox and Drewes, 2001; Sloss et al., 1996; Sloss et al., 1999; Yanko 1999). PCR is now commonly used to study pathogens and indicators by detecting the DNA or RNA in the environment. PCR is useful because the methods are sensitive. In addition, PCR can be much less expensive and time consuming than traditional pathogen methods, and culture methods are not currently available for some pathogens. Recent studies have reported pathogen

DNA and RNA in secondary and advanced municipal wastewater effluents, some recycled water, groundwater, and in ocean water impacted by wastewater discharges (Aw and Gin, 2010; De Roda et al., 2009; Hunt et al., 2010; Jjemba et al., 2010; Symonds et al., 2009, da Silva et al., 2008; da Silva et al., 2007; Haramoto et al., 2007). However, it is important to emphasize that PCR does not determine pathogen viability or infectivity; it only indicates the existence of DNA or RNA derived from the microorganisms. There is ongoing research using PCR-based detection methods into how this information can be used to evaluate potential risk; quantitative PCR in particular has potential to provide data for quantitative microbial risk assessment (QMRA), however, it must be kept in mind that indicators only evaluate “potential” risk. These indicators have not been related to any epidemiological risks except for *E. coli* and *enterococci* in recreational settings (Section 6.3.1). Additionally, evaluation of certain disinfection processes is particularly limited with respect to using molecular tools and indicators, although molecular viability methods are emerging.

6.2.1.6 Removal of Microorganisms

Removal of indicators and pathogens can be demonstrated both by challenge testing and operational monitoring. Challenge testing allows large log removals to be demonstrated by spiking influent concentrations with higher than normal microorganism concentrations to allow detection in the effluent. Because detected concentrations of actual pathogens tend to approach or fall at the lowest detectable concentrations of current analytical methods, further research in this area could provide greater confidence in the sensitivity of operational monitoring. **Table 6-3** presents an indicative range of microbial log reductions reported in the literature for different treatment processes, which are further discussed in Section 6.4. These ranges are intended to present relative removals; they should not be used as the basis of design for treatment schemes.

Table 6-3 Indicative log removals of indicator microorganisms and enteric pathogens during various stages of wastewater treatment

| Type of Microorganism | Indicator microorganisms | | | Pathogenic microorganisms | | | | |
|--|---|--------------------------------|----------------------------|---|-----------------|------------------------|-------------------------------|-----------|
| | <i>Escherichia coli</i> (indicator bacteria) | <i>Clostridium perfringens</i> | Phage (indicator virus) | Enteric bacteria (e.g., <i>Campylobacter</i>) | Enteric viruses | <i>Giardia lamblia</i> | <i>Cryptosporidium parvum</i> | Helminths |
| Bacteria | X | X | | X | | | | |
| Protozoa and helminths | | | | | | X | X | X |
| Viruses | | | X | | X | | | |
| Indicative Log Reductions in Various Stages of Wastewater Treatment ¹ | | | | | | | | |
| Secondary treatment | 1 - 3 | 0.5 - 1 | 0.5 - 2.5 | 1 - 3 | 0.5 - 2 | 0.5 - 1.5 | 0.5 - 1 | 0 - 2 |
| Dual media filtration ² | 0 - 1 | 0 - 1 | 1 - 4 | 0 - 1 | 0.5 - 3 | 1 - 3 | 1.5 - 2.5 | 2 - 3 |
| Membrane filtration (UF, NF, and RO) ³ | 4 - >6 | >6 | 2 - >6 | >6 | 2 - >6 | >6 | 4 - >6 | >6 |
| Reservoir storage | 1 - 5 | N/A | 1 - 4 | 1 - 5 | 1 - 4 | 3 - 4 | 1 - 3.5 | 1.5 - >3 |
| Ozonation | 2 - 6 | 0 - 0.5 | 2 - 6 | 2 - 6 | 3 - 6 | 2 - 4 | 1 - 2 | N/A |
| UV disinfection | 2 - >6 | N/A | 3 - >6 | 2 - >6 | 1 - >6 | 3 - >6 | 3 - >6 | N/A |
| Advanced oxidation | >6 | N/A | >6 | >6 | >6 | >6 | >6 | N/A |
| Chlorination | 2 - >6 | 1 - 2 | 0 - 2.5 | 2 - >6 | 1 - 3 | 0.5 - 1.5 | 0 - 0.5 | 0 - 1 |

(Sources: Bitton, 1999; EPHC, 2008; Mara and Horan, 2003; NRC, 1998; NRC, 2012; Rose et al., 1996; Rose, et al., 2001; EPA, 1999, 2003, 2004; WHO, 1989)

¹Reduction rates depend on specific operating conditions, such as retention times, contact times and concentrations of chemicals used, pore size, filter depths, pretreatment, and other factors. Ranges given should not be used as design or regulatory bases—they are meant to show relative comparisons only.

²Including coagulation

³Removal rates vary dramatically depending on the installation and maintenance of the membranes.

N/A = not available

6.2.1.7 Risk Assessment of Microbial Contaminants

While most microbes are harmless or beneficial, some are extremely dangerous—these are sometimes referred to as biological agents of concern (BAC). All BAC can cause serious and often fatal illness, but they differ in their physical characteristics, movement in the environment, and process of infection. QMRA measures microbes' behavior to identify where they can become a danger and estimate the risk (including the uncertainty in the risk) that they pose to human health. QMRA has four stages, based on the National Academy of Sciences framework for Quantitative Risk Analysis, but is modified to account for the properties of living organisms like BAC (NAS, 1983):

Hazard Identification: This process describes a microorganism and the disease it causes, including symptoms, severity, and death rates from the microbe; it identifies sensitive populations that are particularly prone to infection.

Dose-Response: Establishing the relationship between the dose (number of microbes received) and the resulting health effects is a critical step in the process. Data sets from human and animal studies allow the construction of mathematical models to predict dose-response.

Exposure Assessment: This step describes the pathways that allow a microbe to reach individuals and cause infection (through the air, through drinking water, etc.). It is necessary to determine the size and

duration of exposure by each pathway as well as estimate the number of people exposed and the categories of people affected.

Risk Characterization: The final step of the process integrates information from previous steps into a single mathematical model to calculate risk—the probability of an outcome such as infection, illness, or death. Because the first three steps do not provide a single value but instead offer a range of values for exposure, dose, and hazard, risk needs to be calculated for all values across those ranges. This is accomplished using Monte Carlo analysis, and the result is a full range of possible risks, including average and worst-case scenarios. These are the risks decision-makers evaluate when defining regulatory policy and the risks that scientists review to determine where additional research is needed to obtain better information.

Additional information on QMRA is available in a 2006 report to the European Commission entitled *QMRA: Its Value for Risk Management* (Medema and Ashbolt, 2006).

6.2.2 Chemicals in Wastewater

All water is ultimately reused in the natural cycle and contains detectable levels of various chemicals. Rainwater collects chemicals from atmospheric contact; groundwater contains inorganics from the geology; surface waters collect natural products and possibly pesticides and other chemicals from runoff and discharges from industrial and other facilities. Wastewater contains chemicals, and the number and concentrations of the constituents detected depends on many factors, including the municipal source, the condition of the collection system, and the treatment processes employed.

6.2.2.1 Inorganic Chemicals

Inorganic constituents in wastewater include metals, salts, oxyhalides, nutrients, and, potentially, engineered nanomaterials. The concentrations of inorganic constituents in reclaimed water depend mainly on the source of wastewater and the degree of treatment the water has received. The presence of inorganic constituents may affect the acceptability of reclaimed water for different reuse applications. Wastewater treatment using existing technology can generally reduce many trace elements to below recommended maximum levels for irrigation and drinking water. In general, the health hazards

associated with the ingestion of inorganic constituents, either directly or through food, are well established. Under the SDWA, the EPA has set MCLs for contaminants in drinking water.

Aggregate measures of most inorganic constituents in water are TDS and conductivity, although they both may include some organic constituents, as well. Residential use of water typically adds about 300 mg/L of dissolved inorganic solids, although the amount added can range from approximately 150 mg/L to more than 500 mg/L (Metcalf & Eddy, 2003).

Metals and Salts. Regulatory statutes for treated wastewater discharge and industrial pretreatment regulations promulgated through the CWA specifically target toxic metals; as a result, most municipal effluents have concentrations of toxic metals below public health guidelines and standards. Boron, a metalloid in detergents, can be present in domestic wastewater, but concentrations generally are well below EPA health advisory and WHO guidelines. Boron can be toxic to some plants at concentrations approaching levels that may be present in reclaimed water, which can limit the types of plants that can be irrigated with the water. Likewise, salts (measured as TDS) present in reclaimed water generally do not exceed thresholds of concern to human health but can affect crops [[Israel/Jordan-Brackish Irrigation](#)]. Salinity can cause leaf burn, reduce the permeability of clay-bearing soils, and affect soil structure. Salinity also can cause aesthetic concerns (e.g., taste in potable reuse or residues in car washing operations), scaling, and corrosion. Salinity can be removed in treatment, but options tend to be costly, and liquid waste (brine) disposal is an issue. Salinity management in irrigation reuse applications is described further in Chapter 3.

Oxyhalides. Oxyhalides of concern in water reuse include bromate, chlorate, and perchlorate. Bromate can be created when bromide-containing wastewater is ozonated; therefore, treatment facilities must be designed and operated properly to minimize oxyhalide formation during treatment. Bromate, chlorate, and perchlorate can be derived from household bleach. Perchlorate, a component of propellants, can bioaccumulate in certain plants and must be managed in irrigation.

Nutrients. Nitrogen and phosphorus from human waste products can pose environmental and health concerns but can also be beneficial in certain irrigation

applications. Therefore, the need to remove nutrients during treatment for reuse depends on the intended use of the product water.

Engineered Nanomaterials. Nanomaterials are materials with morphological features on the nanoscale (1 nm = 10^{-9} m), that often have special properties stemming from their dimensions. Nanomaterials have one or more dimensions ranging from 1 to 100 nm: nanofilms (one dimension), nanotubes (two dimensions), and nanoparticles (three dimensions). Larger particles, such as zeolites (1,000 to 10,000 nm, or 1 to 10 μ m), may also be considered nanomaterials because their pores fall into the nanoscale size range (0.4 to 1 nm). Nanomaterials can be organic, inorganic, or a combination of organic and inorganic components.

Nanotechnology promises exciting new possibilities in water treatment and water quality monitoring. Nanosorbents, nanocatalysts, bioactive nanoparticles, nanostructured catalytic membranes, and nanoparticle-enhanced filtration are categories of novel nanotechnologies that may change water treatment and water quality monitoring (Savage and Diallo, 2005). Indeed, research is ongoing to develop novel membranes for water and wastewater treatment (including desalination) built around nanotube pores. Many consumer products now contain engineered nanomaterials because of their unique surface chemistry, catalytic properties, strength, weight, and conductive properties compared to their larger-scale counterparts (National Science and Technology Council, 2011; WEF, 2008). The market for nanomaterials in consumer products is taking off—the United Nations Environment Programme projects that the market for nanomaterial-containing products could exceed \$2 trillion by 2014 (United Nations Environment Programme, 2007).

While naturally-occurring particles in this range include viruses and natural organic matter, the more recent introduction of engineered nanomaterials into the environment from consumer products poses new questions about the fate and potential environmental and health effects of these materials. Preliminary studies to determine the health effects caused by exposure to nanomaterials and the risk assessment, toxicity, and treatability of nanomaterials show inconsistent results, warranting ongoing investigation (WEF, 2008). To date, no link has been made between

trace levels of engineered nanoparticles in wastewater and an adverse human health impact (O'Brien and Cummins, 2010). Because most engineered nanoparticles in municipal wastewater originate from household and personal care products, direct exposure in the household itself is likely far greater than from potential exposure in water reuse. However, potential ecotoxicological risk posed by the release of nanoparticles to surface waters highlights the need for guidance and restriction on the usage and disposal of nanomaterial-containing commercial products (O'Brien and Cummins, 2010). A review of research on the relevance of nanomaterials in water reuse has been compiled (WRRF, 2012d). Limited research has been conducted on their fate in wastewater treatment, but initial findings suggest that engineered nanoparticles will associate with biosolids or remain in effluents, depending on their size and surface chemistry, as well as the type of treatment process employed (Kaegi et al., 2011; Kiser et al., 2009; and WEF, 2008).

6.2.2.2 Organics

The organic composition of raw wastewater includes naturally-occurring humic substances, fecal matter, kitchen wastes, liquid detergents, oils, grease, consumer products, industrial wastes, and other substances that, in one way or another, become part of the sewage stream. The level of treatment for these constituents in reclaimed water is related to the end use of reclaimed water. Some of the adverse effects associated with organic substances include:

- **Aesthetic effects.** Organics may be malodorous and impart color to the water.
- **Clogging.** Particulate matter may clog sprinkler heads or accumulate in soil and affect permeability.
- **Proliferation of microorganisms.** Organics provide food for microorganisms.
- **Oxygen consumption.** Upon decomposition, organic substances deplete the DO content in streams and lakes. This negatively impacts the aquatic life that depends on the oxygen supply for survival.
- **Use limitation.** Many industrial applications cannot tolerate water that is high in organic content.

- **Disinfection effects.** Organic matter can interfere with chlorine, ozone, and UV disinfection, thereby making them less available for disinfection purposes. Further, chlorination may result in formation of potentially harmful chlorinated DBPs.
- **Health effects.** Ingestion of water containing certain organic compounds may result in acute or chronic health effects.

The detection of a variety of organic chemicals in municipal wastewater effluent has raised concerns about the potential presence of wastewater-derived chemical contaminants in reclaimed water as well as about their health effects. And, for some reuse applications, regulatory agencies and utilities have struggled with this issue of wastewater-derived compounds, some of which are often present at extremely low concentrations. Because many of these compounds are not currently regulated, current research has focused on the composition of highly processed wastewaters to identify residual chemicals that might be a health concern, determine what studies would be needed as a basis for risk assessment, and develop lists of compounds for which more information is needed to assess the potential human health concerns (WRRF, 2012e). Additionally, the WRRF has funded work on identification and validation of surrogate parameters and analytical methods for wastewater-derived contaminants to predict removal of wastewater-derived contaminants in reclaimed-water treatment systems (WRRF, 2008).

Parameters that have historically been used for this purpose and can serve as aggregate measures of organic matter include TOC, dissolved organic carbon (DOC) (that portion of the TOC that passes through a 0.45- μm pore-size filter), particulate organic carbon (POC) (that portion of the TOC that is retained on the filter), BOD, and chemical oxygen demand (COD). These measures are indicators of treatment efficiency and water quality for many nonpotable uses of reclaimed water.

Organic compounds in wastewater can be transformed into DBPs where chlorine is used for disinfection purposes. There are strong associations between DBP exposure and bladder cancer among individuals who carry inherited variants in three genes (*GSTT1*, *GSTZ1*, and *CYP2E1*), the code for key enzymes that metabolize DBPs (Freeman, 2010; Cantor et al.,

2010). In the past, most attention was focused on the trihalomethane (THM) compounds; a family of organic compounds typically occurring as chlorine or bromine-substituted forms of methane. Chloroform, a commonly found THM compound, has been implicated in the development of cancer of the liver and kidney. Haloacetic acids (HAAs) are another undesirable by-product of chlorination with similar health effects. Improved analytical capabilities to detect extremely low levels of chemical constituents in water have resulted in identification of several health-significant chemicals and DBPs in recent years. For example, the carcinogen NDMA is present in sewage and is also produced when reclaimed water is disinfected with chlorine or chloramines (Mitch et al., 2003). And because chlorination of wastewater is still the most commonly used form of wastewater disinfection, research to further address the challenge of DBP in *de facto* reuse is a critical need. In some planned reuse applications, the concentration of NDMA present in reclaimed water exceeds action levels set for the protection of human health in drinking water, even after RO treatment. To address concerns associated with DBPs and other trace organics in reclaimed water, several utilities in California have installed UV-AOP for treatment of RO permeate to address NDMA [US-CA-Vander Lans; US-CA-Orange County; US-CA-San Diego].

6.2.2.3 Trace Chemical Constituents

Sophisticated analytical instrumentation makes it possible to identify and quantify extremely low levels of individual inorganic and organic constituents in water. Examples include gas chromatography/tandem mass spectrometry (GC/MS/MS) and high-performance liquid chromatography/mass spectrometry (HPLC/MS). These analyses are costly and may require extensive and difficult sample preparation, particularly for nonvolatile organics. Advancements in these and other analytical chemistry techniques have enabled the quantification of chemicals in water at parts per trillion (ppt) and even parts per quadrillion levels. With further analytical advancements, nearly any chemicals will be detectable in environmental waters, wastewater, reclaimed water, and drinking water in the future, but the human and environmental health relevance of detection of diminishingly low concentrations remains a greater challenge to evaluate.

As analytical techniques have improved, a number of anthropogenic chemical compounds that are not

commonly regulated have been detected in drinking water, wastewater effluent, or environmental waters, generally at very low levels. Detection of these compounds does not imply that they have been recently released to the environment—many have likely been in the environment for decades. This broad group of individual chemicals and classes of compounds present at trace concentrations is sometimes termed contaminants of emerging concern (CECs), TrOCs, or microconstituents. This broad group of CECs can include groups of compounds categorized by end use (e.g., pharmaceuticals, nonprescription drugs, personal care products, household chemicals, food additives, flame retardants, plasticizers, and biocides), by environmental and human health effect, if any (e.g., hormonally active agents, endocrine disruptors [EDs], or endocrine disrupting compounds [EDCs]), or by type of compound (e.g., chemical vs. microbiological, phenolic vs. polycyclic aromatic hydrocarbons). Contaminants under these sub-groupings that are not regulated under national drinking water standards may be on the Drinking Water Contaminant Candidate List (CCL), including some known EDCs, which include chemicals shown to disrupt animal endocrine systems, as well as those with adverse human health interactions. **Table 6-4** provides categories of compounds which may be detectable in reclaimed water.

Although trace chemical constituents are “pollutants” when they are found in the environment at concentrations above background levels, they are not necessarily “contaminants” (that is, found in the environment at levels high enough to induce ecological and/or human health effects). Experts have struggled to agree on a term that captures the range of constituents because the public often finds terms such

as CEC confusing or alarming, as described in Chapter 6. However, describing the numerous constituents by sub-group or as individual chemicals can likewise cause confusion, because these are also not well understood by the general public. Debate and discussion is ongoing in the water community about how to discuss trace chemical compounds, including terminology and relative risk.

Removal of Trace Chemical Constituents. As reclaimed water is considered a source for more and more uses, including industrial process water or potable supply water, the treatment focus has expanded far beyond secondary treatment and disinfection to include treatment for other contaminants, such as metals, dissolved solids, and trace chemical constituents.

Chemical constituents are amenable to treatment depending on the physiochemical properties of the compounds and the removal mechanisms of particular treatment processes. EPA has released a report with results of an extensive literature review of published studies of the effectiveness of various treatment technologies for CECs (EPA, 2010). The results of this literature review are also available in a searchable database, “Treating Contaminants of Emerging Concern—A Literature Review Database” (EPA, 2010). EPA developed this information to provide an accessible and comprehensive body of historical information about current CEC treatment technologies.

Given the wide range of properties represented by trace chemical constituents, there is no single treatment process that provides an absolute barrier to all chemicals. To minimize their presence in treated water, a sequence of diverse treatment processes capable of tackling the wide range of physiochemical

Table 6-4 Categories of trace chemical constituents (natural and synthetic) potentially detectable in reclaimed water and illustrative example chemicals (NRC, 2012)

| End use Category | Examples |
|--|---|
| Industrial chemicals | 1,4-Dioxane, perfluorooctanoic acid, methyl tertiary butyl ether, tetrachloroethane |
| Pesticides, biocides, and herbicides | Atrazine, lindane, diuron, fipronil |
| Natural chemicals | Hormones (17 β -estradiol), phytoestrogens, geosmin, 2-methylisoborneol |
| Pharmaceuticals and metabolites | Antibacterials (sulfamethoxazole), analgesics (acetaminophen, ibuprofen), beta-blockers (atenolol), antiepileptics (phenytoin, carbamazepine), veterinary and human antibiotics (azithromycin), oral contraceptives (ethinyl estradiol) |
| Personal care products | Triclosan, sunscreen ingredients, fragrances, pigments |
| Household chemicals and food additives | Sucralose, bisphenol A (BPA), dibutyl phthalate, alkylphenol polyethoxylates, flame retardants (perfluorooctanoic acid, perfluorooctane sulfonate) |
| Transformation products | NDMA, HAAs, and THMs |

properties is needed (Drewes and Khan, 2010). Full-scale and pilot studies have demonstrated that this can be accomplished by combinations of different processes: biological processes coupled with chemical oxidation or activated carbon adsorption, physical separation (RO) followed by chemical oxidation, or natural processes coupled with chemical oxidation or carbon adsorption. The question is whether all of these technologies are necessary to assure health protection or whether a particular sequence is over-treatment, especially when the water will be returned to the environment via a reservoir or aquifer. The water, therefore, will likely be degraded to some degree prior to being withdrawn for further drinking water treatment.

A recent survey of the fate of pharmaceuticals and personal care products (PPCPs) in WWTPs revealed that many EDCs are present at mg/L concentrations and are not significantly removed during conventional wastewater treatment processes (Miège et al., 2008). Some removal or chemical conversion can be expected during drinking water disinfection (i.e., sulfamethoxazole, trimethoprim estrone, 17 β -estradiol, 17 α -ethinylestradiol, acetaminophen, triclosan, bisphenol A, and nonylphenol). Chlorine, chlorine dioxide, and ozone disinfection are oxidation processes (Alum et al., 2004; Huber et al., 2005); among the three oxidants, ozone is the most reactive with many trace organic chemicals.

Activated carbon adsorption can readily remove many organic compounds from water, with the exception of some polar water-soluble compounds, such as iodinated contrast agents and the antibiotic sulfamethoxazole (Adams et al., 2002; Westerhoff et al., 2005). Although they are very effective, AOP treatment processes are inefficient for oxidizing trace chemical constituents because they are energy intensive and involve random reactions with much of the TOC in addition to the target chemicals present in only minute quantities. Compared to ozone treatment alone, AOPs provide only a small increase in removal efficacy (Dickenson et al., 2009).

Low-pressure membranes, such as MF and ultrafiltration (UF), have pore sizes that are insufficient to retain trace chemical constituents; however, some hydrophobic compounds can still adsorb onto MF and UF membrane surfaces providing some short-term attenuation of the hydrophobic compounds and TOC. However, high-pressure membranes, such as RO and

nanofiltration (NF), are very effective in the physical separation of a variety of pharmaceuticals and other organics and inorganics from water (Bellona et al., 2008). Low-molecular-weight organics are problematic for high-pressure membranes, and the disposal of the concentrate (brine) with elevated levels of trace chemical constituents can be an issue. Natural processes, such as riverbank filtration (RBF) and SAT, can be employed either as an additional treatment step for wastewater reclamation or as a pre-treatment to subsequent drinking water treatment (Amy and Drewes, 2007; Hoppe-Jones et al. 2010). RBF and SAT are very effective in attenuating a wide range of chemicals by sorption and biotransformation processes in the subsurface but are limited in attenuating refractory compounds, such as antiepileptic drugs or chlorinated flame retardants (Drewes et al., 2003).

AOP processes are being researched for their ability to remove organic compounds. For example, while UV photolysis is generally not an effective treatment option for removing organic compounds, UV photolysis in combination with H₂O₂ achieves high removal rates of a variety of potential EDCs, including bisphenol A, ethinyl estradiol, and estradiol (Rosenfeldt and Linden, 2004).

Table 6-5 presents a summary of indicative reductions of organic chemical concentrations. Data presented are intended to present relative removals but should not be used as a design or regulatory basis. Scheme proponents must validate the treatment technology for the specific application and operational conditions.

Risk Assessment of Trace Chemical Constituents.

Because WWTPs using conventional treatment processes cannot remove trace organic chemicals completely, wastewater discharge can introduce some of these constituents into receiving environments. Thus, in *de facto* reuse, chemical constituents can be introduced into drinking water supplies (Benotti et al., 2009). Detection of trace chemical constituents in drinking water systems and environmental waters raise understandable concerns about the potential implications for public and ecological health. Research organizations around the world, including EPA, are exploring these implications and assessing the risks with respect to acute, chronic illness, and sequelae. Although a number of comprehensive studies have been conducted to address the concern about

potential human health risks of unknown and unidentified trace level chemicals in reclaimed water (Nellor et al., 1984; Sloss et al., 1996; Anderson et al., 2010), there is currently no definitive documentation of risk with respect to trace chemicals for the use of reclaimed water to augment drinking water supplies. On the basis of available information, there is no indication that health risks from using highly-treated reclaimed water for potable purposes are greater than those from using existing water supplies (NRC, 2012).

A recent report by the Global Water Research Coalition (GWRC) synthesized results of nine recently published reports addressing the occurrence and potential for human health impacts of pharmaceuticals in the drinking water system (GWRC, 2009). The report concludes that there is no known impact on human health due to pharmaceutical exposure in drinking water, and that if a person consumed drinking water with the reported levels of pharmaceuticals, that person would consume only 5 percent (or less) of *one daily therapeutic dose* (i.e., a single pill) of an individual pharmaceutical over his or her whole lifetime. Further, a recent report from a WHO expert panel concluded that the risk of adverse human health effects from exposure to the trace levels of pharmaceuticals in drinking water is considered to be unlikely (WHO, 2011); this report did not assess nonpharmaceutical trace chemicals.

Public exposure to trace chemical constituents in water reuse for irrigation or other types of nonpotable reuse is negligible. In planned potable reuse, the treatment technologies employed in the United States ensure that concentrations of trace chemicals are at extremely low levels, often below analytical detection limits. And, in fact National Academy of Sciences 2012 Report on water reuse (*Water Reuse: Expanding the Nation's Water Supply Through the Reuse of Municipal Wastewater*) presented a risk comparison between potable reuse projects and *de facto* reuse scenarios (as described in Section 3.7), concluding that potable reuse scenarios have reduced risk of pathogen exposure and lower or equivalent risk of chemical contaminant exposure compared to existing water supplies (NRC, 2012).

While the risk associated with trace chemical constituents in drinking water is indeed very low, the water sector continues to investigate the issue and invest in precautionary treatment technologies.

Because a human health risk of zero is not an achievable condition with exposure of any level, it is necessary to reach a consensus on upper bound *de minimis* risk goals that can be the basis for design and operation of planned potable reuse facilities.

The greater impact of trace chemical constituents may be the ecological effects from the presence of chemicals in wastewater discharges and stormwater runoff to surface waters. Recent concern over ecological effects of discharged chemical constituents is primarily from studies in the 1990s of surface waters receiving treated municipal wastewater where feral fish in proximity of the discharge were found to have altered reproduction strategies and high incidences of hermaphroditism (Sumpter and Johnson, 2008). When advanced wastewater treatment, which includes RO, is used, almost all microconstituents can be effectively removed, and the RO effluent poses no hormonal threat to tissue cultures and live fish (WRRF, 2010b). Thus, while many environmental monitoring programs are underway, toxicological studies conducted at environmentally relevant concentrations are not likely to provide much information due to the very low hypothetical risks at the trace concentrations that are detected, the difficulty in conducting chronic studies, and the large margins of exposures.

In response to uncertainties that may be associated with potential risks in potable reuse applications, adoption of appropriate treatment technologies has been employed to minimize exposure of humans to wastewater-derived trace chemical constituents. Many analytical studies have been conducted to identify the few residual chemicals that may pass through advanced treatment. Residual TOC levels, which can be considered a surrogate for trace chemical constituents in planned potable reuse finished water, are usually a fraction of a milligram per liter.

Additional information on guidance for developing monitoring programs that assess potential CEC threats from water reuse provided by the SWRCB is provided in the regulatory section that follows, **Section 6.3** (SWRCB, 2011; Anderson et al., 2010). Additional research on evaluating and explaining the relative human health risks related to the reuse of reclaimed water continue to be funded, and in 2012 the WRRF published a series of reports in which quantitative relative risk assessments were conducted at the Montebello Forebay [[US-CA-Los Angeles County](#)].

Table 6-5 Indicative percent removals of organic chemicals during various stages of wastewater treatment

| Treatment | Percent Removal | | | | | | | | | | |
|---|-----------------|--------------------------|-----------------|-------|-------|-------|-------|----------------------|-----------------------|-----------|-------|
| | B(a)p | Antibiotics ¹ | Pharmaceuticals | | | | | Hormones | | Fragrance | NDMA |
| | | | DZP | CBZ | DCF | IBP | PCT | Steroid ² | Anabolic ³ | | |
| Secondary (activated sludge) | nd | 10–50 | nd | – | 10–50 | >90 | nd | >90 | nd | 50–90 | – |
| Soil aquifer treatment | nd | nd | nd | 25–50 | >90 | >90 | >90 | >90 | nd | >90 | >90 |
| Aquifer storage | nd | 50–90 | 10–50 | – | 50–90 | 50–90 | Nd | >90 | nd | – | – |
| Microfiltration | nd | <20 | <20 | <20 | <20 | <20 | <20 | <20 | nd | <20 | |
| Ultrafiltration/ powdered activated carbon (PAC) | nd | >90 | >90 | >90 | >90 | >90 | nd | >90 | nd | >90 | >90 |
| Nanofiltration | >80 | 50–80 | 50–80 | 50–80 | 50–80 | 50–80 | 50–80 | 50–80 | 50–80 | 50–80 | |
| Reverse osmosis | >80 | >95 | >95 | >95 | >95 | >95 | >95 | >95 | >95 | >95 | 25–50 |
| PAC | >80 | 20–>80 | 50–80 | 50–80 | 20–50 | <20 | 50–80 | 50–80 | 50–80 | 50–80 | |
| Granular activated carbon | | >90 | >90 | >90 | >90 | >90 | | >90 | | >90 | >90 |
| Ozonation | >80 | >95 | 50–80 | 50–80 | >95 | 50–80 | >95 | >95 | >80 | 50–90 | 50–90 |
| Advanced oxidation | | 50–80 | 50–80 | >80 | >80 | >80 | >80 | >80 | >80 | 50–80 | >90 |
| High-level ultraviolet | | 20–>80 | <20 | 20–50 | >80 | 20–50 | >80 | >80 | 20–50 | nd | >90 |
| Chlorination | >80 | >80 | 20–50 | <20 | >80 | <20 | >80 | >80 | <20 | 20–>80 | – |
| Chloramination | 50–80 | <20 | <20 | <20 | 50–80 | <20 | >80 | >80 | <20 | <20 | |

(Sources: Ternes and Joss, 2006; Snyder et al., 2010)

B(a)p = benz(a)pyrene; CBZ = carbamazepine, DBP = disinfection by-product; DCF = diclofenac; DZP = diazepam; IBP = ibuprofen; NDMA=N-nitrosodimethylamine; nd = no data; PAC = powdered activated carbon; PCT = paracetamol.

¹ erythromycin, sulfamethoxazole, triclosan, trimethoprim

² ethynylestradiol; estrone, estradiol and estriol

³ progesterone, testosterone

The Montebello Forebay project is a potable reuse project that meets drinking water standards for chemical constituents. The second part of this research extended into identifying safe exposure concentrations for a broad range of chemicals of interest to the recycled water community based on published toxicity information; the final task of this work included identification of contaminants that would be a concern in 5 to 20 years (WRRF, 2010c, 2011a, and 2012f). Results from this report point to the potential for a shift in the pharmaceutical industry to increase focus on research, development and production of more biodegradable pharmaceuticals.

Treatment technologies for producing reclaimed water are well documented to remove trace chemical constituents to very low concentrations, resulting in very low risks to human health. However, the continuous stream of reported detection of CECs in reclaimed water has led to public concern about their presence and the implications for adopting planned potable reuse. Better public education regarding the effectiveness of the available treatment technologies and the safety of highly treated reclaimed water, as described in Chapter 6, should be a high priority for scientists and regulators.

Potential Impact of Residual Trace Chemical Constituents. Most WWTPs and many water reclamation facilities are not designed for removal of TrOCs. As a result, residual antibiotics and metabolites are inadvertently released into the environment. This may lead to proliferation of antibiotic resistance (AR) in pathogenic or nonpathogenic environmental microorganisms (Pauwels and Verstraete, 2006). However, the proliferation of AR is not limited to the environment and may actually occur during therapeutic use, during which intestinal flora are exposed to high concentrations of antibiotics, or during wastewater treatment, particularly secondary biological processes (Clara et al., 2004; Dhanapal and Morse, 2009).

A 2000 WHO report identified AR as a critical human health challenge for the next century and heralded the need for “a global strategy to contain resistance” (WHO, 2000). According to the report, more than two million Americans are infected each year with antibiotic-resistant pathogens, and 14,000 die as a result. A potential source of this proliferation of AR is the use, whether for human health or animal

husbandry, and subsequent release of antibiotics and metabolites into the environment. It is estimated that up to 75 percent of antibiotics are excreted unaltered or as metabolites (Bockelmann et al., 2009). And yet, few studies have attempted to identify processes contributing to the selection of AR bacteria. Such information will be critical in the development of treatment strategies to reduce the potential for AR proliferation in the environment.

There are several critical locations within a typical WWTP where AR may accumulate or develop. AR genes may already be present in raw sewage entering a WWTP, but there is also considerable evolutionary pressure within a WWTP to induce such changes. Specifically, the conventional activated sludge (CAS) and MBR processes may be a significant source of AR due to their continuous exposure of bacteria in ideal growth conditions to relatively high concentrations of antibiotics. Despite the direct correlation between solids retention time (SRT) and reductions in antibiotic concentrations, higher SRT also provides prolonged exposure of bacterial populations to relatively high concentrations of antibiotics present in primary effluent (Clara et al., 2005; Gerrity et al., 2012; Salveson et al., 2012). Some MBRs will operate at SRTs on the order of 50 days, while CAS processes may be operated in the range of 1 to 20 days, which is more than sufficient to allow for bacterial adaptation given their high growth rates. In both MBR and CAS configurations, AR bacteria may accumulate in biosolids and may also be discharged to the environment in finished effluent or reclaimed water.

To reduce the potential for AR proliferation, future research should target identification of the major source(s) of AR (i.e., raw sewage, biosolids, or treated effluent), determine treatment conditions that promote AR development, and characterize the persistence of AR in the environment. Ultimately, this knowledge will assist in developing mitigation strategies and alleviating environmental and public health concerns.

6.3 Regulatory Approaches to Establishing Treatment Goals for Reclaimed Water

Countless studies have provided information about the operating conditions of wastewater treatment processes; treatment efficacy; and pathogen and contaminant behavior, fate, and activity in the environment along with geological parameters

necessary for developing and maintaining adequate processes to prevent contamination of groundwater and other water sources. Together, these studies established the role of each unit process in ensuring treatment efficiency. Many state guidelines and regulations emphasize the use of a multiple-barrier approach that combines several unit processes to ensure redundancy. Title 22 of the California Code of Regulations for Water Recycling Criteria (Title 22) (2009) and in Chapter 62-610 of the Florida Administrative Code for Reuse of Reclaimed Water and Land Application (2009) both require a multi-barrier approach.

6.3.1 Microbial Inactivation

With respect to understanding the human health impacts as a function of exposure to microbial contamination, it is useful to review historical work that was conducted and has been used as the basis for the EPA's Recreational Water Quality Criteria (RWQC). The criteria recommendations are for the protection of people using bodies of water for recreational uses, such as swimming, bathing, surfing, or similar water-contact activities, and are based on an indicator of fecal contamination, which is a pathogen indicator. The EPA RWQC may be used by states to establish water-quality standards that can provide a basis for controlling the discharge or release of pollutants from WWTPs. In many cases, individual states have used these criteria as the basis for development of microbial standards for some reuse. Interestingly, many of the states have used the EPA RWQC as the basis for reuse.

In December 2011, EPA released a new draft RWQC that recommended using the bacteria *enterococci* and *E. coli* as indicator organisms for freshwater. While the numeric criteria for the geometric mean of organisms are identical to the 1986 RWQC, there are also recommendations for how to address the maximum statistical values. It is unknown at this time what, if any, changes to the draft will be implemented before the new criteria are published as final.

The historical development of the EPA RWQC began in the 1960s, when the U.S. Public Health Service recommended using fecal coliform bacteria as the indicator of primary contact with fecal indicator bacteria. Studies showed that in surface waters impacted by wastewater discharges, there was a reported, detectable health effect when total coliform

density was about 2,300 per 100 mL (Stevenson, 1953). In 1968, the National Technical Advisory Committee (NTAC) translated the total coliform concentrations to 400 cfu/100 mL based on a ratio of total coliform to fecal coliform, and then halved that number to 200 cfu/100 mL (EPA, 1986). The NTAC criteria for recreational waters were recommended again by EPA in 1976. In the late 1970s and early 1980s, EPA conducted a series of epidemiological studies to evaluate several additional organisms as possible indicators of fecal contamination, including *E. coli* and *enterococci*; these studies showed that *enterococci* are a good predictor of gastrointestinal illnesses in fresh and marine recreational waters and *E. coli* is a good predictor in freshwater (Cabelli et al., 1982; Cabelli, 1983; Dufour, 1984). The current 2012 draft RWQC now has acknowledged the use of quantitative real time polymerase chain reaction (qPCR) data for *enterococci* and set levels in recreational settings. The qPCR method was found to be superior to cfu in predicting illness (Wade et al. 2008), and acceptable risk levels of 8 illnesses per 1,000 exposures have been set. Thus, at the state level this allows discussion if these approaches and levels of risk could be appropriate for the various levels of use for reclaimed water.

Concurrently, several key studies were conducted that contributed significantly to understanding recycled water treatment processes, benefits of the multiple-barrier approach, and the long-term impacts of using recycled water. The Pomona Virus Study (Miele, 1977) was a landmark study that provided a database for wastewater-treatment unit process performances. The data could be used to make regulatory decisions regarding alternative treatment system variances of the California recycled water regulatory requirements (Title 22), at that time (California Administrative Code, 1978; Dryden et al., 1979; Miele, 1977). The study concluded that nearly complete virus removal is possible using additional filtration and disinfection steps and opened up the possibilities of wastewater reuse for various applications.

Since then, the potential health effects from long-term use of recycled water were evaluated in three epidemiological studies (Nellor et al., 1984; Sloss et al., 1996; Sloss et al., 1999). Almost 600 filtered effluent and groundwater well samples were analyzed for human viruses, and no viruses were found. Further, two additional studies were conducted to increase the

understanding of the effectiveness of SAT processes for use in designing, operating, and regulating SAT systems, which are further discussed in Section 6.4.5.3 (Fox et al., 2001; Fox et al., 2006). In these studies, culturable human viruses were found in disinfected secondary effluents and downstream monitoring wells, indicating that SAT does not completely remove these viruses. However, where coagulation and filtration processes are added to the reclaimed water treatment process, the disinfected effluent samples and water associated with groundwater spreading operations does not contain culturable human viruses. These findings reiterate that plants with different levels of treatment produce different qualities of recycled water and that properly-designed treatment can remove viruses to below detection limits.

Thus, there is a substantial body of scientific evidence that most states use in development of microbiological criteria for reuse; and most states that have reuse rules or guidelines base their criteria on the removal of indicator organisms. Generally, reuse applications in which only specific applications with minimal human contact are allowed (e.g., irrigation of fodder crops for livestock use) do not require the same level of disinfection as applications in which human contact is more likely to occur (e.g., irrigation of landscaping or turf in a public area). A majority of states that allow and permit applications specify microbiological effluent quality and do not specifically require certain treatment technologies, with several notable exceptions (e.g., California, Washington, and Hawaii).

For example, North Carolina has recently produced reuse-quality specifications for two categories of reuse applications. The level of treatment required for the use with the highest potential for human contact includes criteria of 6-log (99.9999 percent) removal for *E. coli*, 5-log (99.999 percent) removal for coliphage, and 4-log (99.99 percent) removal for *Clostridium perfringens*. In California, the regulatory approach is based on treatment technology with specific performance requirements. The most stringent reclaimed water treatment uses in California include oxidation, sedimentation, coagulation, filtration, and disinfection. Taken as a whole, these treatment strategies are useful for the removal and inactivation of pathogens to undetectable or very low levels in reclaimed water.

California's recycled water requirements were adopted from the guidelines developed for the SDWA requirements of 1974 and are currently the most protective requirements in the nation. For unrestricted public access, including edible crop irrigation and swimming, the California Title 22 requirements include specific filtration and disinfection criteria that are designed to remove and/or inactivate 5-log of viruses. The requirements also include monitoring limits for total coliform bacteria, while many states have less stringent limits based on fecal coliforms. Rigorous turbidity requirements that are a component of the California criteria are used as a surrogate measure of filtration performance, which, as described in Section 6.4.2, is an important factor in achieving the rigorous microbial inactivation requirements. Further, disinfection technologies that are approved for application in reuse projects must demonstrate the equivalent of 5-log reduction of poliovirus over a range of operating conditions.

More recently in California, new draft groundwater replenishment regulations have been discussed for indirect potable reuse by planned groundwater replenishment reuse projects (GRRP) that use highly treated municipal wastewater to replenish groundwater basins designated as potable water supplies by 2013 (CDPH, 2011). Draft provisions of the GRRP regulations would be based on reducing the risk of waterborne disease and would include pathogen controls requiring treatment systems to achieve 12-log virus reductions and 10-log reductions of the protozoan parasites *Cryptosporidium* oocysts and *Giardia* cysts through at least three treatment barriers. Up to 6-log removal credit would be allowed for surface and groundwater storage that is at least 6 months in duration. Treatment facilities that employ approved filtration and disinfection processes or an approved AOP process with at least 6 months of underground retention prior to use can obtain a 10-log removal credit for *Cryptosporidium* oocysts and *Giardia* cysts. Use of proven, CDPH accepted technology/treatment processes reduces the burden on utilities to pilot proven processes and to prove reduction of microbial contaminants through underground storage.

6.3.2 Constituents of Emerging Concern

The majority of wastewater-derived trace chemical constituents are not specifically regulated in the United States, although pretreatment requirements and

effluent guidelines and secondary and advanced treatment are beneficial for reducing loadings of many chemicals. Moreover, with thousands of chemicals potentially present in reclaimed water, compiling a comprehensive list of chemicals that could be present in trace concentrations is not feasible. In fact, EPA considered a select number of trace chemical constituents on their most recent Candidate Contaminant List (CCL3) and the proposed Unregulated Contaminants Monitoring Rule 3 (UCMR3) for drinking water. In the absence of federal mandates, individual states may choose to regulate individual chemical constituents. The WHO concluded that WHO guidelines were not necessary for pharmaceuticals in water supplies, and it did not recommend general monitoring of water supplies for pharmaceuticals (WHO, 2011).

Extensive regulations for trace chemical constituents in recycled water for potable applications and drinking water are probably neither feasible nor necessary. Treatment specifications or guidelines for particular end uses, such as the approach for all U.S. drinking water supplies, may be useful. However, benchmarks for water quality composition are useful for decision-makers as well as public confidence. Development of benchmarks for specific chemicals, especially pharmaceuticals and pesticides, is feasible because they usually have very extensive databases developed as part of their registration or approval process, and margins of exposures are available relative to therapeutic or toxic doses (Bull, et al., 2011). Screening techniques, such as estimation of Thresholds of Toxicological Concern, are also available for use in prioritizing and reducing long lists of chemicals to those of potential greater interest (Cotruvo, 2011). These techniques could be applied rapidly and at relatively low cost. Another useful model for producing benchmarks for unregulated water contaminants would be like the nonregulatory EPA Drinking Water Health Advisories that were initiated more than 20 years ago (EPA, 2012; Cotruvo, 2012).

While there are no specific regulations for CECs in reclaimed water as of 2012, further investigation is necessary before any final decisions can be made on the subject. While the application of reclaimed water for urban and landscape irrigation (i.e., lawns, golf courses, parks, non-food gardens, etc.) is thought to pose very low risk to humans in contact with the various plants/surfaces irrigated, recent research by

Knapp et al. (2010) indicates that there may be indirect health effects resulting from use of reclaimed water in agricultural applications. In that study, changes in antibiotic resistance in soil bacteria in samples taken and archived in the Netherlands between 1940 (when antibiotic use was beginning to be widespread) until 2008 showed supported growing evidence that resistance to antibiotics is increasing both in benign and pathogenic bacteria, which could pose an emerging threat to public and environmental health (Knapp et al., 2010).

In order to understand these broader, indirect effects of CECs, one of the stated areas of priority for the USDA Agriculture and Food Research Initiative (AFRI) Program is to investigate the potential and relevance of bioaccumulation of CECs when recycled water is applied at typical irrigation rates. The USDA-AFRI is funding work to examine the potential for bioaccumulation of PPCPs by crops under irrigation with reclaimed water. This work is being conducted to help address the concerns over potential health risks posed by consuming raw food crops that may bioaccumulate these chemicals (Wu et al., 2010).

6.3.2.1 Example of California's Regulatory Approach to CECs

Over the years, the CDPH has developed a series of incremental draft criteria for the use of reclaimed municipal wastewater to recharge groundwater basins that are sources of domestic water supply (CDPH, 2008). These criteria were designed to ensure that groundwater supplies are augmented with reclaimed water that meets all drinking water standards, and other requirements.

In 2009, California's SWRCB adopted a new Recycled Water Policy that created a "blue ribbon" panel to guide future state actions relative to CECs by conducting a review of scientific literature related to use of reclaimed water and current knowledge on risks that might be posed by CECs and to make recommendations regarding monitoring for CECs (SWRCB, 2009). Background on the California Recycled Water Policy and CECs, including links to public hearings and reports, is available online (SWRCB, 2011). The Advisory Panel report *Monitoring Strategies for Chemicals of Emerging Concern (CECs) in Recycled Water – Recommendations of a Scientific Advisory Panel* was issued in June 2010 (Anderson et al., 2010).

The panel provided a conceptual framework for assessing potential CEC targets for monitoring and used the framework to identify a list of chemicals that should be monitored currently (Anderson et al., 2010). The panel also recommended that the prioritization process be reapplied on at least a triennial basis and that the state establish an independent review panel to periodically review CEC monitoring efforts. The CECs the panel recommended for monitoring currently are those found in recycled water at concentrations with human health relevance, as defined by the exposure screening approach recommended by the panel. Further, the panel recommends monitoring both the performance of treatment processes to remove CECs using selected “performance indicator CECs,” and surrogate/operational parameters to verify that treatment units are working as designed. Surrogates include turbidity, DOC, and conductivity. Health-based CECs selected for monitoring included caffeine, 17 β -estradiol, NDMA, and triclosan. Performance-based indicator CECs were selected by the panel, each representing a group of CECs: caffeine, gemfibrozil, n,n-diethyl-meta-toluamide (DEET), iopromide, NDMA, and sucralose. Caffeine and NDMA serve as both health and performance-based indicator CECs.

CDPH provided recommendations to the SWRCB specific to CECs and the CDPH monitoring requirements for surface spreading groundwater recharge projects (CDPH, 2010). CDPH recommendations were specific for chemicals on the current CDPH notification-level list, other chemicals, and chemicals specific to a new permit. CDPH notification-list chemicals to be monitored are boron; chlorate; 1,4-dioxane; nitrosamines (NDMA, NDEA, and NDPA); 1,2,3-trichloropropane; naphthalene; and vanadium, with initial quarterly testing that could be reduced to annual testing if the chemicals are not detected. Initial quarterly monitoring was also recommended for chromium-6, diazinon, and nitrosamines NPYR and N-Nitrosodiphenylamine, with the ability to reduce to annual testing if the chemical is not detected. Three additional chemicals, bisphenol A, carbamazepine, and TCEP, were recommended for annual monitoring. CDPH also included a statement that it would consider source waters and treatment process when recommending project-specific monitoring requirements, such as monitoring for formaldehyde when an AOP process is used.

The most current draft regulations, issued in November 2011, are scheduled to be finalized in 2013 (CDPH, 2011). Other scientific oversight groups required by legislation for individual projects have recommended other performance-monitoring regimens to demonstrate the effectiveness of the treatment trains being employed. Very few chemicals are being detected, even at ppt levels, in fully-treated waters.

6.3.2.2 Example of Australia’s Regulatory Approach to Pharmaceuticals

In 2008, Australia was the first country to develop national guidelines for potable reuse with the release of Phase 2 of the *Australian Guidelines for Water Recycling (AGWR): Augmentation of Drinking Water Supplies* (EPHC, 2008). The AGWR provide a risk management framework, rather than simply relying on end-product (reclaimed-water) quality testing as the basis for managing water recycling schemes. They include concentration-based numeric guidelines for at least 86 pharmaceuticals in reclaimed water. The guideline concentrations are based on application of a safety factor of 1,000 to 10,000 relative to a single therapeutic dose. These are not mandatory and have no formal legal status, but they were provided as nationally consistent guidance for those recycling projects. In general, the guideline concentrations are far higher than concentrations found in drinking water or reclaimed water.

While there is no definitive risk assessment tool for some types of trace chemical constituents in recycled water, the Australian guidelines do provide a methodology for evaluating the potential risk from known and emerging chemical constituents (NHMRC-NRMMC, 2004; EPHC, 2008; and Snyder et al., 2010).

6.4 Wastewater Treatment for Reuse

The level of wastewater treatment required for any project depends on the end use or discharge location, but in the United States, all wastewater is required to be treated to secondary levels, at a minimum. Secondary treatment is designed to achieve removal of degradable organic matter and suspended solids. Filtration and disinfection provide additional removal of pathogens and nutrients, and AOPs can target trace chemical constituents. Wastewater treatment from raw to secondary is well understood and covered in great detail in other publications, such as the WEF Manual of Practice (MOP) 8, *Design of Municipal Wastewater Treatment Plants* (WEF, 2010). The discussion here is

limited to treatment processes with a particular application to water reuse and reclamation, which also includes source control.

For many uses of reclaimed water, appropriate water quality can be achieved through conventional, widely-practiced secondary, filtration and disinfection processes. However, as the potential for human contact increases, advanced treatment beyond secondary treatment may be required. As discussed in Section 1.5, the level of treatment and treatment processes to be employed for a reuse project should consider the end use to establish water quality goals and treatment objectives. Not all constituents have negative impacts for all uses. Nutrients, for example, can be beneficial when water is reused for agricultural irrigation, offsetting the need for supplementally applied fertilizers, and in these cases nutrient removal in treatment may not be helpful. On the other hand, where water is reused for environmental flows, nutrient removal could be critical to avoid overloading aquatic ecosystems with these nutrients. Likewise, nutrient removal would be targeted where reclaimed water would impact future drinking water sources, such as groundwater, as excess nutrients can be harmful to human health.

A summary of the level of treatment required for specific reclaimed-water end uses in 10 states is provided in Section 4.5.2. Three processes have seen significant technology advances since publication of the 2004 guidelines: filtration, disinfection, and advanced oxidation. The purpose of this section is to describe these processes and some of the recent technology advances, as well as highlight the increasingly important role of natural treatment systems, such as wetlands and SAT systems, for polishing or further treating the reclaimed water.

6.4.1 Source Control

A critical component of any water reuse program is to develop and implement an effective industrial source control program as the first barrier to preventing undesirable chemicals or concentrations of chemicals from entering the system. The pollutants in industrial wastewater may compromise municipal treatment processes or contaminate the treated effluent by pass-through. To protect municipal treatment plants and the environment, the CWA established the National Pretreatment Program, which requires industrial dischargers to use treatment and management

practices to reduce or eliminate the discharge of harmful pollutants to sanitary sewers. The term “pretreatment” refers to the requirement that nondomestic sources discharging to publicly-owned treatment works control their discharges. EPA has established technology-based numeric effluent guidelines for 56 categories of industry, and the CWA requires EPA to annually review its effluent guidelines and pretreatment standards and to identify potential new categories for pretreatment standards; recommendations are presented in a Preliminary Effluent Guidelines Program Plan. The 2010 Plan included a strategy for the development of BMPs for unused pharmaceutical disposal at hospitals and other healthcare facilities that is intended to eliminate inconsistency in messages and policies regarding flushing of drugs to municipal sewer systems.

Wastewater management agencies are required to establish local limits for industries as needed to comply with NPDES permits and to prevent discharges into sewerage systems that inhibit or disrupt treatment processes, or the uses/disposal of treated wastewater. Generally, pollution prevention programs will be effective if certain conditions can be met:

- The pollutant can be found at measurable levels in the influent and collection system.
- A single source or group of similar sources accounting for most of the influent loading can be identified.
- The sources are within the jurisdiction of the agency to control (or significant outside support/resources are available).

Industrial sources are most easily controlled because industries are regulated and required to meet sewer-use permit requirements. If a pollutant source is a commercial product, such as mercury thermometers or lindane head lice remedies, it may not be within the local agency's power to ban or restrict the use of the product; in such cases, to be effective, restrictions on product use must be enforced on a regional, statewide, or national basis, such as the ban on nonylphenol (a surfactant ingredient with endocrine disrupting properties) use in the European Union.

For agencies implementing IPR projects, source control programs may go beyond the minimum federal requirements. Many agencies have developed local or

statewide “no drugs down the drain programs” and/or drug take-back programs. For example in Texas, SAWS has developed a collection program for unused medications. Other agencies have included additional program elements to enhance their pollution prevention efforts; the OCSD, which provides reclaimed water to the OCWD for the Groundwater Replenishment System Project in southern California, has instituted additional program elements that build on the agency’s traditional source control program. These elements include a pollutant prioritization scheme that includes chemical fate assessment for a broad range of chemicals; an outreach program for industries, businesses, and the public; and a toxics inventory that integrates a geographical information system and chemical fact sheets. The OCSD successfully used its source control program to reduce the discharge of NDMA and 1,4-dioxane from industries into its wastewater management system.

Oregon has passed rules that set trigger levels for pollutants, requiring municipal wastewater facilities to develop toxics reduction plans for listed priority persistent pollutants if any of the pollutants are found in their effluent above the trigger levels set by the rule (Oregon DEQ, n.d.). The rule includes numeric effluent concentration values for 118 priority persistent pollutants for which drinking water MCLs have not been adopted, but that the Oregon Environmental Quality Commission has determined should be included in a permitted facility’s toxic-pollutant reduction plan. The list includes pollutants that persist in the environment, and pollutants that accumulate in animals. All of the pollutants on the list have the potential to cause harm to human health or aquatic life; some are known carcinogens and others are believed to disrupt endocrine functions. The list includes both well-studied pollutants that people have worked to reduce for many years and others for which little information exists. Results of wastewater effluent monitoring will be compared against trigger levels, and where effluent concentrations exceed the trigger level, the facility will be required to develop a toxics reduction plan aimed at reducing levels of that pollutant in its discharge. The Oregon DEQ consulted with a Science Peer Review Panel to develop the list of pollutants and triggers.

6.4.2 Filtration

Filtration removes particulates, suspended solids, and some dissolved constituents, depending on the filter

type. In addition, by removing particles remaining after secondary treatment, filtration can result in a more efficient disinfection process. While chemical or biophysical disinfection processes inactivate or destroy many classes of microorganisms, pathogens removed by filtration are removed by physical adsorption or entrapment. The ability of filtration to help reduce pathogens is a function of the pore size of the media, the size of the pathogen, and the impact of chemical addition, if used. Most types of filtration are able to remove some of the largest pathogens, such as protozoan cysts. Smaller pathogens, including bacteria or viruses, can be removed in filtration either through size exclusion by filters with very small pore sizes, or by filtering out larger particles to which the smaller pathogens are adsorbed. Because a large proportion of pathogens in treated wastewater prior to disinfection tend to be associated with particles, many states with reuse regulations also include requirements for removal of particles. The rationale of these requirements is that effective filtration, and thus particle removal, is part of a multiple-barrier treatment process. A second benefit is improvement in disinfection efficiency with fewer particles, lower turbidity, and higher transmittance.

Regulatory factors can affect the design of filtration, where required, for water reuse activities. For example, the regulatory requirements for water reuse filtration in California and Florida (the two states where the most water reuse occurs) are worth comparing. Florida does not stipulate the type of approved filters or loading rate to the filter as long as water quality requirements for TSS are satisfied. On the other hand, in California, the filtration technology must be conditionally accepted by the CDPH prior to its application for treatment of recycled water, in addition to meeting strict turbidity limits during performance. Many types of filtration, including depth filtration, surface filtration, and membrane filtration, have received approval from CDPH; the loading rate at which the conditionally-accepted filter can be operated is also specified. Both states require chemical feed facilities to improve filtration by first coagulating particles, but the chemical feed facilities can remain idle if the TSS or turbidity limits are satisfied.

In California, several conventional filtration technologies are approved for operation at 2 gpm/ft² (traveling bridge filters) and 5 gpm/ft² (mono-, dual-, or mixed-media filters), and disinfection with chlorine gas

or sodium hypochlorite is allowed under stipulated conditions. All other filtration and disinfection technologies must undergo rigorous third-party testing and receive “conditional acceptance” from the CDPH prior to use. For filtration testing, this includes long-term performance demonstration for meeting turbidity criteria and other objectives.

In recent years, with increased emphasis on improving treatment for reuse, there have been many innovations in filtration, and today there are numerous types of commercially-available filtration technologies. Therefore, a brief discussion of recent advances in filtration technology as it relates to treatment of reclaimed water is merited. Regardless of the significant variations in configurations and characteristics of the filters, there are three types of commercially-available filtration technologies: depth filtration, surface filtration, and membrane filtration.

6.4.2.1 Depth Filtration

Depth filters have the longest history of use at WWTPs. Depth filters consist of a bed of noncompressible or compressible media. Noncompressible media, such as sand, anthracite, or garnet, is most commonly used. Depending on the type of filter (i.e., mono-, dual-, or mixed-media), the effective size of the media in noncompressible media filters varies between 0.0016 and 0.08 in (0.4 and 2.0 mm) in average diameter. Noncompressible media filters contain columns packed with several feet of media, and, depending on the filter configuration, utilize a continuous, semi-continuous, or batch backwash process. Utilities with existing depth filtration plants are also increasing their existing filtration capacity by conducting filtration studies to document the ability of their filters to operate at higher hydraulic loading rates. These advances in loading rates allow for substantial reduction in filtration costs.

In 2000, depth filters with synthetic compressible media became commercially available. These compressible-media filters utilize a synthetic medium that has a diameter of approximately 1.25 in (32 mm). During normal filtration, media in the compressible-media filters is compressed 15 to 40 percent, and filtration occurs. Backwashing occurs in a batch process, during which the media is uncompressed and then cleaned with an air scour and a hydraulic wash. The high porosity of the compressible media (around 88 percent) allows for higher hydraulic loading rates

than other depth filter, while the backwashing continuously recharges the media surface to prepare it for another round of filtration so that filtration efficiency is not compromised. Conditional acceptance of this technology for water reuse applications was granted in 2003 by CDPH for hydraulic loading rates up to 30 gpm/ft² (1200 L/min/m²), which is more than six times the approved filtration rate of conventional depth filters. More recent advances in this technology have resulted in the development of a modified compressible media that operates at even higher hydraulic loading rates (Caliskaner et al., 2011).

6.4.2.2 Surface Filtration

The main difference between surface and depth filters is the depth of the packed media and the media material. Depth filtration typically includes several feet of packed media, while surface filters are generally a fraction of a millimeter to several millimeters thick. Surface filters typically consist of screens or fabric manufactured from nylon, polyester, acrylic, and stainless steel fibers. Most surface filters are gravity fed, and backwashing is semi-continuous; however, for short periods of time it may be necessary to perform backwash in a continuous mode.

Manufacturers of disk filters, which are a type of surface filter with the filtration screen mounted on a series of disks, have made recent improvements in performance and efficiency; increasing numbers of disk filter configurations are gaining regulatory approval in California, where filter technologies must be approved. In 2001, the CDPH approved the first disk filtration technology for water reuse applications at hydraulic loading rates up to 6 gpm/ft² (230 L/min/m²), and other disk filtration configurations have more recently received conditional acceptance at the same loading rate. A high-rate disk filter was granted conditional acceptance for loading rates up to 16 gpm/ft² (620 L/min/m²), in 2009 (State of California, 2009). At least one manufacturer has received CDPH approval for a submerged, fixed cloth media, and there are several others that have applied for acceptance.

6.4.2.3 Membrane Filtration

A membrane may be defined as a thin film separating two phases and acting as a selective barrier to the transport of matter; detailed discussion of membrane filtration processes are provided in EPA’s *Membrane Filtration Guidance Manual* (EPA, 2005). For water to flow through a membrane there must be some type of

driving force, and for reuse applications, membrane processes are typically pressure-driven processes. Some novel desalination approaches, which may gain application in reclamation of brackish waters, use osmotic gradients as the driving force. A summary of the driving force and nominal pore size is provided in **Table 6-6** for major, commercially-available filtration processes.

There are significant differences in the pore sizes of various filter types available (**Table 6-6**). The use of filters from the membrane group will result in a higher filter effluent quality than can be achieved by using either surface or depth filters. This higher effluent water quality with MF or UF membranes comes at a higher cost of 1.5 to 2 times that of depth or surface filtration systems because of energy and equipment costs. NF and RO costs are substantially higher, due to high energy costs and specialized equipment.

The capacity of a filtration system is usually evaluated based on filtration rate and the available surface area in the filtration system. Manufacturers are constantly developing new filtration technologies or modifying their established technologies to improve filter performance by increasing the hydraulic loading rates or increasing water quality, thus making their filters more economical or providing better value.

In San Ramon, Calif., the DSRSD provides filtration of

secondary effluent using a continuous backwash sand filtration system in parallel with a 0.2 nominal pore size MF system for comparison of filtration efficiency [US-CA-San Ramon]. Studies conducted on this reuse system show that a higher level of particle rejection (which was achieved with the MF system) correlates with higher microorganism rejection (*Cryptosporidium*, *Giardia*, and total coliforms), and that the filtration system can be an important part of a multi-barrier approach to reclaimed water treatment (WRRF, 2012a). It is important to note that neither filtration system in this case study example was able to provide virus rejection. While smaller pore size membranes, such as UF, NF, and RO systems, can achieve virus removal when membranes do not have any flaws, chemical disinfection is needed for virus removal, which is why the multi-barrier approach is needed.

6.4.2.4 Biofiltration

Biological filtration or biofiltration is a treatment technique in which a granular media filter is allowed to be biologically active for the purpose of removing biodegradable constituents such as TOC. Most any granular media filter is capable of supporting microbial growth, assuming that the water being filtered does not have a disinfectant residual. As a result, the biological activity can improve treatment performance beyond particle removal such that water quality is improved with respect to a wide range of dissolved organic

Table 6-6 Summary of filter type characteristics¹

| Filter Type | Filtration Driving Force | Nominal Pore Size, μm | Contaminants targeted for removal |
|-----------------------------|----------------------------------|----------------------------------|--|
| Depth | | | |
| Non-Compressible Media | Gravity or pressure differential | 60-300 | TSS, turbidity, some protozoan oocysts and cysts |
| Compressible Media | | | |
| Surface Filtration | | | |
| Surface Filtration | Gravity | 5-20 | TSS, turbidity, some protozoan oocysts and cysts |
| Membrane² | | | |
| Microfiltration | Pressure differential | 0.05 | TSS, turbidity, some protozoan oocysts and cysts, some bacteria and viruses |
| Ultrafiltration | Pressure differential | 0.002-0.050 | Macromolecules, colloids, most bacteria, some viruses, proteins |
| Nanofiltration | Pressure differential | <0.002 | Small molecules, some hardness, viruses |
| Reverse Osmosis | Pressure differential | <0.002 | Very small molecules, color, hardness, sulfates, nitrate, sodium, other ions |

¹ Information taken from California Department of Public Health (2012), Metcalf & Eddy (2003)

² Information from *Water Treatment Membrane Processes* (AWWA, 1996)

contaminants, including pesticides, EDCs, and pharmaceuticals, although the degree to which biological activity contributes to treatment performance varies (Bonne et al., 2006; Wunder et al., 2008; Van der Aa et al., 2003). Several types of biofiltration can be used, including slow sand, rapid-rate, and granular activated carbon (GAC) (Evans, 2010).

Depending on the pore size of the filter media, substantial removal of trace chemical compounds can be obtained. The mechanisms of physical removal include removal of particles with sorbed chemicals, removal of chemicals by sorption into media pores, or electrostatic repulsion (WRRF, 2012a; Kimura et al., 2003). Biofiltration, which is commonly used in potable reuse schemes, enhances the use of common physical and chemical means to remove contaminants through biodegradation. With increasing interest in obtaining higher quality reclaimed water, biofiltration, as part of a multi-barrier treatment process, could replace higher energy processes such as RO in certain applications (see sections 3.1 and 3.7 for the Namibia model for potable reuse).

Slow Sand Filtration. Slow sand filtration, along with natural filtration processes, such as SAT and riverbank filtration, which are discussed in Section 6.4.5, is actually one of the oldest drinking water treatment processes still being used today. Slow sand filtration uses small-diameter sand with low surface-loading rates without chemical coagulation. In slow sand biofiltration, the sand's top surface becomes coated with a biologically active layer called a *schmutzdecke*, which is periodically scraped off or harrowed to renew a system's hydraulic capacity. Although slow sand filtration primarily uses both physical and biological mechanisms to remove contaminants, the biological mechanism dominates.

Rapid-Rate Filtration. Rapid-rate filtration uses larger-diameter media, such as sand and anthracite, and surface loading rates about 100 times higher than slow sand filtration. A coagulant, such as ferric chloride or alum, is added upstream of the process to remove turbidity and organic matter. The filter must be backwashed periodically with chlorinated or nonchlorinated water. A preoxidation process that uses ozone, chlorine, chlorine dioxide, or permanganate is sometimes used, which can enhance biological activity by oxidizing complex organic matter

into smaller, more biodegradable organic compounds that are readily removed by a rapid-rate filter.

GAC Filtration. When compared with sand or anthracite media, GAC has the additional property of adsorption and can accumulate greater microbial biomass (or biofilm) on activated carbon media. Biomass plays an important role in biodegrading contaminants and supplementing GAC filtration. GAC lifetime—the time between media replacements—can be extended by biological processes. Therefore, GAC filtration uses physical and biological processes for contaminant removal. Depending on contact time requirements to remove target contaminants, GAC filtration can be designed as a GAC rapid-rate filter, a mono-media deep-bed contactor, or a filter cap on top of a sand or anthracite filter bed. As with conventional rapid-rate filters, upstream coagulants and oxidants frequently are used to improve contaminant removal. Additionally, GAC's adsorptive properties aids in producing the desired filtered water quality through adsorption; thus, GAC must be regenerated periodically, particularly where adsorption may play a more dominant treatment role than the biological mechanism of contaminant removal.

6.4.3 Disinfection

Relative removal of microbial indicators and pathogens by various treatment stages is included in **Table 6-3**; however, in order to provide reclaimed water that meets the intended use, disinfection using one or more of these technologies is an important part of any reuse scheme. Disinfection is designed to inactivate microorganisms, including viruses, bacteria, protozoan oocysts and cysts, and helminthes; these pathogenic organisms and the associated health risks were discussed in Section 6.2.1. The most common reclaimed water disinfection method in use to date is chlorination. UV disinfection is a well-proven and commonly-used alternative to chlorine. Other disinfection alternatives are peracetic acid (PAA), ozone, pasteurization, and ferrate (WERF, 2008); PAA is not discussed further because no municipal reuse applications have been implemented in the United States, to date.

To date, California is the only state that has technology-based regulations for disinfection, although Florida references the NWRI UV Guidelines in its regulatory code as guidance for permitting reuse applications (NWRI, 2003). Thus, while there are many

disinfection technologies that show promise for reuse applications, this section covers those technologies that have demonstrated pathogen reduction through rigorous research and have obtained “conditional acceptance” from the CDPH for use on reclaimed water treatment, with the exception of ferrate, which is also included. There are four technologies accepted by the CDPH: chlorination, UV disinfection, ozone, and pasteurization. Dose requirements for these disinfection technologies under California Title 22 are provided in **Table 6-7**, along with comparative dose requirements for reuse in Florida under FAC 62-610.

6.4.3.1 Chlorination

Chlorine disinfection may be accomplished using free chlorine or chloramines. Regardless of the mode of chlorination, the efficiency of chlorine disinfection depends on the water temperature, pH, degree of mixing, time of contact, presence of interfering substances, concentration and form of chlorinating species, and nature and concentration of the organisms to be destroyed. In general, bacteria are less resistant to chlorine than viruses, which, in turn, are less resistant than parasite ova and cysts.

Disinfection requirements often include monitoring of total chlorine (which includes free chlorine, chloramines, and other chlorine/organic compounds) remaining in the treated water after a certain contact time. When ammonia is present in wastewater, it will combine with free chlorine to form chloramines (typically monochloramine), which is less effective as a disinfectant than free chlorine and requires a disinfectant dose an order of magnitude or more than

free chlorine (WEF, 2010). Additionally, chlorine reacts with other organic constituents that remain in treated wastewater to form compounds that provide a measurable combined chlorine residual, but with a potentially low disinfection capability. The occurrence and effects of this phenomenon have been well documented (Black and Veatch, 2010; Szerwinski, et al., 2012).

Chlorine disinfection efficacy is typically measured as C_rT , which is the product of the total chlorine residual times the contact time. Methods of calculating C_rT can vary. The CDPH, for example, specifies the C_rT concept, with C_r being the total combined residual and T being the contact time at the point of measurement. C_rT can also be defined as the integration of the residual concentration of the disinfectant concentration C_rT over the measured contact time T . Depending on water quality and chemistry, there may be a significant chlorine demand that yields a difference in the applied and residual concentration at the required or recommended contact time. Because of the complications in wastewater, the chlorine C_rT values required for various rates of inactivation must be determined empirically. Many studies have shown that a C_rT for free chlorine outperforms the same C_rT for chloramines; however, the assumption that a lower dose may be required for disinfection using free chlorine is misleading, because achieving free chlorine residual in wastewater effluents can be challenging for the reasons given above. Planners and designers are cautioned to confirm the currently-accepted calculation approach for any specific project.

Table 6-7 California and Florida disinfection treatment-based standards for tertiary recycled water and high-level disinfection

| Disinfection Process | California | Florida ² |
|----------------------|---|--|
| Chlorination | 450 mg-min/L C_rT ¹ | 25 mg-min/L for fecal coliform <1,000 MPN/100 mL 40 mg-min/L for fecal coliform 1,000 to <10,000 MPN/100mL 120 mg-min/L for fecal coliform >10,000 MPN/100mL |
| UV | 100 mJ/cm ² following sand or cloth filtration; 80 mJ/cm ² following MF or UF; 50 mJ/cm ² following RO | No uniform standard |
| Ozone | 1 mg-min/L CT ¹ | No standard |
| Pasteurization | 10 second contact time at 179 degrees F | No standard |

¹ CT is the multiplication of a measured modal contact time and oxidant residual at the end of the contact period. C_rT is the product of the total chlorine residual times the contact time.

²Florida’s sliding disinfection standards for chlorination assume a direct correlation between fecal coliform concentrations and pathogen levels. Lower fecal coliform counts thus require less disinfection.

Free and combined chlorine have measurable differences in disinfection ability. Free chlorine is a rapid and effective viral disinfectant in wastewater, but a moderate concentration of ammonia results in a combined residual with reduced disinfection potential for poliovirus and MS2 coliphage (MS2) (Cooper, 2000). In California, for example, the C_rT of 450 mg-min/L is required for nonpotable water reuse applications with potential for direct public contact. At this dose, the CDPH assumes that disinfection will provide 4-log virus reduction for chlorine or chloramines. However, recent research has shown that in a high-quality nitrified effluent, a C_rT value of 50 mg-min/L or lower can meet the stringent “tertiary recycled water” disinfection quality for reuse in California (Maguin et al., 2009).

Pathogenic protozoan parasites, such as *Giardia lamblia* and *Cryptosporidium parvum* and *hominis*, are found in the environment as cysts or oocysts, which protect them from environmental insults and inactivation by oxidants such as chlorine (EPA, 2004). In light of recent protozoan treatment goals, research, and publications, concerns over the use of chlorine for reclaimed water disinfection have been raised (Gennaccaro et al., 2003; Garcia et al., 2002). Gennaccaro et al. (2003) found infectious *Cryptosporidium* oocysts in 40 percent of final disinfected effluent samples in a survey of several reclamation facilities that used filtration and chlorination. Thus, *Giardia* and *Cryptosporidium* (some viable) have been documented in the literature to be found in reclaimed water effluents, the majority of which utilized chlorination. Some viable protozoan pathogens in reclaimed water disinfected with chlorine should be anticipated.

Because of the challenges of *Giardia* and *Cryptosporidium* inactivation, combining chlorine disinfectants with UV has recently attracted increasing attention, because of benefits such as disinfection of a wider range of pathogens, improved reliability through redundancy, reduced DBPs, and potential cost savings. A recent report showed that when chloramines were combined with UV, median total coliform levels below 2 cfu/100 mL and 5-log poliovirus inactivation can be achieved; however, free chlorine is still a more effective disinfectant than chloramines (WRRF, 2010d).

EPA specifies that in drinking water treatment engineers should only anticipate significant *Giardia* inactivation with free chlorine (3-log inactivation at a C_rT of 50 mg-min/L, depending on temperature and pH), as combined chlorine requires a C_rT of 1,000 mg-min/L for an equivalent level of treatment. For those states that dictate a required chlorine C_rT , regulatory compliance includes continuous monitoring and control of C_rT in conjunction with maintaining microbiological targets. Some states, such as California, require demonstration of minimum contact times upon completion of new chlorination facilities. And, for reclaimed water entering a reclaimed water distribution system, it is common to increase the chlorine residual based on time of travel and residual demand. If reclaimed water is released to a stream for flow augmentation and dechlorination is required, dechlorination can be provided as an end-of-pipe treatment.

6.4.3.2 Ultraviolet Disinfection

UV disinfection of reclaimed water is gaining in use due to increasingly energy-efficient and lower-cost UV technologies. Large systems are now successfully operating in cities such as Roseville, Calif. (45 mgd; 1,972 L/s), and Mesa/Gilbert, Ariz. (32 mgd; 1,402 L/s) [US-AZ-Gilbert]. As of 2012, UV is a well-proven and robust disinfection method; however, disinfection of treated wastewater by UV can be complicated by several factors. Most of these factors are governed by the level of treatment the utility has implemented prior to the UV disinfection reactor.

Two key water quality issues that can impact UV disinfection performance and efficiency are the presence of particle-associated microorganisms and the UV transmittance (UVT) of the wastewater. Particles can shade target microbes, shielding them from UV light; bacteria frequently become embedded in particulate matter, partially or wholly protecting them from the UV light (Paraskeva et al., 2002; Emerick et al., 1999). Particle size distribution may indicate the potential for UV disinfection efficiency, with smaller particles having less effect on UV efficiency than larger particles, as the shielding effect is reduced (Jolis et al., 2001); particles larger than 10 microns in size can shield microorganisms from disinfection by UV light. UV disinfection is enhanced by filtering water prior to disinfection, both by the reduction in particulates (a reduction in the number of large particles with embedded and shielded microorganisms) and by the

increase in UVT (a reduction in smaller particulates that do not shield organisms but do reduce UVT and thus reduce UV efficiency).

Chevrefils et al. (2006) provide a thorough review of the literature on bacteria, virus, and protozoa disinfection with UV and clearly shows that UV is a powerful disinfectant for most microorganisms, including viruses such as poliovirus, calicivirus, reovirus, coxsackievirus, rotavirus, and hepatitis. Typically, UV systems are designed to meet regulations for bacterial indicator organisms; thus, total and/or fecal coliform bacteria are the primary regulatory targets. For instance, California's regulated total coliform level for "tertiary recycled water" reuse is 2.2 cfu per 100 mL of water (cfu/100 mL), which can be obtained at a relatively low UV doses (~35 to ~75 mJ/cm²), but higher doses are required to meet the 5-log virus requirement (100 mJ/cm²) (NWRI, 2003). UV dose is measured in millijoules seconds per cm² (mJ/cm²) and is calculated by multiplying the UV intensity measured in mW/cm² and the exposure time in seconds.

One challenge with UV disinfection is the possibility that some organisms may undergo photoreactivation after UV exposure; this can occur when the microorganisms repair their DNA damaged by the UV light. Photoreactivation of disinfected organisms can occur when UV-damaged cells are exposed to light in the visible wavelength spectrum (310 to 480 nm) that prompts cell-initiated repair of damaged DNA (Harris et al., 1987; Ni et al., 2002). Photoreactivation can be a function of UV dose, the concentration of organisms, UV transmittance, and suspended solids concentration. But, Lindenauer and Darby (1994) found that photoreactivation of total coliforms in UV disinfected wastewater decreased with increasing UV dose. Thus, where treated water is stored in uncovered basins, the use of moderately higher UV dose values, such as the values required in California for "tertiary recycled water" (100, 80 or 50 mJ/cm² depending upon filtration technology) could be employed.

The UV industry has experienced substantial advances since implementation of the original systems that consisted of vast quantities of low pressure (LP), low intensity lamps, which had reasonable energy efficiency but maintenance challenges due to the large number of lamps that need to be replaced regularly.

Medium pressure (MP) UV systems solved the problem of numerous lamps but resulted in three to four times the energy use of LP systems. The UV industry responded again by developing LP, high output (LPHO) UV systems, ranging in watts/lamp from 160 watts all the way to 1,000 watts of energy to individual lamps. One of the more innovative UV technologies to reach the mainstream marketplace is microwave UV systems, which utilize microwaves to generate UV light instead of the conventional voltage differential from electrode lamps. These innovations in LPHO and microwave technologies allow for lower-cost UV installation at reasonable energy use values. It is not uncommon for UV systems to have lower construction and operational costs compared to the costs for sodium hypochlorite.

For those states where UV dose is regulated (e.g., California, Washington, Hawaii), UV systems must be either pre-validated or undergo on-site validation after construction. The validation process consists of detailed third-party research of individual UV reactors over the range of potential operating conditions. For UV equipment that is to be used for reuse applications in California, validation must adhere to the requirements in Title 22 to receive conditional approval from the CDPH. The CDPH requires detailed testing and operation in accordance with the National Water Research Institute's (NWRI) Ultraviolet Disinfection Guidelines for Drinking Water and Water Reuse (NWRI UV Guidelines). The NWRI UV guidelines apply specifically to the disinfection of wastewater meeting the definition of "filtered wastewater" in California's Water Recycling Criteria (WRC), Title 22, Division 4, Chapter 3, of the California Code of Regulations. The NWRI UV Guidelines present guidance such that after disinfection, the disinfected filtered reclaimed water is essentially pathogen free, meeting the requirement of 5-log poliovirus inactivation and a 7-day median total coliform of 2.2 MPN/100 mL.

Additionally, the NWRI UV guidelines were recently revised and its publication was announced in August 2012, during final preparation of this document. The key revisions with respect to reclaimed water incorporated into the 2012 version include (NWRI, 2012):

- All reclamation systems must undergo commissioning tests that demonstrate disinfection performance is consistent with design intent.
- Velocity profiles have been eliminated as an option for transferring pilot data to full-scale facility design.
- On-site MS-2 based viral assays are used for both the validation and commissioning test.
- A standard MS-2 dose-response curve is used to derive the reduction equivalent dose.
- The design equation is based on the lower 75-percent prediction interval for reclamation systems.
- Commissioning tests will require seven out of eight on-site measurements exceeding the operational design equation.
- Addition of an appendix to illustrate the computations involved in the application and evaluation of UV disinfection systems.

It is important to note that the NWRI UV Guidelines are applicable for specific reuse types, and there are other guidance documents available for low-dose applications. Other validation protocols for low-dose reuse applications have been recently published by Whitby et al. (2011).

6.4.3.3 Ozone

The detection of pharmaceutically active and EDCs in reclaimed water has resulted in an increased interest in the application of ozone disinfection. Ozone is a mature disinfection technology with secondary benefits of removal of CECs as well as color removal. Additional research funded by the WRRF under project WRF-08-05 on use of ozone for water reclamation is ongoing, and a report on contaminant oxidation in reclaimed water using ozone is scheduled for release in 2013. With respect to disinfection, the mechanism of microbial inactivation is similar to chlorine in that it is a chemical process that disrupts cell membranes and nucleic acids, altering transport across the membrane. This causes cell lysis, causing irreversible damage to the DNA. The high oxidation potential of ozone makes it suitable for oxidizing CECs and other compounds that can cause taste and odor issues in indirect potable applications. It also breaks down larger organic compounds that can act as precursors to

chlorinated DBPs and bring about an increase in UVT, thus leading to more energy-efficient UV disinfection following ozonation (Kleiser and Frimmel, 2000).

While ozonation has substantial benefits, as of 2010, it was used at fewer than a dozen treatment plants in the United States, of which only two are specifically reuse applications: El Paso, Texas, and Gwinnett County, Ga. (Oneby et al., 2010). While ozone has been prevalent in the drinking water industry, it is important to recognize the growing body of ozone disinfection research in reuse, as documented in Ishida et al. (2008), which highlights novel approaches to the application of ozone for reclaimed water disinfection. The task of designing and operating ozone disinfection systems for wastewater reclamation may be approached in an alternative manner than utilized in the drinking water industry. Drinking water ozone disinfection is based on the traditional drinking water *Ct* concept, the product of contact time and ozone residual for dose determination (in mg-min/L). Application of the traditional drinking water *Ct* concept may be inappropriate for wastewater disinfection as significant bacterial reduction can be achieved prior to the appearance of an ozone residual, since ozone decays rapidly (Absi et al., 1993; Janex et al., 2000; Lazarova et al., 1998).

Bacterial inactivation by ozone in wastewater disinfection is highly dependent on effluent quality. Compared to drinking water applications, the process is less dependent on contact time than ozone concentrations, once an initial amount of ozone is transferred to the wastewater (Tyrrell et al., 1995; Janex et al., 2000; Ishida et al., 2008). Although this observation may be specific to the target microorganism, the presence or absence of readily oxidizable materials seems to determine the importance of contact time (Sommer et al., 2004). Detailed research on filtered wastewater has resulted in conditional acceptance of ozone by the CDPH for reclaimed water disinfection. For all test conditions, this research demonstrated that a *Ct* below 1 mg-min/L met nondetectable total coliform counts and provided the 5-log virus barrier required by CDPH; thus, CDPH has set an ozone minimum *Ct* requirement of 1 mg-min/L (Ishida et al., 2008). It should be noted that *Ct* values greater than 1.0 mg-min/L have been reported to meet various reclaimed water coliform standards (WRRF, 2012a).

The addition of hydrogen peroxide (H_2O_2) to ozone in wastewater has been shown to reduce bromate formation (Ishida et al., 2008) where this is a concern due to the presence of bromide. Research reports conflicting results, and the reasons for these differences are not fully understood, although it is known to be related to water chemistry. Further, increasing the ozone contact time (while maintaining ozone residual) from 30 seconds to 120 seconds does not appear to substantially boost disinfection performance (WRRF, 2012a).

Because of improvements in ozone generation and dissolution technologies in recent years, which improve the economics of the process along with increasing interest in addressing CECs, several new ozone systems for wastewater disinfection are under design, under construction, and recently in operation. In Anaheim, Calif., a 0.1 mgd (4.4 L/s) pressurized ozone reactor (HiPOx by APTwater) will be in operation by 2012 (Robinson, 2011). This system was installed as part of a combined effort to produce high-quality reclaimed water and to educate the community. The Clark County Water Reclamation District has chosen to upgrade its treatment from sand filtration and UV to membrane filtration and ozone. The first 30 mgd (1,314 L/s) (average annual flow, peak flow of 45 mgd [1,972 L/s]) of this upgrade was under construction in 2012. A second upgrade of an additional 30 mgd (1,314 L/s) of average annual flow is under design (Drury, 2011).

6.4.3.4 Pasteurization

Pasteurization is a process of applying heat to a substance to inactivate pathogenic or spoilage microorganisms. The process was discovered by Louis Pasteur in 1864 and has since become standard practice in the food industry. Pasteurization has also become accepted practice in sewage sludge processing, with the goal of inactivating pathogens to achieve Class A Biosolids standards.

Thermal inactivation of microorganisms may depend on a number of factors: characteristics of the organism, stress conditions for the organism (e.g., nutrient limitation), growth stage, characteristics of the medium (e.g., heat penetration, pH, presence of protective substances like fats and solids, etc.), and temperature and exposure time combinations. In design of pasteurization systems, temperature and exposure time combinations are the dominant

parameters (Moce´-Llivina et al., 2003; Salveson et al., 2011). Pasteurization has been demonstrated at the city of Santa Rosa’s Laguna Wastewater Reclamation Plant, where validation testing was conducted as part of the CDPH program to review new technologies and provide conditional approval (often referred to as “Title 22” approval) (Salveson et al., 2007). Based upon this and other work, the CDPH approved pasteurization to meet the stringent “tertiary recycled water criteria” for specific minimum contact times and temperature.

The economic value of pasteurization is favorable when waste heat can be captured and transferred for disinfection. Heat exchangers can be used to recapture heat from hot disinfected water to preheat undisinfected water, also cooling the disinfected effluent to just a few degrees above the influent undisinfected water. Example sources of waste heat include exhaust heat from a turbine fueled by natural gas, digester gas, or hot water. Favorable economics for pasteurization has been demonstrated in Ventura, Calif., where a 400 gpm (25 L/s) demonstration system (**Figure 6-2**) has been constructed and is in continuous operation. Because of the high cost of power at this utility, pasteurization is projected to save several million dollars in lifecycle costs compared to UV disinfection (US-CA-Pasteurization).



Figure 6-2
Pasteurization demonstration system in Ventura, Calif.

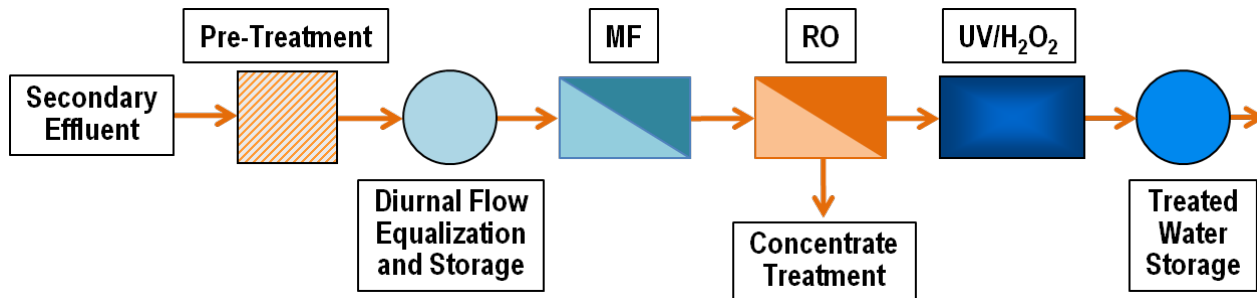

Figure 6-3
Example WRF treatment train that includes UV/H₂O₂ AOP

6.4.3.5 Ferrate

Ferrate was explored in the 1970s as a replacement chemical for chlorine, but prior synthesis methods made its utilization cost prohibitive. With recent advances in new on-site production methods of ferrate, it has the potential to be applied as an alternative to other widely-practiced oxidation and disinfection processes. Research has demonstrated that ferrate can be an extremely competitive oxidizing agent for disinfection processes, with the key benefit of minimizing by-product formation. Ferrate chemistry results from formation of iron in the plus 6 oxidation state, or Fe⁺⁶, and is a powerful oxidant, depending upon the pH of the solution. As pH will dictate the stability and reactivity of ferrate in solution, testing is required to determine the conditions under which ferrate disinfection is feasible. There are many reports on the use of ferrate in wastewater disinfection, and an excellent summary of the most relevant literature has been provided in Skaggs et al. (2009 and 2008).

The on-site generation of ferrate requires bulk caustic, bulk ferric chloride, and bulk liquid sodium hypochlorite solutions. The components of a ferrate disinfection system are similar to that of a liquid hypochlorination system with the exception of the addition of an on-site generation system. Additional solids are produced in ferrate disinfection, so solids handling may be an additional component of a ferrate disinfection system. Site-specific testing must be conducted to determine the required disinfection dose.

While there have been numerous laboratory and pilot-scale investigations, the first full-scale installation of ferrate at the 100 mgd (4,400 L/s) East Bank treatment plant in New Orleans, La., is not anticipated to be implemented until after 2012. The technology was selected for this application due to its advantages over other technologies, including the fact that it can

provide oxidation and disinfection in the same application, similar to ozone. This allows the disinfection process to also address EDCs, which were a concern for reuse of the water at the East Bank WWTP for wetlands restoration (AWWA, 2010).

6.4.4 Advanced Oxidation

AOPs are a class of water treatment technologies, including UV/H₂O₂, ozone/H₂O₂, ozone/UV, UV/TiO₂ (titanium dioxide), and a variety of Fenton reactions (Fe/H₂O₂, Fe/ozone, Fe/H₂O₂/UV) (Asano et al., 2007; Stasinakis, 2008; Munter, 2001) that can be added to the end of a treatment train, as shown in **Figure 6-3**. These technologies have a broad range of applications, from reducing the CECs and toxicity of industrial effluent and wastewater to finishing water for high-tech industries (Munter, 2001; WRRF, 2012f). This process is especially valuable for reclaimed water treatment for potable applications because of its ability to address PPCPs and EDCs that are not significantly removed during conventional wastewater treatment processes (Miège et al., 2008).

Although a variety of base treatment technologies can drive AOPs, each AOP is similar in that it is designed to generate highly reactive, nonspecific intermediate species (such as hydroxyl radicals and superoxide radicals) (Glaze et al., 1987). There are several technologies available for advanced oxidation that show promise for reuse applications. AOPs are designed to take advantage of the high electrochemical oxidation potential of radical species, combining parallel disinfection and oxidation processes as shown in **Table 6-8**.

The hydroxyl radicals formed in an AOP work in parallel to the primary disinfectant by breaking apart toxic organic compounds, resulting in the transformation of toxic organic compounds into less-toxic daughter

compounds (Stasinakis, 2008). Hydroxyl radical formation and availability is affected by pH, but only at pH extremes (Arakaki, 1999); at typical pH values, hydroxyl radical formation rates will not vary significantly (Watts et al., 1994). Free radicals quickly react with electron acceptors in water, and as a result wastewater has a high scavenging capacity (Rosario-Ortiz et al., 2010). Because of this, organic species present in treated wastewater can compete for hydroxyl radicals and it is less likely that the preferred reaction, the oxidation of TrOCs, will take place.

Table 6-8 Electrochemical oxidation potential (EOP) for several disinfectants (adapted from Tchobanoglous et al., 2003)

| Oxidizing Agent | EOP [V] | EOP Relative to Chlorine |
|-----------------------------|---------|--------------------------|
| Hydroxyl Radical | 2.80 | 2.05 |
| Ozone | 2.08 | 1.52 |
| Peracetic Acid ¹ | 1.81 | 1.33 |
| Hydrogen Peroxide | 1.78 | 1.3 |
| Hypochlorite | 1.49 | 1.1 |
| Chlorine | 1.36 | 1 |
| Chlorine Dioxide | 1.27 | 0.93 |

¹ Peracetic acid data courtesy of Enviro-Tech Chemical Services Inc.

Advanced oxidation processes are most commonly used in potable reuse applications to address treatment objectives that include recalcitrant organic compounds, such as PPCPs, and a wide range of potential EDCs. Compared to other treatment alternatives, such as activated carbon, AOPs also disinfect a wide variety of microbial targets and result in an overall removal of pathogens and CECs (WRRF, 2012g), as opposed to simply sequestering compounds via adsorption or physical separation. UV-based AOPs are also frequently employed to destroy nitrosamines, particularly the carcinogenic DBP NDMA in potable reuse applications [US-CA-San Diego]. This is in response to regulations on NDMA in California, which is ahead of EPA in regulating this compound; EPA placed NDMA (and the other five nitrosamines) on its second Unregulated Contaminant Monitoring List (UCMR2) in 2006.

When the operational costs of advanced oxidation systems are compared to the total operational expenses of the treatment process for potable reuse applications, these costs are marginal. In a recent

study from Australia, the electrical costs of running the UV system were only 3.5 percent of the total energy costs, and H₂O₂ costs made up only 4 percent of the total costs of the chemicals used on-site (Poussade et al., 2009). WRRF (2012a) demonstrated that the lowest-cost AOP process following media filtration, MF filtration, and UF filtration is ozone. More expensive technologies following media, MF, and UF filtration included UV/H₂O₂, ozone/H₂O₂, TiO₂/UV, peracetic acid with UV, and several other technologies. Following RO treatment, the optimum AOP system is dependent on the target compound. If NDMA destruction is the key target, UV/H₂O₂ will be the lowest-cost treatment; if an organic compound is the primary target, likely ozone/H₂O₂ or ozone will be the lowest-cost technology.

In some reuse scenarios, augmentation of existing potable water supplies is required. The practice of IPR continues to grow in acceptance and application. One of the main drivers for this acceptance is the growing public knowledge of water treatment, particularly the extensive treatment the wastewater undergoes before being considered safe for potable consumption. A vital component of the extensive treatment train in IPR is the combined use of UV light and H₂O₂. In IPR applications, UV/H₂O₂ not only provides disinfection, but also destroys CECs (Drewes et al., 2002). Examples include the OCWD and the WBMWD, whose IPR projects provide groundwater replenishment, and the community of Big Spring, Texas, which has begun a project that will purify wastewater to quality better than drinking water for the augmentation of local surface water. In these cases, an integrated membrane system (IMS) provides significant pretreatment to the UV/H₂O₂ AOP.

The full-scale Advanced Water Purification Facility at the OCWD's Groundwater Replenishment System, commissioned in 2008, uses filtered secondary wastewater effluent from a neighboring WWTP and treats it to water that meets all drinking water quality standards. The 70-mgd (3,100 L/s) system consists of MF, RO, and UV/H₂O₂. The UV/H₂O₂ treatment step at OCWD consists of a LPHO amalgam lamp UV system comprised of multiple parallel trains of stacked UV chambers (connected in series). To verify predicted NDMA reductions, this UV/H₂O₂ system was tested to demonstrate both NDMA destruction and microorganism disinfection, showing that the system was effective for both treatment objectives.

6.4.5 Natural Systems

Natural filtration processes take advantage of intrinsic characteristics of riverbanks, aquifers, and wetlands comprised of media—soil and plants—that can filter water and in some cases provide a surface for biofilm growth that can biologically oxidize or reduce contaminants. Two natural treatment approaches include wetlands and soil aquifer filtration (which also includes riverbank filtration for the purposes of this discussion). The principles of how these natural filtration processes can be used to confer additional treatment are described in the EPA *Process Design Manual for Land Treatment of Municipal Wastewater Effluents* (EPA, 2006).

6.4.5.1 Treatment Mechanisms in Natural Systems

Natural systems have the potential to reduce or remove pathogens, organic carbon, contaminants of concern, and nutrients during sub-surface transport. As reclaimed water filters through the subsurface, physical, biological, and chemical water quality improvement occurs during SAT where spreading basins are used (Section 2.3.3.2). During ASR, vadose zone injection, or direct injection, these mechanisms can also occur to a varying extent; this is especially true of ASR systems, in which sub-surface residence time can be highly variable.

Pathogens. Pathogens are a major concern in all reclaimed water systems, and the highest risk associated with pathogens is ingestion. Pathogen removal efficacy for SAT systems via filtration and disinfection is described in *Demonstration of Filtration and Disinfection Compliance through SAT* (WRRF, 2012g). Pathogen removal during SAT is most efficient during unsaturated flow but the unsaturated zone is bypassed by direct injection into the aquifer during ASR. For ASR, treatment efficiency determination is site specific. Furthermore, pathogen removal during ASR is less efficient when non-porous media is present, for example, recharge into bedrock (e.g. basalt) rather than into granular aquifers (sand). Concerns over pathogens have resulted in the implementation of travel time requirements for environmental buffers in IPR systems. Travel times are average values and some groundwater takes a faster path and arrives sooner than average. Travel times are most accurately calculated for only porous media aquifers. In non-porous media aquifers, travel times are best determined using site specific field tracer

tests. In either case, travel times are uncertain and are especially uncertain for non-porous media. In California, travel time requirements range from 6 to 12 months, depending on the percentage of reclaimed water in the IPR system. In 2009, Massachusetts adopted a 6-month travel time requirement for environmental buffers in IPR systems. The retention times required for environmental buffers ranges from 50 days to 12 months, and this has a major impact on design and implementation.

The AwwaRF study titled “Water Quality Improvements during Aquifer Storage and Recovery” (2005) reported on extensive laboratory and field studies on the survival of the bacteria, *E. coli*, a nonpathogenic indicator. A summary of studies on *E. coli* decay rates revealed that most researchers found decay rates of 0.1/d or greater when studying the decay of *E. coli* in a sub-surface environment (Roslev et al., 2004). Many of these studies were conducted under controlled conditions in groundwater without the effects of straining and sorption (filtration). Therefore, decay alone may result in 5-log removal of *E. coli* in less than 20 days during sub-surface transport. However, *E. coli* decay rates do not inform pathogenic human viral or parasitic protozoan decay rates.

Concern over viruses has prompted continued research on virus transport and survival in environmental buffers. Soil saturation and aquifer flow type (porous or non-porous media), media composition, ground water pH, and virus strain all interact to affect the sorptive capacity and virus die-off rate in soils and aquifers. Because viral subsurface inactivation rates are an estimate, a second barrier with reliable, effective disinfection is recommended. Furthermore, virus removal by sorption is an active research area and remains difficult to predict in field studies. Similar concerns over protozoa have been raised because *Cryptosporidium* oocysts and *Giardia* cysts have been found in groundwater (Bridgman et al. 1995; Hancock et al. 1998) and in reclaimed water (Gennancaro et al., 2003; Huffman et al., 2006) including infectious *Giardia*. And, there have been *Cryptosporidium* and *Giardia* outbreaks, some associated with heavy rainfall (Bridgman et al. 1995; Willocks et al. 1998; Rose et al. 2000; Curriero et al. 2001), with research revealing that *Cryptosporidium* oocysts and *Giardia* cysts can be transported in the subsurface under normal conditions, soil, especially when preferential porous media flow paths exist

(Darnault et al. 2003 and Park et al., 2012). Additional research into the transport of protozoan pathogens is needed.

Organic Carbon. Residual organic carbon is a concern in IPR systems because these compounds are associated with a broad spectrum of potential health concerns (Asano, 1998). Three groups of residual organic chemicals require attention (Drewes and Jekel, 1998): 1) natural organic matter (NOM) present in most water supplies, 2) CECs added by consumers and generated as DBPs during the disinfection of water and wastewater, and 3) soluble microbial products (SMPs) formed during the wastewater treatment process and resulting from the decomposition of organic compounds. NOM and SMPs are mixtures of compounds that cannot be effectively measured individually. When NOM and SMPs are measured as a group, the concentrations of organic carbon are typically measured in the mg/L range; CECs are typically present in the µg/L to ng/L range. Most waters contain NOM, and reclaimed waters contain a mixture of NOM and SMPs (Drewes and Fox, 2000).

Most reclaimed waters used in managed aquifer recharge systems receive limited characterization of NOM and/or SMPs that comprise the bulk of the organic carbon compounds present. Typically, these compounds are quantified by DOC measurements and ultraviolet absorbance (UVA) (Fox and Drewes, 2001). Organic compounds are removed during sub-surface transport by a combination of filtration, sorption, oxidation/reduction, and biodegradation. Biodegradation is the key sustainable removal mechanism for organic compounds during sub-surface transport (Fox et al., 2005; AWWARF, 2001). The concentrations of NOM and SMPs are reduced during sub-surface transport as high molecular weight compounds are hydrolyzed into lower molecular weight compounds and the lower molecular weight compounds serve as substrate for microorganisms (Drewes et al., 2006). Synthetic organic compounds at concentrations too low to directly support microbial growth may be co-metabolized, as NOM and SMPs serve as the primary substrate for growth (Rausch-Williams et al, 2010, Nalinakumari et al, 2010).

During sub-surface transport, the transformation of organic compounds may be divided up into several different regimes defined as short-term

transformations where relatively fast reactions occur and long-term transformations where recalcitrant compounds continue to transform at slower rates over time (Fox and Drewes, 2001). Easily biodegradable carbon is transformed within a time-scale of days. The environmental buffer of IPR systems typically contains much longer time-scale over which DOC can continue to be transformed.

Constituents of Concern. The removal of CECs in general tends to parallel the removal of DOC. Easily biodegradable constituents of concern, such as caffeine and 17β-Estradiol, tend to degrade on a time-scale of days while more refractory compounds, such as NDMA and sulfamethoxazole, tend to degrade over a time-scale of weeks to months (Dickerson et al., 2008). Persistent compounds, such as carbamezapine and primidone, can persist for months or years in an environmental buffer (Clara et al., 2004, Heberer, 2002). The transformation of organic constituents of concern can depend on the presence of biodegradable dissolved organic carbon (BDOC) because the concentrations of constituents of concern are very low and may not support growth (Rausch-Williams et al., 2010; Nalinakumari et al., 2010).

Nitrogen. Reclaimed water that has not been nitrified or denitrified may contain greater than 20 mg/L of ammonia-nitrogen, which can exert over 100 mg/L of nitrogenous oxygen demand. The majority of studies on the fate of nitrogen have been done in the vadose zone because wet/dry cycles can result in alternating aerobic/anoxic conditions (Miller et al., 2006). Alternating aerobic/anoxic conditions may facilitate nitrogen cycling, and greater than 70 percent nitrogen removal has been observed in the vadose zone at the Tucson Sweetwater Underground Storage and Recovery Facility. Other facilities have also sustained nitrogen removal in the vadose zone when alternating aerobic/anoxic conditions were maintained (Kopchynski et al., 1996). This mechanism for removal is not dependent on the retention time in the buffer zone but is a function of recharge basin operation. The aquifer below a vadose zone becomes anoxic when ammonia is present in recycled water at levels sufficient to deplete oxygen in percolating water (AWWARF, 2001). Reduction of nitrate will occur as a function of retention time under anoxic conditions as nitrate is used as the electron acceptor for organic compound transformations. If nitrate becomes depleted, more reduced conditions can develop,

leading to reduced transformation of organic compounds and the release of soluble iron and manganese. Indirect potable reuse systems are not operated under these conditions because the produced water will require post-treatment. These conditions do occur in bank filtration systems in Europe, and post-treatment for iron and manganese is commonly practiced.

6.4.5.2 Wetlands

Wetland treatment technology has been under development, with varying success, for more than 40 years in the United States. A great deal of research has been performed documenting the ability of wetlands, both natural and constructed, to provide consistent and reliable water quality improvement. With proper execution of design and construction elements, constructed wetlands exhibit characteristics that are similar to natural wetlands in that they support similar vegetation and microbes to assimilate pollutants. In addition, constructed wetlands provide wildlife habitat and environmental benefits that are similar to natural wetlands. Constructed wetlands are effective in the treatment of BOD, TSS, nitrogen, phosphorus, pathogens, metals, sulfates, organics, and other toxic substances. There are hundreds of wastewater treatment wetlands operating in the United States today (Source: EPA832-R-93-005).

Water quality enhancement is provided by transformation and/or storage of specific constituents within the wetland. The maximum contact of reclaimed water within the wetland will ensure maximum treatment assimilation and storage. This is due to the nature of these processes. If optimum conditions are maintained, nitrogen and BOD assimilation in wetlands will occur indefinitely, as they are primarily controlled by microbial processes and generate gaseous end products. In contrast, phosphorus assimilation in wetlands is finite and is related to the adsorption capacity of the soil and long-term storage within the system. The wetland can provide additional water quality enhancement (polishing) to the reclaimed water product. A review of wastewater recycling and reuse alternatives performed by Carey and Migliaccio (2009) indicate that natural or constructed wetlands can, in certain instances, replace other advanced wastewater treatment processes, removing up to 79 percent of total nitrogen and 88 percent of total phosphorus concentrations.

In addition to our current state of knowledge on the design and performance of known pollutants in surface-flow and subsurface-flow constructed wetland systems, including BOD, TSS, nutrients, and pathogens, a description of removal of wastewater-derived organic compounds (WDOCs) is provided in *Evaluate Wetland Systems for Treated Wastewater Performance to Meet Competing Effluent Quality Goals* (WRRF, 2011b). This report provides identification of specific chemicals that best represent or act as surrogates for various classes of pollutants and WDOCs, which supports continuing consideration of constructed wetlands as an option for providing polishing treatment to protect aquatic ecosystems and potable water supplies.

A series of long successful examples of wetlands treatment projects are described in *Constructed Wetlands for Wastewater Treatment and Wildlife Habitat: 17 Case Studies* (EPA, 1993). More recently, constructed wetlands have been employed in Phoenix, Ariz., where in 1990 city managers were faced with needed improvements at the WWTP to meet new state water quality standards. After determining that upgrading the plant might cost as much as \$635 million, managers looked for a more cost-effective solution to provide final treatment for discharge into the Salt River. A preliminary study suggested that a constructed wetland system would address discharge water quality requirements while supporting high-quality wetland habitat for birds, including endangered species, and protect downstream residents from flooding. These benefits would be achieved at a lower cost than retrofitting the existing treatment plant. As a result, the 12-acre Tres Rios Demonstration Project began in 1993 with assistance from the USACE, the BOR, and EPA's Environmental Technology Initiative. The Tres Rios treatment wetlands are currently the largest of their kind in Arizona. Highly-treated effluent from the 91st Avenue WWTP was first delivered to a 98-ac cell in July 2010 with discharges regulated under a NPDES permit overseen by EPA and an Aquifer Protection Permit as mandated by the ADEQ. The remaining two wetland cells are developing mature wetland vegetation and were brought online late in 2011. Treated water from the Tres Rios wetlands is reused to support approximately 137 ac of wetland and riparian habitat along the north bank of the Salt River while at the same time conveying water to satisfy contractual obligations to the Buckeye Water Conservation District. This site, which serves as a

home for thousands of birds and other wildlife, will be open to the public and will serve as a platform for environmental education and passive recreation [US-AZ-Phoenix].

Thus, while in most reclaimed water wetland projects the primary intent is to provide additional treatment of effluent prior to discharge from the wetland, it is also important to consider the design considerations that will maximize wildlife habitats, and thereby provide important ancillary benefits, which are discussed in Section 3.4.1.1. With respect to constructed wetlands, there are some well-established types of treatment systems, including free water surface wetlands that have open water areas and emergent vegetation, and subsurface flow (SSF) wetlands in which water does not flow above the surface of the media. There are several key documents available that provide information that can be used to assist in the design of wetland treatment systems, including: *Treatment Wetlands, Second Edition*; *Treatment Wetlands; Small-scale Constructed Wetland Treatment Systems: Feasibility, Design Criteria, and O&M Requirements*; *Constructed Wetlands for Pollution Control: Process, Performance, Design and Operation*; *Water Environment Federation Manual of Practice FD-16. Natural Systems for Wastewater Treatment, Chapter 9: Wetland Systems*; and *Free Water Surface Wetlands for Wastewater Treatment*.

6.4.5.3 Soil Aquifer Treatment Systems

Essentially, SAT is a low-technology, advanced wastewater treatment system. The process is most commonly implemented at spreading basins (Section 2.3.3.2), where reclaimed water percolates into the soil, consisting of layers of loam, sand, gravel, silt, and clay. As the reclaimed water filters through the soil, these layers allow it to undergo further physical, biological, and chemical treatment through the SAT (WRRF, 2012g). SAT systems require unconfined aquifers, vadose zones free of restricting layers, and soils that are coarse enough to allow for sufficient infiltration rates but fine enough to provide adequate filtration. This process of filtration, in which the unsaturated or vadose zone acts as a natural filter and can remove essentially all suspended solids, biodegradable materials, bacteria, viruses, and other microorganisms, results in significant reductions in nitrogen, phosphorus, and heavy metals concentrations. Additional information on piloting and design of SAT systems is presented in *Soil Treatability*

Pilot Studies to Design and Model Soil Aquifer Treatment Systems (AwwaRF, 1998). Because the soil and aquifer are natural treatment systems, SAT systems have a positive impact on public acceptance.

6.4.6 Monitoring for Treatment Performance

Reliable monitoring to detect process failures and assess water quality in a reuse scheme have been recommended in several recent reference documents (NRC, 2012; WRRF, 2011c; Colford et al., 2009) and, in summary, should include:

1. A source control program documenting contaminant concentrations and diversion alternatives;
2. Individual evaluation of multiple barriers that mitigate pathogenic contaminants;
3. Robust study designs to determine contaminant fate e.g. biodegradation, sorption, photolysis, or health effects like gastrointestinal illness;
4. Documented travel time without short circuits;
5. Certified operators; and
6. Communication protocols for corrective actions.

While the appropriate monitoring parameters represent an ongoing subject of research, particularly for potable reuse applications, the selection of which biological and chemical constituents to monitor must be carried out as part of a larger QA/QC program, as described in Chapter 4. But, it is useful to highlight some case study examples of performance assessment and monitoring to demonstrate that the treatment practices described in this chapter have been shown to be effective for meeting the objectives for the specified end uses of the treated reclaimed water.

As part of the Montebello Forebay Groundwater Recharge Project, five studies were conducted following initial replenishment efforts in 1962: Pomona Virus Study, 1977; Health Effects Study, 1984; An Investigation of Soil Aquifer Treatment for Sustainable Water Reuse, 2006; Rand Study, 1996; and Rand Study, 1999 [US-CA-Los Angeles County]. These studies included flow modeling, virus monitoring, toxicology, and limited epidemiological studies and showed that the majority of CECs are effectively removed through SAT.

In King County, Wash. [[US-WA-King County](#)], all reclaimed water meets “Class A” standards and is safe to use for irrigating food crops. However, to both gain customer confidence and illustrate that local soil and reclaimed water characteristics are suitable for a range of crops, King County partnered with the University of Washington to conduct a greenhouse study and a field trial to test for the potential for pathogen transfer and metal uptake from reclaimed water to garden vegetables. Soils, water samples, and washed and unwashed edible portion of plant tissue were analyzed for bacterial indicators (total coliforms, fecal coliforms, and *E. coli*) and heavy metals. Metal concentrations in the reclaimed water were at least two orders of magnitude below EPA regulations for drinking water, and the bacteria tests were either negative or below the state regulatory limit of 2 cfu per 100 mL.

In Tossa de Mar, Costa Brava, Spain, the implementation of a reuse system that distributes reclaimed water for landscape irrigation in public spaces, fire hydrants, and wash-down water at a dog shelter included an extensive assessment of the overall human health infection risk and an ongoing monitoring program. The high quality of reclaimed water, the systematic follow-up studies, and the educational programs implemented have all contributed to assure a very positive public perception [[Spain-Costa Brava](#)].

6.4.7 Energy Considerations in Reclaimed Water Treatment

Conventional wastewater treatment is an energy-intensive process, and adding filtration and disinfection systems, which is a typical practice to upgrade WWTPs for water reclamation for nonpotable reuse, only adds to energy consumption. Overall, the energy use in this scenario is dominated by pumping, aeration, and disinfection. It is critical to note that the quality of the water being disinfected will dictate the energy requirements for this process. For instance, for UV disinfection, a nitrified filtered secondary effluent with a UVT of 70 percent will require about half as much energy to disinfect as a non-nitrified filtered secondary effluent with a UVT of 55 percent (WRRF, 2012h).

Treatment alternatives that lower energy requirements represent the future of reclaimed water treatment. A recent study by the WRRF examined processes that could provide dramatic energy savings. In general,

new approaches are moving treatment process toward higher mechanical efficiency, decreased oxygen use, and more effective biochemistry. The tradeoff to these gains may be increased complexity and reliance on technology. The full evaluation of the costs and benefits of these technologies must be conducted for a specific site based on local power rates, but general trends in energy savings are presented in Challenge Projects on Low Energy Treatment Schemes for Water Reuse (WRRF, 2012h).

Disinfection processes can make up about a third of the total energy used at a WWTP, excluding pumping energy (WEF, 2009; EPRI, 2002). Novel approaches including pasteurization, UV disinfection using light emitting diodes (LEDs), and electrochemical reactors for combined coagulation/filtration/disinfection have potential to reduce this power demand. As discussed in Section 6.4.3.4, pasteurization has undergone rigorous testing, demonstrating near-zero energy input by capturing waste heat, and is now undergoing large-scale piloting. UV LEDs save energy through the use of a better UV dose distribution, but this technology is at the very early stages of development for wastewater disinfection.

As aeration is a key consumer of energy at WWTPs, significant research has gone into optimizing processes to minimize this requirement. A range of energy-saving technologies at different levels of development offer up to 50 percent energy savings through improvements in aeration or reduced aeration requirements, optimized microorganisms for nutrient removal processes, and novel anaerobic processes (WRRF, 2012h).

In typical nonpotable reuse applications, filtration makes up about 3 percent of the total energy use of a WWTP (WEF, 2009; EPRI, 2002). While representing a small percentage of the overall energy budget, improved filtration technologies that optimize filtration backwash modes or the type of filter media have demonstrated reduced energy use compared to conventional sand filtration (Parkson, 2011).

Natural treatment of reclaimed water in wetlands or through managed aquifer recharge systems are key treatment options for water reuse. These systems, in addition to potentially providing secondary environmental benefits such as enhanced stream flows, wildlife habitat, or a barrier from saltwater intrusion into groundwater, can also reduce the energy

footprint of the overall treatment system, depending on the treatment application. Additional discussion of managed aquifer recharge is provided in Section 2.3.3; and a description of the treatment mechanisms through wetlands and SAT systems are provided in Section 6.4.5.

6.5 References

- Absi, F., F. Gamache, R. Gehr, P. Liechtiand, and J. Nicell. 1993. "Pilot Plant Investigation of Ozone Disinfection of Physico-Chemically Treated Municipal Wastewater." *Ozone in Water and Wastewater Treatment, Proceedings of the 11th Ozone Congress*. San Francisco, CA.
- Adams, C., Y. Wang, K. Loftin, and M. Meyer. 2002. "Removal of antibiotics from surface and distilled water in conventional water treatment processes." *Journal of Environmental Engineering*, 128(3):253.
- Alum, A., Y. Yoon, P. Westerhoff, and M. Abbaszadegan. 2004. "Oxidation of bisphenol A, 17beta-estradiol, and 17.alpha.-ethynyl estradiol and byproduct estrogenicity." *Environmental Toxicology*, 19(3):257.
- American Water Works Association (AWWA). 2010. "New Orleans Plans to Restore Wetlands using Effluent have 'Wow' Factors," *Streamlines*. 2(24).
- American Water Works Association (AWWA). 1996. *Water Treatment Membrane Processes*. McGraw-Hill. New York, NY.
- American Water Works Association Research Foundation (AwwaRF). 2005. "Water Quality Improvements during Aquifer Storage and Recovery." AwwaRF. Denver, CO.
- American Water Works Association Research Foundation (AwwaRF). 2001. *Investigation on Soil-Aquifer Treatment for Sustainable Water Reuse*. AwwaRF. Denver, CO.
- American Water Works Association Research Foundation (AwwaRF). 1998. *Soil Treatability Pilot Studies to Design and Model Soil Aquifer Treatment Systems*. AwwaRF, Denver, CO.
- Amy, G., and J. E. Drewes. 2007. "Soil-aquifer treatment (SAT) as a natural and sustainable wastewater reclamation/reuse technology: Fate of wastewater effluent organic matter (EfOM) and trace organic compounds." *Environmental Monitoring and Assessment*. 129(1-3):19.
- Anderson, P., N. Denslow, J. E. Drewes, A. Olivieri, D. Schlenk, and S. A. Snyder. 2010. *Final Report: Monitoring Strategies for Chemicals of Emerging Concern (CECs) in Recycled Water – Recommendations of a Scientific Advisory Panel*. California Water Resources Control Board, June 25, 2010.
- Arakaki, T. 1999. "pH Dependent Photoformation of Hydroxyl Radical and Absorbance of Aqueous-Phase N(III) (HNO₂ and NO₂)" *Environmental Engineering Science*, 33(15):2561.
- Asano, T., F. Burton, H. Leverenz, R. Tsuchihashi, and G. Tchobanoglous. 2007. *Water Reuse: Issues, Technologies, and Applications*. McGraw-Hill. New York, NY.
- Asano, T. 1998. *Wastewater Reclamation and Reuse*. Technomic Publishing Company. Lancaster, PA.
- Aw, T. G., and K. Y. Gin. 2010. "Environmental Surveillance and Molecular Characterization of Human Enteric Viruses in Tropical Urban Wastewaters." *Journal of Applied Microbiology*, 109:716.
- Bitton, G. 1999. *Wastewater Microbiology, 2nd. Edition*. Wiley-Liss Pub, New York, NY.
- Bellona, C., J. E. Drewes, G. Oelker, J. Luna, G. Filteau, and G. Amy. (2008). Comparing Reverse Osmosis and Nanofiltration for Water Reclamation. *JAWWA*, 100(9), 102-116.
- Benotti, M. J., R. A. Trenholm, B. J. Vanderford, J. C. Holady, B. D. Stanford, and S. A. Snyder. 2009. "Pharmaceuticals and Endocrine Disrupting Compounds in U.S. Drinking Water," *Environmental Science & Technology*. 43(3):597.
- Black & Veatch. 2010; *White's Handbook of Chlorination and Alternative Disinfectants*, Fifth Edition. John Wiley & Sons, Inc. Hoboken, NJ.
- Blanch, A. R. and J. Jofre. 2004. "Emerging Pathogens in Wastewaters." *The Handbook of Environmental Chemistry*. 5(1):141.
- Bockelmann, U., H. Dorries, M. N. Ayuso-Gabella, M. S. de Marçay, V. Tandoi, C. Levantesi, C. Masciopinto, E. Van Houtte, U. Szewzyk, T. Wintgens, and E. Grohmann. 2009. "Quantitative PCR monitoring of antibiotic resistance genes and bacterial pathogens in three European artificial groundwater recharge systems." *Applied Environmental Microbiology* 75:154.
- Bonadonna, L., R. Briancesco, M. Ottaviani, and E. Veschetti. 2002. "Occurrence of Cryptosporidium oocysts in sewage effluents and correlation with microbial, chemical and physical water variables." *Environmental Monitoring and Assessment*. 75:241.
- Bonne, P. A. C.; J. A. M. H. Hofman; and J. P. van der Hoek. 2006. "Long-term capacity of biological activated carbon filtration for organics removal." *Water Science and Technology: Water Supply*. 2(1):139.

- Bridgman, S. A., R. M. Robertson, Q. Syed, N. Speed, N. Andrews, and P. R. Hunter. 1995. "Outbreak of cryptosporidiosis associated with a disinfected groundwater supply." *Epidemiology and Infection*. 115(3):555.
- Bull, R., J. Crook, M. Whittaker, and J. Cotruvo. 2011. "Therapeutic dose as the point of departure in assessing potential health hazards from drugs in recycled municipal wastewater." *Regulatory Toxicology and Pharmacology*. 60(1):1.
- Cabelli, V. J., A. P. Dufour, L. J. McCabe, and M. A. Levin. 1982. "Swimming Associated Gastroenteritis and Water Quality." *American Journal of Epidemiology*. 115:606.
- Cabelli, V. J. 1983. *Health Effects Criteria for Marine Recreational Waters, Technical Report EPA 600/1-80-031*. U.S. Environmental Protection Agency, Health Effects Research Laboratory. Research Triangle Park, NC.
- California Administrative Code. 1978. *Title 22, Division 4, Environmental Health – Wastewater Reclamation Criteria*. State of California, Department of Health Services, Sanitary Engineering Section. Berkeley, CA.
- California Department of Public Health (CDPH). 2012. *Alternative Treatment Technology Report for Recycled Water*. October 2012. Retrieved November 29, 2012 from <<http://www.cdph.ca.gov/certlic/drinkingwater/Documents/DWdocuments/AlternativeTreatmentTechnologyReportforRecycledWater-October2012.pdf>>.
- California Department of Public Health (CDPH). 2011. *Groundwater Replenishment Reuse DRAFT Regulation, Title 22, CALIFORNIA CODE OF REGULATIONS DIVISION 4. ENVIRONMENTAL HEALTH CHAPTER 3. RECYCLING CRITERIA, November 21, 2011*. CDPH. Sacramento, CA.
- California Department of Public Health (CDPH). 2010. *Recommendations on Chemicals of Emerging Concern Expert Panel Report, September 13, 2010*. Retrieved April 9, 2012, from <http://www.waterboards.ca.gov/water_issues/programs/water_recycling_policy/docs/cec111610/cdphletter.pdf>.
- California Department of Public Health. 2009. *Regulations Related to Recycled Water*. Accessed Sept. 29, 2012 from <<http://www.cdph.ca.gov/certlic/drinkingwater/Documents/Lawbook/RWregulations-01-2009.pdf>>.
- California Department of Public Health (CDPH), 2008. *Groundwater Recharge Reuse DRAFT Regulation, August 5, 2008*. Retrieved October 10, 2011, from <<http://www.cdph.ca.gov/certlic/drinkingwater/Documents/Recharge/DraftRechargeReg2008.pdf>>.
- California State Water Resources Control Board (SWRCB). *Recycled Water – Constituents of Emerging Concern (CECs), January 11, 2011*. Retrieved April 9, 2012, from <http://www.waterboards.ca.gov/water_issues/programs/water_recycling_policy/recycledwater_cec.shtml>.
- California State Water Resources Control Board (SWRCB). *Resolution No. 2009-0011. Adoption of a Policy for Water Quality Control for Recycled Water, February 3, 2009*. Retrieved April 9, 2012, from <http://www.waterboards.ca.gov/board_decisions/adopted_orders/resolutions/2009/rs2009_0011.pdf>.
- Caliskaner, O., G. Tchobanoglous, A. Carolan, and M. Downey. 2011. "Evaluation of the New Compressible Media Filter at Filtration Rates Between 30 and 40 GPM/ft² for Unrestricted Reuse." *Water Environment Federation 84th Annual Technical Exhibition and Conference*. Water Environment Federation Alexandria, VA.
- Cantor, K. P., C. M. Villanueva, D. T. Silverman, J. D. Figueroa, F. X. Real, M. Garcia-Closas, N. Malats, S. Chanock, M. Yeager, A. Tardon, R. Garcia-Closas, C. Serra, A. Carrato, G. Castaño-Vinyals, C. Samanic, N. Rothman, and M. Kogevinas. 2010. "Polymorphisms in *GSTT1*, *GSTZ1*, and *CYP2E1*, Disinfection By-products, and Risk of Bladder Cancer in Spain." *Environmental Health Perspectives*. 118(11).
- Carey, R. O. and K. W. Migliaccio. 2009. "Contribution of wastewater treatment effluents to nutrient dynamics in aquatic systems: a review." *Environmental Management*. 44(2):205.
- Chalmers, R. B.; D. Yoder; M. Patel; and D. Cutler. 2011. "Indirect Potable Reuse versus Potable Reuse-What's the Difference." *WaterReuse Symposium*, Phoenix, AZ.
- Chevrefils, G., E. Caron, H. Wright, G. Sakamoto, P. Payment, B. Bargeau, and B. Cairns. 2006. "UV Dose Required to Achieve Incremental Log Inactivation of Bacteria, Protozoa, and Viruses." *IUVA News*. 8(1):38.
- Clara, M., B. Strenn, and N. Kreuzinger. 2004. "Carbamezapine as a Possible Anthropogenic Marker in the Aquatic Environment: Investigations on the Behavior of Carbamezapine in Wastewater Treatment and During Groundwater Recharge." *Water Research*, 38:947.
- Clara, M., N. Kreuzinger, B. Strenn, O. Gans, and H. Kroiss. 2005. "The solids retention time – a suitable design parameter to evaluate the capacity of wastewater treatment plants to remove micropollutants." *Water Research*, 39: 97.
- Colford, J. M., J. F. Hilton, C.C. Wright, B. F. Arnold, S. Saha, T. J. Wade, J. Scott, and J. N .S. Eisenberg. 2009. "The Sonoma water evaluation trial: a randomized drinking water intervention trial to reduce gastrointestinal illness in

- older adults." *American Journal of Public Health*, 99(11):1988.
- Cooper, R. 2000. "Comparison of the Resistance of MS-2 and Poliovirus to UV and Chlorine Disinfection." *Water Reuse Association Symposium XV, September 12-15, 2000. Napa, CA*.
- Cotruvo, J. A., 2011. "A Suggested Comprehensive Regulatory Strategy for Implementing the Safe Drinking Water Act." Proceedings of the 2011 AWWA Annual Conference. Washington, D.C.
- Cotruvo, J. A., 2012. "The Safe Drinking Water Act: Current and Future." *Journal of the AWWA*, 104(1):9.
- Curriero, F. C., J. Patz, J. B. Rose, and L. Subhash. 2001. "The association between extreme precipitation and waterborne disease outbreaks in the United States, 1948-1994." *American Journal of Public Health*. 91(8): 1164–199.
- Darnault, C. J. G.; P. Garnier; Y. J. Kim; K. L. Oveson; T. S. Steenhuis; J. Y. Parlange; M. Jenkins; W. C. Ghiorse and P. Baveye. 2003. "Preferential transport of *Cryptosporidium parvum* oocysts in variably saturated subsurface environments." *Water Environment Research*. 75(2):113.
- da Silva, A. K., F. S. Le Guyader, J.-C. Le Saux, M. Pommepey, M. Montgomery, and M. Elimelech. 2008. "Norovirus Removal and Particle Association in a Waste Stabilization Pond." *Environmental Science & Technology*, 42: 9151.
- da Silva, A. K., J. C. Le Saux, S. Parnaudeau, M. Pommepey, M. Elimelech, and F. S. Le Guyader. 2007. "Evaluation of Removal of Noroviruses during Wastewater Treatment, Using Real-Time Reverse Transcription-PCR: Different Behaviors of Genogroups I and II." *Applied Environmental Microbiology*, 73(24):7891.
- De Roda Husman, A. M., W. J. Lodder, S. A. Rutjes, J. F. Schijven, and P. F. M. Teunis. 2009. "Long-Term Inactivation Study of Three Enteroviruses in Artificial Surface and Groundwaters, Using PCR and Cell Culture." *Applied Environmental Microbiology*, 75:4.
- Dhanapal, L. P., and A. N. Morse. 2009. "Effect of analgesics and their derivatives on antibiotic resistance of environmental microbes." *Water Science and Technology*. 59:1823.
- Dickenson, E. R. V., J. E. Drewes, D. L. Sedlak, E. Wert, and S. A. Snyder. 2009. "Applying Surrogates and Indicators to Assess Removal Efficiency of Trace Organic Chemicals during Chemical Oxidation of Wastewater." *Environmental Science & Technology*. 43: 6242.
- Dickenson, E., J. E. Drewes, S. Snyder, and D. Sedlak. 2008. "Applying Surrogates to Determine the Efficacy of Groundwater Recharge Systems for the Removal of Wastewater Organic Contaminants." *World Environment and Water Resource Congress*.
- Drewes, J. E., and S. Khan. 2010. "Water Reuse for Drinking Water Augmentation." In *Water Quality and Treatment, 6th Edition*. American Water Works Association. Denver, CO.
- Drewes, J. E., D. M. Quanrud, G. L. Amy, and P. K. Westerhoff. 2006. "Character of Organic Matter in Soil-Aquifer Treatment Systems." *ASCE Journal of Environmental Engineering*. 132:1447.
- Drewes, J. E., T. Heberer, T. Rauch, and K. Reddersen. 2003. "Fate of pharmaceuticals during groundwater recharge." *Ground Water Monitoring and Remediation*. 23(3):64.
- Drewes, J., T. Heberer, and K. Reddersen. 2002. "Fate of pharmaceuticals during indirect potable reuse." *Water Science and Technology*. 46(3):73.
- Drewes, J. E. and P. Fox. 2000. "Impact of Drinking Water Sources on Reclaimed Water Quality in Water Reuse Systems." *Water Environment Research*, (72)3:353.
- Drewes, J. E., and M. Jekel. 1998. "Behavior of DOC and AOX using Advanced Treated Wastewater for Groundwater Recharge." *Water Research*. 32:3125.
- Drury, D. 2011. Personal communication with Dr. Doug Drury with the Clark County Water Reclamation District. 11/1/2011.
- Dryden, F. D., C.-L. Chen, and M. W. Selna. 1979. "Virus Removal in Advanced Wastewater Treatment Systems." *Journal of the Water Pollution Control Federation*. 51(8).
- Dufour, A. P. 1984. *Health effects criteria for fresh recreational waters*. EPA 600/1-84-004, U.S. Environmental Protection Agency. Cincinnati, OH.
- Emerick, R. W., F. Loge, D. Thompson, and J. Darby. 1999. "Factors Influencing Ultraviolet Light Disinfection Performance Part II. Association of Coliform Bacteria with Wastewater Particles." *Water Environment Research*. 71(6):1178.
- Electric Power Research Institute (EPRI). 2002. *Water & Sustainability (Volume 4): U.S. Electricity Consumption for Water Supply & Treatment. Topical Report. EPRI. Palo Alto, CA*.
- Environment Protection and Heritage Council (EPHC), the National Health and Medical Research Council (NHMRC), and the Natural Resource Management Ministerial Council

- (NRMCC). 2008. *Australian Guidelines for Water Recycling (AGWR): Augmentation of Drinking Water Supplies*. Environment Protection and Heritage Council. Canberra, Australia.
- Evans, P. J. 2010. "Nature Works Biological Treatment Methods Yield High-Quality Water." *Opflow*, July 2010.
- Feachem R. G., D. G. Bradley, H. Garelick, and D. D. Mara. 1983. "Sanitation and Disease: Health aspects of excreta and wastewater management." *World Bank Studies in Water Supply and Sanitation 3*. John Wiley & Sons. Chichester, U.K.
- Florida Administrative Code. 2009. Chapter 62-610, Reuse of Reclaimed Water and Land Application. Accessed Nov. 29, 2012 from <https://www.flrules.org/gateway/chapterhome.asp?chapter=62-610>
- Fox, P., S. Houston, P. Westerhoff, M. Nellor, W. Yanko, R. Baird, M. Rincon, J. Gully, S. Carr, R. Arnold, K. Lansey, D. Quanrud, G. Amy, M. Reinhard, and J. E. Drewes. 2006. *Advances in Soil Aquifer Treatment Research for Sustainable Water Reuse*. AWWA Research Foundation. Denver, CO.
- Fox, P., W. Aboshanp, and B. Alsmadi. 2005. "Analysis of Soils to Demonstrate Sustained Organic Carbon Removal during Soil Aquifer Treatment." *Journal of Environmental Quality*. 34:156-163.
- Fox; P., S. Houston, P. Westerhoff, J. E. Drewes, M. Nellor, W. Yanko, R. Baird, M. Rincon, R. Arnold, K. Lansey, R. Bassett, C. Gerba, M. Karpiscak, G. Amy, and M. Reinhard. 2001. *Soil Aquifer Treatment for Sustainable Water Reuse*. AWWA Research Foundation. Denver, CO.
- Fox, P., and J. E. Drewes. 2001. "Monitoring Requirements for Groundwater Under the Influence of Reclaimed Water." *Journal of Environmental Assessment and Monitoring*. 70:117.
- Freeman, K. S. 2010. "Disinfection By-products and Bladder Cancer: Common Genetic Variants May Confer Increased Risk." *Environmental Health Perspectives*. 118(11):118.
- Garcia, A., W. Yanko, G. Batzer, and G. Widmer. 2002. "Giardia Cysts in Tertiary-Treated Wastewater Effluents: Are They Infective?" *Water Environment Research*. 74(6):541.
- Geldreich, E. E. 1990. "Microbiological quality of source waters for water supply." In *Drinking Water Microbiology: Progress and Recent Developments*. Springer-Verlag. New York.
- Gennaccaro, A. L., M. McLaughlin, W. Quintero-Betancourt, D. Huffman, and J. Rose. 2003. "Infectious *Cryptosporidium parvum* oocysts in final reclaimed effluent." *Applied and Environmental Microbiology*. 69(8):4983.
- Gerrity, D., J. C. Holady, D. B. Mawhinney, O. Quinones, R. A. Trenholm, and S. A. Snyder. 2012. The effects of solids retention time in full-scale activated sludge basins on trace organic contaminant concentrations. *Water Environment Research*. In press.
- Glaze, W. H., J. W. Kang, and D. Chapin. 1987. "The Chemistry of Water-Treatment Processes involving Ozone, Hydrogen Peroxide, and Ultraviolet Radiation." *Ozone Science and Engineering*. 9(4):335.
- Global Water Research Coalition (GWRC). 2009. *Occurrence and Potential for Human Health Impacts of Pharmaceuticals in the Water System Science Brief*. Global Water Research Coalition. London, UK.
- Hancock, C. M., J. B. Rose, and M. Callahan. 1998. "Cryptosporidium and Giardia in US groundwater." *Journal of the American Water Works Association*. 90(3):58.
- Haramoto, E., H. Katayama, K. Oguma, and S. Ohgaki. 2007. "Quantitative analysis of human enteric adenoviruses in aquatic environments." *Journal of Applied Microbiology*. 103:2153.
- Harris, G. D., V. Adams, D. Sorensen, and M. Curtis. 1987. "Ultraviolet inactivation of selected bacteria and viruses with photoreactivation of the bacteria." *Water Research*. 21(6):687.
- Harwood, V. J., A. D Levine, T. M. Scott, V. Chivukula, J. Lukasik, S. R. Farrah, and J. B. Rose. 2005. "Validity of the Indicator Organism Paradigm for Pathogen Reduction in Reclaimed Water and Public Health Protection." *Applied and Environmental Microbiology*, 71(6): 3163.
- Havelaar, A. H., M. van Olphen, and Y. C. Drost. 1993. "F-specific RNA bacteriophages are adequate model organisms for enteric viruses in fresh water." *Applied Environmental Microbiology*. 59:2956.
- Heberer, T. 2002. "Occurrence, Fate, and Removal of Pharmaceutical Residues in the Aquatic Environment: A Review of Recent Research Data." *Toxicology Letters*. 131(1-2):5.
- Hoppe-Jones, C., G. Oldham, and J. E. Drewes. 2010. "Attenuation of Total Organic Carbon and Unregulated Trace Organic Chemicals in U.S. Riverbank Filtration Systems." *Water Research*. 44:4643.
- Huber, M. M., S. Korhonen, T. A. Ternes, and U. Von Gunten. 2005. "Oxidation of pharmaceuticals during water treatment with chlorine dioxide." *Water Research*, 39(15):3607.

- Huffman, D., A. L. Gennaccaro, T. L. Berg, G. Batzer, and G. Widmer. 2006. "Detection of infectious parasites in reclaimed water." *Water Environment Research*, 78(12):2297.
- Hunt, R. J., M. A. Borchardt, K. D. Richards, and S. K. Spencer. 2010. "Assessment of Sewer Source Contamination of Drinking Water Wells Using Tracers and Human Enteric Viruses." *Environmental Science & Technology*. 44:7956.
- Hurst, C. J., W. H. Benton, and R. E. Stetler. 1989. "Detecting viruses in water." *Journal of the American Water Works Association*. 81(9):71.
- Ishida, C., A. Salveson, K. Robinson, R. Bowman, and S. Snyder. (2008) "Ozone disinfection with the HiPOX™ reactor: streamlining an "old technology" for wastewater reuse." *Water Science and Technology*, 58(9):1765.
- Janex, M. L., P. Savoye, P. Xu, J. Rodriguez, and V. Lazarova. 2000. "Ozone for Urban Wastewater Disinfection: A New Efficient Alternative Solution." *Proceedings of the Specialized Conference on Fundamental and Engineering Concepts for Ozone Reactor Design*, Toulouse, France.
- Jjemba, P. K., L. Weinrich, W. Cheng, E. Giraldo, and M. W. LeChevallier. 2010. *Guidance Document on the Microbiological Quality and Biostability of Reclaimed Water and Distribution Systems (WRF-05-002)*. WaterReuse Research Foundation, Alexandria, VA.
- Jolis, D., C. Lam, and P. Pitt. 2001. "Particle effects on ultraviolet disinfection of coliform bacteria in recycled water." *Water Environment Research*. 73(2): 233.
- Kaegi, R., A. Voegelin, B. Sinnet, S. Zuleeg, H. Hagendorfer, M. Burkhardt, and H. Siegris. 2011. "Behavior of metallic silver nanoparticles in a pilot wastewater treatment plant." *Environmental Science & Technology*. 45(9): 3902.
- Kimura, K., G. Amy, J. Drewes, T. Heberer, T.U. Kim, and Y. Watanabe. 2003. "Rejection of Organic Micropollutants (Disinfection By-Products, Endocrine Disrupting Compounds, and Pharmaceutically Active Compounds) by NF/RO Membranes." *Journal of Membrane Science*. 227(1-2):113.
- Kiser, M. A., P. Westerhoff, T. Benn, Y. Wang, J. Pérez-Rivera, and K. Hristovski. 2009. "Titanium nanomaterial removal and release from wastewater treatment plants." *Environmental Science & Technology*. 43: 6757.
- Kleiser, G., and F. H. Frimmel. 2000. "Removal of precursors for disinfection by-products (DBPs) – differences between ozone- and OH-radical-induced oxidation." *Science of the Total Environment*, 256:1.
- Kopchynski, T., P. Fox, B. Alsmadi, and M. Berner. 1996. "The Effects of Soil Type and Effluent Pre-Treatment on Soil Aquifer Treatment." *Water Science & Technology*. 34(11):235.
- Knapp, C. W., J. Dolfig, P. A. I. Ehlert, and D. W. Graham. 2010. "Evidence of increasing antibiotic resistance gene abundances in archived soils since 1940." *Environmental Science & Technology*. 44:580.
- Lazarova V., B. Levine, and P. Renaud. 1998. "Wastewater reclamation in Africa : assessment of the reuse applications and available technologies." *Proceedings IXème Congrès de l'Union Africaine des Distributeurs d'Eau*, Casablanca, 16–20 February.
- LeCann, P., S. Ranarijaona, S. Monpoeho, F. Le Guyader, and V. Ferré. 2004. "Quantification of human astroviruses in sewage using real-time RT-PCR." *Research in Microbiology*. 155(1):11.
- Lindenauer, K. G., and J. L. Darby. 1994. "Ultraviolet disinfection of wastewater - effect of dose on subsequent photoreactivation." *Water Research*. 28(4):805.
- Maguin, S., P. Friess, S. Huitric, C. Tang, J. Kuo, and N. Munakata. 2009. "Sequential Chlorination: A New Approach for Disinfection of Recycled Water." *Environmental Engineer: Applied Research and Practice*. Vol. 9.
- Mara, D. and N. Horan. 2003. *Handbook of Water and Wastewater Microbiology*, Academic Press, London.
- Mara, D. D., and S. A. Silva. 1986. "Removal of intestinal nematode eggs in tropical waste stabilization ponds." *Journal of Tropical Medicine and Hygiene*. 89(2):71.
- Metcalf and Eddy. 2003. *Wastewater Engineering, Treatment and Reuse*. 4th ed. McGraw-Hill. New York, NY.
- Medema, G., and N. Ashbolt. 2006. *QMRA: It's Value for Risk Management*. Retrieved July 2012 from <http://www.camra.msu.edu/documents/QMRA_framework.pdf>.
- Miège, C., J. M. Choubert, L. Ribeiro, M. Eusèbe, and M. Coquery. 2008. "Removal efficiency of pharmaceuticals and personal care products with varying wastewater treatment processes and operating conditions – conception of a database and first results." *Water Science and Technology*. 57(1):49.
- Miele, R. P. 1977. *Pomona Virus Study Final Report*. Prepared for California State Water Research Control Board and U.S. EPA. Sanitation Districts of Los Angeles County. Sacramento, CA.

- Miller, J. H., W. P. Ela, K. E. Lansey, P. L. Chipello, and R. G. Arnold. 2006. "Nitrogen Transformations during Soil–Aquifer Treatment of Wastewater Effluent—Oxygen Effects in Field Studies." *ASCE Journal of Environmental Engineering*, 132.
- Mitch, W. A., A. C. Gerecke, and D. L. Sedlak. 2003. "A N-Nitrosodimethylamine (NDMA) precursor analysis for chlorination of water and wastewater." *Water Research*. 37:3733.
- Moce´-Llivina, L., M. Muniesa, H. Pimenta-Vale, F. Lucena, and J. Jofre. 2003. "Survival of bacterial indicator species and bacteriophages after thermal treatment of sludge and sewage." *Applied and Environmental Microbiology*. 69:1452.
- Munter, R. 2001. "Advanced Oxidation Processes-Current Status and Prospects." *Proceedings of the Estonian Academy of Science and Chemistry*, 50(2):59.
- Myrmel, M., E. M. M. Berg, B. Grinde, and E. Rimstad. 2006. "Enteric viruses in inlet and outlet samples from sewage treatment plants." *Journal of Water and Health*. 4(2):197.
- Nalinakumari, B., W. Cha, and P. Fox. 2010. "Effects of Primary Substrate Concentration On N-nitrosodimethylamine (NDMA) During Simulated Aquifer Recharge." *ASCE Journal of Environmental Engineering*, 136(4):373-380.
- National Academy of Science (NAS). (1983) *Risk Assessment in Federal Government: Managing the Process*, National Academy Press. Washington, D.C.
- National Health and Medical Research Council and Natural Resource Management Ministerial Council (NHMRC–NRMMC). 2004. *Australian Drinking Water Guidelines*. NHMRC-NRMMC. Canberra, Australia.
- National Research Council (NRC). 2012. *Water Reuse: Potential for Expanding the Nation's Water Supply Through Reuse of Municipal Wastewater*. The National Academies Press: Washington, D.C.
- National Research Council (NRC). 1998. *Issues in Potable Reuse: The Viability of Augmenting Drinking Water Supplies with Reclaimed Water*. Committee to Evaluate the Viability of Augmenting Potable Water Supplies with Reclaimed Water, National Research Council. Washington, D.C.
- National Research Council (NRC). 1996. *Use of Reclaimed Water and Sludge in Food Crop Production*. National Academy Press, Washington, D.C.
- National Science and Technology Council. 2011. *National Nanotechnology Initiative, Strategic Plan*. National Science and Technology Council, Committee on Technology (CoT), Subcommittee on Nanoscale Science, Engineering, and Technology (NSET), Washington, D.C.
- National Water Research Institute (NWRI). 2012. *Ultraviolet Disinfection Guidelines for Drinking Water and Water Reuse, 3rd Edition*. National Water Research Institute. Fountain Valley, CA.
- National Water Research Institute (NWRI). 2003. *Ultraviolet Disinfection Guidelines for Drinking Water and Water Reuse, 2nd Edition*. National Water Research Institute. Fountain Valley, CA.
- Nellor, M. H., R. B. Baird, and J. R. Smyth. 1984. *Health Effects Study Final Report*. For: The Orange and Los Angeles Counties Water Reuse Study, U.S. EPA, and California Dept. of Water Resources. Sanitation Districts of Los Angeles County, Whittier, CA.
- Ni C., J. Chen, Y. Tsai, W. Chen, and C. Chen. 2002. "Ozonation of domestic secondary effluent for recycling and reuse - a pilot plant study." *Water Science and Technology*. 46(4-5):361.
- O'Brien, N., and E. Cummins. 2010. "Ranking initial environmental and human health risk resulting from environmentally relevant nanomaterials." *Journal of Environmental Science and Health, Part A: Toxic/Hazardous Substances and Environmental Engineering*. 45(8):992-1007.
- Oneby, M., C. Bromley, J. Borchardt, and D. Harrison. 2010. "Ozone Treatment of Secondary Effluent at U.S. Municipal Wastewater Treatment Plants." *Ozone: Science & Engineering*, 32(1):43.
- Oragui, J. I., T. P. Curtis, S. A. Silva, and D. D. Mara. 1987. "Removal of excreted bacteria and viruses in deep waste stabilization ponds in northeast Brazil." *Water Science and Technology*. 19:569.
- Oregon Department of Environmental Quality. n.d. *Water Quality: Senate Bill 737*. Retrieved August 14, 2012 from <<http://www.deq.state.or.us/wq/SB737>>.
- Paraskeva, P., and Nigel J. D. Graham. 2002. "Ozonation of Municipal Wastewater Effluents." *Water Environment Research* 74(6):569.
- Park, Y., E. R. Atwill, L. Hou, A. I. Packman, and T. Harter. 2012. "Deposition of *Cryptosporidium parvum* Oocysts in Porous Media: A Synthesis of Attachment Efficiencies Measured under Varying Environmental Conditions" *Environmental Science & Technology*, In Press.
- Parkson Corporation. Dynas and EcoWash Filter. 2011. *Full Scale Test Report*. City of Pompano Beach Florida. Pompano Beach, FL.

- Pauwels, B., and W. Verstraete. 2006. "The treatment of hospital wastewater: An appraisal." *Journal of Water and Health*. 4:405.
- Poussade, Y., A. Roux, T. Walker, and V. Zavlanos. 2009. "Advanced Oxidation for Indirect Potable Reuse: a Practical Application in Australia." *Water Science Technology*. 60(9):2419.
- Rauch-Williams, T., C. Hoppe-Jones, and J. E. Drewes. 2010. "The Role of Organic Matter in the Removal of Emerging Trace Organic Chemicals during Managed Aquifer Recharge." *Water Research*. 44(2):449.
- Robinson, K. 2011. Personal communication with Keel Robinson with APTWater. 10/31/2011.
- Rosario-Ortiz, F., E. C. Wert, and S. A. Snyder. 2010. "Evaluation of UV/H₂O₂ Treatment for the Oxidation of Pharmaceuticals in Wastewater." *Water Research*. 44:1440.
- Rose, J. B., L. J. Dickson, S. R. Farrah, and R. P. Carnahan. 1996. "Removal of pathogenic and indicator microorganisms by a full-scale water reclamation facility." *Water Research*. 30:2785.
- Rose, J. B., S. Daeschner, D. R. Easterling, F. C. Curriero, S. Lele, and J. A. Patz. 2000. "Climate and waterborne disease outbreaks." *Journal of the American Water Works Association*. 92(9):77.
- Rose J. B., D. E. Huffman, K. Riley, S. R. Farrah, J. O. Lukasik, and C. L. Hamann. 2001. "Reduction of enteric microorganisms at the Upper Occoquan Sewage Authority water reclamation plant." *Water Environment Research*. 73:711.
- Rosenfeldt, E. J., and K. G. Linden. 2004. "Degradation of Endocrine Disrupting Chemicals Bisphenol A, Ethinyl Estradiol, and Estradiol during UV Photolysis and Advanced Oxidation Processes." *Environmental Science & Technology*. 38:5476.
- Roslev, P., L. A. Bjergbaek, and M. Hesseloe. 2004. "Effect of Oxygen on Survival of Fecal Pollution Indicators in Drinking Water." *Journal of Applied Microbiology*. 96:938.
- Sagik, B. P., B. E. Moore, and C. A. Sorber. 1978. "Infectious disease potential of land application of wastewater. Pp. 35-46 in State of Knowledge in Land Treatment of Wastewater, Vol. 1." *Proceedings of an International Symposium, U.S. Army Corps of Engineers, Cold Regions Research and Engineering Laboratory, Hanover, New Hampshire*.
- Salveson, A., T. Rauch-Williams, E. Dickenson, J. E. Drewes, D. Drury, D. McAvoy, and S. Snyder. 2012. *Trace Organic Compound Removal during Wastewater Treatment - Categorizing Wastewater Treatment Processes by their Efficacy in Reduction of a Suite of Indicator TOC*. Water Environment Research Foundation. Alexandria, VA.
- Salveson, A., G. Ryan, and N. Goel. 2011. "Pasteurization – Not Just for Milk Anymore." *Water Environment and Technology*. 23(3).
- Salveson, A. T., K. P. Atapattu, K. Linden, K. Robinson, R. Bowman, J. Thurston-Enriquez, and R. Cooper. 2007. "Innovative Treatment Technologies For Reclaimed Water - Ozone/Hydrogen Peroxide Pilot Test Report At DSRSD." *22nd Annual WaterReuse Symposium*.
- Savage, N., and M. Diallo. 2005. "Nanomaterials and Water Purification: Opportunities and Challenges." *Journal of Nanoparticle Research*. 7:331.
- Skaggs, B. K., R. S. Reimers, A. J. Englande, G. Hunter, and G. C. Austin. 2009. "Disinfection Performance of Iron (VI) for Wastewater Disinfection, Reuse, and Wetland Restoration." *Water Environment Federation's WEFTEC Conference 2009*.
- Skaggs, B. K., R. S. Reimers, A. J. Englande, P. Srisawat, and G. C. Austin. 2008. "Evaluation of the Green Oxidant Ferrate for Wastewater Reuse for Wetland Restoration, Irrigation, and Groundwater Recharge." *Water Environment Federation's Conference on Sustainability 2008*.
- Sloss, E. M., D. F. McCaffrey, R. D. Fricker, S. A. Geschwind, and B. R. Ritz. 1999. *Groundwater Recharge with Reclaimed Water: Birth Outcomes in Los Angeles County, 1982-1993*. Water Replenishment District of Southern California, by RAND. Santa Monica, CA.
- Sloss, E. M., S. A. Geschwind, D. F. McCaffrey, and B. R. Ritz. 1996. *Groundwater Recharge with Reclaimed Water: An Epidemiologic Assessment in Los Angeles County, 1987-1991*. Water Replenishment District of Southern California, by RAND. Santa Monica, CA.
- Snyder, S. A., B. D. Stanford, G. M. Bruce, R. C. Pleus, and J. E. Drewes. 2010. *Identifying Hormonally Active Compounds, Pharmaceuticals, and Personal Care Product Ingredients of Potential Health Concern from Potential Presence in Water Intended for Indirect Potable Reuse*. WaterReuse Research Foundation: Alexandria, VA.
- Sommer, R., W. Pribil, S. Pflieger, T. Haider, M. Werderitsch, and P. Gehringer. 2004. "Microbicidal efficacy of an advanced oxidation process using ozone/hydrogen peroxide in water treatment". *Water Science and Technology*. 50(1):159.
- Stasinakis, A. S. 2008. "Use of Selected Advance Oxidation Processes (AOPs) for Wastewater Treatment-Mini Review." *Global NEST Journal*. 10(3):376.

- State of California Division of Drinking Water and Environmental Management. (2009). *Treatment Technology Report for Recycled Water*. Sacramento, CA.
- Stevenson, A. H. 1953. "Studies of Bathing Water Quality and Health." *American Journal of Public Health*, 43:429-538.
- Sumpter, J. P., and A. C. Johnson. 2008. "10th Anniversary Perspective: Reflections on endocrine disruption in the aquatic environment: from known knowns to unknown unknowns (and many things in between)." *Journal of Environmental Monitoring*. 10:1476–1485.
- Symonds, E. M., D. W. Griffin, and M. Breitbart. 2009. "Eukaryotic Viruses in Wastewater Samples from the United States." *Applied Environmental Microbiology*. 75:5.
- Szerwinski, A., K. Y. Bell, and K. Bordewick. 2012. "Chloramination in a Partially Nitrified Effluent: Process Control Solutions and Case Study." *Proceedings of the 2012 Water Environment Federation Technical Exhibition and Conference*.
- Tchobanoglous, G., F. L. Burton, and D. H. Stensel. 2003. *Wastewater Engineering: Treatment and Reuse*. McGraw-Hill, N.Y., USA.
- Ternes T. A., and A. Joss. 2006. *Human Pharmaceuticals, Hormones and Fragrances: The Challenge of Micropollutants in Urban Water Management*. IWA Publishing. London, UK.
- Tyrrell, S. A., R. Rippey, and W. Watkins. 1995. "Inactivation of bacterial and viral indicators in secondary sewage effluents, using chlorine and ozone." *Water Research*. 29(11):2483.
- United Nations Environment Programme (UNEP). 2007. *Global Environmental Outlook (GEO) Year Book 2007: An Overview of our Changing Environment*. Retrieved March 2012, from <http://www.unep.org/geo/yearbook/yb2007/>.
- U.S. Environmental Protection Agency (EPA), 2012. *2012 Edition of the Drinking Water Standards and Health Advisories*. EPA 822-S-12-001. Environmental Protection Agency, Office of Water, Washington, D.C.
- U.S. Environmental Protection Agency (EPA). 2011. *Draft Recreational Water Quality Criteria*. EPA 820-D-11-002. Environmental Protection Agency, Office of Water, Washington, D.C.
- U.S. Environmental Protection Agency, 2010 (EPA). *Treating Contaminants of Emerging Concern, A Literature Review Database*. EPA-820-R-10-002. Environmental Protection Agency, Office of Water, Washington, D.C. Retrieved August 2012 from <http://water.epa.gov/scitech/swguidance/ppcp/results.cfm>.
- U.S. Environmental Protection Agency (EPA). 2006. *Process Design Manual: Land Treatment of Municipal Wastewater Effluents*. EPA/625/R-06/016. Environmental Protection Agency. Washington, D.C.
- U.S. Environmental Protection Agency (EPA), 2005. *Membrane Filtration Guidance Manual*. EPA 815-R-06-009. Office of Ground Water and Drinking Water, Cincinnati, OH.
- U.S. Environmental Protection Agency (EPA). 2004. *Guidelines for Water Reuse*. EPA 625/R-04/108. Environmental Protection Agency. Washington, D.C.
- U.S. Environmental Protection Agency (EPA). 2003. *Draft Ultraviolet Disinfection Guidance Manual*. EPA 815-D-03-007. Environmental Protection Agency. Washington, D.C.
- U.S. Environmental Protection Agency (EPA). 1999a. *Disinfection Profiling and Benchmarking Guidance Manual*, EPA 815/R-99/013. Environmental Protection Agency. Washington, D.C.
- U.S. Environmental Protection Agency (EPA). 1993. *Constructed Wetlands for Wastewater Treatment and Wildlife Habitat, 17 Case Studies*. EPA 832-R-93-005. Environmental Protection Agency, Office of Wastewater Management, Washington, D.C.
- U.S. Environmental Protection Agency (EPA). 1992. *Use of Microbial Risk Assessment in Setting U.S. Drinking Water Standards*. EPA-814/S-92-001. Environmental Protection Agency, Office of Water, Washington, D.C.
- U.S. Environmental Protection Agency (EPA). 1986. *Ambient Water Quality Criteria for Bacteria*. EPA 440/5-84/002. Office of Research and Development. Cincinnati, OH.
- Van den Berg, H., W. Lodder, W. van der Poel, H. Vennema, and A. M. de Roda Husman. 2005. "Genetic diversity of noroviruses in raw and treated sewage water." *Research in Microbiology*. 156(4):532.
- Van der Aa, L. T. J., R. J. Kolpa, A. Magic-Knezev, L. C. Rietveld, and J. C. van Dijk. 2003. "Biological activated carbon filtration: pilot experiments in the Netherlands." *Water Technology Conference, November 2-6, 2003*.
- WaterReuse Research Foundation (WRRF). 2012a. *Study of Innovative Treatment on Reclaimed Water*. WRF-02-009. WaterReuse Research Foundation: Alexandria, VA.
- WaterReuse Research Foundation (WRRF). 2012b. *The Occurrence of Infectious Cryptosporidium Oocysts in Raw, Treated and Disinfected Wastewater*. WRF-06-003. WaterReuse Research Foundation: Alexandria, VA.

- WaterReuse Research Foundation (WRRF). 2012c. *Potential Infectivity Assay for Giardia lamblia Cysts*. WRF-08-18. WaterReuse Research Foundation: Alexandria, VA.
- WaterReuse Research Foundation (WRRF). 2012d. *Review of Nanomaterial Research and Relevance for Water Reuse*. WRF-10-13. WaterReuse Research Foundation: Alexandria, VA.
- WaterReuse Research Foundation (WRRF). 2012e. *Identifying Health Effects Concerns of the Water Reuse Industry and Prioritizing Research Needs for Nomination of Chemicals for Research*. WRF-06-004. WaterReuse Research Foundation: Alexandria, VA.
- WaterReuse Research Foundation (WRRF). 2012f. *Risk Assessment Study of PPCPs in Recycled Water to Support Public Review*. WRF-09-07. WaterReuse Research Foundation: Alexandria, VA.
- WaterReuse Research Foundation (WRRF). 2012g. *Demonstration of Filtration and Disinfection Compliance through SAT*. WRF-10-10. WaterReuse Research Foundation: Alexandria, VA.
- WaterReuse Research Foundation (WRRF). 2012h. *Challenge Projects on Low Energy Treatment Schemes for Water Reuse, Phase 1*. WRF-10-06, WaterReuse Research Foundation: Alexandria, VA.
- WaterReuse Research Foundation (WRRF). 2011a. *Development and Application of Tools to Assess and Understand the Relative Risks of Regulated Chemicals in Indirect Potable Reuse Projects – The Montebello Forebay Groundwater Recharge Project. Tools to Assess and Understand the Relative Risks of Indirect Potable Reuse and Aquifer Storage & Recovery Projects, Volume 1A*. WRF-06-018-1A. WaterReuse Research Foundation, Alexandria, VA.
- WaterReuse Research Foundation (WRRF). 2011b. *Evaluate Wetland Systems for Treated Wastewater Performance to Meet Competing Effluent Quality Goals*. WRF-05-006. WaterReuse Research Foundation: Alexandria, VA.
- WaterReuse Research Foundation. (WRRF) 2011c. *Attenuation of Emerging Contaminants in Stream Augmentation with Recycled Water*. WRF Report 06-20-1. WaterReuse Foundation. Alexandria, VA.
- WaterReuse Research Foundation (WRRF). 2010a. *Tools to Assess and Understand the Relative Risks of Indirect Potable Reuse Water: Development and Application*. WRF-06-018. WaterReuse Research Foundation: Alexandria, VA.
- WaterReuse Research Foundation (WRRF). 2010b. *Monitoring for Microconstituents in an Advanced Wastewater Treatment Facility and Modeling Discharge of Reclaimed Water to Surface Water Canals for Indirect Potable Reuse*. WaterReuse Research Foundation Final Report 06-019.
- WaterReuse Research Foundation (WRRF). 2010c. *Development and Application of Tools to Assess and Understand the Relative Risks of Drugs and Other Chemicals in Indirect Potable Reuse Water. Tools to Assess and Understand the Relative Risks of Indirect Potable Reuse and Aquifer Storage & Recovery Projects, Volume 2*. WRF-06-018-2. WaterReuse Research Foundation: Alexandria, VA.
- WaterReuse Research Foundation (WRRF). 2010d. *Sequential UV and Chlorination for Reclaimed Water Disinfection*. WRF-06-015. WaterReuse Research Foundation: Alexandria, VA.
- WaterReuse Research Foundation (WRRF). 2008. *Development of Indicators and Surrogates of Chemical Contaminants and Organic Removal in Wastewater and Water Reuse*. WRF-03-014. WaterReuse Research Foundation: Alexandria, VA.
- WaterReuse Research Foundation (WRRF). 2007a. *Pathogen Removal and Inactivation in Reclamation Plants - Study Design*. WRF-03-001. WaterReuse Research Foundation, Alexandria, VA.
- WaterReuse Research Foundation (WRRF). 2007b. *Application of Microbial Risk Assessment to Estimate Risk Due to Reclaimed Water Exposure*. WRF-04-011. WaterReuse Research Foundation: Alexandria, VA.
- WaterReuse Research Foundation (WRRF). 2005. *Irrigation of Parks, Playgrounds, and Schoolyards with Reclaimed Water: Extent and Safety*. WRF-04-006. WaterReuse Foundation, Alexandria, VA.
- Water Environment Federation (WEF). 2010. *WEF Manual of Practice No. 8, Design of Municipal Wastewater Treatment Plants*. 5th Edition. WEF Press. Alexandria, VA.
- Water Environment Federation (WEF). 2009. *Energy Conservation in Water and Wastewater Facilities*. Water Environment Federation. Richmond, VA.
- Water Environment Federation (WEF). 2008. *Effects of Nanoparticles on the Wastewater Treatment Industry*. Technical Practice Update, Water Environment Federation. Arlington, VA.
- Water Environment Research Foundation (WERF). 2008. *Disinfection of Wastewater Effluent – Comparison of Alternative Technologies*. Final Report 04-HHE-4. Water Environment Research Foundation. Alexandria, VA.
- Watts, R. J., S. Kong, M. Dippre, and W. T. Bames. 1994. "Oxidation of Sorbed Hexachlorobenzene in Soils Using

Catalyzed Hydrogen Peroxide.” *Journal of Hazardous Materials*, 39(1):33.

Westerhoff, P., Y. Yoon, S. A. Snyder, and E. Wert. 2005. “Fate of endocrine-disruptor, pharmaceutical, and personal care product chemicals during simulated drinking water treatment processes.” *Environmental Science & Technology*. 39:6649.

Whitby, G. E., O. Lawal, P. Ropic, S. Shmia, B. Ferran, and B. Dussert. 2011. “Uniform Protocol for Wastewater UV Validation Applications.” *IUVA News*. 13(2):2633.

Willocks, L., A. Crampin, L. Milne, C. Seng, M. Susman, R. Gair, M. Moulds, S. Shafi, R. Wall, R. Wiggins, and N. Lightfoot. 1998. “A large outbreak of cryptosporidiosis associated with a public water supply from a deep chalk borehole.” *Communicable Disease and Public Health*. 1(4):239.

World Health Organization (WHO), 2011. *Pharmaceuticals in Drinking Water*. WHO/HSE/WSH/11.05. Retrieved August 23, 2012 from http://www.who.int/water_sanitation_health/publications/2011/pharmaceuticals/en/.

World Health Organization (WHO). 2006. *Guidelines for the Safe Use of Wastewater, Excreta and Greywater. Volume 2*. WHO-UNEP-FAO, Geneva.

World Health Organization (WHO). 2000. *WHO Annual Report on Infectious Disease: Overcoming Antimicrobial Resistance*. Retrieved August 23, 2012 from <http://www.who.int/infectious-disease-report/2000/>.

World Health Organization Scientific Group (WHO). 1989. *Health guidelines for the use of wastewater in agriculture and aquaculture*. Technical Report Series 778. World Health Organization, Geneva.

Wu, C., A. L. Songberg, J. D. Witter, M. Fang, and K. P. Czajkowski. 2010. “Uptake of pharmaceutical and personal care products by soybean plants from soils applied with biosolids and irrigated with contaminated water.” *Environmental Science & Technology*. 44(16):6157.

Wunder, D. B., V. A. Horstman, and R. M. Hozalski. 2008. “Antibiotics in slow-rate biofiltration processes: biosorption kinetics and equilibrium.” *American Water Works Association Water Quality Technology Conference Proceedings*, 2008.

Yanko, W. A. 1999. “An Unexpected Temporal Pattern of Coliphage Isolation in Groundwaters Sampled From Wells at Varied Distances from Reclaimed Water Recharge Sites.” *Water Research*. 33(1):53.

Yates, M. V., and C. P. Gerba. 1998. “Microbial considerations in wastewater reclamation and reuse.” In: Asano, T. ed. *Wastewater reclamation and reuse*. Technomic Publishing Company. Lancaster, PA.

CHAPTER 7

Funding Water Reuse Systems

This chapter provides an overview of the financial viability of reclaimed water and also includes resources for how to properly fund reclaimed water systems.

7.1 Integrating Reclaimed Water into a Water Resource Portfolio

Historically, wastewater utility systems have entered into long-term agreements with agricultural and golf course customers to deliver reclaimed water at little or no cost. Giving treated effluent away was viewed as mutually beneficial. Many of those original agreements for low cost reclaimed water have recently expired—or will soon expire—creating an opportunity to develop reasonable rates and charges for the value provided.

Reclaimed water is now widely recognized as a full-fledged component of integrated water resources planning. As a result, ensuring adequate funding for reclaimed water systems is not dissimilar from funding other water services. Developing and operating a sustainable water system requires the use of sound business decision-making processes that are closely tied to the system's strategic planning process. The underlying principles for a reclaimed water system's funding strategy should reflect the following:

1. Revenues from rates and charges should be sufficient to provide annual operating maintenance and repair expenses, capital improvements costs, adequate working capital, and required reserves.
2. Accounting practices should separate reclaimed water accounts from other governmental or entity operations for transparency and to prevent diversion of funds to uses unrelated to water services; this concept is typically reflected by use of an enterprise fund, which may be stand alone for the reclaimed water system, or combined with the utility's potable water and wastewater systems.
3. Accounting practices should adhere to generally accepted accounting principles and comply with applicable regulatory requirements.

4. Rates and fees should equitably distribute the cost of water service based on cost-of-service principles, compliance with legal requirements, and transparency of communication regarding non-quantifiable benefits to rate payers.
5. Budgeting should be adequate to support asset management, including planned and preventive maintenance, as well as infrastructure re-investment.

There are a number of existing resources to assist utilities in understanding and implementing these principles, including:

- *Principles of Water Rates, Fees, and Charges*, 5th Edition (AWWA, 2000)
- *Water Rates, Fees, and the Legal Environment*, 2nd Edition (AWWA, 2010)
- *Financing and Charges for Wastewater Systems*, (MOP 27) (WEF, 2004)
- *Governmental Accounting, Auditing, and Financial Reporting: Using the GASB 34 Model* (GFOA, 2005)
- *Water Reuse Rates and Charges, Survey Results*, (AWWA, 2008)

Nonetheless, utilities often set reclaimed water rates lower than potable water rates to promote customer conversion to reclaimed water use. In general, reclaimed water is priced from 50 percent to 100 percent of potable water with the median rate 80 percent of potable water rates (AWWA, 2008). This discount enables users to pay for retrofit costs, plus it serves as an incentive to use reclaimed water. There are some jurisdictions where reclaimed water is priced at full parity with potable water, especially where reclaimed water is not subject to the potable water use restrictions during droughts.

The initiation and maintenance of a sound funding strategy for reuse programs requires prudent financial decisions and accounting controls, as well as a

comprehensive understanding of the technical, economic, and social factors that ultimately determine the sustainability of a system's water resource portfolio. A planning process referred to as "Integrated Resource Planning" is often used as a means of accruing information that is critical to a fiscally and socially sustainable water system.

A holistic planning process such as IRP sets the stage for clearly communicating an integrated funding strategy while characterizing and communicating both the costs and benefits of particular elements of the water resources management program. This comprehensive and transparent decision-making framework is critical to sustainable funding to ensure that water management meets a community's needs. In an uncertain business environment (e.g., economic volatility, climate change), sustainable water utility funding strategies are based on a combination of capital, operations and maintenance considerations, and revenue tools that provide the greatest value for the system and its customers, while minimizing the potential "regret" of making a poor investment.

A number of useful integrated planning resources have been published in recent years. The *Water Resources Planning, Manual of Water Supply Practices* (M50) (AWWA, 2007), *Evaluating Pricing Levels and Structures to Support Reclaimed Water Systems* (WRRF, 2009), *Water Reuse Economic Framework Workshop Report* (WRRF, 2004), *An Economic Framework for Evaluating Benefits and Costs of Water Reuse* (WRRF, 2006), and EPA's draft *Total Water Management* document (Rodrigo et al., 2012) provide specific guidance on incorporating reuse into water resources plans.

7.2 Internal and Debt Funding Alternatives

While there are several mechanisms for funding reclaimed water systems, utilities typically use internal funding and debt funding.

Internal funding is based on revenue generated from customers. The customers can be individual large-volume users or a wide network of users within the water reuse district or a region that has an agreement with the utility for taking and paying for the product. Large-volume customers, if available, can finance a significant portion of a project and may have well-defined water quality objectives that would impact the

nature and character of the treatment and distribution system. They may, in fact, dictate these requirements to the utility and be willing to reserve reclaimed water for their operations. Typically these customers are industrial users, large-scale agricultural operations, or golf courses. The concern for the utility is the risk of losing the large-volume customer or the revenue from the service agreement. Protection for both parties should be incorporated into any service agreements that are based on revenue being generated from a small number of large customers. The utility will need to determine and weigh the risk of losing funding from this type of arrangement.

There are several forms of debt funding, including revenue bonds and low interest loans. The benefits of these funding instruments are that they are typically long-term with the funding received up-front from bondholders, in contrast to the project being funded internally through an agreement with a large customer where funding is obtained from rates over the life of the project.

Revenue bonds are supported by net operating income from recurring utility charges. These instruments are issued based on internal policy and financial standing through a bond counsel. The requirements include the assurance that the capital and operations and replacement costs are covered by the rates being charged with typically a 10 percent to 25 percent debt service coverage generation, depending on the bonding authority or other requirements.

7.2.1 State and Federal Financial Assistance

Where available, grant programs are an attractive funding source, but they require that the proposed system meets grant eligibility requirements. These programs reduce the total capital cost borne by system beneficiaries, thus improving the affordability and viability of the project. Some funding agencies have an increasingly active role in facilitating water reuse projects. In addition, many funding agencies are receiving a clear legislative and executive mandate to encourage water reuse in support of water conservation.

To be financially successful over time, a reuse program, however, must be able to "pay for itself." While grant funds may underwrite portions of the

capital improvements necessary in a reuse project—and in a few states, state-supported subsidies can also help a program to establish itself in early years of operation—grant funds should not be used for funding needs associated with annual operating costs. In fact, most federally-funded grant and loan programs explicitly prohibit the funding of operation, maintenance, and replacement (OM&R) costs. Once the project is underway, the program should strive to achieve self-sufficiency as quickly as possible, meeting OM&R costs and debt service requirements of the local share of capital costs by generating an adequate stream of revenues through local sources.

7.2.1.1 Federal Funding Sources

The CWA of 1977, as amended, has supported water reuse projects through the following provisions:

- Section 201 of PL 92-500 was amended to ensure that municipalities are eligible for “201” funding only if they have “fully studied and evaluated” techniques for “reclaiming and reuse of water”. A 201 facility plan study must be completed to qualify for state revolving loan funds.
- Section 214 stipulates that the EPA administrator “shall develop and operate a continuing program of public information and education on water reclamation and reuse of wastewater...”
- Section 313, which describes pollution control activities at federal facilities, was amended to ensure that WWTFs will utilize “recycle and reuse techniques: if estimated life-cycle costs for such techniques are within 15 percent of the most cost-effective alternative.”

There are a number of federal sources that might be used to generate funds for a water reuse project. While there are many funding sources, only certain types of applicants or projects are eligible for assistance under each program, with annual funding dependent on congressional authorizations.

The USDA has several programs that may provide financial assistance for water reuse projects in rural areas, but the definition of a rural area varies depending upon the statutory language authorizing the program. Most of these programs are administered

through the USDA Rural Development Office in each state.

Rural Utilities Service (RUS) offers funds through the Water and Waste Program, in the form of loans, grants, and loan guarantees. The largest is the Water and Waste Loan and Grant Program, with approximately \$1.5 billion available nationwide per year. This program offers financial assistance to public bodies, eligible not-for-profits, and recognized tribal entities for development (including construction and non-construction costs) of water and wastewater infrastructure. Unincorporated areas are typically eligible, as are communities with less than 10,000 people. Grants may be available to communities meeting income limits to bring user rates down to a level that is reasonable for the serviced population. Interest rates for loan assistance depend on income levels in the served areas as well. The Rural Development offices act to oversee the RUS-funded projects from initial application until the operational stage.

The Rural Housing Service (RHS) also known as Rural Development Housing and Community Facilities Programs (HCFP) is a division within the USDA’s Rural Development agency that administers aid to rural communities. The HCFP may fund a variety of projects for public bodies, eligible not-for-profits, and recognized tribal entities where the project serves the community. The HCFP provides grants to assist in the development of essential community facilities in rural areas and towns of up to 20,000 in population.

The Rural Business-Cooperative Service offers the Rural Business Enterprise Grant (RBEG) program. The RBEG program is a broad-based program that reaches to the core of rural development in a number of ways. Examples of eligible fund use include: acquisition or development of land, easements, or rights of way; construction activities, pollution control; and abatement and project planning. Any project funded under the RBEG program should benefit small and emerging private businesses in rural areas. A water reuse system serving a business or industrial park could potentially receive grant assistance through this program. An individual eligible business could apply for loan guarantees through the Rural Business-Cooperative Service to help finance a water reuse system that would support the creation of jobs in a rural area.

Other agencies that have funded projects in cooperation with USDA may provide assistance for water reuse projects if eligibility requirements are met, include the Economic Development Administration, Housing and Urban Development (Community Development Block Grant), Appalachian Regional Commission, and the Delta Regional Commission.

Finally, USBR, authorized under Title XVI, the Reclamation Wastewater and Groundwater Study and Facilities Act; PL 102-575, as amended, Reclamation Recycling and Water Conservation Act of 1996; PL 104-266, Oregon Public Lands Transfer and Protection Act of 1998; PL 105-321, and the Hawaii Water Resources Act of 2000; PL 106-566, provides for USBR to conduct appraisal and feasibility studies on water reclamation and reuse projects. USBR can then fund construction of reuse projects after Congressional approval of the appropriation. This funding source is restricted to activities in the 17 western states unless otherwise authorized by Congress. Federal participation is generally up to 25 percent of the capital cost.

Information about specific funding sources can be found in the *Catalog of Federal Domestic Assistance*, prepared by the Federal Office of Management and Budget and available in federal depository libraries (CFDA, n.d.). It is the most comprehensive compilation of the types and sources of funding available.

7.2.1.2 State, Regional, and Local Grant and Loan Support

There are a number of sources for grant funding and loans for reuse projects. A summary of several state, regional, and local sources of grants and loans is provided in this section.

State Revolving Fund

State support is generally available for WWTFs, WRFs, conveyance facilities, and, under certain conditions, for on-site distribution systems. A prime source of state-supported funding is provided through State Revolving Funds (SRF) loans.

The SRF is a financial assistance program established and managed by the states under general EPA guidance and regulations and funded jointly by the federal government (80 percent) and state matching money (20 percent). It is designed to provide financial assistance to local agencies to construct water pollution control facilities and to implement non-point

source, groundwater, and estuary management activities, as well as potable water facilities.

Under SRF, states make low-interest loans to local agencies. Interest rates are set by the states and must be below current market rates and may be as low as 0 percent. The amount of such loans may be up to 100 percent of the cost of eligible facilities. Loan repayments begin within 1 year of completion of the facility construction and are generally completely amortized in 20 years—although this differs from state to state. Repayments are deposited back into the SRF to be loaned to other agencies.

States may establish eligibility criteria within the broad limits of the Clean Water State Revolving Fund (CWSRF). Basic eligible facilities include secondary and advanced treatment plants, pump stations, and force mains needed to achieve and maintain NPDES permit limits. States may also allow for eligible new and rehabilitated collection sewers, combined sewer overflow correction, stormwater facilities, and the purchase of land that is a functional part of the treatment process. Water conservation and reuse projects eligible under the Drinking Water State Revolving Fund (DWSRF) include installation of meters, installation or retrofit of water efficient devices such as plumbing fixtures and appliances, implementation of incentive programs to conserve water (e.g., rebates, tax breaks, vouchers, conservation rate structures), and installation of dual-pipe distribution systems as a means of lowering costs of treating water to potable standards.

In addition to providing loans to water systems for water conservation and reuse, states can use their DWSRF set-aside funds to promote water efficiency through activities such as development of water conservation plans, technical assistance to systems on how to conserve water (e.g., water audits, leak detection, rate structure consultation), development and implementation of ordinances or regulations to conserve water, drought monitoring, and development and implementation of incentive programs or public education programs on conservation.

States select projects for funding based on a priority system, developed annually and subject to public review. Such priority systems are typically structured to achieve the policy goals of the state and may range from “readiness to proceed” to very specific water quality or geographic area objectives. Each state is

allowed to write its own program regulations for SRF funding, driven by its own objectives with annual approval by EPA. Some states, such as Virginia, provide assistance based on assessing the community's economic health, with poorer areas being more heavily subsidized with lower interest loans. Further information on SRF programs is available from each state's water pollution control agency.

Additional Local Funding Sources

Although the number of states that have developed other financial assistance programs or reuse projects is still limited, there are a few examples. Texas has developed a financial assistance program that includes the Agriculture Water Conservation Grants and Loans Program, the Water Research Grant Program, and the Rural Water Assistance Fund Program. There is also a planning grant program—Regional Facility Planning Grant Program and Regional Water Planning Group Grants—that funds studies and planning activities to evaluate and determine the most feasible alternatives to meet regional water supply and wastewater needs.

Local or regional agencies, such as the regional water management districts in Florida, have taxing authority. In Florida, a portion of the taxes collected has been allocated to funding alternative water resources including reuse projects, which have a high priority, with as much as 50 percent of the transmission system eligible for grant funding. Various methods of prioritization exist, with emphasis on projects that are benefit to multi-jurisdictional users. The Southwest Florida Water Management District states:

“Our Cooperative Funding Initiative program has contributed to more than 300 reuse projects to help communities develop reclaimed water systems. Reuse grant funding since 1987 exceeds \$343 million. Our Regional Water Supply Plan describes a District wide reclaimed water long-term goal of 75 percent utilization of all wastewater treatment plant flows and 75 percent offset efficiency of all reclaimed water used”.

The California SWRCB administers the Water Recycling Funding Program (WRFPP). The mission of the WRFPP is to promote the beneficial use of reclaimed water (water recycling) in order to augment freshwater supplies in California by providing technical and financial assistance to agencies and other stakeholders in support of water recycling projects and

research. The Plan establishes a strategic goal, sets program objectives, and identifies specific measures and targets for tracking program performance. Currently, the WRFPP administers 49 construction projects and 33 facilities planning studies.

In 2006, Proposition 84 (The Safe Drinking Water, Water Quality and Supply, Flood Control, River and Coastal Protection Bond Act of 2006) passed for \$5.4 billion. Proposition 84 funds water, flood control, natural resources, park, and conservation projects. The bonds would be used to fund various projects aimed at 1) improving drinking and agricultural water quality and management; 2) preserving, restoring, and increasing public access to rivers and beaches; 3) improving flood control, and 4) planning for overall statewide water use, conveyance, and flood control.

For example, the DSRSD received a \$1.13 million grant for the Central Dublin Recycled Water project from the California Department of Water Resources Proposition 84 Integrated Regional Water Management Implementation Grant Program. The \$4.6 million project will bring recycled water to irrigate Dublin's oldest neighborhoods, providing a rationing-resistant water supply for schools, parks, and other valuable public landscaping. New distribution pipelines in Central Dublin will connect to existing recycled water infrastructure that already serves other parts of the city.

In 2007, the state of Washington offered \$5.45 million in grants to help local governments in the 12 Puget Sound counties reclaim water and help Puget Sound. The State Department of Ecology was responsible for carrying out the grant program under legislative directive to specifically aid Puget Sound. The highest funding priority was to be given to projects in water-short areas and where reclaimed water will restore important ecosystem functions in Puget Sound.

7.3 Phasing and Participation Incentives

Reclaimed water program phasing can account for the various limitations of the parties involved. Phasing is often necessary to extend capital expenditures over multiple years to better match the funding capacity of the water purveyor. Other limitations that may dictate a phased approach to reclaimed water programs include the impacts of establishing and connecting new services, evaluating whether existing potable water

users can be feasibly connected, educating new users, and the ongoing costs of regulatory requirements, such as annual water quality and backflow prevention valve testing. Phasing may also be considered for agencies that have not yet verified technical and/or financial feasibility of the planned reclaimed water system. Once initial phases have proven successful, constructing additional phases can be considered. Phasing can also be beneficial from the perspective of the new reclaimed water customer. The benefits of reclaimed water may be more immediately apparent to some types of users, while others may be more inclined to implement reclaimed water only after its success has been fully demonstrated.

It is important to identify and obtain commitments from future reclaimed water customers before undertaking costs of design and construction. Those commitments will be critical to determining design capacity, facility sizing, and other decisions about future distribution branches. Securing these commitments often begins by conducting an initial survey in a service area, followed by a formal written agreement. These agreements may include a memorandum of understanding, particularly for customers with significant capacity requirements, such as golf courses, large industrial customers, or agricultural operations. These commitments assure the long-term viability and financial sustainability of the project.

A reclaimed water purveyor can employ participation incentives to help motivate users to convert to reclaimed water. Several variations of incentives have been used, including rate-based, capital-based, or subjective types of incentives. The rate structure for SAWS sets reclaimed water rates comparable to base potable water rates; however, incremental fees for water supply, stormwater, and aquifer management are not applied to the reclaimed water rate. For reclaimed water customers that transfer aquifer pumping rights to SAWS, that same volume of reclaimed water is priced at 25 percent of the basic reclaimed water rate. A combination of incentives can be used to entice the necessary users to convert to reclaimed water. Financial factors that should be considered may include the avoided or reduced costs of wastewater disposal, future expansion of potable treatment and/or storage facilities, and the higher costs of future potable supplies.

Rate-based incentives can emphasize either positive or negative reinforcements. For example, a positive incentive could include a lower rate (volumetric unit price) for reclaimed water, e.g., less than 100 percent of the current potable rate. A negative incentive could include conservation-based increasing block rates that effectively penalize customers that have the types of summer peak usage that would benefit from using reclaimed water.

Capital-based incentives include options to help pay for conversion costs. Some agencies in southern California have paid for and constructed on-site facility conversions, provided grants, or provided low or no-interest loans. At least one agency has used a surcharge that, in effect, sets the reclaimed water rate equal to the potable water rate until the loan is repaid. The Metropolitan Water District of Southern California's Local Resource Program case study provides an example of a capital-based incentive [[US-CA-Southern California WMD](#)].

Subjective incentives may have little cost impact to the reclaimed water purveyor but require effort to educate new reuse customers. Persuading them of the increased reliability and lower cost of reclaimed water is one approach. The increased nutrient levels that reclaimed water may provide are often important factors in obtaining commitments from agricultural customers. Most users can be convinced of the benefits of reclaimed water when there are no available potable supplies and reclaimed water is, therefore, their only option.

7.4 Sample Rate and Fee Structures

There are several types of rate and fee structures that have been used for the recovery of reuse costs, including a fixed monthly fee, volumetric rates, connection fees, impact fees, and special assessments. **Table 7-1** shows a comparison of rate types for a number of U.S. communities.

7.4.1 Service Fees

Service fees are typically charged to cover the cost of the meter or hose bib connection. The fee is typically related to the size of the meter or service line. Connection fees are also used as an incentive, with connection fees for those made in a specified time frame waived. The city of St. Petersburg Beach, Fla., charged a \$250 connection fee that was waived if the connection was made within 1 year of availability.

Table 7-1 Comparison of reclaimed water rates

| Community | Potable Water Rates First Tiers Only) | | Reclaimed Water Rates | | |
|---|--|--|-----------------------|---|----------------------|
| | Rate per 1,000 gal | Use | Rate per 1,000 gal | Use | % of Potable Rate |
| Tucson, AZ | \$2.19 | 1 - 15 ccf | \$2.45 | Variable on all uses | 112% |
| | \$7.82 | 16 - 30 ccf | | | 31% |
| Dublin San Ramon Services District, CA | \$3.28 | Tier 1 Volume charge, first 22,440 gallons | \$3.19 | Flat rate volume charge | 97% |
| | \$3.48 | Tier 2 Volume charge, over 22,440 gallons | | | 92% |
| Eastern Municipal Water District, CA | \$2.07 | Tier 1 Indoor use | \$0.80 | R-452 Non-Ag, Secondary, Disinfected-2009 | 21% of Tier 2 |
| | \$3.79 | Tier 2 Outdoor use | \$0.88 | R-462 Non-Ag, Tertiary, Disinfected, Filtered-2009 | 23% of Tier 2 |
| Glendale Water and Power, CA | \$3.18 | Commercial Rate | \$2.39 | Nonpotable purposes | 75% |
| Irvine Ranch Water District, CA ¹ | \$1.62 | Residential Detached Base Rate 5-9 ccf | \$1.44 | Landscape Irrigation Base Index 41-100% ET | 89% |
| | \$3.34 | Residential Detached Inefficient Rate 10-14 ccf | \$3.01 | Landscape Irrigation Inefficient Index 101-110% ET | 111% |
| | \$5.78 | Residential Detached Excessive Rate 15-19 ccf | \$5.20 | Landscape Irrigation Excessive Index 111-120% ET | 111% |
| Los Angeles Department of Water and Power, CA | \$4.77 | Schedule C-First Tier | 1.42 | Valley and Metro | 30% |
| | | Jul-Sep High Season | 1.76 | West Side and Harbor | 37% |
| Boca Raton, FL | \$0.742 | 0 - 25,000 gal | \$0.449 | 0 - 25,000 gallons Tiered rates per 1,000 gal | 61% |
| Cape Coral, FL | \$3.81 | 0 - 5,000 gal | \$0.0012 | Res per lot sq. ft. multi-family | 13% |
| | | | \$9.50 | Fixed fee | |
| | | | \$0.50 | Non-Res - per 1,000 gal. | |
| Orange County, FL | \$1.04 | 0 - 3,000 gal | \$0.74 | Variable on > 4,000 gal/month | 71% |
| | \$1.39 | 4,000 - 10,000 gal | | | 53% |
| St. Petersburg, FL | \$3.45 | 0 - 5,600 gal | \$17.63 | Unmetered - First acre | 14% |
| | | | \$10.10 | Unmetered > 1 acre | |
| | | | \$0.50 | Metered** | |
| City of Tampa, FL | \$2.43 | 0 - 5 ccf | \$1.60 | Variable on all uses | 66% |
| | \$2.82 | 6 - 13 ccf | | | 57% |
| Cary, NC | \$3.60 | 0 - 5,000 gal | \$3.60 | Variable on all uses | 100% |
| | \$5.79 | 0 - 15,000 gal | | | 62% |
| El Paso, TX | \$1.94 | Over 4 ccf | \$1.24 | Variable on all use | 64% |
| Hampton Roads Sanitation District, VA | \$4.00 | Average rate for all uses | \$1.50 | Variable on all uses | 38% |
| Loudoun Water, Loudoun County, VA | \$1.82 | Variable, non-peak rate | \$1.28 | Variable, non-peak rate | 70 % |
| San Antonio Water System, San Antonio, TX | \$1.09 | Base volume charge at 90 % annual average use | \$0.92 | Base Rate, first 748,000 gal | 84 % |
| | \$1.63 | Volume charge at 125 - 150% annual average use | \$0.99 | Seasonal Rate, first 748,000 gal | 61 % |

ccf = 100 cubic feet

¹Irvine Ranch Water District employs a steep inclined rate based on watering in excess of the evapotranspiration (ET) rate.

7.4.2 Special Assessments

Special assessments are established to defray the initial capital costs of a reuse system, primarily the distribution system. This type of assessment may be applied to those connecting to the reuse system or to all that have reuse system availability. Availability is typically defined as the distance to a nearby pipeline. The cities of Cape Coral and St. Petersburg, Fla., utilize special assessments for this purpose. Cape Coral has established service areas, with all of the residences within that area subject to a special assessment. St. Petersburg relies on a customer application process, with the majority of the owners in a specific area required to agree to the service. While many reuse systems are partially supported by their water or wastewater system revenues, the systems in these two communities are self-supporting.

7.4.3 Impact Fees

Impact fees have been used to recover the capital costs of water and wastewater systems from new customer connections. Included in the calculation of the impact fee are effluent disposal costs for wastewater, as well as the cost of the treatment system. A rational nexus is needed to justify the costs recovered from impact fees. A portion of the reuse system costs may be recoverable from either water or wastewater impact fees due to the ability to defer or reduce the costs of supplying water or wastewater service. Hillsborough County, Fla., has defined the benefit to water and wastewater systems in terms of additional capacity available due to the implementation of the reuse system. The decreased cost of capacity was estimated and identified as a revenue source for the reuse system (percent of impact fee).

7.4.4 Fixed Monthly Fee

Fixed monthly fees are used for a variety of purposes. In some cases, actual use is not metered, and the operation and maintenance costs and/or capital costs are collected from this fee. There are several methods used to establish these fees, such as a cost per acre, a cost per acre-foot, a cost per pervious square feet, a cost per equivalent residential connection, a cost per meter size, or a cost per customer. When there is a combination of a fixed monthly fee and a volumetric rate, the fixed monthly fee may include the costs of administration and customer service only, or this portion of the fee may also include a portion of capital costs. This approach could then base the fixed monthly fee on a per customer basis, per meter size,

or per equivalent residential connection. When there is only a fixed monthly fee and no volumetric rate, there is generally a basis that attempts to relate an estimated use to the fee. The costs per acre, acre-foot, or pervious square foot all provide a means of establishing use without actually metering the use.

The city of St. Petersburg Beach, Fla., has a fixed monthly fee that is consistent for residential customers and a commercial fee that was calculated based on permeable acres. There is no volumetric metering. Another example of a fixed fee with volumetric rates is provided in the reuse rate study for Durham, N.C., where a combination of a fixed monthly fee and volumetric rates were recommended. The fixed monthly fee is designed to recover this wholesale reuse system's capital costs, with the costs allocated per estimated capacity for each of three customers.

7.4.5 Volumetric Rates

Volumetric rates may be the primary fee, with either operation/maintenance and/or capital costs recovered. These rates may be charged per thousand gallons or per hundred cubic feet. The actual volumetric rates may differ per phase of connection. Initial reuse systems may offer incentives for early connections. This is specifically true when reuse is the primary means of effluent disposal. Bulk users, such as agriculture, golf courses, and industrial applications, have benefited from these early connection rates. These large volume users may also need rates that are competitive with the costs of groundwater use rather than potable water. Lee County, Fla., has established user fee rates for their large customers on this basis.

Other variations on the volumetric rates exist when water is distributed in low versus high pressure systems. Such cases are typical for golf courses that utilize storage ponds, where the pipeline distributing reclaimed water does not require high pressure, since high pressure distribution systems also have higher pumping costs. Collier County, Fla. has rates that are set on this basis. Inclining blocks are also used to conserve a limited resource. Hillsborough County and Boca Raton, Fla., have established three tiers of inclining blocks.

7.5 Developing Rates

There are typically two methods used for developing reclaimed water rates. The rate either fully covers the

cost of reclaimed water production, distribution, administration, and operation, or rates are lowered by subsidizing the cost from other sources.

Full cost recovery rates include the appropriate portion of capital and annual costs to plan, design, construct, administer, and operate a reclaimed water program. Capital costs include treatment, distribution, and possibly on-site facilities. The allocation of treatment facilities between reclaimed water and wastewater rates can be challenging, but it is generally accepted that facilities necessary for meeting NPDES discharge requirement levels are attributed to wastewater rates. Anything in addition to costs necessary to produce reclaimed water of a higher quality is attributed to reclaimed water rates.

The annual costs for reclaimed water rates include everything necessary for treatment (as allocated above) and operation of a reclaimed water distribution system. Costs necessary to meet regulatory requirements, such as annual testing and site monitoring, should not be overlooked. Estimating the operating cost of a reclaimed water system involves determining those treatment and distribution components that are directly attributable to the reclaimed water system. Direct operating costs involve additional treatment facilities, distribution, additional water quality monitoring, and inspection and monitoring staff.

Often the current costs of constructing reuse facilities cannot compete with the historical costs of an existing potable water system. Hence, a full cost recovery calculation frequently results in rates higher than potable water rates. As discussed in Section 7.1, reclaimed water rates have historically been expected to be lower than potable water to incentivize current potable water users to convert to reclaimed water. Therefore, reclaimed water rates are often subsidized to reduce the rate at or below the potable water rate. There are many opportunities in the rate calculation for subsidies from other sources, some of which are described below:

Potable water. Reuse reduces potable water demands, thereby allowing the deferral or elimination of developing new potable water supplies or treatment facilities. These savings can be passed on to the reuse customer.

Wastewater. Costs saved from effluent disposal may be considered a credit. Indirect costs include a percentage of administration, management, and overhead. Another cost is replacement reserve, i.e., the reserve fund to pay for system replacement in the future. In many instances, monies generated to meet debt service coverage requirements are deposited into replacement reserves.

General and administrative costs. These costs can also be allocated proportionately to all services, just as they would be in a cost-of-service allocation plan for water and wastewater service. In some cases, lower wastewater treatment costs may result from initiating reclaimed water usage. Therefore, the result may be a reduction in the wastewater user charge. In this case, depending on local circumstances, the savings could be allocated to the wastewater customer, the reclaimed water customer, or both.

Conservation. In California, replacement of potable water with reclaimed water can be applied toward the conservation goal of a 20 percent reduction by the year 2020. Therefore, funds set aside for a conservation program could be applied to the reuse program to subsidize the reclaimed water rate.

With more than one category or type of reclaimed water user, different qualities of reclaimed water may be needed. If so, the user charge becomes somewhat more complicated to calculate, but it is no different than calculating the charges for treating different qualities of wastewater for discharge. For example, if reclaimed water is distributed for two different irrigation needs with one requiring higher quality water than the other, then the user fee calculation can be based on the cost of treatment to reach the quality required. This assumes that it is cost-effective to provide separate delivery systems to customers requiring different water quality. Clearly this will not always be the case, and a cost/benefit analysis of treating the entire reclaimed water stream to the highest level required must be compared to the cost of separate transmission systems. Consideration should also be given to providing a lower level of treatment to a single reclaimed water transmission system with additional treatment provided at the point of use as required by the customer and consistent with local/state regulations.

7.5.1 Market Rates Driven by Potable Water

Reclaimed water rate structures and rate values are set by the utility through the utility's governing council or, in the case of private utilities, the public service commission. Reclaimed water and potable water variable rates are typically expressed as dollars per thousand gallons, dollars per 100 ft³, or dollars per ac-ft. The dollar value of reclaimed water rates is typically based on the value of reclaimed water to those who have nonpotable water demands, such as for irrigation or industrial applications.

Reclaimed water rates are at their lowest values when the availability of freshwater and/or reclaimed water is significantly greater than demand. As fresh and reclaimed water supplies tighten relative to demand, there is pressure on the utility to raise reclaimed water rates to encourage reclaimed water conservation so that increasing demands can be supplied. In some cases, water conservation pricing is used to further encourage efficient reclaimed water use. In areas with sufficient freshwater supply but limited wastewater effluent disposal options, reclaimed water is produced and applied to constructed wetlands, pastures, and irrigated areas to reduce effluent discharges to surface waters or near shore coastal areas. The reclaimed water rates in these areas can be much lower than potable water rates and reclaimed water costs.

In some cases, reclaimed water is provided at no charge or at a nominal charge that does not recover its full costs. As a result, the full costs are recovered through wastewater customers, through water customers, or through state or federal subsidies. For many utilities, reclaimed water use provides significant benefits to other customers by providing an environmentally-safe alternative to wastewater effluent disposal, by reducing ground and surface water pumping, and/or by delaying the need for additional water supply well fields and water treatment plant facility capacity.

Nationally, reclaimed water rates as a percent of potable water rates range from 0 to at least 100 percent. According to a survey by AWWA, the median reclaimed water rate charged by sampled utilities in 2000 and 2007 was 80 percent of the potable water rate (AWWA, 2008). The median reclaimed water rate as a percent of the potable water rate did not change between the two survey years. However, the number

of respondents in 2007 (30) was significantly lower than those in 2000 (109). Of the utilities surveyed in 2007, 42 percent set their reclaimed water rate to encourage reclaimed water use, and 11 percent based their reclaimed water rate on the estimated cost of service. The town of Cary, N.C., Reclaimed Water System case study is an example of setting reclaimed water rates at a level to compete favorably with potable water rates [US-NC-Cary].

Florida treats and uses more reclaimed water per day and per person than any state in the nation, with California running a close second (FDEP, 2011b). Florida has a long history of water reuse beginning with agricultural irrigation in Tallahassee in the mid-1960s and the development of the city of St. Petersburg system in the late-1970s (Toor and Rainey, 2009). Florida utilities charge a wide range of reclaimed water rates recovering from none to most of the reclaimed water costs, depending on the availability of freshwater supplies relative to demand. About 177 utilities provide irrigation water to residential and/or non-residential customers in Florida. Of these, 104 utilities provide reclaimed water use for residential irrigation; for 94 of these utilities, the reclaimed water rate was compared to the potable water rate. For brevity, the evaluation included only the water rates of residential single-family customers.

According to Florida's 2010 Annual Reuse Inventory, the median residential variable rate for reclaimed water was \$0.80 per 1,000 gallons in 2010 for the 29 utilities that did not include a flat rate in their rate structures. For the 49 utilities that collected a flat rate, the median flat rate was \$8.00 per month per account, and the median variable rate was \$0.31 per 1,000 gallons. These utilities do not include the 16 that provided reclaimed water service to their residential customers at no charge.

For each of these 94 utilities, the ratio of the reclaimed water variable rate to the potable water variable rate times 100 was calculated to obtain a percentage comparison metric. The potable water variable rate chosen from each utility's inclining block rate structure was the rate at 10,000 gallons of water per month. For two of these utilities, the potable water rate at 10,001 gallons per month was used because it is the same rate as the reclaimed water rate. These rate values are thought to capture the cost of using potable water for irrigation. Potable water rates are those that were

implemented in either 2010 or 2011. The distribution of these percentages among the 94 utilities is provided in **Table 7-2**.

Table 7-2 Utility distribution of the reclaimed water rate as a percent of the potable water rate for single-family homes in Florida

| Percent Range | Number of Utilities | Percent of Utilities |
|-----------------|---------------------|----------------------|
| 0% | 39 | 41% |
| 1% to 5% | 0 | 0% |
| 6% to 10% | 8 | 9% |
| 11% to 20% | 10 | 11% |
| 21% to 30% | 10 | 11% |
| 31% to 40% | 7 | 7% |
| 41% to 50% | 7 | 7% |
| 51% to 60% | 4 | 4% |
| 61% to 70% | 2 | 2% |
| 71% to 80% | 1 | 1% |
| 81% to 90% | 1 | 1% |
| 91% to 99% | 0 | 0% |
| 100% | 5 | 5% |
| Total | 94 | 100% |
| Average percent | 22% | |
| Median percent | 10% | |
| Minimum percent | 0% | |
| Maximum percent | 100% | |

(a) Reclaimed water rates for single-family residential customers by utility are from the Florida Department of Environmental Protection, "2010 Reuse Inventory," Tallahassee, Fla., May 2011 (FDEP, 2011a). Sources of utility potable water rates at 10,000 gallons per month for residential single-family customers: For utilities in the Southwest Florida Water Management District the source is in-house data provided by the district. For all other public utilities the sources are the individual utility web sites. For all other private utilities, the source is the Florida Public Service Commission, "Comparative Rate Statistics as of December 31, 2010". Potable water rates are those implemented in either 2010 or 2011.

The most common ratio of reclaimed water to potable water rates is 0 percent, with 41 percent of utilities levying either no charge or just a flat charge for residential reclaimed water use. The second most common reclaimed water rate as a percent of the potable water rate is in the range of 11 percent to 30 percent, and 20 utilities, or 22 percent, are in this category. Only 13 utilities, or about 13 percent, set

their reclaimed water rate in the range of 50 percent to 100 percent of the potable water rate. About 5 percent of the utilities charge the same variable rate for reclaimed water as they do for potable water (100 percent). The average reclaimed water rate as a percent of the potable water rate is 22 percent and the median is 10 percent. All of these utilities collect a flat charge for potable water service that ranges from \$2 to \$25 per single-family connection per month. Of these utilities, 49 (or 52 percent) collect a flat charge for reclaimed water service that ranges from \$2.50 to \$25 per connection per month.

Given this comparison of flat and variable rates between residential potable water service and reclaimed water service, most Florida utilities designed their 2010 reclaimed water rates to significantly lower customer water bills when reclaimed water is used instead of potable water. Many nonpotable water users are not fully aware of the benefits that reclaimed water provides. User benefits of reclaimed water may include:

- Having a guaranteed and reliable water supply
- Ability to conserve fresh water for their other uses
- Ability to irrigate more frequently than if a traditional water source was used
- Ability to reduce fertilizer applications
- Ability to apply more water to the crop or landscape than with a traditional water source (Hazen and Sawyer, 2010)
- Typically costs less than potable water

As nonpotable water users begin to understand the benefits of reclaimed water to their household or business, the amount of money they are willing to pay for reclaimed water will increase along with reclaimed water demand.

7.5.2 Service Agreements Based on Take or Pay Charges

There are many types of reclaimed water service agreements with varying complexity, covenants, and restrictions. A survey by the AWWA (2008) indicated that most utilities either recovered less than 25 percent of their operating costs or they did not know how much they were recovering. Service agreements and cost

recovery for utilities is a large part of the socio-economic balance that is required by utilities to properly value a reclaimed water product. The high cost of treating wastewater is one of the reasons that utilities have historically not wanted to pass the entire cost of a system onto their reclaimed water customers. This situation is also prevalent in the costs of potable water systems and is a water industry-wide concern for the future.

Service agreements can be relatively simple with a single rate, but normally they are complex and multi-tiered, depending on water quality, supply and demand, specialized reuse districts, and peaking factors. For example, the Irvine Ranch Water District's recovery costs include no less than nine different classes of commodity charges for nonpotable and reclaimed water. Service agreements that include full cost recovery for reclaimed water should be promoted because reclaimed water is a reclaimed and delivered product that inherently includes all the costs in the value chain, from point of water withdrawal to point of use. First and best use, in terms of a service agreement, is not a factor; all water is reclaimed, and reclaimed water performance should be rated on the basis of delivered water quality. Additionally, the service agreements can include cost recovery for meters, commodity charges, tiered rates, surcharges, seasonal use, and peaking factors, and may include a market analysis to assess supply and demand for a regional system. A schedule of rates for each service agreement should include terms and conditions, covenants and restrictions, water quality parameters, allocations by intended use or service sector, and a dispute resolution clause.

7.5.3 Reuse Systems for New Development

Similar to ordinances that require the installation of roads, water systems, and sewer systems, municipal ordinances can also require installation of reuse systems for new developments. Where new development occurs on sizeable tracts of open land, requiring the installation of a reuse system is an efficient method to provide for facilities to deliver reclaimed water. Examples exist in the southwest where reclaimed water systems were installed years prior to reclaimed water becoming available. Typically, such systems are designed to serve irrigation demands for the common areas of the new development, such as median strips, green belts, and

parks. Under such an approach, developers incur the cost of constructing the reclaimed water delivery system. The installation of a reuse system before or during development will be less expensive than doing so afterwards or as a retrofit.

7.5.4 Connection Fees for Wastewater Treatment versus Distribution

Typically, connection fees for reuse systems are limited to recovering the costs of transmission and distribution. Treatment costs are generally the responsibility of the wastewater utility that provides reclaimed water; the wastewater utility and its customers assume financial responsibility for treating the wastewater to applicable standards, whether for discharge or reuse. Thus, the connection fee for a reclaimed water meter is often the same as the connection fee for a potable water meter because reclaimed water is considered a water resource and often is distributed by the water utility just like potable water. The cost of wastewater treatment would not be part of such a fee.

There are examples of utilities including the cost of reclaimed water treatment in their fees or splitting such costs with the wastewater utility. The reuse utility may be a separate agency that simply takes wastewater treated to discharge standards and provides the necessary extra level of treatment to produce reclaimed water. In that circumstance, connection fees would properly include treatment costs. Situations can also be found where treatment costs are split and any responsibility borne by the water utility could be included in the reuse connection fees. Each situation is unique, and various costs must be identified to be sure a nexus exists between the cost and the ultimate service being provided to end users.

The amount of the potable water connection fees must be considered when setting the reuse connection fees. If the reuse connection fee is higher than the potable water connection fee, there will be less incentive for a user to choose reclaimed water over potable water, unless the reclaimed water is priced at a discount to potable water. This is the same concept that applies to setting reclaimed water rates. Thus, while it may be possible to justify higher reuse fees, practical considerations may dictate that such fees are set below cost.

An excellent case study example of a city successfully expanding its reclaimed water system by managing customer concerns about connection fees is the city of Pompano Beach, Fla. [[US-FL-Pompano Beach](#)].

7.6 References

- American Water Works Association (AWWA). 2000. *Principles of Water Rates, Fees, and Charges (M1)*. 5th edition. American Water Works Association. Denver, CO.
- American Water Works Association (AWWA). 2007. *Water Resources Planning, Manual of Water Supply Practices (M50)*, 2nd edition. American Water Works Association. Denver, CO.
- American Water Works Association (AWWA). 2010. *Water Rates, Fees and the Legal Environment*. 2nd edition. American Water Works Association. Denver, CO.
- American Water Works Association (AWWA). 2008. *Water Reuse Rates and Charges - Survey Results*. American Water Works Association. Denver, CO.
- Catalog of Federal Domestic Assistance (CFDA). n.d. *Catalog of Federal Domestic Assistance*. Retrieved on August 23, 2012 from <<https://www.cfda.gov/>>.
- Florida Department of Environmental Protection (FDEP). 2011a. *2010 Reuse Inventory, Tallahassee, Florida*. Retrieved on August 23, 2012 from <<http://www.dep.state.fl.us/water/reuse/inventory.htm>>.
- Florida Department of Environmental Protection (FDEP). 2011b. "Table of Reuse Flow per Capita for the Nine States that Reported Having Reuse in 2006." *Based on data from the Water Reuse Foundation National Database of Water Reuse Facilities Summary Report, 2006*. Retrieved on August 23, 2012 from <<http://www.dep.state.fl.us/water/reuse/inventory.htm>>.
- Government Finance Officers Association (GFOA). 2005. *Governmental Accounting, Auditing, and Financial Reporting: Using the GASB 34 Model*. Government Finance Officers Association. Washington, DC.
- Hazen and Sawyer. 2010. *Economic Feasibility of Reclaimed Water Use by Non-Utility Water Use Permittees and Applicants, Final Report*, prepared for the Southwest Florida Water Management District, Brooksville, Florida, June 2010.
- Rodrigo, D., E. J. López Calva, and A. Cannan. 2012. *Total Water Management*. EPA 600/R-12/551. U.S. Environmental Protection Agency. Washington, D.C.
- Toor, G. S., and D. P. Rainey. 2009. "History and Current Status of Reclaimed Water Use in Florida." Institute of Food and Agricultural Sciences, University of Florida, Soil and Water Science Department. Gainesville, FL.
- Water Environment Federation (WEF). 2004. *Financing and Charges for Wastewater Systems (MOP 27)*. Water Environment Federation. Alexandria, VA.
- WaterReuse Research Foundation (WRRF). 2009. *Evaluating Pricing Levels and Structures to Support Reclaimed Water Systems, WRRF 05-001*. WaterReuse Research Foundation. Alexandria, VA.
- WaterReuse Research Foundation (WRRF). 2006. *An Economic Framework for Evaluating Benefits and Costs of Water Reuse, WRRF 03-006-02*. WaterReuse Research Foundation. Alexandria, VA.
- WaterReuse Research Foundation (WRRF). 2004. *Water Reuse Economic Framework Workshop Report, WRRF 03-006*. WaterReuse Research Foundation, Alexandria, VA.

This page intentionally left blank.

CHAPTER 8

Public Outreach, Participation, and Consultation

This chapter provides an overview of key elements of public involvement, which is critical to success of any reuse program (WRA, 2009), as well as several case studies illustrating public involvement and/or participation approaches to support successful reuse programs

8.1 Defining Public Involvement

Public outreach, participation, and consultation programs work to identify and engage key stakeholder audiences on planned projects that directly impact the population. Generally, effective public participation programs invite two-way communication, provide education, and ask for meaningful input as the reuse program is developed and refined. Depending on the project, public involvement can involve a range of types and levels of outreach, participation, and consultation. Some projects require only limited contact with a number of specific users. Others take an expanded approach to include formation of a formal advisory committee or an extensive campaign with multiple methods of public engagement.

Regulatory agencies often require some level of public involvement in water management decisions, and stakeholders are increasingly vocal about being involved in those decisions. This is strikingly different from the past when members of the public were often informed about projects only after final decisions had been made. Today, responsible leaders recognize the need to inform and consult with the public to obtain their values and advice about science, technology, and legal aspects. Advancing the understanding of water issues can facilitate real, workable, and implementable solutions tailored to meet specific needs.

Public information efforts often begin by targeting the most impacted stakeholders. Over time, as an early education base is built among stakeholders, the education effort then broadens to include the public at large. Regardless of the audience, all public involvement efforts are geared to help ensure that adoption of a selected water reuse program will communicate benefits and fulfill real user needs and generally recognized community goals, including public health, safety, and program cost.

Two-way communication cannot be emphasized enough. In addition to building community support for a reuse program, public participation can also provide valuable community-specific information to reuse planners. Community residents may have legitimate concerns that quite often reflect their knowledge of detailed technical information. In reuse planning, especially, where one sector of the public comprises potential users of reclaimed water, this point is critical. Several case studies highlight how prompt and regular communication and a collaborative spirit between utilities, regulators, the general public, consultants, and contractors led to project success [US-CA-Southern California MWD], [US-FL-Orlando E. Regional], [US-NC-Cary].

8.1.1 Public Opinion Shift: Reuse as an Option in the Water Management Toolbox

Over the past decade, public dialogue about reuse has increased, particularly in communities of water scarcity, and there is greater general public knowledge about water reuse as an option. In cities in the states of Arizona, California, Florida, and Texas where water reuse is already occurring, a survey by the WRRF found that 66 percent of respondents knew what reclaimed or recycled water is, 23 percent were not sure, and 11 percent were unaware (WRA, 2009). Research has shown that public involvement for water reuse projects can result in a community having a more favorable collective attitude toward a project as its level of familiarity with water reuse increases (USBR, 2004). Proactive education and involvement programs that put water reuse into perspective and promote shared decision-making help to ensure that public understanding develops.

A study conducted by San Diego County Water Authority demonstrates a shift in public opinion about reuse in the community between 2004 and 2011 (Figure 8-1). The percentage of respondents who “strongly oppose” using advanced treated recycled water as an addition to drinking water supply dropped from 45 percent in 2004 to 11 percent in 2011 (San Diego County Water Authority, n.d.).

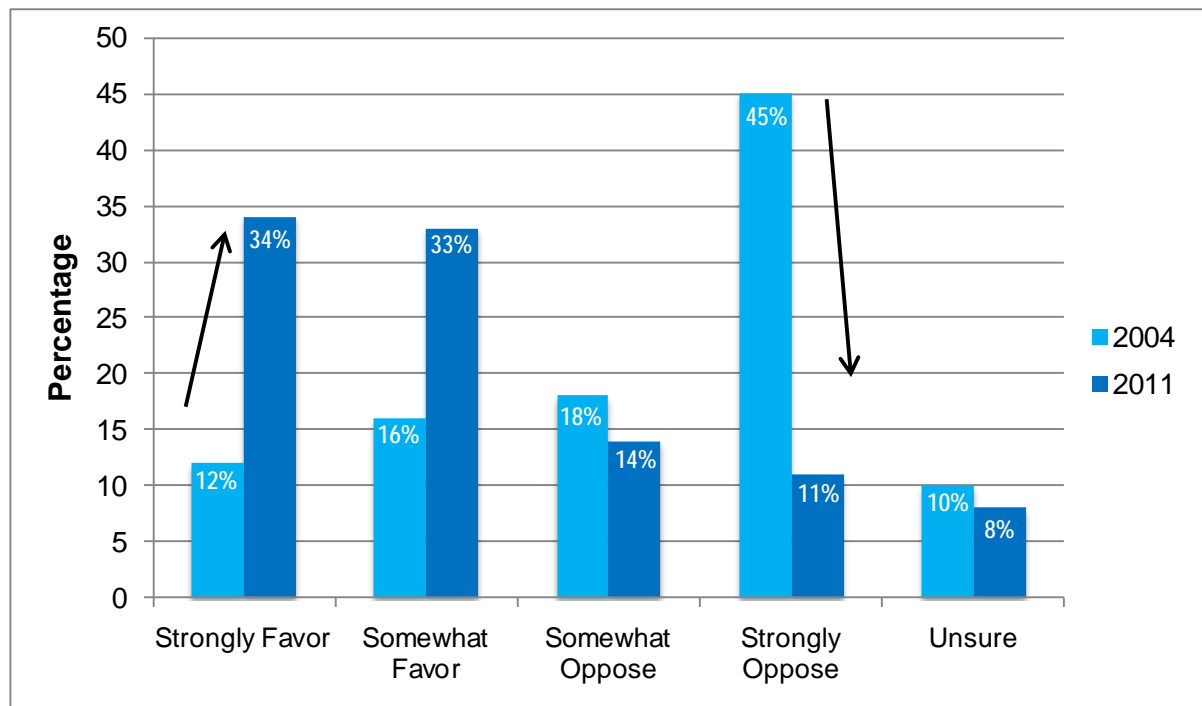

Figure 8-1
Survey results from San Diego: opinion about using advanced treated recycled water as an addition to drinking water supply (2004 and 2011) (SDWWA, 2012)

Media coverage of high-profile water reuse projects has taken center stage in television and national newspapers. In 2011, *USA Today* ran a cover story about potable reuse in Big Spring, Texas. In 2012, the *New York Times* published a front page story titled “As ‘Yuck Factor’ Subsidies, Treated Wastewater Flows From Taps.” By engaging with the media and larger communities, water utility public outreach campaigns have encouraged the dissemination of more science-based information about the risks and benefits of reuse.

8.1.2 Framing the Benefits

The process of public engagement begins with clearly defining the problem: *What is the driving reason for which people are being asked to make a change and investment? What are the options for solving it?* Equally important is discussion of the benefits: *What will the community and the individuals that comprise it gain from each of the solutions?* It is important to discuss how water reuse can be of value to the public and the contexts in which it can surpass other options for securing supply reliability and/or quality. Once the reuse options—including status quo—are fully explored, it is then appropriate to discuss the technologies at our disposal to address the potential

risks associated with reuse. In the past, dialogue has focused on risks and the associated mitigating technologies rather than beginning from a collaborative problem-solving standpoint.

This focus on identifying benefits is stressed in the WRRF report “Best Practices for Developing Indirect Potable Reuse Projects” (Resource Trends, Inc., 2004). The report concludes that, “Although a compelling value may be created with products or services, the customer or audience must perceive that benefit. When a meaningful problem is solved, the perception will likely be that the state of affairs has improved. This goal is why clearly stating the problem is so important.”

So what are the perceived benefits? In a 2009 survey conducted by the WRA in eight target U.S. cities, “Conserving water in my community” was the dominant benefit driver by a 4 to 1 margin (WRA, 2009). Other key benefits that were found to be strong motivators were “positive impact on wetland, streams, and wildlife habitat;” and “irrigating crops without wasting water.” Other possible benefits ranked lower, e.g., “industrial/manufacturing use,” “groundwater replenishment,” and “conserving water in my workplace.”

8.2 Why Public Participation is Critical

Over the past few decades people have come to expect or even demand information and engagement related to utility decision-making and initiatives. The intensity of people's interest in having a role in public decisions parallels the potential for impacts on their health, security, and quality of life. Water recycling in all its forms does or can be perceived to impact all of these factors; thus, public outreach and involvement have become key components in the success of water reuse programs.

Public participation begins with having a clear understanding of why reuse needs to be implemented, the water reuse options available to the community, and the potential concerns related to each option. Once an understanding of possible alternatives is developed, a list of stakeholders, including possible users, can be identified and early public contacts may begin. Why begin engaging stakeholders before a plan is in place? It is important to get early adopters that stakeholders can look to and even access for questions or concerns. These community resident stakeholders can provide early indications regarding acceptance of the reuse program and where management and other implementation team members may need to shore up or spend time on additional information and outreach components. Beyond that, informed residents can help identify and resolve potential problems before they occur and develop alternatives that may work more effectively for the community.

8.2.1 Project Success

Involvement of the public in each stage of project planning can be a critical step in achieving a successful project. Hundreds of water reuse projects have been undertaken in the last two decades; many have succeeded and others have failed. Economic, scientific, and technical soundness have not always translated into public support. Some projects failed after millions of dollars had already been spent for development, design, and community involvement, with opposition groups filing lawsuits as a means of stopping them. Public opposition, where present, has included concerns about potential or perceived risks to human health and the environment, economic concerns such as the cost to produce the water, population growth and development, environmental justice and equity, and competing water rights. In some cases, it has taken the form of general rejection

of reuse except as an “option of last resort” (USBR, 2004). A 2001 AWWA Research Foundation Highlights Report, *Public Involvement – Making It Work*, stresses this approach: “Drinking water utilities must involve the public prior to implementing projects that affect the public. Understanding this principle will save utilities time and money through avoided litigation and project delays. It will also lay the foundations for establishing public trust and support for future projects” (CH2M Hill, 2001).

8.2.2 The Importance of an Informed Constituency

A public participation program can build an informed constituency that is comfortable with the concept of reuse, knowledgeable about the issues involved in reclamation/reuse, and supportive of program implementation. Ideally, community residents who have taken part in the planning process will be effective proponents of the selected plans. Having educated themselves on the issues involved in adopting reclamation and reuse, they will also understand how various interests have been accommodated in the final plan. Public understanding of the decision-making process will, in turn, be communicated to larger interest groups—neighborhoods, clubs, and municipal agencies—of which they are a part. Indeed, the potential reuse customer who is enthusiastic about the prospect of receiving service may become one of the most effective means of generating support for a program. This is certainly true with the urban reuse programs in St. Petersburg and Venice, Fla. In these communities, construction of distribution lines is contingent on the voluntary participation of a percentage of customers within a given area.

8.2.3 Building Trust

Trust lies at the core of people's understanding, support, and acceptance of reclaimed water as a supply alternative. Unfortunately, the current social and political environment has resulted in a general lack of trust and confidence in utility service providers; both public and private. Public involvement provides opportunities to build trust, not only by fully and truthfully informing individuals within the community, but ideally by engaging them to share information, provide feedback, or contribute to utility decisions. Trust is earned over time by actions and not just words, by taking risks and sharing power. Early public engagement and continuing participation throughout

the project (and even beyond) provides greater opportunities to develop trusting relationships. “Trying to sell a completely designed project does not embrace the true spirit of the word *communicate*—coming to a common understanding” (AWWA, 2008; WEF, 2008).

The AWWA/WEF Special Publication *Using Reclaimed Water to Augment Potable Water Resources* provides a path through the process of fully engaging the public in exploring the needs and benefits of water recycling. While targeted at IPR, the ideas and processes in this publication are applicable to all forms of water reuse (AWWA, 2008).

8.3 Identifying the “Public”

Outreach and engagement regarding increased recycled water use must encompass a diverse cross-section of the communities that are impacted or who believe the project has some effect on their interests. Utilities with successful reuse initiatives identify these communities early on and develop a strategy to provide them with information in a format that adds to the credibility of the communication and to hear and address their ideas and concerns.

There is no such thing as “the general public.” People belong to geographic, socio-economic, gender, and age groups. They belong to groups according to political ideology, social orientation, and recreation interests. From a marketing perspective, they are frequent fliers, homeowners, credit card holders, health food eaters, and vacation takers. The segmentation of America is prolific, so there are groups and magazines tailored to just about any issue or interest. When planning for public outreach related to reclaimed water use, this diversity needs to be considered.

Diversity should be considered from a variety of perspectives, including ethnic, demographic, geographic, cultural, professional, and political background. Outreach and engagement also should reach multi-cultural, multi-lingual, and multi-ethnic communities and organizations. Market research has shown that some ethnic groups mistrust the safety of water supplies and are wary of government much more than the general population. Working to build support within multi-cultural organizations that are already trusted in these communities can help build awareness and acceptance of a reuse project more

effectively and quickly than doing so independently. Outreach to organized groups is as important as outreach to individuals, if not more so. Groups that are likely to have an interest in reclaimed water use include chambers of commerce and environmental organizations, as well as health advocacy groups, service organizations, homeowners associations, academia, and organized labor. Outreach and public participation could take significant effort and time upfront but will ultimately save time over the life of the project.

One particularly successful example of this inclusiveness is the diversity of outreach by the OCWD for its Groundwater Replenishment System. For several years, OCWD staff provided presentations to hundreds of community organizations and leaders in the diverse communities of Orange County before seeking their support. Sometimes this meant presenting to three or four groups in a single day. The process was rigorous and time consuming, but the utility was able to secure support from the majority of these organizations. Supporters were listed on the project website, in informational materials, and in other public forums. This far-reaching inclusiveness helped the Groundwater Replenishment System become a reality [[US-CA-Orange County](#)].

8.4 Steps to Successful Public Participation

From the experience of reuse projects over the past decade, it is possible to develop a core set of behaviors common to successful public engagement. Those actions include the steps presented in this section:

- Begin with an assessment of the community and of the utility itself.
- Determine early the level of public involvement that will be sought, including a preliminary list of potential stakeholders.
- Develop and follow a comprehensive strategic communication plan that presents information clearly and anticipates long-term implications of reuse messages.
- Gauge community and utility opinions and attitudes; assess trusted information sources and avenues for participation.

- Meet with community officials and leaders early and then regularly.
- Engage neutral, credentialed outside experts, as potential spokespeople or evaluators while establishing the utility as the primary, credible source of information.
- Engage the media, approaching every available information channel, including social media.
- Involve employees and ensure they are informed with accurate, timely information.
- Dialogue with the broader community of stakeholders directly through various means; understand opposition, and be proactive in responding.

A 2003 Water Environment Research Foundation (WERF) report outlines a framework to help water utilities engage constructively with the public on challenging, contentious issues. While outlining principles for success, the report stresses that no checklist of “to-do’s” exists for establishing public confidence and trust. Quite the opposite, the research suggests that a one-size-fits-all model cannot work because the most appropriate steps must be tailored to the specific context. The report provides an analytical structure that utilities can use to assess the community and design an appropriate approach (Hartley, 2003).

Several case studies illustrate how public participation is tailored to meet the needs of the specific context, from formal outreach and involvement campaigns to simpler informational programs. In an environment of distrust in government, OCWD and the OCSD successfully partnered to build a potentially controversial 70 mgd (3,067 L/s) IPR project that garnered overwhelming public support and overcame the “toilet-to-tap” misperception [[US-CA-Orange County](#)].

In many communities, reclaimed water has been widely accepted with little to no opposition. In these contexts, public education may include tours and websites, but not require dedicated public relations staff or a formal public outreach and communication program [[US-GA-Forsyth County](#)]. In Big Spring, Texas, a new water reclamation plant was launched in 2010 that blends reclaimed water with raw water

supplies. Open and proactive communications with state regulators and the public have been keys to the project’s success [[US-TX-Big Spring](#)].

Another example of public support of reuse comes from Virginia. Reclaimed water has been successfully augmenting the drinking water supply for over three decades at the Occoquan Reservoir in Northern Virginia near Washington, D.C. Though first unintended, a newly-conceived framework set in motion the intentional, planned use of reclaimed water for the purpose of supplementing a potable surface water supply. A number of hearings were conducted to explain what was to be implemented and to allow the public a venue to express their views. While the UOSA has had an active 30-year program to provide information on its website and tours to local students from grade school through college, a formal public outreach campaign has not been necessary [[US-VA-Occoquan](#)].

8.4.1 Situational Analysis

Planning for successful public outreach and engagement should begin with an assessment of the community and of the utility itself. While there are models of successful outreach for water reuse programs to emulate, the selection of specific public involvement approaches, strategies, and tools should be based on the specific attributes and conditions in a community. In combination, this is termed a “Situational Analysis.” In analyzing the community, it is important to assess factors such as:

- The current political environment in which the project will be implemented
- Economic, social, and environmental issues that might indirectly become part of the debate and communication platforms
- Public awareness and knowledge of water-related issues and how these issues may be interconnected
- The history and reputation of the utility, particularly related to trust
- Potential supporters and opponents
- What people currently are seeing and hearing in the media, particularly related to water quality and health

- The principal conduits people rely upon for information, and which of those they trust

Findings likely will vary among differing geographies and demographics within the community. It is important to tap into all of these using tools such as:

- A review of recent media coverage and social media content
- Interviews with elected and appointed officials
- Sit-down conversations with “inherent” community leaders who, though not titled, are respected and listened to by local constituents
- Discussions with customer service staff
- Public opinion surveys and focus groups

The WateReuse guidebook *Marketing Nonpotable Recycled Water* provides a strategic plan template for public outreach, as well as example market research results on the types of messages and modes of communication that would be most reassuring (Humphreys, 2006). As an example, the San Diego County Water Authority conducts annual surveys within its service area to measure public knowledge and opinions of water issues and share the results with the public (San Diego County Water Authority, 2012). Equally important is an inward assessment of the utility to understand factors such as:

- The amount of connectivity with the community and its values
- Openness to engaging people who may express varied perspectives of the project as well as of the utility and its leadership
- Willingness to share decision-making authority
- Willingness and capacity to sustain the hard work of going out to inform and engage the community, including making presentations to diverse and potentially adversarial groups
- Ability and willingness of management to support these efforts over time, including resource allocation

8.4.1.1 Environmental Justice

Environmental justice is of critical concern not only when planning a reuse project, but also while involving the community in the educational process. Environmental justice issues are a result of either procedural or geographic inequity. Procedural inequities occur when there is no “meaningful involvement” of community or stakeholder groups. EPA defines “meaningful involvement” as the seeking out and providing for the affected community an “appropriate opportunity” to participate in the decision-making process, as well as providing the opportunity for the community to have input that will be considered and has the potential to influence the decision-making process. Geographic inequity issues arise when one portion of the community perceives, rightly or wrongly, that it is required to share a majority, or disproportionate share, of the impact from project siting, ultimate water application location (where the water is ultimately used), or potential decreases in property values. Geographic inequity concerns arise primarily where projects are situated in economically or historically disadvantaged areas.

Respectfully and clearly acknowledging and addressing environmental justice issues is critical to success. The guiding principle of environmental justice is that no group of people should bear an unbalanced share of negative environmental impacts of a project or program, and all should have equal right to environmental protection. Insightful tools that can help utilities address the delicate and potentially volatile issues of environmental justice include EPA’s Environmental Justice Web site, EPA “*Toolkit for Assessing Potential Environmental Justice Allegations*”, and Executive Order 12898, established during the Clinton administration (EPA, 2004). Questions to ask with regard to the potential for environmental justice issues related to a project are:

- Is each social group in the community being treated fairly or the same as others?
- Is everyone receiving equal access to safe, reliable drinking water?
- Is everyone protected equally from health risks?
- Is any social group bearing the burden of a negative aspect of this project or program?

Engagement of leaders in minority and under-served communities provides an opportunity to better understand their sense of the potential for environmental justice issues related to a water reuse project to arise, and establishes another forum for public outreach and involvement.

8.4.2 Levels of Involvement

It is important to understand and align community member expectations for public participation with what a utility, municipality, or agency is actually willing to commit to and able to deliver. If the two are aligned, public satisfaction with both the process and the outcome can be enhanced.

The appropriate scope, complexity, and content of public involvement will vary according to the type of reuse proposed, the nature of the community, and the magnitude of the project. A project for median irrigation or industrial uses, for example, is likely to directly touch far fewer individuals and evoke less opposition and controversy than a project involving playground irrigation or indirect potable reuse. (Metcalf & Eddy/AECOM, 2007). All reuse projects, however, warrant a thoughtful, targeted, transparent, and truthful public sharing of information with customers and stakeholders, as well as associated opportunities for participation.

The concept of varying levels of participation is captured by the “Spectrum of Public Participation” developed by the International Association of Public Participation (IAP2). The spectrum designates five levels of involvement ranging from *informing*, which provides balanced and objective information to help people understand the problem as well as alternatives for resolving it, to *empowering*, in which the utility turns over final decision making or a significant portion of it to the public or a representative unit of that public. The IAP2 spectrum articulates a “promise to the public” associated with each progressive level of participation. For example, *informing* promises that the utility will help the public understand, while *empowering* promises the utility will implement what the public decides (IAP2, 2007).

It is important to determine early the level of involvement that will be sought, keeping in mind the willingness and capacity of the utility (particularly its leadership) to broadly share the decision-making power. Once a level of involvement has been publicly promised, it can be more damaging to renege on that promise than to have no public involvement at all.

8.4.3 Communication Plan

Regardless of project scope, it is critical to develop at the earliest possible stage a comprehensive strategic communication plan that identifies how the utility will present information and solicit involvement of stakeholders. This plan should pre-identify and provide for training for those who will speak on behalf of the project, especially. The plan must consider consistent messaging, including the long-term implications of reuse messages. The various references at the end of this chapter may be useful planning tools.

8.4.3.1 The Role of Information in Changing Opinion

To communicate with the public in a way that fosters public understanding, utilities must consider carefully the way information is presented. Two recent WRRF projects provide valuable and surprising feedback for the water industry about public communication about potable reuse, but the lessons are applicable for any type of reuse project. *WRRF 07-03: Talking about Water; Images and Phrases that Support Informed Decisions about Water Reuse and Desalination* illustrates that while some staunch opponents are unlikely to change in opposition, a significant portion of community members may change their opinion to favor reuse when provided clear information (WRRF, 2011). **Figure 8-2** provides data from focus groups where individuals were noted as being of one of three mind-sets according to their responses about drinking reclaimed water: “minded a little,” “don’t mind at all,” or “minded a lot” (WRRF, 2011). Participants were then provided information related to water reuse, including easy-to-understand technical details and graphics explaining the water purification process. Following this information sharing, most of those who had “minded a little,” changed their opinion to “don’t mind at all,” though many had additional questions. Most who had indicated they “minded a lot” maintained that position.

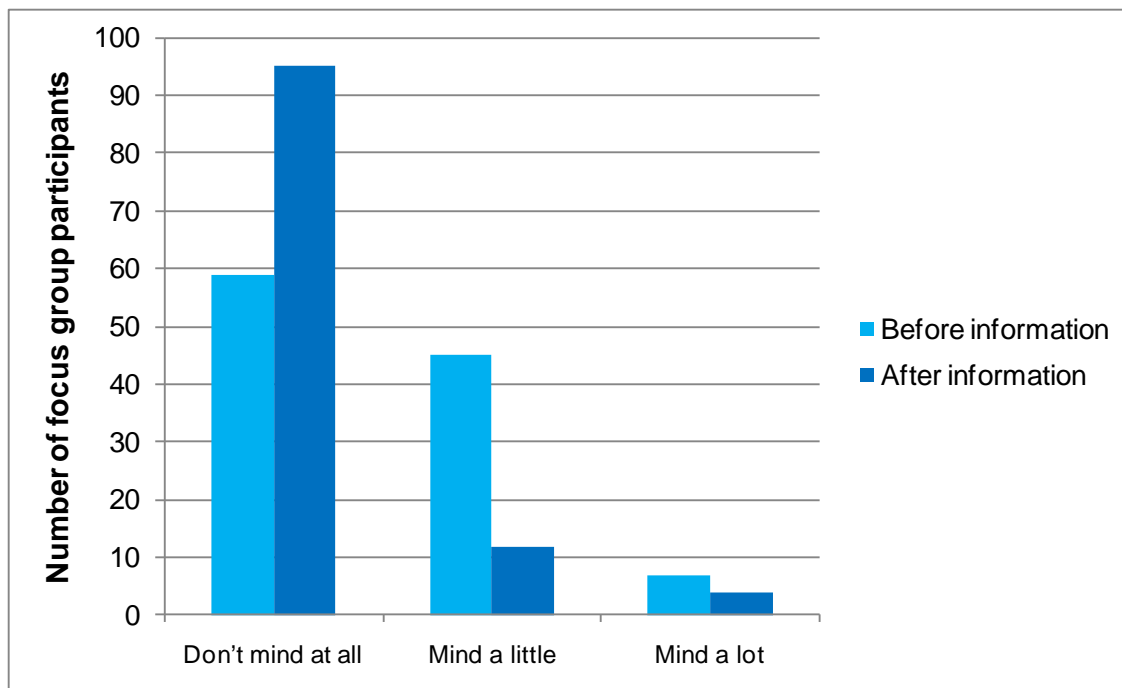

Figure 8-2
Focus group participant responses: before and after viewing information (Source: Adapted From WRRF, 2011)

This research led to the conclusions that information presented to the public needs to be simple enough to understand yet technical enough to trust and that public communications should be treated as a dialogue that avoids technical jargon and acronyms. An interactive web-based urban water cycle was developed to assist in explaining reuse to the public in the context of urban water management. While potential users *generally* know what flow and quality of reclaimed water are acceptable for different applications, it is critical to ensure a common baseline understanding among the community about local water cycle. A water cycle glossary and informational videos have been put together by the WRA to assist in a holistic and contextual understanding of water reuse (A Thirsty Planet, n.d.).

8.4.3.2 Words Count

WRRF 07-03 clearly demonstrated that the industry's vocabulary and means of communicating with the public are not well understood or well received, often resulting in confusion and contributing to public mistrust or lack of acceptance of water reuse projects. The terms to describe reclaimed water produced for augmentation of drinking water supply that survey respondents found the most reassuring all described the very high quality of the water, and did not include

the "re" prefix (reuse, reclaimed, etc.), as summarized in **Figure 8-3**. On the other end of the spectrum, the terms found least reassuring are the terms most often used by the water industry (WRRF, 2011).

This study also found that most participants preferred that reclaimed water quality be described by the uses for which it is suitable, rather than a grading system, degree or type of treatment, or type of pollutants removed. Earlier research speaks of people's "visceral" aversion to human waste and the difficulty overcoming a perception of contamination (Rozin and Fallon, 1987 and USBR, 2004). However, WRRF 09-01: *The Effect of Prior Knowledge of 'Unplanned' Potable Reuse on the Acceptance of 'Planned' Potable Reuse* demonstrated that when reuse options are placed into context of the water cycle's *de facto* "unplanned potable reuse," there is higher acceptance of "planned potable reuse" (WRRF, 2012). When compared to the IPR options of continuing to use the current water supply ("business as usual"), blending reclaimed water in a reservoir, and discharging treated water upstream of a drinking water treatment facility, direct potable reuse was judged to produce the safest drinking water by 41 percent of focus group participants (**Figure 8-4**).

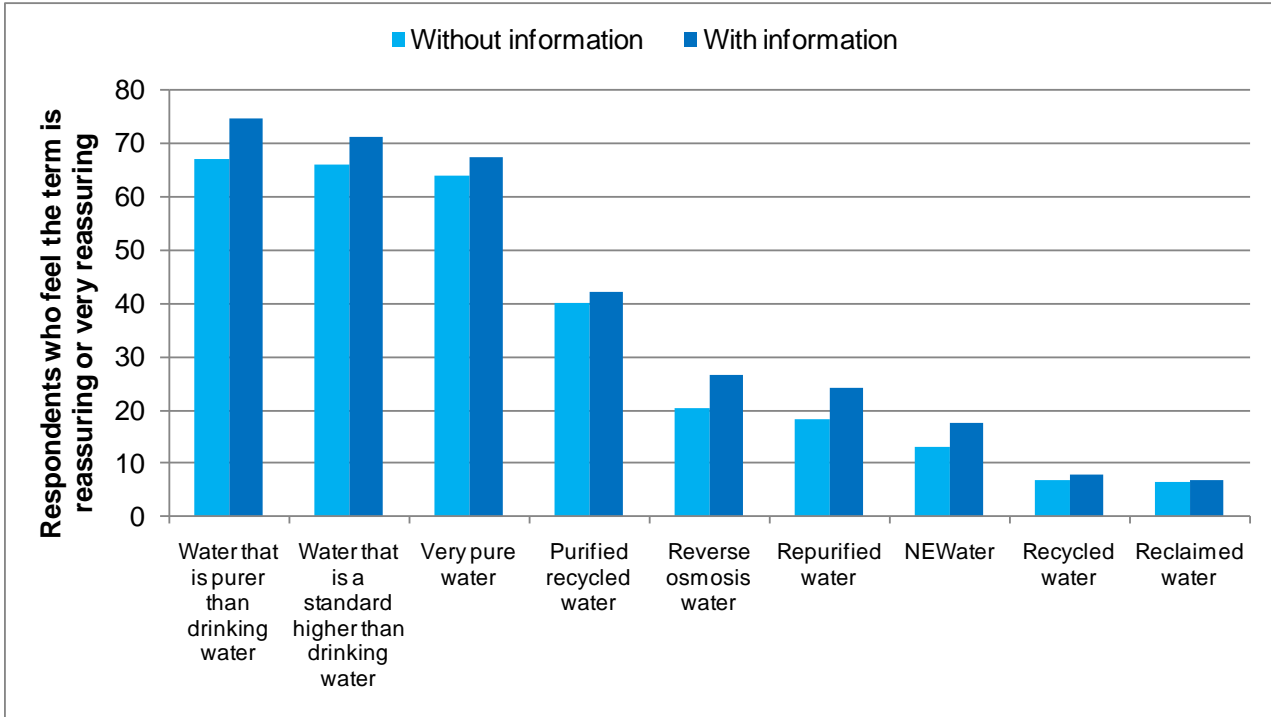

Figure 8-3
Water reclamation terms most used by the water industry are the least reassuring to the public. (Selected data from WRRF 07-03 – refer to the report for the complete list of terms studied.)

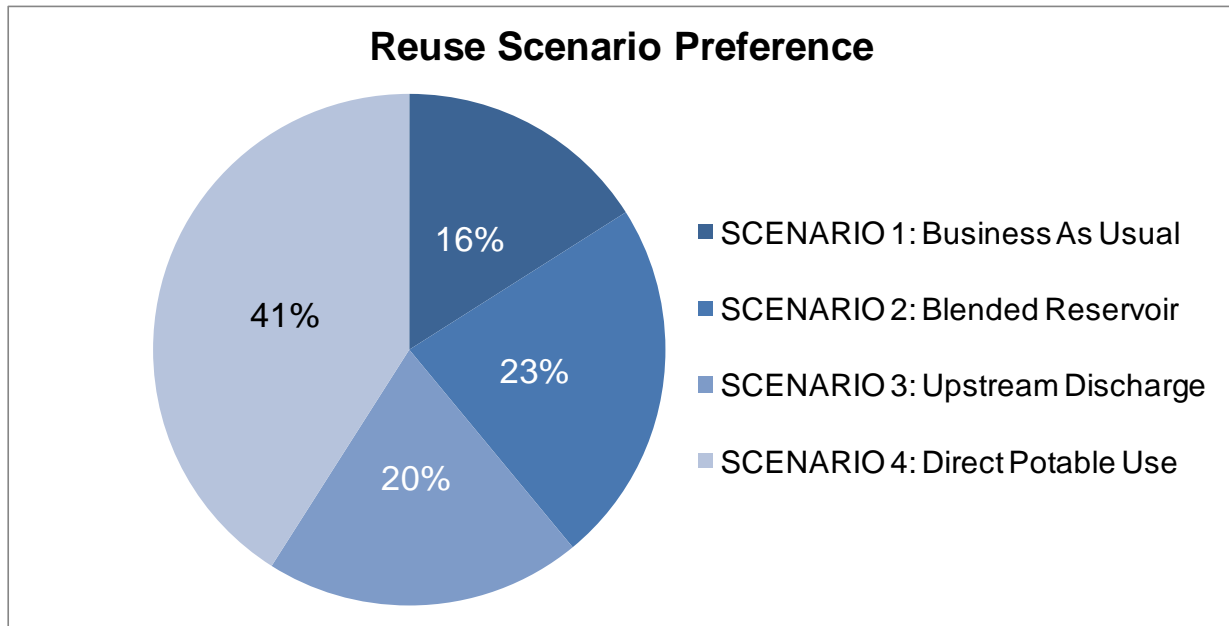

Figure 8-4
Focus group participants preferred “direct potable use” over “business as usual,” “blended reservoir,” or “upstream discharge” IPR options (WRRF 09-01)

The study suggests that the public is less concerned about the source of the drinking water supply than about monitoring and reliability of the safety and taste of their drinking water. Additionally, positive terminology leads to early acceptance of reuse. The water purification plant described in the study appeared to strongly influence people's preference.

A 2010 WRRF study titled *The Psychology of Water Reclamation and Reuse: Survey Findings and Research Road Map* found that only 13 percent of respondents said they would be unwilling to drink certified safe recycled water. In this study, messages of “recycled water is safe” and “all water has the properties of recycled water” were tested—each showed an increase in willingness to drink certified safe recycled water [US-CA-Psychology] (WRRF, 2010a).

Taken together, this research emphasizes the importance of language in setting the context for people's perceptions about reclaimed water. Outcomes of the studies include recommendations for practices and terminology related to water reuse that will facilitate rather than erode people's ability to understand and accept reused water as a safe and reliable water supply option. These include:

- **Facilitate Understanding:** Focus groups demonstrated that simple and easy-to-understand information results in increased knowledge and acceptance of water reuse. At the same time, materials should not be overly simplistic. People want more in-depth information about water, as opposed to general information (WRRF, 2011). This result supports the benefit of informing people early in a reuse initiative, with information specific to the project being proposed.
- **Forget the Past:** Reclaimed water is best presented in terms of its suitability for specific uses, rather than its source.
- **Emphasize Purity:** The word “pure” and its derivatives help reassure people that the water is safe.
- **Show that it is Integral to the Cycle:** Water reuse is best presented in the context of the complete water cycle, setting the framework for people to understand the truth that *all water is recycled*.

- **Avoid Jargon:** Many terms common to water utility professionals (flocculation, primary treatment, effluent) are obscure to most people. It's important to explain the purification process and its outcomes in clear, readily-understandable terms. Some people perceive highly technical terminology as an attempt at obfuscation, which serves to erode rather than engender trust.
- **Use Pictures:** Graphics and pictures that clearly (and even cleverly) illustrate the technical steps of the water treatment process help people to understand and believe in the technology behind water purification.
- **Present Analogies:** Comparisons can help people better understand and evaluate risk. Examples given include the explanation that “Wastewater is mostly water—a 53-gallon drum of it contains only about one tablespoon of dirt.” Similarly, researcher Shane Snyder noted in a Congressional hearing, “The highest concentration of any pharmaceutical compound in U.S. drinking waters is approximately 5 million times lower than the therapeutic dose and that ...one could safely consume more than 50,000 8-ounce glasses of this water per day without any health effects.” (Snyder, 2008). Another useful study is *WRRF 09-07 - Research Update: Risk Assessment Study of PPCPS in Recycled Water to Support Public Review* (WRRF, 2010b).
- **Tell It Like It Is:** Terminology commonly used by the industry can get in the way of public understanding and acceptance of reclaimed water. The terms “constituents of emerging concern,” “trace organic compounds,” and “microconstituents,” are alternative terms to identify a number of anthropogenic chemical compounds that have been detected in water or wastewater, generally at very low levels, but that are not commonly regulated. While experts struggle to identify this category of constituents with an accurate term (as described in Chapter 6), these terms can be confusing or alarming to the public. The term “emerging” is likely to increase a person's sense of worry, connoting this not only exists, but is prone to become larger or more virulent. Use of the word “concern” expresses that this is something that

should be a cause for apprehension. Alternative terms have been proposed, categorizing them by end use (e.g., pharmaceuticals, personal care products, flame retardants), by environmental and human health effect, if any (e.g., hormonally active agents or endocrine disrupting compounds), or by type of compound (e.g., chemical vs. microbiological, phenolic vs. polycyclic aromatic hydrocarbons). The sheer array of different types of compounds can likewise cause confusion and are not well understood by the general public.

The term *endocrine disruptors* can be misinterpreted as having proven implications for human endocrine systems, whereas current evidence is limited to disruptions in frogs and fish. A report by WERF, *Communication Principles and Practices, Public Perception and Message Effectiveness* provides guidance on effective risk communication practices, particularly around TrOC (Deeb, 2010). The report suggests a less stigmatizing term for most of these constituents is “pharmaceuticals and personal care products” with the added words “and other unregulated constituents” to broaden the term to be inclusive of a wider array of constituents.

Common terms like “toilet-to-tap” tend to resurface in people’s minds the link between reclaimed water and wastewater. Still, perpetuation of such words and phrases often is beyond the control of those proposing reuse projects; it is, in fact, in the control of those most commonly perpetuating the words and phrases, namely the media and project opponents. The utility should be prepared and ready (and willing) to clarify the inaccuracy of “toilet-to-tap” and similar terms, either by explaining that reuse is but one segment of the ongoing water cycle or by stressing the multiple intervening treatment steps between toilet and tap.

While a great deal is now understood around how to build public understanding and involvement in reuse, some questions remain, and are described in the case study [US-CA-Psychology] originally reported by WRRF (2010a).

8.4.3.3 Slogans and Branding

As emphasized in the previous section, the choice of slogan for a reuse campaign must be easy to understand and must communicate the benefits that resonate most with the target audience. WRRF found that “*Water... it’s too valuable to be used just once*” was the branding statement that was preferred by more than a 2 to 1 margin over all alternatives in their eight-city stakeholder survey (WRA, 2009). Since public understanding and attitudes about water reuse varies greatly by location and is dynamic, it is important to understand and stay current on stakeholder attitudes and beliefs about key benefits in a given location.

8.4.3.4 Reclaimed Water Signage

One undervalued, and often overlooked, method for communicating the benefits of water reuse to the public is the posted signage provided to reclaimed water irrigation customers. As just described, the terminology presented on the sign can convey the message of the benefits of reuse, while properly advising the community on the type of water being used for irrigation. Many states still require a symbol with drinking glass and a slash with text “Do Not Drink,” but also allow the inclusion of more positive language as shown in the adjacent signage example.

Some states have specific requirements for reuse signage. An additional discussion on signage is provided in Chapter 2. An example of terminology used by the Cucamonga Valley Water District, Calif., (CVWD) is shown in **Figure 8-5**. The signage emphasizes the benefits of using recycled water for irrigation (i.e., supporting conservation) through the use of large centered text. The advisory language, shown in smaller text on the lower right hand corner, is still present but is not the focus of the sign. This simple choice in word selection and imaging results in a positive message being conveyed to the audience and eases public concerns.



Figure 8-5
CVWD encourages its wholesale customers to promote the notification of water reuse benefits (Photo credit: Miguel Garcia)

8.4.4 Public Understanding

To build an informed constituency, pre-conceived notions about reclaimed water and its risks must be identified and addressed. In water reuse, a challenge may lie in the difference between the technical experts' understanding and the lay public's perceptions of water reuse projects.

8.4.4.1 Perception of Risk

In general, the public tends to perceive risks differently than scientists schooled in the statistical analysis of risk. A growing body of research is examining the factors that explain the public's perceptions of risk and thus influence decision-making and project implementation. Researchers in this area of study are finding that the range of factors that underlie the public's perception of risk is very large. Technical information and public participation can influence the public's response to those factors, but it is only one influence and may not be sufficiently persuasive on its own. Other factors that influence the public's perception of risk associated with water reuse include:

- The cluster of mental pictures or associations that follow mention of the words "wastewater," "reclaimed water," or "reuse water"
- The way in which different groups within the general public rank and evaluate other risks relative to water reuse, such as sunbathing, caffeine, a poor diet, or driving without a seatbelt

- The baseline knowledge that different groups already possess about causality or different risk factors associated with disease-specific outcomes
- The level of trust in which the public holds the agency or body responsible for managing a risk

Given the importance of each of these variables to understanding perceptions of different health and environmental risks and to communicating effectively about reuse, public information campaigns must consider:

- Perceived risk
- Effect and image
- Language and stigma
- Mental and cultural models (context)
- Trust

As previously mentioned, a useful study is *WRRF 09-07 - Research Update: Risk Assessment Study of PPCPS in Recycled Water to Support Public Review* (WRRF, 2010b).

8.4.4.2 Trusted Information Sources

Survey research conducted by individual utilities continues to indicate that the public has a greater level of trust in opinions about potable reuse projects provided by scientific experts. A WRRF research study found that independent (e.g., university-affiliated) scientists are the most credible source of information on recycled water, followed by state and federal government scientists (WRRF, 2010a). Hired actors, neighbors, and employees of private water-related companies are least credible, according to this study [US-CA-Psychology]. The WRRF 09-01 study (WRRF, 2012) resulted in slightly different conclusions about which sources of information about reuse the public trusts most to provide information about reuse (**Table 8-1**).

In this study, respondents from the United States and, to an even greater degree, from Australia, identified regulators as the most trustworthy source of reclaimed water information. Regulators were chosen by more people than consultants, professors, doctors, and local water agency spokespeople.

Table 8-1 Focus group participant responses – most trusted sources (Source: Adapted from WRRF, 2012)

| Source | U.S. Respondents (n=302) | | Australia Respondents (n=349) | |
|---------------------------------|-----------------------------|------------|----------------------------------|------------|
| | Number | Percentage | Number | Percentage |
| Regulators | 130 | 43% | 215 | 62% |
| Consultants | 27 | 9% | 13 | 4% |
| University professors | 42 | 14% | 36 | 10% |
| Medical doctors | 56 | 19% | 48 | 14% |
| Local water agency spokesperson | 47 | 16% | 37 | 11% |

Because trusted sources can vary from community to community, state to state, and country to country—as evidenced when comparing the WRRF (2010a) and WRRF 09-01 results—it is best to conduct a public opinion survey in each community where water reuse is being considered.

8.4.5 Community Leaders

Public involvement early in the planning process, even as alternatives are beginning to be identified, allows ample time for the dissemination and acceptance of new ideas among the constituents. Public involvement can even expedite a reuse program by uncovering any opposition early enough to adequately address concerns and perhaps modify the program to better fit the community. As mentioned previously, engagement of leaders in groups with specific interests or from under-served communities provides opportunities to understand the needs and concerns of the community as a whole.

Further, because many reuse programs may ultimately require a public referendum to approve a bond issue for funding reuse system capital improvements, diligently soliciting community viewpoints and addressing any concerns early in the planning process can be invaluable in garnering support. Engaging policy makers, educating them on the facts about reuse, and gaining their acceptance can be a critical component to public involvement. By providing policy makers with proper education on reuse, they will be prepared with facts and tools should stakeholders call them or their representatives with questions or concerns.

8.4.6 Independent Experts

To demonstrate that the utility is seen as taking community concerns seriously and as the primary, credible source of information, the outreach program can target the use of stakeholder advisory groups or

neutral experts to inform the planning and evaluation process.

8.4.6.1 Advisory Groups

Making decisions about recycled water projects, especially potable reuse projects, can be challenging when different interest groups are involved. One way to address those challenges, as well as to ensure that community values and diverse opinions are considered, is to establish an advisory group or taskforce composed of representatives of the range of perspectives in the community. The community advisory group provides a forum to enable stakeholders to enter into a dialogue with each other and even develop recommendations related to a specific project. There is one key element to consider before deciding whether a community advisory group should be established: early agreement on the group's role in the decision-making process and/or work product. An advisory group should clearly understand what they are being asked to do in context of the project, and each group should have and agree to a mission statement and principles of participation. This ensures the group members, as well as utility staff and decision-makers, clearly understand what is expected of the group. Further it is critical to make sure that human and financial resources are available to support the group process, an independent facilitator is retained to guide the group process and ensure its independence, group participants are selected to represent various community perspectives needed by the project team, and also that adequate time is allocated for the group to meet and develop recommendations and input.

There are several benefits that can accrue from a properly designed and administered community advisory group:

- All stakeholders can gain an understanding of each other's perspectives.

- Stakeholders can develop a better understanding of the decision-makers' dilemma in trying to satisfy groups holding differing positions.
- Meetings of the group allow time for members to gain a deeper understanding about technical, fiscal, and community issues that must be considered.
- Participating in a series of meetings on a specific topic can help build trust and also result in ownership of recommendations by the group members.
- The group itself, or its individual members, can become a legitimate voice in the community for supporting a decision.

At the University of California, Santa Cruz campus, future enrollment growth will result in a 25 percent increase in water demand. A campus workshop involving faculty was held to rank a range of potential reuse projects. Steps are now in place to help offset the potential increase in demand [[US-CA-Santa Cruz](#)].

8.4.6.2 Independent Advisory Panels

Another important group to consider is an independent advisory panel composed of science, health, water quality, and other technical experts. Such independent advisory panels have multiple benefits for utilities seeking to implement or expand water recycling. Panel members provide access to a broad range of worldwide technical and scientific expertise. They offer an unbiased review of proposed actions and activities, advancing sound public-policy decisions. And, relative to public outreach and information, the panels offer highly expert and impartial validation of the project's soundness and safety.

Utilities can use a number of independent research organizations to convene and manage an independent advisory group, which further validates their independent evaluation of the project. The utility should recognize from the start that engagement of the panel and work to support its studies is likely to add to the time commitment and cost of the project. Like all aspects of public engagement, it is a matter of weighing costs and benefits. The utility will want to carefully outline the purpose and specific focus areas of the panel, which will help to establish its

membership, guide its work, and avoid unnecessary costs.

Reports from independent advisory panels can serve many purposes, including suggesting technical enhancements to the project design; identifying cost-saving measures; serving as a focal point for public information; providing independent corroboration of the project's validity and safety, particularly to skeptics; and serving as a resource to regulators and oversight agencies. While the independent advisory panel's report will be technical in nature and will be read in its entirety by the project team and those with technical interests, developing an accompanying executive summary is recommended, so that technical findings are accessible and easily understood by a lay audience.

8.4.6.3 Independent Monitoring and Certification

Several reuse projects have benefitted from the use of monitoring and certification programs to build public trust. The city of Tucson has augmented its reuse water service inspection program to build public trust. The program includes testing for cross-connections, ordinances, and inspector training and certification programs [[US-AZ-Tucson](#)]. Tossa de Mar in Spain is one of the leading cities in Costa Brava to recognize the benefits of turning wastewater into reclaimed water after the region suffered from a prolonged drought. The water supply and sanitation agency promoted a high-quality branding through their website, the municipality website, and Facebook [[Spain-Costa Brava](#)].

King County, Wash., is constructing a new WWTF designed to produce Class A reclaimed water, which is safe to use for irrigating food crops. To gain customer confidence and to confirm suitability to end users, King County partnered with the University of Washington to conduct research on the safety and efficacy of Class A reclaimed water use [[US-WA-King County](#)].

As customers connect to the reclaimed water system, outreach is undertaken to inform users of safe and proper applications of reclaimed water. Many states, such as Florida, include customer education as a reuse permit requirement.

8.4.7 Media Outreach

Local media play an integral role in shaping public opinion about projects. Numerous case studies demonstrate the value of media as an outreach conduit regarding water reuse, with the added credibility of originating from a neutral third party. To establish effective media relations, several BMPs will help to create a positive working environment.

- Identify specific reporters who will likely cover the topic on a regular basis and take time to provide them with background information when they are not facing a deadline in order to develop longstanding relationships and foster more accurate reporting.
- Identify, internally, who will speak regularly with the media and provide them with training on how to explain the project in concise, easy-to-understand statements that will, in turn, become good quotes.
- Determine local media preferences for communication and make use of the preferred resources, including formal news releases, Twitter, Facebook, email, phone, fax, and in-person communication.
- Identify local newspaper editorial boards and begin to educate them on the benefits of reuse early on. These are different individuals than the news reporters.
- Be responsive and direct in answering media questions. A reporter who knows that he/she can come to a source for direct answers, even to difficult questions, will develop a respectful relationship with that source.
- Think about ways to help reporters tell the story visually; consider illustrations or props and plan for short-term successes (i.e., landscaped medians) that can be showcased. Many media outlets can take files directly from an in-house graphic artist.
- Humanize the story rather than presenting all details on a clinical level. This also helps to humanize the organization. Reporters will also look for other third-party sources to interview. Be ready to suggest positive interview candidates and story ideas.

- If something negative happens with a project, consider the facts that are most likely to go public and be direct, never evasive, in presenting the facts.

Media coverage of the city of San Diego's Water Purification Demonstration Project with the potential for reservoir augmentation is a prime example of how a utility can work with the media to present more accurate information about a reuse project. In the late 1990s, the San Diego *Union-Tribune*, San Diego's largest regional newspaper, editorialized against water reuse in any form, particularly potable reuse. The city of San Diego conducted the Water Reuse Study, which resulted in a community group endorsing the concept of reservoir augmentation as the most sensible use of the recycled water the city plants were producing. This study laid the groundwork for providing more factual information to reporters, culminating in an article by a *Union-Tribune* writer that very accurately described the purification processes that would be used at the city's Advanced Water Purification Facility, the cornerstone of the Demonstration Project. Four months later, the paper published an editorial titled "The Yuck Factor – Get Over It." Thanks also to the progress made on the potable reuse project in Big Spring, Texas, television and national newspapers began to cover the topic in a more factual way during 2011, including a cover story in *USA Today*. In 2012, the *New York Times* published a front-page story titled "As 'Yuck Factor' Subsides, Treated Wastewater Flows From Taps." Many hard-working water utility public outreach staffers have spent countless hours talking to reporters and encouraging more science-based information about potable reuse, a trend that will hopefully continue.

8.4.7.1 New Media Outreach Methods – Social Networking

In today's dynamic environment, it is important that utility professionals use the most effective and dynamic communication tools available to connect with stakeholders and communities on an ongoing basis. In a 2012 paper titled "Social Media Demonstrates Their Worth for Utilities and Their Stakeholders," the authors present the value that social media can provide as a utility communication tool and describe how D.C. Water has completely integrated social media elements into a larger communications strategy (Peabody et al., 2012).

Social media should not be ignored. In today's dynamic environment, social media can provide interesting insights into the stakeholder population, can offer early alerts to opposition, and can provide direct contact to stakeholder groups. A caution, though, is the reality that effective use of social media requires commitment of staff resources and time that is continuous and can become significant, particularly if there is controversy or opposition surrounding a project. Ignoring or failing to keep current with the flow of conversation in such circumstances can be detrimental to the project and the organization's reputation.

8.4.8 Involving Employees

Employees comprise another often-overlooked but highly important component of the public. People working for the utility (as well as for associated organizations, such as departments within the same city) often are questioned by family and neighbors and are seen as a reliable source of information about projects and initiatives. Special, targeted efforts to inform and engage this specialized audience is a way to ensure they have accurate, timely information to convey to others. It also provides the opportunity for them to bring back ideas and concerns they hear from others.

8.4.9 Direct Stakeholder Engagement

As described in Section 8.1, public involvement often begins by targeting the most impacted stakeholders, with the outreach effort broadening to include the public at large over time. For instance, a community may work closely with golf course owners and superintendents to introduce reclaimed water as a resource to keep the golf course in prime condition, even at times when other water supplies are low. This small, informed constituency can then provide the community with a lead-in to other reclaimed water options in the future. Golf course superintendents spread the word informally, and, as golfers see the benefits, the earliest of education campaigns has subtly begun. Later, the same community may choose to introduce an urban system, offering reclaimed water for irrigation use.

8.4.9.1 Dialogue with Stakeholders

A broad range of involvement techniques are available for direct dialogue with stakeholders, including: surveys, public information programs, public meetings, workshops, interviews with key stakeholders,

community events, presentations, and regular e-updates (Metcalf & Eddy/AECOM, 2007). It is critical that language translation of informational materials is incorporated into the outreach strategy to ensure that all stakeholders within the utility's diverse community of interests will benefit from outreach and public participation opportunities.

8.4.9.2 Addressing Opposition

Opposition frequently is aroused by prospects of water reuse, most often when a project involves children and/or use of reclaimed water as a potable source. As part of public involvement, it is critical to anticipate and be prepared to address opposing viewpoints. In developing groups for public involvement, it is preferable for the utility to include opponents as part of the mix of participants. This will help bring to the surface issues that need to be addressed and also may help to make the opposing individuals more informed and more comfortable with reuse.

People voicing opposition to reclaimed water projects most often cite health concerns, though sometimes there are other underlying drivers of opposition. For example, opposition to urban growth or specific political agendas has underlying factors masked in health-issue opposition to projects. A 2011 WRRF study conducted in Arizona (WRRF 06-016-01) found that survey respondents' views on the acceptability of reclaimed water for various uses was influenced by their perception of the desirability of growth in their community (Scott et al, 2011).

Opposition can surface at any point in the project's lifecycle. In Pompano Beach, objections to development were one source of opposition to reuse [US-FL-Pompano Beach]. The potential for political opportunism during an election cycle underscores the importance of developing a public engagement program where community and stakeholder involvement occurs at all stages of the project so that stakeholders are involved in the decision-making process and the community and politicians know about and accept the project. Project timing must be considered in the broader sense to avoid political opportunism, if possible (USBR, 2004). When met with opposition, it is important to:

- Include both individuals who might support the utility's position as well as those who might oppose it when forming participation groups.

- Be prepared to respond promptly and calmly to misinformation.
- Be prepared to address opposition with clear, readily-comprehensible information and illustrations.
- Get support in writing if someone voices such support.

8.5 Variations in Public Outreach

Public outreach can vary, depending on the project itself and/or the community it will serve. Decision-makers may choose to test a novel approach (whether technological or regulatory) through demonstration projects, in order to demonstrate reliability to constituencies. While demonstration projects can add time to the overall implementation schedule of a reuse project, public buy-in may be enhanced if participation is built from the demonstration phase and an appropriate, tailored solution can be constructed from all available approaches, rather than succumbing to the temptation to simply copy existing ‘proven’ approaches (e.g., the treatment train of Orange County). In some cases, a demonstration project may be an appropriate step prior to setting new regulation, rather than the reverse.

In the case of King County, Wash., in addition to sharing data with the public on the quality of the reclaimed water and the crops irrigated by it, luncheons and tastings were held at the end of each year’s research. The staff of the King County Wastewater Treatment division, potential reclaimed water customers, members of the community, and other stakeholders were invited, as shown in **Figure 8-6** [[US-WA-King County](#)].



Figure 8-6
A luncheon was held in King County, Wash. to present data on reclaimed water used for irrigation, along with lunch featuring crops and flowers from the reuse irrigation study. (Photo courtesy of Jo Sullivan).

In San Diego, Calif., public demonstration is a major phase of the reuse project. In 2004, the city embarked on its Water Reuse Program with the goal of maximizing water reuse, either through nonpotable market expansion, potable reuse, or a combination of the two. IPR through reservoir augmentation was chosen as the preferred strategy and is currently being evaluated in the Water Purification Demonstration Project (anticipated completion in 2013).

A successful public outreach and education program is attributed for a recent shift in perception about IPR in San Diego, cited earlier in this chapter. Aggressive outreach to community leaders and the media, public tours of the Advanced Water Purification demonstration facility, and project presentations to interested groups throughout the community helped to increase public understanding of the processes involved in providing safe reclaimed water [[US-CA-San Diego](#)]. At the Denver Zoo, where reclaimed water is used for animal habitats, animal health and public relations experts have ensured and communicated the safety and beneficial aspects of water reuse through education and outreach efforts [[US-CO-Denver Zoo](#)].

8.6 References

- American Water Works Association (AWWA) and Water Environment Federation (WEF). 2008. *Using Reclaimed Water to Augment Potable Water Resources*. Second Edition. American Water Works Association. Denver, CO.
- CH2MHill. 2001. *Public Involvement – Making It Work*. AWWA Research Foundation. Denver, CO.
- Deeb, R. A. 2010. *Communication Principles and Practices, Public Perception and Message Effectiveness*. Water Environment Research Foundation. Alexandria, VA.
- Hartley, T. 2003. *Water Reuse: Understanding Public Perception and Participation*. Water Environment Research Foundation. Alexandria, VA.
- Humphreys, L. 2006. *Marketing Nonpotable Recycled Water, A Guidebook for Successful Public Outreach & Customer Marketing*. WaterReuse Foundation, accessed on February 29, 2012 from <http://www.swrcb.ca.gov/water_issues/programs/grants_loas/water_recycling/research/03_005_01.pdf>.
- International Association of Public Participation. 2007. *IAP2*. Retrieved on May 4, 2012, from IAP2 from <http://www.iap2.org/associations/4748/files/IAP2%20Spectrum_vertical.pdf>.
- Metcalf & Eddy/AECOM. 2007. *Water Reuse Issues, Technologies and Applications*. McGraw Hill. New York, NY.
- Peabody, K.; A. Heymann; K. Hurlbutt and S. Merrill 2012. "Social Media Demonstrate Their Worth for Utilities and Their Stakeholders." *Joint Water Environment Federation and American Water Works Association Utility Management Conference, February 1, 2012*.
- Resource Trends, Inc. 2004. *Best Practices for Developing Indirect Potable Reuse Projects: Phase 1 Report*. WaterReuse Foundation. Alexandria, VA.
- Rozin, P., and A. E. Fallon. 1987. "A perspective on disgust." *Psychological Review*. 94(1):23 - 41.
- San Diego County Water Authority. n.d. *Public Opinion Research Website*. Retrieved February 29, 2012, from <<http://sdcwa.org/public-opinion-research>>.
- Scott, C. A., A. Browning-Aiken, K. J. Ormerod, R. G. Varady, C. D. Mogollon, and C. Tessmer. 2011. *Guidance on Links Between Water Reclamation and Reuse and Regional Growth*. WRF 06-016-01. WaterReuse Research Foundation and the U.S. Bureau of Reclamation. WaterReuse Foundation. Alexandria, VA.
- Snyder, S. A. 2008. *Pharmaceuticals in the nation's water: Assessing potential risks and actions to address the issue*. Senate Subcommittee on Transportation Safety, Infrastructure Security, and Water Quality Hearing. Tuesday, April 15, 2008. Washington, D.C.
- A Thirsty Planet. n.d.. *Your Water*. Retrieved July 31, 2012, from <http://www.athirstyplanet.com/your_h2o>.
- U.S. Environmental Protection Agency (EPA). 2004. *Toolkit for Assessing Potential Allegations of Environmental Justice Issues*. Retrieved November 8, 2011, from U.S. Environmental Protection Agency. Retrieved August 23, 2012, from <<http://www.epa.gov/compliance/ej/resources/policy/ej-toolkit.pdf>>.
- U.S. Bureau of Reclamation (USBR). 2004. *Successful Public Information and Education Strategies: Southern California Water Recycling Projects Initiative*. Retrieved February 29, 2012, from <http://www.usbr.gov/lc/socal/reports/TM_PublicInfoStrategies.pdf>.
- WaterReuse Association (WRA). 2009. *How To Develop and Water Reuse Program*. WaterReuse Association. Alexandria, VA.
- WaterReuse Association (WRA). 2009. *WaterReuse Association 2008 Property Owner and Homeowner Market Perception Study: Final Report*. Group 3 Research, Pittsburgh, PA.
- WaterReuse Research Foundation (WRRF). 2010a. *The Psychology of Water Reclamation and Reuse: Survey Findings and Research Road Map*. WRF-04-008. WaterReuse Foundation. Alexandria, VA.
- WaterReuse Research Foundation (WRRF). 2010b. *Research Update: Risk Assessment Study of PPCPS in Recycled Water to Support Public Review*. WRRF-09-07. WaterReuse Research Foundation. Alexandria, VA.
- WaterReuse Research Foundation (WRRF). 2011. *Talking About Water: Vocabulary and Images that Support Informed Decisions about Water Recycling and Desalination*. WRF-07-03. WaterReuse Research Foundation. Alexandria, VA.
- WaterReuse Research Foundation (WRRF). 2012. In production. *The Effect of Prior Knowledge of 'Unplanned' Potable Reuse on the Acceptance of 'Planned' Potable Reuse*. WRF-09-01. WaterReuse Research Foundation. Alexandria, VA.

CHAPTER 9

Global Experiences in Water Reuse

9.1 Introduction

This chapter provides an overview of global experiences in water reuse. The primary objectives of this chapter are to 1) review a range of drivers, barriers, benefits, and incentives for water reuse and wastewater use outside of the United States; 2) outline the state of, and geographic variation in, water reuse and wastewater use; and 3) review paths for expanding the scale of safe and sustainable water reuse and wastewater use in different contexts. Discussion is provided to address these objectives; it draws on experiences from more than 40 global case studies that provide an array of approaches to safe and sustainable water reuse. While EPA guidelines focus on water reuse, the global abundance of wastewater use and the gray lines dividing water reuse and wastewater use have led the contributors to broaden the scope of this chapter to discuss both water reuse and wastewater use outside of the United States.

The planning, technical, institutional, and socio-economic settings in which water reuse is practiced varies both among and within countries as a function of specific geographic and economic conditions. As a result, it is important to define the context of these practices, as well as provide case study examples of these practices.

9.1.1 Defining the Resources Context

As this chapter examines water reuse across a spectrum of resource contexts, it is necessary to draw a distinction between resource-endowed and the resource-constrained countries. For the purposes of this chapter, the term “resource-endowed” countries or settings will refer to locations in high-income or “developed” countries, and “resource-constrained” countries or settings will refer to locations in low-income or “developing” countries. Locations in middle-income countries or settings may fall into either category depending on the context.

Most resource-endowed countries have established human health risk guidelines or standards that involve high-technology/high-cost approaches. This enables the institution of practices that extend beyond

protecting human health to providing environmental protection and restoration. Many resource-constrained countries have considered adopting an approach to protecting human health based on the WHO’s recommendations in the *WHO Guidelines for the Safe Use of Wastewater, Excreta, and Greywater*, which usually entail a fit-for-purpose, gradational process toward reducing health risks (WHO, 2006).

9.1.2 Planned Water Reuse and Wastewater Use

For this chapter especially, it is necessary to make a distinction between water reuse and wastewater use. As defined in Chapter 1, water reuse, for the purposes of this document, is the use of treated municipal wastewater. Globally, water reuse occurs both in resource-constrained settings using low-cost methods (as illustrated in case studies [[Palestinian Territories-Auja](#)] and [[Philippines-Market](#)]), as well as in resource-endowed settings, where the more typical high-tech applications are seen (as illustrated in case studies: [[China-MBR](#)], [[India-Bangalore](#)], [[Japan-Building MBR](#)], [[South Africa-eMalahleni Mine](#)], and [[Spain-Costa Brava](#)]).

Wastewater use is the intentional or unintentional use of untreated, partially treated, or mixed wastewater that is not practiced under a regulatory framework or protocol designed to ensure the safety of the resulting water for the intended use. This practice does not occur in the United States, as wastewater treatment is ubiquitous. Wastewater use occurs mainly for agricultural irrigation, and often it is officially prohibited, yet unofficially tolerated (informal irrigation sector), because many people derive their livelihoods from access to untreated or partially treated wastewater. Wastewater use may occur, for example, where wastewater is knowingly taken from outfall pipes or drainage canals because it is easily accessible at no cost or can confer benefit over other sources because of its high nutrient content when water is used for irrigation. Wastewater use can also occur where water is taken from natural stream or river channels that contain large loads of untreated wastewater mixed with freshwater. It should be noted that these definitions do not include any judgment about water

quality and related health risks. In resource-constrained countries, for example, the quality of “treated” wastewater in a planned reuse project can be worse than that of untreated, but diluted, wastewater collected from streams.

Although wastewater use can have various livelihood benefits and support food security, it presents serious risks to human health from a range of pathogens that may be contained in the wastewater, as described in Chapter 6. In addition, where urban or agricultural runoff or industrial wastes impact wastewater, chemical pollutants may also be present. Exposure to untreated wastewater is a likely contributor to the burden of diarrheal disease worldwide (WHO, 2004). Epidemiological studies suggest that the exposure pathways to the use of wastewater in irrigation can lead to significant infection risk for the following groups:

- **Farmers and their families**—Several epidemiological investigations have found excess parasitic, diarrheal, and skin infection risks in farmers and their families directly in contact with wastewater. There is, in particular, a high prevalence of hookworm disease and ascariasis infections among those who do not use protective gear as the organisms that cause those infections (hookworm and roundworm) are common in hot climates (WHO, 2006).
- **Populations living near wastewater irrigation sites, but not directly involved in the practice**—Populations, particularly children, living within or near wastewater irrigation sites using sprinklers may be exposed to aerosols from untreated wastewater and at risk of bacterial and viral infections (Shuval et al. 1989).

- **Consumers of raw produce irrigated with wastewater**—Excess diarrheal diseases and cholera, typhoid, and shigellosis outbreaks have been associated with the consumption of wastewater-irrigated vegetables eaten uncooked (WHO, 2006). In Ghana, for example, a burden of disease of 12,000 disability-adjusted life years (DALY) annually, or 0.017 DALY per person per year was estimated, which represents nearly 10 percent of the WHO-reported DALYs occurring in urban Ghana due to various types of water- and sanitation-related diarrhea (Drechsel and Seidu, 2011). The contribution of wastewater use, and in particular its impact on consumer food safety, has not been quantified so far at larger scale.

In cases where wastewater treatment prior to use is not possible, alternative strategies for protecting human health need to be evaluated and applied (Scott et al., 2010; Amoah et al., 2011). In such cases, guidelines for the development, contracting, and implementation of water reuse can facilitate the transition from wastewater use to planned reuse systems.

9.1.3 International Case Studies

A broad range of global water reuse practices are discussed in this chapter and in accompanying case studies. The geographic location and reuse application associated with each case study is displayed in **Figure 9-1**. As a group, the case studies illustrate water reuse experiences in a variety of contexts and demonstrate the possibilities for expanding the scale of safe and sustainable water reuse practices across geographies and resource settings. Throughout the text, the case studies are referenced by a code name in brackets. In the pdf version of this document, hyperlinks will direct the reader to the international case studies, which are located in Appendix E. A table with links to international regulatory websites is also provided in Appendix E.

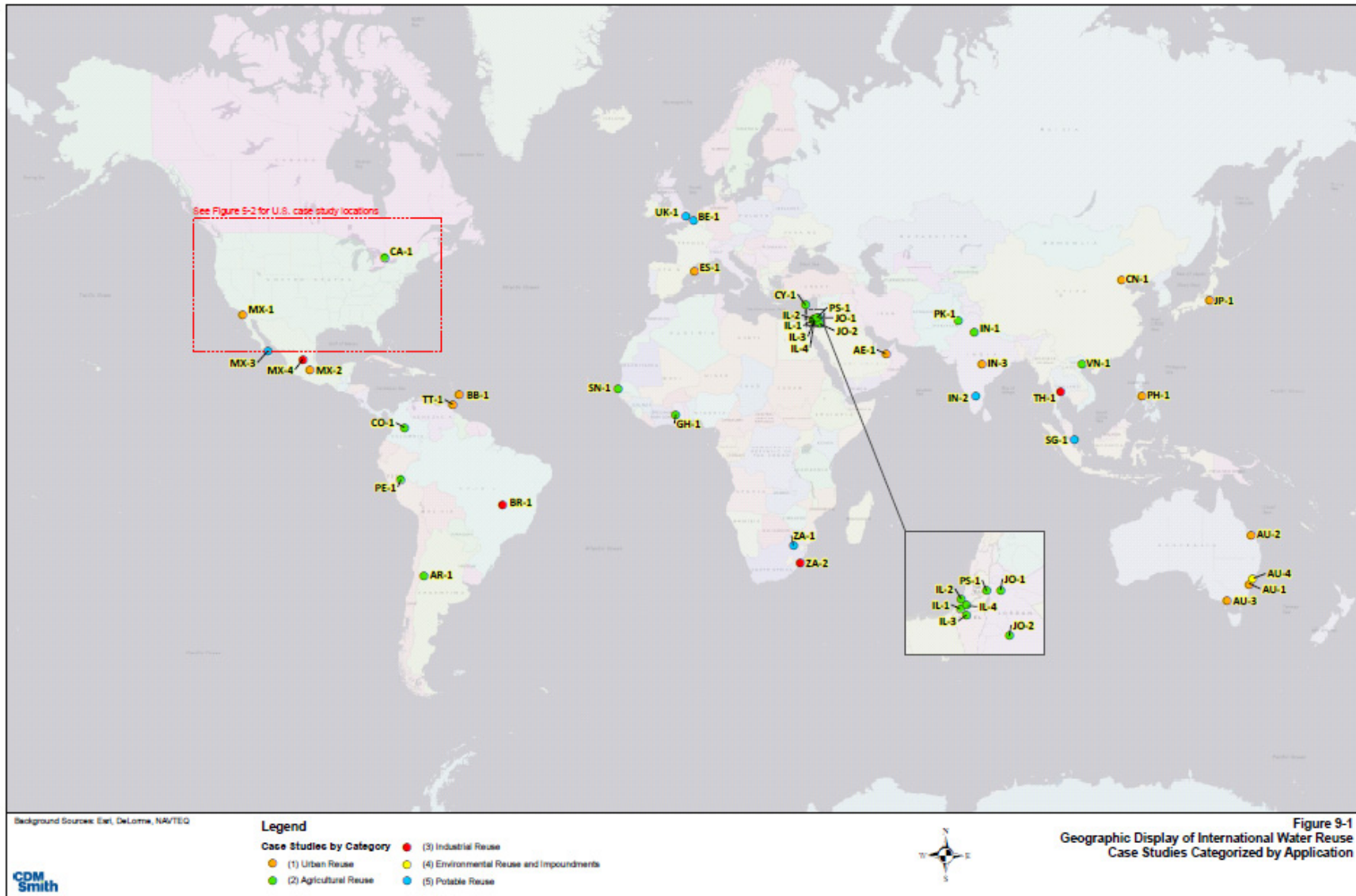

Figure 9-1 Legend

| Map code | Text code | Case Study Name |
|----------|--|---|
| AR-1 | Argentina-Mendoza | Special Restricted Crop Area in Mendoza, Argentina |
| AU-1 | Australia-Sydney | Sewer Mining to Supplement Blackwater Flow in a Commercial High-rise |
| AU-2 | Australia-Graywater | Retirement Community Graywater Reuse |
| AU-3 | Australia-Victoria | End User Access to Recycled Water via Third Party-Owned Infrastructure |
| AU-4 | Australia-Replacement Flows | St Marys Advanced Water Recycling Plant, Sydney |
| BB-1 | Barbados-Economic Analysis | Economic Analysis of Water Reuse Options in Sustainable Water Resource Planning |
| BE-1 | Belgium-Recharge | Water Reclamation for Aquifer Recharge in the Flemish Dunes |
| BR-1 | Brazil-Car Wash | Car Wash Water Reuse - A Brazilian Experience |
| CA-1 | Canada-Nutrient Transfer | Water Reuse Concept Analysis for the Diversion of Phosphorus from Lake Simcoe, Ontario, Canada |
| CN-1 | China-MBR | Water Reuse in China |
| CO-1 | Colombia-Bogotá | The Reuse Scenario in Bogotá |
| CY-1 | Cyprus-Irrigation | Water Reuse In Cyprus |
| GH-1 | Ghana-Agriculture | Implementing Non-conventional Options for Safe Water Reuse in Agriculture in Resource Poor Environments |
| IN-1 | India-Delhi | Reuse Applications for Treated Wastewater and Fecal Sludge in the Capital City of Delhi, India |
| IN-2 | India-Bangalore | V Valley Integrated Water Resource Management: the Bangalore Experience of Indirect Potable Reuse |
| IN-3 | India-Nagpur | City of Nagpur and MSPGCL Reuse Project |
| IL-1 | Israel/Jordan-Brackish Irrigation | Managing Brackish Irrigation Water with High Concentrations of Salts in Arid Regions |
| IL-2 | Israel/Palestinian Territories/Jordan-Olive Irrigation | Irrigation of Olives with Recycled Water |
| IL-3 | Israel/Jordan-AWT Crop Irrigation | Advanced Wastewater Treatment Technology and Reuse for Crop Irrigation |
| IL-4 | Israel/Peru-Vertical Wetlands | Treatment of Domestic Wastewater in a Compact Vertical Flow Constructed Wetland and its Reuse in Irrigation |
| JP-1 | Japan-Building MBR | A Membrane Bioreactor (MBR) Used for Onsite Wastewater Reclamation and Reuse in a Private Building in Japan |
| JO-1 | Jordan-Irrigation | Water Reuse and Wastewater Management in Jordan |
| JO-2 | Jordan-Cultural Factors | Cultural and Religious Factors Influence Water Reuse |
| MX-1 | Mexico-Tijuana | Water, Wastewater, and Recycled Water Integrated Plan for Tijuana, Mexico |
| MX-2 | Mexico-Mexico City | The Planned and Unplanned Reuse of Mexico City's Wastewater |
| MX-3 | Mexico-Ensenada | Maneadero Aquifer, Ensenada, Baja California, Mexico |
| MX-4 | Mexico-San Luis Potosi | Tenorio Project: A Successful Story of Sustainable Development |
| PK-1 | Pakistan-Faisalabad | Faisalabad, Pakistan: Balancing Risks and Benefits |
| PS-1 | Palestinian Territories-Auja | Friends of the Earth Middle East's Community-led Water Reuse Projects in Auja |
| PE-1 | Peru-Huasta | Assessing Water Reuse for Irrigation in Huasta, Peru |

Figure 9-1 Legend

| Map code | Text code | Case Study Name |
|----------|--------------------------------|---|
| PH-1 | Philippines-Market | Wastewater Treatment and Reuse for Public Markets: A Case Study in Sustainable, Appropriate Technology in the Philippines |
| SN-1 | Senegal-Dakar | Use of Wastewater in Urban Agriculture in Greater Dakar, Senegal: "Adapting the 2006 WHO Guidelines" |
| SG-1 | Singapore-NEWater | The Multi-barrier Safety Approach for Indirect Potable Use and Direct Nonpotable Use of NEWATER |
| ZA-1 | South Africa-eMalahleni Mine | Turning Acid Mine Drainage Water into Drinking Water: The eMalahleni Water Recycling Project |
| ZA-2 | South Africa-Durban | Durban Water Recycling Project |
| ES-1 | Spain-Costa Brava | Risk Assessment for <i>Legionella</i> sp. in Reclaimed Water at Tossa de Mar, Costa Brava, Spain |
| TH-1 | Thailand-Pig Farm | Sam Pran Pig Farm Company: Using Multiple Treatment Technologies to Treat Pig Waste in an Urban Setting |
| TT-1 | Trinidad and Tobago-Beetham | Evaluating Reuse Options for a Reclaimed Water Program in Trinidad, West Indies |
| UK-1 | United Kingdom-Langford | Langford Recycling Scheme |
| AE-1 | United Arab Emirates-Abu Dhabi | Water Reuse as Part of Holistic Water Management in the United Arab Emirates |
| VN-1 | Vietnam-Hanoi | Wastewater Reuse in Thanh Tri District, Hanoi Suburb, Vietnam |

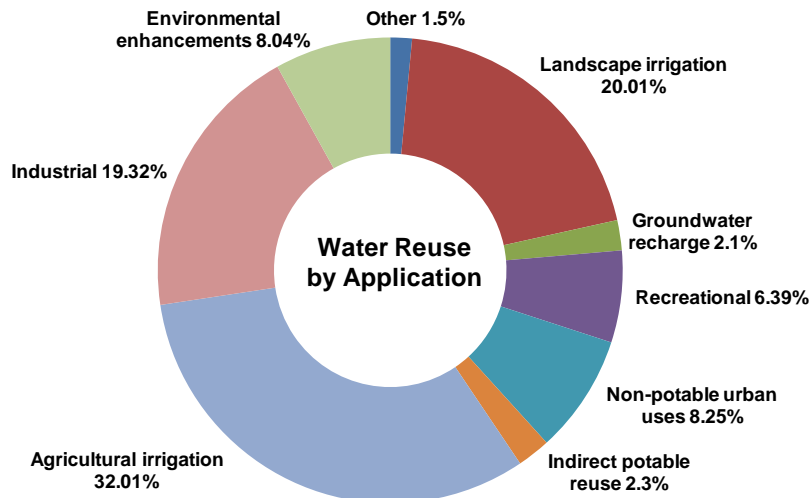

Figure 9-2
Global water reuse after advanced (tertiary) treatment: market share by application (Figure taken from *Municipal Water Reuse Markets 2010* from the publishers of Global Water Intelligence)

9.2 Overview of Global Water Reuse

This section provides an overview of the global status of water reuse, and the case studies illustrate the diverse range of water reuse applications worldwide.

9.2.1 Types of Water Reuse

Water is reused worldwide for agriculture, aquaculture, industry, drinking water, nonpotable household uses, landscape irrigation, recreation, and groundwater recharge. Note that these uses are described in greater detail in Chapter 3, as they are likewise practiced in the United States. **Figure 9-2** shows types of reuse after advanced (tertiary) treatment, which describes only a portion of the actual reuse practiced worldwide.

9.2.1.1 Agricultural Applications

Consistent with the high proportion of fresh water use in the agricultural sector, most reclaimed water used globally serves crop production. Many of the case studies describe applications of using reclaimed water or wastewater for irrigation or other agricultural applications, such as projects highlighted in the following case studies from around the world. In Victoria, reclaimed water is used to irrigate vineyards, tomatoes, potatoes, and other crops in addition to traditional landscape irrigation [[Australia-Victoria](#)]. Citrus and olive trees and fodder crops use approximately 90 percent of the available reclaimed water on Cyprus [[Cyprus-Irrigation](#)]. Constructed

vertical wetlands are being tested and applied for irrigation of fruit trees and gardens in decentralized treatment systems [[Israel/Peru-Vertical Wetlands](#)]. In Mexico City, nearly 46 mgd or reclaimed water is used for irrigation of green areas, recharge of recreational lakes and agriculture [[Mexico-Mexico City](#)]. Fodder crop irrigation predominates in Jordan with some application for irrigation of date palms and olives [[Jordan-Irrigation](#)].

9.2.1.2 Urban and Industrial Applications

Technology-driven approaches that promote advanced reuse include the NEWater project in Singapore [[Singapore-NEWater](#)], sensitive manufacturing operations [[South Africa-Durban](#)], high-rise office treatment and recycling in Sydney [[Australia-Sydney](#)], retirement center toilet flushing and landscape irrigation [[Australia-Graywater](#)], and in high-rise buildings in Japan [[Japan-Building MBR](#)], other industrial reuse including vehicle washing ([[Brazil-Car Wash](#)] and [[Mexico-Mexico City](#)]), and cooling for manufacturing operations or energy production as demonstrated in several case studies throughout the world ([[Jordan-Irrigation](#)], [[Trinidad and Tobago-Beetham](#)], [[Mexico-Mexico City](#)], [[India-Delhi](#)], and [[India-Nagpur](#)]). In the Philippines, reclaimed water from a satellite plant serving the produce market is used for toilet flushing, street washing and plant watering [[Philippines-Market](#)]. Reclaimed water is used in Spain for traditional nonpotable irrigation, street

washing, fire hydrants, and washdown at the community dog shelter [[Spain-Costa Brava](#)]. A wide variety of industries, including commercial laundries, vehicle-washing establishments, pulp and paper industries, steel production, textile manufacturing, electroplating and semiconductor industries, boiler-feed water, water for gas stack scrubbing, meat processing industries, brewery and beverage industries, and power plants, have the capability to use reclaimed water in their operations (Jimenez and Asano, 2008). In the food and beverage industry, reclaimed water is used for cooling and site amenities. Internal process water may also be recirculated or reused with appropriate treatment. Urban amenities, such as stream restoration and other features, may involve reclaimed water, thus representing elements of “cities of the future” visions for sustainable cities (Jimenez and Asano, 2008). In the case study from Barbados, the economic, environmental, and social trade-offs of various reuse schemes were considered [[Barbados-Economic Analysis](#)].

9.2.1.3 Aquifer Recharge

Groundwater or aquifer recharge, both planned and *de facto*, is likewise practiced globally (Jimenez and Asano, 2008). Documented cases of aquifer recharge are reported in Israel, South Africa, Germany, Belgium [[Belgium-Recharge](#)], Australia, Namibia, India, Italy, Mexico, China, Barbados [[Barbados-Economic Analysis](#)], and Cyprus [[Cyprus-Irrigation](#)]. Indirect potable recharge following advanced treatment has been studied in Tijuana but not yet implemented [[Mexico-Tijuana](#)]. Planned recharge with reclaimed water provides subsurface storage and can enable additional treatment, as discussed in Chapters 3 and 6. In addition to storage for nonpotable reuse (e.g., for agricultural or landscape irrigation, industrial use, etc.) or IPR, replenishment of aquifers experiencing higher rates of withdrawal than natural recharge can prevent saltwater intrusion in groundwater supply in coastal areas and supplement groundwater base flows to promote ecosystem health. On a global scale, wastewater-impacted aquifer recharge is widespread. Often highly polluted and only partially treated (if at all), wastewater drains to rivers or drainage canals connected to underlying unconfined aquifers that may be used for drinking water.

Regardless of the type of reuse application, water quality issues are an important dimension. Ideally, the wastewater source and type of treatment should be

matched to the eventual reuse application, also known as “Fit for Purpose,” as described in Chapter 1. Reclaimed water suppliers may need to be certified and provide proof of compliance with water quality specifications before they are allowed to supply water to consumers, and systems should be in place to store and retreat water that fails to meet standards and to avoid cross-connection between the distribution systems for reclaimed water and potable drinking water. The planning and management of water reuse is described in Chapter 2.

9.2.2 Magnitude of Global Water Reuse

The total volume of domestic wastewater generated in the world every day is estimated to be between 180 and 250 billion gallons (680 and 960 million m³), as shown in **Table 9-1** (GWI, 2010; FAO, 2010). The current global capacity to treat wastewater to advanced levels (like tertiary treatment) is approximately 8 billion gallons per day (32 million m³/day), or only 4 percent of the total volume of wastewater that is generated (GWI, 2010). The volume of wastewater treated beyond secondary treatment for reuse has grown by an average of 500 mgd (2 million m³/day) each year since 2000, allowing a greater proportion of water to be safely reused (GWI, 2010). Wastewater production is likely to increase with population growth; with expanded sewerage networks there is great potential for expanding the magnitude of global water reuse, especially for high-end usages.

Table 9-1 Global domestic wastewater generated and treated (in billion gallons per day and million cubic meters per day)

| | Volume (billion gallons per day) | Volume (million m ³ /day) |
|--|----------------------------------|--------------------------------------|
| Total volume of domestic wastewater generated as of 2009 | 180-250 | 680-960 |
| Current global capacity to treat wastewater to advanced levels as of 2009 | 8 | 32 |
| Total volume of domestic wastewater that is not treated to advanced levels as of 2009 | 172-242 | 648-928 |
| Growth in global capacity to treat wastewater to advanced levels (per year since 2000) | 0.5 | 2 |

Sources: GWI, 2010; FAO, 2010

There is limited reliable data documenting quantities of water reuse and wastewater use in the agricultural

sector. The limited evidence that does exist, which is not geographically comprehensive, suggests that the area of land irrigated with untreated wastewater is more than 10 times as great as the area irrigated with reclaimed water (Scott et al., 2010). Rough estimates suggest that about 20 million ha of agricultural land is irrigated with mostly untreated wastewater globally (**Figure 9-3**), and crops produced from such irrigation comprise 10 percent of global agricultural production from irrigation (Scheierling et al., 2010; Drechsel et al., 2010). As such, the proportion of wastewater used in agriculture may be far greater than that shown in **Figure 9-3**, which only summarizes documented cases.

Growth in the global water reuse sector is expected to migrate from being dominated by agricultural reuse toward higher-value applications, mostly in municipal applications, such as potable, industrial, and landscape irrigation reuse. China, the United States, Spain, Mexico, India, Australia, Israel, Kuwait, Japan, and Singapore lead the world in total installed advanced water reuse capacity to date (GWI, 2010). GWI projects that global capital expenditure in advanced water reuse is expected to grow 19.5 percent annually between 2009 and 2016 (GWI, 2010). The countries that are projected to add the greatest additional advanced water reuse are shown in **Table 9-2**. Many of these countries have recently completed major investments in desalination and are now turning to growth in the water reuse sector to meet needs, particularly in growing urban populations.

Table 9-2 Projected reuse capacity in selected countries (data taken from *Municipal Water Reuse Markets 2010* from the publishers of Global Water Intelligence)

| Country | Additional advanced reuse capacity (2009-2016) | |
|----------------------|--|------------------------------|
| | Billion gallons per day | Mjillion m ³ /day |
| USA | 2.8 | 10.7 |
| China | 1.6 | 5.9 |
| Saudi Arabia | 0.9 | 3.5 |
| Australia | 0.7 | 2.5 |
| Spain | 0.6 | 2.1 |
| Mexico | 0.6 | 2.1 |
| United Arab Emirates | 0.5 | 1.9 |
| Oman | 0.4 | 1.6 |
| India | 0.3 | 1.2 |
| Algeria | 0.3 | 1.1 |

Source: GWI, 2010

DPR and planned IPR still account for a minor proportion of water reuse worldwide (2.30 percent), but the proportion is growing. Of all advanced reuse, approximately 2.3 percent is potable reuse (GWI, 2010). Growth in potable reuse applications is driven by pressures on water supply, along with increased public acceptance because of successful records of performance demonstrated by notable installations in the United States, Namibia, South Africa, and Singapore (GWI, 2010, NRC, 2012). A table summarizing a sampling of IPR installations (and potable in Namibia) is provided in Chapter 3 to illustrate that this practice occurs worldwide, at both very small and very large scales. Singapore has made water reuse a national priority, as described in a case study [[Singapore-NEWater](#)]. Decision-makers in Bangalore, India, are developing plans to include IPR as part of an overall approach to narrow gaps between water supply and the demands of a growing population [[India-Bangalore](#)]. And in South Africa, a novel partnership between a mining company and a township is turning acid mine drainage into drinking water [[South Africa-eMalahleni Mine](#)]. Note that countless other planned IPR applications exist where reclaimed water is deliberately recharged to a groundwater aquifer using rapid infiltration basins or injection wells or to a drinking water reservoir. A representative example of this is from Wulpen, Belgium, where reclaimed water is returned to the aquifer before being reused as a potable water source [[Belgium-Recharge](#)]. An example of *de facto* IPR comes from Langford, UK, where reclaimed water is returned upstream to a river that is the potable water source [[United Kingdom-Langford](#)].

9.3 Opportunities and Challenges for Expanding the Scale of Global Water Reuse

While the opportunities for expanding reuse are quite significant, there are some challenges related to the country-specific drivers, the regional variation of climate, social acceptance, and financial resources. While some of these factors are barriers to reuse, the benefits of expanding the water reuse will likely outweigh the challenges, ultimately paving the way for reuse to become an ever-growing part of the global water resource/water supply solution.

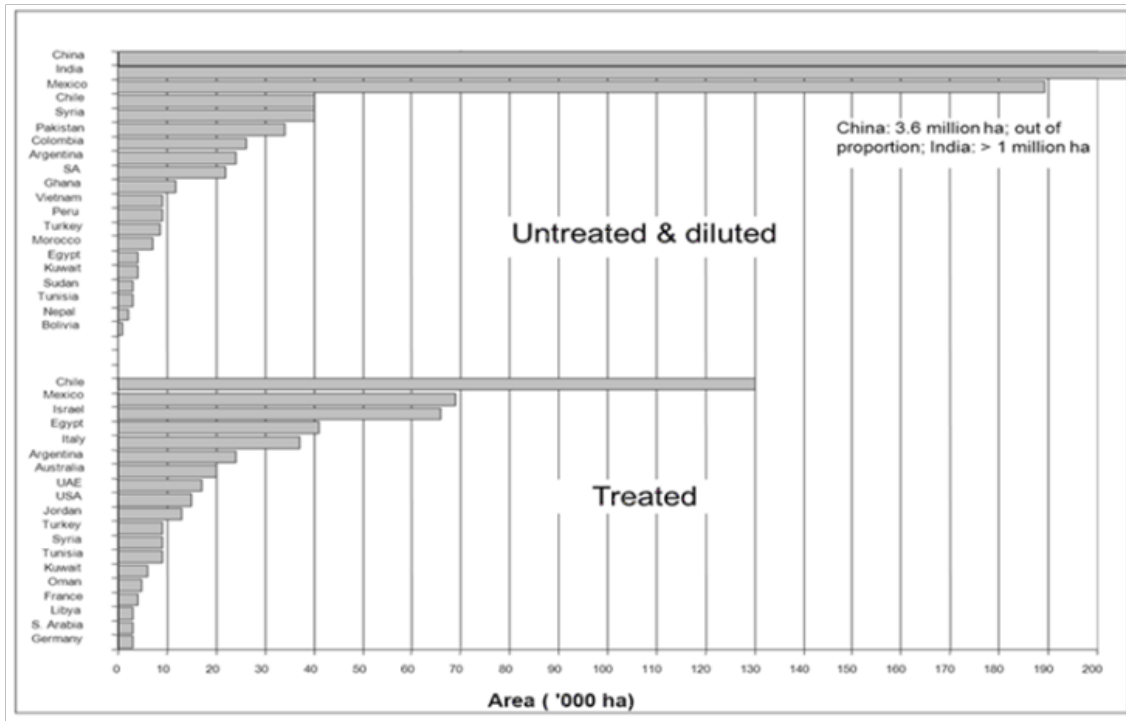

Figure 9-3
Countries with greatest irrigated areas using treated and untreated wastewater
 (Adapted from Scott et al., 2010).

9.3.1 Global Drivers

Global water reuse is primarily driven by two main factors. First, reuse is a response to rising demand for water and limitations on freshwater availability. Second, water reuse is driven by a desire to capture and harness the economic benefits of wastewater. Wastewater use, on the other hand, is usually driven by the lack of wastewater collection and/or treatment facilities, resulting in untreated wastewater being discharged into the environment where, especially in urban and peri-urban areas of resource-constrained settings, safer water sources are difficult to find (Jimenez et al., 2010; Scott et al., 2010).

The first group of drivers for water reuse typically catalyzes reuse in areas of physical water scarcity, such as the Middle East and North Africa region, Australia, Singapore, and parts of southern Africa. Thus, poor water resources management and climate change may exacerbate conditions of scarcity in some countries and create conditions of scarcity in others. In resource-endowed settings, a desire to protect freshwater resources has fostered the creation of environmental regulations that limit the quantity of

water available for human use and uphold standards for the quality of effluent resulting from such use. Application of these regulations has, in turn, promoted greater reuse of existing water rather than development of new water sources.

Economic considerations are also beginning to drive water reuse in high-resource contexts, as the possibility of marketing reclaimed water as a commodity holds the promise of partial return on investment for wastewater treatment (Jimenez et al., 2010). Trends in resource-endowed settings are moving toward the use of treated water at increasingly higher water quality standards for higher-value uses, such as industrial and municipal uses. The prospect of water scarcity begins to discourage lower-value uses, such as agricultural irrigation and aquifer recharge and free or heavily-subsidized use of reclaimed water (GWI, 2010). Economic benefits associated with formal water reuse projects are more likely to be achieved over longer timeframes compared to shorter-term gains from transporting water from distant sources, groundwater mining, and reservoir construction (GWI, 2010).

Wastewater use is often driven by resource constraints and high rainfall variability; wastewater may constitute a large proportion or even all of the flow in water bodies during the dry season. Scarcity of safe water due to the pollution of water resources with wastewater is common in low-resource contexts across any climate, leading to wastewater use. Indeed, in resource-constrained settings, untreated wastewater can serve as an economic resource for poor urban and peri-urban farmers. In many instances, these farmers have no viable alternative to the use of wastewater for their livelihood needs, yet use of such wastewater or polluted stream water often poses a significant threat to the public health of producers and consumers of farm products if not appropriately addressed. An interesting case of wastewater use comes from Pakistan, where local farmers, following extensive legal cases and now with permission from the local water and sanitation authority, have installed a permanent conveyance of untreated wastewater to their irrigation networks. While there is an existing WWTP (a waste stabilization pond), farmers have been opposed to using treated effluent, as it was much lower in nutrients and much higher in salinity (as a result of massive evaporation from the waste stabilization pond) than untreated wastewater [Pakistan-Faisalabad].

9.3.2 Regional Variation in Water Reuse

Factors affecting the regional dynamics of water reuse include economic development priorities, water management options, environmental and climatic factors, social acceptance, and availability of financial resources. Water reuse in the Middle East and North Africa region is typically driven by water scarcity. Some high-income countries in the region use desalination to meet drinking water supply needs and use reclaimed water for agricultural and landscape irrigation using standards based on California Title 22. Middle- and low-income countries in the region use partially-treated or untreated wastewater primarily for specific restricted types of agricultural irrigation and utilize the previous WHO (1989) guidelines to inform approaches to improve human health and safety of water reuse practices (Jimenez and Asano, 2008).

Analysis of reuse patterns in sub-Saharan Africa is hampered by a lack of reliable data. Limited existing evidence suggests that water reuse is driven by water scarcity (Jimenez et al., 2010). In this region, wastewater serves as a reliable water supply for

multiple uses and as a source of high nutrient content for agricultural irrigation. Although much of the wastewater use in this region is informal and occurs in the agricultural sector, one of the most high profile and pioneering examples of potable water reuse is a 40-year ongoing project in Namibia involving direct human consumption of highly-purified reclaimed water.

In northern Europe, water reuse is practiced primarily for environmental and industrial applications, whereas in southern Europe, environmental and agricultural applications dominate. Practices generally follow the WHO (1989) guidelines or regulations that closely emulate California Title 22 standards.

Across Central and South America, water reuse is driven by water scarcity and by a desire to recycle wastewater nutrients in areas of poor soil quality. But lack of sanitation is also leading to some of the largest areas of wastewater use, like in Mexico and Chile. Water scarcity is the main driver for planned reuse in the drier areas of the Caribbean islands, Mexico, and Peru. Agricultural irrigation is the primary application. Wastewater use dominates, although there are many documented cases of planned reuse projects. WHO (1989) guidelines are used to improve the safety of reuse practices, but implementation is not universal.

The situation in Asia varies among its subregions. While China and India show significant progress in high-quality reuse (GWI, 2010), both countries are still among the global leaders of unplanned use of wastewater (**Figure 8-3**), often via contaminated streams. Poor sanitation is also driving wastewater use across Central Asia and, to an even greater degree, Southeast Asia, where, in addition to agriculture, wastewater-fed aquaculture is also common.

Reuse in Australia is driven by both water scarcity and high environmental standards. Key applications include industrial mining, agricultural irrigation, and recreation. National coordinated water policies have incentivized expansion of water reuse practices, and regulations recognize a combination of natural treatment and advanced technology approaches.

9.3.3 Global Barriers to Expanding Planned Reuse

From a technical standpoint, water reuse is a logical part of the overall water supply and water resources management solution. However, there are often projects that are technically feasible but do not get implemented. In these cases, the barriers to implementing reuse are often institutional, economic, organizational, or related to public perception/education. Thus, a discussion of these non-technical barriers to expanding planned reuse is provided in this section.

9.3.3.1 Institutional Barriers

A basic driver of wastewater use—and barrier to wastewater treatment and planned reuse—in much of the world is the dearth of effective collection and treatment systems for fecal matter and sewage (Table 9-3). In resource-endowed urban areas, comprehensive sewer system coverage serves as a conduit for wastewater to be channeled to treatment plants in order to be safely released or reused. In resource-constrained settings, however, such infrastructure often either does not exist or does not terminate in functional treatment plants. While developing an extensive sewerage network is often a recommended step toward improving water reuse, it is important to recognize that improvements in on-site sanitation systems and related collection services can also significantly reduce the environmental burden and health risks associated with wastewater management.

It is worth noting that China has made a strong emphasis on installing urban wastewater treatment over the past decade. As of 2010, 75 percent of Chinese cities are now connected to wastewater treatment, according to official governmental estimates (Xinhua, 2011).

While lack of appropriate infrastructure poses a constraint on water collection, treatment, and safe reuse in some areas, there are at least two broader barriers to planned water reuse. They are 1) limited institutional capacity to formulate and institutionalize enabling legislation and to subsequently conduct adequate enforcement and monitoring of water reuse activities, and 2) lack of expertise in health and environmental risk assessment and mitigation. One limiting factor is a lack of political will to formalize an existing use of untreated or partially treated wastewater due to the institutional and enforcement

hurdles that must be put in place to support planned reuse. Governments may feel they lack the capacity and budget to adequately implement these necessary reforms and thus risk causing farmers to lose access to existing sources of irrigation water. An underlying basis for these barriers, in turn, has been a funding bias towards conventional infrastructure investments, which may not always be fit-for-purpose (Nhapi and Gijzen, 2004; Murray and Drechsel, 2011). A critical issue, highlighted in subsequent sections, is adapting regulations and institutional capacities to local contexts to achieve the achievable rather than adopting over-ambitious policies that spur few sustainable, on-the-ground improvements. Australia has provided technical guidance to providers and users in designing agreements that address the legal and technical aspects of reuse and, therefore, allow providers to better control their costs (Wintgens and Hochstrat, 2006).

Table 9-3 Percent of urban populations connected to piped sewer systems in 2003-2006 (regional averages)

| Region | Number of countries with available data | Connected urban population (%) |
|---|---|--------------------------------|
| United States and Canada | 2 | 94 |
| European Union* | 18 | 90 |
| Australia* | 1 | 87 |
| Central Asia | 5 | 83 |
| Middle East and North Africa | 7 | 83 |
| Namibia, South Africa, Zambia, Zimbabwe | 4 | 68 |
| Latin America and the Caribbean | 21 | 64 |
| China | 1 | 56 |
| South Asia | 6 | 31 |
| Sub-Saharan Africa** | 24 | 9 |
| South-East Asia | 5 | 3 |

Source (all countries except United States): Modified after Evans et al. 2012; based on [Joint Monitoring Programme, 2012](#); [United Nations Department of Economic and Social Affairs, 2011](#); [United Nations Statistics Division, 2011](#); and [Eurostat, 2006](#). US data: GWI, 2010 (population served in 2004) and JMP, 2012 (population in 2004).

* Rural and urban population

** Excluding Namibia, South Africa, Zambia, Zimbabwe

Note: Sewer connection does not automatically imply wastewater treatment.

9.3.3.2 Public Perception/ Educational Barriers

Additional barriers include public perceptions that may drive fear of the dangers of consuming food irrigated with reclaimed water, spurring a preference for use of freshwater. Concerns about the failure of conventional treatment technologies to remove TrOCs, such as pharmaceuticals and endocrine disruptors, are also an impediment to reuse for drinking water supply purposes (GWI, 2010). However, successful potable reuse projects and increased familiarity with advanced treatment technologies, such as UF, RO, and UV disinfection, signal a possibility that public discomfort with potable reuse may be declining (GWI, 2010). As described in Chapter 8, public outreach programs to build awareness and involve community members in planning can change resistance to reuse. Singapore has carried out an impressive public awareness program to build a national commitment to water reuse [[Singapore-NEWater](#)]. In the city of San Diego, Calif., intense public opposition to water reuse changed over a period of many years, largely because of public outreach and stakeholder involvement, in addition to the economic driver of local water scarcity [[US-CA-San Diego](#)].

In resource-constrained settings, public attention to risks of using untreated wastewater has not reached the level of attention as in resource-endowed settings. However, public attitudes are subject to change, particularly in response to real or perceived failures or contamination events and associated media attention (Wintgens and Hochstrat, 2006). Establishing a regulatory framework for water reuse practices and health- or environmental-based standards or guidelines, ideally based on internationally-recognized guidelines, should be a first step (Jimenez and Asano, 2008). To promote risk awareness and behavior change, educational campaigns and social marketing techniques will be required where obvious benefits are not perceived (Karg and Drechsel, 2011)

As discussed in Chapter 8, proper use of language that does not stigmatize reclaimed water is also quite important when water professionals communicate water reuse ideas to the public. Words such as “wastewater reuse,” “reuse water,” etc., are stigmatizing and negative to the public while “water recycling,” “new water,” “purified water”—and to a lesser extent “reclaimed water”—are more appealing and likely to promote public acceptance (Macpherson,

2012). To clarify the appropriateness of reclaimed water to the faithful, certain Muslim scholars have issued Fatwas declaring that reclaimed water is clean enough for ablution and other purposes, as long as technical experts attest to its purity and safety for such uses. Examples of these Fatwas can be viewed in original Arabic and in English translation and are described in a case study from Jordan [[Jordan-Cultural Factors](#)] (Senior Scholars Board in the City of Taif, 1978; Abu Dhabi Islamic Court, 1999).

9.3.3.3 Economic Barriers

The long-term economic viability of reuse projects also represents an important barrier to water reuse. Reclaimed water is often priced just below the consumer cost of drinking water to make it more attractive to potential users, but this may also affect the ability to recover costs (Jimenez and Asano, 2008). Distortion in the market for drinking water supply complicates the pricing of reclaimed water, as does the lack of accounting for externalities, including water scarcity and social, financial, and environmental burdens of effluent disposal in the environment (Wintgens and Hochstrat, 2006; Sheikh et al., 1998). Although there is a movement towards increased or even full operations and maintenance cost recovery in the large market of agriculture water reuse (Morocco, Tunisia, Jordan), this is still the exception among many state-run service providers. There may, however, be opportunities to set different tariff levels for different classes or types of users, thus subsidizing the resource for the poor while recovering costs from groups that are able to pay. Finally, financing of up-front costs remains an important barrier to introducing new reuse programs and often requires government intervention in the form of grants or subsidies combined with eventual revenues.

9.3.3.4 Organizational Barriers

Fragmentation of responsibilities for and authority over different parts of the water cycle is another impediment that must be overcome before water reuse projects can go forward. In many regions the authority over the water supply sector resides in an entirely different organization than that over wastewater management. This separation of powers leads to long periods of inaction, stalemate, disagreement, negotiation, and complex interagency agreements that make the resulting water reuse project far more costly and complex than need be. Regions where the same authority manages water, wastewater, stormwater, and

the watershed are far more nimble, implementing their water reuse projects quickly, efficiently, and at much lower cost (Sheikh, 2004).

9.3.4 Benefits of Expanding the Scale of Water Reuse

Similar to the factors driving current levels of water reuse, a range of incentives for increasing, especially, planned water reuse in the coming years appear to exist. Indeed, there are at least several economic, environmental, and social benefits that can be achieved through expanding safe and sustainable reuse of water.

First, there is an opportunity to increase water availability and reliability without tapping new water sources, which either may not exist or may carry adverse consequences. For example, as there has been increased opposition on environmental grounds to dam-building projects, new desalination plants, and groundwater mining as a means of securing new water supplies, water reuse has emerged as a viable and more environmentally-sound alternative (GWI, 2010). Water reuse also avoids environmental pollution caused by releasing wastewater, treated or not, to receiving streams. Reclaimed water is available continuously, even during drought periods, and is produced where people live. Additionally, the use of reclaimed water may augment natural flows in surface waters (with cascading positive effects on ecosystem health and biodiversity) and may contribute to rising groundwater tables where reclaimed water is used for crop or landscaping irrigation, as has been documented in parts of Mexico (IWMI and Global Water Partnership, 2006).

Second, reuse provides opportunities to recover valuable resources, including water, energy, and nutrients. Third, expanding safe and sustainable water reuse helps reduce the human health costs associated with unplanned wastewater use. Finally, increasing water availability through reuse may help to reduce conflicts over water due to scarcity or resource limitations.

Some benefits are specific to or more commonly occur in resource-endowed or resource-constrained settings. For example, recreational (contact or non-contact) or aesthetic benefits may be experienced in resource-endowed settings when water is reused in urban water features and stream restoration projects. Other

benefits that are more likely to occur in resource-endowed contexts include partial recovery of treatment costs; savings on production costs in industrial reuse scenarios; and cost savings when treatment is matched to eventual reuse applications. In resource-constrained settings, likely benefits include increased nutrition, food security, and income (Keraita et al., 2008) for farmers, as well as other groups along the urban/peri-urban agricultural value chain, including women who are often traders of urban agricultural products in Sub-Saharan Africa (IWMI and GWP, 2006).

9.4 Improving Safe and Sustainable Water Reuse for Optimal Benefits

There are different options for optimizing benefits of safe and sustainable water reuse. In areas where wastewater use is currently being practiced, there are ways to reduce the risks associated with it without treating wastewater prior to use. It may also be possible to begin transitioning to wastewater treatment and water reuse when certain factors are present, as described in Section 9.4. Finally, in areas where water reuse is currently occurring, there are ways to optimize benefits of reuse by transitioning to higher-value uses and imposing stricter regulations for environmental conservation.

Importantly, the sheer scale of the opportunity (or challenge) for increasing safe and sustainable water reuse may call for use of any combination or all of these approaches. There is indeed tremendous potential to increase the scale of safe and sustainable water reuse, for at least two reasons. First, as highlighted above, only a small proportion of wastewater that is currently generated is used in a planned context for high-value applications. Second, given trends in population growth and urbanization, the quantity of wastewater generated is likely to increase substantially in the future.

9.4.1 Reducing Risks of Unplanned Reuse: The WHO Approach

Improving safe and sustainable water reuse in areas of currently unplanned practice has been greatly influenced by the WHO guidelines (1989, 2006). In 2006 the WHO released a four-volume report titled *Guidelines for the Safe Use of Wastewater, Excreta and Greywater*. The first volume focuses on policy and regulatory aspects of wastewater, excreta, and greywater use; the second volume focuses on use of

wastewater in agriculture; the third volume focuses on wastewater and graywater use in aquaculture; the fourth volume focuses on excreta and graywater use in agriculture. The discussion in the WHO guidelines is limited to wastewater, excreta, and graywater from domestic sources that are applied in agriculture and aquaculture.

Rather than relying on water quality thresholds as in past editions (WHO, 1989), the most current WHO guidelines (2006) adopt a comprehensive risk assessment and management framework. This risk assessment framework identifies and distinguishes among vulnerable communities (agricultural workers, members of communities where wastewater-fed agriculture is practiced, and consumers) and considers trade-offs between potential risks and nutritional benefits in a wider development context. As such, the WHO approach recognizes that conventional wastewater treatment may not always be feasible, particularly in resource-constrained settings, and offers alternative measures that can reduce the disease burden of wastewater use. The specific approach utilized by the WHO (2006) guidelines is to 1) define a tolerable maximum additional burden of disease, 2) derive tolerable risks of disease and infection, 3) determine the required pathogen reduction(s) to ensure that the tolerable disease and infection risks are not exceeded, 4) determine how the required pathogen reductions can be achieved, and 5) put in place a system for verification monitoring.

Table 9-4 presents an overview of selected treatment and non- or post-treatment health protection measures in agricultural water reuse and their potential to reduce pathogen loads (WHO, 2006; Amoah et al., 2011). While each of the risk mitigation measures can be employed in isolation, comprehensive risk reduction is best achieved when measures are used in combination—the multi-barrier approach. To protect farmers themselves, awareness campaigns on the invisible risk of pathogens should accompany the promotion of protective clothing (boots, gloves, etc.), hygiene, and where possible, a shift to irrigation methods that minimize human exposure, like drip irrigation. Compared to conventional wastewater treatment, on- and off-farm risk mitigation measures are usually cheaper and more cost-effective, indicating suitability for resource-constrained contexts. For example, estimates from Ghana show that some of these measures can avert up to 90 percent of the

estimated disease burden related to wastewater irrigation at a cost-effectiveness below \$100 per averted DALY [[Ghana-Agricultural](#)] (Drechsel and Seidu, 2011). The case study from Senegal illustrates how unsafe wastewater use can be tied up in complex political factors. In Dakar, Senegal, urban farmers divert wastewater from sewage pipes to irrigate their small plots. As these plots are often seized for housing, farmers choose to grow short-rotation crops such as lettuce. If farmers were guaranteed a more formalized land tenure status, they might be willing to make longer-term investments in on-site water treatment approaches or switch crop choices to those that grow slower (with similar overall profit), but are not eaten raw [[Senegal-Dakar](#)]. The health protection measures listed in **Table 9-4** could be implemented to improve the unsafe use of diluted wastewater for vegetable production pictured in **Figure 9-4**.

The most effective health protection recommendation is the production of crops not eaten raw. However, this option requires appropriate monitoring capacity and viable crop alternatives for farmers. Other options include on-farm treatment and application techniques, as well as the support of natural die-off as described in two Africa case studies, [[Ghana-Agricultural](#)] and [[Senegal-Dakar](#)], and natural attenuation in non-edible aquatic plants lining irrigation canals [[Vietnam-Hanoi](#)] (Amoah, et al., 2011). There is reported success of blending of wastewater with higher-quality water to make it more suitable for production ([[Vietnam-Hanoi](#)], [[Senegal-Dakar](#)], [[India-Delhi](#)], [[Jordan-Irrigation](#)], and [[Israel/Palestinian Territories/Jordan-Olive Irrigation](#)]).

In addition to the risks from pathogen contamination, wastewater may have chemical contaminants from industrial discharges or stormwater runoff. The WHO (2006) guidelines provide maximum tolerable soil concentrations of various toxic chemicals based on human exposure through the food chain. For irrigation water quality, WHO refers to the FAO guidelines, which focus on plant growth requirements and limitations (Ayers and Westcot, 1985; Pescod, 1992). The guidelines do not specifically address how to reduce chemical contaminants from wastewater for use in irrigation. Resource-constrained countries may have historically been less prone to heavy metal contamination that is usually localized and associated with industrial activities, but where industries are emerging, industrial source control measures are required to avoid potential contamination in food crops.

Likewise, where required, stormwater should be diverted and treated to remove pollutants. Alternative options for low-income countries to reduce the potential risk of chemical contamination, like through phytoextraction, crop selection, and soil treatment are limited (Simmons et al., 2010).

Table 9-4 Selected health-protection measures and associated pathogen reductions for wastewater reuse in agriculture

| Control measure | Pathogen reduction (log units) | Notes |
|---|--------------------------------|---|
| A. Wastewater treatment | 1–6 | Pathogen reduction depends on type and degree of treatment technology selected. |
| B. On-farm options | | |
| Alternative land and water source | 6–7 | In Ghana, authorities supported urban farmers using wastewater by drilling wells. In Benin, farmers were offered alternative land with access to safer water sources. |
| Crop restriction (i.e., no food crops eaten uncooked) | 6–7 | Depends on (a) effectiveness of local enforcement of crop restriction, and (b) comparative profit margin of the alternative crop(s). |
| On-farm treatment: | | |
| (a) Three-tank system | 1–2 | One pond is being filled by the farmer, one is settling and the settled water from the third is being used for irrigation |
| (b) Simple sedimentation | 0.5–1 | Sedimentation for ~18 hours. |
| (c) Simple filtration | 1–3 | Value depends on filtration system used |
| Pathogen die-off (fecal sludge) | in line with WHO 2006 | Raw fecal sludge used in cereal farming in Ghana and India should be dewatered on-farm for ≥ 60 days or ≥ 90 days depending on the application method (spread vs. pit) to minimize occupational health risks. |
| Method of wastewater application: | | |
| (a) Furrow irrigation | 1–2 | Crop density and yield may be reduced. |
| (b) Low-cost drip irrigation | 2–4 | 2-log unit reduction for low-growing crops, and 4-log unit reduction for high-growing crops. |
| (c) Reduction of splashing | 1–2 | Farmers trained to reduce splashing when watering cans used (splashing adds contaminated soil particles on to crop surfaces which can be minimized). |
| Pathogen die-off (wastewater) | 0.5–2 per day | Die-off support through irrigation cessation before harvest (value depends on climate, crop type, etc.). |
| C. Post-harvest options at local markets | | |
| Overnight storage in baskets | 0.5–1 | Selling produce after overnight storage in baskets (rather than overnight storage in sacks or selling fresh produce without overnight storage). |
| Produce preparation prior to sale | 1–2 | (a) Washing salad crops, vegetables and fruit with clean water. |
| | 2–3 | (b) Washing salad crops, vegetables and fruit with running tap water. |
| | 1–3 | (c) Removing the outer leaves on cabbages, lettuces, etc. |
| D. In-kitchen produce-preparation options | | |
| Produce disinfection | 2–3 | Washing salad crops, vegetables and fruit with an appropriate disinfectant solution and rinsing with clean water. |
| Produce peeling | 2 | Fruits, root crops. |
| Produce cooking | 6–7 | Option depends on local diet and preference for cooked food. |

Sources: EPHC, NRMCC, and AHMC, 2006; WHO 2006; Amoah et al. 2011; modified from Mara et al., 2010



Figure 9-4
Reducing the pathogenic health risks from unsafe use of diluted wastewater

(Pictured left) The use of diluted untreated wastewater is prevalent in vegetable production in West Africa, such as here from a wastewater canal (Photo credit: IWMI). In the absence of wastewater treatment, possible pathogenic health risks from unsafe wastewater use could be reduced by implementing on-farm, post-harvest, and in-kitchen protection measures. (Pictured right) One on-farm option is the use of settling basins prior to irrigation. Comprehensive risk reduction is best achieved when multiple measures are used in combination. (Photo credit: Andrea Silverman)

9.4.2 Expanding and Optimizing Planned Water Reuse

As countries or municipalities in resource-constrained settings build operational and financial capacity, reuse safety should progress incrementally from on-farm and off-farm safety options to centralized or decentralized wastewater treatment, while establishing sound regulatory and monitoring protocols (Von Sperling and Fattal, 2001; Drechsel and Keraita, 2010; and Scheierling et al., 2010). This step-wise approach, recommended by WHO (2006), provides local public health risk managers with flexibility to address wastewater irrigation risks with locally viable options matching their capacity within a multi-barrier framework (**Figure 9-5**), instead of struggling to achieve water quality threshold levels as the only regulatory option (Von Sperling and Chernicharo, 2002). When treatment capacity has increased and irrigation water quality can be managed, the introduction of water quality standards should follow a similar incremental approach. The shift from water quality standards (WHO, 1989) to health-based targets (WHO, 2006), has helped to support a much broader range of measures for improving safe water reuse.

Reuse schemes often evolve from household and decentralized systems to eventual centralized urban systems (Scheierling et al., 2010). However, it is important to remember that household and decentralized schemes may continue to be desirable in high-resource settings for some applications, such as graywater reuse for toilet flushing and sewer mining ([[Palestinian Territories-Auja](#)] and [[Australia-Graywater](#)]). The regulatory framework for reuse in

these contexts should continue to support small-scale and potentially low-cost options where appropriate and where health and environmental risks can be minimized.

Wastewater quality regulations and standards from 28 countries are compiled by GWI (2011). Common challenges associated with establishing and implementing standards, especially in countries with limited resources, are summarized in **Table 9-5**, along with recommendations to overcome these challenges.

Appropriate technologies and practices for wastewater treatment for agricultural reuse are one way to reduce risks to public health where direct wastewater use is prevalent. There is a wide range of wastewater treatment options for safe water, nutrient recovery, and irrigation with particular relevance for resource-constrained countries. Many experts in the field have summarized appropriate treatment options, including Mara (2004), Laugesen et al. (2010), Von Sperling and Chernicharo (2005), and Scheierling et al. (2010). As advances are made to drive down the cost of centralized and decentralized treatment technologies in resource-endowed contexts, some of the “high-tech” technologies, including MBR, may be adapted to lower-resource settings. Advances in decentralized wastewater treatment technologies and schemes may be particularly relevant in rapidly growing urban contexts where installation of centralized collection and treatment infrastructure is not cost-effective ([[Japan-Building MBR](#)] and [[Australia-Graywater](#)]). However, decentralized systems are not a panacea where institutional capacities are generally low (Murray and Drechsel, 2011).

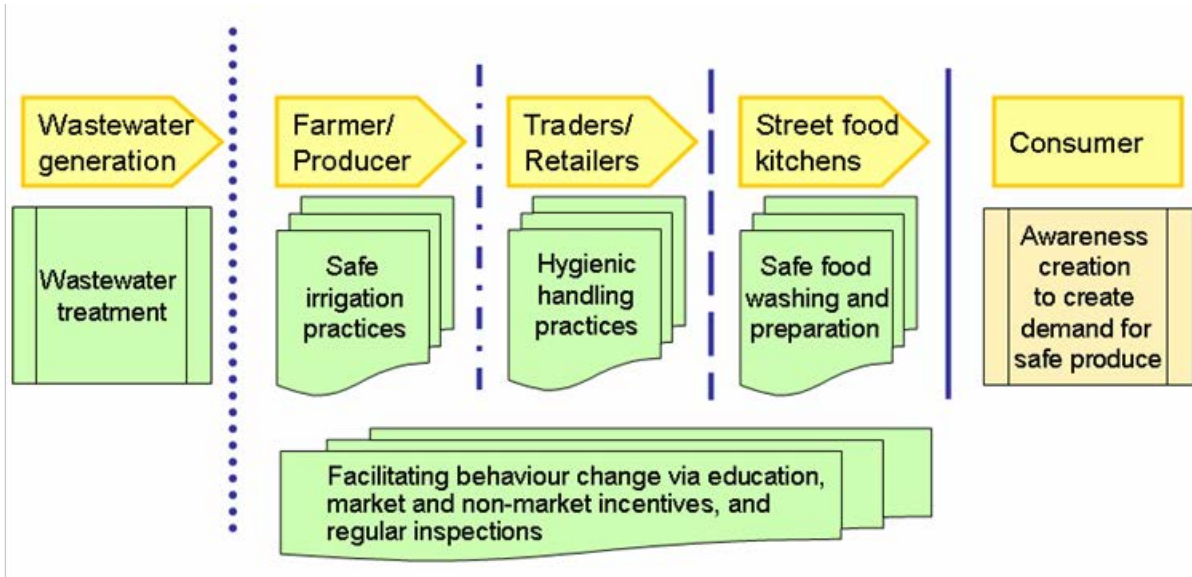

Figure 9-5
Multi-barrier approach to safeguard public health where wastewater treatment is limited (Amoah et al., 2011)

Table 9-5 Challenges and solutions for reuse standards development and implementation

| Observation | Recommendation |
|--|--|
| Guidelines, frequently copied from developed countries, are directly adopted as national standards. | Each country should adapt the guidelines, based on local conditions, and derive the corresponding national standards. In developed countries, these resulted from a long period of investment in infrastructure, during which standards were progressively improved. Cost and maintenance implications of too strict standards in the short term should be taken into account. |
| Guideline values are treated as absolute values, and not as target values. | Guideline values should be treated as target values, to be attained on a short, medium or long term, depending on the country's technological, institutional or financial conditions. |
| Treatment plants that do not comply with global standards do not obtain licensing or financing. | Environmental agencies should license and banks should fund control measures which allow for a stepwise improvement of water quality, even though standards are not immediately achieved. However, measures should be taken to effectively guarantee that all steps will be effectively implemented. |
| There is no affordable technology to lead to compliance of standards. | Control technologies should be within the countries' financial conditions. The use of appropriate technology should always be pursued. |
| Standards are not actually enforced. | Standards should be enforceable and actually enforced. Standard values should be achievable and allow for enforcement, based on existing and affordable control measures. Environmental agencies should be institutionally well developed in order to enforce standards. |
| Discharge standards are not compatible with water quality standards. | In terms of pollution control, the true objective is the preservation of the quality of the water bodies. Discharge standards should be based on practical (and justifiable) reasons, assuming a certain dilution or assimilation capacity of the water bodies. |
| Number of monitoring parameters are frequently inadequate (too many or too few). | The list of parameters should reflect the desired protection of the intended water uses and local laboratory and financial capacities, without excesses or limitations. |
| There is no institutional development that could support and regulate the implementation of standards. | The efficient implementation of standards requires an adequate infrastructure and institutional capacity to license, guide, and control polluting activities and to enforce standards. |
| Reduction of health or environmental risks due to compliance with standards is not immediately perceived by decision makers or the population. | Decision makers and the population at large should be well informed about the benefits and costs associated with the maintenance of good water quality, as specified by the standards. |

When transitioning from wastewater use to planned reuse, it is important to consider a country or city's readiness to sustain investments in wastewater collection and treatment and the value added by treatment versus risk reduction through non-treatment barriers. There is no shortage of sanitation infrastructure that has fallen into disrepair, for example, and restrictions associated with reuse of treated wastewater has at times caused farmers to return to using untreated wastewater (Scheierling et al., 2010). It is therefore necessary to move toward planned reuse in a circumspect, phased approach whereby initial implementation is monitored for efficacy and sustainability before a larger-scale initiative is undertaken. Moving from wastewater use toward planned reuse requires a context-specific approach in light of institutional limitations and resource constraints. The following lessons of transitioning to wastewater collection, treatment, and reuse can be drawn from global experiences:

Consider overall infrastructure needs. In many cities of the world without functioning wastewater collection systems, stormwater and wastewater flow through unlined engineered or natural drainage paths. The cost of upgrading or constructing a collection system must be considered.

Consider local capacities. A key consideration in choosing appropriate treatment technologies is operator capacity. If a water reuse scheme is being planned and institutionalized at the municipality level, as exemplified in several case studies from India ([[India-Nagpur](#)], [[India-Delhi](#)], and [[India-Bangalore](#)]), as opposed to a community or small institution scale ([[Palestinian Territories-Auja](#)], [[Israel/Peru-Vertical Wetlands](#)], and [[Peru-Huasta](#)]), a different set of technologies and practices will be appropriate and perhaps required in consideration of differing operator capacity, sophistication, and resource levels. Treatment and reuse schemes should therefore be designed to align with the social, environmental, technological, and economic circumstances of the target location/operator to achieve maximum sustainability (Von Sperling and Chernicharo, 2002; Nhapi and Gijzen, 2004).

Match treatment approach with reuse application at design stage. Several considerations should be taken into account when choosing an appropriate set of technologies to incorporate into the design of a

planned reuse scheme. The treatment approach should be chosen to match the intended reuse application at the design stage rather than retrofitted after construction (Huibers et al., 2010; Murray and Buckley, 2010). This approach may represent a departure from conventional approaches that treat wastewater immediately to meet water quality standards for discharge to receiving waters. This goal may not be achievable where there is an existing WWTP and no capability to convey treated wastewater directly to the reuse application. It also may not apply where the reuse application can only absorb a small amount of the discharged wastewater. However, where there is an opportunity to design a new facility with a reuse component, there is potential to achieve significant cost and energy savings by matching the level of treatment (and thus the investment in treatment technology and construction) to the intended reuse, as water quality standards for uses such as irrigation of forest plantations and cooling water for industrial processes may be much lower than standards for aquatic discharge. Also, for some irrigation applications it is necessary to reduce fertilization rates based on the increased nutrient content found in reclaimed water. Where possible, it will be important to implement a design flexible enough to accommodate future increases in demand for reclaimed water for the same application, as well as additional applications. This may require a phased approach to constructing treatment capacity and a design that does not preclude potential future treatment processes required for a broader range of water reuse applications.

Consider overall costs and benefits. As highlighted in the Hyderabad Declaration of 2002, wastewater irrigation can have significant positive livelihood implications for poor smallholder farmers (EPA, 2004). These cost benefits can be considerable—even where wastewater is used without ideal treatment, especially in a low-resource context where households are facing multiple health risks. These economic benefits might outweigh health risks to the farmer and his/her family. Overly strict standards in these circumstances might be counterproductive, even for public health. In Ouagadougou and Lima, for example, farmers are not allowed to use treated wastewater as it does not meet ideal standards. As a result, farmers continue using untreated wastewater for crop production.

Resource Recovery and Reuse: a Strategic Research Portfolio

An international research program addressing water reuse—Resource Recovery and Reuse (RRR) Strategic Research Portfolio—was recently launched by the Consultative Group on International Agricultural Research (CGIAR). The RRR research is part of the CGIAR’s strategic objective to enhance sustainable management of the natural resource base supporting agriculture to feed a rapidly growing global population. The first three-year budget (2011–13) is estimated at US\$ 7 million and is coordinated by IWMI, a CGIAR center. USAID is one of several major donors to the CGIAR system.

The research under this theme will look at how to enhance the recovery of water, nutrients, organic matter, and energy from otherwise wasted resources for use in agriculture, serving two critically important goals. First, more nutrients and water will be available for use in agriculture even as the natural stocks of nutrients, such as phosphorus, become more expensive to mine. Second, the research will engage the private sector to identify opportunities for generating revenue that will support the sanitation service chain for the benefit of those exposed to poor sanitation and unsafe food.

The research will explore existing, emerging, and potential business models; provide scientific guidance; and make policy recommendations to maximize the untapped potential for recovering water, essential nutrients, and biogas. At the same time, the research will promote safer and healthier practices when reusing waste materials on farms and when processing crops for consumption in local markets.

Critically, the research will contribute to notable gains in food security by helping to alleviate water scarcity and restore nutrient losses on agricultural lands.

For more information, see IWMI’s website on the research program:

<www.iwmi.org/Topics/RRR>

Where planned reuse is already being undertaken, there are at least two ways to strengthen its safety and sustainability for optimal benefits:

1. Transition to higher-value planned water reuse
2. Give greater consideration to environmental protection

Both options for strengthening planned water reuse imply moving beyond the WHO guidelines focus on protecting human health. The first point above calls for a shift from viewing treatment of wastewater as an obligation, either to protect human health or to satisfy environmental regulations, to viewing it as an opportunity to exploit a valuable economic resource. There is, indeed, growing recognition on the part of governments, from Arizona to Saudi Arabia, that the sale of treated wastewater can generate valuable revenues (GWI, 2010).

However, the greatest revenues come almost entirely from advanced water reuse applications, which require more advanced treatment and as such are better suited to applications other than agriculture. A major constraint to unlocking the market potential of water reuse are policies in many countries that force utilities to provide treated wastewater—even wastewater treated to an advanced level—to the agriculture sector. A major key to tapping the high value potential of water reuse, therefore, is overcoming strict government regulations and the public perceptions that often drive them, in order to open the domestic and industrial sectors to greater use for treated water (GWI, 2010).

It should be noted that liberalizing the allocation of reused water could result in a greater proportion of wastewater allocation to high-value, non-agriculture uses, possibly resulting in less water for agriculture. However, it is important to remember that this is not a zero-sum game. As highlighted above, there are large quantities of wastewater that are currently untreated and/or unused. It may very well be possible with treatment of growing volumes of wastewater, for example, to continue to provide reclaimed water to agriculture in addition to fostering increased reuse for higher-value applications, such as industrial and municipal applications.

Nonetheless, transitioning to higher-value uses can be hampered by the often low, subsidized price of

drinking water, which drives down the sale price of recycled water, as well as the subsidized cost of sanitation and treatment services (Jimenez and Asano, 2008). Water pricing policies may need to be adopted that promote total water management, cost recovery of treatment, and service provision as a means of incentivizing water reuse. Comparing the cost of highly-treated recycled water with the price of highly-subsidized potable or irrigation water is an economic fallacy. This common comparison ignores both the numerous benefits inherent in water reuse and externalized costs of potable water under nearly all circumstances. The more appropriate comparison takes into account both sets of economic values and services using sophisticated quantification methods that go beyond simplistic benefit/cost ratios or price-versus-cost comparisons.

In addition to transitioning to higher-value uses, a second way to strengthen the safety and sustainability of planned water reuse is to give greater consideration to environmental protection, enhancement, and restoration. Indeed, countries may decide to graduate from the WHO model and address environmental concerns along with public health issues. In particular, water quality standards and guidelines for environmental flows may be instated to promote a desired level of treatment and volumes to divert for reuse. Standards are often set to reflect the degree of pathogen and contaminant removal possible with best-available treatment technologies. An overall regulatory strategy for water reuse is typically driven by the economics of treatment and monitoring, as well as enforcement capacity (Jimenez and Asano, 2008). In the agricultural sector, water quality standards for water reuse on export crops may also be influenced by standards required by the importing countries or regions. These improvements would build on previous low-cost steps to reduce public health risks and toxic contamination at the source, as outlined in the Hyderabad Declaration (IWMI and International Development Research Centre, 2002).

9.5 Factors Enabling Successful Implementation of Safe and Sustainable Water Reuse

Global experiences have demonstrated that choosing an appropriate set of technologies or regulations is not in itself sufficient to ensure the safety and sustainability of a given water reuse project, especially under resource-constrained conditions. A set of factors

must be established to support the long-term functioning of the water reuse program to achieve sustainability. Some of these factors are discussed in this section.

Stakeholder process. Although participatory processes can take more time compared with less-participatory approaches, risk of failure will be reduced by explicit integration of all relevant institutions and stakeholders in the planning and design phases of water reuse schemes. This applies in particular to water reuse in agriculture, which links different sectors (sanitation, agriculture, health, and environment). While regulatory frameworks that govern wastewater treatment and reuse schemes are typically crafted at the national or regional level of government, it is usually the responsibility of local or municipal institutions to implement the programs, including long-term financing, cost recovery, operations and maintenance, and performance monitoring. In the case of Ghana, for example, treatment plants at universities, hospitals, and military camps were operated by the Ministries of Education, Health, and Defense, respectively (Murray and Drechsel, 2011). This places a significant responsibility on local institutions without ensuring their improved capacities. National-level frameworks are indeed a key enabling factor, as illustrated in the Nagpur, India case study [[India-Nagpur](#)].

Another critical element of the multi-stakeholder planning process is involving the end users in the planning and design phases. If end-user preferences for reclaimed water volumes and quality are not taken into account during the planning phase, the end users may not be able to make full use of the provided water or may refuse to pay for the service. Also, the treatment technology selected for the project should consider local experience in what works and what does not. Involving representatives from the communities that both supply and use the treated water will facilitate negotiations and “water swaps.” For example, farmers may be willing to transfer a portion of their freshwater allocations to meet urban water demand if they are provided access to treated, nutrient-rich, and reasonably-priced reclaimed water for agricultural activities (Winpenny et al., 2010; Huibers et al., 2010). Transitioning from a traditional top-down approach to a user-centered approach for planning and design has the potential to achieve more

sustainable outcomes. This approach is described further in Chapter 8.

Sustainable Financial and Institutional Capacity Management. Forward-minded consideration of financing and capacity building is critical to sustainability. Operation and maintenance costs are often underestimated, and high staff turnover is a key challenge of public sector projects such as those related to water reuse. These factors often drive a run-to-failure trajectory (Murray and Drechsel, 2011). Development of a longer-term strategy and/or involvement of the private sector could help avoid such an outcome. Although WWTPs are often publicly financed, the public-private partnership model is being piloted (e.g., Scheierling et al., 2010; Murray et al., 2011). An example of cost-recovery is the use of treatment ponds for aquaculture in Ghana (Waste Enterprisers, 2012).

Public Outreach. A successful and sustainable water reuse program must integrate a public involvement campaign, particularly where the involved public will be consumers of the reclaimed water or the product developed using the reclaimed water. This is described further in Chapter 8. Just as a water reuse project may fail due to a lack of early stakeholder involvement, failure to garner public acceptance of water reuse through a well-conceived and implemented communication campaign can limit market demand for the product. There are several good examples of public acceptance campaigns for water reuse associated with potable reuse [Singapore-NEWater] and [India-Bangalore], irrigation [Spain-Costa Brava], [Palestinian Territories-Auja], [Israel/Peru-Vertical Wetlands], and industrial reuse [India-Nagpur]. Public outreach will be more challenging where risk awareness is low or hazards of multiple origins (water-borne, food-borne) affect households, such as in many low-resource settings. In these circumstances, a significant investment in risk education is required. Lessons can be learned from hand-washing campaigns.

9.6 Global Lessons Learned About Water Reuse

There are key themes emerging in the global dialogue on water reuse that are of relevance to the United States and that merit discussion; regardless of the context of reuse, there are common challenges.

We have a common challenge. Pressure on the world's water resources has been growing dramatically, and climate change is accentuating patterns of droughts and floods. Water scarcity is affecting communities around the world, presenting an incredible opportunity for collaboration. And as solutions are developed in one context, they can be adapted to new contexts. For example, the U.S. is one of the world's leaders in advanced water reclamation technologies and stands to benefit from taking advantage of low-cost, low-energy solutions being demonstrated as described in several case studies from outside of the U.S. [Brazil-Car Wash], [Israel/Peru-Vertical Wetlands], [Philippines-Market]. Likewise, advances in salinity management and drip irrigation in agricultural reuse is a key topic for scientific exchange between the United States and countries in the Middle East and other arid regions. The world has learned a great deal from Singapore's advanced reuse technology as well as its leadership in integrated management and holistic planning under its long-term water supply strategy called "Four National Taps." Regulators in the United States have gained insight from the experience of other countries setting national guidelines and regulations, notably Australia. Current challenges in reuse, including economic models for partial or full cost recovery and technical challenges in nutrient recovery and energy efficiency, are also opportunities for international exchange.

Multi-purpose reuse. Some of the reuse projects described in the international case studies are multi-purpose programs, where reclaimed water within one system is treated to different water quality standards to supply reclaimed water to an array of end uses. In contrast, most water reuse applications in the United States are designed for water reuse for a singular purpose. Multi-purpose systems may be more robust and adaptable than single-use applications, and new installations in the United States might take note from successes in other regions of the world.

Fine tuning the treatment. The concept of "fit-for-purpose" is illustrated dramatically in many of the international reuse case studies ([Australia-Replacement Flows], [Brazil-Car Wash], [Colombia-Bogota], [India-Nagpur], [South Africa-eMalahleni Mine], and [South Africa-Durban]). In these reuse installations, careful study was conducted to ensure that the water produced would have the appropriate water quality for the intended use. Water reuse market

growth is projected to take this approach—designing reuse for a specific purpose to achieve economic efficiency. Both high- and low-tech solutions are imminently relevant to tuning our approaches, and as mentioned above, multiple endpoints may be appropriate for multi-purpose systems. Global experiences can help reuse planners answer the following questions: *Are we choosing the easiest solution or the best solution? How carefully have the options been weighed?*

Increasing dialogue about water reuse in all corners of the world. Confidence in water and wastewater treatment technologies has grown among scientists and engineers, regulators, and increasingly, the general public such that the public and the decision-makers have security in the safety of reclaimed water. As the market grows, public awareness will increase, which has been shown to improve acceptance of and investment in reuse. Countries with only emerging wastewater collection and treatment systems will benefit from this dialogue if their opportunities and constraints are taken into account. The case studies show an encouraging spectrum of options where increased sanitation and wastewater management efforts in resource-constrained countries can move unplanned wastewater use to planned reuse, while taking advantage of modern treatment and non- or post-treatment options for safeguarding public health. With increasing population pressures for more available water resources, increasing recovery of the water resource from wastewater can help in meeting the total water needs of many nations.

9.7 References

Abu Dhabi Islamic Court. 1999. *Treated Waste Water*. Retrieved on August 23, 2012 from <http://www.bahmansheikh.com/pdf_files/FATWA_Recycled_Water_Abu_Dhabi_05_1999.pdf>.

Amoah, P., B. Keraita, M. Akple, P. Drechsel, R. C. Abaidoo, and F. Konradson. 2011. *Low-Cost Options for Reducing Consumer Health Risks From Farm to Fork Where Crops are Irrigated With Polluted Water in West Africa*. International Water Management Institute. Colombo, Sri Lanka.

Ayers, R. S., and S. D. Westcot. 1985. "Water quality for agriculture." *FAO Irrigation and Drainage Paper*, 29, Revision 1. FAO. Rome, Italy.

Drechsel, P., and R. Seidu. 2011. "Cost-effectiveness of Options for Reducing Health Risks in Areas Where Food Crops are Irrigated with Treated or Untreated Wastewater." *Water International* 36(4):534-547.

Drechsel, P., and B. Keraita. 2010. "Applying the Guidelines Along the Sanitation Ladder." *Third Edition of the WHO Guidelines for the Safe Use of Wastewater, Excreta and Greywater in Agriculture and Aquaculture*. Guidance note for National Programme Managers and Engineers. Retrieved on August 23, 2012 from <http://www.who.int/water_sanitation_health/wastewater/FLA_SH_OMS_WSHH_Guidance_note1_20100729_17092010.pdf>.

Drechsel, P., C. A. Scott, L. Raschid-Sally, M. Redwood, and A. Bahri (eds.). 2010. *Wastewater Irrigation and Health: Assessing and Mitigating Risk in Low-income Countries*. Earthscan. London, UK.

Evans, A. E. V., M. A. Hanjra, Y. Jiang, M. Qadir, and P. Drechsel. 2012. "Water Quality: Assessment of the Current Situation in Asia." *International Journal of Water Resources Development*, (28)2:195-216.

Environment Protection and Heritage Council (EPHC); Natural Resource Management Ministerial Council (NRMMC); and Australian Health Ministers' Conference (AHMC). 2006. *Australian Guidelines For Water Recycling: Managing Health and Environmental Risks (Phase 1)*. Retrieved on August 23, 2012 from <<http://www.ephc.gov.au/>>.

Eurostat. 2006. *90% of EU25 Population Connected to Waste Water Collection Systems*. Retrieved on August 23, 2012 from <http://epp.eurostat.ec.europa.eu/cache/ITY_PUBLIC/8-21032006-AP/EN/8-21032006-AP-EN.PDF>.

Food and Agriculture Organization of the United Nations (FAO). 2010. *Aquastat Database*. Retrieved on August 23, 2012 from <http://www.fao.org/nr/water/aquastat/dbase/AquastatWorld_ataEng_20101129.pdf>.

Global Water Intelligence (GWI). 2011. *Global Water and Wastewater Quality Regulations 2012: The Essential Guide to Compliance and Developing Trends*. Media Analytics Ltd. Oxford, UK.

Global Water Intelligence (GWI). 2010. *Municipal Water Reuse Markets 2010*. Media Analytics Ltd. Oxford, UK.

- Huibers, F., M. Redwood, and L. Raschid-Sally. 2010. "Challenging Conventional Approaches to Managing Wastewater Use in Agriculture." In Drechsel, P., C. A. Scott, L. Raschid-Sally, M. Redwood and A. Bahri (eds.) *Wastewater Irrigation and Health: Assessing and Mitigating Risks In Low Income Countries*. Earthscan. London, UK.
- International Water Management Institute (IWMI) and Global Water Partnership (GWP). 2006. "Recycling realities: Managing health risks to make wastewater an asset." *Water Policy Briefing*, Issue 17. Battaramulla, Sri Lanka.
- International Water Management Institute (IWMI) and International Development Research Centre (IDRC). 2002. "The Hyderabad Declaration on Wastewater Reuse in Agriculture." *Workshop on Wastewater Use in Irrigation Agriculture: Confronting the Livelihood and Environmental Realities*, November 11-14, 2002, Hyderabad, India.
- Jiménez, B., P. Drechsel, D. Koné, A. Bahri, L. Raschid-Sally, and M. Qadir. 2010. "Wastewater, Sludge and Excreta Use in Developing Countries: An Overview." In Drechsel, P., C.A. Scott, L. Raschid-Sally, M. Redwood and A. Bahri (eds.) *Wastewater Irrigation and Health: Assessing and Mitigating Risks in Low-income Countries*. Earthscan. London, UK.
- Jimenez, B., and T. Asano (eds.). 2008. *Water Reuse: An International Survey of Current Practice, Issues and Needs*. IWA Publishing. London, UK.
- Joint Monitoring Programme. 2012. *WHO/UNICEF Joint Monitoring Programme (JMP) for Water Supply and Sanitation*. Retrieved on August 23, 2012 from <<http://www.wssinfo.org/>>.
- Karg, H., and P. Drechsel. 2011. "Motivating Behavior Change to Reduce Pathogenic Risk Where Unsafe Water is Used for Irrigation." *Water International*. 36(4):476-490.
- Keraita, B., P. Drechsel, and F. Konradsen. 2008. "Perceptions of Farmers on Health Risks and Risk Reduction Measures in Wastewater-irrigation Urban Vegetable Farming in Ghana." *Journal of Risk Research*. 11(8):1047-1061.
- Laugesen, C., O. Fryd, H. Brix, and T. Koottatop. 2010. *Sustainable Wastewater Management in Developing Countries: New Paradigms and Case Studies from the Field*. ASCE Press. Reston, VA.
- Macpherson, L. 2012. "Water: Nature's Amazing Reusable Resource." In *Water Sensitive Cities*. IWA Publishing. London, UK.
- Mara, D., A. Hamilton, A. Sleight, and N. Karavarsamis. 2010. "More Appropriate Tolerable Additional Burden of Disease Improved Determination of Annual Risks Norovirus and Ascaris Infection Risks. Extended Health-protection Control Measures. Treatment and Non-treatment Options." *Discussion Paper: Options for updating the 2006 WHO Guidelines*. Retrieved on August 23, 2012 from <http://www.who.int/water_sanitation_health/wastewater/guidance_note_20100917.pdf>.
- Mara, D. D. 2004. *Domestic Wastewater Treatment in Developing Countries*. Earthscan. London, UK.
- Murray, A., G. D. Mekala, and X. Chen. 2011. "Evolving Policies and the Roles of Public and Private Stakeholders in Wastewater and Faecal-sludge Management in India, China and Ghana." *Water International*. 36(4):491-504.
- Murray, A., and P. Drechsel. 2011. "Why Do Some Wastewater Treatment Facilities Work When the Majority Fail? Case Study From the Sanitation Sector in Ghana." *Waterlines*. 30(2):135-149.
- Murray, A., and C. Buckley. 2010. "Designing Reuse-oriented Sanitation Infrastructure: The Design For Service Planning Approach." In Drechsel, P., C.A. Scott, L. Raschid-Sally, M. Redwood and A. Bahri (eds.) *Wastewater irrigation and Health: Assessing and Mitigating Risks in Low-Income Countries*. Earthscan. London, UK.
- National Research Council (NRC). 2012. *Water Reuse: Potential for Expanding the Nation's Water Supply Through Reuse of Municipal Wastewater*. The National Academies Press, Washington DC.
- Nhapi, I., and H. J. Gijzen 2004. "Wastewater Management in Zimbabwe in the Context of Sustainability." *Water Policy*. 6(2004):501-517.
- Pescod, M.B. 1992. "Wastewater treatment and use in agriculture." *FAO Irrigation and Drainage Paper*, 47. FAO. Rome, Italy.
- Scheierling, S. M., C. Bartone, D. D. Mara, and P. Drechsel. 2010. "Improving Wastewater Use in Agriculture: An Emerging Priority." *Policy Research Working Paper*, 5412. The World Bank. Washington, D.C.
- Scott, C., P. Drechsel, L. Raschid-Sally, A. Bahri, D. Mara, M. Redwood, and B. Jimenez. 2010. "Wastewater Irrigation and Health: Challenges and Outlook for Mitigating Risks in Low Income Countries." In Drechsel, P., C.A. Scott, L. Raschid-Sally, M. Redwood and A. Bahri (eds.) *Wastewater Irrigation and Health: Assessing and mitigating risks in low income countries*. Earthscan. London, UK.
- Shual, H. I., N. Guttman-Bass, J. Applebaum, and B. Fattal. 1989. "Aerosolized enteric bacteria and viruses generated by spray irrigation of wastewater." *Water Science and Technology*. 21(3): 131 – 135.

- Senior Scholars Board in the City of Taif. 1978. *Use of Recycled Water for Ablution and Other Purposes*. Retrieved on August 23, 2012 from http://www.bahmansheikh.com/pdf_files/FATWA_Recycled_Water_Taif_City_09_1978.pdf.
- Sheikh, B., E. Rosenblum, S. Kasower, and E. Hartling. 1998. "Accounting for All the Benefits of Water Recycling." *Proceedings, Water Reuse '98, a joint specialty conference of WEF and AWWA*. Orlando, Florida.
- Sheikh, B. 2004. "Impact of Institutional Requirements on Implementation of Water Recycling/Reclamation Projects." *Proceedings of the 2004 Water Sources Conference*. Austin, Texas.
- Shuval, H. I., N. Guttman-Bass, J. Applebaum, and B. Fattal. (1989). "Aerosolized enteric bacteria and viruses generated by spray irrigation of wastewater." *Water Science and Technology* 21(3): 131 – 135.
- Simmons, R., M. Qadir, and P. Drechsel. 2010. "Farm-based Measures for Reducing Human and Environmental Health Risks from Chemical Constituents in Wastewater." In: Drechsel, P., C.A. Scott, L. Raschid-Sally, M. Redwood and A. Bahri (eds.) *Wastewater Irrigation and Health: Assessing and Mitigation Risks in Low-Income Countries*. Earthscan-IDRC-IWMI. UK.
- United Nations Department of Economic and Social Affairs. 2011. *World Urbanization Prospects, the 2011 Revision*. Retrieved on August 23, 2012 from <http://esa.un.org/unpd/wup/index.htm>.
- United Nations Statistics Division. 2011. *Environmental Indicators: Inland Water Resources*. Retrieved on August 23, 2012 from <http://unstats.un.org/unsd/environment/wastewater.htm>.
- U.S. Environmental Protection Agency (EPA). 2004. *Guidelines for Water Reuse*. EPA. 625/R04/108. Environmental Protection Agency. Washington, D.C.
- Von Sperling, M. and C.A.L. Chernicharo. 2005. *Biological Wastewater Treatment in Warm Climate Regions*. IWA Publishing. London, UK.
- Von Sperling, M. and C. A. L. Chernicharo. 2002. "Urban Wastewater Treatment Technologies and the Implementation of Discharge Standards in Developing Countries." *Urban Water*. 4(1): 105–114.
- Von Sperling, M., and B. Fattal. 2001. "Implementation of Guidelines: Some Practical Aspects." *Water Quality: Guidelines, Standards and Health; Assessment of Risk and Risk Management for Water Related Infectious Diseases*. IWA Publishing. London, UK.
- Waste Enterprisers. 2012. *Aquaculture*. Retrieved on August 23, 2012 from <http://www.waste-enterprisers.com/our-businesses>.
- Winpenny, J., I. Heinz, and S. Koo-Oshima. 2010. "The Wealth of Waste." *FAO Water Reports*, 35. FAO. Rome, Italy.
- Wintgens, T., and R. Hochstrat. 2006. *Report On Integrated Water Reuse Concepts – Integrated Concepts for Reuse of Upgraded Wastewater*. AQUAREC. EVK1-CT-2002-00130 Deliverable D19. Retrieved on August 23, 2012 from http://www.amk.rwth-aachen.de/fileadmin/files/Forschung/Aquarec/D19_final_2.pdf.
- World Health Organization (WHO). 2006. *Guidelines for the Safe Use of Wastewater, Excreta and Greywater*. WHO. Geneva.
- World Health Organization (WHO). 1989. "Health Guidelines for the Use of Wastewater in Agriculture and Aquaculture." *Technical Report Series 778*. WHO. Geneva.
- World Health Organization (WHO). 2004. *The Global Burden of Disease: 2004 Update*. Retrieved April 3, 2012. http://www.who.int/healthinfo/global_burden_disease/2004_report_update/en/index.html.
- Xinhua. 2011. "China's Municipal Wastewater Treatment Rate Up By 24 Percentage Points." *Xinhua News*, March 15, 2011.

APPENDIX A

Funding for Water Reuse Research

A.1 Federal Agency Reuse Research

Several federal agencies provide funding for various aspects of water reuse research, including EPA, USAID, U.S. Bureau of Reclamation (USBR), USDA, U.S. Geological Survey (USGS), the Centers for Disease Control and Prevention (CDC), the Department of Energy (DOE), and the National Science Foundation (NSF). The only agency with a specific directive driving research in water reuse is USBR, which is focused mainly on water quantity. EPA's research looks at water quality, while DOE's research examines the energy requirements of water reuse. USDA focuses on the benefits of water reuse in agriculture. USDA, CDC, and USGS fund research examining public health and water reuse. USAID's research targets water reuse as a component of sustainable development in developing countries and as a collaboration tool for developing peace and security between nations. NSF funds water reuse research around the themes of water treatment technology and infrastructure renewal.

A.1.1 EPA

Water reuse is relevant to the water elements of EPA's 2011-2015 Strategic Plan (EPA, N.D.), which include strengthening water quality standards, adoption of sustainable management practices, and promoting innovative, cost-effective practices to protect water quality. EPA has many ongoing efforts related to water reuse, with no single lead office on the topic. Research that supports water reuse includes EPA's program on human health effects of chemicals (using screening and laboratory studies) and pathogens (using epidemiological data). Advances in analytical methods and monitoring are supported through research with the Unregulated Contaminant Monitoring Rule (UCMR) program. The program also collects and analyzes data on the occurrence of endocrine-disrupting chemicals in the environment to better understand human health and environmental effects (NRC, 2012).

A.1.2 USAID

USAID has a major programmatic focus on integrated water resources management and in water and sanitation for health in developing countries. USAID

has sponsored projects to implement nonpotable water reuse projects in India, Jordan, Morocco, Philippines, Thailand, and West Bank/Gaza, as illustrated in several case studies.

USAID also provides some funding for water reuse research in three different programmatic areas. First, USAID supports the Consultative Group on International Agricultural Research (CGIAR), which is global partnership that unites organizations engaged in research for sustainable development. Part of the CGIAR research portfolio includes research in the area of water reuse and resource recovery. This research is described further in Chapter 9 in the text box "Resource Recovery and Reuse: a Strategic Research Portfolio."

USAID's Middle East Research Cooperation Program (MERC) was created in 1979 to promote Arab-Israeli cooperation through joint applied research projects; and to contribute to the peace process through the establishment of cooperative relationships that will last beyond the life of the projects. As part of its portfolio of research, MERC has funded peer-reviewed cooperative projects in the areas of agriculture, health, environment, economics, and engineering, including wastewater treatment and water reuse. Case studies from Israel, Jordan, and West Bank/Gaza include examples of MERC-funded projects [[Israel/Jordan-AWT Crop Irrigation](#); [Israel/Palestinian Territories/Jordan-Olive Irrigation](#); [Israel/Jordan-Brackish Irrigation](#)].

USAID's U.S.-Israel Cooperative Development Research (CDR) Program was created in 1985 to support joint research projects between Israeli (and U.S.) scientists with their counterparts in developing countries around the globe to address problems facing the developing-country partners. Each project's budget is spent primarily on capacity-building measures in the participating developing country such as student training, essential equipment and outreach. As part of its portfolio of research, CDR has funded peer-reviewed cooperative projects in the areas of agriculture, health, and environment, including wastewater treatment and water reuse. CDR is,

however, presently closed to new applications. A CDR case study from Israel and Peru is included [Case study: [Israel/Peru - Vertical Wetlands](#)].

A.1.3 USBR

The only federal agency with a directive to fund water reuse research is USBR. The USBR water reclamation and reuse program is authorized by the Reclamation Wastewater and Groundwater Study and Facilities Act of 1992 (Title XVI of Public Law 102-575) (USBR, 2009). Also known as Title XVI, the act directs the Secretary of the Interior to undertake a program to investigate and identify opportunities for water reclamation and reuse of municipal, industrial, domestic and agricultural wastewater, and naturally impaired ground and surface waters, and for design and construction of demonstration and permanent facilities to reclaim and reuse wastewater. It also authorized the Secretary to conduct research, including desalting, for the reclamation of wastewater and naturally impaired ground and surface waters. Currently, funding is used for demonstration and desalination projects and the WateReuse Research Foundation. Reclamation's partnership with the WateReuse Research Foundation funds applied research in the areas of water reclamation, reuse and desalination. Both solicited and unsolicited projects are funded for cutting edge research that expands the water and wastewater communities knowledge in a wide range of subjects, which include: chemistry and toxicology; desalination and concentrate management; microbiology and disinfection; natural systems, groundwater recharge, storage; policy, social sciences, and applications; treatment technologies. The Foundation is funded primarily by a group of subscribers, which typically include: water and wastewater utilities, consulting firms, equipment suppliers and other organizations. Reclamation's financial contributions supplement these subscriber funds.

Active reclaimed water research funded by the 2008 National Irrigation Water Quality Program (NIWQP) of USBR sought to develop tools and guidelines for risk management decisions based on the microbial monitoring of surface derived irrigation water and assessing potential risks from using treated effluent for irrigation of food crops in the Lower Colorado River Basin. Project directors are finalizing the determination of the variation and environmental factors affecting the microbial risks from reclaimed irrigation water,

identifying relationships among total fecal coliform, generic *E. coli*, and *E. coli* O157:H7 in irrigation water and corresponding levels found in irrigated vegetables, shaping criteria needed to estimate cumulative risk of reclaimed irrigation water followed by appropriate testing and decision tools, assess the microbial risk, and conduct an aggressive outreach program to implement irrigation water risk assessment management practices.

A.1.4 USDA

USDA has interest in water reuse as an alternative reliable supply of water for irrigation. USDA currently funds research on the potential health and agricultural sector effects of using reclaimed water for crops. USDA/NIFA has made funding for water reuse research, education, and extension one of its priorities. As a result of the 2005 Agricultural Water Security Listening Session (Dobrowolski and O'Neill, 2005), NIFA (formerly the Cooperative State Research, Education and Extension Service, CSREES) chose to develop three research, education, and extension themes. These three themes—biotechnology, conservation, and reclaimed water—fit within the research and education challenges (water availability, quantity and quality, water use, and water institutions) described by the National Research Council (2004). Subsequent to the 2005 session, NIFA sponsored two specialty conferences in 2007 and 2008 in partnership with the WateReuse Association titled “Water Reuse in Agriculture Opportunities and Challenges” and “Water Reuse in Agriculture Ensuring Food Safety.” The purpose of the conferences is to provide a forum for discussion, collaboration, and coordinated funding in reclaimed water among USDA agencies and others. More recently, the Research, Education, and Economics mission area of USDA drafted a Strategic Action Plan with water as a sub-goal and recycled water in agriculture as an action item for both research agencies. This included a commitment to invest in research, development, and extension of new irrigation techniques and management of limited water resources, including strategies for water reuse. NIFA-funded research includes studies on impacts of reclaimed water on plants and soils, treatment methods to prevent impacts to soils, long-term effects of irrigating with reclaimed water, minimizing food safety hazards, and fate of pharmaceuticals and hormones in agricultural production.

USDA/NIFA's Agriculture and Food Research Initiative (AFRI) Foundational program in 2010 funded six projects currently investigating the bioaccumulation and potential contamination of reclaimed water constituents applied at typical irrigation rates used exclusively or through blending with surface and ground water sources. NIFA awarded these projects competitively, evaluated by peer-review panels. Scientists focused their studies on six issues:

- The bioaccumulation of pharmaceutical and personal care products (PPCPs) by common vegetables and fruit (lettuce, cabbage, bell pepper, tomato, carrot, parsley, radish, and strawberry) in both field and greenhouse hydroponic experiments irrigating with treated wastewater.
- The dose-dependent bioaccumulation of chemicals of emerging concern (CEC) assessed in both laboratory and field studies with reclaimed water fortified with CECs; subsequent studies will examine the effects of soil organic matter and cumulative use of recycled water on selected crops eaten fresh.
- The uptake of reclaimed water chemicals from irrigation of commonly grown vegetable crops with water containing several isotopically labeled chemicals, using a range of irrigation regimens to simulate varying degrees of water stress.
- The integration of hydroponic, column, and greenhouse studies to evaluate bioaccumulation of antimicrobials by food crops with fate modeling and risk assessment to determine relevance; with results synthesized into an assessment of health risk from antimicrobial exposure through food, water, and reclaimed water use.
- The minimization of antibiotic resistant (ABR) Salmonella in vegetables irrigated with reclaimed water; identifying the fate of ABR Salmonella in soil and lettuce after irrigation, and developing best management practices both lowering pathogen levels through blending water source and avoiding using reclaimed water at critical stages of plant growth, to minimize accumulation in lettuce.

- The clear understanding of the fate and potential bioaccumulation of estrogenic chemicals (endocrine disrupting compounds, EDCs) within the edible portion of crop plants through root and foliar exposure followed by sap flow and plant extraction methodologies; results will be useful for predicting bio-concentration potential, potential dietary intake, and risks to human health.

NIFA also collects annual information on the extent of the use of reclaimed water in irrigation in an annual inventory of farms conducted by its National Agricultural Statistics Service (NRC, 2012). This research will provide a more in-depth understanding of the impacts of long-term water reuse on the nation's agricultural sector.

A.1.5 USGS

USGS supports water reuse research through its Water Census, aquifer storage and recovery (ASR) program, and program on the occurrence of human-use compounds in the nation's surface waters. The Water Census is nation-wide accounting of water supplies and water use in the United States, which is cited in Chapter 5 for each region of the United States. The ASR research program looks at how geochemistry changes with subsurface storage of water. USGS's surface water program has also conducted extensive research on the occurrence, pathways, uptake, and effects of these human-derived contaminants, including from wastewater (NRC, 2012).

A.1.6 CDC

The CDC has supported research on water reuse as a means to protect human health during drought conditions and a research project to enhance capacity to investigate links between wastewater, groundwater contamination, and human health (NRC, 2012).

A.1.7 DOE

As part of DOE's National Energy Technology Laboratory's efforts to reduce water demands in energy production, DOE is conducting research on the technical, financial, and long-term challenges and benefits associated with using reclaimed wastewater for power plant cooling (NRC, 2012).

A.1.8 NSF

NSF sponsors one fifth of the water resources research in the United States (NRC, 2004), but does

not have a specific funding emphasis on water reuse. Water reuse is a consideration under many of the urban/suburban focused “Water Sustainability and Climate” grants, a new NSF initiative. The goal of these grants is to assess the overall impact of decisions about water resources, including downstream impacts on water quality. An NSF-funded center on water treatment technology (the Center of Advanced Materials for the Purification of Water with Systems (WaterCAMPWS) includes research related to water reuse technologies (NRC, 2012). Another NSF-funded engineering research center ReNWUIt brings together environmental engineering, earth sciences, hydrology, ecology, urban studies, economics, and law to address the nation’s urban water infrastructure.

A.2 Non-Governmental Organization (NGO)-Sponsored Research

Several U.S.-based and international NGOs sponsor research in water reuse.

A.2.1 Global Water Research Coalition (GWRC)

The GWRC is a collaboration between 12 research organizations around the globe, with partnership from EPA. The GWRC aims to leverage funding and expertise toward water quality research of global interest (NRC, 2012).

A.2.2 National Water Research Institute

The National Water Research Institute (NWRI) supports research and outreach related to ensuring clean and reliable water. NWRI was founded in 1991 and has six member organizations, all based in Southern California. NWRI has invested over \$17 million in research, largely focused on water reuse since its member organizations have strong interest in sustainable water solutions. Research has included disinfection guidelines for water reuse, the fate and transport of trace organic contaminants, subsurface transport of bacteria and viruses, and use of bioassays and monitoring to assess trace contaminant removal in water reuse (NRC, 2012).

A.2.3 Water Environment Research Foundation

The Water Environment Research Foundation (WERF) is a subscriber-based organization that funds wastewater- and stormwater-related research. WERF’s areas of active water reuse research include:

- Advanced wastewater treatment processes for removal of trace organic compounds
- Fate and transport of trace organic chemicals in treated municipal wastewater used for turf irrigation
- Demonstration of membrane zero liquid discharge technologies as a long-term solution for concentrate disposal following municipal wastewater treatment
- Demand, waste and cost estimation tools for urban water management
- Source separation of household graywater from blackwater for graywater reuse
- Fate and transport of chemical and pathogen constituents in household graywater used for landscape irrigation
- Technologies and practices for sustainable stormwater reuse

A.2.4 WateReuse Research Foundation

The WateReuse Research Foundation is an educational, nonprofit public benefit corporation that serves as a centralized organization for the water and wastewater community to advance the science of water reuse, recycling, reclamation, and desalination. The Foundation funds research covering a broad spectrum of issues, including chemical contaminants, microbiological agents, treatment technologies, salinity management, public perception, economics, marketing, and industrial reuse.

The Research Foundation's primary sources of funding are its subscribers and its funding partners, which include the Bureau of Reclamation, the California State Water Resources Control Board, and the California Energy Commission. The Foundation's subscribers include water and wastewater agencies and other interested organizations. The Foundation is committed to pursuing new partners to collaborate on research and leverage resources.

Full reports are available for purchase through the WateReuse Research Foundation website (<http://www.watereuse.org/foundation/publications>).

A.2.5 Water Research Foundation

The Water Research Foundation (formerly known as the American Water Works

Association Research Foundation) supports applied research related to drinking water. The Water Research Foundation is a subscriber-based organization. Water reuse-related research has included research on soil aquifer treatment and on trace organic contaminants in drinking water, including assessment of exposure, improvements in analytical methods, and improved frameworks for risk communication for utilities (NRC, 2012).

A.3 Research Funding Outside the U.S.

This section describes government initiatives in Australia, Egypt, and Qatar to fund water reuse research. Though this is not meant to be comprehensive of global efforts; instead it illustrates the interest in water reuse by many countries around the world.

A.3.1 Australian Federal Funding

In Australia, water reuse (generally referred to as water recycling in Australia) has been growing at around 10% per year over the past 5 years. Rapidly growth in investment in reuse began in the mid 2000s, partially in response to a dry period from 2001 to 2009. For urban areas the greatest value of water reuse is attached to replacement of potable demand. Concurrent with the rapid investment in water reuse projects, state and federal government agencies, water utilities, research institutions and the broader water sector embarked upon a rapid increase in water reuse research. There were two major driving forces behind this increased research investment.

First, national health and environmental guidelines were developed for potable and non-potable water reuse. In response to conservative targets based on existing data, regulators and utilities soon identified a range of research needs to manage and reduce treatment costs while ensuring that risk management and prevention remained the critical underpinning of water reuse projects.

Second, politics around potable reuse drove investments in research. In a referendum in Toowoomba, Queensland in 2006, the community voted against potable reuse to alleviate their water supply problems. This highlighted the need for greater

community engagement and how political water decisions could be. Just a few years later, having spent billions on an indirect potable reuse scheme in South East Queensland, elected officials decided at the last minute to set very conservative requirements to introduce highly purified water into the local surface reservoirs that would not be reached for many years and beyond the subsequent few electoral cycles. Again, potable reuse had been stymied by politics.

This background leads to the current state of water reuse research in Australia which is well funded and is addressing the highest priority issues:

1. The Federal Government has provided \$20 million dollars (over 5 years) to develop a Centre of Excellence. The Australian Water Recycling Centre of Excellence is now half way through its term and has 4 major research goals encompassing community and stakeholder acceptance of potable reuse, developing a national framework for validation of treatment technologies, a program of projects dedicated to understanding and measuring the sustainability of water recycling, and development of skills and capability in managing the complexity of water reuse projects from a planning, technological and operational perspective.
2. Water utilities have had an ongoing research program working both collaboratively through Water Services Association of Australia, Water Quality Research Australia and through local and state based Research collaborations including the Smart Water Fund in Victoria and the Urban Water Security Research Alliance in Queensland. These collaborative research programs continue to generate highly valued research in water quality, health and ecosystem protection and sustainability analysis. Water utilities also undertake their own research on water reuse covering issues such as treatment technology and validation and customer and community research.
3. More recently, the Federal Government has provided multi million dollars of funding over 8 years to a Cooperative Research Centre on Water Sensitive Cities which, inter alia, will be addressing the next frontier of water reuse, the safe and sustainable use of storm water harvesting. This large national collaboration

brings together researchers, industry, governments and utilities to research approaches to urban water management that encompass traditional water supplies, water reuse from sewage, graywater and storm water and the integration of desalinated supplies.

Other research entities funding water reuse research in Australia include the National Groundwater Centre of Excellence and the Commonwealth Scientific and Industrial Research Organisation (CSIRO), Australia's national science agency. These entities undertake water reuse research under contract or through strategic partnerships. In addition, in 2012 the Australian Water Recycling Centre of Excellence (AWRCE) announced Aus\$ 3 million (US\$ 3 million) for a research project to investigate and address the barriers to public acceptance of reusing water for augmenting drinking water supplies.

A.3.2 Egypt National Water Research Center (NWRC)

Egypt's NWRC funds research on drainage water reuse that is conducted by the Drainage Research Institute (one of the NWRC twelve institutes), through its governmental budget. Research areas under this topic include drainage water quantity and quality monitoring and assessment and simulation of national drainage water reuse policy in the context of integrated water resources management of the Nile Delta. The NWRC also provides guidelines for drainage water reuse in irrigating old and newly reclaimed lands.

A.3.3 Qatar National Research Fund (QNRF) and Qatar Water Sustainability Center

The purpose of the Qatar National Research Fund (QNRF) is to foster a research culture in Qatar. Water reuse is one of the research areas identified as relevant to Qatar's national needs, based on an internal study commissioned by Qatar Foundation after consultation with a variety of relevant stakeholders in Qatar. The Global Water Sustainability Center will work with industrial and municipal organizations in Qatar to promote water recycling and reuse.

References

- Dobrowolski, J.P. and M.P. O'Neill. 2005. *Agricultural Water Security Listening Session Final Report*. USDA REE. Washington, D.C.
- National Council for Science and the Environment. 2004. *Water for a Sustainable and Secure Future: A Report of the Fourth National Conference on Science, Policy and the Environment*. Washington, D.C.
- National Research Council (NRC). 2004. *Confronting the Nation's Water Problems: The Role of Research*. National Academies Press: Washington, DC.
- National Research Council (NRC). 2012. *Water Reuse: Potential for Expanding the Nation's Water Supply Through Reuse of Municipal Wastewater*. The National Academies Press: Washington, D.C.
- U.S. Bureau of Reclamation. (USBR) 2009. *Title XVI (Water Reclamation and Reuse) Program*. Retrieved July 31, 2012. <<http://www.usbr.gov/lc/social/titlexvi.html>>.
- U.S. Environmental Protection Agency (EPA). N.D. *An Introduction to the Water Elements of the EPA's Strategic Plan*. Retrieved July 31, 2012. <http://water.epa.gov/aboutow/goals_objectives/goals.cfm>.

APPENDIX B

Inventory of Recent Water Reuse Research Projects and Reports

| Project Number | Publication Date | Title | Organization |
|----------------|------------------------|---|-------------------------------------|
| - | 2009 | Sustainable Wastewater Management in Developing Countries: New Paradigms and Case Stories from the Field | American Society of Civil Engineers |
| - | 2009 | Planning for the Distribution of Reclaimed Water | AWWA |
| - | 2012 (pre-publication) | Assessment of Water Reuse as an Approach for Meeting Future Supply Needs | AWWA |
| - | | Advanced Oxidation of Pharmaceuticals and Personal Care Products: Preparing for Indirect and Direct Water Reuse | AWWA |
| - | 2008 | Survey of High Recovery and Zero Liquid Discharge Technologies for Water Utilities | AWWA |
| - | 2008 | Regional Solutions for Concentrate Management | AWWA |
| - | 2008 | The Impacts of Membrane Process Residuals on Wastewater Treatment: Guidance Manual | AWWA |
| - | 2011 | Membrane Treatment of Impaired Irrigation Return and Other Flows: Creating New Sources of High Quality Water | AWWA |
| - | | Research Strategy for Water Reuse Workshop | AWWA |
| - | 2008 | Inland Membrane Concentrate Treatment Strategies for Water Reclamation Systems | AWWA |
| - | 2008 | Design, Operation and Maintenance for Sustainable Underground Storage Facilities | AWWA |
| - | 2007 | Comparing Nanofiltration and Reverse Osmosis for Treating Recycled Water | AWWA |
| - | 2009 | Water Quality Changes During Aquifer Storage and Recovery | AWWA |
| - | 2006 | Organic Nitrogen in Drinking Water and Reclaimed Water | AWWA |
| - | 2004 | Industrial Water Quality Requirements for Reclaimed Water | AWWA |
| - | 2005 | Water Quality Improvements During Aquifer Storage and Recovery | AWWA |
| - | 2003 | ASR in Wisconsin Using the Cambrian-Ordovician Aquifer | AWWA |
| - | 2003 | Comparison of Alternative Methods of Recharge of a Deep Aquifer | AWWA |
| - | 1996 | Aquifer Storage and Recovery of Treated Drinking Water | AWWA |
| - | 2002 and 2006 | Investigation of Soil-Aquifer Treatment for Sustainable Water Reuse | AWWA |
| - | 1998 | Issues with Potable Reuse: The Viability of Augmenting Drinking Water Supplies with Reclaimed Water | AWWA |
| - | 2004 | Industrial Water Quality Requirements for Reclaimed Water | AWWA Research Foundation |

| Project Number | Publication Date | Title | Organization |
|----------------|------------------|---|---------------------------------------|
| - | 2007 | Removal of EDCs and Pharmaceuticals in Drinking and Reuse Treatment Processes | AWWA Research Foundation |
| - | 2006 | Characterizing and Managing Salinity Loadings in Reclaimed Water Systems | AWWA Research Foundation |
| 94-PUM-1CO | 1998 | Soil Treatability Pilot Studies to Design and Model Soil Aquifer Treatment Systems | AWWAWERF |
| - | 2010 | Whitepaper on Graywater | AWWAWERF/ WaterReuse Foundation |
| - | 2009 | Technical Memorandum on Gray Water | Black and Veatch |
| - | 2005 | Water Reuse for Irrigation: Agriculture, Landscapes, and Turf Grass | Chemical Rubber Company Press |
| - | 2006 | Growing Crops with Reclaimed Wastewater | CSIRO Publishing |
| - | 2009 | Sustainable Water for the Future, Volume 2: Water Recycling Versus Desalination | Elsevier, Amsterdam Netherlands |
| - | 2010 | Municipal Water Reuse Markets 2010 | Global Water Intelligence |
| - | 2012 | Water-Energy Interactions in Water Reuse | International Water Association |
| - | 2008 | Water Reuse: An International Survey of Current Practice, Issues and Needs | International Water Association |
| - | 2012 | Sustainable Treatment and Reuse of Municipal Wastewater for Decision Makers and Practicing Engineers | International Water Association |
| - | | Milestones in Water Reuse: The Best Success Stories | International Water Association |
| - | 2006 | Water Reuse: Issues, Technologies, and Applications | McGraw-Hill |
| - | 2012 | Water Reuse: Potential for Expanding the Nation's Water Supply through Reuse of Municipal Wastewater | National Research Council |
| - | 2011 | Water Recycling and Water Management (Water Resource Planning, Development and Management) | Nova Science Publishers |
| - | 2011 | Onsite Residential and Commercial Water Reuse Treatment Systems | NSF |
| - | Jan-12 | Direct Potable Reuse: Benefits for Public Water Supplies, Agriculture, the Environment, and Energy Conservation | NWRI |
| - | Apr-10 | Regulatory Aspects of Direct Potable Reuse in California | NWRI |
| - | 2008 | Efficient Management of Wastewater: Its Treatment and Reuse in Water-Scarce Countries | Springer-Verlag, Berlin Germany |
| - | 2011 | Waste Water Treatment and Reuse in the Mediterranean Region | Springer-Verlag, Berlin Germany |
| - | 2009 | Development of Indicators and Surrogates for Chemical Contaminant Removal During Wastewater Treatment and Reclamation | Water Environment Research Foundation |
| - | 2006 | Advances in Soil Aquifer Treatment Research for Sustainable Water Reuse | Water Environment Research Foundation |
| - | 2007 | Towards an Innovative DNA Array Technology for Detection of Pharmaceuticals in Reclaimed Water | Water Environment Research Foundation |
| - | 2005 | Membrane Treatment of Secondary Effluent for Subsequent Use | Water Environment Research Foundation |
| - | 2006 | Long-Term Effects of Landscape Irrigation Using Household Graywater | Water Environment Research Foundation |
| - | 2011 | Guidance Manual for Separation of Graywater from Blackwater for Graywater Reuse | Water Environment Research Foundation |

| Project Number | Publication Date | Title | Organization |
|----------------|------------------|---|---------------------------------------|
| - | 2004 | Evaluation of Microbial Risk Assessment Techniques and Applications | Water Environment Research Foundation |
| - | 2008 | Using Reclaimed Water to Augment Potable Water Resources | Water Environment Research Foundation |
| 92-WRE-1 | - | Water Reuse Assessment | Water Environment Research Foundation |
| 92-HHE-1-CO | - | Use of Reclaimed Water and Sludge in Food Crop Production | Water Environment Research Foundation |
| 97-IRM-6 | - | Non-Potable Water Reuse Management Practices | Water Environment Research Foundation |
| 98-CTS-1 | - | Research Needs to Optimize Wastewater Resource Utilization | Water Environment Research Foundation |
| 98-CTS-5 | - | Feasibility and Application of Membrane Bioreactor Technology for Water Reclamation | Water Environment Research Foundation |
| 98-HHE-1 | - | Cryptosporidium in Wastewater Occurrence, Removal and Inactivation | Water Environment Research Foundation |
| 98-PUM-1CO | - | A Comparative study of Physiochemical Properties and Filtration of Several Human and Bacteria Viruses: Implication for Groundwater Recharge | Water Environment Research Foundation |
| 99-HHE-1 | - | Effects of Wastewater Disinfection on Human Health | Water Environment Research Foundation |
| 99-HHE-4ET | - | Handheld Advanced Nucleic Acid Analyzer (HANNA) for Waterborne Pathogen Detection | Water Environment Research Foundation |
| 99-HHE-5-UR | - | Development of Molecular Methods for Detection of Infectious Viruses in Treated Wastewater | Water Environment Research Foundation |
| 99-PUM-4 | - | Impact of Surface Storage on Reclaimed Water: Seasonal and Long Term | Water Environment Research Foundation |
| 99-WWF-6 | - | Online Monitoring of Water Effluent Chlorination Using ORP vs. Residual Chlorine Measurement | Water Environment Research Foundation |
| 00-CTS-8 | - | Membrane Technology: Feasibility of Solid/Liquid Separation in Wastewater Treatment | Water Environment Research Foundation |
| 00-CTS-11 | - | Membrane Technology: Pilot Studies of Membrane-Aerated Bioreactors | Water Environment Research Foundation |
| 00-CTS- 14-ET | - | A Novel Membrane Process for Autotrophic Denitrification | Water Environment Research Foundation |
| 00-HHE-2A | - | Overcoming Molecular Sample Processing Limitations: New Platform Technologies | Water Environment Research Foundation |
| 00-HHE-2C | - | Overcoming Molecular Sample Processing Limitations: Quantitative PCR | Water Environment Research Foundation |
| 00-HHE-7-CO | - | Endocrine Disruptors and Pharmaceutically Active Chemicals in Drinking Water | Water Environment Research Foundation |
| 00-HHE-2C | - | Overcoming Molecular Sample Processing Limitations: Fiber Optic Biosensors | Water Environment Research Foundation |
| 00-PUM-1 | - | Water Reuse: Understanding Public Perception and Participation | Water Environment Research Foundation |
| 00-PUM-2T | - | Reduction of Pathogens, Indicator Bacteria, and Alternative Indicators by Wastewater Treatment and Reclamation Processes | Water Environment Research Foundation |
| 00-PUM-3 | - | Evaluation of Microbial Risk Assessment Techniques and Applications | Water Environment Research Foundation |
| 00-WSM-6 | - | Strategies for Sustainable Water Resource Management | Water Environment Research Foundation |

| Project Number | Publication Date | Title | Organization |
|------------------------|------------------|---|---------------------------------------|
| 00-WSM-6A | - | Moving Towards Sustainable Water Resources Management: A Framework and Guidelines for Implementation | Water Environment Research Foundation |
| 01-CTS-6 and 01-CTS-6A | - | Membrane Treatment of Secondary Wastewater Effluent for Subsequent Use | Water Environment Research Foundation |
| 01-CTS-19-UR | - | Effects of Biosolids Properties on Membrane Bioreactors and Solids Processing | Water Environment Research Foundation |
| 01-CTS-31-ET | - | Dynamic Medialess Microfiltration for Membrane Prefiltration | Water Environment Research Foundation |
| 01-HHE-1 | - | Applications of DNA Microarray Technology for Wastewater Analysis | Water Environment Research Foundation |
| 01-HHE-2A | - | Molecular Alternatives to Indicator and Pathogen Detection: Real-Time PCR | Water Environment Research Foundation |
| 01-HHE-4A | - | Online Methods of Evaluating the Safety of Reclaimed Water | Water Environment Research Foundation |
| 02-CTS-4 & 02-CTS-4A | - | Membrane Bioreactors for Anaerobic Treatment of Wastewaters | Water Environment Research Foundation |
| 03-CTS-17cCO | - | Impacts of Membrane Process Residuals on Wastewater Treatment | Water Environment Research Foundation |
| 03-CTS-18C0 | - | Long-Term Effects of Landscape Irrigation Using Household Graywater | Water Environment Research Foundation |
| 03-CTS-22-UR | - | Fate of Pharmaceuticals and Personal Care Products through Wastewater Treatment Processes | Water Environment Research Foundation |
| 04-SW-1 | - | Using Rainwater to Grow Livable Communities | Water Environment Research Foundation |
| 04-HHE-3 | - | Microbial Risk Assessment Interface Tool and User Documentation Guide | Water Environment Research Foundation |
| 06-CTS-1C0 | - | Long-Term Study on Landscape Irrigation using Household Graywater- Experimental Study (Phase 2) | Water Environment Research Foundation |
| DEC3R06 | - | When to Consider Distributed Systems in an Urban and Suburban Context | Water Environment Research Foundation |
| - | 2007 | Dewatering Reverse Osmosis Concentrate from Water Reuse Applications Using Forward Osmosis | WateReuse Foundation |
| - | 2009 | How to Develop a Water Reuse Program : Manual of Practice | WateReuse Foundation |
| - | 2010 | Reaction Rates and Mechanisms of Advanced Oxidation Processes (AOP) for Water Reuse | WateReuse Foundation |
| - | 2005 | Irrigation of Parks, Playgrounds, and Schoolyards with Reclaimed Water: Extent and Safety | WateReuse Foundation |
| - | 2006 | Rejection of Wastewater-Derived Micropollutants in High-Pressure Membrane Applications Leading to Indirect Potable Reuse: Effects of Membrane and Micropollutant Properties | WateReuse Foundation |
| - | 2009 | The Psychology of Water Reclamation and Reuse : Survey Findings and Research Roadmap | WateReuse Foundation |
| - | 2006 | Marketing Nonpotable Recycled Water | WateReuse Foundation |
| - | 2004 | Water Reuse Economic Framework Workshop Report | WateReuse Foundation |
| - | 2011 | Talking About Water : Vocabulary and Images That Support Informed Decisions About Water Recycling and Desalination | WateReuse Foundation |
| - | 2006 | An Economic Framework for Evaluating the Benefits and Costs of Water Reuse | WateReuse Foundation |

| Project Number | Publication Date | Title | Organization |
|----------------|------------------|---|-----------------------|
| - | 2004 | Best Practices for Developing Indirect Potable Reuse Projects: Phase 1 Report | WaterReuse Foundation |
| - | 2008 | The Impacts of Membrane Process Residuals on Wastewater Treatment Guidance Manual | WaterReuse Foundation |
| - | 2011 | Optimization of Advanced Oxidation Processes for Water Reuse : Effect of Effluent Organic Matter on Organic Contaminant Removal | WaterReuse Foundation |
| - | 2010 | Low-Cost Treatment Technologies for Small-Scale Water Reclamation Plants | WaterReuse Foundation |
| - | 2011 | Direct Potable Reuse : A Path Forward | WaterReuse Foundation |
| - | 2010 | Oxidative Treatment of Organics in Membrane Concentrates | WaterReuse Foundation |
| WRF-01-001 | Dec-05 | Alternative Methods for the Analysis of NDMA and Other Nitrosamines in Water and Wastewater | WaterReuse Foundation |
| WRF-01-002 | May-06 | Removal and/or Destruction of NDMA in Wastewater Treatment Processes | WaterReuse Foundation |
| WRF-01-004 | Jun-05 | Best Practices for Developing Indirect Potable Reuse Projects: Phase 1 Report | WaterReuse Foundation |
| WRF-01-005 | May-06 | Characterizing and Managing Salinity Loadings in Reclaimed Water Systems (AWWARF 91009) | WaterReuse Foundation |
| WRF-01-006 | May-06 | Characterizing Microbial Water Quality in Reclaimed Water Distribution Systems (AWWARF 91072F) | WaterReuse Foundation |
| WRF-01-007 | 2006 | Removal of Endocrine Disrupting Compounds in Water Reclamation Processes (WERF 01HHE20T) | WaterReuse Foundation |
| WRF-01-008 | 2007 | Innovative DNA Array Technology for Detection of Pharmaceuticals in Reclaimed Water (WERF 01HHE21T) | WaterReuse Foundation |
| WRF-02-001 | May-06 | Rejection of Wastewater-Derived Micropollutants in High-Pressure Membrane Applications | WaterReuse Foundation |
| WRF-02-002 | Jun-06 | Investigation of NDMA Fate and Transport | WaterReuse Foundation |
| WRF-02-003 | Aug-11 | Filter Loading Evaluation for Water Reuse | WaterReuse Foundation |
| WRF-02-004 | Nov-08 | National Database on Water Reuse Facilities - Summary Report | WaterReuse Foundation |
| WRF-02-006a | Aug-08 | Survey of High Recovery and Zero Liquid Discharge Technologies for Water Utilities | WaterReuse Foundation |
| WRF-02-006b | Sep-06 | Beneficial and Non-Traditional Uses of Concentrate | WaterReuse Foundation |
| WRF-02-006c | Jul-08 | The Impacts of Membrane Process Residuals on Wastewater Treatment | WaterReuse Foundation |
| WRF-02-006d | Aug-08 | Regional Solutions for Concentrate Management | WaterReuse Foundation |
| WRF-02-007 | 2003 | Using Surfactants in Optimizing Water Usage on Turf Grasses | WaterReuse Foundation |
| WRF-02-008 | Mar-09 | A Reconnaissance-Level Quantitative Comparison of Reclaimed Water, Surface Water, and Groundwater | WaterReuse Foundation |
| WRF-02-009 | Aug-12 | Study of Innovative Treatment on Reclaimed Water | WaterReuse Foundation |
| WRF-02-011 | 2005 | Framework for Developing Water Reuse Criteria with Reference to Drinking Water Supplies (UKWIR 05/WR/29/1) | WaterReuse Foundation |
| WRF-03-001 | 2007 | Pathogen Removal and Inactivation in Reclamation Plants - Study Design | WaterReuse Foundation |
| WRF-03-005 | Sep-06 | Marketing Nonpotable Recycled Water: A Guidebook for Successful Public Outreach & Customer Marketing | WaterReuse Foundation |
| WRF-03-006-01 | 2004 | Water Reuse Economic Framework Workshop Report | WaterReuse Foundation |

| Project Number | Publication Date | Title | Organization |
|----------------|------------------|---|----------------------|
| WRF-03-006-02 | Sep-06 | An Economic Framework for Evaluating Benefits and Costs of Water Reuse | WateReuse Foundation |
| WRF-03-009 | Aug-07 | Reclaimed Water Aquifer Storage and Recovery: Potential Changes in Water Quality | WateReuse Foundation |
| WRF-03-010 | 2004 | Water Reuse Foundation's Water Reuse Research Needs Workshop | WateReuse Foundation |
| WRF-03-011 | 2004 | Research Needs Assessment Workshop on Integrating Human Reactions to Water Reclamation into Reuse Project Design | WateReuse Foundation |
| WRF-03-012 | Aug-08 | Salt Management Guide | WateReuse Foundation |
| WRF-03-013 | 2008 | Rejection of Contaminants of Concern by NF and ULPRO Membranes for Treating Water of Impaired Quality | WateReuse Foundation |
| WRF-03-014 | Dec-08 | Development of Indicators and Surrogates of Chemical Contaminants and Organic Removal in Wastewater and Water Reuse | WateReuse Foundation |
| WRF-04-001 | 2008 | Prospects for Managed Underground Storage of Recoverable Water | WateReuse Foundation |
| WRF-04-002 | May-06 | Effects of Recycled Water on Turfgrass Quality Maintained Under Golf Course Fairway Conditions | WateReuse Foundation |
| WRF-04-003 | 2008 | Toxicological Relevance of Endocrine Disruptors & Pharmaceuticals in Drinking Water (AWWARF 91238) | WateReuse Foundation |
| WRF-04-004 | Jan-09 | Honolulu Membrane Bioreactor Pilot Study | WateReuse Foundation |
| WRF-04-005 | Mar-12 | Use of Recycled Water for Community Gardens | WateReuse Foundation |
| WRF-04-006 | 2005 | Irrigation of Parks, Playgrounds, and Schoolyards with Reclaimed Water: Extent and Safety | WateReuse Foundation |
| WRF-04-007 | 2005 | GWRC Water Reuse Research Strategy | WateReuse Foundation |
| WRF-04-008 | Dec-09 | The Psychology of Water Reclamation and Reuse: Survey Findings and Research Roadmap | WateReuse Foundation |
| WRF-04-009 | Aug-12 | Reclaimed Water Inspection and Cross Connection Control Guidebook | WateReuse Foundation |
| WRF-04-010 | Nov-07 | Extending the IRP Process to Include Water Reuse and Other Non-Traditional Water Sources | WateReuse Foundation |
| WRF-04-011 | Nov-07 | Application of Microbial Risk Assessment Techniques to Estimate Risk Due to Exposure to Reclaimed Waters | WateReuse Foundation |
| WRF-04-012 | Aug-09 | Exploring, Interpreting, and Presenting Microbial Data Associated with Reclaimed Water Systems: A Guidance Manual | WateReuse Foundation |
| WRF-04-013 | Aug-10 | Improved Sample Collection and Concentration Method for Multiple Pathogen Detection | WateReuse Foundation |
| WRF-04-014 | Apr-09 | Decision Support System for Selection of Satellite vs. Regional Treatment for Reuse | WateReuse Foundation |
| WRF-04-016 | Jun-09 | A Protocol for Estimating Potential Water Quality Impacts of Recycled Water Projects | WateReuse Foundation |
| WRF-04-017 | Mar-10 | Reaction Rates and Mechanisms of Advanced Oxidation Processes (AOP) for Water Reuse | WateReuse Foundation |
| WRF-04-018 | 2009 | Contributions of Household Chemicals to Sewage and Relevance to Municipal Wastewater Systems and the Environment (WERF 03CTS21UR) | WateReuse Foundation |
| WRF-04-019 | Apr-09 | Methods for the Detection of Residual Concentrations of Hydrogen Peroxide in Advanced Oxidation Processes | WateReuse Foundation |

| Project Number | Publication Date | Title | Organization |
|----------------|------------------|--|-----------------------|
| WRF-04-021 | Dec-09 | Selecting Treatment Trains for Seasonal Storage of Reclaimed Water | WaterReuse Foundation |
| WRF-05-001 | Nov-09 | Evaluating Pricing Levels and Structures to Support Reclaimed Water Systems | WaterReuse Foundation |
| WRF-05-002 | Jan-10 | Microbiological Quality/Biostability of Reclaimed Water Following Storage and Distribution | WaterReuse Foundation |
| WRF-05-004 | Nov-11 | Development of Surrogates to Determine the Efficacy of Soil Aquifer Treatment Systems for the Removal of Organic Chemicals | WaterReuse Foundation |
| WRF-05-005 | Aug-10 | Identification of PPCPs for Screening Based on Persistence through Treatments used for Indirect Potable Reuse and Toxicity | WaterReuse Foundation |
| WRF-05-006 | Jan-11 | Evaluate Wetland Systems for Treated Wastewater Performance to Meet Competing Effluent Quality Goals | WaterReuse Foundation |
| WRF-05-007 | Jun-09 | Selection and Testing of Tracers for Measuring Travel Times in Groundwater Aquifers Augmented with Reclaimed Water | WaterReuse Foundation |
| WRF-05-008 | Sep-09 | The Effect of Salinity on the Removal of Contaminants of Concern during Biological Water Reclamation | WaterReuse Foundation |
| WRF-05-009 | Aug-07 | Dewatering Reverse Osmosis Concentrate from Water Reuse Applications Using Forward Osmosis | WaterReuse Foundation |
| WRF-05-010 | May-10 | Oxidative Destruction of Organics in Membrane Concentrates | WaterReuse Foundation |
| WRF-05-011 | Aug-09 | Formation and Fate of Chlorination Byproducts in Desalination Systems | WaterReuse Foundation |
| WRF-06-001 | Nov-08 | Conduct Survey Research to Obtain Information/Data from all Water Recycling Facilities in CA | WaterReuse Foundation |
| WRF-06-002 | Jan-09 | Developing a Pragmatic Research Agenda for Examining the Value of Water Supply Reliability | WaterReuse Foundation |
| WRF-06-003 | Expected Oct-12 | The Occurrence of Infectious Cryptosporidium Oocysts in Raw, Treated and Disinfected Wastewater | WaterReuse Foundation |
| WRF-06-004 | Aug-12 | Identifying Health Effects Concerns of the Water Reuse Industry and Prioritizing Research Needs for Nomination of Chemicals for Research | WaterReuse Foundation |
| WRF-06-005 | Dec-09 | Leaching of Metals from Aquifer Soils during Infiltration of Low-Ionic-Strength Reclaimed Water: Determination of Kinetics and Potential Mitigation Strategies | WaterReuse Foundation |
| WRF-06-006 | Expected Mar-13 | Comparisons of Chemical Composition of Recycled and Conventional Waters | WaterReuse Foundation |
| WRF-06-007 | Mar-12 | Investigation of Membrane Bioreactor Effluent Water Quality and Technology | WaterReuse Foundation |
| WRF-06-008 | Jul-10 | Low-Cost Treatment Technologies for Small-Scale Water Reclamation Plants | WaterReuse Foundation |
| WRF-06-009 | Expected Jan-13 | Predictive Models to Aid in Design of Membrane Systems for Organic Micropollutants Removal | WaterReuse Foundation |
| WRF-06-010a | Expected Oct-12 | State of the Science Review of Membrane Fouling: Organic, Inorganic, and Biological | WaterReuse Foundation |
| WRF-06-010b | Expected Sep-12 | Feasibility Study of Offshore Desalination Plants | WaterReuse Foundation |
| WRF-06-010d | Expected Dec-12 | Consideration for the Co-Siting of Desalination Facilities with Municipal and Industrial Facilities | WaterReuse Foundation |
| WRF-06-010e | Expected Jan-13 | Development of Selective Recovery Methods for Desalination Concentrate Salts | WaterReuse Foundation |

| Project Number | Publication Date | Title | Organization |
|----------------|------------------|--|----------------------|
| WRF-06-010f | 2010 | Post Treatment Stabilization of Desalinated Water (WaterRF 4079) | WateReuse Foundation |
| WRF-06-010g | 2011 | Assessing Seawater Intake Systems for Desalination Plants (WaterRF 4080) | WateReuse Foundation |
| WRF-06-011 | Expected Jan-13 | Enhanced Disinfection of Adenoviruses with UV Irradiation | WateReuse Foundation |
| WRF-06-012 | May-11 | Optimization of Advanced Oxidation Processes (AOP) for Water Reuse | WateReuse Foundation |
| WRF-06-013 | Expected Oct-12 | Investigating the Feasibility of MBR to Achieve Low Nitrogen Levels for Water Reuse | WateReuse Foundation |
| WRF-06-014 | Dec-11 | Characterization of US Seawaters & Development of Standardized Protocols for Evaluation of Foulants in Seawater RO Desalination | WateReuse Foundation |
| WRF-06-015 | Dec-10 | Sequential UV and Chlorination for Reclaimed Water Disinfection | WateReuse Foundation |
| WRF-06-016 | Jul-11 | Guidance on Links between Water Reclamation and Reuse and Regional Growth | WateReuse Foundation |
| WRF-06-017 | May-12 | Water Reuse in 2030: Identifying Future Challenges and Opportunities | WateReuse Foundation |
| WRF-06-018 | Apr-11 | Development and Application of Tools to Assess and Understand the Relative Risks of Regulated Chemicals in Indirect Potable Reuse Projects - Tasks 1-3 | WateReuse Foundation |
| WRF-06-018 | Nov-10 | Tool to Assess and Understand the Relative Risks of drugs and Other Chemicals in Indirect Potable Reuse Water: Development and Application | WateReuse Foundation |
| WRF-06-018 | Expected Oct-12 | Tool to Assess and Understand the Relative Risks of drugs and Other Chemicals in Indirect Potable Reuse Water: Executive Summary | WateReuse Foundation |
| WRF-06-019 | May-10 | Monitoring for Microcontaminants in an Advanced Wastewater Treatment Facility and Modeling Discharge of Reclaimed Water to Surface Canals for Indirect Potable Use | WateReuse Foundation |
| WRF-06-020 | Sep-11 | Attenuation of Emerging Contaminants in Streams Augmented with Recycled Water | WateReuse Foundation |
| WRF-06-021 | Jun-12 | Interagency Partnerships to Facilitate Water Reuse | WateReuse Foundation |
| WRF-07-01 | Expected Nov-12 | Validation of Microbiological Methods for Use with Reclaimed Waters | WateReuse Foundation |
| WRF-07-02 | Expected Oct-12 | Development of a Knowledge Base on Concentrate and Salt Management Practices | WateReuse Foundation |
| WRF-07-03 | Jul-11 | Talking About Water: Vocabulary and Images that Support Informed Decisions about Water Recycling and Desalination | WateReuse Foundation |
| WRF-07-04 | Expected Oct-12 | Evaluation of Impact of Nanoparticle Pollutants | WateReuse Foundation |
| WRF-07-05 | Expected Oct-12 | Membrane Distillation using Nanostructured Membranes | WateReuse Foundation |
| WRF-07-06 | Expected Oct-12 | Recycled Water Use in Zoo/Wildlife Facility Settings | WateReuse Foundation |
| WRF-08-01 | Nov-10 | Assessment of Approaches to Achieve Nationally Consistent Reclaimed Water Standards | WateReuse Foundation |
| WRF-08-02 | Dec-12 | Attenuation of PPCP/EDCs through Golf Courses using Reuse Water (WERF1C08) | WateReuse Foundation |
| WRF-08-04 | Expected Jan-13 | Approaches to Maintain Consistently High Quality Reclaimed Water in Storage and Distribution Systems | WateReuse Foundation |

| Project Number | Publication Date | Title | Organization |
|----------------|------------------|--|----------------------|
| WRF-08-05 | Expected Feb-13 | Use of Ozone in Water Reclamation for Contaminant Oxidation | WateReuse Foundation |
| WRF-08-06 | Expected Jan-13 | Evaluation of Alternatives to Domestic Ion Exchange Water Softeners | WateReuse Foundation |
| WRF-08-07 | Expected Nov-12 | Disinfection Guidelines for Satellite Water Recycling Facilities | WateReuse Foundation |
| WRF-08-08 | Expected Apr-13 | Pilot-Scale Oxidative Technologies for Reducing Fouling Potential in Membrane Systems | WateReuse Foundation |
| WRF-08-09 | Expected Oct-12 | Value of Water Supply Reliability in Residential Sector | WateReuse Foundation |
| WRF-08-10 | Dec-11 | Maximizing Recovery of Recycled Water for Groundwater Recharge | WateReuse Foundation |
| WRF-08-11 | Expected Jul-13 | Process Optimization, Monitoring and Control Strategies, and Carbon and Energy Footprint UV/H ₂ O ₂ | WateReuse Foundation |
| WRF-08-12 | Expected Dec-12 | Assess water use requirements and establish water quality criteria | WateReuse Foundation |
| WRF-08-13 | Expected Oct-12 | Renewable energy, peak power management, and optimization of advanced treatment technologies | WateReuse Foundation |
| WRF-08-14 | Expected Oct-12 | Evaluation and optimization of existing and emerging energy recovery devices | WateReuse Foundation |
| WRF-08-15 | Expected Sep-12 | Evaluating Emergency Planning under Climate Change Scenarios | WateReuse Foundation |
| WRF-08-16 | Aug-12 | Implications of Future Water Supply Sources on Energy Demands | WateReuse Foundation |
| WRF-08-17 | Feb-12 | Reclaimed Water Desalination Technologies: Performance/Cost Comparison EDR & MF/RO | WateReuse Foundation |
| WRF-08-18 | Mar-12 | Infectivity Assay for Giardia lamblia Cysts | WateReuse Foundation |
| WRF-08-19 | Expected Mar-13 | Investigation of Desalination Membrane Biofouling | WateReuse Foundation |
| WRF-09-01 | Expected Dec-12 | The Effect of Prior Knowledge of 'Unplanned' Potable Reuse on Acceptance of 'Planned' Potable Reuse | WateReuse Foundation |
| WRF-09-02 | Expected Jun-13 | Develop a Framework to Determine When to Use Indirect Potable Reuse Systems vs. Dual Pipe | WateReuse Foundation |
| WRF-09-03 | Expected Apr-13 | Utilization of HACCP Approach for Evaluating Integrity of Treatment Barriers for Reuse | WateReuse Foundation |
| WRF-09-04 | Expected Apr-13 | The Value of Water Supply Reliability in the CII Sector | WateReuse Foundation |
| WRF-09-05 | Expected Sept-12 | Case Studies of Seasonal Storage of Reclaimed Water for Discharge into Surface Waters | WateReuse Foundation |
| WRF-09-06a | Expected Mar-13 | Develop New Techniques for Real-Time Monitoring of Membrane Integrity | WateReuse Foundation |
| WRF-09-06b | Expected Mar-13 | Develop New Techniques for Real-Time Monitoring of Membrane Integrity | WateReuse Foundation |
| WRF-09-07 | May-12 | Risk Assessment Study of PPCPs in Recycled Water to Support Public Review - Toolkit | WateReuse Foundation |
| WRF-09-07 | Expected Oct-12 | Risk Assessment Study of PPCPs in Recycled Water to Support Public Review - Main Report | WateReuse Foundation |
| WRF-09-08 | Expected Feb-13 | Evaluation of Potential Nutrient Impacts Related to Florida's Water Reuse Program | WateReuse Foundation |
| WRF-09-09 | Expected Sep-12 | Pilot Testing Pre-Formed Chloramines as a Means of Controlling Biofouling in Seawater Desalination | WateReuse Foundation |
| WRF-09-10 | Feb-13 | Use of UV & Fluorescence Spectra as Surrogate Measures for Contaminant Oxidation and Disinfection in Ozone/Peroxide Advanced Oxidation Processes | WateReuse Foundation |
| WRF-09-11 | Expected Feb-14 | Development of New Tracers for Determining Travel Time Near MAR Operations | WateReuse Foundation |

| Project Number | Publication Date | Title | Organization |
|---------------------|--------------------|---|-----------------------|
| WRF-09-12 | Expected Nov-12 | Continuous Flow Seawater RO System for Recovery of Silica Saturated RO Concentrate | WaterReuse Foundation |
| WaterReuse-10-01 | Expected May-14 | Fit for Purpose Water: The Cost of "Over-Treating" Reclaimed and other Water | WaterReuse Foundation |
| WaterReuse-10-02 | Expected Mar-13 | Treatment, Public Health, and Regulatory Issues Associated with Graywater Reuse | WaterReuse Foundation |
| WaterReuse-10-03 | Expected Jun-13 | Regulatory Workshop on Critical Issues of Desalination Permitting | WaterReuse Foundation |
| WaterReuse-10-04 | Expected Jul- 2013 | Improvements to Minimize I&E of Existing Intakes | WaterReuse Foundation |
| WaterReuse-10-05 | Expected Nov-14 | Role of Retention Time in the Environmental Buffer of Indirect Potable Reuse Projects | WaterReuse Foundation |
| WaterReuse-10-06a | Aug-13 | Lower Energy Treatment Schemes for Water Reuse, Part A | WaterReuse Foundation |
| WaterReuse-10-06b | Expected Aug-13 | Lower Energy Treatment Schemes for Water Reuse, Part B | WaterReuse Foundation |
| WaterReuse-10-06c | Expected May-13 | Lower Energy Treatment Schemes for Water Reuse, Part C | WaterReuse Foundation |
| WaterReuse-10-06d | Expected Aug-13 | Lower Energy Treatment Schemes for Water Reuse, Part D | WaterReuse Foundation |
| WaterReuse-10-06 II | TBD | Lower Energy Treatment Schemes for Water Reuse - Phase II | WaterReuse Foundation |
| WaterReuse-10-07 | Expected May-14 | Bio-analytical Techniques to Assess the Potential Human Health Impacts of Reclaimed Water | WaterReuse Foundation |
| WaterReuse-10-08 | Expected Feb-13 | Guidance for Implementing Reuse in New Buildings & Developments to Achieve LEED/Sustainability Goals | WaterReuse Foundation |
| WaterReuse-10-09 | Expected Apr-13 | Guidance for Selection of Salt, Metal, Radionuclide, and other Valuable Metal Recovery Strategies | WaterReuse Foundation |
| WaterReuse-10-10 | Expected Nov-12 | Demonstration of Filtration and Disinfection Compliance through SAT | WaterReuse Foundation |
| WaterReuse-10-11 | Expected Jul-13 | Ozone Pretreatment of Non-Nitrified Secondary Effluent before Microfiltration | WaterReuse Foundation |
| WaterReuse-10-12 | Expected May-13 | Feasibility Study on Model Development to Estimate/Minimize GHG Concentrations and Carbon Footprint of WaterReuse and Desalination Facilities | WaterReuse Foundation |
| WaterReuse-10-13 | Expected Nov-12 | Review of Nano-Material Research and Relevance for Water Reuse | WaterReuse Foundation |
| WaterReuse-10-14 | Expected Nov-12 | Future of Purple Pipes: Exploring best use of non-potable recycled water in diversified urban water systems | WaterReuse Foundation |
| WaterReuse-10-15 | Expected Oct-13 | Establishing Nitrification Reliability Guidelines for Water Reuse | WaterReuse Foundation |
| WaterReuse-10-16 | Expected Oct-13 | Enzymes: The New Wastewater Treatment Chemical for Water Reuse | WaterReuse Foundation |
| WaterReuse-10-17 | Expected Jul-13 | Understanding the Influence of Stakeholder Groups on the Effectiveness of Urban Recycled Water Program Implementation | WaterReuse Foundation |
| WaterReuse-10-18 | Expected Dec-13 | Regulated and Emerging Disinfection by-Products during the Production of High Quality Recycled Water | WaterReuse Foundation |
| WaterReuse-11-01 | Expected Mar-16 | Monitoring for Reliability and Process Control of Potable Reuse Applications | WaterReuse Foundation |
| WaterReuse-11-02 | Expected Jul-15 | Equivalency of Advanced Treatment Trains for Potable Reuse | WaterReuse Foundation |

| Project Number | Publication Date | Title | Organization |
|-----------------|------------------|---|----------------------|
| WateReuse-11-03 | Expected Sep-14 | Develop Best Management Practices to Control Potential Health Risks and Aesthetic Issues Associated with Storage/Distribution of Reclaimed Water | WateReuse Foundation |
| WateReuse-11-04 | Expected Mar-15 | Emerging Desalination Technologies for Energy Reduction | WateReuse Foundation |
| WateReuse-11-05 | Expected May-14 | Demonstrating the Benefits of Engineered Direct versus Unintended Indirect Potable Reuse Systems | WateReuse Foundation |
| WateReuse-11-06 | Expected Oct-13 | Real Time Monitoring for Microbiological Contaminants in Reclaimed Water: State of the Science Assessment | WateReuse Foundation |
| WateReuse-11-07 | Expected Jan-15 | Application of the Bioluminescent Saltwater Assimilable Organic Carbon Test as a Tool for Identifying and Reducing Reverse-Osmosis Membrane Fouling in Desalination | WateReuse Foundation |
| WateReuse-11-08 | Expected Oct-14 | Formation of Nitrosamines and Perfluorochemicals during Ozonation in Water Reuse Applications | WateReuse Foundation |
| WateReuse-11-09 | Expected Jan-14 | Desalination Concentrate Management Policy Analysis for the Arid West | WateReuse Foundation |
| WateReuse-11-10 | Expected Dec-13 | Evaluation of Risk Reduction Principles for Direct Potable Reuse | WateReuse Foundation |
| WateReuse-12-01 | TBD | Desalination Facility Guidelines (Scoping Study) | WateReuse Foundation |
| WateReuse-12-02 | TBD | Development of Public Communication Toolbox for Desalination Projects | WateReuse Foundation |
| WateReuse-12-03 | TBD | Analysis of Technical and Organizational Issues in the Development and Implementation of Industrial Reuse Projects | WateReuse Foundation |
| WateReuse-12-05 | TBD | Management of Legionella in Water Reclamation Systems | WateReuse Foundation |
| WateReuse-12-06 | TBD | Guidelines for Engineered Storage Systems | WateReuse Foundation |
| WateReuse-12-07 | TBD | Standard Methods for Integrity Testing of NF and RO Membranes | WateReuse Foundation |
| WateReuse-12-08 | TBD | Public Acceptance Clearinghouse of Information for Website | WateReuse Foundation |
| WateReuse-12-10 | Expected Sept-13 | Demonstrating an Innovative Combination of Ion Exchange Pretreatment and Electrodialysis Reversal for Reclaimed Water RQ Concentrate Minimization | WateReuse Foundation |

This page intentionally left blank.

APPENDIX C

Websites of U.S. State Regulations and Guidance on Water Reuse

The WaterReuse Association will maintain links of the state regulatory sites containing water reuse regulations as links and current regulations are subject to change by the states. Readers may access the state regulations link at <https://www.watereuse.org/government-affairs/usepa-guidelines>.

| State | Title of Regulations or Guidelines | Link to State Reuse Regulations or Guidance | Alternate Link to Reuse Fact Sheet or Report |
|--|--|---|---|
| Alabama | Guidelines and Minimum Requirement for Municipal, Semi-Public and Private Land Treatment Facilities | http://adem.alabama.gov/alEnviroRegLaws/default.cnt | |
| Alaska | Alaska Administrative Code, Title 18 – Environmental Conservation, Chapter 72 - Wastewater Disposal | http://dec.alaska.gov/commish/regulations/pdfs/18%20AAC%2072.pdf | |
| Alaska - additional | | http://dec.alaska.gov/water/wwdp/index.htm | |
| Arizona | Arizona Administrative Code - Title 18, Environmental Quality | http://www.azsos.gov/public_service/Title_18/18_table.htm | http://www.azdeq.gov/environ/water/permits/reclaimed.html |
| Arkansas | 40 CFR 257, 40 CFR 503, and guidance from NRCS (for animal wastes) | http://www.adeq.state.ar.us/water/regulations.htm | |
| California | Title 22 California Code of Regulations | http://www.cdph.ca.gov/certlic/drinkingwater/Pages/Lawbook.aspx | http://www.waterboards.ca.gov/water_issues/programs/grants_loans/water_recycling/directory.shtml |
| California - additional | | http://www.cdph.ca.gov/HealthInfo/environhealth/water/Pages/Waterrecycling.aspx | |
| Colorado | Water Quality Control Commission: Regulation No. 84 - Reclaimed Water Control Regulation (effective 9/30/07) | http://www.cdphe.state.co.us/regulations/wqccregs/ | |
| Colorado - additional | | http://www.cdphe.state.co.us/regulations/wqccregs/100284wqccreclaimewater.pdf | |
| Commonwealth of the Northern Mariana Islands | Commonwealth of the Northern Mariana Islands Wastewater Treatment and Disposal Rules and Regulations | http://www.deq.gov.mp/artdoc/Sec6art32ID130.pdf | |
| Connecticut | No regulations or guidelines at this time | http://www.ct.gov/dep/cwp/view.asp?a=2709&q=324216&depNav_GID=1643 | |
| Delaware | | http://www.dnrec.delaware.gov/wr/Information/regulations/Pages/GroundWaterDischargesRegulations.aspx | |
| Delaware - additional | | http://www.dnrec.state.de.us/water2000/Sections/GroundWat/Library/ReclaimedWaterFactSheet.pdf | |

| State | Title of Regulations or Guidelines | Link to State Reuse Regulations or Guidance | Alternate Link to Reuse Fact Sheet or Report |
|----------------------|--|---|---|
| District of Columbia | The District of Columbia currently does not have any regulations or guidelines addressing water reuse but considers projects on a case-by-case basis. The city is currently developing rules and water quality requirements for stormwater use. | | |
| Florida | Chapter 62-610 of the Florida Administrative Code "Reuse of Reclaimed Water and Land Application; Section 403.064 of the Florida Statutes | http://www.dep.state.fl.us/water/reuse/apprules.htm | |
| Georgia | Guidelines for Water Reclamation and Urban Water Reuse; Georgia Guidelines for Reclaimed Water Systems for Buildings; Constructed Wetlands Municipal Wastewater Treatment Facilities Guidelines; Guidelines for Slow-Rate Land Treatment of Wastewater Via Spray Irrigation (LAS Guidelines) | http://www.gaepd.org/Files_PDF/techguide/wpb/reuse.pdf | |
| Georgia - additional | | http://www.gaepd.org/Documents/techguide_wpb.html | |
| Guam | | http://epa.guam.gov/rules-regs/regulations/water-pollution-regulations/ | |
| Hawaii | Guidelines for the Treatment and Use of Recycled Water | http://hawaii.gov/wastewater/pdf/reuse-final.pdf | |
| Hawaii - additional | | http://hawaii.gov/dlnr/cwrm/planning_augmentation.htm | |
| Idaho | Idaho Administrative Code, Title 01, Chapter 17, IDAPA 58.01.17 - Recycled Water Rules | http://adminrules.idaho.gov/rules/current/58/0117.pdf | |
| Idaho - additional | | http://adminrules.idaho.gov/rules/current/58/index.html | |
| Illinois | Title 35 Illinois Administrative Code Part 372 - Illinois Design Standards for Slow Rate Land Application of Treated Wastewater | http://www.ipcb.state.il.us/documents/dsweb/Get/Document-12046/ | http://www.ilga.gov/legislation/ilcs/fulltext.asp?DocName=007023050K7 |
| Indiana | Article 6.1 "Land application of Biosolid, Industrial Waste Product, and Pollutant-bearing Water" of Title 327 Water Pollution Control Board, Indiana Administrative Code. | http://www.in.gov/idem/4877.htm | http://www.in.gov/legislative/iac/title327.html |
| Iowa | Iowa Administrative Code Chapter 62: Effluent and Pretreatment Standards: Other Effluent Limits or Prohibitions | http://www.iowadnr.gov/InsideDNR/RegulatoryWater/NPDES/WastewaterPermitting/NPDESRules.aspx | http://www.iowadnr.gov/portals/idnr/uploads/water/wastewater/dstandards/chapter21.pdf?amp;tabid=1316 |
| Kansas | | http://www.kdheks.gov/water/download/28_16.pdf | http://www.kwo.org/Kansas_Water_Plan/KWP_Docs/VolumeIII/LARK/Rpt_LARK_BPI_Role_Reuse_KWP2009.pdf |

| State | Title of Regulations or Guidelines | Link to State Reuse Regulations or Guidance | Alternate Link to Reuse Fact Sheet or Report |
|----------------------------|--|---|---|
| Kentucky | No regulations or guidelines at this time | Web Address could not be located at time of publication. | |
| Louisiana | No regulations or guidelines at this time | Web Address could not be located at time of publication. | |
| Maine | No regulations or guidelines at this time | Web Address could not be located at time of publication. | |
| Maryland | Environment Article, Title 9, Subtitle 3; COMAR 26.08.01 through 26.08.04 and 26.08.07. | http://www.mde.state.md.us/assets/document/MDE-WMA-001%20%28land-treatment%20Guidelines%29.pdf | http://www.mde.state.md.us/programs/Permits/WaterManagementPermits/Documents/www.mde.state.md.us/assets/document/permit/MDE-WMA-PER014.pdf |
| Maryland - additional | | http://www.mde.state.md.us/programs/Permits/WaterManagementPermits/WaterDischargePermitApplications/Pages/Permits/WaterManagementPermits/water_permits/index.aspx | |
| Massachusetts | | http://www.mass.gov/dep/service/regulations/314cmr20.pdf | http://www.mass.gov/dep/water/wastewater/wrfaq_s.htm#permit |
| Massachusetts - additional | | http://www.mass.gov/dep/service/regulations/314cmr05.pdf | |
| Michigan | | Web Address could not be located at time of publication. | |
| Minnesota | | http://www.pca.state.mn.us/index.php/view-document.html?gid=13496 | |
| Mississippi | | http://www.deq.state.ms.us/newweb/MDEQRegulations.nsf?OpenDatabase | |
| Missouri | | http://www.sos.mo.gov/adrules/csr/current/10csr/10csr.asp#10-20 | http://www.dnr.mo.gov/en/v/wpp/permits/index.html |
| Montana | | http://deq.mt.gov/wqinfo/pws/docs/deq2_revisions.pdf | |
| Nebraska | Title 119, Chapter 12 - Land Application of Domestic Effluent, Land Application of Single Pass Noncontact Cooling Water and Disposal of Domestic Biosolids | http://www.deq.state.ne.us/RuleAndR.nsf/pages/119-Ch-12 | http://www.deq.state.ne.us/RuleandR.nsf/Pages/Rules |
| Nebraska - additional | | http://www.deq.state.ne.us/RuleAndR.nsf/23e5e39594c064ee852564ae004fa010/97c32c5cd6c1802d8625674b006da528?OpenDocument | |
| Nebraska - additional | | http://www.deq.state.ne.us/RuleAndR.nsf/23e5e39594c064ee852564ae004fa010/235cf139930e82d08625674b006e0738?OpenDocument | |
| Nebraska - additional | | http://www.deq.state.ne.us/RuleAndR.nsf/23e5e39594c064ee852564ae004fa010/6fc9b4ab05f90c8e8625674b006fa9ab?OpenDocument | |

| State | Title of Regulations or Guidelines | Link to State Reuse Regulations or Guidance | Alternate Link to Reuse Fact Sheet or Report |
|-------------------------|--|---|---|
| Nevada | Nevada Administrative Code, Chapter 445A, Sections 274 - 280; WTS-1A General design criteria for reclaimed water irrigation use; WTS-1B General design criteria for preparing an effluent management plan; WTS-3 Guidance Document For An Application For Rapid Infiltration Basins; WTS-7 Guidance Document for Reclaimed Water Storage Ponds | http://www.leg.state.nv.us/nac/nac-445a.html#NAC445ASec275 | http://ndep.nv.gov/bwpc/fact01.htm |
| Nevada - additional | | http://ndep.nv.gov/admin/nrs.htm | |
| New Hampshire | No regulations or guidelines at this time | http://des.nh.gov/organization/commissioner/legal/rules/index.htm#water | |
| New Jersey | | http://www.state.nj.us/dep/dwg/714a.htm | http://www.state.nj.us/dep/dwg/techmans/reuseman.pdf |
| New Mexico | NMED Ground Water Quality Bureau Guidance: Above Ground Use of Reclaimed Domestic Wastewater | http://www.nmenv.state.nm.us/gwb/documents/NMED_REUSE_1-24-07.pdf | http://www.rmwea.org/reuse/NewMexico.html |
| New Mexico - additional | | http://www.nmenv.state.nm.us/gwb/NMED-GWQB-Regulations.htm | |
| New York | | Web Address could not be located at time of publication. | |
| North Carolina | 15A North Carolina Administrative Code Subchapter 02U – Reclaimed Water | http://reports.oah.state.nc.us/ncac.asp?folderName=Title%2015A%20-%20Environment%20and%20Natural%20Resources\Chapter%2002%20-%20Environmental%20Management | http://reports.oah.state.nc.us/ncac/title%2015a%20-%20environment%20and%20natural%20resources/chapter%2002%20-%20environmental%20management/subchapter%20u/subchapter%20u%20rules.html |
| North Dakota | Criteria for Irrigation with Treated Wastewater; Recommended Criteria for Land Disposal of Effluent | http://www.ndhealth.gov/WQ/ | |
| Ohio | | http://www.epa.state.oh.us/portals/35/rules/42-13.pdf | http://www.epa.state.oh.us/portals/35/rules/42-13_factsheet_feb08.pdf |
| Ohio - additional | | http://www.epa.state.oh.us/dsw/pti/index.aspx | |
| Oklahoma | OAC 252:656 "Water Pollution Control Construction Standards; OAC 252:627 Operation and Maintenance of Water Reuse; These regulations OAC 252:656 Subchapter 27 and OAC 252:627 are proposed. | http://www.deq.state.ok.us/rules/656.pdf | http://normantranscript.com/x1552633625/City-of-Norman-considers-using-reclaimed-water-for-purposes |
| Oklahoma - additional | | http://www.deq.state.ok.us/rules/627.pdf | |
| Oregon | Oregon Administrative Rules, Division 55 - Recycled Water Use | http://arcweb.sos.state.or.us/pages/rules/oars_300/oar_340/340_055.html | http://www.deq.state.or.us/wq/reuse/reuse.htm |

| State | Title of Regulations or Guidelines | Link to State Reuse Regulations or Guidance | Alternate Link to Reuse Fact Sheet or Report |
|---------------------------|---|---|---|
| Pennsylvania | Manual for Land Treatment of Wastewater; Reuse of Treated Wastewater Guidance Manual | http://www.elibrary.dep.state.pa.us/dsweb/Get/Document-88575/385-2188-002.pdf | http://www.elibrary.dep.state.pa.us/dsweb/View/Collection-10105 |
| Puerto Rico | | Web Address could not be located at time of publication. | |
| Rhode Island | | http://www.dem.ri.gov/programs/beniviron/water/permits/wtf/pdfs/reuseguid.pdf | |
| South Carolina | Section 67.300 of South Carolina Regulation 61-67, Standards for Wastewater Facility Construction "State Land Application Permit" | http://www.scdhec.gov/environment/water/landpage.htm | |
| South Dakota | | http://www.denr.sd.gov/des/sw/documents/DesignCriteriaManual.pdf | |
| South Dakota - additional | | http://legis.state.sd.us/statutes/DisplayStatute.aspx?Type=StatuteChapter&Statute=34A-2 | |
| Tennessee | | www.tn.gov/environment/permits/wqoperm.shtml | www.tn.gov/environment/wpc/publications/#tech |
| Tennessee - additional | | http://denr.sd.gov/des/sw/eforms/D0449V1-a_potw_appl.pdf | |
| Texas | | http://www.tceq.texas.gov/rules/index.pdf.html#210 | |
| US Virgin Islands | | Web Address could not be located at time of publication. | |
| Utah | Reuse requirements moved to UCA R317-3-11 (from UCA R317-1-2). | http://www.rules.utah.gov/publicat/code/r317/r317-001.htm#T4 | http://www.rules.utah.gov/publicat/code/r317/r317-003.htm#T11 |
| Vermont | Environmental Protection Rules, Chapter 14, Indirect Discharge Rules | http://www.anr.state.vt.us/dec/ww/rules.htm#os | http://www.anr.state.vt.us/dec/ww/Rules/IDR/Adopted-IDR-4-30-03.pdf |
| Virginia | Virginia Administrative Code Agency 25, Chapter 740 - Water Reclamation and Reuse Regulation | http://lis.virginia.gov/000/reg/TOC09025.HTM#C0740 | |
| Washington | Chapter 90.46 Revised Code of Washington - Reclaimed water use | http://apps.leg.wa.gov/rcw/default.aspx?cite=90.46&full=true | http://www.ecy.wa.gov/programs/wq/reclaim/index.html |
| West Virginia | Title 64 Series 47 Chapter 16-1 Sewage Treatment and Collection System Design Standards | http://apps.sos.wv.gov/adlaw/csr/ruleview.aspx?document=2802 | |
| Wisconsin | Domestic Wastewater to Subsurface Soil Absorption Systems Permit (WI-0062901-2) | http://dnr.wi.gov/org/water/wm/ww/statauth.htm | |
| Wyoming | Chapter 21 Water Quality Rules - Standards for the Reuse of Treated Wastewater | http://soswy.state.wy.us/Rules/RULES/2804.pdf | http://deq.state.wy.us/wq/d/WQDrules/index.asp |

This page intentionally left blank.

APPENDIX D

U.S. Case Studies

List of Case Studies by Title and Authors¹

| Page No. | Text code | Case Study Title | Authors |
|----------|-------------------------------|---|--|
| D-5 | US-AZ-Gilbert | Town of Gilbert Experiences Growing Pains in Expanding the Reclaimed Water System | Guy Carpenter, P.E. (Carollo Engineers) |
| D-7 | US-AZ-Tucson | Tucson Water: Developing a Reclaimed Water Site Inspection Program | Karen Dotson (Retired, Tucson Water) |
| D-10 | US-AZ-Sierra Vista | Environmental Operations Park | Kerri Jean Ormerod (University of Arizona) |
| D-12 | US-AZ-Phoenix | 91st Avenue Unified WWTP Targets 100 Percent Reuse | Steve Rohrer, P.E. and Tim Francis, P.E., BCEE (Malcolm Pirnie, the Water Division of ARCADIS); Andrew Brown, P.E. (City of Phoenix) |
| D-14 | US-AZ-Blue Ribbon Panel | Arizona Blue Ribbon Panel on Water Sustainability | Channah Rock, PhD (University of Arizona); Chuck Graf, R.G. (Arizona Department of Environmental Quality); Christopher Scott, PhD (University of Arizona); Jean E.T. McLain, PhD (USDA-Agricultural Research Service, U.S. Arid Land Agricultural Research Center); and Sharon Megdal, PhD (University of Arizona) |
| D-18 | US-AZ-Prescott Valley | Effluent Auction in Prescott Valley, Arizona | Christopher Scott, PhD (University of Arizona) |
| D-20 | US-AZ-Frito Lay | Frito-Lay Process Water Recovery Treatment Plant, Casa Grande, Arizona | Al Goodman, P.E. (CDM Smith) |
| D-22 | US-CA-Psychology | The Psychology of Water Reclamation and Reuse Survey: Findings and Research Roadmap | Brent M. Haddad, MBA, PhD (University of California, Santa Cruz) |
| D-24 | US-CA-San Ramon | Managing a Recycled Water System through a Joint Powers Authority: San Ramon Valley | David A. Requa, P.E. (Dublin San Ramon Services District) |
| D-27 | US-CA-San Diego | City of San Diego – Water Purification Demonstration Project | Marsi A. Steirer; Amy Dorman, P.E.; Anthony Van; and Joseph Quicho (City of San Diego Public Utilities Department) |
| D-30 | US-CA-Orange County | Groundwater Replenishment System, Orange County, California | Mike Markus, P.E., D.WRE; Mehul Patel, P.E.; William Dunivin (Orange County Water District) |
| D-33 | US-CA-North City | EDR at North City Water Reclamation Plant | Eugene Reahl and Patrick Girvin (GE) |
| D-35 | US-CA-Santa Cruz | Water Reuse Study at the University of California Santa Cruz Campus | Tracy A. Clinton, P.E. (Carollo Engineers) |
| D-38 | US-CA-Monterey | Long-term Effects of the Use of Recycled Water on Soil Salinity Levels in Monterey County | B.E. Platts (Monterey Regional Water Pollution Control Agency) |
| D-40 | US-CA-Southern California MWD | Metropolitan Water District of Southern California's Local Resource Program | Raymond Jay (Metropolitan Water District) |

¹ To search for case studies by region or by category of reuse, please refer to Figure 5-2.

List of Case Studies by Title and Authors¹

| Page No. | Text code | Case Study Title | Authors |
|----------|-------------------------------|---|--|
| D-42 | US-CA-Los Angeles County | Montebello Forebay Groundwater Recharge Project using Reclaimed Water, Los Angeles County, California | Monica Gasca, P.E. and Earle Hartling (Los Angeles County Sanitation Districts) |
| D-46 | US-CA-Elsinore Valley | Recycled Water Supplements Lake Elsinore | Ronald E. Young, P.E., DEE (Elsinore Valley Municipal Water District) |
| D-48 | US-CA-Temecula | Replacing Potable Water with Recycled Water for Sustainable Agricultural Use | Graham Juby, PhD, P.E. (Carollo Engineers) |
| D-51 | US-CA-Santa Ana River | Water Reuse in the Santa Ana River Watershed | Celeste Cantú (Santa Ana Watershed Project Authority) |
| D-53 | US-CA-Vander Lans | Leo J. Vander Lans Water Treatment Facility | R. Bruce Chalmers, P.E. (CDM Smith) and Paul Fu, P.E. (Water Replenishment District) |
| D-55 | US-CA-Pasteurization | Use of Pasteurization for Pathogen Inactivation for Ventura Water, California | Andrew Salveson, P.E. (Carollo Engineers) |
| D-57 | US-CA-Regulations | California State Regulations | James Crook, PhD, P.E., BCEE (Water Reuse Consultant) |
| D-61 | US-CA-West Basin | West Basin Municipal Water District: Five Designer Waters | Shivaji Deshmukh, P.E. (West Basin Municipal Water District) |
| D-63 | US-CO-Denver Zoo | Denver Zoo | Abigail Holmquist, P.E. (Honeywell); Damian Higham (Denver Water); and Steve Salg (Denver Zoo) |
| D-65 | US-CO-Denver | Denver Water | Abigail Holmquist, P.E. (Honeywell); Mary Stahl, P.E. (Olsson Associates); and Steve Price, P.E. (Denver Water) |
| D-68 | US-CO-Denver Energy | Xcel Energy's Cherokee Station | Abigail Holmquist, P.E. (Honeywell) and Damian Higham (Denver Water) |
| D-70 | US-CO-Denver Soil | Effects of Recycled Water on Soil Chemistry | Abigail Holmquist, P.E. (Honeywell) and Damian Higham (Denver Water) |
| D-73 | US-CO-Sand Creek | Sand Creek Reuse Facility Reuse Master Plan | Bobby Anastasov, MBA and Richard Leger, CWP (City of Aurora) |
| D-76 | US-CO-Water Rights | Water Reuse Barriers in Colorado | Cody Charnas (CDM Smith) |
| D-77 | US-DC-Sidwell Friends | Smart Water Management at Sidwell Friends School | Laura Hansplant, RLA, ASLA, LEED AP (Andropogon Associates [formerly] and Roofmeadow) and Danielle Pieranunzi, LEED AP BD+C (Sustainable Sites Initiative) |
| D-80 | US-FL-Miami So District Plant | South District Water Reclamation Plant | R. Bruce Chalmers, P.E. (CDM Smith) and James Ferguson (Miami Dade Water and Sewer Department) |
| D-83 | US-FL-Pompano Beach | City of Pompano Beach OASIS | A. Randolph Brown and Maria Loucraft (City of Pompano Beach) |
| D-85 | US-FL-Orlando E. Regional | Eastern Regional Reclaimed Water Distribution System | Victor J. Godlewski Jr. (City of Orlando); Greg D. Taylor, P.E. and Karen K. McCullen, P.E., BCEE (CDM Smith) |
| D-87 | US-FL-Economic Feasibility | Economic Feasibility of Reclaimed Water to Users | Grace M. Johns, PhD (Hazen and Sawyer) and C. Donald Rome, Jr. (Southwest Florida Water Management District) |
| D-90 | US-FL-Reedy Creek | Reuse at Reedy Creek Improvement District | Ted McKim, P.E., BCEE (Reedy Creek Improvement District) |
| D-93 | US-FL-Marco Island | Marco Island, Florida, Wastewater Treatment Plant | Jennifer Watt, P.E. (General Electric); Solomon Abel, P.E. (CDM Smith); and Rony Joel, P.E., DEE (AEC Water) |

List of Case Studies by Title and Authors¹

| Page No. | Text code | Case Study Title | Authors |
|----------|--------------------------|---|---|
| D-96 | US-FL-Everglade City | Everglade City, Florida | Rony Joel, P.E., DEE (AEC Water) |
| D-98 | US-FL-Orlando Wetlands | City of Orlando Manmade Wetlands System | Mark Sees (City of Orlando) |
| D-99 | US-FL-SWFWMD Partnership | Regional Reclaimed Water Partnership Initiative of the Southwest Florida Water Management District | Alison Ramoy (Southwest Florida Water Management District) |
| D-102 | US-FL-Altamonte Springs | The City of Altamonte Springs: Quantifying the Benefits of Water Reuse | David Ammerman, P.E. (AECOM) |
| D-104 | US-FL-Clearwater | Evolution of the City of Clearwater's Integrated Water Management Strategy | Laura Davis Cameron, BSBM; Tracy Mercer, MBA; Nan Bennett, P.E.; and Rob Fahey, P.E. (City of Clearwater Public Utilities) |
| D-107 | US-FL-Turkey Point | Assessing Contaminants of Emerging Concern (CECs) in Cooling Tower Drift | James P. Laurenson (HEAC) and Edward L. Carr (ICF International) |
| D-110 | US-GA-Clayton County | Sustainable Water Reclamation Using Constructed Wetlands: The Clayton County Water Authority Success Story | Veronica Jarrin, P.E. and Jim Bays, P.W.S (CH2M HILL); Jim Poff (Clayton County Water Authority) |
| D-113 | US-GA-Forsyth County | On the Front Lines of a Water War, Reclaimed Water Plays a Big Role in Forsyth County, Georgia | Daniel E. Johnson, P.E. (CDM Smith) |
| D-115 | US-GA-Coca Cola | Recovery and Reuse of Beverage Process Water | Dnyanesh V Darshane, PhD, MBA; Jocelyn L. Gadson, PMP; Chester J. Wojna; Joel A. Rosenfield, Henry Chin, PhD; Paul Bowen, PhD (The Coca-Cola Company) |
| D-118 | US-HI-Reuse | Reclaimed Water Use in Hawaii | Elson C. Gushiken (ITC Water Management, Inc.) |
| D-121 | US-MA-Southborough | Sustainability and LEED Certification as Drivers for Reuse: Toilet Flushing at The Fay School | Mark Elbag (Town of Holden) |
| D-123 | US-MA-Hopkinton | Decentralized Wastewater Treatment and Reclamation for an Industrial Facility, EMC Corporation Inc., Hopkinton, Massachusetts | Mike Wilson, P.E. (CH2M Hill) |
| D-124 | US-MA-Gillette Stadium | Sustainability and Potable Water Savings as Drivers for Reuse: Toilet Flushing at Gillette Stadium | Mike Wilson, P.E. (CH2M Hill) |
| D-126 | US-ME-Snow | Snowmaking with Reclaimed Water | Don Vandertulip, P.E., BCEE (CDM Smith) |
| D-129 | US-MN-Mankato | Reclaimed Water for Peaking Power Plant: Mankato, Minnesota | Mary Fralish (City of Mankato) and Patti Craddock (Short Elliott Hendrickson Inc.) |
| D-132 | US-NC-Cary | Town of Cary, North Carolina, Reclaimed Water System | Leila R. Goodwin, P.E. (Town of Cary) and Kevin Irby, P.E. (CDM Smith) |
| D-134 | US-NY-PepsiCo | Identifying Water Streams for Reuse in Beverage Facilities: PepsiCo ReCon Tool | Liese Dallbauman, PhD (Pepsi-Co Global Operations) |
| D-136 | US-PA-Kutztown | The Water Purification Eco-Center | Jeff Moyer and Christine Ziegler Ulsh (Rodale Institute) |
| D-139 | US-PA-Mill Run | Zero-Discharge, Reuse, and Irrigation at Fallingwater, Western Pennsylvania Conservancy | Mike Wilson, P.E. (CH2M Hill) |
| D-141 | US-TN-Franklin | Franklin, Tennessee Integrated Water Resources Plan | Jamie R. Lefkowitz, P.E. and Kati Bell, PhD, P.E. (CDM Smith); and Mark Hilty, P.E. (City of Franklin) |

List of Case Studies by Title and Authors¹

| Page No. | Text code | Case Study Title | Authors |
|----------|-----------------------|--|--|
| D-145 | US-TX-San Antonio | San Antonio Water System Water Recycling Program | Pablo R. Martinez (San Antonio Water System) |
| D-148 | US-TX-Big Spring | Raw Water Production Facility: Big Spring Plant | David W. Sloan, P.E., BCEE (Freese and Nichols) |
| D-150 | US-TX-Landscape Study | Site Suitability for Landscape Use of Reclaimed Water in the Southwest | Seiichi Miyamoto, PhD and Ignacio Martinez (Texas A&M Agrilife Research Center at El Paso) |
| D-152 | US-TX-NASA | U.S. Water Recovery System on the International Space Station | J. Torin McCoy (NASA Johnson Space Center) |
| D-154 | US-TX-Wetlands | East Fork Raw Water Supply Project: A Natural Treatment System Success Story | Ellen T. McDonald, PhD, P.E. and Alan H. Plummer, Jr., P.E., BCEE (Alan Plummer Associates Inc.) and James M. Parks, P.E. (North Texas Municipal Water District) |
| D-157 | US-VA-Occoquan | Potable Water Reuse in the Occoquan Watershed | Robert W. Angelotti (Upper Occoquan Service Authority) and Thomas J. Grizzard, PhD, P.E. (Virginia Tech) |
| D-160 | US-VA-Regulation | Water Reuse Policy and Regulation in Virginia | Valerie Rourke, CPSS, LPSS, CNMP (Virginia Department of Environmental Quality) |
| D-163 | US-WA-Sequim | City of Sequim's Expanded Water Reclamation Facility and Upland Reuse System | Chad Newton, P.E. (Gray & Osborne, Inc.) |
| D-166 | US-WA-Regulations | Washington State Regulations | Chad Newton, P.E. (Gray and Osborne, Inc.) and Craig Riley, P.E. (Washington State Department of Health) |
| D-169 | US-WA-King County | Demonstrating the Safety of Reclaimed Water for Garden Vegetables | Sally Brown, PhD (University of Washington) |
| D-172 | US-WA-Yelm | City of Yelm, Washington | Shelly Badger (City of Yelm) |

Town of Gilbert Experiences Growing Pains in Expanding the Reclaimed Water System

Author: Guy Carpenter, P.E. (Carollo Engineers)

US-AZ-Gilbert

Project Background or Rationale

The Town of Gilbert, population 208,453, is a 73 mi² (190-km²) city located in the Phoenix, Arizona, metropolitan area. By 1986, and with a population of over 11,000, Gilbert's rudimentary sewage treatment system was replaced by a facility that produced reclaimed water of sufficient quality for open access urban irrigation. While Gilbert had a water resources portfolio sufficient to meet near-term water demands, there were a number of drivers for Gilbert to implement reuse.

First, Gilbert is several miles away from any possible discharge outfall to receiving waters (such as a river or lake), so there was no cost effective disposal option for treated wastewater. Second, the State of Arizona Groundwater Management Act's stringent water conservation requirements (which regulate all sources of water, not just groundwater) encourage the use of reclaimed water to maintain compliance with the act. The Act was adopted in 1980 to stop the rapid decline of aquifer water levels and for Arizona to receive congressional approval to build the Central Arizona Project, the 336-mile (540 km) canal that brings Colorado River water to Arizona's largest urban and agricultural centers. These factors encouraged town leaders to install a reclaimed water distribution system with connections required for new development, thereby ensuring a systematic and cost-effective expansion of the system.

Reclaimed water is an important element of the town's ability to demonstrate a 100-year assured water supply (a requirement of the act), a designation without which the town would be subject to a state-imposed growth moratorium.

Capacity and Type of Reuse Application

Gilbert operates two WRFs that treat produce A+ quality reclaimed water, with a loss of approximately 8 to 10 percent of the influent total to solids treatment. The Neely Water Reclamation Facility (WRF) has a

treatment capacity of 11 mgd (482 L/s). The Greenfield WRF is a joint facility operated in partnership with the city of Mesa and the town of Queen Creek. The plant capacity is currently 16 mgd (700 L/s), with 8 mgd (350 L/s) of capacity available to Gilbert, and is planned to be expanded to treat up to 42 mgd (1840 L/s), with Gilbert's share of the capacity at 16 mgd (700 L/s).

Reclaimed water was initially used by a single customer, the town parks and recreation department. Over the past two decades, with rapid population growth, the system has expanded to include a distribution system throughout newly developed areas, the Riparian Preserve at Water Ranch, the South Recharge facilities, and eight facilities. The town of Gilbert now has over 60 miles (96 km) of reclaimed water transmission mains and approximately 37 reclaimed water customers.

In addition to reclaimed water distribution, because Gilbert is committed to 100 percent reuse, reclaimed water that is not used in the distribution system is recharged for the purpose of accumulating Long Term Storage Credits, which are utilized to offset current and future groundwater pumping, as well as to firm up the Assured Water Supply. Recharge facilities consist of percolation basins and injection wells.

Initial Phase of Implementation

In 1986, the new reclamation facility provided water to the Town's first regional park, Freestone Park, which is approximately two miles east of the Neely WRF. Freestone Park is a 60-acre (24 hectares) multi-use park with two attractive, non-recreational lakes out of which reclaimed water is pressurized and distributed throughout the park for spray irrigation.

Soon after the construction of the Neely WRF, a rapid increase in population growth and lack of additional reclaimed water customers forced Gilbert to look at alternatives. The evaporation ponds that were constructed to receive reclaimed water that was not otherwise used by the park were under capacity.

Because evaporating the unused reclaimed water did not meet the objectives of the Groundwater Management Act, the evaporation ponds on 35 ac (14 ha), adjacent to the Neely WRF were converted to recharge basins in 1989.

Growing Pains and Lessons Learned

As the town continued to grow, additional reclaimed water customers eventually responded to the availability of the inexpensive and continuous supply of reclaimed water. Additionally, recharge basins were expanded by another 40 ac (16 ha) and in response to suggestions by the public, the recharge facility was enhanced to include habitat for native and migratory birds.

At the time of the town's implementation of the reclaimed water system, there were no state, county, regional, or local construction standards specifically for reclaimed water systems. Several design issues caused operational problems. Basic, regional potable water system construction standards were used for expansion of the reclaimed water system, but valve spacing was allowed to be greater than that in the potable system. Thus, when breaks occurred, draining the lines for repair took significant time and reclaimed water cannot be drained to a retention basin without a permit, so management of a break was a labor and administrative intensive effort. Other challenges were related to developer-installed reclaimed water pipeline additions which often had valve boxes of the same specification as the potable water system. This caused confusion for operators and utility locators attempting to respond to system breaks and water delivery changes; incorrect valves were opened and closed due to the lack of differentiating features. This was also problematic from a health and safety standpoint.

Positive changes also occurred at this time, such as reclaimed water identification standards. To ensure compliance with its reuse permit through the state, and to provide limited system design guidance to developers, the town developed a reclaimed water user's manual. Along with the manual, each customer, except Gilbert Parks and Recreation, was required to enter a reclaimed water use agreement stipulating requirements and an annual volume of water that must be taken by the customer.

In 1999, in response to increasing conservation requirements, the mayor formed an "ad hoc" water

conservation committee made up of the mayor, two council members, landowners, developers, engineers, and the large untreated water providers whose service areas overlapped the town of Gilbert water service area. Accurate information regarding the complexities of water resource management was conveyed and understood by stakeholders and the attitude of "disposing" reclaimed water was effectively overcome, and the importance of reclaimed water was finally understood.

Also in 1999, and in response to the need to recharge water to offset groundwater pumping debits and to manage "excess" reclaimed water associated with seasonal demand fluctuations, a second basin recharge facility was constructed on 120 ac (49 ha). Following the success of the original recharge facility's habitat enhancements, the new facility (called the Riparian Preserve at Water Ranch) was designed as an open-access, passive recreation park, in addition to a fully functional recharge facility (**Figure 1**).



Figure 1
Reclaimed water sustains a diverse wildlife habitat at the Gilbert Riparian Preserve, while replenishing the regional aquifer (Photo credit: Patty Jordan, Town of Gilbert)

Expansion

In 2005, the South Recharge Facility was constructed to accommodate increases in wastewater flows from the Greenfield Water Reclamation Plant, which began operation in 2005. In 2006, the Town's integrated water resources master plan was updated to guide the allocation of reclaimed water to ensure a long-term water supply.

Tucson Water: Developing a Reclaimed Water Site Inspection Program

Author: Karen Dotson (Retired, Tucson Water)

US-AZ-Tucson

Project Background or Rationale

The city of Tucson is part of a metropolitan area of over 1 million people in the northern semi-arid reaches of the Sonoran Desert in eastern Pima County, Arizona. The City owns and operates Tucson Water, the largest regional municipal water utility in the area. Tucson Water provides potable water to about 75 percent of the metropolitan area's population and non-potable reclaimed water service in the City and three other governmental jurisdictions. Recognizing the importance of maintaining public safety, protecting the quality of water supplies, and fostering a positive public perception of reclaimed water for non-potable purposes, Tucson Water developed a program to periodically inspect all sites having reclaimed water service. This program includes training and certification for staff conducting testing at reclaimed water sites.

Capacity and Type of Reuse Application

Until 1993, when Colorado River water was introduced as part of the potable water supply, the Tucson area relied exclusively on pumped groundwater. Today, Colorado River water makes up over half of Tucson Water's potable supplies –approximately 98,000 ac-ft/yr (121 MCM/yr) as of 2010. In 2010, 15,000 ac-ft (18.5 MCM) were delivered to over 900 reclaimed water customers – water that would otherwise have been drawn from the potable water system of Tucson Water or another water provider. Fifty-six percent of the deliveries went to 18 golf courses; another 17 percent was delivered to parks. The remainder was delivered to schools (8 percent), other water providers (13 percent), and single family, agriculture, commercial, multi-family, and street landscape irrigation (6 percent).

Reuse Treatment Technology

Since 1984, Tucson Water has operated its reclaimed water system while systematically expanding it to accommodate areas of growing customer demand.

Today, the system has more than 160 miles (257 km) of pipeline and 15 million gallons (57,000 m³) of surface storage. Reclaimed water is produced in three ways and depending on the demand, water from a combination of the sources below is delivered through the Reclaimed Water System:

1. Secondary effluent from Pima County's Roger Road WWTP that receives additional filtration and disinfection at Tucson Water's Filtration Plant
2. Secondary effluent from Pima County's Roger Road WWTP that is recharged in constructed basins or the Santa Cruz River and later recovered and disinfected
3. Tertiary effluent from Pima County's Randolph Park WWTP

The average daily delivery of reclaimed water is 13.5 mgd (657 L/s), and the summer peak delivery is approximately 31 mgd (1358 L/s).

Project Description

1. Until 2010, Tucson Water only inspected sites with reclaimed water service once (prior to the initiation of service). At these inspections, a Tucson Water cross-connection control specialist checked the site for compliance with state and local regulations and conducted a dye test (**Figure 1**) to identify cross-connections. A manual was developed to guide cross-connection control specialists step-by-step through the dye test procedure (Tucson Water, 2010). The Reclaimed Water Site Inspection Program was implemented in phases:
2. Adoption of an ordinance requiring periodic reclaimed water site inspections
3. Development of a Reclaimed Water Site Testers Certification Program and training manual for Reclaimed Water Site Testers
4. Development of a training program

5. Inspection of reclaimed water sites

The first phase of implementation of the Reclaimed Water Site Inspection Program was the adoption of a 2010 ordinance requiring all reclaimed water sites to be inspected periodically, with provisions including the following:

- Annual inspections for schools, parks, and commercial sites
- Residential site inspections once every five years
- Inspection of non-residential sites by a private sector certified Reclaimed Water Site Tester beginning in 2015

The second phase included development of a reclaimed water site database and Reclaimed Water Site Testers certification program. Tucson Water's backflow prevention online database was modified to allow the addition of reclaimed water site information and the results of Reclaimed Water Site Testers' site inspections the same way that the annual backflow prevention assembly tests are entered.

The Reclaimed Water Site Testers certification program requires attendance at an eight-hour class instructed by Tucson Water, and a passing score on a written examination. Re-certification is required every three years. Because the site inspection program focused heavily on prevention and identification of cross-connections, Tucson Water required that a current certification as a Backflow Prevention Tester from a recognized agency, (e.g. AWWA or American Backflow Prevention Association), would be required.

The Tucson Water Cross-connection Control Specialists developed a training manual that includes chapters addressing: Tucson Water's reclaimed water system, Tucson Water's responsibilities, reclaimed water customers' responsibilities, and reclaimed water site testers' responsibilities; concepts addressed include:

- Ensuring that reclaimed water sites comply with state and local regulations
- Visiting a reclaimed water site and hands on experience conducting pressure tests

- Reporting cross-connections to Tucson Water and the customer
- Entering test results online into Tucson Water's database

Tucson Water conducts Reclaimed Water Site Tester classes several times a year and has certified more than 30 Reclaimed Water Site Testers. The initial classes were attended by cross-connection control specialists from Tucson Water and the Peoria, Arizona Public Works Utilities Department, and backflow prevention testers from the City of Tucson Parks and Transportation Departments, Pima County Natural Resources and Transportation Departments, Tucson Unified School District, the University of Arizona, and the Arizona Department of Environmental Quality (ADEQ). The ADEQ has approved the class for eight hours of professional development credit.

The Tucson Water Cross-connection Control Specialists are now working closely to mentor newly certified Reclaimed Water Site Testers as they begin inspecting schools, parks, and street medians. The mentoring program provides confidence that sites are being correctly inspected and tested and gives the new Site Testers a positive environment in which to ask questions. In 2013 Tucson Water Site Testers will begin inspecting residential sites.

Project Funding and Management Practices

The Reclaimed Water Site Inspection Program was developed by existing staff from the Backflow Prevention/Reclaimed Water Section. The only new expense for the Program's development was \$10,000 for consultant services to modify the backflow prevention database to accommodate reclaimed water site information. When the program was implemented, a fifth cross-connection control specialist was hired and the total recurring annual cost for this position, including benefits, is \$72,000. There was also a one-time \$37,000 expense, including a vehicle, equipment, and training for the new specialist.

Successes and Lessons Learned

Development of the Reclaimed Water Site Inspection Program took more than 5 years from conception to implementation. Although the importance of the program was recognized, competing priorities often overshadowed implementation efforts. Ultimately, the

program was implemented as the result of a project “champion” within Tucson Water and support from the Southern Arizona Office of the ADEQ. Once the commitment to implement the program had been made, strict adherence to the schedule made its completion a reality.

Tucson Water’s Reclaimed Water Site Inspection Program is the first of its type in Arizona and will hopefully be used as a model for other programs and a template for State certification of Reclaimed Water Site Testers.

References

Tucson Water. 2010. *Dye Testing: Ensuring the Separation of Potable and Reclaimed Water Systems*. Available from <<http://cms3.tucsonaz.gov/files/water/docs/dyetesting.pdf>>.

City of Tucson. 2010. *Mayor and Council Ordinance: Requiring Inspections*. Available from <<http://cms3.tucsonaz.gov/sites/default/files/water/docs/backflow-ordinance.pdf>>.

Tucson Water. 2010. *A Training Manual for Reclaimed Water Site Testers*. Available at <<http://cms3.tucsonaz.gov/files/water/docs/recl-train-1-2.pdf>>.

Environmental Operations Park

Author: Kerri Jean Ormerod (University of Arizona)

US-AZ-Sierra Vista

Project Background or Rationale

The key water management challenges in Arizona are increasing demands for water, fully allocated existing water resources, and groundwater depletion. Groundwater depletion, or overdraft, is a result of excessive groundwater pumping and is problematic for numerous reasons, including its environmental impacts. Groundwater sustains rivers, streams, lakes, and wetlands providing the riparian habitat for wildlife. In the 19th century, wetlands, marshlands or cienegas, were common along rivers in Arizona; however, heavy pumping of groundwater beginning in the mid-20th century led to dewatered rivers and streams and loss of riparian ecosystems (Glennon, 2002).

Recently, artificially constructed wetlands have been designed to simultaneously provide natural wastewater treatment and enhance wildlife habitat. Environmental Operations Park (EOP) in southern Arizona serves as a case study, where water from the wastewater reclamation facility is polished in constructed wetlands and recharged to the local aquifer in order to mitigate the adverse impacts of continued groundwater pumping in the San Pedro River system.

The EOP is operated by the city of Sierra Vista, Arizona, in Cochise County in the southeastern corner of the state. Sierra Vista is adjacent to the upper San Pedro River and the U.S. Army's Fort Huachuca. The city and surrounding communities in Cochise County are experiencing rapid growth and subsequent increases in water demand. The addition of over 13,500 new residents between 2000 and 2010 represented a 12 percent change in population (U.S. Census Bureau, 2010) and by 2025 an estimated 7,000 ac-ft (8.6 MCM) will be necessary to serve the projected population (Glennon, 2002). Cochise county communities rely on the groundwater resources in the Sierra Vista sub-watershed, part of the bi-national San Pedro Watershed. Within the watershed, the San Pedro River flows north from Mexico into Arizona. The river is distinct as the last free-flowing undammed river in Arizona, which supports a unique desert riparian ecosystem. The wells supporting Sierra Vista and Fort

Huachuca have created cones of depression that threaten the surface flow of the river (Glennon, 2002). While there is technically sufficient groundwater to sustain the rising population in and around Sierra Vista, a significant drop in the water table will reduce the amount of water available to the river and its riparian vegetation. Ecological considerations, including the protection of endangered species, prompted the decision to recharge available reclaimed water supplies to the underlying aquifer.

The ecological importance of Arizona's San Pedro River was recognized by Congress in 1988 when it established the San Pedro Riparian National Conservation Area with the explicit mission to protect approximately 40 miles (64 km) of the river and its riparian habitat. The San Pedro River system provides habitat for over two-thirds of all bird species in North America and is an internationally renowned attraction for birders (Glennon, 2002; Sprouse, 2005). In addition to the hundreds of bird species, the San Pedro provides habitat 82 mammals, 43 reptiles, including seven federally recognized endangered species (Sprouse, 2005).

In Sierra Vista, reclaimed water functions solely as a water supply for aquifer recharge. The artificial recharge occurs a couple miles from the San Pedro River with the ultimate goal of safe yield (balance between water withdraw and natural and artificial recharge). The immediate goal of the recharge is to mitigate groundwater pumping by creating a mound between the existing cone of depression and the San Pedro River in order to protect baseflow of the river.

Capacity and Type of Reuse Application

The Sierra Vista EOP was established as a multi-use center. The park spans 640 ac (260 ha) and includes 30 open basins that recharge nearly 2,000 ac-ft (2.5 MCM) of reclaimed water to the aquifer on an annual basis, 50 ac (20 ha) of constructed wetlands, nearly 200 ac (81 ha) of native grasslands, and an 1,800 ft² (170 m²) wildlife viewing facility. The reclamation

facility includes a 10-ac (4-ha) complete mix/partial mix lagoon system. The constructed wetlands provide numerous beneficial services, including filtering and improving water quality as plants take up available nutrients. In the EOP wetlands secondary treated effluent is treated to tertiary standards naturally.

The primary purpose of EOP is to offset the effects of continued groundwater pumping that negatively impact the river and protect the habitat for native and endangered species. The present volume of wastewater generated from the EOP treatment plant is 2.5 mgd (110 L/s). The facility system capacity is 4 mgd (175 L/s). Over 11,000 ac-ft (13.5 MCM) of water have been recharged since opening in 2002. The recharge facility is permitted and monitored by Arizona Department of Water Resources, the agency responsible for protecting water quality in the state.

Project Funding and Management Practices

The \$7.5 million reclamation project at EOP was funded through a cooperative agreement with the City of Sierra Vista and the Bureau of Reclamation with assistance from Arizona Water Protection Fund Program and Department of Housing and Urban Development. Per the Bureau of Reclamation funding, the City of Sierra Vista is required to recharge all wastewater at the EOP facility until 2022.

Institutional/Cultural Considerations

In response to growing environmental concerns, considerable collaborative community effort has been made to protect the region's assets, including the watershed, endangered species, and the continued presence of Fort Huachuca—the region's biggest employer. The most influential group is the Upper San Pedro Partnership, a consortium of interested parties including federal, state, and local agencies, development groups, and environmental organizations committed to actively protecting the river and the fort.

Successes and Lessons Learned

Reclaimed water is utilized in Sierra Vista to protect the San Pedro River from the principal threat of increased groundwater pumping associated with population growth. The primary benefits reclaimed water provides to the region are recreational and economic. In addition to providing wastewater treatment, the wetlands, foot trails, trees, native grasses and animals at EOP are recognized as a

community amenity. Recharge of reclaimed water within the watershed assists in sustaining the baseflows of the river and mitigating the damaging effects of continued groundwater pumping, helping to maintain essential migration corridors for wildlife and protect the habitat for endangered species. Nonetheless, future development and its associated increase in water demand are expected to exacerbate the environmental impacts of groundwater overdraft in the region (Glennon, 2002).

References

- Glennon, R.J. (2002). *Water Follies: Groundwater Pumping and the Fate of America's Fresh waters*. Washington, D.C: Island Press.
- Sprouse, T. (2005). *Water issues on the Arizona-Mexico border, the Santa Cruz, San Pedro and Colorado Rivers*. Water Resources Research Center, University of Arizona.
- U.S. Census Bureau (2010). *Census 2000 Redistricting Data (Public Law 94-171) Summary File, Table PL1, and 2010 Census Redistricting Data (Public Law 94-171) Summary File, Table P1*.

91st Avenue Unified Wastewater Treatment Plant Targets 100 Percent Reuse

Authors: Steve Rohrer, P.E. and Tim Francis, P.E., BCEE (Malcolm Pirnie, the Water Division of ARCADIS); Andrew Brown, P.E. (City of Phoenix)

US-AZ-Phoenix

Introduction

The 91st Avenue Wastewater Treatment Plant (WWTP) treats wastewater from the cities of Glendale, Mesa, Phoenix, Scottsdale, and Tempe, Arizona, which together constitute the Sub-Regional Operating Group (SROG), formed in 1979 and jointly owns the WWTP. The 230 mgd (10,100 L/s) facility uses nitrification/denitrification in treating municipal and industrial wastewater from the SROG cities. The WWTP is one of the largest water reclamation facilities in the country. Currently, the plant processes approximately 158,000 ac-ft/year (195 MCM/yr), of which approximately 60 percent is reused; 67,700 ac-ft/yr (83.5 MCM/yr) is delivered to a nuclear, power-generating station for cooling tower makeup water, 1,400 ac-ft/yr (1.7 MCM/yr) is delivered to new constructed wetlands, and 28,200 ac-ft (34.8 MCM/yr) is delivered to an irrigation company for agricultural reuse. The remaining effluent is discharged to the dry Salt River riverbed that bisects the SROG communities.

The 91st Avenue WWTP

The original 5 mgd (219 L/s) WWTP was built in 1958 near 91st Avenue and the Salt River in Phoenix. This plant was later replaced with a 45 mgd (1,970 L/s) plant that was subsequently expanded throughout the years. The plant initially discharged secondary treated wastewater to the dry Salt River, but in 2000, the SROG developed a 25-year Facility Master Plan that envisioned a unified plant concept for all future expansions. The first project under this plan, the Unified Plant 2001 (UP01), was designed in 2001 and completed in September 2008, increasing plant capacity to 204 mgd (8,900 L/s). The second plant expansion project, UP05, was completed in October 2010 and increased the capacity to the current 230 mgd (10,100 L/s).

The unified plant concept consists of process units that operate as part of an integrated system. Flow from

each process is combined into a common channel so that the following process can be fed to any of the subsequent process units. One of the major advantages of the unified plant concept is that, in the event of a process upset or a scheduled maintenance event, a single process unit can be taken out of service while maintaining the treatment capacity in adjacent and follow-on process areas. Process units have been sized with built-in redundancy such that follow-on process units with slightly decreased influent quality can still satisfy the plant's permit water quality requirements, thus maintaining reliable reclaimed water production.

91st Avenue WWTP Water Reuse Program

The 25-Year Master Plan considered the likelihood of future advanced treatment that may be required as the result of evolving regulations or customer requirements. It is estimated that, by 2025, up to 60 mgd (2630 L/s) of the WWTP effluent could be allocated to end uses that require advanced treatment and the SROG envisions a Market Resource Center on the WWTP site that could include membrane filtration and reverse osmosis systems. As a result, planning estimates for the development area include space on the plant site for advanced treatment systems. Currently, the reuse program includes several agreements for delivery of the reclaimed water, including consideration for future uses of the resource.

Cooling Tower Use at the Palo Verde Nuclear Generating Station. SROG's original water pact with the Palo Verde Nuclear Generating Station (PVNGS) was signed in 1973 and water deliveries under that agreement began in 1985 when the facility's Unit 1 began operations. Because of its desert location, the PVNGS is the only nuclear power plant in the world that uses treated effluent for cooling tower use. Treated effluent is piped from the 91st Avenue WWTP a distance of 36 miles (58 km) to the PVNGS site,

where it is further treated to meet the nuclear energy plant's cooling needs.

The original agreement required SROG to set aside 105,000 ac-ft/yr (130 MCM/yr) for the PVNGS. And, although the plant used considerably less water than this, SROG was required to maintain this capacity under the terms of the contract. In early 2010, SROG and owners of PVNGS renegotiated a new, comprehensive water contract which calls for an annual allotment of 80,000 ac-ft (98.7 MCM/yr) through 2050, freeing up an annual volume of 25,000 ac-ft (30.8 MCM) for other SROG uses.

Tres Rios Constructed Wetlands. The SROG worked with the U.S. Army Corps of Engineers to develop the Tres Rios Constructed Wetlands Project along the Salt River downstream of the 91st Avenue WWTP. The project will restore eight miles of unique riparian habitat near the confluence of the Salt, Gila and Agua Fria Rivers using reclaimed water from the 91st Avenue WWTP. In addition to meeting water quality and supply objectives, the project is intended to restore habitats for threatened and endangered fish and wildlife species, reduce potential for flood damage, and provide public recreation opportunities. The wetlands were constructed and put into operation in 2010 and are currently receiving 1,400 ac-ft/yr (1.7 MCM/yr) of reclaimed water. It is projected that the wetlands can accept 19,000 to 23,000 ac-ft (23 to 28 MCM) annually as it matures and operations are stabilized.

Buckeye Irrigation Company Agricultural Irrigation. Buckeye Irrigation Company (BIC) has a service area located approximately 20 miles (32 km) west of the 91st Avenue WWTP. The company got its start in 1907 after many periods of drought, floods, economic downturns, changing land and water policies, and fiscal uncertainties. Currently, some of BIC's water supply is purchased reclaimed water; BIC operates a diversion structure downstream from the plant, capturing and diverting reclaimed water discharged from the WWTP and/or the Tres Rios Constructed Wetlands into agricultural canals. BIC, by agreement, can take up to 20,000 ac-ft/yr (25 MCM/yr) of effluent through the year 2015, with options to extend to 2030.

Potential Future Reuses. Critical riparian and wetland habitats along the Salt, Gila and Agua Fria Rivers have been lost because of water resources development in the Phoenix metropolitan area. In addition to the Tres Rios Constructed Wetlands project, the SROG cities have evaluated other major groundwater recharge and habitat restoration projects near these three rivers. The projects will play significant roles in the transformation of the 91st Avenue WWTP, and likely other area WWTPs, in becoming major providers of reclaimed water.

Summary

The 91st Avenue WWTP currently delivers 60 percent of its reclaimed water produced to industrial, wetlands and irrigation uses. If current reuse customers take their full allotments, the effective reuse rate could be as high as 80 percent of the current plant production. In addition to increasing deliveries to the wetlands and continuing deliveries to the other reclaimed water customers, the SROG cities envision implementing other regional groundwater recharge and environmental and riparian habitat restoration projects. These projects, along nearby riverbeds, could accept all the remaining reclaimed water that would otherwise be discharged to the riverbed. This would effectively make the 91st Avenue WWTP the largest water reclamation facility in the country whose effluent is 100 percent reused.

Arizona Blue Ribbon Panel on Water Sustainability

Authors: Channah Rock, PhD (University of Arizona); Chuck Graf, R.G. (Arizona Department of Environmental Quality); Christopher Scott, PhD (University of Arizona); Jean E.T. McLain, PhD (USDA-Agricultural Research Service, U.S. Arid Land Agricultural Research Center); and Sharon Megdal, PhD (University of Arizona)

US-AZ-Blue Ribbon Panel

Background or Rationale

In response to the pressure of population growth coupled with an arid environment, Arizona has conventionally addressed water challenges by increasing supply. This case study demonstrates how decision-makers are reconsidering the other side of the equation—alleviating water demand, especially through conservation, recycling, and reuse. In particular, the expanding practice of water reuse has become the centerpiece of efforts to achieve sustainability.

Blue Ribbon Panel on Water Sustainability

In 2009, Arizona Governor Jan Brewer announced formation of the Blue Ribbon Panel on Water Sustainability (BRP) to focus on water conservation and recycling as strategies to improve water sustainability in Arizona. The BRP was jointly chaired officials responsible for regulation and management of water resources: Ben Grumbles, Director, Arizona Department of Environmental Quality (ADEQ); Herb Guenther, Director, Arizona Department of Water Resources (ADWR); and Kris Mayes, Chairperson, Arizona Corporation Commission (ACC), Arizona's constitutionally established regulatory body for privately owned utilities. Additionally, 40 members representing diverse water interests in Arizona were appointed to the BRP, including representatives of large and small cities, counties, agriculture, industry, Indian Tribes, environmental interests, universities, legislative leaders, and other experts. The BRP held its first meeting in January 2010 and was challenged to identify and overcome obstacles to increase water sustainability. The initial goal was to agree upon a succinct purpose statement:

To advance water sustainability statewide by increasing reuse, recycling, and conservation to protect Arizona's water supplies and natural environment while supporting continued economic development and to do so in an effective, efficient and equitable manner.

Members agreed to provide recommendations on statute, rule, and policy changes that, by the year 2020 in Arizona, would significantly;

1. Increase the volume of reclaimed water reused for beneficial purposes in place of raw or potable water
2. Advance water conservation, increase the efficiency of water use by existing users, and increase the use of recycled water for beneficial purposes in place of raw or potable water
3. Reduce the amount of energy needed to produce, deliver, treat, and reclaim and recycle water by the municipal, industrial, and agricultural sectors
4. Reduce the amount of water required to produce and provide energy by Arizona power generators
5. Increase public awareness and acceptance of reclaimed water uses and the need to work toward water sustainability

BRP Working Groups

Five working groups were formed, chaired by BRP members, with participation open to the public, to facilitate discussion of issues and involve broadest broad spectrum of stakeholders and technical expertise. Working groups were chaired by Arizona representatives from Pima County Regional Wastewater Reclamation; WaterReuse Association; Arizona WaterReuse Association; Arizona Municipal Water Users Association; and Pinal County to explore:

- Public perceptions related to reclaimed water reuse quality
- Regulatory and policy changes to further promote reuse and recycling
- Reclaimed water infrastructure and retrofit best practices
- Conservation/efficiency and energy/water nexus issues
- Economic and funding opportunities, including both public and private mechanisms

The chairs and working group participants accomplished substantial work from January through November 2010. Cumulatively, 58 meetings were held, involving some 320 individuals. The working groups identified 40 separate issues, which the BRP condensed and prioritized. The working groups were directed to write "white papers" analyzing these challenges and provided recommendations based on the analyses. Priority issues included a diversity of subjects, including public perception, education, research needs, regulatory impediments, efficient use of water supplies, expanded use of rainwater and storm water, the interface between water and energy, funding and incentives.

BRP White Papers

Subsequent panel meetings were used to provide an overview of the 26 issues and to present the recommendations developed in the white papers. The BRP reviewed recommendations and consolidated them into categories: 1) education/outreach, 2) standards, 3) information development and research agenda, 4) regulatory improvements, and 5) incentives.

BRP Final Report and Recommendations

Although the final report contains too many recommendations to summarize here, several involving data collection and management stand out because they cross all three agencies chairing the BRP. Accurate information is essential to promoting a common understanding of Arizona's water supplies and the extent to which water sustainability is achieved. Development of rational policies and regulations that encourage use of recycled water while protecting public health and safety, and fostering public confidence depends on appropriate, timely, and accurate data. In addition to data management, a few select recommendations of the Panel, relevant to reuse are presented.

Data Management. Most generators and end users of reclaimed water submit data manually, which is time-consuming and often involves more than one permit or application. Data may be submitted to one agency and the same data or data in a slightly different form may be required by another report or agency. Agencies store this information in paper files and multiple electronic databases, which are hard to access and often difficult to compare. This creates administrative complexity and added costs for both the regulatory agencies and the regulated community, and is not conducive to expanding the use of recycled water in Arizona.

The BRP recommended streamlining data submission and management as a means of reducing administrative burden and improving data quality. ADEQ and ADWR would initiate a process to review and revise permit and non-permit data submittal requirements for frequency, consistency, and relevance. Electronic data submittal should be standard, and agencies should develop common data management systems available to regulators, permittees, contractors, and the public. The system also should incorporate data needs of the ACC in support of their application and review process. The BRP also recommended that agencies utilize expertise of independent information technology professionals and share costs of developing data management system(s).

Regulatory Programs. Ultimately, the BRP recommended no new regulatory programs for reuse and water sustainability or major reconstruction of existing programs. Instead, less dramatic adjustments to Arizona's existing toolbox of water management, education, and research capabilities are highlighted. The BRP concluded that current programs administered by ADWR, ADEQ, and the ACC constitute an exceptional framework within which water sustainability and reuse can be pursued.

No major new programs were recommended for addressing reuse; this reflected the success of transformative rule changes adopted by ADEQ in January, 2001. At that time, following more than two years of stakeholder involvement, ADEQ adopted rules for reclaimed water permits for end users, reclaimed water conveyances, and reclaimed water quality standards. Simultaneously, ADEQ adopted rules requiring modern, high-performance, tertiary treatment for new or expanding wastewater treatment plants (WWTPs) under BADCT (Best Available Demonstrated Control Technology) provisions of its Aquifer Protection Permit program. The BADCT requirements provide that the high-quality, reclaimed water produced is suitable for reuse. This allows the permitting program for end users to be simple, concentrating on operation, maintenance and reporting matters, because end users are delivered high quality reclaimed water. Arizona's modern approach to wastewater treatment, combined with comprehensive but relatively simple requirements, has incentivized reuse throughout the state. Arizona's rules governing reclaimed water and prescribing high-performance WWTPs constitute a framework for regulating reclaimed water that can be used as a model for other states developing their own regulatory programs.

Reclaimed Water Infrastructure Standards. ADEQ adopted criteria for reclaimed water distribution systems in 2001 for both pipeline and open water conveyances; however, these criteria, which pertain to design and construction, are quite limited. For example, they do not address retrofit situations, including conversions of drinking water system piping to reclaimed water or vice versa. They insufficiently address cross connection control and do not address augmentation of the reclaimed water system with other sources, such as pumped groundwater. The BRP recommended convening a stakeholder group to compile a matrix of state, regional and local

specifications and infrastructure standards to identify similarities, inconsistencies, and gaps and develop recommendations on a suite of standards to provide a common foundation of safety and good engineering practices.

Indirect Potable Reuse (IPR) Guidelines. Recognizing trends in other states, the BRP saw a need to develop definitions and guidance for IPR to clarify and facilitate drinking water source approval and local and state agency permitting requirements. The BRP believed that IPR guidance would facilitate a standardized and efficient approach to design, permitting and operation of advanced treatment operations with the intent of IPR and suggested that regulations be established to address water quality standards (regulated and unregulated constituents), hydro-geological circumstances of recharge and recovery, and multiple/engineered barriers needed to obtain approval. Thus, the BRP recommended creation of an IPR Multi-Agency Steering Committee comprised of diverse membership with the mission to develop approaches to streamlining agency reviews, incorporating new technologies, and devising a statewide policy on IPR. The policy would define the objectives of IPR; clarify how recharged reclaimed water can become acceptable for potable purposes; and outline the process for issuing approvals for IPR facilities.

Next Steps

Each BRP recommendation can be moved forward by the Governor, Legislature, the ACC, ADEQ, and ADWR. However, many recommendations involve implementation by ADEQ and ADWR, which will be a challenge in light of budget cuts that have reduced staff and program capabilities. Accordingly, agency efforts have recently focused on recommendations with university involvement to increase collaboration and move forward some of the research issues identified by the BRP, ranging from investigations in public perception to determinations of the linkages, if any, between residual trace organic compounds in treated wastewater effluents and impacts on the environment and human health.

Although implementation will take time, a clear punch list exists. As the agencies begin work, resulting progress in water conservation and reuse will benefit all the citizens of Arizona and stand as a tribute to the

dedication and intellect of the participants who contributed long hours to the BRP process.

References

ADEQ, Arizona Department of Environmental Quality Annual Report: Water Quality Report, Appendix iii, 1997.

ADHS, Arizona Department of Health Services, Engineering Bulletin No. 11: Minimum Requirements for Design, Submission of Plans and Specifications of Sewage Works, July 1978.

Arizona Administrative Code, A.A.C. Title 18, Ch. 9, Art. 6, R18-9-601 through 603

Arizona Administrative Code, A.A.C. Title 18, Ch. 11, Art. 3, R18-9-301 through 309

Arizona Administrative Code, A.A.C. Title 18, Ch. 9, Art. 7, R18-9-701 through 720

Arizona Administrative Code, A.A.C. Title 18, Ch. 9, Art. 2, Part B, R18-9-B201 through B206

Arizona Revised Statutes, A.R.S. 49-203(A)(6)

Arizona Department of Water Resources. 2010. "Final Report of the Governor's Blue Ribbon Panel on Water Sustainability." Retrieved on Spet. 7, 2012 from <<http://www.azwater.gov/AzDWR/waterManagement/BlueRibbonPanel.htm>>.

Effluent Auction in Prescott Valley, Arizona

Author: Christopher Scott, PhD (University of Arizona)

US-AZ-Prescott Valley

Background

Arizona and other areas of the Southwest are experiencing rapid growth in population and water demand (Eden and Megdal, 2006). Despite the economic and real estate downturn that began in 2007, future demands for water and the resulting need for wastewater reclamation and reuse are expected to continue to grow (Scott et al., 2011), especially in Arizona's urban corridor stretching from Flagstaff and Prescott in the north, through Phoenix, and to Tucson and Nogales in the south (Morrison Institute, 2008). This region has a semiarid to arid climate with warm, mostly dry winters, and hot summers. Rainfall primarily occurs in convective thunderstorms that characterize the North American monsoon. Surface waters are subject to increased climate change and variability, exerting ever-greater pressure on groundwater and effluent as sources of supply (e.g., Tucson Water, 2008).

Arizona formed Active Management Areas (AMAs) under the Groundwater Management Act of 1980 in order to address long-term water sustainability and as a *quid pro quo* to secure federal funding for the Central Arizona Project aqueduct and canal system. Among other stipulations, the Act requires that assured water supply for 100 years be demonstrated for any new growth that is planned in the AMAs. In a process regulated by the Arizona Department of Water Resources (ADWR), jurisdictions have thus far exclusively relied on surface water or groundwater to meet assured water supply rules.

In a first-of-its-kind, in Arizona and the nation, the Town of Prescott Valley in 2006 made the case, in physical-hydrological terms and according to institutional and administrative rules, that effluent recharged into aquifers within town limits could be used to meet future water demands. As a result, in 2007, Prescott Valley auctioned rights to its future effluent to the highest bidder, allowing real estate interests to continue development that could otherwise have been restricted due to water scarcity. The bidder would receive credits to extract groundwater to be

used to satisfy the assured water supply requirement. Prescott Valley intended to use the proceeds to help pay its share of the costs of a pipeline to move water from the Big Chino ranch to Prescott and Prescott Valley, both part of the Prescott AMA. The prospect of receiving water in the future from this pipeline was deemed to be uncertain by ADWR in 2006, and therefore was disallowed as a source of assured water supply for Prescott Valley.

This case study describes the Prescott Valley effluent auction and demonstrates that a) specific institutional conditions were necessary to allow the effluent-rights transfer to occur, b) effluent is a marketable commodity that benefits a specific set of interests, and thus requires further scrutiny to ensure broader, beneficial outcomes, and c) policy choices favoring effluent for growth must consider environmental uses and in-stream flows. These observations have implications for water reuse within Arizona, across the Southwest, and beyond.

Effluent Auction: Water Resources and Regulatory Considerations

Prescott Valley offered for auction the right to 2,724 ac-ft (3.36 MCM) of effluent on an annual basis. By Arizona's assured water supply rules, this would provide the buyer the right to use the effluent for 100 years. The initial auction in 2006 failed, bringing only one bid that did not conform to the conditions established. Subsequently, the Town entered into an agreement with Nebraska-based Aqua Capital Management, which provided a floor-price guarantee at a pre-negotiated price of \$19,500 per ac-ft (\$15.80/m³). This left the Town the option to auction the effluent for a better price, but by doing so, it would pay a contract breakup penalty. In 2007, WestWater Research coordinated the auction, which brought in three bids. Water Asset Management through its subsidiary Water Property Investors, LLC offered the highest bid at \$24,650/ac-ft (\$19.98/m³) for a total of \$67 million.

There is extensive U.S. and international experience with marketing effluent pollution credits. However, the Prescott Valley case has set precedent in creating marketable rights for effluent as a commodity (Scott and Raschid-Sally, 2012). This was only possible with prior institutional and legal arrangements, briefly summarized here.

Effluent from Growth, Effluent for Growth

Effluent, and reclaimed water of other qualities suitable for a range of uses, is generated as a result of urban growth. Under conditions of water scarcity such as those in Arizona, effluent is viewed as a resource to meet growth-related water demands. This is increasingly the case in the context of regulatory limits on new surface water diversions and additional groundwater pumping. At the same time, climate change and variability, which water managers in the region address as “extended drought,” make effluent an integral part of water supply planning—an attractive alternative to conventional supplies.

Two features of the Prescott Valley case are especially interesting. First, the Town chose not to retain the rights to its effluent and instead used it as a financial mechanism to secure other, more conventional, water supplies from the Big Chino ranch. Second, the purchaser of the effluent, Water Property Investors, was not an Arizona developer but instead a holding company – essentially a speculator in effluent – that subsequently sold portions of the effluent rights it had purchased at auction. In 2009, developer John Crowley II of Denver, Colorado, purchased 200 ac-ft (0.25 MCM) and Cavan Real Estate Investments of Scottsdale, Arizona purchased 700 ac-ft (0.86 MCM) – both for undisclosed amounts price. These aspects of the effluent sale have important management and policy implications for water use, real estate growth, and environmental quality in Prescott Valley and more broadly.

According to the town manager, the auction process that resulted in the transfer of water credits to developers heightened competition in water markets with resulting financial benefits for local residents. The water resources manager of Prescott Valley observed that: a) existing infrastructure and available effluent were necessary, b) effluent rights needed to be eligible under assured water supply rules, and c) partnering with the private sector was necessary in order to

navigate water markets and to structure financial risks allowing the town to auction its effluent.

Conclusions and Lessons Learned

It appears inevitable that markets for effluent as a resource will expand. The Prescott Valley case is likely the first of many such transactions. Markets in effluent as a resource require regulatory oversight of the actual sale process and the transfer of water rights. In July 2006 Prescott Valley was granted by ADWR, a Physical Availability Demonstration of 2,724 ac-ft (3.36 MCM) of effluent (that meets water quality criteria) for 100 years. In addition, Prescott Valley applied for a certificate to utilize the effluent on 14,000 ac (5670 ha) of land within the Prescott Valley Water District. This required a Notice of Intent to Serve, Verification of Construction Assurance, and evidence of financial capability. However, the environmental impacts of allocating effluent flows to real estate development were not required under the regulatory process. Effluent that is released to local streams plays an important role in sustaining riparian vegetation. In many instances, effluent is the primary source of water in streams that have been diverted for use in agriculture and urban areas. The quality of riparian vegetation is not simply a habitat and biodiversity issue—which are important in their own right; it also has implications for recreation, the attractiveness of local surroundings and indirectly for the value of real estate.

References

- Eden, S., S. Megdal. 2006. Water and Growth, Chapter 4, pp. 63-101. 88th Arizona Town Hall Background Report.
- Morrison Institute. 2008. Megapolitan Sun Corridor. Retrieved on Sept. 7, 2012 from http://morrisoninstitute.asu.edu/publications-reports/Mega_AzSunCorr/view.
- Scott, C.A., A. Browning-Aiken, K.J. Ormerod, R.G. Varady, C.D. Mogollon, C. Tessmer. 2011. Guidance on Links between Water Reclamation and Reuse and Regional Growth. WaterReuse Research Foundation Report 06-016-1. WaterReuse Research Foundation, Arlington Virginia. 67 pp.
- Scott, C.A., L. Raschid-Sally. 2012. The global commodification of wastewater. *Water International* 37(2): 147–155.
- Tucson Water. 2008. Water Plan: 2000-2050, 2008 Update.

Frito-Lay Process Water Recovery Treatment Plant, Casa Grande, Arizona

Author: Al Goodman, P.E. (CDM Smith)

US-AZ-Frito Lay

Project Background

PepsiCo and Frito-Lay, a key brand within PepsiCo, are proud to be reducing the effect of their operations on the environment. Since 1979, Frito-Lay has implemented conservation programs to shrink its overall environmental footprint as part of its snack food production. Frito-Lay's manufacturing plant in Casa Grande, Arizona, makes snacks including corn and potato products (Lay's, Ruffles, Doritos, Tostitos, Fritos and SunChips). In the arid region of the southwest U.S., Frito-Lay completed a project with the ambitious goal to run the plant almost entirely on renewable energy and reclaimed water while producing nearly zero waste—something the company refers to as “Near Net Zero.” Major environmental projects implemented at the facility to achieve “Near Net Zero” included: process water recovery and reuse, use of renewable solar energy, generating steam from a renewable biomass boiler, and zero landfill waste projects.

Frito-Lay sought to integrate state-of-the-art technology and best practices from other Frito-Lay plants for a Process Water Recovery Treatment Plant (PWRTP). This PWRTP allowed the previous wastewater treatment system (which used land application of treated effluent) to be decommissioned, allowing those fields to be repurposed for solar energy production. The PWRTP system recycles up to 75 percent of the facility's process water—enabling Frito-Lay to reduce its water use by 100 million gallons (380,000 m³) annually. An aerial view of the PWRTP is shown in **Figure 1**.

Production at the facility is a 24 hours/day, 7 days/week operation, requiring the PWRTP to be robust, reliable, and cost efficient. Design/build of the facility began in August 2009 with startup in June 2010.



Figure 1
Aerial View of PWRTP (Photo credit: Frito-Lay)

Capacity, Water Quality Standards, and Type of Reuse

The average daily design flow of the PWRTP is 0.648 mgd (28 L/s) from the production facility; characteristics of the influent are biochemical oxygen demand of 2,006 mg/L and total dissolved solids of 2,468 mg/L. All sanitary wastes (i.e. bathroom connections) are segregated and discharged to the city sanitary sewer for conventional treatment at the City of Casa Grande Wastewater Treatment Plant.

The reuse quality established by Frito-Lay/PepsiCo required the water to meet EPA primary and secondary drinking water standards. The process water that is used to move and wash potatoes and corn, clean production equipment, and for other in-plant cleaning and production needs, is reclaimed for reuse in the process. The reclaimed water quality from the PWRTP is of higher quality than the local potable water supply in terms of alkalinity, arsenic, and silica. A photo of the reclaimed water at various stages of the treatment process is shown in **Figure 2**.



Figure 2
Water at Various Stages of the Treatment Process
 (Photo credit: Frito-Lay)

Treatment Technology

The treatment train at the PW RTP is depicted in **Figure 3**. Oily wastewater (from specific production processes) is segregated to minimize adverse effects on the membrane bioreactor (MBR) and low pressure reverse osmosis (LPRO) processes; it is collected by separate drains and a free oil recovery sump. In addition, the plant recovers starch from specific production steps to recover resources for cost recovery and reduce nutrient loads on the PW RTP.

The treatment process includes: internal-feed rotary drum screening, equalization with pH adjustment using carbon dioxide, primary clarification/sedimentation, activated sludge with biological nutrient (nitrogen) removal in concentric steel bioreactor tanks, MBR, granular activated carbon (GAC), UV disinfection, LPRO, and chlorine disinfection prior to reuse. Treated water is stored in a 200,000 gallon storage tank. The GAC system was added in 2011 to enhance treatment for additional recovery and to further protect the LPRO membranes; the system uses lead-lag parallel carbon

vessels. Reject water from the LPRO is discharged to the city of Casa Grande Wastewater Treatment Plant.

Solids generated from the screening (corn and potato wastes) are collected and combined with the primary clarifier sludge for dewatering by centrifuge and is used as animal feed. The waste activated sludge is dewatered by a dedicated centrifuge and disposed by land application.

Providing MBR equipment outdoors, in pre-engineered vessels, using factory-mounted skids enabled faster installation and startup, helped control costs, and reduced ventilation challenges in the control building. The prepackaged GAC filters and LPRO membranes are housed in an isolated room with that are visible from the control room. A laboratory, conference room and offices are provided within an 8,000+ square foot control building and visitors center. All PW RTP systems are SCADA monitored and controlled.

Project Funding and Management Practices

The project was fully funded by PepsiCo and Frito-Lay; project costs are confidential. A staff of six full-time operators is contracted by Frito-Lay to operate and maintain the PW RTP.

Public Considerations

Frito-Lay and PepsiCo have received the several state and national awards for this facility and include: WateReuse Association Small Plant Award (2011); Clean Water America Alliance U.S. Water Prize (2012); 2009 BE Inspired Award in the “Innovation in Water and Wastewater Treatment Plants” category, Plant-of-the-Year Award by *Food Engineering* magazine.

In October 2009, Frito-Lay Casa Grande became the first snack food manufacturing facility to be certified LEED 2.0 Existing Building Gold in the company, the state of Arizona, and the United States.

Successes and Lessons Learned

The project provides better water quality than initially targeted by designers, and has enabled Frito-Lay to install 5 megawatts of solar photovoltaic and Sterling dish technology on land previously used for land application of treated wastewater effluent.

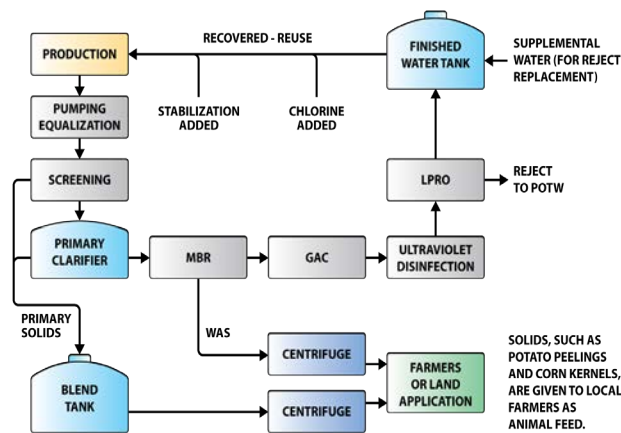

Figure 3
PW RTP process flow diagram

The Psychology of Water Reclamation and Reuse: Survey Findings and Research Roadmap

Brent M. Haddad, MBA, PhD (University of California, Santa Cruz)

US-CA-Psychology

Project Background

The primary message of this report is the U.S. public is open to considering water reclamation and reuse for both potable and non-potable uses. Surveys were taken from 2695 respondents in five locations (San Diego, San Jose, Philadelphia, Oregon, and Phoenix) in 2006-2007. Surveys used the term “certified safe recycled water” as a term that would have meaning to the lay public although it does not correspond to any regulatory category of reclaimed water.

Survey Results

There were no significant regional or demographic differences in willingness to drink reclaimed water. And, other key findings included:

- Only 13 percent of respondents said they would be unwilling to drink certified safe recycled water.
- Roughly 26 percent of respondents do not believe that treatment systems can bring recycled water to a state of purity at which they would want to use the water. These respondents generally expressed a preference for natural treatment over technological treatment of water.
- Independent (e.g., university-affiliated) scientists are the most credible source of information on recycled water. State and federal government scientists are also credible. Hired actors, neighbors, and employees of private water-related companies are least credible.
- 30 percent of respondents are not interested in technical explanations of the water’s safety as long as they have credible and trustworthy assurances of its safety.
- Systems that include natural barriers such as groundwater recharge or reintroduction to a

river are slightly more trustworthy compared to systems without these features.

- In the short run (long run was not tested), exposure to information about the safety of reclaimed water has an effect on willingness to use it, even those initially fully opposed to drinking certified safe recycled water. Both the approach of *recycled water is safe* and *all water has the properties of recycled water* (i.e., no such thing as pure or pristine water) were tested and each showed an increase in willingness to drink certified safe recycled water.
- Although the statistical relationships are often weak, the person most likely to reject certified safe recycled water has the following characteristics:
 - Highly concerned about and easily disgusted by the presence of potential contagions in many settings (not just water-related)
 - Self-identified as not politically moderate
 - Less trusting in government institutions and science
 - Less favorable toward technology in general
 - Less impressed by successively more effective water treatment technologies
 - More interested in knowing about the history of one’s drinking water
- Individuals most likely to accept and use certified safe recycled water have the following characteristics:
 - They have been exposed to the idea that all water is used

- They have been exposed to statements about the purity of certified safe recycled water
- They are confident they will get used to drinking certified safe recycled water over time if it is introduced
- Reclaimed water intended for drinking is least likely to be rejected by individuals if it is:
 - Certified safe by scientists
 - Extensively treated prior to use
 - Used in some natural way (river, lake, groundwater replenishment) prior to it being directly reintroduced to the drinking water system
- Research into modes of introduction of reclaimed water. Two approaches include slow, incremental introduction versus rapid, complete introduction. Each has general strengths and weaknesses when used in other contexts of introducing new technologies. Insights would inform how agencies introduce water reuse to their service territories.
- Research into opposition and opponents of water reuse. Insights could inform the public decision-making process and other modes of agency-public communication and decision-making that may be unnecessarily fueling the stridency of opposition.
- Research into the relationship between understanding water treatment technology and public acceptance of recycled water. How do images and statements about water treatment technology found in mailers, facility tours, public meetings, and websites influence the public? Results could help water agencies communicate with the public.

Future Research Needs

The study identified research needs in the following areas:

- Fundamental research on human reactions to water quality, including demographic factors; psychological attributes; beliefs about hydrology, geology and water technology; and beliefs about natural systems and hybrid natural-engineered water treatment systems. Insights would inform agency-public communication strategies and regulatory reform.

References

Haddad, B., Rozin, P., Slovic, P., and Nemeroff, C., 2010. *The Psychology of Water Reclamation and Reuse: Survey Findings and Research Roadmap*. Arlington, VA: WaterReuse Foundation.

Managing a Reclaimed Water System through a Joint Powers Authority: San Ramon Valley

Author: David A. Requa, P.E. (Dublin San Ramon Services District)

US-CA-San Ramon

The Dublin San Ramon Services District (DSRSD) and the East Bay Municipal Utility District (EBMUD) formed a joint powers authority to develop and manage the San Ramon Valley Reclaimed Water Program. Despite differences in size, structure, and culture, the two California agencies have successfully used the joint powers model to plan a system that serves both newly built and retrofitted neighborhoods, to work through multiple phases of construction, and to coordinate distribution and customer service.

Project Background

DSRSD and EBMUD have delivered potable water to adjacent communities since 1967. Although they rely on different water sources, both agencies face supply constraints in dry years; as a result, both agencies have long supported water recycling to increase reliability of potable water supplies. The DSRSD and

EBMUD service areas and recycled water system are shown in **Figure 1**.

In the early 1990's DSRSD agreed to provide water for major new developments approved by the two cities in its service area. Its water service plans were predicated upon requiring customers to use reclaimed water to irrigate large landscapes. DSRSD had an available supply of secondary effluent from its own wastewater treatment plant, and in 1993 obtained a state permit to distribute reclaimed water. EBMUD had developed reclaimed water projects in other parts of its service area, but in the San Ramon Valley it lacked a local source of effluent. A reclaimed water partnership was a cost-effective solution for both agencies. As a much larger agency, EBMUD also could provide the financial and political base to support the program and better obtain grant funding.

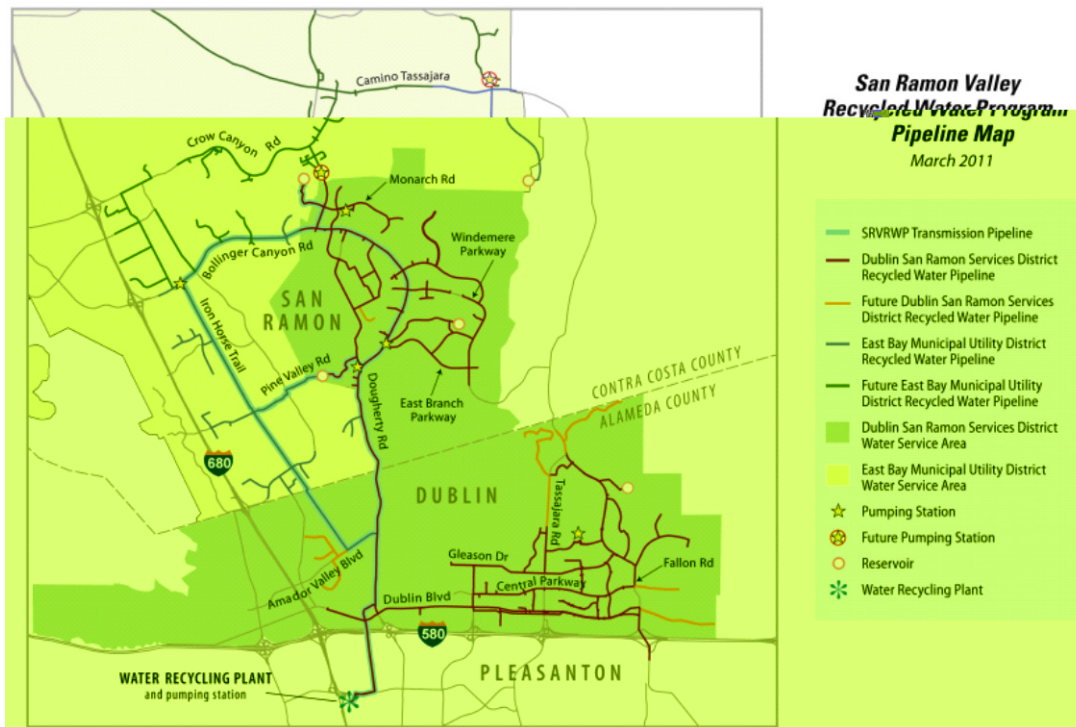

Figure 1
San Ramon Valley reclaimed water system (March 2010)

Management Practices

In 1995, the two agencies formed the DSRSD-EBMUD Reclaimed Water Authority (DERWA) to plan, build and operate the new program. DERWA is a wholesale entity with two retail customers—EBMUD and DSRSD. It is governed by a four-member Board of Directors comprised of two board members from each partner. Day-to-day operations are handled by an authority manager, who is a part-time contract employee.

The program is designed to ultimately deliver 6,420 ac-ft/yr (7.9 MCM/yr)—3,730 ac-ft/yr (4.6 MCM/yr) to DSRSD customers and 2,690 ac-ft/yr (3.3 MCM/yr) to EBMUD customers (DERWA 2003). The DERWA system consists of a sand filtration/UV disinfection (SFUV) treatment facility, a microfiltration/UV disinfection (MFUV) system used as backup and during the winter, three pump stations, two reservoirs, and 16 miles (26 km) of main transmission pipeline.

EBMUD and DSRSD designed and constructed the parts of the system to operate with minimal DERWA staffing (one part-time administrator to assist the authority manager). Ownership and labor are divided as follows:

- DSRSD owns the treatment plant and an initial high-lift pumping station at the plant.
- DERWA owns two pumping stations, two reservoirs, and the backbone transmission pipelines.
- Under contract to DERWA, DSRSD operates and maintains the entire system.
- EBMUD provides the DERWA treasurer and manages financial matters.
- Each agency owns and operates its distribution system and interacts with its own customers.

Funding

DSRSD and EBMUD divided \$82 million dollars in DERWA capital costs based upon the benefit received from each facility or reach of pipeline. The resulting cost-share—52 percent DSRSD and 48 percent EBMUD—also was applied to grants and loans that DERWA obtained to build joint-use facilities (DSRSD, 2011b). These included \$5 million in grants from the California State Water Resources Control Board (SWRCB), \$14.5 million in grants from the U.S. Army

Corps of Engineers, and \$25 million in SWRCB low-interest loans. EBMUD and DSRSD provided remaining funding from internal sources. DERWA divides the annual cost of operation between DSRSD and EBMUD in proportion to the amount of reclaimed water delivered by each agency during the year.

The backbone of the system was completed in stages, from 1998 to 2010. DSRSD's initial customers were located in newly developed areas, where reclaimed water use is mandated by ordinance. DSRSD is building its reclaimed water distribution systems at the same time as other infrastructure in those areas develop. EBMUD has the more difficult task of connecting existing customers to its reclaimed water distribution system. In addition to managing complex infill construction, EBMUD must work with customers to retrofit their irrigation systems.

Water Quality and Treatment Technology

In 2010, the partnership produced 2,174 ac-ft (2.68 MCM) of reclaimed water that meets California Title 22 standards for unrestricted non-potable reuse (DSRSD, 2011c). When irrigation demand is high, SFUV facilities produce up to 9.7 mgd (425 L/s); during the winter, MFUV is typically used to produce smaller, intermittent deliveries up to 3 mgd (131 L/s). The redundant treatment systems increase reliability and operational flexibility. The two systems may also be operated in parallel to produce up to 12.7 mgd (556 L/s). A planned future expansion will increase the SFUV capacity to 16.5 mgd and the total treatment capacity to 19.5 mgd (854 L/s) (DSRSD, 2011a).

Institutional/Cultural Considerations

EBMUD has close to 2,000 employees and DSRSD about 110. The partners have had to overcome differences in size and corporate culture to communicate efficiently with each other and their customers. For example, as operations began in 2006, small bits of plastic debris began clogging sprinklers and meters. DSRSD and EBMUD field crews responded to their customers and began looking for causes, but in the early stages they did not discuss the problem with each other. The problem was eventually traced to dime-sized plastic produce labels passing through the SFUV system. Both agencies realized they could have provided better customer service by comparing notes earlier during the troubleshooting process (Requa et al., 2008).

Similarly, DSRSD failed to notify EBMUD when the reclaimed water plant went offline after a series of process upsets in 2007. DSRSD staff assessed the quantity of water in storage and struggled for many hours to resume reclaimed water production before deciding to add potable water to the distribution system. However, a major EBMUD customer ran out of water, and EBMUD was unaware of the production problem until contacted by a customer (Requa et. al., 2008).

The partners have since jointly developed and agreed to processes to improve communications and coordinate responses. In the second year of operation, they also began conducting an annual communications roundtable to walk through potential incidents such as cross-connections, pressure problems, and water quality concerns. These roundtables bring together a cross-section of staff from each agency. Simply getting to know each other has helped to foster a team culture.

Successes and Lessons Learned

The partners also have found ways to leverage their differences. For example, it was a challenge to standardize automated meter reading (AMR) devices. EBMUD had a pilot AMR study in progress and decided to also evaluate DSRSD's device. Since DSRSD had meters in stock, its employees installed them for EBMUD, avoiding lengthy procurement and training delays. DSRSD crews also installed isolation couplings on both DSRSD and EBMUD connections to the DERWA backbone. The couplings protect field staff from stray current from overhead electrical lines. Because DSRSD operates the DERWA system, its staff was already trained in how to avoid shocks while working on DERWA pipelines and could install the needed protection more quickly (Requa et. al., 2008).

Using a joint powers authority to develop reclaimed water service has benefited both partners. They share construction and operations costs and are maximizing the beneficial reuse of the only source of effluent in the area. Because the distribution systems are completely integrated, the two agencies must communicate about water quality and customer service on almost a weekly basis. Unexpected operational issues always occur in a new enterprise. Partners must work as a team to successfully operate a joint system.

References

- DSRSD•EBMUD Reclaimed Water Authority. 2003. Agreement for the Sale of Reclaimed Water by the DSRSD•EBMUD Reclaimed Water Authority to the Dublin San Ramon Services District and the East Bay Municipal Utility District. Dublin, California.
- Dublin San Ramon Services District. 2011a. 2010 Urban Water Management Plan. Dublin, California.
- Dublin San Ramon Services District. 2011b. DERWA Budget, Fiscal Year 2011-2012. Dublin, California.
- Dublin San Ramon Services District. 2011c. DERWA Report of Operations, January-December 2010. Dublin, California.
- Requa, David, Dan Gallagher, and Linda Hu. 2008. "Startup Challenges of a Joint Agency Reclaimed Water System." 2008 WateReuse California Annual Conference Proceedings. Newport Beach, California. March 24-26, 2008.

City of San Diego – Water Purification Demonstration Project

Authors: Marsi A. Steirer; Amy Dorman, P.E.; Anthony Van; and Joseph Quicho
(City of San Diego Public Utilities Department)

US-CA-San Diego

Project Background or Rationale

The City of San Diego is the eighth largest city in the United States and delivers an annual average of 210 mgd (9200 L/s) to 1.3 million people in a water service area of 404 square miles (1,046 km²). With approximately 10 inches of rain a year, nearly 85 percent of San Diego's water supply is imported from the Colorado River and the California State Water Project. In the past, importing water from the Colorado River and Northern California has been a low-cost, dependable water supply option, but in recent years, these sources have become less reliable and more expensive. Additionally, the cost of imported water has increased by 85 percent in the last eight years and is expected to double by 2020. These conditions have intensified the need to identify new, locally controlled water sources.

San Diego has had an active water conservation program since the mid-1980s, and has been recycling water for irrigation and industrial use since the late 1990s. While this has helped reduce dependence on imported water, non-potable reclaimed water use is seasonal, does not provide relief the entire year, and requires a separate distribution infrastructure to be operated and maintained. In 2004, the city embarked on its Water Reuse Program with the goal of maximizing water recycling, either through a non-potable market expansion, potable reuse, or a combination of these practices. The Water Reuse Study was the first phase of the Water Reuse Program and was completed in 2006; indirect potable reuse through reservoir augmentation was identified as the preferred strategy. This case study focuses on the second phase of the Water Reuse Program, the Water Purification Demonstration Project (Demonstration Project), which will conclude in early 2013.

Type of Reuse Application and Capacity

The Demonstration Project will evaluate the feasibility of using advanced treatment technology to produce water that can be sent to the city's San Vicente Reservoir, to be later treated for distribution as potable water. This multiple barrier concept is depicted in Figure 1. If this concept for developing a new local supply proves viable, Phase 3 of the Water Reuse Program would implement a full-scale facility.

As part of the Demonstration Project, the city is testing and operating a 1 mgd (44 L/s) demonstration-scale Advanced Water Purification (AWP) Facility at the North City Water Reclamation Plant (North City). It is using the tertiary-treated water from North City as feed and is producing purified water of distilled water quality. Water quality is being monitored across the entire purification process to determine the effectiveness of the process and to ensure that all systems are functioning properly. Ultimately, the city will be able to determine if the purified water meets all drinking water standards and can be put in the San Vicente Reservoir; test water will not be placed in San Vicente Reservoir during the demonstration phase. Additionally, an independent advisory panel (IAP) of experts has been convened to provide the technical oversight and input throughout the demonstration process.

A limnology study of the San Vicente Reservoir is being conducted to establish minimum residence time, water quality, and other regulatory requirements. The dam is currently being raised to nearly triple the reservoir's storage capacity. The primary tool for this study is a three-dimensional computer model of the enlarged reservoir, which has been calibrated, reviewed by an IAP, and validated for use on this project.

City of San Diego's
Demonstration Project
 Water Purification Demonstration Process

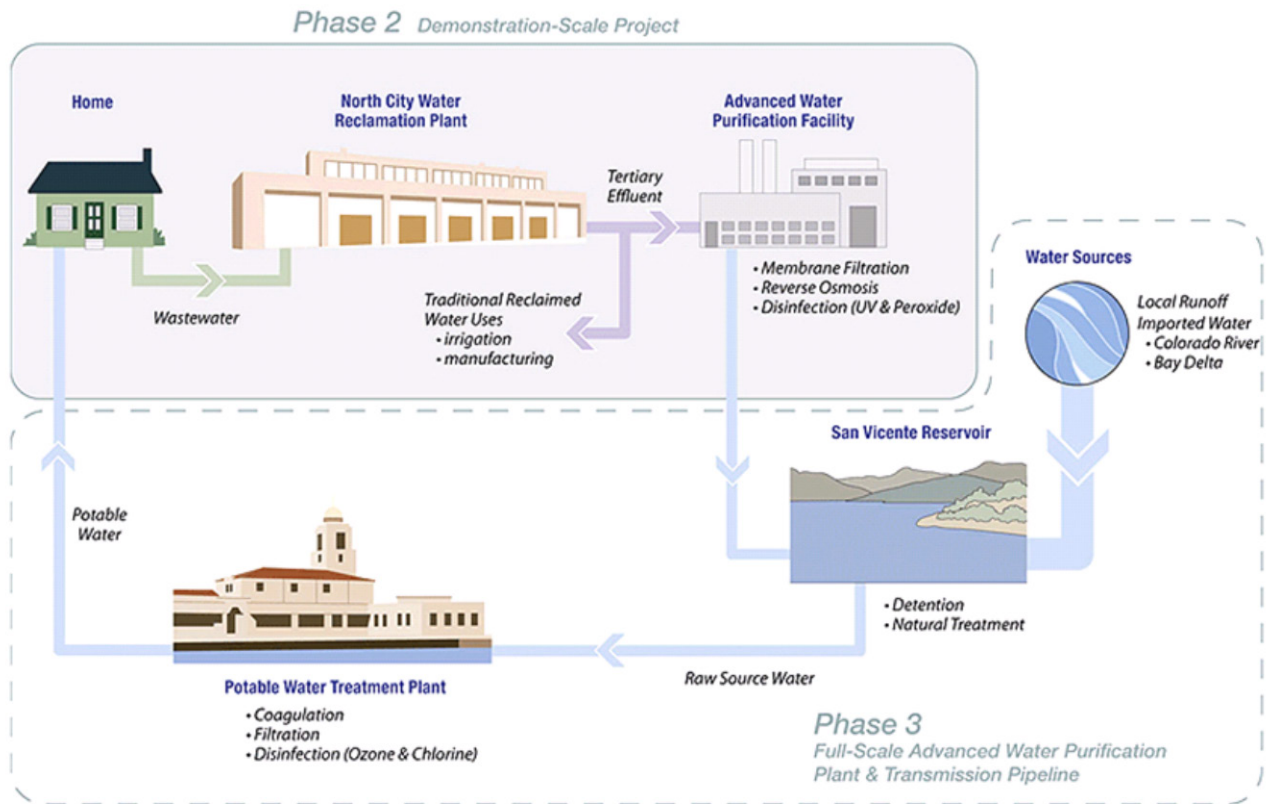

Figure 1
 Water Purification Demonstration Process

As of 2012, regulatory requirements for Indirect Potable Reuse through reservoir augmentation have not been defined in California. Thus, defining such requirements is a key component of this demonstration project, and the city has engaged both the California Department of Public Health (CDPH) and Regional Water Quality Control Board (RWQCB). The State's draft guidelines for groundwater recharge systems are being referenced for the advanced water treatment performance criteria.

Treatment Technology and Water Quality Parameters

The AWP Facility is equipped with microfiltration (MF) and ultrafiltration membranes, reverse osmosis, and advanced oxidation (ultraviolet and hydrogen peroxide); the demonstration system incorporates membranes of the same size, specification, and configuration as those that would be utilized for a full-

scale facility. Demonstration testing is being conducted over a 12-month period and in accordance with the Testing and Monitoring Plan that incorporated review comments from the IAP, CDPH, and RWQCB. Monitoring of several water quality parameters in the Testing and Monitoring Plan include, but not limited to the following:

- Contaminants regulated by the Safe Drinking Water Act or California State regulations
- Disinfection by-products and trace constituents
- Nutrients that may lead to eutrophication of San Vicente Reservoir
- Specific contaminants and surrogates that effectively monitor integrity of each unit process

- Local constituents of concern, endocrine disrupting compounds, pharmaceuticals, and personal care products

Project Funding and Management Practices

In 2008, the San Diego City Council approved a temporary water rate increase to fund the project. The Water Purification Demonstration Project has a budget of \$11.8 million with federal and state grants providing up to \$4 million in assistance. In addition to the AWP Facility and reservoir study, the project also includes public outreach, energy and economic analysis, and an alignment study for the 23-mile (37-km) purified water pipeline to San Vicente Reservoir.

Institutional/Cultural Considerations

The indirect potable reuse concept was first introduced to the community in the mid-1990s. There was negative public reaction at the time that continued well into the next decade. Some dubbed it, “toilet to tap.” However, comprehensive education efforts about the need for conservation, increasing calls for water supply diversification and increased awareness of the region’s existing raw water supply sources, have all helped turn the tide. In January 2011 an editorial in the local paper stated, “...this water would likely be the purest and safest water in the system.”

To build upon the growing awareness of the need for local supplies, a comprehensive public outreach program was launched as part of the Demonstration Project. Through the program substantial collateral material has been produced, a project website was created, e-updates and e-newsletters are sent out regularly to a growing interested parties list, and over 100 project presentations have been given to community and business groups, especially those of underserved communities, throughout the city. These efforts will continue through the duration of the project. With the completion of the AWP Facility, facility tours are being offered to the public.

Successes and Lessons Learned

While the project is ongoing there have been two interim successes that can be highlighted. One success is the regulatory agencies involvement and cooperation. Both CDPH and RWQCB have been willing to attend and engage in project workshops on approximately a quarterly basis and provided comments to Demonstration Project reports.

Another success is that public outreach and education program efforts appear to be effective. There has been a recent shift in perception regarding purified water within the media and the community. The Demonstration Project received positive coverage both locally and nationally in early July 2011. It is not just the media who are coming to accept water purification as a viable option for San Diego. Public opinion polls show that strong opposition to indirect potable reuse dropped from 45 percent in 2004, to 12 percent in 2009, and to 11 percent in 2011 (SDCWA, 2011). The same 2011 study by the San Diego County Water Authority found that 65 percent of respondents somewhat or strongly favor adding purified water to the drinking water supply and 77 percent of respondents informed about the Demonstration Project either strongly favor or somewhat favor the goals of the Demonstration Project.

With continued regulatory involvement and public outreach and education efforts the Demonstration Project is on the path for gaining regulatory approval and public acceptance. If the concept of using purified water to augment local reservoir supplies is deemed viable by the mayor, the city council, and the regulators, the city would implement it on a large scale. Full-scale facilities could produce up to 15 mgd (660 L/s) of purified water.

References

- City of San Diego Water Reuse Study Final Draft Report. 2006, prepared by PBS&J for the City of San Diego. <<http://www.sandiego.gov/water/waterreuse/waterreusestudy/news/fd2006.shtml>>.
- City of San Diego Public Utilities Department – Water Purification Demonstration Project website. 2011. <<http://www.sandiego.gov/water/waterreuse/demo/>>.
- San Diego Water Authority (SDCWA). 2011. Public Opinion Research. Retrieved on Sept. 7, 2012 from <www.sdcwa.org/public-opinion-research>.

Groundwater Replenishment System, Orange County, California

Authors: Mike Markus, P.E., D.WRE; Mehul Patel, P.E.; William Dunivin (Orange County Water District)

US-CA-Orange County

Project Background and Rationale

For decades, semi-arid Orange County, Calif., has depended on Northern California and the Colorado River for much of its drinking water. However, with multi-year droughts and environmental constraints, imported water is becoming more expensive and less available. Population studies indicate that California could increase by 15 million people by 2020; Southern California alone could grow by 7 million and Orange County by 300,000. As new water supplies are sought, water recycling plays an important and key role.

In the 1990s, the Orange County Water District (OCWD) and Orange County Sanitation District (OCSD) joined efforts to provide a reliable water supply by developing a water purification program called the Groundwater Replenishment System (GWRS), which came on-line in January 2008. Prior to the GWRS, OCWD operated Water Factory 21 (WF-21), a first-of-its-kind water treatment facility that produced 15 mgd (960 L/s) for a seawater intrusion barrier, from 1976 through 2004.

Using up to two-thirds less energy than it would take to import water from Northern California, and three times less energy than ocean desalination, the GWRS currently produces enough water for nearly 600,000 residents, while saving enough energy to power 21,000 homes each year. Additional benefits include eliminating the need for another ocean outfall and increasing “water diversity” in an arid region.

Capacity and Type of Reuse Application

The GWRS is the largest advanced water purification facility of its kind, capable of producing 70 mgd (3070 L/s) for indirect potable reuse (IPR). This revolutionary and innovative system removes pharmaceuticals, pesticides and other harmful contaminants before it is pumped to recharge basins, where it naturally filters into the groundwater basin, replenishing scarce

drinking water supplies. The heart of the GWRS is the Advanced Water Treatment Facility (AWPF) facility, which includes microfiltration, reverse osmosis, and advanced oxidation processes, which consist of ultraviolet and hydrogen peroxide (**Figures 1, 2 and 3**). The plant may be upsized in the future to produce 130 mgd (5,700 L/s).



Figure 1
GWRS microfiltration system (Photo Credit: Gina DePinto)



Figure 2
GWRS reverse osmosis trains (Photo Credit: Gina DePinto)

Water Quality and Treatment Technology

During startup of the AWPf, monitoring water quality was an important component of the permit issued by the Regional Water Quality Control Board (RWQCB), in conjunction with the California Department of Public Health (CDPH). During acceptance testing of the AWPf, specific water quality tests were required.

Water quality monitoring is a fundamental component of ongoing GWRS operations. During the first two years of operation (2008-2009), concentrations of metals (e.g., aluminum and chromium), organic contaminants (e.g., trichloroethylene, NDMA, and 1,4-dioxane), nutrients (nitrogen and phosphorous), and microbial indicators were all either non-detectable or well below state and federal drinking water quality limits. Similarly, unregulated chemicals such as pharmaceuticals and personal care products (e.g., ibuprofen, bisphenol-A) and endocrine disruptors (e.g., hormones) were consistently non-detectable in 2008, at parts per trillion concentrations. Nearly identical results were found in 2009, with two isolated detections (e.g., caffeine) occurring at concentrations below available health screening guidelines.

The GWRS water quality data is reported quarterly and formally documented in an annual report to state regulators. The GWRS is also reviewed annually by an Independent Scientific Advisory Panel of experts appointed by the National Water Research Institute (NWRI).

Project Funding and Management Practices

The GWRS capital cost was \$480.9 million. OCWD received \$92 million in grants from state and federal agencies and a \$196 million contribution from OCSD. OCWD used a combination of long-term debt and state loans to fund the remaining capital cost, which has an annual debt service of \$11.5 million. The debt service and cost to operate the GWRS is covered

by OCWD's general fund. The annual operating budget (excluding debt service) is about \$28.5 million, which includes electricity, chemicals, labor and maintenance. The project receives an annual operational subsidy of approximately \$7.5 million for 12 years from the Metropolitan Water District of Southern California for reducing demand on the state's imported water supplies.

OCWD receives revenue primarily from three sources: the replenishment assessment paid by retail agencies for pumping groundwater, a percentage of local property taxes, and investment income. The assessment is currently \$249/ac-ft (\$0.20/m³), which is well below the cost of imported water supplies that start at \$750/ac-ft (\$0.61/m³). To replenish the groundwater basin, OCWD uses a combination of flows from the Santa Ana River, GWRS water and imported water. The cost of GWRS water is less than treated imported water and is the highest quality, drought-proof and reliable source of water available. Imported water supplies, especially untreated or raw water supplies, can be interruptible and available for purchase only when a surplus exists.



Figure 3
GWRS ultraviolet reactor system (Photo Credit: Gina DePinto)

Institutional/Cultural Considerations

The GWRS program is a direct result of a mutually beneficial partnership between OCWD and OCSD, cultivated over nearly 40 years, beginning with WF-21 in the 1970s. In the mid-1990s, OCSD faced the possibility of building a second ocean outfall at a cost of \$200 million. At the same time, OCWD was dealing with problems of seawater intrusion and the need to expand WF-21 from 15 to 35 mgd (920 to 1530 L/s). Joining efforts in 1997, OCSD agreed to supply OCWD with 96 mgd (4200 L/s) of secondary treated wastewater at no cost. OCSD committed to maintaining a stringent source control program to keep potentially harmful contaminants out of the treated wastewater before it was supplied to the GWRS. OCSD and OCWD also agreed to share the \$481

million cost to construct the GWRS. Approving the GWRS was a significant and risky step for its Boards of Directors because, at the time, IPR had been politicized and suffered major defeat in San Diego.

Coordinating two Boards and gaining support was challenging. One month after signing a cooperative agreement to plan and construct the GWRS, OCWD and OCSD established the GWRS Steering Committee to oversee planning, design and construction in cooperation with each agency's governing board. The committee made decisions and approved expenditures, while OCWD led engineering, construction, operations and outreach with OCSD's engineers and Public Affairs. Today, communication between the staffs is excellent and the Steering Committee is still intact to work through ongoing operational issues.

One of the most important measures OCWD uses to evaluate success is public acceptance of IPR. An aggressive outreach program was established to educate and secure support from local, state and federal policymakers, business and civic leaders, health experts, environmental advocates and academia. Because of the negative and misinformed public perception of purifying wastewater to drinking water, the agencies decided that the "clean water" agency should be out front to manage day-to-day management of the outreach campaign.

To brand the safety, purity and high quality of water, OCWD staff led outreach and interfaced with consumer media, while OCSD staff served as advisors on outreach decisions and helped manage trade media relations. The team made more than 1,200 presentations from 1999 to 2007, secured thousands of media impressions, and garnered more than 600 letters of support including those from all 21 city councils, the district's senators and congressional representatives, local state assembly members, state senators, the governor, and the Orange County Board of Supervisors. Agencies that govern or influence water policy were also supportive including the Department of Water Resources, CDPH and the Santa Ana RWQCB.

Without such strong support from policymakers, the project may not have moved forward, nor would OCWD have been able to secure \$92 million in state, federal and local grants to help fund the project. The Metropolitan Water District of Southern California also

awarded GWRS an \$85 million operational subsidy for reducing dependence on the state's imported water supplies.

As public support grew, a comprehensive supporter list was developed, and eventually the Boards formed a committee of respected community opinion leaders and experts that served as project spokespeople. In preparation of the initial expansion to 100 mgd (4381 L/s), the agencies are mindful that opposition is still a threat, and so the outreach effort continues. OCWD continues to make presentations to business and civic groups and at conferences, employs social media, and conducts tours of the GWRS. In 2010, about 4,000 visitors toured the facility. Many were elected officials and water experts from across the United States, Africa, Australia, China, Japan, Korea, Spain, Italy, Germany and Israel. To date, there has been no organized or significant public opposition to the GWRS and the outreach initiative is touted as one of the key reasons for the project's success.

Successes and Lessons Learned

OCWD and OCSD successfully partnered to build a potentially controversial water project that garnered overwhelming public support and overcame a "toilet-to-tap" misperception. The GWRS has revolutionized how consumers look at wastewater—as another resource they should take care of and reuse.

The partnership between OCWD and OCSD has become an international model for water recycling recognized globally with numerous awards, including the prestigious Stockholm 2008 Industry Water Award, Sâid Khoury Award for Engineering Construction Excellence and the American Society of Civil Engineers Outstanding Civil Engineering Achievement. Municipalities across California, the United States, and Australia are planning similar projects, and the city-state of Singapore modeled a smaller scale IPR project after the GWRS. By developing a project that puts recycled water into the drinking water supply, OCWD is paving the way for others to gain public acceptance of this environmentally-friendly and safe practice.

EDR at North City Water Reclamation Plant

Authors: Eugene Reahl and Patrick Girvin (GE)

US-CA-North City

Project Background

The city of San Diego, Calif., shares a problem common with many other western cities—meeting the ever-increasing challenge of developing adequate drinking water supplies to satisfy regional development. Unfortunately, new sources of fresh water are not readily available without large capital expenditures. As a result, in the late 1990s, San Diego took a major step in helping to solve this problem by equipping the brand new North City Reclamation Plant with an electrodialysis reversal (EDR) system. The EDR system could desalinate tertiary treated wastewater to provide a new source of high quality irrigation water, thereby reducing demand on the fresh water supply.

Treated wastewater effluent that supplies the reclamation facility has salinity levels up to 1,300 mg/L TDS during the summer and early fall. In order to use this water for golf courses, plant nurseries, parks, highway green belts, and irrigation water for common areas in homeowner associations, the treated water needed to have a water quality of less than 1,000 mg/L TDS with low sodium levels. EDR was able to achieve the required removals and also allow for blending of a stream of raw water with the feed, increasing total volume of reuse water produced.

Treatment Process and Capacity

The EDR system operates at 85 percent recovery of the treated flow, compared to 80 percent offered by a more conventional microfiltration-reverse osmosis (MF-RO) system, which was originally evaluated as an alternative to the existing system. Another added benefit of the EDR system is a reduction in use of chemicals compared to other technologies for reducing TDS concentrations. The EDR runs with no chemicals added to the feed stream; although, chlorine is added to the concentrate recirculation loop of the EDR to help prevent biological growth. The EDR membranes are not sensitive to chlorine and can tolerate brine residuals, reducing frequency of cleaning.

When the reclamation plant was originally installed in 1998, the capacity of the EDR system was 2.2 mgd (96 L/s). Since this initial installation, the facility has undergone 4 expansions. In 2011, the EDR capacity at the plant could produce 6.6 mgd (290 L/s) as shown in **Figure 1**. This treated water is blended with treated wastewater effluent to provide up to 15 mgd (660 L/s) of total blended reclaimed water flow.



Figure 1
North City WRP with 6th EDR unit installed

San Diego used an existing 47-mile (75 km) pipeline to deliver high quality reclaimed water to local customers. This challenge of this strategy was to sell this water as an attractive alternative to using hard-to-replace fresh drinking water in non-potable applications such as irrigation. But, after successful implementation, the end result has been a reduction in use of potable water for these applications, conserving that precious supply for potable water uses.

Project Funding and Management Practices

Over the years, the facility has been expanded several times. For most of these projects, the city has provided their own funding for the expansion to their facility; however, addition of the 6th unit was partially funded through the Bureau of Reclamation.

Successes and Lessons Learned

The plant has successfully operated for over 10 years. Much of the plant’s success may be attributed to the excellent operation and maintenance of the equipment. The EDR system utilizes liquid sodium hypochlorite addition to minimize biogrowth, and regular cleanings help maintain optimum membrane performance.

Due to the variable quality of the feed water to the facility, the EDR’s ability to handle higher organic loading, up to 15 mg/L of total organic carbon was an important factor in keeping the facility running. The system could accept the higher levels without any negative impact on the product water conductivity. This produced a consistent product to the City’s customers as shown in **Figure 2**.

References

Reahl, Eugene. 2004. *San Diego Uses EDR Technology for Desalination*, GE Water & Process Technologies.

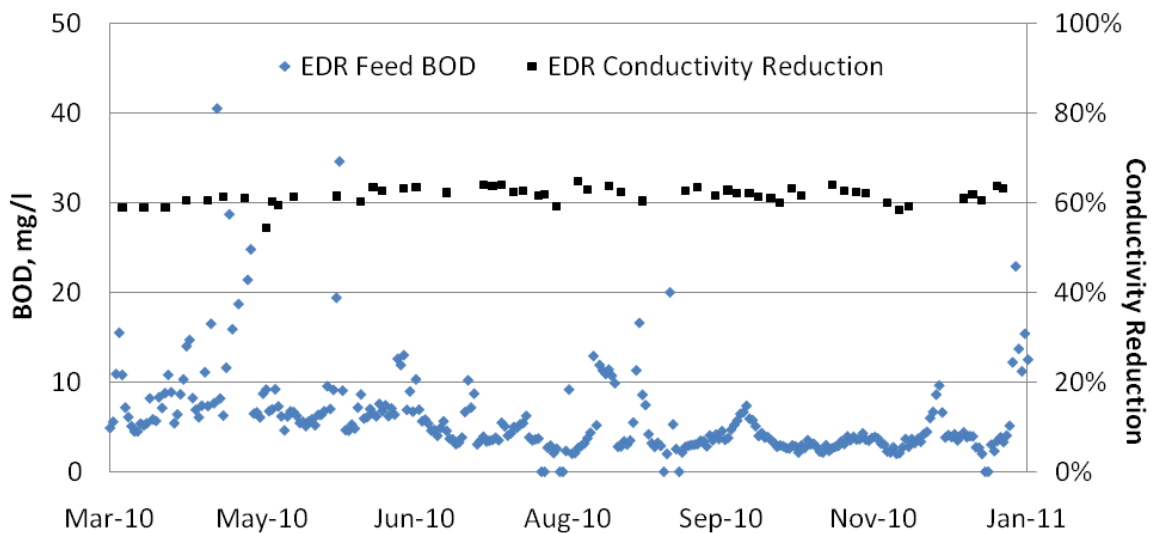

Figure 2
Performance of North City EDR system

Water Reuse Study at the University of California Santa Cruz Campus

Author: Tracy A. Clinton, P.E. (Carollo Engineers)

US-CA-Santa Cruz

Project Background

In response to the master plan for higher education, the president of University of California (UC) asked UC campuses to consider enrollment growth. For UC Santa Cruz (UCSC), this request corresponded to a 25 percent increase in student population. Already faced with severe water supply shortages and limited to no possibilities for increases, UCSC decided to increase self-reliance and sustainability of campus water resources, and define measures for utilization of recycled water. These goals were to be achieved while considering challenges such as seasonal population fluctuations of the UCSC campus, city water supply limitations, campus elevation gradients, and the future challenge of UCSC population growth. Although campus water demand was expected to grow from 200 million gallons per year (MGY) (760,000 MCM/yr) in 2009 to 400 MGY (1.5 MCM/yr) in 2020, the city of Santa Cruz had previously reported that there was little to no increase in water supply available to UCSC. In response, the campus began addressing challenges by developing a decision analysis framework to enable the selection and ranking of a range of potential reuse projects that could be implemented both immediately, and in response to future potable water and/or energy reduction requirements.

Capacity and Type of Reuse Application

Approximately one-half of the allocation of total campus water consumption included non-potable uses (**Table 1**) that could be offset by using alternate sources (Maddaus, 2007). In addition, roughly 97 MGY (0.37 MCM/yr) could be offset with recycled water, rainwater, graywater, and well water, which are available in sufficient volumes (**Table 2**). Both the demand and the alternate water supplies have seasonal dependencies that must be considered. For example, water use is highest when classes are in session and lowest during summer and between quarters. The reuse opportunities that UCSC considered were ones that minimize energy

consumption, maximize sustainability, and where seasonal and spatial dependence considering varying campus elevations of sources and demands for non-potable water are aligned.

Table 1 Summary of non-potable water demands

| Demand | Volume Required (MGY) | Seasonal Dependence |
|-----------------|-----------------------|--|
| Toilet Flushing | 6.3 | Dependent on student populations |
| Irrigation | 29 ¹ | Dependent on weather |
| Cooling Towers | 8 ² | Dependent on student populations and weather |

¹ Volume for irrigation by the top 10 users; submetered irrigation demand on campus is 40 MGY

² Includes volume required at new cooling tower location

Table 2 Summary of alternate water supplies available for non-potable use

| Demand | Volume Required (MGY) | Seasonal Dependence |
|-----------|-----------------------|----------------------------------|
| Rainwater | 8.3 | Dependent on weather |
| Graywater | 13.8 | Dependent on student populations |
| Recycled | 157 ¹ | Dependent on student populations |
| Well | 56.5 | Not seasonally dependent |

¹ Represents entire campus wastewater flow

The lower area of campus, which includes administration offices and faculty housing, has an elevation of 426 feet and receives about 30 inches (76 cm) of rain annually. The upper area of campus, with an elevation of 982 feet (300 m) and about 48 inches (122 cm) of annual rainfall, includes residences and academic buildings. The middle area of the campus is open space and agricultural land. Peak rainfall occurs in January with little to no rain in the summer months of June through September. Rainwater is currently collected and systematically conveyed from the campus to minimize erosion. **Figure 1** shows the

existing non-potable supplies and demands by general campus location/elevation. Options for replacing potable water demands were identified and grouped with respect to implementability into immediate, near-term, or long-term projects.

Water Quality Standards and Treatment Technology

The regulatory requirements defined for reuse of non-potable sources are outlined in **Table 3**.

Project Management Practices

A “Model College” was developed as a planning tool. This model considers non-potable supplies and demands assuming 100 beds (i.e., residential component only). This model can be used by the campus to analyze future proposed reuse projects regarding demands relative to non-potable water supplies, sustainability, and energy use. UCSC now has tools to move aggressively to offset the increased water demand that will accompany its growth. The campus potentially has more supply of non-potable water than demand for it, so factors other than maximizing supply can be figured into project selection. For example, future project selection criteria include cost per gallon of non-potable water, construction cost of specific projects, volume of potable water offset, components of sustainability (mainly environmental impacts), educational value, and ease of operations of the project.

The cost of implementing a reuse project is largely driven by the storage volume required for it, thus matching the seasonality of supply and demand (such as using rainwater for toilet flushing instead of irrigation) helps in reducing the cost of reuse projects. Another driver of cost is the proximity of supplies and demands because of energy requirements for pumping, particularly on this campus, which has over 550 ft (168 m) elevation difference between the upper and lower campus areas.

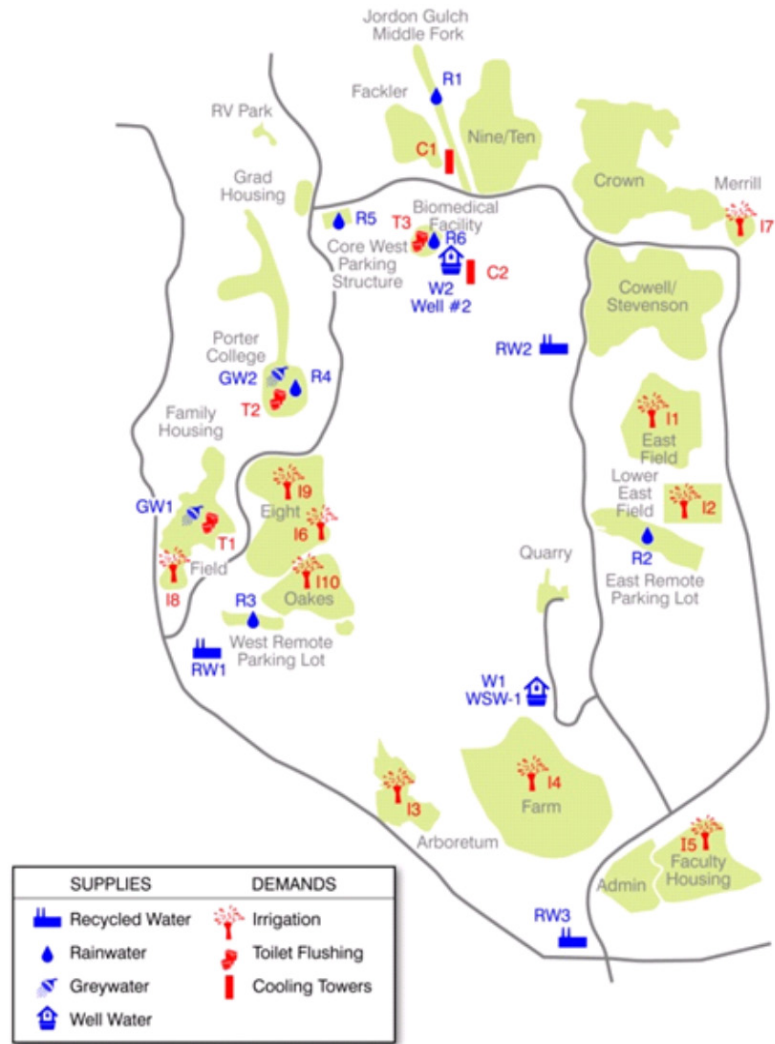

Figure 1
Existing non-potable supplies and demands on UC campus

Institutional/Cultural Considerations

The UC released a Policy on Sustainable Practices in May 2007 which provided guidelines to all the UC campuses to: *Incorporate the principles of energy efficiency and sustainability in all capital projects, renovation projects, operations and maintenance within budgetary constraints and programmatic requirements.* The current version of the Policy requires LEED™ Silver certification for new UC construction and existing renovations.

Table 3 Requirements for reuse depending on source water

| Source | Possible Reuse Applications | Appendix G Graywater Guidelines | Title 22 Reuse Guidelines | Campus Plumbing Codes and Ordinances |
|--|---|---------------------------------|---------------------------|--------------------------------------|
| Rainwater | Irrigation, Toilet Flushing, HVAC processes | | | X |
| Graywater ¹ | Subsurface Irrigation | X | | X |
| Additionally Treated Graywater ² | Irrigation, Toilet Flushing, HVAC processes | | X | X |
| Tertiary Treated/Disinfected Wastewater ³ | Irrigation, Toilet Flushing, HVAC processes | | X | X |
| Well Water | Irrigation, Toilet Flushing, HVAC processes | | | X |

¹ Treated and applied as outlined in the California Greywater Reuse Guidelines - Appendix G, Title 24, Part 5, California Administrative Code.

² Treated to greater levels than outlined in the California Greywater Reuse Guidelines

³ Treated to levels outlined in the Recycled Water Requirements – Title 22.

A campus workshop was held to determine screening criteria for construction and renovations; these criteria were then used to review the proposed projects. Key conclusions from the workshop included establishing a minimum microbial water quality requirement for all non-potable water, comparing the cost per gallon of non-potable to potable sources, developing a “model college” as a planning tool for future projects, and considering the educational value of a project in the project screening.

Successes and Lessons Learned

The campus study did not recommend which projects should be implemented; rather it provided a decision analysis framework to select and rank projects as triggers occur that require a reduction in use of potable water and/or energy. Project selection is a two-stage process. First, the projects are grouped into “implement,” “maybe implement,” and “currently infeasible.” “Implement” reuse projects are those that are the easiest to execute and that UCSC sees a clear value in implementing right away. The “maybe implement” are projects that merit further discussion. The projects should also be sorted into immediate, near and long-term periods. The second stage involves screening and ranking the projects, such as with a pairwise analysis, based on the screening criteria developed at the beginning of the process.

A small subset of possible projects were selected using the Campus Model based on input from USCS staff; six near-term projects were identified (**Table 4**). A trigger-based approach allows UCSC to implement projects activated by flow triggers based on a demand

matrix. This approach considers meeting immediate needs such as droughts, short-term needs when a dormitory is being updated and refurbished, and long-term needs for future planned facilities. The outcome of this project is being monitored by all UC campuses for sustainably meeting growth demands. With the implementation of projects identified on the campus, UCSC has the opportunity to become a model campus for schools and areas in water stressed regions throughout the country.

Table 4 Summary of campus reuse projects selected for near-term implementation

| Project | Supply | Demand |
|---|----------------|-----------------|
| 1. East Parking Lot East Field Irrigation | Rainwater | Irrigation |
| 2. Porter College Toilet Flushing | Rainwater | Toilet Flushing |
| 3. Biomedical Sciences Facility Toilet Flushing | Rainwater | Toilet Flushing |
| 4. Jordan Gulch Middle Fork Cooling Towers | Rainwater | Cooling Towers |
| 5. Irrigation | Recycled Water | Irrigation |
| 6. Family Student Housing Landscape Irrigation | Graywater | Irrigation |

References

Maddaus Water Management and UC Santa Cruz. 2007. UC Santa Cruz Water Efficiency Survey, Draft Report.

Long-term Effects of the Use of Recycled Water on Soil Salinity Levels in Monterey County

Author: B.E. Platts (Monterey Regional Water Pollution Control Agency)

US-CA-Monterey

Project Background or Rationale

Agriculture in Monterey County, Calif., is more than a \$3 billion per year industry. Over-pumping of groundwater has caused sea water to intrude into wells located near the coast. In an effort to reduce groundwater extraction in the northern Salinas Valley, the Monterey Regional Water Pollution Control Agency (MRWPCA) in partnership with the Monterey County Water Resources Agency (MCWRA) began providing reclaimed water to 12,000 acres (4,860 hectares) of prime farmland used to grow cool season vegetables in April 1998. The dominant soil types in this region are clay loam and heavy clay soils, both of which are susceptible to sodium accumulation and water penetration problems. Because of grower concerns that salts, particularly Na and Cl, in the reclaimed water would reduce yield and quality of their crops a long-term study was developed to monitor salinity levels in commercial vegetable fields.

Capacity and Type of Reuse Application

The MRWPCA water recycling facility provides a relatively constant flow, around 20 mgd (876 L/s) of reclaimed water. This rate is inadequate to serve the Monterey County Water Recycling Projects (MCWRP) service area during peak demand periods. Therefore, supplemental wells, tapping groundwater from the 400-ft (122-m) aquifer, are used to augment the reclaimed water supply, as necessary. During periods when reclaimed water must be supplemented, incidental blending of reclaimed water with well water takes place within the pressurized distribution system. The prime irrigation water constituents of concern are sodium and chloride. Reclaimed water, blended with well water, is used to irrigate artichokes, broccoli, Brussels sprouts, celery, cauliflower, lettuce, spinach, and strawberries within the project area.

Water sampling was conducted throughout the recycling project system as standard procedure in the MCWRP Monitoring Program. First, MRWPCA's

tertiary effluent was sampled on a weekly basis to determine the levels of salt present in the reclaimed water before blending with the supplemental well water. Second, monthly delivery system sampling confirmed the specific quality of the water received by the growers after supplemental well water was added to the reclaimed water. These data were used to generate the observed and calculated values of water delivered to each field sampling location. The water samples were analyzed for pH, conductivity, sodium, potassium, magnesium and chloride. The MRWPCA laboratory, an accredited laboratory, analyzed the water.

Soil salinity levels were monitored at eight sites receiving reclaimed water beginning in the spring of 2000. The different sites received a range of blends of the reclaimed and well water depending on location. The range of blends was from 1:1 reclaimed to well water to reclaimed water only. The soil was sampled three times per year at each site and composites of 4 cores were collected from the 1- to 36-in (2- to 90-cm) depth at 12-in (30-cm) intervals. Soil samples were analyzed for pH, electrical conductivity (EC_e), extractable cations (B, Ca, Mg, Na, and K) and extractable anions (Cl, NO_3 , and SO_4). Valley Tech Agriculture Lab Services in Tulare, CA, an accredited laboratory, analyzed the soil samples.

Water Quality Standards and Treatment Technology

Reclaimed water in the state of California must meet Title 22 standards for microbiological quality. However, there are no legal requirements in the state of California for the quality of reclaimed water in reference to agronomic standards for agricultural use. MRWPCA's long-term study early on in the development of the water recycling project found no ill effects on vegetable production with the use of water of the estimated quality to be supplied (Engineering Science, 1987). By agronomic standards, the average sodium adsorption ratio (SAR) of the reclaimed water at 4.94, in combination with an EC_w (electrical

conductivity) of 1.6, are quite safe for long-term irrigation (Richards, 1969). The optimum level of sodium in agricultural irrigation water is less than 5.0 meq/L (115 mg/L) (Ayers, 1985). The average sodium in reclaimed water before addition of supplemental well water is 7.64 meq/L (175 ppm). The optimum level of chloride in agricultural irrigation water is less than 5.0 meq/L (177 mg/L) (Ayers, 1985). The average chloride of reclaimed water before addition of supplemental well water is 7.36 meq/L (257 ppm). Thus, sites receiving reclaimed water only were at risk for increasing levels of sodium and chloride.

After 10 years of monitoring, data showed that soil salinity levels exhibited a range of responses including increased salinity, decreased salinity and stable salinity at different sites. The increase at some sites was due to chloride accumulation and was large enough to potentially affect chloride sensitive crops such as strawberries. The decrease in soil salinity at some sites and improved the soil productivity and was due to sodium leaching. Sites with stable salinity were at values acceptable for growing cool season vegetable and berry crops. Average soil salinity values were highly correlated with average water quality over the length of the study.

Project Funding and Management Practices

Funding for the salinity monitoring project was incorporated into the annual operations and maintenance costs by MRWPCA. The water sampling plan was an expansion of the standard operating procedure. The incremental cost of the soil sampling program was approved by the Water Quality and Operations committee, which provides input to MRWPCA and MCWRA in regard to operational and budgetary decisions for the recycling water project. MRWPCA, MCWRA and grower representatives have reviewed water quality and operations decisions monthly since the project became operational in 1998.

Institutional/Cultural Considerations

The value of crops and farmland within the MCWRP area is significant. At the inception of the water recycling projects, MRWPCA and MWCWRA were very aware that grower acceptance would be key to the project's success. Therefore, the initial water quality study studying agricultural productivity was conducted to provide data to the growers. Throughout the development of the project, grower support and

cooperation were good and the Agencies provided multiple avenues for grower input and participation in making critical decisions. The Water Quality and Operations Committee has been the long-term method of incorporating stakeholder involvement in the project.

Successes and Lessons Learned

The variation in annual water quality and annual variation in soil values for SAR, sodium and chloride at each site did not correlate. However, average water quality and average soil values for these parameters over the ten-year study correlated very well. This indicates that short-term studies may not accurately reflect changes in soil salinity. Correlation coefficients for averages over the study were robust. It is important to note that the range of SAR, sodium and chloride in the reclaimed water, applied to the different sites, were near or only slightly higher than optimum values. This demonstrates that slight increases in SAR, sodium and chloride in irrigation water are associated with increasing levels of SAR, sodium and chloride in the heavy clay irrigated soils within the water recycling project area. Therefore, initial concerns about changes in soil salinity were justified.

Variability of the trends between different sites is an important observation. For all three salinity parameters, SAR, sodium and chloride, there were multiple trends observed. The different test sites were selected to represent the range of water quality, farming and soil type conditions within the water recycling project area. The wide variety of sites resulted in a wide range of soil salinity trends, indicating that soil salinity studies should include broad range of conditions in order to accurately estimate the variability of soil salinity responses.

References

- Ayers, R. S. and Westcot, D.W. *Water Quality for Agriculture – FAO irrigation and drainage paper 29*. Rome: Food and Agriculture Organization of the United Nations, 1985.
- Engineering Science. 1987. *Monterey Wastewater Reclamation Study for Agriculture final report*, 25 October, 2011. Retrieved on August 30 from <<http://www.mrwpc.org/downloads/wr/mwrsa.pdf>>.
- Richards, L.A. (Ed). *Diagnosis and improvement of saline and alkali soils. Agriculture Handbook No. 60*. Washington: U.S.D.A., U.S. Govt. Printing Office, 1969.

Metropolitan Water District of Southern California's Local Resource Program

Author: Raymond Jay (Metropolitan Water District)

US-CA-Southern California MWD

Can regional incentive programs maximize development of local recycled water projects?

Background

The Metropolitan Water District of Southern California (Metropolitan) was established in 1928 by the state legislature to import water supplies to Southern California. Metropolitan is a regional water wholesaler to 26 member agencies serving approximately 19 million people across six counties and delivers approximately 1,700 mgd (74,500 L/s) of water from the Colorado River Aqueduct and State Water Project in its 5,200-square-mile (13,470-km²) service area.

Metropolitan is in the Southwest part of California, the most urbanized and populous region of the state, with slightly more than half of the state's population. The region has a mild, dry subtropical climate with approximately 75 percent of the rainfall occurring between December and March. The region experienced significant drought and regulatory reductions in the past challenging Metropolitan's ability to meet growing demand with imported water. As a result, Metropolitan is both actively developing imported water and incentivizing the development of local water resources for the region.

Metropolitan's Integrated Resources Plan (IRP), provides a long-term strategy to protect the region from future supply shortages, with an emphasis on water-use efficiency through conservation and local supply development. The 2010 IRP calls for meeting increased future demand within Southern California through expanded local supplies and conservation programs. The IRP includes a target of 580,000 acre-feet (189 billion gallons) per year of combined water conservation and water recycling, which incorporates California's goal of 20 percent reduction in per capita potable water use by the year 2020.

In order to meet long-term water demands, Metropolitan provides financial incentives through the Local Resource Program (LRP) for recycled water and

groundwater recovery projects that reduce demand on imported water supplies. Metropolitan also provides educational outreach to stakeholders to advance acceptance of recycled water and the LRP program.

LRP History

The LRP was initiated in 1982 to provide financial incentives to local and member agencies for water recycling projects that reduce demand on Metropolitan's imported water supplies and enhance local supply reliability. In consultation with its member agencies, Metropolitan has made periodic improvements to the LRP including refinements to eligibility, selection, performance, and incentive levels. The program has evolved from a fixed incentive to competitive selection and now to its current version providing a sliding scale incentive based on actual project costs up to Metropolitan's estimated avoidable cost of importing water, currently \$250/ac-ft (\$0.20/m³). The LRP program is currently undergoing review by a Local Resources Development Strategy Task Force to assess alternate approaches to support and expand local resources development.

Metropolitan currently accepts LRP applications on a continual basis. Applications are reviewed for estimated yield and readiness to proceed. Incentives up to \$250/ac-ft (\$0.20/m³) are provided monthly based on the difference between the actual cost and Metropolitan's prevailing water rates. Incentives are reconciled annually. LRP agreements can last up to 25 years or until the maximum yield is achieved, or until the average price of Metropolitan's water exceeds the cost of the project water.

LRP Analysis

To date, Metropolitan has provided incentives to 64 water recycling projects throughout Metropolitan's service area (**Figure 1**). The map in Figure 1 shows the wide distribution and success of the LRP. Participating projects are expected to produce an

ultimate yield of about 323,000 ac-ft/yr (398 MCM/yr) when fully implemented.

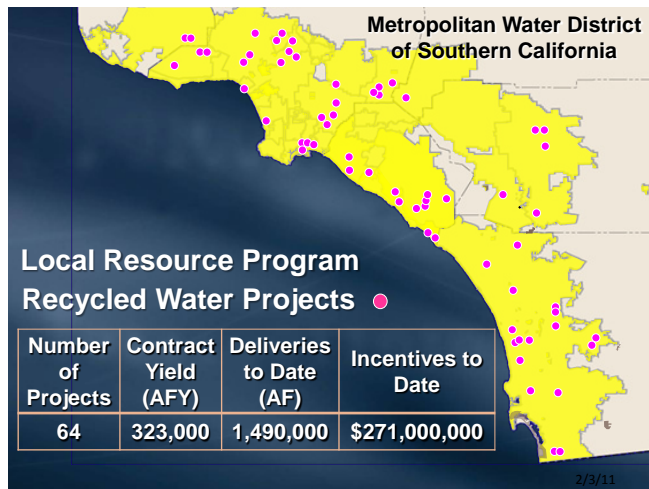

Figure 1
Local Resource Program Recycled Water Projects

Most recycled water developed through the program is used for irrigation, groundwater replenishment and seawater intrusion barriers for coastal groundwater basins. LRP funding can be used for treatment, storage, or distribution facilities. Water quality and treatment technology for each project is based on the proposed use and appropriate California standards. Treatment technologies differ among projects.

Since inception of the LRP in 1982, Metropolitan has provided approximately \$271 million for production of about 1.5 million ac-ft (1,850 MCM) of recycled water. During fiscal year 2009/10, Metropolitan provided \$29,000,000 for development of 177,000 ac-ft (218 MCM) of recycled water.

Successes and Lessons Learned

Several key factors that contribute to the success of the LRP include: cost effective financial incentives; collaboration among local and regional agencies; appropriate recycled water targets; an open application process; strong performance provisions including requiring construction within 2 years and operational within 5 years; allowing long-term agreements up to 25 years for the project to be completed; and regular refinement of the program have contributed to the success of the LRP.

Summary and Conclusions

There are several long-standing constraints to the development of recycled water including cost, public acceptance, institutional coordination, and regulatory approval. Metropolitan addresses three of these constraints with the LRP. Cost and institutional barriers are directly addressed through the LRP. Metropolitan’s incentives reduce the cost of recycled water projects and Metropolitan’s regional structure provides strong institutional coordination and collaboration opportunities. The LRP also facilitates public acceptance of recycled water by incentivizing local projects throughout the region. Although, the LRP does not directly address regulatory approval constraints, Metropolitan’s participation in organizations like the WaterReuse Association facilitates sound regulatory reform. The LRP has played a significant and important role in expanding the number of recycled water projects developed in Southern California.

Recycled water projects require large upfront capital and take a significant amount of time to build and become fully utilized. Without strong local support, development of additional recycled water projects is slow.

California is unlikely to meet recycled water goals adopted in the State Recycled Water Policy without regional support like Metropolitan’s LRP. Recycled water projects can be increased through incentive programs like the LRP but also require strong local commitment and often additional State and federal funding. Funding sources for recycled water including SRF and Title XVI are necessary to maximizing development of local recycled water projects.

References

Metropolitan Water District of Southern California. 2010 Integrated Water Resources Plan, Report 1373.

Metropolitan Water District of Southern California. 2011 Local Resources Program summary report.

Montebello Forebay Groundwater Recharge Project using Recycled Water, Los Angeles County, California

Authors: Monica Gasca, P.E. and Earle Hartling
(Los Angeles County Sanitation Districts)

US-CA-Los Angeles County

Project Background

The Montebello Forebay Groundwater Recharge Project (MFGRP) has successfully been recharging the groundwater with recycled water since August 20, 1962. This is the oldest planned groundwater recharge project using recycled water in California. To date, over 1.6 million ac-ft (1,970 MCM) of recycled water has been recharged at the MFGRP to replenish the Central Groundwater Basin, which provides 40 percent of the total water supply for Los Angeles County.

In the 1950's, following a rapid population growth in the region, excessive and unregulated pumping resulted in an overdraft that dropped the groundwater table and allowed seawater to intrude into the aquifer. In response, the Water Replenishment District of Southern California (WRD) was formed to manage this basin by regulating pumping and purchasing supplemental water supplies for replenishing the groundwater.

Sources of groundwater replenishment in the Central Basin include recycled water, imported river water (Colorado River and State Project water), and local storm runoff. Use of recycled water for replenishment began at the Montebello Forebay area of the Central Basin in 1962, following construction of the Whittier Narrows WRP. The effectiveness of reuse from the Whittier Narrows WRP led to the decision to construct additional WRPs in the Los Angeles area in the 1970's, two of which (San Jose Creek and Pomona) also contribute to the recharge of the Central Basin. In the late 1970's, the WRPs were upgraded with tertiary treatment resulting in production of an effluent that met federal and state drinking water standards for heavy metals, pesticides, trace organics, major minerals, nitrogen, and radionuclides, and had extremely low levels of microorganisms and turbidity.

In the early 2000's, the WRPs were upgraded again, to provide nitrification/denitrification, further improving the quality of the recycled water. In the late 2000's,

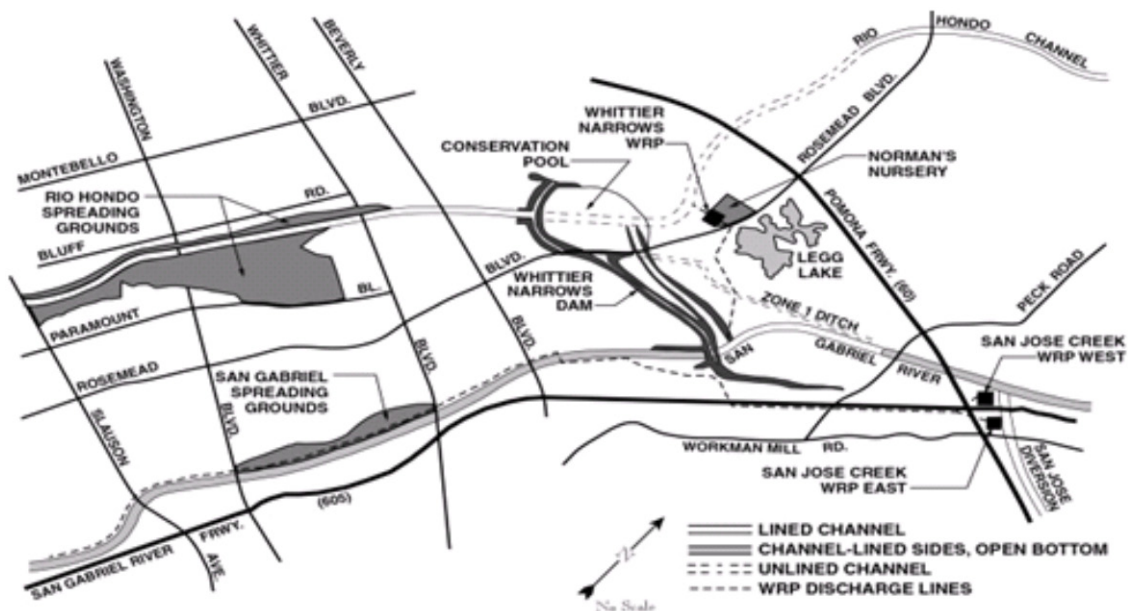

Figure 1
Montebello Forebay Groundwater Recharge Sites

sequential chlorination was implemented, minimizing production of trihalomethanes and N-nitrosodimethylamine. And in 2011, the Whittier Narrows WRP began using UV disinfection. All of these water quality improvements increased the suitability of recycled water for indirect augmentation of potable water supplies through groundwater recharge (**Table 1**).

Project Operation

Water is percolated into the groundwater using two sets of spreading grounds (**Figure 1**): the Rio Hondo Coastal Spreading Grounds, which consist of 570 ac (235 ha) with 20 individual basins, and the San Gabriel Coastal Spreading Grounds which consists of 128 ac (52 ha) with 3 individual basins, and within portions of the San Gabriel River (308 ac [125 ha]). Recycled water is conveyed to spreading grounds by gravity through existing waterways and operated under a wetting/drying cycle designed to optimize inflow and discourage development of vectors. Extensive monitoring is conducted at the WRPs, at the headworks to the spreading grounds, and in the groundwater aquifers.

Project Effectiveness

In a typical year, more recycled water from the Sanitation Districts' WRPs is used for groundwater recharge than for all other (direct non-potable) applications combined due to its cost-effectiveness. The major advantage of the MFGRP is that it avoids significant construction costs and energy requirements of a dual distribution system for delivering recycled water to direct non-potable users by taking advantage of existing waterways to convey the water to spreading grounds. In addition, greater quantities of recycled water can be conserved by utilizing the substantial under-ground storage capacities of the local aquifers, and there is no strict daily, or even seasonal, timeframe in which recharge must take place; it can occur whenever recycled water supplies are available and infiltration capacity is not taken up by storm runoff.

Project Management and Funding

The MFGRP is jointly managed by three agencies: WRD manages the basin, Los Angeles County Department of Public Works (LACDPW) operates the system, and Los Angeles County Sanitation Districts (Sanitation Districts) provides the recycled water.

Funding is provided by the respective agencies. Treatment is funded by the Sanitation Districts through charges to users of its sewerage system. The recycled water must be treated to a tertiary level even if it's to be discharged to the river and wasted to the ocean; therefore, no additional treatment costs are incurred for this project. Delivery costs are minimal, as the WRPs were constructed alongside rivers for disposal and are upstream of the spreading grounds. Recycled water is delivered by gravity through existing infrastructure, obviating the need for additional capital or energy costs. Operation costs for the river channels, through which the recycled water is transported, and the spreading grounds are incurred by LACDPW as part of their ongoing maintenance and operation of their flood control system and their mission to conserve local water. Recycled water is purchased by WRD as part of their mission to increase storage of groundwater in the Central Groundwater Basin. The Sanitation Districts sells recycled water to WRD at a significant discount over imported water for the same purpose. Groundwater monitoring costs are also borne by WRD as part of their mission to ensure the groundwater quality in their service area. WRD's funds are derived from replenishment fees collected from pumpers of groundwater in their service area, which are collected as part of the basin adjudication.

Project Driven Research

The three agencies involved have successfully collaborated to perform in-depth research over the years to reassure regulators and the public that recycled water is safe for aquifer recharge. The effectiveness of Soil Aquifer Treatment (SAT) has been demonstrated for decades, and a number of health effects studies related to the use of groundwater for human consumption have been undertaken over that time. In addition, numerous studies have been performed on the presence and fate of pharmaceuticals and personal care products in the water, virus fate and transport, recycled water residence time in the aquifers using tracer tests, and total organic carbon reduction. None of these studies have found any adverse health effects associated with using the recycled water for groundwater recharge in the Montebello Forebay.

Table 1 Average recycled water quality and California drinking water limits October 2010-September 2011

| Constituent | Units | SJC- East | SJC- West | Whit. Nar. | Pomona | Limit |
|----------------------------------|-------|-----------|-----------|------------|---------|--------|
| Organics | | | | | | |
| 1,1-Dichloroethane | ug/L | < 0.50 | < 0.50 | < 0.50 | < 0.50 | 5 P |
| 1,1-Dichloroethene | ug/L | < 0.50 | < 0.50 | < 0.50 | < 0.50 | 6 P |
| 1,1,1-Trichloroethane | ug/L | < 0.50 | < 0.50 | < 0.50 | < 0.50 | 200 P |
| 1,1,2-Trichloroethane | ug/L | < 0.50 | < 0.50 | < 0.50 | < 0.50 | 5 P |
| 1,1,2,2-Tetrachloroethane | ug/L | < 0.50 | < 0.50 | < 0.50 | < 0.50 | 1 P |
| 1,2-Dichloroethane | ug/L | < 0.50 | < 0.50 | < 0.50 | < 0.50 | 0.5 P |
| 1,2-Dichloropropane | ug/L | < 0.50 | < 0.50 | < 0.50 | < 0.50 | 5 P |
| 1,2,4-Trichlorobenzene | ug/L | < 5.0 | < 5.0 | < 5.0 | < 5.0 | 5 P |
| 2,4-D | ug/L | < 0.56 | < 0.60 | < 0.53 | < 0.53 | 70 P |
| 2,4,5-TP (silvex) | ug/L | < 0.56 | < 0.60 | < 0.53 | < 0.53 | 50 P |
| Atrazine | ug/L | < 0.12 | < 0.10 | < 0.11 | < 0.11 | 1 P |
| Benzene | ug/L | < 0.50 | < 0.50 | < 0.50 | < 0.50 | 1 P |
| bis(2-Ethylhexyl) phthalate | ug/L | < 2.0 | < 2.0 | < 2.0 | < 2.0 | 4 P |
| Carbon tetrachloride | ug/L | < 0.50 | < 0.50 | < 0.50 | < 0.50 | 0.5 P |
| Chlorobenzene | ug/L | < 0.50 | < 0.50 | < 0.50 | < 0.50 | 70 P |
| cis-1,2-Dichloroethene | ug/L | < 0.50 | < 0.50 | < 0.50 | < 0.50 | 6 P |
| Endrin | ug/L | < 0.01 | < 0.01 | < 0.01 | < 0.01 | 2 P |
| Ethylbenzene | ug/L | < 0.50 | < 0.50 | < 0.50 | < 0.50 | 300 P |
| Gamma-BHC (Lindane) | ug/L | < 0.01 | < 0.01 | < 0.01 | < 0.01 | 0.2 P |
| Heptachlor | ug/L | < 0.01 | < 0.01 | < 0.01 | < 0.01 | 0.01 P |
| Heptachlor epoxide | ug/L | < 0.01 | < 0.01 | < 0.01 | < 0.01 | 0.01 P |
| Methoxychlor | ug/L | < 0.01 | < 0.01 | < 0.01 | < 0.01 | 30 P |
| Methylene chloride | ug/L | < 0.50 | < 0.50 | < 0.50 | < 0.50 | 5 P |
| o-Dichlorobenzene | ug/L | < 0.50 | < 0.50 | < 0.50 | < 0.50 | 600 P |
| p-Dichlorobenzene | ug/L | < 0.50 | < 0.50 | < 0.50 | < 0.50 | 5 P |
| Pentachlorophenol | ug/L | < 1.0 | < 1.0 | < 1.0 | < 1.0 | 1 P |
| Polychlorinated biphenyls (PCBs) | ug/L | ND | ND | ND | ND | 0.5 P |
| Simazine | ug/L | < 0.12 | < 0.10 | < 0.11 | < 0.11 | 4 P |
| Tetrachloroethene | ug/L | < 0.50 | < 0.50 | < 0.50 | < 0.50 | 5 P |
| Toluene | ug/L | < 0.50 | < 0.50 | < 0.50 | < 0.50 | 150 P |
| Toxaphene | ug/L | < 0.5 | < 0.5 | < 0.5 | < 0.5 | 3 P |
| trans-1,2-Dichloroethene | ug/L | < 0.50 | < 0.50 | < 0.50 | < 0.50 | 10 P |
| Trichloroethene | ug/L | < 0.50 | < 0.50 | < 0.50 | < 0.50 | 5 P |
| Trichlorofluoromethane | ug/L | < 1.0 | < 1.0 | < 1.0 | < 1.0 | 150 P |
| Vinyl chloride | ug/L | < 0.50 | < 0.50 | < 0.50 | < 0.50 | 0.5 P |
| Xylenes | ug/L | ND | ND | ND | ND | 1750 P |
| Inorganics | | | | | | |
| Arsenic | ug/L | 0.347 | 0.592 | 0.722 | 0.295 | 10 P |
| Barium | ug/L | 61.6 | 26.9 | 38.8 | 34.5 | 1000 P |
| Cadmium | ug/L | < 0.20 | < 0.20 | < 0.20 | < 0.20 | 5 P |
| Total Chromium | ug/L | 0.74 | 0.83 | 1.0 | 0.83 | 50 P |
| Copper | ug/L | 3.00 | 5.69 | 5.00 | 5.47 | 1000 S |
| Fluoride | mg/L | 0.446 | 0.708 | 0.685 | 0.342 | 2 P |
| Iron | ug/L | 66 | 51 | 25 | 29 | 300 S |
| Manganese | ug/L | 23.5 | 25.4 | 9.38 | 6.17 | 50 S |
| Mercury | ug/L | 0.00123 | 0.00150 | 0.00245 | 0.00147 | 2 P |
| Nickel | ug/L | 5.83 | 3.01 | 7.83 | 1.96 | 100 P |
| Nitrate + Nitrite nitrogen | mg/L | 4.50 | 9.49 | 6.59 | 6.90 | 10 P |
| Selenium | ug/L | <1.00 | <1.00 | <1.00 | <1.00 | 50 P |
| Silver | ug/L | < 0.20 | < 0.20 | < 0.20 | < 0.20 | 100 S |
| Zinc | ug/L | 52.4 | 47.0 | 56.3 | 62.3 | |
| Other Constituents | | | | | | |
| Color | CU | 9 | 8 | 13 | 14 | 15 S |
| Surfactant (MBAS) | Mg/L | < 0.10 | < 0.10 | < 0.10 | 0.0083 | 0.5 S |
| Gross alpha radioactivity | pCi/L | 0.898 | 1.40 | 1.02 | 0.670 | 15 P |

P = Primary Maximum Contaminant Level (health)

S = Secondary Maximum Contaminant Level (aesthetic)

Values with "<" were below the Reporting Detection Limit reported

Regulatory Climate

Replenishment of the groundwater with recycled water in Montebello Forebay is regulated by the California Department of Public Health (CDPH) and Los Angeles Regional Water Quality Control Board (RWQCB) for protection of human health and of beneficial uses of groundwater. The recycled water used at the MFGRP receives rigorous tertiary treatment that ensures the high water quality standards are met.

Initially, the annual amount of recycled water recharged was limited to 32,700 ac-ft/yr (40 MCM/yr), which was determined to be the amount of effluent that had historically entered the groundwater from other sources. In 1987 (following the *Health Effects Study*), the maximum amount of recycled water used for recharge was increased to 50,000 ac-ft/yr (62 MCM/yr). In 1991, this was again increased to 60,000 ac-ft/yr (74 MCM/yr) in order to allow WRD to make up for those years in which excessive rainfall runoff prevented full utilization of the previous recycled water allotment.

In April 2009, the limit was revised again, as the RWQCB, with CDPH's concurrence, removed the quantity limits, replacing them with a dilution-based limitation of no more than 35 percent in any running five year period. WRD estimates that this could allow for the recharge of an additional 5,000 to 7,000 ac-ft/yr (6.2 to 8.6 MCM/yr) of recycled water, with a long-term goal of increasing replenishment with recycled water to 75,000 ac-ft/yr (93 MCM/yr). Currently, about 44,000 ac-ft/yr (54 MCM/yr) of disinfected tertiary municipal wastewater is being delivered to the MFGRP for groundwater recharge.

Successes

The MFGRP provides a new water supply, roughly equivalent to the demands of a quarter of a million people. After fifty years of operation, the WRPs continue to operate consistently, producing an extremely high quality effluent, and monitoring continues to indicate that groundwater quality has not been adversely impacted. In addition, the use of recycled water in lieu of imported water for replenishing the groundwater has saved tens of millions of dollars a year in water purchases.

Because recycled water is highly reliable, cost effective, locally controlled, and drought-resistant, there are ongoing plans to increase the amount of recycled water recharged in the Central Groundwater Basin and ultimately eliminate the basin's dependence on imported water.

References

- Nellor, 1984. *Health Effects Study*.
- Rand Corporation, 1996. *Groundwater Recharge with Reclaimed Water: An Epidemiological Assessment in Los Angeles County, 1987-1991*.
- Rand Corporation, 1999. *Groundwater Recharge with Reclaimed Water: Birth Outcomes in Los Angeles County, 1982-1993*.
- Fox, Nellor, et al., 2006. *An Investigation of Soil Aquifer Treatment for Sustainable Water Reuse*.
- Sanitation Districts of Los Angeles County, 1977. *Pomona Virus Study*.

Recycled Water Supplements Lake Elsinore

Author: Ronald E. Young, P.E., DEE (Elsinore Valley Municipal Water District)

US-CA-Elsinore Valley

Project Background or Rationale

As imported water becomes more expensive, finding ways to make the most of existing water supplies becomes increasingly important. One of the best ways to stretch supplies is to recycle water. Elsinore Valley Municipal Water District (EVMWD) in southern California is finding more ways to use recycled water, including water for local playgrounds, commercial landscapes and most importantly, maintaining stable water levels in Lake Elsinore.

Lake Elsinore is southern California's largest natural lake and is situated at the bottom of the San Jacinto Watershed. Because Lake Elsinore is a natural lake, fed only by rain and natural runoff, with annual evaporation of 4.5 feet, it has been plagued, for decades, by low water levels and high concentrations of nutrients. Large amounts of nutrients are responsible for producing algae blooms which choke off oxygen in the lake and result in fish kills. The lake is a full body contact recreational lake with fishing, speed boats, beaches and swimming areas. The lake is not a drinking water source.

Water Quality Standards and Treatment Technology

In 1997, a local task force comprised of community leaders issued a white paper on the benefits and safety of using recycled water in the community and to fill Lake Elsinore. In 2003, through a 2-year pilot program, EVMWD implemented an extensive monitoring program to examine biological and nutrient impacts that recycled water might have on water quality in the outflow channel and throughout the entire lake.

The monitoring program was administered by Dr. Michael Anderson of University of California Riverside. The Anderson report was used by the Regional Water Quality Control Board to set total maximum daily load (TMDL) load allocations in 2004, which were then translated into the 2005 National Pollutant Discharge Elimination System (NPDES) Permit for EVMWD. This resulted in a lake target value of total phosphorus of

0.01 mg/l by 2015 and a reclaimed water limit of 0.5 mg/l based on phosphorus mass loading, instead of concentration.

Thus, phosphorus reduction was needed and ultimately grant funded to achieve the NPDES requirements. The Anderson report concluded "stabilizing the lake level may be of greater short-term concern than increasing nutrient concentrations. The poorest water quality observed in the lake was, in fact more closely associated with declining lake level than inputs of recycled water or high lake nutrient concentrations."

In 2005, the Regional Water Quality Control Board approved EVMWD's two-year pilot project to introduce recycled water into Lake Elsinore. Over this two year period EVMWD successfully completed the various State required permits to be able to permanently provide recycled water to Lake Elsinore as part of TMDL requirements for the watershed.

Project Summary

The two year EVMWD pilot study resulted in a construction project including almost 4,000 feet of pipeline, at a cost of \$2.2 million. The project delivers approximately 5 mgd (219 L/s) of recycled water to Lake Elsinore. Also included in the project, was repair and retrofit of three local, shallow groundwater wells that deliver approximately 1 mgd (44 L/s) of non-potable water to Lake Elsinore. An additional \$1.5 million project added chemical phosphorus removal to the Regional WRP.

The project was funded by EVMWD and the Lake Elsinore San Jacinto Watershed Authority (LESJWA). LESJWA was formed in 2000 to improve water quality and protect wildlife habitats in the 700 square mile watershed that runs from the San Jacinto Mountains to Lake Elsinore. The annual operations and maintenance costs are borne equally between EVMWD and the City of Lake Elsinore through a cooperative agreement that outlines funding guidelines and operating requirements.

Successes and Lessons Learned

EVMWD received several honors for its state of the art reclamation facility and the recycled water program for Lake Elsinore including being named 2006 Plant of the

Year by the California Water Environment Association and the Theodore Roosevelt Environmental Award from the California Association of Water Agencies. **Figure 1** shows the Project Commemoration Ceremony.



Figure 1
October 2007 Commemoration Ceremony (Photo credit: Elsinore Valley Municipal Water District)

Replacing Potable Water with Recycled Water for Sustainable Agricultural Use

Author: Graham Juby, PhD, P.E. (Carollo Engineers)

US-CA-Temecula

Project Background

The city of Temecula, Calif., is located about 60 miles (97 km) north of San Diego. To the east and west lie agricultural areas that produce avocados, citrus and grapes. The agricultural area falls within the boundary of the Rancho California Water District (Rancho Water), which provides irrigation water to the local farmers. Rancho Water provides over 30,000 ac-ft/yr (37 MCM/yr) of fully-treated, drinking water for irrigation. Recognizing that delivering such large volumes of drinking water to agricultural users in water-short southern California is unsustainable, and the fact that discounted water rates for farmers was being phased out, Rancho Water conducted a study to determine the feasibility and cost of delivering recycled water.

In addition to purchasing irrigation water, farmers spend considerable funds on commercial fertilizers to provide nutrients to their crops, while treatment facilities spend considerable sums to remove some of the very same nutrients. The opportunity to provide nutrient-rich recycled water to farmers would benefit both sectors. Additionally, recycled irrigation water could improve plant nutrient uptake, and reduce nutrient runoff, providing another benefit to the region.

Capacity and Type of Reuse Application

Approximately 30,000 ac-ft/yr (37 MCM/yr) of drinking water is applied to the east and west farming areas. This project would be built in phases to ultimately replace the drinking water with 18,000 ac-ft/yr (22 MCM/yr) of recycled water and 12,000 AFY (315 MCM/yr) of untreated drinking water.

Recycled water would be obtained from two existing WWTPs centrally located between the eastern and western agricultural areas. One treatment plant is owned and operated by Rancho Water and has a capacity of 5 mgd (219 L/s). The second facility is owned and operated by the Eastern Municipal Water

District and has a current capacity of 18 mgd, (790 L/s) expandable to 23 mgd (1000 L/s). Some of the treated tertiary effluent produced by these plants is already recycled for landscape irrigation, so the agricultural reuse project would make use of any remaining water. In order to implement such a project, significant new infrastructure would be needed to distribute the recycled water. Most of the agricultural demand, about 25,000 AFY (8.1 billion gallons), is in the western region (Santa Rosa Division) where avocado farms are located. This area also has steep terrain (**Figure 1**) and construction of new distribution pipes will be challenging.



Figure 1
Avocado farming area, west of Temecula, Calif. (Photo credit: Graham Juby)

Untreated surface water supply would be used to make up the required volume to match irrigation demands; water would be provided from the existing connections to Metropolitan Water District of Southern California's raw water system. Seasonal storage would be provided to match seasonal demand for agricultural irrigation water by constructing additional storage volume to augment Rancho Water's existing seasonal irrigation storage capacity.

Water Quality Standards and Treatment Technology

Water quality goals for the project were twofold. The first is the requirement of the San Diego Regional Water Quality Control Board that specifies irrigation water contains less than 500 mg/L of total dissolved

solids (TDS), which applies to both the eastern and western areas that overlie groundwater basins. The second water quality requirement is limits for chloride, sulfate and boron, which are key considerations for irrigation of avocados, citrus and grapes.

The two WWTPs produce tertiary effluent containing between 690 and 720 mg/L TDS thus some salt removal would be required. However, once the TDS is reduced to below 500 mg/L to satisfy the groundwater basin objectives, the concentrations of other constituents that are of concern for agricultural use are also reduced to acceptable levels (Welch, 2006).

To achieve the desired recycled water quality for agricultural irrigation, conventional and advanced treatment would be required. Two treatment approaches were evaluated. The first treatment approach (**Figure 2**) would use microfiltration (MF) and reverse osmosis (RO) to treat about a third of the secondary effluent to result in a combined stream with the desired TDS limit of less than 500 mg/L. Considering that wastewater treatment includes nutrient removal, this approach would result in irrigation water that would apply nitrogen and phosphate at a rate of about 17 and 16 lb/ac, respectively, based on present agricultural-use water data.

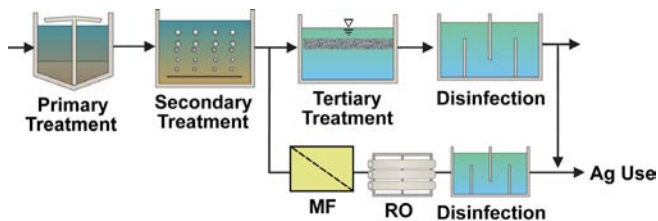

Figure 2
Conventional approach to producing partially desalted recycled water

Such nutrient application rates are much lower than typical rates used in California for oranges, avocados and grapes; which are 85, 116 and 33 lb/ac (95, 130 and 37 kg/ha) for nitrogen, and 34, 61 and 38 lb/ac (38, 68 and 43 kg/ha) for phosphate, respectively (Agricultural Statistics Board, 2004). Consequently, farmers would still need to apply significant quantities of commercial fertilizer.

A novel treatment approach that was also evaluated included the use of MF and RO treatment of primary

effluent rather than secondary effluent. This approach would allow nutrients in the primary effluent be retained through the MF step, resulting in higher concentrations after blending with one third of the stream that passes through RO, as shown in **Figure 3**. The recycled water, in this case, would increase irrigation water nitrogen and phosphorus concentrations such that the application rates would become 124 and 25 lb/acre (139 and 28 kg/ha), for nitrogen and phosphate, respectively. These application rates would provide sufficient nitrogen for oranges, avocados and grapes; meaning that farmers would not need to supplement nutrients with commercial fertilizers.

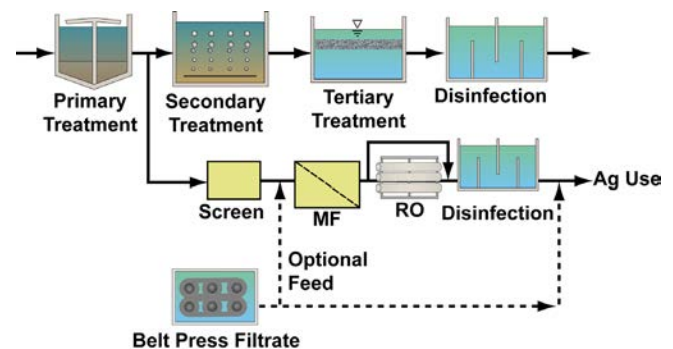

Figure 3
Use of primary effluent as source water results in higher nutrient concentrations in recycled water

As shown in **Figure 3**, other nutrient-rich side streams in the treatment plant (such as the belt press filtrate) could be utilized to further increase nutrient concentrations in the agricultural reuse water, avoiding the energy-intensive treatment of the high-nutrient return stream in the plant. By blending streams appropriately, nutrient levels could be controlled to supply a suitable range for agricultural reuse.

Providing water and nutrients are benefits of the treatment approach described in Figure 3; energy savings would be significant too. Avoiding the need for nitrogen removal in the secondary treatment process would save about 2060 BTU/lb (4.8 GJ/tonne) of nitrogen removed. But the biggest energy saving comes from manufacturing less commercial fertilizer – about ten times more energy than that needed to remove nitrogen via wastewater treatment, equating to 19,000 BTU/lb (44 GJ/tonne) of nitrogen (EFMA, 2007). For Phase I of the project, the 10,000 ac-ft/yr (12 MCM/yr) reuse is estimated to result in energy savings (associated with nitrogen) equivalent to 3,600

bbl/yr of oil, also reducing greenhouse gas emissions by 2800 tons/yr (2,500 tonnes/yr) of carbon dioxide equivalent (Juby et al., 2010).

Project Costs

Project cost estimates were updated in 2010 to include avoided costs and the latest projections for potable water costs in the region. Avoided costs included savings that would result from implementation of the project, such as the costs saved by importing less water to the region, and capital and operations and maintenance (O&M) costs that would be saved as a result of the modified treatment process.

The project was assumed to have a 30-year life, and interest on capital was calculated at an annual rate of 5 percent. Capital and O&M costs were annualized to develop an annual total, from which unit costs were calculated. The cost analysis showed that building the project to include 18,000 ac-ft/yr (22 MCM/yr) of partially-desalted, recycled water would result in the biggest long-term savings, \$545 million over the life of the project. The project payback is projected to be between 8 and 10 years when compared with the “do-nothing” alternative that assumes continued use of potable water for crop irrigation.

Project Funding and Management Practices

Rancho Water applied for Title XVI funding through the U.S. Department of the Interior, Bureau of Reclamation. A total of \$20 million was available for the project from this source. An additional \$4 million was potentially available through the State of California via Proposition 84, and the Metropolitan Water District of Southern California offered a credit of \$250/ac-ft (\$0.20/m³) of recycled water used to off-set potable water production through a local resources program.

A key to success of potential funding applications was the fact that this project had regional benefits in terms of its ability to reduce the demand for imported water and that it would free-up significant treated potable water; enough for a city of more than 120,000 people. The project’s more sustainable approach in terms of water use and energy savings were also important success factors.

Institutional/Cultural Considerations

The key aspect for the overall success of this project is the availability of excess wastewater from the local treatment plants. Linked to that factor, is the institutional issue of sharing water between agencies. The economic downturn in Southern California since 2008, coupled with a drive to increase water conservation, has resulted in wastewater flows declining to most treatment plants. Concurrently, the rapid increase in potable water cost has resulted in two challenges for this project. First, the decline in wastewater flows has delayed the implementation plan for the project by several years. Second, other uses for recycled water have left less wastewater available for this project.

Consequently, Rancho Water has recently investigated smaller, alternative projects that would utilize around 5,000 to 10,000 ac-ft/yr (6 to 2 MCM/yr) of recycled water. These projects would not involve conversion of the entire agricultural region to recycled water; but one alternative would convert the entire eastern farming region (vineyards) to recycled water. The current lack of “excess” wastewater flow for reuse equates to higher risk of stranded assets, if costly infrastructure is installed without guarantee that water will be available in future. Another risk to the project is if farmers go out of business, due to the rising cost of potable water, before the recycled water project can be built.

Successes and Lessons Learned

This project is still in development however, a key lesson for success is securing wastewater resources for recycled water projects early in arid regions where these resources are in high demand.

References

- Agricultural Statistics Board. 2004. Agricultural Chemical Usage 2003 Fruit Summary, NASS, USDA, August.
- EFMA. 2007. European Fertilizer Manufacturers Association, Harvesting Energy with Fertilizers, Brussels, Belgium. Retrieved on August 29, 2012 from <www.efma.org>.
- Juby, G.J.G, Zacheis, G.A and Louck, P. 2010. “Possible Paradigm Shift Ahead”, Water Environment & Technology, January pp 44-48.
- Welch, M.R. 2006. “Demineralization and Non-Potable Conversion Project: Recommended Recycled Water Quality”, Report to Carollo Engineers, Inc.

Water Reuse in the Santa Ana River Watershed

Author: Celeste Cantú (Santa Ana Watershed Project Authority)

US-CA-Santa Ana River

Project Background

Water reuse has long been seen as key to integrated regional water management planning in the Santa Ana River watershed and has been used as a strategy to stretch water supplies and improve supply reliability. The watershed includes most of Orange County, the western corner of Riverside County, the southwestern corner of San Bernardino County and a small portion of Los Angeles County in Southern California. When the watershed is viewed as a system, a comprehensive approach to managing water can be implemented, allowing available water to be matched to end uses by quality. For example, in the Santa Ana River watershed, there is significant demand for irrigation of landscaping, parks, golf courses and sports fields. Typical domestic wastewater can be recycled for these purposes without much more expense than would be required to discharge the wastewater legally to local receiving waters. In this case, reuse requires less energy than pumping imported water over the mountains into the watershed. Additionally, recycled water often contains nutrients, which can reduce the fertilizer needs for smart landscape managers.

Project Development

The Santa Ana Watershed Project Authority (SAWPA) has led the agencies and stakeholders in the watershed in a comprehensive, integrated planning process called “One Water One Watershed” (OWOW). The OWOW Steering Committee and the SAWPA Commission have developed goals for the watershed, several of which are related to water reuse, including increasing use of recycled water, matching water quality with intended uses, leveraging existing assets, reducing energy consumption, and identifying projects with multiple benefits.

SAWPA’s member agencies have been leaders in reusing domestic wastewater. The Eastern Municipal Water District, Inland Empire Utilities Agency, Orange County Water District, and Western Municipal Water

District have all developed recycled water supplies; other retail agencies in the watershed have also been very aggressive in making use of recycled water.

Capacity and Type of Reuse Application

The Santa Ana River watershed currently meets 10 percent of its total demand in average years with water reused within the watershed, and SAWPA expects this to increase to 15 percent by 2030. Recycled water uses include municipal use, agricultural irrigation, groundwater recharge, habitat and environmental protection, industrial use, and lake stabilization.

California currently recycles approximately 725,000 ac-ft (894 MCM) per year and has a goal of reusing 2.5 million ac-ft (3080 MCM) per year. This watershed represents a significant opportunity for the State to reach its recycling goal as the Santa Ana River watershed already reuses 217,000 ac-ft (268 MCM) per year or 29 percent of all of California’s current reuse. The OWOW plan envisions increasing that to 437,000 ac-ft (539 MCM).

Water Quality Standards

Another of the OWOW goals includes salinity management, which has also been a key effort of SAWPA for forty years on a watershed scale. Salt is introduced into the watershed by way of domestic sewage, industrial discharges, and the importation of water. A side effect of increasingly efficient water use is that less water flows to the ocean, which normally also reduces the export of salt. As a result, water reused in the watershed can cause a salinity increase which has undesirable consequences.

Thus, SAWPA and its member agencies constructed the Inland Empire Brine Line, which is used to collect salty wastes from industry, allowing those economic activities to thrive while keeping the salt segregated from the river, the groundwater, and the reusable wastewater. The isolation and export of brine creates capacity for reuse of domestic wastewater.

Importation of water from the Colorado River accounts for about one-third of the salt inputs to the system. In addition to the Inland Empire Brine Line, SAWPA and its member agencies also invested in groundwater desalters, which also discharge brine to the Inland Empire Brine Line.

In the lower part of the watershed, another SAWPA member agency, the Orange County Water District (OCWD), operates extensive diversion and recharge facilities to capture as much surface flow as possible and move it to groundwater storage. For decades OCWD has used recycled water to protect the basin from salinity by injecting it to create a seawater intrusion barrier. More recently, OCWD has partnered with the Orange County Sanitation District to develop the Groundwater Replenishment System (GWRS), the premier indirect potable reuse project in the U.S., which treats and percolates 72,000 ac-ft (89 MCM) per year back into the basin for storage and reuse. The OCWD GWRS uses RO treatment to remove salt, ultimately keeping it out of the basin.

The upper watershed's desalters and the Inland Empire Brine Line reduce the salinity of the surface flows that OCWD captures and recharges, also protecting the quality of the groundwater resource. As a result, the Orange County groundwater basin supplies 65 to 75 percent of the water needs of the 2.5 million residents of north Orange County.

Successes and Lessons Learned

The Santa Ana River watershed experience illustrates the need for a comprehensive, watershed approach to resources management, as even laudable actions can have negative impacts that need to be balanced. The desire to increase water use efficiency and to reuse water to stretch supplies and improve reliability has focused attention on the need to manage salinity. The need to integrate strategies and invest in significant infrastructure to achieve these goals required collaboration and trust among stakeholders throughout the watershed.

The communities and stakeholders in the watershed are now implementing the OWOW plan and will continue to look for ways to optimize available water resources. Moving forward, the OWOW Steering Committee and the SAWPA Commission will look even harder at addressing the long-term impacts associated with climate change. In Southern California, this is likely to create greater impetus to increase efficiency and maximize the use of local supplies and groundwater storage. Water reuse, storm water management, and salinity management are key strategies in the plan, and the SAWPA and its member agencies will continue to aid watershed stakeholders in developing new cooperative agreements for implementing strategies in the context of a system-wide plan.

Leo J. Vander Lans Water Treatment Facility

Authors: R. Bruce Chalmers, P.E. (CDM Smith) and Paul Fu, P.E. (Water Replenishment District)

US-CA-Vander Lans

Project Background or Rationale

The Water Replenishment District of Southern California (WRD) was established in 1959 to manage groundwater resources of the Central and West Coast Basins. WRD is responsible for maintaining adequate groundwater supplies, preventing seawater intrusion into underground aquifers, and protecting groundwater quality against contamination. WRD operates a program to artificially replenish the Central and West Coast Groundwater Basins by spreading and injecting replenishment water. Several sources are used for replenishment, including imported water and treated recycled water. WRD utilizes spreading facilities and three seawater intrusion barriers, including the Alamitos Seawater Intrusion Barrier.

Capacity and Type of Reuse Application

WRD constructed the Leo J. Vander Lans Water Treatment Facility (LVLWTF) in 2005 with a capacity of 3 mgd (130 L/s). The plant is being expanded to increase capacity to 8 mgd (350 L/s). WRD receives tertiary treated (Title 22) reclaimed water from the Los Angeles County Sanitation Districts (LACSD) Long Beach Water Reclamation Plant (LBWRP). WRD is also planning to acquire tertiary effluent from LACSD's Los Coyotes Water Reclamation Plant (LCWRP), approximately 6 miles (9.6 km) to the north of LVLWTF, to provide a sufficient supply of water to meet expansion requirements of the LVLWTF.

Treated water from the existing plant is mixed with imported potable water prior to injection into the Alamitos Barrier. The LVLWTF expansion will provide the entire supply to the barrier; therefore, eliminating the need for imported water.

Water Quality and Treatment Technology

Water quality from the LCWRP is essentially the same as the LBWRP. Comparison of average influent and effluent water quality parameters from 2010 is shown in **Table 1**.

Table 1 Influent and effluent water quality from 2010

| Parameter | Influent | | Product |
|---------------------|----------|-------|---------|
| | LBWRP | LCWRP | LVLWTF |
| TOC (mg/L) | 6.7 | 7.5 | 0.44 |
| Turbidity (NTU) | 0.48 | 0.50 | 0.07 |
| TDS (mg/L) | 703 | 787 | 83 |
| pH (SU) | 7.9 | 7.9 | 8.12 |
| TN (mg/L) | 9 | 9.3 | 2.05 |
| Nitrate (mg/L as N) | 6 | 5.3 | 1.74 |
| Ammonia (mg/L) | 1.5 | 2.0 | 0.22 |
| NDMA (ng/L) | 291 | 296 | 4.9 |
| 1,4 Dioxane (ug/L) | RNR | 2.55 | ND |

The treatment processes used at the LVLWTF follow the "California Model" for indirect potable reuse, using microfiltration (MF), reverse osmosis (RO), and ultraviolet (UV) (**Figure 1**). Facilities are located on a site adjacent to the LBWRP shown in **Figure 2**.

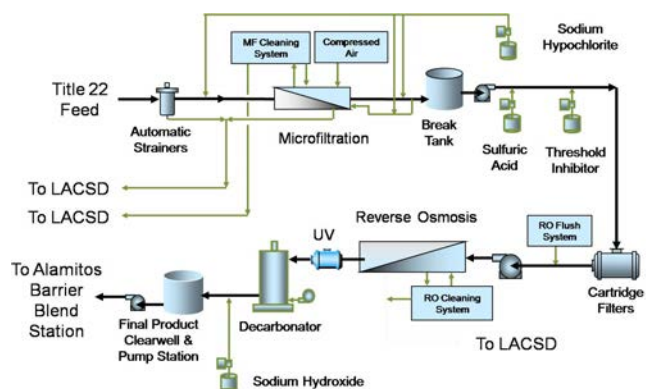

Figure 1 LVLWTF process flow diagram (Photo credit: CDM Smith 2011)

Microfiltration System. The existing MF system will be expanded to provide 8.35 mgd (370 L/s) of filtrate. The expanded system will have 6 MF racks with 100 modules per rack and is sized for a flux rate of 35 gallons per square foot per day (gfd) (58 L/m²/hr) and a recovery rate of about 95 percent. Maintenance

cleans can be performed daily while clean-in-place protocols are performed monthly. Half of the existing MF system will be modified to treat MF backwash from expanded MF equipment; while the remaining modules will be moved to the new MF racks.



Figure 2
LVLWTF site (Photo credit: CDM Smith 2011)

MF Backwash Treatment. MF backwash will be treated with a DAF and MF membranes as shown in **Figure 3**. Due to this level of treatment and the fact that no virus removal credit is being taken for the MF, 0.42 mgd (18 L/s) of water can be used as influent to the RO system.

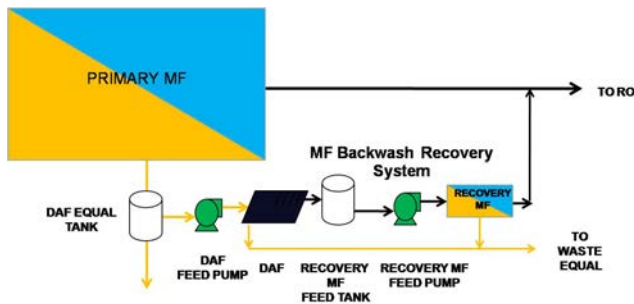

Figure 3
MF and MF backwash treatment systems (Photo credit: CDM Smith 2012)

Reverse Osmosis System. The current two stage RO system will be expanded to produce 8 mgd (350 L/s) of RO permeate at a flux rate of 12.2 gfd (20.3 L/m²/hr). The two stage RO system will be supplemented with a third stage to increase the overall RO recovery to approximately 92 percent (**Figure 4**).

UV-A System. Additional equipment is being added to the UV system during the expansion to increase capacity to 8 mgd (350 L/s). Hydrogen peroxide will also be added to provide advanced oxidation. The system will provide 1.62-log to 2-log removal of NDMA and 0.5-log 1,4-dioxane removal.

Appurtenances. Finished water pumps deliver water to the barrier. Calcium chloride and sodium hydroxide

will be added to provide minerals and pH control to stabilize the water. A chloramine residual will be required for the barrier injection. Plant wastes, including the RO concentrate, are conveyed to the local trunk sewer for further treatment downstream prior to discharge to the ocean outfall.

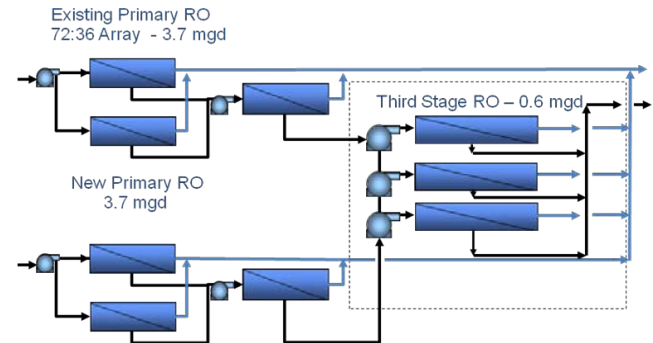

Figure 4
Three stage RO system (Photo credit: SPI 2011)

Project Funding and Management Practices

A Federal Title XVI grant and California Proposition 84 grant provided partial funding for the design and construction of the LVLWTF, with the remaining funded by WRD via debt financing. Operation of the LVLWTF is contracted to the Long Beach Water Department (LBWD). Influent water is obtained from the LBWD and the LACSD. The Alamitos Barrier is owned and operated by the LACDPW.

Institutional/Cultural Considerations

The expansion is similar to the existing facility except the waste flow is limited to 760,000 gpd (2,900 m³/d). The LVLWTF expansion provides the additional 5 mgd (220 l/s) of treatment capacity without increasing waste flows to sewer. To accomplish this, backwash from the MF system will be treated and used while a third stage will be added to the RO to increase the recovery. The expanded plant will have an overall 92 percent water recovery rate.

Successes and Lessons Learned

The LVLWTF was the first indirect potable reuse plant in California to be designed to remove NDMA while the expansion construction may be the first permitted under the California Recycled Water Recharge regulations.

Use of Pasteurization for Pathogen Inactivation for Ventura Water, California

Author: Andrew Salveson, P.E. (Carollo Engineers)

US-CA-Pasteurization

Project Background or Rationale

Pasteurization, discovered by Louis Pasteur in 1864, is a process of applying heat to inactivate pathogenic or spoilage microorganisms. The process has since become standard practice in the food industry and has recently become an accepted practice in sewage sludge processing, to achieve Class A Biosolids standards. This technology has the ability to be used in sewage sludge processing as well as treated wastewater disinfection. The use of pasteurization as a disinfection technology was originally demonstrated to the California Department of Public Health (CDPH) at the City of Santa Rosa, California's, Laguna Wastewater Reclamation Plant. A demonstration scale system (**Figure 1**) was built by Pasteurization Technology Group for Ventura Water at the Ventura Water Reclamation Facility in Ventura, Calif.



Figure 1
400 gpm Wastewater Pasteurization Demonstration System in Ventura California (Photo credit: Greg Ryan, Pasteurization Technology Group)

Treatment Technology

Pasteurization is based on thermal inactivation of microorganisms. This process may depend on a number of factors: characteristics of the organism, stress conditions for the organism (e.g. nutrient limitation), growth stage, characteristics of the medium (e.g. heat penetration, pH, presence of protection

substances like fats and solids, etc.), and temperature and exposure time combinations. In design of pasteurization systems, temperature and exposure time combinations are the dominant parameters. The most useful information within the literature is the demonstration of the relative sensitivities to heat for various pathogens and indicator organisms. The particular temperature and contact time required for bacterial and viral disinfection of treated wastewater is presented in **Figures 2** and **3**, respectively (adapted from Salveson [2007]).

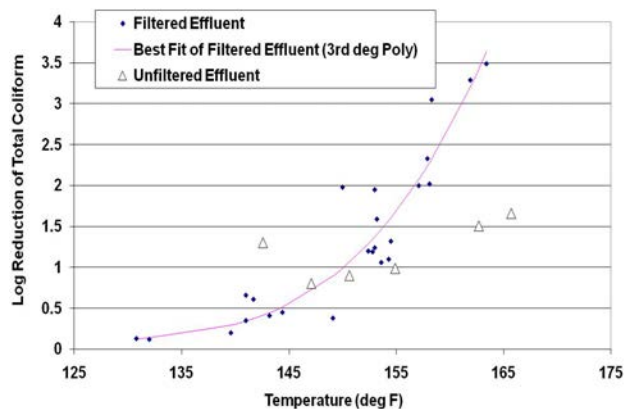

Figure 2
Disinfection of total coliform in treated effluent (Salveson, 2007)

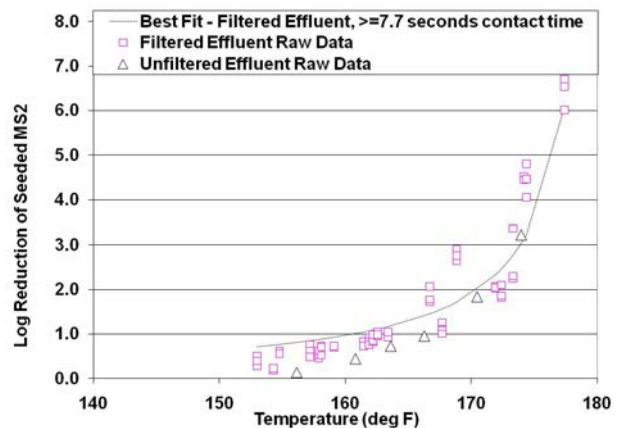

Figure 3
Disinfection of MS2 Coliphage in treated effluent (Salveson, 2007)

Moce-Llivina et al. (2003) investigated pasteurization of seeded bacteriophages and enteroviruses in raw sewage and tested the effect of pasteurization at 140 degrees F (60 degrees C) for 30 minutes. They found that MS2 was the most heat sensitive coliphage and that somatic coliphages and phages infecting *B. fragilis* were the most resistant. Enteroviruses were significantly more heat sensitive than any of the phages, with poliovirus being the most heat sensitive.

Based upon this and other work, primarily the testing in Santa Rosa, Calif., the CDPH determined that a 4-log reduction in a seeded MS2 coliphage test conservatively provided equivalent disinfection to 5-log reduction of poliovirus. Pasteurization to this rigorous reclaimed water standard was demonstrated at the City of Santa Rosa's Laguna Wastewater Reclamation Plant where validation testing was conducted as part of the CDPH program to review new technologies and provide conditional approval (often referred to as "Title 22" approval). The detailed research is summarized in Salveson et al. (2011).

The CDPH approved pasteurization to meet the stringent "tertiary recycled water criteria" for coliform and virus reduction based upon a minimum contact time of 10 seconds at or above 179 degrees F (81.6 degrees C). **Figures 2** and **3** illustrate disinfection performance for bacteria and virus, respectively in filtered and unfiltered effluents. This data suggests that water quality does play a role in pasteurization disinfection kinetics, particularly with regard to coliform disinfection.

Economic and Management Practices

The economic value of pasteurization is favorable when waste heat can be captured and transferred for disinfection. The goal of pasteurization is to keep all heat in a loop, continuously transferring the heat in the disinfected water with the cool undisinfected water. To accomplish this, a series of carefully designed heat exchangers are used. The ongoing demonstration testing in Ventura, Calif., shows that all but two degrees of heat is continuously transferred, resulting in only a minimal need for continuous heat addition.

Example sources of waste heat include exhaust heat from a turbine fueled by natural gas, digester gas, hot water, or a combination of the waste heats. The economics of pasteurization appear extremely favorable where power costs are high. In Ventura,

Calif., pasteurization costs project to be millions of dollars less than other alternative disinfection technologies. These economics (summarized in Salveson et. al, 2011) led to the demonstration testing in Ventura. Pasteurization Technology Groups has a worldwide patent for the process.

References

Salveson, A., Ryan, G., Goel, N. (2011) Pasteurization – Not Just for Milk Anymore. *Water Environment and Technology*, March 2011, p. 42-45.

Salveson, A. (2007) RP&P Wastewater Pasteurization System Validation Report. *Technical Report by Carollo Engineers Submitted to the CDPH*; July 2007.

Moce-Llivina, L., Muniesa, M., Pimenta-Vale, H., Lucena, F., and Jofre, J. (2003). Survival of Bacterial Indicator Species and Bacteriophages after Thermal Treatment of Sludge and Sewage. *Applied and Environmental Microbiology*, Mar. 2003, p. 1452-1456.

California State Regulations

Author: James Crook, PhD, P.E., BCEE (Water Reuse Consultant)

US-CA-Regulations

Project Background or Rationale

The state of California has a long history of water reuse and regulatory activity and was the first agency to develop regulations specifically directed at the safe use of reclaimed water. The evolution of water reclamation and reuse criteria truly began in California, and the philosophy and rationale behind that state's regulations have pervaded many other regulations around the world.

Regulatory Authority

The principal state regulatory agencies involved in water recycling in California are the California Department of Public Health (CDPH), the California State Water Resources Control Board (SWRCB), and the nine Regional Water Quality Control Boards (RWQCBs) (Crook, 2010). In 1991, the SWRCB and RWQCBs were brought together with five other state environmental protection agencies under the newly crafted California Environmental Protection Agency (Cal/EPA).

The nine semi-autonomous RWQCBs are divided by regional boundaries based on major watersheds. Each RWQCB makes water quality planning and regulatory decisions for its region. The SWRCB is generally responsible for setting statewide water quality policy and considering petitions contesting RWQCB actions. CDPH has statutory authority in two areas with respect to direct potable reuse. It regulates public water systems (drinking water purveyors) and develops and adopts water recycling criteria.

History of Regulation Development

At the turn of the 20th century, California had at least 20 communities using either raw or settled sewage for agricultural irrigation. The earliest reference to a public health viewpoint on water quality requirements in California appeared in the California State Board of Health Monthly Bulletin dated February 1906, in which it was stated:

1906: "Oxnard is installing a septic tank system of sewage disposal, with an outlet in the ocean. Why not use it for irrigation and save the valuable fertilizing properties in solution, and at the same time completely purify the water? The combination of the septic tank and irrigation seems the most rational, cheap, and effective system for this State." (Ongerth and Jopling, 1977)

Therefore, the first water quality requirement for reclaimed water use in California was septic tank treatment.

Official control on the sewage irrigation of crops began in 1907, with the publication of State Board of Health's April 1907 Bulletin specifying that local health authorities "watch irrigation practices" and not allow use of "sewage in concentrated form and sewage-polluted water...to fertilize and irrigate vegetables which are eaten raw, and strawberries." (Crook, 2002)

The first standards adopted by the State Board of Health in 1918, titled *Regulation Governing Use of Sewage for Irrigation Practices* (California State Board of Health, 1918), prohibited the use of raw sewage for crop irrigation and limited the use of treated effluents to irrigation of nonfood crops and food crops that were cooked before being eaten or food crops that did not come in direct contact with the wastewater. Garden crops of the type that are cooked before being eaten could be irrigated if the application of effluent was not made within 30 days of harvest. The regulations provided several exemptions, such as permitting irrigation of melons if the sewage did not come in contact with the vine or product and irrigation of tree-bearing fruit or nuts if windfalls or products lying on the ground were not harvested for human consumption.

The regulations were revised in 1933 and renamed *Regulations on the Use of Sewage for Irrigating Crops* (CDPH, 1933). These regulations prohibited the use of raw sewage for crop irrigation and prohibited the use of sludge as a fertilizer for growing vegetables, garden truck, or low growing fruits or berries unless the sludge

was rendered innocuous. It prohibited the use of settled or undisinfected sewage effluent for the irrigation of the same type of crops and for the irrigation of orchards or vineyards during seasons in which windfalls or fruit lie on the ground. Irrigation of fodder, fiber, or seed crops with settled or undisinfected sewage was allowed, but milk cows could not be pastured on the land that was moist with sewage. The regulations exempted restriction of wastewater for the irrigation of garden truck crops eaten raw if the wastewater was well oxidized, nonputrescible, and reliably disinfected or filtered to meet a bacterial standard approximately the same as the then-current drinking water standard. Disinfection reliability was emphasized in that two or more chlorinators, weighing scales, reserve supply of chlorine, twice daily coliform analyses, and records were required. It was noted that the revisions were made because of an expressed interest by the Los Angeles Chamber of Commerce and others in the nearby communities to conserve water, to provide employment for fieldworkers in contemplated truck gardens, and to save beaches (Ongerth and Jopling, 1977). The 1933 standards marked the first appearance of cross connection control regulations. Cross connections between wastewater and domestic water supply pipelines were prohibited, and signs warning against drinking the water were specified on pipes and appurtenances that contain wastewater.

The 1933 regulations continued in effect until passage of the Water Pollution Act of 1949 eliminated the permit system that constituted the statutory basis for the regulation (Ongerth and Jopling, 1977). They were re-issued without change in 1953 as *Regulations Relating to Use of Sewage for Irrigating Crops* (CDPH, 1953).

The number of water reuse projects increased dramatically in the 1960s, and it became necessary to develop water reclamation standards for various types of use. In 1967, a state legislative committee reported that legislation relating to the use of reclaimed wastewater was needed to protect public health and that the CDPH should be required to establish statewide contamination standards. The committee recommended that the RWQCBs establish requirements for the use of reclaimed water that are in conformity with the statewide contamination standards. These recommendations resulted in revisions to the California Water Code in 1967, which gave the CDPH

the authority and responsibility to establish reclamation criteria and gave the RWQCBs the responsibility to enforce the criteria (California State Water Resources Control Board, 1967).

As a result of the above-mentioned legislation, more comprehensive regulations were enacted in 1968 that were directed mainly at the control of disease agents. These *Statewide Standards for the Safe Direct Use of Reclaimed Water for Irrigation and Impoundments* (CDPH, 1968) included treatment and quality requirements intended to assure that the use of reclaimed water for the applications specified in the regulations would not impose undue risks to the public health.

Several studies conducted by the Department of Health in the late 1960s and early 1970s indicated a record of poor reliability at wastewater treatment plants (Crook, 1976; California Department of Health, 1973). At the request of the Department of Health, a modification in state law authorized the Department of Health to establish regulations on treatment reliability. The 1968 standards specified levels of constituents of reclaimed water and were revised in 1975 to include treatment reliability requirements, then renamed *Wastewater Reclamation Criteria* (California Department of Health Services, 1975). There have been two subsequent revisions to the criteria, one in 1978 that added general requirements for groundwater recharge and differentiated between different types of landscape irrigation (California Department of Health Services, 1978). Research and demonstration studies conducted in the late 1970s and 1980s, along with advances in treatment technology and a need to include requirements for additional types of reuse, resulted in a protracted effort to revise the 1978 criteria. This effort, begun in 1988, culminated in adoption of a new set of criteria in 2000. These *Water Recycling Criteria* include requirements for several new applications of reclaimed water, modify some of the treatment and quality requirements, prescribe requirements for dual water systems, include cross connection control requirements, and include use area requirements that formerly were issued as guidelines (California Department of Health Services, 2000). In conformance with terminology in the California Water Code, the word “reclaimed” was replaced with “recycled” and “reuse” was replaced with “recycling” in all regulations.

Additional information on the decision-making and rationale that went into the details of the 1968, 1975, 1978, and 2000 updated water reuse regulations in California is available in Crook (2002). California has used advisory committees, public meetings, and other means of communication with a broad spectrum of interested parties, including waste dischargers, regulatory agencies, and potential users over the years during development of its water reuse regulations in order to arrive at a proper balance of realistic and workable standards that ensure an acceptable level of public health protection.

Recycled Water Policy

In 2009 the SWRCB adopted a Recycled Water Policy (California State Water Resources Control Board, 2009). In response to an unprecedented water crisis brought about by the collapse of the Bay-Delta ecosystem, climate change, continuing population growth, and a severe drought on the Colorado River, the SWRCB was prompted to “exercise the authority granted to them by the Legislature to the fullest extent possible to encourage the use of recycled water, consistent with state and federal water quality laws.” The policy also declared, “Recycled water is a valuable resource and significant component of California’s water supply” (California State Water Resources Control Board, 2009). These recent declarations are part of broad state-wide objectives to achieve sustainable water resource management.

The SWRCB included a provision in the 2009 Recycled Water Policy to establish a Science Advisory Panel to provide guidance for future development of monitoring programs that assess potential threats from constituents of emerging concern (CECs) where recycled water is used for various water recycling applications. Recycling applications could include urban landscape irrigation and indirect potable reuse via surface water augmentation as well as drinking water aquifer recharge using surface spreading or subsurface injection. The Science Advisory Panel’s report, entitled “Monitoring Strategies for Chemicals of Emerging Concern in Recycled Water” was published in 2010 (California State Water Resources Control Board, 2010). The SWRCB subsequently released draft amendments to the Recycled Water Policy (California State Water Resources Control Board, 2012) in response to the Science Advisory Panel’s report that added many of the Panel’s

recommendations related to monitoring strategies for CECs in recycled water.

Proposed Indirect Potable Reuse Regulations

CDPH first began crafting comprehensive regulations for indirect potable reuse (IPR) via groundwater recharge by surface spreading and direct injection into potable water supply aquifers more than two decades ago. The most recent version of the draft regulations (California Department of Public Health, 2011) was released in November 2011. The draft regulations include (among other criteria) requirements for treatment unit processes, water quality, dilution, source control programs, response time between treatment and extraction of the water for potable purposes, monitoring wells, and monitoring for indicators, surrogates, and selected CECs. They are scheduled to be finalized and adopted by the end of 2013. Upon adoption, the groundwater recharge regulations will be included in the CDPH *Water Recycling Criteria*.

References

- California Department of Health. 1973. *Development of Reliability Criteria for Water Reclamation Operations*. California Department of Health Services, Water Sanitation Section, Berkeley, California.
- California Department of Health Services. 1975. *Wastewater Reclamation Criteria*. California Administrative Code, Title 22, Division 4, California Department of Health Services, Water Sanitation Section, Berkeley, California.
- California Department of Health Services. 1978. *Wastewater Reclamation Criteria*. California Administrative Code, Title 22, Division 4, California Department of Health Services, Sanitary Engineering Section, Berkeley, California.
- California Department of Health Services. 2000. *Water Recycling Criteria*. California Code of Regulations, Title 22, Division 4, Chapter 3. California Department of Health Services, Sacramento, California. Retrieved on August 30, 2012 from <http://www.cdph.ca.gov/certlic/drinkingwater/Documents/Lawbook/RWregulations-01-2009.pdf>.
- California Department of Public Health. 1933. Special Bulletin No. 59: *Regulations on Use of Sewage for Irrigating Crops*. State of California Department of Public Health, Sacramento, California.

California Department of Public Health. 1953. *Regulations Relating to Use of Sewage for Irrigating Crops*. California Administrative Code, Title 17, Chapter 5, Subchapter 1, Group 7, State of California Department of Public Health, San Francisco, California.

California Department of Public Health. 1968. *Statewide Standards for the Safe Direct Use of Reclaimed Water for Irrigation and Recreational Impoundments*. California Administrative Code, Title 17, Group 12, California Department of Public Health, Berkeley, California.

California Department of Public Health. 2011. *Groundwater Replenishment Reuse DRAFT Regulation*. California Department of Public Health, Drinking Water Program, Sacramento, California. Retrieved on August 30, 2012 from <<http://www.cdph.ca.gov/certlic/drinkingwater/Documents/Recharge/DraftRechargeReg-2011-11-21.pdf>>.

California State Board of Health. 1918. *Regulations Governing Use of Sewage for Irrigation Purposes*. California State Board of Health, Sacramento, California.

California State Water Resources Control Board. 1967. *Wastewater Reclamation and Reuse Law*. California Water Code, Chapter 6, Division 7, California State Water Resources Control Board, Sacramento, California.

California State Water Resources Control Board. 2009. *Water Recycling Policy*. California State Water Resources Control Board, Sacramento, California. Retrieved on August 30, 2012 from <http://www.waterboards.ca.gov/water_issues/programs/water_recycling_policy/index.shtml>.

California State Water Resources Control Board. 2010. *Final Report: Monitoring Strategies for Chemicals of Emerging Concern (CECs) in Recycled Water*. Recommendations of a Science Advisory Panel, State Water Resources Control Board, Sacramento California.

California State Water Resources Control Board. 2012. Draft Revised Water Recycling Policy. State Water Resources Control Board, Sacramento California. Retrieved on August 30, 2012 from <http://www.waterboards.ca.gov/water_issues/programs/water_recycling_policy/docs/amendment_docs/draft_rwp_clean.pdf>.

Crook, J. 1976. *Reliability of Wastewater Reclamation Facilities*. State of California Department of Health, Water Sanitation Section, Berkeley, California.

Crook, J. 2002. The Ongoing Evolution of Water Reuse Criteria. In: *Proceedings of the AWWA/WEF 2002 Water Sources Conference* (CD-ROM), January 27-30, 2002, Las Vegas, Nevada.

Crook, J. 2010. *Regulatory Aspects of Direct Potable Reuse in California*. White paper published by the National Water Research Institute, Fountain Valley, California.

Ongerth, H.J., and W.F. Jopling. 1977. Water Reuse in California. In: *Water Renovation and Reuse*, pp.219-256, Academic Press, Inc., New York, New York.

West Basin Municipal Water District: Five Designer Waters

Author: Shivaji Deshmukh, P.E. (West Basin Municipal Water District)

US-CA-West Basin

Project Background or Rationale

West Basin Municipal Water District (West Basin) is a special district of the State of California and an innovative public agency that provides drinking and recycled water to its 185-square-mile (480-km²) service area located in coastal Los Angeles County. West Basin purchases imported water from the Metropolitan Water District of Southern California and wholesales the imported water to cities, water agencies, and private water companies in its service area. In order to reduce the dependence on imported water supplies, West Basin developed a world renowned recycled water program that currently produces more than 30 million gallons per day (1,300 L/s) of “designer” recycled water. West Basin recently began a new program, Water Reliability 2020, to expand its portfolio of locally produced water to ensure water supply reliability for future residents and businesses. This program is designed to reduce the dependence on imported water by increasing the amount of water conserved and produced locally. By 2020, West Basin will double water recycling and water conservation programs and include environmentally responsible ocean-water desalination as part of the water supply portfolio.

Capacity and Type of Reuse Application

West Basin’s Water Recycling Facility is named the Edward C. Little Water Recycling Facility (ECLWRF) (**Figure 1**) to honor the 6-term commitment made to West Basin and our constituents by Director Edward C. Little. The ECLWRF is a world-class, state-of-the-art facility that is the largest of its type in the world. Working with customers such as Toyota, Honda, Chevron, Goodyear, California State University, Home Depot Center, Raytheon, Los Angeles Air Force Base, and Marriott, West Basin has built a unique water recycling program with the capacity to expand throughout our service area.



Figure 1
The Edward C. Little Water Recycling Facility is located in El Segundo, California

This facility produces more than 30 million gallons of recycled water every day for over 380 customer sites. Uses of recycled water include irrigation, boiler feeds, cooling towers, street sweepers, and injection into seawater barriers to provide protection for local groundwater supplies from saltwater intrusion by the ocean. This water purification facility produces five types of “designer” waters to serve specific customer needs for various uses, including golf courses, professional soccer fields, street sweeping, restrooms, boilers, cooling towers and other commercial, municipal and industrial uses. All five types of “designer” water meet the treatment and water quality requirements specified in the California Department of Public Health’s Water Recycling Criteria and permitted by the Los Angeles Regional Water Quality Control Board. “Designer” Waters that are fit for various purposes include:

1. **Tertiary Water:** Secondary treated wastewater that has been filtered and disinfected for a wide variety of industrial and irrigation uses

2. **Nitrified Water:** Tertiary water that has been nitrified to remove ammonia for industrial cooling towers.
3. **Reverse Osmosis Water:** Secondary treated wastewater by microfiltration, followed by reverse osmosis (RO) and UV disinfection and advanced oxidation using hydrogen peroxide for groundwater injection, which is superior to state and federal drinking water standards.
4. **Pure Reverse Osmosis Water:** Secondary treated wastewater that has undergone micro-filtration and RO can be used for low-pressure boiler feed water.
5. **Ultra-Pure Reverse Osmosis Water:** Secondary treated water that has undergone micro-filtration and two passes through RO for high-pressure boiler feed water.

In addition to providing recycled water for commercial and industrial uses, high-quality recycled water produced by West Basin is injected into the groundwater basin to prevent seawater intrusion into the local aquifers. The West Coast Barrier is a series of injection wells positioned between the ocean and the groundwater aquifer. These wells inject water along the barrier to ensure that the water level near the ocean stays high enough to prevent the seawater from seeping into the aquifer. In April 2009, West Basin and the Water Replenishment District of Southern California (WRD) signed an agreement to increase the amount of water supplied to the barrier by 100 percent by 2012.



Figure 2
Reverse osmosis treatment at the ECLWRF

Water Quality Standards and Treatment Technology

With five distinct “designer” waters, many water quality requirements exist for West Basin’s recycled water program. While each has established water quality guidelines, the most regulated is recycled water for injection into the groundwater basin. This quality meets and exceeds all potable drinking water guidelines. In order to improve the flux through the microfiltration process of this treatment train, West Basin will soon implement the use of ozone as a pretreatment step prior to this filtration process. **Figure 2** shows the heart of the treatment process, reverse osmosis.

Project Funding and Management Practices

The recycled water program is funded through capital investment from major customers, state and federal grants, local supply subsidies, and recycled water rates. West Basin maintains a relatively small work force. Its operational model includes contract operations for the treatment plant and the distribution system. It also has employed various project delivery methods including design-build.

Institutional/Cultural Considerations

The focus of West Basin’s outreach is its award winning Water Reliability 2020 program. The district conveys news about water supply through multiple mediums including community events, media affairs, conservation classes and the district’s website. West Basin offers free conservation classes, classroom education and facility tours to more than 10,000 people each year.

Successes and Lessons Learned

West Basin has been a leader in application of technology to produce water for indirect potable reuse. Some of the technology successes have included application of microfiltration as a pretreatment step for reverse osmosis as well as implementation of low pressure, high intensity UV disinfection for disinfection and advanced oxidation of indirect potable water, leading the way for other agencies to follow suit with similar treatment processes. Once complete later this year, West Basin will be one of the first to use ozone as a pretreatment before microfiltration to improve water quality.

Denver Zoo

Authors: Abigail Holmquist, P.E. (Honeywell); Damian Higham (Denver Water); and Steve Salg (Denver Zoo)

US-CO-Denver Zoo

Project Background

Denver Zoo is one of the most popular cultural institutions in Colorado and is widely recognized as one of the nation's premier zoos. Denver Zoo's mission to "secure a better world for animals through human understanding" embraces not only worldwide wildlife habitat preservation, but local conservation as well. One practical way Denver Zoo is achieving its goals is through water conservation efforts and use of recycled water.

Capacity and Type of Reuse Application

Through a partnership with Denver Water, Denver Zoo has successfully reduced its water consumption by 42 percent over the past decade. Added to this accomplishment is implementation of a recycled water system. Denver Zoo is unique in that it uses recycled water not only for irrigation, but for enclosure wash-down and animal swimming pools (**Figure 1**). Denver Zoo currently uses approximately 2 million gallons (7600 m³) of recycled water annually. At build-out of its master plan, Denver Zoo hopes to expand recycled water use to 75 percent of its total water consumption, representing over 134 million gallons (609,000 m³) of recycled water per year.



Figure 1
Predator Ridge Exhibit in Denver Zoo (Photo credit: Denver Zoo)

Water Quality Standards and Treatment Technology

The Colorado Department of Public Health and Environment regulates recycled water through Regulation 84, which sets forth treatment standards, allowable uses and water quality standards for different water categories. Category 3 water is produced by the reclamation plant and has an *E. coli* maximum of 25 percent detectable in any given month and 126 cfu/100ml in any sample. Turbidity results must not exceed 5 NTU in more than 5 percent of samples in a month and 3 NTU as a monthly average. Additional treatment targets for ammonia and phosphorous at Denver Water's recycling plant were developed in cooperation with industrial customers to ensure that recycled water quality would be suitable for needs. Typical recycled water quality parameters are shown in **Table 1**.

Institutional/Cultural Considerations

As the animals are one of the primary assets of Denver Zoo, it was paramount that their safety be top priority when considering recycled water uses and implementation strategies. Veterinarians examined the chemical composition of Denver Water's recycled water and determined which animals should be allowed to come into contact with or consume recycled water.

Public and worker education programs are also important to impart the value of recycled water use, as well as the hazards associated with its use. These messages are communicated to the public with signage at the main entrance to Denver Zoo and in use areas with public access (**Figure 2**). Workers undergo annual training provided by Denver Water and by Denver Zoo ensuring they work with recycled water in a manner that will protect the animals, the public and coworkers.

Table 1 Typical water quality parameters

| Parameter | Units | Typical Range |
|-----------------------------------|-----------|---------------|
| Alkalinity, as CaCO ₃ | mg/L | 50-150 |
| Ammonia as N | mg/L | 0-0.4 |
| Boron | mg/L | 0.2-0.4 |
| Calcium | mg/L | 40-70 |
| Chloride | mg/L | 65-170 |
| Chlorine, Total | mg/L | 1.5-4.0 |
| Iron | mg/L | 0.05-0.6 |
| Magnesium | mg/L | 5-20 |
| Manganese | mg/L | 0.003-0.08 |
| Nitrate + Nitrite as N | mg/L | 5-30 |
| Nitrate as N | mg/L | 5-20 |
| Nitrite as N | mg/L | 0.01-0.05 |
| Ortho Phosphorous, Dissolved as P | mg/L | 0.04-0.3 |
| pH | SU | 6-8 |
| Phosphorous, as P | mg/L | 0.04-0.4 |
| Potassium | mg/L | 10-20 |
| Sodium | mg/L | 90-200 |
| Specific Conductance | mg/L | 360-1250 |
| Sulfate | mg/L | 80-250 |
| Temperature | °C | 10-30 |
| Total Coliform | MPN/100mL | <1.0 |
| Total Kjeldahl Nitrogen | mg/L | 0.2-2 |
| Total Organic Carbon | mg/L | 4-8 |

Successes and Lessons Learned

Denver Zoo has saved \$14,700 on water during the infancy of their program, and with water use expected to nearly quadruple during the next two years, that trend should continue. Recycled water use has also contributed to Denver Zoo being named the greenest zoo in the nation by the Association of Zoos and Aquariums.

While the use of recycled water is beneficial to the zoo and Denver Water, the conversion of a complicated system to recycled water can be challenging. Even when only licensed plumbers are working on the system, there is still room for error. In 2006, while conducting a cross-connection control audit, Denver Water discovered an uncontrolled cross-connection on the potable system. Fortunately, this connection was not feeding water used for consumption, so the risk to the public was minimal.



Figure 2
Public education signage (Photo credit: Denver Zoo)

“The addition of recycled water has resulted in significant opportunities for Denver Zoo. The ability to reuse our natural resources fits perfectly with Denver Zoo’s core values of conservation. With close to 2 million visitors annually, we can help spread the message of recycled water to the community. Plus, the money we save by switching to recycled water enables us to allocate some of those funds toward animal management programs and other important conservation efforts.”

—Steve Salg (Denver Zoo Project Manager)

Denver Water

Authors: Abigail Holmquist, P.E. (Honeywell); Mary Stahl, P.E. (AECOM); and Steve Price, P.E. (Denver Water)

US-CO-Denver

Project Background

The population along the Front Range of Colorado is expected to increase significantly in the next few decades; recent statewide reports project the Denver-metro population to double by 2050, fueling the need for additional renewable water supplies. Water use in this region includes significant irrigation; Denver is in an arid region (less than 20 in [50 cm] of annual rainfall) with warm summers. Amenities such as parks, sports fields, and golf courses require irrigation. Denver Water has operated a reclaimed water system since 2004 and will expand its system over the next decade to help meet demands.

Water rights are critical considerations for reuse projects in Colorado because local water law follows a first-in-time, first-in-right allocation; this is also known as the “prior appropriation principle.” It typically prohibits rainwater harvesting and graywater use. Because the majority of the population in Colorado lives on the east side of the state, and the majority of the water originates on the West Slope, many water providers have a long history of diverting water out of its river basin to supply water where the demand is located. Once water is diverted out of its basin, it can typically be reused “to extinction.” Recycling water helps Denver Water fulfill the 1955 Blue River Decree, which gave Denver Water the ability to reuse water that had been diverted out of this basin on the West Slope.

Capacity and Type of Reuse Application

Many of Denver Water’s users do not require high quality such as provided for cooling systems and irrigation. Thus, reclaimed water for these uses should match the right water quality for the right use. In 2004, Denver Water commissioned a 30 mgd (1,310 L/s) reclaimed water plant to supply water for non-potable uses. Current demand for reclaimed water varies between 5,000 and 6,000 acre-feet (6 to 7.5 million m³) annually, depending on precipitation and weather conditions. Current uses include cooling water for a

large electric utility; irrigation of parks, golf courses, and schools; and operations at the Denver Zoo.

The water recycling plant is expandable to 45 mgd with an ultimate goal for Denver Water to shift 17,500 ac-ft (21.5 MCM) per year of demand to the reclaimed water system. During the 2010 irrigation season, Denver Water served a total of 29 customers. A recently completed master plan identified over 300 additional customers that will need to connect to the system to reach the reuse goal of 17,500 ac-ft (21.5 MCM) per year.

Water Quality and Treatment Technology

The reclaimed water treatment plant uses biological activated filtration, alum coagulation/flocculation/sedimentation, single media filtration, chlorine-based disinfection. Denver Water produces reclaimed water that meets Category 3 standards of Colorado Department of Public Health and Environment Regulation 84 that must meet the following requirements:

- No detects of *E. coli* in at least 75 percent of samples in a calendar month, and less than 126 cfu/100 mL in a single sample
- Turbidity, NTU: Not to exceed 3 NTU as a monthly average and not to exceed 5 NTU in more than 5 percent of the individual samples during any calendar month

Since Denver Water has implemented a reclaimed water program, interpretation of the state regulations has changed directly impacting the ability of certain customers to use reclaimed water, and how Denver Water operates its system. These issues are currently being addressed through a statewide update to the regulations and on an individual customer basis. Additionally, Denver Water has conducted studies related to commercial, industrial, and landscape operations to identify options for current and future

customers to successfully use reclaimed water at their facilities.

Project Funding and Management Practices

Denver Water has funded the reclaimed water system via revenues from water rates, system development charges, and bonds. Water rates for all customers include funding the reclaimed water treatment plant because it is considered a source of new water supply. This methodology results in reclaimed water rates that are economically attractive for customers compared to potable water rates. Water rates for different water service are shown in **Figure 1**.

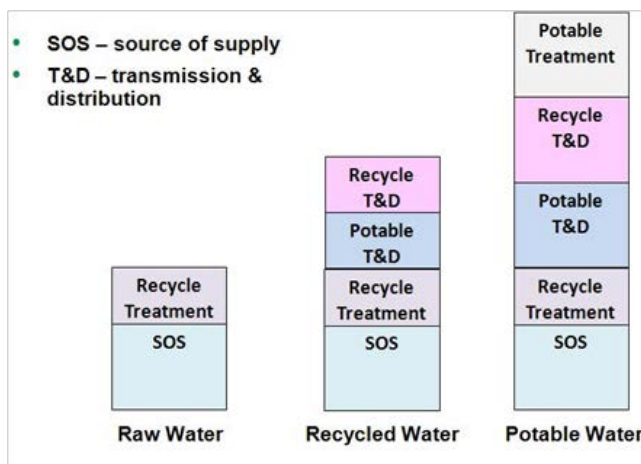

Figure 1
Water rates structure

Denver Water’s rate structures include a monthly service charge and a volume rate structure that varies by customer class. The volumetric rate structures include uniform, seasonal, and inclining blocks. Rate structures (**Figure 2**) are applied to each class and are designed to encourage efficient water use.

Denver Water has developed policies to address different approaches to providing reclaimed water:

- Customer requests a conversion: Customer pays all conversion costs, including main extensions, service lines and point of service upgrades
- Denver Water requires a customer to convert: Denver Water pays all conversion costs, including main extensions and service lines, up to the first valve on the property

- New development in reclaimed water service area: Developer installs all infrastructures necessary for reclaimed water service

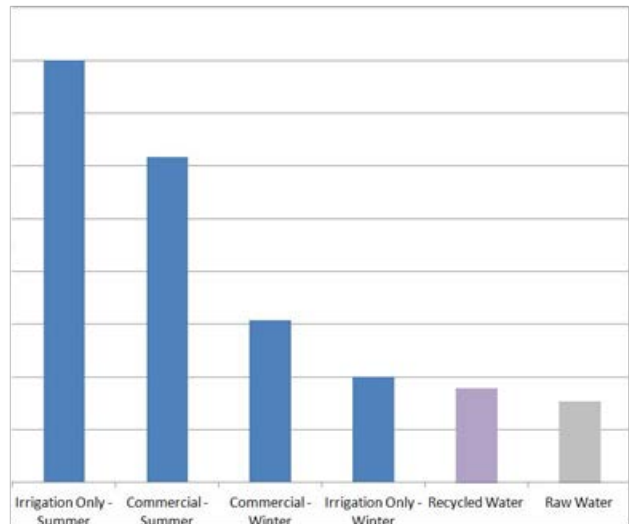

Figure 2
Relative water rates by class of service

Institutional and Cultural Considerations

Until the reclaimed water system began operating in 2004, Denver Water had only been responsible for operating raw and potable water systems. Thus, the water reclamation plant is staffed by drinking water operators and operations are strongly focused on maintaining internal water quality goals that are more stringent than those required by regulations and Denver Water has never violated reclaimed water quality criteria. CDPHE’s Regulation 84 requires annual reports, training and inspections that require customers to employ best management practices and employee education. Denver Water personnel have an on-going relationship with reclaimed water customers that includes significantly more communication than is typical between a utility and its customers.

Successes and Lessons Learned

In general, the reclaimed water program received support when it was implemented. Denver Water has also implemented a youth education program that includes sixth grade curriculum covering the overall water cycle, including reuse. As part of this program, school children and teachers tour the reclaimed water facility each year. The program has achieved great success including the adoption of reuse at the Denver

Zoo and the electric company. Two Denver Water customers, the Denver Zoo and Common Ground Golf Course, have received awards from the WaterReuse Association in recognition of their adoption of reclaimed water. In areas where reclaimed water service is available, some customers are now beginning to pay their own costs to connect to the reclaimed water due to long-term water savings and overall alignment with sustainability goals.

While the Denver Water reclaimed water program has been successful, there remain opportunities to address challenges that have the potential to impact the program. The reclaimed water system is a branched rather than a looped system, which creates challenges in providing water supply during planned/unplanned outages. Additionally, there is still limited infrastructure available for customers to connect to the system, prohibiting some customers from connecting as soon as desired. Customers are continuing to conserve water, which has resulted in reclaimed water being available to more customers than originally anticipated and these decreased customer consumption patterns are anticipated to result in a greater number of customer connections to the reclaimed water system being required to meet the overall recycling goal of 17,500 ac-ft (21.5 MCM) per year. Therefore, due to additional infrastructure needed to reach more customers, the overall system cost has increased compared to original estimates.

Xcel Energy's Cherokee Station

Authors: Abigail Holmquist, P.E. (Honeywell) and Damian Higham (Denver Water)

US-CO-Denver Energy

Project Background

Cherokee Station is one of Xcel Energy's largest Colorado power plants in terms of power production capability, **Figure 1**. Cherokee Station is located just north of downtown Denver, and can produce 717 MW of power. Cherokee is a coal-fired, steam-electric generating station with four operating units. The fuel source for the plant is low-sulfur coal supplied by several mines in western Colorado. The plant is also capable of burning natural gas as fuel. Cherokee uses 5,000 to 9,000 ac-ft/yr (393 MCM/yr) of water for cooling tower feed. Historically, all cooling tower water originated from nearby rivers that provided raw water to the plant.

Capacity and Type of Reuse Application

The Denver Water Recycling Plant is located about a half mile away from Cherokee and can produce 30 mgd (1310 L/s) of reclaimed water. As a conservation effort, Xcel Energy has taken steps to reduce fresh water consumption at the power plant. As part of this effort, Cherokee began using reclaimed water in 2004 and is now the largest customer of reclaimed water from the Denver Water Recycling Plan, using up to 5,200 ac-ft/yr (227 MCM/yr) of reclaimed water.

Today, Cherokee utilizes multiple sources of water to provide a diverse, reliable and affordable source water portfolio. Raw water is the least expensive option, and is used as the primary source. Cherokee combines raw water with reclaimed water in a large reservoir before feeding the cooling towers. This blend of raw and reclaimed water is also used on site for ash silo wash down and fire protection. The recirculating water system for the cooling towers typically runs four to five cycles and uses bleach as a biocide. When the conductivity of the cooling water necessitates blowdown, the cooling tower wastewater is treated with lime and ferric chloride to meet permit requirements for metals and other constituents before it is discharged into the South Platte River.



Figure 1
Cherokee Station (Photo credit: Xcel Energy)

Water Quality Standards and Treatment Technology

The Denver Water Recycling Plant purifies secondary effluent using a biological aerated filter to nitrify high source water ammonia which can cause brass fittings, common in industrial plants, to become brittle over time. This process is followed by conventional drinking water treatment to remove high phosphorus and turbidity. Unit processes in this treatment train include coagulation, flocculation, sedimentation, filtration and disinfection.

The Colorado Department of Public Health and Environment regulates reclaimed water through Regulation 84, which sets forth treatment standards and allowable uses for different reuse categories. Category 3 water is produced by the plant and has a limit for *E. coli* that includes less than 25 percent

detects in any month, with a maximum of 126 cfu/100mL in a single sample.

Turbidity must not exceed 5 NTU in more than 5 percent of samples in a month and 3 NTU as a monthly average. Additional treatment targets for ammonia and phosphorous at the recycling plant were developed, in cooperation with Xcel Energy to ensure that reclaimed water quality would be suitable for cooling tower feed. Typical reclaimed water quality parameters are shown in **Table 1**.

Table 1 Water quality parameters

| Parameter | Units | Typical Range |
|--|---------------|---------------|
| Alkalinity, Total as CaCO ₃ | mg/L | 50-150 |
| Ammonia as N | mg/L | 0-0.4 |
| Boron | mg/L | 0.2-0.4 |
| Calcium | mg/L | 40-70 |
| Chloride | mg/L | 65-170 |
| Chlorine, Total | mg/L | 1.5-4.0 |
| Iron | mg/L | 0.05-0.6 |
| Magnesium | mg/L | 5-20 |
| Manganese | mg/L | 0.003-0.08 |
| Nitrate + Nitrite as N | mg/L | 5-30 |
| Nitrate as N | mg/L | 5-20 |
| Nitrite as N | mg/L | 0.01-0.05 |
| Ortho Phosphorous, Dissolved as P | mg/L | 0.04-0.3 |
| pH | SU | 6-8 |
| Phosphorous, Total as P | mg/L | 0.04-0.4 |
| Potassium | mg/L | 10-20 |
| Sodium | mg/L | 90-200 |
| Specific Conductance | mg/L | 360-1250 |
| Sulfate | mg/L | 80-250 |
| Temperature | °C | 10-30 |
| Total coliform | MPN/ 100mL | <1.0 |
| Total Kjeldahl Nitrogen | mg/L | 0.2-2 |
| Total Organic Carbon | mg/L | 4-8 |

Project Funding

In order to receive reclaimed water service, Xcel Energy paid a system development charge (tap fee) to Denver Water and for construction of transmission facilities dedicated to their service. Costs were funded as capital improvements through Xcel Energy's annual

capital budget. Cherokee pays \$1.05/1,000 gallons (\$0.28/m³) of reclaimed water and a \$5.58 monthly service charge. The rate increases to \$1.11/1,000 gallons (\$0.29/m³) in 2012.

Successes and Lessons Learned

Cherokee has not encountered any problems using reclaimed water in the cooling water system or other plant processes, including fire protection and ash silo washdown. The major benefit of reclaimed water to Cherokee is the availability of a new water source and an overall increase of water supply. This is very important in dry or drought years when raw water sources may be less readily available or water rights priorities come into play.

There were factors that played larger roles than anticipated after initial program implementation. One was the effect that raw water pricing had on reclaimed water demand; a minimum use of reclaimed water was incorporated into the initial contract to provide the necessary demand to justify construction of the WRF. The expectation was that usage would grow with time; however, usage instead remained stagnant at the contract minimum due to the price of raw water making it the preferred water source. Another factor was accounting for possible changes in fuel sources when forecasting future reclaimed water demand. Natural gas power generation is less water-intensive than coal, reducing demand from on the plant; this was not anticipated in preliminary use projections.

Other emerging factors included possible effects of peripheral ground water regulations on the legality of impoundments, which were thought to be covered only by reclaimed water regulations. Recently, however groundwater discharge permitting has been discussed which would have significant repercussions, such as lining an impoundment or obtaining a ground water discharge permit. Another emerging factor is the impact of reclaimed water quality on Cherokee meeting effluent limits of its industrial discharge permit; changes to discharge parameter limits may necessitate modification of the current treatment process to meet potentially more stringent discharge limits due to reclaimed water use.

Effects of Recycled Water on Soil Chemistry

Authors: Abigail Holmquist, P.E. (Honeywell) and Damian Higham (Denver Water)

US-CO-Denver Soil

Project Background

In 2004, Denver Water began providing recycled water to customers in the greater Denver metro area. Nearly all of the original and current recycled water customers are landscape irrigators who had historically used potable water or raw water for irrigation. In an effort to provide information regarding effective recycled water use, Denver Water implemented a soil monitoring program designed to study soil characteristics of landscape irrigation sites before commencing irrigation with recycled water, and after 5 years of irrigation with recycled water. The results are provided as a resource for landscape managers irrigating with recycled water to help identify options for management strategies to ensure healthy landscapes.

Recycled Water Treatment and Quality

The Denver Water Recycling Plant utilizes a biological aerated filter to nitrify high source water ammonia. The biological process is followed by conventional drinking water treatment to remove high phosphorus and turbidity. Unit processes in the treatment train include coagulation, flocculation, sedimentation, filtration and disinfection. The plant is capable of producing up to 30 mgd (1300 L/s) and was constructed to allow build-out of 45 mgd (1970 L/s). The plant produces water, designated as “Category 3” as defined by the Colorado Department of Public Health and Environment (CDPHE), which must meet the following limits:

- *E. coli* - 126 cfu/100mL maximum and non-detect in at least 75 percent of samples
- Turbidity – 3 NTU or less as a monthly average and 5 NTU or less in 95 percent of samples.

While *E. coli* and turbidity are the only additional requirements CDPHE requires providers to meet through the recycled water regulations, nitrate is of concern whenever there is a potential discharge to surface or groundwater, making permitting necessary for most dewatering and unlined storage activities. Typical characteristics of recycled water are shown in **Table 1**.

Table 1 Typical reclaimed water quality

| Water Quality Parameter | Value |
|---|-------|
| Electrical Conductivity EC _w (dS/m) | 0.89 |
| Total Dissolved Solids TDS (mg/L) | 570 |
| pH | 6.92 |
| Sodium Adsorption Ratio, adjusted (SAR _{adj}) | 3.7 |
| Sodium - Na (mg/L) | 130 |
| Chloride - Cl (mg/L) | 99.3 |
| Boron - B (mg/L) | 0.28 |
| Bicarbonate - HCO ₃ (mg/L) | 66 |
| Nitrate - NO ₃ -N (mg/L) | 14.1 |

The nitrogen in Denver Water’s recycled water allows irrigators, who make up 35 percent of the demand on the system, to cut back significantly on fertilization. This water also has higher concentrations of salts, primarily sodium and chloride, than potable water, and thus requires different management approaches to ensure soil and plant health.

Soil Sampling and Testing

In the fall of 2004, samples were taken from 10 sites including golf courses, parks and school grounds. At least three soil borings were collected from each site up to 40 in (100 cm) in depth. The cores were split into sub-samples representing 8-in (20-cm) strata and composited for each stratum at each sample site. The sampling protocol was repeated in the fall of 2009 at the same sites with samples being collected one foot from previous locations. Soil compaction and irrigation uniformity were also evaluated during both sampling events.

Testing was performed at the Colorado State University Soil, Water & Plant Testing Laboratory. Soil samples were evaluated for texture and dried, ground and screened prior to further testing. Boron, calcium, cation exchange capacity (CEC), chloride, copper, electrical conductivity, exchangeable sodium, iron, magnesium, manganese, nitrate, organic matter, pH, phosphorous, potassium, sodium and zinc were

measured using standard methods. These results were used to calculate sodium absorption ratio (SAR), salinity and exchangeable sodium percentage (ESP).

Results

Results suggested that sodium and sodium-related parameters are of the greatest concern for soil health, with average ESP and SAR values approximately doubling over the five-year period.

Nitrate concentrations in soil irrigated with potable and recycled water was studied in 2009 as a function of soil depth (**Figure 1**). Nitrate content decreased significantly with soil depth, indicating that nitrate contamination of groundwater should not be of great concern when using recycled water for the irrigation of turf systems. This data demonstrates that dense, well-managed, and active-growing turf grasses serve as bio-filtration systems for removal of excess nitrate.

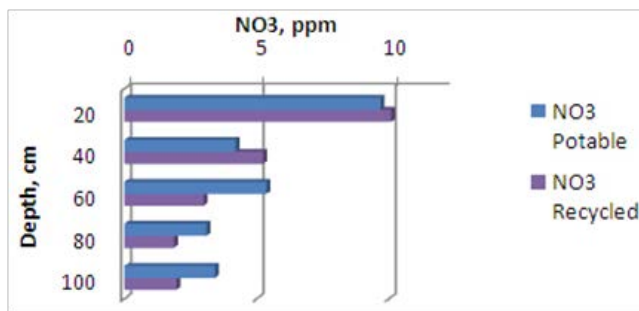

Figure 1
Soil nitrate profile

While reclaimed water quality affects landscapes, other factors, such as soil compaction, irrigation uniformity and precipitation can affect how water quality impacts landscape health and how that health is quantified. For example penetrometer readings of greater than 300 psi (2,070 kPa) indicate potential problems for plant growth due to soil compaction and this reading was exceeded in at least one subsample location, at four of ten study sites.

Irrigation uniformity (IU) is the measure of the consistency of water application. A poor IU can result in one area of landscape receiving too much water and another area receiving too little. All sites, except two, had a good to excellent irrigation uniformity. No clear relationship between irrigation distribution uniformity and measured soil parameters was observed.

Lessons Learned: Management Options for Recycled Water Providers

Recycled water can be a good source of irrigation water, depending on its quality, the type of soil, type of plants and the management practices employed. Denver Water's recycled water is well-suited for most landscapes in the surrounding area. Some tree species and soil types, however, can be sensitive to elevated sodium and other constituents and may require proper management to avoid damaging effects.

Because conditions vary by location, each recycled water provider must evaluate its system and the needs of potential customers to identify the most appropriate recycled water management strategy. Wherever recycled water is used for irrigation, regular monitoring of water and soil quality is recommended. Based on this research and the findings of others, the following best management practices can help to mitigate potential negative effects of irrigating with recycled water:

- **Flushing:** While consistent over-irrigation is not recommended, periodic over-watering or flushing may facilitate the movement of salts out of the root zone. This may also occur with heavy rainfall.
- **Aeration:** Aeration is the practice of removing small plugs of soil from the root zone and randomly discarding them on the turf surface. Aeration improves the movement of water through the soil, reduces soil compaction, and decreases thatch buildup thus minimizing potential for ponding and salt buildup in the root zone.
- **Rotor head replacement:** Using low-trajectory heads to avoid excessive spray on tree foliage can reduce harmful effects.
- **Sodium replacement amendments:** Gypsum (CaSO_4), calcium chloride (CaCl_2), or utilization of "sulfur burners" or sodium blockers have shown promise in limiting effects of sodium by displacing sodium bound to soil, thereby helping to leach sodium to deeper depths.
- **Humates:** Humates and humic acid are organic materials derived from decaying plant material. These substances are claimed to buffer salts,

augment micronutrient availability to plants, promote soil aeration and water penetration, and encourage flocculation of soil particles.

- Vesicular-arbuscular mycorrhizal (VAM) inoculation: In some studies, recycled water irrigation has been found to deplete arbuscular mycorrhizae, which help plants to capture nutrients from the soil, though the mechanism for the depletion is unclear. This affect may be a significant constraint on landscape plant performance under saline conditions. Inoculation with VAM has been shown to be beneficial in some studies, especially when mycorrhizae are not well-established in the soil.
- In cases where the potential for cross connections can be minimized or eliminated, blending recycled water with potable or raw water for irrigation or rotating between different water sources can help minimize sodicity issues.
- More intensive cultivation programs (deep aeration and water injection) to maintain oxygen diffusion and water movement, improved drainage systems and more vigorous traffic control programs, to avoid overuse of turf areas, can help alleviate compaction problems and promote drainage.
- Recycled water can provide nutrients, potentially fully or partially offsetting the need for chemical fertilizer. To avoid nutrient imbalances, analyses should be conducted to account for the nitrogen and phosphorous fertilizer value present in recycled water compared to soil nutrient content and crop requirements. Maintaining healthy plants that can withstand environmental stresses better and replacing susceptible plants with adapted, salt tolerant species and cultivars will alleviate most problems that cannot be solved with other corrective measures presented in this study.

As reuse becomes more prevalent, additional information will be collected to ensure proper use of this valuable resource. Denver Water will continue to monitor both new and existing sites to build an understanding of how sites evolve with recycled water use in the future.

Institutional and Cultural Considerations

Introducing recycled water as a source of irrigation water supply has necessitated significant outreach to the public, in general, and especially in areas supplied with recycled water. The source of recycled water and relative infancy of regulatory programs led to apprehension on the part of irrigators and the public as to health effects of recycled water use for the landscapes irrigated and the public enjoying them.

Panel discussions including industry experts, irrigators and the public were held at the start of this process to gauge concerns and how best to address them. Denver Water attended events parks and schools using recycled water to provide an opportunity to inform and address questions and concerns of local residents. Users were afforded the opportunity to attend forum discussions to voice concerns and find solutions to problems arising from recycled water use. Users were also required to attend an informational training session triennially to inform personnel about hazards associated with handling recycled water use and how to mitigate those hazards.

Some concerns surrounding recycled water use emerged within Denver Water as well. The cost of treating recycled water was higher than that of potable water and a holistic approach involving costs of new sources of supply and drought preparedness needed to be conveyed effectively in order to overcome those internal concerns. Additionally, supplanting potable use with recycled use shifted demands and led to some potable systems already in place becoming over-sized resulting in additional management and operational considerations.

References

Yaling Qian, 2009. *Soil Testing Five Years after Irrigation with Recycled Water*.

Sand Creek Reuse Facility Reuse Master Plan

Authors: Bobby Anastasov, MBA and Richard Leger, CWP (City of Aurora)

US-CO-Sand Creek

Project Background

The city of Aurora, Colo., developed a Reuse Water System Master Plan Update with short-range and long-range plans to improve and expand its reuse water system. A previous study (2003) explored options for maximizing reuse by building a large reclaimed water reservoir in the eastern plains or constructing new treatment facilities. The goal of this update was to explore other options for optimization of the reuse system, including expansion of the Sand Creek Water Reuse Facility (WRF), addition of operational storage system, and eventual inclusion of annual storage for reuse water. The study included the following:

1. Evaluation of sources and availability of reclaimed water
2. Evaluation of existing and future demands
3. Evaluation of potential reuse storage sites for local, operational and annual storage
4. Development of a hydraulic model of the existing reuse water system and scenarios for phased expansion of the system
5. Development of a capital improvements plan (CIP) for the Sand Creek WRF service area
6. Evaluation of Prairie Waters as a potential raw water irrigation source
7. Cost evaluation of reuse water produced at the Sand Creek WRF versus raw water from the Prairie Waters, a drinking water project utilizing Aurora's water rights to extract water through riverbank filtration along the South Platte River for drinking water supply

Two water sources were identified for non-potable irrigation sources: reuse water from the Sand Creek WRF and raw water from the Prairie Waters (PW) pipeline. The Sand Creek WRF is capable of providing 5.0 mgd (219 L/s) as currently operated, with potential to expand to 6.5 or 7.3 mgd (285 or 320 L/s). Raw

water from PW will be available at an initial capacity of 12 mgd (526 L/s) in 2011, with an ultimate capacity of 50 mgd (2190 L/s).

A comprehensive list of demands was developed as part of the study including: parks, golf courses, schools, greenbelts, medians, cemeteries, residential developments, office parks and industrial users. More than 200 separate demand locations were identified throughout Aurora. Generally, demands within the existing system and surrounding the Tollgate Creek corridor were considered to be served from the Sand Creek WRF. Demands east of E-470 and north of I-70 were to be served from the PW pipeline. Demands located within the Cherry Creek Basin will not be served by either source due to nutrient loading (phosphorus) restrictions.

Capacity and Type of Reuse Application

Existing customers are provided reuse water from the Sand Creek WRF. The facility uses a biological nutrient removal (BNR) activated sludge process followed by tertiary filtration and UV disinfection to produce 5 mgd (219 L/s) of reclaimed water. In-plant waste flow generated at the facility is returned to the Metro Wastewater Reclamation District's (MWRD) interceptors for further treatment at the MWRD's Central Plant. Reuse water is pumped from the Sand Creek WRF into the reuse water system.

Currently, the Sand Creek WRF only utilizes approximately 26 percent of its available annual volume for distribution to reuse customers, largely due to a lack of storage within the system, requiring the Sand Creek WRF to provide each demand location with peak day flows. Addition of operational or annual storage within the system would allow for a greater percentage of total annual volume to be reused. More than 30 storage sites were evaluated ranging from 0.3 to 1,140 million gallons (1135 m³ to 4.3 MCM) of reuse water storage. Storage sites are located throughout the city and many of the sites for operational storage are located within the limits of the existing reuse water

system. Sites for annual storage are generally located at the eastern boundary of the city.

One of the primary goals of the study was to optimize the reuse water system by making use of the portion of reuse volume from the Sand Creek WRF that is currently being discharged to Sand Creek. A plan for optimizing the system was developed which uses a combination of pipeline, pump station and storage facility improvements to increase the irrigated acreage of the reuse water system. A schedule of major recommended improvements has been incorporated into a capital improvements plan (CIP) to provide a framework for design, construction, operation and financing of the improvements required to optimize the reuse water system (**Table 1**). Each phase is a step toward the ultimate goal of extending reuse water down the Tollgate Creek corridor to provide reuse water to the central and southern portions of Aurora.

Project Funding and Management Practices

The CIP outlining expansion of the reuse water system through 2025 phases improvements to limit rates to approximately 75 percent of anticipated commercial potable water rates and 66 percent of anticipated potable irrigation rates.

The costs of using treated water from the Sand Creek WRF versus using raw water from the PW system were compared for the existing and future irrigation water demands of the city's reuse system. The following costs were included in the comparison:

- Water loss in the South Platte River (7 percent)
- Capital improvements for the Sand Creek WRF and PW connection
- Sand Creek WRF operation and maintenance (O&M) costs
- MWRD O&M costs for additional wastewater treatment with the Sand Creek WRF offline
- Transmission and distribution (T&D) O&M costs and T&D capital improvements
- Debt service for the Sand Creek WRF
- Debt service for the existing T&D system and PW T&D

Successes and Lessons Learned

Without a master plan the city of Aurora would have no comprehensive document guiding its long term vision of the reuse water system. The plans should be revisited on a regularly to ensure they still reflect the vision of the city.

Table 1 Summary of recommended improvements

| Phase and Year | Pipeline Improvements | Pumping Improvements | Storage Improvements | Additional Irrigated Acres | Total Construction Cost ^{1,2} |
|------------------|--|---|---|----------------------------|--|
| Phase 1 2010 | <ul style="list-style-type: none"> ▪ Coal Creek Area/Rio Grande Pit Connection ▪ Sand Creek Park Connection ▪ Signature Park Connection | SCWRF Pump Station Expansion (6.5 mgd) | <ul style="list-style-type: none"> ▪ Aurora Hills GC Pond Expansion (1.2 MG) ▪ Rio Grande GC Pond Expansion (2.0 MG) ▪ Sand Creek Park Pond (0.4MG) ▪ Signature Park Pond (2.7MG) ▪ Spring Hill GC Pond Expansion (1.1MG) | 197 | \$11.4 M |
| Phase 2 2015 | n/a | n/a | <ul style="list-style-type: none"> ▪ Fitzsimons GC Pond Expansion (1.6 MG) ▪ Murphy Creek GC Pond Expansion (1.4 MG) ▪ Sand Creek pond Expansion (2.0 MG) ▪ SCWRF Operational Storage (2.0 MG) | 306 | \$16.1 M |
| Phase 3 2020 | <ul style="list-style-type: none"> ▪ Delaney Farm Pump Station ▪ Main Iliff Pump Station ▪ Main Iliff Service Main ▪ Wheel Park Connection | <ul style="list-style-type: none"> ▪ Delaney Farm Pump Station (6.5 mgd) ▪ Iliff Pump Station (2.2 mgd) | <ul style="list-style-type: none"> ▪ Delaney Farms Operational Storage (5.0 MG) ▪ Wheel Park Pond (2.5 MG) | 364 | \$39.5 M |
| Phase 4A 2025 | <ul style="list-style-type: none"> ▪ Heather Gardens GC Connection ▪ Heather Ridge GC Connection | n/a | <ul style="list-style-type: none"> ▪ Heather Gardens GC Pond (1.6 MG) ▪ Heather Ridge GC Pond (4.1MG) | 486 | \$82.8 M |
| Phase 4B 2025 | <ul style="list-style-type: none"> ▪ Aurora Dog Park Connection ▪ Aurora Hills Interconnect ▪ Buckley Air Force Base Connection ▪ Expo Park Connection ▪ Quincy Reservoir Main Rocky Ridge Park Connection ▪ Summer Valley Park Connection | n/a | <ul style="list-style-type: none"> ▪ Aurora Dog Park Pond (3.7 MG) ▪ Buckley Air Force Base Pond (4.3 MG) ▪ Expo Park Pond (6.4 MG) ▪ Heather Ridge GC Pond Expansion (0.7 MG) ▪ Quincy Reservoir (380 MG) ▪ Rocky Ridge Park Pond (2.3 MG) ▪ Summer Valley Park Pond (4.7 MG) ▪ Wheel Park Pond Expansion (2.1 MG) | 1416 | \$97.6 M |

¹ Construction costs are in 2008 dollars

² Construction costs for each phase include costs for previous phases

Water Reuse Barriers in Colorado

Author: Cody Charnas (CDM Smith)

US-CO-Water Rights

Background of Colorado Water Law

Due to water laws in Colorado, water reuse has many barriers that limit its implementation. Due to the limited amount of precipitation in Colorado, it is a precious resource that is essential for its residents. All the rain and moisture that falls within the state of Colorado is property of the state. The allocation of water is governed by “prior appropriation,” which is also commonly referred to as “first in time, first in right.”

Residents of Colorado can use the water for beneficial use if they own the water rights. This process of obtaining a water right is known as adjudication. With a water right, a resident owns the right to use the water, but they don’t own the water. In addition, water that is not consumed for beneficial use must be returned to the river or stream by surface run-off or through subsurface infiltration. These returned flows are used by junior appropriators downstream.

As the population continues to increase in Colorado, the demand for water is also increasing. Other states with limited water supplies, such as Arizona and California, reuse water to supplement the limited resource. As a result of water laws in Colorado, water reuse and use of alternative water supplies is often not allowed. For example, rainwater harvesting and graywater use are prohibited.

Reuse in Colorado

In general, Colorado water law allows for one use of the water by the original appropriator. However, any water that is brought in to a watershed that is not connected to its original source is considered foreign water. Water that is considered foreign can be reused by its owner as it will never enter back into its source watershed. For example, water that is diverted from the West Slope to the east side of the Continental Divide is considered foreign as it will never flow back to the west side of the Continental Divide. Waters that are also considered foreign include nontributary groundwater introduced into a surface stream as well as water imported from an unconnected stream system (“transmountain water”).

Once the importer brings foreign water from an unconnected source the owner can reuse the water to extinction as it is considered “fully consumable.” However, the owner must maintain dominion and control over the water. “Dominion and control in this context refers to the intent to recapture or reuse such water, and is not lost when a municipal provider delivers water to a customer’s tap or when consumers use such water to irrigate lawns” (CWCB, 2010).

In addition to being able to reuse water classified as foreign, agricultural water rights that are transferred to municipal use are considered fully consumable and can be used to extinction. The reason for this is “because the applicant in a change of use proceeding may take credit for, and reuse, the historical consumptive use (CU) associated with the prior decreed use” (CWCB, 2010). The water attributable to the historical CU of the senior water right may be reused to extinction.

Two larger utilities in Colorado that are currently reusing water include Denver Water and Colorado Springs Utilities. The reclaimed water is used for irrigating parks, golf courses and schools, cooling at power generating plants, and the Denver Zoo.

References

- Colorado Foundation for Water Education. 2004. *Citizen’s Guide to Colorado Water Law*. 2nd Edition.
- Colorado Water Conservation Board (CWCB). 2010. *Statewide Water Supply Initiative 2010*.
- Trout, R.V., Witwer, J.S., and Freeman, D.L. 2004. *Acquiring, Using, and Protecting Water in Colorado*. Denver, CO: Bradford Pub.

Smart Water Management at Sidwell Friends School

Authors: Laura Hansplant, RLA, ASLA, LEED AP (Andropogon Associates [formerly] and Roofmeadow) and Danielle Pieranunzi, LEED AP BD+C (Sustainable Sites Initiative)

US-DC-Sidwell Friends

Project Background or Rationale

Sidwell Friends School (SFS) in Washington, DC, incorporated a constructed wetland into its Middle School building renovation. This water reuse system is part of an overall transformation of a 50-year-old facility into an exterior and interior teaching landscape that seeks to foster an ethic of social and environmental responsibility in each student. With a focus on smart water management, a central courtyard was developed with a rain garden, pond, and constructed wetland that utilizes storm and wastewater for both ecological and educational purposes. More than 50 plant species, all native to the Chesapeake Bay region, were included in the landscape and there was extensive use of reclaimed stone for steps and walls. Concrete containing recycled slag is used for walkways and reclaimed wood was used for the decking surfaces. Completed in 2007, the Middle School project was the first K-12 school to achieve a

Leadership in Energy and Environmental Design (LEED) Platinum rating from the U.S. Green Building Council.

Capacity and Type of Reuse Application

The SFS facilities sit on a 15-acre campus in northwest Washington, D.C. The environmentally responsible stormwater and wastewater management systems are prominent in the landscape in order to promote education and to build awareness. The centerpiece of the new Middle School is a natural wastewater treatment and reuse system that produces high-quality water suitable for non-potable uses. A constructed wetland forms the heart of this system. It uses biological processes to clean water and serves as a living laboratory where students can learn about biology, ecology, and chemistry (**Figures 1 and 2**).

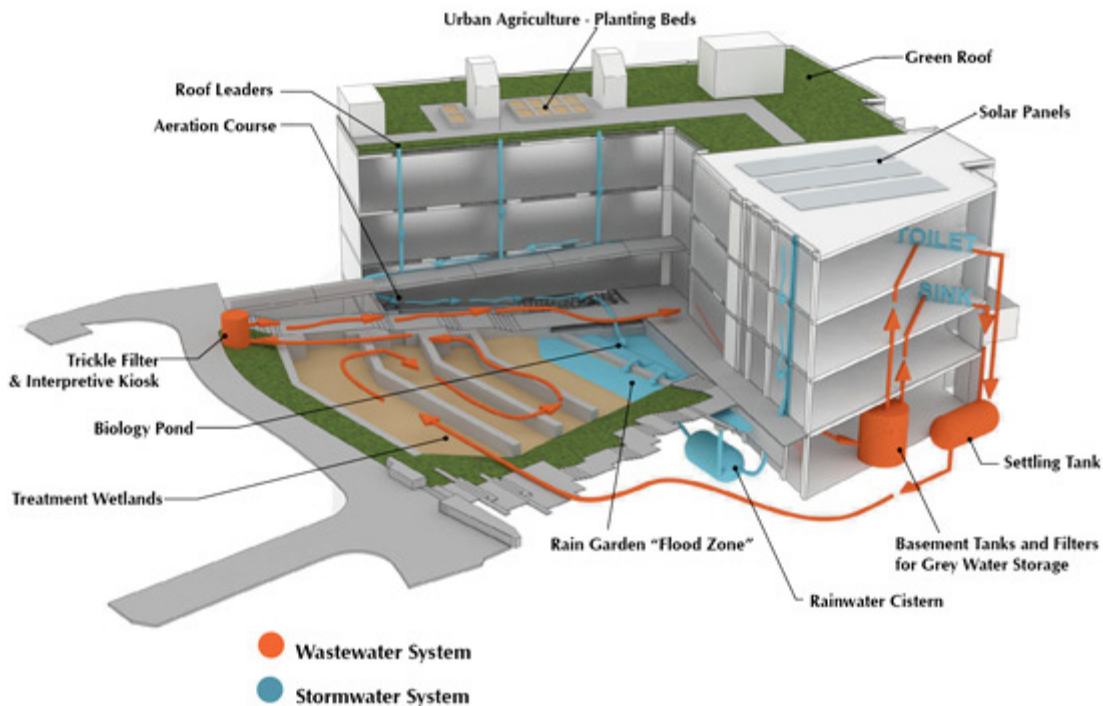

Figure 1
Natural wastewater treatment and reuse system (Image: Courtesy of Andropogon Associates)



Figure 2
View of new building extension (Photo: Courtesy of Andropogon Associates)

Wastewater is processed through the courtyard systems for approximately 3 to 5 days before entering a storage tank in the basement. From there it passes through 10 and 100 micron filters and is UV disinfected before being fed back into toilets and urinals in the building through a parallel set of pipes designated for recycled water. The project cost approximately \$4 million (for site-related work) and was funded by the school.

Water Quality and Treatment Technology

Wastewater from the Middle School building is processed in a multi-step system that incorporates a variety of ecologies to provide robust, diverse treatment. System components include a passive primary treatment tank, followed by a series of terraced subsurface-flow constructed wetland cells, a recirculating sand filter, and trickling filter, which are all tightly integrated into the courtyard's landscape. The choice of subsurface-flow, as opposed to surface-flow, reduces or eliminates odor and prevents contact with the water. A variety of native and local wetlands plants provide an aesthetically pleasing landscape while their roots host a wide diversity of microorganisms that help break down contaminants from the water. The trickling filter and sand filter provide further polishing and reduction of nutrients such as nitrogen.

SFS engaged Lucid Design Group to monitor water quality within the constructed wetland system, and to display the data on a website for classroom use. The District of Columbia requires both regular water quality

monitoring of the waste water system and periodic groundwater monitoring, to confirm that the system is functioning as planned.

The Middle School's stormwater system is a combination of vegetated roofs, swales, rain gardens, and a pond that double as outdoor classroom space. All the building roof runoff is conveyed to the pond via downspouts and an aqueduct along the access ramp that provides handicap access to the building. During large storm events, the pond overflows into the rain garden for biofiltration and infiltration, mimicking the functions of a natural floodplain. The rain garden is planted with native wet meadow species. The vegetated roof provides habitat for pollinators and also reduces runoff volumes. To address improving runoff water quality, the overland flow of runoff from paved areas is routed through a storm filter to remove suspended solids and excess nutrients. Excess water from the lawn also flows to the courtyard's pond. Some of the roof runoff is stored in an underground cistern, which provides additional water for the pond during dry weather. No permanent irrigation system was installed. None of the stormwater is combined with treated wastewater for non-potable use in buildings.

Institutional/Cultural Considerations

The water reuse installation is used in the school curriculum (**Figure 3**). SFS students monitor the building functions and constantly measure the "health" of the facility. Teachers of every grade level have access to the building's exposed systems for the study of flora and fauna, rainforests, human cellular structure, and environmental science, as well as many aspects of the mechanical, electrical, structural, and plumbing systems. For their Environmental Science class, 8th Grade students participate in labs in which they measure and compare nitrogen and phosphorus levels in various levels of the wetland and in the basement reuse holding tank, and learn the valuable role that wetlands play in purifying water. The Advanced Placement Environmental Science students conduct labs including comparing water quality in the on-campus biology pond to water in a nearby tributary, studying the invertebrate biodiversity in the soil on the green roof, and comparing stormwater runoff from the green roof with runoff from the conventional roof. Students and others at SFS are also encouraged to record wildlife sightings such as a Snowy Owl or Monarch Butterflies through the school's website. The biodiversity in the woods, wetlands, and native

vegetation provide real-life lessons for the science classes. On the green roof, students also learn how to grow vegetables and herbs that are used in the school's cafeteria.



Figure 3
View of rain garden and pond (Photo: Courtesy of Andropogon Associates)

The Center for Sustainable Environmental Design, a collaborative effort between the Yale School of Forestry and Environmental Studies and the Yale School of Architecture, is conducting research to connect environmental science and management with architectural design and engineering. At SFS, a research team is studying the school to determine if the project's green strategies have a measurable effect on student and faculty performance and health. While the school was still using the older building, extensive questionnaires were administered to students, teachers, and staff. Numerous questions probed their awareness of the building, satisfaction, and environmental sensitivity. The response to these questionnaires will act as the baseline for the study. Additional surveys will continue to be conducted. This data will provide the first analytical examination of the

effect of biophilic design on occupant satisfaction and performance.

Successes and Lessons Learned

When site systems become highly integrated, they achieve both efficiency and interdependence. For example, the green roof provides efficiency for both the stormwater system and the building HVAC systems; this efficiency also means that the stormwater system and the HVAC system also became dependent on the green roof for their efficient sizing. Consequently in integrated designs of this type, changes to project scope, whether for budgetary or philosophical reasons, need to be considered holistically. Projects of this complex nature are difficult to implement with a standard project delivery system. A very close partnership between the design team, the client, and the construction team is needed in order to help the contractors effectively organize and build these new, sustainable, site systems.

South District Water Reclamation Plant

Authors: R. Bruce Chalmers, P.E. (CDM Smith) and James Ferguson (Miami Dade Water and Sewer Department)

US-FL-Miami So District Plant

Project Background or Rationale

The Miami Dade Water and Sewer Department (MDWASD) is the largest water and sewer utility in Florida, serving more than 2.2 million residents. It has three major water treatment plants, providing approximately 90 percent of the county's public water supply. Rapid population growth, drought, and environmental efforts to restore the Everglades created pressure for increased groundwater extraction to meet the additional demands. At the same time, the South Florida Water Management District (SFWMD) prohibited additional withdrawals from the Biscayne aquifer, which required MDWASD to develop new alternative water sources.

MDWASD agreed to implement a series of projects to meet the increasing demand, including aquifer storage and recovery (ASR), Floridan aquifer blending, Floridan aquifer brackish water treatment, and the South District Water Reclamation Plant (SDWRP) for indirect potable reuse. The SDWRP will help the

county meet future water demands while protecting environmental resources.

Capacity and Type of Reuse Application

SDWRP will treat South District Wastewater Treatment Plant (SDWWTP) tertiary effluent to potable water quality. The capacity of the SDWRP will be 21 mgd (920 L/s) of advanced water treatment. Product water from the SDWRP will be recharged approximately 6 miles (9.6 km) away, at the Miami-Dade Metro Zoo. Recharged water will be injected into the Biscayne aquifer, the county's main drinking water source, upgradient of a county water supply wellfield. There will be seven groundwater injection wells with a total hydraulic mound of less than 1 foot. The recharged water will offset an average annual flow of 18.6 mgd (815 L/s) at the new South Miami Heights potable water treatment plant (SMHWTP). The SDWRP project facilities are shown in **Figure 1**. The SDWRP is required to be online by the end of 2014.

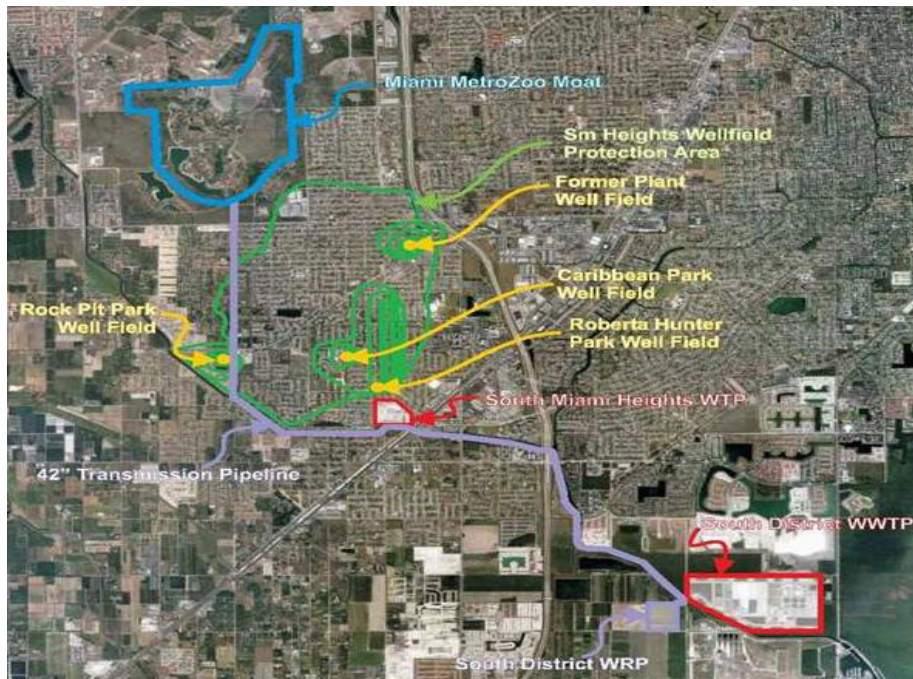

Figure 1
SDWRP facilities (Photo credit: CDM Smith 2008)

Water Quality Standards and Treatment Technology

The Florida Department of Environmental Protection is the state agency that has jurisdiction over implementation of reclamation treatment plants, specifically Part V of the Florida Administrative Code, Section 62-610 that regulates the detailed requirements applicable for the SDWRP. Part V also regulates applications for recharge facilities, including injection wells. Significant SDWRP water quality requirements are shown in **Table 1**.

Table 1 SDWRP water quality requirements

| Parameter | FDEP Part V (mg/L) | DERM WQ Standards (mg/L) | DERM CTLs (mg/L) |
|-------------------|--------------------|--------------------------|------------------|
| TOC | 3 | N.R. | N.R. |
| TDS | 500 | 500 | |
| Total Nitrogen | 10 | N.R. | N.R. |
| Ammonia | N.R. | 0.5 | 2.8 |
| Phosphorus (µg/L) | N.R. | N.R. (< 10 proposed) | N.R. |
| NDMA (ng/L) | N.R. | N.R. | <2 |

A local county agency, the Department of Environment Resources Management (DERM) also has water quality standards (WQs) that govern discharges and groundwater clean-up target levels, which are implemented for groundwater clean-up activities. Using the county's non-degradation policy, DERM also required very low effluent concentrations for phosphorus, NDMA, and other limits not specifically included in the WQs. DERM requirements are also shown in **Table 1**.

Figure 2 shows the SDWRP process flow diagram. The SDWRP will have technologies successfully proven at Orange County Water District's (OCWD) Groundwater Replenishment System in Fountain Valley, California, including membrane filtration (MF), reverse osmosis (RO), and ultraviolet light with hydrogen peroxide (UV-AOP). Ion exchange will be added after the RO to meet the required ammonia limit. Major design criteria are shown in **Table 2**. MF backwash will be returned to the SDWWTP for treatment. RO brine will be discharged to a deep well for disposal.

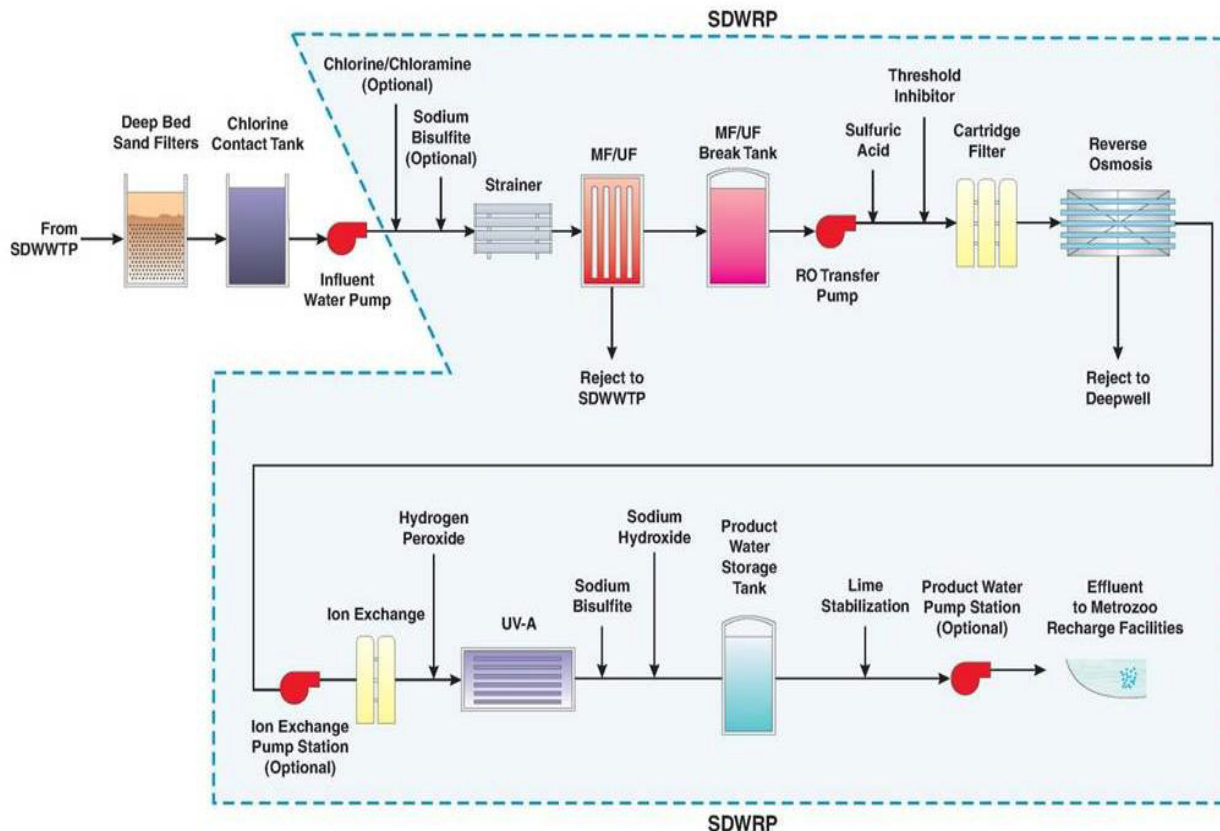

Figure 2
SDWRP process flow diagram (Photo credit: CDM Smith/Hazen and Sawyer 2008)

Table 2 Major system design information

| System | Number of Trains | Train Capacity (mgd) | Comments |
|--------|------------------|----------------------|---------------------------------|
| MF | 13+1 | 1.9 (1.76) | 94% Recovery |
| RO | 4+1 | 5.25 | 3-stage, 12 gfd 85% Recovery |
| IX | 12+2 | 1.75 (1.5) | Regeneration |
| UV-AOP | 4+1 | 5.25 (4.2) | 97% UVT |

Project Funding and Management Practices

The SDWRP will have a total project cost of \$357 million and will be funded by Miami Dade County bonds. The estimated cost for each of the construction contract is provided in **Table 3**.

Table 3 Estimate of probable construction costs

| Phase | Contract | Cost |
|-------|-----------------------------|---------------|
| A | MF Offer | \$13,400,000 |
| B | UV Offer | \$4,100,000 |
| C | Site Preparation/ Earthwork | \$18,800,000 |
| D | Off-site Pipelines | \$23,000,000 |
| E | SDWRP | \$195,100,000 |
| F | SDWWTP Deep Injection Well | \$1,700,000 |

Institutional and Cultural Considerations

The benefits of the SDWRP include implementation of a new, reliable, sustainable source of water; local control; support from the regulators, and reuses water previously discharged to deep injection wells and wasted.

The MDWASD's Public Affairs staff has developed an initial, conceptual, strategic communication plan for the SDWRP that identifies some broad goals for a public outreach program under the outreach efforts conducted as part of the 20-year Water Use Permit campaign.

Lessons Learned and Project Status

Because of the recession, substantial reductions in demand, financing/costs, and changes in the regulatory environment, MDWASD is rethinking its commitment to completing the SDWRP project at this time. An alternative project, extracting water from the brackish Floridan aquifer, thereby eliminating the need to construct the SDWRP, reduces project costs substantially, making it a more favorable option. Lower growth rates also reduced the increases in water demands, allowing a delay in implementation to further evaluate alternatives.

Therefore, MDWASD has suspended the design of the SDWRP at the 90 percent design completion point. If the regulatory commitments to Floridan injection and reuse are not obtained, the project may be restarted with a new completion date.

References

Chalmers, R., J. Ferguson, and L. Llewelyn. *South Florida's Blueprint for Implementing an Advanced Recycled Water Treatment Facility*, AWWA Annual Conference and Exposition, Washington D.C., June 12-16, 2011, AWWA, Denver, CO.

City of Pompano Beach OASIS

Authors: A. Randolph Brown and Maria Loucraft (City of Pompano Beach)

US-FL-Pompano Beach

Project Background or Rationale

The city of Pompano Beach, Fla., began providing reuse for irrigation in 1989. Reuse began when the city's golf course over-pumped its groundwater wells and was unable to obtain further withdrawals upon renewal of the consumptive use permit. When the city Utilities Department attempted renewal of the consumptive use permit for the city's drinking water supply, the South Florida Water Management District (SFWMD) included reuse water as a permit requirement. The SFWMD also required an alternative water supply to address saltwater intrusion issues.

This was a challenge for the city, as it owned a sewer collection system, but no wastewater treatment facility (treatment is provided by the Broward North Regional Wastewater Facility), and could not reclaim its own wastewater. Fortunately, the Broward North Regional Wastewater Facility had an ocean outfall line running through Pompano Beach to the ocean. The city built the reuse plant adjacent to the 54-in (137-cm) line to divert secondary effluent for further treatment (filtration and disinfection) to improve its quality for use in irrigating the golf course, medians, and parks within the city. This reuse practice has reduced groundwater withdrawals and increased recharge, which has contributed to the reversal eastward of the saltwater intrusion line in this area. Over 20 years later, the city also provides reuse water to another city (Lighthouse Point) and to residential customers. The city's reuse pioneers gave the city a tremendous gift—the ability to sustain its water resources and better tolerate droughts.

Several drivers have made increasing reuse the most promising means of sustaining water resources and quality of life in the city. Recent legislation limits withdrawals from the region's groundwater aquifer (Biscayne Aquifer), requires closure of six ocean outfall lines in Eastern Florida by 2025 except during high volume stormwater periods, and requires a 60 percent of the previously discharged secondary effluent to be used for beneficial reuse. For the North Broward County ocean outfall, this amounts to 22 mgd

(964 L/s) for inland reuse. Conservation requirements for consumptive use permits, high population growth, and severe droughts with minimal stormwater storage capacity have likewise put pressure on the city to increase reuse.

The city's OASIS (Our Alternative Supply Irrigation System) program takes a systematic approach to increase reuse and further increase capacity to achieve the region's reuse requirements. Current plant capacity is 7.5 mgd (329 L/s), of which only 1.8 mgd (79 L/s) are produced because of a lack of demand. With expansion possible up to 12.5 mgd (548 L/s), it is possible that OASIS could become a prime regional reuse provider.

The city's greatest reuse challenge has been in convincing single family residential customers to connect to the system. While connection is mandatory for commercial and multi-family customers, the city did not mandate connection for single family residences. Approximately 1,200 homes to date are connected to the reuse system with only 73 single family connections. Even though construction of reuse mains required work in neighborhoods that placed a reuse meter box at each home, single family residential customers chose not to connect to the system. Reasons ranged from the cost of connection to permitting issues. Residents also complained about the annual backflow preventer assembly certifications and the resulting payback time.

In 2010, the City Manager and the City Commission approved development of a connection program to target connection of single family residential customers. The new program allows the city, working through a contractor, to perform the necessary plumbing to connect the customer to the reuse system and eliminates the annual certification requirement for the customer. Installation cost is covered by the city's Utilities department, which also retains ownership of the dual check valve and meter. These costs are recovered through a slightly higher reuse usage rate (\$0.85/1,000 gallons [\$0.22/m³] for the smallest meter size) than existing reuse usage rates (\$0.61/1,000

gallons [\$0.16/m³]). The program includes a public outreach campaign, “I Can Water,” which launched in July 2011 with meetings, media outreach, mailers, cable TV, webpage, and a hotline. To reward the existing 73 customers, the city will replace their backflow devices and keep them at the current lower rate. Customer response has been high.

Capacity and Type of Reuse Application

In 1989, the original plant was constructed with a 2 million gallon (7570 m³) ground storage tank and a 2.5 mgd (110 L/s) design flow. The plant was expanded to 7.5 mgd (330 L/s) in 2002, with the ability to expand up to 12.5 mgd (550 L/s). The city produces reclaimed water for parks, golf courses, playing fields, medians, and residential irrigation. Current usage is about 1.8 mgd (80 L/s).

Water Quality Standards and Treatment Technology

Broward County effluent, which is the OASIS influent, is required to meet the state’s CBOD standard as part of its NPDES permit. The reuse facility consists of: two filter structures; associated pumps; a chlorine contact basin; two reuse water ground storage tanks (6 million gallon [22,710 m³] capacity); two dedicated distribution systems (a high pressure system for the golf course and a low pressure system for irrigation of parks, medians, and residential customers); and a control system (run on Supervisory Control and Data Acquisition Systems [SCADA]) with telemetry to the water treatment plant for monitoring and control functions. Water quality requirements include:

- Fecal coliforms - 75 percent of samples must be non-detect with no single sample exceeding 25 cfu/100mL
- Total suspended solids less than 5.0 mg/L
- Chlorine residual greater than 1.0 mg/L

Project Funding and Management Practices

The city finances the reuse program through user fees, an availability fee, and a use rate based on meter size. The potable water rate subsidizes 47 percent of the reuse program, spreading the costs to all customers. OASIS is required by the city’s potable water consumptive use permit and helps to defer additional

capital improvements for potable water as well as defer other alternative water supply investments. The city issued a bond for construction of the treatment facility and main trunk line. The city has continued to aggressively seek grants for distribution system expansion, as well as feasibility/research projects. Broward County is providing a cost share grant up to \$220,000 for the new “I Can Water” campaign. Since 2004, the city has received \$1.4 million in grants to further the reuse program.

Institutional and Cultural Considerations

Broward County has stricter water quality standards than the State of Florida, which limits reclaimed water use in ways that are acceptable in other parts of the state or country. Local rules do not allow reclaimed water to be stored in unlined ponds, requiring lining storage ponds or using closed distribution systems to reach all end users. Local water quality standards also impede permitting of reuse recharge systems, such as rapid infiltration basins or shallow wells without advanced treatment beyond tertiary treatment.

In this case, reuse was not implemented as an effluent disposal method (the city has no wastewater treatment plant), but rather as a water supply and saltwater intrusion abatement tool, making this program different from reuse projects that cover the cost of their program as part of effluent disposal. The use of reclaimed water as a resource means its benefit must be evident to the public as a protective and sustainability measure.

Successes and Lessons Learned

The most important lesson learned is that public outreach and marketing is critical to the success of the project. Utility staff are usually technically and scientifically oriented and many are not adept at communicating with the general public. Having a third party communicate utility issues often helps the public accept the validity of the information.

Another lesson learned is that reuse as a water resource is the key to a city’s future growth and development. Some interests attempt to limit the expansion and use of reclaimed water in order to limit development. Objections raised during a project startup may have little to do with the issue described by the resident/business owner and more to do with restricting growth.

Eastern Regional Reclaimed Water Distribution System

Authors: Victor J. Godlewski Jr. (City of Orlando);
Greg D. Taylor, P.E., and Karen K. McCullen, P.E., BCEE (CDM Smith)

US-FL-Orlando E. Regional

Introduction

The city of Orlando, Fla., has completed the longest, single reclaimed water project in Florida, representing a regional effort to provide reclaimed water throughout central Florida. The Eastern Region Reclaimed Water Distribution System (ERRWDS) provides public access reclaimed water to residential, commercial, and industrial users in the city of Orlando, Seminole County, Orange County, the city of Oviedo, and the University of Central Florida (UCF). The ERRWDS distributes reclaimed water, supplied by six wastewater utilities, through 35 miles (56 km) of transmission pipe, ranging in size from 20- to 48-in (50- to 120-cm) diameter.

Due to the size of the region and the location of WRFs, the regionalized system was effectively separated into the eastern and western service areas. The eastern system, the focus of this case study, serves areas in two state Water Management Districts (WMDs), the St. Johns River and the South Florida WMDs. For the eastern system, the primary source of reclaimed water would be provided from the Iron Bridge Regional WRF. Through system interconnects, Orange County's Eastern WRF would also be a source of reclaimed water.

Project Background

The Central Florida region is one of the fastest growing areas in the state; central Florida region's population increased 24.3 percent, while the state of Florida's population increased 17.6 percent from 2000 to 2010. Almost all of the region's drinking water is obtained from the upper and lower Floridan aquifer system. Reclaimed water has been used extensively in Florida to reduce potable water demands and stress on the Floridan aquifer system. Prior to the existence of regional systems like the ERRWDS, many individual utilities in central Florida, including the city of Orlando, and Seminole and Orange Counties, used reclaimed water for domestic irrigation and commercial crops.

These organizations were often motivated by their ability to obtain Consumptive Use Permits (CUP) for water withdrawals from the Floridan aquifer; a typical requirement of the permit is to participate in implementation and advancement of reuse. Thus, to reduce potable water demands and provide beneficial reuse, the city pursued a strategy that included a regional public-access reclaimed water system. The city of Orlando took the lead in planning, design, construction and operation of the ERRWDS and other organizations contributed financially, to secure reclaimed water from the system.

Capacity and Type of Reuse Application

Reclaimed water from the Iron Bridge Regional WRF is managed through a permitted 28 mgd (1,230 L/s) surface water discharge to the Little Econlockhatchee River, a 35 mgd (1,530 L/s) man-made treatment/reuse wetland system [US-FL-Orlando Wetlands], and a 20 mgd (875 L/s) public access reuse system. The ERRWDS is ultimately designed to transport an annual daily average flow of 24 mgd (1,050 L/s) throughout approximately 35 miles (56 km) of pipe, accounting for a peak hour flow factor of 4.5. An additional component of the ERRWDS is an inline booster pump station to deliver water from the north portion of the system to the south portion of the system, with a firm pumping capacity of 21 mgd (920 L/s). There is also a plan to construct a 10 million gallon (38,000 m³) storage and re-pump facility in the southeast portion of the city of Orlando in order to feed the growing population and help attenuate the peak demands.

Water Quality Standards and Treatment Technology

The permitted capacity of the Iron Bridge WRF is 40 mgd (1,750 L/s). Although the majority of the wastewater treated by the Iron Bridge WRF is from the city of Orlando, flows are contributed from other

sources, including parts of the City of Winter Park, the city of Maitland, the city of Casselberry and unincorporated portions of Seminole County. The treatment process is a 5-stage biological nutrient removal (BNR) system, designed to produce an effluent, after clarification and filtration, with the following characteristics expressed as annual average concentrations (total suspended solids is a maximum):

- Carbonaceous Biochemical Oxygen Demand (CBOD5): 4.28 mg/L
- Total Suspended Solids: 5 mg/L
- Total Nitrogen: 3.08 mg/L
- Total Phosphorus: 0.75 mg/L

Project Funding and Management Practices

The city of Orlando obtained grants from the EPA and the St. Johns River WMD, and loans through the FDEP State Revolving Fund and bond issuance. This allowed for low interest rate loans to fund design and construction of the facilities. The total design cost was \$6.5 million and the projected construction cost of the Iron Bridge Regional WRF improvements, the supplemental ERRWDS pipeline, inline booster pump station, ground storage tank and re-pumping facility, and other facilities was approximately \$47.5 million.

To help with project management and oversight, the ERRWDS pipeline and treatment plant improvements were broken up into multiple construction contracts allowing staging the work, lessening the impact on local ratepayers. Staging construction also allowed more stakeholders to be engaged during the process and permitted neighborhoods along the path to be connected to during construction, minimizing disturbances.

Project Success

The core success of this project is the collaborative effort of multiple reclaimed water utilities and potable water utilities in a regional project for the economic, environmental, and social benefit for all. Potable water from the Floridan aquifer is becoming a scarce resource, fostering competition between potable water utilities for access (permits) to utilize this precious and least expensive option for potable water. The potable water utilities (most of which are also reclaimed water providers) have permit conditions requiring them to

incorporate reclaimed water in their supply plans for domestic and commercial irrigation. Collaboration among potable water utilities, reclaimed water utilities and water management districts, focused by the city of Orlando, allowed reclaimed water to be transported across political boundaries (WMD boundaries and county boundaries), cost-sharing from multiple reclaimed water and potable water suppliers, and created a win-win solution to delivering reclaimed water for all stakeholders.

Lessons Learned

A regional approach to solve a regional water supply problem can be a cost-effective way for stakeholders to benefit from cooperation. The project sponsor or leader must be willing to thoughtfully consider each stakeholder's unique needs and concerns and to develop a plan that attempts to address stakeholder issues. Creating a successful regional project through a master plan that identifies potential customers, construction routes, funding sources, and an implementation schedule requires each of the stakeholders to understand their individual systems. This allows accurate demand projections and in turn, better estimates on the amount of reclaimed water they so that appropriate system sizing can be planned for long-term benefits without additional costs; it also allows fair cost-sharing on a capacity basis.

Prompt, regular communication and collaboration between utilities, regulators, the general public, consultants, and contractors allowed participants to weigh-in as on the scope and planning of the project. Therefore, collective agreement on the final design was easier to obtain and construction was easier to manage. Each stakeholder had input into the planning of the reclaimed water system, with the overall decision of the design and construction of the pipeline resting with the city of Orlando.

Finally, public awareness of construction and availability of reclaimed water proved to be an invaluable asset. By informing the general public of the construction activities, better and more productive lines of communication, it was easier to anticipate possible issues and resolve the many of them prior to construction.

Economic Feasibility of Reclaimed Water to Users

Authors: Grace M. Johns, PhD (Hazen and Sawyer) and C. Donald Rome, Jr.
(Southwest Florida Water Management District)

US-FL-Economic Feasibility

Project Background and Goals

Reclaimed water can be an effective way to diversify Florida’s water resources in order to use fresh water more efficiently. The Southwest Florida Water Management District (District) developed evaluation criteria and a decision support model called “The Reclaimed Water Benefit-Cost Calculator for Irrigation and Industrial Applications,” which is being used by the District to assess economic feasibility of reclaimed water in various applications.

Reclaimed water is economically feasible if the present value of reclaimed water benefits is comparable to or greater than the present value of reclaimed water costs to the user. The model guides potential users in collecting and assembling the necessary information and provides estimates of benefits, costs, and net

benefits. The model can be used to conduct sensitivity analyses to evaluate uncertainties in the input data and can evaluate partial offsets, where a portion of the next available water source is replaced with reclaimed water.

Evaluation criteria in the model were developed from a survey of 37 reclaimed water users in Florida including farmers using reclaimed water for crop irrigation; golf courses and a homeowner association using reclaimed water for turf, lawn, and landscape irrigation; and industries using reclaimed water primarily for cooling. Ninety-seven percent of the respondents were either very satisfied or satisfied with reliability of their reclaimed water supply and 86 percent and 84 percent, respectively, were either very satisfied or satisfied with water quality. The survey responses

Table 1 Benefits of reclaimed water for irrigation and industrial applications (Survey Results)

| Reclaimed Water Benefits (a) | Respondents Who Said Yes to Benefit | | |
|--|-------------------------------------|----------------|------------------------------|
| | Number Said Yes | % of Responses | Total No. of Respondents (b) |
| 1. Have a guaranteed and reliable water source | 25 | 68% | 37 |
| 2. Able to conserve fresh water for their other uses | 25 | 68% | 37 |
| 3. Able to irrigate more frequently | 17 | 63% | 27 |
| 4. Able to apply more water to the crop/lawn/ landscape | 15 | 56% | 27 |
| 5. Better able to supply water to crops during drought | 5 | 50% | 10 |
| 6. Irrigation or water costs are lower | 17 | 46% | 37 |
| 7. Our permitting requirements have been reduced | 3 | 30% | 10 |
| 8. Net income is higher than with traditional water source | 11 | 30% | 37 |
| 9. Fertilization costs are lower | 7 | 26% | 27 |
| 10. Revenue is higher than with traditional water source | 9 | 24% | 37 |
| 11. Business increased during fresh water restrictions | 4 | 24% | 17 |
| 12. Better able to protect crops from freezing | 2 | 20% | 10 |
| 13. Crop yield or product quantity has been higher | 2 | 10% | 20 |
| 14. Pounds of juice per acre is higher | 1 | 10% | 10 |
| 15. Our production cost is lower | 1 | 10% | 10 |
| 16. Water storage costs are lower | 3 | 8% | 37 |
| 17. Quality of crop/lawn/landscape/product is higher | 3 | 8% | 37 |

(a) All changes are relative to the freshwater source.

(b) Total number of respondents is: 37 if the question was asked of all respondents; 27 if the question was asked of the Agricultural and Recreation / Aesthetic respondents; 20 or 10 if the question was asked of the Agricultural respondents and/or the Industrial respondents, respectively.

demonstrated that there are cost-savings and value-added benefits of reclaimed water use. Benefits are listed in **Table 1** in order of importance, with the top five benefits being that more water is available when needed relative to fresh water sources. Additional details of the survey results are provided in **Table 1**.

Benefits of Reclaimed Water Use

Survey results were used to validate the model, which provides guidance in estimating benefits of reclaimed water to the user relative to the next available water source (NAWS), which include:

1. Nitrogen fertilizer cost savings - annual.
2. Change in value of crop production - annual.
3. Value of change in quality of crop, lawn, and/or landscape - annual.
4. Value of additional water available from the reclaimed water source - annual.

5. Value of additional water “freed up” by the reclaimed water use - annual.
6. Value of water available during NAWS water shortage restrictions - annual.

Costs of Reclaimed Water Use

The model compares costs associated with accessing and using reclaimed water to those from using the NAWS. There are potentially three costs associated with using reclaimed water: (A) installation costs; (B) annual operations and maintenance (O&M) costs; and (C) recurring non-annual O&M costs (**Table 2**). A reclaimed water user will not necessarily need to spend money on all of these cost items. The model directs the user to enter costs relevant to their potential reclaimed water use, and relative to using the NAWS. It reminds the user to consider the need and cost for a backup water supply when reclaimed water is not available.

Table 2 Costs of reclaimed water for irrigation and industrial applications

| Potential Initial Costs |
|--|
| 1. Install pipes to connect system to reclaimed water pipeline |
| 2. Install pressure regulating valves to control water pressure |
| 3. Install water meter |
| 4. Install storage pond or tank and pump station |
| 5. Disconnect existing water source from system |
| 6. Install or expand the water pretreatment system (industrial applications) |
| 7. Install or upgrade filtration and/or chemical injector systems to reduce micro-jet and drip emitter clogging |
| 8. Create disposal area when reclaimed water flows are higher than crop water needs |
| 9. Change plant material to more salt tolerant species |
| 10. Costs associated with the provision of water from the existing water source for other uses due to the reclaimed water connection |
| Potential Operations and Maintenance Costs, Annual and Recurring, Non-Annual |
| 11. Reclaimed water payment to the utility |
| 12. Maintain water meter, pipeline, pump and storage pond; repair pipeline due to fluctuating water pressure; repair or replace rusty controllers, power boxes and equipment |
| 13. Fertilizer management including water quality and plant tissue testing and nutrient evaluations |
| 14. Salinity and pH management including chemical applications, water blending, soil leaching and mechanical means |
| 15. Pest or algae management including cleaning or repairing nozzles, water chlorination, pesticide applications, and filter replacement |
| 16. Chemicals needed for reclaimed water treatment prior to industrial application |
| 17. Recording water data and providing reports to regulatory agencies |

Economic Feasibility of Reclaimed Water

Given the data provided by the user, the model provides the following results:

- Total benefit in dollars (other than cost savings) relative to next available water source: Annual and per 1,000 gallons
- Total cost in dollars, including cost savings, relative to NAWS: Annual and per 1,000 gallons
- Net benefit (benefit minus cost) of reclaimed water use relative to NAWS: Annual and per 1,000 gallons

A partial screen shot of the model is provided in **Figure 1**, showing the portion of the model that provides nitrogen fertilizer cost savings. The green-shaded cells indicate that information is provided by the user. The dark blue-shaded cell indicates that the data came from a public source, specified in the model. The light blue-shaded cells contain values calculated by the model.

Summary

The Economic Feasibility report and model are available on the District’s website (SFWMD, n.d.). The model assists water users and the District in evaluating economic feasibility when a water use permittee or applicant is required to consider the use of reclaimed water. This would be the case where reclaimed water is available from a wastewater treatment plant located in a water resource caution area. The model results are viewed in the proper context of all other information submitted and relevant to the water use permit application or renewal.

References

Southwest Florida Water Management District (SFWMD). n.d. Retrieved on Sept. 4, 2012 from <<http://www.swfwmd.state.fl.us/permits/wup/>>.

| Reclaimed Water Benefit Cost Calculator for Irrigation | | | | |
|--|---|------------------------------------|---|--|
| Economic Comparison of Reclaimed Water Versus Next Available Water Source For Irrigation by Agricultural, Recreation and Aesthetic Water Users | | | | |
| Row No. | Benefit or Cost Item | Next Available Water Source (NAWS) | Reclaimed Water Used Instead & Other Sources if Applicable (RW/Other) | NAWS Minus RW/Other (Except A. which is RW/Other minus NAWS) |
| (1) | (2) | (3) | (4) | (5) |
| 70 | E. Nitrogen Fertilizer Cost Savings - Annual: | | | |
| 71 | N Fertilizer Cost per Ton: Nitrogen concentration in ppm or mg/l of Irrigation Water (for reclaimed water, obtain from utility. For NAWS, use available info or assume 0): | \$552 | \$552 | |
| 72 | | 0 | 6 | |
| 73 | Percent of Nitrogen in water that is taken up by the plant: | 50% | 50% | |
| 74 | Nitrogen Fertilizer Cost Savings Per 1,000 gallons of irrigation water: | \$0.00 | -\$0.015 | \$0.015 |
| 75 | Nitrogen Fertilizer Cost Savings due to N in applied water - Annual | \$0 | -\$1,258 | \$1,258 |

Figure 1
Partial screen shot of reclaimed water benefit cost calculator for irrigation, nitrogen fertilizer cost savings module

Reuse at Reedy Creek Improvement District

Author: Ted McKim, P.E., BCEE (Reedy Creek Improvement District)

US-FL-Reedy Creek

Project Background or Rationale

Reedy Creek Improvement District (RCID) is a special district in central Florida that serves the Walt Disney World resort with municipal services, including water supply, wastewater treatment, and reuse. Reuse has been practiced since the early 1970s, and began with irrigation of a tree farm and nursery operations, utilizing 2 to 3 percent of the effluent. From that modest beginning, reuse practices have grown and today RCID practices 100 percent reuse, and has done so for over 20 years. Reclaimed water meets the majority of irrigation demands of the Walt Disney World resort, and is used for cooling tower makeup, wash down of sidewalks and streets, fire protection and fire suppression, vehicle washing, dust control, clean up, and process uses at the treatment plant and solid waste transfer station. Reuse currently provides between 25 and 30 percent of the total water supply needs of the District, and meets a majority of the non-potable demand, typically between 5 and 6 mgd.

The primary reason for instituting reuse stemmed from a climate of conservation and sustainability and regulatory desires. In the 1980s, Florida Department of Environmental Protection (FDEP) encouraged utilities to reuse as a means of reducing surface water discharges. Additionally, planning projections indicated that traditional water supplies would be unable to meet future demands unless alternative sources were utilized. Finally, most utilities also discovered that reuse was a cost-effective means of meeting both of these needs.

Capacity and Type of Reuse Application

RCID employs a treatment plant with a 15 mgd (657 L/s) capacity. Reclaimed water is provided to two reuse systems, one with a 10 mgd (438 L/s) capacity and a rapid infiltration basin system (RIB) of 12.5 mgd (548 L/s). The reuse system capacities exceed plant capacity to meet variations in demand due to distinct wet and dry seasons. The reuse systems consist of a distribution system with about 80 miles (129 km) of pipeline, a pump station, and reservoirs with 15 million

gallons (56,800 m³) of storage capacity. Reclaimed water is used principally for landscape with over 80 percent of irrigated areas within RCID using reclaimed water (**Figure 1**). When the supply of reclaimed water exceeds demand, reclaimed water is used to recharge groundwater through the RIB system, which consists of 85 1-ac (0.4-ha) basins constructed in a sandy ridge area located 2 to 3 miles (3.2 to 4.8 km) from the plant site. The USGS conducted studies in the early 1990s concluding that approximately 70 percent of water applied to the RIBs reaches the Upper Floridan aquifer and the balance diffuses to the surficial aquifer. The Upper Floridan aquifer is the primary source of drinking water for much of central Florida.

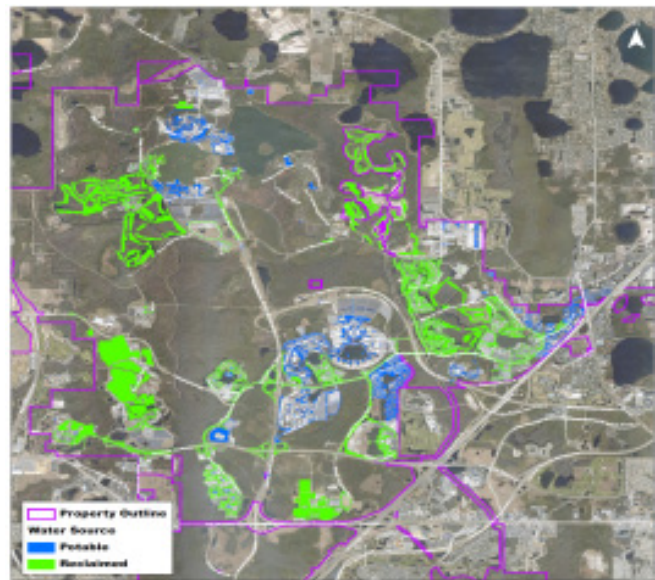

Figure 1
Areas irrigated with potable water and RCID reclaimed water (Photo credit: Reedy Creek Energy Services Surveying and Mapping Department)

In a typical year, flow is split about equally between the two systems but is weather dependent. In dry weather, demand on the distribution system increases (typically peaking in April and May); some augmentation with groundwater is typically required to supplement flows in the reclaimed water distribution system during dry weather to meet peak demands. In

wet weather, demand on the distribution system drops and flow is diverted to the RIBs, which are used almost exclusively during storms and hurricane events. **Figure 2** shows the historical distribution of flow between the RIBs and reuse distribution system (values are shown as annual averages).

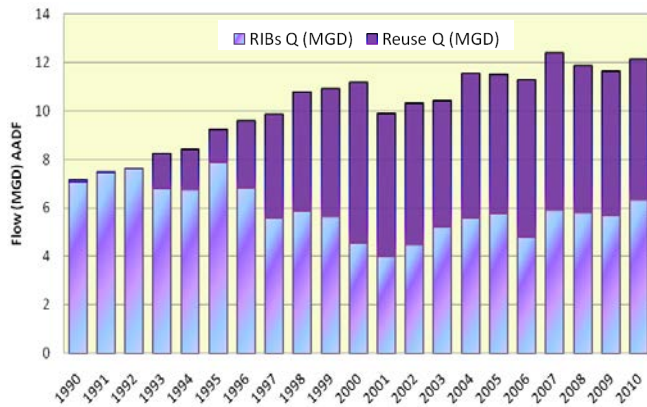

Figure 2
Allocation of reclaimed water to RIBs and reuse distribution system

Water Quality Standards and Treatment Technology

RCID employs a five stage Bardenpho™ process for carbon and nutrient removal, followed by filtration and chemical disinfection (hypochlorite solution) to achieve a water quality suitable for public access reuse purposes per Chapter 62-610 of the Florida Administrative Code.

Annual testing of the reclaimed water shows that it typically meets USEPA primary and secondary drinking water standards, with one exception for TTHMs (**Table 1**). The reclaimed water also meets the targeted thresholds for protozoan parasites (*giardia* and *cryptosporidium*) as recommended by FDEP (5 oocysts/100 mL). The facility operates under an FDEP permit because the facility is a zero-discharge operation, and does not have an NPDES permit.

Project Funding and Management Practices

The reuse distribution system is operated much like a typical water distribution system, and matches the pressures in the potable system, which facilitates conversions. Reclaimed water is metered, invoiced, and monitored similar to potable water, and the distribution system is constructed using similar standards for materials, installation, and testing.

Chloride concentrations in the reclaimed water are typically an order of magnitude higher than the potable water (>120 mg/L versus 10 mg/L) and this marked difference is used in the field as an aid in identifying the source of the water during leak detection procedures. Indicator test strips are used for determination of chloride levels. All reclaimed water piping is color-coded using purple (Pantone #522C); plastic pipe is pigmented and other pipe materials are striped with paint, tape, or both. Buried pipe is installed with identification tape. Additionally, all above, or at-grade appurtenances, are identified with purple coloring and purple and yellow markers and tags, including fire hydrants. RCID employs a robust backflow prevention and cross connection program to ensure that reclaimed and potable water systems are not inadvertently cross connected. RCID also requires all new development to connect to the reclaimed water system for non-potable uses.

Institutional and Cultural Considerations

Sustainability has been a driving force for use of reclaimed water for non-potable uses and for aquifer recharge at RCID. The realization that the Upper Floridan aquifer is a finite and precious resource has led to its conservation, which in turn has fostered growth of reuse as an alternative water supply. As a result, reclaimed water is an accepted and desired utility, and has gained increasing acceptance as a valuable resource.

Successes and Lessons Learned

The reuse system employed by RCID has reaped many benefits and has undergone transformation in its 40-year history. Initially employed as a means of ceasing surface water discharge, it has evolved into an alternative water supply and a means of achieving a higher level of sustainability by returning a significant portion of the consumed water to its source, in effect practicing indirect potable reuse. The reuse distribution system and related consumption has allowed RCID to remain within its Water Use Permit, which limits the amount of groundwater that can be withdrawn). The recharge of the aquifers by the RIBs has also allowed the net withdrawal of groundwater at RCID to remain relatively constant over the past 20 years, despite a more than doubling of growth and development within the service area.

Table 1 Water quality characteristics of RCID effluent (2007 – 2011) compared to drinking water standards

| Parameter | Units | 2007 | 2008 | 2009 | 2010 | 2011 | Drinking Water Standard |
|-----------------------------|-------|----------|----------|----------|----------|----------|-------------------------|
| Inorganics | | | | | | | |
| Arsenic | mg/L | <0.0015 | <0.0015 | <0.0015 | <0.0015 | <0.0015 | 0.05 |
| Barium | mg/L | <0.0025 | 0.0028 | 0.0035 | 0.0015 | 0.0015 | 1 |
| Cadmium | mg/L | <0.00038 | <0.00038 | <0.00038 | <0.00038 | <0.00038 | 0.01 |
| Chromium | mg/L | <0.006 | <0.006 | <0.006 | <0.006 | <0.006 | 0.05 |
| Flouride | mg/L | 0.31 | 0.08 | 0.19 | 0.03 | 0.02 | 4 |
| Lead | mg/L | <0.00054 | <0.00054 | <0.00054 | <0.00054 | <0.00054 | 0.05 |
| Mercury | mg/L | <0.00005 | <0.00005 | <0.00005 | <0.00005 | <0.00005 | 0.002 |
| Nitrate as N | mg/L | 0.391 | 0.57 | 0.664 | 0.688 | 0.402 | 10 |
| Selenium | mg/L | <0.0015 | <0.0015 | 0.0018 | <0.0015 | <0.0015 | 0.01 |
| Silver | mg/L | <0.0005 | <0.0001 | <0.0001 | <0.0001 | <0.0001 | 0.05 |
| Sodium | mg/L | 160 | 73.8 | 71.9 | 82.3 | 77.9 | 160 |
| Volatile Organics | | | | | | | |
| Ethylene dibromide (EDB) | µg/L | <0.01 | <0.006 | <0.009 | <0.009 | <0.0081 | 0.02 |
| Para-dichlorobenzene | µg/L | <1.0 | <1.0 | <1 | <0.1 | <1 | 75 |
| Vinyl chloride | µg/L | <0.5 | <0.5 | <0.5 | <0.083 | <0.71 | 1 |
| 1,1 -dichloroethane | µg/L | <0.5 | <0.5 | <0.5 | <0.15 | <0.5 | 7 |
| 1,2-dichloroethane | µg/L | <0.5 | <0.5 | <0.5 | <0.082 | <0.5 | 3 |
| 1,1,1-trichloroethane | µg/L | <0.5 | <0.5 | <0.5 | <0.00015 | <0.5 | 200 |
| Carbon tetrachloride | µg/L | <0.5 | <0.5 | <0.5 | <0.082 | <0.5 | 3 |
| Trichloroethane | µg/L | <0.5 | <0.5 | <0.5 | <0.068 | <0.55 | 3 |
| Tetrachloroethane | µg/L | <1.0 | <1.0 | <1.0 | <0.099 | <1.0 | 3 |
| Benzene | µg/L | <0.5 | <0.5 | <0.5 | <0.05 | <0.58 | 1 |
| Trihalomethanes | | | | | | | |
| Total Trihalomethane (TTHM) | µg/L | 66.7 | 59.4 | 179** | 46.5 | 54.2 | 80 |
| Organics | | | | | | | |
| Endrin | µg/L | 0.021** | <0.02 | <0.019 | <0.003 | <0.01 | 0.02 |
| Lindane | µg/L | 0.097 | 0.03 | <0.025 | <0.0031 | <0.005 | 4 |
| Methoxychlor | µg/L | <0.0021 | <0.02 | <0.024 | <0.024 | <0.019 | 100 |
| Toxaphene | µg/L | <0.090 | <0.09 | <0.09 | <0.00022 | <0.96 | 5 |
| 2,4-D | µg/L | <0.12 | 0.32 | <0.091 | <0.099 | <0.037 | 100 |
| 2,4,5-TP (Silvex) | µg/L | <0.11 | <0.087 | <0.056 | <0.05 | <0.06 | 10 |
| Radiologicals | | | | | | | |
| Gross Alpha | pCi/L | <2.1 | <1.6 | <1.3 | 1.3 | 1.6 | 15 |
| Radium 226 and 228 | pCi/L | 0.75 | 0.2 | 0.7 | 0.7 | 0.8 | 5 |
| Secondary Chemistry | | | | | | | |
| Chloride | mg/L | 104 | 142 | 166 | 110 | 114 | 250 |
| Copper | mg/L | 0.0021 | <0.0015 | 0.0015 | <0.0015 | 0.0015 | 1 |
| Iron | mg/L | 0.12 | 0.13 | 0.1 | 0.15 | 0.16 | 0.3 |
| Manganese | mg/L | 0.0038 | <0.0015 | 0.0017 | <0.0015 | <0.0015 | 0.05 |
| Sulfate | mg/L | 50.9 | 60.3 | 53.9 | 55.3 | 47.1 | 250 |
| Zinc | mg/L | <0.025 | <0.025 | 0.025 | <0.025 | 0.025 | 5 |
| pH (units) | mg/L | 7.4 | 6.2 | 7.5 | 7.6 | 8.15 | 6.5 - 8.5 |
| Total Dissolved Solids | mg/L | 391 | 410 | 419 | 402 | 414 | 500 |
| Foaming Agents | mg/L | 0.045 | <0.006 | 0.021 | 0.059 | 0.12 | 0.5 |

mg/L are milligrams per liter or parts per million

µg/L are micrograms per liter or parts per billion

pCi/L are picoCuries per liter

BDL means below the detection limit of the analysis technique employed

** Indicates sample parameters that did not meet or exceeded the drinking water standard

N/A indicates that an average value was not possible to calculate due to a mix of results above and below detection

Marco Island, Florida, Wastewater Treatment Plant

Authors: Jennifer Watt, P.E. (General Electric); Solomon Abel, P.E. (CDM Smith); and Rony Joel, P.E., DEE (AEC Water)

US-FL-Marco Island

Project Background

The City of Marco Island, Fla., is located in southwest Florida among the 10,000 islands that are part of the Florida Everglades. This resort community population varies from 17,000 in summer to 40,000 in winter. The majority of Marco Island was man-made in the late 1960s to early 1970s, by filling mangrove and swamp areas, and creating a back yard canal system.

The Marco Island Wastewater Treatment Plant (WWTP) is about 40 years old and the original treatment technology has been expanded in phases to accommodate its growing community. Originally, wastewater treatment consisted of onsite residential septic tanks and a 3 mgd (130 L/s) central sewage treatment plant for condominium and commercial facilities. In 2005, the city initiated a 7-year residential septic tank replacement program. In an effort to protect the clean Gulf of Mexico waters that lap the local beaches and draw tourists and winter residents, city officials launched a 7-year plan to phase out all septic systems.

Capacity and Treatment Technology

In 2003, Marco Island Utilities selected a packaged membrane bioreactor (MBR) system to upgrade the existing contact stabilization process and increase treatment capacity. Because the existing plant is surrounded by water, commercial facilities, and other utilities, little room is available for expansion and an increase in capacity with conventional technology would not have been possible.

The MBR process offered a high level of treatment for producing reclaimed water in a small footprint by eliminating secondary clarifiers and tertiary filtration systems required in conventional treatment. The treatment capacity in 2012 is 3.5 mgd (150 L/s); projections of population growth and septic tank conversions are anticipated to result in a wastewater demand on the island of 5.0 mgd (220 L/s).

The existing contact stabilization process was upgraded in multiple phases to minimize interruptions of treatment operations, stage funding requirements, and ease of constructability. The first phase added the MBR treatment process in four trains and kept part of the contact stabilization process in operation. In the second phase of the project, the remaining contact stabilization plants were taken out of service. A second bioreactor tank with anoxic and aerobic volume to match the existing tank was installed, as well as a fifth membrane train to provide a total capacity of 5 mgd (220 L/s) with one standby membrane train (**Figure 1**).



Figure 1
Marco Island WWTP membrane trains (Photo credit: Jeff Poteet)

Final disinfected water flows to a pump-station wet well for transfer to two onsite 0.5-million-gallon (1,900 m³) storage tanks. Reclaimed water is used to irrigate the Marco Island, Hideaway Beach, and Marco Shores golf courses or sent to an onsite deep-injection well when reclaimed water demands have been met.

The MBR system produces effluent exceeding Marco Island discharge requirements and provides high-quality reuse water, reducing the demand of potable

supplies by creating a continuous drought-proof supply for golf course and residential property irrigation.

Project Funding and Management Practices

A challenge to the new system was financing the expansion project. The original system was financed by users; each condominium that connected was allocated a capital cost and provided a 10-year finance plan. Those that joined the system were guaranteed a \$0.52/1,000 gallon (\$0.14/m³) cost for the 10-year period.

It was important not to burden consumers that were not going to receive direct benefits of using irrigation water. The indirect benefit is that the size of the water plant capacity expansion could be reduced by the volume of reuse water that is distributed, saving all water utility customers the cost of plant expansion.

The reuse system expansion cost was \$1.6 million; \$750,000 of funding was a grant award from Big Cypress Basin, a component of South Florida Water Management District. The balance of the project was paid for by condominiums connecting to the system. The city mandated that all condominiums adjacent to the reuse system must connect to the system within 365 days to provide cost recovery. Based on the cost to be recovered and the volume of water used for irrigation by each condominium, the cost per 1,000 gallons (3.8 m³) of the reuse water was the same as the potable water for 24 months. At the end of this period, the cost of reclaimed water was reduced to the same rate as all other reuse water customers (40 percent of the potable water rate). The FY12 cost for reuse is \$1.56/1,000 gallons (\$0.41/m³).

The FY2012 potable water cost is:

- Base rate - \$30.89
- Use rate - \$3.85/1,000 gallons (\$1.01/m³)

The FY2012 wastewater cost is:

- Base rate - \$25.14
- Use rate - \$4.97/1,000 gallons (\$1.31/m³)

Institutional/Cultural Considerations

The biggest cultural challenge was for operations staff at Marco Island Utilities to transition from operating a contact-stabilization facility to MBRs. Monitoring the biological process and amount of settling in the clarifier

was the measure of performance for the original system. Operators had to learn how to monitor the membrane system and view the biological process in a different light—important for optimization but not in relation to settling and treatment quality. The transition required a comprehensive training program and extra attention to automation and controls, including the creation of a new position devoted to instrumentation and controls. All the team members were trained extensively in the new process and were closely involved with the construction before MBR start-up.

A public education program was developed to demonstrate the benefits of expanding the system and reducing use of potable water for irrigation. The per capita water consumption is approximately 450 gallons (1.7 m³) per day on Marco Island. Considering interior consumption is approximately 110 gpcd (0.4 m³ per capita per day), the majority of water is used for irrigation.

No single family homes have access to reuse water, which became an issue, as these customers wanted access to the low cost irrigation water. The challenge to meet this demand is twofold: first, the supply of reuse water is dependent on the volume of wastewater generated, and second, a distribution system does not exist. Based on interior residential water consumption, approximately four full-time occupied homes would generate the volume required to irrigate one home. In addition to not having available product, the cost to install new irrigation lines would be approximately \$6,000 per residential site resulting in a 10-year recovery for the capital investment.

Successes and Lessons Learned

The biggest success of the project was the expansion of the existing WWTP from 1 to 3 mgd (44 to 130 L/s) with only the addition of membrane trains. Use of membranes required only a small additional footprint so that the plant could be expanded on the existing site. Modular expansion with additional membrane trains to 5 mgd (220 L/s) allowed for phased construction to match increases in capacity demands, funding, and schedule requirements including construction activity scheduling between the rainy season (May to August) and the arrival of winter residents around the beginning of January.

References

Joel, R., B Weinstein, J. Poteet, S. Abel, S. Haecker and J. Watt. 2008. "No Space? No Problem!" *WE&T*.

Abel, S., A.R. Joel, B. Weinstein, P Tunncliffe and W. Kimball. 2008. "Implementation of the Largest Package MBR WWTP." SEDA/AMTA.

Watt, J. 2006. "Marco Island Welcomes Recycled Water." *Membrane Technology*.

Force, J. 2010. "Learning New Tricks." *Treatment Plant Operator*.

Everglade City, Florida

Author: Rony Joel, P.E., DEE (AEC Water)

US-FL-Everglade City

Project Background or Rationale

The city of Everglade City, Fla., is a small fishing community in the southernmost portion of Collier County on the western coast of Florida (**Figure 1**). The city is the interface to Big Cypress Swamp with coastal wetlands lining the north coast of Chokoloskee Bay. This highly sensitive estuarine, shallow water region is part of the “Ten Thousand Island” area that is known to be a vital part of the ecology of Southern

Everglades National Park, and is home to many species of birds, fish, and other wildlife. The outer portions of the city are characterized by mangrove wetlands.

The city has a total of 250 single family residential homes and 130 mobile home units. At build-out (2030), an additional 482 home units will be added. The current population of the city is approximately 800.

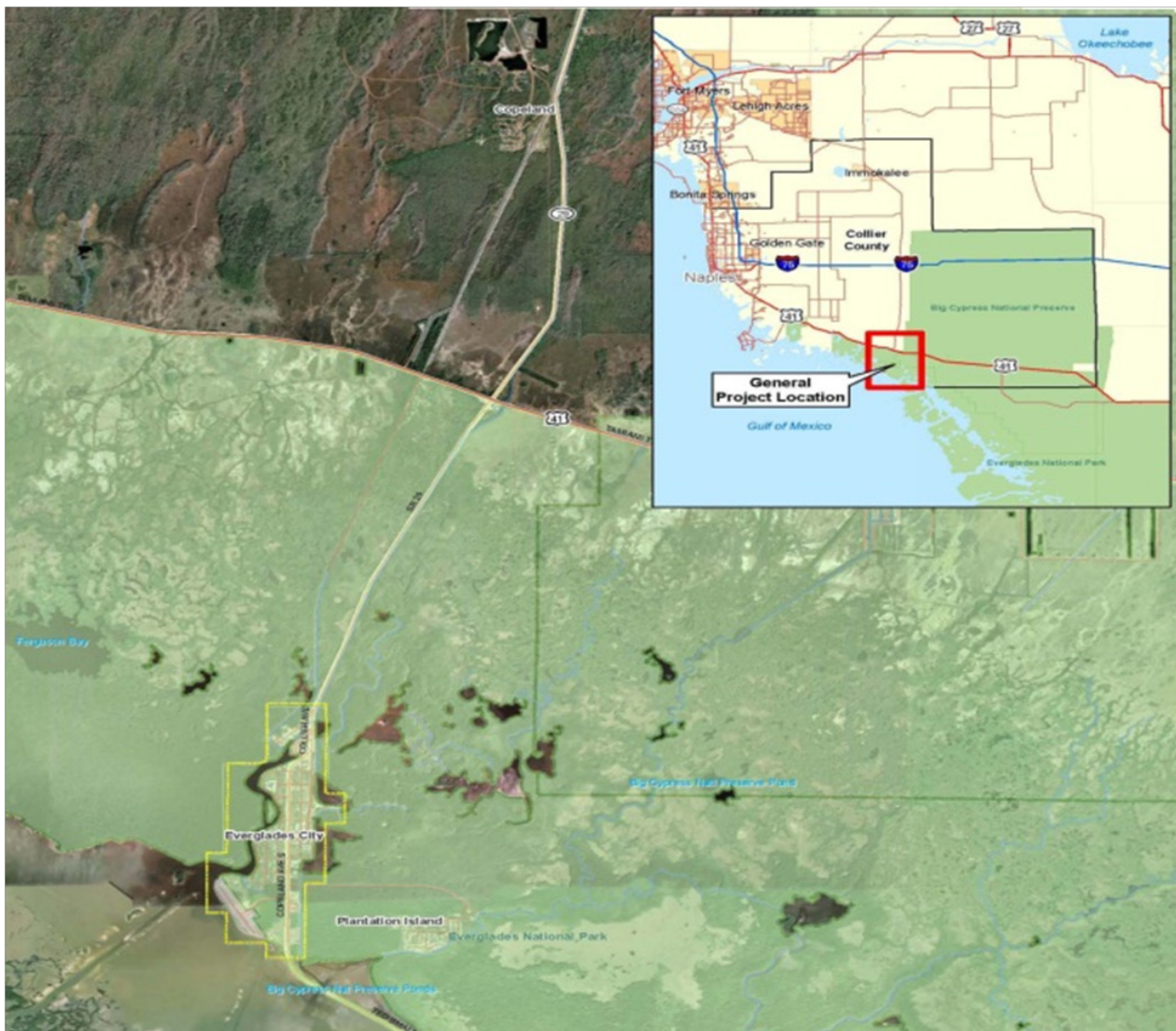

Figure 1
Location of Everglade City (Photo credit: Collier County, Fla. Appraiser)

The city has developed areas that are at an elevation of 2 to 5 feet (0.6 to 1.5 meters). Because of the low elevation, the city and surrounding areas experience tidal and storm surge flooding.

Capacity and Type of Reuse Application

The Everglades City wastewater treatment system provides service to the incorporated area of the city and to portions of Copeland and Chokoloskee. The existing plant has a capacity of 0.16 mgd (7 L/s) on an annual average daily flow basis.

The treatment process consists of flow equalization, aeration, secondary clarifications, membrane filtration, chlorination, dechlorination, aerobic sludge digestion, sludge drying beds, reject storage, reclaimed storage and distribution, and surface water discharge. Flow is delivered to the plant via 245 grinder pump stations in the city and two master pump stations (Copeland and Chokoloskee).

The city has two permitted options for land application of reclaimed water. The first option is for distribution or reclaimed water for public reuse for irrigation of residential lawns, city landscape areas, roadway medians, the airport, school, and park. If the demand for reclaimed water is less than the total production of reclaimed water, the remaining water is used to recharge the local shallow aquifer through a rapid infiltration basin.

Water Quality Standards and Treatment Technology

The Florida Department of Environmental Protection operating permit mandates the following annual average treatment standards:

- biochemical oxygen demand, Carbonaceous 5 day – 20 mg/L
- total suspended solids – 5 mg/L
- coliform – 25 #/100 mL
- pH – 6.0 min to 8.5 max
- chlorine residual – 1 mg/L
- total nitrogen – no limit
- total phosphorous – no limit

The monitoring is required at the following locations: after chlorination, but before dechlorination, at the discharge point to the percolation ponds, and at the discharge point to the public access reuse system.

Project Funding and Management Practices

The city distributes reuse water at no cost to their customers. The average monthly cost of potable water (base and use fee) for a user of 4,000 gallons (15 m³) is \$17; this typically reflects a \$13 base fee that includes 3,000 gallons (11 m³) of water and \$4/1,000 gallons (\$1.03/m³) for use above the base volume. The monthly wastewater treatment cost for the same level of service is \$16.20 (\$13 base fee plus \$3.20/1,000 gallons (\$0.83/m³) above 3,000 gallons (7.74 m³) water use).

The current wastewater plant is at the end of its useful life. The city is evaluating the need to upgrade the plant for full build out and increasing their service area. The total flow at build out is estimated to be 0.50 mgd (22 L/s). At this flow, new use opportunities for the generated reuse water will need to be established.

The city's current customer base cannot sustain the projected needs without a rate increase. A consultant has determined to meet the current 5-year capital improvements plant, and would require a rate increase in excess of 100 percent over the next 3 years. To reduce the rate impact, the city has started the process of applying for grants to reduce the rate increase.

Institutional/Cultural Considerations

The city of Everglades City has demonstrated that small communities can effectively incorporate a reuse water system into their effluent disposal scheme and not charge a fee for its use.

Mayor Sammy Hamilton, Jr. stated that: “The only negative comments I receive about city operations is when our homeowners do not get the reuse water they have become accustomed to receiving.” He also states, “Our water supply is treated as our community life blood and any alternative water source we can identify will sustain our community for the next 100 years.”

The city has landscaped its medians with Florida native plantings and as a component of the city conservation program; it uses the reuse water to irrigate the plantings. Annually the city has a 2-day seafood festival attended by over 60,000 persons. They call commenting how green the city is.

City of Orlando Manmade Wetlands System

Author: Mark Sees (City of Orlando)

US-FL-Orlando Wetlands

Project Background or Rationale

The Orlando Easterly Wetlands is an effort by the city of Orlando to enhance the environment with highly treated reclaimed water from its 40-mgd (1,750 L/s) Iron Bridge Regional WRF. The project began in the mid-1980s when the city, faced with the need to expand its permitted treatment capacity, was unable to increase nutrient discharge into sensitive waterways. Nitrogen and phosphorus were of concern because Florida water bodies are particularly susceptible to algae blooms, as a result of nutrient loading; these blooms can deplete oxygen and result in fish kills and other undesirable conditions during periods of very low flows that occur in the summer.

At its inception, there were no existing large-scale wetland treatment systems to serve as an example for city environmental services staff, consultants, or state regulators. But with the cooperation of all parties, work began on a 1,200-ac (485-ha), created wetland to provide nutrient removal for 20 mgd (876 L/s) of reclaimed water from the Iron Bridge facility. The Orlando Easterly Wetlands (OEW) site is located in east Orange County, Fla., approximately 2 mi (3.2 km) west of the main channel of the St. Johns River. Surveys performed in 1848 indicate that the site had once been a wet prairie, with smaller areas consisting of hardwood swamps and hammocks.

During the early to mid-1900s, land was ditched and drained for agricultural development; the ditches and swales that drain this site discharged directly into the St. Johns River. The drainage system had also lowered the groundwater table and transported runoff to the St. Johns River so that wetland vegetation could no longer be sustained throughout the site.

Water Quality Standards and Treatment Technology

Recognizing that aquatic ecosystems could be used to naturally remove nitrogen and phosphorus, the city used this site to create the large-scale wetland treatment system. Earthen berms were constructed, and 2.1 million aquatic plants were planted in 17 cells

to "polish" reclaimed water that filters through the wetlands. Water is collected and discharged into the St. Johns River with no adverse impact. Creation of the wetland treatment system allowed the city to meet treatment and disposal needs, reclaim a vital wetland, and create valuable habitat for wildlife. The OEW has been continuously monitored through a Domestic Wastewater Operating Permit, which includes regulated daily, weekly, monthly, and annual water quality standards as shown in **Table 1**.

Table 1 Permit limits and wetlands performance in 2011

| Parameter | Monthly/Annual Limit | 2011 Wetlands Discharge |
|--|----------------------|-------------------------|
| pH | 6.0 – 8.5 s.u. | 7.24 s.u. |
| Total Suspended Solids | 15.0 mg/L | 1.07 mg/L |
| Total Nitrogen | 2.31 mg/L | 1.00 mg/L |
| Total Phosphorus | 0.20 mg/L | 0.026 mg/L |
| Carbonaceous Biochemical Oxygen Demand | 10 mg/L | 0.67 mg/L |
| Dissolved Oxygen | 3.8 mg/L | 4.9 mg/L |

Institutional/Cultural Considerations

In addition to providing outstanding water quality, the Easterly Wetlands is open as a park for passive recreation. Each year more than 12,000 people visit the park enjoying hiking, jogging, bicycling, bird watching, nature photography, and horseback riding. The park has an educational center where volunteers promote the success of the wetland treatment system by offering guided tours. Each year, more than 1,600 people are given personal tours of the system and 5 to 10 tours are given to delegates and representatives of foreign countries who are interested in economical alternatives for reuse.

Successes and Lessons Learned

After more than 2 decades of demonstrated performance, the Orlando Easterly Wetlands reclamation project has proven that large-scale, created wetlands can be used on a long-term basis, with resounding success, for the advanced treatment of wastewater and beneficial reuse.

Regional Reclaimed Water Partnership Initiative of the Southwest Florida Water Management District

Author: Alison Ramoy (Southwest Florida Water Management District)

US-FL-SWFMD Partnership

Project Background or Rationale

The Southwest Florida Water Management District (SWFWMD) is one of five regional water management districts directed by state law to protect and preserve water resources in its boundaries (**Figure 1**). The district encompasses roughly 10,000 mi² (26,000 km²) in all or part of 16 west-central Florida counties, serving more than 5 million people. The Regional Reclaimed Water Partnership Initiative (RRWPI) was developed in 2008 to maximize beneficial use of reclaimed water, while offsetting groundwater use. As part of its Cooperative Funding Initiative, a cost-share program for water resources management projects, SWFWMD was requested to fund up to half the cost of a series of projects that would accomplish these goals.

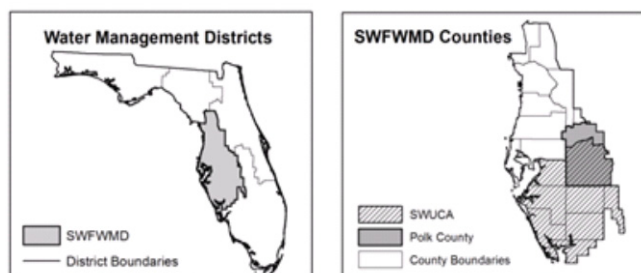

Figure 1
Water management districts and SWFWMD counties

Several potential concepts were initially proposed and after a series of meetings, the partners identified an industrial reuse project that would provide the Tampa Electric Company (TECO) with reclaimed water to offset groundwater use at its Polk Power Station in Mulberry, Florida. The location of this project (**Figure 2**) is significant because it is an area with depressed aquifer levels, which has caused saltwater intrusion, reduced river flows, and lowered lake levels. This area is the Southern Water Use Caution Area (SWUCA) and the district approved the SWUCA Recovery Strategy in 2006 (SWFWMD, 2006). Implementation of the strategy will ensure adequate water supplies to meet growing demands, while protecting and restoring water and related natural

resources of the area. Among the SWUCA Recovery Strategy's components are alternative supply development and permitting.

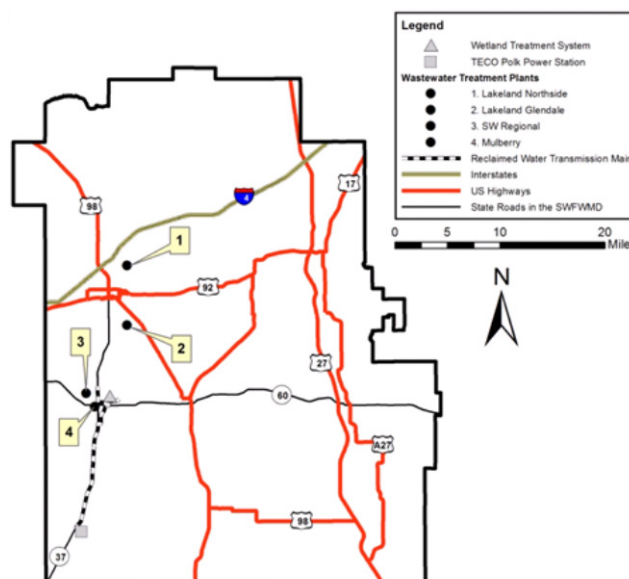

Figure 2
Project location

The primary source of water supply has been groundwater and developing alternative water supplies from surface water, reclaimed water and desalination will reduce groundwater use, while meeting growing water demands. SWFWMD's permit program requires water use permit holders to use alternative water sources where economically, technologically, and environmentally practical. This longstanding commitment to developing alternative water supplies along with the permit program has contributed to a trend of declining groundwater use in the SWUCA.

Capacity and Type of Reuse Application

This project is a unique public-private partnership that will provide TECO with approximately 7 mgd (300 L/s) of reclaimed water for industrial cooling and other uses for power generation expansion at its Polk Power Station. Three sources of reclaimed water have been identified.

The first source to come online will be the city of Lakeland's reclaimed water wetland treatment system. Lakeland has two wastewater treatment plants (WWTPs) with a combined capacity of 21.7 mgd (950 L/s) and an annual average flows of 11.5 mgd (500 L/s) (FDEP, 2010). In 2010, the city's McIntosh Power Plant used 4.79 mgd (210 L/s). The remainder was combined with 1.85 blowdown water from the McIntosh Power Plant and sent to the 1,400-ac (570 ha) wetland treatment system. TECO has agreed to use approximately 5 mgd (220 L/s) from the wetland treatment system, which is currently being discharged to the Alafia River and ultimately Tampa Bay. TECO's use of the reclaimed water will offset groundwater use and reduce nitrogen loading to Tampa Bay.

The second source of reclaimed water is the Polk County Southwest Regional WWTP. A separate transmission main will be constructed from the WWTP to connect to the transmission main being constructed from the Lakeland wetland treatment system to the Polk Power Station. It is anticipated that Polk County will initially provide 1 mgd (44 L/s) for use at the Polk Power Station, reclaimed water flows could increase to 2 mgd (90 L/s) by 2030 as wastewater flows continue to increase.

The third source is from the city of Mulberry, with approximately 0.5 mgd (22 L/s) of reclaimed water initially being provided from its WWTP for use at the Polk Power Station. Similar to the Polk County portion of the project, a separate transmission main will be constructed from the Mulberry WWTP and connected to the transmission main from the Lakeland wetland treatment system to the Polk Power Station.

Water Quality Standards and Treatment Technology

Water from Lakeland and Mulberry meets advanced waste treatment standards required for surface water discharge (Section 403.086, F.S.). In addition to high

level disinfection, the following is required on an annual average basis:

- biochemical oxygen demand (BOD) less than 5 mg/L
- total suspended solids (TSS) less than 5 mg/L
- Total nitrogen less than 3 mg/L
- Total phosphorus less than 1 mg/L

Project Funding and Management Practices

The project is possible, in part, from funding allocated by SWFWMD through its Cooperative Funding Initiative program. The district and TECO entered into an agreement in 2009 for design and construction of approximately 15 miles (24 km) of reclaimed water transmission main, a pump station, and additional treatment. The anticipated cost is \$72.7 million, and SWFWMD has been requested to reimburse TECO for up to half the cost. Because this project is a component of the West-Central Florida Water Restoration Action Plan, an implementation plan for components of the SWUCA Recovery Strategy, additional funding in the amount of \$3.3 million has been allocated from the state. The project is under way and construction is expected to be complete in 2014.

TECO and the city of Lakeland have entered into a 30-year service agreement for delivery of reclaimed water, which was also a condition of the water use permit issued by SWFWMD to the city of Lakeland. As a result, the district was able to issue a 20-year water use permit to Lakeland. This is significant because SWFWMD has generally not issued 20-year water use permits for traditional sources in stressed water resource areas such as the SWUCA. This set the stage for a 20-year water use permit to also be issued to Polk County for its Southwest Regional Utility Service Area.

Successes and Lessons Learned

The RRWPI has resulted in a public-private partnership enabling TECO to continue plans for expansion at its Polk Power Station, while reducing its reliance on groundwater for cooling. Reclaimed water that will be used will no longer be discharged to surface waters, also benefiting Tampa Bay by

reducing nitrogen loading. Maximizing the beneficial use of reclaimed water ensures that the water resources of the SWUCA can continue to recover. Most importantly, the RRWPI has provided opportunity for the partners, and other stakeholders, to identify uses for reclaimed water that can offset use of limited groundwater supplies, allowing the recovery of the resource, while meeting growing water needs.

References

Florida Department of Environmental Protection. 2010. *2010 Reuse Inventory*.

Florida Statutes. Section 403.086 (4).

Southwest Florida Water Management District. 2006. *Southern Water Use Caution Area Recovery Strategy*.

The City of Altamonte Springs: Quantifying the Benefits of Water Reuse

Author: David Ammerman, P.E. (AECOM)

US-FL-Altamonte Springs

Reclaimed Water and Potable Water

Potable water systems experience demands for drinking water, car washing, irrigation, and many other uses. Design of potable water delivery systems are also subject to fire flow requirements, which provide capacity in excess of routine water demands. This collection of uses and design requirements dilutes the impact of any one use on seasonal and diurnal patterns associated with that demand; the opposite is often true of reclaimed water systems. In many nonpotable reclamation systems, reclaimed water is used almost exclusively for irrigation and influences of irrigation on hourly, daily, and monthly demands dominate in these systems.

A second, important difference between potable and reclaimed water supplies is the nature of the source. In Florida, most utilities derive potable water from groundwater sources that are vast with respect to the short-term water supply demands. Reclaimed water supplies, on the other hand, are limited to wastewater

flows on a given day. To complicate matters, wastewater flows vary considerably throughout a day and on an annual basis, and these variations are often opposite of variations in irrigation demands.

A 5-year historical water-use record for the City of Altamonte Springs in central Florida (**Figure 1**) shows seasonal peaks and valleys typical of municipal water demands in the area. However, unlike most cities, Altamonte Springs operates an extensive urban reuse system and can track water uses by source. The blue area at the base of the bar chart reflects average monthly potable water demands. Because a majority of the city has reclaimed water available for outside uses, it is reasonable to assume that potable water use that remains is primarily within homes and commercial units. The purple area indicates reclaimed water flows from the city's water reclamation facility into a dual distribution system for use as irrigation. In addition to these two local sources, the city has found it necessary to augment its reclaimed water system in

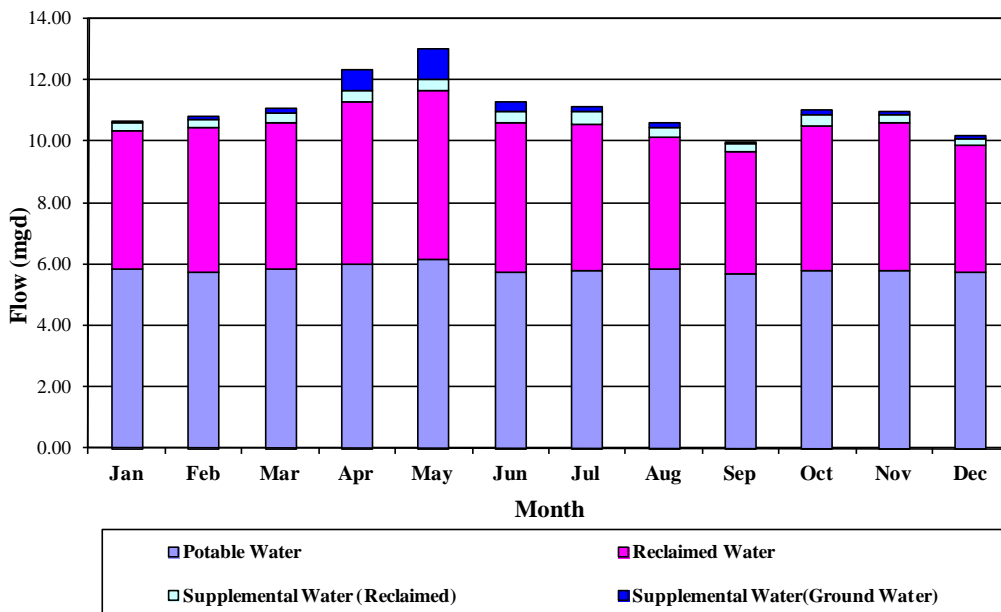

Figure 1
Average monthly water use by source

periods of peak irrigation demand to avoid shortages. The supplemental water sources include reclaimed water from a neighboring utility, raw groundwater supplies, and surface water.

It is worth considering the variability in potable and reclaimed water demands in the City of Altamonte Springs in more detail. Overlays the 5-year average monthly demands for both potable and reclaimed water are provided in **Figure 2**. It is apparent that seasonal variability in potable water demands is less than that in the reclaimed water system, suggesting that implementation of an urban reuse system has been successful in transferring seasonal variations in water demands associated with irrigation from the potable water system to the reclaimed water system. Undoubtedly, this has resulted in a reduction in the maximum-day and peak-hour demands for potable water, which in theory could be translated into reducing the design criteria used for max day water treatment capacity and peak-hour pumping facilities.

Conservation of Potable Supplies

Given the time, effort, and expense of implementing dual distribution projects, consideration for the expected gains is warranted. How well do these systems work in reducing the use of potable water?

Potable water use in Altamonte Springs, from 1975 to 2010, (**Figure 3**) shows a continuous increase until 1989; the decline in potable demands, despite continued population growth corresponds to implementation of the dual distribution system. The continued decline in demand correlates to expansion

of the system. The city has also implemented a conservation program and by 2010, potable water demands were back to 1979 levels, such that the per capita use of potable water is currently 30 percent less than prior to construction of the reuse system. Concurrently, the city was able to reduce the volume of effluent discharged to surface waters to approximately 20 percent of their flows.

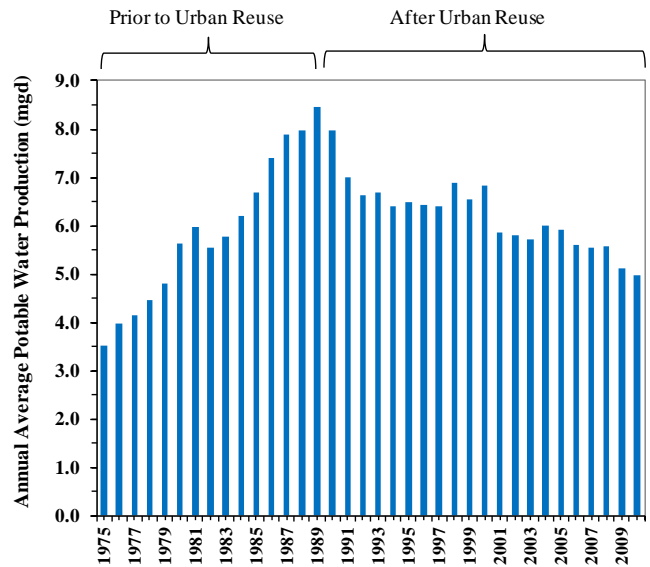

Figure 3
Potable water use

Lessons Learned

Implementation of a dual distribution system within the City of Altamonte Springs has allowed the city's potable water demand to reach levels last seen in 1979, despite an increase in population. The use of a dual distribution system has resulted in the reclaimed water system bearing the majority of the seasonal variations in demand, which could theoretically result in reduced design criteria.

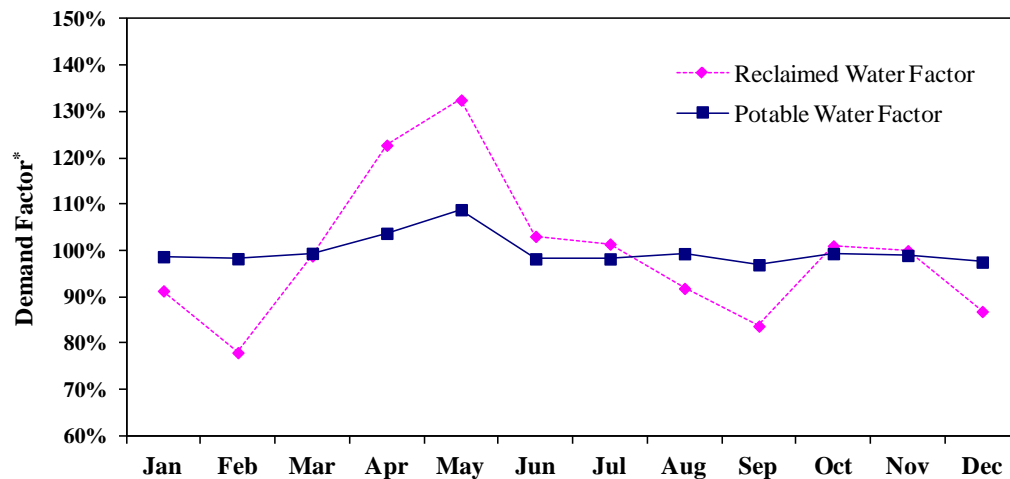

Figure 2
Comparison of seasonal variations in reclaimed and potable water demands

Evolution of the City of Clearwater's Integrated Water Management Strategy

Authors: Laura Davis Cameron, BSBM; Tracy Mercer, MBA; Nan Bennett, P.E.; and Rob Fahey, P.E. (City of Clearwater Public Utilities)

US-FL-Clearwater

Project Background

Clearwater, a coastal Florida city straddled by Tampa Bay and the Gulf of Mexico, distributes potable drinking water to more than 110,000 residents and nearly 800,000 visitors annually (Clearwater, 2007). As a coastal Florida city, only about 33 percent of the potable water demand, which was 11 mgd (480 L/s) in 2010, can be met with local sources; excess demand is met by importing water from surrounding counties, and purchases from some sources are at a high rate. The excess demand is purchased and imported at a higher rate from Pinellas County.

Clearwater realized the need to decrease water demand through conservation and use of reclaimed water, which also reduces treated wastewater effluent discharge to local surface waters. Education and incentive programs sparked the genesis of Clearwater's conservation plan, which included low-flow toilet rebates, high-efficiency shower heads, and faucets. Education moved to 5th grade classrooms, where students learned about conservation and brought home conservation devices for family use. This multi-level water use and conservation plan was the beginning of Clearwater's Integrated Water Management Strategy (IWMS), formally adopted in 2007 with specific goals:

- Conserve limited water supplies
- Preserve drinking water source
- Produce more drinking water locally
- Protect coastal environment
- Manage the rising cost of potable water

The prelude to the program, which began in 1990, provided reclaimed water to local golf courses for irrigation. Initially, these users were not charged but later, a bulk rate was established, and a metered bulk rate was created for larger, interruptible customers. In 1998, residential customers were added. Expansion

strategies to retrofit areas of high potable water irrigation demand (500 gpd [1.9 m³/d] or higher) were included in the Reclaimed Water Master Plan. Addition of residential projects and interconnection of the city's three wastewater treatment plants provides a city-wide system serving over 3,000 metered accounts.

Expansion of the Reclaimed Water System

As part of the IWMS, Clearwater is expanding use of reverse osmosis (RO) technology and considering groundwater recharge (GWR), a form of indirect potable reuse (IPR). The GWR project includes construction of a water purification plant on the WRF site to supply 3 mgd (131 L/s) of highly treated water to recharge the Floridian Aquifer. Clearwater's GWR project is now in pilot demonstration to optimize treatment and verify groundwater injection. Conditions are favorable to support GWR and additional withdrawal of groundwater for potable use in the future. GWR's further benefits to the IWMS are projected as increasing permitted raw water supply, reducing bulk potable water purchases, reducing surface water discharges, and complying with total maximum daily load (TMDL) requirements and improving sustainability of the water resources.

Clearwater prides itself in its holistic view of water resources and technologies, both traditional and advanced, from wells to purchased water, conventional treatments to reverse osmosis, and reclaimed to potable reuse utilizing groundwater replenishment. **Figure 1** illustrates the reduction in potable water demand over the past 2 decades due to conservation, education, and IWMS steps. Clearwater hopes to continue this trend in potable water use reduction.

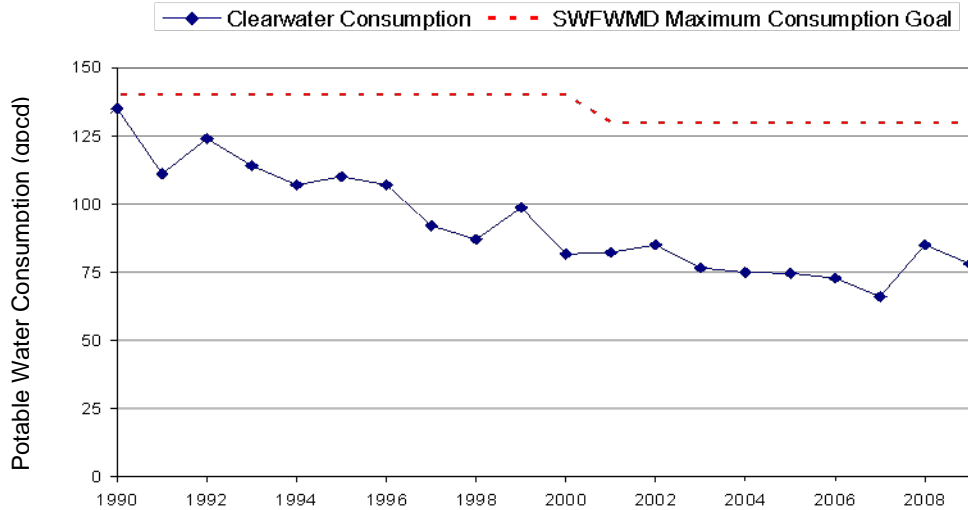

Figure 1
Potable water consumption compared to District goals

Public engagement is critical as Clearwater implements its IWMS plan. A Community Partnership Program, launched in 2008, includes communication with leaders in business, civic groups, and other community stakeholders. Clearwater Public Utilities also chairs meetings with local municipalities’ utility leaders to discuss regulations, technologies, and other issues.

Capacity and Type of Reuse Application

Clearwater is built-out with minimal growth reflected by a flat water demand; **Figure 2** shows the proportion of total potable demand eliminated by the use of reclaimed water.

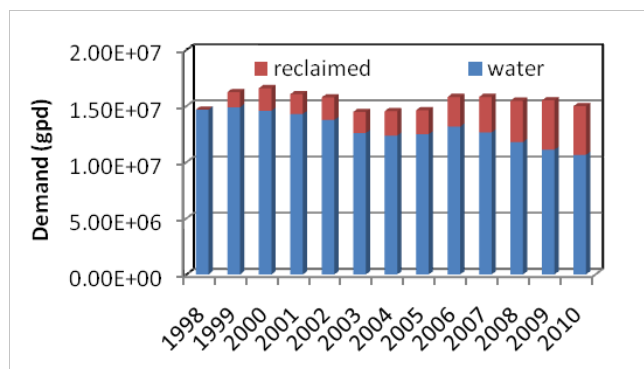

Figure 2
Total water demand

Project Funding

IWMS considers all water resources, and funding has been derived from rate payers and cooperative grants from the Southwest Florida Water Management District for infrastructure. From 1998 and projected through 2014, infrastructure costs are expected to be \$56.7 million. Wellfield expansion is \$6 million, water treatment plant upgrades will be \$46.7 million, and GWR will cost \$29 million in capital improvement costs; all are slated for 50 percent grant funding.

Successes and Lessons Learned

Expansion of the reclaimed water system was based upon a cost-benefit ratio determined by weighing the cost to bring water to a certain geographic area compared to how much reclaimed water use could be expected. The more lushly landscaped neighborhoods ranked highly as well as coastal areas that had limited availability to fresh well water. As an incentive to connect and utilize the reclaimed water system, an availability charge was added to the utility bill of those properties that had opted to not connect to the reclaimed water system after completion of construction in their service area.

The city had to overcome a conflict in its ordinance, allowing private well owners and those irrigating from lakes and ponds to be exempt from the reclaimed water system. As the master plan moved inland from coastal neighborhood service areas, the number of well owners increased, and the payback period would have made some projects unsuccessful had the old

ordinance remained. A modification was made in response to the definition and implementation of the IWMS. The strategy outlines the hydrologic cycle and illustrates that well owners draw from either the surficial or the Floridian aquifer, which is the same source that provides the city with its drinking water. Thus, if lower quality water is available for irrigation, it should be used first, allowing for best use of local drinking water resources.

References

City of Clearwater, 2007. Clearwater's Integrated Water Management Strategy. Clearwater Public Utilities, 1650 N. Arcturas Ave., Bldg C, Clearwater, FL 33765.

Assessing Contaminants of Emerging Concern (CECs) in Cooling Tower Drift

Authors: James P. Laurenson (HEAC) and Edward L. Carr (ICF International)

US-FL-Turkey Point

Background

One of the primary industrial uses of reclaimed water is for recirculating evaporative wet cooling at electric power generation plants. With power generation expected to increase by about 18 percent in the United States and close to 70 percent globally between 2012 to 2035 (EIA, 2011), the use of reclaimed water is expected to increase as fresh water supplies for cooling declines.

Wet cooling at power plants typically results in the majority of cooling water leaving the plant via evaporation and aerosolization, often collectively known as drift. Drift, and any associated microorganisms, particulate matter (PM), or chemicals, can be inhaled by plant workers and the public. Other exposures might occur, such as through dermal contact or ingestion, but inhalation is expected to be the dominant exposure pathway. If exposure is greater than health-based thresholds, such as minimum infective doses for pathogens, PM standards, or minimal risk levels (MRLs) for chemicals, then risks could be considered significant and require mitigation through additional treatment or greater setback distances from the towers. While considerable attention in recent years has been given to the risks and mitigations related to microorganisms and PM levels in cooling tower drift at power plants, less attention has been given to contaminants of emerging concern (CECs), which are present in reclaimed water.

Capacity and Type of Reuse Application

Florida Power & Light Company (FPL) and Miami-Dade County (MDC) have been collaborating on an agreement to use reclaimed water as the primary supply for cooling for two new nuclear power units (Units 6 and 7) that are proposed for completion in 2023 at the Turkey Point, Fla., facility (FPL, 2011). The reclaimed water also would be used for cooling an existing natural gas combined-cycle steam electric generating unit (Unit 5) that currently uses

groundwater for cooling. Saltwater from Biscayne Bay would provide a backup cooling water supply for all three units. Waste heat would be dissipated by mechanical draft cooling towers. Draw-down (blowdown) wastewater from these towers would be discharged through the use of deep injection wells to the lower Floridan aquifer.

The use of reclaimed water at Units 5, 6, and 7 would be in addition to the current primary cooling system in place for existing units. The current system is a closed-loop set of approximately 5,900 ac (2,390 ha) of canals used for two natural gas/oil steam electric generating units (Units 1 and 2) and two existing nuclear units (Units 3 and 4). Because the canals are not lined, groundwater flow interacts with the hypersaline water in the canals, which has become a source of concern for this ecologically sensitive area within the Everglades watershed. Further, as part of a broader water resources management plan, MDC must increase its use of reclaimed water to more than 170 mgd (7450 L/s) by 2025. Thus, an MDC resolution was passed that prevents FPL from applying for any water withdrawals from the Biscayne aquifer and encourages the use of reclaimed water.

As part of the Environmental Impact Statement (EIS) being developed by the Nuclear Regulatory Commission (NRC) for the application process, the impact of the reclaimed water on the environment and human health is being assessed (NRC, n.d.). One area of concern highlighted by public comments is inhalation of cooling tower drift by workers and the public (NRC, 2010).

Water Quality Standards and Treatment Technology

Under the current plan, MDC would produce and deliver up to 90 mgd (3940 L/s), or 75 mgd (3290 L/s) on average, of reclaimed water to Turkey Point (FPS, 2011). The reclaimed water would be treated using high-level disinfection in accordance with Florida Department of Environmental Protection (FDEP)

regulations (Florida Administrative Code 62-610.668). Reclaimed water would be conveyed 9 mi (14 km) via pipelines from to the Turkey Point plant property where an onsite FPL treatment facility would further treat reclaimed water to reduce iron, magnesium, oil and grease, total suspended solids, nutrients, and silica to suitable concentrations for the circulating water system.

For each of the two proposed nuclear power units, the cooling system would consist of three mechanical draft cooling towers and an open channel (flume) with a pump intake structure. Heated cooling water would flow through return piping to the mechanical draft cooling towers where heated cooling water would be circulated and heat would be transferred to the ambient air via evaporative cooling and conduction. After passing through the cooling tower, the cooled water would collect in the tower basin and be pumped back to the power unit, completing the closed cycle cooling water loop.

Makeup water from the FPL reclaimed water treatment facility would compensate for water losses during plant operation from drift and blowdown. Six circulating water cooling towers for Units 6 and 7, plus the existing Unit 5 towers, are estimated to result in evaporation and aerosol water losses of approximately 50 mgd (2190 L/s) during normal plant operation, or approximately 67 percent of the makeup water.

Exposure Modeling

An Environmental Report (ER), often used as a reference for developing an EIS, has been developed for Turkey Point (FPL, 2011). In the ER, the EPA CALPUFF and AERMOD dispersion models were used to evaluate cooling tower plume behavior. Five years (2001 through 2005) of hourly meteorological data from the Miami International Airport were used, along with physical and performance characteristics of the mechanical draft cooling towers. In the current version of the ER, CEC exposure has not been assessed, in large part because the additional treatment that FPL will apply to the reclaimed has yet to be fully designed. In the meantime, NRC is examining as a surrogate analysis the expected salt deposition described in the ER for the scenario whereby saltwater from Biscayne bay would be used as a backup cooling water source for Units 6 and 7. **Figure 1** illustrates the predicted salt deposition near the plant when these units would be using salt water

only. Non-volatile CECs thus also are likely to be deposited in a similar fashion, i.e., with the majority of deposition occurring in the immediate vicinity of the cooling towers. Screening level modeling of CECs exposure is being conducted by NRC and will become publicly available when the draft EIS is published in the near future.



Figure 1
 Surrogate for CECs deposition: predicted monthly salt deposition from use of only Biscayne Bay water for backup cooling (Photo credit: FPL, 2011)

References

Energy Information Administration (EIA). 2011. International Energy Outlook 2011. Retrieved on April 2, 2012 from <<http://www.eia.doe.gov/oiaf/ieo/electricity.html>>.

Florida Power & Light (FPL). 2011. Turkey Point Plant, Units 6 & 7, COL Application, Part 3, Environmental Report. Retrieved on March 25, 2012 from <<http://pbadupws.nrc.gov/docs/ML1136/ML11362A171.html>>.

U.S. Nuclear Regulatory Commission (NRC). n.d. Turkey Point, Units 6 and 7 Application. Retrieved on Sept. 5, 2012 from <<http://www.nrc.gov/reactors/new-reactors/col/turkey-point.html>>.

U.S. Nuclear Regulatory Commission (NRC). 2010. Environmental Impact Statement Scoping Process, Summary Report. Retrieved on March 25, 2012 from <<http://pbadupws.nrc.gov/docs/ML1031/ML103130609.html>>.

Sustainable Water Reclamation Using Constructed Wetlands: The Clayton County Water Authority Success Story

Authors: Veronica Jarrin, P.E. and Jim Bays, P.W.S (CH2M HILL); Jim Poff (Clayton County Water Authority)

US-GA-Clayton County

Project Background

The key water management challenges in Arizona are increasing demands for water, fully allocated existing water resources, and groundwater depletion. Groundwater depletion, or overdraft, is a result of excessive groundwater pumping and is problematic for numerous reasons, including its environmental impacts. Groundwater sustains rivers, streams, lakes, and wetlands providing the riparian habitat for wildlife. In the 19th century, wetlands, marshlands or cienegas, were common along rivers in Arizona; however, heavy pumping of groundwater beginning in the mid-20th century led to dewatered rivers and streams and loss of riparian ecosystems (Glennon, 2002).

Just south of Atlanta, Georgia, the Clayton County Water Authority (CCWA) provides water, sewer, and stormwater services to more than 280,000 county residents and portions of adjacent counties. Since its creation in 1955, CCWA's need for water supply and wastewater treatment has increased steadily with population growth, despite limitations on water supply and the assimilative capacity of the small local streams. CCWA began water reuse in the 1970s when a land application system (LAS) was selected as a way to increase water supplies for its growing population while minimizing the stream impact of wastewater discharges.

CCWA operated two LASs for almost 30 years as the County matured into a densely developed urbanized area. In response to the need for additional wastewater treatment capacity and as part of CCWA's master planning process, numerous wastewater treatment alternatives were evaluated. With their consultant, CCWA reviewed existing treatment wetlands in Georgia (Inman et al. 2001) and identified constructed wetlands as the most reliable and sustainable option for both treatment and water supply augmentation (Inman et al., 2000).

CCWA constructed its first wetland reuse system in the southern end of the county. The Shoal Creek LAS was converted into a series of treatment wetlands (Panhandle Road Constructed Wetlands, **Figure 1**) and the existing wastewater treatment plant was replaced with an advanced, biological treatment plant (Inman et al., 2003). Following this success, CCWA began developing a larger wetlands complex on the E.L. Huie Jr. Site (**Figure 2**). Wetland construction was phased with portions of the existing LAS taken out of service and replaced with wetlands.



Figure 1
The Panhandle Road Constructed Wetlands (Photo credit: Aerial Innovations of Georgia, Inc.)



Figure 2
The E.L. Huie Constructed Wetlands (Photo credit: Aerial Innovations of Georgia, Inc.)

Capacity and Type of Reuse Application

The wetlands consist of a series of interconnected, shallow ponds planted with native vegetation. The cells follow the site topography to allow water to flow passively through the wetlands by gravity. Even though a portion of the water in the wetlands is expected to infiltrate into the groundwater supply, the vast majority flows into two of CCWA's water supply reservoirs, Shoal Creek and Blalock Reservoirs. Water typically takes 2 years under normal conditions to filter through wetlands and reservoirs before being reused; the detention time is less than a year under drought conditions (Thomas, 2005).

The Panhandle Road Constructed Wetlands consists of three multi-cell treatment trains, in parallel with a treatment capacity of 4.4 mgd (190 L/s) (CCWA, 2011). The E.L. Huie Constructed Wetlands consist of nine multi-cell treatment trains built in four phases with a total treatment capacity of 17.4 mgd (760 L/s) (Table 1).

Table 1 Characteristics of constructed wetland systems

| System | Date | Sites | Wet Area (ac) | Capacity (mgd) | Total Capacity (mgd) |
|-------------------------------------|------|-----------------------|---------------|----------------|----------------------|
| Panhandle Road Constructed Wetlands | 2002 | North, Central, South | 53 | 4.4 | 4.4 |
| E.L. Huie Constructed Wetlands | 2005 | G | 54 | 3.5 | 17.4 |
| | 2006 | D, E, F | 40 | 2.6 | |
| | 2007 | B, C, H, I | 47 | 3.2 | |
| | 2010 | A | 123 | 8.1 | |

Water Quality Standards

Both wetland systems polish highly treated effluent from primary and secondary wastewater treatment facilities that include nutrient removal followed by disinfection. These treatment processes provide a multiple-barrier approach to water reclamation and enhance the removal of nutrients, microbial contaminants, and other trace organic compounds, providing a safe and secure supply of water. In addition, the constructed wetlands buffer the reservoirs in the unlikely event of a treatment plant upset.

A National Pollutant Discharge Elimination System (NPDES) permit was received for the constructed wetlands following an extensive review and approval process through the Georgia Department of Natural Resources (GAEPD, 2002). The first step in the

process was for the Georgia Environmental Protection Division to set discharge limits by determining the allowable pollutant application to the wetlands. Both systems are required to comply with the waste load allocations established in their NPDES permit. These systems have proven to exceed their treatment expectations and effluent quality (Table 2).

Table 2 NPDES discharge limits

| Parameter | Panhandle Road Constructed Wetlands | | E.L. Huie Constructed Wetlands | |
|--------------------|-------------------------------------|----------------------------|--------------------------------|----------------------------|
| | Limit (mg/L) | Actual ³ (mg/L) | Limit (mg/L) | Actual ³ (mg/L) |
| Flow (MGD) | monitor only | 1.35 | monitor only | 14.45 |
| BOD ₅ | 10/15 ¹ | 1 | 10/15 ¹ | 3 |
| TSS | 30/45 ¹ | 4 | 15/22.5 ¹ | 5 |
| NH ₃ -N | 4/6 ¹ (May-Oct.) | 0.03 | 1.4/2.1 ¹ | 0.06 |
| | 8/12 ¹ (Nov.-Apr.) | | | |
| TP | 2/3 ¹ | 0.59 | 0.6 ² | 0.24 |

¹ Monthly/weekly averages
² Annual average monitored only at the lake discharge
³ Average effluent data for 2011

With the completion of the largest phase of constructed wetlands in the fall of 2010, CCWA is able to recycle as much as 65 percent of daily water use into their existing reservoirs. This system augments CCWA's water supply and reduces the need to withdraw water from the small streams that flow out of the county. During Georgia's second worst drought on record, this system sustained raw water reserves at 77 percent of capacity or greater. CCWA also has documented reductions in micro-constituents such as pharmaceuticals, hormones, and pesticides (CCWA, 2011).

Funding and Management Practices

CCWA's innovative water supply system and watershed protection program have required a significant commitment of resources. CCWA built the wetland system on land first purchased for the LAS in the late 1970s. Funding for the land purchase and construction of the LAS was primarily through the Federal Construction Grants program, under the Clean Water Act. Wetland cells were built using low-interest loans from State Revolving Funds, bonds, and rate payer revenue. Approximately four cents of every dollar collected for water and sewer service is set

aside for watershed protection (American Rivers, 2009).

The transition from LAS to wetlands has saved energy costs through reduced pumping. The wetlands system is less expensive to maintain and operate and has allowed CCWA to reduce maintenance staff, equipment, and materials. Rather than maintaining miles of irrigation pipes and numerous valves and pumps, routine maintenance consists primarily of checking hydraulics and vegetation management.

Successes and Lessons Learned

CCWA has been recognized as one of the most innovative and well-managed utilities in the southeastern United States. Most recently, the American Academy of Environmental Engineers awarded CCWA's wetlands projects the "Excellence in Environmental Engineering" award for environmental stewardship. This approach to total water management has demonstrated that a sustainable water supply can be developed for a dense urban area where fluctuations in rainfall and water supply are common (Patwardhan, et. al, 2007). The wetlands treatment system and indirect reuse program have lowered CCWA's need for additional reservoir storage and water withdrawals.

The constructed wetlands have proven to require much less land, energy, and maintenance than the irrigation systems while sustainably using natural systems for water reclamation. Environmental benefits include CCWA's use of the constructed wetlands facilities as an educational tool for customers to explain the importance of protecting water resources. CCWA was recognized by American Rivers as one of America's "Water Smart" communities in 2009 and has received many awards for operations and innovation (CCWA and CH2M HILL, 2011).

This project is also an example of publicly accepted indirect potable reuse. CCWA has been polishing treated wastewater using natural treatment systems for more than 30 years and has actively communicated the wetlands reuse plan to the community. CCWA uses the constructed wetlands as an educational tool for customers to explain the importance of protecting water resources and hosts numerous community events. The wetlands also support the goals of land conservation. CCWA currently manages a wetlands education center that is open to the public to provide

its customer base with information about how CCWA incorporates total water management in its day-to-day operations.

References

- American Rivers. 2009. *Natural Security: How sustainable water strategies are preparing communities for a changing climate*. Retrieved on Sept. 5, 2012 from <<http://www.americanrivers.org/library/reports-publications/natural-security-report-pubs.html>>.
- CCWA. 2011. *Unpublished monitoring data 2009-2011*.
- CCWA and CH2M HILL. 2011. *Clayton County Water Authority Sustainable Water Supply Project*. Entry for Excellence in Environmental Engineering American Academy of Environmental Engineers.
- CCWA. *Water Reclamation*. Retrieved on May 7, 2012 from <<http://www.ccwa.us/water-reclamation>>.
- Georgia Environmental Protection Division. (GAEPD). 2002. *Guidelines for constructed wetlands municipal wastewater treatment facilities*.
- Inman, B.L., M. Thomas, and J. Kirk. 2003: *Construction and Startup of Treatment Wetlands on a Sloping Site*. Proceedings of the Water Environment Federation (WEFTEC). Session 31 through Session 40, pp. 391-391(1).
- Inman, B.L.; J. Kirk. S. Eakin, J. Bays, M. Thomas, L. Philpot, Lonnie; B. Knight, R. Clarke. 2001. *Review of Georgia's Constructed Treatment Wetlands and Their Performance*. Proceedings of WEFTEC: Session 11 through Session 20, pp. 621-632(12).
- Inman, Brad L.; M. Thomas, R.L. Knight. 2000. *Maximizing Treatment Capacity with Natural Systems*. Proceedings of WEFTEC: Session 11 through Session 20, pp. 283-301(19).
- Patwardhan, A.S., D. Baughman, A. Tyagi, and J. Thorpe. 2007. *Developing and Implementing a TWM Strategy – Approaches and Examples*. *Journal AWWA*, 99, (2), 64-75.
- Thomas, M. 2005. *Sustainable water resources management by Georgia utilities: Clayton County Water Authority*. Proceedings of the 2005 Georgia Water Resources Conference, Athens, Georgia. April 25-27, 2005.

On the Front Lines of a Water War, Reclaimed Water Plays a Big Role in Forsyth County, Georgia

Author: Daniel E. Johnson, P.E. (CDM Smith)

US-GA-Forsyth County

Project Background or Rationale

Forsyth County, Ga., lies on the west bank of one of the most controversial bodies of water in the country—Lake Lanier. Since 1989, Lake Lanier has ridden the front lines of the battle between Georgia, Alabama, and Florida dubbed the “Water Wars.” Lake Lanier is the uppermost of four major water bodies along the Chattahoochee River system that runs from the North Georgia Mountains, through Atlanta and Columbus, Ga., the Florida panhandle, and eventually discharging to the Gulf of Mexico. Given that over three million people in Atlanta currently rely on Lake Lanier as a source for drinking water, and the fact that this number is expected to grow by 55 percent by 2035, downstream users are fighting to maintain flows in the rivers. The U.S. Army Corps of Engineers (USACE), who controls the lake system, has temporarily placed a cap on new water withdrawals from Lake Lanier until the legal fight has run its course.

The Forsyth County Department of Water and Sewer currently serves over 46,000 water customers and completely relies on raw or purchased water from neighboring utilities. The county has repeatedly requested a USACE surface water withdrawal from Lake Lanier and been denied each time. Throughout the 2000’s Forsyth County has maintained its status as one of the top 5 fastest growing counties in the nation having grown from a population of 98,367 in 2000 to 175,511 in 2010. In order to meet the growing water demands for an ever increasing population, the county evaluated alternatives for water supply including increased water conservation and reuse.

In the late 1990’s Forsyth County realized it needed a centralized wastewater treatment plant to support rapid development and the projected growth. During the planning phase, the county understood the value that reclaimed water could play with respect to minimizing its potable water demand. The county embarked on design and construction of one of the first membrane facilities in Georgia. In addition to the new facility, a reclaimed water pipeline leading to a

land application system was constructed. In 2004, Forsyth County completed construction of the Fowler Water Reclamation Facility (WRF) and reclaimed water pipeline. Soon after startup, the county implemented a reuse program that included construction standards, public information, and applications and end user agreements for connecting to the system. Today, Forsyth County serves 16 major end users with reclaimed water including several parks, schools, shopping centers, golf courses, a bus wash facility, neighborhood green space, and a rock quarry.

In 2011, Forsyth County purchased the James Creek WRF whose reuse quality effluent is also discharged into the common 20-in (50-cm) distribution main. With connection of the James Creek WRF an additional 1 mgd (44 L/s) of capacity was added to the reclaimed water system.

Reclaimed Water Use and Climate

Reclaimed water has been widely accepted within the community with little to no opposition. Local residents are intimately familiar with the value of water, having suffered through two severe droughts during the 2000’s when the state ordered a ban on all outdoor water use. Generally, the metro Atlanta area receives over 50 in (127 cm) of rainfall per year. With such a high average rainfall, most communities are adorned with lush hydrophilic landscapes. When the outdoor watering bans were implemented, the interest in reuse increased.

During the summer months, Forsyth County distributes approximately 700,000 gallons (2,650 m³) of reclaimed water per day, but this is reduced to less than 20,000 gallons (76 m³) per day during the winter months. Up to 100 percent of the reclaimed water is distributed to end users during summer month peak demands, thus Forsyth County is limited in the number of end users that it can serve until it receives additional wastewater from new development.

Capacity and Type of Reuse Application

The Fowler WRF current capacity to produce reclaimed water is 1.25 mgd (55 L/s) with a permit to upgrade the facility to 2.50 mgd (110 L/s) with the installation of additional membranes. The reclaimed distribution system pumps treated effluent from a 6 million gallon (22,700 m³) ground storage tank through the 20-in (50-cm) pipeline to its end at a land application field where any unused reclaimed water is discharged. The 16 end user connections are scattered along the 11 mile pipeline route. The system is designed to maintain a minimum pressure of 20 psi (140 kPa) at the high point of the pipeline.

Reclaimed water in Forsyth County is generally supplied for irrigation however the school system utilizes reclaimed water for bus washing. Additionally, hydrants are provided in multiple locations for contractor use in dust control, paving, hydro seeding, etc.

Water Quality Standards and Treatment Technology

In Georgia, reclaimed water must undergo secondary treatment (30 mg/L BOD₅ and 30 mg/L TSS) followed by coagulation, filtration and disinfection, or equivalent treatment. The reclaimed water treatment criteria are summarized in **Table 1**.

Table 1 Georgia reclaimed water treatment criteria

| Parameter | Criteria |
|------------------|---|
| BOD ₅ | ≤ 5 mg/L |
| TSS | ≤ 5 mg/L |
| Fecal Coliform | ≤ 23 cfu/100mL monthly geometric mean, 100 cfu/100mL maximum per sample |
| pH | 6-9 standard units |
| Turbidity | ≤ 2 NTU |

The Fowler WRF utilizes hollow fiber membrane filtration and UV disinfection to achieve reuse quality effluent. The James Creek WRF utilizes flat plate membrane filtration and UV disinfection.

Project Funding and Management Practices

Forsyth County constructed the Fowler WRF and 20-inch reuse pipeline with revenue bonds. The County sells reclaimed water for \$1.75/1,000 gallons (\$0.45/m³), equivalent to half the potable rate, which it uses to repay its debt in conjunction with its water and

sewer fees. Forsyth County has a designated representative from the water and sewer department in charge of managing end user accounts, providing public education to end users, overseeing system operations and performing cross-connection testing.

Institutional/Cultural Considerations

The public education program includes an in-person learning session after which the end user is required to satisfactorily pass a 20-question application test prior to connecting to the system. Open house style public information sessions have not been needed as the public is generally in favor of the reuse program.

Successes and Lessons Learned

The key factors for success for this project included the early considerations for sufficient reclaimed water storage to handle peak demands and the installation of infrastructure sized for the future growth of the system.

A few lessons have been learned from the management of a reclaimed water system. First, when connecting any new user to the system, a cross-connection test should always be performed by the utility. Cross-connection tests should also be performed by the end user on an annual basis. Second, consideration should be made to maintain a minimum pressure in the distribution main to meet pressure requirements of an irrigation system. Otherwise, end users will require a booster pump station to increase system pressures.

References

Georgia Environmental Protection Division. *Guidelines for Water Reclamation and Urban Water Reuse*. 2002.

Atlanta Regional Commission website. 2011. Accessed on Sept. 5, 2012 at <<http://www.atlantaregional.com/>>.

Georgia Water Council, Georgia Comprehensive State-wide Water Management Plan, 2008.

Recovery and Reuse of Beverage Process Water

Authors: Dnyanesh V. Darshane, PhD, MBA; Jocelyn L. Gadson, PMP; Chester J. Wojna; Joel A. Rosenfield, Henry Chin, PhD; Paul Bowen, PhD (The Coca-Cola Company)

US-GA-Coca Cola

Project Background or Rationale

In the face of increased water scarcity, water costs, growth projections, and other drivers, Coca-Cola bottling plants sought to further improve their water use efficiency. This led to the pursuit of a scientifically rigorous, widely applicable water recovery and reuse approach that could be used by virtually any of the nearly 900 bottling plants in the Coca-Cola system.

Capacity and Type of Reuse Application

Water is typically recycled for applications such as floor washing, landscape irrigation, etc. Though used for non-product activities and applications, the quality of this highly purified water enables its use for a higher degree of purpose, such as indirect potable reuse.

Water Quality Standards and Treatment Technology

The framework for this project was based on the water safety plan approach consisting of: source vulnerability assessment, source water protection plan, system design, operational monitoring, and management plans.

The system design takes beverage process wastewater and further purifies it to high standards for use in non-product applications. This process uses a combination of technologies: chemical treatment, biological treatment in a membrane bioreactor, ultrafiltration (UF), reverse osmosis (RO), ozonation, and ultraviolet (UV) disinfection. These technologies are described below.

- Secondary biological treatment.
- UF uses a pressure-driven barrier to remove suspended solids and pathogens.
- RO forces water through membranes under high pressure, removing some dissolved chemicals and other compounds to produce

water with very high purity and low total dissolved solids.

- Ozonation destroys microorganisms and oxidizes organic materials.
- Medium pressure UV light disinfects water by rendering microorganisms inactive.
- Mixed oxidant disinfection.
- Chlorination at several points, as appropriate for disinfection and oxidation.

The choice of treatment technologies would be dependent upon the characteristics of the beverage waste stream and the planned point-of-use of the water. Some of these technologies effectively remove contaminants, such as heavy metals, while others disinfect. Further, the system employed significant continuous monitoring, automation, and controls.

Two water recovery options were assessed: in-process treatment and process waste water treatment. The in-process reuse option involves the manufacturing process wastewater stream being treated and reused in the same manufacturing function before it reaches the wastewater treatment system, reducing the fresh water requirements for the manufacturing function. The wastewater stream from a given manufacturing process is sent directly to advanced treatment, bypassing the plant-wide wastewater treatment process. After passing through appropriate treatment the process waste stream is recycled back into the process from which it originated. The quality of the water meets the water standards required for the process.

In the process wastewater treatment configuration, the wastewater streams from all manufacturing processes are sent to the existing wastewater treatment system. A portion of the treated effluent is then sent through required advanced treatment steps and recycled back

to one or more manufacturing processes. This option provides the greatest quantity of reuse water because it aggregates manufacturing waste streams (but not sanitary or cafeteria waste streams) from the entire plant. **Figure 1** shows both options for in-process reuse and advanced process wastewater treatment.

Project Funding and Management Practices

On-going sustainability activities are imperative to our business and community. The Coca-Cola Company is implementing a holistic approach to water stewardship, recognizing that water must be considered in the greater context of political, societal and ecological dynamics (TCCC, 2012). Industry-sponsored guidelines for the implementation of water reuse in the beverage industry are currently in development (ILSI, 2012). Future work will include measures to reduce the overall impact of energy usage. By implementing this recycle and reuse model, The Coca-Cola Company will continue to reduce its water usage.

Successes and Lessons Learned

The highly purified water from this commercial trial consistently met internal and external regulatory standards and specifications. Samples were analyzed throughout the process treatment train to assess the efficiency and capabilities of each step of the treatment process. The quality of the final effluent water was crucial to the success of the commercial trial.

Samples at each intermediate process as well as the final effluent were tested extensively by internal and external laboratories. Analyses by the third party labs were conducted for 126 parameters, including: inorganics, synthetic organics, “semivolatile organics,” volatile organics, disinfection related chemicals (including trihalomethanes), pesticides, and microbial analysis for *E. coli*.

The analytical results of final treated water were compared to internal standards, WHO guidelines for drinking water, EPA drinking water regulations, and applicable local regulations per plant locations.

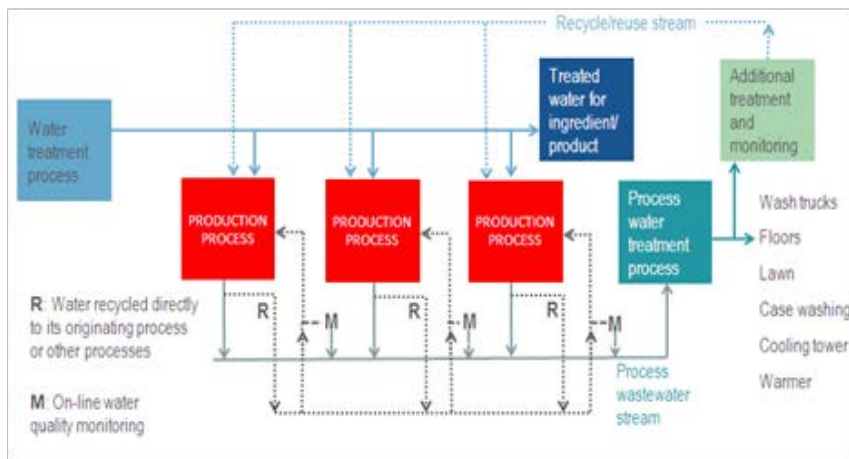

Figure 1
Water recovery schematic of The Coca-Cola Company

Meeting drinking water quality specifications was considered to be essential for much of the recovered water even though the water was only reused for non-product activities. The results (**Table 1**) comply with all parametric limits: 1) chemical, 2) microbial, and 3) operational. The analysis indicated all results were below specification limits or non-detected.

Table 1 Summary of six months of process performance indicators (sample frequency every 4 hours)

| Parameter | Internal Specification | Average | Standard Deviation |
|------------|-------------------------------|------------|--------------------|
| Alkalinity | 85 mg/mL as CaCO ₃ | 27.72 | 3.02 |
| pH | 4.9 minimum | 6.32 | 0.68 |
| TDS | 500 mg/l | 34.91 | 4.63 |
| Turbidity | 0.3 NTU | 0.11 | 0.02 |
| TOC | 0.5 mg/L | 0.17 | 0.03 |
| Color | Sensory | Acceptable | |
| Odor | Sensory | Acceptable | |

In addition to microbial analysis of the renewed water, the plant was required to assess the microbial levels at the start and end of each process step. The plant analyzed for total plate count (TPC) and coliforms; an external laboratory performed the analysis for *E. coli*. Neither coliforms, nor *E. coli* were detected in any of the samples. The results (**Table 1**) of our 6 months of monitoring process performance indicators every four hours demonstrate the effective operation of each process step of the wastewater recovery and reuse system.

The commercial trial conducted in this study successfully demonstrated the capability to recover and treat process wastewater to the highest quality

standard using a multi-barrier approach with advanced treatment technologies.

The treatment system was operationally stable and consistently produced highly purified water that met all physical, chemical, and microbial specifications. This highly purified water meets the stringent drinking water guidelines and requirements of World Health Organization, the European Union, EPA, the Coca-Cola Company, as well as local regulatory requirements for each plant location.

Reclaimed Water Use in Hawaii

Author: Elson C. Gushiken (ITC Water Management, Inc.)

US-HI-Reuse

Project Background or Rationale

Hawaii has been established a reclaimed water program over the past two decades. The program varies by county, based on specific drivers for water reuse. Hawaii has six major islands (Hawaii, Maui, Oahu, Kauai, Molokai and Lanai) and two smaller islands (Niihau and Kahoolawe) totaling 6,463 mi² (16,740 km²) that comprise an island chain stretching northwest to southeast over a zone 430 mi (706 km) long. Each island has wet areas and dry areas with great surpluses in some areas and great deficiencies in others. Historically, there has been an overall abundance of water but the challenge has been one of distribution rather than a general water shortage. The majority of Hawaii's potable water sources are groundwater. A growing population is increasing stress on the sustainability of these limited groundwater resources. Almost 70 percent of Hawaii's potable water is used to irrigate agricultural crops, golf courses, and residential and commercial landscaping.

The state of Hawaii, the city and county of Honolulu (Oahu), the county of Maui (Maui, Lanai and Molokai), the county of Kauai, and the county of Hawaii are increasing water conservation and water reuse efforts to manage and preserve potable water resources. The Hawaii State Department of Land and Natural Resources Commission on Water Resource Management, in partnership with the U.S. Army Corps of Engineers, has determined that a water conservation plan for Hawaii should be established. Reclaimed water is anticipated to be a significant contributing component of the plan's policy and program development.

Regulatory Requirements

Explosive growth in Japanese visitors to Hawaii in the 1970's and 1980's spurred a corresponding increase in resort and golf course developments. The search for nonpotable water resources for resort golf course and landscape irrigation led to many inquiries to the Hawaii State Department of Health about the availability of reclaimed water for reuse. Thus, in the early 1990's the Hawaii State Department of Health deemed the

state's existing wastewater regulations deficient in providing proper guidance for the treatment and beneficial use of reclaimed water, which led to the development of Hawaii's first reuse guidelines. The Hawaii "Guidelines for the Treatment and Use of Reclaimed Water" were issued in November 1993 and were adopted into Hawaii Administrative Rules Title 11, Chapter 62, Wastewater Systems. The guidelines were updated in May 2002 and re-titled the "Guidelines for the Treatment and Use of Recycled Water." The guidelines define three classes of recycled water as R-1, R-2, and R-3 water.

R-1 Water is the highest quality recycled water. It is treated effluent that has undergone filtration and disinfection and can be utilized for spray irrigation without restrictions on use.

R-2 Water is disinfected secondary (biologically) treated effluent. Its uses are subjected to more restrictions and controls.

R-3 Water is the lowest quality recycled water. It is undisinfected secondary treated effluent whose uses are severely limited.

Water Reuse Program

Although all six major Hawaiian Islands have reclaimed water projects, the existence or non-existence of reclaimed water programs varies by county. The county of Maui and city and county of Honolulu have committed significant resources to promote and develop their respective reclaimed water programs. The county of Kauai does not have a stated reclaimed water program. The county of Hawaii does not have a reclaimed water program.

County of Maui (Islands of Maui, Molokai and Lanai)

The county of Maui consists of three islands; Maui, Molokai, and Lanai and are located to the northwest of the Big Island of Hawaii. The county's water reuse efforts are led by its municipal wastewater agency, the Wastewater Reclamation Division. The first feasibility studies were conducted in 1990 and led to a long-term

program to reuse millions of gallons of reclaimed water, previously disposed into injection wells. The program began with passing of a mandatory reclaimed water ordinance. In 1996, the county then adopted its own County of Maui Rules for Reclaimed Water Service incorporating the State of Hawaii's Guidelines for the Treatment and Use of Recycled Water, the State of Hawaii's Water System Standards and Chapter 11-62 of the Hawaii Administrative Rules. To date, Maui County provides reclaimed water for irrigation, toilet flushing at the National Park Service, and dust control. Currently, landscape irrigation using reclaimed water occurs at five golf courses, five community parks, the elementary school, intermediate school, public library, fire station and fire system, community center, four multi-family housing units, highway shoulders and medians, a shopping center, landscape at commercial buildings, seed corn crop irrigation, green waste composting/vermiculture, and constructed wetlands.

County of Honolulu (Island of Oahu)

Honolulu is located on the Island of Oahu northwest of Maui County's Islands. The municipal drinking water agency on the Island of Oahu is the Honolulu Board of Water Supply (BWS). The Honolulu BWS expects to meet Oahu's water demands through 2030 through an integrated strategy of combining existing water system capacities, planned infrastructure improvements and watershed protection strategies. As part of Oahu's integrated water resources plan, the Honolulu BWS has taken the lead on water reuse efforts on the island. With a heavy military presence on Oahu, the various military branches, in collaboration with the state of Hawaii and the Honolulu BWS, are implementing energy and water conservation programs. In 2000, the Honolulu BWS purchased the newly completed Honouliuli Water Recycling Facility from U.S. Filter. The facility produced 12 mgd (526 L/s) of R-1 water, 10 mgd (438 L/s) designated for irrigation and 2 mgd (88 L/s) for reverse osmosis (RO) water.

Honolulu BWS incorporated into its rules and regulations that if a suitable nonpotable water supply is available, the department shall require the use of nonpotable (reclaimed) water for irrigation of large landscaped areas such as golf courses, parks, schools, cemeteries, and highways.

In 2004, the U.S. Army awarded a 50-year privatization contract for the upgrading the Schofield Wastewater Treatment Plant in order to produce R-1 water for irrigating the Schofield Army Barracks/Wheeler Army Air Field golf course, athletic fields, parade grounds and parks.

R-1 water produced at the Honouliuli Water Recycling Facility currently provides reclaimed water to numerous sites and is continually adding additional users. Existing users include nine golf courses, four community parks, municipal and state building facilities, public library, police station, highway shoulders and medians, four multi-family housing units, private college campus, shopping center, sports field, commercial landscaping, agriculture, feed for RO water for steam generation at refinery and energy facilities, and dust control at construction sites.

County of Hawaii (Island of Hawaii)

The county of Hawaii, which encompasses the Big Island (Island of Hawaii), does not currently have a water reuse program. All municipal wastewater facilities produce R-2 quality water, for permitted infiltration basin and permitted ocean outfall disposal. The use of reclaimed water on the island of Hawaii is primarily driven by private resort developments with their own wastewater treatment plants that produce R-2 water. Most reclaimed water is blended with brackish water sources and used for irrigation. The blended water is used for irrigation at six private golf courses, pasture, airport landscaping, plant nursery, sod farm, and composting.

County of Kauai (Island of Kauai)

The County of Kauai is located on the Island of Kauai, in the northwestern most island of the state. Kauai has four municipal wastewater treatment facilities (WWTFs). Although water reuse is a responsibility of the county of Kauai's Division of Wastewater Management under its Wastewater Treatment Facilities Program, the county does not have a stated reclaimed water program. Kauai's abundant surface water resources provide nonpotable irrigation water for many golf courses and agricultural operations. As such, historically, reclaimed water use on Kauai, whether derived from municipal or private WWTFs, was considered more of a convenient effluent disposal option rather than a water supply resource.

In 2011, the county's Lihue WWTF was upgraded to an R-1 facility through funding from an adjacent private resort development seeking higher quality R-1 irrigation water for golf course expansion and subdivision development. In addition, the county's Waimea WWTF located on the dryer, west side of the island is being upgraded to an R-1 facility to provide irrigation water for parks, school fields and a future golf course.

Project Funding and Management Practices

Funding for the county of Maui's R-1 water reuse program is through a combination of recycled water fees and sewer user fees. Sewer user fees pay for approximately 75 percent of program costs including debt service and operation and maintenance expenses. Fees for reclaimed water service are set in Maui County's annual budget. Reclaimed water fees are divided into three consumer classes: major agriculture, agriculture, and all others.

Most of the funding of the Kihei WWRF R-1 water production and distribution infrastructure was obtained through the State Revolving Fund program general obligation bonds.

Engineering design and physical improvements to upgrade the county of Kauai's Lihue Wastewater Treatment Facility from an R-2 to R-1 facility was borne by the owners of the existing adjacent Kauai Lagoons Golf Club resort development. The developers needed the higher quality R-1 water to spray irrigate the common landscaped areas of proposed private home developments within the resort property and the newly redesigned golf course.

Successes and Lessons Learned

Public acceptance of reclaimed water throughout Hawaii over 20 years has been very positive. This success can be largely attributed to the understanding primarily by state and municipal officials, private consultants and developers of lessons learned gleaned from the early challenges and hurdles faced by water reuse advocates in other parts of the country, especially California. Early involvement of reclaimed water stakeholders and ongoing public education has been key to Hawaii's successful reclaimed water program.

References

- Hawaii State Department of Health Wastewater Branch, *Guidelines for the Treatment and Use of Recycled Water*, May 15, 2002. Retrieved on Sept. 5, 2012 from <<http://hawaii.gov/wastewater/pdf/reuse-final.pdf>>.
- Honolulu Board of Water Supply, *Oahu Water Management Plan Overview*, May 31, 2006. Retrieved on Sept. 5, 2012 from <http://www.boardofwatersupply.com/files/03_Overview.pdf>.
- South Maui R-1 Recycled Water Verification Study, Department of Environmental Management, Wastewater Reclamation Division and Department of Water Supply, Water Resources Planning Division, December 2009. Retrieved on Sept. 5, 2012 from <<http://www.co.maui.hi.us/documents/11/28/456/South%20Maui%20R-1%20Recycled%20Water%20Verification%20Study.pdf>>.
- Central Maui R-1 Recycled Water Verification Study, Department of Environmental Management, Wastewater Reclamation Division and Department of Water Supply, Water Resources Planning Division, December 2010. <<http://www.co.maui.hi.us/documents/11/28/456/Central%20Maui%20Recycled%20Water%20Verification%20Study.pdf>>.
- The Limtiaco Consulting Group, 2005. 2004 *Hawaii Water Reuse Survey and Report Final*.
- Hawaii QuickFacts for the US Census Bureau. Retrieved Sept. 5, 2012 from <<http://quickfacts.census.gov/qfd/states/15000.html>>.
- State of Hawaii Department of Business, Economic Development and Tourism, Visitor Statistics, 2010 Annual Visitor Spreadsheet. Last Accessed January 2012. <<http://hawaii.gov/dbedt/info/visitor-stats/visitor-research/>>.
- University of Hawaii Department of Geology, Atlas of Hawaii, Second Edition, 1983. University of Hawaii Press, Honolulu.
- Western Regional Climate Center, Desert Research Institute, National Oceanic and Atmospheric Administration Narrative Summaries, Tables and Maps for Each State with Overview of State Climatologist Programs, Third Edition, Volume 1: Alabama-New Mexico, 1985 - Gale Research Company, Climate of Hawaii. Accessed on January 2012 from <<http://www.wrcc.dri.edu/narratives/HAWAII.htm>>.

Sustainability and LEED Certification as Drivers for Reuse: Toilet Flushing at the Fay School

Author: Mark Elbag (Town of Holden)

US-MA-Southborough

Project Background or Rationale

The Fay School is a private day and boarding school for elementary and middle school students in Southborough, Massachusetts (**Figure 1**). It consists of 22 buildings that facilitate 552 students and faculty, 30 percent of which reside on campus as part of the boarding school. In 2011, the school was producing 7,900 gpd (30 m³/d) of wastewater and is projecting a 20 percent growth of students and faculty resulting in a future wastewater production of 10,500 gpd (40 m³/d). The most significant opportunities for water reuse at the Fay School were identified. Project drivers for the implementation of a water reuse program included cost savings from reduced water use, environmental awareness and sustainability teaching opportunities, and the potential for LEED Gold Certification.



Figure 1
The Fay School, Southborough, Massachusetts

Capacity and Type of Reuse Application

This project was part of a campus expansion that included LEED certification of buildings and use of “green” technologies and construction practices. The consultant worked closely with the school and the Massachusetts Department of Environmental Protection (DEP) on the water reuse system permitting, effluent testing and quality requirements. Construction of a 26,500 gpd (100 m³/d) membrane bioreactor wastewater treatment facility was completed

in 2009. A portion of the reclaimed water is to be reused for toilet flushing in five new dormitory facilities and a new maintenance building. Based on fixture count, the water reuse demand was estimated at 40 gpm (262 m³/d). As a school facility, the Fay School experiences significant fluctuations in wastewater flow rate over the course of a day and throughout the year. Careful planning was required so that adequate pre-treatment and post-treatment storage capacity was provided and the treatment capabilities of the equipment at the facility would be able to address these fluctuations.

Water Quality Standards and Treatment Technology

The system is designed to produce effluent total nitrogen concentrations below 10 mg/L. The membranes are designed to produce filtered effluent with less than 2 NTU, as required for reuse in the state of Massachusetts. Ultraviolet disinfection is designed to meet reuse limits of less than 14 cfu/100 mL as a monthly median fecal coliform concentration.

Project Funding and Management Practices

The project was privately funded through Fay School student tuition. The additional capital cost for wastewater treatment attributable to reuse was \$75,000. The cost of potable water at the Fay School is approximately \$6/1000 gallons (\$1.59/m³). A financial analysis was conducted that showed when water demand is greater than 5,000 gpd (19 m³/d), the cost of reclaimed water is less than potable water based on a 20-year lifecycle analysis (**Figure 2**).

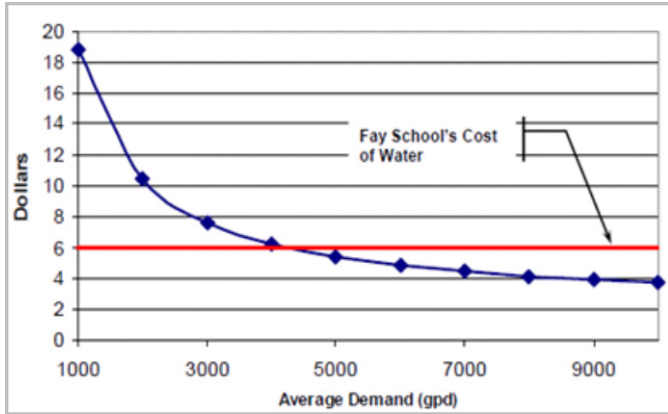

Figure 2
Cost of water per 1,000 gallons

Successes and Lessons Learned

Fay School Achieved LEED Gold Certification from the U.S. Green Building Commission for the Phase 1 Project. Fay School students now monitor building energy and building water consumption from a digital readout in each new dormitory building. The entire project was developed out of the Fay Schools interest in sustainable design principles which is a benefit to the education of students and the importance of water reuse. This concept is an excellent example of how to integrate and promote water reuse into an educational institution.

References

Water Reuse Foundation (WRF). 2005. *An Economic Framework for Evaluating the Benefits and Cost of Reuse Water*. September 2005.

Decentralized Wastewater Treatment and Reclamation for an Industrial Facility, EMC Corporation Inc., Hopkinton, Massachusetts

Author: Mike Wilson, P.E. (CH2M Hill)

US-MA-Hopkinton

Project Background or Rationale

EMC manufacturers electronic data storage systems and has a one million square foot campus located in Hopkinton, Mass. The corporation had an interest in LEED certification and green design principles for engineering and production facilities, which are located in watersheds of the Charles, Concord, and Blackstone Rivers.

EMC is the town's largest potable water user. Water supply is groundwater from wells in the town, and a neighboring town. During summer peak seasonal demand, Hopkinton can experience water shortages and in these periods has banned outdoor water use. EMC went beyond basic environmental compliance and built a decentralized wastewater treatment plant and wastewater reclamation facility which produces reclaimed water for toilet flushing and irrigation. Construction of the EMC Corporate Headquarters achieved a LEED EB certification for use of sustainable design best management practices and energy reductions. The project reduced potable water demand on a seasonally limited aquifer and provided needed groundwater recharge.

Capacity and Type of Reuse Application

The plant includes a sequencing batch reactor activated sludge process followed by cloth media filtration and UV disinfection before storage in a finished water tank. The facility went into service in 2000 and has a capacity of approximately 83,000 gpd (314 m³/d) and has the ability to reclaim 100 percent of its wastewater. Approximately 25 percent is used for toilet flushing and the remaining 75 percent is used for groundwater recharge and irrigation. Approximately 4 million gallons (18,000 m³) of water is reclaimed per year.

Water Quality Standards and Treatment Technology

The reclaimed water quality exceeds the requirements for reuse in Massachusetts. A summary of the typical influent wastewater characteristics and reclaimed water quality is provided in **Table 1**.

Table 1 Typical water quality

| Parameter | Raw Wastewater | Effluent |
|-----------------|----------------|----------|
| BOD (mg/L) | 221 | < 2 |
| TSS (mg/L) | 286 | < 2 |
| TN (mg/L) | 64 | < 2 |
| Turbidity (NTU) | | < 1 |

Project Funding and Management Practices

The project was constructed with private funds from EMC Corporation; the water reclamation facility decreases the potable water demand by approximately 25 percent. Approximately \$500,000 per year in cost savings is realized due to reduced water and sewer fees from the town. The plant's annual operating cost is approximately \$400,000.

Successes and Lessons Learned

Monitoring of toilet flush valves, flows, and system demand is important because a sticking toilet flush valve can significantly impact the use of reclaimed water by rapidly depleting the finished water storage. Installation of flow limiters and low flush toilets has reduced the impacts of this issue.

References

Sauvageau, Paul. "EMC's Visionary Plan, Embracing Water Sustainability." Presentation to the Environmental Business Council New England, February 24, 2010.

Metropolitan Area Planning Council, "Once is Not Enough – A Guide to Water Reuse in Massachusetts." The 495 Metrowest Corridor Partnership, November 2005.

Sustainability and Potable Water Savings as Drivers for Reuse: Toilet Flushing at Gillette Stadium

Author: Mike Wilson, P.E. (CH2M HILL)

US-MA-Gillette Stadium

Project Background or Rationale

The New England Patriots management determined that the new Gillette Stadium (**Figure 1**) was projected to increase potable water demand by as much as 600,000 gpd (2,300 m³/d) during home games, largely due to toilet flushing. Increased water demand would stress water supply wells and storage tank system, and the corresponding increase in wastewater produced at the stadium would be greater than the capacity of Foxborough's wastewater treatment plant. To reduce impacts of the projected increases in potable water use and wastewater demand, the Patriots worked with the town and Massachusetts Department of Environmental Protection (DEP) to construct a new water reclamation facility (WRF) that would reduce demand for potable water. The benefits of the new system were reduced potable water demands and recharge of the groundwater. The system was put into operation in 2002 when the new stadium opened.



Figure 1
Gillette Stadium, Foxborough, Mass. (Photo credit: Kathleen Esposito)

Capacity and Type of Reuse Application

A 0.25 mgd (11 L/s) wastewater reclamation plant that is expandable to 1.3 mgd (57 L/s) was constructed, along with a subsurface disposal system for a portion

of the reclaimed water. The plant includes a membrane bioreactor (MBR), and ozone and UV disinfection (American Water, n.d.). Reclaimed water is pumped to a 500,000 gallon (1900 m³) elevated storage tank or to the subsurface disposal system. A new purple pipe (to indicate reclaimed water) system was constructed because it was determined to be favorable to retrofitting existing piping. On average about 60 percent of the wastewater is reused for toilet flushing at the stadium. The remaining reclaimed water is pumped to the subsurface disposal system where it recharges the groundwater. Toilet flushing demands can vary dramatically and to accommodate these demands, the new reclaimed water supply system includes a one million gallon elevated storage tank at the stadium, and several thousand feet of new water distribution mains.

Water Quality Standards and Treatment Technology

The complete system required integration of a groundwater discharge permit with water reuse requirements because the system included infiltration basins under the parking area. The project included design of an on-site infiltration field and "daylighting" of the Neponset River from an underground culvert to a meandering open channel. When the system was designed, the Massachusetts DEP did not have formal water reuse regulations; there were however, guidelines and precedents had been established through implementation of several other previous water reuse projects. The plant is meeting all of its permit limits and water quality objectives which include biochemical oxygen demand, total suspended solids, total nitrogen, and fecal coliform. The facility reuses approximately 10 million gallons (38,000 m³) of reclaimed wastewater per year.

Project Funding and Management Practices

The project was constructed with private and municipal funds and the reuse system was constructed on a

design-build basis (AW, n.d.). The complete water and wastewater system project had an overall capital construction cost of \$13 million.

Successes and Lessons Learned

The town owns the potable water system and the WRF is operated by a private contract operator (American Water, n.d.). The WRF was designed and built by the private contract operator and constructed adjacent to the stadium in order to minimize the cost of the reclaimed water distribution system.

The design-build delivery of the WRF allowed a public-private partnership to plan and implement a reuse system for a major stadium. The lesson learned is that major private projects can be successful using a design and construction method that reduces risks, by placing that risk on a single entity.

References

American Water. n.d. Water Reuse. Retrieved on Sept. 5, 2012 from <<http://www.amwater.com/corporate-responsibility/corporate-responsibility-reporting/our-priority-your-water/integrating-water-resource-management/water-reuse.html>>.

Esposito, Kathleen. "The Role of Wastewater Reuse in the Future of Rhode Island Water Resources Management." February 2004.

Metropolitan Area Planning Council, 495/Metro West Partnership. "Once is Not Enough, A Guide to Water Reuse in Massachusetts." November 2005.

The Kraft Group. Website accessed July 2012 at <<http://www.thekraftgroup.com/environment/#gilletteStadium>>.

Water Environment Research Foundation (WERF). 2012. "When to Consider Distributed Systems in an Urban and Suburban Context." Retrieved July 2012 from http://www.werf.org/i/c/Decentralizedproject/When_to_Consider_Dis.aspx#table>.

Snowmaking with Reclaimed Water

Author: Don Vandertulip, P.E., BCEE (CDM Smith)

US-ME-Snow

Reclaimed Water Use for Snowmaking

While recreational use of reclaimed water is most often associated with irrigation of golf courses, winter sports venues can also benefit from reclaimed water use as an alternate or supporting water source in the seasonal production of engineered snow. The practice of snowmaking by large ski resorts is increasing, especially with recent changes in weather patterns and a need to provide an adequate snow base to attract skiers throughout the ski season.

Snowmaking in Maine

The use of reclaimed water for snowmaking is a relatively new practice, but the potential for its use to replace groundwater or stream-flow that could otherwise support domestic water supplies and aquatic habitat is increasingly attractive to many ski resorts. In the United States, the use of reclaimed water for snowmaking developed in New England as a means to allow for continued discharge of treated effluent from zero discharge lagoons and land application systems during the winter.

The Carrabassett Valley Sanitary District (CVSD) in Maine operated a state permitted lagoon and land application site serving the Sugarloaf Mountain Ski Resort area. By the early 1990's, the treatment system was receiving 50 million gallon (189,000 m³) of wastewater per year, mostly during the winter months, filling the seven storage lagoons. Because cold climates and varied topography can limit land applications of treated effluent during the colder months, in the spring of 1994 CVSD investigated use of the Snowfluent™ developed by Delta Engineering of Ottawa, Canada. Snowfluent™ is essentially snowmaking during winter months with treated wastewater effluent as the water source for snow. Testing was conducted by the Maine Department of Environmental Protection (MDEP) during the 1994 ski season; with no adverse impacts observed during the testing period, the MDEP permitted a permanent system which was installed in 1995 (Nelson, 1992).

Following the first successful year of operations that included treatment and use of 28 million gallons (106,000 m³), CVSD acquired three additional snowmaking towers (**Figure 1**) and a diesel generator, and later added SCADA controls to more effectively manage the system. Operationally, CVSD has found that by beginning snowmaking as freezing weather starts, the ground does not freeze, which aids the infiltration of melting snow in spring through early summer (Maine Lagoons online, 2012).



Figure 1
CVSD District employee Joseph Puleo checks the nozzles atop a snow gun tower. (Photo credit: David Keith)

Another Maine site, the Chick Hill Pollution Control Facility serving the town of Rangeley, was completed in fall 1996. Seven snow guns were added in 1998 for winter operation with construction of the winter effluent storage and disposal facility. The system treats over 14 million gallons (53,000 m³) annually with one 28 million gallon (106,000 m³) lagoon and 40 ac (16 ha) of application fields. The Mapleton Sewer District (**Figure 2**) formed in 1965 upgraded its treatment facility in 2004 by adding a 5 million gallon (19,000 m³) facultative lagoon, 14.5 million gallon (55,000 m³) storage lagoon, and snowmaking system on its land

application site, converting to a zero-discharge system and eliminating recurring discharge permit violations to the North Branch of the Presque Isle Stream. The use of snowmaking with spray irrigation allowed year-round operations using a smaller storage lagoon facility.



Figure 2
Mapleton Sewer District Wastewater Treatment Facility sign (Photo credit: Gilles St. Pierre)

Snowmaking in Pennsylvania

Two ski resorts in Pennsylvania are starting to include reclaimed water as a portion of their snowmaking water supply. Seven Springs Mountain Resort uses diluted recycled wastewater to augment the collected surface water it uses to make snow. The executive director of operations says "It's been treated, it's filtered, it's probably better than the pond water" (Nasaw, 2011). Seven Springs has developed a virtually closed-circuit water system for snowmaking and developed a potable water system that recycles water by treating and returning it back to drainage areas to recharge its sources. The water used for snowmaking is captured in a series of collector ponds at the base of the mountain, which are filled by rain, run-off and melting snow. During the snowmaking process, the water is pumped to the top of the mountain and then with the help of gravity, which minimizes energy use, it is supplied to more than 900 snowmaking towers on the mountain. Water is stored on the slopes in the form of snow until the melting process returns it through channels to the collector

ponds for the process to begin again (Seven Springs, 2009).

The Bear Creek Mountain Resort general manager hopes to begin using recycled wastewater to make ski snow in the 2012 season, at a 9 to 1 ratio with untreated fresh water (Nasaw, 2011). The on-site wastewater treatment system uses biological treatment processes to produce reclaimed water that is also used for irrigation and ground water recharge.

Western Snowmaking

In the western U.S. states, reclaimed water is viewed as a resource. In California, Donner Summit Public Utilities District in Soda Springs has a wastewater discharge permit that allows stream discharge, land application and snowmaking at Discharge Point "REC-1." Reclaimed water must meet California Title 22 standards that include a median concentration of total coliform bacteria in the disinfected effluent that shall not exceed 2.2MPN/100mL. This pPermit includes a provision (IV.C.12) that requires chlorine disinfection with a chlorine concentration/contact time of 450 mg-min and average NTU of 2 (CRWQCB-CVR, 2009). Title 22 requirements for disinfected tertiary recycled water allow use of demonstrated, alternative disinfection processes with filtration; however, only chlorination is allowed under this permit.

In Cloudcroft, N.M., severe drought has caused water shortages that required trucking of potable water to the community at up to 20,000 gpd (76 m³/d). In response to this shortage, the community moved forward with development of an integrated water conservation plan that includes indirect potable reuse. Cloudcroft implemented membrane technology to produce highly treated reclaimed water that would be used to supplement the existing spring and well water sources. The reclaimed water, produced using an ultrafiltration (UF) membrane bioreactor and chloramine disinfection, is stored in a small reservoir. A portion of the water is diverted for non-potable purposes (golf course and athletic field irrigation) with 100,000 gpd (380 m³/d) further treated with reverse osmosis (RO) through a three stage, single-pass system using high rejection, low pressure thin film composite membranes. The RO permeate is treated with hydrogen peroxide and UV, and stored in two covered, lined reservoirs, prior to blending with spring flow and groundwater. The final stage in the water treatment process is ultrafiltration of the blended water source,

GAC filtration, and disinfection with sodium hypochlorite prior to distribution in the potable water system.

The two streams from the water treatment process, the RO concentrate and UF backwash are diverted to a 250,000 gallon (950 m³) reservoir that stored water used for road dust control, construction, snowmaking for the ski area, gravel mining operations, forest fire fighting, and other beneficial purposes (Government Engineering, 2008).

Snowmaking in Australia

The Mt. Buller and Mt. Stirling Alpine Resort are located 3 hours northeast of Melbourne. An expanded wastewater treatment plant can provide an additional 503,000 gpd (2,000 m³/d) of Class A recycled water for snowmaking per day. Class A is the highest achievable standard in recycled water in Australia and is allowed for use on food crops. The production of artificial snow requires large volumes of water and with global climate change induced forecasts for decreasing snowfalls in the future, ski resorts worldwide are increasing reliance on snowmaking. Mt. Buller has invested in this technology in order to provide a better, longer ski season.

Prior to 2008, when use of reclaimed water for snowmaking was implemented, water was drawn from Boggy Creek. Treatment of Mt. Buller's recycled water also provides benefits to the local environment by improving the quality of run-off that enters surrounding areas and waterways. Mt. Buller management advises skiers that if snow made from recycled water is ingested, it will not have any significant health implications; however, just like natural snow, once it hits the ground it is vulnerable to contamination by animals, vehicles and other skiers, so snow should not be eaten. In addition, Mt. Buller management plans to also use this reclaimed water for household use in new developments and for irrigating open spaces to deliver further benefits to the local alpine environment (Mt. Buller, 2012).

References

- Bear Creek Mountain Resort. 2012. *Bear Creek's Green Initiatives*. Retrieved on March 25, 2012 from <<http://www.bcmountainresort.com/environmental-sustainability>>.
- California Regional Water Quality Control Board Central Valley Region (CRWQCB-CVR, 2009), Order No. R5-2009-0034 NPDES No. CA0081621, April 24, 2009
- Government Engineering. 2008. *Pioneering Water Reuse System: Necessity, Once Again, is the Mother of Invention*. May-June 2008. Retrieved on March 25, 2012 from <<http://www.govengr.com/>>.
- Maine Lagoons on Line. 2012. Retrieved on March 24, 2012 from <<http://www.lagoonsonline.com/cvsd.htm>>.
- Mt. Buller. 2012. Mt Buller Web Page. Retrieved on March 25, 2012 from <<http://www.mtbuller.com.au/Winter/Environment/Water-Reuse-Project-and-Snowmaking>>.
- Nasaw, Daniel. 2011. *Indians oppose 'recycled' sewage for Arizona skiing*. BBC World News. Retrieved on October 19, 2011 from <<http://www.bbc.co.uk/news/magazine-15176711>>.
- Nelson, Leslie B., 1992. *The Role Of Forest Soils In A Northern New England Effluent Management System*, Thesis, The University of Maine, May 1992.
- Seven Springs. 2009. *Seven Springs Mountain Resort Selected For National Environmentalism Award, May 14, 2009*. Retrieved on March 25, 2012 from <<http://www.7springs.com/page/category.detail/nav/5358/Facts-and-Figures.html>>.

Reclaimed Water for Peaking Power Plant: Mankato, Minnesota

Authors: Mary Fralish (City of Mankato) and
Patti Craddock (Short Elliott Hendrickson Inc.)

US-MN-Mankato

Project Background or Rationale

The city of Mankato, Minn., supplies reclaimed water for cooling water at the Mankato Energy Center (MEC), a peaking power plant with an ultimate design capacity of 640 MW (2,300 GJ/hr). The first phase of the energy project was initiated in 2005 and included the installation of a 365 MW (1,300 GJ/hr) plant with two natural-gas fired combustion turbines, two heat recovery steam generators, and one steam turbine generator estimated to operate about 60 percent of the year. Calpine Corporation approached the city of Mankato about a water supply, and through a collaborative process the decision was made to use reclaimed water for cooling water.

Mankato uses groundwater and shallow wells under the influence of the Minnesota River for its potable supply. Aquifer limitations in the area posed concerns for use of the groundwater supply for the MEC. The local surface water supply, the Minnesota River, is heavily influenced by upstream agricultural land use and would require treatment prior to use as cooling water. As the power plant was being constructed, a fast-track project to provide new water reclamation facilities at the wastewater treatment facility (WWTF) was also initiated. Calpine's experience with use of reclaimed water at other facilities, city staff that embraced and understood the value of reclaimed water for their community, and early involvement with the state regulatory agency provided for a collaborative environment for the facility improvements.

Capacity and Type of Reuse Application

A new water reclamation building and treatment processes were added at the existing WWTF site (**Figure 1**). The system was sized to provide up to 6.2 mgd (272 L/s) of water to meet the maximum water supply needs of the MEC. The supply is provided on an intermittent basis, and through 2011 the peak daily

flow has not exceeded 2.6 mgd (114 L/s). Additional capacity was added to provide a peak flow of 18 mgd (789 L/s) for phosphorus removal, for more efficient operations and capacity to meet more stringent effluent standards in the future.



Figure 1
Mankato WRF

The MEC uses the reclaimed water for cooling water on an intermittent basis to meet peaking power needs. The cooling water blowdown, which is approximately 25 percent of the reclaimed water used by the power plant, is returned to the Mankato WWTF for discharge under its NPDES discharge permit, as the power plant has a pretreatment permit but not a discharge permit.

The process train improvements added at the WWTF to provide reclaimed water include: high-rate clarification process with ferric chloride and polymer addition; cloth media disk filtration; chlorine contact basins; secondary pump station, and a standby generator. Existing sodium hypochlorite and bisulfate chemical systems are used for disinfection and dechlorination.

Water Quality Standards and Treatment Technology

The state of Minnesota permits water reuse projects on a case-by-case basis using the California Title 22 reuse criteria (State of California, 2000) as the basis for design and effluent requirements. Site-specific

conditions and monitoring are applied to each unique permitted application.

Mankato was required to provide tertiary treated water that meets a total coliform limit of 2.2 cfu/100 mL as a 7-day median, with a maximum single sample not to exceed 23 cfu/100 mL and provide 90 minutes of chlorine contact time. The existing NPDES permit requirements for fecal coliform and other constituents characterizing the effluent discharge to the Minnesota River were not changed, but additional requirement for reuse including the total coliform limit and monitoring were added. Because a scalant with phosphorus in it is added to the MEC cooling water and the MEC blowdown water is sent to the city's WWTF prior to river discharge, additional phosphorus monitoring was required to ensure the city's phosphorus permit limits are not exceeded.

Project Funding and Management Practices

The new water reclamation center capital project was funded by Calpine Corporation. The city of Mankato selected an engineering firm to design the new processes and building, with construction provided by Calpine Corporation. The city owns, operates, and maintains the facility and there is no cost to Calpine for reclaimed water until cumulative operations and maintenance costs exceed the capital cost or 20 years is reached, at which time Calpine will be charged on a per gallon basis. A 20-year agreement was established with four 10-year renewal options including one item specifically requested by the city identifying that the city has priority to use reclaimed water for plant and other city uses. The city of Mankato is expanding its use of reclaimed water to include urban irrigation of a new city park and for street washing and vehicle cleaning.

This project provided a unique opportunity for the city of Mankato to incorporate more flexibility in their operations to meet their existing phosphorus effluent discharge limits, as well as the ability to meet more stringent future limits, by adding capacity for phosphorus removal. The city also made improvements to their internal water systems to replace use of secondary effluent water with reclaimed water, which has resulted in fewer issues with effluent pump screen clogging and maintenance.

Successes and Lessons Learned

While the facility has operated well since startup in 2007, there was a learning curve related to providing a chlorinated supply for intermittent use. Intermittent production also required establishing a good communication system with the energy facility and laboratory staff to ensure efficient operations for intermittent demand and proper laboratory sampling.

One impending issue for the city of Mankato and other Minnesota communities is the potential for new dissolved solids discharge limits. While many industrial NPDES permits have limits for chlorides, sulfates, and other ions, municipal WWTFs do not. For Mankato, this could be a concern given the MEC cooling water blowdown has elevated dissolved solids. It is possible that future partnerships like Mankato and the MEC may not be viable if there are new ion limits.

This project was a collaborative partnership of an industry, municipality, contractor, engineer, and regulatory agency to provide a system to meet both the needs of the energy facility and the short and long term needs of the municipal WWTF. The energy facility met its schedule and continues to receive high quality water for their operation. Use of reclaimed water has reduced use of the local aquifer by 130 million gallons per year which extrapolates to over 300 million gallons per year with the MEC operating at design capacity.

The municipality has also provided a significant environmental benefit to the Minnesota and downstream Mississippi River watersheds, and helped numerous communities and industries delay major capital improvements. Mankato has supported the phosphorus trading permit framework established for the Minnesota River by using its excess capacity to remove phosphorus for other permitted dischargers that do not have the infrastructure to meet new phosphorus limits. The trading program resulted in meeting phosphorus goals for the watershed ahead of schedule.

References

State of California. 2000. Water Recycling Criteria. Title 22, Division 4, Chapter 3, California Code of Regulations. California Department of Health Services, Drinking Water Program, Sacramento, CA.

State of Minnesota, Minnesota Pollution Control Agency. 2011. "Salty Discharge" Monitoring at NPDES/SDS Permitted Facilities." Retrieved on February 8, 2012 from <http://www.pca.state.mn.us/index.php/view-document.html?gid=16079>.

Town of Cary, North Carolina, Reclaimed Water System

Authors: Leila R. Goodwin, P.E. (Town of Cary) and Kevin Irby, P.E. (CDM Smith)

US-NC-Cary

Project Background

The town of Cary, N.C., conducted a reclaimed water feasibility study in 1997 to evaluate how best to meet its goals of reducing per capita water consumption by 20 percent by 2015, to preserve the town's allocation of raw water from its drinking water source, Jordan Lake. In June 2001, Cary became the first municipality in North Carolina to pump reclaimed water to homes and businesses for irrigation and cooling.

Capacity and Type of Reuse Application

The town of Cary treats wastewater for Cary, Morrisville, the Raleigh-Durham International Airport, and the Wake County portion of the Research Triangle Park at its two water reclamation facilities (WRFs). Both the North Cary WRF and South Cary WRF have reclaimed water systems consisting of piping systems as well as bulk reclaimed water distribution stations.

The town of Cary's reclaimed water system began with several hundred customers in targeted service areas identified through an analysis of high irrigation demands and proximity to the WRFs. The system provides reclaimed water for irrigation and cooling for commercial facilities, lawn irrigation for single and multi-family homes, and irrigation for schools and a recreational complex. The system also includes bulk reclaimed water distribution stations at the town's two WRFs for filling tanks for uses such as irrigation, road construction, dust control, sewer flushing, and street cleaning (**Figure 1**).

Cary's reclaimed water system has a production capacity of approximately 5 mgd (219 L/s). The system produces approximately 1 mgd on a peak day and up to 20 million gallons per month (76,000 m³) during the summer.

The North Cary WRF reclaimed water service area includes a 9 mgd (394 L/s) pump station and 1 million gallon (3,800 m³) storage tank at the North Cary WRF required to meet peak day peak hour demands. It also includes approximately 9 miles (14.5 km) of 4- to 20-in

(10- to 51-cm) transmission and distribution mains. The South Cary WRF reclaimed water service area includes a 1.2-mgd (52.5-L/s) pump station at the South Cary WRF and approximately 1.4 miles (2.3 km) of 8- to 12-in (20- to 30-cm) transmission and distribution mains. The reclaimed water pumps at the town's WRF are shown in **Figure 2**.



Figure 1
Bulk reclaimed water distribution station (Photo credit: David Heiser)



Figure 2
New reclaimed water pumps at the WRF (Photo credit: David Heiser)

Water Quality Standards and Treatment Technology

The town of Cary's reclaimed water system was designed to meet the state's mandatory treatment standards (**Table 1**). Both WRFs treat wastewater

using biological nutrient removal and regularly meet the state reclaimed water quality standards.

Table 1 Minimum state reclaimed water quality standards

| Parameter | Daily Maximum | Maximum Monthly Average |
|-----------------|---------------|-------------------------|
| BOD5 | 15 mg/L | 10 mg/L |
| TSS | 10 mg/L | 5 mg/L |
| NH ₃ | 6 mg/L | 4 mg/L |
| Fecal coliform | 25 cfu/100mL | 14 cfu/100mL |
| Turbidity | 10 NTU | 10 NTU |

Project Funding

The total project cost for the reclaimed water system including both the North Cary and South Cary WRFs was \$11 million. The project was funded through the town's capital improvement budget.

Reclaimed water in the town of Cary currently costs \$3.60/1,000 gallons (\$0.93/m³), which is the same as the town's Tier 1 potable water use rates. Reclaimed water rates were set less than potable water while recovering a substantial part of the town's capital cost for implementing the system. Use of reclaimed water allows customers to avoid higher Tier 2, 3, and 4 water rates that apply to water use greater than 5,000 gallons (19 m³) per month. Reclaimed water customers are also exempt from the town's alternate day watering restrictions. The town does not charge customers for reclaimed water obtained at its bulk reclaimed water distribution stations.

Reclaimed Water Program Management

The town of Cary's reclaimed water program is managed by a Reclaimed Water Coordinator, who is responsible for development of policy recommendations and selection of program alternatives; evaluating program effectiveness; collecting data; working with homeowners, businesses, and other potential reclaimed water customers; coordinating programs to encourage the use of reclaimed water; and inspecting the reclaimed water system for potential problems such as cross connections.

During implementation of its initial reclaimed water program, Cary sponsored numerous public education efforts, including public information sessions and hearings, fact sheets, news releases, meetings with

homeowners groups and other potential customers, an education program for plumbers and contractors, and information on the town's website. The town requires bulk reclaimed water users to complete a 1-hour training session in order to obtain a permit to use the reclaimed water.

Expansion of the Reclaimed Water Program

The town of Cary is currently expanding its reclaimed water system into a third service area. The town of Cary, Wake County, and Durham County are jointly implementing the Jordan Lake Water Reclamation and Reuse project. This project will provide reclaimed water from Durham County's Triangle Wastewater Treatment Plant to customers in the Wake County portion of Research Triangle Park and to the town of Cary's Thomas Brooks Park, the site of the USA Baseball national training center. The service area also includes some currently undeveloped portions of northwestern Cary.

The project is being financed by a State and Tribal Assistance Grant (STAG) from the federal government (administered by the Environmental Protection Agency) as well as the town of Cary, Wake County, and Durham County. The portion of this project serving the Wake County portion of Research Triangle Park and some of western Cary began operating in early 2012 and the remainder will be completed in 2013.

The town has recently initiated a comprehensive master planning study to develop a roadmap for future expansion of the town's reclaimed water program.

References

- Black and Veatch. 2007. *Reclaimed Water System Master Plan*. Prepared for the Town of Cary.
- CDM Smith. 1997. *Reclaimed Water and Wastewater Reuse Program*. Prepared for the Town of Cary.
- CDM Smith. 2000. Application for Modification to North Cary Reclaimed Water System Non-Discharge Permit WQ0017923. Prepared for the Town of Cary.
- Town of Cary website. 2011. Retrieved on Sept. 4, 2012 from <<http://www.townofcary.org/>>.
- Wake County website. 2011. Retrieved on Sept. 4, 2012 from <<http://www.wakegov.com/>>.

Identifying Water Streams for Reuse in Beverage Facilities: PepsiCo ReCon Tool

Author: Liese Dallbauman, PhD (PepsiCo Global Operations)

US-NY-PepsiCo

Project Background or Rationale

The beverage industry is dependent on sustainable supplies of water for the ongoing survival of its business. Water is included within most of the final products, and also used within the supply chain. The beverage sector has taken the concept of water stewardship very seriously for decades, partly because of the direct financial impact on the business that water efficiency can afford through productivity savings, and partly because of the broader importance of corporate social responsibility in preserving water supplies and using water resources wisely.

Capacity and Type of Reuse Application

The Beverage Industry Environmental Roundtable (BIER) is a technical coalition of leading global beverage companies working together to advance environmental sustainability within the beverage sector. Formed in 2006, BIER aims to accelerate sector change and create meaningful impact on environmental sustainability matters. Through development and sharing of industry-specific analytical methods, best practice sharing, and direct stakeholder engagement, BIER accelerates the process of analysis to sustainable solution development.

Each year, the industry water dataset continues to grow in size, with 2011 representing the most robust report to date, including over 1,600 facilities distributed across six continents. Analyses were conducted to determine industry water use, production, and water use ratio over the three year period from 2008 to 2010. Over this period, the industry aggregate water use ratio improved by 9 percent, avoiding the use of approximately 39 billion liters of water in 2010—enough water to supply the entire population of New York City for 8 days. So the beverage industry as a sector has been quantitatively using water more efficiently. An important part of water efficiency practices is identifying opportunities for water reuse.

Project Funding and Management Practices

At PepsiCo, ReCon is the name given to our corporate global set of best practice tools for resource conservation. The first tool was constructed several years ago for energy management within the beverage production plants, based heavily on tools and information from the U.S. Department of Energy. The ReCon suite has grown to include ReCon Water, ReCon GHG, and ReCon Waste. The power of these tools comes from leveraging a common approach. Each first quantifies a plant's resource usage streams and sub-streams and calculates the relative value of the streams. In the case of water, for example, the online ReCon Water Profiler allows the plant to dissect its water use and then provides a mapping of the relative volumes and values of each stream (**Figure 1**). The values are determined based on local cost of incoming water, treatment or conditioning chemicals, energy used to heat or cool prior to use, and finally costs associated with discharge.

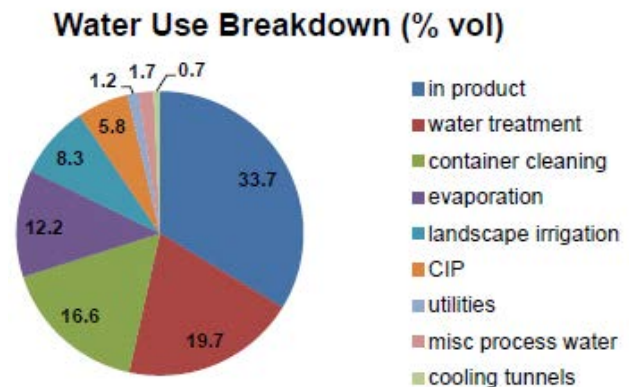

Figure 1
Example output from ReCon Water Profiler that compares water use volume for different uses at a beverage plant

Comparing these data allows a quantitative assessment of which streams offer the greatest opportunities for saving water, whether by avoiding water use altogether, reducing the volume of water used, or reusing spent water. The Diagnostic, a series of customized audit-type questions, then assesses whether the plant is following best practices, and which opportunities exist for improvement. Involvement of the plant's quality organization ensures that any changes in water use practices meet strict quality standards.

The Water Purification Eco-Center

Authors: Jeff Moyer and Christine Ziegler (Rodale Institute)

US-PA-Kutztown

Project Background/Rationale

The Water Purification Eco-Center (WPEC) is a decentralized wastewater treatment and disposal system for Rodale Institute's new Visitor Center in Kutztown, Pennsylvania. Rodale Institute is a nonprofit research, education and training facility. The WPEC Project was developed to maintain and demonstrate an on-site wastewater treatment system that captures rainwater and uses it several times before returning it to the soil as clean water. The system, which incorporates a cistern, a septic/equalization tank, a constructed wetland cell, a trickling filter, and subsurface drip irrigation disposal unit, utilizes wastewater as a resource, demonstrating an alternative to standard septic and sand mound on-lot sewage systems. This system is scalable and can be used in sustainable landscapes for small commercial entities as well as residential units (**Figure 1**).

Capacity and Type of Reuse Application

The system demonstrates wastewater treatment utilizing natural systems, as well as resource conservation and recycling. The system was constructed to provide fresh, collected and/or recycled water source to toilet fixtures designed to conserve water. Effluent passes to a dual-compartment septic tank, and then on to a flow equalization tank to provide uniform flow rates and to allow compensation for intensified use. Wastewater is then directed through a wetland treatment cell, where soil biology and plant roots utilize excess nutrients from the water, where pathogens are also neutralized. Once wastewater has passed through the wetland treatment cell, it is sent to a trickling filter and then back through the wetlands cell. Finally, the treated water is directed to the subsurface irrigation system servicing the landscaped areas surrounding the Visitor Center.

The design capacity of the system is 400 gpd ($1.5 \text{ m}^3/\text{d}$) and flow equalization allows the system to address a peak flow of 800 gpd ($3 \text{ m}^3/\text{d}$). This is the typical size used for a single residence, minus the flow

equalization tank, which was added to account for usage patterns specific to a visitor center.

Water Quality and Treatment Technology

Water quality tests at several points in the system allow researchers to capture information on how the various treatment stages are working. Annual sampling of the surrounding soils will indicate the impacts of the system on its immediate environment, demonstrating how the wetlands system design can achieve and surpass EPA discharge standards for secondary effluent.

Many watersheds in the state of Pennsylvania house residential communities with on-lot sewage systems located within their boundaries, and the numbers are growing daily. The materials leaving these systems, if treated properly are no longer to be viewed as waste products; rather, they need to be viewed as resources. The proper use of these resources can have a profound impact on land use and water quality in the areas where they are located. Viable and practical alternatives to both standard septic and sand mound systems are needed for residential communities using on-lot sewage systems.

The water quality objective of this project is to transform standard septic effluent into clean water that will meet EPA discharge standards for secondary effluent, while affecting no net change in the nutrient parameters of the soil or water surrounding the system. In order to achieve this objective, each component of the treatment system must be functioning properly. Thus, treatment component integrity is being assessed through analysis of monthly water samples drawn from lysimeters (porous access tubes) located in the surrounding soil, and component function will be assessed through analysis of monthly water samples collected at the outflow of each component, and at the end of the system. All water samples are being collected and processed in accordance with standard operating procedures and the analysis being conducted by MJ Reider and

Associates, Inc. laboratory is being assessed for statistical changes in nutrients and other contaminants.

Project Funding and Management Practices

The WPEC project is funded by the EPA (Congressionally Mandated Projects - Wetlands for the Prevention of On-Lot System Pollution, Agreement Number XP-83369301-0, CFDA Number 66.202), the Pennsylvania Department of Environmental Protection, Rodale Institute and other corporate and private funders. The Berks County Community Foundation has also provided funding for addition of solar panels to the facility.

This project is managed as a research and education facility, to highlight the viability and functionality of the system as an alternative to traditional sewage management. A broad cross-section of society is being educated on concepts and principles of regeneration that are applied through the system. The intended audiences include two main groups. First, on the demand side, are those who want or need a decentralized system. Second, on the supply side, there are those who will provide and regulate the systems. These groups include elementary school children, municipal officials, land developers, watershed management groups, planning commissioners, policy makers, and sewage enforcement officers. Rodale Institute is also reaching out to those who cannot visit the center, in person, through a distance learning program and information on the project website.

Institutional/Cultural Considerations

Since the grand opening of the facility in 2011, outreach and education efforts have included development of an informational project brochure, newsletter features, site tours that include an electronic kiosk featuring informational text, animation of the whole system and interactive games that test visitors' knowledge of water-related issues. Other educational outreach has included on-site and off-site speaking engagements and workshops. The first on-site workshop, entitled "Constructed Wetlands in Wastewater Treatment," was conducted in June 2011 and a second workshop was held in June 2012. Rodale Institute is also arranging continued speaking engagements at targeted tradeshows that will help

increase understanding and expand use of wetland technology.

The WPEC has been featured in local, regional and national print publications and in electronic media. A Rodale Institute website re-design in 2012 will enhance capacities to present the WPEC in a clear and accessible manner for a wider range of audiences. Other Water Purification projects across the nation that have similar goals, and fit with the mission of Rodale Institute will be featured on the website.

Successes and Lessons Learned

The facility was considered "on-line" as of the grand opening in June 2011 and the systems have been up and running, as designed, since October 2011 purifying wastewater without any issues. Continuous monitoring allows tracking system performance and will allow minor adjustments to optimize the operations of each individual component of the system.

Some minor issues with automated controllers were experienced in early stages of this system. Water float control adjustments and pump timing changes have been made. Once tested and confirmed effective, the adjustments will be shared in project trainings and documentation. Also, water sampling protocols have been finalized and sampling is in the early stages. Once several months of data have been collected, information will be shared and possible system adjustments will be made, if needed. This shared information will be helpful to other institutions and private individuals who may choose to install similar systems for their projects, properties and landscapes.

Figure 1
Schematic of the WPEC system components (Photo credit: Rodale Institute and NEWVISION Communications)

Zero-Discharge, Reuse, and Irrigation at Fallingwater, Western Pennsylvania Conservancy

Author: Mike Wilson, P.E. (CH2M Hill)

US-PA-Mill Run

Project Background or Rationale

In 1999, the Western Pennsylvania Conservancy (WPC) implemented a water reuse plan at Fallingwater to promote sustainable design principles and reduce potable water use through a zero-discharge wastewater reclamation system. Fallingwater, the world-famous “house on the waterfall,” was designed and built by Frank Lloyd Wright—one of the most important architecture and design figures of the 20th century. The Main and Guest Houses were constructed in the 1930s and the Main House (shown in **Figure 1**) was cantilevered over a waterfall located on Bear Run, a stream of “exceptional value” as categorized by the state of Pennsylvania.



Figure 1
Main House (Photo credit: WEFTEC 2002)

Capacity and Type of Reuse Application

The visitors' center and onsite facilities produce approximately 8,000 gpd (30 m³/d) of wastewater. The wastewater is pumped to the treatment facility, which is housed in a separate 1,800-square-foot (194 m²) structure located away from the main house

(**Figure 2**). The system recycles 100 percent of the wastewater that is produced by the facility's 140,000 annual visitors.



Figure 2
Treatment facility (Photo credit: WEFTEC 2002)

The treatment processes include an MBR followed by carbon adsorption and UV disinfection. The process produces an effluent suitable for public access reuse. Following treatment, the reclaimed water is recycled for use as toilet flush water at the visitor's pavilion, and at other site buildings. The system also includes irrigation of a forested site with a subsurface drip irrigation system to provide redundant reuse capacity during the winter months and wet periods.

Water Quality Standards and Treatment Technology

The membrane bioreactor treats wastewater to the reuse standards required by the Pennsylvania Department of Environmental Protection (DEP) as shown in **Table 1**.

Table 1 Typical water quality

| Parameter | Raw Water | Effluent |
|-----------------|-----------|----------|
| BOD (mg/L) | 350 | < 5 |
| TSS (mg/L) | 350 | < 5 |
| TN (mg/L) | 75 | <10 |
| Turbidity (NTU) | — | < 2 |

Project Funding and Management Practices

The project was paid for by the Conservancy Trust. The entire project cost \$15 million and was completed as a design-build project. The system was put into operation in 2005. This approach provided a single point of accountability and allowed the conservancy to provide critical input to all project phases.

Successes and Lessons Learned

The project provided the conservancy with an opportunity to include sustainable design practices in their mission of environmental stewardship. The project had the added benefit of educating the public on an innovative sustainable water reclamation process and the benefits of reuse. The Fallingwater Wastewater Pumping, Treatment, and Reuse Systems won the National Design-Build Award for water projects under \$15 million in 2005. The wastewater reclamation system can be a model for other sites facing similar constraints in the Northeast.

References

Brubaker, G.F., L. Waggoner, K. Speer, and C. Edwards. 2002. "Preserving the Fallingwater Environment by Implementing a Zero-Discharge Wastewater Reclamation System." Proceedings of WEFTEC 2002, Water Environment Federation.

Franklin, Tennessee Integrated Water Resources Plan

Authors: Jamie R. Lefkowitz, P.E. and Kati Bell, PhD, P.E. (CDM Smith); and Mark Hilty, P.E. (City of Franklin)

US-TN-Franklin IWRP

Project Background or Rationale

Located 20 miles south of Nashville, the city of Franklin, Tenn., is a rapidly growing community of approximately 60,000 people. Franklin is one of the fastest growing cities in the nation—twice as many people live in the city today compared to a decade ago. And the trend is expected to continue: Franklin's population is projected to double again during the next 30 years. The rapid growth in Franklin is placing pressure on capacities for drinking water supply and wastewater treatment, along with increased maintenance of the collection, distribution, and stormwater infrastructure. As a result, the city faces a tremendous need for water resources planning in order to continue providing reliable water, wastewater, and stormwater services to its growing residential and commercial user base. These services must be provided to support growth, while protecting community's most valuable and resource—the Harpeth River.

Reuse is one key aspect of an integrated plan developed by Franklin to determine a course of action for water resources projects over the next 30 years. Currently, the city provides drinking water (approximately one-third from its own treatment plant and two-thirds from wholesale purchase), wastewater treatment, and reclaimed water for irrigation. Raw water is withdrawn from the Harpeth River for treatment at the Franklin drinking water plant, and treated wastewater effluent that is not further treated and reused for irrigation is discharged to the Harpeth River.

Capacity and Type of Reuse Application

Franklin's reuse system is fed directly from the wastewater reclamation facility (WWRF) that receives and treats almost all of the city's wastewater. The WWRF capacity is currently 12 mgd (526 L/s) and as of 2012 operates at approximately 80 percent of its

permitted capacity. All wastewater treated at the plant receives tertiary treatment through a biological denitrification filter following secondary biological treatment, is of exceptionally high quality, and is available for reuse.

The reuse distribution system was installed in 1992 when the city entered into an agreement with a local golf course to supply reclaimed water for irrigation. The distribution system currently consists of a 7.5 mgd (329 L/s) pump station and more than 15 miles (24 km) of distribution pipelines. The distribution system delivers reclaimed water to customers that have connected to the reuse network and includes golf courses, residential communities, commercial developments, a recreational facility, and the high school. The highest demands occur in July and August averaging 2.6 mgd (114 L/s) in 2011; however, when considering daily peaking factors, there have been days when reclaimed water is not available to meet reuse demand.

Integrated Planning Process

In order to meet water resources demands of the growing population, Franklin must expand the capacity of its WWRF. The first step in this process is to obtain new discharge permits under the challenging regulatory situation involving water quality impairments in the Harpeth River. A total maximum daily load (TMDL) was completed for the Harpeth River in 2001 that defined stringent waste load allocations for the Franklin WWRF through its National Pollutant Discharge Elimination System permit. Faced by these challenges, the city opted to take a more holistic look at how it manages its water resources. The result was an integrated plan that would not only satisfy the wastewater and reclaimed water demands, but also provide long-term, sustainable solutions to Franklin's water challenges, and environmental enhancements to the Harpeth River.

In 2010, city officials, administration and staff embarked on a 2-year process to evaluate Franklin's water resources from a long-term, holistic perspective encompassing water supply and treatment, wastewater collection and treatment, biosolids treatment and disposal, reclaimed water distribution, stormwater management, ecological preservation, and restoration in the Harpeth River and its tributaries. Franklin decided that a facilitated, stakeholder process would be the best means to develop a broadly acceptable Integrated Water Resources Plan (IWRP). As a result, a broad range of representatives from city administration and staff, state regulatory agencies, the county, neighboring utilities, environmental advocates, and the community were involved in developing the project goals, objectives, performance measures and alternatives, and ultimately the recommended plan.

The Integrated Model

Franklin's water resources are a network of natural and man-made systems that satisfy demands on water (e.g., irrigation, industrial use, human consumption, habitat, and recreation). Water moves between these network segments through completely natural, altered natural, and manmade pathways. In order to conduct an alternatives evaluation of various sets of stakeholder-derived project options, a simulation model of the city's water resources system was developed to represent the system's segments and their interconnectivity.

An integrated network model was developed to represent the city of Franklin's water resources system, allowing the physical flow systems to be modeled with operational and planning level resolution. The integrated model was developed utilizing the STELLA software tool (Systems Thinking Experimental Learning Laboratory with Animation), which is a dynamic and graphical tool used to simulate interactions between, and within, subsystems that are part of a larger interconnected system. Because dozens of alternatives were identified by stakeholders (alternate water sources, use and reuse options, operational triggers, etc.), this tool was able to rapidly help screen information, identify key drivers, and understand the causal relationships throughout the complex water system.

The integrated model was divided into segments which represent the categories of the city's water resources: the Harpeth River, water supply, wastewater,

reclaimed water, and stormwater. These sectors of the water resources system are interconnected so decisions or policies aimed at managing water within one sector often has direct effects and interacts with the other systems. For example, increasing the volume of reclaimed water use would effectively decrease demand on the potable water supply and treatment associated with irrigation demand; however, it would also decrease the volume of water returned to the river limiting supplemental flows during potential low-flow periods.

Evaluating the Benefit of Reuse

One of the most challenging and interesting components of the Franklin IWRP process was analysis and integration of the wastewater, reuse, and potable water systems. The initial driver of this project was addressing issues associated with the existing WWRF. Already in excess of its design capacity, the WWRF was evaluated to determine how much additional capacity could be achieved while meeting the anticipated permit limits for nutrients in the Harpeth River; nitrogen was the limiting factor for this project. Topography of the service area and previous development of the collection system in the city provides gravity flow of wastewater that could be split and routed to two separate locations. The first location is the existing facility and the second is a site where a facility in the southern portion of the city's service area could be constructed. The southern WWRF site is located approximately 3 river miles upstream of the existing drinking water treatment plant (WTP), and could provide additional benefits of augmented flows upstream of the WTP intake, particularly during seasonal low flows.

As part of the integrated plan, the probable increase in demand for reuse irrigation water was estimated based on potential new customers located near existing lines and could tie-in without a substantial capital expenditure by the customers or the city. The level of less-certain demand for the reuse water was also estimated. To serve these customers, new lines would need to be constructed and current development trends would need to continue. While less certain, the future reuse demands could increase the potential for reuse more than the base case, but only if the city completes infrastructure projects to treat and distribute the reuse water, and the anticipated development within Franklin results in a significant increase in wastewater volume for reuse supply.

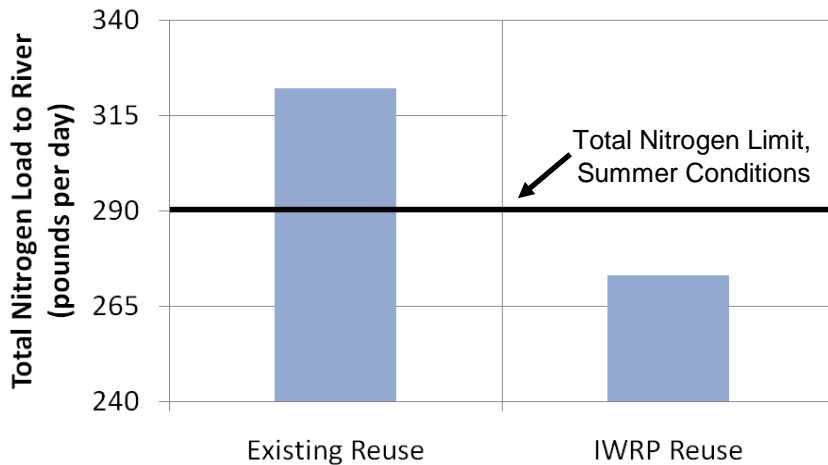

Figure 1
Estimated reduction in nutrient loading to Harpeth River resulting from increased effluent reuse

Increased reuse would help relieve non-potable irrigation demands, as well as alleviating nutrient discharges to the Harpeth River, allowing permitting and implementation of capacity expansion to meet the future wastewater demands. Results of the model demonstrated that increasing reuse was the key to implementing projects to address future wastewater demands, as shown in **Figure 1**. This graph compares the nutrient loading for the future wastewater capacity with no increases in the reclaimed water capacity to the IWRP alternative that results in reduction of nitrogen loading to the river by meeting the probable future reuse demands with reclaimed water (using projected 2040 wastewater flows).

Project Funding and Management Practices

Reclaimed water in Franklin has historically been used for non-potable uses such as irrigation. Although middle Tennessee is a water-rich region and potable water is sometimes used for irrigation, the cost of distributing potable water makes it increasingly attractive for customers to irrigate with reclaimed water instead. As with wastewater utilities across the country, Franklin's current water and sewer rates do not keep pace with infrastructure maintenance costs. However, providing low-cost reclaimed water allows the city to treat and purchase less potable water through its wholesaler by reducing overall demand for the relatively expensive commodity.

Institutional/Cultural Considerations

The inclusion of reuse in Franklin's integrated water resources plan allows the city to consider the complete water use cycle when planning for future growth. Utilizing reuse water gives the city flexibility in water supply and wastewater demand to better meet the needs of customers and environmental requirements. The final preferred option that was developed through a stakeholder process included future construction of a new WWRF upstream of the city where much of the new development is expected and where that wastewater would

flow to the plant by gravity. To fully implement this plan, however, the public perception issues associated with discharging wastewater effluent upstream of the water treatment plant intake will require continued public outreach and communication.

Successes and Lessons Learned

The Harpeth River is a small river that is impaired with respect to dissolved oxygen and nutrients which creates challenges for permitting additional withdrawals and discharges. The use of reclaimed water is an essential part of planning for increased water service capacities in the city of Franklin; increased reuse can allow the city to meet stringent effluent permit limits by reducing nutrient loads to the receiving stream while also reducing demand for potable water. Franklin is only one of a handful of cities in the state of Tennessee with a centralized reuse treatment and distribution system that is serving as a model for other communities wishing to adopt the sustainable practice of integrating reuse into water resources management.

To address these needs, the IWRP was developed using a facilitated process involving stakeholders to assist with the definition of the goals, objectives, performance measures and alternatives, and ultimately the recommended plan as the final product. One of the most critical components in development of the plan was the transparency in the technical evaluations and stakeholder involvement in the planning process. Ultimately, adoption of the final IWRP, which identifies projects that would be

adaptively implemented in phases over the next 30-year planning period, would not have been possible without this stakeholder participation.

References

City of Franklin, Tenn., website. n.d. "Integrated Water Resources Planning." Retrieved on August 20, 2012 from <<http://www.franklintn.gov/index.aspx?page=618>>.

San Antonio Water System Water Recycling Program

Author: Pablo R. Martinez (San Antonio Water System)

US-TX-San Antonio

Project Background or Rationale

The Edwards Aquifer is the primary water source for San Antonio, serving a population of 1.3 million. Reclaimed water is one resource in the San Antonio Water System (SAWS) water supply portfolio along with conservation and surface water. The SAWS continues to plan and develop additional water resources to meet current and projected demands and as a result, has a nationally recognized reclaimed water program designed to deliver 35,000 ac-ft/yr (43 MCM/yr) to customers using the product for stream augmentation, irrigation, cooling towers and industrial processes. The system includes 130 miles (210 km) of distribution pipeline, in-line storage tanks, and pumping facilities to deliver reclaimed water produced at three Water Recycling Centers (WRCs).

Capacity and Type of Reuse Application

Reclaimed water is produced at the Dos Rios, Leon Creek and Medio Creek WRCs, which have a combined capacity of 233 mgd (10,200 L/s). Above ground storage tanks provide in-line storage for reclaimed water which is distributed through 130 miles (210 km) of pipe ranging in sizes from 42-in to 24-in (107 cm to 61 cm) in diameter. The system is comprised of two major branches. Capacity in the east leg is 13,000 ac-ft/yr (16 MCM/yr) and capacity in the west leg is 22,000 ac-ft/yr (27 MCM/yr). At this point, both legs are near capacity with agreements for reclaimed water service. The reclaimed water is used for a range of uses, as shown in **Figure 1**.

Water Quality Standards and Treatment Technology

The state of Texas recognizes two types of reclaimed water quality (Type I and II). SAWS' WRCs produces type I reclaimed water, as shown in **Table 1**. The treatment technology used to meet these standards is advanced secondary treatment, filtration and chlorine disinfection at the WRCs and system high service pump and storage facilities. The reclaimed water

quality falls under the responsibility of WRC operators who provide that reclaimed water is treated to regulatory and contractual standards.

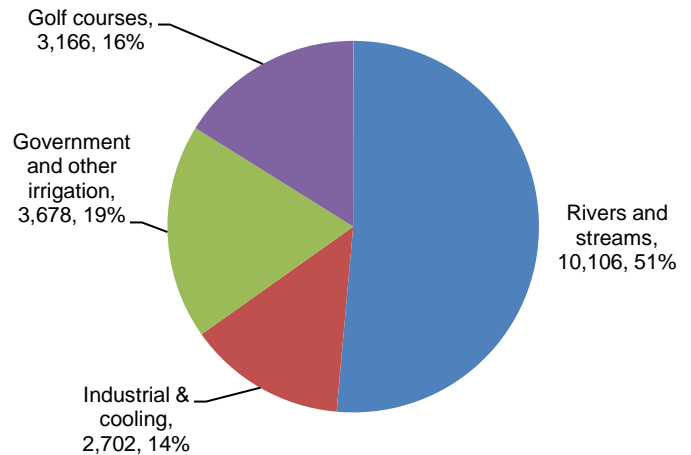

Figure 1
Reclaimed water use in ac-ft/yr and percent

The reclaimed water infrastructure maintenance is conducted by existing distribution and operations personnel and includes daily equipment checks, monitoring chlorine feed rates and addressing any system concerns or maintenance when needed.

Table 1 Standard and SAWS reclaimed water quality

| Constituent | Type I Standard (Texas) | SAWS Reclaimed Water Quality |
|------------------|-------------------------|------------------------------|
| BOD ₅ | 5 mg/L | 2 mg/L |
| Turbidity | 3 NTU | <1 NTU |
| Fecal Coliform | <20 cfu/100 mL | <2 cfu/100 mL |

Project Funding and Management Practices

Funding for the reclaimed water system infrastructure (pipelines, storage tanks and pumps) was supported through the existing capital program with support from a state loan program. Initial capital cost for the system was \$124 million. The cost for reclaimed water is about \$1.00/1000 gallons (\$0.26/m³). Commercial,

potable water can cost \$2 to 3/1000 gallons (\$0.52 to 0.77/ m³) depending on the customer's rate structure, seasonal and out of city limit rates plus water supply and Edwards Aquifer Management Fee based on volume and stormwater fee based on size of property.

Institutional and Cultural Considerations

When the reclaimed water program was developed, management and operational aspects were not formulated into designated departments or organizations. All planning, design, operations and customer service responsibilities were incorporated into existing water utility functions.

San Antonio is most notably known for its Downtown Riverwalk, which is the cultural center of San Antonio and visited annually by millions of visitors, aside from those who live in San Antonio. Approximately 4.6 mgd (200 L/s) of reclaimed water can flow into the Riverwalk; thus, stakeholder input to address issues such as water quality, policy and rates was critical. Public involvement included informational packages and numerous public presentations to gain confidence from the ratepayers that the program was a viable alternative non-potable water project.

Successes and Lessons Learned

The key factors to ensure project success included three phases of implementation:

Planning phase. Public opinion can change from skepticism to acceptance, and building public trust takes work to gain and keep. Stakeholders (citizens, government leaders, business leaders and organizations, schools) were included in information fairs and presentations to educate the public on the pressing need to manage the local water resources better for all.

In San Antonio, the federal lawsuit over endangered species was front page news for several years. The lawsuit covered seven endangered species and ruled that pumping water from two springs for urban and agriculture use had to be curtailed to support minimum flows in two springs to protect the endangered species. Most of the individuals engaged in discussion of building a reclaimed water system knew San Antonio lost 20 percent of its water supply with the judge's ruling. SAWS presented a reasonable option to

maintain quality of life for the community and minimize impact on water/wastewater rates.

Operations staff were included in initial planning and worked with water resources staff and customers to help provide a reclaimed water system to meet customer needs. Because staff were involved, they were accountable for the reclaimed water program's success.

Construction phase. It is common to coordinate with impacted neighborhoods by holding town hall meetings and information fairs in advance of construction. Because reclaimed water was a new utility bringing a new water supply, many residents had concerns about potential health impacts of reclaimed water. SAWS staff collected three samples of water in large glass containers (potable water, reclaimed water and San Antonio River water) for the information fairs and neighborhood meetings and most residents quickly excluded the river water but could not visually determine which jar contained potable or reclaimed water. This simple visual experience convinced many that reclaimed water was acceptable and clearly not sewage.

River discharge of reclaimed water is a benefit in urban environments; and once politicians were convinced reclaimed water was an acceptable alternative, the benefits of increased baseflow in the river and Riverwalk area downtown were evident to most businesses in the area, reinforcing the need for reclaimed water.

Operations phase. Get over the "us and them" attitude in organizations. The reclaimed water program at SAWS merged into previously distinct areas of the organization (water and sewer) and staff worked together to meet the program needs with their individual experience base. There were challenges such as chlorine dosing at low flows during system startup. When final phases of the project with rechlorination systems were complete, higher quality water was obtained in all parts of the distribution system, eliminating the few customer complaints that had been received.

Acknowledging that issues will happen (i.e. cross connections) in the best of reclaimed water systems and develop customer and staff training programs to educate all involved with immediate steps to resolve

cross connections, pipe failures, or other anticipated actions.

References

Pape-Dawson Consultant Team, Pape-Dawson Consulting Engineers, Inc. San Antonio Water System Water Recycling Program Engineering Feasibility Report, p. 3-29. October 1996.

San Antonio Water System website. 2011. Retrieved on Sept. 5, 2012 from <<http://www.saws.org>>.

Eckhardt, Gregg. The Edwards Aquifer Website. Retrieved on August 02, 2012 from <<http://www.edwardsaquifer.net/>>.

Raw Water Production Facility: Big Spring Plant

Author: David W. Sloan, P.E., BCEE (Freese and Nichols)

US-TX-Big Spring

Project Background or Rationale

Aiming to “reclaim 100 percent of the water, 100 percent of the time,” the Colorado River Municipal Water District (CRMWD, the District) in Texas anticipates launching operation of its first water reclamation plant in 2012 as step one in its ambitious program. In developing this plan, a 2005 feasibility study included the following:

- An inventory of effluent quantity and quality
- Determination of quality requirements for various blending scenarios
- Initial coordination with state regulators
- Concept-level cost estimates
- Development of a public information strategy

The Permian Basin of West Texas has always been challenged with water supply issues, and like much of the southwestern United States, has been subject to extended periods of low rainfall through the early 21st century. Since 1996, long-term drought has resulted in dangerously low reservoir levels prompting providers to consider new water supply sources. Water reuse has been practiced in the region for decades, and is increasing with application of new concepts in supply integration.

The CRMWD supplies water to its member cities: Big Spring, Snyder, and Odessa, Texas, as well as several customer cities such as Midland. The population of the CRMWD service area is about 350,000. Key components of CRMWD’s water reclamation plan include:

- Facilities to capture treated wastewater effluent prior to discharge
- Local and regional reclamation facilities to purify captured water
- Blending facilities to combine the reclaimed water with other raw water supplies

Although treatment facilities and transmission costs will be significant, CRMWD anticipates savings over other raw water source development options and a reduction in long-distance pumping costs. Three projects are envisioned, with a potential net average yield of 13 mgd (570 L/s).

Capacity and Type of Reuse Application

The District has proceeded with implementation of its first project, near CRMWD headquarters in Big Spring. This project will intercept up to 2.5 mgd (110 L/s) of filtered secondary effluent from the City of Big Spring WWTP and transfer it to an adjacent site, where additional treatment will be provided. The additional processes consist of microfiltration (MF), reverse osmosis (RO) and advanced oxidation prior to blending with raw surface water in the District’s raw water transmission pipeline as shown in **Figure 1**.

Project construction began in June 2011, with startup of treatment and transmission anticipated in fall 2012. Reclaimed water will represent up to 15 percent of the blended raw water in the existing pipeline network supplying member and customer cities, which operate conventional surface water plants which will continue to provide final treatment, including disinfection, prior to distribution.

Water Quality Standards

Due to the unique nature of this project—it is the first system in North America that directly blends reclaimed water with raw drinking water supply—there were no existing regulations or water quality standards that would drive specific treatment goals. The District worked closely with the Texas Commission on Environmental Quality to confirm that the proposed project approach and treatment level would be acceptable to protect public health and comply with source water approval regulations.

Treatment Technology

The established systems of the Orange County Water District in California and the Singapore NEWater

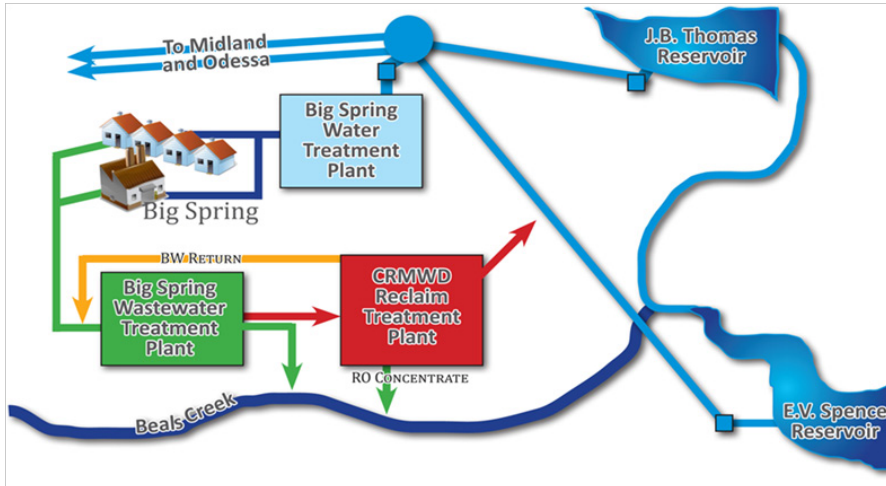

Figure 1
Project schematic, Raw Water Production Facility – Big Spring Plant

facilities provided an established treatment approach for high-exposure potable reuse. This treatment precedent was determined to be applicable for this project.

In selecting treatment processes, local conditions were considered. The use of natural systems such as wetlands or reservoirs was precluded due to high evaporation rates. In lieu of such an option, a rigorous, multi-barrier mechanical treatment scheme was deemed necessary. Water supplies in the District are high in dissolved solids, which are then further concentrated in the treated wastewater effluent. Desalination was therefore indicated as an essential element of the proposed treatment to meet total dissolved solids (TDS) standards for drinking water supply.

In the CRMWD plant system, MF provides removal of particulate material, including protozoan cysts resistant to chemical disinfection. RO provides removal of dissolved salts, viruses and bacteria, as well as many trace compounds such as pharmaceuticals and personal care products. Advanced oxidation with UV and hydrogen peroxide provides an additional barrier to potential pathogens and trace contaminants, not amenable to removal by RO.

Project Funding

The project has been funded primarily by District revenues from the sale of raw water. The initial feasibility study and preliminary design report were funded in part by a state water supply planning grant,

which represented approximately 22 percent of the cost for those phases of the project. Construction is funded by a state loan program available for financing new water supplies. Study costs were approximately \$440,000 and costs of design and construction of the reclamation plant and transmission facilities are approximately \$13.6 million.

Institutional/Cultural Considerations

Local public awareness regarding scarcity of water and an independent, pioneering spirit have contributed to acceptance of the reuse concept by the Permian Basin communities. The area's historic struggle to develop a dependable supply of potable water has resulted in a profound local understanding of the area's needs.

The District has developed a transparent process to inform the public throughout the project. Public meetings were held near completion of the initial feasibility study and again during preparation of the preliminary design report. Numerous media releases, radio announcements, and website descriptions have been provided to raise awareness of the concept and the developing project. The District developed literature and illustrations to distribute at meetings and generally as the project progressed.

Successes and Lessons Learned

Open, proactive communications with state regulators and the public have been key to the success of this project, along with the open-minded evaluation by regulators and public. Lessons learned include recognition of the time required for working out agreements with other entities, such as the member cities of the District.

Site Suitability for Landscape Use of Reclaimed Water in the Southwest

Authors: Seiichi Miyamoto, PhD and Ignacio Martinez
(Texas A&M Agrilife Research Center at El Paso)

US-TX-Landscape Study

Project Background

As population and demand for potable water increase, reuse of reclaimed water for landscape irrigation is becoming a more attractive practice in many communities in the U.S. Southwest. It saves potable water, and provides a stable supply of irrigation water for maintaining urban greenery and recreational facilities. While the objective of conserving potable water is being achieved, there have been cases of landscape quality degradation at some reclaimed water use sites including foliar damage, stunted growth, early defoliation, and at times, tree mortality.

Reclaimed water in west Texas and southeastern New Mexico has elevated salinity, up to 1650 ppm (**Table 1**). The sodium adsorption ratio (SAR) is highly variable, but typically ranges from 7 to 12 in the Rio Grande watershed, and 2 to 3 in other areas. For comparison, salinity of reclaimed water used for landscape irrigation in California is generally less than 750 ppm, rarely exceeding 1000 ppm.

Type of Reuse Application

This study was conducted in five project areas where reclaimed water was used for urban landscape irrigation. The landscape areas involved were estimated at 150 to 300 ac (60 to 120 ha). Treated, secondary, municipal effluent is piped to storage facilities and then applied to various reuse sites

including golf courses, municipal parks, school yards, and some apartments or commercial real estate irrigated with sprinklers, and occasionally, drip systems. Irrigation was usually managed by regional estimates of consumptive use, and for golf courses, following real-time monitoring.

Water Quality Standards

Municipal effluent in the study area is treated to meet “Public Access” reuse (Type I). The Texas regulation (TAC 210.33) for Type I use mandates biochemical oxygen demand, turbidity, fecal coliform (or *E. coli*), but not salinity. However, regulatory agencies or water providers can place additional stipulations for water quality goals. California guidelines, which are also the basis for the Food and Agriculture Organization (FAO) guidelines, outline hazard ranges, with no problems likely if salinity is less than 450 ppm, and increasing problems at 450 to 2000 ppm. The United States Golf Association (USGA) recommends a 1000 ppm limit for salinity, and a SAR limit of 6, except for special cases. **Table 1** includes typical water quality data of reclaimed water in west Texas and southern New Mexico, along with observed landscape degradation. The quality of the reclaimed water varies temporally, and data may not reflect current quality; some samples in the study area exceeded the USGA guidelines for salinity.

Table 1 Reclaimed Water Quality in West Texas, Southern New Mexico with Landscape Degradation Issues

| Water Sources | Water Quality | | | | | Soil Suborder | Landscape Degradation |
|-------------------------|---------------|--------------------------|------|----------|----------|-------------------------|---------------------------|
| | TDS (ppm) | EC (dS m ⁻¹) | SAR | Na (ppm) | Cl (ppm) | | |
| El Paso | | | | | | | |
| Rio Grande | 660 | 0.9 | 3.2 | 110 | 92 | Torrifluvents, Entisols | Soil salinization |
| Fred Hervey | 680 | 0.9 | 3.7 | 150 | 180 | Calciorthid, Aridisols | No problem (turf only) |
| Haskell | 980 | 1.6 | 7.3 | 250 | 280 | Torrifluent, Entisols | Leaf damage, salinization |
| Northwest | 1200 | 2.2 | 11.0 | 350 | 325 | Paleorthid, Aridisols | Leaf damage, salinization |
| Alamogordo ¹ | 1800 | 2.7 | 2.0 | 310 | 480 | Camborthid, Aridisols | Leaf damage, salinization |
| Odessa ² | 1650 | 2.4 | 1.9 | 330 | 520 | Paleustal, Alfisols | Leaf damage |

¹ These water sources contain substantial quantities of Ca and SO₄

² Reclaimed water quality of this source changes with season

Lessons Learned

In general, design of reclaimed water projects begin with the estimate of green areas with an assumption that all green areas can be irrigated with reclaimed water. This study has shown that this assumption may not be entirely valid for several reasons: 1) many landscape plants can be very sensitive to foliar salt adsorption caused by sprinkler application of water, 2) soil permeability can be too low to achieve necessary salt leaching to avoid buildup, and 3) difficulties of instituting policy changes necessary to reduce salinity and/or sodicity hazard.

Foliar-Induced Salt Damage. This problem is the most wide-spread. Plants adsorb salts through leaves when sprinkled, especially under high frequency irrigation. The extent of foliar damage is species-dependent, and ranged from minor leaf-tip burn to premature defoliation, and plant mortality. Sensitive species, such as broad leaf trees can suffer leaf burn at 150 ppm of sodium or chloride in irrigation water. At 250 ppm, nearly all species can be affected, except for pines and waxy leaf shrubs (Miyamoto and White, 2002). Because of the widespread occurrence of this problem, site suitability assessments should include identification of species sensitive to overhead irrigation with water of elevated salinity (Miyamoto, 2006). An alternative is to convert sprinklers to low trajectory or under-canopy types. (Ornelas and Miyamoto, 2003).

Degradation through Soil Salinization. Landscape degradation caused by soil salinization depends on plant species (Miyamoto et al., 2004; Miyamoto, 2008). Soil salinization is also soil-type dependent and the most extensive soil salinization, was found in public sports fields developed on clayey Torrifluvents and irrigated with water from the Rio Grande. These soils do not have sufficient permeability to maintain a salt balance, especially when compacted. Some sports fields which were constructed at upland sites with topsoiling were also found to be salinized. The cause and process is still being studied. At the same time, little salt accumulation was found in golf courses developed on upland soils with high permeability, even when irrigated with water of nearly 2000 ppm total dissolved solids. Likewise, apartment and commercial building landscape developed on upland soils have shown no significant level of soil salinization, especially when the site is located on sloped topography which allows lateral salt leaching.

Soil salinization can be minimized through subsoiling and soil profile modification (Miyamoto, 2008), and a change in construction protocols. However, there is a need to develop guidelines for soil improvements and design changes. Site suitability assessment must include identification of soil types prone to salinization.

Institutional Constraints. Methods of reducing salinity impact on landscape, such as proper plant selection, irrigation system alteration, and soil improvements are relatively easy to implement, except for upscale sports fields with many expensive features. However, voluntary implementation of these measures was not observed, especially at public facilities due significant changes in reuse expectations and policies. Site suitability assessments should include the evaluation of existing landscape codes and maintenance practices using potable water. Such information can provide indications of success potential when converting irrigation systems to reclaimed water.

References

- Miyamoto S. and A. Chacon, 2006. *Soil salinity of urban turf areas irrigated with saline water: II. Soil factors*. Landsc. & Urban Plan. 77(1-2):28-38.
- Miyamoto S. 2008. *Salt tolerance of landscape plants common to the southwest*. Texas Water Resource Inst. TR-316:1-37 May 2008.
- Miyamoto, S. 2006. *Site suitability assessment for irrigating urban landscape with moderately saline water in the southwest*. Presented at the 21st Annual WaterReuse Symposium in Hollywood, CA on September 10, 2006.
- Miyamoto, S. and J. White, 2002. *Foliar Salt damage of landscape plants induced by sprinkler irrigation*. Texas Water Resources Inst. TR-1202, March 2002.
- Miyamoto, S., I. Martinez, F. Luna and D. Tirre, 2008. *Improving permeability and salt leaching in irrigated sports fields: Exploratory testing*. Texas Water Resources Inst. TR-310, February 2008.
- Miyamoto, S., I. Martinez, M. Padilla, A. Portillo and D. Ornelas, 2004. *Landscape plan lists for salt tolerance assessment*. Texas A&M Univ. Agr. Res. Cent. at El Paso, TX.
- Ornelas, D., and S. Miyamoto, 2003. *Sprinkler conversion to reduce foliar salt damage*. Water Reuse Conference, San Antonio, TX.

U.S. Water Recovery System on the International Space Station

Author: J. Torin McCoy (NASA Johnson Space Center)

US-TX-NASA

Project Background or Rationale

International Space Station (ISS) crew members must conserve as much water as possible because each crew member is allocated only about two liters of water per day. Reclaimed spacecraft water (humidity condensate and urine distillate) was recognized as an efficient, innovative, and safe source for potable water for the ISS. The ability to recover water on ISS has allowed for habitation of six crew members and made the ISS less dependent on ground resupply.

In early phases of the ISS, astronauts relied on a Russian Mir system, in which atmospheric humidity condensate was collected and processed into potable water by a condensate water processor. NASA's water recovery system (WRS), launched to ISS in 2008, goes one step further: it recovers urine in addition to humidity. The system can recover about 85 percent of the water in urine. In order to accomplish this treatment goal, the process necessitated careful engineering and enhanced water quality monitoring and assessment.

The WRS uses physical and chemical processes to remove contaminants from wastewater (**Figure 1**). The produced water is tested by onboard sensors; unacceptable water is cycled back through the water processor assembly. The reliability and safety of the system was demonstrated using a 90-day "checkout" on-orbit, during which no crew consumption of the reclaimed water was allowed. Monitoring during that timeframe showed that inflight chemical and microbial characteristics were similar to those observed in pre-flight system design and testing (Straub et al., 2010). U.S. crews

have obtained approximately 75-100 percent of their potable water from this source, and have been able to store excess water for contingencies. Processing downtimes have been limited, and the WRS has proven reliable and efficient.

Microbial growth has been observed, but primarily only during periods of stagnancy. No pathogenic organisms have been detected and monitoring for non-pathogenic levels of microorganisms have been generally consistent with ground-based potable water systems in terms of concentrations and types of microorganisms. In addition to potable uses, other ISS systems (such as oxygen generation) successfully utilize reclaimed water.

Capacity and Treatment Technology

Under optimized conditions, the WRS will process approximately 7 liters of condensate daily, along with a similar volume of urine distillate. Approximately 12 liters of potable water per day are reclaimed for potable purposes. As shown in **Figure 1**, recovered crew urine is distilled in the urine processor assembly

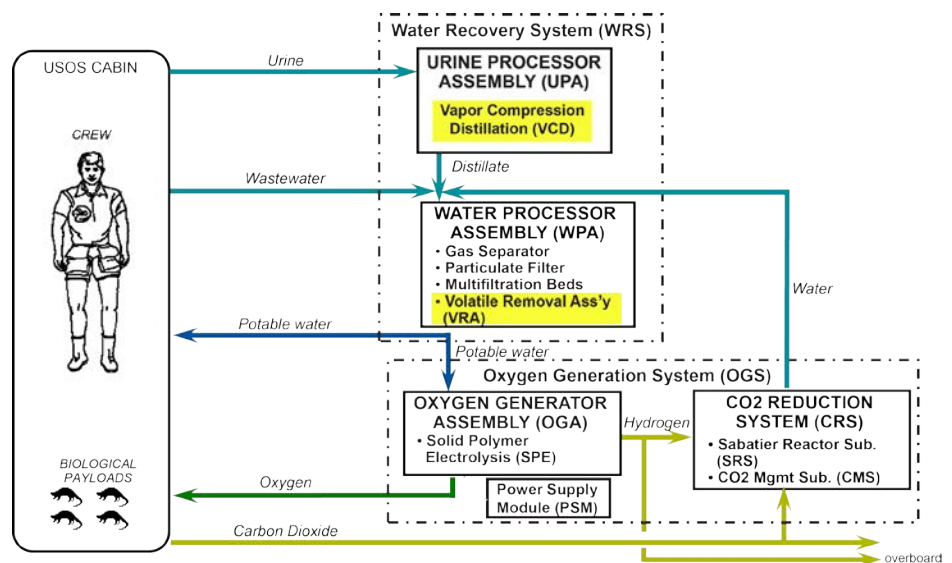

Figure 1
WRS and Oxygen Generator Assembly (OGS) process flow diagram

(UPA), and fed to the water processor assembly (WPA) along with humidity condensate/wastewater; these elements together constitute the U.S. water recovery system (WRS), as shown in **Figure 2**. Reclaimed water is used by the crew as a potable source, and is fed to the oxygen generation assembly (OGA) as a source of electrolytic oxygen that is returned to the spacecraft cabin.



Figure 2
Water recovery system on ISS

Project Funding and Management Practices

The ISS had substantial investments in the implementation of the WRS. Costs for launching water are approximately \$10,000/lb (\$50,000/liter) because of the relatively large weight of water necessary to support six crew members on ISS (~25 lbs/day or 11.3 kg/day), which makes a strong rationale for use of reclaimed water. Recycling water also serves to

reduce crew dependency of resupply. Management was also interested in proving technologies such as WRS that represented skills/resources needed for more remote spaceflight missions.

Institutional and Cultural Considerations

Given the unique setting and end users, there were not significant objections to implementation of WRS on ISS. However, there were indeed stigmas regarding the reclaimed water use (especially in regard to urine recycling). Those stigmas were overcome through openness and effective communication with stakeholders. “Taste tests” and other forums were used to encourage acceptance among crew and decision-makers.

Successes and Lessons Learned

WRS has operated successfully since 2008, and serves as a model for implementation of complex and innovative hardware in a remote environment. Lessons learned have included the value of proper planning, the need for continued monitoring, and the challenges/strengths of multi-disciplinary collaboration.

References

- Bagdigian, R., L. Carter, and G. Sitler. “Status of the Regenerative ECLSS Water Recovery System.” International Conference of Environmental Systems (ICES) Proceedings, 2008. AIAA Paper 2008-01-2133. SAE.
- Straub, J., D. Plumlee, and J. Schultz. “ISS Expeditions 16-20: Chemical Analysis Results for Potable Water.” International Conference of Environmental Systems (ICES) Proceedings, 2010. Paper AIAA 2010-6042. SAE.

East Fork Raw Water Supply Project: A Natural Treatment System Success Story

Authors: Ellen T. McDonald, PhD, P.E. and Alan H. Plummer, Jr., P.E., BCEE (Alan Plummer Associates Inc.) and James M. Parks, P.E. (North Texas Municipal Water District)

US-TX-Wetlands

Project Background or Rationale

North Texas Municipal Water District (NTMWD) currently provides potable water to a population of over 1.6 million in a region north and east of the City of Dallas. Water is diverted for treatment from the NTMWD's primary raw water supply reservoir, Lavon Lake, which is located in the Trinity River basin and has a firm yield of approximately 104,000 acre-feet per year (~93 mgd). This supply is supplemented with transfers to Lavon Lake from two other water supply reservoirs, one located in the Red River basin and one in the Sulphur River basin. In addition to its potable water supply facilities, NTMWD owns and operates 4 regional wastewater treatment plants and operates 12 smaller wastewater treatment plants within its service area.

NTMWD is located in one of the fastest growing regions in the United States. By 2020, the service area population is anticipated to grow by nearly 700,000 and more than double in the next 50 years. As a result of this unprecedented growth and a strong commitment to the efficient use of water resources, NTMWD developed the East Fork Raw Water Supply Project (EFRWSP) in order to further augment water supply in Lavon Lake.

The EFRWSP diverts return flows from the East Fork of the Trinity River, contributed by NTMWD-owned or customer-owned wastewater treatment facilities, and conveys the return flows through a constructed wetland prior to delivery to Lavon Lake. The project, when developed at full capacity, will add 91 mgd of raw water supply to Lake Lavon for subsequent treatment and use by NTMWD customers.

Capacity and Type of Reuse Application

The wetland covers 1,840 acres and is designed to remove sediments and nutrients from the water, where it is retained for 7-10 days prior to delivery to Lavon

Lake. Work on the wetland began in 2004 with the design and construction of the first of two nursery wetlands. The initial nursery, 25 acres in size, was used to provide plant stock of selected emergent wetland species for a 180-acre second phase nursery. The 180-acre nursery was completed in 2006 and was used to provide over 1.6 million plants for the full-scale wetland (**Figure 1**).



Figure 1
EFRWSP wetland, May 2009 (Photo credit: Alan Plummer Associates, Inc.)

The general layout of the wetland is shown in **Figure 2**. The diversion pump station includes a river diversion structure and 165 mgd pump station which is used to divert flow from the East Fork Trinity River to the upstream end of the wetland. Currently this pump station includes two 250 horsepower (hp), 16,810 gallon per minute (gpm) and two 500 hp, 33,620 gpm vertical turbine pumps. Space has been provided for one additional pump. The conveyance pump station also has a capacity of 165 mgd, and currently includes three 3,000 horsepower, 33,620 gpm vertical turbine pumps used to convey the wetland-polished water to Lavon Lake. Space for two additional pumps has been provided.

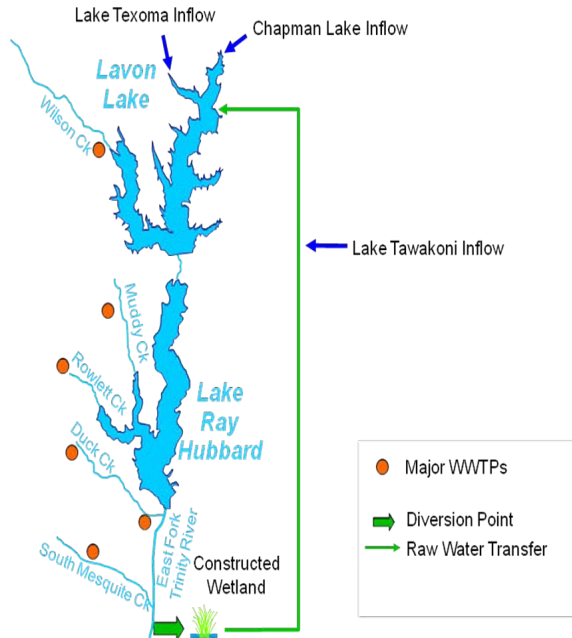

Figure 2
ERWSP Flow Directions

Water enters at the north end and travels through sedimentation basins prior to entering the main cells. The wetland includes parallel trains with multiple cells. There are three distinct geographic zones; the wetland trains in each zone discharge to a common channel or pool where outflows from each individual train commingle. The flow is subsequently redistributed to the uppermost cells of the trains in the next zone. In effect, this arrangement creates three distinct treatment wetlands which present some design challenges, but provide additional operational flexibility. Deep water zones were included at the inlet and outlet of each cell. Intermediate deep water zones were also included to help redistribute flow across the cells should preferential flows or short circuiting develop.

Water Quality Standards and Treatment Technology

Water quality within Lavon Lake was a key consideration during planning of the project. One of the imported supplies originates from a relatively high total dissolved solids (TDS) source. Furthermore, in addition to the imported supplies, the NTMWD's largest regional wastewater treatment plant (currently permitted at a capacity of 48 mgd) discharges into the western arm of Lavon Lake. Thus, the assimilative capacity of the lake as it relates to dissolved solids,

nutrients and eutrophication, as well as potential impacts of microconstituents were addressed within the planning process.

Project Funding and Management Practices

The wetland was developed through a partnership with the Carolyn Hunt Trust Estate, which owns and operates a ranch and a smaller wetland on the property. This partnership has resulted in the construction of the largest water supply project of its kind in the United States.

Water rights permitting was also a key component of the EFRWSP planning process. Return flows from the Dallas-Fort Worth Metroplex travel down the Trinity River, ultimately reaching Lake Livingston, which is a major water supply reservoir serving the city of Houston. In addition, several of the NTMWD wastewater treatment plants supplying the EFRWSP discharge into an upstream reservoir owned by the City of Dallas. Furthermore, several environmental interest groups expressed concerns about potential decreases in freshwater inflows to Galveston Bay, located downstream of Lake Livingston. Securing the water right for the project required a lengthy negotiation process with all of these parties.

Institutional/Cultural Considerations

As indicated above, water rights in a water-short state raised significant discussions. By working together over several years, parties came to agreement, including several environmental interest groups initially concerned with Instream flows and cumulative flows to the Texas bays and estuaries. Through education and negotiations to limit internal Lavon Lake blending to 30 percent, these interest groups recognized the inherent environmental benefits of potential deferral of the need to construct new water supply reservoirs and the development of additional aquatic life habitat created by the wetland.

The wetland and nature center was developed through a partnership with the Carolyn Hunt Trust Estate, which owns and operates a ranch and a smaller wetland on the property. The project has experienced very little public opposition, and overall is seen as an asset to area by environmental interest groups, the water supply community and the general public. This positive image is largely attributed to the constructed wetland, which provides multiple benefits associated

with water supply, aquatic life habitat enhancement, and extensive educational and research opportunities.

Successes and Lessons Learned

The EFRWSP is operational and providing immediate benefit to area water supply customers and the public. Time educating and negotiating differing opinions has resulted in a project with benefits for all interested parties.

Potable Water Reuse in the Occoquan Watershed

Authors: Robert W. Angelotti (Upper Occoquan Service Authority)
and Thomas J. Grizzard, PhD, P.E. (Virginia Tech)

US-VA-Occoquan

Project Background or Rationale

The Occoquan Reservoir is a critical component of the water supply for approximately 1.5 million residents of Northern Virginia, a highly urbanized region located west of Washington, D.C. (**Figure 1**). Reclaimed water represents a significant supplement to potable water supply yield from the reservoir and has been successfully augmenting the drinking water supply for over three decades.



Figure 1
Aerial view of the Occoquan Reservoir (Photo credit: Roger Snyder, Manassas, Virginia)

Rapid transformation from a largely rural to a predominantly urban/suburban region began in the 1960s as a result of unprecedented growth from the westward expansion of the urban core of Washington, D.C. By the mid-1960s, this urbanization was adversely affecting water quality of the Occoquan Reservoir, resulting in an unplanned and unintended indirect potable reuse scenario, where 11 small wastewater treatment plants were discharging effluent upstream of the reservoir. Poorly treated wastewater, with urban and agricultural runoff, threatened continued use of the Occoquan Reservoir for public water supply.

In 1971, the Virginia State Water Control Board (VDEQ) and the Virginia Department of Health (VDH) adopted a plan to protect the Occoquan Reservoir as a drinking water supply. The Occoquan Policy mandated a newly conceived framework for water reuse and set in motion the first planned and intentional use of reclaimed water for supplementing a potable surface water supply in the United States (VDEQ and VDH, 2012).

The Occoquan Policy mandated creation of a regional State authority, the Upper Occoquan Service Authority (UOSA), to provide collection and reclamation of wastewater, and the Occoquan Watershed Monitoring Program (OWMP), to continuously monitor the watershed and reservoir to provide independent water quality assessments and advice on protective measures for the reservoir. By the 1970s, Fairfax Water was responsible for potable water production and distribution for much of Northern Virginia. The VDEQ and VDH were also highly involved in developing the ultimate solution.

While water quality improvement was the primary driver for implementing planned and intentional potable water reuse in the Occoquan system, supplementing the raw water supply was always an underlying objective. Although the mid-Atlantic region of the U.S. is not considered dry or arid, the population density results in stressed water supply, and limited per capita water availability. This situation becomes more pronounced during periodic extended drought conditions.

Capacity and Type of Reuse Application

A diagram illustrating how the UOSA reclamation system interacts with the drinking water supply is provided in **Figure 2**. The UOSA reclamation plant produces about 32 mgd (1,400 L/s) of water on an annual average basis and the plant has the capacity to reclaim as much as 54 mgd (2,370 L/s) of water. A future annual average plant flow of around 65 mgd is

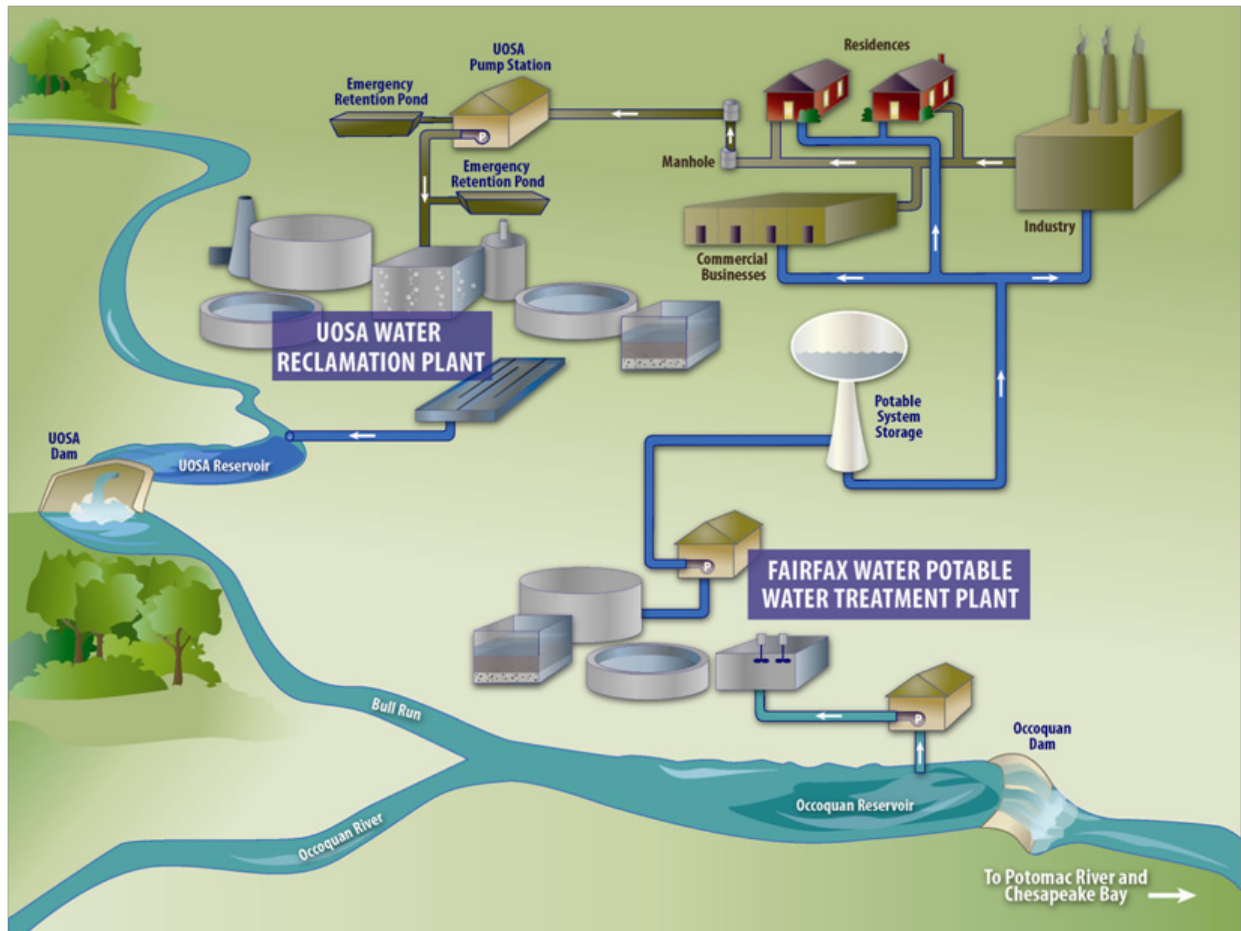

Figure 2
The UOSA Reclamation Plant provides an important source of water for the service area (Photo credit: CDM Smith for UOSA)

associated with the build out condition within the UOSA service area. Future reclaimed water production is anticipated to effectively double the safe yield of the Occoquan Reservoir. Although the majority of water produced supplements the drinking water supply, 1 to 3 mgd (44 to 130 L/s) is also delivered for nonpotable uses on the UOSA campus.

Water Quality Standards and Treatment Technology

The water reclamation process includes preliminary and primary treatment followed by complete mixed activated sludge with biological nitrogen removal. Advanced water treatment processes include lime precipitation and two stage recarbonation with intermediate settling; these processes remove phosphorus and are barriers to pathogens and heavy metals. Final polishing is accomplished with multimedia filtration, granular activated carbon adsorption, chlorination and dechlorination.

Reclaimed water is produced at concentrations that meet all Federal Primary and Secondary Drinking Water Standards except occasionally for nitrate and total dissolved solids. Seasonally, the nitrate drinking water standard is exceeded purposefully to accomplish specific reservoir water quality goals. Reclaimed water quality permit standards are provided in the UOSA discharge permit (UOSA and VDEQ, 2012), and typical characteristics of the reclaimed water are available from UOSA (UOSA, 2012).

Management Practices and Institutional Considerations

Today, the concept of indirect potable reuse is well communicated to regulators and public official stakeholders within the region. Interested parties within local municipalities are well aware that a significant portion of the water supply is comprised of reclaimed water. Both Fairfax Water and UOSA are run by a board of directors. Board members are representatives for their community and make

decisions in the best interest of the communities they serve. It is not uncommon for UOSA to collaborate closely with representatives of local governments about issues relating to water quality.

The community and the independent water quality monitoring entity, OWMP, both openly acknowledge that the reclaimed water produced by UOSA is the most reliable and highest quality water entering the Occoquan Reservoir. The OWMP has a technical advisory panel that is comprised of members from EPA, VDEQ, VDH, and an expert from an accredited and well-renowned academic institution within the state (Virginia Polytechnic Institute and State University, otherwise known as Virginia Tech). This provides even greater confidence and credence for potable reuse in the region.

Periodically, water related issues within the region result in the formation of technical advisory groups, citizen action committees and task forces. These may be composed of agency stakeholders, city or county government officials, community representatives, water experts and interested citizens. Examples of issues tackled by such groups include: land zoning around the reservoir to protect water quality, siting of a major semiconductor industry within the UOSA service area, and consumptive use of reclaimed water by a proposed power plant. These collaborative efforts with interested and affected parties are used to gather input before important decisions are made that might impact water quality or its availability to users.

Cultural and Social Considerations

When water reclamation was first proposed, a number of hearings were conducted to explain what was to be implemented and to provide the public a venue to express their views. UOSA has always engaged in an active program to provide tours to local students, from grade school through college, during which potable reuse is thoroughly explained. These tours have been conducted for more than 30 years, providing public outreach to the local population on the importance of UOSA's mission. In addition, UOSA maintains a public website where its role in potable water reuse is clearly expressed. UOSA's success has not required dedicated public relations staff or a formal public outreach and communication program.

Successes and Lessons Learned

Perhaps the greatest key to success of this project is that it was implemented specifically to improve water quality problems in the existing surface water reservoir being used as the drinking water supply. The project was initiated by the Commonwealth of Virginia, via state regulation (the Occoquan Policy) which was developed by the VDEQ and VDH. Early water quality problems in the Occoquan Reservoir were clearly articulated and the best solution for the region was presented to stakeholders and interested citizens. Although water quality was the major driver, it was clearly recognized that treated wastewater flows returned to the reservoir would be a significant and valuable resource in the future.

This project is unique in that there is a separate watershed management program (OWMP), along with its associated water quality monitoring laboratory (OWML) that provides oversight, independent accountability and recommendations to the water reclamation agent (UOSA), the potable water treatment and distribution entity (Fairfax Water) and state regulatory agencies. This was critical in establishing a credible voice of endorsement and recommendation for the plan. Collaboration among major institutional entities that work toward common goals of protecting and improving the water quality of the reservoir demonstrates the leadership for water-related issues for the community. More than 34 years of successful implementation has demonstrated confidence that the original plan is still working well today.

References

Upper Occoquan Service Authority (UOSA), 2012. Typical Water Product Quality. typical performance characteristics. Retrieved July 27, 2012 from <<http://uosa.org/Information/Water Product Quality>>.

Upper Occoquan Service Authority (UOSA) and Virginia Department of Environmental Quality (VDEQ). 2012. Authorization to Discharge Under the Virginia Pollutant Discharge Elimination System and the Virginia State Water Control Law. Retrieved July 27, 2012 from <<http://uosa.org/Information/VPDES Permit>>.

Virginia Department of Environmental Quality (VDEQ) and Virginia Department of Health (VDH), 2012. Occoquan Watershed water reuse policy. Retrieved July 27, 2012 from <<http://lis.virginia.gov/cgi-bin/legp604.exe?000+reg+9VAC25-410-10>>.

Water Reuse Policy and Regulation in Virginia

Author: Valerie Rourke, CPSS, LPSS, CNMP (Virginia Department of Environmental Quality)

US-VA-Regulation

Project Background

The Commonwealth of Virginia has had a long history of water reuse, which formally began with the operation of an indirect potable reuse project by the Upper Occoquan Sewage Authority (now the Upper Occoquan Service Authority) (UOSA) in 1978 [US-VA-Occoquan]. Consistent with national trends, water reuse has continued to gain greater acceptance and application in Virginia due primarily to efforts to reduce or avoid wastewater treatment facility discharges to surface waters, and increasing urban population growth.

EPA has developed a total maximum daily load (TMDL) for nutrients that are discharged to the Chesapeake Bay. The TMDL affects all point source discharges of states, including Virginia, within the watershed of the Chesapeake Bay. As a result, Virginia's discharging wastewater treatment facilities are required to meet lower nutrient limits through nutrient trading¹, the installation of nutrient removal technology or the implementation of non-discharging alternatives, such as water reuse.

From 1950 to 2010, Virginia's population more than doubled from 3.2 million to 8.0 million inhabitants with an increase of 13 percent during the period of 2000 to 2010. Projected population growth will be in mostly urban centers of the state. Although Virginia has an average annual rainfall of 40 inches, it experiences water shortages during periods of prolonged drought. Such water shortages are compounded by population growth, which places an increasing demand on water

¹ Nutrient trading is a market-based program that provides incentives for entities to create nutrient reduction credits by going beyond statutory, regulatory or voluntary obligations and goals to remove nutrients from a watershed. To achieve a desired load reduction, trades of nutrient credits can take place between point sources (usually wastewater treatment plants), between point and nonpoint sources (a wastewater treatment plant and a farming operation) or between nonpoint sources (such as agriculture and urban stormwater sites or systems).

supply. As a result, Virginia's Local and Regional Water Supply Planning Regulations ([9VAC25-780](#)) now require localities to develop water plans to ensure the availability of adequate and safe drinking water for citizens of the Commonwealth, and to protect all other beneficial uses of the Commonwealth's water resources. As part of their water plan, localities must provide a statement of water need and alternatives to meet this need; alternatives may include nontraditional options, such as inter-connection, desalination, recycling and reuse.

Current Regulations and Guidelines

Virginia does not have a singular, comprehensive policy or program for reuse of all types of water that have historically been wasted or disposed. Rather, multiple state agencies have regulations or guidelines that affect water reuse, determined in most cases by the type of wastewater to be reclaimed, with some degree of redundancy. For example, the following agencies have regulations or guidelines governing aspects of water reuse:

- The Virginia Department of Environmental Quality (DEQ) has regulations for the reclamation and reuse of domestic, municipal or industrial wastewater collected and treated through centralized systems.
- The Virginia Department of Health has regulations that allow the onsite treatment and reuse of sewage for toilet flushing in conjunction with a permitted onsite sewage system, and has guidelines for the non-potable use and reuse of harvested rainwater and graywater, respectively.
- The Virginia Department of Housing and Community Development has regulations for the indoor treatment and plumbing of recycled gray water and harvested rainwater, and for the indoor plumbing of reclaimed water meeting appropriate regulatory standards administered by the DEQ for indoor reuses.

- The Virginia Department of Conservation and Recreation has limited regulations for the reclamation and reuse of storm water and evaluates such proposals on a case-by-case basis.

History and Regulation Development

Virginia's process to adopt regulations for the reclamation and reuse of domestic, municipal and industrial wastewater first began in 1999. The Virginia General Assembly directed DEQ to convene a committee to assist the agency with the development of a report ([House Document No. 92](#)), examining the advantages and disadvantages of water reuse as the basis for future legislation on this subject. In 2000, the General Assembly incorporated some of the recommendations of the report into the Code of Virginia, providing the statutory basis for the State Water Control Board to develop regulations for water reuse. Following two separate consecutive actions to develop such regulations, the Virginia Water Reclamation and Reuse Regulation ([9VAC25-740](#)) was adopted and became effective on October 1, 2008.

The Water Reclamation and Reuse Regulation is unique among other water regulations adopted by the State Water Control Board (SWCB). Most water regulations of the SWCB fall distinctly within policy, permitting, standards or technical categories. The Water Reclamation and Reuse Regulation ([9VAC25-740](#)) however, contains standards for reclaimed water and provides technical design and operational requirements for facilities that produce, store and distribute reclaimed water for reuse. It is not a permit regulation but, describes existing water permit types that may be used to authorize water reclamation and reuse projects. It is also a "bridging" regulation for projects that have both wastewater treatment and water resources or supply components, such as for indirect potable reuse.

The development or amendment of any regulation adopted by the SWCB must follow the procedures described in the Administrative Process (Act [§2.2-4000 et seq. of the Code of Virginia](#)). The SWCB typically delegates its authority to develop and implement regulations to the DEQ. In accordance with agency's Public Participation Guidelines ([9VAC15-11](#)), the DEQ may assemble a regulatory advisory panel or a technical advisory committee to assist the agency with the development of a regulation. DEQ assembled a

technical advisory committee for the Water Reclamation and Reuse Regulation, which provided significant input and support during this process.

Resources Used to Develop the Regulations

To develop the Water Reclamation and Reuse Regulations, DEQ relied upon and benefitted from a variety of existing resources. These included the EPA *Guidelines for Water Reuse* (2004); rules, regulations, guidelines and regulatory contacts of water reuse programs in other states; the WaterReuse Association; and WaterReuse Symposiums. The EPA *Guidelines for Water Reuse* provided a preliminary framework and basic items that should be considered as part of any regulatory program for water reuse. Other states' water reuse rules, regulations and guidelines provided information about more detailed items to consider as part of a regulatory program. Discussions with other water reuse regulators, particularly through the WaterReuse Association or at the annual WaterReuse Symposium, were invaluable regarding unique problems and solutions, and the implementation of a water reuse program.

Media Involvement

The media was involved to occasionally cover the status of the regulation during development and eventual adoption.

Institutional/Cultural Considerations

There were no institutional or cultural issues that drove decisions during the development of the regulation.

Details Particular to Virginia

Water reclamation and reuse is strictly voluntary in Virginia. However, when a facility chooses to reclaim domestic, municipal or industrial wastewater for reuse, the facilities must comply with the requirements of the Water Reclamation and Reuse Regulation with some exceptions as described in [9VAC25-740-50](#). Treatment requirements and reclaimed water standards in the regulation were developed to be protective of public health and the environment, while providing options that, to the greatest extent possible, would allow most existing wastewater treatment facilities to produce reclaimed water with little or no change in their treatment processes. Less treatment, however, will limit reuse options in most cases. Indirect potable reuse projects may be permitted on a case-by-case

basis but, direct potable reuse is prohibited. The Water Reclamation and Reuse Regulation specifically excludes graywater reuse and does not address the reclamation and reuse of storm water or harvested rainwater, which are addressed by the guidelines or regulations of other state agencies.

Unlike the water reuse rules, regulations and guidelines of other states, the Virginia Water Reclamation and Reuse Regulation requires that all irrigation with reclaimed water be supplemental. Supplemental irrigation is defined as irrigation, which in combination with rainfall, meets but does not exceed the water necessary to maximize production or optimize growth of the irrigated vegetation. This definition is intended to distinguish land treatment of wastewater, a method of disposal, from irrigation reuse that involves irrigation of crops for a beneficial use rather than disposal. Due to this difference, land treatment will generally require ground water monitoring, while irrigation reuse will not. Also, irrigation reuse may be either bulk or non-bulk determined by the size of the irrigation site. For bulk irrigation reuse of reclaimed water (irrigation of areas greater than five acres on one contiguous property), a nutrient management plan will be required where non-biological nutrient removal (non-BNR) reclaimed water (reclaimed water with annual average concentrations of total nitrogen and total phosphorus greater than 8 and 1.0 mg/l, respectively) will be applied to the irrigation reuse sites. Irrigation of non-bulk irrigation sites with non-BNR reclaimed water will not require a nutrient management plan but will be required to implement other measures to manage nutrients at the irrigation reuse site.

Successes and Lessons Learned

While water reclamation and reuse poses some unique issues in Virginia, it is still viewed as a useful tool among others to optimize water resources long term. It is shifting the paradigm from one that has viewed water resources and wastewater treatment separately, to one that views water resources and wastewater treatment as related and affecting each other.

References

§ 2.2-4000 et seq., Administrative Process Act.

9 VAC 15-11-10 et seq., Virginia Administrative Code, Public Participation Guidelines.

9 VAC 25-740-10 et seq., Virginia Administrative Code, Water Reclamation and Reuse Regulation.

9 VAC 25-780-10 et seq., Virginia Administrative Code, Local and Regional Water Supply Planning Regulations.

Report of the Virginia Department of Environmental Quality: Land Application, Reclamation and Reuse of Wastewater to the Governor and General Assembly of Virginia, House Document No. 92, DEQ, 2000.

City of Sequim's Expanded Water Reclamation Facility and Upland Reuse System

Author: Chad Newton, P.E. (Gray & Osborne, Inc.)

US-WA-Sequim

Project Background or Rationale

The city of Sequim is a community on the Olympic Peninsula in Washington State, along the Strait of Juan de Fuca and adjacent to the Dungeness River. Sequim is a rapidly growing community in part because, unlike the rest of the peninsula, Sequim has a dry climate and averages 15 inches of rainfall per year due to the storm-blocking effect of the Olympic Mountains. Adjacent to Sequim are marine waters with major shellfish harvesting areas for Dungeness crab, oysters, geoducks, and clams.

The city constructed the first wastewater treatment facilities at the current site in 1966 with a marine outfall into the Strait of Juan de Fuca. In 1994, following several years of contention over deteriorating surface water quality, shellfish restrictions and insufficient water supply, the city of Sequim signed an agreement with two state agencies to develop a plan for upland reuse of their wastewater. The 1998 Class "A" Reclaimed Water 100 Percent Upland Reuse Plan included three primary water reuse sites.

Development of Water Reclamation Facility

In 1998, parallel to the water reuse plan, the city upgraded its wastewater treatment facility into a 0.79 mgd (35 L/s) Class A Water Reclamation Facility (WRF). Class A is the highest quality class of reclaimed water in Washington State's reuse guidelines and must be continuously oxidized, coagulated, filtered and disinfected. The project upgraded the existing processes, including influent screening, grit removal, activated sludge treatment in an oxidation ditch, secondary clarification and aerobic sludge digestion. The project also added chemical coagulation, anthracite media filtration and low-pressure/low-intensity UV disinfection to produce reclaimed water. The effluent quality requirements at the Sequim WRF are summarized in **Table 1**. The facility is equipped with a bypass holding pond for diversion of inadequately treated wastewater if online

monitoring indicates that reclaimed water does not meet permit requirements.

Table 1 Reclaimed Water Quality Requirements

| Parameter | Effluent Limit | |
|-----------------------------|------------------------|-----------------------|
| | Monthly Average | Weekly Average |
| BOD ₅ (mg/L) | 30 | 45 |
| TSS (mg/L) | 30 | 45 |
| D.O. (mg/L) | Must be present | |
| Filtration | Monthly Average | Sample Maximum |
| Turbidity (NTU) | 2 | 5 |
| Disinfection | 7-Day Median | Sample Maximum |
| Total Coliform (MPN/100 mL) | <2.2 | 23 |
| Nitrogen Removal | Monthly Average | Daily Maximum |
| Ammonia (mg/L) | 3.3 | 5.7 |
| Total Nitrogen (mg/L) | 10 | N/A |

Following construction of the WRF and the water reuse sites, the Washington State Department of Health opened 2,800 acres of previously closed shellfish beds for harvesting, retaining only a 300-foot radius closure around the outfall.

Water Reuse System

The city has developed a reclaimed water distribution system that seasonally diverts a large portion of the reclaimed water away from the marine outfall. Reclaimed water is conveyed from the WRF to the reuse sites for the following uses:

- Reuse Demonstration Site at Carrie Blake Park, where reclaimed water is used for park irrigation, toilet-flushing and, following re-aeration, stream flow augmentation to Bell Creek (**Figure 1**) to improve stream flows for fisheries and habitat restoration.

- Highway 101 Bypass future rest stop, planned landscape irrigation system (rest stop and irrigation system have not yet been constructed).
- The City Shop, where reclaimed water is used for vehicle washing, street cleaning and fire truck water, and made available to the public for construction purposes such as dust control.
- Landscape irrigation of street medians.



Figure 1
Introduction of reclaimed water to Bell Creek (Photo credit: Gray & Osborne, Inc.)

WRF Expansion Project

In 2007, due to rapid population growth in the region, the city expanded the WRF, doubling capacity and converting the WRF from an oxidation ditch to a conventional activated sludge plant employing the Modified Ludzack-Ettinger (MLE) process for enhanced nitrogen removal. Construction of the expansion project began in August 2008 and was completed September 2010 at a project cost of \$11 million.

The reclaimed water permit for the expanded WRF is not yet finalized, but is anticipated to retain the effluent quality limitations in **Table 1**. The 2008-10 WRF expansion project included:

- Conversion of the existing equalization basin (EQB) into a plug-flow activated sludge basin (MLE process with nitrogen removal)
- Conversion of the existing oxidation ditch into an EQB

- Addition of a third secondary clarifier
- Addition of a fabric filter to increase the filtration capacity of the existing anthracite media filter

The WRF expansion (**Figure 2**) project also included redundant aeration blowers with a dissolved oxygen control system, additional coagulation equipment, and a remote alarm system. Electric power for the entire treatment process is backed up by generators. For the protection of public health and the environment (including shellfish beds), expansion of the disinfection system was designed to meet the pathogen removal criteria developed by the National Water Research Institute (NWRI) to produce essentially pathogen free reclaimed water.



Figure 2
Sequim Water Reclamation Facility expansion (Photo credit: Gray & Osborne, Inc.)

Water Reuse System Expansion Project

In 2008, the city began an effort to identify additional uses of reclaimed water in order to reduce the volume discharged to the Strait of Juan de Fuca, and reduce demands on the Dungeness River aquifer for irrigation and potable water. The city received a grant from the Washington State Department of Ecology for planning and design of a water reuse system expansion.

A study identified potential new uses including groundwater recharge and additional irrigation areas. Five sites were studied for groundwater infiltration basins, which would allow year-round augmentation of the shallow aquifer with reclaimed water and significantly reduce marine outfall discharge outside

the irrigation season. The 2008-10 WRF Expansion project provided reclaimed water with nitrogen levels suitable for groundwater recharge. Hydrogeological studies were performed at two of the sites in 2010, including monitoring well studies with pilot infiltration pits.

In 2011, an engineering plan was completed for the water reuse system expansion, which recommends the following improvements:

- Construction of 1.3 ac (0.53 ha) of rapid infiltration basins at the Reuse Demonstration Site, with an estimated capacity of 1.3 mgd (57 L/s).
- Construction of a booster pump station and reservoir to provide reclaimed water to the city's high pressure zone, for irrigation uses.
- Expansion of the distribution system to provide access to reclaimed water to additional irrigation users.
- Construction of additional reclaimed water storage at the WRF and the Reuse Demonstration Site.
- Conduct a pilot project of groundwater recharge at the City Shop property. If successful, reclaimed water could be applied to shallow groundwater throughout the reclaimed water pipeline system.

The city plans to implement the design and construct the water reuse system expansion projects as funds become available.

Results and Conclusion

In the mid-1990s, following several years of contention over deteriorating surface water quality, shellfish restrictions and insufficient water supply, the city of Sequim embarked on a water reuse program by upgrading their existing wastewater treatment plant into a "Class A" water reclamation facility and developing a reclaimed water distribution system and reuse sites. However, irrigation was the primary use for reclaimed water and the marine outfall was still needed, especially during the non-irrigation season. Ten years later, as the population continued to grow and the reclaimed water system matured, the city has

expanded the WRF treatment capacity and is planning for a significant expansion of water reuse capacity.

The water reuse program at the city of Sequim has been successful since 2000 when 2,800 ac (1,130 ha) of previously closed shellfish beds were reopened for harvesting. Due to the upgrades in reliability and pathogen removal provided by the 2008-10 WRF expansion, the Washington State Department of Health concluded that the existing shellfish closure zone, a 300-yard (274-m) radius around the marine outfall, would not require enlargement, despite a doubling of flow capacity.

Due to the parallel efforts of the city to expand the WRF and develop additional reuse facilities, the city will experience improvements in fish and wildlife habitat and a reduction in the amount of reclaimed water sent through the marine outfall, and, eventually, achieve the goal of the 1998 "Class A" Reclaimed Water 100 Percent Upland Reuse Plan.

References

- CH2M Hill, 1998. *Operation and Maintenance Manual: City of Sequim Wastewater Treatment Plant Reclamation Facilities*. CH2M Hill, Bellevue, Washington.
- Gray & Osborne, Inc., 1998. *Class "A" Reclaimed Water 100 Percent Upland Reuse Plan, Amendment to the Comprehensive Wastewater Facilities Plan*. Gray & Osborne, Inc., Seattle, Washington.
- Gray & Osborne, Inc., 2007. *Water Reclamation Facility Expansion Engineering Report*. Gray & Osborne, Inc., Seattle, Washington.
- National Water Research Institute, 2003. *Ultraviolet Disinfection: Guidelines for Drinking Water and Water Reuse*. National Water Research Institute, Fountain Valley, California.
- Washington State Department of Ecology and Washington State Department of Health, 1997. *Water Reclamation and Reuse Standards, Publication #97-23*. Washington State Department of Ecology and Washington State Department of Health, Olympia, Washington.

Washington State Regulations

Authors: Chad Newton, P.E. (Gray and Osborne, Inc.)
and Craig Riley, P.E. (Washington State Department of Health)

US-WA-Regulations

Project Background

Washington State has a reclaimed water program governed by comprehensive guidelines that define water quality standards and a variety of allowed beneficial uses. At the time of this publication, there are at least 25 water reclamation systems in operation or are in the process of being permitted in the state.

In 1992, Washington State initiated the Reclaimed Water Law, Revised Code of Washington (RCW) 90.46 after a prolonged drought. In 1995, the legislature declared that reclaimed water was no longer wastewater. In 1997 the Washington State guidelines, *Water Reclamation and Reuse Standards* were adopted, directing the State Departments of Ecology and Health to jointly administer the reclaimed water program (Washington State Department of Ecology and Washington State Department of Health, 1997). This created a framework to tap an unused water resource while assuring public health protection and environmental stewardship.

In 2006, the Department of Ecology began developing a Reclaimed Water Rule, a state regulation that would supersede the existing guidelines. The current draft of the regulation (Washington State Department of Ecology, 2010) was made available to the public in May 2010, and refers to a *Reclaimed Water Facilities Manual* for supplemental guidance on implementing

the rule. The guidance manual is currently under development. Legislative amendments have been proposed to consolidate all regulatory duties at Department of Ecology, and to authorize fees to support the state's water reclamation program through rule for reclaimed water permits or for reviewing proposals. The draft rules are on hold due to 2011 governor and legislative mandates to halt non-critical rule-making because of state budget constraints. Adoption of the draft regulation and the guidance manual is tentatively anticipated in 2013.

Current Guidelines

The 1997 standards drew heavily from California's Title 22 recycled water program. The Washington State guidelines define four classes of reclaimed water, Class A, B, C and D, based on applied treatment processes and water quality (**Table 1**). Class A reclaimed water, the highest quality class, is oxidized, coagulated, filtered and disinfected. Reclamation plants must also meet reliability standards and have storage or alternate discharge locations for non-compliance. As the standards are based on 1997 common treatment technologies, other technologies are accepted if they can be demonstrated to provide the same level of treatment efficiency, reliability and public health protection.

Table 1
Requirements for reclaimed water in Washington State

| Class | OXIDIZED | | COAGULATED | FILTERED | DISINFECTED | |
|-------|----------------------------|------------------|------------|--------------------------|-----------------------------|------------------|
| | Secondary Treatment (mg/L) | Dissolved Oxygen | Y/N | Turbidity (NTU) | Total coliform (MPN/100 mL) | |
| | | | | | 7-Day Median | Single Sample |
| A | 30 | Must be present | Yes | 2 NTU avg. 5 NTU max. | ≤ 2.2 | 23 |
| B | 30 | Must be present | No | No | ≤ 2.2 | 23 |
| C | 30 | Must be present | No | No | ≤ 23 | 240 |
| D | 30 | Must be present | No | No | 240 | N/A ¹ |

¹ Not applicable

The guidelines provide use area and water quality standards for the following beneficial uses of reclaimed water:

- Irrigation of food and non-food crops
- Landscape irrigation
- Landscape and recreational impoundments
- Commercial, municipal and industrial uses
- Groundwater recharge (by surface percolation or direct injection)
- Streamflow augmentation
- Wetlands

Proposed Regulations

In the 2006 draft regulation, the current four classes of reclaimed water would be streamlined to two: Class A and Class B. The regulation includes new provisions for production of Class A reclaimed water with membrane filtration and membrane bioreactor processes, for which stricter turbidity standards are provided. New virus removal standards for Class A reclaimed water are included: disinfection facilities must be designed to provide 5-log virus removal or inactivation (unless a 1-log filtration credit is applicable). Disinfection facilities must also be verified through a field-commissioning test prior to producing reclaimed water.

While Washington State law grants exclusive rights to distribute and use reclaimed water, the law also prohibits the facility from impairing existing downstream water rights without agreed compensation or mitigation. The draft regulation includes procedures for completing a satisfactory assessment of the potential to impair water rights that may be impacted by a water reclamation project.

Rule-making Process

An advisory committee was created that included stakeholders representing affected regulatory agencies, public and private reclaimed water utilities, environmental organizations, water rights attorneys, Native American tribes, engineers, and potable water utility and local governmental organizations. Several subgroups studied specific areas and developed direction and language for the committee and agencies.

- Removing Barriers Subtask Force: Identified major road blocks to developing and implementing reclaimed water, such as

restrictive regulations, funding limitations, and public perception of the product and where it could be used.

- Long Term Funding Subtask Force: Assessed the effect of financial limitations on development of water reclamation projects.
- Water Rights Impairment Task Force: Defined the impacts and remedies for the effect on existing water rights when wastewater return flows are reduced or removed. The group could not find consensus on solutions during their two year effort.
- Technical Advisory Panel: Provided technical expertise to address issues with applying and implementing new technologies, including how to assure public health protection through treatment. The final draft rule includes the panel's recommendations.
- Trace Organics Committee: Considered concerns from the environmental community, such as potential public health and environmental impacts from trace organic chemicals in reclaimed water. The committee recommended no additional monitoring in the rule. They also requested that agencies remain cautious and be ready to respond as more information becomes available.

The advisory committee was still reviewing and commenting on a well-developed draft rule when it was put on hold in 2011. Concerns included:

- Waters rights impairment: State law requires that a facility producing reclaimed water must not impair "existing downstream water rights" without agreed upon compensation or mitigation. The advisability of reducing or removing wastewater discharges to water bodies within watersheds closed to further water rights appropriations, and to streams with minimum in-stream flows set to protect aquatic habitats, is not yet resolved.

- Rule implementation: What might happen during implementation of the rule as drafted? A guidance manual was initiated which would include details surrounding implementation. The manual was in its second draft when rule development was suspended.

Media Involvement

The Washington rule-making process requires that all meetings be open to the public and public hearings be conducted. Meeting minutes and outcomes are available to the public electronically through the Department of Ecology website. Newspaper articles were written after the three public hearings. There was little public feedback (Washington State Department of Ecology, n.d).

Details Particular to Washington

The Washington State program is similar to, and builds on the California recycled water program for technical detail. The Washington State program has to refine certain administrative and policy details related to state organization and existing requirements.

- Lead agency: Responsibility is shared by two separate state agencies with similar but different requirements. To help avoid confusion, a “lead agency” and “non-lead agency” is designated for each project. Since Department of Health hasn’t developed a permit program for water reclamation yet, Department of Ecology will issue permits until then.
- Enforcement: The two state agencies have significantly different regulatory requirements and processes for enforcement. This has to be clearly addressed in the rule.
- Aquifer recharge responsibilities: RCW 90.46 requires Department of Ecology to be responsible for land application projects. Aquifer recharge projects are, in concept, land application projects. Reclaimed water can recharge an aquifer and be recovered as a potable water supply, which is regulated by the Department of Health. Significant coordination is needed to assure public health and environmental protection without redundancy.
- Access to reclaimed water: RCW 90.46 grants the exclusive right to distribute and use

reclaimed water to the owner of the facility producing the water. Current state laws are silent regarding control or access to “sewage” and “sewage effluent”. Areas served by regional collection and treatment entities and multiple public water systems have ownership and water rights disputes. This is a barrier to development of satellite reclaimed water facilities.

- Fees: RCW 90.46 doesn’t give either agency authority to collect fees necessary to support the state’s water reclamation program through rule for reclaimed water permits or for reviewing proposals. Another legislative amendment will be needed to ensure the agencies receive fee support.

[Note that due to budget issues and staffing cuts the state's regulatory program will experience significant but as yet undefined changes after July 1, 2012.]

References

Washington State Department of Ecology, 2010. Chapter 173-219 Washington Administrative Code - Draft Reclaimed Water. Washington State Department of Ecology, Olympia, Washington.

Washington State Department of Ecology and Washington State Department of Health, 1997. Water Reclamation and Reuse Standards, Publication #97-23. Washington State Department of Ecology and Washington State Department of Health, Olympia, Washington.

Washington State Department of Ecology. n.d. Water Quality Website. Retrieved on Sept. 6, 2012 at <<http://www.ecy.wa.gov/programs/wq/reclaim/index.html>>.

Demonstrating the Safety of Reclaimed Water for Garden Vegetables

Author: Sally Brown, PhD (University of Washington)

US-WA-King County

Project Background or Rationale

Currently, less than 1 percent of the 200 mgd (8760 L/s) of wastewater that is treated in King County, Washington is treated to produce Class A reclaimed water, with the remainder discharged to Puget Sound. Concern over Puget Sound's health and future nutrient discharge limitations prompted King County to explore reducing reliance on marine discharges. Increasing the use of reclaimed water could address this issue and assist with meeting existing and expected water demands. King County is constructing a new wastewater treatment facility designed to produce Class A reclaimed water using a membrane bioreactor (King County Reclaimed Water Division). In addition to this system, one of King County Reclaimed Water Division's existing treatment plants produces small quantities of Class A water using sand filtration.

As part of the process to expand the reclaimed water program, a study was conducted to identify potential users for reclaimed water. End uses including industry, landscape irrigation, ecological enhancement, plant nursery, and truck farm irrigation were identified. Prior research and regulations in Washington State have established the safety and efficacy of reclaimed water for these end uses. In Washington, reclaimed water is regulated according to the Reclaimed Water Reuse Act of 1992, and is monitored by the Washington State Departments of Ecology and Health. Treatment requirements are dictated by the required effluent quality which is designated by the Class of reclaimed water, ranging from A–D, with A requiring the most stringent level of treatment and D requiring the least (Stensel, 2006). Class A reclaimed water is safe to use for watering food crops.

In King County, all reclaimed water meets Class A standards. However, to both gain customer confidence and illustrate that local soil and reclaimed water characteristics are suitable for the end uses identified, King County partnered with the University of Washington to conduct research on the safety and efficacy of Class A reclaimed water. One series of

studies focused on the use of reclaimed water for truck farms—small-scale farms that grow fruits, vegetables, and flowers for local farmers markets and community-supported agriculture (CSA) organizations. Here, the public concerns have been centered on pathogens, potential for heavy metal accumulation, and changes in flavor as a result of using reclaimed water.

Reclaimed Water for Edible Crops

The University of Washington conducted both a greenhouse study (**Figure 1**) and a field trial to demonstrate the low potential for pathogen transfer (as indicated by presence of bacteria indicator species) and metal uptake from reclaimed water to garden vegetables. Lettuce, carrots and strawberries were included in the study, as each of these are commonly grown by local farmers and each presents potential risk pathways to test the contaminants of concern.



Figure 1
Greenhouse trial of Class A reclaimed water (Photo credit: Dana Devin Clarke)

Lettuce is known for high uptake of heavy metals and has been used as an indicator crop for metal availability (Brown et al., 1998). The edible portion of carrots is grown directly in soil and so may be more susceptible to pathogen contamination. Strawberries are often consumed without washing, also making them likely candidates for pathogen transfer.

During the greenhouse and field studies, reclaimed water source samples were collected weekly; crop and soil samples were collected at the end of the study when plants were ready for harvest. Soils, water samples and washed and unwashed edible portions of plant tissue were analyzed for bacterial indicators (total coliforms, fecal coliforms, and *E. coli*) and metals (arsenic, cadmium, lead, and nickel). Metal concentrations in the reclaimed water were at least 2 orders of magnitude below EPA regulations (Metcalf & Eddy, 2007). Bacteria tests were either negative or below the regulatory limit of 2 cfu/100 mL.

In general, metal uptake for plants grown using reclaimed water was similar to that for those grown with tap water. Results for lettuce from the field study are shown in **Figure 2**.

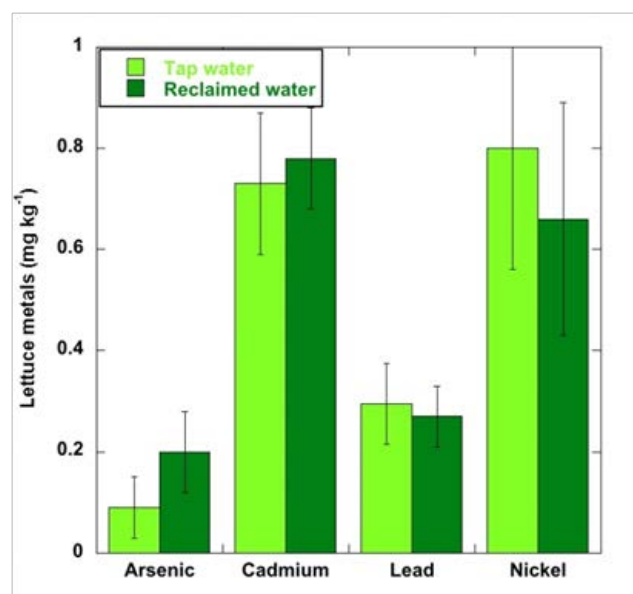

Figure 2
Metal concentrations in lettuce from field trial

In the greenhouse study, there were also no differences in bacterial indicators between the tap water irrigated crops or the reclaimed water irrigated crops for both washed and unwashed samples. Total coliforms were the only bacteria detected and they were only detected in the tap water control. In the field trial, total coliform counts were higher for all vegetables grown using reclaimed water in comparison to the tap water. This was likely due to increased contact with soil and coliform bacteria in the soil. Fecal coliform and *E. coli* were not detected in any of the vegetable samples grown in the field trial.

Public Outreach

Results of both studies reflect the quality of the source water, with respect to bacterial indicators and metal concentrations. It could be argued that these studies were superfluous based on the analysis of the reclaimed water. However, public perception and understanding of reclaimed water is an essential component in the development of a beneficial use program. To that end, luncheons and tastings were held at the end of each year's research. The first luncheon was limited to staff within the King County Wastewater Treatment division and featured presentations on the edible crops and ornamental plant research. Guests were served a main course and desert that included crops from the greenhouse study (**Figure 3**).



Figure 3
Dr. Brown presenting study data at luncheon (Photo credit: Jo Sullivan)

In the second year of the program, the luncheon was held at the wastewater treatment plant near the field site plots. Stakeholders, potential customers, and members of the community were invited. The menu was designed to feature crops grown in the garden and tables were decorated with flowers from the garden with bouquet giveaways at the end of the event. Presentations during the luncheon centered on results from these studies. Following the lunch, guests toured the gardens and were given bags to fill with potatoes (**Figure 4**). This type of outreach, in combination with research on locally produced reclaimed water has been an effective means for increasing acceptance and understanding of the safety and benefits of reclaimed water for irrigating food crops.



Figure 4
Harvesting potatoes after luncheon (Photo credit: Jo Sullivan)

Lessons Learned

The research described here, demonstrates the absence of plant metal uptake and bacteria transfer, and largely confirmed what was anticipated based on characteristics of the Class A reclaimed water. The research was important however, as it provided local data to help the municipality build trust with potential customers for their product. The public outreach efforts were also a critical component for public acceptance. The King County Wastewater Treatment division now has a number of farmers interested in using the Class A reclaimed water.

References

Brown, S.L., R.L. Chaney, J.S. Angle, and J. A. Ryan. 1998. "Organic carbon and the phytoavailability of cadmium to lettuce in long-term biosolids-amended soils". *J. Environ. Qual.* 27:1071-1078.

King County Reclaimed Water Division website. n.d. Accessed September 5, 2012 at www.kingcounty.gov/environment/wastewater/ResourceRecovery/ReWater.aspx.

Metcalf & Eddy. 2007. *Water reuse. Issues, technologies, and applications* McGraw-Hill Publisher, New York

Washington Department of Ecology website. 2011. Accessed September 5, 2012 at <http://www.ecy.wa.gov/programs/wq/reclaim/standards.html>.

City of Yelm, Washington

Author: Shelly Badger (City of Yelm)

US-WA-Yelm

Project Background or Rationale

The city of Yelm began its wastewater facility planning efforts to safeguard public health from septic system contamination of the area's shallow drinking water wells. In 1990, the city chose an affordable option that included a centralized collection system and a secondary wastewater treatment lagoon discharging to the Nisqually River. This quickly became a short-term solution. The Nisqually River supports five species of Pacific salmon and sea-run cutthroat trout and ends in a national wildlife refuge. Yelm was under considerable legal pressure from a variety of parties to find a better environmental option. The community wanted to embrace reclaimed water as the best solution to safeguard public health, protect the Nisqually River, and to provide an alternate water supply for city use. However, Yelm faced a number of new challenges in implementing this strategy:

- Finding additional funding to upgrade the treatment plant – again.
- Building local support to make the project work.
- Locating customers who could use the water immediately.

Institutional and Cultural Considerations

Yelm conducted intensive community outreach on these topics and as a result, in 1999 the city expanded its system into one of the first Class “A” Reclaimed Water Facilities in the State of Washington. Yelm constructed a wetlands park to have a highly visible and attractive focal point promoting reclaimed water use. A local reclaimed water ordinance was adopted establishing the conditions of reclaimed water use. The ordinance includes a “mandatory use” clause allowing Yelm to require construction of reclaimed water distribution facilities as a condition of development approval. Yelm continues to plan expansion of storage, distribution, and reuse facilities. In 2002, the city received Ecology’s Environmental

Excellence Award for successfully implementing Class “A” reclaimed water into its community.

Capacity and Type of Reuse Application

The Class A reclaimed water facility currently produces approximately 0.30 mgd (13 L/s) of reclaimed water and has capacity to produce up to 1.0 mgd (44 L/s) to accommodate growth.

Water Quality Standards and Treatment Technology

The Yelm reclamation plant had to modify the wastewater treatment plant significantly for reclaimed water production. The city chose to use sequencing batch reactor (SBR) technology for secondary treatment (biological oxidation) and nitrogen removal. Advanced treatment is followed by chemical coagulation, upflow sand filters, and chlorine disinfection. On-line monitoring of system and equipment performance provides that reclaimed water distributed to customers always meets the reclaimed water quality standards.

Project Funding and Management Practices

The total project cost including engineering and construction was \$9.6 million. Funding was provided from state and federal grants and loans, along with a local utility improvement district. Yelm’s annual operation and maintenance costs are approximately \$1.4 million. This includes operator salaries and benefits, sewage collection, treatment and water reclamation, monitoring, solids removal, power, distribution, and public uses. The annual debt service for the project is \$350,000.

Residential monthly sewer rates are \$45.91 per month. The charge for a new residential connection is \$6,219. Contractual agreements allow Yelm to recover some of the costs through charges for reclaimed water supplies. Yelm reclaimed water rates are approximately 80 percent of their drinking water rate.

References

Washington State Department of Ecology. 2005 Case Studies in Reclaimed Water Use – Creating New Water Supplies Across Washington State. Retrieved on Sept, 5, 2012 from <<http://www.ecy.wa.gov/pubs/0510013.pdf>>.

This page intentionally left blank

APPENDIX E

International Case Studies and International Regulations

List of Case Studies by Title and Authors¹

| Page No. | Text code | Case Study Title | Authors |
|----------|-----------------------------|---|--|
| E-5 | Argentina-Mendoza | Special Restricted Crop Area in Mendoza, Argentina | Carl R. Bartone (Environmental Engineering Consultant) |
| E-8 | Australia-Sydney | Sewer Mining to Supplement Blackwater Flow in a Commercial High-rise | Colin Fisher (Aquacell) |
| E-11 | Australia-Graywater | Retirement Community Graywater Reuse | Colin Fisher (Aquacell) |
| E-13 | Australia-Victoria | End User Access to Recycled Water via Third Party-Owned Infrastructure | Geoff Jones (Barwon Water) |
| E-15 | Australia-Replacement Flows | St Marys Advanced Water Recycling Plant, Sydney | Stuart Khan, PhD (University of South Wales) and Peter Chapman (Sydney Water) |
| E-18 | Barbados-Economic Analysis | Economic Analysis of Water Reuse Options in Sustainable Water Resource Planning | William Y. Davis and Jason Johnson, P.E. (CDM Smith) |
| E-21 | Belgium-Recharge | Water Reclamation for Aquifer Recharge in the Flemish Dunes | Emmanuel Van Houtte, Intercommunale Waterleidingsmaatschappij van Veurne-Ambacht (Intermunicipal Water Company of the Veurne Region, IWVA) |
| E-24 | Brazil-Car Wash | Car Wash Water Reuse – A Brazilian Experience | Rafael N. Zaneti, MSc; Ramiro G. Etchepare, MSc; and Jorge Rubio, PhD, DIC (Universidade Federal do Rio Grande do Sul) |
| E-27 | Canada-Nutrient Transfer | Water Reuse Concept Analysis for the Diversion of Phosphorus from Lake Simcoe, Ontario, Canada | David C. Arseneau, P.Eng, MEPP (AECOM); David K. Ammerman, P.E. (AECOM); Michael Walters (Lake Simcoe Region Conservation Authority) |
| E-30 | China-MBR | Water Reuse in China | Allegra K. da Silva, PhD (CDM Smith) and Liping Lin (GE Water and Process Technologies) |
| E-33 | Colombia-Bogotá | The Reuse Scenario in Bogotá | Juan M. Gutierrez, MS (Javeriana University) and Lucas Botero, P.E., BCEE (CDM Smith) |
| E-36 | Cyprus-Irrigation | Water Reuse In Cyprus | Iakovos Papaioacovou and Constantia Achileos, MSc (Sewerage Board of Limassol Amathus); Ioanna Ioannidou, MSc, MBA (Larnaca Sewerage and Drainage Board); Alexia Panayi, MBA (Water Development Department); Christian Kazner, Dr.-Ing. (University of Technology Sydney); and Rita Hochstrat, MTechn. (University of Applied Sciences Northwestern Switzerland) |
| E-40 | Ghana-Agriculture | Implementing Non-conventional Options for Safe Water Reuse in Agriculture in Resource Poor Environments | Bernard Keraita, PhD and Pay Drechsel, PhD (International Water Management Institute) |

¹ To search for case studies by region or by category of reuse, please refer to Figure 9-1

List of Case Studies by Title and Authors¹

| Page No. | Text code | Case Study Title | Authors |
|----------|--|---|---|
| E-43 | India-Delhi | Reuse Applications for Treated Wastewater and Fecal Sludge in the Capital City of Delhi, India | Priyanie Amerasinghe, PhD and Pay Drechsel, PhD (International Water Management Institute); Rajendra Bhardwaj (Central Pollution Control Board) |
| E-47 | India-Bangalore | V Valley Integrated Water Resource Management: the Bangalore Experience of Indirect Potable Reuse | Uday G. Kelkar, PhD, P.E., BCEE and Milind Wable, PhD, P.E. (NJS Consultants Co. Ltd.); and Arun Shukla (NJS Engineers India Pvt. Ltd.) |
| E-51 | India-Nagpur | City of Nagpur and MSPGCL Reuse Project | Uday G. Kelkar, PhD, P.E., BCEE (NJS Consultants Co. Ltd) and Kalyanaraman Balakrishnan (United Tech Corporation) |
| E-54 | Israel/Jordan-Brackish Irrigation | Managing Irrigation Water with High Concentrations of Salts in Arid Regions | Alon Ben-Gal, PhD and Uri Yermiyahu, PhD (Agricultural Research Organization, Gilat Research Center, Israel); Sirenn Naoum, PhD; Mohammad Jitan, PhD; Naeem Mazahreh, PhD; and Muien Qaryouti, PhD (National Center for Agricultural Research and Extension, Jordan) |
| E-58 | Israel/Palestinian Territories/Jordan-Olive Irrigation | Irrigation of Olives with Recycled Water | Arnon Dag, PhD; Uri Yermiyahu, PhD; Alon Ben-Gal, PhD; and Eran Segal, PhD (Agricultural Research Organization, Gilat Research Center, Israel) and Zohar Kerem, PhD (The Hebrew University of Jerusalem, Israel) along with colleagues from the Association for Integrated Rural Development, West Bank and the National Center for Agricultural Research and Extension, Jordan |
| E-60 | Israel/Jordan-AWT Crop Irrigation | Advanced Wastewater Treatment Technology and Reuse for Crop Irrigation | Josef Hagin, PhD and Raphael Semiat, PhD (Grand Water Research Institute Technion – Israel Institute of Technology, Haifa, Israel) |
| E-63 | Israel/Peru-Vertical Wetlands | Treatment of Domestic Wastewater in a Compact Vertical Flow Constructed Wetland and its Reuse in Irrigation | Ines Soares, PhD; Amit Gross, PhD; Menachem Yair Sklarz, PhD; Alexander Yakirevich, PhD; and Meiyang Zou, MSc (Ben Gurion University of the Negev, Israel); and Ignacio Benavente, Eng, PhD; Ana Maria Chavez, Eng, MSc; Maribel Zapater, MSc; and Diana Lila Ferrando, Eng, MSc (Universidad de Piura, Peru) |
| E-66 | Japan-Building MBR | A Membrane Bioreactor (MBR) Used for Onsite Wastewater Reclamation and Reuse in a Private Building in Japan | Katsuki Kimura, Dr.Eng. and Naoyuki Funamizu, Dr.Eng. (Hokkaido University, Sapporo, Japan) |
| E-69 | Jordan-Irrigation | Water Reuse and Wastewater Management in Jordan | Bader Kassab, MSc (USAID Jordan) and Ryujiro Tsuchihashi, PhD (AECOM) |
| E-71 | Jordan-Cultural Factors | Cultural and Religious Factors Influence Water Reuse | Tom A. Pedersen (CDM Smith) |
| E-74 | Mexico-Tijuana | Water, Wastewater, and Recycled Water Integrated Plan for Tijuana, Mexico | Enrique López Calva (CDM Smith) |

List of Case Studies by Title and Authors¹

| Page No. | Text code | Case Study Title | Authors |
|----------|------------------------------|---|---|
| E-76 | Mexico-Mexico City | The Planned and Unplanned Reuse of Mexico City's Wastewater | Blanca Jiménez-Cisneros, PhD (Universidad Nacional Autónoma de México) |
| E-79 | Mexico-Ensenada | Maneadero Aquifer, Ensenada, Baja California, Mexico | Leopoldo Mendoza-Espinosa, PhD and Walter Daesslé-Heuser, PhD (Autonomous University of Baja California) |
| E-82 | Mexico-San Luis Potosi | Tenorio Project: A Successful Story of Sustainable Development | Alberto Rojas (Comision Estatal del Agua), Lucina Equihua (Degremont S.A. de C.V.), Fernando Gonzalez (Degremont, S.A. de C.V.) |
| E-85 | Pakistan-Faisalabad | Faisalabad, Pakistan: Balancing Risks and Benefits | Jeroen H. J. Ensink, PhD (London School of Hygiene and Tropical Medicine) |
| E-88 | Palestinian Territories-Auja | Friends of the Earth Middle East's Community-led Water Reuse Projects in Auja | Elizabeth Ya'ari (Friends of the Earth Middle East) |
| E-90 | Peru-Huasta | Assessing Water Reuse for Irrigation in Huasta, Peru | Daphne Rajenthiram (CDM Smith); Elliott Gall and Fernando Salas (University of Texas) and Laura Read (Tufts University) |
| E-93 | Philippines-Market | Wastewater Treatment and Reuse for Public Markets: A Case Study in Sustainable, Appropriate Technology in the Philippines | Mary Joy Jochico (USAID) and Ariel Lapus (USAID-PWRF Project) |
| E-96 | Senegal-Dakar | Use of Wastewater in Urban Agriculture in Greater Dakar, Senegal: "Adapting the 2006 WHO Guidelines" | Seydou Niang, PhD (Cheikh Anta Diop University of Dakar) |
| E-99 | Singapore-NEWater | The Multi-barrier Safety Approach for Indirect Potable Use and Direct Nonpotable Use of NEWATER | Harry Seah, MSc and Chee Hoe Woo, MSc (PUB Singapore) |
| E-102 | South Africa-eMalahleni Mine | Turning Acid Mine Drainage Water into Drinking Water: The eMalahleni Water Recycling Project | Jay Bhagwan (Water Research Commission) |
| E-104 | South Africa-Durban | Durban Water Recycling Project | Jay Bhagwan (Water Research Commission) |
| E-107 | Spain-Costa Brava | Risk Assessment for <i>Legionella</i> sp. in Reclaimed Water at Tossa de Mar, Costa Brava, Spain | Rafael Mujeriego, PhD (Universidad Politécnic de Cataluña) and Lluís Sala, (Consorti Costa Brava) |
| E-110 | Thailand-Pig Farm | Sam Pran Pig Farm Company: Using Multiple Treatment Technologies to Treat Pig Waste in an Urban Setting | Pruk Aggarangsi, PhD (Energy Research and Development Institute-Nakornping, Chiang Mai University, Thailand) |
| E-112 | Trinidad and Tobago-Beetham | Evaluating Reuse Options for a Reclaimed Water Program in Trinidad, West Indies | Matt McTaggart, P.Eng, R.Eng; Jim Marx, MSc, P.E.; and Kathy Bahadoorsingh, PhD, R.Eng (AECOM) |
| E-114 | United Kingdom-Langford | Langford Recycling Scheme | Afsaneh Janbakhsh, MSc, Cchem, MRSC, Csci (Northumbrian Water Ltd, UK) |

List of Case Studies by Title and Authors¹

| Page No. | Text code | Case Study Title | Authors |
|----------|--------------------------------|--|--|
| E-116 | United Arab Emirates-Abu Dhabi | Water Reuse as Part of Holistic Water Management in the United Arab Emirates | Rachael McDonnell, PhD (International Center for Biosaline Agriculture) and Allegra K. da Silva, PhD (CDM Smith) |
| E-120 | Vietnam-Hanoi | Wastewater Reuse in Thanh Tri District, Hanoi Suburb, Vietnam | Lan Huong Nguyen, MSc; Viet-Anh Nguyen, PhD ; and Eiji Yamaji, PhD; (Hanoi University of Civil Engineering, Vietnam) |

Websites of International Regulations and Guidance on Water Reuse

| Country | Title of Regulations or Guidelines | Link to Country Regulations or Guidance |
|-----------|---|---|
| Australia | Guidelines for Environmental Management: Use of Reclaimed Water | http://epa.vic.gov.au/our-work/publications/publication/2003/november/464-2 |
| Australia | Australian Guidelines for Water Recycling | http://www.ephc.gov.au/taxonomy/term/39/ |
| Brazil | RESOLUÇÃO No 54, DE 28 DE NOVEMBRO DE 2005 | http://www.aesa.pb.gov.br/legislacao/resolucoes/cnrh/54_2005_criterios_gerais_uso_agua.pdf |
| Cyprus | Τομέας Ελέγχου της Ρύπανσης | http://www.moa.gov.cy/moa/environment/environment.nsf/All/26C40CAAAAEF746CC22578D1003B1FEA?OpenDocument |
| India | General Standards for Discharge of Environmental Pollutants Part-A: Effluents | http://cpcb.nic.in/GeneralStandards.pdf |
| Israel | | http://www.water.gov.il/Hebrew/ProfessionalInfoAndData/Water-Quality/Pages/treated_waste_water.aspx?P=print |
| Israel | קובץ התקנות | http://www.justice.gov.il/NR/rdonlyres/DF355FDA-0616-4D36-B8D3-64F706C494C9/19866/6886.pdf |
| Mexico | Normas Oficiales Mexicanas ordenadas por Materia | http://www.semarnat.gob.mx/LEYESYNORMAS/Pages/nomsxmateria.aspx |
| Mexico | Norma Oficial Mexicana Nom-001-Semarnat-1996, Que Establece Los Límites Máximos Permisibles De Contaminates En Las Descargas De Aguas Residuales En Aguas Y Bienes Nacionales | http://www.bvsde.paho.org/bvsacd/cd38/Mexico/NOM001ECO L.pdf |
| Mexico | Law: NOM-003-Semarnat-1997 | www.conagua.gob.mx |
| Spain | Spanish Regulations for Water Reuse | http://www.asersagua.es/publicaciones/SpanishRegulationsforWaterReuseEN.pdf |
| Thailand | Pig Farm's Standard Waste Water Level | http://ptech.pcd.go.th/website/index.php?option=com_content&view=article&id=22:wwstd&catid=8:envlaw&Itemid=31 |
| Vietnam | National Technical Regulation on Water Quality for Irrigated Agriculture | http://www.epe.edu.vn/file/C_Documents%20and%20Settings_CQ%2040_Local%20Settings_Application%20Data_Mozilla_Firefox_Profiles_6zquphxp.pdf |

Special Restricted Crop Area in Mendoza, Argentina

Author: Carl R. Bartone (Environmental Engineering Consultant)

Argentina-Mendoza

Project Background or Rationale

Mendoza is located in an arid region in the foothills of the Andes in western Argentina. The city's wastewater has traditionally been used indirectly for irrigation. During the dry season, untreated wastewater represented 40 percent of resources available for irrigation in the Mendoza River Basin, raising serious health concerns (Zuleta, 2011).

At the time of this project, the greater Mendoza metropolitan area had 700,000 inhabitants, with 75 percent of the population connected to sewers. The projected population for 2010 was one million with a projected 95 percent sewer connection coverage (Idelovitch and Ringskog, 1997).

As part of the modernization of the water sector in the Province of Mendoza in the early 1990s, a number of reforms were put in place that helped introduce planned reuse of treated wastewater. One such case was the upgrading of the Campo Espejo waste stabilization ponds in 1993 and the introduction of microbiological standards for reuse.

Capacity and Type of Reuse Application

The Campo Espejo waste stabilization ponds were built in 1976 and upgraded in 1996. The new plant consists of 12 modules of three waste stabilization ponds in series (facultative, aerobic, and polishing), occupying some 790.7 ac (320 ha) in total (Idelovitch and Ringskog, 1997). Today they provide 39 mgd (147,000 m³ /d) of effluent for direct irrigation (Zuleta, 2011).

The effluent from the Campo Espejo treatment plant is discharged to the Moyano Canal and conveyed to a special 6,672 ac (2,700 ha) restricted irrigation area, *Area de Cultivos Restringidos Especiales* (ACRE), for reuse (Zuleta, 2011). Farmers with properties within the special area receive treated effluent free of charge and are obliged to follow the irrigation regulations established for the ACRE. About one quarter of the irrigated area is devoted to the production of grapes,

another quarter to the cultivation of tomatoes and squash, and the remaining area to the cultivation of alfalfa, artichokes, garlic, peaches, pears, and poplar biomass (Barbeito, 2001). The soil is slightly saline and therefore treated water is also used to wash salts from it (Jimenez, 2008).

Excess irrigation and drainage water from the Campo Espejo ACRE is discharged downstream into the Jocoli Canal, where it mixes with river water, and is used for the subsequent irrigation of an additional 17,297 ac (7,000 ha) (Zuleta, 2011).

Water Quality Standards and Treatment Technology

The provincial water and sanitation agency, *Ente Provincial del Agua y Saneamiento* (EPAS), was created in 1993 to regulate, control, and guarantee the provision of water and sewerage services in the Province of Mendoza. By means of EPAS' Resolution 35/96 (EPAS, 1996) standards were established for treated wastewater discharges and, in particular, for irrigation reuse in ACRE, including microbiological standards for fecal coliforms and nematodes. The latter standards were based on the World Health Organization Health Guidelines for the Use of Wastewater in Agriculture and Aquaculture. (WHO, 1989). The upgrade of the Campo Espejo treatment plant in 1996 was in part to meet these new standards. Because of the generally low cost of land in Mendoza, waste stabilization ponds are a suitable treatment option for complying with the WHO guidelines.

Project Funding and Management Practices

The upgrade was carried out under a 20-year build-own-operate-transfer (BOOT) concession from the metropolitan water and sewerage company, *Obras Sanitarias de Mendoza* (OSM), to the private operator *Union Transitoria de Empresas* (UTE). UTE operates and maintains the existing installations, as well as designs, constructs, and operates the 12 new modules (Idelovitch and Ringskog, 1997). The bidding documents specified criteria for the quality of effluent,

such as a maximum of 1,000 fecal coliforms per 100 mL, a maximum of one helminth egg per liter, removal of at least 70 percent of biochemical oxygen demand, and removal of at least 30 percent of suspended solids.

Under the 1993 concession agreement, UTE committed to an initial investment of U.S. \$15 million. The new plant was inaugurated in 1996. Under the BOOT agreement, UTE charges OSM U.S. \$0.05 per m³ of wastewater treated. OSM guaranteed a minimum of 3 million m³ (793 million gallons) per month. Based on the average treated effluent flow, UTE's initial investment had an expected payback period of 7 years.

Institutional/Cultural Considerations

The chief provincial institutions responsible for wastewater treatment and use for irrigation in Mendoza are: OSM, which is responsible for water and sewerage services in Greater Mendoza; EPAS, which regulates and controls the provision of water and sewerage services; and the *Departamento General de Irrigación* (DGI), which is responsible for the management of water resources (Kotlis, 1998).

A special Sanitation Planning process was developed for the Campo Espejo ACRE (Barbeito, 2001). Furthermore, regulations were promulgated governing the conformation and operation of the ACRE (DGI, 2003). The DGI, OSM, and the ACRE Inspectorate were jointly responsible for developing and carrying out the Sanitation Plan and for supervising and controlling the direct use of treated wastewater in ACRE. The Inspectorate is comprised of members of the ACRE water users' association, and oversees the distribution of treated wastewater, control of authorized crops, irrigation methods allowed, and overall operational management within the ACRE.

The quality of the agricultural produce and the health of the agricultural workers are monitored by a special office of the DGI.

An agreement of cooperation was recently signed between OSM and ACRE farmers to study concerns of mutual interest, including the possibility of building effluent storage reservoirs that would optimize wastewater use during the dry season without requiring changes in the treatment plant operations, as well as the possibility of charging farmers part of the cost of treatment (Egocheaga and Moscoso, 2004).

Successes and Lessons Learned

The Mendoza ACRE model provides a practical and productive way of ensuring that there is sufficient land for the controlled use of available effluent from centralized treatment (Scheierling et al., 2010).

Zuleta (2011) summarized the benefits of the ACRE model as providing for:

- Reliable and steady supply of water
- Reduced cost of treatment
- Management of microbial health risks
- Reduced soil and aquifer pollution
- Natural fertilization of soils
- Attenuated aquifer exploitation

Other ACREs have since been established in Mendoza, including for the Paramillos treatment plant and the Pescara Canal industrial zone.

References

- Barbeito, E. 2001. *Estudio general del caso: Campo Espejo del Aglomerado Gran Mendoza, República de Argentina*. PAHO, Lima, Peru.
- DGI. 2003. *Anexo I: Reglamento de Area de Cultivos Restringidos Especiales (ACRE)*. Resolución No. 400/03, Departamento General de Irrigación, Mendoza, Argentina.
- Egocheaga, L. and J. Moscoso. 2004. *Una estrategia para la gestión de las aguas residuales domésticas: haciendo más sostenible la protección de la salud en América Latina y otras regiones en desarrollo*. PAHO, Lima, Peru.
- EPAS. 1996. *Normas de calidad de agua y efluentes: Anexo II, Directrices sobre la calidad microbiológica de las aguas residuales empleadas en agricultura para riego restringido (ACRE)*. Resolución No. 35/96, Ente Provincial del Agua y Saneamiento, Mendoza, Argentina.
- Idelovitch, E. and K. Ringskog. 1997. *Wastewater Treatment in Latin America: Old and New Options*. New Directions in Development Series, The World Bank, Washington, D.C.
- Jimenez, B. 2008. "Wastewater reuse in Latin America and the Caribbean." In *Water reuse: An international survey of current practice, issues and needs*. Jimenez, B. and T. Asano (eds). Scientific and Technical Report No. 20, IWA Publishing, London.
- Kotlis, L. 1998. "Water Reuse in Argentina." *Water Supply*, 16(1-2): 293-94.

Scheierling, S.M., C.R. Bartone, D.D. Mara, D.D., and P. Drechsel. 2010. *Improving wastewater use in agriculture: An emerging priority*. Policy Research Working Paper 5412, The World Bank, Washington, D.C.

WHO. 1989. *Health Guidelines for the Use of Wastewater in Agriculture and Aquaculture*. Technical Report Series No. 778, World Health Organization, Geneva.

Zuleta, J. 2011. *Integrated planning for direct wastewater irrigation in Mendoza, Argentina*. Seminar Presentation, The World Bank, Washington, D.C. Retrieved on Sept. 5, 2012 <<http://water.worldbank.org/sites/water.worldbank.org/files/5.%20Zuleta%20Mendoza.pdf>>.

Sewer Mining to Supplement Blackwater Flow in a Commercial High-rise

Author: Colin Fisher (Aquacell)

Australia-Sydney

Project Background or Rationale

Australia's warm climate and habitual droughts have resulted in innovative water conservation practices in commercial developments, such as 1 Bligh Street in Sydney. Commissioned in May 2011, the highly acclaimed 29 story office tower overlooking the Sydney Harbor captures nearly 100 percent of its wastewater and reuses it in the building. By recycling the vast majority of the waste stream, the developers have avoided sewer capacity issues and reduced the building's freshwater demand by approximately 90 percent. Not all of the wastewater reused at Bligh Street comes from the building itself.

Calculations revealed the building's total waste stream would not meet the non-potable demand for cooling tower makeup and toilet flushing (the desired reuse applications). Rather than supplementing non-potable demand with city water, the development has engaged in 'sewer mining', which involves tapping into the city's sewer main as a source of water (see **Figure 1**).

Capacity and Type of Reuse Application

The blackwater plant, located just off the parking garage in a maintenance room, treats approximately 26,000 gallons (100 m³) of blackwater onsite daily.

A modular membrane bioreactor (MBR) was chosen, which would meet Water Industry Competition Act (WICA) and project objectives. Advances in modular mechanical design, membrane and instrument development, and remote monitoring via the Internet have helped improve the cost and reliability of MBR systems significantly in recent years. The MBR treatment consists of mechanical screening, biological treatment, and ultrafiltration (UV) (0.04 micron membranes). This approach provides the building a small footprint system with high yields (more than 99 percent) and high quality effluent. Disinfection via UV and a chlorine residual follows the MBR to provide multiple barriers of treatment. The recycled water

reused for cooling tower makeup is also treated with reverse osmosis to remove salts.

Water Quality Standards and Treatment Technology

The reuse scheme required a New South Wales (NSW) WICA operator's and retail license. The NSW government introduced WICA in 2006 as part of its strategy for a sustainable water future. WICA is intended to harness the innovation and investment potential of the private sector in the water and wastewater industries. At the same time, the Act establishes a licensing regime for private sector entrants to ensure the continued protection of public

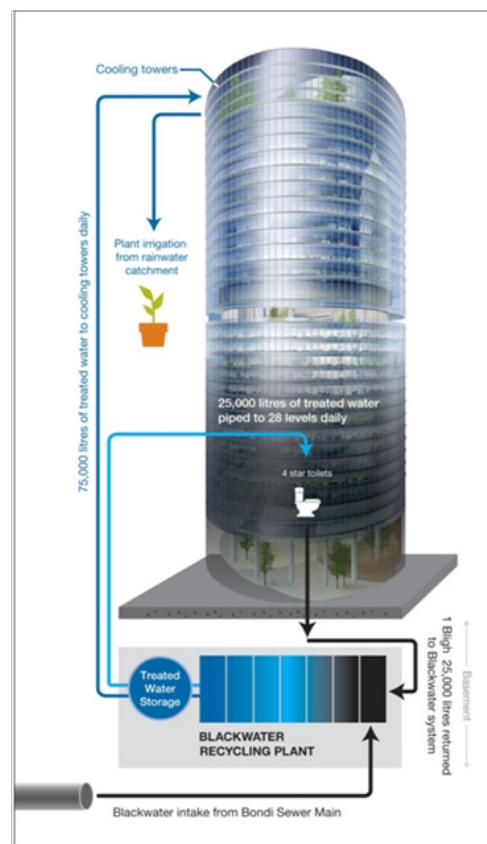

Figure 1
Bligh St Sewer mining and reuse schematic

health, consumers, and the environment (Independent Pricing and Regulatory Tribunal, 2011).

A corporation (other than a public utility) must obtain a license under the Act to construct, maintain or operate any water industry infrastructure, supply water (potable or non-potable), or provide sewerage services by means of any water infrastructure.

The approach in the WICA legislation is based on the Australian Guidelines for Water Recycling (AGWR); a risk based methodology that provides a framework for assessing the risks associated with reuse projects (Natural Resource Management Ministerial Council, Environment Protection and Heritage Council and Australian Health Ministers' Conference, 2006). The Bligh Street treatment program was deemed appropriate for the particular reuse scheme and adequate to manage the associated risks.

The application process for Bligh Street was done at the state level, submitted to the Independent Pricing and Regulatory Tribunal (IPART), which is responsible for ensuring a level playing field for private and public suppliers. IPART then sent the application to Public Health Offices for their input and it was also posted on IPART's website for public comment. Environmental concerns, plumbing and drainage codes, sewer access, waste disposal licenses, and potable water backup were all taken into consideration at this time. Successfully passing an independent audit of the treatment plant infrastructure and associated system management plans is additionally required for the plant to begin treating wastewater. Next, a verification period was initiated, where the treated water is sampled and tested according to a sampling protocol from the management plan. The plant must demonstrate the water is "fit for purpose" before treated water can be distributed throughout the building.

Institutional/Cultural Considerations

The *Australian Guidelines for Water Recycling* employs a "fit for purpose water" methodology (Natural Resource Management Ministerial Council, Environment Protection and Heritage Council and Australian Health Ministers' Conference, 2006). This approach involves an exposure risk calculation adopted from the World Health Organization's (WHO) Guidelines for Drinking-water Quality (WHO, 2004). The methodology designates tolerable risk to be 10^{-6}

Disability Adjusted Life Years (DALYs), or 1 infection per 1,000,000 people per year. DALYs have been used extensively to account for illness severity by organizations such as WHO. For this particular site, in order to reach 10^{-6} DALYs for Protozoa, Viruses, and Campylobacter, calculations determined Log Reduction Values (LRVs) needed to be 4.6, 6.0, and 4.8, respectively. Information on how these calculations are performed can be found in tables, 3.3, 3.7, and A2.1 of the AGWR (2006). Once LRVs have been established, plant performance objectives and components can be determined. In this case, a UV unit provides 1 LRV for Viruses and 4 LRV for Protozoa. A reverse osmosis (RO) unit provides >1 for each and chlorine disinfection provides 4 LRV for viruses. Thus, the performance requirements for the system are met. Note that in the LRV calculations there are no LRV credits sought for the submerged membranes. This may change in the future as California Title 22 gains wider acceptance.

Project Funding and Management Practices

The Bligh Street scheme was funded entirely by the building's developer thus it was critical the blackwater scheme be commercially viable from the outset. An innovative risk management methodology was adopted at first principles to properly address the economic challenges small schemes face with ongoing operations.

For many years the food industry has used Hazard Analysis and Critical Control Points (HACCP) risk management methodology. More recently HACCP has been adopted in the water industry. In a HACCP assessment the process is broken down into steps and at each step the question "what might happen and how might it occur" is asked. At Bligh Street, 6 CCPs were identified. These are influent pH, Turbidity, Electrical Conductivity across the RO, UV dosing, Chlorine residual and effluent pH. For each CCP, upper and lower limits were identified. If, during the course of production any one of the six CCPs is outside the limits, production is halted and an alarm is sent via SMS to a technician. Thus, HACCP ensures water quality fit for purpose will be delivered. As a result, end of pipe monitoring frequency can be reduced accordingly which reduces lab costs and directly effects the viability of the treatment plant without sacrificing public safety. Whereas *E. coli* sampling might have typically been required daily on a project

like Bligh Street, with HACCP real-time verification monitoring in place, regulators agreed to monthly sampling of *E. coli*. The monthly sampling for *E. coli* simply serves as confirmation that the HACCP methodology is functioning properly.

Lessons Learned

The Bligh Street project was one of the first NSW WICA licensing schemes in Sydney Central Business District to include sewer mining for cooling tower reuse. Working in an uncharted regulatory environment is always challenging and requires a vendor that fully understands risk assessment, and treatment technology, and has operational experience. Permitting is one of the more significant hurdles often overlooked by private scheme proponents. The permitting process can be time consuming. As new regulations are phased in, there is a period of overlap where the existing and new regulations both apply. The potential for miscommunication and confusion between regulatory bodies and the applicants is real. In order to meet all requirements, applications under the existing and the new regulations have been filed in parallel, which doubles the effort involved. Officials are extremely cautious at every step of the process and this has the effect of slowing down the process to a point where a 12-month lead time for approvals is normal. Accordingly, customers who would like to engage water recycling should be aware that the approval process adds a dimension of complexity and cost to the project. This will change as officials become more familiar with the practice and regulations and requirements for small systems become more transparent.

References

- Independent Pricing and Regulatory Tribunal. 2011. *Licensing: Private Water Utilities*. [Cited 15 December 2011]. Retrieved on Sept. 5, 2012 from <http://www.ipart.nsw.gov.au/Home/Industries/Water/Private_Sector_Licensing_WICA>.
- Natural Resource Management Ministerial Council, Environment Protection and Heritage Council and Australian Health Ministers' Conference. 2006. *Australian Guidelines for Water Recycling: Managing Health and Environmental Risks*. Natural Resource Management Ministerial Council, Environment Protection and Heritage Council and Australian Health Ministers' Conference, Canberra, Australia. [Cited 15 December 2011]. Retrieved on Sept. 5, 2012 from <http://www.ephc.gov.au/sites/default/files/WQ_AGWR_GL_Managing_Health_Environmental_Risks_Phase1_Final_200611.pdf>.
- World Health Organization. 2004. *Guidelines for Drinking-water Quality*. World Health Organization, Geneva, Switzerland. Retrieved on Sept. 5, 2012 from <http://www.who.int/water_sanitation_health/dwg/GDWQ2004web.pdf>.

Retirement Community Graywater Reuse

Author: Colin Fisher (Aquacell)

Australia-Graywater

Project Background or Rationale

RSL Care's Sunset Ridge Retirement Community resides near the Pacific coast in Zilzie, Queensland, Australia. The retirement community includes 100 independent living villas, a 120-bed aged care residential complex, and resort style facilities. Although Zilzie averages 31 in (79 cm) of annual rainfall, RSL Care sought to install a graywater recycling system because of the environmental benefits and to secure and maintain an adequate water supply for the community's residents.

Capacity and Type of Reuse Application

The graywater treatment plant installed at the Sunset Ridge Retirement Community treats approximately 6,600 gallons (25 m³) of graywater per day. The plant captures graywater discharged from the community's showers, bathtubs, and hand basins. The treated water is then reused in all of the toilets on site and for landscape irrigation.

Water Quality Standards and Treatment Technology

In Queensland, all graywater treatment plants must be granted Chief Executive Approval by the Queensland Department of Infrastructure and Planning before they are allowed to operate (Queensland Australia Government, 2011). Formal approval is based on 26 weeks of independent monitoring to demonstrate that the plant is able to treat graywater to the regulated quality standards. Once a system has been approved, it can be employed in other projects of similar nature.

Where treated graywater is used in high level reuse applications (e.g. toilets, urinals, laundry reuse, vehicle washdown) the Queensland regulations require the treated effluent to achieve the following minimum quality:

- BOD₅ <10 mg/L
- TSS <10 mg/L
- *E. coli* (max) <10 cfu/100 mL

- *E. coli* (95th percentile) <1 cfu/100 mL
- turbidity (max) <5 NTU
- turbidity (95th percentile) <2 NTU

The challenge of meeting these effluent standards in decentralized scenarios is that wastewater quality and flows are often highly variable. As such, the design of the treatment plant needs to be robust enough to manage a range of situations.

The core technology at Sunset Ridge is a modular membrane bioreactor (MBR), which encompasses a bioreactor with ultrafiltration membranes of 0.04 micron. MBRs are an advanced low footprint treatment technology typically used for blackwater treatment. However, this technology has been adopted to treat graywater primarily because of the soluble and insoluble organics that are commonly seen in commercial graywater influents. Graywater is by no means clean water with a few dirt particulates. Filtration based processes are sometimes used to treat graywater, but they do not provide the resilience needed for commercial systems, which MBRs afford. Once the effluent has been through the ultrafiltration membrane in the MBR, it is disinfected with ultraviolet (UV) and chlorine to achieve a chlorine residual. This multi-barrier treatment approach is what ensures the treatment plant is able to confidently handle variable wastewater qualities that are typical of decentralized graywater schemes.

Project Funding and Management Practices

One of the key considerations that clients and regulators want addressed when establishing reuse treatment plants of any size is who will operate the plant in the long-term. This is especially important if the scheme is to be implemented by the private sector for a specific private project. In this case, RSL Care privately funded the graywater scheme at Sunset Ridge.

Reuse schemes require a long-term strategy and cannot be treated as a fixed piece of plumbing

equipment. The challenge for many private sector decentralized reuse schemes is that they typically do not have wastewater specialists located on site. Therefore, longer-term arrangements need to be considered early on and should inform decision making throughout the project. For example, a cheap solution with poor equipment may win on capital price, but may also lead to the highest overall life cycle costs because of poor performance and operational difficulties. Life cycle analysis (LCA) must be considered.

The Sunset Ridge graywater plant operation is managed as a shared responsibility between the onsite maintenance staff at Sunset Ridge and the graywater system contractor. Day to day servicing and management is provided by Sunset Ridge locally, with twice yearly full technical servicing, remote monitoring, and regulatory reporting being provided by the contractor. Different projects will have different maintenance arrangement outcomes.

Institutional/Cultural Considerations

The graywater contractor is able to provide local staff with a high level of support particularly due to the capabilities of its risk management methodology in combination with the system's built-in remote monitoring system. Utilizing Hazard Analysis and Critical Control Points (HACCP), a risk management methodology most commonly used in the food and beverage industry, the graywater contractor can ensure the delivery of high quality treated water. Different Critical Control Points (CCPs) of the treatment process are monitored in real-time providing data to the contractor. Corrective actions are programmed into the system if any of the CCPs are out of range, thus providing Sunset Ridge an additional layer of confidence with the quality of the treated graywater. In addition to the safety provided by the HACCP risk management approach, remote monitoring and controls allow technical staff to take the reins of the graywater plant if necessary. Operational data from the CCPs is continuously relayed back to the contractor's headquarters where technical staff can increase/decrease aeration levels, change chlorination dosing, turn pumps on/off and so on. Remote monitoring and controls means the client has the security of knowing operational experts always have an eye on the plants operation.

Results and Lessons Learned

The Sunset Ridge graywater plant has consistently met effluent quality expectations since commissioning in early 2010 and the success of the scheme can be summarized down to contractor experience. It is important that managing regulatory approvals, delivering a robust technology suitable for commercial applications (commercial and domestic approaches are very different), and ensuring the appropriate operational partnerships are established and considered at the onset of the project.

References

Queensland Australia Government. 2011. *Queensland Development Code Part MP 4.3*. Retrieved on Sept. 5, 2012 from <http://www.hpw.qld.gov.au/construction/BuildingPlumbing/Pages/default.aspx>.

End User Access to Recycled Water via Third Party-Owned Infrastructure

Author: Geoff Jones (Barwon Water)

Australia-Victoria

Background

Barwon Water supplies recycled water from five of its nine water reclamation plants (WRP). During times where there is no customer demand, the recycled water is discharged to the ocean, lakes or onsite tree lots. The water is used for a number of commercial and municipal uses, including:

- Irrigating golf courses, sporting grounds, and public open spaces
- Irrigating vineyards, hydroponic tomatoes, potatoes, and other crops
- Irrigating turf and flower farms
- Dust suppression for road works and major construction works

Barwon Water is a government owned water authority operating in Victoria, Australia. In Victoria recycled water schemes must be approved by the Environment Protection Authority (EPA Victoria) and recycled water pricing must be approved by the Victorian Essential Services Commission (ESC).

Recycled Water Schemes

Barwon Water does not construct the recycled water distribution infrastructure. Transport of recycled water from the WRP to a customer's reuse site is the responsibility of the recycled water customer. Generally a single large customer within a distribution network funds construction, operation and maintenance of the distribution pipelines. These infrastructure owners transport the recycled water from Barwon Water WRPs to other customers. Infrastructure owners are able to recover their capital and operational costs by charging an infrastructure service fee in addition to the cost of the water from Barwon Water. In this arrangement, even though Barwon Water does not own the distribution assets, Barwon Water has been able to supply additional customers via the privately owned infrastructure.

All private scheme owners pay Barwon Water to maintain and service their network.

Three main recycled water networks (schemes) have been constructed in the region:

- Torquay Scheme (Black Rock WRP) - 1997
- Portarlington Scheme - 1999
- Barwon Heads Scheme (Black Rock) - 2000

In all three of these schemes, the majority of the distribution infrastructure is owned by one of the recycled water customers.

This arrangement is uncommon in Australia as most recycled water schemes are usually wholly owned and operated either by the water authority or a private owner.

Recycled Water Quality

The recycled water supplied is guaranteed as Class C quality as defined by EPA Victoria (**Table 1**) which implies suitability for a range of agricultural and horticultural purposes.

Table 1 EPA Victoria Class C recycled water license limits (EPA, 2003)

| Parameter | Range |
|----------------|-------------------|
| <i>E. coli</i> | < 1000 org/100 mL |
| pH | 6 to 9 |
| BOD | < 20 mg/L |
| SS | < 30 mg/L |

These are the only guaranteed parameters—other parameters are monitored but not guaranteed.

Legal Agreements

Barwon Water uses two legal agreements for supplying recycled water. EPA Victoria provides guidance on the content of legal supply agreements;

however this advice is brief and limited to suggested contents.

Recycled Water Supply Agreement: This agreement is between Barwon Water and the recycled water customer. Barwon Water treats all customers the same, the approach does not alter if they receive their water directly or via a privately-owned pipeline. The Supply Agreement states that the customer must negotiate directly with the infrastructure owner for access to their pipeline. An Infrastructure Access Agreement is negotiated between these parties.

Other conditions of the Supply Agreement include:

- An annual allocation (maximum volume) is defined, however this is not guaranteed due to unforeseen events.
- The quality is only guaranteed to a specific class, not individual parameters. The end user accepts responsibility for suitability of the recycled water to their purpose.
- The pressure is not guaranteed, nor is the recycled water supplied at a pressure suitable to power irrigation equipment. All end users must store the water and apply it at their own cost.
- A “take-or-pay” clause ensures that an allocation is not “locked up” unused. This clause is only enforced when other customers are able to use the water not currently being used.

Infrastructure Access Agreement: This agreement is between the infrastructure owner and the recycled water customer.

Infrastructure Access Agreements have been written to various levels of detail, from a one page letter to a several page legal agreement. Barwon Water has developed a pro-forma agreement to assist new customers reach agreement with the infrastructure owners. The pro-forma agreement is provided to customers to use or modify as they see fit.

Fees and Tariffs

In accordance with ESC pricing principles, Barwon Water's recycled water tariff is calculated to only recover the cost of production. No additional profit margin is included.

In addition to Barwon Water's recycled water tariff, customers are also charged for transfer of the recycled water by the private scheme owners. These owners may seek one or more of the following fees from the customer:

- Once-off connection fee
- Annual fee (based on either the end user annual volume (allocation) or a portion of the overall scheme capital)
- Volumetric (transfer) fee

While not a party to the negotiation, Barwon Water must be satisfied the agreement is fair and reasonable. Despite no legal regulation for this requirement, Barwon Water has been able to facilitate these negotiations. In newer agreements, a clause is specifically included to ensure that private scheme owners are obliged to accept reasonable requests by new customers to access their infrastructure.

Successes and Lessons Learned

Barwon Water has intervened twice to mediate better terms (i.e., cheaper price) for new customers. Both times the scheme owners were intending to charge customer an exorbitant volumetric transfer fee.

Over time the various agreements have been improved by way of new and revised clauses. The current arrangements include a more robust arbitration process.

To date, this form of supply arrangement has worked well and in the last 14 years facilitated the reuse of more than 12,200 acre-feet or 4,000 billion gallons (15,000 mL) of water.

References

EPA. 2003. *Guidelines for Environmental Management: Use of Reclaimed Water* [publication 464.2]. EPA Victoria, Southbank, Victoria.

St Mary's Advanced Water Recycling Plant, Sydney

Authors: Stuart Khan, PhD (University of South Wales) and
Peter Chapman (Sydney Water)

Australia-Replacement Flows

Project Background or Rationale

Drinking water supplies in the main storage reservoir for Sydney (Warragamba Dam) were rapidly diminishing between 2000 and 2006. The declining storage volume was primarily due to severe drought in the greater Sydney region. During this time, Warragamba Dam was also required to continue to provide satisfactory environmental flows in the downstream Hawkesbury Nepean River system.

The St Marys Advanced Water Recycling Plant is based in western Sydney and was developed by Sydney Water as a component of the New South Wales (NSW) State Government's Metropolitan Water Plan. The objective of the project was to produce an alternative high quality water source to replace more than 4.8 billion gallons (18 billion liters) of drinking water annually released from Warragamba Dam for the environmental flows of the downstream river, and improve river health through reducing the nutrient load.

Three existing wastewater treatment plants (St Marys, Penrith, and Quakers Hill) were identified, that could together supply the required volumes of source water to a new water recycling plant at St Marys. Advanced water treatment processes were required to ensure that the recycled water would be of a water quality standard suitable for environmental release into the Hawkesbury Nepean River system.

Capacity and Type of Reuse Application

A new advanced water recycling plant was designed to produce up to 4.8 billion gallons (18 billion liters) of highly treated recycled water annually.

The water recycling plant receives tertiary treated wastewater from the three wastewater treatment plants in variable ratios, depending on demand. Advanced treatment is then applied by ultrafiltration (UF) and reverse osmosis (RO), followed by decarbonation and chlorine disinfection.

Water Quality Standards and Treatment Technology

Water quality and treatment performance were subject to rigorous scrutiny by the relevant public health regulator, the NSW Department of Health (NSW Health). The Australian Guidelines for Water Recycling (AGWR) require the adoption of a risk management framework for managing water quality (NRMMC, EPHC, and NHMRC, 2006). An important aspect of the framework is a risk assessment to identify key potential hazards and hazardous events that may lead to elevated risks to the community. Although these guidelines were in draft form at the time, NSW Health imposed general compliance with the guidelines and the presentation of a satisfactory risk assessment as key criteria to be met in order for the project to receive the necessary endorsement for planning approval.

Risk Assessment and Performance Validation

A screening level human health risk assessment was undertaken at the concept stage for the St Marys project by the University of New South Wales (UNSW) (Khan *et al.*, 2007). Partially on the basis of that assessment, the NSW Government (including NSW Health) approved construction of the advanced water recycling plant with a number of conditions. One of those conditions was the construction and performance assessment of a pilot-scale plant. The pilot was constructed and a comprehensive chemical risk assessment and treatment performance assessment was then undertaken by UNSW (Khan *et al.*, 2009).

As an essential component of the chemical risk assessment, a chemical monitoring program was developed with the primary aim of validating many of the assumptions made in the screening-level risk assessment (Drewes *et al.*, 2010). This chemical monitoring program demonstrated that key prioritized chemicals of potential toxicological concern (including

pharmaceuticals, endocrine disrupting chemicals, and emerging disinfection by-products) in the product water were either absent or present at trace concentrations that were not a risk to human health for downstream users of the river.

Lognormal probability plots were prepared for statistical analysis of the variability in concentrations of chemical contaminants in UF influents and filtrates; and RO influents permeates and three-stage concentrates ("conc 1", "conc 2" and "conc 3"). An example is provided for the chemical dibromochloromethane in **Figure 1**.

The full-scale water recycling plant was then constructed adjacent to the site of the existing St Marys wastewater treatment plant and commissioned in June 2010. This was immediately followed by a 42-day process proving period, which included validation monitoring.

An objective of the chemical validation monitoring was to confirm that the performance of the new full-scale plant was comparable to the pilot-scale plant, which had been subject to a more intensive performance assessment. The focus of the validation was on the reverse osmosis process since the pilot-scale

assessment confirmed that this was the most important and effective barrier to trace chemical contaminants present in feed water. The validation testing successfully confirmed that the full-scale water recycling plant was operating with equivalent performance to the pilot plant (Khan and McDonald, 2010). Monitoring of chemical indicators in the recycled water provided evidence of high level of treatment performance and ultimately led to the final approval by NSW Health.

Project Funding and Management Practices

The project was funded through Sydney Water's customer charges as approved by Sydney Water's economic regulator, the NSW Independent Pricing and Regulatory Tribunal (IPART). Following a competitive tender process, Deerubbin Water Futures was engaged to design and construct the scheme, and operate and maintain the new advanced water recycling plant for a 10 year period.

Operations of the new advanced plant and transfer system have been completely integrated with the existing three wastewater plants, which are still required to meet pre-existing recycled water supply requirements for municipal irrigation and downstream irrigators.

Institutional/Cultural Considerations

Planning approval for the overall project included conditions of public consultation, and the proposed project was reviewed at public forums as part of the Metropolitan Water Plan. The project team also worked closely with the community while 32 miles (52 kilometers) of pipelines were laid through residential suburbs of western Sydney.

Several heritage areas were identified and protected by boring the necessary pipework beneath them. The team consulted indigenous Aboriginal groups on managing

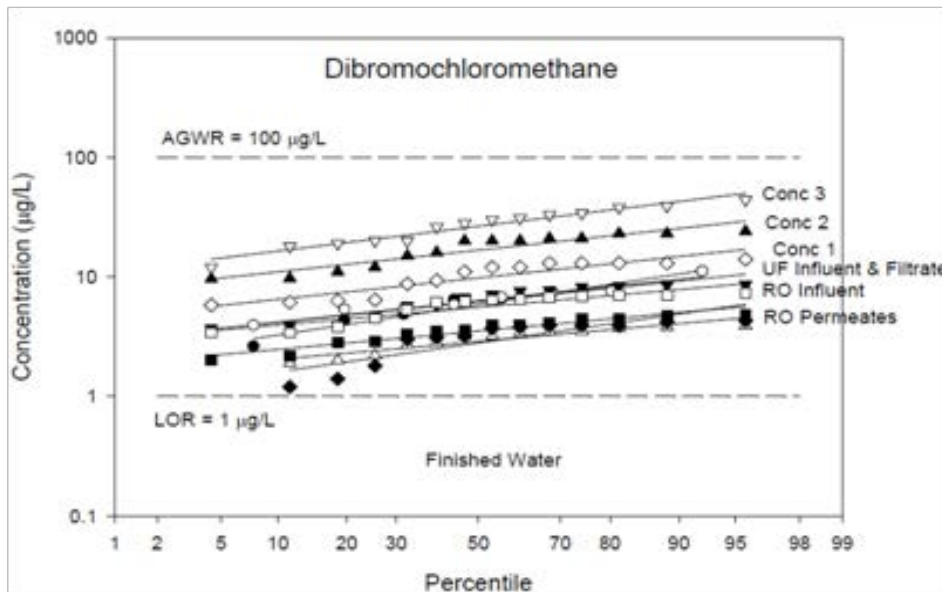

LOR = limit of reporting

Figure 1
Example of comprehensive monitoring of chemical contaminants in the St Marys Water Recycling Plant

significant artifacts, and monitored and recorded artifacts during the excavation works.

Successes and Lessons Learned

The project was completed on time, below budget, and met all objectives. The plant was officially launched in October 2010.

Water quality from the new plant has exceeded expectations on all quality parameters. To date, actual concentrations of nutrients are about half the predicted amounts, further reducing the nutrient load in the Hawkesbury-Nepean River. A Recycled Water Education Centre has also been included in the plant.

A key lesson learned from a project delivery and operations perspective, was that integration was critical. Successful operation of the plant relies on the ongoing contribution of approximately 20 different teams within Sydney Water, with one manager providing leadership and strategy. The approach taken through design and construction and into the operations and maintenance phase was to engage stakeholders early, and integrate the project into standard systems, processes, procedures and responsibilities, in order to realize the benefits of the project and achieve performance targets.

The initial construction of an *in situ* pilot plant for the risk assessment phase was also shown to be a highly worthwhile investment. With scalable technologies such as membranes, the pilot plant enabled realistic testing of the plant performance using water obtained from the actual catchment and this provided a high level of confidence to inform the design and construction of the full-scale plant.

References

Drewes, J.E., J.A. McDonald, T. Trinh, M.V. Storey, and S.J. Khan. 2010. "Chemical monitoring strategy for the assessment of advanced water treatment plant performance." *Water Science & Technology: Water Supply*, 10(6): 961-968.

Khan, S.J. and J.A. McDonald. 2010. *Replacement Flows: Chemical Validation Monitoring*. Report for Sydney Water Corporation. UNSW Water Research Centre, University of New South Wales.

Khan, S.J., D.J. Roser, N.J. Ashbolt, A. Lovell, and M. Angles. 2007. "Health risk assessment for recycling for replacement river flows." In *Water Reuse & Recycling*. Khan, S.J., R.M. Stuetz, and J.M. Anderson (Eds). UNSW Publishing, Sydney, 263-272. ISBN: 978 0 7334 2517 2.

Khan, S. J., McDonald, J. A., Trinh, T., and Drewes, J. E. 2009. *Sydney Water Replacement Flows Project: Chemical Risk Assessment*. UNSW Water Research Centre, Sydney.

National Resource Management Ministerial Council (NRMMC), Environment Protection and Heritage Council (EPHC), and National Health and Medical Research Council (NHMRC). 2006. *National Guidelines for Water Recycling: Managing Health and Environmental Risks (Phase 1)*.

Economic Analysis of Water Reuse Options in Sustainable Water Resource Planning

Authors: William Y. Davis and Jason Johnson, P.E. (CDM Smith)

Barbados-Economic Analysis

Project Background or Rationale

The West Coast Sewerage Project is a plan by the Barbados Water Authority to provide sewer service to residents and businesses on the west coast of the island nation of Barbados. The designated “West Coast” area is a strip of land between the Caribbean coast and the base of the lower terrace. The area is approximately one-half mile wide from east to west and about 12 miles (20 km) from north to south. The white sand beaches and accessible coral reefs draw tourists from around the world. The West Coast is densely developed and accounts for about 80 percent of Barbados’ billion dollar (U.S.) annual tourism industry.

The Government of Barbados signed onto international agreements related to the discharge of water through ocean outfalls to marine environments. In addition, the Government of Barbados mandated the appropriate implementation of water reuse into the water management strategy for the country.

The proposed West Coast Sewerage project has multiple components that address collection, treatment, and disposal. Option A called for a collection system with a secondary treatment facility at the south end of the region where an ocean outfall could be constructed without impacting coral reefs. In addition, five alternative discharge/disposal options (Options B, C, D, E and F) were considered with different configurations of reuse distribution systems and aquifer recharge.

The level of treatment is consistent for each option since the international agreements mandate advanced treatment requirements similar to those required for water reuse and recharge to potable aquifers.

A prior study determined the reuse potential of golf courses and other industries in proximity to the West Coast. Most of the potential for golf course irrigation with reclaimed water is midway up the West Coast and would occur only during the dry season. Aquifer

recharge areas in proximity to the West Coast are in potable aquifer zones while non-potable aquifer zones are further distances from the planned treatment facilities.

Economic Analysis

The quantifiable present worth costs and benefits were estimated for each option. The economic benefits included residents’ willingness to pay for sewage service, reduction of sanitation costs at commercial establishments, tourists’ willingness to pay for sewage service, value of water reuse, reduced beach erosion, avoidance of beach closures, enhanced tourism activities, and public health. The value of water reuse was determined as the cost of the water to be used if reclaimed water were not available. Thus, costs were determined for potable water, desalinated water for irrigation, groundwater for irrigation, and brackish water for cooling.

The costs and benefits of each option were discounted from their future values to an equivalent present value for comparison. A range of discount rates was used to test the sensitivity of the results to changes in the discount rate. The different discount rates affected the net project costs but did not change the ranking of the options in the quantifiable economic analysis. Results using a discount rate of 6 percent are show in **Table 1**.

Table 1 Economic indicators

| Options | A | B | C | D | E | F |
|----------|-------|-------|-------|-------|-------|-------|
| Costs | \$270 | \$371 | \$398 | \$322 | \$350 | \$381 |
| Benefits | \$427 | \$500 | \$500 | \$490 | \$490 | \$500 |
| NPV | \$156 | \$129 | \$102 | \$168 | \$141 | \$119 |
| BC Ratio | 1.58 | 1.35 | 1.26 | 1.52 | 1.40 | 1.31 |
| ERR | 11.8% | 9.7% | 8.8% | 11.6% | 10.5% | 9.6% |

Dollars are U.S. million
Discount rate is 6%

Based solely on the quantitative criteria, Option A was the most cost-effective option as it had the lowest costs, the highest ratio of benefits to costs (BC Ratio) (1.58) and the highest economic internal rate of return (EIRR) (11.8 percent). Option C, on the other hand, had the highest costs, the lowest benefit to cost ratio (1.26) and the lowest economic internal rate of return (8.8 percent) of the six options. Even though Option C ranked lowest among the options, it is still economically viable in that the benefits exceed the costs and the rate of return is acceptable.

Triple Bottom Line

The multi-criteria analysis evaluated the options based on environmental, social, and operational factors. The **environmental** factors included marine impacts, groundwater impacts, provision of a saltwater barrier for aquifers, overall sustainability, and odor control. **Social** factors included disruption during construction, overall public acceptance, meeting the government's objectives of compliance with marine discharges and reuse, land use conflicts, and promoting public education and awareness of stewardship of water resources. The **operational** factors included system reliability, flexibility complexity and emergency responsiveness, with a preference for less complexity and more reliability, flexibility and responsiveness in operations.

Weights ranging from 1 (low importance) to 5 (high importance) were assigned to each of these factors. Ratings on a scale of 0 (not applicable) to 10 (highest) were assigned to each option for each of these factors. These weightings and ratings were assigned, reviewed and refined in a stakeholder workshop.

Option C had the best (highest) score followed by Option A. On the environmental criteria, Option B had the highest score and Option A the lowest. On the social criteria, Option A is the least disruptive and thus scored best socially. Operationally, Option A is the most reliable and the least complex. However, Option C has the highest overall score.

Rankings of the options based upon results of the cost-benefit analysis and the multi-criteria analysis are shown in **Table 2**. Table 2 shows the rankings for both weighted and unweighted scores. The unweighted score gives equal weight to the five indicators (multi-criteria score and four economic indicators). In the unweighted score, the environmental and social impacts represent only 20 percent of the overall score. Alternatively, weights were assigned to the five indicators to provide a weighted score of indicators. A variety of weighting scenarios was used to test the sensitivity of the rankings to changes in the weighting of indicators. For example, the weighted score shown in Table 2 is based upon a weight of 70 percent for the multi-criteria score with the remaining 30 percent divided equally among the four economic indicators.

Table 2 Overall rankings

| Options | A | B | C | D | E | F |
|--|-------|-------|-------|-------|-------|-------|
| Life-cycle Costs (US\$ million) | \$270 | \$371 | \$398 | \$322 | \$350 | \$381 |
| Rank (1=lowest) | 1 | 4 | 6 | 2 | 3 | 5 |
| NPV* (US\$ million) | \$156 | \$129 | \$102 | \$168 | \$141 | \$119 |
| Rank (1=lowest) | 2 | 4 | 6 | 1 | 3 | 5 |
| BC Ratio* | 1.58 | 1.35 | 1.26 | 1.52 | 1.40 | 1.31 |
| Rank (1=lowest) | 1 | 4 | 6 | 2 | 3 | 5 |
| EIRR* | 11.8% | 9.7% | 8.8% | 11.6% | 10.5% | 9.6% |
| Rank (1=lowest) | 1 | 4 | 6 | 2 | 3 | 5 |
| Total MCA Score | 700 | 653 | 723 | 605 | 679 | 676 |
| Rank (1=lowest) | 2 | 5 | 1 | 6 | 3 | 4 |
| Unweighted Score | 7 | 21 | 25 | 13 | 15 | 24 |
| Unweighted Rank | 1 | 4 | 6 | 2 | 3 | 5 |
| Weighted Score | 1.78 | 4.70 | 2.50 | 4.73 | 3.00 | 4.30 |
| Weighted Rank | 1 | 5 | 2 | 6 | 3 | 4 |

* At 6% discount rate

In the weighted analysis, Option A received the best ranking regardless of the weighting of indicators. However, Option A does not meet the government mandate to develop a water management strategy that includes the reuse of valuable wastewater effluent. The analysis illustrates that meeting this reuse mandate imposes the acceptance of certain economic, environmental and social costs.

Summary

The importance of operational criteria became evident through the stakeholder workshop process. Barbados Water Authority staff determined that management of “worst-case” conditions of a highly complex wastewater and reclaimed water system was a critical

factor. Thus, options were limited to those that included the ocean outfall infrastructure for emergency backup disposal in the rare instance of a plant failure. Again, the analysis illustrated the additional economic, environmental and social costs, or trade-offs, imposed operational preferences and the reuse mandate.

References

CDM, *Benefit-cost Analysis for the West Coast Sewerage Project Master Plan (WCSMP)*, completed for the Barbados Water Authority, 2009.

Water Reclamation for Aquifer Recharge in the Flemish Dunes

Author: Emmanuel Van Houtte, Intercommunale Waterleidingsmaatschappij van Veurne-Ambacht (Intermunicipal Water Company of the Veurne Region, IWVA)

Belgium-Recharge

Project Background or Rationale

In the western part of Belgium's Flemish coast, water demand increased from 426 ac-ft (526,000 m³) in 1950 to 4,500 ac-ft (5,500,000 m³) in 1990. The dune water catchments, where fresh groundwater is pumped from the unconfined aquifer by the Intermunicipal Water Company of the Furnes Region (IWVA), could no longer produce more water as continued pumping could cause saline intrusion. Ecological interest in the dunes was also growing (Van Houtte and Vanlerberghe, 1998), so alternative exploitation methods were studied to remediate decreasing water levels and to guarantee current and future water extraction possibilities. This resulted in the development of a project for artificial recharge of the unconfined dune aquifer of St-André. Because no other water sources were available for year-round aquifer recharge, the IWVA decided to use reclaimed water from the Torreele facility for the production of infiltration water (Van Houtte and Vanlerberghe, 2001).

Capacity and Type of Reuse Application

The Torreele facility in Wulpen indirectly reuses reclaimed water to augment the potable water supply. The largest portion of the reclaimed wastewater is from households. The treatment process consists of primary sedimentation, predenitrification, and aerobic treatment, followed by secondary clarification and RO. Because the rainwater is collected in the same sewer system, the effluent water quality can vary greatly. In the first 9 years of operation, 4.6 billion gallons (17.5 million cubic meters) of infiltration water was produced at Torreele. Before being recharged in a 196,000 ft² pond (18,200 m²) in the dunes of St-André, the water undergoes a small pH correction dosing with NaOH. The extraction rate was 6.2 billion gallons (23.6 million m³) during that period, and the average residence time in the dunes was 55 days (Vandenbohede et al., 2009).

The recovered water is conveyed to the potable water production facility at St-André which consists of aeration, rapid sand filtration, storage, and ultraviolet (UV) disinfection prior to distribution. Dosing of chlorine is possible as a preventive action to prevent regrowth and recontamination in the distribution network.

Since the project started, 35 to 40 percent of IWVA's annual drinking water demand is fulfilled by the combination of reuse/recharge.

Water Quality Standards and Treatment Technology

The recharge water is subject to stringent water quality standards due to the sensitive environmental nature of the dune area to be recharged (**Table 1**). Because reclaimed water is high in both salt and nutrient content, RO was chosen as the final treatment step at the Torreele facility. RO requires a high-quality influent, so UF membranes precede the RO process (**Figure 1**).

Table 1 Quality standards set for the infiltration water

| Parameter | Infiltration water |
|----------------------------------|--------------------|
| Conductivity (µS/cm) | 1,000 |
| Chloride (mg Cl/l) | 250 |
| Sulphate (mg SO ₄ /l) | 250 |
| Total hardness (°F) | 40 |
| Nitrate (mg NO ₃ /l) | 15 |
| Nitrite (mg NO ₂ /l) | 0.1 |
| Ammonia (mg NH ₄ /l) | 1.5 |
| Total phosphorous (mg P/l) | 0.4 |

The RO system is a two-stage configuration with 21:6 pressure vessels in the first pass and 10:6 pressure vessels in the second pass. Scaling is prevented by pH adjustment and antiscalant dosing. Biofouling is prevented by dosing monochloramines. The average annual recovery is 77 percent.

Water reuse intended for drinking water production, both direct and indirect, is not possible without intensive water quality monitoring. Both UF and RO processes performed as expected – UF produced water free of bacteria and suspended solids. UF proved to be a good pretreatment for RO, and the infiltration water meets the quality standards that were set for the infiltration water (Table 2).

Table 2 Overview of quality in 2010

| Parameter | Infiltration Water |
|---|--------------------|
| Conductivity (µS/cm) | 45 (<10 – 89) |
| pH | 6.29 (5.28 – 6.86) |
| Total Organic Carbon (mg/l) | 0.4 (0.1 – 1.1) |
| Total hardness (mg/l as CaCO ₃) | <0.5 |
| Chlorides (mg /l) | 3.2 (1.0 – 4.7) |
| Fluorides (mg/l) | <0.2 |
| Sulfates (mg/l) | <1 |
| Nitrate (mg NO ₃ /l) | 2.5 (<1 – 6.3) |
| Ammonia (mg NH ₄ /l) | 0.13 (0.03 – 0.38) |
| Phosphate (mg PO ₄ /l) | <0.1 |
| Silicium (mg SiO ₂ /l) | 0.3 (0.1 – 0.4) |
| Total trihalomethanes (µg/l) | 3.8 (1.2 – 6.7) |
| Aluminum (µg/l) | 12 (2 – 59) |
| Chromium (µg/l) | <2.5 |
| Copper (µg/l) | <5 |
| Lead (µg/l) | <5 |
| Mercury (µg/l) | <0.2 |
| Nickel (µg/l) | <3 |
| Sodium (mg/l) | 10.5 (4.5 – 17.7) |
| Zinc (µg/l) | <20 |
| Totale Coliform bacteria (counts/100 ml) | 0 |
| E. coli (counts/100 ml) | 0 |
| HPC 22°C (counts/ml) | <1 (0 – 10) |

Project Funding and Management Practices

The project was funded with IWVAs resources; no external funding was used. The total investment was 7 million Euros (\$9 million) and the contractors remained responsible during a 10-year period. The daily operation is conducted by IWVA.

All membranes have been replaced only once since startup: the RO membranes in 2009, and the UF membranes between 2009 and 2011.

Successes and Lessons Learned

Meteorological and seasonal variations are a big challenge at the Torreele facility and influence operating conditions. Ongoing monitoring at the plant includes online and daily measurements taken by the operator.

Submerged UF (ZeeWeed), using outside-in filtration and air not only proved to be a good pretreatment prior to RO, but was also capable of handling the expected variations in influent water quality. Suspended solids and bacteria were removed from the water and turbidity is monitored as the first quality control step.

Biofouling and scaling prevention is a constant concern with water reuse when using membranes. Reduction in consumption of chemicals and energy has been achieved since start-up by reducing aeration in the UF system, optimizing RO recovery rates to minimize scaling, and intermittent chloramination for control of biofouling (Van Houtte and Verbauwhe, 2008).

The membrane waste concentrate streams are now combined with the portion of the treated wastewater that is not reclaimed and discharged in the nearby brackish canal. However, IWVA investigated natural systems for concentrate treatment (Van Houtte and Verbauwhe, 2011).

Temperature influences the volume of infiltration; more water is infiltrated in summer when temperatures are higher, which matches IWVA's demand for drinking water in a tourist area. The project was developed for an extraction rate of 1.4 times the infiltration rate. During the first years of operation, there was a surplus of recharged water. Since the beginning of 2009, however, the accumulated surplus appears to be corrected and currently averages 264 million gallons (1 million m³). In winter the surplus decreases as colder temperatures have a negative impact on the infiltration rate. Though Vandenbohede et al. (2008) predicted a dynamic equilibrium would not occur, even after 10 years of recharge, it appears that equilibrium may have already occurred. The latest ratio over the last 12 months for recharge/infiltration rate was 1:39, indicating that the dynamic equilibrium has been reached.

In recent years the drinking water demand in the area decreased from 1.5 billion gallons (5.5 million m³) in 2002 to just below 1.3 billion gallons (4.9 million m³) in

2010. Public education on the proper use of drinking water, increased prices due to higher taxes for discharge of the used water, and decreased leakage of the distribution network all contributed to this decrease. It is difficult to make a prognosis on how the evolution will be in the next years but the decreased use of drinking water meant that less infiltration has been required in recent years.

References

Vandenbohede, A., Van Houtte, E. and Lebbe, L. 2009.

Water quality changes in the dunes of the western Belgian coastal plain due to artificial recharge of tertiary treated wastewater. *Applied Geochemistry* 24 (2009) 370–382.

Van Houtte, E and F. Vanlerberghe, 1998. Sustainable groundwater management by the integration of effluent and

surface water to artificially recharge the phreatic aquifer in the dune belt of the western Flemish coastal plain. *IAH International Groundwater Conference, Groundwater: Sustainable Solutions*, Melbourne, Australia, p 93-99.

Van Houtte, E. and F. Vanlerberghe, 2001. Preventing biofouling on RO membranes for water reuse - Results of different tests. *AWWA Membrane Technology Conference*, San Antonio, 2001.

Van Houtte, E. and J. Verbauwhe, 2008. Operational experience with indirect potable reuse at the Flemish coast, *Desalination* 218 (2008), p 198-207.

Van Houtte, E., Berquin, S., Pinoy, L. and J. Verbauwhe, 2012. Experiment with willows to treat RO concentrate. Presentation in preparation for *AMTA Membrane Conference* in Glendale, AZ, 2012.

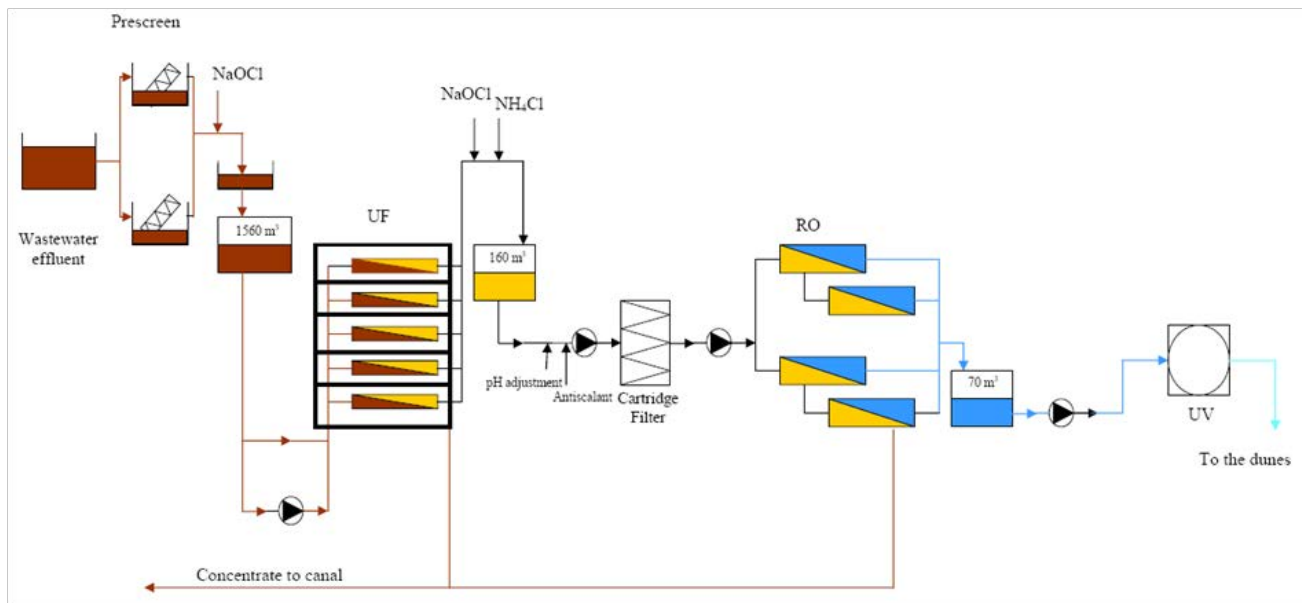

Figure 1 Process scheme of Torreele

Car Wash Water Reuse – A Brazilian Experience

Authors: Rafael N. Zaneti, MSc; Ramiro G. Etchepare, MSc; and Jorge Rubio, PhD, DIC
(Universidade Federal do Rio Grande do Sul)

Brazil-Car Wash

Project Background or Rationale

A full-scale car wash (hand washing) facility in Porto Alegre, South Brazil demonstrates the ability to utilize wastewater reuse (reclamation) for commercial car washing. This project validates an innovative process—Flocculation-Column Flotation (FCF), filtration, and chlorination—proposed by Rubio and Zaneti (2009), and Zaneti et al. (2011). Full evaluation was performed over a period of 20 weeks. The main parameters monitored were water consumption, quality of the reclaimed treated wastewater, water risks to health (customers and operators), vehicles, and washing machine damages.

Capacity and Type of Reuse Application

The installed car wash wastewater reclamation system (**Figure 1**) had capacity for reclaiming 264 gallons/hr (1 m³/hr) to meet the requirements for a demand of around 60 car washes per day.

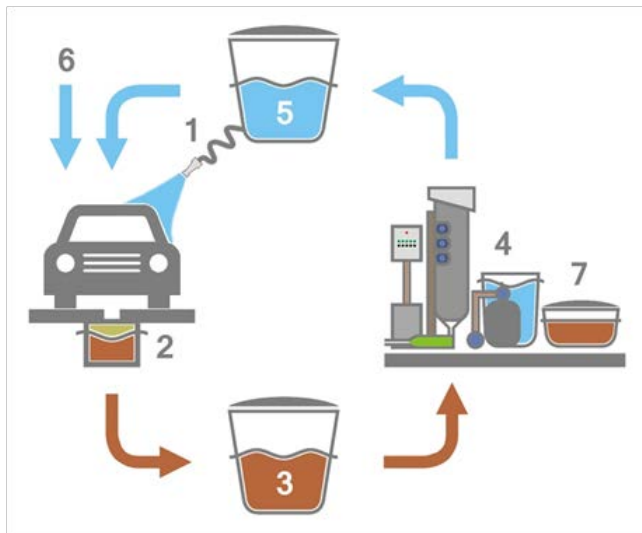

Figure 1
Car wash water reclamation system - Total storage capacity: 2,640 gallons (10 m³). Stages include: 1.) Hand-operated car wash; 2.) Oil/water separator; 3.) Wastewater reservoir (sample point 1); 4.) FCF equipment; 5.) Reclaimed water reservoir (sample point 2); 6.) Fresh water supply; 7.) Sludge dewatering.

Neutral and alkali detergents, as well as waxes are employed in the wash procedure. Reclaimed water was utilized in the pre-soak, wash and first rinse (wash process). Makeup (fresh) water was used in the final rinse before the cars were dried. Water usage was monitored daily by single-jet water meters. A single three stage oil/water separator was employed after the wash rack to remove excess oil content (free oil) and grit particles.

Water Quality Standards and Treatment Technology

The water quality for vehicle washing has to be sufficiently high to avoid damage to vehicles and washing equipment (Brown, 2002). In addition, the water quality must minimize risk to operators and users and be aesthetically acceptable, lacking odor and having a turbidity of less than 15 NTU (Jefferson et al., 2004).

The FCF principle is to encourage rapid formation of flocs, followed by flotation using fine (micro) bubbles to remove particles. Chlorine is then used to disinfect the FCF treated wastewater. The floc generator reactor (FGR) (Carissimi et al., 2007) and the flotation column (Zaneti et al., 2011) are patented processes and are low energy, easy to control, and compact. The FCF system was run semi-automatically. The water level in the reclaimed water tank was monitored with an electric level sensor, triggering the treatment process to turn on automatically when sufficient volume was reached in the tank. A tannin-based polymer (concentration of 80–350 mg L⁻¹) was used in the coagulation-flocculation step and sodium hypochlorite (0.5 mg Cl₂ L⁻¹) to disinfect the effluent.

Study Methods and Results

To ensure acceptable human health risk, risk analysis was performed employing dose-response models (Haas et al., 1999) using *E. coli* as an indicator of microbiological quality. Aerosol and ingestion exposure routes were considered for car wash

customers (1 exposure per week) and operators (15 exposures per day).

Corrosion and/or scaling are the main concerns in wastewater reclamation systems for vehicle washing (Metcalf & Eddy, 2006). Total dissolved solids (TDS) and chloride were monitored and predicted using a mass balance model, assuming constant inputs of contaminants per wash cycle and no water loss.

The chemical, physicochemical and micro-biological water analysis results are shown in **Table 1**. Samples were collected at points 1 and 2 (Figure 1) and analyzed using standard methods (APHA 2005).

Table 1
FCF-SC process: Characteristics of wastewater and reclaimed water (20 samplings; mean values \pm 1/2 standard deviation)

| Parameters | Wastewater | Reclaimed Water | Examination Methods* |
|---|----------------|-----------------|----------------------|
| pH | 7.4 \pm 0.8 | 7.3 \pm 0.5 | - |
| TSS, mgL ⁻¹ | 89 \pm 54 | 8 \pm 6 | 2540 D |
| TDS, mgL ⁻¹ | 344 \pm 25.5 | 388 \pm 42 | - |
| Turbidity, NTU | 103 \pm 57 | 9 \pm 4 | 2130 B |
| Total coliforms, CFU/10 | 3.1E \pm 5 | 3.3E \pm 4 | 9223 B |
| <i>E. coli</i> , CFU/100 mL ⁻¹ | 2.1E \pm 4 | 7.4E \pm 2 | 9221 E |

* APHA, 2005.

Results showed that reclamation of 70 percent of the feed water was possible [only 11 gallons (42 L) of fresh water per car] in order to maintain odorless and clear water over 27 water cycles. A risk analysis indicated that car wash users were not at risk, and that a limit of 200 CFU 100mL⁻¹ of *E. coli* would be recommended for an acceptable risk for car wash operators (risk analysis data not shown). This would be achieved, by increasing the chlorine concentration to 15 mg CL₂ L⁻¹ (data not shown). Moreover, the mass balance analysis indicated that the reclaimed water will have dissolved inorganic constituents below guideline parameters (TDS < 1000 mgL⁻¹ and chloride < 400 mg.L⁻¹) (Nace 1975).

Project Funding and Management Practices

The work was supported by several research and educational institutions in Brazil, mainly the Ministry of Science and Technology and the Ministry of Education.

Successes and Lessons Learned

Based on comparison to other studies, reducing fresh water consumption in car washes is more effective through wastewater reclamation rather than rainwater harvesting systems (Zaneti et al., 2011). Rainwater harvesting for water savings in petrol stations with car washes in Brasilia, Brazil was studied by Ghisi et al. (2009). The author reported that large roof areas (550 m²) and a large tank (100 m²) are required to capture intermittent rainfall to reach the same 70 percent of water savings attained in the present study (at a demand of 15 car washes per day). Furthermore, according to the results of these authors, rainwater harvesting systems require longer pay-back periods for installed equipment.

In this study, more than 2000 cars were washed (16 daily washes) during the study period (20 weeks), with no reported problems regarding the wash service quality. The results have encouraged the application of FCF-SC process in many Brazilian bus companies and in more environmentally friendly car washes. However, public policies need to be developed that help to encourage effective implementation of water reuse, including by addressing water pricing.

References

- APHA - Standard Methods for the Examination of Water and Wastewater, 2005. 21st, American Public Health Association/American Water Works Association/Water Environment Federation, Washington, D.C., USA.
- Brown C., 2002. Water use in the Professional Car Wash Industry. Report for International Car Wash Association, Washington D.C., USA.
- Carissimi E, Miller JD, Rubio J. 2007. Characterization of the high kinetic energy dissipation of the flocs generator reactor (FGR). International Journal Mineral Processing, 85(1–3):41–9.
- Ghisi E, Tavares D F, Rocha V L. Rainwater harvesting in petrol stations in Brasília: Potential for potable water savings and investment feasibility analysis. Resources, Conservation and Recycling 2009;54:79–85.
- Haas C, Rose J, Gerba C. Quantitative microbial risk assessment. New York: John Wiley & Sons; 1999.
- Jefferson B., Palmer A., Jeffrey P., Stuetz R. and Judd S., 2004. Grey water characterization and its impact on the selection and operation of technologies for urban reuse. Water Science and Technology, 50(2), 157-164.

Metcalf and Eddy, 2006. *Water Reuse: Issues Technologies, and Applications*. New York, USA.

National Association of Corrosion Engineers (NACE). The corrosivity of recirculation car wash water. *NACE* 1975; 3N275:9-10.

Rubio J. and Zaneti R.N., 2009. Treatment of washrack wastewater with water recycling by advanced flocculation–column flotation. *Desalination*, 8, 146-153.

Zaneti R, Etchepare R, Rubio J., 2011. Car wash wastewater reclamation: Full-scale application and upcoming features. *Resources, Conservation and Recycling*, 55, 953-959.

Water Reuse Concept Analysis for the Diversion of Phosphorus from Lake Simcoe, Ontario, Canada

Author: David C. Arseneau, P.Eng, MEPP (AECOM); David K. Ammerman, P.E. (AECOM); Michael Walters (Lake Simcoe Region Conservation Authority)

Canada-Nutrient Transfer

Project Background or Rationale

Lake Simcoe is one of the largest inland lakes in Ontario, Canada and supports a cold-water recreational fishing community that is vital to the local tourism economy. Human activity over the last two centuries has degraded water quality in the Lake, creating significant eutrophication from excessive phosphorus loading. The Lake Simcoe area is serviced by 14 water pollution control plants (WPCP), which discharge 5.3 tonnes of phosphorus per year (MOE, 2010). Such impacts are anticipated to increase

due to the rapidly growing population. The Lake Simcoe Protection Act mandates the reduction of phosphorus discharges into the Lake, including effluent from all WPCPs servicing the urban areas of the watershed.

Costly upgrades to WPCP treatment technologies have been proposed to meet these reductions. In the interest of pursuing alternative means of reducing phosphorus loadings, this study was commissioned by the Lake Simcoe Region Conservation Authority

(LSRCA) and Ministry of Environment (MOE) to evaluate the feasibility of implementing water reuse applications to divert effluent from the Lake. Implementing reclaimed water programs can divert wastewater effluent, and the associated nutrients, away from receiving watercourses while providing non-potable water for uses such as irrigation of farms and golf courses. Water reuse is an emerging practice in Ontario, with few implemented projects and an absence of dedicated legislation or policies to establish acceptable end uses or water quality requirements.

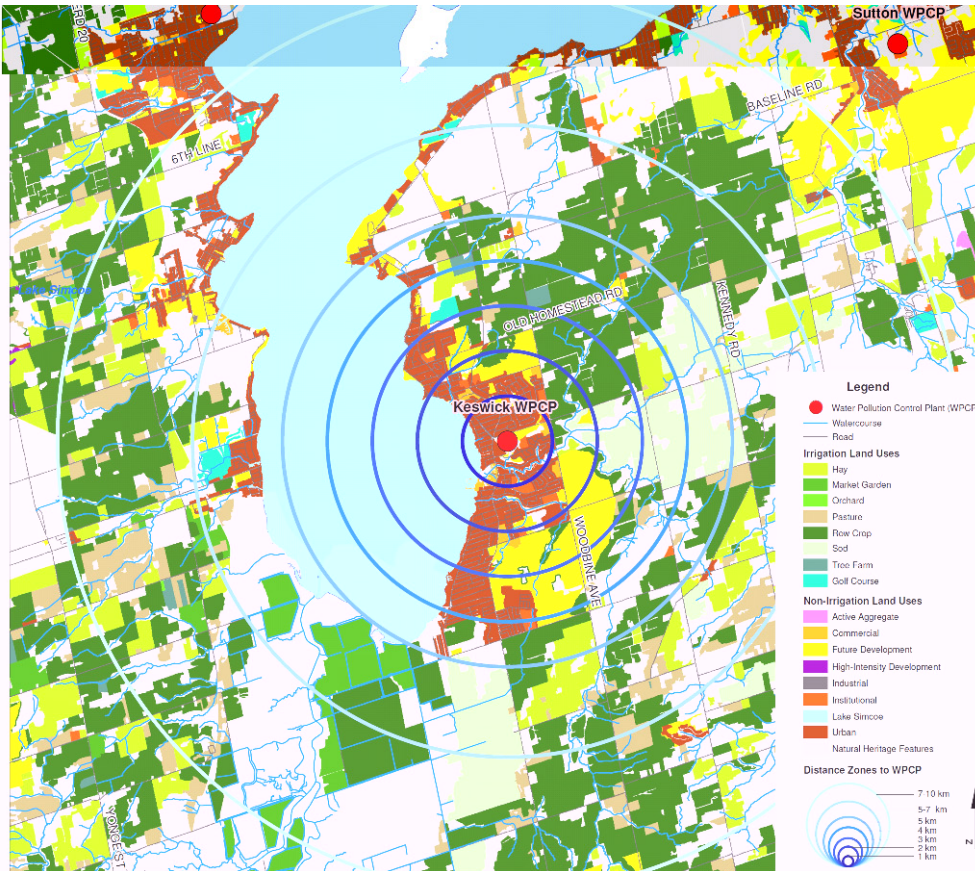

Figure 1
Illustration of the demand screening analysis for the Keswick Water Pollution Control Plant

Methodology

The water reuse conceptual analysis consisted of four stages. This approach was designed to address key questions to establish the feasibility of water reuse to contribute to the reduction of phosphorus loadings to Lake Simcoe:

1. *Characterization of potential water reuse applications:* what types of reuse applications are available in the watershed, how much water do they need, and how much phosphorus is diverted or reduced?
2. *Characterization of reclaimed water supplies:* where are the treatment plants located, how much reclaimed water is potentially available, what is the quality of the reclaimed water (i.e., which reuse application is the water suitable for), and what is the current phosphorus load from each plant?
3. *Reclaimed water demand screening analysis:* which water reuse applications are available in proximity to each of the treatment plants (**Figure 1**), what are the annual reclaimed water demands, and what is the potential annual phosphorus reduction?
4. *Conceptual water reuse scenarios:* what are the costs and benefits associated with the water reuse applications, as established through three conceptual scenarios?

The water reuse scenarios evaluated in this study included:

- *Keswick WPCP:* irrigation of sod farms
- *City of Barrie:* satellite reuse facility for reuse in new growth urban areas
- *Uxbridge Brook WPCP:* municipal effluent disposal via land application

Findings

The results of the cost assessment are shown in **Table 1**. The costs are reported on a dollars per kilogram of phosphorus removed (\$/kg P) to facilitate comparison with other phosphorus reduction methods in the watershed, such as treatment plant upgrades,

stormwater management and agricultural controls, as part of a potential credit trading program. **Figure 2** provides a comparison of water reuse scenario

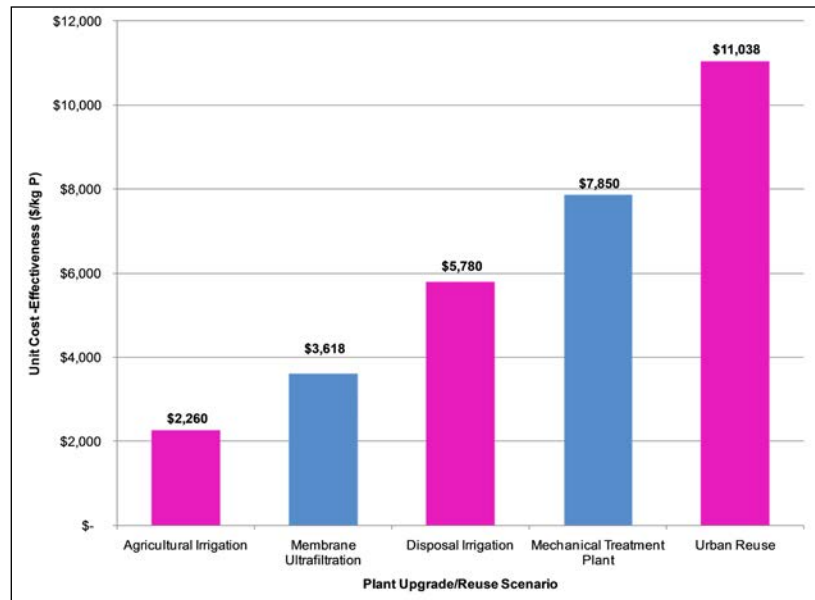

Figure 2
Comparison of water reuse cost-effectiveness (Magenta, AECOM) with treatment plant upgrade cost-effectiveness (Blue, XCG, 2010) in reducing phosphorus loadings

Irrigation of agricultural areas can be a cost-effective alternative to installation of tertiary filtration at existing secondary treatment facilities. These costs do not consider the potential benefits to farmers with respect to water security, reduced pumping costs and reduced need for added fertilizer. The land application (i.e., disposal) scenario becomes relatively cost-effective when considering installation of tertiary filtration at small treatment plants, as well as when upgrading existing sewage lagoons into secondary treatment plants. Urban reuse applications were not found to be cost-effective when solely considering phosphorus removal; however there are many other benefits to urban reuse, including reduction of potable water demands, alleviation of municipal servicing and water/wastewater plant capacity restrictions, conservation of natural water resources and potential improvements to potable water quality in distribution pipes due to smaller pipe sizes. Recognition of these additional benefits for both irrigation and urban reuse should be developed to further characterize the potential for reuse as a viable means of reducing phosphorus loadings.

Table 1 Summary of reuse scenario costs and phosphorus removal rates

| Reuse Scenario | 25-year Life Cycle Cost (\$CAD 2010) | Annual Phosphorus Removed (kg/yr) | Percent Phosphorus Reduction (%/year) ¹ | 25-year Phosphorus Removal (kg) | Phosphorus Removal Cost Effectiveness (\$/kg P) |
|--|--------------------------------------|-----------------------------------|--|---------------------------------|---|
| Keswick WPCP Sod Farm Irrigation | \$5.4-\$10.4MM | 116-184 | 22%-35% | 2,900-4,600 | \$1,850-\$2,250 |
| Barrie Reuse for New Urban Development | \$4.7-\$9.5MM | 12.6 | 0.50% | 315 | \$14,950-\$30,200 |
| Uxbridge Brook WPCP Land Application | \$3.2-\$6.4MM | 25-49 | 25%-49% | 625-1,225 | \$5,080-\$5,200 |

¹ Compared to current phosphorus loading levels

Conclusions

This study demonstrates the evaluation of the potential cost-effectiveness of water reuse for a variety of applications. The methodology used is scalable to large or small areas, and the parameters of the analysis can be readily modified to suit the management objectives of the operating authority, agency or municipality.

References

- Ministry of Environment of Ontario. Lake Simcoe Phosphorus Reduction Strategy. PIBS 7633e. Queen's Printer for Ontario, 2010.
- XCG, Keiser Associates. Water Quality Trading in the Lake Simcoe Watershed, Feasibility Study. Feb. 2010.

Water Reuse in China

Authors: Allegra K. da Silva, PhD (CDM Smith) and Liping Lin (GE Water and Process Technologies)

China-MBR

Project Background or Rationale

Urbanization and accelerated economic growth have strained water resources in China and are the key drivers for water reuse. Though China has the fourth largest fresh water resources in the world by volume, the distribution of this resource is dramatically uneven, with Northern regions of the country experiencing severe shortages. Because of China's large population, current water resource volume per capita is 1.8 ac-ft (2,200 m³), which places China 88th in the world in per capita water availability. As China's population grows to a forecasted 1.6 billion in the mid-21st century, per capita water resource will decrease to 1.4 ac-ft (1,760 m³), which would result in serious water shortages. More than 400 cities throughout China face water shortages, with more than 100 cities facing serious water shortages, especially large cities such as Beijing and Tianjin. In addition to absolute volume shortages, environmental pollution of surface and groundwater sources has rendered many sources unfit for drinking water or industrial use.

China has taken on the challenge of dramatically improving its water and wastewater infrastructure, making significant improvements over the past decade. As of 2002, the official municipal wastewater treatment rate was 40 percent by total volume produced. According to Xinhua news, as of 2010, China increased its municipal wastewater treatment rate to 75 percent (Xinhua, 2011).

Water reuse is still a minor player in the water supply market in China. Installations that provide reclaimed water mostly for industrial installations including cooling water, but two example installations show how advanced treatment will likely play a growing role in water reuse to help meet China's future urban water needs:

1. Hohhot (capital city of Inner Mongolia province) – 8 mgd (31,000 m³/d) water reclamation facility to supply cooling water for the Jinqiao Power Plant
2. Beijing – 21 mgd (80,000 m³/d) water reclamation facility to supply landscape irrigation water for Olympic Park, as well as water for road washing, toilet flushing, vehicle washing and other nonpotable uses

Both systems were commissioned in 2006.

Capacity and Type of Reuse Application

Hohhot, located in Northern China, is dealing with serious water shortages. Municipal wastewater reuse in Hohhot is becoming more necessary and viable through the use of advanced treatment. In order to provide reclaimed water for a major water user, the Jinqiao Power Plant, an advanced multi-barrier approach was required, which uses a tertiary membrane bioreactor (T-MBR) system with ZeeWeed® MBR technology (Figure 1) and ion exchange.



Figure 1
Hohhot MBR facility (Photo credit: Courtesy of GE Water and Process Technologies)

The Jinqiao Reuse Water Plant (JRWP) treats 8 mgd (31,000 m³/d) of secondary effluent from a local municipal wastewater treatment plant. The high concentration of ammonium (20-30 mg/L) present in the secondary effluent is targeted for removal to meet

requirements for the industrial cooling water application. The JRWP uses a The Zee-Weed®-membrane fiber has a nominal pore size of 0.04µm, which provides an absolute barrier to biomass, bacteria and most viruses, retaining them in the process tank.

The permeate from the membrane tank is then pumped to a weak acid resin system for hardness removal and then disinfected by a chlorination system. The reclaimed water from the JRWP system is used as influent for cooling tower water supply of Jinqiao power plant.

As mentioned, Beijing was also facing water shortages. In advance of the 2008 Beijing Olympics, the Beijing Wastewater Group installed the Qinghe Reclaimed Water Plant (QRWP), a 21 mgd (80,000 m³/d) MBR water reclamation facility to provide water for municipal uses (**Figure 2**). Approximately 75 percent of the reclaimed water from WRWP is used as landscape supply water for Olympic Park, with the remaining water supplied to municipality of Haidian and Chaoyang District for road washing, toilet flushing, vehicle washing, and other nonpotable purpose. The system may also provide water periodically to Wanquan River, Xiaoyue River, North Tucheng Channel and the old summer palace.



Figure 2
Beijing MBR facility (Photo credit: Courtesy of GE Water and Process Technologies)

The QRWP system includes ZeeWeed® ultrafiltration (UF) technology followed by an activated carbon filter. The operation of QRWP will play an important role in relieving the growing water shortage in the northern area of Beijing.

Water Quality Standards and Treatment Technology

The Chinese central and regional governments have set up specific urban wastewater reuse targets, for example the overall reuse rate is expected to reach 20 percent for the whole country and 75 percent for Beijing by 2015. Technology wise, the Chinese government also published a series technical guidance (GB50335-2002, GB50336-2002, Jianke [2006] #100 etc.) and reuse quality guidance (GB/T18919-2002, GB/T18920-2002, GB/T18921-2002, GB/T19772-2005, GB/T19923-2005, GB20922-2007).

Project Funding and Management Practices

Urban reuse projects could be funded by local government budgets (such as Qinghe through government owned Beijing Drainage Group), by BOT investors and by reclaimed water users (such as Huaneng Power for the Hohhot case).

Institutional/Cultural Considerations

China's main legislation governing water resources, the Water Resource Law, was revised in 2002, introducing water tariffs, usage quotas, and wastewater treatment fees. The revised law also opened the possibility of foreign and non-state-owned capital financing for public water infrastructure. Prior to enacting these legislative changes, the water and wastewater treatment industry was a commonwealth enterprise in China, with only limited fees levied for the consumption of resources and provision of services. The market mechanisms introduced in the revised law have helped to incentivize conservation and reuse, by creating a value for water as a resource (International Trade Administration, 2005). The country has witnessed an increase in investment in water reuse over the past decade as a result (Frost & Sullivan, 2012).

Successes and Lessons Learned

The applications described in this case study demonstrate how advanced technology can be applied to upgrade existing secondary wastewater treatment plants to facilitate water reuse. The use of the activated carbon filter was found to not be a good option for tertiary treatment because of rapid exhaustion and regeneration issues. As a result, the QRWP was recently upgraded to an ozone AOP system.

References

International Trade Administration. 2005. "Water Supply and Wastewater Treatment Market in China." U.S. Department of Commerce.

Xinhua. 2011. "China's municipal wastewater treatment rate up by 24 percentage points." Xinhua News, March 15, 2011. Retrieved on March 14, 2012 at <http://news.xinhuanet.com/english2010/china/2011-03/15/c_13780003.htm>.

Frost & Sullivan. 2012. "Water-stressed Chinese Industries Make a Beeline for Membrane Bioreactor Technology," February 13, 2012. Retrieved on March 14, 2012 at <<http://www.frost.com/prod/servlet/press-release.pag?docid=253494255>>.

The Reuse Scenario in Bogotá

Authors: Juan M. Gutierrez, MS (Javeriana University) and
Lucas Botero, P.E., BCEE (CDM Smith)

Colombia-Bogotá

Project Background or Rationale

Bogotá is the capital of Colombia and the home of almost 10 million people. The city is upgrading and expanding its existing wastewater treatment to improve the water quality of the Bogotá River. This will have many benefits, including making the water quality suitable for reuse for agricultural irrigation. In addition, as the Bogotá River is used to produce 7 percent of the country's energy needs through hydropower energy generation, improved water quality will make the operation significantly more efficient and safer for operators.

This case study illustrates how holistic water management planning benefits by considering reuse at the planning phases for wastewater treatment. Additionally, this is a case where water scarcity is not the key driver of reuse. Water reuse may be critical for a country with abundant freshwater resources, as providing water supply for dense urban populations drives the need to look at alternative sources for the various needs and uses.

Treatment Capacity and Technology

The city's sewer system is largely separated between sanitary and storm sewers, except for the old area of the city, which has combined sewers. The local utility company has been investing heavily to separate combined sewers. The city's sewer system is mainly divided into three sewersheds: Salitre at the north, Fucha in the middle, and Tunjuelo at the south. Effluent from the entire sewer system is discharged into the Bogotá River.

Early sewer master plan studies identified the need for two wastewater treatment plants. The first phase of the Salitre Wastewater Treatment Plant (WWTP) was constructed in the late 1990s as a chemically enhanced primary treatment (CEPT) process. Currently, the Salitre WWTP treats 91 mgd (4 m³/s) with CEPT. The Salitre WWTP is in the process of upgrading to secondary treatment and increasing capacity to a projected total capacity of 167 mgd

(7.3 m³/s) in order to treat all wastewater from the north of the city.

The second municipal wastewater treatment plant is the Canoas WWTP, which will be constructed by 2016. The Canoas WWTP is planned to treat flows from the remaining sewersheds, Fucha and Tunjuelo, located in the southern portion of the city, serving approximately 7.2 million inhabitants. Presently, these two sewersheds discharge their untreated flows directly into the Bogotá River. The Canoas WWTP will have a build out capacity of 320 mgd (14 m³/s).

Type of Reuse Application

There are relatively large agricultural areas located near the Salitre WWTP called La Ramada irrigation district. This district currently uses 39 mgd (1.7 m³/s) for irrigation purposes, but there have been plans for expanding the district, resulting in the need for roughly 114 mgd (5 m³/s) in capacity. The water used for irrigation comes directly from the Bogotá River, which has already received a large amount of partially treated or untreated wastewater discharged by smaller towns located north of Bogotá. The existing irrigation infrastructure is operated by the environmental regional authority, Corporación Autónoma Regional (CAR).

Several years ago, some power agencies developed a hydroelectric generation scheme to use water from the Bogotá River, taking advantage of the river's 3,280 ft (1,000 m) drop in the area south of Bogotá, before discharging into Colombia's largest river, the Magdalena River. In fact, to enhance the water energy generation potential further, most of the river flow is currently being pumped to the Muña reservoir to allow the diversion of the river water through a newer hydropower complex. This reuse scheme provides for roughly 20 percent of the energy the city needs or 7 percent of the total energy required by the whole country. Due to this, water reuse from the Bogotá River is considered a national priority by the Colombia government and it is critical to the economic stability of the country.

Figure 1 shows the main components of the Bogotá River wastewater treatment scheme including the agricultural and power generation schemes associated with the Bogotá River.

In the past 5 years, the local utility company has been evaluating several alternatives to use wastewater treatment plant effluent in a different way other than the current energy generation. Studies by the Javeriana University evaluated the quality of the effluent water and have concluded that the effluent from the Salitre WWTP should be used in the near future as a supplementary source for the Ramada district, based on its proximity to the district. The anticipated water quality would allow restricted agricultural reuse after the secondary treatment is implemented, in accordance with Colombian water quality use requirements for the Bogotá River for Class 4 usage (CAR, 2006). Though there is not current agricultural pressure for increased water reuse in the Canoas area, the plans for expanding the Ramada district southwardly would present a driver to reuse the Canoas WWTP effluent in the expanded area. This option has the potential benefit of relieving the existing Ramada district agricultural area from drawing excessive water out of the Bogotá River.

Water Quality Standards and Treatment Technology

As the regulating agency for the Bogotá River, CAR established different water quality standards for river water reuse. There are five different classes that range from reuse water for human use and agricultural use with or without restrictions, to energy generation and industrial use. Criteria for Class 4 (restricted agricultural irrigation) are provided in **Table 1**.

Table 1 Water quality requirements for the use of Bogotá River water for Class 4 use (restricted agricultural irrigation)

| Parameter | Unit | Allowable Level |
|------------------|------------|-----------------|
| pH | pH units | 4.5-9.0 |
| BOD | mg/L | < 50 |
| Total coliforms | MPN/100 mL | < 20000 |
| Nitrites | mg/L | < 10 |
| Suspended solids | mg/L | < 40 |
| Aluminum | mg/L | < 5 |
| Arsenic* | mg/L | < 0.1 |
| Beryllium* | mg/L | < 0.1 |
| Boron | mg/L | < 0.3-0.4 |
| Cadmium* | mg/L | < 0.01 |
| Cobalt | mg/L | < 0.05 |

Table 1 Water quality requirements for the use of Bogotá River water for Class 4 use (restricted agricultural irrigation)

| Parameter | Unit | Allowable Level |
|-----------------|------|-----------------|
| Copper* | mg/L | < 0.2 |
| Chromium (Cr+6) | mg/L | < 0.1 |
| Fluoride | mg/L | < 1 |
| Iron | mg/L | < 5 |
| Lithium | mg/L | < 2.5 |
| Manganese | mg/L | < 0.2 |
| Mercury | mg/L | < 0.01 |
| Molybdenum | mg/L | < 0.01 |
| Nickel | mg/L | < 0.02 |
| Lead | mg/L | < 0.1 |
| TDS | mg/L | < 3000 |
| Selenium | mg/L | < 0.02 |
| Vanadium | mg/L | < 0.1 |
| Zinc* | mg/L | < 2 |

* Based on CL 96/50, the concentration of an element or compound that produces a mortality rate of 50% in bioassays lasting 96 hours.

Project Funding and Management Practices

Because water from the Bogotá River plays such a big role in Colombia's energy generation, and the wastewater from Bogotá contributes up to 50 percent of the Bogotá River average flow, the sanitation of the Bogotá River has become a national priority project. And, because there are so many different agencies and institutions that benefit from the river (the Bogotá Water and Sewer Authority–EAAB, the Colombian national government, CAR, the energy generation company, and the state of Cundinamarca), they all came to an agreement to fund the projects collectively. However, most of the projects' funding will come from the national government, the CAR, and the EAAB.

Institutional/Cultural Considerations

The sanitation of the Bogotá River involves several interested parties as noted above. Since they all have different objectives, negotiating the project implementation scheme and the project funding was a complex process that required more than 15 years. Political pressures from the interested parties slowed down the project implementation significantly.

Successes and Lessons Learned

Water reuse may be critical even for countries with abundant freshwater resources. Therefore, water scarcity does not necessarily drive water reuse. Despite political difficulties, this case shows how

different entities with different objectives can join forces to implement water reuse projects successfully.

Some issues that have arisen from the current irrigation with wastewater-impacted Bogotá River water include increased salinity of the soils, making them less fertile than they were originally.

References

Corporación Autónoma Regional de Cundinamarca (CAR). 2006. "Acuerdo 43 de 2006 de la CAR: Clasificación de Usos del Agua Para La Cuenca del Rio Bogotá y Valores de Los Parámetros de Calidad a Aplicar por Clase." Retrieved on Sept. 5, 2012 from <<http://www.car.gov.co/?idcategoria=16034#>>.

Figure 1

Components of the Bogotá River wastewater treatment scheme, showing components already constructed (red), under construction (grey), and planned (hatched grey). The two WWTPs, or PTARs in Spanish, are shown as squares (Salitre and Canoas). The Ramada irrigation district is shown in the green parallelogram in the bottom left-hand corner. The Muña reservoir (on the right) is the source for the hydropower complex.

Water Reuse in Cyprus

Authors: Iacovos Papaïacovou and Constantia Achileos, MSc (Sewerage Board of Limassol Amathus); Ioanna Ioannidou, MSc (Larnaca Sewerage and Drainage Board); Alexia Panayi, MBA (Water Development Department); Christian Kazner, Dr.Ing. (University of Technology Sydney); and Rita Hochstrat (University of Applied Sciences Northwestern Switzerland)

Cyprus-Irrigation

Project Background or Rationale

Cyprus is the third largest island in the Mediterranean, measuring 150 miles (240 km) long and 62 miles (100 km) wide at its widest point. It is located in the eastern part of the Mediterranean, next to the Middle East countries. Cyprus is the most water-stressed member state of the European Union with a water exploitation index exceeding 45 percent (AQUAREC, 2006; EEA, 2009). At present, almost all of the renewable water resources in Cyprus are utilized and the amount of water extracted vastly exceeds natural recharge. As a result, in a number of areas, groundwater is being rapidly depleted, and sea water intrusion is occurring in the main coastal aquifers. Providing water for the expanding domestic and tourism sectors, while maintaining the agricultural sector, is becoming a critical issue.

For decades, water management in Cyprus has been characterized by impressive infrastructure projects to capture rainwater. The theme “Not a Drop of Water to the Sea,” Cyprus’s policy since the 1960s, was directed towards maximum capturing of run-off. Dam storage capacity increased by a factor of 50, from 4,700 to 240,000 ac-ft (6 Mm³ to 300 Mm³).

In 2008, after a series of dry years, the reservoirs dropped to unprecedented low levels and necessitated water supply cuts and water imports from Greece. The need to better adapt to aggravated water scarcity and drought further drives the development of water recycling. On the other hand, drinking water production is increasingly based on desalination which satisfies around 65 percent of the demand (WDD, 2010).

Capacity and Type of Reuse Application

In general, about 90 percent of treated wastewater is reused, primarily for the irrigation of agricultural land,

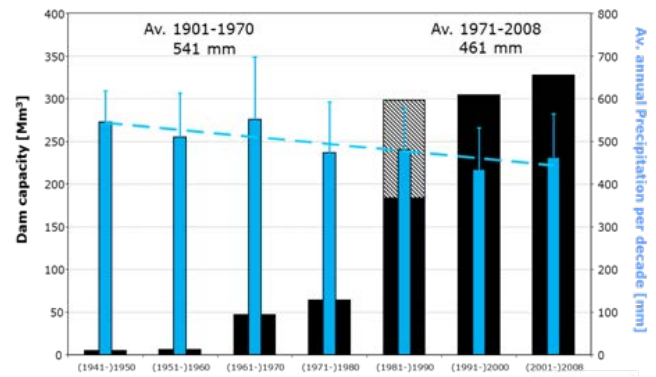

Figure 1
Installed dam capacity and corresponding average precipitation per decade (prepared from WDD statistics) (Hochstrat and Kazner, 2009)

parks, gardens and public greens. Most crops irrigated are trees such as citrus and olive or fodder crops.

A small proportion of reuse is used for groundwater recharge. Near the city of Paphos, the Ezousa aquifer is recharged artificially with 1,620 to 2,430 acre-feet (2-3 Mm³) reclaimed water per year, which is re-abstracted for irrigation. Investigations by Christodoulou (2007) showed that the aquifer would be able to store a total of 4,000 ac-ft (5 Mm³) from the municipal wastewater treatment plant.

Currently, the contribution of recycled water to irrigation water supplied through the Government Water Works makes up to about 10 percent of the demand which equals 10,500 to 12,200 ac-ft (13-15 Mm³). The use of recycled water was a substantial benefit during the extreme drought of 2008 (WDD 2010a). After full implementation of planned schemes, the reclaimed water flow will amount to 48,000 ac-ft per year (59 Mm³/yr) in 2012-2014 and increase further through 2025, as summarized in **Table 1** (WDD, 2008). The annual water recycling is expected to use 42,000 ac-ft (52 Mm³) by 2012-2014 which

equals 28.5 percent of today's agricultural water demand (WDD, 2008a).

Table 1 Estimated volumes of treated wastewater (WDD, 2008 and 2008a)

| | 2012 | 2015 | 2025 |
|---------------------------------------|---------------------|-----------|-----------|
| | Mm ³ /yr | | |
| Municipal wastewater treatment plants | 46 | 51 | 69 |
| Rural wastewater treatment plants | 13 | 14 | 16 |
| Total | 59 | 65 | 85 |
| Annual water recycling | 52 | | |

Water Quality Standards and Treatment Technology

Cyprus Regulation K.D.269/2005 specifies the reclaimed water quality criteria produced from agglomerations with less than 2,000 population equivalent. **Table 2** summarizes the tiered approach valid for different irrigation applications.

For agglomerations of more than 2,000 population equivalent (p.e.), the quality characteristics (**Table 3**) and use of the treated effluent are specified within the Wastewater Discharge Permits, issued by the Ministry of Agriculture for the Sewerage Boards and the Water

Development Department (WDD, 2008).

The prevailing treatment technology until recently was conventional activated sludge treatment with secondary clarifiers followed by sand filtration and chlorination. However, most new projects under planning (new wastewater treatment plants as well as extension of existing ones) are beginning to consider advanced technologies such as membrane application, e.g. bioreactor technology (Larnaca, Limassol, and Nicosia) or reverse osmosis.

Project Funding and Management Practices

Costs for construction and operation of municipal wastewater collection and treatment infrastructure are funded by the local communities through the sewerage rates. Tertiary treatment and reclaimed water distribution networks are financed and operated by the government, through the Water Development Department. Customers are charged different prices for reclaimed water depending on the end use (cf. **Table 4** Selling rates of the treated effluent (WDD, 2008b).

Table 2 Cyprus guidelines for irrigation urban reclaimed water from agglomerations with population less than 2000 population equivalent (K.D.P. 269/2005)

| No | Type of Crops | BOD mg/L | SS mg/L | Fecal coliforms/100ml | Intestinal worms/L ^{***} | Treatment required |
|----|--|-------------------------------------|--------------------------------------|---|-----------------------------------|---|
| 1 | All crops ^(a) | ^(A) 10 | 10 | 5 ^{**} 15 ^{**} | Nil | Tertiary and disinfection |
| 2 | Amenity areas of unlimited access and vegetables eaten cooked ^(b) | 10 15 ^{**} | 10 15 ^{**} | 50 100 ^{**} | Nil | Tertiary and disinfection |
| 3 | Crops for human consumption and amenity areas of limited access | 20 [*] 30 [*] | 30 [*] 45 ^{**} | 200 [*] 1000 [*] | Nil | Secondary, disinfection and storage >7 days or Tertiary and disinfection. |
| 4 | Fodder crops | 20 [*] 30 ^{**} | 30 ^{**} 45 ^{**} | 1000 ^{**} 5000 ^{**} | Nil | Secondary, disinfection and storage >7 days or Tertiary and disinfection. |
| | | ^(B) - | - | 1000 [*] 5000 ^{**} | Nil | Stabilization-maturation ponds with total retention time >60 days |
| 5 | Industrial crops | 50 [*] 70 ^{**} | - | 3000 ^{**} 10000 ^{**} | - | Secondary and Disinfection |
| | | ^(B) - | - | 3000 [*] 10000 ^{**} | - | Stabilization-maturation ponds with total retention time >60 days |

* These values must not be exceeded in 80% of samples per month (Min. number of samples = 5).

** Maximum value allowed

*** Once a year (Summer Season)

(A) Mechanized methods of treatment (activated sludge etc.)

(B) Stabilization ponds

(a) Irrigation of leafy vegetables, bulbs and corms eaten uncooked is not allowed

(b) Potatoes, beetroots, colocasia

Table 3 Reused effluent quality characteristics included in the discharged permits for agglomerations with population above 2000 p.e. (WDD, 2008)

| Parameter | Maximum permitted value | Frequency of analyses |
|-----------------------------------|-------------------------|-----------------------|
| BOD5 (mg/l) | 10 | 1/15 days |
| COD (mg/l) | 70 | 1/15 days |
| Suspended solids (mg/l) | 10 | 1/15 days |
| Conductivity ($\mu\text{S/cm}$) | 2200 | 1/15 days |
| Total Nitrogen (mg/l) | 15* | 1/15 days |
| Total Phosphorous (mg/l) | 10** | 1/15 days |
| Chlorides (mg/l) | 300 | 1/ month |
| Fat and oil (mg/l) | 5 | 1/month |
| Zinc (mg/l) | 1*** | 2/year |
| Copper (mg/l) | 0.1 | 2/year |
| Lead (mg/l) | 0.15 | 2/year |
| Cadmium (mg/l) | 0.01 | 2/year |
| Mercury (mg/l) | 0.005 | 2/year |
| Chromium (mg/l) | 0.1 | 2/year |
| Nickel (mg/l) | 0.2 | 2/year |
| Boron (mg/l) | 1 | 2/year |
| E. Coliforms | 5/100 ml | 1/15 days |
| Eggs of intestinal worms | Nothing/l | 4/year |
| Residual Chlorine (mg/l) | 1**** | 1/15 days |
| pH | 6.5-8.5 | 3/week |

* for discharge in sensitive areas and into the sea maximum level 10 mg/l

** for discharge in sensitive areas and into the sea maximum level 2 mg/l

*** for discharge into the sea maximum level 0.1 mg/l

**** for sensitive areas and discharge into the sea 0.5 mg/l

Proven Benefits of Reclaimed Water Use

For example, the Larnaca recycling scheme materializes substantial benefits for the farmers.

Instead of importing silage from abroad, fodder crops are now produced locally with recycled water, which results in cost advantages of up to 1.5 million EUR per year. With a lack of other conventional water resources, this is a viable way of sustaining local agriculture. Acceptance of and confidence in the use of reclaimed water among the user group grew through testimonials and evident positive results for crop productivity (Ioannidou et al., 2011). Another example of increasing confidence is the case of Limassol, where 100 percent of reclaimed water is reused in agriculture, with demand not exceeding substantially existing supply.

Challenges

Due to seasonal demand of water for irrigation and limited storage capacity, certain amounts of effluents are discharged to the sea during the winter months. It poses a challenge to establish both treatment technology and acceptance for utilizing these volumes for building up strategic reserves or restoring over-pumped aquifers. In addition, treated wastewater standards must be revised in order to address a wider variety of substances of concern, such as micro-pollutants.

Table 4 Selling rates of treated effluent from tertiary treatment plants (WDD, 2008)

| A/A | Use | Existing selling Rate of Tertiary Treated Effluent Euro Cent/m ³ | Suggested selling rate of fresh not filtered water from governmental water works Euro Cent/m ³ |
|-----|--|---|---|
| 1 | a. For irrigation divisions for agricultural production | 5 | 15 |
| | b. For persons for agricultural production | 7 | 17 |
| 2 | For sports | 15 | 34 |
| 3 | For irrigation of hotels green areas and gardens | 15 | 34 |
| 4 | For irrigation of golf courses | 21 | 34 |
| 5 | For pumping from an underground aquifer recharged by treated effluent | 8 | |
| 6 | For over consumption for items 1 to 5 | Increase by 50% | 56 |
| 7 | For municipal parks, green areas etc. for rural communities where a plant has been built within its limits and the quantity does not exceed the approved quantity of more than 10% | | |

In view of the expected growth in wastewater availability and reclamation a long term Strategic Plan for sustainable nationwide water reuse should be designed and implemented.

An Environmental Impacts Study on the Strategic Plan should be issued. Continuous monitoring of the quality and review of the standards regulating the water reclamation and reuse should be incorporated in the strategic plan.

References

Aquarec (2006). Report on integrated water reuse concepts, Deliverable D19, authored by T. Wintgens and R. Hochstrat. Accessed on Sept. 5, 2012 from <<http://www.aquarec.org>>.

Christodoulou, G.I., Sander, G.C. and. Wheatley, A.D (2007). Characterization of the Ezousas aquifer of SW Cyprus for storage recovery purposes using treated sewage effluent, Quarterly Journal of Engineering Geology and Hydrogeology 2007; Vol. 40; p. 229-240

EEA (2009) Water resources across Europe — confronting water scarcity and drought. EEA Report No 2/2009, Copenhagen, Denmark.

Hochstrat, R. and C. Kazner (2009). Flexibility in coping with water stress and integration of different measures. Case Study Report Cyprus, Deliverable D134. Accessed on Sept. 5, 2012 from <<http://www.techneau.org>>.

Ioannidou I., Theopemptou E., and Ventouris J. (2011). Water Reuse in Larnaca: a sustainable partner in the fight against water scarcity in Cyprus, 8th IWA International Conference on Water Reclamation and Reuse.

K.D.P.269/2005 Ministry of Agriculture, Natural Resources and Environment, General Terms for the Disposal of Effluents from Waste Water Treatment Plants , Government Gazette Appendix III(I) No 4000, 3.6.2005.

WDD. (2008). Reuse of treated effluent in Cyprus. Presented by A. Yiannakou at the 48th ECCE Meeting, 17-18 October 2008, Larnaca, Cyprus.

WDD (2008a). Addressing the Challenge of Water Scarcity in Cyprus. Presented by Charis Omorphos at the Global Water Efficiency 2008, International Conference and Exhibition, 27-28 November 2008, Limassol, Cyprus.

WDD. (2008b). The Implementation of the Urban Waste Water Treatment Directive (UWWTD) 91/271/EEC. Written by Ioanna Stylianou, published in 'Agrotis' magazine dated 23/04/2008.

WDD (2010) Desalination in Cyprus, presented by A. Manoli at the Spanish Cypriot Partnering Event, 15 March 2010, Nicosia, Cyprus.

WDD (2010a) Ministry of Agriculture, Natural Resources and Environment, Water Development Department, Water Demand Management. Retrieved on Sept. 5, 2012 from <[http://www.moi.gov.cy/moa/wdd/wdd.nsf/All/E5F7AAC8FC99E111C2257849002ACD65/\\$file/Meleti.pdf](http://www.moi.gov.cy/moa/wdd/wdd.nsf/All/E5F7AAC8FC99E111C2257849002ACD65/$file/Meleti.pdf)>.

Implementing Non-conventional Options for Safe Water Reuse in Agriculture in Resource Poor Environments

Authors: Bernard Keraita, PhD and Pay Drechsel, PhD
(International Water Management Institute)

Ghana-Agriculture

Project Background

There is increasing water scarcity and contamination of water sources with untreated wastewater in urban environments in many low income countries (Raschid-Sally and Jayakody, 2008). This is because many cities in low-income countries lack the capacity to effectively collect and treat wastewater. In Ghana, urban vegetable farming which has been relying on these water sources over the years for irrigation water is the most affected in terms of benefits and risks. In many cases, farmers have no other option other than using the contaminated water sources for irrigation, which in most cases are more affordable, reliable and enables cultivation of vegetables throughout the year. Risk assessments done in major cities in Ghana shows high fecal contamination levels in irrigation water and vegetables grown with this water potentially leading to an annual loss of 12,000 disability adjusted life years (DALY) per year (Amoah et al., 2005; Razak and Drechsel, 2010). This is equally a concern for authorities who have encouraged research on safe irrigation practices to address the challenge, as recommended in Ghana's national irrigation policy.

Comprehensive wastewater treatment coupled with strict implementation of water quality standards in wastewater irrigated agriculture could significantly reduce health risks. However, this conventional approach is at least for now not feasible in most low-income countries in sub-Saharan Africa, where only less than 1 percent of wastewater produced is treated. Monitoring water quality is also difficult due to the nature of the practice: informal, small-scale, with a large number of farmers spread all over cities. The WHO (2006) recommendation in these situations targets alternative, locally feasible strategies for risk reduction at any point between wastewater generation and the consumption of contaminated food. This multiple-barrier approach is known from the HACCP approach where treatment cannot meet water quality thresholds.

Non-Conventional Options for Risk Reduction

Some options for risk reduction, which have mostly been tested in Ghana, are shown in **Table 1**. These options can easily be combined for optimum reduction in contamination. For example, water treatment at the farm level can be combined with good irrigation techniques, better handling at markets and vegetable washing in households for higher cumulative reduction in contamination.

Project Implementation Considerations

A participatory approach was adopted in this study where key stakeholders such as urban vegetable farmers, vegetable sellers, street-food vendors, and local authorities (agriculture, health) were involved throughout the project. For example, farmers were involved in identifying most suitable options, developing criteria for assessment, testing them in their farms, while extension staff suggested materials for knowledge sharing.

Factors that can Enhance Adoption

1. **Identify economic or social incentives for behavior change:** Social marketing might help (learning from hand wash campaigns) where market incentives are lacking. For farmers, tenure security, credit access and media recognition could provide incentives.
2. **Enabling farmers to see and understand the invisible risk:** If we can visualize impacts that safer practices could have on risk reduction, it will influence farmers risk perceptions and encourage adoption of safe practices. Microbial contamination cannot easily be visualized and physical indicators that farmers use such as smell, odor, and color might not necessarily correlate with microbial contamination. Developing parameters for routine monitoring will be important as laboratory assessments are not feasible for many of these farmers.

Table 1 Non-conventional health-protection control measures and associated pathogen reductions

| Control Measure | Pathogen Reduction (log units) | Notes |
|---|--------------------------------|--|
| A. Wastewater treatment | 6–7 | Reduction of pathogens depends on type and degree of treatment selected. |
| B. On-farm options | | |
| Crop restriction (i.e., no food crops eaten uncooked) | 6–7 | Depends on (a) effectiveness of local enforcement of crop restriction, and (b) comparative profit margin of the alternative crop(s). |
| <i>On-farm water treatment:</i> | | |
| (a) Three-tank system | 1–2 | One pond is being filled by the farmer, one is settling and the settled water from the third is being used for irrigation. |
| (b) Simple sedimentation | 0.5–1 | Sedimentation for ~18 hours. |
| (c) Simple filtration | 1–3 | Value depends on filtration system used. |
| <i>Method of wastewater application:</i> | | |
| (a) Furrow irrigation | 1–2 | Crop density and yield may be reduced. |
| (b) Low-cost drip irrigation | 2–4 | Reduction of 2 log units for low-growing crops, and reduction of 4-log units for high-growing crops. |
| (c) Reduction of splashing | 1–2 | Farmers trained to reduce splashing when watering cans used (splashing adds contaminated soil particles on to crop surfaces which can be minimized). |
| Pathogen die-off (cessation) | 0.5–2 per day | Die-off between last irrigation and harvest (value depends on climate, crop type, etc.). |
| C. Post-harvest options at local markets | | |
| Overnight storage in baskets | 0.5–1 | Selling produce after overnight storage in baskets (rather than overnight storage in sacks or selling fresh produce without overnight storage). |
| Produce preparation prior to sale | 1–2 | (a) Washing salad crops, vegetables and fruits with clean water. |
| | 2–3 | (b) Washing salad crops, vegetables and fruits with running tap water. |
| | 1–3 | (c) Removing the outer leaves on cabbages, lettuce, etc. |
| D. In-kitchen produce-preparation options | | |
| Produce disinfection | 2–3 | Washing salad crops, vegetables and fruits with an appropriate disinfectant solution and rinsing with clean water. |
| Produce peeling | 2 | Fruits, root crops. |
| Produce cooking | 5–7 | Option depends on local diet and preference for cooked food. |

Sources: Amoah et al. (2011).

- 3. Innovative knowledge sharing:** In this project, various initiatives were used to facilitate empirical knowledge exchanges between key stakeholders and scientists. Research findings were synthesized to make farmer-friendly training and extension materials, translated into different local languages and presented in various forms like illustrated flip charts, books, radio and video and demonstrated in farmer field schools and markets.
- 4. Involving authorities:** Local authorities and relevant government ministries should be involved from the start. In Ghana, the project involved local authorities, the Ministry of Food and Agriculture and other relevant agencies such as the food safety regulators. This is necessary because these agencies set policies and regulations for waste

reuse, hence help in institutionalization of safe practices. They also have a mandate of offering extension services to farmers.

- 5. Linking with other food safety projects:** Wastewater reuse represents only one contamination pathway affecting farm households and food safety in general. For best impact, campaigns on safer irrigation options or vegetable washing in markets could be combined e.g. with hand-wash campaigns.

The here described activities were piloted in different cities in Ghana to test their feasibility but await final implementation.

References

Amoah P., B. Keraita, M. Akple, P. Drechsel, RC. Abaidoo and F. Konradson. 2011. Low cost options for health risk reduction where crops are irrigated with polluted water in West Africa. IWMI Research Report 141, Colombo.

Amoah P., P. Drechsel P, RC. Abaidoo. 2005. Irrigated urban vegetable production in Ghana: Sources of pathogen contamination and health risk elimination. *Irrigation and Drainage* 54: 49–61.

Keraita B., J. Blanca, P. Drechsel. 2008. Extent and implications of agricultural reuse of untreated, partly treated, and diluted wastewater in developing countries. *CAB Reviews: Perspectives in Agriculture, Veterinary Science, Nutrition and Natural Resources* 3 (058).

Raschid-Sally L., P. Jayakody. 2008. Drivers and characteristics of wastewater agriculture in developing countries: Results from a global assessment, IWMI Research Report 127, International Water Management Institute Colombo, Sri Lanka.

Seidu, R. and P. Drechsel. 2010. Cost effectiveness analysis of interventions for diarrhoea disease reduction among consumers of wastewater-irrigated lettuce in Ghana. In: Drechsel P., et al. (eds.) *Wastewater irrigation and health: Assessing and mitigation risks in low-income countries*. Earthscan-IDRC-IWMI, UK, p. 261-283.

WHO. 2006. Guidelines for the safe use of wastewater, excreta and grey water: Wastewater use in agriculture (Volume 2). WHO, Geneva.

Reuse Applications for Treated Wastewater and Fecal Sludge in the Capital City of Delhi, India

Authors: Priyanie Amerasinghe, PhD, and Pay Drechsel, PhD (International Water Management Institute); Rajendra Bhardwaj (Central Pollution Control Board)

India-Delhi

Project Background or Rationale

Based on current urbanization trends, the gap between water supply of 24.5 billion gallons per day (bgd) (95 billion liters per day [bld]) and demand of 48.8 bgd (189 bld) is expected to increase sharply by 2030 (McKinsey Report, 2010). Currently, 78 percent of the urban population in India has access to safe drinking water; however, only 38 percent receive sanitation services (CPCB, 2009). The cost of inadequate sanitation is estimated at \$53.8 billion USD per year (World Bank, 2010). With a grim forecast for water availability and sanitation, India is exploring options for water saving, harvesting, recycling, and reuse of wastewater within cities.

The capital city of Delhi, with its population of nearly 15 million, requires a water supply of over 1.1 bgd (4300 million liters per day [mLd]) presently. Municipal sewage generation is estimated at 981 mgd (3,800 mLd), with a treatment capacity of about 594 mgd (2,300 mLd). A total of 30 sewage treatment plants (STPs) situated in 17 locations process 61 percent of wastewater generated in the city at varying degrees. Sewage is collected and transported through a network of pipes and sewage pump stations, and treatment occurs at primary, secondary, and tertiary levels, depending on the design capacity.

This case study describes reuse applications of treated wastewater generated at the Okhla STP, and the utilization of its by-products by communities close to the city for soil conditioning and energy needs.

Capacity and Type of Reuse Application

The Okhla STP is situated at Okhla, Mathura Road, New Delhi. Its current treatment capacity for sewage is 164 mgd (636 mLd), and is managed by the Delhi Jal Board (Delhi Water Board). The STP was developed in five phases between 1937 and 1990:

- Phase I – 14.2 mgd (55 mLd)
- Phase II – 18.8 mgd (73 mLd)

- Phase III – 35.1 mgd (136 mLd)
- Phase-IV – 43.4 (168 mLd)
- Phase V – 52.9 mgd (205 mLd)

The treatment involves a conventional activated sludge process and is being managed by the Delhi Jal Board (DJB, 2010). A flow diagram of the water treatment plant, and performance evaluation of 5 treatment units are shown in **Figure 1** and **Table 1**, respectively.

A raw sewage inlet chamber is common for all the units, after which liquid sewage is screened and conveyed to the five units for treatment. Figure 1 depicts the key steps in the treatment process. In its entirety, the STP receives around 140.6 mgd (545 mLd) of sewage at present for treatment at all five units. The different units have been upgraded in stages to optimize its capacity for treatment, and increase the reuse potential of its by-products.

At present, 40.8 mgd (158 mLd) of treated effluent is being issued to the Badarpur Thermal Power Station (705 MW) for cooling purposes, 23.2 mgd (90 mLd) for Central Public Works Department for horticulture, 11.6 mgd (45 mLd) to Minor Irrigation Department for irrigation (through gravity flow), and the rest is discharged into Agra canal, which reaches the Yamuna river (dilution of pollution). The government departments are charged a nominal fee for accountability. It is estimated that over 300 farmers (Jaitpur area) utilize the treated water for vegetable (cucumber, brinjal, tomato, cabbage, raddish, green leafy vegetables etc.) production. Private users pay up to INR 1.25 for 258 gallons (1000 L) of treated water, which is recommended for gardening and agriculture only. For industrial use the charge rate currently is INR 4.00 for 258 gallons (1000 L). At present the biogas is being issued to a small community living around the STP.

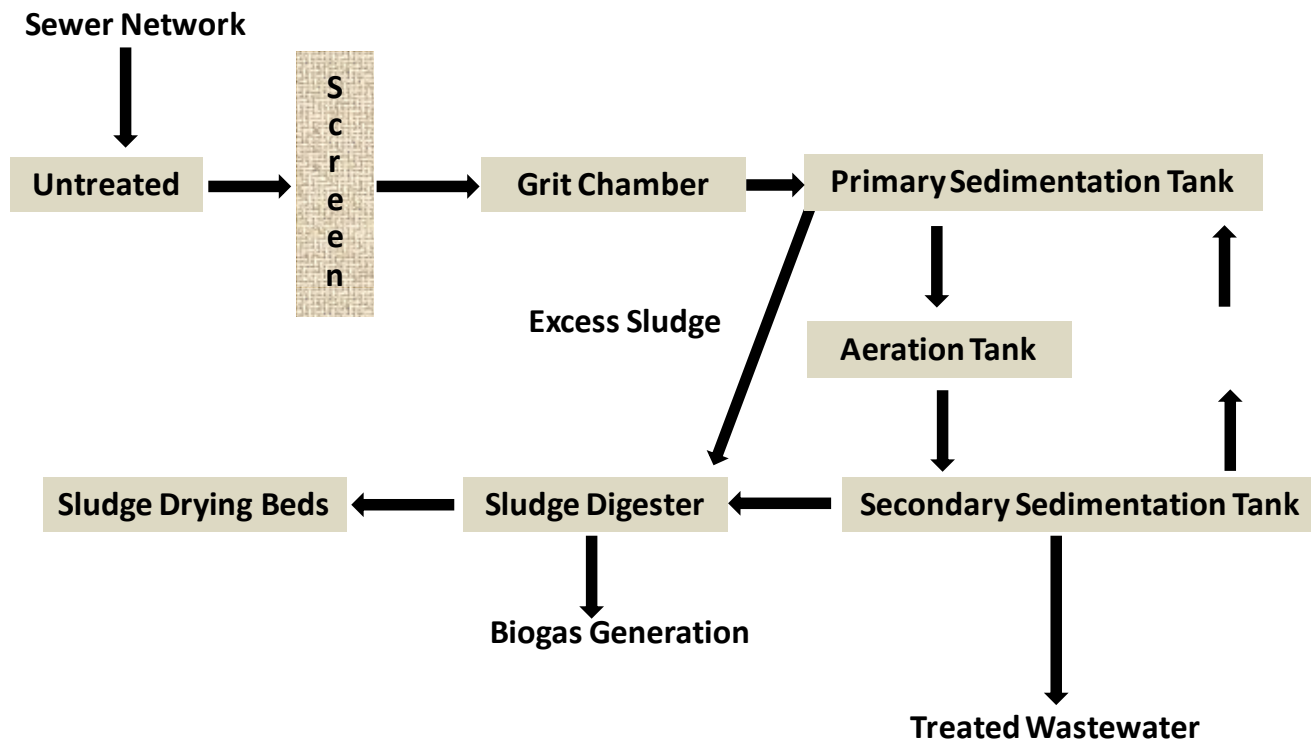

Figure 1
Flow diagram depicting the wastewater treatment pathway at the Okhla STP

Table 1 Performance evaluation of five sewage treatment units at Okhla STP

| Phase | Capacity mLd | Flow mLd | Influent Quality | | | | | Effluent Quality | | | | | % Reduction | | |
|-------|--------------|----------|------------------|----------|----------|----------|------|------------------|----------|----------|----------|------|-------------|----------|----------|
| | | | pH | TSS mg/L | COD mg/l | BOD mg/l | Con | pH | TSS mg/L | COD mg/L | BOD mg/L | Con | TSS mg/L | COD mg/L | BOD mg/L |
| I | 54.55 | 39.09 | 7.3 | 498 | 517 | 204 | 1440 | 7.8 | 21 | 54 | 10 | 1460 | 95.8 | 89.56 | 95.1 |
| II | 72.73 | 40.91 | 7.4 | 291 | 486 | 207 | 1510 | 7.7 | 83 | 108 | 48 | 1400 | 71.5 | 77.78 | 76.8 |
| III | 136.38 | 136.98 | 7.4 | 647 | 551 | 222 | 1480 | 7.6 | 76 | 153 | 45 | 1470 | 88.3 | 72.23 | 79.7 |
| IV | 168.2 | 159.11 | 7.3 | 480 | 515 | 249 | 1590 | 7.8 | 32 | 62 | 12 | 1540 | 93.3 | 87.96 | 95.2 |
| V | 204.57 | 181.84 | 7.3 | 480 | 515 | 249 | 1590 | 7.7 | 27 | 51 | 19 | 1530 | 94.4 | 90.1 | 92.4 |

TSS = Total suspended solids; COD = Chemical oxygen demand; BOD = Biological oxygen demand; Con = Conductivity

In an attempt to reduce energy costs and earn carbon credits, the Jal Board is also planning for power generation from biogas. Improved business models for sludge disposal are also being discussed. The Jal Board subjects its process management to outside audit to assess operational capacity and pollution removal efficiency.

Water Quality Standards and Treatment Technology

Treated effluent from the plant is meeting design standards for BOD and suspended solids, which are set by the Central Pollution Control Board (CPCB), as shown in **Table 2** (CPCB, 1986).

The current percent reduction in pollution levels for purpose of horticulture, irrigation, and cooling is considered to be acceptable. The activated sludge process that is used for treatment is described elsewhere (CPCB, 2007).

Institutional and Management Practices

Installation of the Okhla STP spans over a long period (1937 to 1990). Infrastructure evaluation and upgrades have taken place at various times with funds received from different sources. The most recent support was received from USAID in 2005 for a feasibility study to assess the reuse applications.

Currently the Delhi Jal Board is responsible for the infrastructure and day-to-day operational management of its SPTs, treatment processes, flow measurements, and distribution of treated water, as well as by-products with the support of a number of government and private stakeholders who serve as service partners. Education and awareness-raising are also a

part of the activities of the Board, especially on the reuse applications. When services are provided to the beneficiary partners, it is advertised the public domain.

Augmentation of the capacity of the STP is being considered with an additional plant at 35.2 mgd (136.38 mLD) under Yamuna Action Plan II, which is under implementation with JBIC funding.

Successes and Lessons Learned

Wastewater reuse applications are becoming popular among the public in part due to increased demand caused by shortages of water and increased domestic energy needs. Alternative uses for recycled water are recognized by government authorities (Delhi Jal Board and City Administration), while attempts are also being made to explore different treatment processes. It is envisaged that by popularizing alternative uses for treated water, the city's drinking water supply will be conserved.

However, quantitative information is not available for citation, presently. There is an increased demand for by-products like bio-gas and sludge manure, which can generate revenue for maintenance and upgrading the system. With the emergence and use of new technologies for reuse applications, staff training and capacity building in relevant institutions are important. At the same time, regular re-evaluation of private and public partnerships is also crucial. Health risk assessments on the use of treated wastewater, especially for crop production can be easily formalized, considering that the water quality data are available at the time of discharge.

Table 2 Water quality standards for India

| | DO (mg/L) | BOD (mg/L) | Total coliform (MPN/100 mL) | pH | Free ammonia (mg/L) | Conductivity | SAR | Boron (mg/L) |
|---------|-----------|------------|-----------------------------|---------|---------------------|--------------|-----|--------------|
| Class A | 6 | 2 | 50 | 6.5-8.5 | NA | NA | NA | NA |
| Class B | 5 | 3 | 500 | 6.5-8.5 | NA | NA | NA | NA |
| Class C | 4 | 3 | 5000 | 6.5-8.5 | NA | NA | NA | NA |
| Class D | 4 | NA | NA | 6.5-8.5 | 1.2 | NA | NA | NA |
| Class E | NA | NA | NA | 6.5-8.5 | NA | 2.25 | 26 | 2 |

Class A: Drinking water source without conventional treatment

Class B: Water for outdoor bathing

Class C: Drinking water with conventional treatment

Class D: Water for wildlife and fisheries

Class E: Water for recreation and aesthetics, irrigation and industrial cooling

Source: CPCB, 2000

References

Central Pollution Control Board (CPCB). 1986. General Standards for Discharge of Environmental Pollutants Part-A: Effluents. Retrieved on Sept. 5, 2012 from <<http://cpcb.nic.in/GeneralStandards.pdf>>.

Central Pollution Control Board (CPCB). 2007. Evaluation of Operation and Maintenance of Sewage Treatment Plants in India. Ministry of Environment & Forests. Delhi.

Central Pollution Control Board (CPCB), 2009. Status of water supply, wastewater generation, and treatment in Class I cities and Class II towns of India. Retrieved on Sept. 5, 2012 from <http://www.cpcb.nic.in/upload/NewItems/NewItem_153_Foreword.pdf>.

Delhi Jal Board. 2010. Retrieved on Sept. 5, 2012 from http://www.delhi.gov.in/wps/wcm/connect/DOIT_DJB/djb/home

McKinsey Report. 2010. *India's Urban Awakening: Building Inclusive Cities, Sustaining Economic Growth*. McKinsey Global Institute, McKinsey and Company.

World Bank. 2010. Economic impacts of inadequate sanitation in India 2010. World Bank Water and Sanitation Program, New Delhi, India. Available from www.wsp.org/wsp/sites/wsp.org/files/publications/wsp-esi-india.pdf

V Valley Integrated Water Resource Management: the Bangalore Experience of Indirect Potable Reuse

Authors: Uday G. Kelkar, PhD, P.E., BCEE, and Milind Wable, PhD, P.E. (NJS Consultants Co. Ltd.), and Arun Shukla (NJS Engineers India Pvt. Ltd.)

India-Bangalore

Project Background or Rationale

To bridge the ever increasing gap between the demand and supply of drinking water to its customers in Bangalore, the Bangalore Water Supply and Sewerage Board (BWSSB) has plans for non-conventional solutions to increase water supply. In this context, based on sufficient availability of treated wastewater and feasibility of diverting the treated wastewater to indirect potable use, BWSSB initiated a group of “Water Recycle and Reuse” projects under two broad initiatives:

1. Integrated water management in Vrishabhavathi Valley (V Valley) – an area of Bangalore
2. Integrated water management - lakes projects

This case study describes the development of new projects in V Valley to address water requirements. The lake projects are not described in this case.

Under the V Valley projects, drinking water supply will be indirectly augmented by water reuse. Secondary treated wastewater will be further refined through advanced treatment processes including membrane treatment and granular activated carbon (GAC) and discharged to a receiving river feeding a water reservoir that is a source for one of the drinking water treatment plants in Bangalore. This indirect potable reuse scheme will augment BWSSB's existing water supply sources, which are currently insufficient to meet current and projected demands.

History of Water Supply in Bangalore

Bangalore, the capital city of the state of Karnataka is today ranked the sixth largest city in India and is one of the fastest growing metropolitan cities in the world. The 2011 census population for Bangalore was about 8.4 million. As Bangalore is perched on rocky strata without a substantial groundwater aquifer, the city relies entirely on surface water for supply. The Arkavathy River was historically the main water supply

source for the city, providing 39.3 mgd (149 mLd) under two water supply schemes, the Hesarghatta and Tippegondanahalli (TG Halli) water supply schemes, which were developed in multiple stages (1896, 1957, 1964, and 1993).

BWSSB was constituted in 1964 to provide for the drinking water supply and sewage disposal needs of the city. The Cauvery Water Supply Scheme implemented by the Board quadrupled the available piped water supplies to the city by developing the Cauvery River as an additional source. This scheme was planned in three stages (1974, 1982 and 1995). At the end of stage III, the total water available to Bangalore was 178 mgd (675 mLd). Reduction in rainfall duration and intensity and encroachment in the Arkavathy River's catchment area has resulted in decline in the volume of water received in the TG Halli reservoir.

Despite this dramatic overall increase in supply, the total present supply from both the Arkavathy and Cauvery Rivers, 222 mgd (840 mLd), provides a net per capita consumption of 26 gpd (100 Lpd), well below the national standard of 40 gpd (150 Lpd). To address shortfalls, Stage-IV of the Cauvery Water Supply Scheme has begun, which involves two phases. In Phase I, a new drinking water plant drawing Cauvery River water over a distance of 62 mi (100 km) was commissioned in 2002 to treat 79 mgd (300 mLd) of water. In Phase II, a new treatment plant at the same location is being constructed to treat 145 mgd (550 mLd) of Cauvery River water that is expected to be completed by December 2012.

In addition, eight urban local bodies and 110 villages around Bangalore have recently been merged forming Bruhat Bangalore Mahanagar Palike (BBMP – Greater Bangalore Municipal Corporation) which has resulted in increase in water demand on Bangalore City. The progressively widening gap between availability of freshwater and the demand is indicated in **Table 1**.

Table 1 Current and projected water demand and availability of fresh water for the BWSSB

| Year | Population million | Demand MLd | Available mLd | Shortfall mLd |
|------|--------------------|------------|-------------------|---------------|
| 2001 | 5.4 | 870 | 540 | 310 |
| 2007 | 7.5 | 1219 | 840 | 379 |
| 2015 | 8.8 | 1720 | 1500 ¹ | 220 |
| 2021 | 10 | 2125 | 1500 | 615 |
| 2036 | 12.5 | 2550 | 1500 | 1050 |

¹ In 2015, the projected available water (1500 mLd) is based on an increase of 148 mgd (560 mLd) which will be withdrawn from the Cauvery River under the Stage IV Phase II expansion (expected to be completed in December 2012). At this threshold, the maximum withdrawal (off take) sanctioned by the Government of Karnataka (GOK) is fully utilized and there will be no other conventional water sources to develop.

Capacity and Type of Reuse Application

To address projected shortfalls, a range of solutions are being developed. It is feasible to harness 53 mgd (200 mLd) wastewater for indirect potable reuse in Bangalore after appropriate advanced treatment in the V Valley by 2015. As a first stage in the overall V Valley reuse scheme, 36 mgd (135 mLd) will be

treated for reuse. Based on the technical and economic performance of this scheme, further refinements will be made and a second phase is planned to reuse the remaining 17 mgd (65 mLd).

WQ Standards and Treatment Technology

Under the V Valley Reuse Scheme, water that has gone through tertiary treatment and disinfection with chlorine at V Valley sewage treatment plant (STP) will be pumped to the Tavarekere advanced treatment facility. There, the water will pass through ultrafiltration (UF) membranes and granular activated carbon (GAC) adsorption filter followed by low dose of terminal chlorination. It is anticipated that there is not a need for a dechlorination facility, as chlorine concentrations are expected to be non-detect by the time the water flows through the initial portion of the engineered wetland. However, there is a provision to add a dechlorination facility if chlorine levels are a problem in the future. This treatment scheme will achieve less than 1 mg/L biochemical oxygen demand (BOD) and total organic carbon (TOC), and below Detectable Level for fecal coliforms (FC) and total coliforms (TC). The highly

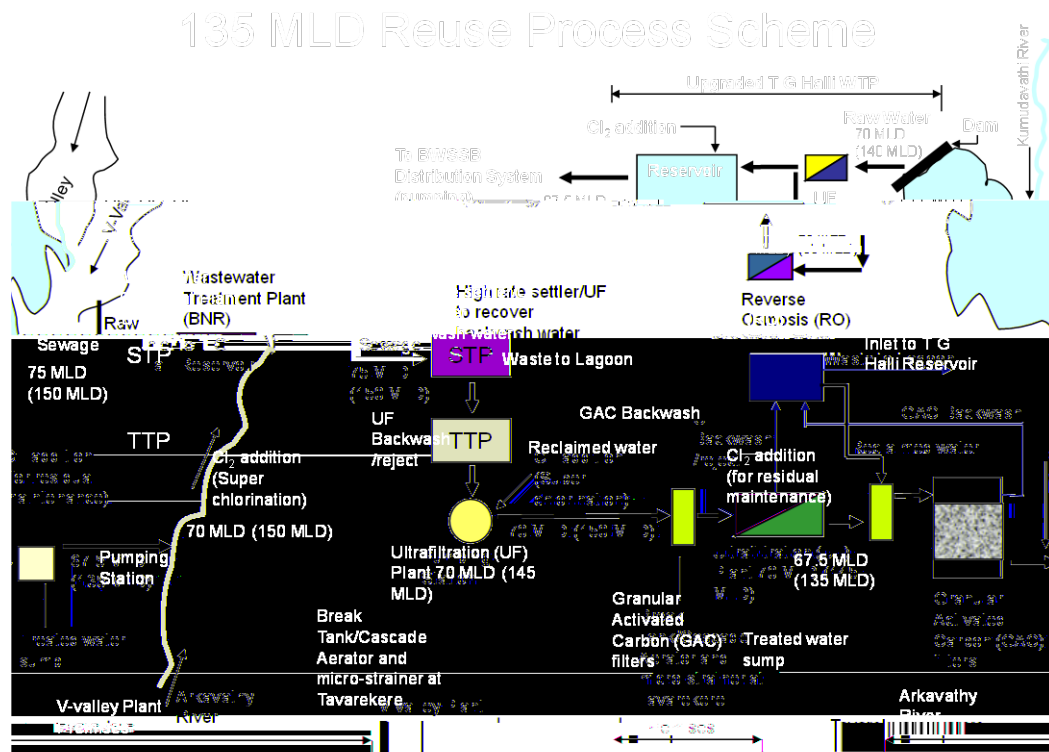

Figure 1
Proposed V Valley reuse scheme (Phase 1)

treated water will then be discharged into the Arkavathy River which feeds the TG Halli reservoir. The water will not result in polluting or degrading the quality of water present in the TG Halli reservoir. On the contrary, the quality of the TG Halli reservoir is likely to improve with respect to TOC and FC. This type of indirect potable reuse scheme follows in the path of similar projects around the world.

To get better understanding of what water quality is achievable and to understand public perception, BWSSB initiated a one year long pilot study (conducted from 2009 to 2010) that mimicked the actual treatment process that will be adopted for the full-scale plant. The pilot study included a 13,200 gpd (50 kL/day) membrane pilot followed by a 11,900 gpd (45 kL/day) GAC filter, pictured in **Figure 2**.

The pilot plant data (**Table 2**) provided encouragement and clarified that indeed the water quality from this tertiary treated plant was superior to that of existing Arkavathy river water quality.

The 2004 EPA *Guidelines for Water Reuse* was used as a guidance document in the pilot studies and designs, as there are currently no national or state treatment standards for reuse in India.

Project Funding and Management Practices

Based on the pilot study data, BWSSB completed detailed design (30 percent completion level) to



Figure 2
During the pilot study, water quality testing was conducted

implement the plant on PPP mode Design Finance (60 percent) Build & Operate concept. The operation will be for a period of 15 years. With the design and bidding documents complete, BWSSB approached both the Government of India under the Jawaharlal Nehru National Urban Renewal Mission (JnNURM) for viability gap funding and the State of Karnataka. Considering the importance of the project, both the Governments budgeted and approved a total of 41 million USD (2000 million rupees), which was equivalent to 30 percent of overall project cost. The remaining 70 percent would come from the Contractor through a PPP mode.

Table 2 Results of water reuse pilot study: Quality of water leaving V Valley STP and leaving the tertiary treatment plant, as compared to existing water quality in the Arkavathy River and the TG Halli Reservoir; values are averages over a 12-month period (December 2009 – January 2010).

| Parameter | Concentration | | | |
|---------------------------|--|--|--|--|
| | Effluent from secondary treatment (V Valley Plant) | Effluent from tertiary Treatment (Tavarekere Plant) ¹ (reclaimed water, which is discharged to river) | Arkavathy River (7 km upstream of Reservoir) | TG Halli Reservoir (values at the reservoir intake to WTP) |
| BOD mg/L | 22 | 1.6 | 12 | 9 |
| COD mg/L | 65 | 8 | 27 | 22 |
| Sulfate mg/L | 25 | 13 | 86 | 27 |
| Magnesium mg/L | 28 | 19 | 63 | 16 |
| Phosphate mg/L | 1.8 | 0.6 | 2.8 | 1.4 |
| Ammonia mg/L | 25 | 5 | 8 | 8 |
| TDS mg/L | 450 | 228 | 320 | 300 N/A |
| Fecal coliforms #/100 mL | > 1600 | 2 | > 1600 | > 1600 N/A |
| <i>E. coli</i> MPN/100 mL | > 400 | 3 | > 600 | > 600 N/A |

¹ Reclaimed water that is discharged to river
N/A indicates data was not collected

Present BWSSB planning activities include:

- Improvements in V Valley STP to achieve nutrients removal from the current volume of 36 mgd (135 mLd), pumping of tertiary treated water to Tavarekere to undergo advanced treatment, including plans for UF and GAC adsorption.
- Construction of a 36 mgd (135 mLd) capacity drinking water treatment plant at TG Halli (which draws from the reservoir) based on UF membrane treatment followed by reverse osmosis (RO) membrane treatment for a portion of the flow. RO is included as a provision in case TDS levels start increasing in the reservoir over time due to water reclamation. RO will be employed to maintain the finished water TDS below 500 mg/L. This phase also includes pumping and distribution of the drinking water from TG Halli to Bangalore and installation of 10 mi (16 km) of new pipeline.

Institutional/Cultural Considerations

No matter how great are the technological advancements and availability of treatment technologies for advance treatment, projects tend to fail unless consumers have bought into the concept. This is especially true for reuse projects due to the apathy of consumers towards the word “reuse.” Public outreach and involvement is crucial for the acceptance of even a very well planned reuse project. A health effect study to ensure the health and safety of indirect potable reuse must be conducted in a rigorous and defensible manner.

Based on the 1-year pilot study data, BWSSB is planning to conduct a number of workshops and open discussion forums, which will not only have consumer participation but participation from politicians as well as local leaders. The workshops and public outreach programs were started in late 2011. In addition to this, BWSSB is also developing a media campaign on the importance of recycle and reuse and how reuse is beneficial to the city for its future. School kids have been targeted to become more active in this campaign.

Successes and Lessons Learned

The successful implementation of pilot plant and data analysis presented to decision makers helped to gain momentum on possibility of adding a new and first of its kind planned-indirect potable reuse project in Bangalore, India, thereby increasing the water availability to city of Bangalore.

City of Nagpur and MSPGCL Reuse Project

Authors: Uday G. Kelkar, PhD, P.E., BCEE (NJS Consultants Co. Ltd) and Kalyanaraman Balakrishnan (United Tech Corporation)

India-Nagpur

Project Background or Rationale

The primary goal of this project is to establish a wastewater recycle and reuse project in India that is both economically feasible and beneficial to the City of Nagpur as well as the Maharashtra State Power Generation Corporation (MSPGCL – a public sector unit of Govt. of Maharashtra, India). The project will also reduce the freshwater demand for non-potable applications and increasing the quantity of fresh water available for the City of Nagpur's use.

Nagpur, the second capital of Maharashtra, is at the geographic center of India, with all major national and state highways passing through the city. Nagpur is located geographically between Latitude 21° 9' North and Longitude 79° 6' East (Survey of India Top sheet No. 55 O/4) at an altitude of 1017 ft (310 m) above MSL. The soil type around Nagpur is mostly black cotton with very high fertility and rich in organic contents. Major cash crops are orange, cotton, sugarcane, and chili. Maximum, average, and minimum rain fall values are 78 in (1990 mm), 47 inches (1200 mm) and 24 inches (600 mm) respectively. The maximum temperature reaches 118 degrees F (47.8 degrees C) in May and minimum is 43 degrees F (6 degrees C) in mid December.

The current population of Nagpur is 2.35 million. The city presently receives freshwater from three different sources, the Kanhan River, Pench River and Gorewada reservoir tank, for a total of 124 mgd (470 mLd) of water at the rate of 35-40 gallons/cap./day (135-150 L/cap./day) . At present, 124 mgd (470 mLd) of water supply in the city generates about 100 mgd (380 mLd) (approx. 80 percent recovery) of sewage that is partially treated and discharged into natural water courses – drains and Nallas.

Maharashtra State Power Generation Corporation (MSPGCL, formerly known as MSEB) has two existing thermal power stations (TPS) to the north of Nagpur City at a distance of about 7 miles (12 kilometers). One TPS of 840MW capacity is at Khaperkheda, and the other TPS of 1100MW is at Koradi. The power

stations are approximately 1 mile (1.5 km) away from each other. Due to growing power demand by the State of Maharashtra, MSPGCL has planned for three new power stations – one at Khaperkheda and two at Koradi, each with 500MW capacity. Coal linkage for the proposed power stations was established earlier and MSPGCL was in the process of securing water linkage for the power stations. MSPGCL had the existing allocation from Pench River for 45,000 ac-ft/yr (55 Mm³/year). With the addition of three new power stations, MSPGCL was looking for a total additional water requirement of 47,000 ac-ft/yr (58 Mm³/year) starting in 2015, when the new power plants come on-line. The existing percent consumption of water for various uses at the power station is shown in **Figure 1**.

Existing Fresh Water Consumption

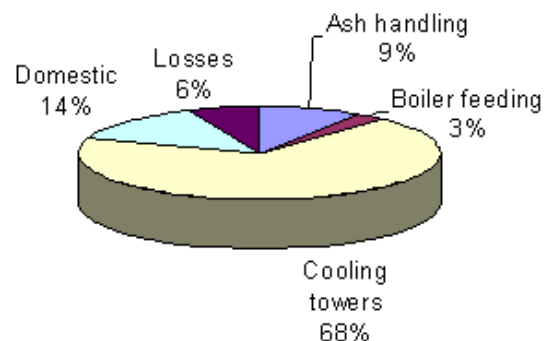

Figure 1
Percent consumption of water by type of use for the power station

Following a request from MSPGCL, the Irrigation department of Government of Maharashtra, increased the water allocation of 45,000 ac-ft/yr (55 Mm³/year) to 54,000 ac-ft/yr (67 Mm³/year) with a max. to 60,000 ac-ft/yr (75 Mm³/year) within 10 percent variation). However, this was projected to be insufficient for all three units, and there was no additional freshwater allocation available for MSPGCL from any other source.

Project Funding and Management Practices

To resolve the issue of water availability for MSPGCL, USAID, through its project titled Water Energy NEXUS Phase - II (WENEXA - Phase II), initiated a feasibility study that included demand assessment and evaluation of alternate water sources, including but not limited to use of high quality tertiary treated water from the city of Nagpur's wastewater plant. The project also implemented a six month long pilot plant (**Figure 2**) to showcase achievable output water quality and get buy-in from both Nagpur Municipal Corporation (NMC) as well as MSPGCL that reuse is effective and feasible. The pilot plant was constructed by M/s. Triveni Engineering and Industries Ltd., using Memcor/Siemens ultrafiltration unit that received secondary treated wastewater from the NMC's existing Bhandewadi STP.



Figure 2
Pilot setup for Nagpur water reuse scheme

The pilot study also helped gain public acceptance as well as support from State Government of Maharashtra, which issued a policy paper on reuse of wastewater for non-potable applications as a means of conserving freshwater for the city.

The water quality requirements, when compared with the tertiary-treated wastewater quality from the pilot plant and existing fresh water quality from the Pench Reservoir, indicated that the reclaimed water can be used for a number of applications at the power plant, including ash handling without further treatment, and can be used for cooling tower with the addition of a disinfectant. Based on the pilot plant study, the total reuse potential at the plant by 2015 was determined to be 69,000 ac-ft/yr (84.64 MM³/yr) (**Figure 3**).

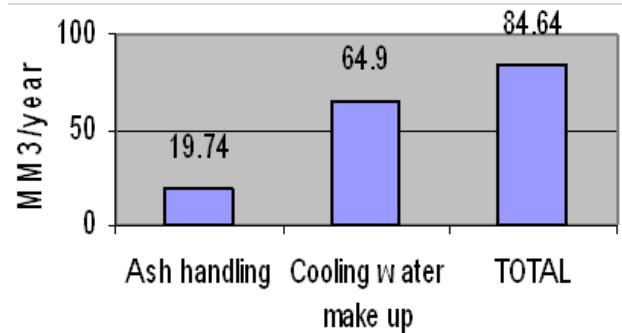

Figure 3
Total reuse potential at the power plant for ash handling and cooling water make-up by 2015

Comparative assessment between the available fresh water sources and reuse water indicated that MSPGCL can construct the reuse plant by 2014 at a capital cost of 2000 million rupees (200 Crores – 10 million equal to 1 Crore) while the cost of constructing a new dam and construction of new pipeline from a fresh water source could cost 3500 million (350 Crores) rupees and could take more than 10 years to get completed as the construction of new dam would have to go through various requirements and clearances through Ministry of Environment and Forest (MOEF) and address the issue of submergence and re-settlement of farmers. In addition, with the lower capital cost, the reuse project showcases an environmental friendly solution, solving NMC's wastewater treatment and discharge issues.

Based on the study results, pilot plant data and the potential for getting good quality reclaimed water in short period of time, MSPGCL signed a Memorandum of Understanding (MOU) with Nagpur Municipal Corporation (NMC) in support of NMC's Water Reuse Project, and to supply treated water from municipal sewage plant as the water linkage to meet additional demand of Mahagenco's proposed expansion plan. In addition, MSPGCL agreed to pay NMC 150 million rupees (15 crores) every year for the next 15 years as royalty fee. In addition, MSPGCL agreed to construct a new sewage treatment plant with tertiary treatment capability with the capability to pump the treated water to its thermal power stations. Based on this agreement, NMC being a municipality, approached the central Government and received a grant for a sum of 800 million rupees towards the project under the Jawaharlal Nehru National Urban Renewal Mission (JnNURM), while the remainder of the cost 1200 million rupees will be borne by MSPGCL.

Institutional/Cultural Considerations

The use of pilot plant data and results were helpful in getting both government officials and the public at large to get acceptance for the use of reclaimed water for non-potable applications. In addition to conducting pilot studies, the team also conducted a number of workshops and willingness surveys. The results of these activities helped the Government of Maharashtra to develop a policy paper in support of water reuse (Figure 4).



Figure 4
Government of Maharashtra published a written policy paper in support of water reuse

Successes and Lessons Learned

Based on the USAID study, public workshops, and pilot plant results, the project was finalized. The full scope of the project is given in **Table 1**:

The project is now under contract finalization with the selected contractor, who will have to construct the plant and other ancillary parts in a 24 month period and then operate the plant over the next 10 years as part of an operation and management contract.

Table 1 Scope of Work for Nagpur Reuse Scheme

| Sr. No. | Module | Description |
|---------|--------|---|
| 1 | A | Construction of Kolhapur type collection weir, intake structure, sump and pump house, and miscellaneous works |
| 2 | B | Construction of sewage treatment plant (for primary and secondary treatment) |
| 3 | C | Construction of micro filtration tertiary treatment plant |
| 4 | D | Construction of tertiary water sump, pump house, transmission main up to Koradi 8.60 Kms, storage tank at Korado, and other miscellaneous works |
| 5 | E | Interconnectivity arrangement from Bhandewadi, i.e., sump, pump house, transmission main up to Pioli Nadi 7.62 Kms or up to Koradi T.P.S. |

References

Design Report and Bid Documents – submitted to MSPGCL on Koradi Reuse Project, NJS Consultants Co. Ltd., 2010.

Detailed Project Report (DPR), Nagpur Recycle and Reuse Project, Submitted to JnNURM Govt. of India for Grant Funding, 2008.

Water Energy Nexus (WENEXA-II), USAID Report “Water Reuse Options and Pilot plant Study for Greater Nagpur municipal Corporation(NMC) – PA Consulting Group and CDM, 2007.

Managing Irrigation Water with High Concentrations of Salts in Arid Regions

Authors: Alon Ben-Gal, PhD, and Uri Yermiyahu, PhD (Agricultural Research Organization, Gilat Research Center, Israel); Sirenn Naoum, PhD, Mohammad Jitan, PhD, Naeem Mazahreh, PhD, and Muien Qaryouti, PhD (National Center for Agricultural Research and Extension, Jordan)

Israel/Jordan-Brackish Irrigation

Project Background or Rationale

Agricultural development of the Middle East is contingent upon use of high amounts of low-quality irrigation water. Available water sources for irrigation, including reclaimed wastewater, often contain high levels of salts, including ions specifically toxic to plants such as sodium (Na) and boron (B).

Under a study made possible through support provided by The Middle East Regional Cooperation Program, US Agency for International Development, Grant M24-014, water management, both in terms of leaching requirements (water applied to remove salts from root zone) and in terms of understanding crop response to stress conditions caused by salinity-excess B combinations, was evaluated. Ultimately the results of this investigation provided growers with decision making tools for irrigation with low-quality water under arid conditions.

Capacity and Type of Reuse Application

Field and lysimeter experiments were conducted in arid regions of Jordan and Israel to investigate the response of vegetable crops, irrigated with saline water, to irrigation levels and to elevated concentrations of B. The experiments included bell pepper (*Capsicum annuum*), melon (*Cucumis melo* L.), green beans (*Phaseolus vulgaris* L.), and tomatoes (*Lycopersicon esculentum*). Water application rates were studied in greenhouses at the Al-Karameh experimental station in the mid Jordan Valley. For each crop, four irrigation water rates were used (80, 100, 120 and 140 percent return of potential evapotranspiration ETp). Irrigation water had electrical conductivity (EC) of 2.4 dSm⁻¹. In Israel, salinity-water combinations were investigated in studies on bell pepper in the Arava Valley. Tomatoes and peppers were evaluated for salinity-B interactions. For peppers

in Jordan, irrigation water had B solutions at concentrations of 0.046, 0.37, 0.74, and salinity levels of 5, 15, 25, and 35 millimolar (mM) NaCl. Tomatoes in Israel were irrigated with water having EC of 1, 3, 6, and 9 dS m⁻¹ and B levels of 0.028, 0.185, 0.37, 0.74, 1.11, and 1.48 mM.

The project utilized state-of-the-art lysimeter facilities in Jordan (Karameh) and in Israel (Gilat, Arava Valley). In addition to growth and yield, data collected included actual plant-scale transpiration and amount and quality of water leached out of the root zone, thus facilitating environmental as well as agronomic and economic considerations.

Water Quality Standards and Treatment Technology

The quality of water in experiments was designed to represent across-the-scale expected qualities of reclaimed municipal wastewater. Salt and B concentrations in wastewater are mostly a function of their concentrations in background water and additions from human sources. Typical wastewater treatment, up to tertiary processes, does not remove dissolved salts. Less intensive treatments schemes (aeration ponds) actually concentrate these salts due to evaporation. Only desalination would remove or reduce salinity and such treatment of wastewater is currently considered highly uneconomical.

Leaching Requirements

When salinity is negligible, yield increases as a function of increased application of water to a crop, up until the point that the demand for evapotranspiration is satisfied. When salts are present, they depress water uptake and growth and therefore, additional water application is accompanied by a positive yield response. The mechanism for this is leaching of salts from the soil and maintenance of relatively salt-free environment for root activity.

Figures 1 and 2 show that while total yield is limited by source water salinity and sensitivity of the crop, as salinity increases, so does the marginal effect of increasing water application rate over ET requirements. In other words, when the water is salty, higher application means higher yield. In **Figure 1**, Relative total biomass production of peppers (Yield normalized to maximum yield) is graphed as a function of irrigation application level for three irrigation water salinity (EC_w) levels. Symbols are experimental measurements from two seasons (open symbols fall, closed symbols spring) and lines are results from an analytical model (Ben-Gal et al., 2008; Shani et al., 2007) The results from this figure show that the highest yields reached with non-saline water are impossible when salts are present but can be approached—under the condition that leaching requirements are satisfied.

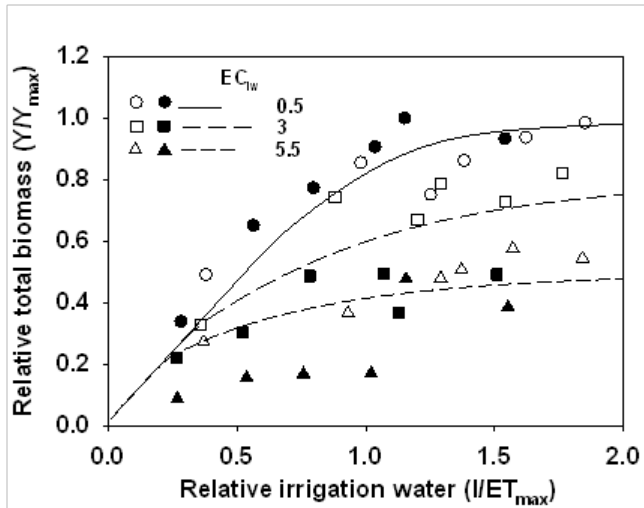

Figure 1
Relative total biomass production of peppers

Figure 2 displays fruit yield of three crops grown in Jordan irrigated with increasing rates of brackish (EC = 2.4 dSm⁻¹ water) where ET_p is potential evapotranspiration). Pepper is more sensitive to irrigation water salinity than melon which is more sensitive than beans as seen in slopes of water response curves in Figure 2 as application over 100 percent ET_p is reached.

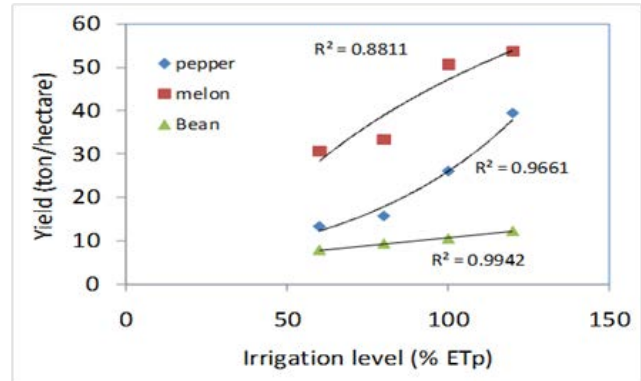

Figure 2
Fruit yield of three crops grown in Jordan

Salinity-boron interactions

Tomato and pepper were found to have decreased plant growth, yields and transpiration in response to either boron (**Figure 3**) or salinity. **Figure 3** shows Dry Matter (DM) g plant⁻¹ accumulation in organs of bell pepper (*Capsicum annum*.cv. Saphir) as affected by soil boron in Karameh Jordan.

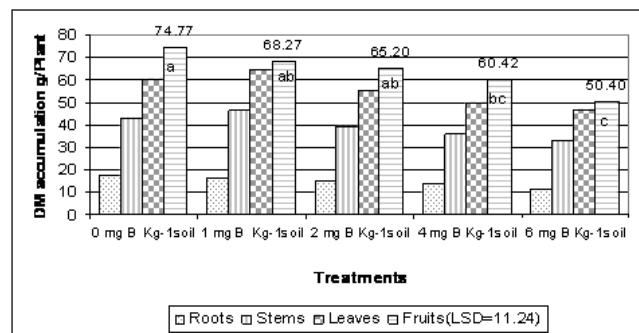

Figure 3
Dry matter (DM) g plant⁻¹ accumulation in organs of bell pepper

A number of modeling approaches were applied to experimental results to investigate the nature of salinity-boron interactions on crop production. For both tomatoes and peppers, an antagonistic relationship for excess B and salinity was found (**Figure 4**). In other words, toxic effects on growth and yield were less severe for combined B toxicity and salinity than what would be expected if effects of the individual factors were additive. (Ben-Gal and Shani, 2002; Yermiyahu et al, 2008).

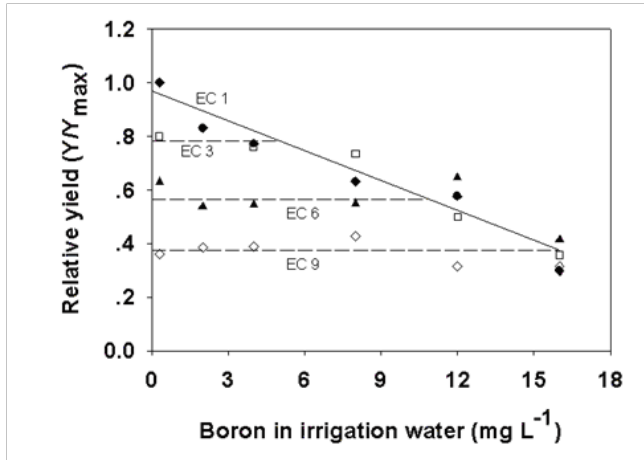

Figure 4
Biomass production of tomatoes

Figure 4 presents biomass production of tomatoes as a function of boron in irrigation water for varied salinity conditions where EC is electrical conductivity of irrigation water. Symbols shown in the figure are experimental measurements, Yotvata, Israel, lines depict dominant factor modeling approach (Ben-Gal and Shani, 2002).

Project Funding and Management Practices

This work was made possible through support provided by The Middle East Regional Cooperation Program, US Agency for International Development, Grant M24-014.

Institutional/Cultural Considerations

Irrigation water salinity decreases transpiration and biomass production of horticultural crops. The extent of the salinity response is dependent upon the level of leaching of salts from the root zone. Application of saline water to the soil exceeding the quantity used by the crop for transpiration, succeeds in improving conditions for water uptake and growth (Figures 1, 2, 5). The addition of such water has higher relative benefit as the salinity of the water and the sensitivity of the crop increase. Lysimeter, field, and modeled experimental results in dry regions of Jordan and Israel suggested that potential economic benefits from increased yields exist for irrigation application rates reaching more than 200 percent of the ET_p for a high value but relatively salt sensitive crop like bell pepper. Leaching fractions were seen to increase as a result of reductions in transpiration caused by increases in salinity.

Decision making by growers benefits from consideration of soil-crop-climate specific predictions of yield as a function of irrigation water quality and quantity (Figure 5). For example, a farmer in the Jordan Valley irrigating with EC 3 water cannot expect to reach greater than 70 percent of the potential yield for a pepper crop even with exorbitant rates of water application. By choosing a more tolerant melon crop, the farmer can achieve 90 percent of potential yield with the same water that yielded 70 percent peppers. Figure 5 presents a compensation presentation of Iso-yield curves for irrigation water salinity (EC) and applied irrigation water quantity relative to climate demand (I T_p-1) for pepper and melon crops. Curves were computed using the ANSWER model (Shani et al., 2007). Isolines show 10 percent increases in relative yield.

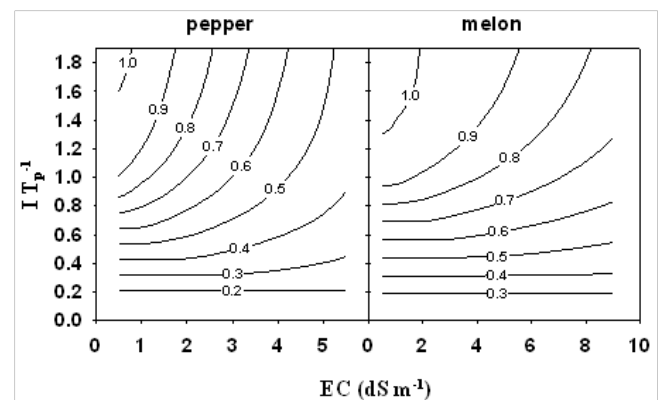

Figure 5
Compensation presentation of Iso-yield curves for irrigation water salinity

Successes and Lessons Learned

This investigation found that irrigation of horticultural crops with brackish water can be economically feasible as long as sufficient excess water is applied to control root zone conditions.

It was also found that the combined effects of simultaneous high salinity and excess boron were less than those predicted by combining the expected individual effects of each stress causing factor. This opens the door for utilization of water sources that otherwise would be considered unacceptable.

In spite of these successes, the results indicate that irrigation with saline water under arid conditions is problematic. Sustainable cultivation must provide for collection and disposal of the leached salts and water

or alternatively, reduce the leaching. Reduced leaching is only possible through cultivation of highly tolerant crops or via the reduction of water salinity prior to irrigation (Ben-Gal et al 2008, Shani et al., 2007). In the case of wastewater reuse, it may be preferable to reduce salinity and boron in source water, prior to its reaching the wastewater stream, and long before its use for irrigation, rather than loading the environment with these problematic salts. Many sources of B (detergents, sea water) can be avoided or treated in source water using available legislative and technological tools. Desalination technology is becoming increasingly attractive and offers an elegant way to remove salts in source (municipal) water where they can be best managed and to leave agriculture with water that will lead to higher yields and lower environmental impact (Ben-Gal et al., 2009).

References

- Ben-Gal A, Ityel E, Dudley L., Cohen S, Yermiyahu U, Presnov E, Zigmond L, Shani U. 2008. "Effect of irrigation water salinity on transpiration and on leaching requirements: A case study for bell peppers". *Agric. Water Manag.* 95, 587-597.
- Ben-Gal A., and Shani, U. 2002 "Yield, transpiration and growth of tomatoes under combined excess boron and salinity stress". *Plant Soil*, 247, 211-221.
- Ben-Gal A. Yermiyahu U. and Cohen S. 2009. "Fertilization and blending alternatives for irrigation with desalinated water". *J Environ. Quality*. 38:529-536.
- Shani, U., Ben-Gal, A. Tripler E. and Dudley, L.M. 2007. "Plant response to the soil environment: an analytical model integrating yield, water, soil type and salinity". *Water Resources Res.* Vol. 43, W08418, 10.1029/2006WR005313
- Yermiyahu U., Ben-Gal A., Keren R. and Reid R.J. 2008. "Combined effect of salinity and excess boron on plant growth and yield". *Plant and Soil*. 304, 73-87.

Irrigation of Olives with Recycled Water

Authors: Arnon Dag, PhD; Uri Yermiyahu, PhD; Alon Ben-Gal, PhD; and Eran Segal, PhD (Agricultural Research Organization, Gilat Research Center, Israel) and Zohar Kerem, PhD (The Hebrew University of Jerusalem, Israel) along with colleagues from the Association for Integrated Rural Development, West Bank and the National Center for Agricultural Research and Extension, Jordan

Israel/Palestinian Territories/Jordan-Olive Irrigation

Project Background or Rationale

There is increasing use of low quality water for olive grove irrigation in the Mediterranean, due to scarcity of fresh water.

The aims of the present study were: 1) to evaluate the effect of irrigation with recycled wastewater (RWW) on tree growth, fruit, and oil yield and quality; 2) to assess the contribution of RWW to plant nutrition and; 3) to quantify nitrate and chloride losses when using RWW.

Capacity and Type of Reuse Application

A 4-year field study comparing two olive cultivars, Barnea and Leccino, was conducted within a 20 ha commercial high density (900 trees/ha) olive orchard. Three treatments were tested: A) fresh water with standard fertigation (drip irrigation using water amended with fertilizer (potassium and nitrogen), B) RWW with standard fertigation, and C) RWW with reduced fertigation (accounting for the potassium and nitrogen available in the RWW). The RWW was secondary-treated domestic wastewater from the City of Jerusalem and fresh water originated from the local costal aquifer. Water composition is presented in **Table 1**. Annual average irrigation application was 470 mm (18.5 inches). The total annual amount of nutrients arriving with the RWW were substantial, equaling some half of the recommended fertilization dosages.

Diagnostic leaves sampled in July each year were tested for macro elements and salts. Trunk circumference was measured once a year. Upon reaching the appropriate ripeness level, fruit was harvested and yield, fruit size, water, and oil content were measured. Oil was extracted, tested for free fatty acid content, peroxide level and polyphenol content, and evaluated for organoleptic attributes by a trained panel.

Table 1 Composition of fresh water and RWW. Values represent the 4-year average and standard deviation (2006-9, n=18)

| Constituent | Units | RWW | Fresh Water |
|--------------------|--------------------|-------------|-------------|
| pH | | 7.7 (0.3) | 7.5 (0.2) |
| EC | ds m ⁻¹ | 1.65 (0.13) | 0.9 (0.2) |
| NH ₄ -N | mg L ⁻¹ | 4.8 (6.8) | 0.0 (0.0) |
| NO ₃ -N | | 15.2 (3.9) | 3.4 (2.2) |
| Total N | | 19.9 (6.0) | 3.4 (2.2) |
| K | | 29.6 (2.2) | 4.4 (2.8) |
| P | | 5.8 (1.8) | 0.0 (0.0) |
| Cl | | 323 (30) | 168 (56) |
| Na | | 198 (25) | 81 (28) |
| SAR | | 4.9 (0.8) | 4.2 (1.9) |

Results

Diagnostic leaves. Mineral concentration in diagnostic leaves serves as a benchmark for salinity and nutritional status of olive trees. The measured concentrations of N, P, and K in the leaves obtained from trees receiving the three treatments were within a range considered normal (Therois, 2009), indicating adequate nutritional status across the treatments. There were no significant differences in leaf concentration of Na and Cl across the treatments, indicating that the additional application of these elements from RWW application did not accumulate in leaves.

Tree growth, fruit and oil yield. For both cultivars in each year, no significant differences were found between treatments for the parameters: trunk diameter, fruit number, average fruit weight oil content, water content, fruit yield, and oil yield. Fruit from “Barnea” trees had higher oil content (ranging from 19.2 to 26.6 percent) than “Leccino” (ranging from 17.8 to 20.5 percent). Multiplying olive fruit yield by oil content provided oil yield per tree which ranged from 4.6 to 9.3 lb (2.1 to 4.2 kg) (1686-3372 lb/ac or 1890-3780 kg/ha) in the “On” years (2006, 2008) in “Leccino.” The “Barnea” trees had similar oil yields,

ranging from 4.4 to 9.7 lb/tree (2.0 to 4.4 kg/tree) (1606-3533 lb/ac or 1800-3960 kg/ha).

Oil quality. Oil quality (free fatty acid level, polyphenol content and peroxide level) did not differ significantly among the treatments. Organoleptic assessments to grade the oil taste (bitterness, pungency and fruitiness) did not reveal any negative attributes in any of the tested oils. In respect to positive attributes, fruitiness and pungency were similar among the different treatments. Bitterness, on the other hand, was much lower (~ 1 on a 10-point scale with 10 being a very intense taste) in oil obtained from trees receiving RWW with standard fertigation (condition B) compared to oil from trees receiving fresh water (bitterness level of 6.5) (control condition). However, this effect was reduced when the fertigation regime was adjusted (condition C), with bitterness value reduce to 5.

Bacteriological tests. Total bacteria count in the RWW was 17,000 per 100 ml and <1 for the fresh water. No Salmonella bacteria were found in the two types of water. No differences were found between bacteria counts in oil obtained from trees irrigated with fresh water and those irrigated with RWW water.

Soil salinity. While similar amounts of water were applied, the RWW treatments loaded the soil profile with 1.75 times more Cl than the fresh water treatment. Additionally, significantly more nitrates were transported out of the root zone in the RWW with standard fertigation in comparison to the RWW with reduced fertigation and fresh water treatments for both cultivars. This implies that consideration of nutrients originating with the RWW is vital for its sustainable utilization.

The result of this experiment, together with our previous findings on negative effects of over fertilization on productivity (Erel et al., 2008) and oil quality (Dag et al., 2009), have inspired the olive experts of Israel's agricultural extension service to adjust their fertilization recommendations. The new recommendations take the amount of N and K in the RWW into account when planning fertilization regimes.

Project Funding and Management Practices

The research was supported by grant M26-062 of the USAID Middle East Regional Cooperation Program, as well as by grant 203-0620 from the Chief Scientist of

the Israeli Ministry of Agriculture and Rural Development.

Institutional/Cultural Considerations

Due to overall scarcity of water in Israel, water available for irrigation of olive orchards is limited to recycled wastewater and brackish groundwater. In the past, some sectors restricted use of RWW due to religious objections, but the necessity for water combined with modernization and education have overcome these and other obstacles for utilization of recycled water across all sectors. Consumers in Israel generally do not object to the use of RWW. The opposite is actually the case, as water recycling is perceived as "green" and promoting resource conservation. Moreover, the people in Israel are keenly aware that fresh water is very scarce and tend to object its allocation to the agricultural sector.

Successes and Lessons Learned

Irrigation of olives with RWW did not affect tree nutritional status, growth, productivity or oil quality. RWW can be used safely with no negative effects on the oil produced, but fertilization regimes need to be adjusted in order to consider nutrients delivered with RWW to avoid negative effects of over fertilization. In this way, contamination of water resources from nutrient leaching can be minimized and the RWW can provide an additional benefit from reduced fertilizer costs (Segal et al., 2011).

References

- Dag, A., Ben-David, E., Kerem, Z., Ben-Gal, A., Erel, R., Basheer, L. and U. Yermiyahu. 2009. Olive oil composition as a function of nitrogen, phosphorus and potassium plant nutrition. *Journal of the Science of Food and Agriculture*. 88: 1524-1528.
- Erel, R., Dag, A., Ben-Gal, A., Schwartz, A. and U. Yermiyahu. 2008. Flowering and fruit set of olive trees in response to nitrogen, phosphorous, and potassium. *Journal of the American Society for Horticultural Science* 133: 639-647.
- Segal, E., Dag, A., Ben-Gal, A., Zipori, I., Erel, R., Suryano, S. and U. Yermiyahu. 2011. Olive orchard irrigation with reclaimed wastewater: Agronomic and environmental considerations. *Agriculture, Ecosystem and Environment*, 140: 454-461.
- Therois, I. 2009. Olive. Crop production science in horticulture no. 18 Cabi, MA.

Advanced Wastewater Treatment Technology and Reuse for Crop Irrigation

Author: Josef Hagin, PhD, and Raphael Semiat, PhD (Grand Water Research Institute Technion – Israel Institute of Technology, Haifa, Israel)

Israel/Jordan-AWT Crop Irrigation

Project Background

Shortage of water in sub-humid and semi-arid regions like the southeast Mediterranean, leads to use of wastewater for agricultural irrigation. Most of the effluent used is derived from secondary wastewater treatment plants or from sources having even lower water quality. Secondary-treated wastewater still contains some pathogens, organic compounds, and salts. Irrigation with this water induces, in a shorter or longer term, increased soil salinity that damages soils and crops. Sustainable agricultural production requires high water quality. Membrane treatment is a promising technology for the environmentally friendly removal of pollution agents and for rendering wastewater into a resource for unlimited use (J. Hagin et al., 2007; and J. Hagin et al., 2010). This project was carried out as a collaboration between researchers from the Technion – Israel Institute of Technology, Al-Quds University in Jerusalem, and the National Center for Agricultural Research and Extension in Jordan.

Application of Membrane Technologies

Advanced membrane treatment technologies based on ultra filtration (UF) and two stage reverse osmosis (RO) yield effluent of suitable quality for unrestricted irrigation.

Operation of the UF, mainly flow rate and water recovery, was monitored continuously. Steady UF performance required weekly cleaning by a NaOH solution, periodic acidic (HCl) cleaning for removal of inorganic scaling and backwash cycles. The operation included chlorination of the UF feed as an anti-biofouling agent, followed by dechlorination of the permeate prior to entering the RO membranes, to prevent damage.

During the lengthy operation, changes in quality of the secondary effluent (organic matter and suspended solids) resulted in parallel decrease of UF performance. Adjustments of the filtration-backwash cycle compensated fully for the performance decrease.

This showed the system's ability to operate at varying and reduced feed quality.

Water recovery from the UF system was up to 88 percent. Recycling the rejected UF concentrate to the feed tank contributed an additional 6-9 percent to the UF water recovery. The UF operated at a flux of 93.78 gallons/ ft²/hr (33 l/m²/hr) and the permeability was about 0.89 gallons/ft²/psi/hr (40 l/m²/bar/hr).

The first RO stage (RO1) receives the UF permeate. It operated at a feed rate of about 1,717 gallons/hr (6.5 m³/hr) under 88.2 psi (6 bar) pressure, at a recovery ratio of about 50 percent, and a pH of 6.5. Osmotic backwash is executed automatically every 60 minutes by shutting down the pressure pump for 1 minute. Scaling, organic fouling, and phosphate precipitation were negligible.

The second RO stage (RO2) received the RO1 brine. The RO2 membrane feed rate is about 607.6 gallons/hr (2.3 m³/hr), 449.1 gallons/hr (1.7 m³/hr) fresh feed (RO1 brine), and the rest is recycled concentrate operated at a pressure of 102.9 psi (7 bar) and a pH of 6.5. Osmotic backwash is automatic, the same as for the RO1 membrane.

Measurements indicated a long-term reduction in RO2 membrane performance. Calculations of mass balance showed that 33 percent of the inflow phosphate and 15 percent of the calcium were precipitated on the membrane. The pH control was not sufficient for steady operation, and chemical precipitation was required. Phosphate in the RO1 brine precipitated on the RO2 membrane as a complex calcium-phosphate. Phosphate removal was achieved by injecting ferric chloride into the RO1 brine pipe, forming a solid strengite—FePO₄·2H₂O, thus preventing its precipitation on the membrane (Katz and Dosoretz, 2008).

The RO2 stage extracted additional water from the rejected brine stream of the RO1 stage and its addition improved total system recovery to up to about 85 percent.

The overall operational cost of the pilot plant, following the process improvements, is estimated at \$0.55-0.60/m³.

Crop Irrigation with Treated Wastewater

Secondary treated effluents, permeates of RO and mixtures of RO and UF membranes permeates were used for irrigation on a number of crops on several Palestinian, Jordanian and Israeli sites.

Irrigation using secondary-treated effluent induced significantly higher soil salinity, expressed as electrical conductivity (EC), than RO permeate, or UF and RO permeates combined (**Tables 1 and 2**). In addition, increased dripper clogging was noted.

In experiments running for several years at the same site, a significant decrease in crop yield was measured in plots irrigated by secondary-treated effluent compared to those irrigated by membrane-treated water (**Table 3**).

Biological tests of membrane treated irrigation water did not show any fecal coliform contamination.

Table 1 Electrical conductivity (EC) in soil, Jordanian site after 2 seasons of irrigation

| | Irrigation water quality | | | |
|-----------|--------------------------|----------------------|-------------|-----------------|
| | Depth (cm) | Sec. treat. effluent | UF permeate | Mix UF-RO 50-50 |
| EC (dS/m) | 0-20 | 3.24 | 2.83 | 1.14 |
| | 20-40 | 3.01 | 2.71 | 0.99 |

Table 2 Electrical conductivity (EC) and Sodium adsorption ratio (SAR) values in soil samples after 6 years irrigation with various water streams, Arad site, Israel

| Water Quality: | Sec effl. | UF permeate | UF-RO 70-30 | UF-RO 30-70 | RO permeate |
|----------------|-----------|-------------|-------------|-------------|-------------|
| EC, dS/m | 16 | 9 | 6 | 5 | 2 |
| SAR | 25 | 20 | 16 | 12 | 3 |

Table 3 Crop yields (tons per hectare) for plots irrigated with different blends of reclaimed water at the Arad site, Israel

| Irrigation Water | Watermelon | Garlic | Corn grain |
|----------------------|------------|--------|------------|
| Sec. treat. effluent | 28 | 24 | 7.8 |
| UF permeate | 36 | 30 | 10.7 |
| UF- RO 70-30 | 34 | 30 | 10.1 |
| UF- RO 30-70 | 44 | 32 | 10.3 |
| RO permeate | 50 | 37 | 11.3 |

Measurement of pharmaceuticals, aspirin, paracetamol, X-ray contrast media, diatrizoate and carbamazepine and their degradation products, showed their complete removal by RO membranes.

Successes and Lessons Learned

The project's results provide guidelines for large-scale, economically and technically feasible operation of wastewater treatment systems, regional and worldwide. They indicate the potential of adding a substantial amount of quality water (up to 600,000 m³) to the regional resources for irrigation and aquifer recharge. The overall conclusion and recommendation to water authorities, for maintaining an adequate water supply to agriculture and ensure production sustainability, is to construct membrane systems on a large scale at secondary treatment sites in the entire region.

Project Funding

The project is a cooperative Palestinian-Jordanian-Israeli project, coordinated by the Grand Water Research Institute, Technion and generously supported by the U.S. Agency for International Development – MERC Program, the Peres Center for Peace and other foundations.

Institutional/Cultural Considerations

The project created an excellent basis for Palestinian-Jordanian-Israeli cooperation. Over the years, professional and personal ties have developed between the investigators. Investigators at the participating institutes acquired a deeper understanding and greater experience regarding the processes and performances of membrane systems. This makes them experts in consulting authorities for large-scale wastewater treatment systems.

References

- Katz, I. Dosoretz, C.G. (2008). Desalination of domestic wastewater effluents: phosphate removal as pretreatment. *Desalination* 222, 230-242.
- Hagin, J. Oron, G. Fardous, A.N. Boulad, A. Haddad, M. Khamis, M. Ben Hur, M. (2007). Wastewater treatment and reuse in agricultural production. Final Report submitted to the USAID – MERC, Project M22-006 and Semi – Annual Reports 2003 – 2007
- Hagin, J. Khamis, M. Bulad, A. Al Hadidi, L. Oron G. (2010). Advanced wastewater treatment technology and reuse. *Semi – Annual Report submitted to USAID – MERC, Project M28-028 and Semi – Annual Reports 2008/2009.*
- Hagin, J. Khamis, M. Manassra, A. Abbadi, J. Qurie, M. Bulad, A. AlHadidi, L. Semiat, R. Shaviv, A. Katz, I. Dosoretz, C. Blonder, O. (2010) Treatment and use of wastewater for agricultural irrigation. *Proceedings International Fertiliser Society* 680, UK.

Treatment of Domestic Wastewater in a Compact Vertical Flow Constructed Wetland and its Reuse in Irrigation

Authors: Ines Soares, PhD; Amit Gross, PhD; Menachem Yair Sklarz, PhD; Alexander Yakirevich, PhD; and Meiyang Zou, MSc (Ben Gurion University of the Negev, Israel); Ignacio Benavente, Eng, PhD; Ana Maria Chavez, Eng, MSc; Maribel Zapater, MSc; and Diana Lila Ferrando, Eng, MSc (Universidad de Piura, Peru)

Israel/Peru-Vertical Wetlands

Project Background or Rationale

The quantity of freshwater available worldwide is declining, and there is a pressing need for alternative sources, such as reuse of treated wastewater. In heavily populated areas, the most common strategy to treat domestic wastewater (DWW) for disposal or reuse is via intensive, centralized, often sophisticated and expensive systems. This approach is often unsuitable in developing countries, in lightly populated areas, or on remote farms where on-site (decentralized) treatment by low-cost low-tech systems should be considered. Treatment by constructed wetlands (CW) is recognized as an economically favorable option, even in the most developed countries (IWA, 2000).

Reuse of treated DWW for irrigation may involve certain risks of soil pollution due to salinization, boron accumulation, hydrophobicity (e.g., caused by detergents), pathogens and other pollutants. Particularly in on-site scenarios, variability in water quantity and quality might negatively impact treatment efficiency. Thus, any treatment system has to address these issues and consistently produce effluents that comply with defined quality guidelines.

In our approach to decentralized DWW treatment and reuse in irrigation we have developed a small footprint CW (**Figure 1**) — the recirculating vertical flow constructed wetland (RVFCW) (Gross *et al.*, 2008; Sklarz *et al.*, 2009; Zapater *et al.*, 2011). The diversity and dynamics of the RVFCW bacterial community were analyzed to enhance our understanding of the treatment efficiency and stability (Sklarz *et al.*, 2011), and a mathematical model that can be used as a tool to design and operate these systems was formulated (Sklarz *et al.*, 2010). Lastly, possible effects of irrigation with RVFCW effluent on soil properties were assessed (Sklarz, 2009). This research was carried

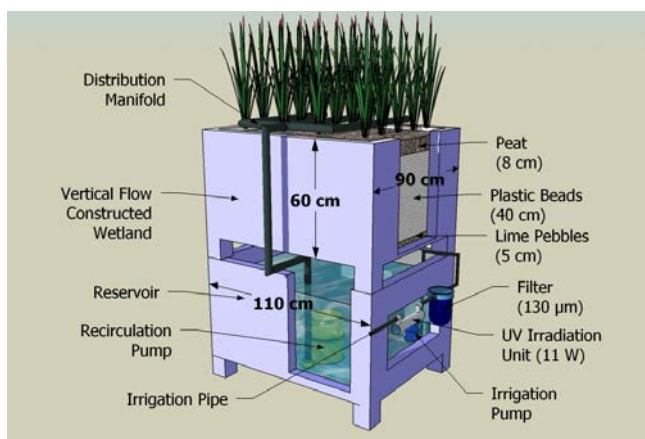

Figure 1
Schematic representation of the field RVFCW

out in Israel at the Zuckerberg Institute for Water Research at Ben Gurion University of the Negev.

Two similar 130 gallon (500 L) RVFCWs were used in the study. The systems consist of a three-layer bed (a thin upper-layer of organic soil planted with macrophytes, a middle thicker layer of high surface porous medium, and a thin lower-layer of limestone gravel) and a reservoir located beneath the bed. Wastewater is introduced in batches to the bed, percolates through it and trickles down into the reservoir, allowing for passive aeration; from the reservoir the water is recirculated back to the bed with a small pump until the effluent quality meets the relevant regulation (i.e., according to its use and the country standards).

Prior to irrigation, the treated DWW passes through a standard 130-micron filter to prevent clogging of the irrigation system and enhance the efficiency of the subsequent UV disinfection treatment. The high oxygen levels in the water allow for the conversion of nitrogen in the DWW to nitrate and minimize its loss, a

desirable added value in that it lowers the need for crop fertilizer (Table 1).

Table 1 Quality of the raw DWW after primary sedimentation and of the RVFCW effluent after 6 h of treatment. Values shown are the arithmetic mean values (except where noted as geometric mean) and standard errors for samples from July 2007 to March 2008.

| Parameter (mg L ⁻¹) | Raw (influent) Mean (SE) | Effluent Mean (SE) | Israeli Standard* |
|-------------------------------------|--------------------------|--------------------|-------------------|
| TSS | 103 (11) | 6.8 (1.0) | 10 |
| BOD ₅ | 178 (19) | 6.2 (0.9) | 10 |
| COD | 200 (13) | 18 (2.6) | 100 |
| TN | 36 (2) | 27 (1.1) | 25 |
| NH ₄ ⁺ -N | 29 (2.4) | 1.3 (0.4) | 20 |
| NO ₂ ⁻ -N | BD** | 0.62 (0.1) | |
| NO ₃ ⁻ -N | 0.3 (0.0) | 23 (0.9) | |
| DO | 0.2 (0.1) | 8.2 (0.2) | |
| pH | 7.4 (0.0) | 7.6 (0.1) | |
| EC (mS cm ⁻¹) | 0.96 (0.1) | 0.94 (0.1) | 1.4 |
| E. coli (CFU 100 mL ⁻¹) | 1×10 ⁶ | 5.4*** | 10 |

*Unrestricted irrigation (Inbar, 2007)

**Below detection

***Geometric mean

An irrigation experiment was conducted in which barrels 32 gallon (120 L) were filled with a naive sandy loamy soil and irrigated daily, at a rate of 2.6 gpd (10 l/d), with one of four types of water: fresh water (FW), FW amended with 7:3:7 (N:P:K) fertilizer (FW+F), settled raw-DWW and RVFCW-treated-DWW after UV light disinfection. No further treatment was applied to the soil. Periodically, 20-inch (50-cm) deep soil cores were removed and analyzed. After three years, the physicochemical characteristics (pH, electrical conductivity, organic and water contents, and macro- and micro- elements) and bacterial community of the soil irrigated with the treated DWW were similar to those of the soils irrigated with FW+F but differ from soils irrigated with raw-DWW (data not shown). This may imply changes in the biochemical processes in the soil irrigated with raw-DWW.

The treatment efficiency under extreme variations in quality of the DWW was tested in a set of experiments

using 8 gallon (30 L) bench-scale systems. In this study we assessed the resilience and recovery capacity of the RVFCW upon exposure to possible disturbances, which included high and low water pH, interruption of water recirculation, and high concentrations of *E. coli*, surfactants (i.e., detergents) and bleach. The effects of these disturbances were short-lived and recovery was observed within 24 hours, attesting to the robustness of the RVFCW (data not shown).

Capacity and Type of Reuse Application

The RVFCW is modular, enabling more units to be attached, serially or in parallel. Thus, the system can be up-scaled to serve a small community or a neighborhood. The required water quality will dictate the DWW load and the retention time, as well as the recirculation rate. Interestingly, the experimental results demonstrate that the size of the unit does not significantly affect the system's efficiency (Sklarz *et al.*, 2010). Different volumes were treated in the different experiments, ranging from 0.03 to 4 m³/d (80 to 1,060 gpd). A typical hydraulic load is 0.5 m³ m⁻² d⁻¹ and the retention time to meet high water quality standards for unrestricted DWW reuse in irrigation (Inbar, 2007) is about 5 hours, which corresponds to potential organic load capacity of over 270 g COD m⁻² d⁻¹ and 120 g BOD₅ m⁻² d⁻¹.

Water Quality Standards and Treatment Technology

When treated with the UV disinfection unit, the effluent of the RVFCW consistently met the stringent Israeli standards for reuse in irrigation of <10 CFU *E. coli* 100 mL⁻¹ (Inbar, 2007).

Project Funding and Management Practices

Funds from Ben-Gurion University of the Negev and USAID supported this research.

Institutional/Cultural Considerations

Based on the pilot results, the RVFCW was chosen for installation in two low-income Bedouin communities. The first, designated “Project Wadi Attir,” aims to develop and demonstrate a model for sustainable, community-based organic farming, adapted to a desert environment (The Sustainability Laboratories, n.d.). The treated wastewater will be used for unrestricted landscape and possibly fodder irrigation. Construction has started and the site is expected to start operating during 2012. In the second community, installation of several units is planned in the Egyptian Bedouin village of St. Catharine in the Sinai desert (funding is expected via a UN project). The initiation of this project is unclear due to the current political situation in Egypt. The water will be used for unrestricted irrigation mainly of the local fruit trees and gardens. The choice of the RVFCW was interesting, considering the electricity requirements for recirculation in places where electricity is often scarce and not always reliable. The use of solar energy could be an alternative, should electricity supply become problematic. The justification for using the RVFCW, and not gravity-based systems, was the high treatment efficiency, the low maintenance, and the low footprint, particularly important in areas with high evaporation rates. Moreover, two-dozen units have been installed by private households throughout Israel for onsite graywater reuse, and have been operated successfully for more than three years for unrestricted ornamental garden irrigation.

Successes and Lessons Learned

We demonstrated that it is possible to safely reuse DWW by simple low-cost low-tech treatment means. The system design must consider the unique conditions associated with on-site DWW reuse, such as high variability in water quality and quantity, and exposure to short events of extreme conditions. The system can produce treated DWW of very high quality for unrestricted reuse such as for urban, agriculture and landscape irrigation.

References

Gross, A., M. Y. Sklarz, A. Yakirevich and M. I. M. Soares. 2008. “Small scale recirculating vertical flow constructed wetland (RVFCW) for the treatment and reuse of wastewater”. *Water Science and Technology* 58(2):487-494.

Inbar Y. 2007. “New standards for treated wastewater reuse in Israel.” In: Zaidi M. (Ed.). *Wastewater Reuse - Risk*

Assessment, Decision-Making and Environmental Security. Springer, Dordrecht, Netherlands, pp. 291-296.

IWA, Specialist Group on Use of Macrophytes in Water Pollution Control. 2000. *Constructed Wetlands for Pollution Control*. IWA Publishing, London.

Sklarz, M. Y. 2009. *Development and Optimization of a Recirculating Vertical Flow Constructed Wetland for Treatment of Domestic Wastewater*. PhD thesis, Ben-Gurion University of the Negev, Israel.

Sklarz, M. Y., O. Gillor, A. Gross, A. Yakirevich and M. I. M. Soares. 2011. “Microbial diversity and community composition in recirculating vertical flow constructed wetlands.” *Water Science and Technology* 64(11):2306-2315.

Sklarz M. Y., A. Gross, M. I. M. Soares and A. Yakirevich. 2010. “Mathematical model for analysis of recirculating vertical flow constructed wetlands.” *Water Research* 44:2010-2020.

Sklarz, M. Y., A. Gross, A. Yakirevich and M. I. M. Soares. 2009. “A recirculating vertical flow constructed wetland for the treatment of domestic wastewater.” *Desalination* 246:617-624.

The Sustainability Laboratories. n.d. “Project Wadi Attir - Model Sustainable Desert Community.” Retrieved on Sept. 6, 2012 from <<http://www.sustainabilitylabs.org/page/project-wadi-attir-model-sustainable-desert-community>>.

Zapater M., A. Gross and M. I. M. Soares. 2011. “Capacity of an on-site recirculating vertical flow constructed wetland to withstand disturbances and high variable influent quality.” *Ecological Engineering* 37:1572-1577.

A Membrane Bioreactor (MBR) Used for Onsite Wastewater Reclamation and Reuse in a Private Building in Japan

Author: Katsuki Kimura, Dr.Eng., and Naoyuki Funamizu, Dr.Eng.
(Hokkaido University, Sapporo, Japan)

Japan-Building MBR

Project Background or Rationale

In Japan, about 2,500 urban buildings reuse wastewater and harvest roof runoff for various purposes. In several large cities including Tokyo, regulations require a wastewater reuse system or a runoff harvest system to be installed in a new building if the total floor area of the building exceeds a certain size. A sample of 2,500 buildings with reuse/harvest systems found that 25.9 percent are public office buildings, 12.5 percent are private office buildings, and 15.7 percent are schools. Reclaimed wastewater and/or harvested rainwater are used for a variety of purposes. The water is most commonly used for toilet flushing, but can also be used for landscape irrigation, cooling, car cleaning and fire protection.

A treatment system for wastewater reclamation in an individual building should be compact, easy to maintain and resistant to fluctuation of inflow. Low production of odor and sludge is also an important requirement for such a system. Membrane bioreactors (MBRs) can meet these criteria and are therefore often used for onsite wastewater reclamation. An example of an MBR system used for onsite wastewater reclamation/reuse system in a private building is shown (Figures 1 and 2).

Capacity and Type of Reuse Application

The MBR system was installed in a business complex building in Tokyo in 2007. Treatment capacity of the system is 180,000 gallons per day (680 m³/day) and reclaimed water is used solely for the purpose of toilet flushing. Wastewater reclaimed for toilet flushing includes graywater from restaurants, graywater from offices, and blowdown from a cooling tower system. Black water from the toilet is not recycled and is prohibited by regulations. **Figure 3** presents the flow of water in the wastewater reuse system.



Figure 1
A business complex building in Tokyo in which the MBR system was installed (Photo credit: Drico. Ltd.)



Figure 2
View of the MBR system installed (Photo credit: Drico. Ltd.)

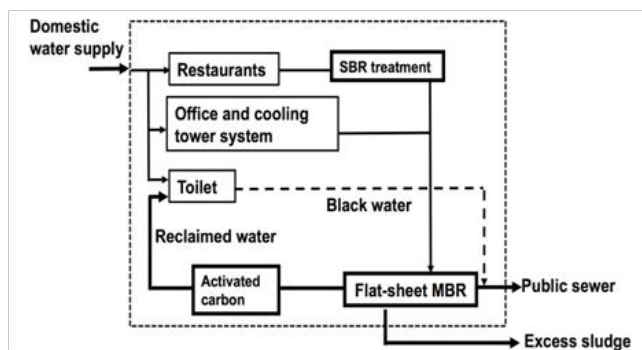

Figure 3
Wastewater reuse system flow diagram

Treatment Technology

Both hollow fiber membranes and flat-sheet membranes can be used in MBRs. Due to the ease of maintenance, flat-sheet membranes are often preferred in applications to small-scale systems such as onsite wastewater reclamation. The MBR system in this study used 1,800 flat-sheet membrane elements submerged in the reaction tank. The material of the membrane is chlorinated polyethylene with a nominal pore size of 0.4 μm .

Compared to the MBRs used in municipal wastewater treatment (i.e., large-scale treatment), mixed liquor suspended solids (MLSS) concentration in the reactor tends to be higher (15-20 g/L) in the case of MBRs used for onsite wastewater treatment. Graywater from restaurants contains substantial amounts of oil/grease, which can cause operational problems in MBRs. Thus, this heavily contaminated graywater is treated by sequencing batch reactors (SBRs) before being mixed with the other wastewater. Effluents from MBRs are used for toilet flushing only after the addition of chlorine, as mandated by the government.

In this particular MBR in Tokyo, they use activated carbon adsorption to remove color from the reclaimed water before the chlorine is added. Conditions of the system (e.g., trans-membrane pressure in the MBR) are continuously monitored by an automatic system.

Water Quality

Quality requirements for reclaimed water used for toilet flushing are summarized in **Table 1**. The averaged data obtained with the system are shown in **Table 2**. Design water quality in the effluent from the treatment

system is also shown in the parenthesis in **Table 2**. It should be noted that quality of wastewater in **Table 2** represents the mixture of graywater from offices, blowdown from the cooling tower system, and effluents from the SBRs treating restaurants wastewater.

Table 1 Quality requirements for reclaimed water used for toilet flushing

| Parameter | Requirement |
|--------------------------|----------------------------------|
| pH | 5.8-8.6 |
| Odor | Not abnormal |
| Color and transparency | Almost colorless and transparent |
| E. coli | Must not be detected |
| Residual chlorine (mg/L) | 0.1 (free) 0.4 (combined) |
| BOD (mg/L) | <20 |
| COD (mg/L) | <30 |

Table 2 Water quality observed in the treatment system

| Parameter | Raw Wastewater | Effluent |
|----------------------------|----------------|--------------|
| pH | 6-8 | 7.7 (6-8) |
| Odor | | Not abnormal |
| E. coli | | Not detected |
| BOD (mg/L) | 215 | <1.0 (<10) |
| SS (mg/L) | 215 | <1.0 (<5) |
| n-Hex (mg/L) | 43 | <1.0 (5) |
| Color (color unit) | | 4 (<10) |
| Turbidity (turbidity unit) | | <1 (<2) |

Project Funding

The regulations for the construction of new buildings require a wastewater reuse system or a runoff harvest system to be installed. This policy driven water reuse intervention places the financial burden on the project developer.

Successes and Lessons Learned

The customer is satisfied with the net reduction of domestic water supply. Performance of the MBR system has been satisfactory as shown in **Table 2**. Operation and maintenance of the MBR were found to be very easy. Withdrawal of sludge and chemical cleaning of the membrane were carried out every 30 days and every 4 months, respectively, and have been sufficient to maintain stable operation of the system. When possible, use of graywater from restaurants as a source for reclamation should be prevented because

of the difficulty in treatment. Unfortunately, the amount of “clean” graywater produced in the building is not sufficient to cover the amount needed for toilet flushing. To fill the gap, graywater produced in restaurants is also included as the source of reclaimed water at the cost of pretreatment.

References

Public Building Association. 2005. *Design of wastewater reclamation and rainwater harvest systems* (in Japanese).

Kimura, K., Mikami, D. and Funamizu, N. 2007. “Onsite Wastewater Reclamation and Reuse in Individual Buildings in Japan.” In: Proceedings of 6th Conference on Wastewater Reclamation and Reuse for Sustainability, Antwerp, Belgium, October 9-12, 2007.

Water Reuse and Wastewater Management in Jordan

Authors: Bader Kassab, MSc (USAID Jordan) and Ryujiro Tsuchihashi, PhD (AECOM)

Jordan-Irrigation

Introduction

Water management has long been recognized as one of the most critical issues for the sustainability of the Hashemite Kingdom of Jordan. According to Jordan's Water Strategy (2009), the country's annual per capita water availability is less than 40,000 gallons per year (150 m³/yr). Available water supply is less than demand, and with continuing population growth, per capita availability is projected to continue declining in the coming years.

Jordan's Water Strategy states that "Wastewater is not managed as 'waste' but is collected, treated, managed, and used in an efficient and optimized manner." Beneficial use of reclaimed water is recognized as a crucial water management component and controlled use of reclaimed water has grown significantly during the past decade.

Institutional Arrangement and Regulations

The use of treated municipal wastewater is regulated through the water reuse standard JS893:2006, issued by the Institution for Standards and Metrology. The current standard was issued in 2006, replacing previous standards from 1995 and 2002. The standards allow irrigation of agricultural crops that will not be eaten raw. The standards also specify requirements for the use of reclaimed water for groundwater recharge to the aquifer not connected to drinking water sources, but planned groundwater recharge with reclaimed water has not yet been implemented in Jordan. The use of reclaimed water for other purposes such as cooling and fire fighting is permitted on a case-by-case basis, when confirmed with appropriate studies. Water reuse is planned concurrently with the construction of wastewater treatment plants. The Water Authority of Jordan (WAJ) is responsible for the management of the water and wastewater systems and for managing the supply of treated effluent for reuse purposes.

Promoting Water Reuse Practice

WAJ has been contracting with farmers to provide them with reclaimed water for agricultural irrigation; larger scale sites of this kind include As-Samra, Madaba, Ramtha, Akeder, and Mafraq, among others. As of 2009, about 1,900 acres (760 hectares) are irrigated with reclaimed water under contracts with WAJ.

As-Samra, located approximately 19 miles (30km) northwest of Amman, is the largest wastewater treatment plant in Jordan, with 70 mgd (267,000 m³/d) treatment capacity. A lagoon treatment system was built in 1985, and replaced by an activated sludge plant with partial funding from USAID. The new plant came online in 2008 to provide better effluent quality. As of 2008, the treatment plant received approximately 58 mgd (220,000 m³/d) (MWI, 2010), and treated effluent is discharged to the Zarqa River, which flows into the King Talal Reservoir where it is mixed with surface water. The water from the reservoir is used for irrigation in the Jordan Valley for various food crops including vegetable crops, citrus and bananas.

It is worth noting that fodder crop irrigation is the dominant application for all other water reuse schemes in Jordan, with the exception of trees such as date palm and olive. This is partly due to the high dependency on imported livestock feed. It is also due to the reluctance of farmers to use reclaimed water for food crops that may be exported to neighboring countries as those countries may have some reservations about importing such crops.

Water Reuse Project Case Study

USAID has been supporting the efforts to promote water reuse in Jordan. The water reuse pilot project at Wadi Mousa is an example of a USAID-funded project that promotes sustainability of local communities through the beneficial use of reclaimed water.

A demonstration pilot program for the use of reclaimed water for irrigation was first established in Wadi Mousa

in 2002 as a 17 acres (6.9 ha) demonstration site at the time of the Wadi Mousa wastewater treatment plant (WWTP) upgrade; it was later expanded to approximately 90 acres (37 ha) to include the use of reclaimed water by a local community. The wastewater treatment plant has a treatment capacity of 0.9 mgd (3400 m³/d) and consists of preliminary treatment (coarse screen and grit removal), activated sludge (oxidation ditch), final clarifiers, polishing ponds and disinfection. Effluent from the treatment plant is transferred to the irrigation water storage pond within the WWTP boundary, and reclaimed water is distributed through an irrigation water pump station and an irrigation water distribution main. As of 2010, the plant inflow is approximately 0.5 mgd (2000 m³/d). Reclaimed water quality is routinely monitored by the plant engineer and consistently meeting Jordanian Standards for all reuse applications.

During the USAID Reuse for Industry, Agriculture and Landscaping Project (RIAL: 2004-7), the pilot program was further expanded, and reclaimed water was used to irrigate alfalfa, olive, fruit trees and other tree crops. The pilot has been operated by the Sad Al-Ahmar Association, a water reusers' association established in 2002 with the support of USAID to ensure sustainability of the project. Currently, the association is operated with support from the Hashemite Fund for the Development of Jordan Badia (HFDB). The Association represents the local community, from which 40 farmers (34 men, six women) work directly with the pilot program. Each farm unit was allocated 0.75 to 1.1 acres (0.3 to 0.45 ha), and cropping patterns were identified with the technical support of the project team. The pilot program demonstrated that reclaimed water use can be practiced safely and introduce stable income into local communities. By the winter of 2006-7, total area used for reclaimed water irrigation was over 130 acres (52 ha), and the net income per farm ranged from \$3100 to \$4600 per year, depending on the type of crops irrigated (in 2007 dollars; RIAL Completion Report: 2008). The net income accounted for the costs of maintaining the Association and the irrigation system. Alfalfa was the dominant crop grown with reclaimed water; olive trees were also grown at the pilot site. Most of the harvested olives were consumed by the farmers; indirect economic benefits to farmers were achieved through the reduction in their food expenses.

The RIAL project also demonstrated the beneficial use of reclaimed water for landscaping and industry in Amman and Aqaba. In Aqaba, reclaimed water has been used for industries (mainly cooling for potash operations) and the city's landscaping areas. Aqaba WWTP, constructed by USAID funds, consists of a lagoon treatment train and tertiary treatment process with oxidation ditch, clarifier, filtration and disinfection. Reclaimed water from the lagoon system is used for agricultural irrigation, whereas tertiary-treated reclaimed water is used for landscape irrigation and industrial applications. The industrial use provided mutual economic benefits for both Aqaba Water Company (which will finance the system after the conclusion of USAID's funding period) and the industry, and saved about 1,200 ac-ft/yr or 400 Mgal/year (1.5 million m³/year) of fresh water that could then be dedicated for domestic and commercial uses. A pilot program was also established at the Jordan University of Science and Technology (JUST) to investigate the effects of reclaimed water irrigation on various agricultural crops and landscaping plants. Plans to support additional water reuse schemes are underway with various USAID Office of Water Resources and Environment projects, including the Water Reuse and Environmental Conservation Project. Currently the focus is to promote efficient reclaimed water irrigation to promote income generation for local communities, and industrial water management and pollution prevention through the integration of efficient use and reuse of water in industrial sectors. An analysis of lessons learned from previous demonstration projects will be used to establish sustainable and self-sustaining programs for the livelihood enhancement of local communities.

References

- MWI (2010). Ministry of Water and Irrigation Annual Report, Ministry of Water and Irrigation, Amman.
- MWI (2009). Water for Life, Jordan's Water Strategy 2008-2022, Ministry of Water and Irrigation, Amman.
- Task 1 Completion Report (2008) USAID Reuse for Industry, Agriculture and Landscaping project.

Cultural and Religious Factors Influence Water Reuse

Author: Tom A. Pedersen (CDM Smith)

Jordan-Cultural Factors

Project Background or Rationale

Although global water resources are theoretically adequate to meet all human needs, water scarcity is the reality for many in arid and semi-arid areas around the world. When freshwater supplies are insufficient to meet ecosystem and human demand, water stress or water scarcity results. According to the United Nations (2007), water stresses occurs when the water supply drops below 450,000 gallons per person per year (gallons/person/yr) [1,700 cubic meters per person per year (m^3 /person/yr)], and water scarcity results when supplies drop below 264,170 gallons/person/yr (1,000 m^3 /person/yr). Further, the United Nations (2007) has estimated that 40 percent of the world's population will live in water scarce regions of the globe by 2025. Per capita water supply in Jordan is expected to fall to 24,040 gallon/person/yr (91 m^3 /person/yr) by 2025 should the current population growth trend be maintained putting Jordan in the category of having an absolute water shortage (Hashemite Kingdom of Jordan Geography and Environment, 2012).

Maplecroft (2012) ranks the Hashemite Kingdom of Jordan as 10th among the 17 countries in the world having extreme water risk as measured by their water stress index. The index is based on the ratio of domestic, industrial, and agricultural water consumption, against renewable supplies of water from precipitation, rivers, and groundwater.

Jordan is undertaking aggressive programs to address its current and future water needs and key among these is the use of treated wastewater effluent in agricultural production. Cultural and religious factors have been shown to have significant bearing on the success of wastewater reuse projects in Jordan, as in other Islamic cultures.

Culture and Religion

As stated in *Water – The Epic Struggle for Wealth, Power, and Civilization*, “Everyone understands that water is essential to life. But many are only just now beginning to grasp how essential it is to everything in life – food, energy, transportation, nature, leisure,

identity, culture, social norms, and virtually all the products used on a daily basis. With population growth and economic development driving accelerated demand for everything, the full value of water is becoming increasingly apparent to all.” (Solomon, 2010)

The World Bank (2012) reports that wastewater use in agriculture is increasing especially in areas of water scarcity, increasing population, and where demand for food is on the rise. The expanding recognition of wastewater has nutrient value along with irrigation value is leading to increased acceptance for use in agricultural production. Although wastewater can be a reliable source of irrigation water, the World Health Organization (WHO) cautions that wastewater is always a public health risk and WHO Guidelines for the Safe Use of Wastewater, Excreta and Greywater (2006a) employ an approach integrating risk assessment and risk management to control water-related diseases.

The WHO guidelines recognize that in addition to technical issues, cultural and religious factors are important to the success of wastewater irrigation practice. WHO reports that societal concerns related to use of untreated human excreta range from abhorrence to acceptance (WHO, 2006b). In Africa, the America's and Europe excreta use is generally regarded with “disaffection,” whereas in Asia its use is accepted and in keeping with Chinese and Japanese “traditions of frugality.” In Islamic societies however, direct contact with excrement is abhorred however its use after treatment would be acceptable if the treatment were to remove impurities. Further, in Islamic countries it has been judged that wastewater can be used for irrigation provided that the impurities present in raw wastewater are removed (WHO, 2006a).

Islamic Fatwas

Fatwas are Islamic religious rulings of a scholarly opinion on a matter of Islamic law issued by a recognized religious authority in Islam (About Islam). A fatwa is based in knowledge and wisdom and those

issuing the fatwas must supply evidence from Islamic sources for their opinions. However, it is not uncommon for scholars to come to different conclusions regarding the same issue. WHO (2006a) cites the 1978 Council of Leading Islamic Scholars of Saudi Arabia issuing a fatwa concerning the use of wastewater in Islamic Societies which stated “Impure wastewater can be considered as pure water and similar to the original pure water, if its treatment using advanced technical procedures is capable of removing its impurities with regard to taste, colour and smell, as witnessed by honest, specialized and knowledgeable experts.”

The following question was posed to the World Fatwa Management and Research Institute website in 2007: “From the Islamic point of view, is the reuse of treated wastewater permissible for irrigation of crops or park areas?” The response reads in part: “If water treatment restores the taste, color, and smell of unclean water to its original state, then it becomes pure and hence there is nothing wrong to use it for irrigation and other useful purposes” (INFAD, 2012).

Jordan RIAL Projects

The United States Agency for International Development’s (USAID) Reuse in Industry, Agriculture and Landscaping (RIAL) projects have engaged farmers in the successful use of treated wastewater in agricultural production. The projects have been successful because they have addressed not only technical and economic, but institutional and cultural issues as well (USAID, 2008). The RIAL projects pioneered the first Water User Association (WUA) in Jordan for operation, maintenance and management of a wastewater-based irrigation system and the introduction of urban wastewater use for the first time Jordan.

The Wadi Mousa WUA is comprised of women and men who work together on developing cropping patterns and schedules, equitable water distribution agreements, and utilize commonly-owned machinery and equipment. WUA pay their water fees to sustain a viable, independent, and productive irrigation system and they work with system operators and with the Petra Regional Authority in planning new activities (Abu Awwad, 2006).

The RIAL projects have shown that wastewater can be safely used in agricultural irrigation. Social acceptance

of these practices have no doubt been furthered by the understanding of the benefits derived from the wastewater and the acceptance of its use in this Islamic culture through the issuances of fatwas allowing wastewater use in agriculture.



Figure 1
Irrigated alfalfa field in Wadi Mousa, Jordan (Photo credit: Tom Pedersen, CDM Smith)

Successes and Lessons Learned

The RIAL projects have demonstrated multiple benefits from well-managed reuse projects including environmental improvement as wastewater is no longer discharged into streams and wadis, increased farmer income, and a resultant enhancement of the quality of life.

References

- About Islam. n.d. Website accessed March 23, 2012 <<http://islam.about.com/od/law/g/fatwa.htm>>.
- Abu-Awwad, Ahmad M.2006. RIAL Project Presentations. April 2006.
- Hashemite Kingdom of Jordan Geography and Environment. 2012. Retrieved on Sept. 6, 2012 from <http://www.kinghussein.gov.jo/geo_env4.html>.
- INFAD. 2012. Wastewater Treatment. World Fatwa Management and Research Institute, Islamic Science University of Malaysia. Retrieved on March 23, 2012 from <<http://infad.usim.edu.my/>>.
- Maplecroft, 2012. Retrieved on March 23, 2012 from <http://maplecroft.com/about/news/water_stress_index.html>.
- Solomon, S. 2010. *Water - The Epic Struggle for Wealth, Power, and Civilization*. New York: HarperCollins Publishers.

United Nations. 2007. "Coping with Water Scarcity: Challenge of the Twenty-first Century World Water Day." March 22, 2007.

USAID. 2008. RIAL Task 1 Completion Report - Reuse for Industry, Agriculture and Landscaping Project.

WHO. 2006a. Guidelines for the Safe Use of Wastewater, Excreta and Greywater. Volume II - Wastewater Use in Agriculture.

WHO. 2006b. *ibid* Volume IV - Excreta and Greywater Use in Agriculture.

World Bank. 2012. "Wastewater and Excreta Reuse." Retrieved on March 23, 2012 from <http://water.worldbank.org/water/shw-resource-guide/infrastructure/menu-technical-options/reuse>.

Water, Wastewater, and Recycled Water Integrated Plan for Tijuana, Mexico

Author: Enrique López Calva (CDM Smith)

Mexico-Tijuana

Project Background or Rationale

The municipalities of Tijuana and Playas de Rosarito, with a combined population of more than 1.3 million people, represent one of the largest metropolitan areas in Mexico, having at the same time one of the highest population growth rates in the country. Water resources in the region, however, have always been a challenge. The accelerated growth, coupled with the scarcity of water resources in the area, require significant investments to assure water supply for this area. Significant challenges exist for the provision of water and sanitation services in the area, and deficits for the next 20 years are projected to occur if no action is taken.

Recognizing the need for immediate planning, the Comisión Estatal de Servicios Públicos de Tijuana (CESPT) developed a Water, Wastewater and Reclaimed Water Integrated Plan (Master Plan) for Tijuana and Playas de Rosarito. This master plan was developed to address the short-term improvements necessary to correct existing system deficiencies and long-term upgrades necessary to meet future growth through the year 2020.

Capacity and Type of Reuse Application

The Technical Committee selected a water supply alternative that resulted in a capital improvement program of more than \$1 billion U.S. dollars. This alternative includes the construction of a desalination facility, additional wastewater treatment plants, rehabilitation and expansion of the water and the wastewater collection network, effluent conveyance and disposal lines, and wastewater advanced treatment and recycling, including aquifer recharge. In addition to the facilities listed in the CIP, the plan includes guidelines for aggressive industrial pretreatment programs.

Eight wastewater treatment options were identified based on the discharge limits established by the existing regulations and on the specific discharge

quality goals established as part of the master plan. These technologies include: natural systems (lagoons), mechanized lagoon systems, conventional activated sludge, trickling filters, extended aeration, a combination of trickling filters and activated sludge, and sequencing batch reactors.

Based on a comparison of the advantages and disadvantages of these options, conventional activated sludge was pre-selected for the development of alternatives. For reuse options, additional treatment was necessary and selected for specific projects depending on discharge and/or reuse requirement.

The wastewater treatment plants “La Morita” and “Monte de los Olivos” combined effluent was recommended for indirect potable reuse, with a capacity of 21 mgd (930 L/s). Additionally, 14 mgd (600 L/s) were recommended for indirect potable reuse from the “Alamar WWTP”. About 20 mgd (900 L/s) additional were recommended for nonpotable reuse in different parts of the city.

Water Quality Standards and Treatment Technology

The water quality goals for the project varied according to the reuse options for the different plants. Plants that would discharge treated effluent into the Rodriguez reservoir, which can supply potable water, required quality goals and standards much higher than reuse for non-potable uses.

Plants discharging to the Rodriguez reservoir were conceptually designed to have conventional activated sludge followed by microfiltration/reverse osmosis (MF/RO). This advanced treatment requirement is necessary due to the indirect potable use scheme of the plants. The plants with effluent destined for non-potable uses were conceptually designed for conventional activated sludge followed with additional filtration and hypochlorite disinfection.

Project Funding and Management Practices

The master planning project was funded by the North American Development Bank, which in turn used funds from the U.S. Environmental Protection Agency (EPA). After the planning project, implementation of the different planning recommendations has proceeded with a number of different funding schemes. These include financing from foreign banks, funding from the national infrastructure bank in Mexico (Banobras), funding from the Mexican National Water Commission, funding from the North American Development Bank, and the EPA.

Any project financed in total or partially by U.S. funds has required environmental documentation in the United States under the National Environmental Policy Act (NEPA). EPA has developed environmental assessments to evaluate transboundary impacts (projects in Mexico that could have environmental impacts in the U.S. side of the border).

The projects are managed by the water and wastewater utility in Tijuana. The management of some projects requires the participation of the U.S. and Mexico sections of the International Boundary and Water Commission (IBWC).

Institutional/Cultural Considerations

The project's decision-making body was formed by agencies in Mexico and the United States. A binational technical committee was formed to oversee the master plan and make technical decisions and recommendations. This was necessary due to the funding scheme where U.S. funds were utilized for the planning project. On the Mexico side of the project, the federal government was involved, in addition to the local utility, to have a counterpart to EPA. Additionally, the project included significant involvement by the Border Environment Cooperation Commission and the North American Development Bank which are agencies with binational character.

For the implementation of projects, an additional level of institutional involvement has been added that includes the IBWC.

The planning project included significant public involvement in the United States and on the Mexico side of the border. Subsequent phases of implementation have continued to include community

stakeholder participation through the environmental document process that has been required on both sides of the border.

A key consideration on the project recommendations was the "high-tech" and energy intensive nature of some of the projects recommended, namely the MF/RO plants. The recommendations were made due to the indirect potable reuse nature of some of the projects. Alternative plans included no indirect potable reuse, eliminating the need for MF/RO.

Successes and Lessons Learned

The recommendations from the study were accepted by the binational technical committee and the great majority of community stakeholders. The success of the project was due to the high level of bi-national cooperation transparency in the decision-making process. While conducting a project with a multi-agency technical committee is more challenging than dealing with one agency only, the benefit is that the recommendations from the plan are more likely to be accepted and supported.

The non-potable water reuse options recommended in the plan have proceeded successfully with environmental documentation, design, and construction. While indirect potable reuse options requiring MF/RO have not proceeded, a successful element of the project and the associated environmental documentation is that no secondary effluent is being discharged in Rodriguez reservoir, which supplies potable water to the city's residents.

References

Comision Estatal de Servicios Publicos de Tijuana, 2003. Potable Water and Wastewater Master Plan for Tijuana and Playas de Rosarito. Prepared by CDM Smith.

The Planned and Unplanned Reuse of Mexico City's Wastewater

Author: Blanca Jiménez-Cisneros, PhD (Universidad Nacional Autónoma de México)

Mexico-Mexico City

Project Background or Rationale

Mexico City is located in what used to be a closed basin, at an altitude of 7,350 feet (2,240 meters above sea level). The basin was artificially opened in 1857 to dispose of waste and stormwater. Mexico City is the capital of Mexico and comprises the Federal District plus 37 municipalities, and is home to 21.4 million people. Water availability in the basin is of the order 43,600 gallons/inhabitant/yr (165 m³/inhabitant/ yr) and there is a water intensity use of 120 percent. Total demand for water is around 1,950 mgd (85,700 L/s). The local aquifer is overexploited by 120 percent (CONAGUA, 2010), leading to the subsidence of the soil in some places at a rate of up to 18 in/yr (40 cm/yr). In addition, water has to be imported from two other basins. One is located 62 mi (100 km) away, from which water is gravitationally transported, while the other is 81 mi (130 km) away, and water must be pumped up a height of 3,600 ft (1,100 m). Despite these efforts, one million people in the city depend on the delivery of a limited amount of water in tankers, while the rest of the population receives water through the network intermittently and sometimes at a very reduced flow, rendering it necessary to have water storage tanks and pumping systems in the home (Jiménez, 2008).

To face the challenge of meeting a constantly increasing demand for water, the local water utilities which also manage wastewater have implemented different projects to reuse wastewater for municipal and industrial purposes, some of which have been in operation since 1956. In addition, the Federal Government has been responsible for a program of reuse of water in Mexico City and a second basin for agricultural irrigation since 1920 (Jiménez, 2010).

Capacity and Type of Reuse Application

At the present time, 6 mgd (260 L/s) of water are reused to supply different industries. It is problematic to sell treated wastewater to industry as it is more

expensive than tap water and there are no compulsory rules to oblige companies to use reclaimed water. It is estimated that with a proper legal framework industrial reuse could be increased by an additional 23 mgd (1,000 L/s). Furthermore, 30 mgd (1,300 L/s) of water is supplied to power plants merely for cooling. Nearly 46 mgd (2,000 L/s) are used for irrigation of green areas, recharge of recreational lakes and agriculture; 27 mgd (1,200 L/s) are used for groundwater recharge and 4 mgd (175 L/s) for car washing. New car washing service centers are compelled to use reclaimed water. In addition, one treatment plant produces 14 mgd (600 L/s) for ecological purposes. Its effluent is being used to recharge a lake that was dried by the Spanish during the colonial period and was the source of particulate matter heavily polluting Mexico City's air. The last planned public projects began to operate at the end of the 1980s. In most of these cases, e.g. the power plant, the restored lake, some irrigated areas and recreational lakes, pipelines convey treated water to the facilities. The other projects receive effluent from water tankers. The amount of water reused from public plants represents 10 percent of the total supply. Additionally, although they are not formally registered, several dozen private wastewater treatment plants in sports clubs, golf courses and schools treat wastewater and reuse it for lawn irrigation or toilet flushing. Private reuse is not controlled by the government.

The remainder of the wastewater produced in Mexico City, amounting 1,370 mgd (60,000 L/s), is reused with no treatment for the irrigation of 220,000 acres (90,000 hectares) in the Tula Valley (**Figure 1**). This is located 62 mi (100 km) north of Mexico City. Reuse has been performed, although not always officially, for more than 110 years and as a result the infiltration of the water used for irrigation (estimated in more than 570 mgd (25,000 L/s) has created new groundwater sources. These sources are used to supply the 500,000 people living in the Valley with municipal water, using only chlorination for treatment. The water has proven to be of acceptable quality (Jiménez and Chavez, 2004)

Figure 1
Use of water in Mexico City and the Tula Valley

thanks to several natural occurring treatment mechanisms that happen during its transport, storage, and infiltration into the soil. In fact, some pollutants such as heavy metals and emerging pollutants have been shown to remain in agricultural soils for several years or even decades (Siebe, 1995; Gibson et al., 2007; Duran et al., 2009).

Water Quality Standards and Treatment Technology

With regard to standards, the reuse of wastewater for agriculture has been regulated since the 1980s using criteria that were modified in 1986 (NOM-001-SEMARNAT 1986) to manage the quality of the treated water to control health risks, i.e., by limiting the fecal coliform content to 103 MPN/100 mL and 1 helminth egg/L for non-restricted irrigation or 5 helminth eggs/L for restricted irrigation. In addition, a higher content of BOD was allowed in order to improve the quality of agricultural soils while the amount of heavy metals was limited using values set out by the EPA, 2004 *Guidelines for Water Reuse*. There is no standard for the reuse of water for industrial purposes.

For public reuse, water standard NOM-003-SEMARNAT-1997 is in use, but this only covers restrictions for biological pollutants. To regulate the infiltration of reused water to groundwater, a relatively new standard (NOM-014-CONAGUA-2003) has been adopted. This basically only requires compliance with the Mexican drinking water standard prior to infiltration.

The planned reuse of wastewater for industrial and municipal purposes is always performed after at least secondary treatment coupled with filtration. The effluent produced has proven to be adequate for most uses, other than for the recharge of recreational lakes, notably the Xochimilco Lake, which is currently suffering from eutrophication. The power plant provides tertiary treatment to a secondary effluent at its own cost to avoid the formation of deposits in its cooling towers. To recharge the aquifer, treatment up to the tertiary level is provided, to remove suspended solids and organic matter. No data has been published with regard to effluent quality or its impacts on groundwater.

The massive reuse of wastewater for agricultural irrigation in the valley is performed with no treatment at all, although plans to treat the wastewater and its financing have been in place since the mid 1990s.

Project Funding and Management Practices

All investments for public projects have been through public funding. All but two wastewater treatment plants providing water to industries have been operated by private companies since the mid 2000s. Public reuse projects are managed by the water utilities of Mexico City and the municipalities, while the reuse of water on agricultural fields outside the Mexico City basin is operated by the federal government.

Institutional/Cultural Considerations

In general, society is aware of the reuse of water and considers it a positive practice. In fact, in the city there are many examples of people, forced by the lack of water, reusing wastewater from showers, or the washing of clothes for lawn irrigation or the manual flushing of toilets with graywater.

Successes and Lessons Learned

The main lessons learned are that relatively low risk practices for reuse have been readily accepted by a society that suffers from lack of water. However, possible future reuse projects, either in the form of new sources of water from the Tula Valley or the direct reuse of wastewater in Mexico City for drinking purposes, probably will not be accepted as easily for many reasons. Perhaps it is time for Mexico City to begin to plan to control, its urban growth.

References

- CONAGUA 2010 Water Statistics, SEMARNAT [In Spanish].
- Jiménez, B. and Chávez, A. 2004. Quality assessment of an aquifer recharged with wastewater for its potential use as drinking source: “El Mezquital Valley” case. *Water Science and Technology*, 50(2): 269–273.
- Jiménez, B. (2008) Water and Wastewater Management in Mexico City in Integrated Urban Water Management in Arid and Semi-arid Regions around the world. L. Mays Editor. *Taylor Francis Ltd.*
- Durán-Álvarez, J.C., Becerril E., Castro V., Jiménez B., and Gibson R. (2009) The analysis of a group of acidic pharmaceuticals, carbamazepine, and potential endocrine disrupting compounds wastewater irrigated soils by gas chromatography-mass spectrometry. *Talanta* 78(3):1159-66.
- Gibson, R., Becerril, E., Silva, V. and Jiménez B. (2007) Determination of acidic pharmaceuticals and potential endocrine disrupting compounds in wastewaters and spring waters by selective elution and analysis by gas chromatography – mass spectrometry. *Journal of Chromatography A*, 1169(1-2):31-39.
- Siebe, C. Heavy metal availability to plants in soils irrigated with wastewater from Mexico City, *Water Science and Technology*, 1995; 32 (12):29-34

Maneadero Aquifer, Ensenada, Baja California, Mexico

Authors: Leopoldo Mendoza-Espinosa, PhD, and Walter Daesslé-Heuser, PhD
(Autonomous University of Baja California)

Mexico-Ensenada

Project Background or Rationale

The Maneadero aquifer, one of four aquifers supplying water to the City of Ensenada, is located in the Mexican state of Baja California, where the annual average temperature is 63 degrees F (17 degrees C) and precipitation is 12 in/yr (299 mm/yr). Groundwater is extracted for supplying approximately 100,000 habitants and to irrigate 16,600 acres (6,714 hectares) of a variety of crops, most of which are exported to the United States. Overexploitation is calculated at 16,000 ac-ft/yr (20 Mm³/y) and has caused severe deterioration of groundwater due to saline intrusion (Daesslé et al., 2005). Ensenada is growing at a rate of 3.7 percent (INEGI, 1997) and so is the demand on water supply. Thus, there is the need for short-term strategies for the efficient use of water and the sustainability of the aquifer.

Ensenada has the advantage of being one of the few Mexican cities to treat all of its wastewater. A study conducted by Mendoza-Espinosa et al. (2004) determined that the El Naranjo wastewater treatment plant produces 5,000 gpm (316 L/s) of secondary effluent that can be safely used for agriculture irrigation yet it is being discharged to the ocean. In contrast, in central Mexico wastewater with little or no treatment is being used for the irrigation of crops for human consumption (Jiménez, 2005).

In order to explore and integrate water management alternatives such as water markets, reuse and seawater desalination, an optimization model was employed (Medellín-Azuara et al., 2007). The study indicated that reclaimed water for irrigation and aquifer recharge is the most economically promising alternative options to meet future water needs. Seawater desalination and new aqueducts are not economically viable alone, but may also have some utility if combined with other options for the region.

Only recently has there been Mexican legislation for planned artificial recharge through the standard NOM-014-CONAGUA-2003 (DOF, 2009). Studies by Reynoso-Cuevas et al. (2011) demonstrated that

reclaimed water complies with this norm, and could represent an alternative for stopping saline intrusion.

Capacity and Type of Reuse Application

The city of Ensenada has five wastewater treatment plants (WWTP), providing treatment to approximately 9,500 gpm (600 L/s) of wastewater. The main WWTP is called El Naranjo and has a treatment capacity of 8,000 gpm (500 L/s). It is located approximately 8 mi (13 km) north of the Maneadero aquifer. A 25-ft (7.6 m) pipe was built in 2008 connecting El Naranjo with a holding tank of 530,000 gallons (2,000 m³) at a cost of \$4.8 million U.S. dollars. The reclaimed water is intended to be used for crop irrigation although it could also be used for artificial aquifer recharge.

Water Quality Standards and Treatment Technology

According to Mexican legislation for wastewater disposal, for "land application" of wastewater (effectively crops irrigation) practically no treatment is necessary, hence its extensive use in Central Mexico. However, according to Mexican water reclamation standards, the reclaimed water must comply with standards similar to those required by California Law (Title 22) and suggested in EPA guidelines. The new Mexican norm for aquifer recharge requires that for direct recharge reclaimed water must basically comply with potable water standards; for indirect recharge, tests must be undertaken to demonstrate that the soil percolation would guarantee the safety and protection of the groundwater. Currently the city of San Luis Rio Colorado in the state of Sonora is the only Mexican city where artificial recharge of a local aquifer has been implemented. Ensenada has the potential for becoming the second city to achieve this goal.

Studies by Reynoso-Cuevas et al. (2011) demonstrated that Ensenada's wastewater does not appear to have high concentration of trace organic chemical contaminants like phenol and 10 of its derivatives, 16 polycyclic aromatic hydrocarbons and 7

aroclor. The concentration below analytical detection limits of these compounds indicates that their concentrations are not significant and/or that they are transformed to other metabolites through conventional wastewater treatment process. Risk minimization should certainly be the main element in the development of groundwater recharge project; results suggest that a combination of controls, such as wastewater treatment processes, water quality, recharge methods, recharge site and integral monitoring, would guarantee the success of the recharge operation and preserve a chemically safe groundwater. There is the potential for using the treated wastewater for direct injection to the aquifer although the high levels of total dissolved solids (TDS) in the aquifer 1.0-26.0 $\text{g}\cdot\text{l}^{-1}$ (Daessle et al. 2011) remains the biggest challenge for aquifer recharge. Its removal via membrane systems will probably be required. In view of the high salinity of the aquifer, the National Water Commission could grant a special permit even if the 1.0 $\text{g}\cdot\text{l}^{-1}$ TDS limit is exceeded in percolation water and only if a minimum distance of 0.62 mile (1 km) exists between the recharge site and the sites of drinking water extraction; further hydrogeological studies are being carried out by the authors to determine any potentially adverse effects to the aquifer.

Project Funding and Management Practices

Funding for Ensenada's WWTPs and the construction of the pipe that connects the Naranja WWTP with Maneadero has been provided by a combination of federal and state funds. Comisión Estatal de Servicios Públicos de Ensenada (CESPE) has provided funds since 1999 for Universidad Autónoma de Baja California (UABC) for the continuous monitoring of the quality of its WWTPs. All specific research studies have been conducted by direct involvement of UABC researchers. Government officials expect farmers to provide their own investment in order to connect to the current holding tank and, therefore, to be in a position to use reclaimed water for irrigation. On the other hand, it is unclear who would provide funds if reclaimed water is to be used for the artificial recharge of the Maneadero aquifer.

Although it has been demonstrated that water has an economic value (Medellín-Azuara et al., 2009) it appears that the availability of water, although of low quality due to high TDS as a result of saline intrusion

is still economically viable even when reverse osmosis is needed to obtain irrigation water suitable for crops. As TDS in the groundwater continue to increase, it may reach a point when this will be no longer viable and, thus, reclaimed water could be preferred for irrigation.

Institutional/Cultural Considerations

Farmers are unwilling to irrigate crops with high-quality reclaimed water because they believe that the United States will block them for exporting their produce. Several meetings have been undertaken promoted by the academic sector in order to facilitate information about reuse schemes in the United States, particularly in California. Nevertheless, farmers are reticent as they believe that even if they comply with U.S. standards for crop irrigation, farmers' organizations in the U.S. may block their produce arguing health risks. Moreover, the actual cost for farmers of the reclaimed water has not been clearly established. Hence, the actual implementation of the reuse scheme has not been reached.

Successes and Lessons Learned

As with many water reclamation projects, the scientific and technical aspects can be dealt with. In the Maneadero case, this has been done slowly but surely, often by own initiative of the academic sector. Federal and state governments have invested in wastewater treatment plants and in reclamation facilities. However, the actual implementation of the reclamation schemes has been hindered by economic/cultural reasons, as farmers are not willing to pay for reclaimed water, opting for the continuous extraction of underground water. Farmers also worry that their product will not be able to be exported to the United States if farmers unions in the U.S. find out that it is being irrigated with reclaimed water, despite its compliance with U.S. norms. It appears that this deadlock can only be resolved by continuing to reach consents between the government and farmers in which the academic sector can continue to be a facilitator and, by all means, undertaking the research to guarantee the adequate implementation of water reclamation schemes.

References

Daesslé LW, Sánchez EC, Camacho-Ibar VF, Mendoza-Espinosa LG, Carriquiry JD, Macías V. & Castro P. (2005) Geochemical evolution of groundwater in the Maneadero

coastal aquifer during a dry year in Baja California. *Hydrogeology J.*, 13, 584-595.

Daesslé L.W., Perez L., Mendoza-Espinosa L.G., Manjarrez E., Licona, A. (2011) An interdisciplinary study of a coastal aquifer under the perspective of its overexploitation and recharge with treated wastewater. 8th IWA's International Conference on Water Reclamation & Reuse, Barcelona, Spain, 26-29 September.

DOF - Diario Oficial de la Federación (2009). Norma Oficial Mexicana NOM-014-CONAGUA-2003, Requisitos para la recarga artificial de acuíferos con agua residual tratada. 18-agosto-2009.

Jiménez, B. (2005). Treatment technologies and standards for agricultural wastewater reuse: a case study in Mexico. *Irrigation and Drainage*, 54, S23-S33.

Medellín-Azuara, J., Mendoza-Espinosa, L. G., Lund, J. R., and Ramírez-Acosta, R. J. (2007). The application of economic-engineering optimization for water management in Ensenada, Baja California, Mexico. *Water Sci. Technol.* 55(1-2), 339-347.

Medellín-Azuara, J., Howitt, R., Waller-Barrera, C. Mendoza-Espinosa, L. G., Lund, J. R., and Taylor, J. E. (2009). A calibrated agricultural demand model for three regions in Northern Baja California. *Agrociencia*, 43(2), 83-96.

Mendoza-Espinosa LG, Orozco-Borbón MV & Silva-Nava P. (2004). Quality assessment of reclaimed water for its possible use for crop irrigation and aquifer recharge in Ensenada, Baja California, Mexico. *Water Sci. Technol.* 50(2), 285-291.

Reynoso-Cuevas, L., Mendoza-Espinosa, L. G. & Daesslé, L. W. (2011). Towards the implementation of planned artificial recharge in a coastal aquifer: the Maneadero case. 8th IWA's International Conference on Water Reclamation & Reuse, Barcelona, Spain, 26-29 September.

Tenorio Project: A Successful Story of Sustainable Development

Authors: Alberto Rojas (Comision Estatal del Agua), Lucina Equihua (Degremont S.A. de C.V.), Fernando Gonzalez (Degremont, S.A. de C.V.)

Mexico-San Luis Potosi

Project Background or Rationale

In San Luis Potosi, Mexico, wastewater is considered as an asset rather than as a disposable waste. In the late 1990s, the State Government of San Luis Potosi decided to implement an Integral Plan for Sanitation and Water Reuse to stop the use of raw wastewater in agriculture and foster the substitution of groundwater for reclaimed water for all non-potable uses. Currently, the state has built seven wastewater treatment plants (WWTPs) to treat 70 percent of wastewater and 100 percent of the treated wastewater is reused. The project has not only economical benefits but also a positive impact for the local community, in terms of public health and environment enhancement.

The reuse program and the industrial users funding/ payments gave the system economical viability while the augmented water resources become available for potable use. The largest WWTP and reuse operation (irrigation and industry) of the system is the Tenorio Project, a tangible example of how to build and operate a sustainable reuse system, water governance, balance between treatment and supply costs and water rates, performance and reliability.

Capacity and Type of Reuse Application

The Tenorio plant has a total capacity of 24 mgd (90,720 m³/d). The infrastructure consists of primary treatment enhanced with chemicals and a natural engineered polishing system in a 13.7 mgd wetland for agricultural irrigation of fodder crops.

The treatment required for industrial reuse was designed to supply make-up water for cooling towers in the "Villa de Reyes" Power Plant, focusing on saving

groundwater for the surrounding population. The industrial reuse relies on a 10.3 mgd treatment process using activated sludge with nutrient removal, tertiary treatment with lime softening, and sand filtration and ion exchange for silica and hardness removal.

The reuse system is comprised of a complex distribution system with several pumping stations, an irrigation network and a 24 mile (39 km) conveyance system with an equalization tank to adjust to the industrial hourly demand.

Water Quality Standards and Treatment Technology

The reclaimed water for irrigation meets standards established by Mexican Regulation. These standards (**Table 1**) require guaranteed values in terms of biochemical oxygen demand (BOD), total suspended solids (TSS), and fecal coliform, which were largely exceeded by the treatment chosen.

For the industrial reuse application, the standards were established as per the requirements of the Power Plant operation. The water quality should guarantee at least the same concentration cycles in the cooling towers obtained with the groundwater. Therefore, the most significant parameters were silica, hardness and phosphate content as well as conductivity. However, the Power Plant also set limits in BOD, TSS, ammonia, fecal coliform, and ferruginous bacteria, in order to avoid the increase in cost of conditioning products to prevent development of algae and bacteria. To meet the latest standards and to prevent biofilm growth in the distribution system, a non oxidant biocide control was implemented as a complement of the original treatment.

Table 1 Main water quality standards for agricultural and industrial reuse 2007-2011

| Parameter | Raw Wastewater* | Tenorio Tank Effluent to Reuse in Agriculture** | Criteria for Agricultural Reuse | Reclaimed Water to Power Plant* | Criteria for Industrial Reuse in Power Plant |
|-------------------------|---|---|---------------------------------|---------------------------------|--|
| TSS mg/L | 188 (±76) | 28.8 (±10.6) | 30 | 3.58 (±3.06) | 10 |
| BOD ₅ mg/L | 275 (±99.5) | 31 (±7.3) | 40 | 2.87 (±2.05) | 20 |
| COD mg/L | 518 (±259) | 84 (±19) | Not required | 15.8 (±14.45) | 60 |
| P _{TOTAL} mg/L | 8.7 (±3.9) | 6.5 (±0.2) | 15 | 1.3 (±0.9) | 2 |
| TKN mg/L | 32.6 (±9.6) | 22.3 (±5.1) | 25 | 1.5 (±3.87) | 15 |
| Fecal Coli /100 mL | 4.8.10 ⁹ (±1.3.10 ²) | 161 (±402) | 1000 | 18.4 (±16.6) | 70 |
| Total hardness mg/L | 111.3 (±19.3) | Not measured | Not required | 105.6 (±24.2) | 120 |
| Silica mg/L | 104 (±20.3) | Not measured | Not required | 64.9 (±9.3) | 65 |

Project Funding and Management Practices

The WWTP, the 24 mile (39 km) distribution system of treated water, an irrigation system for 1236 acre (500 Ha) and 37 mile (59 km) of sewer pipes required a total investment of \$67 million USD (May 2004). To guarantee reliability and long term operation, the project was built with a BOOT (build-own-operate-transfer) scheme and with 18 years of operation. The Mexican Federal Government provided 40 percent of the capital costs as a grant, while private funding provided the remaining 60 percent. Investment and operational costs are recovered by the collection of three tariffs: one for the private return of the investment, and the other two for the fixed and variable operational costs.

The Power Plant demand for reclaimed water allowed the San Luis Potosi State Water Commission (CEA) to undertake the investment risks. The income generated from this industrial reuse practically covers the total operation cost of the WWTP. Water reuse also accounts for an overall reduction of groundwater extractions, contributing to the aquifer sustainability.

Economic benefits to the Power Plant are also accomplished by a lower cost and more reliable quality of water coming from the WWTP. The fee collected for this reclaimed water is 0.23 USD/1000gal (0.85 USD/m³).

Institutional/Cultural Considerations

Industrial and economic development in San Luis Potosi has always been related to water availability and water conservation efforts. Since 1961, water withdrawal from the two main aquifers (San Luis Potosi and Jaral-Villa de Reyes) has been strongly

restricted and farmers used non-treated wastewater for irrigation purposes.

This particular project treats 43 percent of the total wastewater, and it is the first one in Mexico which makes possible the production of different qualities of treated water for multipurpose planned water reuse.

Local farmers considered themselves as the rightful owners of all the untreated water available. Farmers strongly opposed to any type of water treatment under the belief that it would reduce the nutrient content that served as fertilizer for their crops. CEA has negotiated with them the supply of better quality water and convinced them of the sanitary and economical benefits gained by using properly treated water.

Successes and Lessons Learned

In terms of public outreach, through local educational projects and participation in national forums, the Tenorio Project has already demonstrated how the economic and environmental benefits of reclaimed water are helping the city, farmers, and industry. Wastewater reuse provides industry with a water source which is 33 percent cheaper than groundwater. The high-quality water used for irrigation makes it possible for farmers to diversify crop production and reduce morbidity rate of intestinal and skin diseases.

At the same time, the significant restoration of the ecosystem in the Tenorio Tank, that initially received wastewater without treatment, was one the major successes of the project. The Tank functions as an artificial wetland that polishes and improves water quality. At present, migratory birds returned to nest in the surroundings of the wetland.

After 6 years of operation, this Project accounts for a net reduction of groundwater extractions of at least

40,000 ac-ft (48 million m³). Within the next 2 years, the system will be expanded with an additional treatment train with an RO unit. This expansion will allow the Villa de Reyes Power Plant to replace 100 percent of its water demand with reclaimed water and the San Luis Potosí water availability will be increased by 10 mgd when the power station transfers all their groundwater rights to the city, for potable use.

References

- Medellín P. (2003) *Tanque Tenorio, 10 años después, Pulso de San Luis Potosí*, 4a Edition
- Equihua L. O. (2006) *Reuso de agua en la agricultura y en la industria en México: Caso del Proyecto San Luis Potosí, Foro del Agua*, 2006
- Diario Oficial de la Federación (2009) *Actualización de la disponibilidad media anual de agua subterránea acuífero (2411) San Luis Potosí*, Estado de San Luis Potosí
- Díaz de León U. (2008) *Saneamiento integral y reutilización del agua en la ciudad de San Luis Potosí México*, Expo Zaragoza, 2008
- Rojas A. (2011) *Experiencia de reuso del agua tratada en la Zona Metropolitana de San Luis Potosí.*, Jornadas técnicas sobre la recarga artificial de acuíferos y reuso del Agua, Instituto de Ingeniería UNAM.

Figure 1
Aerial view of Tenorio Tank, WWTP, and land irrigated with reclaimed water (Photo credit: Degremont)



Figure 2
Tenorio Tank with different species of migratory birds (Photo credit: Degremont)

Faisalabad, Pakistan: Balancing Risks and Benefits

Author: Jeroen H. J. Ensink, PhD (London School of Hygiene and Tropical Medicine)

Pakistan-Faisalabad

Project Background or Rationale

The International Water Management Institute (IWMI) started a program in 2000 that aimed to quantify both the risks and benefits of wastewater use in Pakistan. For this purpose the city of Faisalabad was selected for a 5-year study program. This city was selected for a number of reasons: 1) over 6,200 ac (2,500 ha) of land is irrigated with domestic wastewater, and 2) even though a waste stabilization pond (WSP) was present, farmers preferred to use untreated wastewater. At the start of the study different cost (health risks) and benefits were identified for which separate studies were designed.

Capacity and Type of Reuse Application

The WSP in Faisalabad is located in a predominantly agricultural area and has been in operation since January 1998 and was constructed with the aid of an international grant. It covers an area of almost 250 ac (100 ha) and consists of six parallel anaerobic ponds and two series each comprising one facultative pond and two maturation ponds. The plant was designed for a wastewater flow of 24 mgd (90,000 m³/d) with an average influent biochemical oxygen demand (BOD) of 380 mg/L. BOD removal at the design stage, based on a total hydraulic retention time (HRT) of 16.5 days and calculated following standard procedures, was determined to be 80 mg/L. This would result in an effluent with BOD in compliance with the Pakistan Environmental Protection Agency's standard for the disposal of municipal and industrial wastewater effluents which is set at ≤80 mg/L.

Wastewater is pumped on a 24-hour basis from the main sewerage network into a primary drain bringing wastewater to the WSP. Local farmers, following extensive legal cases and now with permission from the local Water and Sanitation Authority (WASA), have installed five permanent outlets in the primary drain to convey untreated wastewater to their existing irrigation

networks. Farmers were reluctant to use treated effluent as they claimed it was unsuitable for use in agriculture as it was much lower in nutrients and much higher in salinity (as a result of massive evaporation from the WSP) than untreated wastewater.

Approximately 290 farming households paid annual fees totaling USD \$7,500 (440,000 Pakistan rupees) to the WASA to use wastewater. The main crops cultivated with wastewater were fodder, wheat, and vegetables. The vegetables included: spinach, cauliflower, eggplant, chilies, and tomatoes.

Farmer Perception and WSP Performance

A 1-year study showed a strong increase in salinity from untreated wastewater to final effluent with a clear decline in nitrogen concentration, thereby confirming farmer perceptions. The performance of the WSP was poor and did not comply with WHO and FAO guidelines for irrigation water. The poor performance of the WSP could be attributed to a combination of factors: poor design, the extreme climatic conditions, which causes evaporation exceeding 0.4 in/day (10 mm/day) during several months of the year. Also the large quantities of untreated wastewater that were diverted for agricultural irrigation by farmers meant that the hydraulic retention time was more than doubled due the reduced amount of raw wastewater inflow.

Water Quality

The water used for irrigation was untreated wastewater with high concentrations of *E. coli* (geometric mean: 1.8x10⁷ CFU/100 mL) and helminth eggs (over 950 eggs/L) and exceed international standards, though no official wastewater use standards were adopted by the state of Pakistan.

Risks to Farmers

The health risks of wastewater use in agriculture were investigated through a cross-sectional study. The

study showed an increased risk of intestinal nematode infection, and in particular hookworm infection, in wastewater farmers (OR = 31.4, 95% CI 4.1-243) and their children (OR = 5.7, 95% CI 2.1-16) when compared to farming households using regular (non-wastewater) irrigation water, though the prevalence of infections was low (Ensink, 2005). In addition an increased risk of *Giardia intestinalis* infections was found within the wastewater farming communities, though the large majority of infections were found to be asymptomatic (Ensink, 2006). The study further found elevated levels of heavy metals in soil irrigated by untreated wastewater but levels remained within permissible guidelines set by international agencies. No elevated levels of heavy metals were found in edible parts of agricultural produce (Ensink, 2008).

Farmer Benefits

During the study farmers using different types of irrigation water (untreated wastewater, and 'normal' [non-wastewater] irrigation water) were followed. Crop choice, crop yields, water use and fertilizer applications were monitored for all selected farmers for the duration of a year. Farmers using untreated sewage were found to grow crops of higher value (predominantly vegetables), have a higher cropping intensity per hectare and finally and most important only applied fertilizer through wastewater, with minimal amounts of chemical fertilizer. On average a farmer using untreated wastewater had an income that was US\$ 600/ha higher than a farmer that used normal irrigation water (Ensink, 2007)

Risks to Consumers

The risk to consumers were quantified in a year-long study in which produce grown on untreated wastewater was analyzed for the presence of *E. coli* and helminth eggs. At time of harvest one batch of sample was collected from the fields and the same batch of vegetables was followed up and collected at the local market the next day. The study found that slow growing vegetables had the highest levels of contamination, though in general contamination levels were low with on average 1.9 *E. coli*/gram of produce. Higher concentrations of *E. coli* (14.3 *E. coli* g-1) were recovered from the vegetables collected from the market, with the results of the survey suggesting that unhygienic post harvest handling was the major source of produce contamination (Muhktar, 2008).

The construction of WSP has been suggested to pose a risk to urban populations as the large reservoirs could provide breeding sites to disease vectors. The WSP in Faisalabad was found to generate large amounts of mosquitoes; most notably the vectors of malaria, Japanese encephalitis, dengue, and lymphatic filariasis (Ensink, 2007). However mosquito breeding was predominantly associated with emergent grasses and the absence of grids within the WSP. Removal of grasses and the reinstallation of the grids reduced mosquito breeding to almost zero (Ensink, 2007)

Benefits to Consumers

A comparative analysis of food prices found that locally grown wastewater irrigated cauliflower was almost 50 percent cheaper than produce irrigated with non-wastewater water brought into the city (Ensink, 2007).

Risks and Benefits to Downstream Water Users

A nationwide survey in Pakistan found that only 2 percent of all cities with a population of over 10,000 inhabitants had wastewater treatment facilities, and in those that did have wastewater treatment facilities at maximum 50 percent of all wastewater received some form of treatment. In addition in 80 percent of all cities in Pakistan untreated wastewater seemed to occur, and occurred in all cities that had a sewerage systems (Ensink, 2004).

As a result of natural occurring salinity approximately 50 million people in Pakistan rely on irrigation canals for their domestic water supply, including drinking (Van der Hoek, 2001). In the absence of wastewater treatment, wastewater is disposed of untreated into irrigation canals and rivers, thereby exposing downstream water users to unknown health risks.

Lessons Learned

The Faisalabad case study shows that wastewater use for crop production is a practice with many benefits. It sustains livelihoods of poor peri-urban farming families, contributes to urban food security, helps in solving the urban sanitation problem by preventing pollution of surface water, and makes optimal use of the resources (water and nutrients). The health risks associated with wastewater use in agriculture to farmers and consumers of produce can be reduced by proper irrigation water management and implementa-

tion of existing public health measures, even when wastewater treatment is not feasible. It is therefore paramount that when wastewater treatment facilities are planned, farmers' views need to be taken in consideration.

References

- Ensink, J.H.J., et al., High risk of hookworm infection among wastewater farmers in Pakistan. *Trans R Soc Trop Med Hyg*, 2005. 99(11): p. 809-18.
- Ensink, J.H., W. van der Hoek, and F.P. Amerasinghe, *Giardia duodenalis* infection and wastewater irrigation in Pakistan. *Trans R Soc Trop Med Hyg*, 2006. 100(6): p. 538-42.
- Ensink, J.H.J., R.W. Simmons, and W. van der Hoek, Livelihoods from wastewater: water reuse in Faisalabad, Pakistan, in *International survey on water reuse*, B. Jimenez and T. Asano, Editors. 2008, International Water Association Publishing: London, UK.
- Ensink, J.H., T. Mahmood, and A. Dalsgaard, Wastewater irrigated vegetables: market handling versus irrigation water quality. *Trop Med Int Health*, 2007. 12 Suppl 2: p. 2-7.
- Ensink, J.H., et al., Simple intervention to reduce mosquito breeding in waste stabilisation ponds. *Trans R Soc Trop Med Hyg*, 2007. 101(11): p. 1143-6.
- Ensink, J.H.J., et al., A nation-wide assessment of wastewater in Pakistan: an obscure activity or a vitally important one? *Water Policy*, 2004. 6: p. 197-206.
- Mukhtar, M., et al., Importance of waste stabilization ponds and wastewater irrigation in the generation of vector mosquitoes in Pakistan. *J Med Entomol*, 2006. 43(5): p. 996-1003.
- Van der Hoek, W., et al., Irrigation water as a source of drinking water: is safe use possible? *Trop Med Int Health*, 2001. 6(1): p. 46-54.

Friends of the Earth Middle East's Community-led Water Reuse Projects in Auja

Author: Elizabeth Ya'ari (Friends of the Earth Middle East)

Palestinian Territories-Auja

Project Background or Rationale

The Village of Auja is located adjacent to the Jordan River just north of the City of Jericho. It is a small community of 4,500 residents, well known in Palestinian society due to the nearby Auja Spring, where an estimated 9 million cubic meters (m^3) (7,300 ac-ft) of water annually flows out of the desert rocks. The oasis created by the Auja Spring attracts thousands of visitors each year.

In close partnership with the community and the Auja Municipality, Friends of the Earth Middle East (FoEME) established its Jordan Valley Environmental Education Center with guest house facilities in 2010 (**Figure 1**). The center has quickly become a central institution of Auja and a focal point for environmental awareness for visitors and students about the geology, fauna, flora, water resources, and cultural heritage of Wadi Auja and the Jordan Valley as a whole.

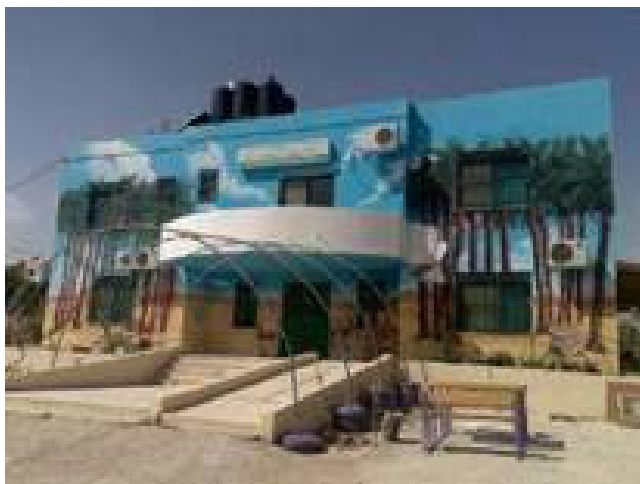

Figure 1
FoEME's Auja Environmental Education Center

Capacity and Type of Reuse Application

The center was designed at the outset to include educational demonstration model water reuse installations including a graywater treatment system. These systems reduce water consumption, save costs and scarce resources, provide a source of irrigation water for the center's trees, and serve as educational models in action for visitors to the center.

The center's graywater reuse system treats graywater generated by the guest house and center's kitchen and bathroom sinks and showers for reuse in irrigating trees in the center's grounds. The system includes two parallel filtration systems, with 10 containers each, connected in a series (**Figure 2**). The system acts as a series of constructed wetlands, whereby in the first 8 containers gravel and phragmites (similar to bamboo) filters the graywater, followed by a gravel and sand composite in the 9th container, and finally an all sand-filled container for the last stage. The treated water is held in a 35.3-ft^3 (1-m^3) storage container, where an automatic pump pushes the treated water through the drip-irrigation system at the center. At full capacity the system can treat an estimated 8,000 gallons (30 m^3) of water a day.



Figure 2
Graywater reuse system

Project Funding and Management Practices

The water reuse system cost approximately \$5,000 US and was funded by the U.S. Agency for International Development (USAID) and other donors as part of their support for the Auja Environmental Education Center. It has been operational for a year and is quickly becoming a model installation for water reuse projects for private homes in Auja and throughout the West Bank.

To ensure the project's replication and sustainability, FoEME produced a graywater installation manual (Figure 3) and led a training course at the center in which dozens of area residents were training in the installation and maintenance of graywater systems (Figure 4).



Figure 3
FoEME's graywater system installation manual in Arabic



Figure 4
Graywater workshop for youth at Auja Center

Institutional/Cultural Considerations

Trainings, seminars, and workshops at the Auja Center have involved a total of 384 people with an additional 3,318 youth and adults receiving an environmental education experience as part of their visit to the Auja EcoCenter in the last 6 months. Building on the success of this wastewater solution for the Palestinian community of Auja, Osprey Foundation agreed to support the installation of graywater systems at homes throughout the community of Auja.

Successes and Lessons Learned

Building on the success of this wastewater solution for the Palestinian community of Auja, Osprey Foundation agreed to support the installation of graywater systems at homes throughout the community of Auja.

Assessing Water Reuse for Irrigation in Huasta, Peru

Authors: Daphne Rajenthiram (CDM Smith); Elliott Gall and Fernando Salas (University of Texas); Laura Read (Tufts University)

Peru-Huasta

Project Background

The rural community of Huasta is located in the southern portion of the district of Huasta, within the Bolognesi province of the Ancash region Peru (Figure 1). A key organization within Huasta is the Campesina Community. The Campesina Community may be thought of as a “Homeowners Association,” where members collectively decide how community resources (land, agriculture, livestock etc.) will be utilized, managed, and distributed to participating members.



Figure 1
Location of Huasta, Peru

As a proactive response to the persistent dry summers, five communities (including Huasta) have formed the Tres Cuencas Commonwealth for the sole purpose of collectively mitigating water issues within these communities. This collaborative effort initiated by the communities themselves has presented a unique opportunity for Engineers without Borders Greater Austin Chapter (EWB-AUS) to get involved. The five communities in the commonwealth are populated with indigenous Andeans, who are traditional small-scale farmers and ranchers who live closely in shared residences with their neighbors. Residents live in courtyard-type dwellings where the kitchen and common areas are shared. Houses in Huasta are typically set up with a central courtyard that connects the sleeping rooms, kitchen, and washing area. Huasta has a central plumbing system with flush toilets implemented in combination with the community wastewater treatment plant built approximately 6 years ago.

The community of Huasta has a vested interest in improving water availability in the area, as it is a driver for economic success. The community owns a number of livestock, primarily cows whose milk is sold regionally to produce cheese. Since cows require grass to graze on throughout the year, and the summer months provide little to no rainfall, limited water resources are further stressed during the dry season. The President of the community and a representative from the agricultural water committee identified water for irrigation in the dry season as their major concern for continuing to expand their dairy production. Members of the community own parcels of land that are permitted for use for grazing animals.

Type of Reuse Application

The municipality of Huasta and the Campesina Community conveyed their interest in a water reclamation project to EWB-AUS during the initial program assessment in August 2011. They were particularly interested in the idea as it would increase the area of productive land in the community and draw

from a currently unused resource. The project may also improve on current flood irrigation techniques and promote water conservation gains through an enclosed pipe to transport irrigation water for flood, spray, and/or drip irrigation systems.

The purpose of the follow-up assessment trip in January 2012 was to determine the feasibility of utilizing reclaimed water from the community wastewater treatment plant to irrigate a 0.405-ac (1-ha) community-owned pasture. This land is currently not served by the community's irrigation network as it is at a higher elevation than the canals that provide water during the dry season (from June-August). The current treatment train at the wastewater treatment plant (WWTP) (**Figure 2**) consists of a headworks grate at the influent inlet, three sedimentation basins in parallel, two clean out tanks in parallel, followed by a sand filtration (currently bypassed) structure. EWB-AUS is currently analyzing viable and feasible options to improve water quality of the effluent including getting the sand/gravel filter bed operational, increasing the residence time at the sedimentation tanks, etc. From the plant inspection made in January of 2012, it was observed that if the treatment structures are operated as intended, the water quality of the effluent will be satisfactory for irrigating a grass field which will be used to graze the community livestock.



Figure 2
Existing WWTP

WQ Standards

To our knowledge, two levels of reuse regulations exist for Peru, the first stipulates minimum requirements for WWTP effluent. The other Peruvian rule defines reuse

requirements for watering animals. But no national regulation exists for irrigation reuse.

Also, the World Health Organization (WHO) recommends treatment processes for restricted and unrestricted irrigation. The team was guided by the WHO Guidelines for the Use of Wastewater in Agriculture to ensure that the existing WWTP meets or exceeds the requirements for non-contact irrigation (WHO, 1989).

Project Funding and Management Practices

Funding for the EWB-Peru project for travel, materials, installation, etc. has and will be raised by the local EWB-AUS. Also, if the reuse project proceeds as planned, a wastewater committee will be formed consisting of the local Campesino Community members. This committee will be expected to collect community tax, as applicable, and will be the decision making authority over the long-term operation and maintenance of the reuse system. The committee's role is crucial for this project's sustainability. The project team travelling this summer is planning to educate the proposed committee on importance of maintaining the WWTP and the impact of operation/maintenance of the plant on the effluent quality. As a part of this workshop, the members of the wastewater committee will be trained in monitoring the effluent quality for bacterial population and biochemical oxygen demand (BOD).

The project is currently managed by EWB-AUS members working in conjunction with The Mountain Institute (TMI), a local non-profit organization in Peru for coordination and input from the community in the decision making process of the project.

Stakeholder Involvement

Existing effluent water quality data was collected by the team and presented to the community and the local municipality (**Figure 3**). Since the bacterial population in the effluent is exponentially higher than recommended levels, the travel team accepted the request from the community to create a maintenance and monitoring plan for the WWTP to improve treatment and effluent quality. Currently, EWB-AUS is working on preparing a maintenance plan and monitoring kit designed to train the local community members to properly operate and maintain the WWTP.



Figure 3
Community meeting

Successes and Lessons Learned

The positive outcome from the assessment trip was identifying the need to educate the community on the importance of the operation and maintenance of the WWTP. The fate of the reuse project depends on the results from the continued plant monitoring against WHO standards (mainly bacteria and BOD) that is to be performed by the Huasta community. The feasibility of the reuse project depends upon the data collected from monitoring. EWB-AUS will continue to work with the community of Huasta throughout this project.

References

WHO (1989) *Health Guidelines for the Use of Wastewater in Agriculture and Aquaculture. Report of a WHO Scientific Group*, Technical Report Series No. 778, WHO, Geneva.

MINAM. 2008. *Arpueba los Estandares Nacionales de Calidad Ambiental para Agua*. Decreto Supremo N° 002-2008-MINAM.

Wastewater Treatment and Reuse for Public Markets: A Case Study in Sustainable, Appropriate Technology in the Philippines

Authors: Mary Joy Jochico (USAID) and Ariel Lapus (USAID PWRP Project)

Philippines-Market

Project Background or Rationale

Public markets in the Philippines and around Asia pose significant challenges for wastewater treatment due to the relatively high strength of the discharges and variability of flows. The Muntinlupa Public Market, located in Muntinlupa City in the southern part of Metro Manila, is one of the largest public markets in the metropolitan area with 1,448 stalls and 24 hours a day operation (**Figure 1**). Wastewater generated at Philippine public markets tends to be very high strength and land available for treatment is generally quite small, necessitating a unique solution.



Figure 1
Location of water reuse – the Muntinlupa
City public market

With support for planning and design provided by the United States Agency for International Development (USAID) through the Local Initiatives for Affordable Wastewater Treatment (LINAW) project, the city constructed a treatment facility that began operating in

February 2006. In addition to treating wastewater from the public market, the system incorporates a water recycling system that allows reuse of the treated effluent for flushing toilets, watering plants and street cleaning. In addition to Muntinlupa, the LINAW project is assisting six cities in the Philippines to build wastewater treatment facilities for public markets using appropriate, low-maintenance technologies

Capacity and Type of Reuse Application

The wastewater generated from the public market contains high levels of organic matter (more than 600 mg/L biochemical oxygen demand [BOD]) and solids classifying it as high-strength wastewater. The wastewater is from the market comfort rooms (sinks and toilets) and from cleaning/rinsing of fish, meat, poultry, vegetables, etc. The treatment system that was designed for the Muntinlupa Public Market Wastewater Treatment Facility is an innovative combination of anaerobic and aerobic treatment coupled with filtration to meet local discharge standards. Since the available land area for the treatment system was very small, the solution was to place the 5,646 ft² (160 m³) treatment system underneath a parking lot. The water recycling system treats 0.055 mgd (210 m³/day) of wastewater per day, of which 50 percent is discharged to Laguna de Bay Lake, and 50 percent is reused for flushing toilets, watering plants, and street cleaning. This technology is being applied elsewhere in the Philippines and is suitable for other locations in the region.

Water Quality Standards and Treatment Technology

The technology is low-cost and low-maintenance, costing a third less to construct and nearly half of the monthly operation and maintenance costs of a conventional (activated sludge) plant. The system is an anaerobic baffled reactor coupled with a sequencing batch reactor, followed by media filtration

and disinfection. Wastewater enters the tank from the bottom of the first zone of the anaerobic baffled reactor (ABR) where a granular sludge blanket is formed. As the wastewater flows upwards through the sludge blanket, organic particles are trapped and degraded by the anaerobic bacteria present in the sludge blanket. With each pass through subsequent chambers, the wastewater is further treated. When it arrives in the sequencing batch reactor (SBR), atmospheric oxygen is mixed with the flow to produce a highly treated oxygenated effluent. The final step is secondary clarification followed by disinfection using chlorine injection to meet local discharge standards. **Figure 2** shows the final stage of treatment - filtration through coco-peat, a waste product from coconut husk processing. Another project was demonstrated in the public market in which a container of 'coco-peat,' is used as a wastewater treatment filter. This is now being replicated for wastewater treatment in two schools in Muntinlupa City.



Figure 2
The public market was also the demonstration site of the use of "coco-peat" for wastewater filtration

The Philippine Revised Effluent Regulations of 1990 (DAO-35) sets national requirements for treated wastewater discharge into various receiving water body classes. New or proposed industries and wastewater treatment plants that will discharge to Class C (inland waters) must meet the following effluent standards (in addition to other limits for toxic compounds), as shown in **Table 1**.

Table 1 Philippine DAO-35 Class C wastewater discharge requirements

| Parameter | Unit | Class C Requirements |
|---|-------------|----------------------|
| Color | Pt-Co units | < 150 |
| Temperature (max rise in degree Celsius in RBW) | °C rise | <3 |
| pH (range) | | 6.5 – 9.0 |
| COD | mg/L | < 100 |
| Settleable Solids (1-hour) | mg/L | < 0.5 |
| 5-Day 20°C BOD | mg/L | < 50 |
| Total Suspended Solids | mg/L | < 70 |
| Total Dissolved Solids | mg/L | — |
| Surfactants (MBAS) | mg/L | < 5.0 |
| Oil/Grease (Petroleum Ether Extract) | mg/L | < 5.0 |
| Phenolic Substances as Phenols | mg/L | < 0.1 |
| Total Coliforms | MPN/100mL | < 10,000 |

All required parameters are being met by the system.

Project Funding and Management Practices

The system was installed over a 7-month period and cost 6.8 million Philippine pesos (P) (\$130,000). The ongoing operating costs are P 27,000 per month, but an overall savings of P 15,000 per month is realized because of lower overall water consumption at the market.

Muntinlupa City formed a Lake Management Office (LMO) whose function is to manage and protect a portion of the nearby lake. Covering a total area of 14,589 ac (5,904 ha), the LMO took over operations of monitoring and controlling pollution of the lake area, implement environmental laws, regulating structures in the lake community and serving the fishermen who relied on the lake for their livelihood; The Local Government passed Local Ordinance No. 02-070 which stipulates proper disposal of wastewater and gives strict sanctions/fines for noncompliance.

Two employees regularly monitor the operation of the facility and report any problems that will occur during the operation to the Muntinlupa Public Market Cooperative.

Cost recovery is through a daily charge of \$0.10 to individual stall owners. Mr. John Emmanuel Pabilonia, LINAW Team Leader for Muntinlupa City, confirmed that since its operation in 2006 Muntinlupa City has fully recovered the cost of the construction and the fees sustain the operation and maintenance of the facility.

Institutional/Cultural Considerations

As part of this project, a demonstration was done to help inform the public and policy makers about the unique solution and application of water reuse. The public market also hosted a demonstration project to show the public how a container full of coco-peat is used as a filter for final treatment in some wastewater treatment schemes being installed in two schools in Muntinlupa City (**Figure 2**). As part of the start-up of the system, former Muntinlupa City Mayor Jaime Fresnedi was asked to inaugurate the public market wastewater treatment plant by turning on a faucet of treated water for reuse (**Figures 3 and 4**).

The LGU's key partners include USAID's Local Initiative for Affordable Wastewater Project and the public market cooperative as direct stakeholder.

Successes and Lessons Learned

This project was able to demonstrate that proper incentives and identifying economic drivers can motivate local governments to prioritize environmental protection. In the case of Muntinlupa City, capital investment for environmental protection was not necessarily a high priority of the local government but with increased awareness on the environmental and health impacts of pollution along with the technical assistance that showed that capital investments can be recovered through user charges, the local government willingly paid for the construction of the wastewater treatment plant.

References

Revised Effluent Regulations of 1990. 1990. Department of Environment and Natural Resources (DENR) Administrative Order (DAO)-35, Government of the Republic of the Philippines. Retrieved April 4, 2012, from <http://www.emb.gov.ph/laws/water%20quality%20management/dao90-35.html>.



Figure 3
LINAW Team Leader for Muntinlupa City John Emmanuel Pabilonia and former Muntinlupa City Mayor Jaime Fresnedi inspect the construction of the public market treatment facility.



Figure 4
Former Muntinlupa City Mayor Jaime Fresnedi, with former Environment Secretary Elisea Gozun (behind the Mayor) inaugurates the public market wastewater treatment plant by turning on a faucet of treated water for reuse.

Use of Wastewater in Urban Agriculture in Greater Dakar, Senegal: “Adapting the 2006 WHO Guidelines”

Author: Seydou Niang, PhD (Cheikh Anta Diop University of Dakar)

Senegal-Dakar

Background

Although the city of Dakar, Senegal, is located in a developed zone of favorable micro-climate and hydrology, its ecosystem is very sensitive (permeable sandy soil, shallow groundwater level). Furthermore, in the coastal aquifer (Thiaroye) northeast of Dakar City (**Figure 1**), severe problems concerning groundwater quality occur: 1) salinization due to seawater intrusion or dissolution of salts in the unsaturated zone, and 2) degradation from anthropogenic contamination (septic tanks leaking, latrines, urban agriculture). An important increase in nitrate concentration and salt load are the most pronounced impacts (Pfeifer and Niang, 2009).

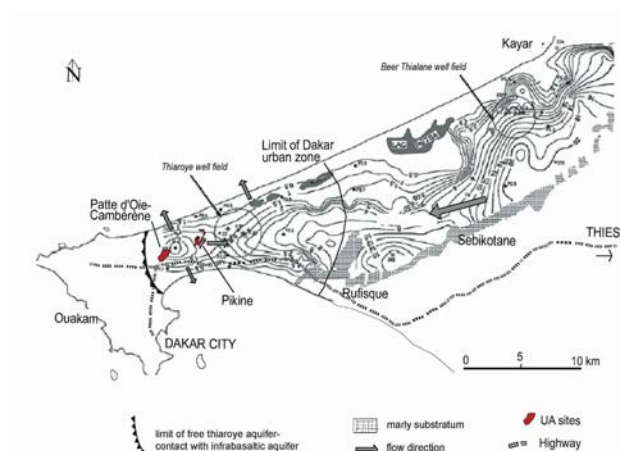

Figure 1
Hydrogeology and field situation (Pfeifer and Niang, 2009)

The scarcity of good quality freshwater resources in and around the city has led local populations to make greater use of wastewater in urban agriculture. Reuse of wastewater helps to sustain the city's thriving agriculture sector. Indeed, urban agriculture in and around Dakar is critical to the city's economy and livelihoods, ensuring more than 70 percent of the city's fresh vegetable supply and employing thousands of people (Ndiaye, 2009). This greater use of wastewater nonetheless imposes costs. Irrigation with wastewater, enhances salt accumulation in soils that releases to the shallow groundwater (Kass et al., 2005; Leal et al.,

2009; Vengosh, 2003) and leads to microbiological contamination of crops, soils, groundwater and increases health risks for farmers, handlers and consumers (Ndiaye, 2009).

Project Rationale

This project sought to understand 1) how livelihoods and health of the local population could be improved through analysis of microorganisms and parasites from their source (wastewater, manure) to the markets where the produced vegetables are sold, and 2) how current urban agricultural practices (such as amendments, irrigation, use of pesticide) influence the environment, in particular the soil and groundwater quality.

The main result of the study was to provide policy makers with new guidelines based on the recommendations of WHO in 2006. The goals of these guidelines are, in terms of microbiological reduction, 6-7 \log_{10} pathogen reduction through sets of measures:

- Wastewater treatment with 3-4 \log_{10} pathogen reduction
- Die off (delay between last irrigation and harvesting) with 3-4 \log_{10} pathogen reduction
- Washing of produce with 1 \log_{10} pathogen reduction

Capacity and Type of Reuse Application

The main wastewater reuse site in urban agriculture in Dakar is Pikine. Of Pikine's total cultivated area of approximately 120 acres (50 ha), about 40 acres (16 ha) makes use of raw wastewater for irrigation. Usually, farmers divert wastewater from the sewage using pipes to load narrow wells located in their plot (**Figure 2**). From that well, they use water cans to irrigate crops such as lettuce, which grow rapidly—a crop characteristic that is important to farmers without

secure land tenure. This practice of raw wastewater reuse for irrigation is being reduced due to upgrades/expansion of the city sewage system performance.

Water Quality Standards and Treatment Technology

In Senegal, the law which regulates wastewater use in agriculture is the Hygiene Code. It stipulates in its article 41 (Law N° 8371 of July 5, 1983) that dumping of rubbish or discharge of wastewater is forbidden on all lands where fruits and vegetables consumed raw are grown, where the edible parts are grown in contact with the rubbish or wastewater. Organic fertilizers, manure, and compost cannot be utilized within one month before harvesting. Fruits and vegetables should be soil free. If washing of fruits or vegetables is necessary, only potable water can be used, which then must be properly drained for disposal. (Gaye and Niang, 2010).



Figure 2
Loading narrow well with raw wastewater (Gaye and Niang, 2010)

This law, inspired by the 1992 WHO guidelines, needs to be updated based on the new WHO vision that now considers epidemiological risks instead of focusing on the calculation of microbiological concentration levels in irrigation water and vegetables. Currently, WHO recommends a set of measures to reduce risks related to the use of wastewater in urban agriculture.

Using the 2006 WHO guidelines, the study tested the viability of using three types of lagoon systems. The first treatment line is a combination of four ponds of

530 gallons (2 m³) in series: two stabilization ponds, one pond planted with Cattail, and an immersed gravel filter pond. A surface and subsurface inverse vertical flow system circulates the water through the system. The second treatment line, with the same number and size of ponds, consists of one stabilization pond followed by three reed-planted ponds with free water surface and surface water flow. The third treatment line has one stabilization pond and three planted filters with *Vetivera* sp. For *E. coli*, all treatment lines achieved 4 log units reduction, and for *Ascaris* eggs 100 percent removal was achieved everywhere (Niang *et al.* 2009).

Institutional/Cultural Considerations

The local land tenure situation constitutes the biggest obstacle to investments of farming improvements and expansion. While there is one Council Order that provides some protection for local access to land, farmers often lack clear legal right to specific plots. As a result, plots are often taken and used for housing; therefore, farmers are reluctant to make medium to long-term investments.

A clear policy statement by public health officials concerning the use of wastewater under certain conditions will help farmers secure a more formalized status rather than potentially being in violation of the law.

As farmers are placed under the stress of losing their plot because of housing or their harvest because of hygiene issues, they prefer fast growing crops like lettuce.

Successes and Lessons Learned

In applying the 2006 WHO guidelines to Pikine, the following results were achieved:

- Treatment of wastewater with the three lagooning systems showed total removal of parasites and achieved 3-4 log unit reduction of *E. coli*.
- A two-day delay between last irrigation and harvesting of lettuce achieved 77 percent reduction of roundworm eggs on lettuce (from 35 eggs/g to 8 eggs/g) and 1 log unit reduction for *E. coli*.
- Twenty-six percent of farmers who were provided with masks, gloves, and boots had

roundworm infection compared 50 percent of farmers who did not use protective equipment.

- For disinfection of lettuce with bleach at the household level, 42 women have been involved in the test. We advised the use of one capsule (cap of the bottle) of bleach at 8° (around 6 mL = 0.2 fluid ounces) in 2.6 gallons (10L) of tap water (7.6 mg Cl/L) as a solution for disinfection of lettuce being soaked for 30 minutes before rinsing with tap water. The results have shown only 12 percent of women had lettuce still contaminated with *E. coli*.

References

- Gaye, M. Niang, S. 2010. Manuel des bonnes pratiques de l'utilisation saine des eaux usées dans l'agriculture urbaine. FAO/LATEU/Enda Rup. ISBN 92 91 30079 9.
- Gueye-Girardet, A. 2010. Evaluation des pratiques d'irrigation, de fertilization et d'application de pesticides dans l'agriculture periurbaine de Dakar, Sénégal. Thèse de doctorat. Faculté des Géosciences et de l'Environnement. Institut de Minéralogie et de Géochimie. Université de Lausanne.
- Kass, A., Gavrieli, I., Yechieli, Y., Vengosh, A. and Starinsky, A., 2005. The impact of freshwater and wastewater irrigation on the chemistry of shallow groundwater: a case study from the Israeli Coastal Aquifer. *Journal of Hydrology*, 300(1-4): 314-331.
- Leal, R.M.P., Herpin, U., da Fonseca, A.F., Firme, L.P., Montes, C.R. and Melfi, A.J., 2009. Sodicity and salinity in a Brazilian Oxisol cultivated with sugarcane irrigated with wastewater. *Agricultural Water Management*, 96(2): 307-316.
- Ndiaye, M.,L. 2009. Impacts sanitaires des eaux d'arrosage de l'agriculture urbaine de Dakar (Sénégal). *Terre et Environnement*. Vol. 86. Insitut Forel/ Département de Minéralogie/Départemen de Géologie et Paléontologie. Section des Sciences de la Terre, Université de Genève.
- Niang, S., Epoté, M., Mfoné, N., Pfeifer H. R., Ndiaye, M.,L., Gueye-Girardet, A., Diarra, K., Gaye, M. L., Dieng, Y., Niang, Y., Tall H. 2009. Effectiveness of three constructed wetlands for treatment of faecal sludge liquid at the experimental plant of LATEU-IFAN Ch.A.Diop/Dakar. Scientific report. FNS Switzerland.
- Pfeifer, H. R. and Niang, S. 2009. Use of wastewater in urban agriculture in the Dakar area, Senegal: an interdisciplinary study towards sustainability Scientific Final report. Project FNS Switzerland 2005-2009.
- Vengosh, A., 2003. Salinization and Saline Environments. In: B.S. Lollar (Editor), *Environmental Geochemistry. Treatise on Geochemistry*. Elsevier-Pergamon, Oxford.

The Multi-barrier Safety Approach for Indirect Potable Use and Direct Nonpotable Use of NEWATER

Author: Harry Seah, MSc and Chee Hoe Woo, MSc (PUB Singapore)

Singapore-NEWater

Project Background or Rationale

Singapore, being a small island city-state of about 270 square miles (700 square km) and a population of 5 million, has no natural aquifers or groundwater, and relies on rainfall from catchments and raw water imported from the neighboring Johor state in Malaysia. These sole water sources, however, are subject to the vagaries of nature, leaving Singapore vulnerable to water shortages.

In order to achieve a sustainable and robust water supply to meet increasing water demand, Singapore has diversified its water sources, termed the 4 National Taps, namely:

- Imported water from Johor, Malaysia
- Local catchment water
- NEWater
- Desalinated water

NEWater, high grade reclaimed water of drinking water standards, is key to achieving water sustainability in Singapore because of the multiplier effect through infinite recycling within the water system.

Capacity and Type of Reuse Application

Currently, NEWater is supplied from five NEWater factories in Singapore, with total capacities of 122 mgd (554,600 m³/day). The total capacities of the NEWater factories are projected to reach some 192 mgd (873,000 m³/day) by 2020.

Because it is ultra clean, NEWater is ideal for industry use, such as wafer fabrication processes. NEWater is mostly used for direct nonpotable use (DNU) into wafer fabrication and electronics industries, where the necessary water quality is more stringent than that for drinking, as well as in commercial and institutional complexes for air-conditioning cooling purposes. This frees up potable water for domestic use.

In addition, NEWater supplements Singapore's potable water supply via planned indirect potable use (IPU). Planned IPU involves blending NEWater with raw reservoir water, and then subjecting the blended water to the same conventional water treatment process as raw reservoir water to produce potable water.

In February 2003, the Public Utilities Board (PUB), the national water agency of Singapore began pumping 2 mgd of NEWater into reservoirs for IPU. It was increased progressively to about 2.5 percent of total potable water consumption in 2011.

Treatment Technology and Water Quality Standards

NEWater is produced from treated used water (wastewater) that is purified further using advanced membrane technologies and ultraviolet (UV) disinfection, making the water ultra-clean and safe to drink.

The U.S. Environmental Protection Agency (EPA) Primary and Secondary Drinking Water Standards (Safe Drinking Water Act) and WHO Drinking Water Quality Guidelines are the benchmarks set for NEWater quality.

Project Management Practice

To ensure that NEWater is of a quality safe for IPU, the multiple safety barrier approach is rigorously adopted through enforcement, plant design, plant operation, plant maintenance and water quality monitoring.

This approach is audited bi-annually by an External Audit Panel comprised of 2 experts from the local tertiary institution and 5 overseas experts of international standing, and also by an Internal Audit Panel.

The multi safety barrier approach starts from the source and extends to taps in households in the following stages:

- Source control at the industries to ensure the used water received at the water reclamation plants (WRPs)¹ will be fully treated and provides a consistent good quality secondary effluent as feedwater for NEWater production;
- More than 85 percent of used water is used from domestic sources to provide additional safety through dilution
- Comprehensive secondary wastewater treatment is used to provide consistent good quality effluent for NEWater production
- Microfiltration (MF)/Ultrafiltration (UF) process, reverse osmosis (RO) process, and ultraviolet (UV) disinfection in NEWater production
- Natural attenuation in surface reservoirs
- Conventional water treatment process of coagulation, flocculation, sand filtration and disinfection

The approach is further enhanced by a Sampling and Monitoring Programme (SAMP), which covers the entire delivery chain of NEWater to determine the suitability of NEWater for IPU and DNU; and a strict operating philosophy.

The SAMP is comprised of a comprehensive physical, chemical and microbiological sampling and analysis of water samples. To-date, 300 parameters are monitored including emerging contaminants of concern listed in the USEPA Priority List of Contaminants.

The operating philosophy adopted in NEWater factories is based on operating with reference to the baseline performance of the plants. Such mode of operation is to maintain the water quality of the treated permeate close to the expected baseline readings, which are well within the WHO Drinking Water Guidelines and EPA Drinking Water Standards, during the daily operations.

NEWater Quality

Since the operation of the first membrane (demonstration) plant began in year 2000 to produce

NEWater, water analysis through grab sampling and on-line monitoring has shown consistently that NEWater quality is of drinking water standards, even as the membrane ages over the expected life span of 5 years.

Table 1 shows the NEWater quality of selected parameters, out of the 300 parameters currently monitored for NEWater under the SAMP.

Institutional/Cultural Considerations

An important part of the NEWater success story is its high public acceptance. This was achieved through a long and extensive public education program done in various phrases.

Before NEWater's launch, extensive briefings were held for critical groups, which comprised of community leaders, business communities and government agencies. An educational tour was also organized to bring the media from Europe and the United States to observe the various places where water reuse has been practiced for many years. A documentary on the technology of NEWater and the water reuse experience of other countries was also produced and televised.

Successes and Lessons Learned

NEWater is the product of years of investment in used water infrastructure and research on water technologies. Countries interested in water reuse on a municipal scale would need to have a comprehensive used water infrastructure in place.

Accurately pricing the reclaimed water is also crucial for the reuse program's long term financial sustainability.

¹ Water Reclamation Plants in Singapore refer to treatment plants that provide secondary treatment to wastewater, via the activated sludge process.

Table 1 Quality of NEWater since year 2000

| Parameter | Unit | Analytical Methods | Detection Limits | Value |
|------------------------------------|------|--------------------------|------------------|-----------|
| Physical Parameter Controls | | | | |
| TOC | µg/L | Sievers 820 TOC Analyser | 20 | 40 to 100 |
| SS | Mg/L | USEPA 160.2 | 2.5 | <2.5 |
| Turbidity | NTU | USEPA 180.1 | 0.1 | <0.1 |
| Trace Contaminants | | | | |
| Total estrogen | µg/L | NGCMS_1124 | 0.003 | <0.003 |
| Estrones (E1) | µg/L | NGCMS_1124 | 0.001 | <0.001 |
| 17β-estradiol (E2) | µg/L | NGCMS_1124 | 0.001 | <0.001 |
| Ethinylestradiol (EE2) | µg/L | NGCMS_1124 | 0.001 | <0.001 |
| Ibuprofen | µg/L | LC-MS/MS | 0.005 | <0.005 |
| Naproxen | µg/L | LC-MS/MS | 0.005 | <0.005 |
| Gemfibrozil | µg/L | LC-MS/MS | 0.005 | <0.005 |
| N-nitrosodimethylamine (NDMA) | ng/L | PTV-GC/MS | 2 | <2 to 10 |
| 1,4 Dioxane | µg/L | USEPA 8270C | 1 | <1 |
| Methyl Tertiary Butyl Ether (MTBE) | µg/L | USEPA 8260B | 5 | <5 |
| Polychlorinated biphenyls (PCBs) | µg/L | USEPA 8082 | 0.2 | <0.2 |

Public acceptance is crucial to the success of such projects. It is thus critical to translate complex technical jargon into terms that are easily understood by the public. In order to sustain people's acceptance of NEWater, the NEWater Visitor Centre was set up in early 2003 to for the visitors to appreciate the philosophies and technologies used in the production of NEWater.

Moving forward, the production costs of NEWater can be further lowered through the adoption of new technologies, such as using membrane bioreactors (MBR), which will consume less energy, and will result in lower costs.

References

- Asian Development Bank website. 2011. Retrieved on Sept. 6, 2012 from <http://www.adb.org/features/harry-seah-making-unthinkable-drinkable>.
- H. Seah, T. P. Tan, M. L. Chong and J. Leong. 2008. NEWater—Multi Safety Barrier Approach for Indirect Potable Use. *Water Science & Technology: Water Supply*, Vol 8 No 5 pp 573–588
- Public Utilities Board (PUB) website. 2011. Retrieved on Sept. 6, 2012 from <http://www.pub.gov.sg/Pages/default.aspx>.
- U.S. Environmental Protection Agency (EPA). 2006. National Primary Drinking Water Regulations.
- World Health Organisation. 2006. First addendum to Guidelines for Drinking-Water Quality (3rd edition). Vol.1 Recommendations.

Turning Acid Mine Drainage Water into Drinking Water: The eMalahleni Water Recycling Project

Author: Jay Bhagwan (Water Research Commission)

South Africa-eMalahleni Mine

Project Background or Rationale

Population growth, rising service levels and economic development means that in many parts of South Africa, demand for water is growing faster than the supply available.

In a first for South Africa, a pioneering public-private partnership (PPP) between eMalahleni Local Municipality and two leading coal mining companies (BHP Billiton and Anglo Coal) has led to the establishment of a major mine water reclamation plant. Acidic, saline, underground water from four nearby coal mines is treated and purified to drinking water standards and supplied to the Municipality.

This type of collaboration between two large mining corporations has few precedents in South Africa, and highlights the growing importance attached to responsible environmental management. This innovative partnership has averted a water supply crisis in eMalahleni. At the same time, a major water contamination problem and environmental hazard has been transformed into a valuable resource which meets the needs of a range of users, safely and reliably.

Capacity and Type of Reuse Application

The eMalahleni Municipality is the main user and now receives 4.2 million gallons (16 megalitres) of safe, treated drinking water each day from the reclamation plant to boost domestic water supplies. Since April 2009, this amount increased to 5.3 million gallons (20 megalitres) per day. The outcome of this solution is based on ten years of research by Anglo Coal into water quality management options identifying a range of possible treatment technologies. No less than 13 different treatment technologies to remove heavy metals and sulphates were evaluated in demonstration projects. In 2004, Anglo Coal short-listed seven technologies for further evaluation, and after extensive investigation, opted for a technology that relied on advanced membrane desalination. The key

advantages of this technology were low life-cycle costs, a high rate of water recovery (greater than 99 percent), and waste streams suitable for reprocessing and reuse.

A 31,700 gallons (120 m³/day) pilot plant began in 2005 to test the technology rigorously over a three month trial. Its performance exceeded expectations and Anglo Coal moved swiftly to develop a much larger plant, able to deliver 5.3 million gallons (20 megalitres) a day of potable water, with further capacity to provide safe industrial-grade water for routine mining operations.

Water Quality Standards and Treatment Technology

The treatment process is designed to produce water quality, which meets South African National Standard for Drinking Water Quality (SANS 0241 Class 0 potable water) and uses the High Recovery Precipitating Reverse Osmosis (HiPRO) process from which low salinity product water is generated by the membrane process. This design's chief characteristic is that it makes use of reverse osmosis to concentrate the water and produce supersaturated brine from which the salts can be released in a simple precipitation process. The project's schematic is shown in **Figure 1**.

This technology offers the following key advantages:

- Very high recovery
- Simple system configuration
- Easy operation
- Low operating costs
- Low capital costs
- Minimum waste

The plant is designed to treat 6.5 mgd (25 megalitres/day) of acid mine drainage (AMD) with a recovery consistently greater than 99 percent, producing potable water with a guaranteed total dissolved solids (TDS) of under 450 mg/L (SABS

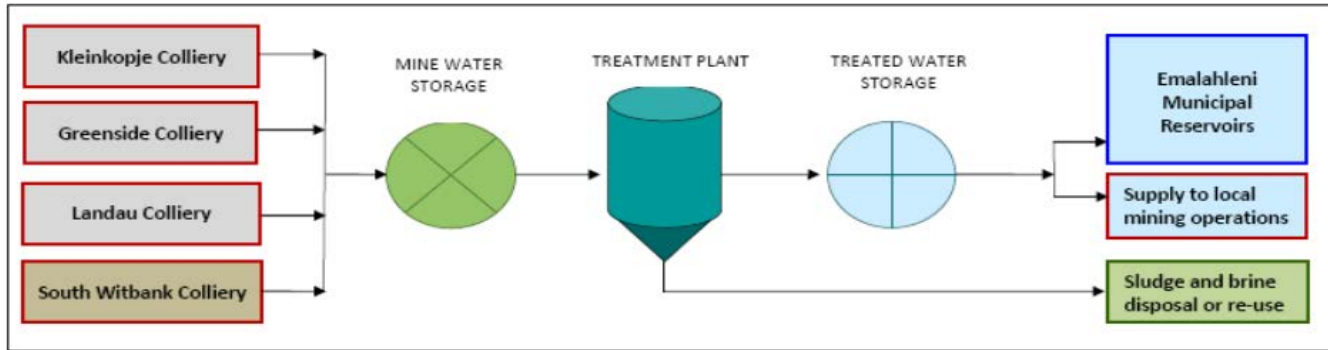

Figure 1
Schematic diagram of key component of the reclamation approach (Source: Gunther and Mey 2006)

Class 0). The treated water is stored in two large concrete reservoirs before being pumped to a municipal reservoir for distribution to users in eMalahleni. Additional water is piped to a number of Anglo Coal sites for domestic use and for mining activities such as dust suppression.

By-products of the treatment process are 26,400 gallons (100 m³) of brine and 100 tons (90,700 kg) of gypsiferous waste each day. Plastic-lined evaporation ponds are used to concentrate the brine further and Anglo Coal is exploring a number of cost-effective options for re-use. Gypsum-based wastes will be used in building construction, and the intention is to establish a market for gypsum-based building products on a large scale.

A second phase, completed in 2010, added a further 2.1 to 2.6 mgd (8-10 megalitres/day) of industrial quality water for use on nearby mines and plans are in place to increase the capacity to 13 mgd (50 megalitres/day).

Project Funding and Management Practices

Financing of this option of treating acid mine water was way beyond the means of the municipality, and any proposed alternatives for augmentation had a long lead period before any water was supplied. The fact that the client eMalahleni Municipality realized this constraint and the constraint of managing such an advanced technology, the only lucrative option was this long term arrangement to purchase the water. The mines needed to continue to dewater to sustain its ongoing operation and where in a better position to raise the capital, based on the all-round benefits which were envisaged to accrue. The purchase of the treated

water made the project viable for the mining companies, while meeting the municipality's urgent need for additional water supplies. Ingwe Collieries owns South Witbank Colliery, where mining activities ended in 1969. In 2005, BECSA's Ingwe Collieries entered a Joint Venture with Anglo Coal to develop the R296 million eMalahleni Water Reclamation Plant.

Successes and Lessons Learned

The water reclamation plant and project offers a number of direct benefits. For the municipality, over and above an additional assured supply of clean water, perhaps the three most important benefits are cost-effectiveness, delivery of safe drinking water that requires no further treatment, and the technical expertise and financial resources of two major mining companies who funded the plants' capital cost of nearly US \$43 million. For the mines, there is a small financial loss in subsidizing this treated water of the cost of treatment is US \$1.50 per 264 gallons (m³) and sold to the Municipality for US\$1.00 per 264 gallons (m³). However the environmental and social gains are much higher in that they have avoided serious future environmental damage.

References

- Mr. Peter Gunther, Project Manager, Anglo Coal (personal communication)
- P. Gunther and W. Mey. 2006. "Selection of Mine Water Treatment Technologies for the eMalahleni (Witbank) Water Reclamation Project," unpublished paper presented at the 2006 Bi-ennial WISA Conference.

Durban Water Recycling Project

Author: Jay Bhagwan (Water Research Commission)

South Africa-Durban

Project Background or Rationale

Water supply sources within South Africa are becoming ever more limited, while the need for alternative solutions is becoming increasingly more important with reuse becoming more attractive over traditional solutions.

The city of Durban in the Ethekeeni municipality, located on the east coast of South Africa, was faced with the challenge of sewage capacity constraints and the high cost of constructing a new outflow or marine outfall pipeline. They put together plans to increase capacity by building a duplicate sewer line, but found that the costs of wastewater disposal would be too high. The other option available was effluent recycling for reuse. However, even this option posed a financial and technical management challenge. The solution that emerged is an example of a Public Private Partnership (PPP) that harnesses the synergies of the partners to achieve an outcome that is unprecedented in the water industry in South Africa. The projects demonstrate innovative approaches to the sustainable development of water resources, minimization of water consumption and environmental pollution, and the achievement of technically challenging water and wastewater treatment goals. The result was the construction of a secondary waste water treatment plant and a water recycling plant, aimed at treating and supplying treated effluent to a level which was acceptable to an industrial recipient (Mondi Paper Mills) funded and managed through a partnership with the private sector Veola Water Services (VWS). This demonstrated that by pooling resources and expertise in a PPP, and by focusing on long-term sustainability goals, all participants can benefit, including the environment.

The Durban Water Recycling Project demonstrates that innovative approaches to water resource management, environmental management, wastewater treatment technology and institutional arrangements can yield exceptional results.

Capacity and Type of Reuse Application

The resulting solution was a plant consisting of an upgrade of the existing activated sludge process from 12.9 mgd to 19.9 mgd (50 megaliters/d to 77 megaliters/d), the construction of a new 12.3 mgd (47.5 megaliters/d) tertiary plant (**Figure 1**), refurbishment of the high level storage tank and the installation of the reclaimed water reticulation system. This solution produced treated effluent (12.1 mgd or 47 megaliters/d) for reuse in industrial application. Mondi uses the reclaimed water for the production of fine paper and is extremely sensitive to processed water quality and its impact on paper brightness.



Figure 1
Construction of the Durban Wastewater Recycling Plant (Photo credit: Ethekeeni Metro Water Services)

Water Quality Standards and Treatment Technology

The technology produces reuse water of a quality which has to comply with 32 contractually specified parameters based on regulatory requirements. The activated sludge process is a conventional design and serves to remove 95 percent of the incoming COD and 98 percent of the incoming ammonia loads. Typically, activated sludge plant effluent COD and ammonia concentrations are 15 mg/L and 0.2 mg/L respectively. The first step in the tertiary treatment process is lamella settling. Poly Aluminum Chloride (PAC) is placed in the water leaving behind the lamella settlers and is employed for the removal of iron. The final

reclaimed water achieves iron levels of 0.04 mg/L, which is five times lower than the South African standards for class 1 potable water (SABS 241:1999). The dual media filtration step is the last solids removal barrier in the process. Iron precipitate is removed in the dual media filter. The final step is ozonation used to break up the remaining non-biodegradable organic compounds, including color causing compounds. Mondi Paper's reclaimed water specification includes 23 parameters that are measured in the South African potable standard (SABS 241:1999) of these parameters; Mondi's specification meets or exceeds the potable standard for 77 percent of the parameters for class 1 potable water. In practice, VWS operationally meets or exceeds the Class 1 potable standard for 96 percent of the parameters. The Class 1 potable water standard gives the water quality levels that are known to be acceptable for lifetime human consumption.

Project Funding, Management Practices, and Benefits

The preliminary and primary wastewater treatment process is comprised of screening, degritting and primary settling operations; performed by Ethekweni Metro Water Services (EMWS). Meanwhile, the effluent from the primary settling tank is fed to the activated sludge plant operated by VWS. The funding of the capital for upgrade and new technologies, as well as the risks of meeting the water quality is undertaken by VWS under a 20 year production, operation and transfer concession. The incentive rested on the fact that the industry partner was prepared to accept a treated effluent water quality at a tariff, which was attractive and with offered high supply assurance. For the private sector it was a financially viable proposition, and for the municipality there were significant benefits to be achieved.

For EWS, the project has delayed capital investment for the increased marine outfall pipeline capacity; it also has delayed capital investment for future bulk potable water supply infrastructure. There was no capital investment and risks associated with the recycling plant; and a long term revenue stream from a levy raised on the production of recycled water was created thereby reducing cost of water services to Durban's citizens.

For Mondi the benefits were a 50 percent reduction on normal industrial water tariffs, representing a

significant cost saving in Mondi's paper production. The project provided a higher assurance of water supply for the functioning of Mondi and greater security in terms of additional water requirements.

Successes and Lessons Learned

The success of the project demonstrated a true partnership between the public and private sectors and the success of the partnership lies in the mobilization of the inherent strengths of both sectors. Some of these key outcomes are as follows:

At operational capacity 12.3 mgd/47.5 megaliters/d) the reclamation plant will meet 7 percent of the city's current potable water demand and will reduce the city's treated wastewater output by 10 percent. EWS currently treats 121.3 mgd (470 megaliters/d) of wastewater. Of this volume, approximately 200 51.6 mgd (megaliters/d) is discharged into the sea as screened and degrittied wastewater. The reclamation project reduces the city's total treated wastewater discharge by 10 percent and reduces the partially treated load on the marine environment by up to 24 percent. Further, the volume of potable water saved on a daily basis afforded the opportunity to extend supply to up to 220,000 households in the greater Durban area.

Individually the water treatment steps employed in the Durban Water Recycling process are relatively standard in terms of water industry technologies. Together, however, the treatment steps create a highly specialized process, tailored specifically to meet the quality requirements of the main client, Mondi Paper Mills. The treatment of raw wastewater from both domestic and industrial sources to a potable standard, within the financial pressures of the business environment, is a significant technical achievement.

This 20-year concession project was the first PPP of its kind in South Africa. Within the South African context, the project broke new ground in its approach to manage and implement water projects and may be regarded as model for future PPPs in South Africa, and possibly elsewhere. The acceptance of PPPs and the involvement of the private sector in business opportunities for the provision of water services in South Africa are enhanced by the success of the Durban Water Recycling Project.

This project has also changed the way industry in South Africa views wastewater. Sewage is no longer

regarded simply as a waste product, but a beneficial resource spurring many new initiatives which have unlocked innovation and technology.

References and Sources

Fischer, P. (2001), Submission for the Visionary Client award 2001, South African Association of Consulting Engineers. Stewart Scott (Pty) Ltd.

Kuck, K., Freeman, M., Gisclon, A., Marche, O.(2002), Water Reclamation Project in an Environmentally Stressed Area. Technical poster paper presented at the 2002 WISA Biennial Conference.

SABS. (1999), South African Bureau of Standards Specification Drinking Water. SABS 241:1999

Sagren, Govender., personal communication. General Manager – Veola Water, VWS Envig Pty Ltd., Sagren.govender@veoliawater.com.

Risk Assessment for *Legionella* sp. in Reclaimed Water at Tossa de Mar, Costa Brava, Spain

Authors: Rafael Mujeriego, PhD (Universidad Politécnica de Cataluña) and Lluís Sala, (ConSORCI Costa Brava)

Spain-Costa Brava

Project Background or Rationale

Tossa de Mar is a Mediterranean coastal resort city in southern Costa Brava (Girona, NE Spain) and member of Consorci Costa Brava (CCB), the water supply and sanitation agency for Costa Brava. Tossa de Mar's population goes from 6,000 people in winter to 60,000 people in summer. Its drinking water use is 264 mgd (1 m³/year), of which 20 percent comes from local sources and the remainder from external sources: 52 percent is groundwater from the Tordera river aquifer and 28 percent is desalinated water from Blanes desalination plant, both located 9 miles (15 km) southwest. Tossa de Mar was one of the leading cities in Costa Brava to recognize the benefits of turning wastewater into reclaimed water. Reclaimed water is now a new municipal water resource for non-potable use, with lower production and conveyance energy requirements than the conventional sources.

Capacity and Type of Reuse Application

The water reclamation plant (WRP) of Tossa de Mar has a capacity of 0.22 mgd [35 m³/hr (840 m³/day)] upgradable to 0.89 mgd (140 m³/hr). The current WRP capacity represents 13 percent of the potable water use during the peak tourist season. It includes: coagulation-flocculation, lamella settling, rapid sand filtration, and a combined disinfection process with sodium hypochlorite and UV light. Reclaimed water is stored in a 185,000 gallon (700 m³) tank, where it is further chlorinated and mixed, and then pumped to the reclaimed water distribution system. Reclaimed water use for street cleansing and public garden irrigation began in 2003 by water tanks loading at a hydrant located at the doorstep of the WRP. By 2007 a reclaimed water distribution system was already in operation. The pipeline was brown in color with a blue plastic film that says "Atención: Agua no potable". By mid 2011, the distribution system had reached a length of 3.5 miles (5.7 km) after an investment of US \$477,000 (365,000 €) from municipal and regional

government sources. The distribution system provides reclaimed water to the main municipal services and landscape areas, fire hydrants, and other publicly-owned facilities, such as the county's dog shelter (Figure 1) as well as to public spaces in new residential areas. In addition, landscape irrigation with reclaimed water at the Sa Riera Park is indirectly supplying recharge water flows to the local stream, avoiding its total summer desiccation and protecting its fragile aquatic ecosystems.



Figure 1
Reclaimed water use at Tossa de Mar dog shelter
(Photo credit: Lluís Sala)

Water Quality Standards and Treatment Technology

Spanish water reclamation and reuse regulations are established by Royal Decree 1620/2007. Reclaimed water quality is defined by four main parameters: parasitic helminth eggs, *E. coli*, suspended solids, and turbidity. Other micro-biological parameters, like *Legionella* sp. and physico-chemical parameters are applicable to specific uses of reclaimed water. Compliance is determined by the 90 percentile (P90) of the series of water quality parameters recorded during a water reuse period. Applicable limits for current reclaimed water uses in Tossa de Mar are

those for unrestricted urban use (Quality Use 1.2) with SS, turbidity, parasitic helminths and *E. coli* P90 concentration limits below 20 mg/L, 10 NTU, 1 egg/10L and 200 cfu/100mL, respectively. Future mid-term plans include the supply of reclaimed water for irrigation of private gardens, which requires compliance with quality limits for unrestricted residential use (Quality Use 1.1): P90 values below 10 mg/L for SS, 2 NTU for turbidity, 1 egg/10L for parasitic helminths and absence of *E. coli* (cfu/100 mL).

Since 2007, CCB is conducting an extensive assessment of the overall *Legionella* infection risk posed by the use of reclaimed water for irrigation of urban and private gardens, following the Technical Guidelines for the Prevention and Control of Legionellosis established by the Spanish Ministry of Public Health and Consumer Affairs. These technical guidelines are used to assess such public health risk, based not only on the microbiological quality of the water (concentration of total aerobic bacteria, TAB < 105 cfu/mL), but also on several other parameters and characteristics of the materials used in the distribution and application system, such as pipelines and sprinklers, among others. The upper limit of this index is 100 and anything below 60 is considered to be a “low infection risk” condition.

The studies conducted since 2007 indicate that: 1) TAB concentrations increase as water flows away from the point at the WRP where sodium hypochlorite is applied; 2) changes in TAB concentrations along the network system provide valuable information on how to manage the regrowth process and to maintain the network within the safety limits required by the Technical Guidelines; and 3) the overall infection risk resulting for spray irrigation in urban areas, considering the most unfavorable points of use (sprinklers) and under the most unfavorable microbiological conditions recorded, is just below 60 units, the limit officially set for “low infection risk” conditions.

This monitoring program also provided useful information for determining whether re-chlorination is needed and where to apply it. Furthermore, Tossa de Mar complies with the requirements of Royal Decree 865/2003 (2003) relative to the prevention and control of Legionellosis, by systematically cleaning and

disinfecting all the sprinklers under its responsibility, whether they use drinking or reclaimed water.

Project Funding and Management Practices

The investment completed so far amounts to US \$477,000 (365,000 €), which was provided by the Catalan Water Agency (CWA), CCB, Girona’s provincial government and the city of Tossa de Mar. Operation and maintenance of the water reclamation plant has been assured by CCB, while operation and maintenance of the reclaimed water distribution system has been assured by the city’s technical services. CCB is completing the official permitting process necessary to become a wholesale reclaimed water producer and supplier as prescribed by CWA. At that time, CCB will be able to establish the appropriate supply contracts with cities, which will be responsible for managing the technical and economic aspects of reclaimed water distribution to end users. In the event that CCB becomes a wholesale supplier, the responsibilities will be the same, as delegated under Spanish Water Reuse Regulations (RD 1620/2007).

Institutional/Cultural Considerations

The use of reclaimed water in Tossa de Mar was prompted by the severe drought of the late 1990s and early 2000s. The high quality of reclaimed water and the clear benefits of its use for non-potable uses quickly raised a very positive perception from local and seasonal residents. Since then, CCB has promoted a high quality branding through CCB’s website, municipality website, and Facebook page, of the non-potable use of reclaimed water in Tossa de Mar. Technical personnel wear white lab coats while conducting the on-site water testing and sampling, which has improved the citizen’s perception of the high microbiological and aesthetic quality of reclaimed water (**Figure 2**).



Figure 2
Reclaimed water quality monitoring in Tossa de Mar
(Photo credit: Lluís Sala)

Successes and Lessons Learned

Water scarcity and the favorable assessment of the energy balance of the municipal water cycle were the main factors for the project development. The quick and effective response of municipal services in close collaboration with CCB and the CWA were instrumental for the project success. The high reclaimed water quality, its high quality branding, the systematic follow-up studies and the educational programs implemented have all contributed to assure a very positive perception and acceptance from local and seasonal residents. The very favorable results of the *Legionella* risk assessment study have paved the way for the extension of the use of reclaimed water to irrigation of private gardens and possibly the supply of reclaimed water for toilet flushing in the very near future.

References

- Ministry of Public Health and Consumer Affairs (2003). Royal Decree 865/2003 on the Hygienic and Public Health Criteria for the Prevention and Control of Legionellosis. BOE no. 171, pp. 28055-69. Retrieved on Sept. 7, 2012 from <<http://www.boe.es/boe/dias/2003/07/18/pdfs/A28055-28069.pdf>>.
- Ministry of Public Health and Consumer Affairs. Technical Guidelines for the Prevention and Control of Legionellosis in Facilities. Retrieved on Sept. 7, 2012 from <<http://www.msc.es/ciudadanos/saludAmbLaboral/agenBiologicos/guia.htm>>.
- Ministry of the Environment, Rural and Marine Affairs (2007). Royal Decree 1620/2007 about the Spanish regulations for water reuse. Boletín Oficial del Estado núm. 294, pp. 50639-61. Retrieved on Sept. 7, 2012 from <<http://www.boe.es/boe/dias/2007/12/08/pdfs/A50639-50661.pdf>>.
- Water Reuse Project of Tossa de Mar, CCB (2011). WaterReuse Barcelona 2011. Retrieved on Sept. 7, 2012 from <<http://www.waterbcn2011.org/download/Water%20Reuse%20Project%20of%20Tossa%20de%20Mar.pdf>>.

Sam Pran Pig Farm Company: Using Multiple Treatment Technologies to Treat Pig Waste in an Urban Setting

Authors: Pruk Aggarangsi, PhD (Energy Research and Development Institute-Nakornping, Chiang Mai University, Thailand)

Thailand-Pig Farm

Project Background or Rationale

In Thailand, there are numerous pig farms which must treat the pig effluent in order to meet the standards set by the Pollution Control Department (PCD) of Thailand's Ministry of Natural Resources and Environment (MNRE) (MNRE, 2005). This case study illustrates the use of Upward-flow Anaerobic Sludge Blanket (UASB) reactors as adopted by one pig farm, the Sam Pran Pig Farm, in Nakhon Pathom Province, located approximately 40 miles (65 km) southwest of Bangkok.

Capacity and Type of Reuse Application

The Sam Pran Pig Farm Company raises between 5,000 and 8,000 pigs at a time, ranging from 22 to 220 pounds (10 to 100 kg) each, with an average size of 130 lbs (60 kg). The pig farm has 18 single level, open pig stables with an average size 45 ft by 280 ft (13.5 m by 85 m). The pigs generate solid fecal matter at a rate of 860 lb/day (390 kg/day) and liquid waste including urine, stable wash water and fecal liquid run off at a rate of 29,000 gallons (110 m³/day). All waste generation is collected daily.

The farm utilizes two sets of channel digesters (CDs) each integrated with a UASB reactor plus additional subsequent treatment steps (including aeration and water hyacinth ponds) to process wastewater. These reactors produce biogas (methane and carbon dioxide) via an anaerobic decomposition process that eliminates more than 90 percent of the biochemical oxygen demand (BOD) and chemical oxygen demand (COD). The system also removes most solids from the wastewater. The waste is converted into fertilizer, biogas and water for washing the pig barns.



Figure 1
Composition of the system at Sam Pran (from top to bottom): channel digester and solids drying beds for use as fertilizer, aeration tank, water hyacinth pond, and biogas-fueled generator.

Treatment Technology

The top industrial uses of UASBs include treatment of wastewater from breweries, distilleries, other beverage and fermentation operations, the food processing industry, and pulp and paper operations. While UASBs are generally used in many applications for rapid treatment of wastewater with high BOD, the treatment system for Sam Pran farm is specially designed by Chiang Mai University to cope with specific pig waste. The system consists of one channel digester with serial-integrated UASB module running at 6-7 days Hydraulic Retention Time (HRT).

Wastewater Treatment System Performance

After a 6-month system stabilization period, the performance of the system was measured. The system produced 440-880 lbs (200-400 kg) per day of fertilizer, 7,000 to 14,000 cubic feet (200-400 m³) biogas per day (which produces 300-600 kW.h per day of electricity) and 26,400 gallons (100 m³) per day of recycling water acceptable for washing the pig barns. The performance of the treatment system is designated in **Table 1**.

Project Funding and Management Practices

In 2004 when Sam Pran farm initialized the project, a total investment cost of the digester, approximately 3.0 million THB (\$100,000 USD), 20 percent is funded by Energy Conservation Fund through Livestock biogas subsidizing program by Thailand Ministry of Energy. The farm owner has to cover the rest of the investment including the land and electricity generation equipment.

Institutional/Cultural Considerations

The project seems to be a best model in practice for collaboration between community, local government and academia to find and implement the best solution to this difficult waste management problem.

Successes and Lessons Learned

Sam Pran farm founded their business more than 30 years ago in the area designated as the pig raising community away from the residential area. The growth of city's population forced an expansion of the residential area in all directions. Currently, Sam Pran farm is located in the city's municipal area. Thus, the farm has to conform to strict regulations in terms of effluent and odor control in order to continue their business. Anaerobic digesters were their only option in both the technical aspect and land use effectiveness.

References

Ministry of Natural Resources and Environment. 2005. *Pig Farm Effluent Standards*, Royal Thai Government Gazette, Vol. 122, Sec. 125-, December 2005, pp. 14-17.

Energy Research and Development Institute-Nakornping, 2008, *Internal Report on Biogas Subsidizing Program*.

Table 1 Performance of installed CMU CD+UASB System in Sam Pran Farm

| Parameters | Digester Influent | Flow Leaving UASB towards Aeration Tank | Final Discharge | Thailand Waste Water Standard |
|-------------------------|-------------------|---|-----------------|-------------------------------|
| pH | 7.1 | 7.7 | 7.8 | 5.5-9.0 |
| BOD ⁵ (mg/L) | 3,245 | 86 | 327 | 100 |
| TCOD (mg/L) | 1,513 | 306 | 65 | 400 |
| TKN (mg/L) | 463 | 397 | 261 | 200 |
| TSS (mg/L) | 812 | 150 | 59 | 200 |

TKN = Total Kjeldahl nitrogen (i.e. the combination of organically bound nitrogen and ammonia in wastewater)

Evaluating Reuse Options for a Reclaimed Water Program in Trinidad, West Indies

Authors: **Matt McTaggart, P.Eng, R.Eng; Jim Marx, MSc, P.E.; and Kathy Bahadoorsingh, PhD, R.Eng (AECOM)**

Trinidad and Tobago-Beetham

Project Background or Rationale

The island of Trinidad is the most southern island of the Caribbean and covers an area of approximately 1,841 mi² (4,768 km²). Trinidad's economy is primarily energy based and there are industrial estates concentrated in the southern section of the island. The Beetham Wastewater Treatment Plant (WWTP) effluent could therefore provide a supply that is not severely affected by seasonal variation, as well as reduce the demand on high quality potable water in applications where appropriately treated, non-potable supply could suffice. There is also a thriving agricultural sector with large farms located throughout the island.

The island has experienced continued economic growth over recent years and consequently there was an increasing demand for water. This steady increase in water demands prompted the Government of the Republic of Trinidad and Tobago (GORTT) together with its Water and Sewerage Authority (WASA) to capitalize on the valuable resource available from the Beetham WWTP, which is located towards the northwestern section of Trinidad just east of the capital city of Port of Spain.

Capacity and Type of Reuse Application

The Beetham WWTP is the largest wastewater treatment plant in Trinidad. The plant treats approximately 21 mgd (80 ML/d) of wastewater collected from Trinidad's capital city Port of Spain and its environs. The wastewater entering the plant undergoes preliminary treatment comprising screening and grit removal. It then receives secondary treatment from an activated sludge process that incorporates nitrogen removal. Conventional gravity clarifiers provide solid-liquid separation and the clarified effluent undergoes ultraviolet disinfected before it is discharged to the Black River that flows to the Gulf of Paria.

The Beetham WWTP, which was commissioned in 2005, consistently meets its effluent design criteria. **Table 1** summarizes the average effluent quality for the period 2005 to 2010 together with the plant's design criteria.

Table 1 2005 - 2010 average WWTP influent, effluent data compared to design criteria

| Parameter | Influent | Effluent | Design Criteria |
|--------------------------|----------|----------|-----------------|
| Flow, ML/d | 78 | 75 | 80 |
| pH | 7.2 | 7.7 | 6-9 |
| TSS, mg/L | 163 | 4 | 20 |
| BOD, mg/L | 125 | 2 | 20 |
| COD, mg/L | 301 | 18 | - |
| NH ₄ -N, mg/L | 15.4 | 0.2 | - |
| Total P, mg/L | 2.9 | 1.7 | - |
| Residual Chlorine, mg/L | | | 0.01 |
| Fecal Coliform, #/100 mL | | 85 | 200 |

The flow data from the Beetham WWTP over the period July 2005 to December 2010 indicated that the plant maintained an average effluent flow near its design capacity of 21 mgd (80 ML/d) throughout the dry season. This is in contrast to the monthly average rainfall records as shown in **Figure 1**.

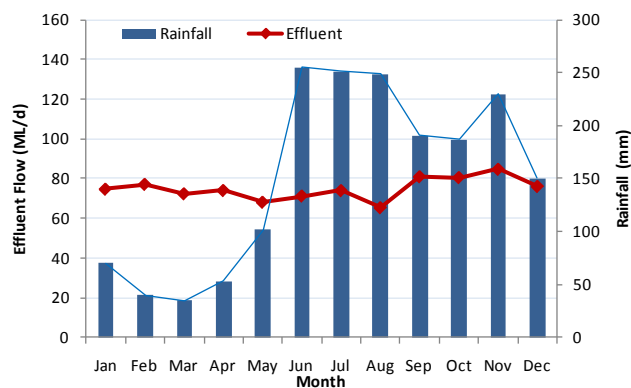

Figure 1
Average WWTP effluent flow and monthly average rainfall

The projected water demand for 2015 shows domestic users as having the greatest demand of 195 mgd (736 ML/d) followed by industry at 65 mgd (245 ML/d) and then irrigated agriculture at 7 mgd (27 ML/d) (WRA, 2001; WASA, 2007). The options therefore focused on reuse applications in urban, agricultural, industrial and indirect potable reuse.

Water Quality Standards and Treatment Technology

Currently there are no local reuse water quality standards or regulations for Trinidad and hence, standards for the Beetham Reuse Project were adopted from the United States, specifically the states of California and Florida. These states were selected because they have significant reuse programs in place and well established regulations to govern these programs.

Project Funding and Management Practices

Based on the reuse possibilities and the required treatment level, reuse options were developed that considered the location of the end users, the route taken to deliver the reclaimed water, and the water quality requirements of the end users. Four general options were formulated as follows:

- Option 1: Reclaimed Water (RW) delivered to industrial users via marine routes
- Option 2: RW delivered to primarily industrial end users plus some agricultural end users via marine route and then overland
- Option 3: RW delivered to primarily industrial end users plus some agricultural end users via overland routes
- Option 4: RW delivered to agricultural, industrial and other end users via overland routes

Three end uses were evaluated within each option as follows:

- a. Unrestricted urban reuse, medium quality industrial
- b. Food crop irrigation, indirect water supply augmentation, general purpose industrial
- c. Aquifer recharge by injection

Life-cycle cost analyses were performed for the 12 alternations. Two funding mechanisms were evaluated, private equity in the form of build-own-operate-transfer (BOOT) contract, and funding by

GORTT. Non-monetary decision variables also included technical, social, and environmental factors that would influence the reuse program implementation. These were ranked using a numerical scoring system.

The highest rated option, based on a benefit to cost ratio, was a multi-user concept that would provide reclaimed water for food crop irrigation, indirect potable water augmentation, and general purpose industrial use.

Institutional/Cultural Considerations

While reclaiming WWTP effluent for reuse purposes is new to Trinidad, it appears the concept would be acceptable to the general public based on a short-term project in which secondary effluent was dyed, chlorinated, and used for urban irrigation during a significant drought in 2009. However, the program has not moved forward. One of the biggest issues keeping the program from being implemented is the outdated water rates that undervalue potable water such that a true comparison with alternative sources cannot be made.

Successes and Lessons Learned

Implementation of the Beetham Reuse Program was put on hold in 2011 for several reasons including the high cost of distributing reclaimed water to the potential end users and the election of a new government that had different priorities and approaches for solving the water shortage problem. It appears that the best chance for reviving the program would be to identify a major user near the WWTP that could be economically supplied with RW to meet their demands. The most promising user identified to date is the Trinidad and Tobago Electrical Commission. They are planning to build a new power plant about 1.2 miles (2 km) east of the WWTP and reclaimed water would be an ideal cooling medium for the new facility.

References

WASA (2007) Future Water Supplies for Trinidad and Tobago: The Challenges and the Solutions.

WRA (2001) National Report on Integrating the Management of Watersheds and Coastal Areas in Trinidad and Tobago. Prepared for the Ministry of the Environment, March 2001. Retrieved on Sept. 7, 2012 from

<<http://www.oas.org/reia/iwcam/pdf/trinidad%20and%20tobago/trinidad%20and%20tobago%20national%20report.pdf>>.

Langford Recycling Scheme

Author: Afsaneh Janbakhsh, MSc, Cchem, MRSC, Csci (Northumbrian Water Ltd, UK)

United Kingdom-Langford

Project Background or Rationale

Essex & Suffolk Water (ESW) is in the southern operating area of Northumbrian Water Limited (NWL) which supplies a population of approximately 1.5 million people with potable water. In response to a supply deficit, Essex & Suffolk Water identified the Langford Recycling Scheme (the Scheme) as a new resource. The scheme involves diverting the Chelmsford Sewage Treatment Works (CSTW) effluent from the Blackwater Estuary to the Langford Recycling Plant (LRP). The reclaimed water is then discharged in the River Chelmer at Scotch Marsh to be abstracted 8 km downstream for drinking water supply.

In April 2000, ESW was granted a permit by the UK Environment Agency (EA) to discharge reclaimed wastewater, originally from CSTW, into the river Chelmer at Scotch Marsh, Ulting. In addition, the Company was allowed to vary its abstraction license to benefit from this extra water. The granting of the permits effectively gave approval for the construction of the wastewater recycling plant for indirect potable reuse with an output of up to 10.5 mgd (40 ML/d). The scheme has been operating successfully since 2003, providing additional flow in the river Chelmer during the periods of low flow.

Capacity, Type of Reuse Application and Treatment Technology

The purpose of the recycling scheme is indirect potable reuse. Although the LRP is licensed to recycle up to 10.5 mgd (40 ML/d) the average daily output is normally between 5.3 to 6.6 mgd (20-25 ML/d). During drought periods, these volumes represent up to 70 percent of the raw water available in the River Chelmer at ESW's drinking Water's intake. The scheme is normally operated from April to November when the temperatures support the biological treatment process at the LRP. From October 2003 to November 2011, a total of 3.47 billion gallons (13,139.7 ML) of reclaimed water was produced for indirect potable reuse. The highest production was during the drought periods during 2005 to 2006 and 2010 to 2011.

The advanced treatment process at the LRP includes the following processes:

- Biological nitrification-denitrification
- Chemical phosphorus removal
- UV disinfection

The treated reclaimed water from the LRP is consistently much higher quality than the receiving river water in terms of chemical and bacteriological contaminants.

Water Quality Standards

The EA consent conditions for the LRP aim to protect the receiving stream water quality; the treated water quality standards are summarized in **Table 1**. The treated reclaimed water meets all established water quality standards (**Table 2**) and as such, the LRP is considered the tertiary stage of the CSTW. In addition, the following consent limits apply to the discharge: iron 2mg/L, copper 40mg/L, and nonylphenol 4.0 µg/L.

Environmental Impact

Environmental monitoring was conducted to assess the impact of reclaimed water discharge on the receiving stream. The monitoring program included weekly chemical and bacteriological sampling as well as monthly macrophytes, phytoplankton and invertebrate monitoring. In addition, the LRP final effluent and Clemsford effluent were tested for possible endocrine disruption effects using fish bioassays. Monthly algae and zooplankton surveys were carried out at the Hanningfield Reservoir

Environmental impact assessments on the estuary (a Ramsar site, a Site of Special Scientific Interest, a Special Area of Conservation and a Special Protection Area) from where the wastewater is diverted consisted mainly of studies on marine invertebrates and wildfowl that preyed upon them. The impact of increased water abstraction on siltation in a local port on the estuary was also evaluated. In order to mitigate the effect of diverting the wastewater, ESW carries out annual dredging at Maldon Port to reduce the impact of siltation.

Table 1 Water framework directive standards

| Parameter | 90 Percentile | 95 Percentile | Maximum | Annual Mean |
|---------------------------------------|---------------|---------------|------------|-------------|
| BOD | | 10 mg/L | 20 mg/L | 3.2mg/L |
| Ammonia | | 2 mg/L | 7mg/L | 0.28 mg/L |
| Suspended Solids | | 20 mg/L | | 3.1 mg/L |
| SRP | | | 1,000 µg/L | 255 µg/L |
| Total Nitrogen | | | 15 mg/L | 3.9mg/L |
| Dissolved Oxygen (percent saturation) | >70 % | | >40% | 89 % |

Table 2 Urban wastewater treatment directive (UWWTD) standards

| | UWWTD limit | Annual Average Removal Rate Limit | LRP Annual Mean Removal Rate |
|------------------|-------------|-----------------------------------|------------------------------|
| BOD | 25mg/L | 70-90% | 96% |
| COD | 125 mg/L | 75% | 85% |
| Total phosphorus | 1000 µg/L | 80% | 96% |
| Total Nitrogen | | 70-80% and 57% by LRP only | 83% total, 72% by LRP only |

Project Funding and Management Practices

Funding for the studies, promotion and building of the LRP was through the UK water industry's normal regulated business planning process. The funding was obtained through price increases for potable water with this particular scheme having a low capital expenditure (CAPEX) cost but a higher than normal operational expenditure (OPEX) cost because the practice of using reclaimed water as a potable water source requires additional treatment that is not normally required for a conventional raw water source.

Institutional/Cultural Considerations

This is the first example of a planned indirect potable reuse scheme in Europe. There were no precedents that could be used for justification of the project and a great deal of effort was required to demonstrate to the government, regulators and the public the value and safety of the proposed project. The success of the final scheme was a result of significant stakeholder engagement with customer representative groups and customers. This included the purchase and fitting of a mobile information workshop that was taken to all areas that would receive the potable water.

Successes and Lessons Learned

Years of baseline and pilot plant data that demonstrated improvement to water quality were key to securing the reuse license. However, even with solid scientific information, public acceptance is not a

given and early engagement and clear communication with project stakeholders was essential to project success. The solid science, regulatory coordination and public engagement were all important components of this project that promotes sustainable water use, enhances the aquatic environment through a reduction in polluting discharges and mitigates the impacts of drought.

References

- A.Janbakhsh, 2011, Langford Recycling Scheme; 10 year review, Essex & Suffolk, Water Resources Department.
- S.J. Wishart, S.W. Mills, J.C. Elliott, 2000, Considerations for recycling sewage effluent in the UK, vol. 14, pp. 284-290, J.CIWEM.
- V. Lazarova, B Levin, J.Sack, G. Cirelli, P. Jeffrey, H. Muntau, M. Salgot, F. Brissaud, 2001, Role of water reuse for enhancing integrated water management in Europe and Mediterranean countries, vol.43, No 10, pp 25-33. Water Science and Technology.
- D.Walker, 2000, Oestrogenicity and wastewater recycling, Experience from Essex and Suffolk Water, vol.14, pp. 427-431, J. CIWEM.
- J. Harries, A.Janbakhsh, S.Jobling, J. Sumpter, C. Tyler, 1999, Estrogenic potency of effluent from two sewage treatment works in the United Kingdom, vol. 18, No. 5, pp. 932-937, Environmental Technology and Chemistry.

Water Reuse as Part of Holistic Water Management in the United Arab Emirates

Authors: Rachael McDonnell, PhD (International Center for Biosaline Agriculture)
and Allegra K. da Silva, PhD (CDM Smith)

United Arab Emirates-Abu Dhabi

Project Background or Rationale

As a region, the Middle East and North Africa (MENA) is the driest in the world, with only 1 percent of the globe's freshwater resources. About 43 percent of wastewater generated in the MENA region is treated with a wide range in the percent of wastewater treated between countries (Qadir et al., 2010). While several countries in the region have very little wastewater treatment, other countries with the financial resources have a very high percentage of treatment and treat wastewater to very high quality for reuse. In countries that are dependent on desalination to supply major portions of their water demands, water reuse can be a relatively lower energy and cost alternative. As a region, approximately one quarter of all wastewater generated is treated and reused. The Abu Dhabi emirate has been one of the few leaders in the region with the commitment to implement substantial wastewater treatment and reuse programs utilizing over seventy percent of this resource.

Abu Dhabi's mean annual rainfall is extremely low—only 32 mm (1.25 inches) per year. Water resources in the United Arab Emirates (UAE) have traditionally been met through shallow groundwater wells. However, rapid economic development and population increases over the last three decades have dramatically increased the emirates' water demands. About 70 percent of the emirate's water comes from brackish groundwater. This non-renewable resource has been used predominantly to support expansions in agriculture. Salinization of some aquifer resources and soils has resulted (Murad et al., 2010 and Al-Katheeri et. al, 2008). The UAE's groundwater deficit is largely met by desalinated water (24 percent) and the reuse of treated wastewater for agriculture and landscape irrigation (6 percent).

To improve the current water situation, the emirate of Abu Dhabi has adopted a water resources master plan and a water reuse strategy to maintain the emirate's water security.

Water Reuse as Strategy in Abu Dhabi

Abu Dhabi Emirate is the largest of the seven emirates that compose the UAE. Abu Dhabi's urban population (1.4 million) is projected to increase by an average of 50 percent every seven years up to 2030. In 2003, water consumption in Abu Dhabi was 92.5 gallons (350 litres) per capita per day, among the highest rates in the world (Global Water Intelligence, 2009).

Water reuse has been practiced in Abu Dhabi for over a decade for landscape irrigation. As of 2010, reclaimed water adds about 6 percent to overall water supplies (EAD, 2010).

The formulation of *Abu Dhabi Water Resources Master Plan* (Pitman et al., 2009) published by the Environment Agency Abu Dhabi (EAD) in 2009 was a major strategic step towards achieving its vision for a sustainable future for Abu Dhabi. The plan identified existing total water availability and demand and projected forward to examine future conditions and options. To address the lack of renewable freshwater resources, the plan recommended water reclamation to minimize environmental costs of desalination, particularly energy consumption and greenhouse gas emissions.

Taking the water resources planning process forward, EAD recently established a bold wastewater reuse strategy for the Emirate of Abu Dhabi (EAD, 2010) that was developed by the International Centre for Biosaline Agriculture (ICBA). This reuse strategy provides a roadmap for diversifying the application of recycled water in the emirate for agriculture, forestry, and amenities. The strategy identifies the opportunities for reuse in the emirate, technical aspects of reuse (including protecting public safety, and the incorporation of both decentralized and centralized systems). The strategy also addressed associated institutional and regulatory issues. Since reclaimed water is such a valuable resource in Abu Dhabi, the strategy specifically outlines licensing approaches and

high efficiency farming to avoid profligate use of reclaimed water in agriculture.

The water reuse strategy also calls for several implementation components, including:

1. A survey of public acceptance
2. A wastewater market assessment to help design systems that achieve the best possible economic conditions
3. A commitment that the design and location of future wastewater treatment plants should take potential reuse as the starting point
4. A commitment to view water reuse as an element in a broader water management approach which also encompasses demand management, conservation, and a recognition of the economic value of water

International and local expertise was enlisted in ICBA's development of this master plan, from both the public and private sectors, involving all relevant agencies, including the Regulation and Supervision Bureau (RSB), the Abu Dhabi Sewage Services Company (ADSSC), and the Abu Dhabi Food Control Authority (ADFCA). This integrated approach to stakeholder involvement is key to the success of the strategy.

Matched with this policy commitment is a strong financial commitment to urban regeneration, including water and wastewater system improvements. The overall strategic vision for Abu Dhabi, Plan 2030, includes a planned total investment of over \$1 trillion in infrastructure, with a commitment to state-of-the-art wastewater infrastructure (Stedman, 2010). Where wastewater treatment will be installed in Abu Dhabi, the focus will be on reuse, driven by the opportunities presented by water scarcity. Reclaimed water is expected to provide around 10-13 percent of overall water supplies by 2030, by progressively substituting reuse for expensive desalinated water and rapidly dwindling fresh groundwater supplies (EAD, 2010). The two main wastewater treatment plants that currently serve the emirate, at Mafraq and Al Ain, have been operating above design capacity. Four new large WWTP are currently being built in the Emirate of Abu Dhabi which will add a treatment capacity of 225 mgd (850,000 m³/day) to serve more than 3 million inhabitants (Al Wathba Veolia Besix Waste Water, 2012). This new infrastructure has been designed with state-of-the-art technologies enabling 100 percent reuse of the wastewater treated for irrigation purposes.

Figure 1 shows the predicted water supply by sectors in UAE through 2030.

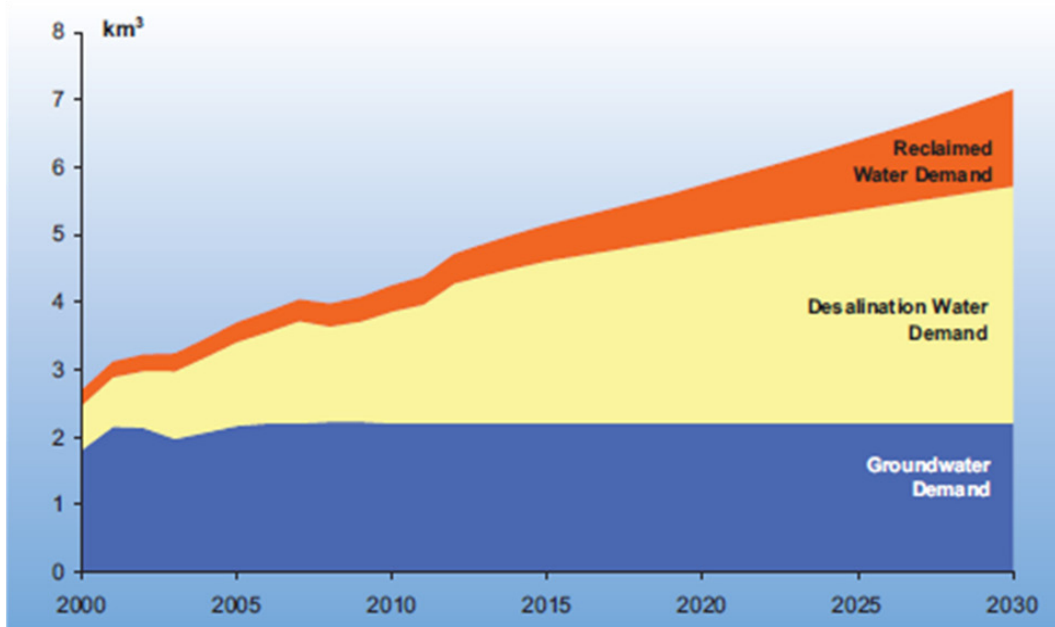

UAE Water Conservation Strategy, 2010, MOEW

Figure 1
Predicted water supply by sectors in UAE

Types of Reuse Applications

For over a decade, Abu Dhabi has implemented reuse for irrigation under the municipality's Sewerage Projects Committee, under the direction of His Highness Sheikh Zayed Bin Sultan Al Nahyan. An investment of around U.S. \$149 M (547.5 M UAE Dirhams) has resulted in an irrigation system using reclaimed water from the Mafraq wastewater treatment facility to irrigate approximately a quarter of the island section of the city's area to create a green oasis in the city. This has generated fresh water savings and a series of ecological, social, and economic benefits. The greening of the city has enhanced the urban environment and offset pollution and carbon emissions. During peak summer demand, irrigation requirements surpass the volume of reclaimed water generated by Mafraq and is supplemented with valuable potable water. The city has initiated a series of studies to improve the system through data collection, modeling, system upgrades including strategic storage, landscape redesign, and data management (Shepherd, 2003).

Water reuse is also a key opportunity to achieving adequate long-term storage capacity. Artificial aquifer recharge on a large scale could be beneficial to help the emirate achieve emergency water supply storage. Existing pilot projects are examining the feasibility of aquifer recharge using reclaimed water (Al-Katheeri et al., 2008).

While under the new Abu Dhabi wastewater reuse strategy, reclaimed water will substitute about 10 percent of the emirate's water supply, projected demands will be 40 percent greater than potential supplies by 2025, requiring improvements in water use efficiency and careful targeting of highest added-value reuse (Shepherd, 2003).

Water Quality Standards and Treatment Technology

One important component of Abu Dhabi's approach has been the setting of clear regulatory standards for trade effluent discharge control, and recycled water and biosolid products and use by the regulator, the RSB. Two categories are defined with the strictest standards defined for end uses where the public are more exposed such as in flushing toilets and urban irrigated areas.

Project Funding and Management Practices

The emirate of Abu Dhabi has committed all the investment to set the national policies and water reuse strategy. In addition to significant commitments to the development of new infrastructure, \$13 billion of private investment has also been attracted (GWI, 2009).

Successes and Lessons Learned

Coordinated efforts between the various agencies involved in water management in Abu Dhabi has shown clear leadership in making a strong commitment to including water reuse as part of its overall water resource strategic planning for the growth and sustainability of the emirate. Through the Abu Dhabi Technical Committee for Wastewater, activities between different institutions and users involved in reuse have been harmonized, and may become a focal point for water reuse advocacy, public education, and outreach (EAD, 2010). Also by including provisions for wastewater reuse infrastructure development at the outset of new developments, the most financially and environmentally sound solutions can be incorporated for both handling wastewater, but also addressing water demands.

References

- Abu Dhabi Emirate. (2006) *Water Resources Statistics 2006*.
- Al-Katheeri, E. S. 2008. "Towards the establishment of water management in Abu Dhabi Emirate." *Water Resources Management* 22(2): 205-215.
- Al Wathba Veolia Besix Waste Water (2012) "Water Conservation in Abu Dhabi." Accessed online May 9, 2012 at http://www.istp2.ae/en/Missions/History_of_wastewater_treatment/.
- Environment Agency Abu Dhabi (2010). *A Strategy for the Reuse of Wastewater: Emirate of Abu Dhabi*. Volume 1 – Main Report.
- Global Water Intelligence. 2009. *Water Market Middle East 2010*. Global Water Intelligence. London, United Kingdom.
- Murad, A. A. 2010. "An Overview of Conventional and Non-Conventional Water Resources in Arid Region: Assessment and Constraints of the United Arab Emirates (UAE)." *Journal of Water Resource & Protection*, 2(2): 181-190.

Qadir, M., A. Bahri, et al. 2010. "Wastewater production, treatment, and irrigation in Middle East and North Africa." *Irrigation and Drainage Systems*, 24(1): 37-51.

Ratcliff, R., Minney, I., Smolenska, K., and Duquez, R. (2007) "Closing the Loop Reuse in Dubai." *Proceedings of the Water Environment Federation*, (10): 7532-7545.

Pitman, K., McDonnell, R. A., and Dawoud, M. (eds). 2009. Abu Dhabi Water Resources Master Plan. Environmental Agency Abu Dhabi. UAE.

Shepherd, P. 2003. "Seeing green." *Water 21 Magazine of the International Water Association* (DEC.): 39-41.

Stedman, L. I. S. 2010. "Project progress in the Middle East and Africa." *Water 21 Magazine of the International Water Association*, (4): 33-37.

Ministry of Environment and Water (2010). *United Arab Emirates Water Conservation Strategy*.

Water21. (2011). "Pilot project for Dubai." *Water 21 Magazine of the International Water Association* 2011(3): 24-24.

Wastewater Reuse in Thanh Tri District, Hanoi Suburb, Vietnam

Authors: Lan Huong Nguyen, MSc; Viet-Anh Nguyen, PhD; and Eiji Yamaji, PhD
(Hanoi University of Civil Engineering, Vietnam)

Vietnam-Hanoi

Project Background or Rationale

In Vietnam, a large number of urban and peri-urban farmers rely on wastewater for irrigated agriculture and aquaculture. In Hanoi alone, an estimated 658,000 farmers use wastewater to irrigate 108,178 ac (43,778 ha) of land (Raschid-Sally and Jayakody, 2008).

Thanh Tri is a peri-urban district located in the south of Hanoi, downstream of the To Lich River, one of the main streams contaminated with wastewater from urban areas. Irrigation systems designed to uptake water from the To Lich River have been in use in some communes of the district water since the 1960s and are used to irrigate hundreds of hectares of agricultural land.

In recent years, increased contamination from urban wastewater and industrial effluents has created problems for the traditional practice of wastewater reuse: loss of agriculture and aquaculture production affect the health of farmers and consumers. Thanh Liet commune in this district has designed a decentralized wastewater management system (DWMS) to accommodate wastewater reuse.

Capacity and Type of Reuse Application

To combat the negative impact of wastewater effluent on crops, productivity, public health and the increase of unusable land, the Local Agriculture Cooperative (LAC), in agreement with local farmers, decided to transfer large areas of low productivity agricultural land to fishponds by gathering farmers' fields and leasing them to fish raising men. In other words, the intervention does not seek to change the quality of the water itself, but instead change the type of reuse application to aquaculture, which is a safer use of the contaminated water.

The fishpond areas in Thanh Liet were originally used as a low land paddy for rice. Rice is less tolerant to contaminated water, so they shifted to other aquatic

vegetables and fish ponds, which also have higher market values. Aquatic vegetables and fish production can generate 120 million Vietnamese dong (VND) per ha per year and 150 million VND/ha-yr (\$5,760/ha-yr and \$7,200/ha-yr), respectively which is three times higher than rice production. The total land area dedicated to aquaculture in Thanh Liet has increased over the last 10 years from about 25 to 85 hectares (60 to 210 acres) in 2011. More constructors are interested in this area since they could get substantial benefit from wastewater fed fishponds.

Institutional/Cultural Considerations

Thanh Liet commune area has a population of 241,000 people (2010) and is not yet covered by the service from Hanoi Sanitation and Drainage Company (SADCO). Therefore, the management of local sewerage and drainage system belongs to the commune's People's Committee (PC), who delegates the task to the LAC of the commune.

There is a policy for providing water for irrigation free of charge, creating a financial barrier for the LAC to invest in improving irrigation water quality and involving local farmers to the operations and maintenance (O&M) activities of the system.

Water Quality Standards and Treatment Technology

There are no official regulations for wastewater use in Vietnam, except for microbiological quality standards specifying a maximum total coliform count for effluent discharge to surface water.

Project Funding and Management Practices

For the construction of drainage canals and sewers along the roads of the commune, funding is mobilized from the city's budget, via the District PC. In some cases, local farmers contribute, especially for their household connection to the drainage lines. Under the

management of the local PC, the Thanh Liet LAC is assigned the function to operate water supply, sewage, drainage and irrigation systems. They are also providing other agricultural services for farmers such as supply of fertilizers, seeding crops and fish fingerlings.

Institutional decentralization has created a strict separation of institutions at upper levels of management, causing difficulties for the LAC to integrate irrigation, drainage and sewage management at the local level. For instance, all of the wastewater collected by the centralized wastewater system in Hanoi is discharged to the upper level of the canals. The LAC is unable to collect the wastewater discharge fee to cover the cost of treatment; therefore the water from these canals is diverted to the local irrigation system without proper treatment.

Locations of fishponds are usually along the open drainage canals. One reason is the availability of leased land; since the soil is contaminated with wastewater and not suitable for growing crops, another reason is that fishermen could actively exploit the wastewater and do not solely depend on the LAC's pumping services. Meanwhile, the cropping land is about 250 ac (100 ha) of which only 25 ac (10.5 ha) is used for cultivating rice and the rest is for aquatic vegetables. These fields are located further from drainage canals to reduce the impact of wastewater since the quality of the wastewater is improved in terms of nutrients, pathogens, and heavy metal concentration after partial treatment in ponds with the presence of aquatic plant cultivation and long channels.

Farmers and fishermen experience the negative impacts from wastewater such as skin and worm diseases. They have carried out different measures to reduce perceived impacts. Fishermen are more proactive; they combine wastewater and groundwater to dilute the wastewater, and in addition, wastewater pumps provide more oxygen to boost wastewater treatment process through biochemical oxygen demand breakdown in the ponds. Farmers and fishermen wear protective clothes while working to reduce the exposure level to wastewater.

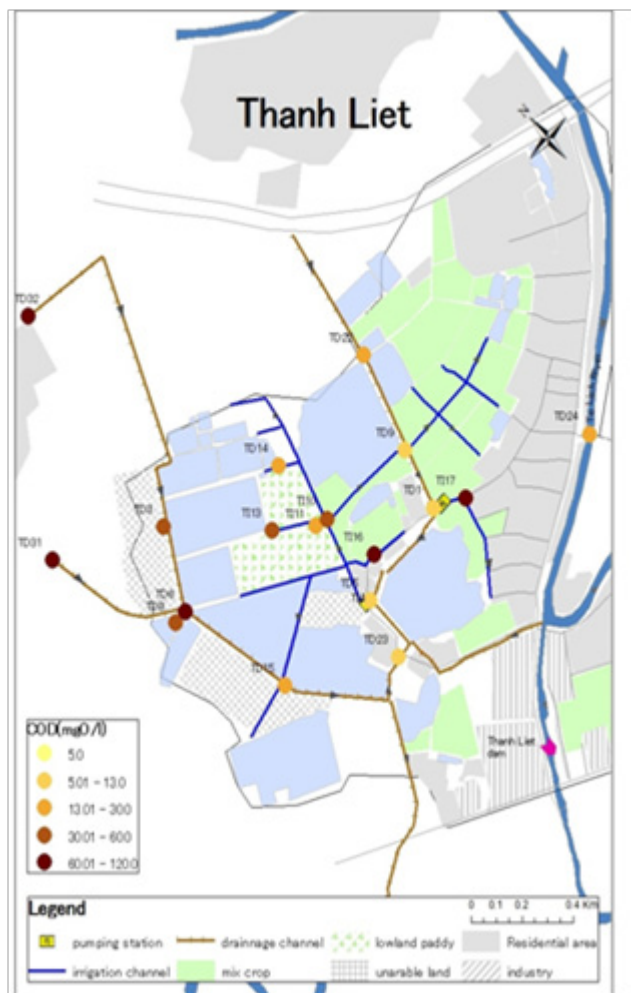

Figure 1
Chemical Oxygen Demand (KMnO_4) measured along the drainage channel in March 2011

Moreover, the farmers and fishermen are encouraged to participate in the agricultural extension training program organized by the LAC and the extension division of the district. The content of these training programs include the safe practice of wastewater reuse. Most of the crops and all fish products are required to be cooked before eating.



Figure 2
Farmer working in the field in protective clothing
(Photo credit: Lan Huong Nguyen)

Successes and Lessons Learned

Through a combination of various activities, e.g., conjunctive use of wastewater and groundwater, protective gear, improving hygienic condition, and raising awareness among producers and consumers, the impact of wastewater reuse has been minimized to a certain level. The practice of wastewater reuse in Thanh Liet behaves as *spot market* with complex and unpredictable long-term outcomes.

Despite the numerous challenges, the DWMS of Thanh Tri could provide a concrete framework to build up an integrated system of wastewater reuse for irrigation at a local level where decentralized provision allows wastewater reuse to maximize resource recovery, i.e., where wastewater is collected and treated to the acceptable level for agriculture and aquaculture use in the area.

Finally, further studies on the measurements taken out by the Thanh Liet people and reinforced with scientific base are needed to support the management of LAC by providing information to set up guidelines, standards, and regulations of the reuse of wastewater for application in other areas of the country.

References

Lan Huong Nguyen, Yamaji Eiji. 2011. *Integrating Urban Wastewater Management and Wastewater Irrigated Agriculture - A case study on farmers' participation in Hanoi*. Graduate School of Frontier Sciences, the University of Tokyo, Japan (Master's thesis).

Viet-Anh Nguyen, Hanh T.H. Tran, Thanh T.M. Vu, Parkinson J., Barriero W. 2004. *Decentralized wastewater management – A Hanoi case study*. 30th WEDC International Conference, Vientiane, Lao PDR.

Raschid-Sally, L.; and Jayakody, P. 2008. *Drivers and Characteristics of Wastewater Agriculture in Developing Countries: Results from a Global Assessment*. IWMI RR 127.

Appendix F

Case Studies in 2004 Guidelines for Water Reuse

| Section in 2004 Guidelines | U.S. Case Study Title | City | State |
|----------------------------|--|---------------------|-------|
| 2.7.1 | Water Reuse at Reedy Creek Improvement District | Orlando | FL |
| 2.7.2 | Estimating Potable Water Conserved in Altamonte Springs due to Reuse | Altamonte Springs | FL |
| 2.7.3 | How Using Potable Supplies to Supplement Reclaimed Water Flows can Increase Conservation | Hillsborough County | FL |
| 2.7.4 | Water Reclamation and Reuse Offer an Integrated Approach to Wastewater Treatment and Water Resources Issues in Phoenix | Phoenix | AZ |
| 2.7.5 | Small and Growing Community: Yelm, Washington | Yelm | WA |
| 2.7.6 | Landscape Uses of Reclaimed Water with Elevated Salinity | El Paso | TX |
| 2.7.7 | Use of Reclaimed Water in a Fabric Dyeing Industry | Santa Fe Springs | CA |
| 2.7.8 | Survey of Power Plants Using Reclaimed Water for Cooling Water | Multiple | US |
| 2.7.9 | Agricultural Reuse in Tallahassee, Florida | Tallahassee | FL |
| 2.7.10 | Spray Irrigation at Durbin Creek WWTP Western Carolina Regional Sewer Authority | Fountain Inn | SC |
| 2.7.11 | Agricultural Irrigation of Vegetable Crops: Monterey, CA | Monterey | CA |
| 2.7.12 | Water Conserv II: City of Orlando and Orange County, FL | Orange County | FL |
| 2.7.13 | The Creation of a Wetlands Park: Petaluma, CA | Petaluma | CA |
| 2.7.14 | Geysers Recharge Project: Santa Rosa, CA | Santa Rosa | CA |
| 2.7.15 | Advanced Wastewater Reclamation in California | Orange County | CA |
| 2.7.16 | An Investigation of Soil Aquifer Treatment for Sustainable Water | 6 sites | AZ/CA |
| 2.7.17 | The City of West Palm Beach, Florida Wetlands-Based Water Reclamation Project | West Palm Beach | FL |
| 2.7.18 | Types of Reuse Applications in Florida | Statewide | FL |
| 2.7.19 | Regionalizing Reclaimed Water in the Tampa Bay Area | Tampa Bay FL | |
| 3.8.1 | Code of Good Practices for Water Reuse | Statewide | FL |
| 3.8.2 | Examples of Potable Water Separation Standards from the State of Washington | Statewide | WA |
| 3.8.3 | An Example of using Risk Assessment to Establish Reclaimed Water Quality Study | | US |
| 5.7.1 | Statutory Mandate to Utilize Reclaimed Water: California | Statewide | CA |
| 5.7.2 | Administrative Order to Evaluate Feasibility of Water Reclamation: Fallbrook Sanitary District, Fallbrook, CA | Fallbrook | CA |
| 5.7.3 | Reclaimed Water User Agreements Instead of Ordinance: Central Florida | Orlando | FL |
| 5.7.4 | Interagency Agreement Required for Water Reuse: Monterey County Water Recycling Project, Monterey, CA | Monterey | CA |
| 5.7.5 | Public/Private Partnership to Expand Reuse Program: The City Of Orlando, Orange County and The Private Sector | Orlando | FL |
| 5.7.6 | Inspection of Reclaimed Water Connections Protect Potable Water Supply: Pinellas County Utilities, Florida | Pinellas County | FL |
| 5.7.7 | Oneida Indian Nation/Municipal/State Coordination Leads to Effluent Reuse: Oneida Nation, New York | Oneida | NY |
| 5.7.8 | Implementing Massachusetts' First Golf Course Irrigation System Utilizing Reclaimed Water: Yarmouth, MA | Yarmouth | MA |

| Section in 2004 Guidelines | U.S. Case Study Title | City | State |
|----------------------------|---|---------------------|---------------|
| 6.7.1 | Unique Funding Aspects of the Town of Longboat Key Reclaimed Water System | Longboat Key | FL |
| 6.7.2 | Financial Assistance in San Diego County, California | San Diego | CA |
| 6.7.3 | Grant Funding Through the Southwest Florida Water Management District | SW Florida | FL |
| 6.7.4 | Use of Reclaimed Water to Augment Potable Supplies: An Economic Perspective (California) | LA/Orange Co. | CA |
| 6.7.5 | Impact Fee Development Considerations for Reclaimed Water Projects: Hillsborough County, FL | Hillsborough County | FL |
| 6.7.6 | How Much Does it Cost and Who Pays: A Look at Florida's Reclaimed Water Rates | Statewide | FL |
| 6.7.7 | Rate Setting for Industrial Reuse in San Marcos, TX | San Marcos | TX |
| 7.5.1 | Accepting Produce Grown with Reclaimed Water: Monterey, California | Monterey | CA |
| 7.5.2 | Water Independence in Cape Coral – An Implementation Update in 2003 | Cape Coral | FL |
| 7.5.3.1 | Learning Important Lessons-San Diego, California | San Diego | CA |
| 7.5.3.2 | Public Outreach May not be Enough: Tampa, FL | Tampa | FL |
| 7.5.4 | Pinellas County, Florida Adds Reclaimed Water to Three R's of Education | Pinellas County | FL |
| 7.5.5 | Yelm, Washington, A Reclaimed Water Success Story | Yelm | WA |
| 7.5.6 | Gwinnett County, Georgia – Master Plan Update Authored by Public | Gwinnett County | GA |
| 7.5.7 | AWWA Golf Course Reclaimed Water Market Assessment | | National U.S. |

| Section in 2004 Guidelines | International Case Study by Country |
|----------------------------|---|
| 8.5.1 | Argentina |
| 8.5.2 | Australia |
| 8.5.2.1 | Aurora, Australia |
| 8.5.2.2 | Mawson Lakes, Australia |
| 8.5.2.3 | Virginia Project, South Australia |
| 8.5.3 | Belgium |
| 8.5.4 | Brazil |
| 8.5.4.1 | Sao Paulo, Brazil |
| 8.5.4.2 | Sao Paulo International Airport, Brazil |
| 8.5.5 | Chile |
| 8.5.6 | China |
| 8.5.7 | Cyprus |
| 8.5.8 | Egypt |
| 8.5.9 | France |
| 8.5.10 | Greece |
| 8.5.11 | India |
| 8.5.12.1 | Hyderabad, India |
| 8.5.12 | Iran |
| 8.5.13 | Israel |
| 8.5.14 | Italy |
| 8.5.15 | Japan |
| 8.5.16 | Jordan |

| Section in 2004 Guidelines | International Case Study by Country |
|----------------------------|---|
| 8.5.17 | Kuwait |
| 8.5.18 | Mexico |
| 8.5.19 | Morocco |
| 8.5.20.1 | Drarga, Morocco |
| 8.5.20 | Namibia |
| 8.5.21 | Oman |
| 8.5.22 | Pakistan |
| 8.5.23 | Palestinian National Authority |
| 8.5.24 | Peru |
| 8.5.25 | Saudi Arabia |
| 8.5.26 | Singapore |
| 8.5.27 | South Africa |
| 8.5.28 | Spain |
| 8.5.28.1 | Costa Brava, Spain |
| 8.5.28.2 | Portbou, Spain |
| 8.5.28.3 | Aiguamolls de l'Emporda Natural Preserve, Spain |
| 8.5.28.4 | The City of Victoria, Spain |
| 8.5.29 | Sweden |
| 8.5.30 | Syria |
| 8.5.31 | Tunisia |
| 8.5.32 | United Arab Emirates |
| 8.5.33 | United Kingdom |
| 8.5.34 | Yemen |
| 8.5.35 | Zimbabwe |

This page intentionally left blank.

APPENDIX G

Abbreviations

Abbreviations for Names of States

| Full Name | Text Abbreviation | Case Study Abbreviation |
|----------------------|-------------------|-------------------------|
| Alabama | Ala. | AL |
| Alaska | Alaska | AK |
| Arizona | Ariz. | AZ |
| Arkansas | Ark. | AR |
| California | Calif. | CA |
| Colorado | Colo. | CO |
| Connecticut | Conn. | CT |
| Delaware | Del. | DE |
| District of Columbia | D.C. | DC |
| Florida | Fla. | FL |
| Georgia | Ga. | GA |
| Hawaii | Hawaii | HI |
| Idaho | Idaho | ID |
| Illinois | Ill. | IL |
| Indiana | Ind. | IN |
| Iowa | Iowa | IA |
| Kansas | Kan. | KS |
| Kentucky | Ky. | KY |
| Louisiana | La. | LA |
| Maine | Maine | ME |
| Maryland | Md. | MD |
| Massachusetts | Mass. | MA |
| Michigan | Mich. | MI |
| Minnesota | Minn. | MN |
| Mississippi | Miss. | MS |
| Missouri | Mo. | MO |
| Montana | Mont. | MT |
| Nebraska | Neb. | NE |
| Nevada | Nev. | NV |
| New Hampshire | N.H. | NH |
| New Jersey | N.J. | NJ |
| New Mexico | N.M. | NM |
| New York | N.Y. | NY |
| North Carolina | N.C. | NC |
| North Dakota | N.D. | ND |
| Ohio | Ohio | OH |
| Oklahoma | Okla. | OK |
| Oregon | Ore. | OR |
| Pennsylvania | Pa. | PA |
| Rhode Island | R.I. | RI |
| South Carolina | S.C. | SC |
| South Dakota | S.D. | SD |
| Tennessee | Tenn. | TN |
| Texas | Texas | TX |
| Utah | Utah | UT |
| Vermont | Vt. | VT |
| Virginia | Va. | VA |
| Washington | Wash. | WA |
| West Virginia | W. Va. | WV |
| Wisconsin | Wis. | WI |
| Wyoming | Wyo. | WY |

Abbreviations for Units of Measure

| Abbreviation | Unit |
|-------------------|---------------------------------|
| ac | Acre |
| ac-ft | Acre-foot |
| ac-ft/yr | Acre-foot per year |
| bbl/yr | Barrels per year |
| BTU | British thermal unit |
| cfu | Colony forming units |
| cm | Centimeter |
| m ³ | Cubic meter |
| m ³ /d | Cubic meters per day |
| d | Day |
| °C | Degrees Celsius |
| °F | Degrees Fahrenheit |
| ft | Foot (feet) |
| gallon | Gallon |
| GJ | Gigajoules |
| gpd | Gallons per day |
| gpcd | Gallons per capita per day |
| gpm | Gallons per minute |
| g | Gram |
| ha | Hectare |
| hp | Horsepower |
| hr | Hour |
| ccf | Hundred cubic feet |
| in | Inch |
| J | Joules |
| kg | Kilogram (10 ³ g) |
| kg/ha | Kilogram per hectare |
| km | Kilometer (10 ³ m) |
| kPa | Kilopascal (10 ³ Pa) |
| kW | Kilowatt (10 ³ W) |
| kWh | Kilowatt hour |
| L | Liter |
| Lpcd | Liters per capita per day |
| L/s | Liters per second |
| MW | Megawatt (10 ⁶ W) |
| MW hr | Megawatt hours |

| Abbreviation | Unit |
|-----------------|--|
| m | Meter |
| m/s | Meters per second |
| µg | Microgram (10 ⁻⁶ g) |
| µg/L | Micrograms per liter |
| MCM | Million cubic meters |
| MCM/yr | Million cubic meters per year |
| mgd | Million (10 ⁶) gallons per day |
| µm | Micrometer (10 ⁻⁶ m) |
| mi | Mile |
| mph | Miles per hour |
| mg | Milligram (10 ⁻³ g) |
| mg/L | Milligrams per liter |
| mL | Milliliter (10 ⁻³ l) |
| mm | Millimeter (10 ⁻³ m) |
| meq/L | Milliequivalent per liter |
| MAFY | Million acre feet per year |
| min | Minute |
| MPN | Most probable number |
| nm | Nanometer (10 ⁻⁹ m) |
| NTU | Nephelometric turbidity units |
| ppt | Parts per trillion |
| Pa | Pascal |
| pfu | Plaque forming unit |
| lb | Pound |
| lb/ac | Pounds per acre |
| psi | Pounds per square inch |
| s | Second |
| ft ² | Square foot |
| in ² | Square inch |
| km ² | Square kilometers |
| m ² | Square meter |
| mi ² | Square mile |
| TWh/yr | TWh/yr |
| W | Watt |
| yr | Year |



Office of Research and Development
National Risk Management
Research Laboratory
Cincinnati, OH 45268



Ronald Reagan Building
1300 Pennsylvania Avenue, N.W.
Washington D.C. 20523

EPA/600/R-12/618
September 2012
www.epa.gov



50 Hampshire Street
Cambridge, MA 02139