

# Midwest Home Fruit Production Guide

Cultural Practices and Pest Management



# Midwest Home Fruit Production Guide

## Cultural Practices and Pest Management

A comprehensive guide to cultural practices, pest identification and management, and uses of fruit crops for backyard fruit growers, small-scale professional growers, landscapers, garden center employees, horticultural students and educators, and Master Gardeners.

### Authors

#### Dr. Gary Gao, Editor

Associate Professor and Extension Educator  
Ohio State University Extension, Delaware County  
149 North Sandusky Street  
Delaware, OH 43015

#### Ron Becker

Program Assistant  
Ohio State University Extension, Wayne County  
428 West Liberty Street  
Wooster, OH 44691

#### Dr. Maurus Brown

Assistant Professor and Extension Specialist  
Ohio State University South Centers  
1864 Shyville Road  
Piketon, OH 45661

#### Dr. Mike Ellis

Professor and Extension Plant Pathologist  
Department of Plant Pathology  
Ohio Agricultural Research and Development Center  
The Ohio State University  
1680 Madison Avenue  
Wooster, OH 44691

#### Dr. Steve Prochaska

Associate Professor and Extension Educator  
Ohio State University Extension, Crawford County  
112 East Mansfield Street Suite 303  
Bucyrus, OH 44820-2389

#### Dr. Celeste Welty

Associate Professor and Extension Entomologist  
Extension Entomology  
The Ohio State University  
1991 Kenny Road  
Columbus, OH 43210

#### Dr. Roger Williams

Professor  
Department of Entomology  
Ohio Agricultural Research and Development Center  
The Ohio State University  
1680 Madison Avenue  
Wooster, OH 44691

### Acknowledgments

The authors would like to extend our appreciation to Brad Bergefurd, Garth Cahoon, Dave Ferree, Ted Gestier, Joe Scheerens, Dave Scardena, Dave Scurlock, Ernie Shannon, Joy Ann Fischer, Lauren Farr, Heather Murphy Gates, Shawn Wright, and Dave Shetlar for their help with this bulletin. The authors also acknowledge the efforts of Jim Utzinger, Dick Funt, Mike Ellis, and Dick Miller. They were the authors of the bulletin that was first published in 1984 as bulletin 591. We would also like to thank John Rawson for preparing the details of the grape arbor construction. Last, but not least, our heartfelt appreciation goes to those who have contributed images and illustrations to this publication, including Adams County Nursery for the apple and peach cover photos, and The Blueberry Patch, Mansfield, Ohio, for the blueberry cover photo.

This is a for sale publication. Additional copies can be ordered from your local OSU Extension office. For a list of Ohio State University Extension offices, log on to: <http://extension.osu.edu/counties.php>. Copies are also available through Media Distribution, Ohio State University Extension, 216 Kottman Hall, 2021 Coffey Road, Columbus, OH 43210-1044. Phone: 614-292-1607.

Bulletin 940

Copyright © 2009, The Ohio State University

Ohio State University Extension embraces human diversity and is committed to ensuring that all research and related educational programs are available to clientele on a nondiscriminatory basis without regard to race, color, religion, sex, age, national origin, sexual orientation, gender identity or expression, disability, or veteran status. This statement is in accordance with United States Civil Rights Laws and the USDA.

Keith L. Smith, Ph.D., Associate Vice President for Agricultural Administration and Director, Ohio State University Extension  
TDD No. 800-589-8292 (Ohio only) or 614-292-1868

# Contents

|                                                  |    |                                                  |    |
|--------------------------------------------------|----|--------------------------------------------------|----|
| <b>Chapter 1. Introduction</b> .....             | 5  | Fruit Thinning.....                              | 33 |
| Benefits of Growing Fruit at Home .....          | 5  | Mulching and Watering the Fruit Trees .....      | 33 |
| Potential Challenges.....                        | 6  | Espalier Training of Dwarf Apple Trees .....     | 34 |
| Climate.....                                     | 6  | First Season.....                                | 34 |
| Cold Hardiness.....                              | 6  | Second Season .....                              | 35 |
| USDA Plants Cold Hardiness Zones.....            | 7  | Third and Later Seasons .....                    | 35 |
| Growing Season .....                             | 7  | Disease and Pest Control .....                   | 35 |
| Soil .....                                       | 7  | <b>Chapter 3. Small Fruits</b> .....             | 37 |
| Soil Reaction (pH) and Fertility .....           | 8  | Selecting Small Fruits.....                      | 37 |
| Fertilization.....                               | 9  | Strawberries ( <i>Fragaria x Ananassa</i> )..... | 37 |
| Timing of Fertilizer Application .....           | 10 | June-Bearing vs. Everbearing                     |    |
| Soil Management .....                            | 11 | Strawberries .....                               | 38 |
| Pollination for Successful Fruit Production ...  | 11 | Cultivar Selection.....                          | 38 |
| <b>Chapter 2. Tree Fruits</b> .....              | 15 | Planting Site Requirements for                   |    |
| Selecting Tree Fruits.....                       | 15 | Strawberry Plants.....                           | 40 |
| Selecting Tree Fruit Cultivars .....             | 15 | Cultural Practices for Growing                   |    |
| Tree Fruit Cultivar Descriptions .....           | 16 | Strawberry Plants.....                           | 40 |
| Apples ( <i>Malus domestica Borkh</i> ) .....    | 16 | Planting and Spacing.....                        | 40 |
| Pears.....                                       | 18 | Weed Control .....                               | 41 |
| Apricots ( <i>Prunus spp.</i> ).....             | 19 | Lime and Fertilizers.....                        | 41 |
| Cherries ( <i>Prunus spp.</i> ) .....            | 19 | Blossom Removal.....                             | 42 |
| Peaches ( <i>Prunus persica</i> ) and Nectarines |    | Watering .....                                   | 42 |
| ( <i>Prunus persica var. nucipersica</i> ) ..... | 20 | Renovation of Strawberries After Harvest ..      | 42 |
| Plums .....                                      | 21 | Disease and Pest Control .....                   | 43 |
| Selecting Fruit Tree Nursery Stock .....         | 21 | Mulching for Winter Protection .....             | 43 |
| Planting Fruit Trees .....                       | 23 | Frost Protection .....                           | 43 |
| Fertilizing Fruit Trees .....                    | 25 | Brambles (Raspberries and Blackberries).....     | 44 |
| Rate of Fertilization .....                      | 25 | Site Selection.....                              | 45 |
| Supporting Fruit Trees.....                      | 27 | Soil Preparation .....                           | 45 |
| Pruning and Training Young Fruit Trees .....     | 27 | Cultivars .....                                  | 45 |
| Central Leader System .....                      | 27 | Nurseries.....                                   | 48 |
| Open Center or Open Vase System.....             | 29 | Planting.....                                    | 48 |
| At Planting.....                                 | 29 | Trellis System .....                             | 49 |
| Summer Pruning .....                             | 29 | Mulch.....                                       | 49 |
| Succeeding Years.....                            | 30 | Soil and Plant Fertility.....                    | 49 |
| Pruning Mature Fruit Trees .....                 | 30 | Disease and Pest Control .....                   | 49 |
| Pruning Old, Neglected Apple                     |    | Watering .....                                   | 49 |
| and Pear Trees.....                              | 32 | Harvest .....                                    | 49 |

|                                                 |    |                                                  |    |
|-------------------------------------------------|----|--------------------------------------------------|----|
| Pruning and Training . . . . .                  | 50 | Persimmon . . . . .                              | 68 |
| <i>Red Raspberries</i> . . . . .                | 50 | Quince . . . . .                                 | 68 |
| Removing Canes After Fruiting . . . . .         | 50 | Mulberry . . . . .                               | 69 |
| Thinning Shoots and Canes . . . . .             | 50 | Medlar . . . . .                                 | 69 |
| Heading Back Shoots and Canes . . . . .         | 51 | Juneberry . . . . .                              | 70 |
| Training . . . . .                              | 51 | Bush Cherries . . . . .                          | 70 |
| <i>Fall Red Raspberries</i> . . . . .           | 51 | Cornelian Cherries . . . . .                     | 70 |
| Pruning . . . . .                               | 51 | Hardy Kiwi . . . . .                             | 71 |
| <i>Black and Purple Raspberries</i> . . . . .   | 52 | Highbush Cranberry . . . . .                     | 71 |
| Summer Heading (Tipping) . . . . .              | 52 | Ground Cherries . . . . .                        | 72 |
| Removing Canes After Fruiting . . . . .         | 52 |                                                  |    |
| Thinning Canes . . . . .                        | 52 | <b>Chapter 5. Landscape Aspects</b>              |    |
| Heading Back Laterals . . . . .                 | 52 | <b>of Fruit Plants</b> . . . . .                 | 73 |
| <i>Blackberries</i> . . . . .                   | 53 | Landscape Design Principles . . . . .            | 73 |
| Pruning . . . . .                               | 53 | Foundation, Bed, and Border Planting . . . . .   | 73 |
| Grapes ( <i>Vitis spp.</i> ) . . . . .          | 53 | Espalier Dwarf Apple or Pear Trees . . . . .     | 74 |
| Site Selection . . . . .                        | 54 | Supporting Brambles . . . . .                    | 75 |
| Soil Preparation . . . . .                      | 54 | Trellis and Arbor Training of Grapes             |    |
| Trellising . . . . .                            | 54 | and Other Fruit Plants . . . . .                 | 75 |
| Cultivars . . . . .                             | 55 | Growing Fruit Plants in Limited Space . . . . .  | 77 |
| Planting . . . . .                              | 57 | Material Required for a Square Terrace . . . . . | 77 |
| Pruning and Training Grapevines . . . . .       | 58 | Building the Terrace . . . . .                   | 77 |
| What To Do With a Neglected Grapevine . . . . . | 60 |                                                  |    |
| Soil and Plant Fertility . . . . .              | 60 | <b>Chapter 6. Obtaining and</b>                  |    |
| Disease and Pest Control . . . . .              | 61 | <b>Using Fruits</b> . . . . .                    | 79 |
| Blueberries ( <i>Vaccinium spp.</i> ) . . . . . | 61 | Pick-Your-Own Fruit . . . . .                    | 79 |
| Site Selection . . . . .                        | 62 | When to Harvest . . . . .                        | 79 |
| Site Preparation . . . . .                      | 62 |                                                  |    |
| Cultivars . . . . .                             | 62 | <b>Chapter 7. Pest Management and</b>            |    |
| Nurseries . . . . .                             | 63 | <b>Disease Control in Home</b>                   |    |
| Planting . . . . .                              | 63 | <b>Fruit Plantings</b> . . . . .                 | 83 |
| Mulch . . . . .                                 | 64 | How Can I Manage the Pests That                  |    |
| Soil and Plant Fertility . . . . .              | 65 | Get into My Fruit Plantings? . . . . .           | 83 |
| Watering . . . . .                              | 65 | What Is Integrated Pest Management? . . . . .    | 83 |
| Pruning and Training . . . . .                  | 65 | How Do I Use IPM Control Measures? . . . . .     | 84 |
| Harvest . . . . .                               | 66 | Cultural Controls . . . . .                      | 84 |
| Disease Pest Control . . . . .                  | 66 | Sanitation . . . . .                             | 84 |
|                                                 |    | Mechanical Controls . . . . .                    | 84 |
| <b>Chapter 4. Less Commonly</b>                 |    | Biological Controls . . . . .                    | 85 |
| <b>Grown Fruits</b> . . . . .                   | 67 | Chemical Controls (Pesticides) . . . . .         | 85 |
| Pawpaw . . . . .                                | 67 | What Resources Are There to Help Me              |    |
|                                                 |    | Identify a Pest? . . . . .                       | 86 |
|                                                 |    | Understanding Fruit Diseases . . . . .           | 86 |
|                                                 |    | What Causes Diseases to Develop                  |    |
|                                                 |    | on My Plants? . . . . .                          | 86 |

|                                                                                                |            |                                                          |            |
|------------------------------------------------------------------------------------------------|------------|----------------------------------------------------------|------------|
| What Pests Should I Be Concerned About? . . . . .                                              | 87         | Planting and Nutritional Requirements . . . . .          | 140        |
| Disease and Pest Identification and Management . . . . .                                       | 87         | Pruning . . . . .                                        | 140        |
| Apple and Pear Diseases . . . . .                                                              | 87         | Harvest. . . . .                                         | 141        |
| Apple and Pear Insects . . . . .                                                               | 95         | White Pine Blister Rust . . . . .                        | 141        |
| Cultural and Mechanical Practices for Disease and Insect Control on Apples and Pears . . . . . | 102        | <b>Chapter 9. Some Sources of Fruit Plants . . . . .</b> | <b>143</b> |
| Stone Fruit Diseases. . . . .                                                                  | 103        | <b>Chapter 10. Glossary of Terms. . . . .</b>            | <b>145</b> |
| <i>Peaches, Nectarines, and Apricots . . . . .</i>                                             | <i>103</i> |                                                          |            |
| <i>Plums and Cherries . . . . .</i>                                                            | <i>106</i> |                                                          |            |
| Stone Fruit Insects . . . . .                                                                  | 108        |                                                          |            |
| Cultural and Mechanical Practices for Disease and Insect Control on Stone Fruit. . . . .       | 113        |                                                          |            |
| Bramble Diseases . . . . .                                                                     | 114        |                                                          |            |
| Bramble Insects . . . . .                                                                      | 119        |                                                          |            |
| Cultural and Mechanical Practices for Disease and Insect Control on Brambles . . . . .         | 121        |                                                          |            |
| Strawberry Diseases. . . . .                                                                   | 122        |                                                          |            |
| <i>Leaf Diseases. . . . .</i>                                                                  | <i>122</i> |                                                          |            |
| <i>Fruit Diseases . . . . .</i>                                                                | <i>123</i> |                                                          |            |
| <i>Root Diseases . . . . .</i>                                                                 | <i>125</i> |                                                          |            |
| Strawberry Insects . . . . .                                                                   | 126        |                                                          |            |
| Cultural and Mechanical Practices for Disease and Insect Control on Strawberries . . . . .     | 129        |                                                          |            |
| Grape Diseases . . . . .                                                                       | 130        |                                                          |            |
| Grape Insects . . . . .                                                                        | 134        |                                                          |            |
| Cultural and Mechanical Practices for Disease and Insect Control on Grapes . . . . .           | 136        |                                                          |            |
| Blueberry Diseases. . . . .                                                                    | 136        |                                                          |            |
| Blueberry Insects . . . . .                                                                    | 137        |                                                          |            |
| Cultural and Mechanical Practices for Disease and Insect Control on Blueberries . . . . .      | 138        |                                                          |            |
| <b>Chapter 8. Ribes—Gooseberries and Currants . . . . .</b>                                    | <b>139</b> |                                                          |            |
| Cultivar Selection . . . . .                                                                   | 139        |                                                          |            |
| Gooseberries. . . . .                                                                          | 139        |                                                          |            |
| Currants (Red) . . . . .                                                                       | 139        |                                                          |            |
| Currants (White and Pink). . . . .                                                             | 140        |                                                          |            |
| Currants (Black). . . . .                                                                      | 140        |                                                          |            |
| Currants (Clove or Buffalo) . . . . .                                                          | 140        |                                                          |            |



# Chapter 1. Introduction

## Benefits of Growing Fruit at Home

Fresh fruit is an excellent source of fiber, vitamin C, and minerals. In recent years, consumption of fruits and vegetables has been consistently shown to reduce the risk of many cancers. Many chemical compounds found in fruits are being recognized for their potential in protection against heart disease and cancer.



Figure 1. Ripening red raspberries.

The American Cancer Society has developed guidelines for nutrition and cancer prevention. These guidelines are similar to the Dietary Guidelines for Americans (HHS and USDA) and include the following:

- Choose most of the foods you eat from plant sources.
- Limit your intake of high-fat foods, particularly from animal sources.
- Be physically active. Achieve and maintain a healthy weight.

- Limit consumption of alcoholic beverages if you drink at all.

The guideline stating to “choose most of the foods you eat from plant sources” has been recognized for years as being important for good health. More importantly, recent research has begun describing positive properties, specifically chemicals, contained in fruits, vegetables, grains, legumes, seeds, licorice root, soy, and green tea.



Figure 2. “An apple a day keeps the doctor away.”  
Photo by Keith Weller, USDA/ARS.

A home fruit planting can provide fresh, tasty, and nutritious fruits for family use or sale. There are many excellent benefits to home fruit production:

- Growing fruit at home makes an excellent hobby for many gardeners. It can be a good source of fun and enjoyment. It is also a good way to exercise and release stress.
- You can be a proud producer of large amounts of delicious fruit in a relatively small area.
- Home fruit production can encourage children and adults to eat more fruit.
- Home fruit plantings can be incorporated into the landscape and can greatly enhance your home’s landscape.
- Home fruit gardeners can grow cultivars that are not available in local grocery stores or farm markets.
- Home fruit growers have direct control over pesticide inputs and can apply less chemicals in their fruit plantings.

- Growing fruit at home is an excellent educational experience for the young and the young at heart.

## Potential Challenges

There is much more to growing fruit than planting and harvesting the crop. Fruit plantings require a great deal of continuous care and attention. Growing fruit requires considerable knowledge about planting site, planting techniques, soil and nutrition, cultivar selection, training and pruning, and pest management.

Fruit growing requires some investment in basic tools and equipment, including a sprayer for pesticide application. Some fruit crops (usually strawberries, brambles, and blueberries) can be grown without the use of pesticides. However, production of tree fruits without the use of pesticides will generally result in poor-quality fruit.

Some fruits are definitely easier to grow than others. For example, strawberries are very similar to herbaceous perennials or annuals. Some strawberry cultivars (day neutral and everbearing types)

produce berries during the first year of planting while others (June-bearing type) produce berries one year after planting. Raspberries and blackberries are like ornamental shrubs and are not difficult to grow. However, tree fruits require much more time for pruning and pest management and take three to four years to bear fruit.

Before you begin a fruit planting, it is a good idea to consider disease resistance, pollination needs, site requirements, susceptibility to frosts, and cold hardiness of fruit plants. You might also want to attend a few training programs on fruit production or consult with your State University Extension professionals.

## Climate

### Cold Hardiness

Cold hardiness, or the capacity of plants to tolerate low winter temperatures, varies greatly among different fruit crops and cultivars within fruit crops (Table 1). Cold damage that may occur can include the splitting of tree trunks, damage to strawberry crowns, or death of stems and buds.

**Table 1. Approximate Low Temperatures That Damage Dormant Plants and/or Flower Buds.**

| <b>Tree Fruit</b>               | <b>Temperature</b> |
|---------------------------------|--------------------|
| Apple                           | -30°F              |
| Pear                            | -30°F              |
| Peach and Nectarine             | -15°F              |
| Plum                            | -15°F              |
| Cherry                          | -20°F              |
| Apricot <sup>1</sup>            | -25°F              |
| <b>Small Fruit</b>              | <b>Temperature</b> |
| Strawberry <sup>2</sup>         | -10°F              |
| Blueberry                       | -20°F              |
| Blackberry (erect)              | -20°F              |
| Blackberry (trailing thornless) | -5°F               |
| Raspberry (red) <sup>1</sup>    | -30°F              |
| Raspberry (black)               | -20°F              |
| Grape <sup>3</sup>              | -15°F              |
| Gooseberry                      | -30°F              |
| Currant                         | -30°F              |

<sup>1</sup> Some cultivars are subject to flower bud damage with fluctuating temperatures and strong cold winds.

<sup>2</sup> Use of straw mulch will help protect against cold weather damage during winter, plant heaving in heavy soils, and frost damage to flowers and buds in the spring.

<sup>3</sup> Some fruit cultivars are sensitive to strong cold winds.



## USDA Plant Cold Hardiness Zones

Each state in the Midwest is divided into cold hardiness zones by the USDA. As an example, Ohio is divided into four hardiness zones based on the average annual minimum temperature. They are Zones 5a (-15°F to -20°F), 5b (-10°F to -15°F), 6a (-5°F to -10°F), and 6b (-0°F to -5°F). Refer to the USDA hardiness zone map (Figure 3). The majority of Ohio is in Zone 5b, while the southern end of Ohio is mainly in Zone 6a. The type of fruit crop and cultivar of fruit crop should be based on the average winter temperatures for your area. Check with your state's Cooperative Extension Service for information on cold hardiness zones.

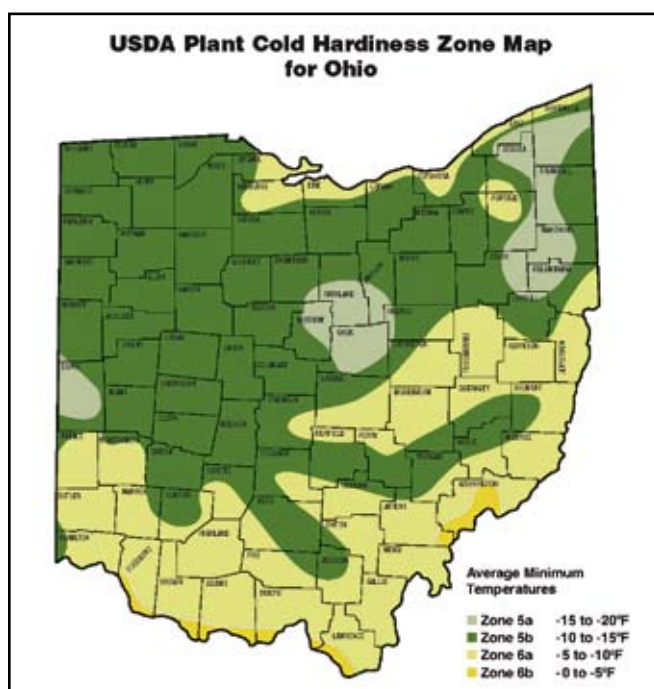

Figure 3. USDA Plant Cold Hardiness Zone Map for Ohio. Courtesy of the Ohio Nursery and Landscape Association. Used with permission.

Different fruit crops have varying degrees of susceptibilities to low temperatures (Table 1.) With each type of fruit crop, different plant parts and cultivars may have different thresholds for low temperature injuries. Plants that are healthy and properly acclimated for winter tend to withstand cold temperatures better than plants that are not acclimated and plants that are weakened.

Sudden changes or fluctuations in temperatures are common in the Midwest. Protecting plants from strong, cold winds can be beneficial. Planting on the east side of buildings or solid fences provides some protection from wind.

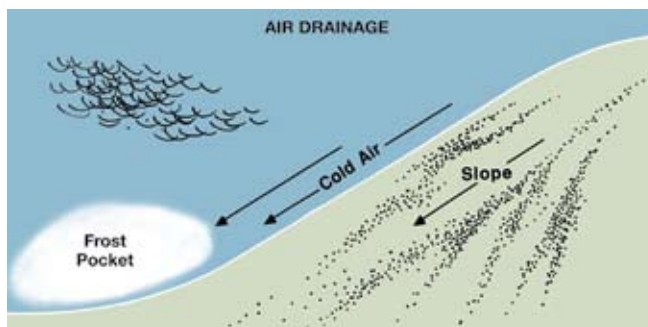

Figure 4. Air movement reduces moisture and humidity around plants in summer, prevents conditions that promote and spread diseases, and provides protection against late spring frosts.

Some fruits bloom early, such as apricot, sweet cherry, and peach, and are susceptible to frost damage to the blossom during early spring. In addition, frost damage will occur more frequently where cold air settles in low spots. It is best not to establish fruit plantings in such areas.



Figure 5. Strawberry flowers with symptoms of frost damage. Note the black (dead) centers.

## Growing Season

The number of frost-free days during the growing season at any location can be an important factor in selecting adapted fruit crops. The growing season (number of frost-free days) in most of the Midwest is usually sufficient to grow most temperate-zone fruit crops. However, for certain fruit crops, the length of growing season is an important factor when selecting late-maturing cultivars for planting.

## Soil

It is very important to select soil with proper characteristics since fruit crops are perennial and may occupy an area for many years. Fruit plants grow best in a fairly fertile, well-drained soil of loamy texture. A well-drained soil is essential to promote soil aeration and good root development. Never plant any fruit crop on a poorly drained (wet)

site. Although some trees might survive in poorly drained soil for a few years, they are destined to be short-lived and unproductive.



Figure 6. Gardeners should avoid planting fruit plants in soils that are consistently wet during the growing season.

Poorly drained soils are usually high in clay content and very sticky when wet. They tend to form a hard crust after a heavy rain, are easily compacted, and may hold water puddles for long periods after a rain. At the other extreme, very coarse sandy soils that drain rapidly dry out excessively during periods of prolonged drought.

A choice of soil types usually is not available to the homeowner. Where soil is unsuited to fruit crops, it should be improved prior to planting. Installing tile drainage and/or incorporating large amounts of organic matter, such as compost, will aid in improving soil structure, aeration, drainage, and fertility. Poorly drained soils should not be used for fruit production, unless fruit gardeners are willing to install raised beds or use other practices to improve soil drainage.

### Soil Reaction (pH) and Fertility

Frequently, soils contain the proper amounts of most nutrients, but they may be in a chemical form that is unavailable to plants. This condition may result from an undesirable soil reaction, or pH. Soil reaction refers to whether a soil is acidic or alkaline (basic) or neutral. Soils with a pH 7 are neutral. Soils with a pH below 7 are acidic, and those with a pH above 7 are alkaline (Figure 7). Most fruit crops prefer slightly acidic soils where most mineral nutrients are readily available to the plants. Blueberries require highly acidic soils. Please refer to the chapters on individual fruit crops for more information on soil requirements for specific crops.

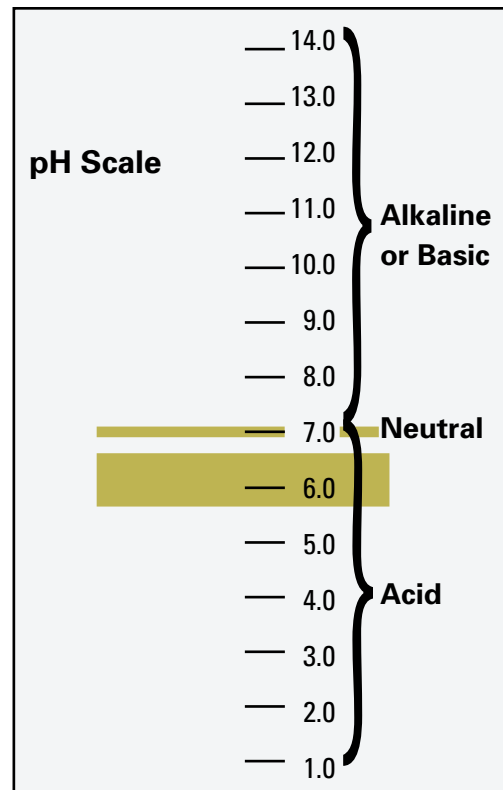

Figure 7. The pH scale shows whether soil reaction is acidic, neutral, or alkaline.

It is very important to take a soil test through a reliable laboratory to determine soil pH. The same report will also tell you what the lime index or buffer pH is. With both values, the soil testing lab can recommend soil amendments to lower or raise pH. Typically, sulfur is used to lower soil pH, while lime is used to raise soil pH. A soil test will also reveal specific nutrient levels. A typical soil test report will show you how much fertilizer to apply and whether you need to apply lime or sulfur.

The amount and type of fertilizer and lime or sulfur to apply for growing specific fruit crops is provided to the gardener along with the soil test reports. This is invaluable for successful fruit production. Applying fertilizer, lime, or sulfur without the benefit of soil test results and recommendations as a guide makes soil fertility maintenance and improvement haphazard. This can create more problems than it solves.

If your soil test report indicates a need for lime or sulfur to correct soil pH, fall is a good time to do that. Since the chemical reaction for pH adjustment takes three months to one year, an application of lime or sulfur can be applied in the fall prior to the year of planting since fruit crops are typically planted in spring. Soil pH requirements

are quite different for different fruit crops. Refer to the appropriate chapters and sections for specific recommendations for each fruit crop.



*Figure 8. Do not guess; soil test! A soil probe (shown here) or a garden trowel can be used to take a soil sample.*

Some garden centers carry soil test kits. However, these test kits do not provide an accurate reading of nutrient levels and soil pH. Gardeners are encouraged to work with their local county Extension office to determine how soil samples can be taken and where the soil samples can be sent for testing. State University Extension offices can provide gardeners with a list of suggested private soil testing labs.

Soil tests do carry a charge. However, such tests are an excellent investment. A soil test costs approximately \$15 to \$20. Check with your soil testing lab for latest rates. Gardeners should have their soil tested every three years.

## Fertilization

Fertilization is an important practice in growing all fruit crops since a large amount of minerals are removed each year through fruit harvest, fallen leaves, and pruned stems. When properly used, fertilizers help improve plant health and increase yields and fruit quality. Improperly used, they may be wasted or result in plant damage, excessive growth, lack of fruit production, or poor quality fruit.

Even though fertilizers are very important, they cannot:

1. Correct or improve a soil structure that does not allow sufficient aeration or drainage for satisfactory root and plant growth.
2. Adjust an unsuitable soil reaction (pH).

3. Compensate for poor-quality plants or poorly adapted cultivars.

Gardeners may use either synthetic or organic fertilizer. A lot more research has been done on the use of synthetic fertilizers by universities and federal agencies. The recommendations for the rate and timing of synthetic fertilizers are very accurate because of the availability of research-based information from reputable sources. Synthetic fertilizers can also be available in both fast-release and controlled-release forms.

Generally speaking, it is more economical to use synthetic fertilizer. However, some gardeners prefer organic fertilizers. Organic fertilizers are products of living things and include manure, fish meal, and blood meal. Generally, organic fertilizers act more slowly than synthetic. Although poultry and rabbit manures are organic in nature, they must be used with caution on fruit crops because of the high concentration of nitrogen they contain.

Many different types and brands of fertilizers are available today. Fertilizers commonly used today in fruit production include the ones with an analysis of 10-10-10, 12-12-12, 15-15-15, 5-10-15, or 5-20-20. The types of fertilizers used for fruit plantings depend greatly on the nutrient levels in the soil and the type of the fruit crops grown. This is why soil tests are highly encouraged. Soil testing through a reputable lab is the best way to determine the nutrient levels, soil pH, lime index, or buffer pH. You will also receive recommendations on fertilizer and any materials needed to adjust soil pH.

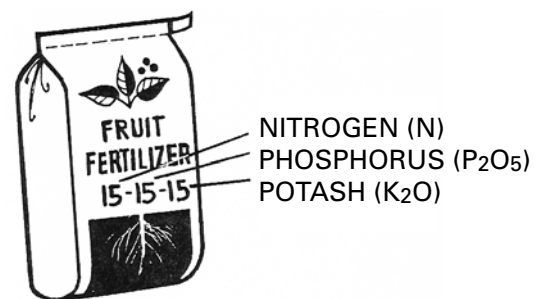

*Figure 9. A complete fertilizer is typically recommended for home fruit plantings. Only a soil test can reveal the fertilizer needs of a given fruit crop.*

Some more serious home gardeners may choose to conduct tissue analysis, *i.e.*, foliar (leaf) analysis. Tissue analysis is a great way to determine what is taken up by plants. It is a good supplemental test

to soil analysis and should probably be reserved for fairly large-scale fruit plantings.

Essential nutrients for fruit plants are best supplied from the soil. Complete fertilizers contain the three primary plant nutrients— nitrogen, phosphorus, and potassium. An example of a complete fertilizer is 12-12-12. The three number sequence used to describe fertilizers is known as fertilizer analysis. The first number in the analysis refers to the percentage of nitrogen by weight. The second number refers to phosphorus as the percentage of water-soluble phosphoric acid equivalent ( $P_2O_5$ ), while the third number refers to potassium as potash ( $K_2O$ ). Incomplete fertilizers lack one or more primary plant nutrients. Examples are 0-20-0 or 0-20-20. Soil test results and plant performance are valuable guides to the type and amounts of fertilizer to use.

Nitrogen generally needs to be applied each year since it is essential for all areas of plant growth. It is important in the development of chlorophyll, the pigment responsible for the dark green color in leaves, and photosynthesis, the conversion of carbon dioxide to carbohydrates. Hence, nitrogen is essential in promoting vegetative growth and in improving the quality of fruit. Nitrogen must be applied in proper amounts. Too much nitrogen causes excessive growth. This excessive growth can result in greatly decreased fruit production.

In apples and pears, the bacterial disease fire blight may develop and spread rapidly in plants with excessive, succulent growth. In addition, poorer fruit color and some physiological disorders in apples are also common when excessive nitrogen has been applied. Too much of any nutrient can cause damage or even kill plants.

Phosphorus promotes early root development and growth. It gives plants a rapid and vigorous start. It also stimulates flower bud formation and blooming, aids in shoot growth, and hastens maturity. Since phosphorus moves slowly in the soil profile, it is quite beneficial to add phosphorus in the planting hole prior to planting fruit plants, if soil test recommendations call for addition of phosphorus.

Potassium is essential to plant health and disease resistance and improves fruit quality. It is also important for the efficient use of water. Hence,

plants that are deficient in potassium may experience marginal scorching of leaves, which mimics drought stress.

Even though fertilizers that contain nitrogen, phosphorus, and potassium are often called complete fertilizers, fruit plants still need 11 other mineral nutrients called secondary elements and trace elements or micro nutrients. These elements are also essential to fruit crops. They will need to be added if the soil test report and/or plant tissue testing indicate an insufficient amount.

Common methods of applying fertilizers are broadcast application, sidedressing, topdressing, fertilizer solution application, and foliar spray. Broadcasting refers to uniformly applying the fertilizer over the entire area. Sidedressing refers to placing the fertilizer beside the row during the growing season. Topdressing is similar to sidedressing except that the fertilizer is applied around the plant. Caution: Fertilizer applied too close to the plant can cause fertilizer burn. Foliar applications are dilute fertilizer solutions applied directly to the leaves.

### Timing of Fertilizer Application

The timing for fertilizing fruit crops differs greatly among fruit crops. Refer to the individual chapters and sections on specific fruit crops for recommended fertilizers and their timing. In order for fertilizers to promote growth, they must be soluble and present in the root zone in the correct concentrations. Fertilizers in very dry soil generally do not produce the desired results. Watering or rain may help improve fertility. Too much fertilizer may cause plant injury or plant death.



*Figure 10. Fruit trees should be fertilized in early spring before growth starts. Shown here are dormant peach trees. Timing for fertilizing small fruits can be very different.*

## Soil Management

It is a good idea to prepare the soil a year before planting. Planting a cover crop and correcting soil pH imbalances will go a long way in soil improvement. Plant a cover crop to increase soil organic matter content and prevent soil erosion. You may also add organic matter at planting. Cover crops established in the fall should be turned over in the spring before plant growth is so tall that it is difficult to completely turn under. Cover crops may be seeded in September between rows of grapes and raspberries. Annual ryegrass and winter rye are good examples of cover crops. They need to be sowed before September 15 for best results.



Figure 11. Good planning is very critical for successful fruit plantings. It is a good idea to conduct a soil test and improve your soil the year before you plant your fruit crops.

When growing fruit crops, the planting should be mulched to a depth of two to three inches in the row for most fruit crops except blueberries. Blueberries require a thicker layer of mulch. Refer to the blueberry section for specific recommendations. Mulch helps conserve soil moisture, suppress weeds, and reduce fruit diseases. Areas between rows for most fruit crops except strawberries are usually seeded with perennial grass and mowed. The areas between the rows of strawberry plants are not usually seeded with grasses. Straw typically is used between and within the rows as mulch to control weeds, conserve soil moisture, and keep berries clean. In addition, straw can be used to cover plants for both winter and frost protection.

## Pollination for Successful Fruit Production

Many home gardeners have experienced abundant blooms on various fruit crops without fruit production. There can be several causes for this problem. Unsuccessful pollination is at the top of the list. Pollination is the transfer of pollen from *anthers* (male part of the flower) to *stigmas* (female part of the flower) which may, or may not, be on the same flower or on the same plant. If the flower is not satisfactorily pollinated, fruit may drop, be poorly shaped, or malformed and unattractive.



Figure 12. Honeybees are required for pollination of many fruit crops.

Some fruits are *self-fruitful*, meaning that pollen from the same cultivar will result in successful pollination, fertilization, and fruit formation. For these, you do not need to plant two different cultivars that bloom at the same time. However, some fruits are *not self-fruitful*, (e.g., apple trees) and pollen from its own flower or pollen from a flower of another tree of the same cultivar is incapable of producing fertilization. This is because a biological antagonism exists between the pollen and the style of the flower. Therefore, *cross pollination*, or the transfer of pollen from the anthers of one cultivar to the stigma of another cultivar, is necessary when a cultivar is not self-fruitful. In addition, some cultivars have *sterile pollen* and cannot pollinate others. Gardeners are encouraged to consult with their local Extension office, garden centers, or mail-order nurseries when purchasing fruit plants to determine pollination requirements for a specific fruit crop or cultivar.

Many fruit crops also need honeybees or wild bees to carry pollen from one flower to the next since their pollens are heavy and sticky. These pollens are not carried to any extent by wind. Honeybees and wild bees are good carriers of pollen from the anthers of one cultivar to the stigma of another cultivar. The pollen adheres to the surface of the stigma and germinates and, if compatible, forms a pollen tube that grows down the style to the ovule. The sperm fuses with the egg cell, fertilization is completed, and seed development begins.

During recent years, honeybee populations have been drastically reduced by parasitic honey bee mites. Pesticide usage during bloom has also had a detrimental effect on honey bee populations. In addition, feral bee colonies (wild honey bees nesting in trees or other cavities) have been decreased dramatically. If you do not see any bees when your fruit trees are in bloom, your fruit size and yield can be greatly reduced. Misshapen fruit could result as well. Gardeners should refrain from applying insecticides when fruit trees are in bloom.

Other than the lack of viable pollen, other factors affecting pollination include cool, wet or humid weather, or strong wind that can limit or stop bee activity and lead to poor pollination. Frost damage frequently kills the *pistil*, the female part of the flower. Cold temperatures before or during bloom can cause poor seed count or poor seed formation, therefore causing malformed fruit and possibly fruit drop. Insects such as the tarnished plant bug feed on anthers and cause deformed strawberry fruit. Several other factors can adversely affect fruit set.

Apples, sweet cherry, plum, and nut crops, such as hickories, Persian (English) walnut, and filbert (hazelnut), require cross pollination and are generally considered self unfruitful. Therefore, two different cultivars need to be planted within 50 feet of each other for semi-dwarf fruit trees and 20 feet for dwarf fruit trees. Ideally, they should be planted side by side for much greater chance of successful pollination.



*Figure 13. Apple, sweet cherry, plum, and nut crops, such as hickories, Persian (English) walnut, and filbert (hazelnut), require cross pollination and are generally considered self unfruitful. Photo by Scott Bauer, USDA/ARS. Used with permission.*



*Figure 14. A bumper crop of blueberries. Photo courtesy of The Blueberry Patch, Mansfield, Ohio. Blueberries will yield more fruit if two different cultivars are planted near each other. Black walnut, chestnut, and butternut will also yield more if two trees of the same cultivar are planted together. Refer to Table 2 for best pollinizers, which are plant species or cultivars that produce the pollen for various fruit crops.*

| <b>Table 2. The Best* Pollinizers (the Plant Species or the Cultivars That Produce the Pollen) for Various Fruit Crops.</b>       |                                                                                                     |
|-----------------------------------------------------------------------------------------------------------------------------------|-----------------------------------------------------------------------------------------------------|
| <b>Apple</b><br>Enterprise, Golden Delicious, Jonafree, Jonathan, Liberty, Lodi, Pristine, Rome Beauty                            | <b>Sweet Cherry</b><br>Hedelfingen, Black Tartarian, and Rainer                                     |
| <b>Pear</b><br>Clapp's Favorite and Maxine                                                                                        | <b>Japanese Plum</b><br>Abundance, Methley (for Santa Rosa), and Shiro                              |
| <b>European Plum</b><br>Stanley and Shropshire Damson                                                                             | <b>Blueberry and Nut Crops</b><br>Plant two different cultivars of the same crop for higher yields. |
| * Many other cultivars of each fruit crop can be good pollinizers. Refer to your nursery catalogs for more recommended cultivars. |                                                                                                     |

Peaches, nectarines, apricots, grapes, brambles, strawberries, currants, gooseberries, and sour cherries (pie cherry or tart cherry) do not require cross pollination but all except grapes require bee activity for maximum yield and desirable fruit shape.



*Figure 15. Peach does not need cross pollination for a successful crop.*

Pollen source does not influence fruit flavor. For example, McIntosh will be McIntosh in size, color, and flavor when pollinated by Golden Delicious. However, the seeds when planted would produce different seedling hybrids than their parents. Very few seedlings, if any, produce fruits of acceptable quality. This is why fruit plants are not propagated by seeds. They are propagated by cuttings, bud and stem grafts, or root suckers, depending on the fruit species.





# Chapter 2. Tree Fruits

## Selecting Tree Fruits

When selecting tree fruits, first consider how much growing space is available. Tree fruits occupy more space than small fruits. Many tree fruits require two (sometimes three cultivars) for pollination, unless two to three cultivars are grafted onto the same tree. Larger size trees may bear more fruits; however, they are more difficult to prune, spray, and harvest than dwarf and semi-dwarf trees. For example, dwarf apple trees typically reach 8 to 10 feet tall and are much easier to care for than the standard-sized trees. The mature height of semi-dwarf apple trees ranges from 12 to 20 feet, depending on the rootstocks selected.

Dwarf cherry, peach, and nectarine trees can be grown in a smaller area and only require 10 square feet of garden area. However, fruit quality may not be equal to that of standard cultivars.

Dwarf peach, pear, apricot, or plum are generally not recommended because 50 percent or more may not live beyond five years of age. Generally, standard-size trees can be kept smaller by annual pruning.

## Selecting Tree Fruit Cultivars

A very important factor that affects the ultimate success and satisfaction with the fruit planting is the selection of appropriate fruit cultivars. Some fruit cultivars and types are not suited for growing

under midwest conditions. Time and effort devoted to fruit production will be more rewarding if cultivars proven to be dependable under your specific growing conditions are selected and planted.

Home gardeners should also consider that certain fruit crops and cultivars that are grown successfully in commercial orchards may not always be suited for home fruit plantings due to requirements for regular pesticide applications and the inability to obtain more effective pesticides. Home fruit growers are encouraged to select disease-resistant fruit cultivars to reduce the need for sprays.



Figure 17. It is very important to select fruit cultivars that are disease resistant when possible. 'Liberty' is an apple cultivar that is very similar to McIntosh and is highly resistant to most apple diseases. Photo courtesy of Adams County Nursery.

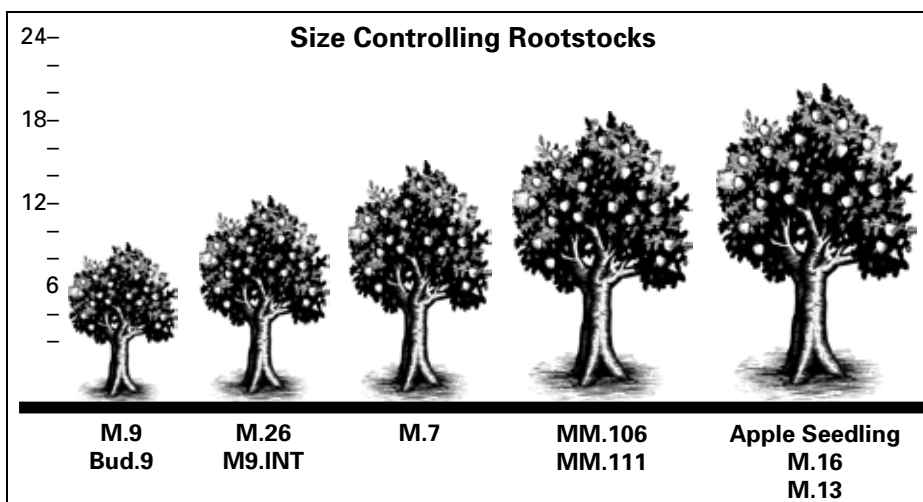

Figure 16. Dwarf or semi-dwarf fruit trees are better suited for home fruit production than the standard-size trees.

While looking through nursery catalogs, one can find many cultivars of fruit plants for sale. Deciding which of the many cultivars to purchase for planting is a dilemma. To assist gardeners in making cultivar selections, some of the most common cultivars of tree fruit crops are listed in Tables 3 to 9.

## Tree Fruit Cultivar Descriptions

### Apples (*Malus domestica* Borkh)



Figure 18. Goldrush is immune to apple scab disease and is a high quality apple for cooking and eating fresh.

Photo courtesy of Adams County Nursery.

**Table 3. Scab-Resistant Apple Cultivars Recommended for Home Planting in the Midwest.**

(Listed in order of ripening.) All cultivars listed are immune to apple scab.

| Cultivar       | Characteristics                                                                                                                                                                                               | Ripening Period              | Disease Rating <sup>b</sup> |     |     |
|----------------|---------------------------------------------------------------------------------------------------------------------------------------------------------------------------------------------------------------|------------------------------|-----------------------------|-----|-----|
|                |                                                                                                                                                                                                               |                              | CAR <sup>a</sup>            | PM  | FB  |
| Pristine       | Very early, medium-sized yellow apple. Pleasant tart flavor with a smooth, attractive finish.                                                                                                                 | Late July to early August    | M                           | R   | M   |
| Williams Pride | Early, dark red-purple apple. Large fruited. Semi-tart flavor. Sometimes shows water-core or bitter pit.                                                                                                      | Mid-August                   | R                           | M   | R-M |
| Redfree        | An early, red-skinned, sweet summer apple. Crisp. Does not have a long storage life.                                                                                                                          | Late August to Mid-September | R                           | R-M | R-M |
| Crimson Crisp  | Rich flavor with moderately acidic and spicy aftertaste. Bright red fruit with cream-colored flesh.                                                                                                           | Early September              | M                           | M   | S   |
| Crimson Gold   | Fruit has a full red-orange blush on a yellow background. Flesh is white, firm, and juicy. Medium in size with a sweet-tart flavor. Fruit will store up to eight months in commercial controlled-air storage. | Mid-September                | U                           | U   | U   |
| Crimson Topaz  | Medium-sized fruit. Crisp and juicy with good flavor. Fruit has 50% orange-red striping over a yellow background. Growth habit is spur-like, vigorous, and upright.                                           | Mid-September                | S                           | M   | M   |
| Jonafree       | Mid-season; firm, red apple; slightly tart. Flavor improves after storage. Similar to Jonathan.                                                                                                               | Mid-to late September        | S                           | R   | M   |
| Scarlet O'Hara | Large round fruit with medium red to orange color. Rich, pleasant, slightly spicy flavor.                                                                                                                     | Early to mid-October         | R                           | M   | S   |
| Sundance       | Medium-sized fruit with a sweet, tart flavor. Yellow fruit with some russet.                                                                                                                                  | Mid-October                  | R                           | M   | R   |
| Enterprise     | Good-quality; late-season; smooth, glossy red apple similar to McIntosh. Stores well. Susceptible to a fruit spotting disorder.                                                                               | Mid-October                  | R                           | M   | R   |
| Goldrush       | Excellent quality fruit; good storage apple. Very late maturing Golden Delicious type. Fruit may russet.                                                                                                      | Late October                 | S                           | R   | M   |

Notes:

<sup>a</sup> CAR = cedar apple rust; PM = powdery mildew; FB = fire blight.

<sup>b</sup> R = resistant; M = moderate; S = susceptible; U = unknown.



Figure 19. Gala, though not resistant to apple scab, is one of many excellent apple cultivars recommended for planting in the Midwest. Photo courtesy of Adams County Nursery.

| <b>Table 4. Apple Cultivars Not Resistant to Apple Scab But Recommended for Home Planting in the Midwest.</b> (Listed in order of ripening.) |                                                                                                                                                                                                                                                          |                                 |
|----------------------------------------------------------------------------------------------------------------------------------------------|----------------------------------------------------------------------------------------------------------------------------------------------------------------------------------------------------------------------------------------------------------|---------------------------------|
| <b>Cultivar</b>                                                                                                                              | <b>Characteristics</b>                                                                                                                                                                                                                                   | <b>Ripening Period</b>          |
| Lodi                                                                                                                                         | Early improved yellow transparent or large transparent. A green cooking apple. Large, clear yellow fruit with sweet-tart flavor. Excellent choice for apple sauce.                                                                                       | Early to mid-July               |
| Jerseymac                                                                                                                                    | Early McIntosh type. Crisp, red apple of excellent quality. Good for eating, sauce, and pies.                                                                                                                                                            | Late July to early August       |
| Zestar                                                                                                                                       | Medium to large, red-over-yellow fruit. Flavor is well balanced. Slightly sweeter than tart. Flesh is crisp and medium to coarse. Good for fresh eating and sauce.                                                                                       | Early to mid-August             |
| Ginger Gold                                                                                                                                  | Golden-type apple ripening in mid- to late August. High-quality, russet-free fruit. Good for eating fresh and pies.                                                                                                                                      | Mid-August                      |
| Gala                                                                                                                                         | Orange-red fruit, sweet and hard with high quality. Developed in New Zealand. Good for eating fresh and sauce.                                                                                                                                           | Late August to September        |
| McIntosh                                                                                                                                     | Old-time favorite. Purchase new high-coloring strains. Available as a spur type. Good for fresh eating, pies, and sauce.                                                                                                                                 | Early September                 |
| <b>Cultivar</b>                                                                                                                              | <b>Characteristics</b>                                                                                                                                                                                                                                   | <b>Ripening Period</b>          |
| Honeycrisp                                                                                                                                   | Large, explosively crisp, and juicy fruit. Fruit color is red-over-green ground color. Weak-growing tree. Fruit may show bitter pit when the trees are young.                                                                                            | Mid-September                   |
| Delicious                                                                                                                                    | Most popular commercially grown cultivar. Available in spur and nonspur strains. Good for fresh eating.                                                                                                                                                  | Early to mid-October            |
| Empire                                                                                                                                       | Dark-red apple of excellent dessert quality. An all-purpose apple that keeps well. Good for fresh eating, pies, and sauce.                                                                                                                               | Mid- to late September          |
| Golden Delicious                                                                                                                             | Excellent all-purpose apple. Heavy producer. Avoid spur strains because they tend to russet more than nonspur strains.                                                                                                                                   | Late September to early October |
| Idared                                                                                                                                       | Popular older cultivar. Produces large, mildly tart, red fruit that keeps well. Good for all uses.                                                                                                                                                       | Early to mid-October            |
| Jonagold                                                                                                                                     | Developed in New York as a cross between Jonathan and Golden Delicious. High-quality fruit. Develops a red blush over yellow skin. It is a triploid and produces sterile pollen. (See section on pollination.) Good for fresh eating, sauce, and baking. | Early to mid-October            |
| Melrose                                                                                                                                      | It is the official Ohio state apple. Fruit is large with yellowish green skin with red streams. High quality apple for dessert or cooking.                                                                                                               | Early to mid-October            |
| Mutsu                                                                                                                                        | Cross between Golden Delicious and Indo. Very large, light-green to yellow fruit. It is a triploid and produces sterile pollen. Good for fresh eating, pies, and sauce.                                                                                  | Mid-October                     |

**Table 4. (continued). Apple Cultivars Not Resistant to Apple Scab But Recommended for Home Planting in the Midwest.** (Listed in order of ripening.)

|          |                                                                                                                                                                                                                                                                                                                                                                     |                      |
|----------|---------------------------------------------------------------------------------------------------------------------------------------------------------------------------------------------------------------------------------------------------------------------------------------------------------------------------------------------------------------------|----------------------|
| SunCrisp | Golden-type apple that can develop a red or orange cheek in cooler years. Unusual cinnamon spice-flavored fruit. Tastes better after a period of storage. Good for fresh eating, sauce, and pies.                                                                                                                                                                   | Mid- to late October |
| Fuji     | Developed in Japan. Late-ripening apple. People located above Interstate 80 might have difficulty in maturing the fruit each year. There are, however, some early-maturing strains available, such as Daybreak and September Wonder. Very firm. Red-over-green fruit that is sweet. Stores extremely well in regular refrigeration. Good for fresh eating and pies. | Late October         |
| Braeburn | Newer apple cultivar that ripens in late October. Red-over-green fruit that is semi-tart but very firm. Good for fresh eating and sauce. Do not plant if you live north of Interstate 80.                                                                                                                                                                           | Late October         |

Note: New fruit cultivars that may be superior to currently recommended varieties are constantly being released. Check with your local Extension Educator or the nursery you order plants from to obtain information on newly released cultivars for your location.

## Pears



Figure 20. Pear production in the Midwest is greatly limited by fire blight, a bacterial disease, and occasional spring frosts.

**Table 5. Recommended Pear Cultivars for Midwest Gardens.\* Uses: Fresh Eating, Mixed Fruit Deserts, and Canning.**

| Cultivar           | Season             | Remarks                                                                                                                                                                                             |
|--------------------|--------------------|-----------------------------------------------------------------------------------------------------------------------------------------------------------------------------------------------------|
| Clapp's Favorite   | Early              | Fruit large and attractive, resembling Bartlett in size. Susceptible to fire blight.                                                                                                                |
| Cultivar           | Season             | Remarks                                                                                                                                                                                             |
| Harrow Delight     | Early              | Fruit medium in size, high quality, and attractive. Similar to Bartlett. Excellent flavor with yellow ground color and red blush. Resistant to fire blight.                                         |
| Seckel             | Early              | Fruit small in size, but very sweet and extremely flavorful. Self-fruitful. Moderately susceptible to fire blight.                                                                                  |
| Moonglow           | Early              | Fruit medium in size and light green to yellow in color with a red blush. White and soft flesh with a mild flavor. Moderately resistant to fire blight.                                             |
| Harvest Queen      | Early<br>Midseason | Fruit almost identical to Bartlett in appearance and flavor, only slightly smaller. Cross pollinates with Harrow Delight. Resistant to fire blight.                                                 |
| Bartlett           | Early<br>Midseason | Fruit medium in size with smooth yellow skin. Flesh is smooth and juicy. It is the leading commercial cultivar in the United States and also is very popular in Europe. Susceptible to fire blight. |
| Bosc (Beurre Bosc) | Mid Season         | Fruit medium to large in size with a juicy flesh and smooth texture. Fruit skin is golden yellow with a bronze color when ripe. Susceptible to fire blight.                                         |

\* Plant at least two different cultivars for cross pollination.

Note: New fruit cultivars that may be superior to currently recommended varieties are constantly being released. Check with your local Extension Educator or the nursery you order plants from to obtain information on newly released cultivars for your location.

### Apricots (*Prunus spp.*)

Apricot is a delightful stone fruit, but unfortunately, crops are frequently lost when blooms are killed by spring frost. Gardeners should keep this in mind before selecting this fruit crop for establishment in the home fruit planting. Trees grown in protected areas may have a better chance of producing fruits. Some common cultivars are Moorpark, Goldrich, Moongold, Harcot, Veccot, Hargrande, Harogem, Harlayne, and Sungold.

### Cherries (*Prunus spp.*)



Figure 21. Cherries can be grown in throughout the Midwest with varying degrees of success. Shown here are tart or pie cherries.

#### Tart Cherries

Tart cherries are self-fruitful. There is no need to plant two different cultivars for cross pollination.



Figure 22. Sweet cherries are a delightful fruit that require excellent soil drainage for tree growth and fruit production. Shown here is the cultivar Kristin.

Photo Courtesy of Adams County Nursery.

#### Sweet Cherries

Sweet cherries require excellent soil drainage for survival and are typically not recommended for planting in Ohio. If gardeners are willing to try to grow sweet cherries, some of the common sweet cherry cultivars are Emperor Francis, Schmidt's Bigarreau, Kristin, Hedelfingen, Ulster, Royalton, and Windsor. Plant at least two different cultivars for cross pollination.

| <b>Table 6. List of Recommended Tart Cherry Cultivars. Uses: Pies, jellies, jams, and desserts.</b> |                             |                                                                                                                                                                                                                                                                        |
|-----------------------------------------------------------------------------------------------------|-----------------------------|------------------------------------------------------------------------------------------------------------------------------------------------------------------------------------------------------------------------------------------------------------------------|
| <b>Cultivar</b>                                                                                     | <b>Ripening Season</b>      | <b>Remarks</b>                                                                                                                                                                                                                                                         |
| Standard<br>Early Richmond<br>Jubileum<br>Montmorency                                               | Early<br>Early<br>Midseason | Fruits of fair quality; trees productive.<br>The best of the red tart cherry cultivars.<br>Early, ripens 10 days before Montmorency. Excellent fruit quality and productive.<br>The standard for pie cherries. Fruit red, tart, and of good quality.<br>Self-fruitful. |
| Dwarf (Genetic)<br>Meteor<br>North Star                                                             | Midseason<br>Midseason      | Hardy, high-quality fruit that is medium in size and claimed to be resistant to leaf spot.<br>Hardy; fruit quality less than Montmorency and medium in size.<br>Self-fruitful and claimed to be resistant to leaf spot.                                                |

Note: New fruit cultivars that may be superior to currently recommended varieties are constantly being released. Check with your local Extension Educator or the nursery you order plants from to obtain information on newly released cultivars for your location.

**Peaches** (*Prunus persica*) and **Nectarines** (*Prunus persica* var. *nucipersica*)



Figure 23. Peach blooms are extremely attractive and brighten the landscape in early spring.

Uses: Fresh eating, pies, cobbler, jams, jellies, preserves, in mixed fruit desserts, in and over ice cream.

Nectarine is a fuzzless peach and is used similarly to peach, but is best suited for fresh eating.



Figure 24. Tree-ripe peaches are a delightful sight in summer.  
Photo courtesy of Adams County Nursery.

| <b>Table 7. Recommended Peach and Nectarine Cultivars for Midwest Gardens.</b>                                                                                                                                                                                      |                        |                       |                    |                   |                        |                                    |
|---------------------------------------------------------------------------------------------------------------------------------------------------------------------------------------------------------------------------------------------------------------------|------------------------|-----------------------|--------------------|-------------------|------------------------|------------------------------------|
| <b>Fruit</b>                                                                                                                                                                                                                                                        | <b>Ripening Season</b> | <b>Stone Freeness</b> | <b>Flesh Color</b> | <b>Fruit Size</b> | <b>Dessert Quality</b> | <b>Additional Remarks</b>          |
| <b>Peach</b>                                                                                                                                                                                                                                                        |                        |                       |                    |                   |                        |                                    |
| Harbinger                                                                                                                                                                                                                                                           | Very Early             | Freestone             | Yellow             | Medium            | Good                   | Hardy                              |
| Garnet Beauty                                                                                                                                                                                                                                                       | Very Early             | Semi-Free             | Yellow             | Medium to Large   | Good                   | Hardy                              |
| Sunhaven                                                                                                                                                                                                                                                            | Very Early             | Freestone             | Yellow             | Large             | Excellent              | Productive                         |
| Harken                                                                                                                                                                                                                                                              | Early                  | Freestone             | Yellow             | Medium            | Excellent              | Hardy                              |
| Redhaven                                                                                                                                                                                                                                                            | Very Early             | Freestone             | Yellow             | Medium            | Excellent              | Hardy                              |
| Reliance                                                                                                                                                                                                                                                            | Early                  | Freestone             | Yellow             | Medium            | Good                   | Very hardy                         |
| Glohaven                                                                                                                                                                                                                                                            | Mid                    | Freestone             | Yellow             | Large             | Excellent              | Vigorous and productive            |
| Canadian Harmony                                                                                                                                                                                                                                                    | Mid                    | Freestone             | Yellow             | Large             | Excellent              | Hardy                              |
| Cresthaven                                                                                                                                                                                                                                                          | Mid                    | Freestone             | Yellow             | Large             | Excellent              | Hardy                              |
| Harcrest                                                                                                                                                                                                                                                            | Mid                    | Freestone             | Yellow             | Medium            | Excellent              | Hardy                              |
| Madison                                                                                                                                                                                                                                                             | Late                   | Freestone             | Yellow             | Medium            | Excellent              | Hardy                              |
| Redskin                                                                                                                                                                                                                                                             | Late                   | Freestone             | Yellow             | Large             | Excellent              | Heavy producer                     |
| Belle of Georgia                                                                                                                                                                                                                                                    | Late                   | Freestone             | White              | Large             | Excellent              | Very hardy                         |
| White Hale                                                                                                                                                                                                                                                          | Late                   | Freestone             | White              | Large             | Excellent              | Hardy                              |
| <b>Nectarine</b>                                                                                                                                                                                                                                                    |                        |                       |                    |                   |                        |                                    |
| Independence                                                                                                                                                                                                                                                        | Early                  | Cling                 | Yellow             | Large             | Excellent              | Fairly hardy                       |
| Summerbeaut                                                                                                                                                                                                                                                         | Early                  | Freestone             | Yellow             | Large             | Excellent              | Hardy and productive               |
| Hardired                                                                                                                                                                                                                                                            | Mid                    | Freestone             | Yellow             | Medium            | Good                   | Vigorous and productive            |
| Mericrest                                                                                                                                                                                                                                                           | Mid                    | Freestone             | Yellow             | Medium            | Excellent              | The hardiest nectarine             |
| Red Gold                                                                                                                                                                                                                                                            | Late                   | Freestone             | Yellow             | Large             | Excellent              | Productive and most widely planted |
| Fantasia                                                                                                                                                                                                                                                            | Late                   | Freestone             | Yellow             | Large             | Excellent              | Productive and relatively hardy    |
| Note: New fruit cultivars that may be superior to currently recommended varieties are constantly being released. Check with your local Extension Educator or the nursery you order plants from to obtain information on newly released cultivars for your location. |                        |                       |                    |                   |                        |                                    |

## Plums



Figure 25. Plums are an excellent crop for home fruit production. Photo courtesy of Adams County Nursery.

| <b>Table 8. List of Recommended Plum Cultivars for Midwest Gardens. Uses: Fresh eating, canning, freezing, jams, jellies, pies, cobblers, and mixed fruit dessert.</b>                                                                                              |               |                                                                                                                                                                                                   |
|---------------------------------------------------------------------------------------------------------------------------------------------------------------------------------------------------------------------------------------------------------------------|---------------|---------------------------------------------------------------------------------------------------------------------------------------------------------------------------------------------------|
| <b>Cultivar</b>                                                                                                                                                                                                                                                     | <b>Season</b> | <b>Remarks</b>                                                                                                                                                                                    |
| <b>European</b>                                                                                                                                                                                                                                                     |               |                                                                                                                                                                                                   |
| Bradshaw*                                                                                                                                                                                                                                                           | Early         | Trees slow growing and late into production. However, they are hardy, long lived, and productive. Fruits are medium to large in size with yellow flesh and freestone habit. Only fair in quality. |
| Italian Prune*                                                                                                                                                                                                                                                      | Mid Season    | Trees are large, vigorous, and productive. Fruit skin color is blue and of fair to good dessert quality.                                                                                          |
| Stanley                                                                                                                                                                                                                                                             | Mid Season    | Trees are vigorous and relatively hardy. Fruit is blue and medium in size. Self-fruitful and a good pollinizer for other plum cultivars.                                                          |
| Green Gage                                                                                                                                                                                                                                                          | Mid Season    | Trees are only moderately vigorous but productive. Fruit is greenish yellow in color, of medium size, and of high quality. Self-fruitful.                                                         |
| Bluefree*                                                                                                                                                                                                                                                           | Mid Season    | Trees are productive. Fruit large and blue with yellow flesh. Has a tendency toward split pits.                                                                                                   |
| <b>Japanese*</b>                                                                                                                                                                                                                                                    |               |                                                                                                                                                                                                   |
| Generally not recommended for planting in Ohio because of their early blooming habit. Gardeners should keep this in mind before selecting this fruit crop for establishment in the home fruit planting.                                                             |               |                                                                                                                                                                                                   |
| * Plant with another cultivar for cross pollination.                                                                                                                                                                                                                |               |                                                                                                                                                                                                   |
| Note: New fruit cultivars that may be superior to currently recommended varieties are constantly being released. Check with your local Extension Educator or the nursery you order plants from to obtain information on newly released cultivars for your location. |               |                                                                                                                                                                                                   |

## Selecting Fruit Tree Nursery Stock

Fruit trees can be purchased from local garden centers or mail-order nurseries. More and more local garden centers carry a good selection of fruit trees that are often grown and sold in containers and may be two to three years old. The trees grown in containers are easy to work with and may not experience much transplanting shock because they have an established root system in the container. However, it may be difficult to get the selection of cultivars you may wish to try.



Figure 26. Bare-rooted fruit trees from mail-order nurseries are an excellent way to start a home fruit planting.

Mail-order nurseries usually carry a much greater selection of fruit trees. There are quite a few reputable mail-order nurseries. A list of nurseries is provided in Chapter 8 as a resource. Trees from mail-order nurseries generally come as *bare-rooted plants*. They do quite well if they are shipped at the appropriate time (early spring), correctly planted, and well cared for.

As fruit trees do not come true from seeds, seedling trees found in the landscape or started from seeds should be avoided in making new plantings. Instead, purchase fruit trees that have been budded or grafted to perpetuate superior genetic features of proven cultivars.

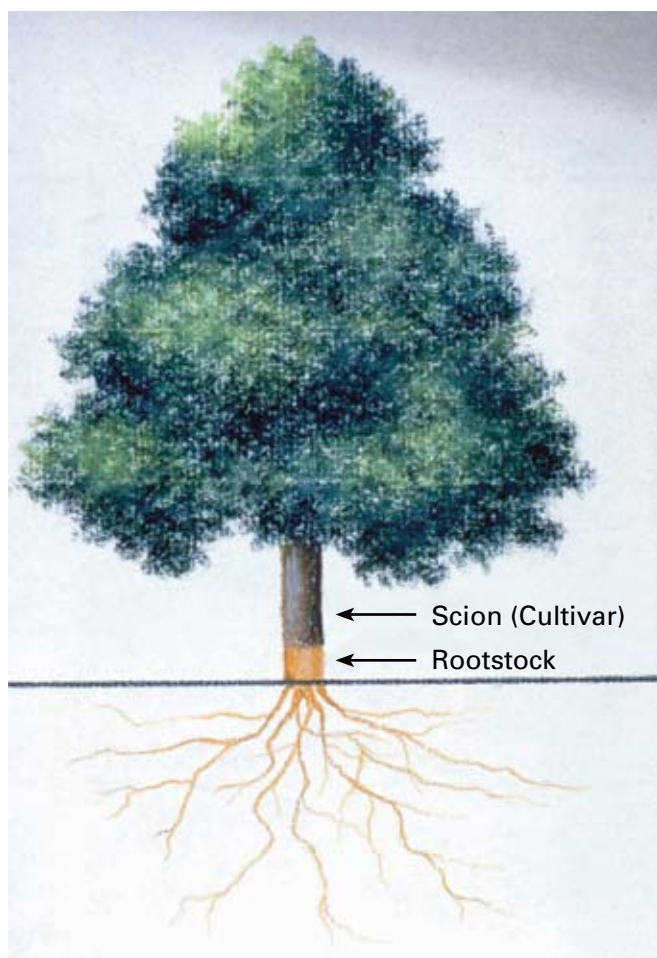

Figure 27. A lot of fruit trees are budded or grafted where the top portion is the scion, which determines the cultivar, and the bottom portion is the rootstock, which determines the tree size.

Fruit trees can be on their own roots or grafted onto rootstocks. The top portion of the fruit tree determines the cultivar of the tree, and the rootstock determines the tree height (Fig. 27). When purchasing trees from a mail-order nursery, gar-

deners can specify a cultivar on a particular rootstock. The same cultivar can be grafted onto dwarf or semi-dwarf rootstocks. A dwarf Liberty apple tree reaches a mature height of 8-10 feet while a semi-dwarf reaches a mature height of 15-20 feet tall.

Over the years, there has been a tremendous amount of research done on size control of apple trees. Many rootstocks have become available to fruit growers. The size ranges are dwarf, semi-dwarf, and standard. For example, a 'Liberty' apple can be on its own roots, which is standard size, and may be 25 feet tall or more at maturity. This is called a seedling tree. It can also be grafted onto dwarf or semi-dwarf rootstock and can be maintained at a height of 10 to 12 feet, or less for dwarf trees trained to a trellis.

Sometimes, nurseries may graft an interstem between the scion (the desired cultivar) and the rootstock. The interstem helps determine the overall tree height. The rootstock is not selected for size control, but for its good adaptability to local soil conditions, disease resistance, or other horticultural characteristics.

When purchasing trees, make sure you purchase vigorous, disease-free trees. They will have a much better chance of getting established. It is not a good idea to propagate fruit trees from your neighbors' trees since these trees might carry unwanted insects and diseases.

Bare-rooted fruit trees from a nursery should have 3/8 to 5/8 inch trunk diameter with few branches. Larger trees are more difficult to train and sometimes more difficult to transplant. However, many trees available at local garden centers are grown in containers and have been well-trained in the nurseries.

Apples, pears, sweet cherries, and plums are not self fruitful and need another cultivar with viable pollen within 50 feet, or more ideally 20 feet, for maximum fruit production. Ornamental crabapples have been used in pollinizing fruit apples. A few suggested crabapple cultivars are 'Manchurian,' 'Pioneer Scarlet,' 'Rosedale,' 'Golden Hornet,' and 'Snowdrift.' Gardeners should exercise caution, however, in selecting a particular crabapple for their home fruit plantings. Not all crabapples are suitable for use as pollinizers.





Figure 28. Two different apple cultivars should be planted close to each other for successful pollination.

Based on the research trials conducted at Pennsylvania State University, white single-flowering crabs may be better for cross-pollination because these flowers are most like apple flowers. Crabapples with darker-colored flowers may alter honeybee visitation patterns and are not suited for

use as pollinizers. Refer to cultivar descriptions for pollinizers.

Sometimes, two to three cultivars can be grafted onto one rootstock. These trees are called “Two in One” or “Three in One.” The trees with multiple fruit cultivars can be an excellent choice when gardeners have limited space.

Apricot, nectarine, peach, and sour cherries are self-fruitful and do not require another cultivar.

### Planting Fruit Trees

If fruit trees are ordered from mail-order nurseries, they should be ordered to arrive early for spring planting in March or April. Fruit trees can be purchased from local garden centers in spring and planted then. Fruit trees grown in containers can be planted anytime in the growing season, if regular watering is practiced. However, these trees will be better established if they are planted in spring. Refer to Table 9 for suggested spacing, expected yield, and years to bearing.

| <b>Table 9. Guide to Spacing, Expected Yield, and Years to Bearing for Various Fruit Crops.</b> |                            |                            |                              |                            |                                                                                                                                                                                                                                        |
|-------------------------------------------------------------------------------------------------|----------------------------|----------------------------|------------------------------|----------------------------|----------------------------------------------------------------------------------------------------------------------------------------------------------------------------------------------------------------------------------------|
| <b>Fruit Rootstock</b>                                                                          | <b>Bearing Age (Years)</b> | <b>Spacing<sup>1</sup></b> | <b>Average Yields (Lbs.)</b> | <b>Useful Life (Years)</b> | <b>Special Considerations</b>                                                                                                                                                                                                          |
| <b>APPLE</b> (M refers to Malling.)                                                             |                            |                            |                              |                            |                                                                                                                                                                                                                                        |
| <b>Semi-Dwarf</b>                                                                               |                            |                            |                              |                            |                                                                                                                                                                                                                                        |
| M. 7                                                                                            | 3-4                        | 15' x 25'                  | 150                          | 20                         | May require eight to 10 spray applications, depending upon cultivar selected, harvest time, and weather conditions. Cross pollination is usually necessary for full production. Dwarf trees must be supported with a stake or trellis. |
| M. 106                                                                                          | 4-5                        | 20' x 30'                  | 200                          | 20                         |                                                                                                                                                                                                                                        |
| <b>Dwarf-rootstock<sup>2</sup></b>                                                              |                            |                            |                              |                            |                                                                                                                                                                                                                                        |
| M. 9, Bud. 9<br>M. 9/M.106                                                                      | 2-3                        | 10' x 20' or<br>12' x 22'  | 75<br>100                    | 15<br>15                   |                                                                                                                                                                                                                                        |
| <b>CHERRY</b>                                                                                   |                            |                            |                              |                            |                                                                                                                                                                                                                                        |
| <b>Tart</b>                                                                                     |                            |                            |                              |                            |                                                                                                                                                                                                                                        |
| Standard                                                                                        | 3-5                        | 20' x 25'                  | 75                           | 15                         | May require several spray applications and fruit protection such as netting to prevent loss to birds.                                                                                                                                  |
| Genetic Dwarf                                                                                   | 2-3                        | 20' x 25'<br>15' x 20'     | 75<br>100                    | 15<br>10                   |                                                                                                                                                                                                                                        |
| Sweet Standard                                                                                  | 4-7                        | 25' x 30'                  | 80                           | 20                         |                                                                                                                                                                                                                                        |
| <b>PEACH or NECTARINE<sup>3</sup></b>                                                           |                            |                            |                              |                            |                                                                                                                                                                                                                                        |
| Standard                                                                                        | 3-4                        | 20' x 25'                  | 120                          | 12                         | May require five to eight spray applications. Borers and bacterial cankers can be serious problems.                                                                                                                                    |

**Table 9 (continued). Guide to Spacing, Expected Yield, and Years to Bearing for Various Fruit Crops.**

| Fruit Rootstock                                                                                                                                                                                                                                                                                                                                                         | Bearing Age (Years) | Spacing <sup>1</sup> | Average Yields (Lbs.) | Useful Life (Years) | Special Considerations                                                            |
|-------------------------------------------------------------------------------------------------------------------------------------------------------------------------------------------------------------------------------------------------------------------------------------------------------------------------------------------------------------------------|---------------------|----------------------|-----------------------|---------------------|-----------------------------------------------------------------------------------|
| <b>PEAR</b>                                                                                                                                                                                                                                                                                                                                                             |                     |                      |                       |                     |                                                                                   |
| Standard                                                                                                                                                                                                                                                                                                                                                                | 4-5                 | 20' x 25'            | 120                   | 15                  | May require five to six spray applications. Fire blight can be a serious problem. |
| <b>PLUM</b>                                                                                                                                                                                                                                                                                                                                                             |                     |                      |                       |                     |                                                                                   |
| Standard                                                                                                                                                                                                                                                                                                                                                                | 4-5                 | 20' x 25'            | 100                   | 15                  | May require several spray applications.                                           |
| <sup>1</sup> Example: Apple cultivar on M. 7 rootstock is spaced 15 feet between trees and 25 feet between rows.<br><sup>2</sup> M. 9 dwarf apple trees should be trained to espalier system on a trellis. Trees can be six to eight feet apart and 12 feet between rows.<br><sup>3</sup> Genetic dwarf can be planted six feet between trees and 14 feet between rows. |                     |                      |                       |                     |                                                                                   |

When plants arrive, do not let the roots dry out. Keep plants in a cooler to keep them fresh and healthy. It might be best to “heel in” the plants until the soil is dry enough for proper planting. *Heeling in* means temporarily planting the plants in a hill or row of soil until they can be planted permanently. It is best to adjust the soil pH to suit the type of fruit crop being heeled in.

The depth of planting is dependent on soil type or texture (size of soil particles, e.g., sand [largest], silt [next largest], and clay [smallest]). In sandy loam soils that drain well, plants should be positioned in the planting hole at the level they were originally grown in the nursery. The original depth can be identified by a soil line on the stem or trunk of plants or by the top of the soil for container-grown plants.

Most Ohio soils, however, are not well drained. They usually consist of silt and clay particles, and drainage is often less than desirable. In soils that drain poorly, plants should be planted somewhat higher than they were in the nursery. More air needs to reach the root system when soils drain poorly. In these soil conditions, plants can be placed from two to four inches higher than they were during their growth in the nursery.

If you buy a container-grown fruit tree, the width of the planting hole should be at least two or three times the diameter of the root ball. Recent research results have indicated feeder roots of fruit trees remain close to the soil surface, usually in the top six to nine inches. This suggests that the major area

of soil preparation should be the upper 12 inches, and the wider the area prepared for planting, the better.

If the sides of the planting hole have become compacted or glazed in the digging process, which is quite common in machine digging, use a shovel or spade to scarify or roughen the smooth surface. This provides for better air and moisture movement as well as root penetration.

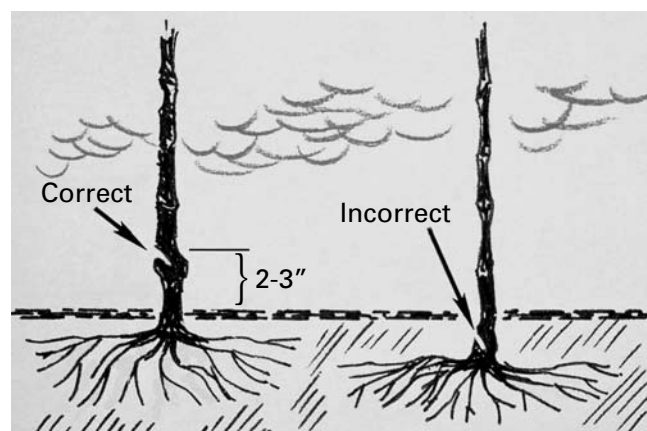

*Figure 29. The bud union or graft union needs to be two to three inches above the soil line. Otherwise, the scion will root and the size control by the rootstock will be lost.*

For bare-rooted plants, dig a wide planting hole. Spread the roots before back filling the hole. Hold the tree in place so that the bud union or graft union is two to three inches above the soil line (Fig. 29). Otherwise, the scion will start rooting, the rootstock then dies, and the dwarf or semi-dwarf trees will turn into standard-size trees.

Cover the roots with top soil and leave the subsoil for use last. Before the hole is completely filled with soil, add two gallons of water.

After planting, prune the tree to the correct height. Apply fertilizer two weeks after planting based on the soil test recommendations. Regular watering is critical for the successful establishment of fruit trees. Natural rainfall is usually not adequate to provide the moisture needs of newly planted fruit trees. The limited root system of bare-root plants makes them highly susceptible to dry weather conditions. Pay particularly close attention to plantings of container plants. The potting media used for container plants dries out much more rapidly than soil.

Determine the amount of soil moisture by sampling the soil with a narrow trowel or soil probe at a depth of six to eight inches. Squeeze the soil. If it holds together and is not sticky, soil moisture is adequate. If the soil does not stick together, it is too dry, and water is necessary. At each watering, wet the soil thoroughly to the base of the root system. Apply a minimum of one inch of water per square foot per week between rainfall or watering. It is much better to water plants in the morning instead of noon or evening. If the temperature is high or the soil is very dry, apply more than one inch per week.

Be cautious not to over-water or the amount of oxygen in the soil will be lowered to a level that will damage roots. Make certain the timing patterns of lawn-watering systems are not overlapping into plant beds and applying too much water to landscape plants. Monitoring the soil for moisture with a soil probe or a trowel, as mentioned earlier, is recommended.

Keep an area free of grasses and weeds for at least 12 inches away from the trunk of the tree. A two-to three-inch layer of mulch will also help control weeds and conserve moisture. The mulched area needs to be expanded as the tree grows bigger. Ideally, the entire area underneath the tree canopy is mulched, when practical. Maintaining a grass-free area around the trunk of a tree looks attractive in the landscape and helps keep the lawn mower away from the base of the tree. Hitting the trees

with lawn mowers is a common source of serious damage to fruit trees in the landscape.

## **Fertilizing Fruit Trees**

Fruit trees typically need to be fertilized once a year in early spring before growth starts. It is very important to do a soil test to determine accurate fertilizer recommendations. Generally speaking, a common fertilizer recommended for fruit trees is one with an analysis of 12-12-12 or 10-10-10. However, fertilizers of other analyses can also be used. The rate of application needs to be adjusted based on soil test analysis and recommendations.

## **Rate of Fertilization**

The rates of fertilization suggested in Table 10 are general and should be adjusted by the gardener according to specific situations. In these adjustments, the gardener should consider leaf color, terminal growth, and fruiting characteristics of the previous season as well as results from soil and foliar analysis.

In general, a satisfactory nutritional condition exists in mature apple trees when leaves are of moderate, dark-green color; yield is good; overall color of fruit is satisfactory; and annual terminal growth is eight to 12 inches (12 to 18 inches for peaches and nectarines). When these conditions exist from year to year, there is little need to make appreciable changes in the rate or nature of the fertilizer program.

Annual terminal growth of 15 to 30 inches is considered satisfactory for non-bearing fruit trees. Pears are an exception, and terminal growth should average 12 to 16 inches for non-bearing trees to keep fire blight at a minimum. Should the terminal growth exceed 12 inches on mature bearing apple trees (18 inches for peach), then the annual rate of nitrogen should be reduced, or the fertilization should be skipped the following year.

Heavy pruning on trees of normal vigor will typically stimulate growth in a manner similar to over-fertilization. Reduced rates of nitrogen fertilizer should accompany heavy pruning to prevent this excessive terminal growth. Vertical shoot growth is not productive.

**Table 10. Tree Fruit Fertilization Guidelines. Adjust Rate by Annual Tree Growth Rate.**

| Kind of Fruit                | Material and Rate of Application                                                                                                                                                                                                                                                                                                                                                                                                                                                                                                                                                                                                                                                                                                                                                                                                                           | Timing and Placement                                                                                                                                                                                                                                                 | Remarks                                                                                                                                                                                                                                                                                                                  |
|------------------------------|------------------------------------------------------------------------------------------------------------------------------------------------------------------------------------------------------------------------------------------------------------------------------------------------------------------------------------------------------------------------------------------------------------------------------------------------------------------------------------------------------------------------------------------------------------------------------------------------------------------------------------------------------------------------------------------------------------------------------------------------------------------------------------------------------------------------------------------------------------|----------------------------------------------------------------------------------------------------------------------------------------------------------------------------------------------------------------------------------------------------------------------|--------------------------------------------------------------------------------------------------------------------------------------------------------------------------------------------------------------------------------------------------------------------------------------------------------------------------|
| Apple                        | Generally, apple trees need fertilizing each year. Nitrogen is the most important essential nutrient. Two other nutrients, phosphorus and potassium, are needed in relatively large amounts when the tree is young; however, after it reaches maturity, it usually requires only nitrogen. Broadcast 8 ounces of 10-10-10 over a two-foot circle about one month after planting. Do not put any fertilizer in the hole before planting. In June following the planting, broadcast another 8 ounces of 10-10-10 around the tree. Increase the amount of 10-10-10 applied by 0.25 pound per year to 2.5 pounds per tree for a dwarf tree, 5 pounds per tree for a semi-dwarf, and 10 pounds per tree for a standard tree. Maintain pH at 6.0 to 6.5. (Source, <i>Fruit Production for the Home Gardener: A Comprehensive Guide</i> , Penn State University). | Apply fertilizer in early spring before growth starts. Spread it uniformly in the area beneath the tree canopy, from the tree trunk to the dripline, the imaginary line at the edge of the tree canopy. Keep the fertilizer six inches away from the tree trunk.     | Suggested applications should be reduced or eliminated following severe pruning or a severe crop loss after a spring frost. Mature apple trees should have nine to 15 inches of annual growth. Adjust fertilizer application accordingly.                                                                                |
| Peach, Plum, Cherry, Apricot | Shortly after planting, apply 8 ounces of 10-10-10 per plant. Do not place fertilizer in the planting hole. In subsequent years, broadcast 8 ounces of 10-10-10 under each tree in the early spring. Increase the amount applied by another 1/2 pound per year, up to 5 pounds per tree regardless of age. Maintain soil pH at 6.0 to 6.5. Never fertilize after June 15.                                                                                                                                                                                                                                                                                                                                                                                                                                                                                  | Spread the fertilizer uniformly in the area beneath the tree canopy, from the tree trunk to the dripline, the imaginary line at the edge of tree canopy. Keep the fertilizer six inches away from the tree trunk.                                                    | In “no crop” years, mature trees should produce 12 to 18 inches of shoot growth each year. Adjust fertilizer application accordingly.                                                                                                                                                                                    |
| Kind of Fruit                | Material and Rate of Application                                                                                                                                                                                                                                                                                                                                                                                                                                                                                                                                                                                                                                                                                                                                                                                                                           | Timing and Placement                                                                                                                                                                                                                                                 | Remarks                                                                                                                                                                                                                                                                                                                  |
| Pear                         | Generally, pear trees need fertilizing each year. Nitrogen is the most important essential nutrient. Two other nutrients, phosphorus and potassium, are needed in relatively large amounts when the tree is young; however, after it reaches maturity, it usually requires only nitrogen. Broadcast 8 ounces of 10-10-10 over a two-foot circle about one month after planting. Do not put any fertilizer in the hole before planting. In June following the planting, broadcast another 8 ounces of 10-10-10 around the tree. Increase the amount of 10-10-10 applied by 0.25 pound per year to 2.5 pounds per tree for a dwarf tree, 5 pounds per tree for a semi-dwarf, and 10 pounds per tree for a standard tree. Maintain pH at 6.0 to 6.5. (Source, <i>Fruit Production for the Home Gardener: A Comprehensive Guide</i> , Penn State University).  | Apply fertilizer in early spring before the growth starts. Spread it uniformly in the area beneath the tree canopy, from the tree trunk to the dripline, the imaginary line at the edge of the tree canopy. Keep the fertilizer six inches away from the tree trunk. | Suggested applications should be reduced or eliminated following severe pruning or a severe crop loss after a spring frost. Mature pear trees should have 9 to 15 inches of annual growth. Adjust fertilizer application accordingly. Too much nitrogen results in excessive growth and increased hazard of fire blight. |
| All Fruit Trees              | Other fertilizer elements should be applied at rates recommended by soil and possibly foliar (leaf) analysis results.                                                                                                                                                                                                                                                                                                                                                                                                                                                                                                                                                                                                                                                                                                                                      | Follow recommendations from the soil test report.                                                                                                                                                                                                                    | Soil test every two to three years.                                                                                                                                                                                                                                                                                      |

## Supporting Fruit Trees

Dwarf apple trees need to be supported since they tend to have shallow root systems that do not anchor properly in the soil. Dwarf apple trees may be placed on a trellis for support. Refer to the section on espalier pruning and training for more information. Fruit trees trained on a trellis or espalier can be incorporated into the home landscape as a part of the edible landscape. Semi-dwarf trees (e.g., M.7 root stock) generally do not require support and are free standing.

Other fruit trees such as cherry, peach, or pear require support for the first few years where strong winds occur. Otherwise, these fruit trees might topple over, especially when they are loaded with fruit.



Figure 30. Dwarf fruit trees need to be supported since they have shallow root systems and anchorage may be a problem.

## Pruning and Training Young

### Fruit Trees

Pruning of young fruit trees is very important for them to develop a good framework and a desirable form for easy spraying and harvesting. Most fruit trees are trained to a *central leader system*, while peach, plum, and apricot trees are normally trained to an *open center or open vase system*. The central leader system consists of a central trunk around which scaffolds (primary side branches)

of the desired number and spacing can be arranged with wide-angle crotches. Three to eight scaffold branches are commonly developed from the central leader trunk. The open center or vase system of training simply involves maintaining a framework of branches around an open vase in the middle of the tree. This allows sunlight to penetrate into all parts of the tree, allowing for good production in all areas.

A *modified central leader* tree is cut back each winter, and a new central leader shoot is selected each spring. Pecans, apples, and pears are generally pruned in this manner. The top center of modified central leader trees is often thinned out for better light penetration into the interior of the tree canopy. Uniformly space the scaffolds around the central leader.

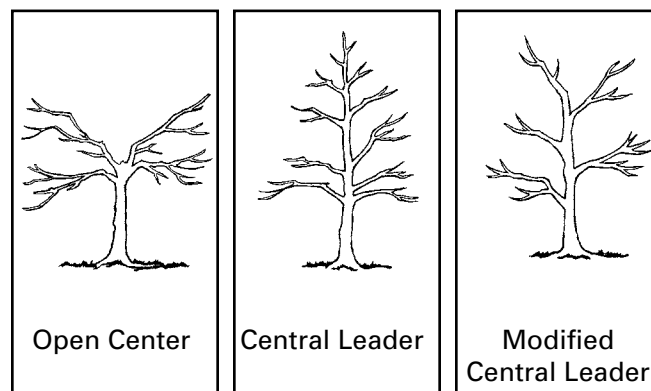

Figure 31. Common training systems for fruit trees are open center or open vase, central leader, and modified central leader.

### Central Leader System

Bare-root whips need to be pruned and trained so that they will develop into properly shaped trees. Container-grown apple trees are normally two- to three-year-old trees. These trees usually require light pruning.

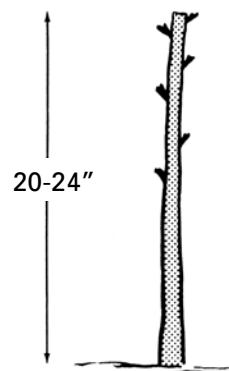

Figure 32. A heading back cut is made to a young apple tree at planting.

Bare-root trees should be cut or headed back to 24 to 28 inches above ground at planting. All broken or damaged limbs should be removed. This procedure allows branches to form at desired heights, improves the strength of the tree, and provides a balance between the top and the roots.

As the branches reach four to six inches in length, spring-loaded clothes pins can be used to form proper crotch angles. Crotch angles refer to the branch angles between the central leader and the side shoot. Typically, side shoots (laterals) should be spread out to form an angle of 60 to 70 degrees between the leader and the side shoot. Branches without a wide branch angle are overly vigorous and have a weak point of attachment to the central leader. These branches frequently break under a heavy fruit load or a windstorm. Spreading the lateral branches will also slow the growth of the branches to a manageable level and promote the development of secondary or side shoots on the scaffolds, thus flower bud formation. These clothes pins should be removed at the end of the first season. Branches that begin to grow at 18 inches or lower can be cut off during the summer.

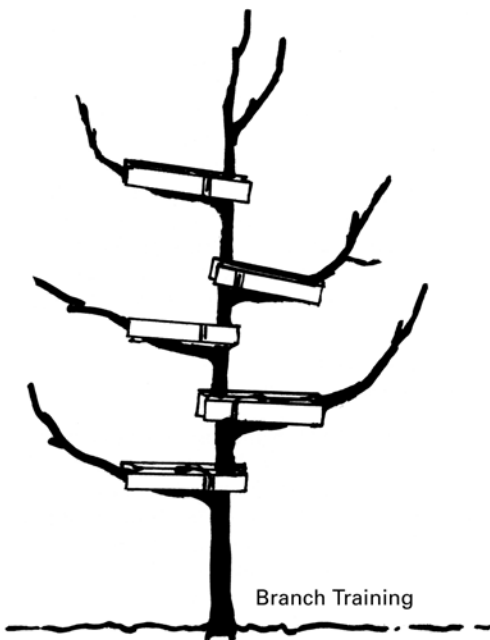

Figure 33. Well-placed laterals and wide crotch angles form through proper pruning and training of trees when they are young. Spring-loaded clothes pins are commonly used to hold small branches at the desired position. Remove clothes pins at the end of the growing season.

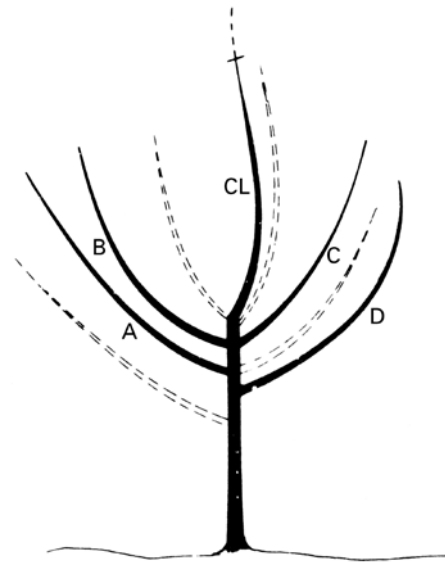

Figure 34. One-year-old apple tree with lateral branches and central leader (CL).

After one and two years of growth, all lateral branches 18 inches or below the first lateral are removed. Remove limbs that have narrow crotch angles (less than 45 degrees). Apple trees trained to the central-leader system will allow three to four groups of four branches to develop for a normal-sized tree. The central leader is cut in March at 18 to 24 inches above the last group of limbs to ensure the development of more limbs.

All lateral branches should have a wide branch angle, and spreading of lateral branches is essential for many varieties. Lateral branches will need to be spread for about the first five years, using a larger spreader each year. Spreaders can be made with one-inch-square wood pieces with a finishing nail driven in the end and cut off at an angle. Spreaders are frequently made in lengths of 6, 12, and 18 inches. Spreaders with steel points or notches are also available for purchase from fruit-grower supply companies.

Spreading branches in later years reduces vigor and promotes fruit development on the lateral branches. The reduced growth rate and the weight of the crop load will also help pull the branches down to a proper angle. However, it is important that the young tree is not allowed to crop too early. Otherwise, the weight of the fruit pulls the branches below horizontal. Once the branches are below horizontal, they are weak and nonproductive and need to be removed and replaced. Adapted from *Training and Pruning Fruit Trees* by Michael L. Parker, North Carolina State University. Used with permission.

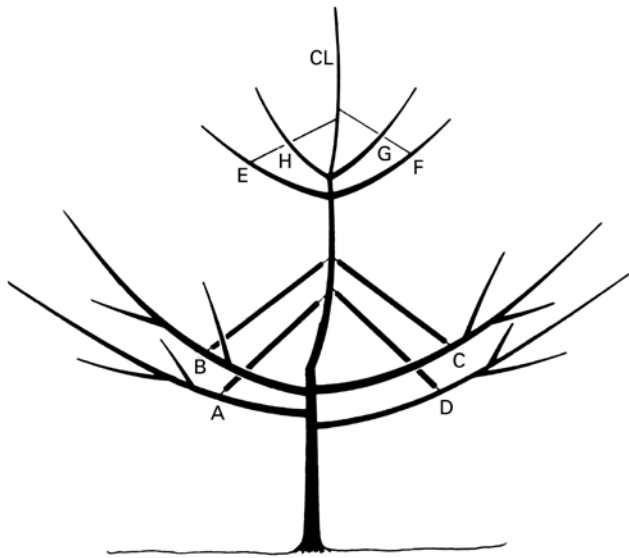

Figure 35. A two-year-old apple tree with spreaders.



Figure 36. An example of a young apple tree with spreaders.

During the third and fourth years, remove all unwanted branches from central leaders and continue to spread limbs as necessary. The central leader will eventually be cut back into second-year wood, to bring the central leader into balance with the rest of the tree. Maintain a central leader and a pyramidal form into maturity. Never allow an upper tier to shade out or outgrow lower limbs.

### Open Center or Open Vase System

The open center system is recommended for peach and nectarine trees for maximum sunlight exposure, maximum yield, and best quality. Pruning and training should be done in the year of planting and every year after to develop a strong, well-balanced framework of scaffolds (a tree with a strong trunk and well-positioned side branches) and to maintain the balance between vegetative growth and fruit production.

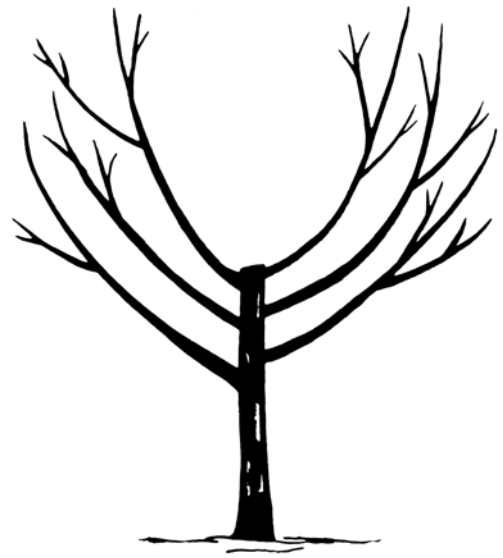

Figure 37. A one-year-old peach, cherry, apricot, or plum tree trained to the open vase system.

### At Planting

At planting, peach trees should be set so that the graft union will be 2 inches above the soil surface. As the buds begin to swell, the unbranched trees (whips) are generally headed approximately 30 to 34 inches above the soil surface. New branches will come from the buds that are 6 to 9 inches below the heading cut.

Trees that are branched at planting are handled differently than the whips. The work that needs to be done under the tree determines the appropriate height for branching, which is usually 24 to 32 inches. Remove branches that are too low. If there are three to four uniformly spaced branches around the tree that can be selected as scaffolds, the tree is headed just above the highest selected scaffold. Any remaining branches not selected as scaffolds should be removed. However, if there are less than three scaffolds, the tree should be cut back to a whip and the side branches removed.

### Summer Pruning

After the new vegetative growth is approximately 3 to 4 inches long, it is time to select the shoots that will become the major scaffolds. The lowest scaffold should be 24 to 32 inches above the soil surface to avoid interfering with cultural work under the tree, such as harvesting and weed control. It is best to select three to four scaffolds that are uniformly spaced around the tree, with wide branch angles, and not directly across from another scaffold.

During the summer, these shoots should be spread out to a 45- to 60-degree angle and held in place with a toothpick or clothespin. All other upright growth should be removed. It is best to come back through every month during the summer to remove upright growth that is shading the primary scaffolds and to make sure that the scaffolds have been spread to a proper angle. Many times the crotch angle is proper initially, but as the scaffolds grow, they turn upright. A spring clothespin placed on or near the end of a shoot will pull the scaffold down to a proper angle. Extreme care must be taken when using the clothespins as weights. Periodic checking is essential to assure that the scaffolds are not too flat.

### Succeeding Years

After the first year of growth, the primary scaffolds should be selected and properly trained outward. Scaffolds should be headed during the dormant season of the first three years to promote continued lateral branching on the scaffolds and to stiffen and strengthen the scaffold. Scaffolds should be headed to outward-growing shoots similar in angle to those being removed. Bench cuts should be avoided.

If summer pruning is being practiced, undesirable shoot growth can be removed as soon as growth is 4 to 6 inches long. Summer pruning can also be used to direct scaffold growth outward to the desired growing points instead of waiting until the dormant season.

For bearing trees, the goal of dormant pruning is to remove vigorous upright growth on the scaffolds and trunk that was not removed during the summer. The upright growth left in the tree during the growing season may shade out lateral growth near the trunk. This shading causes lateral fruiting wood only on the ends of the scaffolds, which results in broken scaffolds under a heavy fruit load. It is best to keep the fruiting wood on the scaffolds as close to the tree trunk as possible to reduce tree breakage and to produce the highest quality fruit.

During the dormant season, damaged, dead, and diseased wood, such as cankers, should be removed from the tree. Shoots with shriveled and dried fruit from the previous season, called mummies, should also be removed from the orchard to reduce disease pressure for the coming season. Source: *Training & Pruning Fruit Trees* by Dr. Michael L. Parker, North Carolina State University. Used with permission.

### Pruning Mature Fruit Trees

Mature fruit trees need to be pruned each year. The best time to prune fruit trees is March. The primary purpose of pruning is to increase sunlight penetration, remove less productive wood, and shape the crown into an efficient, stable form. If left unpruned, the quantity of fruit produced might be greater, but the quality much lower. Pruning increases fruit size, promotes uniform ripening, increases sugar content, and decreases disease and insect problems by allowing better spray coverage and faster drying following rainfall. It also allows easier access for timely harvesting.

The following points apply to pruning all fruit trees:

1. Prune late in the dormant season (March) to minimize cold injury.
2. Prune heavily on neglected trees or vigorous cultivars, less so on less vigorous cultivars.
3. Make all heading-back cuts just beyond a bud or a branch.
4. Make all thinning cuts just beyond the base of the branch being removed. Do not leave large stubs. Leave only the growth collar at the base of the branch.
5. Avoid pruning too close (see Figure 38).
6. Don't prune a large neglected fruit tree back to a normal producing fruit tree in one year. Spread the thinning over several years.
7. Wound dressings are not necessary for trees pruned in dormant season.
8. Match pruning tools to the size of the wood being removed. Use hand shears for small twigs, lopping shears for medium branches, and a saw for larger limbs.

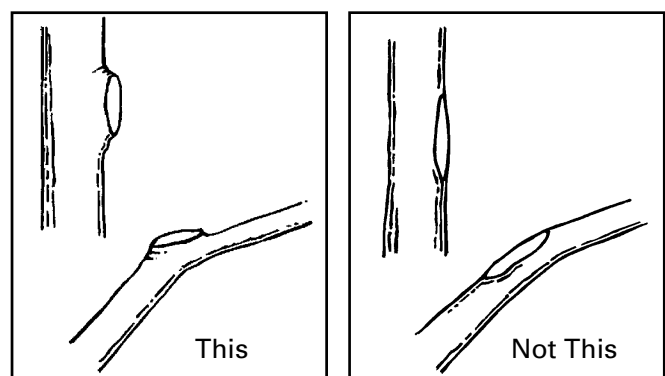

Figure 38. When making thinning cuts, cut as close to the collar of the branch as possible, without cutting into the collar, so that the wound will heal properly.



When making thinning cuts, it is important to cut as close to the collar of the branch as possible without cutting into it (Figure 38a). The branch collar is the area at the base of the stem that is thicker than the stem. Leave the collar at the base of the branch. This will help the branch heal quickly. Do not leave a stub, which will cause the stem to die back.

It is helpful to visualize a tree as seen from above without its leaves. From the trunk, branches radiate out like the spokes of a wheel. In order to allow sunlight and spray penetration and to allow access for harvesting, it is necessary to thin out some of these spokes.

When making thinning cuts of large branches, it is important to use proper cutting techniques. The weight of branches can cause the bark to tear, as a branch breaks before being completely cut off. This kind of damage to tree bark is permanent, but completely avoidable with a three-step cut (Figure 39). First, make a cut on the bottom side of the branch that is being removed. The cut should be

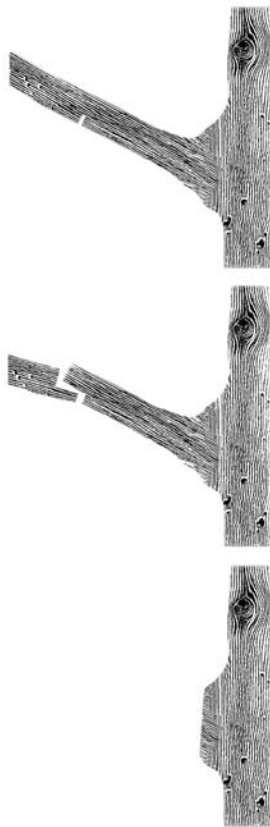

Figure 39. Three steps in properly removing a large branch: Make a cut on the underside first, then cut from the top side, and finally remove the stub with a clean, sharp cut.

1/3 into the diameter of branch. Second, cut the top side of the branch about four inches from the branch collar and completely cut the branch off. Making a cut on the under side of the branch will stop the bark tearing to the point of the cut, if there is any bark tearing. Third, cut off the remaining stub as close to the collar as possible without cutting into it. Make sure the third cut is a very clean cut so that the wound can heal properly.

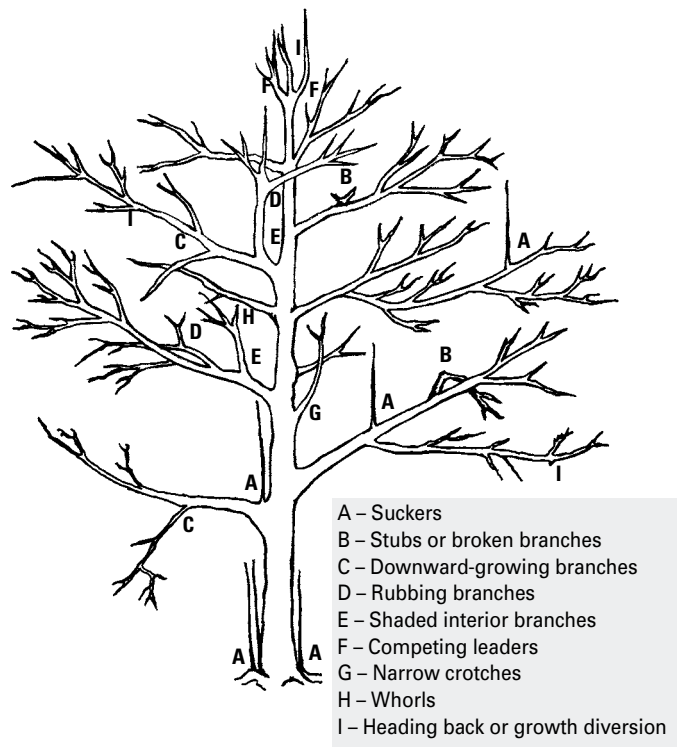

Figure 40. Suggested pruning cuts on a mature apple or pear tree.

Some of the commonly suggested cuts are shown in Figure 40. Each year, many branches need to be removed for the production of quality fruits year after year. Many gardeners get nervous about making pruning cuts. Fortunately, it is hard to cut too many branches off trees.

Here are some general guidelines for fruit tree pruning:

- A. Suckers or watersprouts are vigorous vegetative shoots that drain nutrients needed for fruit production. They often appear at the base of grafted trees, or in crotches and sites of previous pruning cuts, and should be removed.
- B. Stubs or broken branches result from storms, heavy fruit loads, or improper pruning. Diseases and insects may enter the tree at

these sites, so they should be headed back to healthy side branches or removed.

- C. Downward-growing branches develop few fruit buds and eventually shade or rub more productive scaffold branches and should be removed.
- D. Rubbing branches create bark injury which also invites insects or disease. Head back or remove the less productive of the two.
- E. Shaded interior branches develop fewer quality fruit and limit access for harvest.
- F. Competing leaders result when suckers or branches near the top of the tree are allowed to grow taller than the uppermost bud of the trunk or central leader. Head these back or an unbalanced, structurally unsound tree will develop.
- G. Narrow crotches are not desirable and occur when a branch develops more parallel than perpendicular to the trunk or limb from which it originates. As each grows, bark trapped between the two interferes with the growth of a strong joint.
- H. Whorls occur when several branches originate at the same point on the trunk or limb. Joints are weaker there, so select the best-located branch and remove the others.
- I. Heading back or growth diversion cuts are used to limit or redirect the growth of the central leader or branches. For limiting growth, cut back to a weak bud or lateral twig; for diversion of growth, cut back to a bud, twig, or branch oriented in the preferred direction.

## Pruning Old, Neglected

### Apple and Pear Trees

Before you decide to work on your old, neglected apple or pear trees, you need to ask yourself several questions. First, do I enjoy growing fruit trees? Second, does the fruit taste good to me? Third, are these trees in pretty good shape overall? If the answers to all these questions are “yes,” then you could proceed.

It is still a good idea to plant a few disease-resistant fruit trees near the neglected trees. Prune and train the young fruit trees while rejuvenating the older

neglected trees. After three years, the neglected trees may or may not be turned into productive trees. If not, the large trees can be removed and used for firewood. That is the bad news. However, there is good news. The young fruit trees should be developing into well-formed trees. Within a year or two, these young trees should bear fruits.

Typically, old, neglected apple or pear trees that have not been pruned for a few years are tall, unproductive, and crowded with many branches. Many of those branches are severely weakened from diseases or insects. Some of them may be dying or dead. Fruits produced on old, neglected trees are small, sour, poorly colored, and misshapened.

Extensive pruning is essential to bring old, neglected trees back into shape. This type of pruning is done when trees are dormant, preferably in March. Complete rejuvenation of old, neglected apple or pear trees may take two to three years.

Before attempting to remove large branches from trees, make sure you follow safety procedures. Make sure you use a three- or four-legged ladder. Do not use a chainsaw since the risk of injury is too high.

The objectives of pruning old, neglected apple or pear trees are to:

- Reduce the tree’s height.
- Improve the tree’s shape.
- Increase the vigor of fruiting wood.
- Reduce crowding of branches for improved sunlight penetration and accessibility for spraying and harvesting.
- Reduce disease and insect pressure.
- Improve fruit yield and quality.

Steps in pruning to restore old, neglected apple or pear trees:

1. Remove all dead, diseased, and broken branches.
2. Reduce the tree height by heading back the central leader to an outward-growing lateral. Up to 5 feet of the top can be removed in one year.
3. Scaffold limbs can also be cut back to laterals to reduce the tree height.
4. Remove the weakest branches of crossing

limbs and closely parallel branches.

5. Remove branches that grow toward the center of the tree.
6. Prune off water sprouts, which are the branches that grow rapidly and often vertically.
7. Cut off low-hanging branches.

Apple and pear trees after rejuvenation pruning should be wider at the bottom and narrower on top to allow light to penetrate the center of the trees. This kind of pruning should be performed over a three-year period. Once rejuvenated, trees should be pruned every year to maintain tree shape and productivity.

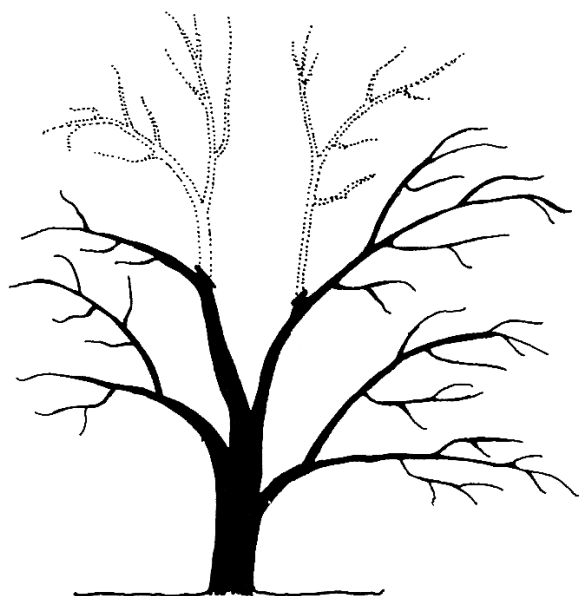

Figure 41. One or more large limbs may be removed from excessively tall trees. Large cuts should be made close to the remaining limb.

### Fruit Thinning

At times most fruit trees may set too many fruits which can reduce fruit size, color, and quality. Too heavy of a fruit load can also reduce cold hardiness of fruit trees. Large tree limbs can also be broken off by the weight of excessive fruit. Peaches and certain cultivars of plums usually set too many fruits when they are not thinned by a spring frost. Excess fruits should be removed by hand when young developing fruits are about 3/4 of an inch, around June 1 to 15, leaving four to six inches between peaches and two to three inches between

plums.

Apples do not usually set heavy crops every year. Some cultivars will not bear fruit the year following a year of excessive crop. This phenomenon is called *alternate year bearing*. When a heavy set does occur, the fruits should be thinned to six inches apart during early June. Use the thumb and forefinger to snap the apples from the stem, leaving the stem on the tree. When there is more than one apple in a cluster, remove the smaller fruits and keep the largest apple, which is called the *king apple*. If this is done no later than 50 days from when the trees are in full bloom, trees are more likely to produce a good crop the following year.



Figure 42. A Gala apple tree that has been properly fruit thinned. Note that the remaining fruit are spaced about six inches apart.

### Mulching and Watering the Fruit Trees

Mulches offer several benefits. They suppress weeds and help conserve moisture and keep roots evenly moist. When organic mulches decompose, they increase the organic content and improve soil structure. Mulches should be applied at a depth of two and one-half inches. Pull back mulch in the fall, leaving a 1-foot circle of bare soil surrounding the tree trunk.

The objectives of mulching are to:

1. Prevent weed growth.
2. Conserve moisture in the soil.
3. Cool the soil surface and stabilize the soil temperature.
4. Reduce heaving (plant roots forced upward out of the soil) of small fruit plants such as strawberry as a result of alternate freezing and

thawing of the soil in autumn, winter, and spring.

5. Add organic matter to the soil, if mulch materials are organic in nature.
6. Reduce soil erosion on slopes.
7. Improve aesthetics of the fruit tree planting and add to property values.

Mulches may present some potential problems as well. Mulches can attract rodents that can girdle fruit tree bark and kill fruit trees. In wet areas, mulches can hold too much moisture.



Figure 43. Use rodent guards if you mulch your fruit trees.

Many forms of mulch are available. Wood chips and bark mulch work best since they are less attractive to voles. Wood chips decompose rapidly and should be supplemented with fertilizer at the rate of one pound of actual nitrogen per 1,000 square feet of mulched area.

The mulched area should extend from near the tree trunk to the end of the tree branches, which is called the *drip line*. Do not place mulch against the tree trunk to prevent damage from voles and other rodents and rotting of the tree bark. Use rodent guards for mulched trees to prevent damage to tree bark.

When organic mulches decompose, the depth of the mulch decreases. Gardeners should add more mulch so that the final depth of mulch stays at four inches.

Along with mulching, fruit trees will need watering for maximum production. Generally, cherries and apricot will not need much watering. However, peaches, nectarines, and plum will need watering two to three weeks before harvesting on large and mature four- to 12-year-old trees. Apply 12 to 16

gallons of water under the tree twice a week when there is no rainfall.

Apples will also respond to watering; however, this must be done throughout the season to maximize size. Dwarf apple trees are particularly susceptible to drought in early bearing years.

## Espalier Training of Dwarf Apple Trees

An espalier or trellis for dwarf apple trees can be an attractive part of a home landscape. An espalier may be constructed for three to six or more wires, depending on the vertical spacing of the wires and the ultimate height desired. In most instances, the wires are spaced 18 to 24 inches apart vertically with the bottom wire 18 to 24 inches from the ground. The height of the top wire is determined somewhat by the harvesting method to be used. If all picking is to be done from the ground, the top wire would be six feet from the ground.

Posts to carry the wires may be set before or after planting the trees, with the line posts spaced 35 to 45 feet in the row and located halfway between trees. End posts should be anchored. The wires, usually No. 9 galvanized, should be in place and secured firmly to the posts by the middle of the first growing season.

### First Season

Training begins at planting. If no branches are present near the bottom wire, head the tree at the height of the bottom wire or four inches below, in the case of Delicious. This will induce branching just below the wire. The uppermost new shoot usually grows in an upright position and assumes the position of a central leader. At least two other shoots will arise below this one. The two most suitable branches are tied loosely (plastic ties) to the bottom wire as soon as they are long enough, one in each direction. Any other shoots are cut back to short stubs.

In tying a shoot to a wire, do not bend it downward to a level that puts the tip at a lower level than the point of attachment on the trunk. To do so greatly retards extension shoot growth. The shoot will be in the best position when the tip is a few inches higher than its base. Also, this position is less likely to induce vigorous risers on the scaffold. Growth of the uppermost shoot should

extend well beyond the second wire by the end of the first growing season.

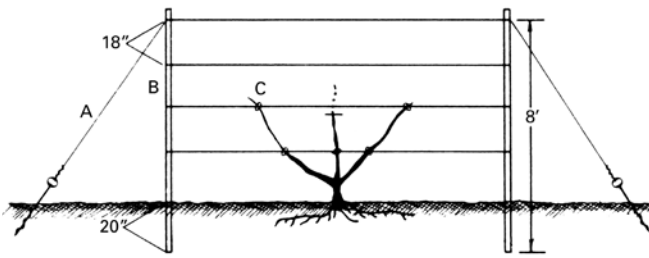

Figure 44. Espalier-trained apple trees after one year of growth and headed back below the second wire. A - anchor, B - eight-foot treated post, C - cloth or plastic tie.

### Second Season

During dormant pruning the next spring, head back this central stem at a point just below the second wire. Branching will occur just below the cut. Tie two of the lateral shoots, as they develop, to the second wire—one in each direction. Train the uppermost shoot to the central leader position. For production efficiency, it is important to cover the trellis with fruiting wood as quickly as possible. If possible, it is best to bend by tying shoots that compete with primary laterals rather than delay fruiting by pruning. The branches trained to the lower wire need little pruning the second year, other than to maintain terminal growth and to prevent vigorous upright shoot growth. Strong upright growth is headed back severely so as to contain it well below the second wire.

### Third and Later Seasons

Pruning during the succeeding years of training will be similar to that described for the second year until the basic framework is complete. When the central leader reaches the top wire, one of two procedures may be followed. The leader may be bent in one direction and tied to the top wire. Then, when a lateral shoot develops below the bend and becomes large enough, it may be secured to the wire in the opposite direction.

The other procedure is to head the leader just below the top wire. When new lateral shoots develop, tie the two uppermost to the top wire, as soon as they have sufficient length, extending each in opposite directions. The latter method gives a little more assurance of adequate branches for developing into scaffold branches.

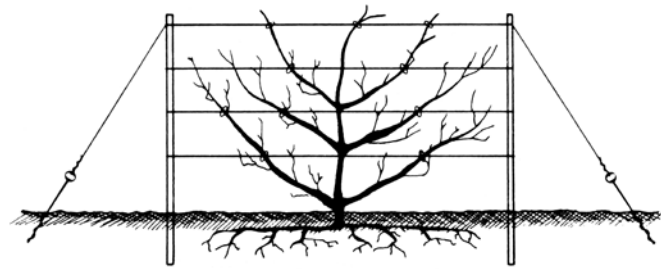

Figure 45. Espalier-trained apple tree at four years of age.

As the arms or scaffold branches touch those of the adjoining tree, an overlap (10 to 20 percent) may be desirable to ensure that all portions of the trellis are covered with fruiting wood. Each year, after the fruiting wood covers the trellis, pruning should be limited to thinning out to ensure good sunlight penetration. Extra scaffold shoots left in during the early years should be removed gradually over a three- to four-year period to permit no more than one primary scaffold per side per wire. Prune side branches lightly with thinning cuts to maintain the desired three- to four-foot width of tree row.

Mature plantings in the trellised hedge-row system require only a moderate amount of annual dormant pruning. It is often helpful to go over the planting in August each year and remove excessive or unwanted shoot growth.

### Disease and Pest Control

Refer to Chapter 7 on pest management in this bulletin. For specific disease and insect control recommendations, including the use of fungicides and insecticides, consult your local Cooperative Extension Service. In Ohio, obtain a copy of Ohio State University Bulletin 780, *Controlling Diseases and Insects in Home Fruit Plantings*.



# Chapter 3. Small Fruits

## Selecting Small Fruits

Some of the commonly grown small fruits in the Midwest are strawberries, brambles (*e.g.*, raspberries and blackberries), grape, and blueberries.

Small fruits are relatively easier to grow than tree fruits since they require less space and produce fruits sooner. Home-grown berries are very delicious and nutritious. During recent years, there has been strong linkage between antioxidants in berries and cancer prevention. This is one more reason to grow small fruits in the home garden!

Each type of small fruit is very different and is discussed in a separate section. It is very important to select disease-resistant or disease-tolerant cultivars, whenever possible. Site selection, planting techniques, and proper care are also essential for successful production of small fruits.



*Figure 46. Small fruits, such as blueberries, brambles, and strawberries, are delicious and nutritious. Photo by Scott Bauer, USDA/ARS. Used with permission.*

## Strawberries (*Fragaria x Ananassa*)

Strawberries are well-suited for planting in the home garden since they produce fruit very quickly and require a relatively small amount of space. Each plant may produce up to one quart of fruit when grown in a matted row during the first fruiting year. Two dozen plants will normally produce enough strawberries for a family of four. Production usually declines during the second and third years of fruiting; therefore, for maximum production, a new planting should be established after strawberry plants produce fruit for more than three to four years.



*Figure 47. Strawberries are an excellent crop for home fruit plantings.*

*Photo courtesy of Nourse Farms Nursery.*

Strawberry plants produce attractive fruit with fine flavor. Strawberries have a very high vitamin C content and are versatile as a dessert food. Most cultivars of strawberries are well-suited for freezing and processing as well as for fresh use. Many people enjoy eating the fresh-picked fruit.



Strawberries are also excellent for jams, jellies, and pies. Freshly sliced and sugared strawberries are excellent when served chilled, either alone or over shortcake or ice cream. In addition, strawberries contain a natural substance called ellagic acid, which is an anti-carcinogenic (cancer-preventing) compound.

*Figure 48. A berry slushy is one great way to enjoy fresh berries from your own garden and get your vitamins and antioxidants.*

## June-Bearing vs. Everbearing Strawberries

Strawberry plants may be of two major types, June-bearing or everbearing. June-bearing plants are cultured to produce a full crop the season after planting. In the Midwest, the ripening season of June-bearing strawberry cultivars ranges from late May to early July. Everbearing types produce two smaller crops, one in late spring and the second in early fall. The day-neutral plants make up a third type. These plants are capable of producing fruit throughout most of the growing season. Of the three types, June-bearing strawberries normally produce the largest yield per season.



*Figure 49. June-bearing strawberries produce higher yields than everbearing and day-neutral types.*

Everbearing strawberry plants differ from the standard or June-bearing types in that they produce a crop in fall the first season they are planted. The June-bearing types are most popular for the home garden and commercial use and are well worth waiting for because of their flavor and quality. Day-neutral types produce a full crop in the first year and can be treated as annuals. One cannot tell by looking at the plant whether it is June-bearing or everbearing; therefore, when purchasing plants, it is important to specify which type is desired. It is certainly a good idea to plant all three types to get fruit production in the first year from everbearing and day-neutral strawberries, and high yield and quality from June-bearing strawberries during the second and later years.

### Cultivar Selection

Home fruit growers have a large number of strawberry cultivars to select from. The selection is much greater for the June-bearing type than for

the day-neutral type. Strawberry cultivars recommended for growing in the Midwest are listed in Tables 11 and 12.



*Figure 50. Earliglow is one of the best-tasting strawberry cultivars. It is also disease resistant.*

It is important to know the ripening season, yield, berry size, freezing quality, and dessert quality of recommended cultivars in order to select cultivars according to personal needs (Table 11). In addition, selecting disease-resistant cultivars will help gardeners reduce the risks of damage from plant diseases. Refer to Table 12 for the disease resistance of the recommended strawberry cultivars. Home strawberry growers are encouraged to check the references listed or talk with Extension Educators or specialists or local commercial strawberry growers for additional information about strawberry cultivars.



*Figure 51. Tristar is a very good everbearing cultivar.*



| <b>Table 11. Cultural Characteristics of Recommended Strawberry Cultivars.</b>                                                                                                                                                                                      |               |                   |                         |                        |              |
|---------------------------------------------------------------------------------------------------------------------------------------------------------------------------------------------------------------------------------------------------------------------|---------------|-------------------|-------------------------|------------------------|--------------|
| <b>Cultivar</b>                                                                                                                                                                                                                                                     | <b>Season</b> | <b>Berry Size</b> | <b>Freezing Quality</b> | <b>Dessert Quality</b> | <b>Yield</b> |
| <b><i>June-Bearing</i></b>                                                                                                                                                                                                                                          |               |                   |                         |                        |              |
| Allstar                                                                                                                                                                                                                                                             | Mid           | Large             | Fair                    | Good                   | High         |
| Annapolis                                                                                                                                                                                                                                                           | Early         | Medium Large      | Good                    | Good                   | High         |
| Cabot                                                                                                                                                                                                                                                               | Mid-Late      | Very Large        | Fair                    | Excellent              | Medium       |
| Clancy                                                                                                                                                                                                                                                              | Mid           | Large             | Good                    | Good                   | Medium       |
| Earliglow                                                                                                                                                                                                                                                           | Early         | Medium, Large     | Very Good               | Very Good              | Medium       |
| Eros                                                                                                                                                                                                                                                                | Mid           | Large             | Good                    | Good                   | High         |
| Evangeline                                                                                                                                                                                                                                                          | Early         | Medium            | Excellent               | Good                   | Medium       |
| Guardian                                                                                                                                                                                                                                                            | Mid           | Very Large        | Fair                    | Good                   | High         |
| Jewel                                                                                                                                                                                                                                                               | Mid-Late      | Large             | Excellent               | Excellent              | High         |
| Kent                                                                                                                                                                                                                                                                | Mid           | Large             | Poor                    | Fair                   | High         |
| L'Amour                                                                                                                                                                                                                                                             | Early-Mid     | Large             | Good                    | Good                   | Fair         |
| Lateglow                                                                                                                                                                                                                                                            | Mid-Late      | Large             | Fair                    | Good                   | High         |
| Ovation                                                                                                                                                                                                                                                             | Late          | Large             | Good                    | Good                   | Medium       |
| Sparkle                                                                                                                                                                                                                                                             | Mid-Late      | Large             | Excellent               | Excellent              | High         |
| Surecrop                                                                                                                                                                                                                                                            | Early-Mid     | Large             | Good                    | Good                   | Medium       |
| Winnona                                                                                                                                                                                                                                                             | Mid-Late      | Medium Large      | Fair                    | Good                   | High         |
| <b><i>Everbearing (Day-Neutral)</i></b>                                                                                                                                                                                                                             |               |                   |                         |                        |              |
| Everest                                                                                                                                                                                                                                                             | N/A           | Large             | Fair                    | Good                   | High         |
| Seascape                                                                                                                                                                                                                                                            | N/A           | Large             | Good                    | Good                   | High         |
| Tribute                                                                                                                                                                                                                                                             | N/A           | Small             | Good                    | Fair                   | Medium       |
| Tristar                                                                                                                                                                                                                                                             | N/A           | Small             | Good                    | Fair                   | Medium       |
| Note: New fruit cultivars that may be superior to currently recommended varieties are constantly being released. Check with your local Extension Educator or the nursery you order plants from to obtain information on newly released cultivars for your location. |               |                   |                         |                        |              |

| <b>Table 12. Disease Resistance of Recommended Strawberry Cultivars.</b> |                  |                    |                  |                          |                       |
|--------------------------------------------------------------------------|------------------|--------------------|------------------|--------------------------|-----------------------|
| <b>Cultivar</b>                                                          | <b>Leaf Spot</b> | <b>Leaf Scorch</b> | <b>Red Stele</b> | <b>Verticillium Wilt</b> | <b>Powdery Mildew</b> |
| <b><i>June-Bearing</i></b>                                               |                  |                    |                  |                          |                       |
| Allstar                                                                  | R                | I                  | R                | R-T                      | T                     |
| Annapolis                                                                | S                | S                  | R                | I                        | S                     |
| Cabot                                                                    | R                | I                  | R                | U                        | U                     |
| Clancy                                                                   | R                | S                  | R                | U                        | U                     |
| Earliglow                                                                | R                | R                  | R                | R                        | S to I                |
| Eros                                                                     | I                | I                  | R                | S                        | U                     |
| Evangeline                                                               | R                | R                  | S                | U                        | R                     |
| Guardian                                                                 | S to I           | R                  | R                | R                        | S                     |
| Jewel                                                                    | R                | R                  | S                | S                        | R                     |
| Kent                                                                     | S                | I                  | S                | S                        | S                     |
| L'Amour                                                                  | R                | I                  | U                | U                        | U                     |
| Lateglow                                                                 | R                | R                  | R                | VR                       | S                     |

| <b>Table 12 (continued). Disease Resistance of Recommended Strawberry Cultivars.</b>                                                                                                                                                                                                                                                                                                                                                                                                                                                                                                |                  |                    |                  |                          |                       |
|-------------------------------------------------------------------------------------------------------------------------------------------------------------------------------------------------------------------------------------------------------------------------------------------------------------------------------------------------------------------------------------------------------------------------------------------------------------------------------------------------------------------------------------------------------------------------------------|------------------|--------------------|------------------|--------------------------|-----------------------|
| <b>Cultivar</b>                                                                                                                                                                                                                                                                                                                                                                                                                                                                                                                                                                     | <b>Leaf Spot</b> | <b>Leaf Scorch</b> | <b>Red Stele</b> | <b>Verticillium Wilt</b> | <b>Powdery Mildew</b> |
| Lester                                                                                                                                                                                                                                                                                                                                                                                                                                                                                                                                                                              | U                | R                  | R                | S                        | R                     |
| Ovation                                                                                                                                                                                                                                                                                                                                                                                                                                                                                                                                                                             | T                | I                  | U                | U                        | U                     |
| Sparkle                                                                                                                                                                                                                                                                                                                                                                                                                                                                                                                                                                             | U                | U                  | R                | S                        | S                     |
| Surecrop                                                                                                                                                                                                                                                                                                                                                                                                                                                                                                                                                                            | I to R           | I                  | R                | VR                       | U                     |
| Winnona                                                                                                                                                                                                                                                                                                                                                                                                                                                                                                                                                                             | R                | R                  | R                | T                        | U                     |
| <b>Everbearing (Day-Neutral)</b>                                                                                                                                                                                                                                                                                                                                                                                                                                                                                                                                                    |                  |                    |                  |                          |                       |
| Everest                                                                                                                                                                                                                                                                                                                                                                                                                                                                                                                                                                             | U                | U                  | R                | S                        | R                     |
| Seascape                                                                                                                                                                                                                                                                                                                                                                                                                                                                                                                                                                            | S                | U                  | S                | U                        | U                     |
| Tribute                                                                                                                                                                                                                                                                                                                                                                                                                                                                                                                                                                             | T                | T                  | R                | R                        | R                     |
| Tristar                                                                                                                                                                                                                                                                                                                                                                                                                                                                                                                                                                             | T                | T                  | R                | T to R                   | R                     |
| <p>S = susceptible, VS = very susceptible, I = intermediate reaction, R = resistant (the disease does not occur on that cultivar or only to a very small degree), VR = very resistant, T = tolerant (the disease is clearly evident, but with little or no apparent detrimental effect on plant or yield), U = unknown.</p> <p>* Cultivars are only resistant to specific races of the red stele fungus. If races for which resistance genes are not available are present in the planting or are introduced into the planting, red stele can develop on "resistant" cultivars.</p> |                  |                    |                  |                          |                       |

**Planting Site Requirements for Strawberry Plants**

Strawberry plants require full sun for the maximum yield and the best fruit quality. They will grow and produce crops in several different types of soil. However, best results are obtained when the plants are grown in loose, fertile soils containing large quantities of organic matter. The soil should be slightly acidic, having a pH of 5.8 to 6.5. If the extent of soil acidity or fertility is unknown, it is suggested that the soil be sampled and tested. Arrangements for soil testing can be made through your county Extension office. Request special tests for organic matter and micronutrients (e.g., boron). Lime and fertilizers should be applied to soils according to soil test results.



Figure 52. Strawberries need well-drained soil. They do very well in raised beds.

The strawberry plant is sensitive to excessive soil moisture. Strawberries should be planted in raised beds or on ridges if drainage is a problem (Fig. 52). If drainage is too poor, strawberries should not be planted. Also, avoid planting strawberry plants in areas where potatoes, tomatoes, or sod were grown recently. Insect and disease problems may result in serious plant damage in such areas.

**Cultural Practices for Growing Strawberry Plants**

Important cultural practices for growing strawberries include planting techniques and spacing, weed control, proper fertilizer, blossom removal from Junebearing strawberries in the first year, irrigation, renovation of strawberries after harvest, insect and disease control, and mulch (e.g., straw) for protection from cold temperatures and diseases.

**Planting and Spacing**

Early spring is the best time to plant strawberry plants as long as the soil is not too wet. Fall planting is not recommended because plants can be injured by soil heaving (alternate freezing and thawing). Strawberry plants have roots, a crown, and leaves. The *crown* is a short stem between the roots and leaves (Fig. 53).

When planting, make sure to cover the roots and only half of the crown with soil. Make a trench deep enough to set the roots vertically. Do not bend roots horizontally (Fig. 54).

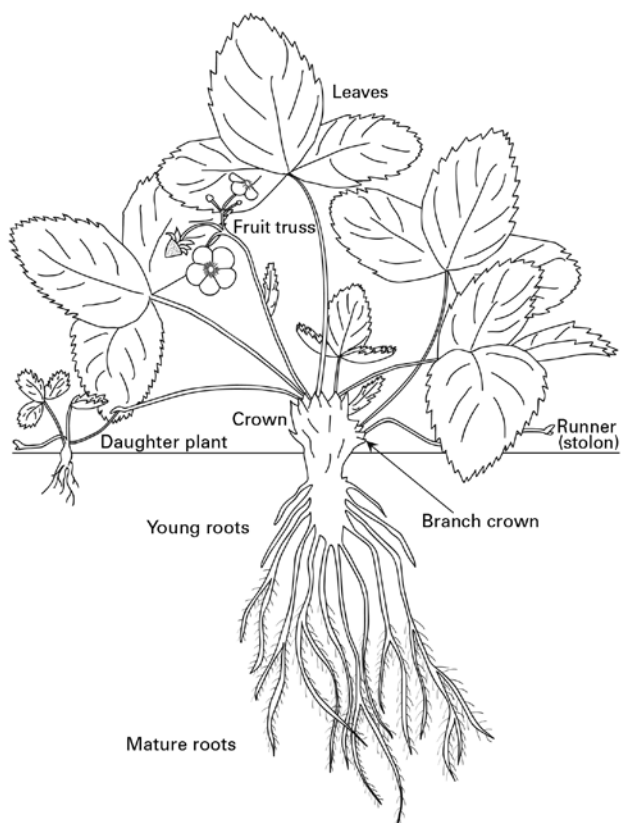

Figure 53. Diagram of a strawberry plant.

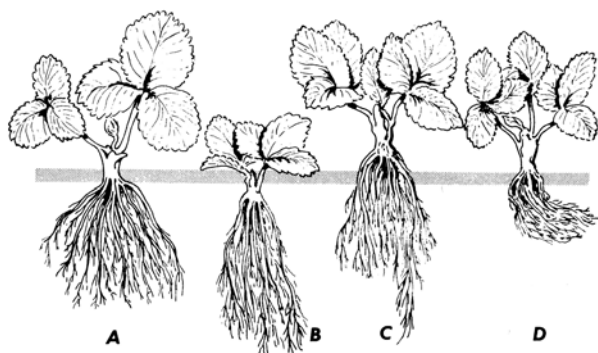

Figure 54. Proper planting method (A) and improper methods (B, C, and D) for strawberry planting. At B the crown is too deep; at C the crown is too high; and at D the roots are bent and remain near the surface.

June-bearing plants are spaced 12 to 24 inches apart. On close-spaced plants, runners are controlled by removing unwanted runners during the first season. In August, rows should be 18 to 24 inches wide with plants six to eight inches apart in the row. Generally, rows are 36 to 40 inches apart. A circular terrace can be used if one has limited space. Refer to the section on *Growing Fruits in Limited Space* for more information.

For everbearing strawberries, plants are set eight to 12 inches apart in the row with 30 to 36 inches

between rows. Remove runners throughout the first season and remove flowers for the first six weeks after planting. Mulch the planting with three to four inches of straw or wood chips to conserve moisture and to help control weeds.

### Weed Control

Mechanical cultivation, mulching, and certain herbicides may be required to maintain an essentially weed-free planting. Very few weed-killers or herbicides are labeled for use in strawberry beds and are generally not recommended for home use. Read the pesticide label carefully before any pesticide application. A good method of weed control is to use a good layer of straw mulch that is free of weed seeds (Fig. 55). The straw will help prevent weeds from becoming established and is also used to cover the plants for winter protection and frost protection in the spring. The layer of straw also helps to keep berries clean and healthy because they do not touch the soil.



Figure 55. It is a good idea to use straw as mulch to prevent weeds and keep strawberries clean.

### Lime and Fertilizers

Soil testing every three years is highly recommended for the best yield and fruit quality. Apply nutrients and lime (if needed) prior to planting according to soil test results. Before planting, broadcast five pounds of 6-24-24 per 100 feet of row area. Work this fertilizer into the soil. Sidedress three pounds of 12-12-12 fertilizer per 100 feet of row several weeks after planting if plants lack vigor or the area was not fertilized prior to planting. An additional sidedressing in late June

could be made if the plant growth is weak. An August application of nitrogen might be helpful in increasing flower bud formation.

During the second and subsequent years, apply four to six pounds of 12-12-12 fertilizer per 100 feet of row immediately after harvest. A late summer application of one pound of ammonium nitrate or three pounds of 12-12-12 per 100 feet of row may be helpful in increasing flower bud formation.

### Blossom Removal

Remove the flower stalks of June-bearing strawberry plants as they appear throughout the first growing season. More production can be expected if the plants are allowed to attain large size before fruiting. Remove the blossoms of everbearing types of plants as they appear until about the middle of June (first year only). Then allow flowers to set fruit for harvest during the remainder of the season (August through October).

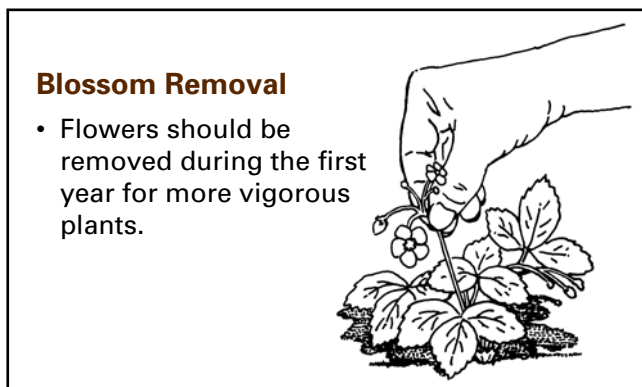

Figure 56. During the first year of planting, the blossoms on June-bearing strawberries should be removed to encourage plant growth and flower bud formation in the second year.

### Watering

Additional watering is needed during dry seasons. Strawberry plants require 1 to 1.5 inches of water per week from mid-June to mid-August. Take care in watering so that the soil does not remain soggy for any prolonged period.

### Renovation of Strawberries After Harvest

Strawberry plants can be fruited more than one year but probably not for more than three or four harvest seasons, depending on the vigor and number of plants. June-bearing strawberries should be renovated every year right after harvest if one desires excellent fruit production for more than one year. Renovation refers to renewing the planting.

Renovation restores life, vigor, and growth to the planting. The renovation process must begin immediately after harvest and must be completed before July 15. The new canopy must be sufficiently developed and finished in growth by early September when flower buds form for June-bearing strawberry cultivars.

The major goals of renovation are to:

1. Replace diseased leaves with new leaves.
2. Improve sunlight exposure to the plant canopy.
3. Fertilize for improved plant vigor, flower bud formation and berry improvement.
4. Place soil up to the root crown for improved root development.
5. Control seeds.



Figure 57. Strawberry patch right after most old leaves have been mowed off with a mower or a sickle.



Figure 58. The strawberry patch one week after old leaves have been mowed off. Note the flush of new leaves.

These renovation goals are achieved through conducting the following practices:

1. Control weeds by mechanical means or a labeled weedkiller.
2. Remove old strawberry leaves with a mower or a sickle. Make sure you set the blade high to avoid injuring plant crowns.
3. Narrow the rows to 12 inches by using a rotary tiller.
4. Thin the plants within each row, leaving 4 to 6 inches between plants.

Topdress beds with one-half to one inch of soil. Broadcast two and one-half pounds of 10-10-10 fertilizer per 100 square feet of planting. Apply one inch of water each week to promote growth if it does not rain. The strawberry patch may not look very attractive right after renovation. However, strawberry plants do recover beautifully and will be much more productive.

After four to five years of production, a strawberry patch may become very unproductive. Gardeners should remove all of the strawberry plants and plant new virus-indexed plants from nurseries or garden centers. Virus-indexed plants are free of viruses, very vigorous, and should be very productive.

### **Disease and Pest Control**

Refer to Chapter 7 on pest management in this bulletin. For specific disease and insect control recommendations, including the use of fungicides and insecticides, consult your local Cooperative Extension Service. In Ohio, obtain a copy of Ohio State University Bulletin 780, Controlling Disease and Insects in Home Fruit Plantings.

### **Mulching for Winter Protection**

In addition to having value for weed control, mulching is necessary for winter protection for the plants. Mulching helps avoid having strawberry crowns heaved out of the ground. Apply straw that is free of weed seeds at a depth of 3 to 4 inches over the plants after they have been subjected to several sharp freezes in the low 30s or high 20s in late fall. This is generally done between November 15 and 30, but should be done no later than December 15.”



*Figure 59. Between November 15 and December 15, cover strawberry plants with three inches of straw to provide winter protection and frost protection.*

### **Frost Protection**

Strawberry flower buds and flowers are very susceptible to spring frosts. Mulch used for winter protection should be pulled from plants in early spring, before there is much leaf yellowing under the mulch. The mulch should be left in the alleyways and can be used to cover plants in order to protect blossoms in the spring when frost is predicted, especially with early cultivars, such as Earliglow. Small plantings can be covered at night with a sheet or other form of row cover to protect blossoms from frost. The covers should be removed the next morning when the danger from frost is over. Frost protection can make a difference in the amount of fruit that sets in the spring.



*Figure 60. Strawberry flowers with frost damage next to undamaged flowers.*



Figure 61. The straw mulch used for frost protection needs to be pulled away from the strawberry plants when soil temperatures reach 40°F or above.

## Brambles (Raspberries and Blackberries)

Raspberries (*Rubus* sp.; subgenus: *Idaobatus*) and blackberries (*Rubus* sp.; subgenus: *Eubatus*) are referred to as brambles. Brambles can be an excellent fruit crop in the home fruit planting, if properly managed. Once the fruit has been harvested, it will normally last in the refrigerator for only a few days. Therefore, fruit should be processed or consumed rapidly. Being able to harvest fresh raspberry or blackberry fruits from your garden allows you to taste completely mature berries that are of good quality.



Figure 62. Brambles, which include blackberries and raspberries, are well suited for home fruit plantings.

Bramble plants can start producing fruit in the second year. Raspberry and blackberry plants are referred to as perennials with biennial cane and fruit production. Roots of these plants are cold-hardy and continue to produce above-ground growth each year. As new canes emerge during the growing season, they are referred to as the *primocanes*. Primocanes are vegetative only for most bramble cultivars and do not produce fruit during the first year. There are exceptions in which some do flower and produce fruit in the fall. Since bramble canes are biennial, they continue to grow in the second year. During the second growing season, the canes are referred to as *floricanes* on which flowers and fruit are produced.

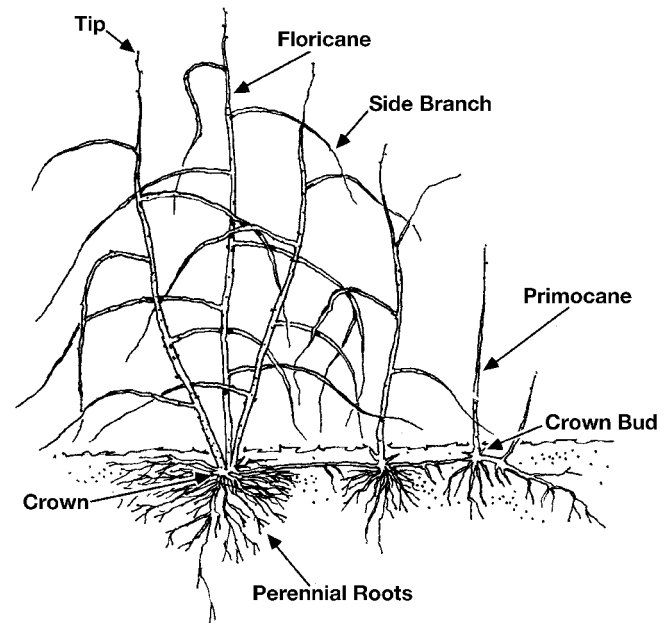

Figure 63. Diagram of a bramble plant.

Primocanes emerge from the base of the crowns on black raspberries, certain purple raspberries, and thornless blackberries. These plants do not spread and fill in the row as commonly seen with thorny blackberries and red and yellow raspberries which have *adventitious buds* on the roots. Adventitious buds are the buds that arise in an unusual location, as from the stem instead of the axils of the leaves. These buds grow to produce new shoots all through the row. Therefore, the canopy of the thorny blackberries and red and yellow raspberries tends to fill in and become thick.

Buds in red raspberries tend to be more winter hardy than other bramble species and tolerate temperatures of -30°F to -40°F without injury. If the

dormant rest period is short and is broken with a few hours of temperatures above 40°F, a rapid loss of cold hardiness occurs. If this is followed by severe cold, plant injury or bud kill may result.

Reducing the effects of fluctuating temperatures through site selection or use of protective cover might be necessary to achieve consistent fruit production. Care should be taken to select bramble cultivars that are tolerant of the winter and spring climate in your area. Site selection is very important, but not always possible based on the location of your home property. Yellow raspberries are similar in cold hardiness and root system to red raspberries.

Black and purple raspberries and thornless blackberries are less winter hardy than red raspberries. Primocanes have been damaged or killed by strong, cold winds or drastic temperature fluctuations. Generally, yields of black and purple raspberries and thornless blackberries have been reduced in winters where temperatures were recorded at -10°F to -15°F. It is very important to select cultivars that are more winter hardy to avoid yield loss and plant injuries.

### Site Selection

Choose a site that is always in full sun and away from frost pockets. To combat the winter damage that occurs when temperatures fluctuate, choose a north slope or a site on the north side of a wind-break or building. Winter shade will help keep raspberries from breaking dormancy too early.



*Figure 64. Brambles should be planted in a sunny area and away from frost pockets. Shown here is a pick-your-own operation.*

### Soil Preparation

Clear all debris and grass from your intended site before deep tilling. It is important to thoroughly work the area and add compost and top soil as needed. Take a soil sample and submit it for analysis to determine if lime needs to be added to adjust the pH and determine if the soil fertility needs to be amended through a fertilizer application.

### Cultivars

Raspberries can be red, black, purple, or yellow. Know the particular cultivar chosen; otherwise, incorrect cultural practices may interfere with fruit production. Most types of raspberries and blackberries produce one crop. However, some raspberries produce two crops, one in spring and another in fall. This type is called ever-bearing or fall-bearing. All brambles are self-fruitful and produce fruit without cross-pollination. Refer to Tables 13 and 14 for recommended bramble cultivars.



*Figure 65. Red raspberries (right) and black raspberries (left). It is important to know which type of raspberries or blackberries you have since they require different pruning and training techniques. Photos courtesy of Nourse Farms Nursery.*

Several primocane fruiting blackberries have been released by the University of Arkansas under the name of Prime-ARK. Prime-Jim® and Prime-Jan® are two first releases for home use. Ongoing research is looking at new potential primocane fruiting varieties.

**Table 13. Recommended Raspberry Cultivars and Their Cultural Characteristics.**

| <b>Fruiting Habit</b> | <b>Cultivar</b> | <b>Ripening Season</b> | <b>Cultural Characteristics</b>                                                                                                        |
|-----------------------|-----------------|------------------------|----------------------------------------------------------------------------------------------------------------------------------------|
| Summer Blacks         | Haut            | Early                  | Medium-sized fruit with good flavor. Plants are vigorous and productive. It is for trial in Ohio.                                      |
|                       | Bristol         | Early                  | Large and attractive fruit that is firm and has good flavor. Plants are vigorous and productive.                                       |
|                       | Allen           | Early-Mid              | Large and attractive fruit with mild flavor. Plants are vigorous and productive.                                                       |
|                       | Jewel           | Early-Mid              | Long and attractive fruit with good flavor. Plants are vigorous and productive.                                                        |
|                       | Mac Black       | Mid-Late               | Probably the latest-producing cultivar. Attractive fruit with good quality. Plants are productive.                                     |
|                       | Black Hawk      | Late Season            | Medium to large fruit with good quality and flavor. Plants are vigorous, productive, and resistant to anthracnose.                     |
| Summer Reds           | Prelude         | Very Early             | Good quality fruit. Plants are productive and very winter hardy. Prelude is also fall-bearing but produces most of its crop in spring. |
|                       | Reveille        | Early                  | Medium to large fruit with good flavor. Vigorous and high yielding.                                                                    |
|                       | Boyne           | Early                  | Deep-red, medium-sized fruit with good flavor and production. Very winter hardy.                                                       |
|                       | Killarney       | Early                  | Large, firm berries with good flavor. Very winter hardy.                                                                               |
|                       | Nova            | Early-Mid              | Berries are firm, bright, and medium to large in size with good flavor and shelf life. Good producer and very winter hardy.            |
|                       | Titan           | Early-Mid              | Largest fruit size of any red raspberry. Very attractive fruit with good quality. Moderately susceptible to phytophthora root rot.     |
|                       | Liberty         | Mid-season             | Medium to large fruit with good flavor and freezing quality. Plants are productive.                                                    |
|                       | Latham          | Mid-season             | Small fruit with good color and fair flavor. Moderately productive. Very cold hardy.                                                   |
|                       | Newburgh        | Mid-season             | Medium-sized fruit with good flavor. Moderately productive. Cold hardy.                                                                |
|                       | Sentry          | Mid-season             | Bright red, firm, and medium-sized fruit with good flavor. Productive with fair winter hardiness.                                      |
|                       | Encore          | Mid-Late               | Large, good quality fruit. Plants are productive with good winter hardiness.                                                           |
| Summer Purples        | Brandywine      | Late                   | Large, reddish and tart fruits that are good for jellies and jams. More vigorous and productive than most black raspberries.           |
|                       | Royalty         | Late                   | Large and reddish fruits that are sweet and flavorful when eaten fresh. Plants are vigorous and productive.                            |
| Everbearing Reds      | Polana          | Early                  | Ripens three weeks before Heritage. Very productive with large, flavorful fruit.                                                       |
|                       | Autumn Britten  | Early-Late             | Very large, firm, and flavorful fruit. Ripens before Heritage.                                                                         |
|                       | Carolina        | Early-Late             | Very large and flavorful fruit. Very productive. Widely adapted cultivar.                                                              |
|                       | Heritage        | Mid-Late               | Medium-sized fruits with good color and flavor, firmness, and freezing quality. High yielding.                                         |



| Fruiting Habit      | Cultivar  | Ripening Season | Cultural Characteristics                                                                                                                       |
|---------------------|-----------|-----------------|------------------------------------------------------------------------------------------------------------------------------------------------|
|                     | Redwing   | Mid-season      | Large and soft fruits with good flavor. Moderately productive.                                                                                 |
| Everbearing Yellows | Fall Gold | Early           | Medium-sized and soft fruits with excellent flavor. Moderately yielding.                                                                       |
|                     | Anne      | Mid-Late        | Largest and best-lasting yellow raspberry. Ripens the same time as Heritage. Can be pruned for summer production or mowed for full production. |

Note: New fruit cultivars that may be superior to currently recommended varieties are constantly being released. Check with your local Extension Educator or the nursery you order plants from to obtain information on newly released cultivars for your location.



Figure 66. Thornless blackberries are wonderful for eating fresh and in pies and other pastries. Shown here is the cultivar Chester.  
Photo courtesy of Nourse Farms Nursery.

| Stem Thorniness      | Cultivar     | Cane Type      | Yield           | Berry Size      | Winter Hardiness | Firmness and Quality | Ripening Season |
|----------------------|--------------|----------------|-----------------|-----------------|------------------|----------------------|-----------------|
| Thorny Blackberry    | Choctaw      | Erect          | Low             | Small           | Fair             | Good                 | Late            |
|                      | Darrow       | Erect          | High            | Large           | Very Good        | Very Good            | Late            |
|                      | Illini Hardy | Erect          | High            | Medium          | Very Good        | Good                 | Middle          |
|                      | Kiowa        | Erect          | High            | Very Large      | ?                | Good                 | Late            |
|                      | Shawnee      | Erect          | Medium          | Large           | Good             | Very Good            | Late            |
| Thornless Blackberry | Apache       | Erect          | Medium          | Large           | ?                | Very Good            | Late            |
|                      | Arapaho      | Erect          | Medium          | Medium          | Good             | Good                 | Middle          |
|                      | Black Satin  | Semi-Erect     | High            | Medium to Large | Fair             | Good                 | Late            |
|                      | Chester      | Trailing       | High            | Large           | Good             | Good                 | Late            |
|                      | Dirksen      | Erect          | High            | Large           | Good             | Very Good            | Late            |
|                      | Hull         | Trailing       | High            | Medium          | Fair             | Good                 | Late            |
|                      | Navaho       | Erect          | Medium          | Small           | Fair             | Very Good            | Late            |
|                      | Ouachita     | Erect          | High            | Large           | ?                | Good                 | Middle          |
| Triple Crown         | Erect        | Medium to High | Medium to Large | ?               | Very Good        | Late                 |                 |

Note: New fruit cultivars that may be superior to currently recommended varieties are constantly being released. Check with your local Extension Educator or the nursery you order plants from to obtain information on newly released cultivars for your location.

Plants that are certified disease-free ensure a good start and an abundant crop over the years. Reputable nurseries and mail-order companies offer certified stock. However, this guarantee does not mean that plants are immune to diseases. Plants obtained from friends or companies that do not guarantee disease-free stock can result in plant loss and contaminated soil where brambles and other susceptible crops cannot be grown for years.

### Nurseries

Before purchasing brambles for your new planting, be sure to order plant material from a reputable nursery. See Chapter 9 for a list of nurseries. Your local Extension office may also be able to provide information on potential nursery suppliers. Any plants that you order should come from certified stock that is disease and insect free. Establishing clean and healthy plants will be a good start to a successful bramble planting.

You may have to order from different nurseries in order to obtain all desired cultivars. Local nurseries can be good sources of raspberry and blackberry plants. Be sure to look over the leaves and canes carefully for any sign of diseases or insects. Also, pull the plant out of the pot and carefully examine the root system. Healthy roots should be white in appearance and evenly distributed in the soil.

### Planting

Bramble root systems develop in the upper 10 to 20 inches of soil. Brambles should be grown in a sandy loam soil that contains three to four percent organic matter and has good fertility and soil drainage. Raspberries grow best in a soil pH of 5.8 to 6.5, but they will grow and produce in many different soils. Use a soil test as a guide before applying lime or fertilizers. Avoid areas where tomatoes, potatoes, or eggplants have been previously grown. These plants carry disease-causing organisms that

also infect brambles (primarily *Verticillium* root rot). Red raspberries are generally more disease resistant than black and purple raspberries.



*Figure 67. Red raspberries are generally more disease resistant than black or purple raspberries.*

*Photo courtesy of Nourse Farms Nursery.*

Newer cultivars of black raspberries have been developed with greater disease resistance. Avoid locations within 300 feet of

wild raspberries and blackberries. Wild brambles may harbor diseases and insect pests that can spread to your healthy plants.

Plant in early spring, if the soil is not overly wet. Fall planting is acceptable but not preferred. Apply a mulch to fall-planted stock to prevent heaving due to the soil freezing and thawing. Keep mulch away from the stems.

New plants will be either bare-root or planted in a pot. Plants ordered by mail will usually be short sticks or canes a few inches long with a bare (not in soil) fibrous root system. These are referred to as bare-rooted plants. Plants purchased at a garden center are often in pots of soil. Bare-rooted stock will be packed in moist peat moss or some other sterile, moisture-retaining material. Soak bare-rooted plants in a bucket of water for 20 to 30 minutes before planting. Move plants from the bucket directly to the planting hole.

Dig a hole that is one and a half times larger than the root mass. Fan out roots in the hole and fill in soil to the soil line around the canes. Select appropriate planting systems and spacing according to the types of brambles (Table 15.) Water plants immediately after planting and every two or three days if no rain occurs.

**Table 15. Suggested Spacing and System of Management for Brambles.**

| Type of Bramble                 | Spacing Between Plants and Rows | Management System     |
|---------------------------------|---------------------------------|-----------------------|
| Red and Yellow Raspberry        | 2' x 10'                        | Hedge row—low trellis |
| Black Raspberry                 | 2.5' x 10'                      | Linear—low trellis    |
| Erect Blackberry                | 3' x 10'                        | Linear—no trellis     |
| Purple Raspberry                | 3' x 12'                        | Linear—no trellis     |
| Trailing (Thornless) Blackberry | 6 - 8' x 12'                    | Linear—high trellis   |

## Trellis System

A trellis system can be used to keep canes and berries off the ground, making the planting more manageable. Use a No. 8 gauge wire strung in two parallel lines at a height of 30 inches. Because of growth habit, red and yellow raspberries and thorned blackberries are usually grown in a hedge or row. Black and purple raspberries and thornless blackberries are grown in hills. For more information on building a trellis, refer to the section on *Supporting Brambles* in Chapter 5.



Figure 68. Brambles supported on a trellis can help reduce wind damage to canes and yield loss.

## Mulch

Mulching is recommended for weed control and moisture retention. A two- to three-inch layer of shredded leaves, straw, sawdust, or other material is suitable. Keep mulch away from the stems. Mulch keeps the stems moist and increases the chances of disease infection. Root competition from nearby weeds or other vegetation can drastically affect fruit production. When cultivating for weeds, applying fertilizers, or adding organic matter, remember that brambles have very shallow root systems. Some mulches remove nitrogen from the soil, so be sure to supplement with nitrogen when appropriate.

## Soil and Plant Fertility

A good general fertilizer (10-10-10 or 12-12-12) should be applied at a rate of 1/8 to 1/4 cup per plant about one to two weeks after planting. Fertilizer does not need to be applied directly after planting if it was incorporated into the soil before planting. In about one month after planting, make another application at this rate. This should be an adequate amount of fertilizer to assure good plant growth in the first year of establishment.

Depending on the amount of growth, flower buds will be set on all primocanes and lateral shoots in late summer and early fall. This will have a direct bearing on the amount of fruit produced on floricanes the next year. In the second growing season, apply 1/2 cup of complete fertilizer in early spring at bud break and then one month later. Adjustments in the amount of N-P-K can be made based on the soil test results. Do not apply fertilizer after July 1.

## Disease and Pest Control

Refer to Chapter 7 on pest management in this bulletin. For specific disease and insect control recommendations, including the use of fungicides and insecticides, consult your local Cooperative Extension Service. In Ohio, obtain a copy of Ohio State University Bulletin 780, *Controlling Diseases and Insects in Home Fruit Plantings*.

## Watering

Because brambles have 75 percent of their roots in the top 12 inches of soil, they can quickly become water stressed. Supplemental watering is especially critical during blossoming, fruit ripening, and fall flower bud development. About one to one-and-one-half inches of water per week is needed from rainfall or supplemental watering. More watering is needed if your soil is loamy or sandy. Observe the condition of plants and adjust watering accordingly. More watering might be needed just prior to harvest to increase fruit size.

Avoid wetting foliage and fruit to reduce risk of disease infection. If overhead watering is the only available method, apply water early in the day so leaves dry quickly. Directional watering wands can be used to apply water to soil. Directional watering wands, soaker hoses, and drip systems can also be used to avoid wetting foliage and fruit.

## Harvest

Once fruit has fully matured, it should be harvested and used right away. Each cultivar of raspberry and blackberry will have a different maturity date. One of the best ways to assure that you are picking at the appropriate time is to taste some fruit. If it is sweet enough to consume, it is time to harvest.

Do not pick based on the color alone. Many times gardeners will pick fruit solely based on color. This has been proved to be the wrong approach. You should follow the color changes, but also harvest fruit that taste sweet and can be easily removed

from the cane. If you place the fruit between your forefinger and thumb and gently twist the fruit. On raspberries, the fruit should immediately detach from the *torus*, or white receptacle that connects the fruit to the pedicle and then the cane.

On blackberries, fruits become detached from the *pedicle* or fruit stem and are not hollow in the center like raspberries. (Figure 69). Raspberry fruits become detached from the receptacle or torus (which connects fruit to pedicel or stem) and are hollow in the center (Figure 70). Fruit that does not readily detach should be left to mature longer on the cane.



Figure 69. At harvest, the receptacle remains in the blackberry fruit, and the fruit is solid.



Figure 70. At harvest, the receptacle remains on the raspberry plant, and the fruit is hollow.

## Pruning and Training

### Red Raspberries

The pruning and training of red raspberries differ from that of the other raspberries and blackberries and will be discussed first. Pruning suggestions for summer red raspberries, which have been established for two or more years, follow.

### Removing Canes After Fruiting

Because floricanes die after fruiting, they must be removed. This will be a large part of pruning rasp-

berries and blackberries. It is preferable to do it after plants are dormant in mid-March. Cuts should be made close to the ground. The cut canes can be further chopped up into smaller pieces with a mower and then lightly worked into the soil by cultivation, or removed completely and burned.

### Thinning Shoots and Canes

From spring to the end of harvest, new shoots and fruiting canes occur together in the row. Competition exists between them for light, water, and nutrients. If competition is severe, new shoot growth is weak, spindly (small diameter), and very susceptible to winter injury. If rows are too thick or dense, diseases are favored because of poor air circulation; berry size is small; and berry picking is difficult. To prevent severe competition, some thinning of both new shoots and fruit canes is required. Fruiting canes within the row should be thinned in the early spring when they are dormant. Remove weak canes. Keep large canes that are spaced about four to six inches apart as evenly as possible over the width of row. Confine row width to 12 to 18 inches (Figure 71). Generally, three to five large-diameter canes per linear foot of row is optimal.

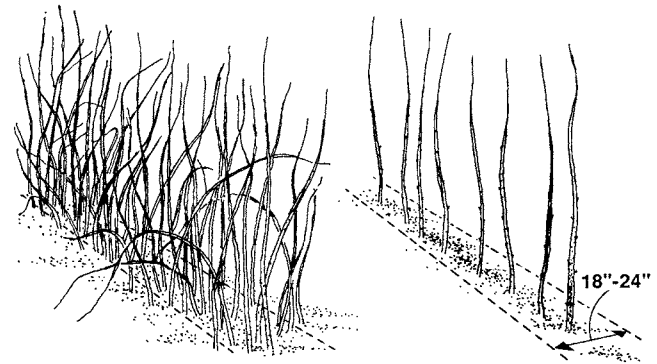

Figure 71. Red raspberry before and after pruning. These plants are planted in a narrow hedge row.

The number of new shoots produced varies with the cultivar as well as the growing conditions. Certified plants are especially vigorous and produce numerous suckers, particularly the first few years after planting. It may be necessary to mow along the edges of the row during the growing season to reduce the number of suckers. Also, when the old fruiting canes are removed after harvest, some of the weak suckers can be removed by hand (with a glove). However, the complete thinning job should not be done at this time because this could promote growth and lead to winter injury.

## Heading Back Shoots and Canes

Pinching off the tips (heading back) of young red raspberry shoots in the summer to promote growth of side branches is not recommended. No particular advantages result, and the laterals produced are more subject to winter injury than are unbranched canes.

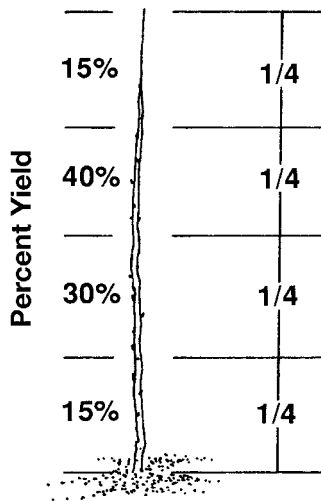

Figure 72. Heading back a red raspberry cane. Do not cut more than the top one fourth or yields will be decreased.

Heading back of canes (cutting back tops) should be done in the spring (Figure 72). It is preferable to delay this until the extent of winter injury can be determined (after February 15). Ideally, all canes in a row do not require heading back to the same height. Vigorous canes can be left longer than weaker ones. Cane height varies with cultivar and growing conditions. Tall canes (more than five feet) should be cut back to some extent to bring canes down to a convenient height for picking, prevent excessive bending over of canes with the weight of the crop, and increase berry size by reducing the number of berries produced per cane. Head tall vigorous canes four to eight inches above the trellis wire and cut back.

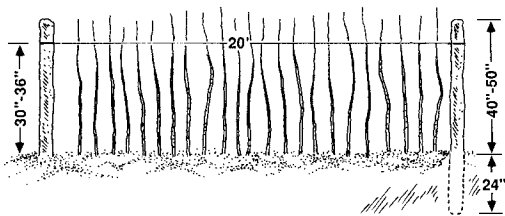

Figure 73. Permanent trellis posts are spaced about 20 feet apart. Set posts at least two feet in the ground.

Because heading back removes part of the potential crop, severe heading back should not be done as the loss of crop will not be offset by increasing berry size. As a guide, a height of 4-1/2 to 5 feet has been satisfactory when irrigation is practiced. A somewhat shorter height may be required when irrigation is not available. When winter injury occurs, all canes need to be cut below the point of winter injury.

With canes shorter than 4-1/2 to 5 feet, heading back is frequently done to remove winter-injured tips or tips severely infected with powdery mildew. Removal of infected tips is an important control measure for powdery mildew. It is a good idea to remove the weak tip growth as indicated by the close spacing of buds.

## Training

Red raspberries are generally grown in hedgerows in Ohio. The canes are confined to narrow rows or hedges, and no attempt is made to keep the suckers of one plant separate from those of another.

## Fall Red Raspberries

### Pruning

Fall-fruiting red raspberries (Heritage and other cultivars) produce new canes from the roots and the crown, the same as summer-fruiting cultivars, but the upper third to a half of each cane is likely to produce fruit during the first year of growth. Portions of canes that produce fruit in the first year will die after harvest. Portions of the cane that did not produce fruit in the first year will produce fruiting shoots during the next spring, the same as second-year canes of June cultivars.

Dormant season removal of all fruiting canes is done either with a rotary or flail-type mower. The canes can be mowed (one to two inches above the soil) in the spring as soon as weather permits. The canes should be collected and removed to control disease. This converts the so-called “everbearing” or “twice-bearing” kind to a single cropping mode, a fall-crop-only system of management.

Vigorous, early growth of first-year canes is necessary to achieve high fall-fruit-only yields. Such growth results in long canes (4-1/2 to 5-1/2 feet) whose tips are laden with fruit. Plants begin flowering in mid to late July, and fruit can generally be harvested until the first frost in fall.

## **Black and Purple Raspberries**

### **Summer Heading (Tipping)**

If shoots of these plants are allowed to grow unchecked, they get long and are very difficult to manage without support of some kind. To prevent this, the tips of new canes should be pinched off (headed) when the canes have reached a certain height (Figure 74). This induces growth of side branches and results in plants that are stocky and self-supporting and have a large amount of bearing wood.



Figure 74. Remove three to four inches of top growth to promote the formation of laterals.

Black raspberry shoots should be tipped when canes reach about 28 to 30 inches (Figure 75). Brandywine purple raspberries are usually tipped about 36 inches. Generally, plant height will be less than two feet for the planting year. Therefore, heading is done every year from the second season. Royalty purple raspberries do not require heading, because their growth is similar to red raspberries.

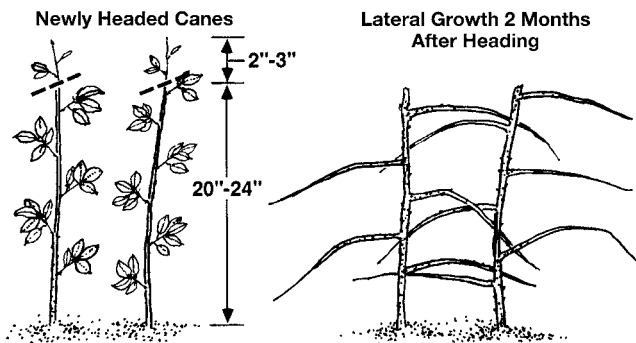

Figure 75. Heading or summer pruning of black and purple raspberries. Black raspberries are headed at 28 to 30 inches and purple raspberries at 36 inches.

In heading, the usual practice is to remove four inches of the top. It is necessary to go over the planting several times, because all shoots do not reach the same height at the same time. If shoots are permitted to grow much above the desired height and then headed, the extra shoot growth is wasted, and the side branches will not be as strong as if heading had been done at the proper time. The laterals should not be shortened until the following spring.

In most cases, the laterals mature sufficiently well and are not winter-killed to an extent that yields are lowered. Canes that do not reach the height for tipping by the time harvesting is started are usually not tipped. These weak canes will not grow much higher, and late tipping results in weak, immature laterals.

### **Removing Canes After Fruiting**

After fruiting, canes die and should be removed in March. The considerations for removing canes mentioned under Red Raspberries apply to these crops as well.

### **Thinning Canes**

Because black and purple raspberries do not produce suckers, the canes are located in clusters or hills where the original plants are set instead of being distributed all over the row. Remove canes less than half an inch in diameter at the base in the spring. Usually, no further thinning is needed as plants should be able to support as many vigorous canes as they produce. Because yields depend on the number of strong canes, conditions should be made favorable enough so that from four to six strong canes are produced per hill.

### **Heading Back Laterals**

The laterals or branches produced as a result of summer tipping may grow quite long (three feet or more) (Figure 76). Most of the buds on the laterals are fruit buds. If all were left, there would be so much competition for water and nutrients that fruit size would be small. Therefore, laterals must be headed back to thin the fruit crop. Head back laterals in the early spring after the extent of winter injury can be determined but before the buds swell and grow.



Figure 76. Black and purple raspberries before and after pruning.

Promocane-fruiting blackberries are being developed at the University of Arkansas under the plant patent of Prime-Ark™. ‘Prime-Jim®’ and ‘Prime-Jan®’ are the first releases that are intended for home fruit plantings. Fruit can be produced on both primocanes (fall bearing) and floricanes (summer bearing).

With black raspberries, eight to 10 buds (eight- to 12-inches long) per lateral are usually enough. Purple raspberries are somewhat more vigorous than blacks, and a few more buds per lateral can be left. The length of laterals in both purple and black raspberries can be increased somewhat if canes have only two to three laterals and if there are only a few canes per hill or when irrigation is available.

## Blackberries

### Pruning

Erect blackberry cultivars differ in their fruiting habits. In some cultivars, the fruit clusters occur well out on the laterals; in others, they are close to the main stem; and in others, they are well distributed over the lateral. Generally, at least half of each lateral may be removed. The erect blackberry should be handled similar to the black raspberry. Some growers prefer to allow canes to reach at height of 4 to 5 feet before tipping to promote lateral production.

Thornless blackberries that have not been damaged by cold temperatures need to have all laterals removed within 18 to 24 inches of the soil (Figure 77). These low-positioned laterals will produce fruit that will not be harvested or will be covered with soil. Next, head all laterals back to 12 to 18 inches. If the main shoot is excessively long, it can be cut back to give space to other plants. Thin out small diameter canes and leave four to six canes per plant. If the thornless blackberries have been damaged by cold temperatures, remove all dead wood. If there are only three or four laterals that

show signs of life, these may be headed back to three to four feet after being tied to the first wire of the trellis.

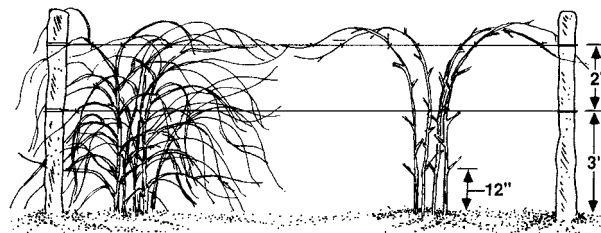

Figure 77. Thornless blackberries before and after dormant pruning.

It may be advisable to summer prune or head back thornless blackberries. Summer pruning may stiffen canes, create vigorous laterals near the pruning cut, and be helpful under heavy snowfall. A strong trellis will be necessary under heavy fruiting.

## Grapes (*Vitis* spp.)

Grapes are some of the oldest cultivated fruit, dating back to 5,000 to 10,000 years ago. They can be a wonderful addition to the home fruit planting. When grown on a grape arbor, grapes can be a very attractive addition to the home landscape. Grapes are fairly tolerant of soil fertility, pH, and drought. With proper care, grapes can be productive for 40 years or more.



Figure 78. A grape arbor can be a great addition to the home landscape.

Grape plants are woody perennial vines that produce fruit on the current season's shoots. The buds that produce these shoots are formed the previous year. Care of the plant after harvest is important to the formation of buds for the next year.

Grapes have compound buds that contain three individual buds. The largest is the primary bud

which produces flowers. A smaller, secondary bud will produce flowers and a smaller fruit crop if the primary bud is killed by frost in spring. The third bud will produce foliage if the secondary bud is killed. The fruit-producing buds are located on the primary shoot opposite a leaf. Buds at other nodes produce tendrils and shoots.

### Site Selection

Choose a site that is sunny and away from frost pockets. To combat winter damage that occurs when temperatures fluctuate, choose a north slope or a site on the north side of a windbreak or a building. Winter shade will keep grapes from breaking dormancy too early.

Select certified, disease-free plants from local garden centers or reputable mail-order nurseries. Early spring is the time to plant new vines. Place orders so that plants are received close to planting time. Choose well-rooted, one-year-old, bare-root, or potted plants. Some nurseries offer two-year-old plants. Older plants will produce more vigorously after the first season, but they also cost more.



*Figure 79. Grapevines require full sun and well-drained soil.*

Grapevines require three years (from one-year-old plants) to become established and produce maximum yields. Grapes are deep-rooted. They quickly grow roots six to eight feet deep in a well-drained, sandy-loam soil. Soil preparation ensures success. Grapes, although fairly tolerant of soil types and pH, do best in a pH of 5.5 to 6.5. American-type grape cultivars do best in a soil pH range of 5.5 to 6.0, while French/European cultivars prefer a pH range of 6.2 to 6.8. The French American hybrids do best in a soil pH ranging from 5.8 to 6.5.

Sun and exposure are important factors in site consideration. Full sun is critical for healthy vines

and fruit sweetness. Never locate vines in a frost pocket. Freezing temperatures in spring can damage or destroy flower clusters. Unusually cold spring weather will reduce pollination and prevent grape formation.

Eliminate perennial weeds from the site through cultural techniques or using non-residual herbicides. Test the soil and add recommended amendments the fall before planting if possible.

### Soil Preparation

Clear all debris and grass from your intended site before deep tilling. It is important to thoroughly work the area and add compost and top soil as needed. Take a soil sample and submit it for analysis to determine if lime needs to be added to adjust the pH and to determine if the soil fertility needs to be amended through a fertilizer application.

### Trellising

Grapes must be trellised for good fruit production. Choose and install trellis systems prior to planting new vines to prevent damaging roots. Trellising permits sun to reach each flower cluster. Trellising also promotes good air circulation which cuts down on disease problems. Trellis systems determine how plants should be trained and pruned. There are several methods of trellising grapevines. Most home gardeners use vertical trellising or an overhead arbor. Grapes can be planted parallel to the garden on a trellis or on a fence that borders the property. An arbor can provide shade over a hot, sunny patio, as well as support an attractive and productive grapevine. Refer to Chapter 5 on *Landscape Aspects of Fruit Plants* for more information on building a grape arbor.



*Figure 80. Grapes must be trellised for good fruit production.*



## Cultivars

Three main types of grapes are grown in home fruit plantings—table, juice, and wine. Grape cultivars are also classified as American (*Vitis labrusca*), French/European (*Vitis vinifera*), and French-American hybrids.

Recommended grape cultivars and their disease susceptibility are listed in Tables 16–19. Additional cultivars can be found in Ohio State University Extension Bulletin 919, *Midwest Grape Production Guide*. Each of the cultivars has been chosen for its adaptability to midwest soils and climate. European/

French cultivars are more difficult to grow due to their lack of winter hardiness for this region of the country. Both American and French-American hybrids are recommended. You will find a good selection of white and red wine grapes to grow in the backyard. Several nurseries sell red, white, or blue table grape cultivars that are either seeded or seedless. Home fruit growers should select cultivars that taste good to them and have good winter hardiness for the Midwest. Planting cultivars with different harvest dates will ensure that you can enjoy fresh grapes over a longer period of time.



Figure 81. Concord grape is the most commonly grown cultivar in home fruit planting in the Midwest.

Photo by Garth A. Cahoon, Professor Emeritus, Ohio Agricultural Research and Development Center, The Ohio State University. Used with permission.

**Table 16. American Cultivars Recommended for the Midwest.**

| Cultivar | Color | Winter Hardiness | Ripening Season | Remarks                             |
|----------|-------|------------------|-----------------|-------------------------------------|
| Concord  | Blue  | Hardy            | Late            | Most commonly grown backyard grape. |
| Fredonia | Blue  | Hardy            | Midseason       | Earlier Concord; vigorous.          |
| Steuben  | Red   | Hardy            | Midseason       | Spicy flavor; non-uniform color.    |
| Catawba  | Red   | Hardy            | Late            | Used for wine and sherry.           |
| Delaware | Red   | Hardy            | Midseason       | Used for wine; stores well.         |
| Niagara  | White | Hardy            | Late Midseason  | Used for wine and white juice.      |

Note: New fruit cultivars that may be superior to currently recommended varieties are constantly being released. Check with your local Extension Educator or the nursery you order plants from to obtain information on newly released cultivars for your location.



Figure 82. Marquis is a very promising new seedless cultivar and is recommended for home gardens. This cultivar was developed and released by Cornell University.

**Table 17. Seedless Table Grape Cultivars Recommended for the Midwest.**

| Cultivar | Color | Winter Hardiness | Ripening Season | Remarks                            |
|----------|-------|------------------|-----------------|------------------------------------|
| Canadice | Red   | Moderately Hardy | Very Early      | Productive; good clusters.         |
| Einset   | Red   | Hardy            | Very Early      | Slip skin; mild strawberry flavor. |
| Himrod   | White | Moderately Hardy | Very Early      | High quality; straggly clusters.   |
| Mars     | Blue  | Hardy            | Early           | High productivity; medium cluster. |

**Table 17 (continued). Seedless Table Grape Cultivars Recommended for the Midwest.**

| Cultivar    | Color | Winter Hardiness | Ripening Season | Remarks                                                                |
|-------------|-------|------------------|-----------------|------------------------------------------------------------------------|
| Reliance    | Red   | Hardy            | Early Season    | High quality; productive; uneven color; susceptible to berry cracking. |
| Vanessa     | Red   | Hardy            | Midseason       | Adherent skin; tight clusters; firm, crisp fresh; small berries.       |
| Jupiter     | Blue  | Moderately Hardy | Early           | Muscat flavor; oval berries; very large.                               |
| Neptune     | White | Moderately Hardy | Midseason       | Compact clusters; low vigor; adherent and thick skin; oval berry.      |
| Suffolk Red | Red   | Moderately Hardy | Midseason       | Loose clusters; good flavor.                                           |

Note: New fruit cultivars that may be superior to currently recommended varieties are constantly being released. Check with your local Extension Educator or the nursery you order plants from to obtain information on newly released cultivars for your location.



Figure 83. Chambourcin is an excellent wine grape cultivar.

Note: No French/European cultivars are listed here since they are not winter-hardy in Ohio. Some of the examples are Carbernet Franc, Chardonnay, White Riesling, and Carbernet Sauvignon. These cultivars need to be covered with soil each year to overwinter. This is not practical for most home gardeners. However, some more experienced or dedicated gardeners can try to grow them. Refer to the *Midwest Grape Production Guide* for more detailed information.

**Table 18. French-American Hybrid Wine Grape Cultivars Recommended for the Midwest.**

| Cultivar       | Color | Winter Hardiness | Ripening Season | Remarks                                                                               |
|----------------|-------|------------------|-----------------|---------------------------------------------------------------------------------------|
| Cayuga White   | White | Moderately Hardy | Midseason       | Fully ripened produces labrusca character.                                            |
| Chambourcin    | Blue  | Moderately Hardy | Late            | Moderate vigor; large clusters; needs thinning; high-quality wine.                    |
| Chancellor     | Blue  | Hardy            | Early Midseason | Fruit thinning necessary; good vigor.                                                 |
| DeChaunac      | Blue  | Hardy            | Midseason       | Moderate red wine quality; good vigor and productivity; requires fruit thinning.      |
| Edelweiss      | White | Hardy            | Early           | Excellent disease resistance; early budbreak                                          |
| Frontenac      | Red   | Hardy            | Midseason       | Good disease resistance; requires thinning                                            |
| Frontenac Gris | White | Hardy            | Midseason       | Good disease resistance; requires thinning                                            |
| Marquette      | Red   | Hardy            | Early Midseason | Very good disease resistance; early budbreak                                          |
| Seyval Blanc   | White | Hardy            | Early Midseason | Moderate vigor; requires thinning; excellent wine quality.                            |
| Vidal Blanc    | White | Moderately Hardy | Late Midseason  | Good vigor; late budbreak, requires thinning; loose clusters; excellent wine quality. |
| Vignoles       | White | Hardy            | Midseason       | Small tight cluster; moderate yields and vigor.                                       |

Note: New fruit cultivars that may be superior to currently recommended varieties are constantly being released. Check with your local Extension Educator or the nursery you order plants from to obtain information on newly released cultivars for your location.

| <b>Cultivar</b> | <b>Black Rot</b> | <b>Downy Mildew</b> | <b>Powdery Mildew</b> | <b>Botrytis</b> |
|-----------------|------------------|---------------------|-----------------------|-----------------|
| Canadice        | ***              | **                  | *                     | **              |
| Catawba         | ***              | ***                 | **                    | *               |
| Cayuga White    | *                | **                  | *                     | *               |
| Chambourcin     | ***              | **                  | *                     | **              |
| Chancellor      | *                | ***                 | ***                   | *               |
| Concord         | ***              | *                   | **                    | *               |
| DeChaunac       | *                | **                  | **                    | *               |
| Delaware        | **               | ***                 | **                    | *               |
| Einset          | ***              | **                  | ***                   | *               |
| Fredonia        | **               | ***                 | **                    | *               |
| Himrod          | **               | *                   | **                    | *               |
| Jupiter         | **               | *                   | ***                   | *               |
| Marquis         | *                | ***                 | *                     | *               |
| Mars            | *                | *                   | *                     | *               |
| Neptune         | NS               | NS                  | NS                    | NS              |
| Niagara         | ***              | ***                 | **                    | *               |
| Reliance        | ***              | ***                 | **                    | *               |
| Seyval Blanc    | **               | **                  | ***                   | ***             |
| Steuben         | **               | *                   | *                     | *               |
| Suffolk Red     | NS               | NS                  | NS                    | NS              |
| Vanessa         | ***              | **                  | **                    | *               |
| Vidal Blanc     | *                | **                  | ***                   | *               |
| Vignoles        | *                | **                  | ***                   | ***             |

Key to ratings: \*\*\* = Highly susceptible or sensitive; \*\* = moderately susceptible or sensitive; \* = slightly susceptible or sensitive; NS = berries not susceptible.

## Planting

Grapevines are commonly planted in the spring after the last average frost-free date in a local area. Plants that are dormant can be planted ahead of time and will break bud when the ambient air temperature stays above 50°F for more than three days. Vines that come in pots can be planted into a properly dug hole. Roots should be checked thoroughly for good health and carefully loosened before planting in the freshly dug hole.

Dormant bare-rooted vines should be inspected to see if the root system is healthy. Do not allow the vine's roots to dry out. Keep the plants packed in the shipping media and in cold storage until you are ready to plant. Then remove the vines from their package and place them in water prior to planting. Allow the vines to soak for one to two hours before planting.

Position the vines about eight feet apart in a straight row and in line with the trellis or arbor. In some cases, vines may be planted closer than eight feet, especially if Vinifera wine grape cultivars are being grown. Vinifera wine grapes are not as vegetative and generally do not require the amount of trellis space as needed by the juice or table-grape cultivars. Those grown on an arbor can be placed four feet apart. If row planting is planned, arrange rows in a north-south orientation. This allows maximum exposure to sunlight.

Be careful to not trim off too much of the grapevine root system when planting. The vine needs a good strong root system to become established. Dig a hole that is more than adequate to accommodate the size of the root system. Depending on how many canes the new plant has, remove extra canes back to two to three canes. Once the vines

break bud and shoots begin to grow, you can select how many shoots to keep and then properly orient the shoots upward onto the trellis.

An alternative approach is to allow the new vines to grow without any pruning in the first season. Then in the second year, you will prune back each cane to two buds and allow the new growth to emerge. At that point, all new growth is trained onto the trellis or arbor.



Figure 84. Grapevines should be planted after the last frost-free date. However, dormant plants can be planted sooner.

### Pruning and Training Grapevines

Proper training of grapevines is essential to maintain plant size, shape, and productivity. If left unattended, grapevines can become unruly, and fruiting will be poor due to overproduction of vegetation. Pruning should be done each year in either late February or during March. At this time, the canes are still dormant, and there is little or no chance of buds being damaged.



Figure 85. Grapevines need to be pruned every year in either late February or during March.

There are several ways to prune and train grapevines. For home grapevines, gardeners might want to stay with a training system that is easier to manage. One of the most common training systems is called the *high bilateral cordon system* (Figure 86). The cordon, the extension of grapevine trunk, is approximately 5-1/2 to 6 feet above the ground on a single wire.

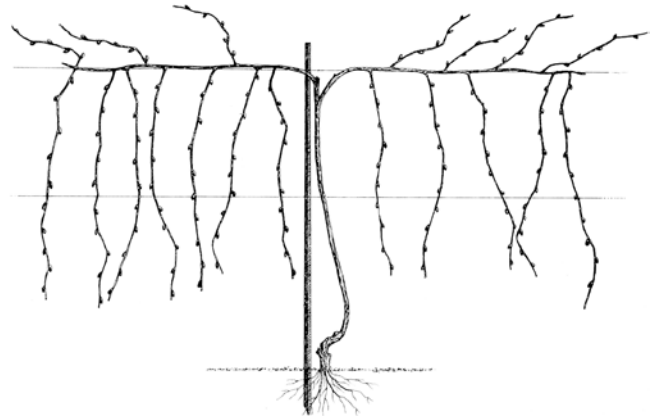

Figure 86. The high bilateral cordon system is a very good training system for home fruit plantings.

In the first year, newly planted grapevines should be pruned back to one bud. During the first growing season, a strong shoot with lateral shoots and possibly fruit clusters will develop from this bud. It is important to remove all fruit and unwanted lateral shoots from the young vines throughout the growing season. Grapevines tend to grow rapidly from the apical end (main growing point) when lateral shoots and fruit are removed.

Vines should be staked and tied (using twine or string) to allow the new shoot to form a straight trunk. The leaves should remain on the developing trunk to produce necessary carbohydrates to feed the plant; all lateral shoots, however, should be removed. Only lateral shoots at the top wire will be left.

New growth may reach the top wire (around five to 5-1/2 ft.) during the first year. If this occurs, pinch off the end of the shoot(s) at the top wire and then the lateral shoots will grow horizontally in both directions along the top wire. These will be used to form the new cordons. Pruning of one-year-old hardwood (dormant canes) will be minimal, but some pruning may be necessary to help shape the vine before second-year growth begins.

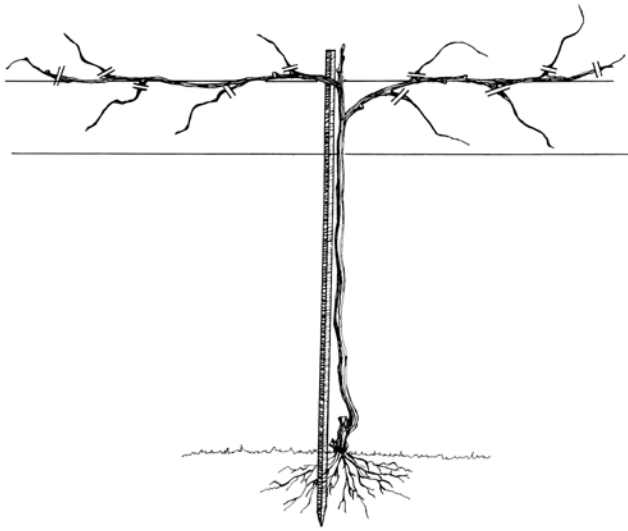

Figure 87. Vines should be staked and tied (using twine or string) to allow the new shoot to form a straight trunk.

During the second year of growth, remove all fruit and any lateral shoots that emerge along the trunk of the grapevine. If vines did not complete their structural development in the first year, be sure to train new shoot growth so that the grapevine will completely cover the intended area along the trellis or arbor.

Once the lateral shoots have grown along the top wire to the desired location, pinch the terminal ends of the main lateral shoots (on the top wire). This will force secondary shoots to develop along the two main laterals laid down to establish the cordon. The cordon is a permanent structure that exists on the top wire, from which hardwood canes (hardened-off shoots) are pruned.

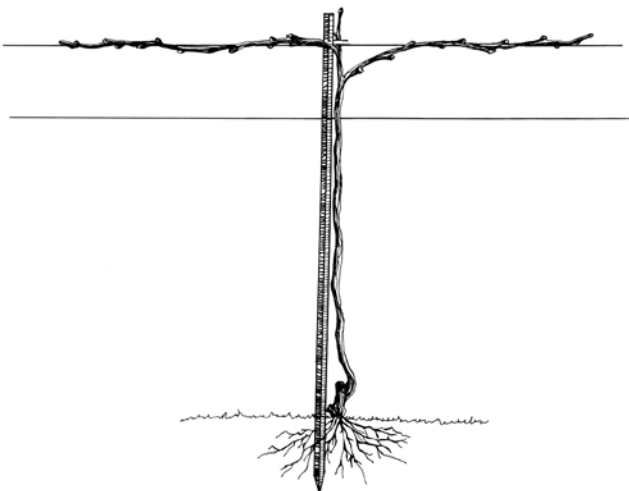

Figure 88. Pinch or cut the main lateral shoots that are on the top wire once they reach four feet long to keep the total width of the cordon at eight-feet wide.

Lateral shoots that emerge from the cordon should be allowed to grow uninterrupted. Only necessary shoot positioning should be done to direct growth in an orderly manner.

During late February or March, each one-year-old cane (dormant cane) that grew along the cordon should be pruned back to either a five-node spur (fruiting spur) or a one-node renewal spur (vegetative spur). The remaining fruiting wood should be approximately pencil size in diameter. Renewal spurs produce vegetative shoots that are used for the following year's fruiting wood.

Year three is the first fruiting year. Dormant pruning should be done some time in late February through March (Figure 89 and 90). One-year-old wood (dormant canes) should be pruned back to five-node spurs. The spurs should be evenly spaced along the cordon and pointing downward.

To determine how many buds to retain for fruiting, weigh all pruned one-year-old wood. Use the pruning weight to count the number of fruiting buds to leave. You may choose to use different approaches for determining the number of fruiting buds to leave. One system is the 30-10-10 method, which requires the person pruning to keep track of the weighed prunings and the number of buds remaining on the intact vine.

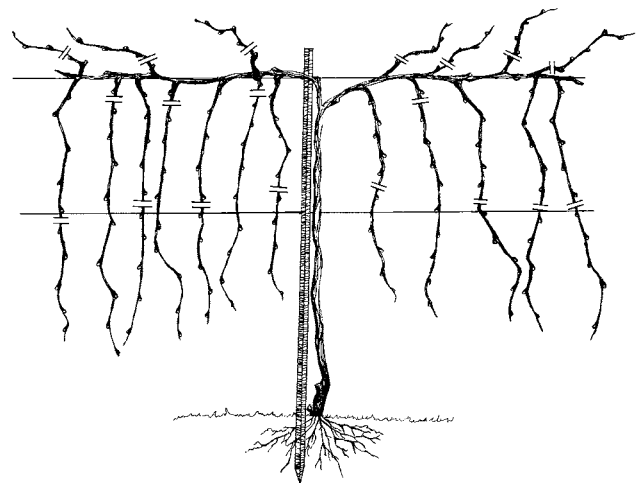

Figure 89. Grapevine before pruning in the third year.

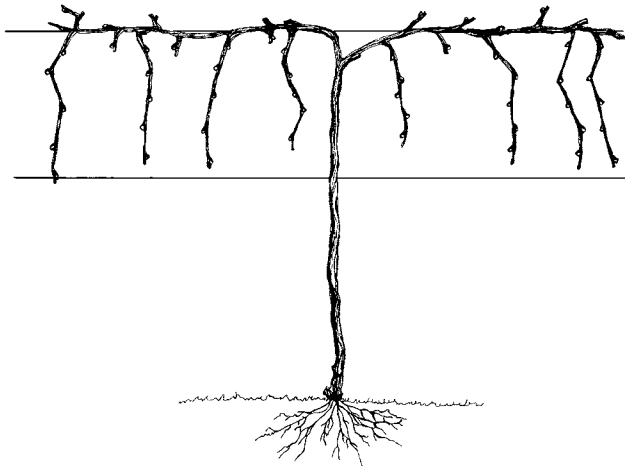

Figure 90. Grapevine after pruning in the third year.

For the first pound of pruned-off wood, leave 30 buds; for the second pound of wood, leave 10 buds; and continue adding 10 buds for each pound of wood thereafter. For example: Three pounds of one-year-old wood have been pruned off; a total of 50 fruiting buds should be retained on the vine.



Figure 91. Balanced pruning consists of weighing the pruned wood from one-year-old canes to determine the number of buds to retain for optimum cropping.

After the fourth year, gardeners can prune all of the canes on a grapevine back to five-bud (node) canes first in March. Then, convert every other five bud (node) cane to a one bud (node) renewal spur. This process is repeated each year.

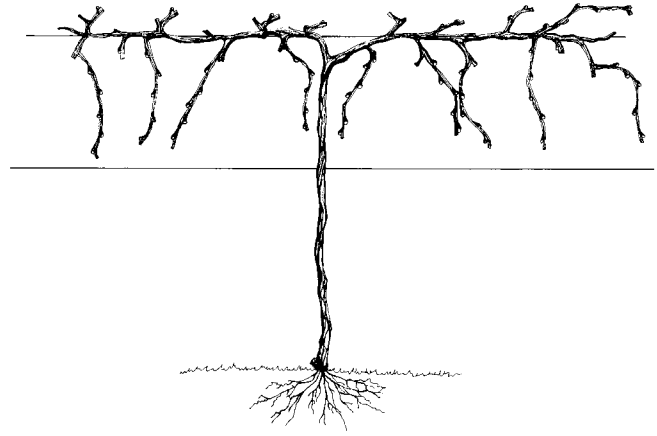

Figure 92. A mature grapevine that has been properly pruned.

### What To Do With a Neglected Grapevine

If a grapevine has not been pruned for years, it becomes a big mess. Gardeners can select two strong canes from the base of the grapevine and turn them into two main trunks. The rest of the canes can be removed. Stake these two canes and tie the rest of the canes to the top wire.

Another approach is to propagate a new plant by layering. A long shoot can be bent down and partially buried in the soil. The terminal portion of the shoot is then allowed to grow upward. Eventually, the buried portion of the shoot will root. A new vine will develop from this process. It can be treated as a one-year-old vine.

If all else fails, gardeners can purchase new plants and start all over. You will get better cultivars and healthier plants in the end.

### Soil and Plant Fertility

Based on soil test results, fertilizer should be applied to promote good vegetative growth and fruit production. One to two weeks after vines are planted, apply 1/8 cup of complete fertilizer (e.g., a fertilizer with an analysis of 10-10-10 or 12-12-12) to help promote vine establishment. Grapes can grow in soil with a pH of 5.5 to 6.8. Vinifera cultivars (i.e., Chardonnay, Pinot Gris) grow best in soil pH of 6.5 to 6.8, and American cultivars (i.e., Concord, Niagara) can grow in a high acid soil with a pH as low as 5.5. French hybrids (i.e., Chambourcin, Vidal Blanc) can produce good vegetation and fruit production in soil with a pH just below 6.0 up to 6.8.

Vines should be well-established in the first three years to assure full production by the fourth

year. This will require careful management of the macro-nutrients (primary and secondary) and micro-nutrients.

Nitrogen is normally found to be lacking in Ohio soils, which require supplemental applications of this essential element each year. Normally, one-half to one pound of N should be applied each year per vine. If the new plant growth is not adequate (*i.e.*, less than two pounds of one-year-old wood per year), then additional nitrogen should be applied. Do not apply more than one pound per vine each year to avoid excessive vegetative growth. American cultivars will require more nitrogen than Vinifera cultivars. American cultivars, by their genetic adaptability to Ohio soil and climate, will produce more vegetative growth than either French-American hybrids or French-European cultivars.

Soil tests should be conducted every three years to keep track of the soil fertility. More serious backyard grape growers are also encouraged to take leaf petiole samples to monitor the nutrient levels in the vines. By using soil and tissue analysis, grape growers are better able to track changes in plant growth based on fertility levels. An even distribution of fertilizer starting six inches out from the vine, but no further than 1-1/2 feet away from the trunk, should be made each year.

Phosphorus and potassium, along with other secondary nutrients, can be applied at any time during the year. Nitrogen should be applied as a single application or split in two or three separate applications from early April on through the middle of June. Growers should be careful to not apply nitrogen beyond June 15 to avoid forcing vines to be actively growing during the fall. Each year, new plant growth must harden-off completely before the first frost to avoid cold damage. Any green tissue on the vine will die following the first freeze. Applying too much nitrogen can also cause vines to produce excessive vegetation, which creates a micro-environment in the canopy that is more conducive to disease development.

### **Disease and Pest Control**

Refer to Chapter 7 on pest management in this bulletin. For specific disease and insect control recommendations, including the use of fungicides and insecticides, consult your Cooperative Extension Service. In Ohio, obtain a copy of Ohio

State University Extension Bulletin 780, *Controlling Diseases and Insects in Home Fruit Plantings*.



*Figure 93. Fertilization and pest management are all essential parts of successful grape production.*

### **Blueberries (*Vaccinium spp.*)**

Blueberries (*Vaccinium spp.*) are woody perennial plants that can readily be included in any home landscape. They make a wonderful addition to any home fruit planting. Blueberries will come into bearing in the third year after bushes have an opportunity to establish. Once fruit fully mature and are harvested, they can be maintained in the refrigerator for several days. One advantage to growing your own blueberries is that you can pick fresh blueberries from your yard during the growing season. The taste of fresh blueberries is very enjoyable.



*Figure 94. Blueberries taste delicious and are very high in antioxidants.*

*Photo courtesy of The Blueberry Patch, Mansfield, Ohio.*

Blueberry bushes have fine, fibrous root systems and are relatively cold hardy if mulched properly. Fruit is produced on one-year-old wood or older.

New shoots emerge each year from the root crown and as lateral shoots from existing canes. Refer to Figures 95 and 96 for the anatomy of a mature blueberry plant and a blueberry stem. Knowing which buds are vegetative buds and which ones are flower buds will help you gain a better understanding of pruning and training.

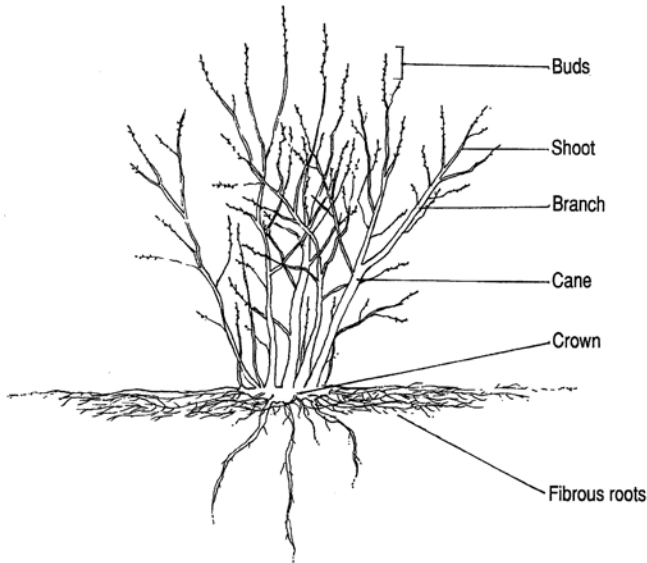

Figure 95. A mature blueberry plant during the dormant season.

Reprinted with permission from *Highbush Blueberry Production Guide*, NRAES-55. Natural Resource, Agriculture, and Engineering Service (NRAES), P.O. Box 4557, Ithaca, NY 14852-4557. [www.nraes.org](http://www.nraes.org)

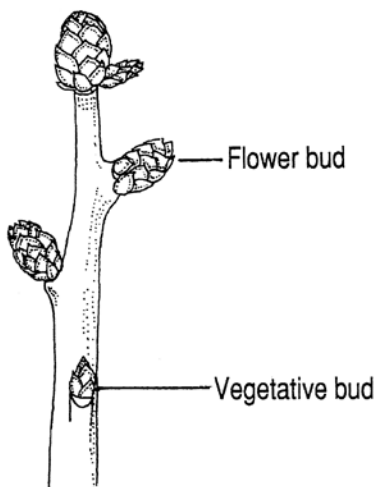

Figure 96. Flower and vegetative buds on dormant shoot.

Reprinted with permission from *Highbush Blueberry Production Guide*, NRAES-55. Natural Resource, Agriculture, and Engineering Service (NRAES), P.O. Box 4557, Ithaca, NY 14852-4557. [www.nraes.org](http://www.nraes.org)

## Site Selection

Choose a site that is sunny and away from frost pockets. To combat the winter damage that occurs when temperatures fluctuate, choose a north slope or a site on the north side of a windbreak or a building. Winter shade will keep blueberries from breaking dormancy too early. Blueberries will not grow well on a wet site. If the site is poorly drained, the plants will probably die.

## Site Preparation

Clear all debris and grass from your intended site before deep tilling. It is important to thoroughly work the area and add compost and top soil as needed. Take a soil sample and submit it for analysis to determine if sulfur is needed to lower the soil pH and determine if the soil fertility needs to be amended through a fertilizer application. Reducing soil pH is extremely important. Blueberries require a soil pH between 4.5 and 5.0. Most backyard soils are higher than this in pH. If the pH is not lowered properly, the plants will have yellow leaves and will not be productive.



Figure 97. To grow and be productive, blueberries require very acidic soil with high organic matter. Photo courtesy of The Blueberry Patch, Mansfield, Ohio.

## Cultivars

Several highbush blueberry cultivars are well suited for Ohio. Ohio's growing climate ranges from USDA winter hardiness Zone 5 to 6. A list of specific named cultivars is listed in Table 20. Blueberries are considered self-fruitful, which means one single blueberry plant or cultivar can produce fruit. However, it is still a good idea to plant several different blueberry cultivars for cross-pollination. Higher yields will result from honeybees moving pollens from one cultivar to another.



**Table 20. List of Recommended Highbush Blueberry Cultivars for Midwest Home Fruit Plantings.**

| Cultivar | Ripening Season | Yield    | Fruit Size | Fruit Quality | Remarks                                                                                                |
|----------|-----------------|----------|------------|---------------|--------------------------------------------------------------------------------------------------------|
| Berkeley | Mid             | Good     | Large      | Medium        | Hardy, vigorous plant.                                                                                 |
| Bluecrop | Mid             | Good     | Large      | Medium        | Hardy, vigorous, and drought resistant.                                                                |
| Bluetta  | Early           | Good     | Medium     | Fair          | Vigorous and upright.                                                                                  |
| Bluegold | Mid             | Good     | Large      | Good          | Very winter hardy; bushy growth habit; ripening is concentrated.                                       |
| Bluejay  | Mid             | Moderate | Large      | Good          | Mummy berry resistant.                                                                                 |
| Chandler | Mid-Late        | Good     | Very Large | Good          | Ripens over long season.                                                                               |
| Collins  | Early           | Fair     | Large      | Good          | Hardy, vigorous, and upright.                                                                          |
| Duke     | Early-Mid       | Good     | Medium     | Good          | Vigorous and upright; blooms late to avoid frost. Tolerates fluctuating winter temperatures.           |
| Elliot   | Late            | Good     | Very Large | Good          | Hard and vigorous plant. Mummy berry resistant.                                                        |
| Herbert  | Late            | Good     | Large      | Excellent     | Hardy, vigorous plant.                                                                                 |
| Patriot  | Early-Mid       | Good     | Large      | Good          | Vigorous and upright; small to medium height; very cold hardy but blooms early. Resistant to root rot. |

Note: New fruit cultivars that may be superior to currently recommended varieties are constantly being released. Check with your local Extension Educator or the nursery you order plants from to obtain information on newly released cultivars for your location.

### Nurseries

It is important to purchase certified stock that is disease- and insect-free. Establishing clean and healthy plants will be a good start to a successful bramble planting. You may have to order from more than one nursery to obtain all desired cultivars. Local nurseries or garden centers can be a good source of potted blueberry plants.

Be sure to look over the leaves and canes carefully for any sign of diseases or insects. Also, pull the plant out of the pot and carefully inspect the root system. Healthy roots should be white in appearance and evenly distributed in the potting soil. Certified pest-free plants are good for establishing a new fruit planting. Reputable nurseries offer many cultivars as certified stock (see the list of nurseries in Chapter 9). However, this does not guarantee that they are immune to plant pests.

Plant material that is acquired from family and friends is not guaranteed to be free of diseases or insects. As a result, there is a possibility that the acquired plant material may be contaminated.

Caution is advised when propagating or transplanting fruit plants from one garden site to another.

Blueberries ordered from catalogs are generally shipped as bare-rooted, single-shoot plants that have been asexually propagated from cuttings in nursery beds. These plants should arrive with a sufficient root system to be planted directly in your garden. Bare-rooted plants are normally shipped in moist peat moss and placed in plastic bags to preserve the moisture. Plants should be carefully inspected when you receive them to assure that the correct cultivars were shipped and that the plants are of good quality. Keep all plant material in the shipping medium and place in a cold room or non-food refrigerator until planting day.

### Planting

Blueberries grow naturally in sandy to loam soil with a pH between 4.5 and 5.0. The soil must be moist, yet well-drained throughout the year. Raised beds can be used to provide a well-drained growing site for blueberries to grow in. Some growers may choose to tile their garden area to

assure proper soil drainage. Blueberries, like other fruit crops, do not like wet feet and must be established in a soil that drains adequately. Blueberries planted on wet sites will probably not survive.

If the soil is not in the appropriate pH range (4.5 to 5.0), then apply elemental sulfur (S) to amend the soil. Soil pH needs to be adjusted prior to planting. Soil should be tested six months after sulfur has been added to assure that the pH levels are appropriate. Blueberry bushes will not grow properly or produce adequate fruit if the pH is too high. Improper soil pH is probably the most common and serious problem affecting blueberry production in the Midwest. See Table 21 on the amount of sulfur needed to reduce soil pH.

Blueberries that are dormant can be planted in the spring. Plants that have broken dormancy and are actively growing (green buds or shoots) should be held in a greenhouse, a garage, or a back porch until after the last average frost date in your area. Remove blueberry plants from their shipping container and place in a bucket of water to soak for about one hour before planting.

Mark off the exact location where you will be planting each blueberry bush. Highbush blueberries are commonly spaced four feet apart. Use a shovel or spade to dig holes approximately two to three times the size of the root system. This will assure adequate space for the root system to fit in the hole and will also allow you to add peat moss and compost as needed.

Once a hole is dug, approximately one gallon of peat or sphagnum moss should be added to the planting hole along with compost, if desired. This

medium should be thoroughly mixed with the natural garden soil during the planting process. The root system should be spread out to fill the hole evenly. Position the root crown evenly with the line of the soil surface and backfill with the top soil/peat moss mixture. Be careful to not place plants too deep or too shallow. Once planting is complete, water in each bush to promote good root-soil contact that will help keep the root system from drying out.

**Mulch**

Sawdust and wood chips can be used to mulch around blueberry bushes. Do not use any wood product from black walnut trees; an allelopathic chemical called juglone is produced in various parts of the tree. This chemical can inhibit growth of many plants, including blueberries.

Once established, blueberry bushes can be mulched to a depth of four to six inches. An annual application of mulch is recommended to help reduce weeds, hold moisture, and promote winter hardiness of blueberry bushes. Blueberry roots grow at the soil/mulch interface and if the mulch decomposes too much and is not replaced, the roots will become exposed. Reapply mulch when it rots down to a depth of three to four inches.

Keep a three-inch circle around the base of the plant free from the mulch to prevent damage to the stems. As additional mulch is added, adjust the amount of nitrogen applied. Soil bacteria are very active at breaking down wood-based mulch and tie up available nitrogen that is needed by the blueberry bushes to grow.

**Table 21. Amount of Sulfur in Pounds per 100 Square Feet Required to Lower Soil pH for Blueberries.**

| Present pH of Soil | Desired pH Value for Blueberries |      |      |      |      |      |
|--------------------|----------------------------------|------|------|------|------|------|
|                    | 4.5                              |      |      | 5.0  |      |      |
|                    | Sand                             | Loam | Clay | Sand | Loam | Clay |
| 4.5                | 0.0                              | 0.0  | 0.0  | 0.0  | 0.0  | 0.0  |
| 5.0                | 0.4                              | 1.2  | 1.4  | 0.0  | 0.0  | 0.0  |
| 5.5                | 0.8                              | 2.4  | 2.6  | 0.4  | 1.2  | 1.4  |
| 6.0                | 1.2                              | 3.5  | 3.7  | 0.8  | 2.4  | 2.6  |
| 6.5                | 1.5                              | 4.6  | 4.8  | 1.2  | 3.5  | 3.7  |
| 7.0                | 1.9                              | 5.8  | 6.0  | 1.5  | 4.6  | 4.8  |
| 7.5                | 2.3                              | 6.9  | 7.1  | 1.9  | 5.8  | 6.0  |

Source: Pennsylvania State University, *Small Fruit Production and Pest Management Guide*. Used with permission.



*Figure 98. Established blueberry plants can be mulched at a depth of four to six inches. An annual addition of mulch is also needed.*

### **Soil and Plant Fertility**

Based on current soil test results, use an appropriate fertilizer for applying nitrogen and other essential elements. Fertilizer with acid-forming ions (*e.g.*, ammonium sulfate) will help to lower and sustain pH levels for blueberry production. Any material used from a compost pile should be analyzed to determine what the pH levels are before application. Composted manure and yard waste can be a good source of nitrogen. By maintaining the proper soil fertility, blueberry bushes will have the best opportunity to grow and produce fruit at their maximum potential. Bushes that are healthy will be better able to ward off an attack from diseases and insects.

If soil is properly prepared before planting, only nitrogen fertilizer should be required on a routine annual basis. Do not fertilize plants during the first year or the young roots may be burned. In subsequent years, always fertilize with ammonium sulfate in March or April. To each plant, apply four ounces of ammonium sulfate in year two, five ounces in year three, six ounces in year four, seven ounces in year five, and eight ounces in year six and subsequent years. Spread fertilizer under the drip line of each plant and do not allow fertilizer to come in direct contact with the canes.

Soil pH should be rechecked every two to three years or if plants appear to have nutrient deficiencies. If leaves start to turn light-green to yellow or reddish in color and poor growth and yield are observed, the soil pH is probably no longer in the optimum range of 4.5 to 5.0.

### **Watering**

Blueberries have a fibrous root system and can expand downward one to two feet into the soil. It is important not to over water blueberry bushes, but

on the other hand do not allow them to dry out. Blueberries can handle some drought stress; however, they often do not show the stress symptoms until advanced drought stage. Once wilting has started, it may be too late to save the bush from complete desiccation. Because blueberries have 75 percent of their roots in the top 12 inches of soil, they can be quickly water stressed. Supplemental watering is especially critical during blossoming, fruit ripening, and fall flower bud development. Mature blueberries require one to two inches of water every 10 days from rainfall or supplemental watering.

### **Pruning and Training**

Pruning is done to properly maintain the plant structure, size, shape, and fruit production and quality. Pruning can be done from the end of February through bud break. Avoid pruning after bud break because many buds and flowers will be rubbed off in the process.

First, obtain good quality pruning tools that include hand pruners and loppers. This will allow you to easily remove any plant vegetation. For the first three years after planting the only pruning you will need to do is to remove diseased or damaged limbs. Blooms should be rubbed off during the first two years to promote better growth and increased production in the future. After the third growing season, prune bushes to an open vase shape and remove excess shoots at ground level. Leave the most vigorous and largest diameter canes.

On mature bushes, remove any diseased or injured canes. If two canes are rubbing against each other, remove one of them. An ideal bush has two to three canes of each age up to six years old. Each year, two of the oldest should be removed, and two new canes should be allowed to develop. A mature bush can have up to 10 to 15 canes on it and should not be allowed to get over five to six feet tall.

Here are a few basic concepts for pruning blueberry bushes.

- Observe the blueberry bush visually.
- Imagine what the plant should look like when pruning is completed.
- Remove all diseased and broken canes first.
- Consider canes that are seven years old or older for removal.
- Remove no more than two to three mature canes each year.

- Avoid pruning out too many fruit buds.
- Use selective pruning to help stimulate new cane growth each year.
- Remove branches that are touching and remove any dead twigs.

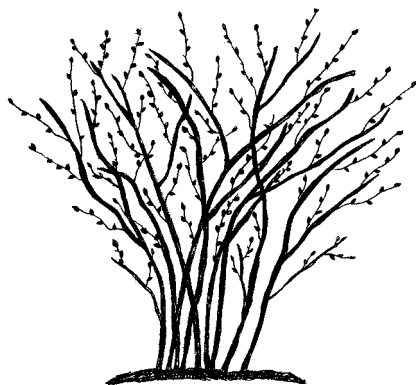

Figure 99. A mature blueberry plant before pruning.

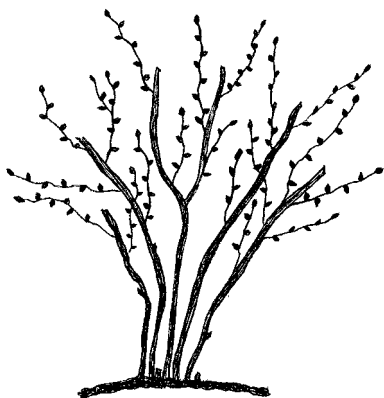

Figure 100. A mature blueberry plant after pruning.

When pruning is completed, the bush should be narrow at the base, open in the center, and free of vegetative clutter. This will help to promote good air circulation and sunlight penetration through the canopy. Proper pruning of a blueberry bush will help to reduce disease and insect pressure.



Figure 101. Properly pruned blueberry bushes should be narrow at the base and open in the center.

## Harvest

Once fruit has fully matured, it should be harvested right away. To avoid bird damage, cover the entire blueberry bush with some type of netting. Fruit-eating birds can consume a mature crop within a few days. Date of harvest depends on the cultivar of blueberries being grown. One of the best ways to assure that you are picking fruit at the appropriate time is to simply taste the fruit to determine if it is sweet enough to pick. Color of the fruit is one indicator of maturity, but not the sole reason to pick.

The fruit of the blueberry is a true berry. Place the berry between your forefinger and thumb and gently twist the fruit; it should immediately detach from the pedicle—the part of the plant that connects the fruit to the cane. Fruit that does not readily detach should be left to mature on the bush.



Figure 102. When harvesting blueberries, it is important to taste them rather than rely solely on fruit color.

Photo courtesy of Nourse Farms Nursery.

## Disease and Pest Control

Although blueberries are considered one of the fruit crops that are least likely to be affected by diseases and insects, there are still various pests that can influence blueberry production. Refer to Chapter 7 on pest management in this bulletin for identification of blueberry insects and diseases as well as comments for their control.

## Chapter 4. Less Commonly Grown Fruits

Minor fruits, such as quince, persimmon, and pawpaw, are sometimes grown by homeowners who are interested in unusual or hard-to-obtain fruits. Some of these are native to Ohio and surrounding areas, though more fruits of foreign origin (yet suitable for midwest conditions) are becoming available through commercial nurseries. Several of the fruits listed here have attractive blossoms or foliage as well as edible fruit, making them good multi-purpose plants as part of an edible landscape. They also tend to be good for wildlife plantings. Whether gardeners have a large open field or just a few extra square feet, planting some of these lesser grown fruits can be fun and possibly add a new experience to a gardener's palate.

### Pawpaw

A native plant, the pawpaw (*Asimina triloba*) was known to Native Americans and early explorers alike. The pawpaw flower is dark lavender to purple-red and is very attractive upon close inspection, hanging like a little hat in mid-spring. Pawpaws are sometimes referred to as the custard apple or poor-man's banana.



Figure 103. Pawpaw flower.

Photo courtesy of the Ohio State University Extension Nursery, Landscape, and Turf Team.

The nutritious fruit produced by this tree ripens from mid September till frost and varies somewhat in flavor and size among the different cultivars. Most commonly the flavor is described as banana-like or even like a combination of banana, mango, and pineapple. The fruit is normally three to six

inches in length (the largest fruit of any native fruit tree) and has large seeds surrounded by the edible custard-like pulp. The skin is not edible.

The fruit may be used in making breads, pies, puddings, cookies, ice cream, or simply eaten out of hand. The pulp also freezes well so it can be used at a later time.



Figure 104. Pawpaw fruit.

Photo by Scott Bauer, USDA/ARS. Used with permission.

The large leaves of this pyramidal-shaped tree also make it desirable as a landscape plant. By removing the suckers that will grow from the root system in the first few years of growth, the pawpaw can be grown as a tree, or the suckers can be left to grow, resulting in a hedge or thicket of pawpaw plants. A seedling may take as long as six to eight years before producing fruit, and two unrelated pawpaws are required for pollination.

Because pawpaws do not transplant well, potted plants tend to establish better than bare-root, field-dug seedlings. Grafted cultivars are also more likely to remain true to strain than are seedlings. The pawpaw can be grown in full sun or partial shade and does best in moist but well-drained soils. Aside from picnic beetles, raccoons, deer, and other wildlife that enjoy feeding on the ripe fruit, the pawpaw is considered to be pest free.

Because the pawpaw has a short shelf life (two to three days at room temperature or no more than three weeks in the refrigerator), fruit do not ship well. It is likely that you will only be able to enjoy the flavor of this native fruit if you grow it yourself.

More information on growing pawpaws and research associated with them can be found at this Kentucky State University web site: <http://www.pawpaw.kysu.edu>.

## Persimmon

The American persimmon (*Diospyros virginiana*) is native to the southern two-thirds of the eastern United States, with an east-west line across central Ohio representing the northernmost limit of its native range (though it can be planted much further north in terms of cold hardiness). The fruit of this species is very astringent (due to tannin content) until it is fully ripe, when the fruit develops a sweet, mild, unique flavor. These one to one-and-one-half-inch fruits may be eaten fresh, in fruit salads, or used in making sauces, preserves, baked items, and many other culinary delights. The fruits can be ripened on or off the tree. However, since they bruise easily when ripe, they are often picked when fully colored, yet still firm, and allowed to ripen off the tree.

Though most cultivars of American persimmon will need both a male and a female plant for proper pollination, Meader is one cultivar that is reliably self-fruitful. The tree will get as large as 50 feet tall and 30 feet wide.



Figure 105. American persimmon.  
Photo courtesy of Hugh Wilson, Texas A&M University. Used with permission.



Figure 106. A fully ripe or overripe persimmon is very sweet and delicious.  
Photo courtesy of Andrew Boose, Metro Parks (Columbus and Franklin County Metropolitan Park District), Columbus, Ohio. Used with permission.

The Asian and Japanese persimmons have a larger fruit than the American cultivars but are generally not hardy enough to be grown in Ohio. However,

there are now Asian-American hybrids that combine the hardiness of the American persimmon with the larger fruit size (up to 2-1/2 inches) of the Asian persimmon. Two of these hybrid cultivars 'Russian Beauty' and 'Nikita's Gift' are also said to be self-fertile.

Persimmons have few pest problems and are adapted to a wide variety of soil conditions. They can tolerate some shade but will grow best in full sun. Persimmons are often trained to an open center system with three to four scaffold branches early in their growth, with little maintenance being required after that. They will fruit (usually in October) two to three years after planting and can be expected to live for 50 to 75 years.

## Quince

The quince (*Cydonia oblonga*), a member of the apple and pear family, is native to the Middle East. The fruit of most cultivars is too hard and sour to eat raw and therefore is used primarily for making preserves or sometimes is added to apple cider. However, there are a few cultivars, such as 'Aromatnaya' and 'Kaunching,' that are sweet enough to be eaten fresh.



Figure 107. Quince fruit.  
Photo Courtesy of Dr. Mark Rieger, University of Georgia. Used with permission.

The fruit grows on a large bush or a small tree that requires little maintenance outside of removing dead branches and making occasional thinning cuts to encourage new shoot growth. It is also considered to be self-fertile, therefore needing only one plant to produce a crop. The quince tends to be susceptible to fire blight and codling moth injury.

Flowering quince (*Chaenomeles*) produces fruit that are usable as well, but they are generally smaller and of lower quality than are true quince.

Quince grows best in soils that are deep, well drained, and loamy, though it is able to tolerate wet soils better than many other fruits. The fruit, which is picked and allowed to ripen off the tree, normally ripens in late September and October. Some quince cultivars are available in the market now (Table 22).

| <b>Table 22. List of Recommended Quince Cultivars.</b> |           |              |
|--------------------------------------------------------|-----------|--------------|
| Uses: Preserves, jams, and jellies.                    |           |              |
| Cultivar                                               | Season    | Remarks      |
| Orange                                                 | September | Good quality |
| Pineapple                                              | September | Good quality |
| Champion                                               | November  | Cold hardy   |

### Mulberry

Considered by some to be an undesirable weed tree, the mulberry tree (*Morus*) can produce an abundant crop of fruit that somewhat resembles raspberries. The American or red mulberry is native to the eastern United States, with the white and black mulberries being native to Asia. Mulberries can be used for jellies, dessert toppings, or pies as well as to make wine. In general, the black mulberry is not hardy enough for Ohio conditions. White mulberries may be preferred if planting near the house or patio, as the fruits do not stain surfaces as do the other types.

Several trees are needed to provide the cross-pollination needed to ensure fruit set. Mulberries will grow well in droughty or poor soil, but they require full sun and plenty of space (at least 15 feet between trees). Mulberries are considered to be nearly pest free and require little maintenance other than removing broken or crowded branches.



Figure 108. Mulberry.  
Photo courtesy of Larry Allain, National Wetland Research Center, USGS. Used with permission.



Figure 109. Close-up of a mulberry fruit.  
Photo courtesy of Hugh Wilson, Texas A&M University. Used with permission.

### Medlar

The medlar (*Mespilus germanica*) is native to the eastern Mediterranean area and has been grown in Europe for centuries. Considered to be related to the pear, these self-fertile trees grow to a height of about 10 to 20 feet and produce one-inch diameter fruit that is picked after a hard frost. The fruit must be ripened, a process called *bletting*, after picking before they are edible. They can be kept in a cool area for several months. The flavor of the fruit is said to be like a rich, cinnamon applesauce. The fruit can be eaten raw or made into jelly. The variety ‘Nottingham’ is said to produce the best quality fruit. Medlars will also add to the landscape as they bloom in late spring with large white flowers that fade to pink.



Figure 110. Medlar fruits.  
Photo courtesy of Dr. Richard J. Naskali, University of Idaho. Used with permission.

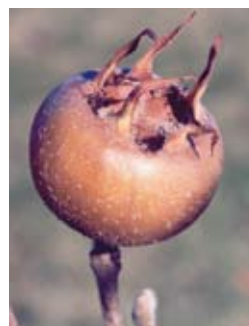

Figure 111. Closeup of a medlar fruit.  
Photo courtesy of Dr. Richard J. Naskali, University of Idaho. Used with permission.

## Juneberry

The Juneberry (*Amelanchier alnifolia*), also called shad-bush, Saskatoon (Canada), or serviceberry, is native to North America and was collected by Native Americans as well as early settlers. The fruit is a 1/4- to 1/2-inch berry that resembles blueberries both in appearance and flavor. The seeds also have somewhat of an almond flavor. They are very winter hardy and can grow in any soil except for poorly drained soils. The plant can be grown as a bush, which increases the fruiting potential, or trained to grow like a tree. The Juneberry is self-fruitful, though planting several cultivars is said to increase production.

Several of the available cultivars include 'Shannon' and 'Indian,' which are very productive cultivars with larger fruit, and 'Smoky' and 'Pembina,' which are reported to have the best flavor. With showy white blossoms in May, this plant may also be desirable for landscaping purposes.

The fruit is ready to pick in late June and can be used for pies, preserves, or eaten fresh. Some consider the Juneberry to be a good substitute for blueberries since an acid soil is not required for good growth. Spider mites can sometimes be a problem in dry situations.



Figure 112. Young developing fruits of Juneberry (also called Saskatoon or serviceberry.)

Photo courtesy of J. S. Peterson, USDA-NRCS PLANTS Database. Used with permission.



Figure 113. Mature fruits of Juneberry.

Photo courtesy of Dr. Volodymyr M. Mezhenykyj, Artemivsk Nursery Experimental Station, Institute of Horticulture of UAAS, Ukraine. Used with permission.

## Bush Cherries

Bush cherries consist of several species, including the Nanking Cherry (*Prunus tomentosa*) and Hansens Bush Cherry (*Prunus besseyi*), and are native to Asia. They are considered very cold hardy. These bushes grow six to 10 feet in height and have an abundance of white to pinkish flowers, making them a good multipurpose shrub.

The cherries produced by these shrubs are slightly more tart and have a slightly larger pit than do tree-grown sour cherries, making them more desirable for pies and preserves than eating out of hand. They will usually start to fruit the second year after planting. They require full sun, do best in a loamy soil, and are considered to be self-fruiting.



Figure 114. Nanking Cherry.

Photo courtesy of Dr. Richard J. Naskali, University of Idaho. Used with permission.

## Cornelian Cherries

Cornelian cherries (*Cornus mas*) are actually a member of the dogwood family and have an edible fruit. The fruits ripen in late summer and are similar in taste to tart cherries and can be used for jellies, pies, or eaten fresh and are very high in vitamin C. An early flowering plant that can be trained as a tree or shrub, Cornelian cherry grows well in most soils, though it does best in fertile, well-drained soils with full sun or light shade. It is considered to be pest free.





Figure 115. Cornelian cherries.  
Photo courtesy of the Ohio State University Extension Nursery, Landscape, and Turf Team. Used with permission.

## Hardy Kiwi

Hardy kiwi, also known as arctic kiwi or Chinese gooseberry, is a member of the Actinidia family and native to northern China, Siberia, Japan, and Korea. This family of plants also includes the commercially available kiwi fruit, which cannot be grown under Ohio conditions. Those kiwi that are able to be grown in Ohio include *Actinidia kolomikta*, sometimes called ‘Arctic Beauty Kiwi,’ and *Actinidia arguta*, which is often listed as ‘Hardy Kiwi.’ Of these species, *A. kolomikta* is considered to be hardier, with the plant (though not necessarily the fruit buds) being able to survive temperatures as low as -40°F.

Though hardy kiwis have not proved to be successful in commercial plantings in Ohio, with care, they have been successful for backyard fruit growers. Fruit produced by these hardier species is cherry to grape size, sweeter and without the fuzz of the commercially grown species, and can be used for pies and jams or simply eaten fresh. Though it may take five to seven years before they begin to fruit, the vines have been known to survive for 50 years or more. Depending on cultivar, the fruit begins to ripen in mid August, continuing into September.



Figure 116. Hardy kiwi.  
Photo courtesy of Dr. Richard J. Naskali, University of Idaho. Used with permission.



Figure 117. Ripe fruits of hardy kiwi on a vine in a well-protected area.

With either species of kiwi, male and female flowers are produced on separate plants. Therefore, both male and female plants are necessary for fruit production. An exception to this rule, the Issai cultivar of *A. arguta* is said to be self-fruitful, but produces larger fruit when a male plant is available for pollination. The vines will need a sturdy trellis to grow on.

Growers as far north as Minnesota have successfully grown hardy kiwi by using a trellis that is able to be lowered to the ground for the winter. This allows the vines to be mulched and protected from winter temperatures. In the spring, the trellis is returned to its upright position. The kiwis will grow best in well-drained soils in areas protected from heavy winds. Possible pest problems include root rots (if planted in too wet an area), spider mites, and Japanese beetles.

For more information on growing kiwi, consult Ohio State University Extension Fact Sheet HYG 1426 *Kiwifruit and Hardy Kiwi*, or the Minnesota Extension Yard and Garden Brief *Growing Kiwi in Minnesota*.

## Highbush Cranberry

Though the fruit resembles the cranberry in both appearance and flavor, the Highbush Cranberry (*Viburnum trilobum* or *Viburnum opulus* var. *americana*) is actually a member of the honeysuckle family. It is a cold-hardy Native American shrub that grows to a height of six to 10 feet, making it also useful for hedges or privacy screens. The fruit, harvested in late summer or fall, is used in jellies, preserves, or sauces.

The cultivars ‘Wentworth,’ ‘Andrews,’ and ‘Hahs’ are specifically noted for their fruit qualities. The Highbush Cranberry will grow well in most soils in full sun or partial shade and has few pests.

Note: This plant should not be confused with the European cranberry bush (*Viburnum opulus*), which has more astringent fruit with large seeds.



Figure 118. Highbush cranberry fruits.  
Photo courtesy of the Ohio State University Extension Nursery, Landscape, and Turf Team. Used with permission.

### Ground Cherries

An annual plant rather than a perennial, the ground cherry (*Physalis peruviana*) is a member of the tomato family. Ground cherries are also referred to as strawberry tomatoes or husk tomatoes. The plants grow to a height of 18 to 24 inches and produce their fruit in a papery Chinese lantern-

type husk that drops to the ground as the fruit begins to ripen. The fruit is fully ripe when the berry inside the husk turns yellow. At this point it has a unique flavor that some people say resembles a mild orange-strawberry or even a pineapple flavor. It can be used in preserves, pies, and other baked goods or just eaten out of hand. If left in the husk, the fruit will keep for several weeks without refrigeration. The fruit are also well suited for freezing so that they can be used at a later time.

The seeds can be purchased from seed catalogs, but there are no standard varieties, and therefore the fruit may vary in size and flavor from one source to another. They can be started indoors to be transplanted after frost similar to tomatoes or sown directly in the garden after the frost-free date. Once established in an area, ground cherries often will continue to come up as volunteer plants each spring. The main pests are flea beetles with control rarely being needed.



Figure 119. Ground cherries, showing fruit inside the papery husk as well as the yellow fruit with the husk removed.

# Chapter 5. Landscape Aspects of Fruit Plants

Fruit plants can be quite attractive and interesting additions to the home landscape. In addition to a practical role in providing food, they can be used as specimen plants, groundcovers, and in foundation and border plantings. Fruit plants can be used as espalier plants, in pyramids, barrels, or related structures. Some landscapes may include combinations of fruit plants; for example, an apple tree under-planted with gooseberries. Fruit plants will require both a full-sun location and good soil drainage for the production of high-quality fruit.



Figure 120. Strawberries make a very good ground-cover as a part of the edible landscape.

## Landscape Design Principles

Fruit plants can be incorporated into the landscape by following standard design principles. Think of your landscape as a series of outdoor rooms that may include a public entry area, service or work area, and a restricted or private space. Fruit plants should be placed in the landscape to be in unity with other elements. Think of unity in terms of form, size, color, leaf, and branch texture. Plant small fruit plants such as currant, gooseberry, and jostaberry in beds of three, five, seven, etc. Repeat elements in the landscape and balance or equalize design elements.

Take note that some fruit plants may require pruning as well as insect and disease control to remain attractive and productive. Also, there are many landscape plants that have edible fruit such as *Amelanchier* (Serviceberry), *Cornus kousa* (Dogwood), *Viburnum prunifolium* (blackhaw viburnum), and *Chaenomedes speciosa* (Quince). Finally, some fruit plants can also function as specimen plants (key focal landscape points) in the

landscape. Sour cherry, peaches, and certain cultivars of apple or pear are very attractive in flower, fruit, and form and could function as specimen plants.



Figure 121. Many fruit trees are very attractive in bloom. Shown here is a row of apple trees in bloom. Photo by Doug Wilson, USDA/ARS. Used with permission.

## Foundation, Bed, and Border Planting

Jostaberries, currants, gooseberries, blueberries, and elderberries can be effectively used in bed and border plantings. Blackberries and raspberries are effective where traffic control is important and in situations where the gardener has time to properly contain the plants to the designated growing area through a trellis or fence structure.



Figure 122. Blackberries and raspberries make an excellent living hedge for traffic control.

Fruit plants, such as blueberries, can be used effectively in the home landscape in situations where azaleas and rhododendrons can be grown.

Being acid-loving plants, blueberries require acid soil (pH 4.2 to 5.2) and should be sited in full sun for best quality. Many cultivars are available with different growth habits. These plants have especially attractive foliage, bloom, fall color, and twig structure and are a good source of fruit.

In situations where groundcovers are desired in sunny locations, strawberry plants with prolific runner development and high levels of disease resistance can be used effectively. With weed and insect control, effective watering, mulching, and good soil drainage, an excellent strawberry plant groundcover can be established and maintained. Such covers could be useful up to four years before re-establishment is necessary.

### **Espalier Dwarf Apple or Pear Trees**

Espalier denotes a trellis or lattice, usually made of wood, on which trees or shrubs may be trained to grow in a flattened form. The word is also applied to a tree or a shrub that has been so trained. Espalier training is particularly advantageous for use with fruit trees in places where space for trees of ordinary size and shape is not available. Espalier apple trees are usually propagated on dwarfing rootstocks such as Malling 26, Malling 9, or Bud 9. Also, consider disease-resistant cultivars such as 'Liberty,' 'Redfree,' 'Enterprise,' 'Gold Rush,' or 'Jonafree.'



*Figure 123. An espalier-trained apple tree at Longwood Gardens, Kennett Square, Pa.*

Advantages of this method of growing fruit trees, in addition to requiring less space, are:

- Trees begin to flower and bear fruit earlier.
- Trees are easier to spray, prune, and harvest.
- Fruit is generally highly colored and above average in size.

Several trees have various cultivars with different ripening dates that may be grown in the space usually occupied by one standard tree. Pollination may be ensured by planting several cultivars in a limited space. In addition, espalier fruit trees are unique in appearance and form and are usually very attractive.

In the United States, posts and wires are used more than trellises of wood. However, trees may also be trained to fences and walls of buildings. To add to the attractiveness of the planting, yellow-fruited cultivars such as 'Pristine' may be alternated in the row with red-fruited cultivars such as 'Jonafree.'



*Figure 124. Apple trees can be trained to form a beautiful natural fence.*

If wood posts and wires are used, posts should be eight to nine feet long and set two to three feet deep so that the post extends six feet above the ground.

One type of espalier consists of four No. 9 gauge wires stretched between posts, allowing 18 inches above ground level and between wires. Trees may be planted as close as eight to 10 feet along the support, and laterals allowed to grow along each wire in each of the two directions from the trunk of the tree. Usually, the top wire is placed a maximum of six feet high and the lowest wire one-and-one-half to two feet above the ground with the other at two intermediate positions.

Tie laterals to the wires with soft string to train the tree in the desired form. Summer pruning to maintain the desired plant configuration will likely be necessary, and these training methods will require considerably more care and attention.

Pears can also be effective espalier plants in the landscape. Their training can be accomplished in a manner similar to that used for the apple.

### Supporting Brambles

Supporting for bramble fruit canes is not essential except in the case of trailing type blackberries and red raspberries. Supports can be used to advantage to contain the canes, to minimize loss of crop due to wind damage, and to facilitate harvest and other cultural practices. Where supports are not used, more severe pruning is required. Because of the cost involved, supports are more widely used in home garden plantings than large commercial plantings in Ohio.

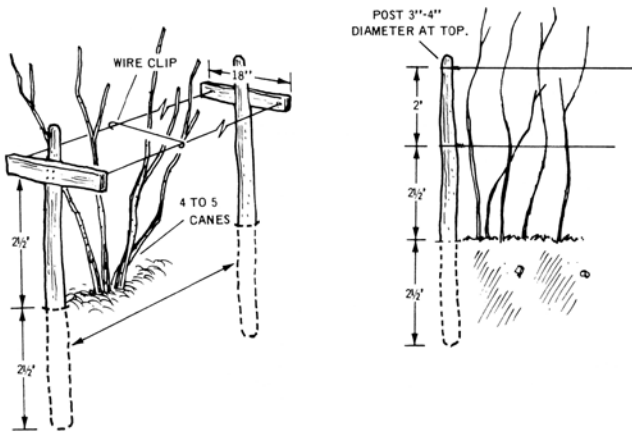

Figure 125. Typical trellises used with bramble fruit.

A wire trellising system is most practical where the hedgerow type of training is used. The crossarm, two-wire system is common. Set posts about every 20 feet with three-and-one-half to five feet remaining above the ground. Near the top of each post, attach an 18-inch long cross piece. To the end of the cross pieces along each side of the row, attach wires. Wireclips, used between the posts, will keep the wires from spreading.

A trellis of two single wires, one above the other, may also be used. It is most useful with red raspberries and trailing blackberries. Set posts in the same manner as for the two-wire crossarm trellis. Tie individual canes, following dormant pruning, to the wires.

### Trellis and Arbor Training of Grapes and Other Fruit Plants

Arbors make an interesting focal point in the landscape and provide a shady, restful area in an otherwise sunny landscape.

Grapes, dwarf fruit trees, and thornless blackberries can be effectively trained to trellises in the home planting. Such an arrangement makes good use of available space and provides essential support to the plant.

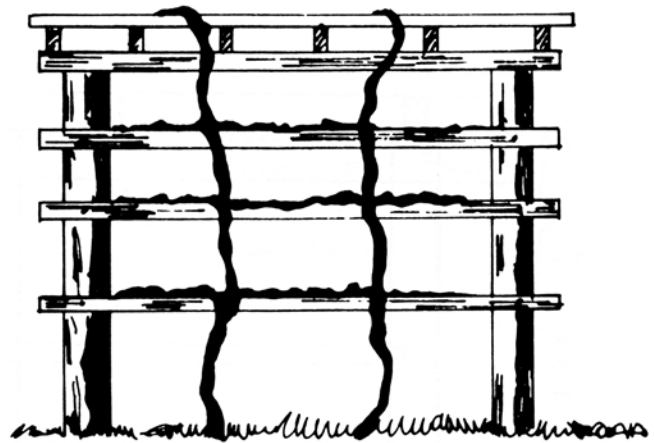

Figure 126. Grape arbors provide ideal support for grapes and make an interesting focal point in the landscape.

Grapevines are generally vigorous and can quickly form a canopy of shade during the growing season. Where more shade is desired and the space is available, the arbor can be much wider than five feet. Grapes such as Concord may have vines 12- to 15-feet long. Adjust the length of the arbor to the available space. Build two or three units, or modules, and link them together to create an interesting landscape effect. The design of the arbor can be modified to fit the landscape.

**Table 23. Materials Required for the Home Grape Arbor.**

| Lumber                                                                                                      | Use                                                                                            |
|-------------------------------------------------------------------------------------------------------------|------------------------------------------------------------------------------------------------|
| 4—4" x 4" x 10' (Redwood)                                                                                   | See A Side View                                                                                |
| 2—2" x 4" x 10' (Redwood or Pine)                                                                           | See B Side View                                                                                |
| 3—2" x 4" x 8' (Redwood or Pine)*                                                                           | See A Top View and C Side View                                                                 |
| 1—2" x 4" x 16' (Redwood or Pine)**                                                                         | See D Side View                                                                                |
| 6—1" x 2" x 8' (Redwood or Pine)                                                                            | See E Side View and A End View                                                                 |
| 7—1" x 2" x 10" (Redwood or Pine)                                                                           | See B Top View and B End View                                                                  |
| * Saw two of the pieces to 7-foot lengths; saw the remaining piece into two pieces that are 6'10-3/8" long. |                                                                                                |
| ** Saw into two pieces each 7'8-1/3" long.                                                                  |                                                                                                |
| Other Materials                                                                                             | Tools Required                                                                                 |
| 2 pounds 2" nails                                                                                           | Posthole digger or auger                                                                       |
| 2 pounds 2-1/2" nails                                                                                       | Carpenter's saw, square, and level                                                             |
| 7—68-pound bags of concrete mix                                                                             | Claw hammer                                                                                    |
| Pointed stakes                                                                                              | Concrete mix equipment: Mortar box or wheelbarrow, shovel, hoe, tape measure or folding ruler. |

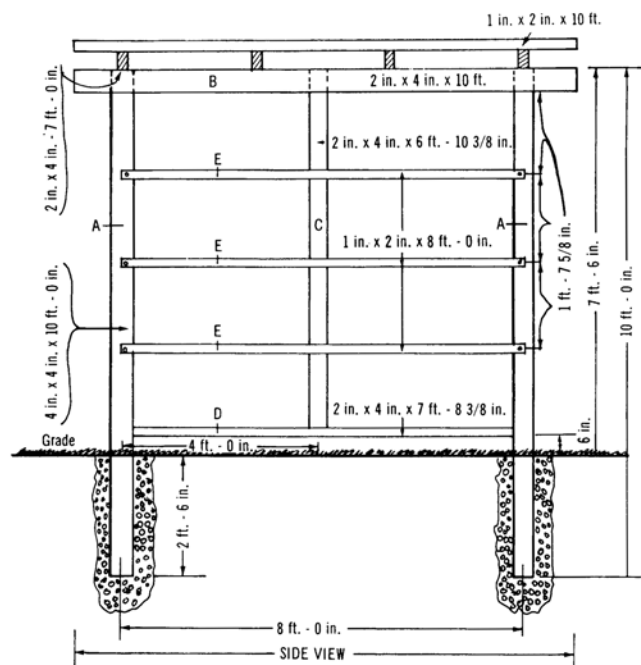

Figure 127. Construction details for a home grape arbor—side view.

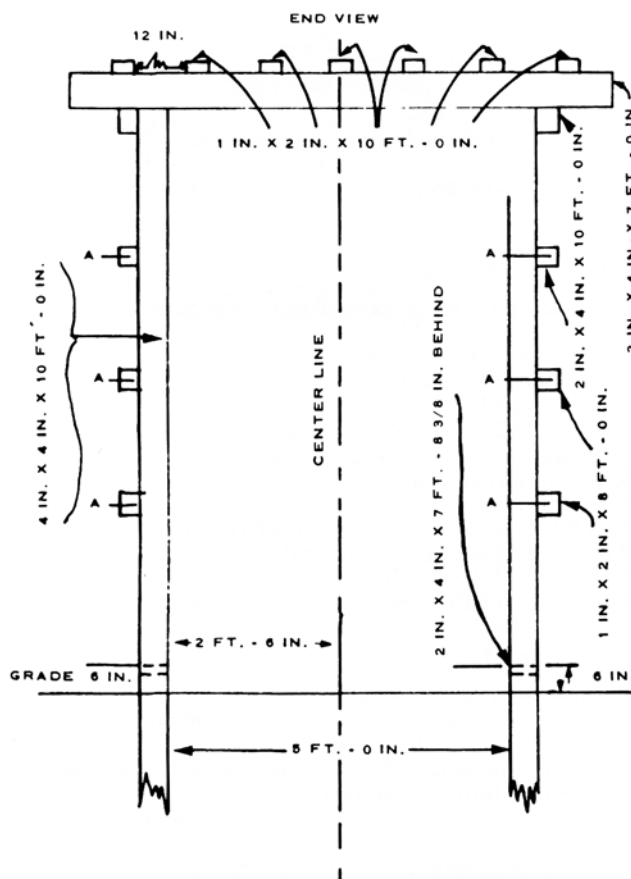

Figure 128. Construction details for a home grape arbor—end view.

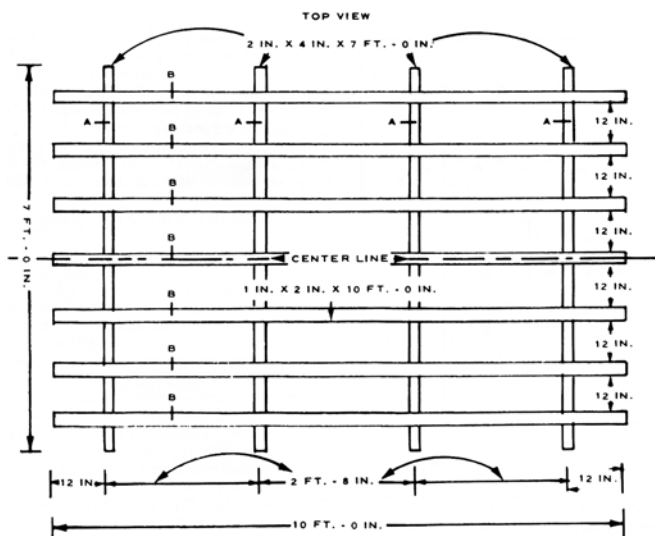

Figure 129. Construction details for a home grape arbor—top view.

## Growing Fruit Plants in

### Limited Space

If space for growing fruits is limited, fruit plants such as strawberries can be grown in different levels of square or round terraces or pyramids. By using a terrace, the grower is able to get many plants into a small area of space and add an attractive and productive structure to the home landscape. Fruit grown in these structures will require greater attention to watering, fertilizing, and winter protection.

Commonly, a square pyramid of three levels is used. One design has the bottom level six feet square, the second level four feet square, and the top level two feet square. This design allows for plant rows 12 inches wide on the two lower levels of the terrace.

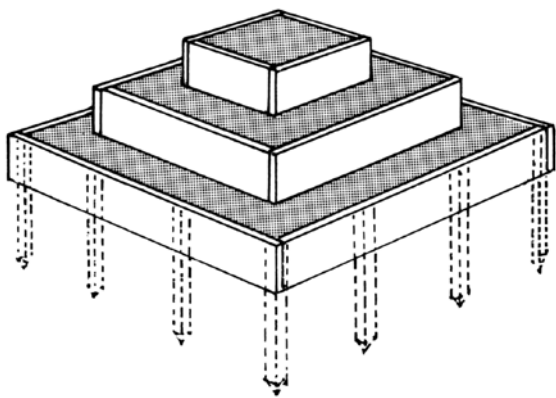

Figure 130. The square terrace for growing ever-bearing strawberry plants.

Using the plant spacing indicated here, 53 strawberry plants can be on a terrace, which takes up 36 square feet of space.

Level 1 (ground level): 9-inch plant spacing—28 plants

Level 2 (second level): 9-inch plant spacing—16 plants

Level 3 (top level): 8-inch plant spacing—9 plants

Total: 53 plants

### Material Required for a Square Terrace

4—2 inch x 6 inch x 12 foot redwood boards sawed to make:

4 boards 6 feet long

4 boards 4 feet long

4 boards 2 feet long

2—2 inch x 2 inch x 12 foot boards sawed and pointed to make 12 stakes two feet in length

1/2 pound 2-inch-long nails

1/2 pound 2-1/2 inch-long nails

13-1/2 bushels (16 cubic feet) of fertile soil

5 bushels (6 cubic feet) of peat moss

1 pound 5-10-10-fertilizer

5 bushels (6 cubic feet) of perlite or sand

### Building the Terrace

Using 2-1/2-inch-long nails:

Nail four boards 2 inches x 6 inches x 6 feet together to make a six-foot square

Nail four boards 2 inches x 6 inches x 4 feet together to make a four-foot square

Nail four boards 2 inches x 6 inches x 2 feet together to make a two-foot square.

Lay the largest, or six-foot square, on a level surface in a sunny location.

Prepare the soil mixture consisting of 16 cubic feet of soil (13-1/3 bushels), six cubic feet of peat moss, six cubic feet of perlite or sand (five bushels), and the 5-10-10 fertilizer. Mix the soil on a smooth hard surface by making alternating layers of soil, peat moss, and perlite or sand, sprinkling the fertilizer between each layer. Mix with a shovel until well mixed. Fill the six-foot frame with the soil mixture, firming it so as to prevent excess settling, particularly around the edges. Next, center

the 4-foot frame on the filled 6-foot frame. Anchor it at the corners with 2 inch x 2 foot stakes. Now fill this frame, firming the soil mixture as before. Repeat this operation for the 2-foot frame.

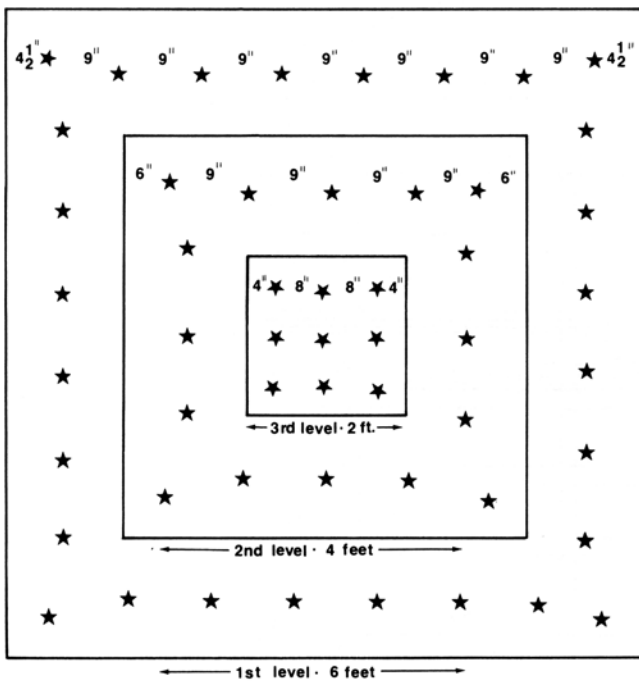

Figure 131. Planting plan for a three-level strawberry terrace.

The square pyramid can be modified according to individual wishes. In some situations, it may be desirable to have more than three levels. In this case it will be necessary to adjust row width and possibly use 2 inch x 6 inch lumber for building the terrace in order to prevent plant shading. There are also other materials and forms, such as circles, hexagons, or octagons, that could be used, depending upon personal preference.

The circular terrace must be made of a strong and flexible material that can be easily formed. Frequently, corrugated aluminum lawn edging is used. The strips are fastened together to form a circle, either by nailing the ends to a stake or by riveting the ends together. Terraces of this type are offered for sale by some nurseries and garden stores.

The circular terrace will accommodate 38 plants, spaced 9 inches apart.

- Level 1 — 20 plants
- Level 2 — 12 plants
- Level 3 — 6 plants
- Total: 38 plants

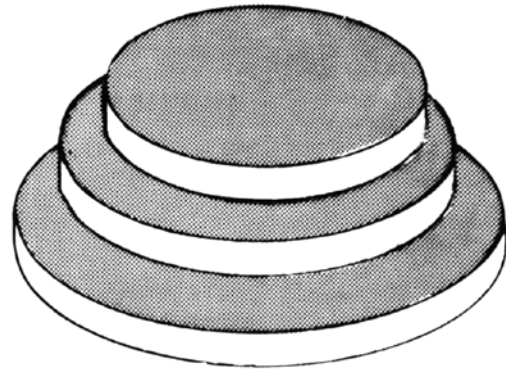

Figure 132. Diagram of a circular terrace for growing strawberries.



Figure 133. A circular strawberry terrace in a home landscape.

June-bearing or everbearing strawberries are suited to this type of culture. Keep runners removed from the plants and maintain a spaced plant system of culture.

Another way to grow strawberries in limited space is to use soil-filled nail kegs, barrels, clay, or ceramic containers with holes at spaced intervals to accommodate the plants. Such containers are often used for many other annual and perennial ornamental plants.

When growing strawberries in such containers, important cultural considerations include the use of a light, well-drained soil mixture well-supplied with organic matter and containing the necessary plant nutrients for best plant growth. Watering practices are also critical to success in this venture.



# Chapter 6. Obtaining and Using Fruits

It is hard to grow all the fruits that you need for home consumption. Fortunately, much high-quality fruit is produced in Ohio and is seasonally available, depending on the types of fruits (Table 24). In addition, Ohio's fruit supplies are supplemented by tropical and sub-tropical fruits shipped into the state. Although fruit is particularly available during the summer months, we are fortunate that we can enjoy fruit throughout the year because of modern transportation, refrigeration, processing, and distribution systems.

|                         |                                                       |
|-------------------------|-------------------------------------------------------|
| June-Bearing Strawberry | Late May, June, and early July                        |
| Everbearing Strawberry  | June, August to October                               |
| Currant                 | July and early August                                 |
| Sour Cherry             | Late June to late July                                |
| Gooseberry              | Late June to mid-July                                 |
| Black Raspberry         | Late June to late July                                |
| Red Raspberry           | Late June and July, and September with some cultivars |
| Blueberry               | Mid-July to early October                             |
| Sweet Cherry            | July                                                  |
| Apple                   | July to early November                                |
| Peach                   | Late July and late September                          |
| Pear                    | Mid August to late October                            |
| Plum                    | Late August to late September                         |
| Grape                   | Early September and mid-October                       |

If you are lucky enough to live near an orchard, you should make a point to take your family there to experience what fresh fruits should taste like.

Children and many adults might be surprised by how much better fresh fruits can taste.

Purchasing high-quality fruit requires some knowledge. Desired quality attributes of fruit are given in Table 26. Fruit properly ripened prior to harvest will give the most satisfaction. Fruit harvested improperly may be hard, poorly colored, sour, and lack aroma. Some poor-quality fruits usually have not developed enough for best dessert quality. Fruit harvested when over-ripe may be soft, poor textured, and off flavored.

Ways to determine when fruit are properly matured for harvest, whether from your own home garden or from pick-your-own situations, may be found in Table 25. Use this information to get more enjoyment from the fruit used in your family meals.

## Pick-Your-Own Fruit

Consumers who want to enjoy fresh fruit without growing their own may take advantage of pick-your-own opportunities, usually available in most localities. Such fruits as apples, strawberries, cherries, raspberries, and blueberries are available from fruit farms on a pick-your-own basis. The customer can personally select and harvest all the fruit that he/she purchases and, at the same time, can involve the entire family in a recreational excursion to the country. Look for pick-your-own fruit harvesting opportunities in your area.

## When to Harvest

Nothing can beat the ripe fruits grown at home or at local fruit farms. Some fruits need to be picked when fully ripe on the plant while other fruits ripen after they are harvested and stored for a while. Listed in Table 25 are the ways to determine when to harvest various fruits. Experienced consumers will get to pick the best fruits of highest quality; this will help to maximize the entire experience of growing and consuming fresh fruits.

**Table 25. Ways to Determine When to Harvest Various Fruits.**

| <b>Type of Fruit Crop</b> | <b>Indication of Maturity</b>                                                                                                                                                                                                                                                                                                                                                                                                                                                                                                                                    | <b>Further Ripening for Quality Improvement off the Plant</b>                                                                    |
|---------------------------|------------------------------------------------------------------------------------------------------------------------------------------------------------------------------------------------------------------------------------------------------------------------------------------------------------------------------------------------------------------------------------------------------------------------------------------------------------------------------------------------------------------------------------------------------------------|----------------------------------------------------------------------------------------------------------------------------------|
| Apple                     | Fruit increases in size with full color development. Ground color becomes straw yellow to creamy in color in red cultivars. Yellow cultivars develop a golden color upon ripening.                                                                                                                                                                                                                                                                                                                                                                               | Yes, if fully mature prior to harvest.                                                                                           |
| Blackberry                | Berries, upon ripening, become dull black in color and begin to become soft and sweet. The small depression in each druplet should be well filled. The small fruits or drupelets are harvested on the central core of the receptacle. Harvest every two or three days.                                                                                                                                                                                                                                                                                           | No                                                                                                                               |
| Cherry, Red Tart          | Cherries increase in size and develop full color as they ripen. They should be left on the tree until juicy and fully flavored. Bird protection is generally necessary.                                                                                                                                                                                                                                                                                                                                                                                          | No                                                                                                                               |
| Cherry, Sweet             | Cherries increase in size and develop full color as they ripen. They should be left on the tree until fully colored and sweet. Bird protection is generally necessary.                                                                                                                                                                                                                                                                                                                                                                                           | No                                                                                                                               |
| Currant                   | Currants for jelly making should be harvested prior to full ripeness. At this stage of development, the pectin content is high. Fully ripe currants are of full size and color, juicy, and beginning to get slightly soft.                                                                                                                                                                                                                                                                                                                                       | No                                                                                                                               |
| Elderberry                | Fruit should be plump, of full color, and just beginning to soften.                                                                                                                                                                                                                                                                                                                                                                                                                                                                                              | No                                                                                                                               |
| Gooseberry                | Pick gooseberries at their full size and still firm, but before they turn reddish-brown and become fully ripe.                                                                                                                                                                                                                                                                                                                                                                                                                                                   | No                                                                                                                               |
| Grape                     | Grapes change color long before they are fully ripe. Therefore, it is possible to pick the clusters before they have reached their peak in flavor, size, and sweetness, if berry color alone is used as a guide to harvest. For best results, taste the grapes prior to harvest. If grapes taste good, it is time to harvest. If not, wait for a few days. Grapes need to be protected from loss to birds.                                                                                                                                                       | No                                                                                                                               |
| Peach                     | Harvest yellow-fleshed cultivars when the ground color is changing from green to yellow. Harvest white-fleshed cultivars when the ground color changes to white. Correlate this color with a taste sample prior to harvesting many fruits.                                                                                                                                                                                                                                                                                                                       | Yes                                                                                                                              |
| Pear                      | Pears should be harvested before they are tree ripe. However, they must not be harvested too green or they will shrivel in storage and have a poor flavor. Some signs of pear ripening include the change of ground color from green to yellow, change of lenticels (small spots on the fruit surface) from white to brown in color. Ripe pears are also more rounded and develop a waxiness on the skin. They also easily separate from the fruit spur. The shoulder of the fruit (the side that is attached to the fruit stem) also becomes soft to the touch. | Yes, but for best dessert quality, most cultivars of pears should be ripened at 60 to 70F, and a relative humidity of 80 to 85%. |
| Plum                      | It is difficult to detect by color alone when a plum is ripe. The best guide to plum ripeness is to apply gentle pressure to the fruit with the thumb and determine if the flesh is beginning to soften. If so, the fruit should be ready for consumption.                                                                                                                                                                                                                                                                                                       | Yes                                                                                                                              |

| <b>Type of Fruit Crop</b> | <b>Indication of Maturity</b>                                                                                                                                                                                                                                       | <b>Further Ripening for Quality Improvement off the Plant</b> |
|---------------------------|---------------------------------------------------------------------------------------------------------------------------------------------------------------------------------------------------------------------------------------------------------------------|---------------------------------------------------------------|
| Raspberry                 | Ripe raspberries are of full color and separate easily from the receptacle (torus) or center part of the fruit. Harvest frequently, as berries continue to ripen over a period of several days. Pick the berries by gently lifting them with the thumb and fingers. | No                                                            |
| Strawberry                | Ripe strawberries are uniformly red in color, firm, but beginning to soften. Harvest fruit with the calyx (cap) on so that it will keep better. Do this by pinching the stem off about 1/4 inch above the cap.                                                      | No                                                            |

| <b>Fruit</b> | <b>Quality Attributes</b>                                                                                                                                                                                                                             |
|--------------|-------------------------------------------------------------------------------------------------------------------------------------------------------------------------------------------------------------------------------------------------------|
| Apple        | Firm, solid, and well-colored. Not overripe; free of bruises and deep external blemishes due to insect, disease, or mechanical injury.                                                                                                                |
| Blackberry   | Solid, dull black color with plump, juicy fruitlets.                                                                                                                                                                                                  |
| Blueberry    | Plump, firm berries of dark blue color with a silvery bloom (waxy covering). Ripe fruits should be sweet and juicy and come off the plant easily with a light tickle.                                                                                 |
| Cherry       | Bright, glossy, plump-looking surfaces and fresh-looking surfaces. Mature so as to be juicy and of good flavor.                                                                                                                                       |
| Grape        | Well-colored, plump, and firmly attached to the stem. White or green cultivars should have fruit of yellowish cast or straw color with a tinge of amber. Red cultivars should have all berries of the cluster predominantly red.                      |
| Peach        | Fruit fairly firm or becoming a bit soft. Ground color yellow or creamy with bright red over color. Fruit free of bruises and decay.                                                                                                                  |
| Pear         | Fruit firm, not overly soft. Color depends upon the cultivar. Generally, pears are considered mature when the small spots (lenticels) on the fruit are brown rather than white.                                                                       |
| Plum         | Fruit firm to slightly soft stage of ripeness. Color varies with the cultivar. With experience in matching skin color and firmness with taste and consistency, one can learn to select quality plums.                                                 |
| Raspberry    | Fruit firm and of bright, clean appearance without attached caps. Fruitlets should be plump and juicy but not mushy. Berries should be of uniform color and ripeness.                                                                                 |
| Strawberry   | Berries should be firm, plump, and shiny with full red color and an attached dark green attractive cap. Well-developed berries have small seeds well scattered over the fruit surface. Berries should not be overly soft and should be free of decay. |

**Table 27. Nutritive Value of Selected Fruits.**

| Fruit (Raw fruit)                                                                                                                                                                                                                                                                                                                                             | Approximate measure | Wt. in grams | % Water | Calories | % Fiber (gm) | Carbohydrates (gm) | Fat (gm) | Folate (mcg) | Protein (gm) | Iron (mg) | Calcium (mg) | Potassium (mg) | Vitamin A (IU) | Vitamin C (mg) | Vitamin E (mg) |
|---------------------------------------------------------------------------------------------------------------------------------------------------------------------------------------------------------------------------------------------------------------------------------------------------------------------------------------------------------------|---------------------|--------------|---------|----------|--------------|--------------------|----------|--------------|--------------|-----------|--------------|----------------|----------------|----------------|----------------|
| Apples                                                                                                                                                                                                                                                                                                                                                        | 1 cup               | 125          | 86      | 65       | 3            | 17                 | 0.2      | 3.8          | 0.3          | 0.1       | 7.5          | 134            | 68             | 5.7            | 0.2            |
| Blackberry                                                                                                                                                                                                                                                                                                                                                    | 1 cup               | 144          | 88      | 62       | 8            | 14                 | 0.7      | 36           | 2.0          | 0.9       | 41.8         | 233            | 308            | 30.2           | 1.7            |
| Blueberry                                                                                                                                                                                                                                                                                                                                                     | 1 cup               | 145          | 84      | 83       | 3            | 21                 | 0.5      | 8.7          | 1.0          | 0.4       | 8.7          | 112            | 78             | 14.1           | 0.8            |
| Cherry, Sour                                                                                                                                                                                                                                                                                                                                                  | 1 cup               | 155          | 86      | 77       | 2            | 19                 | 0.5      | 12.4         | 1.6          | 0.5       | 24.8         | 268            | 1,988          | 15.5           | 0.1            |
| Cherry, Sweet                                                                                                                                                                                                                                                                                                                                                 | 1 cup               | 117          | 82      | 74       | 2.5          | 19                 | 0.2      | 4.7          | 1.2          | 0.4       | 15.2         | 260            | 75             | 8.2            | 0.1            |
| Elderberry                                                                                                                                                                                                                                                                                                                                                    | 1 cup               | 145          | 80      | 106      | 10           | 27                 | 0.7      | 8.7          | 1.0          | 2.3       | 55.1         | 406            | 870            | 52.2           | ~              |
| Grape, American                                                                                                                                                                                                                                                                                                                                               | 1 cup               | 92           | 81      | 62       | 0.8          | 16                 | 0.3      | 3.7          | 0.6          | 0.3       | 12.9         | 176            | 92             | 3.7            | 0.2            |
| Ground Cherries                                                                                                                                                                                                                                                                                                                                               | 1 cup               | 140          | 86      | 74       | ~            | 16                 | 1.0      | ~            | 2.7          | 1.4       | 12.6         | ~              | 1,008          | 15.4           | ~              |
| Kiwi                                                                                                                                                                                                                                                                                                                                                          | 1 cup               | 177          | 83      | 108      | 5            | 26                 | 0.9      | 44.2         | 2.0          | 0.5       | 60.2         | 552            | 154            | 164.0          | 2.6            |
| Mulberry                                                                                                                                                                                                                                                                                                                                                      | 1 cup               | 140          | 88      | 60       | 2            | 14                 | 0.5      | 8.4          | 2.0          | 2.6       | 54.6         | 272            | 350            | 51.0           | 1.2            |
| Pawpaw <sup>1</sup>                                                                                                                                                                                                                                                                                                                                           | 1 fruit             | 100          | 73      | 80       | 2.6          | 19                 | 1.2      | ~            | 1.2          | 7.0       | 6.3          | 345            | 87             | 18.3           | ~              |
| Peach                                                                                                                                                                                                                                                                                                                                                         | 1 cup               | 170          | 89      | 66       | 2.5          | 16                 | 0.4      | 6.8          | 1.5          | 0.4       | 10.2         | 323            | 554            | 11.2           | 1.2            |
| Pear                                                                                                                                                                                                                                                                                                                                                          | 1 cup               | 165          | 84      | 96       | 5.1          | 26                 | 0.2      | 11.6         | 0.6          | 0.3       | 14.8         | 196            | 38             | 6.9            | 0.2            |
| Persimmon, American                                                                                                                                                                                                                                                                                                                                           | 4 fruit             | 100          | 64      | 127      | ~            | 33                 | 0.4      | ~            | 0.8          | 2.5       | 27.0         | 310            | 3,640          | 66.0           | ~              |
| Plum                                                                                                                                                                                                                                                                                                                                                          | 1 cup               | 165          | 87      | 76       | 2.3          | 19                 | 0.5      | 8.3          | 1.2          | 0.3       | 9.9          | 259            | 569            | 15.7           | 0.4            |
| Quince                                                                                                                                                                                                                                                                                                                                                        | 1 fruit             | 92           | 84      | 52       | 1.7          | 14                 | 0.1      | 2.8          | 0.4          | 0.6       | 10.0         | 181            | 37             | 13.8           | ~              |
| Raspberry                                                                                                                                                                                                                                                                                                                                                     | 1 cup               | 123          | 85      | 64       | 8            | 15                 | 0.8      | 25.8         | 1.5          | 0.8       | 30.7         | 186            | 41             | 32.2           | 1.1            |
| Strawberry                                                                                                                                                                                                                                                                                                                                                    | 1 cup               | 152          | 90      | 49       | 3            | 12                 | 0.5      | 36.5         | 1.0          | 0.6       | 24.3         | 233            | 18             | 89.4           | 0.4            |
| Antioxidants: Though most fruit are considered to be good sources of antioxidants, a USDA study found blueberries, blackberries, raspberries, strawberries, apples, sweet cherries, and plums (highest to lowest, respectively) are considered to be exceptionally high in antioxidants. ( <i>Journal of Agricultural and Food Chemistry</i> , June 9, 2004.) |                     |              |         |          |              |                    |          |              |              |           |              |                |                |                |                |
| ~—Information not available                                                                                                                                                                                                                                                                                                                                   |                     |              |         |          |              |                    |          |              |              |           |              |                |                |                |                |
| Source for all fruits other than those noted otherwise: U.S. Department of Agriculture, Agricultural Research Service. 2005. USDA Nutrient Database for Standard Reference, Release 18. Nutrient Data Laboratory Home Page, <a href="http://www.ars.usda.gov/ba/bhnrc/ndl">http://www.ars.usda.gov/ba/bhnrc/ndl</a>                                           |                     |              |         |          |              |                    |          |              |              |           |              |                |                |                |                |
| <sup>1</sup> Source: Kentucky State University Extension, <a href="http://www.pawpaw.kysu.edu/pawpaw/cooking.htm#Table%202">http://www.pawpaw.kysu.edu/pawpaw/cooking.htm#Table%202</a>                                                                                                                                                                       |                     |              |         |          |              |                    |          |              |              |           |              |                |                |                |                |

# Chapter 7. Pest Management and Disease Control in Home Fruit Plantings

Growing fruit crops in the home garden can be a rewarding experience and a source of enjoyment for many years. It can also be a disappointing venture and a source of frustration. The difference is most often due to the many diseases and insect pests that attack fruit crops and to understanding how to best avoid or reduce the damage they cause. Some problems are minor, but others have the potential to destroy the entire crop or to kill the plants. Resistant cultivars reduce some losses and good cultural practices reduce others, but some use of chemical pesticides might also be necessary to ensure an abundant crop of wholesome fruit.

## How Can I Manage the Pests That Get into My Fruit Plantings?

When considering pests in fruits, there are three basic types—weeds, insects, and diseases. In most situations, chemicals will rarely be used for weed control in the home fruit planting. Instead, you will tend to use physical weed barriers or hand weeding as your weed-control measures. However, for insects and diseases, chemical pesticides are sometimes used. The pesticides used can be either natural or synthetic, but rather than relying on pesticides alone, it is suggested that growers use a more environmentally friendly approach called *integrated pest management (IPM)*.

## What Is Integrated Pest Management?

Integrated pest management (IPM) is a concept of pest control that relies on using a variety of control measures to control a pest population. Though we sometimes make use of chemical controls, some of the other types of control measures that are extremely helpful are disease resistance, sanitation, cultural controls, mechanical controls, and biological controls.

At the heart of IPM is the understanding that many crops can tolerate a certain amount of pest damage without it being significantly harmful to the plant or the fruit. As a result, pesticide applications are not needed until the pest population reaches a

critical level usually referred to as a *threshold*. For the backyard fruit grower, this threshold may be economic, but it is more likely to be aesthetic.

A commercial grower's produce must be blemish free, or nearly so, if sold for fresh market use. If an apple is found to have apple maggot damage, it will probably be culled or sold at a lower price, making the threshold economic. However, the threshold for home-grown fruit is often dependent on an individual grower's tolerance to the damage. For example, the damaged portion of an apple fruit can be cut out, and the remaining portion used for making sauce or pies.

It should also be noted that for many insects, having a low population of pests present to support a resident population of beneficial predator insects can actually be better than having no pests at all. On the other hand, doing what you can to prevent initial infections is the best option for controlling diseases, whether through sanitation, cultural, or chemical control, because once they get started they can be difficult to control. Even with diseases, the amount of effort put into controlling them is dependent on the growers' tolerance to the damage they can cause.

Making observations or scouting your crops is also an important aspect of IPM. These observations need to be done on a regular basis, at least one to two times per week, in order to determine if pest populations are present and how severe they are. By identifying problems early, there is often more of a variety of control options available rather than waiting until a condition is severe enough that chemical controls are the only option.

Scouting can be done by the use of direct visual observation. Visual scouting is carried out by looking at a plant closely, examining leaves, blossoms, twigs, or fruit for signs of damage or presence of the pest itself. When scouting a planting, you don't have to look at every plant or every part of a plant, but rather look at enough of them thoroughly enough that you are comfortable that you know what is happening in your planting.

Another way of monitoring some insects is to use traps. The most common type of trap is a pheromone trap, which uses a lure that is attractive to a single species. Several important fruit pests for which pheromone traps are available are codling moth, Oriental fruit moth, peachtree borer, and grape berry moth. These traps do not control the pests, but they do give information about when a pest is active in its adult stage. The best time to scout for caterpillar pests is one to two weeks after moth activity is detected in traps.



*Figure 134. Insect traps are an excellent tool in monitoring insect populations. Shown here is a codling moth trap.*

## How Do I Use IPM Control Measures?

### Cultural Controls

One of the main cultural controls to consider is crop selection and cultivar selection. As a rule, tree fruits require more pesticides than most small fruits. However, some apple cultivars are highly or moderately resistant to a number of important diseases. These cultivars can be grown using few if any fungicides but might still require some use of insecticides.

Similarly, nectarines are more likely than peaches to have serious problems with brown rot disease. Some cultivars of strawberries have higher degrees of resistance to root or leaf diseases than others. If pesticide use is not acceptable in the home garden, then blueberries, raspberries, thornless blackberries, and strawberries offer the greatest chance for success.

Choosing the proper location for your planting is another important cultural control. Try to locate your tree fruits as far away as possible from abandoned orchards to help reduce the influx of pests from that planting into your own. Select a planting site that is exposed to sunlight and has good soil drainage and air circulation.

Apple and pear scab, powdery mildew, and most other diseases are more serious in moist, shaded locations. These diseases can be reduced by improving air movement through and sunlight penetration into the canopy of the tree. Prune away overhanging vegetation from nearby landscape trees. Prune fruit trees to promote greater sunlight penetration.

Keeping your plants healthy by keeping them properly fertilized and maintaining proper soil moisture, especially in dry periods (but don't over water!), will help to prevent stress to your plants. This will make them less vulnerable to pest infestation. If watering is needed, irrigate the soil around the trees rather than using overhead sprinklers, so long periods of leaf wetness are avoided.

Starting off with disease-free transplants is also important in establishing your fruit planting. This can be done by buying nursery stock only from reputable growers; inspecting all purchases for galls, root decay, stem cankers, or insect pests; and excluding diseased plants from the home fruit planting.

### Sanitation

Sanitation means keeping the fruit planting cleaned up. Good sanitation should be followed regardless of whether or not conventional pesticide use is planned. Because fruit crops are perennial, many of the more serious disease and insect problems tend to overwinter in or near the planting. Good sanitation practices in and around the home garden reduce the risk of pest damage and can significantly reduce the need for pesticide treatments. Neglected fruit plants harbor many pests and should be eliminated.

Good weed control in most small-fruit plantings not only reduces the competition for water and nutrients but also promotes rapid drying after a rain or a dew and thus reduces the likelihood of infections by several important pathogens. Depending on the crop and the pests involved, sanitation measures can be as simple as a light raking in blueberries to more time-consuming pruning and leaf removal with apples. Specific measures needed in managing each crop are given later in this bulletin.

### Mechanical Controls

Mechanical controls can mean the physical removal of the pest — for example, hoeing out weeds or handpicking insects. It can also mean the use

of physical barriers, such as row covers, to prevent infestation by insects or vertebrate pests. Apple maggot traps and bagging are other examples of mechanical control.



Figure 135. Bagging apples is an example of mechanical control of insects.



Figure 136. Using this sticky ball trap, which resembles an apple, is a good way to control apple maggots.

### Biological Controls

Biological controls involve the release or preservation of organisms that are beneficial to your crop. These are generally most effective against insect and mite pests rather than disease or weeds. Predators include mantids, ladybugs, lacewings, hover flies, and damsel bugs. Parasitic organisms include parasitoid wasps, parasitoid flies, and beneficial fungi. These organisms can sometimes be purchased to be released into your fruit planting to help control pests.

For release efforts to be effective, the release must be made when pest numbers are low. Pests need to be present in order for the beneficial insects to have something to feed and reproduce on; otherwise they will die off or migrate to where prey is readily available. However, if the pest population

is too high, the release of beneficials will not be enough to adequately control the pest in a timely manner.

Though some beneficials are generalists in their feeding habits, which means they feed on many kinds of insects, others are fairly specific as to what they can be used to control. In home fruit planting, it is often more beneficial to preserve the naturally occurring populations of beneficial organisms by avoiding unnecessary pesticide applications or using pesticides known to be soft on beneficials rather than to try to carry out release efforts.



Figure 137. Ladybug is the poster child of beneficial insects. It is a great predator of aphids.

### Chemical Controls (Pesticides)

If the alternative methods previously mentioned do not provide adequate control, then the use of pesticides may be required. If pesticides are to be used, it is important to keep several things in mind.

1. Make sure the instructions on the pesticide package label of the pesticide you use has both the pest and the plant you are treating listed on it.
2. Make applications at the proper time or times and at the proper rates.
3. Obtain good plant coverage, especially for fungicides.
4. Use pesticides safely:
  - A. Do not buy more than needed for the season.
  - B. Keep materials in their own labeled containers.
  - C. Keep materials locked and away from children, pets, and unauthorized people.
  - D. Always read and follow label instructions.

Specific recommendations for chemical applications are not given in this publication. Instead, you should refer to Ohio State University Extension Bulletin 780, *Controlling Diseases and Insects in Home Fruit Plantings*, which is available through your county OSU Extension office.

## What Resources Are There to Help Me Identify a Pest?

It is important for home fruit growers to be able to recognize the major diseases and insect pests of the fruit crops they grow. There are many pictures of common insects and diseases of fruit crops in this bulletin. Proper disease and insect identification is critical to making the correct management decisions.

In addition, gardeners should develop a basic understanding of the pathogen or insect's biology and life cycle. The more you know about the disease or insect pest, the better equipped you will be to make sound and effective management decisions. Maintaining a good library is an extremely important part of successful disease and insect management. The literature listed here contains photographs of fruit diseases and insect pests; information on their biology, development, and control; and other information on various aspects of fruit production in general. Most of these publications are available for purchase through your local county OSU Extension office in Ohio. If you live in other areas of the Midwest, contact your Cooperative Extension Service for additional publications or information on home fruit production.

*Apple Rootstocks and Cultivars*, Bulletin 758

*Brambles: Production, Management, and Marketing*, Bulletin 783

*Common Tree Fruit Pests*, North Central Regional Extension Publication No. 63

*Controlling Diseases and Insects in Home Fruit Plantings*, Bulletin 780

*Diseases of Tree Fruits in the East*, North Central Regional Extension Publication No. 45

*Insect Traps for Home Fruit Insect Control*, North Central Regional Extension Publication No. 359

*Midwest Grape Production Guide*, Bulletin 919

*Midwest Small Fruit Pest Management Handbook*, Bulletin 861

*Midwest Strawberry Production Guide*, Bulletin 926

*Midwest Tree Fruit Pest Management Handbook*, Bulletin ID 93

Backyard fruit growers who desire more information about chemical control of diseases, insects, and weeds or who require a more intensive spray

program than is described in the bulletins listed previously will find these publications useful:

*Midwest Commercial Small Fruit and Grape Spray Guide*, Bulletin 506 B2

*Midwest Commercial Tree Fruit Spray Guide*, Bulletin 506 A2

Many of the previously mentioned publications, as well as numerous Ohio State University Extension fact sheets and other useful publications, are available on the World Wide Web at: <http://ohioline.osu.edu>. The sections in the rest of this bulletin should also help you in identifying your pest problems and learning about their life cycles.

You may bring insect samples to your local Extension office for identification. Ohio State University also operates the C. Wayne Ellett Plant and Pest Diagnostic Clinic. Plant and pest samples can be sent to this clinic for identification. There is a fee for this service. The C. Wayne Ellett Plant and Pest Diagnostic Clinic is a great tool when combating pest problems in fruit production. To learn more about the services the clinic offers, go to: <http://ppdc.osu.edu/>. Contact your local Extension office for information on disease diagnosis and pest identification in your state.

## Understanding Fruit Diseases What Causes Diseases to Develop on My Plants?

In order for a plant disease to develop, three basic things are needed—a susceptible host plant, the *pathogen* (disease-causing organism), and favorable environmental conditions for the pathogen to grow and infect the plant. When these three factors are present, the pathogen can enter the plant and disease develops.



*Figure 138. Grape black rot is a very common disease caused by a fungus.*

All types of fruit produced in the Midwest are subject to attack by plant pathogens. Unless plant diseases are controlled, severe losses in fruit



quality and yield may result. In addition, some diseases such as root rots can kill the entire tree or plant. Knowing the types of pathogens that can cause plant disease will aid a person in understanding why various methods and materials are used for disease control. Most plant diseases are caused by one of the following:

### ***Bacteria***

*Bacteria* live in soil or on plant refuse and are spread by splashing rain, wind-driven rain, man, animals, equipment, and plants. Bacteria are too small to be seen with the naked eye and are capable of causing diseases such as soft rots, leaf spots, blights, wilts, and galls. Bacteria enter plants through wounds or natural openings such as stomates. Once inside the plant, they can kill cells or, in a few cases, cause them to grow abnormally, resulting in galls or abnormal growths. High moisture conditions are generally necessary for development of bacterial diseases.

### ***Fungi***

*Fungi* cause the majority of diseases on fruit crops. They are small microscopic plant-like organisms that are unable to produce their own food and must obtain it from other sources such as common plants. Many different types of fungi are capable of causing plant disease. It is important to know what type of fungus is causing the disease in order to apply the proper control measures. Many fungi can penetrate healthy plant tissues directly and produce symptoms very similar to those caused by bacteria. Most fungi, like bacteria, require conditions of high moisture to cause plant disease.

### ***Nematodes***

*Nematodes* are small eel-like round-worms, 1/25 to 1/50 of an inch long, that cannot be seen with the naked eye. Not all nematodes are bad; some actually help by feeding on harmful insects or fungi in the soil. However, many nematodes feed on small roots and can cause a general decline in plant growth. Root knot nematodes can cause knots or galls on roots that can be seen with the naked eye. Nematodes live in the soil and are transported from one area to another in or on plant roots, infested soil, and sometimes on equipment.

### ***Viruses***

*Viruses* are infectious agents that are nucleo-protein in nature and cannot be seen with an ordinary light microscope. Some virus diseases are easily

transmitted from diseased to healthy plants by mere contact. Others can be spread only by feeding and plant-to-plant movement of certain insects. Viruses often overwinter in perennial weeds and in bodies of certain insects. Symptoms of virus disease include mosaic or mottling patterns, vein-clearing, streaking, yellowing, stunting, and malformation of certain plant parts.

### ***Mycoplasmas***

*Mycoplasmas* are similar to bacteria but lack a rigid cell wall. They are generally much smaller than bacteria and cause disease symptoms very similar to those caused by viruses. Mycoplasmas are spread primarily by insects.

### ***Non-Infectious Disease***

*Non-infectious diseases* cannot be spread from one plant to another. Non-infectious diseases are usually due to adverse environmental conditions such as too little or too much soil moisture or sunlight; deficiency or excess of nutrients; too high or too low a temperature to be most favorable for plant growth; accidental exposure to herbicides, salt damage, and air pollution.

## **What Pests Should I Be Concerned About?**

Information about the most common fruit diseases and insects that occur in the Midwest is presented in the following pages. For each disease or pest, a brief description of symptoms and general comments for control are given. This list is intended to familiarize the reader with the most common pests and cultural control methods.

## **Disease and Pest Identification and Management**

### **Apple and Pear Diseases**

#### ***Phytophthora Crown and Root Rot of Tree Fruits***

*Phytophthora root and crown rots* (sometimes called collar rot) are caused by a fungus-like pathogen called an oomycete. These pathogens live in the soil and can attack the roots of trees when the ground is saturated with water. This disease is one of the main reasons it is so important to plant fruit crops on well-drained sites. *Phytophthora root rot* is a common and destructive disease of fruit trees throughout the world.

In Ohio, apple, cherry, and peach trees are usually attacked. Pear and plum trees appear to be relatively resistant. Trees declining and dying from

phytophthora root and crown rots are frequently misdiagnosed as suffering from wet feet (root asphyxiation) or are sometimes confused with those suffering from winter injury.

Diseased trees are commonly found in poorly drained areas of the orchard or yard. Heavy, wet soils that remain saturated for extended periods of time are required for disease development. Above-ground symptoms vary between tree species but generally include reduced tree vigor and growth, yellowing or chlorosis of leaves (Figure 139), and eventual collapse or death of the tree.



*Figure 139. Above-ground symptoms on an apple tree with phytophthora root rot. Note the yellowing of leaves and loss of vigor (reduced growth).*

Infected trees may decline slowly over one or more years, or they may collapse and die rapidly after resuming growth in the spring. The rapid collapse and death is more common on stone fruit trees than apple and pear. Trees may also appear healthy in the spring, but die suddenly in the latter part of the growing season. Rapid death of trees usually occurs following excessively wet periods. On trees that decline gradually, a reddish or purple discoloration of the leaves often occurs in autumn (Figure 140), while leaves on healthy trees remain green.



*Figure 140. Above-ground symptoms on an apple tree with phytophthora root rot in the fall. Note the difference between a diseased and a healthy tree.*

To observe below-ground symptoms, you need to remove several inches of soil around the base of the declining tree. A diagnostic reddish-brown discoloration of the inner bark and wood can be observed after cutting away the outer bark layer (Figure 141). A sharp line demarcates the reddish-brown (diseased) and white (healthy) portion of the crown (Figure 142). Similar symptoms can be found on roots, but it is generally difficult to see root symptoms without removing the tree.



*Figure 141. Below-ground symptoms of phytophthora root rot on apple roots. Note the brown rotted roots and the line between healthy and diseased tissues.*



*Figure 142. Below-ground symptoms of phytophthora root rot on the crown of a peach tree. Note the brick red discoloration and the sharp line of demarcation between healthy and diseased tissues.*

This reddish discoloration and line of demarcation between diseased and healthy tissue distinguishes phytophthora root and crown rot from other causes of tree decline and collapse such as wet feet (drowning) or winter injury. Roots on trees killed by excessive water are usually completely black (have no line of demarcation) and oftentimes have an unpleasant smell. Discoloration from winter injury is usually confined to the above-ground part of the trunk, particularly on the southwest side of the tree, while the below-ground portion of the tree may still appear healthy.

## Control

Control of phytophthora crown and root rots is most successful using an integrated program of cultural practices, choosing the most resistant tree species or rootstock, and when necessary, chemical control.

1. Avoid sites that drain slowly or poorly or are subject to periodic flooding.

Marginal sites should be modified (install drain tiles, create diversion ditches, rip underlying pan layers) to provide the additional drainage recommended for growing tree fruit crops. Planting trees on ridges or berms will raise their crowns above the primary zone of zoospore activity and provide an important margin of safety, especially in a wet year.

2. Select rootstocks or tree species that are less susceptible to phytophthora and are best adapted to your individual site.

Pears are the most resistant tree fruit crop and are most likely to remain healthy in a relatively wet site. Among apple rootstocks, seedlings are relatively resistant.

Among dwarfing-apple rootstocks, M-9 is relatively resistant. The Canadian rootstock Ottawa-3 has M-9 type resistance. M-7 and MM-111 are moderately susceptible; M-26 and MM-106 are susceptible; and MM-104 is highly susceptible.

Among stone fruits, plums are relatively resistant, whereas the remainder are susceptible to very susceptible. Mahaleb is the most susceptible cherry rootstock, whereas Mazzard, Morello, and Colt are somewhat more resistant and would be recommended on heavier soils.

3. Fungicides for controlling this disease are generally not recommended for home fruit plantings.

## Apple Scab

*Apple scab* is one of the most serious and common diseases of apples. The disease is caused by a fungus, and development is favored by wet, cool weather that generally occurs in spring and early summer. Both leaves and fruit can be affected. Infected leaves may drop, resulting in unsightly trees with poor fruit production. This early defoliation may weaken trees and make them more susceptible to winter injury or other pests. Infected

fruits are blemished and often severely deformed. Infected fruits may also drop early.

Symptoms first appear in the spring as spots (lesions) on the lower leaf surface, the side first exposed to fungal spores as buds open. At first, the lesions are usually small, velvety, olive green in color, and have unclear margins. As they age, the infections become darker and more distinct in outline (Figure 143). Lesions may appear more numerous closer to the mid-vein of the leaf. If heavily infected, the leaf becomes distorted and drops early in the summer. Trees of highly susceptible cultivars may be severely defoliated by mid to late summer.



Figure 143. Apple scab lesions on apple leaves.

Fruit symptoms are similar to those found on leaves. The margins of the spots, however, are more distinct on the fruit. The lesions darken with age and become black and scabby (Figure 144). Scabs are unsightly but are only skin deep. Badly scabbed fruit becomes deformed and may fall before reaching good size.



Figure 144. Apple scab lesion on fruit.

*Pear scab*, which is caused by a fungus that is related to the one that causes apple scab, can likewise cause damage to pears but is less common than is apple scab. Symptoms are similar to apple scab, though pear leaves do not become infected as often

as apple leaves. Unlike apple scab, however, twig infections are common with pear scab. Early in the growing season, lesions on young shoots appear as brown, velvety spots. Later, these lesions become corky, canker-like areas. The following spring, pustules will develop within these over-wintered lesions. These pustules produce spores that perpetuate the spread of the disease.

The use of resistant or scab-immune cultivars is the ideal method for controlling scab. Currently there are several apple cultivars that are totally resistant (immune) to scab. Backyard growers are strongly encouraged to consider using these resistant cultivars in order to reduce or eliminate the need for fungicide applications. Scab-resistant apple cultivars include Freedom, Liberty, Jonafree, Enterprise, Goldrush, Redfree, Pristine, Williams Pride, Sundance, Scarlet O'Hara, Galarina, Crimson Gold, and Crimson Crisp (Table 3 in Chapter 2).

All other apple cultivars, including most commercially grown cultivars, are susceptible to scab; however, they differ in their degree of susceptibility (Table 4 in Chapter 2). At present there are no scab immune or resistant pear cultivars; however, there is a variation in cultivars as to their susceptibility to this disease. Flemish Beauty and Seckel are considered very susceptible.

Raking and removing fallen leaves will help to prevent the carry over of the fungus from year to year. If growing susceptible cultivars, a good fungicide spray program will be essential in obtaining blemish-free fruit.

### **Powdery Mildew**

*Powdery mildew* is caused by a fungus and may be found on buds, blossoms, leaves, twigs, and fruit on apples. Symptoms first appear in the spring on the lower surface of leaves, usually at the ends of branches. Small, whitish felt-like patches of fungal growth appear and quickly cover the entire leaf. Diseased leaves become narrow, crinkled, stunted, and brittle (Figure 145).

The fungus spreads rapidly to twigs, which stop growing and become stunted. In some cases, the twigs may be killed back. Leaves and blossoms from infected buds will be diseased when they open the next spring. Also, the fruit surface may become russeted, or discolored, and dwarfed. Heavily mildewed trees are weakened and are more susceptible to other pests and winter injury.



*Figure 145. Malformation of apple leaves caused by powdery mildew.*

One measure that you can take to help avoid powdery mildew is planting your trees in a sunny area with good air drainage. If you are planting your trees in an area that does not allow for good air drainage, do not plant highly susceptible cultivars such as Jonathon, Rome Beauty, Cortland, Baldwin, Monroe, Granny Smith, and Idared. Where powdery mildew is a problem, a good fungicide spray program is generally required for control.

### **Rust Diseases**

There are three different forms of rust that can infect apples. All are caused by different species of the fungus *Gymnosporangium* and have various junipers and red cedars (*Juniperus* species) as an alternate host. Apples are generally most susceptible to infection by the rust fungi during the period from early bloom until about 30 days after bloom.

One disease, cedar-apple rust, will affect both the leaves and the fruit of apple. On leaves, pale yellow spots appear on the upper surface during May or June. These spots are up to 1/4 inch in diameter, will turn orange with time, and often have a reddish border (Figure 146). Small black fungal bodies (pycnidia) form within the spots and may exude an orange fluid.

In time, yellow spots develop on the underside of the leaf. These spots thicken, and during late spring and early summer, a number of small, orange-yellow tubular projections (aecia) appear. These develop into open, cylindrical tubes that split toward the base into narrow strips and curl backward. Infected leaves may turn yellow and drop.



Figure 146. Cedar-apple rust leaf spot on upper surface of apple leaf.

Defoliation of rusted leaves is most common in dry summers. On fruit, similar yellow-orange spots appear, usually at or near the calyx end (Figure 147). These spots usually occur on immature fruit and are much larger than the spots on leaves (up to 3/4 inch in diameter). The light green color of the young fruit becomes a darker green around the infected area. The tube-like aecia may form on the slightly raised fruit lesions. Infected fruits are often stunted and misshapen and may drop early.



Figure 147. Symptoms of cedar-apple rust on apple fruit.

Cedar-quince rust affects only the fruit of apples. Infected fruit become puckered at the blossom end and later develop a sunken, dark green area. The flesh under the sunken, dark green area becomes brown and spongy. Apples are susceptible

to cedar-quince rust during the period from early bloom through third cover. Cedar-hawthorn rust has leaf symptoms similar to those caused by cedar-apple rust; however, fruit infection is rare.

Planting disease-resistant cultivars is one method of control. The disease can also be avoided by removing nearby worthless or wild junipers that are infected with the rust. Rust can be controlled with a fungicide spray program.

### **Fire Blight**

*Fire blight* is a common and very destructive disease of apples and pears caused by a bacterium. The disease is so named because infected leaves on very susceptible trees will suddenly turn brown, appearing as though they had been scorched by fire (Figure 148). Damage from fire blight on apple can range from delay of bearing in young trees due to frequent blighting of shoots and limbs, to loss of limbs or entire trees in older plantings as the result of girdling by fire blight cankers. Fire blight will also cause direct loss of fruit due to blighting of blossoms and young fruit.



Figure 148. Fire blight on apple twigs. Note the curved shepherd's crook at the tip of infected twigs.

Blossom and twig blight symptoms appear in the spring. Diseased blossoms become water-soaked and turn brown. The bacteria may then grow down into the blossom-bearing twigs (spurs). Leaves on the spur become blighted, turning brown on apple and black on pear. Droplets of milky tan-colored bacterial ooze may be visible on the surface of diseased tissue. These droplets contain millions of bacteria which can cause new infections.

Twig blight starts at the growing tips of shoots and moves down into older portions of the twig.

Blighted twigs first appear water-soaked and then turn dark brown or black. Blighted leaves remain attached to the dead branches through the summer. The end of the branch may bend over, resembling a shepherd's crook or an upside down J. As the fire blight bacteria move through blighted twigs into main branches, the bark sometimes cracks along the margin of the infected area on the main branch, causing a distinct canker.

Fire blight is one of the most difficult apple diseases to control, and there is no one procedure that will give complete control. However, by using an integrated approach, damage can be kept to a minimum.

The first line of defense is to plant cultivars of apples and pears that are less susceptible to the disease. Fire blight is generally a serious problem on most of the more desirable pear cultivars, with Bartlett pears being very susceptible to fire blight. Pear cultivars that are resistant to fire blight include Magness, Maxine, and Honeysweet.

Next, prune out fire blight cankers and blighted twigs. By doing this during the dormant season (winter), there is much less chance of spreading bacteria. Branches that are more than half-girdled by cankers should be removed. Cut off blighted twigs by making cuts at least four inches below the visible dead wood. Cankers can be cut out of trunks or large branches by removing dead tissue down to wood that appears healthy.

During the growing season, sanitation methods for fire blight consist of thoroughly examining the trees at least once a week from the time blossoms appear in the spring until late June and immediately removing all blighted twigs, spurs, etc. If blighted twigs are pruned out during summer, cuts should be made 12 to 15 inches below diseased wood, and pruning tools should be disinfested by dipping in a 1:10 solution of household bleach in water after each cut.

Follow good pruning and fertilization practices, avoiding heavy applications of nitrogen which cause lush growth that is more susceptible to infection. Terminal growth on susceptible cultivars should not exceed 12 inches per year.

### **Black Rot and Frogeye Leaf Spot**

*Black rot* and *frogeye leaf spot* are caused by the same fungus and are phases of a widespread and

damaging disease of apple and crabapple. The fruit rot phase is called black rot, and on the leaf it is called frogeye leaf spot. The disease can result in rotting of fruit both before harvest and in storage, a weakening of the tree from defoliation, and a blighting and dieback of twigs and limbs from cankers. The premature dropping of infected leaves results in small, poor-quality fruit and reduces crop yield the following year. All apple cultivars appear to be equally susceptible to fruit rot. Jonathan and Winesap appear to have the greatest susceptibility to leaf infection.

Symptoms on the fruit usually start at the calyx or blossom end of the fruit. The fungus usually enters the fruit through wounds caused by insects, hail, growth cracks, or an open calyx tube. At first, a light brown spot forms on the fruit. Usually only one spot occurs per fruit. With time, the spots enlarge and commonly develop a series of brown and black concentric bands or rings (Figure 149). The rotted fruit finally turns black.

The decayed tissue remains firm to leathery and holds its original shape until the entire fruit is rotted. The completely decayed fruit finally dries and shrivels into a wrinkled black mummy that may remain on the tree a year or longer. Black, pimple-like fruiting bodies (pycnidia) of the causal fungus appear on the surface of rotted fruit. In cold storage, the flesh of black rot-infected fruits remains firm, in contrast to several other apple rots.



*Figure 149. Golden delicious apple fruit with black rot on calyx end.*

Starting at petal-fall or somewhat later, small, purple specks appear on infected leaves. These specks enlarge to form spots 1/8 to 1/4 inch in diameter. The round to irregularly lobed spots develop a light brown-to-gray center surrounded by one or more dark-brown concentric rings and a purple margin giving it a “frogeye” appearance (Figure

150). Black pycnidia, like those that appear on rotted fruit, may develop on the upper surface in the centers of the older leaf spots. These pycnidia help to distinguish frog-eye leaf spots from similar spots caused by spray injury.



Figure 150. Frog-eye leaf spot on apple leaf.

On the twigs, limbs and trunk, small, slightly sunken, reddish-brown areas develop in the bark. These areas slowly enlarge and darken to form cankers. Cankers may continue to expand a little each year and may extend down the limb for three feet or more. These areas remain somewhat sunken, except for the slightly raised and lobed margin.

Cankers may appear as a superficial roughening of the bark, or the bark may be killed and conspicuously cracked, especially at the margins. In recently killed areas, the bark is firmly attached to the wood, but after a year or so, it cracks and falls away and can be easily removed from the wood. Black pimple-like pycnidia and another very similar fungal fruiting structures (*perithecium*) are usually abundant in older cankers.



Figure 151. Black rot canker on apple limb.

The use of fungicides combined with good sanitation is beneficial for controlling the fruit rot phase of the disease. Piles of prunings are an important source of inoculum and should be removed from the perimeter of the orchard or burned. Removing mummified apples and pruning out dead wood in the tree are important for reducing the inoculum within the tree.

Pruning out current-season shoots infected with fire blight is also important, because they can be colonized and serve as an inoculum source during the same growing season. Any practice that helps to maintain trees in a healthy vigorous condition is critical for controlling the canker phase of the disease.

Cankers generally develop only on stressed or weakened trees. Prune trees annually and maintain a balanced fertility program based on soil and foliar nutrient analysis. Cankers generally develop rapidly on winter-injured trees. Fungicides are not effective for controlling the canker phase of the disease on weakened trees.

#### ***White Rot and Botryosphaeria Canker of Apple***

*White rot* of apple fruits is also referred to as *Bot Rot* or *Botryosphaeria rot*. The fungus that causes fruit rot can also cause a canker on limbs and other above-ground woody portions of the tree. The canker phase of the disease is most severe in trees weakened by drought, winter injury, sunscald, poor pruning, low or unbalanced nutrition, and other plant diseases. The fruit rot phase can be sporadic in appearance, being serious one season and difficult to find in the following season.

The *Botryosphaeria* fungus attacks a wide range of woody plants that are common in Ohio. Dutchess, Golden Delicious, Grimes Golden, Gallia Beauty, Rome, and Yellow Transparent apple cultivars are all very susceptible to fruit rot. Jonathan and Red Delicious are less likely to be affected than other cultivars.

On the fruit, small, reddish-brown spots appear around the lenticels (Fig 152). The spots enlarge and become slightly depressed. On yellow-skinned cultivars, these spots may be bordered by one or more red “halo” rings. Spots on red-skinned apples often become bleached. The tissue under the spots is soft and egg shaped, with the long axis parallel to that of the core. Several spots may merge to involve all or much of the fruit.

As the rot progresses, the skin color becomes dark brown and superficially resembles black rot, except that with black rot the decayed tissue is firm, instead of soft and mushy. Beads of exudate appear on the surface of fruits completely rotted by white rot. Small, black fruiting bodies (pycnidia) that are filled with spores (conidia) develop on the surface of rotted fruits during warm, moist conditions.

Mature fruits are most susceptible to the disease. Apple fruits often become infected from mid-summer on without showing external symptoms. Thus, fruit may be infected without symptoms appearing in the orchard.



Figure 152. Early stages of white rot on Golden Delicious apple fruit.

The canker phase causes small circular spots or blisters to appear on the twigs in June and July. The spots enlarge, become somewhat sunken, and fill with a watery fluid. The fungus may grow rapidly through the tissues to form slightly sunken, dark-colored cankers that may extend to the cambium on very susceptible apple cultivars. Under favorable conditions, several cankers may fuse to girdle and kill large limbs.

On older cankers, the outer bark becomes tan to orange and papery, and the margins of the canker crack and fissure (Fig 153). The outer bark sloughs off, and the underlying tissue appears slimy. In the fall, twig and limb cankers stop growing and may split along the edges. Rings of small, black, spore-producing bodies are formed on the surface of the cankers or under the papery outer bark. The following spring, a canker may resume growth or be corked off and become inactive.



Figure 153. *Botryosphaeria* canker (white rot) on apple limb.

The use of fungicides combined with good sanitation is beneficial for controlling the fruit rot phase of the disease; however, fungicides are not effective for controlling the canker phase of the disease on weakened trees. Removal of mummified apples and pruning out dead wood in the tree are important for reducing the inoculum within the tree. These prunings then need to be removed from the perimeter of the orchard or burned. Pruning out current-season shoots infected with fire blight is also important, because they can be colonized and serve as an inoculum source during the same growing season.

### **Sooty Blotch and Flyspeck**

*Sooty blotch* and *flyspeck* are two different diseases that often occur together on the same fruit. Sooty blotch and flyspeck are caused by different fungi and cause a discoloration or blemish on near-mature fruit. These diseases are a serious problem in commercial production where blemish-free fruit is mandatory. For homeowners, the superficial blemishes can be removed with the peel, and the remaining fruit is normal.

Although all apple cultivars are susceptible to infection by both fungi, symptoms are most severe on yellow or light-colored cultivars such as Golden Delicious or Grimes. Both diseases are most common during years with a cool, wet spring, rains in late summer, and low temperatures in early fall.

For sooty blotch, brown to dull black sooty blotches with an indefinite outline form on the fruit



surface. The blotches may merge to cover practically the entire fruit (Figure 154). The sooty blotch fungus is restricted to the outer surface of the fruit, and in many cases, the blotches can be easily rubbed off. However, if infection occurs early in the season, you may need to rub or bleach the fruit vigorously to remove it.



Figure 154. Severe sooty blotch on a Golden Delicious fruit.

For flyspeck, groups of six to 50 or more black and shiny round dots that resemble fly excreta appear on the surface of the fruit (Figure 155). The individual flyspeck are clearly separated and can be easily distinguished from sooty blotch. Like sooty blotch, flyspeck infections are superficial; however, they are usually harder to rub off than sooty blotch.



Figure 155. Flyspeck on apple fruit.

Any practice that opens up the trees to greater air movement and promotes faster drying will help in controlling these diseases. This can include locating the orchard in an area that provides plenty of sunlight and air movement as well as pruning trees annually to provide an open center for maximum air movement. For the back-yard fruit grower, it

should be remembered that the results of this disease are very superficial and rarely affect the quality of the fruit. Removal of the fungus by washing, rubbing, or peeling the fruit results in fruit that is acceptable for cooking or eating fresh.

## Apple and Pear Insects

### Codling Moth

The *codling moth* is one of the most serious pests of apples. It also attacks pears, crabapples, English walnuts, quince, and other fruits. The larva is the familiar worm in the apple. The larva usually tunnels to the core of the apple, oftentimes making it unfit for people to eat. As it feeds, it pushes out a mass of chewed material, or excrement, called frass, which accumulates around the entrance hole.



Figure 156. Codling moth larva and its damage to an apple.

Photo by Doug Wilson, USDA/ARS. Used with permission.



Figure 157. An apple with codling moth damage.



*Figure 158. Codling moth damage. Note the excrement, or frass.*

The codling moth overwinters as a fully grown larva in a silken cocoon, usually located under loose bark on the tree trunk and limbs. Cocoons can also be found in other places in the orchard such as in brush, on fence posts, in cracks in the soil, and on harvesting crates. The larva transforms into a pupa and later into a grayish-brown moth.

The moth is distinctive because its wings are crisscrossed with lighter gray lines, and there is a bronze or copper-colored patch near the outer edges of the forewings. The moth is 5/16-inch long when it is at rest with its wings folded and has a 11/16-inch wingspan. The first moths of the season usually appear as the last petals fall from the apple blossoms. The peak of moth emergence is usually about two weeks later, depending on weather conditions. About three days after emergence, the female moths begin to lay single eggs on the fruit and leaves. Each female lays an average of 50 to 60 eggs, and the eggs hatch in eight to 14 days.

The newly hatched larva is yellowish-white with a black head; it immediately begins crawling to seek a fruit on which to feed. On the fruit, the larva wanders about seeking a rough area, such as the calyx end or scab spot, in which to make an easier entrance into the fruit. Early in the season, the favorite point of entrance is apparently through the calyx, but later many larvae attack the side of the apple. The larva spends about three weeks feeding and growing. The fully grown larva is one-half-inch long, white, with a pinkish tinge on the upper surface, and has a brown head.

When nearly full-grown, the larva leaves the fruit by either enlarging the entrance burrow or cutting a new channel to the outside. On leaving the fruit,

it seeks a suitable place to spin a cocoon similar to the type described for the overwintering larva. Although a number of these larvae can remain in cocoons until the following spring, especially in northern Ohio, many emerge as adults in 12 to 21 days. This summer brood of adults usually starts emerging sometime in July. The peak of summer moth emergence occurs about the first of August in northern Ohio, with the last emergence about September 1. In southern Ohio, these dates can be seven to 10 days earlier, and in extreme northern Ohio, two to eight days later.



*Figure 159. Adult of a codling moth. Photo by Scott Bauer, USDA/ARS. Used with permission.*

Nature sometimes helps in controlling the codling moth. Birds are important predators of hibernating larvae that are under loose bark, and parasitoids can attack eggs and larvae of the developing codling moth. A cultural practice that can help to reduce problems with codling moth is picking up and placing fallen fruits in a plastic bag and putting the bag in the trash weekly or disposing of the fallen fruit in a compost pile. Larvae in these fruit will then not reach adulthood in your orchard.

Another option is to attach corrugated cardboard strips tightly to the tree trunk, and scaffold branches in June and August to provide a site for the larvae to make their cocoons. Then remove and destroy the strips after cocoons are formed but before moths emerge. Before the bands are attached, the bark should be scraped to remove loose pieces that would prevent a tight fit by the strips.

Yet another alternative is bagging of individual fruits. This practice can also help protect the fruit from apple maggot and flyspeck. Special two-layered fruit bags made in Japan or ordinary paper bags and twist ties can be used. Fruit should be bagged when it is one-half to three-fourths inch in diameter, which is usually about three weeks after petal fall. Bags should be removed two to three weeks before harvest to allow normal color develop-

ment. However, some worms always escape natural or cultural controls; therefore, chemical controls are usually needed to obtain good quality fruit.

Codling moth populations can be monitored by traps so that the best time for an insecticide spray can be determined.

### **Plum Curculio**

If you find that a lot of your fruit is dropping early and has crescent-shaped scars on it, you have seen the effects of the *plum curculio*. The adult plum curculio, which is rarely seen because it is active at night and drops to the ground when it is disturbed, is a small, hard-bodied, brownish-black weevil mottled with white and orange areas. It has four prominent black humps on its top surface. It is about one-fourth-inch long and has a long snout, the end of which bears chewing mouthparts.



*Figure 160. The adult plum curculio.*  
Photo by Dave Shetlar, The Ohio State University. Used with permission.

The insect overwinters as an adult under debris in and around the yard or in protected places in or near an orchard. In spring, shortly after peaches bloom or when apples are near the pink bud stage, the weevils come out of hibernation and begin to walk or fly to fruit trees to feed. Damage caused by this insect is a crescent-shaped scar on the fruit and excessive fruit drop. This insect can be found on apples, pears, quince, plums, peaches, and blueberries.



*Figure 161. The crescent-shaped scar caused by plum curculio.*

Both the adult and larval stages injure fruits. In spring, adults feed on buds, blossoms, leaves, and new fruits. Feeding scars appear as shallow cavities or raised bumps on the fruit surface. The major injury occurs from the laying of eggs by the adults. A small cavity is made in the fruit for the egg, then a crescent-shaped cut is made adjacent to the egg pocket. Fuzz on peaches makes it difficult to see this egg scar. The early feeding and egg-laying punctures can cause marked scarring and malformation of the fruit. Early feeding on the surface of peaches is one of the causes of severely deformed fruits known as cat-faced peaches.

After eggs hatch, plum curculio larvae feed inside the fruit until they are fully grown. Larvae usually complete development in peaches and plums. On some fruits, such as most apples, few if any of the young larvae survive to maturity if the fruits continue to grow on the tree. Larval feeding in apples can cause distortion of the fruit. The mechanical injury by adults in feeding and egg deposition can cause premature fruit drop. When the summer brood of adults appears in August, feeding cavities can be found on the fruits.

A helpful form of cultural control of plum curculio is to pick up fallen fruit two to three times a week, put them in a plastic bag, tie it tightly, and place it in the trash can or dispose of the fruit in a compost pile. This will help keep larvae in fallen fruit from developing in the soil and, if done regularly, should lessen the damage done by this insect.

Mechanical control, by jarring the sluggish weevils from trees in the morning and capturing them on sheets, was an early method of control and can still be practical today on a small scale. Natural control of the curculio results from winter mortality, attacks by birds and other predators, and from parasitoids.

To control the curculio chemically, only two sprays are needed. The first should be applied at petal fall, and the second spray applied seven to 10 days later. This should control the curculio enough to help prevent excessive fruit drop. Feeding damage by curculio later in the season is normally not sufficient to warrant a pesticide application.

### **Apple Maggot**

*Apple maggot* larvae are white, tapered maggots that tunnel at random throughout the flesh of the fruit, usually avoiding the core. Rapid decay and

browning along the trails in infested fruit occur as the maggots feed. External signs of maggot infestation are the minute brownish egg punctures in the skin. The adult fly is a little more than one-fourth inch in length, dark brown, with a distinct white spot on the thorax and dark markings on the wings. Female flies lay eggs just under the skin of the apple. These are often small, distorted, or pitted areas on the surface of the apple, and sometimes a white wax covers the puncture.



Figure 162. External signs of apple maggot infestation.



Figure 163. Internal damage from apple maggot.



Figure 164. Adult of an apple maggot.

In Ohio, the apple maggot overwinters as a pupa in the soil. Adult flies begin emerging from the pupae in late June and continue for a month or more. The peak emergence occurs from late July to early August, but some adults emerge in September.

Apple maggot infestations can be effectively prevented by the use of sticky red ball traps that attract and catch the adult female apple maggot flies before they lay their eggs on apple fruit, if used at a rate of one ball trap per 100 apple fruits (Figure 136). Maggot traps should be placed in trees from mid-June until mid-August.

To help reduce the number of apple maggots that winter over from year to year, dropped fruits of early cultivars should be collected two to three times per week and those of later cultivars at least once per week. These fruit should then be put in a tightly sealed plastic bag and placed in a garbage can or disposed of in a compost pile. In addition, the removal of hawthorn, plum, pear, crabapple, and cherry, which are alternate hosts, from the vicinity is a good practice.

Spraying is the most reliable method of reducing maggot injury to apples. Sprays for maggots should be applied in late June, mid-July, late July, and again in mid-August.

#### **San Jose Scale**

*San Jose scale* can infest apples, pears, peaches, and plums. The young crawlers feed on limbs, leaves, and fruit, causing red, spotted areas. Infested leaves usually drop, and limbs lose vigor and die. Fruit will have an undesirable finish because of the red, spotted appearance caused by scale feeding and the presence of the scale.

The yellow female is underneath a gray, round, and flattened scale-like cap. When mature, the scale is about 1/20 inch in size. The male is a tiny, yellow, two-winged, gnat-like insect. The minute crawlers are orange-yellow and oval, and they have six legs. *San Jose scale* overwinters as a nymph under a scale on tree limbs and resumes feeding when sap begins to flow in the tree. In the spring, adult males emerge at the time of apple bloom (about early May) and seek out wingless females. Mating occurs, and crawlers emerge about one month later. These tiny yellow insects move around on bark, foliage, and fruit until they locate a suitable site to settle down permanently. Once settled, the crawler

sticks its mouthparts into the tree and secretes a waxy shell over its body. There are two or more generations per year.

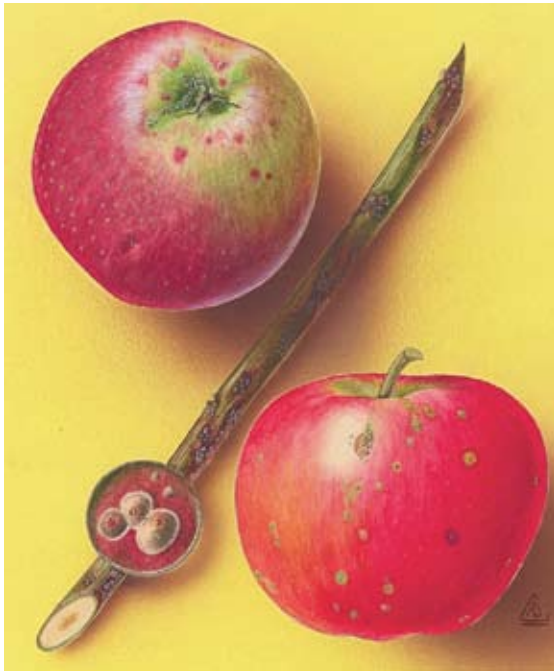

Figure 165. San Jose scale damage. Photo by Art Cushman, USDA; property of the Smithsonian Institution, Department of Entomology, Bugwood.org. Used with permission.

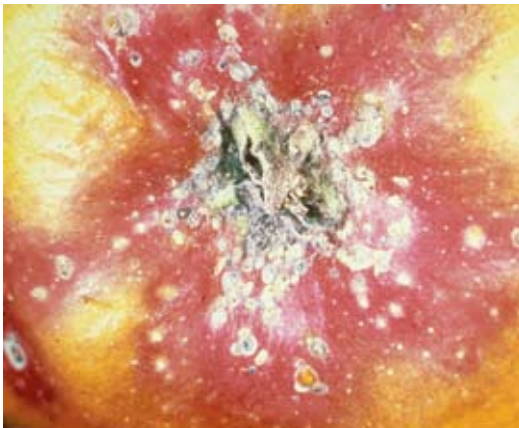

Figure 166. Close up of adult female *Quadraspidiotus perniciosus*, showing circular grey scale. Photo by Biologische Bundesanstalt für Land-und Forstwirtschaft Archive, Bugwood.org. Used with permission.

Examine twigs for scale during pruning operations. If twigs look unhealthy or are dead, examine them closely for the crusty scales. Look for the scales or their feeding blemishes on the fruit skin at harvest. If found, be prepared to control the scale the following spring because once an infestation is detected, it is unlikely to go away and will probably continue to get worse if no action is taken.

If an infestation is detected in its early stage, then dormant pruning of infested wood can help control the problem. The primary chemical control measure for the backyard fruit grower is to apply a dormant oil spray in the early spring before growth starts; however, foliar sprays can also be targeted at the crawler stage of this insect, usually in mid-June. To detect crawlers, place black sticky electrical tape around several infested branches, sticky side out, in late May or early June. Examine the tape several times per week, looking for tiny bright yellow crawlers.

### Mites

Mites suck sap from the leaves, causing them to turn an off-green color, eventually “bronzing” the tree. Infested trees are sickly looking, with the fruit and foliage smaller than on healthy trees, and fruit buds can be affected for the following season. Mites can be a problem on many types of tree fruit and small fruit.

The *European red mite*, the most common mite found on apple trees, passes the winter in the egg stage in cracks of the bark. Eggs begin hatching when some apple trees are in the pink bud stage, with the hatch usually completed in seven to 10 days. Young mites move to open leaves and begin feeding. In about nine days, the mites reach maturity, mate, and females begin laying eggs. Several generations are produced each year. The mites and eggs can be observed with the use of a 10x to 15x hand lens.

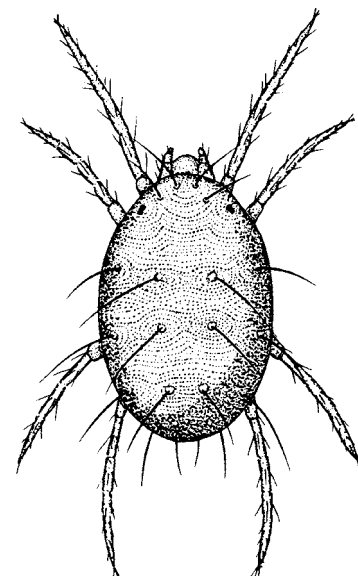

Figure 167. *European red mite*.



Figure 168. Egg masses of European red mite.

European red mite is more troublesome on Red Delicious and Fuji apples than on other cultivars. Other mites that cause problems include the *two-spotted spider mite* (see under strawberries) and *rust mites*.

To control mites, apply an oil spray in the spring. Oil controls mites best if applied at the half-inch green to tight cluster bud stage. Do not apply oil on the day before or the day after temperatures are close to freezing. Insecticidal soaps or miticides can be used if mites flare up during the growing season; however, care needs to be taken to not over-use miticides because a resistance to them can quickly build up.

### **Aphids**

Aphids are soft-bodied insects that feed on sap from several different areas on the trees. Tail-pipe type appendages on their back (properly called cornicles) help make them easy to identify. Various aphids can be found in an apple orchard, including the *Spirea aphid* and the *apple grain aphid*, but the most common type is the *green apple aphid*. Most aphids feed on the young leaves on the tree, sometimes causing twisting of the leaves and twigs.



Figure 169. Aphids. Shown here are green apple aphids.

A secondary effect of aphids on trees is the growth of a sooty mold on the leaves and fruit where the aphids have secreted a sweet, sticky substance called honeydew. The presence of the sooty mold can interfere with photosynthesis by the leaves as well as giving an unsightly appearance to the fruit. Aphids generally overwinter as eggs on the tree with the eggs hatching about the time the buds show green. The young aphids will then start feeding on the buds, flowers, and leaves. As these young aphids mature in two to three weeks, they give birth to live young rather than laying eggs.

*Rosy apple aphid* is not as common as green apple aphid, but it causes greater damage. It feeds on leaves but causes nearby fruit to become dwarfed and deformed. The rosy apple aphid is a pinkish purple color and can be found before and during apple bloom.

The damage by the *woolly apple aphid* is different than the aphids mentioned previously as it feeds on the more woody portions of the tree and may cause a decline or death of the tree. Above ground, it is often found on pruning cuts or wounds on the woody portions of the tree. However, colonies of this aphid may also be found feeding on the root system of the tree. Tree decline from woolly apple aphids feeding on the roots is likely to be more of a problem on young trees rather than mature ones.

Small populations of aphids can be tolerated and are often suppressed by naturally occurring predators such as lady beetles, lacewings, gall midge larvae, and hover fly larvae. Green apple aphid is easily monitored by checking the bottom sides of young terminal leaves. Examine three to 10 growing shoots from each of five to 10 trees.

When predators are too few and conditions are favorable for aphid reproduction, aphid populations can quickly grow to high densities. Dormant oil sprays can be used to reduce the number of overwintering eggs, or foliar applications of pesticides can be made during the growing season if aphid numbers get high. Thorough coverage is important if foliar applications are to be successful.

### **Pear Psylla**

Found on pear trees rather than apples, the *pear psylla* is another insect that, like aphids, can cause problems by taking sap from the tree and producing sticky honeydew on the leaves. The presence of honeydew allows for the growth of a black sooty

mold that interferes with photosynthesis as well as giving an unsightly appearance to the tree and the fruit. By sucking sap from the foliage, psyllids cause a stunting of the twig and branch growth as well as a reduction in pear size.



*Figure 170. Pear with black sooty mold caused by honeydew from pear psylla.*

The adult pear psylla resembles a miniature cicada (1/10th of an inch in length), with large eyes and wings that are held roof-like over the body. The immature stage is yellowish with no wings. They overwinter as adults under the bark of the tree and under leaves and trash on the ground.



*Figure 171. Pear psylla adult—top view.*

Adults come out of hibernation early in the spring, and females lay eggs around the base of buds and smaller crotches of the twigs. Later, the eggs are deposited along the midribs, petioles of developing leaves, and on the stem and sepals of the blossoms. Egg laying continues until two to three weeks after petal fall, with each female laying up to 650 eggs.

The eggs hatch in one to two weeks. There are two to three generations per year. Psyllids are active primarily before succulent leaves have had time to harden off.



*Figure 172. Pear psylla adult—side view. Photo by Jack Dykinga, USDA/ARS. Used with permission.*



*Figure 173. Pear psylla nymph.*

Pear psyllids are fed on by many beneficial types of insects and therefore may not pose that much of a problem in the home orchard. Pruning or pulling off succulent water sprouts from the trunk in mid-summer is a helpful cultural control that removes the psylla's preferred habitat. However, if populations become high, chemical controls may be needed. Chemical control includes the use of a dormant oil spray applied before growth starts in the spring followed by two sprays spaced two weeks apart when young psyllids are present.

**Table 28. Cultural and Mechanical Practices for Disease and Insect Control on Apples and Pears and the Time of Year to Conduct Them.**

| <b>Time of Year for Conducting Various Cultural Control Practices</b>                                                                                                                                                                                                                | <b>Problem Targeted</b>                                                                 |
|--------------------------------------------------------------------------------------------------------------------------------------------------------------------------------------------------------------------------------------------------------------------------------------|-----------------------------------------------------------------------------------------|
| <b><i>When establishing a planting</i></b>                                                                                                                                                                                                                                           |                                                                                         |
| Choose a well-drained sunny location. If the only site available is wet, then improve soil drainage by ditching and tiling. Plant only in an open area with direct sunlight all day.                                                                                                 | Drainage for phytophthora root and crown rot. Direct sunlight for all other diseases.   |
| Buy nursery stock only from reputable growers; inspect all purchases to be free of galls, cankers, or rotted roots.                                                                                                                                                                  | Crown gall, phytophthora root and crown rot.                                            |
| Plant cultivars resistant to apple scab and other diseases (See Tables 2 and 3.)                                                                                                                                                                                                     | Apple scab, powdery mildew, fire blight, cedar apple rust.                              |
| If cedar apple rust is a problem in your area, do not plant apples near red cedars (junipers) if you have cultivars susceptible to cedar apple rust. Remove cedar apple rust galls from infected cedars (junipers).                                                                  | Cedar apple rust.                                                                       |
| <b><i>During winter—before growth starts in the spring</i></b>                                                                                                                                                                                                                       |                                                                                         |
| Prune out and destroy all dead or diseased shoots and limbs while trees are dormant (mid-March is usually a good time).                                                                                                                                                              | Fire blight, powdery mildew, summer rots.                                               |
| Prune healthy growth to improve air movement and sunlight penetration, to minimize shading and decrease drying time of leaves and fruit during the growing season. Minimize heavy pruning on pears.                                                                                  | Scab, powdery mildew, fire blight, summer rots, sooty blotch and flyspeck, pear psylla. |
| <b><i>During spring and summer</i></b>                                                                                                                                                                                                                                               |                                                                                         |
| Minimize nitrogen fertilizer application.                                                                                                                                                                                                                                            | Fire blight on apples and pears, and pear psylla.                                       |
| Remove cedar apple rust galls from infected cedars (junipers) early in the spring.                                                                                                                                                                                                   | Cedar apple rust.                                                                       |
| Place paper bags over individual fruit when one-half to three-fourths inch in diameter, which is about three weeks after petal-fall.                                                                                                                                                 | Codling moth, apple maggot, flyspeck.                                                   |
| Remove and destroy fruit with insect entry or exit holes.                                                                                                                                                                                                                            | Codling moth, apple maggot.                                                             |
| Collect and destroy prematurely fallen fruit.                                                                                                                                                                                                                                        | Codling moth, apple maggot, plum curculio.                                              |
| Strap six-inch-wide corrugated cardboard strips around tree trunk to provide site for codling moth to pupate. For first generation, place on tree in early June, remove and destroy in mid-July. For second generation, place on tree in early August, remove and destroy in winter. | Codling moth.                                                                           |
| Hang red sticky balls to attract and kill apple maggot (adult females) before eggs are laid, from mid-June to mid-August.                                                                                                                                                            | Apple maggot.                                                                           |
| Remove water sprouts on pears in mid-summer.                                                                                                                                                                                                                                         | Pear psylla.                                                                            |
| If watering is needed during dry periods, irrigate the soil around trees rather than using overhead sprinklers.                                                                                                                                                                      | Scab, mildew, fire blight and summer rots.                                              |
| <b><i>In the fall</i></b>                                                                                                                                                                                                                                                            |                                                                                         |
| Collect and destroy all leaves, including those from nearby flowering crabapples.                                                                                                                                                                                                    | Apple scab, pear scab, leaf spot.                                                       |
| On nearby cedars (junipers), remove and destroy all galls of cedar apple rust that were missed in the spring.                                                                                                                                                                        | Cedar apple rust.                                                                       |



## Stone Fruit Diseases

### *Peaches, Nectarines, and Apricots*

#### **Brown Rot**

*Brown rot* is caused by a fungus and is one of the most common diseases of stone fruit. The symptoms of brown rot are very similar on all stone fruit. Symptoms first appear in the spring as the blossoms open. Diseased flowers wilt, turn brown, and may become covered with masses of brownish-gray spores. The diseased flowers usually remain attached into the summer.

Young fruits are normally resistant but may become infected through wounds. As fruits mature, they become more susceptible to attack, even in the absence of wounds. Thus, fruit rot is most common at or near harvest. Fruit infections appear as soft brown spots that rapidly expand and produce a tan powdery mass of conidia (fungal spores) (Figures 174 and 175). The entire fruit rots rapidly, then dries and shrinks into a wrinkled mummy (Figure 176). Rotted fruit and mummies may remain on the tree or fall to the ground. Fruit infection may spread rapidly, especially if environmental conditions are favorable (wet) and fruits are touching one another.



Figure 174. Brown rot on peach fruit. Note the fungus is also infecting the twig.



Figure 175. Brown rot on cherry fruit.



Figure 176. Brown rot mummy from an infected peach fruit.

The fungus may move from diseased blossoms or fruit into the spurs. The fungus may then invade and cause diseased areas (cankers) on the twigs below. Succulent shoots are sometimes infected by direct penetration near their tip. A canker may form encircling the twig, causing death of the twig beyond the canker (twig blight).

Any type of injury to the fruit will provide entry points for brown rot spores. Insect and hail wounds, fruit cracking, limb rubs, twig punctures, and a variety of picking and packing injuries greatly increase the losses due to brown rot. Growers must realize that brown rot spores are practically everywhere during the fruit-ripening period. Infection is almost certain to occur if the weather is moist and if the fruit skin is broken in some way. Sanitation is very important in controlling brown rot. All dropped and rotted fruit should be picked up and destroyed promptly. At the same time, remove all mummies from the trees. Prune out all cankers during the dormant season. Control of insects that feed on fruit is also essential.

Remember that anything that causes wounding of the fruit will increase the incidence of brown rot. Special care should be taken during harvesting and packing to prevent puncturing or bruising of ripe fruit. The use of fungicide is also an important part of the disease-management program for brown rot.

#### **Peach Leaf Curl**

*Peach leaf curl* is a springtime disease that occurs on peach, nectarine, and related ornamental

plants. The disease, though not a problem every spring, can be severe during cool, wet springs that follow mild winters. The leaf curl fungus damages peach trees by causing an early leaf drop. This weakens the trees, making them more susceptible to other diseases and to winter injury. Weakened trees also will produce fewer fruit the following season. Yield may be further reduced when blossoms and young fruit become diseased and drop. Developing leaves become severely distorted (thickened and puckered) and have a reddish or purple cast (Figure 177). Later, as spores form on the leaf surface, the leaves become powdery gray in color. Shortly after this, the leaves turn yellow or brown and drop. The fungus survives the winter as spores on bark and buds. Infection occurs very early in the growing season. During cool, wet spring weather, new leaves are infected as they emerge from the buds. The leaves are susceptible for only a short period. As the leaves mature they become resistant.

Leaf curl is not difficult to control. Since the fungus survives the winter on the surface of twigs and buds, a single fungicide spray applied while the trees are dormant (just prior to bud swell), thoroughly covering the entire tree, will provide control. If leaf curl does result in significant defoliation in the spring, the fruit on affected trees should be thinned to compensate for the loss of leaves. Over-cropping the tree will weaken it and make it more susceptible to winter injury.



Figure 177. Peach leaf curl.

### **Scab**

The *scab* fungus affects fruit, leaves, and young green twigs, with the principle loss being the unsightly spotting of the fruit skin. Premature defoliation and a dieback of infected twigs can also

occur. Scab is most common in home orchards where fungicide spray programs are not practiced. Losses are generally greater on peaches than on nectarines, plums, and apricots.

Lesions on fruit are very superficial and are removed with the peel. For the homeowner, infected fruit may be perfectly good for cooking or fresh eating. However, losses can be greatest for commercial growers who must provide blemish-free fruits. This disease is most often observed on fruit as small, greenish, circular spots on the surface. Spots usually appear when fruit is half-grown and are concentrated at the stem end. Older spots become black and velvety (Figures 178 and 179). Scab is controlled primarily with fungicide sprays.



Figure 178. Peach scab on fruit.



Figure 179. Severe peach scab on fruit.

### **Bacterial Spot**

*Bacterial spot* affects peaches, nectarines, apricots, plums, prunes, and cherries and can affect leaves, twigs, and fruit. Severe infection results in reduced fruit quality and yield. Fruit infection is most serious on late-maturing cultivars. If proper environmental conditions occur, up to 50 percent or more of the fruit of susceptible cultivars may have to be discarded.

Defoliation by bacterial spot may weaken the tree, making it more susceptible to winter injury and attack by other diseases. The disease is usually more severe where soils are light and low in fertility.

Vigorous trees are usually less susceptible to the disease than devitalized, neglected trees.

Small (1/25 to 1/5 inch) spots form in the leaves. Spots are irregular to angular and have a deep purple to rusty-brown or black color. In time, the centers dry and tear away leaving ragged shot-holes (Figure 180). When several spots merge, the leaf may appear scorched, blighted, or ragged. Badly infected leaves may turn yellow and drop early.

Nitrogen deficiency can cause leaf symptoms that are very similar to those of bacterial spot. In both cases, the leaves of affected trees turn yellow and drop prematurely. With bacterial spot, symptoms are most likely to appear at the tip of the leaf, but with nitrogen deficiency, symptoms are usually most evident along the midrib. Leaf tissues surrounding shot-holes caused by a nitrogen deficiency are more likely to have a reddish color than when bacterial spot is involved.



*Figure 180. Bacterial spot on peach leaves.*

On the fruit, this disease causes small, round, olive-brown to black spots to form (Figure 181).

They are usually sunken and frequently surrounded by a water-soaked margin. On peaches, spots usually form on the side exposed to the sun. Spots may slowly enlarge and merge to cover large irregular areas on the fruit. On some cultivars, the spots may exude a yellowish gum after rainy periods. Skin cracking and pitting may occur near the spots during fruit enlargement. Fruit infected at an early stage of development are usually the most malformed.

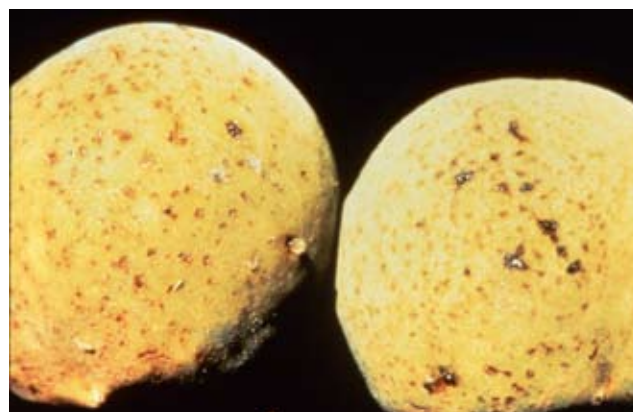

*Figure 181. Bacterial spot on peach fruit.*

On plums, however, symptoms are different than on peaches. Large, sunken, black spots form on some cultivars; on others, small pit-like lesions are common.

Bacterial spot will also cause cankers to form on the twigs. Spring cankers develop on young twigs produced the previous summer. Spring cankers first appear as water-soaked, slightly darkened blisters about the time the first leaves appear. If these cankers encircle the twig, it will die. As the season progresses, the tissues over the blister-like lesions rupture, and bacteria are released. These bacteria can be spread by windblown or splashing rain and can result in new infections. In time, spring cankers heal and become inactive.

Summer cankers develop on green twigs of the current season's growth. They usually occur later in the summer after leaf spots are evident. At first, they are water-soaked, dark purplish spots. In time, they enlarge, turn brown to purple-black, become slightly sunken, and are round to elliptical with water-soaked margins.

To help avoid bacterial spot, select peach cultivars with resistance to bacteria spot. Belle of Georgia, Biscoe, Candor, Comanche, Garnet Beauty, Harbrite, Harken, Late Sunhaven, Loring,

Madison, Norman, Pekin, Raritan Rose, Redhaven, Redskin, and Sunhaven are all considered to be somewhat resistant while Babygold S, Blake, Elberta, Halehaven, Jersey Queen, Jerseyland, July Elberta, J. H. Hale, Kalhaven, Rio-Oso-Gem, Suncling, Suncrest, and Sunhigh are all considered to be very susceptible to bacterial spot.

Planting your trees in an area with good air circulation and water drainage and pruning to provide an open canopy and maintain tree vigor will also help. There are no pesticides considered to be completely effective for controlling this disease.

### **Peach Canker**

*Peach canker* (sometimes called *perennial* or *cytospora canker*) is a disease common on apricot, prune, plum, and sweet cherry trees as well as on peach trees. The disease is common in peach orchards and is a frequent cause of limb dying and death of peach trees. The fungi that cause this disease enter the plant through wounds, resulting in dead and weakened twigs and branches, and in reduced yields.

The first symptoms appear in early spring as gummy drops of sap around wounded bark. The diseased inner bark begins to break down, causing the cankered surface to appear depressed. Black specks, which are fungal spore-producing bodies, appear on the bark surface or under the bark tissue. During wet periods, spores ooze out of these fungal bodies in tiny orange or amber-colored curled strands. During the summer, healthy bark (callus tissue) grows over the edges of the narrow, oval-shaped cankers.

In the fall, the fungus resumes growth, attacking and killing the new callus tissue. Over a period of years, a series of dead callus ridges form as the canker gets larger. Eventually, the canker may completely surround a branch (Figure 182). The portion of the branch beyond the canker then dies.

Large amounts of gum are usually produced around cankered areas. Peach canker is often confused with other problems that cause cankering and gumming. Among these are bacterial canker, insect borer injury, and mechanical injury. When insects are involved, chewed-up wood dust is usually visible under the gum. Mechanical injury can often be verified by carefully reviewing recent operations in the area.



*Figure 182. Perennial canker on peach limb.*

There are a number of cultural controls that can help to avoid peach canker. Promote vigorous, healthy trees with proper fertilization, pruning (avoid narrow-angled crotches), and water. Prune in the early spring (this promotes quick healing), including the removal of cankered branches and dead wood, making sure to cut flush to the next larger branch. Also make sure to remove or burn all infested branches as they can serve as a source of infection for the orchard.

Prevent wounds to the tree by avoiding mechanical injury as well as controlling boring type insects. If limbs are damaged during the growing season, pruning them back to the growth collar should be done immediately to encourage quick healing rather than waiting till the trees are dormant. Applying a white latex paint to the southwest side of trunks and lower scaffold branches may help avoid bark cracking associated with cold injury.

### **Plums and Cherries**

#### ***Black Knot of Plum and Cherry***

*Black knot* is caused by a fungus and is a common disease in the Midwest on wild plums and cherries and in home orchards where pruning and spraying are not regularly practiced. The disease becomes progressively worse during each growing season, and unless effective control measures are taken, it can stunt or eventually kill the tree. The black knot fungus can infect American, European, and Japanese cultivars of cultivated plums and prunes. Sweet, tart, and Mahaleb cherries are also affected by the fungus, but they are generally less susceptible than plum or prune. Occasionally, the fungus may also infect apricots, peaches, and other *Prunus* species.

The black knot fungus mainly affects twigs, branches, and fruit spurs. Occasionally, trunks may also become diseased. Usually, infections originate on the youngest growth. On infected plant parts, abnormal growth of bark and wood tissues produces small, light-brown swellings that eventually rupture as they enlarge.



*Figure 183. Black knot of plum. Note the hard black galls that are formed on plum twigs.*

In late spring, the rapidly growing young knots have a soft (pulpy) texture and become covered with a velvety, olive-green growth of the fungus. In summer, the young knots turn darker and elongate. By fall, they become hard, brittle, rough, and black (Figure 183). During the following growing season, the knots enlarge and gradually encircle the twig or branch. The cylindrical or spindle-shaped knots may vary from one-half inch to a foot or more in length and up to two inches in diameter. Small knots may emerge from larger knots, forming extensive galls.

After the second year, the black knot fungus usually dies, and the gall is invaded by secondary fungi that give old knots a white or pinkish color during the summer. Smaller twigs usually die within a year after being infected. Larger branches may live for several years before being girdled and killed by the fungus. The entire tree may gradually weaken and die if the severity of the disease increases and effective control measures are not taken.

Most plum cultivars grown in Ohio, including Stanley and Damson, are susceptible to this disease. It has been reported that Early Italian, Bradshaw, Fallenburg, Methley, and Milton are somewhat less susceptible than Stanley. Shiro, Santa Rose, and Formosa are much less susceptible, and President is apparently resistant to black knot. Japanese cultivars of plums are generally less susceptible than most American cultivars.

When planting new plum or prune trees, avoid planting trees next to or downwind from an old or abandoned orchard with a significant black knot problem. Similarly, remove all wild plum and cherry trees (potential disease reservoirs) from fence rows or woodlands next to the orchard site.

Trees should be scouted or examined each year for the presence of black knot, and infected twigs should be pruned out and destroyed (burned) or removed before bud break. It is important to prune at least two to four inches (5-10 cm) below each knot because the fungus grows beyond the edge of the knot itself. If pruning is not possible because knots are present on major scaffold limbs or the trunk, they can be removed by cutting away the diseased tissue down to healthy wood and out at least one-half inch beyond the edge of the knot.

Fungicides can offer significant protection against black knot, but are unlikely to be effective if pruning and sanitation are ignored. The timing of fungicide sprays should be adjusted to account for inoculum levels and weather conditions. Where inoculum is high because of an established black knot problem or a neighboring abandoned orchard, protection may be needed from bud break until early summer. Where inoculum has been maintained at low to moderate levels, sprays are most likely to be useful from white bud through shuck split. Fungicides are most necessary and will provide the greatest benefit if applied before rainy periods, particularly when temperatures are greater than 55°F.

### **Cherry Leaf Spot**

*Cherry leaf spot* is caused by a fungus and only affects sweet and tart cherries. During the latter part of May and the first half of June, small circular purple spots appear on the upper surface of cherry leaves (Figure 184). Spots gradually enlarge to about one-fourth inch in diameter and turn reddish-brown. Lesions may merge to produce large,

irregular spots. Whitish-pink masses of sticky fungal spores form within the spots on the undersides of infected leaves during periods of damp weather.



Figure 184. Cherry leaf spot.

After six to eight weeks, the centers of the spots may dry up and drop out, giving a shot-hole appearance. The shot-hole effect is more common on sour than on sweet cherries. Diseased leaves drop prematurely, and severely affected trees may be defoliated by mid-summer. Early and repeated defoliation can result in reduced fruit quality, stunting of the tree, and possibly eventual death of the tree.



Figure 185. Leaves usually turn yellow or gold before they drop prematurely.

The most conspicuous symptom, especially on sour cherries, is the golden yellowing of older infected leaves before they drop off (Figure 185). Although this symptom does not occur every season, the spotting of infected leaves is always visible. Spots similar to those on the leaves may also form on leaf petioles and fruit pedicels, causing fruit to ripen unevenly. Spots usually do not form on fruit. The fungus overwinters in the leaves; therefore, collecting and destroying the fallen cherry leaves in late autumn should be quite beneficial for backyard growers with just a few trees (Table 29). Any practice that promotes faster drying of leaves will also reduce the risk of infection. This includes

selecting a planting sight that is always exposed to direct sunlight and has good air circulation and soil drainage. Proper pruning to open the canopy will help by increasing sunlight penetration and air circulation.

## Stone Fruit Insects

### *Oriental Fruit Moth*

The *Oriental fruit moth* can cause two types of damage to your fruit planting. Symptoms of the initial damage found each season include a wilting and dieback of the terminal end of new shoot growth. This is caused by larvae feeding inside the twigs. Later in the season, larvae can feed inside the fruit and cause extensive damage. Though primarily a pest of stone fruits, the *Oriental fruit moth* is also known to cause damage to apples and pears.



Figure 186. Wilting and dieback of the terminal end of the new shoot in stone fruits caused by the *Oriental fruit moth*.



Figure 187. Damage to fruit by *Oriental fruit moth*.

The adults are small, grayish brown moths, with wings silvery on the undersurface and figured with

light, wavy lines above. The wingspread is about one-half inch; body length is about one-third inch. The newly hatched larva is white with a black head and measures less than a tenth of an inch in length. When full grown, the larva has a brownish head and a pink body and is about one-half inch long.



**Figure 188. Oriental fruit moth adult.**  
Photo by Eric LaGasa, Washington State Department of Agriculture. Bugwood.org. Used with permission.



**Figure 189. Larva of Oriental fruit moth.**  
Photo by Clemson University-USDA Cooperative Extension Slide Series. Bugwood.org.

The Oriental fruit moth has three full generations and occasionally a partial fourth generation each year. The moths overwinter as full-grown larvae in cocoons in tree bark crevices, weed stems, and trash on the ground. In the spring, the larvae turn into pupae and then emerge as adults about the time the peaches start to blossom. The adults lay their eggs, which hatch within about a week. Larvae from the first generation primarily bore into the twigs with little damage to the fruit. However, the second and third generation larvae can cause considerable fruit damage. A symptom of this fruit feeding is a gummy excretion mixed with frass on the surface of the fruit.

Naturally occurring parasitic insects may parasitize a large percentage of the Oriental fruit moth eggs or larvae. If wilting tips are found in the spring, prune them off and destroy them to help prevent the larvae from reaching maturity. If insecticides are to be used, pheromone traps are available that can be used to monitor the moth flight and help to determine the best timing of the spray schedule.

The Oriental fruit moth trap uses a sex pheromone lure that attracts only adult male Oriental fruit moths. The lure should be placed in a sticky cardboard trap or a bucket-style trap. The trap should be set up at bloom.

The best time to spray insecticide for Oriental fruit moth control is when eggs are hatching. A rough rule for the best time to spray is about two weeks after the first moth is trapped or one week after peak catch. A more refined rule is to calculate *degree days* (base 45°F) after sustained trap catch begins and spray after 150 degree-days have accumulated. Each day, the number of degree-days is the average temperature minus the base temperature. For a base of 45°F, daily degree days = [(maximum temperature + minimum temperature) / 2] - 45.

Getting good control of the first generation by pruning or insecticides can help to avoid problems from the later ones.

#### **Tarnished Plant Bug**

The *tarnished plant bug* can be a pest on almost any fruit tree as well as many small fruits. Damage caused by this insect includes feeding on the blossoms, buds, twigs, and fruit. Damage by this insect often causes a distortion of the fruit commonly called *catfacing* on peaches or *button berry* on strawberries.



**Figure 190. Tarnished plant bug damage to an apple.**

The tarnished plant bug is one of the so-called true bugs, having a shield shape to the body. Adults of tarnished plant bug are about one-quarter-inch long, somewhat flattened, and generally brassy in appearance. They are coppery brown with a yellow-tipped triangular area on their backs. The immature stages, or nymphs, are smaller and bright green. Nymphs resemble aphids but are much more active.



*Figure 191. The adult of a tarnished plant bug. Photo by Scott Bauer, USDA/ARS. Used with permission.*

The tarnished plant bug overwinters in protected areas. As the temperatures warm in the spring, the adults come out of hibernation and begin laying eggs on crops and weeds alike. These eggs are laid in the plant stems, petioles, or mid-ribs of the leaves and hatch in about a week. The young bugs feed and become adults in about 30 days. There are multiple generations each year with the tarnished plant bug active from April or May until a hard frost occurs in the fall.

Monitoring for the tarnished plant bug can be done by placing a white paper plate (or other white material) underneath blossoms and then tapping the blossoms to dislodge them and make them drop onto the plate for observation. They can also be found simply by examining the flowers, buds, or leaves. White sticky traps have also been used for monitoring purposes, but are not always reliable.

If tarnished plant bugs are found or if you had significant damage from them the previous year, an insecticide can be applied just before blossoms open or after the fruit has set. Insecticides should not be applied while blossoms are open in order to protect honey bees and other pollinating insects.

### **Cherry Fruit Fly**

The *cherry fruit fly* and the black cherry fruit fly can be pests in both sweet and sour cherries. Their damage is caused by the maggot-type larvae tunneling through the flesh of the fruit, making it unfit for human consumption.



*Figure 192. Cherry fruit fly on a cherry.*

The adult cherry fruit fly is slightly smaller than a house fly, has a yellow head, a white spot near the base of the wings, and four white cross bands across the abdomen. The black cherry fruit fly is similar in appearance, but it has no cross bands on the abdomen. The patterns of the bands on the wings also help to distinguish these fruit flies from each other as well as from the closely related apple maggot and blueberry maggot flies.

Cherry fruit flies spend nearly 10 months of each year in the ground beneath the trees. The adults emerge anywhere from late May to early July to lay their eggs in the fruit of the cherry trees. These eggs hatch in four to seven days, and the maggots feed within the fruit for approximately two weeks. When fully grown, the maggots drop to the ground and pupate for the next 10 months. There is only one generation per year.

Cherry fruit flies can be monitored with yellow sticky cards hung in the trees in late May. Examine the traps twice a week to determine when adult emergence begins, using the banding on the wing to distinguish between the species.

Because the female flies insert the eggs beneath the skin of the fruit, the eggs and the larvae that emerge are protected from insecticides. Therefore, sprays need to be made from early June until harvest in order to target the adults before egg laying begins. Adults should be controlled five to six days after they emerge, as detected by traps.

### **Peach Tree Borers**

There are two species of borers: the *peach tree borer*, which is sometimes referred to as the greater peachtree borer, and the lesser peachtree borer.



The greater peachtree borer is common in young nonbearing trees or in unmanaged plantings, while the lesser peachtree borer is common in large managed orchards.

The greater peachtree borer attacks healthy bark near the soil line, usually just below the ground line or in the lower 12 inches of the trunk. The lesser peachtree borer infests the upper parts of the trunk and scaffold branches and is most troublesome on injured or weak trees.

Borers can kill young trees when trunks are girdled by feeding. Borers feed on the growing inner bark of trees, and tunnel between the inner bark and the sapwood. The bark eventually peels off damaged areas. Damage weakens the tree and predisposes it to attack by other pests and diseases. A gummy mass mixed with sawdust is usually found on the outer bark at the place where a borer started an attack. Entries are often found where there are cankers or wounds caused by other factors such as winter injury.



Figure 193. Damage of the greater peachtree borer to tree trunk.



Figure 194. The adult of a greater peachtree borer.  
Photo by Clemson University–USDA Cooperative Extension Slide Series. Bugwood.org. Used with permission.



Figure 195. The larva of a greater peachtree borer.

The adults of these borers are clearwing moths and look more like wasps than moths. The larvae are dull white with a brown head and three pairs of short jointed legs. The greater peach tree borer has only one generation per year, where the lesser peach tree borer has two generations per year. They both overwinter as inactive larvae under the bark, and resume feeding and complete their larval stages in spring. When fully grown, the larvae pupate under bark, or sometimes in the soil near the tree base for the greater peach tree borer, then emerge as new adults. The adult is the only stage that leaves the tree.



Figure 196. Damage of lesser peachtree borer.  
Photo by Carroll E. Younce, USDA Agricultural Research Service. Used with permission.



Figure 197. Lesser peachtree borer adult male.  
Photo by Carroll E. Younce, USDA Agricultural Research Service. Used with permission.



Figure 198. Lesser peachtree larva.

Photo by Clemson University–USDA Cooperative Extension Slide Series. Bugwood.org. Used with permission.

To monitor for these borers, examine the scaffold branches and trunk of the tree carefully when doing early spring pruning. If damage is found, then control measures are needed. Pheromone traps are available to help in monitoring the adult stage of these pests. It should be noted that other types of borer moths may also be drawn to these traps, especially the trap intended for the greater peach tree borer.



Figure 199. Greater peachtree borer trap.

The backyard fruit grower can use a variety of control measures. There are a number of naturally occurring predators, including ants, spiders, and lacewings, that prey on larvae in exposed locations, and birds that feed on larvae and adults. However, these natural enemies are not capable of adequately controlling borers.

A mechanical control that can be used in small plantings is inserting a knife or a wire into holes that indicate where borers are located, with the intention of smashing the larvae. This is an effective

way of controlling the borer larvae and can be carried out in the spring at the time buds are bursting, or this can be done in late fall.

Avoid mechanical injuries that can attract borers. Insecticides can be applied to new trees by dipping them into a pesticide solution prior to planting, or established tree trunks can be painted with an insecticide solution to protect them.

### **Japanese Beetles**

The adults of *Japanese beetles* feed on the fruits and foliage of many tree fruits and small fruits as well as other plants. The larva of the Japanese beetle is a white grub that spends the winter several inches underground. In June the coppery-colored adults emerge from the ground and begin feeding on a variety of plants.

In July, the females lay their eggs, which hatch in a few weeks. The larvae then feed on grass roots until October, when they head down several inches into the ground to overwinter. Damage caused by the adults can be direct feeding on the fruit or a skeletonizing of the leaves. When beetle numbers are high, the damage can be severe.



Figure 200. Adult of a Japanese beetle.

Control of the Japanese beetle is best done with the use of an insecticide when damage is severe enough to warrant control. Although the grub stage of this beetle can also be treated for in April and/or July by using soil insecticides, this will not necessarily prevent damage by the adult as the adults can migrate in from untreated areas. If the infestation is small enough, the beetles can also be removed by hand, and then disposed of in a container filled with soapy water. Hand picking is most effective if done daily, starting as soon as the first beetles arrive.

**Plum Curculio and Aphids**—See these pests under apples and pears.

**Table 29. Cultural and Mechanical Practices for Disease and Insect Control on Stone Fruit and the Time of Year to Conduct Them.**

| <b>Time of Year for Conducting Various Cultural Control Practices</b>                                                                                                                                                                                                  | <b>Problem Targeted</b>                                                     |
|------------------------------------------------------------------------------------------------------------------------------------------------------------------------------------------------------------------------------------------------------------------------|-----------------------------------------------------------------------------|
| <b><i>When establishing a planting</i></b>                                                                                                                                                                                                                             |                                                                             |
| Choose a well-drained sunny location. If the only site available is wet, then improve soil drainage by ditching and tiling. Plant only in open area with direct sunlight all day.                                                                                      | Drainage for phytophthora root rot. Direct sunlight for all other diseases. |
| Buy nursery stock only from reputable growers; inspect all purchases to be free of galls, cankers, or rotted roots.                                                                                                                                                    | Crown gall, phytophthora root rot.                                          |
| Remove wild plums and wild cherries near plum plantings.                                                                                                                                                                                                               | Black knot.                                                                 |
| <b><i>During late winter or early spring</i></b>                                                                                                                                                                                                                       |                                                                             |
| Prune healthy growth to improve air movement and sunlight penetration in the canopy. This will reduce wetness and shading in the canopy. Delay pruning until March or April.                                                                                           | Brown rot and most other diseases.                                          |
| Remove cankers on shoots or limbs.                                                                                                                                                                                                                                     | Cytospora canker.                                                           |
| On plums, prune out and destroy branches with black knot (rough, black tumors or overgrowths that develop on shoots and limbs).                                                                                                                                        | Black knot.                                                                 |
| Kill borer larvae mechanically by inserting a wire or knife into holes where fresh sawdust is found.                                                                                                                                                                   | Peachtree borer and lesser peachtree borer.                                 |
| <b><i>During spring and summer</i></b>                                                                                                                                                                                                                                 |                                                                             |
| Keep nearby ground cover and weeds mowed, especially before, during, and right after bloom.                                                                                                                                                                            | Tarnished plant bug, stink bugs.                                            |
| Set out a pheromone trap for Oriental fruit moth at bloom; monitor the trap to determine when the adult (moth) stage of this pest is active. The best time to use insecticide is 200 degree-days (base 45°F) after moth flight begins and again 200 degree-days later. | Oriental fruit moth.                                                        |
| Prune flagging (wilted) shoots as soon as they are noticed.                                                                                                                                                                                                            | Oriental fruit moth.                                                        |
| Remove and destroy fruit with insect entry or exit holes or with symptoms of brown rot.                                                                                                                                                                                | Oriental fruit moth, plum curculio, brown rot.                              |
| Collect and destroy prematurely fallen fruit.                                                                                                                                                                                                                          | Brown rot, Oriental fruit moth, plum curculio.                              |
| Pull off excess fruit in early summer to prevent limb breakage from excess crop load. Borers are attracted to broken limbs.                                                                                                                                            | Lesser peachtree borer.                                                     |
| Repair any damaged limbs immediately.                                                                                                                                                                                                                                  | Cytospora canker.                                                           |
| If watering is needed during dry periods, irrigate the soil around trees rather than using overhead sprinklers.                                                                                                                                                        | Most diseases.                                                              |
| Pick fruit as they ripen; remove any fallen or decaying fruit.                                                                                                                                                                                                         | Brown rot, yellowjackets, wasps.                                            |
| Do not allow fruit to over-ripen or soften before harvest.                                                                                                                                                                                                             | Brown rot.                                                                  |
| <b><i>During fall or winter</i></b>                                                                                                                                                                                                                                    |                                                                             |
| Collect and destroy all mummified fruit beneath trees and hanging in trees. Rake and destroy old leaves of cherry.                                                                                                                                                     | Brown rot, cherry leaf spot.                                                |

## Bramble Diseases

### *Anthracnose*

*Anthracnose* is caused by a fungus and can cause severe damage to black and purple raspberries and susceptible cultivars of red raspberries throughout the United States. The disease reduces the size and quality of fruit on infected canes and may kill canes or weaken them so that they do not survive the winter.

Anthracnose first appears in the spring on the young shoots as small, purplish, slightly raised or sunken spots (Figure 201). Later, they enlarge and become ash gray in the center with slightly raised purple margins. The spots are often so close together on black and purple raspberries that they form large irregular areas (cankers). The cankers may encircle the cane, sometimes causing the death of the cane beyond the canker. The bark in badly cankered areas often splits.



Figure 201. Anthracnose symptoms on black raspberry canes.

Late season infections result in superficial gray, oval spots. The spots have definite margins but are not sunken. This is the characteristic gray-bark symptom that is common on red raspberry. Dark-colored specks (fungal fruiting bodies) develop in circles on the gray bark.

Anthracnose sometimes attacks the leaves and can cause some leaf drop. Small spots, about 1/16 inch in diameter with light gray centers and purple margins, appear on the leaves. Lesion centers later fall out, leaving a shot-hole effect.

To help prevent anthracnose, all steps possible should be taken to improve air circulation within

a planting, to allow faster drying of foliage and canes. Reducing the number and duration of wet periods should reduce the potential for infection. Excessive applications of fertilizer (especially nitrogen) should be avoided, since it promotes excessive growth of very susceptible succulent plant tissue. Plants should be maintained in narrow rows and thinned to improve air circulation and allow better light penetration. Weeds are very effective in reducing air movement; therefore, good weed control within and between rows is important for improving air circulation within the planting.

After harvest, remove and destroy all old fruited canes (floricanes) and any new primocanes that are infected. It is best to remove old canes after canes become dormant in the fall. It is critical to have them removed before new growth starts in the spring as the fungus overwinters on old infected canes. Remove all wild brambles growing in the area because they can serve as a reservoir for the disease. Where the disease is established in the planting, fungicide applications are generally required to achieve adequate control.

### *Cane Blight*

*Cane blight* is one of the more damaging diseases of raspberries. The disease is most common on black raspberries but also occurs on red and purple cultivars. The disease occasionally occurs on blackberries and dewberries. Cane blight can result in wilt and death of lateral shoots, a general weakening of the cane, and reduced yield. It is usually most severe during wet growing seasons.

On first-year canes (primocanes), dark brown to purplish cankers form on new canes near the end of the season where pruning, insect, and other wounds are present. The cankers enlarge and extend down the cane or encircle it (Figure 202), causing lateral shoots above the diseased area to wilt and eventually die.

Black specks (pycnidia), which are reproductive bodies of the cane blight fungus, develop in the brown cankered bark. In wet weather, large numbers of microscopic spores ooze out of the pycnidia. This ooze gives the bark a dark-gray, smudgy appearance. During winter, infected canes commonly become cracked, brittle, and snap off easily. On infected second-year canes (floricanes), the side branches may suddenly wilt and die, usually between blossoming and fruit ripening. Upon

close examination, the presence of dark brown or purplish cankers can be observed on the main cane or branches below the wilted area.



Figure 202. Cane blight lesion on thornless blackberry cane.

To help prevent cane blight, all steps possible should be taken to improve air circulation within a planting, to allow faster drying of foliage and canes (see Table 30). Reducing the number and duration of wet periods should reduce the potential for infection. Excessive applications of fertilizer (especially nitrogen) should be avoided, since it promotes excessive growth of very susceptible succulent plant tissue.

Plants should be maintained in narrow rows and thinned to improve air circulation and allow better light penetration. Weeds are very effective in reducing air movement; therefore, good weed control within and between rows is important for improving air circulation within the planting. Raspberries should be planted in sunny, open areas where water and air drainage are good. This allows plants to dry quicker after wet periods and reduces the chance of infection.

After canes become dormant in the fall, remove and destroy all old fruited floricanes and any new primocanes that are infected. Old canes should be removed before growth starts in the spring. Keep plantings free of insects, since they may cause wounds that serve as entry points for the fungus. Avoid any other pests or cultural practices that result in wounding of the canes. Remove all wild brambles growing in the area because they can serve as a reservoir for the disease. Special sprays for control of cane blight are generally not warranted.

### **Spur Blight**

*Spur blight* occurs only on red and purple raspberries. Spur blight has been considered to be a serious disease of red raspberry; however, recent studies suggest that spur blight actually does little damage to the cane. Though the extent of damage caused by spur blight in the United States is not clearly understood, the spur blight fungus has been reported to reduce yields in several ways. It can blight the fruit-bearing spurs that are produced on the side branches, cause premature leaf drop, and kill buds on the canes that later develop into fruit-bearing side branches. In addition, berries produced on diseased canes may be dry, small, and seedy.

The symptoms first appear on young first-year primocanes in late spring or early summer. Purple to brown areas (lesions) appear just below the leaf or bud, usually on the lower portion of the stem (Figure 203). These lesions expand, sometimes covering all the area between two leaves.



Figure 203. Symptoms of spur blight on red raspberry canes.

In late summer or early fall, bark in the affected area splits lengthwise and small black specks, which are fungal fruiting bodies, appear in the lesions. They are followed shortly by many slightly larger, black, erupting spots, another form of the fungal fruiting body.

Leaflets sometimes become infected and show brown, wedge-shaped diseased areas, with the widest portion of the wedge toward the tip of the leaf. Infected leaflets may fall off, leaving only petioles without leaf blades attached to the cane. When diseased canes become fruiting floricanes during the next season, the side branches growing from diseased buds are often weak and withered.

Like the other cane diseases, improving air circulation by using proper spacing, pruning, and weed control will help to prevent the disease (see Table 30). [Removal of any wild brambles in the area may also help to prevent infection. If spur blight becomes an important problem in the planting, growers may want to consider the use of fungicides; however, special fungicide sprays specifically for control of spur blight are generally not warranted.

### **Orange Rust**

*Orange rust* is the most important of several rust diseases that attack brambles. All cultivars of black and purple raspberries and most cultivars of erect blackberries and trailing blackberries are very susceptible. However, orange rust does not infect red raspberries. Orange rust fungus grows systemically throughout the roots, crown, and shoots of an infected plant and is perennial inside the below-ground plant parts.

Orange rust-infected plants can be easily identified shortly after new growth appears in the spring. Newly formed shoots are weak and spindly. The new leaves on such canes are stunted or misshapen and pale green to yellowish (Figure 204). This is important to remember when one considers control, because infected plants can be easily identified and removed at this time.



*Figure 204. Early season symptoms of orange rust on a black raspberry cane. Leaves are stunted, yellowish, and growth is spindly.*

Within a few weeks, the lower surfaces of infected leaves are covered with blister-like pustules that are waxy at first but soon turn powdery and bright orange (Figure 205). This bright orange, rusty appearance is what gives the disease its name. Rusted leaves wither and drop in late spring or early summer.



*Figure 205. Orange rust symptoms on the underside of a black raspberry leaf.*

Later in the season, the tips or infected young canes usually appear to have outgrown the fungus and may appear normal. However, once a plant is infected by orange rust, it is infected for life. Orange rust does not normally kill plants, but it causes them to be so stunted and weakened that they produce little or no fruit.

Cultural controls are the only methods available for control of this disease (see Table 30). These include starting out with disease-free transplants when starting your planting, removing from the area any wild brambles that may carry the disease, and maintaining good air circulation in the planting by pruning out and destroying old fruited canes after harvest, and keeping the planting free of weeds.

If orange rust does appear in your planting in early spring, dig infected plants out (including roots) and destroy them before pustules form, break open, and discharge the orange masses of spores. If plants are not removed, these spores will spread the disease to healthy plants.

***Botrytis Fruit Rot—See under Strawberries***

### **Root Diseases of Brambles**

#### ***Verticillium Wilt***

*Verticillium wilt* can be a serious disease of raspberry. This disease is caused by a soil-borne fungus and reduces raspberry yields by wilting, stunting, and eventually killing the fruiting cane or the entire plant. Once the fungus is in the soil, it can survive for many years. The disease is usually more severe in black raspberries than in red raspberries. Blackberries are also susceptible to the disease, but seldom suffer severe losses.

Verticillium wilt is usually a cool-weather disease and is most severe in poorly drained soils and following cold, wet springs. The appearance of symptoms on new canes frequently coincides with water stress caused by hot, dry mid-summer weather.

Disease symptoms usually appear on black raspberries in June or early July and on red raspberries about a month later. The lower leaves of diseased plants may at first appear to have a dull green cast as compared to the bright green of normal leaves. Starting at the base of the cane and progressing upward, leaves wilt, turn yellow and drop. Eventually, the cane may be completely defoliated except for a few leaves at the top (Figure 206). Black raspberry canes may exhibit a blue or purple streak (Figure 207) from the soil line extending upward to varying heights. This streak is often not present or difficult to detect on red raspberries.



Figure 206. Symptoms of verticillium wilt on black raspberry.



Figure 207. Purple discoloration can sometimes be seen on raspberry canes infected with verticillium wilt.

The final effects of the disease are observed on fruiting canes that were infected the year before. In the spring, many of the diseased canes will be

dead. Others will be poorly developed and have shriveled buds. The new leaves are usually yellow and stunted. Infected canes may die before the fruit matures, resulting in withered, small, and tasteless fruit.

The disease can only be controlled through the use of cultural practices. Applications of fungicides are ineffective in control. Avoid planting your raspberries where tomato, peppers, potato, eggplant, melons, okra, mint, brambles, stone fruits, chrysanthemums, rose, or related susceptible crops have grown for the past five years.

Only disease-free nursery stock from fields known to be free of verticillium should be used to establish new plantings. Satisfactory resistance in commercial raspberry cultivars is not available. It is generally recommended that raspberries not be replanted in an area where the disease has been a problem.

### ***Phytophthora Root Rot***

*Phytophthora* root rot is caused by several related species of soil-borne pathogens called oomycetes. The disease occurs on red, black, and purple raspberries, although in the northeastern United States, it has been documented most commonly on red raspberries. The disease has been reported to occur on blackberries in Kentucky.

Phytophthora root rot can be an extremely destructive disease on susceptible cultivars where conditions favor its development. Infected plants become weak and stunted and are particularly susceptible to winter injury; seriously infected plants commonly collapse and die.

The disease is most commonly associated with heavy soils or portions of the planting that are the slowest to drain (lower ends of rows, dips in the field, etc.). In fact, most declining plants that are considered to be suffering from wet feet may be suffering from phytophthora root rot.

Symptoms include a general lack of vigor and a sparse plant stand. Apparently healthy canes may suddenly decline and collapse during the late spring or summer (Figure 208). In such cases, leaves may initially take on a yellow, red, or orange color or may begin scorching along the edges. As the disease progresses, affected canes wilt and die. Infected plants frequently occur in patches, which may spread along the row if conditions remain favorable for disease development.



*Figure 208. Above-ground symptoms of phytophthora root rot on red raspberry. Note the rapid collapse of the canes.*

Because wilting and collapsing plants may be caused by other factors (winter injury, cane borers, etc.), it is necessary to examine the root system of infected plants to diagnose the disease. Suspect plants should be dug up, and the epidermis (outer surface) scraped off the main roots and crown. On healthy plants, the tissue just beneath the epidermis will be white; on plants with phytophthora root rot, this tissue will be a characteristic brick red (eventually turning dark brown as the tissue decays). Sometimes a distinct line can be seen between infected and healthy tissue (Figure 209), especially on the below-ground portion of the crown.



*Figure 209. Below ground symptoms of phytophthora root rot on red raspberry. Note the brick red discoloration of infected tissues and the sharp line of demarcation between healthy (white) and diseased (red-brown) tissues.*

In many plantings, plants that are dying and declining because of phytophthora root rot had previously been diagnosed as suffering from winter injury or wet feet. One major difference in distinguishing between root rot and winter injury is that plants infected with phytophthora root rot will continue

to decline as time goes on and will not produce healthy primocanes, whereas winter-injured plants will usually send up healthy primocanes the year following the damaging winter.

There is no one simple cure for this disease. However, there are a number of different practices or methods that growers can use to avoid or minimize losses. Because no single method is completely effective by itself, the best strategy is to develop an integrated disease management program, where as many control practices as possible are used within an integrated approach.

These methods should be considered and used:

**1. Exclusion.**

Avoid introducing the phytophthora fungi if you are planting into an uninfested site, especially one that has not previously contained fruit crops. Always start with disease-free nursery stock from a reputable nursery. Do not use plants from your friends' or neighbors' plantings.

**2. Drainage.**

Any practice that will prevent water from collecting around plants will reduce the incidence and severity of phytophthora root rot. This includes both good planting-site selection and site modification when necessary. Included in site modification are the placement of tile drains and growing plants on raised beds. Using a raised-bed planting system can provide substantial control of phytophthora root rot of raspberry.

**3. Resistance.**

One of the best techniques for controlling any disease is the planting of resistant cultivars and the avoidance of highly susceptible cultivars. Phytophthora root rot is most serious on red raspberries and some of the hybrids. The black raspberry cultivars Cumberland and Munger are reported to be susceptible. The cultivars Bristol, Dundee, and Jewel appear to be moderately to highly resistant.

Among red raspberry cultivars, none are immune to the disease, but cultivars do differ greatly in their level of susceptibility. Among cultivars grown in the Midwest and Northeast, Titan and Hilton are extremely susceptible, with Festival, Heritage, Reveille, and Taylor moderately to highly susceptible. Newburgh



is somewhat resistant, and Latham, Boyne, Killarney, and Prelude are considered to be fairly resistant.

The use of fungicide to control this disease is not recommended in home fruit plantings

### **Bramble Insects**

#### ***Raspberry Crown Borer***

Crowns infested by *crown borer* larvae often swell, and all canes from those crowns can die. The entire crown might eventually die. Infested canes will break easily when given a sharp tug, and a larva may be found at the break point. When injured plants are dug up, roots and crowns may be girdled and marked with swellings, galls, cracks, or cavities. Piles of sawdust-like frass may be present.

The adult is a clearwing moth that resembles a yellow jacket and takes two years to complete its life cycle. Eggs are laid on lower leaf surfaces in late July or August, and the eggs hatch in 30 to 60 days. In October, the larvae (dull white with a brown head) hatch and form a hibernation cavity at the base of a cane below the soil line. The following spring they tunnel and girdle new canes and the crown, then pass the second winter in the root system of the plant.



Figure 210. Raspberry crown borer adult.



Figure 211. Raspberry crown borer larva.



Figure 212. Raspberry crown borer egg.

If plants are found to be infested with this insect, complete removal and burning of the plant is the only method of control. Eliminating wild brambles close by can also help to prevent an infestation.

#### ***Cane Borers***

Two *cane borers* can be of concern to the home fruit grower. Both are beetles. The damage caused by the females laying eggs in the cane differs between the two; however, the larvae of both cause damage to the canes by tunneling through them. Control measures are the same.



Figure 213. The adult of a raspberry cane borer. Photo by Steve Nanz at SteveNanz.com. Used with permission.



Figure 214. Raspberry cane borer damage.



Figure 215. Raspberry cane borer damage.



Figure 216. Raspberry cane borer damage.



Figure 217. Raspberry cane borer damage.

The female raspberry cane borer girdles the cane by chewing two rings of puncture marks around the cane, between which she lays her eggs. This causes the tip of the cane to wilt, blacken and possibly fall off.

The rednecked cane borer lays eggs on the bark of new canes, usually within about 10 inches of the base of the cane. When the larvae hatch and begin tunneling through the canes, galls or swellings form near the feeding sites, indicating the presence of this insect. Canes may die and break off at the point where these galls occur.



Figure 218. Rednecked cane borer adult.



Figure 219. Rednecked cane borer damage.

For both types of borers, the primary method of control is to prune out and destroy the infested canes. With the raspberry cane borer, canes can be cut about an inch below the girdled area. However, for the red-necked cane borer, the entire infested cane should be removed. The removal of wild brambles nearby can also help to prevent infestations.

### Tree Crickets

Damage done by *tree crickets* is evidenced by a series of holes up and down the canes where the female has laid her eggs. This damage is done in the late summer or early fall and can cause the canes to die and break off above the damaged area. The nymphs that hatch from these eggs in the spring are actually beneficial because they are predatory on aphids and other insects; however, later on they can feed on the foliage and ripening fruit, though they rarely cause much damage.

The adults are approximately one inch in length with soft transparent wings, a small head, long hind legs, and antennae that are longer than the body. Nymphs are slender, somewhat flattened, and pale white in color. There is only one generation per year.



Figure 220. Tree cricket adults: male (left) and female (right).



Figure 221. Damage by female tree crickets.



Figure 222. Feeding damage by tree crickets.

Pruning out and burning infested canes after the last harvest can help to prevent the carry over of the pest from year to year. Insecticides can also be applied in early summer to control the young crickets.

**Sap Beetles and Picnic Beetles**—See these pests under Strawberries.

**Japanese Beetles**—See this pest under Stone Fruit.

| <b>Table 30: Cultural and Mechanical Practices for Disease and Insect Control on Brambles.</b>                                                                                                                                                                                                                                                                                                                                                                             |                                                                          |
|----------------------------------------------------------------------------------------------------------------------------------------------------------------------------------------------------------------------------------------------------------------------------------------------------------------------------------------------------------------------------------------------------------------------------------------------------------------------------|--------------------------------------------------------------------------|
| <b>Time of year for conducting various cultural control practices</b>                                                                                                                                                                                                                                                                                                                                                                                                      | <b>Problem targeted</b>                                                  |
| <b><i>When establishing a planting</i></b>                                                                                                                                                                                                                                                                                                                                                                                                                                 |                                                                          |
| Always plant in a well-drained location with all-day sun (no shade).                                                                                                                                                                                                                                                                                                                                                                                                       | All diseases.                                                            |
| Do not plant near wild brambles (or remove wild brambles in the vicinity).                                                                                                                                                                                                                                                                                                                                                                                                 | Orange rust.                                                             |
| <b><i>During late winter or early spring</i></b>                                                                                                                                                                                                                                                                                                                                                                                                                           |                                                                          |
| Mow or cut old Heritage canes in the early spring before new shoots begin to develop. Cuts should be made at ground level (no stubs), and all old canes should be removed from the planting.                                                                                                                                                                                                                                                                               | Cane diseases                                                            |
| Prune canes damaged by raspberry cane borer, red-necked cane borer, raspberry cane maggot, tree crickets.                                                                                                                                                                                                                                                                                                                                                                  | Cane infesting insects.                                                  |
| <b><i>During spring and summer</i></b>                                                                                                                                                                                                                                                                                                                                                                                                                                     |                                                                          |
| Each spring when new shoots are about 12 to 14 inches tall, survey black raspberry and blackberry plantings for symptoms of orange rust and remove infested plants, including the roots.                                                                                                                                                                                                                                                                                   | Orange rust.                                                             |
| Good weed control promotes rapid drying conditions within the fruiting canopy and discourages populations of insects and diseases that damage the canes and fruit. In order to promote better penetration of sunlight and faster drying within the canopy of red raspberries, canes should be thinned (removed) to obtain no more than five large canes per linear foot of row, and row width should not exceed two feet. Do not over fertilize, especially with nitrogen. | Spur blight, cane blight, anthracnose, orange rust, tarnished plant bug. |
| Problems with fruit rots and several insects will be less severe if the berries are harvested regularly throughout the ripening period so that overripe fruits do not accumulate. Fermenting fruit attracts these pests. Place over-ripe fruit in bait buckets outside the planting.                                                                                                                                                                                       | Sap beetles, wasps, fruit flies, and fruit rots.                         |
| <b><i>During fall or winter</i></b>                                                                                                                                                                                                                                                                                                                                                                                                                                        |                                                                          |
| After harvest, cut and remove from the planting canes that have fruited (except for Heritage or other fall-fruiting red raspberry cultivars).                                                                                                                                                                                                                                                                                                                              | Spur blight, cane blight, anthracnose, cane and crown boring insects.    |

## Strawberry Diseases

### Leaf Diseases

Several leaf diseases are found in strawberry plantings and are all treated in a similar manner.

#### Leaf Spot

*Leaf spot* first appears as circular, deep purple spots on the upper leaf surface. These spots enlarge, and the centers turn grayish to white on older leaves and light brown on young leaves (Figure 223). A definite reddish purple to rusty brown border surrounds the spots.

On fruit, superficial black spots may form under moist weather conditions. The spots form on ripe berries around groups of seeds. The spots are about one-fourth inch in diameter, and there are usually only one or two spots per fruit. However, some fruits may be more severely infected.

The fungus overwinters as spores in lesions on leaves. The fungus produces more spores in spots on the upper and lower leaf surface that spread the disease during early summer. These spores are spread by splashing rain. Middle-aged leaves are most susceptible. Lesions also develop on stems, petioles, and runners.



Figure 223. Leaf spot on strawberry.

#### Leaf Scorch

*Leaf scorch* consists of numerous small, irregular, purplish spots or blotches that develop on the upper surface of leaves (Figure 224). The centers of the blotches become brownish. Blotches may coalesce until they nearly cover the leaflet, which then appears purplish to reddish to brown. The fungus overwinters on infected leaves.

The fungus produces spore-forming structures in the spring on both surfaces of dead leaves. These

structures produce spores abundantly in midsummer. In the presence of free water, these spores can germinate and infect the plant within 24 hrs. Older and middle-aged leaves are infected more easily than young ones.



Figure 224. Leaf scorch on strawberry.

#### Leaf Blight

*Leaf blight* infections begin as one to several circular reddish-purple spots on a leaflet (Figure 225). Spots enlarge to V-shaped lesions with a light brown inner zone and a dark brown outer zone. Lesions follow major veins, progressing inward. The whole leaflet may turn brown.

In severe cases, stolons, fruit trusses, and petioles may become infected; the infection may girdle and kill the stem. The fungus overwinters as mycelium or fruiting structures on the old leaves that remain attached to the plant. Spores are spread by rain splash early in the spring. Leaf blight is most destructive to older leaves in the late summer. Petioles, calyxes, and fruit may also be infected earlier in the season.



Figure 225. Strawberry leaf blight.

Leaf spot and leaf scorch are controlled most effectively by the use of resistant cultivars (see Table 12). Allstar, Canoga, Cardinal, Delite, Earliglow, Honeoye, Jewell, Lester, Midway, and Redchief are June-bearing cultivars that are reported to be resistant to both leaf spot and leaf scorch. The ever-bearing cultivars, Tribute and Tristar, are reported to be tolerant to leaf spot and leaf scorch as well. There are no cultivars with reported resistance to leaf blight.

However, cultural practices should help reduce infection to all of these diseases (see Table 31). Remove the older and infected leaves from runner plants before setting. Take care in spacing runner plants in matted-row culture. Plant in light, well-drained soil in a location exposed to all-day sun and good air circulation.

Control weeds in the planting, as they tend to reduce air circulation and increase drying time for leaves. Removing infected leaves after harvest (during renovation) is helpful in reducing inoculum. If leaf diseases are a problem in the planting, fungicides will aid in control.

### **Fruit Diseases**

#### ***Botrytis Fruit Rot (Gray Mold)***

One of the most serious and common fruit-rot diseases affecting both brambles and strawberries is *gray mold*. The gray mold fungus can affect petals, flower stalks, fruit caps, and fruit. In wet, warm seasons, probably no other disease causes a greater loss of flowers and fruit. The disease is most severe during years with prolonged rainy and cloudy periods during bloom or during harvest.

Fruit infections usually appear as soft, light brown, rapidly enlarging areas on the fruit. If infected fruits remain on the plant, the berry usually dries up, mummifies, and becomes covered with a gray, dusty powder of fungus spores, which gives the disease its name *gray mold* (Figures 226 and 227). Fruit infection is most severe in well-protected areas of the plant, where the humidity is high and air movement is poor. Berries resting on soil or touching another decayed berry or a dead leaf in dense foliage are most commonly affected.

Strawberries are susceptible to botrytis during bloom and again as fruits ripen. During the blossom blight phase of the disease, the fungus colonizes senescing flower parts, turning the blossoms

brown. The fungus usually enters the fruit through flower parts, where it remains inactive within the tissues of infected green fruits. As the fruit matures, the fungus becomes active and rots the fruit. Thus, while infection actually occurs during bloom, symptoms are usually not observed until harvest. This is important to remember when one considers the use of fungicides for control. After picking, mature fruits are extremely susceptible to gray mold, especially if bruised. During picking, the handling of infected fruit will spread the fungus to healthy ones. Under favorable conditions for disease development, healthy berries may become a rotted mass within 48 hours after picking.



*Figure 226. Botrytis fruit rot on a mature strawberry fruit. Note the coating of dusty, gray spores.*



*Figure 227. Botrytis fruit rot on raspberry fruit.*

To help control botrytis, select a planting site with good soil drainage and air circulation. Plants should be exposed to direct sunlight. Plant rows with the direction of the prevailing wind to promote faster drying of foliage and fruit. On strawberries, a good layer of straw mulch (or other material) between the rows or around the plants aids greatly in controlling fruit rots. The mulch acts as a barrier that reduces fruit contact with the soil.

Proper spacing of plants and timing of fertilizer applications are also important. Excessive applications of nitrogen fertilizer, especially in the spring before harvest, can produce excessive amounts of dense foliage. Shading of berries by thick foliage prevents rapid drying of the fruit during wet periods and creates ideal conditions for disease development.

Good weed control is very important. Weeds prevent air movement in the plant canopy. This slows drying time of flowers and fruits and increases the chances for infection. Pick fruit frequently and early in the day as soon as plants are dry. Cull out all diseased berries but do not leave them in the planting. Handle berries with care to avoid bruising and refrigerate fruit promptly at 32°F to 50°F to check gray mold. Strawberries and raspberries are highly perishable. They should be processed or consumed soon after harvest.

### **Leather Rot**

*Leather rot* is caused by a fungus-like organism called an oomycete and can infect berries at any stage of development. Where the disease has been a problem in Ohio, infection of green fruit is common. On green berries, diseased areas may be dark brown or natural green outlined by a brown margin. As the rot spreads, the entire berry becomes brown (Figure 228), maintains a rough texture, and appears leathery. The disease is more difficult to detect on ripe fruit.

On fully mature berries, infection may result in little color change or discoloration ranging from brown to dark purple (Figure 229). Infected ripe fruit are usually softer to the touch than healthy fruit. When diseased berries are cut crosswise, a marked darkening of the water-conducting system to each seed can be observed. In later stages of decay, mature fruits also become tough and leathery. Occasionally, a white moldy growth can be observed on the surface of infected fruit. In time, infected fruit dry up to form stiff, shriveled mummies.

Berries that are affected by leather rot have a distinctive, unpleasant odor and taste. Even the healthy tissue on a slightly rotted berry has a bad flavor. An infected mature berry with little color change may appear normal and be picked and processed with healthy berries. This has led to complaints of bitter-tasting jam and jelly made with berries from fields where leather rot was a

problem. Leather rot is observed most commonly in poorly drained areas where there is or has been free standing water, or on berries in direct contact with the soil.



*Figure 228. Leather rot of strawberry on an immature (green) fruit.*



*Figure 229. Leather rot of strawberry on a ripe fruit.*

To help prevent the occurrence of leather rot, select a planting site with good soil drainage and air circulation (see Table 31). Good soil drainage is critical. Sites that drain poorly or are subject to periodic flooding are ideal for leather rot development.

Plants should have plenty of direct sunlight and be planted in rows parallel to the direction of the prevailing wind to promote faster drying of foliage and fruit. Mulch strawberry plants with straw or other material that reduces fruit contact with soil. Research in Ohio has shown that a good layer of straw mulch is very beneficial in controlling leather rot. Proper spacing of plants and timing of fertilizer applications are important. Excessive applications of nitrogen fertilizer can produce excessive amounts of dense foliage, creating ideal conditions for disease development.

Pick fruit frequently and early in the day (as soon as plants are dry). Cull out all diseased berries, but do not leave them in the field. Fungicide use for controlling leather rot is generally not recommended in backyard fruit plantings.

## Root Diseases

Two specific root diseases can be a problem in home strawberry plantings if precautions are not taken to prevent them. When plants start wilting and dying in the more poorly drained portions of the strawberry field, the cause is very likely red stele disease.

### Red Stele

*Red stele* is caused by a fungus-like organism called an oomycete. Infected plants are stunted, lose their shiny green luster, and produce few runners. Younger leaves often have a metallic, bluish-green cast. Older leaves turn prematurely yellow or red. With the first hot, dry weather of early summer, diseased plants wilt rapidly and die. Diseased plants have very few new roots compared to healthy plants that have thick, bushy white roots with many secondary feeder roots.

The best way to identify the disease is to carefully dig up a wilted plant and peel off the outside portion of several roots. The inside or central portion of the root is known as the *stele*. If the stele is pink to brick red or brownish red (rather than the normal yellowish-white), the plant has the red stele disease (Figure 230). The red color may show only near the dead tip of the root or it may extend the length of the root. The red stele is best seen in the spring up to the time of fruiting. No other disease of strawberry produces this symptom.



Figure 230. Section of an infected strawberry root (left) showing reddish-brown discoloration from red stele disease. Healthy root is shown on right.

### Verticillium Wilt

The second root disease, *Verticillium wilt*, is caused by a soil-borne fungus and is known to affect more than 300 different types of plants. This disease can remain in the soil for more than 25 years. The first symptoms of *Verticillium wilt* in new strawberry plantings often appear about the time runners begin

to form. In older plantings, symptoms usually appear just before picking time.

On infected strawberry plants, the outer and older leaves droop, wilt, turn dry, and become reddish-yellow or dark brown at the margins and between veins (Figure 231). Few new leaves develop, and those that do tend to be stunted and may wilt and curl up along the mid-vein. Severely infected plants may appear stunted and flattened, with small yellowish leaves.

Brownish to bluish-black streaks or blotches may appear on the runners or petioles. New roots that grow from the crown are often dwarfed with blackened tips. Brownish streaks may occur within the decaying crown and roots. If the disease is serious, large numbers of plants may wilt and die rapidly. When the disease is not so serious, an occasional plant or several plants scattered over the entire planting may wilt and die.



Figure 231. Strawberry plant infected with *Verticillium wilt*. Note the outer leaves on the plant usually die first.

To control these root diseases, there are several precautions that can be taken (see Table 6). For *Verticillium wilt*, avoid planting your strawberries (especially susceptible cultivars) where tomato, peppers, potato, eggplant, melons, okra, mint, brambles, stone fruits, chrysanthemums, rose, or related susceptible crops have grown for the past five years. For either disease, locate your strawberry bed in an area in fertile, light, well-drained soil, making sure to avoid low, wet spots. If you suspect that you have either of these diseases in your soil, the use of disease resistant cultivars is essential (Table 12).

### Black Root Rot

*Black root rot* is a disease that is most common in fields with a long history of strawberry production. The term black root rot is actually the general

name for several root disorders that produce similar symptoms. The disorders are not clearly understood and are generally referred to as a root-rot complex. For this reason, it is difficult to discuss black root rot as we do other diseases which usually have a specific cause.

Symptoms begin with some plants in a field showing reduced vigor, often in low or wet spots or in portions of the field where the soil has become compacted. This decline in vigor usually begins during the first fruiting year. The symptoms are most apparent the last couple of weeks before harvest. Although severely affected plants may die before harvest, it is more common for diseased plants to continue living but become stunted and produce a reduced crop of small berries. The percentage of plants affected in any individual field usually increases significantly the year following the first appearance of symptoms.

Determining if you have black root rot is done by digging up declining plants and examining their root systems about the time that fruit begin to color. Abundant fleshy white roots and fine lateral roots will be seen on healthy plants, and the interior of the older woody roots is yellowish-white. With black root rot, there is usually a loss of many fine lateral roots, and irregular black patches occur along the length of the fleshy white roots. In severely affected plants, these black patches grow together so that no white roots are visible (Figure 232). The interior of infected older woody roots turns black.



Figure 232. Black root rot of strawberry.

It is likely that black root rot symptoms result from one or more of the following:

- Gradual buildup in the soil of disease-causing microorganisms and nematodes when strawberries are grown with inadequate rotation.
- Interaction of these organisms with environmental or other stress factors, such as herbicide injury, winter or cold injury, and excessive soil moisture, that might make plants more susceptible to attack.
- Certain soil conditions such as heavy (clay) or poorly drained soils that might favor the activity of disease-causing fungi and/or inhibit the ability of the strawberry plant to produce new roots to compensate for their damage. Additional factors may also be involved.

Because several factors appear to be involved in the black root-rot complex, no general control measure is totally effective. These practices may help to reduce its incidence:

- Always start plantings with healthy white-rooted plants from a reputable nursery.
- Rotate out of strawberries for at least two to three years before replanting.
- Minimize soil compaction and increase tilth by incorporating organic matter, such as compost or straw.
- Avoid heavy, wet soils and improve drainage in marginal soils by tiling or planting on raised beds.

## Strawberry Insects

### *Tarnished Plant Bug*

Slightly to severely uneven berry growth and deformed berries with hollow seeds can result from tarnished plant bug feeding on flower buds and developing fruit. Ripening berries that remain small, with a concentration of seeds at the tip, may be called button berries, cat-faced berries, or nubbins. Injured berries can be woody and unmarketable. Later-maturing cultivars are more seriously affected by this pest than early cultivars.

Cultural practices, such as the selection of less susceptible cultivars and controlling weeds in the surrounding area, and using a row cover put on in the fall, can help. Insecticides should be applied soon after the first flower buds become visible and again if reinfestation occurs just before bloom. To protect bees and other insect pollinators, do not spray insecticide during bloom.





Figure 233. Tarnished plant bug on strawberry flower.

### **Two-Spotted Spider Mites**

The *two-spotted spider mite* can infest many horticultural and ornamental plants in the backyard fruit setting including, but not limited to, strawberries, apples, peaches, and pears. Heavy infestations of this sucking mite cause leaves to appear light in color, or leaves can dry up and turn reddish brown. Silken threads are usually found on the lower surface of the leaves or sometimes over the whole leaf. Damage such as this can cause a stunting of the fruit as well as the plant in general.



Figure 234. Damaged of two-spotted spider mite.

The female adult overwinters in grassy ditch banks and other protected areas. As temperatures warm in the spring, the females come out of hibernation and begin laying eggs. With warm, dry conditions the two-spotted spider mite can complete its life cycle in as little as eight to 12 days.



Figure 235. Spider mite adult.

Wet weather and an abundance of naturally occurring beneficial insects often are enough to keep spider mite populations below injurious levels. However, dry weather in combination with the over use of pesticides can cause spider mite populations to flare up.

For control, the release of purchased beneficial mites can be advantageous if they are released when the two-spotted spider mite levels are still low. However, if the spider mite levels become too high, beneficial mites will not sufficiently control the problem. In this case, miticides or insecticidal soaps, applied very thoroughly, would be necessary for control.

### **Spittlebug**

Nymphs of *spittlebugs* form frothy masses of spittle which are the primary indicator of spittlebug presence. These nymphs look similar to large leafhopper nymphs, although they are relatively slow moving. The brown adults are about one-fourth inch in length and appear like leafhoppers with blunt heads and large eyes.

Spittlebugs overwinter as eggs that are laid in the fall on the leaves and stems of strawberry and other plants. As weather conditions become warm in the spring, eggs hatch into nymphs that proceed to locate a suitable host and generate the characteristic spittle mass. In five to eight weeks, the nymph matures into an adult, and the spittle mass dries out. There is only one generation per year.

The presence of large numbers of nymphs causes stress to the plant host and stunting of growth. However, if numbers are few, they are most often considered only a nuisance because of the presence of the spittle mass. Though rarely needing to be controlled in the home strawberry planting, the spittlebug can be controlled with pesticide if needed.



Figure 236. Hidden beneath masses of frothy spittle on stems or leaves are the immatures of spittlebugs.

### **Strawberry Clipper Weevil**

Nearly mature blossom buds are injured by adult clippers that puncture buds with their snouts, deposit eggs inside buds, then clip the stem below the buds. Clipped buds hang down or fall to the ground, thus preventing fruit from forming. The adults also eat holes in the petals and blossoms in order to feed on the pollen.



Figure 237. Strawberry clipper damage.

The *strawberry clipper* adult is a dark, reddish-brown weevil about 1/10-inch long; its head is prolonged to form a slender, curved snout about one-third as long as the body. The larva is white and 1/16-inch long. It overwinters as adults in protected places on the ground.

In the spring, adults come out of hibernation and lay their eggs about the same time that strawberries begin to bloom. The eggs hatch in about one week, and the larvae feed on the damaged bud for the next three to four weeks before they reach maturity and drop to the ground. Here they pupate and emerge as an adult in June or July. These adults feed for only a short period of time before seeking shelter to overwinter.

There is only one generation per year. This same beetle can cause damage to raspberries and blackberries as well.



Figure 238. Strawberry clipper adult.

Non-chemical methods of control include locating the strawberry planting away from prime overwintering sites such as woods or hedgerows, and

planting later-maturing cultivars, because early cultivars are more often damaged than later ones.

### **Sap Beetles and Picnic Beetles**

These beetles can be found on many fruits and vegetables. They most often feed on over-ripe fruits, but they can also infest fruits that are nearing maturity. This damage can cause fruit to rot all the more quickly. The adult strawberry *sap beetle* is about one-eighth inch in length, oval, and mottled brown in color. Picnic beetles are black with yellowish spots.



Figure 239. Strawberry sap beetle damage.



Figure 240. Strawberry sap beetle adult.

The sap beetles overwinter in wooded areas or in decaying vegetation. As fruit begins to ripen, they move to the fruit to feed and lay their eggs. The eggs hatch in two to three days, and the larvae feed inside the rotting fruit for about a week.

Control is best achieved by keeping the fruit picked before it over-ripens. Over-ripe fruit should be put into a bait bucket that can be placed outside the planting to intercept and draw beetles away from the planting.

### **Slugs**

*Slugs* damage fruit by chewing deep ragged holes into the surface of berries, especially under the cap. They are also capable of severely damaging the foliage of many plants as well. Slugs are soft-bodied, slimy, worm-like mollusks that survive best in moist conditions. The straw mulches that are put down to help protect strawberries from diseases unfortunately also provide a perfect habitat for slugs.



Figure 241. Slug and its damage on strawberry.

A variety of slugs may be found, ranging in size and color from the small (one-half inch) black marsh slug up to the large (three inch) orange dusky slug. The most common and damaging of the slugs in our area is the gray garden slug.

Eggs are generally laid in the fall with the juvenile slugs hatching out in the early spring. This juvenile stage can often be the most damaging. Slugs feed primarily from dusk till dawn and are best observed during those hours. During the day, slime

trails that glisten in the sunlight can also be indicators of the slug's presence.

A variety of control measures can be used to avoid slug damage. Cultural practices that can reduce the attractiveness of the planting to slugs include planting at lower densities, removal of straw mulch after harvest, summer renovation, and delaying fall mulching as long as is practical. Removal of trash and debris around the planting also helps to eliminate slug breeding grounds.

Traps made of wet boards or burlap bags can be set out in the evening, followed by removing and destroying trapped slugs the following morning. Shallow dishes of beer can be used as a bait under the traps. Although trapping can remove many slugs, it usually does not remove enough to result in significantly less injury to fruit. In cases where slug damage is severe, slugs are best controlled with the use of commercial slug baits.

| <b>Table 31: Cultural and Mechanical Practices for Disease and Insect Control on Strawberries and the Time of the Year to Conduct Them.</b>                                                                                                                            |                                                             |
|------------------------------------------------------------------------------------------------------------------------------------------------------------------------------------------------------------------------------------------------------------------------|-------------------------------------------------------------|
| <b>Time of year for conducting various cultural control practices</b>                                                                                                                                                                                                  | <b>Problem targeted</b>                                     |
| <b><i>When establishing a planting</i></b>                                                                                                                                                                                                                             |                                                             |
| Select a planting site with good soil drainage and all-day exposure to direct sun. Avoid poorly drained, shaded areas.                                                                                                                                                 | All diseases.                                               |
| Select and use cultivars with resistance to leaf diseases, Verticillium wilt, and red stele.                                                                                                                                                                           | Leaf and root diseases.                                     |
| Do not plant after sod or grasses.                                                                                                                                                                                                                                     | White grubs.                                                |
| When old plantings are replaced by new ones, select a different growing site.                                                                                                                                                                                          | Soil-borne diseases, insects, and weeds.                    |
| <b><i>During late winter or early spring</i></b>                                                                                                                                                                                                                       |                                                             |
| Apply a straw mulch before the fruit begins to ripen to help keep the berries from touching or being splashed with soil.                                                                                                                                               | Fruit rots.                                                 |
| <b><i>During spring and summer</i></b>                                                                                                                                                                                                                                 |                                                             |
| Control weeds that can compete with the strawberry plants and interfere with good runner production. Weeds can also harbor insect pests and prevent rapid drying after rains. Do not over fertilize, especially with nitrogen.                                         | Fruit rots, leaf diseases, tarnished plant bug, spittlebug. |
| Row covers after pollination.                                                                                                                                                                                                                                          | Tarnished plant bug.                                        |
| Problems with fruit rots and certain insects will be less severe if the berries are harvested regularly throughout the ripening period so that overripe fruits do not accumulate. Fermenting fruit attracts these pests. Use bait buckets placed outside the planting. | Sap beetles, slugs, fruit rots.                             |
| Renovate beds immediately after harvest to reduce pest problems. Rake and destroy cut-off leaves and stems after renovation.                                                                                                                                           | Slugs, mites, fruit rots, and leaf diseases.                |
| Remove mulch after harvest.                                                                                                                                                                                                                                            | Slugs.                                                      |

## Grape Diseases

### **Black Rot**

*Black rot* is caused by a fungus and is one of the most damaging grape diseases in the Midwest. Symptoms of black rot first appear as small yellowish spots on leaves (Figure 242). As the spots (lesions) enlarge, a dark border forms around the margins. The centers of the lesions become reddish brown.



Figure 242. Black rot lesion on grape leaf.

By the time the lesions reach one-eighth to one-fourth inch in diameter (approximately two weeks after infection), minute black dots appear. These are fungal fruiting bodies (pycnidia) and contain thousands of summer spores (conidia). Pycnidia are often arranged in a ring pattern, just inside the margin of the lesions.

Lesions may also appear on young shoots, cluster stems, and tendrils. The lesions are purple to black, oval in outline, and sunken. Fruit symptoms often do not appear until the berries are about half grown. Small, round, light-brownish spots form on the fruit. The rotted tissue in the spot softens and becomes sunken. The spot enlarges quickly, rotting the entire berry in a few days.

The diseased fruit shrivels, becoming small, hard, black, and wrinkled (*mummies*) (Figure 242). Tiny black pycnidia are also formed on the fruit mummies. The mummies usually remain attached to the cluster. Black rot survives the winter in cane and tendril lesions and fruit mummies.



Figure 243. Symptoms of black rot on grape fruit. Note that infected fruit dry down to form hard mummies.

Sanitation is important in attempting to control black rot. Destroy mummies, remove diseased tendrils from the wires, and select fruiting canes without lesions (see Table 32). It is very important not to leave mummies attached to the vine. Research has shown that mummies on the ground release most or all of their ascospores before the end of bloom. Mummies left up in the trellis can produce ascospores and conidia throughout the growing season, thus making control of this disease much more difficult. If only a few leaf lesions appear in the spring, remove those infected leaves.

Plant grapes in sunny open areas that allow good air movement. Proper row orientation to prevailing winds and good weed control beneath the vines also enable plants to dry more quickly during wet weather. If black rot has been a problem in the past few years, it is likely that a good fungicide spray program will be needed as well.

Early season control must be emphasized. The most critical period for controlling black rot fruit infections with fungicide is from immediate pre-bloom (as flowers begin to open) through three to four weeks after bloom. If controlled during this period, the need for late season applications of fungicide for black rot control is eliminated.

### **Downy Mildew**

*Downy mildew* is caused by a fungus-like organism called an oomycete and is a very common and

potentially severe disease of grapes in the Midwest. On leaves, young infections of downy mildew are very small, greenish-yellow, translucent spots that are difficult to see. With time the lesions enlarge, appearing on the upper leaf surface as irregular pale-yellow to greenish-yellow spots up to one-fourth inch or more in diameter (Figure 244).

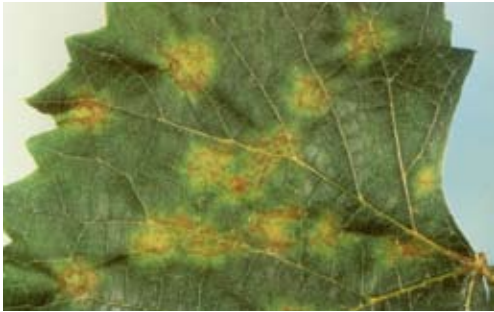

*Figure 244. Pale yellow spots on the upper surface of grape leaf caused by downy mildew.*

On the underside of the leaf, the fungus mycelium (the downy mildew) can be seen within the border of the lesion as a delicate, dense, white to grayish, cotton-like growth (Figure 245). Infected tissue gradually becomes dark brown, irregular, and brittle. Severely infected leaves eventually turn brown, wither, curl, and drop. The disease attacks older leaves in late summer and autumn, producing a mosaic of small, angular, yellow to red-brown spots on the upper surface. Lesions commonly form along veins, and the fungus sporulates in these areas on the lower leaf surface during periods of wet weather and high humidity.

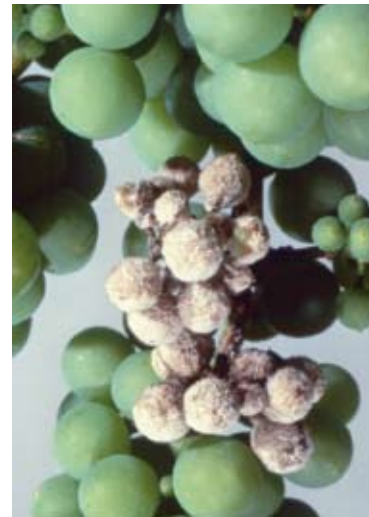

*Figure 245. Downy mildew on lower surface of grape leaf. Fungus growth is directly beneath the yellow spots seen on the upper surface.*

On fruit, most infection occurs during the period from immediate prebloom (as flowers begin to open) through three to four weeks after bloom. When infected at this stage, young berries turn light brown and soft, fall off easily, and under humid conditions, the entire cluster may become

covered with the white downy-like growth of the pathogen (Figure 246).

On shoots and tendrils, early symptoms appear as water-soaked, shiny depressions on which the dense downy mildew growth appears. Young shoots usually are stunted and become thickened and distorted. Severely infected shoots and tendrils usually die.



*Figure 246. Grape berries infected with downy mildew.*

For controlling downy mildew, any practice that speeds the drying time of leaves and fruit will reduce the potential for infection. Select a planting site where vines are exposed to all-day sun, with good air circulation and soil drainage. Space the vines properly in the row, and if possible, orient the rows to maximize air movement down the row. To further improve air circulation, control weeds and tall grasses around your planting.

Sanitation is also important. Remove dead leaves and berries from vines and the ground after leaf drop (see Table 32). It may be beneficial to cultivate the vineyard before bud break to cover old berries and other debris with soil. Cultivation also prevents over-wintering spores from reaching developing vines in the spring.

When pruning, select only strong, healthy, well-colored canes of the previous year's growth. Practices such as shoot positioning and leaf removal that help to open the canopy for improved air circulation and spray coverage can also help.

Grape cultivars vary greatly in their susceptibility to downy mildew. In general, vinifera (*Vitis vinifera*) cultivars are much more susceptible

than American types, and the French hybrids are somewhat intermediate in susceptibility. Cabernet Franc, Cabernet Sauvignon, Catawba, Chancellor, Chardonnay, Delaware, Fredonia, Gewürztraminer, Ives, Merlot, Niagara, Pinot Blanc, Pinot Noir, Riesling, Rougeon, and Sauvignon Blanc are reported to be highly susceptible to downy mildew. A good fungicide spray program is extremely important in that downy mildew can be effectively controlled by properly timed and effective fungicides.

### **Powdery Mildew**

*Powdery mildew* is caused by a fungus and is generally considered less economically important in home fruit plantings in the Midwest than black rot or downy mildew. However, uncontrolled, the disease can be devastating on susceptible cultivars under the proper environmental conditions. Unlike black rot and downy mildew, the powdery mildew fungus does not require free water on the plant tissue surface to infect.

Powdery mildew can result in reduced vine growth, yield, fruit quality, and winter hardiness. The powdery mildew fungus can infect all green tissues of the vine. Small, white or grayish-white patches of fungal growth appear on the upper or lower leaf surface. These patches usually enlarge until the entire upper leaf surface has a powdery, white to gray coating (Figure 247). The patches may remain limited throughout most of the season. Severely affected leaves may curl upward during hot, dry weather. Expanding leaves that are infected may become distorted and stunted. On young shoots, infections are more likely to be limited, and they appear as dark-brown to black patches that remain as dark patches on the surface of dormant canes.



*Figure 247. Grape leaf severely infected with powdery mildew.*

If blossom clusters are affected, the flowers may wither and drop without setting fruit. Infections on cluster stems often go unnoticed, but can be very damaging. Infected cluster stems may wither and dry up, resulting in berry drop (shelling). Affected berries may have patches of fungal growth on the surface similar to those on the leaves, or the entire berry may be covered with the white, powdery growth. Infected berries often are misshapen or have rusty spots on the surface. Severely affected fruit often split open (Figure 248). When berries of purple or red cultivars are infected as they begin to ripen, they fail to color properly and have a blotchy appearance at harvest. Late in the season, many tiny black specks (fungal fruiting bodies) may develop on the surface of infected areas.



*Figure 248. Grape berry cluster infected with powdery mildew.*

For control measures, select an open planting site with direct sunlight. Plant rows in the direction of the prevailing wind in order to promote good air circulation and faster drying of foliage and fruit and prune and train vines properly in such a way as to reduce shading and increase air circulation. Cultivars differ greatly in their susceptibility to powdery mildew with *Vinifera* and French hybrids generally being more susceptible than American cultivars. On highly susceptible cultivars, fungicides can effectively control powdery mildew.

### ***Phomopsis* Cane and Leaf Spot**

*Phomopsis* cane and leaf spot is caused by a fungus. Spots or lesions on shoots and leaves are common symptoms of this disease. Small, black spots on the internodes at the base of developing shoots

are probably the most common disease symptom. These spots are usually found on the first three to four basal internodes. The spots may develop into elliptical lesions that may grow together to form irregular, black, crusty areas (Figure 249). Under severe conditions, shoots may split and form longitudinal cracks. Although cane lesions often appear to result in little damage to the vines, it is important to remember that these lesions are the primary source of overwintering inoculum for the next growing season.



*Figure 249. Spotting and cracking of grape cane caused by Phomopsis.*

Leaf infections first appear as small, light-green spots with irregular, occasionally star-shaped, margins (Figure 249). Usually only the lower one to four leaves on a shoot are affected. In time, the spots become larger, turn black, and have a yellow margin. Leaves become distorted and die if large numbers of lesions develop. Infections of leaf petioles may cause leaves to turn yellow and fall off.



*Figure 250. Symptoms of Phomopsis cane and leaf spot on young grape leaf early in the season.*

All parts of the grape cluster (berries and rachises or cluster stems) are susceptible to infection throughout the growing season; however, most infections appear to occur early in the growing season. Lesions developing on the first one or two

cluster stems (rachises) on a shoot may result in premature withering of the cluster stem. Infected clusters that survive until harvest often produce infected or poor-quality fruit.

If not controlled early in the growing season, berry infection can result in serious yield loss under the proper environmental conditions. Berry infections first appear close to harvest as infected berries develop a light-brown color. Black, spore-producing structures of the fungus then break through the berry skin, and the berry soon shrivels. At this advanced stage, Phomopsis cane and leaf spot can be easily mistaken for black rot (Figure 251).

Gardeners should remember that the black rot fungus only infects green berries and will not infect berries after they start to mature. Berries become resistant to black rot infection by three to four weeks after bloom. Fruit rot symptoms caused by Phomopsis generally do not appear until close to harvest on mature fruit. Severe fruit rot has been observed in several Ohio vineyards, but is not common.



*Figure 251. Symptoms of fruit infected by Phomopsis. Symptoms are similar to black rot, but only develop near harvest, while black rot appears shortly after bloom.*

Research has shown that berry infection can occur throughout the growing season; however, most fruit rot infections probably occur early in the season (pre-bloom to two to four weeks after bloom). Once inside green tissues of the berry, the fungus becomes inactive, and the disease does not continue to develop. Infected berries remain without symptoms until late in the season when the fruit matures. Thus, fruit rot that develops at harvest may be due to infections that occurred during bloom.

To aid in controlling this disease, select planting sites with direct, all-day sunlight (avoid shade). Good soil drainage and air circulation are also very important. Orient rows to take full advantage of sunlight and wind movement. Cultural practices that increase air circulation and light penetration in the vineyard will reduce wetting periods and should be beneficial for control. While dormant pruning, cut out infected canes and destroy them. Select only strong, healthy canes that are uniform in color to produce the next season's crop. Proper timing of early-season fungicide sprays is important for control in commercial vineyards.

## Grape Insects

### Grape Flea Beetle

*Grape flea beetles* are occasional pests of the vineyard, causing two types of damage. The initial and most serious damage caused by this pest is when the adult chews holes in the sides and ends of the buds prior to them opening in the spring. This can cause the loss of the fruit buds and therefore reduce the amount of fruit that can be produced. The adults and larvae will also sometimes feed on the leaves after they have opened, though this damage is seldom serious. Therefore, early in the season prior to leaf emergence is the main time to scout for this pest. The adult beetles are steel blue in color and approximately 3/16 inch in length.



Figure 252. *Grape flea beetle* damage.



Figure 253. *Grape flea beetle* adult.



Figure 254. *Grape flea beetle* larva.

Locating your grapes away from wooded areas or waste areas can help to prevent an initial infestation. Chemical controls can be applied during the budding stage if damage is found. A spray can also be applied to the larvae feeding on the leaves later in the season in order to reduce the overwintering population.

### Grape Berry Moth

*Grape berry moths* can damage grapes in several ways. In early June, the first generation of larvae web flower buds or small fruit together and feed on them externally. The larvae may be difficult to find at this point. The second generation of larvae will feed on the grapes internally, with a single larvae infesting up to six grapes in a cluster. There can be multiple larvae per cluster. As a result, at harvest, severely infested clusters may contain several larvae and some grapes that are completely hollowed out. This damage can open the fruit up to diseases as well as to infestation by secondary pests.

The adult is a small moth that is mottled-brown with some bluish-gray on the inner halves of the front wings. The larvae are active, greenish to purplish caterpillars about 3/8-inch long when fully grown. The moths overwinter in a cocoon on leaf trash under the vines, emerging in late May to lay their eggs. The larvae from the first generation emerge from eggs in early June, and the second generation larvae emerge in August.



Figure 255. *Grape berry moth* damage, resulting in what is called stung berries.



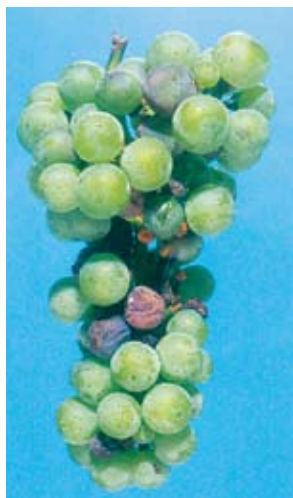

Figure 256. Grape berry moth damage in a fruit cluster.

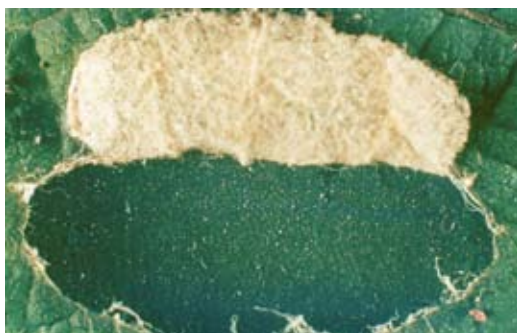

Figure 257. Grape berry damage by a pupa.



Figure 258. Grape berry moth adult.

Pheromone traps are available to help monitor for the moth flight, and scouting of the grapevine can also help to determine if an infestation is present. To scout your grapes, check clusters for any signs of webbing between the berries or for the reddish spots on the berries where the larvae have entered them. Cleaning up and burning leaf debris under the vines in the fall can help to reduce the number of overwintering pupae. Also, locating your grapes away from wooded areas that contain wild grapes can help to avoid an infestation. Insecticides can

be applied if moths are found in the traps or larvae are found through scouting.

### **Multicolored Asian Lady Beetles**

Though considered a beneficial insect when it is feeding on aphids and other pests throughout much of the growing season, this member of the lady beetle family can become a pest as fruit becomes mature in the fall and temperatures begin to drop. Though it is thought that *multicolored Asian lady beetles* do not cause the initial damage to a ripe grape, they do feed where other fruit-feeding pests (yellow jackets, birds, raccoons, etc.) or mechanical injuries have already broken the skin. Their presence in wine grapes is especially troublesome as they can impart a bitter taste to the wine if the beetles are crushed along with the grapes.

The multicolored Asian lady beetle is not a native species and therefore has few enemies in our environment. Its population tends to fluctuate each year, with the highest population in the years when the soybean aphid has high numbers. Keeping ripe fruit picked to avoid the initial damage by other insects is one way to reduce the number of these lady beetles in the clusters. There are pesticides that can be used to kill off the lady beetles; however, the pre-harvest intervals must be followed closely when doing so.



Figure 259. Adult of a multicolored Asian lady beetle.

Photo by Scott Bauer, USDA/ARS.



Figure 260. Multicolored Asian lady beetles in a grape cluster.

**Japanese Beetle**—See this pest under Stone Fruit.



Figure 261. Skeletonizing damage of Japanese beetles to grape leaves.

### Blueberry Diseases

As a rule, blueberries are the most pest free (therefore requiring the least amount of pesticide) of all the major fruit crops in Ohio. The best pest management approach is to apply no pesticide to new plantings until some problem develops. Watch plants closely for any symptoms of disease (dieback or fruit rot) or insect damage and begin spraying only when needed. Some fruit loss can be expected the first year that mummy berry disease or fruit rot develops. In subsequent years, this can

be controlled with fungicides. Generally, fungicides are not required for blueberries in the home fruit planting.

Probably the most common problems associated with blueberries are nutrient deficiencies related to soil pH requirements and water imbalance due to lack of proper mulching. Common symptoms of nutrient deficiency are yellow (chlorotic) leaves and stunted growth. The cause is too high of a pH. The pH of the soil in a blueberry planting should be maintained at 4.5 by applying sulfur at rates recommended by a soil test.

### Mummy Berry

The fungus causing *mummy berry* overwinters in mummified fruit on the ground. The mummies form cup- or globe-shaped structures called *apothecia*. Apothecia produce spores that infect young tissue and cause rapid wilting. This is called leaf and twig blight, or bud and twig blight. These symptoms are difficult to distinguish from frost injury.

These first infections form more spores, which are spread by rain, wind, and bees to blossoms and other young tissue. The fungus infects and invades the developing fruit. The fruit becomes malformed, looking like a pumpkin, and turns salmon or gray by midsummer (Figure 262). By

| <b>Table 32: Cultural and Mechanical Practices for Disease and Insect Control on Grapes and the Time of the Year to Conduct Them.</b>                                                       |                                                 |
|---------------------------------------------------------------------------------------------------------------------------------------------------------------------------------------------|-------------------------------------------------|
| <b>Time of year for conducting various cultural control practices</b>                                                                                                                       | <b>Problem targeted</b>                         |
| <b>When establishing a planting</b>                                                                                                                                                         |                                                 |
| Always plant in a well-drained location with all-day sun (no shade) and good air circulation.                                                                                               | Leaf and fruit diseases.                        |
| <b>During late winter or early spring</b>                                                                                                                                                   |                                                 |
| Prune vines during the dormant season, removing old clusters, cluster stems, mummified fruit, and infected canes.                                                                           | Leaf diseases, phomopsis, and black rot.        |
| <b>During spring and summer</b>                                                                                                                                                             |                                                 |
| If black rot lesions appear on leaves before fruit set, remove infected leaves.                                                                                                             | Black rot.                                      |
| Control weeds to encourage rapid drying of foliage.                                                                                                                                         | Leaf and diseases.                              |
| Pick off and destroy Japanese beetles daily.                                                                                                                                                | Japanese beetles.                               |
| Harvest berries regularly throughout the ripening period so that overripe fruits do not accumulate.                                                                                         | Sap beetles, yellow jackets, wasps, fruit rots. |
| <b>During fall or winter</b>                                                                                                                                                                |                                                 |
| Remove all clusters of mummified fruit from the planting, as well as those that have fallen to the ground. This is best done at harvest or soon after, while they are still easily visible. | Fruit diseases.                                 |
| Collect and destroy leaf debris under vines.                                                                                                                                                | Grape berry moth.                               |

fall, these fruit drop to the ground where they turn into mummies, ready to produce apothecia the next spring.



Figure 262. Mummy berry symptoms on infected blueberry fruit.

Cultural controls are extremely important in reducing inoculum levels in the spring. In very small plantings, mummies can be raked up and burned. In larger plantings, mummies can be buried by cultivating or by covering them with a new layer of mulch at least two inches in thickness. Combining cultivation and an application of nitrogen in the spring speeds destruction of the mummies. Cultivation between rows and raking under plants to disturb or cover mummies should be done as early as possible in the spring and should be repeated after each hard rain until after bloom. If just a few mummies are missed, they can produce enough spores to infect the planting. Where mummy berry has become a problem, fungicides can aid in its control.

## Blueberry Insects

### *Blueberry Maggot*

Larvae feed inside the berries, generally one per berry. Infested fruit may drop, therefore reducing yields. The life cycle and appearance is similar to that of the apple maggot (see under apples and pears). Because damage by the *blueberry maggot* is rare in blueberries in Ohio, it is best to avoid application of any insecticides to the blueberries until a problem develops. This will allow for natural predators to build up and aid in controlling any insect infestations.

Yellow sticky traps baited with ammonium acetate crystals can be used to monitor for the blueberry maggot fly. However, insecticide applications

should only be considered if several adults are found consistently each week. If an insecticide is to be used, it needs to target the adult. The timing for this type of spray will be close to harvest, so pre-harvest limitations listed on the label must be observed.



Figure 263. Blueberry maggot adult.



Figure 264. Blueberry maggot larva.

### *Fruitworms*

Larvae of both the *cherry fruitworm* and *cranberry fruitworm* can cause damage to ripening blueberries. Eggs are laid in late May and June. The larva enters the blueberry through the blossom end to feed and develop. Traps are available to monitor the moths that lay these eggs. If light infestations of the fruitworms are found, hand picking them may be suitable for the backyard grower. If the infestation is severe at harvest, consider using an insecticide after blossom drop the following year.



Figure 265. Cherry fruitworm.



Figure 266. Cranberry fruitworm.

**Fall Webworms**

*Fall webworms* or other tent-making caterpillars (bagworms or gypsy moths) may occasionally be found in the blueberry planting, especially if it is near a wooded area or other host trees. The best control is to prune off and destroy the nest of caterpillars while the nest is still small. Do not try to burn the nest while it is still on the bush as it may do additional damage to the plants.

**Japanese Beetles**—See this pest under Stone Fruit.

**Plum Curculio**—See this pest under Apples and Pears.

| <b>Table 33: Cultural and Mechanical Practices for Disease and Insect Control on Blueberries and the Time of the Year to Conduct Them.</b>                                                |                           |
|-------------------------------------------------------------------------------------------------------------------------------------------------------------------------------------------|---------------------------|
| <b>Time of year for conducting various cultural control practices</b>                                                                                                                     | <b>Problem targeted</b>   |
| <b><i>When establishing a planting</i></b>                                                                                                                                                |                           |
| Select a site with good air circulation and water drainage. Avoid shaded areas.                                                                                                           | Root and foliar diseases. |
| Do not plant near fruit trees.                                                                                                                                                            | Plum curculio.            |
| Use disease-free planting stock.                                                                                                                                                          |                           |
| <b><i>During late winter or early spring</i></b>                                                                                                                                          |                           |
| Maintain proper soil conditions by applying fertilizer and sulphur as recommended by soil tests and applying bark mulch to a depth of two to four inches. Maintain soil pH at 4.5 to 5.0. | General plant health.     |
| Remove mummified fruit from beneath plants. Cultivation or application of mulch can also be used to cover the mummified fruit.                                                            | Mummy berry.              |
| <b><i>During spring and summer</i></b>                                                                                                                                                    |                           |
| Control weeds.                                                                                                                                                                            | Foliar diseases.          |
| Use netting or visual scare devices as berries start to ripen.                                                                                                                            | Birds.                    |
| Promptly remove all ripe and cull berries.                                                                                                                                                | Japanese beetles.         |
| Prune out and dispose of disease-infested twigs and branches                                                                                                                              | Leaf and twig diseases.   |

# Chapter 8. Ribes—Gooseberries and Currants

Gooseberries and currants (*Ribes* spp.) have enjoyed great popularity in the past, particularly in Europe, where in the 1800s as many as 722 gooseberry varieties were in existence, and “gooseberry clubs” were established by enthusiasts. Most of the European varieties were large fruited and sweet as a result of centuries of selection and breeding, while American types had less desirable flavor and more disease resistance. The gooseberries grown today are primarily hybrids of these two types, offering good flavor as well as disease (powdery mildew) resistance. Although they seldom are eaten fresh due to their tart flavor, both red and white currants make excellent jams and jellies. Gooseberries and currants are woody perennial shrubs that reach a height of 3 to 6 feet when mature. Unlike other fruiting plants, they will tolerate partial shade. Plants are self-fruitful and, therefore, do not require two or more varieties for adequate pollination. Currants and gooseberries also are very winter hardy, tolerating temperatures as low as -22 to -31°F.

## Cultivar Selection

### Gooseberries

**CAPTIVATOR:** An American-European hybrid that produces large, sweet, pinkish-red fruit. Plants are resistant to powdery mildew.

**PIXWELL:** Sold most often and is very productive and hardy, but the fruit is only of fair quality. Fruit is best if harvested slightly under ripe. Plants are powdery mildew-resistant.

**POORMAN:** Red-fruited, large, and flavorful. The fruit ripens over a long season and is the best variety of the American types for home gardens since it is vigorous and has fewer and smaller thorns than most varieties. It is resistant to powdery mildew. Several European varieties are available from specialty nurseries. The fruit of the European types usually is larger and better flavored; however, the varieties without resistance to powdery mildew can be devastated by the strains of the fungus found in the United States.

**HINNONMAKI RED:** Has a tart skin but sweet, aromatic flesh. Plants are moderately vigorous and partially resistant to powdery mildew.

**INVICTA:** Has large, pale-green fruit and less flavor than most European types. Plants are large and have many spines. Has good resistance to powdery mildew.



Figure 267. Gooseberries make excellent jams and jellies. The cultivar shown here is *Invicta*. Photo courtesy of Nourse Farms Nursery.

### Currants (Red)

**CASCADE:** Matures early. Fruit is large and dark red, but vigor and productivity are only medium.

**JONKEERS VAN TETS:** Produces heavy yields. Fruit is dark red and has a very good flavor. Resistant to powdery mildew and aphids; susceptible to botrytis fruit rot.

**RED LAKE:** A vigorous, hardy, and productive variety. The fruit is large, bright red when mature, and of good quality. The long-stemmed clusters are easy to pick. Susceptible to powdery mildew.

**ROVADA:** A dependable producer. It blooms and fruits late, so frost is less of a problem than with other varieties. Resistant to powdery mildew and other leaf diseases.



Figure 268. Like gooseberries, red currants also make excellent jams and jellies. The cultivar shown here is *Rovada*.

Photo courtesy of Nourse Farms Nursery.

**WILDER:** Very much like Red Lake—high yielding with good-quality berries. Has more resistance to leaf spot.

### **Currants (White and Pink)**

**BLANKA:** Dependable and produces heavy yields. Plants are vigorous and easy to grow.

**PINK CHAMPAGNE:** Has good quality and flavor. As the name indicates, fruit is an interesting shade of pink, but yields tend to be low.

**PRIMUS:** Produces fruit late in the season. Plants are vigorous. Similar to Blanka in most characteristics, but yields are slightly lower.

**WHITE IMPERIAL:** Has low acidity and produces moderate yields. Plants have a spreading habit.

### **Currants (Black)**

Only varieties with good resistance to white pine blister rust are listed below.

**BEN SAREK:** Highly recommended for the home gardener. Bushes are compact, approximately 3 feet in height at maturity, with high yields and easy-to-pick fruit. Makes excellent jam and jelly and is recommended for wine making. Highly resistant to white pine blister rust.

**CONSORT:** Produces a medium crop of small to medium fruit. Plants are self-fertile. Though resistant to white pink blister rust, this variety is susceptible to leaf spots and powdery mildew.

**CORONET:** Yields are usually low and fruit is of marginal quality. A pollinator is required.

**CRUSADER:** Only marginally productive, and quality is low. A pollinator is required.

**TITIANA:** Produces heavy crops of large, high-quality fruit. Has very high resistance to white pine blister rust.

### **Currants (Clove or Buffalo)**

**CRANDALL:** A native species of currant that is sometimes considered more closely related to gooseberries than currants. Valued for its highly fragrant blossoms.

## **Planting and Nutritional Requirements**

In fall or early spring, plant well-rooted, 1- or 2-year-old dormant plants, cutting back the top portions of the plant to 6 to 10 inches. Space plants 3 to 4 feet apart in rows 6 to 8 feet apart. Note that plants can be vegetatively propagated by stem cuttings. Another possibility is to graft gooseberries and/or currants onto a tree species of *Ribes* called *Ribes aureum*. Grafting can be done on a convenient height of the tree, allowing the bush to produce fruit higher up, thus aiding in ease of harvest and weed control around the base of the plants. Remove flower blossoms from plants in the first year to encourage plant establishment and growth for future years. Well-established plants can fruit for 10 to 15 years or more. To fertilize, apply 6 to 8 ounces of 10-10-10 annually in an 18-inch ring around the plant in early spring.

## **Pruning**

Red currants and gooseberries produce fruit at the base of 1-year-old wood, with the greatest production on spurs of 2- and 3-year-old wood. After 3 or 4 years, the older wood becomes less productive and therefore should be gradually replaced with young shoots by a thinning and renewal process. Black currants produce the best fruit on wood that is 1 year old, although this wood is supported by the 2- to 3-year-old shoots. All canes older than 3 years old should be removed to encourage the growth of new canes.

Prune dormant plants in early spring just before growth resumes, usually in March or early April in Pennsylvania. Remove canes that drop on the soil or canes that shade out the center of the plant. After the first season of growth, remove all but six to eight of the most vigorous shoots. After the

second season, retain four or five 1-year-old shoots and three or four 2-year-old canes. Following the third season, keep three or four canes each of 1-, 2-, and 3-year-old wood. In subsequent years, remove all of the oldest canes, replacing them annually with new canes.

## Harvest

Pick fully colored fruit as they appear, usually in late June or July in Pennsylvania. Each plant will produce between 5 to 7 pounds when mature (usually during the third or fourth year).

*\*Most of the above information on gooseberries and currants was taken from PennState Bulletin #AGRS-99 "Fruit Production for the Home Gardener."*

## White Pine Blister Rust

White pine blister rust is not a serious disease of currants and gooseberries; however, it is a very serious disease of white pines (*Pinus strobus*). Currants and gooseberries serve as an alternate host for the rust fungus that causes white pine blister rust. Therefore, planting currants and gooseberries in areas where white pines are present can lead to serious losses of white pines. North American white pine species, including bristlecone, limber, sugar, eastern white, southwestern white, western white, and white bark, are highly susceptible. White pine blister rust causes significant damage in pine forests by forming cankers on the branches of white pines. These cankers ultimately kill the trees. Black currant is the most susceptible of the *Ribes* species.

On *Ribes* in the spring, tiny yellowish spots become visible on the upper surface of the leaves, while on the underside, orange-yellow blister-like fruiting bodies appear (Figure 267). By late summer, yellow to brown threadlike growths develop on or near these infection spots on the leaf. Bushes also will have premature defoliation.



Figure 269. Symptoms of white pine blister rust on the underside of a current leaf.

On white pine, the symptoms include dead branches, chlorotic foliage, branch girdling by lesions that exude resin or sticky yellowish fluid (spermatogonia), cankers that are diamond-shaped to elliptic with a dead center surrounded by a band of yellowish-green infected bark, light yellow-orange aecia, and death of the tree.

To protect white pine forests, several states have enacted laws concerning planting of black currants. The current Ohio law (Regulation AG-71-85.01) to suppress and control white pine blister rust disease is as follows:

- (A) The European black currant, *Ribes nigrum* L. or any cultivar of this species, is hereby declared to be a public nuisance, and it shall be unlawful for any person to possess, transport, plant, propagate, sell, or offer for sale, plants, roots, scions, seeds, or cuttings of these plants in this state.
- (B) Recognized cultivars, e.g., 'Consort' produced by the hybridization of *Ribes nigrum* L. or a cultivar thereof with a resistant or immune species, known to be immune or highly resistant to the White Pine Blister Rust fungus, (*Cronartium ribicola*, Fischer) are exempt from the restrictions imposed by paragraph (A) above.

To aid in prevention of this disease, remove susceptible *Ribes* species and infected plants and plant only disease-free resistant cultivars of *Ribes* approved by the Ohio Department of Agriculture. Some examples of resistant cultivars of black currant are 'Consort,' 'Crusader,' 'Coronet,' 'Ben Sarek,' and 'Ben Nevis.'

Red currants and gooseberries are not affected by Ohio law and are legal to plant. There are no fungicides labeled on currants and gooseberries for control of white pine blister rust.

Consult your state's Department of Agriculture or your Cooperative Extension Service for laws or regulations on the production of currants in your area.



## Chapter 9. Some Sources of Fruit Plants

| Name                                                                                                                                             | Address                                                           | Product                            |
|--------------------------------------------------------------------------------------------------------------------------------------------------|-------------------------------------------------------------------|------------------------------------|
| <b>Adams County Nursery</b><br><a href="http://www.acnursery.com/">http://www.acnursery.com/</a>                                                 | P. O. Box 108,<br>Aspers, PA 17304<br>717-677-8105                | Tree fruit                         |
| <b>Blossomberry Nursery</b><br><a href="http://www.blossomnursery.com/">http://www.blossomnursery.com/</a>                                       | Hwy. 21 N Ludwig<br>Clarksville, AR 72803<br>479-754-6489         | Small fruit                        |
| <b>Boyer Nurseries</b><br><a href="http://www.bojernurseries.com/">http://www.bojernurseries.com/</a>                                            | 405 Boyer Nursery Rd<br>Biglerville, PA 17307<br>717-677-8558     | Old fashioned and<br>unusual fruit |
| <b>Concord Nursery</b><br><a href="http://www.concordnurseries.com/">http://www.concordnurseries.com/</a>                                        | 10175 Mile Block Rd,<br>North Collins, NY 14111<br>800-223-2211   | Grapes                             |
| <b>C&amp;O Nursery</b><br><a href="http://www.c-onursery.com/">http://www.c-onursery.com/</a>                                                    | P. O. Box 116<br>Wenatchee, WA 98807                              | Tree fruit                         |
| <b>Cooley's Strawberry Nursery</b>                                                                                                               | P. O. Box 47<br>Augusta, AR 72006<br>870-347-2026                 | Strawberry                         |
| <b>Cumberland Valley Nursery</b>                                                                                                                 | Box 394<br>McMinnville, TN 37110<br>800-492-0022                  | Tree fruit                         |
| <b>Daisy Farms</b><br><a href="http://www.daisyfarms.net/">http://www.daisyfarms.net/</a>                                                        | 28355 M-152<br>Dowagiac, MI 49047<br>269-782-6321                 | Small fruit                        |
| <b>DeGrandchamps Blueberry Farm</b><br><a href="http://www.degrandchamps.com/">http://www.degrandchamps.com/</a>                                 | 76241 14th Ave.<br>South Haven, MI 49047<br>888-483-7431          | Blueberry                          |
| <b>Edible Landscaping</b><br><a href="http://www.eat-it.com/">http://www.eat-it.com/</a>                                                         | P. O. Box 77<br>Afton, VA 22920<br>800-524-4156                   | Old fashioned and<br>unusual fruit |
| <b>Forrest Keeling Nursery</b><br><a href="http://www.fknursery.com/index.asp">http://www.fknursery.com/index.asp</a>                            | 88 Keeling Ln.<br>Elsberry, MO 63343<br>800-FKN-2401              | General fruit                      |
| <b>Wholesale</b>                                                                                                                                 |                                                                   |                                    |
| <b>Grootendorst Nursery</b>                                                                                                                      | 15202 Lakeshore Rd.<br>Lakeside, MI 49116<br>616-469-2865         | Rootstocks                         |
| <b>Haley Nursery Co., Inc.</b>                                                                                                                   | 1207 Haley Rd.<br>Smithville, TN 37116<br>800-251-1878            | Tree fruit                         |
| <b>Hartmann's Plant Company</b><br><a href="http://www.hartmannsplantcompany.com/index.html">http://www.hartmannsplantcompany.com/index.html</a> | P. O. Box 100<br>Lacota, MI 49063-0100<br>616-253-4281            | Blueberry                          |
| <b>Hilltop Fruit Trees</b><br><a href="http://www.hilltopfruittrees.com/">http://www.hilltopfruittrees.com/</a>                                  | P. O. Box 578, 60395 CR 681<br>Hartford, MI 49057<br>800-253-2911 | General fruit                      |

| Name                                                                                                                              | Address                                                        | Product                                              |
|-----------------------------------------------------------------------------------------------------------------------------------|----------------------------------------------------------------|------------------------------------------------------|
| <b>Wholesale (continued)</b>                                                                                                      |                                                                |                                                      |
| <b>Holly Dale Nursery</b>                                                                                                         | Hwy. 415<br>Pelham, TN 37366<br>931-467-3600                   | Tree fruit                                           |
| <b>Indiana Berry and Plant</b><br><a href="http://www.inberry.com/index2.html">http://www.inberry.com/index2.html</a>             | 52118 W 500 S<br>Huntingburg, IN 47542<br>800-295-2226         | Small fruit                                          |
| <b>Ison's Nursery</b><br><a href="http://www.isons.com/">http://www.isons.com/</a>                                                | 6857 Hwy. 16<br>Brooks, GA 30205<br>800-733-0324               | Small fruit                                          |
| <b>Krohne Plant Farms</b><br><a href="http://www.krohneplantfarms.com/shop/">http://www.krohneplantfarms.com/shop/</a>            | 65295 CR 342<br>Hartford, MI 49057<br>269-424-5434             | Strawberries                                         |
| <b>Lawson's Nursery</b><br><a href="http://www.lawsonsnursery.com/">http://www.lawsonsnursery.com/</a>                            | 2730 Yellow Creek Rd.<br>Ball Ground, GA 30107<br>770-893-2141 | Old fashioned and unusual tree fruits                |
| <b>Northwoods Nursery/One Green World</b><br><a href="http://onegreenworld.com/">http://onegreenworld.com/</a>                    | 29696 S. Cramer Rd.<br>Molalla, OR 97038<br>877-353-4028       | Old fashioned and unusual fruit                      |
| <b>Nourse Farms</b><br><a href="http://www.noursefarms.com/">http://www.noursefarms.com/</a>                                      | 41 River Rd.<br>South Deerfield, MA 01373<br>413-665-2658      | Small fruit tissue cultured (tissue cultured plants) |
| <b>Raintree Nursery</b><br><a href="http://www.raintreenursery.com/">http://www.raintreenursery.com/</a>                          | 391 Butts Rd.<br>Morton, WA 98233<br>360-496-6400              | Disease-resistant fruit, rootstocks                  |
| <b>Sakuma Bros. Farms</b><br><a href="http://www.sakumabros.com/index.html">http://www.sakumabros.com/index.html</a>              | P. O. Box 427<br>Burlington, WA 98233<br>360-757-6611          | Strawberry, bramble (tissue-cultured plants)         |
| <b>Southmeadow Fruit Gardens</b><br><a href="http://www.southmeadowfruitgardens.com/">http://www.southmeadowfruitgardens.com/</a> | P. O. Box 211<br>Lakeside, MI 49116<br>269-422-2411            | Old fashioned and unusual fruit, rootstocks          |
| <b>Stark Brothers Nursery</b><br><a href="http://www.starkbros.com/index.jsp">http://www.starkbros.com/index.jsp</a>              | P. O. Box 10<br>Louisiana, MO 63353<br>800-325-3189            | General fruit                                        |
| <b>Tower View Nursery</b>                                                                                                         | 70912 CR 388<br>South Haven, MI 49090<br>616- 637-1279         | Blueberry                                            |
| <b>Van Well Nursery</b><br><a href="http://www.vanwell.net/">http://www.vanwell.net/</a>                                          | P. O. Box 1339<br>Wenatchee, WA 98807<br>800-572-1553          | Tree fruit                                           |
| * This list is a reference, not a recommendation.                                                                                 |                                                                |                                                      |

# Chapter 10. Glossary of Terms

**Adventitious buds:** Adventitious buds are the buds that arise at sites other than the terminal or axillary position. They may develop from roots, a stem internode, the edge of a leaf blade, or callus tissue at the cut end of a stem or a root. Adventitious buds allow stem, leaf, and root cuttings to develop into entirely new plants.

**Alternate year bearing:** The tendency to bear heavy fruit crops in one season and a light crop or no crop in the following season.

**Anther:** The pollen-bearing part of a stamen, which is the male part of a flower.

**Aphids:** Aphids, or plant lice, are small, soft-bodied insects which are common pests of nearly all indoor and outdoor ornamental plants, as well as vegetables, field crops, and fruit trees.

**Apothecia:** Cup- or globe-shaped structures, formed by mummies, that produce spores that infect young tissue and cause rapid wilting.

**Bacteria:** A large group of single-cell microorganisms. Some cause infections and disease in animals, humans, and plants.

**Banding:** Spreading and scattering fertilizer in a uniform strip or band along plant rows.

**Bare-rooted plants:** Plants that are sold or shipped with roots exposed, rather than in soil.

**Biennial:** A plant or plant parts, such as bramble canes, that complete their life cycle within a two-year period.

**Bilateral high cordon system:** This is a form of training system for grapevines where cordons, or the “permanent” arms of the grapevines, extend along the top wire of the trellis in both directions, instead of the bottom wire as in Low Cordon system. The cordons on a High Cordon then remain as semi-permanent extensions of the trunk, though they may need replacement every few years.

**Bletting:** The process in which fruit must be ripened after picking before it is edible.

**Button berry:** Term for damage to strawberries caused by tarnished plant bug.

**Calyx:** The ring of green, leaf-like structures enclosing a flower bud, immediately beneath the petals in an open flower; the blossom end of the fruit.

**Canker:** A necrotic, localized disease area with a sharp line of demarcation between healthy and disease tissue. Usually on trunks or stems.

**Catfacing:** Distortion of fruit caused by insect or mechanical injuries.

**Central leader system:** A system for training fruit trees to grow with a central trunk around which side branches of the desired number and spacing are developed and arranged.

**Chlorophyll:** The pigment responsible for the dark green color in leaves and for photosynthesis.

**Chlorosis:** Abnormal yellowing of foliage, often due to a deficiency of one or more nutrients or a lack of sufficient sunlight.

**Cold hardiness:** The capacity of plants to tolerate low winter temperature.

**Conidia:** Fungal spores that develop on the surface of rotted fruits during warm, moist conditions.

**Cornicles:** Tail-pipe type appendages on the back of aphids.

**Cross pollination:** The transfer of pollen from the anthers of one cultivar to the stigma of another cultivar; necessary for fertilization, fruit growth, and fruit development when a cultivar is not self-fruitful.

**Crown:** A short stem between the roots and leaves of a strawberry plant.

**Cultivar:** A variety of a plant that has been created and maintained through cultivation. Cultivars may differ in growth habit, season of maturity, fruit color, fruit shape, etc. Examples are Liberty apples, Earliglow strawberries, and Bartlett pears.

**Deciduous:** Woody plants that lose their leaves at the end of each growing season.

**Degree days:** Degree-days are the accumulated product of time and temperature between the developmental thresholds for each day. One degree-day is one day (24 hours) with the temperature above the lower developmental threshold by one degree.

**Dormancy:** The period during which plants cease visible growth due to unfavorable environmental conditions.

**Dripline:** The imaginary line at the edge of tree canopy.

**Ellagic acid:** A natural substance contained in strawberries that is an anti-carcinogenic (cancer-preventing) compound.

**Espalier:** Training plants to grow on a flat surface such as a trellis and pruning to confine growth in one plane. Plants so trained are called espalier.

**Everbearing:** Bearing two or more distinct crops of fruit in a single growing season.

**Fertilizer analysis:** Fertilizer analysis represents the percentages of nitrogen, phosphorus, and potassium that are available from the bag of fertilizer by weight. Using the fertilizer 5-10-15 as an example, the bag with this analysis will contain 5% nitrogen, 10% phosphorus, and 15% potassium.

**Fire blight:** Caused by the bacterium *Erwinia amylovora*, fire blight affects more than 130 plant species in the rose family. Fire blight is quite often seen on apple, crabapple, pear, mountain ash, and cotoneaster.

**Floricanes:** Canes on which flowers and fruit are produced during the second growing season.

**Frass:** Mass of chewed material, or excrement, produced by insects.

**Fruit set:** Development of the parts of the ovary after fertilization of the egg(s) and swelling of the ovary is noticeable.

**Fungus:** Any of a kingdom (Fungi) of saprophytic and parasitic spore-producing eukaryotic typically filamentous organisms formerly classified as plants that lack chlorophyll and include molds, rusts, mildews, smuts, mushrooms, and

yeasts. Many infectious diseases in plants are caused by fungi.

**Graft union:** The part of the lower stem of a woody plant, usually enlarged, where the scion (cultivar) was joined to the rootstock.

**Ground color:** The color of the skin of developing fruit, which may be blushed, striped, or washed with a different color.

**Growing season:** Number of frost-free days.

**Hardiness:** The ability of fruiting plants to withstand low temperature injury to woody tissue; may also refer to the ability of fruit buds to survive cold injury.

**Heading back:** Pinching off the tips of a plant.

**Heading back cut:** Cutting a woody branch to a lateral or a bud.

**Heaving:** Forcing of plant roots upward out of the soil as a result of alternate freezing and thawing of the soil in autumn, winter, and spring; occurs on small fruit plants such as strawberry.

**Hedge row:** A dense, closely spaced planting, creating a wall of foliage or hedge effect.

**Heeling in:** Preventing roots of nursery stock from drying out prior to planting by placing roots in a shallow V-shaped trench and covering them with moist soil, peat moss, and sawdust. Heeling in means temporarily planting the plants in a hill or row of soil until they can be planted permanently.

**Hill planting:** Planting fruit plants with enough space between plants to permit cultivation in two different directions.

**Integrated pest management (IPM):** Pest control that relies on using a variety of control measures.

**Interstem:** Part of a plant, usually a short piece of stem tissue, grafted between the rootstock and a desired cultivar.

**June bearing:** Strawberries bearing one crop of fruit per growing season, usually in late spring or early summer.

**King apple:** The largest apple in a cluster of apples; the smaller fruits are removed, leaving only the king apple.

**Maturity:** A stage of development in fruit when eating or processing quality is at its peak.

**Micronutrients:** Micronutrients are seven essential elements: boron, chlorine, copper, iron, manganese, molybdenum, and zinc. Plants need them in order to grow normally or complete their life cycle, but in much smaller amounts than macronutrients, such as nitrogen, phosphorus, and potassium.

**Modified central leader system:** A system for training fruit trees in which a tree is cut back each winter, and a new central leader shoot is selected each spring.

**Mulch:** A material applied to the soil surface to conserve soil moisture, maintain a more even soil temperature, and/or aid in weed control.

**Mutation:** A genetic change within a plant structure that changes its characteristics.

**Mycoplasmas:** Mycoplasma are small parasitic organisms that have long been known to cause disease in plants, animals, and man. The organisms produce spherical- to ellipsoid-shaped bodies that are smaller than bacteria but larger than most virus particles.

**Nematodes:** Nematodes belong to many families of long, legless, worm-shaped animals including tens of thousands of species worldwide. Some species are aquatic, in freshwater or the sea. Some species are parasites of birds, mammals, or other vertebrate animals. Some species are parasitoids of insects. Others feed on plant roots.

**Not self-fruitful:** Pollen from a plant's own flower or from the flower of another tree of the same cultivar is incapable of producing fertilization.

**Oomyceet:** A fungus-like pathogen.

**Open center or open vase system:** Open center system is a common training system for stone fruit, such as peach or nectarine, where the main stem in the center is removed. The shape of the tree looks like a bowl or a vase.

**Pathogen:** A disease-causing organism.

**Pedicle:** Fruit stem; the part of a plant that connects the fruit to the cane.

**Perennial:** A plant with a life span of more than two years; such plants flower and produce a crop each year. Examples: grapes, cherry trees.

**Perithecium:** Fungal fruiting structures.

**pH:** A scale used to indicate the degree of soil acidity and alkalinity.

**Photosynthesis:** The conversion of carbon dioxide to carbohydrates.

**Pistil:** The female part of the flower.

**Pollination:** The transfer of pollen from the anther to the stigma.

**Primocanes:** First-year canes that are vegetative only for most bramble cultivars. There are exceptions in which some do flower and produce fruit in the fall.

**Pruning:** The proper and judicious removal of such plant parts as leaves, twigs, shoots, buds, branches, or roots of a plant to increase its usefulness.

**Pycnidia:** Small, black, fungal fruiting bodies that contain thousands of summer spores or conidia.

**Renovation (renewal):** Cutting back or narrowing of plant rows to promote new plant development.

**Rest period:** A period of non-visible growth, controlled by internal factors; growth will not occur during this period, even when environmental conditions are favorable.

**Rootstock:** Root material to which other cultivars are united by grafting or budding.

**Scaffold branch:** A main branch of a woody plant structure.

**Scion:** Part of a plant, usually the desired cultivar, grafted or budded to a specific rootstock or interstem.

**Self-fruitful:** Pollen from the same cultivar will result in successful pollination, fertilization, and fruit formation.

**Shuck split:** Development stage in stone fruit where the growth of fruit splits the shuck, the sepals that serve as the outer cover of developing fruits.

**Sports (bud sports):** Strains or mutations of a cultivar having superior growth and fruiting characteristics.

**Spur:** Short, woody fruit-bearing stem.

**Spur type:** Having the tendency to produce large numbers of fruiting spurs on individual limbs.

**Standard rootstock:** The type of rootstock producing a full-sized tree, which may be up to 35 to 40 feet for apple.

**Sterile pollen:** Apple cultivars such as Jonagold, Mutsu, Stayman, and Winesap have a third set of chromosomes (triploid) and produce pollen that cannot pollinize each other or any other cultivar. A pollinizer must be provided for these cultivars. If an apple cultivar is used for this purpose, a second pollinizer cultivar should be provided for the first cultivar pollinating the cultivar with sterile pollens.

**Stomates:** Wound or natural openings.

**Suckers:** A vigorous vegetative shoot, arising from roots or the lower part of a plant stem, that drains nutrients needed for fruit production.

**Summer topping:** Removal of terminal or tip growth on new shoots to stimulate branching.

**Thinning-out cut:** Removing a branch to its point of origin on the crown, trunk, or scaffold.

**Threshold:** A term used in integrated pest management where a number of insects present on plants is set as a limit. This number is called a threshold. Insect densities at or above the threshold should be controlled.

**Torus:** The white receptacle that connects the fruit to the pedicle and then the cane.

**Trace element:** Same as micronutrient. It is a mineral required by plants and animals in relatively small quantities.

**Training:** Orienting a plant in a space by supporting, tying, and/or pruning.

**Triploid:** A plant with three sets of chromosomes (the genetic materials.) Some apple cultivars such as Jonagold, Mutsu, Stayman, and Winesap are triploids.

**Virus:** A microorganism smaller than a bacteria, which cannot grow or reproduce apart from a living cell. A virus invades living cells and uses their chemical machinery to keep itself alive and to replicate itself.

**Watersprout:** A vigorous vegetative shoot that drains nutrients needed for fruit production.

**Wet feet:** Root asphyxiation caused by soil that drains inadequately.

**Whip:** A shoot with lateral branches or with lateral branches removed.



T · H · E  
OHIO  
STATE  
UNIVERSITY  
EXTENSION