

Methods of Installing United States National Seismographic Network (USNSN) Stations— A Construction Manual

By John R. McMillan



Open-File Report 02-144

2002

This report is preliminary and has not been reviewed for conformity with U.S. Geological Survey editorial standards or with the North American Stratigraphic Code. Any use of trade, firm, or product names is for descriptive purposes only and does not imply endorsement by the U.S. Government.

**U.S. DEPARTMENT OF THE INTERIOR
U.S. GEOLOGICAL SURVEY**

TABLE OF CONTENTS

Introduction	1
Constructing an Outdoor Installation	1
Seismometer Vault Construction	3
Selecting a vault location	3
Installing the Door Covering the Top of the Seismometer Vault	11
Installation of the Seismometers	11
High-gain seismometer installation	11
Low-gain seismometer installation	11
Preventing thermal air currents around the high-gain sensors	12
Finishing the sensor installation	13
Conclusion	14
Component Descriptions and Sources	15

FIGURES

Figure 1. Station AHID	1
Figure 2. Assembling vault door frame.	4
Figure 3a. Barrels in Positioning Jig Station NHSC	5
Figure 3b. Barrels in Positioning Jig.	5
Figure 4. Placing concrete in excavated hole	7
Figure 5. Vault door frame placed in concrete.	8
Figure 6. Polyurethane insulation in place	10
Figure 7. Vault door attached to frame	11
Figure 8. Guralp CMG-3NSN seismometers installed.	11
Figure 9. Strong motion sensor installed.	11
Figure 10a-c. The process of pouring sand around seismometers.	12
Figure 11. Insulation plug in place	13
Figure 12. Tarp used to prevent condensation from dripping on insulation	13
Figure 13. Seismometer feedback electronics connected to seismometers.	13
Figure 14. Barrels ready for lids.	14
Figure 15. Vault construction and installation complete	14
Figure 16. Station LRAL	14

DRAWINGS

Drawing 1. USNSN Vault Section	17
Drawing 2. Bulkhead Fitting Detail.	18
Drawing 3. Vault Door Frame	19
Drawing 4. Barrel Position JIG	20
Drawing 5. Concrete Form	21
Drawing 6. Generic Site Plan	22
Drawing 7. Barrel Tightening Tool	23

Introduction

Unlike older sensor technology, broadband seismic sensors can respond to seismic energy, temperature, and, in some instances, atmospheric pressure. Optimally, these sensors should be installed in a structure that effectively controls environmental variables such as temperature and humidity (for example, a vault or a bunker-like room constructed of a large amount of concrete that is situated in or on bedrock). However, due to the elaborate design and expense of these vaults, it may not be feasible to build large numbers of them around the country. Our design includes many features of an elaborate, bunker-type vault, is easier to install, and can be built on the surface. The intended use of the seismic data, the number of stations in the network, and the money available to construct the network will all affect seismic station and network design.

More than a decade ago the basic design concepts of the United States National Seismographic Network (USNSN) were determined. After many years of network operation these design concepts have not changed significantly. Some of the important design features of the USNSN network include:

1. Use of off-the-shelf electronic equipment when possible;
2. The ability to install a seismic station in diverse environments;
3. A physically protective, dry, and thermally stable environment for the broadband sensors;
4. An overall station design that is easy to maintain;
5. Manageable installation costs.

The following section describes the construction of the USNSN seismic vaults. It also explains why some of the features and installation techniques are important. Installation of the electronic equipment, other than seismometers and the interconnected cabling, can be done using accepted electrical/electronics procedures and will not be discussed here. Descriptions and sources of the components used to construct these sites are listed in the *Component Descriptions and Sources*.

Constructing an Outdoor Installation

Figure 1 shows a typical example of an outdoor USNSN installation. This site design allows a local contractor with only general experience to construct a large portion of the site without having U.S. Geological Survey (USGS) personnel on site to supervise. However, because of the special knowledge required, the USGS team should construct the seismometer vault and install the seismic sensors, interconnecting cabling, and satellite communications equipment.



Figure 1. Station AHID

A local contractor can complete the preliminary site construction, which includes the following work in this order: (Refer to Drawing 6; *Generic Site Plan*.)

1. *Earthmoving*

Level the site where the prefabricated electronics shelter will sit on a constructed concrete pad. Excavate the holes for the satellite-dish pole mount, seismic vault, and conduit trenches.

All earthmoving and excavating can be accomplished at one time. If a contractor performs this work, we recommended that excavation of the vault hole be delayed until the USGS installation team is on site. Because of the detailed nature of the vault-hole excavation (described later), a knowledgeable person must be on site when the excavation is done.

2. *Conduit Installation*

Two or three conduit runs should terminate inside the equipment shelter near its inside wall. Care should be taken to install the conduit up through the concrete pad and the floor of the shelter. The prefabricated equipment shelter manufacturer may use pressure-treated timbers to keep the building from resting directly on the ground, or in this case, the concrete pad. The location of these timbers, or other features in the floor of the prefabricated equipment shelter, may interfere with the conduit, if the conduit penetrates the concrete pad at the wrong location. The conduit should enter the shelter floor close to the inside wall.

3. *Placing the Concrete Pad for the Equipment Shelter and the Satellite-Dish Mount*

The design of the concrete used in the pad is not critical. A compressive strength of 3,000 pounds per square inch is adequate for these two uses. Refer to standard references such as The Uniform Building Code (UBC) or American Concrete Institute (ACI) for design guidelines to construct the concrete pad including the proper use of reinforcement steel bar. Ideally, the concrete equipment shelter pad should cure for 7 days before any significant load is placed on it. The concrete for the satellite-dish post should be at least 24 hours old before installing the satellite dish on the post.

4. *Installation of Commercial Power*

Bringing commercial power to the equipment shelter can also present problems. A licensed electrician should be used to bring electricity to the equipment shelter when possible. Be aware that objects such as power poles or trees may be a source of ground movement in high winds; therefore, locate the vault, if possible, a minimum of two and one-half times the height of the object. Power can be routed up through the concrete in conduit similar to the seismometer signal cables and the VSAT cable, or it can be trenched to a short pole located within a few feet of the equipment shelter. Route the power conduit either through the floor of the equipment shelter or up the outside of the shelter and through the shelter wall to a breaker box located inside the shelter. Care must be taken to avoid crossing the cable trenches containing the seismometer cables. (See Drawing 6; *Generic Site Plan*.)

5. *Installing the Equipment Shelter*

High winds should be anticipated at all locations. The equipment shelter should be anchored using anchor bolts either to the concrete pad underneath it or by using buried anchors in the ground. Anchor bolts should preferably be installed a minimum of 4 inches in from the edge of the pad. If buried

anchors are used, talk to the supplier of the building. They will often recommend the best way to do the job. New concrete can be easily damaged; therefore, the concrete pad should be allowed to cure for a few days before placing the building on it.

Seismometer Vault Construction

Construction of the seismometer vault is the most important aspect of the station installation. The purpose of the station is to acquire the best seismic data available at that location, and the quality of the vault construction will affect the environment of the seismometers and the quality of the data. Keep in mind that this vault will probably be used for many years to come.

Selecting a vault location

1. There probably is no such thing as an “ideal” site. Every site may require compromises. The important thing is to use what is available at each location to best advantage.
2. The vault should not be placed in water run-off paths where water will accumulate around it.
3. Locate the seismometer vault uphill from the equipment enclosure. To prevent moisture from entering the conduit running between the vault and the equipment shelter, carefully join the conduit sections together and seal the conduit at each end after the cables are installed (see *The vault construction can be broken up into these different steps*, part 13). Thus, if the conduit is damaged and water enters the conduit, it will not accumulate at the sensor end and potentially damage expensive instrumentation.
4. The seismometer vault should be constructed on or as near to bedrock as possible or in undisturbed weathered rock, if a hard-rock site is not available. Alluvial deposits should be avoided; however, the design of the network may determine the actual location of the stations. Therefore, sediment deposits may be the only geology available at a specific location.

Vault construction requires the following steps:

1. *Excavation of the vault hole*

A standard vault excavation measures 6 feet in length by 4 feet in width by 4 feet deep. A knowledgeable person should be on site when the hole is excavated. Decisions will often need to be made while the backhoe is digging. A backhoe should be used to dig the vault hole at all locations and to smooth access for the concrete truck.

Do not attempt to mix the concrete yourself for the following reasons:

- A. It is expensive. Mixing by hand can add several man/days of labor to each site.
- B. Portland Cement is dusty and caustic; it therefore poses a health threat and requires the use of safety equipment.
- C. Concrete is heavy. Approximately 100 cubic feet of concrete are used in each vault hole. The weight of the dry concrete alone is close to 12,000 pounds.
- D. Consistent quality of the concrete mix from site to site is also important and may be difficult to achieve, if mixed by hand.

The vault hole should be located in or on hard rock. The concrete must be well coupled to the earth to obtain the best data. Clean the rock face at the bottom of the hole by scrubbing with a stiff brush or pressure washing. Loosen and remove any material that may interfere with the bonding of the concrete. Use a wet/dry vacuum to remove the water, soil, and rock fragments that remain in the bottom of the hole. Use a hammer or pick to remove all loose fragments from the rock surface.

2. *Constructing the form at the top surface of the excavation. (See Drawing 5, Concrete Form.)*

After excavation, use 2"x6" lumber (at or above grade) to construct a form around the top of the excavation. Deck screws can be used to assemble the form, thus making it easier to disassemble the form once the concrete has set up. Level the form at the top of the hole and use stakes to hold the form in position while placing the concrete. This form will give a finished, squared-up appearance to the top of the concrete and provides an attachment point to the Barrel Positioning Jig (see item 5 below and Drawing 4).

3. *Installing the vault door frame*

To construct the vault door frame, we use a special type of lumber made from recycled plastic. This lumber, which can be found at most large hardware/lumber stores, withstands severe weather conditions over a long period of time. Lumber intended for use as deck planks is ideal for this application. Each side of the frame is constructed using two deck planks placed against each other side by side. Using angle iron at the corners and carriage bolts, join the deck planks at the corners through the angle iron. The angle iron should be cut to an overall length of 18 inches. This will allow 7 inches of the angle iron to extend below the plank frame. Two more pieces of angle iron are used at the middle on the long sides of the frame to provide lateral support. These two pieces also extend down into the concrete like the corner angle iron. The angle iron of the frame assembly will be placed into the concrete while it is still wet and will serve as anchors for the frame. This unit must be completely constructed before the concrete truck arrives (see Drawing 3, *Vault Door Frame*).



Figure 2. Assembling vault door frame.

4. *Preparation of the seismometer enclosure barrels*

The barrels that enclose the seismometers were originally designed as hazardous waste storage containers. They feature a water-tight seal and a screw-top lid with a square notched rim, which allows a 2"x4" to be used as a tightening tool. (Drawing 7 describes a tightening tool that can be fabricated.) The bottoms of the barrels must be removed before placing them in concrete. A reciprocating saw works very well for this purpose. Using a hole saw, a hole must be cut in the side of each barrel near the top to allow a 2-inch piece of conduit and waterproof bulkhead fittings to join the two barrels.

Another hole must be cut on the opposite side of one barrel from where the two barrels are joined. Thus, cables from the equipment enclosure can enter the barrels. (See Drawing 1, *USNSN Vault Section and Drawing 2, Bulkhead Fitting Detail.*)

5. *Installing the barrels in the locating jig at the top of the excavation*

The barrels must be held in place by a plywood jig to ensure that they don't move out of position when the concrete is being placed. The jig rests on and is secured to the concrete form at the top of the excavation. Cutouts in the jig allow concrete to be poured around all sides of the barrels. (See Drawing 4, *Barrel Positioning Jig.*)

6. *Connecting the conduit to the barrels*

After the barrels are in the positioning jig and are fastened to the form at the top of the hole, the conduit leading to the equipment shelter must be connected to the barrels by the waterproof bulkhead fitting mentioned in step 4.

7. *Ordering concrete*

Things you need to know about concrete.

(This is important information that will contribute to the success of the installation.)

Concrete is composed of Portland Cement, aggregate (gravel), and water. Concrete hardens not because it "dries" but because of a chemical reaction between the water and cement. This type of reaction is known as an exothermic reaction because it gives off heat as it cures.

The aggregate adds strength to the Portland Cement. Enough water must be available in the mixture to completely react with the Portland Cement. The concrete mix design recommended has ample water for this use.

For most concrete projects wire mesh is used in addition to reinforcement bar. Although steel reinforcement is compatible with concrete and could be used in this vault construction, we highly recommend against its use for several reasons.



Figure 3a. Barrels in Positioning Jig Station NHSC.



Figure 3b. Barrels in Positioning Jig. Notice conduit running to barrels.

- A. Reinforced steel is a strengthening component that is not needed in this vault design and adds unnecessary complexity to the structure.
- B. Introducing steel to the structure adds a potential failure source to the concrete. If surface cracks develop in the concrete, moisture could attack the steel and cause rust, which could result in swelling, cracking, and more moisture entering the concrete. Thus, a failure cycle begins.

While the surface of the concrete is curing, it must be protected from drying out. If the concrete dries out, due to weather or other factors, it can lose strength, especially at the surface. The damage caused by drying can lead to cracking and spalling, which makes the concrete susceptible to freeze/thaw damage. A curing compound can be applied to seal the surface or a plastic tarp can be used to shade the concrete.

Concrete designers use “compressive strength” and “slump” to describe concrete properties. Concrete cures at an exponential rate. When concrete mixes are designed, the compressive strength of these mixes is tested at 7 days and at 28 days to insure that the predicted strength curve fits the actual strength. The specified strength of the concrete is the 28-day value.

Slump describes workability. To test slump, concrete designers use a special tapered, cylindrical mold, which is filled with concrete and consolidated in the mold in a prescribed manner. The mold is then turned upside down onto a flat surface, and the mold is carefully removed. This mound of concrete, because it is still plastic, will try to flatten (slump). After a prescribed time has elapsed (about 2½ minutes), the height (or slump) of the wet concrete is compared to the height of the cylinder in inches. The difference describes the slump of that mix. The amount of water in a concrete mix directly affects slump. Too much water can weaken the mix and allow future freeze/ thaw damage. In most applications a balance between too much and too little water is desirable. More water makes it flow better (workability), but too much water may weaken the mix. Workability need not be considered for this vault design.

What type of concrete should be ordered?

- A. Specify a low-slump mix (4 inches). Workability is not an important consideration for this application.
- B. Ask for a superplasticizer additive. Superplasticizer, a water-reducing admixture, produces a high-slump concrete mix with low water content and no loss of strength. A 4-inch slump does not flow well down the delivery chute of the concrete truck. It is also more difficult to easily place around the barrels without vibrating the concrete. A very small amount of superplasticizer will make the mix act like a high-slump mix without the risk of shrinkage cracks. Concrete mixed with superplasticizer is very cohesive and results in little or no internal segregation of the aggregate.
- C. Type II Portland Cement is preferred because it is resistant to freeze/thaw damage and will not produce as much heat as Type I Portland Cement. This is particularly important if the concrete is being placed in hot weather. Type II Cement is also somewhat resistant to sulfate attack. Sulfates in soil or ground water can attack the concrete and cause the surface to deteriorate and become more vulnerable to freeze/thaw damage. Type II Cement will also gain strength more rapidly than Type I, even though this is not an important factor.

- D. Curing inhibitor. If the concrete is placed when the weather is very hot (90°-100° F), too much heat could build up in the concrete during curing. Curing inhibitors will slow down the curing rate and the amount of heat produced.
- E. A compressive strength of 3,000 pounds per square inch is adequate. Strength is not an important factor in the type of concrete we use in constructing our vault. Higher strength concrete contains more cement, which again is a factor in the amount of heat produced.
- F. Order more concrete than you can actually use. The volume of the hole described above is slightly less than 3 cubic yards. Other factors, such as the 2"x6" form at the top of the hole will add more volume. On the other hand, the concrete level inside the barrels will be much lower than the concrete level outside the barrels. We have found that 3 cubic yards is adequate for this standard installation.

The concrete specified is very generic and is available at all Ready Mix-type batch plants. The superplasticizer admixture mentioned above is common but not universally available.

8. *Placing the concrete*

When the concrete truck arrives at the site, it is important to discuss with the driver exactly how you want the concrete placed. The driver may need to move the delivery chute and possibly the truck several times to get the concrete exactly where it's needed.

If the excavated hole is dry, spraying the sides of the hole with water before placing the concrete is suggested. The concrete truck carries water and a hose that you can use for this purpose. Be careful to avoid dislodging loose material from the sides of the hole. The bottom should already have been cleaned.



Figure 4. Placing concrete in excavated hole.

A garden hoe, rake, shovel, or a long 2"x4" will be needed to move concrete around in the hole. If a superplasticizer is used, the concrete will move very easily without much help. Care should be taken to avoid over-tamping the concrete. The mix can become less uniform and the larger aggregate can separate away in the concrete.

When the concrete is being placed, it may flow up inside the cut-off end of the barrels to reach equilibrium inside and outside the barrel. This is normal. Don't try to do anything about it until all the concrete is placed in the hole and around the barrels the way you want it.

IMPORTANT! Do not place the concrete in the hole too quickly. It is very easy to place too much concrete on one side of the hole and the barrels than on the other. The Barrel Position Jig will hold the top of the barrels in their proper place. However, when the concrete moves across the hole trying

to level itself, the concrete will exert a lot of uneven pressure and force the barrel bottoms into an oval shape. This barrel distortion will most likely occur if superplasticizer is not used. If this happens, you must work **very** hard to fix the problem. To keep this from happening, place the concrete slowly and evenly in the hole. The driver will need to be patient with your frequent requests to move the delivery chute and the concrete truck to ensure that the concrete is placed where it's needed. It may also be necessary to remove the lid of a problem barrel and place concrete directly into the barrel. This will create more outward force inside the barrel. **The important thing is to go slowly.** Be aware that this can be a problem, and be prepared to correct it.

When all of the concrete has been placed in the hole, remove the lids of the barrels and ensure that the concrete inside the barrels is approximately 23 inches down from the top of the barrel rim. As mentioned previously, the concrete will tend to reach a point of equilibrium inside and outside the barrels. Most likely you will need to scoop out the excess concrete from inside each barrel. When the elevation of the concrete inside of the barrel is correct, trowel that surface smooth and level. When troweling the concrete around the outside of the barrels, make sure that the concrete is tapered slightly higher directly around the outside of the barrels, down lower to the edge of the concrete form to ensure that any water that collects underneath the cover of the vault will not stand or puddle around the barrels. Later, when the concrete is solid, a glass plate will be mortared to the concrete inside the barrel (see item 10 below).

9. Installing the above-ground enclosure frame

While the concrete is still plastic, remove the plywood Barrel Positioning Jig by removing the barrel lids and lifting them off. With the assistance of another person, position the Door Enclosure Frame over the concrete, with the angle iron pointed down. Align the frame so that it is centered in both directions. Push the protruding angle iron of the frame into the concrete until the frame itself pushes slightly into the concrete. Use a bubble level to level the frame in both directions. Then push one side of the frame deeper yet into the concrete until the bubble is slightly off center. When the door is installed on the frame, this slope will ensure that rain/snow water will run off the door.



Figure 5. Vault door frame placed in concrete.

10. Installing the glass seismometer mounting plates

After the concrete has hardened, the seismometer mounting plates can be mortared in place. These glass plates are one-half inch thick and are sandblasted on both sides. The size of the glass plate used in the strong motion barrel is 13"x13". The glass plate used in the high-gain barrel measures 15"x15". Glass plates offer several advantages over placing the seismometers directly on the concrete.

- A. When properly installed, the glass plates provide a smooth, level surface, which makes the orientation and leveling of the sensors easier.

- B. Sandblasting creates a rougher surface on the glass which helps prevent inadvertent movement of the sensor during adjustment of orientation and level.
- C. Some sensors require electrical isolation to prevent ground loops. Glass serves as an effective insulator.

A hole must be drilled through the low-gain seismometer plate to allow the anchor bolt to protrude up from the concrete and through the glass plate. This anchor bolt must be installed in the concrete before the glass plate is mortared down. Otherwise, the glass may become detached from the concrete while drilling the hole. Both of the glass plates should be attached to the concrete using thin-set mortar. When the thin-set mortar is placed on the concrete surface in the barrels, care should be taken to ensure that the area covered by the glass is completely covered by the mortar. The surface must be well coated to provide good adhesion between the glass and concrete. After covering this area, trowel the mortar back into a mound in the middle of the concrete. When the glass is pushed down onto the mounded mortar, mortar will push out from the middle and prevent air bubbles from being trapped under the glass. It's important to use more than enough mortar. Excess mortar should push out from under all sides of the glass. It is very difficult to lift the glass back up to add more mortar. Use a bubble level to level the glass plate. Allow enough time for the mortar to harden before marking the glass or placing seismometers on it.

11. Marking true north/south east/west on the glass mounting plates

Orientation lines should be marked on the glass before any other work is done in the barrel. Marks for true north/south and east/west could be useful over the life of the seismometer vault. Any permanent mark should be placed using as thin a line as possible to increase the accuracy of the seismometer orientation.

12. Installing the tubular form on the glass plates

We use a wax-impregnated, cardboard tube called Sonotube to form a space for the seismometer and at the same time form an area between the inside of the barrel and the outside of the Sonotube for application of foam-in-place insulation. Other types of tubes such as Plexiglas, PVC, or aluminum sheeting rolled and fastened into a tube of a suitable diameter can be used. The tube should be approximately 19 inches long and 13 inches in diameter for the strong motion barrel and 15 inches in diameter for the high-gain barrel. The tube can be held in place by using duct tape at the place where the tubing sets on the glass to prevent movement while placing the insulation.

13. Installing the polyurethane foam thermal insulation

As stated in the introduction, the purpose of the vault is to provide a dry, thermally stable environment for the sensors. We recommend using foam-in-place “minimal” expanding polyurethane foam insulation (see *Component Description* and *Sources List*) as a thermal insulator. It has a thermal resistance value of R5 per inch, which gives an average R-value of



Figure 6. Polyurethane insulation in place.

about R25. In the relatively small area that it protects, this insulation provides a stable thermal environment for the broadband seismometers used in the USNSN network.

Use rubber gloves and safety glasses when installing this foam insulation. The glue-like properties of the insulation will cause it to stick to whatever it touches. The insulation should be kept warm prior to installation. If the air temperature is cold, it may be necessary to use a styrofoam cooler to keep the foam insulation warm. Chemical hand warmer packets of the type used by campers and skiers can be placed in the styrofoam cooler to ensure that the foam stays warm. The manufacturers of this type of foam insulation indicate that when placing it in large voids it is best to install it in stages or layers rather than all at one time. About 30 minutes after placing the insulation, the surface of the foam will form a “crust.” The insulation below will try to continue expanding and will sometimes erupt in an uncontrolled manner. If too much foam insulation is added at one time, this behavior can be excessive. We recommend placing the foam in the barrel over a period of a couple of days to minimize this behavior. The manufacture also indicates that moisture will help the foam set up. Having a spray bottle of water available to add moisture to the new foam will make the foam set up faster, especially in a dry environment. Continue to add insulation until about 2 inches of the Sonotube tubing is left exposed above the hardened foam. When the foam has hardened and the signal cables are installed into the barrels, a small amount of the polyurethane foam must be squirted into the conduit openings of each barrel. We have found that a relatively large amount of water can build up inside the top of the barrels over a period of time due to condensation. If the conduit is not blocked, the barrels tend to “breathe” due to temperature and atmospheric pressure changes, thus carrying more humidity into the barrels and causing even more condensation inside the barrels. A small amount of the insulation will plug the conduit, effectively blocking movement of air through the conduit. Desiccant packets should be placed in the barrels to dry out the air in the barrels once the lids are closed.

No moisture should be allowed to enter the barrels. In addition to air moving through the conduit, moisture can enter the barrels, if the lids are not tightly closed and/or if the surface of the new concrete is not sealed. The foam insulation manufacturer recommends this type of insulation as an effective moisture barrier. It will prevent moisture from the exposed concrete collecting inside the barrels. If these methods and materials are used, moisture cannot migrate into the barrel from the bottom.

Installing the Door Covering the Top of the Seismometer Vault

The door should be constructed from three-quarter-inch pressure-treated plywood. Hinges should be used to attach the door to the frame, which is embedded in the concrete. Use rolled roofing to cover the top surface of the door and short roofing nails to prevent nail points from extending through the plywood. Roofing nails that are $\frac{3}{4}$ " will work well for this use.



Figure 7. Vault door attached to frame.

Installation of the Seismometers

High-gain seismometer installation

After the foam has been placed and has hardened, the high-gain seismometer can be installed. Orientation must always be done before the masses are unlocked. If you need to move the seismometer, always lock the masses before doing so. The seismometer signal should be monitored after the sensors are properly positioned. Adjusting the sensors at this point is easier than doing it later.



Figure 8. Guralp CMG-3NSN seismometers installed.

Low-gain seismometer installation

Low-gain sensors require a mechanism to attach them to the concrete. This is usually a concrete anchor of some type that ensures the sensor will not move, producing an output proportional to ground motion in a high-acceleration earthquake. The method suggested by the sensor manufacturer should be used to attach this sensor.



Figure 9. Strong-motion sensor installed.

Preventing thermal air currents around the high-gain sensors

After the sensors have been installed in the barrels and have been checked for proper function, a packet of desiccant should be placed next to the sensors. Slowly pour a good grade of clean, dry sand evenly around the high-gain sensors until they are completely covered. The sand will add thermal mass around the sensor and will prevent any possibility of thermal air currents. No sand is needed around the low-gain sensors.



Figure 10a. Pouring sand around seismometers



Figure 10b. Sand will completely cover seismometers when finished.



Figure 10c. Sand placement complete.

Finishing the sensor installation

The previously installed foam insulation used around the outside of the tube provides an effective thermal isolation around the sides of the sensors. The top of this tube requires an insulating plug to thermally seal the top of the sand around the sensor. A good insulating material should be formed into a plug and then pushed down into the top of the tube until it comes into contact with the sand, or in the case of the low-gain sensor, push the insulation just below the top of the tube. Good quality, closed-cell insulation works well. Fiberglass batting can also be rolled up to make this plug.

Cut a piece of plastic tarp into a large square and push the tarp over the top of the tube. Use a bungee cord to hold the tarp in place. The piece of plastic tarp will add another moisture barrier to the top of the tube that contains the seismometer. If the barrel is sealed properly, this piece of tarp is not needed. If not, condensation will form on the underside of the barrel lid, and drip onto the insulating plug, wetting the sand underneath.

There is adequate space for Guralp feedback boxes, Streckeisen STS-2 host boxes, and extra cabling in the top of the barrels. Use desiccant bags above the insulation. Finally, screw the lid of each barrel down as tightly as possible. As mentioned previously, the barrel manufacturer designed the lid so that a wooden 2"x4" can be used to tighten it. Since the lid of the barrel is not as accessible as the manufacturer intended, the tool described in the attached drawing (Drawing 7, *Barrel Tightening Tool*) can make this job easier.



Figure 11. Insulation plug in place.



Figure 12. Tarp used to prevent condensation from dripping on insulation.



Figure 13. Seismometer feedback electronics connected to seismometers.

Conclusion

The methods described in this report were developed based on a decade of experience installing and maintaining more than 50 broad-band seismic stations in the USNSN network. Locating the station in a suitable geologic setting away from potential noise sources (cultural and others) and in a dry, thermally stable, sensor environment will contribute significantly to quality data collection and effective operation of the seismic station.



Figure 14. Barrels ready for lids.



Figure 15. Vault construction and installation complete.



Figure 16. Station LRAL

Component Descriptions and Sources

1. Poly-Over Pac 50, one each.

Source: MSC Industrial Supply Company, 1-800-645-7270, www.mscdirect.com

2. Poly-Over Pac 95, one each.

Source: MSC Industrial Supply Company, see item 1.

3. Plastic Lumber, for quantity see Drawing 3, Vault Door Frame.

Source: This material is available nationwide at many chain hardware stores such as Home Depot and Lowe's Home Improvement Warehouse as well as local lumber yards.

4. Glass Seismometer Mounting Plate 13"x13"x½", one each, sandblasted on both sides.

Source: Plate glass that is ½" thick would likely be a special order item for most glass retailers. PPG Industries is a source for this type of glass, and they have retailers throughout most of North America, www.ppg.com. Sandblasting is available through many metal-fabricating businesses.

5. Glass Seismometer Mounting Plate 15"x15"x½", one each.

Source: See item 4.

6. Thin-set mortar

Source: This is available at any retailer that sells ceramic or quarry tile.

7. Polyurethane Insulation. Quantity needed depends on the ambient temperature when it's used. Suggest a minimum of six, 16-oz. cans per barrel. Use more as needed.

Source: Made by several manufacturers. Dow Chemical Company manufactures one type marketed under Great Stuff registered brand name. Available at most home improvement stores in 16-oz. cans. It is also available in 25-pound canisters from the manufacturer.

8. Sono-Tube 12" diameter x 18" long, one each.

Source: Most home improvement stores and lumber yards that sell pre-sacked concrete.

9. Sono-Tube 15" diameter x 18" long, one each.

Source: See item 8.

10. Angle Iron 1½"x1½"x18" long, six each.

Source: Home improvement stores and lumber yards. Usually found in longer pieces and will require cutting to length.

11. Pressure Treated Plywood ¾"x48"x84", one each.

Sources: Home improvement stores and lumber yards.

12. Galvanized Carriage Bolts $\frac{5}{16}$ "x2", 40 each (include one flat washer, one lock washer, and one nut for each bolt).

Source: Home improvement stores and lumber yards.

13. Galvanized Carriage Bolts, $\frac{1}{4}$ "x1 $\frac{1}{2}$ ", 20 each (include one flat washer, one lock washer, and one nut for each bolt).

Source: See item 12.

14. Bulkhead Adapter Fitting PVC, schedule 80, 2", Part number 871-020, three each.

Source: Spears Manufacturing Company, www.spears.com, is the most common manufacture of this type of fitting. The fittings are available through their distributors.

15. Plywood, CDX, $\frac{3}{8}$ "x48"x64", modified as per Drawing 4, *Barrel Positioning Jig*.

Source: Lumber yards and home improvement stores.

16. Lumber, 2"x4"x56", three each.

Source: Lumber yards and home improvement stores.

17. Lumber 2"x6"x72", four each.

Source: See item 16.

18. Strap Hinges 6", two each.

Source: See item 16.

19. Lock Hasp, two each.

Source: See item 16.

20. Rolled "Mineral" Roofing

Source: See item 16.

21. Galvanized Roofing Nails $\frac{3}{4}$ " long.

Source: See item 16.

22. Deck Screws, #8x2 $\frac{1}{2}$ ", 1 pound.

Source: See item 16.

REVISIONS				
ZONE	REV	DESCRIPTION	DATE	APPROVED

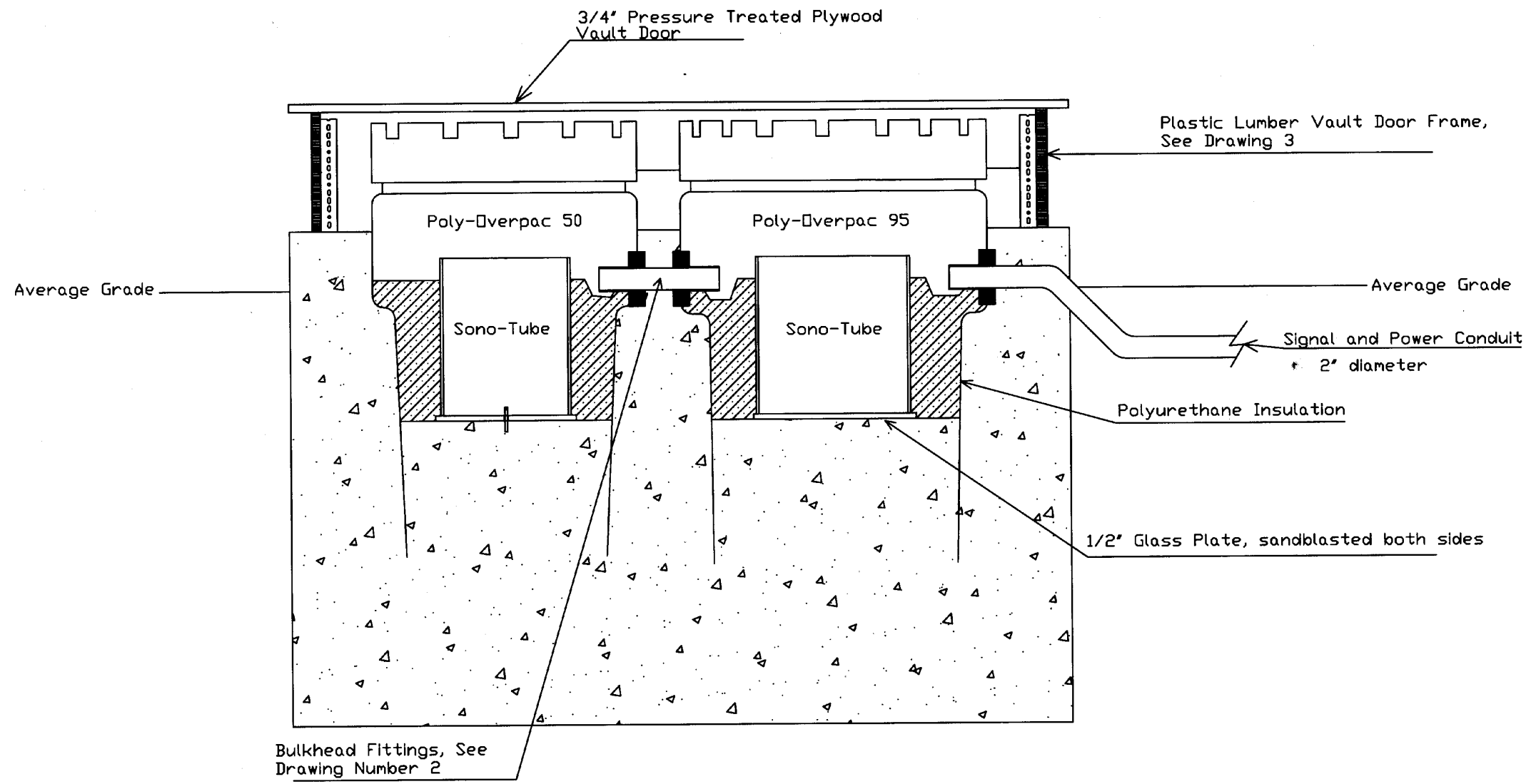

DRAWING NUMBER 1			
USNSN VAULT SECTION			
SIZE B	FSCM NO.	DWG NO.	REV A
SCALE None		SHEET 1 of 7	

SECTION VIEW OF BARRELS

REVISIONS				
ZONE	REV	DESCRIPTION	DATE	APPROVED

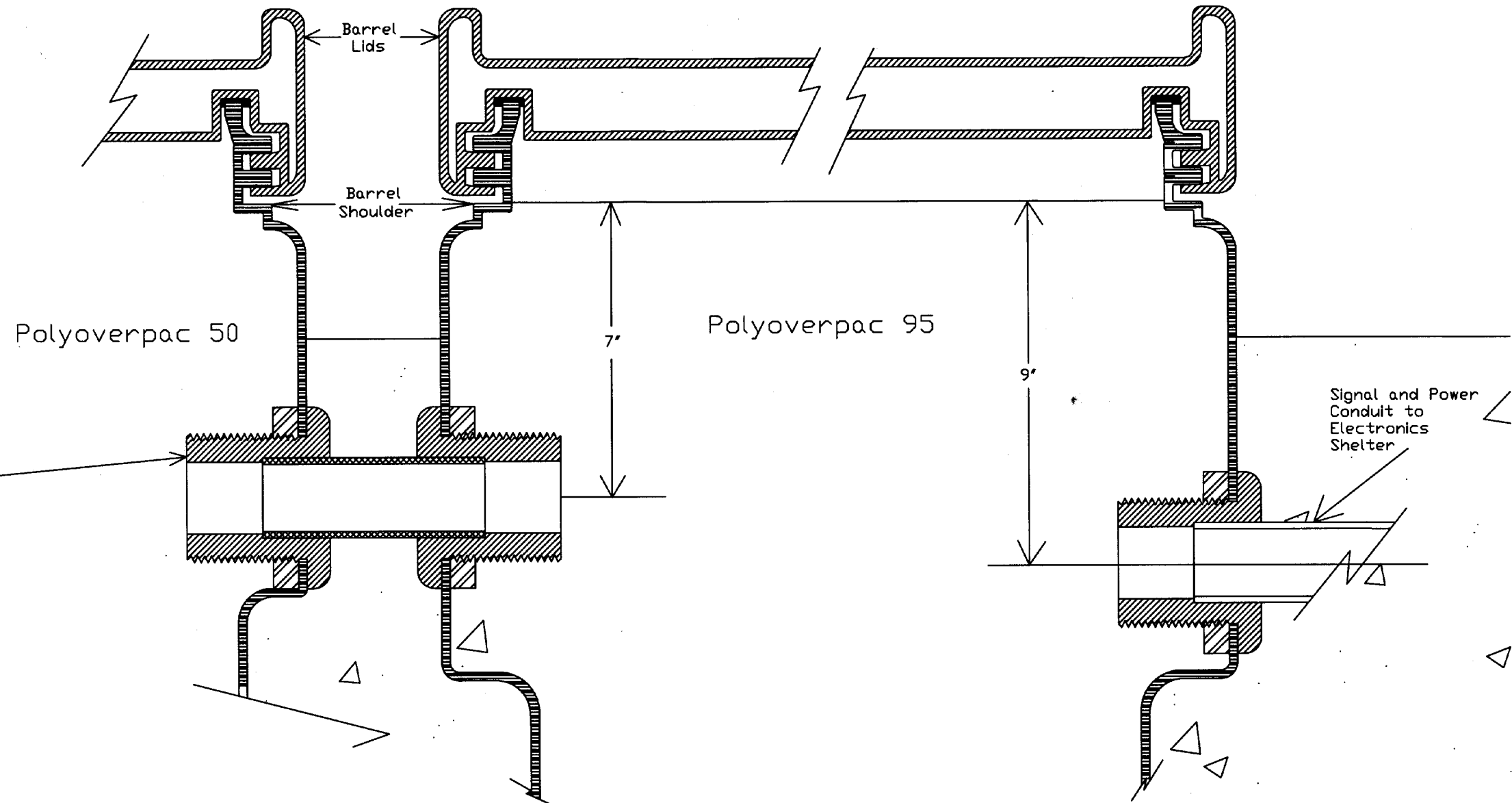

The Positioning Jig (see DRAWING NUMBER 4) is held between the bottom of the barrel lids and the top of the barrel shoulders. To avoid problems cut the holes for the Bulkhead Adapters 7 inches below the shoulder of each barrel (for the between the barrels connection), and 9 inches below the shoulder for the bulkhead adapter going to the electronics shelter.

Bulkhead Adapter
 (Spears Manufacturing Co.
 Tank Adapter with gasket.
 Part # 871E-020

Drawing Number 2			
Bulkhead Fitting Detail			
SIZE	FSCM NO.	DWG NO.	REV
B			
SCALE NONE		SHEET 2 of 7	

REVISIONS				
ZONE	REV	DESCRIPTION	DATE	APPROVED

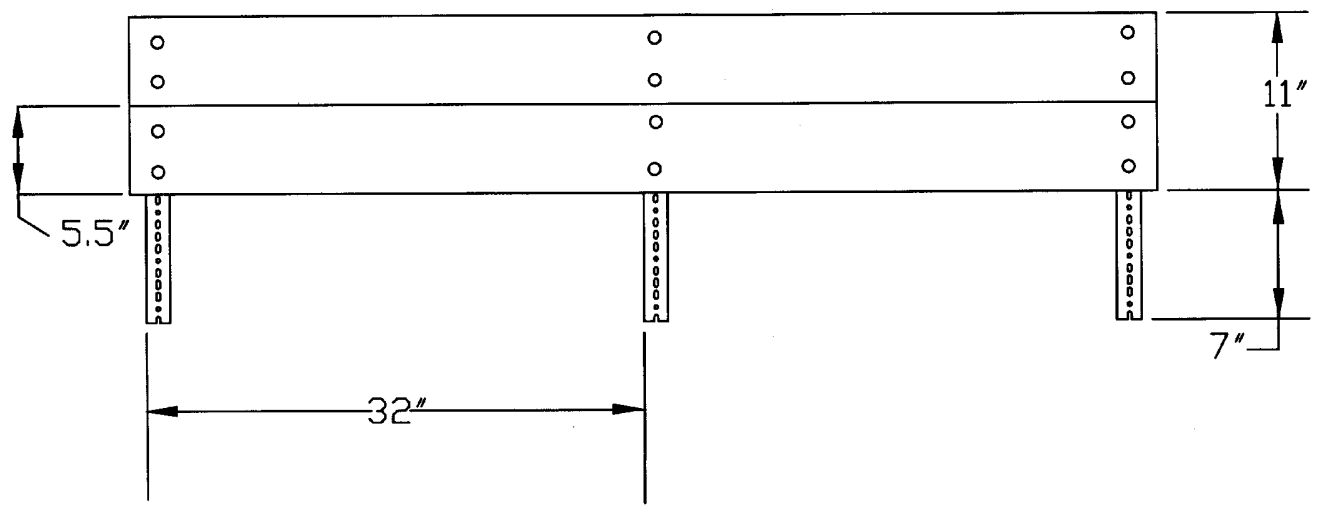

The 2" X 6" lumber is intended to be used as deck planking by the manufacturer. See Component Descriptions and Sources.

The hardware is galvanized carriage bolts, 5/16" X 2", 40 each. Use galvanized nuts, lock washers, and flat washers.

The angle iron is 1 1/2" X 1 1/2" X 18 ". Angle Iron with pre-drilled holes is preferred.

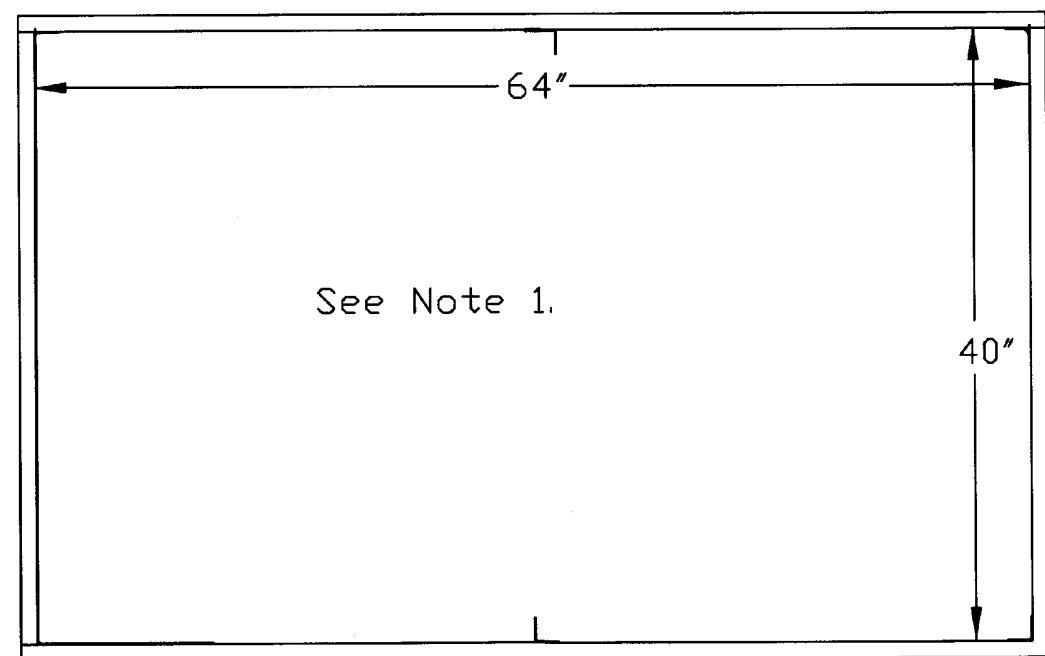

Note 1.
Note that the dimensions are for the inside area of this frame.

DRAWING NUMBER 3			
VAULT DOOR FRAME			
SIZE B	FSCM NO.	DWG NO.	REV
SCALE	SHEET 3 of 7		

REVISIONS

ZONE	REV	DESCRIPTION	DATE	APPROVED
------	-----	-------------	------	----------

Use # 8 or #10 X 2" Deck Screws to attach the CDX Plywood to the 2" X 4" lumber as shown.

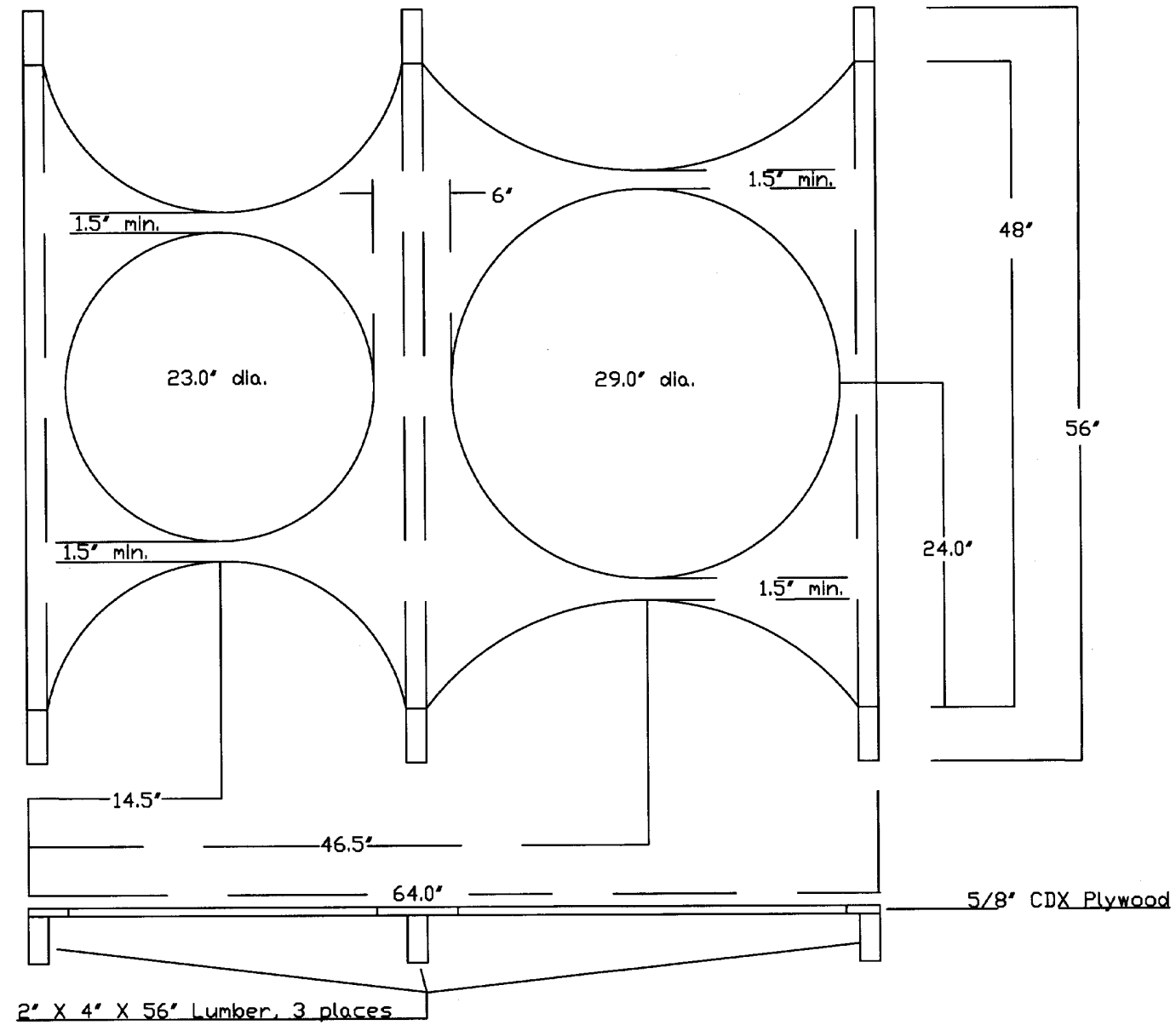

DRAWING NUMBER 4
 BARREL POSITION JIG

SIZE B	FSCM NO.	DWG NO.	REV
SCALE None		SHEET 4 of 7	

REVISIONS				
ZONE	REV	DESCRIPTION	DATE	APPROVED

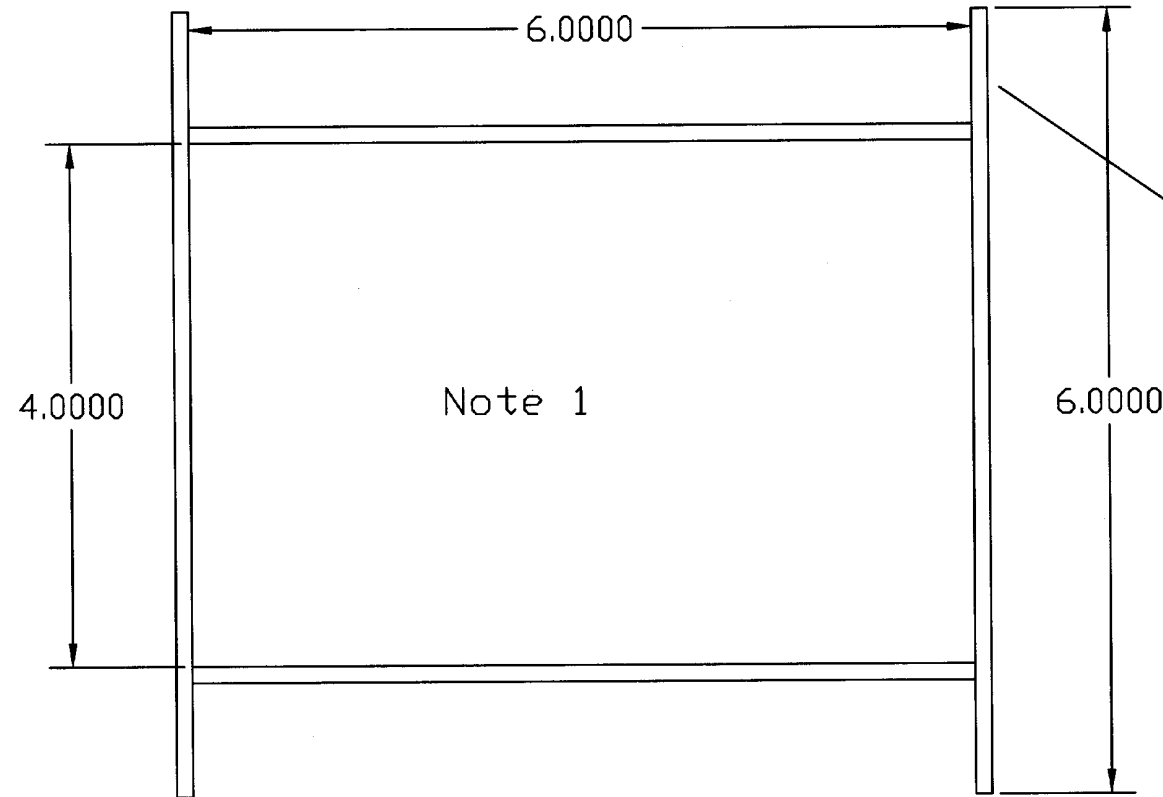

To prevent form from moving while placing concrete, and to avoid collapsing edge of hole, place stakes into earth at the extended part of form.

Material: 2" x 6" x 6' lumber, 4 each.

Use # 8 or #10 deck screws, 3"(min.) to assemble form.

Note 1
Dimensions refer to inside of form.

Note 2.
All dimensions in feet.

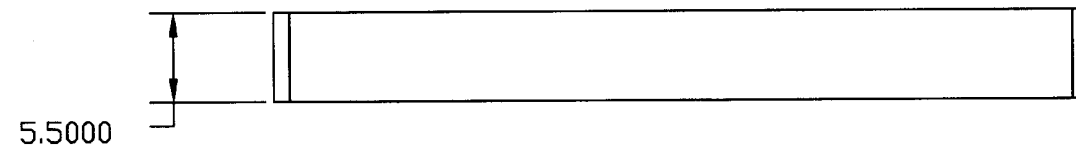

DRAWING NUMBER 5			
CONCRETE FORM			
SIZE B	FSCM NO.	DWG NO.	REV A
SCALE NONE		SHEET 5 of 7	

REVISIONS				
ZONE	REV	DESCRIPTION	DATE	APPROVED

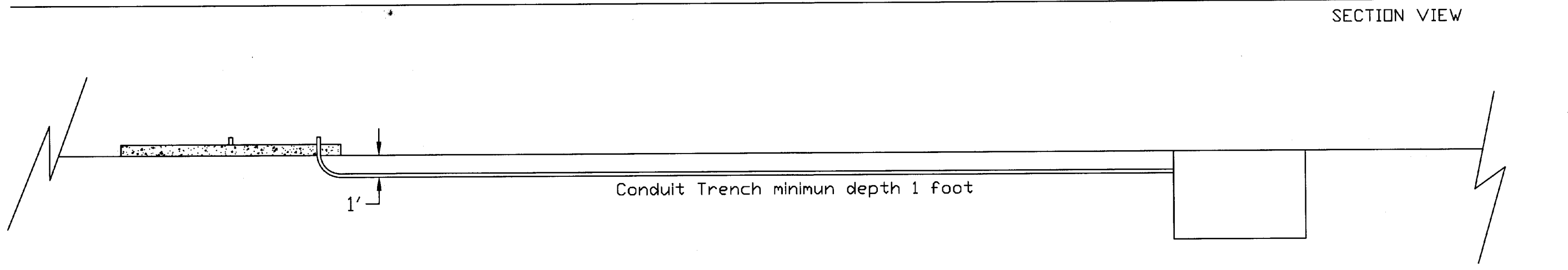
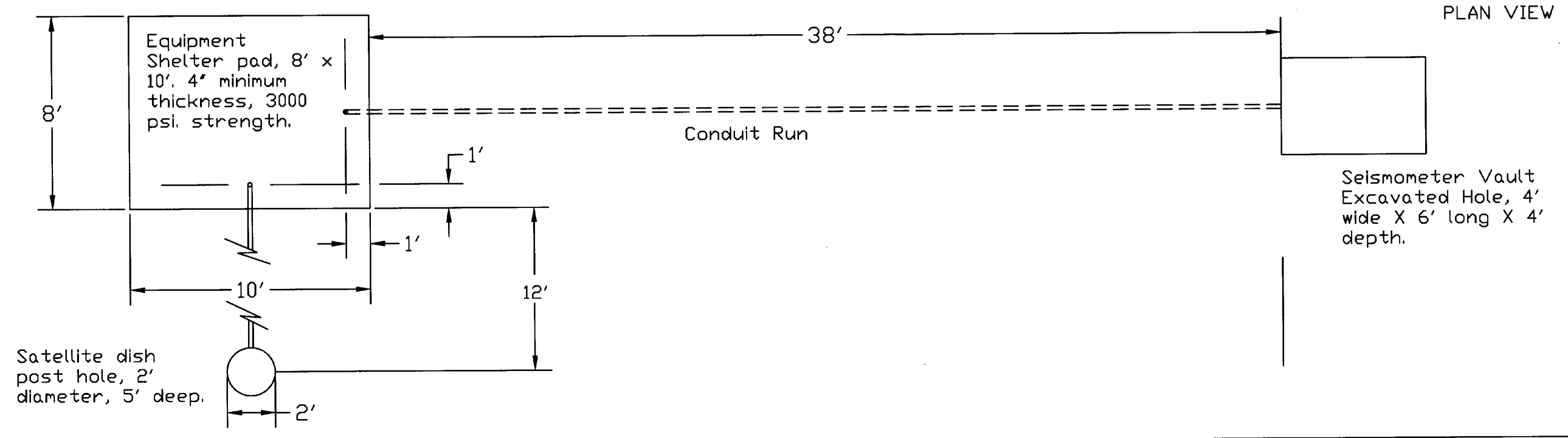

DRAWING NUMBER 6			
GENERIC SITE PLAN			
SIZE B	FSCM NO.	DWG NO.	REV A
SCALE NONE		SHEET 6 OF 7	

REVISIONS				
ZONE	REV	DESCRIPTION	DATE	APPROVED

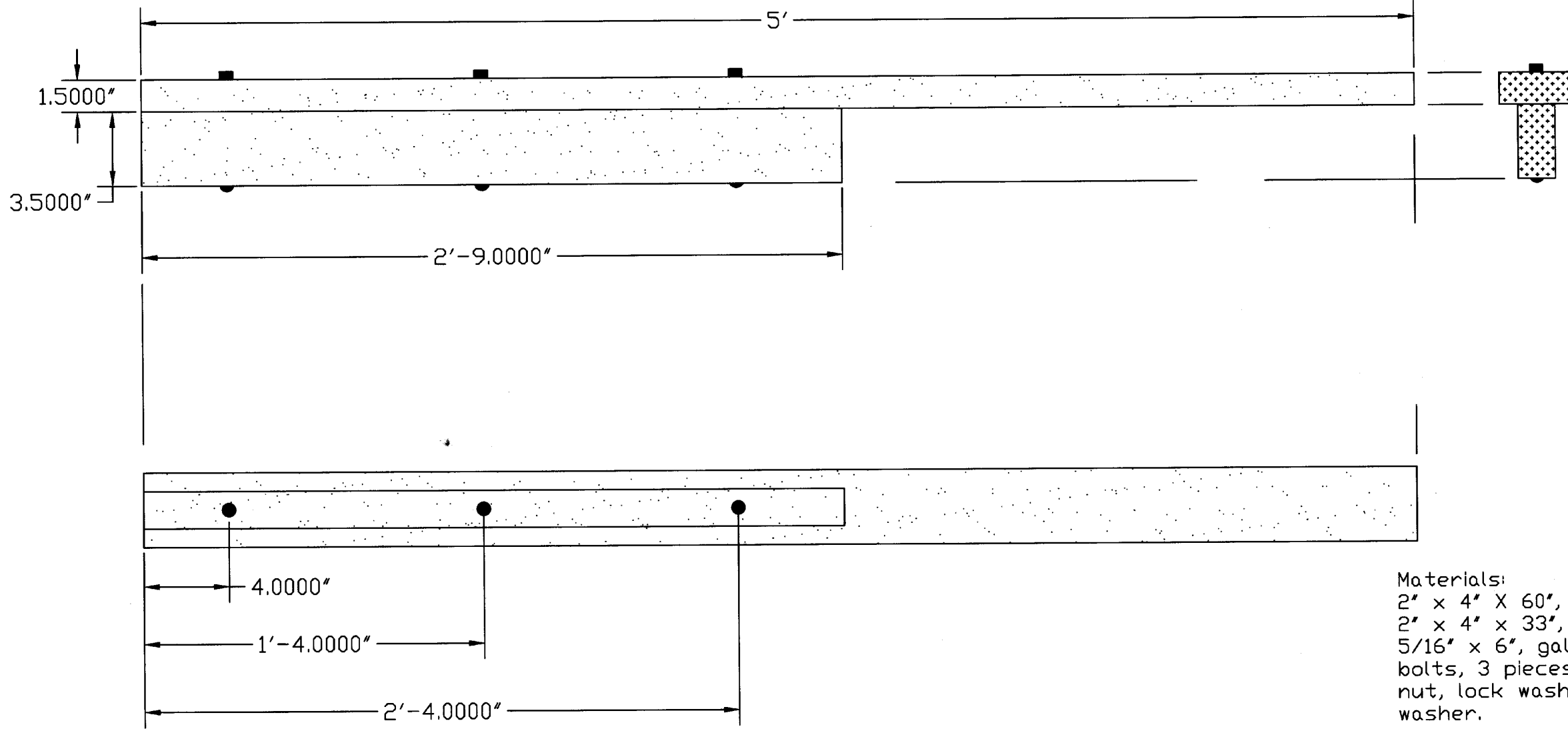

Materials:
 2" x 4" X 60", 1 piece.
 2" x 4" x 33", 1 piece.
 5/16" x 6", galvanized carriage bolts, 3 pieces with galvanized nut, lock washer, and flat washer.

DRAWING NUMBER 7	
BARREL TIGHTENING TOOL	
SIZE B	FSCM NO. DWG NO. REV A
SCALE NONE	SHEET 7 of 7