



# ClimaVue™ 50

Compact Digital Weather Sensor



# Please read first

---

## About this manual

Please note that this manual was produced by Campbell Scientific Inc. primarily for the North American market. Some spellings, weights and measures may reflect this. In addition, while most of the information in the manual is correct for all countries, certain information is specific to the North American market and so may not be applicable to European users. Differences include the U.S. standard external power supply details where some information (for example the AC transformer input voltage) will not be applicable for British/European use. Please note, however, *that when a power supply adapter is ordered from Campbell Scientific it will be suitable for use in your country.*

Reference to some radio transmitters, digital cell phones and aerials (antennas) may also not be applicable according to your locality. Some brackets, shields and enclosure options, including wiring, are not sold as standard items in the European market; in some cases alternatives are offered.

## Recycling information for countries subject to WEEE regulations 2012/19/EU

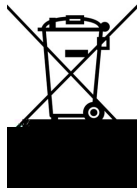

At the end of this product's life it should not be put in commercial or domestic refuse but sent for recycling. Any batteries contained within the product or used during the products life should be removed from the product and also be sent to an appropriate recycling facility, per [The Waste Electrical and Electronic Equipment \(WEEE\) Regulations 2012/19/EU](#). Campbell Scientific can advise on the recycling of the equipment and in some cases arrange collection and the correct disposal of it, although charges may apply for some items or territories. For further support, please contact Campbell Scientific, or your local agent.

# Table of contents

---

<b>1. Introduction</b> .....	<b>1</b>
<b>2. Precautions</b> .....	<b>1</b>
<b>3. Initial inspection</b> .....	<b>2</b>
<b>4. QuickStart</b> .....	<b>3</b>
<b>5. Overview</b> .....	<b>6</b>
5.1 Drip counter rain gage .....	7
5.2 Pyranometer .....	8
5.3 Anemometer .....	8
5.4 Relative humidity sensor .....	8
5.5 Thermistor .....	9
5.6 Tilt sensor .....	9
5.7 Barometric pressure sensor .....	9
5.8 Lightning sensor .....	9
<b>6. Specifications</b> .....	<b>10</b>
<b>7. Installation</b> .....	<b>12</b>
7.1 Wiring to the data logger .....	13
7.2 Programming .....	13
7.2.1 CRBasic programming .....	14
7.3 Siting .....	14
7.4 Mounting .....	14
7.4.1 Required tools .....	15
7.4.2 Mounting procedure .....	15
7.4.3 Optional bird spike kit .....	18
<b>8. Operation</b> .....	<b>20</b>
8.1 Sensor measurements .....	20
8.1.1 Measurements at fast scan rates .....	23
8.2 Snow and ice accumulation .....	23
8.3 Heavy rain and strong wind .....	24
8.4 Correcting pressure to sea level .....	24

8.5 Bird spike kit and solar radiation data .....	24
8.5.1 Proper installation .....	26
<b>9. Troubleshooting and maintenance .....</b>	<b>28</b>
9.1 Maintenance and calibration .....	28
9.2 Troubleshooting .....	33
<b>Appendix A. Importing Short Cut code into CRBasic Editor .....</b>	<b>35</b>
<b>Appendix B. Determining True North and sensor orientation .....</b>	<b>36</b>
<b>Appendix C. SDI-12 sensor support .....</b>	<b>39</b>
C.1 SDI-12 command basics .....	39
C.1.1 Acknowledge active command (a!) .....	40
C.1.2 Send identification command (al!) .....	40
C.1.3 Start verification command (aV!) .....	41
C.1.4 Address query command (?!) .....	41
C.1.5 Change address command (aAb!) .....	41
C.1.6 Start measurement commands (aM!) .....	42
C.1.7 Start concurrent measurement commands (aC!) .....	42
C.1.8 Stopping a measurement command .....	44
C.1.9 Send data command (aD0! ... aD9!) .....	44
C.1.10 Continuous measurement command (aR0! ... aR9!) .....	45
C.1.11 Extended commands .....	45
C.2 SDI-12 transparent mode .....	46
C.2.1 Changing an SDI-12 address .....	46
C.3 References .....	48

# 1. Introduction

---

The ClimaVue™50 is an affordable all-in-one meteorological sensor that has no moving parts, consumes little power, and is quickly deployed. It uses the SDI-12 serial protocol to report air temperature, relative humidity, vapor pressure, barometric pressure, wind (speed, gust, and direction), solar radiation, precipitation, and lightning strike (count and distance). A built-in tilt sensor indicates when the mounting mast has tilted. The ClimaVue 50 must be level for the precipitation sensor to operate properly. This diverse product is ideal for remote locations to fill gaps in large networks or when a simple solution is needed.

## CAUTION:

The ClimaVue 50 is a commercial-grade device, and is not intended for applications that require research-grade performance.

## NOTE:

This manual provides information only for CRBasic data loggers. For retired Edlog data logger support, contact Campbell Scientific.

# 2. Precautions

---

- READ AND UNDERSTAND the [Safety](#) section at the back of this manual.
- Care should be taken when opening the shipping package to not damage or cut the cable jacket. If damage to the cable is suspected, consult with a Campbell Scientific support and implementation engineer.
- The ClimaVue 50 is a precision instrument. Please handle it with care.
- To avoid shock or damage to the instrument, never apply power while wiring.
- Ensure that the ClimaVue 50 is properly wired to the data logger before applying power. Applying power when incorrectly wired could damage the ClimaVue 50 beyond repair.
- When mounting the ClimaVue 50 to the mast, do not over-tighten the V bolt as it will cause the plastic to break.

- For the precipitation sensor to operate properly, the ClimaVue 50 must be mounted within 2 degrees of level on a mast that will not tilt in the wind.

**NOTE:**

The built-in bubble level and the internal tilt sensor can be used during installation to level the ClimaVue 50 to within these specifications. Recording and monitoring the tilt sensor readings can spot when the sensor is no longer level. Refer to [Tilt sensor](#) (p. 9) and [Mounting procedure](#) (p. 15) for more information.

- The scan rate must be longer than 10 seconds.
- Routine maintenance is essential for accurate rainfall measurements. Debris blocking the inlet (funnel, spring, downspout, and flared hole) can result in under reporting of rainfall. Debris blocking the downspout screen can result in over reporting of rainfall.
- When attaching the extension cable to the ClimaVue 50 cable, only hand tighten the connectors. Using tools to tighten the connectors can permanently weld the stainless steel connectors together.
- When cleaning or handling, avoid more than light pressure on the sonic transducers.
- When cleaning, do not immerse the sensor in water and do not touch the temperature sensor needle.
- Before integrating the ClimaVue 50 into a system, make sure to follow the recommended installation instructions and have the proper protections in place to safeguard sensors from damage.
- This non-heated sensor is not suitable for solid precipitation or riming environments ([Snow and ice accumulation](#) [p. 23]).
- Heavy rains and strong winds can temporarily affect the accuracy of the measurements ([Heavy rain and strong wind](#) [p. 24]).



## 3. Initial inspection

---

Upon receipt of the ClimaVue 50, inspect the packaging and contents for damage. File damage claims with the shipping company.

# 4. QuickStart

A video that describes data logger programming using *Short Cut* is available at:

[www.campbellsci.com/videos/cr1000x-data-logger-getting-started-program-part-3](http://www.campbellsci.com/videos/cr1000x-data-logger-getting-started-program-part-3) . *Short Cut* is an easy way to program your data logger to measure the sensor and assign data logger wiring terminals. *Short Cut* is available as a download on [www.campbellsci.com](http://www.campbellsci.com) . It is included in installations of *LoggerNet*, *RTDAQ*, and *PC400*.

The following procedure also shows using *Short Cut* to program the ClimaVue 50.

1. Open *Short Cut* and click **Create New Program**.
2. Double-click the data logger model.
3. In the **Available Sensors and Devices** box, type ClimaVue or locate the sensor in the Sensors > **Meteorological** > **Basic Weather** folder. Double-click **ClimaVue 50**.

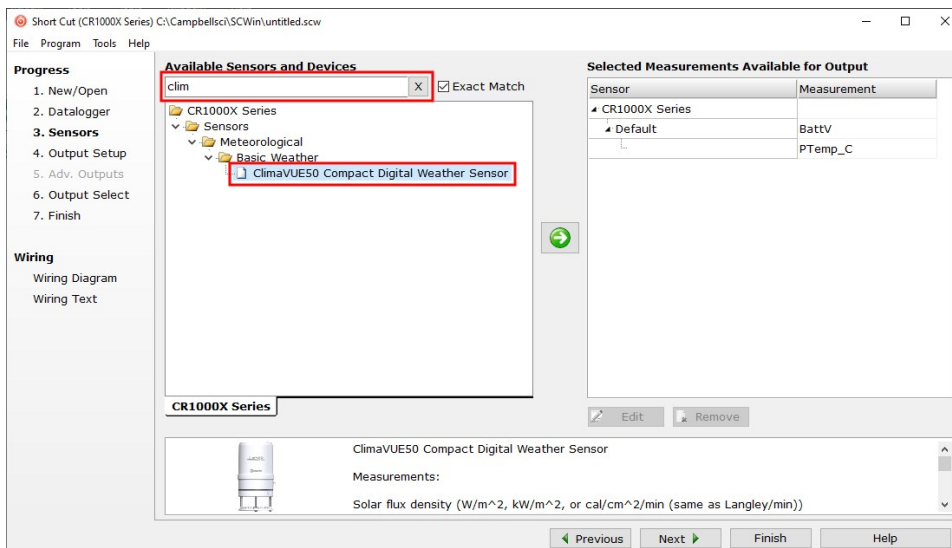

- Type the correct **SDI-12 Address** (default is zero). Type the elevation of the site in the same units as the **Site elevation units**. Default units are meters, which can be changed by clicking on the **Site elevation units** box and selecting **Feet**.

**Properties Wiring**

SDI-12 address (0-9, A-Z, or a-z)

Site elevation for correcting barometric pressure to sea level (0=no correction)

Site elevation units

Solar flux density

Rain

Lightning strikes

Average distance of lightning strikes

Wind speed

Wind direction

Maximum wind speed

Air temperature

Vapor pressure

Barometric pressure

Relative humidity  

Relative humidity sensor temperature

North-south tilt

West-east tilt

Solar total flux

ClimaVUE50 metadata

- Click on the **Wiring** tab to see how the sensor is to be wired to the data logger. If measuring additional SDI-12 sensors and an unused control terminal is available on the data logger, click on the control terminal (C) and change it to an unused control terminal, then use the ClimaVue 50 factory default address of 0 for the SDI-12 address. If an unused control terminal is not available, type a new SDI-12 address in the **SDI-12 address** box, then change the SDI-12 address in the ClimaVue 50 ([Change address command \(aAb!\)](#) [p. 41]). Click **OK** after wiring the sensor.

**Properties Wiring**

ClimaVUE50	CR1000X Series
Brown	12V
White	C1
Clear	G
Black	G

Click a CR1000X Series terminal name to change a wire's location.



- In **Output Setup**, type the scan rate (60 seconds recommended), meaningful table names, and **Data Output Storage Interval**. Click **Next**.

**NOTE:**

The scan rate must be longer than 10 seconds.

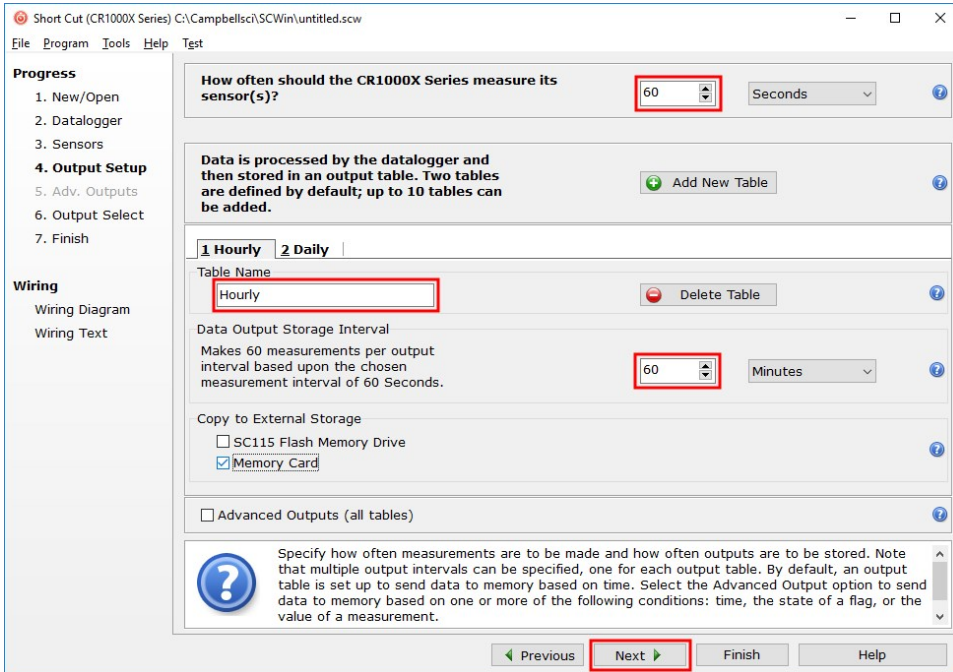

- Select the measurement and its associated output option.

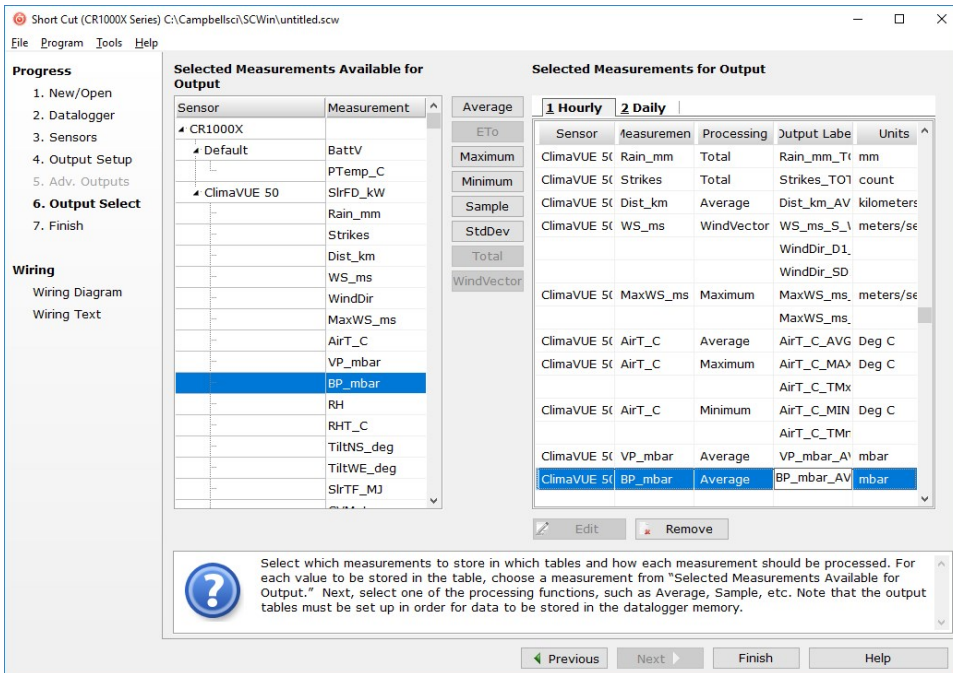

8. Click **Finish** and save the program. Send the program to the data logger if the data logger is connected to the computer.
9. If the sensor is connected to the data logger, check the output of the sensor in the data display in *LoggerNet*, *RTDAQ*, or *PC400* to make sure it is making reasonable measurements.

## 5. Overview

---

All sensors are integrated into a single, small form-factor unit, requiring minimal installation effort. With a robust, no-moving-parts design that prevents errors because of wear, the ClimaVue 50 is ideal for long-term, remote installations.

Upon power up, the ClimaVue 50 initializes an internal timer to 55. This internal timer is incremented by 1 every second and resets to 0 after incrementing to 59. In addition, issuing an averaging command (**M!**, **R0!**, **R3!**, **R7!**, and **C!**) resets this timer to 55.

While powered up, the ClimaVue 50 takes solar radiation, precipitation, wind, and air temperature measurements every 10 seconds at internal time intervals of 0, 10, 20, 30, 40, and 50 seconds, then logs the values internally. By default, tilt, atmospheric pressure, relative humidity, and the temperature of the RH sensor are measured every 60 seconds at the internal timer interval of 4 seconds, and logged internally. Vapor pressure is computed from the relative humidity and air temperature every 60 seconds and logged internally.

The **R7!** command will force the instantaneous return of all the previous parameters, but must be used at intervals of 10 seconds or greater. When **R7!** is executed at a 10-second rate, the sensor returns samples. When the **R7!** or other SDI-12 measurement commands are issued slower than two times their default measurement interval, the sensor returns averages, accumulations, or maximums of the values it logged internally. It then resets its internal averaging counters and accumulators. Hence, oversampling is not necessary. Less frequent sampling decreases power consumption. For example, 10 seconds polling frequency requires 1 mA current compared to 0.4 mA at the recommended polling frequency of 60 seconds. The ClimaVue 50 has two error codes available—general error code –9999 and invalid wind measurement error code –9990.

## Features:

- All the common meteorological measurements with one simple digital (SDI-12) output
- Less than 1 mA average current at 12 VDC consumption making it ideal for solar-powered sites
- Integrated tilt sensor helps assure that the sensor stays level over time
- No sensor configuration required
- Compact design for quick, low impact installation
- Low maintenance—no moving parts significantly reduces maintenance cost and time
- Detachable cable from sensor for fast sensor swap / servicing
- Compatible with the Aspen 10 Edge Device.
- Compatible with Campbell Scientific CRBasic data loggers: CR6 series, CR1000X series, CR800 series, CR350 series, CR300 series, and CR1000

## 5.1 Drip counter rain gage

The ClimaVue 50 has a 9.31-cm diameter rain-collection funnel. A spring in the funnel acts as a filter to keep out large particles while allowing enough flow so water does not back up. Rain collected by the funnel exits the funnel through a precision flared hole that forms the rain into drops of a known size. The falling drops hit and momentarily bridge the gap between two gold pins, creating an electrical pulse.

The ClimaVue 50 counts the pulses (drops) and calculates the water volume based on 0.017 mm of rain per drop. The resolution of the drip counter allows light precipitation events and heavy dew accumulations to be recorded.

### CAUTION:

The accuracy decreases during high-intensity rain storms (greater than 50 mm/hr). For applications that require accurate, long-term accumulation measurements, Campbell Scientific recommends using a standard, tipping-bucket rain gage, such as the RainVue 10.

### NOTE:

To test the rain sensor before installation, slowly (~5 ml/min) drip water into the funnel to mimic rainfall. Pouring water too fast will result in inaccurate pulse measurements.

## 5.2 Pyranometer

A silicon-cell pyranometer integrated into the lip of the rain gage funnel measures total incoming (direct and diffuse) solar radiation. The pyranometer has a cosine-corrected head to ensure accurate readings regardless of sun angle. Accurate solar radiation measurements require the sensor to be level and clean.

## 5.3 Anemometer

An ultrasonic anemometer underneath the rain gage measures wind speed. Two pairs of orthogonally oriented transducers emit ultrasonic signals that bounce off the porous sintered glass plate and back up to the opposite sensor. The ClimaVue 50 calculates wind speed by measuring differences in the time it takes for sound to travel back and forth between the transducers. The wind measurement takes 42 milliseconds followed by 60 milliseconds of processing.



The ClimaVue 50 measures the wind speed and direction every 10 seconds and records the instantaneous wind vector components. When queried, the ClimaVue 50 outputs the average of the instantaneous measurements since the last query for wind speed and direction and the maximum instantaneous wind speed value for wind gust.

The ClimaVue 50 keeps a running average of the last 10 measurements. If an instantaneous measurement is more than eight times the running average, the instantaneous measurement is rejected. It is not reported as the maximum gust or included in the data that are averaged over the output interval.

## 5.4 Relative humidity sensor

The relative humidity sensor is located behind the circular Teflon® screen in the same housing as the sonic transducers. The screen protects the sensor from liquid water and dust while allowing water vapor to freely pass to the sensor. The sensor measures relative humidity and temperature of the cavity, then uses those measurements to calculate vapor pressure. Vapor pressure doesn't change with temperature, but relative humidity does. Because the true air temperature (measured by the thermistor needle and corrected using wind and solar measurements) differs from the cavity temperature, the true relative humidity is computed using the true air temperature and the calculated vapor pressure.

## 5.5 Thermistor

A small stainless steel needle containing a thermistor extends from the middle of the four sonic transducers in the center of the anemometer. The thermistor sits in open air. Instead of using a radiation shield to prevent solar loading, the temperature measurement is corrected by an energy balance equation that uses solar radiation and wind speed measurements. The equation calculates the true air temperature based on the solar load on the needle and the convective cooling of the thermistor to an accuracy of  $\pm 0.6$  °C. Compare this error to the combined temperature and radiation shield errors of competitive units. For more information, refer to the [ClimaVue™50—Correction of air temperature measurements from a radiation-exposed sensor](#)  White Paper available at: [www.campbellsci.com/app-notes](http://www.campbellsci.com/app-notes) .

## 5.6 Tilt sensor

After initial leveling with a small level or the built-in bubble level, the internal tilt sensor helps users keep the ClimaVue 50 level. Regularly check the X and Y tilt data. Adjust the ClimaVue 50 leveling if it has tilted. More than two degrees off level can cause errors in the rain and solar radiation measurements. Although this tilt sensor may be used to level the instrument, it is much easier to use the small bubble level on the bottom of the anemometer plate.

The tilt sensor is an accelerometer that reads whatever acceleration it is experiencing. Under static conditions, this is the gravitational acceleration, and therefore provides an accurate indication of tilt. However, if the sensor is not securely mounted, the tilt sensor measures a combination of gravity and vibration.

## 5.7 Barometric pressure sensor

The barometric pressure sensor is located behind the Teflon screen next to the relative humidity sensor on the same circuit board. It measures the atmospheric pressure in the range of 500 to 1100 hPa.

## 5.8 Lightning sensor

The lightning sensor uses AM radio signals, which are disrupted by lightning. Circuitry inside the sensor detects disrupted AM signal. The ClimaVue 50 records the time of the disruption and determines strike distance based on the intensity of the signal.

# 6. Specifications

Measurement	Range	Resolution	Accuracy or repeatability
Air temperature	-50 to 60 °C	0.1 °C	±0.6 °C
Vapor pressure	0 to 47 kPa	0.01 kPa	Varies with temperature and humidity, ±0.2 kPa typical below 40 °C. <a href="#">Figure 6-1</a> (p. 11) shows accuracies for different temperature and humidity values.
Relative humidity	0 to 100%	0.1	Varies with temperature and humidity, ±3% RH typical. <a href="#">Figure 6-2</a> (p. 11) shows accuracies for different temperature and humidity.
Barometric pressure	500 to 1100 hPa	0.1 hPa	±1 hPa (-10 to 50 °C) ±5 hPa (-40 to 60 °C)
Wind speed	0 to 30 m/s	0.01 m/s	0.3 m/s or 3%, whichever is greater
Wind speed max - 10 s gust	0 to 30 m/s	0.1 m/s	0.3 m/s or 3%, whichever is greater
Wind direction	0 to 359°	1°	±5°
Solar radiation	0 to 1750 m/s	1 W/m <sup>2</sup>	Accuracy: ±5% of measurement typical Stability: <2% per year
Precipitation	0 to 400 mm/hr	0.017 mm	±5% of measurement from 0 to 50 mm/hr <sup>1</sup>
Tilt	±90	0.1°	±1°
Lightning strike count	0 to 65535 strikes	1 strike	variable with distance, >25% detection at <10 km, typical
Lightning average distance	0 to 40 km	3 km	variable

<sup>1</sup>The accuracy decreases during high-intensity rain storms (greater than 50 mm/hr).

HUMIDITY (%RH)	100%	± 0.05	± 0.09	± 0.16	± 0.29	± 0.49	± 0.81	± 1.30	± 2.62	± 6.32
	95%	± 0.05	± 0.09	± 0.14	± 0.24	± 0.41	± 0.68	± 1.08	± 2.26	± 5.27
	90%	± 0.05	± 0.07	± 0.09	± 0.15	± 0.33	± 0.54	± 1.06	± 2.23	± 5.20
	85%	± 0.05	± 0.07	± 0.08	± 0.15	± 0.33	± 0.53	± 1.05	± 2.19	± 5.13
	80%	± 0.04	± 0.07	± 0.08	± 0.15	± 0.32	± 0.53	± 0.83	± 1.84	± 4.07
	75%	± 0.04	± 0.07	± 0.08	± 0.14	± 0.31	± 0.52	± 0.82	± 1.80	± 4.00
	70%	± 0.04	± 0.07	± 0.08	± 0.14	± 0.31	± 0.51	± 0.81	± 1.77	± 3.93
	65%	± 0.04	± 0.07	± 0.08	± 0.13	± 0.30	± 0.50	± 0.79	± 1.73	± 3.86
	60%	± 0.04	± 0.05	± 0.07	± 0.13	± 0.22	± 0.36	± 0.57	± 1.38	± 3.30
	55%	± 0.04	± 0.04	± 0.07	± 0.13	± 0.22	± 0.35	± 0.56	± 1.34	± 3.23
	50%	± 0.03	± 0.04	± 0.07	± 0.12	± 0.21	± 0.34	± 0.55	± 1.31	± 3.16
	45%	± 0.03	± 0.04	± 0.07	± 0.12	± 0.20	± 0.33	± 0.53	± 1.27	± 2.60
	40%	± 0.03	± 0.03	± 0.07	± 0.12	± 0.20	± 0.33	± 0.52	± 1.24	± 2.53
	35%	± 0.03	± 0.05	± 0.06	± 0.11	± 0.19	± 0.32	± 0.50	± 1.20	± 2.46
	30%	± 0.03	± 0.05	± 0.06	± 0.11	± 0.19	± 0.31	± 0.49	± 1.17	± 2.39
	25%	± 0.03	± 0.04	± 0.06	± 0.10	± 0.18	± 0.30	± 0.48	± 1.14	± 2.32
	20%	± 0.03	± 0.06	± 0.06	± 0.10	± 0.25	± 0.41	± 0.67	± 1.10	± 2.25
15%	± 0.03	± 0.05	± 0.05	± 0.10	± 0.24	± 0.40	± 0.85	± 1.39	± 2.67	
10%	± 0.05	± 0.07	± 0.08	± 0.14	± 0.31	± 0.52	± 0.84	± 1.67	± 4.08	
5%	± 0.05	± 0.10	± 0.12	± 0.22	± 0.38	± 0.64	± 1.03	± 1.96	± 5.00	
0%	± 0.08	± 0.15	± 0.12	± 0.22	± 0.45	± 0.75	± 1.22	± 3.21	± 5.92	
	0°C	10°C	20°C	30°C	40°C	50°C	60°C	70°C	80°C	
	TEMPERATURE (°C)									

Figure 6-1. Vapor pressure accuracy at different temperatures and relative humidity

HUMIDITY (%RH)	100%	±5%	±5%	±5%	±5%	±5%	±5%	±5%	±6%	±10%
	95%	±5%	±5%	±4%	±4%	±4%	±4%	±4%	±5%	±8%
	90%	±5%	±4%	±2%	±2%	±3%	±3%	±4%	±5%	±8%
	85%	±5%	±4%	±2%	±2%	±3%	±3%	±4%	±5%	±8%
	80%	±4%	±4%	±2%	±2%	±3%	±3%	±3%	±4%	±6%
	75%	±4%	±4%	±2%	±2%	±3%	±3%	±3%	±4%	±6%
	70%	±4%	±4%	±2%	±2%	±3%	±3%	±3%	±4%	±6%
	65%	±4%	±4%	±2%	±2%	±3%	±3%	±3%	±4%	±6%
	60%	±4%	±3%	±2%	±2%	±2%	±2%	±2%	±3%	±5%
	55%	±4%	±2%	±2%	±2%	±2%	±2%	±2%	±3%	±5%
	50%	±4%	±2%	±2%	±2%	±2%	±2%	±2%	±3%	±5%
	45%	±4%	±2%	±2%	±2%	±2%	±2%	±2%	±3%	±4%
	40%	±4%	±2%	±2%	±2%	±2%	±2%	±2%	±3%	±4%
	35%	±4%	±3%	±2%	±2%	±2%	±2%	±2%	±3%	±4%
	30%	±4%	±3%	±2%	±2%	±2%	±2%	±2%	±3%	±4%
	25%	±4%	±3%	±2%	±2%	±2%	±2%	±2%	±3%	±4%
	20%	±4%	±4%	±2%	±2%	±3%	±3%	±3%	±3%	±4%
15%	±5%	±4%	±2%	±2%	±3%	±3%	±4%	±4%	±5%	
10%	±8%	±5%	±3%	±3%	±4%	±4%	±4%	±5%	±8%	
5%	±8%	±8%	±5%	±5%	±5%	±5%	±5%	±6%	±10%	
0%	±12%	±12%	±5%	±5%	±6%	±6%	±6%	±10%	±12%	
	0°C	10°C	20°C	30°C	40°C	50°C	60°C	70°C	80°C	
	TEMPERATURE (°C)									

Figure 6-2. Relative humidity accuracy at different temperatures and relative humidity

Output:	SDI-12 Version 1.3 compliant
Operating temperature range:	–50 to 60 °C (except barometer and RH, which are –40 to 60 °C)
Supply voltage:	3.6 to 15.0 VDC (continuous)
<b>Power consumption</b>	
Quiescent:	0.3 mA
Maximum peak current:	33 mA
Average:	1.0 mA (using R7! every 10 s), 0.4 mA (using R7! every 60 s or slower)
Digital voltage (logic high):	2.8 V (minimum), 3.0 V (typical), 5.5 V (maximum)
Digital voltage (logic low):	–0.3 V (minimum), 0.0 V (typical), 0.8 V (maximum)
Measurement duration:	110 ms (typical), 3000 ms (maximum)
Diameter (includes rain gage filter):	10 cm (4 in)
Height:	34 cm (13.4 in)
<b>Application of Council Directive</b>	
2011/65/EU:	Restrictions of Substances Directive (RoHs2)
2014/30/EU:	Electromagnetic Compatibility Directive (EMC)
<b>Standards to which conformity is declared</b>	
EN 61326-1:2013:	Electrical equipment for measurement, control and laboratory use—EMC requirements—for use in industrial locations
EN 50581:2012:	Technical documentation for the assessment of electrical and electronic product with respect to the restriction of hazardous substances
Compliance documents:	View at: <a href="http://www.campbellsci.com/climavue-50">www.campbellsci.com/climavue-50</a> 
Power line slew rate:	1.0 V/ms (use an oscilloscope to measure the voltage at the power input to the sensor as it is turned on to ensure it is supplying 1 V per millisecond or faster)

## 7. Installation

---

If you are programming the data logger with *Short Cut* or using the Aspen 10, skip [Wiring to the data logger](#) (p. 13) and [Programming](#) (p. 13). See [QuickStart](#) (p. 3) for a *Short Cut* tutorial. Refer to the Aspen 10 manual, available at [www.campbellsci.com/aspen10](http://www.campbellsci.com/aspen10) , for information about using the Aspen 10 with the ClimaVue 50.



## 7.1 Wiring to the data logger

### CAUTION:

To avoid shock or damage to the instrument, never apply power while wiring.

### CAUTION:

Ensure that the ClimaVue 50 is properly wired to the data logger before applying power. Applying power when incorrectly wired could damage the ClimaVue 50 beyond repair.

Connect the ClimaVue 50 to the data logger in the order shown in [Table 7-1](#) (p. 13).

Wire color	Wire function	Data logger connection
White	SDI-12 signal	C <sup>1</sup> or U configured for SDI-12 <sup>1</sup>
Clear	Shield	G
Brown	Power	12V
Black	Power ground	G

<sup>1</sup> C and U terminals are automatically configured by the measurement instruction.

If multiple SDI-12 sensors are connected to a data logger, Campbell Scientific recommends using separate terminals when possible. However, multiple SDI-12 sensors or multiple ClimaVue 50 sensors can connect to the same data logger control or U terminal. Each must have a unique SDI-12 address. Valid addresses are 0 through 9, a through z, and A through Z. The ClimaVue 50 ships with a default SDI-12 address of 0.

For the CR6 and CR1000X, triggering conflicts may occur when a companion terminal is used for a triggering instruction such as [TimerInput\(\)](#), [PulseCount\(\)](#), or [WaitDigTrig\(\)](#). For example, if the ClimaVue 50 is connected to C3 on a CR1000X, C4 cannot be used in the [TimerInput\(\)](#), [PulseCount\(\)](#), or [WaitDigTrig\(\)](#) instructions.

## 7.2 Programming

*Short Cut* is the best source for up-to-date data logger programming code. If your data acquisition requirements are simple, you can probably create and maintain a data logger program exclusively with *Short Cut*. If your data acquisition needs are more complex, the files that *Short Cut* creates are a great source for programming code to start a new program or add to an existing custom program.

**NOTE:**

*Short Cut* cannot edit programs after they are imported and edited in *CRBasic Editor*.

A *Short Cut* tutorial is available in [QuickStart](#) (p. 3). If you wish to import *Short Cut* code into *CRBasic Editor* to create or add to a customized program, follow the procedure in [Importing Short Cut code into CRBasic Editor](#) (p. 35). Programming basics for CRBasic data loggers are provided in the following section. Downloadable example program is available at [www.campbellsci.com/downloads/climavue50-example-program](http://www.campbellsci.com/downloads/climavue50-example-program) .

## 7.2.1 CRBasic programming

The **SDI12Recorder**  instruction is used to measure a ClimaVue 50. This instruction sends a request to the sensor to make a measurement and then retrieves the measurement from the sensor. See [Sensor measurements](#) (p. 20) for more information.

For most data loggers, the **SDI12Recorder**  instruction has the following syntax:

```
SDI12Recorder(Destination, SDIPort, SDIAddress, "SDICommand", Multiplier, Offset, FillNAN, WaitonTimeout)
```

For the **SDIAddress**, alphabetical characters need to be enclosed in quotation marks (for example, "A"). Also enclose the **SDICommand** in quotation marks as shown. The **Destination** parameter must be an array. The required number of values in the array depends on the command (see [Table 8-1](#) [p. 21]).

**FillNAN** and **WaitonTimeout** are optional parameters (refer to the *CRBasic Editor* help for more information).

## 7.3 Siting

Locate the sensor away from obstructions such as trees and buildings. The horizontal distance from an obstruction should be at least ten times the height of the obstruction. If mounting the sensor on the roof of a building, the height of the sensor above the roof, should be at least 1.5 times the height of the building.

Ensure that the solar radiation sensor is not shaded.

## 7.4 Mounting

The ClimaVue 50 includes a V-bolt for mounting to a pipe with a nominal outer diameter of 31.8 to 50.8 mm (1.25 to 2.0 in). The CM310 mounting pole is recommended to mount the ClimaVue 50 with a small enclosure and solar panel (no other sensors). The ClimaVue 50 can mount to a

crossarm by using the ClimaVue50, MetSENS, or WindSonic Mounting Pipe Kit, which includes a mounting tube and a CM220 Right Angle Mounting Kit (includes bracket, two U-bolts, and four nuts).

## 7.4.1 Required tools

- 1/2-in open-end wrench
- Torpedo level
- UV-resistant cable ties
- Compass
- Ladder

## 7.4.2 Mounting procedure

1. If using a crossarm, attach the mounting tube to the crossarm by using the CM220 Right Angle Mounting Kit, then mount the crossarm to the tripod or tower ([Figure 7-1](#) [p. 15]).

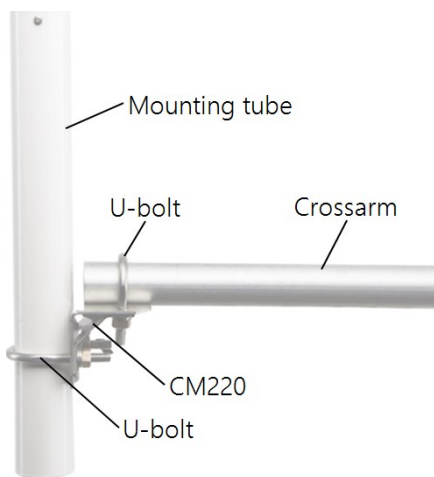

*Figure 7-1. ClimaVue50, MetSENS, or WindSonic Mounting Pipe Kit and crossarm*

- Loosely mount the ClimaVue 50 to the tripod mast, CM300-series pole, or mounting tube by using the V-bolt, washers, and nuts ([Figure 7-2](#) [p. 16]).



*Figure 7-2. ClimaVue 50 mounted to a pole with V-bolt and nuts*

- Orient the ClimaVue 50 so that the engraved **N** points to True North ([Figure 7-3](#) [p. 16]). [Determining True North and sensor orientation](#) (p. 36) contains detailed information on determining True North using a compass and the magnetic declination for the site.

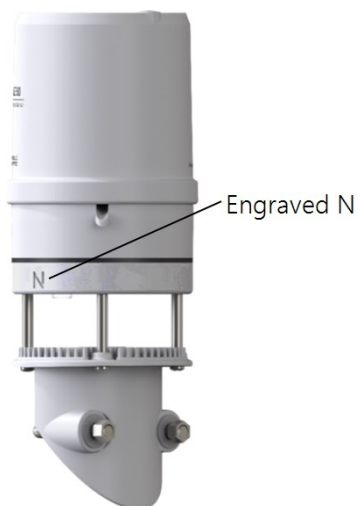

*Figure 7-3. Engraved N on the ClimaVue 50*

- Use a torpedo level or the bubble level underneath the sensor to level it ([Figure 7-4](#) [p. 17]). The angle of the instrument mount may need to be adjusted if the mast is not vertical. Shims can be added between the top of the mast and the bottom of the ClimaVue 50 to

achieve level. The sensor must be within  $\pm 2^\circ$  of dead level (0, 0) in both the X and Y directions to accurately measure rainfall and solar radiation. The  $\pm 2^\circ$  can be confirmed by viewing the Tilt North(+)/South(-) and Tilt West(+)/East(-) orientation values returned by the R7! command.

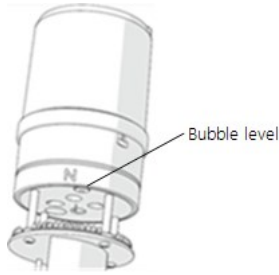

Figure 7-4. Bubble level on the Climavue 50

5. Once level, tighten the V-bolt nuts by hand until hand-tight, then gently tighten with a wrench and recheck the level (Figure 7-5 [p. 17]).

**CAUTION:**

Do not over-tighten V-bolt as it will cause the plastic to break.



Figure 7-5. Climavue 50 with connector cable

6. Mate the extension cable connector to the cable connector shown in [Figure 7-5](#) (p. 17). Only hand tighten the connectors.

**CAUTION:**

Hand tighten only! Using tools to tighten the connectors can permanently weld the stainless steel connectors together.

7. Route the cable down the pole to the instrument enclosure or Aspen 10 Edge Device.
8. Secure the cable to the crossarm (if applicable) and tripod or pole by using cable ties.

### 7.4.3 Optional bird spike kit

**NOTE:**

With the bird spike kit installed, dips in the pyranometer data may occur (<6% error in total daily solar radiation during clear sky conditions). Correct installation reduces possible errors. For more information, refer to [Bird spike kit and solar radiation data](#) [p. 24].

The optional bird-spike kit helps discourage birds from roosting on the ClimaVue 50. The kit consists of a plastic ring with flexible spikes. When installed, the spikes point upwards and extend 10.2 cm (4 in) above the funnel. Their shape and location minimize interference with rain and solar measurements. The spikes are designed not to hurt the birds.

The plastic ring includes secondary spike positions that can be drilled by the user to install additional short spikes. The additional spikes are to be provided by the user.

Items included in kit:

- (13) Spikes (includes one spare)
- (1) Spike ring

Required tools (not included):

- (1) Pliers

Bird-spike kit installation procedure:

1. Count all parts to ensure nothing was lost in shipping.
2. Gently press a bird spike into a slot on the bird spike ring by hand.
3. Using pliers, pinch the bird spike near its base and press down until it is fully seated.

- Repeat steps 2 and 3 for all bird spikes ([Figure 7-6](#) [p. 19]).



*Figure 7-6. Spikes inserted into the plastic ring slots*

- Tug upward on each spike to make sure the spike is pressed in.
- Position the ring on top of the ClimaVue 50 with the pyranometer aligned with the triangle between two spikes ([Figure 7-7](#) [p. 19]); this will limit spike shadows on the sensor.

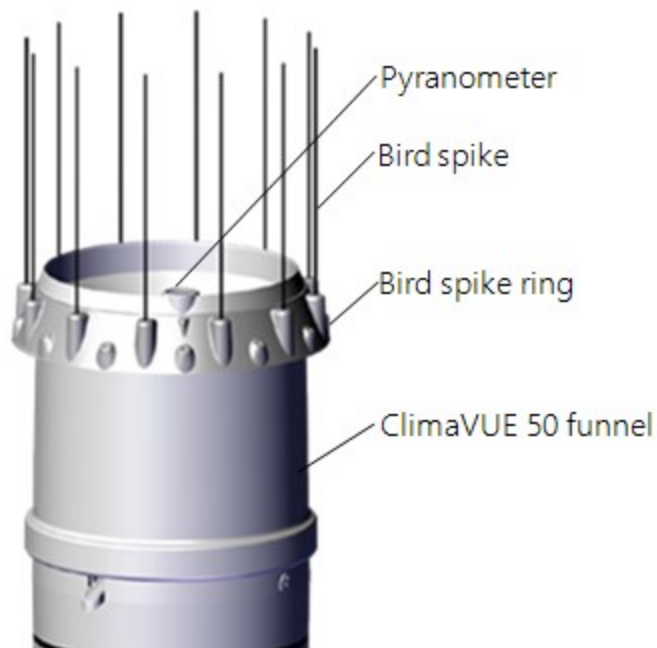

*Figure 7-7. Bird-spike kit mounted properly*

7. Press finished bird deterrent onto the ClimaVue 50 funnel to at least the depth shown in [Figure 7-7](#) (p. 19).

**NOTE:**

You can bend the spikes to minimize the shadow on the pyranometer.

# 8. Operation

---

8.1 Sensor measurements .....	20
8.1.1 Measurements at fast scan rates .....	23
8.2 Snow and ice accumulation .....	23
8.3 Heavy rain and strong wind .....	24
8.4 Correcting pressure to sea level .....	24
8.5 Bird spike kit and solar radiation data .....	24
8.5.1 Proper installation .....	26

## 8.1 Sensor measurements

The ClimaVue 50 responds to the standard SDI-12 commands shown in [Table 8-1](#) (p. 21); refer to [Table C-4](#) (p. 45) for extended commands.

When using an **M!**, **M1!**, or **M3!** command, the data logger waits for the time specified by the sensor, sends the **D!** command, pauses its operation, and waits until either it receives the data from the sensor or the sensor timeout expires. If the data logger receives no response, it will send the command a total of three times, with three retries for each attempt, or until a response is received. Because of the delays this command requires, it is only recommended in measurement scans of 10 seconds or more.

A **C!** command follows the same pattern as an **M!** command with the exception that it does not require the data logger to pause its operation until the values are ready. Rather, the data logger picks up the data with the **D!** command on the next pass through the program. Another measurement request is then sent so that data is ready on the next scan.

The **R7!** command directly reads the sensor measurements and outputs all of its values.



**NOTE:**

This section briefly describes using the SDI-12 commands. For additional SDI-12 information, refer to [SDI-12 sensor support](#) (p. 39), [www.sdi-12.org](http://www.sdi-12.org), or the videos [SDI-12 Sensors | Watch or Sniffer Mode](#) and [SDI-12 Sensors | Transparent Mode](#).

**Table 8-1: Standard ClimaVue 50 SDI-12 commands**

SDI-12 command <sup>1</sup>	Values returned (units)
<b>aR7!</b> <sup>2,3</sup>	<ol style="list-style-type: none"> <li>1. Solar flux density (W/m<sup>2</sup>)</li> <li>2. Precipitation (mm)</li> <li>3. Lightning strike count</li> <li>4. Strike distance (km)</li> <li>5. Wind speed (m/s)</li> <li>6. Wind direction (°)</li> <li>7. Wind speed max. – 10 s gust (m/s)</li> <li>8. Air temperature (°C)</li> <li>9. Vapor pressure (kPa)</li> <li>10. Barometric pressure, absolute (kPa)</li> <li>11. Relative humidity (fraction [0 to 1])</li> <li>12. Humidity sensor temperature (°C)</li> <li>13. Tilt North(+)/South(–) orientation (°)</li> <li>14. Tilt West(+)/East(–) orientation (°)</li> </ol>
<b>aM!</b> <sup>2</sup>	<ol style="list-style-type: none"> <li>1. Solar flux density (W/m<sup>2</sup>)</li> <li>2. Precipitation (mm)</li> <li>3. Lightning strike count</li> <li>4. Wind speed (m/s)</li> <li>5. Wind direction (°)</li> <li>6. Wind speed max. – 10 s gust (m/s)</li> <li>7. Air temperature (°C)</li> <li>8. Vapor pressure (kPa)</li> <li>9. Barometric pressure, absolute (kPa)</li> </ol>
<b>aM1!</b> <sup>2</sup>	<ol style="list-style-type: none"> <li>1. Tilt North(+)/South(–) orientation (°)</li> <li>2. Tilt West(+)/East(–) orientation (°)</li> <li>3. Compass heading, disabled (°)</li> </ol>

**Table 8-1: Standard ClimaVue 50 SDI-12 commands**

SDI-12 command <sup>1</sup>	Values returned (units)
<b>aM3!</b> <sup>2</sup>	<ol style="list-style-type: none"> <li>1. Strike distance (km)</li> <li>2. Relative humidity (fraction [0 to 1])</li> <li>3. Humidity sensor temperature (°C)</li> <li>4. Tilt North(+)/South(-) orientation (°)</li> <li>5. Tilt West(+)/East(-) orientation(°)</li> <li>6. Compass heading (disabled) (°)</li> <li>7. North wind speed (m/s)</li> <li>8. East wind speed (m/s)</li> <li>9. Wind speed max. – 10 s gust (m/s)</li> </ol>
<b>aC!</b> <sup>2</sup>	<ol style="list-style-type: none"> <li>1. Solar flux density (W/m<sup>2</sup>)</li> <li>2. Precipitation (mm)</li> <li>3. Lightning strike count</li> <li>4. Strike distance (km)</li> <li>5. Wind speed (m/s)</li> <li>6. Wind direction (°)</li> <li>7. Maximum wind speed (m/s)</li> <li>8. Air temperature (°C)</li> <li>9. Vapor pressure (kPa)</li> <li>10. Barometric pressure, absolute (kPa)</li> <li>11. Relative humidity (fraction [0 to 1])</li> <li>12. Humidity sensor temperature (°C)</li> <li>13. Tilt North(+)/South(-) orientation (°)</li> <li>14. Tilt West(+)/East(-) orientation (°)</li> <li>15. Compass heading, disabled (°)</li> <li>16. North wind speed (m/s)</li> <li>17. East wind speed (m/s)</li> <li>18. Wind speed max. – 10 s gust (m/s)</li> </ol>
<b>aI!</b>	<p><i>a13CAMPBELLCLIM50SN-aaaaaaaa</i></p> <p>Where:</p> <p><i>a</i> = SDI-12 address  13 = sdi-12 version  Clim50 = model name  aaaaaaaa = the serial number</p>

**Table 8-1: Standard ClimaVue 50 SDI-12 commands**

SDI-12 command <sup>1</sup>	Values returned (units)
<i>aV!</i>	<ol style="list-style-type: none"> <li>1. Operating system (OS) version</li> <li>2. Hardware version</li> <li>3. Watchdog errors</li> <li>4. Uptime (sec)</li> </ol>
<i>aAb!</i>	<i>b</i> Where: <i>b</i> = a new SDI-12 address
<i>?!</i>	SDI-12 Address

<sup>1</sup>*a* is the SDI-12 address. In the [SDI12Recorder\(\)](#) CRBasic instruction, the command parameter does not include the SDI-12 address because the address is a separate parameter.

<sup>2</sup>The *aR7!*, *aM!*, *aM1!*, *aM3!*, and *aC!* commands reset the internal averaging, totalizing, and maximizing processes.

<sup>3</sup>The *aR7!* command resets the internal averaging, totalizing, and maximizing processes. To allow enough time to internally initiate all measurements, this command only takes a measurement if 10 seconds have passed between the commands. If a new measurement has not been taken, the sensor returns the last reported value, except for the lightning strike count, which is interrupt based.

See [SDI-12 sensor support](#) (p. 39) for additional commands and details of the SDI-12 protocol.

## 8.1.1 Measurements at fast scan rates

Using the [SlowSequence](#) function allows the SDI-12 instruction to run as a background process, causing minimum interference to other measurements that use the analog hardware. Measuring the ClimaVue 50 in a [SlowSequence](#) section of the program allows faster programs to run as the main scan. However, if the data logger is too busy to complete all of its tasks, some slow sequence commands may be skipped, resulting in **NANs** (not a number) instead of measurements.

## 8.2 Snow and ice accumulation

The ClimaVue 50 is not heated, so it will not measure frozen precipitation until snow and ice that have accumulated in the funnel melt. In locations with heavy snowfall or long periods below freezing, snow accumulation will fill the funnel and no longer accumulate, leading to inaccurate precipitation measurements even when the precipitation melts. Accumulation of snow, ice, or frost also adversely affects the accuracy of the solar radiation measurement and can compromise the wind measurements if accumulation occurs in the anemometer acoustic pathway or on the acoustic mirror.

## 8.3 Heavy rain and strong wind

During strong storms, water can splash off of the horizontal bottom plate of the anemometer envelope and interrupt the signal passing between the sonic transducers. The spikes on the bottom plate help dissipate the rainwater to minimize splashing and reduce the likelihood that the wind measurements are interrupted. Additionally, porous polyethylene membranes protect the ultrasonic transducers from direct splashing and the sintered (porous) glass construction draws water from the upper surface of the acoustic mirror to keep a constant sound path length. Despite these features, heavy rain and strong winds can cause water to reach the membranes and also cause temporary water buildup on the acoustic mirror. The hydrophobic nature of the transducer protective membranes and the quick-draining ability of the acoustic mirror should limit wind measurement interruptions to heavy rain and should bring wind measurement back online soon after extreme conditions abate.

## 8.4 Correcting pressure to sea level

The weather service, most airports, radio stations, and television stations adjust the atmospheric pressure to a common reference (sea level). Eq. 1 (p. 24) can be used to find the difference in pressure between the sea level and the site in kPa. That value (**dP**) is then added to the absolute pressure measurement returned by the ClimaVue 50 as seen in the example program. Once that is done, the program shows the pressure conversion to hPa. U. S. Standard Atmosphere and dry air were assumed when Eq. 1 (p. 24) was derived (Wallace, J. M. and P. V. Hobbes, 1977: *Atmospheric Science: An Introductory Survey*, Academic Press, pp. 59-61).

$$dP = 101.325 \left\{ 1 - \left( 1 - \frac{E}{44307.69231} \right)^{5.25328} \right\} \quad \text{Eq. 1}$$

The value **dP** is in kPa and the site elevation, **E**, is in meters. Add **dP** value to the offset in the measurement instruction.

Use Eq. 2 (p. 24) to convert feet to meters.

$$E(m) = \frac{E(ft)}{3.281ft/m} \quad \text{Eq. 2}$$

The corrections involved can be significant. For example, at 100 kPa and 20 °C, barometric pressure will decrease by 0.11 kPa for every 10 m increase in altitude.

## 8.5 Bird spike kit and solar radiation data

With the bird spike kit installed, dips in the pyranometer data may occur during clear sky conditions. This is caused by the wire shadows that move across the pyranometer sensor

throughout the day on sunny days. The wire shadow effects are negligible (<1% error) on a diffuse day with continuous cloud cover and should be less than 6% error in total daily solar radiation on a clear sky day.

**NOTE:**

Correcting for wire shadow effects is impractical because different cloud cover, time of day, time of year, and location will cause the shadows to vary.

Figure 8-1 (p. 25) provides solar radiation data of ClimaVue 50s with and without bird spike kits. On 3/9/2019, ClimaVue 50s with bird spike kits installed show dips in solar radiation data. The bird spike kit did not affect the solar radiation data on completely cloudy days, when no wire shadows are present (see 3/8/2019 in Figure 8-1 [p. 25]).

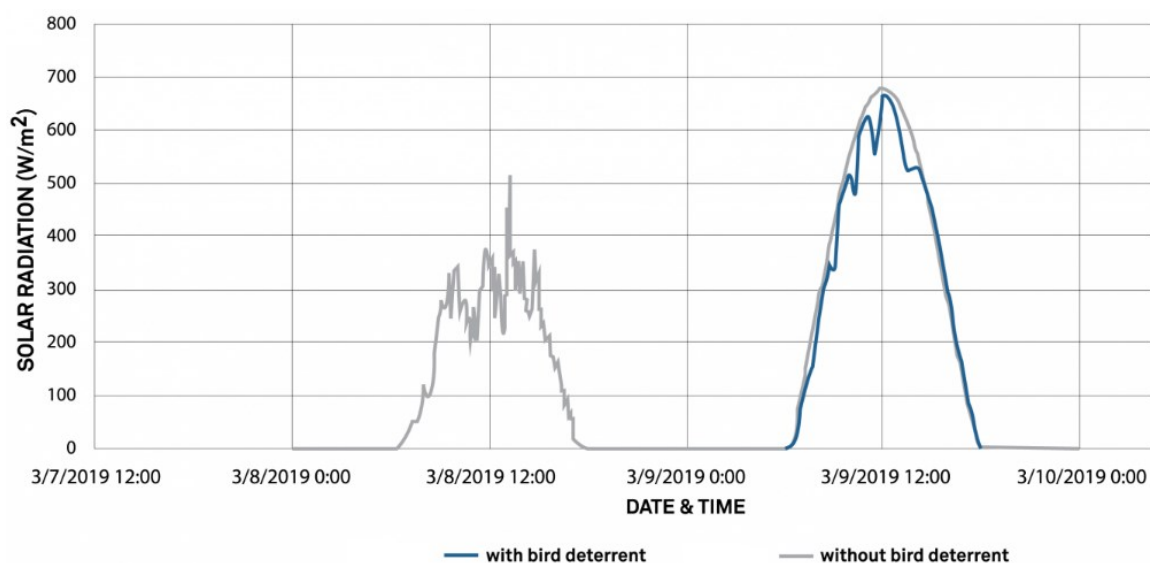

Figure 8-1. ClimaVue 50 solar radiation data with and without bird spike kit

On a mostly clear sky day, the error caused by the bird spike kit was a decrease in total solar radiation by 3.0% and 4.7% for two ClimaVue 50 pyranometer sensors. On a cloudy day, the error caused by the bird spike kit was less than 1%. On a clear sky day, the error caused by the bird spike kit was a decrease in total solar radiation by 2.6% and 5.7%. The error was estimated by summing the daily solar radiation of ClimaVue 50s with bird spike kit (experimental) and without bird spike kit (control) and calculating the percent error. Data was collected at 5 minute intervals. Without summing daily solar radiation, the percent error when the pyranometer dips are most drastic resulted in a decrease of 13 to 17% solar radiation (clear sky day). The most dramatic dips occurred on 3/9/2019 and resulted in a decrease of 83 to 113 W/m<sup>2</sup> (Figure 8-2 [p. 26]).

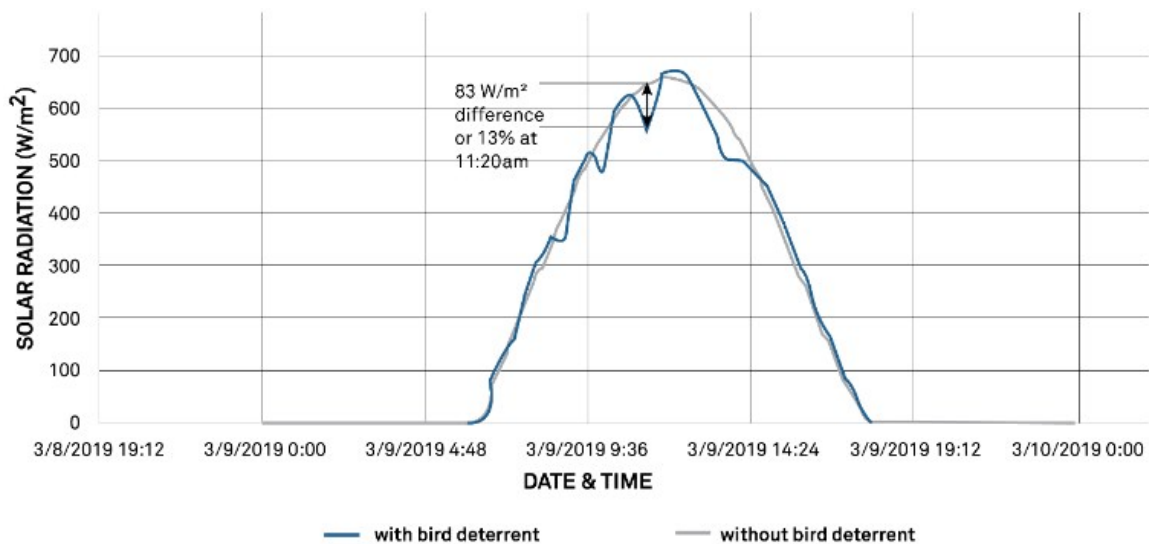

Figure 8-2. ClimaVue 50 solar radiation data for 3/9/2019

## 8.5.1 Proper installation

The pyranometer sensor should be in the middle of two wires, indicated by the triangle (Figure 8-3 [p. 26]). Expect increased errors when bird spike kits are not correctly installed (Figure 8-4 [p. 27]).



Figure 8-3. Correct installation: sensor is centered at the triangle



Figure 8-4. Incorrect installation: sensor is slightly offset from the triangle

Table 8-2 (p. 27) shows solar radiation data from a ClimaVue 50 with a properly installed bird spike kit and another ClimaVue 50 with an improperly installed bird spike kit. The measurements were made when there was no snow cover. The errors were less than 5% decrease in summed daily solar radiation.

Table 8-2: Percent error of summed daily solar radiation by date		
Sky condition, date	Percent error of summed daily solar radiation	
	ClimaVue 50 with properly installed bird spike kit	ClimaVue 50 with improperly installed bird spike kit
Partly cloudy, 3/14/2019	1.8%	4.7%
Partly cloudy, 3/15/2019	2.4%	2.1%
Partly cloudy, 3/16/2019	2.0%	4.2%
Mostly sunny, 3/17/2019	2.4%	3.7%
Sunny, 3/18/2019	2.1%	4.2%
Sunny, 3/19/2019	2.3%	4.1%
Sunny, 3/20/2019	2.3%	4.1%
Mostly sunny, 3/21/2019	1.9%	4.5%

**NOTE:**

The ClimaVue 50 with a properly installed bird spike kit was about 1% higher than the control when compared to the baseline data with no bird spike; the other ClimaVue 50 was about -1% lower than the control when comparing baseline data with no bird spike (for summed daily radiation on a clear sky day).

# 9. Troubleshooting and maintenance

---

**NOTE:**

All factory repairs and recalibrations require a returned material authorization (RMA) and completion of the "Statement of Product Cleanliness and Decontamination" form. Refer to the [Assistance](#) page for more information.

<a href="#">9.1 Maintenance and calibration</a> .....	28
<a href="#">9.2 Troubleshooting</a> .....	33

## 9.1 Maintenance and calibration

Sensor maintenance should be performed at regular intervals, depending on the desired accuracy and the conditions of use.

1. Remove cobwebs, leaves, bird droppings, wasp nests, or other debris from the temperature sensor ([Figure 9-1](#) [p. 29]), ultrasonic transducer openings ([Figure 9-1](#) [p. 29]), rain gage funnel ([Figure 9-2](#) [p. 29]), pyranometer ([Figure 9-2](#) [p. 29]), and sintered glass reflection plate ([Figure 9-3](#) [p. 30]).

**CAUTION:**

Do not touch the temperature sensor when cleaning because it is very delicate and can be damaged if pushed into the body.



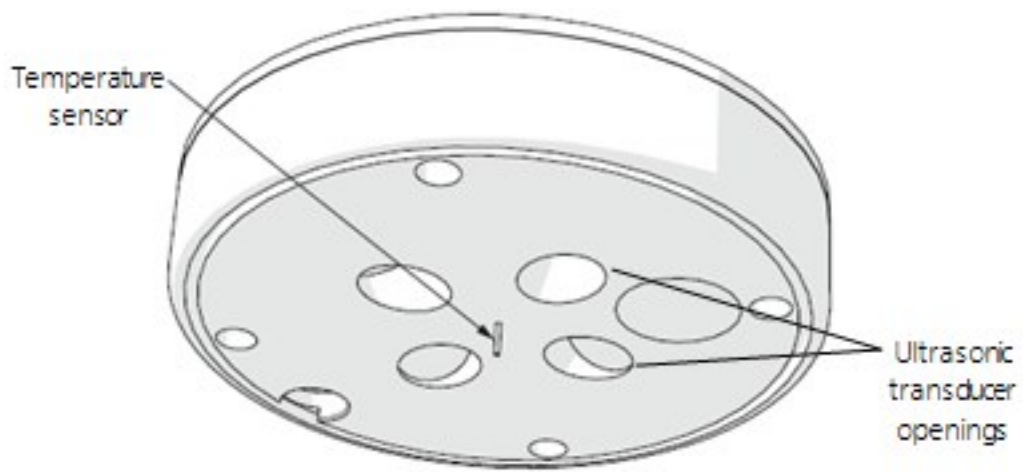

Figure 9-1. Temperature sensor and ultrasonic transducer openings

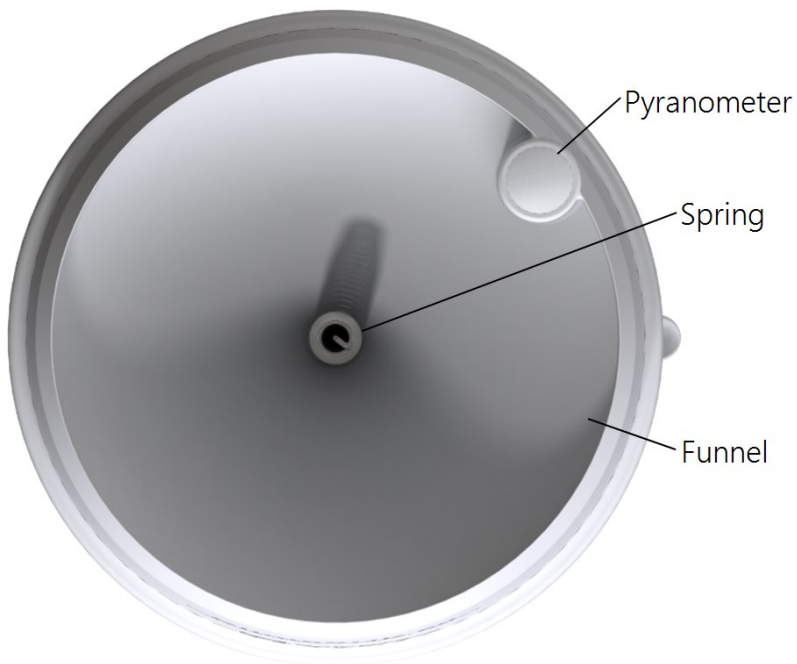

Figure 9-2. Top view of ClimaVue 50



Figure 9-3. Sintered glass reflection plate and splash guard

2. Scrub the body with light to medium pressure using a warm, damp cloth.

**CAUTION:**

Gently clean the sonic transducers and do not allow water to enter the ultrasonic sensors (Figure 9-1 [p. 29]). Water may corrode the metal parts inside the sensors and ruin them.

3. Clean around posts and between crevices using a dry brush.

4. Inspect the Teflon screen (Figure 9-4 [p. 31]) and replace if dirty.

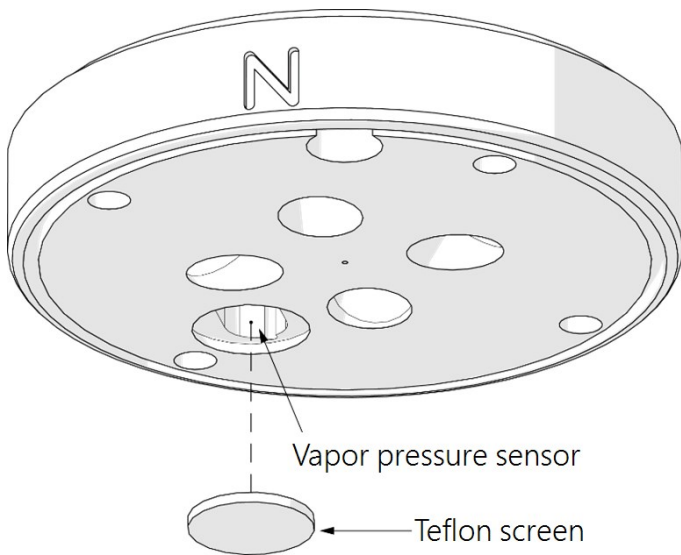

Figure 9-4. Teflon screen

5. Rain gage maintenance. Routine maintenance is essential for accurate rainfall measurements. Debris blocking the inlet (funnel, spring, downspout, and flared hole) can result in under reporting of rainfall. Debris blocking the downspout screen can result in over reporting of rainfall. The funnel locks in place using two pegs on the side of the funnel. To access the inside of the rain gage:

- a. Press the funnel down against the spring and turn counter clockwise.
- b. If necessary, unplug the pyranometer and remove funnel.

**CAUTION:**

The pyranometer must be unplugged before fully removing the funnel.

- c. Check the downspout for debris (Figure 9-5 [p. 32]). Use a pipe cleaner or small soft brush to clean the downspout.
- d. If needed, clean the spring after twisting it loose. Ensure that the gold electrodes are free of debris and contamination.
- e. Reattach the pyranometer connector.

- f. Check to be sure the downspout screen is clean and in place on the water exit downspout. If this screen gets plugged with debris, water can back up to the drip counting gold electrodes causing extra counts that can more than double the recorded rain. The screen keeps bugs out of the interior of the sensor.
- g. Replace the funnel by lining up the lock/unlock label located on the side of the funnel with the notch on the interface plate. Ensure the pyranometer cable and connector are on the same side. If the funnel is misaligned (rotated 180 degrees), the pyranometer wire can get caught up in the spring that locks the two pieces together. Additionally, the wire can divert rain drops away from the sensing electrode if it crosses that section.
- h. Press the funnel down against the spring and turn clockwise until it clicks in place.
- i. Check the level of the ClimaVue 50 (either with a torpedo level, bubble level, or the built-in tilt sensor).

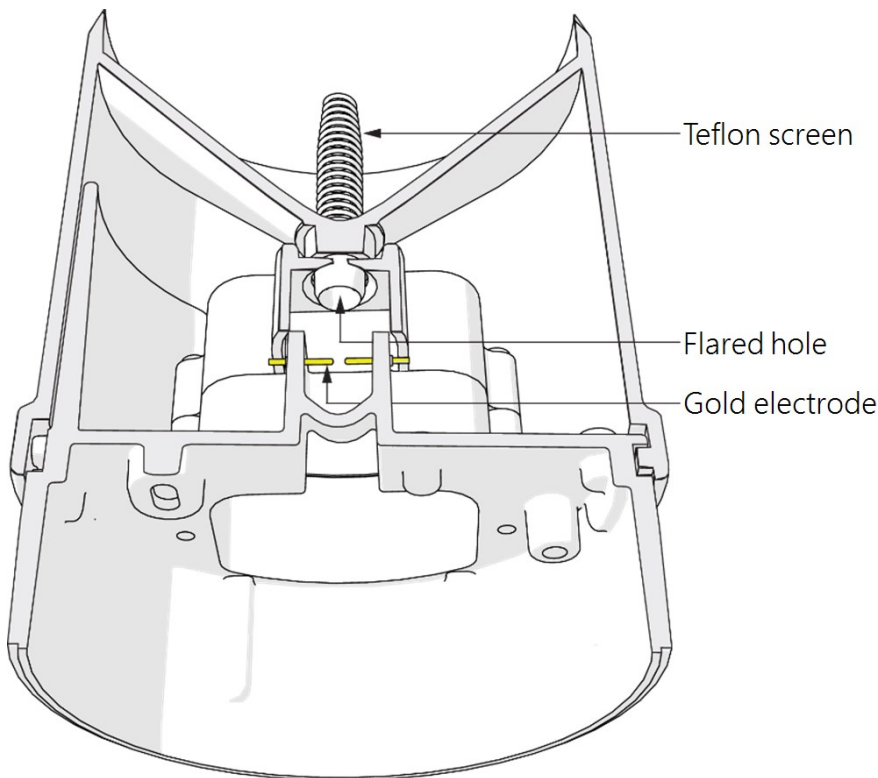

Figure 9-5. Rain gage cutout

6. Pyranometer maintenance. Gently clean the pyranometer first with a spray of distilled/clean water and next with a soft damp cloth. Install the bird spike kit if bird droppings are present ([Optional bird spike kit](#) [p. 18]).

Calibrate or replace the pyranometer every two years. The pyranometer calibration number needs to be changed when the funnel containing the pyranometer is replaced. Campbell Scientific will send a calibration certificate listing the new number with the recalibrated or replaced pyranometer. An extended SDI-12 command is used to replace the calibration number ([Extended commands](#) [p. 45]). Contact Campbell Scientific for more information.

To determine if the pyranometer needs to be cleaned or recalibrated, compare the data from one or more clear sky days with data calculated using a clear sky calculator. Several clear sky calculators are available online.

If the pyranometer data is less than the comparison clear sky data on a clear day, the pyranometer sensor is dirty or needs to be calibrated. Collect and review a couple days of data to be sure it wasn't a bird covering the sensor.

7. Relative humidity and barometric pressure maintenance. A field-replaceable module contains the barometric pressure and relative humidity sensors. This module is under the Teflon screen ([Figure 9-4](#) [p. 31]) and should be replaced every two years.

## 9.2 Troubleshooting

Symptom: NAN readings. NAN readings indicate the data logger isn't receiving data from the ClimaVue 50.

1. Check that the sensor is wired to the control or U terminal specified by the [SDI12Recorder\(\)](#) instruction.
2. Check the voltage to the sensor with a digital voltage meter. If a switched 12V terminal is used and programmed using CRBasic (not *Short Cut*), temporarily connect the red wire to a 12V terminal (non-switched) for test purposes.
3. Verify the probe SDI-12 address matches the address entered for the [SDI12Recorder\(\)](#) instruction. The address can be verified or changed with the commands described in [SDI-12 sensor support](#) (p. 39).

Symptom: Not reading any rain

1. Remove debris from rain gage (see step 5 in [Maintenance and calibration](#) [p. 28]).
2. Check the sensor level. The ClimaVue 50 must be within approximately  $\pm 2$  degrees of dead level (0, 0) in both the X and Y directions to accurately measure rainfall. If not within this

range, drops from the flared hole can miss the gold electrodes entirely. Use a torpedo level, the bubble level, or the internal tilt measurements to confirm that the ClimaVue 50 is level.

Symptom: No wind speed (–9,990, –9,999 or –7999)

1. Check anemometer pathway to ensure debris is not blocking the path of the sonic transducer measurement (between transducers and acoustic mirror on base).
2. Check the sonic transducers for water build-up. Use a dry cloth to remove moisture.
3. Check to see that the sintered glass plate (Figure 9-3 [p. 30]) is not dirty.
4. Clean by flushing with water and dry with a dry cloth.
5. Ensure that the ClimaVue 50 is level.

Symptom: No temperature reading

1. Check the temperature needle to be sure it is not pushed in, which will break the thermistor wires.

**CAUTION:**

Always gently handle the temperature sensor needle. It has delicate wires that can be easily damaged.

# Appendix A. Importing *Short Cut* code into *CRBasic Editor*

---

*Short Cut* creates a .DEF file that contains wiring information and a program file that can be imported into *CRBasic Editor*. By default, these files reside in the C:\campbellsci\SCWin folder.

Import *Short Cut* program file and wiring information into *CRBasic Editor*:

1. Create the *Short Cut* program, then save it. Click the **Advanced** tab then the **CRBasic Editor** button. Your program file will open in CRBasic with a generic name. Provide a meaningful name and save the CRBasic program. This program can now be edited for additional refinement.

**NOTE:**

Once the file is edited with *CRBasic Editor*, *Short Cut* can no longer be used to edit the program.

2. To add the *Short Cut* wiring information into the new CRBasic program, open the .DEF file located in the C:\campbellsci\SCWin folder. Copy the wiring information found at the beginning of the .DEF file.
3. Go into the CRBasic program and paste the wiring information at the beginning of the program.
4. In the CRBasic program, highlight the wiring information, right-click, and select **Comment Block**. This adds an apostrophe (') to the beginning of each of the highlighted lines, which instructs the data logger compiler to ignore those lines when compiling. The **Comment Block** feature is demonstrated at about 5:10 in the [CRBasic | Features](#) video .

# Appendix B. Determining True North and sensor orientation

---

Orientation of the wind direction sensor is done after programming the data logger, and determining the location of True North. True North is usually found by reading a magnetic compass and applying the correction for magnetic declination; where magnetic declination is the number of degrees between True North and Magnetic North. The preferred method to obtain the magnetic declination for a specific site is to use a computer service offered by NOAA at [www.ngdc.noaa.gov/geomag](http://www.ngdc.noaa.gov/geomag) . The magnetic declination can also be obtained from a map or local airport. A general map showing magnetic declination for the contiguous United States is shown in [Figure B-1](#) (p. 37).

Declination angles east of True North are considered negative, and are subtracted from 360 degrees to get True North as shown [Figure B-2](#) (p. 37) ( $0^\circ$  and  $360^\circ$  are the same point on a compass). For example, the declination for Logan, Utah is  $11.78^\circ$  East (11 August 2015). True North is  $360^\circ - 11.78^\circ$ , or  $348.22^\circ$  as read on a compass. Declination angles west of True North are considered positive, and are added to 0 degrees to get True North as shown in [Figure B-3](#) (p. 38).

Orientation:

1. Establish a reference point on the horizon for True North.
2. Sighting down one pair of the ClimaVue 50 north south posts, aim the pair at True North. If the wind is blowing and a flag or banner can be used to determine the true wind direction, the data logger displayed wind direction reading can be compared to the true wind direction.



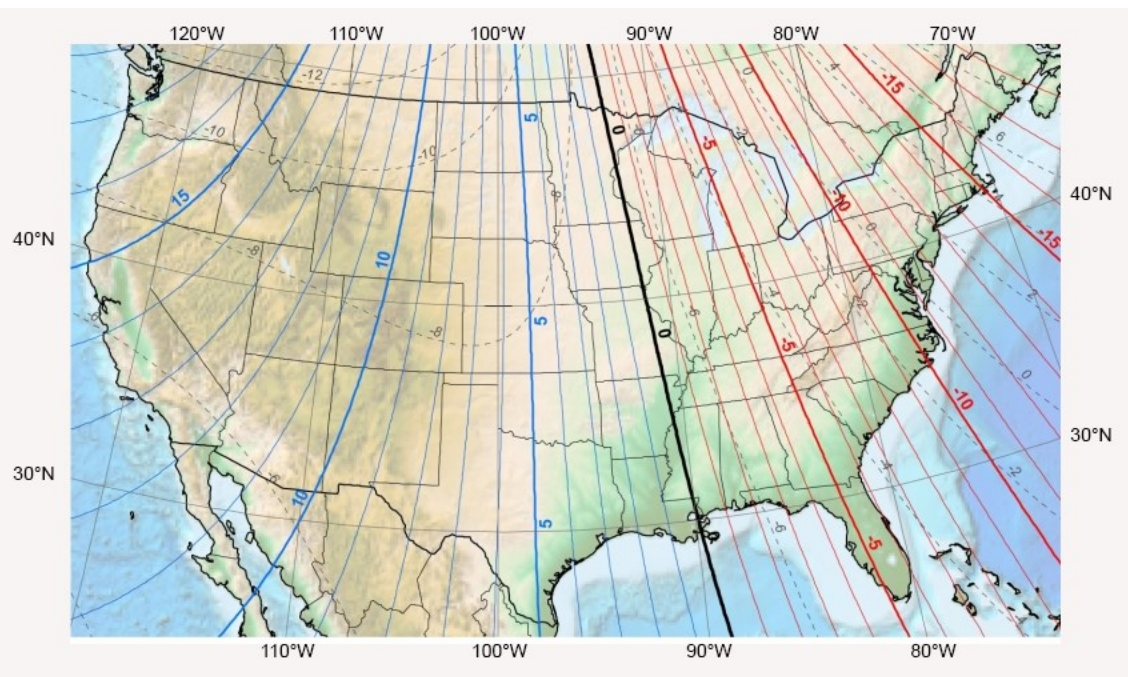

Figure B-1. Magnetic declination for the conterminous United States (2015)

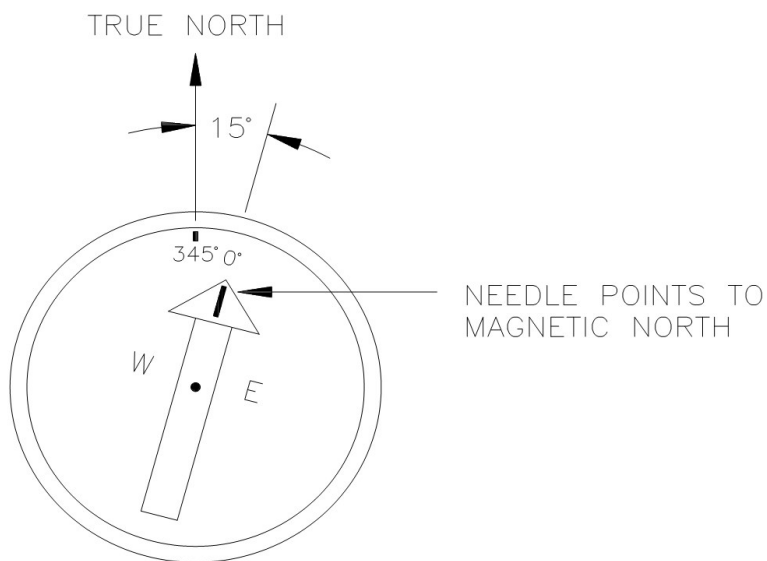
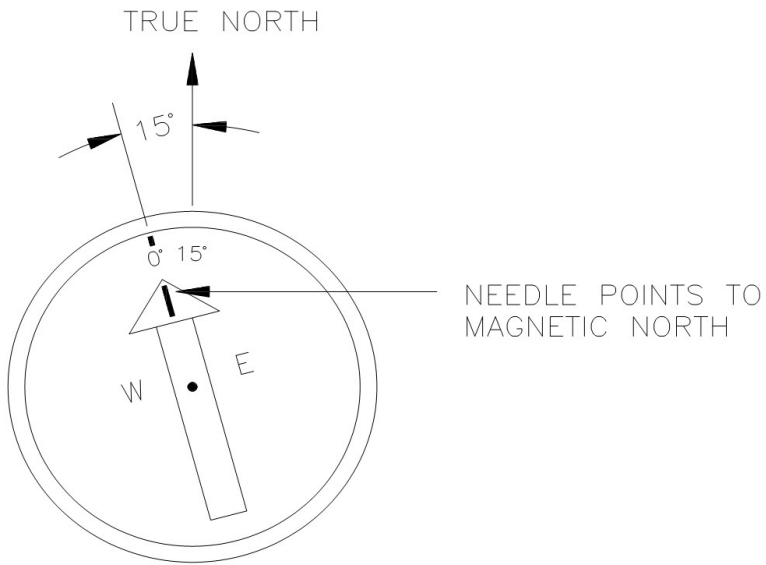

Figure B-2. Declination angles east of True North are subtracted from 360 to get True North



*Figure B-3. Declination angles west of True North are added to 0 to get True North*

# Appendix C. SDI-12 sensor support

Serial Data Interface at 1200 baud (SDI-12) is a protocol developed to simplify sensor and data logger compatibility. Only three wires are necessary—serial data, ground, and 12 V. With unique addresses, multiple SDI-12 sensors can connect to a single SDI-12 terminal on a Campbell Scientific data logger.

This appendix discusses the structure of SDI-12 commands and the process of querying SDI-12 sensors. For more detailed information, refer to version 1.4 of the SDI-12 protocol, available at [www.sdi-12.org](http://www.sdi-12.org).

For additional information, refer to the [SDI-12 Sensors | Transparent Mode](#) and [SDI-12 Sensors | Watch or Sniffer Mode](#) videos and the [SDI-12 Sensors Troubleshooting Tips](#) application note.

## C.1 SDI-12 command basics

SDI-12 commands have three components:

- **Sensor address (a)** – a single character and the first character of the command. Use the default address of zero (0) unless multiple sensors are connected to the same port.
- **Command body** – an uppercase letter (the “command”), optionally followed by one or more alphanumeric qualifiers.
- **Command termination (!)** – an exclamation mark.

An active sensor responds to each command. Responses have several standard forms and always terminate with <CR> <LF> (carriage return and line feed). Standard SDI-12 commands are listed in [Table C-1](#) (p. 39).

Name	Command <sup>1</sup>	Response
Acknowledge active	a!	a<CR><LF>
Send identification	aI!	allccccccmmmmmmvvvxxx...xx <CR><LF>

**Table C-1: Campbell Scientific sensor SDI-12 command and response set**

Name	Command <sup>1</sup>	Response
Start verification	aV!	atttn<CR><LF>
Address query	?!	a<CR><LF>
Change address	aAb!	b<CR><LF>
Start measurement	aM! aM1! . . . aM9!	atttn<CR><LF>
Start concurrent measurement	aC! aC1! . . . aC9!	atttnn<CR><LF>
Send data	aD0! . . . aD9!	a<values><CR><LF> or a<values><CRC><CR><LF>
Continuous measurement	aR0! . . . aR9!	a<values><CR><LF>
Extended commands	aXNNN!	a<values><CR><LF>
<sup>1</sup> Information on each of these commands is given in the following sections.		

## C.1.1 Acknowledge active command (a!)

The acknowledge active command (a!) is used to test a sensor on the SDI-12 bus. An active sensor responds with its address.

## C.1.2 Send identification command (aI!)

Sensor identifiers are requested by issuing command aI!. The reply is defined by the sensor manufacturer but usually includes the sensor address, SDI-12 version, manufacturer name, and sensor model information. Serial number or other sensor-specific information may also be included. Source: SDI-12: A Serial-Digital Interface Standard for Microprocessor-Based Sensors (see [References](#) [p. 48]).

Command: aI!

Response: *llccccccmmmmmmvvvxxx...xx*<CR><LF>

Where

*a* = sensor address

*ll* = SDI-12 version number (indicates compatibility)

*cccccc* = eight-character vendor identification

*mmmmmm* = six characters specifying the sensor model

*vvv* = three characters specifying the sensor version (operating system)

*xxx...xx* = up to 13 optional characters used for a serial number or other specific sensor information that is not relevant for operation of the data logger

<CR> <LF> = terminates the response

### C.1.3 Start verification command (aV!)

The response to a start verification command can include hardware diagnostics, but like the **aI!** command, the response is not standardized.

Command: **aV!**

Response: *attffffhhn*<CR><LF>

Where

*a* = sensor address

*ttt* = time, in seconds, until verification information is available

*fff* = firmware (OS) version

*hhh* = hardware version

*n* = number of values to be returned when one or more subsequent **D!** commands are issued

### C.1.4 Address query command (?!)

Command **?!** requests the address of the connected sensor. The sensor replies to the query with the address(*a*). This command should only be used with one sensor on the SDI-12 bus at a time.

### C.1.5 Change address command (aAb!)

Multiple SDI-12 sensors can connect to a single SDI-12 terminal on a data logger. Each device on a single terminal must have a unique address.

A sensor address is changed with command **aAb!**, where *a* is the current address and *b* is the new address. For example, to change an address from 0 to 2, the command is **0A2!**. The sensor responds with the new address *b*, which in this case is 2.

#### NOTE:

Only one sensor should be connected to a particular terminal at a time when changing addresses.

## C.1.6 Start measurement commands (aM!)

A measurement is initiated with the **M!** command. The response to each command has the form *attn*<CR><LF>, where

*a* = sensor address

*t**t**t* = time, in seconds, until measurement data is available; when the data is ready, the sensor notifies the data logger, and the data logger begins issuing **D** commands

*n* = number of values returned when one or more subsequent **D** commands are issued; for the **aM!** command, *n* is an integer from 0 to 9

When **aM!** is issued, the data logger pauses its operation and waits until either it receives the data from the sensor or the time (*t**t**t*) expires. Depending on the scan interval of the data logger program and the response time of the sensor, this may cause skipped scans to occur. To avoid this, make sure your scan interval is longer than the longest measurement time (*t**t**t*).

<b>0M!</b>	The data logger makes a request to sensor 0 to start a measurement.
00352<CR><LF>	Sensor 0 immediately indicates that it will return two values within the next 35 seconds.
0<CR><LF>	Within 35 seconds, sensor 0 indicates that it has completed the measurement by sending a service request to the data logger.
<b>0D0!</b>	The data logger immediately issues the first <b>D</b> command to collect data from the sensor.
0+.859+3.54<CR><LF>	The sensor immediately responds with the sensor address and the two values.

## C.1.7 Start concurrent measurement commands (aC!)

A concurrent measurement (**aC!**) command follows the same pattern as the **aM!** command, with the exception that it does not require the data logger to pause its operation, and other SDI-12 sensors may take measurements at the same time. The sensor will not issue a service request to notify the data logger that the measurement is complete. The data logger will issue the **aD0!** command during the next scan after the measurement time reported by the sensor has expired. To use this command, the scan interval should be 10 seconds or less. The response to each command has the form *attn*<CR><LF>, where

*a* = sensor address

*t**t**t* = time, in seconds, until measurement data is available

*nn* = number of values to be returned when one or more subsequent **D** commands are issued  
 See the example in [Table C-3](#) (p. 43). A data logger has three sensors wired into terminal **C1**. The sensors are addresses X, Y, and Z. The data logger will issue the following commands and receive the following responses:

Table C-3: Example aC! sequence	
<b>XC!</b>	The data logger makes a request to sensor X to start a concurrent measurement.
X03005<CR><LF>	Sensor X immediately indicates that it will have five (05) values ready for collection within the next 30 (030) seconds.
<b>YC!</b>	The data logger makes a request to sensor Y to start a concurrent measurement.
Y04006<CR><LF>	Sensor Y immediately indicates that it will have six (06) values ready for collection within the next 40 (040) seconds.
<b>ZC!</b>	The data logger makes a request to sensor Z to start a concurrent measurement.
Z02010<CR><LF>	Sensor Z immediately indicates that it will have ten (10) values ready for collection within the next 20 (020) seconds.
<b>ZD0!</b>	After 20 seconds have passed, the data logger starts the process of collecting the data by issuing the first <b>D</b> command to sensor Z.
Z+1+2+3+4+5+6+7+8+9+10<CR><LF>	Sensor Z immediately responds with the sensor address and the ten values.
<b>XD0!</b>	10 seconds later, after a total of 30 seconds has passed, the data logger starts the process of collecting data from sensor X by issuing the first <b>D</b> command.
X+1+2+3+4+5<CR><LF>	The sensor immediately responds with the sensor address and the five values.

Table C-3: Example aC! sequence	
YD0!	10 seconds later, after a total of 40 seconds has passed, the data logger starts the process of collecting data from sensor Y by issuing the first D command.
Y+1+2+3+4+5+6<CR><LF>	The sensor immediately responds with the sensor address and the six values.

## C.1.8 Stopping a measurement command

A measurement command (M!) is stopped if it detects a break signal before the measurement is complete. A break signal is sent by the data logger before most commands.

A concurrent measurement command (C!) is aborted when another valid command is sent to the sensor before the measurement time has elapsed.

## C.1.9 Send data command (aD0! ... aD9!)

The send data command requests data from the sensor. It is issued automatically with every type of measurement command (aM!, aMC!, aC!, aCC!). When the measurement command is aM! or aMC!, the data logger issues the aD0! command once a service request has been received from the sensor or the reported time has expired. When the data logger is issuing concurrent commands (aC! or aCC!), the send data command is issued after the required time has elapsed (no service request will be sent by the sensor). In transparent mode (see [SDI-12 transparent mode](#) [p. 46]), the user asserts this command to obtain data.

Depending on the type of data returned and the number of values a sensor returns, the data logger may need to issue aD0! up to aD9! to retrieve all data. A sensor may return up to 35 characters of data in response to a D command that follows an M! or MC! command. A sensor may return up to 75 characters of data in response to a D command that follows a C! or CC! command. Data values are separated by plus or minus signs.

Command: aD0! (aD1! ... aD9!)

Response: a<values><CR><LF> or a<values><CRC><CR><LF>

where

*a* = sensor address

<values> = values returned with a polarity sign (+ or -)

<CR><LF> = terminates the response



<CRC> = 16-bit CRC code appended if data was requested with aMC! or aCC!

## C.1.10 Continuous measurement command (aR0! ... aR9!)

Sensors that are able to continuously monitor the phenomena to be measured can be read directly with the R commands (R0! ... R9!). The response to R commands mirrors the send data command (aD0!). A maximum of 75 characters can be returned in the <values> part of the response to the R command.

## C.1.11 Extended commands

Many sensors support extended SDI-12 commands. An extended command is specific to a make of sensor and tells the sensor to perform a specific task. They have the following structure. Responses vary from unit to unit. See the sensor manual for specifics.

Command: aXNNNN!

The command will start with the sensor address (*a*), followed by an X then a set of optional letters, and terminate with an exclamation point.

Response: a<optional values><CR><LF>

The response will start with the sensor address and end with a carriage return/line feed.

The only extended command a customer might need is the following command which is used to enter a new pyranometer calibration factor when the rain gage funnel and pyranometer are replaced.

Operating system (OS) upgrades require additional equipment and extended commands and therefore are not practical for most customers. Contact a Campbell Scientific repair department for assistance if a OS upgrade is needed.

Table C-4: ClimaVue 50 extended commands

SDI-12 command <sup>1</sup>	Function
aXc!	Displays the pyranometer calibration.
aXcnnnn!	Changes the pyranometer calibration number to <i>nnnn</i> . Where: <i>nnnn</i> = calibration number

<sup>1</sup>*a* is the sensor address.

## C.2 SDI-12 transparent mode

System operators can manually interrogate and enter settings in probes using transparent mode. Transparent mode is useful in troubleshooting SDI-12 systems because it allows direct communication with probes. Data logger security may need to be unlocked before activating the transparent mode.

Transparent mode is entered while the computer is communicating with the data logger through a terminal emulator program. It is accessed through Campbell Scientific data logger support software or other terminal emulator programs. Data logger keyboards and displays cannot be used.

The terminal emulator is accessed through Campbell Scientific *Device Configuration Utility* software.

Watch [videos/sdi12-sensors-transparent-mode](https://www.campbellsci.com/videos/sdi12-sensors-transparent-mode)  from the Campbell Scientific website.

Data loggers from other manufacturers will also have a transparent mode. Refer to those manuals for information on how to use their transparent mode.

The following examples show how to enter transparent mode and change the SDI-12 address of an SDI-12 sensor. The steps shown in [Changing an SDI-12 address](#) (p. 46) are used with most Campbell Scientific data loggers.

### C.2.1 Changing an SDI-12 address

This example was done with a CR1000X, but the steps are only slightly different for Granite-series, CR6, CR800-series, CR300-series data loggers.

1. Connect an SDI-12 sensor to the CR1000X.
2. Open *Device Configuration Utility*.
3. Under **Device Type**, type the data logger model and double-click on the model type. This example uses a CR1000X directly connected to the computer USB port.

4. Select the correct **Communication Port** and click **Connect**.

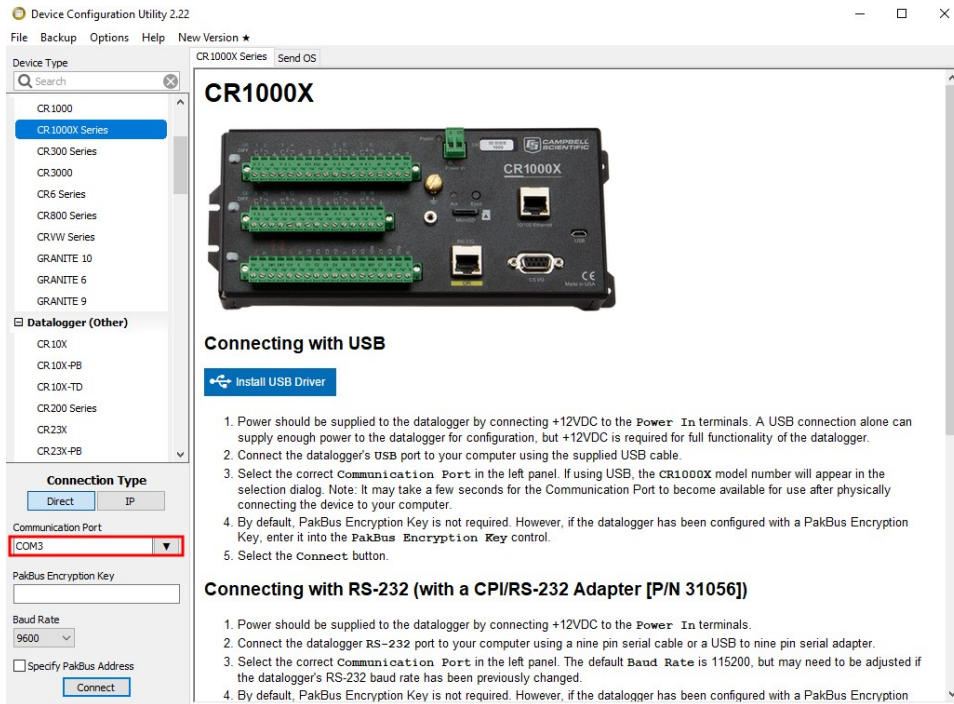

5. Click the **Terminal** tab.

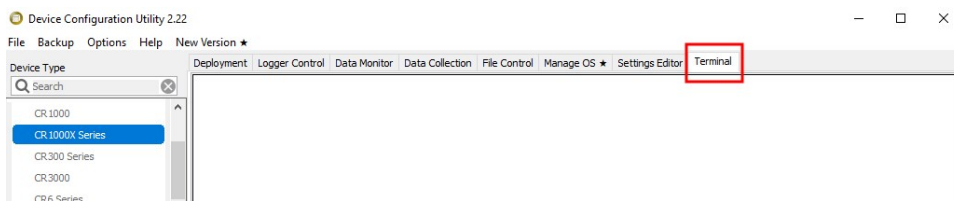

6. Select **All Caps Mode**.

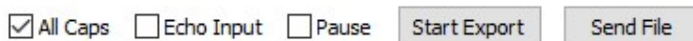

7. Press **Enter** until the data logger responds with the data logger (**CR1000X>**) prompt.

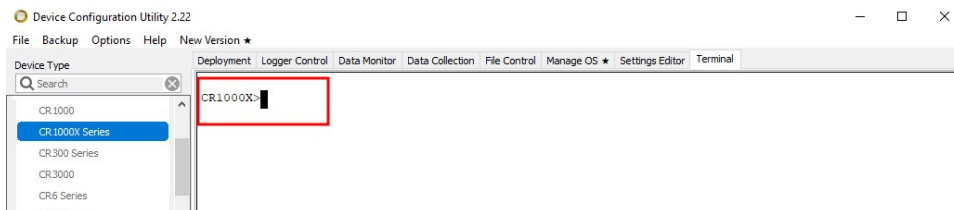

8. Type **SDI12** and press **Enter**.

9. At the **Select SDI12 Port** prompt, type the number corresponding to the control port where the sensor is connected and press **Enter**. In this example the sensor is connected to C3. The

response **Entering SDI12 Terminal** indicates that the sensor is ready to accept SDI-12 commands.

```
CR1000X>
CR1000X>SDI12
1: C1
2: C3
3: C5
4: C7
Select SDI12 Port: 2
```

10. To query the sensor for its current SDI-12 address, type **?!** and press **Enter**. The sensor responds with its SDI-12 address. If no characters are typed within 60 seconds, the mode is exited. In that case, simply type **SDI12** again, press **Enter**, and type the correct control port number when prompted.

```
?!
0
```

11. To change the SDI-12 address, type **aAb!**, where **a** is the current address from the previous step and **b** is the new address. Press **Enter**. The sensor changes its address and responds with the new address. In the following example, the sensor address is changed from 0 to B.

```
SDI12
SDI12>0AB!B
```

12. To exit SDI-12 transparent mode, click **Close Terminal**.

#### NOTE:

The transparent mode for the Granite-series, CR6, CR3000, CR800-series, CR300-series data loggers is similar to that shown for the CR1000X.

## C.3 References

SDI-12 Support Group. 2017. *SDI-12: A Serial-Digital Interface Standard for Microprocessor-Based Sensors – Version 1.4*. River Heights, UT: SDI-12 Support Group. [http://www.sdi-12.org/current\\_specification/SDI-12\\_version-1\\_4-Dec-1-2017.pdf](http://www.sdi-12.org/current_specification/SDI-12_version-1_4-Dec-1-2017.pdf) .

# Limited warranty

---

Covered equipment is warranted/guaranteed against defects in materials and workmanship under normal use and service for the period listed on your sales invoice or the product order information web page. The covered period begins on the date of shipment unless otherwise specified. For a repair to be covered under warranty, the following criteria must be met:

1. There must be a defect in materials or workmanship that affects form, fit, or function of the device.
2. The defect cannot be the result of misuse.
3. The defect must have occurred within a specified period of time; and
4. The determination must be made by a qualified technician at a Campbell Scientific Service Center/ repair facility.

The following is not covered:

1. Equipment which has been modified or altered in any way without the written permission of Campbell Scientific.
2. Batteries; and
3. Any equipment which has been subjected to misuse, neglect, acts of God or damage in transit.

Campbell Scientific regional offices handle repairs for customers within their territories. Please see the back page of the manual for a list of [regional offices](#) or visit [www.campbellsci.com/contact](http://www.campbellsci.com/contact)  to determine which Campbell Scientific office serves your country. For directions on how to return equipment, see [Assistance](#).

Other manufacturer's products, that are resold by Campbell Scientific, are warranted only to the limits extended by the original manufacturer.

CAMPBELL SCIENTIFIC EXPRESSLY DISCLAIMS AND EXCLUDES ANY IMPLIED WARRANTIES OF MERCHANTABILITY OR FITNESS FOR A PARTICULAR PURPOSE. Campbell Scientific hereby disclaims, to the fullest extent allowed by applicable law, any and all warranties and conditions with respect to the products, whether express, implied, or statutory, other than those expressly provided herein.

Campbell Scientific will, as a default, return warranted equipment by surface carrier prepaid. However, the method of return shipment is at Campbell Scientific's sole discretion. Campbell Scientific will not reimburse the claimant for costs incurred in removing and/or reinstalling equipment. This warranty and the Company's obligation thereunder is in lieu of all other

warranties, expressed or implied, including those of suitability and fitness for a particular purpose. Campbell Scientific is not liable for consequential damage.

In the event of any conflict or inconsistency between the provisions of this Warranty and the provisions of Campbell Scientific's Terms, the provisions of Campbell Scientific's Terms shall prevail. Furthermore, Campbell Scientific's Terms are hereby incorporated by reference into this Warranty. To view Terms and conditions that apply to Campbell Scientific, Logan, UT, USA, see [Terms and Conditions](#). To view terms and conditions that apply to Campbell Scientific offices outside of the United States, contact the [regional office](#) that serves your country.

# Assistance

---

Products may not be returned without prior authorization. Please inform us before returning equipment and obtain a **return material authorization (RMA) number** whether the repair is under warranty/guarantee or not. See [Limited warranty](#) for information on covered equipment.

Campbell Scientific regional offices handle repairs for customers within their territories. Please see the back page of the manual for a list of [regional offices](#) or visit [www.campbellsci.com/contact](http://www.campbellsci.com/contact)  to determine which Campbell Scientific office serves your country.

When returning equipment, a RMA number must be clearly marked on the outside of the package. Please state the faults as clearly as possible. Quotations for repairs can be given on request.

It is the policy of Campbell Scientific to protect the health of its employees and provide a safe working environment. In support of this policy, when equipment is returned to Campbell Scientific, Logan, UT, USA, it is mandatory that a "[Declaration of Hazardous Material and Decontamination](#)" form be received before the return can be processed. If the form is not received within 5 working days of product receipt or is incomplete, the product will be returned to the customer at the customer's expense. For details on decontamination standards specific to your country, please reach out to your [regional Campbell Scientific](#) office.

## NOTE:

All goods that cross trade boundaries may be subject to some form of fee (customs clearance, duties or import tax). Also, some regional offices require a purchase order upfront if a product is out of the warranty period. Please contact your [regional Campbell Scientific](#) office for details.

# Safety

---

DANGER — MANY HAZARDS ARE ASSOCIATED WITH INSTALLING, USING, MAINTAINING, AND WORKING ON OR AROUND TRIPODS, TOWERS, AND ANY ATTACHMENTS TO TRIPODS AND TOWERS SUCH AS SENSORS, CROSSARMS, ENCLOSURES, ANTENNAS, ETC. FAILURE TO PROPERLY AND COMPLETELY ASSEMBLE, INSTALL, OPERATE, USE, AND MAINTAIN TRIPODS, TOWERS, AND ATTACHMENTS, AND FAILURE TO HEED WARNINGS, INCREASES THE RISK OF DEATH, ACCIDENT, SERIOUS INJURY, PROPERTY DAMAGE, AND PRODUCT FAILURE. TAKE ALL REASONABLE PRECAUTIONS TO AVOID THESE HAZARDS. CHECK WITH YOUR ORGANIZATION'S SAFETY COORDINATOR (OR POLICY) FOR PROCEDURES AND REQUIRED PROTECTIVE EQUIPMENT PRIOR TO PERFORMING ANY WORK.

Use tripods, towers, and attachments to tripods and towers only for purposes for which they are designed. Do not exceed design limits. Be familiar and comply with all instructions provided in product manuals. Manuals are available at [www.campbellsci.com](http://www.campbellsci.com) You are responsible for conformance with governing codes and regulations, including safety regulations, and the integrity and location of structures or land to which towers, tripods, and any attachments are attached. Installation sites should be evaluated and approved by a qualified engineer. If questions or concerns arise regarding installation, use, or maintenance of tripods, towers, attachments, or electrical connections, consult with a licensed and qualified engineer or electrician.

## General

- Protect from over-voltage.
- Protect electrical equipment from water.
- Protect from electrostatic discharge (ESD).
- Protect from lightning.
- Prior to performing site or installation work, obtain required approvals and permits. Comply with all governing structure-height regulations, such as those of the FAA in the USA.
- Use only qualified personnel for installation, use, and maintenance of tripods and towers, and any attachments to tripods and towers. The use of licensed and qualified contractors is highly recommended.
- Read all applicable instructions carefully and understand procedures thoroughly before beginning work.
- Wear a hardhat and eye protection, and take other appropriate safety precautions while working on or around tripods and towers.
- Do not climb tripods or towers at any time, and prohibit climbing by other persons. Take reasonable precautions to secure tripod and tower sites from trespassers.
- Use only manufacturer recommended parts, materials, and tools.

## Utility and Electrical

- You can be killed or sustain serious bodily injury if the tripod, tower, or attachments you are installing, constructing, using, or maintaining, or a tool, stake, or anchor, come in contact with overhead or underground utility lines.
- Maintain a distance of at least one-and-one-half times structure height, 6 meters (20 feet), or the distance required by applicable law, whichever is greater, between overhead utility lines and the structure (tripod, tower, attachments, or tools).
- Prior to performing site or installation work, inform all utility companies and have all underground utilities marked.
- Comply with all electrical codes. Electrical equipment and related grounding devices should be installed by a licensed and qualified electrician.
- Only use power sources approved for use in the country of installation to power Campbell Scientific devices.

## Elevated Work and Weather

- Exercise extreme caution when performing elevated work.
- Use appropriate equipment and safety practices.
- During installation and maintenance, keep tower and tripod sites clear of un-trained or non-essential personnel. Take precautions to prevent elevated tools and objects from dropping.
- Do not perform any work in inclement weather, including wind, rain, snow, lightning, etc.

## Internal Battery

- Be aware of fire, explosion, and severe-burn hazards.
- Misuse or improper installation of the internal lithium battery can cause severe injury.



- Do not recharge, disassemble, heat above 100 °C (212 °F), solder directly to the cell, incinerate, or expose contents to water. Dispose of spent batteries properly.

#### Use and disposal of batteries

- Where batteries need to be transported to the installation site, ensure they are packed to prevent the battery terminals shorting which could cause a fire or explosion. Especially in the case of lithium batteries, ensure they are packed and transported in a way that complies with local shipping regulations and the safety requirements of the carriers involved.
- When installing the batteries follow the installation instructions very carefully. This is to avoid risk of damage to the equipment caused by installing the wrong type of battery or reverse connections.
- When disposing of used batteries, it is still important to avoid the risk of shorting. Do not dispose of the batteries in a fire as there is risk of explosion and leakage of harmful chemicals into the environment. Batteries should be disposed of at registered recycling facilities.

#### Avoiding unnecessary exposure to radio transmitter radiation

- Where the equipment includes a radio transmitter, precautions should be taken to avoid unnecessary exposure to radiation from the antenna. The degree of caution required varies with the power of the transmitter, but as a rule it is best to avoid getting closer to the antenna than 20 cm (8 inches) when the antenna is active. In particular keep your head away from the antenna. For higher power radios (in excess of 1 W ERP) turn the radio off when servicing the system, unless the antenna is installed away from the station, e.g. it is mounted above the system on an arm or pole.

#### Maintenance

- Periodically (at least yearly) check for wear and damage, including corrosion, stress cracks, frayed cables, loose cable clamps, cable tightness, etc. and take necessary corrective actions.
- Periodically (at least yearly) check electrical ground connections.

WHILE EVERY ATTEMPT IS MADE TO EMBODY THE HIGHEST DEGREE OF SAFETY IN ALL CAMPBELL SCIENTIFIC PRODUCTS, THE CUSTOMER ASSUMES ALL RISK FROM ANY INJURY RESULTING FROM IMPROPER INSTALLATION, USE, OR MAINTENANCE OF TRIPODS, TOWERS, OR ATTACHMENTS TO TRIPODS AND TOWERS SUCH AS SENSORS, CROSSARMS, ENCLOSURES, ANTENNAS, ETC.

# Global Sales and Support Network

A worldwide network to help meet your needs



## Campbell Scientific Regional Offices

### Australia

**Location:** Garbutt, QLD Australia  
**Phone:** 61.7.4401.7700  
**Email:** [info@campbellsci.com.au](mailto:info@campbellsci.com.au)  
**Website:** [www.campbellsci.com.au](http://www.campbellsci.com.au)

### Brazil

**Location:** São Paulo, SP Brazil  
**Phone:** 11.3732.3399  
**Email:** [vendas@campbellsci.com.br](mailto:vendas@campbellsci.com.br)  
**Website:** [www.campbellsci.com.br](http://www.campbellsci.com.br)

### Canada

**Location:** Edmonton, AB Canada  
**Phone:** 780.454.2505  
**Email:** [dataloggers@campbellsci.ca](mailto:dataloggers@campbellsci.ca)  
**Website:** [www.campbellsci.ca](http://www.campbellsci.ca)

### China

**Location:** Beijing, P. R. China  
**Phone:** 86.10.6561.0080  
**Email:** [info@campbellsci.com.cn](mailto:info@campbellsci.com.cn)  
**Website:** [www.campbellsci.com.cn](http://www.campbellsci.com.cn)

### Costa Rica

**Location:** San Pedro, Costa Rica  
**Phone:** 506.2280.1564  
**Email:** [info@campbellsci.com](mailto:info@campbellsci.com)  
**Website:** [www.campbellsci.com](http://www.campbellsci.com)

### France

**Location:** Montrouge, France  
**Phone:** 0033.0.1.56.45.15.20  
**Email:** [info@campbellsci.fr](mailto:info@campbellsci.fr)  
**Website:** [www.campbellsci.fr](http://www.campbellsci.fr)

### Germany

**Location:** Bremen, Germany  
**Phone:** 49.0.421.460974.0  
**Email:** [info@campbellsci.de](mailto:info@campbellsci.de)  
**Website:** [www.campbellsci.de](http://www.campbellsci.de)

### India

**Location:** New Delhi, DL India  
**Phone:** 91.11.46500481.482  
**Email:** [info@campbellsci.in](mailto:info@campbellsci.in)  
**Website:** [www.campbellsci.in](http://www.campbellsci.in)

### Japan

**Location:** Kawagishi, Toda City, Japan  
**Phone:** 048.400.5001  
**Email:** [jp-info@campbellsci.com](mailto:jp-info@campbellsci.com)  
**Website:** [www.campbellsci.co.jp](http://www.campbellsci.co.jp)

### South Africa

**Location:** Stellenbosch, South Africa  
**Phone:** 27.21.8809960  
**Email:** [sales@campbellsci.co.za](mailto:sales@campbellsci.co.za)  
**Website:** [www.campbellsci.co.za](http://www.campbellsci.co.za)

### Spain

**Location:** Barcelona, Spain  
**Phone:** 34.93.2323938  
**Email:** [info@campbellsci.es](mailto:info@campbellsci.es)  
**Website:** [www.campbellsci.es](http://www.campbellsci.es)

### Thailand

**Location:** Bangkok, Thailand  
**Phone:** 66.2.719.3399  
**Email:** [info@campbellsci.asia](mailto:info@campbellsci.asia)  
**Website:** [www.campbellsci.asia](http://www.campbellsci.asia)

### UK

**Location:** Shephed, Loughborough, UK  
**Phone:** 44.0.1509.601141  
**Email:** [sales@campbellsci.co.uk](mailto:sales@campbellsci.co.uk)  
**Website:** [www.campbellsci.co.uk](http://www.campbellsci.co.uk)

### USA

**Location:** Logan, UT USA  
**Phone:** 435.227.9120  
**Email:** [info@campbellsci.com](mailto:info@campbellsci.com)  
**Website:** [www.campbellsci.com](http://www.campbellsci.com)