

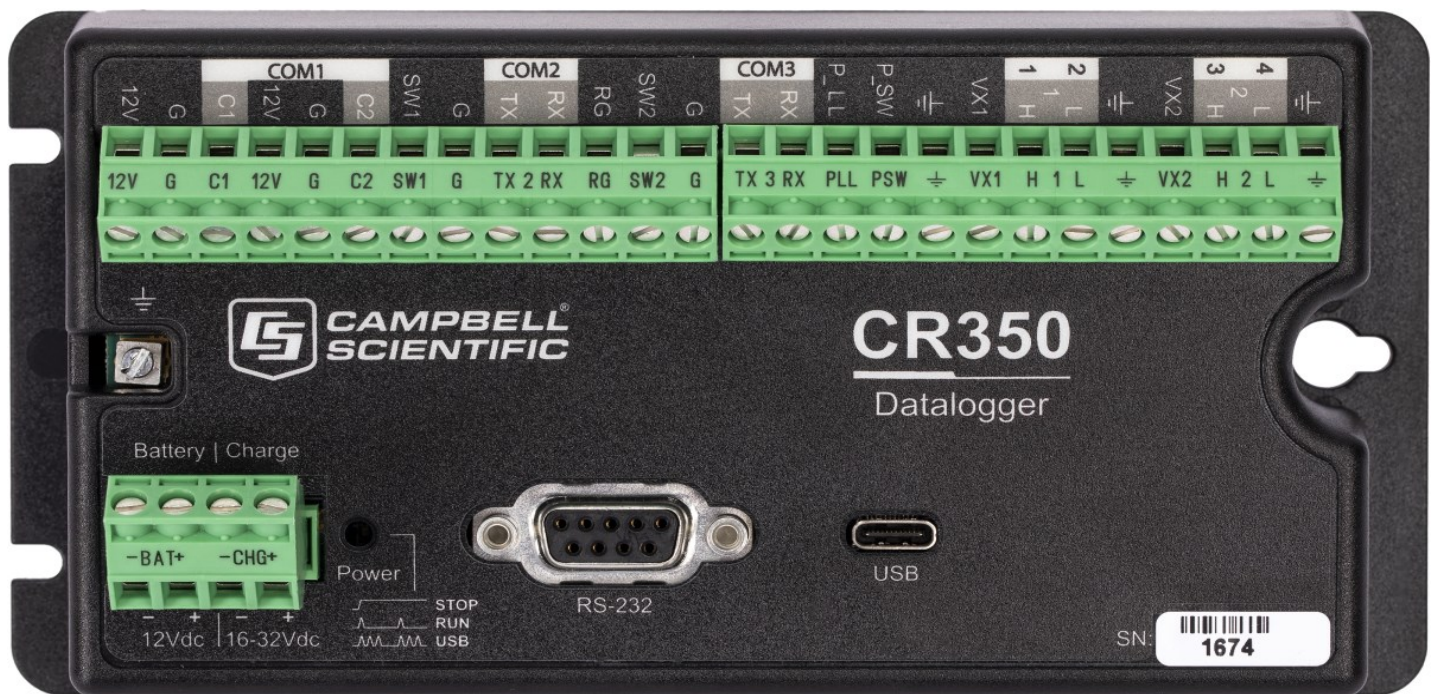

CR350 Series

Compact Datalogger



Please read first

About this manual

Please note that this manual was produced by Campbell Scientific Inc. primarily for the North American market. Some spellings, weights and measures may reflect this. In addition, while most of the information in the manual is correct for all countries, certain information is specific to the North American market and so may not be applicable to European users. Differences include the U.S. standard external power supply details where some information (for example the AC transformer input voltage) will not be applicable for British/European use. Please note, however, *that when a power supply adapter is ordered from Campbell Scientific it will be suitable for use in your country.*

Reference to some radio transmitters, digital cell phones and aerials (antennas) may also not be applicable according to your locality. Some brackets, shields and enclosure options, including wiring, are not sold as standard items in the European market; in some cases alternatives are offered.

Recycling information for countries subject to WEEE regulations 2012/19/EU

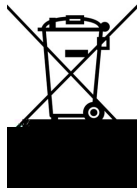

At the end of this product's life it should not be put in commercial or domestic refuse but sent for recycling. Any batteries contained within the product or used during the product's life should be removed from the product and also be sent to an appropriate recycling facility, per [The Waste Electrical and Electronic Equipment \(WEEE\) Regulations 2012/19/EU](#). Campbell Scientific can advise on the recycling of the equipment and in some cases arrange collection and the correct disposal of it, although charges may apply for some items or territories. For further support, please contact Campbell Scientific, or your local agent.

Table of Contents

1. Introduction	1
2. Precautions	2
3. Initial inspection	3
4. CR350 data acquisition system components	4
4.1 The CR350 data logger	5
4.1.1 CR350 product line	5
4.1.2 Overview	5
4.1.3 Operations	6
4.1.4 Programs	6
4.2 Sensors	6
5. Wiring panel and terminal functions	8
5.1 Power input	11
5.1.1 Power LED indicator	12
5.2 Power output	13
5.3 Grounds	13
5.4 Communications ports	15
5.4.1 USB device port	15
5.4.2 USB host port	15
5.4.3 C and COM terminals for communications	16
5.4.3.1 SDI-12 ports	16
5.4.3.2 RS-232, RS-422, RS-485, TTL ports	16
5.4.4 RS-232 Port	17
5.4.4.1 RS-232 Power States	17
5.5 Programmable logic control	18

6. Setting up the CR350	20
7. Setting up communications with the data logger	21
8. USB or RS-232 communications	23
9. Virtual Ethernet over USB (RNDIS)	26
10. Wi-Fi communications option	28
10.1 Hosting a Wi-Fi network	28
10.1.1 Configure the data logger to host a Wi-Fi network	29
10.1.2 Connect your phone to the data logger over Wi-Fi	30
10.1.3 Set up LoggerLink	30
10.1.4 Connect your computer to the data logger over Wi-Fi	31
10.1.5 Set up LoggerNet or PC400W	32
10.2 Joining a Wi-Fi network	33
10.2.1 Configure the data logger to join a Wi-Fi network	33
10.2.2 Set up LoggerNet or PC400W	34
10.3 Wi-Fi configurations and mode button	35
10.3.1 Join a Network	35
10.3.2 Create a Network	35
10.3.3 Normally Off, Join Network on Button Press (default)	36
10.3.4 Normally Off, Create Network on Button Press	36
10.3.5 Join Network, Create Network on Button Press	36
10.3.6 Disable	37
10.4 Wi-Fi LED indicator	37
11. Cellular communications option	38
11.1 Pre-installation	39
11.1.1 Establish cellular service	39
11.1.1.1 Campbell Scientific cellular data service	39
11.1.1.2 Other service providers	39
11.1.2 Install the SIM card	40
11.1.3 Konect PakBus Router setup	41
11.1.3.1 Get started	41
11.1.3.2 Set up Konect PakBus Router	42
11.2 Installation	43
11.2.1 Determining if IP address is private dynamic or public static	43
11.2.2 Modules using Konect PakBus Router (private dynamic IP)	44

11.2.2.1 Configure data logger	44
11.2.2.2 Set up LoggerNet	46
11.2.2.3 Test the connection	48
11.2.3 Modules using a public static IP	48
11.2.3.1 Configure data logger	48
11.2.3.2 Set up LoggerNet	50
11.2.3.3 Test the connection	52
11.3 Cellular (TX/RX) LED Indicator	52
11.4 Signal strength and quality	52
11.4.1 Signal strength	53
11.4.2 Signal quality	53
12. Radio communications option	55
12.1 Configuration options	56
12.2 Basic RF407 networks	57
12.2.1 Configure the base RF407-series radio	57
12.2.2 Configure the remote RF407-series data logger(s)	59
12.3 RF407-series radio communications with multiple data loggers through a data logger router	62
12.3.1 Configure the RF407-series base radio	63
12.3.2 Configure the data logger acting as a router	64
12.3.2.1 Add routing data logger to LoggerNet network	67
12.3.3 Configure remote (leaf) data loggers	70
12.3.3.1 Add leaf data loggers to the network	70
12.3.4 Using additional communications methods	71
12.4 RF452 radio communications with one or more data loggers	71
12.4.1 Configuring the RF452 radio connected to the computer	72
12.4.2 Configuring endpoint RF452 data loggers	73
12.4.3 Setting up communications between the RF452 data logger and the computer	74
12.5 RF452 communications with multiple data loggers using one repeater	75
12.5.1 Configuring the RF452 radio connected to the computer	76
12.5.2 Configuring the data logger acting as a repeater	77
12.5.3 Adding the endpoint/repeater data logger to the LoggerNet network	78
12.5.4 Adding endpoint data loggers to the network	78
12.5.5 Using additional communications methods	79

13. Testing communications with EZSetup	80
13.1 Making the software connection	81
14. Creating a Short Cut data logger program	82
14.1 Sending a program to the data logger	85
15. Working with data	87
15.1 Default data tables	87
15.2 Collecting data	88
15.2.1 Collecting data using LoggerNet	88
15.2.2 Collecting data using PC400	88
15.3 Viewing historic data	89
15.4 Data types and formats	90
15.4.1 Variables	90
15.4.2 Constants	91
15.4.3 Data storage	92
15.5 About data tables	93
15.5.1 Table definitions	94
15.5.1.1 Header rows	94
15.5.1.2 Data records	96
15.6 Creating data tables in a program	96
16. Data memory	99
16.1 Data tables	99
16.2 Flash memory	100
16.2.1 CPU drive	100
16.3 USB host (USB: drive)	100
16.3.1 USB host precautions	101
16.3.2 LED indicator	101
16.3.3 Data type collection speed	101
16.3.4 Skipped scans	101
16.3.5 Formatting drives 32 GB or larger	102
17. Measurements	103
17.1 Voltage measurements	103
17.1.1 Single-ended measurements	104
17.1.2 Differential measurements	105
17.2 Current-loop measurements	105

17.2.1 Voltage ranges for current measurements	105
17.2.2 Example current-loop measurement connections	106
17.3 Resistance measurements	108
17.3.1 Resistance measurements with voltage excitation	108
17.3.2 RTD and PRT	111
17.3.3 Strain measurements	111
17.3.4 Accuracy for resistance measurements	113
17.4 Period-averaging measurements	114
17.5 Pulse measurements	114
17.5.1 Low-level AC measurements	116
17.5.2 High-frequency measurements	116
17.5.3 Switch-closure and open-collector measurements	117
17.5.3.1 P_SW Terminal	117
17.5.3.2 C terminals	118
17.5.4 Quadrature measurements	118
17.5.5 Pulse measurement tips	119
17.5.5.1 Input filters and signal attenuation	119
17.5.5.2 Pulse count resolution	120
17.6 Vibrating wire measurements	120
17.6.1 VSPECT®	120
18. Communications protocols	121
18.1 General serial communications	122
18.1.1 RS-232	124
18.1.2 RS-485/RS-422	125
18.1.3 TTL	126
18.1.4 TTL-Inverted	126
18.2 Modbus communications	127
18.2.1 About Modbus	128
18.2.2 Modbus protocols	129
18.2.3 Understanding Modbus Terminology	130
18.2.4 Connecting Modbus devices	130
18.2.5 Modbus client-server protocol	130
18.2.6 About Modbus programming	131
18.2.6.1 Endianness	131
18.2.6.2 Function codes	132
18.2.7 Modbus information storage	132

18.2.7.1 Registers	133
18.2.7.2 Coils	133
18.2.7.3 Data Types	134
Unsigned 16-bit integer	134
Signed 16-bit integer	134
Signed 32-bit integer	134
Unsigned 32-bit integer	135
32-Bit floating point	135
18.2.8 Modbus tips and troubleshooting	135
18.2.8.1 Error codes	135
Result code -01: illegal function	135
Result code -02: illegal data address	136
Result code -11: COM port error	136
18.3 Internet communications	136
18.3.1 IP address	137
18.3.2 FTP server	137
18.4 MQTT	138
18.4.1 Sending data to an MQTT broker	139
18.4.1.1 Mosquitto	139
Configure the data logger	139
Program the data logger	140
18.4.1.2 AWS	140
Setup AWS IoT	140
Configure the data logger	147
Program the data logger	148
Verify data in AWS IoT	149
18.5 DNP3 communications	149
18.6 PakBus communications	150
18.7 SDI-12 communications	150
18.7.1 SDI-12 transparent mode	151
18.7.1.1 Watch command (sniffer mode)	152
18.7.1.2 SDI-12 transparent mode commands	153
18.7.1.3 aXLOADOS! command	153
18.7.2 SDI-12 programmed mode/recorder mode	155
18.7.3 Programming the data logger to act as an SDI-12 sensor	155
18.7.4 SDI-12 power considerations	156

19. Installation	158
19.1 Default program	159
19.2 Data logger security	160
19.2.1 Device Configuration Utility Security Check	160
19.2.1.1 PakBus	161
19.2.1.2 Web services	161
HTTP	161
HTTPS	161
19.2.1.3 Network services	162
FTP	162
Telnet	162
Ping	162
19.2.1.4 Operating System Status	162
19.2.2 Other security measures reviewed by Device Configuration Utility	163
19.2.2.1 PakBus TCP Enabled	163
19.2.2.2 Account manager	163
19.2.2.3 IP Broadcast Filtered	163
19.2.2.4 Other communications protocols	163
19.2.3 TLS	163
19.2.3.1 Obtaining certificate and private key	165
From a Certificate Authority	165
From your IT department	167
19.2.4 Other security measures	167
19.2.4.1 CRBasic	167
19.2.4.2 Other	168
19.2.4.3 The .csipasswd file	168
Deprecated API functionality	170
19.3 Web user interface	170
19.4 Power budgeting	171
19.5 Field work	171
19.6 Data logger enclosures	172
19.7 Electrostatic discharge and lightning protection	173
20. CR350 maintenance	175
20.1 Data logger calibration	175
20.2 Internal battery	176
20.2.1 Replacing the internal battery	177

20.3 Updating the operating system	177
20.3.1 Sending an operating system to a local data logger	178
20.3.2 Sending an operating system to a remote data logger	179
20.4 gzip	180
21. Tips and troubleshooting	182
21.1 Checking station status	183
21.1.1 Viewing station status	183
21.1.2 Watchdog errors	184
21.1.3 Results for last program compiled	184
21.1.4 Skipped scans	185
21.1.5 Skipped records	185
21.1.6 Variable out of bounds	185
21.1.7 Battery voltage	185
21.2 Understanding NAN and INF occurrences	185
21.3 Timekeeping	186
21.3.1 Clock best practices	186
21.3.2 Time stamps	187
21.3.3 Avoiding time skew	187
21.4 CRBasic program errors	188
21.4.1 Program does not compile	188
21.4.2 Program compiles but does not run correctly	189
21.5 Troubleshooting radio communications	189
21.6 Resetting the data logger	190
21.6.1 Processor reset	190
21.6.2 Program send reset	190
21.6.3 Manual data table reset	191
21.6.4 Formatting drives	191
21.6.5 Full memory reset	191
21.7 Troubleshooting power supplies	192
21.8 Using terminal mode	192
21.8.1 Serial talk through and comms watch	194
21.8.2 SDI-12 transparent mode	195
21.8.2.1 Watch command (sniffer mode)	196
21.8.2.2 SDI-12 transparent mode commands	197
21.8.3 Terminal master	197
21.9 Ground loops	197

21.9.1 Common causes	198
21.9.2 Detrimental effects	198
21.9.3 Severing a ground loop	200
21.9.4 Soil moisture example	201
21.10 Improving voltage measurement quality	202
21.10.1 Deciding between single-ended or differential measurements	202
21.10.2 Minimizing ground potential differences	203
21.10.2.1 Ground potential differences	204
21.10.3 Minimizing power-related artifacts	204
21.10.3.1 Minimizing electronic noise	205
21.10.4 Filtering to reduce measurement noise	206
21.10.5 Minimizing settling errors	209
21.10.5.1 Measuring settling time	210
21.10.6 Factors affecting accuracy	212
21.10.6.1 Measurement accuracy example	213
21.10.7 Minimizing offset voltages	213
21.11 Field calibration	215
21.12 File name and resource errors	215
22. Information tables and settings (advanced)	216
22.1 DataTableInfo table system information	217
22.1.1 DataFillDays	217
22.1.2 DataRecordSize	217
22.1.3 DataTableName	217
22.1.4 RecNum	217
22.1.5 SecsPerRecord	218
22.1.6 SkippedRecord	218
22.1.7 TimeStamp	218
22.2 Status table system information	218
22.2.1 Battery	218
22.2.2 CalGain	218
22.2.3 CalOffset	218
22.2.4 CommsMemFree	219
22.2.5 CompileResults	219
22.2.6 CPUDriveFree	219
22.2.7 DataStorageFree	219
22.2.8 DataStorageSize	219

22.2.9 FullMemReset	219
22.2.10 LastSlowScan	219
22.2.11 LithiumBattery	219
22.2.12 MaxProcTime	220
22.2.13 MaxSlowProcTime	220
22.2.14 MeasureTime	220
22.2.15 MemoryFree	220
22.2.16 MemorySize	220
22.2.17 OSDate	220
22.2.18 OSSignature	220
22.2.19 OSVersion	220
22.2.20 PakBusRoutes	221
22.2.21 PanelTemp	221
22.2.22 PortConfig	221
22.2.23 PortStatus	221
22.2.24 ProcessTime	221
22.2.25 ProgErrors	221
22.2.26 ProgName	222
22.2.27 ProgSignature	222
22.2.28 RecNum	222
22.2.29 RunSignature	222
22.2.30 SerialNumber	222
22.2.31 SerialFlashErrors	222
22.2.32 SkippedScan	222
22.2.33 SlowProcTime	223
22.2.34 StartTime	223
22.2.35 StartUpCode	223
22.2.36 StationName	223
22.2.37 SW12Volts	223
22.2.38 TimeStamp	223
22.2.39 VarOutOfBound	224
22.2.40 WatchdogErrors	224
22.2.41 WiFiUpdateReq	224
22.3 Settings	224
22.3.1 Baudrate	225
22.3.2 Beacon	225
22.3.3 Cell Settings	225

22.3.4 CentralRouters	225
22.3.5 CommsMemAlloc	226
22.3.6 DNS	226
22.3.7 FilesManager	226
22.3.8 FTPEnabled	226
22.3.9 FTPPassword	226
22.3.10 FTPPort	227
22.3.11 FTPUserName	227
22.3.12 HTTPEnabled	227
22.3.13 HTTPPort	227
22.3.14 IncludeFile	227
22.3.15 IPBroadcastFiltered	227
22.3.16 IPAddressEth	228
22.3.17 IPGateway	228
22.3.18 IPMaskEth	228
22.3.19 IPMaskWiFi	228
22.3.20 IPTrace	228
22.3.21 IPTraceCode	228
22.3.22 IPTraceComport	229
22.3.23 IsRouter	229
22.3.24 KeepAliveURL (Ping keep alive URL)	229
22.3.25 KeepAliveMin (Ping keep alive timeout value)	229
22.3.26 MaxPacketSize	229
22.3.27 Neighbors	230
22.3.28 PakBusAddress	230
22.3.29 PakBusEncryptionKey (PakBus Encryption Key)	230
22.3.30 PakBusNodes	230
22.3.31 PakBusPort	230
22.3.32 PakBusTCPClients	231
22.3.33 PakBusTCPEnabled	231
22.3.34 PakBusTCPPassword	231
22.3.35 PingEnabled	231
22.3.36 pppDial	231
22.3.37 pppDialResponse	232
22.3.38 pppInfo	232
22.3.39 pppInterface	232
22.3.40 pppIPAddr	232

22.3.41 pppPassword	232
22.3.42 pppUsername	232
22.3.43 RouteFilters	233
22.3.44 RS232Power	233
22.3.45 Security(1), Security(2), Security(3)	233
22.3.46 ServicesEnabled	233
22.3.47 TCPClientConnections	233
22.3.48 TCPPort	233
22.3.49 TelnetEnabled	234
22.3.50 TLSConnections (Max TLS Server Connections)	234
22.3.51 TLSPassword	234
22.3.52 TLSStatus	234
22.3.53 IPAddressUSB (USB Virtual Ethernet Address (RNDIS))	234
22.3.54 UTCOffset	234
22.3.55 Verify	235
22.3.56 Cellular settings	235
22.3.56.1 CellAPN	235
22.3.56.2 CellEnabled	235
22.3.56.3 CellInfo	236
22.3.56.4 CellKeepAlive	236
22.3.56.5 CellKeepAliveTime	236
22.3.56.6 CellPDPAuth	236
22.3.56.7 CellPDPPassword	237
22.3.56.8 CellPDPUserName	237
22.3.56.9 CellPwrDuration	237
22.3.56.10 CellPwrRepeat	238
22.3.56.11 CellPwrStartTime	238
22.3.56.12 CellRSRQ	238
22.3.56.13 CellRSSI	239
22.3.56.14 CellState	239
22.3.56.15 CellStatus	240
22.3.57 Wi-Fi settings	240
22.3.57.1 IPAddressWiFi	241
22.3.57.2 IPGatewayWiFi	241
22.3.57.3 IPMaskWiFi	241
22.3.57.4 WiFiChannel	241
22.3.57.5 WiFiConfig	242

22.3.57.6 WiFiEAPMethod	242
22.3.57.7 WiFiEAPPassword	242
22.3.57.8 WiFiEAPUser	242
22.3.57.9 Networks	242
22.3.57.10 WiFiEnable	242
22.3.57.11 WiFiPassword	243
22.3.57.12 WiFiPowerMode	243
22.3.57.13 WiFiSSID (Network Name)	243
22.3.57.14 WiFiStatus	243
22.3.57.15 WiFiTxPowerLevel	244
22.3.57.16 WLANDomainName	244
22.3.58 MQTT settings	244
22.3.58.1 MQTTBaseTopic (MQTT base topic)	244
22.3.58.2 MQTTCleanSession (MQTT connection)	245
22.3.58.3 MQTTClientID (MQTT client identifier)	245
22.3.58.4 MQTTEnable (Enable or disable MQTT)	245
22.3.58.5 MQTTEndpoint (MQTT broker URL)	245
22.3.58.6 MQTTKeepAlive (MQTT keep alive)	245
22.3.58.7 MQTTPassword (MQTT password)	246
22.3.58.8 MQTTPortNumber (MQTT port number)	246
22.3.58.9 MQTTStatusInterval (Status information publish interval)	246
22.3.58.10 MQTTState (MQTT state)	246
22.3.58.11 MQTTStateInterval (State publish interval)	247
22.3.58.12 MQTTUserName (MQTT user name)	247
22.3.58.13 MQTTWillMessage (MQTT last will message)	247
22.3.58.14 MQTTWillQoS (Quality of service)	247
22.3.58.15 MQTTWillRetain (MQTT last will message retained by broker)	248
22.3.58.16 MQTTWillTopic (MQTT last will topic)	248
22.3.59 RF407-series radio settings	248
22.3.59.1 RadioAvailFreq	248
22.3.59.2 RadioChanMask	249
22.3.59.3 RadioEnable	249
22.3.59.4 RadioHopSeq	249
22.3.59.5 RadioMAC	249
22.3.59.6 RadioModel	250
22.3.59.7 RadioModuleVer	250
22.3.59.8 RadioNetID	250

22.3.59.9 RadioProtocol	250
22.3.59.10 RadioPwrMode	251
22.3.59.11 RadioRetries	252
22.3.59.12 RadioRSSI	252
22.3.59.13 RadioRSSIAddr	253
22.3.59.14 RadioStats	253
22.3.59.15 RadioTxPwr	253
22.3.60 RF452 radio settings	254
22.3.60.1 RadioCarrier	254
22.3.60.2 RadioDataRate	254
22.3.60.3 RadioDiag	255
22.3.60.4 RadioEnable	255
22.3.60.5 RadioFirmwareVer	255
22.3.60.6 RadioFreqKey	255
22.3.60.7 RadioFreqRepeat	256
22.3.60.8 RadioFreqZone	256
22.3.60.9 RadioHopSize	257
22.3.60.10 RadioHopVersion	257
22.3.60.11 RadioLowPwr	257
22.3.60.12 RadioMaxPacket	257
22.3.60.13 RadioMinPacket	258
22.3.60.14 RadioMMSync	258
22.3.60.15 RadioModOS	258
22.3.60.16 RadioModuleVer	259
22.3.60.17 RadioNetID	259
22.3.60.18 RadioOpMode	259
22.3.60.19 RadioPacketRepeat	260
22.3.60.20 RadioRepeaters	261
22.3.60.21 RadioRetryOdds	261
22.3.60.22 RadioRetryTimeout	262
22.3.60.23 RadioRxSubID	262
22.3.60.24 RadioEndpointRepeat	262
22.3.60.25 RadioEndpointRetry	263
22.3.60.26 RadioTxPwr	263
22.3.60.27 RadioTxRate	263
22.3.60.28 RadioTxSubID	264
22.3.61 GOES settings	264

22.3.61.1 GOESComPort	264
22.3.61.2 GOESEnabled	265
22.3.61.3 GOESGainSetting	265
22.3.61.4 GOESMsgWindow	265
22.3.61.5 GOESPlatformID	265
22.3.61.6 GOESRepeatCount	265
22.3.61.7 GOESRTBaudRate	266
22.3.61.8 GOESRTChannel	266
22.3.61.9 GOESRTInterval	266
22.3.61.10 GOESSTBaudRate	266
22.3.61.11 GOESSTChannel	266
22.3.61.12 GOESSTInterval	266
22.3.61.13 GOESSTOffset	267
23. CR350 specifications	268
23.1 System specifications	268
23.2 Physical specifications	269
23.3 Power requirements	269
23.4 Power output specifications	271
23.5 Analog measurement specifications	272
23.5.1 Voltage measurements	272
23.5.2 Resistance measurement specifications	274
23.5.3 Period-averaging measurement specifications	274
23.5.4 Current-loop measurement specifications	275
23.6 Pulse measurement specifications	275
23.6.1 Switch-closure input	275
23.6.2 High-frequency input	276
23.6.3 Low-level AC input	276
23.6.4 Quadrature input	276
23.7 Digital input/output specifications	277
23.7.1 Pulse-width modulation	277
23.8 Communications specifications	278
23.8.1 Wi-Fi specifications	278
23.8.2 RF radio option specifications	279
23.8.3 Cellular option specifications	280
23.9 Standards compliance specifications	281

Appendix A. Configure cellular settings and retrieve status information with SetSetting()	283
Appendix B. Verizon Wireless and AT&T	284
B.1 Verizon Wireless	284
B.2 AT&T	285
Appendix C. Cellular module regulatory information	286
C.1 Important information for North American users	286
C.2 RF exposure	286
C.3 EU	287
C.4 UK	287
Appendix D. Glossary	289

1. Introduction

CR350s are multipurpose, compact, low-cost measurement and control data loggers. These entry level data loggers, with their rich instruction sets, can measure most hydrological, meteorological, environmental, and industrial sensors. They concentrate data, making it available over varied networks, and deliver it using your preferred protocol. The CR350 also performs automated on-site or remote decision making for control and mobile-to-mobile communications. This manual provides a detailed look at the CR350 measurement and control data logger and discusses the steps necessary to begin using it in your application.

The CR350-series includes the following data loggers:

- CR350-CELL200
- CR350-CELL205
- CR350-CELL210
- CR350-CELL215
- CR350-CELL220
- CR350-CELL230
- CR350-RF407
- CR350-RF412
- CR350-RF422
- CR350-RF427
- CR350-RF452
- CR350-WIFI

Throughout this manual, reference to the CR350 also applies to other CR350-series data loggers, unless specifically noted.

The [Getting Started Guide](#)  provides an introduction to data acquisition and walks you through a procedure to set up a simple system. You may not find it necessary to progress beyond this. However, should you want to dig deeper into the complexity of the data logger functions or quickly look for details, extensive information is available in this and other Campbell Scientific manuals.

Additional Campbell Scientific publications are available online at www.campbellsci.com .

Video tutorials are available at www.campbellsci.com/videos . Generally, if a particular feature of the data logger requires a peripheral hardware device, more information is available in the help or manual written for that device.

2. Precautions

READ AND UNDERSTAND the [Safety](#) section at the back of this manual.

An authorized technician shall verify that the installation and use of this product is in accordance to the manufacturer’s instructions, recommendations and intended use.

Although the CR350 is rugged, it should be handled as a precision scientific instrument.

Maintain a level of calibration appropriate to the application. Campbell Scientific recommends factory recalibration every three years.

RF452 radios must be configured to use the proper hop table version to comply with local laws and to avoid interference with other RF installations such as cellular services. The **Hop Table Version** setting allows the user to choose the portion of the band in which the transceiver will operate. Radios purchased through Campbell Scientific for use outside of the United States and Canada will have the country-specific **Hop Table Version** set.

WARNING:

Connect a suitable load to the antenna port before applying DC power to the RF452. This load should be either a 50-ohm antenna or an attenuator with a power rating of 2 watts or higher. Failure to follow this procedure may damage the radio voiding the warranty.

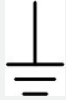
Symbol	Description
	Direct current
	Earth (ground) terminal

3. Initial inspection

Upon receiving the CR350, inspect the packaging and contents for damage. File damage claims with the shipping company.

Immediately check package contents. Thoroughly check all packaging material for product that may be concealed. Check model numbers, part numbers, and product descriptions against the shipping documents. Model or part numbers are found on each product. Report any discrepancies to Campbell Scientific.

Check the CR350 operating system version as outlined in [Updating the operating system](#) (p. 177), and update as needed.

4. CR350 data acquisition system components

A basic data acquisition system consists of sensors, measurement hardware, and a computer with programmable software. The objective of a data acquisition system should be high accuracy, high precision, and resolution as high as appropriate for a given application.

The components of a basic data acquisition system are shown in the following figure.

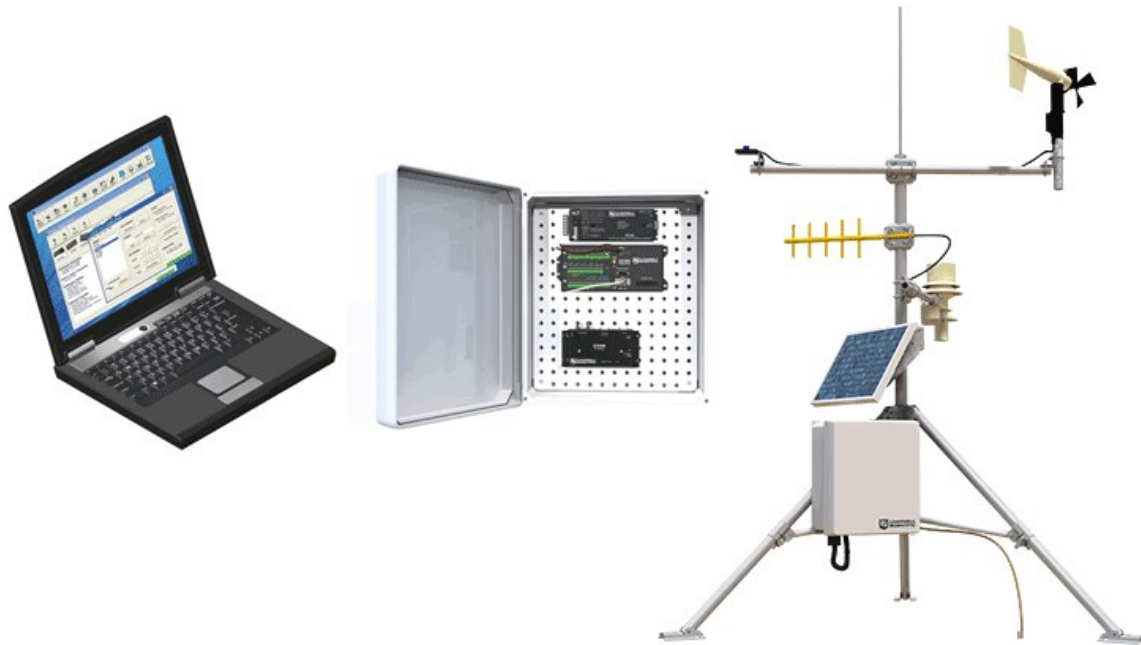

Following is a list of typical data acquisition system components:

- **Sensors** - Electronic sensors convert the state of a phenomenon to an electrical signal (see [Sensors](#) (p. 6) for more information).
- **Data logger** - The data logger measures electrical signals or reads serial characters. It converts the measurement or reading to engineering units, performs calculations, and reduces data to statistical values. Data is stored in memory to await transfer to a computer by way of an external storage device or a communications link.

- **Data Retrieval and Communications** - Data is copied (not moved) from the data logger, usually to a computer, by one or more methods using data logger support software. Most communications options are bi-directional, which allows programs and settings to be sent to the data logger. For more information, see [Sending a program to the data logger](#) (p. 85).
- **Datalogger Support Software** - Software retrieves data, sends programs, and sets settings. The software manages the communications link and has options for data display.
- **Programmable Logic Control** - Some data acquisition systems require the control of external devices to facilitate a measurement or to control a device based on measurements. This data logger is adept at programmable logic control. See [Programmable logic control](#) (p. 18) for more information.

4.1 The CR350 data logger

CR350 data loggers are multi-purpose, compact, measurement and control data loggers. These small, low-cost, high-value data loggers offer fast communications, low power requirements, built-in USB, and excellent analog input accuracy and resolution. They can measure most hydrological, meteorological, environmental, and industrial sensors. They concentrate data, make it available over varied networks, and deliver it using your preferred protocol. They also perform automated on-site or remote decision making for control and M2M communications. CR350 data loggers are ideal for small applications requiring long-term remote monitoring and control.

4.1.1 CR350 product line

The CR350 can include Wi-Fi, cellular, or the following radio options for different regions:

- RF407: US and Canada
- RF412: Australia and New Zealand
- RF422: Europe
- RF427: Brazil

NOTE:

Throughout this document CR350 refers to all of the models unless specified otherwise.

4.1.2 Overview

The CR350 data logger is the main part of a data acquisition system (see [CR350 data acquisition system components](#) (p. 4) for more information). It has a central-processing unit (CPU), analog and digital measurement inputs, analog and digital outputs, and memory. An operating system

(firmware) coordinates the functions of these parts in conjunction with the onboard clock and the CRBasic application program.

The CR350 can simultaneously provide measurement and communications functions. Low power consumption allows the data logger to operate for extended time on a battery recharged with a solar panel, eliminating the need for ac power. The CR350 temporarily suspends operations when primary power drops below 9.6 V, reducing the possibility of inaccurate measurements.

4.1.3 Operations

The CR350 measures almost any sensor with an electrical response, drives direct communications and telecommunications, reduces data to statistical values, performs calculations, and controls external devices. After measurements are made, data is stored in onboard, nonvolatile memory. Because most applications do not require that every measurement be recorded, the program usually combines several measurements into computational or statistical summaries, such as averages and standard deviations.

4.1.4 Programs

A program directs the data logger on how and when sensors are measured, calculations are made, data is stored, and devices are controlled. The application program for the CR350 is written in CRBasic, a programming language that includes measurement, data processing, and analysis routines, as well as the standard BASIC instruction set. For simple applications, *Short Cut*, a user-friendly program generator, can be used to generate the program. See also:

- [Creating a Short Cut data logger program](#) (p. 82)
- <https://www.campbellsci.com/videos/datalogger-programming> 

For more demanding programs, use the full-featured *CRBasic Editor*. The *CRBasic Editor* help contains program structure details, instruction information and program examples:

<https://help.campbellsci.com/crbasic/cr350/> .

4.2 Sensors

Sensors transduce phenomena into measurable electrical forms by modulating voltage, current, resistance, status, or pulse output signals. Suitable sensors do this with accuracy and precision. Smart sensors have internal measurement and processing components and simply output a digital value in binary, hexadecimal, or ASCII character form.

Most electronic sensors, regardless of manufacturer, will interface with the data logger. Some sensors require external signal conditioning. The performance of some sensors is enhanced with

specialized input modules. The data logger, sometimes with the assistance of various peripheral devices, can measure or read nearly all electronic sensor output types.

The following list may not be comprehensive. A library of sensor manuals and application notes is available at www.campbellsci.com/support  to assist in measuring many sensor types.

- Analog
 - Voltage
 - Current
 - Strain
 - Thermocouple
 - Resistive bridge
- Pulse
 - High frequency
 - Switch-closure
 - Low-level AC
 - Quadrature
- Period average
- Vibrating wire (through interface modules)
- Smart sensors
 - SDI-12
 - RS-232
 - Modbus
 - DNP3
 - TCP/IP
 - RS-422
 - RS-485

5. Wiring panel and terminal functions

The CR350 wiring panel provides ports and removable terminals for connecting sensors, power, and communications devices. It is protected against surge, over-voltage, over-current, and reverse power. The wiring panel is the interface to most data logger functions so studying it is a good way to get acquainted with the data logger. Functions of the terminals are broken down into the following categories:

- Analog input
- Pulse counting
- Analog output
- Communications
- Digital I/O
- Power input
- Power output
- Power ground
- Signal ground

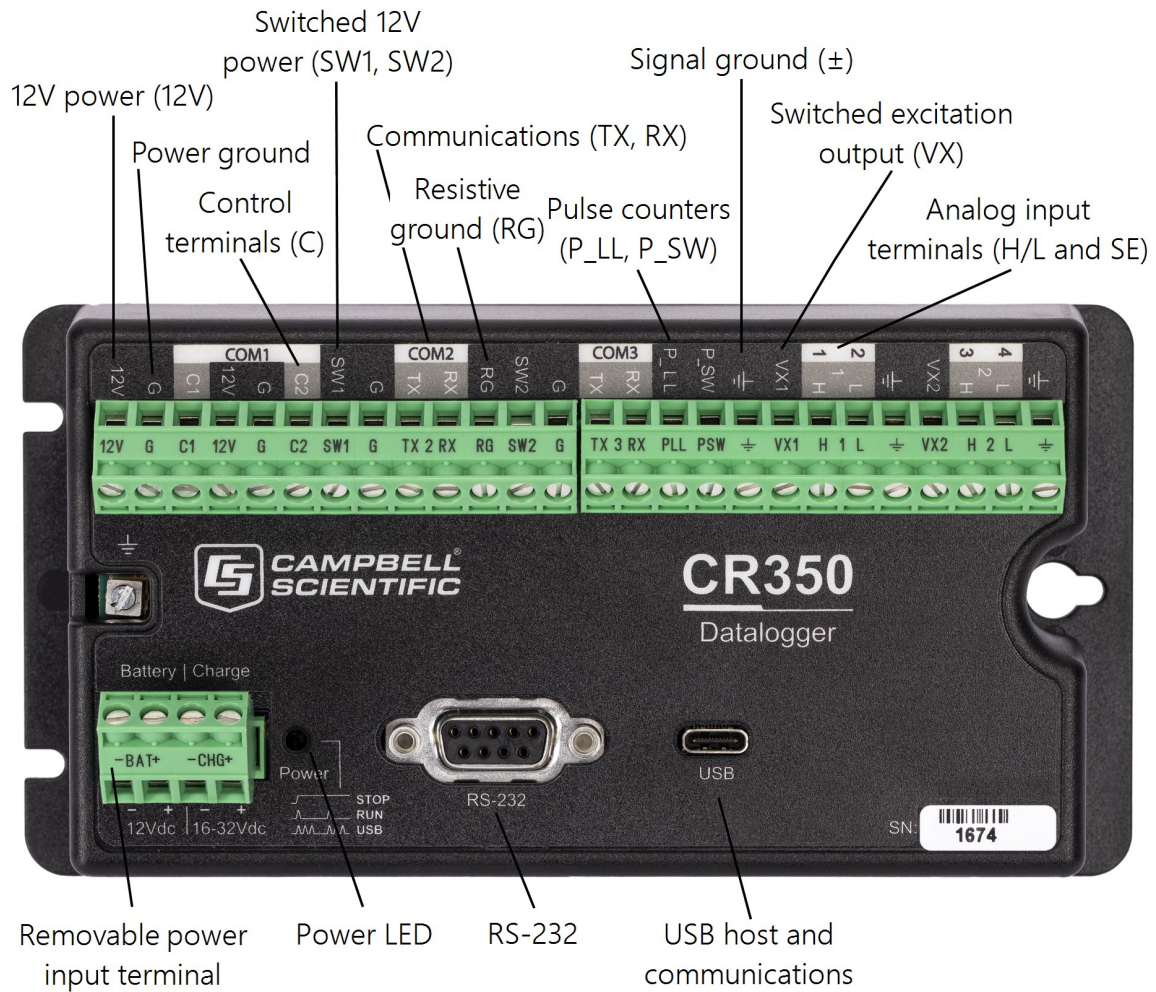

Table 5-1: Analog input terminal functions

SE DIFF	1 H	2 L	3 H	4 L
Single-Ended Voltage	✓	✓	✓	✓
Differential Voltage	H	L	H	L
Ratiometric/Bridge	✓	✓	✓	✓
Thermocouple	✓	✓	✓	✓
Current Loop	✓	✓		

	C1	C2	P_SW	P_LL	SE1	SE2	SE3	SE4
Switch-Closure	✓	✓	✓		✓	✓	✓	✓
High Frequency	✓	✓	✓	✓	✓	✓	✓	✓
Low-level AC				✓				
Quadrature	✓	✓			✓	✓	✓	✓
Period Average	✓	✓			✓	✓	✓	✓

	VX1	VX2
Switched Voltage Excitation	✓	✓

	C1	C2	SE1-4	VX1	VX2	P_SW	12V	SW1 SW2
3.3 VDC			✓	✓	✓	✓		
5 VDC	✓	✓		✓	✓			
BAT +							✓	✓

	C1	C2	SE1-3	RS-232	COM2	COM3
SDI-12	✓	✓				
RS-232				✓	✓	✓
RS-232 0-5V	✓	✓				
GPS Time Sync	✓	✓	✓			
GPS NMEA Sentences	Rx	Rx		Rx		

	C1	C2	SE1-3	RS-232	COM2	COM3
RS-485 Half duplex					Tx (A-) Rx (B+)	Tx (A-) Rx (B+)
RS-485 Full duplex					Tx pair	Rx pair
Communications functions also include USB						

	C1	C2	P_SW	SE1	SE2	SE3	SE4
General I/O	✓	✓	✓	✓	✓	✓	✓
Pulse-Width Modulation Output	✓			✓	✓	✓	✓
Interrupt	✓	✓	✓	✓	✓	✓	✓

5.1 Power input

The data logger requires a power supply. It can receive power from a variety of sources, operate for several months on non-rechargeable batteries, and supply power to many sensors and devices. The data logger operates with external power connected to the green **BAT** and/or **CHG** terminals on the face of the wiring panel. The positive power wire connects to +. The negative wire connects to -. The power terminals are internally protected against polarity reversal and high voltage transients.

In the field, the data logger can be powered in any of the following ways:

- 10 to 18 VDC applied to the **BAT** + and – terminals
- 16 to 32 VDC applied to the **CHG** + and – terminals

To establish an uninterruptible power supply (UPS), connect the primary power source (often a transformer, power converter, or solar panel) to the **CHG** terminals and connect a nominal 12 VDC sealed rechargeable lead-acid battery to the **BAT** terminals. See [Power budgeting](#) (p. 171) for more information.

WARNING:

Sustained input voltages in excess of 32 VDC on **CHG** or **BAT** terminals can damage the transient voltage suppression.

Ensure that power supply components match the specifications of the device to which they are connected. When connecting power, switch off the power supply, insert the connector, then turn the power supply on. See [Troubleshooting power supplies](#) (p. 192) for more information.

Following is a list of CR350 power input terminals and the respective power types supported.

- **BAT terminals:** Voltage input is 10 to 18 VDC. This connection uses the least current since the internal data logger charging circuit is bypassed. If the voltage on the **BAT** terminals exceeds 19 VDC, power is shut off to certain parts of the data logger to prevent damaging connected sensors or peripherals.
- **CHG terminals:** Voltage input range is 16 to 32 VDC. Connect a primary power source, such as a solar panel or VAC-to-VDC transformer, to **CHG**. The voltage applied to **CHG** terminals must be at least 0.3 V higher than that needed to charge a connected battery. When within the 16 to 32 VDC range, it will be regulated to the optimal charge voltage for a lead acid battery at the current data logger temperature, with a maximum voltage of approximately 15 VDC. A battery need not be connected to the **BAT** terminals to supply power to the data logger through the **CHG** terminals. The onboard charging regulator is designed for efficiently charging lead-acid batteries. It will not charge lithium or alkaline batteries.
- **USB port:** 5 VDC via USB connection. If power is also provided with **BAT** or **CHG**, power will be supplied by whichever has the highest voltage. If USB is the only power source, then the **12V** and **SW12V (SW1, SW2)** terminals will not be operational. When powered by USB (no other power supplies connected) **Status** field **Battery** = **0**. Functions that will be active with a 5 VDC source include sending programs, adjusting data logger settings, and making some measurements. The maximum excitation on **VX1** and **VX2** is reduced to 2500 mV.

NOTE:

The **Status** field **Battery** value and the destination variable from the **Battery()** instruction (often called **batt_volt** or **BattV**) in the **Public** table reference the external battery voltage. For information about the internal battery, see [Internal battery](#) (p. 176).

5.1.1 Power LED indicator

When the data logger is powered, the Power LED will turn on according to power and program states:

- **Off:** No power, no program running.
- **1 flash every 10 seconds:** Powered from **BAT**, program running.
- **1 flash every 10 seconds:** Powered from **CHG**, program running.
- **3 flashes every 10 seconds:** Powered via USB, program running.
- **Always on:** Powered, no program running.

5.2 Power output

The data logger can be used as a power source for communications devices, sensors and peripherals. Take precautions to prevent damage to these external devices due to over- or under-voltage conditions, and to minimize errors. Additionally, exceeding current limits causes voltage output to become unstable. Voltage should stabilize once current is again reduced to within stated limits. The following are available:

- **Continuous 12 V: BAT +** and **–** provide a connection to the unregulated, nominal 12 VDC battery. It may rise above or drop below the power requirement of the sensor or peripheral.
- **SW12**: program-controlled, switched 12 VDC terminals. It is often used to power devices such as sensors that require 12 VDC during measurement. Voltage on a **SW12** (**SW1**, **SW2**) terminal will change with data logger supply voltage. CRBasic instruction **SW12()** controls the **SW12** terminal. See the *CRBasic Editor* help for detailed instruction information and program examples: <https://help.campbellsci.com/crbasic/cr350/>.
- **VX** terminals: supply precise output voltage used by analog sensors to generate high resolution and accurate signals. In this case, these terminals are regularly used with resistive-bridge measurements (see [Resistance measurements](#) (p. 108) for more information). Using the **SWVX()** instruction, **VX** terminals can also supply a selectable, switched, regulated 3.3 or 5 VDC power source to power digital sensors and toggle control lines.
- **C**, **SE 1-4**, and **P_SW** terminals: can be set low or high as output terminals (**SE 1-4** and **P_SW** to 3.3 V, and **C** to 5 V). With limited drive capacity, digital output terminals are normally used to operate external relay-driver circuits. Drive current and high-state voltage levels vary between terminals. See also [Digital input/output specifications](#) (p. 277).

See also [Power requirements](#) (p. 269).

5.3 Grounds

Proper grounding lends stability and protection to a data acquisition system. Grounding the data logger with its peripheral devices and sensors is critical in all applications. Proper grounding will ensure maximum ESD protection and measurement accuracy. It is the easiest and least expensive insurance against data loss, and often the most neglected. The following terminals are provided for connection of sensor and data logger grounds:

- **Signal Ground (≡)** - reference for single-ended analog inputs, excitation returns, and a ground for sensor shield wires.
 - 3 common terminals
 - sometimes called analog ground (AG)
- **Power Ground (G)** - return for 3.3 V, 5 V, 12 V, current loops, and digital sensors. Use of **G** grounds for these outputs minimizes potentially large current flow through the analog-voltage-measurement section of the wiring panel, which can cause single-ended voltage measurement errors.
 - 4 common terminals
- **Resistive Ground (RG)** - used for decoupling ground on RS-485 signals. Includes 100 Ω resistance to ground.
- **Earth Ground Lug (≡)** - connection point for heavy-gauge earth-ground wire. A good earth connection is necessary to secure the ground potential of the data logger and shunt transients away from electronics. Campbell Scientific recommends 14 AWG wire, minimum.

NOTE:

Several ground wires can be connected to the same ground terminal.

A good earth (chassis) ground will minimize damage to the data logger and sensors by providing a low-resistance path around the system to a point of low potential. Campbell Scientific recommends that all data loggers be earth grounded. All components of the system (data loggers, sensors, external power supplies, mounts, housings) should be referenced to one common earth ground.

In the field, at a minimum, a proper earth ground will consist of a 5-foot copper-sheathed grounding rod driven into the earth and connected to the large brass ground lug on the wiring panel with a 14 AWG wire. In low-conductive substrates, such as sand, very dry soil, ice, or rock, a single ground rod will probably not provide an adequate earth ground. For these situations, search for published literature on lightning protection or contact a qualified lightning-protection consultant.

In laboratory applications, locating a stable earth ground is challenging, but still necessary. In older buildings, new VAC receptacles on older VAC wiring may indicate that a safety ground exists when, in fact, the socket is not grounded. If a safety ground does exist, good practice dictates to verify that it carries no current. If the integrity of the VAC power ground is in doubt, also ground the system through the building plumbing, or use another verified connection to earth ground.

See also:

- [Ground loops](#) (p. 197)
- [Minimizing ground potential differences](#) (p. 203)

5.4 Communications ports

The data logger is equipped with ports that allow communications with other devices and networks, such as:

- Computers
- Smart sensors
- Modbus and DNP3 networks
- Modems
- Campbell Scientific PakBus® networks
- Other Campbell Scientific data loggers

Campbell Scientific data logger communications ports include:

- RS-232
- USB Device
- USB Host
- C terminals
- COM ports (TX and RX)

5.4.1 USB device port

The USB device port supports communicating with a computer through data logger support software or through virtual Ethernet (RNDIS), and provides 5 VDC power to the data logger (powering through the USB port has limitations - details are available in the specifications). Although the USB connection supplies 5 V power, a 12 VDC battery will be needed for field deployment.

NOTE:

CR350 data loggers have a single USB port that acts as both a device and host.

5.4.2 USB host port

USB host provides portable data storage on a USB thumb drive. A FAT32-formatted USB thumb drive can be inserted into the host port and will show up as a drive (**USB:**) in file-related operations. Measurement data is stored on **USB:** as discrete files by using the [TableFile\(\)](#)

instruction. Files on **USB:** can be collected by inserting the thumb drive into a computer and copying the files.

USB: can be used in all CRBasic file-access-related instructions. Because of data reliability concerns in non-industrial rated drives, this drive is not intended for long-term unattended data storage. Rather, configure [Tablefile\(\)](#) for milking (plug-and-pull) to periodically collect data. Files on **USB:** are not affected by program recompilation or formatting of other drives.

See the *CRBasic Editor* help for detailed instruction information and program examples:

<https://help.campbellsci.com/crbasic/cr350/> 

5.4.3 C and COM terminals for communications

C terminals are configurable for the following communications types:

- SDI-12
- RS-232 (–5 V to 5 V)
- TTL (0 to 5 V)

Some communications types require more than one terminal, and some are only available on specific terminals. See [Communications specifications](#) (p. 278) for more information.

5.4.3.1 SDI-12 ports

SDI-12 is a 1200 baud protocol that supports many smart sensors. **C1** and **C2** can each be configured as an **SDI-12** communications port. Maximum cable lengths depend on the number of sensors connected, the type of cable used, and the environment of the application. Refer to the sensor manual for guidance.

For more information, see [SDI-12 communications](#) (p. 150).

5.4.3.2 RS-232, RS-422, RS-485, TTL ports

RS-232, RS-422, RS-485, TTL communications are typically used for the following:

- Reading sensors with serial output
- Creating a multi-drop network
- Communications with other data loggers or devices over long cables

Configure **COM** terminals as serial ports using *Device Configuration Utility* or by using the [SerialOpen\(\)](#) CRBasic instruction. Terminals are configured in pairs for TTL, RS-232, and half-duplex RS-422 and RS-485 communications. For full-duplex RS-422 and RS-485, four terminals are required. See also [Communications protocols](#) (p. 121).

NOTE:

RS-232 ports are not isolated.

See also [Communications specifications](#) (p. 278).

5.4.4 RS-232 Port

RS-232 represents a loose standard defining how two computing devices can communicate with each other. For instruction on setting up RS-232 communications with a computer, see [USB or RS-232 communications](#) (p. 23).

One nine-pin DCE port, labeled **RS-232**, normally is used to communicate with a computer running data logger support software, to connect a modem, or to read a smart sensor. The **RS-232** port functions as either a DCE or DTE device. The most common use of the **RS-232** port is as a connection to a computer DTE device (using a standard DB9-to-DB9 cable). Pins 1, 4, 6, and 9 function differently than a standard DCE device to accommodate a connection to a modem or other DCE device via a null modem cable. For the **RS-232** port to function as a DTE device, a null modem adapter is required.

RS-232 communications normally operate well up to a transmission cable capacitance of 2500 picofarads, or approximately 50 feet of commonly available serial cable.

5.4.4.1 RS-232 Power States

Under normal operation, the RS-232 port is powered down waiting for input. Upon receiving input, there is a 40-second software timeout before shutting down. The 40-second timeout is generally circumvented when communicating with data logger support software because it sends information as part of the protocol that lets the data logger know it can shut down the port.

When in sleep mode, hardware is configured to detect activity and wake up. Sleep mode may lose the first character of the incoming data stream. PakBus takes this into consideration in the "ring packets" that are preceded with extra sync bytes at the start of the packet. [SerialOpen\(\)](#) leaves the interface powered-up, so no incoming bytes are lost. See the *CRBasic Editor* help for detailed instruction information and program examples:

<https://help.campbellsci.com/crbasic/cr350/>

When the data logger has data to send via RS-232, if the data is not a response to a received packet, such as sending a beacon, it will power up the interface, send the data, and return to sleep mode without a 40 second timeout.

See also [Wiring panel and terminal functions](#) (p. 8).

5.5 Programmable logic control

The data logger can control instruments and devices such as:

- Controlling cellular modem or GPS receiver to conserve power.
- Triggering a water sampler to collect a sample.
- Triggering a camera to take a picture.
- Activating an audio or visual alarm.
- Moving a head gate to regulate water flows in a canal system.
- Controlling pH dosing and aeration for water quality purposes.
- Controlling a gas analyzer to stop operation when temperature is too low.
- Controlling irrigation scheduling.

Control decisions can be based on time, an event, or a measured condition. Controlled devices can be physically connected to **C**, **VX**, **SE1 -SE4**, **P_SW**, or **SW12** (**SW1**, **SW2**) terminals. *Short Cut* has provisions for simple on/off control. Control modules and relay drivers are available to expand and augment data logger control capacity.

- **C** terminals are selectable as binary inputs, control outputs, or communications ports. These terminals can be set low (0 VDC) or high (5 VDC) using the **PortSet()** or **WriteIO()** instructions. See the *CRBasic Editor* help for detailed instruction information and program examples: <https://help.campbellsci.com/crbasic/cr350/>. Other functions include device-driven interrupts, asynchronous communications and SDI-12 communications. A **C** terminal configured for digital I/O is normally used to operate an external relay-driver circuit because the terminal itself has limited drive capacity.
- **VX** terminals can be set low or high using the **PortSet()** or **SWVX()** instruction. For more information on these instructions, see the CRBasic help.
- **SW12** terminals can be set low (0 V) or high (12 V) using the **SW12()** instruction (see the CRBasic help for more information).

The following image illustrates a simple application wherein a C terminal configured for digital input, and another configured for control output are used to control a device (turn it on or off) and monitor the state of the device (whether the device is on or off).

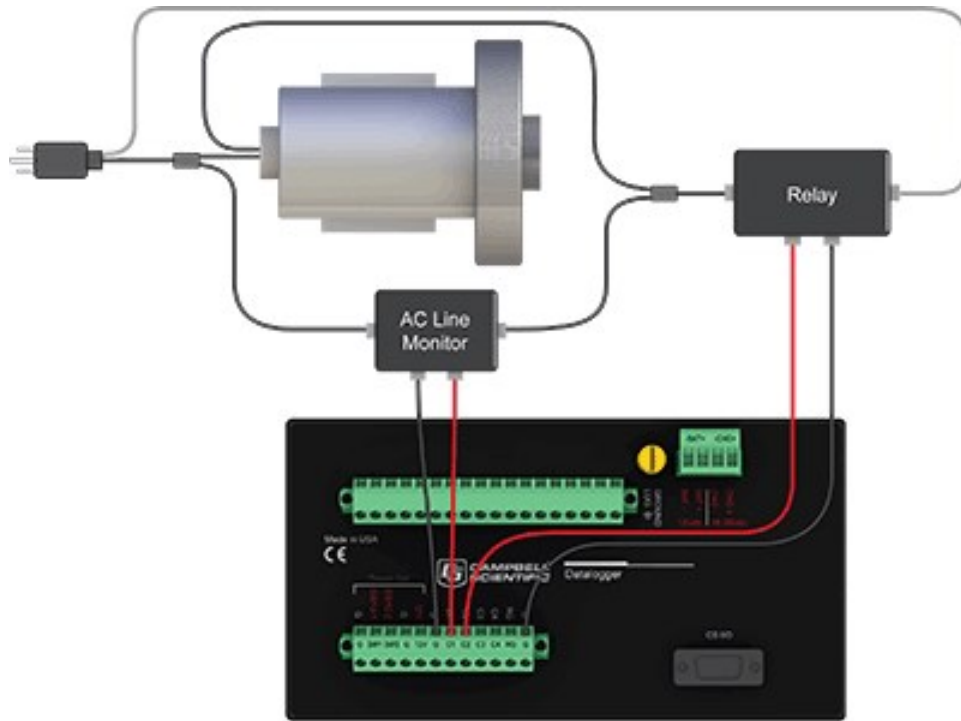

In the case of a cell modem, control is based on time. The modem requires 12 VDC power, so connect its power wire to a data logger **SW12** terminal. The following code snip turns the modem on for the first ten minutes of every hour using the **TimeIsBetween()** instruction embedded in an **If/Then** logic statement:

```
If TimeIsBetween (0,10,60,Min)Then
    SW12(SW12_1,1) 'Turn phone on.
Else
    SW12(SW12_1,0) 'Turn phone off.
EndIf
```

6. Setting up the CR350

The basic steps for setting up your data logger to take measurements and store data are included in the following sections:

- [Setting up communications with the data logger](#) (p. 21)
- [Virtual Ethernet over USB \(RNDIS\)](#) (p. 26)
- [Wi-Fi communications option](#) (p. 28)
- [Cellular communications option](#) (p. 38)
- [Radio communications option](#) (p. 55)
- [Testing communications with EZSetup](#) (p. 80)
- [Creating a Short Cut data logger program](#) (p. 82)

7. Setting up communications with the data logger

The first step in setting up and communicating with your data logger is to configure your connection. Communications peripherals, data loggers, and software must all be configured for communications.



The default settings for the data logger allow it to communicate with a computer via USB or RS-232. For other communications methods or more complex applications, some settings may need adjustment. Settings can be changed through *Device Configuration Utility* or through data logger support software.

You can configure your connection using any of the following options. The simplest is via USB. For detailed instruction, see:

- [USB or RS-232 communications](#) (p. 23)
- [Virtual Ethernet over USB \(RNDIS\)](#) (p. 26)
- [Wi-Fi communications option](#) (p. 28) (WIFI models only)
- [Cellular communications option](#) (p. 38) (CELL models only)
- [Radio communications option](#) (p. 55) (RF models only)

For other configurations, see the *LoggerNet* EZSetup Wizard help. Context-specific help is given in each step of the wizard by clicking the **Help** button in the bottom right corner of the window. For complex data logger networks, use Network Planner. For more information on using the Network Planner, watch a video at <https://www.campbellsci.com/videos/loggernet-software-network-planner> .

Additional information is found in your specific peripheral manual, and the data logger support software manual and help. See also:

- www.campbellsci.com/cellular-communications  for links to CELL200-series, RV50X, cellular data services, Konect PakBus router, and other cellular products
- www.campbellsci.com/spread-spectrum-radios  for links to the RF452 and RF407-series spread spectrum radios
- www.campbellsci.com/satellite-communications  for links to the TX325, TX326, HUGHES9502, and other satellite products

- www.campbellsci.com/loggernet
- www.campbellsci.com/pc400

Manuals for retired products are found at: www.campbellsci.com/manuals. These include, but are not limited to: RF401, RV50, TX321, TX320, and TX312.

8. USB or RS-232 communications

Setting up a USB or RS-232 connection is a good way to begin communicating with your data logger. Because these connections do not require configuration (like an IP address), you need only set up the communications between your computer and the data logger. Use the following instructions or watch the Quickstart videos at <https://www.campbellsci.com/videos> .

TIP:



You will physically connect your data logger to your computer in step 6.

Follow these steps to get started. These settings can be revisited using the data logger support software **Edit Datalogger Setup** option .

1. Using data logger support software, launch the EZSetup Wizard.

NOTE:

New software installations automatically open the EZSetup Wizard the first time they run.

- *LoggerNet* users, click **Setup** , select the **View** menu and ensure you are in the **EZ (Simplified)** view, then click **Add Datalogger** .
 - *PC400* users, click **Add Datalogger** .
2. Click **Next**.
 3. Select CR300 Series from the list. In the **Datalogger Name** field, type a meaningful name for your data logger (for example, a site identifier or project name), and click **Next**.
 4. Select the **Direct Connect** connection type and click **Next**.
 5. If this is the first time connecting this computer to a CR350 via USB, click **Install USB Driver**, select your data logger, click **Install**, and follow the prompts to install the USB driver.
 6. Plug the data logger into your computer using a USB-C or RS-232 cable. The USB connection supplies 5 V power as well as a communications link, which is adequate for setup, but a 12 V power source is necessary to power cellular functions of CR350-CELL series models. A 12 V battery will be needed for field deployment as the USB connection cannot power most sensors. If using RS-232, external power must be provided to the data

logger.

NOTE:

The Power LED on the data logger indicates the program and power states. Because the data logger ships with a program set to run on power-up, the Power LED flashes three times every 10 seconds when powered over USB. When powered with a 12 V battery, it flashes once every 10 seconds. When no program is running, the LED is always on.

7. From the **COM Port** list, select the COM port used for your data logger. It will appear as CR350 (COM number).
8. USB and RS-232 connections do not typically require a **COM Port Communication Delay**; this type of delay allows time for hardware devices to "wake up" and negotiate a communications link. Accept the default value of **00 seconds** and click **Next**.
9. You **must match** the baud rate and PakBus address hardware settings of your data logger. A USB connection does not require a baud rate selection, keep the default. RS-232 connections default to 115200 baud. The default PakBus address is 1.

NOTE:

Unlike the RS-232 port on some other Campbell Scientific data loggers that autobaud, the CR350 RS-232 port does not. The hardware and software settings for baud rate and PakBus address must match in order to connect.

10. Set an **Extra Response Time** if you have a difficult or marginal connection and you want the data logger support software to wait a certain amount of time before returning a communications failure error. Accept the default value of **00 seconds**.
11. Set a **Max Time On-Line** to limit the amount of time the data logger remains connected. When the data logger is connected, communications with it are terminated when this time limit is exceeded. A value of **0** in this field indicates that there is no time limit for maintaining a connection to the data logger.
12. Leave the **Neighbor PakBus Address** as the default of **0**.
13. Click **Next**.
14. By default, the data logger does not use a security code. Therefore, the **Security Code** can be left at **0**. If the code has been changed in the data logger, enter the new code.
The **PakBus Encryption Key** can be left blank for direct USB connections.
15. Click **Next**.

16. Review the **Setup Summary**. If you need to make changes, click **Previous** to return to a previous window and change the settings.
17. Setup is now complete. The EZSetup Wizard allows you to **Finish**, or you may click **Next** to test communications, set the data logger clock, and send a program to the data logger. See [Testing communications with EZSetup](#) (p. 80) for more information.

9. Virtual Ethernet over USB (RNDIS)

CR350 data loggers support RNDIS (virtual Ethernet over USB). This allows the data logger to communicate via TCP/IP over USB. Watch a video at

<https://www.campbellsci.com/videos/ethernet-over-usb>  or use the following instructions.

1. Supply power to the data logger. If connecting via USB for the first time, you must first install USB drivers by using *Device Configuration Utility* (select your data logger, then on the main page, click **Install USB Driver**). Alternatively, you can install the USB drivers using EZ Setup. A USB connection supplies 5 V power (as well as a communications link), which is adequate for setup, but a 12 V battery will be needed for field deployment.

NOTE:

Ensure the data logger is connected directly to the computer USB port (not to a USB hub). We recommended always using the same USB port on your computer.

2. Physically connect your data logger to your computer using a USB cable, then in *Device Configuration Utility* select your data logger.
3. Retrieve your IP Address. On the bottom, left side of the screen, select **IP** as the Connection Type, then click the browse button next to the **Server Address** box. Note the IP Address (default is **192.168.66.1**). If you have multiple data loggers in your network, more than one data logger may be returned. Ensure you select the correct data logger by verifying the data logger serial number or station name (if assigned).
4. A virtual IP address can be used to connect to the data logger using *Device Configuration Utility* or other computer software, or to view the data logger internal web page in a browser. To view the web page, open a browser and enter linktodevice.com  or the IP address you retrieved in the previous step (for example, **192.168.66.1**) into the address bar.

To secure your data logger from others who have access to your network, we recommend that you set security. For more information, see [Data logger security](#) (p. 160).

NOTE:

Ethernet over USB (RNDIS) is considered a direct communications connection. Therefore, it is a trusted connection and **Administrator** privileges are automatically granted for all functionality.

10. Wi-Fi communications option

The CR350-WIFI default Wi-Fi configuration is **Normally Off, Create Network on Button Press**. With a button press it can create and host its own Wi-Fi network. This allows for easy on-site communications during routine maintenance. Once Wi-Fi communications are complete the data logger returns to a low-power state.

It also can be configured to join an existing Wi-Fi network.

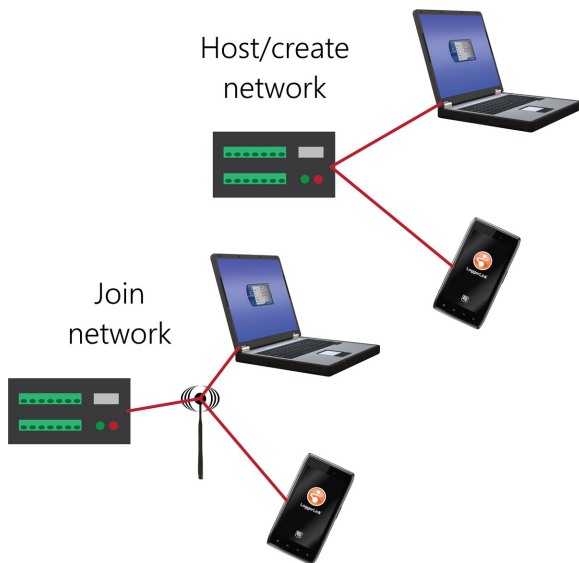

NOTE:

A 12 VDC power source is necessary to power Wi-Fi functions of the CR350-WIFI.

NOTE:

The user is responsible for emissions if changing the antenna type or increasing the gain.

See also [Communications specifications](#) (p. 278).

10.1 Hosting a Wi-Fi network

By default, the CR350-WIFI is configured to host a Wi-Fi network when the button is pressed. Up to eight devices can be connected at one time. The hosted network times out after a minimum of

five minutes. See: [Normally Off, Join Network on Button Press \(default\)](#) (p. 36) for more information. Use data logger support software or the [LoggerLink](#)  mobile app for iOS and Android to connect to the CR350-WIFI network.

See also: [CR350 QuickStart Part 5 - Wi-Fi Communications](#) .

10.1.1 Configure the data logger to host a Wi-Fi network

Follow these instructions to check the data logger settings or reconfigure it.

1. Ensure your CR350-WIFI is connected to an antenna and 12 VDC power.
2. Using *Device Configuration Utility*, connect to the data logger.
3. On the **Deployment** tab, click the **Wi-Fi** sub-tab.
4. In the **Configuration** list, select the **Create a Network** or **Normally Off, Create Network on Button Press** option.
5. Optionally, set security on the network to prevent unauthorized access by typing a password in the **Password** box (recommended).
6. Click **Apply**.

10.1.2 Connect your phone to the data logger over Wi-Fi

1. Press the CR350-WIFI button.
2. Open your phone settings  and connect to the Wi-Fi network hosted by the data logger. The default name is **CR350** followed by the serial number of the data logger.

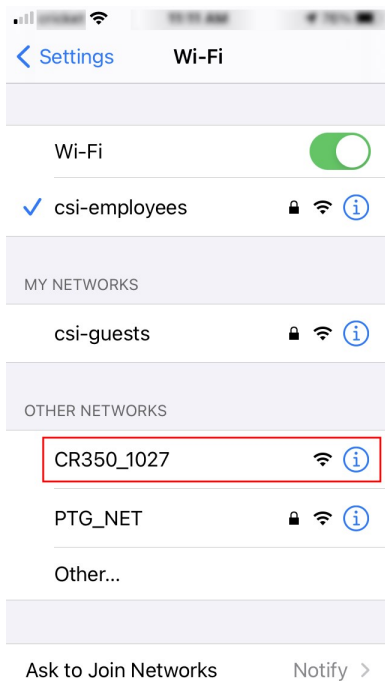

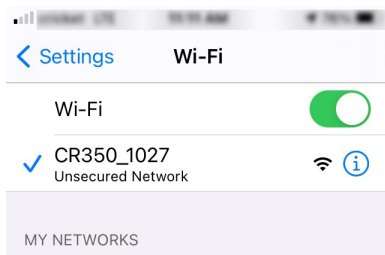

3. If you set a password, enter it. The resulting setting will look similar to this image.



4. Close the phone settings.

10.1.3 Set up *LoggerLink*

1. Open the *LoggerLink*  phone app.
2. Read through the Getting Started information if this is your first time using *LoggerLink*.
3. Click + then the UDP discovery button .

4. Select the CR350.

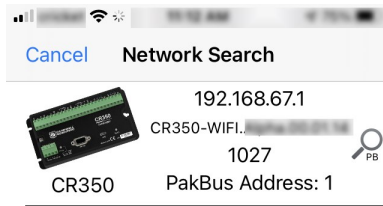

5. Save.
6. All *LoggerLink* features are now available until the Wi-Fi connection times out with inactivity or the CR350-WIFI button is pressed. See the in-app help for more information about *LoggerLink*.

10.1.4 Connect your computer to the data logger over Wi-Fi

1. Press the CR350-WIFI button.
2. Open the Wi-Fi network settings on your computer.

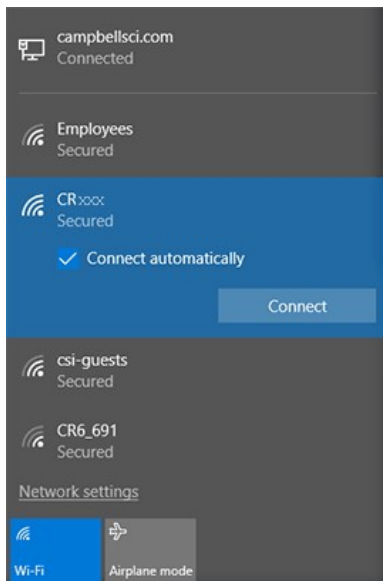

3. Select the Wi-Fi-network hosted by the data logger. The default name is **CR350** followed by the serial number of the data logger. In the previous image, the Wi-Fi network is **CRxxx**.
4. If you set a password, select the **Connect Using a Security Key** option (instead of a PIN) and

type the password you chose.



5. Connect to this network.

10.1.5 Set up *LoggerNet* or *PC400W*

1. Using data logger support software, launch the EZSetup Wizard.

NOTE:

New software installations automatically open the EZSetup Wizard the first time they run.

- *LoggerNet* users, click **Setup** , select the **View** menu and ensure you are in the **EZ (Simplified)** view, then click **Add Datalogger** .
 - *PC400* users, click **Add Datalogger** .
2. Select the **IP Port** connection type and click **Next**.
 3. In the **Internet IP Address** field, type **192 . 168 . 67 . 1**. This is the default data logger IP address created when the CR350-WIFI creates a network.
 4. Click **Next**.
 5. The PakBus address must match the hardware settings for your data logger. The default PakBus address is **1**.
 - Set an **Extra Response Time** if you want the data logger support software to wait a certain amount of time before returning a communication failure error. This can usually be left at **00 seconds**.
 - You can set a **Max Time On-Line** to limit the amount of time the data logger remains connected. When the data logger is contacted, communication with it is terminated when this time limit is exceeded. A value of **0** in this field indicates that there is no time limit for maintaining a connection to the data logger.
 6. Click **Next**.
 7. By default, the data logger does not use a security code or a PakBus encryption key. Therefore, the **Security Code** can be set to **0**, and the **PakBus Encryption Key** can be left blank. If either setting has been changed, enter the new code or key. See [Data logger security](#) (p. 160) for more information.
 8. Click **Next**.

9. Review the **Setup Summary**. If you need to make changes, click **Previous** to return to a previous window and change the settings.
10. Setup is now complete. The EZSetup Wizard allows you to **Finish**, or you may click **Next** to test communications, set the data logger clock, and send a program to the data logger. See [Testing communications with EZSetup](#) (p. 80) for more information.

10.2 Joining a Wi-Fi network

By default, the CR350-WIFI is configured to host a Wi-Fi network. Alternatively it can be set up to join an existing Wi-Fi network. Then a computer or mobile device **on the same network** can communicate with it.

10.2.1 Configure the data logger to join a Wi-Fi network

1. Ensure your CR350-WIFI is connected to an antenna and 12 VDC power.
2. Using *Device Configuration Utility*, connect to the data logger.
3. On the **Deployment** tab, click the **Wi-Fi** sub-tab.
4. In the **Configuration** list, select the **Join a Network** option.
5. Next to the **Network Name (SSID)** box, click **Browse** to search for and select a Wi-Fi network. To join a hidden network, manually enter its SSID.
6. If the network is a secured network, you must enter the password in the **Password** box and add any additional security in the **Enterprise** section of the window.
7. Enter the **IP Address**, **Network Mask**, and **Gateway**. These values should be provided by your network administrator. A static IP address is recommended.
 - Alternatively, you can use an IP address assigned to the data logger via DHCP. To do this, make sure the IP Address is set to **0 . 0 . 0 . 0**. Click **Apply** to save the configuration changes. Then reconnect. The IP information obtained through DHCP is updated and displayed in the **Status** section of the **Wi-Fi** subtab. Note, however, that this address is not static and may change. An IP address here of **169.254.###.###** means the data logger was not able to obtain an address from the DHCP server. Contact your network administrator for help.
8. Click **Apply**.



10.2.2 Set up *LoggerNet* or *PC400W*

For each data logger you want to connect to the network, you must follow the instruction in [Configure the data logger to join a Wi-Fi network](#) (p. 33).

1. Using data logger support software, launch the EZSetup Wizard.

NOTE:

New software installations automatically open the EZSetup Wizard the first time they run.

- *LoggerNet* users, click **Setup** , select the **View** menu and ensure you are in the **EZ (Simplified)** view, then click **Add Datalogger** .
 - *PC400* users, click **Add Datalogger** .
2. Click **Next**.
 3. Select CR300 Series from the list. In the **Datalogger Name** field, type a meaningful name for your data logger (for example, a site identifier or project name), and click **Next**.
 4. Select the **IP Port** connection type and click **Next**.
 5. Use **UDP Search...** to find and **Add** the data logger IP address.
 6. Click **Next**.
 7. The PakBus address must match the hardware settings for your data logger. The default PakBus address is **1**.
 - Set an **Extra Response Time** if you want the data logger support software to wait a certain amount of time before returning a communication failure error. This can usually be left at **00 seconds**.
 - You can set a **Max Time On-Line** to limit the amount of time the data logger remains connected. When the data logger is contacted, communication with it is terminated when this time limit is exceeded. A value of **0** in this field indicates that there is no time limit for maintaining a connection to the data logger.
 8. Click **Next**.
 9. By default, the data logger does not use a security code or a PakBus encryption key. Therefore, the **Security Code** can be set to **0**, and the **PakBus Encryption Key** can be left blank. If either setting has been changed, enter the new code or key. See [Data logger security](#) (p. 160) for more information.

10. Review the **Setup Summary**. If you need to make changes, click **Previous** to return to a previous window and change the settings.
11. Setup is now complete. The EZSetup Wizard allows you to **Finish**, or you may click **Next** to test communications, set the data logger clock, and send a program to the data logger. See [Testing communications with EZSetup](#) (p. 80) for more information.

10.3 Wi-Fi configurations and mode button

Configure the Wi-Fi mode and button using *Device Configuration Utility* software.

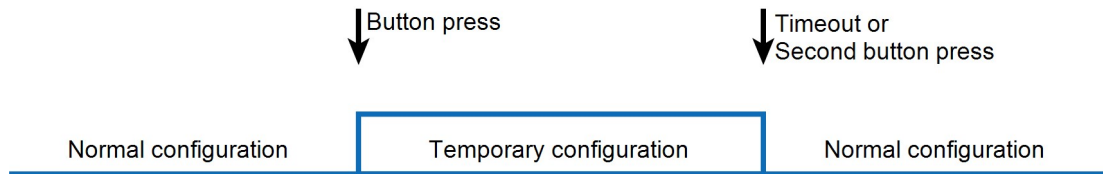

10.3.1 Join a Network

The CR350 will scan for available Wi-Fi networks and attempt to join the network specified by the **SSID** field. If the data logger cannot join the desired SSID (for example, the network is out of range or there are incorrect parameters), it will go to a low power state and retry about every one minute.

When this mode is selected, the Wi-Fi button is disabled. The WIFI LED (labeled TX/RX) will turn solid green while attempting to join the specified network and will flash green with network activity. If the attempt to join the network fails, the LED will flash red while waiting for the periodic retry.

10.3.2 Create a Network

The data logger will create and host a Wi-Fi network. Enter the desired name of the network in the **SSID** field. A network created by the CR350 supports up to eight joiners. If a password is supplied, the network created will be secured by WPA2 encryption. If no password is supplied, the network created will be an open network with no encryption.

When this mode is selected, the Wi-Fi button is disabled. The WIFI LED (labeled TX/RX) will turn solid amber while attempting to create the specified network and will flash amber with activity while hosting the network.

10.3.3 Normally Off, Join Network on Button Press (default)

The Wi-Fi will be normally turned off until the Wi-Fi button is pressed. When the button is pressed, the CR350 will attempt to join the network specified. The Wi-Fi will stay powered, and joined to the network until it times out or until the button is pressed again. Then the Wi-Fi shuts off. The timeout will be a minimum of five minutes with a two minute refresh on any communications sent by the data logger.

When the button is pressed, the WIFI LED (labeled TX/RX) will turn solid green while attempting to join the specified network and will flash green with network activity. The LED will turn off when the WIFI is no longer powered following a time-out or another button press.

10.3.4 Normally Off, Create Network on Button Press

The Wi-Fi will be normally turned off until the Wi-Fi button is pressed. When the button is pressed, the data logger will create and host the network specified. The Wi-Fi will stay powered and hosting the network until it times out or until the button is pressed again. Then the Wi-Fi shuts off. The timeout will be a minimum of five minutes with a two minute refresh on any communications sent by the data logger.

When the button is pressed, the WIFI LED (labeled TX/RX) will turn solid amber while attempting to create the specified network and will flash amber with activity while hosting the network. The LED will turn off when the WIFI is no longer powered following a time-out or another button press.

10.3.5 Join Network, Create Network on Button Press

The CR350 will attempt to join the network specified. It will remain joined to the network until the Wi-Fi button is pressed. When the button is pressed, the data logger will disassociate with the previously joined network and create and host an open (unencrypted) network with the name *model_serialnumber*. The data logger will continue hosting the network until it times out or until the button is pressed again. Then the Wi-Fi will switch back to join mode and attempt to join the network specified. The timeout on the hosted network will be a minimum of five minutes with a two minute refresh on any communication sent to the data logger .

NOTE:

During the time the data logger is creating and hosting the temporary network, no communications can take place on the previously joined network until the created network has timed out and the data logger re-joins the other network.

The WIFI LED (labeled TX/RX) will turn solid green while attempting to join the specified network and will flash green with network activity. When the button is pressed, the LED will turn solid amber while creating a network and will flash amber with activity while hosting the network.

10.3.6 Disable

Wi-Fi communications will be disabled and the module turned off.

NOTE:

When the Wi-Fi configuration is set to **Join a Network** or **Create a Network** the Wi-Fi button is disabled.

10.4 Wi-Fi LED indicator

When the data logger is powered, the Wi-Fi LED (labeled TX/RX) will turn on according to Wi-Fi communication states:

- **Off:** Insufficient power, Wi-Fi disabled, or data logger failed to join or create a network (periodic retries will occur).
- **Solid for 2 seconds:** Attempting to join or create a network.
- **Flashing:** Successfully joined or created a network. Flashes with network activity and once every four seconds when there is no activity.

11. Cellular communications option

The CR350-CELL can be purchased with an integrated cellular module.

Use of the CR350-CELL series requires a cellular line of service. The products compatible with Verizon, AT&T, T-Mobile, Vodafone, and Telstra are shown in the following table.

Product	Cellular technology	Market	Verizon	AT&T	T-Mobile	Vodafone	Telstra	Other ¹
CELL205	4G LTE with automatic 3G fallback ²	North America		✓	✓			✓
CELL210	4G LTE CAT-1	United States	✓					
CELL215	4G LTE with automatic 3G and 2G fallback	EMEA				✓		✓
CELL220	4G LTE with automatic 3G fallback	Australia and New Zealand					✓	✓
CELL225	4G LTE	Japan						✓
CELL230	LTE CAT-M1 LTE NB-IoT	Global	✓					✓

¹ More than 600 other providers are available worldwide through Campbell Scientific.

² AT&T ended support of their 3G network service on February 22, 2022. To continue operation the CR350-CELL series requires operating system 2.030 or newer. Use the web interface to find the CR350-CELL series OS version on the OS Date field of the Status Tab.

11.1 Pre-installation

11.1.1 Establish cellular service	39
11.1.2 Install the SIM card	40
11.1.3 Konect PakBus Router setup	41

11.1.1 Establish cellular service

For better security, we recommend using Konect PakBus® Router with a private dynamic IP address. This method allows only incoming PakBus communications. No other incoming communications are supported. However, all forms of outbound communications from the data logger are supported, including but not limited to PakBus, email, and FTP.

NOTE:

When the data logger is connected to both Ethernet and a cellular modem, [IPRoute\(\)](#) may be used to specify which interface to use for the outbound communications, such as email, FTP, and HTTP.

A public static IP address can also be used. This provides more incoming communications functionality, but is less secure and more vulnerable to unsolicited traffic.

11.1.1.1 Campbell Scientific cellular data service

Campbell Scientific can provide subscriptions to cellular service through Verizon, AT&T, T-Mobile, Vodafone, Telstra, and over 600 other providers worldwide. When this cellular service is purchased with the module, the module will come pre-provisioned with the required SIM card and APN. If you have already purchased the CR350-CELL series, call Campbell Scientific to set up service.

11.1.1.2 Other service providers

While using Campbell Scientific is the simplest way to obtain cellular data service for your module, you can go directly to a provider. For more information on obtaining service directly from Verizon and AT&T, see [Verizon Wireless and AT&T](#) (p. 284).

TIP:

Prepaid cellular data plans may experience service slow downs when data limits are reached. If file transfer from a cellular-connected data logger works initially, but later has problems, check for data overage on the cellular plan.

This does not apply to Campbell Scientific cellular data services.

11.1.2 Install the SIM card

NOTE:

If you purchased cellular service from Campbell Scientific with the module, it will come with the SIM (Subscriber Identity Module) card already installed.

CAUTION:

Observe precautions for handling electrostatic sensitive devices.

1. Remove the screws from the bottom panel.
2. Pull the bottom and top of the data logger apart.
3. Note the location of the notched corner on the SIM card for correct alignment. The gold contact points of the SIM face down when inserting the SIM card as shown in the following figure. **Gently** slide the card into the slot until it stops and locks into place. To eject the SIM card, press it in slightly and release.



Figure 11-1. SIM card installation

11.1.3 Konect PakBus Router setup

NOTE:

If you are not using Konect PakBus Router, skip this section.

11.1.3.1 Get started

You will need the Konect PakBus Router redemption code that came on a card with the CR350-CELL series.



Konect
Data Services from Campbell Scientific

Safe, secure routing for access to your IP-connected datalogger

Important Information! Do not discard!
Activate a Complimentary PakBus® Router on Campbell Scientific's Konect PakBus Routing Service. See the Getting Started Guide at:
<http://campbellsci.com/start/pbrouter>



REDEMPTION CODE [blacked out]

Open a web browser and go to www.konectgds.com .

First-time users need to create a **free account**. After you submit your information, you will receive two emails up to five minutes apart. One email will contain a Passport ID and the other your Password. If emails are not received, check your email junk folder.



11.1.3.2 Set up Konect PakBus Router

1. Sign in to www.konectgds.com  using your Passport ID and Password found in the two received emails. Once logged in, you will be at the Welcome page.
2. Click **Devices and services**  on the command bar to the left and select **Redeem PakBus Router Code**. Enter your complimentary Router Code found on the included card with your cellular-enabled device and click **Submit**.

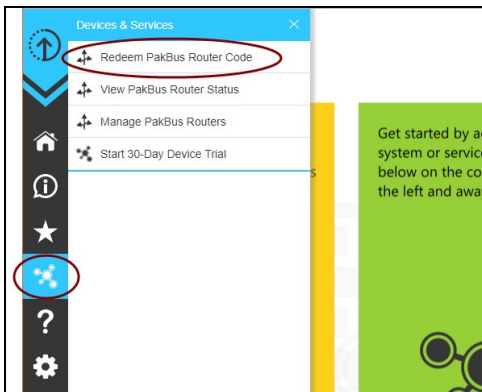

3. The next screen shows the assigned **DNS** address and **Port** for the router. Enter a **TCP Password** and select a unique **PakBus Address** for your data logger.

TIP:

Make note of this information; it will be required for data logger configuration as well as *LoggerNet* setup. Please note your **DNS**, **Port**, **TCP Password** and **PakBus address**; you will need them later.

Cluster Details

DNS:

Port:

Enter a TCP Password or leave blank if not required

TCP Password:

Maintained Nodes (PakBus Addresses in use)

(no addresses currently in use)

You can select a PakBus address to use between 1 - 3999, excluding any addresses already in use.

PakBus Address:

11.2 Installation

- 11.2.1 Determining if IP address is private dynamic or public static 43
- 11.2.2 Modules using Konect PakBus Router (private dynamic IP) 44
- 11.2.3 Modules using a public static IP 48

11.2.1 Determining if IP address is private dynamic or public static

The Provisioning Report received with your Cellular Data Service shows whether the module was configured with a private dynamic or public static IP address. See the following figure for an example of a Campbell Scientific Provisioning Report. Other cellular providers should provide similar information.



Cellular Data Service Provisioning Report

The following device has been provisioned for Campbell Scientific Cellular Data Service.

Sales Order #	12/31/1969	Sales Order Due Date	12/31/1969
Sales Order Date	12/31/1969	Date Provisioned	11/06/2018
Company	Campbell Scientific Inc Marketing	Customer ID	10000
Address	1000 100th St NE	Contact	
City	Eden Prairie	Phone	952-221-9800
State	Minnesota	Email	marketing@campbellsci.com
Country	United States		
Postal Code	55324		
Hardware	1986-17	Datalogger (40 to +70C) -CELL210 w/4G LTE CAT1 VZ -VS Verizon	
Model #	1986-17	Static IP	
Serial #	1986-17		
Provision Code	1986-17	CR300-CELL210-VS	Datalogger (40 to +70C) -CELL210 w/4G LTE CAT1 VZ -VS Verizon US Static IP
Data Plan	1986-14	CELLDATA-VS-A250	Campbell Scientific Cellular Data Service Subscription -VS Verizon US Static IP - A250 250MB/Mon for 1 Yr
Data Limit	1986-14	Network	Verizon
ICCID	89012345678901234567	IP Address	166.167.167.167
MSISDN	1986-14	Konect PakBus R	IP Address: 166.167.167.167
IMEI	1986-14	Redemption Code	
Renewal Due Date	2019-09-22	Service Period	11/15/2018 to 12/14/2019

Additionally, Campbell Scientific cellular modules configured with a public static IP address will have two stickers on the module, as shown in the following image. One sticker will show the module phone number and data plan. The second sticker will show the static IP address.

Campbell Scientific cellular modules configured with a private dynamic IP address will have one sticker on the module. It will show the module phone number and data plan.

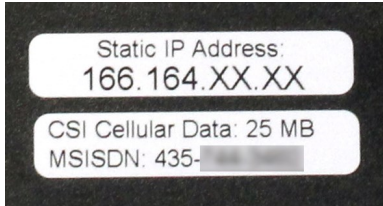

Figure 11-2. Module with public static IP address

11.2.2 Modules using Konect PakBus Router (private dynamic IP)

The basic steps for setting up your modem with a Konect PakBus Router are included in the following sections:

11.2.2.1 Configure data logger	44
11.2.2.2 Set up LoggerNet	46
11.2.2.3 Test the connection	48

11.2.2.1 Configure data logger

1. Connect the cellular antenna if it is not already connected. When using a MIMO antenna with multiple cellular connections, connect the primary cable to **Primary**, **Primary Antenna**, or **Antenna** and the secondary to **Diversity** or **Diversity Antenna** (depending on the label). If the cables are not marked in this way, they can be connected to either antenna port.

The CELL230 has both **Antenna** and **GPS** antenna connections. Use [Ce11GNSS\(\)](#) to enable and disable the GPS under program control.

2. Connect to your data logger by using *Device Configuration Utility*.

- On the **Datalogger** tab, change the data logger **PakBus Address** and **PakBus/TCP Password** to match the values entered in the Konect PakBus Router setup. The **PakBus/TCP Password** will make the data logger authenticate any incoming or outgoing PakBus/TCP connection.

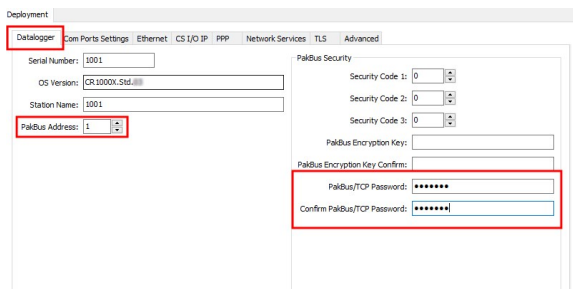

- On the **Network Services** tab in the **PakBus/TCP Client** field, enter the DNS address and Port number noted during the Konect PakBus Router setup.
- On the **PPP** tab, set **Config/Port Used** to **CS I/O SDC8** or **RS-232**, depending on how you are connected to the data logger.
- (Optional) On the **PPP** tab, set **User Name** and **Password** if required by your cellular carrier (usually outside of the United States).
- (Optional) If your cellular carrier requires user name and password authentication, on the **Settings Editor > Cellular** tab, set **PDP Authentication Type**, **PPP Authentication Username** and **PPP Authentication Password**.
- Verify the **Modem Dial String** setting is blank.
- If connecting through RS-232, on the **Comport Settings** tab, set **RS232 BaudRate** to **115200 Fixed**.
- Click **Apply**.
- Shut down **Device Configuration Utility** and start it again. This will activate the **Cellular** tab needed for the next step.
- On the **Cellular** tab, enter the **APN** provided by your cellular provider.

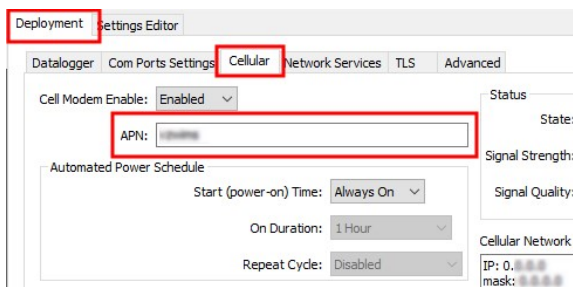

- Click **Apply**.

14. Click **Disconnect** and close *Device Configuration Utility*.

11.2.2.2 Set up *LoggerNet*

The *LoggerNet* Network Map is configured from the **LoggerNet Setup** screen.

NOTE:

Setup has two options, EZ (simplified) and Standard. Click on the **View** menu at the top of the **Setup** screen, and select **Standard** view.

From the *LoggerNet* toolbar, click **Main > Setup** and configure the Network Map as described in the following steps:

1. Select **Add Root > IPPort**.
2. Select **PakBusPort** and **pbRouter** for PakBus data loggers such as the CR6 or CR1000X.

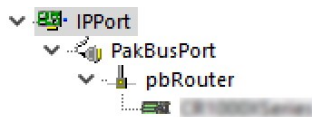

NOTE:

PakBus data loggers include the following models: GRANITE-series, CR6, CR3000, CR1000X, CR800-series, CR300-series, CR1000, and CR200(X)-series.

3. Add a data logger to the **pbRouter**.
4. From the Entire Network, on the left side, select the **IPPort**. Enter the Konect PakBus Router DNS address and port number as noted in the Konect PakBus Router setup ([Set up Konect PakBus Router](#) [p. 42]). Enter them into the **Internet IP Address** field in the format DNS:Port with a colon separating DNS and Port. For example, axanar.konectgds.com:pppp where pppp is the port number.

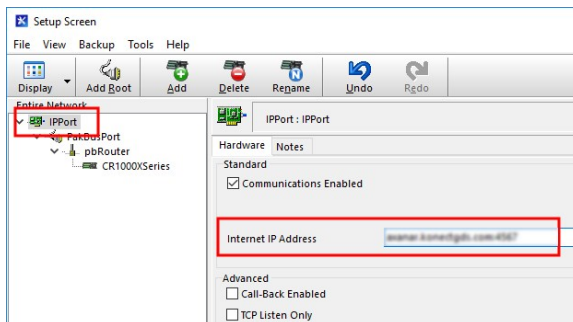

5. Leave the default settings for the **PakBusPort**. **PakBus Port Always Open** should **not** be checked. In the **TCP Password** field enter the TCP Password; this must match the value entered in the Konect PakBus Router setup and *LoggerNet* setup.

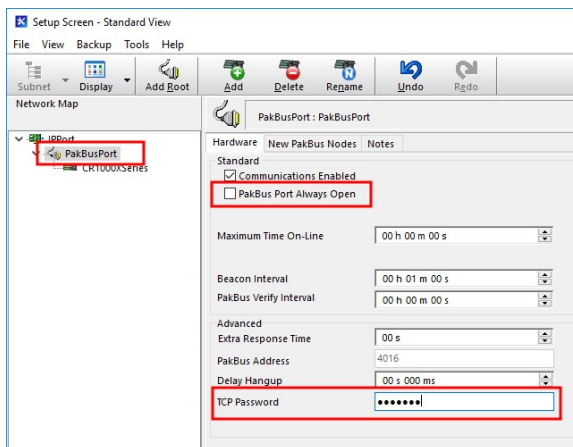

6. Select the pbRouter in the Network Map and set the **PakBus Address** to 4070.

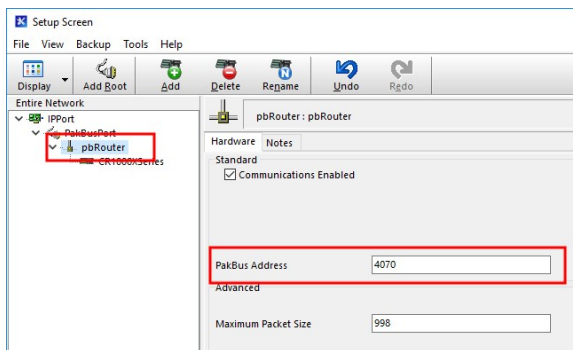

7. Select the data logger in the Network Map and set the **PakBus Address** to match that of the data logger (default address in the data logger is 1). If a **PakBus Encryption Key** was entered during data logger setup, also enter it here. Click **Apply** to save the changes.

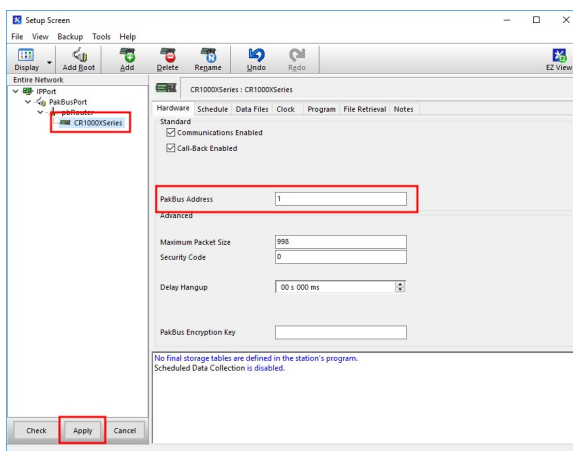

11.2.2.3 Test the connection

Use the **Connect** screen to test the connection. Click on the appropriate station and click **Connect** to initiate a call to the data logger. The data logger must have 12 V power.

TIP:

The connection time is subject to many external factors. It is often less than 30 seconds but could be up to 15 minutes. Be patient.

If the connection is successful, the connectors icon at the bottom of the screen will come together and clock information from the data logger will be displayed in the **Station Date/Time** field. If the connection fails, a **Communications Failure** message will be displayed.

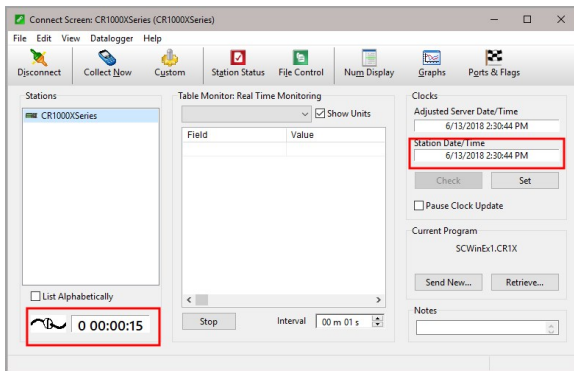

11.2.3 Modules using a public static IP

The basic steps for setting up your modem with a public static IP address are included in the following sections:

- 11.2.3.1 Configure data logger 48
- 11.2.3.2 Set up LoggerNet 50
- 11.2.3.3 Test the connection 52

11.2.3.1 Configure data logger

1. Connect the cellular antenna if it is not already connected. When using a MIMO antenna with multiple cellular connections, connect the primary cable to **Primary, Primary Antenna, or Antenna** and the secondary to **Diversity or Diversity Antenna** (depending on the label). If the cables are not marked in this way, they can be connected to either antenna port.

The CELL230 has both **Antenna** and **GPS** antenna connections. Use **Ce11GNSS()** to enable and disable the GPS under program control.

2. Connect to your data logger by using *Device Configuration Utility*.
3. On the **PPP** tab, set **Config/Port Used** to **CS I/O SDC8** or **RS-232**, depending on how you are connected to the data logger.
4. (Optional) On the **PPP** tab, set **User Name** and **Password** if required by your cellular carrier (usually outside of the United States).
5. (Optional) If your cellular carrier requires user name and password authentication, on the **Settings Editor > Cellular** tab, set **PDP Authentication Type**, **PPP Authentication Username** and **PPP Authentication Password**.
6. Verify the **Modem Dial String** setting is blank.
7. If connecting through RS-232, on the **Comport Settings** tab, set **RS232 BaudRate** to **115200 Fixed**.
8. On the **Cellular** tab, enter the **APN** provided by your cellular provider.

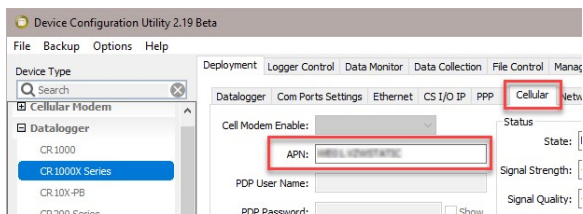

9. (Optional) By default, the CR350-CELL series will accept incoming communications from any IP address. This can be a security risk. You may specify up to four IP addresses, with wild cards, to limit connections to only those trusted sources. Use an asterisk (*) as a wild card. For example, a setting of 166.22.*.* would allow connections from devices that have IP addresses starting with 166.22. Both IPv4 and IPv6 addresses are supported.

CAUTION:

Only set a Trusted IP address if you are familiar with their use. Consult your IT department or Campbell Scientific for assistance.

NOTE:

This setting does not affect outbound connections, only incoming connections.

In the *Device Configuration Utility* go to the **Settings Editor** then **Network Services**. Next to the **Trusted Hosts** field, click **Edit** and **Add** your trusted IP addresses, one at a time.

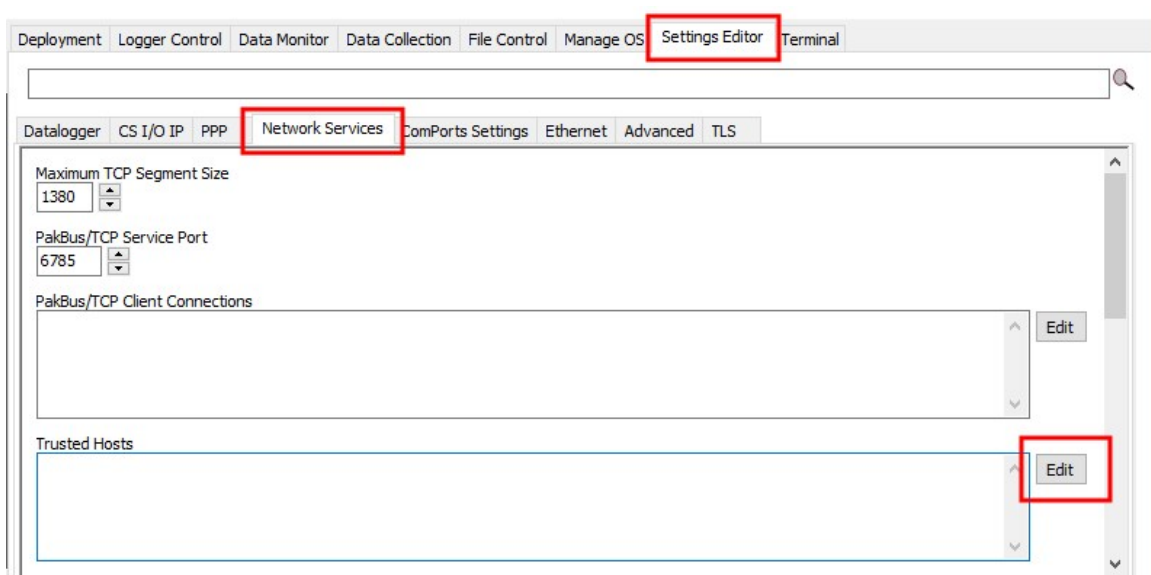

10. Click **Apply** to save the changes.

11.2.3.2 Set up *LoggerNet*

The *LoggerNet* Network Map is configured from the **LoggerNet Setup** screen.

NOTE:

Setup has two options, EZ (simplified) and Standard. Click on the **View** menu at the top of the **Setup** screen, and select **Standard** view.

From the *LoggerNet* toolbar, click **Main > Setup** and configure the Network Map as described in the following steps:

1. Select **Add Root > IPPort**.
2. Select **PakBusPort**.
3. Add a data logger to the **PakBusPort**.

- Select the **IPPort** in the Network Map. Enter the CR350-CELL series IP address and port number. The IP address and port number are input in the **Internet IP Address** field separated by a colon. Preceding zeros are not entered in the **Internet IP Address** (for example, 070.218.074.247 is entered as 70.218.74.247). The default port number is 6785.

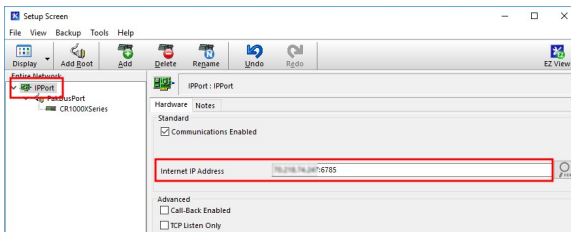

- For PakBus data loggers, leave the default settings for the **PakBusPort**. **PakBus Port Always Open** should **not** be checked. If a **TCP Password** is used, enter it.

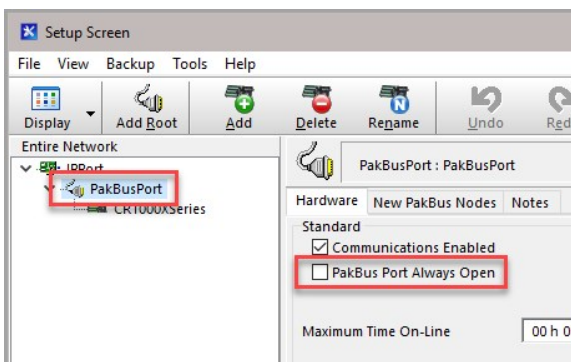

- For PakBus data loggers, select the data logger in the Network Map and set the **PakBus Address** to match that of the data logger (default address in the data logger is 1). If a **PakBus Encryption Key** was entered during data logger setup, also enter it here. Click **Apply** to save the changes.

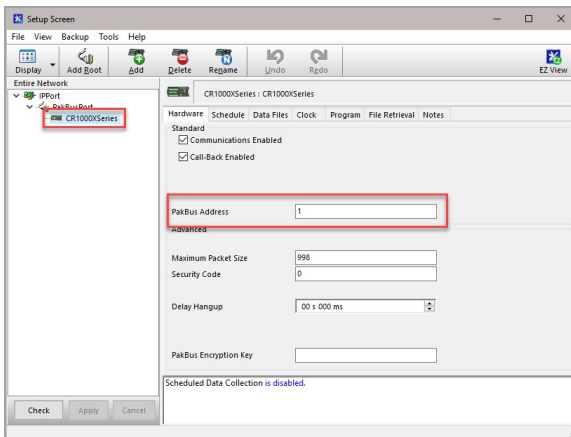

11.2.3.3 Test the connection

Use the **Connect** screen to test the connection. Click on the appropriate station and click **Connect** to initiate a call to the data logger. The data logger must have 12 V power.

TIP:

The connection time is subject to many external factors. It is often less than 30 seconds but could be up to 15 minutes. Be patient.

If the connection is successful, the connectors icon at the bottom of the screen will come together and clock information from the data logger will be displayed in the **Station Date/Time** field. If the connection fails, a **Communications Failure** message will be displayed.

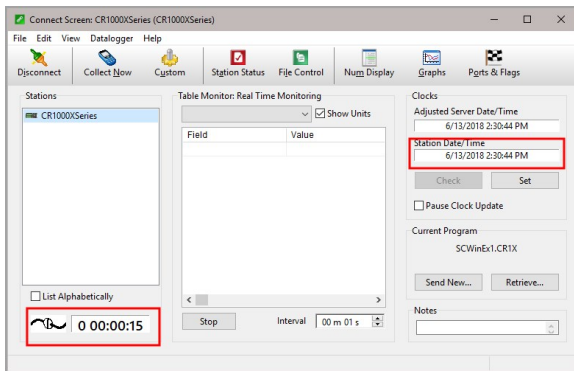

11.3 Cellular (TX/RX) LED Indicator

When the data logger is powered, the cellular LED will turn on according to cellular modem communications states:

- **Off:** Cellular modem off, insufficient power, or failure to establish a connection with the provider (periodic retries will occur).
- **Solid:** Cellular modem is powering up and attempting to establish a connection with a provider.
- **Quick Flashing** (approximately 1 second duration): Indicates successful network registration.
- **Flashing:** Flashes with network activity.

11.4 Signal strength and quality

Both signal strength and quality contribute to successful cellular data communications. The factors that influence signal strength and quality include but are not limited to:

- proximity to the cellular tower
- tower load
- competing signals
- physical barriers (mountains, buildings, vegetation)
- weather

Because signal strength and quality can vary due to many factors, they may not give a true indication of communications performance or range. However, they can be useful for activities such as:

- determining the optimal direction to aim a Yagi antenna
- determining the effects of antenna height and location
- trying alternate Yagi antenna (reflective) paths
- seeing the effect of vegetation and weather over time

11.4.1 Signal strength

Signal strength is how strong the received signal is. The closer your CR350-CELL series is to the cellular tower, the more signal the antenna will pick up. Signal strengths are lower the farther away from the tower the CR350-CELL series is.

For 3G networks, signal strength is reported as RSSI (Received Signal Strength Indicator). For 4G, it is RSRP (Reference Signal Received Power).

Signal strength units are $-dBm$; -70 is a stronger signal than -100 .

Strength estimate	RSSI (3G) dBm	RSRP (4G) dBm
Excellent	-70 or greater	-90 or greater
Good	-71 to -85	-91 to -105
Fair	-86 to -100	-106 to -115
Poor	less than -100	less than -115

11.4.2 Signal quality

Signal quality shows how much interference there is between the cellular tower and CR350-CELL series, or how noisy a band is. Cellular signal noise comes from reflections, ghosting and other interference. Better signal quality is an indicator of more successful communications during precipitation events such as rain and snow.

For 3G networks, signal quality is ECIO (Energy to Interference Ratio). For 4G, this is RSRQ (Reference Signal Received Quality).

Signal quality units are $-dBm$; 0 is a better signal than -10 .

Table 11-2: Signal quality		
Quality estimate	ECIO (3G) dBm	RSRQ (4G) dBm
Excellent	0 to -6	>-9
Good	-7 to -10	-9 to -12
Fair to poor	-11 to -20	-13 or less

12. Radio communications option

CR350-RF data loggers include radio options. The RF407-series frequency-hopping spread-spectrum (FHSS) radio options include the RF407, RF412, RF422, and RF427. The RF452, another radio option, has a 902-to-928 MHz operating-frequency range typically used for long-range communications. RF407-series are designed for license-free use in several countries:

- The RF407 option has a 902 to 928 MHz operating-frequency range appropriate for use in the United States and Canada (FCC / IC compliant).
- The RF412 option has a 915 to 928 MHz operating-frequency range appropriate for use in Australia and New Zealand (ACMA compliant).
- The RF422 option has an 863 to 873 MHz operating-frequency range appropriate for use in most of Europe and some of Asia (ETSI compliant).
- The RF427 option has a 902 to 907.5 MHz/915 to 928 MHz operating-frequency range appropriate for use in Brazil.
- The RF452 option is typically used for long-range communications. It has the following operating frequency ranges:
 - 902 to 928 MHz for use in the United States and Canada (FCC / IC compliant)
 - 915 to 928 MHz in Australia
 - 921 to 928 MHz in New Zealand

WARNING:

Connect a suitable load to the antenna port before applying DC power to the RF452. This load should be either a 50-ohm antenna or an attenuator with a power rating of 2 watts or higher. Failure to follow this procedure may damage the radio voiding the warranty.

NOTE:

This equipment has been tested and found to comply with the limits for a Class A digital device, pursuant to part 15 of the FCC Rules. These limits are designed to provide reasonable protection against harmful interference when the equipment is operated in a commercial environment. This equipment generates, uses, and can radiate radio frequency energy and, if not installed and used in accordance with the instruction manual, may cause harmful interference to radio communications. Operation of this equipment in a residential area is likely to cause harmful interference in which case the user will be required to correct the

interference at his or her own expense.

CAUTION:

Radio options cannot be mixed within a network. An RF407 can only be used with other RF407-type radios, an RF412 can only be used with other RF412-type radios, an RF422 can only be used with other RF422-type radios, and an RF427 can only be used with other RF427-type radios, and an RF452 can only be used with other RF452-type radios.

Throughout these instructions, RF407-series represents each of the RF407, RF412, RF422, and RF427 radio options, unless otherwise noted.

The following sections provide instructions for setting up basic networks. For more complicated networks, see the full radio manuals.

- <https://www.campbellsci.com/rf407>
- <https://www.campbellsci.com/rf452>

12.1 Configuration options

The following images show the most frequently used configurations with the RF-series data logger and RF-series radio:

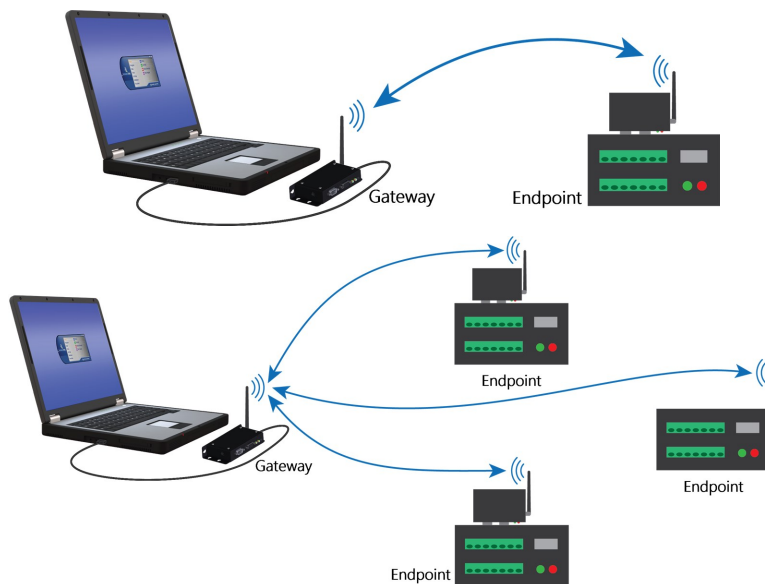

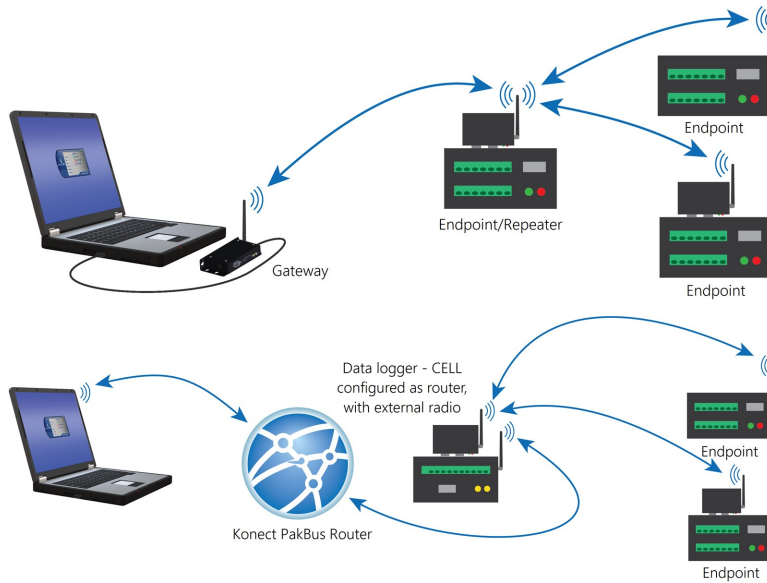

12.2 Basic RF407 networks

NOTE:

This procedure assumes the RF407-series devices are using factory default settings.

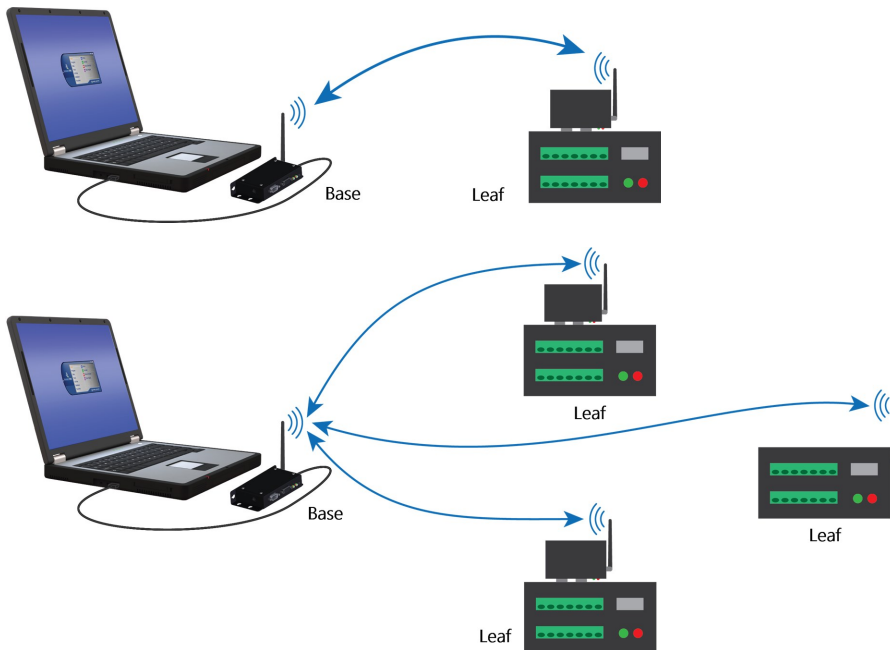

12.2.1 Configure the base RF407-series radio

Configure the RF407-series radio that is connected to the computer. This is sometimes referred to as the base radio.

1. Ensure that an antenna is connected to the RF407-series radio.
2. If connecting via USB for the first time, you must first install USB drivers using *Device Configuration Utility* (select your radio, then on the main page, click **Install USB Driver**).

RF407 Series Send OS

RF407 Series



Connecting with USB

[Install USB Driver](#)

1. Connect the device USB port to your computer using the
2. Select the correct **Communication Port** in the left pane
Note: It may take a few seconds for the Communication to your computer.
3. Select the **Connect** button.

3. Connect the **USB** port on your RF407-series radio to your computer.



4. Using *Device Configuration Utility*, select the **Communication Port** used for your radio and connect to the RF407-series radio.

5. On the **Main** tab, set the **Active Interface** to **USB** or **RS-232** (depending on how your computer will be connected to the RF407-series radio).

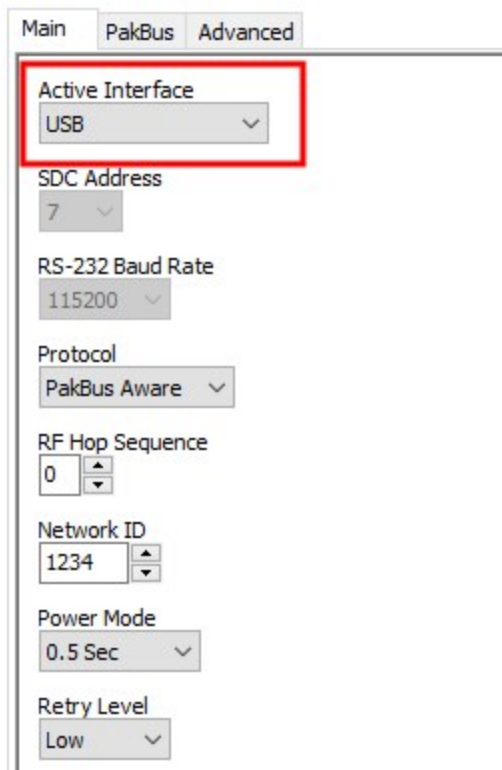

The screenshot shows the 'Main' tab of the Device Configuration Utility. The 'Active Interface' dropdown menu is highlighted with a red box and is set to 'USB'. Other configuration options include: SDC Address (7), RS-232 Baud Rate (115200), Protocol (PakBus Aware), RF Hop Sequence (0), Network ID (1234), Power Mode (0.5 Sec), and Retry Level (Low).

6. **Apply** to save your changes.
7. Close *Device Configuration Utility*.
8. The **TX/PWR** and **RX** LEDs flash once, after which the **TX/PWR** LED returns to blinking at the **Power Mode** interval (0.5 sec, by default).
9. Leave the radio connected to the computer.

If the **Active Interface** was set to RS-232, disconnect the USB cable. Use a serial cable to connect the computer RS-232 port to the RF407 **RS-232** port.

12.2.2 Configure the remote RF407-series data logger(s)

Follow these instructions multiple times to set up multiple data loggers. In this case, each data logger must be given a unique PakBus address (see [PakBus communications](#) (p. 150) for more information). For more complicated networks, it is recommended that you use Network Planner.

NOTE:

Most Campbell Scientific devices come from the factory with a default PakBus address of 1. For this reason, it is best not to assign PakBus address 1 to any device in the network. Then, if a new device with default settings is added to the system, it will not create a conflict.

1. Ensure the antenna is connected.

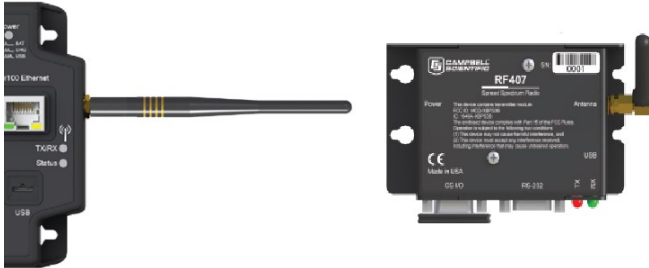

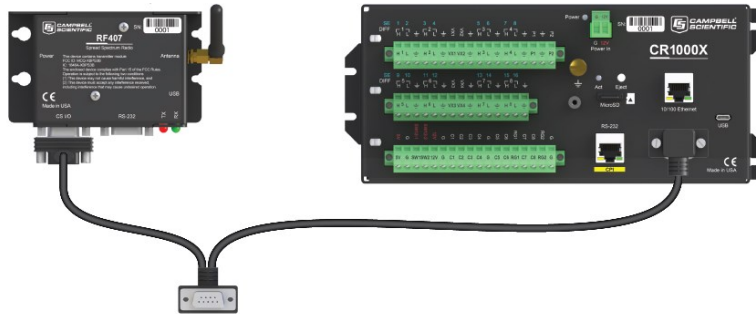

2. For data loggers with an external radio, connect the radio and data logger CS I/O ports using an SC12 cable.

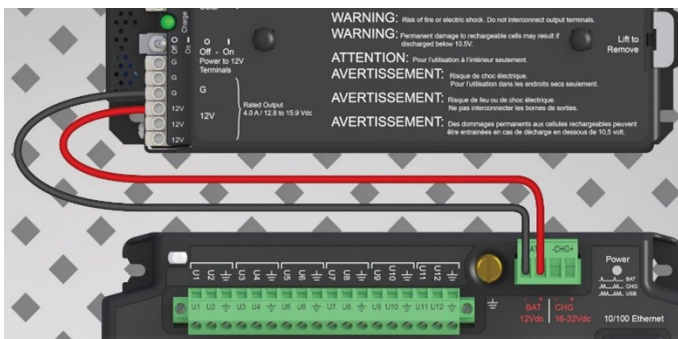

3. Supply 12 VDC power to the data logger.
 - connect 12 VDC at the green **BAT** terminals
 - or connect 16 to 32 VDC at the **CHG** terminals



4. Using data logger support software, launch the EZSetup Wizard.
 - *LoggerNet* users, from the *Main* category click **Setup**  and select the **View** menu to ensure you are in the **EZ (Simplified)** view, then click **Add** .
 - *PC400* users, click **Add Datalogger** .
5. Click **Next**.
6. Select CR300 Series from the list, type a meaningful name for your data logger (for example, a site identifier or project name), and click **Next**.
7. Select the **Direct Connect** connection type and click **Next**.
8. Select the communications port used to communicate with the RF407-series radio from the **COM Port** list. It should be listed as **RF407-Series (COMX)**.

TIP:

If the **RF407-Series (COMX)** is not in the list ensure your RF407 is connected to your computer.

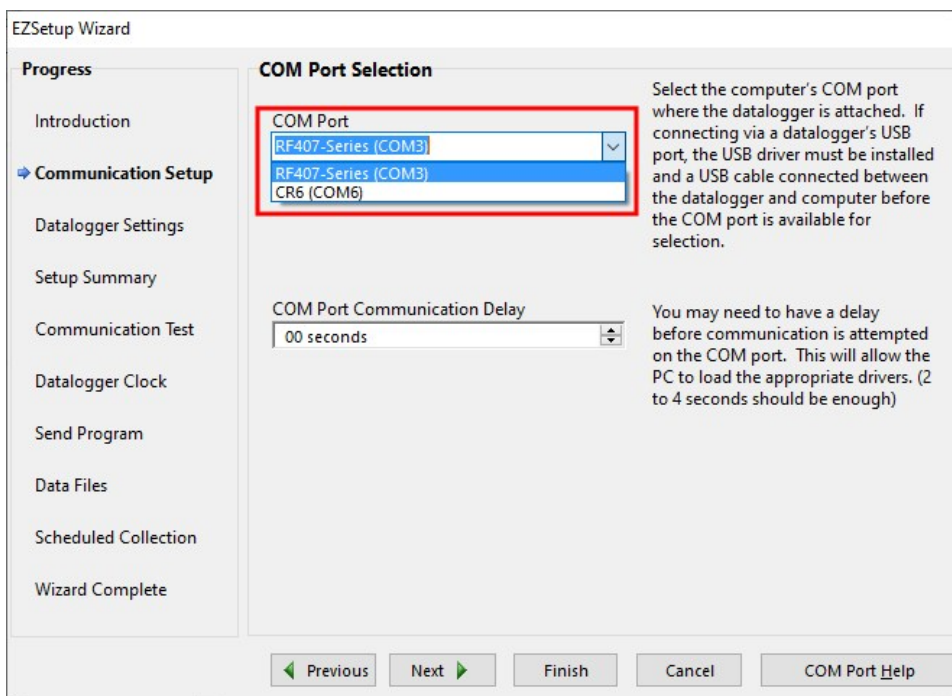

9. Accept the default value of **00 seconds** in the **COM Port Communication Delay** - this box is used to allow time for hardware devices to "wake up" and negotiate a communications link. Click **Next**.

10. In [Configure the base RF407-series radio](#) (p. 57) you selected an active interface option of USB or RS-232. If you selected USB as the active interface for the radio, you do not need to select a baud rate. If you selected RS-232, set the baud rate to the one chosen during that step. The radio default baud rate is 115200. The PakBus address must match the hardware settings for your data logger. The default **PakBus Address** is 1.
11. Click **Next**.
12. By default, the data logger does not use a security code or a PakBus encryption key. Therefore, the **Security Code** can be set to **0**, and the **PakBus Encryption Key** can be left blank. If either setting has been changed, enter the new code or key. See [Data logger security](#) (p. 160) for more information.
13. Click **Next**.
14. Review the **Setup Summary**. If you need to make changes, click **Previous** to return to a previous window and change the settings.

Setup is now complete. The EZSetup Wizard allows you to **Finish**, or you may click **Next** to test communications, set the data logger clock, and send a program to the data logger. See [Testing communications with EZSetup](#) (p. 80) for more information.

NOTE:

The RF407-series radio to RF407-series data logger link is not indicated in the *LoggerNet* Setup Standard View.

If you experience network communications problems, see [Troubleshooting radio communications](#) (p. 189) for assistance.

12.3 RF407-series radio communications with multiple data loggers through a data logger router

This type of network configuration is useful for communicating around an obstacle, such as a hill or building, or to reach longer distances.

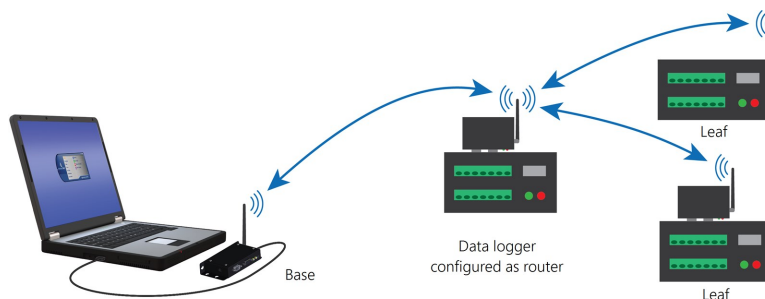

NOTE:

Most Campbell Scientific devices come from the factory with a default PakBus address of 1. For this reason, it is best not to assign PakBus address 1 to any device in the network. Then, if a new device with default settings is added to the system, it will not create a conflict.

12.3.1 Configure the RF407-series base radio

Configure the base radio. This is the RF407-series radio that is connected to the computer (see previous image for reference).

1. Ensure that an antenna is connected to the RF407-series radio.
2. If connecting via USB for the first time, you must first install USB drivers using *Device Configuration Utility* (select your radio, then on the main page, click **Install USB Driver**).



RF407 Series Send OS

RF407 Series



Connecting with USB

[Install USB Driver](#)

1. Connect the device USB port to your computer using the
2. Select the correct **Communication Port** in the left pane
Note: It may take a few seconds for the Communication to your computer.
3. Select the **Connect** button.

3. Connect the **USB** port on your RF407-series radio to your computer.



- Using *Device Configuration Utility*, select the **Communication Port** used for your radio and connect to the RF407-series radio.
- On the **Main** tab, set the **Active Interface** to **USB** or **RS-232** (depending on how your computer will be connected to the RF407-series radio).

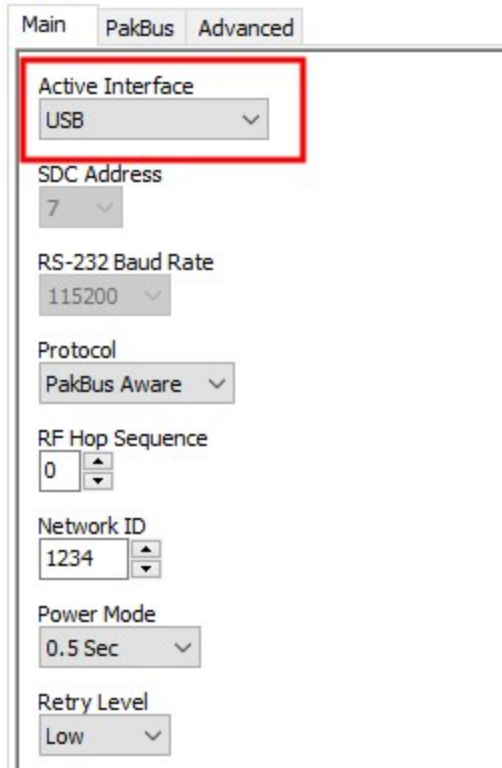

- Apply** to save your changes.
- The **TX/PWR** and **RX** LEDs flash once, after which the **TX/PWR** LED returns to blinking at the **Power Mode** interval (0.5 sec, by default).

12.3.2 Configure the data logger acting as a router

- Ensure the antenna is connected.

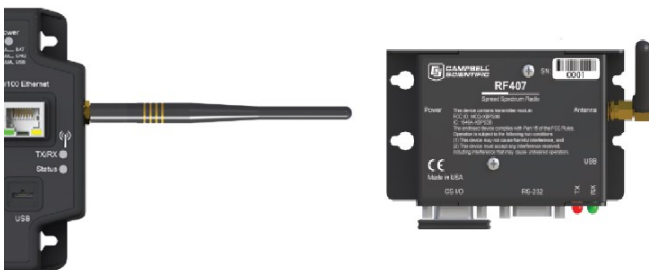

- For data loggers with an external radio, connect the radio and data logger CS I/O ports using an SC12 cable.

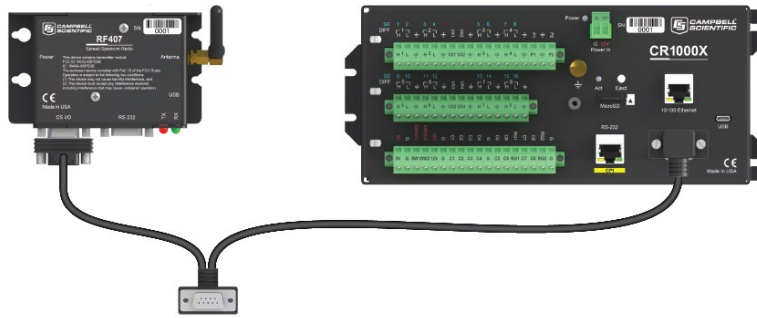

- Supply 12 VDC power to the data logger.
 - connect 12 VDC at the green **BAT** terminals
 - or connect 16 to 32 VDC at the **CHG** terminals

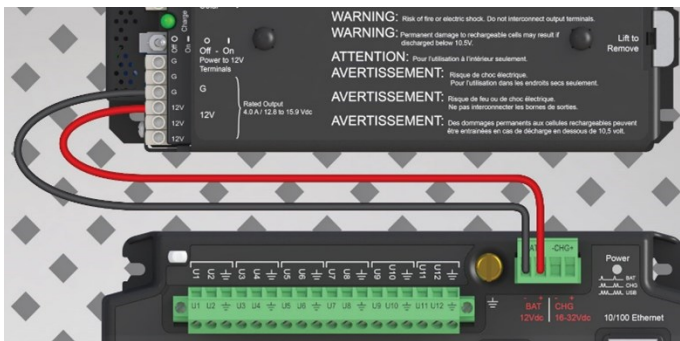

- If connecting via USB for the first time, you must first install USB drivers using *Device Configuration Utility* (select your radio, then on the main page, click **Install USB Driver**).

RF407 Series Send OS

RF407 Series

Connecting with USB

[Install USB Driver](#)

- Connect the device USB port to your computer using the
- Select the correct **Communication Port** in the left pane
 Note: It may take a few seconds for the Communication to your computer.
- Select the **Connect** button.

5. Using *Device Configuration Utility*, connect to the data logger that will serve as a router.
6. On the **Deployment** > **Datalogger** tab, assign a unique PakBus address(see [PakBus communications](#) (p. 150) for more information).
7. On the **Deployment** tab, click the **Com Ports Settings** sub-tab.
8. From the **Select the ComPort** list, select **RF**.
9. Set the **Beacon Interval** to **60** seconds (or the amount of time you are willing to wait for the leaf data loggers in the network to be discovered).

NOTE:

A beacon is a packet broadcast at a specified interval intended to discover neighbor devices.

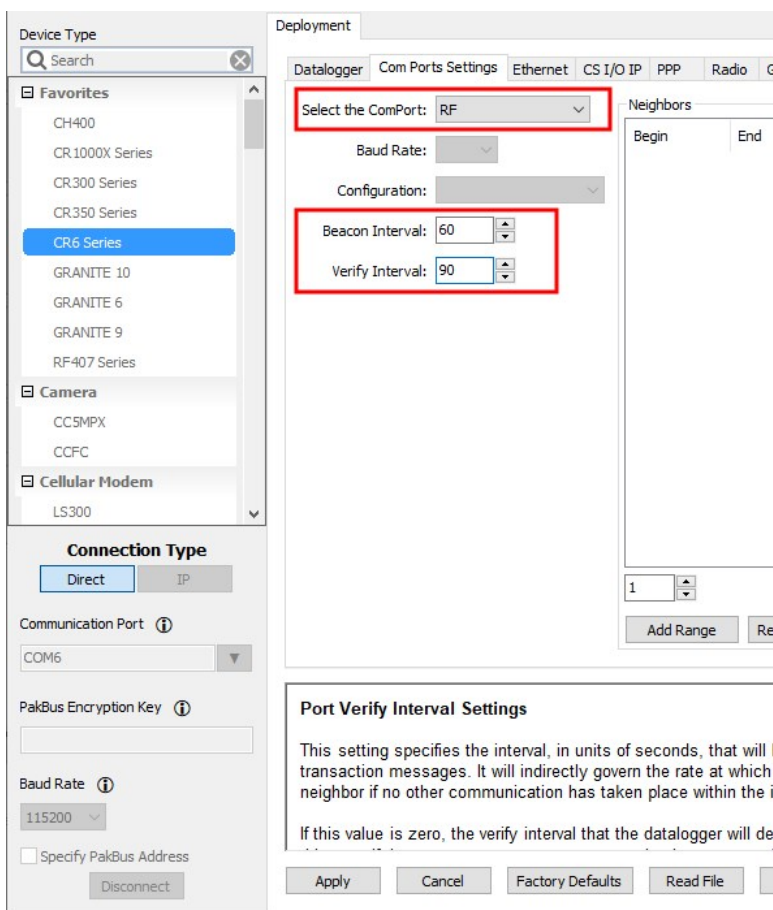

10. Set the **Verify Interval** to something slightly greater than the expected communications interval between the router and the other (leaf) data loggers in the network (for example, 90 seconds).

11. Click the **Advanced** sub-tab and set **Is Router** to **True**.

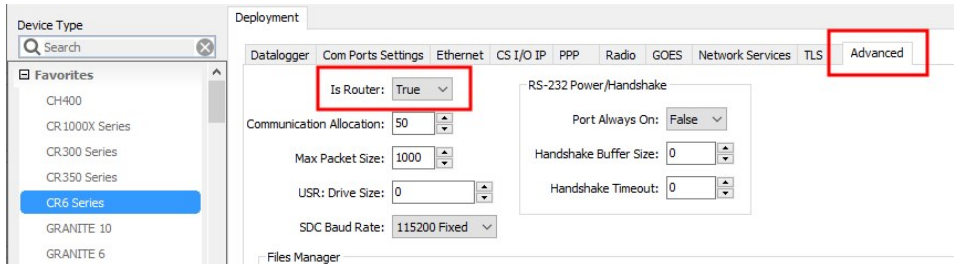



12. **Apply** to save your changes.

CAUTION:

Typically only the base data logger is configured as a router. Configuring multiple data loggers as routers may create unnecessary network traffic.

12.3.2.1 Add routing data logger to *LoggerNet* network

1. Using *LoggerNet*, click **Setup**  and click the **View** menu to ensure you are in the **Standard** view.
2. Click **Add Root** .
3. Click **ComPort**, then **PakBusPort (PakBus Loggers)**, then **CR300Series**.
4. Click **Close**.
5. In the Entire Network pane on the left side of the window, select the **ComPort**.

6. On the **Hardware** tab on the right, click the **ComPort Connection** list and select the communications port assigned to the RF407-series radio.

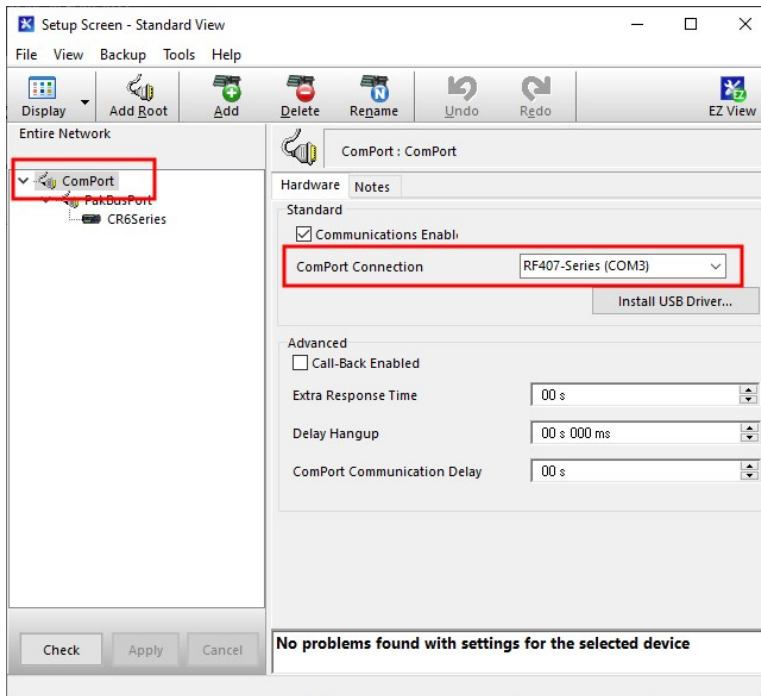

7. In the Entire Network pane on the left side of the window, select **PakBusPort**.
8. On the **Hardware** tab on the right, select the **PakBus Port Always Open** check box.
 - If you would like to prevent the possibility of *LoggerNet* communicating directly with any other data loggers in the network without going through the router, set the **Beacon Interval** to 00 h 00 m 00s.

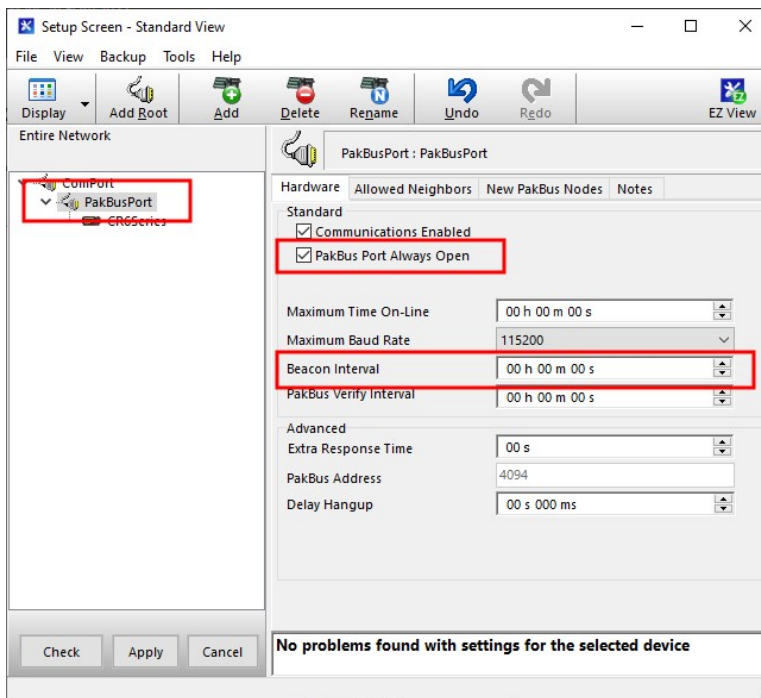

9. In the Entire Network pane on the left side of the window, select the router data logger (CR300Series) from the list.
10. On the **Hardware** tab on the right, type the **PakBus Address** you assigned to the router data logger in *Device Configuration Utility*.

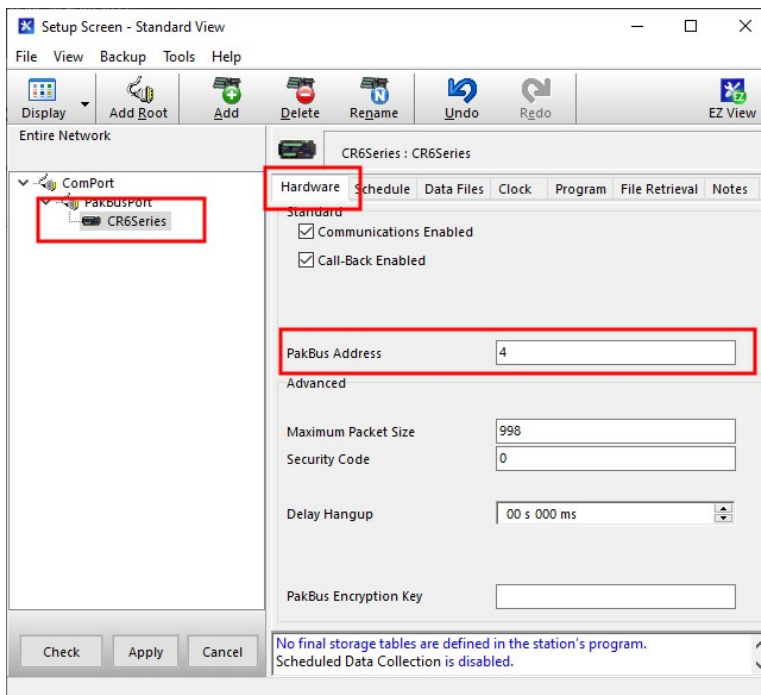

11. Click **Rename**  to provide the data logger a descriptive name.
12. **Apply** to save your changes.

12.3.3 Configure remote (leaf) data loggers

Follow steps 1 – 6 in [Configure the data logger acting as a router](#) (p. 64) to assign a unique PakBus address to each leaf data logger. Do not configure leaf data loggers as routers.

12.3.3.1 Add leaf data loggers to the network

1. In the *LoggerNet Standard Setup* view (click the **Setup**  option and click the **View** menu to ensure you are in the **Standard** view), right-click on the router data logger in the Entire Network pane on the left side of the window and select **CR300Series**.
2. With the newly added data logger selected in the **Entire Network** pane, set the **PakBus Address** to the address that was assigned to the leaf data logger in *Device Configuration Utility*.

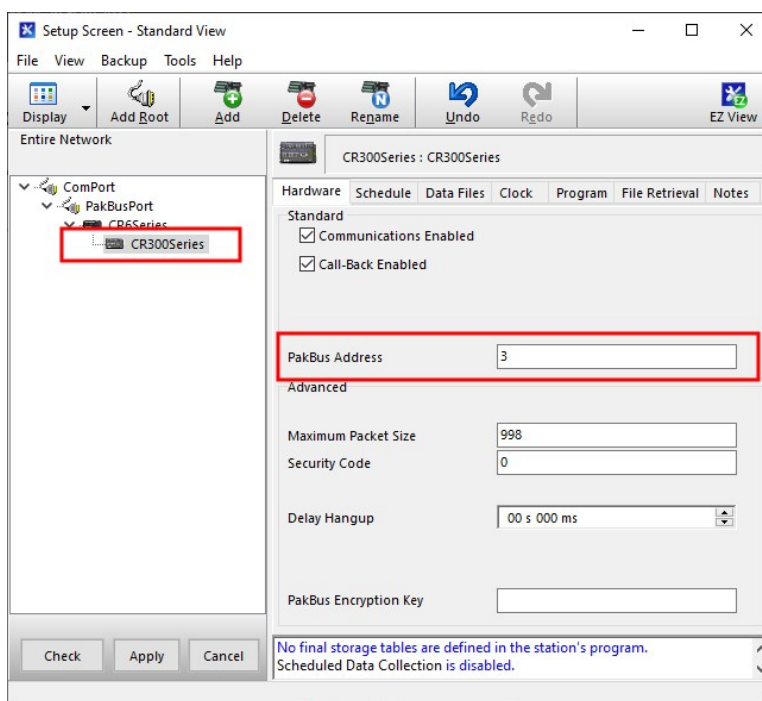

3. Click **Rename**  to provide the data logger a descriptive name.
4. **Apply** to save your changes.
5. Repeat these steps for each leaf data logger in the network.

If you experience problems with network communications, see [Troubleshooting radio communications](#) (p. 189) for assistance.

12.3.4 Using additional communications methods

Using similar instructions, a RF407-series data logger can be used in a system with additional communications methods. For example, in the following image, the router RF407-series data logger communicates with **LoggerNet** through Konect PakBus Router. The router RF407-series data logger communicates with the leaf RF407-series data loggers over RF.

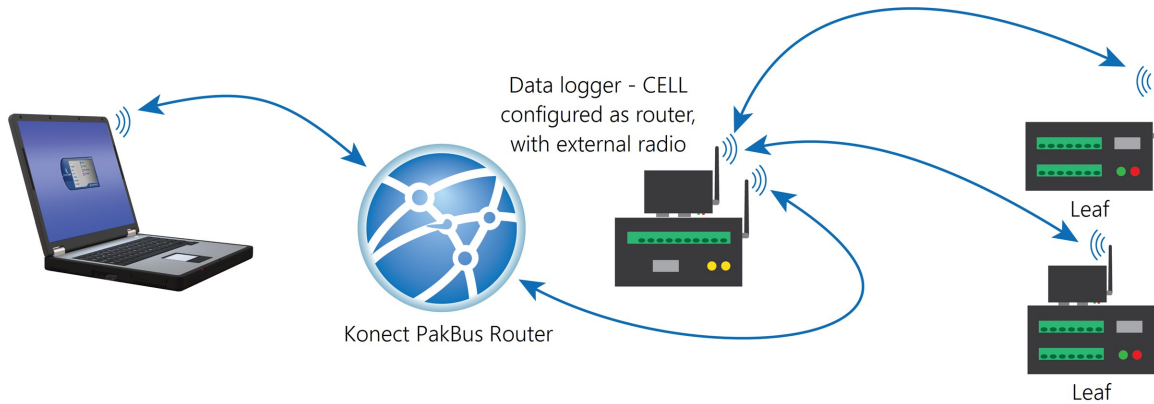

The RF portion of this network requires no changes to the hardware settings described in the previous procedure.

See the [Konect Pakbus Router Getting Started Guide](#) for more information on setting up that part of the network.

12.4 RF452 radio communications with one or more data loggers

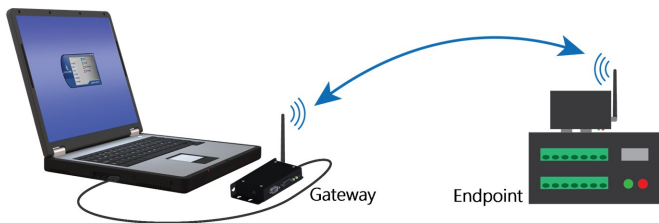

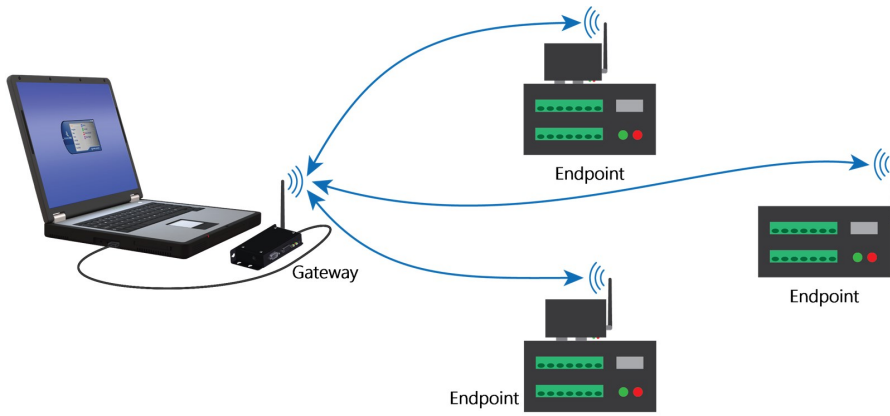

NOTE:

This procedure assumes the RF452 radios are using factory default settings.

Table 12-1: Settings for RF452 radio communications with one or more data loggers

	Gateway	Endpoint(s)
Hardware	RF452 connected to computer running <i>LoggerNet</i>	RF452 connected to data logger CS I/O port
Keep all factory default settings except:		
Active Interface	USB or RS-232 (to match how <i>LoggerNet</i> will be communicating with the radio)	CS I/O SDC (with SDC Address set to an unused SDC address on the data logger)
Radio Operation Mode	Gateway	Endpoint
Network ID	1726 (yours may be different)	1726 (yours may be different)
Frequency Key	1 (yours may be different)	1 (yours may be different)
Radio ID	4094 (to match <i>LoggerNet</i> PakBus address)	2 (to match data logger PakBus address) ¹

¹All endpoint radios in the network will have these same settings except for the **Radio ID**. The **Radio ID** setting allows a transceiver to be designated an arbitrary, user-selectable, 4-digit number which identifies the transceiver in diagnostics mode. When used in conjunction with PakBus data loggers, we recommend this setting be assigned the PakBus address of the station. This is because the Radio ID appears in the Network Diagnostics application within the FreeWave Tool Suite software, and it allows the user to associate a particular data logger with its attached radio.

12.4.1 Configuring the RF452 radio connected to the computer

Configure the RF452 radio connected to the computer.

1. Ensure your RF452 radio is connected to an antenna before applying power.
2. If connecting via USB for the first time, you must first install USB drivers using *Device Configuration Utility* (select your radio, then on the main page, click **Install USB Driver**). Plug the RF452 radio to your computer using a USB cable.
3. Using *Device Configuration Utility*, connect to the RF452 radio.
4. On the **Deployment** tab, set the **Active Interface** to **USB** or **RS-232** (depending on how your computer will be connected to the radio).
5. Set the **Radio Operation Mode** to **Gateway**.
6. In the **Network ID** field, type a unique number between 0 and 4095 (excluding 255). This is used to communicate with RF452 devices in the network. Make note of this number. All radios in the network require the same Network ID.
7. Select a **Frequency Key** between 0 and 14 and make note of this number. Generally all radios in the network will have the same Frequency Key.
8. **Apply** to save your changes.
9. Connect the RF452 radio to the computer communications port selected in the previous step.



12.4.2 Configuring endpoint RF452 data loggers

Follow these instructions multiple times to set up multiple data loggers. In this case, each must be given a unique name and PakBus address. For more complicated networks, it is recommended that you use Network Planner.

1. Ensure your RF452 radio is connected to an antenna before applying power.
2. Using *Device Configuration Utility*, connect to the RF452 data logger.
3. On the **Deployment > Datalogger** tab, assign a unique PakBus address.
4. On the **Deployment > Radio** tab, set the **Radio Operation Mode** to **Endpoint**.
5. In the **Network ID** field, type the same number set in the previous section: [Configuring the RF452 radio connected to the computer](#) (p. 72).
6. Select the same **Frequency Key** set in the previous section.
7. **Apply** to save your changes.

12.4.3 Setting up communications between the RF452 data logger and the computer

These instructions provide an easy way to set up communications between the RF452 data logger and the computer with an RF452 radio. Follow these instructions multiple times to set up multiple data loggers. For more complicated networks, it is recommended that you use Network Planner.

1. Ensure your RF452 radio is connected to an antenna before applying power.
2. Connect the RF452 data logger to the computer communications port that was selected as the active interface in *Device Configuration Utility*.
3. Using data logger support software, launch the EZSetup Wizard.
 - *LoggerNet* users, from the *Main* category click **Setup**  and select the **View** menu to ensure you are in the **EZ (Simplified)** view, then click **Add** .
 - *PC400* users, click **Add Datalogger** .
4. Click **Next**.
5. Select CR300 Series from the list, type a meaningful name for your data logger (for example, a site identifier or project name), and click **Next**.
6. If prompted, select the **Direct Connect** connection type and click **Next**.
7. Select the communications port used to communicate with the RF452 from the **COM Port** list.
8. Accept the default value of **00 seconds** in the **COM Port Communication Delay** - this box is used to allow time for hardware devices to "wake up" and negotiate a communications link. Click **Next**.
9. You do not need to select a baud rate. The PakBus address must match the hardware settings for your data logger.
10. Click **Next**.
11. By default, the data logger does not use a security code or a PakBus encryption key. Therefore, the **Security Code** can be set to **0**, and the **PakBus Encryption Key** can be left blank. If either setting has been changed, enter the new code or key. See [Data logger security](#) (p. 160) for more information.
12. Click **Next**.
13. Review the **Communication Setup Summary**. If you need to make changes, click the **Previous** button to return to a previous window and change the settings.

Setup is now complete. The EZSetup Wizard allows you to **Finish**, or you may click **Next** to test communications, set the data logger clock, and send a program to the data logger. See [Testing communications with EZSetup](#) (p. 80) for more information.

If you experience network communications problems, see [Troubleshooting radio communications](#) (p. 189) for assistance.

12.5 RF452 communications with multiple data loggers using one repeater

This type of network configuration is useful for communicating around an obstacle, such as a hill or building, or to reach longer distances.

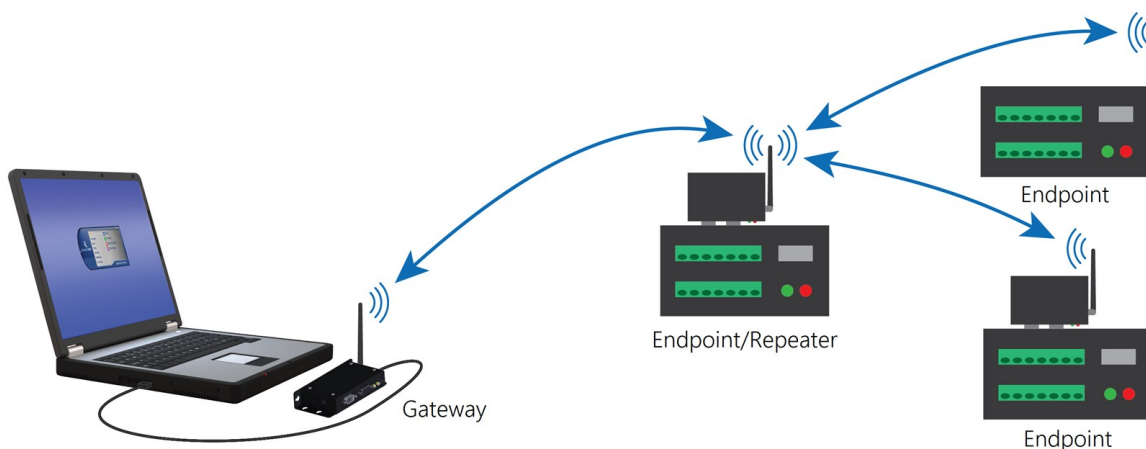

The following table summarizes the hardware settings for this type of network.

	Gateway	Endpoint/repeater	Endpoint(s)
Hardware	RF452 connected to computer running <i>LoggerNet</i>	RF452 connected to data logger CS I/O port	RF452 connected to data logger CS I/O port
PakBus Address	4094	2	3
Keep all factory default settings except:			

Table 12-2: RF452 settings for RF452 communications with multiple data loggers using one repeater

	Gateway	Endpoint/repeater	Endpoint(s)
Active Interface	USB or RS-232 (to match how <i>LoggerNet</i> will be communicating with the radio)	CS I/O SDC (with SDC Address set to an unused SDC address on the data logger)	CS I/O SDC (with SDC Address set to an unused SDC address on the data logger)
Radio Operation Mode	Gateway	Endpoint/Repeater	Endpoint
Repeaters Used	Yes, select box	Yes, select box	Yes, select box
Network ID	1726 (yours may be different)	1726 (yours may be different)	1726 (yours may be different)
Frequency Key	1 (yours may be different)	1 (yours may be different)	1 (yours may be different)
Radio ID	4094 (to match LoggerNet PakBus address)	2 (to match data logger PakBus address) ¹	3 (to match data logger PakBus address) ¹
¹ All endpoint radios in the network will have these same settings except for the Radio ID . The Radio ID should match the PakBus address of the data logger it is connected to.			

12.5.1 Configuring the RF452 radio connected to the computer

Configure the RF452 radio connected to the computer (see previous image for reference).

1. Ensure your RF452 radio is connected to an antenna before applying power.
2. Using *Device Configuration Utility*, connect to the RF452 radio.
3. On the **Deployment** tab, set the **Active Interface** to **USB** or **RS-232** (depending on how your computer will be connected to the radio).
4. Set the **Radio Operation Mode** to **Gateway**. In the **Network ID** box, type a unique number between 0 and 4095 (excluding 255). This is used to communicate with RF452 devices in the network. Make note of this number. All radios in the network require the same Network ID.

5. In the **Frequency Key** box, type a number between 0 and 14, and make note of this number. Generally, all radios in the network will have the same Frequency Key.
6. Select the **Repeaters Used** box.

The screenshot shows a 'Deployment' configuration window with the following fields and values:

- Serial No: 711-8807
- Versions: RF451/452: RF45X.03.00/ FreeWave: v
- Active Interface: USB
- SDC Address: 7
- Baud Rate: (empty)
- Radio Operation Mode: Gateway
- Repeater Used (highlighted with a red box)
- Use Repeater Frequency Key:
- Network ID: 1234
- Frequency Key: 5
- Transmit Power: 10
- Low Power Mode: 2
- Receive SubNet ID: 15
- Transmit SubNet ID: 15
- Radio ID: 4094

7. **Apply** to save your changes.

12.5.2 Configuring the data logger acting as a repeater

1. Ensure your RF452 radio is connected to an antenna before applying power.
2. Supply power to the data logger. If connecting via USB for the first time, you must first install USB drivers by using *Device Configuration Utility* (select your data logger, then on the main page, click **Install USB Driver**). Alternately, you can install the USB drivers using EZ Setup. A USB connection supplies 5 V power (as well as a communications link), which is adequate for setup, but a 12 V battery will be needed for field deployment.
3. Using *Device Configuration Utility*, connect to the RF452 data logger.

4. Click the **Radio** sub-tab and select the **Repeaters Used** box.

Deployment ! Security Check

Datalogger Com Ports Settings Ethernet PPP Radio GOES Network Services TLS Adv

Radio Enabled

Serial No: 712-0211 Versions Free

Radio Operation Mode: Endpoint/Repeater Repeaters Used

Network ID: 1234 Frequency Key: 5 Use Repeater Frequency Key

Transmit Power: 10 Low Power Mode: 2

Receive SubNet ID: 15 Transmit SubNet ID: 15

5. Also on the **Radio** sub-tab, set the **Radio Operation Mode** to **Endpoint/Repeater**. In the **Network ID** box, type the same number set in the previous instruction [Configuring the RF452 radio connected to the computer](#) (p. 76).
6. In the **Frequency Key** box, type the same number set in the previous instruction.
7. **Apply** to save your changes.

12.5.3 Adding the endpoint/repeater data logger to the *LoggerNet* network

To add the repeater data logger to the *LoggerNet* network, follow the instructions found in [Setting up communications between the RF452 data logger and the computer](#) (p. 74).

12.5.4 Adding endpoint data loggers to the network

1. In the *LoggerNet Standard Setup* view (click **Setup** and then the **View** menu to ensure you are in the **Standard** view), right-click on the repeater data logger in the **Entire Network** pane on the left side of the window and select your data logger model such as **CR6Series**.
2. With the newly added data logger selected in the **Entire Network** pane, set the **PakBus Address** to the address that was assigned to the endpoint data logger in *Device Configuration Utility*.
3. Click **Rename** to provide the data logger a descriptive name.
4. **Apply** to save your changes.
5. Repeat these steps for each endpoint data logger in the network.

If you experience network communications problems, see [Troubleshooting radio communications](#) (p. 189) for assistance.

12.5.5 Using additional communications methods

Using similar instructions, an RF452 data logger can be used in a system with additional communications methods. For example, in the following image, the router RF452 data logger communicates with *LoggerNet* through Konect PakBus Router. The router RF452 data logger communicates with the endpoint RF452 data loggers over RF.

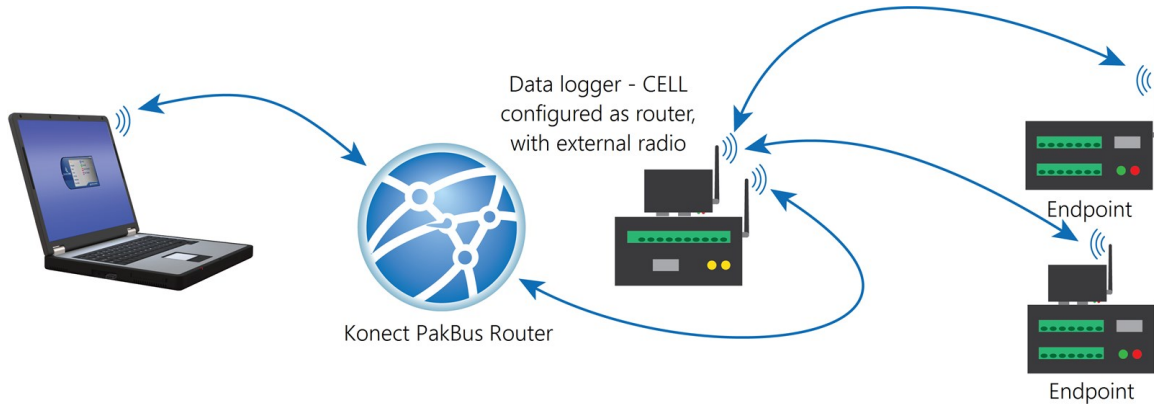

The RF portion of this network requires no changes to the hardware settings described in the previous procedure.

See the [Konect Pakbus Router Getting Started Guide](#) [↗](#) for more information on setting up that part of the network.

13. Testing communications with EZSetup

1. Advance to, or select, the **Communication Test** step in EZ Setup. See [USB or RS-232 communications](#) (p. 23) for more information.

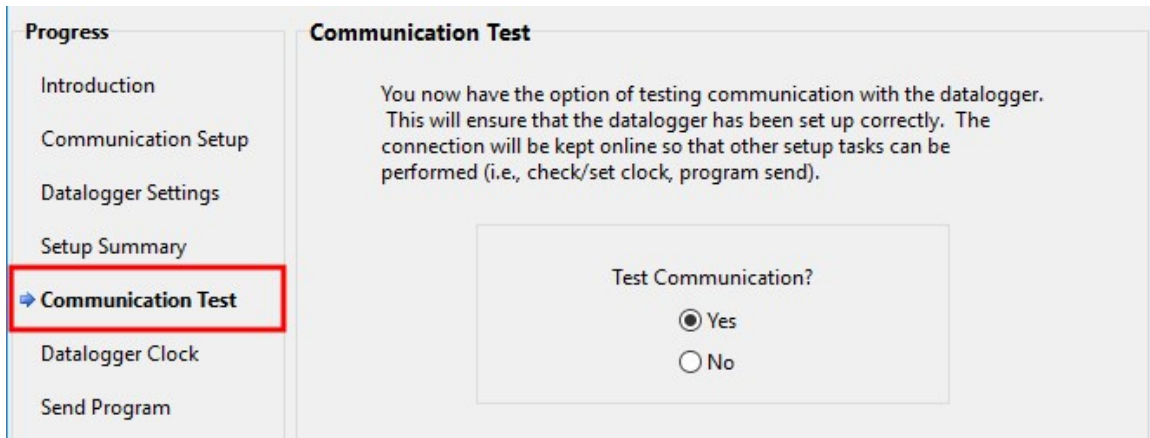



2. Ensure the data logger is physically connected to the computer, select **Yes** to test communications, then click **Next** to initiate the test. To troubleshoot an unsuccessful test, see [Tips and troubleshooting](#) (p. 182).
3. With a successful connection, the **Connection Time** with the data logger is displayed in the lower-left corner of the wizard. Click **Next**.
4. The **Datalogger Clock** window displays the time for both the data logger and the computer (server).
 - The **Adjusted Server Date/Time** displays the current reading of the clock for the computer running your data logger support software. If the **Datalogger Date/Time** and **Adjusted Server Date/Time** do not match, click **Set Datalogger Clock** to set the data logger clock to the computer clock.
 - Optionally, specify a positive or negative **Time Zone Offset** to apply when setting the data logger clock. This offset allows you to set the clock for a data logger that is in a different time zone than the computer (or to accommodate for changes in daylight saving time).
5. Click **Next**.

6. The data logger ships with a default **QuickStart** program. If the data logger does not have a program, you can choose to send one by clicking **Select and Send Program**. Click **Next**.
7. **LoggerNet** only - Use the following instructions or watch the [Scheduled/Automatic Data Collection video](#) 
 - The **Datalogger Table Output Files** window displays the data tables available to be collected from the data logger and the output file name. By default, all data tables set up in the data logger program will be included for collection. Make note of the **Output File Name** and location. Click **Next**.
 - Check **Scheduled Collection Enabled** to have **LoggerNet** automatically collect data from the data logger on the **Collection Interval** entered. When the **Base Date** and **Time** are in the past, scheduled collection will begin immediately after finishing the EZSetup wizard. Do not set up a scheduled collection during this tutorial. Click **Next**.
8. Click **Finish**, or you may click **Next** to test communications, set the data logger clock, and send a program to the data logger.

13.1 Making the software connection

Once you have configured your hardware connection (see [Setting up communications with the data logger](#) [p. 21]), your data logger and computer can communicate. Use the **Connect** screen to send a program, set the clock, view real-time data, and manually collect data.

- **LoggerNet** users, select **Main** and **Connect**  on the **LoggerNet** toolbar, select the data logger from the **Stations** list, then **Connect** .
- **PC400** users, select the data logger from the list and click **Connect** .

To disconnect, click **Disconnect** .

For more information, see the [Connect Window Tutorial](#) .

14. Creating a *Short Cut* data logger program



You must provide a program for the data logger in order for it to make measurements, store data, or control external devices. There are several ways to write a program. The simplest is to use the program generator called **Short Cut**. For more complex programming, *CRBasic Editor* is used. The program file may use the extension **.CRB**, or **.DLD**.

Data logger programs are executed on a precise schedule termed the scan interval, based on the data logger internal clock.

Measurements are first stored in temporary memory called variables in the **Public** table. Data stored in variables is usually overwritten each scan. Periodically, generally on a time interval, the data logger stores data in tables. The data tables are later copied to a computer using your data logger support software.

Use **Short Cut** software to generate a program for your data logger. **Short Cut** is included with your data logger support software.

This section guides you through programming a CR350 data logger to measure the voltage of the data logger power supply, the internal temperature of the data logger, and a thermocouple. With minor changes, these steps can apply to other measurements. Use the following instructions or watch the [Quickstart part 3 video](#) :

1. Using data logger support software, launch **Short Cut**.
 - **LoggerNet** users, click **Program** then **Short Cut** .
 - **PC400** users, click **Short Cut** .
2. Click **Create New Program**.
3. Select **CR350** and click **Next**.

NOTE:

The first time **Short Cut** is run, a prompt asks for a noise rejection choice. Select **60 Hz Noise Rejection** for North America and areas using 60 Hz ac voltage. Select **50 Hz Noise Rejection** for most of the Eastern Hemisphere and areas that operate at 50 Hz.

A second prompt lists sensor support options. **Campbell Scientific, Inc. (US)** is usually the best fit outside of Europe.

To change the noise rejection or sensor support option for future programs, use the **Program** menu.

4. Lists of **Available Sensors and Devices** and **Selected Measurements Available for Output** are displayed. Battery voltage **BattV** and internal temperature **PTemp_C** are selected by default. During operation, battery and temperature should be recorded at least daily to assist in monitoring system status.
5. Use the Search feature or expand folders to locate your sensor or device. Double-click on a sensor or measurement in the **Available Sensors and Devices** list to configure the device (if needed) and add it to the **Selected** list. For the example program, expand the **Sensors** and **Temperature** folders and double-click **Type T Thermocouple**.
6. If the sensor or device requires configuration, a window displays with configuration options. Click **Help** at the bottom of the window to learn more about any field or option. For the example program, accept the default options:
 - 1 **Type T TC** sensor
 - **Temp_C** as the **Temperature** label, and set the units to **Deg C**
 - **PTemp_C** as the **Reference Temperature Measurement**
7. Click the **Wiring** tab at the top of the page to see how to wire the sensor to the data logger. With the power disconnected from the data logger, insert the wires as directed in the diagram. Ensure you clamp the terminal on the wire, not the colored insulation. Use the included flat-blade screwdriver to open and close the terminals.
8. Click **OK**.
9. Click **Next**.
10. Use the **Output Setup** options to specify how often to make measurements and how often outputs are to be stored. Type **1** in the **How often should the data logger measure its sensor(s)?** box. Leave the units as **Seconds**.
11. Multiple output intervals can be specified, one for each output table (**Table1** and **Table2** tabs). For the example program, only one table is needed. Click the **Table2** tab and click **Delete Table**.
12. In the **Table Name** box, type a name for the table. For example: **OneMin**.
13. Select a **Data Output Storage Interval**. For example: **1 minute**.
14. Click **Next**.

15. Select a measurement from the **Selected Measurements Available for Output** list, then click an output processing option to add the measurement to the **Selected Measurements for Output** list. For the example program, select **BattV** and click the **Minimum** button to add it to the **Selected Measurements for Output** list. Do not store the exact time that the minimum occurred. Repeat this procedure for an **Average PTemp_C** and **Average Temp_C**.

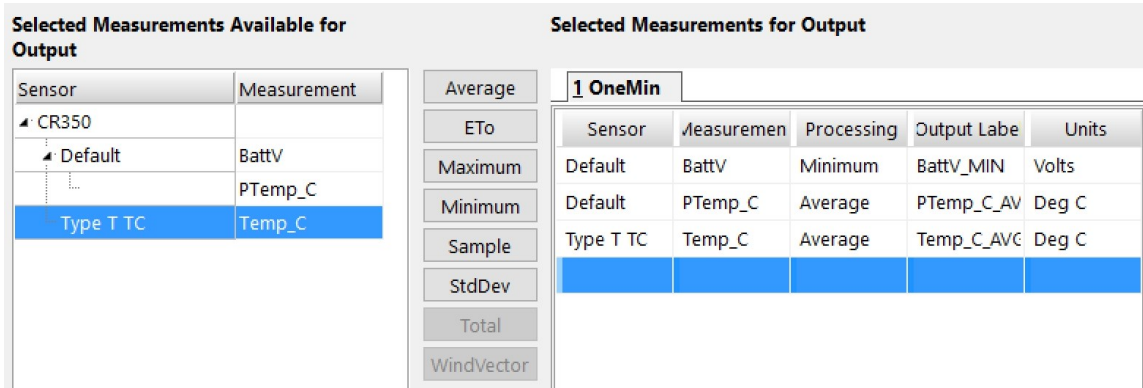

16. Click **Finish** and give the program a meaningful name such as a site identifier. Click **Save**.
17. If **LoggerNet** or other data logger support software is running on your computer, and the data logger is connected to the computer (see [Making the software connection](#) (p. 81) for more information), you can choose to send the program. Generally it is best to collect data first; so, we recommend sending the program using the instructions in [Sending a program to the data logger](#) (p. 85). Click **No**, do not send the program to the data logger.

TIP:
It is good practice to always retrieve data from the data logger before sending a program; otherwise, data may be lost. See [Collecting data](#) (p. 88) for detailed instruction.

18. Make note of the newly generated program location and filename. By default, programs created with **Short Cut** are stored in `C:\Campbellsci\SCWin\`.
19. Close **Short Cut**.

If your data acquisition requirements are simple, you can probably create and maintain a data logger program exclusively with **Short Cut**. If your data acquisition needs are more complex, the files that **Short Cut** creates are a great source for programming code to start a new program or add to an existing custom program using CRBasic. See the **CRBasic Editor** help for detailed information on program structure, syntax, and each instruction available to the data logger <https://help.campbellsci.com/crbasic/cr350/>.

NOTE:

Once a *Short Cut* generated program has been edited with *CRBasic Editor*, it can no longer be modified with *Short Cut*.

14.1 Sending a program to the data logger



TIP:

It is good practice to always retrieve data from the data logger before sending a program; otherwise, data may be lost. See [Collecting data](#) (p. 88) for detailed instruction.

Some methods of sending a program give the option to retain data when possible. Regardless of the program upload tool used, data will be erased when a new program is sent if any change occurs to one or more data table structures in the following list:

- Data table name(s)
- Data output interval or offset
- Number of fields per record
- Number of bytes per field
- Field type, size, name, or position
- Number of records in table

Use the following instructions or watch the [Quickstart part 4 video](#) .

1. Connect the data logger to your computer (see [Making the software connection](#) (p. 81) for more information).
 - *LoggerNet* users, select **Main** and **Connect**  on the *LoggerNet* toolbar, select the data logger from the **Stations** list, then **Connect** .
 - *PC400* users, select the data logger from the list and click **Connect** .
2. *LoggerNet* users, click **Send New...** (located in the **Current Program** section on the right side of the window).
PC400 users, click **Send Program...** (located in the **Datalogger Program** section on the right side of the window).
3. *PC400* users, confirm that you would like to proceed and erase all data tables saved on the data logger. Click **Yes**.
4. Navigate to the program, select it, and click **Open**. For example: navigate to **C:\Campbellsci\SCWin** and select **MyTemperature.CRB**. Click **Open**.
5. *LoggerNet* users, confirm that you would like to proceed and erase all data tables saved on the data logger. Click **Yes**.
6. The program is sent and compiled.

7. Review the **Compile Results** window for errors, messages and warnings.
8. **LoggerNet** users, click **Details**, select the **Table Fill Times** tab.

PC400 user click **OK** then click **Station Status** , select the **Table Fill Times** tab.

Ensure that the times shown are expected for your application. Click **OK**.

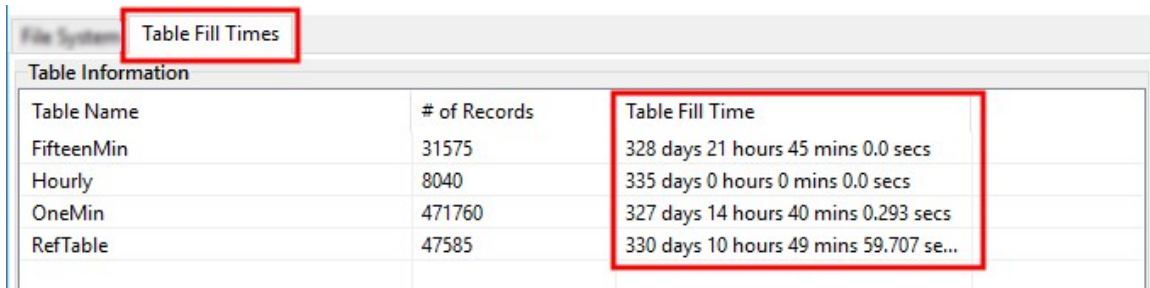

Table Name	# of Records	Table Fill Time
FifteenMin	31575	328 days 21 hours 45 mins 0.0 secs
Hourly	8040	335 days 0 hours 0 mins 0.0 secs
OneMin	471760	327 days 14 hours 40 mins 0.293 secs
RefTable	47585	330 days 10 hours 49 mins 59.707 se...

After sending a program, it is a good idea to monitor the Public table to make sure sensors are taking good measurements. See [Working with data](#) (p. 87) for more information.

15. Working with data



15.1 Default data tables

By default, the data logger includes three tables: **Public**, **Status**, and **DataTableInfo**. Each of these tables only contains the most recent measurements and information.



- The **Public** table is configured by the data logger program, and updated at the scan interval set within the data logger program. It shows measurement and calculation results as they are made.
- The **Status** table includes information about the health of the data logger and is updated only when viewed.
- The **DataTableInfo** table reports statistics related to data tables. It also only updates when viewed.
- User-defined data tables update at the schedule set within the program.

For information on collecting your data, see [Collecting data](#) (p. 88).

Use these instructions or follow the [Connect Window tutorial](#)  to monitor real-time data.

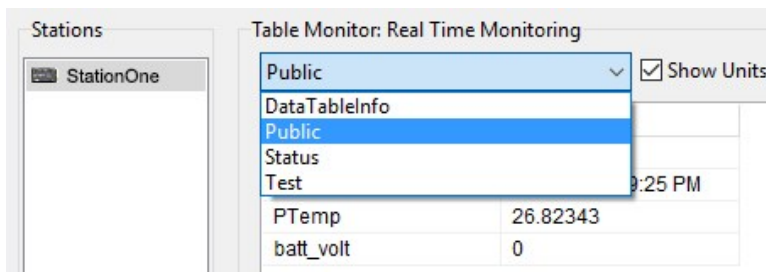
LoggerNet users, select the **Main** category and **Connect**  on the **LoggerNet** toolbar, then select the data logger from the **Stations** list, then click **Connect** . Once connected, select a table to view in the **Table Monitor**.



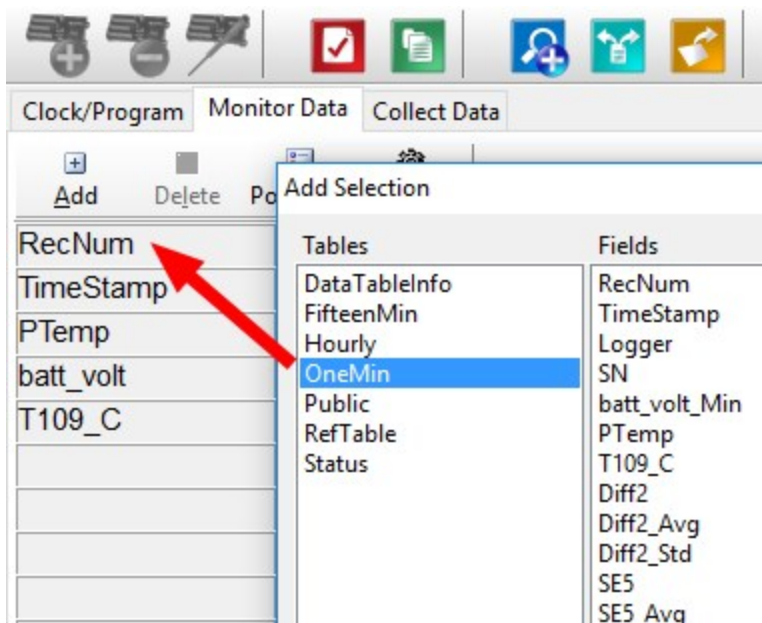

PC400 users, click **Connect** , then **Monitor Data**. When this tab is first opened for a data logger, values from the **Public** table are displayed. To view data from other tables, click **Add** , select a table or field from the list, then drag it into a cell on the **Monitor Data** tab.



15.2 Collecting data

The data logger writes to data tables based on intervals and conditions set in the CRBasic program (see [Creating data tables in a program](#) (p. 96) for more information). After the program has been running for enough time to generate data records, data may be collected by using data logger support software. During data collection, data is copied to the computer and still remains on the data logger. Collections may be done manually, or automatically through scheduled collections set in *LoggerNet Setup*. Use these instructions or follow the [Collect Data Tutorial](#) .

15.2.1 Collecting data using *LoggerNet*



1. From the *LoggerNet* toolbar, click **Main** and **Connect** , select the data logger from the **Stations** list, then **Connect** .
2. Click **Collect Now** .
3. After the data is collected, the **Data Collection Results** window displays the tables collected and where they are stored on the computer.
4. Select a data file, then **View File** to view the data. See [Viewing historic data](#) (p. 89).

15.2.2 Collecting data using *PC400*



1. Click **Connect**  on the main *PC400* window.
2. Go to the **Collect Data** tab.

3. By default, all output tables set up in the data logger program are selected for collection. Typically, the default tables (DataTableInfo, Public, and Status) are not collected.
4. Select an option for **What to Collect**. Either option creates a new file if one does not already exist.
 - **New data from data logger (Append to data files)**: This is the default, and most often used option. Collect only the data, in the selected tables, stored since the last data collection from this instance of *PC400* and append this data to the end of the existing files on the computer.
 - **All data from data logger (Overwrite data files)**: Collects all of the data in the selected tables and overwrites (or replaces) the existing data files on the computer.
5. Click **Start Data Collection**.
6. After the data is collected, the **Data Collection Results** window displays the tables collected and where they are stored on the computer.
7. Select a data file, then **View File** to view the data. See [Viewing historic data](#) (p. 89).

15.3 Viewing historic data

View Pro  contains tools for reviewing data in tabular form as well as several graphical layouts for visualization. Use these instructions or follow the [View Data Tutorial](#) .

Once the data logger has had enough time to store multiple records collect and review the data.

1. To view the most recent data, connect the data logger to your computer and collect your data (see [Collecting data](#) (p. 88) for more information).
2. Open View Pro:
 - *LoggerNet* users click **Data** then **View Pro**  on the *LoggerNet* toolbar.
 - *PC400* users click **View Data Files** via **View Pro** .
3. Click **Open** , navigate to the directory where you saved your tables (the default directory is `C:\Campbellsci\your data logger software application`). For example: navigate to the `C:\Campbellsci\LoggerNet` folder and select **OneMin.dat**.
4. Click **Open**.

15.4 Data types and formats

Data takes different formats as it is created and manipulated in the data logger, as it is displayed through software, and as it is retrieved to a computer file. It is important to understand the different data types, formats and ranges, and where they are used.

See the *CRBasic Editor* help for additional data types and formats, and program examples: <https://help.campbellsci.com/crbasic/cr350/>

Data type	Description	Range	Resolution	Where used
Float	IEEE four-byte floating point	+/-1.8 *10 ⁻³⁸ to +/-3.4 *10 ³⁸	24 bits (about 7 digits)	variables
Long	four-byte signed integer	-2,147,483,648 to +2,147,483,647	1 bit	variables, output
Boolean	four-byte signed integer	-1, 0	True (-1) or False (0)	variables, sample output
String	ASCII String			variables, sample output
IEEE4	IEEE four-byte floating point	+/-1.8 *10 ⁻³⁸ to +/-3.4 *10 ³⁸	24 bits (about 7 digits)	internal calculations, output
IEEE8	IEEE eight-byte floating point	+/-2.23 *10 ⁻³⁰⁸ to +/-1.8 *10 ³⁰⁸	53 bits (about 16 digits)	internal calculations, output
FP2	Campbell Scientific two-byte floating point	-7999 to +7999	13 bits (about 4 digits)	output
NSEC	eight-byte time stamp		nanoseconds	variables, output

15.4.1 Variables

In CRBasic, the declaration of variables (via the **DIM** or the **PUBLIC** statement) allows an optional type descriptor **As** that specifies the data type. The data types are **Float**, **Long**, **Boolean**, and **String**. The default type is **Float**.

Example variables declared with optional data types

```
Public PTemp As Float, Batt_volt  
Public Counter As Long  
Public SiteName As String * 24
```

As Float specifies the default data type. If no data type is explicitly specified with the **As** statement, then **Float** is assumed. Measurement variables are stored and calculations are performed internally in IEEE 4 byte floating point with some operations calculated in double precision. A good rule of thumb is that resolution will be better than 1 in the seventh digit.

As Long specifies the variable as a 32 bit integer. There are two possible reasons a user would do this: (1) speed, since the CR350 Operating System can do math on integers faster than with **Floats**, and (2) resolution, since the **Long** has 31 bits compared to the 24 bits in the **Float**. A good application of the **As Long** declaration is a counter that is expected to get very large.

As Boolean specifies the variable as a 4 byte Boolean. Boolean variables are typically used for flags and to represent conditions or hardware that have only 2 states (e.g., On/Off, High/Low). A Boolean variable uses the same 32 bit long integer format as a **Long** but can set to only one of two values: True, which is represented as -1, and false, which is represented with 0. When a **Float** or **Long** integer is converted to a **Boolean**, zero is False (0), any non-zero value will set the Boolean to True (-1). The Boolean data type allows application software to display it as an On/Off, True/False, Red/Blue, etc.

The CR350 uses -1 rather than some other non-zero number because the **AND** and **OR** operators are the same for logical statements and binary bitwise comparisons. The number -1 is expressed in binary with all bits equal to 1, the number 0 has all bits equal to 0. When -1 is anded with any other number the result is the other number, ensuring that if the other number is non-zero (true), the result will be non-zero.

As String * size specifies the variable as a string of ASCII characters, NULL terminated, with an optional size specifying the maximum number of characters in the string. A string is convenient in handling serial sensors, dial strings, text messages, etc. When size is not specified, a default of 24 characters will be used (23 usable bytes and 1 terminating byte).

As a special case, a string can be declared **As String * 1**. This allows the efficient storage of a single character. The string will take up 4 bytes in memory and when stored in a data table, but it will hold only one character.

15.4.2 Constants

The **Const** declaration is used to assign a name that can be used in place of a value in the data logger CRBasic program. Once a value is assigned to a constant, each time the value is needed in the program, the programmer can type in the constant name instead of the value itself. The use of the **Const** declaration can make the program easier to follow, easier to modify, and more secure against unintended changes. Unlike variables, constants cannot be changed while the program is running.

Constants must be defined before they are used in the program. Constants can be defined in a **ConstTable/EndConstTable** construct allowing them to be changed using the keyboard display, the **C** command in terminal mode, or via a custom menu.

Constants can also be typed For example: **Const** A as Long = 9999, and **Const** B as String = "MyString". Valid data types for constants are: **Long**, **Float**, **Double**, and **String**. Other data types return a compile error.

When the CRBasic program compiles, the compiler determines the type of the constant (**Long**, **Float**, **Double**, or **String**) from the expression. This data type is communicated to the software. The software formats or restricts the input based on the data type communicated to it by the data logger.

You can declare a constant with or without specifying a data type. If a data type is not specified, the compiler determines the data type from the expression. For example: **Const** A = 9999 will use the **Long** data type. **Const** A = 9999.0 will use the **Float** data type.

15.4.3 Data storage

Data can be stored in IEEE4 or FP2 formats. The format is selected in the program instruction that outputs the data, such as **Minimum()** and **Maximum()**.

Additionally, data can be stored in IEEE8 format when high precision is needed. For more information on double-precision math, watch an instructional video at: <http://www.campbellsci.com/videos/double-precision> .

While **Float** (IEEE 4 byte floating point) is used for variables and internal calculations, **FP2** is adequate for most stored data. Campbell Scientific 2 byte floating point (**FP2**) provides 3 or 4 significant digits of resolution, and requires half the memory space as **IEEE4** (2 bytes per value vs 4).

Zero	Minimum magnitude	Maximum magnitude
0.000	±0.001	±7999.

The resolution of **FP2** is reduced to 3 significant digits when the first (left most) digit is 8 or greater. Thus, it may be necessary to use **IEEE4** output or an offset to maintain the desired resolution of a measurement. For example, if water level is to be measured and output to the nearest 0.01 foot, the level must be less than 80 feet for **FP2** output to display the 0.01 foot increment. If the water level is expected to range from 50 to 90 feet the data could either be output in **IEEE4** or could be offset by 20 feet (transforming the range to 30 to 70 feet).

Absolute value	Decimal location
0 – 7.999	X.XXX
8 – 79.99	XX.XX
80 – 799.9	XXX.X
800 – 7999.	XXXX.

NOTE:

String and **Boolean** variables can be output with the **Sample()** instruction. Results of Sampling a **Boolean** variable will be either -1 or 0 in the collected Data Table. A Boolean displays in the **Numeric Monitor** Public and Data Tables as **true** or **false**.

15.5 About data tables

A data table is essentially a file that resides in data logger memory (for information on data table storage. See [Data memory](#) (p. 99). The file consists of five or more rows. Each row consists of columns, or fields. The first four rows constitute the file header. Subsequent rows contain data records. Data tables may store individual measurements, individual calculated values, or summary data such as averages, maximums, or minimums.

Typically, files are written to based on time or event. The number of data tables is limited to 20, which includes the **Public**, **Status**, **DataTableInfo**, and **ConstTable**. You can retrieve data based on a schedule or by manually choosing to collect data using data logger support software. See [Collecting data](#) (p. 88).

TOA5, MyStation, CR350, 1142, CR350.Std.01, CPU:MyTemperature.CRB, 1958, OneMin				
TIMESTAMP	RECORD	BattV_Avg	PTemp_C_Avg	Temp_C_Avg
TS	RN	Volts	Deg C	Deg C
		Avg	Avg	Avg
2019-03-08 14:24:00	0	13.68	21.84	20.71
2019-03-08 14:25:00	1	13.65	21.84	20.63
2019-03-08 14:26:00	2	13.66	21.84	20.63
2019-03-08 14:27:00	3	13.58	21.85	20.62

Table 15-4: Example data				
TOA5, MyStation, CR350, 1142, CR350.Std.01, CPU:MyTemperature.CRB, 1958, OneMin				
TIMESTAMP	RECORD	BattV_Avg	PTemp_C_Avg	Temp_C_Avg
TS	RN	Volts	Deg C	Deg C
		Avg	Avg	Avg
2019-03-08 14:28:00	4	13.64	21.85	20.52
2019-03-08 14:29:00	5	13.65	21.85	20.64

15.5.1 Table definitions

Each data table is associated with descriptive information, referred to as a “table definition,” that becomes part of the file header (first few lines of the file) when data is downloaded to a computer. Table definitions include the data logger type and OS version, name of the CRBasic program associated with the data, name of the data table (limited to 20 characters), and alphanumeric field names.

15.5.1.1 Header rows

The first header row of the data table is the environment line, which consists of eight fields. The following list describes the fields using the previous table entries as an example:

- **TOA5** - Table output format. Changed via *LoggerNet Setup*  *Standard View, Data Files* tab. Other formats include: TOB1 and TOAC11.
- **MyStation** - Station name. Changed via *LoggerNet Setup, Device Configuration Utility*, or CRBasic program.
- **CR350** - Data logger model.
- **1142** - Data logger serial number.
- **CPU:MyTemperature.CRB** - Data logger program name. Changed by sending a new program (see [Sending a program to the data logger](#) (p. 85) for more information).
- **1958** - Data logger program signature. Changed by revising a program or sending a new program (see [Sending a program to the data logger](#) (p. 85) for more information).
- **OneMin** - Table name as declared in the running program (see [Creating data tables in a program](#) (p. 96) for more information).

The second header row reports field names. Default field names are a combination of the variable names (or aliases) from which data is derived, and a three-letter suffix. The suffix is an abbreviation of the data process that outputs the data to storage. A list of these abbreviations follows in [Data processing abbreviations](#) (p. 95).

If a field is an element of an array, the field name will be followed by a indices within parentheses that identify the element in the array. For example, a variable named `Values`, which is declared as a two-by-two array in the data logger program, will be represented by four field names: `Values(1,1)`, `Values(1,2)`, `Values(2,1)`, and `Values(2,2)`. There will be one value in the second header row for each scalar value defined by the table.

If the default field names are not acceptable to the programmer, the `FieldNames()` instruction can be used in the CRBasic program to customize the names. `TIMESTAMP`, `RECORD`, `BattV_Avg`, `PTemp_C_Avg`, and `Temp_C_Avg` are the default field names in the previous [Example data](#) (p. 93).

The third header row identifies engineering units for that field. These units are declared at the beginning of a CRBasic program using the optional `Units()` declaration. In *Short Cut*, units are chosen when sensors or measurements are added. Units are strictly for documentation. The data logger does not make use of declared units, nor does it check their accuracy.

The fourth header row reports abbreviations of the data process used to produce the field of data.

Data processing name	Abbreviation
Totalize	Tot
Average	Avg
Maximum	Max
Minimum	Min
Sample at Max or Min	SMM
Standard Deviation	Std
Moment	MMT
Sample	No abbreviation
Histogram	Hst
Histogram4D	H4D
FFT	FFT
Covariance	Cov
Level Crossing	LCr
WindVector	WVc

Data processing name	Abbreviation
Median	Med
ET	ETsz
Solar Radiation (from ET)	RSo
Time of Max	TMx
Time of Min	TMn

15.5.1.2 Data records

Subsequent rows are called data records. They include observed data and associated record keeping. The first field is a time stamp (**TS**), and the second field is the record number (**RN**).

The time stamp shown represents the time at the beginning of the scan in which the data is written. Therefore, in record number 3 in the previous [Example data](#) (p. 93), **Temp_C_Avg** shows the average of the measurements taken over the minute beginning at 14:26:01 and ending at 14:27:00. As another example, consider rainfall measured every second with a daily total rainfall recorded in a data table written at midnight. The record time stamped 2019-03-08 00:00:00 will contain the total rainfall beginning at 2019-03-07 00:00:01 and ending at 2019-03-08 00:00:00.

NOTE:

TableName.Timestamp syntax can be used to return the timestamp of a data table record, expressed either as a time into an interval (for example seconds since 1970 or seconds since 1990) or as a date/time string. For more information,

see: <https://www.campbellsci.com/blog/programmatically-access-stored-data-values> .

15.6 Creating data tables in a program

Data is stored in tables as directed by the CRBasic program. In *Short Cut*, data tables are created in the **Output** steps. See [Creating a Short Cut data logger program](#) (p. 82) Data tables are created within the CRBasic data logger program using the **DataTable()**/**EndTable** instructions. They are placed after variable declarations and before the **BeginProg** instruction.

```

Public 'Declare Public Variables

DataTable()
    'Output Trigger Condition(s)
    'Output Processing Instructions
EndTable

'Main Program
BeginProg

```

Between **DataTable()** and **EndTable()** are instructions that define what data to store and under what conditions data is stored. A data table must be called by the CRBasic program for data processing and storage to occur. Typically, data tables are called by the **CallTable()** instruction once each program scan.

See the *CRBasic Editor* help for detailed instruction information and program examples: <https://help.campbellsci.com/crbasic/cr350/>.

Use the **DataTable()** instruction to define the number of records, or rows, allocated to a data table. You can set a specific number of records, which is recommended for conditional tables, or allow your data logger to auto-allocate table size. With auto-allocation, the data logger balances the memory so the tables “fill up” (newest data starts to overwrite the oldest data) at about the same time. It is recommended you reserve the use of auto-allocation for data tables that store data based only on time (tables that store data based on the **DataInterval()** instruction). Event or conditional tables are usually set to a fixed number of records. View data table fill times for your program on the **Station Status > Table Fill Times** tab (see [Checking station status](#) (p. 183) for more information). An example of the Table Fill Times tab follows. For information on data table storage see [Data memory](#) (p. 99).

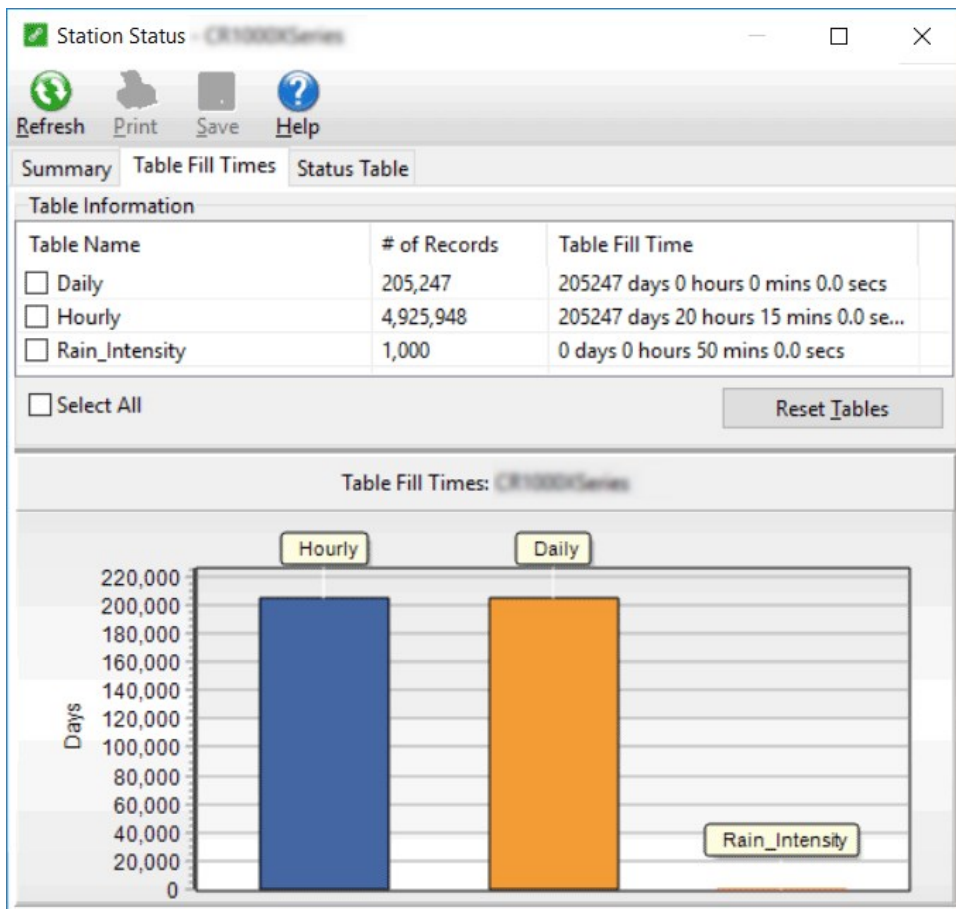

For additional information on data logger memory, visit the Campbell Scientific blog article, [How to Know when Your Datalogger Memory is Getting Full](#).

16. Data memory

The data logger includes three types of memory: RAM, Flash, and Serial Flash. The USB host port supports optional portable storage devices such as USB flash or thumb drives.

- CPU Drive: 50 MB serial flash
- Data Storage: 50 MB serial flash
- Operating System: 2 MB flash
- Settings, Calibration, TLS Certificates and Key, System Information: 3 MB serial flash
- Background Tasks and Table Information, Buffers, System Memory, Program Variables: 7 MB RAM

16.1 Data tables

Measurement data is primarily stored in data tables within serial flash. Data is usually erased from this area when a program is sent to the data logger. Final-data memory for the CR350 is organized in 4 KB sectors. Each sector is rated for 100,000 serial flash erases.

During data table initialization, memory sectors are assigned to each data table according to the parameters set in the program. Program options that affect the allocation of memory include the **Size** parameter of the `DataTable()` instruction, the **Interval** and **Units** parameters of the `DataInterval()` instruction. The data logger uses those parameters to assign sectors in a way that maximizes the life of its memory. See the *CRBasic Editor* help for detailed instruction information and program examples: <https://help.campbellsci.com/crbasic/cr350/> .

By default, data memory sectors are organized as ring memory. When the ring is full, oldest data is overwritten by newest data. Using the `FillStop` statement sets a program to stop writing to the data table when it is full, and no more data is stored until the table is reset. To see the total number of records that can be stored before the oldest data is overwritten, or to reset tables, go to **Station Status > Table Fill Times** in your data logger support software.

Data concerning the data logger memory are posted in the **Status** and **DataTableInfo** tables. For additional information on these tables, see [Information tables and settings \(advanced\)](#) (p. 216).

For additional information on data logger memory, visit the Campbell Scientific blog article, [How to Know when Your Datalogger Memory is Getting Full](#) .

16.2 Flash memory

The data logger operating system is stored in a separate section of flash memory. To update the operating system, see [Updating the operating system](#) (p. 177).

Serial flash memory holds the CPU drive, web page, and data logger settings. Because flash memory has a limited number of write/erase cycles, care must be taken to avoid continuously writing to files on the CPU drive.

16.2.1 CPU drive

The serial flash memory CPU drive contains data logger programs and other files. This memory is managed in File Control.

NOTE:

When writing to files under program control, take care to write infrequently to prevent premature failure of serial flash memory. Internal chip manufacturers specify the flash technology used in Campbell Scientific CPU: drives at about 100,000 write/erase cycles. While Campbell Scientific's in-house testing has found the manufacturers' specifications to be very conservative, it is prudent to note the risk associated with repeated file writes via program control.

See also [SerialFlashErrors](#) (p. 222).

Also, see [System specifications](#) (p. 268) for information on data logger memory.

16.3 USB host (USB: drive)

USB host provides portable data storage on a USB thumb drive. A FAT32-formatted USB thumb drive can be inserted into the host port and will show up as a drive (**USB:**) in file-related operations. Measurement data is stored on **USB:** as discrete files by using the [TableFile\(\)](#) instruction. Files on **USB:** can be collected by inserting the thumb drive into a computer and copying the files.

USB: can be used in all CRBasic file-access-related instructions. Because of data reliability concerns in non-industrial rated drives, this drive is not intended for long-term unattended data storage. Rather, configure [Tablefile\(\)](#) for milking (plug-and-pull) to periodically collect data. Files on **USB:** are not affected by program recompilation or formatting of other drives.

See the *CRBasic Editor* help for detailed instruction information and program examples:

<https://help.campbellsci.com/crbasic/cr350/> 

16.3.1 USB host precautions

Observe the following precautions when using an optional USB thumb drive:

- When the data logger is powered and a USB thumb drive is connected for plug and pull data-collection mode, the Power LED will flash red during read/write activity.
- Do not remove a USB drive while the drive is active, or data corruption and damage to the USB drive may result.

16.3.2 LED indicator

When the data logger is powered and a USB thumb drive is connected for data collection, the Power LED will rapidly flash red indicating read/write activity. It is safe to remove the USB flash drive when the LED flashing returns to normal power indication mode (see [Power LED indicator](#) (p. 12)). The data logger will write new data files to the USB flash drive again once it is removed and reinserted. Do not leave the USB flash drive attached long term.

16.3.3 Data type collection speed

File type declared in the [Tablefile\(\)](#) `TFOption` parameter can affect plug and pull data-collection speed. Data is buffered in the data logger as binary. While data is collected, the data logger converts the binary data to the declared data type. TOB1 options are binary and require very little processor overhead to convert from the binary buffer. TOA5, CSIXML, and JSON are ASCII options and are much slower since they consume significant processor overhead to convert to ASCII from the binary buffer. CSIXML is especially slow. The effects on collection time will be particularly noticeable if the data logger is running a long or complex program. In short, if large files need collection, using the TOB1 format may save considerable time. Consult the *Loggernet* manual for options available to convert TOB1 data files on the computer to easier-to-read formats.

16.3.4 Skipped scans

CR350 programs run in sequential mode. In sequential mode, the [Tablefile\(\)](#) instruction must finish before continuing to the next instruction, resulting in skipped scans unless the scan interval is long enough to complete all communications, measurement processing, and [Tablefile\(\)](#) tasks. Sequential mode ignores any scan buffers that may be assigned.

To avoid skipped scans, ensure the scan interval in the data logger program is long enough to include writing to the USB thumb drive. We recommend adding at least 100 ms to the program

scan interval for each instance of the `Tablefile()` instruction to allow sufficient time to execute and process each `Tablefile()` instruction.

16.3.5 Formatting drives 32 GB or larger

Windows does not support creating a FAT32 partition on a 32 GB or greater drive. The work-around is to use a Windows computer to format the drive as NTFS (NT file system). Then use the data logger to format the drive as FAT32.

17. Measurements

17.1 Voltage measurements	103
17.2 Current-loop measurements	105
17.3 Resistance measurements	108
17.4 Period-averaging measurements	114
17.5 Pulse measurements	114
17.6 Vibrating wire measurements	120

17.1 Voltage measurements

Voltage measurements are made using an Analog-to-Digital Converter (ADC). A high-impedance Programmable-Gain Amplifier (PGA) amplifies the signal. Internal multiplexers route individual terminals within the amplifier. The CRBasic measurement instruction controls the ADC gain and configuration – either single-ended or differential input. Information on the differences between single-ended and differential measurements can be found here: [Deciding between single-ended or differential measurements](#) (p. 202).

A voltage measurement proceeds as follows:

1. Set PGA gain for the voltage range selected with the CRBasic measurement instruction parameter **Range**. Set the ADC for the first notch frequency selected with **fN1**.
2. If used, such as with bridge measurements, turn on excitation to the level selected with **ExmV**.
3. Multiplex selected terminals (**SEChan** or **DiffChan**).
4. Delay for the entered settling time (**SettlingTime**).
5. Perform the analog-to-digital conversion.
6. Repeat for input reversal as determined by parameter **RevDiff**.
7. Apply multiplier (**Mult**) and offset (**Offset**) to measured result.

Conceptually, analog voltage sensors output two signals: high and low. For example, a sensor that outputs 1000 mV on the high signal and 0 mV on the low has an overall output of 1000 mV. A sensor that outputs 2000 mV on the high signal and 1000 mV on the low also has an overall output of 1000 mV. Sometimes, the low signal is simply sensor ground (0 mV). A single-ended

measurement measures the high signal with reference to ground; the low signal is tied to ground. A differential measurement measures the high signal with reference to the low signal. Each configuration has a purpose, but the differential configuration is usually preferred.

In general, use the smallest input range that accommodates the full-scale output of the sensor. This results in the best measurement accuracy and resolution (see [Analog measurement specifications](#) (p. 272) for more information).

A set overhead reduces the chance of overrange. Overage limits are available in the specifications. The data logger indicates a measurement overrange by returning a **NAN** for the measurement.

WARNING:

Sustained voltages in excess of -6 V or +9 V (SE1, SE2), ±17 V (SE3 to SE4) applied to terminals configured for analog input will damage CR350 circuitry.

17.1.1 Single-ended measurements

A single-ended measurement measures the difference in voltage between the terminal configured for single-ended input and the reference ground. For example, single-ended channel 1 is comprised of terminals **SE 1** and \ominus . Single-ended terminals are labeled in blue. For more information, see [Wiring panel and terminal functions](#) (p. 8). The single-ended configuration is used with the following CRBasic instructions:

- [Vol_tSE\(\)](#)
- [BrHa_lf\(\)](#)
- [BrHa_lf3W\(\)](#)
- [TCSE\(\)](#)
- [Therm107\(\)](#)
- [Therm108\(\)](#)
- [Therm109\(\)](#)

See the *CRBasic Editor* help for detailed instruction information and program examples: <https://help.campbellsci.com/crbasic/cr350/>.

17.1.2 Differential measurements

A differential measurement measures the difference in voltage between two input terminals. For example, DIFF channel 1 is comprised of terminals 1H and 1L, with 1H as high and 1L as low. For more information, see [Wiring panel and terminal functions](#) (p. 8). The differential configuration is used with the following CRBasic instructions:

- `VolDiff()`
- `BrFull()`
- `BrFull6W()`
- `BrHalf4W()`
- `TCDiff()`

For more information on voltage measurements, see [Improving voltage measurement quality](#) (p. 202) and [Analog measurement specifications](#) (p. 272).

17.2 Current-loop measurements

Terminals SE1 and SE2 can be configured to make analog current measurements using the `CurrentSE()` instruction. Current is measured across the 100 Ω resistor with 140 Ω total resistance to ground. The following image shows a simplified schematic of a current measurement.

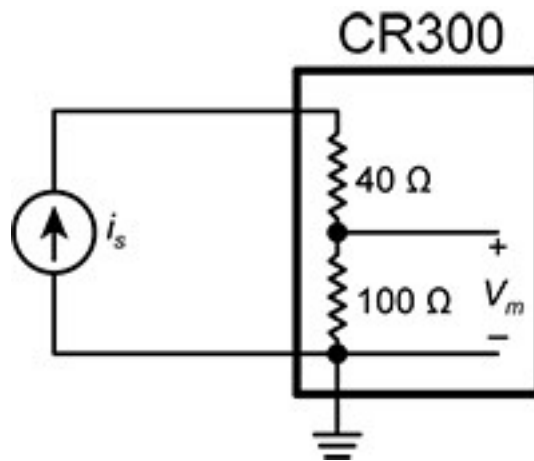

Use a CURS100 terminal input module when an application needs more than 2 current inputs or measurements. For detailed instructions, see <http://www.campbellsci.com/curs100>.

17.2.1 Voltage ranges for current measurements

The data logger measures the current through the use of a 100 Ω resistor. Thus, like a single-ended voltage instruction, it requires a voltage range option. In general, use the smallest fixed-

input range that accommodates the full-scale output of the transmitter. This results in the best measurement accuracy and resolution.

To select the appropriate voltage range, the expected current output range must be known. Using Ohm's Law, multiply the maximum expected current by $100\ \Omega$ to find the maximum voltage to be measured. Because the maximum voltage input is 2500 mV, the maximum current input must be 25 mA or less.

17.2.2 Example current-loop measurement connections

The following table shows example schematics for connecting typical current sensors and devices. See also [Current-loop measurement specifications](#) (p. 275).

Sensor type	Connection example
2-wire transmitter using data logger power	
2-wire transmitter using external power	

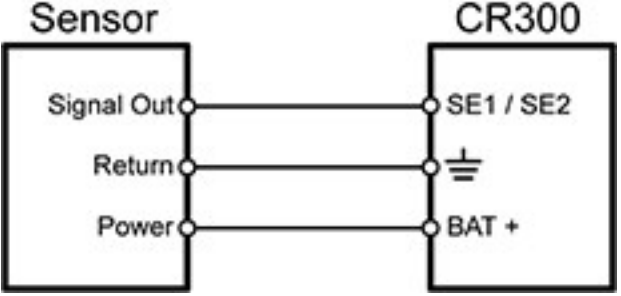
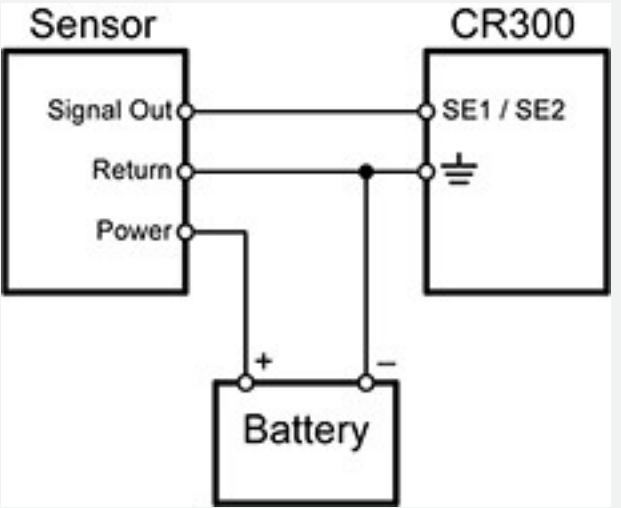
Sensor type	Connection example
3-wire transmitter using data logger power	
3-wire transmitter using external power	

Sensor type	Connection example
4-wire transmitter using data logger power	
4-wire transmitter using external power	

17.3 Resistance measurements

Bridge resistance is determined by measuring the difference between a known voltage applied to the excitation (input) of a resistor bridge and the voltage measured on the output arm. The data logger supplies a precise voltage excitation via **VX** terminals. Return voltage is measured on analog input terminals configured for single-ended (**SE**) or differential (**DIFF**) input. The result of the measurement is a ratio of measured voltages.

See also [Resistance measurement specifications](#) (p. 274).

17.3.1 Resistance measurements with voltage excitation

CRBasic instructions for measuring resistance with voltage excitation include:

- [BrHalf\(\)](#) - half bridge
- [BrHalf3W\(\)](#) - three-wire half bridge
- [BrHalf4W\(\)](#) - four-wire half bridge

- **BrFull()** - four-wire full bridge
- **BrFull6W()** - six-wire full bridge

See the *CRBasic Editor* help for detailed instruction information and program examples:
<https://help.campbellsci.com/crbasic/cr350/>

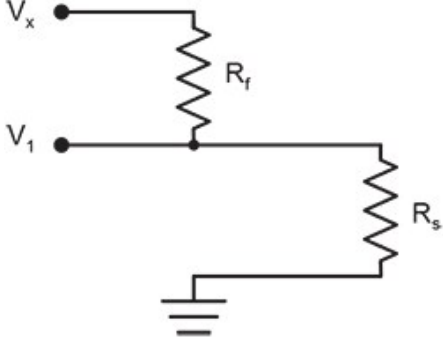
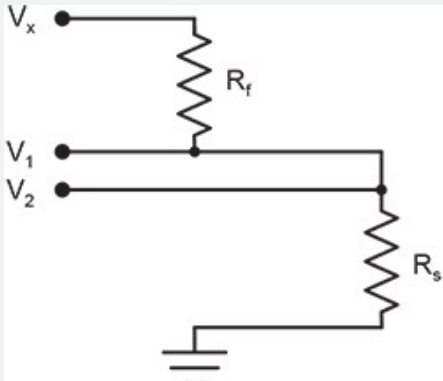
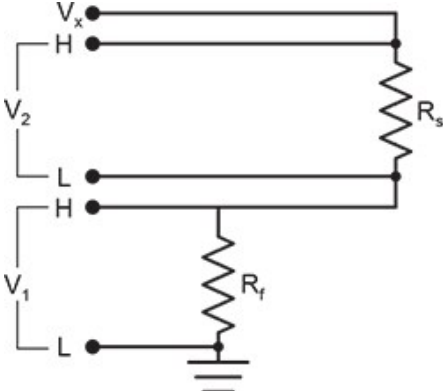
Resistive-bridge type and circuit diagram	CRBasic instruction and fundamental relationship	Relational formulas
<p style="text-align: center;">Half Bridge¹</p> 	<p>CRBasic Instruction: BrHalf()</p> <p>Fundamental Relationship: $X = \text{result w/mult} = 1, \text{offset} = 0$ $X = \frac{V_1}{V_x} = \frac{R_s}{R_s + R_f}$</p>	$R_s = R_f \frac{X}{1 - X}$ $R_f = \frac{R_s(1 - X)}{X}$
<p style="text-align: center;">Three Wire Half Bridge^{1,2}</p> 	<p>CRBasic Instruction: BrHalf3W()</p> <p>Fundamental Relationship: $X = \text{result w/mult} = 1, \text{offset} = 0$ $X = \frac{2V_2 - V_1}{V_x - V_1} = \frac{R_s}{R_f}$</p>	$R_s = R_f X$ $R_f = \frac{R_s}{X}$
<p style="text-align: center;">Four Wire Half Bridge^{1,2}</p> 	<p>CRBasic Instruction: BrHalf4W()</p> <p>Fundamental Relationship: $X = \text{result w/mult} = 1, \text{offset} = 0$ $X = \frac{V_2}{V_1} = \frac{R_s}{R_f}$</p>	$R_f = \frac{R_s}{X}$ $R_s = R_f X$

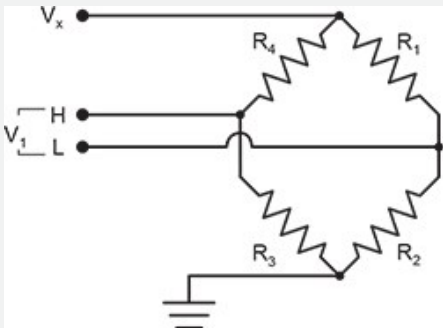
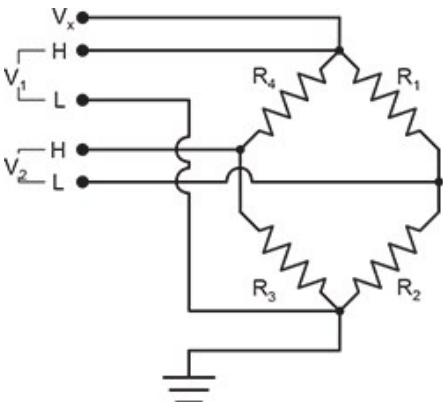
Resistive-bridge type and circuit diagram	CRBasic instruction and fundamental relationship	Relational formulas
<p style="text-align: center;">Full Bridge^{1,2}</p> 	<p style="text-align: center;">CRBasic Instruction: BrFull()</p> <p style="text-align: center;">Fundamental Relationship:</p> <p style="text-align: center;">$X = \text{result w/mult} = 1, \text{offset} = 0$</p> <p style="text-align: center;">$X = 1000 \frac{V_1}{V_x} = 1000 \left(\frac{R_3}{R_3+R_4} - \frac{R_2}{R_1+R_2} \right)$</p>	<p style="text-align: center;">These relationships apply to to BrFull() and BrFull6W()</p> <div style="border: 1px solid black; padding: 5px; margin: 5px 0;"> $R_1 = \frac{R_2(1 - X_1)}{X_1}$ $R_2 = \frac{R_1 X_1}{1 - X_1}$ </div> <p style="text-align: center;">where $X_1 = \frac{-X}{1000} + \frac{R_3}{R_3+R_4}$</p> <div style="border: 1px solid black; padding: 5px; margin: 5px 0;"> $R_3 = \frac{R_4 X_2}{1 - X_2}$ $R_4 = \frac{R_3(1 - X_2)}{X_2}$ </div> <p style="text-align: center;">where $X_2 = \frac{X}{1000} + \frac{R_2}{R_1+R_2}$</p>
<p style="text-align: center;">Six Wire Full Bridge¹</p> 	<p style="text-align: center;">CRBasic Instruction: BrFull6W()</p> <p style="text-align: center;">Fundamental Relationship:</p> <p style="text-align: center;">$X = \text{result w/mult} = 1, \text{offset} = 0$</p> <p style="text-align: center;">$X = 1000 \frac{V_2}{V_1} = 1000 \left(\frac{R_3}{R_3+R_4} - \frac{R_2}{R_1+R_2} \right)$</p>	<p style="text-align: center;">These relationships apply to to BrFull6W()</p>

¹ Key: V_x = excitation voltage; V_1, V_2 = sensor return voltages; R_f = fixed, bridge or completion resistor; R_s = variable or sensing resistor.

² Campbell Scientific offers terminal input modules to facilitate this measurement.

Offset voltage compensation applies to bridge measurements. **RevDiff** and **MeasOff** parameters are discussed in [Minimizing offset voltages](#) (p. 213). Much of the offset error inherent in bridge measurements is canceled out by setting **RevDiff** and **MeasOff** to **True**.

CRBasic Example 1: Four-wire full-bridge measurement and processing

```

'This program example demonstrates the measurement and
'processing of a four-wire resistive full bridge.
'In this example, the default measurement stored
' in variable X is deconstructed to determine the
' resistance of the R1 resistor, which is the variable
' resistor in most sensors that have a four-wire
' full-bridge as the active element.
' Declare Variables
Public X
```

CRBasic Example 1: Four-wire full-bridge measurement and processing

```
Public X_1
Public R_1
Public R_2 = 1000 'Resistance of fixed resistor R2
Public R_3 = 1000 'Resistance of fixed resistor R3
Public R_4 = 1000 'Resistance of fixed resistor R4
'Main Program
BeginProg
  Scan(500,mSec,1,0)
  'Full Bridge Measurement:
  BrFull(X,1,mV2500,1,Vx1,1,2500,False,True,0,60,1.0,0.0)
  X_1 = ((-1 * X) / 1000) + (R_3 / (R_3 + R_4))
  R_1 = (R_2 * (1 - X_1)) / X_1
  NextScan
EndProg
```

17.3.2 RTD and PRT

RTDs (resistance temperature detectors) are resistive devices made of platinum, nickel, copper, or other material. Platinum RTDs, known as PRTs (platinum resistance thermometers) are very accurate temperature measurement sensors.

A PRT element is a specialized resistor with two connection points. Most PRTs are either 100 Ω or 1000 Ω. This number is the resistance the PRT has at 0 °C. The resistance of a PRT increases as it is warmed. Industry standards define how PRTs respond to temperature.

BrHalf4W() in combination with **PRTCalc()** are the recommended CRBasic instructions for measuring RTDs.

See the *CRBasic Editor* help for detailed instruction information and program examples: <https://help.campbellsci.com/crbasic/cr350/>

17.3.3 Strain measurements

A principal use of the four-wire full bridge is the measurement of strain gages in structural stress analysis. **StrainCalc()** calculates microstrain (με) from the formula for the specific bridge configuration used. All strain gages supported by **StrainCalc()** use the full-bridge schematic. 'Quarter-bridge', 'half-bridge' and 'full-bridge' refer to the number of active elements in the bridge schematic. In other words, a quarter-bridge strain gage has one active element, a half-bridge has two, and a full-bridge has four.

StrainCalc() requires a bridge-configuration code. The following table shows the equation used by each configuration code. Each code can be preceded by a dash (-). Use a code without the dash when the bridge is configured so the output decreases with increasing strain. Use a

dashed code when the bridge is configured so the output increases with increasing strain. A dashed code sets the polarity of V_r to negative.



Table 17-1: StrainCalc() configuration codes	
BrConfig code	Configuration
1	Quarter-bridge strain gage: $\mu\varepsilon = \frac{-4 * 10^6 V_r}{GF(1 + 2V_r)}$
2	Half-bridge strain gage. One gage parallel to strain, the other at 90° to strain: $\mu\varepsilon = \frac{-4 * 10^6 V_r}{GF[(1 + \nu) - 2V_r(\nu - 1)]}$
3	Half-bridge strain gage. One gage parallel to + ε , the other parallel to - ε : $\mu\varepsilon = \frac{-2 * 10^6 V_r}{GF}$
4	Full-bridge strain gage. Two gages parallel to + ε , the other two parallel to - ε : $\mu\varepsilon = \frac{-10^6 V_r}{GF}$

Table 17-1: StrainCalc() configuration codes

BrConfig code	Configuration
5	<p>Full-bridge strain gage. Half the bridge has two gages parallel to $+\epsilon$ and $-\epsilon$, and the other half to $+\nu\epsilon$ and $-\nu\epsilon$</p> $\mu\epsilon = \frac{-2 * 10^6 V_r}{GF(\nu + 1)}$
6	<p>Full-bridge strain gage. Half the bridge has two gages parallel to $+\epsilon$ and $-\nu\epsilon$, and the other half to $-\nu\epsilon$ and $+\epsilon$:</p> $\mu\epsilon = \frac{-2 * 10^6 V_r}{GF[(\nu + 1) - \nu(\nu - 1)]}$
<p>Where:</p> <p>ν: Poisson's Ratio (0 if not applicable).</p> <p>GF: Gage Factor.</p> <p>V_r: 0.001 (Source-Zero) if BRConfig code is positive (+).</p> <p>V_r: -0.001 (Source-Zero) if BRConfig code is negative (-).</p> <p>and where:</p> <p>"source": the result of the full-bridge measurement ($X = 1000 \cdot V1 / Vx$) when multiplier = 1 and offset = 0.</p> <p>"zero": gage offset to establish an arbitrary zero.</p>	

17.3.4 Accuracy for resistance measurements

Consult the following technical papers for in-depth treatments of several topics addressing voltage measurement quality:

- [Preventing and Attacking Measurement Noise Problems](#) 
- [Benefits of Input Reversal and Excitation Reversal for Voltage Measurements](#) 
- [Voltage Measurement Accuracy, Self- Calibration, and Ratiometric Measurements](#) 

NOTE:

Error discussed in this section and error-related specifications of the CR350 do not include error introduced by the sensor, or by the transmission of the sensor signal to the data logger.

For accuracy specifications of ratiometric resistance measurements, see [Resistance measurement specifications](#) (p. 274). Voltage measurement is variable V_1 or V_2 in resistance measurements. Offset is the same as that for simple analog voltage measurements.

Assumptions that support the ratiometric-accuracy specification include:

- Data logger is within factory calibration specification.
- Effects due to the following are not included in the specification:
 - Bridge-resistor errors
 - Sensor noise
 - Measurement noise

17.4 Period-averaging measurements

Use [PeriodAvg\(\)](#) to measure the period (in microseconds) or the frequency (in Hz) of a signal on a single-ended channel. For these measurements, the data logger uses a high-frequency digital clock to measure time differences between signal transitions, whereas pulse-count measurements simply accumulate the number of counts. As a result, period-average measurements offer much better frequency resolution per measurement interval than pulse-count measurements. See also [Pulse measurements](#) (p. 114).

SE 1-4 terminals on the data logger are configurable for measuring the period of a signal.

See also [Period-averaging measurement specifications](#) (p. 274).

TIP:

Both pulse count and period-average measurements are used to measure frequency output sensors. However, their measurement methods are different. Pulse count measurements use dedicated hardware - pulse count accumulators, which are always monitoring the input signal, even when the data logger is between program scans. In contrast, period-average measurements use program instructions that only monitor the input signal during a program scan. Consequently, pulse count scans can occur less frequently than period-average scans. Pulse counters may be more susceptible to low-frequency noise because they are always "listening", whereas period-averaging measurements may filter the noise by reason of being "asleep" most of the time.

Pulse count measurements are not appropriate for sensors that are powered off between scans, whereas period-average measurements work well since they can be placed in the scan to execute only when the sensor is powered and transmitting the signal.

17.5 Pulse measurements

The output signal generated by a pulse sensor is a series of voltage waves. The sensor couples its output signal to the measured phenomenon by modulating wave frequency. The data logger detects the state transition as each wave varies between voltage extremes (high-to-low or low-to-high). Measurements are processed and presented as counts, frequency, or timing data. Both

pulse count and period-average measurements are used to measure frequency-output sensors. For more information, see [Period-averaging measurements](#) (p. 114).

The data logger includes terminals that are configurable for pulse input as shown in the following image.

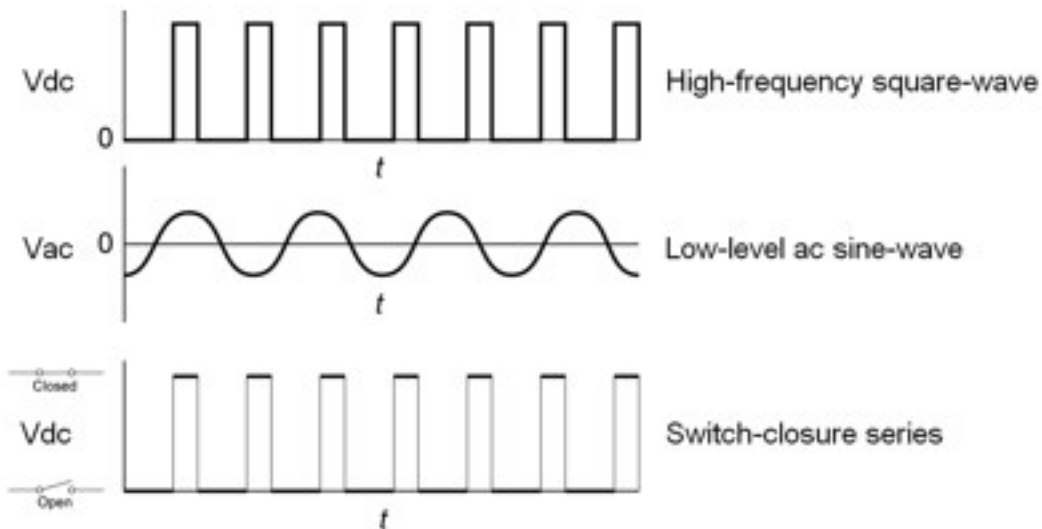

Table 17-2: Pulse input terminals and the input types they can measure

Input type	Pulse input terminal
High-frequency	C (all) SE 1-4 P_SW P_LL
Low-level AC	P_LL
Switch-closure	C (all) P_SW

Using the `PulseCount()` instruction, P_LL, P_SW, SE 1-4, and C terminals are configurable for pulse input to measure counts or frequency. Maximum input frequency is dependent on input voltage. If pulse input voltages exceed the maximum voltage, third-party external-signal conditioners should be employed. Do not measure voltages greater than 20 V.

Terminals configured for pulse input have internal filters that reduce electronic noise, and thus reduce false counts. Internal AC coupling is used to eliminate DC offset voltages. For tips on working with pulse measurements, see [Pulse measurement tips](#) (p. 119).

Output can be recorded as counts, frequency or a running average of frequency.

See also [Pulse measurement specifications](#) (p. 275).

See the *CRBasic Editor* help for detailed instruction information and program examples: <https://help.campbellsci.com/crbasic/cr350/>

17.5.1 Low-level AC measurements

Low-level AC (alternating current or sine-wave) signals can be measured on P_LL terminals. AC generator anemometers typically output low-level AC.

Measurement output options include the following:

- Counts
- Frequency (Hz)
- Running average

Rotating magnetic-pickup sensors commonly generate AC voltage ranging from millivolts at low-rotational speeds to several volts at high-rotational speeds.

CRBasic instruction: [PulseCount\(\)](#). See the *CRBasic Editor* help for detailed instruction information and program examples: <https://help.campbellsci.com/crbasic/cr350/>

Low-level AC signals cannot be measured directly by C terminals. Peripheral terminal expansion modules, such as the Campbell Scientific LLAC4, are available for converting low-level AC signals to square-wave signals measurable by C terminals.

For more information, see [Pulse measurement specifications](#) (p. 275).

17.5.2 High-frequency measurements

High-frequency (square-wave) signals can be measured on terminals:

- P_LL, P_SW, SE 1-4 or C

Common sensors that output high-frequency pulses include:

- Photo-chopper anemometers
- Flow meters

Measurement output options include counts, frequency in hertz, and running average.

- CRBasic instruction: [PulseCount\(\)](#)

17.5.3 Switch-closure and open-collector measurements

Switch-closure and open-collector (also called current-sinking) signals can be measured on terminals:

- P_SW or C

Mechanical switch-closures have a tendency to bounce before solidly closing. Unless filtered, bounces can cause multiple counts per event. The data logger automatically filters bounce. Because of the filtering, the maximum switch-closure frequency is less than the maximum high-frequency measurement frequency. Sensors that commonly output a switch-closure or an open-collector signal include:

- Tipping-bucket rain gages
- Switch-closure anemometers
- Flow meters

Data output options include counts, frequency (Hz), and running average.

17.5.3.1 P_SW Terminal

An internal 47 kΩ pull-up resistor pulls an input to 3.3 VDC with the switch open, whereas a switch-closure to ground pulls the input to 0 V.

- CRBasic instruction: [PulseCount\(\)](#). See the *CRBasic Editor* help for detailed instruction information and program examples: <https://help.campbellsci.com/crbasic/cr350/>

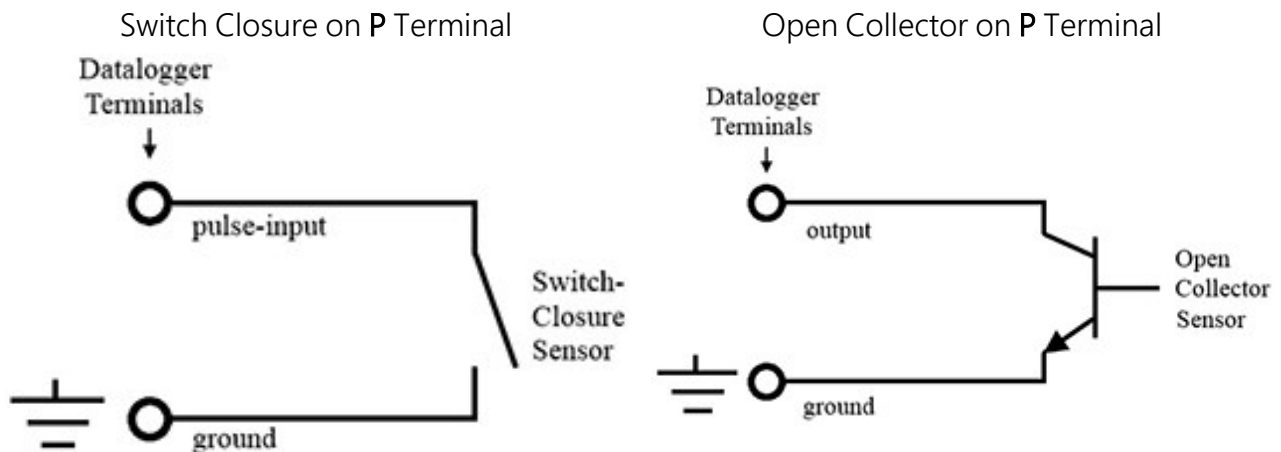

17.5.3.2 C terminals

Switch-closure measurements on C terminals require a 100 k Ω pull-up resistor to 12 V. Switch-closure mode is a special case edge-count function that measures dry-contact switch-closures or open collectors. The operating system filters bounces.

- CRBasic instruction: [PulseCount\(\)](#).

See also [Power output specifications](#) (p. 271).

17.5.4 Quadrature measurements

The [Quadrature\(\)](#) instruction is used to measure shaft or rotary encoders. A shaft encoder outputs a signal to represent the angular position or motion of the shaft. Each encoder will have two output signals, an A line and a B line. As the shaft rotates the A and B lines will generate digital pulses that can be read, or counted, by the data logger.

In the following example, channel A leads channel B, therefore the encoder is determined to be moving in a clockwise direction. If channel B led channel A, it would be determined that the encoder was moving in a counterclockwise direction.

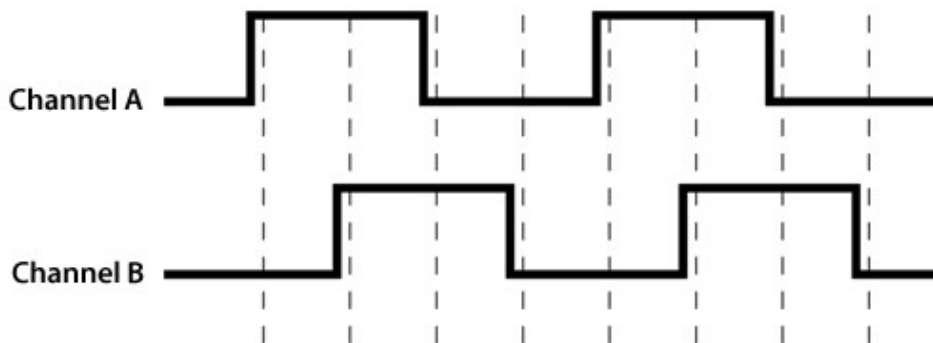

Terminals SE1 and SE2 or C1 and C2 can be configured as digital pairs to monitor the two channels of an encoder. The [Quadrature\(\)](#) instruction can return:

- The accumulated number of counts from channel A and channel B. Count will increase if channel A leads channel B. Count will decrease if channel B leads channel A.
- The net direction.
- Number of counts in the A-leading-B direction.
- Number of counts in the B-leading-A direction.

Counting modes:

- Counting the increase on rising edge of channel A when channel A leads channel B. Counting the decrease on falling edge of channel A when channel B leads channel A.
- Counting the increase at each rising and falling edge of channel A when channel A leads channel B. Counting the decrease at each rising and falling edge of channel A when channel A leads channel B.
- Counting the increase at each rising and falling edge of both channels when channel A leads channel B. Counting the decrease at each rising and falling edge of both channels when channel B leads channel A.

For more information, see [Digital input/output specifications](#) (p. 277).

17.5.5 Pulse measurement tips

The **PulseCount** () instruction uses dedicated 24-bit counters to accumulate all counts over the programmed scan interval. The resolution of pulse counters is one count. Counters are read at the beginning of each scan and then cleared. Counters will overflow if accumulated counts exceed 16,777,216 (2^{24}), resulting in erroneous measurements. See the *CRBasic Editor* help for detailed instruction information and program examples:

<https://help.campbellsci.com/crbasic/cr350/> .

Counts are the preferred **PulseCount** () output option when measuring the number of tips from a tipping-bucket rain gage or the number of times a door opens. Many pulse-output sensors, such as anemometers and flow meters, are calibrated in terms of frequency (Hz) so are usually measured using the **PulseCount** () frequency-output option.

Use the **LLAC4** module to convert non-TTL-level signals, including low-level AC signals, to TTL levels for input to **C** terminals

Understanding the signal to be measured and compatible input terminals and CRBasic instructions is helpful. See [Pulse input terminals and the input types they can measure](#) (p. 115).

17.5.5.1 Input filters and signal attenuation

Terminals configured for pulse input have internal filters that reduce electronic noise. The electronic noise can result in false counts. However, input filters attenuate (reduce) the amplitude (voltage) of the signal. Attenuation is a function of the frequency of the signal. Higher-frequency signals are attenuated more. If a signal is attenuated too much, it may not pass the detection thresholds required by the pulse count circuitry. See [Pulse measurement specifications](#) (p. 275) for more information. The listed pulse measurement specifications account for attenuation due to input filtering.

17.5.5.2 Pulse count resolution

Longer scan intervals result in better resolution. `PulseCount()` resolution is 1 pulse per scan. On a 1 second scan, the resolution is 1 pulse per second. The resolution on a 10 second scan interval is 1 pulse per 10 seconds, which is 0.1 pulses per second. The resolution on a 100 millisecond interval is 10 pulses per second.

For example, if a flow sensor outputs 4.5 pulses per second and you use a 1 second scan, one scan will have 4 pulses and the next 5 pulses. Scan to scan, the flow number will bounce back and forth. If you did a 10 second scan (or saved a total to a 10 second table), you would get 45 pulses. The total is 45 pulses for every 10 seconds. An average will correctly show 4.5 pulses per second. You wouldn't see the reading bounce on the longer time interval.

17.6 Vibrating wire measurements

The data logger can measure vibrating wire sensors through vibrating-wire interface modules. Vibrating wire sensors are the sensor of choice in many environmental and industrial applications that need sensor stability over very long periods, such as years or even decades. A thermistor included in most sensors can be measured to compensate for temperature errors.

17.6.1 VSPECT®

Measuring the resonant frequency by means of period averaging is the classic technique, but Campbell Scientific has developed static and dynamic spectral-analysis techniques (VSPECT) that produce superior noise rejection, higher resolution, diagnostic data, and, in the case of dynamic VSPECT, measurements up to 333.3 Hz. For detailed information on VSPECT, see [Vibrating Wire Spectral Analysis Technology](#) .

18. Communications protocols

Data loggers communicate with data logger support software, other Campbell Scientific data loggers, and other hardware and software using a number of protocols including PakBus, Modbus, DNP3, and TCP/IP. Several industry-specific protocols are also supported. See also [Communications specifications](#) (p. 278).

18.1 General serial communications	122
18.2 Modbus communications	127
18.3 Internet communications	136
18.4 MQTT	138
18.5 DNP3 communications	149
18.6 PakBus communications	150
18.7 SDI-12 communications	150

Some communications services, such as satellite networks, can be expensive to send and receive information. Best practices for reducing expense include:

- Declare **Public** only those variables that need to be public. Other variables should be declared as **Dim**.
- Be conservative with use of string variables and string variable sizes. Make string variables as big as they need to be and no more. The default size, if not specified, is 24 bytes, but the minimum is 4 bytes. Declare string variables **Public** and sample string variables into data tables only as needed.
- When using **GetVariables()** / **SendVariables()** to send values between data loggers, put the data in an array and use one command to get the multiple values. Using one command to get 10 values from an array and swath of 10 is more efficient (requires only 1 transaction) than using 10 commands to get 10 single values (requires 10 transactions). See the *CRBasic Editor* help for detailed instruction information and program examples: <https://help.campbellsci.com/crbasic/cr350/>.

- Set the data logger to be a PakBus router only as needed. When the data logger is a router, and it connects to another router like *LoggerNet*, it exchanges routing information with that router and, possibly (depending on your settings), with other routers in the network. Network Planner set this appropriately when it is used. This is also set through the **IsRouter** setting in the Settings Editor. For more information, see the Device Configuration **Settings Editor IsRouter** (p. 229).
- Set PakBus beacons and verify intervals properly. For example, there is no need to verify routes every five minutes if communications are expected only every 6 hours. Network Planner will set this appropriately when it is used. This is also set through the **Beacon** and **Verify** settings in the **Settings Editor**. For more information, see the Device Configuration **Settings Editor Beacon()** and **Verify()** settings.

For information on Designing a PakBus network using the Network Planner tool in *LoggerNet*, watch the following video: <https://www.campbellsci.com/videos/loggernet-software-network-planner> .

18.1 General serial communications

The data logger supports two-way serial communications. These communications ports can be used with smart sensors that deliver measurement data through serial-data protocols, or with devices such as modems, that communicate using serial data protocols.

CRBasic instructions for general serial communications include:

- `SerialOpen()`
- `SerialClose()`
- `SerialIn()`
- `SerialInRecord()`
- `SerialInBlock()`
- `SerialInChk()`
- `SerialOut()`
- `SerialOutBlock()`
- `SerialBrk()`
- `SerialFlush()`

See the *CRBasic Editor* help for detailed instruction information and program examples: <https://help.campbellsci.com/crbasic/cr350/> .

To communicate over a serial port, it is important to be familiar with the protocol used by the device with which you will be communicating. Refer to the manual of the sensor or device to find its protocol and then select the appropriate options for each CRBasic parameter. See the application note [Interfacing Serial Sensors with Campbell Scientific Dataloggers](#)  for more programming details and examples.

Configure **COM** terminals as serial ports using *Device Configuration Utility* or by using the [SerialOpen\(\)](#) CRBasic instruction. Terminals are configured in pairs for TTL, RS-232, and half-duplex RS-422 and RS-485 communications. For full-duplex RS-422 and RS-485, four terminals are required.

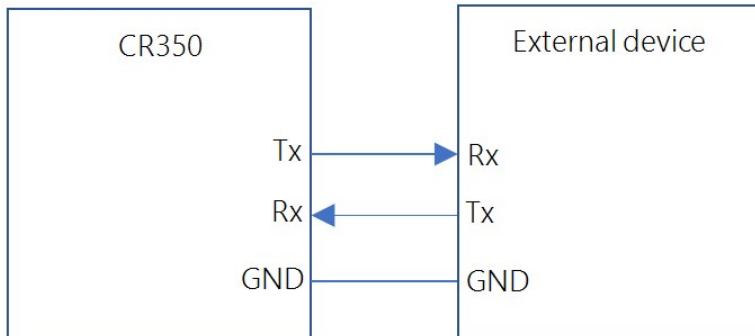

Figure 18-1. RS-232 single-ended full-duplex communications

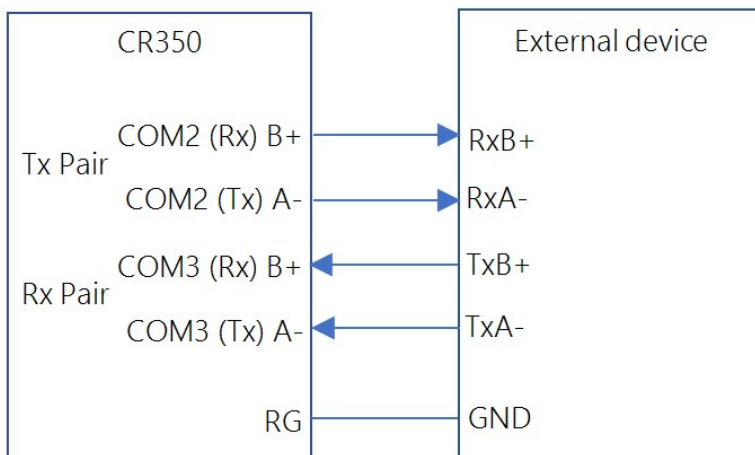

Figure 18-2. RS-485/RS-422 differential-pair full-duplex communications

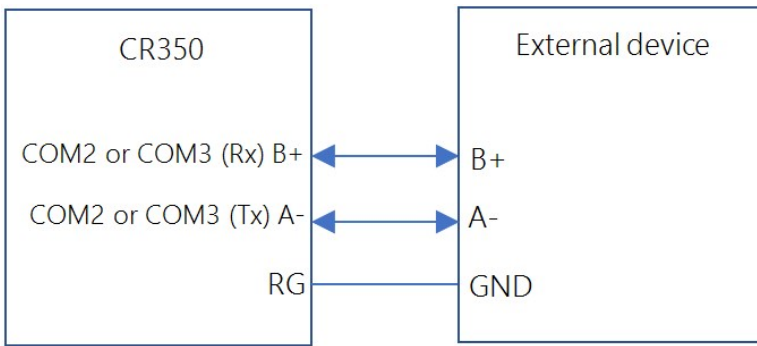

Figure 18-3. RS-485 differential-pair half-duplex communications

	RS-232	RS-485/ RS-422	TTL	TTL-INV
Communications	Point-to-point	Multi-drop	Point-to-point	Point-to-point
Maximum number of devices	1 Transmitter 1 Receiver	32 Transmitters 32 Receivers	1 Tx 1 Rx	1 Tx 1 Rx
Mode type	Full duplex	Full duplex Half duplex	Full duplex	Full duplex
Reference	Single wire Tx ref to GND	Differential pair TxB+ referenced to TxA-	Single wire Tx referenced to GND	
Voltage range	-25 V to 25 V	-5 V to 5 V	0 V to 5 V	0 V to 5 V
Idle voltage	-25 V to -3 V	-0.2 V to 5 V	5 V	0 V

18.1.1 RS-232

RS-232 supports point-to-point communications between one base (usually the data logger) and one external device. See [Figure 18-1](#) (p. 123). Data bits are sent from the base to external devices across the transmit (Tx) line with respect to DC ground. The Tx line idle state is between -25 V and -3 V, depending on the transmitter. The transition from negative voltage to above 3 V begins data transmission.

NOTE:

Most RS-232 devices are also compatible with the data logger using TTL-inverted communications.

NOTE:

The data logger uses about -7 V to represent logic 1, and about 5.8 V to represent logic 0.

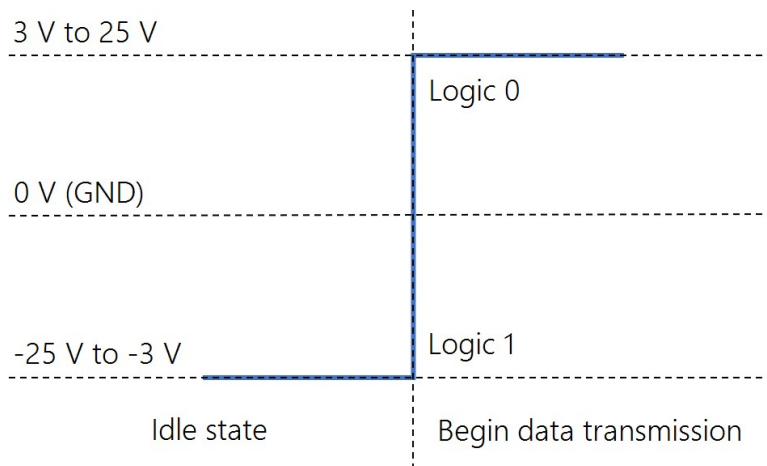

Figure 18-4. RS-232 Tx voltage with respect to GND

18.1.2 RS-485/RS-422

RS-485 and RS-422 support communications between 32 base and 32 external devices. See [Figure 18-3](#) (p. 124) and [Figure 18-2](#) (p. 123). Differential voltage between two lines (A & B) transmit data. When the voltage of B with respect to A is between -0.2 V and -5 V that is interpreted as logic 0. When the differential voltage in the range of positive 0.2 V to 5 V that is interpreted as logic 1.

NOTE:

The CR350 uses about -1 V to represent logic 0, and about 1 V to represent logic 1.

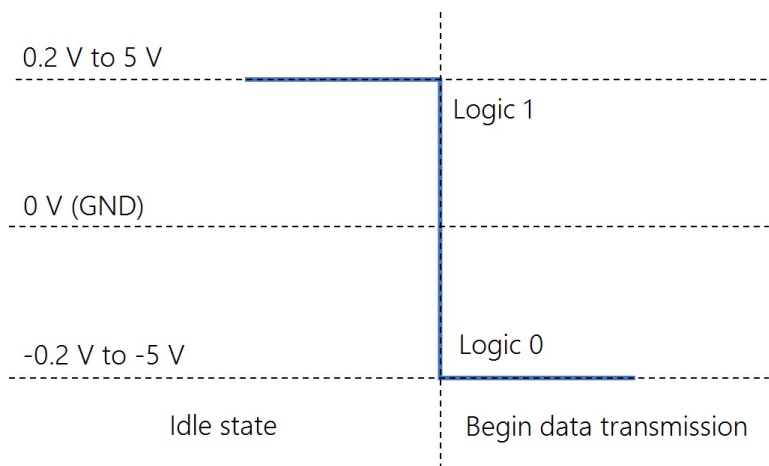

Figure 18-5. RS-485 Voltage B with respect to A

18.1.3 TTL

TTL supports point-to-point communications between one base and one external device. See [Figure 18-1](#) (p. 123). Data bits are sent from base to external device with a voltage between transmit (Tx) and ground. The transmit line idle state is 5 V (logic 1). Data is sent after one clock cycle once the voltage is pulled low (to 0 V).

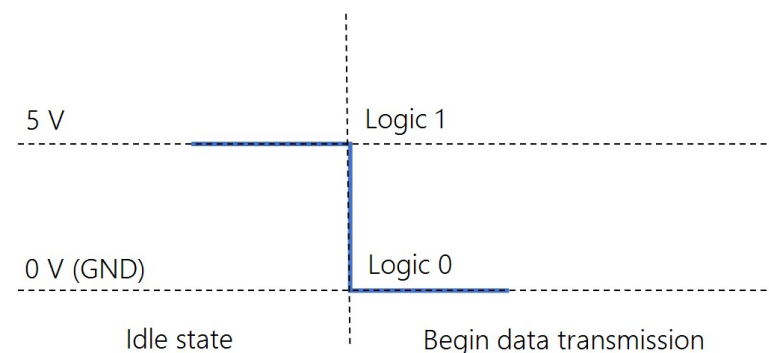

Figure 18-6. TTL Tx voltage with respect to GND

18.1.4 TTL-Inverted

The only difference between TTL-inverted and TTL is that the logic is inverted. The idle state for TTL-inverted is 0 V instead of 5 V. See [Figure 18-1](#) (p. 123). Data is sent after the voltage is pulled high (to 5 V).

NOTE:

Many RS-232 devices are compatible with this communications protocol.

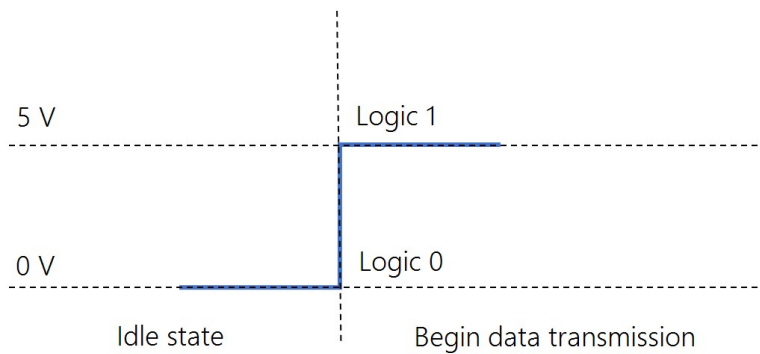

Figure 18-7. TTL-inverted Tx voltage with respect to GND

18.2 Modbus communications

The data logger supports Modbus RTU, Modbus ASCII, and Modbus TCP protocols and can be programmed as a Modbus client (master) or Modbus server (slave). These protocols are often used in SCADA networks. Data loggers can communicate using Modbus on all available communications ports. The data logger conducts Modbus over TCP using an Ethernet or Wireless connection. The data logger supports RTU and ASCII communications modes on RS-232 and RS-485 connections.

CRBasic Modbus instructions include:

- [ModbusClient\(\)](#)
- [ModbusServer\(\)](#)
- [MoveBytes\(\)](#)

See the *CRBasic Editor* help for detailed instruction information and program examples:

<https://help.campbellsci.com/crbasic/cr350/>

For additional information on Modbus, see:

- [About Modbus](#) (p. 128)
- [Why Modbus Matters: An Introduction](#)
- [How to Access Live Measurement Data Using Modbus](#)
- [Using Campbell Scientific Dataloggers as Modbus Slave Devices in a SCADA Network](#)

Because Modbus has a set command structure, programming the data logger to get data from field instruments can be much simpler than from some other serial sensors. Because Modbus uses a common bus and addresses each node, field instruments are effectively multiplexed to a data logger without additional hardware.

When doing Modbus communications over RS-232, the data logger, through *Device Configuration Utility* or the *Settings* editor, can be set to keep communications ports open and

awake, but at higher power usage. Set **RS-232Power** to **Always on**. Otherwise, the data logger goes into sleep mode after 40 seconds of communications inactivity. Once asleep, two packets are required before it will respond. The first packet awakens the data logger; the second packet is received as data. This would make a Modbus client fail to poll the data logger, if not using retries.

More information on Modbus can be found at:

- www.simplyModbus.ca/FAQ.htm 
- www.Modbus.org/tech.php 
- www.lammertbies.nl/comm/info/modbus.html 

18.2.1 About Modbus

Modbus is a communications protocol that enables communications among many devices connected to the same network. Modbus is often used in supervisory control and data acquisition (SCADA) systems to connect remote terminal units (RTUs) with a supervisory computer - allowing them to relay measurement data, device status, control commands, and configuration information.

The popularity of Modbus has grown because it is freely available and because its messaging structure is independent of the type of physical interface or connection that is used. Modbus can coexist with other types of connections on the same physical interface at the same time. You can operate the protocol over several data links and physical layers.

Modbus is supported by many industrial devices, including those offered by Campbell Scientific. Not only can intelligent devices such as microcontrollers and programmable logic controllers (PLCs) communicate using Modbus, but many intelligent sensors have a Modbus interface that enables them to send their data to host systems. Examples of using Modbus with Campbell Scientific data loggers include:

- Interfacing data loggers and Modbus-enabled sensors.
- Sending and retrieving data between data loggers and other industrial devices.
- Delivering environmental data to SCADA systems.
- Integrating Modbus data into PakBus networks, or PakBus data into Modbus networks.

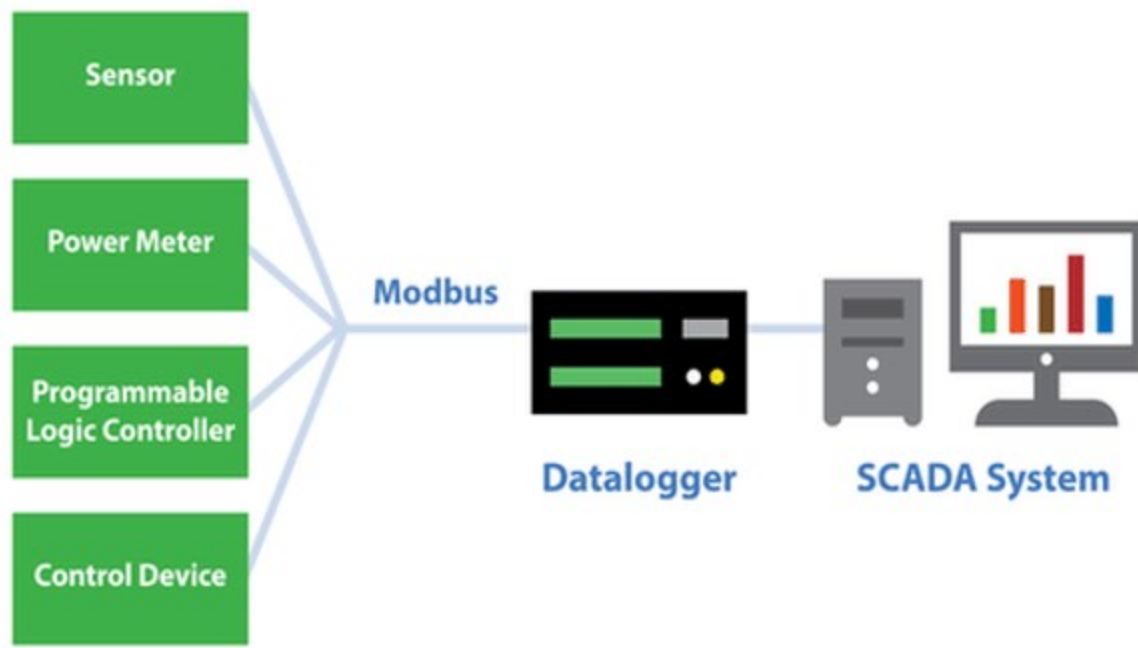

18.2.2 Modbus protocols

There are three standard variants of Modbus protocols:

- **Modbus RTU** — Modbus RTU is the most common implementation available for Modbus. Used in serial communications, data is transmitted in a binary format. The RTU format follows the commands/data with a cyclic redundancy check checksum.

NOTE:

The Modbus RTU protocol standard does not allow a delay between characters of 1.5 times or more the length of time normally required to receive a character. This is analogous to “pizza” being understood, and “piz za” being gibberish. It’s important to note that communications hardware used for Modbus RTU, such as radios, must transfer data as entire packets without injecting delays in the middle of Modbus messages.

- **Modbus ASCII** — Used in serial communications, data is transmitted as an ASCII representation of the hexadecimal values. Timing requirements are loosened, and a simpler longitudinal redundancy check checksum is used.
- **Modbus TCP/IP or Modbus TCP** — Used for communications over TCP/IP networks. The TCP/IP format does not require a checksum calculation, as lower layers already provide

checksum protection. The packet structure is similar to RTU, but uses a different header. Devices labeled as Modbus gateways will convert from Modbus TCP to Modbus RTU.

Campbell Scientific data loggers support Modbus RTU, Modbus ASCII, and Modbus TCP protocols. If the connection is over IP, Campbell Scientific data loggers always use Modbus TCP. Modbus server functionality over other comports use RTU. When acting as a client, the data logger can be switched between ASCII and RTU protocols using an option in the `ModbusClient()` instruction. See the *CRBasic Editor* help for detailed instruction information and program examples: <https://help.campbellsci.com/crbasic/cr350/> .

18.2.3 Understanding Modbus Terminology

Many of the object types are named from using Modbus in driving relays: a single-bit physical output is called a coil, and a single-bit physical input is called a discrete input or a contact.

Information is stored in the server device in up to four different tables. Two tables store on/off discrete values (coils) and two store numerical values (registers). The coils and registers each have a read-only table and read/write table.

18.2.4 Connecting Modbus devices

Data loggers can communicate with Modbus on all available communications ports. Consideration should be given to proper surge protection of any cabled connection. Between systems of significantly different ground potential, optical isolation may be appropriate. For additional information on grounds, see [Grounds](#) (p. 13).

18.2.5 Modbus client-server protocol

Modbus is a client-server protocol. The device requesting the information is called the Modbus client, and the devices supplying information are Modbus servers. In a standard Modbus network, there is one client and up to 247 servers. A client does not have a Modbus address. However, each Modbus server on a shared network has a unique address from 1 to 247.

A single Modbus client device initiates commands (requests for information), sending them to one or more Modbus server devices on the same network. Only the Modbus client can initiate communications. Modbus servers, in turn, remain silent, communicating only when responding to requests from the Modbus client.

Every message from the client will begin with the server address, followed by the function code, function parameters, and a checksum. The server will respond with a message beginning with its address, followed by the function code, data, and a checksum. The amount of data in the packet will vary, depending on the command sent to the server. Server devices only process one

command at a time. So, the client needs to wait for a response, or timeout before sending the next command.

A broadcast address is specified to allow simultaneous communications with all servers. Because response time of server devices is not specified by the standard, and device manufacturers also rarely specify a maximum response time, broadcast features are rarely used. When implementing a system, timeouts in the client will need to be adjusted to account for the observed response time of the servers.

Campbell Scientific data loggers can be programmed to be a Modbus client or Modbus server - or even both at the same time! This proves particularly helpful when your data logger is a part of two wider area networks. In one it uses Modbus to query data (as a client) from localized sensors or other data sources, and then in the other, it serves that data up (as a server) to another Modbus client.

18.2.6 About Modbus programming

Modbus capability of the data logger must be enabled through configuration or programming. See the *CRBasic Editor* help for detailed information on program structure, syntax, and each instruction available to the data logger.

CRBasic Modbus instructions include:

- [ModbusClient\(\)](#)
- [ModbusServer\(\)](#)
- [MoveBytes\(\)](#)

See the *CRBasic Editor* help for detailed instruction information and program examples:

<https://help.campbellsci.com/crbasic/cr350/> 

18.2.6.1 Endianness

Endianness refers to the sequential order in which bytes are arranged into larger numerical values when stored in memory. Words may be represented in big-endian or little-endian format, depending on whether bits or bytes or other components are ordered from the big end (most significant bit) or the little end (least significant bit).

In big-endian format, the byte containing the most significant bit is stored first, then the following bytes are stored in decreasing significance order, with the byte containing the least significant bit stored last. Little-endian format reverses this order: the sequence stores the least significant byte first and the most significant byte last. Endianness is used in some Modbus programming so it is important to note that the CR350 is a little-endian instrument.

18.2.6.2 Function codes

A function code tells the server which storage entity to access and whether to read from or write to that entity. Different devices support different functions (consult the device documentation for support information). The most commonly used functions (codes 01, 02, 03, 04, 05, 15, and 16) are supported by Campbell Scientific data loggers.

Most users only require the read- register functions. Holding registers are read with function code **03**. Input registers are read with function code **04**. This can be confusing, because holding registers are usually listed with an offset of 40,000 and input registers with an offset of 30,000. Don't mix up the function codes. Double check the register type in the device documentation.

Function code	Action	Entity
01 (01 hex)	Read	Discrete Output Coils
05 (05 hex)	Write single	Discrete Output Coil
15 (0F hex)	Write multiple	Discrete Output Coils
02 (02 hex)	Read	Discrete Input
04 (04 hex)	Read	Input Registers
03 (03 hex)	Read	Holding Registers
06 (06 hex)	Write single	Holding Register
16 (10 hex)	Write multiple	Holding Registers

The write-register functions will only work on holding registers. Function **06** only changes one 16-bit register, whereas function 16, changes multiple registers. Note, when writing registers, the **Variable** parameter for the `ModbusClient()` instruction refers to a source, not a destination.

18.2.7 Modbus information storage

With the Modbus protocol, most of the data values you want to transmit or receive are stored in registers. Information is stored in the server device in four different entities. Two store on/off discrete values (coils) and two store numerical values (registers). The four entities include:

- Coils – 1-bit registers, used to control discrete outputs (including Boolean values), read/write.
- Discrete Input – 1-bit registers, used as inputs, read only.
- Input Registers – 16-bit registers, used as inputs, read only.

- Holding Registers – 16-bit registers; used for inputs, output, configuration data, or any requirement for “holding” data; read/write.

See the *CRBasic Editor* help for detailed instruction information and program examples:

<https://help.campbellsci.com/crbasic/cr350/>

18.2.7.1 Registers

In a 16-bit memory location, a 4-byte value takes up two registers. The Modbus protocol always refers to data registers with a starting address number, and a length to indicate how many registers to transfer.

Campbell Scientific uses 1-based numbering (a common convention for numbering registers in equipment) in the `ModbusClient()` instruction. With 1-based numbering, the first data location is referred to as register number 1. Some equipment uses 0-based numbering (check the equipment documentation). With 0-based numbering, the first register is referred to as 0.

Reading register numbers can be complicated by the fact that register numbers are often written with an offset added. Input registers are written with an offset of 30000. So, the first input register is written as 30001, with 1-based numbering. Holding registers are numbered with an offset of 40000. You must remove the offset before writing the number as the **Start** parameter of `ModbusClient()`.

There are rare instances when equipment is designed with the registers mapped including the offset. That means 40001 in the documentation is really register number 40001. Those are rare instances, and the equipment is deviating from standards. If 1 or 2 don't work for the **Start** parameter, try 40001 and 40002.

18.2.7.2 Coils

Discrete digital I/O channels in Modbus are referred to as coils. The term coil has its roots in digital outputs operating solenoid coils in an industrial environment. Coils may be read only or read/write. A read only coil would be a digital input. A read/write coil is used as an output. Coils are read and manipulated with their own function codes, apart from the registers. Many modern devices do not use coils at all.

When working with coils, the data logger requires Boolean variables. When reading coils, each Boolean in an array will hold the state of one coil. A value of **True** will set the coil, a value of **False** will unset the coil.

18.2.7.3 Data Types

Modbus does not restrict what data types may be contained within holding and input registers. Equipment manufacturers need to indicate what binary data types they are using to store data. Registers are 16-bit, so 32-bit data types use 2 registers each. Some devices combine more registers together to support longer data types like strings. The `ModbusClient()` instruction has a `ModbusOption` parameter that supports several different data types.

When data types use more than 1 register per value, the register order within the data value is important. Some devices will swap the high and low bytes between registers. You can compensate for this by selecting the appropriate `ModbusOption`.

Byte order is also important when communicating data over Modbus. Big Endian byte order is the reverse of Little Endian byte order. It may not always be apparent which a device uses. If you receive garbled data, try reversing the byte order. Reversing byte order is done using the `MoveBytes()` instruction. There is an example in CRBasic help for reversing the bytes order of a 32-bit variable.

After properly reading in a value from a Modbus device, you might have to convert the value to proper engineering units. With integer data types, it is common to have the value transmitted in hundredths or thousandths.

Unsigned 16-bit integer

The most basic data type used with Modbus is unsigned 16-bit integers. It is the original Modbus data type with 1 register per value. On the data logger, declare your destination variable as type `Long`. A `Long` is a 32-bit signed integer that contains the value received. Select the appropriate `ModbusOption` to avoid post-processing.

Signed 16-bit integer

Signed 16-bit integers use 1 register per value. On the data logger, declare your destination variable as type `Long`. A `Long` is a 32-bit signed integer that contains the value received. Select the appropriate `ModbusOption` to avoid post-processing.

Signed 32-bit integer

Signed 32-bit integers require two registers per value. This data type corresponds to the native `Long` variable type in Campbell data loggers. Declare your variables as type `Long` before using them as the Variable parameter in `ModbusClient()`. Select the appropriate `ModbusOption` to avoid post-processing.

Unsigned 32-bit integer

Unsigned 32-bit integers require two registers per value. Declare your variables as type **Long** before using them as the **Variable** parameter in **ModbusClient()**. The **Long** data type is a signed integer, and does not have a range equal to that of an unsigned integer. If the integer value exceeds 2,147,483,647 it will display incorrectly as a negative number. If the value does not exceed that number, there are no issues with a variable of type **Long** holding it.

32-Bit floating point

32-bit floating point values use 2 registers each. This is the default **FLOAT** data type in Campbell Scientific data loggers. Select the appropriate **ModbusOption** to avoid post-processing.

18.2.8 Modbus tips and troubleshooting

Most of the difficulties with Modbus communications arise from deviations from the standards, which are not enforced within Modbus. Whether you are connecting via Modbus to a solar inverter, power meter, or flow meter, the information provided here can help you overcome the challenges, and successfully gather data into a Campbell data logger. Further information on Modbus can be found at:

- www.simplyModbus.ca/FAQ.htm 
- www.Modbus.org/tech.php 
- www.lammertbies.nl/comm/info/modbus.html 

18.2.8.1 Error codes

Modbus defines several error codes, which are reported back to a client from a server. **ModbusClient()** displays these codes as a negative number. A positive result code indicates no response was received.

Result code -01: illegal function

The illegal function error is reported back by a Modbus server when either it does not support the function at all, or does not support that function code on the requested registers. Different devices support different functions (consult the device documentation). If the function code is supported, make sure you are not trying to write to a register labeled as read-only. It is common for devices to have holding registers where read-only and read/write registers are mapped next to each other.

An uncommon cause for the **-01** result is a device with an incomplete implementation of Modbus. Some devices do not fully implement parsing Modbus commands. Instead, they are

hardcoded to respond to certain Modbus messages. The result is that the device will report an error when you try selectively polling registers. Try requesting all of the registers together.

Result code -02: illegal data address

The illegal data address error occurs if the server rejects the combination of starting register and length used. One possibility, is a mistake in your program on the starting register number. Refer to the earlier section about register number and consult the device documentation for support information. Also, too long of a length can trigger this error. The `ModbusClient()` instruction uses length as the number of values to poll. With 32-bit data types, it requests twice as many registers as the length.

An uncommon cause for the -02 result is a device with an incomplete implementation of Modbus. Some devices do not fully implement parsing Modbus commands. Instead, they are hard coded to respond to certain Modbus messages. The result is that the device will report an error when you try selectively polling registers. Try requesting all of the registers together.

Result code -11: COM port error

Result code -11 occurs when the data logger is unable to open the COM port specified. For serial connections, this error may indicate an invalid COM port number. For Modbus TCP, it indicates a failed socket connection.

If you have a failed socket connection for Modbus TCP, check your `TCPOpen()` instruction. The socket returned from `TCPOpen()` should be a number less than 99. Provided the data logger has a working network connection, further troubleshooting can be done with a computer running Modbus software. Connect the computer to the same network and attempt to open a Modbus TCP connection to the problem server device. Once you resolve the connection between the computer and the server device, the connection from the data logger should work.

18.3 Internet communications

The internet protocols listed in [Communications specifications](#) (p. 278), are supported when using a cell modem with the CR350. The most up-to-date information on implementing these protocols is contained in *CRBasic Editor* help.

CRBasic instructions for internet communications include:

- [EmailRelay\(\)](#)
- [EmailSend\(\)](#)
- [EmailRecv\(\)](#)
- [FTPClient\(\)](#)
- [HTTPGet\(\)](#)
- [HTTPOut\(\)](#)
- [HTTPPost\(\)](#)
- [HTTPPut](#)
- [IPInfo\(\)](#)
- [PPPOpen\(\)](#)
- [PPPClose\(\)](#)
- [TCPOpen\(\)](#)
- [TCPClose\(\)](#)

Once the hardware has been configured, PakBus communications over TCP/IP are possible. These functions include the following:

- Sending programs
- Retrieving programs
- Setting the data logger clock
- Collecting data
- Displaying the current record in a data table

Data logger callback to *LoggerNet* and data logger-to-data logger communications are also possible over TCP/IP. For details and example programs see the CRBasic help.

See the [FTP streaming technical paper](#)  for information on using [FTPClient\(\)](#) or [HTTPPut\(\)](#) to stream data.

18.3.1 IP address

When connected to a server with a list of IP addresses available for assignment, the data logger will automatically request and obtain an IP address through DHCP. Once the address is assigned, look in the **Settings Editor > Ethernet > {information box}** to see the assigned IP address.

The CR350 provides a DNS client that can query a DNS server to determine if an IP address has been mapped to a hostname. If it has, then the hostname can be used interchangeably with the IP address in some data logger instructions.

NOTE:

When setting a static IP address, first manually set a **DNS Server Address** in **Settings Editor > Advanced**.

18.3.2 FTP server

An FTP server facilitates file transfers. Use *Device Configuration Utility* to configure the data logger to act as an FTP server. This is useful when receiving and storing images from an Ethernet

enabled device such as a camera.

Select [FTPEnabled](#) (p. 226) and assign a **User Name** and **Password**.

The screenshot shows a configuration interface with several tabs: Deployment, Datalogger, Com Ports Settings, PPP, GOES, Network Services, TLS, and Advanced. The 'Network Services' tab is active. Under this tab, there are several options: 'HTTP Enabled' (unchecked), 'HTTPS Enabled' (unchecked), 'FTP Enabled' (checked), 'Telnet Enabled' (unchecked), and 'Ping (ICMP) Enabled' (unchecked). The 'FTP Enabled' section includes a text field for 'FTP User Name' containing 'anonymous', and two password fields for 'FTP Password' and 'Confirm FTP Password', both masked with dots. There is also a 'PakBus/TCP Port' field set to 6785. A red box highlights the 'FTP Enabled' section.

Specify the CPU drive in the path when putting or getting files. For example, to put a file named *image.jpg* on the CPU drive, use a command similar to **put image.jpg /CPU/image.jpg**.

NOTE:

Use [FTPclient\(\)](#) to send files to a remote server. This is different than setting up the data logger to act as an FTP server. See the [FTP Streaming technical paper](#) and [FTP Troubleshooting technical paper](#) for more information.

18.4 MQTT

MQTT is an open communications protocol often used in the Internet of Things (IoT). It uses a publish/subscribe architecture to send and receive data. A broker facilitates the communications between publishers and subscribers by receiving published messages and distributing them to subscribers. One advantage of MQTT is that communications are initiated by the CR350 so firewalls do not cause problems.

For full MQTT specifications see: <https://mqtt.org/>

18.4.1 Sending data to an MQTT broker

MQTT communications require a broker configured for data logger communications. There are many available; it is recommended that you consult with an IT professional.

18.4.1.1 Mosquitto

This example uses the public Mosquitto test broker <https://test.mosquitto.org/> for testing. This section is provided as a convenience; Campbell Scientific does not provide technical support for Mosquitto.

Configure the data logger

1. Ensure your data logger is connected to the internet.
2. Using *Device Configuration Utility*, connect to the data logger.
3. (Recommended) On the **Logger Control** tab, set the **Reference Clock Setting** to UTC.

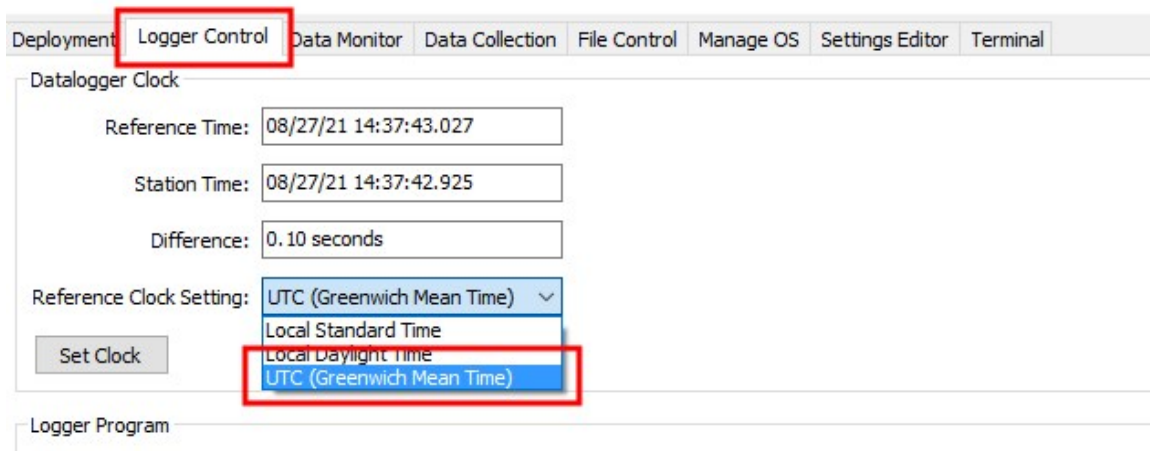

4. On the **Settings Editor** tab, click the **MQTT** sub-tab.

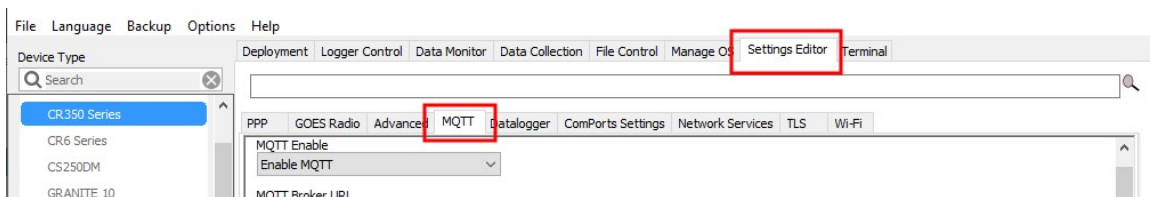

- a. **Enable MQTT.**
- b. Enter the **Broker URL**. Enter `test.mosquitto.org` for this example.
- c. Select **Persistent** for **MQTT Connection type**.
- d. Enter **1883** for the **Port Number**.
- e. Write down the **MQTT Base Topic**; it is case sensitive. By default it is `cs/v1/`.

- f. Keep all other MQTT settings as their defaults.
5. Click **Apply**.

Program the data logger

Use `MQTTPublishTable()` within a `DataTable/EndTable` declaration to publish stored data via MQTT. See the *CRBasic Editor* help for detailed instruction information and program examples: <https://help.campbellsci.com/crbasic/cr350/>.

```
DataTable(Five_Min,True,-1)
DataInterval(0,5,Min,10)
Average(1,Temp_C,FP2,False)
Minimum(1,BattV,FP2,False,False)
Publish every 5 min in CSJSON format. The last three
parameters are optional to specify longitude, latitude, and
altitude. Here we use NaN as placeholders for these values.
MQTTPublishTable(0,0,5,Min,1,NaN,NaN,NaN)
EndTable
```

Five minutes is the fastest recommended publishing interval in order to ensure that ingestion and processing of data sent to the MQTT broker are completed before new data is received.

18.4.1.2 AWS

This example uses the public Amazon Web Services (AWS) IoT test broker <https://aws.amazon.com/free/iot/> for testing. This section is provided as a convenience; Campbell Scientific does not provide technical support for AWS.

Setup AWS IoT

1. Open a web browser and set up an account at <https://aws.amazon.com/free/iot/>.
2. Go to <https://us-west-2.console.aws.amazon.com/iot/>.

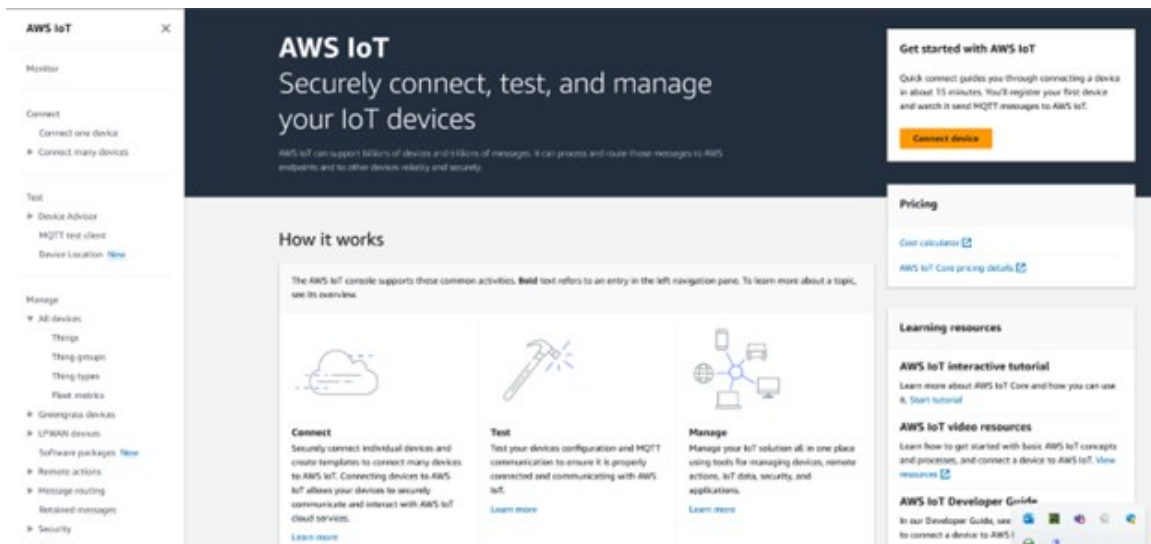

3. Near the bottom of the left menu select **Settings**. Copy the **Endpoint** address. It will end in something like `iot.us-west-2.amazonaws.com`. You will need this later to configure the data logger.
4. Go to **Manage** > **All Devices** > **Things**. In this case the CR350 is the *Thing*.
5. Click the **Create Things** button.

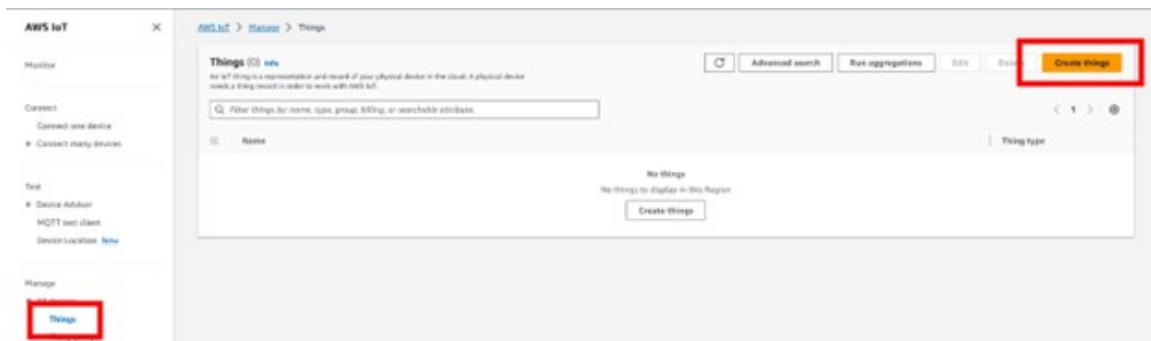

6. Select **Create single thing**.
7. Click **Next**.

[AWS IoT](#) > [Manage](#) > [Things](#) > Create things

Create things Info

A thing resource is a digital representation of a physical device or logical entity in AWS IoT. Your device or entity needs a thing resource in the registry to use AWS IoT features such as Device Shadows, events, jobs, and device management features.

Number of things to create

Create single thing
Create a thing resource to register a device. Provision the certificate and policy necessary to allow the device to connect to AWS IoT.

Create many things
Create a task that creates multiple thing resources to register devices and provision the resources those devices require to connect to AWS IoT.

Cancel **Next**

8. Give your *Thing* a name in the **Thing name** field. Make note of this value, it will also be the **MQTT Client ID** in the data logger configuration later.

NOTE:

Thing name cannot contain spaces.

CAUTION:

Each data logger in the network must have a unique **MQTT Client ID**. Duplicate Client IDs can cause unstable connections, and high data usage over a cellular connection when only a small amount of data is being published.

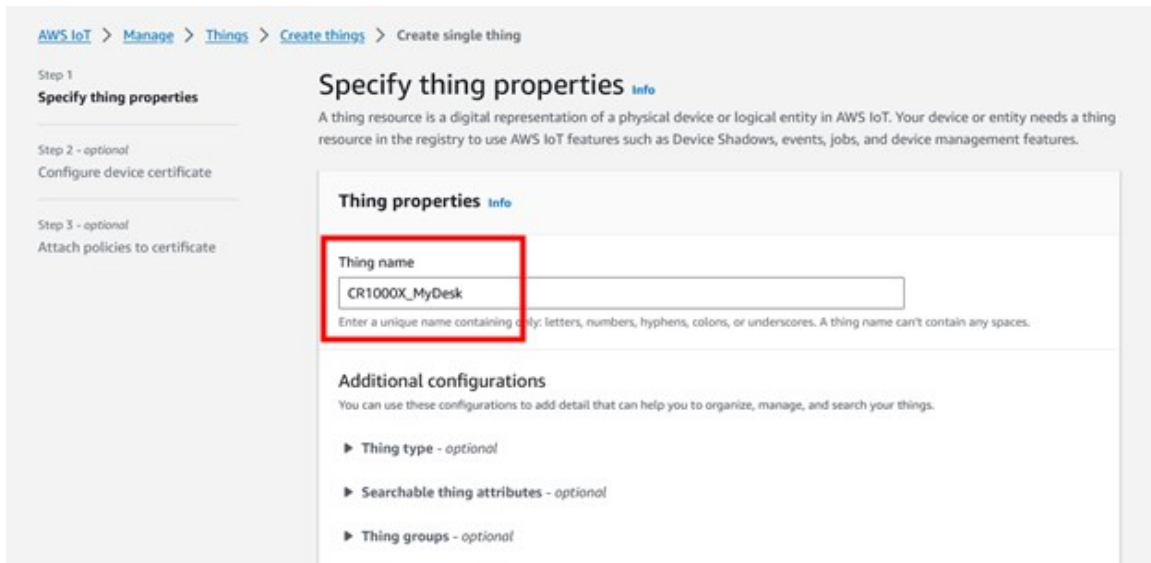

9. Click **Next**.
10. On the **Configure device certificate** screen, select **Auto-generate a new certificate**. Click **Next**.

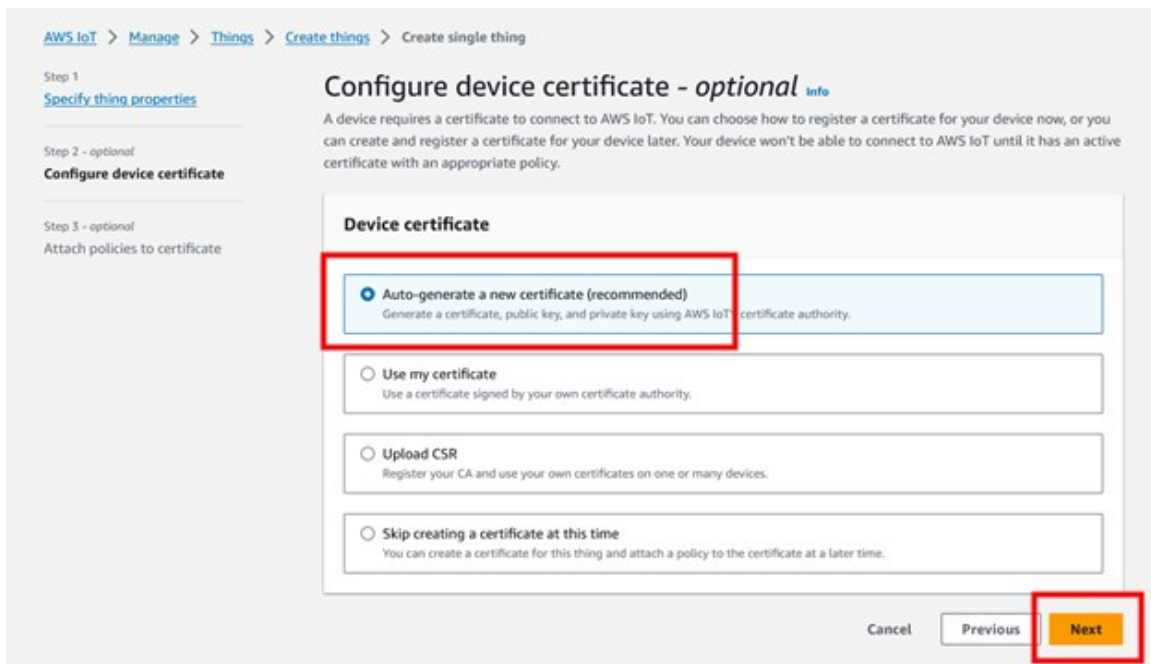

11. On the **Attach policies to certificate** screen, click **Create policy**. This will open a new tab.

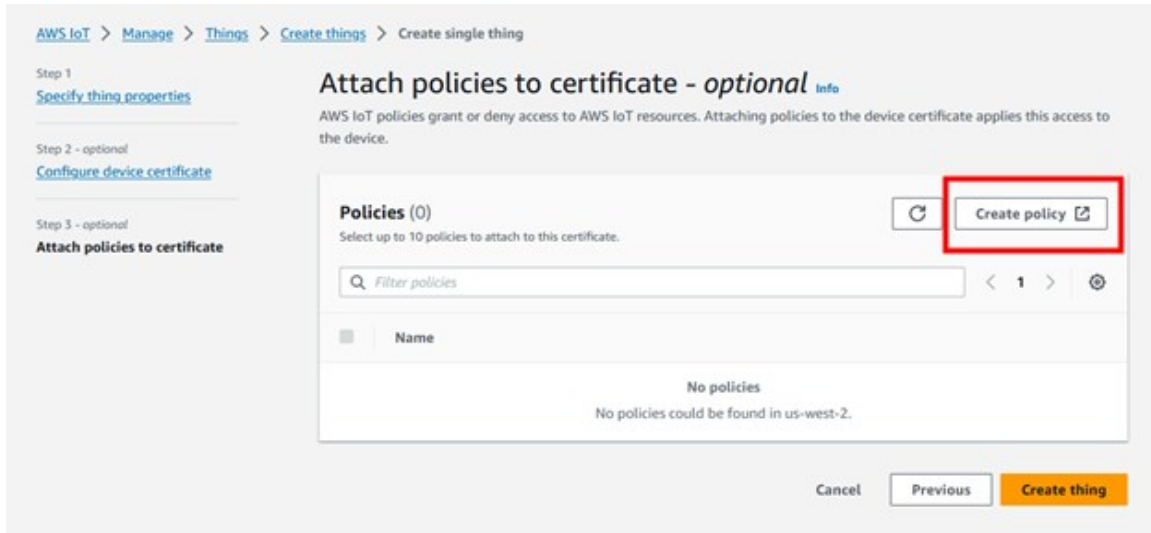

12. On the **Create policy** screen enter a **Policy name**. Ensure that **Allow** is set for the **Policy effect**. In the **Policy action** and **Policy resource** fields enter an asterisk ***** for a wild card. Click **Create**.

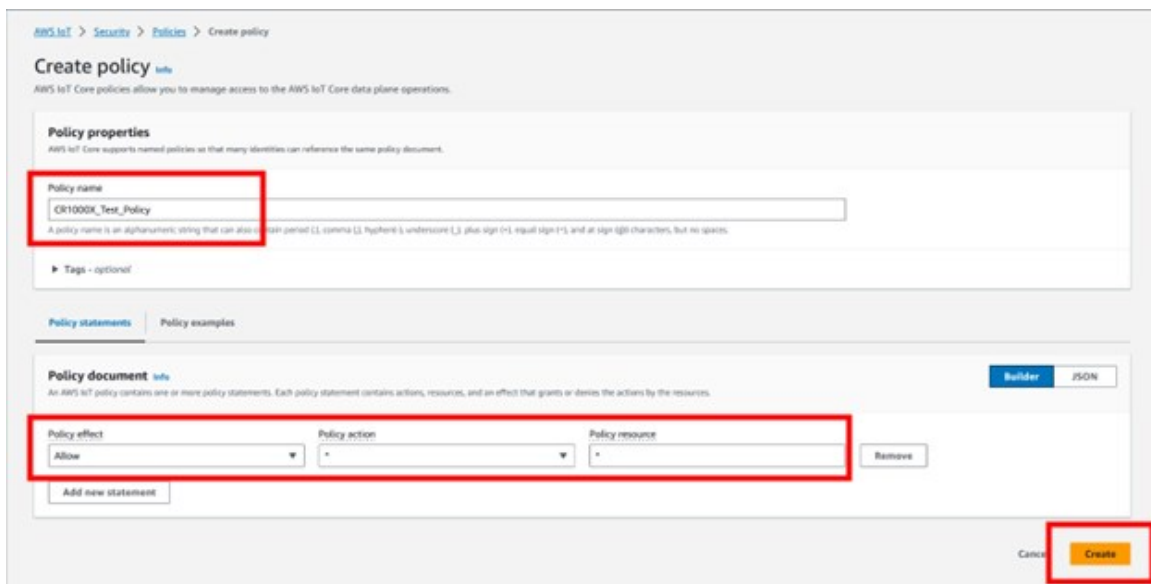

- On the **Attach policies to certificate** screen, select the **Policy** you created and click **Create thing**.

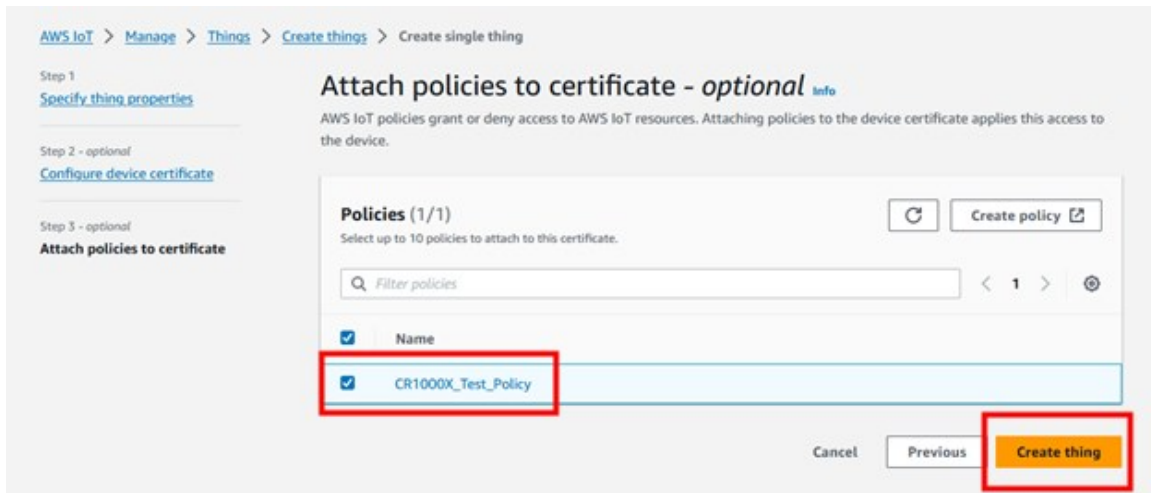

14. On the **Download certificates and keys** screen save all your certificates and keys. This is the only time you can download the key files for this device. In a secure location, save the device certificate, Public key file, Private key file, and Root CA certificate. They'll be needed for setting up the data logger. Click **Done**.

Download certificates and keys

Download certificate and key files to install on your device so that it can connect to AWS.

Device certificate

You can activate the certificate now, or later. The certificate must be active for a device to connect to AWS IoT.

Device certificate
b4842c69d01...te.pem.crt

Deactivate certificate **Download**

Key files

The key files are unique to this certificate and can't be downloaded after you leave this page. Download them now and save them in a secure place.

⚠ This is the only time you can download the key files for this certificate.

Public key file
b4842c69d010fb25ab0a04e...3abdb7c-public.pem.key **Download**

Private key file
b4842c69d010fb25ab0a04e...abdb7c-private.pem.key **Download**

Root CA certificates

Download the root CA certificate file that corresponds to the type of data endpoint and cipher suite you're using. You can also download the root CA certificates later.

Amazon trust services endpoint
RSA 2048 bit key: Amazon Root CA 1 **Download**

Amazon trust services endpoint
ECC 256 bit key: Amazon Root CA 3 **Download**

If you don't see the root CA certificate that you need here, AWS IoT supports additional root CA certificates. These root CA certificates and others are available in our developer guides. [Learn more](#)

Done

Configure the data logger

1. On your computer, navigate to the location your certificates and keys are saved.
2. Rename the `AmazonRootCA1.pem` file to `CAroot.pem`.
3. Connect to your data logger via USB.

NOTE:

For a secure TLS setup the certificates and key must be sent over a direct connection. They cannot be sent over IP.

4. Using *Device Configuration Utility*, connect to the data logger.
5. Select the **File Control** tab and click **Send**.

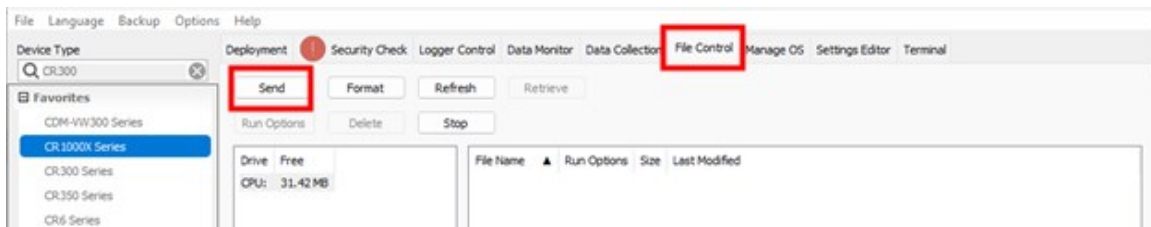

6. Browse to the `CAroot.pem` file. Click **Open**.

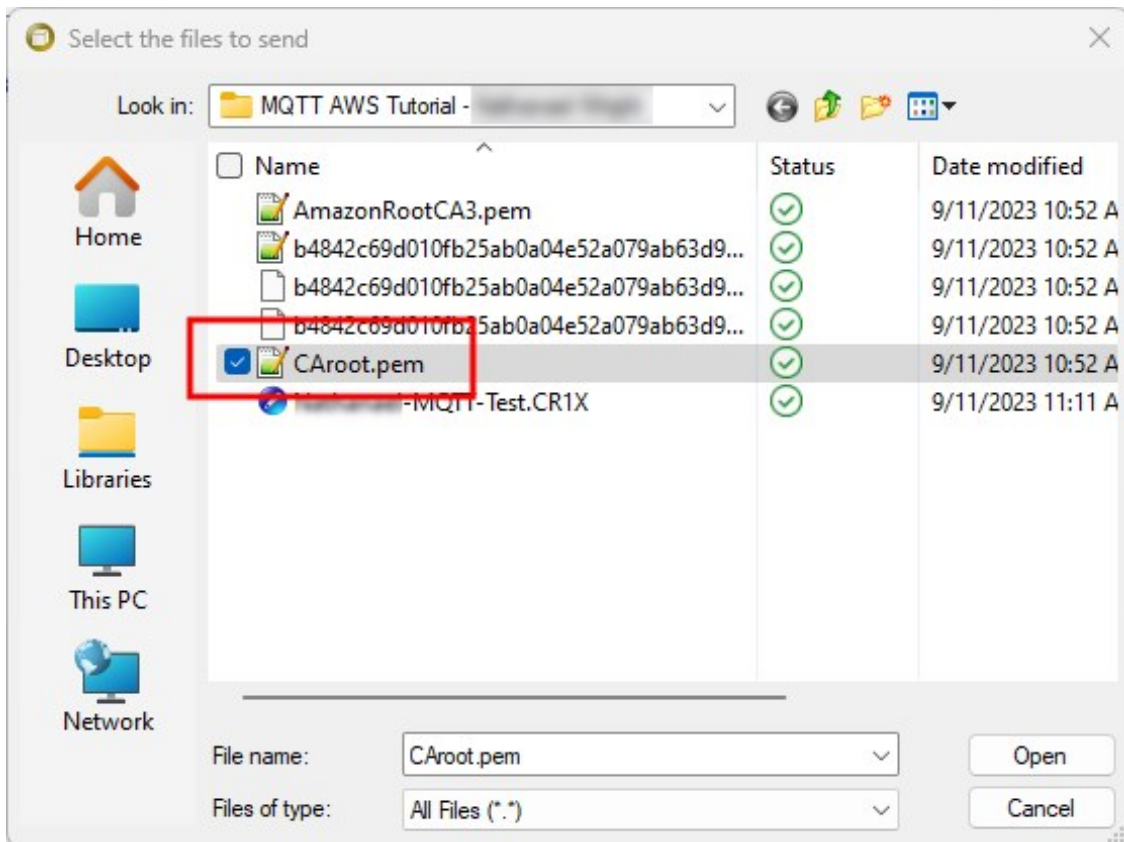

7. Select **Deployment** > **TLS**.

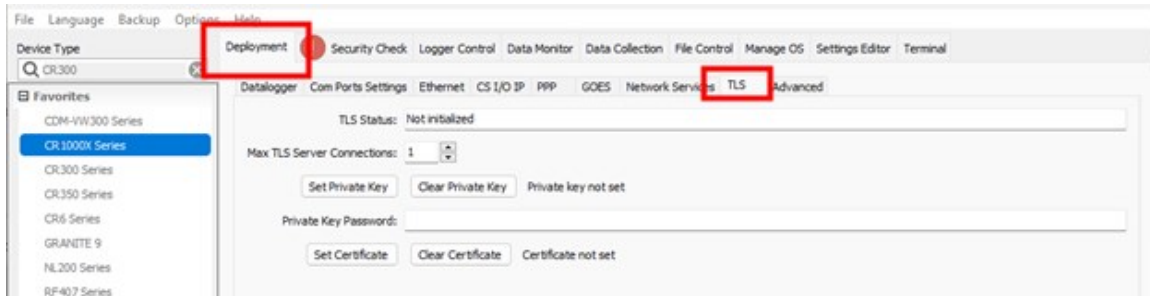

8. Set **Max TLS connections** to 5.
9. Click **Set Private Key** and upload the Private key file by browsing to it and clicking **Open**. The file name will end in **private.pem.key**.
10. Click **Set Certificate** and upload the Certificate by browsing to it and clicking **Open**. The file name will end in **certificate.pem.crt**.
11. Click **Apply** to save the changes.
12. Click **Connect** to reconnect to your data logger.
13. On the **Settings Editor** tab, click the **MQTT** sub-tab.

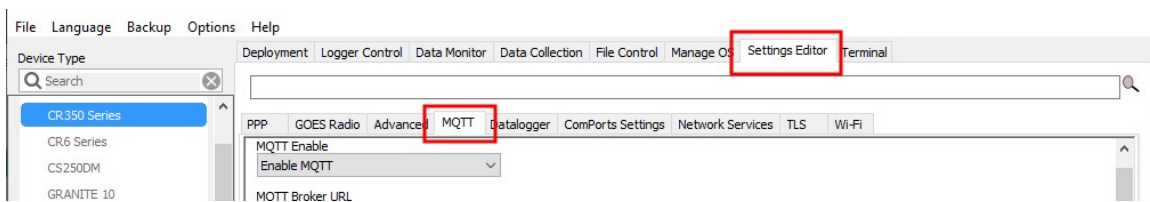

14. On the **MQTT** tab set the following:
 - a. **MQTT Enable** to **Enable with TLS** or **Enable with TLS-Mutual Authentication**
 - b. **MQTT Broker URL** to the Endpoint address that you copied, saved, or noted. See [Setup AWS IoT](#) (p. 140) step 3.
 - c. Enter **8883** for the **Port Number**.
 - d. **MQTT Client ID** to the **Thing name** set in [Setup AWS IoT](#) (p. 140) step 8.
 - e. **MQTT Base Topic** is the **Publish Policy** set in [Setup AWS IoT](#) (p. 140) step 10.
15. Click **Apply** to save the changes.

Program the data logger

Use `MQTTPublishTable()` within a `DataTable/EndTable` declaration to publish stored data via MQTT. See the *CRBasic Editor* help for detailed instruction information and program examples: <https://help.campbellsci.com/crbasic/cr350/>.

```

DataTable(Five_Min,True,-1)
DataInterval(0,5,Min,10)
Average(1,Temp_C,FP2,False)
Minimum(1,BattV,FP2,False,False)
Publish every 5 min in CSJSON format. The last three parameters are optional to specify longitude, latitude, and altitude. Here we use NaN as placeholders for these values.
MQTTPublishTable(0,0,5,Min,1,NaN,NaN,NaN)
EndTable

```

Five minutes is the fastest recommended publishing interval in order to ensure that ingestion and processing of data sent to the MQTT broker are completed before new data is received.

Verify data in AWS IoT

1. In AWS IoT click **MQTT test client** > **Subscribe to a topic**.
2. Enter a **#** symbol (wildcard) in the **Topic filter** field. Click **Subscribe**.

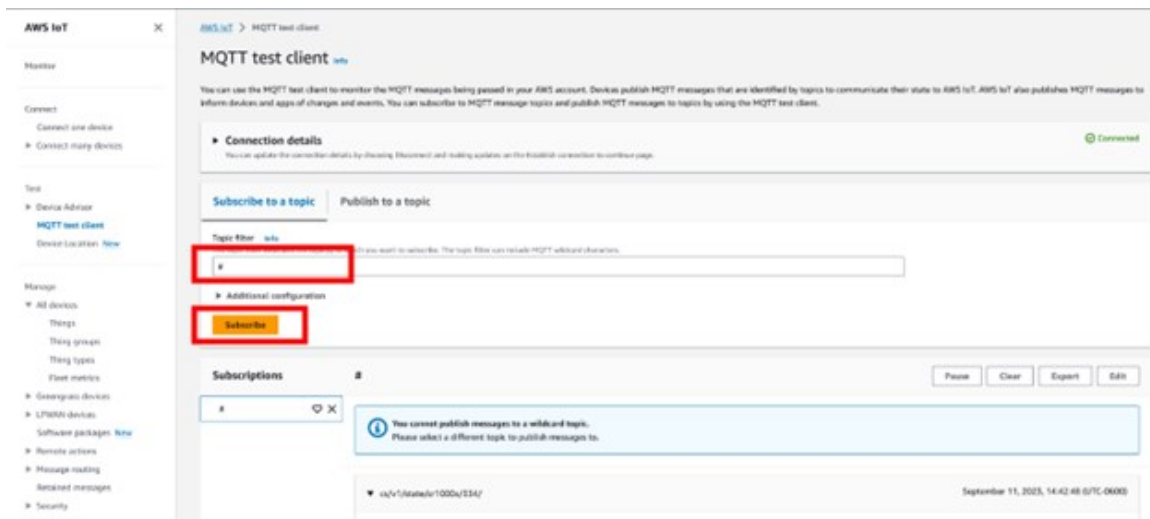

3. Confirm data is being received in the **Subscription** area at the bottom of the screen.

18.5 DNP3 communications

DNP3 is designed to optimize transmission of data and control commands from a master computer to one or more remote devices or outstations. The data logger allows DNP3 communications on all available communications ports. CRBasic DNP3 instructions include:

- **DNP()**
- **DNPUpdate()**
- **DNPVariable()**

See the *CRBasic Editor* help for detailed instruction information and program examples: <https://help.campbellsci.com/crbasic/cr350/>.

When **DNPUpdate** is used to set up the data logger as a remote (slave) device, up to three DNP3 clients (masters) are supported.

For additional information on DNP3 see:

- [DNP3 with Campbell Scientific Dataloggers](#)
- [Getting to Know DNP3](#)
- [How to Access Your Measurement Data Using DNP3](#)

18.6 PakBus communications

PakBus is a Campbell Scientific communications protocol. By using signed data packets, PakBus increases the number of communications and networking options available to the data logger. The data logger allows PakBus communications on all available communications ports. For additional information, see [The Many Possibilities of PakBus Networking](#) blog article.

Advantages of PakBus include:

- Simultaneous communications between the data logger and other devices.
- Peer-to-peer communications - no computer required. Special CRBasic instructions simplify transferring data between data loggers for distributed decision making or control.
- Data consolidation - other PakBus data loggers can be used as "sensors" to consolidate all data into one data logger.
- Routing - the data logger can act as a router, passing on messages intended for another Campbell Scientific data logger. PakBus supports automatic route detection and selection.
- Short distance networks - a data logger can talk to another data logger over distances up to 30 feet by connecting transmit, receive, and ground wires between the data loggers.

In a PakBus network, each data logger is assigned a unique address. The default PakBus address in most devices is 1. To communicate with the data logger, the data logger support software must know the data logger PakBus address. The PakBus address is changed using *Device Configuration Utility*, data logger **Settings Editor**, or **PakBus Graph** software.

18.7 SDI-12 communications

SDI-12 is a 1200 baud communications protocol that supports many smart sensors, probes and devices. The data logger supports SDI-12 communications through two modes — transparent mode and programmed mode (see [SDI-12 ports](#) (p. 16) for wiring terminal information).

Transparent mode facilitates sensor setup and troubleshooting. It allows commands to be manually issued and the full sensor response viewed. Transparent mode does not record data. See [SDI-12 transparent mode](#) (p. 195) for more information.

Programmed mode automates much of the SDI-12 protocol and provides for data recording. See [SDI-12 programmed mode/recorder mode](#) (p. 155) for more information.

CRBasic SDI-12 instructions include:

- [SDI12Recorder\(\)](#)
- [SDI12SensorSetup\(\)](#)
- [SDI12SensorResponse\(\)](#)
- [SDI12Watch\(\)](#)

See the *CRBasic Editor* help for detailed instruction information and program examples: <https://help.campbellsci.com/crbasic/cr350/>

The data logger uses SDI-12 version 1.4.

18.7.1 SDI-12 transparent mode

All SDI-12 probes have just three wires—a signal, ground, and 12 V power line. They are connected to the data logger according to the following table.

Wire function	Data logger connection
SDI-12 signal	C1, C2
Shield	G
Power	12V
Power ground	G

System operators can manually interrogate and enter settings in probes, connected to the data logger, using transparent mode. Transparent mode is useful in troubleshooting SDI-12 systems because it allows direct communications with probes.

Transparent mode may need to wait for commands issued by the programmed mode to finish before sending responses. While in transparent mode, the data logger programs may not execute. Data logger security may need to be unlocked before transparent mode can be activated.

Transparent mode is entered while the computer is communicating with the data logger through a terminal emulator program such as through *Device Configuration Utility* or other data logger

support software. Keyboard displays cannot be used. For how-to instructions for communicating directly with an SDI-12 sensor using a terminal emulator, watch this video: <https://www.campbellsci.com/videos/sdi12-sensors-transparent-mode> .

To enter the SDI-12 transparent mode, enter the data logger support software terminal emulator:



```
Deployment | Logger Control | Data Monitor | File Control | Send OS | Settings Editor | Terminal
CR350>
CR350>SDI12
Enter Cx Port 1,2,3 or ?
1
Entering SDI12 Terminal
+
Exit SDI12 Terminal
```

1. Press **Enter** until the data logger responds with the prompt **CR350>**.
2. Type **SDI12** at the prompt and press **Enter**.
3. In response, the query **Select SDI12 Port** is presented with a list of available ports. Enter the port number assigned to the terminal to which the SDI-12 sensor is connected, and press **Enter**. For example, **1** is entered for terminal **C1**.
4. An **Entering SDI12 Terminal** response indicates that SDI-12 transparent mode is active and ready to transmit SDI-12 commands and display responses.

18.7.1.1 Watch command (sniffer mode)

The terminal-mode utility allows monitoring of SDI-12 traffic by using the watch command (sniffer mode). Watch an instructional video: <https://www.campbellsci.com/videos/sdi12-sensors-watch-or-sniffer-mode>  or use the following instructions.

1. Enter the transparent mode as described previously.
2. Press **Enter** until a **CR350>** prompt appears.
3. Type **W** and then press **Enter**.
4. In response, the query **Select SDI12 Port:** is presented with a list of available ports. Enter the port number assigned to the terminal to which the SDI-12 sensor is connected, and press **Enter**.
5. In answer to **Enter timeout (secs):** type **100** and press **Enter**.
6. In response to the query **ASCII (Y)?**, type **Y** and press **Enter**.
7. SDI-12 communications are then opened for viewing.

18.7.1.2 SDI-12 transparent mode commands

SDI-12 commands and responses are defined by the SDI-12 Support Group (www.sdi-12.org) and are available in the [SDI-12 Specification](#). Sensor manufacturers determine which commands to support. Commands have three components:

- Sensor address (**a**): A single character and the first character of the command. Sensors are usually assigned a default address of zero by the manufacturer. The wildcard address (?) is used in the **Address Query** command. Some manufacturers may allow it to be used in other commands. SDI-12 sensors accept addresses 0 through 9, a through z, and A through Z.
- Command body (for example, **M1**): An upper case letter (the “command”) followed by alphanumeric qualifiers.
- Command termination (!): An exclamation mark.

An active sensor responds to each command. Responses have several standard forms and terminate with <CR><LF> (carriage return–line feed).

18.7.1.3 aXLOADOS! command

aXLOADOS! is an example of an SDI-12 transparent mode command. It is used to send an operating system (OS) update from a data logger to an SDI-12 sensor.

NOTE:

Verify with the sensor manufacturer that the sensor supports this command.

Use aXLOADOS! in the following procedure to send an OS update to an SDI-12 sensor.

1. Supply power to the data logger. If connecting via USB for the first time, you must first install USB drivers by using *Device Configuration Utility* (select your data logger, then on the main page, click **Install USB Driver**). Alternatively, you can install the USB drivers using EZ Setup. A USB connection supplies 5 V power (as well as a communications link), which is adequate for setup, but a 12 V battery will be needed for field deployment.
2. Physically connect your data logger to your computer using a USB cable, then in *Device Configuration Utility* select your data logger.
3. Copy the sensor OS file from the computer to the data logger.
 - a. Select **File Control** > **CPU: drive** > **Send** and navigate to the file on the computer.
 - b. Click **Open**.

c. Click OK.

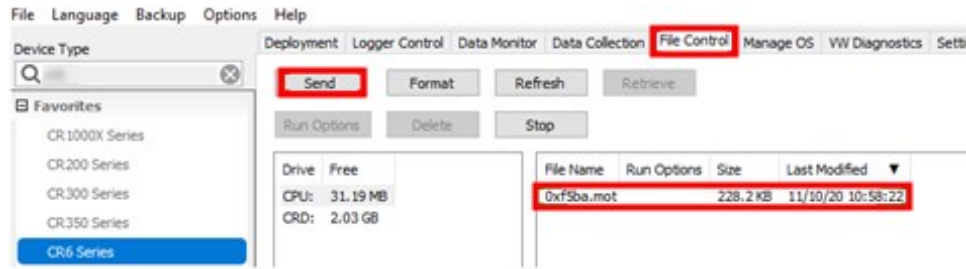

4. Enter the transparent mode as described in [SDI-12 transparent mode](#) (p. 195).
5. An **Entering SDI12 Terminal** response indicates that SDI-12 transparent mode is active and ready to transmit SDI-12 commands and display responses.

The load OS command has the following format:

aXLOADOS Baudrate drive:filename!

For example: **0XLOADOS 9600 CPU:0XF5BA.MOT!**

Type the command, including the ending exclamation point (!) then press **Enter**.

```
CR6>SDI12
1: C1
2: C3
3: 01
4: 03
5: 05
6: 07
7: 09
8: 0B
Select SDI12 Port: 1
Entering SDI12 Terminal
0XLOADOS 9600 CPU:0XF5BA.MOT!
```

6. The screen will show OS send updates and the **bytes sent** will continue to increase. The process is slow, it can take several minutes, but not hours.

```
0XLOADOS 9600 CPU:0XF5BA.MOT!
file size 228234, bytes sent 9098
```

7. A **SUCCESS** message indicates the process is complete.

```
0XLOADOS 9600 CPU:0X49ED.MOT!
file size 228582, bytes sent 225465 SUCCESS
```

18.7.2 SDI-12 programmed mode/recorder mode

The data logger can be programmed to read SDI-12 sensors or act as an SDI-12 sensor itself. The [SDI12Recorder\(\)](#) instruction automates sending commands and recording responses. With this instruction, the commands to poll sensors and retrieve data is done automatically with proper elapsed time between the two. The data logger automatically issues retries. See *CRBasic Editor* help for more information on this instruction.

Commands entered into the [SDIRecorder\(\)](#) instruction differ slightly in function from similar commands entered in transparent mode. In transparent mode, for example, the operator manually enters **aM!** and **aD0!** to initiate a measurement and get data, with the operator providing the proper time delay between the request for measurement and the request for data. In programmed mode, the data logger provides command and timing services within a single line of code. For example, when the [SDI12Recorder\(\)](#) instruction is programmed with the **M!** command (note that the SDI-12 address is a separate instruction parameter), the data logger issues the **aM!** and **aD0!** commands with proper elapsed time between the two. The data logger automatically issues retries and performs other services that make the SDI-12 measurement work as trouble free as possible.

For troubleshooting purposes, responses to SDI-12 commands can be captured in programmed mode by placing a variable declared **As String** in the variable parameter. Variables not declared **As String** will capture only numeric data.

See the *CRBasic Editor* help for detailed instruction information and program examples:
<https://help.campbellsci.com/crbasic/cr350/>

18.7.3 Programming the data logger to act as an SDI-12 sensor

The [SDI12SensorSetup\(\)](#) / [SDI12SensorResponse\(\)](#) instruction pair programs the data logger to behave as an SDI-12 sensor. A common use of this feature is to copy data from the data logger to other Campbell Scientific data loggers over a single data-wire interface (terminal configured for SDI-12 to terminal configured for SDI-12), or to copy data to a third-party SDI-12 recorder.

See the *CRBasic Editor* help for detailed instruction information and program examples:
<https://help.campbellsci.com/crbasic/cr350/>

When programmed as an SDI-12 sensor, the data logger will respond to SDI-12 commands **M**, **MC**, **C**, **CC**, **R**, **RC**, **V**, **?**, and **I**.

When acting as a sensor, the data logger can be assigned only one SDI-12 address per SDI-12 port. For example, a data logger will not respond to both **0M!** and **1M!** on SDI-12 port **C1**. However, different SDI-12 ports can have unique SDI-12 addresses.

18.7.4 SDI-12 power considerations

When a command is sent by the data logger to an SDI-12 probe, all probes on the same SDI-12 port will wake up. However, only the probe addressed by the data logger will respond. All other probes will remain active until the timeout period expires.

Example:

Probe: Water Content

Power Usage:

- Quiescent: 0.25 mA
- Active: 66 mA
- Measurement: 120 mA

Measurement time: 15 s

Timeout: 15 s

Probes 1, 2, 3, and 4 are connected to SDI-12 port **C1**.

The time line in the following table shows a 35-second power-usage profile example.

For most applications, total power usage of 318 mA for 15 seconds is not excessive, but if 16 probes were wired to the same SDI-12 port, the resulting power draw would be excessive. Spreading sensors over several SDI-12 terminals helps reduce power consumption.

Time into measurement processes	Command	All probes awake	Time out expires	Probe 1 (mA)	Probe 2 (mA)	Probe 3 (mA)	Probe 4 (mA)	Total (mA)
Sleep				0.25	0.25	0.25	0.25	1
1	1M!	Yes		120	66	66	66	318
2-14				120	66	66	66	318
15			Yes	120	66	66	66	318
16	1D0!	Yes		66	66	66	66	264
17-29				66	66	66	66	264

Table 18-3: Example power use for a network of SDI-12 probes

Time into measurement processes	Command	All probes awake	Time out expires	Probe 1 (mA)	Probe 2 (mA)	Probe 3 (mA)	Probe 4 (mA)	Total (mA)
30			Yes	66	66	66	66	264
Sleep				0.25	0.25	0.25	0.25	1

19. Installation

Campbell Scientific data loggers support research and operations all over the world in a variety of applications. The limits of the CR350 are defined by your application needs. Therefore, every installation will be unique. See www.campbellsci.com/solutions .

TIP:

Time spent in the office, setting up and testing hardware and software, will make time in the field more efficient.

Recommended tools:

- Voltmeter
- Screwdrivers
 - Flat-blade
 - Phillips-head
 - Small flat-blade
- Wire cutter/stripper
- Crescent wrench
- Pliers
- Pad and pen
- Laptop computer, fully charged, with software and drivers installed
- USB cable

Tools required to install a Campbell Scientific tripod or tower:

- Shovel
- Rake
- Open-end wrench set
- Socket wrench set
- Magnetic compass
- Tape measure
- Nut driver
- Level
- Sledgehammer
- Pliers
- Flat-bladed screwdrivers
- Phillips screwdrivers

For more information, watch a video at: <http://www.campbellsci.com/videos/toolbox-for-installation-and-maintenance> .

19.1 Default program

Many data logger settings can be changed remotely over a communications link. This convenience comes with the risk of inadvertently changing settings and disabling communications. For example, external cellular modems are often controlled by a switched 12 VDC (**SW12 (SW1, SW2)**) terminal. **SW12 (SW1, SW2)** is normally off; so, if the program controlling **SW12 (SW1, SW2)** is disabled, such as by changing a setting or sending a new operating system, the cellular modem is switched off and the remote data logger will not turn it on. This could require an on-site visit to correct the problem unless a special program called **default** has been installed.

Having a **default.CRB** program stored on the data logger will also ensure that a non-compiling CRBasic program does not lock out a remote user.

NOTE:

The default program may use the extension **.CRB** or **.DLD**.

When a file named **default.CRB** is stored on the data logger CPU: drive, it is loaded if no other program takes priority. Program execution priorities are as follows:

1. When the CR350 powers up, a program file marked as **Run On Power-up** will run. If that program includes a file specified by the **Include File** setting, it will be incorporated into the program that runs.
2. If there is no program file marked **Run Now** or **Run On Power-up** (or if the program selected to run cannot be compiled), the data logger will run the program specified by the **IncludeFile** setting. For more information see [IncludeFile](#) (p. 227).
3. If the **IncludeFile** program cannot be compiled or if no program is specified, the data logger will attempt to run the program named **default.CRB** on its CPU: drive.
4. If there is no **default.CRB** file or it cannot be compiled, the CR350 will not automatically run any program.

The **default.CRB** program generally contains instructions to preserve critical datalogger settings such as communications settings, but should not be more than a few lines of code.

CRBasic Example 2: **default.CRB** example

```
'This program turns ON the SW12 (SW1, SW2) switched  
'power terminal, for 30 seconds every 60 seconds.  
BeginProg
```

CRBasic Example 2: default.CRB example

```
Scan(1,Sec,0,0)
  If TimeIsBetween (15,45,60,Sec) Then SW12(SW12_1,1)
NextScan
EndProg
```

Downloading operating systems over communications requires much of the available CR350 memory. If the intent is to load operating systems via a communications link and have a `default.CRB` file in the CR350, the `default.CRB` program should not allocate significant memory, as might happen by allocating a large `USR:` drive. Also, do not auto-allocate tables in `DataTable()` instructions; if it is necessary to use `DataTable()` instructions, set small fixed table sizes. Refer to [Sending an operating system to a remote data logger](#) (p. 179) for information about sending the operating system.

19.2 Data logger security

Data logger security concerns include:

- Collection of sensitive data
- Operation of critical systems
- Networks that are accessible to many individuals

19.2.1 Device Configuration Utility Security Check

A Security Check is provided through *Device Configuration Utility*, starting with version 2.29. This check helps you identify areas where security can be improved.

All suggestions shown in *Device Configuration Utility* are optional and no changes will be made unless you make them. For example, *Device Configuration Utility* uses a simple set of criteria to suggest a strong password. If you have your own criteria, you can use it. Because every deployment can be different, *Device Configuration Utility* will provide you with the information you need to ensure your data logger security is optimized for your application.

In general, green, blue, and red icons indicate password strength.

- Green: strong password
- Blue: weak password
- Red: no password set

A strong password has the following:

- Eight or more characters
- One upper case letter
- One lower case letter
- One digit
- One special character

The green, blue, and red icons may also show the potential severity of a security vulnerability.

- Green: good, no action needed
- Blue: advisory information
- Red: action recommended

19.2.1.1 PakBus

PakBus encryption is the best data logger option to secure PakBus communications. Setting a PakBus Encryption (AES-128) Key in *Device Configuration Utility* forces PakBus data to be encrypted during transmission. The Security Check will check if the data logger has a PakBus Encryption Key set and a PakBus/TCP Password.

When neither of these is set, the Security Check will indicate that action is recommended.

The Security Check will not suggest setting a PakBus/TCP password if PakBus Encryption is already enabled. However, a PakBus/TCP password can be used with PakBus Encryption.

19.2.1.2 Web services

The Security Check will check to see if HTTP or HTTPS is enabled. If these protocols are not being used but are enabled, we recommend disabling them.

HTTP

HTTP, enabled by default, is an insecure protocol and can allow access to data logger data, settings, and programming. HTTP should only be enabled if it is required, and the data logger is on a secure network. If the data logger is not using web API or a hosted web page then HTTP should be disabled. If HTTP protocol is used, a `.csipasswd` file and user accounts should also be used.

See [The .csipasswd file](#) (p. 168) and [Web user interface](#) (p. 170) for more information.

HTTPS

HTTPS is a secure protocol but does allow access to data logger data, settings, and programming. HTTPS should only be enabled if it is required. If the data logger is not using web

API or a hosted web page then HTTPS should be disabled. If HTTPS protocol is used, a `.csipasswd` file and user accounts should also be used. Expect delays when using HTTPS, especially when first connecting.

See [The `.csipasswd` file](#) (p. 168) and [Web user interface](#) (p. 170) for more information.

19.2.1.3 Network services

The Security Check will check to see if any of the following network services are enabled. These services can be used to discover your data logger on an IP network. See *Device Configuration Utility* > **Deployment** > **Network Services** tab, to make changes.

NOTE:

FTP, Telnet, and Ping services are disabled by default.

FTP

FTP is an insecure protocol that allows access to data logger data and files. FTP should only be enabled if it is required. If the FTP file transfer is not needed, then FTP should be disabled. Some data loggers support using SFTP (only as a client), this can improve file transfer security. Consider using a public/private key pair for SFTP authentication. Load a `.PEM` format file through the *Device Configuration Utility Settings Editor* > **Advanced** tab.

Telnet

Telnet is an insecure protocol. It should only be enabled if it is required, and the data logger is on a secure network. PakBus is the preferred way of accessing the data logger terminal interface.

Ping

Ping makes the data logger visible to network scans. It should only be enabled if it is required.

19.2.1.4 Operating System Status

The Security Check will check to see if your data logger is running the latest operating system. Newer operating systems may have enhanced security measures. See [Updating the operating system](#) (p. 177) for more information.

19.2.2 Other security measures reviewed by *Device Configuration Utility*

Many of these settings can be accessed from the *Device Configuration Utility* Settings Editor tab. Settings are organized in tabs and can be searched for.

19.2.2.1 PakBus TCP Enabled

By default, PakBus TCP communications are enabled. Normally this would not be disabled as it would prevent data logger support software from connecting to a data logger using TCP.

See *Device Configuration Utility* > Settings Editor > Network Services tab.

19.2.2.2 Account manager

The Security Check only checks password strength when entering passwords in *Device Configuration Utility* for the `.csi passwd` file. It does no other checking.

See *Device Configuration Utility* > Settings Editor > Advanced tab.

19.2.2.3 IP Broadcast Filtered

Set to one if all broadcast IP packets should be filtered from IP interfaces. Do not set this if you use the IP discovery feature of the *Device Configuration Utility* or of *LoggerLink*. If this is set to one, the data logger will fail to respond to the broadcast requests.

See *Device Configuration Utility* > Settings Editor > Advanced tab.

19.2.2.4 Other communications protocols

Specific protocols such as PPP or MQTT have settings that involve security. The Security Check does not consider these settings other than password strength.

19.2.3 TLS

Transport Layer Security (TLS) is an internet communications security protocol. TLS settings are necessary for **server** applications, not for client applications. The primary reason for using TLS is to encrypt communications between a server and its clients. Using TLS is recommended when connecting to a data logger over an IP connection using the web interface. TLS does not affect PakBus communications.

Example server application instructions include:

- [DNP\(\)](#) using the optional [DNPTLS](#) parameter

Example client application instructions include:

- [HTTPGet\(\)](#), [HTTPPut\(\)](#) and [HTTPPost\(\)](#)
- [EmailRelay\(\)](#)
- [EmailSend\(\)](#) and [EmailRecv\(\)](#)
- [FTPClient\(\)](#)
- [MQTTConnect\(\)](#)
- [MQTTPublishTable\(\)](#)
- [MQTTPublishConstTable\(\)](#)

CSI Web Server can also use TLS.

NOTE:

For enhanced security, TLS settings are only shown in *Device Configuration Utility* when using a direct USB connection, or an IP connection using PakBus Encryption.

Use the following steps to configure TLS:

1. Use the *Device Configuration Utility* to enable HTTPS and disable HTTP. See **Deployment > Network Services** tab.
2. Use the *Device Configuration Utility* to enable and set up TLS. See **Deployment > Datalogger > TLS** tab.
 - a. Increase the number of **Max TLS Server Connections** to greater than zero. Each additional connection uses about 20 KB of memory. For general use, such as publishing web pages, use a minimum of five connections. Add more if multiple users may access the hosted web pages at the same time. See [Web user interface](#) (p. 170)
 - b. Use **Set Private Key** and **Set Certificate** to upload files in **.PEM** format. These can either be self-signed or issued from a trusted 3rd party organization. See [Obtaining certificate and private key](#) (p. 165) for more information.
 - **Maximum key file size:** 4 KB public, 4 KB private

Review the **Will send *file path*** message to ensure you have the correct files.

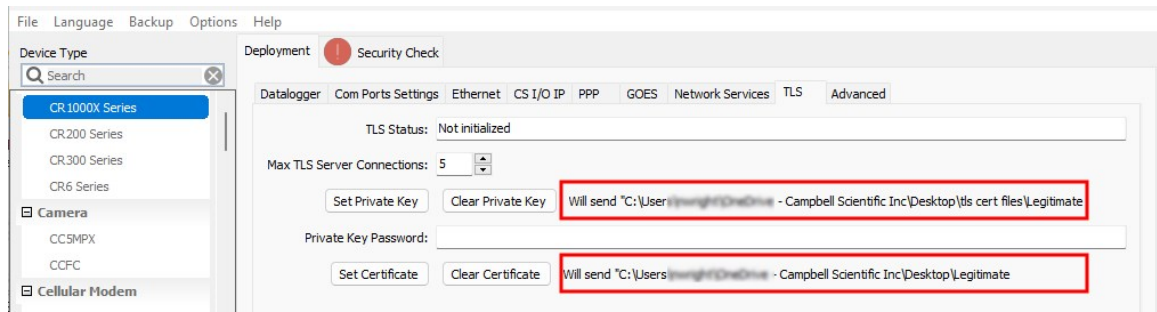

3. **Apply** to save your changes.
4. Confirm your TLS security settings by connecting to the data logger using a web browser. See [Web user interface](#) (p. 170)

NOTE:

If the certificates uploaded to the data logger are from an unknown source, such as most self-signed certificates, the web browser will likely display a warning. If the issuer can be trusted, this warning can be bypassed.

19.2.3.1 Obtaining certificate and private key

This section is provided as general guidance only. Have your IT department provide you with the required certificate and key files, or work with them to obtain them.

From a Certificate Authority

Some things you will need to know before starting the process with a Certificate Authority:

- Your website domain name, or common name
- Proof that you control the domain. This could include the email associated with the domain name.

The general steps when using an outside source for the certificate and keys are as follows:

1. Select a Certificate Authority (CA) such as DigiCert, Symantec, or GoDaddy, to generate your certificate and key files.

NOTE:

Generally there is a cost associated with this process, and it may take several days. It is common to refile the application several times to get the correct files in the correct format.

2. Create an account with your selected CA. Sign in.

3. Generate a private key and Certificate Signing Request (CSR). Save these files to a secure location on your computer. Some Certificate Authorities may offer to generate these for you. If not, then they will require the CSR and private key you generated.

NOTE:

This is the private key file you will need later. If the file saved has a `.txt` extension, make a copy and change the extension to `.PEM`.

TIP:

If your CA generates your private key and CSR, save a copy of both. For your security, the CA will not keep a record of either the CSR or private key. If you fail to save them you will have to generate new ones and this will take additional time.

4. Provide proof that you control the domain. Often additional instructions are received in an email from the CA.
5. Receive the certificate from the CA. This may take two or more business days. Save this file to a secure location on your computer.
6. Verify that the key file is in `.PEM` format. The contents of a valid `.PEM` formatted key will look similar to the following when viewed as a text file. The `-----BEGIN RSA PRIVATE KEY-----` header and `-----END RSA PRIVATE KEY-----` footer indicate that the key was generated in the correct format.

```
-----BEGIN RSA PRIVATE KEY-----
MIIEpQIBAAKCAQEAo8GRTJKW+grlRfuuUNr1qCc4aodqaRnNd+L+/WjpbzAWXjbPc
+Gn6fPlzFwZjjoa08ANqkk8H3h50c5sntFLMEIDHo0tvzpFxxShZN4I14hlCVzqY
19YNrOji8K+7Q7QEgV26rjsva36YARW/HsaNqrGgQYa4YbLvppPOI95dlGW2vd80
AzJBYe6qd1KME8W/3XMxrcalB3hxvtx+dAdqIEna6v8C4DIznFtpc6ScJ+Al38zI
Tnr8XuzKuiw9u6Syp263zUDFm2SOhGxAjNodt11XZCRDSwTmXg6ySITWEUKgKu3
mRAJS6cprGutGUoyIB7/sLE6dhhdJxdkzvonuwIDAQABAoIBADgZtGF7RuXanblg
341oYo9YiMnh...JQG946vbMv...s9uyAb9mMcn.../LgHzvVcD
...
atLDRK1cEba...JZCJECDOOUc...zegOs55BLFSNa...JRmdpjNsDXKje...
2wUifDn8vh/xLaAv61WuJlJQHhNqluZzCQ7mRQ8peV70remNkZozddD1KouLtYJZ
3LB7z+0CgYEAxH/ThGqQ10/DURP6OZghxrW0G7ulLiEas+p9uCr/+VtXco4Q2Zb2
fP23+EAbVeKZaE2yuMO2rSoNwIB3m05jxy4E2Xq/WQLH/PBzLCfyrBWMusoebaU7
hzvJyEpmxY5sA416UR5Dfg/jI13K3ZsSfPxH9C1JL3I9vex40bAVlw0=
-----END RSA PRIVATE KEY-----
```

7. Verify that the certificate file is in `.PEM` format. The contents of a valid `.PEM` formatted certificate will look similar to the following when viewed as a text file. The `-----BEGIN CERTIFICATE-----` header and `-----END CERTIFICATE-----` footer indicate that the key was generated in the correct format.

```

-----BEGIN CERTIFICATE-----
MIIEEDzCCAvEgAwIBAgIJANW2Fdyr28GdMA0GCSqGSIb3DQEBBQUAMIGdMQswCQYD
VQQGEwJVUzENMAsGA1UECAVlVXRhaDEOMAwGA1UEBwwFTG9nYW4xIjAgBgNVBAoM
GUNhbXBiZWxsIFNjaWVudGlmaWMsIEluYy4xJzAlBgNVBAMMHmpvbi10cmFibnR2
ZWluLmNhbXBiZWxsIjEwNDA4MDQxNzE3MzRaFw00NzA2MTIxNzE3MzRaMIGdMQswCQYD
VQQGEwJVUzENMAsGA1UECAVlVXRhaDEOMAwGA1UEBwwFTG9nYW4xIjAgBgNVBAoM
-----END CERTIFICATE-----

-----BEGIN RSA PRIVATE KEY-----
MIIEpQIBAAKCAQEAo8GRTJKW+gr1RfuuUNr1qCc4aodqaRnNd+L+/Wj pz
-----END RSA PRIVATE KEY-----
Proc-Type: 4, ENCRYPTED
DEK-Info: DES-EDE3-CBC, 556C1115CDA822F5
AHi/3++BAAKCAQEAo8GRTJKW+gr1RfuuUNr1qCc4aodqaRnNd+L+/Wj pz
-----END RSA PRIVATE KEY-----

```

From your IT department

If your IT department provides the key and certificate files you need to determine if the key requires a private key password. To determine if your .PEM formatted key requires a private key password:

1. Open the key file in a text editor.
2. The following header is an example of the key without a private key password.

```

-----BEGIN RSA PRIVATE KEY-----
MIIEpQIBAAKCAQEAo8GRTJKW+gr1RfuuUNr1qCc4aodqaRnNd+L+/Wj pz
-----END RSA PRIVATE KEY-----

```

3. The following header is an example of the key with a private key password.

```

-----BEGIN RSA PRIVATE KEY-----
Proc-Type: 4, ENCRYPTED
DEK-Info: DES-EDE3-CBC, 556C1115CDA822F5
AHi/3++BAAKCAQEAo8GRTJKW+gr1RfuuUNr1qCc4aodqaRnNd+L+/Wj pz
-----END RSA PRIVATE KEY-----

```

4. If the key header is similar to that shown in step 3 you need to specify a private key password. Your IT department should provide this.

NOTE:

Never specify a key password if your key does not have one.

19.2.4 Other security measures

19.2.4.1 CRBasic

Encrypt program files if they contain sensitive information. See CRBasic help [FileEncrypt\(\)](#) or use *CRBasic Editor* > File > Save and Encrypt.

Hide program files for extra protection. See CRBasic help [FileManage\(\)](#) instruction.

19.2.4.2 Other

Monitor your data logger for changes by tracking program and operating system signatures, as well as CPU file contents.

Secure the physical data logger and power supply under lock and key.

WARNING:

Some security features can be subverted through physical access to the data logger. If absolute security is a requirement, the physical data logger must be kept in a secure location.

Some options to secure your data logger from mistakes or tampering include:

- Setting a PakBus/TCP password. The PakBus TCP password controls access to PakBus communications over a TCP/IP link. PakBusTCP passwords can be set in *Device Configuration Utility*.
- Disabling FTP or setting an FTP username and password in *Device Configuration Utility*.
- Disabling HTTP or creating a `.csipasswd` file to secure HTTP (see [The .csipasswd file](#) (p. 168) for more information).

For additional information on data logger security, see:

- [4 Ways to Make your Data More Secure](#)
- [Available Security Measures for Internet-Connected Dataloggers](#)
- [How to Use Datalogger Security Codes](#)
- [How Can Data be Made More Secure on a CRBasic PakBus Datalogger](#)
- [How to Generate SFTP Keys Easily](#)

19.2.4.3 The `.csipasswd` file

Basic access authentication was implemented in the form of an encrypted password file named `.csipasswd`. It defines read/write access to the web interface. A file named `.csipasswd` is stored, and hidden, on the data logger CPU drive. Multiple user accounts with differing levels of access can be defined for one data logger. Four levels of access are available:

- **Anonymous:** Read-only access. This account cannot be removed, but privileges can be disabled.
- **Read Only:** Data collection is unrestricted. Clock and writable variables cannot be changed. Programs cannot be viewed, stopped, deleted, or retrieved.
- **Read/Write:** Data collection is unrestricted. Clock and writable variables can be changed. Programs cannot be viewed, stopped, deleted, or retrieved.

- **All (Administrator):** Data collection is unrestricted. Clock, writable variables, and settings can be changed. Programs can be viewed, stopped, deleted, and retrieved. Hidden tables can be viewed. Files, including programs can be sent to the data logger.

NOTE:

All levels of access allow data collection.

Starting with OS version 1.05, the `.csipasswd` file must be updated with *Device Configuration Utility*. The data logger will no longer accept `.csipasswd` files sent with web API commands or from the *RTMC Web Publisher*. If you are using the *RTMC Web Publisher* to publish directly to a data logger you will now need to configure the `.csipasswd` with *Device Configuration Utility*.

NOTE:

Ethernet over USB (RNDIS) is considered a direct communications connection. Therefore, it is a trusted connection and **Administrator** privileges are automatically granted for all functionality.

Create an encrypted password file or modify an existing password file using *Device Configuration Utility*:

1. Connect to your device in *Device Configuration Utility*.
2. Click the **Network Services** tab, then the **Edit .csipasswd File** button.
3. Define user accounts and access levels.
4. Click **Apply**. The `.csipasswd` file is automatically saved to the data logger CPU drive.

When access to the data logger web interface is attempted without the appropriate security level, the data logger will prompt for a username and password. If an invalid username or password is entered, the data logger will default to the level of access assigned to "anonymous". As noted previously, anonymous is assigned a user level of read-only, though this can be changed using *Device Configuration Utility*.

When a `.csipasswd` file is used, the PakBus/TCP Password security setting is not used when accessing the data logger via HTTP.

CAUTION:

The `.csipasswd` file is not reset or deleted when setting the data logger back to factory defaults or formatting the CPU drive.

Deprecated API functionality

Starting with OS version 1.05, the `.csipasswd` file must be updated with *Device Configuration Utility*. The data logger will no longer accept `.csipasswd` files sent with web API commands or from the *RTMC Web Publisher*.

See the *CRBasic Editor* help for information about the data logger web server and API commands: <https://help.campbellsci.com/crbasic/cr350/#Info/webserverapicommands1.htm> .

19.3 Web user interface

For data loggers with an IP connection, the built-in web user interface (web UI) provides browser access to real-time and stored data, files, settings, and more. No remote browser access is available until at least one user account is configured. Use an RNDIS connection to set up the first account. See [Virtual Ethernet over USB \(RNDIS\)](#) for more information.

Once a user account is configured, enter the CR350 IP address into a web browser. By default, it is `192.168.66.1` for an RNDIS connection.

NOTE:

Ethernet over USB (RNDIS) is considered a direct communications connection. Therefore, it is a trusted connection and **Administrator** privileges are automatically granted for all functionality.

Use **Manage Accounts** to set permissions to access web UI features. Once a **New Account** is setup, basic access authentication is enabled in the data logger. Multiple user accounts with differing levels of access can be defined for one data logger. Four levels of access are available:

- **Anonymous:** Read-only access. This account cannot be removed, but privileges can be disabled.
- **Read Only:** Data collection is unrestricted. Clock and writable variables cannot be changed. Programs cannot be viewed, stopped, deleted, or retrieved.
- **Read/Write:** Data collection is unrestricted. Clock and writable variables can be changed. Programs cannot be viewed, stopped, deleted, or retrieved.
- **All (Administrator):** Data collection is unrestricted. Clock, writable variables, and settings can be changed. Programs can be viewed, stopped, deleted, and retrieved. Hidden tables can be viewed. Files, including programs can be sent to the data logger.

NOTE:

The default account is read-only with a user name of **anonymous** and no password. No **Administrator (All)** accounts are setup by default for security reasons. User accounts must be

changed manually; they are not restored by resetting the data logger to factory defaults. See [Resetting the data logger](#) for more information.

19.4 Power budgeting

In low-power situations, the data logger can operate for several months on non-rechargeable batteries. Power systems for longer-term remote applications typically consist of a charging source, a charge controller, and a rechargeable battery. When ac line power is available, a VAC-to-VDC wall adapter, the onboard charging regulator, and a rechargeable battery can be used to construct an uninterruptible power supply (UPS).

When designing a power supply, consider worst-case power requirements and environmental extremes. For example, the power requirement of a weather station may be substantially higher during extreme cold, while at the same time, the extreme cold constricts the power available from the power supply. System operating time for batteries can be estimated by dividing the battery capacity (ampere hours) by the average system current drain (amperes).

For more information see:



- [Power Supplies Application Note](#) 
- [Battery Care Blog](#) 
- [Troubleshooting Your Solar Panel blog](#) 
- [Power Budget Spreadsheet](#) 
- [Power Budgeting Video](#) 





See also:

- [Power input](#) (p. 11)
- [Power output](#) (p. 13)
- [Power requirements](#) (p. 269)
- [Power output specifications](#) (p. 271)

19.5 Field work

Field installation is site- and application- specific. This section lists resources to aid with system installation.

- [Data logger enclosures](#) (p. 172)
- [Grounds](#) (p. 13)
- [Electrostatic discharge and lightning protection](#) (p. 173)
- [Weather Station Siting and Installation Technical Paper](#) 
- [Protect Station from Birds Blog](#) 

- [Tripod Manual](#) 
- [Tripod Installation Videos](#) 
- [Tower Manual \(UT20 and UT30\)](#) 
- [UTBASE Installation Video](#) 
- [Surge Protector Kits: Installation and Troubleshooting White Paper](#) 

19.6 Data logger enclosures

The data logger and most of its peripherals must be protected from moisture and humidity. Moisture in the electronics will seriously damage the data logger. In most cases, protection from moisture is easily accomplished by placing the data logger in a weather-tight enclosure with desiccant and elevating the enclosure above the ground. Desiccant in enclosures should be changed periodically.

WARNING:

Do not completely seal the enclosure if lead-acid batteries are present; hydrogen gas generated by the batteries may build to an explosive concentration.

The following details a typical installation using a Campbell Scientific enclosure. The data logger has mounting holes through which small screws are inserted into nylon anchors in the backplate.

1. Insert the included nylon anchors into the backplate. Position them to align with the mounting holes on the base of the data logger.
2. Holding the data logger to the backplate, screw the screws into the nylon anchors.

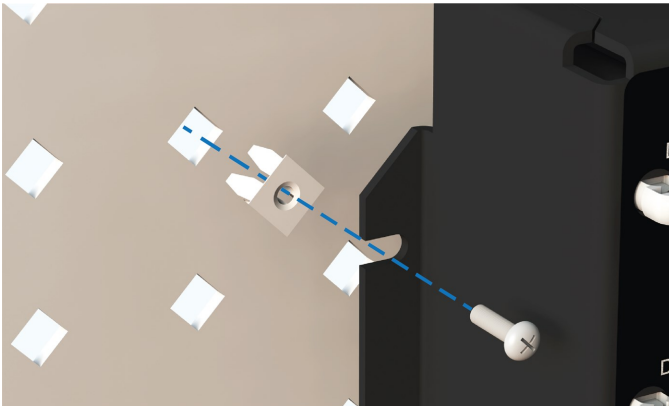

See also [Physical specifications](#) (p. 269).

19.7 Electrostatic discharge and lightning protection

WARNING:

Lightning strikes may damage or destroy the data logger, associated sensors and power supplies.

Electrostatic discharge (ESD) can originate from several sources, the most common and destructive are primary and secondary lightning strikes. Primary lightning strikes hit instrumentation directly. Secondary strikes induce voltage in power lines or wires connected to instrumentation. While elaborate, expensive, and nearly infallible lightning protection systems are on the market, Campbell Scientific, for many years, has employed a simple and inexpensive design that protects most systems in most circumstances. The system consists of a lightning rod, metal mast, heavy-gauge ground wire, and ground rod to direct damaging current away from the data logger. This system, however, is not infallible. The following image displays a typical application of the system:

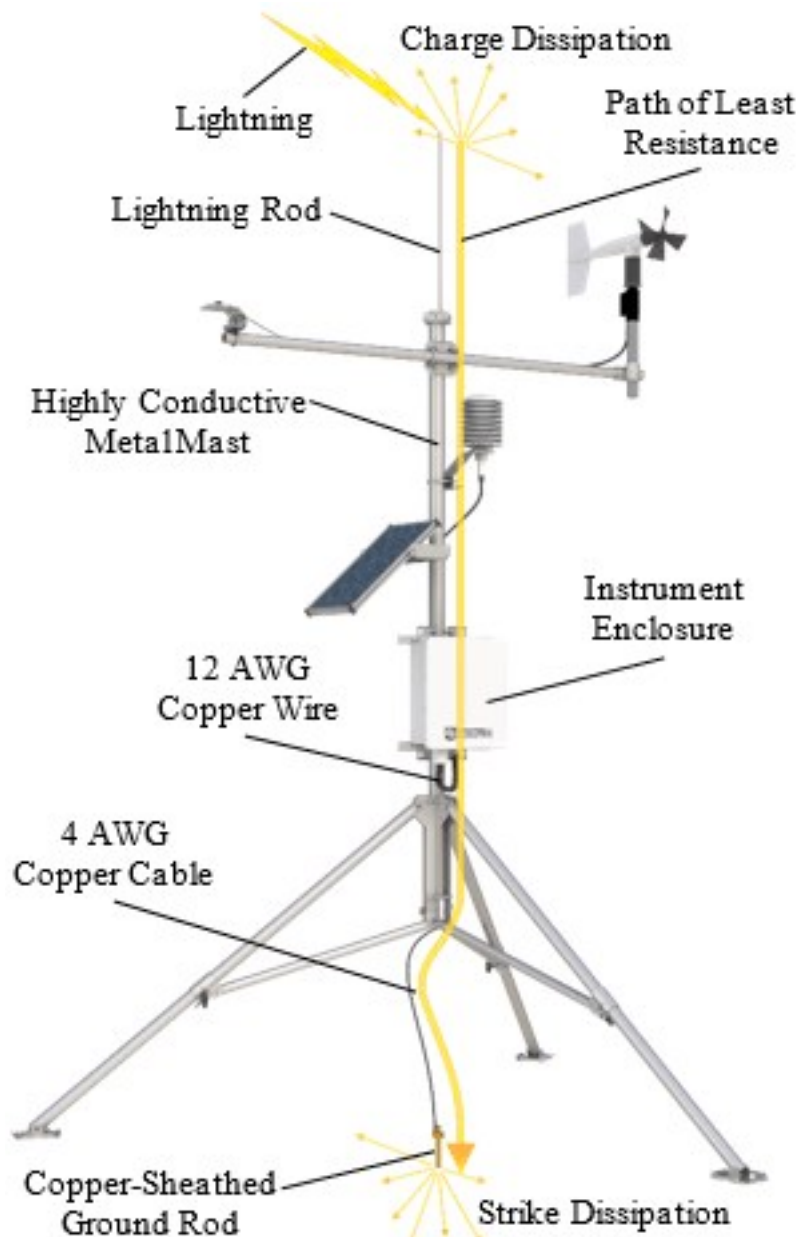

All critical inputs and outputs on the data logger are ESD protected. To be effective, the earth ground lug must be properly connected to earth (chassis) ground.



Communications ports are another path for transients. You should provide communications paths, such as telephone or short-haul modem lines, with spark-gap protection. Spark-gap protection is usually an option with these products; so, request it when ordering. Spark gaps must be connected to earth (chassis) ground.



For detailed information on grounding, see [Grounds](#) (p. 13).

20. CR350 maintenance

Protect the data logger from humidity and moisture. When humidity levels reach the dewpoint, condensation occurs, and damage to data logger electronics can result. Adequate desiccant should be placed in instrumentation enclosure to provide protection, and control humidity. Desiccant should be changed periodically.

If sending the data logger to Campbell Scientific for calibration or repair, consult first with Campbell Scientific. If the data logger is malfunctioning, be prepared to perform some troubleshooting procedures. See:

- [Tips and troubleshooting](#) (p. 182)
- [Does Your Data Logger Need to be Repaired Blog](#) 
- [Troubleshooting Data Acquisition System Blog](#) 

Also, consider checking, or posting your question to, the Campbell Scientific user forum <https://www.campbellsci.com/forum> . Our web site www.campbellsci.com  has additional manuals (with example programs), FAQs, specifications and compatibility information for all of our products.

Video tutorials www.campbellsci.com/videos  and blog articles www.campbellsci.com/blog  are also useful troubleshooting resources.

If calibration or repair is needed, the procedure shown on: <https://www.campbellsci.com/repair>  should be followed when sending the product.

20.1 Data logger calibration

Campbell Scientific recommends factory recalibration every three years. During calibration, all the input terminals, peripheral and communications ports, operating system, and memory areas are checked; and the internal battery is replaced. The data logger is checked to ensure that all hardware operates within published specifications before it is returned. To request recalibration for a product, see <https://www.campbellsci.com/repair> .

It is recommended that you maintain a level of calibration appropriate to the data logger application. Consider the following factors when setting a calibration schedule:

- The importance of the measurements
- How long the data logger will be used

- The operating environment
- How the data logger will be handled

You can download and print calibration certificates for many products you have purchased by logging in to the Campbell Scientific website and going to: <https://www.campbellsci.com/calcerts> .

NOTE:

Note, you will need your product's serial number to access its certificate.

Watch an instructional video: <http://www.campbellsci.com/videos/calibration-certs> .

20.2 Internal battery

The lithium battery powers the internal clock when the data logger is not powered. This voltage is displayed in the LithiumBattery. See [LithiumBattery](#) (p. 219) field in the **Status** table. Replace the battery when voltage is approximately 2.7 VDC. The internal lithium battery life is extended when the data logger is installed with an external power source. If the data logger is used in a high-temperature application, the battery life is shortened.

To prevent clock and memory issues, it is recommended you proactively replace the battery every 5 years, or more frequently when operating continuously in high temperatures. For example, replace at least every 2 years if operating continuously at 80 °C.

NOTE:

The battery is replaced during regular factory recalibration, which is recommended every 3 years. For more information, see [Data logger calibration](#) (p. 175).

When the lithium battery is removed (or is depleted and primary power to the data logger is removed), the CRBasic program and most settings are maintained, but the following are lost:

- Temporary program memory (current values for variables).
- Routing and communications logs (relearned without user intervention).
- Time. Clock will need resetting when the battery is replaced.

A replacement lithium battery can be purchased from Campbell Scientific or another supplier.

- 3 V coin cell CR2025 for battery-backed clock. 6-year life with no external power source.

See [Power requirements](#) (p. 269) for more information.

WARNING:

Misuse or improper installation of the internal lithium battery can cause severe injury. Fire, explosion, and severe burns can result. Do not recharge, disassemble, heat above 100 °C (212 °F), solder directly to the cell, incinerate, or expose contents to water. Dispose of spent lithium batteries properly.

NOTE:

The **Status** field **Battery** value and the destination variable from the **Battery()** instruction (often called `batt_volt`) in the **Public** table reference the external battery voltage.

For additional information on the internal battery, visit the Campbell Scientific blog article, [Get to Know Your Data Logger's Spare Tire: The Lithium Battery](#) .

20.2.1 Replacing the internal battery

It is recommended that you send the data logger in for scheduled calibration, which includes internal battery replacement. See [Data logger calibration](#) (p. 175).

WARNING:

Any damage made to the data logger during user replacement of the internal battery is not covered under warranty.

1. Loosen the screws from the bottom of the data logger.
2. Pull the bottom and top of the data logger apart.
3. Remove the lithium battery by gently prying it out with a small flat-bladed screwdriver.
4. Install new battery.
5. Reassemble the data logger.

20.3 Updating the operating system

Campbell Scientific posts operating system (OS) updates at <https://www.campbellsci.com/downloads>  when they become available. It is recommended that before deploying instruments, you check operating system versions and update them as needed. The data logger operating system version is shown in the **Status** table, **Station Status Summary**, and **Device Configuration Utility Deployment > Datalogger**. An operating system may be sent through **Device Configuration Utility** or through program-send procedures.

WARNING:

Because sending an OS resets data logger memory and resets all settings on the data logger to factory defaults, data loss will certainly occur. Depending on several factors, the data logger may also become incapacitated until the new OS is programmed into memory.

TIP:

It is recommended that you retrieve data from the data logger and back up your programs and settings before updating your OS. To collect data using *LoggerNet*, connect to your data logger and click **Collect Now** . To backup your data logger, connect to it in *Device Configuration Utility*, click the **Backup** menu and select **Backup Datalogger**.

20.3.1 Sending an operating system to a local data logger

Send an OS using *Device Configuration Utility*. This method requires a direct connection between your data logger and computer.

1. Download the latest Operating System at <https://www.campbellsci.com/downloads> .
2. Locate the .exe download and double-click to run the file. This will extract the .obj OS file to the C:\Campbellsci\Lib\OperatingSystems folder.
3. Supply power to the data logger. If connecting via USB for the first time, you must first install USB drivers by using *Device Configuration Utility* (select your data logger, then on the main page, click **Install USB Driver**). Alternatively, you can install the USB drivers using EZ Setup. A USB connection supplies 5 V power (as well as a communications link), which is adequate for setup, but a 12 V battery will be needed for field deployment.
4. Physically connect your data logger to your computer using a USB cable, then open *Device Configuration Utility* and select your data logger.
5. Select the communications port used to communicate with the data logger from the **COM Port** list (you do not need to click **Connect**).
6. Click the **Send OS** tab. At the bottom of the window, click **Start**.
7. On the **Avoid Conflicts with the Local Server** window, click **OK**.
8. Navigate to the C:\Campbellsci\Lib\OperatingSystems folder.
9. Ensure **Datalogger Operating System Files (*.obj)** is selected in the **Files of type** list, select the new OS .obj file, and click **Open** to update the OS on the data logger.

Watch a video: [Sending an OS to a Local Datalogger](#) .







20.3.2 Sending an operating system to a remote data logger

CAUTION:

Sending an OS remotely to a data logger with Operating System 4 or earlier is not recommended. These data loggers should be updated using the previous instruction ([Sending an operating system to a local data logger](#) (p. 178)).

If you have a data logger that is already deployed, you can update the OS over a telecommunications link by sending the OS to the data logger as a program. In most instances, sending an OS as a program preserves settings. This allows for sending supported operating systems remotely (check the release notes). However, this should be done with great caution as updating the OS may reset the data logger settings, even settings critical to supporting the telecommunication link.

The `default.CRB` program can be edited to preserve critical data logger settings such as communications settings. See [Default program](#) (p. 159) for more information.

1. Download the latest Operating System at <https://www.campbellsci.com/downloads> .
2. Locate the .exe download and double-click to run the file. This will extract the .obj OS file to the `C:\Campbellsci\Lib\OperatingSystems` folder.
3. Using data logger support software, connect to your data logger.
 - *LoggerNet* users, select **Main** and click **Connect**  on the *LoggerNet* toolbar, select the data logger from the **Stations** list, then click **Connect** .
 - *PC400* users, select the data logger from the list and click **Connect** .
4. Select **File Control**  at the top of the Connect window.
5. Click **Send**  at the top of the File Control window.
6. Navigate to the `C:\Campbellsci\Lib\OperatingSystems` folder.

7. Ensure **Datalogger Operating System Files (*.obj)** is selected in the files of type list, select the new OS .obj file, and click **Open** to update the OS on the data logger.

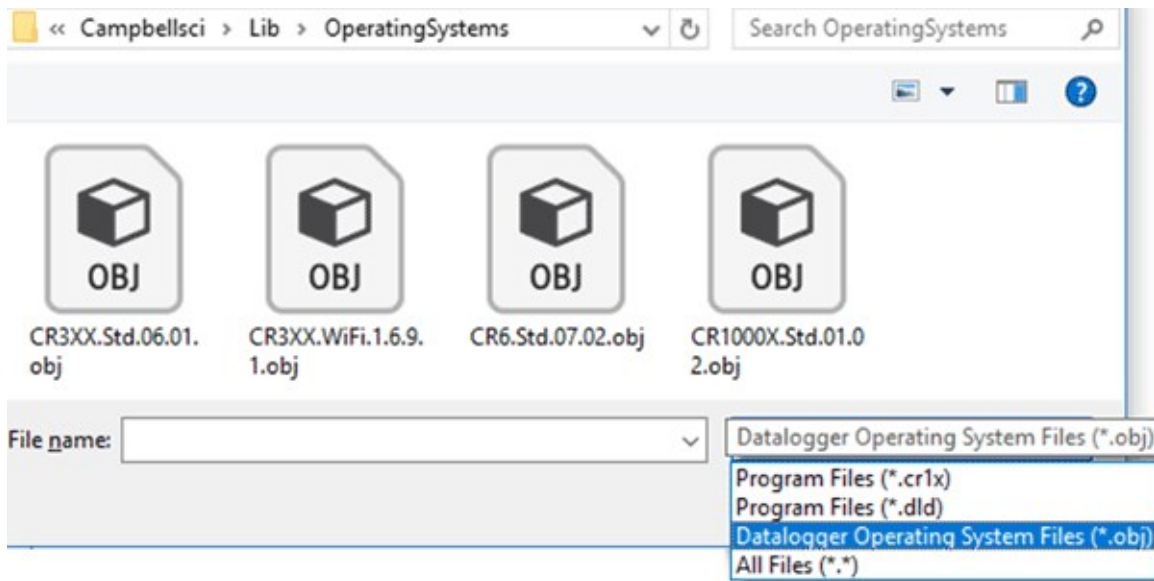

Note the following precautions when sending as a program:

- Any peripherals being powered through the **SW12** terminal will be turned off until the program logic turns them on again.
- Operating systems are very large files. Be cautious of data charges. Sending over a direct serial or USB connection is recommended, when possible.

20.4 gzip

The CR350 supports the ability to extract the contents of program, operating system, and other files that have been created using **gzip**. The file name must be in the format:

filename.fileextension.gz (for example: **TestPgm.CRB.gz**, **CR350.Std.01.obj.gz**, or **CR350.Std.01.web.obj.gz**).

For more information see: www.gzip.org .

Zipping a file can significantly reduce its size, resulting in fewer bytes to transfer when sending a zipped file to a data logger. This is especially beneficial over slow, high-latency, or costly telecommunications links. Therefore, those using low-baud-rate radios, satellite, or restricted cellular data plans should consider zipping operating systems and large programs before sending.

Compatible files can be created using any utility that supports the **gzip** file format. Use a file **tarball** (*filename.tar.gz*) to compress multiple files. Several free utilities provide zipping to these formats.

Send the zipped file to the **CPU**;, **CRD**; or **USB**; drive using data logger support software. Files sent using **Connect > Send Program** will be unzipped automatically. However, the data logger will not automatically unzip files that are sent using **File Control > Send File**. To unzip files sent with **File Control**, mark them as **Run Now**.

Unzipping and installing file contents takes a long time; expect several minutes for operating systems and additional time for **.web** files. The details of unzipping and installing files from a **gzip** file are as follows:

1. The data logger receives the **gzip** file and restarts.
2. The data logger unzips the **.gz** file to the same drive to which it was sent.
3. The **.tar** portion of the file, if available, is processed.
4. Operating system (**.obj** or **.iobj** files) are programmed to the respective destination.
5. The data logger restarts.
6. When an **.obj** file is involved the OS will be loaded by the boot code resulting in another restart.
7. Web user interface (**.web**) files, if available, are installed. This may take over ten minutes.

NOTE:

Compression has little effect on an encrypted program (**FileEncrypt()**) and on files that already employ compression such as JPEG or MP4.

TIP:

The data logger also has the ability to compress files using **GZip()**. See the *CRBasic Editor* help for detailed instruction information and program examples:

<https://help.campbellsci.com/crbasic/cr350/> .

21. Tips and troubleshooting

Start with these basic procedures if a system is not operating properly.

1. Ensure your system is well grounded. See [Grounds](#) (p. 13). The symptoms of a poorly grounded system range from bad measurements, to intermittent communications, to damaged hardware.
2. Using a voltmeter, check the voltage of the primary power source at the **CHG** and **BAT** terminals on the face of the data logger, it should be 10 to 18 VDC. If connecting to a power source via the **CHG** terminals, voltage measured should be 16 to 32 VDC.
3. Check wires and cables for the following:
 - Incorrect wiring connections. Make sure each sensor and device are wired to the terminals assigned in the program. If the program was written in *Short Cut*, check wiring against the generated wiring diagram. If written in *CRBasic Editor*, check wiring against each measurement and control instruction.
 - Loose connection points
 - Faulty connectors
 - Cut wires
 - Damaged insulation, which allows water to migrate into the cable. Water, whether or not it comes in contact with wire, can cause system failure. Water may increase the dielectric constant of the cable sufficiently to impede sensor signals, or it may migrate into the sensor, which will damage sensor electronics.
4. Check the CRBasic program. If the program was written solely with *Short Cut*, the program is probably not the source of the problem. If the program was written or edited with *CRBasic Editor*, logic and syntax errors could easily have crept in. To troubleshoot, create a simpler version of the program, or break it up into multiple smaller units to test individually. For example, if a sensor signal-to-data conversion is faulty, create a program that only measures that sensor and stores the data, absent from all other inputs and data.
5. Reset the data logger. Sometimes the easiest way to resolve a problem is by resetting the data logger (see [Resetting the data logger](#) (p. 190) for more information).

For additional troubleshooting options, see:

21.1 Checking station status	183
--	-----

21.2 Understanding NAN and INF occurrences	185
21.3 Timekeeping	186
21.4 CRBasic program errors	188
21.5 Troubleshooting radio communications	189
21.6 Resetting the data logger	190
21.7 Troubleshooting power supplies	192
21.8 Using terminal mode	192
21.9 Ground loops	197
21.10 Improving voltage measurement quality	202
21.11 Field calibration	215
21.12 File name and resource errors	215

Also, consider checking, or posting your question to, the Campbell Scientific user forum <https://www.campbellsci.com/forum>. Our web site www.campbellsci.com has additional manuals (with example programs), FAQs, specifications and compatibility information for all of our products.

Video tutorials www.campbellsci.com/videos and blog articles www.campbellsci.com/blog are also useful troubleshooting resources.

21.1 Checking station status

View the condition of the data logger using **Station Status**. Here you see the operating system version of the data logger, the name of the current program, program compile results, and other key indicators. Items that may need your attention appear in **red** or **blue**. The following information describes the significance of some entries in the station status window. Watch a video at: <https://www.campbellsci.com/videos/connect-station-status> or use the following instructions.

21.1.1 Viewing station status

Using your data logger support software, access the **Station Status** to view the condition of the data logger.

- From *LoggerNet*: Click **Connect**, then **Station Status** to view the **Summary** tab.
- From *PC400*: Select the **Datalogger** menu and **Station Status** to view the **Summary** tab.

21.1.2 Watchdog errors

Watchdog errors indicate that the data logger has crashed and reset itself. Experiencing occasional watchdog errors is normal. You can reset the Watchdog error counter in the **Station Status > Status Table**.

TIP:

Before resetting the counter, make note of the number accumulated and the date.

Watchdog errors could be due to:

- Transient voltage
- Incorrectly wired or malfunctioning sensor
- Poor ground connection on the power supply
- Numerous **PortSet()** instructions back-to-back with no delay
- High-speed serial data on multiple ports with very large data packets or bursts of data

The error "Results for Last Program Compiled: Warning: Watchdog Timer IpTask Triggered" can result from:

- The IP communications on the data logger got stuck, and the data logger had to reboot itself to recover. Or communications failures may cause the data logger to reopen the IP connections more than usual. Check your data logger operating system version; recent operating system versions have improved stability of IP communications.

If any of these are not the apparent cause, contact Campbell Scientific for assistance (see <https://www.campbellsci.com/support>). Causes that may require assistance include:

- Memory corruption
- Operating System problem
- Hardware problem
- IP communications problem

Additionally, a **watchdogInfo.txt** file may be created on the CPU drive when the CR350 experiences a software reset (as opposed to a hardware reset that increments the **WatchdogErrors** field in the **Status Table**). Postings of **watchdoginfo.txt** files are rare. Contact Campbell Scientific for assistance (see <https://www.campbellsci.com/support>).

21.1.3 Results for last program compiled

Messages generated by the data logger at program upload and as the program runs are reported here. Warnings indicate that an expected feature may not work, but the program will

still operate. Errors indicate that the program cannot run. For more information, see [CRBasic program errors](#) (p. 188).

21.1.4 Skipped scans

Skipped scans are caused when a program takes longer to process than the scan interval allows. An occasional skipped scan can be caused by memory formatting as discussed in [Data memory](#) (p. 99). If any scan skips repeatedly, the data logger program may need to be optimized or reduced. For more information, see: [How to Prevent Skipped Scans and a Sunburn](#) .

21.1.5 Skipped records

Skipped records usually occur because a scan is skipped. They indicate that a record was not stored to the data table when it should have been.

21.1.6 Variable out of bounds

Variable-out-of-bounds errors happen when an array is not sized to the demands of the program. The data logger attempts to catch out-of-bounds errors at compile time. However, it is not always possible; when these errors occur during runtime the variable-out-of-bounds field increments. Variable-out-of-bounds errors are always caused by programming problems.

21.1.7 Battery voltage

If powering through USB, reported battery voltage should be 0 V. If connecting to an external power source, battery voltage should be reported at or near 12 V. See also:

- [Power input](#) (p. 11)
- [Power requirements](#) (p. 269)

21.2 Understanding NAN and INF occurrences

NAN (not a number) and INF (infinite) are data words indicating an exceptional occurrence in data logger function or processing. **INF** indicates that the program has encountered an undefined arithmetic expression, such as $0 \div 0$. **NAN** indicates an invalid measurement. For more information, see [Tips and Tricks: Who's NAN?](#) .

NANs are expected in the following conditions:

- Input signals exceed the voltage range chosen for the measurement.
- An invalid SDI-12 command is sent.

- An SDI-12 sensor does not respond or aborts without sending data.

NAN is a constant that can be used in expressions. This is shown in the following example code that sets a CRBasic variable to **False** when the wind direction is **NAN**:

```
If WindDir = NAN Then
  WDFlag = False
Else
  WDFlag = True
EndIf
```

If an output processing instruction encounters a **NAN** in the values being processed, **NAN** will be stored. For example, if one measurement in a data storage interval results in **NAN**, then the average, maximum and minimum will record **NAN**. However, because **NAN** is a constant, it can be used in conjunction with the disable variable parameter (**DisableVar**) in output processing instructions. Use *variable* = **NAN** in the **DisableVar** parameter to discard **NAN**s from affecting the other good values. The following example code discards **NAN** WindSpeed measurements from the Minimum output:

```
Minimum (1, WindSpeed, FP2, WindSpeed=NAN, False)
```

NOTE:

There is no such thing as **NAN** for integers. Values that are converted from float to integer will be expressed in data tables as the most negative number for a given data type. For example, the most negative number of data type FP2 is -7999; so, **NAN** for FP2 data will appear in a data table as -7999. If the data type is Long, **NAN** will appear in the data table as -2147483648.

21.3 Timekeeping

Measurement of time is an essential data logger function. Time measurement with the onboard clock enables the data logger to run on a precise interval, attach time stamps to data, measure the interval between events, and time the initiation of control functions. Details on clock accuracy and resolution are available in the [System specifications](#) (p. 268). An internal lithium battery backs the clock when the data logger is not externally powered. See [Internal battery](#) (p. 176).

21.3.1 Clock best practices

When setting the clock with *LoggerNet*, initiate it manually during a maintenance period when the data logger is not actively writing to Data Tables. Click **Set** in the Clocks field of the *LoggerNet* Connect Screen.

If you are going to use automated clock check with *LoggerNet* (clock settings can be found on the *LoggerNet* Setup Standard View **Clock** tab). it is recommended that you do this on the order of days (not hours). Set an allowed clock deviation that is appropriate for the expected jitter in the network, and use the initial time setting to offset the clock check away from storage and measurement intervals.

The amount of time required for a **Clock Check** command to reach the data logger, be processed, and for it to send its response is called round-trip time, or time-of-flight. To calculate an estimate of this time-of-flight, *LoggerNet* maintains a history (in order) of the round-trip times for the ten previous successful clock check transactions. It adds this average to the time values received from the data logger and subtracts it from any adjustment that it might make.

21.3.2 Time stamps

A measurement without an accurate time reference often has little meaning. Data collected from data loggers is stored with time stamps. How closely a time stamp corresponds to the actual time a measurement is taken depends on several factors.

The time stamp in common CRBasic programs matches the time at the beginning of the current scan as measured by the real-time data logger clock. If a scan starts at 15:00:00, data output during that scan will have a time stamp of **15:00:00** regardless of the length of the scan, or when in the scan a measurement is made. The possibility exists that a scan will run for some time before a measurement is made. For instance, a scan may start at 15:00:00, execute a time-consuming part of the program, then make a measurement at 15:00:00.51. The time stamp attached to the measurement, if the `CallTable()` instruction is called from within the `Scan()` / `NextScan` construct, will be **15:00:00**, resulting in a time-stamp skew of 510 ms.

21.3.3 Avoiding time skew

Time skew between consecutive measurements is a function of settling and integration times, ADC, and the number entered into the **Reps** parameter of CRBasic instructions. A close approximation is:

$$\text{time skew} = \text{reps} * (\text{settling time} + \text{integration time} + \text{ADC time}) + \text{instruction setup time}$$

where ADC time equals 170 μ s, and instruction setup time is 15 μ s.

If reps (repetitions) > 1 (multiple measurements by a single instruction), no setup time is required. If reps = 1 for consecutive voltage instructions, include the setup time for each instruction.

Time-stamp skew is not a problem with most applications because:

- Program execution times are usually short; so, time-stamp skew is only a few milliseconds. Most measurement requirements allow for a few milliseconds of skew.
- Data processed into averages, maxima, minima, and so forth are composites of several measurements. Associated time stamps only reflect the time of the scan when processing calculations were completed; so, the significance of the exact time a specific sample was measured diminishes.

Applications measuring and storing sample data wherein exact time stamps are required can be adversely affected by time-stamp skew. Skew can be avoided by:

- Making measurements in the scan before time-consuming code.
- Programming the data logger such that the time stamp reflects the system time rather than the scan time using the `DataTime()` instruction. See the *CRBasic Editor* help for detailed instruction information and program examples:
<https://help.campbellsci.com/crbasic/cr350/>

21.4 CRBasic program errors

Analyze data soon after deployment to ensure the data logger is measuring and storing data as intended. Most measurement and data-storage problems are a result of one or more CRBasic program bugs. Watch a video: [CRBasic > Common Errors - Identifying and fixing common errors in the CRBasic programming language](#).

21.4.1 Program does not compile

When a program is compiled, the *CRBasic Editor* checks the program for syntax errors and other inconsistencies. The results of the check are displayed in a message window at the bottom of the main window. If an error can be traced to a specific line in the program, the line number will be listed before the error. Double-click an error preceded by a line number and that line will be highlighted in the program editing window. Correct programming errors and recompile the program.

Occasionally, the *CRBasic Editor* compiler states that a program compiles OK; however, the program may not compile in the data logger itself. This is rare, but reasons may include:

- The data logger has a different operating system than the computer compiler. Check the two versions if in doubt. The computer compiler version is shown on the first line of the compile results. Update the computer compiler by first downloading the executable OS file

from www.campbellsci.com. When run, the executable file updates the computer compiler. To update the data logger operating system, see [Updating the operating system](#) (p. 177).

- The program has large memory requirements for data tables or variables and the data logger does not have adequate memory. This normally is flagged at compile time in the compile results. If this type of error occurs:
 - Check the CPU drive for copies of old programs. The data logger keeps copies of all program files unless they are deleted, the drive is formatted, or a new operating system is loaded with *Device Configuration Utility*.

21.4.2 Program compiles but does not run correctly

If the program compiles but does not run correctly, timing discrepancies may be the cause. If a program is tight on time, look further at the execution times. Check the measurement and processing times in the **Status** table (**MeasureTime**, **ProcessTime**, **MaxProcTime**) for all scans, then try experimenting with the **InstructionTimes()** instruction in the program. Analyzing **InstructionTimes()** results can be difficult due to the multitasking nature of the data logger, but it can be a useful tool for fine-tuning a program. For more information, see [Status table system information](#) (p. 218).

See the *CRBasic Editor* help for detailed instruction information and program examples: <https://help.campbellsci.com/crbasic/cr350/>.

21.5 Troubleshooting radio communications

Intermittent communications problems when connecting via radio, may indicate there is another network in the area causing interference. To help remove the interference, use *Device Configuration Utility* to change the **Network ID** and **RF Hop Sequence** in all RF407, RF412, and RF422 radios within a network (standalone or included in a data logger) to another value. Each of these settings must have the same value in all radios and dataloggers within a network. For example, the **Network ID** in all devices could be set to **1726**, and the **RF Hop Sequence** in all devices could be set to **1**. The **Network ID** can be any number between 0 and 32767. The **RF Hop Sequence** can be any number between 0 and 7 in an RF407 or RF412 network; it can be any number between 0 and 9 in an RF422 network.

NOTE:

Radio options cannot be mixed within a network. An RF407 can only be used with other RF407-type radios, an RF412 can only be used with other RF412-type radios, an RF422 can only be used with other RF422-type radios, and an RF427 can only be used with other RF427-

type radios, and an RF452 can only be used with other RF452-type radios.

See also [Radio communications option](#) (p. 55).

See also: [Troubleshooting large networks paper](#) .

21.6 Resetting the data logger

A data logger reset is sometimes referred to as a "memory reset." Backing up the current data logger configuration before a reset makes it easy to revert to the old settings. To back up the data logger configuration, connect to the data logger using Device Configuration Utility, and click **Backup > Back Up Datalogger**. To restore a configuration after the data logger has been reset, connect and click **Backup > Restore Datalogger**.

The following features are available for complete or selective reset of data logger memory:

- Processor reset
- Program send reset
- Manual data table reset
- Formatting memory drives
- Full memory reset

21.6.1 Processor reset

To reset the processor, simply power cycle the data logger. This resets its short-term memory, restarts the current program, sets variables to their starting values, and clears communications buffers. This does not clear data tables but may result in a skipped record. If the data logger is remote, a power cycle can be mimicked in a **Terminal Emulator** program (type REBOOT <Enter>).

21.6.2 Program send reset

Final-data memory is erased when user programs are uploaded, unless preserve / erase data options are used and the program was not altered. Preserve / erase data options are presented when sending programs using File Control **Send** command and *CRBasic Editor Compile, Save and Send*.

TIP:

It is good practice to always retrieve data from the data logger before sending a program; otherwise, data may be lost. See [Collecting data](#) (p. 88) for detailed instruction.

When a program compiles, all variables are initialized. A program is recompiled after a power failure or a manual stop. For instances that require variables to be preserved through a program

recompile, consider [PreserveVariables\(\)](#) and [PreserveOneVariable\(\)](#) instructions and User Settings. Entries in User Settings are not erased when a program is recompiled.

User Settings can be entered manually in *Device Configuration Utility* in the **Settings Editor** > **User Settings** tab, or they can be written through a CRBasic program using the [SetSetting\(\)](#) instruction.

NOTE:

User settings are stored in flash memory. To avoid corrupting the flash memory, edit these settings infrequently.

21.6.3 Manual data table reset

Data table memory is selectively reset from:

- Datalogger support software: **Station Status**  > **Table Fill Times** tab, **Reset Tables**.
- *Device Configuration Utility*: **Data Monitor** tab, **Reset Table** button.

21.6.4 Formatting drives

CPU, , and USB (module required) drives can be formatted individually. Formatting a drive erases all files on that drive. If the currently running user program is on the drive to be formatted, the program will cease running and data associated with the program are erased. Drive formatting is performed through the data logger support software **File Control** > **Format** command.

21.6.5 Full memory reset

Full memory reset occurs when an operating system is sent to the data logger using *Device Configuration Utility* or when entering **98765** in the **Status** table field **FullMemReset**. See [FullMemReset](#) (p. 219). A full memory reset does the following:

- Clears and formats CPU drive (all program files erased)
- Clears data tables
- Clears **Status** table fields
- Restores settings to default
- Initializes system variables
- Clears communications memory

See [Updating the operating system](#) (p. 177) for more information.

21.7 Troubleshooting power supplies

Power supply systems may include batteries, charging regulators, and a primary power source such as solar panels or ac/ac or ac/dc transformers attached to mains power. All components may need to be checked if the power supply is not functioning properly. Check connections and check polarity of connections.

Base diagnostic: connect the data logger to a new 12 V battery. (A small 12 V battery carrying a full charge would be a good thing to carry in your maintenance tool kit.) Ensure correct polarity of the connection. If the data logger powers up and works, troubleshoot the data logger power supply.

When diagnosing or adjusting power equipment supplied by Campbell Scientific, it is recommended you consider:

- Battery-voltage test
- Charging-circuit test (when using an unregulated solar panel)
- Charging-circuit test (when using a transformer)
- Adjusting charging circuit

If power supply components are working properly and the system has peripherals with high current drain, such as a satellite transmitter, verify that the power supply is designed to provide adequate power. For additional information, see [Power budgeting](#) (p. 171).

21.8 Using terminal mode

[Table 21-1](#) (p. 193) lists terminal mode options. With exception of perhaps the **C** command, terminal options are not necessary to routine CR350 operations.

To enter terminal mode, connect a computer to the CR350. See [Setting up communications with the data logger](#) (p. 21). Open a terminal emulator program from Campbell Scientific data logger support software:

- **Connect** window > **Datalogger** menu item > **Terminal Emulator...**
- *Device Configuration Utility* **Terminal** tab

After entering a terminal emulator, press **Enter** a few times until the prompt **CR350>** is returned. Terminal commands consist of specific characters followed by **Enter**. Sending an **H** and **Enter** will return the terminal emulator menu.

ESC or a 40 second timeout will terminate on-going commands. Concurrent terminal sessions are not allowed and will result in dropped communications.

Terminal commands are subject to change. Please consult Campbell Scientific for assistance if you are not familiar with the effects of a command.

Table 21-1: CR350 terminal commands		
Command	Description	Use
0	Scan processing time; real time in seconds	Lists technical data concerning program scans.
3	Status	Lists the CR350 Status table.
5	Scan information	Technical data regarding the CR350 scan.
7	VARS	Lists Public table variables.
A	Operating system copyright	Lists copyright notice and version of operating system.
C	Modify constant table	Edit constants defined with ConstTable / EndConstTable . Only active when ConstTable / EndConstTable in the active program.
D	MTdbg() task monitor	Campbell Scientific engineering tool
E	Compile errors	Lists compile errors for the current program download attempt.
F	Settings names	Lists settings
H	Terminal emulator menu	Lists main menu.
I	Calibration data	Lists gains and offsets resulting from internal calibration of analog measurement circuitry.
J	Download file dump	Sends text of current program including comments.
L	Peripheral bus read	Campbell Scientific engineering tool
M	Memory check	Lists memory-test results.
N	File system information	Lists files in CR350 memory.
O	Data table sizes	Lists technical data concerning data-table sizes.
P	Serial talk through	Issue commands from keyboard that are passed through the logger serial port to the connected device. Similar in concept to SDI12 Talk Through. No timeout when connected via PakBus.

Command	Description	Use
REBOOT	Program recompile	Typing "REBOOT" rapidly will recompile the CR350 program immediately after the last letter, "T", is entered. Table memory is retained. NOTE: When typing REBOOT , characters are not echoed (printed on terminal screen).
SDI12	SDI12 talk through	Issue commands from keyboard that are passed through the CR350 SDI-12 port to the connected device. Similar in concept to Serial Talk Through. See also SDI-12 transparent mode (p. 195)
T	Terminal master	Communicate through the terminal mode of a remote CR350 by way of another CR350. See also Terminal master (p. 197).
W	Comms Watch (Sniff)	Enables monitoring of CR350 communications traffic. No timeout when connected via PakBus.
PCAP	Wireshark PCAP file capture	Campbell Scientific engineering tool

21.8.1 Serial talk through and comms watch

The **P: Serial Talk Through** and **W: Comms Watch** ("sniff") modes do not have a timeout when connected in terminal mode via PakBus. Otherwise, the timeout can be changed from the default of 40 seconds to any value ranging from 1 to 86400 seconds (86400 seconds = 1 day).

When using options **P** or **W** in a terminal session, consider the following:

- Concurrent terminal sessions are not allowed by the CR350.
- Opening a new terminal session will close the current terminal session.
- The data logger will attempt to enter a terminal session when it receives non-PakBus characters on the **RS-232** port unless the port is first opened with the [SerialOpen\(\)](#) instruction.

If the data logger attempts to enter a terminal session on the **RS-232** port because of an incoming non-PakBus character, and that port was not opened using [SerialOpen\(\)](#), any currently running terminal function, including the comms watch, will immediately stop. So, in programs that frequently open and close a serial port, the probability is higher that a non-PakBus

character will arrive at the closed serial port, thus closing an existing talk-through or comms watch session.

For more information on Comms Watch, see a video

at: <https://www.campbellsci.com/videos/sdi12-sensors-watch-or-sniffer-mode> .

21.8.2 SDI-12 transparent mode

All SDI-12 probes have just three wires—a signal, ground, and 12 V power line. They are connected to the data logger according to the following table.

Wire function	Data logger connection
SDI-12 signal	C1, C2
Shield	G
Power	12V
Power ground	G

System operators can manually interrogate and enter settings in probes, connected to the data logger, using transparent mode. Transparent mode is useful in troubleshooting SDI-12 systems because it allows direct communications with probes.

Transparent mode may need to wait for commands issued by the programmed mode to finish before sending responses. While in transparent mode, the data logger programs may not execute. Data logger security may need to be unlocked before transparent mode can be activated.

Transparent mode is entered while the computer is communicating with the data logger through a terminal emulator program such as through *Device Configuration Utility* or other data logger support software. Keyboard displays cannot be used. For how-to instructions for communicating directly with an SDI-12 sensor using a terminal emulator, watch this

video: <https://www.campbellsci.com/videos/sdi12-sensors-transparent-mode> .

To enter the SDI-12 transparent mode, enter the data logger support software terminal emulator:



```
Deployment | Logger Control | Data Monitor | File Control | Send OS | Settings Editor | Terminal
CR350>
CR350>SDI12
Enter Cx Port 1,2,3 or ?
1
Entering SDI12 Terminal
+
Exit SDI12 Terminal
```

1. Press **Enter** until the data logger responds with the prompt **CR350>**.
2. Type **SDI12** at the prompt and press **Enter**.
3. In response, the query **Select SDI12 Port** is presented with a list of available ports. Enter the port number assigned to the terminal to which the SDI-12 sensor is connected, and press **Enter**. For example, **1** is entered for terminal **C1**.
4. An **Entering SDI12 Terminal** response indicates that SDI-12 transparent mode is active and ready to transmit SDI-12 commands and display responses.

21.8.2.1 Watch command (sniffer mode)

The terminal-mode utility allows monitoring of SDI-12 traffic by using the watch command (sniffer mode). Watch an instructional video: <https://www.campbellsci.com/videos/sdi12-sensors-watch-or-sniffer-mode>  or use the following instructions.

1. Enter the transparent mode as described previously.
2. Press **Enter** until a **CR350>** prompt appears.
3. Type **W** and then press **Enter**.
4. In response, the query **Select SDI12 Port:** is presented with a list of available ports. Enter the port number assigned to the terminal to which the SDI-12 sensor is connected, and press **Enter**.
5. In answer to **Enter timeout (secs):** type **100** and press **Enter**.
6. In response to the query **ASCII (Y)?**, type **Y** and press **Enter**.
7. SDI-12 communications are then opened for viewing.

21.8.2.2 SDI-12 transparent mode commands

SDI-12 commands and responses are defined by the SDI-12 Support Group (www.sdi-12.org) and are available in the [SDI-12 Specification](#). Sensor manufacturers determine which commands to support. Commands have three components:

- Sensor address (**a**): A single character and the first character of the command. Sensors are usually assigned a default address of zero by the manufacturer. The wildcard address (**?**) is used in the **Address Query** command. Some manufacturers may allow it to be used in other commands. SDI-12 sensors accept addresses 0 through 9, a through z, and A through Z.
- Command body (for example, **M1**): An upper case letter (the “command”) followed by alphanumeric qualifiers.
- Command termination (**!**): An exclamation mark.

An active sensor responds to each command. Responses have several standard forms and terminate with <CR><LF> (carriage return–line feed).

21.8.3 Terminal master

Use the Terminal master command from a terminal mode to manually interrogate and enter settings in smart-sensors connected to a remote CR350. The Terminal master is useful for remotely accessing data logger terminal features such as SDI-12 and serial talk through modes for configuration and trouble shooting.

Using a terminal emulator enter the CR350 terminal mode. For more information, see [Using terminal mode](#) (p. 192)

1. Press **Enter** until the data logger responds with the prompt **CR350>**.
2. Type **T** at the prompt and press **Enter**.
3. In response, select the PakBus address of the remote data logger.

Once the Terminal master option is entered, the terminal will present a new prompt, **n*CR350>**, where **n** is the remote CR350 PakBus address.

4. Now, the remote device terminal functions can be accessed.

21.9 Ground loops

A ground loop is a condition in an electrical system that contains multiple conductive paths for the flow of electrical current between two nodes. Multiple paths are usually associated with the ground or 0 V-potential point of the circuit. Ground loops can result in signal noise,

communications errors, or a damaging flow of ground current on long cables. Most often, ground loops do not have drastic negative effects and may be unavoidable. Special cases exist where additional grounding helps shield noise from sensitive signals; however, in these cases, multiple ground conductors are usually run tightly in parallel without conductive shielding material placed between the parallel grounds. If possible, ground loops should be avoided. When problems arise in a system, ground loops may be the source of the problems.

See also [Grounds](#) (p. 13).

21.9.1 Common causes

Some of the common causes of ground loops include the following:

- The drain wire of a shielded cable is connected to the local ground at both ends, and the ground is already being carried by a conductor inside the cable. In this case, two wires, one on either side of the cable shield, are connected to the ground nodes at both ends of the cable.
- A long cable connects the grounds of two electrical devices, and the mounting structure or grounding rod also directly connects the grounds of each device to the local earth ground. The two paths, in this case, are the connecting cable and earth itself.
- When electrical devices are connected to a common metal chassis such as an instrument tower, the structure can create a ground path in parallel to the ground wires in sensor cables running over the structure.
- Conductors connected to ground are found in most cables that connect to a data logger. These include sensors cables, communications cables, and power cables. Any time one of these cables connects to the same two endpoints as another cable, a ground loop is formed.

21.9.2 Detrimental effects

The harm from a ground loop can be seen in different ways. One consideration is the electromagnetically induced effect. This will manifest as AC noise or an AC pulse. As seen in [Figure 21-1](#) (p. 199) the parallel conductive paths form an electrical loop that acts as an antenna to pick up electromagnetic energy.

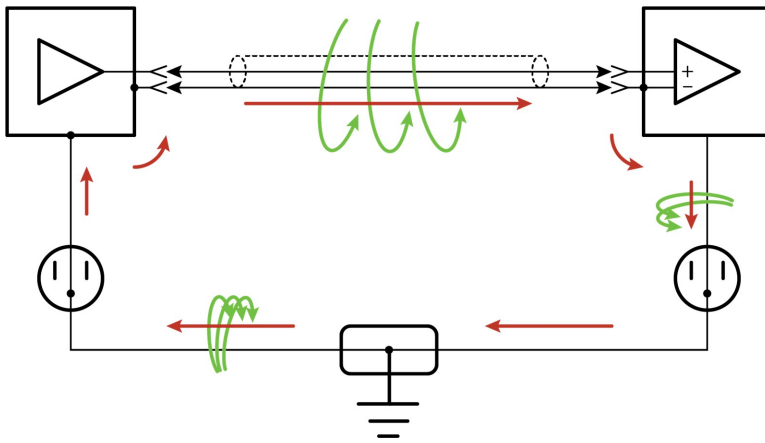

Figure 21-1. Stray AC magnetic fields picked up in loop antenna

- Relatively small electromagnetic energy: This could come from AC current on a nearby power cable, or RF energy transmitting through the air, and can cause electrical noise that either corrupts an analog signal or disrupts digital communications.
- Larger electromagnetic energy: The antenna loop scenario can have a more damaging effect when a large current is discharged nearby. The creation of an electromagnetic pulse can induce a surge that damages attached electronic devices.

Another way ground loops affect a system is by allowing ground current to flow between devices. This can be either a DC or AC effect. For various reasons, the voltage potential between two different points on the surface of the earth is not always 0 V. Therefore, when two electrical devices are both connected to a local earth ground, there may exist a voltage difference between the two devices. When a cable is connected between the two devices at different voltages, physics dictates that an electrical current must flow between the two points through the cable. See [Figure 21-2](#) (p. 199).

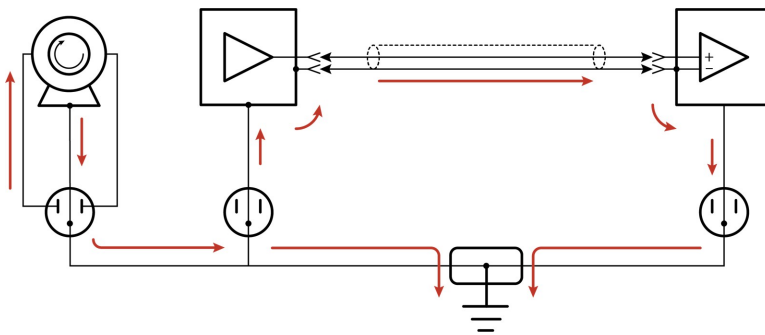

Figure 21-2. Leakage current (AC or DC) from nearby load

- One effect of this DC ground current-flow is a voltage offset error in analog measurements. Errors of this sort are usually not obvious but can have meaningful effects on measurements.
- For digital communications, an offset in the ground voltage reduces the dynamic range of the digital signals. This makes them more susceptible to noise corruption. If the ground voltage changes by one volt or more, the digital communications could stop working because the signals no longer reach the thresholds for determining the state of each bit.
- If the ground voltage differences reach several volts, damaging effects may occur at the terminals of the electronics devices. Damage occurs when the maximum allowable voltage on the internal components is exceeded.

21.9.3 Severing a ground loop

To avoid or eliminate ground loops, when they are detected, requires severing the loop. Suggestions for severing ground loops include:

- Connect the shield wire of a signal cable to ground only at one end of the cable. Leave the other end floating (not connected to ground).
- Never intentionally use the shield (or drain wire) of a cable as a signal ground or power ground.
- Use the mechanical support structure only as a connection for the safety ground (usually the ground lug). Do not intentionally return power ground through the structure.
- Do not use shielded Cat5e cables for Ethernet communications.
- For long distance communications protocols such as RS-485, RS-422, and CAN, use a Resistive Ground (**RG**) terminal for the ground connection. The **RG** terminal has a 100-ohm resistor in series with ground to limit the amount of DC current that can flow between the two endpoints while keeping the common-mode voltage in range of the transceivers. The transceivers themselves have enhanced voltage range inputs allowing for ground voltage differences of up to 7 V between endpoints.
- For exceptional cases, use optical or galvanic isolation devices to provide a signal connection without any accompanying ground connection. These should be used only when ground loops are causing system problems and the other methods of breaking a ground loop don't apply. These devices add expense and tend to consume large amounts of power.

21.9.4 Soil moisture example

When measuring soil moisture with a resistance block, or water conductivity with a resistance cell, the potential exists for a ground loop error. In the case of an ionic soil matric potential (soil moisture) sensor, a ground loop arises because soil and water provide an alternate path for the excitation to return to data logger ground. This example is modeled in the following image:

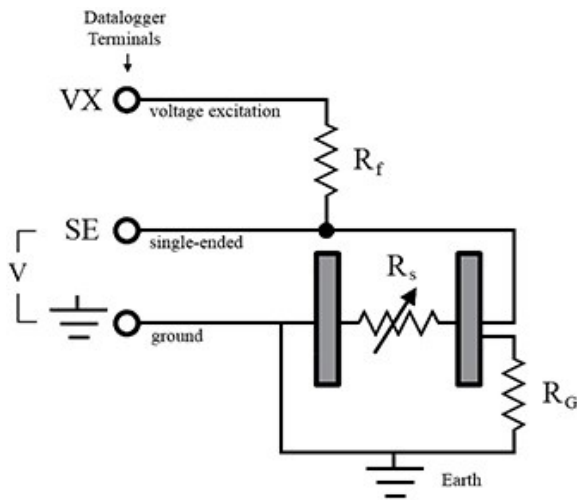

With R_g in the resistor network, the signal measured from the sensor is described by the following equation:

$$V_1 = V_x \frac{R_s}{(R_s + R_f) + R_s R_f / R_g}$$

where

- V_x is the excitation voltage
- R_f is a fixed resistor
- R_s is the sensor resistance
- R_g is the resistance between the excited electrode and data logger earth ground.

$R_s R_f / R_g$ is the source of error due to the ground loop. When R_g is large, the error is negligible. Note that the geometry of the electrodes has a great effect on the magnitude of this error. The Delmhorst gypsum block used in the Campbell Scientific 227 probe has two concentric cylindrical electrodes. The center electrode is used for excitation; because it is encircled by the ground electrode, the path for a ground loop through the soil is greatly reduced. Moisture blocks that consist of two parallel plate electrodes are particularly susceptible to ground loop problems. Similar considerations apply to the geometry of the electrodes in water conductivity sensors.



The ground electrode of the conductivity or soil moisture probe and the data logger earth ground form a galvanic cell, with the water/soil solution acting as the electrolyte. If current is allowed to flow, the resulting oxidation or reduction will soon damage the electrode, just as if DC excitation was used to make the measurement. Campbell Scientific resistive soil probes and conductivity probes are built with series capacitors to block this DC current. In addition to preventing sensor deterioration, the capacitors block any DC component from affecting the measurement.

21.10 Improving voltage measurement quality

The following topics discuss methods of generally improving voltage measurements:

21.10.1 Deciding between single-ended or differential measurements	202
21.10.2 Minimizing ground potential differences	203
21.10.3 Minimizing power-related artifacts	204
21.10.4 Filtering to reduce measurement noise	206
21.10.5 Minimizing settling errors	209
21.10.6 Factors affecting accuracy	212
21.10.7 Minimizing offset voltages	213

Read More: Consult the following technical papers at www.campbellsci.com/app-notes  for in-depth treatments of several topics addressing voltage measurement quality:

- [Preventing and Attacking Measurement Noise Problems](#) 
- [Benefits of Input Reversal and Excitation Reversal for Voltage Measurements](#) 
- [Voltage Accuracy, Self-Calibration, and Ratiometric Measurements](#) 

21.10.1 Deciding between single-ended or differential measurements

Deciding whether a differential or single-ended measurement is appropriate is usually, by far, the most important consideration when addressing voltage measurement quality. The decision requires trade-offs of accuracy and precision, noise cancellation, measurement speed, available measurement hardware, and fiscal constraints.

In broad terms, analog voltage is best measured differentially because these measurements include the following noise reduction features that are not included in single-ended measurements.

- Passive Noise Rejection
 - No voltage reference offset
 - Common-mode noise rejection, which filters capacitively coupled noise

Reasons for using single-ended measurements, however, include:

- Not enough differential terminals are available. Differential measurements use twice as many analog input terminals as do single-ended measurements.
- Rapid sampling is required. Single-ended measurement time is about half that of differential measurement time.
- Sensor is not designed for differential measurements. Some Campbell Scientific sensors are not designed for differential measurement, but the drawbacks of a single-ended measurement are usually mitigated by large programmed excitation and/or sensor output voltages.

Sensors with a high signal-to-noise ratio, such as a relative-humidity sensor with a full-scale output of 0 to 1000 mV, can normally be measured as single-ended without a significant reduction in accuracy or precision.

Sensors with a low signal-to-noise ratio, such as thermocouples, should normally be measured differentially. However, if the measurement to be made does not require high accuracy or precision, such as thermocouples measuring brush-fire temperatures, which can exceed 2500 °C, a single-ended measurement may be appropriate. If sensors require differential measurement, but adequate input terminals are not available, an analog multiplexer should be acquired to expand differential input capacity.

Because a single-ended measurement is referenced to data logger ground, any difference in ground potential between the sensor and the data logger will result in an error in the measurement. For more information on grounds, see [Grounds](#) (p. 13) and [Minimizing ground potential differences](#) (p. 203).

21.10.2 Minimizing ground potential differences

Low-level, single-ended voltage measurements (<200 mV) are sensitive to ground potential fluctuation due to changing return currents from **SW12** and **C** terminals. The data logger grounding scheme is designed to minimize these fluctuations by separating signal grounds (\oplus) from power grounds (**G**). For more information on data logger grounds, see [Grounds](#) (p. 13). To take advantage of this design, observe the following rules:

- Connect grounds associated with **SW12** and **C** terminals to **G** terminals.
- Connect excitation grounds to the nearest \oplus terminal on the same terminal block.

- Connect the low side of single-ended sensors to the nearest \oplus terminal on the same terminal block.
- Connect shield wires to the \oplus terminal nearest the terminals to which the sensor signal wires are connected.

If offset problems occur because of shield or ground wires with large current flow, tying the problem wires into terminals next to terminals configured for excitation and pulse-count should help. Problem wires can also be tied directly to the ground lug to minimize induced single-ended offset voltages.

21.10.2.1 Ground potential differences

Because a single-ended measurement is referenced to data logger ground, any difference in ground potential between the sensor and the data logger will result in a measurement error. Differential measurements **MUST** be used when the input ground is known to be at a different ground potential from data logger ground.

Ground potential differences are a common problem when measuring full-bridge sensors (strain gages, pressure transducers, etc), and when measuring thermocouples in soil.

- **Soil Temperature Thermocouple:** If the measuring junction of a thermocouple is not insulated when in soil or water, and the potential of earth ground is, for example, 1 mV greater at the sensor than at the point where the data logger is grounded, the measured voltage will be 1 mV greater than the thermocouple output. With a Type T (copper-constantan) thermocouple, 1 mV equates to approximately 25 °C measurement error.
- **External Signal Conditioner:** External instruments with integrated signal conditioners, such as an infrared gas analyzer (IRGA), are frequently used to make measurements and send analog information to the data logger. These instruments are often powered by the same VAC-line source as the data logger. Despite being tied to the same ground, differences in current drain and wire resistance result in different ground potentials at the two instruments. For this reason, a differential measurement should be made on the analog output from the external signal conditioner.

For additional information, see [Minimizing offset voltages](#) (p. 213).

21.10.3 Minimizing power-related artifacts

Some VAC-to-VDC power converters produce switching noise or AC ripple as an artifact of the ac-to-dc rectification process. Excessive switching noise on the output side of a power supply can increase measurement noise, and so increase measurement error. Noise from grid or mains

power also may be transmitted through the transformer, or induced electromagnetically from nearby motors, heaters, or power lines.

High-quality power regulators typically reduce noise due to power regulation. Using the 50 Hz or 60 Hz first notch frequency (f_{N1}) option for CRBasic analog input measurement instructions often improves rejection of noise sourced from power mains. The CRBasic standard deviation output instruction, `StdDev()`, can be used to evaluate measurement noise.

The data logger includes adjustable digital filtering, which serves two purposes:

- Arrive as close as possible to the true input signal
- Filter out measurement noise at specific frequencies, the most common being noise at 50 Hz or 60 Hz, which originate from mains-power lines.

Filtering time is inversely proportional to the frequency being filtered.

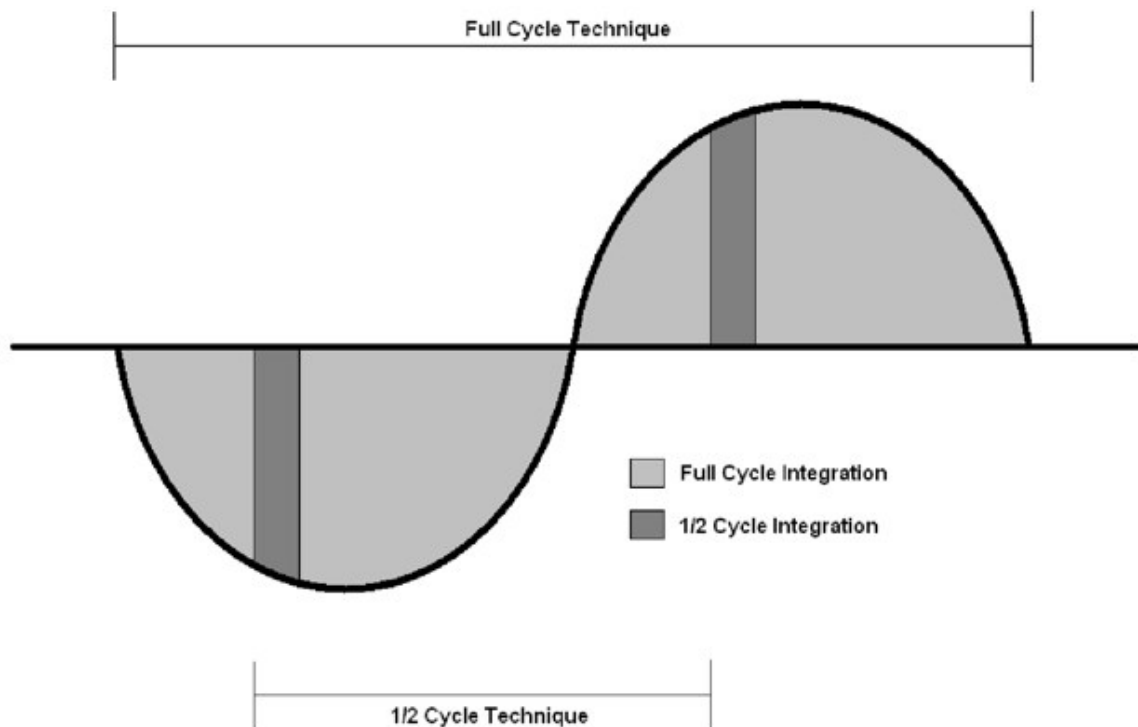

21.10.3.1 Minimizing electronic noise

Electronic noise can cause significant error in a voltage measurement, especially when measuring voltages less than 200 mV. So long as input limitations are observed, the PGA ignores voltages, including noise, that are common to each side of a differential-input pair. This is the common-mode voltage. Ignoring (rejecting or canceling) the common-mode voltage is an essential feature of the differential input configuration that improves voltage measurements. The following image illustrates the common-mode component (V_{cm}) and the differential-mode

component (V_{dm}) of a voltage signal. V_{cm} is the average of the voltages on the $V+$ and $V-$ inputs. So, $V_{cm} = (V+ + V-)/2$ or the voltage remaining on the inputs when $V_{dm} = 0$. The total voltage on the $V+$ and $V-$ inputs is given as $V_H = V_{cm} + V_{dm}/2$, and $V_L = V_{cm} - V_{dm}/2$, respectively.

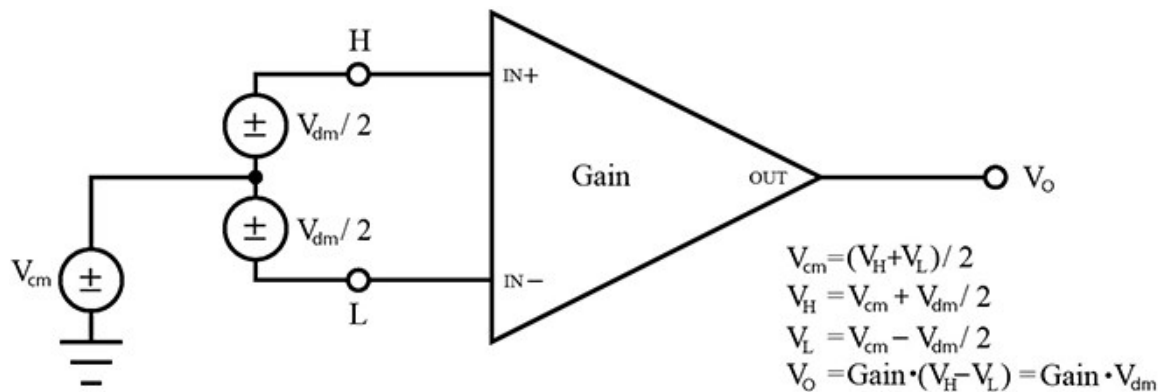

21.10.4 Filtering to reduce measurement noise

The data logger applies an adjustable filter to analog measurements, reducing signal components at selected frequencies. The following figures show the frequency response of the filters applied when the first notch frequency (**fN1**) is set to 4000, 400, or 50/60 Hz, respectively. Note that the same filter is applied when **fN1** is set to either 50 or 60 Hz, simultaneously filtering both 50 and 60 Hz signal components. Commonly, **fN1** is set at 50 or 60 Hz in order to filter 50 or 60 Hz signal components, reducing noise from ac power mains.

Filtering comes at the expense of measurement time. The time required for filtering is 0.5 ms when **fN1** is set to 4000 Hz, 6.226 ms when **fN1** is 400 Hz, and 49.812 ms when **fN1** is set to either 50 or 60 Hz. Random noise in the measurement results decreases, while measurement time increases, as **fN1** is set to smaller values. The total time required for a single result includes settling + filtering + overhead.

A faster filter may be preferred to achieve the following objectives:

- Minimize time skew between successive measurements [Avoiding time skew](#) (p. 187).
- Maximize throughput rate.
- Maximize life of the data logger power supply.
- Minimize polarization of polar sensors such as those for measuring conductivity, soil moisture, or leaf wetness. Polarization may cause measurement errors or sensor degradation.
- Improve accuracy of an LVDT measurement. The induced voltage in an LVDT decays with time as current in the primary coil shifts from the inductor to the series resistance; a long integration may result in most of signal decaying before the measurement is complete.

Consult the following technical paper at www.campbellsci.com/app-notes for in-depth treatment of measurement noise: [Preventing and Attacking Measurement Noise Problems](#).

fN1 set to 4000 Hz:

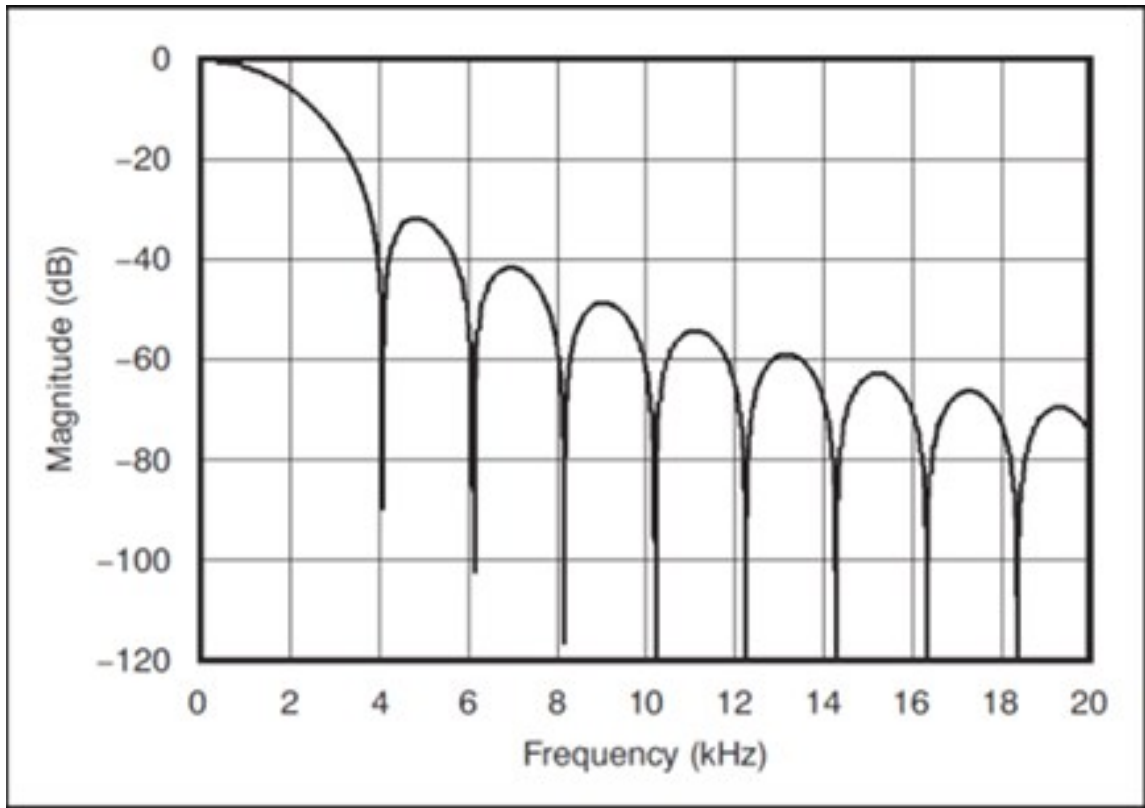

fN1 set to 400 Hz:

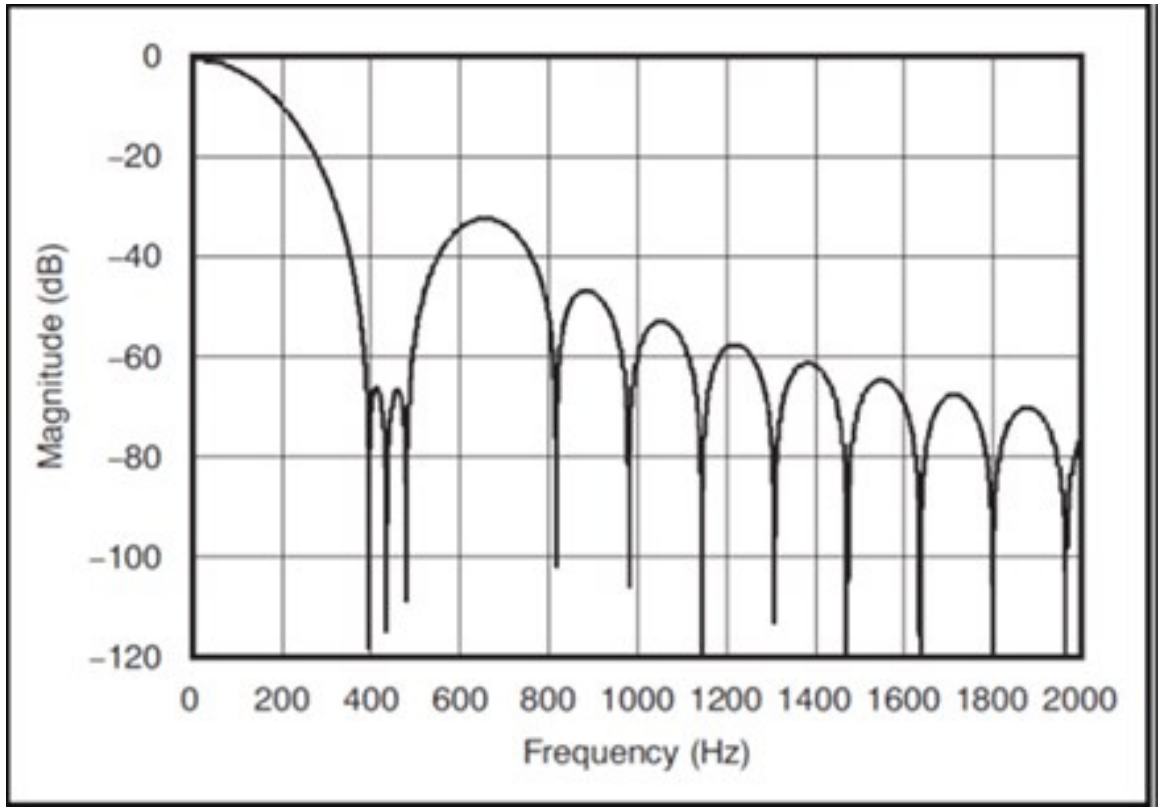

fN1 set to 50 or 60 Hz:

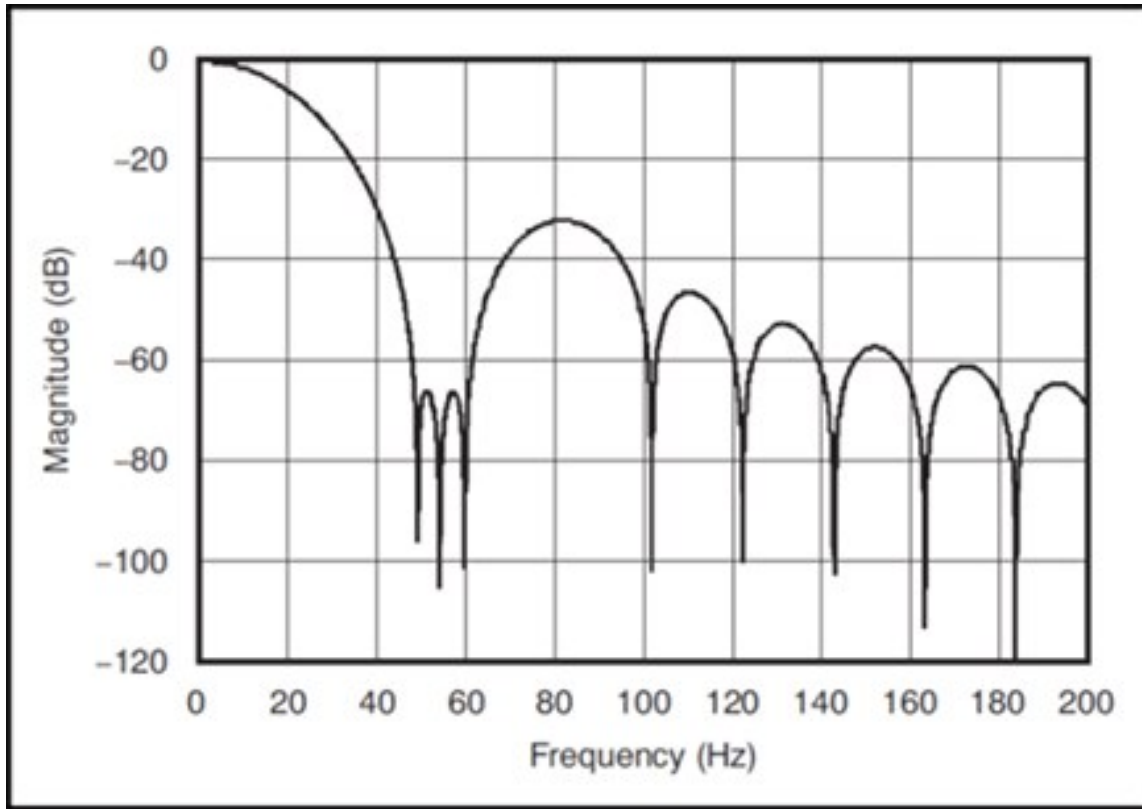

21.10.5 Minimizing settling errors

Settling time allows an analog voltage signal to rise or fall closer to its true magnitude prior to measurement. Default settling times, those resulting when the **SettlingTime** parameter is set to **0**, provide sufficient settling in most cases. Additional settling time is often programmed when measuring high-resistance (high-impedance) sensors, or when sensors connect to the input terminals by long cables. The time to complete a measurement increases with increasing settling time. For example, a 1 ms increase in settling time for a bridge instruction with input reversal and excitation reversal results in a 4 ms increase in time to perform the instruction.

When sensors require long cable lengths, use the following general practices to minimize settling errors:

- Do not use leads with PVC-insulated conductors. PVC has a high dielectric constant, which extends input settling time.
- Where possible, run excitation leads and signal leads in separate shields to minimize transients.

- When measurement speed is not a prime consideration, additional time can be used to ensure ample settling time.
- In difficult cases where measurement speed is a consideration, an appropriate settling time can be determined through testing.

21.10.5.1 Measuring settling time

Settling time for a particular sensor and cable can be measured with the CR350. Programming a series of measurements with increasing settling times will yield data that indicate at what settling time a further increase results in negligible change in the measured voltage. The programmed settling time at this point indicates the settling time needed for the sensor / cable combination.

The following **CRBasic Example: Measuring Settling Time** presents CRBasic code to help determine settling time for a pressure transducer using a high-capacitance semiconductor. The code consists of a series of full-bridge measurements ([BrFull\(\)](#)) with increasing settling times. The pressure transducer is placed in steady-state conditions so changes in measured voltage are attributable to settling time rather than changes in pressure.

CRBasic Example 3: Measuring settling time

*'This program example demonstrates the measurement of settling time
'using a single measurement instruction multiple times in succession.*

```
Public PT(20) 'Variable to hold the measurements
DataTable(Settle,True,100)
  Sample(20,PT(),IEEE4)
EndTable
BeginProg
  Scan(1,Sec,3,0)
    BrFull(PT(1),1,mV2500,1,Vx1,1,2500,False,True,100,60,1.0,0)
    BrFull(PT(2),1,mV2500,1,Vx1,1,2500,False,True,200,60,1.0,0)
    BrFull(PT(3),1,mV2500,1,Vx1,1,2500,False,True,300,60,1.0,0)
    BrFull(PT(4),1,mV2500,1,Vx1,1,2500,False,True,400,60,1.0,0)
    BrFull(PT(5),1,mV2500,1,Vx1,1,2500,False,True,500,60,1.0,0)
    BrFull(PT(6),1,mV2500,1,Vx1,1,2500,False,True,600,60,1.0,0)
    BrFull(PT(7),1,mV2500,1,Vx1,1,2500,False,True,700,60,1.0,0)
    BrFull(PT(8),1,mV2500,1,Vx1,1,2500,False,True,800,60,1.0,0)
    BrFull(PT(9),1,mV2500,1,Vx1,1,2500,False,True,900,60,1.0,0)
    BrFull(PT(10),1,mV2500,1,Vx1,1,2500,False,True,1000,60,1.0,0)
    BrFull(PT(11),1,mV2500,1,Vx1,1,2500,False,True,1100,60,1.0,0)
    BrFull(PT(12),1,mV2500,1,Vx1,1,2500,False,True,1200,60,1.0,0)
    BrFull(PT(13),1,mV2500,1,Vx1,1,2500,False,True,1300,60,1.0,0)
    BrFull(PT(14),1,mV2500,1,Vx1,1,2500,False,True,1400,60,1.0,0)
    BrFull(PT(15),1,mV2500,1,Vx1,1,2500,False,True,1500,60,1.0,0)
    BrFull(PT(16),1,mV2500,1,Vx1,1,2500,False,True,1600,60,1.0,0)
    BrFull(PT(17),1,mV2500,1,Vx1,1,2500,False,True,1700,60,1.0,0)
    BrFull(PT(18),1,mV2500,1,Vx1,1,2500,False,True,1800,60,1.0,0)
    BrFull(PT(19),1,mV2500,1,Vx1,1,2500,False,True,1900,60,1.0,0)
    BrFull(PT(20),1,mV2500,1,Vx1,1,2500,False,True,2000,60,1.0,0)
  CallTable Settle
NextScan
EndProg
```

The first six measurements are shown in the following table:

Timestamp	Record number	PT(1) Smp	PT(2) Smp	PT(3) Smp	PT(4) Smp	PT(5) Smp	PT(6) Smp
8/3/2017 23:34	0	0.03638599	0.03901386	0.04022673	0.04042887	0.04103531	0.04123745
8/3/2017 23:34	1	0.03658813	0.03921601	0.04002459	0.04042887	0.04103531	0.0414396
8/3/2017 23:34	2	0.03638599	0.03941815	0.04002459	0.04063102	0.04042887	0.04123745
8/3/2017 23:34	3	0.03658813	0.03941815	0.03982244	0.04042887	0.04103531	0.04103531
8/3/2017 23:34	4	0.03679027	0.03921601	0.04022673	0.04063102	0.04063102	0.04083316

Each trace in the following image contains all twenty PT () mV/V values (left axis) for a given record number and an average value showing the measurements as percent of final reading (right axis). The reading has settled to 99.5% of the final value by the fourteenth measurement, which is contained in variable PT(14). This is suitable accuracy for the application, so a settling time of 1400 μ s is determined to be adequate.

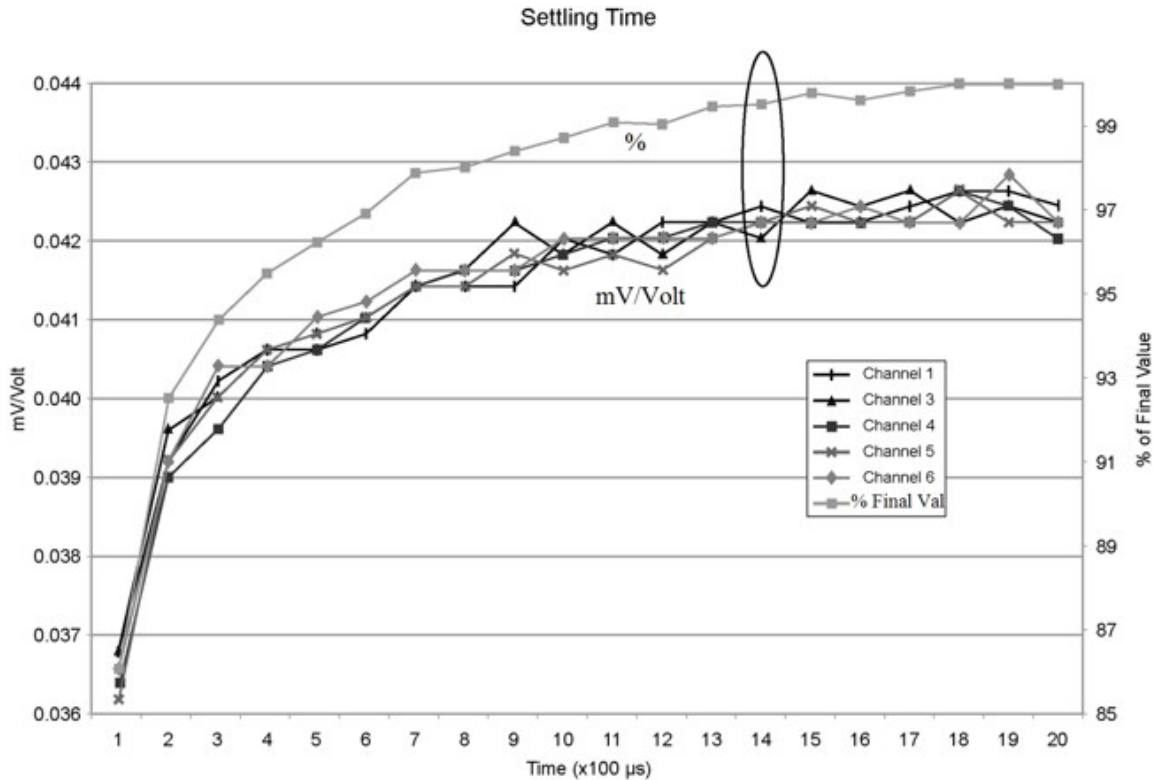

21.10.6 Factors affecting accuracy

Accuracy describes the difference between a measurement and the true value. Many factors affect accuracy. This topic discusses the effect percent-of-reading, offset, and resolution have on the accuracy of an analog voltage measurement. Accuracy is defined as follows:

$$\text{accuracy} = \text{percent-of-reading} + \text{offset}$$

where percents-of-reading and offsets are displayed in the [Analog measurement specifications](#) (p. 272).

NOTE:

Error discussed in this section and error-related specifications of the data logger do not include error introduced by the sensor, or by the transmission of the sensor signal to the data logger.

21.10.6.1 Measurement accuracy example

The following example illustrates the effect percent-of-reading and offset have on measurement accuracy. The effect of offset is usually negligible on large signals.

Example:

- Sensor-signal voltage: approximately 2500 mV
- CRBasic measurement instruction: `Voltdiff()`
- Programmed input-voltage range (`Range`): `mV 2 500` (\pm -100 to 2500 mV)
- Input measurement reversal (`RevDiff`): `True`
- Data logger circuitry temperature: 10° C

Accuracy of the measurement is calculated as follows:

accuracy = percent-of-reading + offset

where

percent-of-reading = 2500 mV • \pm 0.04%

= \pm 1 mV

and

offset = \pm 20 μ V

Therefore,

accuracy = \pm (1 mV + 20 μ V) = \pm 1.02 mV

21.10.7 Minimizing offset voltages

Voltage offset can be the source of significant error. For example, an offset of 3 μ V on a 2500 mV signal causes an error of only 0.00012%, but the same offset on a 0.25 mV signal causes an error of 1.2%. Measurement offset voltages are unavoidable, but can be minimized. Offset voltages originate with:

- Ground currents. See [Minimizing ground potential differences](#) (p. 203).
- Seebeck effect
- Residual voltage from a previous measurement

Remedies include:

- Connecting power grounds to power ground terminals (`G`).
- Automatic offset compensation for single-ended measurements when `MeasOff = False`.

- Using **MeasOff = True** for better offset compensation.
- Programming longer settling times.

Single-ended measurements are susceptible to voltage drop at the ground terminal caused by return currents from another device that is powered from the data logger wiring panel, such as another manufacturer's communications modem, or a sensor that requires a lot of power. Currents greater than 5 mA are usually undesirable. The error can be avoided by routing power grounds from these other devices to a power ground **G** terminal, rather than using a signal ground (\oplus) terminal. Ground currents can be caused by the excitation of resistive-bridge sensors, but these do not usually cause offset error. These currents typically only flow when a voltage excitation is applied. Return currents associated with voltage excitation cannot influence other single-ended measurements because the excitation is usually turned off before the data logger moves to the next measurement. However, if the CRBasic program is written in such a way that an excitation terminal is enabled during an unrelated measurement of a small voltage, an offset error may occur.

The Seebeck effect results in small thermally induced voltages across junctions of dissimilar metals as are common in electronic devices. Differential measurements are more immune to these than are single-ended measurements because of passive voltage cancellation occurring between matched high and low pairs such as **1H/1L**. So, use differential measurements when measuring critical low-level voltages, especially those below 200 mV, such as are output from pyranometers and thermocouples.

When analog voltage signals are measured in series by a single measurement instruction, such as occurs when **VolTSEC()** is programmed with **Reps = 2** or more, measurements on subsequent terminals may be affected by an offset, the magnitude of which is a function of the voltage from the previous measurement. While this offset is usually small and negligible when measuring large signals, significant error, or NAN, can occur when measuring very small signals. This effect is caused by dielectric absorption of the integrator capacitor and cannot be overcome by circuit design. Remedies include the following:

- Programming longer settling times.
- Using an individual instruction for each input terminal, the effect of which is to reset the integrator circuit prior to filtering.
- Avoiding preceding a very small voltage input with a very large voltage input in a measurement sequence if a single measurement instruction must be used.

21.11 Field calibration



Calibration increases accuracy of a measurement device by adjusting its output, or the measurement of its output, to match independently verified quantities. Adjusting sensor output directly is preferred, but not always possible or practical. By adding the `FieldCal()` or `FieldCalStrain()` instruction to a CRBasic program, measurements of a linear sensor can be adjusted by modifying the programmed multiplier and offset applied to the measurement, without modifying or recompiling the CRBasic program. See the *CRBasic Editor* help for detailed instruction information and program examples: <https://help.campbellsci.com/crbasic/cr350/>.

21.12 File name and resource errors

The maximum file name size that can be stored, run as a program, or FTP transferred in the data logger is 59 characters. If the name + file extension is longer than 59 characters, an **Invalid Filename** error is displayed. If several files are stored, each with a long file name, memory allocated to the root directory can be exceeded before the actual memory of storing files is exceeded. When this occurs, an **Insufficient resources or memory full** error is displayed.

22. Information tables and settings (advanced)

Information tables and settings consist of fields, settings, and system information essential to setup, programming, and debugging of many advanced CR350 systems. In many cases, the info tables and settings keyword can be used to pull that field into a running CRBasic program. There are several locations where this system information and settings are stored or changed:

- **Status table:** The **Status** table is an automatically created data table. View the **Status** table by connecting the data logger to your computer (see [Making the software connection](#) (p. 81) for more information) **Station Status** , then clicking the **Status Table** tab.
- **DataTableInfo table:** The **DataTableInfo** table is automatically created when a program produces other data tables. View the **DataTableInfo** table by connecting the data logger to your computer (see [Making the software connection](#) (p. 81) for more information).
 - *PC400* users, click the **Monitor Data** tab and add the **DataTableInfo** to display it.
 - *LoggerNet* users, select **DataTableInfo** from the **Table Monitor** list.
- **Settings:** Settings can be accessed from the *LoggerNet* Connect Screen **Datalogger > Settings Editor**, or using *Device Configuration Utility* **Settings Editor** tab. Clicking on a setting in *Device Configuration Utility* also provides information about that setting.
- **Terminal Mode:** A list of setting field names is also available from the data logger terminal mode (from *Device Configuration Utility*, click the **Terminal** tab) using command "F".
- Status, DataTableInfo and Settings values may be accessed programmatically using `TableName.FieldName` syntax. For example: `Variable = Settings.FieldName`. For more information see: <https://www.campbellsci.com/blog/programmatically-access-stored-data-values> .

Communications and processor bandwidth are consumed when generating the **Status** and other information tables. If data logger is very tight on processing time, as may occur in very fast, long, or complex operations, retrieving these tables repeatedly may cause skipped scans.

Settings that affect memory usage force the data logger program to recompile, which may cause loss of data. Before changing settings, it is a good practice to collect your data (see [Collecting data](#) (p. 88) for more information). Examples of settings that force the data logger program to recompile:

- IP address
- IP default gateway
- Subnet mask
- PPP interface
- PPP dial string
- PPP dial response
- Baud rate change on control ports
- Maximum number of TLS server connections
- PakBus encryption key
- PakBus/TCP server port
- HTTP service port
- FTP service port
- PakBus/TCP service port
- PakBus/TCP client connections
- Communications allocation

22.1 DataTableInfo table system information

The **DataTableInfo** table is automatically created when a program produces other data tables. View the **DataTableInfo** table by connecting the data logger to your computer (see [Making the software connection](#) (p. 81) for more information).

Most fields in the **DataTableInfo** table are **read only** and of a **numeric data type** unless noted. Error counters (for example **SkippedRecord**) may be reset to **0** for troubleshooting purposes.

- *LoggerNet* users, select **DataTableInfo** from the **Table Monitor** list.
- *PC400* users, click the **Monitor Data** tab and add the **DataTableInfo** to display it.

22.1.1 DataFillDays

Reports the time required to fill a data table.

22.1.2 DataRecordSize

Reports the number of records allocated to a data table.

22.1.3 DataTableName

Reports the names of data tables. Array elements are in the order the data tables are declared in the CRBasic program.

- String data type

22.1.4 RecNum

Record number is incremented when any one of the **DataTableInfo** fields change, for example **SkippedRecord**.

22.1.5 SecsPerRecord

Reports the data output interval for a data table.

22.1.6 SkippedRecord

Reports how many times records have been skipped in a data table. Array elements are in the order that data tables are declared in the CRBasic program. Enter **0** to reset.

22.1.7 TimeStamp

Scan time that a record was generated.

- NSEC data type

22.2 Status table system information

The **Status** table is an automatically created data table. View the **Status** table by connecting the data logger to your computer (see [Making the software connection](#) (p. 81) for more information).

Most fields in the **Status** table are **read only** and of a **numeric data type** unless noted. Error counters (for example, **WatchdogErrors** or **SkippedScan**) may be reset to **0** for troubleshooting purposes.

Status table values may be accessed programatically using **SetStatus()** or **Tablename.FieldName** syntax. For example: *Variable = Status.FieldName*. For more information see: <https://www.campbellsci.com/blog/programmatically-access-stored-data-values> .

22.2.1 Battery

Voltage (VDC) of the battery powering the system. Updates once per minute, when viewing the **Status** table, or programatically.

22.2.2 CalGain

Array of floating-point values reporting calibration gain (mV) for each integration / range combination.

22.2.3 CalOffset

Displays the offset calibration factor for the different voltage ranges.

22.2.4 CommsMemFree

Memory allocations for communications. Numbers outside of parentheses reflect current memory allocation. Numbers inside parentheses reflect the lowest memory size reached.

22.2.5 CompileResults

Contains messages generated at compilation or during runtime. Updated after compile and for runtime errors such as variable out of bounds.

- String data type

22.2.6 CPUDriveFree

Provides information on the available bytes for the CPU drive.

22.2.7 DataStorageFree

Serial flash storage bytes free.

22.2.8 DataStorageSize

See [System specifications](#) (p. 268).

22.2.9 FullMemReset

Enter 98765 to start a full-memory reset, all data and programs will be erased.

22.2.10 LastSlowScan

Reports the time of the of the last Slow Sequence scan.

22.2.11 LithiumBattery

Voltage of the internal lithium battery. Updated at CR350 power up and once a day thereafter. For battery information, see [Internal battery](#) (p. 176).

22.2.12 MaxProcTime

Maximum time (μs) required to run through processing for the current scan. Value is reset when the scan exits. Enter **0** to reset. Updated at the conclusion of scan processing, prior to waiting for the next scan.

22.2.13 MaxSlowProcTime

Maximum time (μs) required to run through processing for the current Slow Sequence scan. Value is reset when the scan exits. Enter **0** to reset. Updated at the conclusion of scan processing, prior to waiting for the next scan.

22.2.14 MeasureTime

Reports the time (μs) needed to make measurements in the current scan. Calculated at compile time. Includes integration and settling time. Assumes all measurement instructions will run each scan. Updated when a main scan begins.

22.2.15 MemoryFree

Unallocated final-data memory on the CPU (bytes). All free memory may not be available for data tables. As memory is allocated and freed, holes of unallocated memory, which are unusable for final-data memory, may be created. Updated after compile completes.

22.2.16 MemorySize

Total final-data memory size (bytes) in the CR350. Updated at startup.

22.2.17 OSDate

Release date of the operating system in the format mm/dd/yyyy. Updated at startup.

- String data type

22.2.18 OSSignature

Signature of the operating system.

22.2.19 OSVersion

Version of the operating system in the CR350. Updated at OS startup.

- String data type

22.2.20 PakBusRoutes

Lists routes or router neighbors known to the data logger at the time the setting was read. Each route is represented by four components separated by commas and enclosed in parentheses: (port, via neighbor address, pakbus address, response time in ms). Updates when routes are added or deleted.

- String data type

22.2.21 PanelTemp

Current processor board temperature (°C). Updates once per minute, when viewing the **Status** table, or programatically.

22.2.22 PortConfig

Provides information on the configuration settings (input, output, SDI-12, COM port) for **C** terminals in numeric order of terminals. Default = **Input**. Updates when the port configuration changes.

- String data type

22.2.23 PortStatus

States of **C** terminals configured for control. On/high (**true**) or off/low (**false**). Array elements in numeric order of **C** terminals. Default = **false**. Updates when state changes. Enter **-1** to set to **true**. Enter **0** to set to **false**.

- Boolean data type

22.2.24 ProcessTime

Processing time (μ s) of the last scan. Time is measured from the end of the **EndScan** instruction (after the measurement event is set) to the beginning of the **EndScan** (before the wait for the measurement event begins) for the subsequent scan. Calculated on-the-fly. Updated at the conclusion of scan processing, prior to waiting for the next scan.

22.2.25 ProgErrors

Number of compile or runtime errors for the running program. Updated after compile.

22.2.26 ProgName

Name of current (running) program; updates at startup.

- String data type

22.2.27 ProgSignature

Signature of the running CRBasic program including comments. Does not change with operating-system changes. Updates after compiling the program.

22.2.28 RecNum

Record number increments when the Status Table is requested by support software. Range = 0 to 2^{32} .

- Long data type

22.2.29 RunSignature

Signature of the running binary (compiled) program. Value is independent of comments or non-functional changes. Often changes with operating-system changes. Updates after compiling and before running the program.

22.2.30 SerialNumber

CR350 serial number assigned by the factory when the data logger was calibrated. Stored in flash memory. Updated at startup.

22.2.31 SerialFlashErrors

Reports on the serial flash health and provides the number of errors detected in serial flash. 0 = No errors detected. For detailed information on serial flash, see [Flash memory](#) (p. 100).

22.2.32 SkippedScan

Number of skipped program scans (see [Checking station status](#) (p. 183) for more information) that have occurred while running the CRBasic program. Does not include scans intentionally skipped as may occur with the use of [ExitScan](#) and [Do / Loop](#) instructions. Updated when they occur. Enter **0** to reset.

22.2.33 SlowProcTime

Processing time (μ s) of the last Slow Sequence scan. Time is measured from the end of the **EndScan** instruction (after the measurement event is set) to the beginning of the **EndScan** (before the wait for the measurement event begins) for the subsequent scan. Calculated on-the-fly. Updated at the conclusion of scan processing, prior to waiting for the next scan.

22.2.34 StartTime

Time (date and time) the CRBasic program started. Updates at beginning of program compile.

- NSEC data type

22.2.35 StartUpCode

Indicates how the running program was compiled. Updated at startup. 65 = Run on powerup is running and normal powerup occurred. 0 = Normal shutdown. -1 = Restart due to a power loss. -2 = Restart due to watchdog reset.

22.2.36 StationName

Station name stored in flash memory. This is not the same name as that is entered into your data logger support software. This station name can be sampled into a data table, but it is not the name that appears in data file headers. Updated at startup or when the name is changed.

- String data type

22.2.37 SW12Volts

Status of switched, 12 VDC terminal(s). On/high (**true**) or off/low (**false**) Enter -1 to set to **true**. Enter 0 to set to **false**. Updates when the state changes.

- Boolean data type

22.2.38 TimeStamp

Scan-time that a record was generated.

- NSEC data type

22.2.39 VarOutOfBound

Number of attempts to write to an array outside of the declared size. The write does not occur. Indicates a CRBasic program error. If an array is used in a loop or expression, the pre-compiler and compiler do not check to see if an array is accessed out-of-bounds (i.e., accessing an array with a variable index such as `arr(index) = arr(index-1)`, where `index` is a variable). Updated at runtime when the error occurs. Enter `0` to reset.

22.2.40 WatchdogErrors

Number of watchdog errors that have occurred while running this program. Resets automatically when a new program is compiled. Enter `0` to reset. Updated at startup and at occurrence.

22.2.41 WiFiUpdateReq

Shows if WiFi operating system update is available. Update available (**true**) or not (**false**). Updates when state changes.

- Boolean data type

22.3 Settings

Settings can be accessed from the *LoggerNet* Connect Screen **Datalogger** > **Setting Editor**, or using *Device Configuration Utility* **Settings Editor** tab. **Settings** are organized in tabs and can be searched for.

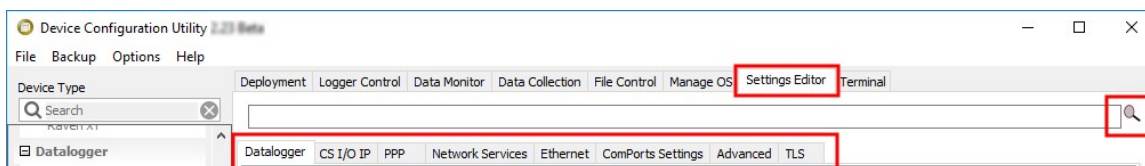

Most **Settings** are **read/write** and of a **numeric data type** unless noted.

Settings may be accessed programmatically using `SetSetting()` or `Tablename.FieldName` syntax. For example: `Variable = Settings.FieldName`. For more information see: <https://www.campbellsci.com/blog/programmatically-access-stored-data-values>.

NOTE:

A list of **Settings** fieldnames is also available from the data logger terminal mode using command `F`.

22.3.1 Baudrate

This setting governs the baud rate that the data logger will use for a given port in order to support serial communications. For some ports (COM), this setting also controls whether the port will be enabled for serial communications.

Some ports (RS-232) support auto-baud synchronization while the other ports support only fixed baud. With auto-baud synchronization, the data logger will attempt to match the baud rate to the rate used by another device based upon the receipt of serial framing errors and invalid packets.

22.3.2 Beacon

This setting, in units of seconds, governs the rate at which the data logger will broadcast PakBus messages on the associated port in order to discover any new PakBus neighboring nodes. If this setting value is set to a value of 0 or 65,535, the data logger will not broadcast beacon messages on this port.

This setting will also govern the default verification interval if the value of the **Verify()** setting for the associated port is zero. If the value of this setting is non-zero, and the value of the Verify setting is zero, the effective verify interval will be calculated as 2.5 times the value for this setting. If both the value of this setting and the value of the Verify setting is zero, the effective verify interval will be 300 seconds (five minutes).

22.3.3 Cell Settings

For data loggers with integrated CELL modules, see [Cellular settings](#) (p. 235).

22.3.4 CentralRouters

This setting specifies a list of PakBus addresses for routers that are able to work as Central Routers. By specifying a non-empty list for this setting, the data logger will be configured as a Branch Router meaning that it will not be required to keep track of neighbors of any routers except those in its own branch. Configured in this fashion, the data logger will ignore any neighbor lists received from addresses in the central routers setting and will forward any messages that it receives to the nearest default router if it does not have the destination address for those messages in its routing table.

- String data type

22.3.5 CommsMemAlloc

Replaces **PakBusNodes**. Specifies the amount of memory that the data logger allocates for maintaining PakBus routing information and communications buffers. This value represents roughly the maximum number of PakBus nodes that the data logger will be able to track in its routing tables. This setting will also affect the amount of memory that the data logger allocates for TCP/IP communications.

22.3.6 DNS

This setting specifies the addresses of up to two domain name servers that the data logger can use to resolve domain names to IP addresses. Note that if DHCP is used to resolve IP information, the addresses obtained via DHCP will be appended to this list.

NOTE:

When setting a static IP address, first manually set a **DNS Server Address** in **Settings Editor > Advanced**.

- String data type

22.3.7 FileManager

This setting controls how the data logger will handle incoming files with specific extensions from various sources. There can be up to four specifications. Each specification has three required fields: **PakBus Address**, **File Name**, and **Count**.

- String data type

22.3.8 FTPEnabled

Set to 1 if to enable FTP service. Default is 0.

22.3.9 FTPPassword

Specifies the password that is used to log in to the FTP server.

- String data type

22.3.10 FTPPort

Configures the TCP port on which the FTP service is offered. The default value is usually sufficient unless a different value needs to be specified to accommodate port mapping rules in a network address translation firewall. Default = 21.

22.3.11 FTPUserName

Specifies the user name that is used to log in to the FTP server. An empty string (the default) inactivates the FTP server.

- String data type

22.3.12 HTTPEnabled

Set to 1 to enable HTTP (web server) service or 0 to disable it.

22.3.13 HTTPPort

Configures the TCP port on which the HTTP (web server) service is offered. Generally, the default value is sufficient unless a different value needs to be specified to accommodate port-mapping rules in a network-address translation firewall. Default = 80.

22.3.14 IncludeFile

This setting specifies the name of a file to be implicitly included at the end of the current CRBasic program or can be run as the default program. In order to work as an include file, the file referenced by this setting cannot contain a **BeginProg()** statement or define any variable names or tables that are defined in the main program file.

This setting must specify both the name of the file to run as well as on the device (CPU:) on which the file is located. The extension of the file must also be valid for a data logger program (.CRB, .DLD).

- String data type

22.3.15 IPBroadcastFiltered

Set to one if all broadcast IP packets should be filtered from IP interfaces. Do not set this if you use the IP discovery feature of the *Device Configuration Utility* or of *LoggerLink*. If this is set to one, the data logger will fail to respond to the broadcast requests.

Default = 0.

22.3.16 IPAddressEth

Specifies the IP address used by the Ethernet interface. If this value is specified as "0.0.0.0" (the default), the data logger will use DHCP to configure the effective value for this setting as well as the **Ethernet Default Gateway** and **Ethernet Subnet Mask** settings. This setting is the equivalent to the `IPAddressEth` status table variable.

- String data type

22.3.17 IPGateway

Specifies the IP address of the network gateway on the same subnet as the Ethernet interface. If the value of the Ethernet IP Address setting is set to "0.0.0.0" (the default), the data logger will configure the effective value of this setting using DHCP.

- String data type

22.3.18 IPMaskEth

Specifies the subnet mask for the Ethernet interface. If the value of the Ethernet IP Address setting is set to "0.0.0.0" (the default), the data logger will configure the effective value of this setting using DHCP.

- String data type

22.3.19 IPMaskWiFi

Specifies the subnet mask for the WiFi interface.

- String data type

22.3.20 IPTrace

Discontinued; aliased to `IPTraceComport`

22.3.21 IPTraceCode

Controls what type of information is sent on the port specified by `IPTraceComport` and via Telnet. Each bit in this integer represents a certain aspect of tracing that can be turned on or off. Values for particular bits are described in the *Device Configuration Utility*. Default = 0, no messages generated.

22.3.22 IPTraceComport

Specifies the port (if any) on which TCP/IP trace information is sent. Information type is controlled by `IPTraceCode`.

22.3.23 IsRouter

This setting controls whether the data logger is configured as a router or as a leaf node. If the value of this setting is **true**, the data logger will be configured to act as a PakBus router. That is, it will be able to forward PakBus packets from one port to another. To perform its routing duties, a data logger configured as a router will maintain its own list of neighbors and send this list to other routers in the PakBus network. It will also obtain and receive neighbor lists from other routers.

If the value of this setting is **false**, the data logger will be configured to act as a leaf node. In this configuration, the data logger will not be able to forward packets from one port to another and it will not maintain a list of neighbors. Under this configuration, the data logger can still communicate with other data loggers and wireless sensors. It cannot, however, be used as a means of reaching those other data loggers. The default value is false.

- Boolean data type

22.3.24 KeepAliveURL (Ping keep alive URL)

The URL to send a ping to when there has been no network activity for the `KeepAliveMin` interval. If there is no ping response then the network connection is reestablished.

- String data type

22.3.25 KeepAliveMin (Ping keep alive timeout value)

When there has been no network activity for this amount of time, in seconds, a ping will be sent to the `KeepAliveURL`. Default = 0 which disables keep alive pings.

- Long data type (allowed values: 0,5,10,15,30,60,120,180,240,300,360,480,720)

22.3.26 MaxPacketSize

Specifies the maximum number of bytes per data collection packet.

22.3.27 Neighbors

This setting specifies, for a given port, the explicit list of PakBus node addresses that the data logger will accept as neighbors. If the list is empty (the default value) any node will be accepted as a neighbor. This setting will not affect the acceptance of a neighbor if that neighbor's address is greater than 3999.

- String data type

22.3.28 PakBusAddress

This setting specifies the PakBus address for this device. Valid values are in the range 1 to 4094. The value for this setting must be chosen such that the address of the device will be unique in the scope of the data logger network. Duplication of PakBus addresses can lead to failures and unpredictable behavior in the PakBus network.

When a device has an allowed neighbor list for a port, any device that has an address greater than or equal to 4000 will be allowed to connect to that device regardless of the allowed neighbor list.

22.3.29 PakBusEncryptionKey (PakBus Encryption Key)

This setting specifies text that will be used to generate the key for encrypting PakBus messages sent or received by this data logger. If this value is specified as an empty string, the data logger will not use PakBus encryption. If this value is specified as a non-empty string, however, the data logger will not respond to any PakBus message unless that message has been encrypted.

- String data type

22.3.30 PakBusNodes

Discontinued; aliased to `CommsMemAlloc`

22.3.31 PakBusPort

This setting specifies the TCP service port for PakBus communications with the data logger. Unless firewall issues exist, this setting probably does not need to be changed from its default value. Default 6785.

22.3.32 PakBusTCPClients

This setting specifies outgoing PakBus/TCP connections that the data logger should maintain. Up to four addresses can be specified.

- String data type

22.3.33 PakBusTCPEnabled

By default, PakBus TCP communications are enabled. To disable PakBus TCP communications, set the PakBusPort setting to **65535**.

22.3.34 PakBusTCPPassword

This setting specifies a password that, if not empty, will make the data logger authenticate any incoming or outgoing PakBus/TCP connection. This type of authentication is similar to that used by CRAM-MD5.

- String data type

22.3.35 PingEnabled

Set to one to enable the ICMP ping service.

22.3.36 pppDial

Specifies the dial string that would follow the ATD command (#777 for the Redwing CDMA).

Alternatively, this value can specify a list of AT commands where each command is separated by a semi-colon (;). When specified in this fashion, the data logger will transmit the string up to the semicolon, transmit a carriage return to the modem, and wait for two seconds before proceeding with the rest of the dial string (or up to the next semicolon). If multiple semicolons are specified in succession, the data logger will add a delay of one second for each additional semicolon.

If a value of PPP is specified for this setting, will configure the data logger to act as a PPP client without any modem dialing. Finally, an empty string (the default) will configure the data logger to listen for incoming PPP connections also without any modem dialing.

- String data type

22.3.37 pppDialResponse

Specifies the response expected after dialing a modem before a PPP connection can be established.

- String data type

22.3.38 pppInfo

Reports the IP address, network mask, and default gateway for each of the data logger's active network interfaces. If DHCP is used for the interface, this setting will report the value that was configured by the DHCP server.

- String data type
- Read only

22.3.39 pppInterface

This setting controls which data logger port PPP service will be configured to use.

22.3.40 pppIPAddr

Specifies the IP address that will be used for the PPP interface if that interface is active (the PPP Interface setting needs to be set to something other than Inactive).

- String data type

22.3.41 pppPassword

Specifies the password that will be used for PPP connections when the value of **PPP Interface** is set to something other than **Inactive**.

- String data type

22.3.42 pppUsername

Specifies the user name that is used to log in to the PPP server.

- String data type

22.3.43 RouteFilters

This setting configures the data logger to restrict routing or processing of some PakBus message types so that a "state changing" message can only be processed or forwarded by this data logger if the source address of that message is in one of the source ranges and the destination address of that message is in the corresponding destination range. If no ranges are specified (the default), the data logger will not apply any routing restrictions. "State changing" message types include set variable, table reset, file control send file, set settings, and revert settings.

If a message is encoded using PakBus encryption, the router will forward that message regardless of its content. If, however, the routes filter setting is active in the destination node and the unencrypted message is of a state changing type, the route filter will be applied by that end node.

- String data type

22.3.44 RS232Power

Controls whether the RS-232 port will remain active even when communications are not taking place.

- Boolean data type

22.3.45 Security(1), Security(2), Security(3)

An array of three security codes. A value of zero for a given level will grant access to that level's privileges for any given security code. For more information, see [Data logger security](#) (p. 160).

22.3.46 ServicesEnabled

Discontinued; replaced by/aliased to HTTPEnabled, PingEnabled, TelnetEnabled.

22.3.47 TCPClientConnections

Discontinued; replaced by / aliased to PakBusTCPClients.

22.3.48 TCPPort

Discontinued; replaced by / aliased to PakBusPort.

22.3.49 TelnetEnabled

Enables (1) or disables (0) the Telnet service.

22.3.50 TLSConnections (Max TLS Server Connections)

This setting controls the number of concurrent TLS (secure or encrypted) client socket connections that the data logger will be capable of handling at any given time. This will affect FTPS and HTTPS services. This count will be increased by the number of [DNP\(\)](#) instructions in the data logger program.

This setting will control the amount of RAM that the data logger will use for TLS connections. For every connection, approximately 20KBytes of RAM will be required. This will affect the amount of memory available for program and data storage. Changing this setting will force the data logger to recompile its program so that it can reallocate memory

22.3.51 TLSPassword

This setting specifies the password that will be used to decrypt the TLS Private Key setting.

- String data type

22.3.52 TLSStatus

Reports the current status of the data logger TLS network stack.

- String data type
- Read only

22.3.53 IPAddressUSB (USB Virtual Ethernet Address (RNDIS))

Specifies the IP address for the USB Network Interface. When set to 0 it defaults to 192.168.66.1.

22.3.54 UTCOffset

Specifies the offset, in seconds, of the data logger's clock from Coordinated Universal Time (UTC, or GMT). For example, if the clock is set to Mountain Standard Time in the U.S. (-7 Hours offset from UTC) then this setting should be -25200 (-7*3600). This setting is used by the **NTP Server** setting as well as [EmailSend\(\)](#) and [HTTP\(\)](#), which require Universal Time in their headers. This setting will also be adjusted by the Daylight Savings functions if they adjust the clock.

If a value of -1 is supplied for this setting, no UTC offset will be applied.

22.3.55 Verify

This setting specifies the interval, in units of seconds, that will be reported as the link verification interval in the PakBus hello transaction messages. It will indirectly govern the rate at which the data logger will attempt to start a hello transaction with a neighbor if no other communications have taken place within the interval.

22.3.56 Cellular settings

Access cellular settings, using *Device Configuration Utility*. Clicking on a setting in *Device Configuration Utility* also provides information about that setting. These settings are available for data loggers with integrated CELL modules.

NOTE:

A list of **Settings** fieldnames is also available from the data logger terminal mode using command F.

22.3.56.1 CellAPN

Specifies the APN, and is required. The APN is the gateway between the cell network and the internet. APN must be obtained from your cellular network provider.

- String data type

Where to find:

- **Settings Editor** tab in *Device Configuration Utility*: Cellular > APN

22.3.56.2 CellEnabled

Global control for cell modem. This overrides the power schedule setting and CRBasic IPNetpower instruction. **0** Disabled, **1** or **<>0** Enabled.

- Boolean data type

Where to find:

- **Settings Editor** tab in *Device Configuration Utility*: Cellular > Cell Modem Enable

22.3.56.3 CellInfo

Cellular network/state information. Reports the cellular IP address, default gateway, DNS, network state, cell carrier, connection type, phone number associated with the SIM card, and data usage.

- String data type
- Read only

Where to find:

- **Settings Editor** tab in *Device Configuration Utility*: Cellular > Diagnostic Info

22.3.56.4 CellKeepAlive

URL for ping to verify network connectivity. This is only sent if there has been no network activity within the CellKeepAliveTime setting. If there is no ping response, the network connection is re-established. To disable keep alive pings, leave this setting blank.

- String data type

Where to find:

- **Settings Editor** tab in *Device Configuration Utility*: Cellular > Ping Keep Alive URL

22.3.56.5 CellKeepAliveTime

Ping keep alive timeout (in seconds).

- Long data type

Where to find:

- **Settings Editor** tab in *Device Configuration Utility*: Cellular > Ping Keep Alive Timeout Value

22.3.56.6 CellPDPAuth

Specifies the PDP authentication type (if used). PDP Authentication is only used if there is a PDP Username and Password AND the PAP or CHAP authentication is required. If a PDP Authentication Type is required, it will be provided by your cellular provider with the APN. 0 None, 1 PAP, 2 CHAP

- Long data type

Where to find:

- **Settings Editor** tab in *Device Configuration Utility*: Cellular > PDP Authentication Type, PPP Authentication User Name, PPP Authentication Password

22.3.56.7 CellPDPPassword

Specifies the PDP password used for authentication. Often there is no password, and this field can be left blank. If a password is required, it will be provided by your cellular provider with the APN.

- String data type

Where to find:

- **Settings Editor** tab in *Device Configuration Utility*: Cellular > PDP Cell Authentication Password

22.3.56.8 CellPDPUserName

Specifies the username used for PDP authentication. Often there is no username, and this field can be left blank. If a Username is required, it will be provided by your cellular provider with the APN.

- String data type

Where to find:

- **Settings Editor** tab in *Device Configuration Utility*: Cellular > PDP Cell Authentication Username

22.3.56.9 CellPwrDuration

Specifies the interval, in minutes, over which the data logger will power its cellular interface. This can be done to save on battery life or cellular charges. This is adjusted using three components:

- **Start (Power-On) Time**: Specifies the time of day in terms of hours and minutes in which the data logger will first enable the cellular interface. If left at the default value of **Always On**, the data logger will power the cellular interface at all times.
- **On Duration**: Specifies the interval, in minutes, to power the data logger cellular interface for the first time of any day as well as for any repeat cycles (if applicable).
- **Repeat Cycle**: Specifies the interval after the first time that the data logger powers on its

cellular interface, that the data logger will power its cellular interface at subsequent times throughout the day.

For example, setting a **Start Time** of **08:00**, with an **On Duration** of **15 minutes**, and a **Repeat Cycle** of **Every Hour**, will result in the cellular module being powered on at 8:00AM for 15 minutes every hour until midnight.

- Long data type

Where to find:

- **Settings Editor** tab in *Device Configuration Utility*: Cellular > On duration

22.3.56.10 CellPwrRepeat

Specifies the interval in minutes to power on the cellular interface following the first time of the day that the data logger powers on its cellular interface. For example usage, see **CellPwrDuration**.

- Long data type

Where to find:

- **Settings Editor** tab in *Device Configuration Utility*: Cellular > Repeat cycle

22.3.56.11 CellPwrStartTime

Specifies time of day in minutes when the data logger will first enable the cellular interface.

Examples:

- 15 = 00:15 '15 minutes after midnight
- 180 = 03:00 '3:00 am
- 1380 = 23:00 '11:00 pm
- 1440 = Always On

For example usage, see **CellPwrDuration**.

- Long data type

Where to find:

- **Settings Editor** tab in *Device Configuration Utility*: Cellular > Start (power-on) time

22.3.56.12 CellRSRQ

CellECIO

Specifies the signal quality of the modem. For 3G, this is ECIO (Energy to Interference Ratio). For 4G, this is RSRQ (Reference Signal Received Quality). Updated when queried by your data logger support software or a program. Ranges expected for Signal Quality for 3G/4G:

Excellent: 0 to -6 (3G), > -9 (4G)

Good: -7 to -10 (3G), -9 to -12 (4G)

Fair to Poor: -11 to -20 (3G), -13 or less (4G)

- Float data type
- Read only

Where to find:

- **Settings Editor** tab in *Device Configuration Utility*: Cellular > Signal Quality

22.3.56.13 CellRSSI

CellRSRP

Specifies the signal strength of the modem in -dBm. For 3G, this is RSSI (Received Signal Strength Indicator). For 4G, this is RSRP (Reference Signal Received Power). Updated when queried by your data logger support software or a program. Ranges expected for Signal Strength for 3G/4G:

Excellent: -70dBm or less (3G), -90dBm or less (4G)

Good: -70dBm to -85dBm (3G), -90dBm to -105dBm (4G)

Fair: -86dBm to -100dBm (3G), -106dBm to -115dBm (4G)

Poor: > -100dBm (3G), > -115dBm (4G)

- Long data type
- Read only

Where to find:

- **Settings Editor** tab in *Device Configuration Utility*: Cellular > Signal Strength

22.3.56.14 CellState

Specifies the current communications state with the cell modem and the network. The following states are available:

- Power off
- Powering up
- Powered up
- SIM authorized
- Setting baud rate

- Waiting for baud rate
- Baud rate set
- Baud rate failure
- Power off. Waiting for retry
- Powered up. SIM auth failure
- Querying modem
- Waiting for network registration
- Configuring modem
- Dialing
- Dialing (retry)
- Dialed
- PPP negotiation
- Network ready
- PPP closing
- PPP paused
- PPP dropped
- Terminal AT command mode
- Firmware update mode
- Shutting down
- String data type
- Read only

Where to find:

- **Settings Editor** tab in *Device Configuration Utility*: Cellular > Cellular State

22.3.56.15 CellStatus

Cellular diagnostic information. Reports the PPP state, IMEI, IMSI, and ICCID for the data logger.

- String data type
- Read only

Where to find:

- **Settings Editor** tab in *Device Configuration Utility*: Cellular > Cell Diagnostic Info

22.3.57 Wi-Fi settings

Access Wi-Fi settings, using *Device Configuration Utility*. Clicking on a setting in *Device Configuration Utility* also provides information about that setting. These settings are available for data loggers with integrated WIFI modules.

Where to find:

- All settings: **Settings Editor** tab in *Device Configuration Utility*: **Wi-Fi** tab.
- Key settings: in *Device Configuration Utility*: **Deployment** > **Wi-Fi** tab.

See also [Wi-Fi communications option](#) (p. 28)

NOTE:

A list of **Settings** fieldnames is also available from the data logger terminal mode using command **F**.

22.3.57.1 IPAddressWiFi

Specifies the IP address for the Wi-Fi Interface. If specified as zero, the address, net mask, and gateway will be configured automatically using DHCP.

- String data type

22.3.57.2 IPGatewayWiFi

Specifies the address of the IP router to which the data logger will forward all non-local IP packets for which it has no route.

- String data type

22.3.57.3 IPMaskWiFi

Specifies the subnet mask for the WiFi interface.

- String data type

22.3.57.4 WiFiChannel

This setting is only applicable when the device is configured to create a network (**Configuration**). It then specifies in which channel the network should be created. If **Auto** is selected, the device will use only channels 1, 6, and 11 to minimize interference from other networks detected in the area.

When manually selecting a channel, it should be noted that two Wi-Fi networks operating on the same channel will interfere with each other and will have to compete for bandwidth. The center frequencies of adjacent channels are 5 MHz apart and the bandwidth of each channel is 20 MHz which means that adjacent channels overlap. To completely avoid interference there must be a spacing of at least 5 channels between each Wi-Fi network. It is therefore recommended to use channels 1, 6, and 11.

- Long data type

22.3.57.5 WiFiConfig

Configure the WiFi network. Join, create, or disable network.

- Long data type, where:
 - 0 = Join network
 - 1 = Create network
 - 4 = Disable network

22.3.57.6 WiFiEAPMethod

The EAP Method must be chosen to match the EAP method being used by the Enterprise Security network. The inner EAP Methods supported are MSCHAPv2, MSCHAP, CHAP, and PAP.

- Long data type

22.3.57.7 WiFiEAPPassword

If joining an Enterprise Security-enabled network enter password here.

- String data type

22.3.57.8 WiFiEAPUser

If joining an Enterprise Security-enabled network enter user name here.

- String data type

22.3.57.9 Networks

Lists the networks available in the area. Information listed for each network is shown as {SSID, RSSI / Signal Strength, Channel, Security}. Sometimes areas are covered by multiple access points configured with the same network name (SSID). In that case multiple unique access points possessing the same network name (SSID) may be listed here.

- String data type
- Read only

22.3.57.10 WiFiEnable

Set to enable or disable the WiFi service. By default, WiFi is enabled. To disable, set the **Configuration** option to **Disable**. **0** Disabled, **1** or **<>0** Enabled.

- Boolean data type

22.3.57.11 WiFiPassword

If joining a WPA or WPA2 security enabled network then this is where the passphrase is entered. If joining a WEP security enabled network then this is where the WEP key is entered.

If creating a network and a password is supplied, the network will be created using WPA2 encryption. The password must be at least 8 characters. If a password is not supplied, an open (unencrypted) network will be created.

When joining a network the device supports 64-bit WEP and 128-bit WEP. For 64-bit WEP enter a 40 bit key in the form of 5 ASCII characters or 10 hexadecimal digits (0-9, A-F). For 128-bit WEP enter a 104 bit key in the form of 13 ASCII characters or 26 hexadecimal digits (0-9, A-F).

- String data type

22.3.57.12 WiFiPowerMode

This setting controls the power saving mode of the device. Regardless of the **Power Mode** setting, the device enables power-save mode when communications are not active. **Power Mode** determines how the device acts when communications are ongoing. This setting only applies when the device is configured to **Join a Network** using the **Configuration** option.

- Long data type

22.3.57.13 WiFiSSID (Network Name)

The Network Name (SSID) is the name that identifies a wireless network (31 character maximum). The SSID differentiates one wireless network from another, so all devices attempting to connect to the same network must use the same SSID. If the device is configured to 'Join a Network', then enter the SSID of the network, including hidden networks, to join here. If the device is configured to **Create a Network** using the **Configuration** option, then the SSID entered here will be the SSID of the network created.

NOTE:

When creating a network, the device will not create the network if the Network Name (SSID) specified is the same as one that already exists in the area.

- String data type

22.3.57.14 WiFiStatus

Specifies the current status of the Wi-Fi module.

- String data type
- Read only

22.3.57.15 WiFiTxPowerLevel

This fixes the transmit power level of the Wi-fi module. This value can be set as follows: Low (7 +/- 1 dBm), Medium (10 +/- 1 dBm), High (15 +/- 2 dBm). The value of this setting does not affect power consumption.

- Long data type

22.3.57.16 WLANDomainName

The **WLAN Domain Name** is only relevant when the device is configured to create a network. When attempting to communicate with the device, attached Wi-Fi client devices can simply use the domain name specified here which will be resolved to the device's IP address. For example, the data logger web page can be accessed simply by entering the domain name specified here into a web browser.

- String data type

22.3.58 MQTT settings

Access MQTT settings using *Device Configuration Utility*. Clicking on a setting in *Device Configuration Utility* also provides information about that setting.

Where to find:

- All settings: **Settings Editor** tab in *Device Configuration Utility*. **MQTT** tab, unless noted.

See also [MQTT](#) (p. 138).

NOTE:

A list of **Settings** fieldnames is also available from the data logger terminal mode using command F.

22.3.58.1 MQTTBaseTopic (MQTT base topic)

This is the base topic which will automatically be used. Use this setting to override the default format: CS/{CAMPBELL CLOUD Account ID}/{MQTT Client Id}/.

- String data type

22.3.58.2 MQTTCleanSession (MQTT connection)

Assigns the MQTT broker connection type. **Persistent** sessions save all relevant client information on the broker. The client gets messages that it misses offline.

If the connection between the client and broker is interrupted during a **Clean** session, topics may be lost and the client needs to subscribe again. The client does not get messages that it misses offline.

- Long data type, allowed values:
 - 0 = Clean
 - 1 = Persistent (default)

22.3.58.3 MQTTClientID (MQTT client identifier)

Unique identifier the data logger uses to connect to MQTT broker. The default is the hardware type_serial number. Example: CR350_123.

- String data type, maximum number of characters is 64

22.3.58.4 MQTTEnable (Enable or disable MQTT)

By default, MQTT is disabled.

- Long data type, allowed values:
 - 0 = Disable (default)
 - 1 = Enable with TLS-Mutual Authentication
 - 2 = Enable with TLS
 - 3 = Enable MQTT

22.3.58.5 MQTTEndpoint (MQTT broker URL)

Server URL for MQTT broker.

- String data type

22.3.58.6 MQTTKeepAlive (MQTT keep alive)

When there has been no network activity for this amount of time, in seconds, a ping will be sent to the **MQTTBrokerURL**. Default = 0 which disables keep alive pings. Valid values are in the range 0 to 65535.

- Long data type

22.3.58.7 MQTTPassword (MQTT password)

Password, in association with **MQTTUserName**, required to connect to the MQTT broker.

- String data type

22.3.58.8 MQTTPortNumber (MQTT port number)

Port number to connect to the MQTT broker.

- Long data type, maximum number of characters is 256

22.3.58.9 MQTTStatusInterval (Status information publish interval)

Time (in minutes) between publishing MQTT status information. This interval determines how often the data logger publishes to the topic: {System Base Topic/}statusInfo. Valid values are in the range **0** to **1440**.

- Long data type

22.3.58.10 MQTTState (MQTT state)

This is a read-only field indicating the current state of the data logger connection to the MQTT broker.

- Long data type, possible results:
 - **0** = Disabled / Off
 - **8** = Disconnected. Sleeping
 - **10** = Waiting for an IP network interface
 - **11** = Connection retry wait
 - **20** = Opening TCP connection
 - **11** = TCP Open failed
 - **22** = TCP connection opened
 - **24** = Closing TCP connection
 - **26** = TCP connection closed
 - **30** = TLS handshake started
 - **31** = TLS handshake failed

- **32** = TLS handshake success
- **50** = MQTT session established
- **51** = Waiting for session start response
- **52** = Publishing
- **100** = Onboard started
- **101** = Onboard retry
- **102** = Onboard processing
- **200** = Waiting for modem startup
- **201** = Configuring SSL
- **202** = Configuring MQTT
- **203** = Opening network
- **204** = Connecting to MQTT broker

22.3.58.11 MQTTStateInterval (State publish interval)

Time (in minutes) between publishing MQTT state information. This interval determines how often the data logger publishes to the topic: {System Base Topic/}State. Valid values are in the range **0** to **1440**. Setting the value to **0** will not disable normal state publishing activity, only interval publishing.

- Long data type

22.3.58.12 MQTTUserName (MQTT user name)

User name, in association with **MQTTPassword**, used to connect to MQTT broker.

- String data type, maximum number of characters is 256

22.3.58.13 MQTTWillMessage (MQTT last will message)

Message published on last will topic by broker if disconnected without a disconnect command.

- String data type, maximum number of characters is 256

22.3.58.14 MQTTWillQoS (Quality of service)

This is an agreement that defines the guarantee of delivery for a specific message. Higher QoS levels are more reliable, but take more time and bandwidth.

- Long data type, allowed values:
 - 0 = At most once (default), no confirmation
 - 1 = At least once, confirmation required
 - 2 = Exactly once using a multi-step handshake

22.3.58.15 MQTTWillRetain (MQTT last will message retained by broker)

Enables or disables the broker to retain **MQTTWillMessage**.

- Long data type, allowed values:
 - 0 = Do not retain (default)
 - 1 = Retain

22.3.58.16 MQTTWillTopic (MQTT last will topic)

Broker will publish the **MQTTWillMessage** to this topic if disconnected without a disconnect command.

- String data type, maximum number of characters is 64

22.3.59 RF407-series radio settings

Access RF407-series radio settings, using *Device Configuration Utility*. Clicking on a setting in *Device Configuration Utility* also provides information about that setting. These settings are available for RF407-series data loggers.

NOTE:

A list of **Settings** fieldnames is also available from the data logger terminal mode using command F.

22.3.59.1 RadioAvailFreq

Displays the bitfield of the frequencies that are available in the module's region of operation.

- String data type
- Read only

Where to find:

- **Settings Editor** tab in *Device Configuration Utility*. Radio > Available Frequencies

22.3.59.2 RadioChanMask

The channel mask allows channels to be selectively enabled or disabled. This allows you to avoid using frequencies that experience unacceptable levels of RF interference.

- String data type

Where to find:

- **Settings Editor** tab in *Device Configuration Utility*: Radio > Radio Channel Mask

22.3.59.3 RadioEnable

Global control for the internal radio module.

Where to find:

- **Settings Editor** tab in *Device Configuration Utility*: Radio > Radio Enable

22.3.59.4 RadioHopSeq

Specifies the radio channel hop sequence. This setting must match in all radios in the same RF network. This setting can also be used to prevent radios in one RF network from listening to transmissions of another.

- Long data type

Where to find:

- **Settings Editor** tab in *Device Configuration Utility*: Radio > RF Hop Sequence

22.3.59.5 RadioMAC

Radio serial number.

- String data type
- Read only

Where to find:

- **Settings Editor** tab in *Device Configuration Utility*: Radio > Radio MAC Address

22.3.59.6 RadioModel

Reports the model of the internal radio module.

- String data type
- Read only

Where to find:

- **Settings Editor** tab in *Device Configuration Utility*: Radio > Radio Model

22.3.59.7 RadioModuleVer

Radio hardware version.

- Long data type
- Read only

Where to find:

- **Settings Editor** tab in *Device Configuration Utility*: Radio > Radio Hardware Version

22.3.59.8 RadioNetID

The RadioNetID specifies the identifier for the RF network. The radio will ignore any packets received that do not use this network identifier - therefore, all radios in the network must use the same value. Valid entries are between **0** and **32767**.

- Long data type

Where to find:

- **Settings Editor** tab in *Device Configuration Utility*: Radio > Network ID

22.3.59.9 RadioProtocol

Specifies the protocol mode that will be used by the radio.

PakBus Aware: This is the most commonly used protocol setting for PakBus networks. The radio will automatically inherit an RF identifier equal to the PakBus address of the device to which it is serially attached. In this mode, the radio will be capable of performing RF level retries and acknowledgments and provide a more reliable link than **Transparent** mode used for broadcast messaging. You do not need to manually set a unique RF Radio Address or a unique PakBus Address. This device will not appear in PakBus Graph.

PakBus Node: Similar to **PakBus Aware**, but requires the device to have a unique PakBus Address specified. Because the radio is PakBus addressable status information, such as RSSI, can be queried through a [GetVariables\(\)](#) transaction. Additionally, if the radio is connected to a PakBus router it will also be viewable in PakBus Graph and accessible by other remote PakBus devices. If attached to a PakBus router, network overhead will increase due the increase in number of PakBus nodes in the network. If **Active Interface** is also set to PakBus Router, this mode will allow the device to function as a standalone RF repeater. This setting must be used if Active Interface is set as PakBus Router. This setting is most commonly used when a user wants to a) use the device as a standalone PakBus repeater, b) make the device available remotely for viewing and editing settings, or c) attach more than one radio to a single data logger.

Transparent: Provides a transparent link with no interpretation of the data packet. This mode is most commonly used with array based data loggers, and it must be used when communicating with other transparent devices such as the stand alone and built-in RF407-series radios. This mode is also used for non-PakBus protocols like Modbus. When used this way, **Retry Level** must be set to **None**.

- Long data type

Where to find:

- **Settings Editor** tab in *Device Configuration Utility*: **Radio > Protocol**

22.3.59.10 RadioPwrMode

This setting governs the duty cycle that the radio will use for powering its receiver circuit. As such, it governs the amortized current drain for the radio. This setting should be set the same for all radios in the same network. Power Modes include:

Always On: The radio is always on and does not transmit a wakeup header.

0.5 Second: The radio wakes every 0.5 seconds for a 100 msec interval to listen for RF activity. It will transmit a 700 msec wakeup header with the first transmission following a period of RF inactivity.

1 Second: The radio wakes every 1 second for a 100 msec interval to listen for RF activity. It will transmit a 1200 msec wakeup header with the first transmission following a period of RF inactivity.

4 Second: The radio wakes every 4 seconds for a 100 msec interval to listen for RF activity. It will transmit a 4200 msec wakeup header with the first transmission following a period of RF inactivity.

- Long data type

Where to find:

- **Settings Editor** tab in *Device Configuration Utility*: **Radio > Power Mode**

22.3.59.11 RadioRetries

Specifies the level to which the radio should retry to deliver an unacknowledged RF packet transmission. When an RF packet fails to be acknowledged by the destination, the radio will resend the packet again. A receiving radio responds to the sending radio with an ACK packet for every radio packet that it receives that is addressed to it and has a valid CRC. Retry levels and counts:

- **None:** 0
- **Low:** 2
- **Medium:** 4
- **High:** 6

Set **Retry Level** to **None** when the **Protocol** setting is set to **Transparent** for the purpose of communicating with other RF407-series radios.

- Long data type

Where to find:

- **Settings Editor** tab in *Device Configuration Utility*: **Radio > Retry Level**

22.3.59.12 RadioRSSI

Indicates the signal strength of the last packet received by this radio.

The units of the RSSI are dBm; -40 is a stronger signal than -70 . Because the received signal strength can vary due to multipath signals, interference, or other environmental effects; this setting may not give a true indication of communications performance or range. However, received signal strength can be useful for activities such as:

- Determining the optimal direction to aim a Yagi antenna
- Determining the effects of antenna height and location
- Trying alternate (reflective) paths
- Seeing the effect of vegetation and weather over time
- Long data type
- Read only

Where to find:

- **Settings Editor** tab in *Device Configuration Utility*: **Radio** > **RFSignalLevel** (first number)

22.3.59.13 RadioRSSIAddr

Indicates the PakBus address of the **RadioRSSI** signal radio.

- Long data type
- Read only

Where to find:

- **Settings Editor** tab in *Device Configuration Utility*: **Radio** > **RFSignalLevel** (second number)

22.3.59.14 RadioStats

Provides performance statistics for the data logger integrated radio. The data logger will maintain a radio routing table for each PakBus neighbor accessed using the integrated radio and this setting is generated from that table. The fields reported for this setting are as follows:

- **PakBus Address**: Specifies the PakBus address of the neighbor reached through an integrated radio link.
- **Sent Packets**: Reports the number of radio packets that have been transmitted to the PakBus neighbor using the integrated radio link.
- **Received Packets**: Reports the number of radio packets that have been received from the PakBus neighbor using the integrated radio link.
- **Packet Retries**: Reports the number of radio packet transmissions to the PakBus neighbor using the integrated radio link that had to be retransmitted by the radio module.
- **Packet Failures**: Reports the number of radio packet transmissions to the PakBus neighbor that were never acknowledged.
- String data type

Where to find:

- **Settings Editor** tab in *Device Configuration Utility*: **Radio** > **Radio Performance Statistics**

22.3.59.15 RadioTxPwr

Specifies the power level at which the RF module transmits.

Levels are approximate. It is very important that the TX power level selected and the gain of the attached antenna do not exceed the maximum allowed ERP permitted by local laws. These rules vary from region to region.

- Long data type

Where to find:

- **Settings Editor** tab in *Device Configuration Utility*: Radio > Radio TX Power Level

22.3.60 RF452 radio settings

Access RF452 radio settings, using *Device Configuration Utility*. Clicking on a setting in *Device Configuration Utility* also provides information about that setting. These settings are available for RF452 data loggers.

22.3.60.1 RadioCarrier

Indicates whether or not a carrier is detected.

- Long data type

Where to find:

- **Settings Editor** tab in *Device Configuration Utility*: RF452 > Carrier Detect

22.3.60.2 RadioDataRate

FreeWave transceivers have two settings for the Radio Data Rate:

- **High RF Data Rate** (Setting 2): Should be used when the transceivers are close together and data throughput needs to be optimized. Setting 2 must also be used when the full throughput of 153.6 Kbps is necessary.
- **Normal RF Data Rate** (Setting 3): Should be used when the transceivers are farther away and a solid data link is preferred over data throughput.

Note: The Radio Data Rate must be set identically in all transceivers. Any transceiver with an Radio Data Rate different from the gateway will not establish a link.

- Long data type

Where to find:

- **Settings Editor** tab in *Device Configuration Utility*: RF452 > RF Data Rate

22.3.60.3 RadioDiag

Provides diagnostics data to be viewed at the gateway in parallel with application data. The diagnostic program MUST be run from the gateway transceiver. Diagnostics require the following:

1. Select **RadioRepeaters** and set **RadioDiag** to (1 to 128) in the gateway.
 2. A second computer or serial connection to run the FreeWave Tool Suite software.
 3. A diagnostics cable.
 4. FreeWave Tool Suite software.
- Long data type

Where to find:

- **Settings Editor** tab in *Device Configuration Utility*: RF452 > Diagnostics

22.3.60.4 RadioEnable

Global control for the internal radio module.

Where to find:

- **Settings Editor** tab in *Device Configuration Utility*: RF452 > RF452 Radio Enable

22.3.60.5 RadioFirmwareVer

Radio firmware version.

- Long data type
- Read only

Where to find:

- **Settings Editor** tab in *Device Configuration Utility*: RF452 > Radio Firmware Version

22.3.60.6 RadioFreqKey

The **Frequency Key** determines the frequency hopping sequence of the transceiver. There are 15 choices available (0–14) which represent 15 unique pseudo-random hop patterns. This setting allows you to minimize RF interference with other FreeWave transceivers operating in the same RF area.

NOTE:

The **Frequency Key** setting should be the same for all radios in the entire network. The exception to this is if the **Repeater Frequency Key** setting is used. If this is used, the repeater's **Frequency Key** would be different from the gateway radio, and downstream radios intended to connect to the repeater would have the same **Frequency Key** setting as the repeater.

- Long data type

Where to find:

- **Settings Editor** tab in *Device Configuration Utility*: RF452 > **Frequency Key**

22.3.60.7 RadioFreqRepeat

This must be set when you want a repeater to use a Frequency Key other than that of the gateway. See [Repeater Frequency Key](#) for more information.

- Long data type

Where to find:

- **Settings Editor** tab in *Device Configuration Utility*: RF452 > **Repeater Frequency**

22.3.60.8 RadioFreqZone

Divides the available band into smaller bands of 7 or 8 channels. A value of 1 enables the band.

- Frequency Zone 1: 902.2464 to 903.8592 MHz
- Frequency Zone 2: 904.0896 to 905.4720 MHz
- Frequency Zone 3: 905.7024 to 907.0848 MHz
- Frequency Zone 4: 907.3152 to 908.6976 MHz
- Frequency Zone 5: 908.9280 to 910.3104 MHz
- Frequency Zone 6: 910.5408 to 911.9232 MHz
- Frequency Zone 7: 912.1536 to 913.5360 MHz
- Frequency Zone 8: 913.7664 to 915.1488 MHz
- Frequency Zone 9: 915.3792 to 916.7616 MHz
- Frequency Zone 10: 916.9920 to 918.6048 MHz
- Frequency Zone 11: 918.8352 to 920.2176 MHz
- Frequency Zone 12: 920.4480 to 921.8304 MHz
- Frequency Zone 13: 922.0608 to 923.4432 MHz
- Frequency Zone 14: 923.6736 to 925.0560 MHz
- Frequency Zone 15: 925.2864 to 926.6688 MHz
- Frequency Zone 16: 926.8992 to 927.8208 MHz

- Long data type

Where to find:

- **Settings Editor** tab in *Device Configuration Utility*: RF452 > Frequency Zone (1-16)

22.3.60.9 RadioHopSize

Defines how many separate channels will be used by the network. Range is 50 to 112.

- Long data type

Where to find:

- **Settings Editor** tab in *Device Configuration Utility*: Radio > Hop Table Size

22.3.60.10 RadioHopVersion

This setting allows the user to choose the portion of the band in which the transceiver will operate.

- Long data type

Where to find:

- **Settings Editor** tab in *Device Configuration Utility*: Radio > Hop Table Version

22.3.60.11 RadioLowPwr

This setting allows an endpoint to consume less power. This is achieved primarily by dimming the transceiver LEDs. When set to 2 through 31, the transceiver will sleep between slots. For example, at a setting of 2, the transceiver sleeps 1 out of 2 slots; at a setting of 3, the transceiver sleeps 2 out of 3 slots, and so on.

See [Low Power Mode](#) for more information.

- Long data type

Where to find:

- **Settings Editor** tab in *Device Configuration Utility*: Radio > Low Power Mode

22.3.60.12 RadioMaxPacket

Determines the maximum number of bytes in the packets. Throughput can be enhanced when packet sizes are optimized.

For example, if small amounts of data is sent and large packet sizes are selected, there would be a certain amount of time "wasted" between each packet. The default settings for Max packet size, Min packet size and RF Data Rate are **8, 9**, and **Normal RF Data Rate**, respectively. The Max Packet Size and Min Packet Size must be set identically in all transceivers.

- Long data type

Where to find:

- **Settings Editor** tab in *Device Configuration Utility*: **Radio > Max Packet Size**

22.3.60.13 RadioMinPacket

Determines the minimum number of bytes in the packets. Throughput can be enhanced when packet sizes are optimized.

For example, if small amounts of data is sent and large packet sizes are selected, there would be a certain amount of time "wasted" between each packet. The default settings for Max packet size, Min packet size and RF Data Rate are **8, 9**, and **Normal RF Data Rate**, respectively. The Max Packet Size and Min Packet Size must be set identically in all transceivers.

- Long data type

Where to find:

- **Settings Editor** tab in *Device Configuration Utility*: **Radio > Min Packet Size**

22.3.60.14 RadioMMSync

This setting is reserved for applications with concentrations of gateway units where it is necessary to reduce interference between the gateways.

- Long data type

Where to find:

- **Settings Editor** tab in *Device Configuration Utility*: **Radio > Multi-Gateway Sync**

22.3.60.15 RadioModOS

Radio firmware version. This setting is available in dataloggers with integrated RF modules.

- String data type
- Read only

Where to find:

- **Settings Editor** tab in *Device Configuration Utility*: **Radio** > **RF452 iBus Module OS**

22.3.60.16 RadioModuleVer

Radio hardware version.

- Long data type
- Read only

Where to find:

- **Settings Editor** tab in *Device Configuration Utility*: **Radio** > **FreeWave Radio Module Firmware Version**

22.3.60.17 RadioNetID

All radios in a network need to have the same **Network ID**. The value must be between 0 and 4095 (excluding 255). The ID of 255 is reserved.

An endpoint will link with the first gateway or repeater it hears with a matching **Network ID**. Assigning a unique **Network ID** will reduce the chance a radio in your network links with another, unrelated network in the same RF area.

If necessary, the **Network ID** function can be used in conjunction with the **SubNet ID** feature. See [Subnet ID](#) for more information.

- Long data type

Where to find:

- **Settings Editor** tab in *Device Configuration Utility*: **Radio** > **Network ID**

22.3.60.18 RadioOpMode

The **Radio Operation Mode** option designates the method RF452 transceivers use to communicate with each other. RF452 transceivers operate in a gateway-to-endpoint configuration. Before the transceivers can operate together, they must be properly set up to communicate.

When setting up the transceiver, remember that a number of parameters are controlled by the settings in the gateway. Also, radio network diagnostics can only be accessed at the gateway radio. Therefore, it is recommended that you deploy the gateway on the communications end where it will be easier to access.

See [Radio Operation Mode](#) for more information.

- Long data type

Where to find:

- **Settings Editor** tab in *Device Configuration Utility*: **Radio > Radio Operation Mode**

22.3.60.19 RadioPacketRepeat

Endpoints do not acknowledge transmissions from the gateway. If endpoints in a large network did acknowledge all data transmissions, the gateway would soon become overwhelmed with acknowledgments from the endpoints. Without acknowledgments, there is not 100% confidence every endpoint has received every packet.

To address this issue, the user may modify the **RadioPacketRepeat** setting, assigning a value between **0** (the packet is transmitted once) to **9** (the packet is transmitted 10 times). For networks with solid RF links, this setting should be set to a low value such as **1** or **2**. If a network has some weak or marginal links it should be set with higher values.

If an endpoint receives a good packet from a gateway more than once, it will discard the repeated packets. Similarly, once a repeater receives a good packet from the gateway, it will discard any further repeated packets. In turn, the repeater will send the packet out to the next repeater or endpoints the number of times corresponding to its own **RadioPacketRepeat** setting.

Increasing the **RadioPacketRepeat** setting increases the probability of a packet getting through, but it also increases latency in the network because each packet from the gateway or repeater is being sent multiple times. It is important to find the optimal mix between network robustness, throughput, and latency. In general, a setting of **2** to **3** will work well for most well designed networks.

GATEWAY PACKET REPEAT IN MULTIPOINT NETWORKS WITH REPEATERS: The **RadioPacketRepeat** setting must also be set in repeaters since a repeater will appear as a gateway to an endpoint. Therefore, the repeater will send the packet out the number of times corresponding to its own **RadioPacketRepeat** setting. If this setting is set improperly the reliability of the overall network may be diminished. For example, if a gateway's **RadioPacketRepeat** is set to **3**, the link between the gateway and repeater should be robust. If the repeater's **RadioPacketRepeat** is set to **0**, this could cause marginal communications between the repeater and the endpoints. The endpoints communicating through this repeater will only receive the initial packet from the gateway with no repeats. Therefore, if the packet is not received on the first try, the endpoint will not respond as expected.

- Long data type

Where to find:

- **Settings Editor** tab in *Device Configuration Utility*: **Radio > Gateway Packet Repeat**

22.3.60.20 RadioRepeaters

Set to true (-1) when there are repeaters in a network. See [Repeater](#) for more information.

- Long data type

Where to find:

- **Settings Editor** tab in *Device Configuration Utility*: **Radio > Repeaters Used**

22.3.60.21 RadioRetryOdds

While packets transmitted from the gateway to the endpoints in a network are not acknowledged, packets transmitted from endpoints to the gateway are acknowledged. It is possible that more than one endpoint will attempt to transmit to the gateway at the same time. Therefore, it is important that a protocol exists to resolve contention for the gateway between endpoints.

This is addressed through **MaxEndpointRetry** and **RadioRetryOdds**. Once the endpoint has unsuccessfully attempted to transmit the packet the number of times specified in **MaxEndpointRetry**, it will attempt to transmit to the gateway on a random basis. **RadioRetryOdds** determines the probability that the endpoint will attempt to retransmit the packet to the gateway; a low setting will assign low odds to the endpoint attempting to transmit. Conversely, a high setting will assign higher odds. For example, this setting might be used when considering two different endpoints in a network, one with a strong RF link, and the other with a weak RF link to the gateway. Assigning a higher **RadioRetryOdds** to the endpoint with the weaker link gives it a better chance of competing with the closer endpoint(s) for the gateway's attention. When **RadioRetryOdds = 0**, after the endpoint has exhausted the number of retries set in **MaxEndpointRetry** and still not gained the gateway's attention, the endpoint's data buffer will be purged, and no further attempts will be made.

- Long data type

Where to find:

- **Settings Editor** tab in *Device Configuration Utility*: **Radio > Retry Odds**

22.3.60.22 RadioRetryTimeout

Setting **RadioRetryTimeout** in an endpoint or repeater sets the delay the unit will wait before dropping the connection to a gateway or repeater. This setting is useful when a network has a roving gateway or endpoint(s). As the link gets weaker, a lower setting will allow a poor link to break in search of a stronger one.

The factory default is set at the maximum of **255**. With a setting of **255**, the gateway will allow an endpoint or repeater to stay connected as long as one packet in 255 is successfully received at the gateway. The minimum setting is **8**. This allows an endpoint or repeater to drop a connection if less than one in eight consecutive packets is successfully received from the gateway.

Setting **RadioRetryTimeout** to **20** is recommended in areas where several FreeWave networks exist. This setting will allow endpoints and repeaters to drop the connection if the link becomes too weak, while at the same time preventing errant disconnects due to interference from neighboring networks.

- Long data type
- Read only

Where to find:

- **Settings Editor** tab in *Device Configuration Utility*: **Radio > Retry Timeout**

22.3.60.23 RadioRxSubID

An endpoint or repeater will connect with the first repeater or gateway that it hears with the same **Network ID**. There are scenarios, however, where communications need to be forced to follow a specific path. For instance, the **SubNet ID** is particularly helpful to force two repeaters in the same network to operate in series rather than in parallel; or, to force endpoints to communicate to a specific repeater for load-balancing purposes.

See [Subnet ID](#) for more information.

- Long data type
- Read only

Where to find:

- **Settings Editor** tab in *Device Configuration Utility*: **Radio > Receive SubNet ID**

22.3.60.24 RadioEndpointRepeat

The endpoint/repeater mode allows a transceiver in a network to switch between endpoint and repeater functions. When in this mode, a transceiver will repeat any packets sent across the

network as well as utilize the wired port.

To operate a transceiver as an endpoint/repeater, the operation mode must be set to **Repeater** and endpoint/repeater set to **Enable Endpoint/Repeater**.

- Long data type

Where to find:

- **Settings Editor** tab in *Device Configuration Utility*: Radio > Endpoint/Repeater

22.3.60.25 RadioEndpointRetry

This setting defines how many times (**0** to **9**) the endpoint will attempt to retransmit a packet to the gateway before beginning to use a back-off algorithm (defined by the **RadioRetryOdds** setting). Endpoint retries will stop when an acknowledgment is received from the gateway.

- Long data type

Where to find:

- **Settings Editor** tab in *Device Configuration Utility*: Radio > Max Endpoint Retry

22.3.60.26 RadioTxPwr

This setting specifies the RF transmit power.

TIP:

Use a transmit power of 0 when bench testing to reduce RF exposure.

See [Transmit Power](#) for more information.

- Long data type

Where to find:

- **Settings Editor** tab in *Device Configuration Utility*: Radio > RF Transmit Power

22.3.60.27 RadioTxRate

There are two options for the **RadioRxRate**, **0** and **1**. For normal operation of the transceiver, **RadioRxRate** = **1**.

- Long data type

Where to find:

- **Settings Editor** tab in *Device Configuration Utility*: **Radio** > **Xmit Rate**

22.3.60.28 RadioTxSubID

An endpoint or repeater will connect with the first repeater or gateway that it hears with the same **Network ID**. There are scenarios, however, where communications need to be forced to follow a specific path. For instance, the **SubNet ID** is particularly helpful to force two repeaters in the same network to operate in series rather than in parallel; or, to force endpoints to communicate to a specific repeater for load-balancing purposes.

See [Subnet ID](#) for more information.

Where to find:

- **Settings Editor** tab in *Device Configuration Utility*: **Radio** > **Transmit SubNet ID**

22.3.61 GOES settings

Access GOES settings, using *Device Configuration Utility*. Clicking on a setting in *Device Configuration Utility* also provides information about that setting. These settings are available for data loggers that have a TX325 or TX326 attached.

Where to find:

- All settings: **Settings Editor** tab in *Device Configuration Utility*: **GOES** tab, unless noted.

NOTE:

A list of **Settings** fieldnames is also available from the data logger terminal mode using command F.

22.3.61.1 GOESComPort

Port used to communicate with the GOES transmitter.

- Long data type; allowed values:
 - 1 = RS-232
 - 4 = CS I/O SDC7
 - 5 = CS I/O SDC8
 - 7 = CS I/O SDC10
 - 8 = CS I/O SDC11
 - 9 = COMC1
 - 10 = COMC3

22.3.61.2 GOESEnabled

Controls whether the data logger polls the **GOESComPort** to see if a GOES radio is attached.

- Long data type, allowed values:
 - 0 = Disable (default). The data logger ignores all other GOES settings.
 - 1 = Enable

22.3.61.3 GOESGainSetting

Specifies the effective antenna gain (in units of 0.1 dbi). This is the maximum specified gain for the antenna minus the loss in the cable connecting the radio to the antenna.

- Long data type, allowed values:
 - 0 = Disable (default). The radio will operate as if the antenna used for its original certification is being used.
 - 1 to 140 = Enable for 300 Bps transmissions (14 dbi maximum)
 - 1 to 200 = Enable for 1200 Bps transmissions (20 dbi maximum)

22.3.61.4 GOESMsgWindow

Length, in seconds, of the assigned self-timed transmission window assigned by NESDIS (TX325) or EUMETSAT (TX326). Valid values are in the range 1 to 110 seconds.

- Long data type

22.3.61.5 GOESPlatformID

8-digit hexadecimal identification number assigned by NESDIS (TX325) or EUMETSAT (TX326).

- String data type

22.3.61.6 GOESRepeatCount

Number of times within the random transmit interval that the GOES transmitter will transmit the message data. Valid entries are 1 to 3.

- Long data type

22.3.61.7 GOESRTBaudRate

Baud rate for the random transmissions. Valid settings are **100**, **300**, or **1200**. The baud rate must match the NESDIS (TX325) or EUMETSAT (TX326) channel assignment.

- Long data type

22.3.61.8 GOESRTChannel

Channel used for the random transmission assigned by NESDIS (TX325) or EUMETSAT (TX326).

- Long data type, allowed values:
 - **0** = Disable (default).
 - **0** to **566** = Channel

22.3.61.9 GOESRTInterval

Average time between random transmissions. Maximum interval is 24 hours; minimum interval is 1 minute.

- String data type entered in the format of "Hours:Minutes:Seconds".

22.3.61.10 GOESSTBaudRate

Baud rate for self-timed transmissions. Valid settings are **300** or **1200**. The baud rate must match the NESDIS (TX325) or EUMETSAT (TX326) channel assignment.

- Long data type

22.3.61.11 GOESSTChannel

Channel used for the self-timed transmission assigned by NESDIS (TX325) or EUMETSAT (TX326).

- Long data type, allowed values:
 - **0** = Disable (default).
 - **0** to **566** = Channel

22.3.61.12 GOESSTInterval

Time between self-timed transmissions. Maximum interval is 14 days; minimum interval is 1 minute.

- String data type entered in the format of "Hours:Minutes:Seconds".

22.3.61.13 GOESSTOffset

Time after midnight for the first self-timed transmission as assigned by NESDIS (TX325) or EUMETSAT (TX326). Maximum offset is 23:59:59. A value of 0 results in no offset.

- String data type entered in the format of "Hours:Minutes:Seconds".

23. CR350 specifications

Electrical specifications are valid over a -40 to +70 °C, non-condensing environment, unless otherwise specified. Recalibration is recommended every three years. Critical specifications and system configuration should be confirmed with Campbell Scientific before purchase.

23.1 System specifications	268
23.2 Physical specifications	269
23.3 Power requirements	269
23.4 Power output specifications	271
23.5 Analog measurement specifications	272
23.6 Pulse measurement specifications	275
23.7 Digital input/output specifications	277
23.8 Communications specifications	278
23.9 Standards compliance specifications	281

23.1 System specifications

Processor: ARM Cortex M4 running at 120 MHz

Memory:

- CPU Drive: 50 MB serial flash
- Data Storage: 50 MB serial flash
- Operating System: 2 MB flash
- Settings, Calibration, TLS Certificates and Key, System Information: 3 MB serial flash
- Background Tasks and Table Information, Buffers, System Memory, Program Variables:
7 MB RAM

Program Execution Period: 100 ms to 1 day

Real-Time Clock:

- Battery backed while external power is disconnected
- **Resolution:** 1 ms
- **Accuracy:** ±3 min. per year

Wiring Panel Temperature: Measured using a sensor, located on the processor board.

NOTE:

The measurement from the [PanelTemp\(\)](#) instruction does not accurately reflect the temperature of the wiring panel, since it measures the temperature of the main processing board. Therefore, if the data logger processor, or charge (CHG) input are active, the [PanelTemp\(\)](#) measurement will be warmer than ambient. This should be taken into consideration if this measurement is used as a reference temperature for other measurements such as thermocouples.

23.2 Physical specifications

Dimensions (additional clearance required for cables, wires and antennas):

- **CR350:** 16.3 x 8.4 x 5.6 cm (6.4 x 3.3 x 2.2 in). For CAD files, see [CR350 Images and CAD 2D Drawings](#).

Weight/Mass:

- **CR350:** 288 g (0.64 lb)
- **CR350-CELL:** 306 g (0.68 lb)
- **CR350-WIFI/RF407/RF412/RF422/RF452 :** 306 g (0.68 lb)

Case Material: High-impact-resistant polycarbonate, recycle code 7

23.3 Power requirements

Power specifications for a communications option are shown within the specifications section for that option.

Protection: Power inputs are protected against surge, over-voltage, over-current, and reverse power. IEC 61000-4 Class 4 level.

Charge Terminal Characteristics (CHG+ and CHG-):

- Input from power converter or solar panel, typical
- Voltage input 16 to 32 VDC
- Current limit at 1.1 A

Battery Terminal Characteristics (BAT+ and BAT-):

- Input from external battery 12 VDC, 7 Ah lead-acid, typical
- Voltage input 10 to 17 VDC
- Current limit at 3.7 A

Internal Lithium Battery (see [Internal battery](#) (p. 176) for more information): 3 V coin cell CR2025 for battery-backed clock. 6-year life with no external power source.

Average Current Drain:

Assumes 12 VDC on **BAT** terminals — add 2 mA if using **CHG** terminals.

- **Idle:** 0.5 mA
- **Active 1 Hz scan w/ one analog measurement:** 1.5 mA
- **Active** (Processor always on): 8 mA
- **Serial** (RS-232): Active + 5 mA

USB Power: Functions that will be active with USB 5 VDC include sending programs, adjusting data logger settings, and making some measurements. If **USB** is the only power source, then the **VX1** and **VX2** ranges are reduced to 150 to 2500 mV. The **SW1**, **SW2**, and **12V** terminals will not be operational. For the control terminals (**C1**, **C2**), voltage output is limited to 4.75 V.

Cellular Average Additional Current Contribution at 12 VDC:

- **Idle:** Connected to network, no data transfer.
 - -CELL205 average = 14 mA
 - -CELL210 average = 28 mA
 - -CELL215 average = 14 mA
 - -CELL220 average = 14 mA
 - -CELL225 average = 14 mA
 - -CELL230 average = 23 mA, 26 mA if GPS is on
- **Transfer/Receive:**
 - -CELL205 average = 75 mA
 - -CELL210 average = 90 mA
 - -CELL215 average = 75 mA
 - -CELL220 average = 75 mA
 - -CELL225 average = 75 mA
 - -CELL230 average = 50 mA, 53 mA if GPS is on

Wi-Fi Additional Current Contribution at 12 VDC:

- **Client mode communicating:** 70 mA typical
- **Client mode idle:** 7 mA typical
- **Access point mode communicating:** 70 mA
- **Access point mode idle:** 62 mA typical
- **Idle** (use [IPNetPower\(\)](#) or DevConfig setting to disable): <0.1 mA

RF Average Additional Current Contribution at 12 VDC

	-RF407, -RF412, -RF427	-RF422	-RF452
Transmit	< 80 mA	20 mA	650 mA, maximum
Idle On	12 mA	9.5 mA	15 mA, maximum
Idle 0.5 s Power Mode	4 mA	3.5 mA	NA
Idle 1 s Power Mode	3 mA	2 mA	NA
Idle 4 s Power Mode	1.5 mA	1.5 mA	NA

See also [Power output](#) (p. 13).

23.4 Power output specifications

System power out limits (when powered with 12 VDC):

Temperature (°C)	Current Limit ¹ (A)
-40°	5.8
20°	3.7
70°	2.0
¹ Limited by self-resetting thermal fuse	

12V: Provide unregulated 12 VDC power with voltage equal to BAT+ input voltage. Disabled when operating on USB power only. Current output limited by thermal fuses. Two 12V terminals share one thermal fuse up to 2.5 A @ 20 °C.

- **Terminals:**
 - **12V:** two terminals, always on
 - **SW1 and SW2:** switched under program control, current limit at 2.1 A each

VX: Two independently configurable voltage terminals (**VX1-VX2**). **VX** outputs are produced by a 12-bit DAC. In this case, these terminals are regularly used with resistive-bridge measurements (see [Resistance measurements](#) (p. 108) for more information). **VX** terminals can also be used to supply a switched, regulated 5 VDC power source to power digital sensors and toggle control lines.

NOTE:

CR350 data loggers are not capable of applying reverse excitation. Set the **RevEx** parameter of all bridge measurement instructions to **False**.

- **Range:** 150 to 5000 mV
- **Resolution:** 1.6 mV
- **Maximum Source Current:** 50 mA total, concurrently or independently.

See also [Voltage measurements](#) (p. 103).

See also [Power output](#) (p. 13).

23.5 Analog measurement specifications

4 single-ended (SE) or 2 differential (DIFF) terminals individually configurable for voltage, thermocouple, current loop, ratiometric, and period average measurements, using a 24-bit ADC. One channel at a time is measured.

23.5.1 Voltage measurements

Terminals:

- **Differential Configuration:** DIFF 1H/1L – 2H/2L
- **Single-Ended Configuration:** SE1 – SE4

Input Resistance:

- 5 G Ω typical ($f_{N1} = 50/60$ Hz)
- 300 M Ω typical ($f_{N1} = 4000$ Hz)

Input Voltage Limits: -100 to +2500 mV

Sustained Input Voltage without Damage:

- SE1-SE2: -6 V, +9 V
- SE3-SE4: ± 17 V

DC Common Mode Rejection:

- >120 dB with input reversal
- ≥ 90 dB without input reversal

Normal Mode Rejection:

- >71 dB at 50 Hz
- >74 dB at 60 Hz

Input Current @ 25 °C:

- ± 0.08 nA typical ($f_{N1} = 50/60$ Hz)
- ± 13 nA typical ($f_{N1} = 4000$ Hz)

Filter First Notch Frequency (f_{N1}) Range: 50/60, 400, 4000 Hz (user specified)

Analog Range and Resolution:

		Differential with input reversal		Single-ended and differential without input reversal	
Notch frequency (f_{N1}) (Hz)	Range ¹ (mV)	RMS (μ V)	Bits ²	RMS (μ V)	Bits ²
4000	-100 to +2500	23	16.8	33	16.3
	-34 to +34	3.0	14.5	4.2	14.0
400	-100 to +2500	3.8	19.4	5.4	18.9
	-34 to +34	0.58	16.8	0.82	16.3
50/60 ³	-100 to +2500	1.6	20.6	2.3	20.1
	-34 to +34	0.23	18.2	0.33	17.7

¹ Range overhead of ~10% on all ranges guarantees that full-scale values will not cause over range

² Typical effective resolution (ER) in bits; computed from ratio of full-scale range to RMS resolution.

³ 50/60 corresponds to rejection of 50 and 60 Hz ac power mains noise.

Accuracy (does not include sensor or measurement noise):

- 0 to 40 °C: $\pm(0.04\%$ of measurement + offset)
- -40 to 70 °C: $\pm(0.1\%$ of measurement+ offset)

Voltage Measurement Accuracy Offsets:

Range (mV)	Typical offset (μ V RMS)		
	Differential with input reversal	Differential without input reversal	Single-ended
-100 to +2500	± 20	± 40	± 60
-34 to +34	± 6	± 14	± 20

Measurement Settling Time: 10 μ s to 50 ms; 500 μ s default

Multiplexed Measurement Time:

These are not maximum speeds. Multiplexed denotes circuitry inside the data logger that switches signals into the ADC.

Measurement time = (multiplexed measurement time + settling time) • reps + 0.8 ms

	Differential with input reversal	Single-ended or differential without input reversal
Example fN ¹ (Hz)	Time ² (ms)	Time ² (ms)
4000	2.9	1.4
400	14.6	7.3
50/60	103	51.5
¹ Notch frequency (1/integration time). ² Default settling time of 500 μs used.		

See also [Voltage measurements](#) (p. 103).

23.5.2 Resistance measurement specifications

The data logger makes ratiometric-resistance measurements for four- and six-wire full-bridge circuits and two-, three-, and four-wire half-bridge circuits using voltage excitation. Typically, at least one terminal is configured for excitation output. Multiple sensors may be able to use a common excitation terminal.

Accuracy:

Assumes input reversal for differential measurements **RevDiff**. Does not include bridge resistor errors or sensor and measurement noise.

Ratiometric accuracy, rather than absolute accuracy, determines overall measurement accuracy. Offset is the same as specified for analog voltage measurements.

- 0 to 40 °C: ±(0.05% of voltage measurement + offset)
- -40 to 70 °C: ±(0.06% of voltage measurement + offset)

23.5.3 Period-averaging measurement specifications

Use [PeriodAvg\(\)](#) to measure the period (in microseconds) or the frequency (in Hz) of a signal on a single-ended channel.

Terminals:

- SE1-SE4
- C1-C2

Accuracy: $\pm(0.01\%$ of measurement + resolution), where resolution is $0.13\ \mu\text{s}$ divided by the number of cycles to be measured

Voltage Range: 0 to 3.3 V

Minimum Pulse Width: 33 ns

Voltage Threshold: Counts cycles on transition from $<0.9\ \text{VDC}$ to $>2.1\ \text{VDC}$

See also [Period-averaging measurements](#) (p. 114).

23.5.4 Current-loop measurement specifications

Two analog inputs terminals may be configured as independent, non-isolated 0-20 mA or 4-to-20 mA current-loop inputs referenced to ground. One channel at a time is measured. Current is measured using a 24-bit ADC.

Terminals: SE1-SE2

Range: 0 to 25 mA

Accuracy:

- 0 to 40 °C: $\pm 0.14\%$ of reading
- -40 to 70 °C: $\pm 0.26\%$ of reading

See also [Current-loop measurements](#) (p. 105).

23.6 Pulse measurement specifications

Terminals are individually configurable for switch closure, high-frequency pulse, or low-level AC measurements.

23.6.1 Switch-closure input

Terminals:

- P_SW
- C1-C2
- SE1-SE4

Maximum Input Frequency: 150 Hz

Minimum Switch Closed Time: 3 ms

Minimum Switch Open Time: 3 ms

Maximum Bounce Time: 1 ms open without being counted

23.6.2 High-frequency input

Terminals:

- SE1-SE4
- P_LL
- P_SW
- C1-C2

Maximum Input Frequency:

- SE1-SE4: 35 kHz
- P_LL: 20 kHz
- P_SW: 35 kHz
- C1-C2: 35 kHz

23.6.3 Low-level AC input

Terminals: P_LL

Maximum Input Voltage: ± 20 VDC

DC-offset Rejection: Internal AC coupling eliminates DC-offset voltages up to ± 0.05 VDC

Input Hysteresis: 12 mV at 1 Hz

Low-Level AC Pulse Input Ranges:

Sine wave (mV RMS)	Range (Hz)
20	1.0 to 20
200	0.5 to 200
2000	0.3 to 10,000
5000	0.3 to 20,000

23.6.4 Quadrature input

Terminals: SE1 and SE2, SE3 and SE4, or C1 and C2 can be configured as digital terminal pairs to monitor the two sensing channels of an encoder.

Maximum Frequency: 2.5 kHz

See [Pulse measurements](#) (p. 114) for additional information.

23.7 Digital input/output specifications

Up to seven terminals may be configured for digital input or output (I/O).

Terminals:

- SE1-SE4
- P_SW
- C1-C2

Digital I/O Voltage Levels:

Terminal	High State	Low State	Current Source	Maximum Input Voltage
C1 C2	5.0 V output 3.3V input	0 V	10 mA at 3.5 V	-10 V, +15 V
SE1 SE2	3.3 V	0 V	100 μ A at 3.0 V	-6 V, +9 V
SE3 SE4 P_SW	3.3 V	0 V	100 μ A at 3.0 V	\pm 17 V

See also [Power output](#) (p. 13) and [Pulse measurement specifications](#) (p. 275).

23.7.1 Pulse-width modulation

Terminals:

- SE1-SE4
- C1

Period Maximum: 2047 ms

Resolution

- 0 – 5 ms: 83.33 ns or 12 MHz
- 5 – 325 ms: 5.00 μ s or 200 kHz
- > 325 ms: 31.25 μ s or 32 kHz

See [Digital input/output specifications](#) (p. 277) for more information.

23.8 Communications specifications

A data logger is normally part of a two-way conversation started by a computer. In applications with some types of interfaces, the data logger can also initiate the call (callback) when needed. In satellite applications, the data logger may simply send bursts of data at programmed times without waiting for a response.

Internet Protocols: Ethernet, PPP, RNDIS, ICMP/Ping, Auto-IP(APIPA), IPv4, IPv6, UDP, TCP, TLS (v1.2), DNS, DHCP, SLAAC, Telnet, HTTP(S), FTP(S), POP3/TLS, NTP, SMTP/TLS, MQTT

Additional Protocols: PakBus, PakBus Encryption, SDI-12, Modbus RTU / ASCII / TCP, DNP3, custom user definable over serial

USB: Type C 2.0. Full speed: 12 Mbps. Operates as:

- Device for computer communications
- Host for mass storage devices

SDI-12 (C1, C2): Two independent SDI-12 compliant terminals are individually configured and meet SDI-12 Standard v 1.4.

RS-232:

- **COMRS232:** Female RS-232, 9-pin interface, 1200 to 115.2 kbps
- **COM1 (C1,C2):** TTL or RS-232 logic
- **COM2 - COM3:** Two independent RS-232 Rx/Tx pairs

RS-485 (COM2 - COM3): Two independent RS-485 half duplex

23.8.1 Wi-Fi specifications

WLAN (Wi-Fi)

Maximum Possible Over-the-Air Data Rates: <11 Mbps over 802.11b, <54 Mbps over 802.11g, <72 Mbps over 802.11n

Operating Frequency: 2.4 GHz, 20 MHz bandwidth

Antenna Connector: Reverse Polarity SMA (RPSMA)

Antenna (shipped with data logger): Unity gain (0 dBd), 1/2 wave whip, omnidirectional. Features an articulating knuckle joint that can be oriented vertically or at right angles

Supported Technologies: 802.11 b/g/n, WPA/WPA2-Personal, WPA/WPA2-Enterprise Security, WEP

Client Mode: WPA/WPA2-Personal and Enterprise, WEP

Access Point Mode: WPA2-Personal

Receive Sensitivity: -97 dBm

For WiFi additional current contribution specifications, see [Power requirements](#) (p. 269).

23.8.2 RF radio option specifications

Antenna Terminal: Reverse Polarity SMA (RPSMA)

Radio Type

- **RF407, RF412, RF427, and RF452:** Frequency-Hopping Spread-Spectrum (FHSS)
- **RF407, RF412, and RF427:** Frequency-Hopping Spread-Spectrum (FHSS)
- **RF422:** SRD860 Radio with Listen Before Talk (LBT) and Automatic Frequency Agility (AFA)

Frequency

- **RF407:** 902 to 928 MHz (US, Canada)
- **RF412:** 915 to 928 MHz (Australia, New Zealand)
- **RF422:** 863 to 870 MHz (Europe, Middle East, and Africa)
- **RF427:** 902 to 907.5 MHz/915 to 928 MHz (Brazil)
- **RF452:** 902 to 928 MHz

Transmit Power Output (software selectable)

- **RF407 and RF412:** 5 to 250 mW
- **RF422:** 2 to 25 mW
- **RF427:** 5 to 250 mW
- **RF452:** 10 mW to 1,000 mW

Channel Capacity

- **RF407:** Eight 25-channel hop sequences sharing 64 available channels.
- **RF412:** Eight 25-channel hop sequences sharing 31 available channels.
- **RF422:** Ten 30-channel hop sequences (default), software configurable to meet local regulations; 10 sequences for reducing interference through channel hop.
- **RF427:** Eight 25-channel hop sequences sharing 43 available channels.
- **RF452:** 50 to 112 user-selectable channels for a given network.

Receive Sensitivity

- **RF407, RF412, and RF427:** -101 dBm
- **RF422:** -106 dBm
- **RF452:**
 - -108 dBm at 115.2 kbps for 10^{-4} BER
 - -103 dBm at 153.6 kbps for 10^{-4} BER

RF Data Rate

- RF407, RF412, and RF427: 200 kbps
- RF422: 10 kbps
- RF452: 115.2 or 153.6 kbps

For RF additional current contribution specifications, see [Power requirements](#) (p. 269).

See also [Radio communications option](#) (p. 55).

Maximum nodes in network

- RF407, RF412, and RF427: 50
- RF422: 20
- RF452: 4 repeaters

23.8.3 Cellular option specifications

Cell Technology:

Option	Cellular technology	Market	Verizon	AT&T	T-Mobile	International
-CELL205	4G LTE with automatic 3G fallback	North America		✓	✓	
-CELL210	4G LTE CAT-1	United States	✓			
-CELL215	4G LTE with automatic 3G and 2G fallback	EMEA				✓
-CELL220	4G LTE with automatic 3G fallback	Australia and New Zealand				✓
-CELL225	4G LTE	Japan				✓
-CELL230	LTE CAT-M1 LTE NB-IoT	Global	✓			✓

* Confirm modem compliance for country/carrier where services are needed.

See

<https://s.campbellsci.com/documents/us/miscellaneous/Cellular%20Modem%20Frequency%20Bands.pdf> for a complete list of supported frequency bands.

Antenna: Two SMA connectors, one for TX/RX, one for diversity RX

SIM Slot: Industry standard 3FF micro-SIM (6 position / contacts) (not externally accessible)

23.9 Standards compliance specifications

View compliance and conformity documents at www.campbellsci.com/cr350.

Shock and Vibration: ASTM D4169

Protection: IP30

EMI and ESD protection:

- **Immunity:** Meets or exceeds following standards:
 - **ESD:** per IEC 61000-4-2; ±15 kV air, ±8 kV contact discharge
 - **Radiated RF:** per IEC 61000-4-3; 10 V/m, 80-1000 MHz
 - **EFT:** per IEC 61000-4-4; 4 kV power, 4 kV I/O
 - **Surge:** per IEC 61000-4-5; 4 kV power, 4kV I/O
 - **Conducted RF:** per IEC 61000-4-6; 10 V power, 10 V I/O
- Emissions and immunity performance criteria available on request.

RF407 Option

- United States FCC Part 15.247: MCQ-XB900HP
- Industry Canada (IC): 1846A-XB900HP
- Mexico IF: RCPDIXB15-0672-A1

RF412 Option

- ACMA RCM
- United States FCC Part 15.247:
 - MCQ-XB900HP
 - Industry Canada (IC): 1846A-XB900HP

RF422 Option: View EU Declaration of Conformity at www.campbellsci.com/cr350.

RF427 Option: Brazil ANATEL standards in Resolution No. 506: 08335-17-10644. View the RF427 Brazilian Certificate of Conformity at www.campbellsci.com/cr350.

RF452 Option:

- United States FCC ID: KNYMM3
- Industry Canada (IC): 2329B-MM3

Wi-Fi

- United States FCC ID: XF6-RS9113SB
- Industry Canada (IC): 8407A-RS9113SB

Cellular Option:

- Industry Canada (IC): 10224A-201611EC21A
- -CELL230:
 - Industry Canada (IC): 10224A-2019BG95M3
 - FCC ID: XMR201910BF95M3

NOTE:

The user is responsible for emissions if changing the antenna type or increasing the gain.

Appendix A. Configure cellular settings and retrieve status information with `SetSetting()`

Downloadable example programs are available at www.campbellsci.com/downloads/cell200-example-programs . The `CELL2XX-SetSettings` example shows how to set up the cellular module using the `SetSetting()` instruction. It also illustrates how to retrieve status information from the module in the `CRBasic` program.

Appendix B. Verizon Wireless and AT&T

NOTE:

Campbell Scientific can provide Verizon Wireless or AT&T service. This is the simplest way to set up your module on the Verizon Wireless or AT&T network. See [Campbell Scientific cellular data service](#) (p. 39).

B.1 Verizon Wireless

What you need:

- Verizon Wireless 4G LTE CAT-1 coverage at the data logger site. For a coverage map, refer to: <https://www.verizon.com/> .
- Verizon Wireless 4G LTE private dynamic IP account in conjunction with Campbell Scientific Konect PakBus Router Service. (A Verizon Wireless 4G LTE static unrestricted IP account can also be used. However, Verizon generally requires new users to have 50 lines of service to obtain the static unrestricted IP account. Also, there is generally a \$500 one-time-per-customer charge to activate static IP on the account.)

To set up an account, you will need the IMEI number of the module. The IMEI number is listed on a label on the module. To set up an account with Verizon Wireless, call:

800-526-3178 for Business Sales

800-256-4646 for Personal Sales

Verizon Wireless will provide a SIM (Subscriber Identity Module) card for each module. The Micro-SIM (3FF) (6 position / contacts) card must be installed inside of the module as described in [Install the SIM card](#) (p. 40). In addition to the SIM card, you should receive:

- 10-digit MSISDN number (telephone number associated with the SIM, used for billing)
- An APN (Access Point Name) for 4G LTE CAT-1 service. A common APN used for this application is: VZWINTERNET. The user must program the APN into the module.
- For static IP accounts only, an IP Address will be included.

B.2 AT&T

What you need:

- AT&T 4G LTE CAT-1 coverage at the data logger site. For a coverage map refer to: www.att.com/maps/wireless-coverage.html .
- AT&T 4G LTE private dynamic IP account in conjunction with Campbell Scientific's Konect Router Service. (An AT&T 4G LTE static unrestricted IP account can also be used. However, AT&T charges \$3/month/device for the static IP account.)

To set up an AT&T account, contact your AT&T Business Account Representative.

An APN (Access Point Name) must be added onto the account to make the module accessible through the Internet. For networks with fewer than 30 modules, the standard 'I2Gold APN' can be used; networks with more than 30 modules will require a 'Custom APN'. A Custom APN has a setup fee starting at \$500 and takes a minimum of 7 to 14 business days to complete. The user must program the APN into the module.

AT&T will provide a Subscriber Identity Module (SIM) card for each module. The Micro-SIM (3FF) (6 position / contacts) card must be installed inside of the module as described in [Install the SIM card](#) (p. 40). In addition to the SIM card, you should receive:

- 10-digit MSISDN number (telephone number associated with the SIM, used for billing)
- An APN (Access Point Name) for 4G LTE CAT-1 service. A common APN used for this application is: BROADBAND. The user must program the APN into the module.
- For static IP accounts only, an IP Address will be included.

Appendix C. Cellular module regulatory information

C.1 Important information for North American users

NOTE:

This equipment has been tested and found to comply with the limits for a Class A digital device, pursuant to part 15 of the FCC Rules. These limits are designed to provide reasonable protection against harmful interference when the equipment is operated in a commercial environment. This equipment generates, uses, and can radiate radio frequency energy and, if not installed and used in accordance with the instruction manual, may cause harmful interference to radio communications. Operation of this equipment in a residential area is likely to cause harmful interference, in which case the user will be required to correct the interference at his own expense.

WARNING:

Changes or modifications to this device not expressly approved by Campbell Scientific could void the user's authority to operate this equipment.

C.2 RF exposure

In accordance with FCC/IC requirements of human exposure to radio frequency fields, the radiating element shall be installed such that a minimum separation distance of 20 cm should be maintained from the antenna and the user's body.

WARNING:

This product is only to be installed by qualified personnel.

To comply with FCC/IC regulations limiting both maximum RF output power and human exposure to RF radiation, the maximum antenna gain must not exceed the specifications listed in the following tables for the device used.

Device	Frequency Band	FCC ID XMR201606EC21A
CELL205	WCDMA Band 2	9.5 dBi
	WCDMA Band 4	6.5 dBi
	WCDMA Band 5	14.9 dBi
	LTE Band 2	9.0 dBi
	LTE Band 4	6.0 dBi
	LTE Band 12	10.7 dBi
CELL210	LTE Band 4	6.5 dBi
	LTE Band 13	10.6 dBi
CELL230	LTE CAT-M1 LTE NB-IoT	21 dBi

C.3 EU

Campbell Scientific hereby declares the CR350-CELL devices are in compliance with the essential requirements and other relevant provisions of Directive 2014/53/EU" (RED Directive).

The CELL215 and CELL230 display the CE mark.



WARNING:

Changes or modifications to this device not expressly approved by Campbell Scientific could void the user's authority to operate this equipment.

WARNING:

This product is only to be installed by qualified personnel.

The Declaration of Conformity made under Directive 2014/53/EU" (RED Directive) is available for viewing at: www.campbellsci.com/cell215.

C.4 UK

Campbell Scientific hereby declares the CR350-CELL devices are in compliance with the essential requirements and other relevant provisions of Regulation 2017 No. 1206 (The Radio Equipment

Regulations 2017).

The CELL215 and CELL230 display the UKCA mark.



WARNING:

Changes or modifications to this device not expressly approved by Campbell Scientific could void the user's authority to operate this equipment.

WARNING:

This product is only to be installed by qualified personnel.

The Declaration of Conformity made under Regulation 2017 No. 1206 is available for viewing at:
www.campbellsci.com/cell215 .

Appendix D. Glossary

A

AC

Alternating current (see VAC).

accuracy

The degree to which the result of a measurement, calculation, or specification conforms to the correct value or a standard.

ADC

Analog to digital conversion. The process that translates analog voltage levels to digital values.

alias

A second name assigned to variable in CRBasic.

allowed neighbor list

In PakBus networking, an allowed neighbor list is a list of neighbors with which a device will communicate. If a device address is entered in an allowed neighbor list, a hello exchange will be initiated with that device. Any device with an address between 1 and 3999 that is not entered in the allowed neighbor list will be filtered from communicating with the device using the list.

amperes (A)

Base unit for electric current. Used to quantify the capacity of a power source or the requirements of a power-consuming device.

analog

Data presented as continuously variable electrical signals.

APN

Cellular Access Point Name (obtained from your cellular network provider)

argument

Part of a procedure call (or command execution).

array

A group of variables as declared in CRBasic.

ASCII/ANSI

Abbreviation for American Standard Code for Information Interchange / American National Standards Institute. An encoding scheme in which numbers from 0-127 (ASCII) or 0-255 (ANSI) are used to represent pre-defined alphanumeric characters. Each number is usually stored and transmitted as 8 binary digits (8 bits), resulting in 1 byte of storage per character of text.

asynchronous

The transmission of data between a transmitting and a receiving device occurs as a series of zeros and ones. For the data to be "read" correctly, the receiving device must begin reading at the proper point in the series. In asynchronous communications, this coordination is accomplished by having each character surrounded by one or more start and stop bits which designate the beginning and ending points of the information. Also indicates the sending and receiving devices are not synchronized using a clock signal.

AWG

AWG ("gauge") is the accepted unit when identifying wire diameters. Larger AWG values indicate smaller cross-sectional diameter wires. Smaller AWG values indicate large-diameter wires. For example, a 14 AWG wire is often used for grounding because it can carry large currents. 22 AWG wire is often used as sensor wire since only small currents are carried when measurements are made.

B

baud rate

The rate at which data is transmitted.

beacon

A signal broadcasted to other devices in a PakBus network to identify "neighbor" devices. A beacon in a PakBus network ensures that all devices in the network are aware of other devices that are viable.

binary

Describes data represented by a series of zeros and ones. Also describes the state of a switch, either being on or off.

BOOL8

A one-byte data type that holds eight bits (0 or 1) of information. BOOL8 uses less space than the 32 bit BOOLEAN data type.

boolean

Name given a function, the result of which is either true or false.

boolean data type

Typically used for flags and to represent conditions or hardware that have only two states (true or false) such as flags and control ports.

burst

Refers to a burst of measurements. Analogous to a burst of light, a burst of measurements is intense, such that it features a series of measurements in rapid succession, and is not continuous.

C

calibration wizard

The calibration wizard facilitates the use of the CRBasic field calibration instructions FieldCal() and FieldCalStrain(). It is found in LoggerNet (4.0 and later) or RTDAQ.

callback

A name given to the process by which the data logger initiates communications with a computer running appropriate Campbell Scientific data logger support software. Also known as "Initiate Comms."

CardConvert software

A utility to retrieve binary final data from memory cards and convert the data to ASCII or other formats.

CDM/CPI

CPI is a proprietary interface for communications between Campbell Scientific data loggers and Campbell Scientific CDM peripheral devices. It consists of a physical layer definition and a data protocol.

CF

CompactFlash®

code

A CRBasic program, or a portion of a program.

Collect button

Button or command in data logger support software that facilitates collection-on-demand of final-data memory. This feature is found in PC400, LoggerNet, and RTDAQ software.

Collect Now button

Button or command in data logger support software that facilitates collection-on-demand of final-data memory. This feature is found in PC400, LoggerNet, and RTDAQ software.

COM port

COM is a generic name given to physical and virtual serial communications ports.

COM1

When configured as a communications port, terminals C1 and C2 act as a pair to form Com1.

command

An instruction or signal that causes a computer to perform one of its basic functions (usually in CRBasic).

command line

One line in a CRBasic program. Maximum length, even with the line continuation characters <space> <underscore> (_), is 512 characters. A command line usually consists of one program statement, but it may consist of multiple program statements separated by a <colon> (:).

CompactFlash

CompactFlash® (CF) is a memory-card technology used in some Campbell Scientific card-storage modules.

compile

The software process of converting human-readable program code to binary machine code. Data logger user programs are compiled internally by the data logger operating system.

conditioned output

The output of a sensor after scaling factors are applied.

connector

A connector is a device that allows one or more electron conduits (wires, traces, leads, etc) to be connected or disconnected as a group. A connector consists of two parts — male and female. For example, a common household ac power receptacle is the female portion of a connector. The plug at the end of a lamp power cord is the male portion of the connector.

constant

A packet of memory given an alpha-numeric name and assigned a fixed number.

control I/O

C terminals configured for controlling or monitoring a device.

CoraScript

CoraScript is a command-line interpreter associated with LoggerNet data logger support software.

CPU

Central processing unit. The brains of the data logger.

cr

Carriage return.

CRBasic

Campbell Scientific's BASIC-like programming language that supports analog and digital measurements, data processing and analysis routines, hardware control, and many communications protocols.

CRBasic Editor

The CRBasic programming editor; stand-alone software and also included with LoggerNet, PC400, and RTDAQ software.

CRC

Cyclic Redundancy Check

CRD

An optional memory drive that resides on a memory card.

CVI

Communications verification interval. The interval at which a PakBus® device verifies the accessibility of neighbors in its neighbor list. If a neighbor does not communicate for a period of time equal to 2.5 times the CVI, the device will send up to four Hellos. If no response is received, the neighbor is removed from the neighbor list.

D

DAC

Digital to analog conversion. The process that translates digital voltage levels to analog values.

data bits

Number of bits used to describe the data and fit between the start and stop bit. Sensors typically use 7 or 8 data bits.

data cache

The data cache is a set of binary files kept on the hard disk of the computer running the data logger support software. A binary file is created for each table in each data logger. These files mimic the storage areas in data logger memory, and by default are two times the size of the data logger storage area. When the software collects data from a data logger, the data is stored in the binary file for that data logger. Various software functions retrieve data from the data cache instead of the data logger directly. This allows the simultaneous sharing of data among software functions.

data logger support software

LoggerNet, RTDAQ, and PC400 - these Campbell Scientific software applications include at least the following functions: data logger communications, downloading programs, clock setting, and retrieval of measurement data.

data output interval

The interval between each write of a record to a final-storage memory data table.

data output processing instructions

CRBasic instructions that process data values for eventual output to final-data memory. Examples of output-processing instructions include Totalize(), Maximize(), Minimize(), and Average(). Data sources for these instructions are values or strings in variable memory. The results of intermediate calculations are stored in data output processing memory to await the output trigger. The ultimate destination of data generated by data output processing instructions is usually final-storage memory, but the CRBasic program can be written to divert to variable memory by the CRBasic program for further processing. The transfer of processed summaries to final-data memory takes place when the Trigger argument in the DataTable() instruction is set to True.

data output processing memory

Memory automatically allocated for intermediate calculations performed by CRBasic data output processing instructions. Data output processing memory cannot be monitored.

data point

A data value which is sent to final-data memory as the result of a data-output processing instruction. Data points output at the same time make up a record in a data table.

data table

A concept that describes how data is organized in memory, or in files that result from collecting data in memory. The fundamental data table is created by the CRBasic program as a result of the DataTable() instruction and resides in binary form in memory. The data table structure resides in the data cache, in discrete data files, and in files that result from collecting final-data memory with data logger support software.

DC

Direct current.

DCE

Data Communications Equipment. While the term has much wider meaning, in the limited context of practical use with the data logger, it denotes the pin configuration, gender, and function of an RS-232 port. The RS-232 port on the data logger is DCE. Interfacing a DCE device to a DCE device requires a null-modem cable.

desiccant

A hygroscopic material that absorbs water vapor from the surrounding air. When placed in a sealed enclosure, such as a data logger enclosure, it prevents condensation.

Device Configuration Utility

Software tool used to set up data loggers and peripherals, and to configure PakBus settings before those devices are deployed in the field and/or added to networks. Also called DevConfig.

DHCP

Dynamic Host Configuration Protocol. A TCP/IP application protocol.

differential

A sensor or measurement terminal wherein the analog voltage signal is carried on two wires. The phenomenon measured is proportional to the difference in voltage between the two wires.

Dim

A CRBasic command for declaring and dimensioning variables. Variables declared with Dim remain hidden during data logger operations.

dimension

To code a CRBasic program for a variable array as shown in the following examples: DIM example(3) creates the three variables example(1), example(2), and example(3); DIM example(3,3) creates nine variables; DIM example(3,3,3) creates 27 variables.

DNP3

Distributed Network Protocol is a set of communications protocols used between components in process automation systems. Its main use is in utilities such as electric and water companies.

DNS

Domain name server. A TCP/IP application protocol.

DTE

Data Terminal Equipment. While the term has much wider meaning, in the limited context of practical use with the data logger, it denotes the pin configuration, gender, and function of an RS-232 port. The RS-232 port on the data logger is DCE. Attachment of a null-modem cable to a DCE device effectively converts it to a DTE device.

duplex

A serial communications protocol. Serial communications can be simplex, half-duplex, or full-duplex.

duty cycle

The percentage of available time a feature is in an active state. For example, if the data logger is programmed with 1 second scan interval, but the program completes after only 100 milliseconds, the program can be said to have a 10% duty cycle.

E

earth ground

A grounding rod or other suitable device that electrically ties a system or device to the earth. Earth ground is a sink for electrical transients and possibly damaging potentials, such as those produced by a nearby lightning strike. Earth ground is the preferred reference potential for analog voltage measurements. Note that most objects have a "an electrical potential" and the potential at different places on the earth - even a few meters away - may be different.

endian

The sequential order in which bytes are arranged into larger numerical values when stored in memory.

engineering units

Units that explicitly describe phenomena, as opposed to, for example, the data logger base analog-measurement unit of millivolts.

ESD

Electrostatic discharge.

ESS

Environmental sensor station.

excitation

Application of a precise voltage, usually to a resistive bridge circuit.

execution interval

The time interval between initiating each execution of a given Scan() of a CRBasic program. If the Scan() Interval is evenly divisible into 24 hours (86,400 seconds), it is synchronized with the 24 hour clock, so that the program is executed at midnight and every Scan() Interval thereafter. The program is executed for the first time at the first occurrence of the Scan() Interval after compilation. If the Scan() Interval does not divide evenly into 24 hours, execution will start on the first even second after compilation.

execution time

Time required to execute an instruction or group of instructions. If the execution time of a program exceeds the Scan() Interval, the program is executed less frequently than programmed and the Status table SkippedScan field will increment.

expression

A series of words, operators, or numbers that produce a value or result.

F

FAT

File Allocation Table - a computer file system architecture and a family of industry-standard file systems utilizing it.

FFT

Fast Fourier Transform. A technique for analyzing frequency-spectrum data.

field

Data tables are made up of records and fields. Each row in a table represents a record and each column represents a field. The number of fields in a record is determined by the number and configuration of output processing instructions that are included as part of the DataTable() declaration.

File Control

File Control is a feature of LoggerNet, PC400, Device Configuration Utility, and RTDAQ data logger support software. It provides a view of the data logger file system and a menu of file management commands.

fill and stop memory

A memory configuration for data tables forcing a data table to stop accepting data when full.

final-data memory

The portion of memory allocated for storing data tables. Once data is written to final-data memory, it cannot be changed but only overwritten when it becomes the oldest data. Final-data memory is configured as ring memory by default, with new data overwriting the oldest data.

final-storage data

Data that resides in final-data memory.

Flash

A type of memory media that does not require battery backup. Flash memory, however, has a lifetime based on the number of writes to it. The more frequently data is written, the shorter the life expectancy.

FLOAT

Four-byte floating-point data type. Default data logger data type for Public or Dim variables. Same format as IEEE4.

FP2

Two-byte floating-point data type. Default data logger data type for stored data. While IEEE4 four-byte floating point is used for variables and internal calculations, FP2 is adequate for most stored data. FP2 provides three or four significant digits of resolution, and requires half the memory as IEEE4.

frequency domain

Frequency domain describes data graphed on an X-Y plot with frequency as the X axis. VSPECT vibrating wire data is in the frequency domain.

frequency response

Sample rate is how often an instrument reports a result at its output; frequency response is how well an instrument responds to fast fluctuations on its input. By way of example, sampling a large gage thermocouple at 1 kHz will give a high sample rate but does not ensure the measurement has a high frequency response. A fine-wire thermocouple, which changes output quickly with changes in temperature, is more likely to have a high frequency response.

FTP

File Transfer Protocol. A TCP/IP application protocol.

full-duplex

A serial communications protocol. Simultaneous bi-directional communications. Communications between a serial port and a computer is typically full duplex.

G

garbage

The refuse of the data communications world. When data is sent or received incorrectly (there are numerous reasons why this happens), a string of invalid, meaningless characters (garbage) often results. Two common causes are: 1) a baud-rate mismatch and 2) synchronous data being sent to an asynchronous device and vice versa.

global navigation satellite system

A satellite navigation system with global coverage such as GPS (North America), Galileo (Europe), and BeiDou (China).

global variable

A variable available for use throughout a CRBasic program. The term is usually used in connection with subroutines, differentiating global variables (those declared using Public or Dim) from local variables, which are declared in the Sub() and Function() instructions.

ground

Being or related to an electrical potential of 0 volts.

ground currents

Pulling power from the data logger wiring panel, as is done when using some communications devices from other manufacturers, or a sensor that requires a lot of power, can cause voltage potential differences between points in data logger circuitry that are supposed to be at ground or 0 Volts. This difference in potentials can cause errors when measuring single-ended analog voltages.

H

half-duplex

A serial communications protocol. Bi-directional, but not simultaneous, communications. SDI-12 is a half-duplex protocol.

handshake

The exchange of predetermined information between two devices to assure each that it is connected to the other.

hello exchange

In a PakBus network, this is the process of verifying a node as a neighbor.

hertz

SI unit of frequency. Cycles or pulses per second.

HTML

Hypertext Markup Language. Programming language used for the creation of web pages.

HTTP

Hypertext Transfer Protocol. A TCP/IP application protocol.

HTTPS

Hypertext Transfer Protocol Secure. A secure version of HTTP.

hysteresis

The dependence of the state of the system on its history.

Hz

SI unit of frequency. Cycles or pulses per second.

I

I2C

Inter-Integrated Circuit is a multi-controller, multi-peripheral, packet switched, single-ended, serial computer bus.

IEEE4

Four-byte, floating-point data type. IEEE Standard 754. Same format as Float.

Include file

A file containing CRBasic code to be included at the end of the current CRBasic program, or it can be run as the default program.

INF

A data word indicating the result of a function is infinite or undefined.

initiate comms

A name given to a processes by which the data logger initiates communications with a computer running LoggerNet. Also known as Callback.

input/output instructions

Used to initiate measurements and store the results in input storage or to set or read control/logic ports.

instruction

Usually refers to a CRBasic command.

integer

A number written without a fractional or decimal component. 15 and 7956 are integers; 1.5 and 79.56 are not.

intermediate memory

Memory automatically allocated for intermediate calculations performed by CRBasic data output processing instructions. Data output processing memory cannot be monitored.

IP

Internet Protocol. A TCP/IP internet protocol.

IP address

A unique address for a device on the internet.

IP trace

Function associated with IP data transmissions. IP trace information was originally accessed through the CRBasic instruction IPTrace() and stored in a string variable. Files Manager setting is now modified to allow for creation of a file in data logger memory.

isolation

Hardwire communications devices and cables can serve as alternate paths to earth ground and entry points into the data logger for electromagnetic noise. Alternate paths to ground and electromagnetic noise can cause measurement errors. Using opto-couplers in a connecting device allows communications signals to pass, but breaks alternate ground paths and may filter some electromagnetic noise.

J

JSON

Java Script Object Notation. A data file format available through the data logger or LoggerNet.

K

keep memory

Keep memory is non-volatile memory that preserves some settings during a power-up or program start up reset. Examples include PakBus address, station name, beacon intervals, neighbor lists, routing table, and communications timeouts.

keyboard/display

The data logger has an optional external keyboard/display.

L

leaf

A PakBus node at the end of a branch. When in this mode, the data logger is not able to forward packets from one of its communications ports to another. It will not maintain a list of neighbors, but it still communicates with other PakBus data loggers and wireless sensors. It cannot be used as a means of reaching (routing to) other data loggers.

leaf node

A PakBus node at the end of a branch. When in this mode, the data logger is not able to forward packets from one of its communications ports to another. It will not maintain a list of

neighbors, but it still communicates with other PakBus data loggers and wireless sensors. It cannot be used as a means of reaching (routing to) other data loggers.

If

Line feed. Often associated with carriage return (<cr>). <cr><lf>.

linearity

The quality of delivering identical sensitivity throughout the measurement.

local variable

A variable available for use only by the subroutine in which it is declared. The term differentiates local variables, which are declared in the Sub() and Function() instructions, from global variables, which are declared using Public or Dim.

LoggerLink

Mobile applications that allow a mobile device to communicate with IP, wi-fi, or Bluetooth enabled data loggers.

LoggerNet

Campbell Scientific's data logger support software for programming, communications, and data retrieval between data loggers and a computer.

LONG

Data type used when declaring integers.

loop

A series of instructions in a CRBasic program that are repeated for a programmed number of times. The loop ends with an End instruction.

loop counter

Increments by one with each pass through a loop.

LSB

Least significant bit (the trailing bit).

LVDT

The linear variable differential transformer (LVDT) is a type of electrical transformer used for measuring linear displacement (position).

M

mains power

The national power grid.

manually initiated

Initiated by the user, usually with a Keyboard/Display, as opposed to occurring under program control.

mass storage device

A mass storage device may also be referred to as an auxiliary storage device. The term is commonly used to describe USB mass storage devices.

MD5 digest

16 byte checksum of the TCP/IP VTP configuration.

milli

The SI prefix denoting 1/1000 of a base SI unit.

MIMO

Multiple-input multiple-output antenna

Modbus

Communications protocol published by Modicon in 1979 for use in programmable logic controllers (PLCs).

modem/terminal

Any device that has the following: ability to raise the ring line or be used with an optically isolated interface to raise the ring line and put the data logger in the communications command state, or an asynchronous serial communications port that can be configured to communicate with the data logger.

modulo divide

A math operation. Result equals the remainder after a division.

MQTT

An open communications protocol for the Internet of Things (IoT). MQTT is not an acronym, it is simply the name of the protocol. Source: <https://www.hivemq.com/blog/mqtt-essentials-part-1-introducing-mqtt/>

MSB

Most significant bit (the leading bit).

multimeter

An inexpensive and readily available device useful in troubleshooting data acquisition system faults.

multiplier

A term, often a parameter in a CRBasic measurement instruction, that designates the slope (aka, scaling factor or gain) in a linear function. For example, when converting °C to °F, the equation is $^{\circ}\text{F} = ^{\circ}\text{C} \times 1.8 + 32$. The factor 1.8 is the multiplier.

mV

The SI abbreviation for millivolts.

N

NAN

Not a number. A data word indicating a measurement or processing error. Voltage overrange, SDI-12 sensor error, and undefined mathematical results can produce NAN.

neighbor device

Device in a PakBus network that communicates directly with a device without being routed through an intermediate device.

Network Planner

Campbell Scientific software designed to help set up data loggers in PakBus networks so that they can communicate with each other and the LoggerNet server. For more information, see <https://www.campbellsci.com/loggernet>.

NIST

National Institute of Standards and Technology.

node

Devices in a network — usually a PakBus network. The communications server dials through, or communicates with, a node. Nodes are organized as a hierarchy with all nodes accessed by the same device (parent node) entered as child nodes. A node can be both a parent and a child.

NSEC

Eight-byte data type divided up as four bytes of seconds since 1990 and four bytes of nanoseconds into the second.

null modem

A device, usually a multi-conductor cable, which converts an RS-232 port from DCE to DTE or from DTE to DCE.

Numeric Monitor

A digital monitor in data logger support software or in a keyboard/display.

O

offset

A term, often a parameter in a CRBasic measurement instruction, that designates the y-intercept (aka, shifting factor or zeroing factor) in a linear function. For example, when converting °C to °F, the equation is $^{\circ}\text{F} = ^{\circ}\text{C} \cdot 1.8 + 32$. The factor 32 is the offset.

ohm

The unit of resistance. Symbol is the Greek letter Omega (Ω). 1.0 Ω equals the ratio of 1.0 volt divided by 1.0 ampere.

Ohm's Law

Describes the relationship of current and resistance to voltage. Voltage equals the product of current and resistance ($V = I \cdot R$).

on-line data transfer

Routine transfer of data to a peripheral left on-site. Transfer is controlled by the program entered in the data logger.

operating system

The operating system (also known as "firmware") is a set of instructions that controls the basic functions of the data logger and enables the use of user written CRBasic programs. The operating system is preloaded into the data logger at the factory but can be re-loaded or upgraded by you using Device Configuration Utility software. The most recent data logger operating system .obj file is available at www.campbellsci.com/downloads.

output

A loosely applied term. Denotes a) the information carrier generated by an electronic sensor, b) the transfer of data from variable memory to final-data memory, or c) the transfer of electric power from the data logger or a peripheral to another device.

output array

A string of data values output to final-data memory. Output occurs when the data table output trigger is True.

output interval

The interval between each write of a record to a data table.

output processing instructions

CRBasic instructions that process data values for eventual output to final-data memory. Examples of output-processing instructions include Totalize(), Maximum(), Minimum(), and Average(). Data sources for these instructions are values or strings in variable memory. The results of intermediate calculations are stored in data output processing memory to await the output trigger. The ultimate destination of data generated by data output processing instructions is usually final-data memory, but the CRBasic program can be written to divert to variable memory for further processing. The transfer of processed summaries to final-data memory takes place when the Trigger argument in the DataTable() instruction is set to True.

output processing memory

Memory automatically allocated for intermediate calculations performed by CRBasic data output processing instructions. Data output processing memory cannot be monitored.

P

PakBus

® A proprietary communications protocol developed by Campbell Scientific to facilitate communications between Campbell Scientific devices. Similar in concept to IP (Internet Protocol), PakBus is a packet-switched network protocol with routing capabilities. A registered trademark of Campbell Scientific, Inc.

PakBus Graph

Software that shows the relationship of various nodes in a PakBus network and allows for monitoring and adjustment of some registers in each node.

parameter

Part of a procedure (or command) definition.

PC200W

Retired basic data logger support software for direct connect.

PC400

Free entry-level data logger support software that supports a variety of communications options, manual data collection, and data monitoring displays. Short Cut and CRBasic Editor are included for creating data logger programs. PC400 does not support scheduled data collection or complex communications options such as phone-to-RF.

PDP

Packet Data Protocol

period average

A measurement technique using a high-frequency digital clock to measure time differences between signal transitions. Sensors commonly measured with period average include water-content reflectometers.

peripheral

Any device designed for use with the data logger. A peripheral requires the data logger to operate. Peripherals include measurement, control, and data retrieval and communications modules.

PGA

Programmable Gain Amplifier

ping

A software utility that attempts to contact another device in a network.

pipeline mode

A CRBasic program execution mode wherein instructions are evaluated in groups of like instructions, with a set group prioritization.

PLC

Programmable Logic Controllers

Poisson ratio

A ratio used in strain measurements.

ppm

Parts per million.

precision

The amount of agreement between repeated measurements of the same quantity (AKA repeatability).

PreserveVariables

CRBasic instruction that protects Public variables from being erased when a program is recompiled.

print device

Any device capable of receiving output over pin 6 (the PE line) in a receive-only mode. Printers, "dumb" terminals, and computers in a terminal mode fall in this category.

print peripheral

Any device capable of receiving output over pin 6 (the PE line) in a receive-only mode. Printers, "dumb" terminals, and computers in a terminal mode fall in this category.

processing instructions

CRBasic instructions used to further process input-data values and return the result to a variable where it can be accessed for output processing. Arithmetic and transcendental

functions are included.

program control instructions

Modify the execution sequence of CRBasic instructions. Also used to set or clear flags.

Program Send command

Program Send is a feature of data logger support software.

program statement

A complete program command construct confined to one command line or to multiple command lines merged with the line continuation characters <space> <underscore> (_). A command line, even with line continuation, cannot exceed 512 characters.

public

A CRBasic command for declaring and dimensioning variables. Variables declared with Public can be monitored during data logger operation.

pulse

An electrical signal characterized by a rapid increase in voltage follow by a short plateau and a rapid voltage decrease.

R

ratiometric

Describes a type of measurement or a type of math. Ratiometric usually refers to an aspect of resistive-bridge measurements - either the measurement or the math used to process it. Measuring ratios and using ratio math eliminates several sources of error from the end result.

record

A record is a complete line of data in a data table or data file. All data in a record share a common time stamp. Data tables are made up of records and fields. Each row in a table represents a record and each column represents a field. The number of fields in a record is

determined by the number and configuration of output processing instructions that are included as part of the DataTable() declaration.

regulator

A device for conditioning an electrical power source. Campbell Scientific regulators typically condition AC or DC voltages greater than 16 VDC to about 14 VDC.

resistance

A feature of an electronic circuit that impedes or redirects the flow of electrons through the circuit.

resistor

A device that provides a known quantity of resistance.

resolution

The smallest interval measurable.

ring memory

A memory configuration that allows the oldest data to be overwritten with the newest data. This is the default setting for data tables.

ringing

Oscillation of sensor output (voltage or current) that occurs when sensor excitation causes parasitic capacitances and inductances to resonate.

RMS

Root-mean square, or quadratic mean. A measure of the magnitude of wave or other varying quantities around zero.

RNDIS

Remote Network Driver Interface Specification - a Microsoft protocol that provides a virtual Ethernet link via USB.

router

A device configured as a router is able to forward PakBus packets from one port to another. To perform its routing duties, a data logger configured as a router maintains its own list of neighbors and sends this list to other routers in the PakBus network. It also obtains and receives neighbor lists from other routers. Routers maintain a routing table, which is a list of known nodes and routes. A router will only accept and forward packets that are destined for known devices. Routers pass their lists of known neighbors to other routers to build the network routing system.

RS-232

Recommended Standard 232. A loose standard defining how two computing devices can communicate with each other. The implementation of RS-232 in Campbell Scientific data loggers to computer communications is quite rigid, but transparent to most users. Features in the data logger that implement RS-232 communications with smart sensors are flexible.

RS-422

Communications protocol similar to RS-485. Most RS-422 sensors will work with RS-485 protocol.

RS-485

Recommended Standard 485. A standard defining how two computing devices can communicate with each other.

RTDAQ

Real Time Data Acquisition software for high-speed data acquisition applications. RTDAQ supports a variety of telecommunication options, manual data collection, and extensive data display. It includes Short Cut for creating data logger programs, as well as full-featured program editors.

RTU

Remote Telemetry Unit

Rx

Receive

S

sample rate

The rate at which measurements are made by the data logger. The measurement sample rate is of interest when considering the effect of time skew, or how close in time are a series of measurements, or how close a time stamp on a measurement is to the true time the phenomenon being measured occurred. A 'maximum sample rate' is the rate at which a measurement can repeatedly be made by a single CRBasic instruction. Sample rate is how often an instrument reports a result at its output; frequency response is how well an instrument responds to fast fluctuations on its input. By way of example, sampling a large gage thermocouple at 1 kHz will give a high sample rate but does not ensure the measurement has a high frequency response. A fine-wire thermocouple, which changes output quickly with changes in temperature, is more likely to have a high frequency response.

SCADA

Supervisory Control And Data Acquisition

scan interval

The time interval between initiating each execution of a given Scan() of a CRBasic program. If the Scan() Interval is evenly divisible into 24 hours (86,400 seconds), it is synchronized with the 24 hour clock, so that the program is executed at midnight and every Scan() Interval thereafter. The program is executed for the first time at the first occurrence of the Scan() Interval after compilation. If the Scan() Interval does not divide evenly into 24 hours, execution will start on the first even second after compilation.

scan time

When time functions are run inside the Scan() / NextScan construct, time stamps are based on when the scan was started according to the data logger clock. Resolution of scan time is equal to the length of the scan.

SDI-12

Serial Data Interface at 1200 baud. Communications protocol for transferring data between the data logger and SDI-12 compatible smart sensors.

SDK

Software Development Kit

SDM

Synchronous Device for Measurement. A processor-based peripheral device or sensor that communicates with the data logger via hardwire over a short distance using a protocol proprietary to Campbell Scientific.

Seebeck effect

Induces microvolt level thermal electromotive forces (EMF) across junctions of dissimilar metals in the presence of temperature gradients. This is the principle behind thermocouple temperature measurement. It also causes small, correctable voltage offsets in data logger measurement circuitry.

semaphore

(Measurement semaphore.) In sequential mode, when the main scan executes, it locks the resources associated with measurements. In other words, it acquires the measurement semaphore. This is at the scan level, so all subscans within the scan (whether they make measurements or not), will lock out measurements from slow sequences (including the auto self-calibration). Locking measurement resources at the scan level gives non-interrupted measurement execution of the main scan.

send button

Send button in data logger support software. Sends a CRBasic program or operating system to a data logger.

sequential mode

A CRBasic program execution mode wherein each statement is evaluated in the order it is listed in the program.

serial

A loose term denoting output of a series of ASCII, HEX, or binary characters or numbers in electronic form.

Settings Editor

An editor for observing and adjusting settings. Settings Editor is a feature of LoggerNet>Connect, PakBus Graph, and Device Configuration Utility.

Short Cut

A CRBasic programming wizard suitable for many data logger applications. Knowledge of CRBasic is not required to use Short Cut.

SI

Système Internationale. The uniform international system of metric units. Specifies accepted units of measure.

signature

A number which is a function of the data and the sequence of data in memory. It is derived using an algorithm that assures a 99.998% probability that if either the data or the data sequence changes, the signature changes.

simplex

A serial communications protocol. One-direction data only. Serial communications between a serial sensor and the data logger may be simplex.

single-ended

Denotes a sensor or measurement terminal wherein the analog voltage signal is carried on a single wire and measured with respect to ground (0 V).

skipped scans

Occur when the CRBasic program is too long for the scan interval. Skipped scans can cause errors in pulse measurements.

slow sequence

A usually slower secondary scan in the CRBasic program. The main scan has priority over a slow sequence.

SMS

Short message service. A text messaging service for web and mobile device systems.

SMTP

Simple Mail Transfer Protocol. A TCP/IP application protocol.

SNP

Snapshot file.

SP

Space.

SPI

Serial Peripheral Interface - a clocked synchronous interface, used for short distance communications, generally between embedded devices.

start bit

The bit used to indicate the beginning of data.

state

Whether a device is on or off.

Station Status command

A command available in most data logger support software.

stop bit

The end of the data bits. The stop bit can be 1, 1.5, or 2.

string

A datum or variable consisting of alphanumeric characters.

support software

Campbell Scientific software that includes at least the following functions: data logger communications, downloading programs, clock setting, and retrieval of measurement data.

synchronous

The transmission of data between a transmitting and a receiving device occurs as a series of zeros and ones. For the data to be "read" correctly, the receiving device must begin reading at the proper point in the series. In synchronous communications, this coordination is accomplished by synchronizing the transmitting and receiving devices to a common clock signal (see also asynchronous).

system time

When time functions are run outside the Scan() / NextScan construct, the time registered by the instruction will be based on the system clock, which has a 10 ms resolution.

T

table

See data table.

task

Grouping of CRBasic program instructions automatically by the data logger compiler. Tasks include measurement, SDM or digital, and processing. Tasks are prioritized when the CRBasic program runs in pipeline mode. Also, a user-customized function defined through LoggerNet Task Master.

TCP/IP

Transmission Control Protocol / Internet Protocol.

TCR

Temperature Coefficient of Resistance. TCR tells how much the resistance of a resistor changes as the temperature of the resistor changes. The unit of TCR is ppm/°C (parts-per-million per degree Celsius). A positive TCR means that resistance increases as temperature increases. For example, a resistor with a specification of 10 ppm/°C will not increase in resistance by more than 0.000010 Ω per ohm over a 1 °C increase of the resistor temperature or by more than .00010 Ω per ohm over a 10 °C increase.

Telnet

A software utility that attempts to contact and interrogate another specific device in a network. Telnet is resident in Windows OS.

terminal

Point at which a wire (or wires) connects to a wiring panel or connector. Wires are usually secured in terminals by screw- or lever-and-spring actuated gates with small screw- or spring-loaded clamps.

terminal emulator

A command-line shell that facilitates the issuance of low-level commands to a data logger or some other compatible device. A terminal emulator is available in most data logger support software available from Campbell Scientific.

thermistor

A thermistor is a temperature measurement device with a resistive element that changes in resistance with temperature. The change is wide, stable, and well characterized. The output of a thermistor is usually non-linear, so measurement requires linearization by means of a Steinhart-Hart or polynomial equation. CRBasic instructions Therm107(), Therm108(), and Therm109() use Steinhart-Hart equations.

thing

A thing resource is a digital representation of a physical device or logical entity in AWS IoT.

throughput rate

Rate that a measurement can be taken, scaled to engineering units, and the stored in a final-memory data table. The data logger has the ability to scan sensors at a rate exceeding the throughput rate. The primary factor determining throughput rate is the processing programmed into the CRBasic program. In sequential-mode operation, all processing called for by an instruction must be completed before moving on to the next instruction.

time domain

Time domain describes data graphed on an X-Y plot with time on the X axis. Time series data is in the time domain.

TLS

Transport Layer Security. An Internet communications security protocol.

TOA5

Also called ASCII, Long Header. Data stored in a comma separated format. Header information for each column is included, along with field names and units of measure if they are available. Table output ascii version 5. See the LoggerNet manual appendix for details on different file formats.

TOAC1

Also called ASCII, Short Header. Data stored in a comma separated format. Header information for each of the columns is included. Table output ASCII version 1. See the LoggerNet manual appendix for details on different file formats.

TOB1

Binary. Data stored in a binary format. Though this format saves disk storage space, it must be converted before it is usable in other programs. Table output binary version 1. See the LoggerNet manual appendix for details on different file formats.

TOB3

Binary. Data stored to a card in a binary format. Table output binary version 1. See the LoggerNet manual appendix for details on different file formats.

toggle

To reverse the current power state.

TTL

Transistor-to-Transistor Logic. A serial protocol using 0 VDC and 5 VDC as logic signal levels.

Tx

Transmit

U

UART

Universal Asynchronous Receiver/Transmitter for asynchronous serial communications.

UINT2

Data type used for efficient storage of totalized pulse counts, port status (status of 16 ports stored in one variable, for example) or integer values that store binary flags.

unconditioned output

The fundamental output of a sensor, or the output of a sensor before scaling factors are applied.

UPS

Uninterruptible Power Supply. A UPS can be constructed for most data logger applications using ac line power, a solar panel, an ac/ac or ac/dc wall adapter, a charge controller, and a rechargeable battery.

URI

Uniform Resource Identifier

URL

Uniform Resource Locator

user program

The CRBasic program written by you in Short Cut program wizard.

V

VAC

Volts alternating current.

variable

A packet of memory given an alphanumeric name.

VDC

Volts direct current.

VisualWeather

Data logger support software specialized for weather and agricultural applications. The software allows you to initialize the setup, interrogate the station, display data, and generate reports from one or more weather stations.

volt meter

An inexpensive and readily available device useful in troubleshooting data acquisition system faults.

voltage divider

A circuit of resistors that ratiometrically divides voltage. For example, a simple two-resistor voltage divider can be used to divide a voltage in half. So, when fed through the voltage divider, 1 mV becomes 500 μ V, 10 mV becomes 5 mV, and so forth. Resistive-bridge circuits are voltage dividers.

volts

SI unit for electrical potential.

VSPECT®

® A registered trademark for Campbell Scientific's proprietary spectral-analysis, frequency domain, vibrating wire measurement technique.

W

watchdog timer

An error-checking system that examines the processor state, software timers, and program-related counters when the CRBasic program is running. The following will cause watchdog timer resets, which reset the processor and CRBasic program execution: processor bombed, processor neglecting standard system updates, counters are outside the limits, voltage surges, and voltage transients. When a reset occurs, a counter is incremented in the WatchdogTimer entry of the Status table. A low number (1 to 10) of watchdog timer resets is of concern, but normally indicates that the situation should just be monitored. A large number of errors (>10) accumulating over a short period indicates a hardware or software problem. Consult with a Campbell Scientific support engineer.

weather-tight

Describes an instrumentation enclosure impenetrable by common environmental conditions. During extraordinary weather events, however, seals on the enclosure may be breached.

web API

Application Programming Interface

wild card

A character or expression that substitutes for any other character or expression.

X

XML

Extensible markup language.

T

τ

Time constant

Limited warranty

Covered equipment is warranted/guaranteed against defects in materials and workmanship under normal use and service for the period listed on your sales invoice or the product order information web page. The covered period begins on the date of shipment unless otherwise specified. For a repair to be covered under warranty, the following criteria must be met:

1. There must be a defect in materials or workmanship that affects form, fit, or function of the device.
2. The defect cannot be the result of misuse.
3. The defect must have occurred within a specified period of time; and
4. The determination must be made by a qualified technician at a Campbell Scientific Service Center/ repair facility.

The following is not covered:

1. Equipment which has been modified or altered in any way without the written permission of Campbell Scientific.
2. Batteries; and
3. Any equipment which has been subjected to misuse, neglect, acts of God or damage in transit.

Campbell Scientific regional offices handle repairs for customers within their territories. Please see the back page of the manual for a list of [regional offices](#) or visit www.campbellsci.com/contact  to determine which Campbell Scientific office serves your country. For directions on how to return equipment, see [Assistance](#).

Other manufacturer's products, that are resold by Campbell Scientific, are warranted only to the limits extended by the original manufacturer.

CAMPBELL SCIENTIFIC EXPRESSLY DISCLAIMS AND EXCLUDES ANY IMPLIED WARRANTIES OF MERCHANTABILITY OR FITNESS FOR A PARTICULAR PURPOSE. Campbell Scientific hereby disclaims, to the fullest extent allowed by applicable law, any and all warranties and conditions with respect to the products, whether express, implied, or statutory, other than those expressly provided herein.

Campbell Scientific will, as a default, return warranted equipment by surface carrier prepaid. However, the method of return shipment is at Campbell Scientific's sole discretion. Campbell Scientific will not reimburse the claimant for costs incurred in removing and/or reinstalling equipment. This warranty and the Company's obligation thereunder is in lieu of all other

warranties, expressed or implied, including those of suitability and fitness for a particular purpose. Campbell Scientific is not liable for consequential damage.

In the event of any conflict or inconsistency between the provisions of this Warranty and the provisions of Campbell Scientific's Terms, the provisions of Campbell Scientific's Terms shall prevail. Furthermore, Campbell Scientific's Terms are hereby incorporated by reference into this Warranty. To view Terms and conditions that apply to Campbell Scientific, Logan, UT, USA, see [Terms and Conditions](#). To view terms and conditions that apply to Campbell Scientific offices outside of the United States, contact the [regional office](#) that serves your country.

Acknowledgements

lwIP v 2.1.1, LIBSSH2 v. 1.8.0, and Newlib

Copyright 2024 Campbell Scientific.

All rights reserved.

Redistribution and use in source and binary forms, with or without modification, are permitted provided that the following conditions are met:

1. Redistributions of source code must retain the above copyright notice, this list of conditions and the following disclaimer.
2. Redistributions in binary form must reproduce the above copyright notice, this list of conditions and the following disclaimer in the documentation and/or other materials provided with the distribution.

THIS SOFTWARE IS PROVIDED BY THE AUTHOR "AS IS" AND ANY EXPRESS OR IMPLIED WARRANTIES, INCLUDING, BUT NOT LIMITED TO, THE IMPLIED WARRANTIES OF MERCHANTABILITY AND FITNESS FOR A PARTICULAR PURPOSE ARE DISCLAIMED. IN NO EVENT SHALL THE AUTHOR BE LIABLE FOR ANY DIRECT, INDIRECT, INCIDENTAL, SPECIAL, EXEMPLARY, OR CONSEQUENTIAL DAMAGES (INCLUDING, BUT NOT LIMITED TO, PROCUREMENT OF SUBSTITUTE GOODS OR SERVICES; LOSS OF USE, DATA, OR PROFITS; OR BUSINESS INTERRUPTION) HOWEVER CAUSED AND ON ANY THEORY OF LIABILITY, WHETHER IN CONTRACT, STRICT LIABILITY, OR TORT (INCLUDING NEGLIGENCE OR OTHERWISE) ARISING IN ANY WAY OUT OF THE USE OF THIS SOFTWARE, EVEN IF ADVISED OF THE POSSIBILITY OF SUCH DAMAGE.

Mbed TLS v. 3.1.0

Copyright 2024 Campbell Scientific.

Apache License

Version 2.0, January 2004

<http://www.apache.org/licenses/>

TERMS AND CONDITIONS FOR USE, REPRODUCTION, AND DISTRIBUTION

1. Definitions.

"License" shall mean the terms and conditions for use, reproduction, and distribution as defined by Sections 1 through 9 of this document.

"Licensor" shall mean the copyright owner or entity authorized by the copyright owner that is granting the License.

"Legal Entity" shall mean the union of the acting entity and all other entities that control, are controlled by, or are under common control with that entity. For the purposes of this definition, "control" means (i) the power, direct or indirect, to cause the direction or management of such entity, whether by contract or otherwise, or (ii) ownership of fifty percent (50%) or more of the outstanding shares, or (iii) beneficial ownership of such entity.

"You" (or "Your") shall mean an individual or Legal Entity exercising permissions granted by this License.

"Source" form shall mean the preferred form for making modifications, including but not limited to software source code, documentation source, and configuration files.

"Object" form shall mean any form resulting from mechanical transformation or translation of a Source form, including but not limited to compiled object code, generated documentation, and conversions to other media types.

"Work" shall mean the work of authorship, whether in Source or Object form, made available under the License, as indicated by a copyright notice that is included in or attached to the work (an example is provided in the Appendix below).

"Derivative Works" shall mean any work, whether in Source or Object form, that is based on (or derived from) the Work and for which the editorial revisions, annotations, elaborations, or other modifications represent, as a whole, an original work of authorship. For the purposes of this License, Derivative Works shall not include works that remain separable from, or merely link (or bind by name) to the interfaces of, the Work and Derivative Works thereof.

"Contribution" shall mean any work of authorship, including the original version of the Work and any modifications or additions to that Work or Derivative Works thereof, that is intentionally submitted to Licensor for inclusion in the Work by the copyright owner or by an individual or Legal Entity authorized to submit on behalf of the copyright owner. For the purposes of this definition, "submitted" means any form of electronic, verbal, or written communication sent to the Licensor or its representatives, including but not limited to communication on electronic mailing lists, source code control systems, and issue tracking systems that are managed by, or on

behalf of, the Licensor for the purpose of discussing and improving the Work, but excluding communication that is conspicuously marked or otherwise designated in writing by the copyright owner as "Not a Contribution."

"Contributor" shall mean Licensor and any individual or Legal Entity on behalf of whom a Contribution has been received by Licensor and subsequently incorporated within the Work.

2. Grant of Copyright License. Subject to the terms and conditions of this License, each Contributor hereby grants to You a perpetual, worldwide, non-exclusive, no-charge, royalty-free, irrevocable copyright license to reproduce, prepare Derivative Works of, publicly display, publicly perform, sublicense, and distribute the Work and such Derivative Works in Source or Object form.

3. Grant of Patent License. Subject to the terms and conditions of this License, each Contributor hereby grants to You a perpetual, worldwide, non-exclusive, no-charge, royalty-free, irrevocable (except as stated in this section) patent license to make, have made, use, offer to sell, sell, import, and otherwise transfer the Work, where such license applies only to those patent claims licensable by such Contributor that are necessarily infringed by their Contribution(s) alone or by combination of their Contribution(s) with the Work to which such Contribution(s) was submitted. If You institute patent litigation against any entity (including a cross-claim or counterclaim in a lawsuit) alleging that the Work or a Contribution incorporated within the Work constitutes direct or contributory patent infringement, then any patent licenses granted to You under this License for that Work shall terminate as of the date such litigation is filed.

4. Redistribution. You may reproduce and distribute copies of the Work or Derivative Works thereof in any medium, with or without modifications, and in Source or Object form, provided that You meet the following conditions:

(a) You must give any other recipients of the Work or Derivative Works a copy of this License; and
(b) You must cause any modified files to carry prominent notices stating that You changed the files; and

(c) You must retain, in the Source form of any Derivative Works that You distribute, all copyright, patent, trademark, and attribution notices from the Source form of the Work, excluding those notices that do not pertain to any part of the Derivative Works; and

(d) If the Work includes a "NOTICE" text file as part of its distribution, then any Derivative Works that You distribute must include a readable copy of the attribution notices contained within such NOTICE file, excluding those notices that do not pertain to any part of the Derivative Works, in at least one of the following places: within a NOTICE text file distributed as part of the Derivative Works; within the Source form or documentation, if provided along with the Derivative Works; or, within a display generated by the Derivative Works, if and wherever such third-party notices

normally appear. The contents of the NOTICE file are for informational purposes only and do not modify the License.

You may add Your own attribution notices within Derivative Works that You distribute, alongside or as an addendum to the NOTICE text from the Work, provided that such additional attribution notices cannot be construed as modifying the License.

You may add Your own copyright statement to Your modifications and may provide additional or different license terms and conditions for use, reproduction, or distribution of Your modifications, or for any such Derivative Works as a whole, provided Your use, reproduction, and distribution of the Work otherwise complies with the conditions stated in this License.

5. Submission of Contributions. Unless You explicitly state otherwise, any Contribution intentionally submitted for inclusion in the Work by You to the Licensor shall be under the terms and conditions of this License, without any additional terms or conditions. Notwithstanding the above, nothing herein shall supersede or modify the terms of any separate license agreement you may have executed with Licensor regarding such Contributions.

6. Trademarks. This License does not grant permission to use the trade names, trademarks, service marks, or product names of the Licensor, except as required for reasonable and customary use in describing the origin of the Work and reproducing the content of the NOTICE file.

7. Disclaimer of Warranty. Unless required by applicable law or agreed to in writing, Licensor provides the Work (and each Contributor provides its Contributions) on an "AS IS" BASIS, WITHOUT WARRANTIES OR CONDITIONS OF ANY KIND, either express or implied, including, without limitation, any warranties or conditions of TITLE, NON-INFRINGEMENT, MERCHANTABILITY, or FITNESS FOR A PARTICULAR PURPOSE. You are solely responsible for determining the appropriateness of using or redistributing the Work and assume any risks associated with Your exercise of permissions under this License.

8. Limitation of Liability. In no event and under no legal theory, whether in tort (including negligence), contract, or otherwise, unless required by applicable law (such as deliberate and grossly negligent acts) or agreed to in writing, shall any Contributor be liable to You for damages, including any direct, indirect, special, incidental, or consequential damages of any character arising as a result of this License or out of the use or inability to use the Work (including but not limited to damages for loss of goodwill, work stoppage, computer failure or malfunction, or any and all other commercial damages or losses), even if such Contributor has been advised of the possibility of such damages.

9. Accepting Warranty or Additional Liability. While redistributing the Work or Derivative Works thereof, You may choose to offer, and charge a fee for, acceptance of support, warranty, indemnity, or other liability obligations and/or rights consistent with this License. However, in accepting such obligations, You may act only on Your own behalf and on Your sole responsibility,

not on behalf of any other Contributor, and only if You agree to indemnify, defend, and hold each Contributor harmless for any liability incurred by, or claims asserted against, such Contributor by reason of your accepting any such warranty or additional liability.

END OF TERMS AND CONDITIONS

APPENDIX: How to apply the Apache License to your work.

To apply the Apache License to your work, attach the following boilerplate notice, with the fields enclosed by brackets "[]" replaced with your own identifying information. (Don't include the brackets!) The text should be enclosed in the appropriate comment syntax for the file format. We also recommend that a file or class name and description of purpose be included on the same "printed page" as the copyright notice for easier identification within third-party archives.

Copyright [yyyy] [name of copyright owner] Licensed under the Apache License, Version 2.0 (the "License"); you may not use this file except in compliance with the License.

You may obtain a copy of the License at <http://www.apache.org/licenses/LICENSE-2.0>

Unless required by applicable law or agreed to in writing, software distributed under the License is distributed on an "AS IS" BASIS, WITHOUT WARRANTIES OR CONDITIONS OF ANY KIND, either express or implied. See the License for the specific language governing permissions and limitations under the License.

Assistance

Products may not be returned without prior authorization. Please inform us before returning equipment and obtain a **return material authorization (RMA) number** whether the repair is under warranty/guarantee or not. See [Limited warranty](#) for information on covered equipment.

Campbell Scientific regional offices handle repairs for customers within their territories. Please see the back page of the manual for a list of [regional offices](#) or visit

www.campbellsci.com/contact  to determine which Campbell Scientific office serves your country.

When returning equipment, a RMA number must be clearly marked on the outside of the package. Please state the faults as clearly as possible. Quotations for repairs can be given on request.

It is the policy of Campbell Scientific to protect the health of its employees and provide a safe working environment. In support of this policy, when equipment is returned to Campbell Scientific, Logan, UT, USA, it is mandatory that a "[Declaration of Hazardous Material and Decontamination](#)" form be received before the return can be processed. If the form is not

received within 5 working days of product receipt or is incomplete, the product will be returned to the customer at the customer's expense. For details on decontamination standards specific to your country, please reach out to your [regional Campbell Scientific](#) office.

NOTE:

All goods that cross trade boundaries may be subject to some form of fee (customs clearance, duties or import tax). Also, some regional offices require a purchase order upfront if a product is out of the warranty period. Please contact your [regional Campbell Scientific](#) office for details.

Safety

DANGER — MANY HAZARDS ARE ASSOCIATED WITH INSTALLING, USING, MAINTAINING, AND WORKING ON OR AROUND TRIPODS, TOWERS, AND ANY ATTACHMENTS TO TRIPODS AND TOWERS SUCH AS SENSORS, CROSSARMS, ENCLOSURES, ANTENNAS, ETC. FAILURE TO PROPERLY AND COMPLETELY ASSEMBLE, INSTALL, OPERATE, USE, AND MAINTAIN TRIPODS, TOWERS, AND ATTACHMENTS, AND FAILURE TO HEED WARNINGS, INCREASES THE RISK OF DEATH, ACCIDENT, SERIOUS INJURY, PROPERTY DAMAGE, AND PRODUCT FAILURE. TAKE ALL REASONABLE PRECAUTIONS TO AVOID THESE HAZARDS. CHECK WITH YOUR ORGANIZATION'S SAFETY COORDINATOR (OR POLICY) FOR PROCEDURES AND REQUIRED PROTECTIVE EQUIPMENT PRIOR TO PERFORMING ANY WORK.

Use tripods, towers, and attachments to tripods and towers only for purposes for which they are designed. Do not exceed design limits. Be familiar and comply with all instructions provided in product manuals. Manuals are available at www.campbellsci.com You are responsible for conformance with governing codes and regulations, including safety regulations, and the integrity and location of structures or land to which towers, tripods, and any attachments are attached. Installation sites should be evaluated and approved by a qualified engineer. If questions or concerns arise regarding installation, use, or maintenance of tripods, towers, attachments, or electrical connections, consult with a licensed and qualified engineer or electrician.

General

- Protect from over-voltage.
- Protect electrical equipment from water.
- Protect from electrostatic discharge (ESD).
- Protect from lightning.
- Prior to performing site or installation work, obtain required approvals and permits. Comply with all governing structure-height regulations, such as those of the FAA in the USA.
- Use only qualified personnel for installation, use, and maintenance of tripods and towers, and any attachments to tripods and towers. The use of licensed and qualified contractors is highly recommended.
- Read all applicable instructions carefully and understand procedures thoroughly before beginning work.
- Wear a hardhat and eye protection, and take other appropriate safety precautions while working on or around tripods and towers.
- Do not climb tripods or towers at any time, and prohibit climbing by other persons. Take reasonable precautions to secure tripod and tower sites from trespassers.
- Use only manufacturer recommended parts, materials, and tools.

Utility and Electrical

- You can be killed or sustain serious bodily injury if the tripod, tower, or attachments you are installing, constructing, using, or maintaining, or a tool, stake, or anchor, come in contact with overhead or underground utility lines.
- Maintain a distance of at least one-and-one-half times structure height, 6 meters (20 feet), or the distance required by applicable law, whichever is greater, between overhead utility lines and the structure (tripod, tower, attachments, or tools).
- Prior to performing site or installation work, inform all utility companies and have all underground utilities marked.

- Comply with all electrical codes. Electrical equipment and related grounding devices should be installed by a licensed and qualified electrician.
- Only use power sources approved for use in the country of installation to power Campbell Scientific devices.

Elevated Work and Weather

- Exercise extreme caution when performing elevated work.
- Use appropriate equipment and safety practices.
- During installation and maintenance, keep tower and tripod sites clear of un-trained or non-essential personnel. Take precautions to prevent elevated tools and objects from dropping.
- Do not perform any work in inclement weather, including wind, rain, snow, lightning, etc.

Internal Battery

- Be aware of fire, explosion, and severe-burn hazards.
- Misuse or improper installation of the internal lithium battery can cause severe injury.
- Do not recharge, disassemble, heat above 100 °C (212 °F), solder directly to the cell, incinerate, or expose contents to water. Dispose of spent batteries properly.

Use and disposal of batteries

- Where batteries need to be transported to the installation site, ensure they are packed to prevent the battery terminals shorting which could cause a fire or explosion. Especially in the case of lithium batteries, ensure they are packed and transported in a way that complies with local shipping regulations and the safety requirements of the carriers involved.
- When installing the batteries follow the installation instructions very carefully. This is to avoid risk of damage to the equipment caused by installing the wrong type of battery or reverse connections.
- When disposing of used batteries, it is still important to avoid the risk of shorting. Do not dispose of the batteries in a fire as there is risk of explosion and leakage of harmful chemicals into the environment. Batteries should be disposed of at registered recycling facilities.

Avoiding unnecessary exposure to radio transmitter radiation

- Where the equipment includes a radio transmitter, precautions should be taken to avoid unnecessary exposure to radiation from the antenna. The degree of caution required varies with the power of the transmitter, but as a rule it is best to avoid getting closer to the antenna than 20 cm (8 inches) when the antenna is active. In particular keep your head away from the antenna. For higher power radios (in excess of 1 W ERP) turn the radio off when servicing the system, unless the antenna is installed away from the station, e.g. it is mounted above the system on an arm or pole.

Maintenance

- Periodically (at least yearly) check for wear and damage, including corrosion, stress cracks, frayed cables, loose cable clamps, cable tightness, etc. and take necessary corrective actions.
- Periodically (at least yearly) check electrical ground connections.

WHILE EVERY ATTEMPT IS MADE TO EMBODY THE HIGHEST DEGREE OF SAFETY IN ALL CAMPBELL SCIENTIFIC PRODUCTS, THE CUSTOMER ASSUMES ALL RISK FROM ANY INJURY RESULTING FROM IMPROPER INSTALLATION, USE, OR MAINTENANCE OF TRIPODS, TOWERS, OR ATTACHMENTS TO TRIPODS AND TOWERS SUCH AS SENSORS, CROSSARMS, ENCLOSURES, ANTENNAS, ETC.

Global Sales and Support Network

A worldwide network to help meet your needs



Campbell Scientific Regional Offices

Australia

Location: Garbutt, QLD Australia
Phone: 61.7.4401.7700
Email: info@campbellsci.com.au
Website: www.campbellsci.com.au

Brazil

Location: São Paulo, SP Brazil
Phone: 11.3732.3399
Email: vendas@campbellsci.com.br
Website: www.campbellsci.com.br

Canada

Location: Edmonton, AB Canada
Phone: 780.454.2505
Email: dataloggers@campbellsci.ca
Website: www.campbellsci.ca

China

Location: Beijing, P. R. China
Phone: 86.10.6561.0080
Email: info@campbellsci.com.cn
Website: www.campbellsci.com.cn

Costa Rica

Location: San Pedro, Costa Rica
Phone: 506.2280.1564
Email: info@campbellsci.com
Website: www.campbellsci.com

France

Location: Montrouge, France
Phone: 0033.0.1.56.45.15.20
Email: info@campbellsci.fr
Website: www.campbellsci.fr

Germany

Location: Bremen, Germany
Phone: 49.0.421.460974.0
Email: info@campbellsci.de
Website: www.campbellsci.de

India

Location: New Delhi, DL India
Phone: 91.11.46500481.482
Email: info@campbellsci.in
Website: www.campbellsci.in

Japan

Location: Kawagishi, Toda City, Japan
Phone: 048.400.5001
Email: jp-info@campbellsci.com
Website: www.campbellsci.co.jp

South Africa

Location: Stellenbosch, South Africa
Phone: 27.21.8809960
Email: sales@campbellsci.co.za
Website: www.campbellsci.co.za

Spain

Location: Barcelona, Spain
Phone: 34.93.2323938
Email: info@campbellsci.es
Website: www.campbellsci.es

Thailand

Location: Bangkok, Thailand
Phone: 66.2.719.3399
Email: info@campbellsci.asia
Website: www.campbellsci.asia

UK

Location: Shephed, Loughborough, UK
Phone: 44.0.1509.601141
Email: sales@campbellsci.co.uk
Website: www.campbellsci.co.uk

USA

Location: Logan, UT USA
Phone: 435.227.9120
Email: info@campbellsci.com
Website: www.campbellsci.com