

ENVISION

SUSTAINABLE INFRASTRUCTURE FRAMEWORK

VERSION 3



Institute for
Sustainable
Infrastructure



ACEC



ASCE



Envision: Sustainable Infrastructure Framework Guidance Manual

Copyright © 2018 by Institute for Sustainable Infrastructure

All rights reserved. This document or any portion thereof may not be reproduced or used in any manner whatsoever without the express written permission of the publisher except for the use of brief quotations in a book review.

Third Edition, 2018

ISBN 978-1-7322147-0-5

Published by Institute for Sustainable Infrastructure
Washington, DC

www.sustainableinfrastructure.org



ENVISION



Credits

The Institute for Sustainable Infrastructure would like to thank the numerous individuals who contributed to this document including the ISI Board of Directors, the Envision Review Board, and the many members of the ISI technical committees and workgroups.

Images are referenced by page number. All photographs and illustrations copyright © by their respective sources.

Photos Courtesy Of:

Cover: CC0
7: Left to right; "Single Turbine" Portland General Electric / CC BY; "Dixon Wastewater Treatment Facility" by Joe DiGiorgio / Stantec; "Waste" by Anthony Kane; "Kansas City Streetcar" HDR; Kunia Country Farms; Pixabay CC0
26-27: @Steve Carrell
35: Skanska USA
37: Skanska USA
51: HDR
57: Alexandria Renew Enterprises
71: City of Surrey

77: Wayne County Airport Authority
87: HDR
90-91: City of Boynton Beach
109: Metro Nashville Airport Authority
115: Kunia Country Farms
122-123: HDR
128: HDR
145 top: Alliant Energy
145 bottom: Kansas City Water Services Department
156-157: Portland General Electric (PGE)
165: HDR
175 left and right: HDR

Table Of Contents

INTRODUCTION		
The Envision Framework	06	
Envision Design	11	
ENVISION		
Envision Credit List	18	
Navigating Credits	20	
Envision Organization and Scoring	21	
Envision Points Table	23	
Third-Party Verification and Award	25	
 QUALITY OF LIFE		
QL1.1 Improve Community Quality of Life	30	
QL1.2 Enhance Public Health & Safety	32	
QL1.3 Improve Construction Safety	34	
QL1.4 Minimize Noise & Vibration	36	
QL1.5 Minimize Light Pollution	38	
QL1.6 Minimize Construction Impacts	40	
QL2.1 Improve Community Mobility & Access	42	
QL2.2 Encourage Sustainable Transportation	44	
QL2.3 Improve Access & Wayfinding	46	
QL3.1 Advance Equity & Social Justice	48	
QL3.2 Preserve Historic & Cultural Resources	52	
QL3.3 Enhance Views & Local Character	54	
QL3.4 Enhance Public Space & Amenities	56	
QL0.0 Innovate or Exceed Credit Requirements	58	
 LEADERSHIP		
LD1.1 Provide Effective Leadership & Commitment	64	
LD1.2 Foster Collaboration & Teamwork	66	
LD1.3 Provide for Stakeholder Involvement	68	
LD1.4 Pursue Byproduct Synergies	70	
LD2.1 Establish a Sustainability Management Plan	72	
LD2.2 Plan for Sustainable Communities	74	
LD2.3 Plan for Long-Term Monitoring & Maintenance	76	
LD2.4 Plan for End of Life	78	
LD3.1 Stimulate Economic Prosperity & Development	80	
LD3.2 Develop Local Skills & Capabilities	82	
LD3.3 Conduct a Life-Cycle Economic Evaluation	84	
LD0.0 Innovate or Exceed Credit Requirements	88	
 RESOURCE ALLOCATION		
RA1.1 Support Sustainable Procurement Practices	94	
RA1.2 Use Recycled Materials	96	
RA1.3 Reduce Operational Waste	98	
RA1.4 Reduce Construction Waste	100	
RA1.5 Balance Earthwork On Site	102	
RA2.1 Reduce Operational Energy Consumption	104	
RA2.2 Reduce Construction Energy Consumption	106	
RA2.3 Use Renewable Energy	108	
RA2.4 Commission & Monitor Energy Systems	110	
RA3.1 Preserve Water Resources	112	
RA3.2 Reduce Operational Water Consumption	114	
RA3.3 Reduce Construction Water Consumption	116	
RA3.4 Monitor Water Systems	118	
RA0.0 Innovate or Exceed Credit Requirements	120	
 NATURAL WORLD		
NW1.1 Preserve Sites of High Ecological Value	126	
NW1.2 Provide Wetland & Surface Water Buffers	130	
NW1.3 Preserve Prime Farmland	132	
NW1.4 Preserve Undeveloped Land	134	
NW2.1 Reclaim Brownfields	136	
NW2.2 Manage Stormwater	138	
NW2.3 Reduce Pesticide & Fertilizer Impacts	140	
NW2.4 Protect Surface & Groundwater Quality	142	
NW3.1 Enhance Functional Habitats	146	
NW3.2 Enhance Wetland & Surface Water Functions	148	
NW3.3 Maintain Floodplain Functions	150	
NW3.4 Control Invasive Species	152	
NW3.5 Protect Soil Health	154	
NW0.0 Innovate or Exceed Credit Requirements	156	
 CLIMATE AND RESILIENCE		
CR1.1 Reduce Net Embodied Carbon	162	
CR1.2 Reduce Greenhouse Gas Emissions	164	
CR1.3 Reduce Air Pollutant Emissions	166	
CR2.1 Avoid Unsuitable Development	168	
CR2.2 Assess Climate Change Vulnerability	170	
CR2.3 Evaluate Risk and Resilience	172	
CR2.4 Establish Resilience Goals and Strategies	176	
CR2.5 Maximize Resilience	178	
CR2.6 Improve Infrastructure Integration	180	
CR0.0 Innovate or Exceed Credit Requirements	182	
GLOSSARY		

Introduction

PURPOSE OF ENVISION®

The purpose of Envision is to foster the dramatic and necessary improvement in the sustainable performance and resiliency of physical infrastructure by helping owners, planners, engineers, communities, contractors, and other infrastructure stakeholders to implement more cost-effective, resource-efficient and adaptable long-term infrastructure investments.

Envision is a framework that provides the guidance needed to initiate this systemic change in the planning, design and delivery of sustainable and resilient infrastructure. Envision is a decision-making guide, not a set of prescriptive measures. Envision provides industry-wide sustainability metrics for all types and sizes of infrastructure to help users assess and measure the extent to which their project contributes to conditions of sustainability across the full range of social, economic, and environmental indicators. Furthermore, the Envision framework recognizes that these sustainability factors are variable across a project's life cycle. As such, Envision helps users optimize project resilience for both short-term and long-term impacts.

Fundamentally, Envision is about supporting higher performance through more sustainable choices in infrastructure development. The framework provides a flexible system of criteria and performance objectives to aid decision makers and help project teams identify sustainable approaches during planning, design, and construction that will carry forward throughout the project's operations and maintenance and end-of-life phases. Using Envision as a guidance tool, owners, communities, designers, contractors, and other stakeholders are able to collaborate to make more informed decisions about the sustainability of infrastructure.

Community infrastructure development is subject to the resource constraints of multiple departments and agencies, each with different schedules, agendas, mandates, budget cycles, and funding sources. Ratings systems and tools intended for buildings are not designed for this context and cannot adequately assess the extensive external benefits and impacts infrastructure has on a community. Envision assesses not only individual project performance, but how well the infrastructure project contributes to the efficiency and long-term sustainability of the communities it serves. In this way, Envision not only asks, "Are we doing the project right?" but also, "Are we doing the right project?"

BACKGROUND

Envision was developed in joint collaboration between the Zofnass Program for Sustainable Infrastructure at the Harvard University Graduate School of Design and the Institute for Sustainable Infrastructure (ISI). ISI is a not-for-profit education and research organization founded by the American Public Works Association, the American Council of Engineering Companies, and the American Society of Civil Engineers.

ISI is the hub of a unique community of organizations and individuals involved in the planning, design, construction, and maintenance of infrastructure. Since the launch of the first version of Envision in 2012, this unique community has continued to push significant progress in the infrastructure industry by applying Envision on billions of dollars' worth of infrastructure projects. ISI has captured lessons learned through the use of Envision and incorporated these key lessons into this third version.

THE NEED FOR ENVISION

Consider the importance of infrastructure in our daily lives. Infrastructure provides the basis for personal security and public health, impacts the economic viability and competitiveness of our communities, moves people and goods, provides us with drinking water and handles our waste, creates spaces for us to enjoy, and allows us to effectively communicate with one another. However, despite the obvious need for infrastructure and the many benefits it provides, historically it is overlooked and underfunded until it breaks down or service is disrupted.

Decades of neglect mean that massive investments in infrastructure are now needed around the world. In North America and Europe aging and outdated infrastructure needs to be replaced and modernized, while in other regions entirely new infrastructure systems are being developed. At the same time, population growth and climate change are stressing financial, material, and technological resources and underscoring the need to adapt to a more sustainable and resilient society. Infrastructure is at the heart of addressing this key challenge of the 21st century, and the standards and methods of the past will not be adequate to meet the needs of the future. A new paradigm is required. In 2017 United Nations Secretary General Antonio Guterres stated,

“Infrastructure investment will be crucial. The world should adopt a simple rule: if big infrastructure projects are not green [sustainable], they should not be given the green light. Otherwise, we will be locked into bad choices for decades to come.”

But how do infrastructure developers know whether their decisions are contributing to sustainability or not? How do they bring attention to the need for more sustainable infrastructure? How do they communicate around a shared understanding of what sustainability means? Envision provides a consistent, consensus-based framework for assessing sustainability and resilience in infrastructure. Envision:

- Sets the standard for what constitutes sustainable infrastructure;
- Incentivizes higher performance goals beyond minimum requirements;
- Gives recognition to projects that make significant contributions to sustainability; and
- Provides a common language for collaboration and clear communication both internally and externally.

The Envision Framework

- 1 Envision Guidance Manual**
The written framework.
- 2 Envision Pre-Assessment Checklist**
An early-phase high-level pre-assessment.
- 3 Envision Online Scoresheet**
The detailed online assessment tool and calculator.
- 4 Envision Sustainability Professional Credential**
Professional training in Envision use.
- 5 Envision Verification**
Independent third-party project review process.
- 6 Envision Awards**
Recognition for qualifying verified projects.

WHAT IS ENVISION?

Envision is a framework that includes 64 sustainability and resilience indicators, called 'credits', organized around five categories: Quality of Life, Leadership, Resource Allocation, Natural World, and Climate and Resilience. These collectively address areas of human wellbeing, mobility, community development, collaboration, planning, economy, materials, energy, water, siting, conservation, ecology, emissions, and resilience. These indicators collectively become the foundation of what constitutes sustainability in infrastructure.

Each of the 64 credits has multiple levels of achievement representing the spectrum of possible performance goals from slightly improving beyond conventional practice, to conserving and restoring communities and environments. By assessing achievement in each of the 64 credits, project teams establish how well the project addresses the full range of sustainability indicators, and are challenged to pursue higher performance.

Through its Envision Sustainability Professional (ENV SP) credential, Envision recognizes and brings attention to individuals trained and dedicated to developing more sustainable infrastructure. When used as a self-assessment tool Envision helps

practitioners better understand and recognize their project's contribution to sustainability. Through an optional process offered by ISI, Envision can also be used to receive third-party verification of a project assessment which gives public recognition to infrastructure projects that make exemplary progress toward sustainability. Collectively the commitments of public agencies, companies, and universities to use Envision draws needed attention to the value and importance of developing infrastructure more sustainably.

Perhaps most importantly, Envision is a shared platform for effectively collaborating and communicating around the complex concepts and challenges of sustainability. Successful use of the framework in either self-assessments or third-party verifications necessitates collaboration, teamwork, and learning. The ENV SP credential is a tool for training these multi-disciplinary teams to use Envision collaboratively. Envision's easy-to-understand approach to sustainable infrastructure becomes a tool for facilitating project team collaboration, inter-organizational cooperation, and public engagement and communication.



Energy

Distribution
Hydroelectric
Coal
Natural Gas
Wind
Solar
Biomass

Water

Treatment
Distribution
Capture / Storage
Stormwater
Flood Control
Nutrient Management

Waste

Solid waste
Recycling
Hazardous
Waste
Collection & Transfer

Transportation

Airports
Roads / Highways
Bikes / Pedestrians
Railways
Transit
Ports
Waterways

Landscape

Public Realm
Parks
Ecosystem Services
Natural Infrastructure
Environmental Remediation

Information

Telecom
Cables
Internet
Phones
Data Centers
Sensors

HOW DOES ENVISION WORK?

When addressing sustainability and resiliency in the face of changing variables, it is difficult to assess the full range of benefits and impacts across the broad scope of social, environmental, and economic factors. Envision's framework provides a structure in which users can more easily measure progress and identify potential trade-offs amid this complex mix of objective, subjective, quantifiable, and qualitative criteria. The rating scale presented for each sustainability indicator helps users identify and align priorities against a common scale.

What constitutes the most sustainable solution is often project and context specific and difficult, if not impossible, to prescribe in advance. For each sustainability indicator in the framework Envision provides users with questions to guide decisions and discussions at the project and system-wide levels in order to arrive at the best choice.

Whether using the Envision checklist, online scoresheet, self-assessment, or third-party verification Envision users find it works for them in numerous ways:

- Calibrating internal accountability and assessment against a common set of sustainability criteria;

- Incentivizing higher achievement in project sustainability;
- Identifying and recognizing organizations committed to sustainability through the procurement process;
- Drawing public attention to positive infrastructure projects and sustainable outcomes;
- Strengthening inter-agency and project team collaboration; and
- Demonstrating good governance to voters, taxpayers, or ratepayers.

WHERE DOES ENVISION APPLY?

Envision is designed as a holistic sustainability rating system for all types and sizes of both public and private infrastructure. A key value of Envision is its universal applicability to all infrastructure. Envision application has ranged across all infrastructure sectors from one million to multi-billion dollar projects.

Envision is not intended to evaluate interior, conditioned, buildings with the primary purpose of human occupation, such as offices, schools, single family homes, or multi-unit residential buildings, but can be used in conjunction with rating systems

“The purpose of Envision is to foster the dramatic and necessary improvement in the sustainable performance and resiliency of physical infrastructure...”

that address these types of spaces. For example, Envision is often applied to airports that contain both infrastructure and human-occupied spaces.

Envision has been applied extensively throughout the US and Canada but is applicable, and has been used, all over the world.

WHO USES ENVISION AND WHY?

Envision was designed to help infrastructure stakeholders implement more sustainable projects. It offers benefits for each category of stakeholder: from owners and design teams, to community and environmental groups, to constructors, regulators, and policymakers.

- Owners, regulators, and policy makers use Envision to set standards for sustainable infrastructure and guide procurement. Envision references appear in RFPs, RFQs, grants, and cost-share programs.
- Engineers, architects, landscape architects, planners, operators, and constructors use Envision to set higher performance goals for projects and to collaborate and communicate on achieving those goals.
- All infrastructure stakeholders use Envision to recognize both trained individuals through the ENV SP credential and high performing projects through the third-party verified awards.
- Community groups, environmental organizations, and the general public use Envision to understand and learn about sustainable infrastructure and to more actively engage in its development.

Anyone can use Envision. Those interested in expert training can become ENV SPs through ISI's online course and exam. These professionals are

qualified to lead teams in project assessments or submit for third-party verification.

As of this publication, Envision has been used on hundreds of projects and tens of billions of dollars in infrastructure projects have pursued third-party verification throughout the US, Canada, and internationally. Thousands of individuals have received the Envision Sustainability Professional credential including in every US state, Canadian province, and over 40 countries. Envision is supported and applied by hundreds of companies, and dozens of public agencies, and universities.

WHEN TO USE ENVISION?

Envision can and should be used throughout the entire life cycle of a project. However, the earlier Envision is applied the greater the value it can deliver. Sustainability begins with the earliest stages of planning and carries through to the end of a project's useful life, but as the project timeline advances the ability to make effective changes decreases while the cost of making changes increases. The false perception that sustainability is more expensive than conventional practice is often a result of adding sustainability 'features' at the end of a conventional process. On the contrary, projects that incorporate sustainable principles of efficiency, resourcefulness, and multi-benefit use from the earliest planning stages often find significant cost savings—even initial capital cost savings—over conventional projects.

Planning: In the planning phase of the project, Envision can be used to assess community values, engage stakeholders, and build consensus around the best project solution. It guides decisions when defining a project scope, prioritizing a list of projects, and comparing project alternatives.

Envision Leaders

Both the City of Los Angeles City Council and the Los Angeles County Board of Supervisors have passed resolutions adopting the use of Envision.

According to City of Los Angeles City Engineer Gary Lee Moore, “The Bureau of Engineering is proud to be an early adopter of Envision, which provides our engineers and architects with nationally recognized standards that work well within our city’s vast and varied landscape. Envision is key to advancing our ability to deliver sustainable infrastructure, open space and architecture projects as we work toward our goal of transforming Los Angeles into the world’s most livable city.”



In 2017 the Miami-Dade Board of County Commissioners passed a resolution adopting Envision and, “directing the County Mayor to incorporate Envision into the planning, design, construction, and operation of County-funded Infrastructure Projects... [and] to develop a plan to train the County staff who are responsible for civil infrastructure projects in becoming Envision Sustainability Professional (ENV SP) credentialed.”

The resolution was inspired by the pioneering work of the Miami-Dade Department of Water and Sewer.



“Envision not only asks, ‘Are we doing the project right?’ but also, ‘Are we doing the right project?’”

Design: In the design phase of a project, Envision guides a thorough evaluation of the design and aids identification of additional improvements toward more sustainable development. The credit levels of achievement benchmark the relative impact and encourage expanding the project goals toward higher levels of sustainability. Integrating the Envision rating system assessment into the design process allows for sustainable-minded decision making throughout the project.

Construction: The construction phase of a project allows for creativity and innovation in how the design is achieved. Envision can be used to guide decisions in this phase for continuity between the sustainable intent in design and actual project delivery. During this phase, sustainable achievement is measured and documented. The impact of the credits on the construction process and costs can also be measured.

Operations and Maintenance: During operations and maintenance, it is important to

measure sustainable performance. The Envision framework provides key sustainable performance indicators that can be monitored over the project life. In this way, Envision supports evaluation of sustainable impacts across project life-cycles.

Communication and Education: The Envision framework provides an organized system for educating stakeholders and garnering support. The transparent nature of the system demonstrates the relationship to the triple bottom line. Advertising sustainable project achievements and awards is further supported by this transparency.

Building Future Sustainability: The recommendations for sustainable development in the Envision framework are used to shape local design standards, construction codes, and development strategies. Adopting some or all of these best practices recommendations promotes the development of durable, high performance infrastructure for decades to come.

BENEFITS OF USING ENVISION

The use of Envision can benefit projects in numerous ways including:

- Long-term viability through increased resiliency and preparedness;
- Lower costs through management and stakeholder collaboration;
- Reduced negative impacts on the community and the environment;
- Potential to save owners money over time through efficiency;
- Credibility of a third-party rating system; and
- Increased public confidence and involvement in decision making.

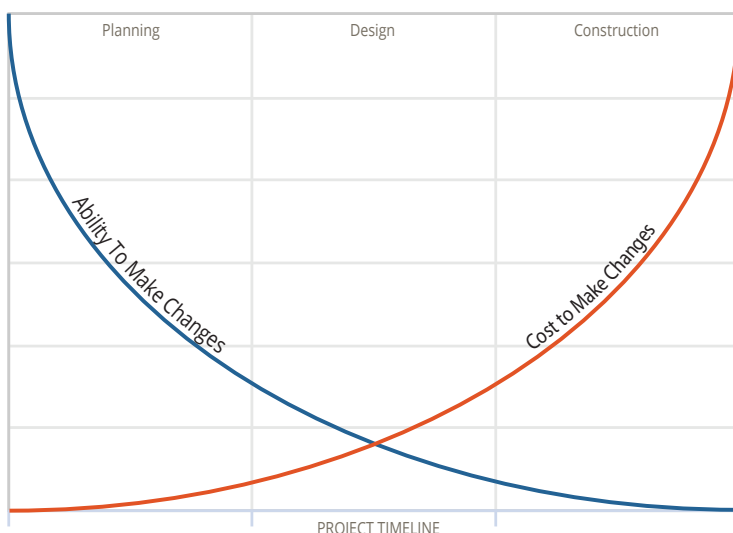

Envision Design

The development of Envision is first based on identifying and understanding what sustainability and sustainable development are, and their key challenges. This is underscored by a recognition that the social, environmental, and economic systems within which sustainable development must occur are constantly changing due to factors like population growth, climate change, and resource constraints. Therefore, increased resilience and adaptability must be added as a fourth pillar of sustainability. Next, it is critical to recognize the specific role and contribution of infrastructure in becoming a sustainable society and a sustainable world. Achieving a sustainable society will require contributions from every industry but infrastructure must first provide the foundation.

How can infrastructure achieve this goal? Through the systematic prioritization of sustainable choices, challenging conventional practice with higher performance goals, fostering innovation, and investing in education and knowledge sharing to advance the industry and build public awareness. These are the strategies and principles embedded within the Envision framework and applied to the full spectrum of sustainability indicators: social wellbeing, environmental stewardship, economic stability, and resilience.

WHAT IS SUSTAINABILITY AND SUSTAINABLE DEVELOPMENT?

The traditional definition of sustainable development is taken from the 1987 UN World Commission on Environment and Development report, also known as the Brundtland Commission Report, “development that meets the needs of the present without compromising the ability of future generations to meet their own needs”. This raises the critical point that our current quality of life cannot be bought at the expense of future generations. Sustainability is not only about

“Development that meets the needs of the present without compromising the ability of future generations to meet their own needs.”

preserving and protecting the environment, but also about preserving the ability of society to sustain itself. These two goals are inextricably linked.

WHAT IS INFRASTRUCTURE’S ROLE?

Efficient infrastructure is an essential component for a prosperous and growing economy. Effective transportation systems bring goods to market, workers to jobs, children to schools, and families to stores and recreation areas in a safe and timely manner. Dependable water and wastewater systems bring fresh water to industry, agriculture, and people. Reliable electricity supplies allow businesses and factories to work unimpeded and bring a high level of convenience and productivity to home life across the nation. Extensive telecommunication networks connect people and businesses across the globe and enable the fast flow of information essential to commerce.

Infrastructure should deliver the required services at affordable costs while conserving natural resources and energy. Moreover, these services must be continually maintained and improved in order to remain competitive in the global marketplace. Today, however, the design, construction and operation of our infrastructure systems have a substantial negative impact on our natural resources and ecological systems. If allowed to continue, this overuse of natural resources will have devastating consequences.

Country Human Development Index and Ecological Footprint

Source: Global Footprint Network

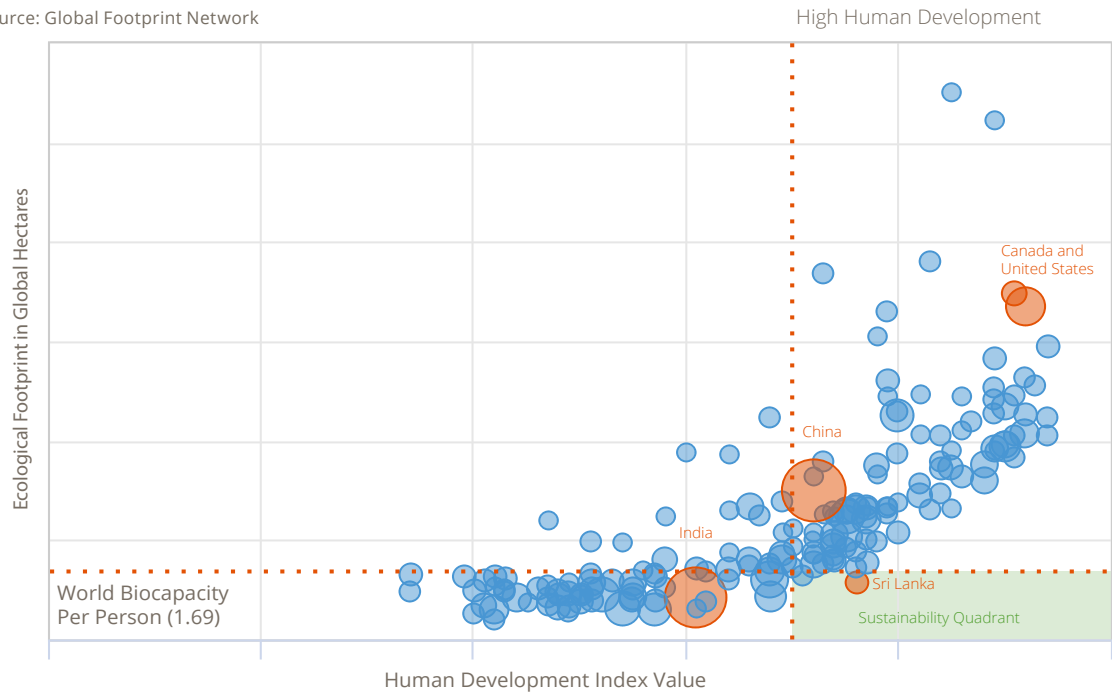

WHAT ARE THE CHALLENGES?

Most developed countries enjoy a high quality of life but do so by consuming materials and natural resources at a rate our planet cannot support. This undermines the ability of future generations to sustain that quality of life. Furthermore, developing countries are rightfully seeking to improve their own quality of life. In following the model set by developed countries, they are consuming resources necessary to do so.

The human development index is a rough measure of quality of life developed by the United Nations. As inputs, it factors life expectancy, education, and gross domestic product. The problems faced by the U.S., Canada, and other nations in preserving natural resources and ecological systems while maintaining or improving their quality of life is depicted in the graph. Here, the ecological footprint of each country is plotted as a function of their human development index. The area of the circle represents population size. Conditions of sustainability are seen as the area bounded horizontally by the world average available biocapacity and vertically by the threshold of high human development.

The challenge faced by developed countries worldwide is how to reduce our net environmental footprint without sacrificing our quality of life. Making a meaningful shift toward the sustainability quadrant is not a small challenge. Taken to its logical conclusion, reaching the sustainable quadrant involves a complete overhaul of our infrastructure, replacing old components with those that are more effective and efficient. Progress will be made incrementally by project owners, designers, and contractors delivering infrastructure projects that make significant improvements in performance across multiple dimensions of sustainability. These projects must also integrate well with the infrastructure in the community, both existing and planned. Lastly, the designers must take into account changes in the environment in which the delivered works must operate.

Changing Operating Environments

For engineers and designers, the primary consequence of working in a non-sustainable operating environment is that many, if not most, of the normal project design assumptions and variables could change significantly over the design life of the project. Assumptions about expected operating

conditions will change, requiring determinations of new averages, variances and possible extremes. New variables and new relationships among existing variables will appear and need to be taken into account. Resource demands will drive up the cost and scarcity of important materials and fuels. Extreme weather events and atypical weather patterns may change the operating environment.

In addition to the physical structure, the project may need to incorporate “soft” engineering solutions, such as new forms of monitoring and data collection, contingency plans, public education and training. Deteriorating infrastructure paired with a growing population yet struggling economy present serious challenges to conventional thinking. The rating system recognizes these changes and incorporates a number of process-based objectives to ensure that these matters are considered by the project team.

WHAT STRATEGIES DISTINGUISH ENVISION'S APPROACH?

Mitigation Hierarchy

In taking practical steps toward sustainability, it can be difficult to discern how to prioritize options or even take the first step. Many sustainability best practices have roots in a mitigation hierarchy. For example, the “3 Rs” of material use include: Reduce, Reuse, Recycle; and these practices are prioritized in this specific order to optimize how materials are used. Expanding this example to a more general hierarchy becomes:

- **Avoidance:** Measures taken to avoid creating impacts from the outset
- **Minimization:** Measures taken to reduce the duration, intensity or extent of impacts that cannot be avoided
- **Abatement:** Measures taken to rehabilitate degraded ecosystems
- **Offsetting:** Measures taken to compensate for any residual adverse impacts

The Envision framework applies this hierarchy across a range of topics. For example, when

considering social impacts of a project it is just as important to first avoid adverse impacts as it is when considering environmental implications.

Restoration

Along with encouraging higher performance across three dimensions, the Envision framework is unique in that it creates opportunities for projects to go beyond mitigation measures and restore the social, economic, and environmental assets of the community. “Restorative” becomes an achievable performance goal and is an explicit level of achievement within the Envision framework. This level may be aspirational in many cases, but it highlights what is possible for infrastructure projects, and it lays out the path for success. Likewise, when projects are able to implement practices that restore their community and site, their efforts are recognized. Collectively, these projects then help set a new bar for how sustainable infrastructure projects should perform.

Higher Performance

Envision promotes high performance across three dimensions:

- **Sustainability Achievement:** Envision recognizes that success in sustainability is incremental, not “all or nothing”. As such, the framework illustrates the incremental changes a project team can implement to reach higher levels of sustainability.
- **Project life cycle:** Credits in the Envision framework address the full project life cycle, beyond planning and design through construction to operations and maintenance. Users are also challenged to consider the project’s end-of-useful-life, such as the ability to disassemble and up-cycle materials.
- **Stakeholder engagement:** When an inclusive, representative group of stakeholders is engaged throughout the project, the results satisfy the widest possible swath of the community. Project team collaboration with stakeholders also identify the widest practical array of sustainability alternatives for consideration, including byproduct synergies and social benefits.

Innovation

The infrastructure industry can be understandably risk averse. Project performance is accountable to the public, and failures are highly visible, sometimes catastrophic events, with lasting repercussions. Yet, in order to be responsive to changing operating environments and fulfill their role in sustainable, resilient development, project teams building tomorrow's infrastructure should be prepared to take measured risks and innovate designs for the future.

The Envision framework encourages innovation across all aspects of sustainability and resilience. Some topics and approaches provided in the Envision framework are aspirational, laying out the best-case scenario and leaving it to project teams to determine how to achieve it. Other approaches are a blank slate, allowing room for innovation and prompting project teams to pioneer solutions that suit the needs of the present and the future.

Education and Knowledge Sharing

The Envision framework is designed to provide, capture and disseminate knowledge. The process and performance objectives included within

the credits are intended to guide sustainable project delivery. They are, however, more than a prescriptive list of specifications. Project teams are able to determine the best path forward in implementing sustainable projects, building on the knowledge of what it takes to deliver a project that truly contributes to sustainability.

In turn, project teams can learn from each other as the knowledge base grows. Many Envision credits have the added goal of collecting industry data. Successive Envision projects build this data set and help set the new sustainable "standard" or baseline for infrastructure design. Furthermore, the Envision framework recognizes projects that excel in sustainability to serve as exemplary models for future projects.

Public attention is often only directed to infrastructure when there is a problem or failure. By recognizing project successes through the Envision framework, teams can begin to educate the public on the value of their often overlooked infrastructure systems. By understanding the inherent value of an infrastructure project, communities are motivated to drive increasingly higher expectations in terms of sustainability.

HOW DOES ENVISION ADDRESS THE FULL RANGE OF SUSTAINABILITY?

Social

Social wellbeing is comprehensively addressed. As stated previously, Envision poses two questions: "Are we doing the project right?" and, more critically, "Are we doing the right project?" For instance, under Envision, a new highway might be designed with features that contribute to sustainable performance (e.g., preserving wildlife corridors, treating and infiltrating stormwater runoff, and incorporating recycled materials in construction). However, if that highway contributes to significantly greater traffic congestion and urban sprawl, its overall contribution to sustainability may not be as high as an alternate solution such as an extension of public transportation services.

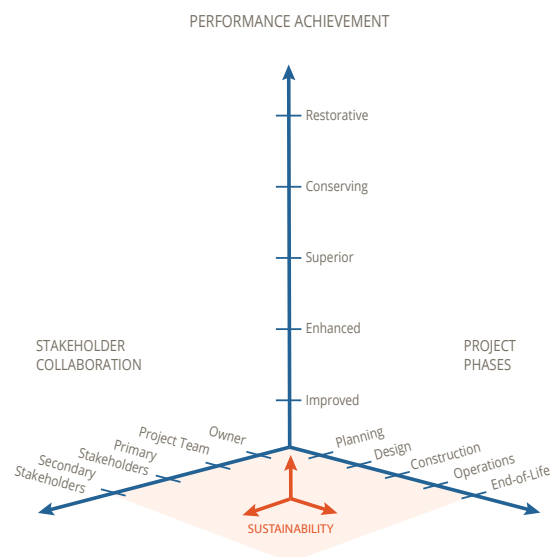

Equity and social justice refer to the responsibility of a society to ensure that civil and human rights are preserved and protected for each individual, and that all persons are treated equally and without prejudice. These issues are particularly relevant to infrastructure development, which often involves the provision of significant benefits as well as potentially significant impacts. Envision addresses equity and social justice by encouraging active engagement from community stakeholders across the entire project life-cycle. Project teams develop two-way communication with impacted communities allowing them to holistically examine a project's impacts from all perspectives.

Environmental

Restoration of natural resources and ecosystem services is an explicit goal within the Envision framework. While improving sustainable performance is an essential and immediate goal, long-term goals should be directed toward restoration where practical. This is intended to reinforce the point that, to really contribute to sustainability, projects must do more than mitigate negative impacts. Mitigation is important, but does not contribute to the restoration of economic, environmental, and social conditions to sustainable levels.

Economic

Economic development conducted without depleting social and natural resources is sustainable development. While not all infrastructure projects are directly connected to economic growth, they are all connected to the economy by driving

community attractiveness and environmental responsibility. The guidance provided in the Envision framework balance these three aspects.

Return on Investment and upfront capital costs are often the key drivers in planning decisions; however they omit the life-cycle costs of the project, risks and uncertainty, or the broader outcomes that impact the environment and society. Envision quantifies these soft benefits and broader outcomes such that owners are less likely to overlook the sustainable returns on investment, such as lower utility costs, operations and maintenance costs, or less replacement costs.

Resilience

Short- and long-term risks are reduced. Project teams are guided to implement measures and infrastructure that prevent committing the community to high fixed costs or create a heavy reliance on resources that could become scarce and/or very expensive. Conversely, projects that create or increase vulnerability to extreme weather events, natural disasters, and/or economic conditions are viewed as being conceptually deficient.

Life-cycle considerations are addressed. Credit is given to project teams that extend design considerations to the full extent of the project life-cycle. Designs that offer increased durability and flexibility to extend the useful life of the constructed works are afforded additional recognition. Extending the useful life of constructed works means that replacement structures are needed less. More recognition is given for designs that incorporate deconstruction principles and enable reuse and up-cycling of materials and equipment.





Envision



Envision is a framework that includes 64 sustainability and resilience indicators, called 'credits', organized into five categories: **Quality of Life, Leadership, Resource Allocation, Natural World, and Climate and Resilience**. These collectively address areas of human wellbeing, mobility, community development, collaboration, planning, economy, materials, energy, water, siting, conservation, ecology, emissions, and resilience. These indicators collectively become the foundation of what constitutes sustainability in infrastructure.



Envision Credit List



**Quality
Of Life**
14 Credits

WELLBEING

- QL1.1 Improve Community Quality of Life
- QL1.2 Enhance Public Health & Safety
- QL1.3 Improve Construction Safety
- QL1.4 Minimize Noise & Vibration
- QL1.5 Minimize Light Pollution
- QL1.6 Minimize Construction Impacts

MOBILITY

- QL2.1 Improve Community Mobility & Access
- QL2.2 Encourage Sustainable Transportation
- QL2.3 Improve Access & Wayfinding

COMMUNITY

- QL3.1 Advance Equity & Social Justice
- QL3.2 Preserve Historic & Cultural Resources
- QL3.3 Enhance Views & Local Character
- QL3.4 Enhance Public Space & Amenities

QL0.0 Innovate or Exceed Credit Requirements



Leadership
12 Credits

COLLABORATION

- LD1.1 Provide Effective Leadership & Commitment
- LD1.2 Foster Collaboration & Teamwork
- LD1.3 Provide for Stakeholder Involvement
- LD1.4 Pursue Byproduct Synergies



PLANNING

- LD2.1 Establish a Sustainability Management Plan
- LD2.2 Plan for Sustainable Communities
- LD2.3 Plan for Long-Term Monitoring & Maintenance
- LD2.4 Plan for End-of-Life



ECONOMY

- LD3.1 Stimulate Economic Prosperity & Development
- LD3.2 Develop Local Skills & Capabilities
- LD3.3 Conduct a Life-Cycle Economic Evaluation
- LD0.0 Innovate or Exceed Credit Requirements

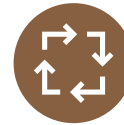

**Resource
Allocation**
14 Credits

MATERIALS

- RA1.1 Support Sustainable Procurement Practices
- RA1.2 Use Recycled Materials
- RA1.3 Reduce Operational Waste
- RA1.4 Reduce Construction Waste
- RA1.5 Balance Earthwork On Site



ENERGY

- RA2.1 Reduce Operational Energy Consumption
- RA2.2 Reduce Construction Energy Consumption
- RA2.3 Use Renewable Energy
- RA2.4 Commission & Monitor Energy Systems



WATER

- RA3.1 Preserve Water Resources
- RA3.2 Reduce Operational Water Consumption
- RA3.3 Reduce Construction Water Consumption
- RA3.4 Monitor Water Systems



RA0.0 Innovate or Exceed Credit Requirements





Natural World
14 Credits

SITING

- NW1.1 Preserve Sites of High Ecological Value
- NW1.2 Provide Wetland & Surface Water Buffers
- NW1.3 Preserve Prime Farmland
- NW1.4 Preserve Undeveloped Land

CONSERVATION

- NW2.1 Reclaim Brownfields (N)
- NW2.2 Manage Stormwater ✎
- NW2.3 Reduce Pesticide & Fertilizer Impacts
- NW2.4 Protect Surface & Groundwater Quality

ECOLOGY

- NW3.1 Enhance Functional Habitats ✎
- NW3.2 Enhance Wetland & Surface Water Functions
- NW3.3 Maintain Floodplain Functions
- NW3.4 Control Invasive Species
- NW3.5 Protect Soil Health

- NW0.0 Innovate or Exceed Credit Requirements



Climate and Resilience
10 Credits

EMISSIONS

- CR1.1 Reduce Net Embodied Carbon ✎
- CR1.2 Reduce Greenhouse Gas Emissions
- CR1.3 Reduce Air Pollutant Emissions

RESILIENCE

- CR2.1 Avoid Unsuitable Development ✎
- CR2.2 Assess Climate Change Vulnerability
- CR2.3 Evaluate Risk & Resilience (N)
- CR2.4 Establish Resilience Goals and Strategies (N)
- CR2.5 Maximize Resilience ✎
- CR2.6 Improve Infrastructure Integration

- CR0.0 Innovate or Exceed Credit Requirements



Rewritten

New



Navigating Credits

1 **2** **3**

4 **5**

6 **7**

8 **9**



QUALITY OF LIFE: WELLBEING

QL1.1 Improve Community Quality of Life

26

POINTS

INTENT

Improve the net quality of life of all communities affected by the project and mitigate negative impacts to communities.

METRIC

Measures taken to assess community needs and improve quality of life while minimizing negative impacts.

IMPROVED A + B	ENHANCED A + B + C + D	SUPERIOR A + B + C + D + E	CONSERVING A + B + C + D + E + F	RESTORATIVE A + B + C + D + E + F + G
(2) Community Considerations	(5) Community Linkages	(10) Broad Community Alignment	(20) Holistic Assessment & Collaboration	(26) Protecting the Future

(A) The project team identifies and takes into account community needs, goals, and issues. For example, the project team has located and reviewed the most recent community planning information and assessed relevant community needs, goals, and/or issues.

(B) The project meets or supports community needs and/or goals.

(C) The project assesses the social impacts it will have on the host and affected communities' quality of life.

(D) The affected communities are meaningfully engaged in identifying how the project supports community needs and/or goals.

(E) Based on the social assessment, potential negative impacts on the host or nearby affected communities are mitigated following a hierarchy that prioritizes avoidance, minimization, restoration, and offsetting.

(F) Community satisfaction is demonstrated by feedback from the stakeholder engagement process verifying actions taken in criteria A, B, C, and D.

(G) The project proactively addresses trends in changing social, economic, and/or environmental conditions within the community in order to ensure a high quality of life over the long term.

with community goals reduces the risk of community conflicts that disrupt project delivery and increase cost.

PERFORMANCE IMPROVEMENT

Improved: The project team can demonstrate an understanding of the community needs, goals, and issues, and communicate how the project meets or supports those goals.

Enhanced: Communication and interactions with community stakeholders are essential to reaffirm and improve the project objectives. The project team works closely with community stakeholders to identify and assess potential social impacts. Social impacts include the intended and unintended social consequences, both positive and negative, of infrastructure projects and any social changes initiated by those projects.

Superior: Infrastructure projects often include difficult trade-offs involving positive and negative impacts, and a project designed to benefit one community may have adverse effects on others. In addition, the needs of a community may conflict with their expressed goals. Because positive impacts in all dimensions of performance may not be possible, the credit seeks a net positive impact. Importantly, the project benefits and impacts should be equitably distributed throughout the host and affected communities.

Conserving: Community satisfaction is the metric for quality of life. It should be evident that the community truly understands the full impact (positive and negative) of the project and is satisfied that it addresses their needs and goals while appropriately mitigating negative impacts. Documentation of community endorsement should be as broad as possible and specific to the requested documentation.

Restorative: The project team proactively identifies instances where long-term trends in socioeconomic or environmental conditions may undermine existing community aspirations and addresses them in the project.

Applicability: It is likely that all projects have the ability to align project objectives with community needs and goals, identified through active engagement, in order to achieve broad community satisfaction. It would therefore be difficult to demonstrate that the credit is not relevant applicable to a project seeking an Envision award.

EVALUATION CRITERIA AND DOCUMENTATION GUIDANCE

A. Has the project team identified and taken into account community needs, goals, and issues?

- Documentation that the project team has located and reviewed the most recent community planning information and assessed relevant community needs, goals, and/or issues. For example, meeting minutes with key stakeholders, community leaders, and decision makers; letters; and memoranda.

B. Does the project meet or support the needs and goals of the host and/or affected communities?

- Evidence showing a comparison of the project vision and goals to the needs, goals, and/or issues of the community.

C. Has the project team assessed the social impacts the project will have on the host and affected communities' quality of life?

- Assessing, identifying and evaluating the positive and negative social impacts of the project on affected communities' quality of life (e.g., a social impact assessment). Expectations for the depth and breadth of documentation are commensurate with the scale of the project and its impact on the broader community. Informal assessments are acceptable for small projects, provided that project teams present evidence supporting their conclusions.

D. Have the affected communities been meaningfully engaged in identifying how the project meets community needs and/or goals?

- Documentation of processes for collecting, evaluating, and incorporating community input into the planning and design process (e.g., meetings, design charrettes, and communications with representatives of affected communities).

E. Has the project team addressed negative social impacts?

- Evidence showing the extent to which options for mitigating negative impacts were identified and prioritized, and reasonable changes to the project made. Strategies for mitigating negative impacts should follow a hierarchy prioritizing avoidance, minimization, restoration, and offsetting.

F. Are the affected communities satisfied that the project addresses their needs and goals as well as mitigates negative impacts?

- Acknowledgments and endorsements by the community that the design participation process was helpful and that their input was appropriately assessed and incorporated into project design.
- Documentation of input and agreement from key stakeholders, community leaders, and/or decision makers regarding the impact assessment and planned actions (e.g., community satisfaction surveys, interviews with representatives of affected communities, comments and reactions from social media platforms). Specific statements about critical issues or actions taken within the project are better indicators of a true understanding of the project's impacts than general endorsements of the project as a whole. Evidence of community satisfaction and endorsement of plans includes:
 - Community endorsement of the project team's assessment of their needs or goals per criterion A.
 - Community endorsement that the project as proposed will address their needs or goals per criterion B.
 - Documentation that the community understands and accepts potential impacts of the project per criterion C.
 - Community endorsement of project strategies to mitigate negative impacts per criterion D.

G. Does the project proactively address long-term social, economic, or environmental changes that impact quality of life?

- Documentation of long-term social, economic, or environmental changes/trends that may impact community goals and needs over time (e.g., aging population, economic transitions, or the degradation of the environment and ecosystem services). Note that social, economic, and environmental shifts are often connected. The degradation of the environment in a coastal community dependent on tourism and fishing negatively impacts the economy, which can lead to social impacts such as shrinking population. Consequently, the quality of life of the community is put at risk.
- Documentation demonstrating how the project will proactively address one or more of these changes/trends.
- Documentation demonstrating how the project represents a smart long-term investment for the community's future.

RELATED ENVISION CREDITS

QL1.2 Enhance Public Health & Safety

QL2.3 Improve Access & Wayfinding

LD1.3 Provide for Stakeholder Involvement

LD2.2 Plan for Sustainable Communities

LD3.1 Stimulate Economic Prosperity & Development

CR2.5 Maximize Resilience

1 **2** **3** **4**

5 **6** **7**

8 **9**

- 1 Credit Title and Identification Number**
Includes the two-letter code identifying the category, and a number identifying the credit.
- 2 Intent**
The purpose of the credit.
- 3 Metrics**
How the credit will be measured.
- 4 Total Possible Points**
Value of the highest level of achievement.
- 5 Levels of Achievement**
Brief description of the requirements necessary to meet each level of achievement. Levels increase in their contribution toward sustainability.
- 6 Description**
Explanation of the sustainability issue addressed by the credit and its significance in infrastructure projects.
- 7 Performance Improvement**
Provides the benchmark for performance. It also provides general strategy for performance improvements.
- 8 Evaluation Criteria and Documentation Guidance**
Specifies the questions that the project must address in order to meet the requirements of a level of achievement. It also provides examples of the types of documents that may be submitted for verification in order to demonstrate that requirements were met.
- 9 Related Envision Credits**
Envision credits which may share documentation requirements, or may relate in a symbiotic way in order to meet level of achievement requirements.

Envision Organization and Scoring

PROJECT SCORING

Project performance is evaluated using a point system. Levels of achievement for each credit are assigned points weighted by three factors:

1. The importance and impact of the sustainability indicator;
2. The difficulty of the specific actions required; and
3. The demonstrable impact meeting the requirements will have.

Guidance is provided in each credit description on how to determine the anticipated level of achievement that may be attained by a given project. Scores for each applicable credit are added together to give the total Envision score. The final Envision score is presented as a percentage of the total achieved points compared to the total applicable points. Scores for each category are always shown in order to emphasize the trade-offs inherent in many project decisions.

CATEGORIES AND SUBCATEGORIES

The Envision framework is comprised of 64 sustainability indicators, called credits, that cover the full dimensions of infrastructure sustainability. Each credit in the Envision system includes an intent statement and metric, levels of achievement, a description, ways to improve performance, evaluation criteria and documentation guidance, and related Envision credits. The credits are organized into five categories and 14 subcategories by subject matter.

- **Quality of Life:** Wellbeing, Mobility, Community
- **Leadership:** Collaboration, Planning, Economy
- **Resource Allocation:** Materials, Energy, Water
- **Natural World:** Siting, Conservation, Ecology
- **Climate and Resilience:** Emissions, Resilience

Every infrastructure project impacts all five Envision categories, often with complex trade-offs. For example, in an effort to avoid critical habitats, projects may have to consume more resources. Conversely, projects that reduce resource consumption may find they are also achieving the benefit of reducing harmful emissions. By grouping the credits into broader categories of impact, Envision helps users to navigate the complex trade-offs or synergies across the credits.

LEVELS OF ACHIEVEMENT

The Envision levels of achievement define the level and quality of project performance in each credit as follows:

- **Improved:** Performance that is above conventional. Slightly exceeds regulatory requirements.
- **Enhanced:** Sustainable performance that is on the right track. There are indications that superior performance is within reach.
- **Superior:** Sustainable performance at a very high level.
- **Conserving:** Performance that has achieved essentially zero negative impact.
- **Restorative:** Performance that restores natural or social systems. Such performance receives the highest award possible and is celebrated as such. The Restorative level is not applicable to all performance objectives.

Not all credits have five levels of achievement. The levels are determined by the nature of the credit and the ability to make meaningful distinctions between levels. The level of achievement table clearly indicates the evaluation criteria that must be addressed for each level.

EVALUATION CRITERIA AND DOCUMENTATION

The evaluation criteria and documentation section within each credit outline what is necessary to demonstrate that a level of achievement has been met. Evaluation criteria, denoted by letters, include both qualitative and quantitative requirements. All evaluation criteria are framed as questions, for which answers and supporting documentation (denoted by numbers beneath each evaluation criterion) needs to be provided if the project submits for ISI's third-party Envision verification program. Examples of evaluation criteria are:

- **Yes/No:** An action taken or an outcome achieved (e.g. the project is not located on sensitive sites).
- **Target:** A specified outcome with discrete quantifiable levels (e.g. the project reduces energy use by 15%).
- **Execution:** A process conducted or a commitment made to accomplish a stated objective (e.g., the project team has a comprehensive sustainability management plan in place).
- **Accomplishment:** A process conducted with a general or unspecified result (e.g. the project team has 'minimized' the use of fertilizers and pesticides on the project).

BASELINES

A baseline references conventional performance or "business-as-usual". Many credits within the Envision framework require the establishment of a baseline against which to measure project performance. Given Envision's applicability to all types and sizes of infrastructure projects, and applicability across countries and regions, baselines may vary regionally or even project to project. Project teams must determine the most appropriate baseline for their project. In order to reach a level of achievement for any Envision credit, projects must exceed the determined baseline.

There are several options for identifying acceptable baselines. The following may be used as baselines for measuring performance improvement (listed in order of preference):

- **Existing conditions** or the existing system(s) the project will replace.
- **A seriously considered project alternative.**
- **Industry "standard practice"** or existing codes, standards, or regulatory requirements (e.g., for energy and water; greenhouse gas and air pollution emissions).
- **A project of similar scope and size** operating within the same geographical area or within a geographical area with similar operating conditions.





PERFORMANCE IMPROVEMENT

Each Envision credit includes guidance on concrete ways to incrementally improve performance above the baseline. Recognizing the leap in achievement from "Improved" to "Restorative", each credit outlines the tangible steps, beginning with how to get started. Guidance for performance improvement is cumulative, such that successive incremental steps become less of a leap to high performing projects. Text within the Performance Improvement section is not required for assessment but is intended to informally provide helpful guidance and context for the evaluation.

APPLICABILITY

As a highly flexible and adaptable resource, Envision recognizes that not all credits will be applicable to all projects or project types. Credits can be omitted from consideration by designating them as "not applicable". This is reserved for cases where the sustainability indicator addressed by the credit does not exist for the project. For example, on a project that is entirely underground external light fixtures would not exist and the project team would not be able to assess credit QL1.5 Minimize Light Pollution. In this example, the credit may be deemed "not applicable". This means that the total point value associated with the credit is removed from the total number of applicable points in the Envision framework for the project. For projects pursuing ISI's third-party verification program, an explanation and supporting documentation as to why the credit is not applicable to the project is required.

ENVISION POINTS TABLE

			Improved	Enhanced	Superior	Conserving	Restorative	Maximum Points
 Quality of Life	Wellbeing	QL1.1 Improve Community Quality of Life	2	5	10	20	26	200
		QL1.2 Enhance Public Health & Safety	2	7	12	16	20	
		QL1.3 Improve Construction Safety	2	5	10	14	—	
		QL1.4 Minimize Noise & Vibration	1	3	6	10	12	
		QL1.5 Minimize Light Pollution	1	3	6	10	12	
		QL1.6 Minimize Construction Impacts	1	2	4	8	—	
	Mobility	QL2.1 Improve Community Mobility	1	3	7	11	14	
		QL2.2 Encourage Sustainable Transportation	—	5	8	12	16	
		QL2.3 Improve Access & Wayfinding	1	5	9	14	—	
	Community	QL3.1 Advance Equity & Social Justice	3	6	10	14	18	
		QL3.2 Preserve Historic & Cultural Resources	—	2	7	12	18	
		QL3.3 Enhance Views & Local Character	1	3	7	11	14	
QL3.4 Enhance Public Space & Amenities		1	3	7	11	14		
 Leadership	Collaboration	LD1.1 Provide Effective Leadership & Commitment	2	5	12	18	—	182
		LD1.2 Foster Collaboration & Teamwork	2	5	12	18	—	
		LD1.3 Provide for Stakeholder Involvement	3	6	9	14	18	
		LD1.4 Pursue Byproduct Synergies	3	6	12	14	18	
	Planning	LD2.1 Establish a Sustainability Management Plan	4	7	12	18	—	
		LD2.2 Plan for Sustainable Communities	4	6	9	12	16	
		LD2.3 Plan for Long-Term Monitoring & Maintenance	2	5	8	12	—	
		LD2.4 Plan for End-of-Life	2	5	8	14	—	
	Economy	LD3.1 Stimulate Economic Prosperity & Development	3	6	12	20	—	
		LD3.2 Develop Local Skills & Capabilities	2	4	8	12	16	
		LD3.3 Conduct a Life-Cycle Economic Evaluation	5	7	10	12	14	
 Resource Allocation	Materials	RA1.1 Support Sustainable Procurement Practices	3	6	9	12	—	196
		RA1.2 Use Recycled Materials	4	6	9	16	—	
		RA1.3 Reduce Operational Waste	4	7	10	14	—	
		RA1.4 Reduce Construction Waste	4	7	10	16	—	
		RA1.5 Balance Earthwork On Site	2	4	6	8	—	
	Energy	RA2.1 Reduce Operational Energy Consumption	6	12	18	26	—	
		RA2.2 Reduce Construction Energy Consumption	1	4	8	12	—	
		RA2.3 Use Renewable Energy	5	10	15	20	24	
		RA2.4 Commission & Monitor Energy Systems	3	6	12	14	—	
	Water	RA3.1 Preserve Water Resources	3	5	7	9	12	
		RA3.2 Reduce Operational Water Consumption	4	9	13	17	22	
		RA3.3 Reduce Construction Water Consumption	1	3	5	8	—	
RA3.4 Monitor Water Systems		1	3	6	12	—		
 Natural World	Siting	NW1.1 Preserve Sites of High Ecological Value	2	6	12	16	22	232
		NW1.2 Provide Wetland & Surface Water Buffers	2	5	10	16	20	
		NW1.3 Preserve Prime Farmland	—	2	8	12	16	
		NW1.4 Preserve Undeveloped Land	3	8	12	18	24	
	Conservation	NW2.1 Reclaim Brownfields	11	13	16	19	22	
		NW2.2 Manage Stormwater	2	4	9	17	24	
		NW2.3 Reduce Pesticide & Fertilizer Impacts	1	2	5	9	12	
		NW2.4 Protect Surface & Groundwater Quality	2	5	9	14	20	
	Ecology	NW3.1 Enhance Functional Habitats	2	5	9	15	18	
		NW3.2 Enhance Wetland & Surface Water Functions	3	7	12	18	20	
		NW3.3 Maintain Floodplain Functions	1	3	7	11	14	
		NW3.4 Control Invasive Species	1	2	6	9	12	
	NW3.5 Protect Soil Health	—	3	4	6	8		
 Climate and Resilience	Emissions	CR1.1 Reduce Net Embodied Carbon	5	10	15	20	—	190
		CR1.2 Reduce Greenhouse Gas Emissions	8	13	18	22	26	
		CR1.3 Reduce Air Pollutant Emissions	2	4	9	14	18	
	Resilience	CR2.1 Avoid Unsuitable Development	3	6	8	12	16	
		CR2.2 Assess Climate Change Vulnerability	8	14	18	20	—	
		CR2.3 Evaluate Risk and Resilience	11	18	24	26	—	
		CR2.4 Establish Resilience Goals and Strategies	—	8	14	20	—	
		CR2.5 Maximize Resilience	11	15	20	26	—	
		CR2.6 Improve Infrastructure Integration	2	5	9	13	18	
	Maximum TOTAL Points							

The following are not acceptable justifications for deeming a credit 'not applicable':

- The scope of a contract does not address the issue;
- Achieving the credit is deemed to be too expensive, difficult, or time-consuming;
- Local laws or regulations prohibit meeting the requirements;
- Those conducting the Envision assessment do not have decision-making authority; or
- Stakeholders have indicated that the issue is not a priority.

In cases where local laws or regulations prohibit actions that would meet the credit requirements project teams must comply with these laws and regulations and pursue points in other credits. However, conflicting local laws and regulations do not make the sustainability indicator nonexistent. For example, certain projects may be required by regulations, or policies to use bright external lighting. This does not mean light pollution, or QL1.5 Minimize Light Pollution, is not applicable to the project.

RELATED ENVISION CREDITS

Many of the Envision credits are interrelated. Each credit includes a list of potentially related credits, so the project team can leverage the synergies created by these connections to improve the overall sustainability of their project. However, for every project the interrelationship of credits may vary. Project teams are still encouraged

to think carefully about how strategies to achieve points in one credit may positively or negatively impact achievement in another.

INNOVATION

The Envision framework strongly encourages innovative methods that advance sustainable infrastructure practices or show exceptional performance beyond the expectations of the credit requirements. Each category includes an "Innovate or Exceed Credit Requirements" credit, indicated by a "0.0". Projects may achieve all or part of the points in these credits. The 0.0 credits are not required and these points act as bonus points that are added to the category and total score.

Innovation credits include three options to earn bonus points. The project team may submit for one or bundle multiple in a single category. The three options are:

- **Innovation:** Sustainability solutions that overcome significant problems, barriers, and/or limitations or create scalable and/or transferable solutions for the industry.
- **Exceptional Performance:** Performance in one or more credits that exceeds the highest available level of achievement.
- **Additional Aspects of Sustainability:** A sustainability indicator not already included in the Envision framework.

ENVISION VERIFICATION PATHWAYS

Pathway A: Design + Post-Construction



Pathway B: Post-Construction



Third-Party Verification and Award

ONLINE SCORESHEET

The Envision Scoresheet is an online tool that allows project teams to collaboratively assess projects using Envision, upload documentation, describe key features of the project, and register the project for third-party verification. Scores are automatically tallied by credit category and for the whole project. An account is required to access the online scoresheet on ISI's website.

VERIFICATION PROCESS

Recognition is an important component of increasing awareness and initiating systemic change. ISI offers an optional third-party verification and awards program for recognizing sustainable project achievements. ISI's independent project verification program is a transparent process to confirm that a project meets Envision evaluation criteria.

For projects seeking verification, users must provide a credit submittal for each credit being pursued. A credit submittal includes both a narrative (or cover sheet), as well as supporting documentation. The narrative must contain clear and direct responses to the evaluation criteria required for the level of achievement being pursued. Supporting documentation—such as that described in the numbered items listed beneath the evaluation criteria—also forms a crucial component of the credit submittal. Supporting documentation should be referenced in the credit narrative, and relevant pages/sections should be annotated or highlighted for ease of reference.

The ENV SP, verifier, and ISI staff play central roles in the verification process. The verifier is a qualified third-party expert contracted by ISI. ISI hires verifiers from a range of backgrounds to conduct peer reviews of infrastructure projects seeking formal recognition for their sustainable attributes. Envision gives recognition to infrastructure projects that make exemplary progress and contribute to a more sustainable future. To this end, the verifier's

primary responsibilities are to thoroughly review project documentation submitted by the ENV SP, determine appropriate levels of achievement, and in cases where the verifier's level of achievement selection differs from that of the ENV SP, provide guidance explaining their selection and what would be required to advance to a higher level of achievement. ISI staff provide oversight and quality control throughout the verification process.

Projects may choose to pursue verification either after the design phase (at or after 95% design completion) or after the construction phase (at or after 95% construction completion). Projects pursuing verification after the design phase will be required to complete an additional post-construction review follow-up. In these cases, this post-construction review is required to maintain the Envision award earned after the design phase. The purpose of the post-construction review is to validate that the commitments made in the planning and design stages of the project were carried through during construction.

Projects may choose to pursue one of two verification pathways:

- **Path A: Design + Post-Construction**
- **Path B: Post-Construction**

VERIFICATION AWARD LEVELS

To receive recognition, projects must achieve a minimum percentage of the total applicable Envision points. Projects can be recognized at four award levels:

- **Verified:** 20%
- **Silver:** 30%
- **Gold:** 40%
- **Platinum:** 50%





Quality of Life

Quality of Life addresses a project's impact on host and affected communities, from the health and wellbeing of individuals to the wellbeing of the larger social fabric as a whole. Quality of Life focuses on assessing whether infrastructure projects align with community goals, are incorporated into existing community networks, and will benefit the community in the long term. Community members affected by the project are considered important stakeholders in the decision-making process. The category is further divided into three subcategories: **Wellbeing, Mobility, and Community.**

14 / credits

Image

Historic Fourth Ward Park in Atlanta, Georgia (Envision Gold, 2016)

- 1 Does the project improve health and safety for the broader community?
- 2 Does the project preserve and enhance cultural resources?
- 3 Does the project meet the needs and goals of the community?
- 4 Does the project make a minimal negative impact on the surrounding community?
- 5 Was the development process fair, equitable, and inclusive?
- 6 Is the project located near public transportation?

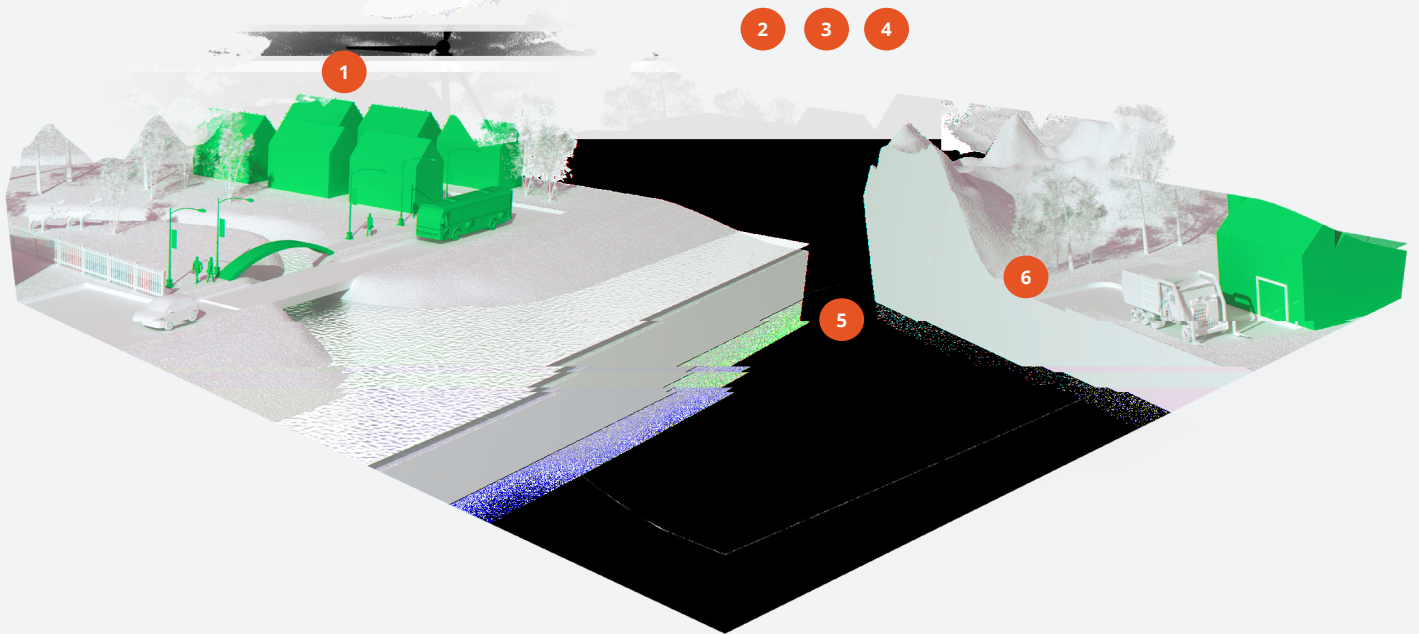

WELLBEING

As integral parts of the community, sustainable infrastructure projects address individual comfort, safety and health. During construction and operation, physical safety of workers and residents are ensured and nuisances minimized (including light pollution, noise, and vibration). These components align to heighten the community experience.

MOBILITY

This subcategory addresses the project’s impact on transportation in and around the community. Attention is given to encouraging sustainable modes of transportation and incorporating the project with the larger community mobility network. Infrastructure owners are encouraged to enable access and mobility to enhance community livability.

COMMUNITY

It is important that the project maintain or enhance strong and cohesive communities. While infrastructure primarily is driven by engineering parameters, its impact on equity, culture, and the community fabric should also be considered during design and construction. While the qualities and boundaries of what constitutes the affected community may vary depending on whether the project is located in a rural or urban setting it is always important to consider the project’s collective impact on society.



Quality of Life

WELLBEING

- QL1.1 Improve Community Quality of Life
- QL1.2 Enhance Public Health and Safety
- QL1.3 Improve Construction Safety
- QL1.4 Minimize Noise and Vibration
- QL1.5 Minimize Light Pollution
- QL1.6 Minimize Construction Impacts

MOBILITY

- QL2.1 Improve Community Mobility and Access
- QL2.2 Encourage Sustainable Transportation
- QL2.3 Improve Access and Wayfinding

COMMUNITY

- QL3.1 Advance Equity and Social Justice
- QL3.2 Preserve Historic and Cultural Resources
- QL3.3 Enhance Views and Local Character
- QL3.4 Enhance Public Space and Amenities

- QL0.0 Innovate or Exceed Credit Requirements
-



QL1.1 Improve Community Quality of Life

26

POINTS

INTENT

Improve the net quality of life of all communities affected by the project and mitigate negative impacts to communities.

METRIC

Measures taken to assess community needs and improve quality of life while minimizing negative impacts.

LEVELS OF ACHIEVEMENT

IMPROVED	ENHANCED	SUPERIOR	CONSERVING	RESTORATIVE
A + B	A + B + C + D	A + B + C + D + E	A + B + C + D + E + F	A + B + C + D + E + F + G
(2) Community Considerations	(5) Community Linkages	(10) Broad Community Alignment	(20) Holistic Assessment & Collaboration	(26) Protecting The Future
<p>(A) The project team identifies and takes into account community needs, goals, and issues. For example, the project team has located and reviewed the most recent community planning information and assessed relevant community needs, goals, and/or issues.</p> <p>(B) The project meets or supports community needs and/or goals.</p>				
<p>(C) The project assesses the social impacts it will have on the host and affected communities' quality of life.</p> <p>(D) The affected communities are meaningfully engaged in identifying how the project supports community needs and/or goals.</p>				
<p>(E) Based on the social assessment, potential negative impacts on the host or nearby affected communities are mitigated following a hierarchy that prioritizes avoidance, minimization, restoration, and offsetting.</p>				
<p>(F) Community satisfaction is demonstrated by feedback from the stakeholder engagement process verifying actions taken in criteria A, B, C, and D.</p>				
<p>(G) The project proactively addresses trends in changing social, economic, and/or environmental conditions within the community in order to ensure a high quality of life over the long term.</p>				

DESCRIPTION

This credit addresses the extent to which a project contributes to the quality of life of the host and affected communities. As this can be subjective, the credit criteria address how well the project team has identified, assessed, and incorporated community needs, goals, and issues into the project. Relevant community plans are assumed to be a viable expression of those needs, goals, objectives, and aspirations. In a real sense, they are the community's desired quality of life.

Unfortunately, infrastructure projects are often perceived as having negative impacts on communities. This "not in my back yard" (NIMBY) mentality can be addressed through active engagement and the proper alignment of projects with community needs, goals, and issues. Community support and engagement are critical to ensure the appropriate and effective investment of resources in infrastructure. Project teams and owners should consider how aligning the project

with community goals reduces the risk of community conflicts that disrupt project delivery and increase cost.

PERFORMANCE IMPROVEMENT

Improved: The project team can demonstrate an understanding of the community needs, goals, and issues, and communicate how the project meets or supports those goals.

Enhanced: Communication and interactions with community stakeholders are essential to reaffirm and improve the project objectives. The project team works closely with community stakeholders to identify and assess potential social impacts. Social impacts include the intended and unintended social consequences, both positive and negative, of infrastructure projects and any social changes initiated by those projects.

Superior: Infrastructure projects often include difficult trade-offs involving positive and negative impacts, and a project designed to benefit one community may have adverse effects on others. In addition, the needs of a community may conflict with their expressed goals. Because positive impacts in all dimensions of performance may not be possible, the credit seeks a net positive impact. Importantly, the project benefits and impacts should be equitably distributed throughout the host and affected communities.

Conserving: Community satisfaction is the metric for quality of life. It should be evident that the community truly understands the full impact (positive and negative) of the project and is satisfied that it addresses their needs and goals while appropriately mitigating negative impacts. Documentation of community endorsement should be as broad as possible and specific to the requested documentation.

Restorative: The project team proactively identifies instances where long-term trends in socioeconomic or environmental conditions may undermine existing community aspirations and addresses them in the project.

Applicability: It is likely that all projects have the ability to align project objectives with community needs and goals, identified through active engagement, in order to achieve broad community satisfaction. It would therefore be difficult to demonstrate that the credit is not relevant or applicable to a project seeking an Envision award.

EVALUATION CRITERIA AND DOCUMENTATION GUIDANCE

A. Has the project team identified and taken into account community needs, goals, and issues?

1. Documentation that the project team has located and reviewed the most recent community planning information and assessed relevant community needs, goals, and/or issues. For example, meeting minutes with key stakeholders, community leaders, and decision makers; letters; and memoranda.

B. Does the project meet or support the needs and goals of the host and/or affected communities?

1. Evidence showing a comparison of the project vision and goals to the needs, goals, and/or issues of the community.

C. Has the project team assessed the social impacts the project will have on the host and affected communities' quality of life?

1. Assessing, identifying and evaluating the positive and negative social impacts of the project on affected communities' quality of life (e.g., a social impact assessment). Expectations for the depth and breadth of documentation are commensurate with the scale of the project and its impact on the broader community. Informal assessments are acceptable for small projects, provided that project teams present evidence supporting their conclusions.

D. Have the affected communities been meaningfully engaged in identifying how the project meets community needs and/or goals?

1. Documentation of processes for collecting, evaluating, and incorporating community input into the planning and design process (e.g., meetings, design charrettes, and communications with representatives of affected communities).

E. Has the project team addressed negative social impacts?

1. Evidence showing the extent to which options for mitigating negative impacts were identified and prioritized, and reasonable changes to the project made. Strategies for mitigating negative impacts should follow a hierarchy prioritizing avoidance, minimization, restoration, and offsetting.

F. Are the affected communities satisfied that the project addresses their needs and goals as well as mitigates negative impacts?

1. Acknowledgments and endorsements by the community that the design participation process was helpful and that their input was appropriately assessed and incorporated into project design.
2. Documentation of input and agreement from key stakeholders, community leaders, and/or decision makers regarding the impact assessment and planned action(s) (e.g., community satisfaction surveys, interviews with representatives of affected communities, comments and reactions from social media platforms). Specific statements about critical issues or actions taken within the project are better indicators of a true understanding of the project's impacts than general endorsements of the project as a whole. Evidence of community satisfaction and endorsement of plans includes:
 - a. Community endorsement of the project team's assessment of their needs or goals per criterion A.
 - b. Community endorsement that the project as proposed will address their needs or goals per criterion B.
 - c. Documentation that the community understands and accepts potential impacts of the project per criterion C.
 - d. Community endorsement of project strategies to mitigate negative impacts per criterion D.

G. Does the project proactively address long-term social, economic, or environmental changes that impact quality of life?

1. Documentation of long-term social, economic, or environmental changes/trends that may impact community goals and needs over time (e.g., aging population, economic transitions, or the degradation of the environment and ecosystem services). Note that social, economic, and environmental shifts are often connected. The degradation of the environment in a coastal community dependent on tourism and fishing negatively impacts the economy, which can lead to social impacts such as shrinking population. Consequently, the quality of life of the community is put at risk.
2. Documentation demonstrating how the project will proactively address one or more of these changes/trends.
3. Documentation demonstrating how the project represents a smart long-term investment for the community's future.

RELATED ENVISION CREDITS

QL1.2 Enhance Public Health and Safety

QL2.3 Improve Access and Wayfinding

LD1.3 Provide for Stakeholder Involvement

LD2.2 Plan for Sustainable Communities

LD3.1 Stimulate Economic Prosperity and Development

CR2.5 Maximize Resilience



QL1.2 Enhance Public Health and Safety

20

POINTS

INTENT

Protect and enhance community health and safety during operation.

METRIC

Measures taken to increase safety and provide health benefits on the project site, surrounding sites, and the broader community in a just and equitable manner.

LEVELS OF ACHIEVEMENT

IMPROVED	ENHANCED	SUPERIOR	CONSERVING	RESTORATIVE
A + B	A + B + C	A + B + C + D	A + B + C + D + E	A + B + C + D + E + F
(2) Understanding Impacts	(7) Prioritizing Risk Reduction	(12) Improving Health & Safety	(16) Shared Benefits	(20) Protecting Communities
(A) The project meets all health and/or safety regulations and laws for operation.				
(B) The project includes health and/or safety improvements beyond minimum requirements established by regulations and laws.				
(C) The project improves health and/or safety for its immediate surroundings.				
(D) The project demonstrates a net positive impact on health and/or safety for the host or affected communities.				
(E) The health and safety benefits and/or negative impacts are equitably distributed within affected communities, and the project team can demonstrate that the project does not disproportionately burden one community over another (i.e., social/environmental justice).				
(F) The project provides critical infrastructure services to communities experiencing, or at risk of experiencing, imminent, negative health and/or personal safety impacts				

DESCRIPTION

Any Envision project must meet all safety and health regulations as required by law. This credit recognizes the opportunities many projects have to exceed minimum regulatory requirements, or to improve health and/or safety within a project or community in other ways. The credit assesses the degree to which infrastructure projects contribute to increased safety and health benefits on the project site, surrounding sites, and the broader community. Envision does not in any way replace, supersede, or create exceptions for existing local, state/provincial, or national health and safety regulations.

Project teams and owners should consider how improving the safety and health benefits of the project, its surroundings, and the broader community, and communicating these benefits to stakeholders, can help combat negative perceptions that lead to conflicts and project delays (e.g., "NIMBY"). Enhancing and emphasizing positive health and safety benefits can help change public perception about the value of infrastructure.

PERFORMANCE IMPROVEMENT

Documentation for this credit may include actions taken in compliance with existing local, state/provincial, or federal regulations or laws. However, to achieve points for this credit, projects must first demonstrate that they include health and/or safety improvements beyond minimum requirements for project operations.

Improved: Envision assesses sustainable performance beyond conventional practice. Therefore, meeting all applicable laws and regulations is an overarching prerequisite. This credit requires projects to demonstrate compliance in order to highlight the value of these actions and to distinguish actions taken above and beyond minimum requirements. The improved level focuses primarily on the scope of impact within the project boundary.

Enhanced: Health and safety improvements expand from an internal focus to include the immediate surroundings. Examples include features to improve safety when entering and exiting

the site; efforts to decrease violence and/or vandalism; and actions taken to prevent spills or local contamination.

Superior: Health and safety improvements benefit not only the immediate surroundings but the broader community, such as improving air quality and water quality, providing access to walking and biking trails, removing or repairing infrastructure at risk of failure, and more.

Conserving: Project teams cannot always eliminate risks to health and safety, but they can demonstrate that both the benefits and exposure to risks associated with the project are distributed in a fair and equitable manner and that one community is not disproportionately burdened over another. When there is resistance to the placement of infrastructure within a region due to potential or perceived negative impacts, it is often those communities least able or least empowered to voice their concerns that eventually receive the burden. Project teams and infrastructure owners should carefully guard against following this path of least resistance.

Restorative: Projects provide relief or critical infrastructure services to communities experiencing, or at risk of experiencing, imminent, negative health and/or personal safety impacts. This is where existing conditions have dropped below minimum standards for health or safety. Examples include communities where drinking water quality has reached unhealthy levels, where bridges are at imminent risk of collapse, or where critical infrastructure services are not available or no longer functioning.

Applicability: It is likely that all projects, large and small, have the ability to positively impact health and/or safety in some way. Safety actions can be relative to the scale of the project, from repainting a crosswalk to preventing major chemical spills. It would therefore be difficult to demonstrate that the credit is not relevant or applicable to a project seeking an Envision award.

EVALUATION CRITERIA AND DOCUMENTATION GUIDANCE

A. Does the project meet all health and safety regulations and laws for operations?

1. Documentation that the design and operation of the project are, or will be, compliant with all relevant health and safety regulations and laws.

B. Has the project exceeded minimum legal health and safety requirements as established by regulations and laws?

1. Documentation of actions taken, beyond what is minimally required by law, to improve health and/or safety during project operations. Project teams may include cases where the project owner has implemented policies that exceed regulations. Note that siting the project to avoid or minimize risks to health or safety may be included. However, documentation must demonstrate these siting decisions were intentional.
2. Index of health and safety improvements identifying improvements to project operations.
3. Project teams may choose to include a detailed narrative of decision making focused on critical health and safety risks that represent the largest or most likely potential impacts for the project, supported by more general documentation indicating how project features reduce these risks.

C. Does the project include health and safety improvements for the immediate surroundings?

1. Index of health and safety improvements identifying improvements to the project's immediate surroundings (e.g., protected areas or elevated walkways for pedestrians, clear lines of sight to traffic, improved lighting, etc.). Improvements may include risk reduction strategies. Note that siting the project to avoid or minimize risks to the immediate surroundings may be included. However, documentation must demonstrate these siting decisions were intentional.

D. Does the project include health and safety improvements for the broader host or affected communities?

1. Index of health and safety improvements identifying improvements to the broader host or affected communities (e.g., reduced pollution in surface waters, higher water quality, better air quality, access to healthy activities, access to health services, etc.). Note that siting the project to avoid or minimize risks to the broader affected communities may be included. Examples may also include the project's ability to reduce external risks (e.g., a park that can be used for flood control). However, documentation must demonstrate these decisions were intentional.

E. Can the project team demonstrate that health and safety risks and impacts are not disproportionately borne by one community over another?

1. Documentation demonstrating that health and safety risks and impacts are not disproportionately borne by a community. Examples may include site maps showing areas of risk or impact overlaid with key demographic data. This evaluation should consider historic factors of equity and social justice within the project context. This is also commonly referred to as "environmental justice."
2. Documentation that mitigation measures were proportionately distributed to communities most impacted by the project.

F. Will the project provide critical infrastructure services to communities experiencing, or at risk of experiencing, imminent negative health and/or personal safety impacts?

1. Documentation of how the community is currently experiencing or is at risk of experiencing health and/or safety impacts (e.g., contaminated drinking water).
2. Documentation of how the project will provide the critical infrastructure services necessary to resolve, or significantly reduce, the impacts. The scale of impact must be at the community level and commensurate with the scope and size of the project. Projects cannot receive the Restorative level for eliminating or reducing health and/or safety impacts solely within the project boundary.

RELATED ENVISION CREDITS

- QL1.1 Improve Community Quality of Life
- QL2.2 Encourage Sustainable Transportation
- QL2.3 Improve Access and Wayfinding
- QL3.1 Advance Equity and Social Justice
- NW2.1 Reclaim Brownfields
- NW2.3 Reduce Pesticide and Fertilizer Impacts
- NW2.4 Protect Surface and Groundwater Quality
- CR1.3 Reduce Air Pollutant Emissions
- CR2.4 Establish Resilience Goals and Strategies



QL1.3 Improve Construction Safety

14

POINTS

INTENT

Enhance public and worker safety during construction.

METRIC

Commitments and measures to monitor safety, provide feedback mechanisms, train personnel, establish security plans, and make health programs available.

LEVELS OF ACHIEVEMENT

IMPROVED	ENHANCED	SUPERIOR	CONSERVING	RESTORATIVE
A + B	A + B + C	A + B + C + D	A + B + C + D + E	Not Available
(2) Commitment to Safety	(5) Risk Analysis, Training and Security	(10) Safe Work Practices and a Secure Site	(14) Health Beyond the Site	
<p>(A) The owner and general contractor/construction manager have made strong commitments to monitor and improve health and safety for onsite construction operations.</p> <p>(B) The project execution plan requires internal documentation that tracks health and safety performance and corrects deficiencies or promotes best practices during construction.</p>				
<p>(C) Contractor implements safety and/or security competency training for all field personnel. Contractor or owner provides minimum training requirements for health and safety programs.</p>				
<p>(D) The owner and contractor have a specific site and project security plan.</p> <p>The plan includes physical security as well as information security when appropriate.</p> <p>The contractor provides minimum training requirements.</p>				
<p>(E) The owner or contractor provides programs that promote health and well-being, such as free health screenings or workshops.</p>				

DESCRIPTION

This credit addresses the critical goal of improving health and safety practices during construction. Having and promoting a common focus on health and safety throughout the construction industry has benefits that extend beyond the individual project.

Improved construction safety can also have benefits beyond the protection of health and human life. Companies that have a record in job site safety attract better employees, have higher retention rates, and are more competitive in the marketplace. The rigor of applying, training, and adhering to health and safety procedures can also increase productivity by standardizing job site activities.

Enhanced health and safety practices are encouraged beyond industry norms. However, a novel approach may introduce risks that were not present prior to instituting the new program or technology. Project teams should conduct hazard analyses and develop construction safety plans to address risks associated with using new materials, technologies, and/or methodologies.

Days Away, Restrictions, or Transfers (DART) rates are a mathematical calculation of the number of recordable incidents per 100 full-time employees that resulted in lost or restricted days or job transfer due to work-related injuries or illnesses. From this data, many leading construction companies find that the return on investment for implementing better health and safety standards is higher than the cost and lost time associated with job site incidents.

PERFORMANCE IMPROVEMENT

The levels of achievement for this credit address safety procedures for onsite workers, personnel training and development, and site and information security. These themes not only protect the men and women working on the site, they help to maintain safe and secure operations of the asset and provide a foundation for proper operations and maintenance of the facility.

Improved: Improved safety begins with commitment at the highest levels and a plan to implement improvements, track performance, and correct deficiencies. There are clearly documented efforts

to assess onsite hazards and implement preventative solutions, leveraging technology to identify and assess hazards and improving the health and well-being of the industry's workforce.

Enhanced: Education and training are critical to achieving increased safety performance.

Superior: Safety plans include the site and information security.

Conserving: Consideration for health and safety extends beyond immediate job site hazards and considers the broader health and well-being of workers.

Applicability: All projects that include construction have the ability to positively impact construction safety. It would therefore be difficult to demonstrate that the credit is not relevant or applicable to a project seeking an Envision award.

EVALUATION CRITERIA AND DOCUMENTATION GUIDANCE

A. Have the project owner and contractor (GC/CM) made strong commitments to monitoring and improving health and safety?

1. Documentation that owners and contractors implemented a proactive safety rewards program to support outstanding safety performance.
2. Documentation that the contractors developed a program/requirements to ensure that their subcontractors maintain a high level of safety per the contract.
3. Documentation that the contractor's senior managers are engaged in the project safety program and conduct safety observations and inspections as part of their standard duties.
4. Documentation through commitments that safety is a core concern.

B. Does the project include reliable feedback mechanisms to identify risks, conduct hazard analyses, and communicate hazards to personnel?

1. Documentation that the owner and contractors developed a proactive investigative process that focuses on root cause and corrective actions vs. disciplinary actions and financial penalties.
2. Documentation that contractors have a proactive injury management system that supports efficient, effective and timely treatment of their employees injured on the job site.
3. Documentation that owners and contractors have an incident review process that involves all levels of management to validate corrective measures to minimize future injuries and incidents on the job site
4. Documentation that contractors develop "lessons learned" reports that allow other contractors and projects the opportunity to review the fact-finding of an incident and implement processes and procedures to minimize similar incidents on the job site.

C. Does the project include safety or security training requirements for personnel?

1. Documentation of safety and/or security competency training programs, either online or in person, for field personnel, including type of training provided and how they specifically target health and safety. Training may include task-specific safety training or general awareness training.

2. Documentation of minimum training requirements for health and safety programs such as occupational safety and health, first aid, CPR, emergency response, active shooter training, or equivalent.

D. Does the project include a comprehensive security plan to protect workers, the public, and sensitive information?

1. Documentation that the owner and contractor have a specific site and project security plan. This plan may include, but is not limited to, contractor background checks on personnel working on the project, and 24-hour security monitoring on the project (physical/electronic). The security plan should be appropriate to the size and scope of the project.
2. For small projects (under \$5 million in cost), owners and contractors may substitute general site security policies for the site-specific plan.

E. Does the project include health and/or well-being programs?

1. Documentation that the project provides health and/or well-being programs beyond the specific activities associated with project delivery. This may include, but is not limited to, health screenings for workers, nutrition or exercise workshops, and/or free vaccinations.

RELATED ENVISION CREDITS

QL1.2 Enhance Public Health and Safety

LD3.2 Develop Local Skills and Capabilities

PROJECT EXAMPLE: BOSTON LANDING STATION

The construction of the Boston Landing Station (Envision Silver, 2017) in Brighton, Massachusetts required a fair amount of "foul time" work to be performed. "Foul time" occurs when work is within 15 feet of active track. For safety reasons, work within this distance from the track must halt until trains pass. Upon further study, the contractor developed a safer approach to perform station construction: by temporarily relocating track, foul time was reduced, and worker safety enhanced.





QL1.4 Minimize Noise and Vibration

<h2 style="font-size: 2em; margin: 0;">12</h2> <p style="margin: 0;">POINTS</p>	<p>INTENT</p> <p>Minimize noise and vibrations during operations to maintain and improve community livability.</p>	<p>METRIC</p> <p>The extent that operational noise and vibration is assessed and mitigated, and target levels achieved.</p>
---	---	--

LEVELS OF ACHIEVEMENT

IMPROVED	ENHANCED	SUPERIOR	CONSERVING	RESTORATIVE
A + B	A + B + C	A + B + C + D	A + B + C + D + E	A + B + C + D + E
(1) Noise Assessment	(3) Target Noise Levels	(6) Stakeholder Support	(10) No Noise Increase	(12) Noise Reductions
<p>(A) The project team assesses the potential for operational noise impacts on the surrounding community and/or environment. This assessment occurs when applicable vibrations are considered as a potential source of noise and/or disruption.</p> <p>(B) Strategies are implemented to mitigate noise and/or vibrations during operations. Noise reduction follows a mitigation hierarchy of avoidance/source elimination, minimization, abatement/receiver reduction, and offsetting/compensation.</p>				
<p>(C) The project adopts existing, or works with the community to set, target project noise levels for the impacted community</p>				
<p>(D) The stakeholder engagement process demonstrates community awareness of targets (i.e. criterion C), mitigation strategies (i.e. criterion B), and noise impacts (i.e. criterion A).</p>				
			<p>(E) Noise reduction strategies and controls are sufficient to not increase noise within the surrounding community beyond existing conditions.</p>	<p>(E) Noise reduction strategies and controls are sufficient to reduce noise within the surrounding community beyond existing conditions.</p>

DESCRIPTION

This credit addresses noise and vibrations during project operations. Credit QL1.6 Minimize Construction Impacts addresses construction-related noise and vibrations. “Noise” is defined as an unwanted or disturbing sound. It becomes unwanted when it interferes with normal activities or diminishes quality of life.

Noise is a common complaint against a wide variety of infrastructure projects. Noise can have significant negative health effects, including hearing impairment, hypertension, and sleep disturbance. It can also reduce performance in cognitive tasks. Residential property values may be improved as a result of reduced ambient noise levels. Noise pollution can also interfere with animal communication, predator-prey relations, and mating habits, particularly among birds.

Addressing operational noise is an important step for incorporating infrastructure into communities and the environment. This is particularly true during stakeholder engagement to demonstrate that community concerns are being heard. Setting noise reduction targets can often provide an impetus to consider creative and innovative alternative solutions.

PERFORMANCE IMPROVEMENT

Improved: The project team assesses the impact of operational noise and implements siting strategies and/or structural controls to minimize noise and/or vibrations. When applicable, project teams should consider vibrations as a potential source of noise transmission. Mitigation measures may include, for example, the use of soundproofing or noise barriers, relocating sources away from populated areas, or pavements designed to reduce traffic noise.

Enhanced: The project team moves beyond unilateral implementation of noise controls and works with impacted stakeholders to establish or adopt existing target noise levels.

Superior: Stakeholder engagement in noise mitigation is comprehensive in terms of understanding noise sources, targets, and the choices and potential consequences of mitigation measures (e.g., a large sound barrier vs. source reduction).

Conserving: The project team eliminates or completely mitigates noise impacts.

Restorative: The project involves actively removing an existing source of noise or implements new controls that reduce existing noise levels.

Applicability: Consideration is given to whether the project will have any operational noise. Noises generated by activities induced by the project, such as cars on roads, pedestrians in parks, and trucks accessing facilities, are applicable to this credit. Projects that do not include any operational noise may apply to have this credit deemed not applicable with supporting documentation.

EVALUATION CRITERIA AND DOCUMENTATION GUIDANCE

A. Has the project team assessed the potential for operational noise impacts on the surrounding community and/or environment?

1. Index of all potential noise generation sources related to the project, including the potential for noise-generating vibrations when applicable.
2. Assessment of impacts generated as a result of the project noise and vibrations. This should include, when applicable, increased vehicle or pedestrian noise generated as a result of the project. This should also include potential noise-generating vibrations.

B. To what extent has the project mitigated noise generated as a result of the project?

1. Documentation of all noise mitigation measures used throughout the project. Examples may include drawings and specifications indicating equipment is inherently quieter than typical (e.g., electric motors rather than combustion engines) or equipment has been modified to reduce noise and vibrations at their source. Noise mitigation may include a variety of strategies, including but not limited to minimizing noise generation, siting to reduce noise impacts, natural vegetation and landscaping buffers, and/or structural controls.
2. Narrative explaining how mitigation measures follow a hierarchy that prioritizes avoidance, minimization, source abatement, receptor abatement, and compensation/offsetting.

C. Does the project set or adopt target noise levels?

1. Documentation that the project has adopted or set target noise levels for communities potentially affected by project noise.
2. Evidence that noise generated as a result of the project will not exceed the target noise levels for impacted communities. Note that these targets are the maximum acceptable noise levels for the receiving communities (people or animals) and should include existing ambient noise levels.

D. Has the project team engaged impacted stakeholders on issues of noise and vibration impacts, mitigation strategies, and target levels?

1. Evidence of community engagement in understanding noise impacts and the development of operational noise targets and mitigation strategies.

E. To what extent will the project maintain or reduce existing noise levels?

1. Analyses and documentation of baseline and anticipated operational noise and vibration levels. In certain cases, project teams may demonstrate why a baseline noise level is not necessary in order to determine credit achievement.
2. Documentation that mitigation measures implemented on the project are sufficient to have no noticeable (to the human ear) noise increase within the surrounding community beyond existing conditions.

OR

Documentation that mitigation measures implemented on the project are sufficient to noticeably (to the human ear) reduce noise within the surrounding community beyond existing conditions.

RELATED ENVISION CREDITS

LD1.3 Provide for Stakeholder Involvement

RA1.5 Balance Earthwork On Site

NW3.1 Enhance Functional Habitats



PROJECT EXAMPLE: EXPO 2 LIGHT RAIL EXTENSION

Several sound recording studios operate in close proximity to the Expo 2 Light Rail Extension project (Envision Platinum, 2017). Located in California, the project connects downtown Los Angeles to Santa Monica. The project team identified and applied non-standard technology to minimize the impact of sound decibels and vibration levels that light rail trains emit through the track system that would negatively impact studio operations. The specialized track was constructed using spring elements under the floating track bed. This allows noise and vibration to dissipate horizontally across the track, rather than vertically, which impacts the quality of the sound recordings in nearby studios.



QL1.5 Minimize Light Pollution

12

POINTS

INTENT

Reduce backlight, uplight, and glare without jeopardizing safety during operations.

METRIC

Lighting meets backlight, uplight, and glare requirements for lighting zones.

LEVELS OF ACHIEVEMENT

IMPROVED	ENHANCED	SUPERIOR	CONSERVING	RESTORATIVE
A + B	A + B + C	A + B + C + D	A + E	A + E + F
(1) Light Pollution Reduction	(3) Master Lighting Plan	(6) Eliminating Uplight	(10) Backlight, Uplight, and Glare Reduction	(12) Night Sky Restoration
(A) The project identifies lighting needs and sensitive community and environmental areas potentially impacted by light pollution during operations.				
(B) The project reduces light pollution following a mitigation hierarchy of avoidance, minimization, protection, and offsetting.				
(C) The project implements a master lighting plan establishing lighting zones. For each zone, the plan outlines lighting goals, safety and security needs, specifies environmental conservation, and reduces lighting when no longer needed.				
			(D) Light emission beyond 90 degrees is prevented. All project lighting meets BUG rating uplight requirements with no light emitted above 90 degrees.	(E) All project lighting meets backlight, uplight, and glare requirements according to IES BUG rating standards.
			(F) The project involves the removal or retrofitting of existing lighting so as to significantly reduce (>10%) overall existing lighting.	

DESCRIPTION

This credit follows the guidelines of the Model Lighting Ordinance issued by the International Dark-Sky Association and the Illuminating Engineering Society (IES) of North America. The Model Lighting Ordinance outdoor lighting template utilizes the IES TM-15-11 “BUG” (Backlight, Uplight, and Glare) classification of outdoor lighting fixtures and is designed to help municipalities develop outdoor lighting standards that reduce glare, light trespass, and skyglow.

High levels of ambient light are undesirable for humans from both an aesthetic and health perspective. Light pollution has the potential to disrupt circadian rhythms and human sleep patterns, which may have numerous health implications. Light spillage also disturbs nocturnal animals and interferes with sensitive environments, including open space, wilderness parks and preserves, areas near astronomical observatories, and other light-sensitive habitats. Finally, the cumulative

exterior light directed upward into the sky because of inappropriate lighting represents a massive waste of energy.

Well-designed lighting can maintain adequate light levels on the ground while reducing light pollution by using lighting more efficiently. Many cities and communities may be using more light than is necessary and could benefit from a lighting-needs audit and assessment. By directing light only to where it is needed, project lighting can be more efficient and save costs.

PERFORMANCE IMPROVEMENT

Improved: The Model Lighting Ordinance methodology includes five lighting zones (LZ) to classify land use with appropriate lighting levels. Project teams should identify potential impacts and reduce light pollution. Activities at this level can be informal.

Enhanced: Lighting assessment is formalized and light pollution reduction strategies are coordinated and comprehensive. However, it is not required to demonstrate total compliance with the ordinances IES TM-15-111 “BUG” (Backlight, Uplight, and Glare) requirements.

Superior: The project helps to preserve the night sky by meeting the uplight requirements that limit lighting to below 90 degrees. This is considered an effective option for projects where safety concerns do not permit lower light levels.

Conserving: The project complies with the ordinance requirements for backlight, uplight, and glare. As an industry standard, these ratings are often readily available by suppliers and manufacturers. However, it is also acceptable for project teams to submit their own BUG calculations.

Restorative: The project team eliminates or retrofits preexisting sources of light pollution.

Applicability: This credit is not applicable if projects do not include any exterior lighting. Certain types of projects may be required to use lighting that is incompatible with the credit requirements. This is not considered an acceptable reason for designating the credit as not applicable. Projects that are unable to demonstrate achievement in this credit are encouraged to pursue higher performance in other credits.

EVALUATION CRITERIA AND DOCUMENTATION GUIDANCE

A. Has the project team conducted an assessment of lighting needs and impacts for the project?

1. A site map indicating lighting needs and potential impacts on the project site and surrounding areas. Site map specifically identifies populated areas and natural habitats.
2. Assessment of how lighting may impact people, flora, and/or fauna in the area.

B. To what extent has the project implemented strategies to reduce light pollution?

1. Documentation indicating that light pollution reduction strategies were assessed and considered according to the following prioritization:
 - a. Avoidance: identifying where lighting may not be needed.
 - b. Minimization: determining the minimum lighting necessary to meet safety and performance requirements.
 - c. Protection: restricting light spillage to sensitive areas or directing light only to where it is needed.
 - d. Offsetting: compensating for lighting in one location by removing lighting in another location.
2. Site map indicating location and type of each lighting strategy deployed.

C. Has the project developed a lighting plan establishing lighting zones?

1. A lighting plan for the project including the establishment of lighting zones, with each zone addressing at minimum the following: lighting goals; safety and security needs; environmental conservation; energy efficiency; and reducing lighting when no longer needed.

Whereas criterion B may include isolated efforts to reduce light pollution, the intent of criterion C is to incorporate these actions under a more comprehensive review of lighting needs in order to maximize performance.

D. Will luminaires prevent light emission above 90 degrees?

1. Location and type of each luminaire.
2. Documentation that each luminaire type restricts light to below 90 degrees.

E. Do all project lights meet backlight, uplight, and glare (BUG) requirements for their respective lighting zones?

1. Location and BUG rating for each luminaire. If luminaires do not have a BUG rating, projects may also provide calculations demonstrating that luminaires meet BUG requirements for backlight, uplight, and glare based on IES and IDA standards.
2. Worksheet demonstrating that BUG ratings meet lighting zone requirements.

F. Does the project involve the removal or retrofitting of existing lighting so as to significantly reduce overall existing lighting?

1. Documentation that existing lighting will be removed or retrofitted as a result of the project. Significant reductions are generally considered to be greater than 10% of total lighting.

RELATED ENVISION CREDITS

QL3.3 Enhance Views and Local Character

RA2.1 Reduce Operational Energy Consumption

NW3.1 Enhance Functional Habitats

Backlight Rating	LZ 0	LZ 1	LZ 2	LZ 3	LZ 4
Mounting height (MH) to property line and properly oriented					
> 2 MH	B1	B3	B4	B5	B5
1-2 MH	B1	B2	B3	B4	B4
0.5-1 MH	B0	B1	B2	B3	B3
< 0.5 MH	B0	B0	B0	B1	B2

Uplight Rating	LZ 0	LZ 1	LZ 2	LZ 3	LZ 4
Allowed Uplight Rating	U0	U1	U2	U3	U4
Allowed % light emission above 90° for street or area lighting.	0%	0%	0%	0%	0%

Glare Rating	LZ 0	LZ 1	LZ 2	LZ 3	LZ 4
Allowed Glare Rating	G0	G1	G2	G3	G4
Reduced Allowed Glare by mounting height (MH)*					
1-2 MH	G0	G0	G1	G1	G2
0.5-1 MH	G0	G0	G0	G1	G1
< 0.5 MH	G0	G0	G0	G0	G1

* Reduced allowed glare for any luminaire not mounted with its backlight perpendicular to any property line within 2x the mounting height.



QL1.6 Minimize Construction Impacts

 POINTS	<p>INTENT</p> <p>Minimize or eliminate the temporary inconveniences associated with construction.</p>	<p>METRIC</p> <p>Extent of issues addressed through construction management plans.</p>
--	--	---

LEVELS OF ACHIEVEMENT

IMPROVED	ENHANCED	SUPERIOR	CONSERVING	RESTORATIVE
A + (B, C, D or E)	A + (B, C, D or E)	A + (B, C, D or E) + F	A + B + C + D + E + F	Not Available
(1) Initial Management Plan	(2) Expanded Plan	(4) Stakeholder Feedback	(8) Complete Plan	
<p>(A) The project team implements a construction management plan or policies to address the temporary inconveniences associated with construction. The plan or policies are informed by stakeholder engagement.</p>				
<p>(B, C, D, or E) The management plan addresses one (1) type of construction impact: noise, safety/wayfinding, access/mobility, or lighting,</p>	<p>(B, C, D, or E) The management plan addresses two (2) types of construction impacts: noise, safety/wayfinding, access/mobility, or lighting,</p>	<p>(B, C, D, or E) The management plan addresses three (3) types of construction impacts: noise, safety/wayfinding, access/mobility, or lighting,</p>	<p>(B, C, D, and E) The management plan addresses four (4) types of construction impacts: noise, safety/wayfinding, access/mobility, and lighting,</p>	
<p>(F) The construction management plan or policies include robust feedback mechanisms and performance monitoring and reporting for construction impacts.</p>				

DESCRIPTION

Infrastructure projects are long-term projects that may take years to complete construction. During this time, it is important for the project to have minimal negative impacts on the surrounding community. While completed infrastructure projects may go unseen by the public, the construction phase is often a time when a new project is most visible. Project teams can harness this as an opportunity to exemplify best practices. In doing so, they instill trust in the community, and can make further strides toward project acceptance.

There are a range of ways a project team can consider a community's needs during the construction phase. Similar to the operational impacts on a community, project teams consider the same impacts during construction because they may be elevated in this phase. Noise, vibrations, and light pollution should be minimized during construction so as to reduce disturbances to surrounding communities. Further, projects in construction should never impede on a community's safety or mobility.

PERFORMANCE IMPROVEMENT

Assessment for this credit is measured by how many impacts are addressed through the construction management plan. Negative impacts during the construction of an infrastructure project include: noise, safety/wayfinding, access/mobility, and lighting.

Improved: the project team must implement a construction management plan that addresses at least one type of construction impact.

Enhanced: The construction management plan includes mitigation of 2 construction impacts.

Superior: The construction management plan addresses 3 construction impacts while adding a robust feedback mechanism and performance monitoring.

Conserving: The construction management plan addresses 4 construction impacts while adding a robust feedback mechanism and performance monitoring.

Applicability: Consideration is given to whether the project includes construction activities with the potential to impact the quality of life of individuals. Projects that do not include construction impacts (e.g. an internal refurbishment of a private facility or extremely remote site) may apply to have this credit deemed not applicable with supporting documentation.

EVALUATION CRITERIA AND DOCUMENTATION GUIDANCE

A. Has the project implemented a construction management plan or policies to address construction impacts?

1. Documentation of a construction management plan or policies.
2. Documentation that the construction management plan or policies address concerns of stakeholders.

B. Does the construction management plan mitigate noise and/or vibrations?

1. Documentation of a management plan or policies to mitigate impacts of construction noise and/or vibrations to the extent feasible. Specifications for minimizing construction noise and vibration should meet or exceed accepted local practices. Programs should include details on the expected sources of significant noise and vibration, how the effects of those sources will be minimized, how noise and vibration will be monitored, and what corrective actions will be taken if specified levels are exceeded.
2. Documentation that the construction noise management plan includes stakeholder engagement and mechanisms for communities to report complaints. Documentation may include corrective actions taken in response to stakeholder reporting.

C. Does the construction management plan address safety and wayfinding for pedestrians and vehicles during construction?

1. Specifications of requirements and procedures for the contractor.

D. Does the construction management plan maintain access to public space and amenities during construction?

1. Documentation of strategies to:
 - a. Limit disruption and maintain access to public space and amenities during construction within the boundaries of safety

- b. Limit interruption of service
- c. Limit restrictions to public space and amenities

Note that moving access points and establishing detours is allowed so long as a similar level of service is provided. Applicants may also demonstrate that access to public space or amenities is not impacted by the project.

E. Does the construction management plan address distracting or intrusive lighting during construction?

1. Documentation that, to the extent feasible while maintaining safety, the project has sought to minimize distracting or intrusive lighting during construction.

F. To what extent have feedback mechanism and performance monitoring been incorporated into the construction management plan?

1. Documentation that there are feedback mechanisms in place for receiving and responding to public and stakeholder concerns during construction. The construction contractor is expected to work with affected neighbors to develop construction plans as well as monitoring and corrective action programs.
2. Documentation of programs to monitor and inform impacted stakeholders on project performance in addressing construction impacts.

RELATED ENVISION CREDITS

- QL1.2 Enhance Public Health and Safety
- LD3.2 Develop Local Skills and Capabilities



QL2.1 Improve Community Mobility and Access

14

POINTS

INTENT

Plan the project as part of a connected network that supports all transportation modes for the efficient movement of people, goods, and services.

METRIC

The extent to which the project broadens mode choices, reduces commute times, reduces vehicle distance traveled, and improves levels of service.

LEVELS OF ACHIEVEMENT

IMPROVED	ENHANCED	SUPERIOR	CONSERVING	RESTORATIVE
A + B	A + B + C	A + B + C + D	A + B + C + D + E	A + B + C + D + E + F
(1) Satisfactory Coordination	(3) Controlled Access	(7) Increased Access and Flow	(11) Connected Networks	(14) Restoring Community Connections
<p>(A) The project team demonstrates consistency with local and regional transportation plans.</p> <p>(B) The project team obtains input from the community and key stakeholders (e.g., public officials and operators of adjacent facilities, amenities, or transportation hubs) regarding improved access.</p>				
<p>(C) The project includes strategies to increase capacity, manage congestion, reduce vehicle distance traveled, or lower accident rates</p>				
<p>(D) The project team works with the community to expand mobility and access options and/or incorporate complete streets policies.</p>				
<p>(E) The project addresses long-term mobility and access needs of the community.</p>				
<p>(F) The project creates new or restores previous connections between communities.</p>				

DESCRIPTION

This credit addresses community mobility as a connected network for all modes, including private automobile usage, and focuses on the broader community benefits achieved from the efficient movement of people, goods, and services. It assesses quality-of-life benefits that mobility provides through greater access to jobs, education, and critical services. These include reducing commute times, reducing vehicle distance traveled, or improving levels of service.

Greater mobility provides freedom of choices when it comes to access to education, jobs, affordable housing, and even healthy food and activities. Congestion and impediments to mobility are also a key source of discontent within communities. Local studies can often be found calculating the lost personal time or economic activity due to congestion.

Project teams should consider how even non-transportation projects can become multi-benefit projects by contributing to more efficient mobility in the community. This may include how site access is configured, the mode with which it is accessed, or the frequency of trips to and from the site. For example, a park that incorporates a pedestrian overpass can improve the mobility of both cars and pedestrians.

PERFORMANCE IMPROVEMENT

The assessment of mobility in this credit is scalable, and expectations regarding the geographic scope of the assessment are relative to the scale of the project. For example, large rail projects might assess mobility across an entire region, while a small park project may assess mobility to and from local neighborhoods.

Improved: The project is consistent with local transportation plans that were developed and adopted through an inclusive public involvement process. Wherever possible, the project should consider its relationship to nearby housing, employment, shops and community facilities. The project team demonstrates a reasonable, inclusive, and coordinated approach to addressing mobility impacts.

Enhanced: Overall mobility is enhanced with a connected network that helps reduce congestion, improves traffic flow, and/or contributes to community livability. Project teams implement strategies to accommodate or support automobile, transit, and commercial vehicles while promoting complete streets policies leading to more active, healthier lifestyles. With the increasing role of technology, project teams should consider ways to utilize open data to enhance project performance.

Conserving: The project team is proactive in identifying the limitations and future mobility needs of the community and incorporating strategies to address these in the project.

Restorative: The project creates or restores community connections. Beyond improving existing performance, the project has created new mobility opportunities with potentially cascading benefits (e.g., better access to schools, commercial districts, healthcare, etc.).

Applicability: Consideration is given to whether the project has any potential to impact mobility. Non-transportation projects that do not include any mobility impacts (positive or negative), and can demonstrate no potential for positively impacting mobility, may apply to have this credit deemed not applicable with supporting documentation. This credit is inherently applicable to all transportation infrastructure projects.

EVALUATION CRITERIA AND DOCUMENTATION GUIDANCE

A. Is the project consistent with local transportation plans?

1. Documentation demonstrating consistency with local and regional transportation plans. When applicable, documentation may include an amendment to the transportation plan(s).

B. Has the project team obtained input from the community and key stakeholders regarding issues of mobility and access?

1. Documentation (e.g., reports, memoranda, and/or minutes) of meetings with the community and key stakeholders (e.g., community officials or managers and operators covering access to adjacent facilities, amenities, and transportation hubs).
2. Records of decisions made and actions taken.

C. Does the project include strategies to increase capacity, manage congestion, reduce vehicle distance traveled, or lower accident rates?

1. Reports documenting access and mobility principles, concepts, requirements, and expected outcomes of the project.
2. Documentation of how the project increases transportation capacity, efficiency (e.g., reduced congestion and/or vehicle distance traveled), or quality (lower accident rates).

D. Has the project team worked with the community to expand mobility and access options and/or incorporate complete streets policies?

1. Assessment of the availability, feasibility, and use of transportation options (e.g., rail, water, active transportation, or mass transportation access).
2. Documentation of how the project expands mobility and access options, including a rationale for making or not making changes to transportation modes.
3. When applicable, reports demonstrating the use of complete streets policies and guidelines.

E. Has the project team considered the long-term mobility and access needs of the community?

1. Documentation of the long-term mobility and access needs of the community (e.g., existing studies, reports, memoranda, and/or minutes).
2. Design components showing the extent to which long-term mobility and access needs and issues were incorporated into the constructed work. For example, expanding considerations to anticipated traffic flows and volumes, changes in technology, preferred modes of access, and effects on mobility and connectivity.
3. Documentation showing how the project addressed the community as a connected network, including long-term transportation infrastructure efficiency, walkability, and incentivized transportation efficiency.

F. Does the project create new or restore previous connections between communities?

1. Documentation of meetings with community officials discussing the need for new connections/reconnections between communities (e.g., reports, memoranda, and/or minutes).
2. Documentation of how the project provides new or improved connections between communities in order to increase overall mobility. For example, connecting housing, jobs, shops, and/or community facilities by utilizing or improving existing transportation infrastructure.

RELATED ENVISION CREDITS

QL1.1 Improve Community Quality of Life

QL3.1 Advance Equity and Social Justice



QL2.2 Encourage Sustainable Transportation

16

POINTS

INTENT

Expand accessibility to sustainable transportation choices including active, shared, and/or mass transportation.

METRIC

The extent to which active, shared, or mass transportation options are accessible, encouraged, and supported as part of a larger integrated transportation network.

LEVELS OF ACHIEVEMENT

IMPROVED	ENHANCED	SUPERIOR	CONSERVING	RESTORATIVE
Not Available	A	A + B	A + B + C	A + B + C + D
	(5) Access to Transit or Active Transportation	(8) Encourages Transit or Active Transportation	(12) Transit or Active Transportation Programs	(16) New Connections
	(A) The project creates or offers convenient access to shared/mass transportation OR active transportation (e.g., extended contiguous trails and/or bicycle networks).			
		(B) Beyond proximity, the project is configured and designed to encourage the use of active, shared, or mass transportation.		
			(C) The project provides programs and/or facilities that support the use of active, shared, or mass transportation.	
				(D) The active and/or shared transportation improvements contribute to a larger integrated transportation strategy for the community or region. The project creates new connections or rehabilitates/repurposes unused, underused, or previously disconnected pathways, bikeways, rail, and/or other modes of transportation to enhance the efficiency, quality, or level of service of the overall network.

DESCRIPTION

This credit addresses the need to expand sustainable transportation choices including active, shared, and/or mass transportation, as a way to increase health, reduce emissions, improve air quality, and increase community development. Active transportation encompasses all forms of non-motorized transportation such as walking or bicycling. Shared transportation includes vehicle sharing such as ride-shares. Mass transportation, or transit, includes traditional high-capacity transportation systems such as subways, buses, streetcars, and others. Project teams should consider how a multi-benefit project that supports active, shared, and/or mass transportation can achieve greater acceptance by the community, have broader access to funding, and deliver a better quality project for owners and operators. Even non-transportation infrastructure often has the opportunity to

support and improve these transportation networks by providing better access, closer proximity, or other area enhancements.

PERFORMANCE IMPROVEMENT

When addressing this credit and designing for current uses, project teams should also consider how to accommodate future transportation trends. In recent years, technology and access to data have dramatically changed mass transportation and shared transportation systems. Transportation infrastructure, or infrastructure dependent on transportation systems, should plan for possible technological shifts in order to be sustainable and resilient.

Enhanced: The credit assessment begins with locating project within walking distance to pedestrian-accessible active transportation and public transit facilities.

Superior: Active, shared, or mass transportation choices are encouraged through the physical characteristics that may enhance the quality of the amenity.

Conserving: Active, shared, or mass transportation choices are supported through the underlying logistical, managerial, or operational programs that can incentivize greater use or ridership.

Restorative: The project understands the integrated transportation system and leverages project enhancements to have impacts beyond the project boundary by creating new connections and new opportunities, or restoring unused, underused, or degraded infrastructure.

Applicability: Consideration is given to whether the project includes transportation infrastructure, or includes the frequent dependence on transportation for access to the project. This credit is applicable to all transportation infrastructure. Projects that do not include transportation infrastructure and are not accessible, unmanned, or have very small maintenance crews, may apply to have this credit deemed not applicable with supporting documentation.

EVALUATION CRITERIA AND DOCUMENTATION GUIDANCE

A. Does the project provide convenient access to active, shared, or mass transportation options?

1. Map showing pedestrian proximity and accessibility to active, shared, or mass transportation. The generally accepted standard for walking distance is 0.5 mi/0.8 km, or a 10-minute walk.

B. Is the project configured and designed in such a way to encourage active, shared, and/or mass transportation options?

1. Documentation demonstrating that beyond the physical proximity to active, shared, or mass transportation options, the project is configured and designed to encourage or facilitate their use. Examples may include but are not limited to:
 - a. Degree of pedestrian convenience and accessibility encourages site users to utilize transit options.
 - b. Restricted parking that encourages choosing transit or active transportation.
 - c. Extended contiguous sidewalks, trails and/or bicycle networks connected to the site and/or the project.

d. Designs that promote security throughout the site via well-lit and clearly visible pathways.

e. Topography that accommodates a network of walkways and bikeways converging on or near the project.

f. Providing accessible options beyond regulatory requirements to accommodate a range of mobility needs.

g. Protection from weather such as covered shelters or walkways.

C. Does the project include programs and facilities that support the use of active transportation and transit?

1. Documentation of programs and/or facilities designed to support the use of active, shared, or mass transportation options.

Programs intended to encourage active or shared transportation can include but are not limited to bicycle sharing stations, mobile apps, marketing programs, subsidy programs, maintenance programs, or repair programs.

Facilities intended to encourage active or shared transportation can include but are not limited to secure bike lockers, covered bike racks, and changing/showering facilities.

Programs designed to encourage the use of mass transportation can include but are not limited to subsidized fare programs, emergency ride home services, coordination with ride-sharing companies, off-board ticketing, real-time arrival information, or mobile apps. Support may also include coordinating with the local transit agency for new transit services.

D. Does the project contribute to a larger integrated active, shared, or mass transportation strategy for the community or region?

1. Documentation that the project integrates the transportation improvements with existing transportation infrastructure and/or a larger transportation infrastructure strategy (e.g., a transportation master plan).
2. Documentation that the project creates new connections or rehabilitates/repurposes unused, underused, or previously disconnected pathways, bikeways, rail, and/or other modes of transportation to enhance the efficiency, quality, or level of service of the overall network. This should include site plans or illustrative documents showing new connections.

RELATED ENVISION CREDITS

QL1.2 Enhance Public Health and Safety

QL2.1 Improve Community Mobility and Access

CR1.2 Reduce Greenhouse Gas Emissions

CR1.3 Reduce Air Pollutant Emissions



QL2.3 Improve Access and Wayfinding

14

POINTS

INTENT

Design the project to provide safe and appropriate access in and/or around the project in a way that integrates the project with the surrounding community.

METRIC

Incorporating and providing clear access, safety, and wayfinding measures to accommodate emergency services and regular vehicular or pedestrian traffic.

LEVELS OF ACHIEVEMENT

IMPROVED	ENHANCED	SUPERIOR	CONSERVING	RESTORATIVE
A	A + B	A + B + C	A + B + C + D	Not Available
(1) Emergency Management	(5) Protecting Surroundings	(9) Safety Audits	(14) Public Access	
(A) The project clearly accommodates incident management for users and emergency personnel.				
(B) The project identifies and utilizes access routes, safety features, and clear signage to reduce negative impact on its surroundings caused by vehicle or pedestrian traffic. The project integrates well with its surroundings through clear signage and wayfinding.				
(C) The project provides points for safe public access. Universal design standards are used to ensure broad accessibility and safety.				
(D) The project has a positive and transformative impact on community or neighborhood access and/or wayfinding.				

DESCRIPTION

This credit encourages designing and operating the project so that users of all ages and abilities can safely access the site and/or clearly and easily navigate around it. Wayfinding encompasses all of the ways in which people orient themselves in physical space and navigate from place to place. This includes, but also extends beyond, signage. This credit is linked to QL3.4 Enhance Public Space and Amenities; however, whereas QL3.4 addresses the broader social benefits and improved livability of public space, this credit focuses specifically on providing access that is both safe and easy to navigate.

Completely walling off sites from the public contributes to community “dead zones” that become attractors for crime and vandalism. Confusing signage or complicated site access is a nuisance that can lead to accidents and injuries. Projects that promote pedestrian-oriented communities encourage active street life with the associated effect of reducing crime and vandalism. Providing clear and safe access whenever possible is helpful in gaining acceptance by local communities, reducing accidents and injuries, reducing crime, and encouraging healthy and vibrant neighborhoods.

By addressing access and wayfinding infrastructure owners and project teams can help reintegrate infrastructure into communities and infrastructure awareness into the public

mindset. Rather than being a barrier, infrastructure can often provide elevated pedestrian walkways, bike trails, safer streets, improved intersections, more direct routes, convenient access to public amenities, and much more.

PERFORMANCE IMPROVEMENT

Improved: The assessment begins with careful accommodation of emergency. While this is often standard it is an important factor in protecting public safety and is relevant to the overall sustainability of the project. Documentation for this credit should extend beyond evidence of basic signage. Project teams should also consider, if applicable, the role critical infrastructure plays in emergency situations or risks to public safety.

Enhanced: The project addresses access, safety, and wayfinding for pedestrians and/or vehicles. Clear access, signage and wayfinding improves overall flow, efficiency, and aids in incident management by reducing accidents. The application may vary depending on the project type. Publicly accessible projects may encourage navigating through the site, while restricted sites may focus on reducing negative impacts on community access to adjacent sites and providing safe and easy to identify alternatives for navigating around the project.

Superior: The project provides public access points. Environmental or universal design makes visitors feel more secure and

accommodates users with disabilities. Universal design is the design and composition of projects and sites so that they can be accessed, understood and used to the greatest extent possible by all people regardless of their age, size, ability or disability.

Conserving: Consideration is also given to how the project design can improve safety and security on and around the site. Examples of strategies for improving physical safety and reducing crime and vandalism include:

Physical Safety

- Improve the safety and accessibility of street crossings by providing universal access curb cuts, pedestrian crossing signs, and high-visibility crosswalks. Or, for major roads, provide pedestrian over-/underpasses.
- Include traffic-calming measures in areas with heavy pedestrian or bicycle traffic.
- Install physical barriers between sidewalks and street traffic exceeding 40 mph.
- Improve bike lane safety by separating bike lanes from street traffic or the door swing radius of parked cars.
- Clearly distinguish between publicly accessible space, where pedestrian traffic is encouraged, and restricted space, where it is not.

Crime and Vandalism

- Locate publicly accessible space to be as visible as possible from surrounding neighborhoods at night.
- Design public space to have clear lines of sight internally and from major pedestrian traffic zones.
- Design public space to integrate to the urban context and encourage pedestrian traffic.
- Design site for easy public access to, from, and around the project with clear signage and wayfinding signals.

Applicability: Consideration is given to the potential for impacting community access on or around the project site. Infrastructure that is inherently inaccessible (e.g., underground) or extremely remote (e.g., inaccessible by public roads) may apply to have this credit deemed not applicable with supporting documentation. Default restrictions on public access are not considered acceptable justification for marking the credit not applicable. This credit is automatically applicable to any project in proximity

to populated areas or other development, adjacent to sensitive sites, or involving regular incoming or outgoing traffic.

EVALUATION CRITERIA AND DOCUMENTATION GUIDANCE

A. Has the project addressed access, safety, and wayfinding for incident management including evacuation and emergency personnel?

1. *Design documents showing plans for access and egress routes for emergency personnel, users, and occupants.*
2. *Documentation of the effectiveness of the design for emergency situations.*

B. Does the project utilize access, safety, and signage to protect or minimize impacts on the surroundings?

1. *Documentation of how the project protects nearby sensitive sites (wetland, cultural sites, etc.) or, in populated/developed areas, separates pedestrian and non-pedestrian zones enhancing safety and security.*
2. *Documentation that clear signage and wayfinding techniques are used to integrate the project with its surroundings. For example, access roads, bikeways, or pedestrian paths are clearly marked in order to facilitate their proper use.*

C. Does the project provide safe public access points for the benefit of the community?

1. *Documentation indicating areas of the project site that are accessible to the public. Public access may include restrictions.*
2. *Documentation that areas open to the public are designed with universal design principles to be inclusive of a broad range of users.*

D. Does the project have a positive and transformative impact on community neighborhood access, safety, and/or wayfinding?

1. *Documentation demonstrating that beyond individual site safety features addressed in criteria A, B, and C, the project itself will improve broader community or neighborhood safety. For example, formerly abandoned or restricted areas prone to crime and vandalism are replaced by safe and accessible spaces that increase community presence and self-monitoring.*

RELATED ENVISION CREDITS

QL1.2 Enhance Public Health and Safety

QL3.4 Enhance Public Space and Amenities



QL3.1 Advance Equity and Social Justice

18

POINTS

INTENT

Ensure that equity and social justice are fundamental considerations within project processes and decision making.

METRIC

Degree to which equity and social justice are included in stakeholder engagement, project team commitments, and decision making.

LEVELS OF ACHIEVEMENT

IMPROVED	ENHANCED	SUPERIOR	CONSERVING	RESTORATIVE
A + B + C	A + B + C + D	A + B + C + D + E	A + B + C + D + E + F	A + B + C + D + E + F + G
(3) Understanding Equity	(6) Mitigation	(10) Empowerment	(14) Equitable Access to Benefits	(18) Equitable Futures
<p>(A) Stakeholder engagement is conducted early and informed by the historic context of equity, social justice, and environmental justice. When projects impact, or potentially impact, indigenous communities, specific attention is given to developing a relationship of respect and mutual understanding that supports the autonomy, authority, and rights of these communities.</p> <p>(B) The project team assesses the social impacts the project will have on the host and affected communities. This includes mapping impacts and benefits across local communities.</p> <p>(C) Key members of the project team make institutional commitments to equity and social justice, including non-discrimination; diversity and inclusion; and pay equity. Large-scale projects make targeted and project-specific commitments.</p>				
<p>(D) Based on the assessment of social impacts, the project addresses or mitigates social impacts. Mitigation strategies are informed by stakeholder consultation and participation.</p>				
<p>(E) The social, economic, and environmental benefits and impacts of the project are shown to not disproportionately favor or disfavor any community.</p>				
<p>(F) The project empowers communities to engage in the development process. Qualified professionals identify unconscious biases and barriers to inclusion. Programs target higher rates of engagement, and include transparent grievance mechanisms to facilitate resolutions.</p>				
<p>(G) The project positively addresses or corrects an existing or historic injustice or imbalance.</p>				

DESCRIPTION

“Equity and social justice” refer to the responsibility of a society to ensure that civil and human rights are preserved and protected for each individual, and that all persons are treated equally and without prejudice regardless of race, color, wealth, religion (creed), gender, gender expression, age, national origin (ancestry), disability, marital status, sexual orientation, or military status. This includes “environmental justice,” which refers to the fair treatment and meaningful engagement of all people with regard to environmental protection.

These issues are particularly relevant to infrastructure development, which often involves the provision of significant benefits as well as potentially significant impacts (e.g., disruption, cost, pollution, and/or consumption of resources). Inequality, or the perception of inequality, in decision making

and the distribution of benefits and impacts can be a potential source of conflict. Conflicts can disrupt project development or become sources for broader social disruption causing new rifts or exacerbating existing rifts between communities, organizations, and governments. Once a relationship of distrust is developed between the public and infrastructure developers, it is difficult to overcome and future projects are potentially impacted regardless of their individual merit.

Holding projects to a higher standard of stakeholder engagement can earn a “social license to operate.” This unofficial license is the acceptance (beyond regulations) of the local community and stakeholders that can build goodwill, speed projects, and smooth the way for future projects. Conflicts that arise in project delivery are often traced to misinformation and distrust. Project teams can combat this mistrust when they invest in understanding and addressing equity and social justice.

Project teams should consider how community resilience is impacted by social cohesion. Social conflict is a stressor that leaves communities more vulnerable during an emergency. Equitable and just systems of infrastructure development are opportunities to strengthen social cohesion, raise awareness, and further develop the social support systems that increase resilience.

PERFORMANCE IMPROVEMENT

Improved: Equity and social justice are complex as well as site and project specific. The first step is to understand the project context from stakeholders and to identify potential social impacts.

Equity, social justice, and environmental justice are rooted in mutual respect. This is of particular concern when projects cross social or political boundaries and are international in nature, impacting autonomous or semi-autonomous nations (e.g. First Nations, sovereign tribes, indigenous peoples, aboriginal peoples, or native populations). All projects using Envision are required to meet all relevant laws and regulations regarding cooperation with indigenous peoples. However, project teams should consider opportunities to improve the relationship and cooperation with indigenous peoples beyond requirements.

Organizations involved in the project have institutional policies that commit to nondiscrimination based on race, color, religion (creed), gender, gender expression, age, national origin (ancestry), disability, marital status, sexual orientation, or military status. This should expand to a policy of active diversity and inclusion. Policies of pay equity, especially as they relate to gender, are a key indicator of inclusivity. If integrated into the project team, these principles should also carry into stakeholder engagement activities on individual projects.

Enhanced: The project team can demonstrate specific actions taken to address social impacts.

Superior: Project teams should demonstrate that critical decisions regarding the distribution of project benefits and impacts were not intentionally or unintentionally biased. One community should not disproportionately receive the benefits of infrastructure services while another disproportionately receives the burden. When there is resistance to infrastructure development, it is often communities least able or least empowered to voice their concerns that receive the burden. Project teams should guard against following this path of least resistance.

Conserving: Equity and social justice is not something that can be “achieved” through good design. Rather, the goal is to empower individuals to participate in the process. This inclusivity should encompass the entire process rather than early consultations alone.

Restorative: Reserved for projects that have the rare opportunity to correct or address an existing or historic injustice. For example, removing a highway that divided a demographic neighborhood, or providing parks for historically underserved communities. Underserved communities do not receive adequate levels of infrastructure service due to economic conditions, lack of political will, or barriers to access.

Applicability: This credit can be designated as not applicable for projects that do not impact the surrounding community. For example, the installation or refurbishment of systems internal to a facility that do not impact the quality or level of service provided by the infrastructure.

EVALUATION CRITERIA AND DOCUMENTATION GUIDANCE

A. Does the stakeholder engagement process take into account the historic context of equity and social justice within affected communities?

1. Documentation demonstrating an understanding of the historic context of equity and social justice within the affected communities.
2. Documentation of how the equity and social justice context informed the stakeholder engagement process.
3. In cases where the project impacts sovereign peoples, especially indigenous peoples, documentation of how the process specifically addressed and prioritized engagement of these stakeholders and how attention was given to developing a relationship of respect and mutual understanding that supported the autonomy, authority, and rights of these communities.

B. Has the project team assessed the social impacts the project will have on the host and affected communities?

1. Documentation of both positive and negative social impacts that specifically include equity and social justice. The assessment may be part of a larger environmental and social risk and impact assessment. The scope and level of effort of the process is relative to the type, scale, and location of the project (e.g., proximity to population centers).
2. The assessment should include:
 - a. Direct impacts of the project and associated activities.
 - b. Impacts from independent secondary development or actions that may occur as a result of the project.
 - c. Indirect impacts on resources or services important to the local community.
3. The social context of the project regarding affected communities should consider, but may expand upon, demographic data, gender equality, health data, income rate, education, and level of historic infrastructure investment.

C. Have key members of the project team made commitments to equity and social justice within their organizations?

1. Documentation of corporate/organizational policies and commitments concerning equity and social justice. This should include, but not be limited to:
 - a. Nondiscrimination
 - b. Diversity and inclusion
 - c. Pay equity

“Key members” of the project team refers to major decision makers involved in the project, as well as those who act as primary advisors, consultants, or specialists on behalf of decision makers. This will almost always include the owner, those who act as lead designers (engineers, architects, landscape architects, etc.), and those who manage and execute the project through construction. Duplicative documentation is unnecessary when more than one of these roles is held by a single entity.
2. In cases where the project may have notable social impacts (e.g., a new road going through a community), documentation of project-specific commitments to addressing equity and social justice.

D. Has the project addressed social impacts related to equity and social justice?

1. *Documentation of a management program(s) to address equity and social justice impacts identified in the assessment of social impacts.*
2. *Documentation of specific decisions, programs, strategies, etc., that were implemented to address social impacts.*
3. *Documentation of how impacts and mitigation strategies were prioritized (e.g., a typical mitigation hierarchy would include avoidance, minimization, restoration, and compensation).*

E. Will the impacts and benefits of the project be distributed equitably throughout affected communities?

1. *Documentation of how the project does not overly burden one or more communities with risk or negative impacts while other communities receive the majority of project benefits.*
2. *Maps showing the key demographic data identified in the assessment of social impacts overlaid with areas likely to receive benefits or impacts of the project.*

F. Has the project team empowered communities to engage in the development process?

1. *Documentation that the project team identified, analyzed, and addressed barriers to inclusion in the stakeholder engagement process. The comprehensiveness of the analysis will be assessed relative to the scope and scale of the project. For large projects, documentation should include the qualifications of individuals responsible for managing the stakeholder engagement process.*
2. *Documentation of how the project specifically targeted underrepresented communities and higher rates of participation and/or inclusion.*

G. Does the project positively address or correct an existing or historic injustice or imbalance?

1. *Documentation that the project positively addressed or corrected an existing or historic injustice or imbalance. This may include, but is not limited to:*
 - a. *The provision or improvement of infrastructure services to historically underserved communities.*
 - b. *The removal of existing infrastructure that historically divided or created barriers within a community.*
 - c. *Addressing historic inequality where one community was disproportionately burdened with negative infrastructure impacts while not receiving the benefits.*
 - d. *Addressing historic socioeconomic trends in infrastructure design, development, and operation related to inclusion.*

RELATED ENVISION CREDITS

- QL1.2 Enhance Public Health and Safety
- QL2.1 Improve Community Mobility and Access
- QL2.2 Encourage Sustainable Transportation
- QL3.2 Preserve Historic and Cultural Resources
- LD1.3 Provide for Stakeholder Involvement
- LD2.2 Plan for Sustainable Communities
- LD3.1 Stimulate Economic Prosperity and Development
- LD3.2 Develop Local Skills and Capabilities

Historic Fourth Ward Park: Atlanta, Georgia

Atlanta's Historic Fourth Ward Park project (Envision Gold, 2016) was developed in partnership between Atlanta BeltLine, Inc. (ABI) and the Atlanta Department of Watershed Management (DWM). Historic Fourth Ward Park was one of the first components in the BeltLine Project—a comprehensive effort providing a network of public parks, multi-use trails and transit along a historic 22-mile railroad corridor circling downtown Atlanta.

Direction for this project originated from conversations among citizens discussing local stormwater issues. As part of the development effort, the stormwater management was enhanced, from what was originally a series of underground pipes, into a community amenity. The project team worked closely with the community to design a park that features a stormwater retention pond, while serving multiple purposes for the adjacent neighborhood.

The park, which is designed to provide much needed stormwater drainage relief within a 300-acre drainage basin, uses artistic elements to aerate and recycle pond water in a dramatic contrast to traditional discharge pipes. The stormwater pond serves as the park's centerpiece, surrounded by walking trails, urban plazas, native plantings and an amphitheater. The project has generated adjacent development and revitalization, providing the cornerstone for a sustainable, high-density and high-quality urban environment along with an outstanding design solution for a combined sewer overflow problem.

The Fourth Ward Park project started as a typical stormwater management/flooding problem, and turned into a solution that addressed the problem and resulted in economic and community development, environmental restoration and creation of a park.

In doing so this project met high standards of sustainability while also improving community livability in Atlanta.

Notable achievements for the Historic Fourth Ward Park within the Envision categories include:

Quality of Life: The park restored an unusable land parcel into a functional community park and provided stimulus for neighboring development. Following project completion, the influx of housing and retail has noticeably changed the economic and social condition of the community.

Leadership: From the early stages of the project, collaboration on every level inspired the creation of a park that now provides a sustainable resource, spurs development and solves an engineering problem. The project team deliberately took into account the relationships to and among other elements of community infrastructure, including physical and visual connectivity to adjacent properties.

Resource Allocation: Resource conservation was designed into the project, including supplying 100 percent of the park's irrigation demand from the pond.

Natural World: Pre-development conditions allowed storm drainage from the connected watershed to discharge directly into the combined sewer. The park now captures and contains stormwater following rain events, and the water has been used to establish newly planted native landscape – introducing biodiversity to the area.

Climate and Resilience: The pond's capacity provides relief to the combined sewer, allowing the system to manage a rain event in excess of a 100-year storm.





QL3.2 Preserve Historic and Cultural Resources

18

POINTS

INTENT

Preserve or restore significant historical and cultural sites and related resources.

METRIC

Steps taken to identify, preserve, or restore cultural resources.

LEVELS OF ACHIEVEMENT

IMPROVED	ENHANCED	SUPERIOR	CONSERVING	RESTORATIVE
Not Available	A + B	A + B + C + D	A + B + C + D + E	A + B + C + D + E + F
	(2) Stakeholder Consultation	(7) Expanded Search	(12) Conservation	(18) Restoration
	<p>(A) The project team works with the community and required regulatory and resource agencies to identify historic and cultural resources in and around the project site.</p> <p>(B) The project implements strategies to document, protect, or enhance historic and cultural resources.</p>			
	<p>(C) The assessment of cultural resources intentionally extends beyond national or subnational registries to identify important parts of the community culture such as places, events, natural features, oral traditions, or local skills.</p> <p>(D) Stakeholders of the historic/cultural resources are consulted early in the project's development and contribute to developing a sensitive design approach.</p>			
	<p>(E) For historic and/or cultural resources identified in criteria A and C the project is designed to fully preserve/protect the character-defining features of those resources.</p>			
	<p>(F) The project enhances or restores a threatened or degraded historic/cultural resource or results in a historical resource being added to a protected registry.</p>			

DESCRIPTION

This credit addresses the historic and cultural resources that make communities unique and that, once lost, cannot be truly replaced. Cultural resources can drive community attractiveness, livability, and tourism that in turn supports economic activity and a strong tax base. While protection is a necessary first step, there are often opportunities to highlight, enhance, or facilitate the continuance or utilization of historic and cultural resources.

Project teams are encouraged to think outside traditional concepts of historic preservation. Cultural resources go beyond those specifically protected in state/provincial, national, or international registries and may include places, events, natural features, oral traditions, or local skills that are important parts of the community culture. For example, in communities seeking to preserve indigenous languages, the erection of multilingual infrastructure signage can help.

The significance of cultural resources can scale with the size of the community. Outsiders may view locally cherished cultural resources as unimportant, which is why community engagement is necessary to fully understand local values. Project teams that engage communities in understanding their culture and history indicate a level of respect and consideration that builds trust, reduces conflict, and facilitates effective project delivery. Community engagement and understanding local culture can also help project teams better understand underlying behavioral patterns, allowing for a higher quality project that better meets the community's needs. There are also occasions where insight into historic methods of meeting infrastructure needs can lead to innovative modern solutions.

PERFORMANCE IMPROVEMENT

Enhanced: The assessment begins with the identification of protected historic resources in and around the project site.

In addition to the project team investigations, this involves some level of engagement with community stakeholders.

Measures are taken to protect resources. Strategies should prioritize avoiding impacts whenever possible, minimizing the impacts that cannot be avoided, restoring resources from impacts that cannot be further minimized, and providing compensation for impacts that cannot be restored.

Superior: Beyond historic and cultural registries, project teams engage with the community in order to identify places, events, natural features, oral traditions, or local skills that are important parts of the community culture. Stakeholders are no longer passive advisors but are actively engaged in developing project solutions that preserve or enhance cultural resources. While project teams may consider themselves capable of safeguarding cultural resources, it is often the cultural stakeholders themselves who are best able to identify the culturally significant aspects of the resource that need protection.

Conserving: The project fully avoids, protects, or maintains the critical features of historic and/or cultural resources.

Restorative: Beyond passive avoidance or protection, the project actively supports, enhances, or restores resources.

Applicability: Project teams that are unable to identify any historic or cultural resources relevant to the project may apply to have this credit deemed not applicable with supporting documentation. Supporting documentation should demonstrate how stakeholder engagement activities, cultural resource studies, or equivalent, were implemented in an effort to identify possible historic or cultural resources. This credit is applicable to all infrastructure projects that impact a historic or cultural resource identified in state/provincial, national, or international registries, or identified through stakeholder engagement. This credit is also applicable, and no points achieved, for projects that cannot demonstrate a serious effort was made to identify potential historic or cultural resources.

EVALUATION CRITERIA AND DOCUMENTATION GUIDANCE

A. Has the project team worked with the community and required regulatory and resource agencies to identify historic and cultural resources?

1. Documentation of meetings with the community and required regulatory and resource agencies to identify historic and cultural resources (e.g., reports, memoranda, and/or minutes).
2. Index of all historic and/or cultural resources that may be impacted by the project.

B. Has the project team developed strategies to document, protect, or enhance historic and cultural resources to the project?

1. Location and design drawings of efforts to mitigate impacts or demonstrating that the site avoids any historic or cultural impacts
2. Design documents of all strategies to document, protect, enhance or mitigate impacts. Mitigation efforts should prioritize, in order: avoidance, minimization, restoration, and offsetting/compensation.

Note that only documenting cultural resources is only acceptable when resources no longer have the integrity to be preserved. Otherwise project actions must also include strategies for protection or enhancement.

C. Does the identification of historic/cultural resources extend beyond registries to identify important parts of the community culture?

1. Documentation that the identification of historic/cultural resources extended beyond registries of historic sites.
2. Index of historic or cultural resources not included in historic registries that may still be significant to the culture of the community. These should be identified in criterion A and may include, but are not limited to, places, events, natural features, oral traditions, or local skills.
3. When applicable, documentation of the level of effort that was deployed to identify important cultural resources of the community even if no relevant cultural resources were found.

D. Has the project team worked with stakeholders to develop a sensitive design and approach?

1. Documentation that the stakeholder engagement process included the identification and discussion of historic/cultural resources.
2. Documentation of how the project plans were informed or approved during stakeholder engagement, specifically relating to historic/cultural resources.

E. Does the project avoid all historic/cultural resources or fully preserve/protect their character-defining features?

1. Documentation of how efforts were sufficient to avoid all historic/cultural resources or fully preserve/protect their character-defining features.

F. Does the project enhance or restore threatened or degraded historic/cultural resources in the community, or add a resource to a protected registry?

1. Documentation of efforts to enhance or restore existing historic and cultural resources. Examples may include, but are not limited to, rehabilitation in accordance with the government standards, restoration of lost features such as a historic landscape or green spaces, upgrade and expansion of facilities used for cultural events, or publicly accessible educational/museum sites in accordance with historic/cultural stakeholder wishes.
2. Documentation that work was done in collaboration with historic or cultural preservationists to ensure that restoration does not damage the quality of the existing historic and/or cultural resource.

OR

3. Documentation that a resource was added to a protected registry as a result of the project.

RELATED ENVISION CREDITS

QL3.1 Advance Equity and Social Justice

LD1.3 Provide for Stakeholder Involvement

NW1.3 Preserve Prime Farmland

NW1.4 Preserve Undeveloped Land



QL3.3 Enhance Views and Local Character

14

POINTS

INTENT

Preserve or enhance the physical, natural, and/or community character of the project site and its surroundings.

METRIC

Steps taken to assess valued community resources, implement preservation measures, and determine overall satisfaction.

LEVELS OF ACHIEVEMENT

IMPROVED	ENHANCED	SUPERIOR	CONSERVING	RESTORATIVE
A + B	A + B + C	A + B + C + D	A + B + C + D + E	A + B + C + D + E + F
(1) Value Identification	(3) Alignment With Community Values	(7) Preservation And Enhancement	(11) Connections And Collaboration	(14) Restoring Community Character
(A) The project team identifies community values and concerns regarding protection and enhancement of views and local character.				
(B) Specific design features preserve or enhance views and local character, and are informed by the stakeholder consultation process.				
(C) Guidelines are adopted or developed to preserve or enhance views and local character. The aesthetic quality of the project is important.				
(D) A construction management plan protects character features, high-value landscapes, or landscape features during construction.				
(E) Community feedback from the stakeholder engagement process verifies actions taken in criteria A, B, and C.				
(F) The project restores previously lost or degraded views or community features OR enhances the community by creating new features of local character. Actions are supported through the stakeholder engagement process.				

DESCRIPTION

This credit addresses a project’s visual impact on the community and its surroundings. Communities may value views of natural settings (e.g., bodies of water, mountains, parks, forests) or manmade structures (e.g., iconic/historic buildings, avenues, skylines). A project must consider its relationship to the viewing public and the community feature. A project may block views of a community feature or, if located within the same view of the feature, may diminish the quality of the view. In the latter case, projects can adopt the local character of its surroundings in order to minimize its impact. Beyond its function, infrastructure often has the potential to enhance the beauty and attractiveness of a community.

Context sensitive design, or context sensitive solutions, includes not only preserving views and fitting in with local character, but also enhancing local character when appropriate. The criteria may change depending on the context, but the goals remain the same. In a rural setting, a project might address views, or vistas, of natural landscapes and prominent features. Design features fit or camouflage the project in its natural

surroundings. In urban settings, projects can maintain important views and be designed to reflect the local streetscapes, material choices, height limitations, and other criteria.

Sometimes, enhancing views and local character is not about fitting in, but about standing out. Project teams should consider when infrastructure has the potential to, or already has, become a visible symbol of the community. Water towers, bridges, and other infrastructure often become a prominent part of a community’s identity. If not approached carefully, replacement or refurbishment may unintentionally lose the defining characteristics of the resource. Conversely, thoughtful consideration has the potential to provide lasting benefit to a community.

For example, many water towers are painted blue in order to camouflage their visibility against the sky. Others stand out with colorfully painted designs as identifying landmarks. Water towers in New York City became so iconic that many non-functioning towers are still preserved as part of the city’s identity.

PERFORMANCE IMPROVEMENT

Improved: The credit begins with understanding the project context and engaging local stakeholders to identify areas of local value and concern. Designs take into account either the natural, or urban, local character in terms of landform or levels, materials, plantings, style/detailing, scale, and landscape/townscape. Designs should be in accordance with the community's goals and plans to protect view corridors, views from public or open spaces, and views of features strongly associated with the identity of the city or community. Special consideration is given to identify and prevent negative impacts to views.

Enhanced: Identified goals are translated into design guidelines to ensure they are carried through to project delivery and to demonstrate the importance of the aesthetic quality of the project.

Superior: Additional care is taken in higher levels to protect against the accidental damage or removal of character features, high-value landscapes, or landscape features during construction.

Conserving: Projects often involve difficult trade-offs of losses and benefits to views and local character, therefore the credit assesses net benefit to the community. An action is a net benefit if it results in the overall enhancement of the viewshed or local character. As these determinations are often qualitative and subjective, achievement relies on community engagement and support of the project to demonstrate that views and local character were indeed enhanced.

Restorative: The project includes restoring degraded features or creating new features. **Applicability:** Projects that have no public visibility or impact on views, such as underground utilities or the refurbishment of equipment within an existing facility, may submit to have this credit deemed not applicable with supporting documentation. Reviewers are unlikely to accept arguments that a publicly visible project has no impact on views or local character.

EVALUATION CRITERIA AND DOCUMENTATION GUIDANCE

A. Has the project team made a reasonable determination of community values and concerns regarding protection and enhancement of views and local character?

1. *Plans, drawings, and reports identifying important elements of the site character including landform or levels, views, natural landscape features, materials, planting, style/detailing, scale, and landscape/townscape pattern.*
2. *Existing policies and regulations regarding public views and design guidelines relevant to the project.*

B. Has the project team implemented specific strategies to preserve or enhance views and local character?

1. *Documentation that the strategies take into consideration the preservation of natural landscape features and balance the need for safety measures and barriers against the desire for protection or enhancement of views and local character.*

C. Has the project team developed or adopted existing guidelines to preserve views and local character?

1. *Documentation demonstrating that the aesthetic quality of the project in its context was an important consideration.*
2. *An inventory of all natural landscape or man-made features to be protected.*

3. *An inventory of all view resources to be protected.*

AND

4. *A plan for addressing public views in the project design. Plans include identifying and locating the areas to be protected, identifying compatible land use, setting development standards, and establishing policies for inappropriate development and land use.*

OR

5. *Design guidelines adopted or written for the project to preserve public views and important natural landscape features, and to generally fit with the local character and context of its surroundings, whether urban or rural.*

D. Does the project include a construction management plan to protect important natural or man-made features?

1. *Documentation of the construction management plan that identifies important natural or man-made features deemed important to views or local character and how they will be protected during construction. This may include temporary relocation and restoration.*

E. Does the community support actions taken to preserve or enhance views and local character?

1. *Documentation that the stakeholder engagement process specifically addressed issues of views and local character. Documentation should include evidence of stakeholder engagement in two key areas:*
 - a. *The identification of important views and elements of local character per criterion A.*
 - b. *Approving or informing design features or guidelines to preserve or enhance views and local character per criteria B and C.*

Note that the aesthetic quality of a project is highly subjective. Project teams should seek to provide honest reporting of both supporting and dissenting opinions on the project. Assessment is not based on unanimous support but rather on whether stakeholders were meaningfully engaged and given the opportunity to voice their acceptance or concerns.

F. Will the project result in the restoration or enhancement of views or local character?

1. *Beyond preservation, the project either restores previously lost or degraded views and elements of local character, or it enhances the community by creating new features of local character. For example, the construction of an iconic bridge intended to support the local community's sense of identity and local pride. Alternatively, the project may involve the removal of degraded infrastructure generally considered to be an eyesore on the natural landscape or blocking valuable views.*

RELATED ENVISION CREDITS

QL1.5 Minimize Light Pollution

LD1.3 Provide for Stakeholder Involvement

NW1.3 Preserve Prime Farmland

NW1.4 Preserve Undeveloped Land



QL3.4 Enhance Public Space and Amenities

14

POINTS

INTENT

Improve amenities and publicly accessible spaces to enhance community livability.

METRIC

Plans and commitments to preserve, conserve, enhance, and/or restore the defining elements of the amenity.

LEVELS OF ACHIEVEMENT

IMPROVED	ENHANCED	SUPERIOR	CONSERVING	RESTORATIVE
A + B	A + B + C	A + B + C + D	A + B + C + D	A + B + C + D
(1) No Net Loss	(3) Community Involvement	(7) Improvement And Enhancement	(11) Overall Net Benefit	(14) Substantial Restoration
<p>(A) The project assesses impacts to existing public amenities and implements mitigation strategies. The project will not result in the net loss of public amenities.</p> <p>(B) The stakeholder engagement process specifically includes issues of public space and amenities.</p> <p>(C) The project team can demonstrate stakeholder support for aspects of the project related to public space/amenities.</p>				
		<p>(D) The project involves significant enhancements to existing public space or amenities (e.g., not minor resurfacing or component replacements).</p>	<p>(D) The project creates a new public resource or amenity to the community that did not previously exist.</p> <p>The scope of the new public space/amenity is commensurate with the scope and scale of the project.</p>	<p>(D) The project restores lost, degraded/unusable, or at-risk public space or amenities.</p> <p>The public space/amenity is an asset of significance to the local community commensurate with the scope and scale of the project.</p>

DESCRIPTION

This credit addresses the potential for infrastructure to create or enhance public space and amenities. Public amenities can be in urban or natural settings and may include, but are not limited to, parks, plazas, trails, playgrounds, recreational facilities, and wildlife refuges. Enhancing public space can also include beautification of streets, sidewalks, or right of ways. For natural settings such as parks and wildlife refuges, “public” refers to space accessible for human recreation and enjoyment. The preservation of habitats and species biodiversity is addressed by credits in the Natural World category.

Opening space for community activity whenever possible is helpful in gaining acceptance by local communities, educating the public about sustainable infrastructure, reducing crime, and encouraging healthy and vibrant neighborhoods. For many decades, the approach for locating infrastructure has been “out of sight, out of mind.” The majority of infrastructure is underground, relocated to the periphery, or even hidden in plain sight. This has contributed to the public’s “not in my back yard” stance and the lack of public will to make necessary infrastructure investments. In addition, completely restricting sites from the public contributes to community “dead zones” that become attractors for crime and vandalism. By incorporating public space into projects, infrastructure owners and project teams can help to reintegrate infrastructure into communities and infrastructure awareness

into the public mindset. When sports fields sit atop wastewater treatment facilities (Alexandria, VA, USA), stormwater treatment ponds double as wetland parks (Los Angeles, CA, USA), and ports provide community bike trails (Vancouver, BC, Canada), public perception about the value of infrastructure changes.

PERFORMANCE IMPROVEMENT

Project teams may include any publicly owned and accessible resource, or privately owned resources where there is significant and formalized public access. Public access does not necessarily mean 24-hour access or “no cost” access. However, projects that limit access or charge fees must make a reasonable argument as to why they qualify as public resources.

Improved: Impacts to existing public space and/or amenities are assessed and mitigated. Concepts of public space and amenities are addressed during stakeholder engagement.

Enhanced: Projects often involve difficult trade-offs of replacing the loss of a public amenity with a new resource; therefore, the credit assesses net benefit to the community. An action is a net benefit if it results in the overall enhancement of the significant activities, features, and attributes of the resource, or if it replaces an underutilized resource with a more beneficial resource. As these determinations are often qualitative and subjective, assessment of this credit relies on community

engagement and support of the project to demonstrate that public space and/or amenities were indeed enhanced.

Superior: The project enhances or expands existing amenities.

Conserving: The project provides new amenities not previously available.

Restorative: The project restores previously degraded or unusable amenities.

Applicability: This credit is applicable to projects that are publicly accessible or that impact, adjoin, or otherwise connect to existing public spaces or amenities. This represents the large majority of infrastructure projects. Designating this credit as not applicable can be difficult. Projects that by their nature preclude the possibility of addressing public space or amenities may submit to have this credit deemed not applicable with supporting documentation (e.g., mechanical system refurbishments, offshore wind farms, etc.). Not addressing the potential for public space or amenities is not sufficient alone to designate this credit not applicable. Infrastructure projects, especially those traditionally viewed as inaccessible, are encouraged to consider how they can benefit their surrounding community through the enhancement or provision of public space and amenities.

EVALUATION CRITERIA AND DOCUMENTATION GUIDANCE

A. Has the project team assessed and mitigated impacts to existing public space and/or amenities?

1. *Assessment of the impact of the project on existing public space and/or amenities.*
2. *Documentation of the mitigation strategies used and how they were prioritized.*
3. *Evidence that the project will not result in a net loss of public space and amenities in quantity or quality. In cases of offsetting, demonstrate that the offsets are of similar or better type and quality and will serve the same community as the lost resources.*

B. Does the stakeholder engagement process specifically address issues of public space and amenities?

1. *Documentation that public space and amenities were specifically included in the stakeholder engagement process. Examples include, but are not limited to, letters, memoranda, and meeting minutes with stakeholders showing stakeholder involvement.*

C. Are public stakeholders satisfied with the project plans involving public space and amenities?

1. *Evidence of stakeholder approval of how the project will address impacts to public space/amenities including, when applicable, the design and access to new or enhanced public space/amenities.*
2. *Evidence of stakeholder understanding and acceptance of construction impacts to public space/amenities, specifically access, during construction.*
3. *Written approval from officials, if relevant, regarding the project plans related to public space/amenities.*

D. To what extent does the project involve significantly enhancing, creating, or restoring public space and/or amenities?

1. *Plans and drawings showing the scope and extent of efforts for new or enhanced public space/amenities.*
2. *Evidence that the new or newly enhanced public space/amenity is a significant asset to the local community. For example, the project contributes to long-term community goals by providing a public park in a neighborhood identified as lacking sufficient park space.*

RELATED ENVISION CREDITS

QL1.1 Improve Community Quality of Life

QL2.3 Improve Access and Wayfinding

LD1.3 Provide for Stakeholder Involvement

LD3.1 Stimulate Economic Prosperity and Development

NW2.2 Manage Stormwater

NW3.2 Enhance Wetland and Surface Water Functions

PROJECT EXAMPLE: NUTRIENT MANAGEMENT FACILITY

The Alexandria, Virginia-based Nutrient Management Facility (Envision Platinum, 2016) is a water resource recovery facility designed to meet some of the strictest wastewater treatment standards in the world. The project includes 18 million gallons in tank capacity with associated pumps, chemical analysis equipment, and an extensive odor control system. The project also restored previously inaccessible land by building a lit, multi-purpose athletic field for the community on top of the facility's process tanks which is operated by the city's Department of Recreation, Parks, and Cultural Activities.





QL0.0 Innovate or Exceed Credit Requirements

+10
POINTS

INTENT

To reward exceptional performance beyond the expectations of the system and application of innovative methods that advance state-of-the-art sustainable infrastructure.

METRIC

Whether project sustainability performance qualifies as innovation, exceptional performance, or is not otherwise recognized in existing credits.

LEVELS OF ACHIEVEMENT

INNOVATION
A or B or C
(+1-10) Innovate or Exceed Credit Requirements
<p>(A) Implement innovative methods, technologies, or processes that are novel either in their use, application, or within the local regulatory or cultural context.</p> <p>OR</p> <p>(B) Implement measures that exceed the highest existing requirements within one or more Quality of Life credits.</p> <p>OR</p> <p>(C) Address additional aspects of sustainability not currently recognized in Envision</p>

DESCRIPTION

This credit addresses instances in which projects:

1. Implement innovative methods, resources, technologies, or processes that are novel in their use, application, or within the local regulatory or cultural context of the project;
2. Exceed the performance requirements of one or more credits; and/or
3. Address additional aspects of sustainability not currently recognized in Envision

Points for this credit are not calculated in the overall applicable points and, therefore, act as bonus points. Given the nature of the credit, the broad format of which is intended to encourage creative infrastructure solutions, thorough documentation is expected. Project teams may pursue more than one of the three possible options for this credit, or pursue multiple for the same option, for a total of up to ten (10) bonus points.

PERFORMANCE IMPROVEMENT

Innovation: To qualify for innovation points, projects must implement innovative methods, resources, technologies, or processes (e.g., the use of a pre-existing technology in a new way or the successful application of a technology or methods in regions or locales where existing policies, regulations, or general opinion have prevented their use). In these circumstances, it is imperative to prove that the application of the technology does, and will continue to, meet performance expectations and that it does not have a corresponding negative impact on the local or global environment, economy, or community.

Projects may demonstrate they implement innovative methods, technologies or processes in several ways:

- The project is an early adopter of new technology or methods that can demonstrably improve project performance without negative trade-offs;
- The project uses technologies or methods that may be general practice in other regions or parts of the world, but within the context of the project (whether climate, regulations, policies, political support, public opinion, etc.) have not yet gained acceptance. Significant efforts are taken to demonstrate the effectiveness of the technology or method within the context and provide a precedent for future adoption.
- The project team takes significant steps to include research goals within the project's development, or work with a university or research organization to advance the general knowledge of the profession. Proprietary research that is not made publicly available cannot count toward achieving this credit.

Project teams must also demonstrate that the innovation serves a purpose. This can be done in one of two ways:

- Overcoming significant problems, barriers, or limitations—Project teams demonstrate that the innovation reduces or eliminates significant problems, barriers, or limitations that previously hampered the use of the new methods, technologies, or processes implemented on the project.
- Creating scalable and/or transferable solutions—Project teams demonstrate that new methods, technologies, or processes implemented on the project are scalable across a wide range

of project sizes and/or are applicable and transferable across multiple kinds of infrastructure projects in multiple sectors.

Exceptional Performance: To qualify for exceptional performance points, projects must meet the highest level of achievement for one or more Quality of Life credits. For example, projects seeking additional points in credit QL3.2 Preserve Historic and Cultural Resources must already be achieving a restorative impact on existing cultural resources. In this instance, exceptional performance may be pursued by projects whose magnitude of preservation and investment in restoration represent a significant percentage of the project budget and a primary objective of the project.

Possible areas of achievement in exceptional performance for Quality of Life may include, but are not limited to, the following:

- Projects where the owner or contractor's commitment to construction health and safety results in a new industry standard through procedures, processes, or equipment;
- Projects for which net positive impact on public space exceeds small-scale parks and plazas to include large parks or reserves, recreational facilities, or urban spaces that represent a significant contribution to the quality of the community;
- Project whose impact will fundamentally change the ability of community residents to access and use sustainable means of transportation on a large scale.

Address Additional Aspects of Sustainability: To qualify for bonus points under this approach, project teams must demonstrate that they are addressing one or more aspect of sustainability not currently recognized in Envision. Sustainability performance must be related to Quality of Life. Addressing an aspect of sustainability not currently covered by the Envision system might sometimes be considered innovative, in which case the requirements for the Innovation path may be followed. For example, a project may earn bonus points for:

- Implementing community education programs to foster public awareness of the functions and benefits of the project;

- Establishing an endowment fund to fund scholarships and/or student internship programs for an extended period of time.

EVALUATION CRITERIA AND DOCUMENTATION GUIDANCE

A. To what extent does the project implement innovative methods, technologies, or processes that overcome significant problems, barriers or limitations, or create scalable and transferable solutions?

1. *Documentation of the application of innovative technologies or methods. Detailed description of how this application will improve existing conventional practice either globally or within the unique context of the project. Provide justification as to why this application should be considered innovative either as a technology, a method, or within the project context (climate, political, cultural, etc.).*

2. *Documentation that the project reduces or eliminates significant problems, barriers, or limitations that previously hampered the use or implementation of certain resources, technologies, processes, or methods that improve the sustainability of the project.*

Alternatively, documentation that the new methods, technologies, or processes implemented on the project are scalable across a wide range of project sizes and/or are applicable and transferable across multiple kinds of infrastructure projects in multiple sectors.

B. To what extent does the project exceed the highest levels of achievement for a given credit?

1. *Detailed documentation of how the project exceeds the existing requirements currently within a given Quality of Life credit.*

C. To what extent does the project address a sustainability aspect that is not currently addressed by the Envision system?

1. *Detailed documentation of how the project addresses a sustainability aspect that is not currently addressed by the Envision system.*

2. *Documentation showing how this aspect relates to the Quality of Life category.*





Leadership

Successful sustainable projects require a new way of thinking about how projects are developed and delivered. Project teams are most successful if they communicate and collaborate early on, involve a wide variety of people in creating ideas for the project, and understand the long-term, holistic view of the project and its life cycle. This section encourages and rewards these actions with the perspective that, together with traditional sustainability actions such as reducing energy and water use, effective and collaborative leadership produces a truly sustainable project that contributes positively to the world around it. This category is divided into three subcategories: **Collaboration, Planning, and Economy.**

12 / credits

- 1 Are there sustainability commitments from the project developers?
- 2 Is there a sustainability management plan in place?
- 3 Are stakeholders engaged?
- 4 Will the project stimulate economic development?
- 5 Are local residents employed on the project?
- 6 Is the project located near public transportation?

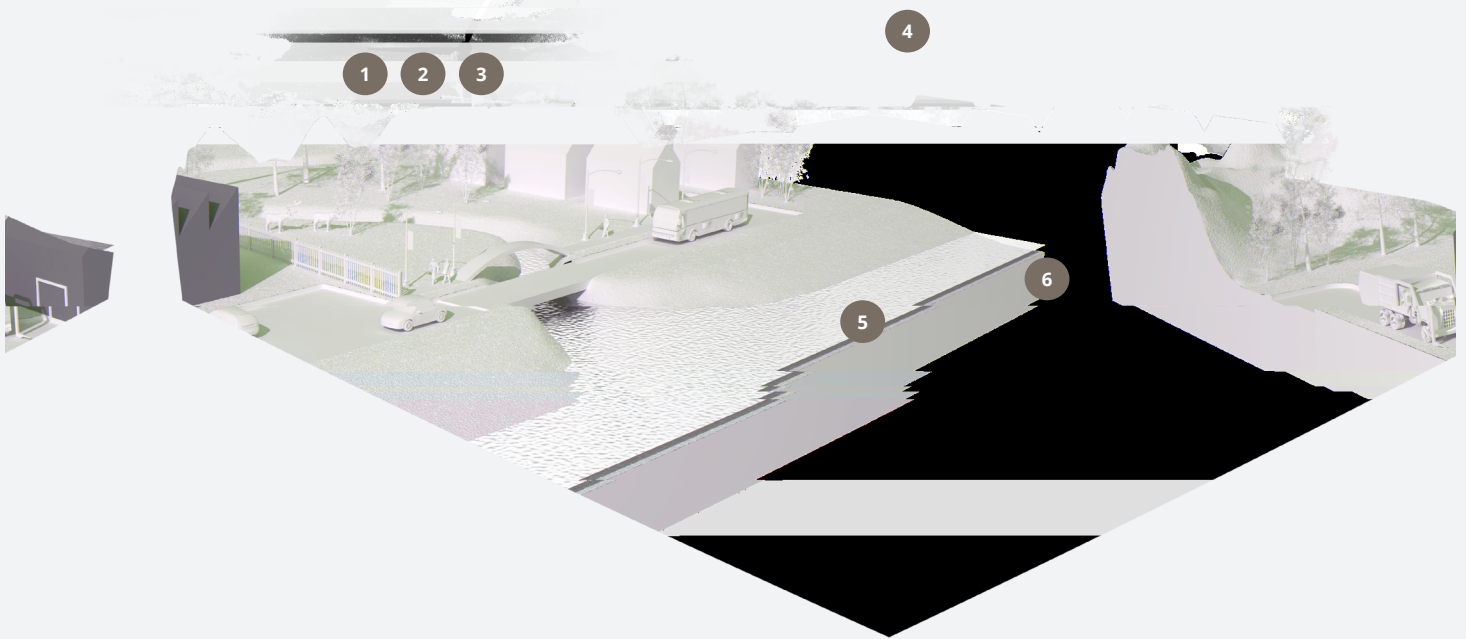

COLLABORATION

Sustainable projects must include input from a wide variety of stakeholders to fully capture synergies, savings, and opportunities for innovation. This type of collaboration requires a new level of leadership and commitment from the project team and new ways of managing the process. Rather than each part of the team working alone on their own piece of the project, teams should meet and communicate, allowing stakeholders to contribute ideas and perspectives.

PLANNING

Taking a long-term view of the project can greatly increase the sustainability of the project. Understanding planning issues, such as future growth trends in the area and the impacts of a project at the end of its life, can lead to a project that avoids pitfalls and plans effectively for its own future. This can reduce costs and streamline the entire project process.

ECONOMY

A broader comprehensive understanding of the project includes examination of direct and indirect economic factors such as growth, development, job creation, and the general improvement of quality of life. Positive results from infrastructure projects can include community education, outreach, knowledge creation, and worker training, among others.



Leadership

COLLABORATION

- LD1.1** Provide Effective Leadership and Commitment
- LD1.2** Foster Collaboration and Teamwork
- LD1.3** Provide For Stakeholder Involvement
- LD1.4** Pursue Byproduct Synergies

PLANNING

- LD2.1** Establish A Sustainability Management Plan
- LD2.2** Plan For Sustainable Communities
- LD2.3** Plan For Long-Term Monitoring and Maintenance
- LD2.4** Plan For End-of-Life

ECONOMY

- LD3.1** Stimulate Economic Prosperity and Development
- LD3.2** Develop Local Skills and Capabilities
- LD3.3** Conduct a Life-Cycle Economic Evaluation

- LD0.0** Innovate or Exceed Credit Requirements
-



LD1.1 Provide Effective Leadership and Collaboration

18

POINTS

INTENT

Provide effective leadership and commitment to achieve project sustainability goals.

METRIC

The degree to which the project owner and project team have made general, and project-specific, sustainability commitments and instituted sustainability management policies.

LEVELS OF ACHIEVEMENT

IMPROVED	ENHANCED	SUPERIOR	CONSERVING	RESTORATIVE
A	A + B	A + B + C	A + B + C + D	Not Available
(2) Initial Commitment	(5) Strong Commitment	(12) Strong Commitment	(18) Sustainability As A Core Value	
<p>(A) A written commitment by the owner and project team to address the social, environmental, and economic aspects of the project. Commitments to sustainability are clearly articulated at the project level in a project chartering session and/or contract documents.</p>				
<p>(B) Commitments are supported by a sustainability management policy that is commensurate with the scope, scale, and complexity of the project.</p>				
<p>(C) Sustainability commitments, and progress toward their achievement, are revisited periodically through meetings or written reports.</p>				
<p>(D) Key members of the project team have made clear commitments to sustainability, as evidenced by:</p> <ul style="list-style-type: none"> • Organizational sustainability policies and/or reports. • Examples of projects, or initiatives, to improve sustainable performance. • Sustainability strategies embedded into their business strategy. • Third-party organizational recognition or commitments. 				

DESCRIPTION

This credit addresses establishing strong leadership to adequately and competently address issues surrounding sustainability in all phases of the project. This credit assesses the degree to which various members of the project team have committed to making sustainability a priority within their respective organizations as well as the project itself. Project teams will be able to better serve the community when they are led and managed by people and organizations that have a strong commitment to the principles of sustainability and have demonstrated the ability to effectively incorporate these principles into projects.

Projects are more likely to achieve sustainable outcomes when owners, designers, contractors, and all involved in the project team make strong commitments to achieve sustainability

goals. Conversely, project performance is most at risk when sustainability is considered an add-on or lower-priority objective.

Many Leadership credits reference the importance of decision making and collaboration within the “project team.” The nature of the project team will depend on several factors, including the project delivery method. The intention of referencing the project team is to capture major decision makers involved in the project, as well as those who act as primary advisors, consultants, or specialists on behalf of decision makers. This will almost always include the project owner, those who act as lead designers (engineers, architects, landscape architects, etc.), and those who manage and execute the project through construction, but ideally would also include those responsible for funding, operating, regulating, subconsulting, or otherwise utilizing the project (e.g., community groups). Those with the

responsibility and authority to implement sustainability efforts should coordinate to ensure their effectiveness. Envision users should take time to review the organizational hierarchy of the project in order to identify at which levels key decisions regarding project sustainability are being made. This will constitute the starting point of defining the project team.

PERFORMANCE IMPROVEMENT

Improved: Project-specific commitments are in place.

Enhanced: A project sustainability management policy is in place that defines the scope of the project and the project team's commitment to sustainable performance improvement. The policy commits the project team to meeting or exceeding all health and safety standards and improving environmental, social and ethical performance. This policy can be a pre-established policy created by the project owner, agreed to by the project team, and customized for the project to the extent required.

Superior: Commitments go beyond initial or singular statements and are revisited, with progress reviewed, throughout project development.

Conserving: Sustainability commitments are supported by a documented history of achievement in sustainable performance. Sustainability is a core value of the organizations involved.

Applicability: It is likely that all projects can benefit from effective leadership and strong commitments to sustainability. It would therefore be difficult to demonstrate that the credit is not relevant or applicable to a project seeking an Envision award.

EVALUATION CRITERIA AND DOCUMENTATION GUIDANCE

A. Have the project owner and project team made written commitments to address the social, environmental, and economic aspects of the project?

1. *Written commitments to address social, environmental, and economic aspects of the project (i.e., sustainability). For example, contract documents clearly articulating commitments to address the social, environmental, and economic aspects of the project, and/or evidence of a chartering, value engineering, or other relevant design sessions that included key members of the project team that clearly expressed commitments to sustainability.*

B. Is the project supported by a sustainability management policy commensurate with the scope, scale, and complexity of the project?

1. *A sustainability management policy that includes commitments to achieving improvements in sustainable performance with clear objectives and targets. The policy references project*

stakeholders, health and safety commitments, environmental commitments, and social/community commitments.

Owner sustainability management policies may be project- or program-specific or agency/department-wide. However, they must establish requirements that a project address sustainability and meet performance targets. Sustainability management policies are more general than a sustainability management plan, referenced in LD2.1. For example, a sustainability management plan would include the processes and strategies by which a sustainability management policy would be implemented on a specific project.

C. Has the project team periodically revisited project sustainability commitments throughout project delivery?

1. *Project-specific sustainability report(s), or meeting minutes, detailing how the project will achieve its goals and which key performance indicators will be used to measure and manage initiatives.*

D. Have key members of the project team made organizational commitments to sustainability?

1. *Identification and description of key members of the project team.*
2. *Documentation of each of the following commitments to sustainability:*
 - a. *Organizational sustainability principles and policies. For example, sustainability reports, preferably either verified or partially verified by an independent third party, with clearly expressed targets and associated performance (e.g., Global Reporting Initiative, corporate GHG emissions reduction targets, corporate energy reduction targets, corporate waste reduction targets).*
 - b. *Recognition of past or ongoing projects, or significant initiatives undertaken, to improve sustainable performance (e.g., project write-ups, awards, or third-party recognition received for sustainable performance, efforts or initiatives to train and/or credential staff in sustainability).*
 - c. *Evidence that the organizations involved in the project have sustainability strategies that are embedded into their business strategy, or evidence of a clear link between the strategies. For example, illustration or description of the governance of sustainability within the organizations and clear demonstration of support and commitment from senior management to sustainability.*
 - d. *Third-party organizational recognition or commitments related to sustainability (e.g., signatory to the UN Global Compact, listed on the CDP Climate Performance Leadership Index, listed on the Jantzi Social Index, listed on the Dow Jones Sustainability Index, BCorp certification, JUST Label, etc.).*

RELATED ENVISION CREDITS

LD1.2 Foster Collaboration and Teamwork

LD2.1 Establish a Sustainability Management Plan

CR2.4 Establish Resilience Goals and Strategies



LD1.2 Foster Collaboration and Teamwork

18

POINTS

INTENT

Enhance project sustainability through interdisciplinary collaboration and teamwork.

METRIC

The breadth and inclusivity of interdisciplinary and collaborative meetings and the resulting sustainability performance enhancements.

LEVELS OF ACHIEVEMENT

IMPROVED	ENHANCED	SUPERIOR	CONSERVING	RESTORATIVE
A	A + B	A + B + C	A + B + C + D	Not Available
(2) Early Collaboration	(5) Achieving Goals	(12) Ongoing Collaboration	(18) Life-Cycle Collaboration	
(A) Sustainability goals are defined early during interdisciplinary collaborative project kickoff meetings among project staff at all levels.				
(B) The project team can demonstrate sustainability performance enhancements that resulted from the interdisciplinary collaborative process. Performance enhancements should result from a whole-systems design approach, rather than sustainability add-ons.				
(C) Ongoing collaboration meetings are conducted throughout design with the owner and the interdisciplinary project team to clarify expectations, discuss potential opportunities, and identify potential barriers to integrated design. Meetings involve a broad set of project participants.				
(D) The interdisciplinary collaboration or integrated design process specifically includes stakeholders from later construction, operations, and/or maintenance phases. Important considerations over the project life are understood and incorporated into the project.				

DESCRIPTION

This credit encourages owner and project team collaboration in the delivery of more sustainable projects. Integrated project delivery brings project team members together early in the planning and design stages to understand how their design assumptions and decisions positively or negatively affect the work of others. This includes members of the project team who are traditionally involved later in the project (e.g., constructor, operator). Working separately, performance is suboptimal, confined to individual project components. Working together as an integrated team, performance can be optimized across the entire project.

Owners and project teams should consider how investing in early and regular collaboration between designers, contractors, and operators can prevent design conflicts, reduce change orders, and result in projects that are easier, faster, and less expensive to construct. Meetings, where each party is able to bring their expertise and knowledge, can prevent errors caused

by assumptions or lack of awareness and can often lead to innovative solutions or higher performance targets. Project teams should consider holding meetings where each of the Envision criteria are discussed and each party is able to offer feedback on how they can contribute to achieving project goals.

PERFORMANCE IMPROVEMENT

The credit assesses the breadth and inclusivity of interdisciplinary and collaborative meetings and the resulting sustainability performance enhancements. The nature of the documentation provided for this credit will vary depending on project delivery type.

Improved: Design charrettes, value engineering sessions, or similar meetings are used during design development to foster an environment for project innovation. Note that project design meetings or value engineering sessions are not inherently about improved sustainability, and therefore Envision users should clearly

identify how these sessions were used to address sustainability (environmental, social, and economic goals) for the project. Written commitments that specify the use of integrated design and how it will be used to improve the sustainable performance of the project can be helpful supporting documentation.

Enhanced: The project team works together to improve sustainable performance and can demonstrate achievement.

Superior: Collaboration extends beyond initial meetings throughout project development.

Conserving: Collaboration extends in scope to include stakeholders from later phases of construction or operation.

Applicability: It is likely that all projects can benefit from better collaboration and teamwork in pursuit of more sustainable projects. It would therefore be difficult to demonstrate that the credit is not relevant or applicable to a project seeking an Envision award.

EVALUATION CRITERIA AND DOCUMENTATION GUIDANCE

A. Was an interdisciplinary collaborative kickoff meeting held early in the project to define sustainability goals?

1. Identification of the various disciplines or project team roles involved in the interdisciplinary collaborative process.
2. Documentation of design charrettes, value engineering sessions, or other meetings to identify opportunities for improving sustainable performance and reducing design conflicts. Documentation should clearly demonstrate that meetings were held early in the process.

B. To what extent has project sustainability performance been enhanced as a result of the interdisciplinary collaboration?

1. Documentation of project improvements or increased performance that can be attributed to the interdisciplinary collaborative process.

C. To what extent did the project team establish regular interdisciplinary and collaborative meetings to set and achieve sustainability goals?

1. Documentation of the interdisciplinary project team's business processes and management controls in the form of procedures, flowcharts, checklists, and other documented control measures to achieve more sustainable outcomes for the project.
2. Documentation demonstrating that interdisciplinary collaborative meetings extended beyond initial kick-off meetings and were regularly occurring throughout the process. Documentation should clearly demonstrate that meetings were held regularly and beyond initial kick-off meetings.

D. Does the process include construction, operations, or maintenance stakeholders, for better incorporation of considerations in later project phases?

1. Documentation that construction, operations and/or maintenance representatives have participated in the integrated design process.
2. Documentation that the integrated process has improved sustainability performance in later phases of the project.

RELATED ENVISION CREDITS

- LD1.1 Provide Effective Leadership and Commitment
- LD2.1 Establish a Sustainability Management Plan
- LD2.2 Plan for Sustainable Communities
- CR2.2 Assess Climate Change Vulnerability
- LD1.4 Pursue Byproduct Synergies

PROJECT EXAMPLE: GRAND BEND AREA WASTEWATER TREATMENT FACILITY

The Grand Bend Area Wastewater Treatment Facility (Envision Platinum, 2015), serving the municipalities of Lambton Shores and South Huron in Ontario, provides an excellent example of community relationship building. Local volunteers and non-profit organizations are involved in the restoration and ongoing maintenance of the natural features on the site, including a constructed wetland and tall grass prairies. The project team also forged relationships with local educational professionals to develop activity books for students about the plant's functions, and about the turtle, bird, small mammal, and insect species that inhabit the site.



LD1.3 Provide for Stakeholder Involvement

18

POINTS

INTENT

Early and sustained stakeholder engagement and involvement in project decision making.

METRIC

Establishment of sound and meaningful programs for stakeholder identification, early and sustained engagement, and involvement in project decision making.

LEVELS OF ACHIEVEMENT

IMPROVED	ENHANCED	SUPERIOR	CONSERVING	RESTORATIVE
A + B	A + B + C	A + B + C + D	A + B + C + D + E	A + B + C + D + E + F
(3) Active Engagement	(6) Direct Engagement	(9) Community Involvement	(14) Community Satisfaction	(18) Stakeholder Partnerships
<p>(A) Primary and secondary stakeholders are identified through a stakeholder mapping process. Stakeholder concerns and specific objectives for stakeholder engagement are defined.</p> <p>(B) A proactive stakeholder engagement process is established with clear objectives. This occurs at the earliest stages of planning and is sustained through project construction. Engagement moves beyond education into active dialogue. Stakeholder views are monitored, and a two-way line of communication is established to reply to inquiries. Sufficient opportunities are provided for stakeholders to be involved in decision making. The participation process is transparent with opportunities to provide meaningful input.</p>				
<p>(C) A lead person from the project team, in addition to any public involvement lead or manager, works with stakeholder groups to understand communication needs and the desire for and scope of involvement.</p>				
<p>(D) There are specific cases in which public input influenced or validated project outcomes. Potentially conflicting stakeholder views were evaluated and addressed equitably during decision making.</p>				
<p>(E) Feedback is sought from stakeholders as to their satisfaction with the engagement process, and the resulting decisions were made based on their input.</p>				
<p>(F) One or more stakeholders, having mutual interests or interdependencies, are identified and engaged as partners.</p>				

DESCRIPTION

This credit addresses the public input process established by the owner and the project team. Relationship building among the public and key stakeholders is an important component of the engagement process. Stakeholder engagement is a critical component of any infrastructure project. While many projects incorporate some level of stakeholder engagement, this credit assesses the degree to which stakeholder engagement was proactive, early, and sustained.

Project teams that do not proactively engage stakeholders risk failing to notice demographic, socioeconomic, or cultural shifts within the community that may impact the overall success of the project. Proactive, early, and sustained stakeholder engagement helps owners and project teams earn a social license to operate. Social license to operate is the acceptance of the community developed through mutual respect and can build goodwill, speed projects, and smooth the way for future projects.

Project teams should consider how a significant number of Envision credits rely on documentation from a robust stakeholder

engagement process and how incorporating these criteria into the stakeholder engagement plan can meet multiple requirements.

PERFORMANCE IMPROVEMENT

Improved: A public participation process is set up to identify and engage key stakeholders in project decision making. Project stakeholders may include local communities, customers, employees, governments and regulators, non-governmental organizations (NGOs), etc. For this credit, stakeholders are categorized as primary or secondary. Primary stakeholders are individuals or groups directly impacted by the project, and secondary stakeholders are individuals or groups indirectly affected by the project.

The stakeholder engagement process includes informing stakeholders of the scope of the project, identification of stakeholder issues and concerns, collecting feedback, and incorporating that feedback into the design, construction, and operation of the project.

Enhanced: A member of the project team is directly engaged with stakeholders.

Superior: The project can demonstrate that the two-way communication established with stakeholders was successful and resulted in benefits to the project. Project teams demonstrate that consideration was given even to conflicting stakeholder feedback (i.e., the project team was not biased toward feedback that supported or reinforced their initial assumptions).

Conserving: Engagement becomes an opportunity to learn and improve for future projects. Stakeholder feedback is sought regarding their satisfaction with the process.

Restorative: Stakeholders are engaged as partners in the project.

Applicability: It is likely that all projects can benefit from stakeholder engagement. Although the types and scope of stakeholders may vary depending on the project, it would be difficult to demonstrate that the credit is not relevant or applicable to a project seeking an Envision award.

EVALUATION CRITERIA AND DOCUMENTATION GUIDANCE

A. To what extent has the project team undertaken a stakeholder mapping exercise to determine stakeholders?

1. *Comprehensive list of potential stakeholders identified, with stakeholder classification (primary or secondary) and a statement or rationale for selection.*
 - a. *Primary stakeholders are individuals or groups directly impacted by the project, such as the communities crossed and served by a new road. This should include stakeholders who could be impacted or affected by the project during its life-cycle.*
 - b. *Secondary stakeholders are individuals or groups indirectly affected by the project.*
2. *Evidence that stakeholders were identified and prioritized in a fair and equitable fashion.*

B. To what extent has the project team analyzed, planned, and executed the engagement for key project stakeholders?

1. *Engagement plans for each stakeholder that consider the issues the project team needs to address and the method(s) of engagement (e.g., some stakeholders may require only one-way communication, while others may require dialogue and partnership-building engagement such as consultations, hosting stakeholder advisory panels, soliciting online feedback, hosting multi-stakeholder forums and partnerships, and/or convening networks of stakeholders).*
 - a. *Stakeholder engagement plans should be proactive. This would be characterized by outreach and a determination to involve those who will be affected by, or are very likely to have an active interest in, the project, as opposed to passive invitations to participation such as public notices with little or no follow-up to ensure a robust response.*
 - b. *Engagement moves beyond education into active dialogue. Stakeholder views are monitored, and a two-way line of communication is established to reply to inquiries.*
 - c. *Sufficient opportunities are provided for stakeholders to be involved in decision making. The participation process is transparent with opportunities to provide meaningful input.*

2. *Documentation of engagement, which may include letters, meeting minutes, or memoranda with stakeholders. Documentation shows the issues that were addressed with stakeholders and their concerns/feedback specific to the project.*

C. Was a lead member of the project team directly involved with stakeholder groups to understand their needs?

1. *Documentation that a lead person from the project team, in addition to any public involvement lead or manager, worked with stakeholder groups to understand communication needs and the desire for and scope of involvement.*

D. To what extent has stakeholder engagement feedback been incorporated into project plans, design, and/or decision making?

1. *Documentation showing that feedback raised by stakeholders was evaluated and prioritized and how feedback changed/impacted/ altered the project plans, design, and/or decision making.*

OR

Documentation showing how feedback raised by stakeholders was already incorporated into the project plans, design, and/or decision making.

2. *Supporting evidence that stakeholder feedback was treated fairly and equitably, according to principles of social and environmental justice, regardless of race, color, wealth, religion (creed), gender, gender expression, age, national origin (ancestry), disability, marital status, sexual orientation, or military status.*

E. Has the project team sought feedback from stakeholders as to their satisfaction with the engagement process and the resulting decisions that were made based on their input?

1. *Letters or other documentation showing support from stakeholders for the engagement process undertaken for this project.*
2. *Letters or other documentation showing support from stakeholders for the decisions that were made based on their input.*
3. *In certain cases, documentation may also demonstrate an absence of significant new stakeholder issues arising as the project advances to final design and construction.*

F. Has the project engaged one or more stakeholders as partners?

1. *Documentation that one or more stakeholders, having mutual interests or interdependencies, are identified and engaged as partners.*

RELATED ENVISION CREDITS

- QL1.1 Improve Community Quality of Life
- QL1.4 Minimize Noise and Vibration
- QL2.1 Improve Community Mobility and Access
- QL3.1 Advance Equity and Social Justice
- QL3.2 Preserve Historic and Cultural Resources
- QL3.3 Enhance Views and Local Character
- QL3.4 Enhance Public Space and Amenities
- LD2.4 Plan for End-of-Life



LD1.4 Pursue Byproduct Synergies

18

POINTS

INTENT

Critically reconsider whether traditional waste streams can be beneficially reused.

METRIC

The extent to which the project team works with external groups to find beneficial use of waste, excess resources, or capacity.

LEVELS OF ACHIEVEMENT

IMPROVED	ENHANCED	SUPERIOR	CONSERVING	RESTORATIVE
A + B	A + B + C	A + B + D	A + B + D	A + B + E
(3) Initial Investigation	(6) Synergy Pursued	(12) Short-Term Byproduct Reuse	(14) Long-Term Byproduct Reuse	(18) Circular Economy
<p>(A) The project team conducts an assessment of the availability and viability of excess resources (i.e., waste) or capacity, including but not limited to waste materials, heating or cooling, financial capacity, land area/space, or management/personnel capacity.</p> <p>(B) Candidates for byproduct synergies or reuse are identified. This can include finding a beneficial reuse for the project's waste or excess resources, or the project's beneficial reuse of external waste or excess resources. Project teams should also consider ecosystem services where project waste or excess resources can support natural systems, or where natural systems can process and remove project waste.</p>				
	<p>(C) The project team demonstrates an active attempt to incorporate at least one byproduct synergy or reuse into the project.</p>	<p>(D) The project successfully includes a byproduct synergy or reuse.</p> <p>Execution is a short-term or one-time byproduct synergy/reuse (e.g., during construction).</p>	<p>(D) The project successfully includes a byproduct synergy or reuse.</p> <p>Execution is a long-term regularly recurring byproduct synergy/reuse throughout project operations.</p>	<p>(E) The project is fully engaged in a "circular economy" system whereby the majority of its operational waste is beneficially reused OR the majority of its operational resources are sourced from external waste streams.</p>

DESCRIPTION

Though byproducts are most commonly thought of as solid waste, they may include a wide variety of excess resources. True byproduct synergy, or reuse, involves identification and cost-effective use of unwanted waste or excess resources (e.g., materials, energy/heat, gas emissions, effluent, water, services, capacity). Byproduct synergies can be accomplished in two ways: finding opportunities for a project's excess resources to be beneficially reused off site, or incorporating off-site excess resources into the project.

The term "byproduct synergy" may also be known as "industrial ecology," through its expression in "eco-industrial parks," or by the broader concepts of "circular economy." Whatever the preferred terminology, the classification of excess resources or services as "waste" is inherently inefficient. Everything has value. In a circular economy, all excess resources or services are directed to local beneficial use. These interconnected systems are more resilient by eliminating waste and reducing dependence on external sources. True circular economies are rare, but every project can contribute toward growing circular economies by investigating opportunities for beneficial reuse.

PERFORMANCE IMPROVEMENT

Improved: Creating byproduct synergy begins with understanding the value of a system's excess resources. Project teams identify excess resources within the project and assess their viability for reuse, as well as the opportunity to reuse excess resources within the project. Potential candidates to receive or provide byproducts are identified.

Enhanced: Byproduct synergies involved a complex matching of supply and demand. As a project is only one side of the arrangement, it is not always possible to successfully implement. However, there is value in actively attempting a byproduct reuse even if unsuccessful. Lessons learned can often carry over into other projects, increase general awareness, and improve the chances of future success.

Superior: While the ideal byproduct synergy creates a closed-loop system of perpetual renewal, this level recognizes the benefits when only short-term or one-time byproduct synergies are possible. For example, the beneficial reuse of a waste product during construction.

Conserving: Projects achieve a true byproduct synergy whereby ongoing excess resources are beneficially reused.

Restorative: Projects are integrated into a circular economy. This is determined by the amount of excess resources beneficially reused and/or the number of byproduct synergy connections in the network.

Applicability: It is likely that all projects that use materials or product waste can benefit from byproduct synergies. It would be difficult to demonstrate that the credit is not relevant or applicable to a project seeking an Envision award.

EVALUATION CRITERIA AND DOCUMENTATION GUIDANCE

A. Has the project team assessed the availability of either internal or external excess resources or capacity?

1. Documentation of efforts to identify available resources or capacity within the project, or project needs that could be met by external resources or capacity. Excess resources or waste may include more than physical waste streams. Consideration should include but not be limited to waste materials, heating or cooling, financial capacity, land area/space, or management/personnel capacity.

B. Has the project team identified opportunities for byproduct synergies or reuse?

1. Documentation that the project team identified opportunities for byproduct synergies or reuse. This can include finding a beneficial reuse for the project's waste or excess resources, or the project's beneficial reuse of external waste or excess resources. Project teams should also consider ecosystem services where project waste or excess resources can support natural systems, or where natural systems can process and remove project waste.

C. Has the project team actively pursued a byproduct synergy or reuse?

1. Documentation that serious overtures were made to potential candidates. Achieving byproduct synergies is not always possible. The intent of this criterion is to recognize projects that attempted to implement a byproduct reuse into the project but were unable due to unavoidable external factors.

D. Does the project include a byproduct synergy by utilizing unwanted excess resources or finding destinations for the beneficial reuse of unwanted excess resources?

1. Documentation that the project includes a byproduct synergy, which is a direct exchange of otherwise unwanted resources. Byproducts may be physical waste streams, emissions, or even energy (heat/electricity).
2. Determination of the nature of the byproduct reuse:
 - a. Short-term/one-time (e.g., during construction or for a limited period of time).

- b. Long-term/regularly recurring (e.g., ongoing reuse throughout project operations).

E. Is the project part of a circular economy, whereby the majority of operational byproducts are beneficially repurposed or the majority of operational resources consumed are beneficially repurposed?

1. Documentation that the project includes multiple byproduct synergies that constitute a majority of its waste streams or feedstock. Documentation should demonstrate that these are part of a broader network of byproduct reuse and not isolated independent activities.

RELATED ENVISION CREDITS

LD1.2 Foster Collaboration and Teamwork

LD2.4 Plan for End-of-Life

RA1.2 Use Recycled Materials

RA1.5 Balance Earthwork On Site

RA3.1 Preserve Water Resources

NW2.1 Reclaim Brownfields

CR2.6 Improve Infrastructure Integration

PROJECT EXAMPLE: SURREY BIOFUEL FACILITY

The Surrey Biofuel Facility (Envision Platinum, 2017) located in the Port Kells industrial area of Surrey, British Columbia, is the first fully integrated closed-loop organics waste management system in North America. This facility processes the city's unwanted kitchen and garden waste into biomethane gas which is used to fuel the city's fleet of waste collection trucks. The facility also produces a compost product suitable for landscaping and agricultural applications.





LD2.1 Establish a Sustainability Management Plan

18

POINTS

INTENT

Create a project sustainability management plan that can manage the scope, scale, and complexity of a project seeking to improve sustainable performance.

METRIC

Extent of organizational policies, authorities, mechanisms, education, and business processes put in place.

LEVELS OF ACHIEVEMENT

IMPROVED	ENHANCED	SUPERIOR	CONSERVING	RESTORATIVE
A + B	A + B + C	A + B + C + D	A + B + C + D + E	Not Available
(4) Plan	(7) "Plan-Do-Check-Act"	(12) Full Implementation	(18) Managing Change	
<p>(A) Roles and responsibilities for addressing sustainability are assigned to key members of the project team. Their authority on the project to affect change is sufficient and clear.</p> <p>(B) The project team develops a sustainability management plan, or adopts existing sustainability management plans or policies sufficient in scope and scale to address the sustainable performance of the project.</p> <p>The plan includes an index of all project features related to sustainability, and an assessment of the environmental, social, and economic aspects of the project.</p> <p>Sustainability goals and performance objectives are established and prioritized to reduce the project's impact. They are aligned with community needs and issues.</p>				
<p>(C) The project management plan contains sufficient processes, action plans, and management controls to achieve its sustainability goals and performance targets.</p>				
<p>(D) Implementation of the sustainability management plan, and progress toward established goals, is revisited periodically through meetings or written reports.</p>				
<p>(E) The plan is adaptable, flexible, and resilient enough to manage changes in environmental, social, or economic conditions of the project over time.</p>				

DESCRIPTION

This credit addresses the importance of supporting the achievement of sustainability goals through the structure of plans and policies. Given the long timelines, complex interorganizational cooperation, and varied consultants and contractors, it is critical to have a sustainability management plan to establish expectations and ensure that sustainability goals and objectives are communicated and carried through project delivery. When time and budgets are limited, sustainability criteria must have this level of institutional support in order to be successful. By clearly establishing roles, responsibilities, and expectations, project owners and project teams realize efficiencies in avoided conflicts, duplications, or miscommunication. Having a clear prioritization of goals helps consultants and contractors correctly devote their time and resources in order to deliver the best possible project for their client.

A sustainability management plan enables an organization to set goals, objectives, and policies; instigate plans and programs; review performance against a plan; and take corrective actions across the full dimensions of sustainability. The International Organization for Standardization (ISO) 14004 standard for social and environmental management plans provides guidance on developing a sustainability management plan.

PERFORMANCE IMPROVEMENT

Sustainability management plans may be stand-alone or incorporated into larger management plans. For smaller projects, sustainability management policies may be sufficient. Documentation should focus on demonstrating that key environmental, social, and economic performance targets are set, plans implemented, and progress tracked as described above.

Sustainability management plans should include the design, construction, and operations and maintenance of the project.

Improved: The project includes a sustainability management plan that can manage the scope, scale, and complexity of the project's sustainable performance goals. This assessment is based on the organizational policies, authorities, mechanisms, education, and business processes that have been put in place and a determination of their sufficiency.

To create the sustainability management plan, the project team should develop a list of all the environmental, economic, and social aspects of the project that relate to sustainability. Once established, the list of aspects is prioritized by the project team based on the importance of meeting both project and sustainability goals.

Enhanced: The sustainability management plan has clear processes and controls in place to achieve the stated goals (i.e., the plan is not solely aspirational in nature). The project team creates an action plan consisting of objectives and performance targets.

Superior: Implementation of the plan is revisited periodically and progress reviewed throughout project development.

Conserving: Sustainability recognizes that changes in socioeconomic and environmental conditions have the potential to significantly impact projects. Sustainability management plans and their subsequent sustainability performance goals take these changing conditions into account.

Applicability: It is likely that all projects can benefit from a sustainability management plan. It would be difficult to demonstrate that the credit is not relevant or applicable to a project seeking an Envision award.

EVALUATION CRITERIA AND DOCUMENTATION GUIDANCE

A. Are roles and responsibilities for addressing sustainability assigned to key members of the project team?

1. *Organizational charts and documentation showing the persons responsible for project sustainability issues, their position in the project organization, and their authority to make project decisions and affect change.*

B. Has a sustainability management plan been developed to assess and prioritize the environmental, economic, and social aspects of the project and set project sustainability goals, objectives, and targets?

1. *Documentation of a sustainability management plan for the project. The plan may be formal or informal and comprise existing organizational or programmatic sustainability management plans or policies that were applied to the project, so long as they are sufficient in scope and scale to address project performance. If a project-specific plan does not exist, documentation should clearly link higher-level plans and policies to their application on the project.*
2. *An index of all project features related to sustainability.*
3. *Assessment of the project's environmental, economic, and social impacts. This may include the potential for existing non-sustainable conditions to further deteriorate environmental, economic, or social conditions if left unaddressed.*

4. *Prioritized list of project goals, objectives, performance targets that take into account project importance and the consequences of change. Alignment of goals, objectives, and targets to community needs and issues.*

C. Does the project include a sustainability management plan that contains sufficient processes and management controls to address the sustainability goals, objectives, and targets?

1. *Documentation of the project's business processes and management controls in the form of procedures, flowcharts, checklists, audits, corrective action reports, and other documented control measures.*
2. *Documentation of a robust plan-do-check-act methodology to identify priorities, evaluate progress, and make adjustments to continually improve project sustainability performance.*
3. *Documentation showing tracking and implementation of the sustainability management plan during construction.*
4. *The sustainability goals are communicated throughout the team through methods such as construction plans, daily job briefings, subcontractor orientations, or on-site field training sessions.*

D. Was the sustainability management plan implemented and periodically revisited?

1. *Documentation that regular monitoring and reporting of progress against the plan's goals and objectives occurred (e.g., meetings or written reports).*

E. Is the project sustainability management plan adaptable, flexible, and resilient enough to manage changes in the environmental, social, or economic conditions of the project over its life?

1. *Identification of potential areas where changes in key design variables may impact project performance over time related to sustainability. Evidence that the plan accounts for these potential changes and is adaptable.*

RELATED ENVISION CREDITS

LD1.1 Provide Effective Leadership and Commitment

LD1.2 Foster Collaboration and Teamwork

LD2.3 Plan for Long-Term Monitoring and Maintenance

LD2.4 Plan for End-of-Life

RA1.1 Support Sustainable Procurement Practices

CR1.2 Reduce Greenhouse Gas Emissions

CR1.3 Reduce Air Pollutant Emissions

CR2.4 Establish Resilience Goals and Strategies



LD2.2 Plan for Sustainable Communities

16
POINTS

INTENT

Incorporate sustainability principles into project selection/identification in order to develop the most sustainable project for the community.

METRIC

The degree to which project selection/identification includes sustainability performance assessments and is part of a larger sustainable development plan.

LEVELS OF ACHIEVEMENT

IMPROVED	ENHANCED	SUPERIOR	CONSERVING	RESTORATIVE
A	A + B	A + B + C	A + B + C + D	A + B + C + D + E
(4) Sustainability Indicators	(6) Alternative Analysis	(9) Sustainability Assessment	(12) Sustainable Planning	(16) More Sustainable Communities
(A) Sustainability indicators or outcomes are considered in project selection/identification and planning.				
(B) Sustainable performance is included in alternative analyses during project identification. Alternatives include the sustainability of a “no-build” option.				
(C) During project identification, the project’s potential impact to broader external systems is assessed, such as growth patterns, congestion, energy and water demand/production, and how these impact the overall long-term sustainability of the community or region.				
(D) The project is part of a comprehensive sustainable development plan at the level of the infrastructure system, municipality/community, or region. The project demonstrates a direct connection and contribution to achieving specific sustainable development goals identified in the plan.				
(E) The project addresses an inherently unsustainable condition within the community.				

DESCRIPTION

Envision is not only about doing the project right, it is about doing the right project. Choosing the right project is a critical first step toward ensuring a sustainable project. These decisions are often made very early in the planning process during project selection/identification. This credit recognizes projects where social, economic, and environmental considerations were incorporated into the selection criteria.

Most infrastructure projects have very long life spans and, once constructed, can commit communities to a certain range of performance outcomes for decades. Furthermore, communities that grow and develop around this infrastructure may face limited choices in the future. This exists today, with communities burdened and limited in their choices for modifying existing infrastructure because of choices made decades ago. Owners and project teams should consider how infrastructure planning impacts the future of a community or region, especially in regards to sustainability and operational or replacement costs.

PERFORMANCE IMPROVEMENT

Improved: The potential sustainability (social, economic, environmental) impacts of the project were considered during project selection/identification.

Enhanced: The sustainability performance of project alternatives were evaluated and considered. Consideration was given to the relative sustainability of a no-build scenario.

Superior: Beyond the project itself (energy efficiency, reduce emissions, etc.), consideration was given to the project’s broader impacts to the overall sustainability of the community or interrelated systems. For example, asking whether a transportation project will drive density or lead to urban sprawl.

Conserving: Achieving a sustainable society requires a coordinated plan. This level is for communities that have invested in developing comprehensive sustainability plans that can leverage the co-benefits and efficiencies achieved from integrating infrastructure systems. In most cases, infrastructure development occurs within the context of existing infrastructure systems.

Restorative: As mentioned, many communities are limited in their sustainability performance by the infrastructure development of the 20th century. In this level, projects correct or mitigate an existing unsustainable condition (for example, a determination to replace an unsustainable energy plant at the end of its life with a sustainable source of energy generation).

Applicability: Consideration is given to the scope and scale of the project and whether it has the potential to more broadly impact community sustainability. For example, small projects that involve the retrofitting or refurbishment of components or systems within an existing facility may contribute to improved sustainability performance but may struggle to demonstrate an impact beyond the project site. Small projects that do not impact the broader community sustainability, and do not have the potential to impact community sustainability, may apply to have this credit deemed not applicable with supporting documentation.

EVALUATION CRITERIA AND DOCUMENTATION GUIDANCE

A. Was sustainability considered during project selection/identification?

1. *Documentation that sustainability indicators or outcomes were factors in considering project alternatives during project selection/identification in the earliest phases of project planning.*

B. Were alternative analyses conducted on sustainability performance during project identification?

1. *Documentation that the project selection/identification process included alternative analyses that included sustainability performance assessments.*
2. *Documentation that alternative analyses included the sustainability performance of a no-build option in order to determine whether new infrastructure construction was necessary.*

C. Was an assessment conducted of the project's impacts to broader long-term community or regional sustainability?

1. *Documentation that early planning assessments considered the broader impacts of the project on the long-term sustainability of the community or region.*

D. Is the project part of a comprehensive sustainable development plan?

1. *Documentation that the project is part of a broader community-wide sustainable development plan. If not clearly identified as a sustainable plan, documentation should include how the development plan advances sustainability objectives.*

E. Does the project address an inherently unsustainable condition within the community or region?

1. *Documentation that the project addresses or corrects an existing unsustainable condition within the community (e.g., nonrenewable resource consumption, water overuse, or environmental contamination).*

RELATED ENVISION CREDITS

QL1.1 Improve Community Quality of Life

QL2.1 Improve Community Mobility and Access

LD1.2 Foster Collaboration and Teamwork

LD3.1 Stimulate Economic Prosperity and Development

RA3.1 Preserve Water Resources

NW1.1 Preserve Sites of High Ecological Value

NW1.3 Preserve Prime Farmland

NW2.1 Reclaim Brownfields



LD2.3 Plan for Long-Term Monitoring and Maintenance

12

POINTS

INTENT

Put in place plans, processes, and personnel sufficient to ensure that long-term sustainable protection, mitigation, and enhancement measures are incorporated into the project.

METRIC

Comprehensiveness of long-term monitoring and maintenance plans, implementation goals, and commitment of resources to fund the activities.

LEVELS OF ACHIEVEMENT

IMPROVED	ENHANCED	SUPERIOR	CONSERVING	RESTORATIVE
A	A + B + C	A + B + C + D	A + B + C + D + E	Not Available
(2) Reduced Maintenance	(5) Maintenance Plan	(8) Securing Resources	(12) Ongoing Improvement	
<p>(A) The project includes strategies to reduce maintenance impacts. This may include better design, durable longer-lasting materials, or ease of access for maintenance and repair with minimal disruption to users and affected communities.</p>				
<p>(B) A monitoring and maintenance plan is developed with specific sustainability performance targets and an implementation schedule with clear goals and milestones. It addresses any unique challenges of monitoring or maintaining the project's sustainability features.</p> <p>(C) The project team meets with operations, monitoring, and maintenance staff to explain and discuss the operations plan.</p>				
<p>(D) Owner identifies the key personnel to carry out the plan, funding sources, and other resources to cover associated costs. This includes training for the operation, monitoring, and maintenance staff, and provisions for necessary future training.</p>				
<p>(E) A schedule is developed for future re-evaluation and modification of the maintenance plan based on monitored data.</p>				

DESCRIPTION

Sustainably designed and constructed projects can fail if they are not operated to maintain, or even enhance, their performance targets. Sustainability is also about reducing the social, environmental, and economic impacts of ongoing maintenance. The maintenance of existing infrastructure systems can be an economic burden on many communities. The frequent repair and replacement of poorly designed components can be wasteful of natural resources and disruptive to communities. However, failure to adequately maintain and monitor infrastructure can also lead to degraded performance with significant environmental, social, and/or financial consequences. For example, the cost to repair and maintain roads exponentially increases the further they degrade. In addition, poorly maintained roads lead to increased congestion, increased vehicle maintenance, accidents, and personal injury, which all create a financial burden on individuals and the community as a whole. The failure to properly plan or coordinate maintenance activities can also result in inefficiencies and waste. Therefore, project teams should consider how a project can be designed, and a maintenance plan

implemented, to reduce the long-term costs of maintenance. Infrastructure owners should also ensure that the resources are available to properly maintain a project over its life.

PERFORMANCE IMPROVEMENT

Improved: The project is intentionally designed and constructed to facilitate efficient and low-impact operations and maintenance while achieving high levels of performance. Designers and contractors work to ensure that the project anticipates and addresses key operations and maintenance activities.

Project teams should consider the new opportunities provided by the proliferation and accessibility of data and technology. Smart systems can reduce operations and maintenance costs, avoid disruptions, improve service, and enhance safety. Providing real-time information to infrastructure operators, key stakeholders, or the general public can create numerous advantages.

Enhanced: A comprehensive long-term plan is prepared and in place before the end of construction. Clear and concise

maintenance requirements and specifications are provided to prevent sustainable performance degradation resulting from the failure to follow specified operations or maintenance procedures required to maintain system performance. Without clear guidance on what is required to maintain sustainable performance, future owners and operators may unknowingly rely on old approaches, processes, and replacement parts.

Superior: Skills and resources are available to ensure that sustainability features are properly maintained. This ensures that the design performance will be maintained throughout the life of the project so long as sufficient resources and personnel are provided to implement the plan.

Conserving: The maintenance plan is treated as a living document with plans to reassess and improve performance over the life of the project.

Applicability: This credit is applicable to all projects that include ongoing monitoring and maintenance. In rare cases where projects do not include operation or maintenance activities, projects may apply to have this credit deemed not applicable with supporting documentation.

EVALUATION CRITERIA AND DOCUMENTATION GUIDANCE

A. Has the project team considered how to reduce ongoing operational impacts?

1. *Documentation of strategies intended to reduce the negative impacts of ongoing operations and maintenance. This may include but are not limited to better design, durable longer-lasting materials, ease of access for maintenance and repair, or minimal disruption to users and affected communities.*

B. Is there a clear and comprehensive plan in place for long-term monitoring and maintenance of the completed project?

1. *Plans for long-term monitoring and maintenance of the completed project.*

C. To what extent has the monitoring and maintenance plan been communicated with operations and maintenance staff?

1. *Documentation that the monitoring and maintenance plan has been communicated and delivered to the staff responsible for ongoing operations, monitoring, and maintenance.*

D. To what extent have sufficient resources been allocated for long-term monitoring and maintenance of the completed project and appropriate training been conducted?

1. *Designations of the persons or organizations assigned to monitor and maintain the completed project.*
2. *Explanation of how funding will be allocated, set aside, and maintained at sufficient levels to fund necessary monitoring and maintenance.*
3. *Documentation or plans showing that these resources will be in place following delivery of the project.*
4. *Documentation of meetings and/or training sessions intended to ensure a successful transition into operations.*

E. Is there a plan in place to re-evaluate and modify the maintenance plan based on monitored data?

1. *Schedule for re-evaluating the monitoring and maintenance plan.*

RELATED ENVISION CREDITS

LD2.1 Establish a Sustainability Management Plan

LD3.1 Stimulate Economic Prosperity and Development

LD3.2 Develop Local Skills and Capabilities

RA2.4 Commission and Monitor Energy Systems

RA3.4 Monitor Water Systems

CR1.1 Reduce Net Embodied Carbon

PROJECT EXAMPLE: RUNWAY 4L/22R AND ASSOCIATED TAXIWAYS RECONSTRUCTION

The project team for the Runway 4L/22R and Associated Taxiways Reconstruction project (Envision Silver, 2016) at the Detroit Metropolitan Wayne County Airport in Michigan realized that extending the useful life of a project can significantly impact the long-term monitoring and maintenance of the completed works. To this end, the team sought to increase the durability of the runway pavement to meet a longer than typical design life. Additionally, the team used pre-framed joints to enable easier repairs and reduce maintenance. These design decisions, considered early on, will minimize the maintenance requirements over the life of the project





LD2.4 Plan for End-of-Life

14

POINTS

INTENT

Ensure that the project team is informed by an understanding of the full impacts and costs of the project's end-of-life.

METRIC

The degree to which the project team analyzes, and communicates with stakeholders, the end-of-life impacts, cost, and value.

LEVELS OF ACHIEVEMENT

IMPROVED	ENHANCED	SUPERIOR	CONSERVING	RESTORATIVE
A + B	A + B + C	A + B + C + D	A + B + C + D + E	Not Available
(2) End-of-Life Plan	(5) Enhancements	(8) Pushing Boundaries	(14) Extending Boundaries	
<p>(A) The project team develops an end-of-life plan, including the necessary replacement/refurbishment of major components over the project life and its ultimate decommissioning, deconstruction, or replacement. Consideration is given to recyclability of materials and components and/or the ease of deconstruction or replacement (e.g., components or materials that can be easily separated for recycling or reuse).</p> <p>The plan is included in operations and maintenance documents.</p> <p>(B) Relevant future demands, loads, or other requirements on the infrastructure system are estimated over the anticipated project life. The project extends useful life by providing opportunities for reconfiguration, future expansion, flexibility, or to beneficially repurpose the project after end-of-life.</p>				
<p>(C) End-of-life impacts are assessed, including the environmental, social, and economic conditions of the site and surrounding community.</p>				
<p>(D) The project includes an analysis of end-of-life costs and salvage value associated with deconstruction, decommissioning, or replacement.</p>				
<p>(E) The project team demonstrates proactive stakeholder engagement in end-of-life planning and can demonstrate that the community understands the full life-cycle costs and benefits of the project.</p>				

DESCRIPTION

This credit encourages project teams to consider the costs and impacts associated with a project's end-of-life. In doing so, consideration should be given to extending the useful life of the project by enabling reconfiguration, future expansion, or flexibility, or by finding a beneficial use for the project. This credit also addresses minimizing end-of-life costs by designing projects to increase their end-of-life value, or the value of their components, including whether materials can be easily disassembled/deconstructed, recycled, or repurposed.

LD2.4 Plan for End of Life completes the series of life-cycle planning credits that include sustainable project selection (i.e., LD2.2 Plan for Sustainable Communities) and efficient low-impact operations and maintenance (i.e., LD2.3 Plan for Long-Term Monitoring and Maintenance). Given the long life of infrastructure, careful consideration should be given to the project's end of useful life.

PERFORMANCE IMPROVEMENT

Improved: replacement or refurbishment for major project components and the ultimate decommissioning, deconstruction, or replacement of the project. This is the foundation for developing an end-of-life plan.

There are many instances where infrastructure is currently operating under conditions that exceed its original design parameters. This causes accelerated degradation of the asset and speeds its end-of-life. Project teams should anticipate future loads and incorporate them into the project in order to prolong the project life. This can be achieved through incorporating capacity for reconfiguration, future expansion, or flexibility.

Enhanced: Project teams should also consider the ultimate end-of-life impacts of the project (for example, whether

decades of operation will render the site contaminated or otherwise environmentally damaged).

Superior: The next step is applying a monetary value to the project at the end of its life. This includes the positive values associated with repurposing components, and the costs associated with replacing/refurbishing, or removal and site mitigation. Understanding end-of-life costs and values can and should inform project planning and delivery.

Conserving: Project teams actively engage stakeholders in end-of-life planning and impact assessment. Communities should clearly understand the timeline and future burden of replacing or deconstructing infrastructure. In addition, end-of-life planning is more effective when the full range of needs of the community is taken into consideration. An infrastructure project or its components may no longer be suitable for their intended purpose at the end of their life. However, they may still retain value in meeting other community needs. For example, the very common repurposing of old rail lines as community bike and pedestrian trails, or the High-Line in New York City, which repurposed an elevated rail line as a public park.

Applicability: It is likely that all projects can benefit from end-of-life planning. It would be difficult to demonstrate that the credit is not relevant or applicable to a project seeking an Envision award.

EVALUATION CRITERIA AND DOCUMENTATION GUIDANCE

A. Has the project team developed an end-of-life plan?

1. *Base case for project useful life (in years).*
2. *Documentation of operations and maintenance documents including the end-of-life plan. The plan includes at minimum the timeline and frequency for replacement or refurbishment of all major components, as well as considerations for the ultimate decommissioning, deconstruction, or replacement of the project.*

B. Has the project team evaluated opportunities to extend the project's useful life or beneficially repurpose the project after end-of-life?

1. *Estimates of the relevant future demands, loads, or other requirements on the infrastructure system.*
2. *Documentation of how the overall design will allow for expansion, reconfiguration, and/or multiple uses*

OR

Documentation of how the project can feasibly and beneficially be repurposed at the end of its useful life.

C. Has the project team assessed potential social, environmental, and economic end-of-life impacts?

1. *Documentation estimating potential impacts associated with the project. Assessment should cover social, environmental, and economic impacts.*

D. Has the project team evaluated the costs and salvage value of the project's deconstruction, decommissioning, or replacement?

1. *Results of the analysis identifying end-of-life costs and ultimate salvage value. Submission should indicate whether costs are calculated in future or present values.*

E. Has the project team proactively engaged stakeholders in end-of-life planning?

1. *Documentation demonstrating that end-of-life costs and impacts were incorporated into the stakeholder engagement process and that the community was engaged in considering end-of-life options for the project.*

RELATED ENVISION CREDITS

- LD1.3 Provide for Stakeholder Involvement
- LD1.4 Pursue Byproduct Synergies
- LD2.1 Establish a Sustainability Management Plan
- LD3.3 Conduct a Life-Cycle Economic Evaluation
- CR1.1 Reduce Net Embodied Carbon



LD3.1 Stimulate Economic Prosperity and Development

20

POINTS

INTENT

Support economic prosperity and sustainable development, including job growth, capacity building, productivity, business attractiveness, and livability.

METRIC

The extent of job creation, increased operating capacity, access, quality, and/or improved socioeconomic conditions.

LEVELS OF ACHIEVEMENT

IMPROVED	ENHANCED	SUPERIOR	CONSERVING	RESTORATIVE
A + B	A + B + C	A + B + C + D	A + B + C + D + E	Not Available
(3) New Capacity	(6) Improved Choices	(12) Business Attraction	(20) Development Rebirth	
<p>(A) Jobs are created during design, construction, and/or operation. The project team determines the number, type, and duration of jobs created as a result of the project.</p> <p>(B) The project adds new operating capacity. Capacity additions can apply to business, industry, or the public.</p>				
<p>(C) The project provides additional access, increases the number of choices, and/or increases the quality of services.</p> <p>The project team can demonstrate that the addition of choices will drive competitiveness, efficiency, or improved productivity for business, industry, or cultural and recreational facilities.</p>				
<p>(D) The project contributes to the host community's attractiveness for businesses, industries, or their workforce by improving the overall business or community environment (i.e., people want to live and/or work in the community).</p>				
<p>(E) The project will stimulate local, regional, or national economic development.</p> <p>The economic projections take into account changing social, economic, and/or environmental conditions.</p>				

DESCRIPTION

This credit recognizes contributions to long-term economic prosperity and sustainable development for the community that are aligned with established community goals. Economic prosperity is the state of a thriving community that supports the needs of the community and businesses, and where people want to live, work, and play. Sustainable development is economic development that is conducted without the depletion of social or natural resources. While not all infrastructure projects are directly connected to economic growth, they are connected to the economy by driving livability and community attractiveness to businesses and the workforce. In this way, infrastructure can contribute to socioeconomic vitality, with infrastructure costs offset by increased economic activity in the community, region, or country. Demonstrating the broader economic benefits of the project provides significant advantages in acquiring project approval, funding, and community support.

Economic prosperity and sustainable development are not synonymous with expansion. Because of economic downturns, changes in demographics, and other factors, many communities face shrinking populations and an eroding tax base. In these situations, it may be more desirable to reduce the quantity of unused and abandoned housing, commercial buildings, and industrial facilities to reduce the associated burden of infrastructure operations and maintenance.

PERFORMANCE IMPROVEMENT

Economic development takes into account what is realistic and affordable, and expectations for Envision assessments are based on the relative scale and scope of the project.

Improved: The project team quantifies job creation associated with the project. The project results in increased capacity. This capacity increase is generally due to projected growth in commercial, industrial, and/or residential

demand. By increasing capacity, infrastructure meets the fundamental requirements for future growth.

Enhanced: The project provides increased access, choices, or quality of service. This results in increased efficiency, competitiveness, or improved productivity. For example, communities that provide access to high-quality multimodal transportation options can realize economic benefits in reduced productivity loss due to congestion.

Superior: The project increases community attractiveness to businesses due to improved socioeconomic conditions (for example, a downtown street revitalization program that makes the community more attractive to businesses and residents).

Conserving: Projects leverage their limited funding to drive systemic change throughout the local, regional, or national economy. However, project teams should consider that long-term economic prosperity and sustainable development require an ability to adapt to changing economic, social, and environmental conditions and the resulting changing operating environment.

Applicability: The scope of this credit is broad, covering commercial, industrial, cultural, and recreational aspects of community development. In determining whether this credit is applicable to a project assessment, it is likely that all projects have the ability to support and stimulate economic prosperity and sustainable development. It would therefore be difficult to demonstrate that the credit is not relevant or applicable to a project seeking an Envision award.

EVALUATION CRITERIA AND DOCUMENTATION GUIDANCE

A. Does the project create a significant number of new jobs during its design, construction, and operation?

1. *Calculations showing the number and type of new jobs created during the design, construction, and operation of the project that benefit the local economy. In this case, "local" is relative to the project scale and may even be "state/provincial" or "national" for large projects. Calculations should distinguish between direct and indirect jobs.*
2. *Explanation of the impact of these jobs on the local economy relative to the project size.*

B. Does the project provide new operating capacity for business, industry, or the public?

1. *Documentation showing how the project expands, or increases the quality of, operating capacity for business, industry, or the public (e.g., cultural and/or recreational facilities).*
2. *Official documents such as community plans, assessments, meeting minutes, or letters from community leaders or decision makers that confirm the project benefits to business, industry, or the public.*

C. Does the project provide additional access, increase the number of choices, and/or increase the quality of infrastructure services for business, industry, or the public?

1. *Documentation of how the project provides additional access, increases the number of choices, and/or increases the quality of infrastructure services.*
2. *Analyses showing how additional access, choices, or quality of services will provide benefits to the local*

economy, e.g., reduced congestion, lower operating costs, increased efficiency, and new operating alternatives.

D. Does the project improve community attractiveness for business, industry, or the public by generally improving the socioeconomic conditions of the community?

1. *Documentation of how the project improves community attractiveness for business, industry, or the public by generally improving the socioeconomic conditions of the community.*
2. *Analyses showing how improved community attractiveness to business, industry, or their workforce as a result of the project will benefit local economic development.*

E. Will the project stimulate economic prosperity and further economic development?

1. *Documentation of how the project will have economic impacts beyond its own scope. For example, a port expansion that will provide benefits to industries throughout a region, or public spaces that will revitalize community property values.*
2. *Analyses showing how the project is likely to cause systemic change in the local economy. Note that while the scale of economic impact is considered relative to the size of the project, broader economic impacts beyond the project design, construction, and operation may not be demonstrable for very small projects.*
3. *Documentation that the project's projected impact on future economic development has factored into changing social, economic, and environmental trends. This may include, but is not limited to, changing demographics of the community, growing or shrinking tax bases, and environmental degradation or climate change.*

RELATED ENVISION CREDITS

- QL1.1 Improve Community Quality of Life
- QL3.1 Advance Equity and Social Justice
- QL3.4 Enhance Public Space and Amenities
- LD2.2 Plan for Sustainable Communities
- LD2.3 Plan for Long-Term Monitoring and Maintenance
- LD3.3 Conduct a Life-Cycle Economic Evaluation
- NW1.3 Preserve Prime Farmland
- NW2.1 Reclaim Brownfields

PROJECT EXAMPLE: LOW LEVEL ROAD

The impetus for the Low Level Road project (Envision Platinum, 2015) in North Vancouver, British Columbia was to improve the quality of existing infrastructure to increase the capacity of Port terminal operations, leading to greater trade opportunities for the province, and the country as a whole. The project team estimated that economic impacts generated by the port terminals are expected to rise from providing 25,996 direct and indirect jobs and \$1.68 billion in GDP in 2007, to 30,823 direct and indirect jobs and \$2 billion in GDP by 2020 as a result of improving the port's capacity and the quality of associated infrastructure.



LD3.2 Develop Local Skills and Capabilities

16
POINTS

INTENT

Expand the knowledge, skills, and capacity of the community workforce to improve their ability to grow and develop.

METRIC

The inclusion of current and future training programs, informed by skill or capability gaps, and targeted to economically depressed or underemployed communities.

LEVELS OF ACHIEVEMENT

IMPROVED	ENHANCED	SUPERIOR	CONSERVING	RESTORATIVE
A	A + B	A + B	A + B + C	A + B + C + D
(2) Gaining Skills	(4) Growing Capacity	(8) Building Communities	(12) Long-Term Opportunities	(16) Community Revitalization
<p>(A) The project includes training programs for local skill development. This may include designers, contractors, subcontractors, or operators.</p>				
<p>(B) Beyond general skill development, the project team identifies specific skill or capability gaps in the local workforce.</p> <p>Training programs target these gaps to improve local capacity. Skills are transferable beyond the end of the project.</p>		<p>(B) The project team works with, or is informed by, community and local/state workforce development agencies to assess local employment and educational needs.</p> <p>Training programs target these gaps to improve local capacity. Skills are transferable beyond the end of the project.</p> <p>Skills developed are likely to provide the local workforce, agencies, and/or companies with a competitive advantage in the future.</p>		
			<p>(C) Education, skill development programs and/or opportunities will continue after project delivery. This may include community education and awareness training. Programs may be at the organizational level but must be relevant to the project.</p>	
			<p>(D) Training and skill development programs specifically target economically depressed, underemployed, or disadvantaged communities.</p>	

DESCRIPTION

This credit addresses the degree to which the project expands the knowledge, skills, and capacity of the community workforce during the project design, construction, and operation and maintenance phases in order to improve their ability to grow and develop. Most businesses recognize the value of investing in workforce development. Transitioning to a sustainable society will require significant growth and education throughout the infrastructure industry and the broader public. Sustainable infrastructure development can often include new or uncommon materials, methodologies, or technology, which require new or uncommon skills and capabilities within the workforce. A lack of capacity to deliver these project objectives creates uncertainty that can lead to higher costs, slower delivery, or lower-quality results. Building local skills and capabilities helps ensure a successful project. More broadly, skills and capacity building within a workforce can create systemic change that carries over to future projects.

Consultants and contractors should consider how capacity building increases marketability and competitiveness that provides an advantage in securing future projects. Infrastructure owners should consider how capacity building within their community could drive competition and decrease future project costs.

PERFORMANCE IMPROVEMENT

This assessment is based on the inclusion of current and future training programs, informed by skill or capability gaps, and targeted to economically depressed or underemployed communities.

Improved: The project includes training programs. The scope of training is relative to the scale of the project. Note that standard internship does not qualify as a providing local skill development.

Enhanced: The project team identifies opportunities to align project needs with gaps in the local workforce.

Superior: Beyond the project team's own assessment, identification of skills and/or training gaps is informed by engagement with the community or workforce development agencies.

Conserving: Training programs associated with the project will be ongoing or there will be future training that extends beyond the end of construction. These activities may be provided by the project owner or other organizations committed to the long-term operation of the project. Education and training activities may also expand beyond workforce training to include broader community education and awareness. Expectations of the level of community education and awareness training are relative to the scope and scale of the project.

Restorative: Projects target skill development and training programs to communities that are economically depressed or underemployed. In this way, the project supports the restoration of the economic prosperity of the community with the goal of sustained and inclusive economic growth, as well as higher rates of productive employment.

Applicability: For this credit, an alternative compliance path is provided in the Evaluation Criteria and Documentation Guidance for projects that are too small to include independent training and skill development. It is therefore unlikely that a project could demonstrate no opportunity for education at any point during its planning, design, or construction. When organizational-level training programs are referenced, project teams must demonstrate a relevance to the project.

EVALUATION CRITERIA AND DOCUMENTATION GUIDANCE

A. Will the project include training programs for local skill development?

1. Evidence of training programs associated with the project. Note that pre-existing internships or internships of limited scope (1-3 people) do not qualify as training "programs."

Alternative compliance path for small projects for which it is impractical to have independent training programs: demonstrate

that the infrastructure owner has extensive or notable training programs. Documentation must still demonstrate relevance of these training programs to the project.

B. Has the project team identified skill or capability gaps in the local workforce and targeted training programs to address them?

1. Documentation of the skill or capability gaps identified (for example, inexperience in deploying sustainable technologies, best practices, or new methods).
2. Evidence of training programs that specifically target identified gaps.

Alternative compliance path for small projects for which it is impractical to have independent training program: demonstrate that the infrastructure owner has extensive or notable training programs. Programs must still meet criteria requirements.

C. Will training, education, or skill development programs continue after project delivery?

1. Documentation of commitments or programs by the project owner or operator to deliver training, education, or skill development programs after construction is completed. This may include, but is not limited to, community education and/or awareness training programs.

D. Will training and skill development programs specifically target economically depressed, underemployed, or disadvantaged communities?

1. Documentation of how economically depressed, underemployed, or disadvantaged communities were determined relative to the local/regional economic conditions.
2. Evidence that efforts were made to specifically target these communities for participation in training programs.

RELATED ENVISION CREDITS

QL1.3 Improve Construction Safety

QL3.1 Advance Equity and Social Justice

LD2.3 Plan for Long-Term Monitoring and Maintenance

LD3.1 Stimulate Economic Prosperity and Development



LD3.3 Conduct a Life-Cycle Economic Evaluation

14

POINTS

INTENT

Utilize economic analyses to identify the full economic implications and the broader social and environmental benefits of the project.

METRIC

The comprehensiveness of the economic analyses used to determine the net impacts of the project, and their use in assessing alternatives to inform decision making.

LEVELS OF ACHIEVEMENT

IMPROVED	ENHANCED	SUPERIOR	CONSERVING	RESTORATIVE
A	A + B	A + B + C	A + C + D	A + C + D + E
(5) Life-Cycle Cost Analysis	(7) Life-Cycle Cost Alternatives Analysis	(10) Benefit Mapping	(12) Sustainability Cost Benefit Analysis	(14) Sustainability CBA Alternatives Analysis
(A) A life-cycle cost analysis (LCCA) is conducted on the whole project to identify the total economic impacts of the project.				
(B) LCCA is used to compare and assess alternatives for at least one major design component.				
(C) The project team maps the social, environmental, and financial costs and benefits of the project. Costs and benefits must be quantified but not necessarily monetized.				
(D) The LCCA in criterion A is expanded into a comprehensive sustainability cost benefit analysis based on monetizing the social, environmental, and financial costs and benefits identified in criterion C.				
				(E) The sustainability cost benefit analysis is used to compare and assess alternatives for at least one major design component. The selected alternative produces a net positive present value including social and environmental benefits.

DESCRIPTION

This credit provides incentives for, and recognition of, the use of sound, industry-accepted economic analysis to provide a better measurement of the value of a project and ultimately encourage greater levels of sustainability. Taking a life-cycle economic approach to project evaluation can enhance decision making by encouraging the effective management of resources and assets that ultimately lead to more sustainable projects. Life-cycle economic evaluations allow for a comprehensive assessment to better understand the trade-offs of upfront capital costs and the longer-term anticipated operational savings that may accrue from sustainable design. An intended outcome of infrastructure is often to generate benefits and/or reduce negative impacts to the community, the environment, and broader society. Economic analysis can be used to measure and value these benefits, which are typically assessed only qualitatively.

Using rigorous economic analysis to more fully assess investments can help organizations best use its funds among competing capital projects. By using a life-cycle approach, design alternatives can be compared on a present value basis, which may ultimately prove the business case for more sustainable projects.

Life-cycle cost analysis (LCCA) is one of several evaluation techniques commonly used to compare and evaluate the financial feasibility of various design alternatives over an assumed service life cycle. LCCA provides a more informed perspective of the total financial costs of the project and allows a more direct comparison of competing projects. At a minimum it is necessary to make sure the project is assessing capital, operations and management, replacement cost, and any residual value over a consistent time period for all alternatives, while incorporating discounting techniques to factor in the time-value-of-money to compare multiple different projects on a common basis.

While life-cycle cost analysis provides greater rigor and insight in the planning process, it does not assess the social and environmental benefits generated by the project. A comprehensive sustainability cost benefit analysis measures the broader financial, social, and environmental benefits of the project. This extended analysis further quantifying those impacts and then monetizes them. A sustainability cost benefit analysis adds the monetary values of social and environmental impacts to the life-cycle financial results (LCCA) to comprehensively measure the sustainability impacts. It allows a direct assessment of the trade-offs for varying levels of financial costs, environmental quality, social impacts, and resiliency, and allows decision makers to identify those projects that are the most-beneficial and cost-effective.

Often, upfront capital costs are the key driver in planning decisions; however this omits the life-cycle costs of the project, risks and uncertainty, or the broader outcomes that impact the environment and society. As a result, owners may overlook sustainability-related investments with higher upfront capital costs, but which ultimately produce cost savings over the life-cycle of the project from lower utility costs, operations and maintenance costs, or less replacement costs.

There is significant guidance that can be found regarding the specific steps to follow in conducting a life-cycle economic evaluation. There is no one prescribed approach that is recommended for this credit; however, a general approach is as follows:

1. Define the base case
2. List feasible alternatives including no-build—these can be design elements or entire projects
3. Specify categories of costs and benefits
4. Quantify costs and benefits as incremental to the base case
5. Monetize costs and benefits
6. Identify and incorporate risks into the analysis
7. Discount future cash flows to calculate net present value

PERFORMANCE IMPROVEMENT

Improved: The credit begins with conducting a life-cycle cost analysis. LCCA is one of several evaluation techniques commonly used to compare and evaluate the financial feasibility of various design alternatives over an assumed service life-cycle. LCCA provides a more informed perspective of the total financial costs of the project. At a minimum it is necessary to make sure the project is assessing capital, operations and management, replacement cost, and any residual value over a consistent time period, while incorporating discounting techniques to factor in the time-value-of-money to compare multiple different projects on a common basis.

Enhanced: LCCA is used for a more direct comparison of competing projects or design alternatives.

Superior: Project teams map and quantify the social and environmental impacts of the project. While life-cycle cost analysis provides greater rigor and insight in the planning process, it also omits the explicit assessment of the social and environmental benefits generated by the project.

Conserving: A comprehensive sustainability cost benefit analysis (CBA) is used to quantify and measure the broader financial, social, and environmental benefits of the project. This may also be known as a “triple bottom line costs benefit analysis” (TBL-CBA) or sustainable return on investment (SROI). CBA is a widely

used, well-documented methodology for assessing the net economic effects of investments or policies. For a sustainability assessment, it is expanded to include social and environmental factors. The approach provides a systematic process for calculating, monetizing, and comparing the economic benefits and costs of a particular project, by putting benefits and costs in a common metric. It allows a direct assessment of the trade-offs for varying levels of financial costs, environmental quality, social impacts, and resiliency, and allows decision makers to identify those projects that are the most beneficial and cost-effective.

Typically, a “base case” is compared to one or more alternatives (which have some significant improvement compared to the base case). The analysis evaluates incremental differences in order to identify additional benefits that will result if the alternative is undertaken, and what additional costs are needed to bring it about. To compare different projects or alternatives of the same project that may have costs and benefits occurring in different years, discounting is used to convert future benefits and costs to a current year perspective. The standard criterion for deciding whether a project can be justified is whether the net present value is positive. The net present value is the discounted monetized value of expected net benefits (i.e., benefits minus costs). Impacts are quantified and monetized through the use of statistical and/or engineering data, and peer-reviewed valuation research.

Restorative: Beyond retroactive assessments, project teams can demonstrate that the results of the analysis actively informed decisions on project selection or the design of at least one major project component.

Applicability: It would be difficult to demonstrate that this credit is not relevant or applicable to a project seeking an Envision award.

EVALUATION CRITERIA AND DOCUMENTATION GUIDANCE

A. Has a life-cycle cost analysis been conducted to identify the financial impacts of the whole project?

1. *A narrative description that is clearly and concisely written for reviewers with limited economic expertise to understand. Project teams should describe the proposed project and expected costs. To the greatest extent possible, it should identify evidence-based practices as the basis for the analysis.*
2. *Documentation of the life-cycle cost analysis, including assumptions, data sources, and methodology. The methodology is to follow best practices, including national or international guidance where appropriate/available. The analysis must be conducted over a consistent time period for all alternatives, while incorporating discounting techniques to factor in the time-value-of-money in order to make comparisons on a common basis. The analysis should at minimum include the following information:*
 - *Project/investment costs (capital costs)*
 - *Replacement costs*
 - *Annual or reoccurring operations and maintenance costs*
 - *Residual value*
 - *Adding financial benefit streams, such as revenues, which offset costs*

B. Have life-cycle cost analyses been used to compare alternatives for at least one major project component?

1. Documentation of the planned use of the financial analysis and how it impacted the decision-making process or alternative selected. This should include specific reference to the inherent design features, technologies, or other elements that differ from the base case. The base case is not necessarily always a “do nothing” alternative, but it is generally the “lowest” capital cost alternative that achieves some basic utility to the project. In the case of a new design, the base case could mean a more basic facility design or one with fewer sustainability-related components.

C. Has the project team mapped the social, environmental, and financial costs and benefits of the project?

1. Index and quantification of project costs and impacts. In addition to the data that would have been collected as part of the life-cycle costs analysis in criterion A, project teams may consider but are not limited to the following topics to guide and structure the social and environmental impacts:
 - Reductions in mortality, morbidity/ injuries – safety improvements
 - Benefit to low- and moderate-income persons and/ or households – distributional impacts
 - Enhanced recreational values – increased biking or walking, exercising, etc.
 - Enhanced aesthetics or streetscape – light pollution, general aesthetics, streetscape enhancements
 - Productivity improvements – enhanced thermal comfort, reduction in respiratory diseases, allergens, air quality, etc.
 - Reduced car or truck mileage – congestion, safety, emissions, road damage, vehicle operating costs
 - Noise/odor levels
 - Ecosystem and biodiversity effects (e.g., from wetlands restoration or reforestation)
 - Air quality – reduced criteria pollutants from reduced energy use, vehicle use, embedded energy in materials, solid waste, among others.
 - Water quality – reduced stormwater runoff, reduced effluent flows
 - Water quantity – reduced demand for freshwater
 - Climate change – reduced greenhouse gas emissions (CO₂ equivalents) from reduced energy use, vehicle use, embedded energy in materials, solid waste, among others.
 - Resiliency value – value of protection from the effects of future/repeat disasters or enhanced reliability that reduces future cost such as damage, displacement, or loss of service.

D. Has a cost benefit analysis been conducted to identify the financial, social, and environmental impacts of the whole project?

1. Documentation of the cost benefit analysis, including assumptions, data sources, and methodology. The methodology is to follow best practices, including national or international guidance where appropriate/available. The analysis must be conducted over a consistent time period for all alternatives, while incorporating discounting techniques to factor in the time-value-of-money in order to make comparisons on a common basis. Note that a cost benefit analysis includes all data that would have been collected as part of a life-cycle cost analysis in criterion A. There is no one prescribed approach that is recommended for conducting a cost benefit analysis comparison; however, project teams may use the following sample generic approach:
 - Define base case
 - List feasible alternatives
 - Specify categories of costs and benefits
 - Quantify costs and benefits (as incremental to the base case)
 - Monetize costs and benefits
 - Identify and incorporate risks into the analysis (this is a best-practice approach to cost benefit analysis, and is optional)
 - Discount future cash flows to calculate NPV and other metrics

E. Have cost benefit analyses, including financial, environmental, and social benefits, been used to compare the alternatives for at least one major project component?

1. Documentation of the planned use of the economic analysis and how it impacted the decision-making process or alternative selected.

RELATED ENVISION CREDITS

- QL1.1 Improve Community Quality of Life
- LD2.3 Plan for Long-Term Monitoring and Maintenance
- LD2.4 Plan for End-of-Life
- LD3.1 Stimulate Economic Prosperity and Development
- CR2.2 Assess Climate Change Vulnerability
- CR2.3 Evaluate Risk and Resilience
- CR2.4 Establish Resilience Goals and Strategies

Kansas City Streetcar: Kansas City, Missouri

The Kansas City Streetcar project (Envision Platinum, 2016) was developed to support the city's downtown revitalization after voters approved sustainable funding through local taxes in 2011. The area within two blocks on either side of the streetcar route is home to 65,000 employees and 4,600 residents; and more than 10 million people visit destinations of interest in the corridor annually. Since the streetcar project was announced, the area has welcomed more than 40 development projects totaling about \$1.8 billion in economic activity.

Propelled by an active partnership between the City, Kansas City Streetcar Authority (KCSA), Kansas City Area Transportation Authority (KCATA), Mid-America Regional Council (MARC), Jackson County, Kansas City Downtown Transportation Development District, and HDR (as the lead planning and design firm), the streetcar project moved from the alternatives analysis phase to final design in less than two years. Design was completed in March 2014, and construction was completed at the end of 2015, followed by a period of testing before opening to the public in May 2016.

The project was designed as a fully integrated transportation system to support the city's focus on Main Street as a key corridor for sustainable economic development, and to foster a sense of community and identity. The success is evidenced in the significant economic development that has initiated in the vicinity of the streetcar corridor and the higher than expected ridership.

Notable achievements for the Kansas City Streetcar within the Envision categories include:

Quality of Life: The Downtown Corridor Alternatives Analysis, that ultimately recommended a streetcar along Main Street, was built around goals directly tied to the needs and objectives of the local community. The streetcar provides an alternative mode of transportation that reduces congestion and improves mobility and accessibility for a heavily developed urban area, within walking distance to a mix of commercial, office, and

residential uses. It provides "last mile" connectivity to other regional transit services, and integrates with bicycle and pedestrian facilities. Designers took care to enhance public spaces while preserving urban aesthetics and neighborhood character to further improve the overall quality of life.

Leadership: The project scored highly in Leadership due to its deeply collaborative planning and design processes and long-term visioning approach. This included its strategy for sustainable growth and economic development, and long-term management of stakeholder processes and community relationship-building.

Resource Allocation: The project was designed and constructed to minimize waste generated by the project, re-use or divert waste from landfills, and to implement green infrastructure solutions where possible. For example, approximately 47 percent of the streetcar maintenance facility contains recycled content and nearly 90 percent of the facility's construction waste was diverted from the landfill. Furthermore, all 845 tons of steel used for the streetcar tracks were made with recycled metal scrap. The project team also took several measures to minimize the amount of excavated material that had to be taken off-site. Concrete removed during construction (from sidewalks, driveways and pavement) was crushed into recycled aggregate and reused in project construction, and all scrap metal was recycled.

Natural World: The project carefully considered water management and stormwater runoff for both the streetcar maintenance facility and the streetcar tracks themselves. Strategies to control erosion, minimize post-development site runoff and encourage groundwater recharge were implemented. In fact, the post-development stormwater runoff levels are below pre-development levels.

Climate and Resilience: The project scored highly in Climate and Risk [now Climate and Resilience] due largely to the system's resilient design for winter weather.





LD0.0 Innovate or Exceed Credit Requirements

+10
POINTS

INTENT

To reward exceptional performance beyond the expectations of the system and application of innovative methods that advance state-of-the-art sustainable infrastructure.

METRIC

Whether project sustainability performance qualifies as innovation, exceptional performance, or is not otherwise recognized in existing credits.

LEVELS OF ACHIEVEMENT

INNOVATION	
A or B or C	
(+1-10) Innovate or Exceed Credit Requirements	
<p>(A) Implement innovative methods, technologies, or processes that are novel either in their use, application, or within the local regulatory or cultural context.</p> <p>OR</p> <p>(B) Implement measures that exceed the highest existing requirements within one or more Leadership credits.</p> <p>OR</p> <p>(C) Address additional aspects of sustainability not currently recognized in Envision</p>	

DESCRIPTION

This credit addresses instances in which projects:

1. Implement innovative methods, resources, technologies, or processes that are novel in their use, application, or within the local regulatory or cultural context of the project;
2. Exceed the performance requirements of one or more credits; and/or
3. Address additional aspects of sustainability not currently recognized in Envision

Points for this credit are not calculated in the overall applicable points and, therefore, act as bonus points. Given the nature of the credit, the broad format of which is intended to encourage creative infrastructure solutions, thorough documentation is expected. Project teams may pursue more than one of the three possible options for this credit, or pursue multiple for the same option, for a total of up to ten (10) bonus points.

PERFORMANCE IMPROVEMENT

Innovation:

To qualify for innovation points, projects must implement innovative methods, resources, technologies, or processes (e.g., the use of a pre-existing technology in a new way or the successful application of a technology or methods in regions or locales where existing policies, regulations, or general opinion have prevented their use). In these circumstances, it is imperative to prove that the application of the technology does, and will continue to, meet performance expectations

and that it does not have a corresponding negative impact on the local or global environment, economy, or community.

Projects may demonstrate they implement innovative methods, technologies or processes in several ways:

- The project is an early adopter of new technology or methods that can demonstrably improve project performance without negative trade-offs;
- The project uses technologies or methods that may be general practice in other regions or parts of the world, but within the context of the project (whether climate, regulations, policies, political support, public opinion, etc.) have not yet gained acceptance. Significant efforts are taken to demonstrate the effectiveness of the technology or method within the context and provide a precedent for future adoption.
- The project team takes significant steps to include research goals within the project's development, or work with a university or research organization to advance the general knowledge of the profession. Proprietary research that is not made publicly available cannot count toward achieving this credit.

Project teams must also demonstrate that the innovation serves a purpose. This can be done in one of two ways:

- Overcoming significant problems, barriers, or limitations— Project teams demonstrate that the innovation reduces or eliminates significant problems, barriers, or limitations that previously hampered the use of the new methods, technologies, or processes implemented on the project.

- Creating scalable and/or transferable solutions—Project teams demonstrate that new methods, technologies, or processes implemented on the project are scalable across a wide range of project sizes and/or are applicable and transferable across multiple kinds of infrastructure projects in multiple sectors.

Exceptional Performance:

To qualify for exceptional performance points, projects must meet the highest level of achievement for one or more Leadership credits. For instance, projects seeking additional points in credit LD2.2 Plan for Sustainable Communities must already be achieving a restorative impact on conditions within a community. In this instance, exceptional performance may be pursued by projects whose magnitude of investment in restoring inherently unsustainable conditions within the host and affected communities represents a significant percentage of the project budget and a primary objective of the project.

- Projects in which a sustainability management plan was the dominant approach to managing the scope, scale, and complexity of the project seeking to improve sustainable performance. This approach must have the potential to be adopted in other related projects;
- Projects for which job development and training far exceed the Restorative achievement expectations, demonstrating that the project will fundamentally revitalize the communities' economy through job creation and skills training.

Address Additional Aspects of Sustainability:

To qualify for bonus points under this approach, project teams must demonstrate that they are addressing one or more aspects of sustainability not currently recognized in Envision. Sustainability performance must be related to Leadership. Addressing an aspect of sustainability not currently covered by the Envision system might sometimes be considered innovative, in which case the requirements for the Innovation path may be followed. For example, a project may earn bonus points for:

- Providing ongoing public reporting of specific metrics related to the project's environmental performance over the life of the project.
- Implementing community education programs to foster public awareness of the functions and benefits of the project.

- Establishing an endowment fund to fund scholarships and/or student internship programs for an extended period of time.
- Working with officials to identify and address conflicting laws, standards, regulations, or policies that run counter to sustainability goals, objectives, and practices.

EVALUATION CRITERIA AND DOCUMENTATION GUIDANCE

A. To what extent does the project implement innovative methods, technologies, or processes that overcome significant problems, barriers or limitations, or create scalable and transferable solutions?

1. *Documentation of the application of innovative technologies or methods. Detailed description of how this application will improve existing conventional practice either globally or within the unique context of the project. Provide justification as to why this application should be considered innovative either as a technology, a method, or within the project context (climate, political, cultural, etc.).*
2. *Documentation that the project reduces or eliminates significant problems, barriers, or limitations that previously hampered the use or implementation of certain resources, technologies, processes, or methods that improve the sustainability of the project. Alternatively, documentation that the new methods, technologies, or processes implemented on the project are scalable across a wide range of project sizes and/or are applicable and transferable across multiple kinds of infrastructure projects in multiple sectors.*

B. To what extent does the project exceed the highest levels of achievement for a given credit?

1. *Detailed documentation of how the project exceeds the existing requirements currently within a given Leadership credit.*

C. To what extent does the project address a sustainability aspect that is not currently addressed by the Envision system?

1. *Detailed documentation of how the project addresses a sustainability aspect that is not currently addressed by the Envision system.*
2. *Documentation showing how this aspect relates to the Leadership category.*

The image shows an industrial piping system. A prominent green pipe in the foreground is labeled "RECYCLED BRINE". Behind it, a complex network of pipes in orange, light blue, and green is supported by a metal rack system. A motor and valve assembly are visible in the background. The entire setup is located outdoors against a light-colored building wall.

RECYCLED BRINE

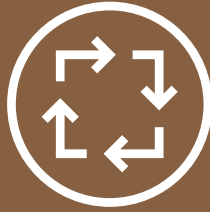

Resource Allocation

Resources are the assets that are needed to build infrastructure and keep it running. This category is broadly concerned with the quantity, source, and characteristics of these resources and their impacts on the overall sustainability of the project. Resources addressed include physical materials (both those that are consumed and that leave the project), energy, and water use. These resources are finite and should be treated as an asset to use respectfully. **Materials, Energy, and Water** comprise the three subcategories of Resource Allocation.

14 / credits

Image
Ion Exchange Resin Plant and East Water Treatment Plant Upgrades City of Boynton Beach, Florida (Envision Bronze, 2017).

- 1 Is the project constructed from sustainable materials?
- 2 Does the project manage construction and operational waste?
- 3 Does the project reduce energy consumption and source renewable energy?
- 4 Does the project reduce water consumption and protect water resources?
- 5 Does the project monitor energy and water use?

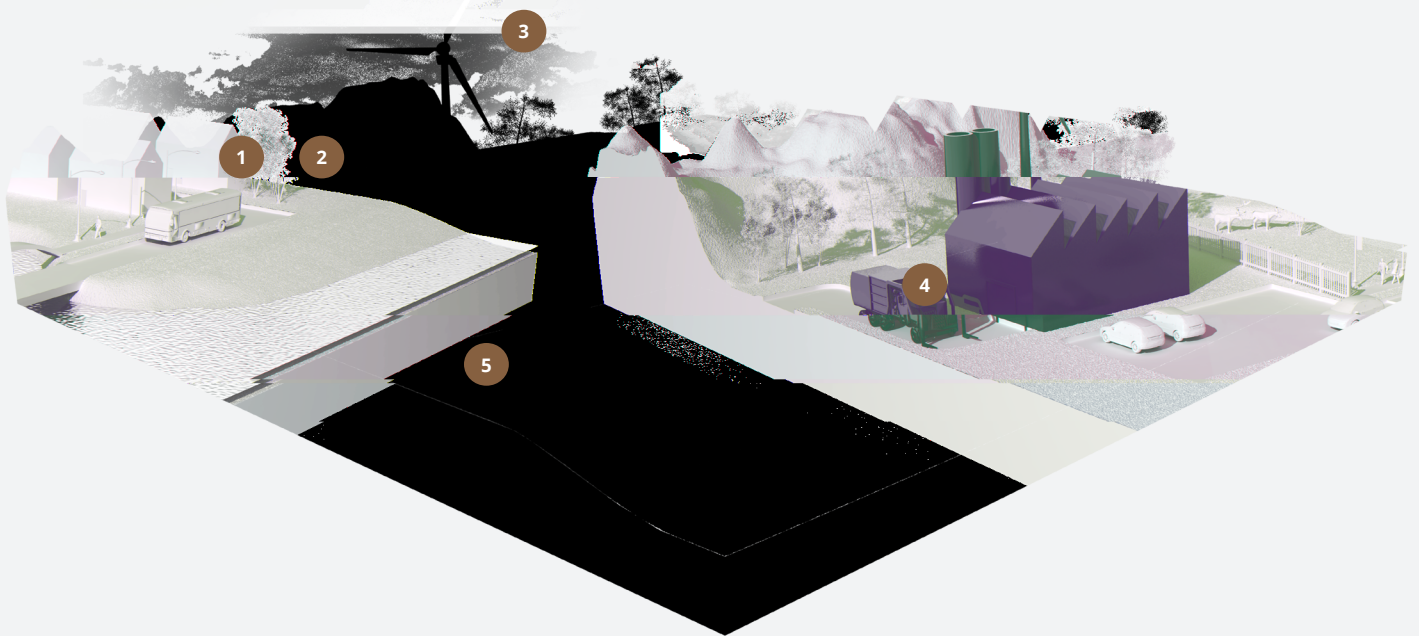

MATERIALS

Minimizing the total impact of material use should be a primary consideration for infrastructure projects. This begins with sourcing more sustainably manufactured materials, using recycled materials, and reducing waste. Always sourcing sustainable materials must be balanced with safety, stability, and durability. The life-cycle of a project and its materials should always be considered: where materials have come from and what waste is created. These factors help to minimize the total amount of natural resources consumed.

ENERGY

Energy from nonrenewable fossil fuel sources is finite. Therefore, use of renewable energy is encouraged as a means to minimize fossil fuel consumption. Reducing overall energy use is crucial and, ideally, projects will both reduce overall energy use and meet the remaining energy needs through renewable sources whenever possible. Commissioning and monitoring energy systems is critical to ensure projects function as planned and maintain the intended level of efficiency throughout the life of the project.

WATER

Between a growing population, increasing consumption, and a changing climate, the future availability of water resources is uncertain. Therefore, it is critical that infrastructure projects reduce overall water use, particularly potable water. Alternative water sources, such as stormwater runoff, can be captured and reused for many functions without reducing the overall water resource. Monitoring water use is an important step in using water efficiently and reducing water loss through leaks.

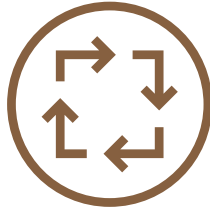

Resource Allocation

MATERIALS

- RA1.1** Support Sustainable Procurement Practices
- RA1.2** Use Recycled Materials
- RA1.3** Reduce Operational Waste
- RA1.4** Reduce Construction Waste
- RA1.5** Balance Earthwork On Site

ENERGY

- RA2.1** Reduce Operational Energy Consumption
- RA2.2** Reduce Construction Energy Consumption
- RA2.3** Use Renewable Energy
- RA2.4** Commission and Monitor Energy Systems

WATER

- RA3.1** Preserve Water Resources
- RA3.2** Reduce Operational Water Consumption
- RA3.3** Reduce Construction Water Consumption
- RA3.4** Monitor Water Systems

- RA0.0** Innovate or Exceed Credit Requirements
-



RA1.1 Support Sustainable Procurement Practices

12

POINTS

INTENT

Develop sustainable procurement policies and programs to source materials and equipment from manufacturers and suppliers that implement sustainable practices.

METRIC

The extent of sustainable procurement programs, and the percentage of materials sourced from manufacturers and/or suppliers that implement sustainable practices.

LEVELS OF ACHIEVEMENT

IMPROVED	ENHANCED	SUPERIOR	CONSERVING	RESTORATIVE
A + B	A + B	A + B	A + B	Not Available
(3) 5% Sustainable Procurement	(6) 15% Sustainable Procurement	(9) 25% Sustainable Procurement	(12) 50% Sustainable Procurement	
<p>(A) A written sustainable procurement policy/program is in place.</p> <p>The program includes a well-defined process for selecting suppliers and/or manufacturers of materials, supplies, and equipment, including selection criteria focused on environmental practices and social responsibility.</p>				
<p>(B) At least 5% of all project materials, supplies, and equipment meet the sustainable procurement policy/program requirements.</p>	<p>(B) At least 15% of all project materials, supplies, and equipment meet the sustainable procurement policy/program requirements.</p>	<p>(B) At least 25% of all project materials, supplies, and equipment meet the sustainable procurement policy/program requirements.</p>	<p>(B) At least 50% of all project materials, supplies, and equipment meet the sustainable procurement policy/program requirements.</p>	

DESCRIPTION

This credit encourages choosing suppliers that incorporate sustainability into their policies and daily practices and operations. Project teams should give preference to suppliers that have taken into account the environmental, economic, and social impacts of their products and have active programs in place for performance improvement.

Infrastructure projects are major consumers of materials, and owners should consider their ability to influence higher sustainability performance upstream in the material manufacturing chain. As owners and project teams request and require sustainability disclosures, this information will become increasingly available and easier to obtain. Such changes have already occurred in the material supply chains for buildings. While this credit is linked to CR1.1 Reduce Net Embodied Carbon, it expands beyond the impacts of per unit material production to include the environmental impacts of the entire manufacturing process.

Supplier integrity and ethical behavior are important considerations. Establishing policies for the procurement of sustainably manufactured products and materials helps safeguard the reputation and achievements of the project, and all organizations involved, from the possibility of future disclosures that project materials were produced in unsafe or environmentally damaging conditions.

PERFORMANCE IMPROVEMENT

Improved – Conserving: Levels in this credit are distinguished by the percentage of total materials the project procures from manufacturers that are protective of human health and the environment. For example, project teams may make efforts to use products certified under a recognized third-party sustainability certification program, utilize products with environmental product declarations, or choose suppliers based on the incorporation of sustainability policies and practices to their operations. As there is no single standard for determining sustainable and ethical manufacturing practices, a variety of indicators are permitted.

Applicability: This credit is applicable to all projects that include the use or consumption of physical materials in construction or operation.

EVALUATION CRITERIA AND DOCUMENTATION GUIDANCE

A. Has the project team implemented a sustainable procurement policy or program?

1. Documentation of a sustainable procurement policy that includes commitments to identify and select manufacturers and/or suppliers that implement sustainable practices. Program documentation includes a well-defined process for selecting suppliers and/or manufacturers of materials, supplies, and equipment, including selection criteria focused on environmental practices and social responsibility. Examples of qualifying requirements include but are not limited to:

- *Environmental management systems consistent with ISO (International Organization for Standardization) 14001*
- *Product-specific type III Environmental Product Declaration (EPD) conforming to ISO 14025, 14044.*
- *Third-party verified sustainability program (e.g., Forest Stewardship Council (FSC), Green Seal, EcoLogo, Underwriters Laboratory, National Biosolids Partnership (NBP), Concrete Sustainability Council (CSC), etc.)*
- *Third-party verified corporate sustainability report consistent with the Global Reporting Initiative (GRI) Sustainability Report or equivalent.*

Note that, given the complex nature of infrastructure procurement, some flexibility is given to project teams to develop additional sustainable procurement best practices that are equivalent to, or exceed, the examples listed above. However, the project team must then justify how their requirements meet the intent of the credit and maintain parity.

B. To what extent do materials, supplies, equipment, manufacturers, and suppliers meet sustainable procurement policy/program requirements?

1. *Calculations of the percentage of the total project materials by cost, weight, or volume that meet the*

sustainable procurement policy/program requirements on social and environmental impacts.

Documentation of the total weight, volume, or cost of materials.

An inventory for all materials being tracked for sustainable procurement practices, including a description of the material and the manufacturer or supplier of the material, along with evidence of the disclosure requirements.

Documentation indicating the sustainable procurement requirements were met.

2. *Material/supplier tracking forms and/or spreadsheets; receipts/invoices.*

RELATED ENVISION CREDITS

QL3.1 Advance Equity and Social Justice

LD2.1 Establish a Sustainability Management Plan

RA1.2 Use Recycled Materials

CR1.1 Reduce Net Embodied Carbon

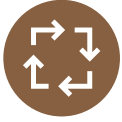

RA1.2 Use Recycled Materials

16

POINTS

INTENT

Reduce the use of virgin natural resources and avoid sending useful materials to landfills by specifying reused materials, including structures, and material with recycled content.

METRIC

Percentage of project materials that are reused or recycled. Plants, soil, rock, and water are not included in this credit.

LEVELS OF ACHIEVEMENT

IMPROVED	ENHANCED	SUPERIOR	CONSERVING	RESTORATIVE
A	A	A	A	Not Available
(4) At Least 5% From Recycled	(6) At Least 15 % From Recycled	(9) At Least 25% From Recycled	(16) At Least 50% From Recycled	
(A) At least 5% (by weight, volume, or cost) of recycled materials including materials with recycled content and/or reused existing structures or materials.	(A) At least 15% (by weight, volume, or cost) of recycled materials including materials with recycled content and/or reused existing structures or materials.	(A) At least 25% (by weight, volume, or cost) of recycled materials including materials with recycled content and/or reused existing structures or materials.	(A) At least 50% (by weight, volume, or cost) of recycled materials including materials with recycled content and/or reused existing structures or materials.	

DESCRIPTION

The purpose of this credit is to reduce the use of virgin natural resources and avoid sending useful materials to landfills. Using recycled, reused, and renewable materials and products, including existing structures and materials on site, reduces demand for virgin materials and the embodied carbon emissions and environmental degradation attributed to their extraction and processing. Using these materials also reduces waste and supports the market for recycled and reused materials. Project teams should consider how salvaging or repurposing existing materials or structures can significantly reduce demand for new construction materials as well as project costs. The reuse of existing materials or elements may also have a significant cultural or aesthetic value, such as street lamps, sidewalk pavers, bridges, and more.

PERFORMANCE IMPROVEMENT

Improved – Conserving: Levels in this credit are distinguished by the percentage of total materials that are reused or recycled. Calculations of recycled materials can be done by weight, volume, or cost, but must remain consistent within the credit. Calculations should compare the total quantity of recycled materials and reused structures with the total quantity of materials on the project. Products that contain a percentage of recycled material should be factored according to the percentage of material that is recycled.

Recycled content is defined in accordance with ISO 14021 as the portion of materials used in a product that have been diverted from the solid waste stream and used in part or whole in place of a new primary material. Material eligible for consideration can also be defined as pre-existing material on site, or from another site, that was previously a product or piece of equipment that is now being repurposed or reused. To

be considered “reused,” the project team must demonstrate some intention or effort to reclaim, salvage, or repurpose the materials or structures in keeping with the credit intent.

Natural materials such as soil and rock when used as backfill do not count toward this credit but are addressed in RA 1.5 Balance Earthwork On Site. If natural resources on the site are harvested and manufactured in order to take the place of new or primary materials, such as pulverizing stone in order to produce aggregate, project teams are responsible for demonstrating that the actions truly replace a new primary material. Likewise, when claiming the reuse of existing structures or materials, project teams must clearly demonstrate that a conscious decision was made to salvage those materials from demolition and disposal. Materials cannot be counted as recycled if, in standard practice, they would not otherwise have been removed. For example, when repairing a road, project teams cannot claim the entirety of the remaining road as “recycled,” as that material would not typically have been removed.

Project teams must always ensure that all project materials meet the necessary quality and performance criteria required for the intended application, whether recycled or not. Materials must also meet all state or local solid waste agency requirements for using recycled materials in construction. Any recycled materials used must not pose unacceptable risks to human health and safety or the environment.

Applicability: This credit is applicable to all projects that include the use or consumption of physical materials in construction or operation.

EVALUATION CRITERIA AND DOCUMENTATION GUIDANCE

A. To what extent has the project team used recycled materials, including materials with recycled content and/or reused existing structures or materials?

1. Total quantity of materials used on the project by weight, volume, or cost.
2. Inventory of specifications for materials containing recycled content. Inventory should include the name of the product, the name of the manufacturer, the weight, volume, or cost of the material, and the percentage of recycled content (either post-industrial or post-consumer recycled content).
3. Calculations of percentage of reused or recycled materials by weight, volume, or cost.

To calculate materials with recycled content, multiply the material weight, volume, or cost by the percentage of recycled content.

Mechanical, electrical, water equipment, and their components may be excluded from the calculations. In these instances, the most efficient equipment should be specified.

Calculations do not include plants, soils, rocks, or water.

4. Inventory of existing materials or structures that have been reused.

Design documents showing the location and weight, volume, or cost of reused structures or materials. In determining weight, volume, or cost, the project team may refer to standard equivalents.

In order to meet the intent of this credit, the project team must be able to demonstrate an intentional choice to salvage materials or structures that might otherwise have been sent to landfills and/or replaced. In addition, they must demonstrate that such action is within the scope of the project. For example, a project to resurface an airport runway cannot claim the entirety of the surrounding airport as "reused" materials. However, a project that intentionally chooses to refurbish an existing bridge, rather than replace it, may count the retained components of the existing bridge as "reused."

RELATED ENVISION CREDITS

LD1.4 Pursue Byproduct Synergies

NW1.4 Preserve Undeveloped Land

CR1.1 Reduce Net Embodied Carbon



RA1.3 Reduce Operational Waste

14

POINTS

INTENT

Reduce operational waste and divert waste streams from disposal to recycling and reuse.

METRIC

Percentage of total operational waste or byproducts diverted from disposal.

LEVELS OF ACHIEVEMENT

IMPROVED	ENHANCED	SUPERIOR	CONSERVING	RESTORATIVE
A + B	A + B	A + B	A + B	Not Available
(4) Recycle/Reuse At Least 25%	(7) Recycle/Reuse At Least 50%	(10) Recycle/Reuse At Least 75%	(14) Recycle/Reuse 95%	
<p>(A) Develop an operational waste management plan that, at a minimum, identifies the materials to be diverted from disposal and whether the materials will be sorted on site or commingled.</p>				
<p>(B) The project team identifies waste streams or byproducts that will occur as a result of the operation of the project.</p> <p>The project is planned or designed to divert at least 25% of operational waste. Diversion may be a combination of waste reduction measures and/or sourcing waste to other facilities for recycling or reuse.</p>	<p>(B) The project team identifies waste streams or byproducts that will occur as a result of the operation of the project.</p> <p>The project is planned or designed to divert at least 50% of operational waste. Diversion may be a combination of waste reduction measures and/or sourcing waste to other facilities for recycling or reuse.</p>	<p>(B) The project team identifies waste streams or byproducts that will occur as a result of the operation of the project.</p> <p>The project is planned or designed to divert at least 75% of operational waste. Diversion may be a combination of waste reduction measures and/or sourcing waste to other facilities for recycling or reuse.</p>	<p>(B) The project team identifies waste streams or byproducts that will occur as a result of the operation of the project.</p> <p>The project is planned or designed to divert at least 95% of operational waste. Diversion may be a combination of waste reduction measures and/or sourcing waste to other facilities for recycling or reuse.</p>	

DESCRIPTION

The goal of this credit is to reduce operational waste and divert waste streams or byproducts from disposal to recycling and reuse. Opportunities exist within the planning, design, and construction of projects to reduce the estimated operational waste produced. Additionally, project teams should consider the ability of the remaining waste generated by the project to be recycled or beneficially reused. Decisions made throughout the project delivery process can either enhance or limit the project's ability to reduce and divert waste.

PERFORMANCE IMPROVEMENT

Improved – Conserving: Levels in this credit are distinguished by the percentage of total operational waste diverted from disposal. As industry standards on waste generation do not exist for most infrastructure projects, project teams are required to provide calculations for an appropriate base case from which to determine percentage reductions. Accepted methodologies for establishing baseline performance data are explained in detail in the front of this manual and include existing conditions, a seriously considered alternative, standard practice, or a comparable existing project/facility.

This credit recognizes decisions that minimize the generation of waste or maximize the opportunities to recycle and/or reuse waste. Minimizing the generation of waste may involve early planning decisions or design features that increase efficiency. For collecting and diverting waste from landfills, project teams are encouraged to think beyond just the collection of recyclables in office or public spaces. While this is important, for large infrastructure projects this activity can be orders of magnitude smaller than the process waste generated by the operation of the project.

Maximizing opportunities for waste to be recycled or reused requires identifying potential sources and destinations for recycling. If material is sent to a recycling facility, project teams should consider whether the facility is certified for meeting acceptable recycling rates. The final application/destination of diverted or reused materials should not pose risks to human health and safety or the environment, and should be in compliance with all state/provincial and local solid waste requirements. Waste deemed hazardous should not be included in the total waste calculations and should be disposed of according to local, state/provincial, and federal law. Methods of diversion should meet the spirit and intent of the credit to reduce the social and environmental impacts of waste generation. Acceptable means of diversion may include but are not limited to:

- Waste reduction;
- Reuse or recycle materials on site;
- Materials sent to recycling or reclamation facilities;
- Materials sent to manufacturers to be used as post-consumer recycled content;
- Materials composted on site or sent to a composting facility;
- Land application of biosolids;
- The use of material, if appropriate, as infill;

Unacceptable means of diversion include:

- Burying waste material unsuited for infill.

Applicability: This credit is applicable to all projects that produce operational waste or byproducts. Projects that do not include any operational waste may apply to have this credit deemed not applicable with supporting documentation.

EVALUATION CRITERIA AND DOCUMENTATION GUIDANCE

A. Has the project team developed a waste management plan to decrease project waste and divert waste from landfills during operation?

1. Documentation of the operational waste management plan,

OR;

Policies, specifications, or contract documents sufficient to address the diversion/recycling of the project's operational waste.

B. To what extent has the project team reduced waste or diverted waste from landfills?

1. Identification of waste streams that will occur during the operations of the project (e.g., sludge produced from the treatment of wastewater, byproduct or residual materials produced as a result of waste to energy facilities).
2. Documentation of how the project was planned or designed in order to reduce the generation of waste during operations or to divert operational waste from landfills. Documentation includes waste type and methods to reduce waste generation.
3. Calculations of estimated total waste reduction measures and percentage of materials diverted to recycling or reuse. The percentage of diverted waste should be calculated as the ratio of material diverted from landfills against the total waste generated during construction or operations. Calculations may be done by weight, volume, or cost but must remain consistent throughout the credit.

Waste deemed hazardous should not be included in the total waste calculations and should be disposed of according to local, state/provincial, and federal law.

RELATED ENVISION CREDITS

LD2.1 Establish a Sustainability Management Plan

CR1.1 Reduce Net Embodied Carbon



RA1.4 Reduce Construction Waste

16

POINTS

INTENT

Divert construction and demolition waste streams from disposal to recycling and reuse.

METRIC

Percentage of total waste diverted from disposal.

LEVELS OF ACHIEVEMENT

IMPROVED	ENHANCED	SUPERIOR	CONSERVING	RESTORATIVE
A + B	A + B	A + B	A + B	Not Available
(4) Recycle/Reuse 25%	(7) Recycle/Reuse 50%	(10) Recycle/Reuse 75%	(16) Recycle/Reuse 95%	
<p>(A) Implement a construction waste management plan that, at a minimum, identifies the materials to be diverted from disposal and whether the materials will be sorted on site or commingled.</p>				
<p>(B) The project team sets a target goal for construction waste diversion.</p> <p>During construction at least 25% of waste materials are recycled, reused, and/or salvaged.</p> <p>Diversion may be a combination of waste-reduction measures and sourcing waste to other facilities for recycling or reuse.</p>	<p>(B) The project team sets a target goal for construction waste diversion.</p> <p>During construction at least 50% of waste materials are recycled, reused, and/or salvaged.</p> <p>Diversion may be a combination of waste-reduction measures and sourcing waste to other facilities for recycling or reuse.</p>	<p>(B) The project team sets a target goal for construction waste diversion.</p> <p>During construction at least 75% of waste materials are recycled, reused, and/or salvaged.</p> <p>Diversion may be a combination of waste-reduction measures and sourcing waste to other facilities for recycling or reuse.</p>	<p>(B) The project team sets a target goal for construction waste diversion.</p> <p>During construction at least 95% of waste materials are recycled, reused, and/or salvaged.</p> <p>Diversion may be a combination of waste-reduction measures and sourcing waste to other facilities for recycling or reuse.</p>	

DESCRIPTION

The goal of this credit is to reduce construction waste and divert waste streams from disposal to recycling and reuse. Project teams can improve performance by considering the ability of waste generated during construction to be recycled or beneficially reused, implementing waste management plans to capture waste, and identifying possible recycling centers with appropriate capabilities.

When considering the extra time or effort involved in collecting and diverting construction waste, consideration should be given to cost savings in dumping fees. Additionally, some recycled materials such as scrap metal have a positive value. Achieving high rates of construction waste diversion is often about the institutional training and operating procedures of the organizations and companies involved. Infrastructure owners should consider these capabilities when choosing project teams.

PERFORMANCE IMPROVEMENT

Improved – Conserving: Levels in this credit are distinguished by the percentage of total construction waste diverted from disposal. This is calculated as the ratio of material diverted from landfills against the total waste generated during construction. Calculations must be done by weight or volume. Though often more difficult to quantify, projects may also

include efforts to minimize construction waste generation if sufficient supporting documentation is provided.

Diversion requires a management plan and identification of potential sources and destinations for recycling. Identification and evaluation of options for recycling and reuse are the first steps in development of effective plans for handling, segregation, and storage of materials. It is important to determine which materials must be separated versus which can be commingled.

The final application/destination of diverted or reused materials should not pose risks to human health and safety or the environment, and should be in compliance with all state/provincial and local solid waste agency requirements. Material sent to landfills for use as cover is still being disposed of in landfills and therefore does not meet the spirit or intent of this credit. If material is sent to a recycling facility, project teams should consider whether the facility is certified for meeting acceptable recycling rates. Waste deemed hazardous should not be included in the total waste calculations and should be disposed of according to local, state/provincial, and federal law. Soils and rocks are not included in this credit, but are addressed in RA1.5 Balance Earthwork On Site. Methods of diversion should meet the spirit and intent of the credit to reduce the social and environmental impacts of waste generation. Acceptable means of diversion may include but are not limited to:

- Waste reduction;
- Reuse or recycle materials on site;
- Materials sent to recycling or reclamation facilities;
- Materials sent to manufacturers to be used as post-consumer recycled content;
- Materials composted on site or sent to a composting facility;
- The use of material, if appropriate, as infill;

Unacceptable means of diversion include:

- Burying waste material unsuited for infill.

Applicability: This credit is applicable to all projects that produce construction waste. Projects that do not include any construction waste may apply to have this credit deemed not applicable with supporting documentation.

EVALUATION CRITERIA AND DOCUMENTATION GUIDANCE

A. Has the project team developed a comprehensive waste management plan to decrease project waste and divert waste from landfills during construction?

1. *Documentation of the construction waste management plan,*

OR;

Policies, specifications, or contract documents indicating a construction management plan will be developed and implemented.

2. *Documentation that the construction management plan was implemented.*

B. To what extent has construction waste been diverted from landfills?

1. *Policies, specifications, contract documents, or commitments by the project team to achieve a target construction waste diversion rate.*

2. *Provide a general description of each type/category of construction and demolition materials generated, location of receiving agent, and quantity of waste diverted (by category) in weight (tons) or volume (cubic yards/meters).*

3. *Calculations of total waste reduction measures and percentage of materials diverted to recycling or reuse. The percentage of diverted waste should be calculated as the ratio of material diverted from landfills against the total waste generated during construction. Calculations may be done by weight (tons) or volume (cubic yards/meters) but must remain consistent throughout the credit.*

Waste deemed hazardous should not be included in the total waste calculations and should be disposed of according to local, state/provincial, and federal law.

RELATED ENVISION CREDITS

LD2.1 Establish a Sustainability Management Plan

CR1.1 Reduce Net Embodied Carbon



RA1.5 Balance Earthwork On Site

 POINTS	<p>INTENT</p> <p>Minimize the movement of soils and other excavated materials off site to reduce transportation and environmental impacts.</p>	<p>METRIC</p> <p>Percentage of excavated material retained on site or nearby.</p>
--	---	--

LEVELS OF ACHIEVEMENT

IMPROVED	ENHANCED	SUPERIOR	CONSERVING	RESTORATIVE
A	A	A	A	Not Available
(2) Reuse At Least 30% On Site	(4) Reuse At Least 50% On Site	(6) Reuse At Least 80% On Site	(8) Fully Balanced Site	
<p>(A) Excavated material moved off site and/or fill brought onto the site does not exceed 70% of total site soil handling.</p> <p>OR</p> <p>100% of fill and excavated materials are sourced or reused within 25 mi/40 km of the site.</p>	<p>(A) Excavated material moved off site and/or fill brought onto the site does not exceed 50% of total site soil handling.</p> <p>OR</p> <p>100% of fill and excavated materials are sourced or reused within 10 mi/16 km of the site.</p>	<p>(A) Excavated material moved off site and/or fill brought onto the site does not exceed 20% of total site soil handling.</p> <p>OR</p> <p>100% of fill and excavated materials are sourced or reused within 5 mi/8 km of the site.</p>	<p>(A) The site is fully balanced. No earthwork is removed from the site and no earthwork is imported.</p>	

DESCRIPTION

Modern construction equipment and methods have made the leveling of large sites a possibility. However, the large-scale removal and/or replacement of soils and excavated materials has impacts that span the categories of Quality of Life, Leadership, Resource Allocation, Natural World, and Climate and Resilience. Impacts include but are not limited to increased noise and congestion, loss of landscape characteristics, increased fuel consumption, increased equipment use, degraded soil health, loss of microbial biodiversity, introduction of invasive species, disrupted hydrology, and increased greenhouse gas and air pollutant emissions. Project teams should consider how finding beneficial uses of excavated soils and rocks on site can reduce social environmental impacts, lead to co-benefits, and save costs.

PERFORMANCE IMPROVEMENT

Improved – Conserving: Levels in this credit are distinguished by the percentage of soil handling retained on site. During planning, design, and construction, project teams should identify opportunities to minimize grading, retain soil on site, and/or eliminate the need to transport additional soil to the site.

For the purpose of this credit, earthwork includes excavation of naturally occurring materials such as soil, rocks, and grubbed plant material. It does not include manufactured materials such as asphalt, concrete pavement, or other manufactured in-ground man-made structures. Excavated materials, such as soils, deemed contaminated or hazardous should not be

included in the total calculations and should be disposed of according to local, state/provincial, and federal law.

An alternative approach is available for projects to source all fill, and find beneficial reuse for all excavated material, within a limited radius of the project. Distances should be calculated as a radius extended from the project boundary. For long, linear infrastructure projects, the center of the distance radius moves along the site (e.g., the center of the radius will be at the beginning of the project and move as the project progresses).

Applicability: This credit is applicable to all projects that involve the excavation of qualifying earthwork. Projects that do not include any earthwork, or only involve the excavation of excluded material considered contaminated or hazardous, may apply to have this credit deemed not applicable with supporting documentation. In rare cases, where the amount of excavated soil is insignificant in comparison to the scale of the project, teams may apply to have this credit deemed not applicable with supporting documentation. However, the reviewer may exercise his/her discretion in determining what constitutes an insignificant quantity of excavated material in the context of the project.

EVALUATION CRITERIA AND DOCUMENTATION GUIDANCE

A. To what extent has the project team designed the project to balance cut and fill to reduce the excavated material taken off site?

1. Documentation showing how the project balanced cut and fill on site and calculations of the percentage of excavated materials remaining on site.
2. Documentation showing the destination of any materials transported off site and their proximity to the project site. For long, linear infrastructure projects, the center of the radius moves along the site (i.e., the center of the radius will be at the beginning of the project and move as the project progresses).

Excavated materials deemed hazardous should not be included in the total calculations and should be disposed of according to local, state/provincial, and federal law.

RELATED ENVISION CREDITS

- QL1.4 Minimize Noise and Vibration
- LD1.4 Pursue Byproduct Synergies
- RA2.2 Reduce Construction Energy Consumption
- NW2.2 Manage Stormwater
- NW2.4 Protect Surface and Groundwater Quality
- NW3.5 Protect Soil Health
- CR1.1 Reduce Net Embodied Carbon
- CR1.2 Reduce Greenhouse Gas Emissions
- CR1.3 Reduce Air Pollutant Emissions



RA2.1 Reduce Operational Energy Consumption

26

POINTS

INTENT

Conserve energy by reducing overall operational energy consumption throughout the project life.

METRIC

Percentage of operational energy reductions achieved.

LEVELS OF ACHIEVEMENT

IMPROVED	ENHANCED	SUPERIOR	CONSERVING	RESTORATIVE
A + B	A + B	A + B	A + B	Not Available
(6) 10% Energy Reduction	(12) 30% Energy Reduction	(18) 50% Energy Reduction	(26) 70% Energy Reduction	
<p>(A) The project team determines the estimated annual energy consumption of the project. If annual energy consumption varies, the project team submits the range of estimated performance over the project life.</p>				
(B) Operational energy is reduced at least 10%.	(B) Operational energy is reduced at least 30%.	(B) Operational energy is reduced at least 50%.	(B) Operational energy is reduced at least 70%.	

DESCRIPTION

This credit addresses the important need to reduce overall energy consumption. Energy generation is the primary source of greenhouse gas emissions and numerous other pollutants harmful to the environment and human health. While use of renewable energy reduces impacts, the primary goal of all projects should be to minimize the overall energy consumed as much as possible.

There are significant and compounding cost savings to reducing operational energy use. Project teams should take a whole-systems design approach when considering options in order to maximize achievement. While single actions like replacing fluorescent lights with light emitting diodes (LEDs) are a positive first step, large energy savings can be achieved when considering project alternatives and the design of major energy consuming systems.

PERFORMANCE IMPROVEMENT

Improving – Conserving: Levels in this credit are distinguished by the percentage of operational energy reductions. As industry standards on operational energy use do not exist for most infrastructure projects, project teams are required to provide calculations for an appropriate base case. Accepted methodologies for establishing baseline performance data are explained in detail in the front of this manual and include existing conditions, a seriously considered alternative, standard practice, or a comparable existing project/facility. It is the intent of Envision to support data collection in order to eventually provide this baseline data for project teams and the industry as a whole. This is why it is required to submit calculations in acceptable standard units.

Calculations should include the anticipated annual energy consumption during the operational life of the project. If industry standards such as ASHRAE (formerly American Society of Heating Refrigerating and Air-Conditioning

Engineers) are available for the project type, they can be used in calculating the project’s anticipated energy consumption as well as the industry base case. Calculations should include energy purchased from the grid, energy generated and used on site, and fuels used on site by the project.

Energy generation projects should use energy conversion efficiency as the measure of energy efficiency, with the goal of increasing the capture of electrical, mechanical, or thermal energy output of the system. Similarly, energy distribution projects should calculate reductions in energy loss, with the goal of achieving better efficiency in energy delivery.

Applicability: This credit is applicable to all projects that consume energy during their operation. Projects that do not include operational energy may apply to have this credit deemed not applicable with supporting documentation. In rare cases, where the amount of operational energy use is insignificant in comparison to the scale of the project, teams may apply to have this credit deemed not applicable with supporting documentation. However, the reviewer may exercise his/her discretion in determining what constitutes an insignificant quantity of operational energy use in the context of the project.

EVALUATION CRITERIA AND DOCUMENTATION GUIDANCE

A. Has the project team determined the estimated annual energy consumption of the project during operations?

1. *Estimates of the annual energy consumption of the project during operations. Energy data should be presented in standard units. If annual energy consumption varies, the project team submits the range of estimated performance over the project life. Energy consumption of the project includes:*

- Energy purchased from the grid
- Energy generated on site
- Fuels used on site by the project

Note that energy generation projects should use energy conversion efficiency as the measure of energy efficiency, with the goal of increasing the capture of electrical, mechanical, or thermal energy output of the system. Similarly, energy distribution projects should calculate reductions in energy loss, with the goal of achieving better efficiency in energy delivery.

B. To what extent has the project reduced operational energy consumption?

1. Calculation of the baseline energy consumption. All energy sources should be converted into standard units.

2. Submit calculations for the project's estimated annual energy consumption over the life of the project. Document the percentage reduction over the baseline. All energy sources should be converted into standard units.

RELATED ENVISION CREDITS

- QL1.5 Minimize Light Pollution
- QL2.2 Encourage Sustainable Transportation
- LD2.1 Establish a Sustainability Management Plan
- RA2.4 Commission and Monitor Energy Systems
- CR1.2 Reduce Greenhouse Gas Emissions
- CR1.3 Reduce Air Pollutant Emissions

**PROJECT EXAMPLE:
SOUTH LOS ANGELES WETLAND PARK**

The South Los Angeles Wetland Park (Envision Platinum, 2014) in California reduced operational energy use by 77% by disconnecting all lighting associated with the project from the electrical grid and using solar powered lighting instead. The project team also designed the pump systems to further reduce operational energy requirements; two smaller sump pumps requiring less energy operate throughout the majority of the year when stormwater discharge rates are low. Only during rain events will three large process pumps that consume more energy operate.



RA2.2 Reduce Construction Energy Consumption

12
POINTS

INTENT

Conserve resources and reduce greenhouse gases and air pollutant emissions by reducing energy consumption during construction.

METRIC

The number of strategies implemented on the project during construction that reduce energy consumption and emissions.

LEVELS OF ACHIEVEMENT

IMPROVED	ENHANCED	SUPERIOR	CONSERVING	RESTORATIVE
A	A + B	A + B	A + B	Not Available
(1) Identify Reduction Opportunities	(4) At Least Two Reduction Strategies	(8) At Least Four Reduction Strategies	(12) At Least Six Reduction Strategies	
(A) The project team conducts one or more planning reviews to identify and analyze options for reducing energy consumption during construction.				
	(B) The project implements, or has written requirements to implement, at least two (2) energy reduction strategies.	(B) The project implements, or has written requirements to implement, at least four (4) energy reduction strategies.	(B) The project implements, or has written requirements to implement, at least six (6) energy reduction strategies.	

DESCRIPTION

This credit addresses the important need to reduce construction energy consumption. As construction energy use is closely linked to emissions, many actions in this credit address energy efficiency, energy reduction, renewable energy use, and reduced emissions. Therefore, in addition to other Resource Allocation credits, RA2.2 Reduce Construction Energy Consumption is also connected to CR1.1 Reduce Net Embodied Carbon, and CR1.2 Reduce Greenhouse Gas Emissions.

Significant cost savings can be achieved by reducing fuel consumption during construction. Project teams should consider the secondary and tertiary benefits of reduced truck trips, improved air quality, and support for renewable energy systems. While single actions like replacing fluorescent lights with light emitting diodes (LEDs) is a positive first step, large energy savings can be achieved when considering broader construction logistics and coordination.

PERFORMANCE IMPROVEMENT

Improved: Project teams begin with a thorough review of the means and methods of constructing the project, including a review of how energy is to be consumed during construction and opportunities for energy reduction. The list of energy reduction strategies should be used as a guide to identify and analyze options.

Enhanced – Conserving: Conducting detailed calculations of construction energy consumption can be burdensome if not impossible. Additionally, like other Resource Allocation credits, industry standards on construction energy use do not exist. Therefore, this credit assesses the number of energy-conserving and emission-reducing strategies deployed on the project as

the metric for achievement. Strategies that meet the credit requirements are listed under criterion B. These activities may be more or less difficult to achieve depending on the project type and context, which is why a wide range of options are available.

Applicability: This credit is applicable to all projects that consume energy during construction. It would therefore be difficult to demonstrate that the credit is not relevant or applicable to a project seeking an Envision award. In rare cases, where the amount of energy used during construction is insignificant in comparison to the scale of the project, teams may apply to have this credit deemed not applicable with supporting documentation. However, the reviewer may exercise his/her discretion in determining what constitutes an insignificant quantity of construction energy use in the context of the project.

EVALUATION CRITERIA AND DOCUMENTATION GUIDANCE

A. Has the project team conducted planning reviews to reduce energy consumption during construction?

1. Documentation that one or more planning reviews were conducted to identify and analyze the potential for reducing energy consumption during construction.

B. To what extent have energy conservation strategies been implemented during construction?

1. Documentation that the project has implemented, or has policies to implement, energy conservation strategies during construction. Strategies that meet the credit requirements include:

- a. Tier IV construction equipment or Tier III with Best Available Technology (BAT) for at least 75% of non-road equipment fleet greater than 50 horsepower;
- b. Alternative fuels in heavy equipment such as biodiesel for at least 5% of total fuel consumption;
- c. Hybrid or fully electric project vehicles for at least 50% of fleet;
- d. Electrified equipment for at least 20% of equipment (vs. gas or diesel engines);
- e. Employee commuting programs with incentives (shuttles to transit, ride-share programs, biking facilities, etc.);
- f. Reduce purchased energy for workstations (construction trailer/ office energy) by 30% for two of the following: (1) lighting; (2) HVAC; (3) plug loads;
- g. Purchase green power (RECs) for 30% of workstation energy consumption;
- h. Offset electrical consumption by generating 5% renewable energy on site (e.g., solar panels on trailer complex, solar-powered temporary light plant, solar-powered cameras and variable message sign boards); and
- i. Reduce overall fuel consumption by 10% through improved planning and logistics. Specific strategies may include:
 - i. Reduce number of deliveries;
 - ii. Reduce idle times;
 - iii. On-site reuse of soils or other materials to decrease truck traffic to and from site (ties into Reduced Excavated Material taken off site);
 - iv. Reduce on-site trucking – proper logistics planning such as staging material in close proximity to installation location;
 - v. Schedule acceleration without additional resource consumption;
 - vi. Waterborne/rail transportation of materials versus trucking (third-party distribution or logistics);
 - vii. On-site plants (concrete plant/asphalt plant) in lieu of trucking material to the site; and
 - viii. Prefabrication of design elements.

RELATED ENVISION CREDITS

- LD2.1 Establish a Sustainability Management Plan
- RA1.5 Balance Earthwork On Site
- CR1.2 Reduce Greenhouse Gas Emissions
- CR1.3 Reduce Air Pollutant Emissions

PROJECT EXAMPLE: HIGHWAY I-4 ULTIMATE

On the Highway I-4 Ultimate project (Envision Platinum, 2017), a 21 mile stretch of highway between Orange County and downtown Orlando in Florida, the contractor deployed state-of-the-art equipment monitoring technologies and software to reduce environmental impacts during construction. Fuel management technologies to monitor fuel dispensing into each piece of equipment and to track consumption were deployed. Also, auxiliary air conditioning units on crawler cranes were implemented. These measures led to a 20% reduction of machine hours and associated fuel consumption.



RA2.3 Use Renewable Energy

24

POINTS

INTENT

Meet operational energy needs through renewable energy sources.

METRIC

Extent to which renewable energy sources are incorporated.

LEVELS OF ACHIEVEMENT

IMPROVED	ENHANCED	SUPERIOR	CONSERVING	RESTORATIVE
A	A	A	A	A
(5) At Least 5%	(10) At Least 15%	(15) At Least 30%	(20) At Least 50%	(24) Net Positive
(A) The project meets: 5% of energy needs (electricity and fuel) from renewable sources.	(A) The project meets: 15% of energy needs (electricity and fuel) from renewable sources.	(A) The project meets: 30% of energy needs (electricity and fuel) from renewable sources.	(A) The project meets: 50% of energy needs (electricity and fuel) from renewable sources.	(A) The project generates a net positive amount of renewable energy.

DESCRIPTION

While reducing energy use is the primary goal, a net-zero energy society will require significant investment in renewable energy sources. When appropriate, renewable energy can be generated on site to help reduce the need for fossil fuel sources. However, it is important to note that large-scale off-site renewable energy sources, such as wind farms, large hydroelectric facilities, or solar arrays, are often more efficient. It can be challenging to demonstrate a direct connection to these sources and ensure that their energy generation is not double-counted by other projects. Project teams should evaluate the feasibility of renewable energy, including nontraditional energy sources, to effectively increase the portion of operational energy that comes from renewable sources.

PERFORMANCE IMPROVEMENT

Improved – Conserving: Levels in this credit are distinguished by the percentage of total energy use from renewable sources. Unlike energy consumption in buildings, which are almost always dominated by electricity, infrastructure operational energy use can include both electricity and fuel consumption. For this credit, project teams should consider both electricity and fuel consumption in their calculations.

Renewable energy can be sourced from on-site generation, purchased in fuels, or purchased from the grid through a direct purchase agreement (e.g., renewable energy power purchase agreement). For purchased renewable energy from the grid, the electricity service provider sources power from a renewable energy source and sells that power directly to the project. Renewable energy sources must be in the same power grid as the project in this type of transaction. Project teams cannot attribute latent renewable energy within the grid to the project without a purchase agreement.

Projects may only count Renewable Energy Credits (RECs) purchased or under contract at the time of assessment. Nonbinding commitments for future REC purchases cannot be counted toward achievement in this credit. Purchased RECs must be annualized over the life of the project. For example, if a project with a 20-year life purchases RECs for 100% of its energy consumption for one year, this would translate to 5% of its overall energy consumption.

On-site generation put back onto the grid is accounted for in determining percentage of electricity used. For example, in a case with 100 kWh of electricity used on site, 20 kWh of renewables purchased from the grid, 10 kWh of renewables generated and used on site, and 5 kWh of renewables returned to the grid, the result is a level of 35% renewables attained.

Applicability: This credit is applicable to all projects that consume energy (fuel or electricity) during their operation. Projects that do not include operational energy may apply to have this credit deemed not applicable with supporting documentation. In rare cases, where the amount of operational energy use is insignificant in comparison to the scale of the project, teams may apply to have this credit deemed not applicable with supporting documentation. However, the reviewer may exercise his/her discretion in determining what constitutes an insignificant quantity of operational energy use in the context of the project.

EVALUATION CRITERIA AND DOCUMENTATION GUIDANCE

A. To what extent does the project meet electricity or fuel needs from renewable sources?

1. Documentation of the anticipated annual output of all renewable sources, direct renewable electricity purchases, or exports to the grid, and the resulting overall percentage of renewable energy

to total energy consumption. The latent renewable energy mix within the grid does not contribute to achievement in this credit. Calculations should be in standard units of energy (Btu or kJ).

2. Breakdown of renewable energy sources by type. Renewable energy may include:

- solar energy (thermal heating, both active and passive, and photovoltaic);
- wind (electricity generation);
- water (hydro or tidal for electricity generation);
- biomass (electricity generation or as fuels);
- geothermal (electricity generation or heating and cooling); and
- hydrogen/fuel cells (used as a fuel).
- renewable transportation fuel or electric vehicle use.

RELATED ENVISION CREDITS

CR1.2 Reduce Greenhouse Gas Emissions

CR1.3 Reduce Air Pollutant Emissions

Common Fuel Conversions

Fuel	Imperial Unit	Btu	Metric Unit	kJ
Electricity	1 Kilowatt-hour	3,412	1 Kilowatt-hour	3,600
Gasoline	1 Gallon	120,476	1 Litre	33,579
Diesel	1 Gallon	137,452	1 Litre	38,310
Natural Gas	1 Cubic foot	1,037	1 Cubic Meter	38,638
Propane LPG	1 Gallon	91,333	1 Litre	25,456
Propane Gas	1 Cubic Foot	2,550	1 Cubic Meter	95,011
Ethanol	1 Gallon	76,330	1 Litre	21,275

Source: US Energy Information Administration

**PROJECT EXAMPLE:
WATER SOURCE GEOTHERMAL**

A lake formed in an abandoned quarry near the Nashville International Airport in Tennessee, long considered a liability for the Airport Authority, was turned into a beneficial resource with the implementation of a Water Source Geothermal project (Envision Silver, 2017). By harnessing the chilled water of the quarry lake, the Airport Authority was able to save more than \$430,000 in electricity costs per year, a 50% improvement over the baseline that was established for the project.





RA2.4 Commission and Monitor Energy Systems

14

POINTS

INTENT

Ensure efficient functioning and extend useful life by specifying commissioning and monitoring of energy systems.

METRIC

The inclusion of monitoring equipment and software, the extent of commissioning, and the commissioning agent's independence from the project.

LEVELS OF ACHIEVEMENT

IMPROVED	ENHANCED	SUPERIOR	CONSERVING	RESTORATIVE
A + B	A + B	A + B + C	A + B + C	Not Available
(3) Basic Initial Commissioning	(6) Extensive Initial Commissioning	(12) Long-Term Commissioning	(14) Advanced Initial And Long-Term Commissioning	
<p>(A) The project includes energy monitoring capabilities.</p> <p>Equipment and/or software are incorporated to allow detailed monitoring of performance during operation.</p> <p>The equipment is capable of independently monitoring all primary project functions, accounting for at least 50% of energy use/consumption.</p>	<p>(A) The project includes energy monitoring capability.</p> <p>Equipment and/or software are incorporated to allow detailed monitoring of performance during operation.</p> <p>The equipment is capable of independently monitoring all primary project functions, accounting for at least 75% of energy use/consumption.</p>	<p>(A) The project includes integrated energy management systems.</p> <p>Energy management software is incorporated to allow for detailed and centralized monitoring and reporting of performance.</p> <p>The equipment is capable of independently monitoring all primary project functions, accounting for at least 90% of energy use/consumption.</p>	<p>(B) The project conducts an initial commissioning of energy systems accounting for at least 90% of the total energy consumption/generation.</p> <p>Commissioning includes a detailed log of issues.</p>	
<p>(B) The project conducts an initial commissioning of energy systems accounting for at least 50% of the total energy consumption/generation.</p> <p>Commissioning includes a detailed log of issues.</p>	<p>(B) The project conducts an initial commissioning of energy systems accounting for at least 75% of the total energy consumption/generation.</p> <p>Commissioning includes a detailed log of issues.</p>	<p>(B) The project conducts an initial commissioning of energy systems accounting for at least 90% of the total energy consumption/generation.</p> <p>Commissioning includes a detailed log of issues.</p> <p>The owner engages a third party or in-house commissioning agent not involved in the planning/design of the project.</p>	<p>(B) The project conducts an initial commissioning of energy systems accounting for at least 90% of the total energy consumption/generation.</p> <p>Commissioning includes a detailed log of issues.</p> <p>The owner engages an independent third-party commissioning agent.</p>	
		<p>(C) A comprehensive plan is developed for ongoing periodic re-commissioning/review of energy systems throughout the expected life of the project.</p>		

DESCRIPTION

Planning, designing, and constructing projects to reduce energy use is the first step toward achieving energy efficiency goals. However, commissioning and ongoing monitoring are necessary to ensure the proper operation of the energy system in order to realize those goals. Systems designed to be energy efficient can fail because of installation errors or degradation over time during operations. Commissioning ensures systems are functioning as intended from the start of operations. Installing advanced monitoring equipment and software better allows operators to

identify efficiency loss. In addition, monitoring equipment allows operators to identify high-energy processes and target them in their own sustainability efforts. Higher-resolution monitoring increases the likelihood that projects will achieve and maintain high levels of energy efficiency throughout their useful life.

PERFORMANCE IMPROVEMENT

Improved: The assessment is based on the scope of the energy monitoring capabilities and initial commissioning. The intent is to focus on important or primary sources of energy consumption.

Enhanced: The project team expands the scope of monitoring capabilities and commissioning.

Superior: The project team can demonstrate that the commissioning agent was independent from the project, though the commissioning may still be conducted within the same organization. Energy management systems include detailed performance monitoring and management capabilities. An operations plan is developed for ongoing performance reviews.

Conserving: The commissioning was conducted by an independent third-party agent.

Applicability: This credit is applicable to all projects that consume energy during their operation. Projects that do not include operational energy may apply to have this credit deemed not applicable with supporting documentation. In rare cases, where the amount of operational energy use is insignificant in comparison to the scale of the project, teams may apply to have this credit deemed not applicable with supporting documentation. However, the reviewer may exercise his/her discretion in determining what constitutes an insignificant quantity of operational energy use in the context of the project.

EVALUATION CRITERIA AND DOCUMENTATION GUIDANCE

A. Does the design incorporate advanced integrated monitoring systems in order to enable more efficient operations?

1. Documentation that equipment and/or software are incorporated in the design to allow detailed monitoring of performance. Design documents and specifications showing the location, purpose,

and type of monitoring equipment installed. Documentation that the equipment installed is capable of monitoring all primary project functions, accounting for the required percentage of energy consumption (e.g., 50%, 75%, 90%).

2. Rationale as to how the monitoring equipment may enable more efficient operations over the industry norm.
3. Documentation that energy management systems and associated software are incorporated into the project accounting for the required percentage of energy consumption (e.g., 50%, 75%, 90%).

B. To what extent has a commissioning been conducted?

1. Documentation that the project has undergone or will undergo a commissioning (e.g., specification, tender document, contract document).
2. Documentation that the commissioning was executed and covered systems responsible for using or generating the required percentage of energy (e.g., 50%, 75%, 90%).
3. Documentation of the relationship between the owner and the commissioning agent depending on the level of achievement being pursued.
Note that for Superior, the owner may engage an in-house commissioning agent so long as they are independent of the planning/design of the project. For Conserving, an independent third-party agent must be used.
4. Documentation of the commissioning log of issues.

C. Is there a plan for ongoing commissioning of the energy systems throughout the project's life?

1. Documentation of a plan for ongoing recommissioning/review of these systems throughout the expected life of the project.

RELATED ENVISION CREDITS

LD2.3 Plan for Long-Term Monitoring and Maintenance

RA2.1 Reduce Operational Energy Consumption



RA3.1 Preserve Water Resources

12
POINTS

INTENT

Assess and reduce the negative net impact on fresh water availability, quantity, and quality at a watershed scale to positively impact the region's water resources.

METRIC

The extent to which the project considers and contributes to positively addressing broader watershed issues.

LEVELS OF ACHIEVEMENT

IMPROVED	ENHANCED	SUPERIOR	CONSERVING	RESTORATIVE
A + B	A + B + C	A + B + C + D	A + B + C + D + E	A + B + C + D + E + F
(3) Increased Awareness Of Watershed Issues	(5) Good Water Resource Management	(7) Wise Water Resource Management	(9) Total Water Management	(12) Positive Impact
<p>(A) Assess the project's watershed context and the watershed-scale fresh water issues, including location, type, quantity, rate of recharge, and quality of water resources, as well as source and impacts of water used and the destination and impacts of wastewater.</p> <p>(B) Estimates of water usage and wastewater generation over the life of the project.</p>				
<p>(C) The project has features intended to reduce the identified negative impacts of water usage, and/or improve watershed-scale issues.</p>				
<p>(D) The project has a net-zero impact on the quantity and availability of fresh surface water and groundwater supplies without compromising water quality.</p>				
<p>(E) The project is part of, or contributes to, a watershed or regional water plan.</p>				
<p>(F) The project makes a direct and significant net-positive improvement to the watershed.</p>				

DESCRIPTION

Water quality and availability is a major concern affecting communities and regions all over the world. While water conservation is a critical first step (addressed in RA3.2 Reduce Operational Water Consumption and RA3.3 Reduce Construction Water Consumption), all projects that impact water quantity or quality should consider the opportunity to positively contribute to the greater watershed.

This credit addresses the increasing demands for fresh water by agricultural, municipal, and industrial users, and encourages project teams to consider regional water resources holistically. In addition, the generation of wastewater and how it is managed has the potential to either positively or negatively impact natural hydrology. These demands, combined with the typical variability in the hydrologic cycle, can affect water availability, quantity, and quality. In many areas, fresh water sources are used at a faster rate than they are being naturally replenished. In certain coastal areas, groundwater mining is allowing saltwater intrusions to groundwater sources. Other land use practices affect the quality of surface water and groundwater supplies.

This credit is inspired by the concept of "one water." This refers to the increasing awareness that water is continuously

reused through the natural water cycle. While social taboos are often a barrier to wastewater reuse, the reality is that water is continuously reused. Too frequently, water is treated to levels exceeding its ultimate use, representing a huge waste of finances, energy, and resources. New efficiencies and cost savings can be achieved if project teams are permitted to view water as a recyclable resource rather than disposable waste.

PERFORMANCE IMPROVEMENT

Improved: Positively addressing broader watershed issues begins with understanding the unique watershed conditions in the context of the project. The scope of the watershed assessed should be commensurate with the scale of the project and its potential impacts. The next step is quantifying water use and determining whether the project has meaningful impact on either water availability or the generation of wastewater. If so, reducing consumption should be a primary concern.

Project teams should be careful and thorough in assessing water usage, including process water consumption associated with the project operation. The assessment should account for irrigation, vehicle or equipment washing operations, facility cleaning, and other usage.

Enhanced: The project deploys strategies to minimize negative impacts of water usage. How is water used, diverted, treated, and disposed of? Where does it go and how does it impact the hydrologic cycle as it relates to water resources? Many factors impact water resources beyond quantity of water use.

Superior: Mitigation measures are sufficient to achieve a net-zero impact.

Conserving: The project positively contributes to the broader watershed.

Restorative: The project is part of a broader coordinated watershed plan. Degradation of water resources is often non-point source, meaning there is no single primary source but rather hundreds or thousands of small sources that accumulate impact. Addressing this environmental impact may require the concerted action of hundreds of communities and thousands of projects.

Applicability: This credit is applicable to all projects that consume water or impact receiving waters. Projects that do not include any impacts to water quantity or quality may apply to have this credit deemed not applicable with supporting documentation. In rare cases, where the impact to water quantity or quality is insignificant in comparison to the scale of the project, teams may apply to have this credit deemed not applicable with supporting documentation. However, the reviewer may exercise his/her discretion in determining what constitutes an insignificant impact to water quantity or quality use in the context of the project.

EVALUATION CRITERIA AND DOCUMENTATION GUIDANCE

A. Has the project team conducted a watershed assessment?

1. *Documentation demonstrating that the project team assessed and understands the project's watershed context. Examples include watershed plans, regional water and wastewater utility plans, climate change reports, etc. The scope of the watershed assessed should be commensurate with the scale of the potential impacts of the projects.*
2. *Documentation of the location, type, quantity, rate of recharge, and quality of water resources in the watershed.*
3. *Identification of the source and impacts of water used and the destination and impacts of wastewater.*

B. Has the project team estimated the water usage and wastewater generation over the life of the project?

1. *Calculations showing the estimated water usage and wastewater generation over the life of the project (gallons/liters).*

C. Does the project include features to minimize the negative impacts of water usage, and/or watershed-scale issues?

1. *Documentation of design features that will reduce negative impacts of water usage and/or watershed-scale issues. Project teams should also consider the indirect ways in which the project may impact water resources. For example, a project may not consume water itself but may include the addition of recycled water lines ("purple pipe") to support water-recycling systems beyond the project boundary.*
2. *Documentation of how the design features specifically address issues identified in the comprehensive water assessment in criterion A.*

D. Does the project have a net-zero impact on the quantity and availability of fresh surface water and groundwater supplies without compromising water quality?

1. *Calculations demonstrating that the project's water usage will have no impact on the quantity and availability of fresh surface water and groundwater supplies.*
2. *Documentation clarifying that the project does not compromise water quality in the watershed.*

E. Is the project part of a watershed-level or regional plan?

1. *Documentation that the project is part of, or contributes to, a larger watershed level or regional plan intended to improve the watershed.*

F. Does the project make a direct net-positive improvement to the watershed?

1. *Documentation that the project has a net-positive impact to the watershed in terms of water quantity and availability or water quality. Examples of watershed improvements may include improved water quality, better hydrologic connectivity, or water storage and availability.*

RELATED ENVISION CREDITS

- LD2.2 Plan for Sustainable Communities
- RA3.2 Reduce Operational Water Consumption
- RA3.3 Reduce Construction Water Consumption
- NW1.1 Preserve Sites of High Ecological Value
- NW1.2 Provide Wetland and Surface Water Buffers
- NW2.2 Manage Stormwater
- NW2.4 Protect Surface and Groundwater Quality
- NW3.2 Enhance Wetland and Surface Water Functions
- CR2.2 Assess Climate Change Vulnerability



RA3.2 Reduce Operational Water Consumption

22

POINTS

INTENT

Reduce overall water consumption while encouraging the use of greywater, recycled water, and stormwater to meet water needs.

METRIC

Percentage reduction in potable water use and overall water use.

LEVELS OF ACHIEVEMENT

IMPROVED	ENHANCED	SUPERIOR	CONSERVING	RESTORATIVE
A + B	A + B + C	A + B + C	A + B + C	A + B + C + D
(4) At Least 25% Reduction	(9) At Least 50% Reduction	(13) At Least 75% Reduction	(17) 95% Reduction	(22) Water Purification
<p>(A) The project team conducts planning or design reviews to identify potable water reduction strategies during operation of the project. The team has considered using alternatives such as nonpotable water, reused water, recycled water, and stormwater.</p>				
(B) The project reduces potable water use by at least 25%.	(B) The project reduces potable water use by at least 50%.	(B) The project reduces potable water use by at least 75%.	(B) The project reduces potable water use at least 95%.	(B) The project reduces potable water use by 100%.
	(C) Overall water use (potable and nonpotable) is reduced by at least 20%.	(C) Overall water use (potable and nonpotable) is reduced by at least 30%.	(C) Overall water use (potable and nonpotable) is reduced by at least 40%.	(C) Overall water use (potable and nonpotable) is reduced by at least 50%.
				(D) The project not only reduces potable water consumption to zero, but also provides water that can be used by the community.

DESCRIPTION

This credit addresses reducing both potable water consumption and overall water consumption. Around the world, countries are increasingly becoming embroiled in water-related conflicts. However, these disputes are not limited to international conflicts and often pit community against community. This will be exacerbated by climate change with increasing water evaporation rates, and changes to the quantity, intensity, and timing of precipitation. Increases in mean temperatures can also affect the amount and duration of snow cover and, in turn, affect the average and peak rates of streamflow. All of these issues have important implications to agricultural irrigation, hydropower, flood management, fisheries, recreation, and navigation.

The treatment and distribution of water also consumes large amounts of energy. In many cases, it is not necessary to use potable (i.e., drinkable) water for the intended task. Greywater (e.g., water that has been used for cleaning or other purposes and has not come into contact with feces), recycled water, and stormwater are alternatives to potable water use. This credit recognizes the added benefit of reducing overall water consumption as well as reducing potable water consumption.

Reducing water consumption can have direct cost savings for many projects. In some circumstances, such as landscaping,

entirely eliminating the need for irrigation systems includes the added benefits of reduced construction costs, maintenance costs, and labor costs associated with maintaining the system.

PERFORMANCE IMPROVEMENT

Improved – Conserving: Levels in this credit are distinguished by percentage reductions in potable and overall water use. In the context of this credit, potable water refers to water that is treated to the level of drinking water. In the majority of projects, this will be municipal drinking water.

As industry standards on operational water use do not exist for most infrastructure projects, project teams are required to provide calculations for an appropriate base case. Accepted methodologies for establishing baseline performance data are explained in detail in the front of this manual and include existing conditions, a seriously considered alternative, standard practice, or a comparable existing project/facility. It is the intent of Envision to support data collection in order to eventually provide this baseline data for project teams and the industry as a whole.

Reductions may be accomplished through design, construction, and operational changes for conservation and the ability to use, treat, and/or reuse nonpotable water. Advanced recycling and reuse of wastewater are encouraged. Condensate and

sump water can be included as potential sources for water recycling. If recycled water is provided by a third party, project teams must verify water supply and replenishment. If projects choose to “upcycle” water through on-site treatment, they should take into consideration potential risks and energy trade-offs. Use of treated wastewater for groundwater recharge may also be counted as recycled/reused water.

The use of untreated surface water and groundwater in lieu of potable water should not be considered if use of these waters will have a negative impact on water availability or quality (see credit RA3.1 Preserve Water Resources). Similarly, stormwater capture/reuse should consider potential impacts to receiving waters and the natural water cycle of the area.

Water treatment projects should address this credit through reducing process water and improved process efficiency. Water distribution projects are not considered to consume the water that flows through mains and pipelines. However, in certain circumstances, such as system refurbishment, projects that include water distribution systems may consider water conservation through locating and stopping or preventing leaks.

Applicability: This credit is applicable to all projects that consume water during operations. Projects that do not include any operational water consumption may apply to have this credit deemed not applicable with supporting documentation. In rare cases, where the amount of water consumption is insignificant in comparison to the scale of the project, teams may apply to have this credit deemed not applicable with supporting documentation. However, the reviewer may exercise his/her discretion in determining what constitutes an insignificant quantity of operational water use in the context of the project.

EVALUATION CRITERIA AND DOCUMENTATION GUIDANCE

A. Has the project team conducted planning and design reviews to identify potable water reduction strategies during operation of the project?

1. Documentation the project team conducted planning and design reviews to identify potable water reduction strategies during operation of the project. Example documents may include reports, memoranda, and minutes of meetings with project teams and owners regarding water reduction strategies.

B. To what extent has the project reduced potable water use?

1. Calculation of the industry baseline for potable water use to be used as a baseline.
2. Calculations of estimated annual potable water consumption over the life of the project. Document the percentage reduction over the industry baseline. Calculations should be converted into standard units such as gallons or cubic meters. Note, water treatment projects should address this credit through reducing process water and improved process efficiency.

C. To what extent has the project reduced overall water use (including potable and nonpotable water)?

1. Calculation of the industry baseline for overall water use to be used as a baseline. In some cases, this may be the same calculation as the baseline for potable water use in criterion B.

2. Calculations of estimated annual total water consumption over the life of the project, and the percentage reduction over the industry baseline. Calculations should be converted into standard units such as gallons or cubic meters.

Note that water treatment projects should address this credit through reducing process water and improved process efficiency.

D. Does the project have a net positive impact on water use?

1. Design documents demonstrating that the project achieves a 100% reduction in potable water use, using no water or meeting water needs entirely through nonpotable sources, and provides an available source of usable water (potable or nonpotable) for neighboring projects or communities to offset their own water needs.

RELATED ENVISION CREDITS

RA3.1 Preserve Water Resources

CR1.2 Reduce Greenhouse Gas Emissions

PROJECT EXAMPLE: KUNIA COUNTRY FARMS

The Kunia Country Farms project (Envision Gold, 2016), one of the largest commercial aquaponics farms and producers of leafy greens in Hawaii, focuses on the development and implementation of “Zero Impact Farming” which minimizes energy and water use, soil degradation, pollution, and other impacts associated with commercial farming practices and aims to maximize land efficiency and labor productivity. This project, a first-of-its-kind for applying the Envision framework, reduced potable water consumption over industry norms by 75% by incorporating a number of water reduction strategies including meeting irrigation needs with captured stormwater, minimizing evaporation by covering all of the irrigation water and storing any excess underground, and maximizing the efficiency of harvesting operations to reduce the number of days workers would need to use potable water for sanitation and hand washing purposes.





RA3.3 Reduce Construction Water Consumption

 8 POINTS	<p>INTENT</p> <p>Reduce potable water consumption during construction.</p>	<p>METRIC</p> <p>The number of strategies implemented during construction that reduce potable water consumption.</p>
---	---	---

LEVELS OF ACHIEVEMENT

IMPROVED	ENHANCED	SUPERIOR	CONSERVING	RESTORATIVE
A + B	A + B	A + B	A + B	Not Available
(1) Identify Consumption And Reduction Options	(3) At Least Three Strategies	(5) At Least Five Strategies	(8) No Potable Water Consumption	
<p>(A) The project team conducts one or more planning reviews to identify and analyze options for reducing water consumption during construction.</p>				
<p>(B) At least one (1) potable water conservation strategy is implemented.</p>	<p>(B) At least three (3) potable water conservation strategies are implemented.</p>	<p>(B) At least five (5) potable water conservation strategies are implemented.</p>	<p>(B) No potable water consumption, except for human consumption and hygiene, by means of implementing as many strategies as necessary.</p>	

DESCRIPTION

This credit addresses the potential to reduce water consumption during construction. Overuse of water not only depletes waterbodies and lowers groundwater levels, but the treatment of water consumes large amounts of energy. In many cases, it is not necessary to use potable (i.e., drinkable) water for the intended task. Greywater (e.g., water that has been used for cleaning or other purposes and has not come into contact with feces), recycled water, and stormwater are alternatives to potable water use, especially in construction. Reducing water consumption during construction can reduce the environmental impact of the project.

PERFORMANCE IMPROVEMENT

Improved – Conserving: The levels in this credit are distinguished by the water conservation strategies implemented during construction. Conducting detailed calculations of construction potable water consumption can be burdensome if not impossible. Additionally, like other Resource Allocation credits, industry standards on construction water use do not exist. Therefore, this credit assesses the number of water conserving strategies deployed on the project as the metric for achievement. Strategies that meet the credit requirements are listed under criterion B. These activities may be more or less difficult to achieve depending on the project type and context, which is why a wide range of options are available.

In the context of this credit, potable water refers to water that is treated to the level of drinking water. In the majority of projects, this will be municipal drinking water. This is not intended to refer to natural sources of water that are of drinking water quality without

treatment. However, the direct use of groundwater or surface water would be included in the calculations for overall water use.

In fulfilling this credit, project teams should begin with a thorough review of the means and methods of constructing the project, including a review of how water is to be consumed during construction. The list of water reduction strategies should be used as a guide to identify and analyze options. The use of surface water and marginal groundwater in lieu of potable water should not be considered if use of these waters will have a negative impact on water availability or quality (see credit RA3.1 Preserve Water Resources).

Applicability: This credit is applicable to all projects that consume water during construction. Projects that do not include any operational water consumption may apply to have this credit deemed not applicable with supporting documentation. In cases where the amount of water consumption during operations is insignificant in comparison to the scale of the project, teams may apply to have this credit deemed not applicable with supporting documentation. However, the reviewer may exercise his/her discretion in determining what constitutes an insignificant quantity of operational energy use in the context of the project.

EVALUATION CRITERIA AND DOCUMENTATION GUIDANCE

A. Has the project team conducted planning reviews to reduce water consumption during construction?

1. Documentation that one or more planning reviews were conducted to identify and analyze the potential for reducing water consumption during construction.

B. To what extent have water conservation strategies been implemented during construction?

1. Documentation that the project has implemented water conservation strategies during construction. Strategies that meet the credit requirements include:

- a. High-efficient fixtures in construction trailers or offices (demonstrate a 40% reduction in usage)
- b. Monitoring and management (demonstrate team's ability to detect leaks and respond to inefficiencies in the system)
- c. Reduce embodied water of materials by reducing waste material (calculate a 10% reduction in material quantities entering the site as new material)
- d. Use alternatives to dust suppression such as dry agents (show 50% reduction in water usage due to alternative controls)
- e. Alternatives for curing concrete (show 50% reduction in water usage due to alternative controls)

f. Alternatives for truck tire wash stations (show 50% reduction in water usage due to alternative controls)

g. Reduced embodied water through material selection (permanent and temporary materials) (Demonstrate how product selection has contributed to reduced potable water consumption by more than 25%)

h. Stormwater harvesting (show 40% savings by using harvested stormwater)

i. Greywater or wastewater effluent reuse (show 40% reuse)

j. Dewatering reuse (show 40% reuse/recycling)

2. Calculation of potable water saved (gallons/liters) for each strategy as compared to not implementing the strategy over the construction duration. Note that projects may wish to also calculate their cost savings for reduction measures.

RELATED ENVISION CREDITS

RA3.1 Preserve Water Resources

CR1.2 Reduce Greenhouse Gas Emissions



RA3.4 Monitor Water Systems

<h2 style="font-size: 2em;">12</h2> <p>POINTS</p>	<p>INTENT</p> <p>Improve operational performance by including monitoring capabilities.</p>	<p>METRIC</p> <p>Extent and capability of water monitoring equipment and inclusion of response plans.</p>
---	---	--

LEVELS OF ACHIEVEMENT

IMPROVED	ENHANCED	SUPERIOR	CONSERVING	RESTORATIVE
A	A	A	A + B	Not Available
(1) One-Time Monitoring	(3) Operations Monitoring	(6) Long-Term Monitoring	(12) Responsive Monitoring	
<p>(A) The project includes monitoring capabilities. Equipment and/or software are incorporated in the design to allow detailed monitoring of performance (quantity or quality).</p> <p>The equipment is capable of monitoring all primary project functions, accounting for at least 50% of water use.</p>	<p>(A) The project includes monitoring capabilities. Equipment and/or software are incorporated in the design to allow detailed monitoring of performance (quantity or quality).</p> <p>The equipment is capable of monitoring all primary project functions, accounting for at least 75% of water use.</p>	<p>(A) The project includes monitoring capabilities. Equipment and/or software are incorporated in the design to allow detailed monitoring of performance (quantity or quality).</p> <p>The equipment is capable of monitoring all primary project functions, accounting for at least 95% of water use.</p>	<p>(B) The project demonstrates that real-time water monitoring equipment and/or software has been incorporated along with a plan for using this data to improve water quality and efficiency, reduce leakage, and/or conserve water.</p>	

DESCRIPTION

Planning, designing, and constructing projects to reduce water use is the first step toward achieving water conservation goals. However, ongoing monitoring is necessary to ensure the proper operation of the water system in order to realize those goals. Systems designed to be water efficient can fail because of installation errors or degradation over time during operations. Monitoring ensures systems are functioning as intended from the start of operations. Installing advanced monitoring equipment also better allows operators to identify leaks and water intensive processes and target them in their own sustainability efforts. Higher resolution monitoring increases the likelihood that projects will achieve and maintain high levels of water efficiency throughout their useful life.

Monitoring water systems and ensuring their proper and efficient operation helps both businesses and the environment. Systems capable of monitoring flows and usage and detecting leaks early save money in operations and prevent the needless

waste of potable water and the embodied energy and emissions associated with its treatment and distribution.

PERFORMANCE IMPROVEMENT

Improved – Superior: Project teams increase the scope of water monitoring capabilities to 50%, 75%, or 95%, respectively, for water consuming functions. Integrated monitoring systems may be used to mitigate negative impacts by shifting water demand to off-peak hours and/or by discharging water to groundwater recharge or constructed wetlands or other best management practices, instead of through direct surface water connections or other means.

Conserving: The project implements real-time water monitoring equipment and software to increase performance of water systems.

Applicability: This credit is applicable to all projects that consume water during their operation or include the conveyance of large quantities of water. Projects that do not include operational

water use or water conveyance may apply to have this credit deemed not applicable with supporting documentation. In rare cases, where the amount of operational water use, or conveyance, is insignificant in comparison to the scale of the project, teams may apply to have this credit deemed not applicable with supporting documentation. However, the reviewer may exercise his/her discretion in determining what constitutes an insignificant quantity of water use in the context of the project.

EVALUATION CRITERIA AND DOCUMENTATION GUIDANCE

A. Does the design incorporate advanced integrated monitoring systems in order to improve performance?

1. Documentation that equipment and/or software are incorporated in the design to allow detailed monitoring of performance. Performance may include water quality and/or quantity depending on the function/purpose of the project. Design documents and specifications showing the location, purpose, and

type of monitoring equipment installed. This may include design documents and specifications identifying the installation of easily accessible and clearly labeled water sub-meters. Documentation that the equipment installed is capable of monitoring all primary project functions, accounting for the required percentage of water consumption or effluent (e.g., 50%, 75%, 95%).

Rationale as to how the monitoring equipment may enable improved performance.

B. Does the project include real-time water monitoring?

1. Documentation that water monitoring equipment is capable of delivering real-time data on water use.
2. Documentation of a plan for using this data to improve water efficiency, reduce leakage, and conserve water overall.

RELATED ENVISION CREDITS

LD2.3 Plan for Long-Term Monitoring and Maintenance

RA3.1 Preserve Water Resources

PROJECT EXAMPLE: HARDEEVILLE WATER RECLAMATION FACILITY

The Hardeeville Water Reclamation Facility (Envision Bronze, 2016) is located in the Town of Hardeeville, South Carolina, with close proximity to the Savannah River. The facility has a SCADA (Supervisory Control and Data Acquisition) system that provides an overview of the entire facility from a central computer terminal, where operators are able to monitor facility performance in real-time and can make adjustments if any deficiencies are detected. For example, operators can respond to surges in incoming flow (e.g., after heavy rain storms) by diverting to the plant's 1.5 million gallon flow equalization tank and then gradually releasing the stored flow over time for treatment.



RA0.0 Innovate or Exceed Credit Requirements

+10
POINTS

INTENT

To reward exceptional performance beyond the expectations of the system and application of innovative methods that advance state-of-the-art sustainable infrastructure.

METRIC

Whether project sustainability performance qualifies as innovation, exceptional performance, or is not otherwise recognized in existing credits.

LEVELS OF ACHIEVEMENT

INNOVATION	
A or B or C	
(+1-10) Innovate or Exceed Credit Requirements	
<p>(A) Implement innovative methods, technologies, or processes that are novel either in their use, application, or within the local regulatory or cultural context.</p> <p>OR</p> <p>(B) Implement measures that exceed the highest existing requirements within one or more Resource Allocation credits.</p> <p>OR</p> <p>(C) Address additional aspects of sustainability not currently recognized in Envision</p>	

DESCRIPTION

This credit addresses instances in which projects:

1. Implement innovative methods, resources, technologies, or processes that are novel in their use, application, or within the local regulatory or cultural context of the project;
2. Exceed the performance requirements of one or more credits; and/or
3. Address additional aspects of sustainability not currently recognized in Envision

Points for this credit are not calculated in the overall applicable points and, therefore, act as bonus points. Given the nature of the credit, the broad format of which is intended to encourage creative infrastructure solutions, thorough documentation is expected. Project teams may pursue more than one of the three possible options for this credit, or pursue multiple for the same option, for a total of up to ten (10) bonus points.

PERFORMANCE IMPROVEMENT

Innovation:

To qualify for innovation points, projects must implement innovative methods, resources, technologies, or processes (e.g., the use of a pre-existing technology in a new way or the successful application of a technology or methods in regions or locales where existing policies, regulations, or general opinion have prevented their use). In these circumstances, it is imperative to prove that the application of the technology does, and will continue to, meet performance expectations

and that it does not have a corresponding negative impact on the local or global environment, economy, or community.

Projects may demonstrate they implement innovative methods, technologies or processes in several ways:

- The project is an early adopter of new technology or methods that can demonstrably improve project performance without negative trade-offs;
- The project uses technologies or methods that may be general practice in other regions or parts of the world, but within the context of the project (whether climate, regulations, policies, political support, public opinion, etc.) have not yet gained acceptance. Significant efforts are taken to demonstrate the effectiveness of the technology or method within the context and provide a precedent for future adoption.
- The project team takes significant steps to include research goals within the project's development, or work with a university or research organization to advance the general knowledge of the profession. Proprietary research that is not made publicly available cannot count toward achieving this credit.

Project teams must also demonstrate that the innovation serves a purpose. This can be done in one of two ways:

- Overcoming significant problems, barriers, or limitations— Project teams demonstrate that the innovation reduces or eliminates significant problems, barriers, or limitations that previously hampered the use of the new methods, technologies, or processes implemented on the project.

- Creating scalable and/or transferable solutions—Project teams demonstrate that new methods, technologies, or processes implemented on the project are scalable across a wide range of project sizes and/or are applicable and transferable across multiple kinds of infrastructure projects in multiple sectors.
- Strategies to reduce construction energy consumption not already addressed in RA2.2 Reduce Construction Energy Consumption.

Exceptional Performance:

To qualify for exceptional performance points, projects must meet the highest level of achievement for one or more Resource Allocation credits. For example, projects seeking additional points in credit RA2.2 Use Renewable Energy must already be generating a net positive amount of renewable energy. In this instance, exceptional performance may be pursued by projects where the magnitude and investment in renewable energy generation represents a significant percentage of the project budget and a primary objective of the project.

Possible areas of achievement in exceptional performance for Resource Allocation may include, but are not limited to, the following:

- Projects for which the use of recycled materials far exceeds the Conserving requirements in credit RA1.3 Use Recycled Materials;
- Projects for which reducing operational energy consumption far exceeds the Conserving requirements in credit RA2.1 Reduce Operational Energy Consumption;
- Projects that achieve significant water efficiency by creatively re-examining water delivery or treatment.

Address Additional Aspects of Sustainability:

To qualify for bonus points under this approach, project teams must demonstrate that they are addressing one or more aspects of sustainability not currently recognized in Envision. Sustainability performance must be related to Resource Allocation. Addressing an aspect of sustainability not currently covered by the Envision system might sometimes be considered innovative, in which case the requirements for the Innovation path may be followed. For example, a project may earn bonus points for:

- Implementing sustainable procurement policies not already addressed in RA1.1 Support Sustainable Procurement Practices.

EVALUATION CRITERIA AND DOCUMENTATION GUIDANCE

A. To what extent does the project implement innovative methods, technologies, or processes that overcome significant problems, barriers or limitations, or create scalable and transferable solutions?

1. *Documentation of the application of innovative technologies or methods. Detailed description of how this application will improve existing conventional practice either globally or within the unique context of the project. Provide justification as to why this application should be considered innovative either as a technology, a method, or within the project context (climate, political, cultural, etc.).*
2. *Documentation that the project reduces or eliminates significant problems, barriers, or limitations that previously hampered the use or implementation of certain resources, technologies, processes, or methods that improve the sustainability of the project. Alternatively, documentation that the new methods, technologies, or processes implemented on the project are scalable across a wide range of project sizes and/or are applicable and transferable across multiple kinds of infrastructure projects in multiple sectors.*

B. To what extent does the project exceed the highest levels of achievement for a given credit?

1. *Detailed documentation of how the project exceeds the existing requirements currently within a given Resource Allocation credit.*

C. To what extent does the project address a sustainability aspect that is not currently addressed by the Envision system?

1. *Detailed documentation of how the project addresses a sustainability aspect that is not currently addressed by the Envision system.*
2. *Documentation showing how this aspect relates to the Resource Allocation category.*





Natural World

Infrastructure projects have an impact on the natural world around them, including habitats, species, and nonliving natural systems. The natural systems around us perform critical functions called ecosystem services that provide us with clean air, clean water, healthy food, and hazard mitigation. The way a project is located within these systems and the new elements they may introduce to a system can create unwanted impacts on these ecosystem services. This section addresses how to understand and minimize negative impacts while considering ways in which the infrastructure can interact with natural systems in a synergistic, positive way. These types of interactions and impacts have been divided into three subcategories: **Siting, Conservation, and Ecology.**

14 / credits

Image

The William Jack Hernandez Sport Fish Hatchery in Anchorage, Alaska (Envision Gold, 2013)

- 1 Does the project avoid sites of high ecological value?
- 2 Does the project protect wetland and surface water quality?
- 3 Does the project maintain hydrological functions?
- 4 Does the project manage stormwater?
- 5 Does the project protect soil health?
- 6 Does the project manage or eliminate invasive species?

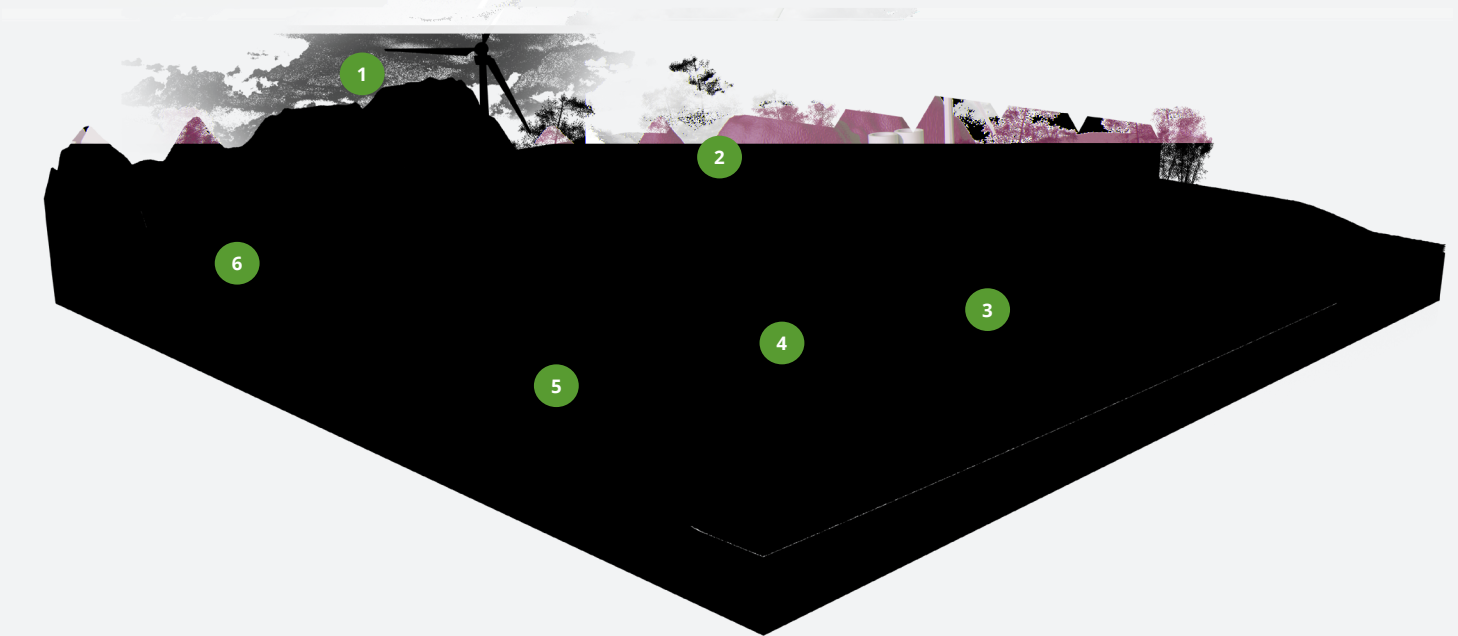

SITING

Infrastructure should be sited to avoid impacts on important ecological areas including farmland and areas that serve as a diverse habitat, such as waterbodies or wetlands. When the nature of the infrastructure project makes it impossible to avoid sensitive sites, mitigation measures should be taken to minimize disruption of systems. Previously developed or disturbed land is ideal for preventing further damage to the environment and improving land value.

CONSERVATION

Special care should also be taken to avoid the introduction of contaminants, whether through stormwater runoff or pesticides and fertilizers. With proper foresight, infrastructure can avoid these harmful disruptions and even remediate previously contaminated sites. It is important to remember that the impact of contamination is often cumulative, and that each project and site shares responsibility for protecting the quality of the larger system.

ECOLOGY

Infrastructure projects should minimize impacts on complex natural systems such as hydrologic and nutrient cycles, and habitats. Through careful design infrastructure projects can minimize habitat fragmentation and promote connectivity and animal movement. Projects should avoid introducing invasive species or inadvertently facilitating their spread. Species of new vegetation should be carefully selected and be appropriate for the location. Infrastructure should not adversely impact wetlands, floodplains, or soil health, which provide critical ecosystem functions.



Natural World



SITING

- NW1.1** Preserve Sites of High Ecological Value
- NW1.2** Provide Wetlands and Surface Water Buffers
- NW1.3** Preserve Prime Farmland
- NW1.4** Preserve Undeveloped Land

CONSERVATION

- NW2.1** Reclaim Brownfields
- NW2.2** Manage Stormwater
- NW2.3** Reduce Pesticide and Fertilizer Impacts
- NW2.4** Protect Surface and Groundwater Quality

ECOLOGY

- NW3.1** Enhance Functional Habitats
- NW3.2** Enhance Wetland and Surface Water Functions
- NW3.3** Maintain Floodplain Functions
- NW3.4** Control Invasive Species
- NW3.5** Protect Soil Health

- NW0.0** Innovate or Exceed Credit Requirements





NW1.1 Preserve Sites of High Ecological Value

22

POINTS

INTENT

Avoid placing the project and temporary works on a site that has been identified as being of high ecological value.

METRIC

Avoidance of high ecological value sites and establishment of protective buffer zones.

LEVELS OF ACHIEVEMENT

IMPROVED	ENHANCED	SUPERIOR	CONSERVING	RESTORATIVE
A + B	A + B	A + C	(A + C + D) or E	A + C + D + F
(2) Improved Siting	(6) Full Mitigation	(12) Total Avoidance	(16) Habitat Protection	(22) Habitat Expansion
(A) The project team identifies areas of high ecological value.				
(B) Mitigation measures, including avoidance, minimization, restoration, and offsets, fully compensate for project impacts to sites of high ecological value. Mitigation may occur off site.	(B) Mitigation measures including avoidance, minimization, restoration, and offsets, fully compensate for project impacts to sites of high ecological value. Mitigation is on site or an adjacent contiguous parcel of equal or higher ecological value. Temporary impacts from construction activities do not decrease the capacity of preserved land.	(C) The project avoids developing or disturbing 100% of areas of high ecological value located on site.		
			(D) The project establishes effective protective buffer zones around areas of high ecological value.	
			OR	(F) The project increases the area of high ecological value. This involves the restoration of areas of high ecological value or conservation of surrounding areas, as determined by a licensed or similarly qualified professional.
			(E) The project team can demonstrate that the site was intentionally chosen to avoid development on or near sites of high ecological value.	

DESCRIPTION

Some areas are especially important in protecting wildlife biodiversity because of their size, location, diversity of habitat types, or presence of a particular type of habitat for plant or animal species. Some of these areas are large and already protected (for example, national parks, national forests, or national wildlife refuges). However, other habitat areas, such as areas of old-growth forest amid a patch of younger trees, may be smaller and undocumented. All play important roles in maintaining biodiversity by providing crucial habitats for wildlife.

Through construction, noise, light pollution, removal of vegetation, and other practices, infrastructure projects can have negative impacts on these areas as well as the local biodiversity. Therefore, siting infrastructure projects to prevent and minimize direct, indirect, and cumulative impacts is crucial. For example, a project with a small initial footprint should consider the potential for disruption caused by future roads, utilities, and other development. Problems associated with a poorly sited project are difficult to correct after construction. Preventing impacts by selecting appropriate sites during planning is significantly more effective.

--Project teams unsure of whether their site is of high ecological value should consider the following factors:

1. Biodiversity

a. Rarity

- i. Sites with a concentration of endemic flora or fauna species
- ii. Sites containing rare or threatened flora or fauna species
- iii. Sites containing rare or threatened habitat types
- iv. Sites containing habitat or species of limited distributional range

b. Richness

- i. Sites concentrating high numbers of flora or fauna species
- ii. Sites concentrating high numbers of habitat types
- iii. Sites seasonally concentrating significant population of migratory species

2. Ecosystem Functions

a. Size

- i. Sites embedded into large areas preserving good environmental conditions (e.g., “core forest”)
- ii. Sites embedded into a large and connected landscape matrix

b. Ecological Processes

- i. Sites maintaining good soil conditions for high-quality habitat development
- ii. Sites maintaining good regeneration conditions for dominant species
- iii. Sites significant to the hydrologic system, including groundwater recharge

c. Age/Maturity

- i. Sites maintaining old-growth forests or similar undisturbed habitats
- ii. Sites containing a variety of age classes of fauna
- iii. Multilayer forest sites with indicator species for each layer

PERFORMANCE IMPROVEMENT

Improved: The credit assessment begins with identifying areas of high-ecological value. Not every undeveloped or vegetated site is considered an area of high ecological value, and the qualifications of what constitutes a site of high ecological value can be subjective. These include all areas designated by municipal, state/provincial, or federal agencies but may also include undocumented areas containing rare or significant habitat, species, or geologic formations.

After identifying sites of high ecological value, projects should follow a mitigation hierarchy prioritizing the avoidance of sensitive sites to the extent possible. Mitigation measures are actions that reduce or address potential adverse impacts of a project on an area of high ecological value. They address specific needs of the site and species involved and are manageable and measurable. Mitigation measures may take many forms, such as:

- Avoidance (e.g., preservation of existing habitat)
- Minimization (e.g., establishment of buffer areas around existing habitats)

- Restoration (e.g., enhancement or restoration of degraded or a former habitat)
- Offsetting (e.g., creation of new habitats)

Enhanced: Mitigation is accomplished on or adjacent to the impacted site. Mitigation measures can be achieved on site through the dedication of a conservation easement that provides restrictions on access and limits, or through the acquisition of an adjoining contiguous parcel of equal or higher quality. Offsets must equal or exceed the area disturbed by the project and cannot be part of an existing conservation easement. Only in rare cases can project teams petition that remote offsetting be considered when it results in positive environmental improvements for the region.

Superior: The project site contains areas of high ecological value but all impacts are avoided.

Conserving: Project teams may meet criteria A, C, and D, or meet criterion E demonstrating that the site was intentionally chosen to avoid development on or near sites of high ecological value. This includes evidence that impacting a site of high ecological value was a seriously considered option and that decisions made during planning or design led to avoiding a sensitive site.

Restorative: The project expands the area of high ecological value. As it is rarely possible to “create” areas of high ecological value, project teams may increase the contiguous area surrounding sites of high ecological value—providing better protection, wider range of species movement, or future opportunities for expansion.

Applicability: Projects that do not contain areas of high ecological value, and cannot demonstrate they actively avoided areas of high ecological value, may apply to have this credit deemed not applicable with supporting documentation.

EVALUATION CRITERIA AND DOCUMENTATION GUIDANCE

A. Has the project team identified whether the site contains areas of high ecological value?

1. Documentation of research undertaken to identify areas of high ecological value on the site. Research may include, but should extend beyond, references to local, state/provincial, or federal agencies or organizations indicating areas of high ecological value on site. Examples may include but are not limited to: old growth forest; habitats important for threatened or endangered species; areas within ecosystems that support significant diversity of species, habitats (native, migratory, breeding, and foraging), and/or important/rare/unusual geomorphological features/processes; and areas that are “pristine” or not adversely affected by human activity.
2. Index of areas of high ecological value on or near the site.

B. Has the project mitigated any areas of high ecological value that are disturbed?

1. A mitigation plan including:
 - a. an assessment of impacts to areas of high ecological value including a calculation of area impacted;
 - b. measures the project will undertake to monitor, minimize, and mitigate impacts;
 - c. the resources that will be made available to implement such measures;

- d. alternative actions that the project analyzed, and the reasons why the project did not adopt such alternatives;
 - e. additional measures that may be required by regulatory agencies, as necessary or appropriate.
2. The plan is appropriately designed to meet mitigation goals. The plan should be prepared by a licensed or similarly qualified professional with expertise in ecological, natural resources and environmental habitat. Depending on the context of the project, this requirement may alternatively be met by regulatory approval of the mitigation plan or by demonstrating that the plan meets guidelines set out by the appropriate regulatory body.
 3. Site plan showing temporary works and their proximity to sites of ecological value.
 4. Documentation that the capacity of ecological sites was not diminished as a result of construction activities.

C. Does the project avoid developing or disturbing areas of high ecological value on site?

**PROJECT EXAMPLE:
MARSHALLTOWN GENERATING STATION**

The Marshalltown Generating Station (Envision Platinum, 2017) in Marshalltown, Iowa avoided development on land considered to be of high ecological value. When assessing the best place to construct the new combined-cycle power plant, the project team undertook a comprehensive siting study to identify the most viable location. In total more than 140 potential locations for the plant were considered based on a number of considerations such as minimum transmission line, natural gas pipeline, and substation infrastructure requirements. This long list of possible sites was narrowed down to 36 locations and environmental considerations—such as avoiding impacts to sensitive species and avoiding impacts to protected areas—were included in the assessment criteria. Ultimately, the project team chose a site for the plant that avoided the development of land judged to be of high ecological value.



1. Documentation showing that no existing areas of high ecological value will be developed as a result of the project.
2. Documentation demonstrating that areas of high ecological value will be protected during construction (e.g., contract documentation, specifications, contractor standard operating procedures).

D. Does the project preserve an effective protective buffer zone around areas of high ecological value?

1. A site map illustrating a protective zone for areas of high ecological value.
2. Documentation demonstrating that the zone provides effective protection. This should include the nature and makeup of the buffer zone.

E. Was the project intentionally sited to avoid areas of high ecological value?

1. Documentation demonstrating to what extent areas of high ecological value were intentionally avoided.
2. Documentation must show that the owner and the project team made meaningful efforts to avoid disturbing areas of high ecological value during the site selection process.

Note that meeting criterion E is an alternative achievement path for the Conserving level. Achieving Conserving by meeting criterion E does not require meeting criteria A, C, and D, and vice versa.

F. Does the project significantly increase the area of high ecological value?

1. Documentation of how areas of high ecological value were increased or restored. The habitat produced can be part of a protective buffer zone. Documentation should include a site map outlining locations and a technical summary describing the methods and materials of restoration.
2. The documentation must be signed by a qualified natural resource professional who attests to the functionality of the restoration, or approved by a similarly qualified regulatory body.

RELATED ENVISION CREDITS

- QL1.1 Improve Community Quality of Life
- LD2.2 Plan for Sustainable Communities
- NW1.2 Provide Wetlands and Surface Water Buffers
- NW1.4 Preserve Undeveloped Land
- NW3.1 Enhance Functional Habitats
- NW3.4 Control Invasive Species
- NW3.5 Protect Soil Health

Sheldon Avenue Stormwater Management: Staten Island, New York

New York City's Sheldon Avenue Stormwater Management project (Envision Silver, 2017) on Staten Island, executed by the Department of Design and Construction (NYCDDC) on behalf of the Department of Environmental Protection (NYCDEP), involves the creation of a natural wetland to more effectively and sustainably manage and filter stormwater captured from the local community. Additionally, installation of sanitary sewers will allow almost 600 local homeowners to be taken off septic systems, improving water quality, increasing home values, and eliminating the headaches for homeowners associated with managing these systems. This project is the largest expansion to date of the Staten Island Bluebelt, an award-winning, ecologically sound and cost-effective stormwater program created in response to frequent flooding on the island during rain events that were caused by a lack of sufficient stormwater drainage.

Key organizations involved in the planning, design, and construction of the project include NYCDDC, which was responsible for both the design of the storm and sanitary sewers as well as construction management; NYCDEP; Hazen and Sawyer, which was responsible for the design of the stormwater Best Management Practice (BMP) wetland; and Arcadis, which provided construction oversight services and steered the Envision application process.

Notable achievements for the Sheldon Avenue stormwater management project within the Envision categories include:

Quality of Life: This project is part of a much larger program—the Staten Island Bluebelt program—designed to address flooding issues and improve water quality throughout the community in a sustainable manner. The overall integration of the existing community wetland infrastructure is well documented in an Environmental Impact Statement document, a holistic evaluation of the wetlands in the Bluebelt system. Beyond integrated wetlands, this project also integrates well with existing transportation infrastructure, and the existing residential and commercial building infrastructure. This project will improve sewerage, drainage, and water quality in the Bluebelt area, without adversely impacting the existing population and associated community infrastructure.

Leadership: New York City has demonstrated a significant commitment to sustainability from the Mayor's office through to its many agencies and offices, including the NYCDEP—the city's agency that manages its water supply, and NYCDDC—the

city's agency responsible for the construction of civic facilities, including the Sheldon Avenue project. Both agencies have made strong commitments to designing projects that adhere to the principles of sustainability, and both also have many in-house Envision Sustainability Professionals (ENV SPs).

Resource Allocation: The original concept called for an all-pipe network for managing stormwater on Staten Island, which would have destroyed existing wetlands. The Bluebelt program, and by extension the Sheldon Avenue project, instead aims to use existing drainage corridors and wetlands as a natural conveyance for stormwater that requires no energy and less water treatment.

Natural World: Wetland restoration is another key component of the project. A badly degraded wetland, overrun with non-native and invasive species, was restored. The project team undertook a comprehensive assessment of potential risks and impacts to existing wetlands, and took steps to mitigate and avoid impacts to the extent possible. Also, the replacement of an existing manmade stormwater pond with stormwater best management practices such as the wetlands is expected to have a significant positive impact on wildlife by improving habitat conditions.

The project team also included an assessment of the area to determine the presence of any adverse geological formations and aquifers. In designing the project, the project team took care to avoid impacting the ground water by installing pipes at a maximum depth of 12 feet below the surface, more than 45 feet above the groundwater levels. Additionally, silt fences and other sediment control measures were installed during construction to prevent runoff into nearby water features.

Climate and Resilience: Wetlands play a vital role in reducing the effects of global warming by absorbing carbon, thereby mitigating the long-term consequences of climate change and helping to make the community more resilient under altered climate conditions. The Sheldon Avenue stormwater projects addresses a range of potentially severe short-term hazards that could affect the area, including flooding, coastal storms, and extreme temperatures, all of which are alleviated by the implementation of green infrastructure solutions for stormwater management, such as the use of wetlands and natural stormwater conveyance systems, as opposed to more traditional "grey infrastructure".



NW1.2 Provide Wetland and Surface Water Buffers

20
POINTS

INTENT

Protect, buffer, enhance, and restore wetlands, shorelines, and waterbodies by providing natural buffer zones, vegetation, and soil-protection zones.

METRIC

Type and quality of natural buffer zone established around all wetlands, shorelines, and waterbodies.

LEVELS OF ACHIEVEMENT

IMPROVED	ENHANCED	SUPERIOR	CONSERVING	RESTORATIVE
A + B + C	A + B + C	A + B + C	(A + B + C) or D	A + B + C + E
(2) Buffers	(5) Managed Buffers	(10) Mixed Buffers	(16) Natural Buffers	(20) Buffer Restoration
<p>(A) The project team identifies wetlands and surface water on or near the site, or with the potential to be impacted by the project.</p> <p>(B) The project team identifies the appropriate type and width of buffer zones for wetlands and surface waters.</p>				
<p>(C) The project provides vegetated or natural buffer zones around at least 90% of wetlands and surface waters on site. The remaining areas (<10%) are protected with engineered controls.</p> <p>Together they are sufficient to slow surface runoff, and trap sediments, pesticides, and other pollutants.</p> <p>Minimum buffer width is 50 ft/15 m unless otherwise justified under criterion B.</p>	<p>(C) The project provides a buffer of managed vegetated zones around all wetlands and surface waters. Managed zones may include grass.</p> <p>The buffer is of sufficient width to slow surface runoff, and trap sediments, pesticides, and other pollutants.</p> <p>Minimum width is 100 ft/30 m unless otherwise justified under criterion B.</p>	<p>(C) The project provides a mixed buffer of managed vegetation and natural zones around all wetlands and surface waters. Natural areas are not managed and consist of natural habitat.</p> <p>The buffer is of sufficient width to slow surface runoff, and trap sediments, pesticides, and other pollutants.</p> <p>Minimum width is 150 ft/45 m unless otherwise justified under criterion B.</p>	<p>(C) The project provides a buffer of natural zones around all wetlands and surface waters.</p> <p>The buffer is of sufficient width to slow surface runoff, and trap sediments, pesticides, and other pollutants.</p> <p>Minimum width is 200 ft/60 m unless otherwise justified under criterion B.</p>	<p>OR</p> <p>(D) The project team can demonstrate the site was intentionally chosen to avoid development on or near wetlands or surface waters.</p>
			<p>(E) The creation of the protective buffers includes returning previously developed or disturbed areas to a natural state.</p> <p>Project teams may alternatively demonstrate the recovery of pre-existing buffer zones that have degraded in quality.</p>	

DESCRIPTION

Wetlands, shorelines, and waterbodies provide a number of important ecological services, including mitigating flooding, improving water quality, and providing wildlife habitat. Buffer zones maintain the integrity of these elements while playing important roles in the following:

- Protecting wildlife habitats, providing connected habitat corridors, and maintaining biodiversity—Many wetland and aquatic-dependent species also require access to riparian or upland habitats for feeding, nesting, breeding, and hibernation;
- Regulating water temperature—Shade from vegetation in buffer areas maintains water temperatures. Increased water temperatures can harm aquatic life;
- Maintaining water quality—Buffer areas provide erosion control and filter excess nutrients and pollutants from runoff;
- Protecting hydrology—Buffer areas regulate the flow of stormwater runoff and help preserve surface water and groundwater levels and flows;
- Protecting against human disturbance—Providing a buffer helps protect wetlands and surface waters

from impacts in nearby areas, including destroying vegetation, compacting soils, debris, noise, and light.

PERFORMANCE IMPROVEMENT

Improved: The project provides full protections around all wetlands and surface waters. However, in areas where vegetated or natural buffers of the minimum distance are not possible, engineered controls are permitted. Total area requiring engineered controls is not to exceed 10%.

Enhanced: Managed vegetated areas (i.e., mowed lawns or managed landscaping) of the minimum distance fully buffer wetlands and surface waters.

Superior: A mix of managed vegetated areas and natural areas of the minimum distance fully buffer wetlands and surface waters.

Conserving: Project teams have two options. The first is to provide fully natural buffers of the minimum distance. The second option is to submit documentation for criterion D demonstrating that the site was intentionally chosen to avoid development on or near wetlands or surface waters. This includes evidence that developing on or near wetlands or surface waters was a seriously considered option and that decisions made during planning or design led to avoiding a sensitive site.

Restorative: The project restores previously developed areas into vegetated buffers or restores existing degraded vegetated buffers.

Applicability: Projects that do not contain wetlands or surface waters, and for which no siting options containing wetlands or surface waters were possible or seriously considered, may apply to have this credit deemed not applicable with supporting documentation.

EVALUATION CRITERIA AND DOCUMENTATION GUIDANCE

A. Has the project team identified wetlands and surface waters on or near the site?

1. Map of wetlands and surface waters in and around the site.

B. Has the project team determined the type and width of buffer zones necessary to protect wetlands and surface waters?

1. Calculation of the proposed buffer type and minimum width or acceptance of Envision minimum width requirements.
2. Documentation that the project team has considered site conditions including soil type, slope, land use, and vegetation mix in determining the appropriate buffer width and type.
3. Documentation that the proposed buffer width and type are sufficient to address: pesticide retention; bank stabilization; sediment control; nutrient retention; litter and debris; water temperature; terrestrial wildlife; and aquatic wildlife.

4. Documentation that the project team has considered the cumulative impacts of acidification and/or eutrophication of the water bodies in the project design.

C. To what extent has the project implemented protective buffer zones around wetlands and surface waters?

1. A site plan showing the final site design, the boundaries of the buffer zone, and the minimal buffer zone width calculated as the shortest point between the buffer zone boundary and the identified wetland, waterbody, or shoreline.
2. Minimum widths are followed unless justified by documentation in criterion B.
3. Documentation that the buffer design matches the level of achievement requirements. Note that as levels increase, the credit requires that more of the protective buffer be natural area rather than managed areas (e.g., mowed grass). For exceptions, project teams can demonstrate in criterion B how a larger-managed vegetated buffer might meet the same performance requirements as a natural buffer of the minimum required width.

D. Was the project intentionally sited to avoid wetlands and surface waters?

1. Evidence that the project team intentionally avoided siting the project on or within the minimum buffer widths of wetlands and surface waters. Evidence should include alternative sites that were seriously considered.

Note that meeting criterion D is an alternative achievement path for the Conserving level. Achieving Conserving by meeting criterion D does not require meeting criteria A, B, and C, and vice versa.

E. Will the project involve returning previously developed or disturbed sites within the buffer zone to a natural state?

1. Maps and plans of developed areas of the project site that will be returned to a natural state within the protective buffer zones. Developed areas include man-made surfaces (e.g., pavement) and/or structures (e.g., facilities). Project teams may not count returning existing vegetated landscape (whether constructed or natural) to a natural state as evidence of restorative actions.

Note that project teams may alternatively demonstrate the recovery of pre-existing buffer zones that have degraded in quality.

RELATED ENVISION CREDITS

RA3.1 Preserve Water Resources

NW1.1 Preserve Sites of High Ecological Value

NW2.2 Manage Stormwater

NW3.2 Enhance Wetland and Surface Water Functions

CR2.2 Assess Climate Change Vulnerability



NW1.3 Preserve Prime Farmland

16
POINTS

INTENT

Identify and protect soils designated as prime farmland, unique farmland, or farmland of importance.

METRIC

Percentage of farmland avoided or preserved during development.

LEVELS OF ACHIEVEMENT

IMPROVED	ENHANCED	SUPERIOR	CONSERVING	RESTORATIVE
Not Available	A + B + C	A + B + C	(A + B) or D	A + B + E
	(2) Less than 10% Disturbance	(8) Less than 5% Disturbance	(12) 100% Avoidance	(16) Restore Productive Farmland
	(A) The project team identifies soils designated as prime farmland, unique farmland, or farmland of importance.			
	(B) Less than 10% of the project site is developed or disturbed prime farmland.	(B) Less than 5% of the project site is developed or disturbed prime farmland.	(B) The project avoids developing or disturbing any prime farmland located on site.	
	(C) Farmland permanently damaged or disturbed as a result of the project is mitigated through offsets. Any farmland temporarily disturbed as a result of construction impacts is restored to a level that does not decrease the capacity of the preserved land.		OR (D) The project team can demonstrate the site was intentionally chosen to avoid areas of prime farmland.	(E) In addition to 100% avoidance, the project includes protecting farmlands for posterity against future disturbance, or restoring previously developed areas to a contiguous, functional, and productive farmland state.

DESCRIPTION

Prime farmland possesses a combination of soil properties, growing season, and moisture supply needed to produce sustained high yields of crops economically if the farmland is treated and managed according to acceptable farming methods. Soil properties are only one of several criteria that are necessary for land to be designated as prime farmland. In general, prime farmland has an adequate and dependable water supply from precipitation or irrigation, a favorable temperature and growing season, an acceptable level of acidity or alkalinity, and an acceptable content of salt or sodium. Its soils are permeable to water and air. Prime farmland is not excessively eroded or saturated with water for long periods of time, and it either does not flood frequently during the growing season or is protected from flooding.

Farmland supports the economic base of many rural and suburban communities. Agricultural land is vital to achieving local and national food, health, and economic security. While some communities may not consider farming a significant contributor to the local economy now, they should look to trends in organic farming, local food sourcing, urban agriculture, and "slow food"/regional cuisine movements that are changing the economic viability of small and local farming. Agricultural land can also be sources of significant cultural and ecological importance, such as social heritage, scenic views, open space, and community character.

PERFORMANCE IMPROVEMENT

Designations of prime farmland, unique farmland, or farmland of local significance by municipal, state/provincial, or federal agencies can be used in documentation for this credit. In the United States, prime farmland is designated by the U.S. Department of Agriculture (USDA); in Canada, it is classified by the Canada Land Inventory (CLI). Farmland designations for most of the United States can now be accessed from the USDA Soil Survey Geographic (SSURGO) soil surveys database. Similar information for Canada can be accessed through the Canadian Soil Information Service (CanSIS) and the Agricultural Census. Many states and provinces also have classifications for farmland of significance. In countries or regions that lack official designations, project teams can use the description of prime farmland above to make their own determinations.

Enhanced: After identifying prime farmland, project teams follow a mitigation hierarchy including avoidance, minimization, restoration, and offsetting. Project teams must demonstrate that they prioritized the avoidance of developing farmland to the extent possible, that remaining temporary impacts were minimized and restored, and that any permanent development on farmland was offset. Disturbed farmland cannot constitute more than 10% of the project site.

Mitigation must be accomplished on or adjacent to the impacted site. Mitigation measures can be achieved on site through the dedication of a conservation easement that provides restrictions on access and limits, or through the acquisition of an adjoining contiguous parcel of equal or higher quality. Offsets must equal or exceed the area permanently disturbed by the project and cannot be part of an existing conservation easement. Remote offsetting does not contribute to achievement in this credit.

Superior: Disturbed farmland cannot constitute more than 5% of the project site.

Conserving: Projects fully avoid disturbing farmland on site, or the site was intentionally chosen to avoid development on prime farmland. This must include evidence that developing on or near prime farmland was a seriously considered option and that decisions made during planning or design led to avoiding a sensitive site.

Restorative : The project includes the preservation of farmland for posterity such as conservation easements.

Applicability: Projects that do not contain prime farmland, and for which no siting options containing prime farmland were possible or seriously considered, may apply to have this credit deemed not applicable with supporting documentation.

EVALUATION CRITERIA AND DOCUMENTATION GUIDANCE

A. Has the project team assessed the project site for soils identified as prime farmland, unique farmland, or farmland of importance?

1. Results of government studies and/or soil surveys designating areas of prime farmland, unique farmland, or farmland of special importance (e.g., USDA, or CLI).

B. To what extent will the project protect or preserve prime farmland, unique farmland, or farmland of importance?

1. Provide calculations and plans showing that less than the required percentage of the project site includes development on farmland. The remaining avoided farmland must be contiguous and functionally viable to support farming.

Note that previously developed land (i.e., structures or paved surfaces) can be excluded from the calculations.

2. Documentation showing that during construction no soils will be stripped from areas to be preserved as farmland.

C. Has the project team mitigated any damage or disturbance to prime farmland, unique farmland, or farmland of importance?

1. Documentation showing how the disturbed farmland has been mitigated on site per local jurisdiction standards.
2. For areas permanently disturbed by the constructed project, offsetting criteria for farmland include:
 - Preservation of adjacent or contiguous farmland of similar quality or better.
 - Preserved area must equal or exceed area disturbed by the project.
 - Preserved land cannot be part of an existing conservation easement.
3. Documentation that a construction management plan includes provisions for protecting farmland during construction. Documentation includes the full restoration of sites disturbed as a result of temporary works.
4. For projects that involve temporary disturbance to farmland, documentation that protection and restoration activities were carried out.

D. Was the project intentionally sited to avoid prime farmland?

1. Evidence that the project team intentionally avoided siting the project on prime farmland. Evidence should include alternative sites that were seriously considered.

Note that meeting criterion D is an alternative achievement path for the Conserving level. Achieving Conserving by meeting criterion D does not require meeting criteria A and B, and vice versa.

E. Does the project preserve existing farmland for posterity or restore previously disturbed farmland?

1. Documentation that farmland has been preserved for posterity against future disturbance or development. Proposed preserved land cannot be part of an existing conservation easement. In certain cases, projects may submit the inclusion of urban agriculture for the Restorative level if it is of a scale commensurate with the project size.

Note that Restorative cannot be achieved if any farmland of importance, as defined in criterion A, is permanently impacted by the project. In addition, Restorative cannot be achieved by converting previously undeveloped natural areas into farmland.

RELATED ENVISION CREDITS

QL1.1 Improve Community Quality of Life

QL3.2 Preserve Historic and Cultural Resources

QL3.3 Enhance Views and Local Character

LD2.2 Plan for Sustainable Communities

LD3.1 Stimulate Economic Prosperity and Development

NW1.1 Preserve Sites of High Ecological Value



NW1.4 Preserve Undeveloped Land

<h2 style="font-size: 48px; margin: 0;">24</h2> <p style="margin: 0;">POINTS</p>	<p>INTENT</p> <p>Conserve undeveloped land by locating projects on previously developed land.</p>	<p>METRIC</p> <p>Percentage of project development that is located on previously developed land.</p>
--	--	---

LEVELS OF ACHIEVEMENT

IMPROVED	ENHANCED	SUPERIOR	CONSERVING	RESTORATIVE
A	A	A	A	A + B
(3) At Least 25% Previously Developed	(8) At Least 50% Previously Developed	(12) At Least 75% Previously Developed	(18) 100% Previously Developed	(24) Restore Natural Areas
(A) At least 25% of the developed area of the project is located on previously developed land.	(A) At least 50% of the developed area of the project is located on previously developed land.	(A) At least 75% of the developed area of the project is located on previously developed land.	(A) 100% percent of the developed area of the project is located on previously developed land.	(B) Return developed areas to a condition that supports, or could support, open space, habitat, or natural hydrology.

DESCRIPTION

This credit addresses conserving undeveloped land (greenfields) by locating project on previously developed land (greyfields). Projects located on previously developed land often have fewer impacts on wildlife by minimizing the likelihood of new habitat fragmentation.

Developing on previously developed land is often an investment in community prosperity. Infrastructure owners that can locate projects on abandoned, underutilized, or degraded properties can remove eyesores that degrade property values and replace them with beneficial projects. Project teams should consider the advantages of locating projects in areas designated or recognized as urban core/desired development zones. Such projects often:

- Promote urban development and channel development to urban areas, resulting in reduced pressure on undeveloped land and conservation of resources;
- Promote socioeconomic urban and neighborhood revitalization. This includes safety improvement, creation of short- and long-term local jobs, and the creation or preservation of parks and other recreational property.

In choosing greyfield sites, projects may realize the following additional benefits:

- Under the Natural World category, projects may provide for the restoration of impaired drainageways and other damaged or stressed natural resources;

- Under the Quality of Life category, these projects may positively impact historically and economically disadvantaged urban populations;
- Under the Resource Allocation category, projects located on greyfield sites may provide for the reuse of existing underground and above-ground structures, including buildings, utilities, and roadways.

PERFORMANCE IMPROVEMENT

While the term “greyfield” in some contexts may refer to underutilized or abandoned sites, this credit defines all previously developed land as greyfields. This also includes contaminated sites referred to as “brownfields.” Developed area consists of paving or construction, while undeveloped area consists of natural or managed vegetation. For the purpose of this credit, vegetated areas of public parks are considered undeveloped land, whereas paved areas are considered developed. In urban areas these vegetated open spaces serve an important function.

Improved – Conserving: Levels for this credit are distinguished by the percentage of project development located on previously developed areas.

Restorative: In addition to locating project development entirely on already developed sites, the project results in a net positive return of previously developed area back into natural or vegetated areas.

Applicability: Assessment of this credit is determined by the extent to which the project is located on previously developed land or

previously undeveloped land. As all land falls within these two classifications, it would be difficult to demonstrate that the credit is not applicable. Inability to locate the project on developed land is not sufficient justification to remove this credit from consideration.

EVALUATION CRITERIA AND DOCUMENTATION GUIDANCE

A. To what extent is the project located on previously developed land?

1. Documentation showing the percentage of the developed area of the site that was developed prior to project construction and may be classified as a greyfield.

Note that this credit considers all previously developed land as greyfields. This includes contaminated sites referred to as "brownfields." Developed land consists of pre-existing paving or construction. Land dedicated to current agricultural use, forestry use, or use as a preserved natural area does not qualify as a greyfield even if it contains pre-existing paving or construction. Sites

with historic development that have since returned to a natural state do not qualify as previously developed or greyfield sites.

B. Has the project returned developed areas to a condition that supports natural open space, habitat, or natural hydrology?

1. Documentation showing previously developed areas that have been returned to a natural state.

RELATED ENVISION CREDITS

QL3.2 Preserve Historic and Cultural Resources

QL3.3 Enhance Views and Local Character

RA1.2 Use Recycled Materials

NW1.1 Preserve Sites of High Ecological Value

NW2.1 Reclaim Brownfields

NW3.1 Enhance Functional Habitats

NW3.3 Maintain Floodplain Functions

NW3.5 Protect Soil Health

CR2.6 Improve Infrastructure Integration



NW2.1 Reclaim Brownfields

22

POINTS

INTENT

Locate projects on sites classified as brownfields.

METRIC

The extent of remediation of the brownfield site.

LEVELS OF ACHIEVEMENT

IMPROVED	ENHANCED	SUPERIOR	CONSERVING	RESTORATIVE
A	B + C	B + C	B + C	B + C + D
(11) Reuse Former Brownfield	(13) Mitigate Exposure	(16) Passive Remediation	(19) Active Remediation	(22) Complete Remediation
(A) The project is located on a site classified as a brownfield that has been remediated by others.	(B) The project is located on a site classified as a brownfield, or is known to contain contamination.			
	(C) Minimum required capping and remediation is performed to reduce human exposure to safe levels. Contaminants remain generally on site at levels that can be addressed by engineering and/or institutional controls.	(C) Passive remediation is performed to reduce human exposure and to gradually remove or break down contamination on the site.	(C) Active remediation, or a combination of active and passive remediation, is performed to reduce human exposure and to remove or break down contamination on the site.	(C) Active remediation, or a combination of active and passive remediation, is performed to restore the entirety of site soils and/or groundwater back to regional background or unrestricted use levels.
				(D) The site is closed/deregulated by regulators, or is in the process of closing and has a long-term site management, monitoring, and inspection plan.

DESCRIPTION

This credit recognizes the incredible benefit and service that projects provide when located on brownfields. A brownfield is a property for which the expansion, redevelopment, or reuse may be complicated by the presence of a hazardous substance, pollutant, or contaminant.

Developing on brownfields comes with certain risks and responsibilities that may increase the cost of a project. Developers and property owners will need to manage past and future environmental liabilities associated with the property's environmental history. Private lenders are often reluctant to give loans for potentially impaired lands. In some cases, cleanup costs for a property may ultimately be more than the property's value. Brownfield projects may take longer than typical development due to environmental assessment and cleanup activities and a more complex permitting and regulatory environment. However, there are often funding sources available to support or offset these costs.

Environmental benefits of brownfield development include cleanup or containment to prevent exposure, thereby reducing the threat to human and ecological health. It can also reduce the runoff of toxics into nearby water bodies, leading to improvements in overall water quality and habitat. As with greyfield development (NW1.4 Preserve Undeveloped Land), brownfield development reduces sprawl by promoting development into urban areas, resulting in reduced pressure on undeveloped land. In some cases, brownfield development may also involve the remediation and restoration of damaged or stressed natural resources.

Socioeconomic benefits to brownfield development include increased local tax revenue both directly from the site as well as neighboring properties. Development improves safety and creates jobs. This type of development can create a catalyst effect that spurs other investment and transformation in communities.

PERFORMANCE IMPROVEMENT

The assessment is based on the degree of remediation of the brownfield. Projects advance to higher levels for sites that require increasing levels of remediation.

Improved: Sites are classified as brownfields but have been previously remediated or contained. This may include a former landfill that has been capped and closed.

Enhanced: Contamination remains on the site but is capped and remediated to the necessary levels for the intended use.

Superior: Less-intensive passive measures are sufficient. Passive remediation is defined as methods and improvements that stimulate or focus on natural attenuation in the ground. Examples include promoting microbial growth or installing a permeable reactive barrier that relies on natural groundwater flow.

Conserving: Sites require active, or a combination of active and passive measures. Active remediation is defined as methods that trap and remove contamination from the site. Examples include soil vapor extraction or “pump and treat” methods.

Restorative: Projects successfully close a contaminated site. This ensures the site is no longer a potential risk for future generations. Often the type or degree of contamination requires years of remediation so achievement of this level may not always be possible.

Applicability: Project teams that were unable to identify a suitable site may apply to have this credit deemed not applicable with supporting documentation that efforts were made. If no evidence is provided that any consideration was given to locating the project on a brownfield, the credit is considered applicable and no points achieved.

EVALUATION CRITERIA AND DOCUMENTATION GUIDANCE

A. Is the project located on a site currently identified as a closed brownfield?

1. Provide documentation showing that the site is closed or an already remediated site according to federal or state/provincial programs. For example, in Canada according to the Federal Contaminated Sites Inventory or provincial brownfields program, or in the United States as a federal or state brownfield or Voluntary Cleanup Program (VCP) site.

B. Is the project located on a site currently identified as an active brownfield?

1. Provide documentation showing that the site is already designated as an active (non-remediated) brownfield according to federal or state/provincial programs.
2. For sites not already designated as a “brownfield” under state/provincial or federal definitions, project teams may provide evidence of contamination.
 - a. Qualifying sites may include, for example, sites classified as “Suspected” in the Canadian Federal Contaminated Sites Inventory or provincial brownfields program, or property under a state-managed Voluntary Cleanup Program (VCP).
 - b. Documentation of contamination should include information delineating the lateral and vertical extents of impact and concentrations of the identified contaminants of concern.

Examples include completed American Society for Testing and Materials (ASTM) or Canadian Standard Association (CSA) Phase I and Phase II Environmental Site Assessment (ESA), appropriate Voluntary Cleanup Program documentation, or site assessments completed under applicable provincial regulations.

3. Submit any deed restrictions, record of decision (ROD), or other legally binding agreements between the site owners or potentially responsible parties and regulatory authorities for the mitigation or remediation of contaminants associated with the property.

C. To what extent has the project mitigated or remediated the site?

1. Submit a mitigation and remediation plan that has been approved by the appropriate regulatory agencies.
2. Documentation showing that the plan meets the target level of achievement in terms of passive and/or active remediation. Examples of documentation could include but are not limited to:
 - a. Identify sampling completed for contaminants of concern identified during the ASTM/CSA Phase I and II ESAs.
 - b. Identify containment, mitigation and/or remediation methods for all remaining contaminants of concern in excess of regulatory or site-specific concentration thresholds, either on site or with the potential to migrate into the proposed development area.
 - c. If the contaminants of concern include potentially volatile compounds, include an evaluation of the vapor intrusion pathway, if applicable, and a mitigation approach, as needed.
3. If applicable, include construction and post-construction phase monitoring and remediation plans to ensure contaminant mobilization is minimized and in compliance with applicable federal, state/provincial, and local exposure requirements and the planned development.

D. Has the brownfield site been closed or deregulated?

1. Documentation that the site has been closed, or is in the process of being closed/deregulated, by the appropriate regulatory agencies (e.g., a closure report).
2. If applicable, the site management, monitoring, and inspection plan that will take the site to closure/deregulation.

RELATED ENVISION CREDITS

- QL1.2 Enhance Public Health and Safety
- LD1.4 Pursue Byproduct Synergies
- LD2.2 Plan for Sustainable Communities
- LD3.1 Stimulate Economic Prosperity and Development
- NW1.1 Preserve Sites of High Ecological Value
- NW2.4 Protect Surface and Groundwater Quality
- NW3.5 Protect Soil Health



NW2.2 Manage Stormwater

24

POINTS

INTENT

Minimize the impact of development on stormwater runoff quantity, rate, and quality.

METRIC

Degree to which the project infiltrates, evapotranspires, reuses, and/or treats stormwater while not exceeding rate or quantity runoff targets.

LEVELS OF ACHIEVEMENT

IMPROVED	ENHANCED	SUPERIOR	CONSERVING	RESTORATIVE
A + B + C	A + B + C	A + B + C	A + B + C	A + B + C + D
(2) Expanded Options	(4) 85th percentile/ 2-year event	(9) 90th percentile/ 10-year event	(17) 95th percentile/ 50-year event	(24) 95th percentile/ 100-year event
(A) Detain and treat 100% of the 85th percentile local 24-hour event. Ensure compliance with local requirements if stricter.	(A) Infiltrate, evapotranspire, and/or reuse 100% of 85th percentile local 24-hour event. OR If infiltration, evapotranspiration, or reuse are not permitted or impracticable detain and treat 150% of 85th percentile 24-hour event.	(A) Infiltrate, evapotranspire, and/or reuse 100% of 90th percentile local 24-hour event. OR If infiltration, evapotranspiration, or reuse are not permitted or impracticable detain and treat 150% of 90th percentile 24-hour event.	(A) Infiltrate, evapotranspire, or reuse 100% of 95th percentile local 24-hour event. OR If infiltration, evapotranspiration, or reuse are not permitted or impracticable detain and treat 150% of 95th percentile 24-hour event.	(A) Infiltrate, evapotranspire, or reuse more than 100% of 95th percentile local 24-hour event. OR If infiltration, evapotranspiration, or reuse are not permitted or impracticable detain and treat more than 150% of 95th percentile 24-hour event.
(B) Do not exceed rate or quantity of runoff for the 2-year 24-hour rainfall event relative to the existing condition (greenfield, greyfield, or brownfield).	(B) Do not exceed rate or quantity of runoff for the 2- and 5-year 24-hour rainfall event relative to the existing condition (greenfield, greyfield, or brownfield).	(B) Do not exceed rate or quantity of runoff for the 2-, 5-, and 10-year 24-hour rainfall event relative to the existing condition (greenfield, greyfield, or brownfield).	(B) Do not exceed rate or quantity of runoff for the 2-, 5-, 10-, 25-, and 50-year 24-hour rainfall event relative to the existing condition (greenfield, greyfield, or brownfield).	(B) Do not exceed rate or quantity of runoff for the 2-, 5-, 10-, 25-, 50-, and 100-year 24-hour rainfall event relative to the existing condition (greenfield, greyfield, or brownfield).
(C) The project includes an erosion, sedimentation, and pollutant control plan for construction activities.				(D) The project manages or treats stormwater from other sites according to criterion A, OR returns the site to a predevelopment hydrological condition.

DESCRIPTION

Stormwater is an increasing concern and source of risk for communities. Climate change is making precipitation rates increasingly unpredictable, with more intense storms becoming common. Historic design standards and regulations may not be sufficient to prepare communities for the future. Infrastructure owners should consider how taking opportunities to improve stormwater management systems reduces their risk exposure. There are significant cost savings in addressing stormwater outside wastewater treatment facilities. Reducing the demand

on wastewater treatment prolongs the ability of existing facilities to provide sufficient capacity without need for expansion.

Improperly managed stormwater can have serious environmental impacts. Increased surface runoff typically leads to increased stream and channel erosion, downstream flooding, water temperatures (and thereby lowered dissolved oxygen in receiving waters), and concentration of pollutants reaching surface waters. It can deposit sediment and pollutants into waterways and warm historically cold-water streams. This can negatively impact aquatic life as native species are replaced with more pollutant-tolerant warm-water species.

Natural systems for stormwater management, often referred to as “green infrastructure,” provide multiple benefits. Bioswales and rain gardens can provide community beautification, reduce heat islands, and present an opportunity to educate the public on the importance of stormwater management. Project teams should consider how incorporating low-impact development measures can reduce and mitigate potential negative impacts associated with increased runoff.

PERFORMANCE IMPROVEMENT

Assessment of this credit begins with ensuring the project does not result in an increase in the quantity and rate of stormwater runoff from a project site nor does it result in a decrease in the quality of the stormwater exiting the site.

All projects must implement an erosion, sedimentation, and pollutant control plan during construction and meet all regulations pertinent to stormwater management.

Improved – Conserving: The levels of achievement for this credit are distinguished by the degree to which the project reduces the amount of pollution discharged from the site through the use of infiltration, evapotranspiration, reuse, or treatment while not exceeding rate or quantity runoff targets.

Teams address the stormwater quality by infiltrating, evapotranspiring, reusing or treating increasing amounts of runoff from a local 24-hour event. Additionally, teams address rate and quantity of runoff by meeting the existing conditions for increasingly intense rainfall events.

Restorative: Reserved for projects that not only meet the requirements for the project site but can demonstrate how the project manages stormwater from other sites, addresses needs of the larger watershed, or returns the site to a predevelopment hydrological condition.

Applicability: This credit is applicable to all projects that impact stormwater runoff. In rare cases, where the impact on stormwater runoff is insignificant in comparison to the scale of the project, teams may apply to have this credit deemed not applicable with supporting documentation. However, the reviewer may exercise his/her discretion in determining what constitutes an insignificant impact on stormwater runoff in the context of the project.

EVALUATION CRITERIA AND DOCUMENTATION GUIDANCE

A. To what extent does the project infiltrate, evapotranspire, reuse, and/or treat stormwater on site?

1. *Site plan and documentation of all stormwater management strategies in the project and their function in infiltrating, evapotranspiring, reusing, or treating.*

Note that beginning with the Enhanced level, criterion A has two compliance paths; it is only necessary to meet one set of requirements.

2. *Calculations showing that stormwater management systems meet the relevant requirements for storm events as laid out in the level of achievement table.*

B. To what extent does the completed project limit rate or quantity of runoff compared to existing conditions?

1. *Site plan, documentation, and calculations of the existing site and stormwater runoff patterns.*
2. *Site plan, documentation, and calculations of the designed project site and stormwater runoff patterns.*
3. *Calculations showing that the project does not exceed rate or quantity of runoff for the relevant 2-, 5-, 10-, 25-, 50-, and/or 100-year 24-hour rainfall event.*

C. Does the project include an erosion, sedimentation, and pollution control plan for all construction activities?

1. *Documentation of an erosion, sedimentation, and pollutant control plan—commonly referred to as Stormwater Pollution Prevention Plan (SWPPP) or Erosion and Sedimentation Control Plan (ESCP)—for all construction activities associated with the project. The plan (SWPPP or ESCP) conforms to all applicable erosion and sedimentation requirements. If the project is located in a region where construction erosion and sedimentation are not regulated, the plan is demonstrated to comply with industry-accepted best practices.*

D. Does the project treat stormwater from other sites or does it function as part of a larger stormwater management plan?

1. *Documentation of stormwater strategies in the project that infiltrate, evapotranspire, reuse, or treat water from other sites.*

OR

2. *Documentation of how the site hydrology has been returned to a predevelopment state.*

Note that criterion D has two compliance paths. It is only necessary to meet one set of requirements.

RELATED ENVISION CREDITS

QL3.4 Enhance Public Space and Amenities

RA1.5 Balance Earthwork On Site

RA3.1 Preserve Water Resources

RA3.2 Reduce Operational Water Consumption

NW1.1 Preserve Sites of High Ecological Value

NW1.2 Provide Wetland and Surface Water Buffers

NW1.4 Preserve Undeveloped Land

CR2.2 Assess Climate Change Vulnerability

CR2.3 Evaluate Risk and Resilience

CR2.4 Establish Resilience Goals and Strategies



NW2.3 Reduce Pesticide and Fertilizer Impacts

12
POINTS

INTENT

Reduce non-point-source pollution by reducing the quantity, toxicity, bioavailability, and persistence of pesticides and fertilizers.

METRIC

Reductions in quantity, toxicity, bioavailability, and persistence of pesticides and fertilizers used on site, selection of plant species, and use of integrated pest management techniques.

LEVELS OF ACHIEVEMENT

IMPROVED	ENHANCED	SUPERIOR	CONSERVING	RESTORATIVE
A + B	A + B + C	A + B + C + D	C	C
(1) Application Management	(2) Less Pesticide Or Fertilizer	(5) Better Selection, Lower Use	(9) No Pesticide Or Fertilizer Use	(12) Pesticide Or Fertilizer Elimination
<p>(A) Operational policies and programs are designed to control the application of pesticides and fertilizers so they are not over-applied.</p> <p>(B) Runoff controls are put in place to minimize contamination of groundwater and surface water.</p>				
<p>(C) Landscaping is designed to incorporate plant species that require fewer fertilizers and pesticides.</p>			<p>(C) Landscaping is designed with plant species that do not require pesticides or fertilizers.</p>	<p>(C) Landscaping is designed with plant species that do not require pesticides or fertilizers. This includes eliminating the need for pesticides and/or fertilizers on sites with prior use of pesticides or fertilizers.</p>
		<p>(D) When needed, pesticides and fertilizers with low toxicity, persistence, and/or bioavailability are specified.</p>		

DESCRIPTION

This credit addresses reducing the quantity, toxicity, bioavailability, and persistence of pesticides and fertilizers used on site, including the selection of plant species and the use of integrated pest management techniques. Pesticides are toxic substances released intentionally into the environment to kill living things. The family of pesticides includes fungicides, herbicides, insecticides, rodenticides, and others.

Pesticides and fertilizers are a significant non-point-source pollutant and, whenever possible, their use should be reduced or eliminated. Overapplication of pesticides and fertilizers can contaminate runoff and pollute streams, rivers, lakes, and groundwater. If chemicals are necessary, licensed applicators and appropriate protocols should be used to source less-toxic pesticides and fertilizers. Improper application of pesticides can also pose risks to human health.

Project teams should consider how better suited plants can be chosen to grow without fertilizers and to resist pests. Integrated pest management is a low-impact approach to

addressing pests that includes the selection of hardier pest-resistant plants and natural prevention and control measures.

Project teams should also consider the socioeconomic benefits of reduced fertilizer and pesticide use. Direct costs are saved in both materials and labor. Plants chosen to be soil tolerant and pest resistant are inherently hardier and less prone to replacement. Plants that do not require fertilizer or pesticides are often native or naturalized plants that enhance the regional character of a community.

PERFORMANCE IMPROVEMENT

The intent of this credit is to address long-term operational application of pesticides and fertilizers. Projects are permitted an initial use of pesticides for the purpose of eradicating or controlling invasive species found on site per credit NW3.4 Control Invasive Species. Similarly, the controlled initial use of fertilizers is permitted when necessary to establish vegetation.

Improved: Project teams focus on application control and reducing runoff and contamination.

Enhanced: Project teams specifically choose landscaping that requires less pesticides or fertilizers.

Superior: When absolutely necessary, pesticides and fertilizers are selected based on reduced impacts. This may include toxicity, persistence (i.e., how long it remains in the environment), and/or bioavailability (i.e., how readily it is absorbed by biological organisms).

Conserving: No pesticides or fertilizers are necessary for landscaping maintenance.

Restorative: The project eliminates the need for the application of pesticides and fertilizers in areas where it was previously applied. For example, an existing landscaped site is redesigned to use plants that do not require pesticides or fertilizers.

Applicability: Consideration is given as to whether the scope of the project includes exterior vegetated areas. Projects that do not include exterior vegetated areas may apply to have this credit deemed not applicable with supporting documentation.

EVALUATION CRITERIA AND DOCUMENTATION GUIDANCE

A. Have operational policies and programs been put in place to control the application of fertilizers and pesticides?

1. *Operational policies and programs for applying fertilizers and pesticides.*

B. Have runoff controls been put in place to minimize contamination of groundwater and surface water?

1. *Plans and drawings showing how runoff controls will be designed, installed, and maintained.*

C. To what extent has the project team designed landscaping to require fewer pesticides and fertilizers?

1. *Documentation of plans for landscaping showing the mix of plant species emphasizing noninvasive plant species.*

2. *Design specifications showing that fewer, little, or no fertilizers or pesticides will be used on the project site during construction and operation.*

- a. *Exceptions are allowed for the controlled use of fertilizer for initial landscaping establishment. Provide documentation indicating the necessity, benefits, and term of use.*

- b. *Exceptions are allowed for the controlled use of pesticides for removal of existing invasive species during project delivery. Provide documentation indicating the necessity, benefits, and term of use.*

3. *Documentation and details about any integrated and pest management approaches demonstrating pesticides will not be required.*

4. *Documentation and details of any natural fertilizer management approaches (e.g., composting) demonstrating no chemical fertilizers will be required.*

Note that project teams are encouraged to consider related issues in landscaping choices, including but not limited to: noninvasive species, drought-tolerant species, native species, low-maintenance species, and species with targeted performance goals (e.g., pollutant reductions).

D. To what extent has the project team selected pesticides and fertilizers that have lower toxicity, persistence, and bioavailability?

1. *Documentation showing the pesticides and fertilizers to be used on the finished project.*
2. *Measurements of pesticide and fertilizer toxicity, persistence, and bioavailability along with recommended application rates and procedures.*
3. *Documentation showing how lower toxicity, persistence, and bioavailability were incorporated into the choice of pesticides and fertilizers.*

RELATED ENVISION CREDITS

QL1.2 Enhance Public Health and Safety

NW2.4 Protect Surface and Groundwater Quality

NW3.5 Protect Soil Health



NW2.4 Protect Surface and Groundwater Quality

20
POINTS

Preserve water resources by preventing pollutants from contaminating surface water and groundwater and monitoring impacts during construction and operations.

METRIC

Designs, plans, and programs instituted to prevent and monitor surface water and groundwater contamination during construction and operations.

LEVELS OF ACHIEVEMENT

IMPROVED	ENHANCED	SUPERIOR	CONSERVING	RESTORATIVE
A + B	A + B + C	A + B + C + D	A + B + C + D + E	A + B + C + D + E + F
(2) New Pathway Avoidance	(5) Community Support	(9) Risk Reduction	(14) Public Reporting	(20) Quality Improvement
<p>(A) The project team determines potential impacts to surface water or groundwater quality, including temperature, during construction and operations.</p> <p>(B) The project includes spill and leak diversion systems, spill prevention plans, and cleanup. The project does not create new direct pathways for surface water and/or groundwater contamination such as:</p> <ul style="list-style-type: none"> • Direct runoff into karst terrain; • Untreated industrial or chemical discharge to unlined industrial ponds or lakes; • ReInjection water wells unless water is treated to secondary levels, or local regulations, whichever is more stringent; or • Chemical, byproduct, or fracking water, injection. 				
<p>(C) Based on the types of impacts identified in criterion A, the project reduces the risk of quality degradation to surface water and/or groundwater. This should include water temperature.</p>				
<p>(D) Adequate measures enable responsive surface water and/or groundwater quality monitoring and reporting mechanisms to provide the public with water quality data.</p>				
<p>(E) The project has actively eliminated at least one source of hazardous and/or potentially polluting substances, or replaced them with nonhazardous or nonpolluting substances or materials.</p>				
<p>(F) The project improves surface water and/or groundwater quality beyond existing conditions.</p>				

DESCRIPTION

The goal of this credit is to preserve water resources by incorporating measures to prevent pollutants from contaminating surface water and groundwater and monitor impacts during construction and operations. Groundwater is a widely used source of drinking water. Protecting wellheads and groundwater recharge areas reduces the chances of groundwater contamination and protects natural water purification processes. In addition, aquatic ecosystems depend on a particular set of water conditions. Changes to any of these factors can adversely affect aquatic life and groundwater quality. Aquatic ecosystems are threatened by changes in pH, decreases in water clarity, and increases in temperature, dissolved solids, coliform bacteria, toxic substances, and nutrients (especially phosphorus and nitrogen).

Leaks, spills, and other sources of contamination have serious environmental, social, and economic costs with prevention almost

always being more economical than cleanup. Contamination takes many forms but can kill flora and fauna, destroy habitats, and cause illness or premature death in humans.

Concerns regarding equipment and facilities containing potentially polluting substances include fuel and chemical storage, pipelines, piles of raw materials, and process areas. At the construction stage, potential sources of groundwater and surface water contamination include spills and leaks from tanks, pipes, and construction vehicles; leaching of pollutants from raw or waste materials; and releases of pollutants from the demolition of previously completed projects.

PERFORMANCE IMPROVEMENT

Improved: Project teams begin by not introducing new pathways for contamination.

Enhanced: Project teams focus on significantly reducing risk of contamination with a priority on reducing or eliminating potentially polluting substances from operations. If unable to do so, they seek to recycle the substances, keeping them within the operation, or sending them off site for use in other applications. Project teams continue to address prevention measures by identifying equipment and facilities containing potentially polluting substances and locating them away from sensitive environments. Runoff interceptors and drainage channels should be designed to accommodate pollutants in stormwater runoff or ice melt, potential spills, and leakage. Water temperature is considered as a potential contaminate.

Superior: Active monitoring of surface water, groundwater, and/or the potential sources of contamination support prevention and response plans.

Conserving: Actions have resulted in the elimination or replacement of a hazardous substance or potential source of pollution in the project.

Restorative: Projects improve surface water or groundwater quality, for example, by cleaning up previously contaminated land, restoring wellhead and groundwater recharge area protection, and installing land-use controls to prevent future contamination. Restoration also may include removal of materials storage piles, rerouting of surface runoff, or restoring groundwater infiltration patterns.

Applicability: This credit is applicable to all projects that contain or use hazardous and/or potentially polluting substances with the potential to contaminate water sources. In addition to chemical use, project teams should consider how chemical leaching from materials may be a source of contamination.

EVALUATION CRITERIA AND DOCUMENTATION GUIDANCE

A. Has project team determined the potential for surface water and/or groundwater contamination during construction and operations?

1. Documentation of hydrologic and/or hydrogeologic delineation studies, taking into consideration the complexity of the aquifers. Note that local authorities may already have done delineation.
2. Documentation explaining potential impacts to surface water and/or groundwater quality, their risk, and consequences. Water temperature should be included as a potential impact.

B. Does the project include spill and leak prevention and response plans, and avoid creating new pathways for contamination during construction and operations?

1. Documentation that the project does not involve any of the following:
 - a. No direct runoff into karst terrain
 - b. No untreated industrial or chemical discharge to unlined industrial ponds or lakes
 - c. No reinjection water wells unless water is treated to secondary levels
 - d. No chemical or fracking water injection
2. Documentation demonstrating that spill and leak prevention and response plans are in place.

3. If applicable, documentation showing the placement of materials storage piles and handling of potentially polluting runoff (e.g., plans and drawings).

C. To what extent does the project reduce the risk of surface water and/or groundwater quality degradation during construction and operations?

1. Documentation of project planning, design, or construction decisions intended to reduce the risk of surface water and/or groundwater quality degradation. These actions may include but are not limited to:
 - a. Siting the project to avoid important groundwater recharge areas (e.g., Karst topography).
 - b. Locating equipment and facilities containing potentially polluting substances away from sensitive environments.
 - c. Installing runoff interceptors and drainage channels designed to accommodate pollutants in stormwater runoff or ice melt, potential spills, and leakage.
 - d. Installing natural systems to capture or prevent potentially polluting substances from reaching surface water and/or groundwater sources.
 - e. Significantly reducing or eliminating potentially polluting substances from operations.
 - f. Recycling potentially polluting substances, including keeping them within the operation or sending them off site for use in other applications.
2. For projects situated in areas where groundwater is used as a source of drinking water, documentation of wellhead and groundwater recharge area protection plans and other requirements including protection areas.

D. Have adequate and responsive surface water and/or groundwater quality monitoring and reporting systems been incorporated into the project?

1. Documentation of surface water and/or groundwater quality monitoring programs or contaminant source monitoring. This may include documentation that discharges to receiving waters and/or the receiving waters themselves are monitored to verify pollutant loading, biological impact, water temperature, and the impact on receiving water flow.
2. Documentation that the frequency and level of monitoring is sufficient to address the potential water quality impacts provided in criterion A.

Note that exceptions can be made for criterion D if the project team has reduced/addressed the potential for surface water or groundwater contamination to such a degree that ongoing monitoring is unnecessary. For example, if the project was able to eliminate the need for potentially polluting materials.

E. Has the project actively eliminated at least one source of hazardous and/or potentially polluting substances, or replaced them with nonhazardous or nonpolluting substances or materials?

1. Documentation that the project team actively designed the project to eliminate the need for a hazardous or potentially polluting substance or material. Project teams may also demonstrate that they have replaced potential sources of pollution or contamination with nonhazardous or nonpolluting substances. In some cases, project teams may demonstrate that a replacement, while still technically hazardous, has substantially reduced or eliminated the potential for groundwater or surface water contamination, thereby meeting the intent of the credit.

F. Does the project improve surface water and/or groundwater quality?

1. *Documentation of water quality baseline prior to the project's development.*
2. *Documentation demonstrating that the project improves overall water quality on site, or in the watershed, compared to the pre-existing baseline. Examples of improving water quality may include but are not limited to:*
 - a. *Implementing land use controls.*
 - b. *Restoring degraded natural systems.*
 - c. *Installing systems to clean or remove contaminants from surface water and/or groundwater.*
 - d. *Cleaning up contaminated areas.*

- e. *Installing systems to prevent existing (non-project-related) contamination from entering receiving waters or altering receiving water flow.*

RELATED ENVISION CREDITS

- QL1.2 Enhance Public Health and Safety
- RA1.5 Balance Earthwork On Site
- RA3.1 Preserve Water Resources
- NW1.1 Preserve Sites of High Ecological Value
- NW2.1 Reclaim Brownfields
- NW2.3 Reduce Pesticide and Fertilizer Impacts
- NW3.2 Enhance Wetland and Surface Water Functions



PROJECT EXAMPLE: DUBUQUE SOLAR

The Dubuque Solar project (Envision Platinum, 2018) in Iowa increased the quantity and connectivity of terrestrial habitats by planting native prairie grasses and forbs on the areas beneath the solar panels and surrounding the array. These native plants replace cultivated row crops on one part of the site, and non-native smooth brome, with patches of invasive species on another portion of the site. Given the project's location within the Upper Mississippi River migration corridor, it is expected that once established, these plantings will provide good foraging habitat for migratory birds and butterflies, and the area will be attractive to pollinators as well. The project owner also collaborated with a local apiary to install several honey bee hives on the property.



PROJECT EXAMPLE: MIDDLE BLUE RIVER

The Middle Blue River (Envision Platinum, 2016) green infrastructure project created functional habitats within the park portions of the site by converting conventionally maintained turf into native landscaping to support local fauna. Furthermore, the smaller right-of-way stormwater BMPs within a residential neighborhood setting were designed to provide additional habitat connectivity than the pre-project conditions. The native grasses and forbs included in the project provide food and shelter for a variety of species including butterflies, other insects, and birds.



NW3.1 Enhance Functional Habitats

18

POINTS

INTENT

Preserve and improve the functionality of terrestrial (land) habitats.

METRIC

The number of habitat functions addressed in order to preserve or enhance the net area and quality of functional habitat.

LEVELS OF ACHIEVEMENT

IMPROVED	ENHANCED	SUPERIOR	CONSERVING	RESTORATIVE
A + B	A + B + (C, D, or E)	A + B + (C, D, or E)	A + B + C + D + E	A + B + C + D + E + F
(2) Mitigate Impacts	(5) One Ecosystem Function	(9) Two Ecosystem Functions	(15) Three Ecosystem Functions	(18) Restore And Create Habitats
<p>(A) The project team identifies existing habitat types on or near the project site. Efforts are made to avoid and minimize impacts to existing terrestrial habitats.</p>				
<p>(B) Mitigation measures ensure that existing habitat functions as defined in criteria C, D, and E are maintained (i.e., not degraded or lost). Mitigation must occur on or adjacent to the site and follow a hierarchy that prioritizes avoidance, minimization, restoration, and compensation.</p>			<p>(B) The project ensures that no existing habitats are disturbed or damaged.</p>	
<p>(C, D, or E) Enhance one or more ecosystem functions compared to existing conditions:</p> <ul style="list-style-type: none"> • Quantity (C) • Quality (D) • Connectivity (E) 		<p>(C, D, or E) Enhance two or more ecosystem functions compared to existing conditions:</p> <ul style="list-style-type: none"> • Quantity (C) • Quality (D) • Connectivity (E) 		<p>(C, D, and E) Enhance all three ecosystem functions compared to existing conditions:</p> <ul style="list-style-type: none"> • Quantity (C) • Quality (D) • Connectivity (E)
				<p>(F) The project returns developed land to natural habitat, or sets aside existing habitat for permanent conservation and protection.</p>

DESCRIPTION

This credit addresses the protection of ecosystem functions of terrestrial (land) habitats. It is distinguished from NW3.2 Enhance Wetland and Surface Water Functions that includes the protection of ecosystem functions of aquatic (water) habitats. Consideration for the impacts of infrastructure development on habitat is too often limited to direct land development. However, development fragments and shrinks areas of suitable habitat. When patches are not individually large enough to support the population of a species, connectivity between patches becomes critical for survival. Infrastructure projects should prioritize protecting and enlarging habitats, connecting patches, and promoting safe movement between patches to create a functional habitat. Functional habitat supports the fundamental requirements of native organisms during all stages of their life-cycle and provides the habitat connectivity necessary to support plants and animals. Preserving and linking habitats is critical to biodiversity because it:

- Preserves basic and natural ecosystem processes and components that provide the life-cycle requirements to satisfy the needs of a range of living organisms;
- Provides sufficient habitat for large-range species (some animals require a large home range);
- Promotes genetic diversity and connectivity between patches, allowing separate populations of the same species to interact and breed.

Project teams should consider how maintaining biodiversity and functional habitats adds value to regions. Functional habitats enrich the quality of a community, making them more desirable places to live and visit. Project sites can become destinations for educational school trips, bird watchers, or other wildlife enthusiasts.

PERFORMANCE IMPROVEMENT

Improved: The project does not result in the net loss in quantity or quality of existing habitat. Project teams follow a mitigation hierarchy demonstrating that they prioritized avoiding the disturbance of existing habitat to the extent possible, that remaining temporary impacts were minimized and restored, and that any permanent disturbance to habitat was offset.

Mitigation offsets can be achieved on site through the dedication of a conservation easement that provides restrictions on access and limits, or through the acquisition of an adjoining contiguous parcel of equal or higher quality. Offsets must equal or exceed the area disturbed by the project and cannot be part of an existing conservation easement. Remote offsetting does not contribute to achievement in this credit.

Mitigation plans must be approved by a habitat professional. Habitat professionals may include, but are not limited to, conservation scientists, professional foresters, environmental scientists/ecologists, wildlife biologists, certified wetland scientists, professional hydrologists, or professional geologists.

Enhanced-Conserving: Levels are distinguished by the number of enhanced ecosystem functions: quantity, quality, and/or connectivity.

Restorative: The project reverts existing development back into natural habitat or sets aside existing habitat for permanent conservation.

Applicability: Consideration is given to whether the project contains or impacts natural habitat. Projects that do not contain or impact natural habitat may apply to have this credit deemed not applicable with supporting documentation.

EVALUATION CRITERIA AND DOCUMENTATION GUIDANCE

A. Has the project team identified existing terrestrial habitats and sited the project to minimize impact?

1. Documentation showing areas of important habitat on site and in the surrounding region, identifying potential and/or likely movement corridors between habitat areas, and potential existing barriers to these corridors on site.
2. The assessment of habitat must be prepared by a trained, certified or licensed habitat professional.
3. Documentation of collaboration with local and state/provincial agencies.

B. Does the project mitigate all disturbances to functional terrestrial (land) habitats?

1. Documentation identifying new impacts or barriers that will result from development and the specific actions that will be taken to minimize or to mitigate them.

2. Acceptable mitigation must be on site, on a contiguous adjacent parcel, or within the affected landscape. Mitigation measures must maintain net habitat quality, quantity, and connectivity to provide a means for animals to access pre-development habitat after development is complete. Mitigation plans that impact sensitive or protected habitats must be prepared by a trained, certified or licensed habitat professional, or approved by a relevant regulatory body.

3. A monitoring plan to ensure that mitigation measures are effective for preserving habitat quality and connectivity.

C. Does the project increase the quantity of terrestrial habitat?

1. A site plan and documentation illustrating the measures taken to provide new habitat.
2. Identification of the species that will benefit from the new habitat.

D. Does the project improve the quality of any existing or proposed new terrestrial habitat?

1. A site plan and documentation illustrating the measures taken to improve the quality of the existing habitat on the project. If new habitat is proposed for the project, document measures taken to improve the quality of proposed habitat.
2. Documentation of habitat improvement efforts and the intended impact they will have on site species.
3. A monitoring or maintenance plan, if applicable, to ensure the measures put in place to improve habitat quality are meeting their performance targets.

E. Does the project facilitate movement between terrestrial habitats, provide new connections, or remove barriers, in order to improve habitat connectivity?

1. Documentation of new connections provided between habitats and their appropriateness for the local wildlife, and/or documentation of the removal of existing barriers to movement and habitat connectivity.
2. A monitoring plan to confirm improved habitat connectivity.

F. Does the project return developed land to natural habitat, or set aside existing habitat for permanent conservation and protection?

1. Documentation of previously developed land being returned to a natural state that supports habitat development. Alternatively, documentation that habitat has been set aside for permanent conservation and protection.

RELATED ENVISION CREDITS

QL1.4 Minimize Noise and Vibration

QL1.5 Minimize Light Pollution

NW1.1 Preserve Sites of High Ecological Value

NW1.4 Preserve Undeveloped Land

NW3.4 Control Invasive Species



NW3.2 Enhance Wetland and Surface Water Functions

20
POINTS

INTENT

Maintain and restore the ecosystem functions of streams, wetlands, waterbodies, and their riparian areas.

METRIC

Number of functions maintained and restored.

LEVELS OF ACHIEVEMENT

IMPROVED	ENHANCED	SUPERIOR	CONSERVING	RESTORATIVE
A + B + (C, D, E or F)	A + B + (C, D, E or F)	A + B + (C, D, E or F)	A + B + C + D + E + F	A + B + C + D + E + F
(3) Enhance One Ecosystem Function	(7) Enhance Two Ecosystem Functions	(12) Enhance Three Ecosystem Functions	(18) Enhance Four Ecosystem Functions	(20) Restore Ecosystem Function
<p>(A) Project team identifies project impacts to hydrologic connection, water quality, aquatic habitat, and sediment transport.</p>				
<p>(B) Efforts are made to avoid and minimize negative impacts to wetland and surface water functions and to compensate for remaining unavoidable losses.</p> <p>Mitigation measures must maintain net aquatic habitat quality and quantity and follow a hierarchy that prioritizes avoidance, minimization, restoration, and compensation.</p>			<p>(B) The project ensures that no existing wetlands or surface water functions are disturbed or damaged as a result of the project.</p>	
<p>(C, D, E or F) Actively protect one ecosystem function.</p> <ul style="list-style-type: none"> • Hydrologic Connection (C) • Water Quality (D) • Aquatic/Riparian Habitat (E) • Sediment Transport/Sedimentation (F) 	<p>(C, D, E or F) Actively protect two ecosystem functions.</p> <ul style="list-style-type: none"> • Hydrologic Connection (C) • Water Quality (D) • Aquatic/Riparian Habitat (E) • Sediment Transport/Sedimentation (F) 	<p>(C, D, E or F) Actively protect three ecosystem functions.</p> <ul style="list-style-type: none"> • Hydrologic Connection (C) • Water Quality (D) • Aquatic/Riparian Habitat (E) • Sediment Transport/Sedimentation (F) 	<p>(C, D, E and F) Actively protect four ecosystem functions.</p> <ul style="list-style-type: none"> • Hydrologic Connection (C) • Water Quality (D) • Aquatic/Riparian Habitat (E) • Sediment Transport/Sedimentation (F) 	<p>(C, D, E and F) Actively protect four ecosystem functions.</p> <ul style="list-style-type: none"> • Hydrologic Connection (C) • Water Quality (D) • Aquatic/Riparian Habitat (E) • Sediment Transport/Sedimentation (F) <p>In addition to protecting all existing wetland and surface water functions, the project can demonstrate it has restored at least one previously degraded wetlands and/or surface water function.</p>

DESCRIPTION

This credit addresses the protection and restoration of the ecosystem functions of streams, wetlands, waterbodies, and their riparian areas. Project teams should prioritize implementing controls and safeguards in order to maintain any existing natural hydrologic functions and consider opportunities to enhance previously degraded functions.

The socioeconomic benefits of protecting or restoring natural wetland and surface water functions. This can include improved water quality, higher diversity of aquatic species, more visible and natural water flow, and reduced need for engineered sediment controls. These all increase the recreational value, sport fishing value, aesthetic value, and property value of the site and surrounding areas while reducing maintenance and remediation costs.

PERFORMANCE IMPROVEMENT

Assessment of this credit begins with ensuring that the project does not result in the net loss in quantity or quality of wetlands or surface waters. Project teams must follow a mitigation hierarchy including avoidance, minimization, restoration, and offsetting.

Mitigation offsets can be achieved on site through the dedication of a conservation easement that provides restrictions on access and limits, or through the acquisition of an adjoining contiguous parcel of equal or higher quality. Offsets must equal or exceed the area disturbed by the project and cannot be part of an existing conservation easement. Remote offsetting does not contribute to achievement in this credit. Wetland mitigation plans must be approved by a licensed professional.

Improved – Conserving: Priority is placed on protecting existing ecosystem functions. Levels are distinguished by the protection of four ecosystem functions:

- Hydrologic Connection – When addressing hydrologic connectivity, project teams should consider that many healthy waterways and wetlands receive much of their normal flow from underground sources.
- Water quality – This may be documented by showing the current source of the waterway’s normal flow, the water quality of its source water, and how the water quality will be protected or enhanced. In some areas, this may mean disconnecting direct surface water discharges and constructing infiltration best management practices that will help remove pollutants and cool stormwater, by means of discharging to the waterbody through groundwater.
- Aquatic/Riparian Habitat – To protect or enhance aquatic and riparian habitats, consider past infrastructure projects may have removed the natural riffle, pool, and meander sequence of rivers and streams that are important in providing a healthy ecosystem.
- Sediment Transport/Sedimentation – Waterways not only move water but sediment as well, and in-waterway sediment transport is important for a healthily functioning ecosystem.

In the context of this credit, protecting wetland and surface water functions is not synonymous with avoidance. Projects must include strategies, controls, safeguards, or other measures to demonstrate active protection of one or more functions. Avoiding wetlands and surface waters is recognized in credit NW1.2 Provide Wetland and Surface Water Buffers.

Restorative: This credit prioritizes protecting the existing natural ecosystem functions of wetlands and surface waters. However, on occasion, projects have the opportunity to restore one or more degraded functions.

Applicability: Consideration is given to whether the project contains or impacts wetlands or surface waters. This includes direct, indirect, and/or cumulative impacts. Projects that do not contain or impact natural wetlands or surface waters may apply to have this credit deemed not applicable with supporting documentation.

EVALUATION CRITERIA AND DOCUMENTATION GUIDANCE

A. Has the project team identified impacts to wetland and surface water functions?

1. Documentation identifying all potential impacts to wetland and surface water functions, including hydrologic connection, water quality, aquatic habitat, and sediment transport.

B. Does the project minimize and mitigate disturbance to wetland and surface water functions?

1. Documentation of strategies implemented to minimize disturbance to wetland and surface water functions: hydrologic connection, water quality, aquatic habitat, and sediment transport.
2. Documentation of mitigation measures to compensate for unavoidable losses in wetland and surface water functions.

C. Does the project protect or restore hydrologic connection?

1. Documentation showing how the project will protect or restore hydrologic connection. This may include:
 - a. For streams, rivers, and lakes, documentation showing how the waterway is connected, or proposed to be connected, to its riparian floodplain. Project teams may use a six-month to two-year frequency flow event.
 - b. For wetlands, documentation showing that structures that drain wetlands will be removed and/or appropriate sources of groundwater or surface waters are reconnected, diverted, or maintained.

D. Does the project protect or restore water quality?

1. Documentation showing the current source of the waterway’s normal flow, the water quality of its source water, and how the water quality will be protected or restored.

E. Does the project protect or restore aquatic habitat?

1. A habitat survey of the waterbody and reference areas conducted by a recognized professional, and a plan to protect or restore the habitat for aquatic and riparian species by plantings and appropriate physical modifications. This survey may include the location and proposed mitigation of existing obstructions to habitat connectivity such as dams, roadway structures, and other infrastructure that may block aquatic or shoreline species migration.

F. Does the project protect sediment transport and reduce sedimentation?

1. Documentation demonstrating that sediment transport will not be disrupted by the proposed project. Projects should also consider sedimentation.
2. Documentation that existing sources of sediment obstruction or sedimentation will be removed or mitigated, and, if appropriate, sediment will be removed.
3. Reports from qualified resource professionals are required as part of the documentation (e.g., an engineer with sediment transport knowledge and experience).

RELATED ENVISION CREDITS

QL3.4 Enhance Public Space and Amenities

RA3.1 Preserve Water Resources

NW1.1 Preserve Sites of High Ecological Value

NW1.2 Provide Wetland and Surface Water Buffers

NW2.4 Protect Surface and Groundwater Quality

PROJECT EXAMPLE: SHELDON AVENUE

For the Sheldon Avenue stormwater management project (Envision Silver, 2017) on Staten Island, New York a comprehensive assessment revealed that the poor water quality of the streams was due to failed septic systems, malfunctioning private wastewater treatment plants, and illegal storm sewer connections. By combining sanitary sewers with the extended detention pond of the stormwater BMP, the project greatly improved water quality standards. Replacing an existing stormwater pond with green infrastructure wetlands also improved habitat in the area.



NW3.3 Maintain Floodplain Functions

<h2 style="font-size: 2em; margin: 0;">14</h2> <p style="margin: 0;">POINTS</p>	<p>INTENT</p> <p>Preserve floodplain functions by limiting development and impacts of development in the floodplain.</p>	<p>METRIC</p> <p>Efforts to avoid floodplains or maintain natural-acting floodplain functions.</p>
---	---	---

LEVELS OF ACHIEVEMENT

IMPROVED	ENHANCED	SUPERIOR	CONSERVING	RESTORATIVE
A + B	A + B + C	A + B + C	(A + B + C) OR D	A + B + C + E
(1) 75% Avoidance	(3) 85% Avoidance	(7) 95% Avoidance	(11) Floodplain Preservation	(14) Floodplain Restoration
<p>(A) The project team identifies the 100-year or design frequency floodplain. Consideration is given to future floodplain scenarios.</p>				
<p>(B) The project site maintains a net quantity of at least 75% of natural/vegetated area within the floodplain.</p>	<p>(B) The project site maintains a net quantity of at least 85% of natural/vegetated area within the floodplain.</p>	<p>(B) The project site maintains a net quantity of at least 95% of natural/vegetated area within the floodplain.</p>	<p>(B) The project site maintains a net quantity of 100% of natural/vegetated area within the floodplain.</p>	<p>(B) The project avoids developing any existing natural/vegetated zones within the floodplain.</p>
<p>(C) Project mitigates impacts to floodplain functions including conveyance and storage. Overall floodplain functions are not diminished as a result of the project. Functions should be maintained both above and below the 10-year flood.</p>			<p>OR</p> <p>(D) The project team can demonstrate the site was intentionally chosen to avoid development on or near the 100-year or design frequency floodplain.</p>	<p>(E) Structures are removed from the floodplain, or previously developed areas are restored to natural/vegetated zones in order to improve floodplain functions.</p>

DESCRIPTION

Floodplains are hydrologically important, environmentally sensitive, and ecologically productive areas, and flooding is a naturally occurring process in every river and coastal area. Development within floodplains that does not account for these ecosystem functions often limits or restricts the natural benefits of flooding while simultaneously putting people and property at greater risk. Project teams should consider how maintaining natural floodplains can provide environmental benefits, protect human health and safety, and reduce risks and costs from flood damage.

Climate change is making precipitation rates increasingly unpredictable, with more intense storms becoming common. This in turn impacts the frequency and severity of flooding. Historic design standards and regulations may be insufficient to prepare communities for the future.

Project teams should avoid developing in floodplains if possible. In addition, infrastructure planning should direct community growth and development away from floodplains. Some infrastructure projects may be unable to avoid the floodplain (e.g., roadway and utility crossings, wastewater treatment facilities, ports, and other water-dependent structures). However, these structures

should be designed to minimize waterway crossings and floodplain impacts. The goal of all projects should be to maintain or enhance floodplain storage and to not increase flood elevations. Infrastructure owners and project teams should consider how these measures can protect assets and the broader community.

PERFORMANCE IMPROVEMENT

Improved – Superior: The assessment begins with identifying the 100-year or design frequency floodplain. Floodplain data may be inconsistent or out of date. Project teams should factor how climate change will impact flood levels in their designs.

Infiltrating floodwater is one of the most critical floodplain functions and is addressed in criterion B by quantifying the amount of vegetated area that remains on the site. This is based on existing conditions prior to the project development. Maximizing impervious surfaces is important and included under criterion C.

Conserving: The project retains the net vegetated area on the project site within the floodplain and mitigates project impacts, or is intentionally sited to avoid floodplain development.

Restorative: Projects return developed impervious surfaces to a natural vegetated state.

Applicability: Projects that are not within the floodplain and do not impact floodplain functions, may apply to have this credit deemed not applicable with supporting documentation.

Some projects that are not directly within the floodplain may still have an impact on flooding and floodplain functions through their handling of stormwater runoff. These projects may also pursue achievement in this credit if they can demonstrate a direct connection to the floodplain. There are strong links between this credit and NW2.2 Manage Stormwater, and some project components and strategies may apply to both credits.

EVALUATION CRITERIA AND DOCUMENTATION GUIDANCE

A. Has the project team identified the 100-year or design frequency floodplain in relation to the project location?

1. Documentation showing the location of the project relative to the 100-year or design floodplain (whichever is more stringent). Projects are encouraged to use existing information. If the 100-year flood is not demarcated, project teams may use the flood of record plus 3 feet/1 meter.
2. Determination whether climate change predictions may significantly impact the floodplain map and potential impacts to the project.

B. To what extent does the project preserve vegetated zones within the floodplain?

1. Site maps indicating the area of natural/vegetated zones within the floodplain before the project development.
2. Site maps indicating the area of natural/vegetated zones within the floodplain after the project development.
3. Calculations of the percentage of existing vegetated areas after development.

Note that for Restorative, the project avoids developing any existing vegetated areas within the floodplain.

OR

4. Documentation that no project development will occur within the floodplain. This alternative documentation option for criterion B should be pursued only by projects located outside a floodplain that still contribute to maintaining floodplain functions.

C. Does the project mitigate impacts to floodplain functions?

1. Documentation that the project preserves floodplain conveyance and floodplain storage. For projects with larger sites, documentation should also demonstrate that conveyance and storage are maintained both above and below the 10-year flood (i.e., the project does not shift net storage capacity from lower to higher elevations, thereby removing storage capacity from higher-frequency floods).
2. Documentation of any additional efforts to mitigate impacts to floodplain functions. Mitigation efforts may include but are not limited to:
 - a. Maintain or increase floodplain storage capacity.
 - b. Maintain pre-development floodplain infiltration, such as amount of impervious surfaces, vegetation and soil protection zones, and other approaches that allow for natural floodwater infiltration and filtration of pollutants.
 - c. Maintain or enhance habitat such as riparian buffers within and along waterways in the floodplain.

D. Was the project intentionally sited to avoid floodplains?

1. Documentation demonstrating that the project was intentionally sited to avoid a floodplain. Documentation must show that the owner and the project team made meaningful efforts to avoid developing or impacting a floodplain during the site selection process.

Note that meeting criterion D is an alternative achievement path for the Conserving level. Achieving Conserving by meeting criterion D does not require meeting criteria A, B, and C, and vice versa.

E. Does the project remove structures from the floodplain or return previously developed areas to a vegetated state?

1. Site maps indicating the location of structures or impervious/vegetated zones within the floodplain before the project development.
2. Site maps indicating the location of structures or impervious/vegetated zones within the floodplain after the project development.

RELATED ENVISION CREDITS

NW1.1 Preserve Sites of High Ecological Value

NW1.4 Preserve Undeveloped Land



NW3.4 Control Invasive Species

12
POINTS

INTENT

Use appropriate noninvasive species, and control or eliminate existing invasive species.

METRIC

Degree to which invasive species have been reduced or eliminated.

LEVELS OF ACHIEVEMENT

IMPROVED	ENHANCED	SUPERIOR	CONSERVING	RESTORATIVE
A	A + B	A + B + C	A + B + C + D + E	A + B + C + D + E + F
(1) Prevention	(2) Assessment And Prevention	(6) Program Controls	(9) Minor Infestation Control	(12) Major Infestation Control
<p>(A) Best practices should be used to prevent unintentional introduction of known invasive species to the site. Landscaping utilizes only species known to be noninvasive. A construction management plan, or policies, includes provisions for preventing the introduction of invasive species (plant or animal).</p>				
<p>(B) Identify, map and/or document invasive species infestations on site, or collaborate with local, state/provincial, and/or federal agencies.</p>				
<p>(C) Establish and implement a program that controls minor infestations of invasive species on site before and throughout construction.</p>				
<p>(D) The project guards against future infestations by supporting the establishment of native and/or noninvasive species. (E) Long-term controls are in place through a minimum three-year management plan to prevent the introduction or reintroduction of invasive species and perform follow-up control actions if populations persist.</p>				
<p>(F) Additionally, the project implements similar programs for controlling major infestations on site, or aquatic invasive species.</p>				

DESCRIPTION

Invasive species include nonindigenous or non-native flora, fauna, insects, and aquatic life that adversely affect the habitats or bioregions they invade. Invasive species may dominate the new region, forcing out existing species by outcompeting native species for nutrients, light, physical space, water, or food. Invasive species may invade and overcome native species through several mechanisms, including rapid reproduction and dispersal, direct competition and/or suppression, and the ability to quickly adapt to a wide range of environmental conditions and food types. Two of the primary methods of limiting the spread of invasive species include protecting existing healthy habitats from disturbance and avoiding the introduction of invasive species.

Non-native invasive species can lead to the decline or extinction of native species or change the function of an ecosystem, altering fire regimens, nutrient cycling, and hydrology. Invasive

plant species may affect fauna by altering available food systems and degrading habitats. Invasive species can have direct operations and maintenance costs for projects or, if left unchecked, communities as a whole. In some cases, entire industries dependent on ecosystem services (fishing, forestry, agriculture, etc.) may be impacted by invasive species.

PERFORMANCE IMPROVEMENT

Improved: Often, invasive species are introduced through transportation pathways and disturbed sites during construction. A construction management plan is developed in order to prevent accidentally introducing invasive species to the site. In addition, species common in one region or climate may be invasive when introduced to another. Landscaping plans should be checked to make sure they do not inadvertently include species that are invasive in the local context.

Enhanced: The project team identifies and maps locations of invasive species on site.

The assessment methodology for this credit distinguishes between major and minor infestations and the different approaches to addressing infestations. Minor infestations are those that can be fully eradicated during project delivery or through a three-year eradication, monitoring, and management plan. Major infestations are those that will likely require indefinite ongoing management on the part of the owner.

Superior: The project addresses any minor infestations of invasive species on site.

Conserving: The project protects existing healthy habitats from disturbance. It is more difficult for invasive species to gain a foothold in dense, natural, and healthy ecosystems. While this does not always require native indigenous plants, project teams should consider the value of reintroducing or expanding the use of native plants.

Restorative: The project includes plans for the ongoing management of major infestations. Projects take initial control steps and develop a long-term management plan.

Applicability: This credit is applicable to all projects with sites that contain invasive species. Project teams that conduct site investigations and do not identify existing invasive species may apply to have this credit deemed not applicable with supporting documentation.

EVALUATION CRITERIA AND DOCUMENTATION GUIDANCE

A. Does the project avoid introducing invasive species to the site?

1. Documentation showing the type and quantity of all species introduced to the site. For example, a landscaping plan that includes all species of vegetation showing that no invasive species will be planted.
2. Documentation that species used on the site are noninvasive.
3. A construction management plan, or policies, to prevent the introduction of invasive species. The plan includes best practices to ensure that construction materials and equipment used on site are free of invasive species and seeds.

B. Has the project team conducted a site assessment to determine if invasive species are present?

1. Mapping of all invasive species populations found on the site.
 - a. The documentation should identify populations of minor or major infestations. Infestations over one hectare (2.5 acres) can generally be considered major. However, exceptions can be made with justification of the type and level of establishment of the infestation.
 - b. The documentation should include the assessment of a trained biologist, ecologist, or environmental professional whether the populations can be eradicated or only controlled.
2. Documentation of collaboration with state or local agencies OR the qualifications of the biologist, ecologist, or environmental professional who conducted the site assessment.

C. Does the project implement controls for existing infestations of invasive species before, during and post-construction?

1. Documentation of plans for the removal of minor infestations of invasive species before and throughout construction to prevent their growth into major infestations. Plans may include specifications, contract language, or operational management plans.
2. Documentation of plans for a post-construction follow-up to remove any invasive species that re-emerges after initial control. Plans may include specifications, contract language, or operational management plans.
3. Documentation of control, containment or suppression activities during construction for any major infestations of invasive species found on site.

D. Does the project guard against future infestations by supporting the establishment of native and/or noninvasive species?

1. Documentation of the inclusion of native species in the project landscaping. Project teams should recognize that the intent of this criterion is to prevent the future introduction of invasive species by establishing or protecting healthy systems of native or naturalized species. Documentation should focus on how landscaping or maintenance plans are intentionally designed to increase the site resilience to infestation.
2. Plan showing areas of existing noninvasive species that will remain undisturbed.

E. Does the project provide long-term controls to prevent the reintroduction of invasive species?

1. A minimum three-year plan that addresses:
 - a. Prevention strategies for reducing the potential for invasive species to become re-established and spread at the site after initial removal.
 - b. Early detection and management strategies that monitor for and remove invasive species emerging on site in the future.
 - c. Rehabilitation and restoration methods to support long-term re-establishment of native or naturalized species on the site.

F. Does the project include the ongoing control, suppression, or containment of major infestations of invasive species after construction?

1. Documentation of ongoing control, containment or suppression plans for major infestations of invasive species.

RELATED ENVISION CREDITS

NW1.1 Preserve Sites of High Ecological Value

NW3.1 Enhance Functional Habitats

PROJECT EXAMPLE: INTEGRATED PIPELINE

Only locally appropriate grasses were used to restore the right of way along the Tarrant Regional Water District's 150-mile long Integrated Pipeline Project (Envision Platinum, 2016), a water transmission system in Texas. Several invasive species were identified and extensive studies were conducted to establish a long-term management, control, and elimination plan for these species. Strategies included barrier methods; special coatings to discourage mussels from adhering; and a monitoring program with sampling at intake structures and reservoirs.



NW3.5 Protect Soil Health

<p>8 POINTS</p>	<p>INTENT Preserve the composition, structure and function of site soils.</p>	<p>METRIC Degree to which the disruption of soil health has been minimized and restored.</p>
---------------------	--	---

LEVELS OF ACHIEVEMENT

IMPROVED	ENHANCED	SUPERIOR	CONSERVING	RESTORATIVE
Not Available	A + B	A + B + C	A + B + C	A + B + C + D
	(3) Restore Soils	(4) Special Feature Plan	(6) Best Management Practices	(8) Soil Restoration
	<p>(A) The project limits the area that is disturbed by development activities.</p> <p>(B) 100% of post-construction vegetated areas disturbed during construction are restored for appropriate soil type, structure, and function to support healthy plant and tree growth.</p>			
		<p>(C) A soil protection plan, or policies, are prepared and implemented. The plan/policies specifically include any special landscape features.</p>	<p>(C) A soil protection plan, or policies, are prepared and implemented. The plan/policies specifically include any special landscape features.</p> <p>The plan is expanded to comply with best management practices from a local soil conservation agency, or is reviewed or prepared under the guidance of a certified soil scientist.</p>	
				<p>(D) All areas disturbed by previous development and planned as vegetated areas have been restored for appropriate soil type, structure, and function to support plant and tree growth.</p>

DESCRIPTION

Climate, organisms, relief, parent material, and time (CORPT) are the factors of soil formation. Given enough time, if all other factors are held constant, soils that have been mechanically disturbed can naturally restore themselves. However, because soil formation is slow, the natural process of soil recovery can take millennia. Various human activities can be used to enhance the ability of mechanically disturbed soils to function as they did before being disturbed. This process is referred to as "soil restoration." The details of which activities should be used are highly dependent on the original soil type, the factors that formed it, and the functions that land managers wish to recover. In the context of this credit, soil restoration refers to the quality and condition of the soil and does not refer to keeping soil on site (this is addressed in RA1.5 Balance Earthwork on Site).

Construction activities can disturb soil health in many ways, the most common being compaction. Disturbed soils cannot hold water, nutrients, or carbon as well as natural, undisturbed soils. Disturbed soil is less capable of absorbing floodwaters or sustaining vegetation. Compaction

caused by construction equipment can kill surrounding plants and trees, and prevent future plant growth.

PERFORMANCE IMPROVEMENT

This credit assesses the ability of the soil in vegetated areas to support healthy plants and trees. This refers to areas that remain as vegetated areas after construction. It does not include soil located under paving or construction.

Enhanced: The project fully restores any disturbed soils. This may include areas used for temporary staging, access for construction equipment, material storage, or others.

Superior: Protection plans are in place to prevent disturbance whenever possible, especially around special landscape features.

Conserving: The soil protection plan is based on established best practices from a local soil conservation agency or is reviewed/prepared by a certified soil scientist.

Restorative: Sites where soils disturbed by previous development are restored to a healthy vegetated state.

Applicability: This credit is applicable to all projects that impact soils during construction. Projects that do not impact soil (e.g. the internal refurbishment of an existing facility) may apply to have this credit deemed not applicable with supporting documentation.

EVALUATION CRITERIA AND DOCUMENTATION GUIDANCE

A. Has the project team limited the area that is disturbed by development activities?

1. Site plans and documentation showing total vegetated areas and percentage that will be disturbed.
2. Documentation of how development plans will limit soil disturbance either through the project design or construction management.

B. Have vegetated areas disturbed by development activities been restored for appropriate soil type, structure, and function to support healthy plant and tree growth?

1. Plans and specifications indicating that at least 95% of post-construction vegetated areas on site, including areas disturbed by development, will be restored to a condition that can support healthy plant and tree growth. Soils must be reused for functions comparable to their original function (i.e., topsoil is used as topsoil, subsoil as subsoil, or subsoil is amended to become functional topsoil).
2. Documentation that disturbed natural soils in vegetated areas will be conserved and reused on site to the extent possible.
3. Documentation, including site plans, showing how soil type, structure and function have been restored. Calculations that soil restoration activities constitute at least 95% of the post-construction vegetated areas on site. Soils must be reused for functions comparable to their original function (i.e., topsoil is used as topsoil, subsoil as subsoil, or subsoil is amended to become functional topsoil).

4. Documentation that disturbed natural soils in vegetated areas were conserved and reused on site to the extent possible.

C. Has the project team implemented a soil protection plan or policies?

1. Documentation that the soil protection plan, or policies, at minimum identify special landscape features and include best management practices to prevent soil disruption within their protective zones.
2. Documentation that the soil protection plan, or policies, are comprehensive and compliant with best management practices according to a local soil conservation agency, or have been reviewed or prepared under the guidance of a certified soil scientist.

D. Has the project restored appropriate soil type, structure, and function to vegetated areas disturbed by previous development?

1. Plans and documentation showing the existing condition of the site and clearly identifying areas previously disturbed by development.
2. Documentation that the project involves restoring previously disturbed areas to a condition that can support healthy plant and tree growth.
3. A soil restoration plan has been reviewed or prepared for designated non-hardscape areas under the guidance of a certified soil scientist. Soils must demonstrate functionality (e.g., restored soils have appropriate water holding capacity, nutrient retention capability, and erosion prevention capability as reference soils).

RELATED ENVISION CREDITS

RA1.5 Balance Earthwork On Site

NW1.1 Preserve Sites of High Ecological Value

NW1.4 Preserve Undeveloped Land

NW2.1 Reclaim Brownfields

NW2.3 Reduce Pesticide and Fertilizer Impacts



NW0.0 Innovate or Exceed Credit Requirements

+10
POINTS

INTENT

To reward exceptional performance beyond the expectations of the system and application of innovative methods that advance state-of-the-art sustainable infrastructure.

METRIC

Whether project sustainability performance qualifies as innovation, exceptional performance, or is not otherwise recognized in existing credits.

LEVELS OF ACHIEVEMENT

INNOVATION
A or B or C
(+1-10) Innovate or Exceed Credit Requirements
<p>(A) Implement innovative methods, technologies, or processes that are novel either in their use, application, or within the local regulatory or cultural context.</p> <p>OR</p> <p>(B) Implement measures that exceed the highest existing requirements within one or more Natural World credits.</p> <p>OR</p> <p>(C) Address additional aspects of sustainability not currently recognized in Envision</p>

DESCRIPTION

This credit addresses instances in which projects:

1. Implement innovative methods, resources, technologies, or processes that are novel in their use, application, or within the local regulatory or cultural context of the project;
2. Exceed the performance requirements of one or more credits; and/or
3. Address additional aspects of sustainability not currently recognized in Envision

Points for this credit are not calculated in the overall applicable points and, therefore, act as bonus points. Given the nature of the credit, the broad format of which is intended to encourage creative infrastructure solutions, thorough documentation is expected. Project teams may pursue more than one of the three possible options for this credit, or pursue multiple for the same option, for a total of up to ten (10) bonus points.

PERFORMANCE IMPROVEMENT

Innovation:

To qualify for innovation points, projects must implement innovative methods, resources, technologies, or processes (e.g., the use of a pre-existing technology in a new way or the successful application of a technology or methods in regions or locales where existing policies, regulations, or general opinion have prevented their use). In these circumstances, it is imperative to prove that the application of the technology does, and will continue to, meet performance expectations

and that it does not have a corresponding negative impact on the local or global environment, economy, or community.

Projects may demonstrate they implement innovative methods, technologies or processes in several ways:

- The project is an early adopter of new technology or methods that can demonstrably improve project performance without negative trade-offs;
- The project uses technologies or methods that may be general practice in other regions or parts of the world, but within the context of the project (whether climate, regulations, policies, political support, public opinion, etc.) have not yet gained acceptance. Significant efforts are taken to demonstrate the effectiveness of the technology or method within the context and provide a precedent for future adoption.
- The project team takes significant steps to include research goals within the project's development, or work with a university or research organization to advance the general knowledge of the profession. Proprietary research that is not made publicly available cannot count toward achieving this credit.

Project teams must also demonstrate that the innovation serves a purpose. This can be done in one of two ways:

- Overcoming significant problems, barriers, or limitations— Project teams demonstrate that the innovation reduces or eliminates significant problems, barriers, or limitations that previously hampered the use of the new methods, technologies, or processes implemented on the project.

- Creating scalable and/or transferable solutions—Project teams demonstrate that new methods, technologies, or processes implemented on the project are scalable across a wide range of project sizes and/or are applicable and transferable across multiple kinds of infrastructure projects in multiple sectors.

Exceptional Performance:

To qualify for exceptional performance points, projects must meet the highest level of achievement for one or more Natural World credits. For example, projects seeking additional points in credit NW1.1 Preserve Sites of High Ecological Value must already be expanding the area of high ecological value for ongoing conservation. In this case, exceptional performance may be pursued by projects whose magnitude of positive impact and investment in high-value land conservation or habitat expansion warrants additional points. Exceptional performance may not be pursued by projects that have a basic primary function that meets the requirements. For example, unless extensive restoration was necessary, a nature reserve providing prime habitat may not qualify.

Possible areas of achievement in exceptional performance for Resource Allocation may include, but are not limited to, the following:

- Projects for which significant efforts were made to preserve important natural resources in perpetuity;
- Projects in which efforts to control invasive species represent a significant aspect of the project;
- Projects for which the avoidance of terrestrial or aquatic habitats required exceptional effort and/or the implementation of innovative methods.

Address Additional Aspects of Sustainability:

To qualify for bonus points under this approach, project teams must demonstrate that they are addressing one or more aspects of sustainability not currently recognized in Envision. Sustainability performance must be related to Natural World. Addressing an aspect of sustainability not currently covered by the Envision system might sometimes be considered innovative, in which case the requirements for the Innovation path may be followed. For example, a project may earn bonus points for:

- Calculating new or future floodplain conditions;

- Urban agriculture programs,
- Composting programs;
- Establishing pollinator habitat.

EVALUATION CRITERIA AND DOCUMENTATION GUIDANCE

A. To what extent does the project implement innovative methods, technologies, or processes that overcome significant problems, barriers or limitations, or create scalable and transferable solutions?

1. *Documentation of the application of innovative technologies or methods. Detailed description of how this application will improve existing conventional practice either globally or within the unique context of the project. Provide justification as to why this application should be considered innovative either as a technology, a method, or within the project context (climate, political, cultural, etc.).*
2. *Documentation that the project reduces or eliminates significant problems, barriers, or limitations that previously hampered the use or implementation of certain resources, technologies, processes, or methods that improve the sustainability of the project. Alternatively, documentation that the new methods, technologies, or processes implemented on the project are scalable across a wide range of project sizes and/or are applicable and transferable across multiple kinds of infrastructure projects in multiple sectors.*

B. To what extent does the project exceed the highest levels of achievement for a given credit?

1. *Detailed documentation of how the project exceeds the existing requirements currently within a given Natural World credit.*

C. To what extent does the project address a sustainability aspect that is not currently addressed by the Envision system?

1. *Detailed documentation of how the project addresses a sustainability aspect that is not currently addressed by the Envision system.*
2. *Documentation showing how this aspect relates to the Natural World category.*





Climate and Resilience

The scope of the Climate and Resilience category is two-fold: minimizing emissions that may contribute to climate change and other short- and long-term risks, and ensuring that infrastructure projects are resilient. In order to be resilient, infrastructure must be informed, resourceful, robust, redundant, flexible, integrated, and inclusive. The Climate and Resilience category is divided into two subcategories: **Emissions** and **Resilience**.

10 / credits

Image

Portland General Electric's Tucannon River Wind Farm near Dayton, Washington (Envision Gold, 2015).

- 1 Does the project reduce greenhouse gas emissions?
- 2 Does the project reduce air pollutant emissions?
- 3 Does the project avoid unsuitable sites?
- 4 Does the project reduce climate change vulnerability?
- 5 Is the project resilient and adaptable?

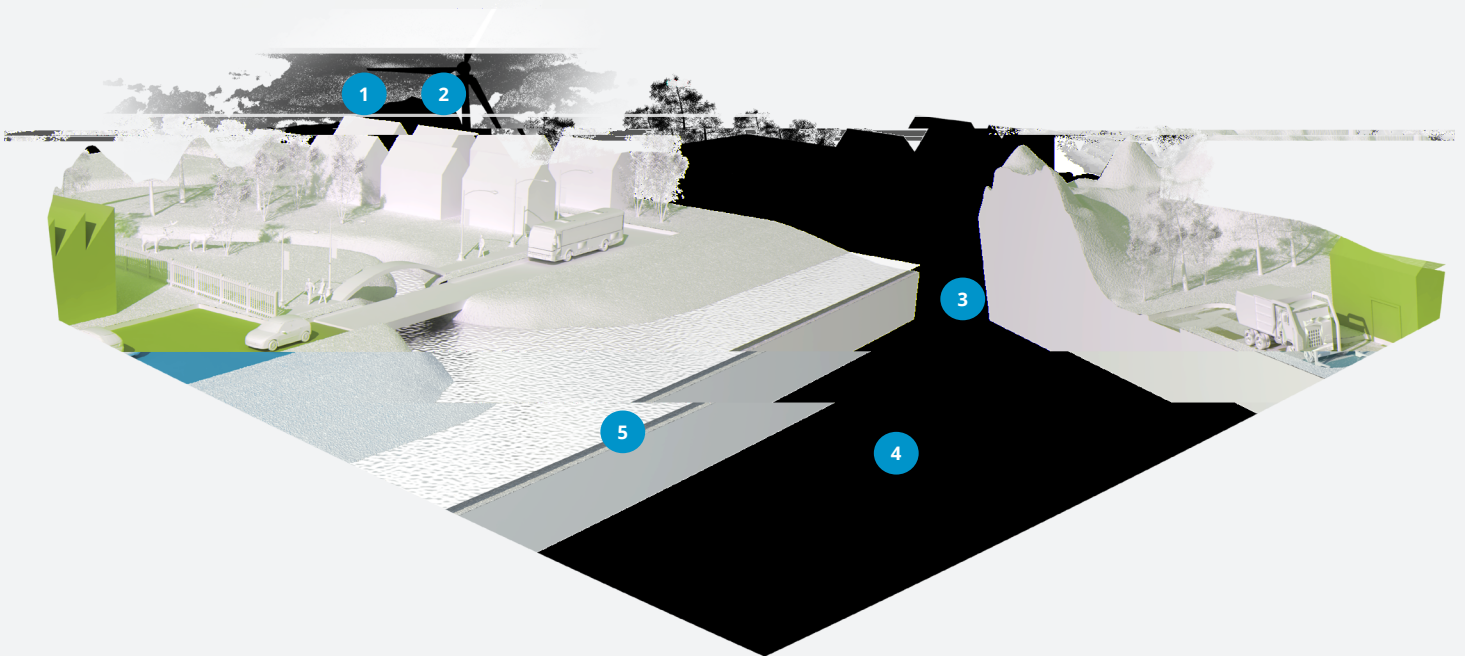

EMISSIONS

The goal of this subcategory is to promote the understanding and reduction of dangerous emissions and the impact of carbon, during all stages of a project's life cycle. While reducing emissions, pollutants, and embodied carbon may not have a direct impact on the consequences of the particular project, it can help to reduce overall global risk and may contribute far beyond the site borders of the project.

RESILIENCE

Resilience includes the ability to withstand short-term risks, such as flooding or fires, and the ability to adapt to changing long-term conditions, such as changes in weather patterns, sea-level rise, or changes in climate. Understanding the types of risks and probability of risks allows the project team to deliver an informed project design that anticipates and withstands these risks, minimizing its overall vulnerability. Maximizing resilience ensures a longer useful life and primes the project to more fully meet the future needs of the community.



Climate and Resilience



EMISSIONS

CR1.1 Reduce Net Embodied Carbon

CR1.2 Reduce Greenhouse Gas Emissions

CR1.3 Reduce Air Pollutant Emissions

RESILIENCE

CR2.1 Avoid Unsuitable Development

CR2.2 Assess Climate Change Vulnerability

CR2.3 Evaluate Risk and Resilience

CR2.4 Establish Resilience Goals and Strategies

CR2.5 Maximize Resilience

CR2.6 Improve Infrastructure Integration

CR0.0 Innovate or Exceed Credit Requirements





CR1.1 Reduce Net Embodied Carbon

20
POINTS

INTENT

Reduce the impacts of material extraction, refinement/manufacture, and transport over the project life.

METRIC

Percentage of reduction in net embodied carbon of materials.

LEVELS OF ACHIEVEMENT

IMPROVED	ENHANCED	SUPERIOR	CONSERVING	RESTORATIVE
A + B + C	A + B + C	A + B + C	A + B + C	Not Available
(5) At Least 5% Reduction	(10) At Least 15% Reduction	(15) At Least 30% Reduction	(20) At Least 50% Reduction	
<p>(A) The project team identifies primary materials to be used on the project during construction and operation. The team determines which materials are the primary contributors to net embodied carbon (collectively >80%).</p> <p>(B) Embodied carbon is calculated, or acquired by a validated source, for the primary materials identified in criterion A. Calculations include:</p> <ul style="list-style-type: none"> • Embodied carbon of production, including raw material extraction, refinement, and manufacture. • Embodied carbon of transporting materials to the project site. • The replacement, repair, or refurbishment of materials over the life of the project. 				
<p>(C) The project team demonstrates at least a 5% reduction in total embodied carbon of materials over the life of the project compared to the baseline. Calculations should be in tons CO₂.</p>	<p>(C) The project team demonstrates at least a 15% reduction in total embodied carbon of materials over the life of the project compared to the baseline. Calculations should be in tons CO₂.</p>	<p>(C) The project team demonstrates at least a 30% reduction in total embodied carbon of materials over the life of the project compared to the baseline. Calculations should be in tons CO₂.</p>	<p>(C) The project team demonstrates at least a 50% reduction in total embodied carbon of materials over the life of the project compared to the baseline. Calculations should be in tons CO₂.</p>	

DESCRIPTION

This credit addresses the embodied carbon of materials used over the life of the project. This combines concepts of sourcing local materials, using materials more efficiently, and using lower-impact materials in order to reduce the combined environmental impacts of material use. In the calculations, carbon is used as a proxy unit of measure to compare various impacts across the entire supply chain of material consumption. One stage of this supply chain involves raw material extraction/harvesting, refinement, and manufacturing into products. The second involves transportation of the materials from the manufacturer to their final destination on site. By designing projects to use less material, use material efficiently, or specifying materials with lower embodied carbon, as well as reducing transportation distances, project teams can reduce the overall impact of the project.

Material use is specifically addressed over the life of the project, including the necessary replacement or renewal of materials. Often, materials with slightly higher initial embodied carbon will have a lower net embodied carbon over the life of the project if they are more durable and less likely to require repair or replacement.

PERFORMANCE IMPROVEMENT

Improved – Conserving: Levels are distinguished by the percentage reduction in embodied carbon of materials over a baseline. As industry standards on carbon intensity of materials do not exist for most infrastructure projects, project teams are required to provide calculations for an appropriate base case. Accepted methodologies for establishing baseline performance data are explained in detail in the front of this manual and include (1) existing conditions, (2) a seriously considered alternative, (3) standard practice, or (4) a comparable existing project/facility. Envision intends to support data collection in order to eventually provide this baseline data for project teams and the industry as a whole. This is why it is required to submit calculations in acceptable standard units.

Availability of data on the carbon intensity of materials is often limited, and some projects may involve hundreds or thousands of products. Therefore, ISI accepts a streamlined method for conducting calculations on this credit. Project teams may identify a select list of primary materials/products that collectively make up greater than 80% of the total embodied carbon. If data on embodied carbon or material intensity is not available from the manufacturer, project teams may use averages or generalized data from studies or material databases. Project teams should track, document, and clearly explain their methodology for calculating material intensity in this credit.

Transportation of materials to project sites can be a significant contributor to the embodied carbon of materials. Local or regional materials—even materials sourced or processed on site—reduce the impact of long transport and support local economies. It is important to note that while it is generally desirable to use locally sourced materials for the aforementioned reasons, use of local materials could have negative impacts on performance if those materials result in reduced durability, safety, or service life. Carbon emissions associated with the transportation of materials to the project site are specifically broken out as they are often simpler to calculate based on distance; quantity; and standard truck, air, rail, or shipping fuel consumption. They are also calculated separately in order to show the possible conflicts that exist of sourcing a lower-intensity material from farther away. Project teams should consider choices that reduce the overall net embodied carbon of materials.

Applicability: This credit is applicable to all projects that include the use or consumption of physical materials in construction or operation.

EVALUATION CRITERIA AND DOCUMENTATION GUIDANCE

A. Has the project team determined materials that are the primary contributors to embodied carbon for the project during construction and operation?

1. Documentation of the primary materials to be used in the construction and ongoing operation of the project over its life. Documentation should include:
 - a. The materials used.
 - b. General estimates of the quantities of materials used. Note that operations materials may need to be multiplied by the frequency of use over the project life. Material estimates should include anticipated repairs/upkeep (e.g., road resurfacing).
 - c. Estimates of the embodied carbon of materials. Estimates may use readily available public information such as regional, national, or global averages.
2. Identification of the select materials that collectively will make up over 80% of the total estimated embodied carbon of the project.

B. Has the project team calculated the primary contributors to overall embodied carbon?

1. Index of the embodied carbon calculations of the primary contributors to carbon intensity over the life of the project (construction and operations) identified in criterion A. This should include:
 - a. Carbon emissions to produce the material, including raw material extraction, refinement, and manufacture including secondary or tertiary processing.
 - b. Carbon emissions from transporting the material from the manufacturer to the project site, including intermediary points.

Embodied carbon data may come from the manufacturer, reputable databases, reputable embodied energy software, or from project team calculations. If the source or specific type of materials is not known at the time of assessment, calculations may present a range of values or rely on likely material choices. Calculations should be in tons CO₂.

C. To what extent does the project reduce the net embodied carbon of materials used in construction and operation?

1. Documentation that the project has set targets for reducing net embodied carbon.
2. Documentation of strategies/plans to reduce net embodied carbon. These may include but are not limited to:
 - a. Sizing the project to require less material;
 - b. Designing the project to use less material;
 - c. Choosing materials that have lower embodied carbon;
 - d. Reducing material needed for repair and maintenance;
 - e. Reducing material waste during construction;
 - f. Reducing material waste during operation;
 - g. Sourcing local materials to reduce transportation emissions;
 - h. Utilizing lower-carbon transportation modes.
3. Calculations of reductions in embodied carbon achieved. Calculations should compare total carbon intensity of materials for the project against the total carbon intensity of the baseline. Calculations should be in tons CO₂.

RELATED ENVISION CREDITS

LD2.3 Plan for Long-Term Monitoring and Maintenance

LD2.4 Plan for End-of-Life

CR1.2 Reduce Greenhouse Gas Emissions

CR1.3 Reduce Air Pollutant Emissions



CR1.2 Reduce Greenhouse Gas Emissions

26
POINTS

INTENT

Reduce greenhouse gas emissions during the operation of the project, reducing project contribution to climate change.

METRIC

Percentage of reduction in operational greenhouse gas emissions.

LEVELS OF ACHIEVEMENT

IMPROVED	ENHANCED	SUPERIOR	CONSERVING	RESTORATIVE
A + B	A + B	A + B	A + B	A + B
(8) At Least 10% Reduction	(13) At Least 25% Reduction	(18) At least 50% Reduction	(22) 100% Reduction	(26) Carbon Negative
(A) The project team demonstrates at least a 10% reduction in total CO ₂ e over the operational life of the project compared to the baseline. Calculations should be in tons CO ₂ e.	(A) The project team demonstrates at least a 25% reduction in total CO ₂ e over the operational life of the project compared to the baseline. Calculations should be in tons CO ₂ e.	(A) The project team demonstrates at least a 50% reduction in total CO ₂ e over the operational life of the project compared to the baseline. Calculations should be in tons CO ₂ e.	(A) The project team demonstrates a 100% reduction in total CO ₂ e over the operational life of the project compared to the baseline. Calculations should be in tons CO ₂ e.	(A) The completed project is carbon negative (i.e., sequesters/removes more CO ₂ e than it produces over the operational life).
(B) The project team maps and calculates the total annual greenhouse gas emissions of the final project design for reporting purposes. This includes direct and indirect greenhouse gas emissions and sequestration associated with project operations. Calculations must be in CO ₂ e.				

DESCRIPTION

This credit addresses greenhouse gas emissions during operations and the project’s contribution in reducing the impacts of climate change. The embodied carbon of materials is specifically addressed in CR1.1 Reduce Net Embodied Carbon. Emission of greenhouse gases during construction is addressed in RA2.2 Reduce Construction Energy Consumption.

The increased release of carbon dioxide (CO₂) and other greenhouse gases (GHGs) has caused a significant increase in the concentration of CO₂ in the atmosphere, enhancing the greenhouse effect. The subsequent increase in the average temperature of the earth’s surface causes various cascading effects, including melting glaciers, arctic sea ice loss, sea level rise, increased ocean temperatures, increased ocean acidity, changing vegetation patterns, increased range of disease vectors, decreased snowmelt, changing precipitation patterns, increased flooding, increased storm intensity, and increased storm frequency, to name a few. This can have many unintended consequences such as flooding when historic periods of snowfall change to rain, drought from increased evaporation and lack of snowmelt, loss of coral reefs and aquatic biodiversity from ocean acidification, and food scarcity as increased temperatures reduce crop production. Reducing the emission of GHGs now will help mitigate the effects of climate change in the future.

PERFORMANCE IMPROVEMENT

Improved – Restorative: Levels in this credit are distinguished by the percentage of reduction in greenhouse gas emissions over a base case. As industry standards on greenhouse gas

emissions do not exist for many infrastructure projects, project teams are required to provide calculations for an appropriate base case. Accepted methodologies for establishing baseline performance data are explained in detail in the front of this manual and include existing conditions (or no-build alternative), a seriously considered alternative, standard practice, or a comparable existing project/facility. Envision intends to support data collection in order to eventually provide this baseline data for project teams and the industry as a whole. This is why it is required to submit calculations in acceptable standard units.

Greenhouse gases are factored according to their global warming potential (GWP), resulting in a CO₂ equivalency (CO₂e). All greenhouse gas emissions calculations should be quantified in tons of CO₂e. Unavoidable CO₂e emissions can be offset by carbon sequestration, in which CO₂ is removed from the atmosphere (e.g., planting trees that absorb and use CO₂ for their growth).

Project teams should take care not to double count greenhouse gas reductions as offsets. For example, if a project will produce 50 percent less greenhouse gas emissions than the baseline over its 25-year life, then it has achieved a 50 percent reduction. This project would not be able to claim that because produced emissions (50%) equal displaced emissions (50%), so it has achieved ‘net-zero’ carbon emissions (i.e., 100% reduction).

Applicability: This credit is applicable to all projects that consume energy, fuel, or otherwise produce greenhouse gas emissions during their operation. Projects that do not include greenhouse gas emissions during operations may apply to have this credit deemed not applicable with supporting documentation. However, projects that do not produce greenhouse gas

emissions because of intentional planning decisions may apply for the Conserving level with supporting documentation.

EVALUATION CRITERIA AND DOCUMENTATION GUIDANCE

A. To what extent does the project reduce greenhouse gas emissions during its operational life?

1. *Calculations of the baseline greenhouse gas emissions over a period equivalent to the operational life of the project (e.g., 25 years).*

2. *Submit calculations for:*

a. *the project's estimated annual greenhouse gas emissions over the life of the project;*

b. *the operational life of the project over which the calculations are made (e.g., 2025-2050); and*

c. *Calculations of the percentage reduction compared to the baseline used over the same period.*

Calculations should include any natural or mechanical methods of carbon sequestration. Purchased carbon offsets may be included in the calculations.

In certain cases where a demand or volume increase is anticipated over the life of the project, project teams may choose to calculate emissions reductions on a per unit basis (passenger miles traveled, millions of gallons of water treated, etc.).

B. Has the project team calculated and reported the annual greenhouse gas emissions of the project?

1. *Calculation of annual greenhouse gas emissions over the life of the project. All greenhouse gas emissions should be in tons of CO₂e (tCO₂e). Calculations include all sources of emissions from facilities, processes, or vehicles owned or controlled within the project boundary, as well as indirect emissions from the off-site generation of energy used by the project. Emissions should be classified by the following categories if applicable:*

a. *Off-Site Energy Generation*

b. *Stationary Fuel Combustion Emissions (non-vehicular combustion occurring at the facility intended for energy production)*

c. *Operations Transportation Emissions*

d. *Waste Emissions*

e. *Wastewater Emissions*

f. *Biomass Emissions*

g. *Industrial Process Emissions*

h. *Fugitive Emissions*

RELATED ENVISION CREDITS

QL2.2 Encourage Sustainable Transportation

LD2.1 Establish a Sustainability Management Plan

CR1.1 Reduce Net Embodied Carbon

RA1.5 Balance Earthwork On Site

RA3.2 Reduce Operational Water Consumption

RA3.3 Reduce Construction Water Consumption



PROJECT EXAMPLE: HOLLAND ENERGY PARK

The Holland Board of Public Works in Michigan considered a number of ways to meet the community's need for more local power and in 2012, they conducted a comprehensive Sustainable Return on Investment (SROI) study to determine whether less expensive and less carbon-intensive alternatives could be pursued rather than the original plan to build a coal-fired power plant. In part through this SROI, the decision was made to build a natural gas combined cycle (NGCC) power plant, known as the Holland Energy Park (Envision Platinum, 2016). The project team undertook a life-cycle assessment (LCA) of greenhouse gas emissions to compare the emissions from the NGCC and the emissions from a coal-fired plant. The LCA revealed the NGCC would result in a more than 50% reduction of greenhouse gas emissions over the life of the project.



CR1.3 Reduce Air Pollutant Emissions

18
POINTS

INTENT

Reduce emissions of air pollutants: particulate matter (including dust), ground-level ozone, carbon monoxide, sulfur oxides, nitrogen oxides, lead, and volatile organic compounds.

METRIC

Reduction of air pollutants compared to baseline.

LEVELS OF ACHIEVEMENT

IMPROVED	ENHANCED	SUPERIOR	CONSERVING	RESTORATIVE
A + B	A + B + C	A + B + C + D	A + B + C + D	A + B + C + D + E
(2) Exceeding Requirements	(4) Ongoing Monitoring	(9) VOC Minimization	(14) Air Pollutant Elimination	(18) Air Quality Improvement
(A) The project meets all applicable air quality standards and regulations for air pollutants.				
(B) The project implements strategies to reduce air pollutant emissions during operations.	(B) The project reduces emissions through the use of best available control systems or best management practices.	(B) Air pollution controls are within the 95th percentile, or represent the lowest levels possible compared to projects of similar type.	(B) The project eliminates air pollutant sources in the design, chooses a non-polluting alternative, or achieves at least a 98% net reduction in air pollution emissions compared to the baseline.	
(C) Systems are in place for the ongoing monitoring of any direct sources of air pollution. Processes are in place to identify and address changes in emissions in order to maintain performance targets.				
(D) The project team assesses whether volatile organic compounds harmful to human health are material to the project and, if so, implement strategies to reduce their use during construction and/or within occupied spaces of the completed project.				(E) The project includes the direct removal of previously existing air pollutant sources, or captures and safely stores/ disposes of air pollutants for a net positive impact.

DESCRIPTION

The criteria pollutants include carbon monoxide, nitrogen oxides, sulfur dioxide, suspended particulate matter smaller than PM-10, ozone, lead, and volatile organic compounds. These pollutants damage human health, property, and the environment. Those most at risk are children, the elderly, and people with lung diseases such as asthma, chronic bronchitis, and emphysema. Dust and odors also can cause a nuisance for nearby residents, reduce property values, and aggravate the aforementioned lung conditions.

PERFORMANCE IMPROVEMENT

The credit assessment begins with demonstrating attainment of applicable air quality standards and/or regulations. Note that use of the terms, or variations of the terms “best available control technology” and “lowest achievable emissions rates” within this credit have no relationship to US EPA guidelines with similar names. These terms should be interpreted at face value.

Project teams are only required to provide supporting documentation for air pollutants relevant to the project. If a project does not emit certain air pollutants listed in the credit intent they can clarify this in their documentation.

Improved: Projects can demonstrate strategies were implemented to reduce air pollutants emissions during operations.

Enhanced: Modeling life-cycle air pollutant emissions can be challenging for some types of infrastructure. This level recognizes project teams that have utilized the best available control systems, technologies, or methods to reduce emissions with the assumption that, if properly monitored and maintained, these will significantly reduce air pollutants emissions over the project life. Project teams are required to provide documentation as to how controls represent industry best practices.

Superior: Completely eliminating air pollutant emissions may not be possible for certain projects. However, this level

recognizes projects that have achieved 'best-in-class' status by reducing air pollutant emissions to the lowest possible levels or within the 95th percentile compared to similar projects. This may include, for example, replacing old or outdated systems with state-of-the-art systems. Project teams are required to determine and provide supporting documentation for what constitutes best-in-class status for their project type.

Conserving: The project completely eliminates air pollutant emissions. Often this is because a non-polluting alternative was chosen. Projects that can demonstrate at least a 98% reduction compared to the baseline are included in this level.

Volatile organic compounds have negative health impacts on building/facility occupants and, in certain conditions, construction workers.

Restorative: Reserved for rare cases where the project eliminates existing sources of air pollutants or captures and safely stores/repurposes air pollutants. Note that replacing existing sources of air pollutants with less polluting sources would count toward a reduction and not an 'elimination' of air pollutants.

Applicability: This credit is applicable to all projects that directly produce any of the criteria pollutants. Projects that do not include air pollutant emissions may apply to have this credit deemed not applicable with supporting documentation. However, projects that do not produce air pollutant emissions because of intentional planning decisions to choose non-polluting alternatives may apply for the Conserving level with supporting documentation.

EVALUATION CRITERIA AND DOCUMENTATION GUIDANCE

Note that use of the terms, or variations of the terms, "best available control technology" and "lowest achievable emissions rates" within this credit have no relationship to US EPA guidelines with similar names. For Envision use of these terms should be interpreted at face value.

A. Does the project meet all relevant minimum air quality standards and regulations?

1. Documentation indicating the local, regional, or national standards and regulations relevant to the project.
2. Documentation demonstrating that the project has met or will meet all relevant standards and regulations.

B. To what extent does the project reduce air pollutant emissions during operations?

1. Estimates of total annual air pollutant emissions over the life of the project.
 2. Documentation of all strategies deployed to reduce air pollutant emissions.
 - a. Documentation demonstrating that the project uses best available control systems or best management practices (Enhanced).
- OR
- b. Documentation demonstrating that air pollution controls are within the 95th percentile, or represent the lowest levels possible compared to projects of similar type (Superior)

OR

- c. Documentation that the project eliminates all air pollutant sources, chooses a non-polluting alternative, or achieves at least a 98% net reduction in air pollution emissions compared to the baseline (Conserving and Restorative).

C. Does the project include the ongoing monitoring and management of direct air pollutant emissions?

1. Documentation that the project includes systems for monitoring any air pollutants directly emitted during operations.
2. Documentation of processes, procedures, or systems designed to identify and address changes in emissions in order to maintain performance.

Note that monitoring is not necessary if the project does not produce air pollutants. Documentation that the project does not produce air pollutants emissions is sufficient to satisfy criterion C for certain projects pursuing Conserving or Restorative. If the project produces air pollutants but achieves zero emissions through control systems, the project is still required to meet the monitoring requirements.

D. Has the project team assessed the materiality of volatile organic compounds to the health of construction workers and the project operators?

1. Documentation that the use of products and materials containing volatile organic compounds (VOCs) and their potential impact on human health over the project life was assessed. If VOCs will be present during construction or operations documentation must include:
 - a. Specifications limiting the use of, or controlling the exposure to, volatile organic compounds during construction.
 - b. For projects/facilities with interior occupied spaces, documentation of steps taken to reduce VOCs in material choices.

E. Does the project remove existing air pollutant sources?

1. Documentation of how the project includes the direct removal of existing air pollutant sources or the capture and sequestration of air pollutants in order to achieve a net positive impact.

RELATED ENVISION CREDITS

QL1.2 Enhance Public Health and Safety

QL2.2 Encourage Sustainable Transportation

LD2.1 Establish a Sustainability Management Plan

RA2.1 Reduce Operational Energy Consumption

RA2.3 Use Renewable Energy



CR2.1 Avoid Unsuitable Development

16
POINTS

INTENT

Minimize or avoid development on sites prone to hazards.

METRIC

The degree to which the project is designed and/or sited to avoid or mitigate site-related risks.

LEVELS OF ACHIEVEMENT

IMPROVED	ENHANCED	SUPERIOR	CONSERVING	RESTORATIVE
A + B	A + B + C	A + B + C + D	A + B + C + E	A + B + C + F
(3) Alternative Assessment	(6) Risk Mitigation	(8) Lowest Risk Alternative	(12) Unsuitable Development Avoided	(16) Strategic Retreat
<p>(A) During planning and project siting, the project team identifies potential siting hazards and determines both the vulnerability of the project to the hazard and the potential for the project to exacerbate the hazard (e.g., creating impervious surfaces in a floodplain, building on potentially unstable hillsides). Potentially adverse sites include but are not limited to:</p> <ul style="list-style-type: none"> • Steep slopes (> 20 degrees) • Permafrost • Adverse geology (e.g., risk of liquefaction, subsidence, or sinkholes) • Flood-prone areas • At-risk coastline (coastal surges, coastal erosion) <p>(B) The project team assesses siting alternatives that avoid or minimize hazard exposure and/or project alternatives less vulnerable to, or likely to exacerbate, site hazards.</p>				
<p>(C) The project includes specific strategies to mitigate the impact of site hazards on the project (e.g., elevating structures and equipment above flood levels), as well as the project development impacts on the site hazard (e.g., erosion controls on steep slopes). This may include monitoring and response plans.</p>				
		<p>(D) Based on alternatives identified in criterion C, the project team can demonstrate the selected project and site resulting in the lowest exposure to site risk while still meeting project objectives and requirements.</p>	<p>(E) The project is intentionally sited to completely avoid site hazards.</p>	<p>(F) The project intentionally modifies or removes existing structures from areas prone to frequent damage and/or at high risk of future damage in order to prevent losses.</p>

DESCRIPTION

This credit addresses how infrastructure siting can significantly reduce risk and improve project resilience. Certain sites such as steep slopes, permafrost, or flood-prone areas should be avoided if possible. Project teams must consider how certain sites not only expose the infrastructure asset to increased risk, but how the development of the project on these sites can lead to additional environmental, social, or economic risks for the surrounding area. For example, a project located on a steep slope is not only at risk itself, but may contribute to erosion or the potential for landslides. Project teams should also consider how infrastructure development may lead to additional development within the at-risk areas.

Whenever possible, infrastructure should avoid developing, or driving development, in areas prone to hazards. Many communities may even consider strategic or managed retreat. This is the

systematic withdrawal and removal of development from areas prone to damage (e.g., frequent flood zones) or at risk of future damage (e.g., low-lying coastal areas impacted by sea-level rise).

PERFORMANCE IMPROVEMENT

Improved: The first step is to identify potential hazards and consider alternatives. Siting risks are a combination of the vulnerability of both the site and the project. In addition to analyzing the site, project teams should consider whether project alternatives would reduce or eliminate the exposure to site risks.

Enhanced: Infrastructure siting choices are often limited. However, project teams can implement strategies to reduce the impact of site hazards.

Superior: Site selection can be a tradeoff, with each site having potential risks. Project teams can demonstrate that the selected project and site resulted in the least exposure to risk compared to the considered alternatives.

Conserving: The project is intentionally sited to avoid site hazards.

Restorative: The project involves the strategic retreat from hazard-prone areas, removing structures, development, or activities from areas prone to damage or at risk of future damage.

Applicability: Projects that are not located within regions at risk of site hazards, and therefore cannot demonstrate they actively avoided site hazards, may apply to have this credit deemed not applicable with supporting documentation.

EVALUATION CRITERIA AND DOCUMENTATION GUIDANCE

A. Has the project team identified potential siting hazards, the vulnerability of the project to the hazard, and the potential for the project to exacerbate the hazard?

1. Documentation of identified site hazards.
2. Documentation of the vulnerability of the project and project alternatives to siting hazards.
3. Documentation that the project team considered the potential for the project to exacerbate potential siting hazards. For example, the potential for a project developed on a hillside to increase erosion, contribute to landslide risk, or to increase damage to downhill development in the event of a landslide.

B. Can the project team demonstrate that siting and project alternatives were seriously considered in order to minimize exposure to risk?

1. Documentation that project and siting alternatives were considered in order to minimize exposure to siting hazards as much as practicable (e.g., review meetings, alternative analyses, siting studies).

C. Has the project team implemented strategies to mitigate the impact of site hazards?

1. Documentation identifying strategies and controls implemented to reduce risk. For certain hazards, this may include monitoring and response plans.
2. Documentation that the project team specifically determined whether the project has the potential to exacerbate site hazards and, if so, mitigation measures were implemented to reduce the project's impact.

D. Can the project team demonstrate that the chosen project and site resulted in the lowest exposure to site hazards while still meeting project requirements?

1. Based on the alternative sites and projects identified in criterion B, the project team presents evidence that the chosen project and site represent the lowest exposure to site hazards while still meeting project requirements. In certain cases, project teams can present evidence that the nature of the infrastructure requires its location in hazard-prone areas. Similarly, in certain cases, project teams can present evidence that a lower-risk alternative would not meet project requirements. The objective of this criterion is for project teams to demonstrate that the project and site were chosen intentionally with full understanding of the risk exposure and to justify why that was the best decision within the context of the project's reasonable constraints.

E. Was the site chosen to intentionally avoid known site hazards?

1. Evidence that the project team intentionally avoided siting the project in proximity to site hazards. Evidence should include alternative sites that were seriously considered.

F. Does the project remove or modify structures subject to frequent damage?

1. Documentation of structures, or other development, removed from the site. This may include structures at high risk of future damage or failure. Evidence should be clear that removal or modification of the structures will prevent or reduce the risk of future damage or loss. Replacing existing structures or other development with similarly at-risk structures does not qualify for this criterion.

RELATED ENVISION CREDITS

CR2.2 Assess Climate Change Vulnerability

CR2.3 Evaluate Risk and Resilience

CR2.5 Maximize Resilience

NW1.4 Preserve Undeveloped Land

NW3.3 Maintain Floodplain Functions

PROJECT EXAMPLE: RIDGEWOOD VIEW PARK RESERVOIR AND PUMP STATION

The siting of the Ridgewood View Park Reservoir and Pump Station (Envision Gold, 2016) in Portland, Oregon was determined after a significant amount of geotechnical work was conducted to find the ideal location for the project, and to ensure the pump station and reservoir facilities would be fully operational in the event of a seismic event. Steep slopes were also avoided; the reservoir could have been constructed on the south end of the park near a steep slope that led to an ephemeral stream, or it could have been constructed within an existing reservoir situated on a steep slope. Neither of these options were selected. Instead, the reservoir was constructed on the north end of the park away from these areas, thus avoiding site-related risks.



CR2.2 Assess Climate Change Vulnerability

20
POINTS

INTENT

Develop a comprehensive climate change vulnerability assessment.

METRIC

Scope and comprehensiveness of climate change vulnerability assessment.

LEVELS OF ACHIEVEMENT

IMPROVED	ENHANCED	SUPERIOR	CONSERVING	RESTORATIVE
A + B	A + B + C	A + B + C + D	A + B + C + D + E	Not Available
(8) Project Vulnerability	(14) System Vulnerability	(18) Community Vulnerability	(20) Knowledge Sharing	
<p>(A) The project team conducts, or relies on, an existing, comprehensive threat/hazard identification study, or assessment, due to climate change. Threats/hazards are classified by:</p> <ul style="list-style-type: none"> • Duration: acute shocks over hours and days, or chronic stressors over years and decades. • Extent of effects: project site (e.g., localized stormwater overflow), infrastructure system wide, or community wide (e.g., changes in climate). <p>The assessment should account for climate change’s impact on the frequency, duration, and severity of threats/hazards.</p> <p>(B) The project team determines vulnerabilities and increased risk to the project, or performance, over its operational life due to climate change-related threats. This should include whether current design variables will continue to meet performance goals over the life of the project under changing operating conditions (i.e., climate, weather patterns, natural hazard frequency and intensity).</p>				
<p>(C) The project team determines vulnerabilities and increased risk to the connected/ related infrastructure system or network due to climate change-related threats. This should include how project vulnerabilities may impact system performance and how system vulnerabilities may impact the project. This should include direct and indirect impacts such as resource and service availability.</p>				
<p>(D) The project team determines vulnerabilities and increased risk to the broader community due to climate change threats. This should include how project vulnerabilities may impact the broader community and how community vulnerabilities may impact the project.</p>				
<p>(E) The project team or owner shares climate threat findings in order to support and facilitate community awareness and their inclusion in future projects.</p>				

DESCRIPTION

The credit addresses the project team’s understanding of potential climate change impacts. This begins with identifying climate change threats and determining project vulnerabilities. The results of this credit assessment may overlap with CR2.3 Evaluate Risk and Resilience, which addresses all potential project risks. Project teams are encouraged to consider the synergies of addressing both CR2.2 and CR2.3.

Climate change is a serious threat to global development and security for current and future generations. Increased temperatures are increasing glacier loss and raising sea levels.

Many low-lying coastal areas are directly at risk, with others facing devastating erosion. Inland areas dependent on snowmelt for freshwater have seen consistent decreases in water availability, and many mountains around the world, once perpetually snowcapped, are now seasonal. Entire permafrost ecosystems collapse as they shift into freeze-and-thaw cycles. Ocean temperatures influence the entire global weather system, and as temperature rises, the frequency, intensity, and pattern of storm systems changes and becomes more unpredictable. The extent of climate change impacts is far-reaching and not entirely understood. Many impacts exacerbate each other; for example, increased storm intensity and rising sea levels compound to make storm surges even more devastating to coastal communities.

Infrastructure development relies heavily on standards that are often based on historic trends that may no longer be an accurate predictor of future conditions. Infrastructure built to the standards of 70 years ago will not provide the level of service needed for the next 70 years. Infrastructure owners and project teams must consider how to make wise economic investments in order to ensure the prosperity, safety, and economic advantages of their community in the face of long-term climate change.

PERFORMANCE IMPROVEMENT

A comprehensive climate change threat and vulnerability assessment is expected for all levels of achievement. Levels in this credit are distinguished by the scope of the assessment, beginning with the project (Improved) and expanding to include the infrastructure system (Enhanced) and broader community (Superior).

Improved: This credit follows the standard methodology of identifying threats and vulnerabilities that is explained in greater detail in credit CR2.3 Evaluate Risk and Resilience. The assessment should specifically address changing design variables.

Enhanced: While project resilience is important, project teams should consider the interdependencies of a project and its connected system. Islands of functionality/operability in a failed system may be of limited value. Infrastructure systems often rely on an interconnected network, or resources and services in order to function. Climate change may not directly impact the project, but it may impact the chain of resources and services a project needs in order to function efficiently.

Superior: Resilience is best applied at a community level. Infrastructure is inherently connected to vast arrays of physical (other infrastructure) and nonphysical (socioeconomic) systems, and the purpose of resilient infrastructure is to support the health, safety, and functions of the broader community as a whole.

Conserving: The assessment of climate change impacts, infrastructure vulnerability to climate change, and how to incorporate climate change considerations into infrastructure project delivery are still relatively new and unevenly applied concepts. There is significant value in project teams sharing their knowledge and experience in order to facilitate incorporating climate change considerations into future projects.

Applicability: This credit is applicable to all projects potentially impacted by climate change, which is the vast majority of infrastructure.

EVALUATION CRITERIA AND DOCUMENTATION GUIDANCE

A. Has the project team determined climate change threats to the project and its surroundings?

1. Documentation that the project team has conducted a climate threat analysis or that an existing climate change study was available for the community.
2. Documentation that the climate threat analysis expands beyond direct impacts to the project and includes threats to the connected infrastructure system or related infrastructure network. For example, a water treatment facility outside the range of heightened storm surges from sea level rise may be disrupted by loss of pump stations located within the heightened range.

3. Documentation that the climate threat analysis expands beyond infrastructure systems and includes threats to the broader community. For example, how water-dependent infrastructure in a region at risk of drought would be competing with the community for limited resources.

B. Has the project team determined the vulnerability of the project to climate change threats?

1. Identification of project vulnerabilities to climate change threats reported in criterion A.
2. Documentation that a review was conducted of key design or performance standards to determine whether they would be impacted by changes in operating conditions due to climate change.

C. Has the project team determined the vulnerability of the infrastructure system to climate change threats?

1. Mapping of the interdependencies between the project and its connected infrastructure system. For example, a light rail station and its connected network of stations and rail lines, or a pump station and its connected water treatment system.
2. Identification of system vulnerabilities to climate change threats reported in criterion A.
3. Documentation that specific consideration was given to the dependence on resources or services such as materials, energy, water, transportation access, etc., and the future reliability or cost of these resources due to climate change impacts.

D. Has the project team determined the vulnerability of the community to climate change threats?

1. Mapping of the interdependencies between the project and community systems. This can include physical systems like energy, water, transportation, communication systems, waste removal, and/or food supply. It may also include nonphysical systems like emergency services, funding, regulations, workforce, and/or community/political support.
2. Identification of community systems' vulnerabilities to climate change threats reported in criterion A.

E. Has the project team or owner shared their climate threat findings?

1. Documentation that the project team or owner have shared, or will share, their climate threat findings with a broader audience. Information is shared publicly in order to increase general knowledge of climate threats, advance awareness, and support/facilitate the inclusion of climate threats into future projects.

RELATED ENVISION CREDITS

- LD1.2 Foster Collaboration and Teamwork
- LD2.2 Plan for Sustainable Communities
- LD3.3 Conduct a Life-Cycle Economic Evaluation
- RA3.1 Preserve Water Resources
- NW1.2 Provide Wetland and Surface Water Buffers
- NW2.2 Manage Stormwater
- CR2.3 Evaluate Risk and Resilience



CR2.3 Evaluate Risk and Resilience

26

POINTS

INTENT

Conduct a comprehensive, multihazard risk and resilience evaluation.

METRIC

Scope and comprehensiveness of the multihazard risk and resilience evaluation.

LEVELS OF ACHIEVEMENT

IMPROVED	ENHANCED	SUPERIOR	CONSERVING	RESTORATIVE
A + B + C + D + E	A + B + C + D + E	A + B + C + D + E	A + B + C + D + E + F	NOT AVAILABLE
(11) Project Evaluation	(18) System Evaluation	(24) Community Evaluation	(26) Integrated and Inclusive Approach	
(A) The project team draws the assessment boundary for subsequent criteria (B, C, D, and E) around the project and its site.	(A) The project team draws the assessment boundary for subsequent criteria (B, C, D, and E) around the interdependencies of the project and its associated/connected infrastructure system/network.	(A) The project team draws the assessment boundary for subsequent criteria (B, C, D, and E) around the interdependencies of the project, its associated/connected infrastructure system/network, and the broader community.		
<p>(B) Understand the Asset: The project team identifies the objectives and performance goals of the project and related systems. It also identifies the critical assets, systems, and networks that are essential to meeting objectives and performance goals. This should include the associated dependencies and interdependencies within the system.</p> <p>(C) Identify Threats/Hazards: The project team identifies threats/hazards (natural hazards and human-induced threats). Project teams may reference existing studies or assessments if relevant to the project and its context. Threats should include both acute shocks and chronic stressors.</p> <p>(D) Identify Vulnerability: The project team identifies the vulnerabilities of the critical functions and dependencies of the infrastructure asset and its primary components identified in criterion B to the threats/hazards identified in criterion C.</p> <p>(E) Evaluate Risk: The project team evaluates the project risk by determining the likelihood/probability of a threat/hazard occurring and the associated consequences/impacts. Consequences and impacts should be classified as social, environmental, and/or economic/financial.</p>				
			(F) The project team conducts the risk evaluation with the owner and a diverse and integrated team of key stakeholders.	

DESCRIPTION

This credit requires a comprehensive risk evaluation in order to understand potential hazards/threats and the project's vulnerability. As climate change is an overarching threat to many projects, CR2.2 Assess Climate Change Vulnerability can be considered a subcomponent of this broader credit addressing all potential risks. In turn, CR2.3 Evaluate Risk can form the foundation for credits CR2.4 Establish Resilience Goals and Strategies and CR2.5 Maximize Resilience.

Different disciplines and industries often use different terminology when discussing risk; however, the principles and processes are largely similar.

- Hazards/threats are events that have the potential to cause damage or harm, whether naturally occurring (hazards) or human-induced (threats).
- Vulnerability is a condition whereby a threat has the potential to disrupt or damage a project or system.
- Risk is the probability of a threat exploiting a vulnerability and the associated impacts and consequences.

For example, flooding might be a threat to a project, critical systems located below flood levels would be vulnerable to that threat, and risk would be an evaluation of the probability and severity of a flood event as a factor of the associated losses if the critical systems were flooded. Below is a list of common hazards/threats classified as acute shocks or chronic stressors.

Acute Shocks (Short-term Duration/ Lower Predictability)	Chronic Stressors (Long-term Duration/ Higher Predictability)
Hurricanes	Aging Population
Earthquakes	Environmental Degradation
Wildfires	Sea Level Rise
Heat Waves	Drought/Water Shortage
Blizzards	Species Extinction
Health Epidemics	Aging Infrastructure
Flooding	Shrinking/Growing Population
Tornadoes	Global Warming
Terrorism	Increased Pollution/Contamination
Infrastructure Failure/Collapse	Food Availability
Subsidence and Liquefaction	Overtaxed/Inefficient Infrastructure
Chemical Spills	Financial Shortages

Risk Evaluation Steps

- 1. Draw the Boundary:** establish the boundary and scope of the assessment (criterion A).
 - Project (assessment includes risks to the project). (Improved)
 - System (assessment includes risks associated with the interdependencies of the project to its connected system) (Enhanced).
 - Community (assessment includes risks associated with the interdependencies of the project to its connected infrastructure system, as well as the interdependencies of the project and infrastructure system to their external network of systems) (Superior and Conserving).
- 2. Understand the Asset** (criterion B):
 - Identify the objectives and performance goals of the project and related systems.
 - Identify the critical assets, systems, and networks that are essential to meeting objectives and performance goals.
 - Identify associated dependencies and interdependencies within the system.
- 3. Identify Threats/Hazards:** Identify potential natural hazards or human-induced threats that have the potential to impact the project, system, and community (criterion C).
 - Identify Short-Term Threats (Acute Shocks)
 - Chronic Stressors
- 4. Identify Vulnerability:** Identify the critical assets, systems, and/or networks essential to meeting objectives and performance goals that are susceptible to the identified threats/hazards (criterion D).
- 5. Evaluate Risk:** Risk is the potential for loss or damage resulting from a threat/hazard exploiting a vulnerability. It is a product of the likelihood of occurrence and the associated consequences (criterion E).
 - Determine the likelihood/probability of a threat/hazard occurrence.

- Determine the associated consequences/impact of the occurrence in each category of social (people, community), environmental (contamination, destruction), or economic (cost of repair, financial losses).

PERFORMANCE IMPROVEMENT

Improved: A comprehensive and thorough risk evaluation is required for all levels of achievement in this credit. Levels are distinguished by the scope of the assessment boundary. This begins with the project and site.

Enhanced: Expands the assessment to the integrated infrastructure system.

Superior: Expands the assessment to the broader network of interdependent systems throughout the community.

Conserving: Additional points are given in Conserving for conducting the risk evaluation through an integrated and diverse process. Often, individuals with diverse backgrounds, perspectives, or skill sets can add value by bringing attention to threats and vulnerabilities that might otherwise be overlooked.

Applicability: It is likely that all projects would benefit from a thorough investigation of potential risks. It would, therefore, be difficult to demonstrate that the credit is not relevant or applicable to a project seeking an Envision award. Risks are not always major catastrophic events; small and large projects alike may consider how crime/vandalism or personal injury are also potential risks with associated impacts.

EVALUATION CRITERIA AND DOCUMENTATION GUIDANCE

A. To what extent does the project team's risk assessment include the project, infrastructure system, and community?

1. Evidence that the documentation in criteria B, C, D, and E sufficiently addresses the scope required in the level of achievement: project (Improved), infrastructure system (Enhanced), and community (Superior and Conserving).

B. Has the project team identified the critical functions and dependencies of the infrastructure asset and its primary components?

1. Documentation that project teams conducted a review to identify critical functions and dependencies of the infrastructure asset and its primary components. Note that documentation for B, C, D, and E can be submitted together as part of the comprehensive risk evaluation.
2. Mapping of the interdependencies between the project and its connected infrastructure system (for example, a light rail station and its connected network of stations and rail lines, or a pump station and its connected water treatment system (Enhanced and above).
3. Mapping of the interdependencies between the project and community systems. This can include physical systems like energy, water, transportation, communication systems, waste removal, and/or food supply. It may also include nonphysical systems like emergency services, funding, regulations, workforce, and/or community/political support (Superior and Conserving).

C. Has the project team identified the threats or hazards to the project and its surroundings?

1. Documentation that the project team has identified threats/hazards or that existing threat/hazard studies were available and are sufficient and comprehensive for the project. Projects that pursue CR2.1 may provide that documentation for climate threats. However, documentation in this credit should extend beyond climate threats.

Note that project teams can and should augment existing threat/hazard studies in their documentation if the studies do not fully capture all potential threats to the project.

D. Has the project team identified the vulnerabilities of the critical functions and dependencies of the infrastructure asset?

1. Identification of the vulnerabilities of the critical functions and dependencies of the infrastructure asset and its primary components identified in criterion B to the threats/hazards identified in criterion C.

E. Has the project team evaluated risks by determining the probability of a threat or hazard occurring and the associated impacts?

1. Documentation of the potential for loss or damage resulting from the threats and hazards identified in criterion C exploiting vulnerabilities identified in criterion D. This should be presented as a product of the likelihood of occurrence and the associated consequences. Consequences and impacts should be classified as social, environmental, and/or economic/financial.

F. Did the risk evaluation conducted by the project include the participation of the owner and a diverse and integrated team of key stakeholders?

1. Documentation of the risk evaluation process and evidence of participation by the owner and key stakeholders. Applicants should explain how the stakeholders represented a diverse set of perspectives appropriate to the scope of the project.

RELATED ENVISION CREDITS

LD2.2 Plan for Sustainable Communities

LD3.3 Conduct a Life-Cycle Economic Evaluation

CR2.2 Assess Climate Change Vulnerability

CR2.4 Establish Resilience Goals and Strategies

CR2.5 Maximize Resilience

PROJECT EXAMPLE: OHIO RIVER BRIDGES-EAST END CROSSING

The Ohio River Bridges-East End Crossing (Envision Platinum, 2016) resulted from a long-planned collaboration between the State of Indiana and the Commonwealth of Kentucky. It is designed to address cross-river mobility challenges in the Louisville Metropolitan Area, improve safety and reduce traffic congestion, stimulate the local economy and integrate with existing highways. It has also been designed to be resilient to significant potential climate change risks such as heat wave intensity and flooding, both of which were identified as risks in the region's climate change assessment and adaptation plans.

Marshalltown Generating Station: Marshalltown, Iowa

Alliant Energy's Marshalltown Generating Station (Envision Platinum, 2017) in Iowa advances clean energy for customers and communities, while significantly reducing its environmental footprint. The project is a natural gas combined cycle facility with a 650-megawatt capacity, providing enough electricity to power 500,000 Iowa homes and businesses. Compared to traditional coal-fired generation, the Marshalltown generating station emits less than half the carbon dioxide, about two-thirds less nitrogen oxide, and roughly 99 percent less sulfur and mercury. The project team credits Envision for helping them design and deliver more sustainability and economic benefits in the project.

Notable achievements for the Marshalltown Generating Station within the Envision categories include:

Quality of Life: The project provides a number of additional benefits for the local community, including improved quality of existing electric and gas capacity for businesses, industry and the public. The new gas pipeline connecting the existing Northern Border Power pipeline and the Marshalltown Generating Station was sized to meet expected future population growth and increased demand for natural gas in the Marshalltown area. Improving the natural gas delivery system in the city will also lower the long-term delivery cost of natural gas to the community, thereby saving residents and businesses an estimated \$1 million annually.

Leadership: The Marshalltown Generating Station created a significant number of jobs during the design, construction and operational phases. During construction, an average of 650 jobs were created with nearly 40% of these workers from Marshalltown, and the remainder commuting from nearby cities and towns. These new jobs brought significant revenue to local businesses, including hotels, restaurants, and other stores. The completed generating station now employs roughly 20 permanent employees.

As the largest development project in the City of Marshalltown in more than twenty years, the USD \$700 million facility is expected to bring millions of dollars in tax revenue benefits to Marshall County and to the state of Iowa.

Natural World: Alliant Energy, working in conjunction with the project team and local stakeholders, restored a significant portion of the project site to create a new nature trail, consisting of natural habitats located near the project. Prairie and pollinator habitats replace previously planted monoculture row crops, and the habitats are accessible to the public. The seven acres of new public space provides visitors with the opportunity to learn more about the benefits of natural prairie and pollinator habitats. A walking trail with educational signage is open to visitors daily.

Climate and Resilience: Alliant Energy completed several detailed studies to understand potential climate change and other risks to the project. For example, the firm undertook a detailed analysis to understand the extent to which the Marshalltown Generating System would reduce greenhouse gas (GHG) emissions from the originally-proposed coal-fired facility that was formerly planned to be constructed in the area. The GHG assessment revealed that the station is expected to reduce emissions by more than 40 percent over a 25-year period.

In addition, Alliant Energy conducted an assessment of resource demands and supplies, and resource and infrastructure vulnerabilities. Seven specific risks to the project were proactively identified by the company and intentionally mitigated by the design, including potential shortages in fuel and water resources; flooding and spills; and changes in heat, snow loads, and wind speeds. Ultimately the generating station was designed to be resilient and adaptive to potential changes in the operating environment over the course of its life.





CR2.4 Establish Resilience Goals and Strategies

20
POINTS

INTENT

To support increased project and community resilience through the establishment of clear objectives and goals.

METRIC

The degree to which resilience goals expand from initial commitments to quantifiable project objectives, long-term operating plans, and community-wide development plans.

LEVELS OF ACHIEVEMENT

IMPROVED	ENHANCED	SUPERIOR	CONSERVING	RESTORATIVE
Not Available	A + B	A + B + C	A + B + C + D	Not Available
	(8) Strategy Development	(14) Stakeholder Input	(20) Shared Community Goals	
	<p>(A) The project team determines the performance goals of the project and the owner’s acceptable level of risk.</p> <p>(B) The project team uses the results of a risk evaluation (e.g., CR2.3) to develop risk management strategies that meet project performance goals and budget, and increase project resilience. The project team prioritizes strategies that result in the greatest reduction of risk within project cost constraints.</p>			
		<p>(C) The project team engages the owner and key stakeholders in developing or reviewing resilience goals and strategies.</p>		
			<p>(D) The project team aligns project resilience goals with broader community- or region-wide resilience goals and plans.</p> <p>OR</p> <p>If community resilience goals are lacking, the project team publicly shares its resilience goals in support of developing broader community goals.</p>	

DESCRIPTION

This credit addresses expanding resilience goals from initial commitments to quantifiable project objectives, long-term operating plans, and community-wide development plans. Projects are more likely to achieve resilience outcomes when owners, designers, contractors, and all involved in the project team establish clear and quantifiable performance targets. Conversely, achieving increased resilience is unlikely when efforts are piecemeal and uncoordinated. While every project contributes to the overall resilience of the infrastructure system, the ultimate objective is always a more resilient community as a whole. This requires coordination and cooperation beyond the boundaries of the project.

The benefits of increased resilience include avoided losses of life, health, assets, and/or operating time and their associated costs. Most studies estimate that every dollar spent on preparedness and prevention saves four dollars in recovery and relief. The increase in global population and spread of human

development, combined with the increased frequency and intensity of extreme weather events, means that more people are being exposed to greater risks. Studies from the reinsurance company Swiss Re indicate that global insured losses due to natural catastrophes have increased dramatically over the past four decades. Infrastructure owners should consider the cost savings and benefits of developing more resilient systems.

According to the Rockefeller Foundation’s City Resilience Framework, characteristics of a resilient system include being resourceful, inclusive, integrated, robust, flexible, redundant, and reflective. Ultimately, the objective is to be as resilient as possible while being as resource efficient (resourceful) as possible. This necessitates an inclusive (people) and integrated (systems) approach. Risk is a factor of the probability of a threat/hazard occurring, the project’s vulnerability, and the associated impacts/consequences ($R = T \times V \times I$).

There are many ways to classify or organize resilience strategies. Below is one way of classifying resilience strategies:

• Vulnerability Reduction

- **Eliminate/Avoid:** The project eliminates or avoids the potential threat.
- **Accommodate:** The project is designed to overcome the threat.
 - Durability/Robustness
 - Adaptability/Flexibility

• Impact/Consequence Reduction

- **Minimize:** The project is designed to minimize the impact of a failure.
 - Redundancy/Diversity
 - Preparedness
- **Restore:** The project is designed to quickly or more easily recover from losses.
 - Recovery/Response

• No Action

- **Accept:** The likelihood and impacts are deemed an acceptable risk.

PERFORMANCE IMPROVEMENT

Enhanced: A comprehensive and thorough risk evaluation is required as a prerequisite for all levels of achievement in this credit. It is not possible to establish resilience goals without first understanding the risks. Levels in this credit are distinguished by the inclusivity of the goal setting process.

Superior: The process for establishing goals and strategies extends beyond the project team to include the owner and key stakeholders (operators, contractors, interdependent facilities, or community stakeholders).

Conserving: While projects can take steps to increase their own resilience, resilience is most effective when considered at the community, city, or regional scale. Therefore, project teams should consider the advantage of engaging with stakeholders to align project goals with those of the broader community.

Applicability: All projects that are exposed to risks would benefit from establishing resilience goals and strategies. It would therefore be difficult to demonstrate that the credit is not relevant or applicable to a project seeking an Envision award.

EVALUATION CRITERIA AND DOCUMENTATION GUIDANCE

A. Has the project team identified the project performance goals and risk appetite of the owner?

1. Documentation identifying key performance objectives of the project that will form the foundation of the risk assessment.
2. Documentation explaining the owner's approach to risk management on the project. This is the guide for separating "acceptable risks" from risks that require mitigation and management.

B. Has the project team developed risk management strategies based on a comprehensive risk evaluation?

1. Documentation that the project team has conducted a risk evaluation, including at minimum:

- Identification of the objectives and performance goals of the project and related systems.
- Identification of the critical assets, systems, and networks essential to meeting objectives and performance goals.
- Threats/hazards identification
- Vulnerability assessment
- Likelihood/probability of threat/hazard occurrence.
- Consequences/impact of the occurrence

2. List or matrix of potential risk management strategies that could be implemented to reduce project risk and increase resilience. Strategies should be prioritized according to their risk reduction potential and any extenuating factors (cost, availability, reliability, effectiveness, etc.)

C. Have key stakeholders been engaged in developing resilience goals?

1. Evidence of participation by the owner and key stakeholders in developing or reviewing resilience goals. Applicants should explain how the stakeholders represented a diverse set of perspectives appropriate to the scope of the project. Evidence should indicate that stakeholder engagement was meaningful and produced useful feedback on establishing or prioritizing resilience goals.

D. Is the project part of, or does it support, larger community resilience or climate change adaptation goals?

1. Documentation of broader community or regional resilience goals (for example, as stated in existing resilience or climate change adaptation or preparedness plans). Documentation may include a pre-existing plan developed independently of the project or a plan developed by the project and shared with relevant government agencies.
2. Documentation of a direct connection between the project and the broader community resilience goals it supports. Documentation explains how the project contributes to or supports these goals.

OR

If the community- or region-wide resilience goals are lacking, the project team can alternatively submit documentation that the project's resilience goals were shared publicly in order to support development of broader resilience goals within the community.

RELATED ENVISION CREDITS

- QL1.2 Enhance Public Health and Safety
- LD1.1 Provide Effective Leadership and Commitment
- LD2.2 Plan for Sustainable Communities
- LD3.3 Conduct a Life-Cycle Economic Evaluation
- CR2.2 Assess Climate Change Vulnerability
- CR2.3 Evaluate Risk and Resilience
- CR2.5 Maximize Resilience



CR2.5 Maximize Resilience

26
POINTS

INTENT

Increase resilience, life-cycle system performance, and the ability to withstand hazards by maximizing durability.

METRIC

The degree to which the project incorporates elements that increase durability, the ability to withstand hazards, and extend useful life.

LEVELS OF ACHIEVEMENT

IMPROVED	ENHANCED	SUPERIOR	CONSERVING	RESTORATIVE
A + B	A + B + C	A + B + C + D	A + B + C + D + E	Not Available
(11) Improved Resilience Performance	(15) Thorough Implementation	(20) Ongoing Resilience Monitoring	(26) Quantifying Improvement	
<p>(A) The project team develops resilience goals and strategies (e.g., CR2.4) based on a detailed risk evaluation of the project (e.g., CR2.3).</p> <p>(B) The project team takes a comprehensive approach to implementing resilience strategies.</p>				
<p>(C) The project team periodically monitors the implementation of resilience strategies and revisits their effectiveness in addressing project risk throughout project development.</p>				
<p>(D) Resilience strategies are incorporated into the operations and maintenance of the project. Organization(s) responsible for the ongoing operation of the project have systems in place to maintain, grow, learn, and continually improve resilience capabilities (i.e., “plan, do, check, act”).</p>				
<p>(E) The project team establishes methods for measuring/quantifying the benefits of resilience strategies implemented (e.g., monetary savings from avoided damage or service loss, accelerated recovery time).</p>				

DESCRIPTION

This credit addresses the implementation of strategies and systems to increase the resilience of the project. While it can be assessed independently, it should be considered as a continuation of the previous resilience credits. After identifying vulnerabilities and risk (CR2.2 Assess Climate Change Vulnerability and CR2.3 Evaluate Risk and Resilience), and establishing resilience goals and strategies (CR2.4), it is time to implement the strategies on the project. This credit is independent because successful and effective implementation requires a range of actions beyond the resilience strategies themselves.

PERFORMANCE IMPROVEMENT

Improved: Resilience is critical to a project’s long-term success and cannot be parsed in partial achievements. Therefore, the credit begins with a comprehensive implementation of resilience strategies sufficient to address identified risks. The levels in this credit are distinguished by the rigor in implementing the strategies.

Enhanced: Consideration of resilience cannot be limited to early conceptual design. Projects change during development, and as such the implementation of resilience strategies should be regularly monitored and revisited in order to ensure their continued effectiveness and to capture new opportunities as they arise.

Superior: Implementation of resilience strategies should also not end with project delivery. While better-designed projects have an advantage, the ultimate test of project resilience will occur during operations. Therefore, operators should be engaged to develop systems of continual learning and improvement.

Conserving: Quantifying the benefits of resilience performance validates project decisions, provides a basis for future operational improvements, and generates valuable knowledge for future projects and the industry as a whole.

Applicability: All projects that are exposed to risks would benefit from increased resilience. It would therefore be

difficult to demonstrate that the credit is not relevant or applicable to a project seeking an Envision award.

EVALUATION CRITERIA AND DOCUMENTATION GUIDANCE

A. Has the project team developed resilience goals and strategies based on a comprehensive risk evaluation?

1. *Documentation of a comprehensive risk evaluation. Projects pursuing CR2.2 may submit their credit documentation. Applicants may refer to CR2.2 for guidance on conducting a risk evaluation and relevant documentation.*
2. *List or matrix of resilience goals and risk management strategies prioritized according to their risk reduction potential and any extenuating factors (cost, availability, reliability, effectiveness, etc.)*

Note that for this criterion, documentation must be relevant and specific to resilience goals.

B. Has the project team implemented resilience strategies sufficient to address major project risks and improve project resilience?

1. *Documentation that strategies implemented in the project increase resilience. Project teams should explain how the strategies address one or more of the core principles of resilient systems:*
 - *Reflective (learning and improving)*
 - *Resourceful (resource efficient, creative)*
 - *Inclusive (shared action and responsibilities)*
 - *Integrated (diverse systems, institutions, and people)*
 - *Robust (durable, well constructed)*
 - *Redundant (diverse, fault tolerant)*
 - *Adaptable (flexible, changeable)*

C. Has the project team periodically monitored the implementation of project resilience strategies and reviewed their continued effectiveness throughout project delivery?

1. *Project-specific report(s), or meeting minutes, detailing how the project will carry out the implementation of resilience strategies through construction and which key performance indicators will be used to measure and manage initiatives.*
2. *Project-specific sustainability report(s), or meeting minutes, detailing how the project team revisited resilience strategies*

during project development to ensure their continued effectiveness in the face of potential changes in project design or parameters.

D. Will resilience goals and strategies be incorporated into the ongoing operations and maintenance of the project?

1. *Documentation of operations and management plans, or coordinated efforts with organizations responsible for project operations, that establish plan-do-check-act systems that learn and continually improve resilience capabilities.*
2. *Documentation that any relevant resilience features provide sufficient operations and maintenance guidance to ensure their effectiveness during operations.*

Note that for this criterion, documentation must be relevant and specific to resilience goals. Project teams are encouraged to share their resilience strategies, as well as their performance and effectiveness over time during operations. Actions and commitments to do so may qualify for innovation points under CR0.0 Innovate or Exceed Credit Requirements.

E. Does the project include methods for measuring or quantifying resilience performance targets?

1. *Documentation of the calculations and methodology the project team used to quantify resilience goals and outcomes. Many risk management strategies are justifiable through qualitative assessments or do not require justification. However, when possible, quantifying the benefits of increased resilience through objective measure (e.g., cost savings, improved service) can support their implementation on the project and benefit the knowledge and understanding of the broader resilience community.*

RELATED ENVISION CREDITS

LD2.3 Plan for Long-Term Monitoring and Maintenance

LD2.1 Establish a Sustainability Management Plan

LD3.1 Stimulate Economic Prosperity and Development

LD1.4 Pursue Byproduct Synergies

QL1.1 Improve Community Quality of Life

QL1.2 Enhance Public Health and Safety

CR2.2 Assess Climate Change Vulnerability

CR2.3 Evaluate Risk and Resilience

CR2.4 Establish Resilience Goals and Strategies



CR2.6 Improve Infrastructure Integration

18
POINTS

INTENT

Enhance the operational relationships and strengthen the functional integration of the project into connected, efficient, and diverse infrastructure systems.

METRIC

The degree to which the project is integrated into other connected systems, where beneficial and appropriate, in order to increase resilience and systems performance.

LEVELS OF ACHIEVEMENT

IMPROVED	ENHANCED	SUPERIOR	CONSERVING	RESTORATIVE
A	A + B	A + B + C	A + B + C + D	A + B + C + D + E
(2) Internal Integration	(5) Risk Reduction	(9) Systems Integration	(13) Community/ Network Integration	(18) Information Integration
(A) The project increases internal systems integration in order to achieve efficiency or system diversity.				
(B) Integration strategies increase resilience and reduce the risk of systemic or cascading failures.				
(C) The project leverages its relationship within a larger infrastructure system in order to achieve efficiency or system diversity.				
(D) The project integrates networks of infrastructure systems (e.g., water and transportation) in order to achieve efficiency or system diversity. In certain cases, projects may substitute the community integration of non-physical social or economic systems.				
(E) The project integrates data or monitoring systems with reporting or preparedness systems in order to learn and improve performance over time.				

DESCRIPTION

This credit assesses the degree to which the project is integrated into other connected systems, where beneficial and appropriate, in order to increase resilience and system performance. Optimal infrastructure performance integrates all infrastructure elements at the community level. Therefore, each new or renovated element of infrastructure ideally is designed and constructed to take into account how that element will link with, support, and act in harmony with other existing and planned infrastructure elements. While historic infrastructure development focused on a “one problem, one solution” model, increasingly communities are realizing cost savings and improved performance from layering and integrating infrastructure goals.

The ubiquitous availability and access to smart technology and data also presents a new opportunity for infrastructure integration. However, project teams should guard against introducing vulnerabilities, and, rather, integrate systems and technology in order to increase resilience and reduce the risk of systemic or cascading failure. Integrated systems can provide multiple benefits, including but not limited to:

- Efficiency – An integrated systems approach can identify conflicts, achieve higher efficiency, or leverage co-benefits.
- Diversity – Integrated systems can often function in a variety of ways, under various conditions, or in multiple configurations. This increases resilience and can reduce the need for redundant backups.

PERFORMANCE IMPROVEMENT

Improved: The project team focuses on integration of internal systems within the project.

Enhanced: The project team focuses on ensuring integration increases resilience and does not introduce vulnerabilities such as cascading or systemic failures.

Superior: The project team considers the role of the project within its larger infrastructure system. This may include networks of water treatment, roads, transit, energy, solid waste, parks, and more.

Conserving: The project contributes to the beneficial integration of multiple infrastructure systems. For example, how improved stormwater design can decrease traffic accident morbidity,

how access across a facility can increase community mobility, or how transportation design can benefit and enhance waste diversion and recycling collection. Infrastructure systems support each other in order to achieve higher performance.

Restorative: The project team integrates data or monitoring systems in order to achieve higher performance beyond project delivery. Integrating systems is not only about physical connections, since integrated systems are often effective only when monitored, maintained, and operated as intended.

Applicability: It is likely that all infrastructure would, and should, benefit from the application of an integrated systems approach. It would therefore be difficult to demonstrate that the credit is not relevant or applicable to a project seeking an Envision award.

EVALUATION CRITERIA AND DOCUMENTATION GUIDANCE

A. Does the project increase internal systems integration?

1. Documentation of how systems within the project were integrated or coordinated in order to achieve efficiencies, redundancies, or system diversity.

B. Will the infrastructure integration reduce the risk of systemic or cascading failures?

1. Documentation that the project team understands critical failure points and that efforts to integrate

internal or external systems will decrease rather than increase the risk of system or cascading failures.

C. Does the project increase external systems integration?

1. Documentation that the project improves the efficiency, redundancy, or system diversity of the larger infrastructure system beyond the project boundary.

D. Does the project integrate infrastructure networks?

1. Documentation that the project team made efforts to identify and leverage opportunities to integrate infrastructure networks in order to achieve efficiency, redundancy, or system diversity. The project may demonstrate that it is part of a larger program, policy, or initiative to improve cross-sector performance and sustainability.

E. Does the project integrate data or monitoring systems in order to improve performance?

1. Documentation that the project includes integrated monitoring or data gathering systems in order to improve performance during operations.

RELATED ENVISION CREDITS

QL2.2 Encourage Sustainable Transportation

LD2.2 Plan for Sustainable Communities

NW1.4 Preserve Undeveloped Land

LD1.4 Pursue Byproduct Synergies



CR0.0 Innovate or Exceed Credit Requirements

+10
POINTS

INTENT

To reward exceptional performance beyond the expectations of the system and application of innovative methods that advance state-of-the-art sustainable infrastructure.

METRIC

Whether project sustainability performance qualifies as innovation, exceptional performance, or is not otherwise recognized in existing credits.

LEVELS OF ACHIEVEMENT

INNOVATION
A or B or C
(+1-10) Innovate or Exceed Credit Requirements
<p>(A) Implement innovative methods, technologies, or processes that are novel either in their use, application, or within the local regulatory or cultural context.</p> <p>OR</p> <p>(B) Implement measures that exceed the highest existing requirements within one or more Climate and Resilience credits.</p> <p>OR</p> <p>(C) Address additional aspects of sustainability not currently recognized in Envision</p>

DESCRIPTION

This credit addresses instances in which projects:

1. Implement innovative methods, resources, technologies, or processes that are novel in their use, application, or within the local regulatory or cultural context of the project;
2. Exceed the performance requirements of one or more credits; and/or
3. Address additional aspects of sustainability not currently recognized in Envision

Points for this credit are not calculated in the overall applicable points and, therefore, act as bonus points. Given the nature of the credit, the broad format of which is intended to encourage creative infrastructure solutions, thorough documentation is expected. Project teams may pursue more than one of the three possible options for this credit, or pursue multiple for the same option, for a total of up to ten (10) bonus points.

PERFORMANCE IMPROVEMENT

Innovation:

To qualify for innovation points, projects must implement innovative methods, resources, technologies, or processes (e.g., the use of a pre-existing technology in a new way or the successful application of a technology or methods in regions or locales where existing policies, regulations, or general opinion have prevented their use). In these circumstances, it is imperative to prove that the application of the technology does, and will continue to, meet performance expectations

and that it does not have a corresponding negative impact on the local or global environment, economy, or community.

Projects may demonstrate they implement innovative methods, technologies or processes in several ways:

- The project is an early adopter of new technology or methods that can demonstrably improve project performance without negative trade-offs;
- The project uses technologies or methods that may be general practice in other regions or parts of the world, but within the context of the project (whether climate, regulations, policies, political support, public opinion, etc.) have not yet gained acceptance. Significant efforts are taken to demonstrate the effectiveness of the technology or method within the context and provide a precedent for future adoption.
- The project team takes significant steps to include research goals within the project's development, or work with a university or research organization to advance the general knowledge of the profession. Proprietary research that is not made publicly available cannot count toward achieving this credit.

Project teams must also demonstrate that the innovation serves a purpose. This can be done in one of two ways:

- Overcoming significant problems, barriers, or limitations— Project teams demonstrate that the innovation reduces or eliminates significant problems, barriers, or limitations that previously hampered the use of the new methods, technologies, or processes implemented on the project.

- Creating scalable and/or transferable solutions—Project teams demonstrate that new methods, technologies, or processes implemented on the project are scalable across a wide range of project sizes and/or are applicable and transferable across multiple kinds of infrastructure projects in multiple sectors.
- Managing urban heat island effects through significant shading, or SRI requirements for both vertical and horizontal hardscape areas.
- Anticipating and addressing security risks from quantum computing.

Exceptional Performance:

To qualify for exceptional performance points, projects must meet the highest level of achievement for one or more Climate and Resilience credits. For example, projects seeking additional points in credit CR1.1 Reduce Net Embodied Carbon must already be achieving at least a 50% reduction in total embodied carbon of materials over the life of the project. In this case, exceptional performance may be pursued by projects whose design and operations achieves a significantly higher percentage than the minimum called for in the Conserving level of achievement. Exceptional performance may not be pursued by projects that have a basic primary function that meets the requirements (e.g., a decommissioning project).

Possible areas of achievement in exceptional performance for Climate and Resilience may include, but are not limited to, the following:

- Projects that exceed 50% reductions in net embodied carbon;
- Projects that go beyond carbon negative to become large-scale carbon sinks for greenhouse gas emissions;
- Projects for which climate change preparedness and resilience is critical for protecting public safety, availability of services, or long-term community finances at a scale beyond project boundaries (e.g., including long-term weather prediction in levees protecting communities).

Address Additional Aspects of Sustainability:

To qualify for bonus points under this approach, project teams must demonstrate that they are addressing one or more aspects of sustainability not currently recognized in Envision. Sustainability performance must be related to Climate and Resilience. Addressing an aspect of sustainability not currently covered by the Envision system might sometimes be considered innovative, in which case the requirements for the Innovation path may be followed. For example, a project may earn bonus points for:

EVALUATION CRITERIA AND DOCUMENTATION GUIDANCE

A. To what extent does the project implement innovative methods, technologies, or processes that overcome significant problems, barriers or limitations, or create scalable and transferable solutions?

1. *Documentation of the application of innovative technologies or methods. Detailed description of how this application will improve existing conventional practice either globally or within the unique context of the project. Provide justification as to why this application should be considered innovative either as a technology, a method, or within the project context (climate, political, cultural, etc.).*
2. *Documentation that the project reduces or eliminates significant problems, barriers, or limitations that previously hampered the use or implementation of certain resources, technologies, processes, or methods that improve the sustainability of the project. Alternatively, documentation that the new methods, technologies, or processes implemented on the project are scalable across a wide range of project sizes and/or are applicable and transferable across multiple kinds of infrastructure projects in multiple sectors.*

B. To what extent does the project exceed the highest levels of achievement for a given credit?

1. *Detailed documentation of how the project exceeds the existing requirements currently within a given Climate and Resilience credit.*

C. To what extent does the project address a sustainability aspect that is not currently addressed by the Envision system?

1. *Detailed documentation of how the project addresses a sustainability aspect that is not currently addressed by the Envision system.*
2. *Documentation showing how this aspect relates to the Climate and Resilience category.*

Glossary

ACTIVE REMEDIATION

Methods that trap and remove contamination from the site. Examples include soil vapor extraction or “pump and treat” methods.

ADAPTATION

The collective set of actions taken to respond to climate change and variability. These actions include alterations in behavior and changes in the use of resources and the application of technologies.

AFFECTED COMMUNITY

Any community that may experience positive or negative effects from the project’s design, planning, construction, operation, or demolition. This may include communities beyond the host or benefited communities.

AQUIFER

A permeable geological formation, group of formations, or part of a formation that contains sufficient saturated permeable material to yield significant quantities of water to wells and springs.

ASHRAE

A global building technology society. ASHRAE was formerly called the American Society of Heating, Refrigerating and Air Conditioning Engineers.

BACKSLIDING

The process by which sustainability performance of a given system is degraded, resulting from failure to follow the specified operations and maintenance procedures needed to maintain performance, using conventional but more familiar procedures instead.

BENCHMARK

A standard by which something can be measured or judged. For Envision, instructions for identifying “benchmarks” are provided in the front of the manual.

BEST MANAGEMENT PRACTICE (BMP)

A technique, process, activity, or structure used to reduce the pollutant content of a stormwater discharge. They include simple, nonstructural methods such as good housekeeping and preventive maintenance and also may include structural modifications such as the installation of bioretention measures. Best management practices are most effective when used in combination with each other and customized to meet the specific needs (drainage, materials, activities, etc.) of a given operation. Best management practices also can function as treatment controls.

BIOAVAILABILITY

The fraction of a substance existing in the environment that reaches and can be absorbed

by living systems. “Bioavailability” refers to the difference between the amount of a substance such as a drug, herb, or chemical to which a living system is exposed and the actual dose of the substance the living system receives. Bioavailability accounts for the difference between exposure and dose.

BIODIVERSITY

The degree of variation of life forms in an environment such as an ecosystem or biome. Biodiversity is one measure of the health of ecosystems. Biological diversity can include species diversity, ecosystem diversity, and genetic diversity.

BIOME

A significant regional or global community produced or caused by living organisms, such as a grassland or desert, characterized chiefly by the dominant forms of plant life and the prevailing climate.

BIORETENTION

The process in which contaminants and sedimentation are removed from stormwater runoff. Stormwater is collected into the treatment area, which consists of a grass buffer strip, sand bed, ponding area, organic or mulch layer, planting soil, and plants.

BMP

See “best management practice”.

BPS

See “byproduct synergy”.

BROWNFIELDS

Former industrial and commercial sites typically containing low levels of environmental pollution such as hazardous waste or industrial byproducts. Brownfield sites have the potential to be reused once they are cleaned up, but cleaning the contamination may pose regulatory and monetary challenges. Brownfield sites are typically located in areas with existing infrastructure and/or transportation, which makes them more sustainable sites for development than greenfield sites.

BUFFER ZONES

An area that lies between two or more other areas to segregate them to enhance the protection of areas under management, typically for the importance of their biodiversity. Buffer zones may be around the periphery of an area or may connect two or more protected areas. Buffer zones are intended to mitigate negative environmental or human influences in areas of greater ecological value.

BYPRODUCT SYNERGY (BPS)

The matching of undervalued waste or byproduct streams from one facility with potential uses at

another facility to create new revenues or savings with potential social and environmental benefits. The resulting collaborative network creates new revenues, cost savings, energy conservation, reductions in the need for virgin-source materials, and reductions in waste and pollution, including potentially climate-changing emissions. These are quantifiable benefits to the environment, economy, and communities.

CARBON DIOXIDE EQUIVALENT (CO₂E)

A measure used to compare the emissions of different greenhouse gases based on their global warming potential.

CARBON SEQUESTRATION

The capture of carbon dioxide, including its removal from the atmosphere and deposit in a reservoir. This long-term storage of carbon dioxide can help mitigate or defer global warming, avoid climate change, and slow the atmospheric and marine accumulation of greenhouse gases.

CHANGING DESIGN VARIABLES

Projects delivered according to design standards and methodologies that are not in alignment with changing environmental or operating conditions or other concerns.

CIRCULAR ECONOMY

An alternative to a traditional linear economy (make, use, dispose) in which resources are kept in use for as long as possible, the maximum value extracted from them whilst in use, and then recovered and regenerated into new products and materials at the end of each service life.

CLIMATE

The average weather or the statistical description in terms of the mean and variability of relevant quantities over a period of time. The relevant quantities are most often surface variables such as temperature, precipitation, and wind.

CLIMATE CHANGE

A change in the state of the climate that persists for an extended period, typically decades or longer. Climate change may result from natural factors such as changes in the sun's intensity or slow changes in the earth's orbit around the sun; natural processes within the climate system (e.g., changes in ocean circulation); human activities that may have the potential to change the atmosphere's composition (e.g., through burning fossil fuels); and the land surface (e.g., deforestation, reforestation, urbanization, desertification, etc.).

COMMUNITY

See "host community" and "affected community".

CONCRETE SUSTAINABILITY COUNCIL (CSC)

The Concrete Sustainability Council (CSC) is a global initiative running a responsible sourcing certification system for concrete, cement & aggregate. The CSC system provides insight about to which level a company is operating in an environmentally, socially and economically responsible way. The CSC certification covers raw materials, their source or origin; the concrete manufacturing process and a range of social and environmental matters.

Certificate holders demonstrate responsible sourcing. The independent certification system awards concrete at Bronze, Silver, Gold and Platinum level. The certificate also applies to aggregates, cement and cementitious materials. The concrete certificate is a weighted average of the scores in the supply chain of the producer and the score of the concrete producer himself. The scope of certification are concrete plants, cement plants and quarries and aggregate quarries. The product certified is the concrete supplied from a plant.

CONFIGURATION TRAP

Characteristics built into an infrastructure project that create configurations that are highly vulnerable to extreme weather events, natural disasters, or economic conditions.

COST BENEFIT ANALYSIS

A widely used, well-documented methodology for assessing the net economic effects of investments or policies.

DARK SKY

The night sky without artificial light pollution.

DECONSTRUCTION

Selective dismantling of building components, typically for reuse, recycling, and waste management. Differs from "demolition", whereby a site is cleared by the most expedient means, which creates significant waste and does not recapture the value of building components.

DISASSEMBLY

Dismantling or taking something apart. In this context, similar to "deconstruction", implying the maintenance of subsequent parts for value extraction through reuse or recycling. Differs from "deconstruction", in which building or construction are not designed to be taken apart. Disassembly is used when the system, building, or construction are designed to be taken apart.

DURABILITY

The ability to resist wear and decay. Implies a longer life cycle, reducing the need for replacement with new goods and waste from worn-out goods.

ECONOMIC DEVELOPMENT

Efforts that seek to improve the economic wellbeing and quality of life for a community by creating and/or retaining jobs and supporting or growing incomes and the tax base.

ECOSYSTEM

A system that includes all living organisms (biotic factors) in an area as well as its physical environment (abiotic factors) functioning together as a unit. An ecosystem's abiotic (non-biological) constituents include minerals, climate, soil, water, sunlight, and all other nonliving elements; its biotic constituents consist of all of its living members.

EMBODIED CARBON

The sum of greenhouse gas emissions for a material or product that was used in the production of the material or product, including raw material extraction, transport, manufacture, and all the undertaken processes until the material or product is completed and ready.

ESCP

Erosion and Sedimentation Control Plan

FLEXIBILITY

Ability of a system to adapt itself to new circumstances, enabling easy reconfiguration and refurbishment, increasing the possibilities for alternative future uses, and, as a result, allowing the system to extend its useful life.

FLOODPLAIN

Flat or nearly flat land adjacent to a stream or river that experiences flooding during periods of high discharge. Floodplains are formed by the natural meandering and flooding of streams and rivers and represent areas likely to experience regular flooding.

GLOBAL WARMING

Global warming is an average increase in the temperature of the atmosphere near the earth's surface and in the troposphere (i.e., lowest layer of the atmosphere). Global warming can occur from a variety of natural causes and may also be human induced. Global warming represents one aspect of climate change.

GLOBAL WARMING POTENTIAL (GWP)

An index based on the radiative characteristics of well-mixed greenhouse gases; represents the combined effect of the differing times these gases remain in the atmosphere and their relative effectiveness in absorbing outgoing infrared radiation. Approximates the time-integrated warming effect of a unit mass of a given greenhouse gas in today's atmosphere relative to that of carbon dioxide.

GREENFIELD

Undeveloped land in a city or rural area being considered for urban development. May contain natural landscape, natural amenities, or agricultural land.

GREENHOUSE GASES

Greenhouse gases are chemical compounds in the earth's atmosphere that absorb and emit radiation, which causes the greenhouse effect that affects regulation of the earth's temperature. Water vapor (H₂O), carbon dioxide (CO₂), nitrous oxide (N₂O), methane (CH₄), and fluorinated gases.

GREENHOUSE EFFECT

The earth's surface absorbs solar radiation and emits infrared radiation. Some of the infrared radiation passes through the atmosphere and some is absorbed and re-emitted in all directions by greenhouse gases. This effect helps regulate the temperature of the earth's surface and the lower atmosphere. Increases in these gases raise the heat trapped in the earth's surface and atmosphere.

GREYFIELD

Previously developed land. Distinct from brownfields in that they typically do not require remediation to redevelop, but offer value through existing infrastructure and by minimizing the environmental impact on greenfields.

HABITAT

An ecological or environmental area that is inhabited by a particular species of animal, plant, or other organism. It is the natural environment in which an organism lives or in which a species population influences and is utilized by.

HEAT ISLANDS (HEAT ISLAND EFFECTS)

An area that is significantly warmer than its surrounding rural areas because of materials that cause heat accumulation and lack of vegetation, which cools through evapotranspiration. It can increase the need for air conditioning and other forms of cooling that require energy.

HOST COMMUNITY

The community in which the project is located.

HYDROLOGIC CYCLE

The continuous movement of water on, above, and below the surface of the earth and throughout various states of liquid, vapor, and solid.

INDUSTRY NORMS

Current industry regulatory and/or operational standards for a particular industrial activity.

INFRASTRUCTURE

Infrastructure projects deliver the technical and physical structures (roads, bridges, water supplies and treatment works, dams, and more) required to support the community economy and contribute to the wellbeing of a community. Typically, they are expected to last 30–70 years, depending on the type of structure and how it is maintained. Infrastructure performance efficiency and effectiveness depend to a large degree on their fit and harmony with other elements of infrastructure and their collective ability to adapt to change.

INFRASTRUCTURE TRAPS

Characteristics built into an infrastructure project that may create difficult conditions within the life of the constructed works, such as excess consumption of money, energy, or increased vulnerability to changing conditions. The three types of infrastructure traps are resource traps, configuration traps, and standards traps.

INTEGRATED PEST MANAGEMENT (IPM)

An effective and environmentally sensitive approach to pest management that relies on a combination of common-sense practices. Integrated pest management programs use comprehensive information on the life cycles of pests and their interaction with the environment. This information, combined with available pest control methods, is used to manage pest damage by the most economical means and with the least possible hazard to people, property, and the environment.

INTEGRATED PROJECT DELIVERY

A project delivery approach that integrates people, systems, business structures, and practices to collaboratively harnesses the talents of all participants early in a project's conceptualization and design to optimize results and maximize efficiency.

KARST TOPOGRAPHY

A geologic formation such as limestone or dolomite that is shaped by the dissolution of layers of bedrock. Karst regions often display distinctive surface features such as sinkholes or caves, and may have limited surface water because of subterranean drainage.

KEY STAKEHOLDERS

Those people who are directly influential to, or will be directly influenced by, the outcome of the project and whose input must be taken into account if the process is to be considered complete and transparent.

LIFE-CYCLE ASSESSMENT (LCA)

A technique to assess environmental impacts associated with all stages of a product's life, from raw material extraction through disposal or recycling.

LIFE-CYCLE COST ANALYSIS (LCCA)

One of several evaluation techniques commonly used to compare and evaluate the financial feasibility of various design alternatives over an assumed service life-cycle including primarily initial capital costs and operations and maintenance costs.

LOW-IMPACT DEVELOPMENT (LID)

A method for managing Stormwater runoff emphasizing conservation and the use of onsite natural features to protect water quality. Low-impact development uses small-scale controls to replicate the pre-development hydrologic regime of watersheds through infiltrating, filtering, storing, evaporating, and detaining runoff close to its source.

MITIGATION HIERARCHY

A structure that guides users in prioritizing and limiting as far as possible the negative impacts from development projects.

OFFICIAL(S) WITH JURISDICTION

The official or officials with authority over the location or system that is affected by the project.

ONE WATER

The recognition that all water has value and is part of a natural water cycle that continually recirculates.

PASSIVE REMEDIATION

Methods and improvements that stimulate or focus on natural attenuation in the ground

PERSISTENCE

The measure of resistance to degradation through chemical, biological, and photolytic processes of pesticides and other pollutants.

PEST

Organisms that cause problems in crops or livestock, compete with humans for food and fiber, or otherwise cause economic or other problems for humans. Pests include insects, nematodes, mites, plant pathogens, vertebrate pests, and weeds. Their distribution and economic effects depend on a wide range of factors that include changes in farming patterns and agroclimatic and ecological conditions.

PEST MANAGEMENT

Aims to manipulate pests and their environment in such a way as to maintain populations below levels that cause economic crop losses, thereby protecting crops from pest damage and/or destruction.

PLAN-DO-CHECK-ACT (PDCA)

"Management by fact" or scientific method approach to continuous improvement. Plan-do-check-act creates a process-centered environment involving the study of the current process, collection, and analysis of data to identify causes of problems, planning for improvement, and decisions regarding how to measure improvement ("plan"). The plan is then implemented on a small scale if possible ("do"). The next step is to determine what happened ("check"). If the experiment was successful, the plan is fully implemented ("act"). The cycle is then repeated using what was learned from the preceding cycle.

PRIMARY STAKEHOLDERS

Individuals or groups directly impacted by the project, such as the communities crossed and served by a new road. This should include stakeholders who could be impacted or affected by the project during its life-cycle.

PRIME FARMLAND

Land that has the best combination of physical and chemical characteristics for producing food, feed, forage, fiber, and oilseed crops and that is available for these uses. In the United States, the U.S. Department of Agriculture Natural Resources Conservation Service determines prime farmland. In Canada, it is classified by the Canadian Land Inventory (CLI).

PRIME HABITAT

The most ideal habitats for protecting wildlife biodiversity caused by their size, location, diversity

of habitat types, or presence of a particular type of habitat for plant or animal species.

PROJECT TEAM

Major decision makers involved in the project, as well as those who act as primary advisors, consultants, or specialists on behalf of decision makers. This will almost always include the project owner, those who act as lead designers (engineers, architects, landscape architects, etc.), and those who manage and execute the project through construction, but ideally would also include those responsible for funding, operating, regulating, subconsulting, or otherwise utilizing the project (e.g., community groups). Those with the responsibility and authority to implement sustainability efforts should coordinate to ensure their effectiveness. Envision users should take time to review the organizational hierarchy of the project in order to identify at which levels key decisions regarding project sustainability are being made. This will constitute the starting point of defining the project team.

PUBLIC SPACE

A social space such as a commons, town square, or public park that is open and accessible to the public.

RAINWATER HARVESTING

Accumulating and storing rainwater for reuse before it reaches the aquifer. This stormwater can be used for irrigation, flushing toilets, and other uses depending on the level of treatment. Rain collected directly from rooftops is referred to as “rainwater harvesting”; water collected from the ground is called “stormwater harvesting”.

RENEWABLE ENERGY

Energy that comes from natural resources such as sunlight, wind, rain, tides, and geothermal heat; these sources can be naturally replenished over short periods of time and do not diminish.

RESILIENCY

The ability to successfully adapt to and/or recover readily from a significant disruption.

RESOURCE AVAILABILITY (RISK)

Characteristics built into an infrastructure project that increase community dependence on resources that could become scarce and expensive.

SECONDARY STAKEHOLDERS

Individuals or groups indirectly affected by the project, such as; national and local government, public utilities, licensing and inspecting organizations that are not directly involved in the project.

SOCIAL CAPITAL

Structures, institutions, networks, and relationships that enable individuals to maintain and develop human capital; includes families, communities, businesses, educational and voluntary organizations, and legal and political systems.

SPILL PREVENTION, CONTROL, AND COUNTER-MEASURE (SPCC)

Includes requirements for oil-spill prevention, preparedness, and response to prevent oil discharges to navigable waters and adjoining shorelines.

SOLAR REFLECTANCE INDEX (SRI)

A measure of a material’s ability to reject solar heat, as shown by a small temperature rise, which incorporates both solar reflectance and emittance in a single value. Solar reflectance index is defined such that standard black (reflectance 0.05, emittance 0.90) is “0” and standard white (reflectance 0.80, emittance 0.90) is “100”.

STAKEHOLDER

A person, group, or organization that has a direct or indirect stake in an organization because it can affect or be affected by the organization’s actions, objectives, and/or policies. Key stakeholders in an infrastructure project may include the project owners, public works officials, the project design team, federal and local regulators, elected representatives, community groups, and members of the community directly affected by the project.

STEEP SLOPES

In general, land with a slope angle of 20% or greater.

STORMWATER

Water that originates during precipitation events. Stormwater that does not soak into the ground becomes surface runoff.

SURFACE WATER

Water collecting on the ground or in a stream, river, lake, wetland, or ocean that is naturally replenished by precipitation and lost through evaporation and subsurface seepage into the ground.

SUSTAINABILITY

A set of environmental, economic, and social conditions in which all of society has the capacity and opportunity to maintain and improve its quality of life indefinitely without degrading the quantity, quality, or availability of natural resources and ecosystems.

SUSTAINABILITY COST-BENEFIT ANALYSIS

An economic assessment methodology based on cost-benefit analysis used to quantify and measure the broader financial, social, and environmental benefits of the project. This may also be known as a triple bottom line costs benefit analysis (TBL-CBA) or sustainable return on investment (SROI).

SUSTAINABILITY MANAGEMENT PLAN

A plan or system for managing an organization’s environmental, social, and economic issues, priorities, and programs in a comprehensive and systematic manner. It serves as a tool for managing and improving sustainable performance. It is also the means by which an organization can address the impacts of its products, processes, and services on the environment and on society.

STORMWATER POLLUTION PREVENTION PLAN (SWPPP)

A plan for storm water discharge that includes erosion prevention measures and sediment controls that will decrease soil erosion and decrease off site nonpoint pollution.

TOXICITY

The degree to which a substance can damage living organisms.

TRIPLE BOTTOM LINE

The concept that business, traditionally concerned with the financial (economic) bottom line, should also be concerned with other performance metrics, such as environmental and social. The economic- environmental-social concept is often referred to as the “three pillars of sustainability”.

UNIQUE FARMLAND

Land other than prime farmland that is used for production of specific high-value food and fiber crops. It has the special combination of soil quality, location, growing season, and moisture supply needed to economically produce sustained high quality or high yields of specific crops when treated and managed according to acceptable farming methods. Examples of such crops include citrus, tree nuts, olives, cranberries, fruits, and vegetables.

UPCYCLING

The process of converting waste materials or unused products into new materials or products of better quality or a higher environmental value.

EPA

U. S. Environmental Protection Agency

VEGETATION AND SOIL PROTECTION ZONE (VSPZ)

The ground area that must be protected and incorporated into the overall landscaping of a site being subdivided or developed.

WASTE STREAMS (SIGNIFICANT WASTE STREAMS)

The flow of varied types of waste from the point of generation to final disposal (i.e., landfill). Can be used to describe waste materials that are either of a particular type (e.g., paper waste stream) or produced from a particular source (e.g., construction waste stream).

WAYFINDING

Means of orienting oneself in the physical environment and navigating from place to place using signs, maps, and other graphic or audible methods.

WELLHEAD PROTECTION AREA

According to the U.S. Environmental Protection Agency, the surface or subsurface area surrounding a water well or wellfield supplying a public water system through which contaminants are reasonably likely to move toward and reach such the well or wellfield; a groundwater recharge area for a well.

WETLAND

An area of land where the soil is saturated with water, either permanently or seasonally. Wetlands are typically categorized by characteristic vegetation and provide a unique ecosystem for flora and fauna that may not be found in other ecosystems.



Washington, DC 20005
www.sustainableinfrastructure.org