

Common Structural Rules for Bulk Carriers

Status and Guidance



Our Mission

The mission of ABS is to serve the public interest as well as the needs of our clients by promoting the security of life and property and preserving the natural environment.

Quality & Environmental Policy

It is the policy of ABS to be responsive to the individual and collective needs of our clients as well as those of the public at large, to provide quality services in support of our mission, and to provide our services consistent with international standards developed to avoid, reduce or control pollution to the environment.

All of our client commitments, supporting actions, and services delivered must be recognized as expressions of quality. We pledge to monitor our performance as an ongoing activity and to strive for continuous improvement.

We commit to operate consistent with applicable environmental legislation and regulations and to provide a framework for establishing and reviewing environmental objectives and targets.



CSR for Bulk Carriers Advisory

Introduction	2
Definition of Bulk Carriers	3
CSR-BC Class Notations	3
Design Loading Conditions	6
Basic Design Parameters	7
Loading Instrument.....	8
Multiple Port Conditions and Block Loading Conditions.....	9
Ballast Holds and Adjacent Ballast Tanks in Heavy Ballast Conditions	11
Steel Mill Products in Flooded Conditions.....	12
Additional Class Notation GRAB[X]	15
Ballast Water Exchange Procedures.....	16
FE Mesh Size and Critical Area Screening.....	18
CSR-BC Fatigue Criteria Change	19
Weld Toe Grinding and Heavy Duty Work on Double Bottom.....	20
Tapering Procedure at Ends.....	20
FEA Procedure for Aft and Foremost Cargo Holds.....	21

Introduction

The Common Structural Rules for Bulk Carriers (CSR-BC) were adopted in December 2005 and came into force on 1 April, 2006. It was an important step in the development of maritime rules. For the first time, comprehensive structural rules have been unified across the International Association of Classification Societies (IACS) combining the knowledge, vast experience, latest practical and technical knowledge, and the state-of-the-art technology embodied by its members. The rules were developed with the aim of providing more transparency. The technical background is posted on the IACS website. Several corrigenda and revisions to the rules have been issued. The CSR Tracking Database (www.iacs-csrtrack.org.uk) provides an easy and quick access to the full revision history of the CSR Rules. The CSR Knowledge Center (KC) contains common interpretations as well as questions and answers concerning the rules in order to assist classification societies and the marine industry in implementing the CSR rules in a consistent manner.

This reference document has been compiled to provide useful information on certain common questions and issues raised by ship-owners and operators over the past several years.

At the time this document was prepared, the draft version (July 2012) of the harmonized Common Structural Rules (CSR-H) for bulk carriers and oil tankers had been released for external review. Therefore, references are also made to certain information from CSR-H where appropriate.

There are 16 sections in this Advisory, each of which is largely an independent and self-contained topic. Contents range from class notations to detailed stress analysis.

This document is not intended as a substitute for the CSR-BC.

Table 1 presents a summary of the ABS CSR bulk carrier fleet at the time of publication. Detailed information on class notations can be found beginning on page 3.

Table 1. Summary of ABS CSR Bulk Carrier Fleet

Service Feature	Number of Ships
CSR Bulk Carriers	530
By Configuration	
Single Side Skin Bulk Carriers	507
Double Hull Bulk Carriers	23
By GRAB Notations	
Notation GRAB[20]	397
Notation GRAB[25]	101
Notation GRAB[30]	32
By BC Notations	
Notation {BC-A}	530
Notation {BC-B}	0
Notation {BC-C}	0
Notation {no MP}	0
Maximum Cargo Density < 3 (t/m ³)	0

Abbreviations used in this document:

CSR	Common Structural Rules
CSR-BC	Common Structural Rules for Bulk Carriers
CSR-H	Harmonized Common Structural Rules
CSR-OT	Common Structural Rules for Double Hull Oil Tankers
FE	Finite Element
FEA	Finite Element Analysis
IACS	International Association of Classification Societies
IMO	International Maritime Organization
KC	Knowledge Center
RCN	Rule Change Notice
UR	IACS Unified Requirement
UI	IACS Unified Interpretation

Definition of Bulk Carriers

There are several definitions of bulk carriers in different IACS and IMO publications. SOLAS contains the broadest definition of a bulk carrier (thus a wider application), while the CSR definition is more restrictive.

CSR-BC, Chapter 1, Section 1 [1.1.2] defines bulk carriers as seagoing self-propelled ships which are generally constructed with single deck, double bottom, hopper side tanks and topside tanks and with single or double side skin construction in the cargo length area, and intended primarily to carry dry cargoes in bulk (see Figure 1). Hybrid bulk carriers, where at least one cargo hold is constructed with a hopper tank and topside tank, are covered by CSR-BC. The structural strength of members in holds constructed without a hopper tank and/or topside tank must comply with the strength criteria defined in CSR-BC.

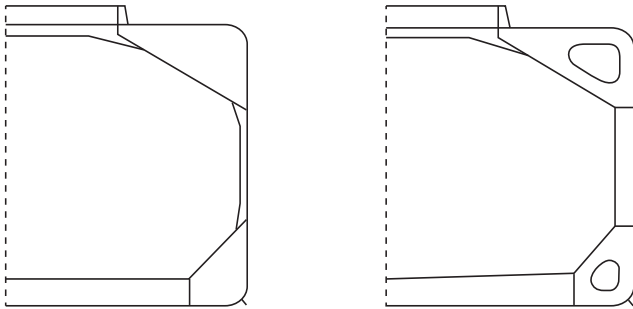

Figure 1. Typical Arrangements of CSR Bulk Carriers

The CSR KC has provided further interpretation on the definition of bulk carriers. Per the Knowledge Center, CSR is not applicable to ore, combination, cement, wood chip or self-unloading bulk carriers. Furthermore, open configuration or box-type bulk carriers are not required to comply with CSR-BC, and examples of such configurations are shown in Figure 2.

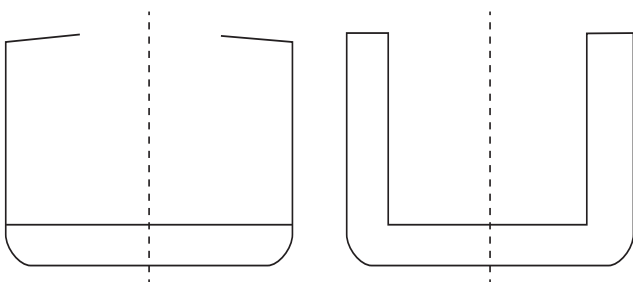

Figure 2. Arrangements of Box-type Bulk Carriers

SOLAS Chapter XII, “Additional Safety Measures for Bulk Carriers,” defines a bulk carrier as “a ship which is intended primarily to carry dry cargo in bulk, including such types as ore carriers and combination carriers” and makes reference to a number of resolutions. IMO Resolution MSC.277(85) titled “Clarification of the term ‘Bulk Carrier’” contains guidance for application of regulations in SOLAS to ships which occasionally carry dry cargoes in bulk and are not determined as bulk carriers in accordance with Regulation XII/1.1 and Chapter II-1.

UR Z11.2.2 contains the same definition as CSR-BC. Other Unified Requirements (URs) for the strength of ships refer to the UR Z11 definition but apply to subsets depending on cargo density, length and side arrangement. This Advisory focuses on CSR bulk carriers. However, certain topics may also be of interest for owners of non-CSR bulk carriers.

CSR-BC Class Notations

Class notations are assigned to vessels to signify the applicable mandatory and optional Rule requirements.

There are three primary class notations for a CSR bulk carrier: BC-A, BC-B and BC-C. These class notations are assigned based on the service features of dry bulk cargo densities and cargo hold loading patterns. BC-A, BC-B and BC-C bulk carriers achieve high, intermediate and low robustness levels of service features, respectively.

BC-A is the most robust and common class notation of the three. Ships designed with a BC-A class notation are intended to carry dry bulk cargoes with a density of 1.0 t/m^3 or above in homogeneous, alternate and where applicable block loading conditions. Empty holds are allowed at the maximum draught for BC-A vessels.

Ships designed with a BC-B class notation are intended to carry homogeneous dry bulk cargoes with a density of 1.0 t/m^3 or above. BC-A and BC-B vessels may also carry cargoes with density below 1.0 t/m^3 .

BC-C is the least robust class notation. Ships designed with BC-C class notation are intended to carry homogeneous dry bulk cargoes with a maximum cargo density less than 1.0 t/m^3 .

Table 2. Applicable Service Features of Primary Class Notations

Applicable Service Features	Primary Notations		
	BC-A	BC-B	BC-C
Rubustness Level	High	Intermediate	Low
Cargo Density (t/m ³)	≥ 1.0	≥ 1.0	< 1.0
Homogeneous Load (at maximum draught)	Yes	Yes	Yes
Alternate Load (at maximum draught)	Yes	No	No
Block Load (at maximum draught)	Yes	No	No
Multiple Port (at maximum draught)	Yes	Yes	Yes

Neither BC-B nor BC-C ships allow empty holds at the maximum draught of cargo conditions, but they do allow empty holds at a shallow draught of cargo conditions if loading and unloading in multiple ports is a service feature of the ship.

Table 2 compares the applicable service features of the three primary class notations. In addition to the three primary class notations, there are four more class notations that place limitations on bulk carrier designs:

- **{allowed combination of specified empty holds} for BC-A ships:** it specifies which cargo holds can be empty in alternate loading conditions.
- **{maximum cargo density (in t/m³)} for BC-A and BC-B ships:** it signifies the maximum cargo density if it is less than 3.0 t/m³.

- **{no MP} for BC-A, BC-B and BC-C ships:** it is assigned to a ship that has not been designed for loading and unloading in multiple ports. Loading and unloading in multiple ports are assumed permissible unless this class notation is assigned.
- **GRAB[X] mandatory for BC-A and BC-B ships:** it indicates an unladen grab weight up to X tons. The minimum grab weight is 20 tons for this class notation.

Table 3 shows the applicability of the additional class notations. There is no additional class notation to be assigned for a maximum cargo density greater than 3.0 t/m³ in CSR-BC. CSR-H (draft version) contains a change to this. As long as a design cargo

Table 3. Applicability of Additional Class Notations

Additional Class Notations	Primary Class Notations		
	BC-A	BC-B	BC-C
{Allowed Combination of Specified Empty Holds}	Yes	No	No
{Maximum Cargo Density (t/m ³)}	Yes	Yes	No
{No MP}	Yes	Yes	Yes
GRAB[X] (mandatory or not)	Yes	No	No



density is different from 3.0 t/m³ for a BC-A or BC-B ship, the maximum density of the cargo that the ship is allowed to carry is to be indicated in a class notation, which can be in the form of {allowed combination of specified empty holds with maximum cargo density x.y t/m³} for a BC-A vessel, or {maximum cargo density x.y t/m³} for a BC-B vessel. The cargo density to be used for strength assessment is to be the maximum cargo density in this case.

A typical notation of a CSR vessel classed with ABS may contain the following class symbols and notations:

✘A1, Bulk Carrier, BC-A (Hold Nos. 2, 4 and 6 may be empty), (E), ✘AMS, ✘ACCU, TCM, GRAB(20), CSR, AB-CM, POT, PMA, RRDA, ESP, UWILD, CRC, PMP where:

✘A1 indicates that the hull and equipment have been built under ABS survey in accordance with the hull requirements of the ABS rules or their equivalent for unrestricted ocean service.

✘AMS indicates that machinery has been built under ABS survey in accordance with the ABS Rules.

(E) indicates that the equipment of anchors and chain cables is in compliance with the requirements of the Rules.

✘ACCU, or Automatic Centralized Control Unmanned, is assigned to a vessel having the means to control and monitor the propulsion-machinery space from the navigation bridge and from a centralized control and monitoring station installed within or adjacent to, the propulsion machinery space.

TCM, or Tailshaft Condition Monitoring, is assigned to vessels with tailshafts specifically arranged with oil-lubricated stern tube bearings, complying with the requirements of the *ABS Guide for Classification Notation Tailshaft Condition Monitoring (TCM)*.

CSR, AB-CM is assigned to vessels designed and built to the requirements of CSR, and in compliance with Appendix 5C-A2, ABS Construction Monitoring Program of the *ABS Rules for Building and Classing Steel Vessels*.

POT, or Protection of Fuel and Lubricating Oil Tanks, is assigned to vessels having an aggregate fuel oil capacity of 600 m³ (21,190 ft³) and above with fuel oil and lubricating oil tanks arranged in accordance with the requirements specified in 4-6-4/17.5 of the *ABS Rules for Building and Classing Steel Vessels*.

PMA is assigned to bulk carriers of 20,000 gross tonnage and over constructed on or after 1 January 2006 to signify that the vessel's means of access meets IMO Resolutions MSC.151(78) – "Adoption of Amendments to the International Convention for



the Safety Of Life At Sea, 1974” and MSC.158(78) – “Adoption of Amendments to the Technical Provisions for Means of Access for Inspections,” and the associated Unified Interpretation (UI) SC 191 for the application of amended SOLAS Regulation II-1/3-6 (Resolution MSC.151 (78)) and revised technical provisions for means of access for inspections (Resolution MSC.158 (78)).

RRDA is assigned to vessels which have been classed in compliance with the ABS *Guide for Rapid Response Damage Assessment*.

ESP, or Enhanced Survey Program, is mandatory for CSR Bulk Carriers and indicates that the vessels are in compliance with the specified survey requirements for the ESP notation in the ABS *Rules for Survey After Construction*.

CRC signifies that the vessel’s crane(s) is designed and constructed in accordance with Chapter 2 of the ABS *Guide for Certification of Lifting Appliances*. A Register of Lifting Appliances attesting to compliance with the requirements of the above Guide will be issued at the request of the owner or builder upon satisfactory completion of plan review, in-plant survey, installation and testing of the crane to the satisfaction of the attending surveyor. Alternatively, for vessels changing class to ABS and having a register issued by a recognized classification society or recognized cargo gear association, suitable evidence of previous design review is to be submitted.

PMP, or Preventive Maintenance Program, is assigned to vessels that are in compliance with the requirements for the Preventive Maintenance Program in the ABS *Rules for Survey After Construction*.

Design Loading Conditions

The design loading conditions required to be included in the loading manual are specified in CSR-BC, Chapter 4, Section 8. The “Standard Loading Conditions” listed in the tables in Chapter 4, Appendix 2 are intended for the strength assessment by direct strength analysis. The combinations of the loading patterns and the target still water bending moments in Chapter 4, Appendix 2 are rule design conditions that may not reflect realistic loading scenarios in operation, and so these loading conditions are not required to be included in the loading manual.

Short voyage conditions may involve reduced bunkers and increased cargoes weight such that the ship is loaded to the maximum draught. It is not mandatory to include the short voyage conditions in the loading manual if the ship is not intended to make short voyages. As a result, the ship will not be able to operate on short voyages with more severe loading conditions than those specified in the loading manual. If the owner requests specific loading conditions for short voyages which include short voyage conditions with more severe filling than the minimum loading condition mentioned

in CSR-BC, Chapter 4, Section 7 [2.1.1] and [2.1.4], the loading conditions should be included in the loading manual and the strength checks for such a severe loading condition be analyzed in accordance with the CSR-BC requirements.

For BC-A and BC-B ships, a cargo density of 3.0 t/m^3 is required as a design basis (Chapter 4, Section 7 [2.1]). Based on the design loading conditions specified in Chapter 4, Section 7, hold mass curves are to be created according to Chapter 4, Section 7 [3.7], which will control the loading and unloading of the vessel in operation. Unless the additional notation {maximum cargo density (in t/m^3)} is assigned, there is no limitation on cargo densities in operation as long as the maximum allowable cargo mass in each hold, still water bending moment and still water shear force are met. Readers can refer to IMO document “International Maritime Solid Bulk Cargoes (IMSBC) Code,” 2012 Edition, for cargo densities of various bulk cargo materials.

As previously stated in the CSR-BC Class Notations section, CSR-H is expected to change the approach for maximum cargo densities above 3.0 t/m^3 .

In the design specification, a clause can be added to require that all anticipated loading conditions are included in the loading manual. These may include, but are not limited to, the following conditions:

1. For BC-A bulk carriers, in addition to alternate loading of high density cargoes (density of 3.0 t/m^3) and homogeneous loading of lower density cargoes (0.9 t/m^3), there should also be alternate loading conditions in the loading manual, for example, densities of 1.3 t/m^3 and 1.78 t/m^3 , as these conditions with higher cargo loading heights can impose extra dry cargo loads on transverse bulkheads.
2. If cement load in alternate loading pattern will be carried in operation, it should be included in the loading manual. In such a case, bulkheads need to be assessed due to increased pressure loads from cement (25 degrees of angle of repose).

3. All possible severe block loading conditions should be included in the loading manual for BC-A vessels intended for block loading operations. For more information, see page 9.
4. If steel mill products are to be carried, a clause for adequate hull girder strength under flooded conditions should be included for hot coils and other steel mill products at a specified deadweight. For more information, see page 12.

Because CSR-H (draft version) requires strength assessment of the actual maximum cargo density, steel mill product loading should be covered, especially under flooded conditions.

Basic Design Parameters

The basic design parameters should be indicated in a vessel's design specification, including the general arrangement and midship section drawings. These generally include vessel dimensions (overall length, freeboard length, length between parpendiculars, scantling length, breadth, depth, design draught, scantling draught, block coefficient at scantling draught), design speed, displacement at scantling draught, deadweight at scantling draught, maximum

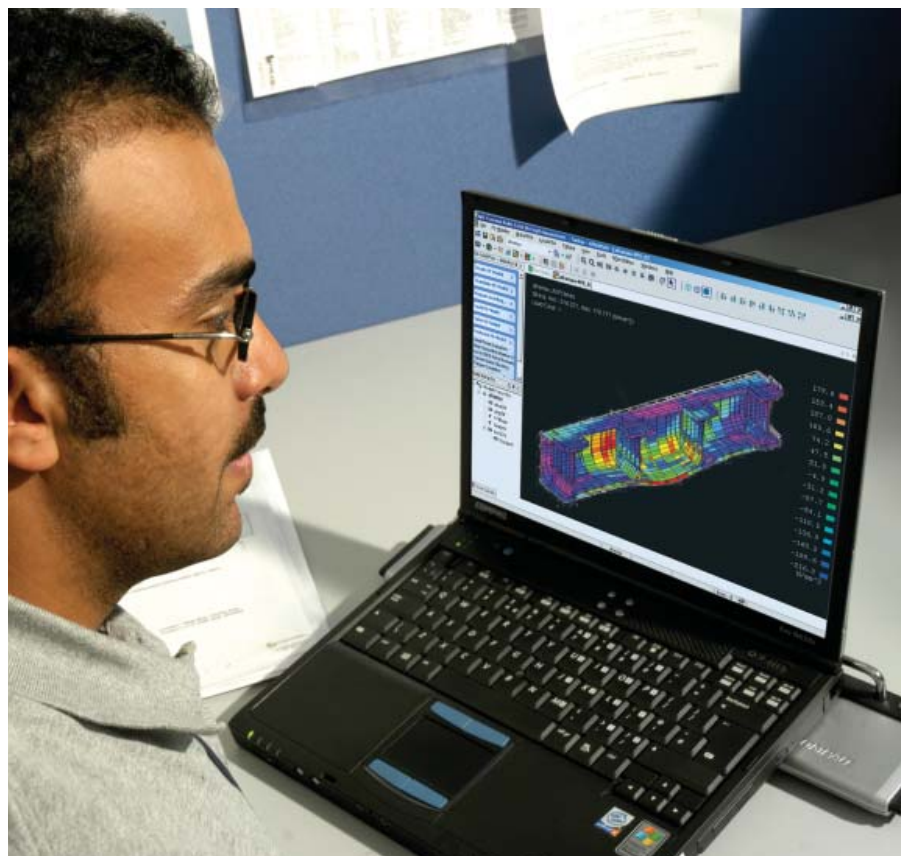



allowable still water bending moment and shear force for intact and flooded conditions, light and heavy ballast condition, ballast water exchange method, maximum cargo weight in each cargo hold, maximum load on inner bottom in each hold, maximum cargo density (if applicable), steel coil loading (if applicable), GRAB notation, etc. The smallest normal ballast draught at forward perpendicular should be indicated in the shell expansion drawing.

Loading Instrument

A loading instrument consists of software and hardware on which it runs. CSR-BC defines a loading instrument as “an instrument which is either analog or digital and by means of which it can be easily and quickly ascertained that, at specified read-out points, the still water bending moments, shear forces, in any load or ballast condition, do not exceed the specified permissible values.”

Bulk carriers of 150 m in length and upwards shall be fitted with a loading instrument capable of providing information on hull girder shear forces and bending moments (SOLAS Chapter XII, Regulation 11).

Bulk carriers of less than 150 m in length constructed on or after 1 July 2006 shall be fitted with a loading instrument capable of providing information on the ship's stability in the intact condition (SOLAS Chapter XII, Regulation 11).

CSR-BC, Chapter 4, Section 8 requires that for all ships, a loading instrument capable of checking the compliance of still water shear forces and bending moments in any cargo and ballast condition be provided. In addition, it requires that for BC-A, BC-B and BC-C ships of 150 m in length and longer, the loading instrument be capable of checking the still water shear forces and bending moments in flooded conditions as well as the mass of cargo and double bottom contents as a function of draught for a single hold and two adjacent holds.

The loading instrument may also be used to perform stability checks if it incorporates stability software. If stability software is installed on board vessels contracted on or after 1 July 2005, it should cover all stability requirements applicable to the vessel (as per UR L5) and is to be approved by ABS.

For vessels on a dedicated trade, the loading manual/trim and stability booklet may be developed to cover all anticipated loading conditions. In such a case, any additional loading conditions need to be verified for structural and stability compliance by submitting them to the flag Administration or Recognized Organization, unless such verification is permitted to be performed on board in accordance with the ABS approval letters and approved documents and software.



Figure 3. Multiple Port Conditions

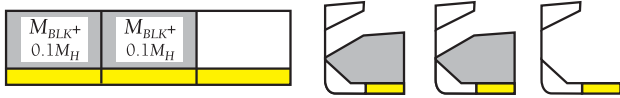

Figure 4. Block Loading Condition

Multiple Port Conditions and Block Loading Conditions

CSR-BC, Chapter 4, Section 7 specifies the loading conditions to be considered in the structural analysis. Multiple port conditions are specified in [3.3.3] and [3.3.4], and block loading conditions are specified in [3.4.3]. Chapter 4, Appendix 2 specifies standard multiple port and block loading conditions for direct strength analysis.

Although multiple port conditions and block loading conditions have similar loading patterns, i.e., they are both non-homogeneous cargo loading conditions with various alternate block loading patterns, it is important to understand that many differences exist between them per the definitions in CSR-BC.

General

- **Additional service features:** multiple port conditions are applicable to all three primary notations BC-A, BC-B and BC-C, while block loading conditions are only applicable to BC-A vessels.
- **Draughts:** multiple port conditions are partial load conditions defined at partial draughts which are fractions of the scantling draught T_s ($0.67 T_s$ and $0.75 T_s$ for maximum allowable and minimum required cargo hold masses, respectively), while block loading conditions are full load conditions defined at scantling draught T_s for maximum allowable cargo hold masses.
- **Loading patterns:** multiple port conditions can reflect two basic loading patterns, i.e., two adjacent cargo holds are loaded (Chapter 4, Section 7, [3.3.3]) and two adjacent cargo holds are empty (Chapter 4, Section 7, [3.3.4]), while block loading conditions only reflect one basic loading pattern, i.e., two adjacent cargo holds are loaded (Chapter 4, Section 7, [3.4.3]).

Strength Check

- **Application conditions:** all bulk carriers are to have multiple port conditions included in their loading manual unless the notation {no MP} is assigned to a vessel, i.e., when multiple port loading and unloading are allowed, while block loading conditions are required only if they are included in the loading manual of a BC-A vessel.
- **Cargo weights:** multiple port conditions use light cargo weight M_{FULL} , while block loading conditions use the actual heavy cargo masses M_{BLK} specified in the loading manual.
- **Cargo densities:** light cargo density is applied to multiple port conditions, while heavy cargo density is applied to block loading conditions.

As an example for the direct strength analysis, Figure 3 shows the two adjacent loaded and empty cargo holds of multiple port conditions, and Figure 4 below shows the two adjacent loaded cargo holds of a block loading condition. The cargo holds in the figures from the left to right-hand sides represent the holds from aft to forward in a three-hold length finite element model.

The combination of multiple port and block loading conditions leads to four possible cases, as shown in Table 4. The draughts, cargo hold masses and primary notations of the four cases can be found in Table 5.

T_{HB} in the table is the deepest ballast draught when the two adjacent holds are empty, and the T_E means that the draught depends on the envelope of Cases #2 and #3. Because the block loading conditions do not reflect the loading case of two adjacent empty holds, the minimum required cargo

Table 4. Combination Case Numbers

Block Loading {no MP}	Block Loading	
	Without	With
With	1	2
Without	3	4

Table 5. Details of Combination Cases

Case No.	Maximum Allowable Mass		Minimum Required Mass		Additional Service Features
	Draught	Mass	Draught	Mass	
1	T_S	M_{FULL}	T_{HB}	0.0	BC-A, BC-B, BC-C
2	T_S	M_{BLK}	T_{HB}	0.0	BC-A
3	$0.67 T_S$	M_{FULL}	$0.75 T_S$	0.0	BC-A, BC-B, BC-C
4	T_E	M_{BLK}	$0.75 T_S$	0.0	BC-A

hold masses are defined through heavy ballast condition and its draught T_{HB} as shown in the table.

Figure 5 combines cargo hold mass curves (not drawn to scale) of two adjacent holds in seagoing conditions for the four cases, and clearly demonstrates the cargo carrying capacities of the four cases. There are two curves for each case. The upper curve represents the maximum allowable cargo mass in the two adjacent holds, and the lower curve represents the minimum required cargo mass in the two adjacent holds. The higher the upper curve is, the higher the requirement is, and the lower the lower curve is, the higher the requirement is.

It can readily be seen from Figure 5 that:

- Case #1 Establishes the lowest strength requirements for both loaded and empty cargo holds.
- Case #2 Establishes the highest requirement for loaded cargo holds at scantling draught T_S , but its requirement of loaded cargo holds at $0.67 T_S$ may be lower than that of Case #3, and its requirement for empty cargo holds is the same as that in Case #1.
- Case #3 May establish the highest requirement of loaded cargo holds at $0.67 T_S$, and establishes the highest requirement for empty cargo holds.

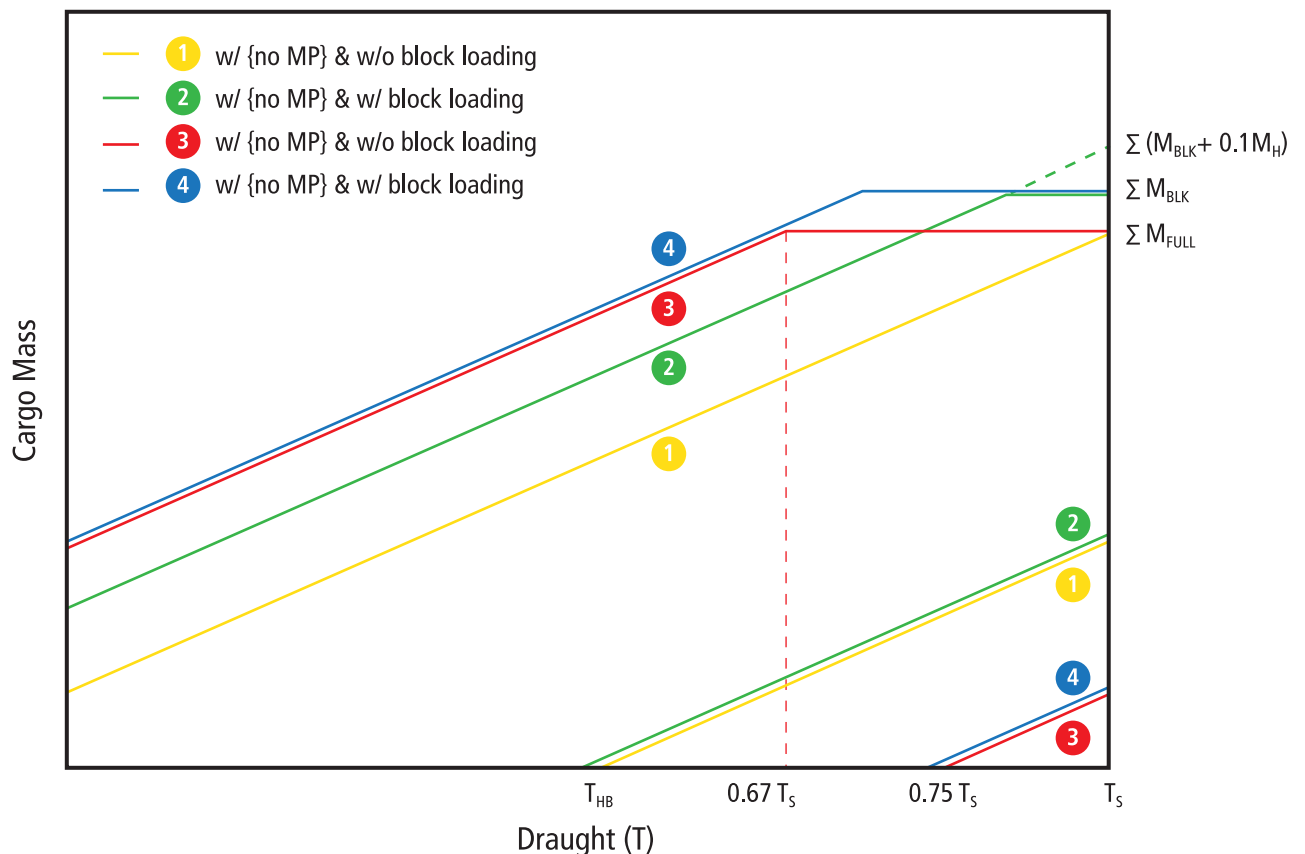

Figure 5. Cargo Hold Mass Curves in Seagoing Conditions



Case #4 Represents the envelope of Case #2 and Case #3. It establishes the highest requirements and thus the most robust cargo carrying capacity for both loaded and empty cargo holds. T_E in Table 3.2 is the draught corresponding to the knuckle point of the upper curve of Case #4.

It is apparent from the figure that Case #4 (without {no MP} and with block loading) establishes the most flexible designs.

Having this background information in mind, the owner should discuss with the designer at an early stage of design review to clarify intended operational flexibility of the vessel regarding such loading operations. For bulk carriers intended for multiple port loading and unloading operations, special attention is to be given to the description of notation {no MP}. For bulk carriers intended for block loading operations, the loading manual is to include all possible severe block loading conditions foreseen for operations. Chapter 4, Appendix 2 covers the standard multiple port and block loading conditions for direct strength analysis, which are intended to provide a design envelope for vessels that undertake multiple port and/or block loading operations.

The clauses in CSR-H related to multiple port loading conditions are the same as those in CSR-BC, while the design load cases have not been finalized at the time this document was prepared.

If the owners are contemplating short trips between loading and discharge ports, then the need for consumables, fuel oil and fresh

water, may be reduced. It is often possible to take advantage of less consumables and increase the cargo carrying capacity. Therefore, the hull structure may be better designed to carry the fully declared deadweight plus some additional cargo corresponding to a fraction, e.g., 50 percent, of the total consumable. In this situation, block loading conditions with full deadweight and short voyage provision should be specifically identified as the design loading conditions and included in the loading manual.

Block loading operation enhances the safety and flexibility in loading in association with additional strengthening. The combination of specified empty holds in the block loading conditions is to be indicated with the additional service feature, such as {holds 2, 5...may be empty}, {holds 1, 4...may be empty}, etc.

Ballast Holds and Adjacent Ballast Tanks in Heavy Ballast Conditions

CSR-BC, Chapter 4, Section 8 [2.2] specifies the “Conditions of approval” for a loading manual. [2.2.2] of the same section provides a list of the loading conditions to be included in a loading manual for ships equal to or greater than 150 m in length and with BC-A, BC-B or BC-C class notations. Special attention should be given to ballast holds under the following heavy ballast loading condition:

“For ships having ballast holds adjacent to topside wing, hopper and double bottom tanks, it shall be strengthwise acceptable that the ballast holds are filled when the topside wing, hopper and double bottom tanks are empty.”

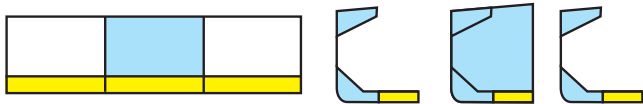

Figure 6. Adjacent Ballast Tanks Loaded

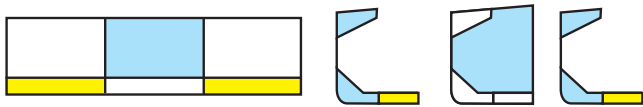

Figure 7. Adjacent Ballast Tanks Empty

This requirement reflects one of the “Design loading conditions for local strength” described in Chapter 4, Section 7 [3.5]:

“3.5.1 Cargo holds, which are designed as ballast water holds, are to be capable of being 100 percent full of ballast water including hatchways, with all double bottom tanks in way of the cargo hold being 100 percent full, at any heavy ballast draught. For ballast holds adjacent to topside wing, hopper and double bottom tanks, it shall be strengthwise acceptable that the ballast holds are filled when the topside wing, hopper and double bottom tanks are empty.”

The above quoted [3.5.1] implies two different heavy ballast conditions under the minimum heavy ballast draught(s) if the ballast hold is adjacent to the topside wing, hopper and double bottom tanks:

Condition A: The ballast hold is loaded with the adjacent ballast tanks loaded, as shown in Figure 6 of a three-hold length model with the ballast hold in the center.

Condition B: The ballast hold is loaded with the adjacent ballast tanks empty, as shown in Figure 7 of a three-hold length model with the ballast hold in the center.

Both loading conditions are included as “standard loading conditions for direct strength analysis” in CSR-BC Chapter 4, Appendix 2, Table 1 (mid-hold is the empty hold: No. 13 and 14); Table 3 (mid-hold is the loaded hold: No. 13 and 14); and Table 5 (BC-B and BC-C: No. 10 and 11). However, as stated in Remark 13 of Table 1, Remark 13 of Table 3 and Remark 11 of Table 5, loading condition B “is not required when such a condition is explicitly prohibited in the loading manual.” As a consequence, loading

condition B may not be considered in the design stage unless it is specifically requested by the owner.

Therefore, it is necessary for the owner to confirm with the designer in writing the design intent when such a loading condition is not included or prohibited in the loading manual. To further enhance the vessel’s operational flexibility, the heavy ballast conditions in the owner’s specifications should include both loading conditions A and B.

Steel Mill Products in Flooded Conditions

For the assessment of structural strength in CSR-BC, the carriage of various types of steel mill products (i.e., steel coils, steel slabs and steel billets) should ideally be considered in the details for:

- Hull-girder longitudinal strength requirements
- Local structural scantling requirements

Under:

- Intact conditions
- Flooded (damage) conditions

The loads of steel mill products largely depend on the variations of the loading patterns of steel mill products. Therefore, the handling of steel mill products involves more complicated factors than those of typical bulk cargoes (e.g., grains, cement and ore) in the structural strength assessment. This is particularly true when flooded conditions are involved.

For bulk carrier designs with scantling lengths equal to or greater than 150 m, the coverage of steel mill product carriage and its related flooded conditions need to comply with four categories of requirements in CSR-BC as given in Table 6.

Although the steel coil loading condition is specified in the CSR-BC sections (A and B in Table 4.1), and is normally included as a standard condition in the loading manual and stability information with damage longitudinal strength calculations as per UR S17 (hull-girder longitudinal strength under flooding conditions), other steel product loading conditions such as steel slabs and steel billets are not normally included in these manuals. The maximum allowable cargo

Table 6. Steel Mill Product Coverage in CSR-BC

Category		CSR-BC Selection	Description
Label	Requirement		
A	Hull-Girder Strength	Chapter 4, Section 3 [2.4.2]	Still water bending moment and shear force for steel mill product cargoes in flooded conditions (For BC-A, BC-B and BC-C ships).
		Chapter 5, Section 1 [5.3]	Permissible still water bending moment and shear forces in flooded conditions (For BC-A and BC-B ships).
B	Local Scantlings	Chapter 6, Section 1 [2.7]	Inner bottom and bilge hopper slope (or inner hull) plate requirements under steel coil cargo loadings in intact conditions.
		Chapter 6, Section 2 [2.5]	Inner bottom and bilge hopper slope (or inner hull) stiffener requirements under steel coil cargo loadings in intact conditions.
		Chapter 6, Section 4 [3.1]	Double bottom capacity and allowable hold loading in flooded condition.
C	Hold Mass Curves	Chapter 4, Appendix 1 [1.1.4]	Hold mass curves under steel coil or other heavy cargoes.
D	Loading Instruments	Chapter 4, Section 8 [3.1.2]	Assertion of still water bending moment and shear force in flooded conditions.

weight for these products is not normally registered in the loading manuals. There are instances where charterers request the loading of such cargoes to the full deadweight. However, if these cargo conditions are checked under damaged flooding criteria, as per UR S17, they may not comply with the hull-girder strength requirements, as the still water bending moment and shear force may exceed their permissible values for the flooded condition.

The problem of overloading is mainly due to the fact that dry cargoes with higher densities will generally result in higher amounts of ingress seawater during flooding. This unfavorable effect can be demonstrated through a comparison of two types of dry cargo cases in the same flooded cargo hold: a typical ore cargo; and a steel mill product cargo. In both cases, the total mass M_{TOTAL} in the cargo hold can be written as the sum of dry cargo mass M_{HD} and ingress seawater mass M_{WATER}

$$M_{TOTAL} = M_{HD} + M_{WATER}$$

And the seawater mass M_{WATER} can be expressed as:

$$M_{WATER} = \rho[V_{TOTAL} - (1-p) M_{HD}/\rho_C]$$

where ρ is seawater density, ρ_C is dry cargo density, p is dry cargo permeability, and V_{TOTAL} is the volume of the hold below the flooded line. According to CSR-BC, $\rho_C = 3.00 \text{ t/m}^3$ and $p = 0.3$ for ore cargo, and $\rho_C = 7.85 \text{ t/m}^3$ and $p = 0.0$ for steel mill product cargo.

It can be concluded from the above formulas that if the dry cargo mass (M_{HD}) is the same for the two cases, i.e., if the same amount of dry cargo weight is loaded into the hold for ore and steel mill products, the mass of the ingress seawater will be about $0.109 \cdot M_{HD}$ greater in the case of the steel mill product cargo. This extra amount of seawater can impose additional hull-girder scantling requirements.

Looking at this in another way, if the total mass (M_{TOTAL}) of cargo and flooding is to be the same for the two cases, there must be about 12.5 percent less dry cargo mass in the case of the steel mill product cargo. This means that if the hull-girder strength requirements under flooded conditions are based on typical ore cargo loading conditions, the steel mill product cargo cannot be loaded to the full deadweight.

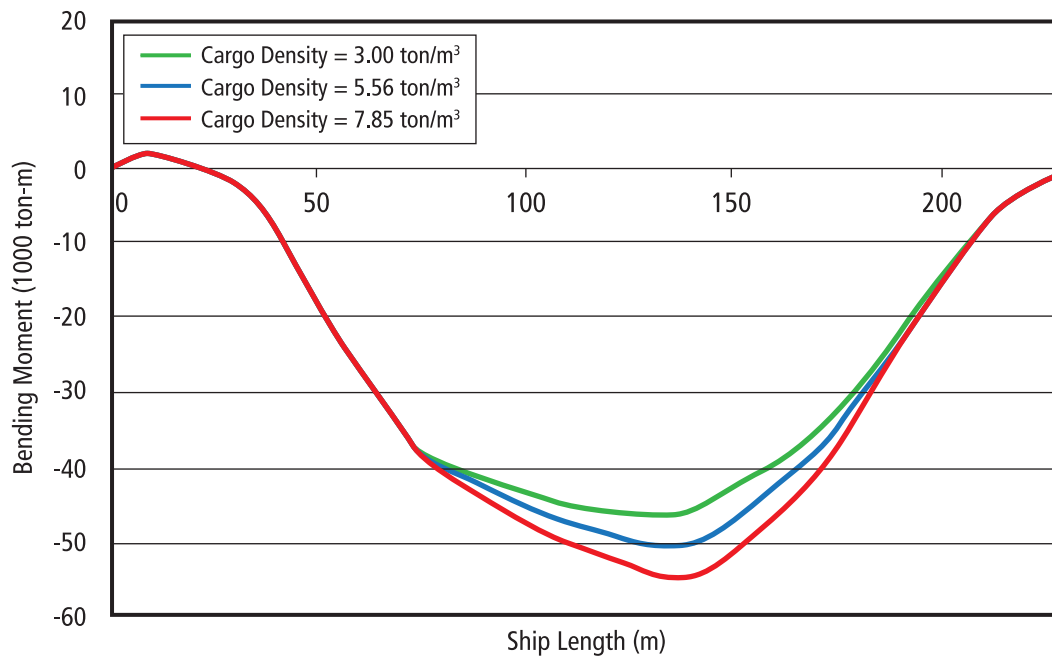

Figure 8. Sample Still Water Bending Moment Curves in a Flooded Condition

In some cases, loading manuals include instructions to the Master of the ship on how to assess strength using the onboard loading computer in flooded conditions for loading cases involving steel mill products. However, these are complicated calculations that cannot be easily performed on board by the Master of the ship.

In the design specifications, a clause for adequate hull girder strength can be included for the carriage of steel coils and steel mill products at maximum

deadweight. It will be highly beneficial for the design loop if curves are drawn depicting the increase of bending moments and shear forces after flooding as a function of the density of the dry cargo. Figure 8 and Figure 9 show the sample still water bending moment and shear force curves in a flooded condition for three different cargo densities. These curves are made under the assumption that the total cargo weights for different cargo densities remain the same.

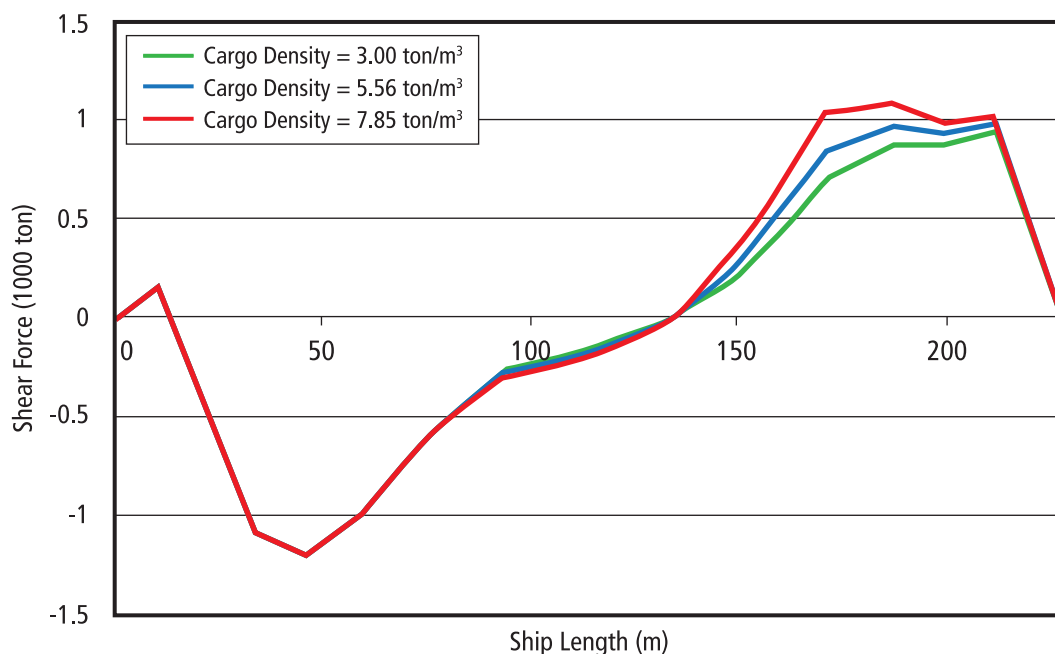

Figure 9. Sample Still Water Shear Force Curves in a Flooded Condition

It should be pointed out that, in addition to the hull girder strength requirement, the steel mill product loadings under flooded conditions may also govern the double bottom (floors and girders) strength requirement specified in Chapter 6, Section 4 [3.1] because of the excessive ingress water compared with the case of typical dry cargoes.

ABS has developed the Steel Coil Calculator Program that facilitates an easy and quick evaluation of the steel coil capacity for various combinations of coil size, weight and dunnage arrangement in accordance with CSR-BC. The program is available to shipowners, operators and designers upon request. Figure 10 shows a sample summary sheet of the program.

Additional Class Notation GRAB[X]

The application conditions of notation GRAB[X] are specified in Chapter 1, Section 1 [3.2.1], and the scantling requirements of GRAB[X] are covered in Chapter 12 of the CSR-BC.

The assignment of the GRAB[X] notation is intended to handle heavy grabs. Therefore, the notation is mandatory for BC-A and BC-B ships only, and optional for all other ships. Furthermore, the scantling requirements as stated in Chapter 12 are to be complied with using a grab weight of not less than 20 tons. These deviate from the requirements of UI SC208 and SOLAS XII, 6.5.1, where there are no restrictions for vessels that request the notation GRAB.

The use of a grab to unload cargo holds typically involves dropping the grab from a certain height in order to submerge the grab teeth into the cargo. This operation may impose dynamic and impact loads on the sides of the lower part of the hold. As such, the formulas of required net plating thickness in Chapter 12 are applied not only to the inner bottom, but also to the hopper tank sloping plate, transverse lower stool, transverse bulkhead plating, and inner hull up to a height of 3 m above the inner bottom. The requirements for the transverse bulkheads are applicable regardless of their design and function, e.g.,

SUMMARY RESULT					
Result					
Location Considered for Acceleration Calculation					
From AE	X_G-sc	100.60			
From CL	Y_G-sc	7.10			
From KL	Z_G-sc	2.15			
Acceleration Result					
Trasverse Acceleration (m/s ²)	a_R	1.47			
Vertical Acceleration (m/s ²)	a_z	4.61			
Steel Coil Arrangement					
Mass of one Steel Coil (kg)	W	30000			
Length of Steel Coil (m)	Ls	1.8			
Diameter of Steel Coil (m)	dsc	1			
Number of Tiers of Steel Coil	n1	1			
Number of Load Points Per Elementary Plate Panel	n2	4			
Numbe of Dunnages Supporting one Steel Coil	n3	3			
Rule Required Value					
		Required Net	Offered Gross	Offered Net	Check
Inner Bottom Plating Net Required (mm)	t_req1	0.00			
Inner Bottom Stiffeners Net Required section Modulus (cm ³)	w	0.00			
Inner Bottom Stiffeners Net Required Section Area (cm ²)	Ash	0.00			
Bilge Hopper Region Plating Net Required (mm)	t_reqh	20.55			
Bilge Hopper Stiffeners Net Required Section Modulus (cm ³)	w_h	653.04			
Bilge Hopper Stiffeners Net Required Section Area (cm ²)	Ash_h	30.85			

Figure 10. Sample Summary Sheet from Steel Coil Calculator Program

Table 7. Required Plate Thickness by Grabs

No.	Inner Bottom Plating				Hopper Tank Sloping Plate, Inner Hull and etc.			
	Spacing s (mm)	Material Factor k	Net Thickness for GRAB[20] (mm)	Net Thickness for GRAB[25] (mm)	Spacing s (mm)	Material Factor k	Net Thickness for GRAB[20] (mm)	Net Thickness for GRAB[25] (mm)
1	750	0.72	14.40	15.43	650	0.72	11.88	12.83
2	750	0.78	14.99	16.06	650	0.78	12.36	13.36
3	800	0.72	14.88	15.94	720	0.72	12.50	13.51
4	800	0.78	15.48	16.59	720	0.78	13.01	14.06
5	860	0.72	15.42	16.52	750	0.72	12.76	13.79
6	860	0.78	16.05	17.20	750	0.78	13.28	14.35

the collision bulkhead and the engine room bulkhead. An exception to this is the webs on the corrugation of a transverse bulkhead. Due to their configuration, grabs usually do not contact corrugation webs. Therefore, the grab requirements are not applicable in such a case.

Since most of the vessels are being designed to operate with 20 tons of grab weight, attention should be paid to heavier grabs, e.g., 25 ton or 30 ton grabs. Chapter 12 states that “this additional class notation does not negate the use of heavier grabs, but the owner and operators are to be made aware of the increased risk of local damage and possible early renewal of inner bottom plating if heavier grabs are used regularly or occasionally to discharge cargo.” The additional scantling requirements for heavier grabs should also be noted. To increase the mass of unladen grab from 20 tons to 25 tons, the required plate thickness increase for concerned structural members is between 7 percent and 8 percent, which is expected to reflect a thickness addition between 1.0 mm and 1.25 mm. Table 7 compares the required net thicknesses for six combinations of inner bottom and lower hopper configurations.

At the time this Advisory was prepared, the draft paragraphs in the CSR-H that are relevant to grabs remained the same, with the exception of using a grab weight of not less than 40 tons for ships above 70,000 deadweight tons. It is well recognized that the additional class notation GRAB[X] for a mass of unladen grab in excess of 20 tons is an important design parameter in the specifications to be agreed on by an owner and a shipyard.

Ballast Water Exchange Procedures

Ballast water exchange (BWE) can be a far reaching topic. ABS published *Advisory Notes on Ballast Water Exchange Procedures* and a *Guide for Ballast Water Exchange*. The following section includes excerpts from these two documents.

Ballast water exchange can be accomplished by either ‘sequential method’ or ‘flow through method’. The sequential method entails completely emptying ballast tanks and refilling them with open-ocean water. The flow through method involves pumping open-ocean water into a full ballast tank.



The primary considerations in assessing sequential exchange scenarios are usually given to hull girder strength, vessel stability, propeller immersion, bridge visibility and list angle. In addition, the effects of BWE on slamming, sloshing, and damage stability and survivability also need to be considered. The sequential method requires considerable planning so that the ship will remain within the acceptable criteria.

The flow through method, on the other hand, will not normally affect as many aspects, but it is important to assess piping and overflow arrangements to verify that tanks will not be over-pressurized.

In the case of the sequential method, CSR-BC, Chapter 4, Section 8 [2.2.2] requires that the typical ballast water exchange plan (BWEP) at sea be included in the loading manual. The longitudinal strength (still water bending moments and shear forces) for each step in the BWE should be within the allowable seagoing limits. The smallest design ballast draught at forward perpendicular (T_{BFP}) used in the calculation of design bottom slamming pressure per Chapter 4, Section 5 [4.2] should be the minimum ballast

draught among all normal ballast conditions and the BWE conditions at sea. A draught less than T_{BFP} in BWEP can only be considered in operation in favorable sea conditions so that the risk of bottom slamming is minimized. Sloshing loads in the ballast hold are to be considered for the BWE conditions. Either sloshing calculations showing strength compliance are to be submitted to ABS for review or the BWE plan should identify which steps of the exchange may impose significant sloshing loads and should be carried out in favorable sea conditions such that the risk of structural damage is minimized.

In the case of the flow through method, CSR-BC, Chapter 4, Section 6 [2.1] introduces additional static pressure head into ballast water pressure for local strength assessments and direct strength analysis. When checking BWE operations by means of the flow through method, the inertial pressure due to ballast water is not to be considered for local strength assessments and direct strength analysis. If the flow through method has not been considered during the vessel's CSR review and approval, the flow through method will not be allowed to be used in its operation.

FE Mesh Size and Critical Area Screening

For detailed stress assessment (yielding) and the FE-based simplified fatigue method for bilge hopper areas, the typical mesh size (approximately one-quarter of the representative spacing of ordinary stiffeners in the corresponding area) specified in Chapter 7, Section 3 [2.3.2] in CSR-BC is equivalent to that of the pre-CSR rules (SafeHull). In general, this mesh size is adequate to determine the stress distributions in way of structural connections and discontinuities. A finer mesh size up to plate thickness may be needed for proper representation of some critical structural areas. In such a case, the allowable stress in Chapter 7, Section 3 [3.1.1] applies to the average stress of all elements included in an area corresponding to a single element of typical size. For FE-based fatigue strength assessment, the required mesh size (txt defined in Chapter 7, Section 4 [2.1.2]) is in line with the practice of the pre-CSR rules (SafeHull).

The fatigue strength of longitudinal stiffener end connections within the midship area and hatch corners are verified using a conventional procedure. Structural connection details listed in Table 8 are subject to FE-based fatigue strength assessment. Additional critical locations may be added to this list with due consideration given to vessel-specific arrangements and structural details.

Screening criteria, fine mesh (50 mm x 50 mm) requirements and mandatory locations for fine mesh analysis are included in the draft CSR-H version released in July 2012.

For owners seeking additional fatigue analysis, a clause can be added to the design specification requiring fatigue strength evaluation of a highly stressed area if the calculated stress of a typical element size in global FEA exceeds 75 percent of the minimum yield stress. Reference may also be made to the draft CSR-H.

For the yielding strength evaluation of a plate panel with openings, Chapter 7, Section 2 [3.2.1] is to be followed. Specifically, if the effects of openings are not considered in the 3-D global FE model, the Von Mises equivalent stress is to be calculated using the shear stress corrected based on the ratio of web height and opening height, and the FEA normal stresses without correction. If this equivalent stress is found in the range of 95 to 100 percent of the allowable stress, the identified opening may be further evaluated using a fine mesh FE model.

For the buckling and ultimate strength assessment of a plate panel with openings, Chapter 7, Section 2 [3.3.3], Chapter 6, Section 3, Table 2 and Chapter 6, Appendix 1 are to be followed. Specifically, the buckling factors due to normal stress components are to be calculated using Buckling Load Case 1 and Buckling Load Case 2 in Chapter 6, Section 3, Table 2, disregarding opening, and the buckling factor due to shear stress component is to be calculated using Buckling Load Case 6 for openings with $d_a/a \leq 0.7$ and $d_b/b \leq 0.7$ (see CSR-BC, Chapter 6, Section 3, Table 2 for definitions of d_a , a , d_b and b). For floors or other high girders with holes with $d_a/a > 0.7$ and/or $d_b/b > 0.7$, the panel is divided into sub-panels as guided by Chapter 6, Appendix 1 and the buckling strength of these sub-panels is to be checked in lieu of the whole panel.

Table 8. Members and Locations Subject to FE Fatigue Assessment

Member	Connection Detail
Inner Bottom Plating	Connection with slopping and/or vertical plate of lower stool
	Connection with slopping plate of hopper tank
Inner Side Plating	Connection with slopping plate of hopper tank
Transverse Bulkhead	Connection with slopping plate of lower stool
	Connection with slopping plate of upper stool
Hold Frames of Single Side Bulk Carriers	Connection with slopping plate of lower wing tank
	Connection with slopping plate of upper wing tank

Table 9. Damage Record (1958-2007)

Member	Connection Detail	Number of Damage Cases	
		Ballast Hold	Dry Holds*
Inner Bottom Plating	Connection with slopping and/or vertical plate of lower stool	365	0
	Connection with slopping plate of hopper tank	173	0.4
Inner Hull Plating	Connection with slopping plate of hopper tank	9	0
Transverse Bulkhead	Connection with slopping plate of lower stool	92	0.2
	Connection with slopping plate of upper stool	63	0.5
Hold Frames	Connection with slopping plate of lower wing tank	15	0
	Connection with slopping plate of upper wing tank	31	0

*Number of damage cases per dry cargo hold.

In the design specifications, a clause can be added for evaluating all of the openings in double bottom floors, girders and stools by very fine mesh FE models (minimum 1/10 longitudinal spacing). Note that this additional analysis should not be expected to lead to extensive scantling increases, and may be used by a designer to optimize structure in way of the openings.

CSR-BC Fatigue Criteria Change

RCN #3 to CSR-BC 2006 entered into force on 12 September 2008, revising the fatigue criteria for notch stress range calculation as indicated in Chapter 8, Section 2 [2.3]. The impact of RCN #3 is explained in its Technical Background. The first change in the RCN was the inclusion of the weld grinding effect. Two additional values (1.10 and 1.15) for the fatigue notch factor K_f are introduced. This change is primarily based on two recommendation documents of the International Institute of Welding.

The second change in the RCN is the revision of the weld residual stress effect on the mean stress correction factor $f_{mean,j}$. This change was made to better match the fatigue calculation with the historical damage record of dry cargo holds. The damage record of bulk carriers has shown that the majority of damages caused by cracks occur in way of inner bottom connections in ballast holds. The reason is that under heavy ballast conditions, the inner bottom tank boundaries are subject to high internal pressure due to ballast water, but the external pressure is relatively low. As a result, these structural members are subject to high tensile stresses in addition to fluctuating stress ranges,

leading to additional fatigue damage. The technical background provided by IACS for RCN #3 includes the surveyed damage data (see Table 9) of 3,015 ships constructed between 1958 and 2007.

According to this data, more than 99 percent of the damage cases were in ballast holds, among which more than 70 percent of damages occurred at inner bottom plating connections. The technical reason behind RCN #3 is to align the known damage record for dry cargo holds with the mismatched fatigue results of CSR-BC. It has been observed from FE analysis results that the weld residual stress does not affect the mean stress correction factor for ballast hold under heavy ballast condition due to the high tensile stress experienced by the hold, but the same may have an unfavorable effect on dry cargo holds. Therefore, the RCN removes the effect of the weld residual stress on the mean stress correction factor for all cases except that of ordinary stiffeners.

In its technical background, the RCN compares the calculated fatigue damage factors before and after the RCN for capesize, panamax and handymax designs. The chart in Figure 11 for a single side skin panamax design reproduced from the technical background compares the results before and after the RCN modification. CSR-B represents the results before the RCN modification, mod_1 represents the results after the RCN without the grinding effect, and mod_1(G) represents the results after the RCN with the grinding effect. The calculated fatigue damage factor reduction due to the RCN can be clearly seen and it is expected that the RCN will allow scantling reductions for the double bottom insert plates at locations outside ballast holds.

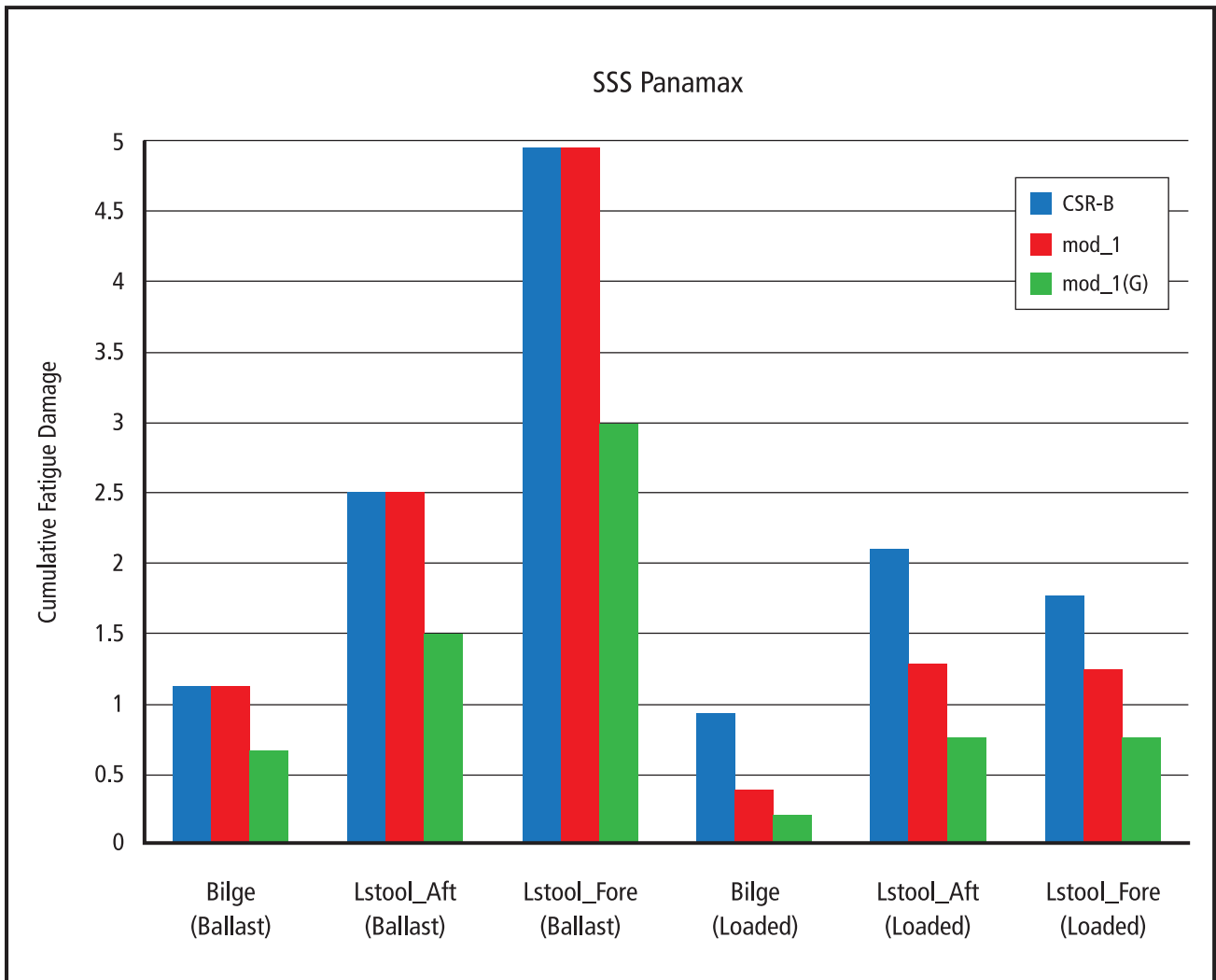

Figure 11. Fatigue Damage Comparison

Weld Toe Grinding and Heavy Duty Work on Double Bottom

The effect of weld toe grinding for fatigue strength improvement is reflected by the fatigue notch factor, K_f , defined in Table 1 of Chapter 8, Section 2 [2.3.1]. Quality control on grinding is to be carried out by the requirements in accordance with Chapter 8, Section 2 [2.3.1].

Grinder finishing for the purpose of removing any undercuts and/or smoothing any welding beads is known to improve fatigue strength. The recommendation of the International Institute of Welding’s “fatigue design welded joint and component” was referenced in RCN #3 as the supporting document. To avoid any risk of root cracking, the application of this technique is limited to deep penetration welding or full penetration welding.

For owners concerned about the fatigue life of structural details exposed to unloading equipment such as grabs and bulldozer blades, a clause may be added to the design specification for a target fatigue life for details within the cargo holds of 25 years without any post-weld treatment.

The draft CSR-H released for external review on 1 July 2012 requires that the structure within the cargo holds of bulk carriers has a fatigue life of 25 years without considering grinding or other post-weld treatment methods.

Tapering Procedure at Ends

In CSR-BC, the scantlings beyond the cargo block are often governed by the requirements for hull girder bending and shear strength in Chapter 5, Section 1 as well as hull girder ultimate strength in Chapter 5, Section 2. Both intact and flooding scenarios are required to be

evaluated by CSR-BC. In addition, the allowable normal stress for hull girder bending in CSR-BC has been set to a lower limit outside 0.4L amidships to force a desired tapering in basic hull girder scantlings.

The transition from the cargo block into the engine room is critical for bulk carrier designs. The general tapering requirements in Chapter 9, Section 3 (machinery space) and specific requirements such as Chapter 9, Section 3 [3.1.2] for side structure and Chapter 9, Section 2 [2.1.4] form the broad basis for compliance verification.

FEA Procedure for Aft and Foremost Cargo Holds

CSR-BC requires that a 3-D FEA be carried out for a three cargo hold model in the midship region. Many owners have requested additional analysis be carried out covering the forward and aft ends of the cargo block (see Figure 12). Since there is no procedure in CSR-BC to carry out a 3-D FEA at the forward and aft ends of the cargo block, ABS has established the following general procedure:

- Allowable hold loading considering hold flooding (Chapter 6, Section 4 [3.1.2] and Chapter 6, Section 4 [3.1.4]).
- Slamming requirements (Chapter 9, Section 1 [5.4.1] and [5.4.2]) for girders and floors.
- Required hopper web thickness at the hopper web and bottom floor connection areas considering access holes.

- Required side frame scantlings in the foremost cargo hold (including first 3 side frames) according to Chapter 6, Section 2 [3.3].
- Required local scantlings of inner bottom longitudinals in the foremost cargo hold.
- Requirements of the web stiffeners on primary supporting members according to Chapter 3, Section 6 [5.2.1].
- Comparison of primary supporting member arrangements and scantlings with those of the midship holds which reflect the FEA results.

Should the final arrangements and scantlings of the primary supporting members of the fore- and aft-most holds not be comparable to those of the midship holds, then additional engineering analysis is to be carried out.

These locations are subject to higher hull girder shear stress. Furthermore, shape changes may lead to increased stiffener spacing on the shell plating. The hull shape will also have an effect on the geometry of transverse deep supporting members. In many cases, the panel arrangements and locations of openings will change, which may make some of these members more susceptible to buckling.

The draft CSR-H released on 1 July 2012 requires FE analysis extending over the entire cargo hold block. Owners concerned with the aft and fore most cargo holds can include a clause in the specifications requiring an FEA assessment.

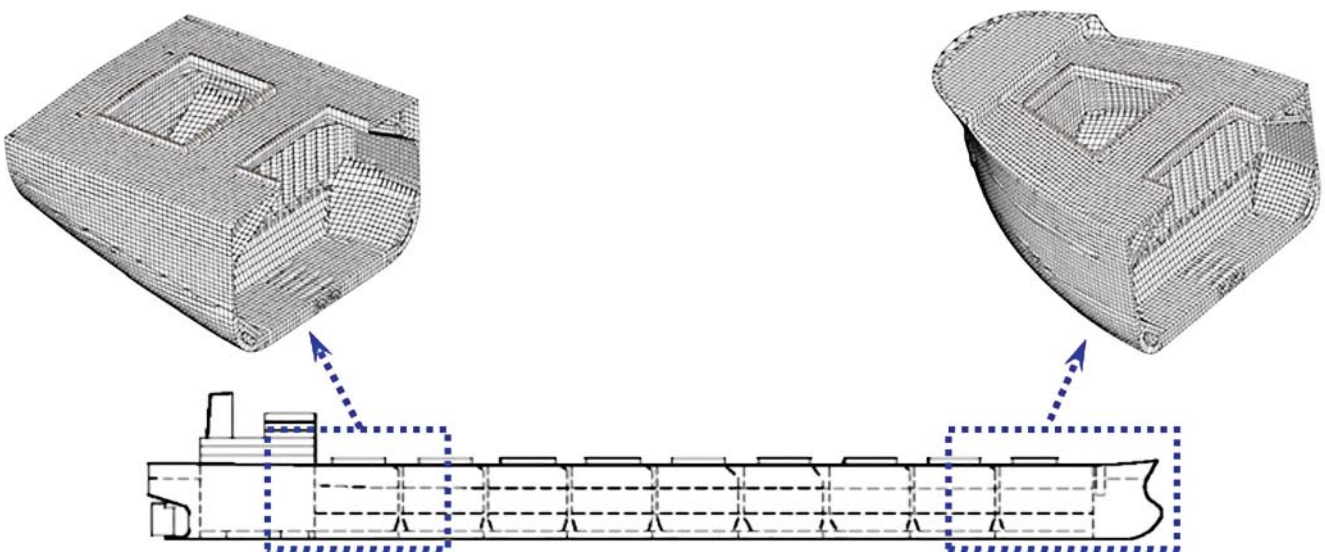

Figure 12. Aft and Foremost Cargo Holds



WORLD HEADQUARTERS

ABS Plaza • 16855 Northchase Drive • Houston, TX 77060 USA
Tel: 1-281-877-5800 • Fax: 1-281-877-5803
Email: ABS-WorldHQ@eagle.org

AMERICAS DIVISION

ABS Plaza • 16855 Northchase Drive • Houston, TX 77060 USA
Tel: 1-281-877-6000 • Fax: 1-281-877-6001
Email: ABS-Amer@eagle.org

EUROPE DIVISION

ABS House • No. 1 Frying Pan Alley • London E1 7HR, UK
Tel: 44-20-7247-3255 • Fax: 44-20-7377-2453
Email: ABS-Eur@eagle.org

GREATER CHINA DIVISION

5th Floor, Silver Tower • No. 85 Taoyuan Road
Luwan District • Shanghai, 200021 P. R. China
Tel: 86-21-2327-0888 • Fax: 86-21-6360-5391
Email: ABSGreaterChina@eagle.org

PACIFIC DIVISION

438 Alexandra Road #10-00 • Alexandra Point • Singapore 119958
Tel: 65-6276-8700 • Fax: 65-6276-8711
Email: ABS-Pac@eagle.org

NAUTICAL SYSTEMS DIVISION

ABS Plaza • 16855 Northchase Drive • Houston, TX 77060 USA
Tel: 1-281-877-5700 • Fax: 1-281-877-5701
Email: NS-info@eagle.org

www.eagle.org