



The Year of Tropics- Midlatitude Interactions and Teleconnections

Cristiana Stan

George Mason University

December 9, 2015

Sub-seasonal to Seasonal (S2S) Prediction Project

Sub-Projects

Teleconnections

Madden-Julian Oscillation

Monsoons

Africa

Extremes

Verification and Products

Research Issues

- Predictability
- Teleconnection
- O-A Coupling
- Scale interactions
- Physical processes

Modelling Issues

- Initialisation
- Ensemble generation
- Resolution
- O-A Coupling
- Systematic errors
- Multi-model combination

Needs & Applications

Liaison with SERA
(Working Group on Societal and Economic Research Applications)

S2S Database

Outline

- Overview of the current knowledge and challenges of the teleconnections on the S2S timescales
 - Observations
 - Modeling studies
- Presentation of the Virtual Field Campaign
 - YTMIT
- Discussion



Observations

The influence of Tropics onto NH Midlatitudes

Overview of the current knowledge and challenges

The virtual field campaign

Discussions

Riehl, 1950

“The most outstanding of these features are the breakdown of the tropical atmosphere into a train of vortices and the complete interlocking of flow between the high and low latitudes.”

“It would seem more than difficult to draw a line separating polar and tropical zones.”

“Heat is injected into the polar zones in few and narrow strips of longitude... in part, change of flow configurations and intensity in higher latitudes must depend on the availability of low latitude disturbances to form extended troughs.”

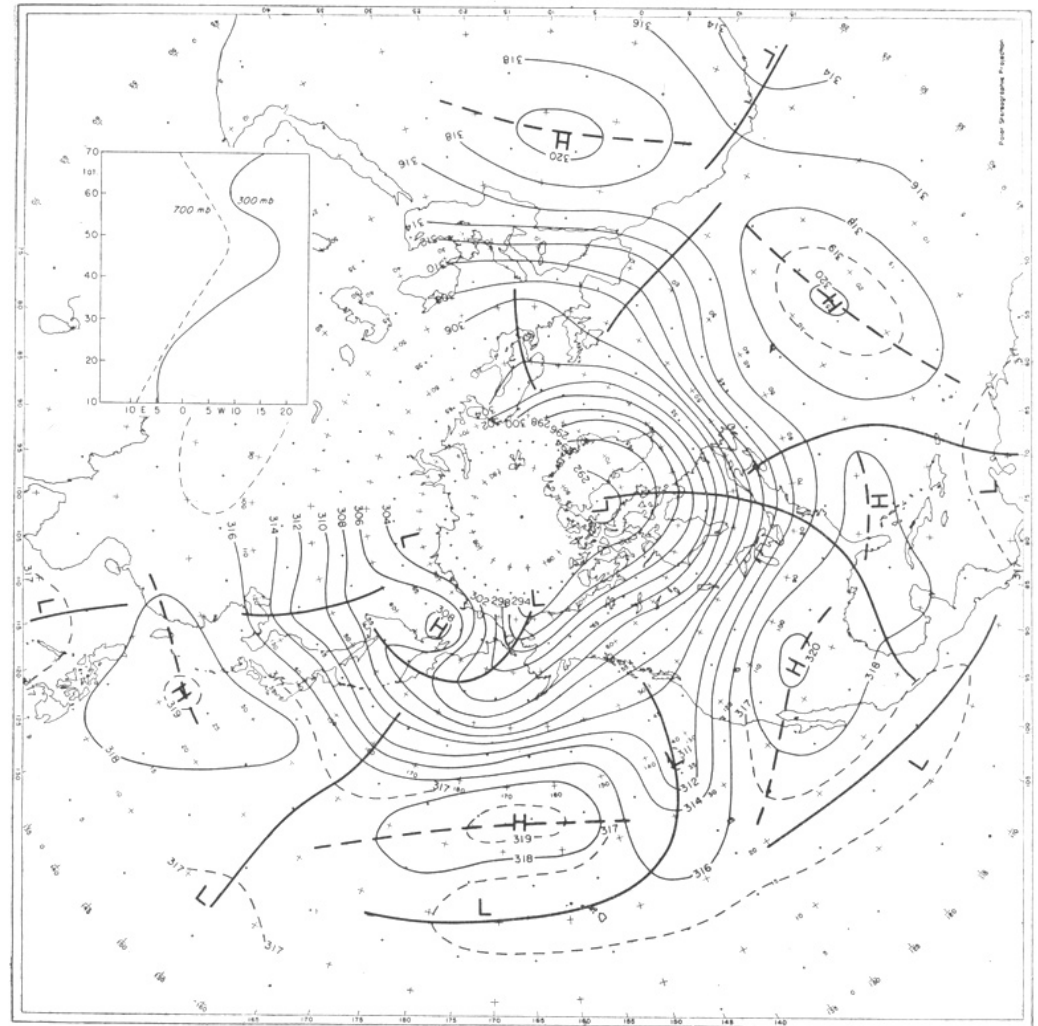

Fig. 2. Topography of the 300-mb surface (100's feet), August 26, 1945, 0600Z. Insert: meridional profile of the zonal wind (mps) at 300 and 700 mb computed between longitudes 20° E and 110° E via western hemisphere.

The role of Tropics in the general circulation of the atmosphere. Tellus.

Observations

The influence of Tropics onto NH Midlatitudes

Overview of the current knowledge and challenges

The virtual field campaign

Discussions

J. Bjercknes, 1966

- Large positive SST anomalies in the eastern Equatorial Pacific strengthen the zonal winds in the Northern Hemisphere winter.
- “A close watch of the temperature anomalies arising over the eastern tropical Pacific is likely to play an important part on the future *seasonal forecasting* of climatic anomalies, over North America and over Europe.”

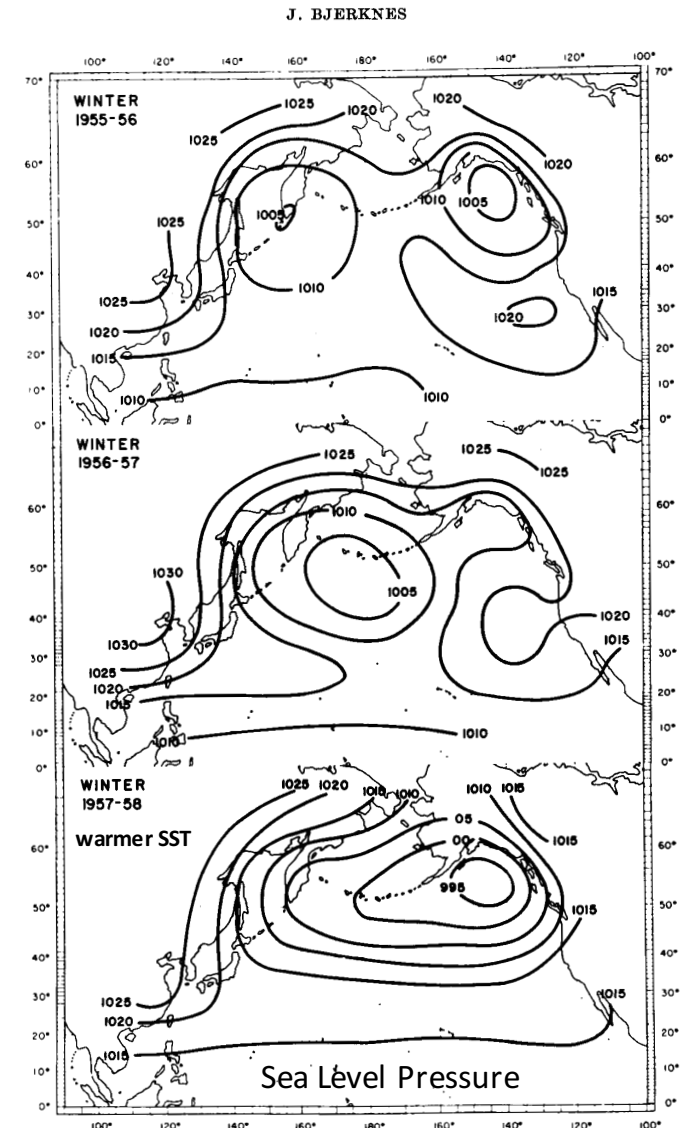

Observations

The influence of Tropics onto NH Midlatitudes

Overview of the current knowledge and challenges

The virtual field campaign

Discussions

Weickmann 1983; Weickmann et al. 1985; Lau and Phillips 1986; Knutson and Weickmann 1987

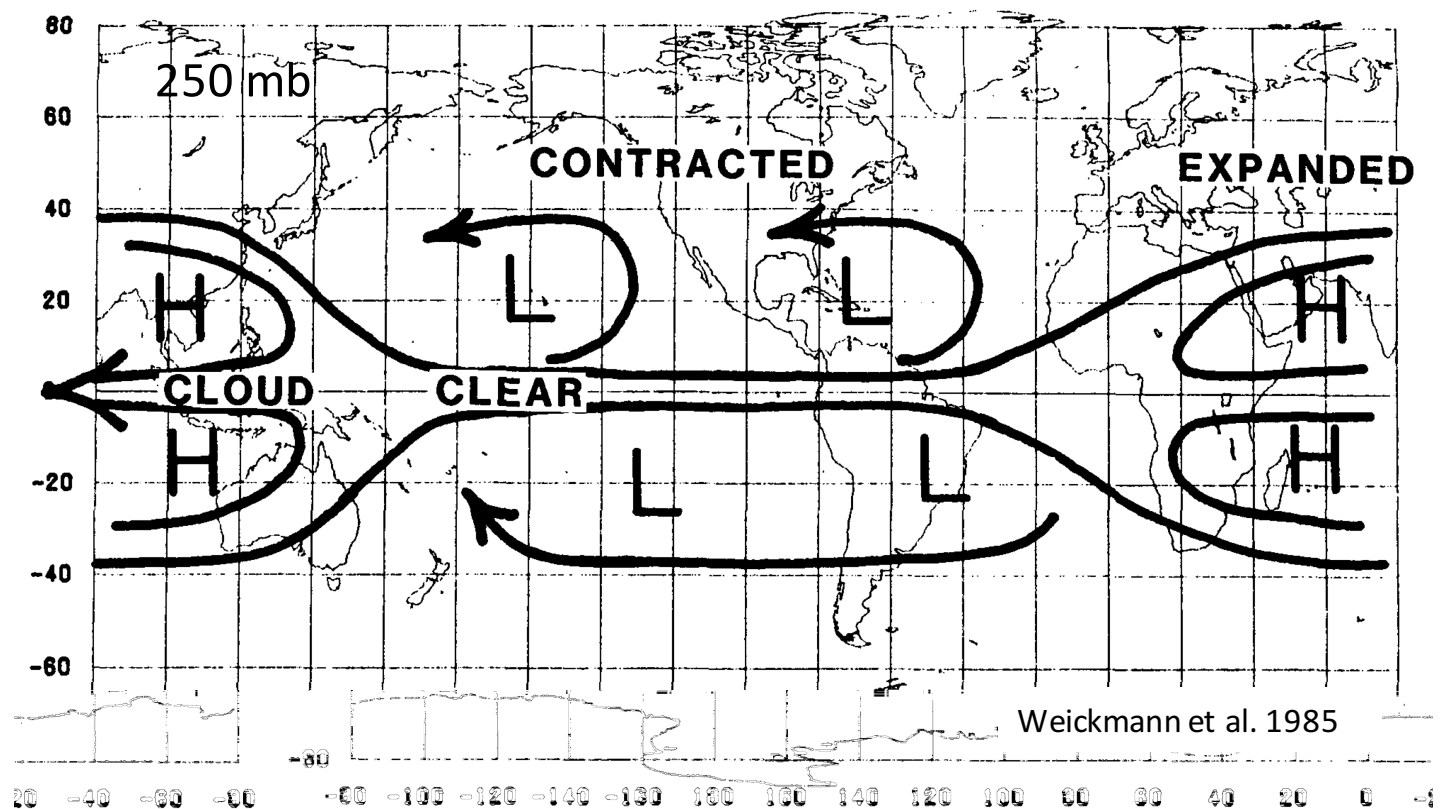

Observations

The influence of Tropics onto NH Midlatitudes

Overview of the current knowledge and challenges

The virtual field campaign

Discussions

Liebmann and Hartmann, 1984

- Region of winter monsoon rainfall over the far western Pacific is forcing the midlatitude flow
- No relationship between regions of equatorial cloudiness and circulation anomalies over North American Atlantic regions

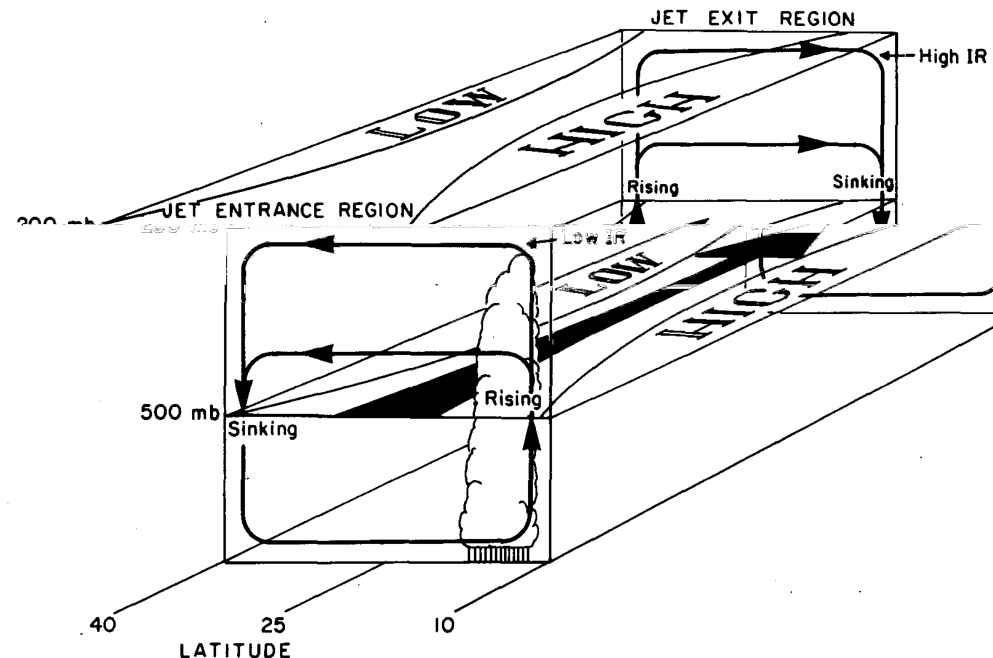

YTMIT

Overview of the
current knowledge
and challenges

The virtual field
campaign

Discussions

Observations

The influence of Tropics onto Midlatitudes

Question

1. What are the geographical regions where tropical forcing is most effective in exciting extratropical circulation anomalies?

Observations

The influence of Tropics onto NH Midlatitudes

Overview of the current knowledge and challenges

The virtual field campaign

Discussions

Ferranti et al. 1990; Gill and Mo 1991a,b; Higgins and Mo 1997; Mathews and Kiladis 1999;

- Variability of the climate patterns of midlatitudes, such as NAO and PNA is linked to the convective activity in the tropics
- In the Northern Hemisphere, there are two modes of oscillation with periods of about 48 and 23 days
- North Pacific circulation anomalies develop one to two weeks after the appearance of anomalous convection over the tropical Pacific

Observations

The influence of Tropics onto SH Midlatitudes

**Nogues-Paegle and Mo 1988; Gil and Mo 1991;
Berbery and Nogues-Paegle 1993; Hsu 1996**

Overview of the
current knowledge
and challenges

The virtual field
campaign

Discussions

- No significant correlation between the Southern Hemisphere circulation and tropical heating
- The impact of tropical heating on midlatitudes has a seasonal dependence

SH Summer

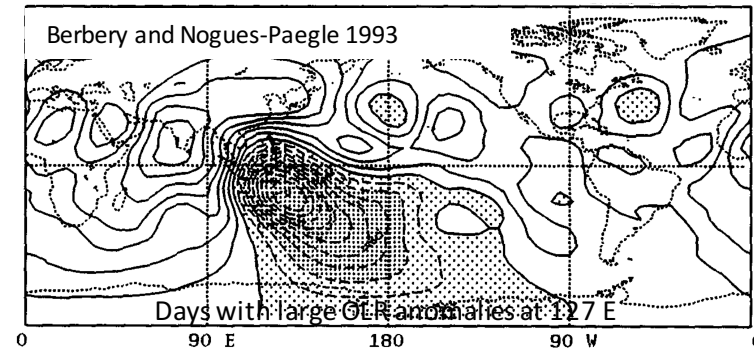

SH Winter

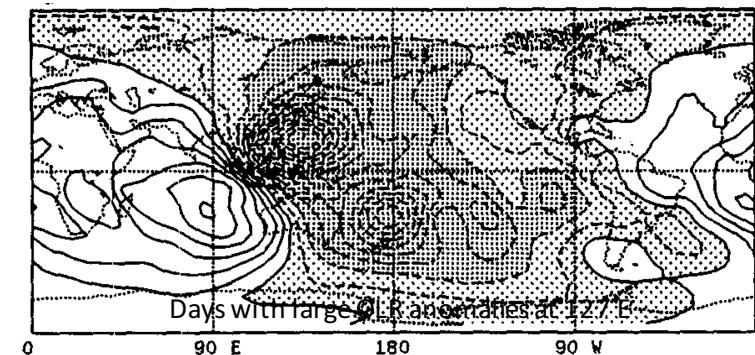

200 hPa Velocity Potential

Observations

The influence of Tropics onto NH Midlatitudes Weather

Overview of the current knowledge and challenges

The virtual field campaign

Discussions

Mo and Higgins 1998; Jones 2000; Bond and Vecchi 2003; Jeong 2005; He et al. 2011; Zhou et al. 2012

- Winter extreme precipitation events over U.S. West Coast and below-average SAT are favored by MJO in phase 2
- Extreme cold surges in the surface air temperature over east Asia are favored by MJO convective activity located over the Indian Ocean

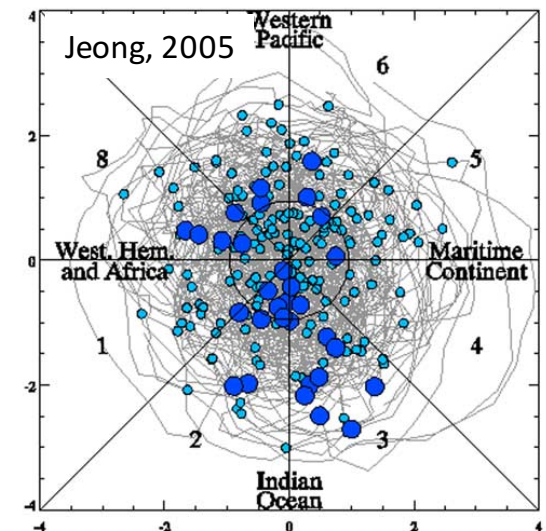
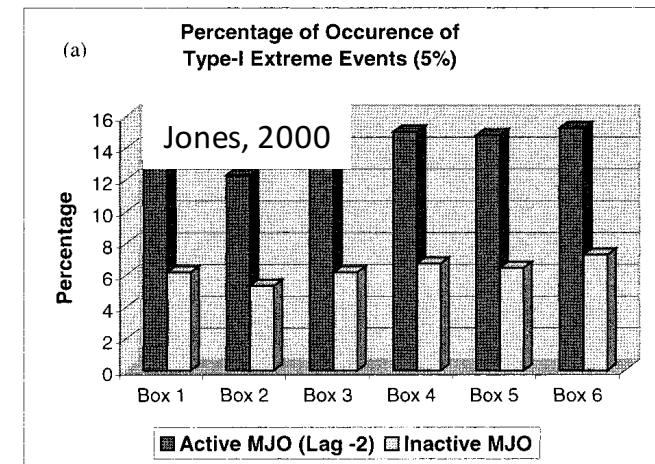

Observations

The influence of Tropics onto Midlatitudes

Overview of the current knowledge and challenges

The virtual field campaign

Discussions

Mori and Watanabe 2008; Lin et al. 2009; Riddle et al. 2013

- Phase locking between PNA and MJO; convective activity associate with the MJO initiation explains 30% of PNA variability
- MJO may not excite a pure PNA pattern, but rather a PNA-like response

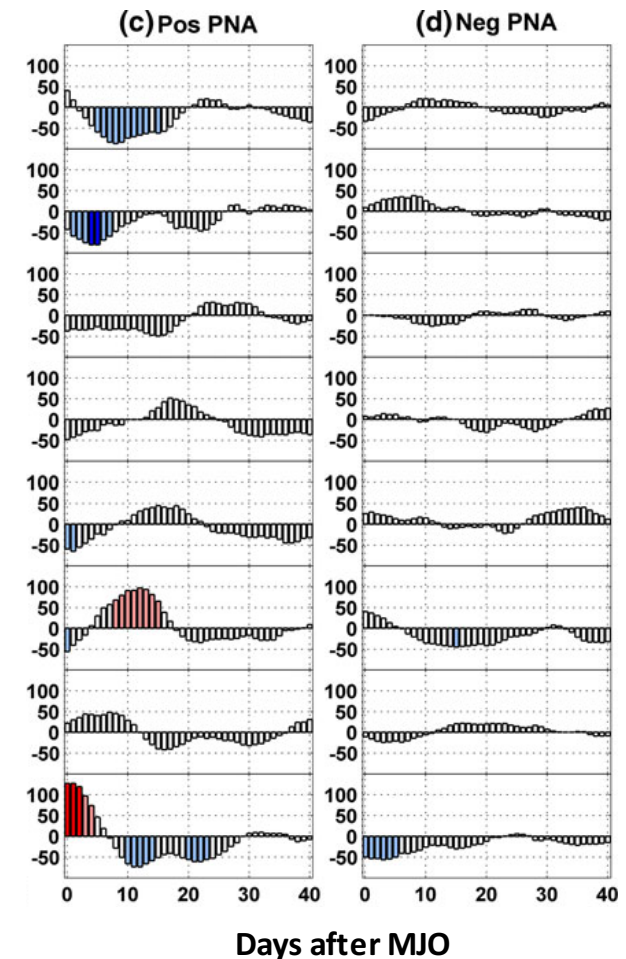

Observations

The influence of Tropics onto Midlatitudes

Overview of the current knowledge and challenges

The virtual field campaign

Discussions

Cassou 2008; Deng and Jiang 2011; Lee and Lim 2012; Grise et al. 2013; Frederiksen and Lin 2013; Lin 2014

- NAO is influenced by tropical convection when MJO is in either phase 2-4 (Indian Ocean-Maritime Continent) or 6-8 (Western Pacific)
- The activity of North Pacific storm track during winter is modulated by the tropical convection associated with MJO variability
- The winter SAT over North America is characterized by a 70-day oscillation forced by MJO

Observations

The influence of Tropics onto Midlatitudes, Boreal Summer

Overview of the current knowledge and challenges

The virtual field campaign

Discussions

Moon et al. 2013

- During the active phase of ISM, WNPSM, and NASM extratropical circulation and surface temperature anomalies develop.
- BSISO teleconnections show both quasi-stationary and eastward propagation characteristics

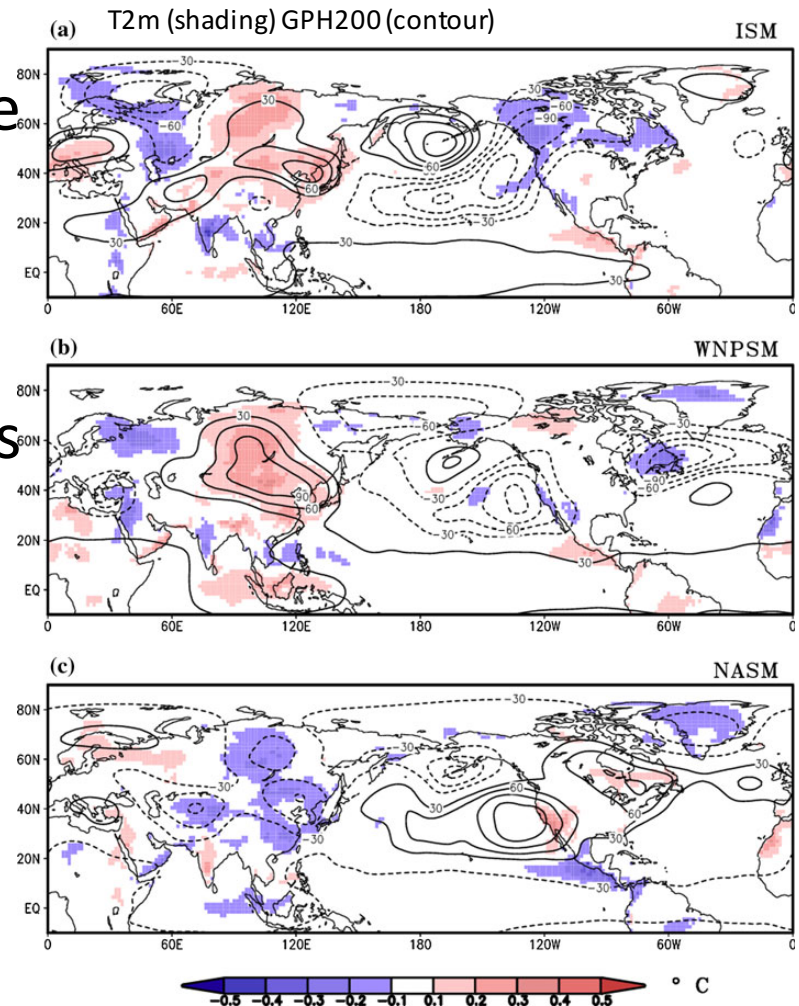

Modeling Studies

The influence of Tropics onto Midlatitudes

Overview of the current knowledge and challenges

The virtual field campaign

Discussions

Opsteegh and Van den Dool 1980; Hoskins and Karoly 1981; Webster 1981

- Linear steady state models with prescribed or numerical schemes for atmospheric heating
- In the upper troposphere, the tropical heating source generates a train of Rossby waves propagating poleward and eastward

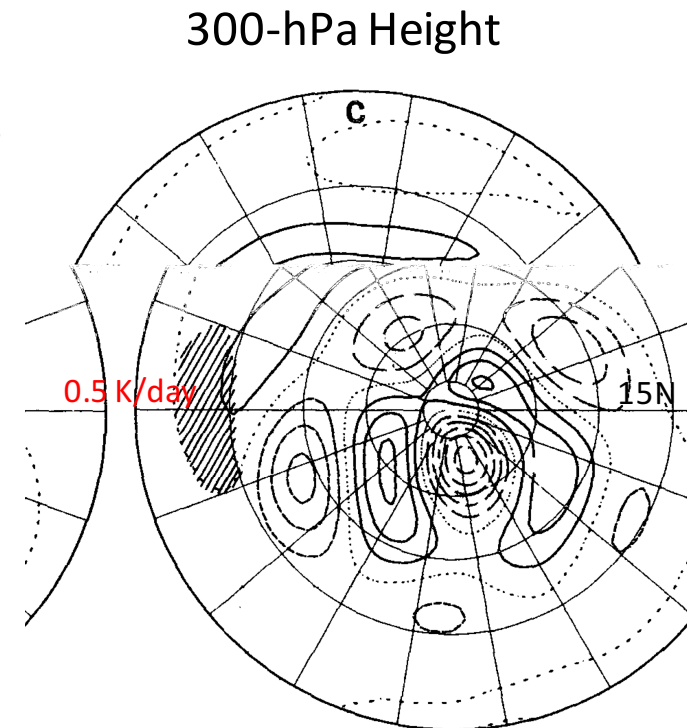

Hoskins and Karoly, 1981

Modeling Studies

The influence of Tropics onto Midlatitudes

Overview of the current knowledge and challenges

The virtual field campaign

Discussions

Simmons et al. 1983; Branstator 1985

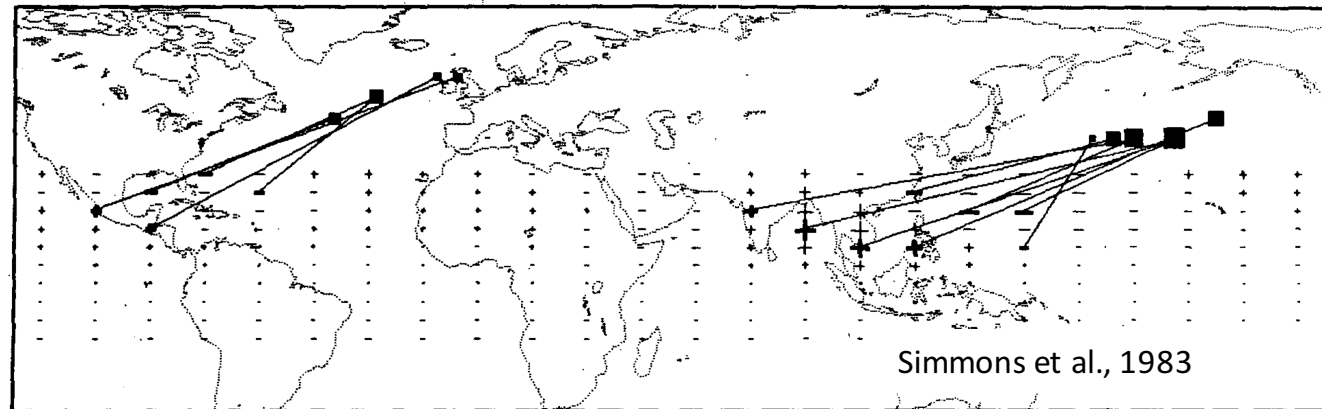

- Perturbations over the northeastern Pacific are *excited* by tropical forcing located over Southeast Asia and tropical western Pacific
- The Atlantic perturbations are *excited* by the tropical forcing located to the southeast

Modeling Studies

The influence of Tropics onto Midlatitudes

Overview of the current knowledge and challenges

The virtual field campaign

Discussions

Sardeshmukh and Hoskins 1988;

- The midlatitude perturbations are associated with the fast growing mode of barotropic instability
- The atmospheric anomalies in the extratropics have an equivalent barotropic structure
- The variability of the midlatitude large-scale flow due to tropical forcing is dominated by a 28-72 day oscillation

YTMIT

Modeling Studies

The influence of Tropics onto Midlatitudes

Question

Overview of the
current knowledge
and challenges

The virtual field
campaign

Discussions

2. How and why do the baroclinic atmospheric anomalies in the tropics transition to barotropic anomalies by the time they reach the extratropics?

Modeling Studies

The influence of Tropics onto Midlatitudes

Overview of the
current knowledge
and challenges

The virtual field
campaign

Discussions

Ferranti et al. 1990

$$F(\mathbf{x}, t) = \frac{\|F\|}{\|E_1^*\|} E_1^*(\mathbf{x}) \exp(i\omega_1 t)$$

Observations

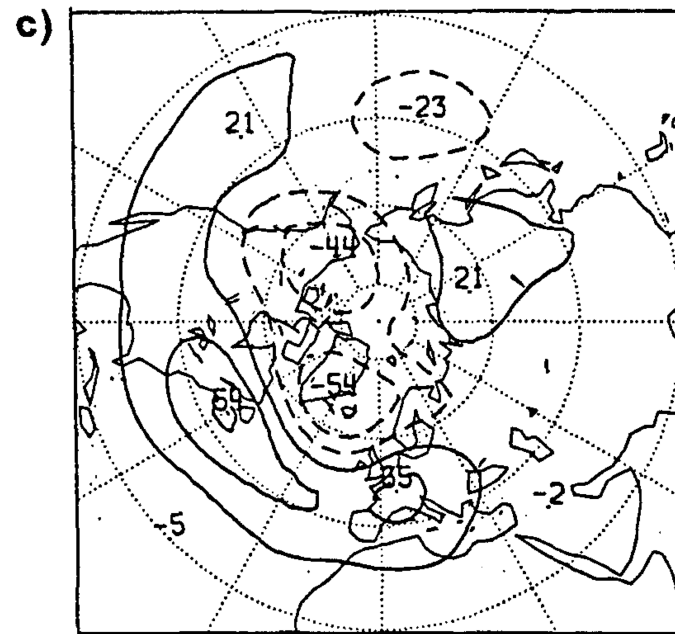

Barotropic model

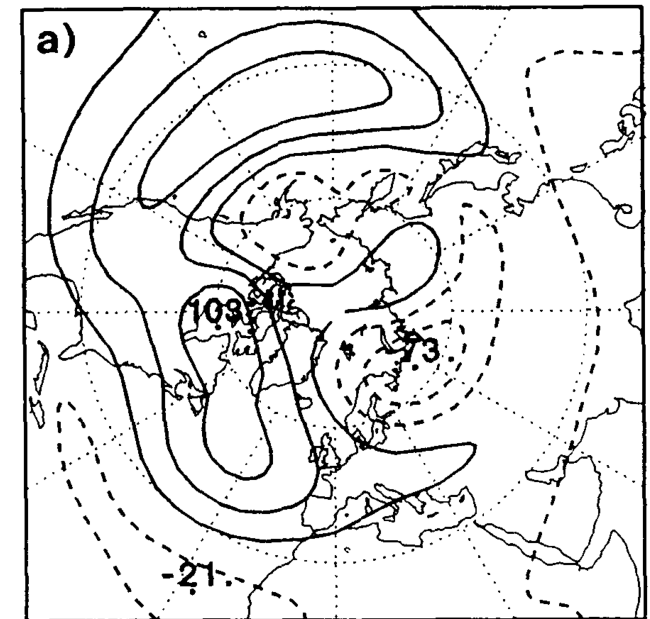

500 hPa Geopotential Height

Modeling Studies

The influence of Tropics onto Midlatitudes

Overview of the current knowledge and challenges

The virtual field campaign

Discussions

Slingo and Slingo 1988, 1991

- Longwave cloud radiative forcing in the Tropics accelerates the sub-tropical jets and generates height perturbations in midlatitudes with a barotropic structure.
- The longwave cloud forcing over South America induces barotropic cyclonic circulation in the midlatitudes and anticyclonic structures in the polar regions of the NH.

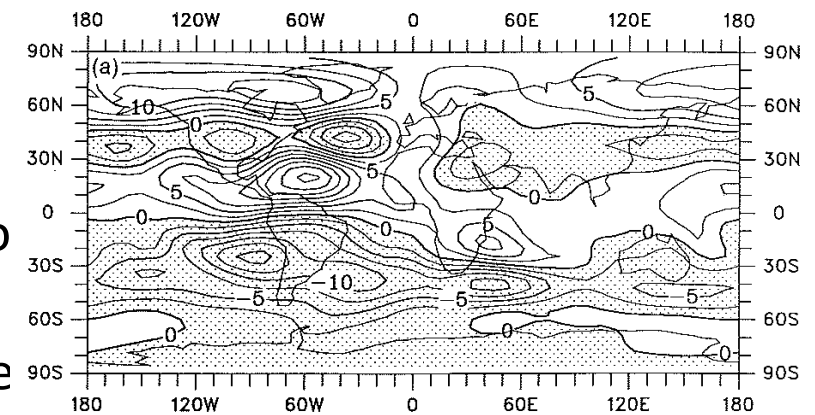
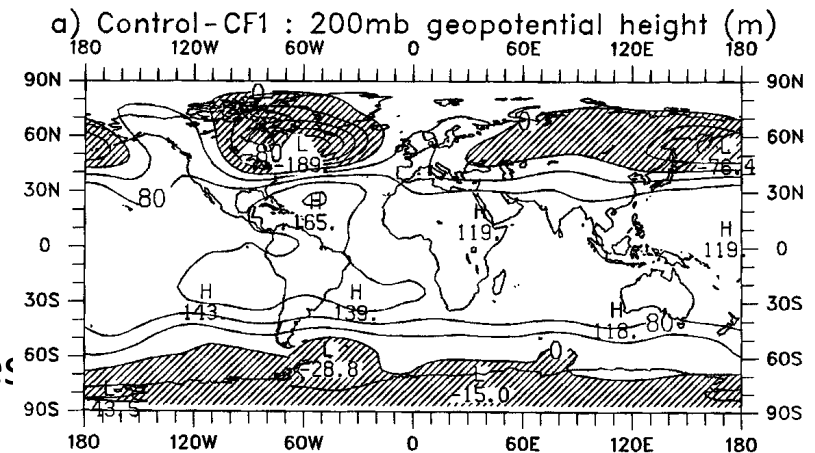

200-mb streamfunction. CLAF applied everywhere
Minus CLAF applied everywhere except South America.

Modeling Studies

The influence of Tropics onto Midlatitudes

Overview of the current knowledge and challenges

The virtual field campaign

Discussions

Schubert and Park, 1991

- Global initialized analyses (ECMWF)
- PNA appears to have its main energy source in midlatitudes, and the link to the tropics manifests as a phase locking with anomalies forced by tropical convection located in the western and central Pacific

Modeling Studies

The influence of Tropics onto Midlatitudes in GCMs

Overview of the current knowledge and challenges

The virtual field campaign

Discussions

Jin and Hoskins 1995;

- Propagation of Rossby waves train is sensitive to the zonally varying basic state, with preferred paths in regions with prevailing westerlies
- The response of the Northern Hemisphere to tropical heating is much stronger than in the Southern Hemisphere
- The Rossby wave response to a fixed tropical heating establishes in 10-15 days

Modeling Studies

The influence of Tropics onto Midlatitudes in GCMs

Overview of the current knowledge and challenges

The virtual field campaign

Discussions

Higgins and Schubert 1996; Hsu 1996;

- GCM simulations tend to reproduce the observed relationships between tropical anomalous convection and midlatitude circulation anomalies during boreal winter
- GCM simulations also show differences from observation, resulting especially from the model inability to reproduce the observed location of the tropical heating anomalies

Modeling Studies

Overview of the current knowledge and challenges

The virtual field campaign

Discussions

Lin et al. 2007

- Primitive equation dry atmospheric model can simulate tropical intraseasonal variability with a Kelvin wave structure
- *Hayashi and Suni, 1986: “No moist processes result in the abrupt disintegration of the 30 day oscillation into Kelvin and Rossby waves. **Strong mode coupling between the equatorial free waves is required to maintain the 30-day oscillation**”*
- The divergent flow in the tropical western Pacific generates wave activity into the PNA region

Modeling Studies

The influence of Tropics onto Midlatitudes in Intervention Experiments

Overview of the current knowledge and challenges

The virtual field campaign

Discussions

Blade and Hartmann 1995; Mathews et al. 2004; Branstator 2014; Straus et al. 2015

- Extratropical response is sensitive to the phase speed of the forcing
- The tropical convection outflow anomalies lead to Rossby waves, which then interact with the midlatitude mean flow and in preferred locations extract energy from the mean flow, in a manner similar to that of unstable barotropic modes.
- The midlatitude response to the MJO depends on the history of heating and cooling and is not just a response to heating at some longitude with some lag.
- Short pulses of tropical heating also affect the midlatitudes and the effect persists for more than two weeks.

Modeling Studies

The influence of Tropics onto Midlatitudes in Forecasts

Overview of the current knowledge and challenges

The virtual field campaign

Discussions

Feranti et al. 1990; Waliser et al. 2003; Vitart and Molteni 2010; Riddle et al. 2013; Vitart 2013; Molteni et al. 2015;

- Extended-range forecasts with small errors in the simulation of tropical heating are skillful
- MJO has significant impact on the midlatitude forecast especially for days 19-25

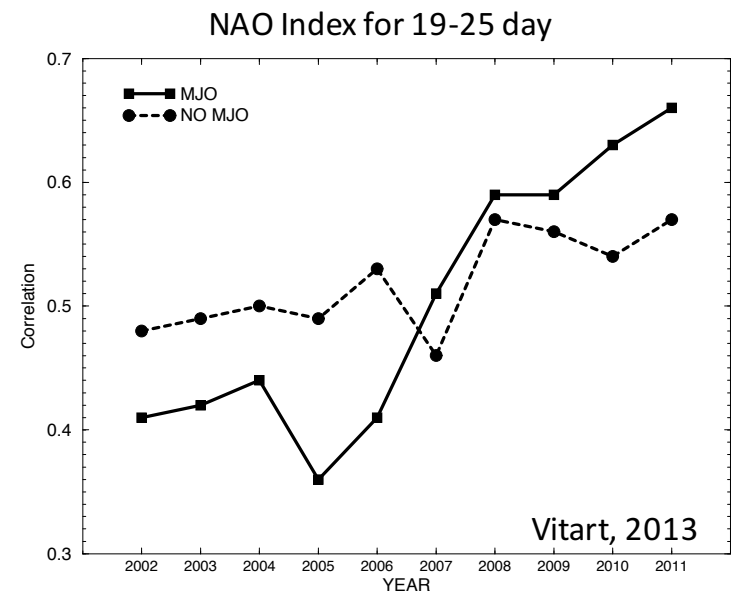

The influence of Midlatitudes onto Tropics

Overview of the
current knowledge
and challenges

The virtual field
campaign

Discussions

Nitta 1970; Zangvil and Yanay 1980; Lim and Chang 1981; Webster and Holton 1982; Yanai and Lu 1983; Libmann and Hartmann 1984; Randel 1992; Frederiksen and Frederiksen 1997

- Only extratropical waves with westward phase speeds larger than the zonal mean wind can propagate into the tropics
- Equatorial upper tropospheric waves are excited by meridional propagation of extratropical waves
- The strongest influence manifests over the Pacific and Atlantic Oceans

The influence of Midlatitudes onto Tropics

Overview of the current knowledge and challenges

The virtual field campaign

Discussions

Matthews and Kiladis 1999; Straus and Lindzen 2000; Lin et al. 2000, Thompson and Lorenz 2004

- Baroclinically unstable disturbances of midlatitudes modulate the tropical convection
- Midlatitude storms maintain the intraseasonal variability of the Tropics
- NAM and SAM have a substantial signature in the tropical troposphere during their winter seasons with a 2-week lag

YTMIT

The influence of Midlatitudes onto Tropics

Question

Overview of the
current knowledge
and challenges

The virtual field
campaign

Discussions

3. What are the systematic aspects and mechanisms of extratropical initiation and maintenance of organized tropical convection?

Two-way Interactions and Feedbacks

Lau and Phillips 1984; Straus and Lindzen 2000;
Krishnan et al. 2009; Moore et al. 2010; Frederiksen
and Lin 2013

- Rossby waves excited by MJO convective activity break in the subtropics and further modulate the convective activity in the Tropics

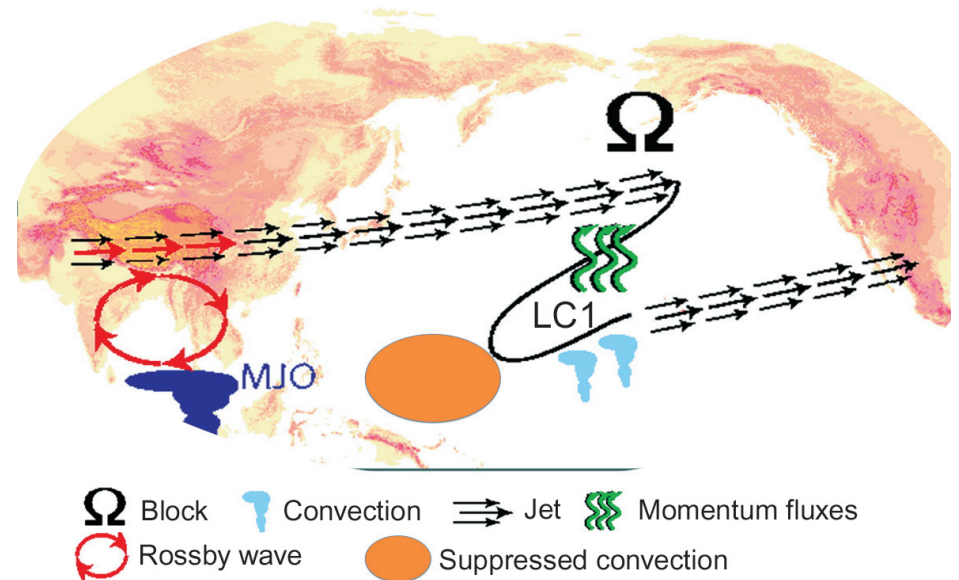

Roundy, 2011

- Monsoon breaks – midlatitude circulation feedbacks lead to long-lasting droughts over India

Two-way Interactions and Feedbacks

Questions

Overview of the current knowledge and challenges

The virtual field campaign

Discussions

4. To what extent are the dominant tropical and extratropical intraseasonal oscillation connected?

Overview of the
current knowledge
and challenges

The virtual field
campaign

Discussions

S2S Teleconnection Sub-project

Members

- Jorgen Frederiksen (CSIRO)
- Hai Lin (EC Canada) and Cristiana Stan *Co-Chairs*
- Eric Maloney (CSU) and Steven Woolnough (U Reading) – *Liaison to the MJO sub-project*
- Franco Molteni (ECMWF)
- Andrew Robertson (IRI) – *Liaison to WGSIP*
- Courtney Schumacher (Texas A&M University)
- David Straus (George Mason University)

Overview of the
current knowledge
and challenges

The virtual field
campaign

Discussions

Broad Objectives

- Better understand sub-seasonal tropical-extratropical interaction pathways
- Identify periods and regions of increased predictability (“forecasts of opportunity”)
- Improve subseasonal-to-seasonal forecasts of weather and climate for applications

Year of Tropics-Midlatitude Interactions and Teleconnections

Description

- Intense coordinated effort involving existing observational data, forecasts and applications, diagnostics, theory and modeling experiments

Mission

- Foster relationship between research, forecasting, and stakeholder communities, and facilitate the sharing of common interests to explore the links between the tropics and midlatitudes for a better prediction skill at intraseasonal time scales

Research Questions

- Are mid-latitude teleconnections from the fluctuating tropical heating fundamentally just time-lagged stationary wave responses to heating, or does time-dependent wave interface play a role?
- Why are the North Atlantic weather regimes so influenced by MJO-related heating in the distant Indian and Pacific Oceans?
- What is the role of synoptic-scale transients?
- Is the impact of extra-tropical forcing associated primarily with the initiation of tropical convection, or can it organize tropical convection of intraseasonal time scale?
- What is the role of PV streamers?



Better
understand
and predict
sub-seasonal
tropical-
extratropical
interaction
pathways



YTMIT

mid 2017-mid 2019

Virtual

Field

Campaign





Better understand and predict sub-seasonal tropical-extratropical interaction pathways



Year of Tropics-Midlatitude Interactions and Teleconnections

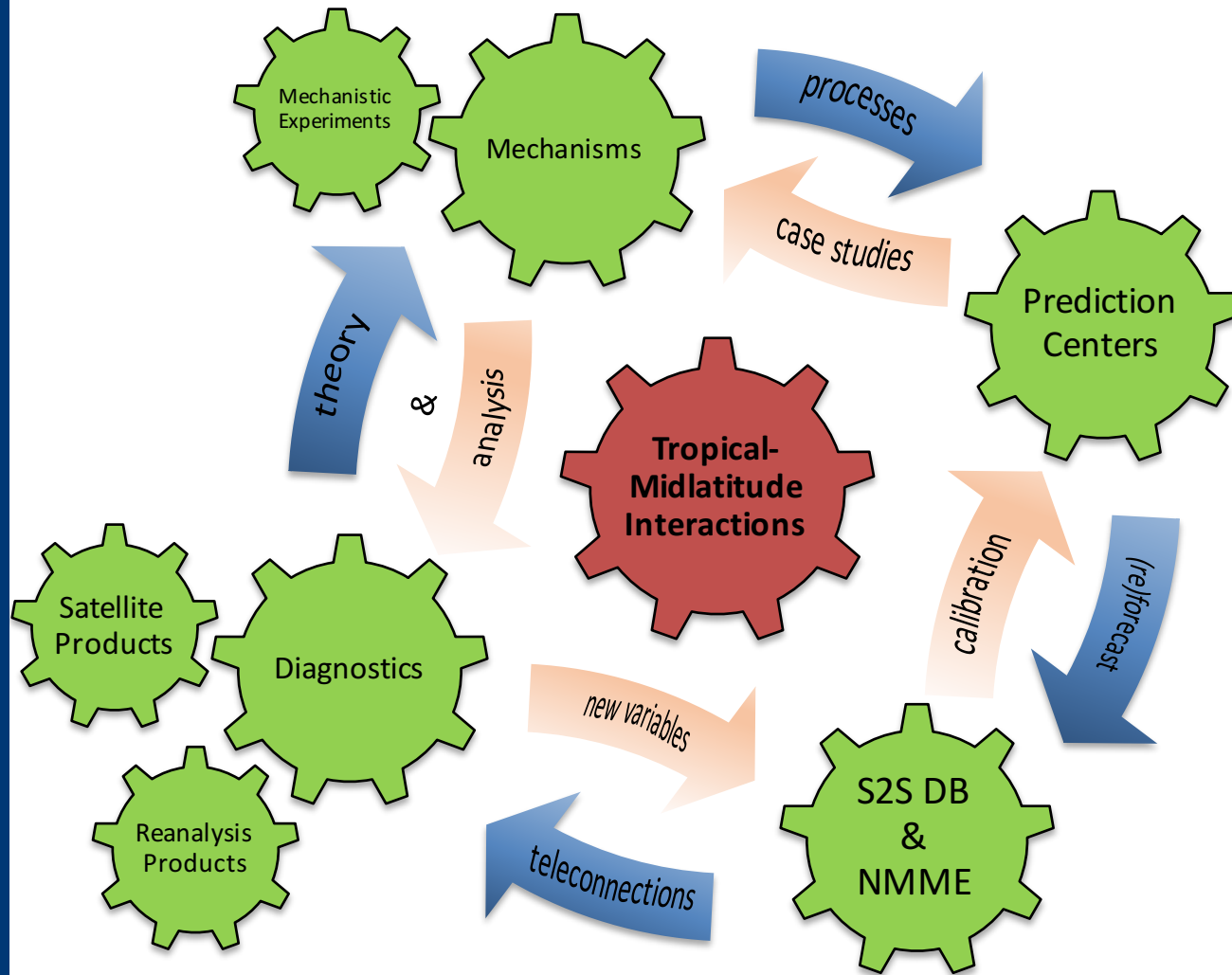

YTMIT

mid 2017-mid 2019

**Virtual
Field
Campaign**



Overview of the
current knowledge
and challenges

The virtual field
campaign

Discussions

Remaining Challenges

- *Can we understand midlatitude teleconnections from the fluctuating tropical heating as time-lagged stationary wave responses to the heating, or does time-dependent wave interface play a role in the response?*
- *How do intense midlatitude storms and poleward propagating tropical storms interact with the polar vortex and alter the annular modes on sub-seasonal time scales?*
- *To what extent are the dominant tropical and extratropical intraseasonal oscillation connected?*
- *What aspects of intra-seasonal heating arising from tropical convection are most important for forcing extra-tropical responses?*

Overview of the
current knowledge
and challenges

The virtual field
campaign

Discussions

Remaining Challenges

- *What is the sensitivity to vertical and horizontal structure and to temporal evolution of the heating, and why?*
- *Does tropical forcing amplify the intrinsic extratropical intraseasonal variability or excite new perturbations?*
- *What explains the hemispheric asymmetry of the responses to tropical forcing?*
- *Role of the basic state errors in simulation of tropical-midlatitude interactions*