

RTOFS Global

v1.1.0

EMC-CCB Meeting May 12, 2015

Teams: EMC: Avichal Mehra, Ilya Rivin, Zulema Garaffo, Bhavani Balasubramaniam, and Todd Spindler
NCO: Rebecca Cosgrove, Carissa Klemmer, Steven Earle
USN: Joe Metzger, Ole Martin Smedstad, Alan Wallcraft, Chris Dehaan

Outline

- Current status of RTOFS Global v1.0
- Upgrades for v1.1
- Evaluation
- Resource/product changes for v1.1.

RTOFS-Global v1.0

- RTOFS Global is the first global eddy-resolving ocean forecast system at NOAA/NCEP implemented in close collaboration with the US Navy.
- This global system is based on a 1/12 degree **HYCOM** (**HY**brid **C**oordinate **O**cean **M**odel) developed by the US Navy with a Pan-Am Global Grid (4500 x 3928).
- The system has 32 vertical hybrid layers (isopycnal in the deep, isolevel in the mixed layer and sigma in shallow waters).
- The initialization is based on a daily live feed of analysis fields provided by NAVOCEANO from a 3D-VAR data assimilation scheme (NCODA) developed by the US Navy which assimilates daily observations (T,S, U,V and sea surface height) in a sequential incremental update cycle.
- The daily global ocean forecasts at NCEP are forced with the GFS surface fluxes of radiation, precipitation and momentum.
- **Strong collaboration with US Navy, leveraging core HYCOM and data assimilation developments at NRL.**

1/12 Degree Global Domain

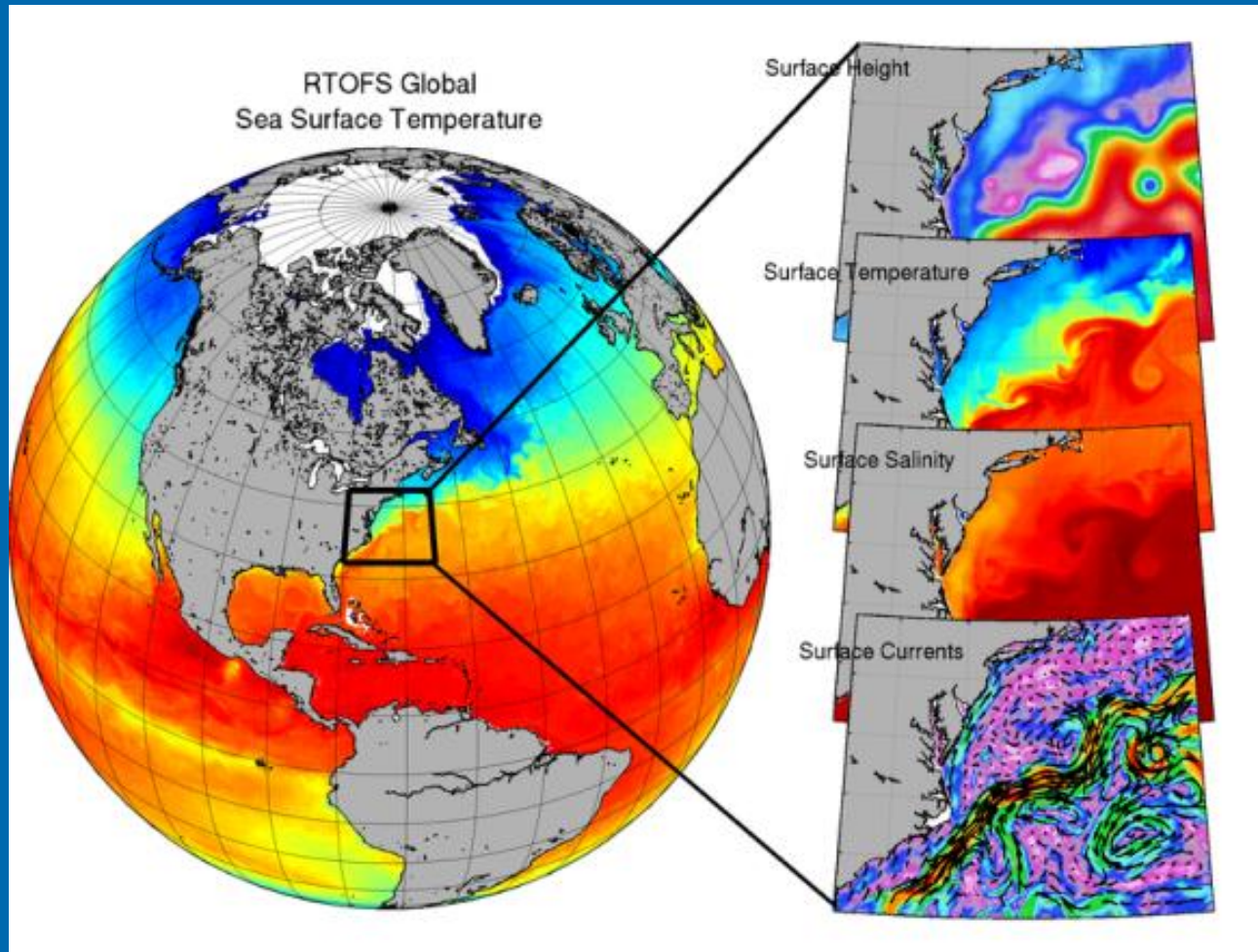

Primary Users:

NWS:

EMC, OPC, NHC,
WFO/NWPS

NOS:

CO-OPS, IOOS RA's

OAR:

OWAQ, AOML/HRD

US Coast Guard

Primary research partners: NRL, ESRL, AOML, NESDIS, JCSDA, JAEA (Japan), UMD, FSU, MSU, INCOIS (India)

Current Status

- NCEP implemented RTOFS-Global v1.0 in operations on 10/25/11
- NAVO is delivering initialization data daily.
- MMAB/EMC has converted Navy model to be forced with GFS/GDAS fluxes.
- Multiple data distribution channels have been developed:
 - NOMADS (operational)
 - FTP (operational)
 - AWIPS (operational)
 - ~~NOMADS (development)~~

Model run setup

RTOFS-Global using 00z – 12z cycles:

- 00z cycle: Dedicated to model initialization:
 - For now, take data from Navy, propagate several days as needed to adjust to GDAS/GFS forcings.
 - Will become full assimilation cycle using last 5-7 days of real time data, **MOA with Navy on implementing NCODA at NCEP.**
- 06z cycle; Forecast days 1-4
- 12z cycle: Forecast days 5-8
- 18z cycle (in reserve)

RTOFS-Global Job Structure

Overview of Stages

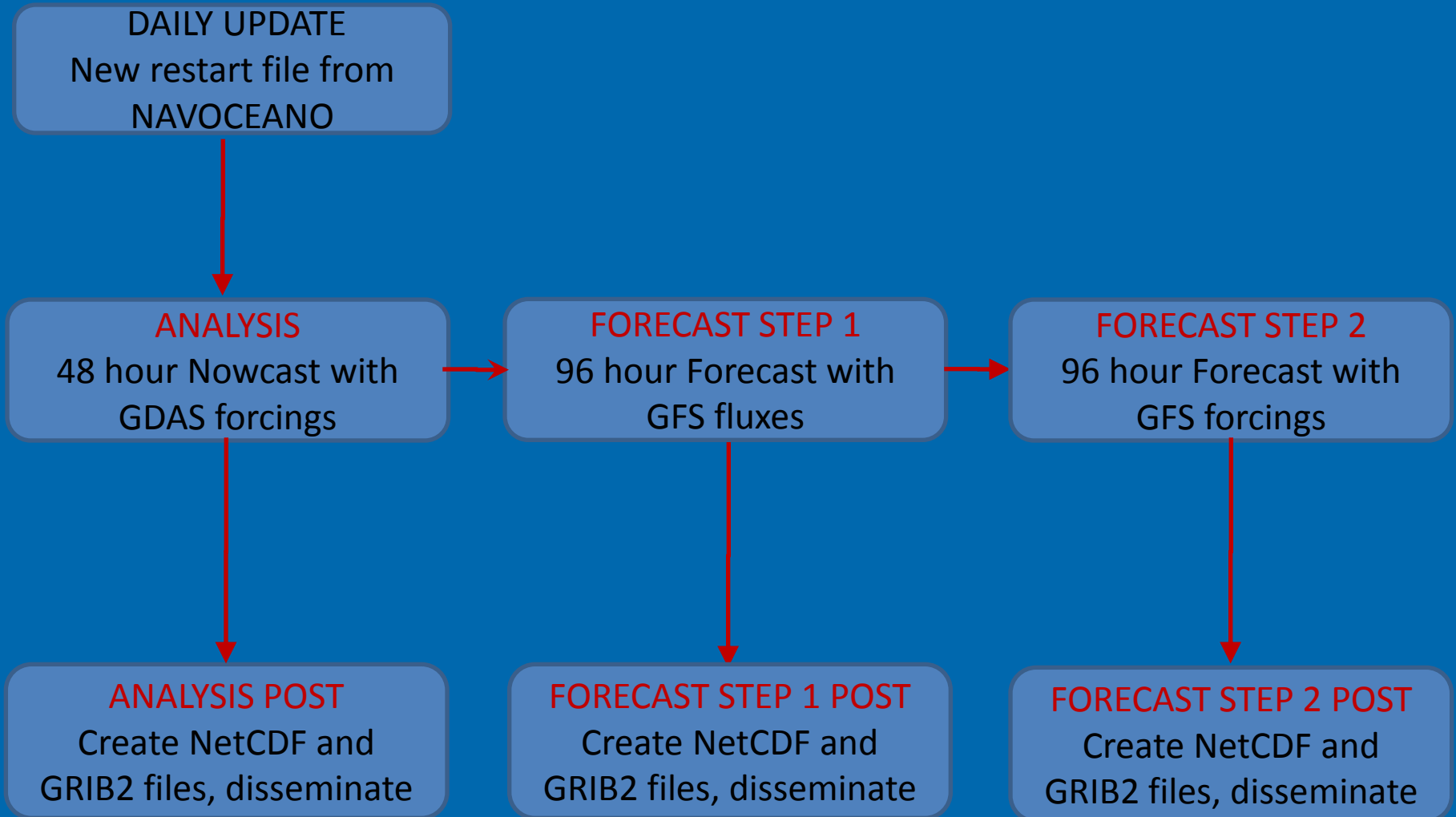

Version 1.1.0

Primary upgrades:

- 41 hybrid layers (increased from 32 layers), iso-levels mostly in the top 200m
- Improved bathymetry which allows better representation of shallow points (minimum depth 5m)
- Updated climatology fields from GDEM 3 to GDEM 4
- An updated equation of state (17 terms vs 9 terms)
- Two-way coupled HYCOM with Los Alamos **CICE** (**C**ommunity **I**ce **C**od**E**) (which replaces Energy-Loan Sea-Ice model)
 - 1 hour coupling frequency
 - Using ESMF v4.0 (non-NUOPC)

Developed fully at US Navy (GOFS 3.1) with ongoing independent validation.

HYCOM CICE coupling

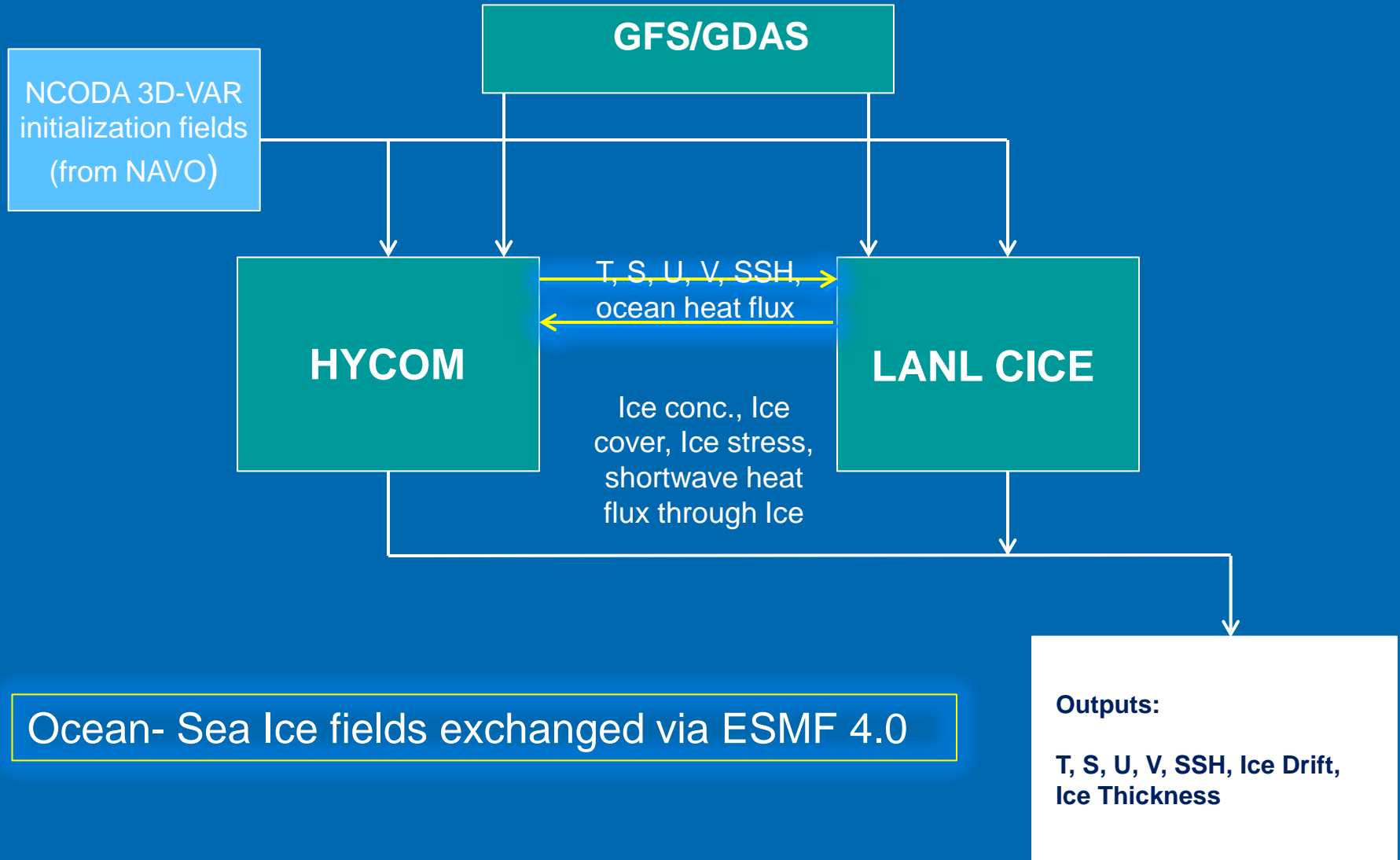

Evaluation

- Coastline/water mass representations
- GS Location
- SSH comparisons
- SST comparisons
- Florida Cable transports
- Profile metrics
- Polar Ice cover

RTOFS v1.1 vs RTOFS v1.0 Improvements in Bathymetry

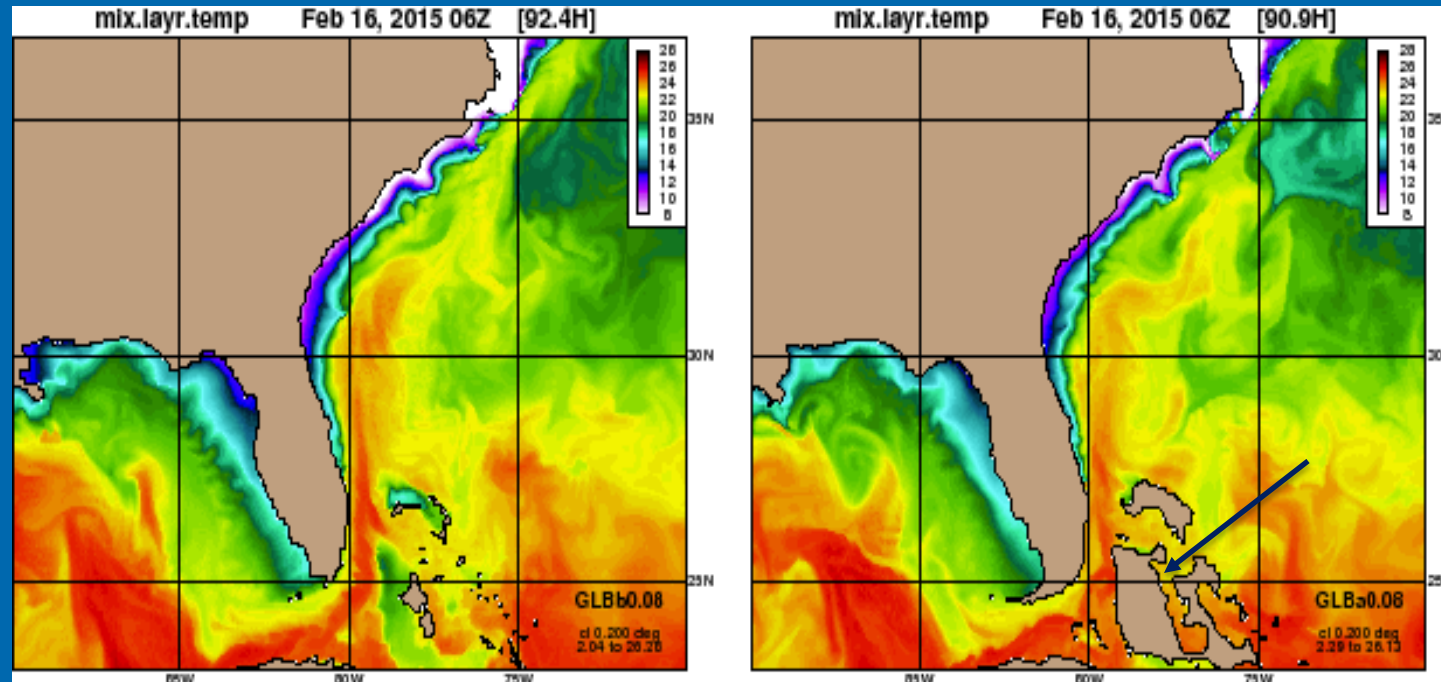

RTOFS-Global SST v 1.1 (left) and version 1.0 (right). The shallow region north of Grand Bahamas is present in version 1.1 while it was masked as land in version 1.0.

RTOFS v1.1 vs RTOFS v1.0

Zonal Temperature Cross Sections

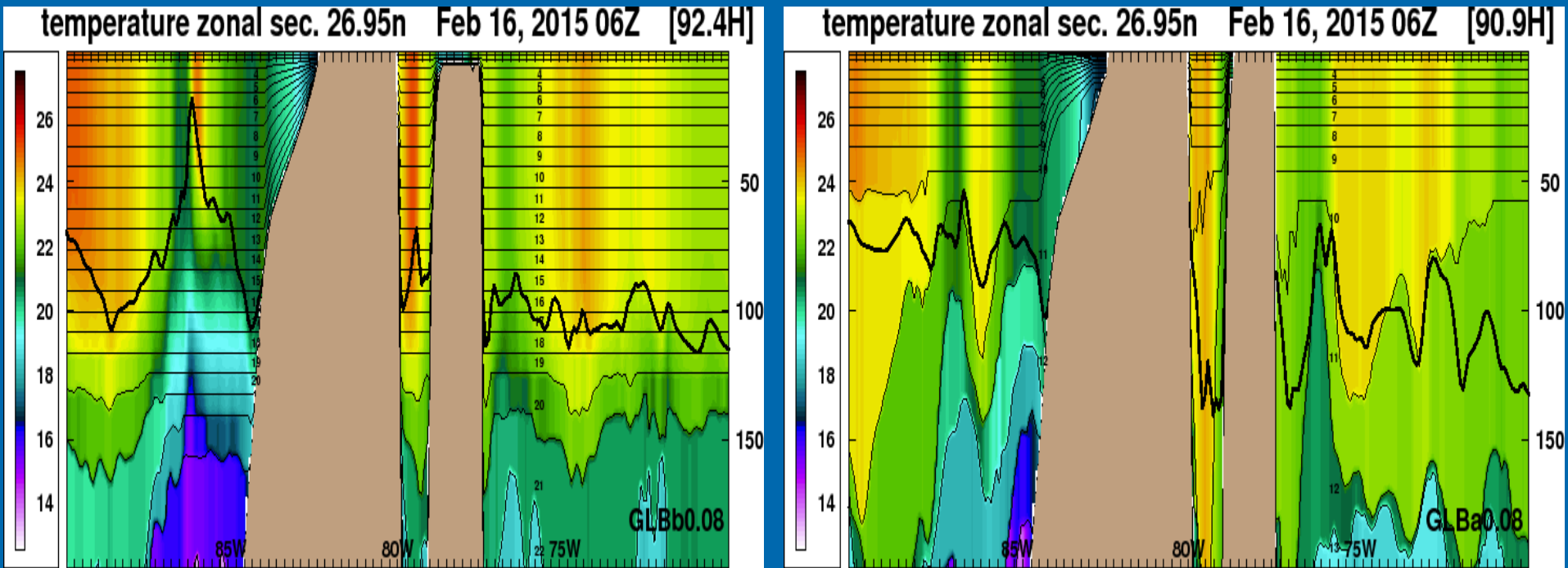

Higher vertical resolution section at 27 N, passing just north of Grand Bahamas, from RTOFS-Global versions 1.1 (left) and version 1.0 (right).

WOCE vs RTOFS v1.0 vs RTOFS v1.1 Vertical Temperature Cross Section

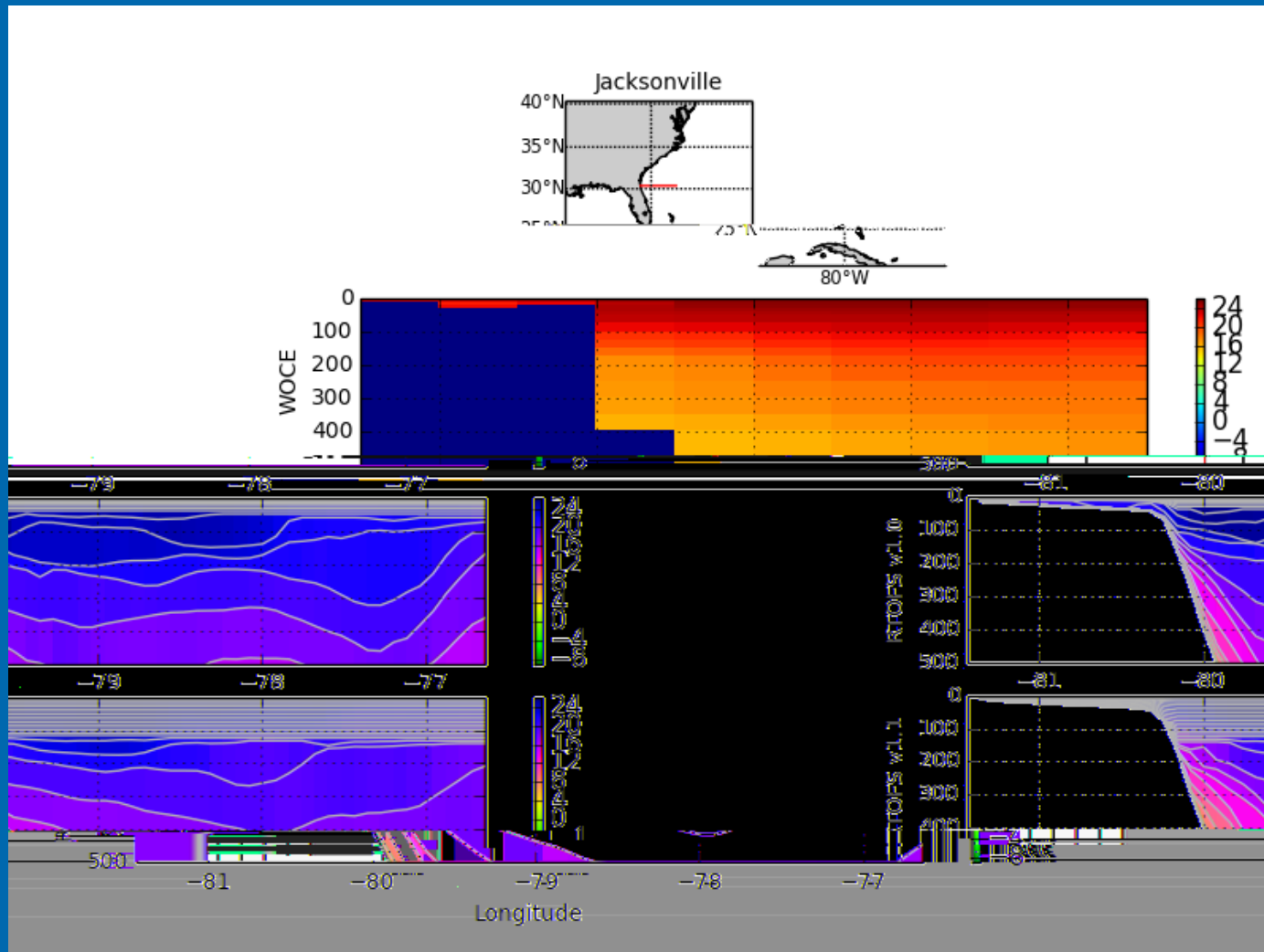

Improved representation for both coastal ocean
and deep ocean upper stratified layers

Obs vs RTOFS v1.1 vs RTOFS v1.0

Vertical Temperature Cross Section for Fall 2013

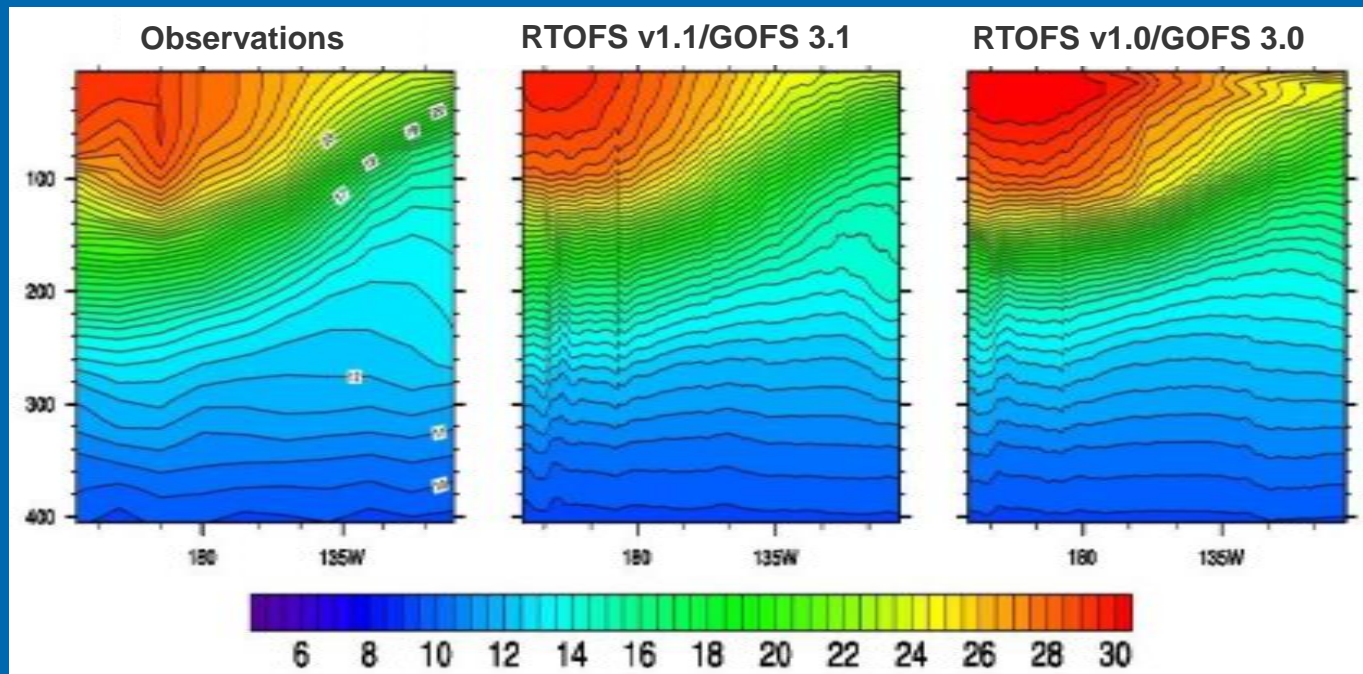

Better representation of warm pool/cold tongue in equatorial Pacific
(reference: Pat Hogan@NRL)

RTOFS v1.1 vs RTOFS v1.0

Global RTOFS Parallel GS Location for 26-Apr-2015
12°C isoth at 400m and SSH

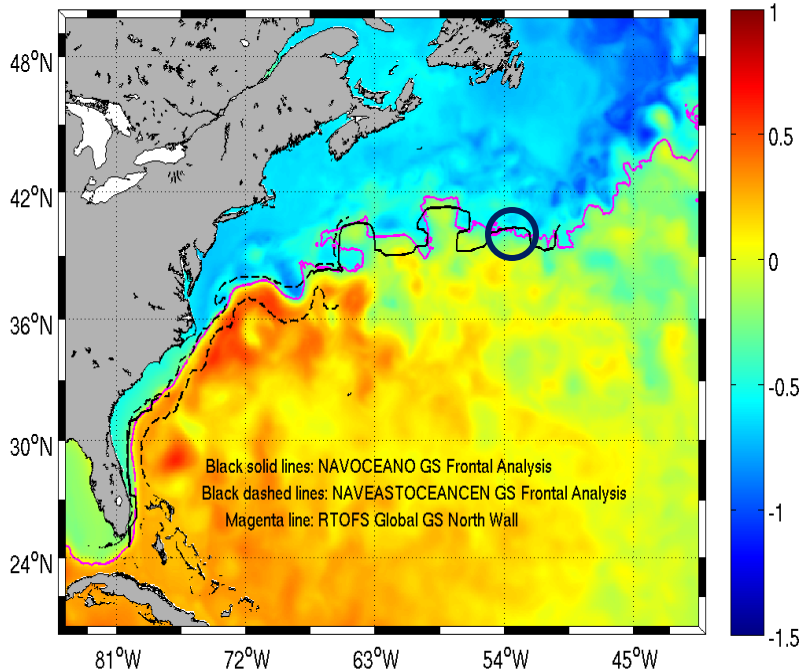

Black solid lines: NAVOCEANO GS Frontal Analysis
Black dashed lines: NAVEASTOCEANCEN GS Frontal Analysis
Magenta line: RTOFS Global GS North Wall

NAVOCEANO for 26-Apr-2015
NAVEASTOCEANCEN for 27-APR-15

27 Apr 2015

RTOFS Global GS Location for 26-Apr-2015
12°C isoth at 400m and SSH

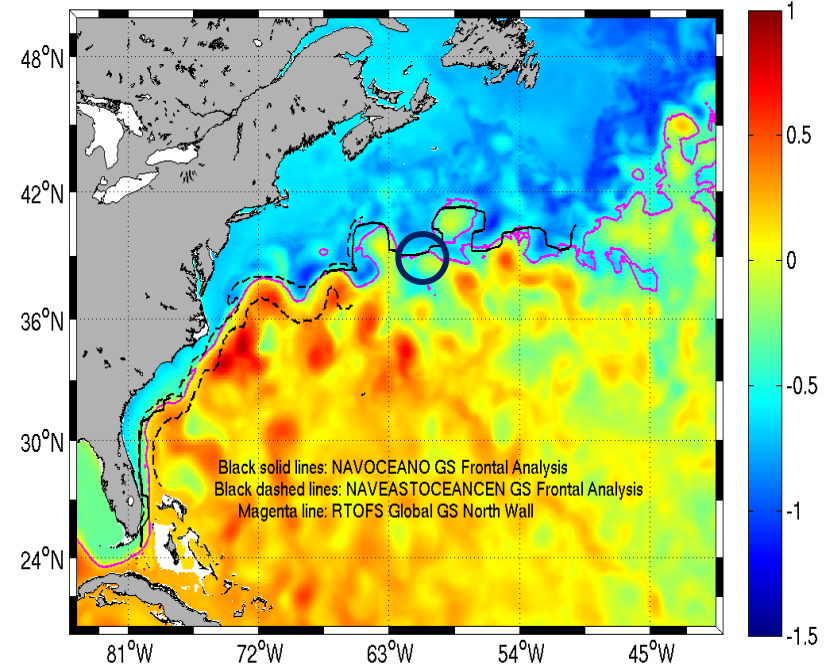

Black solid lines: NAVOCEANO GS Frontal Analysis
Black dashed lines: NAVEASTOCEANCEN GS Frontal Analysis
Magenta line: RTOFS Global GS North Wall

NAVOCEANO for 26-Apr-2015
NAVEASTOCEANCEN for 27-APR-15

NCEP/EMC/MMAB RTOFS (Global)

27 Apr 2015

GS North Wall location very similar with small differences near meanders.
OPC to help with quantitative Hausdorff distance measures

RTOFS vs MADT SSHA

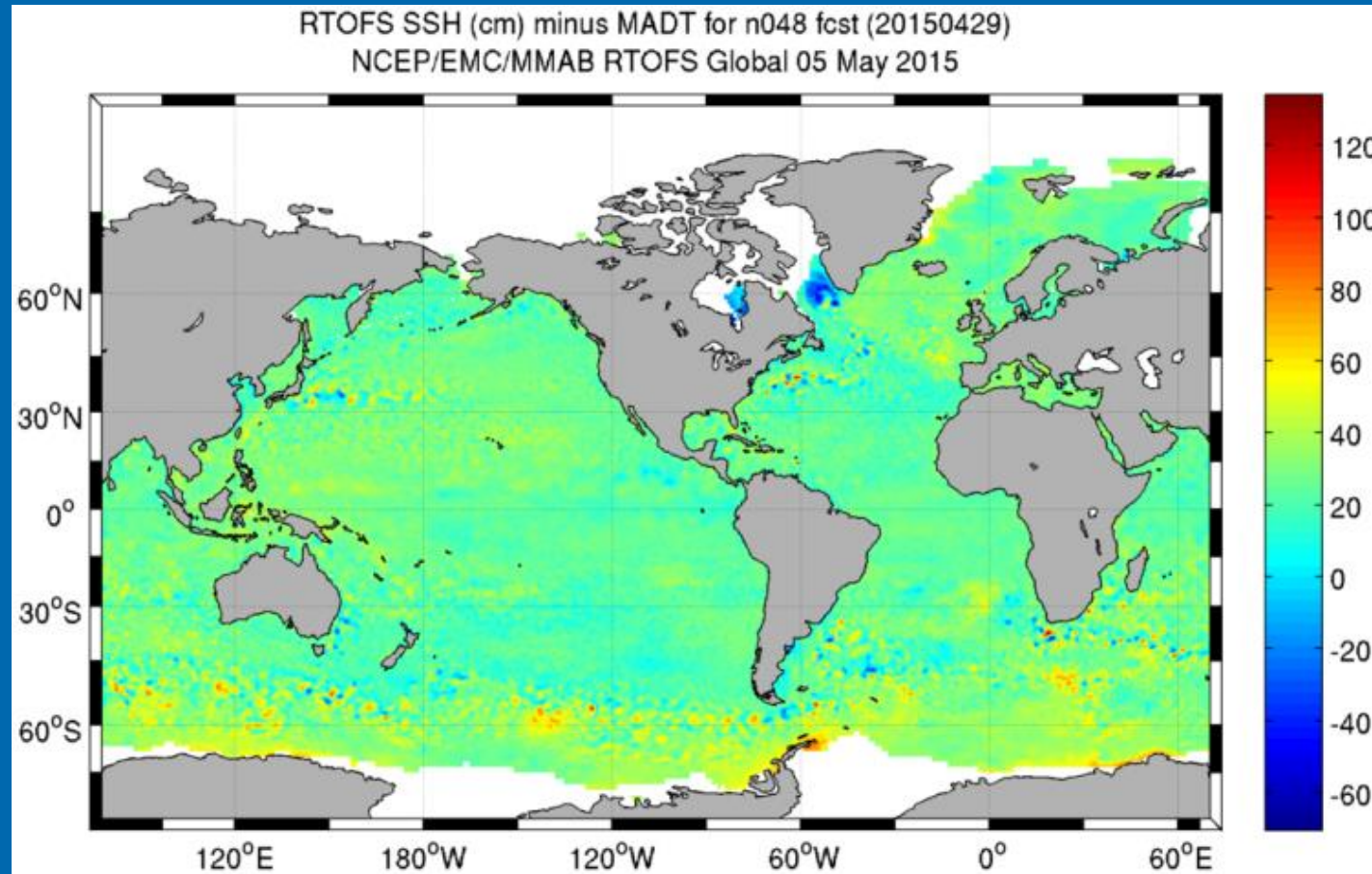

Most of the differences are in regions of large variability

RTOFS v1.1 vs RTOFS v1.0 vs MADT SSHA (Global)

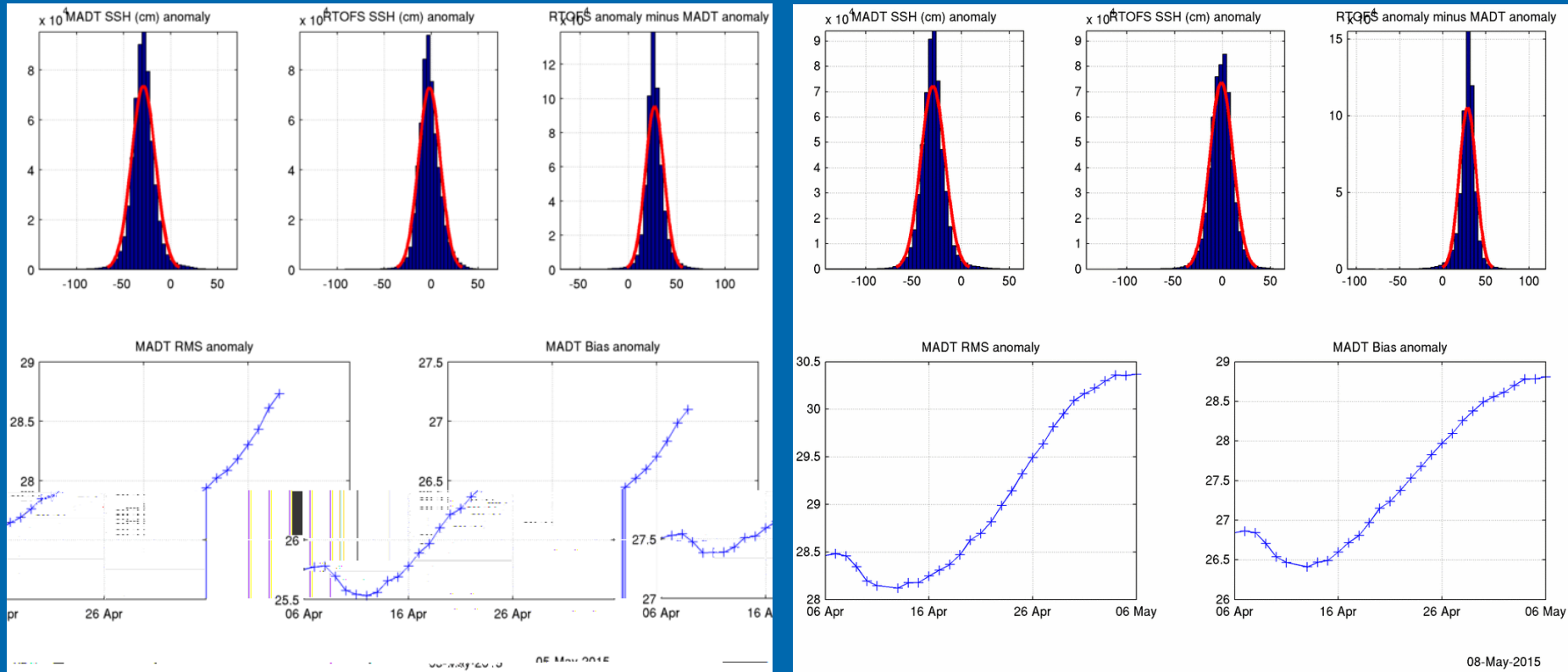

The two simulations are comparable with the parallel (left panel) performing marginally better (approx. 1 cm RMSE and bias).

RTOFS v1.1 vs RTOFS v1.0 vs RTG SST (Global)

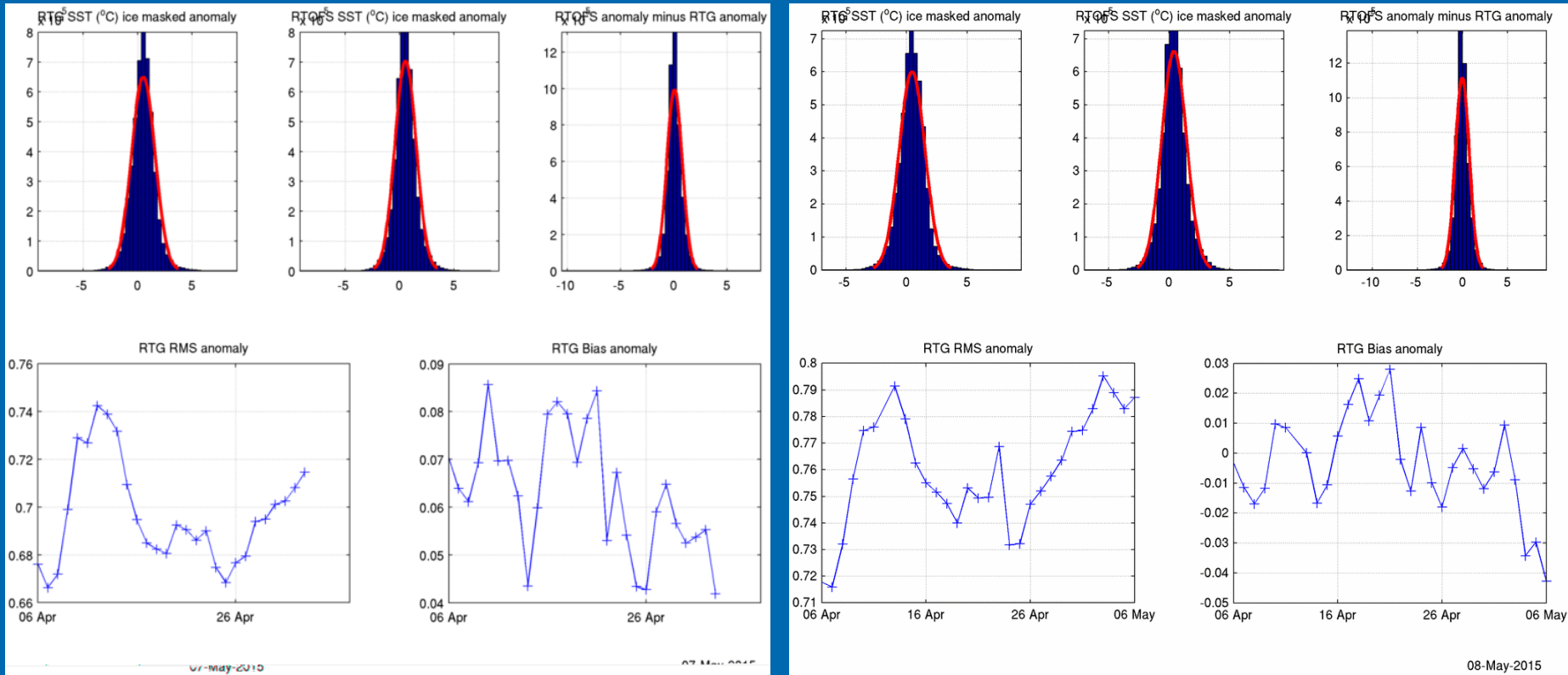

The two simulations are comparable with the parallel (left panel) performing marginally better with smaller RMSE but with a larger average bias/overestimation.

RTOFS v1.1 vs RTOFS v1.0 vs RTG SST (Gulf of Mexico)

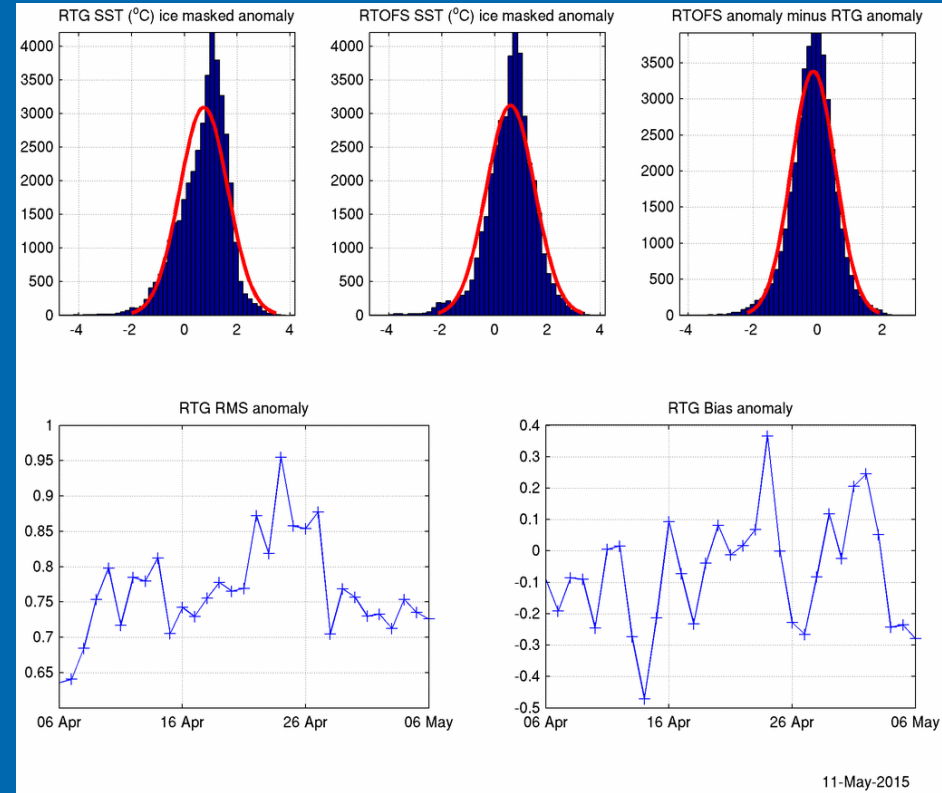
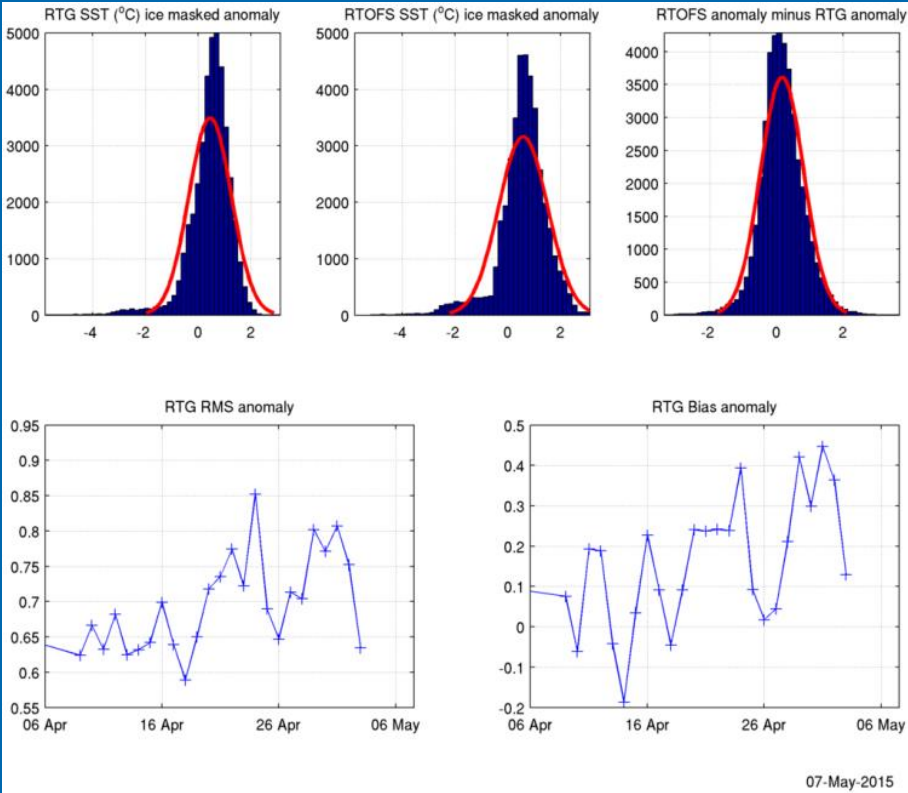

The two simulations are comparable with the parallel (left panel) performing marginally better with smaller RMSE but with a larger average bias/overestimation.

Florida Cable Transports

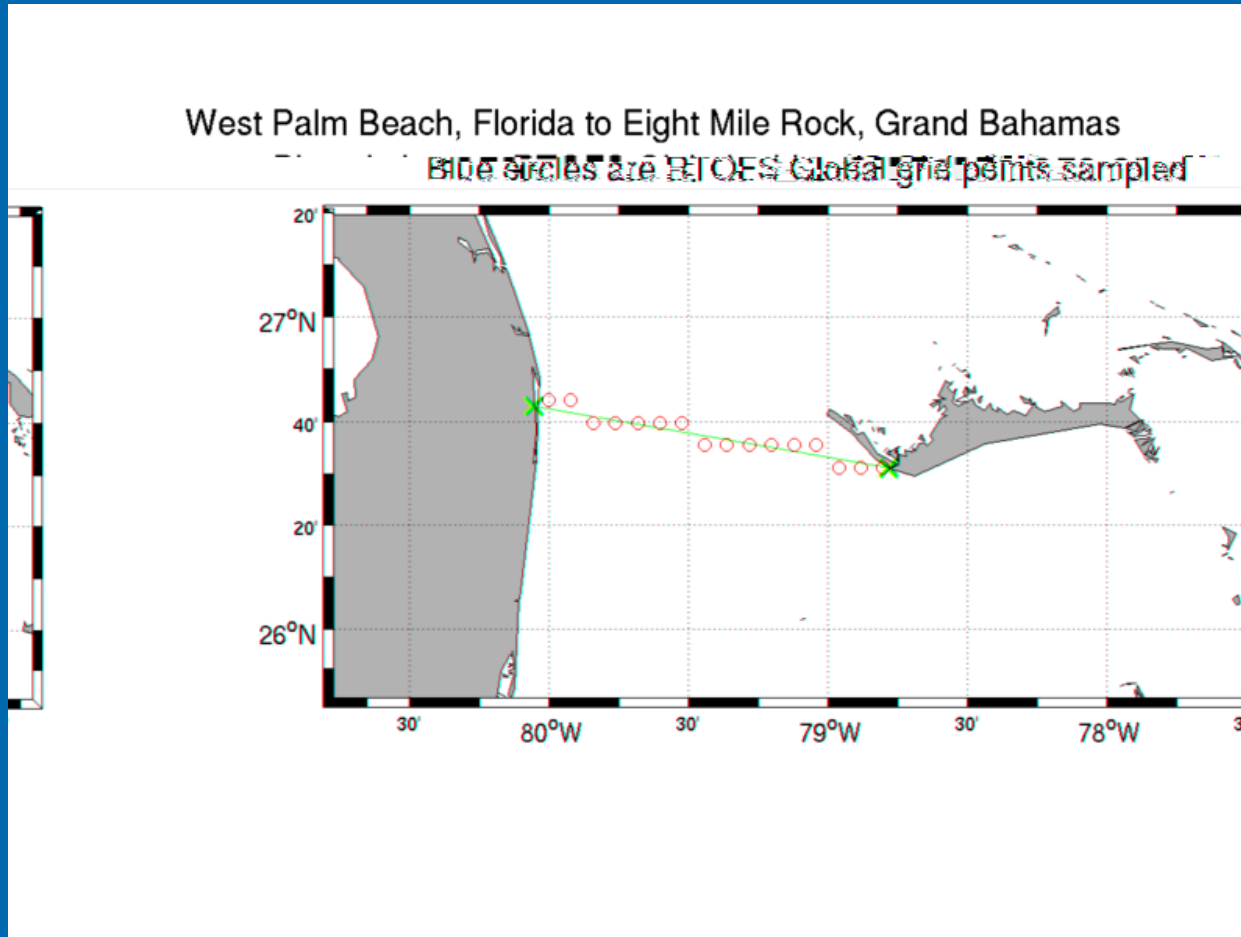

The transport variations of the Florida current using a submarine cable (data from NOAA/AOML).

Florida Cable Transports

RTOFS v1.1 vs RTOFS v1.0

Florida Cable Transport compared to Global RTOFS Transport

Mean: 27.85 Min: 22.66 Max: 32.30 Std: 2.86

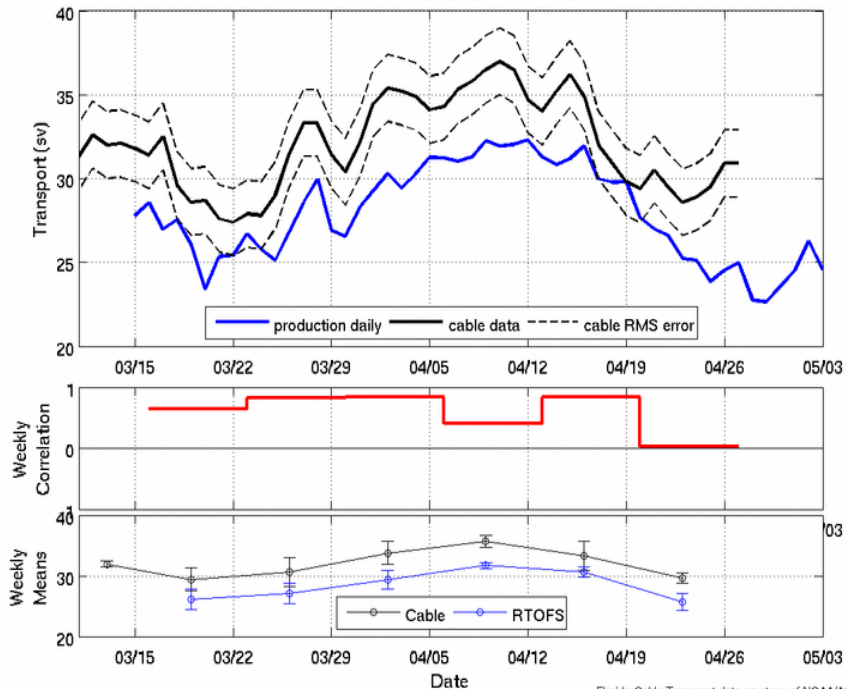

NCEP/EMC/MMAB Global RTOFS PARALLEL

Florida Cable Transport data courtesy of NOAA/ACML/PHOD
06-May-2015

Florida Cable Transport compared to RTOFS Global Transport

Mean: 30.81 Min: 18.27 Max: 38.71 Std: 3.50

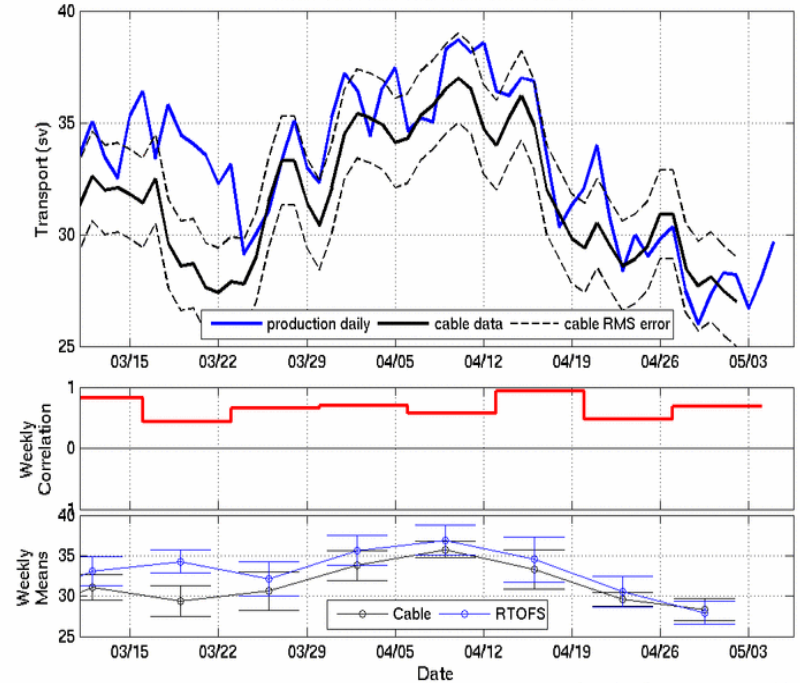

NCEP/EMC/MMAB RTOFS (Global)

Florida Cable Transport data courtesy of NOAA/ACML/PHOD
06-May-2015

Parallel (left panel) underestimates while prod overestimates. Less variability in the parallel due to higher vertical resolution of the fast moving current in the top 200m.

RTOFS v1.1 vs RTOFS v1.0 Vs ARGO

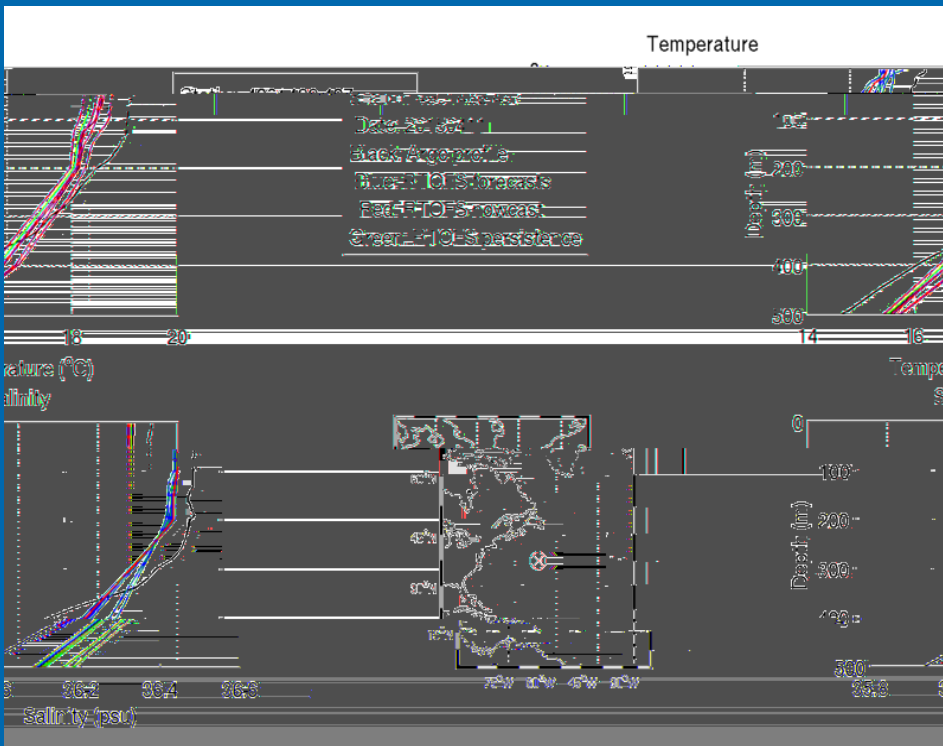

Station 4901466 497
Date: 20150411
Black: Argo profile
Blue: RTOFS forecasts
Red: RTOFS nowcast
Green: RTOFS persistence

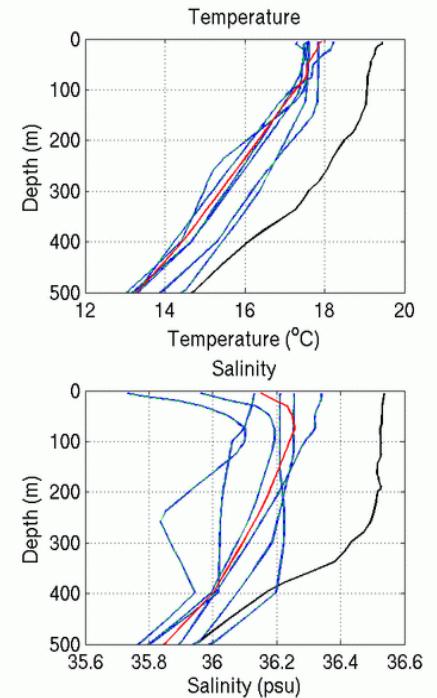
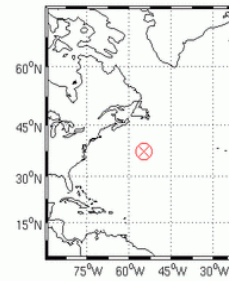

At this location, both parallel (left panel) T & S profiles show much better agreement with ARGO data and significantly less variability in forecasts especially for salinity.

RTOFS v1.1 vs RTOFS v1.0 Vs ARGO

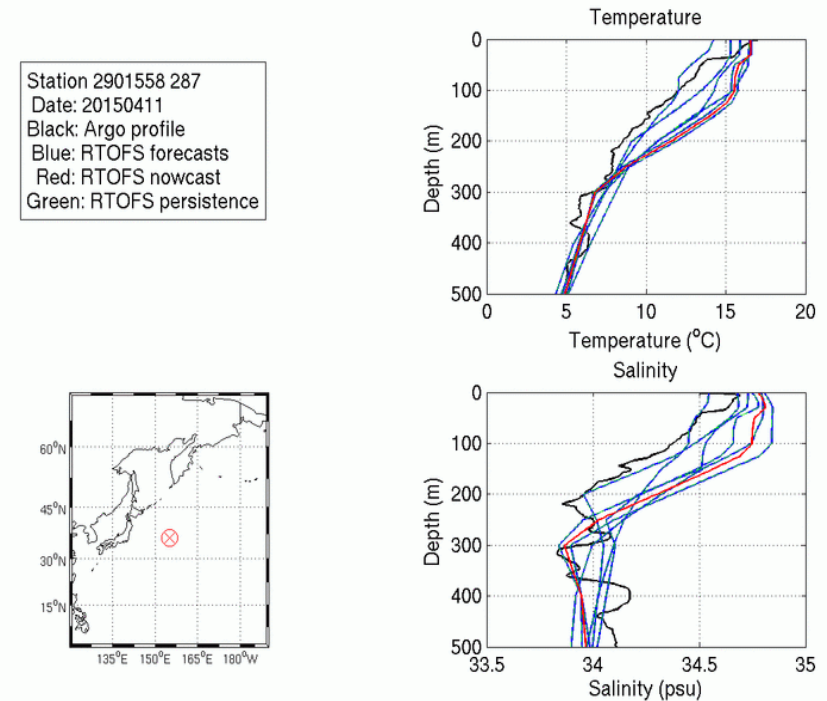
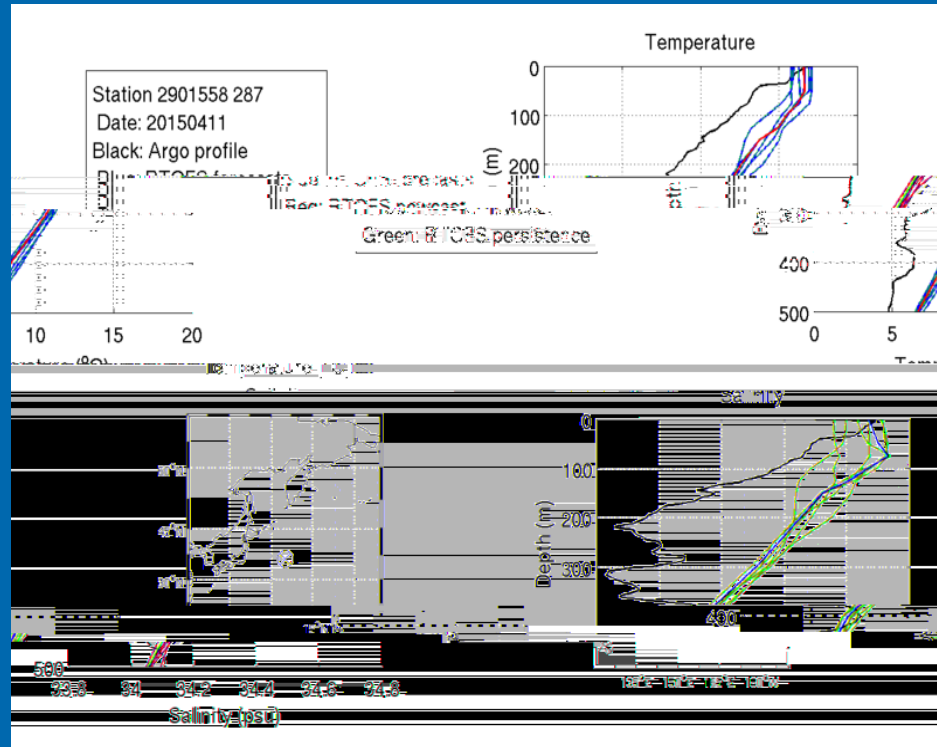

While at this location, production (right panel) T & S show much better agreement with ARGO data but enhanced variability in forecasts especially for salinity.

RTOFS v1.1 vs RTOFS v1.0 Vs ARGO

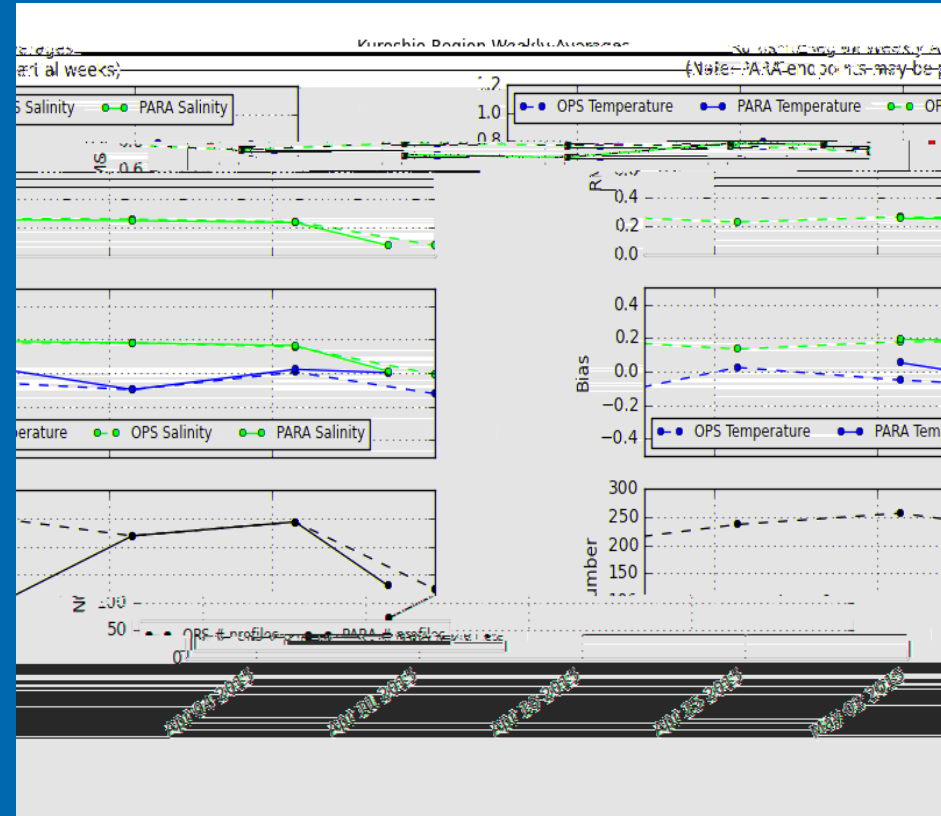
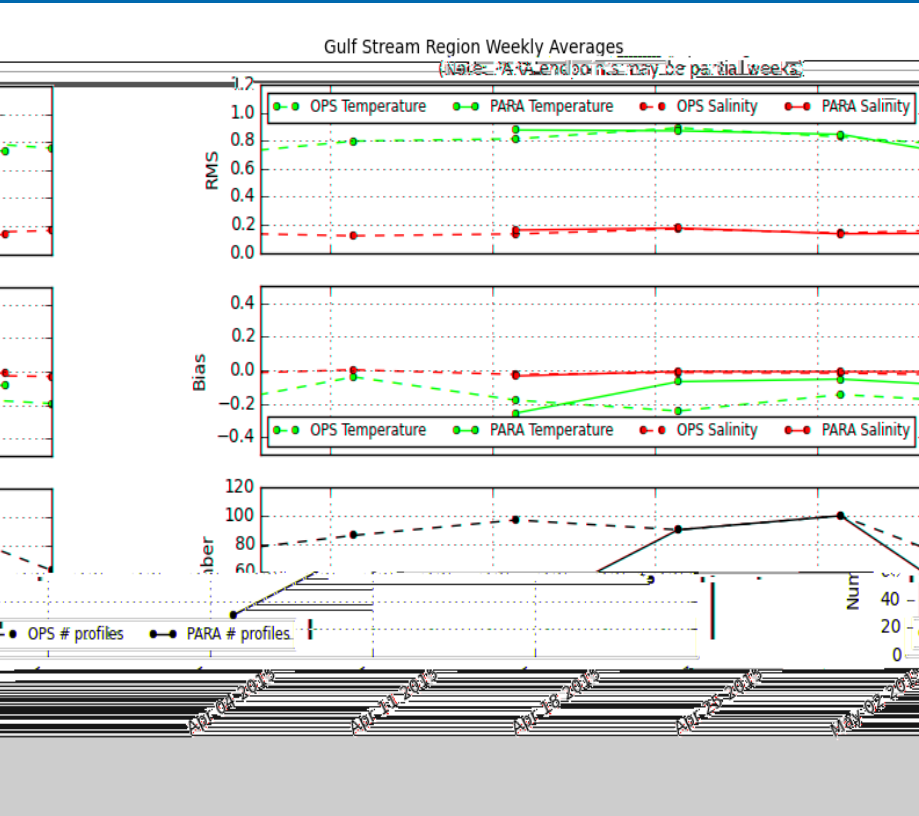

Weekly averaged (and depth averaged) profiles for these two regions show little difference between prod and para.

Sea Ice Cover RTOFS v1.1. vs RTOFS v1.0 vs Analysis

RTOFS PARALLEL minus NCEP ice cover for 20150503
NCEP/EMC/MMAB PARALLEL 07-May-2015

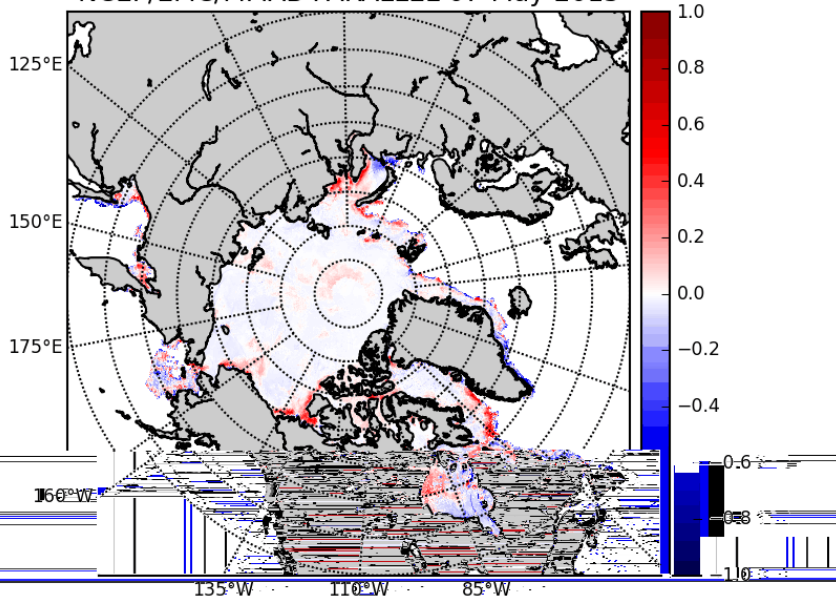

Difference distribution mean=0.009 std dev=0.100

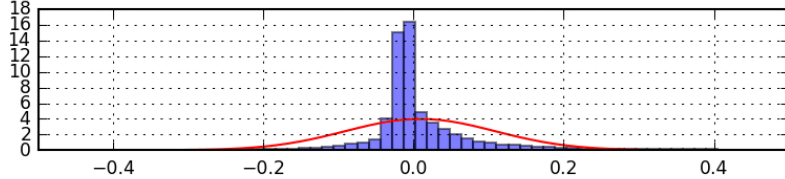

RTOFS minus NCEP ice cover for 20150503
NCEP/EMC/MMAB 04-May-2015

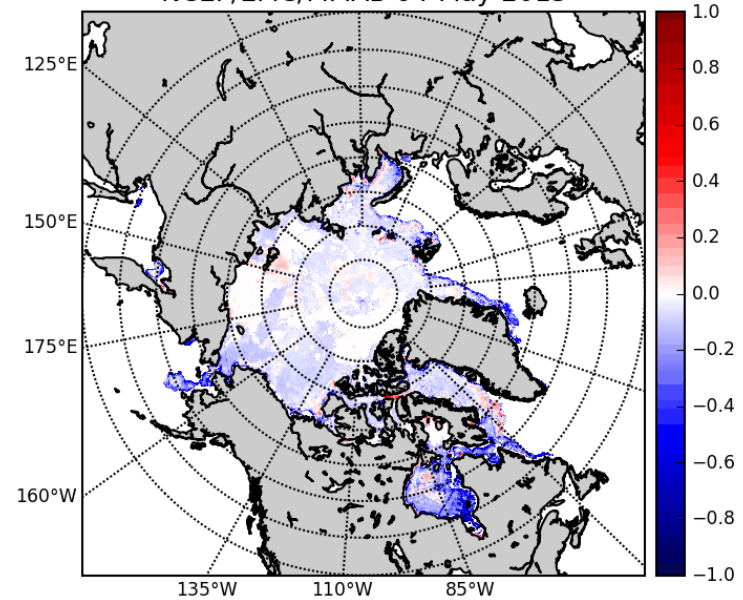

Difference distribution mean=-0.054 std dev=0.125

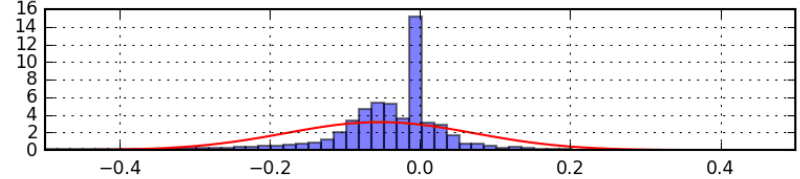

Differences in the Arctic region (May 2015)

Sea Ice Cover RTOFS v1.1. vs RTOFS v1.0 vs Analysis

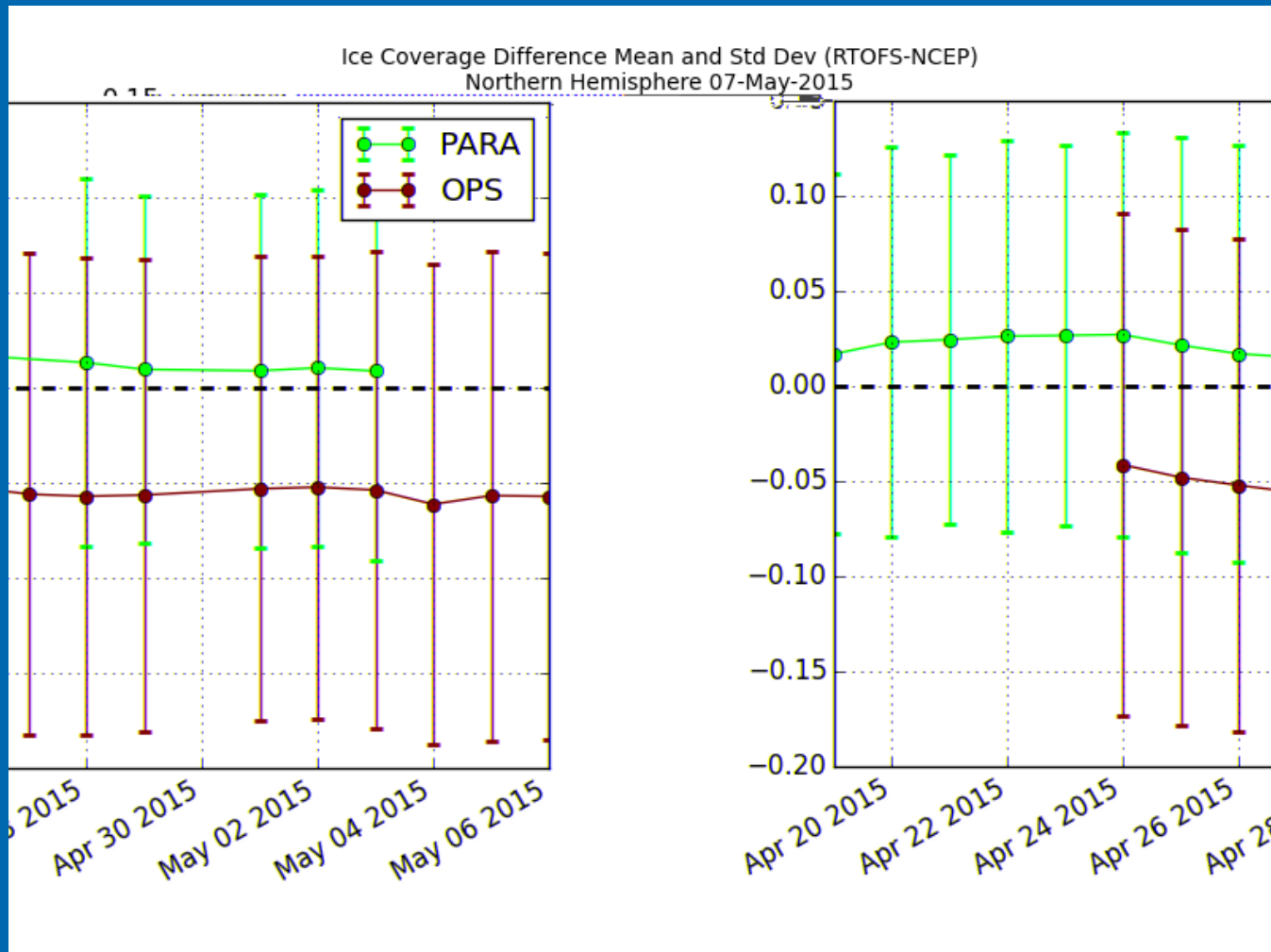

Mean differences in the Arctic region

Sea Ice Cover RTOFS v1.1. vs RTOFS v1.0 vs Analysis

RTOFS PARALLEL minus NCEP ice cover for 20150503
NCEP/EMC/MMAB PARALLEL 07-May-2015

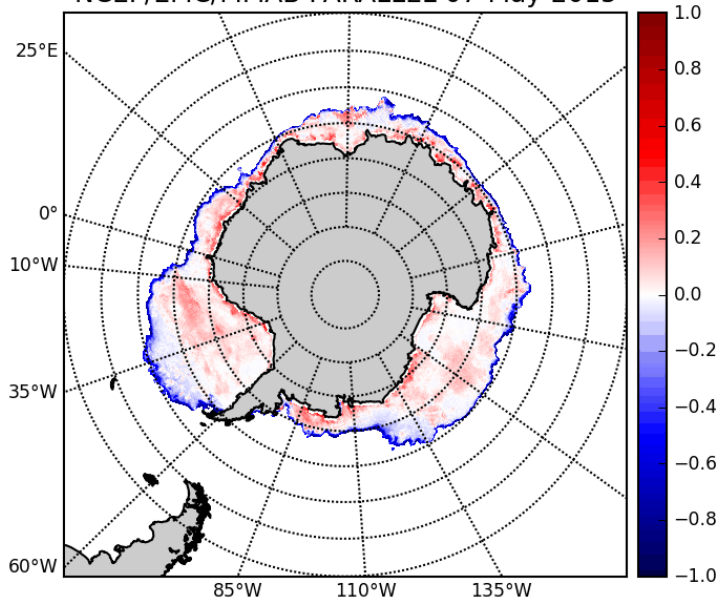

Difference distribution mean=0.022 std dev=0.142

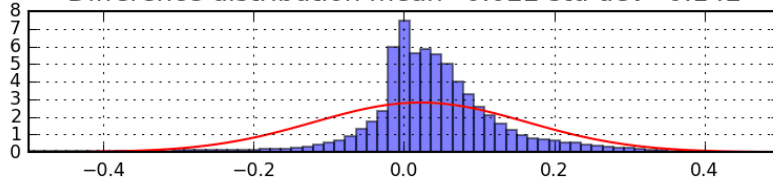

RTOFS minus NCEP ice cover for 20150503
NCEP/EMC/MMAB 04-May-2015

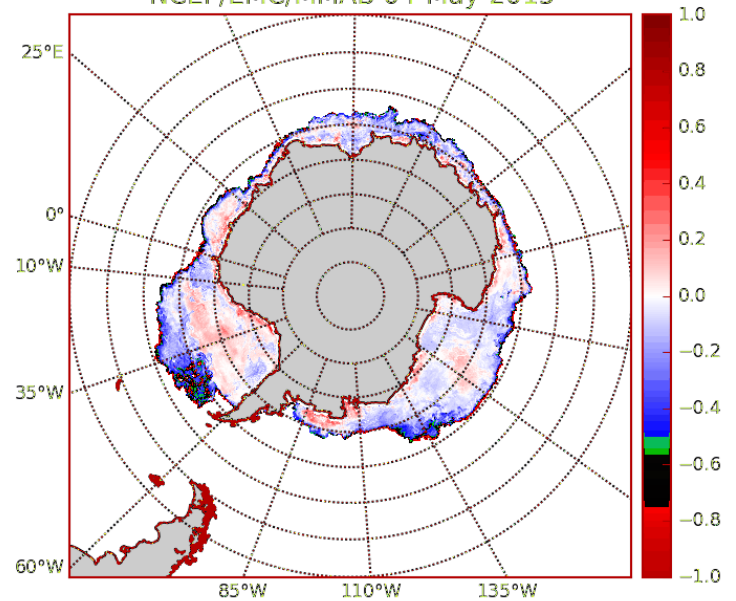

Difference distribution mean=-0.067 std dev=0.177

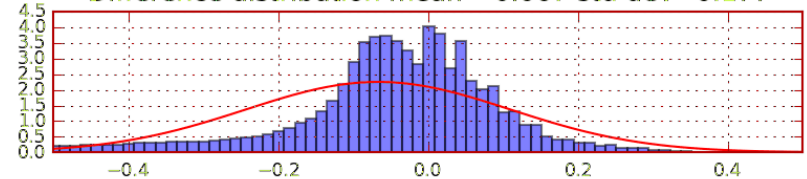

Differences in the Antarctic region (May 2015)

Sea Ice Cover RTOFS v1.1. vs RTOFS v1.0 vs Analysis

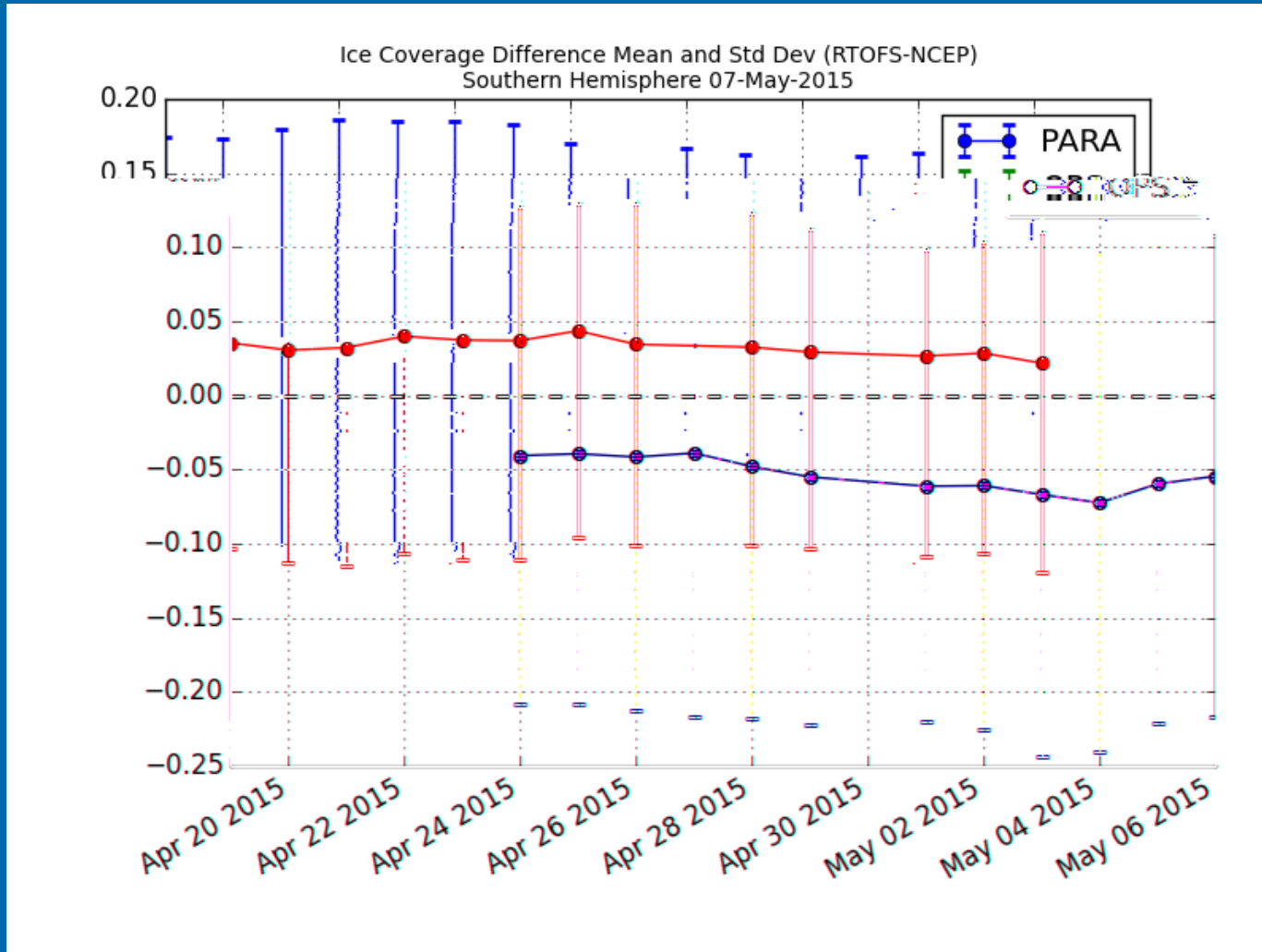

Mean differences in the Antarctic region

Version 1.1.0

Primary impacts:

- Better coastline/water-mass representation for coupled applications (air-sea fluxes for Hurricanes)
- Finer resolution for mixed layer (9 additional near surface layers)
- Improved vertical coastal resolution for downstream applications
- Improved Sea Ice coverage in polar regions
- Additional ice products/forecasts (ice thickness, ice concentration, ice drift and speed)

Resources

- CPU: **v1.1** 1800 PE or 75 nodes
v1.0 2134 PE or 134 nodes
- Runtime: **v1.1** 18 minutes per day
v1.0 10 minutes per day
- Disc: **v1.1** ~25% more than v1.0 (CICE files, 41 levels, OPC products)
- Workflow: **v1.1** same as v1.0

RTOFS-Global v1.0 Product Suite

- Class I : Global netCDF files on native horizontal grid but interpolated to isolevels. Delivery via NOMADS, ftpprd and ~~NODC archives.~~
 - Surface 3 hourly files (8 variables) ~ 120 GB per cycle
 - Volume 3d files daily (8 variables, 33 Z levels) ~ 160 GB per cycle.

Target: General user; maximum flexibility for slicing/dicing data using NOMADS/OpenDAP servers (both GDS & TDS).

- Class II: Sub-regional and basin GRIB2 files on Mercator grid. Delivery via ftpprd and AWIPS.

Surface 3 hourly files (7 variables) ~ 5 GB per cycle

Target: Internal NWS needs to provide results on AWIPS or via FTP.

RTOFS-Global v1.0 Product Suite

- Class III: Regional (CONUS-East, CONUS-West, Alaska) netCDF files.

Delivery via NOMADS and ftpprd.

- Volume 6 hourly files (u,v,T,S)

Target: Other centers within NCEP (NHC, OPC) and NOS OFS systems

- Daily graphics available via web (polar) with restricted access to daily monitoring metrics

Target: General public, collaborators

RTOFS-Global v1.1 Additional Products

- Additional n000, f000 data for aggregated variables from GDS/NOMADS servers
- OPC: Global NetCDF files (time series of variables)

Delivery via OPC ftp servers.

- Surface hourly files (u, v, T, S, SSH)

Target: OPC, USCG/SAROPS

- Product upgrade planned for FY16 Q2 (Sea Ice, HWRF-HYCOM, Ecosystems)

Back Up

WOCE vs RTOFS v1.0 vs RTOFS v1.1 Vertical Temperature Cross Section

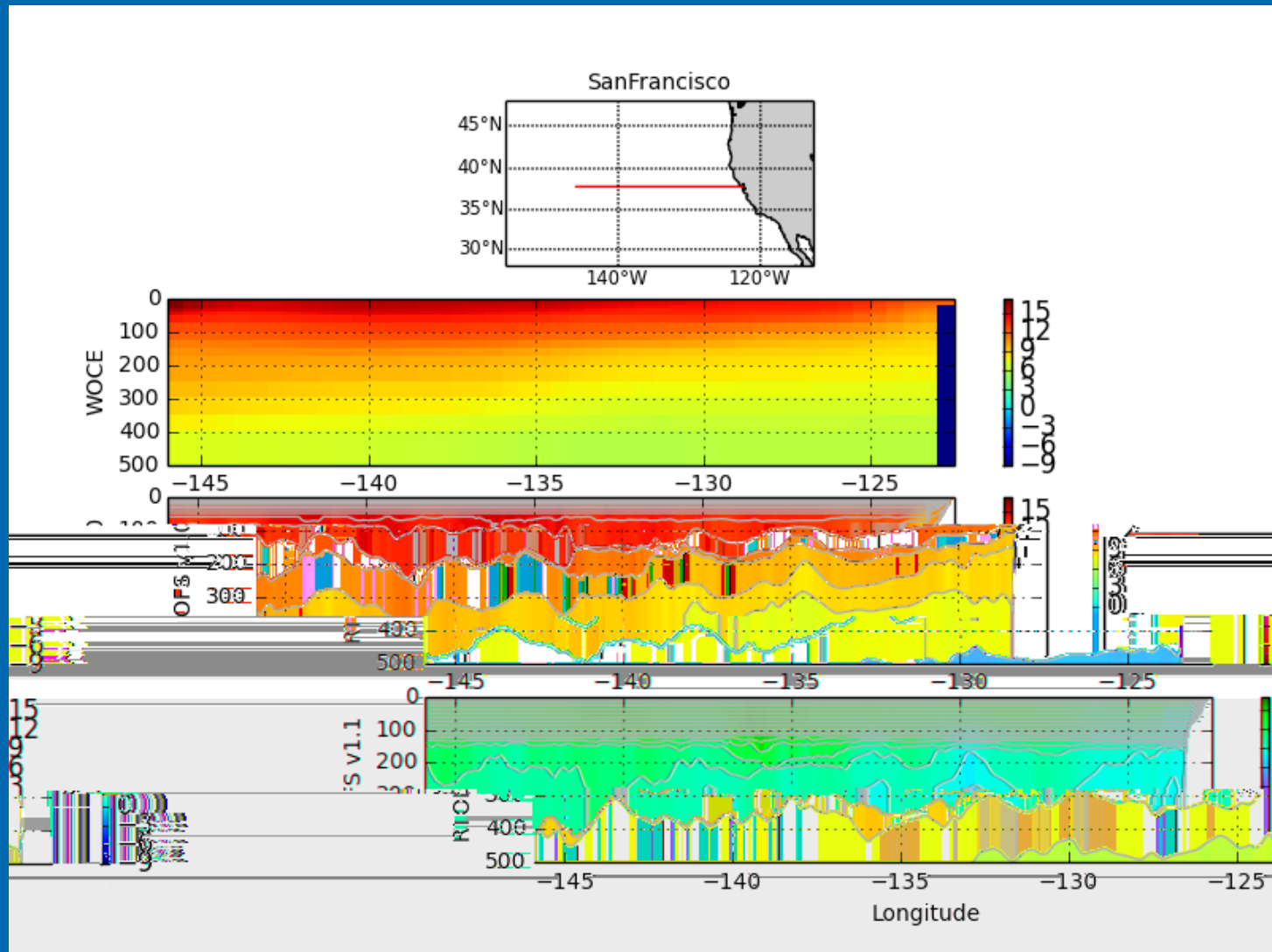

Higher vertical resolution for upper ocean processes (mixed layer)

Recent upgrades for v1.0

- GRIB2 output to ops (OSIP) (Dec: 2013)
- Seven NOS regions use BC's in Coastal Ocean Modeling Framework (March 2014)
- 2 IOOS RA's (NANOOS, GOMOOS) also use v1.0 for BC's. (March 2014)