





# HIRE SERVICES AS A BUSINESS ENTERPRISE

A TRAINING MANUAL FOR SMALL-SCALE MECHANIZATION SERVICE PROVIDERS

**Authors**

Brian Sims  
David Kahan  
Joseph Mpagalile  
Martin Hilmi  
Santiago Santos Valle

**Coordinators**

Josef Kienzle (FAO)  
Bruno Gérard (CIMMYT)

**Editorial support**

Ruth Duffy  
Diana Gutiérrez Méndez  
(FAO)

**Illustrator**

Shalis Stevens

**Book design and layout**

Davide Moretti, Art&Design

Food and Agriculture Organization of the United Nations  
and  
International Maize and Wheat Improvement Center  
Rome, 2018

The designations employed and the presentation of material in this information product do not imply the expression of any opinion whatsoever on the part of the of the Food and Agriculture Organization of the United Nations (FAO) or of the International Maize and Wheat Improvement Center (CIMMYT), concerning the legal or development status of any country, territory, city or area or of its authorities, or concerning the delimitation of its frontiers or boundaries. The mention of specific companies or products of manufacturers, whether or not these have been patented, does not imply that these have been endorsed or recommended by FAO or CIMMYT in preference to others of a similar nature that are not mentioned. The views expressed in this information product are those of the author(s) and do not necessarily reflect the views or policies of FAO or CIMMYT.

ISBN 978-92-5-130513-3 (FAO)  
© FAO and CIMMYT, 2018

FAO and CIMMYT encourage the use, reproduction and dissemination of material in this information product. Except where otherwise indicated, material may be copied, downloaded and printed for private study, research and teaching purposes, or for use in non-commercial products or services, provided that appropriate acknowledgement of FAO and CIMMYT as the sources and copyright holders is given and that FAO's and CIMMYT's endorsement of users' views, products or services is not implied in any way.

All requests for translation and adaptation rights, and for resale and other commercial use rights should be made via [www.fao.org/contact-us/licence-request](http://www.fao.org/contact-us/licence-request), addressed to [copyright@fao.org](mailto:copyright@fao.org).

CIMMYT information products are available on the CIMMYT website ([www.cimmyt.org](http://www.cimmyt.org)) and can be consulted on the section for CIMMYT Publications.

FAO information products are available on the FAO website ([www.fao.org/publications](http://www.fao.org/publications)) and can be purchased through [publications-sales@fao.org](mailto:publications-sales@fao.org)

# CONTENTS

<b>FOREWORD</b>	<b>V</b>
<b>ACKNOWLEDGEMENTS</b>	<b>VII</b>
<b>INTRODUCTION</b>	<b>IX</b>
<b>MODULE 1. INTRODUCTION TO HIRE SERVICES AS A BUSINESS ENTERPRISE</b>	<b>1</b>
SESSION 1.1 SMALL-FARM MECHANIZATION: AN INTRODUCTION	2
SESSION 1.2 HIRE SERVICES AS A BUSINESS ENTERPRISE	3
SESSION 1.3 SUSTAINABLE AGRICULTURAL MECHANIZATION FOR SUSTAINABLE CROP PRODUCTION INTENSIFICATION	6
<b>MODULE 2. UNDERSTANDING THE LOCAL AREA AND MARKET</b>	<b>13</b>
SESSION 2.1 WHAT IS A LOCAL AREA AND MARKET ASSESSMENT?	14
SESSION 2.2 HOW TO CONDUCT AN ASSESSMENT	18
<b>MODULE 3. SELECTING APPROPRIATE MACHINERY: TECHNICAL AND FINANCIAL ASPECTS</b>	<b>27</b>
SESSION 3.1 PLANNING THE SELECTION OF POWER SOURCES AND IMPLEMENTS	29
SESSION 3.2 TECHNICAL AND FINANCIAL CRITERIA FOR THE SELECTION OF A TRACTOR	32
SESSION 3.3 TECHNICAL AND FINANCIAL CRITERIA FOR THE SELECTION OF DRAUGHT ANIMALS	35
SESSION 3.4 TECHNICAL AND FINANCIAL CRITERIA FOR THE SELECTION OF IMPLEMENTS	38
SESSION 3.5 SELECTION CRITERIA AND HOW TO ASSESS	43
SESSION 3.6 PURCHASE PROCESS	57
<b>MODULE 4. OPERATION AND MAINTENANCE OF AGRICULTURAL EQUIPMENT FOR HIRE SERVICE BUSINESSES</b>	<b>61</b>
SESSION 4.1 POWER OPTIONS FOR AGRICULTURAL EQUIPMENT	63
SESSION 4.1.1 FOUR-WHEEL TRACTORS	64
SESSION 4.1.2 TWO-WHEEL TRACTORS	67
SESSION 4.1.3 DRAUGHT ANIMAL POWER	69
SESSION 4.2 AGRICULTURAL EQUIPMENT FOR A HIRE SERVICE BUSINESS	74
SESSION 4.3 MAINTENANCE AND SAFE USE OF AGRICULTURAL EQUIPMENT	77
SESSION 4.3.1 TECHNICAL MAINTENANCE OF TRACTORS	81
SESSION 4.3.2 SAFETY IN THE USE OF MACHINERY AND EQUIPMENT	86
SESSION 4.4 CALIBRATION OF PLANTERS AND SEEDERS	89
SESSION 4.5 CALIBRATION OF SPRAYERS	92
SESSION 4.6 TECHNICAL PERFORMANCE OF EQUIPMENT: SHELLERS AND THRESHERS	94
SESSION 4.7 TECHNICAL PERFORMANCE OF EQUIPMENT: PUMPS	97
<b>MODULE 5. MANAGING THE HIRE SERVICE AS A BUSINESS</b>	<b>101</b>
SESSION 5.1 ENTREPRENEURSHIP AND MANAGEMENT IN THE HIRE SERVICE BUSINESS	102
SESSION 5.2 HIRE SERVICE BUSINESS ORGANIZATION	107
SESSION 5.3 MANAGING OPERATIONS OF THE HIRE SERVICE BUSINESS	111
SESSION 5.4 MANAGING THE FINANCES OF THE HIRE SERVICE BUSINESS	116



## FOREWORD

The world is facing an unprecedented and continued degradation of key components of agro-ecosystems, especially agricultural soils, with negative impacts on food production. In developing countries, smallholder farmers are particularly susceptible to the consequences of soil and land degradation and the increasing variability and unpredictability of weather patterns caused by climate change. Yet, these very same farmers are of critical importance to producing food under these changing and challenging circumstances to meet the demand for food from increasing populations, especially in cities. There is a need to intensify agricultural production while sustainably managing, conserving and restoring natural resources. For farmers to transition to sustainable and resilient agricultural production systems it is necessary to improve their knowledge of and access to appropriate farm power sources.

The United Nations' Sustainable Development Goals (SDGs), which frame development agendas until 2030, include SDG1 (No Poverty) and SDG2 (Zero Hunger) – the most important for improving the livelihoods of the rural poor. In addition, SDG12 (Responsible Consumption and Production) underlines the importance of protecting natural resources while producing sufficient nutritious food for the world's growing population. The sustainable production of food crops requires improvements in farm power, including the application of sustainable mechanization technologies.

Smallholder farmers often do not have the necessary capital, either as savings or via access to financial credit, to invest in the expensive farm power and machinery that is essential for raising land and labour productivity. Moreover, poorly selected or misapplied agricultural machinery can damage, rather than enhance, environmental resources, especially soils. Smallholder farmers require specialized mechanization services that are both environmentally friendly and productivity-enhancing. Appropriately -trained and equipped mechanization service providers can meet this critical need.

This manual is specifically designed to help train actual and potential farm mechanization service providers, in order to increase access to sustainable farm power to raise the productivity of smallholder farmers. It focuses on two crucial aspects: the provision of farm mechanization services as a viable business opportunity for entrepreneurs, and the essential criteria of raising productivity in an environmentally sensitive and responsible way. Practical guidance on the essential business development and management skills required to successfully run a mechanization service provision business are presented. The manual will be of particular interest to policymakers' intent on achieving sustainable intensification in the agricultural sector. It is also a valuable resource for trainers charged with increasing the supply of well-trained and well-equipped entrepreneurial mechanization service providers through the implementation of training courses tailored to the specific course locations.



**Maria Helena Semedo**  
*Deputy Director-General  
Climate and Natural Resources  
Food and Agriculture Organization  
of the United Nations*



**Martin Kropff**  
*Director General  
International Maize and Wheat  
Improvement Center*





## ACKNOWLEDGEMENTS

This training manual is the culmination of a long journey of collaboration between marketing specialists, economists and agricultural engineers. The idea for a manual for aspiring mechanization service entrepreneurs was born in the then Rural Infrastructure and Agro-Industries Division (AGS) of FAO. Alexandra Rottger collaborated with Bill Hancox, Kathleen Charles, Lawrence Clarke, Richard Shetto and Brian Sims under the leadership of Geoffrey Mrema to produce a first draft for consultation. Subsequently, the original concept was further developed in a collaborative project between the Plant Production and Protection Division of FAO (AGP) led by Josef Kienzle, Mechanization Task Group Leader, and the International Maize and Wheat Improvement Center (CIMMYT), coordinated by Bruno Gérard, Director of the Sustainable Intensification Programme.

During this process, Martin Hilmi, Brian Sims, Joseph Mpagalile and Santiago Santos Valle made important contributions from AGP, while David Kahan managed the CIMMYT contribution. Special thanks to Frédéric Baudron, Project Leader, of CIMMYT's 'Farm Mechanization and Conservation Agriculture for Sustainable Intensification (FACASI)' Project for providing valuable expertise, and to the Australian Center for International Agricultural Research (ACIAR) and John Dixon through the FACASI Project for their support and contribution. Support to finalize the manual was also provided by the German-funded FAO Trustfund 'Building the basis for implementing the Save and Grow approach – Regional strategies on sustainable and climate-resilient intensification of cropping systems'.

Valuable inputs were received from Saidi Mkomwa, African Conservation Tillage Network (ACT); Scott Justice, CIMMYT-Asia; Ignazio Ruiz, National Association for Agricultural, Forestry and Landscaping Machinery (ANSEMAT); Li Hongwen, China Agricultural University (CAU); AfricaRice; European Agricultural Machinery Association (CEMA); AGCO Corporation, and others. Special thanks are expressed to the FAO Office in Kenya, in particular to the team working on the EU-funded programme on 'Increased productivity and profitability of small holder farmers through promotion and up-scaling of GAP and CA in productive semi-arid areas of Kenya (IPP-GAP)', the FAO Office of the United Republic of Tanzania, and the Agricultural Engineering Department of the Sokoine University of Agriculture (SUA) for their support in the field testing and practical training courses carried out in Machakos and Morogoro. These experiences provided valuable feedback for refinements and improvements.

Gratitude is expressed for the valuable support provided by William Murray, Deputy Director, Plant Production and Protection Division (AGP) and Divine Njie, Deputy Leader, Food Systems Programme (SP4) of FAO.

This current version of the manual benefited immeasurably from the meticulous work of Diana Gutiérrez Méndez (AGP), who guided the document through the editing, formatting and DTP processes. Ruth Duffy edited the document, Shalis Stevens produced the illustrations and Art&Design undertook the overall design and layout of the publication.



# INTRODUCTION

## INTENTION OF THE MANUAL

This training of trainers (ToT) manual is intended for prospective trainers of hire service providers. It provides trainers at country level with materials covering the basic principles of the use and management of mechanization for smallholder farmers. Trainers may be ministry of agriculture personnel, staff of non-governmental organizations (NGOs) or people attached to the private sector. Hire service providers may lack formal training in the selection and maintenance of small-scale mechanization technologies and the management of their businesses. This ToT programme is designed to provide hire service providers – whether already in the business or intending to start their own hire service business – with skills and competencies in both the technical and the management aspects of the small-scale mechanization business.

## WHO SHOULD USE THE MANUAL?

This manual provides guidance for trainers who are expected to design, organize and deliver training programmes to hire service providers. The trainers should have a strong background in curriculum development, farm mechanization and economics/business management. At least two experts, a mechanization specialist and an economist, are needed to conduct the programme. Indeed, as the training draws from two very distinct disciplines, it is unlikely that any one person will have the necessary technical skills to cover the complete course content. The trainers responsible for designing and organizing the training of hire service providers in the field may sometimes require guidance from the experts involved in the preparation of the materials. The relative organizations – the Food and Agriculture Organization of the United Nations (FAO) and the International Maize and Wheat Improvement Center (CIMMYT) – could, in principle, provide support as required.

## MANUAL CONTENT

The manual includes an instruction guide for trainers and handouts for participants. The guide contains self-instruction materials, with clear explanations of the concepts and tools used, supported by practical examples and exercises.

The training programme covers a range of topics organized in 5 modules and 27 sessions. Each session includes exercises and handouts comprising a comprehensive set of reference materials. There is no specific duration for the training course, as the exact use of the materials is determined by the training team. The **five modules** cover the following topics:

- Module 1 is an introduction to and overview of a mechanization hire service as a business enterprise.
- Module 2 explores the means of assessing the state of

the local agrifood industry and the potential market for service provision.

- Module 3 focuses on the technical and financial selection procedures for tractors, draught animals and farm machinery.
- Module 4 is the main technical section and gives participants a basic grounding in the technical aspects of tractor and machinery operation and maintenance, and draught animal care.
- Module 5 examines the running of a hire service as a business and considers the essential concepts of managing the organization of the business, the operation of services and the financial aspects. It reviews much of the work of the previous sessions and provides a summary of the training programme.

Each module uses sessions as building blocks and these explore in detail the main aspects of the module. Each session includes practical exercises and is accompanied by notes for the trainer and informative handouts for the participants. All materials are comprehensive and should be regarded as reference materials for the trainers to adapt to local circumstances. Thorough preparation is essential to ensure success of the training course.

## DURATION OF THE TRAINING COURSE

There are no set timings for the sessions; the time required depends on the content selected, the knowledge and experience of the participants and the amount of detail covered. Trainers are encouraged to adapt the scheduling, duration and content of the training to the time available. In general, at least 10 days are required to deliver the full training programme.

It is also possible to divide the programme into two or more parts, allowing the participants more time to absorb the lessons presented; on the other hand, this may lead to loss of continuity. In any case, subdivision of the programme may require additional planning and rearrangement of the order of materials suggested in the manual.

## TRAINING PROCESS

The manual is developed around the concept of experiential learning. Trainers present the material, lead discussions and facilitate classroom and field exercises. The training process includes field exercises; participants report the lessons learned in the field during the subsequent training meeting. This dynamic process encourages horizontal learning, in addition to input from the trainer, making the training content immediately relevant in the workplace.

## PREPARING FOR THE TRAINING PROGRAMME

Preparation is key to the success of the programme. The interactive nature of the exercises requires the trainer to be well prepared and it is important to read the manual carefully well in advance of the training programme. Most of the exercises are relevant to a wide variety of circumstances; however, the manual cannot cover all

eventualities, and aspects of mechanization may not be applicable in some countries or regions. Particular attention is needed during preparation of the practical field exercises to guarantee the availability and proper functioning of machinery and equipment, select the cases to be used, and organize the logistics.

Trainers must study every session carefully and pay particular attention to adapting the material to local conditions, including topographical information and units of measurement (note that the \$ symbol used in the materials does not refer to a national currency, but simply means “units of currency”). Trainers must prepare the subject matter in detail and understand the solutions to the exercises before the training session, so that they may explain them to the participants. PowerPoint presentations may be used, but must always be checked and tested. Sufficient copies of materials and handouts must be made for distribution to all trainees.

Before conducting the training session, trainers must allow themselves sufficient time to assimilate the material and thus ensure smooth delivery. Likewise, the participants should be given adequate time to read the handouts. In the trainers guide, it is noted that **handouts should usually be distributed before the start of the session.**

The session guides are written in detail, but the instructor need not follow them exactly. The overall theme of each session is like a basic musical tune: each player (trainer) interprets it as (s)he thinks fit, leaving out some parts, adding others, and varying the sequence, methods and pace according to individual preferences and skills, the needs of the group and the moment by moment situation in the classroom.

Participants may not be able to follow the course in English. In this case, trainers must be able to communicate with the participants in their own **local language**; all handouts should be adapted to the local situation and abbreviated to capture the most salient aspects. Handouts must be translated before the course begins. Even when the course is conducted in English, it may be necessary to modify the material, changing names, crops, sums of money and other aspects of the case studies and exercises. Note that the **best examples come from the participants’ or the trainer’s own experience.**

The training materials are not to be used as a comprehensive fixed programme. The package follows a basic outline and a broad sequence of learning, but it does not specify which of the exercises provided should be used. When deciding the actual programme to follow, trainers must assess the knowledge and skills of existing or potential hire service providers – participants – in the fields of farm mechanization and business management. For this reason, it is strongly recommended to carry out a **training needs assessment** among interested prospective participants. This guidance note does not prescribe a particular form of assessment, as the core trainers in each country or locality are best equipped to conduct such an assessment. Indeed, a training needs assessment may have already been conducted.

## ORGANIZING THE TRAINING

### VENUE

The location of the training requires careful consideration. A luxurious and expensive environment is not appropriate: the focus of the course is on efficient management and this message may be lost if the course itself involves unnecessary expense. The training room needs to provide adequate space for small working groups as well as general presentations – preferably a large flat-floored room with chairs and tables that can be easily moved. The ideal facility will have adjacent rooms large enough to accommodate up to five comfortably around a table, with accommodation for participants and trainers sufficiently close to the training centre to ensure group cohesion and enable late sessions when necessary. Field locations for practical work should be close at hand and easily accessible without major transportation efforts.

### EQUIPMENT AND MATERIALS

Presentation equipment and a display screen are essential. If PowerPoint is not available, slides may be converted into transparencies for use with an overhead projector. If neither PowerPoint nor an overhead projector are available, the trainer should copy the main topics onto flip charts. Trainers are expected to make extensive use of equipment during sessions.

#### Recommended equipment:

- Classroom white board
- Flip chart stands (one for each training group)
- Overhead projector
- Computer/laptop with CD-ROM reading and projection capacity
- Ring binders for handouts/materials (one for each participant)

The trainer must ensure that all materials are ready before starting the programme. The exact material requirements vary according to the specific course.

#### Recommended materials:

- Handouts (punched with holes to fit ring binders)
- Flip chart paper and newsprint
- Heavy paper or light cardboard in a range (5–6) of colours (paper suitable for the pens and markers available)
- Writing pads (one for each participant)
- Paper (A3, A4, A5)
- Thick marker pens in a variety of dark colours (e.g. black, blue, red, green, brown)
- Pens and pencils
- Hand calculator (one for each participant)
- Means of attaching paper to the wall

Practical sessions in the field have additional specific requirements (in particular with regard to the calibration of sprayers and planters in Module 4); these are detailed in the relevant sessions.







Plate 1.1 Field operation of a direct seeder © FAO J. Kienzle

## MODULE 1

# INTRODUCTION TO HIRE SERVICES AS A BUSINESS ENTERPRISE

**Trainer's guide to the module:** Module 1 provides an introduction to and overview of a hire service as a business enterprise. It introduces trainees to mechanization: a vital input for smallholder farmers in the context of sustainable crop intensification, and in particular conservation agriculture (CA).

### Module learning objectives:

- Introduce the role and importance of hire services in the provision of smallholder farm mechanization inputs.
- Enable trainees to define and describe a hire service business.
- Communicate the importance of protecting the natural environment while running a hire service business.

**Note for the trainer:** Session 1.3 deals also with getting to know the equipment. Where possible, keep equipment on site to enable participants to examine, use and gain field experience with it.

When the exercises include group discussions, nominate a moderator for a debate and establish general rules, for example, that only one person speaks at a time and for no longer than one minute.

Recommended background reading: Share with participants any readings you feel may be useful. The publications listed below are freely available online:

- FAO. 2016. *Agricultural mechanization: a key input for sub-Saharan African smallholders*. Rome. Available at: [www.fao.org/3/a-i6044e.pdf](http://www.fao.org/3/a-i6044e.pdf)
- FAO. 2012. *Hire services by farmers for farmers*. Rome. In particular, pp 1–27 and 43–56. Available at: [www.fao.org/3/a-i2475e.pdf](http://www.fao.org/3/a-i2475e.pdf)
- FAO. 2009. *Rural transport and traction enterprises for improved livelihoods*. Rome. In particular, pp 1–45. Available at: [www.fao.org/3/a-i0525e.pdf](http://www.fao.org/3/a-i0525e.pdf)

**Recommended websites and videos:** Share with participants any links you feel may be useful and integrate into exercises in the relevant sessions. Note that the list is subject to updating as new, more appropriate materials become available. The links below are freely available online:

- FAO. 2018. Sustainable agricultural mechanization. FAO website. Available at: [www.fao.org/sustainable-agricultural-mechanization/en](http://www.fao.org/sustainable-agricultural-mechanization/en)
- Video (duration 14.24). Agricultural mechanization for small scale farmers in Uganda. Available at: <https://www.youtube.com/watch?v=PmdjhLkLIkk>.
- Video (duration 3.21). Benefits of farm mechanization. Available at: <https://www.youtube.com/watch?v=OIJ583UZdfo>
- Video (duration 21.06). Farm mechanization in India. Available at: <https://www.youtube.com/watch?v=NAE2kui8RUA>.

## SESSION 1.1

# SMALL-FARM MECHANIZATION: AN INTRODUCTION

**Trainer's guide to the session:** This first session introduces mechanization and highlights the advantages and benefits it can provide to smallholder farmers and other actors in the agrifood supply chain. Trainees need to understand that mechanization is an important component within the agrifood chain, from crop establishment through to processing and marketing.

### Session learning objectives:

- Introduce trainees to the advantages and benefits of mechanization for smallholders.
- Enable trainees to understand the importance of mechanization in the agrifood chain.

**Practical learning:** Exercise 1 comprises four videos. The first is an introductory video, presenting FAO's view on mechanization. The second introduces the overall concept of mechanization, while videos 3 and 4 use examples from Africa and the Philippines to provide a better understanding of the potential solutions that mechanization can provide in the agrifood chain. Depending on the local context and the type of participants, it may not be necessary to show video 2, but you, the trainer, are best placed to judge. After each video, foster discussion, underlining the main messages of the video while encouraging participants to share their own views and experiences. Emphasize that smallholder farmers, as well as other actors in the agrifood chain, are potential customers of the hire service business. Stress the importance of understanding their situation and how services can benefit them.

### EXERCISE 1. MECHANIZATION AND ITS BENEFITS

- › Introduce video 1 (duration 1.52): *The importance of mechanization: FAO's approach.* Available at: <https://www.youtube.com/watch?v=qyMyqqYlviU>.
- › Introduce video 2 (duration 10.56): *The foundations of wealth: Mechanization.* Available at: <https://www.youtube.com/watch?v=dMOreKTruQk>  
Ask participants to identify the main points. Discuss the question: What are the advantages of mechanization?
- › Introduce video 3 (duration 5.05): *Powering smallholder agriculture in eastern and southern Africa.* Available at: <https://www.youtube.com/watch?v=oe8J2ee4rAU>  
Ask participants to identify the main points. Discuss the question: What are the benefits of mechanization in eastern and southern Africa?
- › Introduce video 4 (duration 13.58): *Maize mechanization for production and post-production in the Philippines.* Available at: <https://www.youtube.com/watch?v=kgpWtPmT6Qc>  
Ask participants to identify the main points. Discuss the question: What are the benefits of mechanization in the Philippines?





## SESSION 1.2

# HIRE SERVICES AS A BUSINESS ENTERPRISE

**Trainer's guide to the session:** This session introduces hire services as a business. It aims to encourage participants to think of a hire service as a business enterprise that makes money by selling services at a profit. Participants must understand the characteristics of the services sold and the types of services provided, in order to define the hire service business. It is also important to consider conducting business in an environmentally friendly way to ensure that the hire service business continues to be profitable in the future.

### Learning objectives:

- Define and describe what a hire service business is.
- Define and describe the characteristics of a service and service types.
- Enable trainees to understand the importance of protecting the natural environment while running a hire service business.

**Practical learning:** The session comprises two exercises. Exercise 1 involves the exchange of knowledge and experience, while Exercise 2 comprises a case study followed by questions. Decide in which order to do the exercises, depending on the trainees and the context. Training aids are provided: Handout 1.1 for Exercise 1 and Case study 1.1 for Exercise 2. In some circumstances, it may be preferable to narrate the case study as a story to the group of trainees.

### EXERCISE 1.

## A HIRE SERVICE AS A BUSINESS

Exercise 1 focuses on what a hire service business is and what services it can offer. Distribute Handout 1.1, "What is a hire service as a business?" before conducting the exercise; however, depending on the precise needs and capabilities of your group, you may wish to distribute it afterwards. Allow about 20 minutes to read the handout. Encourage discussion and ask questions:

- What is a hire service as a business?
- What is a service?
- How do you define a hire service?
- What is meant by managing a hire service?
- Why is it important to do business in an environmentally friendly way?

Encourage trainees to assemble an agreed list of points in answer to these questions.

### EXERCISE 2.

## CONSERVATION AGRICULTURE HIRE SERVICE BUSINESS ENTERPRISE

Distribute and ask the participants to read Case study 1.1; allow approximately 30 minutes for this. Encourage and facilitate discussion among participants, asking the following questions about the case study:

- What did Stanley and Anita do about their farming problems?
- What did Anita say about their farming problems and why was it important?
- Why were conservation agriculture and business training important for them?
- How did Stanley and Anita start a hire service?
- What ways did Stanley and Anita find to make money?
- What type of customers did Stanley and Anita serve?
- Why did Stanley and Anita reflect and think about their business at the end of each season?
- Why is it important to do business and make money, but at the same time look after the natural environment?



### CASE STUDY 1.1

## STANLEY AND ANITA: HIRE SERVICE BUSINESSMAN AND BUSINESSWOMEN

Stanley and his wife, Anita, often discuss the need for improved crop yields and higher quality crops. Anita says that they need to protect the natural resources, as looking after the natural environment now will help them achieve good crop production on their farm in the future. A friend told Stanley that in a nearby village, a training course was being held on conservation agriculture hire services as a business. Stanley and Anita both attended the training course.

On returning to their village, they talked a lot about starting a hire service business. Stanley knew that in the immediate vicinity, soil erosion and degradation were increasing problems, and he realized there could be a market for their newly acquired skills. They talked to farmers in the area to try to understand their needs. They consulted many farmers and found out that:

- many farmers did not achieve good yields;
- farmers were willing to pay for help, both in money and in kind;
- farmers needed mainly planting and transport services; and
- farmers were pleased to learn about better production practices and appreciated the importance of conserving natural resources, such as soil, water and forests, for their own benefit, and for that of their children and future generations.

Based on this information, Stanley and Anita set about calculating how much money they could make in a season by providing the required services. They both knew that most soil preparation and planting services would be requested at the same time because of the short planting window. They also had to bear in mind that some farmers would have more cash just after selling their harvest and less just before the next harvest. This would mean that they might sometimes have to extend credit. On the other hand, they could offer a range of services, such as spraying and transport, throughout the year.

Based on these considerations, they determined indicative rates (prices) that they could charge for their services. They calculated the total amount for all the services they thought they could sell in a season. With this figure in mind, they started thinking about the equipment they needed to buy. Considering the services they intended to provide, they knew they needed a no-till planter, a ripper, a subsoiler, a sprayer and a trailer for transport. This would all cost a lot of money, which they did not have. Their savings were not sufficient, as some money had to be kept for family emergencies. They considered the village moneylender, but his interest rates were very high. Stanley owned some farm animals: goats and sheep, as well as two oxen. Selling some of the goats and sheep might generate enough money to buy the equipment; the oxen could be used as muscle power. Their calculations showed that a hire service could be a good business. They visited farmers in their area and

advised them that they could provide the services they required. Most of the farmers approved the idea. Stanley then set off to the nearby town, and sold his goats and sheep. He used the money from the sales combined with his savings to buy the necessary equipment for conservation agriculture. While at the equipment dealer's in the town, he also noted the price of a two-wheel tractor.

The equipment arrived at the village and Stanley started to train the oxen. Anita and Stanley began to provide a range of services using a ripper, subsoiler, sprayer and planter.

The first season went well for the hire service business, but not as well as they had expected. They made a profit, but only a small one. Anita realized that they had to do more and she suggested that they take a risk and buy a two-wheel tractor. Stanley already knew the price of a two-wheel tractor and it was a lot of money, but he also realized that the tractor would allow him to offer more services. Anita talked to a local cooperative and asked if they were interested in transport services, as the cooperative had a lot of produce to deliver to the local town.

Anita and Stanley compared the opportunities and the risks; after further consideration, they decided to buy the two-wheel tractor. However, before Stanley bought the tractor from the dealership in the nearby town, he asked a series of questions to the dealer with regard to: availability of spare parts; fuel consumption and where to obtain diesel; opportunities for learning the basic skills of maintenance and repairs; and, naturally, operating the machine in the field. He made a down payment and the dealer gave them a rapid training session: how to use the tractor, and basic repairs and maintenance tips.

The news spread quickly in the village and Anita and Stanley could not keep up with demand. Farmers requested numerous services, including transport of crops, small animals and people, and pumping water for irrigation. Stanley had to employ a helper so that animal- and tractor-driven equipment could be operational at the same time. He even had to buy another trailer, as transport was the most requested service. His most important client was the cooperative and they always paid him on time. Anita, like Stanley, knew that their customers were important and she maintained good relations with all of them. By the end of the second season, the hire service was doing well, money was coming in and profits exceeded those of the first season. However, Stanley knew that this might not last. He had noticed roadworks underway in town and offered to provide transport services; the road contractor accepted and asked him to provide services during the period of road repairs.

Given the growing demand for Stanley and Anita's services in the community, young people began to ask if they could work for the hire service business and requested training in conservation agriculture and equipment operation. Young people were seeking employment in their own village, rather than migrating to towns in search of work.

Stanley and his wife Anita are a good example of how a hire service can profitably supply a very valuable set of services to other farmers in the immediate and surrounding community.

## SESSION 1.3

# SUSTAINABLE AGRICULTURAL MECHANIZATION FOR SUSTAINABLE CROP PRODUCTION INTENSIFICATION

**Trainer's guide to the session:** The session introduces trainees to sustainable agricultural mechanization (SAM) with a focus on conservation agriculture (CA) in the context of sustainable crop production intensification using FAO's "Save and Grow" approach. The components of sustainable crop production intensification are reviewed in the context of CA and the associated power units and implements. The session examines the equipment available to practise sustainable mechanization (particularly CA) during the production and post-production phases, as well as the associated power sources found in smallholder mechanization systems.

Hire services need to employ sustainable natural resource management practices in the long term to enhance production and productivity for smallholder farmers and ensure profitability; a SAM approach is thus adopted (Box 1.1).

The session introduces the concept of CA as a key tool for achieving sustainable intensification of crop production (Box 1.2).

**Recommended background reading:** Where appropriate, share the material with participants. The publications below are freely available online:

- FAO. 2011. *Save and Grow. A policymaker's guide to the sustainable intensification of smallholder crop production*. Rome. 102 pp. Available at: <http://www.fao.org/docrep/014/i2215e/i2215e.pdf>.
- FAO. 2013. *Save and Grow. Cassava: A guide to sustainable production intensification*. Rome. 129 pp. Available at: [http://www.fao.org/ag/save-and-grow/cassava/index\\_en.html](http://www.fao.org/ag/save-and-grow/cassava/index_en.html).
- FAO. 2016. *Save and Grow in practice: Maize, rice, wheat. A guide to sustainable cereal production*. Rome. 110 pp. Available at: <http://www.fao.org/publications/save-and-grow/maize-rice-wheat/en/>.

**Recommended videos:** Share videos with participants as and when appropriate. The links below are available to the public online:

- Video (duration 14.25). *Conservation agriculture in Zambia*. Available at: <https://www.youtube.com/watch?v=qRh6FCvx91g>.
- Video (duration 15.00). *Conservation agriculture in the Philippines*. Available at: [https://www.youtube.com/watch?v=Vc\\_Atfaq-EA](https://www.youtube.com/watch?v=Vc_Atfaq-EA).

### Session learning objectives:

- Comprehend the essential components of sustainable crop production intensification.
- Understand the essential complementary components of sustainable agricultural mechanization.
- Define and describe conservation agriculture and its role and function in protecting the environment.
- Understand what tasks can be mechanized in CA systems.
- Describe the equipment available to practise sustainable mechanization (CA and other operations along the value chain).

### BOX 1.1:

**Sustainable agricultural mechanization** involves the application of different power sources (human muscles, draught animals and engines). Power sources are used in conjunction with appropriate tools, implements and machines to perform useful work in agricultural production and the subsequent agrifood chain. Sustainable agricultural mechanization must:

- meet farmers' needs efficiently and effectively;
- result in improved farm productivity and reduced drudgery;
- contribute to the development of the agrifood system (from production, through harvesting and processing, to marketing operations).

Sustainable agricultural mechanization takes fully into account economic, social, cultural and institutional issues and the protection of natural resources (especially soil and water).

### BOX 1.2:

**Conservation agriculture**, at its most basic, involves the concurrent application of three key elements:

1. Minimum soil disturbance to protect the soil from erosive and degrading influences and to encourage the healthy development of soil biota (fungi, flora and fauna). In practice, this means direct sowing and planting.
2. Maintaining organic cover on the soil surface to protect the soil from erosive forces and to encourage improvements in soil carbon content and soil fertility. In practice, this means conserving crop residues in situ and establishing cover crops to keep the soil covered for as long as possible.
3. Maintaining a regime of crop rotations, associations and sequences, incorporating in particular the introduction of leguminous species.

**Practical learning:** The session starts by looking at sustainable crop production intensification and in particular emphasizes conservation agriculture (CA). It consolidates information on the principles of CA in order to bring all participants up to the same level of understanding.

It provides information on the range of equipment generally available and specifically used to practise CA on smallholder farms. It aims to familiarize participants with the options available, highlighting the most suitable options available locally.

Arrange, where possible, to have CA equipment on site, so that participants can see it and gain field experience in its use. Note, however, that this is a brief introduction; practical sessions on CA and other equipment are scheduled for later in the training manual, when calibration will be included.

### EXERCISE 1 VIDEOS ON CONSERVATION AGRICULTURE

- › Introduce video 1 (duration 7.11):  
*Conservation agriculture*. Available at:  
<https://www.youtube.com/watch?v=W-suSow738g>.  
Ask participants to identify the main points made and ask the question: Why is it important to farm in an environmentally friendly way?
- › Introduce video 2 (duration 12.05):  
*Conservation agriculture versus traditional agricultural techniques*. Available at:  
<https://www.youtube.com/watch?v=nbOXwXeqKvg>.  
Ask participants to identify the main points made and ask the question: What are the differences between conservation agriculture and traditional agriculture?
- › Introduce video 3 (duration 13.56):  
*Exchanging experiences in conservation agriculture*. Available at:  
<https://www.youtube.com/watch?v=5IjK1n7KTY>.  
Ask participants to identify the main points made and ask the question: Why is it important to exchange experiences on conservation agriculture?

### EXERCISE 2. CONSERVATION AGRICULTURE

Distribute Handout 1.2, “Conservation agriculture (CA)” and ask participants to read it and take notes (about 30 minutes).

Organize participants in groups according to the farming systems they are familiar with and ask the question: Is CA fully applicable to your local farming system? Allow the groups 10 minutes to prepare their answers before presenting them one at a time.

Facilitate discussions on the points raised and invite participants to summarize the debate and reach well-reasoned conclusions.

### EXERCISE 3 FARM MACHINERY AND CONSERVATION AGRICULTURE EQUIPMENT - THEORY

Distribute Handout 1.3, “Implements available for sustainable agricultural mechanization” and invite participants to read it and take notes (about 45 minutes). Divide the participants into two groups according to the farming systems they are most familiar with, and moderate the session as they answer the following questions:

- Can you describe at least five different machines that are used in small-scale agricultural mechanization in this area focusing on the application of mechanization along the agrifood value chain? How are they owned? (Allow about 10 minutes to discuss and prepare responses before reporting back to other members.)
- Are available CA mechanization options applicable to local farming systems in the region? Can smallholders access them? (Each group prepares a “yes” and a “no” response. Allow 10 minutes to prepare points before presenting them.)

Facilitate discussions on the points raised and invite participants to summarize the discussion and reach well-reasoned conclusions.

### EXERCISE 4. FARM MACHINERY AND CONSERVATION AGRICULTURE EQUIPMENT - PRACTICAL

Describe the key parts of each machine and its operating principles. Focus on how these machines are an important part of sustainable mechanization for smallholder farmers and how they are linked to sustainable crop production intensification efforts in terms of the area under cultivation, the timeliness of operations, effective utilization of inputs and overall crop productivity. Highlight how such machines can contribute to services along the agrifood supply chain (e.g. storage, processing and marketing). Machines include:

- two- and four-wheel tractors;
- draught animals;
- water pumps;
- shellers;
- threshers;
- dehullers;
- hammer mills; and
- trailers.

If CA equipment is available, describe each machine.

**CA machines include:**

- jab planter;
- animal-drawn direct planter;
- tractor-mounted direct planter;
- ripper and subsoiler;
- knife roller; and
- sprayer (manual or draught-animal/tractor-powered).

To illustrate power sources and equipment, both descriptions and practical field experience are useful. For fieldwork, ensure that competent regular users of the equipment are on hand to give practical guidance.



### HANDOUT 1.3

## IMPLEMENTS AVAILABLE FOR SUSTAINABLE AGRICULTURAL MECHANIZATION

In smallholder CA, the principal mechanization requirements are for **no-till seeding** and weed control. CA aims for minimum soil disturbance, during both planting and weed control. In addition, implements are commonly required for irrigation, transport and processing. Equipment is available for the full range of power sources, from human and animal muscle power to two- and four-wheeled tractors (2WT and 4WT).

### NO-TILL SEEDING

In no-till planting/seeding, the planter cuts through surface mulch and previous crop residues – the mulch can be penetrated or cut with vertical discs (single or double), chisel tines or jab planter beaks (or even a pointed stick). No-till planting implements:

- Jab planter – manually operated, available with both seed and fertilizer metering, suitable for very small areas (Plate 1.2).
- Double offset disc opener – cuts through residue and forms a V-shaped slot in the soil for both seed and fertilizer, powered by draught animal or small tractor (2WT or 4WT) (Plate 1.3).
- Chisel point tine – chisel preceded by a vertical disc that cuts through the surface mulch allowing the chisel to open a slot for seed and fertilizer, suitable for low-residue cover situations (Plate 1.4).
- Rolling jab planter – not as popular as chisels or discs.
- “Happy seeder” – lifts surface mulch with rotating flails to allow seeding with chisel openers before depositing the mulch back on the surface (and, more recently, with rotating flails to chop residue in front of the seeding tines), suitable for smallholdings.

### Rippers

Ripping is a **modified form of zero tillage** and is increasingly popular in SSA. Rippers (either animal- or tractor-drawn) are used to open a seeding slot. A chisel-tined ripper opens up lines during the dry season (these are usually quite shallow:  $\leq 10$  cm). At the start of the rains, the lines are ripped again to a depth of about 20 cm. Fertilizer (organic and inorganic) and lime (if needed) are then applied by hand to the rip line and covered by light hoeing from the rip line sides. Subsoiling tines, often fitted to the same frame as rippers, are used to remove any compacted layers, such as hoe- and plough-pans. The inter-row area is not tilled and is managed as a CA system (permanent cover and effective weed control) (Plate 1.5).



Plate 1.2 Hand-operated jab planter © FAO / J. Kienzle



Plate 1.3 Animal-drawn no-till planter with double offset disc openers © B. Sims

Notes

---



---



---



---



---



---



---



---



---



---



Plate 1.4 Chisel tine no-till planter © FAO / J. Kienzle



Plate 1.5 Narrow chisel-point tine © C. Thierfelder



Plate 1.6 Animal-drawn knife roller © B. Sims

## WEED CONTROL

Effective weed control is a key component of successful CA and may comprise physical, biological and chemical control:

- **Physical control.** Manually powered mechanical control options include shallow scraping with sharp hand hoes, hand pulling and slashing – all suitable for very small areas. On larger holdings, animal traction and tractor power can be used for knife rolling, which crushes susceptible weeds and cover crops prior to direct planting (Plate 1.6).
- **Biological control.** The soil surface is kept covered and weeds are driven out by competition. It involves crop associations, cover crops undersown in the main crop before harvest and covering the soil until establishment of the main crop.
- **Chemical control.** The use of herbicides can be a contentious issue in smallholder farming systems. Availability, quality, price and precision of application are all potential disincentives – besides the question of whether herbicides should even be considered an option in smallholder agriculture. The conventional option for chemical weed control is the knapsack sprayer – notorious for contaminating the operator. Innovation is, therefore, necessary: knapsack sprayers can be mounted on a wheeled chassis, fitted with a multi-nozzle boom and hand-pulled, thus largely removing the operator from the risk of contamination (Plate 1.7). Spray application is also more uniform. Large-capacity boom sprayers are manufactured for animal traction.

A judicious combination of mechanical, biological and chemical weed control may be the appropriate response.



Plate 1.7 Backpack sprayer adapted to wheeled frame and pulled behind the operator © B. Sims



## IRRIGATION

The increasing impact of climate change has led farmers in many parts of the world to experience rain shortages and higher variability in rainfall. Faced with this challenge, farmers are turning to irrigation in order to enhance crop productivity; water pumps are becoming essential in agricultural production (Plate 1.8). However, as with other machines, not all farmers can afford to have their own water pumps; they therefore rely on hire services. Note that pumps can be driven by 2WT engines.

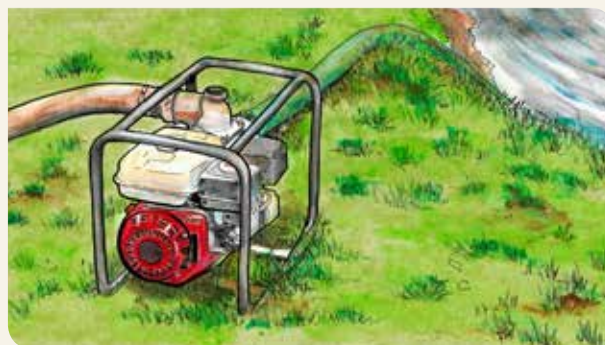

Plate 1.8 Engine-powered water pump suitable for small-scale agricultural production

## TRANSPORT

A good transport system is vital for many smallholdings. Transport is needed to bring inputs to the field and, crucially, to take produce to market in good condition and on time. The provision of transport services in farming areas is a potential year-round source of extra income that can help a service provider reduce operating costs. Tractor-powered mechanized transport is especially important and may be the most attractive aspect of the investment.



Plate 1.9 Animal-drawn trailer used for transportation in rural areas © FAO / A. Esiebo

## CROP PROCESSING

### Threshers and shellers

Threshing of cereal crops and shelling of grains, such as maize, are important post-harvest handling activities and are an attractive prospect for the service provider. Shelling and threshing hire services are also a good option for smallholder farmers, as the equipment can be expensive but not sufficiently used on a single farm. Mobile, engine-powered machines are popular and there are a wide range available on the market (especially made in India and China).

The MUST sheller/chopper (Plate 1.10), developed in the United Republic of Tanzania by the Centre for Agricultural Mechanization and Rural Technology (CAMARTEC), encapsulates the main principles and is a good example of how local manufacturers can meet the needs of local farmers. The machine is trailer-mounted and hauled between sites by a 2WT.

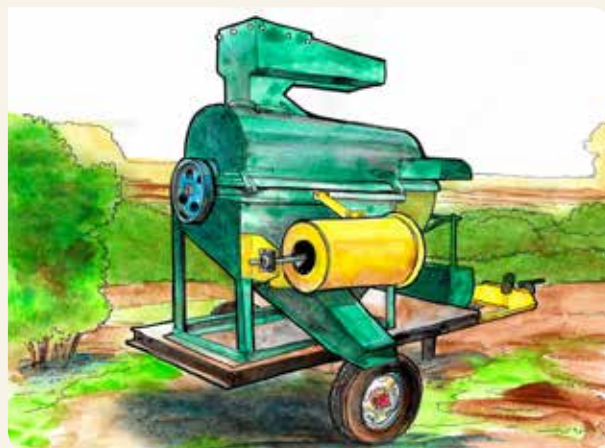

Plate 1.10 MUST sheller/chopper

Another grain-shelling machine (Plate 1.11), also made locally in the United Republic of Tanzania, is powered by a small engine and targeted at small-scale farmers. It is used for removing maize grains from the cob and incorporates a fan that helps to winnow shelled grains and produce clean grain. The machine can be mounted on the trailer of a 2WT or 4WT and transported to provide services to farmers in their homesteads. It can also be powered by 2WT engines or the power-take-off (PTO) from a 4WT. Many companies, such as Intermech Engineering in Morogoro, United Republic of Tanzania, fabricate such machines.



Plate 1.11 Engine-powered maize sheller ©FAO / T. Legesse

### Hammer mill

Hammer mills reduce the drudgery associated with manual milling; they are widely used in Africa for grinding maize. Hammer mills can be fabricated locally or imported through already established networks of dealers. Crucially, a farmer does not need to own an individual machine: milling operations can provide the service to small-scale farmers in many rural areas (Plate 1.12).

### Grain dehuller

Grain dehullers mechanically remove/peel the bran from the grain while also polishing the grain. This machine has had an important impact on small- and medium-scale operations, successfully replacing the arduous manual dehulling operations with a pestle and mortar carried out mainly by women. In general, the grain dehuller is installed alongside the hammer mill: it performs a first-stage milling operation before the grains are ground into flour. Many engineering workshops in Africa fabricate grain dehullers (Plate 1.13).

Plate 1.12 Hammer mill

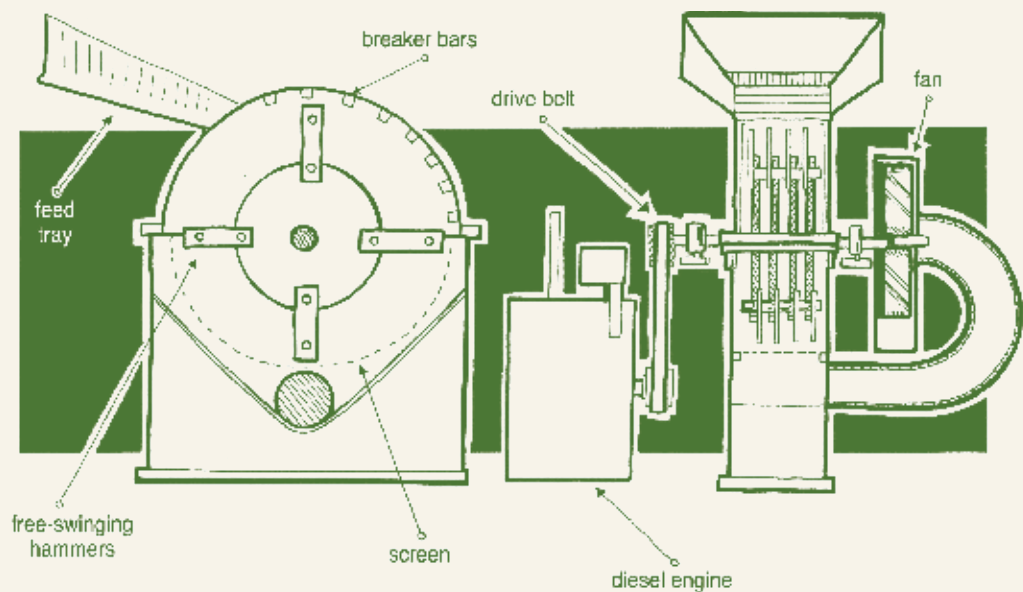

Plate 1.13 Engleberg grain dehuller used for maize, rice or sorghum

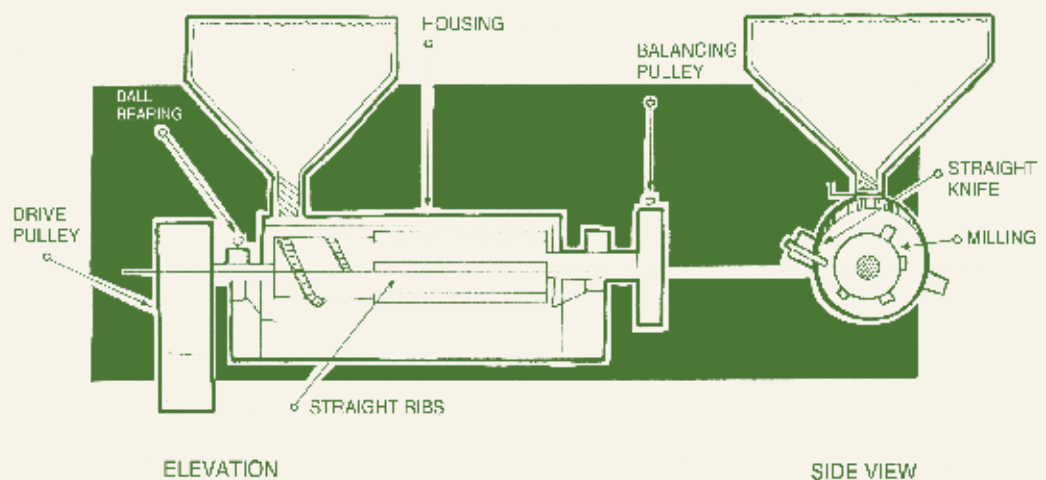



Plate 2.1 Women farmers winnowing rice in Kenema, Sierra Leone © FAO / C. Thomas

## MODULE 2

# UNDERSTANDING THE LOCAL AREA AND MARKET

**Trainer's guide to the module:** This module examines local area assessment: what it is, why it is important and how to carry it out. An assessment of the local area aims to:

- appreciate the potential market for any services offered; and
- understand what services are available to support the mechanization provision business.

Understanding the market entails identifying potential customers, setting prices for services offered and understanding the competitive environment. Knowledge of the support services available in the neighbourhood is required for the business to operate effectively and efficiently. The module discusses why these support services are important and demonstrates how to assess them.

**Support services include:**

- mechanics – for maintenance and repair services;
- fuel suppliers;
- manufacturers and blacksmiths;
- dealers – for tractors, equipment and spare parts;
- veterinarians – for health services and medicines for draught animals;
- credit and finance suppliers – formal and informal; and
- extension services.

The module provides a practical, simple and easy-to-use assessment method to enable the owners/managers of hire service businesses to better understand the local context in which they work, or intend to work.

**Module learning objectives:**

- Define and describe a local area assessment.
- Understand how to carry out a market assessment.
- Describe a support service and explain why it is important.
- Understand how to carry out a support service assessment.

**Recommended background reading:** If appropriate, share the documents with the participants. The publications below are freely available online:

- › FAO. 2012. *Hire services by farmers for farmers*. Rome (pp 31–35 for market assessment, pp 65–72 for support services). Available at: <http://www.fao.org/3/a-i2475e.pdf>.
- › FAO. 2009. *Rural transport and traction enterprises for improved livelihoods*. Rome (pp 47–52 for market assessment, pp 57–65 for support services). Available at: <http://www.fao.org/3/a-i0525e.pdf>.

## SESSION 2.1

# WHAT IS A LOCAL AREA AND MARKET ASSESSMENT?

**Trainer's guide to the session:** A hire service business is a potentially profitable enterprise if owners or managers are familiar with their surrounding area, the location of support services and the whereabouts of existing and potential customers. It is important to assess demand – both prevailing and prospective – to know which hire services to offer and what prices to charge. This session provides an overview of the importance of a local area and market assessment.

### Session learning objectives:

- Describe what a local area and market assessment is.
- Understand the importance of a local area assessment for a hire service business.
- Understand the importance of knowing the agro-ecology of the area – topography, soils and cropping pattern – and feeder road conditions.
- Understand the importance of mapping the area.

**Practical learning:** This session is based on Case study 2.1, "Farmer Dave and his tractor". Exercise 1 stresses the importance of getting to know the locality within which participants run or intend to run their business. It describes what a local area and market assessment

is and conveys why knowledge of the market and of support services is important for a hire service business to prosper. The exercise also provides an opportunity to discuss various issues raised by participants. Highlight and emphasize the main aspects of the local area and market assessment and ensure that participants share their knowledge and experiences.

### EXERCISE 1. FARMER DAVE AND HIS TRACTOR

Distribute Case study 2.1, "Farmer Dave and his tractor" and provide time for participants to read it and take notes of the main points (about 45 minutes). Ask the following questions:

- What are the main steps involved in conducting a market and support service assessment?
- How important is it to formulate good questions to ask people during an assessment? Why is it important?
- Why is it important to plan an assessment?
- What did Dave do during the assessment?
- What important information did he find for his hire service business?
- Why was this information important?
- How did Dave use this information?
- Why do you think mapping a service is so important?

Encourage and facilitate discussion. Record key points on a whiteboard or flip chart.



## CASE STUDY 2.1

### FARMER DAVE AND HIS TRACTOR

Dave has a small farm and lives in a village about 10 km from town. He owns a two-wheel tractor, two oxen, some conservation agriculture equipment, including a no-till planter, ripper and subsoiler, as well as a trailer for transport. Dave knows how important it is to look after natural resources: to work with – not against – the natural environment. For two years, Dave has run a thriving hire service business. How has Dave managed to make such a successful business?

#### DAVE'S STORY

Dave knew that for his hire service business to have a chance of success, he needed to be aware of opportunities in the local market and to understand what support service providers his business might need to operate effectively. Dave also understood the importance of continual assessment: new opportunities might arise and he had to be ready to take advantage of them to keep his hire service business in operation and profitable.

Therefore, before starting his hire service business, Dave needed to discover what business opportunities there were for his services and consider what support service providers were needed to enable his business to function properly. It was necessary to:

- clarify his business goal;
- identify the services to be offered;
- list the information required to understand the local context and better manage his business; and
- consider how to collect the information and from where.

Dave reflected on the information he would have to collect. He drew up a list of questions that would help him to collect the background information he needed:

- Who were his potential customers and where were they located?
- How accessible were they?
- What topography and soil types could be found?
- What size farms were there and what did they produce?
- What hire services were in demand and for what operations?
- What times of the year were services needed?
- How could services be effectively delivered?
- How much would it cost to deliver services?
- What support services were needed for the business to operate well? Where could they be found?

Dave then set about collecting this information. He drew up a **plan**:

- Prepare a set of questions to ask potential customers and support service providers.
- Find out where to collect the information.
- Determine the easiest way to collect the information.

- Estimate how long it would take and how much it would cost.
- Formulate an idea of the profitability of the service being provided.

Dave realized that if he asked sensitive questions directly, he would not always receive answers. He therefore drew up a list of questions to incorporate in informal conversation. He also recognized the importance of carefully observing the people around him, so he decided to visit friends in the village and nearby town, as well as farmers on small plots of land just outside the town. It was important to record the information collected and he carried a note pad and pen. He estimated that he needed 3–4 days to carry out the assessment and about \$4 for food, transport and other expenses. The information gathered is illustrated below.

#### Local context

- Dave's village is close to a town and there is only one road to travel into town. When it rains heavily, the road is not good and often inaccessible; at other times, it is fine.
- There is a fuel supplier on the roadside at the edge of town, and close by there is a farm machinery dealership.
- Early in the morning, there is quite a lot of transportation of produce and small livestock into town; the means of transport comprise mainly animal-drawn carts, tractors and pick-up trucks.
- On certain days, tractors stop at garbage pick-up points to load municipal waste on to trailers.
- There are large mounds of crop by-products in the town market; they are picked up for disposal at irregular intervals by operators with small hand-pulled carts.

#### Potential customers: what, who, where - and when

- Planting and ripping services for farmers in the village (12) and living close to the town (5) – during the planting seasons.
- Transport of produce from Dave's village to the town – every second day, early in the morning.
- Municipal waste collection for the town council, using a trailer to transport it to a landfill and for recycling – late morning and afternoon on every third day.
- Processing services (power supply for milling) for town market traders – occasionally.
- Transport of people to town, coordinating pick-ups and drop-offs with his own work schedule – on a regular basis.

#### Main types of services required

- Transport of produce, people, municipal waste materials and crop by-products.
- Crop production services: planting and ripping.
- Plant protection and chemical weed management services.
- Processing services: milling.
- Irrigation services: pumping water with power from the tractor engine.



### Cost of service delivery

For a breakdown of costs, Dave estimated the cost of fuel and maintenance for operating the machinery, and factored in possible repairs for the equipment and trailer; he made allowances for tractor repairs and spare parts in the case of breakdown, as well as veterinary visits and medicines for his oxen in the event that they got sick. The **estimated costs** for each service were as follows:

- Transport of produce: \$40/week
- Transport of people: \$28/week
- Transport of waste: \$21/week
- Crop production services: \$16/ha
- Processing services: \$5/hour

### Profitability of services

Dave researched what people are willing to pay for his services. The **potential income streams** are as follows:

- Transport of produce: \$80/week
- Transport of people: \$30/week
- Transport of waste: \$45/week
- Crop production services: \$35/ha
- Processing services: \$7/hour

Some services are more profitable than others. Transport of produce, people and municipal waste are potentially the most profitable, crop production and processing services less so. However, when collecting crop by-products from the town market, he could take these back to his farm and compost them. Moreover, when collecting waste from some town houses, if house residents separate vegetable residues from landfill garbage he could use the residues for composting.

### SERVICE MAP

The large quantity of information recorded is difficult to review on a regular basis. In order to plan his business better, it is useful to arrange data in a "service map". The service map highlights the following information:

- Dave's village and farm.
- Location of customers (existing and potential).
- Town and main road system.
- Position of support services providers – repair workshop, machinery dealer, input dealer, bank etc.
- Estimated distances to travel.

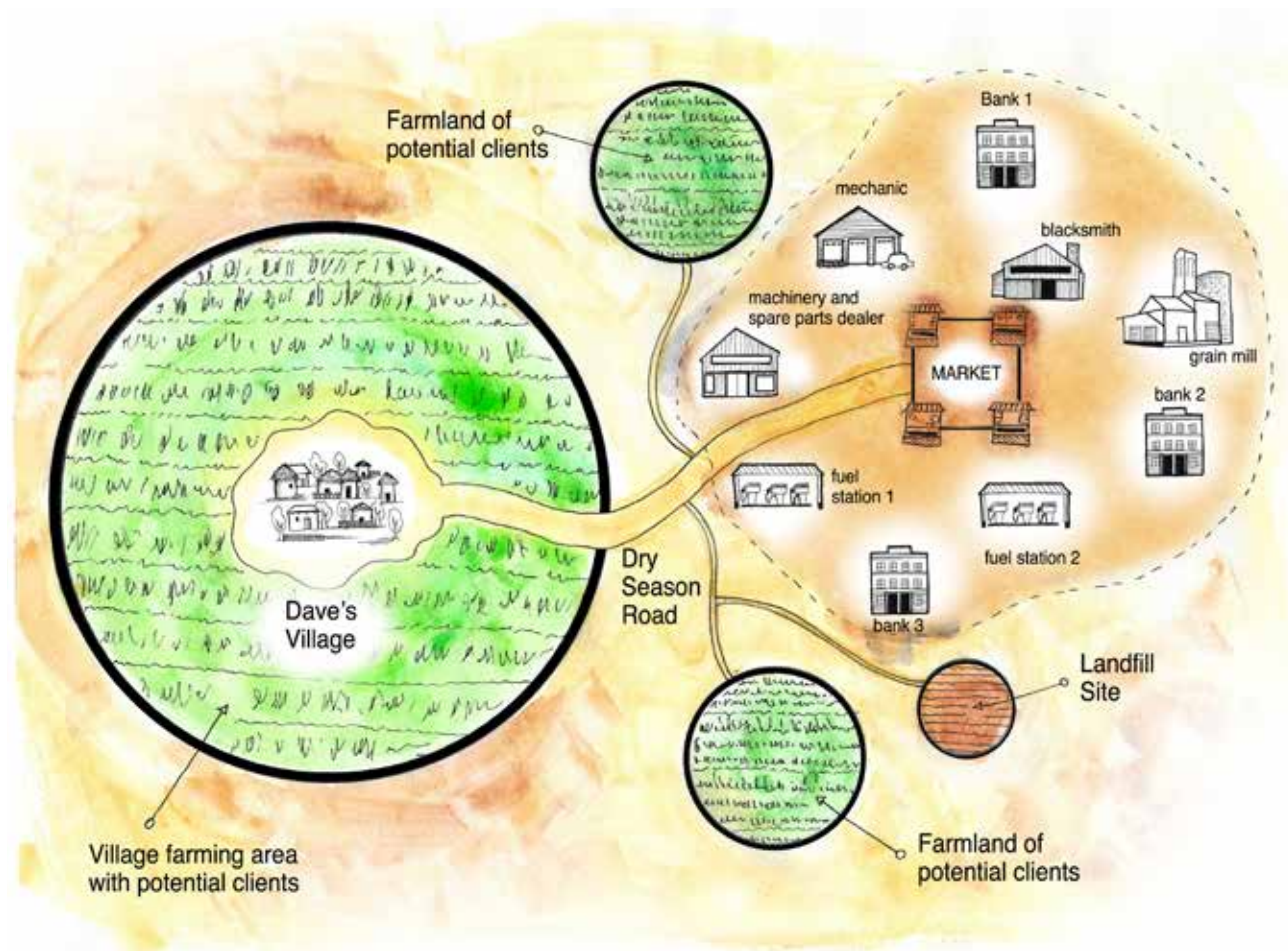

Plate 2.2 Dave's service map

## SESSION 2.2

# HOW TO CONDUCT AN ASSESSMENT

**Trainer's guide to the session:** An assessment of the local area includes a market and support service appraisal. Each step in the assessment process relates to a specific activity to be conducted:

- Identify clear and concise objectives for the assessment.
- Determine what information is needed.
- Establish where the information can be found.
- Devise a plan for information collection.
- Decide how to record this information.
- Analyse the information to enable better decision-making in the business.

**Note to the trainer:** This session presents two options. Option 1 is a field visit exercise and is subject to local circumstances, time availability and budget; you are the best judge to decide if a field visit is possible. Option 2 is available if a field visit is not possible: stakeholders – key local people (e.g. farmers, traders, equipment dealers, blacksmiths, mechanics, bankers and NGOs) – can be invited to the training session to make presentations and be interviewed by the participants. Interviews follow the same steps in both field visits and stakeholder visits.

- **Option 1: Field visit.** Organize the field visit in advance. On a field visit, the participants visit farms and equipment dealers, and meet and talk with people (e.g. farmers, traders, processors, mechanics and bankers). Detailed preparation is essential: contact the key people mentioned to see if they are prepared to have visits on their premises, and whether they are available to meet with the participants and be interviewed; arrange dates and times for visits; ensure that transport is available if required; and estimate the time needed.

- **Option 2: Stakeholder visit to the training session.** Organize the stakeholder visit in advance. A visit by local people (e.g. farmers, traders, processors, mechanics and bankers) to the training session includes a brief presentation by each visitor based on agreed guidelines. Allow plenty of time for interviews by the participants. Meticulous preparation is essential: contact the people in advance to see if they can come to the training session, make a brief presentation and be interviewed by the participants; arrange a specific day and time when visitors can come to the training session; ensure that transport is available if required; and estimate the time needed (it is recommended that visits, presentations and follow-up interviews should not last more than 2–3 hours in total).

### Session learning objectives:

- Understand what to assess and who to interview in the local area.
- Acquire the skills to identify potential customers and assess the services in highest demand.
- Identify and understand what type of support services are needed and available locally.
- Identify formal and informal financial organizations that can provide credit in the vicinity.
- Identify other support services providers and the type and quality of services they provide in the local area.
- Understand the steps involved in the assessment process and demonstrate how to carry this out.

**Practical learning:** The exercises cater for both Option 1 and Option 2. The practical tasks comprise: Exercise 1, "Preparation for the field visit/stakeholder visit"; Exercise 2, "Field visit/stakeholder presentations and interviews"; and Exercise 3, "Presentation of findings". Organize participants into teams to work on the exercises. It is important to enable participants to share their knowledge and experience.

**Note to the trainer:** The exercises are intended both for field visits and for stakeholder visits to the training session.





### EXERCISE 1. PREPARATION FOR THE FIELD VISIT/STAKEHOLDER VISIT

Tasks are to be carried out by participants prior to the field visit or the stakeholder visits to the training session. Stimulate discussion among participants and encourage them to share their experiences.

Provide each team with Handout 2.1, "What and whom to assess?" Ask each team to read the handout. Encourage team discussions and note-taking to distil the main points. In a plenary session, ask questions:

- How would you describe an assessment process?
- Why are customers and support service providers important for a successful hire service business?
- Which types of support services are the most important?
- Why is reliability of support services important?
- What are the most important factors to understand about services offered by support services?
- Why are the local farming systems (farm size, cropping pattern etc.) and the natural resource base so important for your business?

Note the key responses on a whiteboard or flip chart. Encourage discussion among participants.

Distribute Handout 2.2, "Conducting a market assessment", and ask participants to read it in their team groups. Encourage them to take notes during this exercise. In a plenary session, ask questions:

- How would you describe the market assessment process?
- Why is a market assessment important for the successful running of a hire service?
- What can be done to satisfy customers?
- What can be done to develop demand?

Note the key responses on a white board or flip chart. Encourage discussion of each point.

Provide participants with Handout 2.3, "Conducting an assessment of financial sources". Ask them to read it in their teams. During the exercise, record responses and encourage discussion. In a plenary session, ask questions:

- Why is finance/credit important for your business?
- What is an interest rate?
- What is a payback period?
- What are medium-term and long-term loans?
- Why are these relevant for buying tractors, farm machinery and draught animals?

Ask participants to list other possible sources of funding. Discuss the advantages and disadvantages of each source of funding.

Distribute Handout 2.4, "Conducting a field visit or interviewing key stakeholders". For Option 1 (field visit), ask participants to read the handout and allow time for review.

For **Option 1:** Ask participants to do the following **before the field visit:**

- Write down the objectives of the assessment. Define the specific information needed for the assessment. Help participants define clear and concise objectives.
- Consider where they can find the necessary information and formulate the questions to ask. Help participants define clear and concise questions.
- Decide how to record the information collected. Help participants define clear and concise ways to record information.

For **Option 2:** Ask the participants to do the following **before the stakeholder visit to the training session:**

- Write down the objectives for the assessment. Help participants define clear and concise objectives for the exercise.
- Define the specific information needed for the assessment.
- Consider where they can find the required information and formulate the questions to ask. Help participants define clear and concise questions.
- Decide how to record the information collected. Help participants define clear and concise ways to record information.

### EXERCISE 2. FIELD VISIT/STAKEHOLDER PRESENTATIONS AND INTERVIEWS

**Option 1: Field visit:** Participants, working in teams, conduct a field visit to carry out the assessment. You will already have made contact with local farmers, traders, mechanics, bankers etc., to enable interviews to be conducted by the teams. When necessary, provide support, especially transport.

**Option 2: Stakeholders visiting the training session:** Participants, working in teams, interview the invited stakeholders to complete their assessment. When necessary, provide support to the teams.

### EXERCISE 3. PRESENTATION OF FINDINGS

Participants, working in teams, analyse their findings from the assessment (Option 1 or Option 2) and present the results in a plenary session. When necessary, provide support to the teams.



## HANDOUT 2.2 CONDUCTING A MARKET ASSESSMENT

The market assessment process:

- Step 1. Decide what market information is needed.
- Step 2. Consider where the market information can be found.
- Step 3. Make a plan to collect the market information.
- Step 4. Devise a method for recording the market information.
- Step 5. Analyse the market information collected.

### STEP 1. DECIDE WHAT MARKET INFORMATION IS NEEDED

- **Who.** Knowing who **customers** are is a fundamental aspect of a hire service business. A hire business needs to identify its potential consumers, for example, farmers, traders, processors, local construction companies, local municipalities and people needing transport.
- **Why.** Understanding **customers' needs** – why they require hire services – is crucial. Potential customers will buy services to fulfil their particular needs. For example, a trader may need transport services to collect produce from various farms and then take it to a processor and/or market; a farmer may need crop planting services.
- **What.** Identifying the specific **types of services** required is essential. Types of services potentially required include sowing crops, water pumping, harvesting, processing and transport.
- **When.** Understanding not only what services to provide, but when to provide them (**timing**), is critical, as demands for services may occur at the same time of the year.
- **What kind.** Providing the right kind of service is crucial, as customers need to know that the business is not only reliable, but it provides a **quality** service that the customer needs. For example, a quality harvest service is provided on time, is carried out properly with minimum crop damage, has low in-field crop losses and is competitively priced.
- **How much.** Pricing of services is one of the most important aspects of a hire service business. The prices charged for services determine the profits of the hire service business.

**Who, why, what, when, what kind and how much** are the most important questions for a hire service provider. However, other market information is also important and may include, for example, what other new services can be provided or where the most profitable services can be sold.

Identify the information needed, then establish clear and concise **information-gathering objectives** as a guide to the market assessment process, for example:

- Who are the potential customers and who will become the actual customers?
- What are the average farm sizes and what are the predominant cropping systems?
- What specific services are required?
- Where are these services required?

- When are these services required?
- How much will real customers pay for these services?
- How severe is the competition? How many other businesses provide similar services? What quality of service do competitors offer?

### STEP 2. CONSIDER WHERE THE MARKET INFORMATION CAN BE FOUND

Once the information objectives are established, identify where information can be found. For example, to understand customer needs, ask questions directly to potential consumers, farmers and traders. To discover what transport opportunities there are, visual observation of a market entrance may be a good source of information. Visual observation is also useful for ascertaining farm size, what is produced on the farm, soil conditions, how water is used, how farm production is carried out etc.

### STEP 3. MAKE A PLAN TO COLLECT THE MARKET INFORMATION

Gather information methodically, following a plan. For example, a potential plan for collecting information from fuel, spare part and repair service providers, entails the following:

- Decide which providers will be interviewed.
- Fix a time and place for the interviews.
- Prepare the questions to be asked.
- Establish how the information gathered will be recorded.
- Fix a time for the duration of the interview.
- Calculate the costs entailed.

### STEP 4. DEVISE A METHOD FOR RECORDING THE MARKET INFORMATION

Recording the information is essential. Simply remembering information is not sufficient: it is difficult and not reliable. Write down all interview responses and visual observations.

### STEP 5. ANALYSE THE MARKET INFORMATION COLLECTED

Once collected and recorded, the information needs to be read, understood and carefully analysed. Interviews with traders and farmers etc. produce a lot of information. For example: traders need transport services once a week throughout the harvest season, but they are only willing to pay low prices; on the other hand, farmers may need harvesting and threshing services during the harvest season and offer good prices for such services. The provider needs to **analyse the service options and identify the most profitable services** in each season.

The analysis produces a lot of information: what services are required and when; the prices that can be charged. This information is essential for making business decisions. The more assessments are carried out, and the more specific they are, the better hire service providers become at carrying out assessments and the more information they gather. The provider becomes increasingly knowledgeable and capable of creating opportunities to develop the hire service business.

## HANDOUT 2.3 CONDUCTING AN ASSESSMENT OF FINANCIAL SOURCES

The credit and credit organization assessment process in summary:

- Step 1. Decide what information is needed to assess finance and credit organizations.
- Step 2. Consider where the information can be found.
- Step 3. Make a plan for collecting the information.
- Step 4. Devise a method for recording the information.
- Step 5. Analyse the information collected.

### STEP 1. DECIDE WHAT INFORMATION IS NEEDED TO ASSESS FINANCE AND CREDIT ORGANIZATIONS

A hire service provider requires the following information:

- **Credit provider.** A hire business needs to identify who can potentially provide credit, for example, traders, processors, NGOs and banks, and where they are located.
- **Type of credit.** It is important to understand what types of credit are available in the local area. Credit in the medium term (1–3-year payback period) and long term (>3-year payback period) is often used to buy tractors and equipment. However, there may be other types of credit available in the local area, for example, leasing from a manufacturer or dealer. Credit with a <1-year payback period can be useful for covering the running costs of the hire service, for example machinery maintenance and repair costs.
- **Interest rates.** For each of the credit types available, it is important to understand what the interest rates are and how these are applied throughout the payback period.
- **Guarantees.** Credit usually requires the hire service business to provide a guarantee (assets or collateral). It is important to understand what guarantees are required to obtain credit. Guarantees are usually assets that can be easily converted into cash if they are sold. Typical guarantees for credit are land, a house or the business premises of the hire service. It is increasingly common practice for the guarantee to be the tractor

or equipment being purchased; if payments are not made to repay the loan, the tractor is withdrawn and sold to recoup the outstanding loan.

- **Reliability.** Lenders (e.g. a trader, an NGO or a bank) need to be reliable: they provide credit according to agreed terms, within the prescribed time frame and do not change the terms and conditions.

Once this information has been gathered, you can establish clear and concise objectives, which serve as a guide during the assessment process, for example:

- Who are the potential lenders – individuals and organizations – who can be approached for a loan for buying a tractor in the local area?
- What type of credit do they offer?
- What are their terms and conditions?
- What specific guarantees do such loans require?
- What are the interest rates on the various types of loans?
- Will the credit be delivered within the required time frame?
- What happens if loan repayment installments are delayed or not paid?

### STEP 2. CONSIDER WHERE THE INFORMATION CAN BE FOUND

Having established the objectives, identify where to find the information. For example, to learn about types of credit available in the local area, ask questions directly to potential lenders (e.g. machinery franchises).

### STEP 3. MAKE A PLAN FOR COLLECTING THE INFORMATION

Information collection must follow a plan. For example, if information from banks is required, the plan could be as follows:

- Decide which banks and other financial organizations (formal and informal) are to be interviewed.
- Identify where they can be found.
- Specify who is to be interviewed.
- Prepare the questions to ask.
- Decide how to record the information collected.
- Establish the duration of the interviews.
- Calculate the cost.

### STEP 4. DEVISE A METHOD FOR RECORDING THE INFORMATION

As mentioned in Step 3, it is important to record the information collected. Some hire service providers may be able to remember, but this is difficult and unreliable. Therefore, it is important to **write down** or **record** all interview responses and visual observations (using, for example, a mobile phone).

### STEP 5. ANALYSE THE INFORMATION COLLECTED

All the information from the interviews must be read and understood, and pertinent facts need to be absorbed to then carefully analyse the information collected. Use the analysed data to make correct decisions regarding credit.















Plate 3.1 Selection of mechanization options should be based on sound technical and financial criteria

## MODULE 3

# SELECTING APPROPRIATE MACHINERY: TECHNICAL AND FINANCIAL ASPECTS

**Trainer's guide to the module:** Module 3 deals with the technical and financial aspects of machinery selection. The module introduces the steps required for selecting power sources (both tractors and draught animals) and implements for specific tasks, and covers the following:

- Local farming systems, markets and support service considerations.
- Technical and financial selection considerations.
- Estimating machinery outputs.
- Impact of the working environment.
- Selecting the power source (tractors and draught animals) and their matching implements (including post-harvest equipment).
- Making investment decisions.

The module imparts the skills required to understand the importance of selecting power sources and implements. Through an analysis of farming systems and other factors (e.g. costs, customers and priorities), it equips participants to make optimal selections of appropriate power sources and implements, helping them to identify critical factors and understand power source and implement performance in the field.

**Module learning objectives:**

- Recognize the importance of planning in the selection of power sources, machines and associated implements.
- Understand the technical and financial criteria involved in the selection of power sources and equipment.
- Identify the logical steps required in the selection process.
- Demonstrate how to carry out the step-by-step selection process.
- Explain how to make investment decisions.

**Note for the trainer:** Some of the themes covered in this module may be challenging for some participants, in particular those with low levels of numeracy skills. Keep this in mind: take care not to overwhelm any participants lacking the necessary basic skills, but ensure that the fundamental concepts are understood.

When feasible, help participants gain hands-on experience in the selection of power sources and implements. Module 1 includes the option of allowing participants to handle implements in the field, while Module 2 comprises the choice between organizing a field visit and having key stakeholders come to the training to give presentations and be interviewed. In this module, the training experience of participants can be greatly enhanced by a visit to a machinery dealership and/or animal trader. This field visit is highly recommended (see Session 3.6).

Organize the field visit in advance. It provides an opportunity for participants to talk to dealers/animal traders and to observe the tractors, machinery and animals that may be available. It should take place after Sessions 3.1–3.5 of Module 3 have been completed, to allow participants to put into practice what they have learnt. Arrange the dates and times of visits and ensure that transport is available, if needed. Estimate the duration of the visits.

**Recommended background reading:** Share readings with participants if you consider it useful. In particular, FAO (2005) and FAO (2009b) provide a refresher on cash flow and borrowing. All the publications below are freely available online:

- FAO. 1990. Agricultural engineering in development: Selection of mechanization inputs. Agricultural Services Bulletin 84. Rome.

Available at: [https://books.google.it/books?id=aLayu-hXYrqsC&printsec=frontcover&hl=it&source=gb\\_s\\_ge\\_summary\\_r&cad=0#v=onepage&q&f=false](https://books.google.it/books?id=aLayu-hXYrqsC&printsec=frontcover&hl=it&source=gb_s_ge_summary_r&cad=0#v=onepage&q&f=false).

- FAO. 2005. Explaining cash flow and savings. Rome. Available at: [http://www.ruralfinanceandinvestment.org/sites/default/files/1136798915189\\_TAM\\_1\\_edited\\_Jan06.pdf](http://www.ruralfinanceandinvestment.org/sites/default/files/1136798915189_TAM_1_edited_Jan06.pdf).
- FAO. 2009a. Explaining the finances of machinery ownership. Rome. Available at: [http://www.ruralfinanceandinvestment.org/sites/default/files/TAM3\\_Explaining\\_finances\\_machinery\\_ownership.pdf](http://www.ruralfinanceandinvestment.org/sites/default/files/TAM3_Explaining_finances_machinery_ownership.pdf)
- FAO. 2009b. Explaining profitability and borrowing. Rome. Available at: [https://www.microfinancegateway.org/sites/default/files/mfg-en-paper-explaining-profitability-and-borrowing-2009\\_0.pdf](https://www.microfinancegateway.org/sites/default/files/mfg-en-paper-explaining-profitability-and-borrowing-2009_0.pdf)



## SESSION 3.1

# PLANNING THE SELECTION OF POWER SOURCES AND IMPLEMENTS

**Trainer's guide to the session:** This session is an introduction to, and overview of, the planning process for selecting power sources and implements for a hire service business.

### Session learning objectives:

- Understand the importance of planning when selecting power sources, implements and machines.
- Appreciate the numerous factors influencing the selection of power sources and implements.
- Describe the step-by-step planning process for selecting power sources and implements.

**Practical learning:** This introductory session is based on two exercises. In Exercise 1, "Buying a used tractor", participants watch four videos and discuss the main points raised. For Exercise 2, use Handout 3.1, "Importance of planning for the selection of power sources and implements", which spells out the main reasons for taking a logical approach to selection. This session is a prelude to the more specific technical and financial aspects of selection dealt with in subsequent sessions.

### EXERCISE 1. BUYING A USED TRACTOR

Show the following videos to the participants:

- › Part 1 (duration: 2.28): Introduction. Available at: <https://www.youtube.com/watch?v=hQN7AQ9leTE>
- › Part 2 (duration: 3.56): Basic tractor configurations. Available at: <https://www.youtube.com/watch?v=R5D4Fw6sqH8>.
- › Part 3 (duration: 5.35): Age of the tractor. Available at: <https://www.youtube.com/watch?v=niiw2pcqWzk>
- › Part 4 (duration: 5.03): Tractor maintenance. Available at: <https://www.youtube.com/watch?v=V5A8ATCqyJA>

Encourage discussion and ask the question: What are the main points to consider when selecting a used tractor?

### EXERCISE 2. THE IMPORTANCE OF PLANNING FOR SELECTION

Distribute Handout 3.1 for participants to read through and discuss. Encourage participants to share their experiences and ask the following questions:

- Why is it important to carefully plan for the selection of power sources and implements?
- Which factors need to be taken into account when considering the selection of power sources and implements?
- How do you envision/practise the process of selecting power sources and implements?
- Why is a step-by-step approach important in the selection of power sources and implements?

### HANDOUT 3.1. IMPORTANCE OF PLANNING FOR THE SELECTION OF POWER SOURCES AND IMPLEMENTS

The selection of power sources and related implements or equipment depends on a wide range of factors, such as soil type, topography, crop type and financial considerations. It is, therefore, essential to carefully plan for the purchase, use and management of power sources and implements, considering the high costs they represent for a hire service business. Choosing the most appropriate power source and related implements can make the difference between a successful business and a failed venture. Hire service businesses derive their profit from the efficient and profitable use of tractors, machines, draught animals and implements; for this reason, it is fundamental that any investment in power sources and implements results in improved performance and increased profit. Without improvement and profit, no investment should be made.

It is imperative to analyse the potential outcomes of buying agricultural machinery prior to any investment. A detailed assessment must cover a wide range of factors, in particular:

- Local farms (e.g. soil types, crop/livestock systems, intensive or extensive farming, high value crops, farm size, topography, local natural environment and climatic conditions, skilled labour availability).
- Market potential (e.g. priorities of farmers and other agrifood value chain actors, prices that can be charged for services, competition by other hire services in the locality).
- Support services (e.g. farm machinery dealerships, spare parts dealers, repair shops, fuel suppliers, veterinary services).
- Technical and financial aspects – with regard to both purchase and use (e.g. field performance of tractors, draught animals and associated machinery and equipment, purchase prices and running costs, cash availability [cash flow] in the hire service business to make such a purchase and the possibility of taking a loan [loan appraisal]).

Such an assessment is useful in the decision-making process, although it is not sufficient to eliminate the risk of investing in machinery that does not perform to expectations.

The planning process for power source and implement selection comprises four steps:

- Step 1. Assessment of local agricultural context (crops, farm sizes, practices, markets and support services)
- Step 2. Technical and financial assessment of power sources and implements
- Step 3. Selection considerations and criteria
- Step 4. Purchase

### STEP 1. ASSESSMENT OF LOCAL AGRICULTURAL CONTEXT

The selection process begins with a detailed assessment of **farms, markets, competition** and **support services**, providing a foundation on which to plan for the selection of appropriate mechanization equipment. Particular attention is paid to the following factors:

- **Local cropping patterns** (both existing and potential) – an important indication of the types of tractors, machines (including those used for post-harvest handling), draught animals and implements required. Information is required about the cropping patterns practised and the individual crops grown within that pattern (see Module 2). For example, whether the main crop is a small grain crop or maize conditions the choice between a seed drill and a row crop planter for planting, or between a cutter-bar table and a maize header for combine harvesting. Similarly, annual crops (e.g. cereals and legumes) generally have different requirements for mechanization compared with perennial crops (e.g. coffee and sugar cane).
- **Profitability of crops** grown by potential clients – a customer's aspirations do not always match what they are actually prepared to pay for. Farmers are not necessarily in a position to fully mechanize all their crop production; a prospective hire service business should discuss with farmers, and use other knowledge sources, to identify farmers' priorities.
- **Priorities of other customers** in the agrifood value chain (see Module 2), considering, for example, the need for transport services by local traders and processors, or the need for processing operations (shelling, threshing and milling).
- **Non-agricultural opportunities**, such as rural transport, road building and maintenance for local authorities, stationary work (e.g. water pumping) and forestry work.
- **Prices** that farmers and other agrifood value chain actors are willing to pay for services, in order to make a basic comparison between the costs of providing a service and the money received for the service provided. This gives an indication of the potential profit from each service and of what machinery can be justified. Profit calculations give an overall estimation of the money the hire service business needs both to start up and to operate.
- **Competition**: what services competitors are providing and for whom, when, how often, and importantly what prices are charged. An assessment of the competition can indicate new types of services that can be provided in the area. Rates must be competitive.
- **Support services** (see Module 2) available in the local area, for example, financial services, fuel suppliers, spare parts dealers, mechanics and veterinarians, all of which are important for the successful functioning of agricultural machinery.



## SESSION 3.2

# TECHNICAL AND FINANCIAL CRITERIA FOR THE SELECTION OF A TRACTOR

### Trainer's guide to the session:

- **Step 1** of the planning process for the selection of power sources and implements is covered in Module 2. Use the information gathered in the assessment exercises on local farms, markets and support services in this session.
- **Step 2** of the planning process considers the **technical and financial** aspects of power sources and implements. This session introduces tractor assessment criteria to support the selection of an appropriate tractor for a hire service. Sessions 3.3 and 3.4 cover draught animal and implement assessment criteria, respectively.

### Session learning objectives:

- Appreciate the importance of following an assessment process when considering a tractor purchase.
- Understand the criteria for assessing a tractor.

**Practical learning:** The session focuses on an exercise based on Handout 3.2, "Technical and financial criteria for tractor selection".

### EXERCISE 1. TRACTOR ASSESSMENT

Divide participants into groups, encourage the sharing of experiences and ask the question: What criteria would you use to select a tractor?

Following the discussion, ask each group to write down an agreed set of criteria for tractor selection. Distribute Handout 3.2 for participants to read through and discuss. Encourage participants to share their experiences and ask questions:

- What are the main types of tractors available in the area?
- What range of tractor power is most popular in the area? What are the most important tasks undertaken?
- Which type of tractor is most suitable for hire service work in the area? Why is this?
- What criteria are useful when selecting a tractor?
- Why are these selection criteria important?

Ask each group to draw up (and write down) a final list of criteria for selecting a tractor.

**Note to the trainer:** If a visit to a dealership is planned for Session 3.6, advise the groups to keep the lists of criteria they developed, as they can be used during the visit.



## HANDOUT 3.2 TECHNICAL AND FINANCIAL CRITERIA FOR TRACTOR SELECTION

The selection of a tractor for a hire service business involves the complex assessment of several factors. For example:

- What are the most suitable sizes and types of tractors?
- How many are required?
- How much work are they able to carry out?
- What are the risks involved?
- What are the requirements for drivers and support personnel?
- What operating costs are involved?
- What are the financial considerations?

The tractor chosen does not have to be technically the best on the market. However, it must be able to perform the required tasks (services) in a satisfactory way at the lowest feasible cost. Therefore, do not consider only technical criteria: make a financial assessment before deciding to invest in any particular machine.

The tractor is often the core machine of a hire service business. Tractors are extremely versatile and provide the power for a wide range of applications; they pull implements, but they can also deliver engine power through the power take-off (PTO) shaft.

Tractors are available in many different sizes and configurations (including both two- and four-wheel categories). Four-wheel tractors (4WTs) may be either two-wheel drive (rear wheels only are driven) or four-wheel drive (front and rear wheels are driven for greater traction. (Refer to video 2, Exercise 1, Session 3.1.)

To avoid wasted expense, establish how many tractors of what size the hire service needs. A too small tractor can result in long hours in the field, excessive delays and premature replacement; on the other hand, a too large tractor may entail excessive operating and overhead costs. An ideal piece of equipment completes the job (performs the service) on time at the lowest possible cost.

The criteria to consider when selecting a tractor are explained in detail below.

### SERVICES REQUIRED AND PRICES

Consider what services are demanded locally and how much can be charged. Carry out a market assessment (Module 2) to gather this information, together with data on soil types, farm sizes, land preparation and post-harvest services required. You will then have an indication of **what power (hp) the tractor needs to have**. Set feasible prices for the services required in order to calculate potential earnings and, consequently, to determine **what kind of tractor the hire service can afford**. This information (prices, and what services are needed and when) is also useful for estimating the cash coming into the hire service (revenue) and the cash being paid out of the hire service (expenses). It is important to

understand this **cash flow** in order to know what the hire service can afford in terms of repayments if it needs a loan to purchase a tractor.

### POWER REQUIREMENTS

In general, tractors are categorized according to **engine power**, measured in horsepower (hp) or kilowatts (kW) (1 hp = 0.746 kW). However, the actual performance of a particular tractor is rather more complex. For example, for towed implements, not only is the power of the engine important, but the **weight** of the tractor affects the load that can be pulled.

Besides the tractor's weight, other factors determine how much can be pulled. In general, the absolute maximum load that a wheeled tractor can pull when operating on soil is about two-thirds of its weight. Most tractors can increase the weight on the drive wheels by various means: filling the tyres with water; adding wheel and front-end weights; and using the weight transfer gained by using three-point linkage mounted implements.

If, on the other hand, the tractor is to be used with implements powered by the PTO shaft (e.g. for rotary cultivator work in paddy rice), the engine power is the main deciding factor as it is applied directly to the working implement.

For most mixed agriculture applications, a general purpose tractor with power between 40 hp and 100 hp offers the greatest flexibility. For paddy rice applications and for very small farms and field sizes, a smaller range of tractors can be considered (5–25 hp). Therefore, if a hire service has a client base of small farms with small fields, a 100-hp tractor would not be appropriate, as the machine could not be used to its full potential. Likewise, if general transport work accounts for a substantial part of the business, tractors with very low or very high power are not suitable; a more efficient tractor size is 50–70 hp.

For an economic return, the average annual revenue earning usage of a medium-sized 4WT should be at least 700–800 hours. Ownership costs rise sharply when the annual usage falls below 800 hours.

### TRACTOR OPERATIONS AND THEIR COSTS

Ascertain what operations the tractor will be doing and the costs involved, taking into account a range of factors:

- **Working conditions:** topography, weather patterns, soil types, cropping and livestock patterns etc. (see Module 2).
- **Work capacity,** in order, for example, to determine the tractor's field capacity (measured in hectares per hour – see Session 3.5).
- **Tractor efficiency:** field efficiency, travel time, downtime, and maintenance and repairs time – which all affect revenue-earning potential.

The total **costs** of tractor operation are subdivided into fixed and variable:

- **Fixed costs** (e.g. depreciation, interest on investment, taxes and insurance) are incurred whether or not the tractor is used; therefore, the more it is used, the lower is the unit cost of operation (per hour, acre or hectare).
- **Variable costs** (e.g. fuel, lubricants and repair costs) are dependent on both how much the tractor is used and the type of operation.

The **maintenance** schedule is another important factor in costing. Maintenance work costs money; this is exacerbated by the fact that the tractor cannot provide services during the period of maintenance and repairs (downtime), with an effect on revenue.

### SKILLS OF THE TRACTOR OPERATOR

In recent years, tractors have become increasingly sophisticated machines; it is, therefore, essential to consider the time involved and costs implied in tractor operator training.

### FLEXIBILITY

Another major consideration is the degree of flexibility needed. If the hire service has four small (rather than two big) tractors, it can carry out a greater number of field operations; moreover, if one machine breaks down, business capacity is reduced by just 25 percent (one tractor out of four) – compared with 50 percent when one out of two larger machines breaks down. On the other hand, four tractors require four operators, entailing greater costs.

### MACHINE MAKE AND DEALERSHIP

It is important to choose the most suitable make of tractor: the right or wrong decision can make or break a hire service business. Note that different makes of machine dominate in different markets. Asked why a particular machine is dominant, owners and operators insist that it is the best machine on the market. In a neighbouring country or region, a different make is declared the best. The reasons can be quite complex, but are often to do with the level of dealer support a given make receives. A hire service should research the level and quality of service provided by dealers (see Module 2).

### PURCHASE PRICE

When considering the sales price of a tractor, compare prices among the various makes and dealerships available in the local area. Take into account the various services provided. For example, one dealership may present a low sales price but offer few services, while another dealership may place a higher sales price on the same tractor, but include a wider range of services. Credit may be offered by the dealership to support the purchase of a tractor; credit products and schemes need to be carefully assessed.

### FINANCE

If a hire service operator has funds to invest in a tractor, there is no need to assess credit options. However, this is not the case for most small-sized hire services, who must carefully assess possible sources of finance, taking into consideration the role of credit and the risks and responsibilities entailed. Possible sources of finance include:

- one's own savings;
- borrowing from input suppliers;
- borrowing from dealers;
- bank loans; and
- grants.

Take into account any collateral (assets) required to provide a guarantee on the loan, and consider that tractors usually require longer-term loans (with lower interest rates). Many dealerships offer credit products that use the tractor itself (or other expensive item of equipment) as collateral.

A loan appraisal is carried out to ascertain whether a loan's interest rates and payback period can be covered by the hire service. A loan appraisal examines the cash flow – the amount of money earned by the hire service over time (e.g. 1, 2 or 6 months) and the amount of money that spent. Based on the monthly cash balance, it is possible to determine whether the hire service can pay back a loan in the agreed payback period. By determining cash flow, it is possible to identify the times in the year when the hire service business may run short of cash and, on this basis, make a plan to raise the cash needed in time to pay back the loan instalments.

### Notes

---



---



---



---



---



---



---



---



---



---



## SESSION 3.3

# TECHNICAL AND FINANCIAL CRITERIA FOR THE SELECTION OF DRAUGHT ANIMALS

**Trainer's guide to the session:** This introduction to draught animal assessment criteria is designed to support the selection of draught animals for a hire service. The use of draught animals in a hire service business is very locality-specific. Consequently, **this session is only applicable to situations where draught animals are used or have potential.** This session deals exclusively with the use of cattle as a power source. Therefore, in areas or circumstances where other animals, such as buffalos, mules, horses or donkeys, are more important, the session must be modified and local knowledge applied to adapt it accordingly. However, the **assessment criteria provided apply to all types of draught animals.**

### Session learning objectives:

- Understand the importance of following an assessment process when considering draught animal purchase.
- Understand the criteria for assessing draught animals.

**Practical learning:** The session focuses on an exercise based on Handout 3.3, "Technical and financial criteria for the selection of draught animals".

### EXERCISE 1.

#### DRAUGHT ANIMAL ASSESSMENT

Keep participants in the same groups used in the exercise in Session 3.2. Encourage the sharing of experiences and ask the question: What criteria would you use to select draught animals?

Following discussion, ask each group to write down a commonly agreed upon set of criteria for draught animal selection. Then distribute Handout 3.3 for participants to read and discuss. Ask the participants the following questions and encourage them to share their experiences:

- What are the important characteristics of draught cattle from your own perspective and experience?
- What are the main dangers and problems associated with draught animal use in the region?
- What is your strategy for buying and selling draught animals?
- What are the criteria used to select draught animals?

Ask each group to produce and write down a final list of criteria for selecting draught animals.

**Note to the trainer:** If a visit to an animal trader is planned at the end of Module 3, advise each group to keep the criteria developed for use on that occasion.



### HANDOUT 3.3

## TECHNICAL AND FINANCIAL CRITERIA FOR THE SELECTION OF DRAUGHT ANIMALS

The choice of draught animals is location-specific and depends on the type of animals typically used in a given area or region. The most important draught animals, in terms of numbers worldwide, are cattle. Various criteria need to be considered when selecting draught animals:

### SERVICES DEMANDED AND PRICES

Always keep in mind what services are demanded in the local area and what prices these services can command. This information is obtained through a market assessment (see Module 2) and gives an indication of what draught force capacity is required. On the basis of the potential prices for the services, it is possible to calculate how much the hire service can earn and consequently what it can afford in terms of purchasing draught animals. Knowing not only the prices, but also when services will be required, makes it possible to estimate the cash coming into the hire service (revenue) and the cash being paid out (expenses), i.e. the cash flow. It is important to understand the cash flow if a loan is needed to purchase draught animals, as the hire service can know in advance what it can afford in terms of how much it can repay and when.

### PHYSICAL CHARACTERISTICS OF ANIMALS

#### Breed

Cattle are widely available in many countries: easy to purchase, sell and replace. However, being easy to buy and sell can exacerbate the problem of cattle theft where this phenomenon exists. There are many breeds; the largest working oxen of European breeds weigh up to 1 500 kg, while some West African breeds can weigh as little as 150 kg. Draught cattle may be humped zebu breeds (*Bos indicus*) or non-humped breeds (*Bos taurus*), or their crossbreeds.

In general, indigenous **local breeds** are the most suitable in a given region as they are better adapted to local conditions, including climate, diseases and feed. In developing countries in particular, animals may live in a delicate balance with stressful environmental factors (e.g. heat, diseases and parasites and poor quality feed), and local indigenous breeds are more accustomed and adapted to these conditions and the local management systems.

In most of Africa where draught animals are used, zebu cattle are well adapted (compared with exotic breeds). However, local animals are often small and extension staff may sometimes suggest replacing them with imported animals or improving them by crossbreeding. Take such advice with caution, because the small size of local breeds is an adaptation to their environment. Indeed, better management, feeding and disease control will improve local breeds, while the harsh local conditions can have serious deleterious effects on imported or crossbred

animals. Only use large exotic breeds in situations where climatic, nutritional and disease stresses are low.

#### Gender

Male animals are generally heavier than females and bulls are the strongest work animals. **Oxen** (castrated bulls) are commonly used as working animals as they are less aggressive. Cows can be used for draught purposes, although their output is less than for bulls; moreover, if used for reproduction, extra nutritional care is required at critical times during gestation and lactation. Cows are a good choice for farmers who provide good management and do not give a heavy workload; they are unlikely to be the best choice for a hire service seeking to work the animals as much as possible throughout the year.

#### Conformation

The body conformation of an animal refers to its shape. The ideal conformation of working cattle is:

- legs and knees: sturdy – animals with bowed legs and knock knees have difficulty walking and are less suitable for work;
- legs: straight and muscled with strong, thick hooves that do not separate too much when animals are walking;
- chest: deep and wide;
- neck: medium length; and
- back: straight and wide.

#### Temperament and age

**Temperament:** Work animals should be tranquil, not aggressive towards people and other animals. This is especially important for hire service animals, routinely exposed to unfamiliar environments. For this reason, bulls are castrated between the ages of 2 and 4 years.

**Age:** An older animal (4–5 years) is difficult to train and its working life will be shorter than that of a younger animal (2–3 years). In addition, an older animal is nearing its mature weight, which limits the potential profit from an eventual sale of the animal for meat. In contrast, a young animal is lighter, cheaper and easier to train, with good potential for growth; however, it is not immediately at full strength for work and cannot perform as well as a heavier animal.

#### FLEXIBILITY

Large animals are more expensive and require more food. A hire service may decide that there is less risk involved in owning a larger number of smaller animals (see Session 3.2 with regard to tractors): death or incapacity of one work animal is less of a problem when there are many, less valuable animals.

#### LOCAL ENVIRONMENT, WORK RATE AND COSTS

Weather extremes are not usually well tolerated. For example, in hot climates, oxen need to work in early mornings and late afternoons when the sun is less fierce.

Working cattle are generally strong but relatively slow (2–4 km/h), and the draught force that can be maintained



## SESSION 3.4

# TECHNICAL AND FINANCIAL CRITERIA FOR THE SELECTION OF IMPLEMENTS

### Trainer's guide to the session:

This session considers the implements available for different tasks (services) and the appropriate power sources required.

### Session learning objectives:

- Understand the importance of following an assessment process when considering implement purchase.
- Identify the criteria for assessing implements, the relation to power sources and services demanded.

**Practical learning:** The session focuses on an exercise based on Handout 3.4, "Technical and financial criteria for the selection of implements."

### EXERCISE 1. IMPLEMENT ASSESSMENT

Keep participants in the same groups as for the exercises carried out in Sessions 3.2 and 3.3. Encourage the sharing of experiences and ask the question: What criteria would you use to select implements?

Ask each group to write down a commonly agreed set of criteria for implement selection.

Distribute Handout 3.4 for participants to read over and discuss. Encourage participants to share their experiences and ask the following questions:

- What services are needed in your local area/region?
- What implements and power sources are the most suitable to meet the services required?
- What main criteria should be used to select implements?

Ask each group to come up with a final list of criteria for selecting implements and tell them to write it down.

**Note to the trainer:** If a visit to a dealership is planned at the end of Module 3, advise each group to keep the criteria they developed for selecting implements as these will be very useful.

### HANDOUT 3.4 TECHNICAL AND FINANCIAL CRITERIA FOR THE SELECTION OF IMPLEMENTS

Selection of the correct implements for service provision depends on the demand from the customer base and on what is customarily used in the agrifood value chain. It is therefore recommended to observe what other farmers are using as it is difficult for a hire service to persuade farmers to adopt methods they are not familiar with. Farmers tend to be very conservative because the use of something new and untried could lead to decreased yields or even crop failure.

#### SERVICES DEMANDED (OPERATIONS TO BE MECHANIZED) AND PRICES CHARGED

The first step in implement selection is to keep in mind what services are required in the local area and what prices these services can obtain. This defines what implements the hire service needs. This information is provided by a market assessment (see Module 2). Based on the potential prices charged for services, it is possible to calculate how much money can be made and what the hire service can afford to purchase. Furthermore, knowledge of prices and of when services are required enables an estimate to be made of the cash coming into the hire service (revenue) and the cash being paid out of the hire service (expenses). This information – the **cash flow** – is crucial if a loan is needed to purchase implements, as the hire service can know in advance what it can afford in terms of repayments (how much and when).

#### APPROPRIATENESS FOR TASK AND POWER SOURCE REQUIREMENT

There are a vast range of implements available for agricultural tasks. Tables 3.4a and 3.4b give examples of what implements are available for basic mechanized tasks, but the list is far from exhaustive. The power requirement for the field operation of agricultural machinery depends on the configuration and width of work of the machine, and on the soil conditions. The tables give an indication of the probable power sources required; Table 3.5 (Session 3.5, Handout 3.5.2) gives further indications of power requirements and other information.

#### FIELD PERFORMANCE

Estimation of the actual performance of implements in the field is not always a straightforward matter (see Session 3.5). It depends on concepts such as field capacity and field efficiency and these, in turn, depend on many other factors. In the case of processing (shelling and milling, for example) and pumping operations, outputs per hour are usually what are required and these are dealt with in Module 4. Tables 3.4a and 3.4b show some of the equipment that might be required for specific tasks; they provide a basis for the selection of implements suitable for a specific locality. Table 3.4a refers to tractor-powered equipment, Table 3.4b to draught-animal-powered equipment.





**Table 3.4a Indicative overview of tractor and equipment requirements**

Operation	Equipment	Comments
Power source	Tractor (45-100 hp) – 2- or 4-wheel drive	
Crop and material transport	Trailer (3-5 tonnes)	For year-round work.
Ploughing and subsoiling	Disc Subsoiler Mouldboard or chisel plough	Choice of plough depends on method generally practised in the area. If conservation agriculture (CA) is promoted, plough use will be phased out.
Harrowing	Offset disc for heavy operation	Choice depends on soil type. See comments on CA above.
Harrowing	Tandem disc harrow for lighter work	
Harrowing	Power harrow – PTO-driven	Priority in paddy rice areas and horticulture, lower priority in rainfed conditions.
Cultivating	Tined harrow	In some regions with light soil conditions, this is used for all cultivation.
Cultivating/weeding	Inter-row cultivator	Rather specialized – mostly used on large farms.
Ripping	3-point mounted ripper	Often favoured by farmers wishing to eliminate ploughing and moving towards reduced tillage.
Sowing (drilling) - small grains	Seed drill	For cereal crop (e.g. wheat) areas. Direct drill for no-till farming.
Planting - maize, beans	Row planter	For maize areas. Direct planter for no-till.
Fertilizing	Tractor-mounted or trailed spreader	Mostly for large farms and fields.
Spraying	Tractor-mounted sprayer	Mostly for large farms and fields.
Grass and hay cutting	Rotary mower, cutter bar mower, rotary slasher, hay baler	For dairy and beef farms with predominance of grass and forage crops.
Forage harvesting	Self-propelled forage harvester	Expensive, specialized machine for use on large farms and in large fields. Requires supporting tractors and trailers for transport to storage area. This is often a “stand alone” contracting operation.
Milling Pumping	PTO-driven hammer mill PTO-powered water pump	Very good revenue earning operation for out-of-season work.
Harvesting - small grains	Reaper fitted to 2WT Self-propelled combine harvester with cutter bar table	Expensive, specialized machine for use on medium to large farms and in large fields. Requires supporting tractors and trailers for transport to storage area. Selection criteria include width of the table – i.e. ability to travel along the roads in the area and access to fields.
Harvesting - maize	Self-propelled combine harvester with maize header	
Grading	Towed grader (2 tonnes for 50–80-hp tractor) Towed grader (5 tonnes for 70-hp tractor)	
Gravel transport/spreading	Gravel trailer with > 70-hp tractor	Two-wheel tipping trailer.
Water/fuel transport	Tank trailers with > 80-hp tractor	Two-wheel trailer – need not be specialized – can use a tank which can be put on the normal agricultural trailer.





## SESSION 3.5

# SELECTION CRITERIA AND HOW TO ASSESS

**Trainer's guide to the session:** Session 3.5 considers **Step 3 Selection considerations and criteria** (see Session 3.1) of the planning process for mechanization equipment selection. It reviews the selection criteria and provides an introduction on how to assess, in practical terms, using some of the criteria provided in Sessions 3.2, 3.3 and 3.4. In particular, it considers:

- field capacity;
- field efficiency;
- work rate;
- draught requirement;
- impact of field conditions on performance;
- costs;
- making investment decisions; and
- finance (loan appraisal).

**Note to the trainer:** This session involves complex aspects of the practical assessment of tractors, draught animals and implements. Not all participants learn at the same speed: take as much time as is necessary, exercise patience and be prepared to provide support during the exercises to the participants, even on a one-to-one basis. Ensure that all participants grasp the essential basics.

Explain to participants that this session is an introduction on how to assess using some of the main selection criteria. They can adopt the same basic knowledge and skills in other contexts, for example, for the visit organized in Session 3.6.

### Session learning objectives:

- Understand the many criteria needed for assessing the selection of power sources and implements.
- Demonstrate how to carry out the various assessments as defined by the selection criteria.

**Practical learning:** This session involves a number of exercises and handouts. Exercise 1 reviews the criteria for selection of power sources and implements. Exercises 2, 3, 4 and 5 examine how to assess, respectively, machinery performance, costs, investment and loans.

### EXERCISE 1.

#### SELECTION CRITERIA REVIEW

The exercise reviews all the selection criteria covered with regard to power sources and implements, with additional detail on assessing the field performance of implements. Keep the participants in the groups used for previous exercises and provide them with Handout 3.5.1, "Selection criteria". Ask them to review the handout and include any other criteria resulting from previous exercises. Advise participants to keep the lists of criteria developed for use on the field trip.

### EXERCISE 2

#### ESTIMATING MACHINE OUTPUTS

Keep participants in groups, distribute Handout 3.5.2, "Estimating machine performance" and ask them to read it and discuss. Ask the following questions:

- How do you normally estimate the size of the implement you use?
- What is the "field capacity" of a machine?
- What is "field efficiency" and what factors determine it?
- What is "actual work rate"?
- What does the term "draught requirement" mean? How does drawbar power relate to engine power?
- What factors can affect the time available for productive (profitable) work?

In plenary have each group present their answers.

#### EXERCISES 2.1, 2.2 AND 2.3

Keep participants in the same groups and distribute Handout 3.5.3 for reading and discussion. Ask them to develop the necessary calculations for Exercises 2.1, 2.2 and 2.3.

In plenary have each group present their answers.

### Answers

#### Exercise 2.1

Possible solution:

Working width: 2 m (0.5 m/row × 4 rows); forward speed ("x"): 5 km/h (assumption based on experience); field efficiency: 70% (from Table 3.5.2a, Handout 3.5.2)

Work rate = (5km/h × 2 m × 70%) ÷ 10 = 0.7 ha/hour or 3.5 ha/5 hours

#### Exercise 2.2

Possible solution:

Drawbar power = 4 kW/m (from Table 3.5.2b, Handout 3.5.2); for a 2 m planter: 4 kW/m × 2 m = 8 kW

Tractor engine power ≈ 2 × drawbar power = 16 kW (21 hp) (1 kW = 1.3 hp)

### EXERCISE 3 COSTS

Divide participants into two groups based on experience: one group to deal with tractor-powered mechanization, a second group to deal with draught animal power. Provide them with Handout 3.5.4, "Costs".

With reference to Table 3.5.4a, ask the groups to calculate the fixed and variable costs of a power source/implementation combination (e.g. a 50-hp tractor and a 3-row no-till planter, or a pair of oxen and a single-tined ripper). Ask each group to make a list of the fixed and variable costs associated with the combination.

### EXERCISE 4. INVESTMENT APPRAISAL

Distribute Handout 3.5.5, "Investment appraisal". Ask participants to review the simple methods of investment appraisal before the plenary discussion session.

Initiate a discussion among participants on the definition, nature and importance of capital investments for hire service providers. After the discussion, explain what capital investments are. Get participants to differentiate between two types of capital: working capital and investments. Discuss the differences and provide concrete examples. Encourage brainstorming about the different uses of capital and the various types of investment. Discuss why hire service providers make these investments.

With reference to Handout 3.5.5, explain how to calculate the payback period. Explain the advantages and disadvantages of this method and describe the criteria to use when selecting the best investment. Discuss how to calculate the simple rate of return for the example investment. Explain how average annual net income is derived. Interpret, rank and differentiate the result from that obtained using the payback period method. Explain the strengths and weaknesses of this method.

### EXERCISE 5 LOAN APPRAISAL

Keep participants in the same groups and distribute Handout 3.5.6, "Loan appraisal". Encourage discussion and exchange of experiences.

Take participants through the two examples in the handout, explaining each step carefully and in detail.

**Note for the trainer:** In Handout 3.5.6, the figures for money are given in \$ (note that the \$ symbol used in the materials does not refer to a national currency, but simply means "units of currency"). It is recommended to use local currencies where possible and to always adopt realistic figures or money. Ask participants to complete the exercise given in Handout 3.5.6, providing them with support as necessary. Ask the question: Is it advisable for the hire service to take the loan?



## HANDOUT 3.5.2 ESTIMATING MACHINE PERFORMANCE

### TRACTOR-POWERED MACHINERY

**Machine and field capacity:** Field capacity is an indicator of the work capacity of agricultural equipment, estimated by the maximum potential area that can be worked in a given amount of time. The power of the tractor's engine and the tractor's weight determine its performance (see Handout 3.2.1). Knowing the work capacity of a particular tractor/implement combination is essential for determining field capacity and estimating earning potential. The field capacity of a farm machine is measured in hectares (or acres) per hour. On the basis of field capacity, it is possible to calculate the number of tractors, implements and machines needed, the number of operators required and the area to be covered. Field capacity is also useful for scheduling field operations on a daily, monthly and yearly basis.

As an example, take a tractor-mounted direct planter, 3-m working width, travelling at 5 km/h.

$$\text{Field capacity} = \frac{\text{Speed (5 km/h)} \times \text{width (3 m)}}{10} = 1.5 \text{ ha/hour}$$

### Field efficiency (measured in percentage terms):

Field efficiency is the actual rate of work achieved divided by the theoretical maximum rate of work (field capacity). It depends on the actual time spent by the tractor in productive work. On small, irregular fields, field efficiency is low, because the machine spends a lot of time turning and not working productively. Table 3.5.2a shows field efficiencies attainable in practice. However, the field efficiencies actually achieved by a hire service depend on many factors; it is **fundamental to maximize efficiency**.



**Table 3.5.2a Typical field efficiencies for various tractor-powered operations**

Operation	Field efficiency (%)
<b>Tillage</b>	
Mouldboard or disc plough	75–85
Disk harrow	77–90
Field cultivator	75–85
Spring-tooth or spike-tooth harrow	65–80
<b>Seeding and planting</b>	
Maize planter only	60–75
Maize planter with fertilizer attachment	45–65
Grain drill	65–80
<b>Harvesting</b>	
Combine harvester	60–75
Mower-reaper	75–85
Baler	65–80
Forage harvester	50–70
<b>Crop care</b>	
Sprayer	55–65

In the case of the direct planter above, assuming a field efficiency of 65%, the actual work rate is calculated as follows:

$$\text{Actual work rate} = \frac{\text{Speed (5 km/h)} \times \text{width (3 m)} \times \text{efficiency (65\%)}}{10} = 0.98 \text{ ha/hour}$$

The actual work rate depends on **three variables**:

- **Implement width** - effective working width of an implement excluding overlapping.
- **Speed** - safe operating speed under normal work conditions (not taking into account slowing down to turn at the end of the field).
- **Field efficiency** - actual rate of work divided by the theoretical maximum rate of work (implement width × forward speed).

**Overall machine efficiency:** Crucial for the profitability of a service provision business, the overall efficiency takes into consideration **all factors affecting machine output** (in addition to those related to field operation).

It comprises **four factors**:

- **Field efficiency** (see above).
- **Non-productive travel time** - time spent by the machine travelling from one field to the next or from one farm to the next. Working on small fields can lead to very high non-productive travel, as can working on different farms situated a long way from each other. If a machine is a long way from its base, then it may also be worthwhile for management to provide a fuel bowser to go around refuelling machines.

- **Under-utilization** – downtime due to lack of work or bad weather. Achieving zero under-utilization is almost impossible; nevertheless, a principal goal of management is to ensure that machine utilization is maximized.
- **Service or repairs** – resulting in downtime. Management must schedule routine maintenance outside peak work periods. Although routine maintenance reduces the risk of unscheduled downtime, unexpected breakdown is also inevitable at some point and the immediate availability of spare parts is then crucial for minimizing downtime.

#### **Draught requirements for agricultural implements:**

The draught requirements for field operations depend on soil conditions, especially texture, moisture content and compaction. Local knowledge is fundamental for gauging the exact power requirements for the various operations under different field conditions. Table 3.5.2b provides indicative values, which may be useful if no precise data are available for local conditions. For draught power requirements of a range of agricultural machines, refer to: FAO. 1990. *Agricultural engineering in development: Selection of mechanization inputs*, p. 52. Rome.

**Table 3.5.2b Indicative power requirements for field operations**

Operation	Draught power requirement
Mouldboard or disc plough	25 kW/m
Chisel plough or ripper	10 kW/m
Disk harrow	6 kW/m
Direct planter	2-6 kW/planting line

The figures in Table 3.5.2b are for drawbar power, which takes account of forward speed. Note that - typically and depending very much on soil conditions - **a tractor produces about half its engine power at the drawbar**. Therefore, a 5-row direct planter requiring 5 kW/line needs at least a 50-kW (67-hp) tractor to pull it (5 lines × 5 kW × 2).

#### **ANIMAL-POWERED MACHINERY**

The concepts of machine and field efficiency (as discussed above) are also relevant to draught animal power. Animals are better suited than tractors to small fields; on the other hand, unlike tractors, they require rest stops to recuperate. For this reason, the field efficiencies for tractor-powered machinery operations (Table 3.5.2a) should be reduced (by, say, 10–15%) for animal-powered operations.

The section (above) on overall machine efficiency is less relevant to animal-powered machinery, as animals usually work in the local community and are unlikely to be required to travel long distances between client farms.

## FIELD CONDITIONS AFFECTING MACHINERY PERFORMANCE

**Weather patterns:** The weather determines how many days are available for fieldwork in a given time period. Both long-term weather forecasts and historical weather data are useful for assessing optimal machine capacity and making investment decisions. On the one hand, insufficient capacity can lead to crop losses; on the other, extra investment is needed to have sufficient machine capacity for any eventuality. In many tropical climates, heavy rainfall during a short period may make it impossible to carry out agricultural work, especially mechanized work. Note that practising zero tillage in a conservation agriculture (CA) regime and adopting an ecosystems-sensitive approach (climate-smart agriculture) help mitigate the effects of inclement weather patterns and climate change phenomena.

**Field size:** In general, the larger the field, the greater the field efficiency. Relatively long, narrow fields are also better than large wide fields, because the machine spends a greater percentage of its time actually working rather than turning at the ends of the field. The same tractor and implement effectively works 71% of its time on a 40-ha field and only 37% on a 2-ha field (Table 3.5.2c).

**Table 3.5.2c Relationship between field size and area covered by the same tractor**

	Field size (ha)		
	2	10	40
Theoretical output (e.g. direct seeding with a small tractor) (ha/day)	12.6		
	Loss in output (%)		
Losses due to turning in field	20	14	8
Losses due to turning at end of field	4	3	2
Losses due to moving between fields	22	7	2
Losses due to miscellaneous causes	17	17	17
<b>Actual area covered (ha/day) (Theoretical output - Total losses)</b>	<b>4.6</b>	<b>7.4</b>	<b>9.0</b>
<b>Effective work as a % of the theoretical output</b>	<b>37</b>	<b>59</b>	<b>71</b>

Table 3.5.2c provides an overview of the relationship between field size and area covered per day: the smaller the field, the less time a tractor spends actually performing its task. It is striking how field size affects machine efficiency.

**Field shape and other factors:** Field shape also affects tractor output, although not to the same extent as field size. Irregularly shaped fields are significantly less efficient









### HANDOUT 3.5.4 COSTS

The correct and appropriate selection of a power source and equipment determine costs and significantly affect the profitability of a hire service. It is crucial, during the selection process, to estimate the purchase and operation costs involved to obtain an indication of how much money the hire service needs to keep operations going.

Total costs can be broken down into fixed and variable costs (Table 3.5.4a).

**Fixed costs** are those incurred whether or not work is carried out; they do not usually change over time. Fixed costs include depreciation (loss in value), interest on investment (especially if a loan is taken out for machinery purchase), taxes and insurance. Given that they are incurred whether or not the machine is used, the more a machine is used, the lower the unit cost of operation (per hour, acre or hectare). Depreciation is loss of value over time. At the end of its useful life, an old tractor or implement has “scrap value”, i.e. it is worth as much as a purchaser will pay for it. Calculate depreciation by dividing the difference between the purchase price and the scrap value of the machinery by the number of years of useful life:

$$\text{Annual depreciation (\$)} = \frac{\text{Purchase price (\$)} - \text{Scrap value (\$)}}{\text{Useful life (years)}}$$

If the business has alternative investment opportunities for available cash, it might consider estimating the cost of annual interest for an investment in agricultural machinery. Calculate the cost of interest by calculating the average investment over its useful life (purchase price + scrap value) and dividing by 2, and then multiplying by the potential annual interest rate,  $i\%$ :

$$\text{Annual interest foregone (\$)} = \frac{[\text{Purchase price (\$)} + \text{value at the end of useful life (\$)}] \times i}{2}$$

Depreciation costs are not applicable to draught animals. On the contrary, draught animals increase in value over time: they gain strength and weight; the quantity of their meat, hide and bones increases; and cows can provide offspring.

**Variable costs** fluctuate depending on the amount of work done. They include fuel, lubricants and repair costs, and vary according to how much the machinery is used and the type of operation performed. This is applicable also to draught animals: the more they are used, the higher the variable costs, as their feed and water requirements increase and expenses increase for harness and yoke maintenance, veterinary attention and general care.

**Operator costs** may be fixed or variable, depending on whether the operator is a full-time employee (paid

whether operating machinery or not) or someone employed only for actual work with the equipment. The greater the machine capacity, the lower the operator costs per unit of work carried out (hour or unit of area). In the case of a full-time operator, the more work done, the lower the cost per unit. However, in terms of cost, skilled operators cannot be treated in the same manner as unskilled labour: it is in the interests of the hire service business to invest in experienced, skilled operators.

**Table 3.5.4a Costs of tractor/draught animals and associated implements**

Costs	\$
<b>DRAUGHT ANIMAL</b>	
Depreciation:	
Oxen (they maintain their value)	0
Plough (150 – 20)/10 years	13
Cultivator (200 – 30)/10 years	17
Cart (400 – 50)/5 years	70
Yoke, chains 45/3 years	15
Spares: tines, nuts and bolts, tyres	35
Maintenance work: welding etc.	40
Purchased feed: 1.0 tonne of maize bran, 0.5 tonne of cotton seed cake and minerals	180
Medicine and veterinary costs	30
Extra labour	120
<b>TOTAL</b>	<b>520</b>
<b>TRACTOR</b>	
Depreciation:	
Tractor (20 000 – 5 000)/5 years	3 000
Plough (1 600 – 270)/7 years	190
Tractor shed depreciation (1 000/10 years)	100
5 500 litres of fuel and 20 litres of oil	2 835
Spare parts and repair work	950
Part-time driver	500
Insurance and road tax	220
<b>TOTAL</b>	<b>7 795</b>

Source: FAO. 2009. *Explaining the finances of machinery ownership*. Rome.

#### Notes

---



---



---



---



---



---

## HANDOUT 3.5.5 INVESTMENT APPRAISAL

### CASH FLOW ANALYSIS

Cash flow analysis is important for investment appraisal, as it enables a hire service to ascertain the money flowing in (revenue) and the money flowing out (expenses) over the loan repayment period (Figure 3.2). A hire service provider must be sure it is able to make the repayments before taking out a loan. Cash flow analysis helps assess the capacity to repay loans by examining the loan repayment amount and schedule and the effect on the cash flow of the business; it is possible to predict if the hire service may fail to generate the required money.

Figure 3.2 Cash flow



The **cash flow process** follows five steps:

1. Record (or project) the money coming in and out of the hire service. For example, in May there were expenses for fuel, spare parts and labour, while in June payments were made for tillage and transport services. A cash flow calendar is a useful tool (Figure 3.3).
2. Tabulate the money coming in (revenue) and the money going out (expenses) over time (e.g. months and years), creating a cash flow calendar (Table 3.5.5a).

3. Calculate the cash coming into the hire service (cash inflow) and cash leaving the hire service (cash outflows).
4. Calculate the net cash flow, which records, month by month the cash position of the hire service.
5. Ascertain the cumulative net cash flow, defining the availability of money in the hire service, in this case per month.

Once the cash flow calendar is complete, it provides an indication of whether loan repayments can be made during the payback period and predicts the effects on the cash flow of the hire service.

Figure 3.3 Cash flow calendar

	↑								
CASH IN									
	MONTH	Jan	Feb	Mar	Apr	May	Jun	Jul	...
CASH OUT									
	↓								

Source: FAO. 2005. *Explaining cash flow and savings*. Rome.

Table 3.5.5a Monthly cash flow calendar for a hire service over a season

Activity	Sept.	Oct.	Nov.	Dec.	Jan.	Feb.	Mar.	Apr.	May	June	July	Aug.	Total
<b>Cash inflow</b>													
Sales of services	0	0	0	0	0	0	0	0	0	1 590	0	0	1 590
<b>Total cash inflow</b>										1 590			1 590
<b>Cash outflow</b>													
Buy fuel			50										50
Buy spare parts			50										50
Buy oil and lubricants				20									20
Labour-hired		90	90		54				90				264
<b>Total cash outflow</b>		90	190	20	54				90				444
Net cash flow (Inflow - outflow)		-90	-190	-20	-54				-90	+1 590			1 146
Cumulative NCF	0	-90	-280	-300	-354	-354	-354	-354	-444	+1 146	+1 146	+1 146	

## APPRAISAL OF CAPITAL INVESTMENTS FOR HIRE SERVICES

Investment decisions regarding machinery and equipment purchases are crucial. They involve large sums of money and can determine the business's profitability for many years in the future. The long-term benefit of an investment must be greater than the initial cost: the "return on capital". Capital assets are eventually used up – for example, an ox dies or a tractor is sold for scrap – and when an investment is made in a capital item, that item should cover the value of the original investment by the end of its productive life.

There are various **appraisal methods**, each with different timings of the costs, returns and benefits. For example, investment in farm machinery typically entails a large expense (initial purchase) in one period, while the benefits are distributed over different periods in the future. **Two simple methods, payback period and simple rate of return**, are used to assess the profitability of an investment and both are based on cash flow. Each has advantages and disadvantages. Investment decisions for mechanization are potentially complicated, and hire service providers may require assistance selecting the most appropriate method.

### Method 1: Payback period

This method calculates the number of years required for an investment in machinery (or equipment) to return its original cost by generating income. It assesses the time needed for the cumulative income from the investment to equal its initial cost. It highlights investments that are not viable (e.g. those never achieving payback). It is useful for selecting the most appropriate source of financing (e.g. investments with a short payback period only require short-term financing).

To calculate the payback period, assess the annual cash flow expected after making the capital investment: this is the difference between the cash inflows and cash

outflows for each year in the future. An investment with a shorter payback period is more attractive than one with a long payback period (Table 3.5.5b).

In Table 3.5.5b, each investment has an initial capital outlay of \$12 000 but gives rise to different patterns of cash flow (it is convention that the initial cost of the investment occurs in year 0). For the 2WT and seeder plus ripper, the annual cash flow is projected to be the same for each year (\$3500) and regular. The payback period is calculated by dividing the investment by the expected annual cash flow. The payback period is, therefore, 3.4 years (the cost of the investment, \$12 000, divided by the annual average cash flow, \$3 500). For the 2WT and sheller, the annual cash flows are unequal and the payback period is assessed by taking the year where the cash flow is equal to the cost of the investment. The payback period is therefore 5.0 years (adding year 1 through to year 5 of the cash flow amounts). Thus, the cumulative net cash flow covers the cost of the investment, \$12 000, in year 5. Consequently, investing in a two-wheel tractor with a seeder/ripper would be preferred as it has the shorter payback period.

### Method 2: Rate of return

This method recognizes that not only income is important to the business, but the amount of money used to produce it. Income is regarded as a return on the money invested. It expresses the average annual net income as a percentage of the investment.

To calculate the net income, subtract the average annual depreciation of the investment from the average annual net cash flow (Table 3.5.5b). For the seeder plus ripper: \$3 500 (average annual net cash flow) – \$1 000 (depreciation) = \$2 500 (average annual net income).

To calculate the return on money invested:

$$\text{Rate of return} = \frac{\text{Average annual net income}}{\text{Cost of investment}} \times 100\%$$

**Table 3.5.5b Considering two investments: Which one is more viable for the hire service business?**

Year	Annual cash flow (\$)	
	2WT/seeder + ripper	2WT and maize sheller
0	(12 000)	(12 000)
1	3 500	1 000
2	3 500	2 000
3	3 500	2 500
4	3 500	3 000
5	3 500	4 000
Comparison of the two investments		
Total (\$)	17 500	12 500
Payback period (years)	3.4	5.0
Average annual cash flow (5 years)	3 500	2 500
Minus annual depreciation (\$)	-1 000	-1 000
Average annual net income (\$)	2 500	1 500



### HANDOUT 3.5.6 LOAN APPRAISAL

For a hire service business – especially a small-scale hire service – the ideal means for purchasing new equipment are savings or general money availability. However, this is not always possible: loans must be sought and the terms of the loans assessed. In order to understand whether a loan is viable, the hire service must consider numerous factors:

- benefits;
- costs;
- terms and conditions;
- lender reliability;
- interest rate; and
- payback period.

During the selection process, the hire service must determine whether it can afford the loan and has the money available to honour the repayments over the loan period.

To make a loan appraisal, draw up a cash flow calendar to show what is expected in the future: from when the loan is received until it is repaid. The loan appraisal for a tractor typically covers a period of 3-5 years, for draught animals 1-2 years and for implements 1-2 years.

The cash flow calendar should include sufficient detail for the various types of payback period and highlight when repayments are due.

Table 3.5.6a shows a hire service that receives a \$10 000 loan at an interest rate of 10%. The interest paid in year 2 is \$1 000. The principal on the loan has to be repaid in equal instalments over a 5-year period (\$2 000 annually). In year 3, the outstanding balance is \$10 000 minus \$2 000 repaid as the first instalment of the principal, i.e. \$8 000. The interest on \$8 000 is \$800 ( $\$8\,000 \times 10\%$ ), and this is entered as repayment on interest in year 3.

For year 6, the outstanding balance at the end of the previous year has been reduced by the principal repayment of \$2 000 made at the end of year 5. The interest is calculated on the outstanding balance of \$2 000 and amounts to \$200. In this particular example, the cumulative cash flow is positive for every year of the investment starting from year 2. This suggests that the hire service has a liquidity problem in year 1, but in year 2 it is able to finance the costs of the loan. If the cumulative net cash flow shows a financial shortfall, i.e. a negative figure, in any year, the implication is that the hire service business must find additional financing to cover that shortfall.

**Table 3.5.6a Loan appraisal cash flow**

Items	Year 1	Year 2	Year 3	Year 4	Year 5	Year 6	Year 7
Cash flow before financing	-26 000	25 000	25 000	25 000	25 000	30 000	25 000
<b>Loans</b>							
Long-term loans	10 000						
<b>Outstanding balance</b>							
Long-term loans	10 000	8 000	6 000	4 000	2 000	0	0
<b>Repayment of principal</b>							
Long-term loans		2 000	2 000	2 000	2 000	2000	0
<b>Interest payments</b>							
Long-term loans		1 000	800	600	400	200	0
<b>Total cost of financing</b>		<b>3 000</b>	<b>2 800</b>	<b>2 600</b>	<b>2 400</b>	<b>2 200</b>	<b>0</b>
<b>Net financing</b> (inflow of financing less principal and interest payments)	<b>10 000</b>	<b>-3 000</b>	<b>-2 800</b>	<b>-2 600</b>	<b>-2 400</b>	<b>-2 200</b>	<b>0</b>
<b>Net cash flow after financing</b>	<b>-16 000</b>	<b>22 000</b>	<b>22 200</b>	<b>22 400</b>	<b>22 600</b>	<b>27 800</b>	<b>20 000</b>
<b>Cumulative cash flow</b>	<b>-16 000</b>	<b>6 000</b>	<b>28 200</b>	<b>50 600</b>	<b>73 200</b>	<b>101 000</b>	<b>121 000</b>

### CASH FLOW EXERCISE

A hire service is considering a loan of \$12 000 to buy a tractor and two implements, a ripper and a seeder. The hire service needs to see if it can afford the loan, \$12 000, with an interest rate of 10%, and if it can make the repayments due at the end of each year. The principal on the loan must be repaid in equal instalments over a 4-year period. The loan terms indicate that the loan must be paid back in 4 years' time. The hire service provides the following information derived from its estimates over the

next 4 years of cash flow before financing:

- Year 1: Cash flow before financing: – \$4 000
- Year 2: Cash flow before financing: \$2 500
- Year 3: Cash flow before financing: \$3 700
- Year 4: Cash flow before financing: \$3 200
- Year 5: Cash flow before financing: \$3 150

Prepare a loan appraisal cash flow for the hire service and advise if the hire service can afford the loan or not.



## SESSION 3.6

# PURCHASE PROCESS

**Trainer's guide to the session:** This session considers the final step in the planning process: **Step 4. Purchase for power source and implement selection.** It reiterates some of the material covered in Module 2 with regard to assessing dealerships and animal traders and sets the scene for the field visit (if it is to take place). It builds on the previous three steps of the planning process for selecting power sources and implements. The focus is on identifying a reliable dealership and/or animal trader in the local area.

**Note to the trainer:** For the visit, pre-organize the programme and contact the key people mentioned to ensure that they are available to talk and will allow the participants to visit their premises. Arrange the dates and times of the visit and ensure that transport is available, if required. Estimate how long the visit(s) will take.

### Session learning objectives:

- Understand the purchase process and what it involves.
- Understand what credit schemes may be available from the dealership.
- Demonstrate how to carry out the process.
- Provide for a complete checklist of criteria in the final selection of power source and implements.

**Practical learning:** This session involves three exercises based on Handout 3.6, "Purchase process", to prepare participants for the field visit to a dealership and/or animal trader in the local area. Participants need to create a final checklist for the selection of a power source and implements.

### EXERCISE 1

#### PREPARING FOR THE FIELD VISIT

Working in groups, provide the participants with Handout 3.6. Ask them to read and discuss it. Ask them to prepare for the field visit as advised in the handout with reference to the activities they carried out during Module 2. Once they have gathered all the necessary information and prepared questions and observations, the participants will be ready to go on the field visit. Advise them on the practical aspects of this field visit in terms of interacting directly with a dealer and/or animal trader and the possibility of actually examining tractors, draught animals and their associated equipment.

During the field visit provide participants with help and support.

Ask the participants to rank the dealerships and/or animal traders they have visited.

### EXERCISE 2

#### CREATING A FINAL CHECKLIST FOR THE SELECTION OF POWERS SOURCES AND IMPLEMENTS

Working in groups, ask participants to refer to the example checklist provided in Table 3.6a, Handout 3.6. Tell them to create a checklist based on the entire planning process of selecting power sources and implements. Advise participants to use the information collected in Module 2 and the sessions of Module 3. Provide participants with help and support during this process.

### HANDOUT 3.6 PURCHASE PROCESS

The purchase process is the final step in the planning process for selecting power sources and implements and is based on all the previous steps of the planning process and related information. It involves a field trip to local dealerships and/or animal traders, including their assessment, with a focus on the purchasing aspects. It is necessary to prepare for the field visit and then return to the training setting to develop a complete checklist of criteria for selecting mechanization inputs.

#### PURCHASER PREFERENCES, PREJUDICES AND LOYALTIES

Different brands dominate in different markets (Handout 3.2). If you ask owners and operators why a particular machine is dominant, they assure you that it is the best machine on the market. In a neighbouring country or region, owners declare that another make is the best. It is human nature not to admit that a wrong purchasing decision has been made. Nevertheless, there are other reasons why a brand is popular in some markets and not in others, notably the level of **dealer support** provided. When spare parts are readily available, downtimes are kept very short, leaving the impression that the machine in question rarely breaks down. The dealer therefore sells more machines until the make in question dominates the market and it becomes difficult for other makes to compete.

Furthermore, many owners are “prejudiced” in favour of a particular make – a sentiment that cannot be explained on logical or rational grounds. A purely rational purchasing decision-making process (as outlined above) rarely exists. Participants should be aware of these factors and take them into consideration in the decision-making process.

#### DEALER SALES AND SUPPORT

In many countries, especially where there is little competition between agricultural equipment suppliers, the choice of a tractor (or other agricultural and post-harvest machinery) depends on availability in the local market and (critically) availability of spare parts, service and repair services. The **ready availability of spare parts is crucial for a highly weather-dependent business such as agriculture**. Some manufacturers give financial incentives and special warranties to attract purchasers; it is, therefore, worthwhile “shopping around”. Dealerships offer credit products, which may be used as a guarantee for the loan; for example, a tractor itself may be used as collateral. Before deciding to purchase a particular make and type of machine, **establish whether support services are available**. This may be a determining factor in any purchasing decision and its importance cannot be overestimated.

#### FIELD VISIT

Prepare questions in advance and consider what you expect to observe. In particular, this field visit entails assessment of dealerships and/or animal traders and it is necessary to establish criteria for evaluating the

**Table 3.6a Ranking dealerships by equipment availability**

Equipment	Dealers			
	Amio Ltd	METEC	Farm Equip Ltd	Car and General
2WT		X	X	X
Plough	X	X	X	X
Ripper/seeder	X		X	
Pump		X		X
Sheller	X	X	X	
Chopper	X	X	X	
Trailer	X	X	X	X

**Table 3.6b Ranking dealerships according to defined criteria (from 1: poor to 5: good)**

Equipment	Dealers			
	Amio Ltd	METEC	Farm Equip Ltd	Car and General
Price	3	3	2	1
Quality	2	1	3	3
Availability	3	4	3	2
Reliability	3	2	2	1
Credit schemes offered	4	4	2	2
Technical support	1	1	2	1









## MODULE 4

# OPERATION AND MAINTENANCE OF AGRICULTURAL EQUIPMENT FOR HIRE SERVICE BUSINESSES

**Trainer's guide to the module:** Module 4 covers the general aspects of operation and maintenance of the power sources and machinery most likely to be used in a hire service business. The focus is on tractors (both two-wheel, 2WT, and four-wheel, 4WT), draught bovines, sprayers, planters, post-harvest equipment and pumps. The range of machinery may be expanded according to its relevance to any given situation. A hands-on practical approach is recommended, as are visits to commercial machinery suppliers and workshop facilities.

The module covers a wide range of topics related to the operation and maintenance of agricultural equipment. The equipment discussed includes power sources, implements and machines most likely to be of interest to mechanization service providers for smallholder farmers.

The module comprises a sequence of training sessions; select those sessions most appropriate to the training course:

- Session 4.1 covers power sources and comprises three subsessions (4.1.1 and 4.1.2 on 4WTs and 2WTs, respectively; and 4.1.3 on bovines for animal traction).
- Session 4.2 gives a brief introduction to the range of equipment available for use with the different power source options, including human muscle power.

- Session 4.3 covers technical maintenance and safe use in two subsessions (4.3.1 deals with tractor maintenance and 4.3.2 covers safety issues in the use of tractors and sprayers).
- Sessions 4.4 and 4.5 deal with simple calibration procedures for planters and sprayers, respectively.
- Sessions 4.6 and 4.7 give hands-on experience of two frequently encountered options for using tractor power sources beyond crop production: shellers and threshers, and water pumps.

**Note for the trainer:** This module discusses the selection, correct operation and regular maintenance of tractors and agricultural machinery, and covers the importance of draught animal care. Session 4.3 focuses on questions of technical maintenance of 4WTs and 2WTs. The participants need access to the actual machines, tools and qualified technical staff to guide them through the specific procedures. The session could take place in a workshop or, ideally, on a dealer's premises equipped for tractor servicing. Much input is required to organize these practical sessions and ensure their smooth running.

The module also examines the **calibration** of seeders (Session 4.4) and sprayers (Session 4.5) – essential for their effective and efficient operation in the field; and

includes short practical sessions on pumping, and post-harvest equipment, as they have good potential for diversifying a mechanization services business.

Session 4.1.3 on the care of draught animals is optional and depends on the relevance of draught animal power in the region (whether current or future practice).

Stress the importance of reading the user's guide, or **operator's manual**, for tractors and farm equipment: it is fundamental to read and refer to the manual and to keep it safe for future reference.

It is vital to carry out regular maintenance on agricultural equipment to ensure a longer machine life. Understanding how to operate, maintain, service and repair equipment results in more efficient output and a longer life of machinery. Machinery maintenance needs to be preventive rather than reactive. Correct maintenance contributes to a more profitable business operation in the long run.

The module refers, where appropriate, to the costs involved in the maintenance of power sources and implements. This is covered in detail in Module 3 and is referred to in Module 5.

#### Module learning objectives:

- Understand the basic technical elements of the main power options for agricultural equipment.
- Gain an overview of the different types of equipment available for agricultural operations for hire business services.
- Understand the fundamentals of maintenance of 2WTs and 4WTs and the importance of scheduled maintenance of machinery to keep it operational and to prolong its working life.
- Appreciate the vital importance of safety in the operation of agricultural machinery.
- Understand how to calibrate planters and sprayers.
- Understand the principles of the technical performance of pumps and post-harvest equipment.
- Understand the principles of draught animal care.

**Recommended background reading:** Ensure that the **service and operation manuals** are available for study and reference throughout the module.

Test procedures for tractors and a wide range of agricultural machinery are detailed in:

- › FAO. 1994. *Testing and evaluation of agricultural machinery and equipment: Principles and practices*. FAO Agricultural Services Bulletin 110. Available at: <http://www.fao.org/3/a-t1841e.pdf>

## SESSION 4.1

# POWER OPTIONS FOR AGRICULTURAL EQUIPMENT

### Trainer's guide to the session:

This session (which comprises three sub-sessions) introduces the power options that exist for the various agricultural operations offered by a hire services business. Sessions 4.1.1, 4.1.2 and 4.1.3 cover four-wheel tractors, two-wheel tractors and draught animals, respectively. Each session starts with an explanatory presentation followed by practical exercises.

### Session learning objectives:

- Become acquainted with the different options available to power agricultural operations.
- Understand the basic technical components comprising these options and become familiar with their main systems and characteristics

**Note to the trainer:** Gauge the level of knowledge of the trainees and avoid overloading them with unnecessarily complicated information on power options systems. On the other hand, they must understand the basic requirements, even if they entrust servicing to a third party.

For each session, prepare an introduction to cover the main areas of the functioning and operation of tractors and animals for powering agricultural equipment. Use PowerPoint presentations focusing on locally available material, or hold demonstrations in the workshop around a tractor and/or animal. The main points to cover are in Handouts 4.1.1, 4.1.2 and 4.1.3.

The practical exercises involve tractors or draught animals: use a service provider, farmer, NGO or other source to gain access to the relevant machine/animal. Conduct the sessions at a workshop/farm, where participants can see and discuss the various elements presented (tractor, engine, animal etc.). Involve a skilled operator/handler to address questions arising during the practical work.

The local agricultural context may determine the power options available, the participants' familiarity with the equipment and the availability of the equipment in the local/regional market. Adapt the content of the session accordingly.



## SESSION 4.1.1

# FOUR-WHEEL TRACTORS

### Trainer's guide to the session:

This session gives a grounding in the basic technical aspects of four-wheel tractors (4WTs). A theoretical introduction is followed by practical exercises.

### Session learning objectives:

- Understand the principal tractor systems.
- Understand the main points for maintenance and the importance of proper service provision.

**Note to the trainer:** The introductory session can be by means of a PowerPoint presentation or can take place in the workshop around a tractor. The main points to cover are in Handout 4.1.1.

The exercise requires access to a tractor and access to the operator's manual. Ideally, the exercise should take place in a main tractor dealer's workshop under the supervision of trained workshop staff. Alternatively, a tractor can be accessed via a service provider, farmer, NGO or other source. In any case, there must be access to specialist expertise; moreover, it is crucial to refer to a copy of the tractor's operation manual when servicing procedures are detailed.

### Practical learning:

- Give a pre-prepared introductory session covering the main systems of a 4WT (by means of a PowerPoint presentation or a practical demonstration around a tractor in the workshop).
- Following the presentation, distribute Handout 4.1.1 "Overview of main systems of four-wheel tractors".
- Give participants time to study the handout (about 30 minutes).
- Form three groups to focus on specific systems as indicated below. Ask each group, with the help of skilled mechanics and the operator's manual, to discuss, identify and practise the key functions of the following groups of systems:
  - Group 1. Fuel, air intake and exhaust.
  - Group 2. Lubrication, cooling and electrical.
  - Group 3. Transmission, hydraulics and clutch.
- Ask each group to explain the procedures, by demonstration, to the other groups.

## HANDOUT 4.1.1 OVERVIEW OF MAIN SYSTEMS OF FOUR-WHEEL TRACTORS

### TRACTOR INSTRUMENTS

Review the instruments available (hours, revolutions, fuel gauge, oil pressure, temperature, ammeter, air cleaner) and make sure that you understand what they all indicate:

- Hour meter – the number of hours that the tractor has been working (usually presented as the equivalent number of hours at a standard engine speed).
- Revolutions counter – the actual engine speed (in revs/min).
- Fuel gauge – the fuel remaining in the tank.
- Oil pressure gauge – whether the oil pump is working and there is sufficient oil in the system.
- Temperature gauge – the temperature of the engine cooling water (high readings can indicate a problem with the cooling or lubrication systems).
- Ammeter – whether the alternator is working and charging the battery.
- Air cleaner instrumentation – when air cleaner servicing is required to clear dust from the element.

### DIESEL FUEL SYSTEM

Note: This training manual refers only to diesel engines. Outside of the United States of America, there is virtually no use of gasoline (petrol) as fuel for agricultural tractors and machines.

The main components are:

- fuel tank;
- fuel lift pump (carries fuel through to the filters);
- fuel filter (filters fuel into the pump);
- injection pump (meters and delivers fuel into the cylinders under pressure and at the correct time); and
- injector nozzles (atomize and spray fuel into the cylinders).

### AIR INTAKE AND EXHAUST SYSTEMS

The main components are:

- air intake filter and cleaner (collects dust and dirt from incoming air pulled into the engine);
- air inlet manifold (transports the air into the engine cylinders);
- turbocharger (if fitted – normally only on larger engines – forces more air into the engine than could normally be pushed in by atmospheric pressure); and
- inlet and exhaust valves (control the air entering the system and the exhaust gases leaving the cylinder).

### ENGINE LUBRICATION SYSTEM

The major components are (Plate 4.1):

- oil pump;
- crankcase;
- oil cooler (if used);
- oil filter;
- pressure regulating valve; and
- pressure gauge.

### ENGINE COOLING SYSTEM

The main components are (Plate 4.2):

- radiator and pressure cap;
- fan and fan belt; the water pump; and
- thermostat.

Some small tractor engines are air-cooled as air is forced by a fan through “fins” on the cylinder block.

*Plate 4.1 Lubrication system in a typical engine  
Source: Deere, J. 2008. 6076 Diesel Engine Component  
Technical Manual CTM6 (adapted).*

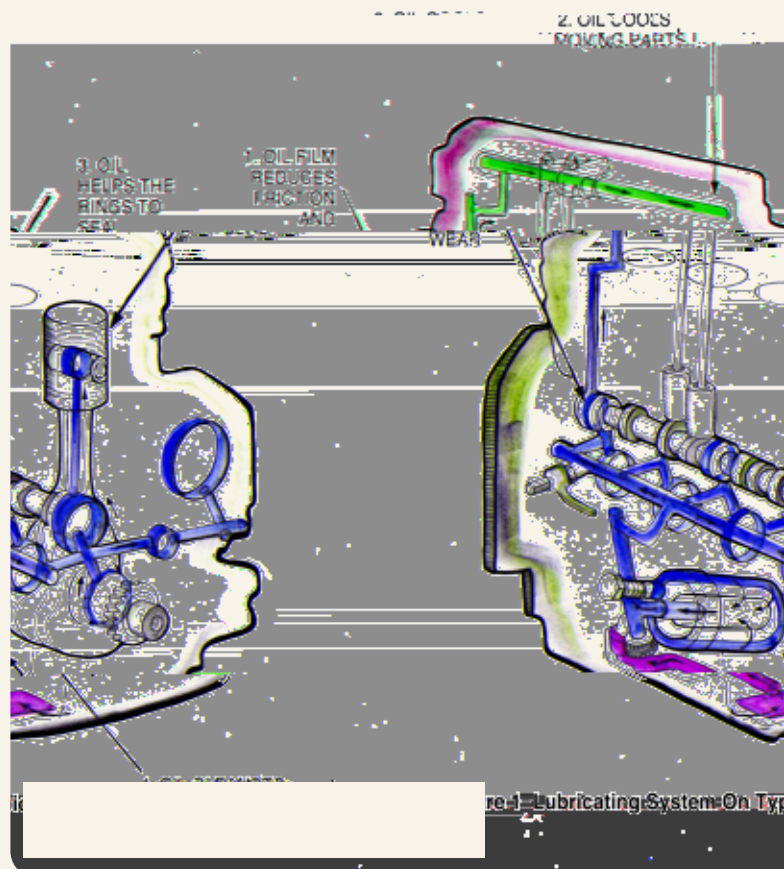

ELECTRICAL SYSTEM

The main components are:

- battery;
- starter motor; and
- alternator.

All elements of the electrical system require supervision and maintenance by specialized automotive electrical engineers, except in the case of basic work (e.g. battery care and alternator belt tension) specified in the operator's manual.

TRACTOR TRANSMISSION, HYDRAULICS AND CLUTCH

Most modern farm tractors use the same oil for both the transmission and hydraulic system. In some tractors the brakes are also immersed in special oils (so-called "wet brakes"). Refer to the operator's manual for full details.

Notes

---

---

---

---

---

---

---

---

---

---

---

---

Plate 4.2 A typical engine cooling system  
Source: Deere, J. 2008. 6076 Diesel Engine Component Technical Manual CTM6 (adapted).

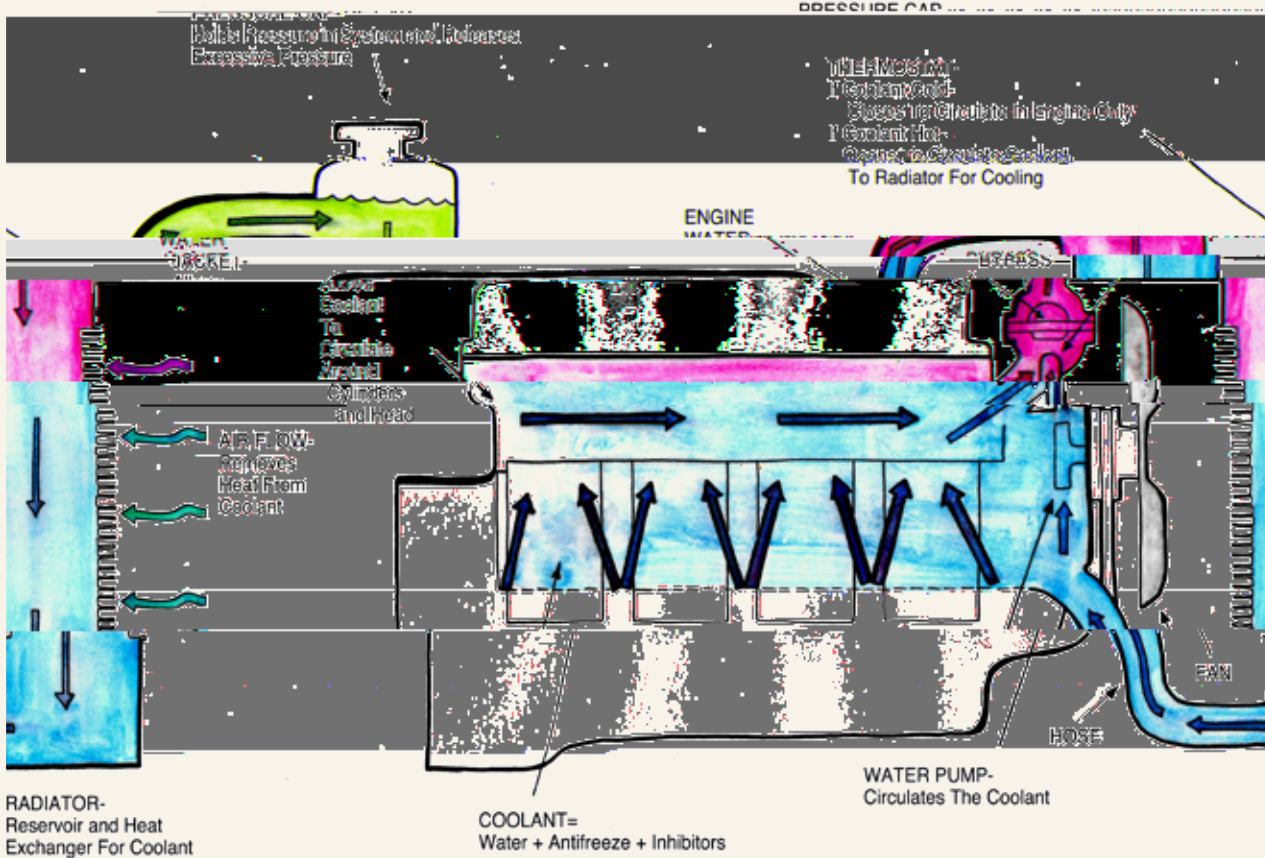



## SESSION 4.1.2

# TWO-WHEEL TRACTORS

### Trainer's guide to the session:

This session gives a thorough grounding in the basic components of two-wheel tractors (2WTs). A theoretical introduction is required, to be immediately followed by practical experience during the session exercise.

### Session learning objectives:

Understand the importance of the maintenance requirements of the principal 2WT systems and understand that adherence to the manufacturer's maintenance schedule is key to keeping the tractor running as it should and minimizing downtime.

**Note to the trainer:** Gauge the level of knowledge of the trainees and do not overload them with unnecessarily complicated information on 2WT systems. Nevertheless, they must understand the basic requirements, even if they entrust servicing to a third party. At the very least, all trainees should be aware of the main tractor systems and their function.

Ideally, arrange for this practical to take place in a main 2WT dealer's workshop under the supervision of trained workshop staff. Alternatively, use a 2WT via a service provider, farmer, NGO or other source.

In any case, access to specialist expertise is essential for the practical session, as is a copy of the tractor's operation manual detailing servicing procedures.

### Practical learning:

Use a PowerPoint presentation (or demonstrate with a 2WT) to introduce the principal areas of a 2WT maintenance schedule. These are given in Handout 4.1.2 and comprise:

- fuel system;
- air intake system;
- lubrication system;
- cooling system
- V-belt tension;
- steering system clutches;
- throttle control; and
- wheel-track adjustment.

Distribute Handout 4.1.2 "Overview of technical maintenance of two-wheel tractors".

Form three groups to focus on specific areas of maintenance. Each group will familiarize themselves with the details of maintenance for their particular areas with the help of skilled mechanics and the operator's manual. The group areas suggested are:

- Group 1. Fuel, air cleaner, lubrication and cooling
- Group 2. Transmission
- Group 3. Connection of implements and adjustment of wheel tracks

Each group demonstrates in plenary the procedures they have learnt.





## SESSION 4.1.3

# DRAUGHT ANIMAL POWER

### Trainer's guide to the session:

Animal traction is still a major power source for agricultural operations and rural activities. This manual focuses on bovines: the most common type of animals used for this purpose. However, DAP (draught animal power) can be supplied by other animals, such as equines and camelids. Proper feeding, watering and sound management are all required to keep working animals in good condition and reduce the risks of sickness. All mature animals have basic daily needs (maintenance requirements) to keep them healthy and at constant weight. Generally, the heavier the animal, the greater the maintenance requirement. Poor body condition (a possible indication of inadequate feeding or poor health) is often manifested as an emaciated and bony appearance and may be coupled with weakness and listlessness. Good management of draught animals reduces costs

### Session learning objectives:

- Understand the requirements of draught bovines in terms of feeding, housing and basic health care.

**Note to the trainer:** This session is only relevant to participants contemplating the use of draught animals as a power source in their hire service businesses. The session and field visit are designed to give participants broad knowledge of the issues surrounding use of draught animals as a power source.

The information provided is basic and can be enriched by including local specialist knowledge provided by local

experts, especially veterinarians. This may be included in the field exercise or alternative arrangements could be made, such as inviting the vet to a question and answer session during the training course. When arranging the field visit, take care to select a farmer or service provider who takes good care of their animals and has access to all necessary services.

### Practical learning:

After a brief introduction on the importance of draught animal care, distribute Handout 4.1.3, "Draught animal care and welfare", and allow 30–40 minutes to read it.

Explain that participants will be visiting a local farmer or service provider who has experience of using draught animals. If possible, a local vet should be present during the field visit; alternatively, a separate visit could be made to a vet.

In plenary have the participants formulate a series of questions on:

- selection of draught animals (see Module 3);
- health issues;
- housing;
- feeding; and
- costs.

Questions should relate to the local reality and will be put to a local service provider or farmer who uses draught animals as a power source.

Ask the group to select individuals to ask the questions during the field visit and to make notes of the responses, which will be discussed in plenary at the end of the session.

Organize a plenary session after the field visit for participants to report and discuss their findings.



## HANDOUT 4.1.3 DRAUGHT ANIMAL CARE AND WELFARE

### FEEDING

Pasture grass and legumes, leaf browse and supplementary feeds contain different and varying amounts of energy, protein, minerals, vitamins and water. The amounts of each are affected by the plant species, growth stage and storage method (if any). Fresh, pre-flowering, grass is relatively nutrient-rich and highly digestible; whereas rice straw is fibrous and difficult to digest.

Oxen must obtain the energy to work from their feed; this is generally provided by grass, maize stover, straw or hay. While cereal grains are rich in energy, they are generally considered too valuable to be fed to work cattle. Oil-rich seeds, such as cotton seed or groundnut, are high-energy feeds. Legumes are relatively protein-rich and legume feeds, such as groundnut, bean or cowpea residues and hay, are palatable and easy to digest. Minerals, such as calcium, iron and phosphorous, are required in small quantities, and requirements are usually satisfied by mixed grazing or browsing.

The principal requirement of work animals is energy. **Working animals require about 2% of their body weight in forage per day:** for example, the daily forage requirement of a 350-kg ox is  $\geq 7$  kg. Additional protein, vitamins and minerals are not normally needed to satisfy the demands of work; however, in practice, most energy-giving feeds also provide extra nutrients. On the other hand, additional salt may be needed to replace that lost through sweat during heavy work sessions. Hand-feeding small quantities of salt is good practice as it enhances animal-human relations, but salt licks can also be used.

Note that providing supplementary feed to draught animals entails expense; this needs to be ascertained and factored in to the cost of their upkeep. In some localities, accessing feed supplies is not easy, and it is important to understand the time and costs involved. Feed prices may vary considerably, depending on composition, quantity and place of purchase. For large supplies, it is necessary to calculate storage costs.

The total **nutritional requirements** of draught animals depend not only on the work they do, but also on their stage of growth (juvenile or mature), and – for female animals – on their state of reproduction (pregnancy or milk production):

- Mature ox – maintenance and work only.
- Young male ox (2½–4 years old) – maintenance and work, plus body development.
- Cow – maintenance and work, plus reproductive functions.

Moreover, the **type of work** undertaken affects the amount of feed needed: work may be light (pulling a cart on level ground), medium (inter-row weeding) or

heavy (ploughing). In addition to the work load, the **duration** must be taken into consideration: light work performed over many hours may, in fact, have a similar energy demand to heavy work done over a shorter period with frequent rests.

Normally, cattle have access to natural pasture and forage, but the availability of these feed sources is cyclical with production concentrated in the rainy season. Grazing cattle therefore tend to lose and then gain weight. However, provided that the temporary loss of weight and condition are not too severe, they may be considered acceptable cyclical changes. The same applies to periods of heavy work: animals can lose some weight, but the loss must not be excessive. An animal's resistance to disease and its willingness to work tend to decline as it loses weight.

Working animals often suffer from the fact that traditional agricultural systems may require them to do heavy soil cultivation at the beginning of the rainy season – precisely the time of year when they are in the poorest body condition. The problem is exacerbated by lack of grazing time: work is generally done during the cooler hours of the day, which is also the best time for grazing. At night, animals may be kept in corrals and during the hottest hours they seek shade. Farmers, therefore, tend to give additional feed during this period until the natural pasture regenerates. Note that, in a conservation agriculture regime, no-till planting is adopted: this dramatically reduces the workload at planting time, greatly reducing the danger of excessive loss of condition.

### Feed resources

- **Natural grazing** – by far the most common feed. Animals feed themselves deriving what they can from available pastures and road verges.
- **Crop residues** – second most common source of feed. Farmers often gather maize stover, cereal straw or legume residues after crop harvest and store them safely to avoid spoilage, wastage and trampling.
- **Forage trees** – an important source of feed in some localities. Animals browse low branches, and farmers may lop off small leafy branches to give to the animals. Leguminous tree species are preferred; species such as *Leucaena*, *Sesbania*, *Gliricidia* and *Acacia* (as well as forage grass species - Plate 4.3) can be grown in fodder banks or live hedgerows for this specific purpose.
- **Hay** – popular in temperate rather than tropical climates. In some areas, grass may be cut and dried in times of plenty and stored for use in times of scarcity. The practice is not particularly common in developing country smallholder situations.
- **Processing residues**, such as maize and rice bran, can be used to make oilseed cake.
- **Purchased supplements** – not commonly used for work animals. Where available, supplements may include brewers' grains, cottonseed cake, wheat bran and molasses. Molasses not only supplies energy, but also can make poor quality crop residues more palatable.

## HOUSING FOR WORKING CATTLE

In many traditional farming systems, cattle are kept overnight in open enclosures. Indeed, working animals are by definition hardy; nevertheless, they still respond well to good treatment. For this reason, owners sometimes construct a special shed to house valuable working cattle at night and to provide shelter when they are not working or grazing. Considerations:

- **Location.** Select a well-drained site, close to the feed store and to the farmer's house for security and access.
- **Design.** Keep it simple and low cost; a thatched roof supported by poles may often be sufficient (Plate 4.4).
- **Materials.** As far as possible, source local materials, such as wood, maize or sorghum stover.
- **Construction and maintenance costs.** Keep track of all costs, including time and labour requirements.
- **Temperature.** In cool climates, it may be necessary to construct half or three-quarter side walls to provide greater animal comfort; in cold highland areas, or where security is a problem, it may be advisable to have a completely enclosed structure with a lockable door.
- **Dimensions.** A shed 3 m square and 2–2.5 m high is generally sufficient to house two adult oxen and to allow easy access.
- **Feed storage.** Keep supplementary fodder stored away from the cropping fields near to the cattle shed.

Stacking on top of the shed itself protects the forage from goats (Plate 4.5). A feeding trough can be made from wood or from a metal drum cut in half (the latter can also be used for water).

- **Manure disposal.** Clean the shed daily to keep the floor clean for the animals to lie down. Pile the manure outside to be distributed to the cropped fields at a later date. Keep the pile high and cover with a simple shade to reduce the loss of valuable nitrogen.

Plate 4.3 Grasses and trees in fodder banks © B. Sims

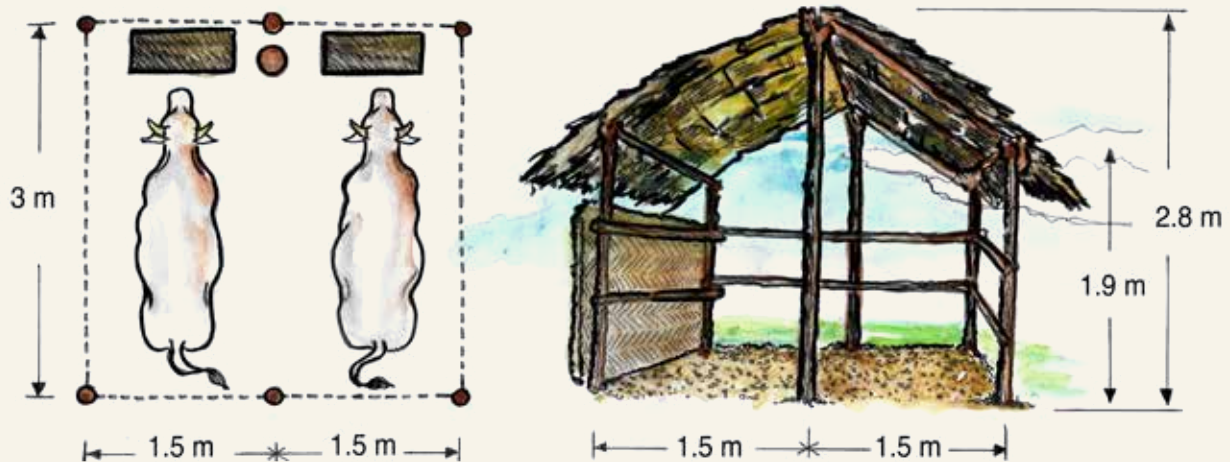

Plate 4.4 Simple shed for working cattle

Source: FAO. 1994. *Draught animal power manual. A training manual for use by extension agents.* Rome. Chapter 1: Selection and care of draught animals.

Plate 4.5 Simple stall with feed trough and fodder storage on roof

Source: FAO. 1994. *Draught animal power manual. A training manual for use by extension agents.* Rome. Chapter 1: Selection and care of draught animals.



## HEALTHCARE OF WORKING LIVESTOCK

For working animals to grow and work to their full potential, they must be healthy. The principal health problems requiring treatment in working animals are specific illnesses (due to disease-causing organisms), parasites, poisonings and wounds. Refer to the local veterinary services and stock owners for information on the main risks present in the area, and how to combat them. Vaccination of young animals and regular veterinary visits for all draught animals may seem costly, but the benefits in terms of animal health, and hence the ability to work, make the investment worthwhile.

Owners should be alert to indications of vitality and health in a working bovine. In particular, **a healthy animal:**

- walks well on sound feet, feeds regularly and breathes regularly;
- stretches its legs on raising itself and passes dung which is firm in consistency;
- passes non-liquid dung that piles up (faeces are normal and not discoloured or blood-stained);
- has bright and alert eyes and a clean head;
- has both nose and mouth clear and free from discharges and its muzzle is usually cool and moist;
- has a smooth coat and shiny flanks and tail free of faeces;
- has ears alert, moving to and fro;
- is curious and inquisitive;
- tends to flock, feed and rest together with other healthy animals;
- has a good appetite and does not suffer a rapid loss of condition; and
- has no fresh wounds or swellings, no ticks and no lice.

Time spent inspecting working animals helps the farmer develop an ability to distinguish between normality and abnormality. The ability to recognize ill health and abnormal behaviour can often prevent the escalation of minor problems into major ones. A **sick animal:**

- is reluctant to work;
- is often on its own or leaves the main group;
- refuses to eat and has dull, watering or swollen eyes;
- has diarrhoea or constipation (a dirty tail can be a first sign of digestive abnormalities);
- is limping (carrying a foot off the ground or with swelling in the joints);
- has a dry, rough coat or skin; or
- breathes rapidly and coughs frequently (a rested ox should have a breathing rate below 25 respirations per minute).

Allow a sick working animal to rest and give it plenty of water. Isolate the animal and seek assistance from a veterinarian if there is no spontaneous improvement.

### Internal parasites

Parasites obtain nutrients from their host; as a consequence, the host animal may suffer a reduced growth rate, lose condition or even die.

The main internal parasites are roundworms living in

the stomachs, lungs and intestines. Flatworms are also important, for example, tapeworms and liver flukes. Working animals can ingest worm eggs when grazing on pasture contaminated with the manure of infected animals. Keeping pasture clear of manure by **adopting rotational grazing** is a sound control measure.

A heavy worm burden reduces the ability of an animal to work and can, in extreme cases, cause death, especially if the animal is underfed and/or overworked. Symptoms of a heavy worm burden include:

- weakness;
- an emaciated body.
- an extended belly;
- pale or yellow gums; and
- a rough coat and dull eyes.

Always seek veterinary advice. It is, however, good practice to treat animals with de-wormer once or twice a year.

### External parasites

External parasites of working animals include ticks, lice, mites, flies and fly larvae. They cause discomfort and can induce weight loss. They may be disease vectors and can make animals more susceptible to disease. Places to search for external parasites include the ears, top of the legs, base of the tail and loose folds of skin. The use of draught oxen is severely restricted by the presence of the tsetse fly, the vector of trypanosomiasis.

**Tick control:** Ticks suck blood and can spread diseases such as East Coast Fever (theileriosis). It is possible to physically remove and destroy ticks; however, acaricide dips are a more effective method of control. Fortunately, some local breeds have developed natural resistance to theileriosis; nevertheless, always seek veterinary advice, especially in eastern and southern Africa where it is endemic.

### Lameness and wounds

A lame ox cannot work effectively. When **lameness** is noted, check the underside of the foot for stones, sharp objects or abscesses and feel the leg for heat or swelling. If there is a wound inside the hoof, soak it in a bucket of clean, warm salty water for 15 minutes twice a day. Rest the animal from work until the lameness is cured.

Minor **wounds** are common in working animals and can be treated on the farm. First, clean the wound with salt solution and then apply antiseptic spray to the affected area.

### Infectious diseases

Information on locally important infectious diseases is available from local veterinary services. Regular prophylactic vaccination may be advisable against diseases such as foot-and-mouth, rift valley fever, bluetongue, contagious bovine pleuropneumonia, haemorrhagic septicaemia and brucellosis.

### Bloat

Bloat is caused by an excessive accumulation of gas in the rumen. In working cattle, it is usually the result of grazing damp, rapidly growing legume pastures. Symptoms include: distension of the left side of the



## SESSION 4.2

# AGRICULTURAL EQUIPMENT FOR A HIRE SERVICE BUSINESS

**Trainer's guide to the session:** A range of equipment is available to service providers to perform agricultural operations. The examples presented here cover different power sources (see Session 4.1), including human muscle power, and various operations compatible with sustainable agricultural production. The service provider must make an informed decision about the equipment to operate, based on technical skills, demand and profitability in the local context. The session discusses the options available and their potential for a hire service business.

### Session learning objectives:

Be aware of the available equipment options for agricultural hire services offering sustainable production intensification options.

**Practical learning:** Exercise 1 is a brief introduction to different types of equipment that can be used from land preparation to harvest with the different power options. The following videos can be shown:

### Jab/hand planters:

- > <https://www.youtube.com/watch?v=SnnYuZ-K6NU>
- > [http://av.voanews.com/Videoroot/Archive/kaltura-test/VOA/VOA\\_-\\_English/mp4/2013/08/0\\_o50fblxs\\_1\\_q0yo0tyz.mp4](http://av.voanews.com/Videoroot/Archive/kaltura-test/VOA/VOA_-_English/mp4/2013/08/0_o50fblxs_1_q0yo0tyz.mp4)

### Animal-drawn planters:

- > <https://www.youtube.com/watch?v=hU3NqITktBo>
- > <https://www.youtube.com/watch?v=U6aOnQii1FU>

### Direct seeding planters:

- > <https://www.youtube.com/watch?v=m3eEqIBDXjg>
- > [https://www.youtube.com/watch?v=YPu\\_3qKif7E](https://www.youtube.com/watch?v=YPu_3qKif7E)
- > <https://www.youtube.com/watch?v=Q7Ej20NzZ28>
- > <https://www.youtube.com/watch?v=togizfnfsnk&feature=youtu.be>

### Maize sheller:

- > <https://www.youtube.com/watch?v=ekzF6v7I230>

Use these videos to introduce the session and to stimulate discussion. Prepare a PowerPoint presentation showing details of locally available equipment for agricultural operations with different power sources. FAO has a database where some of this equipment is displayed; it can serve as starting point to research the options available (available at: <http://www.fao.org/sustainable-agricultural-mechanization/database/en/>).

Exercise 2 involves a plenary discussion where the different types of locally or regionally available agricultural equipment can be displayed and inspected. Distribute Handout 4.2.1, "Sustainable agricultural equipment for a range of power sources", to the participants to support the exercise. Ensure that equipment on display fits the local context and is accessible (economically and technically) to aspiring service providers.

Divide participants into two or three groups to discuss the following topics:

- What are the current types of equipment used in the area for sustainable agricultural production?
- Which of the proposed/displayed equipment may have potential for the hire services considering the agronomic and socio-economic conditions of the participants' (and clients') areas of work? Give reasons for the choices suggested.

Have the groups present their findings and suggestions in plenary and stimulate discussion among participants. Record the main points on a white board or flip chart.



**HANDOUT 4.2.1**  
**SUSTAINABLE AGRICULTURAL EQUIPMENT FOR A RANGE OF POWER SOURCES**

When planning the types of services that a hire service business can provide, it is important to understand what is available. There are various types of equipment, depending on the agricultural operation, power source, crop and field conditions. It is fundamental to plan how to provide the service and then to select the right equipment (see Module 3).

This handout briefly presents some examples for each of the main crop operations for human, animal and engine power. There are, of course, many other possibilities in the market, and you are encouraged to share the knowledge you may have on the equipment that is interesting or available for your hire service business with the other training participants during the plenary session in Exercise 2.

Plate 4.6 shows some options for equipment compatible with sustainable mechanization systems. Equipment is categorized according to agricultural operation and power source.

*Plate 4.6 Equipment options for a range of power sources*

**Land preparation**

Planting stick



Animal-drawn ripper



Tractor-mounted ripper



**Crop establishment**

Hand jab-planter



Animal-drawn direct seeder



Tractor-mounted direct seeder



**Crop management**

Hand- or animal-pulled knife roller



Animal-drawn weeder



Tractor-mounted weeder



**Crop management**

Hand-operated sprayer



Animal-drawn sprayer



Tractor-mounted sprayer

**Crop harvest**

Hand-guided, engine-powered reaper



Animal-drawn harvester



Tractor-mounted reaper

**Post-harvest**

Hand-powered maize sheller

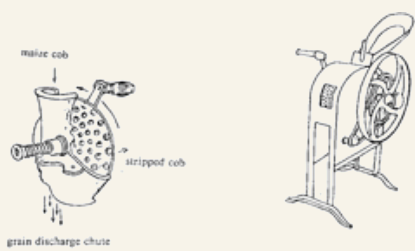

Source: CIRAD

Rice mill



Cereal thresher



## SESSION 4.3

# MAINTENANCE AND SAFE USE OF AGRICULTURAL EQUIPMENT

### Trainer's guide to the session:

The routine maintenance of farm machinery is often neglected, potentially leading to expensive machine failures and machine downtime when income-earning fieldwork has to stop. Investment in training and appropriate-scale workshop facilities, combined with a sound maintenance and servicing schedule, goes a long way to ensuring long-lasting, trouble-free and safe field operation of agricultural machines. It also enables a hire service to work more regularly and predictably, seizing new business opportunities that may arise and thus increasing revenues. This session takes participants through the basic concepts and requirements of effective machinery maintenance.

### Session learning objectives:

- Understand the basic concepts of machinery maintenance: why regular machinery maintenance is a necessary and cost-effective strategy.

**Practical learning:** Exercise 1 is a basic introduction to the concepts of safety, maintenance and operation of four-wheel tractors and their associated implements. Show the following videos and encourage discussion in plenary amongst the participants. The videos are suggestions only – it is recommended to use materials relevant to the local conditions wherever possible.

### How to operate a four-wheel tractor:

- › Part 1 (duration 1.52). Safety checks. Available at: <https://www.youtube.com/watch?v=PtF2YZTVFYg>.
- › Part 2 (duration 3.08). Pre-start checks. Available at: <https://www.youtube.com/watch?v=AVyh92Ongml>.
- › Part 3 (duration 4.15). How to operate tractor. Available at: <https://www.youtube.com/watch?v=OGexMtCf-AQ>.
- › Part 4 (duration 10.20). How to operate tractor attachments. Available at: <https://www.youtube.com/watch?v=8TEfjLpLNYE>.

After each video, ask participants what the main points are and encourage discussion and sharing of personal experiences.

Exercise 2 involves group work, a plenary session and a field visit to machinery dealers and repair workshops. The number of dealers and workshops selected depends on the local situation; if possible, include at least two of each in the visit programme.

Take care in the selection of machinery suppliers and workshop operators: they must be sympathetic to the training aims of the course and convey the importance of machinery maintenance and timely, cost-effective repair.

Verify that the questions prepared to ask the dealers and workshop owners during the visits are complete, logical and clear. Designate one or two participants to pose the questions and others to record the responses.

Prepare a regionally/locally focused PowerPoint presentation covering the main points indicated in Handout 4.3.1, "Importance of maintenance management", and any additional information you believe to be locally relevant.

Distribute Handout 4.3.1 and allow participants time to read it (about 30 minutes).

Split the participants into groups to discuss the following questions:

- Why is regular machinery maintenance important?
- What are the costs and losses in revenues related to not maintaining machinery?
- What are the most important maintenance activities for tractors and other important agricultural machines in use in the region?
- What criteria should be applied when selecting a machinery dealer and repair workshop?
- Would it be cost-effective to invest in your own workshop for machinery servicing?

Ask the groups to formulate additional questions and observations for a discussion in plenary. Questions and observations should focus on real-life experiences, based on the actual situation of agricultural machinery maintenance and servicing in the region.

Ask each group to prepare the results of their discussions for the plenary session. Encourage further discussion on the points raised.

Ask each group to formulate key questions to pose during field visits to dealers and workshops.

Visit local machinery suppliers and workshop facilities. Ask the delegated interviewers to pose the planned questions and the others to record the responses.

Discuss the results of the visits in a final plenary session. Note the main points and conclusions on a whiteboard or flip chart.

### HANDOUT 4.3.1 IMPORTANCE OF MAINTENANCE MANAGEMENT

To invest time in the maintenance of farm machinery is very cost-effective. Good maintenance begins with good operation. Correct operation and regular maintenance are essential for smooth running of the hire service business:

- **Fewer breakdowns.** All machines wear out. How quickly they wear out depends on how well they are operated and how well regular preventative maintenance is carried out.
- **Lower operating costs.** Carrying out regular maintenance costs money. However, the investment pays for itself many times over. A machine kept in good working order costs less to operate and there are fewer breakdowns and lower overall repair costs. Moreover, when one part fails on a machine, other associated parts may also be damaged: the owner not only has to repair the immediate breakage but also the associated damage. Breakdowns increase the risk of failing to deliver required services, resulting in financial losses for the business and tarnishing the image of the service provider.
- **Improved safety.** Badly maintained machines lead to accidents and higher costs.

**Correct machine operation:** When a new machine is delivered, the customer should insist that the supplier provide full instructions on its operation (Plate 4.7). In addition to a comprehensive operator's manual, the customer should also receive a maintenance manual and, if possible, a spare parts manual.

The operator must become familiar with the operating instructions and "respect" the machine. Never underestimate the value of a good operator.

**Machine guarantee:** The owner needs to be aware of the guarantee period and of any obligations under the guarantee.

**Maintenance schedules and records:** The operator and workshop must follow each machine's specific maintenance schedule, which takes the form of a checklist: what work has to be carried out, when (frequency) and the costs involved. The checklist helps ensure that all recommended service and maintenance procedures are carried out at the correct intervals. Table 4.3.1a is an example of a simple maintenance schedule for a 2WT tractor engine.

Plate 4.7 Service providers receiving initial instruction © B. Sims



**Table 4.3.1a Maintenance schedule for a Changchai diesel engine**

Date	Operation	Frequency	Cost	Comments
	Check engine oil level	Daily		
	Change engine oil	After the first 50 hours then every 100 hours		
	Clean oil strainer	50 hours then 100 hours		
	Clean air filter	100 hours or 50 hours in dusty conditions		
	Clean fuel filter	100 hours		
	Retighten main bolts and nuts	50 hours then 300 hours		
	Clean fuel tank and filling screen	50 hours then 500 hours		
	Grind (lap) valve seat.	500 hours		
	Adjust valve clearance	100 hours		
	De-carbonize (de-coke) cylinder head and piston	1 000 hours		
	Clear oil ducts in crankshaft	200 hours		
	Clear cooling water ducts	500 hours		
	Service fuel injector	As required		

**Note:** Table 4.3.1a is illustrative only. Where possible, use information relative to the machines actually available for the training and include indicative costs, as supplied by repair workshops.

**Choosing a supplier:** When selecting a machine, consider not only machine preference, but also the back-up service offered by the dealer, which can sometimes be more important. See Module 3 for assessing dealerships and related maintenance and repair services.

**Selecting maintenance and repair service facilities (workshops):** Research the services available to be able to make an informed decision. Ask the following questions:

- How well equipped are the workshops?
- How well trained are the mechanics?
- Where are spare parts sourced?
- How do the costs of repair and maintenance services compare with competitors?
- How far away is the service facility?
- Are mobile services available?

**Storage of farm machinery:** When deciding on storage for farm machines, there are two main factors to consider:

- **Cost-effectiveness** – Do the benefits of having a shelter for the tractor and machinery justify the costs?
- **Climate** – Are the climatic conditions, especially rainfall and temperature, severe enough to justify protecting the machinery?

Following careful assessment, decide whether to store the machinery inside a building or perhaps under a tarpaulin outside (Plate 4.8). In general, good practice requires that service providers have storage facilities at their base; the cost of the shelter is factored into the fixed costs of the hire services.



Plate 4.8 To house machinery or not?



## SESSION 4.3.1

# TECHNICAL MAINTENANCE OF TRACTORS

**Trainer's guide to the session:** This session gives a thorough grounding on the basic technical maintenance requirements of 4WTs and 2WTs. A theoretical introduction is followed by practical exercises.

**Session learning objectives:**

- Become familiar with the maintenance requirements of the principal tractor systems.
- Understand the importance of adherence to the manufacturer's maintenance schedule – key to smooth-running of the tractor and for minimizing downtime.

**Note to the trainer:** Gauge the knowledge level of the trainees and avoid overloading them with unnecessarily complicated information on tractor systems and maintenance. Nevertheless, all participants must understand the basic requirements – even if they entrust servicing to a third party. At the very least, all trainees need to be aware of the daily checks that the tractor driver has to make. Prepare an introductory session to cover the principal areas of a tractor maintenance schedule. The introduction may be a PowerPoint presentation or a workshop demonstration around a tractor. Handout 4.3.2 (for 4WTs) and Handout 4.3.3 (for 2WTs) cover the main points.

For the exercise, organize access to a tractor, have skilled mechanics on call and refer to the operator's manual. If possible, conduct the exercise in a main tractor dealer's workshop under the supervision of trained workshop staff. Alternatively, it is possible to access a tractor via a service provider, farmer, NGO or other source. Whatever the arrangements, access to **specialist expertise** and reference to the tractor's **operation manual** detailing servicing procedures are fundamental.

**Practical learning:**

Give a pre-prepared introductory session to cover the main areas of a tractor maintenance schedule. Either use a PowerPoint presentation or conduct a session in the workshop around a tractor.

Distribute Handout 4.3.2, "Overview of technical maintenance for four-wheel tractors", or Handout 4.3.3, "Overview of technical maintenance for two-wheel tractors", depending on which type of tractor is to be used for the exercise.

Allow participants time to study the handout (about 30 minutes).

Form three groups focusing on specific areas of maintenance (see below). Ask each group, with the help of skilled mechanics and the operator's manual, to discuss, identify and practise the key maintenance and servicing procedures:

- Group 1. Fuel, air intake and exhaust.
- Group 2. Lubrication, cooling and electrical.
- Group 3. Transmission, hydraulics (only for 4WTs) and clutch(es).

Invite each group to demonstrate and explain the relative procedures to the other groups.

## HANDOUT 4.3.2

## OVERVIEW OF TECHNICAL MAINTENANCE FOR FOUR-WHEEL TRACTORS

## PERIODIC PREVENTATIVE MAINTENANCE – THE MAINTENANCE SCHEDULE

All of the machines owned by a hire service business should have a maintenance schedule. Preventative maintenance reduces the risk of machine failure and costly repairs. See Table 4.3.2a for a representative example of a maintenance schedule indicating the

operations required and their frequency. For details of procedures for specific tractors, always refer to the operator's manual.

**Servicing the fuel system:** Dirt and water are the main enemies of diesel injection systems: it is essential to keep fuels clean. Water, even in extremely small amounts, causes corrosion of the closely fitted metal surfaces of injector pumps and nozzles. To clean fuel filters with drain plugs, loosen the plugs and drain water and dirt from the filter, then drain the filters themselves. Change fuel filter cartridges at regular intervals. Whenever fuel lines and filters are drained, air enters the system and it is necessary to "bleed" the system to expel the air.

Table 4.3.2a Example of maintenance schedule for a tractor (for guidance only)

Frequency	Maintenance operation	Daily	50 hours (weekly)	100 hours (every 2 weeks)	250 hours (monthly)	500 hours (every 2 months)	1 000 hours (yearly)
Daily	Check tyres for damage/loss of pressure	■	■	■	■	■	■
	Inspect for loose nuts and bolts	■	■	■	■	■	■
	Inspect for loose, worn or damaged parts	■	■	■	■	■	■
	Inspect for oil/coolant/fuel leaks	■	■	■	■	■	■
	Clean cab air filter (if fitted)	■	■	■	■	■	■
	Check air cleaner/pre-cleaner	■	■	■	■	■	■
	Check crankcase oil level	■	■	■	■	■	■
	Check cooling system level	■	■	■	■	■	■
	Lubricate grease points	■	■	■	■	■	■
	Check fuel sediment bowl	■	■	■	■	■	■
	Check for leaks	■	■	■	■	■	■
	Check drive belts and hoses	■	■	■	■	■	■
	Fill tank with fuel	■	■	■	■	■	■
	Wash at end of day if very dirty	■	■	■	■	■	■
50 hours (weekly)	Perform 10-hour maintenance		■	■	■	■	■
	Check battery electrolyte level		■	■	■	■	■
	Check hydraulic system fluid level		■	■	■	■	■
	Check transmission oil level		■	■	■	■	■
	Clean dry-element air cleaner or change oil in oil-bath air cleaner		■	■	■	■	■
	Check tyre inflation pressure		■	■	■	■	■
100 hours (every 2 weeks)	Perform 10- and 50-hour maintenance			■	■	■	■
	Change crankcase oil and filter			■	■	■	■
250 hours (monthly)	Perform 10-, 50- and 100-hour maintenance				■	■	■
	Clean battery				■	■	■
	Adjust clutch pedal free travel				■	■	■
	Check belt tension				■	■	■
	Check and adjust brakes				■	■	■
500 hours (every 2 months)	Perform 10-, 50-, 100- and 250-hour maintenance					■	■
	Replace fuel filter					■	■
1 000 hours (yearly)	Perform 10-, 50-, 100-, 250- and 500-hour maintenance						■
	Drain and refill transmission and hydraulic systems						■
	Clean and repack front wheel bearings						■
	Drain, clean and refill cooling system						■
	Check air-conditioning components.						■





### HANDOUT 4.3.3 OVERVIEW OF TECHNICAL MAINTENANCE FOR TWO-WHEEL TRACTORS (2WTS)

Many of the maintenance issues outlined for 4WTs apply also to 2WTs. Table 4.3.1a (Handout 4.3.1) provides an outline of the maintenance schedule for one popular Chinese-made 2WT engine; this gives an indication of the importance, not only of regular maintenance, but of keeping a record of all interventions. This section reviews maintenance procedures for 2WT engines and describes other routine maintenance that 2WTs may require. Always follow the operator's manual for a particular machine and adhere to the recommended maintenance schedule.

The forward-mounted diesel engine of a 2WT drives the transmission via a V-belt and pulley system. The gearbox drives the wheels through dog clutches, which are used to steer the tractor in work. If a rotary tiller is incorporated, it is activated by a separate gear lever and the rotary cultivator shaft is driven by a chain and sprocket transmission. It is not normally possible to engage the rotary cultivator with the tractor reverse gear selected.

Table 4.3.3a provides an overview of a maintenance schedule for a 2WT. It is for guidance only. Refer to the operator's manual of each machine for the specific schedule.

**Servicing the fuel system:** Keep the fuel filter screen in the tank clean at all times – do not allow dirt to build up. Wash the tank internally with clean fuel after every 500 working-hours. Clean the main filter in the fuel line – by washing in clean fuel and blowing with compressed air if needed – after every 100 hours of operation. After servicing, the fuel line needs to be bled to remove air in the system by loosening the vent screw on the injection pump and allowing fuel to flow until it is air-free.

**Servicing the air intake system:** It is common to have oil-bath cleaners on 2WT diesel engines. Fill the oil cup with oil to the level line and change at regular intervals according to the dustiness of the ambient air. At the same time, clean the wire mesh filter with clean fuel and compressed air. Under normal conditions, service the air cleaner after 100 hours, reducing to 50 hours (or fewer) in dusty conditions.

**Servicing the engine lubrication system:** Check the engine oil level daily and replenish the oil as required. After the running-in process, change the engine oil every 100 hours of running. The crankcase usually has an oil strainer incorporated before the oil pump and this requires dismantling and cleaning after 100 hours.

**Servicing the engine cooling system:** Most 2WT diesel engines are cooled by an evaporative system. Water is boiled in the cooling pan above the engine; replenish when the level falls below a pre-determined minimum, signalled by a float system. Use clean, soft water and drain the system over winter if there is any

danger of sub-zero temperatures and freezing. Clean the water pan and cooling channels with a weak acid solution (e.g. 25% hydrochloric acid) every 500 hours to combat possible lime-scale accumulation.

**Adjusting the V-belt tension:** Tension is important: excessive slackness causes the belts to slip, increasing both transmission power losses and V-belt wear; on the other hand, an over-tight belt overloads transmission bearings. Achieve the correct adjustment by sliding the engine forwards or backwards on the tractor chassis.

**Adjusting the transmission clutch:** Adjust the clearance between the clutch engagement lever and clutch bearing (using a feeler gauge) by means of the adjusting and locking nuts. Adjust the clutch-brake system in a similar way with free play eliminated (or reduced to an acceptable level) by adjusting the length of the pull-rod. Adjust the braking system in a similar way by varying the length of the pull-rod to eliminate excessive play.

**Adjusting the steering system dog clutches:** Eliminate play in the system by adjusting the lengths of the steering pull-rods.

**Adjusting the throttle (governor) control:** Adjust the throttle control in order to achieve the rated speed of the engine at the full throttle setting. Usually this is via the engine speed adjustment connected to the hand-operated control.

**Adjusting the wheel-track:** The wheel-track is usually adjustable to cater for ploughing, rotary cultivation or transport. Adjust the wheel-track by changing the position of the wheel mounting on the axle and by interchanging the left and right wheels.

**Checking the transmission:** Change the transmission oil after 500 hours. Check regularly (weekly) transmission oil levels by means of the oil level inspection cap; replenish as necessary. Adjust the built-in chain tensioner to achieve the transmission drive chain tension (if incorporated); adjust when excessive noise indicates slackness.

#### Servicing the rotary cultivator:

- **Rotary cultivator speed.** The rotary cultivator shaft can have two speeds of rotation (at rated engine speed). Adjust by transposing the drive and driven sprockets in the cultivator drive-chain transmission.
- **Rotary cultivator drive-chain tension.** Adjust (as for the transmission chain) by adjusting the chain tensioner (often leaf-spring type). This may involve draining the oil from the drive chain assembly and removing the chain case cover.
- **Tilling blades.** Different blade types may be supplied according to local preferences and soil types. Follow instructions for mounting the blades on the cultivator shaft, whether for full-width rotary cultivation or strip tillage for reduced cultivation of the planting lines only.

**Table 4.3.3a Maintenance schedule for a 2WT (guidance only – always refer to the operator’s manual)**

Item	Maintenance	Period
<b>ENGINE MAINTENANCE</b>		
Cooling water	Replenish water when float drops below hopper rim.	As required
Engine oil and oil strainer	Replenish oil when level falls near to lower dipstick mark.	Daily
	After first 50 hours of operation, change oil and clean crankcase and oil strainer.	50 hours
	Change oil regularly and clean strainer.	100 hours
Air filter	Under normal conditions, clean after:	100 hours
	Under dusty conditions, clean after:	50 hours
Fuel filter element	Clean paper element with clean fuel and blow from inside with compressed air. Replace if damaged.	100 hours
Main nuts and bolts	Retighten main bolts with required torques after first 50 hours and then after 300 hours of operation.	50 hours and 300 hours
Valve grinding (lapping)	Lap valves using proprietary lapping compound.	500 hours
Valve clearance	Adjust tappet clearance.	100 hours
Decarbonization	Remove carbon deposits from cylinder head, cylinder liner and piston.	1 000 hours
Oil ducts in the crankshaft	Clean all oil ducts in crankshaft with clean fuel.	200 hours
Cooling water galleries	Pour weak acid solution (e.g. 25% HCl) into water passages and leave for 10 minutes before washing and blowing to clear.	500 hours
<b>TRACTOR MAINTENANCE</b>		
Visual inspection and general lubrication	Clean mud, dust and oil from tractor.	Daily, before work
	Tighten all nuts and bolts that may have become loose.	
	Check oil levels (engine, transmissions).	
	Check and replenish coolant water.	
	Check tyre pressure.	
	Apply oil to sliding surfaces of clutch–brake system.	
	Apply oil to all hinged joints of control linkages.	
<b>FIRST CLASS MAINTENANCE – performed after 100 hours of operation</b>		
Daily tasks	Perform all “daily” tasks listed above.	100 hours
V-Belt	Check and adjust V-belt tension.	
Clutch-brake controls	Check and adjust main clutch and brake clearances with feeler gauge.	
Transmission and rotary cultivator chains	Check and adjust chain tensions with adjustable tensioners.	
Steering system	Adjust steering system dog clutch action by adjusting pull-rod length.	
<b>SECOND CLASS MAINTENANCE – performed after 500 hours of operation</b>		
First class maintenance	Perform all tasks listed under first class maintenance.	500 hours
Transmission oil	Change transmission oils in gearbox and chain transmission cases. Wash out boxes with clean fuel.	
Grease bearings	Grease clutch and rotary tiller bearings.	

- **Location of the rotary cultivation assembly.** The rotary cultivator is normally mounted directly onto the main gearbox of the tractor, so that the two gearboxes are connected. The two units are fixed by four studs and there may be dowel pins to ensure correct positioning for gear wheel engagement. For some models it may be necessary to drain the gearbox oil before coupling the rotary cultivator assembly.

- **Tillage depth control.** Vary the tail-wheel height.

**Connecting other implements:** Hitch implements and trailers, rather than the rotary cultivator, to the tractor via an adapter frame bolted to the rear of the tractor gearbox.

Notes

---



---



---



---



---



---

## SESSION 4.3.2

# SAFETY IN THE USE OF MACHINERY AND EQUIPMENT

**Trainer's guide to the session:** This session stresses the importance of safety in the operation of agricultural equipment. It comprises a brief handout on safety issues and a brainstorming exercise.

### Session learning objectives:

- Understand the importance of safety in machinery operation.
- Appreciate the specific safety requirements for two- and four-wheel tractors and sprayers.

**Note to the trainer:** The session discusses safety aspects associated with tractor and sprayer use as detailed in Handout 4.3.4, "Safety in the use of equipment and machinery (tractors and sprayers)". Any other equipment available and relevant to the training course may also be included.

To explain the main points in Handout 4.3.4, prepare a PowerPoint presentation, making it as relevant to the local situation as possible.

### Practical learning:

Use PowerPoint to present the information summarized in Handout 4.3.4. Adapt to locally used tractors and farm equipment where possible.

Develop with the participants a series of questions concerning:

- the importance of safe operation of agricultural machinery; and
- the experiences of individuals in the group?.

In plenary, ask participants to add other pertinent questions and make a note of them on the flip chart.

Distribute Handout 4.3.4. Organize the participants into groups and allow 45 minutes to read the handout and discuss issues of safe use of agricultural machinery with special reference to their own experiences. Within their groups, they should ask each other the prepared questions. Ask groups to also discuss the following:

- Do participants have personal experience, or knowledge of health and safety issues related to the use of tractors and agricultural equipment? If so, describe the situation and the consequences. What could have been done to avoid the situation?
- Are there sprayer owners or operators in the group? Or do the participants know a sprayer operator or owner? Do they regularly have access to and use protective clothing? If not, why not?

Have the groups appoint a spokesperson each to report back to the plenary. Note the main findings on the flip chart and encourage discussion among the participants to produce key lessons learnt.

## HANDOUT 4.3.4 SAFETY IN THE USE OF EQUIPMENT AND MACHINERY (TRACTORS AND SPRAYERS)

### TRACTORS

Safe operation of tractors, both 2WTs and 4WTs, is vital for the security of both the operator and others. It is essential to follow the safety instructions in the operator's manual and heed safety warnings on the machine itself at all times.

A common recommendation in developed countries is to fit 4WTs with a "roll-over protection structure" (ROPS) – a safety cab or safety frame. The ROPS on a **4WT** is designed to avoid or limit risks to the operator resulting from tractor roll-over. In tropical and subtropical climates, the ROPS may also function as a climate-controlled operator cabin; if no ROPS is fitted, a sun-roof should be provided to protect the operator from sun and rain.

In the case of **2WTs**, certain situations require extra vigilance. **Safety advice on 2WT use:**

- Never attempt maintenance adjustments on the tractor with the engine running. Rotating parts (e.g. V-belts and pulleys) are particular danger points.
- Keep all guards in place and avoid loose clothing that could catch in moving parts.
- Keep onlookers (especially children) at a safe distance to avoid injury from flying debris.

- Take extra care on sloping ground. Use a low gear and low speed. Always keep the transmission in gear and never attempt to change gear on the move.
- Stay clear of the hot exhaust pipe or radiator.
- Make sure that the gear lever is in neutral before cranking the engine.
- Never attempt sudden turns with the steering clutches at high forward speed; slow down first.

Driving a 2WT with a trailer on public roads can lead to problems. Safety advice for use on public roads:

- Maintain the 2WT and trailer brakes in perfect working order.
- Do not drive at speed.
- Do not attempt sudden turns.
- Observe all public traffic rules and regulations.
- Read, understand and pay strict attention to the safety messages in the operator's manual and heed warnings attached to the tractors.

Working with sprayers requires certain safety measures in order to ensure that occupational health is not under threat. The following are among the basic requirements:

- Use protective clothing to protect the operator from contact with agrochemicals.
- Wash your hands, face, body and spray equipment immediately after handling or using any agrochemical.
- Rinse and clean spray equipment well away from water sources such as wells, ponds or rivers.



- Always store agrochemicals in their original containers, well out of reach of children and animals.
- Dispose of containers in a deep pit, or as indicated by the manufacturer.

Sprayers require **regular maintenance** to ensure efficiency. Basic maintenance entails the following:

- Ensure that the equipment is in good working condition (no leaks or blockages).
- Check that the valves and switches are working properly and that the spray nozzles and filters are not worn or clogged. Replace worn-out or defective parts immediately.
- Clean the equipment immediately after use.
- Lubricate moving parts as indicated in the operator's manual.
- Regularly check for, and tighten, any loose bolts and nuts.

*Notes*

Horizontal lines for writing notes and answers.

## SESSION 4.4

# CALIBRATION OF PLANTERS AND SEEDERS

**Trainer's guide to the session:** This session underlines the importance of the correct calibration of planters (for precision-spaced large seeds) and seeders (continuous flow metering systems for smaller seed sizes). Proper calibration is fundamental for predicting seed and fertilizer rates per hectare (or acre). A theoretical introduction is necessary, to be followed by practical exercises on planters and/or seeders.

### Session learning objectives:

- Understand that calibration of planters is necessary in order for a service provider to know with confidence what rates (of seed and fertilizer) are applied per hectare (or acre).

**Note for the trainer:** Calibration procedures require a basic familiarity with numbers – something that may be lacking in some participants. Be prepared to assist anyone experiencing difficulty. Emphasize the importance of calibration: uncalibrated machines deliver unknown quantities of product (seed and/or fertilizer), resulting in over- or under-application, which is wasteful and may not meet the requirements of the client.

The session covers jab planters, tractor- and draught animal-drawn planters, and requires thorough preparation. Before the exercise begins, ensure that there are supplies of the following:

- Flip chart and marker pens to note the results of the calibration.
- Seed and fertilizer.
- Weighing scales to give precise readings up to 1 kg.
- Weighing scales with 25 kg capacity.
- Plastic bags and rubber bands.
- Chalk to mark the drive wheel.

**Practical learning:** Give a PowerPoint presentation covering the main technical points described in Handout 4.4.1 and using locally available machines. Distribute Handout 4.4.1 and allow participants time to read the handout and take notes (45 minutes).

Form at least three groups and assign the following equipment to them:

- Jab planter.
- Draught animal planter.
- Tractor-drawn planter.

Under your supervision, and that of colleagues, allow the groups about 1 hour to practise the calibration procedure for their machine. Each group should have at least one experienced service provider/technician to lead the discussion and solve any questions arising about the calibration and the equipment.

### Jab planter:

- Inspect the main features of the jab planter, paying particular attention to the seed and fertilizer metering mechanisms.
- Adjust the seed metering mechanism to give a range of seeds per hill and calculate the seed rates per hectare. Use local measurements for distances between rows and between hills (see Handout 4.4.1).
- Adjust the fertilizer metering mechanism to give a range of application rates. Weigh the fertilizer delivered and calculate the application rates per hectare (see Handout 4.4.1).

### Animal- or tractor-drawn planter:

- On the planter to be calibrated, get the group to examine its main features, in particular the seed and fertilizer metering mechanisms.
- Select the adjustment for the lowest **seed delivery** rate.
- Raise the drive wheel and mark a point with chalk (or marker pen).
- Calculate the circumference of the drive wheel ( $C = \pi \times D$ ).
- "Charge" the system by rotating the wheel a few times until the seeds are delivered at a steady rate.
- Attach a plastic bag to the open end of the delivery tube.
- Rotate the drive wheel 10 times.
- Count the seeds delivered and determine the seed spacing as follows:

$$\text{Distance between seeds (cm)} = \frac{\text{Wheel circumference, } C \text{ (cm)} \times \text{No. revs}}{\text{No. seeds dropped}}$$

- Weigh the seeds delivered and calculate the delivery rate per hectare as follows:

$$\text{Seed rate (kg/ha)} = \frac{\text{Weight of seed delivered (kg)} \times 10\,000}{C \text{ (m)} \times \text{No. revs} \times \text{Row spacing (m)}}$$

- Repeat the calibration three times and calculate the mean delivery rate.
- Repeat the exercise for all adjustments throughout the range provided on the machine. Repeat the whole exercise for **fertilizer delivery**, but in this case only calculate the kg/ha.

### HANDOUT 4.4.1 CALIBRATION OF PLANTERS

To meet the requirements of clients and enable their own businesses to grow, service providers must apply the correct amount of seed and fertilizer per hectare at the required spacing. Likewise, for agrochemical applications, clients must be confident that the correct doses of pesticide or herbicide are applied uniformly across their fields. To achieve this, it is necessary to calibrate planters and sprayers. There follows a summary of calibration procedures that are effective and easy to perform with a minimum of equipment. Equipment must be calibrated every time before use – note that the set up recommended by manufacturers will not always deliver the seed/fertilizer density stated in the equipment instructions and calibration is essential.

#### SEED SELECTION

For large seeds (e.g. maize and beans), it is always advisable to use pre-graded seed; however, if the farmer's own seed is used, a uniform sample can be obtained by adopting a system of three sieves. The top sieve retains over-sized seeds, while the bottom sieve allow the passage of under-sized seeds: the selected size collects in the middle sieve. If graded seed is not used, it is not possible to assure the uniformity of the seed rate, and there may be an increased risk of seeds jamming and breaking. This is especially important for planters with horizontal rotating seed plates (Plate 4.9).



Plate 4.9 Horizontal rotating seed disc (for beans) for an animal-drawn direct seed planter © FAO/IS. SantosValle

### JAB PLANTERS

It is usually possible to adjust manually operated jab planters and regulate the number of seeds delivered per planting station and the amount of fertilizer delivered at the same time. Note that the metering mechanism varies between different makes of jab planters, and it is important to follow the operator's instructions. For seeds, for example, there may be a simple sliding shutter that varies the size of the seed cell, or a rotating circular seed disc could need changing to one suited to the size of seed. Operate the jab planter over clean paper or sand and make adjustments until the desired number of seeds is being delivered per operation. Meter fertilizer in the same way and calculate the amount delivered by collecting and weighing the delivery over ten (for example) operations and then calculating the average amount per delivery.

To calculate seed and fertilizer rates per hectare, first determine the distance between planting stations along the row and the distance between rows. For example, dropping 2 seeds at 50-cm intervals along the row with 75 cm between rows will give:  $2 \div (0.5 \times 0.75) = 5.3333$  seeds/m<sup>2</sup> and this is equivalent to  $5.3333 \times 10\ 000$  seeds/ha, that is 53 333 seeds/ha. The equivalent per acre (4 048 m<sup>2</sup>) is  $5.3333 \times 4\ 048 = 21\ 590$  seeds/acre.

To calculate the fertilizer rate, implement the following adjustment process:

- Determine the required application rate of a particular fertilizer, for example, 50 kg/ha.



Plate 4.10 Calibration of seed delivery for a 2WT-drawn no-till planter © B. Sims





## SESSION 4.5

# CALIBRATION OF SPRAYERS

**Trainer's guide to the session:** This session underlines the importance of calibration of sprayers. Without calibration, it is not possible to predict the rates per hectare of agrochemical application. Following a theoretical introduction, it is important to conduct the practical exercise with sprayers.

### Session learning objectives:

- Understand the importance of sprayer calibration so that a service provider can be confident of the rates to apply per hectare.

**Note for the trainer:** Calibration procedures require a basic familiarity with numbers – something that may be lacking in some participants. Be prepared to assist anyone experiencing difficulty. It is important to emphasize the importance of calibration: uncalibrated machines deliver unknown quantities of product, resulting in over- or under-application, which is not only wasteful, but may not meet the requirements of the client.

The session covers backpack (knapsack) sprayers and field sprayers. Thorough preparation and sufficient time are essential to cover all machines properly. Divide participants into two groups, one to calibrate the backpack sprayer and the other to calibrate the field sprayer. Each group then presents its procedures and findings in a plenary session.

Ensure that you procure the following before the exercise:

- Flip chart and marker pens to note the results of the calibration.
- Tape measures (5 m and 25 m).
- Graduated containers to measure the output from each sprayer nozzle and the total amount sprayed per run.
- A ready supply of clean water.
- Weighing scales (25-kg capacity).

**Practical learning:** Give a PowerPoint presentation covering the main points dealt with in Handout 4.5.1, "Calibration of sprayers", and incorporating the machines you have available and ready for the practical exercises, "Calibration of backpack (knapsack) sprayer" and "Calibration of field sprayers".

Distribute Handout 4.5.1. Give participants time to read the handout and take notes (45 minutes).

Form **two groups** and assign, respectively, the following equipment:

- backpack sprayer; or
- field sprayer.

Under your supervision, and that of colleagues, allow the groups 2 hours to practise the calibration procedure for their machine.

### EXERCISE 1.

#### CALIBRATION OF BACKPACK (KNAPSACK) SPRAYER

- Get the group to run over the main features of the sprayer, with particular attention to pressure regulation (if any), and the importance of maintaining the correct boom height, nozzle type and condition.
- Mark an area of, for example, 100 m<sup>2</sup>.
- Fill the tank with clean water and weigh it.
- Spray the 100-m<sup>2</sup> area at normal walking speed and then re-weigh the sprayer.
- Calculate the spray applied and the equivalent application rate per hectare (10 000 m<sup>2</sup>).
- Repeat the test at least three times with the same operator and calculate the average application rate; repeat the calibration procedure with a different operator. Compare the results.
- Calculate the equivalent number of spray tanks applied per hectare; then calculate the amount of chemical to be added to each tank. For example, if 5 tanks of 20 litres (i.e. 100 litres) are applied per hectare and it is necessary to apply 4 litres of agrochemical per hectare, each tankful must contain 0.8 litres of chemical.

### EXERCISE 2

#### CALIBRATION OF FIELD SPRAYER

- Get the group to run over the main features of the sprayer, with particular attention to pressure regulation, boom height adjustment, nozzle type, spacing and condition.
- Mark a track at least 25 m in length.
- Calculate the spray bout width by multiplying the number of nozzles by the nozzle spacing.
- Fill the tank with clean water and "charge" the system by spraying for a few metres.
- Run the length of the test track with the sprayer collecting the spray delivered by each nozzle in a graduated container.
- Measure the total volume of spray delivered.
- Repeat the test at least three times and make a histogram of the average deliveries per nozzle.
- Discuss the histogram and find explanations for any nozzle delivering a markedly different output.
- Calculate the spray application per hectare as follows:

$$\frac{\text{Total spray output on test track (litres)} \times 10\,000 \text{ m}^2/\text{ha}}{\text{Length of test track (m)} \times \text{Width of work (m)}} = \text{Spray applied (litres/ha)}$$

- Calculate the equivalent number of spray tanks applied per hectare and then calculate the amount of chemical to be added to each tank. For example, if two tanks of 50 litres (i.e. 100 litres) are applied per hectare and it is necessary to apply 4 litres of agrochemical per hectare, each tankful must contain 2 litres of chemical.

When each group has perfected the calibration procedure, have them demonstrate to all participants in plenary. Note all results on the flip chart and encourage discussion.

### HANDOUT 4.5.1 CALIBRATION OF SPRAYERS

To meet the requirements of their clients and to enable their businesses to grow, service providers must apply the correct amount of seed and fertilizer per hectare at the required spacing. Likewise with agrochemical applications: clients must be sure that the correct doses of pesticide or herbicide are applied uniformly across their fields. It is, therefore, essential that planters and sprayers are well calibrated. There follows a summary of calibration procedures that are effective and easy to perform with a minimum of equipment.

Sprayers must have **nozzles in good condition** and must be operated at the **correct height above the target** (whether soil surface, crop or weeds). Failure to pay attention to these working practices can lead to incomplete (or excessive) coverage, resulting in inefficient and ineffective spraying and waste of agrochemicals.

#### BACKPACK (KNAPSACK) SPRAYERS

- Completely fill the sprayer with water and weigh it (Plate 4.11).
- Mark out an area of, say 100 m<sup>2</sup>, and spray it at normal working speed and height.
- Re-weigh the sprayer and calculate the amount of spray applied (remember that 1 litre of water weighs 1 kg).
- Calculate the application rate per hectare by multiplying the applied volume by 100.

Plate 4.11 Weighing a backpack sprayer during calibration



#### MULTI-NOZZLE SPRAYERS PULLED BY A PERSON, DRAUGHT ANIMAL OR TRACTOR

To calibrate the sprayer, while checking that the nozzles are in good condition with uniform delivery of liquid, follow the steps below:

- Mark out a track (e.g. length 25 m) and calculate the sprayer working width (number of nozzles × inter-nozzle distance).
- Collect the output of the sprayer over the track by holding calibrated containers under each nozzle (Plate 4.12).
- Calculate the application rate as follows:

$$\frac{\text{Total spray output on test track (litres)} \times 10\,000 \text{ m}^2/\text{ha}}{\text{Length of test track (m)} \times \text{Width of work (m)}} = \text{Spray applied (litres/ha)}$$

- Repeat the test at least three times and calculate an average application rate.
- Calculate the equivalent number of spray tanks applied per hectare; then calculate the amount of chemical to be added to each tank. For example if 5 tanks of 20 litres (i.e. 100 litres) are applied per hectare and it is necessary to apply, for example, 4 litres of agrochemical per hectare, each tankful must contain 0.8 litres of chemical.

Plate 4.12 Calibration of an operator-pulled four-nozzle sprayer



## SESSION 4.6

# TECHNICAL PERFORMANCE OF EQUIPMENT: SHELLERS AND THRESHERS

**Trainer's guide to the session:** Threshing and shelling are key post-harvest requirements: they help farmers reduce crop losses and ensure that clean grain is ready to be safely stored. Demand – especially for shelling, which can be a more arduous manual job than threshing – is high after the harvest, representing a good opportunity for a service provider to offer a profitable mechanization service. Crop threshers remove small grains from crops such as wheat and rice, while shellers separate the grain from maize cobs. Although the principles employed (removing the grain and separating it from chaff and straw) are similar, the mechanisms used are different. This session describes the design features and includes an exercise for hands-on experience.

### Session learning objectives:

- Understand the basic principles of shelling and threshing machines.
- Gain hands-on experience in the use and performance of shellers and threshers.

**Note for the trainer:** This session's exercise is a very simple evaluation of available threshers and shellers using a range of locally produced crops.

The exercise comprises two similar parts, measuring the output of a cereal crop thresher and of a maize sheller. While not a complete evaluation of the machines, it gives participants the opportunity to gain hands-on experience of threshing and shelling machines. Complete evaluation procedures are available in:

- FAO. 1994. *Testing and evaluation of agricultural machinery and equipment: Principles and practices*. Agricultural Services Bulletin 110. Rome.

For the practical exercise:

Ensure that all equipment (sheller and thresher) is in good working order, well-adjusted and ready to work. Make certain that there are adequate supplies of suitable crops for shelling and threshing.

Provide additional materials required, such as receptacles to collect the grain and chaff outputs, weighing scales, flip chart and marker pens.

### Practical learning:

Give a PowerPoint presentation based on the information included in Handout 4.6.1, "Basic principles of shellers and threshers", and applied to the machines available locally that will be used in the practical exercise. Distribute Handout 4.6.1 and give participants time to read it (20 minutes). Stimulate discussion on the points raised in Handout 4.6.1, making reference to the locally available machines.

In plenary, encourage discussion and sharing of participant's views on the potential for shelling and threshing service provision.

### Practical exercise 1: Thresher

- Set the machine up for the available crop, following the manufacturer's instructions.
- Examine the detail of the mechanisms and assemblies found in the machines.
- Discuss and demonstrate preventative maintenance measures (with reference to the operator's manual).
- Ensure that there is a sufficient supply of crop ready for threshing.
- Thresh the crop available for 15 minutes and weigh the threshed grain.
- Record the information on a flip chart and repeat to collect at least three samples.
- Repeat the procedure for any other crops that may be available.
- Calculate the output in kg/hour.

### Practical exercise 1: Sheller

- Set the machine up in accordance with manufacturer's instructions.
- Discuss and demonstrate preventative maintenance measures (with reference to the operator's manual).
- Ensure that there is a sufficient quantity of unshelled maize available.
- Shell the maize for 15 minutes and weigh the shelled grain.
- Record the information on a flip chart and repeat to collect at least three samples.
- Calculate the output in kg/hour.

Throughout the practical exercises, alert participants to visually monitor grain **breakage**, **contamination** with chaff, husks or straw, and **losses** with the blown chaff. Note observations on the flip chart.

At the end of the session in plenary, discuss the results and draw conclusions on the performance and effectiveness of the machines evaluated.

## HANDOUT 4.6.1 BASIC PRINCIPLES OF SHELLERS AND THRESHERS

Threshing or shelling is one of the most important post-harvest handling operations for grain farmers. It is an increasingly popular operation among service providers (especially in sub-Saharan Africa) where motorized threshers in a range of sizes are used. Threshing essentially involves removal or separation of grains from the stalks of the crop. Shelling, on the other hand, is the removal of larger kernels (e.g. separating maize from the cob). Note that effective and efficient threshing and shelling depend on the crop and grain being within the specified moisture content range.

Traditionally, shelling and threshing involve manual beating, treading or rubbing actions; in some countries, farmers use animals (e.g. bullocks) for threshing by trampling, although this can lead to losses and contamination. Mechanical threshers using different power sources, such as engines or electric motors, are commercially available. Mechanical threshers have a much greater capacity compared with hand beating or animal trampling – hence their increase in popularity. Moreover, shellers and threshers come in varying sizes and capacity, and can be transported easily from one location to another, making them even more useful. For large-scale operations, threshing or shelling is an essential function of combine harvesters (considered beyond the scope of this module).

There are **three main operations** involved in the threshing or shelling of grains using machines:

- Separation of grains from the ear, cob, shell or panicle.
- Separation of grains from the grain and chaff/straw mixture.
- Winnowing to remove chaff and leave the clean grain ready for collection.

## CHARACTERISTICS OF SHELLERS AND THRESHERS

A wide range of shellers and threshers are available in the market today, both manual and engine-powered. Shellers and threshers are categorized according to the power source used and the types of crops handled. Manual threshers are normally operated using hand or foot pedals; power shellers and threshers are operated using a diesel or petrol engine or an electric motor. A 4WT is a potential source of power using its power-take-off (PTO) shaft; a 2WT engine can also be employed, usually using a belt and pulley transmission system.

Crops with grains of similar size and nature (e.g. wheat and rice) can be threshed using the same type of thresher, making some simple adjustments where necessary. On the other hand, threshers designed for smaller grains are not easily adapted to shell large grains crops (e.g. maize).

Threshers may be “hold-on” or “throw-in” (also known as “flow-through”); both types have similar basic components. The grain is separated from the remainder of the cut crop by a rotating threshing drum, which strips the seeds from the crop or, in “flow-through” types, feeds the crop between the cylinder and a concave where the seeds are removed. In both cases seed and chaff falls through holes into an airstream, created by a fan, where they are separated (Plates 4.13 and 4.14).

Plate 4.13 Hold-on type thresher

Source: [www.fao.org/docrep/t1838e/T1838E0p.htm](http://www.fao.org/docrep/t1838e/T1838E0p.htm) (adapted).

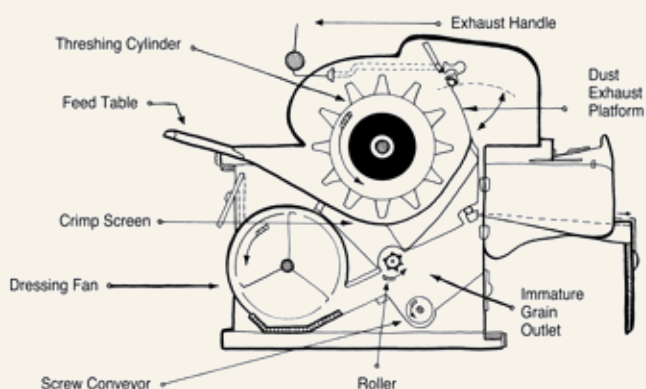
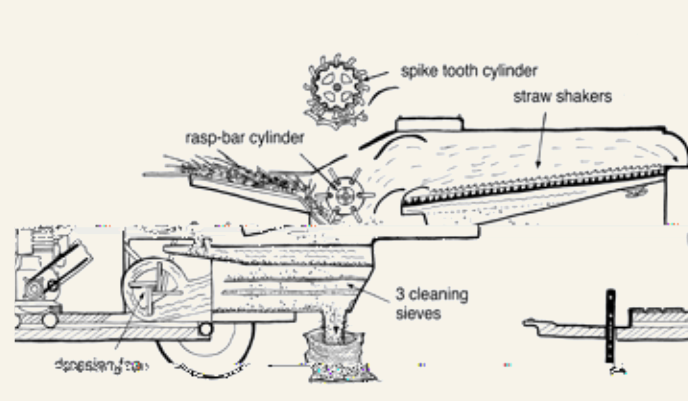

Plate 4.14 Flow-through type thresher

Source: [www.fao.org/docrep/t1838e/T1838E0p.htm](http://www.fao.org/docrep/t1838e/T1838E0p.htm) (adapted).



Other types of thresher (e.g. the IRRI axial flow design or the Vortex rice-fan) may be available locally, in which case they can be incorporated into the practical work of the session.

Maize shellers may hold the cobs against a rotating pegged plate (Plate 4.15) or comprise a rotating peg or bar cylinder; both types strip the grain from the cob and blow the chaff and broken cob pieces clear of the clean grain. The stripped cob is expelled separately.

### REPAIR, MAINTENANCE AND SAFE USE

In order to offer a reliable service and give the best performance in terms of grain quality, operator safety and profitability for the service provider, shellers and threshers require proper maintenance according to the manufacturer's instructions. With regular maintenance, it is possible to:

- avoid grain contamination through oil leaks and metal breakages;
- provide a reliable service resulting in satisfied customers;
- minimize the risk of extensive repairs due to poor maintenance;
- help ensure that the machine works effectively and safely; and
- prolong the working life of the thresher.

A regular maintenance schedule (in line with the manufacturer's instructions where provided) includes the following:

- Clean the machine (including drive engines and motors) thoroughly after each use to remove dust, crop residues and other contaminants.
- Check that all fastening parts, such as bolts and nuts, are tightened.
- Check all pulleys for cracks and chips and replace the damaged ones to avoid damaging the belts.
- Ensure that the belts are well secured and fitted at the correct tension. They must be neither too tight nor too loose.
- Ensure that all damaged parts are replaced as soon as possible.
- If the machine is driven by an engine, check the oil level and top up with the correct oil as necessary.
- Lubricate the machine (grease and oil points) at the recommended intervals (usually daily before use).
- Ensure that all rotating parts, including pulleys, shafts and belts, are covered for the protection of the operators.

Notes

---

---

---

---

---

---

---

---

---

---

---

---

---

---

---

---

---

---

---

---

---

---

---

---

---

---

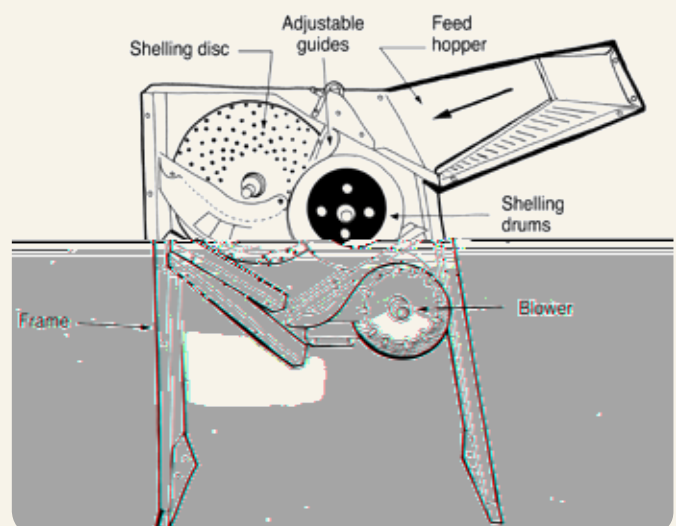

Plate 4.15 Maize sheller with blower

Source: Sims, B.G. 1987. *Mecanización para el pequeño agricultor. Mexico, Instituto Nacional de Investigaciones Forestales y Agropecuarias.* (adapted).

## SESSION 4.7

# TECHNICAL PERFORMANCE OF EQUIPMENT: PUMPS

**Trainer's guide to the session:** Two-wheel (and four-wheel) tractors can be used to power pumps and may be employed by a service provider to supply pumping services to farmers. The most frequent use is for crop irrigation, but other applications exist. During this session, participants have the opportunity to use a 2WT-driven pump and do some basic measurements of output. Note that this is not a technical testing session, rather an opportunity to become familiar with the equipment. Guidance for pump testing procedures can be found in:

➤ FAO. 1994. *Testing and evaluation of agricultural machinery and equipment: Principles and practices*. Agricultural Services Bulletin 110. Rome.

### Session learning objectives:

- Give participants hands-on experience of water pumping with 2WT power.

**Note for the trainer:** This simple exercise measures the output of a water pump attached to a 2WT. It is designed to familiarize participants with the potential for diversification into pumping and to show that a pump's output depends on head (both suction and delivery) and pump speed.

This practical exercise requires considerable preparation, from selecting a suitable site, through deciding how to change the suction and delivery heads, to organizing and measuring the discharge (e.g. with buckets of known capacity).

Make sure that the flip chart is in place and that marker pens are available for the participants to note their measurements in the field and create the graphs.

### Practical learning:

Use a PowerPoint presentation (incorporating the 2WT and pump available for the practical exercise), discuss the main points included in Handout 4.7.1, "Water pumping with a 2WT", which discusses the effect on pump discharge of total head and pump speed of rotation. Distribute Handout 4.7.1 and allow participants sufficient time (30 minutes) to read it.

Long, trouble-free pump operation depends on regular preventative maintenance. For the 2WT/pump combination, run through the checklist included at the end of Handout 4.7.1 and have participants make any necessary adjustments.

Connect the pump to the 2WT, allowing for the possibility to vary both the suction and the delivery heads. For example, pump up a hillside (note, however, that it is recommended to keep the pump in one place, varying the discharge head to known heights, such as 0.5 m, 1 m, 1.5 m and 2 m).

Ensure that there is sufficient clean water available for the pump. Run the pump at its recommended speed and measure the output over a range of total heads. To do so, vary the heights between pump and water source, and between pump and discharge height.

Measure discharge using a series of buckets of known volume to collect the water (if no large tank is available). Measure the capacity of the buckets in advance.

Once the pump is running normally, collect the discharge delivered in one minute. Repeat this process for five or so different heads.

Note the discharge (Q, in litres or cubic metres; note that 1 m<sup>3</sup> = 1 000 litres) at each head (H, in metres) on a flip chart and draw a graph of the results (see Figure 4.1 in the Handout). If the participants are familiar with other units (e.g. feet or gallons), use them when taking the measurements; however, convert to international units (metres and litres) to draw the graph.

If time permits, repeat the process outlined above but with the pump running at a lower speed. Construct a new curve (labelled "reduced speed") on the same graph. Note that it is not necessary to measure pump speed if this is difficult.

Discuss the graphs in a plenary session and encourage discussion among the participants.

### HANDOUT 4.7.1 WATER PUMPING WITH A 2WT

Two-wheel tractors can be coupled to various types of water pump (including axial flow propeller pumps and centrifugal, or volute, pumps). The pumps can be driven either via a transmission belt from a pulley driven by the 2WT engine, or directly via a power-take-off shaft from the tractor's transmission (Plates 4.16 and 4.17).

The output of a pump varies according to the suction and discharge heads. Figure 4.1 shows the relationship between flow and discharge head: the greater the flow, the lower the total head the pump can reach and vice versa. The performance curve of a pump varies depending on the type of pump. For example, axial flow pumps can only work with low heads, but are able to move large volumes of water at surface level; on the other hand, centrifugal pumps, can suck water from deeper heads and pump it to higher heads, but they deliver lower volumes than an axial pump of similar power (they are, therefore, suitable for deep wells or for pumping at locations such as terraces that are higher than 5 m from the water level).

Plate 4.16 Axial flow propeller pump driven by a 2WT through belt transmission



Plate 4.17 Centrifugal pump driven by engine connected directly to power-take-off shaft

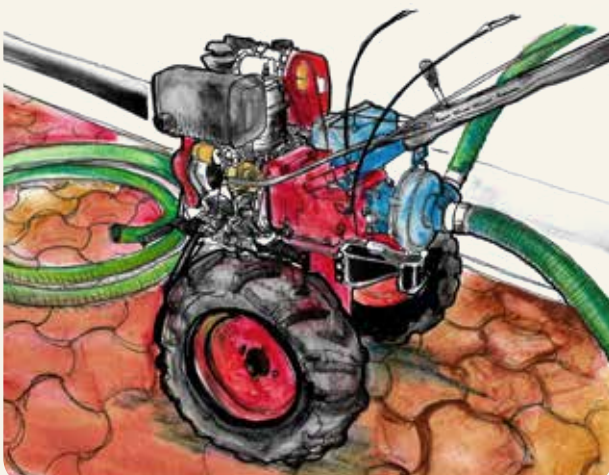

The suction head is the vertical downwards distance between the water source level and the pump; the discharge head is the vertical upwards distance between the pump and the delivery level. The rate of discharge also depends on the speed of rotation of the pump; therefore, it is important to use the appropriate pulley set up in the case of belt-powered pumps, in order to ensure the optimum working speed for the pump.

There are various methods of **measuring the rate of discharge**:

- **Flow meter.** Connected directly to the pump, it gives instant measurements of the water flow.
- **Tank and weir.** The discharge pipe is directed into a tank that has a V-notch weir overflowing into the water source. There are formulae for estimating the flow by measuring the height of water from the base of the notch.
- **Measured tank.** The discharge pipe is directed into a large tank of known dimensions. The time taken to fill the tank is measured and the flow rate calculated (in litres or m<sup>3</sup> per hour). This is the simplest method.

Figure 4.1 indicates how a pump discharge (Q) varies with changes in total head (H). The practical exercise involves putting points on the graph.

Note that pump discharge rates naturally decrease with decreasing pump speed of rotation. Reducing pump speed of rotation has a dramatic effect on the pump's discharge characteristics and performance (Figure 4.2).

### SAFE PUMP OPERATION

The following checklist is for guidance on safe and efficient pump operation. Before the practical exercise, participants run through these points under the guidance of the trainer.

Checklist for safe pump operation		✓
1	Check all bolts and junctions.	
2	Check for holes in the pump body.	
3	Check the greasing of the bushings.	
4	Clear the inlet of the pump from any obstructions.	
5	Check the level of oil and fuel in the engine.	
6	Check the belts for cracks or damage.	
7	Set up the belts.	
8	Ensure that the belts or PTO are correctly aligned with the pump.	
9	Ensure that the pump is not touching the bottom of the river or canal, and that it is not above the water surface.	
10	Check that both the engine and the pump are securely fastened to the ground or 2WT, to ensure they do not move during operation.	









## MODULE 5

# MANAGING A HIRE SERVICE AS A BUSINESS

**Trainer's guide to the module:** Managing a hire service involves diagnosis, planning, organization, leadership and control – running the business and its services in a way that is environmentally friendly. This module covers four basic areas in four separate sessions:

- Entrepreneurship and management in the hire service business.
- Hire service business organization.
- Managing hire service business operations.
- Managing financial aspects of the hire service business.

**Note for the trainer:** Some of the subject matter may be challenging for some of the participants, in particular, for those with low levels of numeracy. Keep this in mind and provide support as necessary.

In many regions acres are still preferred to hectares as the unit of land area. This module uses both measures and you, as the trainer, should make sure that locally used units of area are used.

### Module learning objectives:

- Understand the concepts of entrepreneurship and management.
- Understand the importance of managing a hire service as a business.
- Describe managing a hire service in terms of business organization, operations and finance.

- Demonstrate how to manage a hire service as a business.

**Suggested background reading:** The reference material listed is recommended for you, the trainer; share with participants as appropriate. The publications below are freely available online:

- › FAO. 2012. *Hire services by farmers for farmers*. B. Sims, A. Röttger & S. Mkomwa. Rome. Available at: <http://www.fao.org/3/a-i2475e.pdf>.
- › FAO. 2009. *Rural transport and traction enterprises for improved livelihoods*. P. Crossley, T. Chamen & J. Kienzle. Rome. Available at: <http://www.fao.org/3/a-i0525e.pdf>.
- › FAO. 2009. *Explaining the finances of machinery ownership*, J. Heney. Rome. Available at: [http://www.ruralfinanceandinvestment.org/sites/default/files/1257513712522\\_TAM3\\_final\\_lowres.pdf](http://www.ruralfinanceandinvestment.org/sites/default/files/1257513712522_TAM3_final_lowres.pdf).
- › FAO. 2005. *Explaining cash flow and savings*, J. Heney, Rome. Available at: [http://www.ruralfinanceandinvestment.org/sites/default/files/1136798915189\\_TAM\\_1\\_edited\\_Jan06.pdf](http://www.ruralfinanceandinvestment.org/sites/default/files/1136798915189_TAM_1_edited_Jan06.pdf).
- › FAO. 2009. *Explaining profitability and borrowing*. J. Heney. Rome. Available at: [http://www.ruralfinanceandinvestment.org/sites/default/files/1257513437786\\_TAM2\\_final\\_lowres.pdf](http://www.ruralfinanceandinvestment.org/sites/default/files/1257513437786_TAM2_final_lowres.pdf).

## SESSION 5.1

# ENTREPRENEURSHIP AND MANAGEMENT IN THE HIRE SERVICE BUSINESS

### Trainer's guide to the session:

This session provides an overview of hire service business management and shows the importance of ensuring that the business is managed in an "environmentally friendly way". It presents the concept of risk in business and how to deal with it. Reference is also made to the specific management topics covered in the module: business organization, business operations and finance.

### Learning objectives:

- Understand the difference between entrepreneurship and management.
- Describe what management is and what is involved in managing a hire service business. Why is good management important?
- Understand the main management skills of diagnosis, planning, organization, leadership and control.
- Describe what managing business operations means in a hire service business and why good management is important.
- Understand the importance of managing a hire service business in an environmentally friendly way.
- Understand the importance of risk and learn how to deal with it.

**Note to the trainer:** Exercise 1 includes the possibility of inviting the owner/manager of a hire service to give a brief presentation about their management experience – an undertaking that depends on local circumstances, time availability and budget. If feasible, organize the event in advance of training Session 5.1. Make arrangements, set a date and time when the presentation can be made, and ensure that any transport required is made available. The presentation must not exceed 20 minutes, allowing time for participants to ask questions. An alternative activity could be to have participants with previous experience in managing a hire service make brief presentations. Again, organize well prior to the session: ensure that presentations are brief, especially if there is more than one presenter, and allow sufficient time for participants to raise questions and debate the issues raised.

**Practical learning:** This session is based on two exercises designed to enable participants to understand what management is, the skills it requires and the essential ingredients of management in a hire service business. Exercise 1 is an optional exercise focusing on the hire service managerial experiences of a local hire service provider. Exercise 2 is based on Handout 5.1.1, "Entrepreneurship and management of a hire service business".

### EXERCISE 1. SHARING HIRE SERVICE MANAGERIAL EXPERIENCES

Invite presenters with experience in managing a hire service business to provide a brief presentation, followed by a question and answer session.

Facilitate discussion between participants and presenters and encourage participants to take notes on the main points of the discussions.

Ensure that the main points are recorded and made available to all participants.

### EXERCISE 2 WHAT IS MANAGEMENT IN A HIRE SERVICE BUSINESS?

Organize participants into groups, distribute Handout 5.1.1, and ask them to read and discuss it. Encourage and facilitate discussion and debate, and ask the following questions:

- What are the characteristics of entrepreneurs?
- How would you define management in a hire service business?
- What skills are involved in managing a hire service and why do you think these skills are important?
- Why is good management important?
- What do you think are the greatest challenges involved in management?
- Why is it important to manage a hire service in an environmentally sustainable way?
- What are the major risks that could affect your business?
- What is their likelihood and possible impact? How can you handle these risks?

## HANDOUT 5.1.1 ENTREPRENEURSHIP AND MANAGEMENT OF A HIRE SERVICE BUSINESS

### HIRE SERVICE PROVIDER AS ENTREPRENEUR

As a hire service provider, you are involved in business. Some managers are called “entrepreneurs”. What are entrepreneurs and how do they differ from managers of businesses in general?

Entrepreneurs are a particular type of businessperson with certain characteristics. They are determined and creative leaders. An entrepreneur likes to take calculated risks, and assumes responsibility for making profits and for coping with losses. Entrepreneurs are committed to expanding their business and constantly seek new opportunities, while looking for improved, more efficient and profitable ways of managing the business. An entrepreneur needs to be innovative, especially when the hire service business faces strong competition or operates in a constantly changing environment.

In addition to the “core values” of trustworthiness and honesty, entrepreneurs have qualities that set them apart from the average manager:

- ability to problem solve;
- flexibility;
- competitiveness;
- confidence; and
- drive.

Such qualities allow entrepreneurs to seek out business opportunities, conceptualize and initiate new business ideas, gather the physical, financial and human resources needed to start the business, set goals, and guide the business and its resources to accomplish those goals. Not all entrepreneurs have all of these traits to the same degree;

but they do have all of them to some degree. Without the core values of trustworthiness and honesty, their problem-solving nature, flexibility, drive, sense of competition and confidence, they would not be entrepreneurs.

### MANAGING THE BUSINESS

Hire service entrepreneurs understand the need to develop their business management skills. Aspects of managing a hire service business are covered in previous modules: Module 2 examines the market for services and the support services needed to operate a hire service business; Module 3 describes the step-by-step process of selecting power sources and equipment, based on technical and financial criteria.

What is management? It entails deciding how to use the resources at the disposal of the business, acting on these decisions, and ensuring that activities and tasks are completed effectively and efficiently. This means **doing the right things** (effectiveness) and **doing things right** (efficiency), for example, providing transport services to deliver farm produce to the correct destination as requested by the customer (doing the right things) while ensuring that the service is conducted on time and at a reasonable cost and a fair price (doing things right). To achieve effectiveness and efficiency, the service must be planned, organized, coordinated and controlled properly, i.e. managed as a business. The hire service manager performs these functions in each of the key areas of the business: organizing equipment, dealing with customers, directing marketing and promotion, supervising operations, managing finances and managing risks. Risk management is critical because business involves great risk.

(Note: herein, for “owner/manager”, the term “manager” is used: an owner must exert a managerial role if no specific manager is employed.)

#### Box 5.1: Management skills

**Diagnosis:** Managers of hire services require analytical skills to understand the business in all its parts. They must identify the constraints and opportunities that affect profitability. This entails analysing the cause of problems and identifying ways to overcome them.

**Planning:** Entrepreneurial managers are effective planners. Planning is fundamental for running a profitable business. Plans are based on the resources available and the business objectives set. The planning process involves choosing a particular course of action from various alternatives with the aim of attaining these objectives.

**Organization:** Managers prepare to implement a plan; they get everything in order, obtaining the inputs, materials and money needed to put a plan into effect. Successful managers are good implementers: determined and methodical in executing their plans.

**Leadership:** The successful manager is a good leader, motivating, enabling and drawing out the talent of staff

to achieve the goals of the business. Motivation requires good communication, building trust and confidence, creating a climate that encourages good performance and developing the capabilities, skills and competencies of staff.

**Control:** A successful businessperson understands the importance of controlling the business and making sure that performance goes according to plan and expectations. Sometimes called “monitoring”, control implies checking the progress of the business – in part or as a whole over time. Control is more than observation: a manager must carry out regular checks as plans are implemented, even when implemented successfully. Control requires daily monitoring, comparing expectations with actual performance and results, in order to identify weak points and adjust aspects of the business to improve performance.

The combination of these competencies and skills enables the hire service manager to take advantage of new business opportunities. Success depends on the ability to combine these competencies in practice. Interaction between these competencies and other resources of the business enables them to take advantage of any changes occurring and improve the performance of the business, increasing the chances of success and profitability.

### SUSTAINABLE MANAGEMENT

Sustainable management recognizes the fragility of the natural environment within which the business operates. Given that individual businesses typically focus on profit and rarely consider the impact on the environment, sustainable management is a challenge. Nevertheless, hire service providers increasingly provide “environmentally friendly” services in response to the demand from farmers for minimum tillage operations. Increased awareness among farmers about the negative environmental consequences of traditional mechanized practices makes hire service providers more environmentally sensitive and willing to offer environmentally sound services. This shift in thinking and the interest in providing “conservation-based services” can potentially increase the “bottom line” profitability of the business in the long term. The provision of training to operators in sustainable crop production practices and conservation agriculture (CA), for example, can reduce the environmental impact of a hire service business organization.

Successful hire service providers offering CA services focus on securing profits, while being aware of the long-term negative effect of unsustainable land use. Appropriate land management ensures that profits are maintained in the long term and that the business is sustainable. A true entrepreneurial spirit should strive to achieve natural resource sustainability, as wise use of scarce natural and human resources means staying in business longer.

Improved performance – in terms of productivity, profitability and efficiency – results in cost savings in both resource use and customer services, for example:

- Minimum- and no-tillage practices increase energy-use efficiency, resulting in cost savings.
- Improved planning of business operations and machinery management reduces waste and produces considerable savings in terms of fuel and oil consumption, resulting in lower costs and reduced engine emissions.
- Appropriate maintenance of assets over time ensures that a tractor runs at maximum efficiency, reducing costs and increasing productivity.

If a hire service offers direct seed drilling services using a tractor and no-till seeder that are not maintained properly, not only is fuel consumption higher, but there are other negative consequences: the service is not provided correctly, the soil structure can be damaged and production compromised. Excessive fuel consumption, soil damage and reduced yields are not what is expected from a quality hire service. **Inappropriate service is costly to the hire service, poor value for the customer and damaging to the environment.**

Plate 5.1 Environmentally friendly mechanization services © B. Sims



Environmentally friendly mechanization services lead to cost savings and greater, sustained profitability. Sustainability and profitability are not conflicting business goals. Sustainability is a source of cost efficiency and a way to increase sales of services. It can bring direct benefits to the business while securing its long-term position in the market.

## RISK MANAGEMENT

Hire service providers are exposed to uncertainties of weather, prices and policies. Uncertainty impacts the business both directly and indirectly (through its customers):

- Variations in rainfall condition the timing of machinery operations in land preparation and tillage.
- Attacks by pests and or infection by diseases affect the need for hire services.
- Price variations affect the income of farmers, influencing the demand for custom hire services.

In summary, the **risks faced by farmers affect the risks of the hire business**. Business risks for hire service suppliers lead to uncertain profits and the danger of losses occurring. Although many risks are not actually under the control of the hire service providers themselves, management strategies can still help cope with them. Moreover, a hire service business often faces **interrelated risks**: the ability to repay debts depends on the volume of services contracted and the custom hiring charges set; financing the business depends on the ability to borrow money and the capacity of the lender to supply credit in time. Different types of risk often need to be considered together and a good manager **balances risks**: an action that increases risk in one part of the business can be weighed against actions taken to reduce risk. Given the many sources of risk, management strategies must integrate different responses. This is called risk management.

How people deal with risk depends on their personality, their personal situation and the extent to which they wish to gamble. No two businesspeople are the same; some like to take more risk than others. Decisions depend on the specific situation: Does the businessperson have savings to ensure the family does not go hungry if the business fails? Are there money reserves to cover the repayment of loans?

In general, the greater the demands on the business for cash, the less likely the business is to absorb risk, as it is more vulnerable. Box 5.2 shows some common business strategies.

Notes

**Box 5.2: Risk management strategies**

<b>Offering low risk services</b>	Some services are characterized by reliable customer demand and fewer volatile variations. Transport services tend to be more reliable than tillage services; with the latter, demand may vary from one year to the next.
<b>Expanding the range of business lines</b>	Diversification of the range of services offered is based on the assumption that all lines of business will not fail together. If one line does not do well, the business still has other lines to rely on. The hire service income is not totally dependent on a single line of business. On the other hand, the benefit may be offset by increased costs, as a new line of business can be costly to start and may make very little money in the short term. The income made from two lines may not be as high as if the business specialized in one particular service.
<b>Offering services in different agro-ecological zones</b>	Geographic dispersion of land preparation and tillage services reduces the impact of localized weather conditions. Hire service providers can reduce risks in areas with a short time frame for land preparation and planting by taking advantage of the varying rainfall patterns in different parts of the country. They can move their tractors in line with the peak land preparation seasons, optimizing machinery use and expanding the scope of their business. On the other hand, greater mobility may result in increased expenses, with larger tractors needed to cover longer distances.
<b>Changing operational practices</b>	Using different machines and/or adopting new practices can help spread risk. For example, by investing in appropriate machinery and equipment, the service provider may be able to carry out more timely field operations and reduce the number of passes required for crop establishment.
<b>Maintaining reserves</b>	Reserves provide liquidity, which helps deal with variability. Reserves may be in the form of money or physical inputs. Reserves of spare parts, inputs and materials can protect the business from the risk of price changes. Alternatively, faced with an unexpected event, the assets can be sold and the proceeds used. Another strategy is to keep financial reserves that can be liquidated easily, such as bank accounts, stocks, bonds and financial assets.
<b>Leasing machinery</b>	Leasing (rather than purchasing) machinery allows the service provider to avoid debt commitments and preserve liquidity. Another option is the purchase of used (rather than new) machinery. A start-up business may choose to begin offering services with less than a full line of machinery. An established hire service provider may choose to buy second-hand machinery or rent machinery to be able to carry out a specific operation.
<b>Insuring against losses</b>	Insurance is a financial response to risk and provides a specialized source of liquidity. Businesses can use various forms of insurance to protect against specific types of loss. Insurance is the purchase of protection against a loss. It is logical to insure against risks with a low probability of occurrence but very adverse consequences. A wide range of insurance products with various levels of coverage is available.
<b>Maintaining resources</b>	Resources are valuable; looking after them reduces risks to the business. Examples of good resource maintenance are: proper care of machinery and equipment; keeping staff healthy and well trained; wise investment of cash; prompt repayment of debt; and trustworthiness in all business dealings.
<b>Pacing of investments</b>	Managing the pace of investments is an important response to variability. Postponing capital expenditures, including replacement of durable assets, is a response to risk.



## SESSION 5.2

# HIRE SERVICE BUSINESS ORGANIZATION

### Trainer's guide to the session:

This session covers the business organization of a hire service – how the hire service is set up as a business – with regard to location, ownership, assets, staff management, and supplier and customer relations.

### Learning objectives:

- Understand the importance of organization.
- Describe what business organization means for a hire service and why it is important.
- Describe the importance of ownership, partnerships, laws, staffing, and supplier and customer relations in managing the hire service business.

**Practical learning:** This session is based on two exercises designed to enable participants to understand what a hire service as a business organization is, its main components and the importance of managing them effectively. Exercise 1 is based on Handout 5.2.1, "Hire service business organization".

### EXERCISE 1. MANAGING THE HIRE SERVICE BUSINESS ORGANIZATION

Organize participants into groups, distribute Handout 5.2.1 and ask them to read it. Encourage and facilitate discussions and ask the following questions:

- What are the main organizational aspects of the hire service business?
- Why is it important to manage these aspects of the hire service business effectively?

### EXERCISE 2 SETTING UP A HIRE SERVICE BUSINESS

**Note to the trainer:** Begin the exercise with a plenary discussion about the hire service business in general. The following questions could be used to guide the discussion:

- Why do people start businesses?
- Why do you want to start a business?
- What are the benefits and costs?
- Why do businesses fail?
- What are the risks in setting up the business?
- How can you deal with risks?
- What impact will your business have on the community and the natural environment?
- How important is it to be environmentally sustainable? How can you make your business environmentally sustainable?

Divide participants into groups (of about five). Each group should decide on a particular hire service business. This may be based on their own experiences or on a business with which some of the group are familiar. If the group cannot agree on a single business or prefer to select two businesses, let them divide into subgroups.

Each group should describe the background to the service they selected, answering the following questions:

- Where is the hire service located?
- What is the local farming system?
- What assets do you have?
- What form of organization is it? (e.g. sole proprietorship, partnership, group enterprise, full-time/part-time business).

Ask the groups to plan the organization of their business by answering the following questions:

#### Organization:

- Why did you decide on your organizational model (sole owner-operator, partnership, group)? What are the advantages/disadvantages?
- Is it better to be part of a formal partnership or to form a partnership only for buying equipment and/or selling services?
- Is it beneficial to enter a partnership with an equipment dealer?
- What do you have to consider before going into a partnership?
- What are the pros and cons?
- Should you work as a full-time or part-time business? What are the pros and cons?

#### Services and customer relations:

- Who is your business going to sell services to?
- Will you only try to sell to a specific type of customer or to everyone in an area?
- What services are your customers likely to need?
- What services will you offer?
- How is your business going to sell these services?



## HANDOUT 5.2.1 HIRE SERVICE BUSINESS

The hire service business can be divided into key parts (see Figure 5.1):

- organization of the business;
- management and leadership;
- hire services offered; and
- relationships developed with suppliers, farmer-customers and financial organizations.

For successful operation of the business, hire service providers need strong linkages with machinery and equipment suppliers, spare parts dealers, fuel traders, financial organizations and, of course, their customers. Relations and links to a range of stakeholders help maintain the hire service business and ensure that high quality services are delivered effectively and efficiently to the satisfaction of their customers. Good relations with suppliers and customers contribute to profitability.

Figure 5.1 Organization of a hire service business (SP = service provider)

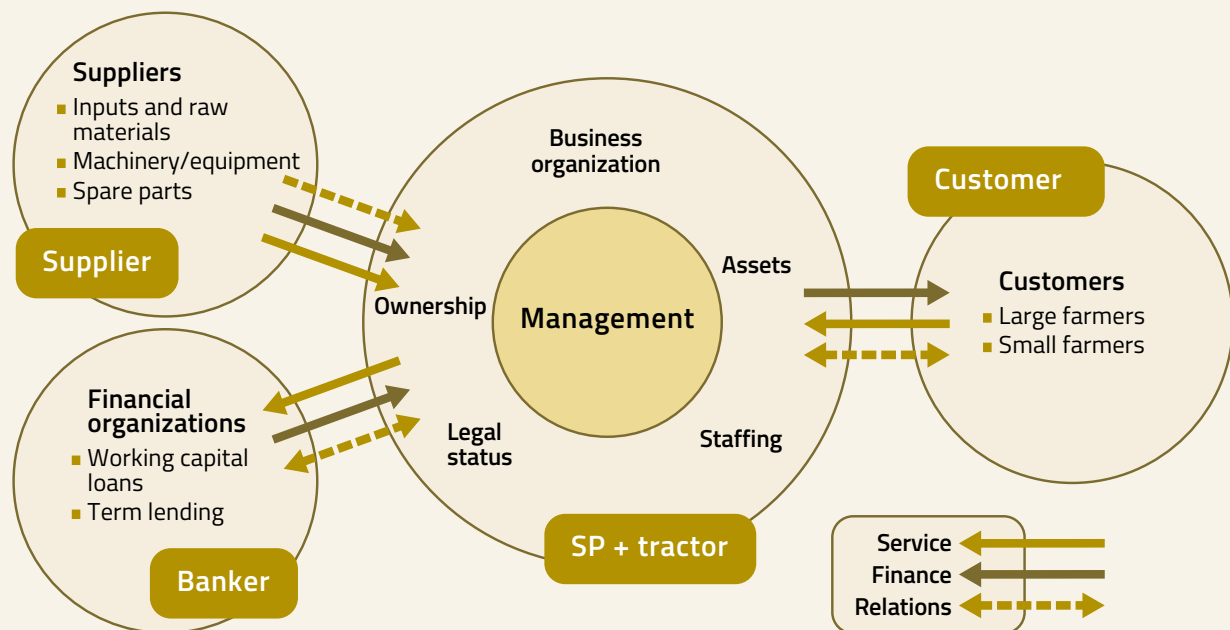

The organization of the business entails a wide range of issues:

**Ownership:** There are various forms of ownership:

- **Sole proprietor:** A single person - a farmer, dealer or other entrepreneur - owns the hire service.
- **Partnership:** Two or more farmers own the business; partnerships can be permanent or temporary.
- **Group:** A group may be a formal organization (e.g. cooperative or farmer association) or an informal association (e.g. self-help group).

There are advantages and disadvantages to each form of ownership and careful consideration is required when deciding the best form of business organization. For example, a partnership between two farmers has the advantage of reduced costs when buying a tractor and equipment; on the other hand, the farmers have their own requirements regarding personal use and, consequently, limitations with regard to availability for hire services.

**Legal status:** Registration of a hire service may be mandatory and a licence needed to operate the business. Tax payments, social security contributions for employees

and insurance to cover against accidents at work may also be required.

**Assets:** Business assets include premises, stores, office, machinery and spare parts. Even a small hire service has business premises, for example, a stable to keep draught animals and a shed to keep equipment and tools. A hire service managed by a machinery dealer may have a wide range of assets, including tractors, equipment, a storage room with spare parts, an office, a repair workshop with tools and a garage for the tractors. The manager must identify, record and know the value of the business assets in order to make effective decisions.

**Staff:** Most small-scale hire services only hire casual workers on an occasional basis. However, when a small business is successful, it grows and eventually needs hired labour. As it expands further, it may also need to employ administrative and financial staff. With growing staff numbers, human resource planning can help understand how many and what kind of staff are needed to run the hire service business. Depending on the range of services offered by the business and following an assessment of customer demand, it is possible to gain



## SESSION 5.3

# MANAGING HIRE SERVICE BUSINESS OPERATIONS

### Trainer's guide to the session:

Managing the operations of a hire service means dealing with all the tasks and activities required to run the business and provide services. This involves diagnosing, planning, organizing, leading and controlling all the components that make up the operations of the hire service business.

### Learning objectives:

- Describe what is meant by managing operations.
- Understand the importance of managing the operations of the business.
- Demonstrate how to prepare a schedule of operations.
- Describe some of the ways operations can be planned and controlled.

**Practical learning:** The exercise enables participants to understand what a hire service operation is, become familiar with its main management aspects and recognize the importance of managing operations. The exercise is based on Handout 5.3.1, "Managing the operations of a hire service business", and Handout 5.3.2, "Case study: Planning hire service operations".

**Note to the trainer:** This is a complicated exercise, but the intention is to get the participants to reflect on the process and raise questions. As the trainer, you should lead them through the solution (Box 5.3).

### EXERCISE

#### (BASED ON HANDOUTS 5.3.1 AND 5.3.2)

Distribute Handout 5.3.1 and allow sufficient time for participants to comprehend the content.

Divide the participants into groups and distribute Handout 5.3.2. Read the case study aloud to the participants.

Explain that the purpose of the exercise is to estimate the demand for hire services. Ask the participants how they would calculate the demand for the service based on the information provided. Encourage them to think seriously about what they would do. Ask if there is likely to be any time left to provide other services. What services would they suggest and why?

Ask each group to prepare a Gantt chart indicating the sequence of operations to be performed. Tell each group to decide on the dispatching rules for managing their business and show how they can be used.

Initiate a plenary discussion. Have each group report back and ask the following questions:

- Why is it important to keep in mind maintenance and repair times when managing operations?
- What more can be done to operate the business effectively?
- How can you make better use of staff and equipment?

Conclude the session by asking participants what they expect the major challenges to be in managing operations and how they would overcome them. Encourage discussion.

### Box 5.3: Solution

- Over the operating period (Nov.–Jan.), 24 days are available for each month. Over 3 months = 72 days (a).
- Note the number of hours that Patrick is willing to work each day (6 hours) (b).
- Calculate the number of hours available over the period ( $a \times b = 432$  hours).
- Acknowledge that there is likely to be downtime and explain why – breakages, travel time to field etc.
- Estimate the likely machinery downtime (40% here).
- Reduce the number of hours available by the downtime (number of hours available ( $432 \times 0.6$ ) [after downtime] = 260 hours).
- Calculate the demand for planting services over the season (average farm size  $\times$  number of farmers =  $1.5 \text{ ha} \times 30 \text{ farmers} = 45 \text{ ha}$ ).
- Calculate the demand in terms of hours needed to plant 45 ha.

- The ripper can cover  $1.4 \text{ ha/hour}$ , which is the same as  $0.71 \text{ hours/ha}$  ( $1/1.4$ ), i.e.  $45 \text{ ha} \times 0.71 = 32$  hours.
- Therefore, there are 260 hours available and only 32 hours of demand. This means that there is considerable time left over to do other work.

**Note:** The demand for planting services is likely to be spread over the 3-month planting period and the calculation should take into account the timing of the demand. While some of the time available will be spent on Patrick's own farm, there is still adequate time available to provide other services at different times of the year (shelling/transport). Depending on the availability of capital, there is potential to expand the business and buy additional multipurpose machines (e.g. for shelling, water pumping and milling).

### HANDOUT 5.3.1 MANAGING THE OPERATIONS OF A HIRE SERVICE BUSINESS

Managing the operations of a hire service business involves planning, organizing, leading and controlling the tasks and activities required to run the business and its services, and offering services in an environmentally sustainable way. The timing of service provision, the quality of the services offered and the need to ensure that the machinery is functioning properly are all critical. Importantly, managers also need to ensure regular maintenance and timely repairs of all power sources and equipment (see Module 4, Session 4.1). Customer satisfaction is vital to ensure a profitable business. The service organization and delivery must be efficient, effective and environmentally friendly. Proper scheduling and timing result in better precision and, consequently, a reduction in waste.

#### PLANNING MACHINERY SERVICES

Table 5.3.1a shows a calendar of work, and Figure 5.2 a tractor-use plan for 2WT operations in a maize-growing area in sub-Saharan Africa. The 2WT operations include ripping/planting as a bundled operation. The machine can also be used for shelling maize, irrigation (water pumping) and transportation. Table 5.3.1a indicates the method, timing and the output, seasonal demand and time required for each operation. Specifically:

- Work rate (output) is based on the service provider's estimate of what can be achieved.
- "Seasonal demand" is based on the number of customers requesting the service and the area/volume of demand for the operation (area of land, distance transported, volume of produce to be processed).
- Tractor-days demanded are obtained by dividing the seasonal demand by the work rate.

Compare the tractor-days demanded with the tractor-days available in a given period. To calculate the available time, multiply the number of days available by the average number of hours of operation per day. Include downtime, by taking into account the estimated time that the machine is not in use due to travelling to the customer's plot, breaks for operators for meals and rests, and breakdown. In Table 5.3.1a, provision is made for 6 working-days a week (48 hours per tractor-week) and for 4 weeks a month. In practice, demand may exceed time available; in this case, it may be necessary to work 7 days a week (instead of 6) and/or double shifts to complete the operation. At times of the year when there is no seasonal demand, it is important to allow the machinery to be used for off-farm operations, such as transportation.

The calendar in Figure 5.2 is a schedule of the demand and supply of 2WT service operations. It shows what machinery is required and when, highlighting when mechanization requirements cannot be met by the

**Table 5.3.1a Work calendar**

Crop	Maize				
Operation	Method	Time	Work rate	Seasonal demand	Tractor-days demanded
Planting/ripping	Double row	Mid-July - mid-Oct	1.2 ha/day	25 ha	21
Shelling	2WT-driven sheller		3 tonnes/day	34 tonnes	11
Water lifting	Axial pump		3 ha/day	4 ha	1
Transport	1-tonne trailer	Jan. - Dec.	4 km/day	40 tonne-km	10

*Figure 5.2 Schedule of demand and supply of tractor services*

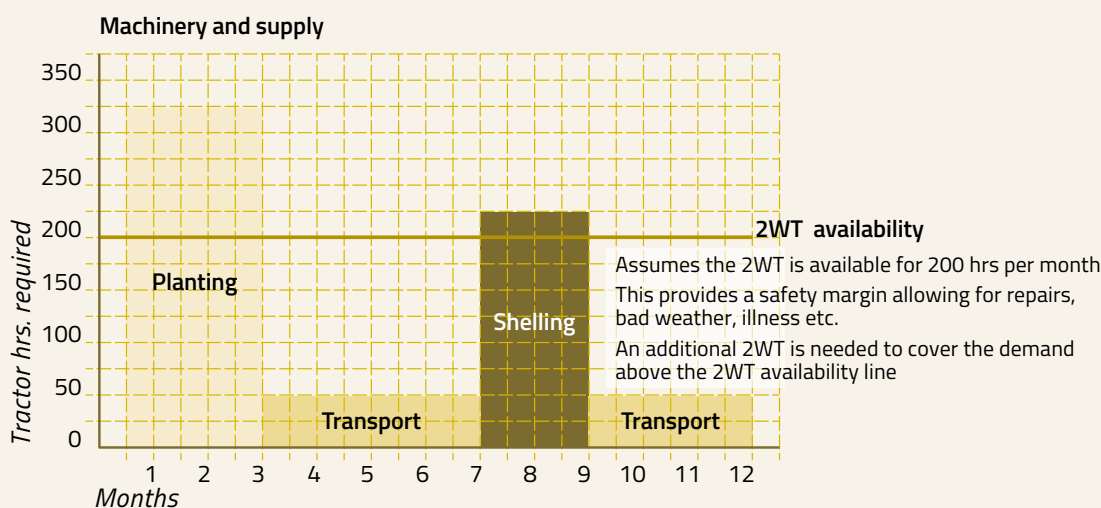

machinery available to the business. The calendar is based on a machine available to work 200 hours/month (8 hours/day, 25 days/month). The figure depicts demand for the different tractor operations on a monthly basis.

The calendar enables efficient management of the capital inputs. It shows what should be done and when, enabling the service provider to better coordinate work and improve machinery performance. Figure 5.2 shows that, in order to fully meet demand, a second 2WT is required between January and March (months 1-3) and between July and September (months 7-9). The manager must decide whether the greater demand in these months warrants the additional costs of purchasing a new machine and accessories. Alternatively, the service provider could decide to hire another machine to address the peak demand. When preparing a calendar of operations, consider the influence of the weather: for example, wet periods in the season could mean that the number of days available is fewer than the 25 days originally assumed.

Checklist of how to prepare a schedule		✓
1	Establish target dates for preparing the soil, planting, harvesting, and shelling/threshing and time available for transportation and other income-earning work.	
2	Establish the sequence of operations for each crop.	
3	Estimate the number of days available for the different operations and the actual time each of the operations is likely to take.	
4	Estimate the number of people needed to operate and assist in the tasks.	

In general, it is recommended to base the schedule on crop planting – because the planting date is critical – fitting other jobs before and after planting. Given the seasonal nature of agricultural services, there is often a shortage of machinery available at peak times of the year and under-use at other times. For this reason, it is advisable to delay or advance the timing of less critical jobs in order to spread machine use as evenly as possible. The manager must strive to improve tractor efficiency and performance by, for example, combining jobs, working in shifts or extending the number of working-hours per week. Based on all these considerations, the hire service provider must decide whether to purchase or hire a second machine.

### SCHEDULING OPERATIONS

Scheduling allows the manager to:

- plan and forecast the needs for the machinery;
- decide the location and timing in order to optimize use of the resources;
- allocate the time of use of the machines available;
- prioritize what services to provide; and
- decide when to conduct services, who will operate the machinery and what equipment will be needed.

Schedules may be on a monthly, seasonal or longer-term basis, but they are usually prepared for the short term. It is necessary to draw up a timing schedule of what is needed, when, where and for how long (see Table 5.3.1b).

Scheduling is important to:

- reduce the costs of operations;
- ensure that operations are completed by the due date or earlier; and
- meet customer expectations.

**Table 5.3.1b Timing schedule for service delivery**

Operation	Ripping service				
Timing	Mid. Jan.–mid. April				
Crop	Maize				
Machinery requirements	2W-tractor Ripper				
Labour requirements	2				
Customer	Area demand (ha)	No. of hours required	Location	Starting date	Completion date
1	2	3	Mohales Hoek	15 Jan.	18 Jan.
2	3	4	Mafeking	19 Jan.	22 Jan.
3	3	4	Manzini	26 Jan.	30 Jan.
4	4	4			
5	2	3			
Estimated total time					

These are sometimes **competing objectives**. Forward planning helps avoid competition and achieve a better balance of the three objectives; nevertheless, note that the weather can affect scheduling. The system for scheduling of field operations must meet the needs of the farmers while ensuring that machinery and operators are employed as continuously as possible and avoiding unnecessary travelling. Service providers (and/or operators) should meet with their customers to discuss their applications for fieldwork. A field schedule and operating plan can then be formulated based on the information collected and reviewed.

Sequencing can be represented in a Gantt chart (Table 5.3.1c). Time is listed in the top row, customers in the first column. The sequence of activities is highlighted in the timeline.

**DISPATCHING OPERATIONS**

Good management requires planning well ahead of time. Nevertheless, uncertainties are inevitable. Reality does not always respect plans, unexpected things happen. While planning is very useful, hire service managers still need a system for deciding the tasks to be done that week, or even on a particular day. This is called dispatching. For effective dispatching of operations, the manager must rapidly assess which jobs take priority. Establish simple rules to prioritize operations, based on, for example:

- **First come first served:** Prioritize the customer who orders a service first. This commonly applied rule is generally regarded as fair.
- **Shortest time to complete the operation:** Start first the task with the shortest operating time.
- **Shortest distance to customer:** Provide services to the nearest customers first. This reduces the costs of transportation.
- **Field size:** Prioritize field operations for customers with largest plots. This reduces turn-around time and increases revenue.
- **Earliest due date:** Start first the operation that needs to be completed the soonest. Operations that are not vital can be postponed.

- **Earliest start date:** Start first the operation that needs to commence the soonest.
- **Random selection of tasks:** Start whatever job happens to come up.
- **Economic importance:** Prioritize operations with the best economic returns.
- **Social network/family connection:** Prioritize customers according to relationships. Family and social obligations often outweigh business interests.

Despite rational decision-making, service providers still face practical obstacles to high productivity and efficiency. For example, service providers tend to prioritize farmers living close by, and when they do need to travel, prefer smallholder farms with at least a full day’s work available to make the journey worthwhile. Moreover, some farmers are reluctant to allow hire service operators to cross their land to reach neighbouring farms once their land has been tilled or planted. To overcome these problems, smallholders can pool their land to obtain a viable unit of land to be served. The service provider can also organize farmers into blocks and reach an agreement with the customers as a group about the logistics of providing services to all. It is also possible to request a deposit from farmers in advance to secure the service.

**CONTROLLING MACHINERY INVENTORY AND OPERATIONS**

Operations require careful monitoring: on completion of a service, it is important to check that the operation has been conducted appropriately and that the intended outcome has been achieved. The manager can visit the site of the service, and talk to both the operator and the customer.

All machines and equipment must undergo careful monitoring. Owners need to conduct inventories of the stocks of equipment, inputs and materials on a regular basis. For effective stock control, all assets – machines, equipment and spare parts – must be recorded accurately.

**Table 5.3.1c Gantt chart to show the sequence of operations for different customers**

	Sunday	Monday	Tuesday	Wednesday	Thursday	Friday	Saturday	Operator responsible
Customer 1								
Customer 2								
Customer 3								



### HANDOUT 5.3.2 CASE STUDY: PLANNING HIRE SERVICE OPERATIONS

Patrick is a maize farmer operating 1.0 ha of land with a 2WT, a plough and a trailer. He uses the 2WT and plough to prepare all his land under maize. Patrick saw demonstrations of minimum-tillage operations and watched a combined double-row ripper/planter in action. He witnessed how the planter reduces the number of passes required to plant maize and became convinced of the need to shift his operations towards conservation farming. He began using the planter on his farm and realized that it enabled him to reduce his energy and labour costs, offering potential to increase his income from farming. Patrick recently decided to extend his farming business and offer hire services to farmers located in his vicinity. He advertised his services and has already found 10 farmers interested in using his ripping/planting services. The average land area under maize for

these farmers is 1.5 ha. The trailer can also be used for transport but he has no idea of the demand.

- Based on the background data in Box 5.4, how would you calculate the demand for the planting service?
- Will there be time left to provide other services? What services would you suggest and why?

#### Box 5.4: Background data

- Timing of the combined ripping/planting operation (Nov.–Jan.)
- Number of available days per month = 24
- Hours of work per day = 6
- Downtime = 40%
- Work rate for maize = 1.4 ha/hour
- Average farm size of farmers = 1.5 ha
- Number of farmers interested in the service = 30

Plate 5.2 Forward planning results in increased efficiency and higher customer satisfaction © B. Sims



## SESSION 5.4

# MANAGING FINANCIAL ASPECTS OF THE HIRE SERVICE BUSINESS

### Trainer's guide to the session:

Managing finance in a hire service means dealing with money. It involves planning, organization and coordination, leadership, and the ability to control money. Financial management includes generating profit for the business, obtaining funds, ordering machinery and equipment to the best advantage, keeping assets in good working order, ensuring adequate cash flow for ongoing activities, and in the long term, achieving business growth. The hire service manager needs to make good financial decisions. Some aspects of finance are covered in Module 3, including cash flow, investment in machinery and loan appraisal. This session examines financial management more broadly and covers the following topics:

- Assessing the profitability of the business.
- Calculating hire charge rates.
- Preparing a business plan

### Learning objectives:

- Explain the concept of profit and show how it can be calculated.
- Understand how custom hire charges for services are set.
- Stress the importance of business planning and explain how to prepare plans.

**Practical learning:** This session is based on three exercises aimed at helping participants to understand what is involved in managing the finances of a hire service, calculating profits and estimating the income and expenses of their business. The session culminates in a demonstration of how to develop a business plan. Exercise 5.4.1 is based on Handout 5.4.1, "Managing the finances of a hire service business". Exercise 5.4.2 is based on Handout 5.4.2, "Setting hire charges", and Handout 5.4.3, "Estimating the income and expenses from Patrick's hire service operation". Exercise 5.4.3 is based on Handout 5.4.4, "The business plan".

### EXERCISE 5.4.1

#### MANAGING THE FINANCES OF A HIRE SERVICE BUSINESS

Maintain the groups formed for the exercise in Session 5.3. Distribute Handout 5.4.1 and allow sufficient time to read it. Encourage and facilitate discussion and ask the following questions:

- What is meant by managing finances in a hire service?
- How can you calculate profit and loss?
- What are the major challenges to managing finances?
- Is it important to keep records? How can they be useful?

### EXERCISE 5.4.2

#### ESTIMATING THE INCOME AND EXPENSES FROM PATRICK'S HIRE SERVICE OPERATION

This exercise is presented in Handout 5.4.3 and builds on the case study presented in Session 5.3 with additional background data. Participants should work in the same groups used in Session 5.3. Allow sufficient time to review Handout 5.4.2.

Some of the calculations in the handout may prove difficult: provide support where needed (Box 5.5).

After carefully reading the handout, the groups should answer the questions below. On completion of the exercise, hold a plenary during which each group presents their findings.

**Question 1:** How much should Patrick charge for the combined ripping/planting operation? Explain why Patrick should set this rate.

**Note to the trainer:** The rate charged for ripping/planting services can be based on the local rate for similar services (e.g. ploughing with draught animals or tractors). It is also possible to calculate more precise estimates of costs and returns.

- Estimate Patrick's revenue flow (on a monthly basis) from the tillage operations of the business.
- Estimate his expenditures (costs) of operating the machinery (on a monthly basis).
- Calculate his cash flow and interpret the findings.

### Box 5.5: Solution

- Cost per hour for the 2WT = \$12 (7+5).
- Factor in a profit margin: 20%. The hire service rate for the 2WT = \$14/hour.
- In the previous exercise, number of hours of operation = 86/month. Demand is 45 ha of ripping/planting service, i.e. the same as 63 hours (45 ha x 1.4 ha per hour).
- The service provider can generate an income of 63 hours x \$14/hour = \$882, spread over the 3 months available for planting. Scheduling depends on each hire service provider. This represents the income flow (inflow).
- Operation costs are the fixed and variable costs: \$12/hour. As calculated above, 63 hours of operation are required to service the 30 farmers. Total expenditure is \$756 (outflow). This should be distributed according to the schedule established by the hire service provider.
- The difference between the inflow and outflow is the net cash flow.

**Question 2:** How can income for the business be increased?

- Consider the data gaps for calculating the revenues and expenses for other operations.

**Note to the trainer:** As noted before, the machinery is not fully utilized throughout the year. There are no data provided to estimate the income and expenses from farm operations. Information is required on the costs of production, prices and yields to calculate the income and costs from growing maize.

If Patrick decides to use his tractor to provide transport services, he needs information about the demand for transportation of goods and people. He also needs to estimate how much to charge per unit transported, as well as the cost of providing the service. This information is currently unavailable.

Patrick could also look into using the 2WT for shelling, water lifting and other operations.

**Question 3:** What strategy do you suggest Patrick adopts to increase demand for his services?

**Note to the trainer:** Patrick could decide on a pricing strategy whereby he offers lower than market prices in order to develop demand and win customers. Once he has regular customers he could raise prices and profits.

He could develop a promotional strategy including demonstrations for new farmers, advertising and raising awareness among people in his area of his business and the services on offer.

He might examine the possibility of broadening the range of services on offer in order to make full use of the machinery throughout the year.

On completion of the exercise, open up a discussion on the experience of the participants and how they (or service providers they may know) set their hire service charges. Make sure you ask how many hours of work they do with the equipment.

### EXERCISE 5.4.3 BUSINESS PLANNING

This exercise involves the participants preparing a business plan.

As the trainer, present the concept of a business plan, explaining its purpose and importance. Initiate a discussion on the experiences of the participants in planning and preparing business plans.

Organize the participants in small groups and ask each group to agree on their own hire service business. Encourage brainstorming about the nature of the business, services offered, location, customers etc.

Ask the participants to review Handout 5.4.4. Instruct each group to complete all parts of the business plan elaborated on in the handout:

- marketing plan,
- assessment of profitability;
- cash flow analysis; and
- risk assessment.

Ask the groups to present their business plan to the plenary. Discuss the business plans with a view to confirming and/or changing them. Ask the participants if the plans are realistic, if they are challenging, whether there are better options.

Encourage participants to discuss the risks to their selected business.

**Note to the trainer:** Refer to Box 5.6 to facilitate discussion with the groups.

### Box 5.6

#### Marketing plan

Brainstorm about the possible target customers for their services. Guide the discussion with the following questions:

- What do you know about your customers?
- What type of services do your customers want?
- When is the best time to provide the service?
- What do you know about the market for your service?
- Is the customer group likely to become larger over time?
- If so, will there be an increase in demand?

**Based on the target customers, ask the participants to consider the following questions:**

- What prices are you likely to charge for your service?
- What costs will you incur to provide the service?
- What are the costs of promoting your business and expanding demand?

Ask participants to work in their groups to develop a market strategy for their selected business.

#### Assessment of profitability

Ask participants to estimate the profitability of their selected business.

#### Cash flow analysis

Review the lessons from the exercise on cash flow. Tell groups to follow the procedure below:

Activity	Sept.	Oct.	Nov.	Dec.	Jan.	Feb.	Mar.	Apr.	May	Jun.	Jul.	Aug.	Total
<b>Cash inflow</b>													
Service charges													
Cash available													
<b>Cash outflow</b>													
e.g. fuel													
Cash needed													
Net cash flow													

#### Steps (Note: See also Table 3.5.5a in Module 3, Handout 3.5.5):

- Calculate the expected income from the provision of machinery hire services and determine when the cash will be received. Write this amount in the appropriate month.
- For each outflow, decide when it will occur (e.g. buying fuel) and how much cash will be needed. Write the amounts in the appropriate rows and months.
- Add up the income for each month and record the total in the appropriate box. Add up the costs for each month and record the total in the appropriate box.
- For each month, calculate the difference between cash in and cash out to show the cash requirements for each month and identify the months with a cash shortfall.
- For each month where there is a cash shortfall, decide if the business will use its own cash or borrow money.
- Decide where to borrow the cash required and record this in the group business plan.

Encourage participants to reflect on their cash flows and credit plans and ask:

- Are the cash flows accurate?
- Has sufficient thought been given to the need to find credit for months with a cash shortfall?

#### Risk management

Each group should set up a table along the following lines:

Risk and the harm it can do	How to handle the risk

### HANDOUT 5.4.1 MANAGING THE HIRE SERVICE BUSINESS FOR PROFIT

A hire service that generates profits has the potential to increase income, address cash shortfalls over the year and cover the costs of new investments and any additional expenses involved in running the business. The hire service business needs to **earn sufficient** to:

- cover the costs of doing business;
- set money aside (savings); and
- buy new machinery and equipment.

Knowing the financial situation of the business enables managers to understand what money is available to expand the business. In order to generate money to cover the expenses involved, the manager needs skills to plan and manage finances.

The main purpose of a hire service business is to make a profit. **Profit is the difference between the revenue (income) and the expenses** associated with the hire service business.

- Revenue comes from the sale of services at different charge rates. These charges could be set on an hourly, daily or area (hectare or acre) basis.
- Expenses include the costs associated with providing the service. These often include salaries of machinery operators, depreciation of equipment and machinery, and the running costs of operating costs of the machines.

A mechanization hire service business is a collection of different lines of operations. The business may provide services for different operations – land preparation, planting, spraying, shelling, pumping and transportation, to name a few. Each operation makes a unique contribution to the profitability of the whole business. The hire service business can make a profit as a whole even when one of its services (or lines of operation) is making a loss. It is important for managers to look not only at the business as a whole, but also at the profitability of each service offered. While they need to be able to make decisions about the whole business, they also need to make decisions about the individual lines of operation. Figure 5.3 presents the factors affecting the profit of a service operation:

- Annual profit is annual revenue minus annual costs.
- Annual revenue is custom hire charge multiplied by throughput.
- Throughput is machine work rate per hour × months per year × hours per month. (Alternatively, throughput can be calculated on an area basis).
- Revenue of the service business is the hire charge (per acre or hectare) multiplied by the number of units of land serviced.
- Annual costs are a combination of fixed and variable costs.

In summary:

Hire charge per unit × number of units serviced = revenue  
– variable costs – fixed costs = profit

Figure 5.1 Organization of a hire service business

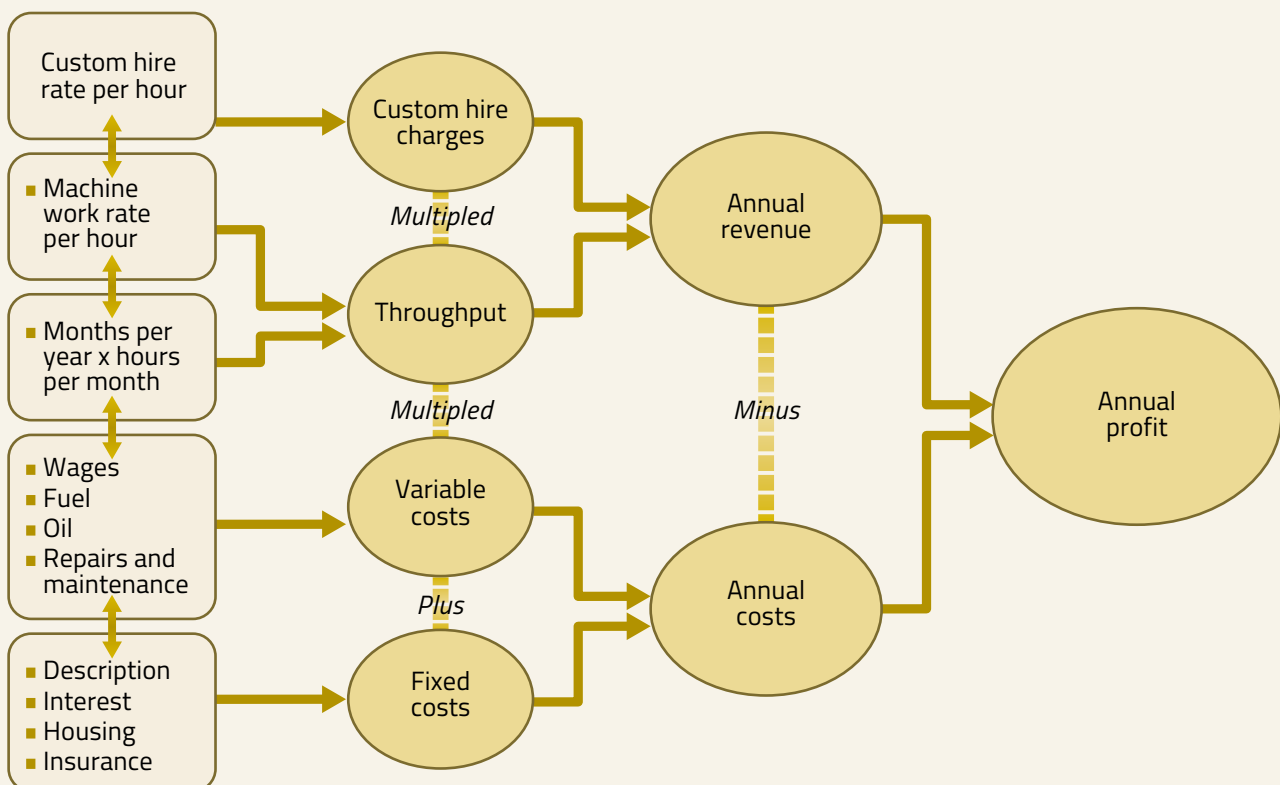

**Example calculation:**

Table 5.4.1a is an example of a planting service in India, based on the following assumptions:

- The hire service provider has 25 days available to provide the planting (seeding) service.
- The work rate for the operation is 3 acres/day.
- The annual use of the machine is assumed to be 1 000 hours.
- The work rate of the tractor is 1.5 hours/acre.
- The tractor can cover 75 acres/year.

A simple calculation shows that the tractor will only be used for the planting services for 11.2% of its annual life:

$$\begin{aligned} \text{Number of acres serviced per year} &= \\ &= 3 \text{ acres/day} \times 25 \text{ days} = 75 \text{ acres} \\ \text{Proportionate use of tractor for planting services} &= \\ &= (75 \text{ acres/year} \times 1.5 \text{ hours/acre}) \div 1\,000 \text{ hours/year} = \\ &= 0.1125 (= 11.25\%) \end{aligned}$$

This is important information to calculate the fixed costs for the planting operation.

**Table 5.4.1a Profit calculation for tractor-powered crop planting service, India<sup>1</sup>**

Profit calculation (on a yearly basis)	
<b>Total revenue (\$)</b>	900 = 75 acres × \$12/acre
<b>Variable costs (\$)</b>	
Fuel	261 = 75 acres × 4 litres/acre × \$0.87/litre
Hired labour	112.5 = 25 days × \$4.5/day
Repair and maintenance: drill	41.25 = \$825 × 0.25/5 years
Repair and maintenance: tractor	37.1 = (\$8 250 × 0.40/10 years) × 0.1125
<b>Total variable costs</b>	<b>451.3</b>
<b>Fixed costs (\$)</b>	
Depreciation of drill	153 = (825 – 60) ÷ 5 years
Interest on capital: drill	44.2 = ((825 + 60) ÷ 2) × 0.10
Prop. Depreciation: tractor <sup>2</sup>	67.5 = ((8 250 – 2 250) ÷ 10 years) × 0.1125
Prop. interest on capital: tractor	59 = ((8 250 + 2 250) ÷ 2) × 0.10 × 0.1125
<b>Total fixed costs (\$)</b>	<b>323.8</b>
<b>Profit (\$)</b>	<b>124.9 = 900 – 451.3 – 323.8</b>
Profit per acre	1.7 = 124.9 ÷ 75 acres
Profit per day	5.0 = 124.9 ÷ 25 days

<sup>1</sup> Keil, A. & Kahan, D. 2016. *Zero-tillage service provision as a business opportunity*. Course manual (1 day), December 2016. CIMMYT.

<sup>2</sup> While the depreciation of the tractor and related interest on capital are fixed costs, the share that can be attributed to planting service provision is proportionate to its use for this activity.

The profit is \$124.9. This indicates that planting service provision is a profitable business (even if the seeder is not used on the service provider's own farm), as both variable and fixed costs are fully covered and some profit is generated. Dividing total profit by the number of acres serviced, the net profit is \$1.7/acre. Likewise, the service provider earns \$5.0/day of planting service provision. Whether the planting service is an attractive business depends on how much the service provider can earn from alternative activities during the same time of year. Note: Profit is not the same as cash. Profit tells whether the business is financially sustainable and can support the manager and his or her family; cash is tied up in equipment, machinery and other assets.

**Calculating overall profit is a step-by-step process:****STEP 1. SETTING A PRICE FOR THE SERVICE**

Setting the right charge for a service is vital for calculating revenue or income flow. If the price is too high, the demand for the service may drop. If the price is too low, the service may not make sufficient to cover its costs. While the price depends on what customers are prepared to pay, the manager needs to check that it at least covers the costs. If the price customers are prepared to pay is less than the cost of providing the service, increasing the charges is not the answer, as it could simply result in no service being on offer. Instead, the manager should examine the costs, both fixed and variable, to see whether it is possible to reduce some of them. However, cutting costs should not result in a lower quality of service, as this would result in fewer people wanting to receive the service. See Handout 5.4.2 for a detailed step-by-step methodology for setting hiring charges.

When a business starts up, the benchmark for hiring charges is the rates of other service providers in the locality, as it is difficult to break into a market by offering more expensive services. Some flexibility in hire rates can and should be allowed (see Table 5.4.1b).

**STEP 2. ESTIMATING COSTS**

For all items of expenditure, detailed cost estimates are needed. They must take into account both fixed and variable costs, which together make up total costs.

**STEP 3. DEMAND FOR SERVICES**

A manager needs to know what the demand is for services in a given time period, when and where they are needed (see Module 2).

**STEP 4. PROFIT AND LOSS CALCULATION**

Following Steps 1–3, it is possible to calculate profit and loss (see Table 5.4.1c).

**Table 5.4.1b Factors affecting hire rates for custom mechanization services**

<b>Factors resulting in lower rates</b>	<b>Factors resulting in higher rates</b>
Informal arrangements between family members and friends	High draught work demanding more fuel and time
Close proximity of customer to business location	Poor conditions in the field (e.g. rocks, tree stumps, steep slopes, irregular shape)
Operator's wish to keep equipment working and recover at least part of the fixed costs (plus variable costs)	Small jobs in conditions of low field efficiency
Use of older equipment which may be fully depreciated	Use of novel machinery giving a superior end result
Discounts for customers demanding large amounts of work	Use of highly skilled operators resulting in improved customer satisfaction

**Table 5.4.1c Profit and loss of the hire service business**

<b>Annual costs of operations (\$)</b>		<b>Annual income from hire services (\$)</b>	
<b>Annual fixed costs</b>		Income from tillage	250
Rent of land	50	Income from irrigation	125
Depreciation of machinery	20	Income from shelling	450
Rent of office	10	Income from transportation	500
Rent of storage	5	<b>Gross income</b>	1 325
<b>Total fixed costs</b>	85		
<b>Annual variable costs</b>			
Fuel and oil	100		
Repairs and maintenance on machinery	200		
Labour	100		
<b>Total variable costs</b>	400		
<b>Total costs</b>	485	<b>Net profit/income</b>	840

## HANDOUT 5.4.2 SETTING HIRE CHARGES

In order to know how much to charge for ripping a field, transporting crops or undertaking any other task (e.g. drilling, spraying or harvesting), it is necessary to understand how much it costs to own and operate equipment on an hourly basis, and all other costs involved in offering hire services. It is then possible to set hiring charges. Hire charges are complex to calculate and need to be based on data collected from records.

Service providers frequently assess hiring charges intuitively based on the rates for other hire services in the market. The market rates may not directly match the service provided and often have to be adapted for small-scale mechanization. Moreover, market rates are often not an accurate reflection of the actual costs involved.

For a precise calculation of **costs**:

- take the total fixed and variable costs;
- apply a common base of time (hours), area (ha) or produce processed (tonnes) – depending on the operation; and
- add margins to account for the return to management and labour.

It is also key to calculate the **work rate** for various items of machinery, i.e. the number of hours per hectare (or ha/tonnes per hour) that a machine can conduct a farm operation (see Module 3, Handout 3.5.2). Work rate depends on:

- travel speed of the machine;
- load pulled; and
- working width of implement.

In countries where a market exists for mechanization services, market rates can be found by conducting an assessment of hire charges in the rural area. In sub-Saharan Africa, 2WT mechanization is a new technology and markets tend to be undeveloped. A market, however, is likely to exist for 4WTs and/or draught oxen and may be used as a base for setting 2WT rates. While this is a quick and easy way of setting hiring charges, note that **custom rates may not be an accurate representation of the full cost** of the machinery to the owner, for example, if:

- owners are not familiar with the operational cost items;
- no records are kept; or
- the machine was purchased a long time ago, the cost may be treated as sunk costs.

The costs of machinery (already owned) are incurred whether or not the business performs additional operations. If a service provider offers custom operations to farmers, the fixed costs are spread over a larger area, reducing per unit costs. For this reason, operations can have different values depending on the volume of work on offer as well as the timing.

## STEP 1. DEFINE THE COSTS INVOLVED

To determine appropriate hire charges, first define the machinery costs (Box 5.7)

### Box 5.7: Costs

Variable costs	Fixed costs
- Labour	- Cost of the machinery
- Fuel and lubricants	- Depreciation
- Spare parts	- Interest charges
	- Insurance and road license
	- Storage costs

## STEP 2. ESTIMATE THE COSTS

Once defined, estimate the actual costs. The cost of machinery is the purchase price of the machine. Machinery repairs include replacement of parts due to age, wear or accident. Fuel and oil expenses are simply the fuel and lubrication expenditures. Fixed costs of operation include depreciation, interest charges, insurance and shelter costs for storing machinery (see Module 3, Handout 3.5.4).

Calculate the **annual costs** of simply owning the machinery, i.e. the fixed costs: depreciation, insurance and interest paid on any loan (see Table 5.4.2a).

Table 5.4.2a Annual fixed costs

Annual fixed costs	\$
Depreciation:	
• Tractor	3 375
• Ripper (5 000 – 250)/10 years	475
• Trailer (6 000 – 400)/8 years	700
• Tractor shed (1 000/10 years)	100
Interest estimated as 8% of average investment in machinery (46 000 + 8 650/2) × 8%	2 186
Insurance	320
<b>Total</b>	<b>7 156</b>

Source: Heney, J. *Talking about money*. No. 3. FAO (adapted).

If the tractor is used for 200 hours a year, the fixed costs per hour are: \$7 156/200 = \$35.7.

The next step is to calculate the **variable costs**. Table 5.4.2b provides estimates based on the assumption that the hire service provider drives the tractor himself and the tractor is used for 200 hours a year.



**Table 5.4.2b. Annual variable costs**

Annual variable costs	\$
1 200 litres fuel (estimated at 6 litres/hour and \$0.75/litre)	900
Oil and filters (estimated at 15% of fuel cost)	135
Repairs and spares (estimated as 5% of purchase price)	2 300
<b>Total</b>	<b>3 335</b>

Notes

**STEP 3. CALCULATE THE WORK RATE**

Apply a common basis to the fixed and variable costs in order to calculate the hiring charge costs. The common basis could be hectares or hours of use (in the example herein, hours). Based on the number of hours for each operation, express costs in hours per hectare. Note that many field operations are seasonal and this affects the number of hours available. Calculate the hourly cost of a given operation by dividing the fixed and variable costs by the number of hours of work.

In the example above:

- The variable costs per hour are \$16.68. Based on these figures, the total costs per hour are \$52.46. Therefore, assuming 4 hours to rip 1 ha, the hire service needs an income of at least \$209.8/ha just to cover the machinery costs.
- An additional 200 hours of work during the year would significantly reduce costs: fixed costs would be spread over 400 hours, reducing them to \$17.89/hour; total variable costs would double, but the hourly rate would remain the same at \$16.68, provided the hire service provider continued to do all the work himself. The overall cost of the machinery would reduce to \$34.57/hour. Therefore, still assuming 4 hours to rip 1 ha, the hire service needs an income of just \$138.28 to cover the basic cost of ripping.
- Naturally, the hire service owner does not wish merely to cover costs, but also to make a profit.

**STEP 4. ESTIMATE THE MARGIN**

The above calculation considers operation costs. It is necessary to add a margin for profit and management, because making money above the costs enables service providers to save more and, crucially, they must earn a salary. Service providers need to make a profit. If the price is too high, customers may not be able to pay and competitors could charge a lower price and take work away. In the example, in order to make a profit, the service provider might charge a customer \$160/ha for ripping land, i.e. a mark-up of just over 15%. Contract charges for transport work in the locality are normally charged on an hourly basis, so the service provider might charge \$40/hour if using his/her tractor for 400 hours a year.



## HANDOUT 5.4.4 BUSINESS PLAN

For the hire service business, planning means working out what to do in the future to improve the business. Business plans may be simple or complex and are an important tool in the decision-making process. It is recommended to draw up plans when starting or expanding a business, but annual plans can also be useful. The plan should lay down the vision of the business and the objectives set by the owner or manager. A vision is a view of how the business will look after some period, typically a number of years. It is a description of the future of the business. In order to achieve the vision, identify goals for the business that will push it, step-by-step, towards its vision. In order to do this, estimate demand and then decide on the services to be offered.

Once the business plan is prepared, **verify that it is operationally possible**. For example:

- Is the necessary machinery ready?
- Is any additional equipment required?
- Are skilled staff available?

Check all these things before committing funds to developing the line of hire service. If the service is technically feasible, verify whether it is likely to be profitable. Make estimates of the expected costs and revenues to show whether the potential income from the service can cover the operating costs of providing the service. **If not profitable, do not provide the hire service.** The business plan comprises: a market assessment; a profitability analysis of the different hire services offered and of the business as a whole; a financial appraisal to check if the required funds are available; and a strategy to cover risks.

**Marketing plan.** The marketing plan should consider the target customers, the current and projected demand for services, the range of services offered to customers, and an estimate of the costs associated with promoting demand. The assessment of demand needs to address the following questions:

- What types of customers are in the market for services?
- What are those services?
- How aware are customers of the services offered?
- Do they understand the benefits that the services can bring?

The most effective way to develop the demand for services is to make sure that the services are high quality, cost-effective and available on time. Satisfied customers will tell friends and neighbours that the services offered are of high quality. As a businessperson, you can actively develop the market by advertising or making field visits to potential clients. Field days and demonstrations are also popular ways of expanding the market.

**Assessment of profitability.** The core of the business plan is an assessment of profitability. Answer the following questions:

- What services are being offered?

- What machinery and equipment are needed?
- How much of each service will be demanded?
- What price per unit will you charge for the services offered?
- What do they cost?
- What are your expected annual fixed and variable costs?
- What are the income streams of your business?
- What is your profit forecast?

**Cash flow analysis.** Even if the hire service business is profitable, the income is likely to come at different times during the year; it is important to know if there will be enough cash to carry out business activities throughout the year. If cash is insufficient, you need to decide what to do. Conduct a cash flow analysis to **assess cash availability**.

**Risk assessment.** The final stage of business planning is to examine the risks that could occur, i.e. things that could happen causing harm to the business. The potential risks need to be considered ahead of time and included as part of the narrative description in the business plan, so that the manager can prepare for them. Potential risks include:

- changes in interest rates for loans;
- drought or dry spells affecting the timing and demand for machinery services; and
- increases in the cost of fuel and oil.

Notes

---



---



---



---



---



---



---



---



---



---



---



---





