

Introduction

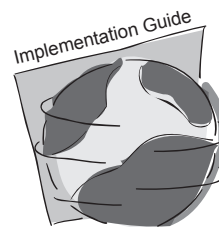

GLOBE is the “quintessentially ideal program for involving kids in science” according to NOBEL Laureate, Dr. Leon Lederman. From the practical standpoint, GLOBE can benefit teachers and students in the following ways:

- GLOBE is an interdisciplinary program.
- GLOBE *Learning Activities* and *Protocols* are aligned with the National Science Education Standards.
- GLOBE activities are consistent with the US Department of Education’s priorities for international education by increasing knowledge and expertise about other regions, cultures, languages and international issues.
- Independent evaluations show that GLOBE improves students’ higher order thinking and science process skills.



What Will You and Your Students Do in the GLOBE Program?

Your students will be carrying out a series of investigations that scientists have designed to gather data about the Earth and how it functions as a global system. Students will be using instruments and their own senses to observe the environment at multiple sites near your school. They will record the data they gather, save it in a permanent school data record, and send it to the GLOBE science data archive (the GLOBE database) using the Internet or email where the Internet is not readily available. The GLOBE *Teacher’s Guide* also includes *Learning Activities* that can be adapted to your local curricular needs.

Don’t worry if you’re not an experienced science teacher. The learning materials provide a range of activities, from beginning activities to be used by teachers of young children who might have had little to no experience with science, to more complicated activities for the advanced level. Each *Learning Activity* provides the background information needed to successfully complete the activity.

Each of the *Protocols* and *Learning Activities* includes a designation of recommended grade levels, in three categories:

- **Primary** - Ages 5-9 years.
- **Middle** - Ages 10-13 years.
- **Secondary** - Ages 14-18.

However, do not feel locked in by these grade level distinctions. Many of the activities can be adapted to lower or higher levels, based on your students’ needs and abilities.

Ultimately, your GLOBE classroom and the study sites where you make the measurements are likely to be very busy places for science and learning. Your students will observe and make measurements, record their data, come to understand accuracy and precision, share their data with other students and scientists, conduct labs, formulate questions, test



hypotheses, and develop theories to make sense of the data. They will use a variety of scientific instruments, calibrate those instruments, and try to understand potential sources of error in the measurements they take with the instruments. They will work with real data, some that they collect and some that they obtain from other GLOBE schools around the world.

There are six key educational elements of the GLOBE program.

1. Selecting local study and sample sites

sites - You will pick local study sites for your recurring measurements along with sample sites, which the students will normally visit only once. For example, the Hydrosphere Study Site should be a nearby river, lake, bay, ocean, or pond. All of the study and sample sites could be within a 15 km x 15 km GLOBE Study Site, with your school at its center. Many schools also choose to maintain additional study sites located outside of their immediate school site in order to gather comparative data for a more complete investigation of their local environment. We have included guidelines for selection of study sites in the *Appendix* section of this Implementation Guide for Teachers.

2. Taking measurements carefully on a regular schedule

- Students should begin with one measurement and then, over the course of a few months, add new measurements one-by-one as they learn how to do them. As their teacher, you need to make sure your students understand the measurements and do them accurately. Most of the measurement *Protocols* specify a regular schedule for taking data and some require observations at specific times. Weather measurements, which are daily, can be done most easily at a sight adjacent to your school. Others, such as the weekly hydrosphere measurements, will require going to the selected study site. Working with your students, their parents, and your school community to have measurements made during weekends and school vacations is also important in obtaining

an accurate record of your local environment for use by scientists and your students.

3. Submitting the data - All data should be submitted to the GLOBE Science Data Archive. The most common way to submit data is by computer and the Internet; email submission of data is also possible using a spreadsheet for which we supply a template and instructions. See the GLOBE website for this information.

4. Complete the Learning Activities

- Each investigation has a set of *Learning Activities* that help your students learn more about the science domains, the instruments and procedures for the measurements, and the ways that students and scientists can use the data collected. We hope you will use these *Learning Activities*, either as described, or by adapting them to your local needs. Your experiences in using these *Learning Activities* or new *Learning Activities* you develop can be shared with other GLOBE teachers to benefit the entire Program.

5. Using GLOBE systems on the Internet to explore and communicate

- GLOBE has created some powerful (and easy to use) computer software, which enables you to communicate with other schools and with scientists participating in the GISN (GLOBE International Scientist Network). It also allows your students see and interact with local and worldwide maps on which the GLOBE data are displayed.

6. Promoting student investigations

- Ultimately, our hope is that your students will do their own investigations at local sites, or by using the GLOBE software and data collected by other students worldwide. Examples of student investigations are given at the end of many of the *Protocols*. Your students might even make some new scientific discoveries of their own that can be published on the GLOBE website and disseminated at GLOBE student conferences!



Science Values and GLOBE Measurements

There are four characteristics needed in GLOBE measurements that will form a foundation for their ultimate contributions to science. They are accuracy, consistency, persistence, and coverage. Data sets which have all four characteristics result in enhanced worldwide understanding of our environment.

Accuracy is the foundation of all scientific observation. For us, care in taking the measurements is the first step. Also, the equipment we use and our effort to keep it in good condition are important. Lastly, we all need to strive for perfection in recording data entries and reporting them to the data archive.

Consistency means that the data from any GLOBE school can be used together with the data from all the others to produce a consistent picture of what is happening around the world. The visualizations illustrate this characteristic. Consistency is also important over time. Students at each school are building a climate record of their location. To see changes and trends in our individual environments, the data that have been taken in the past must be directly comparable to the data we are taking today. Careful adherence to the **Protocols** and documentation of changes in methods and techniques are the best approaches to achieving this characteristic.

Persistence is required to keep interruptions in our climate records to a minimum. Occasional measurements are useful, but regular observations provide more information, allowing a greater understanding of what is happening at a measurement site. Also, regular observations are often easier to interpret and are used with greater confidence, especially when unusual phenomena are measured. The longer a consistent climate record is, the more valuable it is. Think of the lucky GLOBE students five years from now who will be able to look at variations and trends in the environment of their school!

Coverage of whole regions, countries, continents, and as much of our planet as possible will also enhance the value of our data sets. The differences in the visualizations where there are many schools versus only

a few illustrate this. The properties of our environment vary over many different spatial scales locally within our 15 km by 15 km GLOBE Study Sites, regionally across our metropolitan areas, states, or countries, and globally. Measuring these properties on these different scales is essential, and as the GLOBE Program grows to include more schools in more countries, the importance of our collective contributions will continue to grow.

Individually and collectively, all of us in GLOBE must strive for accurate and consistent measurements made persistently across our global environment.

GLOBE Measurements in Time and Space

We live on a changing planet. Moment by moment, day-to-day, year after year change is all around us. Some changes are cycles such as the day, the variations in the tides as the moon orbits the Earth, and the yearly change of seasons. Other changes seem to come and go such as clouds and rainstorms. Still other, gradual change we see as growth such as with trees or other plants or even ourselves. Sometimes big changes happen quickly as when a volcano erupts or a fire sweeps over the land. Each type of change happens on its own time scale.

All of us, especially scientists, want to understand the changes happening all around us. Why do changes happen; how do different changes influence each other; what will happen next? To understand change, and in some cases predict it, we must measure our environment, but we can't measure everything happening in our environment,





everywhere, all the time. Instead we try to make measurements in a way that will give us enough data to tell what is happening locally so that we can make comparisons on a worldwide scale.



In GLOBE, the atmospheric measurements are designed to be made once each day while streams, rivers, lakes, bays, the ocean, or ponds are measured weekly, and soil characteristics in a given place need only be measured once. Other measurements are taken at different intervals. Some measurements are snap shots - what types of clouds do we see right now? Some measurements tell us what has happened over a period of time - how much rain fell in the last day? The time scale on which we make the measurements allows us to analyze the different changes in our environment.



Our environment also varies from place to place. We live on mountains, valleys, plains, and coasts. We live in cities, suburbs, villages, and the countryside. In some places grasslands, fields or forests surround us for as far as we can see. In other places, a mountain may rise next to our town or there may be forests, fields, and lakes all mixed together. On a finer scale, in one place there is a tree or grass, in another a road, in another a house, and in another a stream. Sometimes we can see that it is raining near-by but not where we are. Clearly, our environment varies on different distance scales.



Students at a GLOBE school make recurring measurements at specific locations known as *study sites*. Again, we cannot measure everything about our environment everywhere, so we space our observations to measure the variations on their different spatial scales. In GLOBE, each school is located within their individual GLOBE Study Site, which is a square 15 km on a side. These sites can overlap or be shared among schools. In GLOBE, students learn how to determine the land cover of this whole site looking at variations down to a spatial scale of 30 meters. Other measurements are made only once at a number of *sample sites*. As the number of GLOBE schools increases, more of our global environment is covered by good measurements and variations over smaller distances can be studied.



With all the changes in our environment over time and variations over space, our ability to understand our environment is limited by the number of measurements we can make. Each GLOBE school has the opportunity to add significantly to the total set of measurements being made around the world. As we keep making GLOBE measurements carefully and consistently, we are giving ourselves and everyone else a gift of better knowledge of our environment both locally and globally.

What are the Domains of GLOBE Research?

We can view the entire planet Earth as the domain of GLOBE science research. By collecting environmental data from around the world, scientists, teachers and students will have a better understanding of Earth and its interrelated cycles, which comprise an integrated system. While scientists already have access to much data about Earth, GLOBE students will provide important new data to help scientists. One value of GLOBE student data is that it is worldwide, providing measurements from thousands of locations. Another value is that students do several different types of measurements at the same time, enabling scientists to study how Earth's land, air, water and biology systems interact. Finally, GLOBE students contribute their own analyses of local study sites, becoming in a very real sense the world's experts on their own study areas, which will in turn help the scientists in their research.

Currently, there are four domains of GLOBE scientific research. Each is detailed in one of the GLOBE investigations:

Atmosphere — Students conduct daily measurements of cloud and contrail cover and type, air temperature, precipitation, precipitation pH, barometric pressure, relative humidity, surface ozone, surface temperature, and aerosol optical thickness.

Hydrosphere — Students do weekly (or twice monthly) measurements of water transparency, temperature, dissolved oxygen, pH, either conductivity or salinity, alkalinity, and nitrate-nitrogen of a body of water near the school. Students may also collect

data about the types and abundances of freshwater microinvertebrates.

Soil (Pedosphere) — Students expose a soil profile (either in a soil pit, an augered profile or a road or stream cut), take soil samples, and analyze them to determine the characteristics of various soil layers. They also take measurements of soil moisture at various depths and locations at various time scales (some according to satellite overpass) and take daily to weekly measurements of near-surface soil temperature.

Biosphere — There are two components to the Biosphere Investigation: Phenology and Land Cover. Within phenology, students will study biological indicators of seasonal changes including the migration of arctic birds and/or hummingbirds, lilacs, green-up and green-down, seaweed, and phenological gardens. A series of *Learning Activities* accompany these *Protocols*. Within land cover, students study the types of land cover in their Land Cover Study Site, a 15 km X 15 km area centered on their school. They visit multiple Land Cover Sample Sites where they determine the type of land cover and measure the amounts and species of vegetation. They can ultimately create a land cover type map of their Study Site on analysis of satellite imagery of the area and the observational data collected and even track changes to land cover over time by comparing satellite imagery acquired in different years.

In addition to these direct investigations, there are two supportive investigations included in GLOBE:

Earth as a System — This investigation is presented in two parts: an *Introduction to Seasons* and *Exploring the Connections*. Both contain *Learning Activities* to help students understand the seasons and connections between different aspects of the natural world on a variety of scales, ranging from their own school yard to the entire Earth.

GPS — Global Positioning System (GPS) enables students to determine the latitude, longitude, and elevation of various sites using a small hand-held receiver and a set of Earth-orbiting satellites. This information is essential so that scientists and others will always know exactly where measurements were taken.

How Is This Guide Organized?

There are five investigations in this teacher's guide:

- Earth as a System
- Atmosphere Investigation
- Biosphere Investigation
- Hydrosphere Investigation
- Soil (Pedosphere) Investigation

All of the investigations have the same structure, as detailed below. Each provides background information about the subject, instructions on how to take GLOBE measurements, and a set of *Learning Activities*.

In addition, there is a chapter on GPS measurements required for all sites, and instrument specifications are provided in the *Toolkit*.

As detailed on the next few pages, each investigation has the following sections (except for Earth as a System which contains only a Welcome, Introduction and Learning Activities):

- *Welcome to the Investigation*
- *Introduction*
- *Protocols*
- *Field/Lab Guides*
- *Looking at the Data*
- *Learning Activities*
- *Appendix*



Atmosphere Investigation at a Glance



Protocols

Daily measurements within one hour of local solar noon:
precipitation (rain or snow) including precipitation pH
minimum and maximum air temperature for the last 24 hours
(a Digital Day Max/Min thermometer can be read anytime of day)

At least one measurement per day:
cloud cover and type and contrail cover and type
aerosols
water vapor
relative humidity
snow pack
current temperature
surface temperature
ozone

Suggested Sequence of Activities

- Read the *Introduction*, especially the sections *What Measurements Are Taken and Getting Started*.
- Read the brief description of the learning activities at the beginning of the *Learning Activities* section.
- Review the protocols and plan which measurements your students will take; feel free to start with an easily sustained level of effort and then expand.
- Order any new or replacement instruments required.
- Cloud measurements are the easiest place to start and are required for several other protocols; do these activities with your students before beginning cloud observations:
Observing, Describing, and Identifying Clouds
Estimating Cloud Cover: A Simulation
- Install the instrument shelter which is required for taking air temperature measurements.
- Check the calibrations of your instruments (thermometers and barometer or altimeter).
- Have students define their Study Site and submit site definition data to GLOBE.
- Install your rain gauge and barometer or altimeter and plan out measurement logistics (such as where will required instruments and materials stay, timing and time requirements, etc.).
- Choose which *Atmosphere Data Sheets* your students will use and copy them.
- Copy the *Field Guides* for the protocols your students will follow.
- Teach students how to take the measurements following the *Field Guides*, record their readings on the *Data Sheet(s)*, and report data to GLOBE.
- Transfer to the students as much responsibility as practical for taking measurements and reporting data.
- Have students look at their data and comparable data from other schools.
- Engage students in inquiry and help middle and secondary students conduct student research projects using the Looking at the Data sections of the protocols.

GLOBE® 2014

Welcome - 2

Atmosphere

Investigation at a Glance

Each investigation begins with *Investigation at a Glance*. This is a quick overview of the investigation. It summarizes the measurements your students will do. It also recommends a sequence in which you can interweave the *Learning Activities* and the *Protocols*. There are many differences among schools and their approaches to GLOBE, and there are many differences among the needs and abilities of individual students. Some schools will just implement the *Protocols*. Others may find that students need more background in the science domain in order to complete the *Protocol*.

The general sequence within each investigation is,

1. students learn about the domain of science;
2. students learn how to complete the *Protocol*, in some cases by doing pre-protocol *Learning Activities*, practice measurement techniques;
3. students begin taking measurements; and
4. students learn more about the domain by studying their local data and data from other schools around the world and doing post-protocol *Learning Activities*.

Introduction



Soils are one of Earth's essential natural resources, yet they are often taken for granted. Most people do not realize that soils are a living, breathing world supporting nearly all terrestrial life. Soils and the functions they play within an ecosystem vary greatly from one location to another as a result of many factors, including differences in climate, the animal and plant life living on them, the soil's parent material, the position of the soil on the landscape, and the age of the soil.

Scientists, engineers, farmers, developers and other professionals consider a soil's physical and chemical characteristics, moisture content and temperature to make decisions such as:

- Where is the best place to build a building?
- What types of crops will grow best in a particular field?
- Will the basement of a house flood when it rains?
- How can the quality of the groundwater in the area be improved?

Using the data collected in the *GLOBE Soil Investigation*, students help scientists describe soils and understand how they function. They determine how soils change and the ways they affect other parts of the ecosystem, such as the climate, vegetation, and hydrology. Information about soils is integrated with data from the other GLOBE protocol investigations to gain a better view of Earth as a system.

Why Investigate Soils?

Soils develop on top of Earth's land surface as a thin layer, known as the *pedosphere*. This thin layer is a precious natural resource and so deeply affects every part of the ecosystem that it is often called the "great integrator." For example, soils hold nutrients and water for plants and animals. They filter and clean water that passes through them. They can change the chemistry of water and the amount that recharges the groundwater or returns to the atmosphere to form rain. The foods

we eat and most of the materials we use for paper, buildings, and clothing are dependent on soils. Soils play an important role in the amount and types of gases in the atmosphere. They store and transfer heat, affect the temperature of the atmosphere, and control the activities of plants and other organisms living in the soil. By studying these functions that soils play, students and scientists learn to interpret a site's climate, geology, vegetation, hydrology, and human history. They begin to understand soil as an important component of every ecosystem on Earth.

Scientists Need GLOBE Data

The data students collect through the GLOBE soil measurements are invaluable to scientists in many fields. For example, Soil scientists use the data to better understand how soils form, how they should be managed, and what their potential is for plant growth and other land use. Hydrologists use the data to determine water movement through a soil and a watershed and the effect of soils on water chemistry. They also examine the effects of different types of soil on the sedimentation in rivers and lakes. Climatologists use soil data in climate prediction models. Atmospheric scientists want to know the effect of soils on humidity, temperature, reflected light, and fluxes of gases such as CO₂ and methane. Biologists examine the properties of soil to understand its potential for supporting plant and animal life. Anthropologists study the soil in order to reconstruct the human history of an area.

When data are available for many areas of the world, scientists study the spatial patterns of soil properties. When a full set of GLOBE atmosphere, hydrology, land cover and soils data exists at a specific site, scientists can use the information to run computer models to understand how the whole ecosystem functions and to make predictions about what the ecosystem will be like in the future.

GLOBE® 2014
Introduction - 1
Soil (Pedosphere)

Introduction

The *Introduction* section sets the stage for the investigation. It provides important background information and helps you and your students appreciate the science of the investigation. It includes,

- An introduction to the big picture that puts this investigation in perspective.
- Advice on how to prepare for the field work.
- A description of the student learning goals.
- A table of alignments to national standards.
- Ideas on how you can assess student learning.

These sections give you, the teacher, background information on the investigation to help you guide the students in their work on GLOBE.



Alkalinity Protocol



Purpose
To measure the alkalinity of a water sample

Overview
Students will use an alkalinity kit to measure the alkalinity in the water at their hydrosphere study site. The exact procedure depends on the instructions in the alkalinity kit used.

Student Outcomes
Students will learn to,

- use an alkalinity kit;
- examine reasons for changes in the alkalinity of a water body;
- explain the difference between pH and alkalinity;
- communicate project results with other GLOBE schools;
- collaborate with other GLOBE schools (within your country or other countries); and
- share observations by submitting data to the GLOBE archive.

Science Concepts

Earth and Space Science
Earth materials are solid rocks, soils, water and the atmosphere.
Water is a solvent.
Each element moves among different reservoirs (biosphere, lithosphere/ pedosphere, atmosphere, hydrosphere).

Physical Sciences
Objects have observable properties.

Life Sciences
Organisms can only survive in environments where their needs are met.
Earth has many different environments that support different combinations of organisms.
Humans can change natural environments.
All organisms must be able to obtain and use resources while living in a constantly changing environment.

Scientific Inquiry Abilities
Use a chemical test kit to measure alkalinity.
Identify answerable questions. Design and conduct scientific investigations.
Use appropriate mathematics to analyze data.
Develop descriptions and explanations using evidence.
Recognize and analyze alternative explanations.
Communicate procedures and explanations.

Time
15 minutes
Quality Control Procedure: 20 minutes

Level
Middle and Secondary

Frequency
Weekly
Quality Control Procedure: twice a year

Materials and Tools
Alkalinity test kit
Hydrosphere Investigation Data Sheet
Making the Baking Soda Alkalinity Standard Lab Guide (optional)
Alkalinity Protocol Field Guide
Distilled water in wash bottle
Latex gloves
Safety goggles
For Quality Control Procedure, the above plus:
- Alkalinity standard
- *Hydrosphere Investigation Quality Control Procedure Data Sheet*
- *Quality Control Procedure for Alkalinity Lab Guide*

Preparation
Suggested activities: *Practicing Your Protocols: Alkalinity*

Prerequisites
Discussion of safety procedures when using chemical test kits

GLOBE® 2014
Alkalinity Protocol - 1
Hydrosphere

Welcome
Introduction
Protocols
Learning Activities
Appendix

Protocols

This section describes, in detail, how to conduct the measurements required for the investigation. This includes,

- how to select the study site for the investigation;
- the instruments you need for the investigation;
- how to conduct the measurements; and
- how to submit this data to the GLOBE Science Data Archive.

The precise instructions on how to conduct the measurements are called *Protocols*. You will need to read these *Protocols* very carefully before you take the measurements. Later in this chapter, we offer some advice on *How to Teach a Protocol*. Detailed specifications of the instruments you will need to complete the *Protocols* are provided in the *Toolkit*.

Soil Particle Size Distribution

Lab Guide

Task

To determine the particle size distribution for each horizon in a soil profile

What You Need

- Dry, sieved soil
- 2 Liters distilled water
- Three 250 mL or larger, beakers
- 1 empty plastic 2 liter bottle
- Hydrometer
- Thermometer
- Plastic wrap (or other cover for cylinder)
- Particle Size Distribution Data Sheet*
- 100-mL graduated cylinder
- Pencil or pen
- Soil dispersing reagent
- 500-mL clear cylinders
- Squirrt bottle for washing soil out of beaker
- Meter stick
- Balance accurate to within 0.1 g

In the Lab

1. Prepare the dispersing solution by mixing 50 g of Sodium Hexametaphosphate (or other soil dispersing agent such as non-sudsing dishwasher detergent) in 1 L of distilled water. Stir or shake until the dispersing agent has completely dissolved.



2. Weigh 25 g of dried, sieved soil and pour it into a 250 mL or larger container.

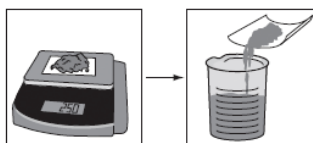

GLOBE® 2014

Particle Size Distribution Protocol - 4

Soil (Pedosphere)

Field/Lab Guides

This section provides step-by-step instructions for collecting data according to the *Protocols*. These may be copied and laminated for use in the field or lab. These guides include,

- a statement of the task to be performed;
- a list of the materials you will need;
- an explanation of any preparations you may need to do before going out in the field; and
- a step-by-step explanation of what to do in the field and/or in the lab.

The purpose of these guides is to give students concise and specific instructions to follow in the field or in the lab.



Precipitation Protocols – Looking At the Data

Are the data reasonable?

Precipitation can vary widely, even over short distances. So, in judging whether precipitation data are reasonable, common sense must be your guide. For example, if you lived in the state of Hawaii, it would be helpful to know that the record amount of rainfall received in the state in a 24-hour time period is about

965 mm. Figure AT-PP-4 from the National Climatic Data Center (NCDC) in Asheville, North Carolina in the U.S.A., shows you the maximum amount of precipitation received in each state of the U.S. in a 24 hour time period. In many areas, the maximum amount of precipitation was the result of a tropical storm or hurricane that hit that region

We can also find the total yearly precipitation for the wettest places in the world from the U.S. National Climatic Data Center, as shown in Table AT-PP-4.

Figure AT-PP-4: Record Maximum 24-hour Precipitation (mm) through 1998 (*estimated)

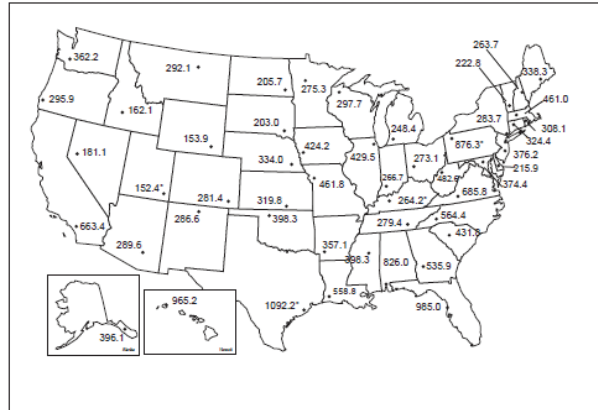

GLOBE® 2014

Precipitation Protocols - 19

Atmosphere

Welcome

Introduction

Protocols

Learning Activities

Appendix

Looking at the Data

This section has been added to encourage data use by students. This section includes three main sections:

- Are the Data Reasonable?
- This will help the students decide if the data they are collecting is within a reasonable range.
- What do Scientists do With the Data?
- This tells students why researchers are interested in the data they are collecting and explains some of the types of projects they use it for.
- An Example of Student Investigation.

In this section we provide one example of a project that could be done by students using the data collected in the *Protocol*. These are meant to provide students with ideas wishing to perform their own investigations.

The *Looking at the Data* section is designed to be used by teachers of younger students and by the older students themselves. It is our hope that this section will facilitate student research projects using GLOBE data.

Global Connections: Earth Systems at the Global Scale

GC2: Components of the Earth System Working Together



Purpose
To develop familiarity with interactions among the major components of the Earth system at the global scale

Overview
Students review a variety of images and maps of the whole Earth in order to identify the major components of the Earth system at the global scale. The maps show solar energy, average temperature, cloud cover, precipitation, soil moisture, and vegetation, and the images are of the Earth from space. As a class, they discuss some ways that the components of the Earth system interact to form the whole Earth system. They describe the water cycle at the global scale in greater detail, identify the components through which water passes and the processes that move it, and draw an abstract diagram.

Student Outcomes
Students will be able to:

- Use images and data about the whole Earth to identify the major components of the Earth system at the global scale and stimulate their thinking about connections among those components;
- Describe the pathway of water among the components, as an example of ways they are connected;
- Translate their understanding of that pathway into an abstract diagram.

Science Concepts
Physical Sciences
Heat is transferred by conduction, convection and radiation.
Heat moves from warmer to colder objects.
Sun is a major source of energy for changes on the Earth's surface.

Energy is conserved.
Chemical reactions take place in every part of the environment.

Earth and Space Sciences
Weather changes from day to day and over the seasons.
The sun is the major source of energy at Earth's surface.
Solar insolation drives atmospheric and ocean circulation
Each element moves among different reservoirs (biosphere, lithosphere, atmosphere, hydrosphere).

Life Sciences
Organisms can only survive in environments where their needs are met.
Earth has many different environments that support different combinations of organisms.
Organisms' functions relate to their environment.
Organisms change the environment in which they live.
Humans can change natural environments.
Plants and animals have life cycles.
Ecosystems demonstrate the complementary nature of structure and function.
All organisms must be able to obtain and use resources while living in a constantly changing environment.
All populations living together and the physical factors with which they interact constitute an ecosystem.
Populations of organisms can be categorized by the function they serve in the ecosystem.
Sunlight is the major source of energy for ecosystems.

Welcome

Introduction

Protocols

Learning Activities

Appendix

GLOBE® 2014 GC2: Components of Earth System Working Together - 1 Earth System Science

Learning Activities

In the *Learning Activities* section of each investigation a set of activities is provided that you can use to help students learn more about the instruments and *Protocols*, understand the data they collect, and use GLOBE data to further understand the investigation's key ideas.

At the beginning of each *Learning Activity* is a box containing essential information in a standard form to help you quickly determine whether this activity is appropriate for your students based on their ages, interests, and ability levels. In the box at the beginning of the *Learning Activities*, Time usually refers to the number of 50 - minute class periods recommended for this activity. Level refers to recommended age levels in three categories: primary (ages 5-9 years), middle (ages 10-13 years), and secondary (ages 14-18 years).

Soil (Pedosphere) Investigation

Soil Particle Density Data Sheet

Note: All measurements should be made without the stopper/cap!!

Date soil is mixed with water: year _____ month _____ day _____

Study Site: _____

Horizon number: _____

How has the soil been stored since it came out of the oven? _____

Length of time since the soil was dried in the oven: _____

Other comments: _____

		Sample Number		
		1	2	3
Mass of empty flask (g)	(B below)			
Mass of soil + empty flask (g)	(A below)			
Mass of water + soil + flask (g)	(D below)			
Water temperature (°C)	(F below)			

Calculation Worksheet

		Sample Number		
		1	2	3
A	Mass of soil + empty flask (g)			
B	Mass of empty flask (g)			
C	Mass of soil (g) (A - B)			
D	Mass of water + soil + flask (g)			
E	Mass of water (g) (D - A)			
F	Temperature of water (°C)			
G	Density of water (g/mL) (approximately 1.0)			
H	Volume of water (mL) (E/G)			
I	Volume of soil (mL) (100 mL - H)			
J	Soil particle density (g/mL) (C/I)			

Appendix

The *Appendix* to each investigation includes *Data Work Sheets* that can be copied and used by students when they collect their data. Using these sheets reinforces the *Protocols* and helps students remember to record all needed observations. Some of the *Appendices* contain extensive tables or write-ups that students should take with them when doing the *Protocols*. Also, copies of the *Data Entry Sheets* from the GLOBE Data Entry pages are provided. These sheets follow the layout of the data entry pages students use to enter their GLOBE data. If your school does not have access to the Internet and you are using email or some other means to report your data, these pages will help you and your students better understand the data entries expected by GLOBE. A glossary is provided of the special terms used in connection with the investigation. Also, other material supportive of the investigation is included in the Appendix. Additional items relating to one or more investigations are found in the *Toolkit*.

Planning to Implement GLOBE in Your Classroom

Generalizations About Teaching and Learning

The following generalizations about teaching and learning provide the theoretical framework for the information presented in this *Implementation Guide* as part of the overall GLOBE *Teacher's Guide*.

Generalization 1

Students enter classrooms with common sense ideas and theories that have worked for them. These ideas may be contradictory to the scientific theories and principles in a specific field.

Generalization 2

Meaningful learning takes place in a classroom where students grapple with concepts until they develop their own understandings.

Generalization 3

Learning requires more than the acquisition of knowledge. It also requires more than hands-on; it must be “brains-on” as well.

Generalization 4

Deep understanding requires a fundamental shift in the way a learner views the world. New conceptualizations greatly alter pre-existing ideas. Students have to face their prior understandings and test them. After testing shows that there may be a better explanation then they will begin to change their ideas.

Generalization 5

Teachers must first be able to grasp how learners have conceptualized an idea in order to present scientific views in ways that are meaningful to the learner. Learners can then view scientific framework as more useful.

Generalization 6

Learning is an active process that requires the learner to engage fully with thinking about and with the content in a range of situations. Dialogue, argument, testing of ideas, and reference to evidence are essential to developing new frameworks and understandings.



Introduction

The GLOBE Program *Teacher's Guide* provides key information to teachers about how they can implement GLOBE activities into their classrooms. The Guide includes all the procedures students follow for taking measurements as well as the specifications for instruments needed to carry out the *Protocols*. Background information is presented to help teachers understand the science associated with the measurements. Recommendations are given for analyzing data and *Learning Activities* are supplied to help teachers introduce new concepts and prepare their students to collect data.

Each chapter in the *Teacher's Guide* provides suggestions for selecting the *Protocols* and *Learning Activities* to use in the classroom. Each *Protocol* and *Learning Activity* begins with a *purpose*, an *overview*, the *time* it takes to carry out the investigation, the appropriate *age level*, the *frequency* for taking the measurement, *key concepts and skills* students will learn, *materials needed*, *preparation* needed to carry out the investigation and any *prerequisites* students need to carry out the investigation.

Independent evaluations have found that GLOBE students have higher levels of conceptual knowledge and procedural knowledge than students who do not participate in the program. For example, GLOBE students will have a better understanding of concepts such as pH and better procedural knowledge of things such as identifying appropriate sampling methods for various tasks.

GLOBE students exhibit greater problem-solving abilities than students from non-GLOBE schools. These abilities include developing arguments to justify decisions based on evidence.¹

Meeting Student Needs

Not all students are ready to tackle the same problem—at the same level of sophistication—at the same time. Using a student-centered approach to learning means teachers can more effectively deal with a wide range of students. GLOBE activities are inherently student-centered and will help effectively teach students of varying skills and ability levels.

Students carrying out GLOBE *Protocols* and *Learning Activities* learn science by doing what scientists do. GLOBE *Protocols* and *Learning Activities* provide real experiences that develop students' curiosity. Students manipulate equipment and materials to test their ideas and make observations. They then analyze observations and present findings in a number of ways.

This scientific inquiry approach to learning is accessible to all students. The following examples show the suitability of GLOBE activities to a differentiated student body.

Language Issues – GLOBE activities are hands-on. Students can participate regardless of their speaking skills. Many portions of the *Teacher's Guide*, including resource information, *Learning Activities*, and *Protocols*, will be available in the six United Nations languages (Arabic, Chinese, English, French, Russian, and Spanish). Some GLOBE countries translate the *Teacher's Guide* into other languages (e.g., Thai, German, Greek). There are also some countries that use GLOBE in the development of foreign language skills (such as English).

See *Appendix-Working with Language and Literacy*, for more information.

Learning Styles - Howard Gardner in his groundbreaking book, *Frames of Mind*, outlined the unique intelligences people possess. Gardner characterizes learners' strengths as

- Linguistic Intelligence;
- Logical-Mathematical Intelligence;
- Visual-Spatial Intelligence;
- Musical Intelligence;
- Bodily-Kinesthetic Intelligence;
- Interpersonal (Social) Intelligence;



- Intrapersonal Intelligence; and
- Naturalist Intelligence.

Special Needs - GLOBE *Protocols* and *Learning Activities* provide opportunities for authentic learning based on students' needs, interests and talents.

GLOBE *Protocols* and *Learning Activities* involve all students and help to create an environment where students become more active and involved learners. The opportunity GLOBE provides enables students to demonstrate and share their strengths. As just one example, schools for the deaf and hard of hearing have been full and active participants in GLOBE from the very beginning.

Multiculturalism – GLOBE *Protocols* and *Learning Activities* are developed according to the scientific methods of an international body of scientists. They do not portray one specific group and allow for students of many cultural backgrounds to participate.

See *Appendix-Alternative Teaching Strategies*, for information about how GLOBE helps teachers build on students' unique areas of strength.

Gardner, H. (1983). *Frames of Mind*, NY: Basic Books.

Designing Science Units With GLOBE Activities

Each lesson a teacher designs in a science unit will consist of one or more activities that develop understanding of specific scientific concepts. Using this approach, teachers pass through a variety of steps in designing a science unit that integrates GLOBE activities.

Step 1

Identify concepts and skills students will learn. Many teachers follow National, State, or District Standards in deciding what students should know and be able to do.

Step 2

Match GLOBE activities to the concepts and skills. The introductory section of each *Protocol* and *Learning Activity* in this Guide lists the science concepts and skills that students will learn by doing that activity. The concepts and skills listed parallel National Science Education Standards in several GLOBE countries.

Step 3

Sequence Lessons into a logical order. In order to properly sequence lessons, teachers need to decide what the students will need to know before they begin each lesson. Organize lessons in a sequence that begins with the development of basic information and skills and steadily increases understanding of the subject matter. The introductory section of each *Protocol* and *Learning Activity* states the prerequisites students need in order to carry out the activities.

Step 4

Plan for Evaluation. Plan evaluation processes to measure student achievement of the concepts and skills they are expected to learn by carrying out the activities of the unit.



Sample Unit Integrating GLOBE

This unit is designed to fully integrate GLOBE into classrooms focused on natural resources, environmental sciences, or agricultural sciences. It assumes that students have had prior instruction in posing questions and basic student inquiry/research. The unit can be expanded (time wise) if it is necessary to add instruction or reinforcement of the process skills identified for this unit.

Unit Goals: Upon completion of this unit the student will

- Understand the importance of soils to the maintenance of earth as a system.
- Understand the relationships between soil properties and various aspects of soil formation, uses, and processes.
- Use equipment properly to take measurements; sort, analyze, interpret and explain measurements.

The following sections illustrate how this unit was developed using the steps on the previous page.

Step 1:

Identify concepts and skills you want students to acquire.

Content Concepts	Skills
Soil use	Identify problem
Soil formation	Design experiment
Soil composition	Identify variables
Soil properties	Pose questions
Soil types	Make accurate observations and measurements
Soil classification	Use equipment properly
Soil moisture holding capacity	Detect measurement errors
Water infiltration	Use math to solve problems
Decomposition	Explain data and relationships
Soil fertility	Present data
Energy transfer/soil as an insulator	Communicate results; present findings in multiple formats
Acids, bases, pH and its measurement	
Chemical reactions	
Specific gravity	
Density, bulk density	
Solutions, suspensions, particle size	
Electrical resistance	



Step 2:

Match these with GLOBE activities using concepts and skills identified for each *Protocol* and *Learning Activity*

Concept or Skill	Matching GLOBE Activities
Soil use	<i>Why Study Soils?, Soil Characterization, Soil pH</i>
Soil formation	<i>From Mud Pies to Bricks, Soils in my Backyard, Soil: The Great Decomposer, Temperature, Characterization</i>
Soil composition and properties <ul style="list-style-type: none"> Type Classification Moisture holding Water infiltration Chemical reactions 	<i>Characterization, Temperature, Gravimetric and Volumetric Moisture, Particle Density, Bulk Density, Particle Size Distribution, pH, Fertility, Why Study Soils?, Just Passing Through, Making Mud Pies, Soil in My Backyard, Digging Around, Soils as Sponges, Soil: The Great Decomposer</i>
Decomposition	<i>Soil: The Great Decomposer, Gravimetric Moisture, pH</i>
Soil fertility	<i>Fertility</i>
Energy transfer	<i>Temperature</i>
Acids, bases, pH	<i>pH</i>
Specific gravity	<i>Characterization</i>
Chemical reactions	<i>pH, Fertility</i>
Density	<i>Particle Density, Bulk Density</i>
Solutions	<i>Characterization</i>
Electrical resistance	<i>Soil Moisture Sensor</i>
Steps in Inquiry: <ul style="list-style-type: none"> Identify problem Pose question Design experiment Identify variables Observe Measure 	<i>Characterization, Temperature, Gravimetric and Volumetric Moisture, Particle Density, Bulk Density, Particle Size Distribution, pH, Fertility, Why Study Soils?, Just Passing Through, Making Mud Pies, Soil in My Backyard, Digging Around, Soil as Sponges, Soil: The Great Decomposer</i>
Use equipment properly	<i>Temperature, Gravimetric Moisture, Particle Density, Bulk Density, Particle Size Distribution, Soil pH, Fertility</i>
Use math to solve problems	<i>Characterization, Temperature, Gravimetric and Volumetric Moisture, Bulk Density, Particle Size Distribution, Soil pH, Fertility, Just Passing Through, Soil as Sponges, Data Game</i>
Explain data and relationships	All
Present data	All
Communicate results	All



Step 3: Sequence Lessons in Logical Order

If you are using a unit plan you have previously developed, you can use the information from Step 2 to integrate GLOBE *Protocols* and *Learning Activities* into that unit in the appropriate places.

(Option 1: 5-6 weeks; Option 2: 2-3 weeks)

Introduction to Soils (2 class periods)

Importance of Soils

Just Passing Through – GLOBE *Learning Activity*

Introduction to Soils, continued (3 class periods)

How Soils are Formed

Soil Properties

Soil Properties, continued (1 class period)

Soil in My Backyard – GLOBE *Learning Activity*

Introduction to Gravimetric Measurements (2-3 class periods)

Digging Around – GLOBE *Learning Activity*

(Requires field trip)

Optional 2 weeks

For more in-depth instruction

Soil Characterization (10 class periods)

Field Measurements

Digging pit may require 1 full day with each group involved

Lab Analysis

Introduction to Group Projects (1-2 class periods)

Soil Moisture (2 class periods)

Soils as Sponges – GLOBE *Learning Activity*

Field Measurements

Lab Analysis

Soil Temperature (1 class period)

Field Measurements

Lab Analysis

Water Infiltration (2 class periods)

Field Measurements (One class period needed to build and test equipment)

Lab Analysis

Soil the Great Decomposer – GLOBE

Learning Activity (3 class periods, plus ongoing observation times)

Group Project Presentations (2 class periods)

Visiting Expert – Presentation by local Soil Conservation Service expert, soil science professor, geologist, etc.

Step 4: Plan Your Evaluation

- Unit Test
- Performance Assessments – Classifying Soils, Identifying Horizons, Experimental Design
- Group Project Report
- Homework, Journals, In-class activities

Instructional Strategies for Teaching GLOBE Activities

Plan to teach GLOBE activities using scientific inquiry:

- Help students pose worthwhile questions to research and investigate.
- Use cooperative learning groups to carry out research.
- Help students devise a plan or an approach for attacking the problem.
- Make available the instruments and tools students need.
- Encourage discourse and writing among students for understanding.
- Require students to justify and explain their answers and results with evidence from their investigations.



Using Scientific Inquiry in the Classroom

Following are 10 actions teachers can take to facilitate scientific inquiry:

1. Begin discussions with a series of questions:

- What do you notice about...?
- What do you observe about...?
- Do you see any patterns...?
- What is similar and/or different about _____ and _____?
- How do you think this works?
- Why does this work/look this way/give this result?
- What questions do you have or what do _____ you want to know about _____?
- What can we do with this information?

2. List responses on the board or overhead. Do not rephrase responses for students.

3. Ask group members to comment about the statements or ideas. Do they make sense? Can they come up with reasons or examples to show that the idea is or is not valid?

4. Ask additional questions that will encourage learners to search deeper for patterns and to make generalizations.

5. Do not correct mistakes in the process used by learners. Ask if there are other ways to accomplish the group's goals.

6. Do not quickly agree/disagree with observations/statements. However, you may need to provide counterexamples or point out implications of incorrect reasoning at some point.

7. Provide examples or suggest situations if students are having trouble with concepts. Ask, "What do you think about...?" or "What if...?"

8. Do not provide answers to questions asked of you. Instead, ask questions!

9. If the desired response/solution is achieved, do not immediately move

on to something else. **Ask if anyone else had alternate methods** for finding a solution. This helps learners see that most problems can be solved in a variety of ways.

10. Be flexible enough to deviate from a planned lesson focus to respond to new insights and unexpected directions proposed by the learners.²

See *Appendix-Inquiry*, for more information on inquiry in the classroom.

Choosing Activities that Engage Students

For students to receive the full benefit of GLOBE, they need to engage in projects based on their questions and curiosity. Consider the following.

Situation 1

You are teaching about the solar system and rotation of planets around the sun. You end with a discussion of earth's own rotation, tilt on its axis, and the effect on seasons. You come to a section comparing seasons in the northern and southern hemispheres. Several students ask why this matters. You can...

Option 1: Use standard videos, text, classroom posters, and *Work Sheet* resources.

Option 2: Have students create visualizations of maximum temperature using the GLOBE student data for locations in the northern and southern hemispheres. They use these visualizations to draw conclusions about temperatures at various times of the year. They follow this with a cooperative Learning Activity to answer the question, "Why?"

Option 3: Have students engage in activities to examine the GLOBE Earth as a Systems poster to draw conclusions about differences between the northern and southern hemisphere.

Which of these options would you choose to engage students at a higher level?



Situation 2

Your national or statewide curriculum requires you to “globalize” your curriculum so students have an opportunity to study phenomena, concepts, and principles within the context of other cultures and areas. You are studying the composition of soils and its relationship to crop growth. You can...

Option 1: Use videos, text, classroom posters, Work Sheet resources, and the Internet to expose students to soils in another country.

Option 2: Have students use GLOBE datasets to compare soils data from your local area to soils data from several locations around the world, particularly those areas with different climates. As part of their overall project, students learn about the kinds of agricultural crops typically grown in their area—these can be anything from forest products to flowers to food crops. Using the collaboration tools on the GLOBE website, students link with another GLOBE school in a different part of the world and begin a dialogue about their soils and agricultural crops. Teachers may need to facilitate this communication.

Which of these options would you choose to engage students at a higher level?

Managing Students

Students, especially those with learning difficulties, learn best using hands-on activities reinforced by pictures, graphs, charts, and (small) group communications. They can maximize their potential for learning if their learning environment allows for the following:

- Opportunities to move around.
- Choices of activities and assessments.
- Variety of instructional resources, environments, social groups.
- To learn during the late morning, afternoons, and evening hours.
- Informal seating arrangements.
- Low light levels, and
- Tactual/visual introductions of materials reinforced by kinesthetic/visual resources (and vice versa). (Meaning: Touching/visual introductions of materials reinforced by opportunities to move around, body as communications agent, etc./visual opportunities to reinforce.)

Cooperative Learning

GLOBE *Protocols* and *Learning Activities* are hands-on activities requiring students to use tools and instruments to measure scientific data for investigative purposes. This hands-on approach to learning is best carried out by students working in small groups. In this manner, students share the work of taking a measurement and reporting the data they collect.

See *Appendix-Cooperative Learning*, for more information about Cooperative Learning.

Assessing GLOBE Activities

The *Teacher’s Guide* offers suggestions for assessing student learning for each investigation area. Areas for evaluation include critical thinking skills, communication skills, and compilation of data in science notebooks and reports. You may also decide to use one or more of the following:

- GLOBE Portfolios.
- Performance Tasks.
- Rubrics.
- Science Journals.
- Open-Ended Questions.
- Performance-Based Assessments.

GLOBE provides teachers with many opportunities to provide performance and other assessments for students. Here are two examples from the *Soil (Pedosphere) Investigation* area:

1. Provide students with three soil core samples and have them identify the horizons, with oral or written justifications for their answers.
2. Have students perform N, P, K tests on soil sample(s) and make fertilizer recommendations based on the results, with oral or written justifications for their answers.

See *Appendix-Student Assessment*, for more details about each of the Assessment Strategies identified above. We have also included a rubric that will be used to evaluate GLOBE Student Journal submissions.



Frequently Asked Questions About GLOBE Supplies and Materials

1. Do teachers have to use special instruments to carry out the *Protocols* of The GLOBE Program?

Other than GLOBE Cloud Identification, each investigation requires accurate, reliable, and calibrated instruments that meet specifications developed by GLOBE scientists to ensure consistent, accurate measurements for use by the international environmental science community.

2. Where do teachers purchase the instruments needed to implement GLOBE?

There are a number of manufacturers who sell the equipment needed to carry out GLOBE *Protocols*. These manufacturers are listed on the GLOBE website (www.globe.gov). The instruments sold by these vendors adhere to the specifications established by GLOBE scientists for quality data collection. Several instruments can be hand-made such as the Instrument Shelter and Snowboard (Atmosphere), Transparency tube and Macroinvertebrate nets (Hydrosphere), and the Clinometer and Densimeter (Biosphere). The materials for the GLOBE *Learning Activities* do not require the same specifications as the *Protocols* and can be purchased from any vendor. The *Learning Activities* make use of common materials found in most schools and therefore can be easily implemented without a large investment in equipment.

3. How much equipment should a school or teacher plan to purchase?

Teachers will need to purchase the equipment for the *Protocols* they plan to implement in their classrooms. Teachers or schools may opt to buy kits that include instruments for all the *Protocols*. All teachers at a school can share these kits.

However, teachers are encouraged to start “where they can” with GLOBE in order to become familiar with the website, entering data, and building student research projects into their curriculums. Teachers can always add equipment and supplies as needed.

4. When should teachers purchase the equipment?

Experience has shown that teachers who have GLOBE equipment to do activities and *Protocols* that fit within their curriculum — soon after they have been trained in the GLOBE *Protocols* — are more likely to implement the program in their classrooms. Teachers who have been trained and then have to wait for equipment tend to become involved in other activities and forget the training they received and therefore are less active participants in the program.



Teachers are encouraged to implement GLOBE as soon as possible after they are trained—many *Learning Activities* and *Protocols* use equipment and materials already available in most schools (i.e. pH paper). Again, teachers can “start small” and build their resources and experiences with student scientific inquiry.

5. Are there GLOBE protocols teachers can do that are inexpensive or need little equipment to implement?

Some *Protocols* do not require expensive equipment. Others use equipment and supplies that can be constructed in the classroom or by developing cooperative arrangements with industrial arts, agriculture, or other technology teachers.

The Physical Classroom

Full-scale GLOBE implementation requires all of the following:

- Outdoor sites.
- Computing facilities.
- Laboratory facilities.
- Equipment and Supplies.

However, teachers may actually be able to do many *Learning Activities* and some GLOBE *Protocols* (i.e. cloud identification) without any of the items mentioned above. For that reason, it is best for teachers to identify the areas of GLOBE they wish to integrate before they purchase equipment or develop outdoor sites. Some teachers find it advantageous to work with their administrators to outline a long-range plan for gradually integrating GLOBE and purchasing equipment and supplies over the course of a few months or years.



Frequently Asked Questions About Building School and Community Resources

1. How can parents and other community members be involved in GLOBE activities?

There are several ways that parents and other community members can be involved with students in GLOBE activities:

- Having parents be chaperones for students collecting GLOBE data;
- Hosting GLOBE nights at schools and inviting parents, businesspersons, and other community members;
- Seeking sponsorship from various community organizations for GLOBE activities;
- Starting a GLOBE Club for during or after school activities and involving parents; and
- Working with local senior centers to collect GLOBE data.

These are just a few ideas. Once teachers and schools begin implementing community-based and interdisciplinary GLOBE projects, opportunities for parent and community member participation will arise.

GLOBE Events

What classroom or school-wide events can be organized with GLOBE activities?

Following are a few examples of school events that can be organized around GLOBE activities:

- Science Discovery Days on which teachers and students organize activities for parents and the public to witness students taking GLOBE measurements and inputting GLOBE data into the computer.
- Science Fairs incorporating GLOBE investigations at all grade levels.
- Enviro-Thons and other competition-based programs in which students carry out GLOBE measurements.
- Poster Contests based on GLOBE themes.
- Design Contests in which teams design research projects.

- Essay Contests focused on the outcomes of a local GLOBE research project.

General Resources

What resources are available to teachers for classroom implementation of GLOBE?

GLOBE makes a variety of resources available to teachers for integrating GLOBE into their curriculums, including,

- lesson plan templates;
- sample lesson plans;
- helpful hints;
- resource information and sources to help design and implement scientific inquiry; and
- interactive Web Pages.

Recognizing Students

The GLOBE website offers teachers certificates that can be used to recognize individual GLOBE students. Click on GLOBE Star Certificate to download and print certificates from the Web.

The GLOBE Website also hosts GLOBE Stars, which feature students, teachers, schools, and friends of GLOBE who have earned special recognition for their contributions to The GLOBE Program and its goals.

Also posted online is the GLOBE Science Honor Roll that recognizes schools for collecting GLOBE data in ways that are particularly useful for science.

References

¹ SRI International, Center for Technology in Learning, Menlo Park, CA.

² Adapted from Pisaura, J. *Instructional Tips for Facilitating Inquiry Discussions*. *ENC Focus*, 9(4):23.



Sample Atmosphere Unit Plan

Unit:

Atmosphere

SubUnit:

Introduction to Scientific Inquiry

Topic:

Maximum, Minimum, and Current Air Temperature: Are the data reasonable?

Time:

Approximately 2 days with additional time allotted for research idea discussions

This subunit is designed to be used as an introduction to scientific inquiry as part of the overall atmosphere unit. The lessons take students through a series of investigations of actual recorded temperature measurements using GLOBE student datasets. Students will work with visualizations and graphs, in order to compare and contrast data. Teachers can help students then explore how research investigations might be conducted using GLOBE student data.

Note: Lessons may be conducted as a 2-day series of lessons if one week is not available for this unit. **Standards:**

Science as Inquiry

Earth and Space Science

Physical and Life Science

Learning Objective(s):

Upon completion of this unit, students will be able to,

1. interpret data represented in graph and map form;
2. use the GLOBE Visualizations pages to create a graph of maximum, minimum, and current temperatures for a specified location; and
3. use the GLOBE Visualizations pages to create a map

Materials/Equipment needed:

Handouts (Exercise directions and *Work Sheets*)

Presentation Slides of handouts

Presentation Slide of Figure IG-I-1

Computer(s) with Internet access (one/group of 2-4 students)

Map of Europe, World Atlas or a Globe for reference

Note: If you have limited access to computers/lab, you will still find it useful to select one or a few of the following exercises to familiarize your students with using GLOBE visualizations to determine reasonableness of data. This unit assumes that students have basic keyboarding skills.



Procedures (Class Period 1):

1. Lesson Prep

Make arrangements in advance to use a computer lab at school so that there is one computer per each 2-4 students. Ideally, this exercise works best with student groups of two. Lesson activities should occur in the lab, if possible. Have presentation slides prepared of Figure IG-I-1 (included). You may wish to provide each student or group of 2-4 with a copy of Figure IG-I-1. Have the presentation slide of Figure IG-I-1 displayed on the screen as students enter the room.

Display the following formula on the board:

$$T_{\max} \geq T_{\text{current}} \text{ and } T_{\min} \leq T_{\text{current}}$$

Make certain that all computers are turned on, connected to the Internet, and that the GLOBE Home page (www.globe.gov) is displayed. Each student should have a copy of the handout/*Work Sheet* for Exercise 1.

2. Lesson Introduction

(10 minutes)

Tell students they will be working the next few days on some activities to help them make decisions about whether data are “reasonable” or make sense. Ask them if they know why this is important (*accurate observations, so results are true and correct, prompt with issues in agricultural, medical, or other research areas*).

Tell students that the first step in looking at temperature data is to see if the data seem reasonable and make sense. Air temperature varies over a 24-hour period. Point to Figure IG-I-1 and tell students that this shows an example of actual recorded temperature variation over a 24-hour period. Ask if someone can identify how often the temperature is recorded on this graph (*every 45 minutes*). Ask for 2 student volunteers to come up front to point out the (1) highest (maximum) temperature for the day and the (2) lowest (minimum) temperature for the day on the projected image.

Point to the formula displayed on the board and ask students to copy it in their Journals. Ask them to discuss what it means. (*Max. temperature must be highest for the 24-hour period—including current temperature—and Min. temperature must be the lowest—*

including current temperature.) Ask students if someone can explain what it means if that is not true. (*If that is not true, then something is wrong with the recorded maximum and minimum temperatures for the day.*)

3. Exercise 1:

(20 - 25 minutes)

Creating a map of Maximum Air Temperature. Provide each student or student group with the *Work Sheet* for Exercise 1. You will need access to a computer lab for this exercise.

4. Wrap-Up

(10-15 minutes)

Ask students to turn off computer monitors, if possible, so you can focus on a whole class discussion of Question 1 from the *Work Sheet*. Ask students if they have any comments to make about the maps that they created. Discuss these, as appropriate. Identify any problems with accessing the GLOBE website or using the Visualizations pages to address at a future time.

Discuss student responses to Question 1; several potential answers are possible: North of the Equator in the Tropics; in the Caribbean, West Africa, and the Arabian Peninsula. If students have incorrectly identified a region of the world show them the map legend and how the colors are arranged. Understanding map legends will help students better comprehend temperature maps.

5. Assignment

Students should watch an evening news program or read a newspaper and record in their Journals how temperature maps are used during the news program. What other information is displayed in maps? Ask them to record the minimum and maximum temperatures during the past 24 hours, as well as the current temperature—noting the time of day. They should write a short paragraph describing these temperatures in relationship to one another and using the formula they recorded in their journals at the beginning of class. Students should also record the predicted maximum and minimum temperature for the following day. If temperatures are reported in degrees Fahrenheit, help the students convert to degrees Celsius to better compare these temperatures with those in the GLOBE database.



6. Evaluation

Evaluation of written assignment to assess understanding of the relationship between maximum, minimum, and current temperatures as well as use of maps for weather forecasts.

Procedures (Class Period 2):

1. Lesson Prep

Make arrangements in advance to use computer lab at school so that there is one computer per each 2-4 students. Ideally, this exercise works best with student groups of two. All lesson activities should occur in the lab, if possible. Each student should have a copy of the handout/*Work Sheet* for Exercise 2. Make certain that all computers are turned on, connected to the Internet, and that the GLOBE Home page is displayed (www.globe.gov).

Create an area on the board to record the Current Temperature (Note the time), Maximum Temperature, and Minimum Temperature for 1) yesterday and 2) predicted for today.

2. Review

(5 minutes)

Ask students what they found out about yesterday's air temperature (minimum and maximum. Have students report out what the predicted air temperature (minimum and maximum) is for today from watching the news or reading a newspaper. Record on board. Discuss what maximum and minimum temperature each mean.

3. Lesson Introduction

(5 minutes)

Tell students that today they will learn how to create graphs of air temperature data from several schools. Ask students if they know what information is contained within graphs of temperature data. Tell students that graphs are sometimes called time series since the x-axis is usually shows time. Tell students that they will be creating graphs using the GLOBE Visualizations tools to look at temperatures for several GLOBE schools.

4. Lesson Activity

(30 minutes)

Pass out handout/*Work Sheet* for Exercise 2. Assist students as needed to complete activity.

5. Wrap-Up

Ask for volunteers to provide answers to the questions. Gather additional answers and feedback. Ask students what other observations they made while creating the graphs of data. Ask students which school experiences similar air temperature as yours.

6. Assignment(s)

Have students write down questions that they could research using air temperature data from schools in different areas of the world.

7. Evaluation

Figure IG-I-1

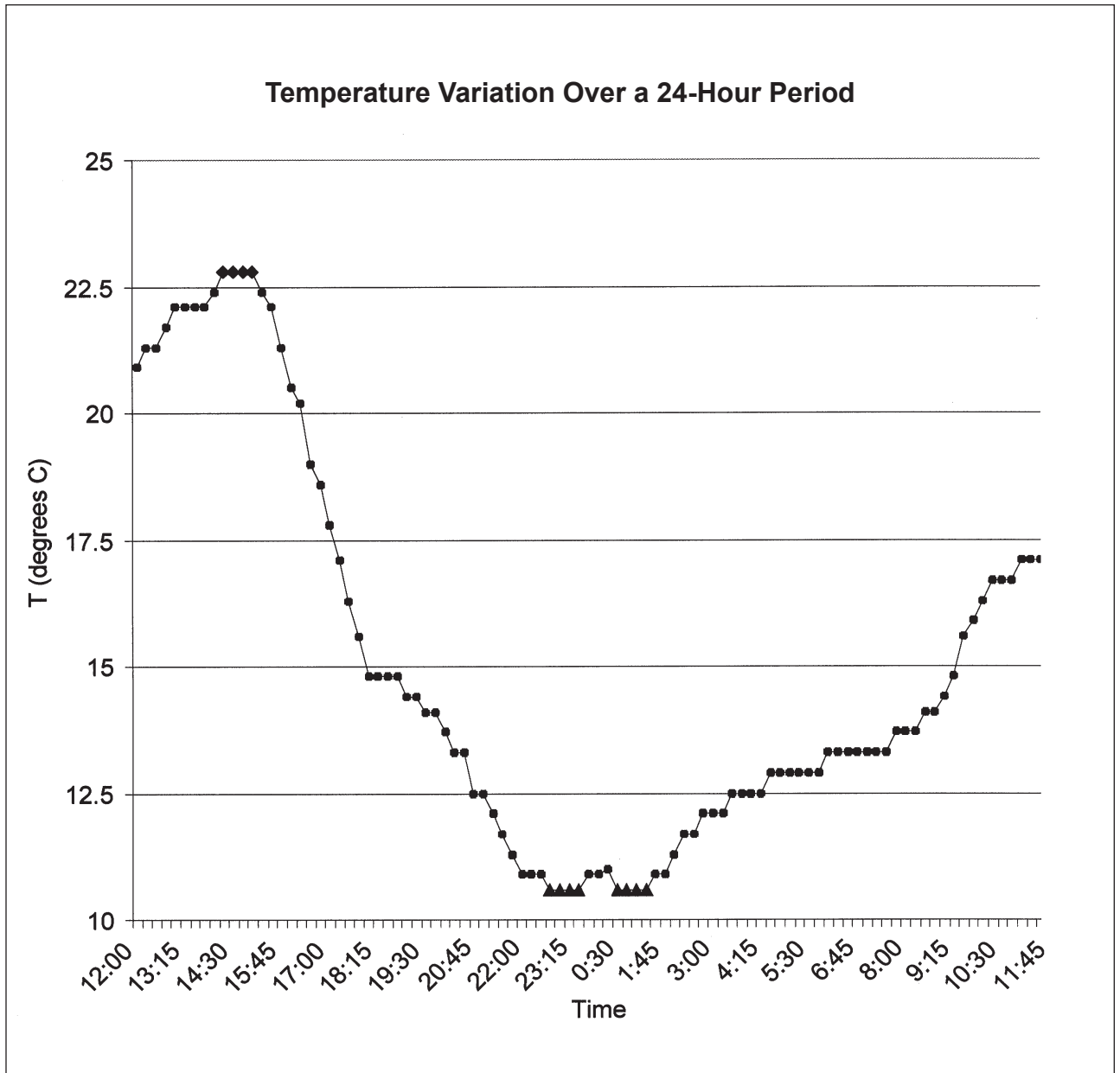

Atmosphere Unit

Work Sheet



Exercise 1: Exploring Data Layers

Task: Add data layers to the GLOBE Visualization map, manipulate the date and learn the navigation.

Step 1: From the GLOBE Home page (www.globe.gov), click on the “Visualize and Retrieve Data” icon.

Step 2: Click on the GLOBE Data Visualization Tools icon; this will launch the GLOBE visualization tools in another browser tab.

Step 3: After closing the Welcome box, click on **Add+** next to Data Layers (Image A); this will open the Measurement pop out box (Image B). Note that the Measurements available to select are on a drop-down box and there are various datasets to select from depending on the measurement selected. The default is Air Temperature Dailies; if you’ve changed the measurement change it back to Air Temperature Dailies.

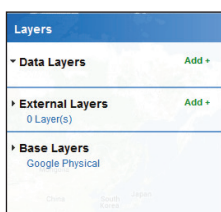

Image A. The Layers tab

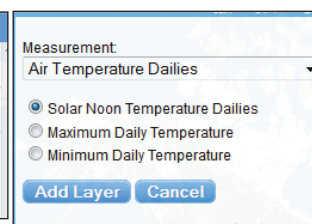

Image B. The Measurement layer selection tool

Step 4: Select Maximum Daily Temperature and click on “Add Layer”. Several data will populate the map and the Filters tab has opened up on the right side of the map (Image C). Notice that the Map Date is the previous day. A legend noting the measurement values appears on the bottom of the page.

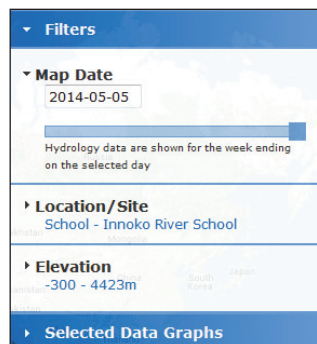

Image C. The Filters tab

Step 5: Click on **Add+** (on the Layers tab) and add the Rain Depth layer from the Precipitation measurement. Notice that two data layers are listed on the layers tab (Rain Depth and Maximum Daily Temperature). There are now two legend rows; Notice that the circle icons for the two layers on the map have different symbols: a thermometer for air temperature and a rain drop for rain depth. The color bars can provide you with a quick way to determine the values represented by the different colors on the map.

Step 6: Click on the Map Date field and change the date to 2010-04-22 (22 April 2010), then the Return key. Notice that the small dark blue box has shifted on the light blue line directly below the Map Date (Image D). This dark blue box can also be moved to modify the date.

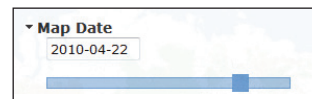

Image D. Map Date and Blue timeline

Step 7: Click on the map (away from data icons) and move the map with your mouse. Double-click on an area of the map (away from data icons; this will increase the magnification of the original view. The magnification tool, to the left of the Filters tab, can also be used to zoom in on a location. Zoom back out to view the entire map.

Step 8: Click on Rain Depth, under the Data Layers. A small pop out box will appear with several options: View Layer Table; Download Layer.kmz; Delete Layer; and Cancel. Click on Delete Layer; this will remove the layer from the map leaving only Maximum Daily Temperature for 22 April 2010. Click in the small box to the right of “Contours” under “Maximum Daily Temperature” on the Layers tab. Click on Base Layers. This will generate several options; the default is Google Physical. Scroll to the bottom of the Layers tab and click in the small box next to “Map Coordinates Grid”. The Filters tab can be closed by clicking on the small almost invisible tab to the left of the word Filters. This will allow more viewing area of the map.

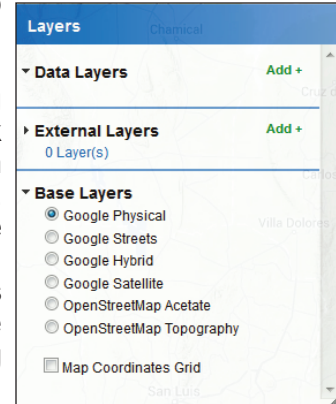

Image E. Base Layers expanded

Use this map to answer the following questions:

Question 1: Based on the colored temperature icons, where on the map (geographically) do the warmest temperatures tend to be located? _____

Click on the pink temperature icon North of the Equator and West of the Prime Meridian. This will open up an information box for the school and site.

Question 2: What is the name of the school? _____

Question 3: What is the Maximum Daily Temperature for 22 April 2010 at this site? _____

Question 4: How many air temperature data does this school have available (the number in parentheses after the protocol) _____

Atmosphere Unit

Work Sheet



Exercise 2: Creating Graphs of Data

Task: Create graphs of air temperature data and make observations and comparisons.

Step 1: From the GLOBE Home page (www.globe.gov), click on the “Visualize and Retrieve Data” icon.

Step 2: Click on the GLOBE Data Visualization Tools icon; this will launch the GLOBE visualization tools in another browser tab.

Step 3: After closing the Welcome box, select the Filters tab, along the right side of the visualization tool. See exercise 1 if you don’t recall where the filter tab is located. Note: the Filters tab is closed upon first opening the visualization tool and may be hard to see; clicking on the small arrow tab above the zoom and movement tools (Image A) will open it up. Click on “Location/ Site”. This will open up several search fields. Ensure that “Schools” is on the Select by dropdown. Type in Gymnazium Dr. A. Hrdlicky in the “School Name” field; make sure that “School Location: ATM-01” is selected under the “Sites” dropdown. [Note: using the scroll bar may be necessary to find the sites filed. Alternatively, it’s possible to grab the bottom of the Filters tab and pull it down.] A white rectangular box should appear on the map for this school (Image B) listing the School as Gymnazium Dr. A. Hrdlicky and the site as School Location: ATM-01. Notice that the “Obtain Data” field is set to Table and the Protocol listed is “Air Temperature Dailies”.

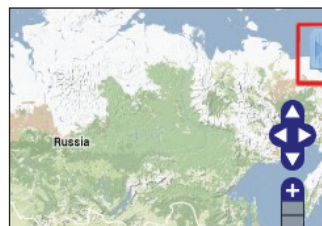

Image A. Filters tab when closed.

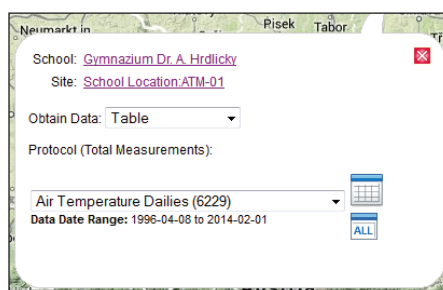

Image B. School Information Box.

Step 4: Click on the “Obtain Data” field and select “Time Series Plot”. Three data selections will be available: Solar Noon Temperature Dailies, Maximum Daily Temperature and Minimum Daily Temperature. Select “Solar Noon Temperature Dailies” by clicking on the radio button to the left of it and click on the Time Series icon.

Step 5: Select the “Maximum Daily Temperature” and click on the Time Series icon and then select the “Minimum Daily Temperature” and click on the Time Series icon.



Step 6: Click on the “Selected Data Graphs” on the Filters tab and scroll to the bottom of the tab (Image C).

Step 7: Change the “Plot Range Dates” by clicking the date and changing the year, month and day to: 2013-01-01 to 2013-03-31. Click on the “Plot All” button.

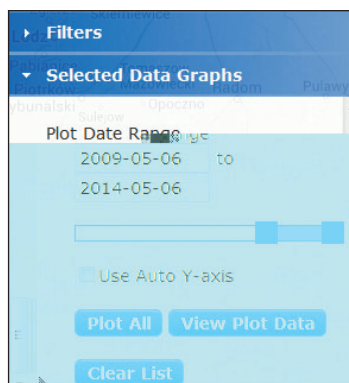

Image C. Selected Data Graphs tab.

The resulting time series plot should have three lines. Use these time series plots to answer the following questions:

Question 1: When did this school experience the coldest day during these three months?

Question 2: What was the temperature on this date? _____ (Hint: move your mouse cursor over the lines to view data)

Question 3: What do you notice, in general, about the shape of these plots? _____

Step 8: Close the time series box by clicking the small x at the top right of the time series box. Scroll up on the “Selected Data Graphs” tab and remove the Maximum and Minimum plots by clicking on the X. (If the Solar Noon Temperature Dailies is accidentally removed add it again by selecting it in the white school information box as in step 4.) Change the Plot Date Range to: 2009-01-01 to 2013-12-31. Click on the Plot All button.

Question 4: What do you notice about this school's data? _____

Step 9: Close the time series box by clicking the small x at the top right of the time series box. Click on the Filters tab. Highlight the current School Name listed in the School Name field (Gymnazium Dr. A. Hrdlicky) and delete it; type in “Escuela Primaria Particular” (this will allow you to select the school's complete name: Escuela Primaria Particular Incorporada N°1345 Nuestra Señora del Carmen). Make sure the site listed is: Investigacion Atmosferica:ATM-01. Change the Obtain Data type to Time Series Plot, select Solar Noon Temperature Dailies, and click on the Time Series icon.

Step 10: Click on the Selected Data Graphs tab of the Filters tab, scroll to the bottom and click on the “Plot All” button.

What do you notice about the two datasets? _____

Atmosphere Unit

Answer Sheet

Exercise 1: Exploring Data Layers

Task: Create graphs of air temperature data and make observations and comparisons.

Question 1: Based on the colored temperature icons, where on the map (geographically) do the warmest temperatures tend to be located?

Answer 1: Students should have generated a map similar to image Q1. Several potential answers are possible: North of the Equator in the Tropics; in the Caribbean, West Africa, and the Arabian Peninsula.

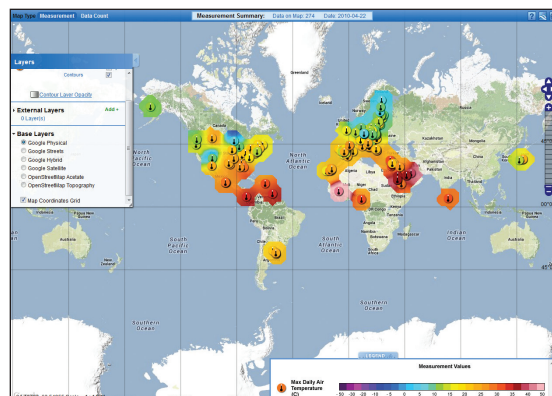

Image Q1. Maximum Daily Temperature, 22 April 2010, showing contours and map coordinates grid.

Question 2: What is the name of the school?

Answer 2: Lycee Mamadou M'Bodj de Sebenikuo (LMBS). See point A on Image Q2.

Question 3: What is the Maximum Daily Temperature for 22 April 2010 at this site?

Answer 3: 44.0 °C. See point B on Image Q2.

Question 4: How many air temperature data does this school have available (the number in parentheses after the protocol)

Answer 4: 3,653 data as of 8 May 2014. See point C on Image Q2.

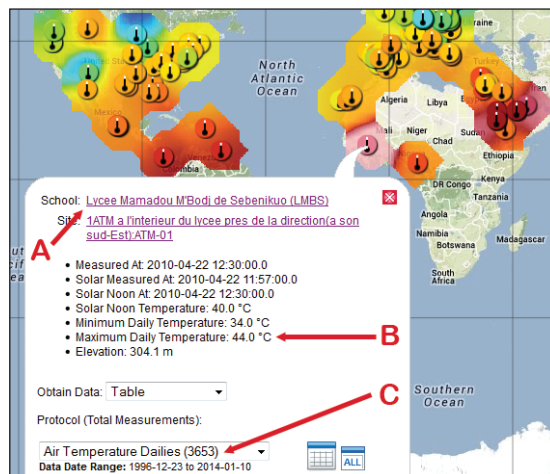

Image Q2. School Data Information box for Lycee Mamadou M'Bodj de Sebenikuo.

Atmosphere Unit

Answer Sheet

Exercise 2: Creating Graphs of Data

Task: Create graphs of air temperature data and make observations and comparisons.

Question 1: When did this school experience the coldest day during these three months?

Answer 1: January 26, 2013; holding the mouse cursor over the lowest point will display this information (See Image Q1 and Image Q1a).

Question 2: What was the temperature on this date?

Answer 2: -17.2 °C; holding the mouse cursor over the lowest point will display this information (See Image Q1 and Image Q1a).

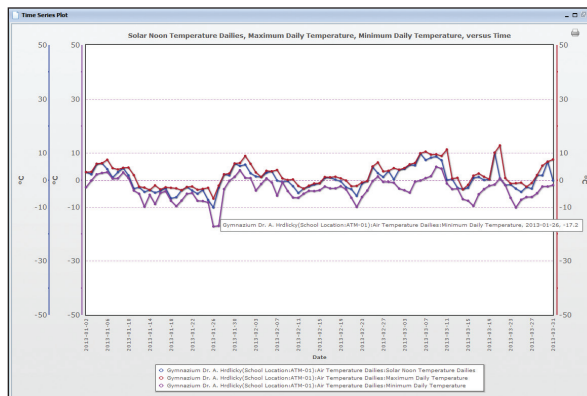

Image Q1. Maximum, Minimum and Solar Noon air temperature graphs for Gymnazium Dr. A. Hrdlicky.

Gymnazium Dr. A. Hrdlicky(School Location:ATM-01):Air Temperature Dailies:Minimum Daily Temperature, 2013-01-26, -17.2

Image Q1a. Enlarged data information box showing date and data details

Question 3: What do you notice, in general, about the shape of these plots?

Answer 3: Several answers are possible based on the time series plots (See Image Q1):

- There was a temperature drop in mid-January;
- The data seem to be erratic, going up and down without a visible trend;
- The Maximum temperature is always greater than the Minimum temperature;
- When the minimum temperature either decreases or increases the solar noon and the maximum temperatures also tends to decrease or increase;
- There appear to be more maximum temperatures above 0 °C while there seem to be more minimum temperatures below 0 °C

Question 4: What do you notice about this school's data?

Answer 4: Several answers are possible based on the time series plot (See Image Q2):

- The temperature increases from December/January (below 0 °C) to July/August (usually at or above 30 °C), showing yearly seasonal patterns;
- The lines are not smooth but rather are very ragged showing how air temperature fluctuates from day-to-day. This is called weather;
- There is a gap in the data during October and November of 2009.

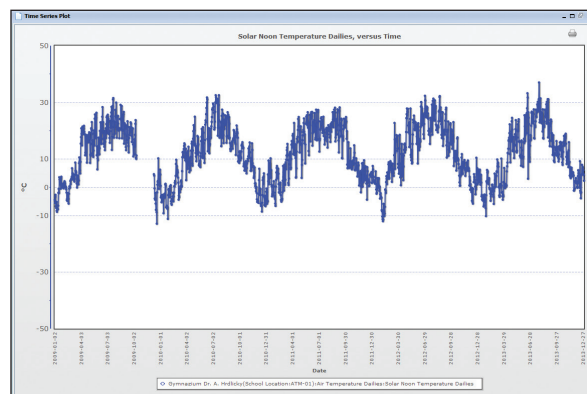

Image Q2. Solar Noon air temperature graph for Gymnazium Dr. A. Hrdlicky, 2009 through 2013.

Atmosphere Unit

Answer Sheet

Exercise 2: Creating Graphs of Data (Continued)

Question 5: What do you notice about the two datasets?

Answer 5: Students should notice that the plots for the two schools appear to be opposite (See Image Q3): when one dataset is increasing, the other is decreasing, showing seasonal trends for northern and southern hemispheres. They may also notice gaps in this second dataset. Even though gaps are present, the data are still valuable for following the overall trends in the data.

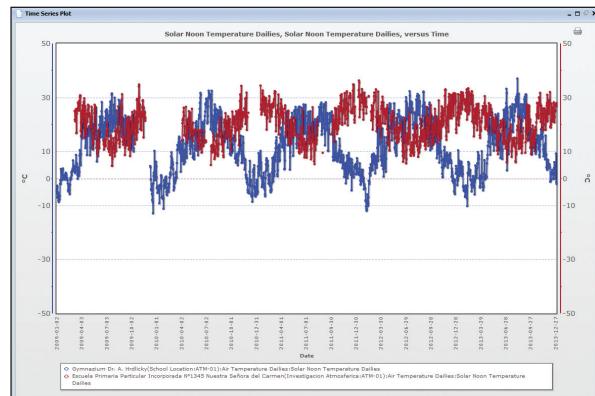

Image Q3. Solar Noon air temperature graphs for Gymnazium Dr. A. Hrdlicky and Escuela Primaria Particular Incorporada N°1345 Nuestra Señora del Carmen, 2009 through 2013.



Sample Soils Unit Plan

**Unit:**

Soils

Topic:

Introduction to Soils; Soil Formation; Soil Characterization

Time:

Option 1: 5-6 Weeks; Option 2: 2-3 Weeks



This soils unit is designed to fully integrate GLOBE into classrooms focused on natural resources, environmental sciences, or agricultural science. It assumes that students have had prior instruction in posing questions and basic student inquiry/research. The unit can be expanded (time wise) if it is necessary to add instruction or reinforcement of the process skills identified for this unit.



Suggestions are provided at the end of the Unit Plan for use of stand-alone lessons and activities in classrooms where a nominal introduction to soils is planned.

Standards:

Science as Inquiry
Physical and Life Science
Earth Science
Science and Technology
History of Natural Science

**Learning Objectives:**

Upon completion of this unit the student will be able to,

1. understand the importance of soils to maintenance of earth as a system;
2. understand the relationships between soil properties and various aspects of soil formation, uses, and processes; and
3. use equipment properly to take measurements; sort, analyze, interpret and explain measurements.

**Materials/Equipment needed:**

Identified with each individual lesson

Chronology of Topics and Activities

(Option 1: 5-6 weeks; Option 2: 2-3 weeks)

Introduction to Soils (2 class periods) (**Lesson Plans Attached**)

Importance of Soils

Just Passing Through – GLOBE Learning Activity

Introduction to Soils, continued (3 class periods) (**Lesson Plans Attached**)

How Soils are Formed

Soil Properties

Soil Properties, continued (1 class period)

Soil in My Backyard – GLOBE Learning Activity

Introduction to Gravimetric Measurements (2-3 class periods)

Digging Around – GLOBE Learning Activity (Requires field trip)

Optional 2 weeks**For more in-depth instruction**

Soil Characterization (10 class periods)

Field Measurements

Digging pit may require one full day with each group

Lab Analysis

Introduction to Group Projects (1-2 class periods)

Soil Moisture (2 class periods)

Soils as Sponges – GLOBE Learning Activity

Field Measurements

Lab Analysis

Soil Temperature (1 class period)

Field Measurements

Lab Analysis

Water Infiltration (2 class periods)

Field Measurements (One class period needed to build and test equipment)

Lab Analysis



Soil the Great Decomposer – GLOBE *Learning Activity* (3 class periods, plus ongoing observation times)
Group Project Presentations (2 class periods)

Visiting Expert – Presentation by local USGS or Soil Conservation Service expert, soil science professor, geologist, etc.

Optional Activities:

1. *The Data Game* – GLOBE *Learning Activity* (Use if unit occurs early in the year, or if students need instruction and/or reinforcement on minimizing errors in data measurements).
2. Making Sense of the Particle Size Distribution – GLOBE *Learning Activity*. Use this activity for students needing enrichment activities, for students enrolled in agricultural education, with students in upper grades of junior high, or as a special project.



Soil Unit

Sample Soils Lesson Plan

**Unit:**

Soils

Topic:

Introduction to Soils – Part I

Time:

2 class periods



This lesson is the first lesson in a Soils Unit designed for Grades 6-10. The lesson spans two days and introduces students to the importance of soil; students will also explore various soil characteristics that they will investigate to greater depth later in the unit such as color, texture, and water-holding capacity.

Standards:

Science as Inquiry

Science in Personal and Social Perspectives

Earth Science

**Learning Objective(s):**

Upon completion of this lesson, the student will,

1. list common uses of soil and discuss its importance;
2. develop an awareness of soil properties that influence water infiltration and flow rates;
3. explain how soil affects water as it passes through;
4. improve observation skills; and
5. work cooperatively in a group to improve skills in scientific inquiry.

**Materials/Equipment Needed:**

Index cards

100 Zip-Loc sandwich bags

Four clear 2-liter bottles

Four 500-ml beakers

Four 500-ml of bottled water (distilled or bottled)

Four 500-ml of bottled water to which salt, vinegar, and baking soda have been added

Fire window screen or panty hose material

Rubber bands

Construction paper or newsprint

pH paper, pen or meter

Work Sheets and handouts (*The Importance of Soil; Just Passing Through*)

Masking tape

Scissors

Markers

Soil samples: clay kitty litter, potting soil, sand, mulch, local soil sample(s).

Procedures (Class Period 1):

1. Lesson Prep

Assemble the *Just Passing Through* apparatus using the instructions from the *GLOBE Teacher's Guide (Soil Learning Activities)*.

Have two sections identified on the board (to create lists) with the following headings: a) What is Soil? and b) Why is Soil Important. A side blackboard/whiteboard is good for this activity, or post-it easel pads, so the lists can remain on the board overnight or longer.

Also, each worktable or desk grouping (4-6 students) should have four small plastic bags with the different soil types used in the *Just Passing Through* apparatus in the center of the table (about 1/2 cup in each bag). Provide four pieces of newsprint or construction paper per group, and markers. Copy *Think-Pair-Share Activity Sheets*.

2. Lesson Introduction

(2-3 minutes)

Have the *Just Passing Through* apparatus set up in front of the classroom as a motivator. Once students are seated, ask them if they know what word or words can describe what is in the 2-liter bottles (*looking for soil or "soil-like" substances as responses*). Tell students that they are going to begin a unit about soil and that you first want to see what ideas they already have about soil and how important it is.

3. Cooperative Learning Activity

(25-30 minutes)

Think-Pair-Share

Distribute *Think-Pair-Share Activity Sheets* to students. Review directions with students and have them complete the activity in groups of two as indicated in the directions. Monitor time and move the students to next activity when appropriate.

Keep students on task. At end of pairing activity, ask the presenters from each group to share responses for the group. You should write each different response on sections of the board as groups present their information.

Group Processing

Discuss items on lists with group. Ask students if there are any surprises? Ask them if there are any items on the lists that they are not sure about and where we could check on those items to clarify. Ask if there are any missing items from the list, and add those as they are presented.

4. Wrap-Up

Ask students to copy lists from board in their journals or notebooks.

*Wrap-Up Only for Extra Time
(or for extended class period)*

Ask each group of 3-4 students to pour out the small samples of soils on their table or work areas onto separate pieces of construction paper or newsprint. Ask them to discuss and record in their journals a) A description of each sample and b) How the samples are alike and how they are different.

5. Assignment(s)

- Provide students with a Zip-Loc style sandwich bag so that they can bring soil samples to class tomorrow. Students should write their names on the bag using a marker. The soil will be used in a later lesson.
- Journal assignment: Write two paragraphs in journal. One paragraph should describe what soil is and the other paragraph should explain why soil is important. Students will have the opportunity to review and revise these paragraphs at the end of the unit for inclusion in their portfolios.

Hint: Printing instructions on large labels and placing on index cards saves time.

6. Evaluation

- Student journal assignments, both original and revised, will be reviewed as part of portfolio review process in order to determine if they understand the basic concept of what is soil as well as the importance of soil.
- Unit and/or semester objective test will include items related to the importance of soil and factors that influence water infiltration and flow-through rates (also covered to more depth in later lessons).



Procedures (Class Period 2):

1. Lesson Prep

Student tables or desk groupings for 3-4 students should have one bottle from the *Just Passing Through* apparatus. You will need four 500-ml bottles of water to which either vinegar or baking soda has been added – keep these at teacher’s desk area for use later if time permits. Label bottles with what has been added. Students will check pH during activity. The following items are also needed at each table:

- Copy *Just Passing Through Work Sheet*
 - pH paper.
 - One 500-ml bottle of distilled or bottled water with pH between 6.5 and 7.5. You should check the pH prior to class. Label as “Water Only” and with the pH.
- Note:** One of the 2-liter bottles to be placed on the tables should contain fairly wet soil.

2. Lesson Introduction

(5 minutes)

Ask students what kinds of things they observe about the soil samples they have brought in from home. (*Some anticipated responses would include the color of each, how they may feel and look, etc.*) If students have not touched or felt the soil samples, direct them to do so at this time. Ask students if they think there is a unique relationship between soil and water—caused by some of the things they observe about their soil samples. Ask why they think this. Explain that today they will be beginning to explore how water moves through soil. Have students put their soil samples back into their plastic bags and set aside.

3. Inquiry Activity/Just Passing Through

(25-30 minutes)

Provide students with Background Information and *Just Passing Through Work Sheet*. Allow them to work together in groups of 4-6; monitor time so that you allow at least 5 minutes for a wrap-up and some discussion.

- a. Groups can complete a “For Extra Time” activity if time permitting, but a whole-class wrap-up and discussion should be planned for the last 5 minutes of class.

4. Wrap-Up

(5 minutes)

Take a survey of the results to see how accurate groups’ predictions were. Ask students to comment on the discrepancies.

- a. Ask students if they can now feel moisture in the soil in the bottles. Assuming that all will, ask them what will happen if you add another 500-ml of water to the bottles.
- b. Ask students if they can identify what properties of the soil in their bottles might have caused the water to flow at a certain rate, its color, pH change, etc.
- c. Tell students that the rest of the soil unit will provide them with answers to those questions.

5. Assignment(s)

Journal – Revisit previous entries. Add any missing information. Write an additional paragraph describing the dynamics of how water moves through soils and what factors (soil characteristics) may be affected by this processes

6. Evaluation

Unit and/or semester objective test will include items related to the importance of soil and factors that influence water infiltration and flow-through rates (also covered to more depth in later lessons).



Introduction to Soils – Part 1

The Importance of Soil Work Sheet

(Think-Pair-Share Activity)

Name: _____ Partner: _____

Part 1

Think quietly about what you already know and think about soil and why soil is important. *Write at least one thing you know about soil and two ways that soil is important in the space below.* (You have 2-3 minutes for this part of the activity.)

1. What I know about soil: _____

2. Soil is important because: _____

Part 2

Pair up with the person sitting next to you. Discuss your answers recorded above. The two of you should decide on what information you will share with your classmates. (You have 5-7 minutes for this part of the activity.)

Roles: **Recorder** – You will write down the ideas in the spaces below.

Presenter – You will share your answers with the class.

1. What I know about soil: _____

2. Soil is important because: _____

Part 3

The presenter will share information with the rest of the class.

Introduction to Soils – Part 1

Just Passing Through Work Sheet

Soils are a thin layer on top of most of the land on Earth. Soil affects every part of the ecosystem and performs important functions for life on Earth:

1. Soils hold nutrients and water for plants and animals.
2. Soils filter and clean water as it flows through.
 - a. This changes the water and affects how much water returns to the atmosphere to form rain.
 - b. Depends on size of soil particles, how tightly they are packed, how they are arranged, and the “attraction” between the soil particles and the water (electronic attraction or electro negativity).
3. Food and other important things we use depend on soils (paper, building materials, clothing).
 - a. Transfer of nutrients to plants depends on water in the soil – Plants do not eat solid food, but take in water that contains nutrients from the soil.
 - b. How “nutritious” soil is depends on how it forms, what it forms from, and how it’s managed.

Directions

Your group will be working with the soil in the bottles on your table to answer the following questions and do the activities. Each group should discuss answers among themselves; each person in the group will complete his/her own answer sheet.

1. In the space below, write a description of the soil in your bottle. Note things such as color, how it feels, presence of rocks or roots, presence of moisture.

2. Think about what will happen if you pour water onto this soil. How much water will flow out of the soil into the bottom container?

Why do you think this? _____

How fast will the water pass through the soil? _____

Why do you think this? _____

Will the pH of the water change? _____

If so, how and why do you think this is happening? _____

What will the water look like when/if it comes out the bottom? _____

Why do you think this? _____

3. Read over the things you are supposed to observe from the following questions. Decide how you are going to pour the water onto the soil. Will it be fast, slow, in one place, all over the surface, etc.

4. One person in your group should pour the water from the bottle labeled “Water Only” onto the soil. One person should time how long it takes. Record your observations below.

pH of Water (from label): _____ Volume of Water: _____

How we decided to pour: _____

Is all the water staying on top? _____

If not, where do you think it is going? _____

Do you see any air bubbles at the top of the water? _____

Does the water coming out of the soil look the same as the water going in? _____

How does it look, if different? _____

Does the soil at the surface appear different than before you began to pour water on it? _____

How is it different? _____

Did the water flow completely through the soil? _____

If yes, how long did it take? _____

5. Test the pH of the water that has gone through the soil and measure its volume.

pH of Water: _____ Volume of Water: _____

Has the pH changed? _____

If so, what do you think might have caused this change? _____

Is the volume of water in the bottom container different than the amount poured at the beginning? _____

If no, what do you think happened to the water that is “missing” from the bottom container? _____

6. Look back at your group’s predictions (guesses, hypotheses) about what would happen when you poured the water into the soil (Question 2). Is what actually happened the same as your predictions? _____

7. **Optional Activity** (or double/lengthened period): Your teacher will give you another bottle of water. Test the pH of a bottle of water using pH paper. Something has been added to the water. Pour this bottle of water into your soil and measure both the volume and pH of the water in the bottom container after it flows through the soil.

Substance added to water: (from label): _____

pH of Water: (before pouring): _____ Volume of Water: _____

pH of Water: (after pouring): _____ Volume of Water: _____

Can you explain what happened? _____



Soil Unit

Lesson Plan

**Unit:**

Soils

Topic:

Introduction to Soils – Part 2

Time:

3 class periods

This lesson is the second lesson in a Soils Unit designed for Grades 6-10. The lesson spans three days and introduces students to how soil is formed as well as soil properties.

Standards:

Science as Inquiry
Science in Personal and Social Perspectives
Earth Science
Life Science

Learning Objective(s):

Upon completion of this lesson, the students will be able to,

1. describe which portion of soil can be used for growing food or other materials;
2. list and describe the various ways that soil is formed;
3. label and describe the horizons of a soil profile;
4. describe the different sized particles of which soil is composed; and
5. work cooperatively in a group.

**Materials Needed:**

Sponge
Shallow cake tin or other pan that will hold water
Soil samples (from previous lesson) in baggies
Eight 2-liter bottles or other clear plastic container
Soil color charts (GLOBE) or Munsell Color Chart books
Handouts – Cooperative Learning Activity (Day 1)
Soil layers/horizons sheet to label,
Presentation Slides - Soil components
Relative soil particle sizes
Various soil structures
Soil profile
Materials for presentations – Blank presentation slides, marking pens, poster boards, construction paper, crayons, scissors, tape, glue, etc.

Procedures (Class Period 1 and part of 2)

1. Lesson Prep

Keep *Just Passing Through* apparatus assembled in front of room, or re-assemble on side table where it is visible to all. There will be four cooperative learning groups; each group will need copies of group activity sheets (enough for one per student). Cut eight 2-liter bottles in half to make a container (or use other clear plastic containers). Place mulch in four containers and pure sand in four containers. Each cooperative learning group should receive one of each. Have activity sheets and containers on tables prior to start of lesson.

Have a color picture of soil profile displayed as students enter the room (e.g., on a screen from a projector).

2. Lesson Introduction

(5 – 7 minutes)

Ask for a student volunteer to come to the front of the room. This student will then take a dry sponge and place it in a shallow pan of water. Tell the students that they will be looking at the sponge the day after tomorrow as they talk about the properties of soil.

Show students a color picture of a soil profile (e.g., on a screen from a projector) – one that prominently shows the bedrock layer. Explain that this is a soil profile, and that much of the soil in the various layers on top of the bedrock layer were once part of the solid rock.

Hints for Inquiry: Explain what a profile is but don't explain how it is formed. Have students get into groups of 4-6 students. Hand out samples of soil from different profiles and ask the students to write down how they think the soil was formed and where they think the soil came from. Then have a class discussion on this topic.

3. Activity: Part 1

Cooperative Learning Discussion.

(15 – 20 minutes)

Students will be working in four cooperative learning groups, each one investigating at

least one factor affecting soil formation. (See attached group activity sheets/handouts: Group 1 – Time/Weathering; Group 2 – Organisms; Group 3 – Parent Material and Topography; and Group 4 - Climate.)

Hint: Research shows that cooperative learning works best with groups that do not exceed five students. If you have more than 20 students in your class, you will need to form more than four student groups resulting that more than one group may be working on any given topic area.

Each group will need at least: *one reader, one facilitator, one recorder, and one presenter.* Make these decisions based on the total number of students in the room and how the groups are divided.

Note: Students can assume two different roles if the group size is small.

Place index cards upside down on each group table with “Reader,” “Facilitator,” “Recorder,” and “Presenter” on them. Ask each student to pick up a card to determine his/her role. Again, the number of cards needed for the various roles will be determined by the number of students.

Note: People learn best when they teach others, but this activity can lead to the formation and discussion of major misconceptions about the content areas being covered. The teacher should monitor student discussions and review each group's presentation prior to any whole-class sharing or group dissemination of information. Refer to the Answer Key (attached) for each group handout to ensure correct student responses.

Activity: Part 2

Preparation of Presentations

(15 – 20 minutes)

Cooperative learning groups will prepare a presentation based on the information presented in handouts provided, including visuals, to present their research to the rest of the groups. Materials for use in the preparation should be displayed in an accessible place. Provide students with the grading rubric.



4. Wrap-Up

Stop presentations at least 3-5 minutes before the end of class in order to allow time for clean-up. Inform students that they will finish giving their presentations during next class.

5. Assignment(s):

Complete any outside preparation needed for projects and presentations the following day.

6. Evaluation

A *Work Sheet* (See attached) will be given to students following Day 3. Student groups will be evaluated using a group presentation rubric (Should be something students are familiar with from prior activities or it can be given to them to review at the beginning of the preparation of presentations.). Objective items will be included on a unit test.

Hints for Inquiry: You may also wish, time permitting, to provide some additional soils and see if students can determine how the soils were formed (if they are new).

Procedures (Class Period 2):

1. Lesson Prep

Keep the *Just Passing Through* apparatus assembled in front of room, or re-assemble on side table where it is visible to all. Be standing by door as students enter to direct them to go immediately to group area to begin working.

2. Lesson Introduction

(3-5 minutes)

Remind students that each group has only 15 minutes to finish presentation. Each presentation should be 5-7 minutes in length.

3. Activity: Part 1

Cooperative learning groups spend 15 minutes finishing their presentations.

Activity: Part 2

Each group gives a 5-7 minute presentation.

Remind students that they will need to take notes on the presentations since this information will be needed for an assignment and will also be included on the unit test. Tell them you will also be taking notes.

4. Wrap-Up

During the last five minutes of class, ask students to help you list things they have learned about soil formation. Write list on the board.

5. Assignment(s)

Journal – Describe at least three new concepts learned from the presentations.

6. Evaluation

A *Work Sheet* will be given to students following Day 3. Student groups will be evaluated using a *group presentation rubric* (Should be something students are familiar with from prior activities or it can be given to them at the beginning of the preparation of presentations. —See sample attached). Objective items will be included on a unit test.

Procedures (Class Period 3 Soil Properties)

1. Lesson Prep

Collect various soil samples, or in advance ask students to bring soil samples to school. You can also use remaining samples from Lesson 1. Label samples as “A,” “B,” and “C,” etc. The samples should be in clear plastic containers suitable to pass around room. Two-liter soda bottles cut in half work well. Prepare presentation slides. (See included presentation slides: *Soil Layers, Composition of an Average Soil, Soil Profile, Relative Soil Particle Sizes, Various Soil Structures*).

2. Lesson Introduction

(10 minutes)

This lesson will involve a discussion of the physical properties of soils.

1. Review the previous lesson with a brief discussion of soil formation. Some useful questions are,
 - a. How is soil formed?
 - b. How is soil transported?
 - c. Can we name the 5 soil forming factors that influence this process? (*parent material, climate, organisms, topography, time*)
2. With a variety of soil samples available for inspection (and in containers



suitable to pass around the room), begin a discussion related to the differences between each of these samples.

Use the senses of sight, touch, and even smell. Add to your discussions from previous days. Some probing questions could include: (List all responses on board)

- a. What are the noticeable differences in each of these samples?
 - b. What components make up these soil samples?
3. Ask students to get out their notebooks and a pen/pencil to take notes on the class discussion.

3. Activity

(30 minutes)

For background see GLOBE *Soils Introduction* pages.

1. Point out to students that one of their observations may have been the presence of organic matter (*decayed plant roots, leaves, etc.*).
 - a. Write on board – organic matter, humus. Ask students to copy in their notebooks and to leave space for later clarification and discussion of the terms.
 - b. *Organic matter* comes from the decomposition of any plant or animal life. Decomposed organic matter is called *humus*.
 - c. Explain to students that a typical soil sample is actually made up of a combination of organic matter 5%, minerals 45%, water 25%, and air 5%. See Presentation Slide IG-I-1. These percentages vary. The total air, and water space available in the soil is also referred to as *pore space*.
 - d. After a rainfall, the percent of air will decline, and the percent of water will rise. Likewise as a soil becomes dry during a summer drought, the percent of water will decline, while the percent of air is increased.
2. The arrangement of various size particles in the soil determines the *soil texture*.

- a. This soil texture is influenced by the percentage of sand, silt, and clay particles found in the soil. (Ask students which of these particles they think is the largest, and which they think are the smallest.) See Soil Textural Triangle from the GLOBE *Teacher's Guide, Soil Investigation*.
- b. Draw a diagram on the board that illustrates the relative size of each particle. Use Presentation SLide IG-I-2 to illustrate the relative sizes of each soil particle.

Hint: Have samples for the students to feel and look at so they see and feel the difference between the textures.

- Sand particles are the largest ranging from 2.00-0.05 mm., silt particles are intermediate in size at 0.05-0.002 mm, clay particles are the smallest at less than 0.002 mm in size.
- Ask students to discuss the function of each particle in the soil. Ask students to remember the *Just Passing Through Learning Activity* and what they can conclude about soil particle size. (*Larger soil particles, allow for greater water infiltration rates, and permeability of the soil, while smaller particles are essential to both the water and nutrient holding capacities of the soil*).

Hint: Give the students soils that have a mixture of textures so they determine what particles make up the soil.

3. A soil profile is a cross sectional view of the face of the soil.
 - a. Provide students with the blank *Soil Layers* handout of a soil profile (See attached – *Soil Layers*) for them to use for labeling and note taking on this section.

Hint: If possible have a real profile for the students to feel and examine and then the handout is done afterward on their own as assessment or in groups as a focal point for their discussion.



- b. Imagine a cut, into the undisturbed layers of soil. These layers are called soil horizons. See Presentation Slide IG-I-3.
- c. Each horizon has specific characteristics.
 - In forested areas, the top horizon is known as the *O-Horizon*. This layer is made up of decomposed organic material typically from the breakdown of leaves, and twigs.
 - The second horizon is known as the *A-Horizon*, because it is the first horizon made up of mineral materials. This horizon is typically referred to as topsoil, and usually contains a large amount of organic material.
 - The next transitional layer is referred to as the *B-Horizon*. This horizon is usually lighter in color than the A horizon above it. It is composed of parent material that has been severely weathered to the point that it is different in appearance. This layer is commonly referred to as *subsoil*.
 - The next major layer is called the *C-Horizon*. This is the horizon that most closely resembles the parent material with no change in color, and no structure formed. The C-Horizon contains a mixture of unconsolidated material below the B-Horizon and above bedrock.
 - The *R-Horizon* represents the layer of bedrock that is sometimes found at the base of a soil profile. This horizon could be the parent material of the soil, or alluvial, glacial, or volcanic materials that have been deposited above this layer and therefore served as the parent material.
- d. Other horizons, or transitional horizons may exist under certain conditions.
- 4. Soil Structure is the shape that the soil takes based on its physical and chemical properties.
 - a. Soil structure can be viewed by close examination of the separation of soil peds in a given horizon.
 - b. Types of soil structure include *blocky, columnar, granular, platy* and *prismatic*.

- c. Soil structure influences water infiltration and air circulation in the soil. It also influences the ability of roots to penetrate a given soil. Relate to movement of water through a sponge.
- d. Students should examine several soil peds to practice identifying various soil structure patterns. Presentation Slide IG-I-4 illustrates different soil structures. (Refer to *GLOBE Protocols* for additional illustrations of soil structure.)
- 5. Soil Color can be an indication of several things.
 - a. Display soil color chart or Munsell Color Chart book.
 - b. Color can be an indication of certain elements such as iron, which has a red color, or calcium carbonate which is white in color. (Point out on chart)
 - c. In the O, or A-Horizons, a dark brown or black color is usually indicative of the presence of organic matter. (Point out on chart)
 - d. Soil color also differs based on how wet or dry the soil is. In poorly drained soils, which are saturated for most of the year, the B-Horizon can often be gray in color.

Hint: Have soil samples and color books for the students to use to see the different colors of soil.

4. Wrap-Up

(5 minutes)

Ask the students questions such as

1. Do soil properties influence soil productivity? (Yes)
2. Why is it important for us to know about soil properties? (*Knowledge of soil properties can help us predict the suitability of a given soil for specific agricultural or industrial purposes.*)
3. What are the components that make up soils? (*Soils are composed of sand, silt, clay, organic matter water and air.*)
4. What does soil color tell us about a soil? (*Soil color can indicate the presence of certain minerals, or other attributes such as organic matter content.*)

5. Assignment(s)

Provide each student with a Work Sheet (See attached – Soil Formation and Composition) that is to be done for homework. Inform them that the *Work Sheet* will be collected at the beginning of class tomorrow and evaluated.

6. Evaluation

Evaluation of *Work Sheet*. Objective items on unit test. Evaluation of group presentation.

Evaluation Hint: A real performance-based test done on an individualized basis would be best. Some sample questions are,

1. Here are 3 core samples; indicate where the horizons are located; and
2. Describe the composition of this soil, etc.

7. Work Sheet Answer Key

1. True
2. False
3. False
4. True
5. False
6. Parent material
7. Weathering
8. Humus
9. Soil texture
10. Soil structure
11. C
12. E
13. B
14. A
15. B
16. D
17. E
18. D
19. B
20. D
21. a. Mineral matter 45%
b. Air 25%
c. Water 25%
22. Water
23. Air
24. Answers will vary
25. a. Physical
b. Chemical
c. Physical
d. Physical

The Formation of Soil

Work Sheet

Group 1: Time/Weathering

There are five factors that influence the formation of soil. They are

1. Parent Material
2. Climate
3. Organisms
4. Topography
5. Time

Your group will examine how time and weathering influence soil formation.

Reader:

Read the following paragraph on the formation of soil and the paragraph on weathering to your group.

The formation of soil happens over a very long period of time. It can take 1000 years or more. Soil is formed from the weathering of rocks and minerals. The surface rocks break down into smaller pieces through a process of weathering and are then mixed with moss and organic matter. Over time this creates a thin layer of soil. Plants help the development of the soil. How? The plants attract animals, and when the animals die, their bodies decay. Decaying matter makes the soil thick and rich. This continues until the soil is fully formed. The soil then supports many different plants.

Weathering: Weathering is the process of breaking down rocks. There are two different types of weathering: 1) Physical weathering and 2) Chemical weathering. **Physical weathering** breaks down the rocks into smaller pieces, but what it's made of stays the same. One example of a physical change is smashing a rock with a hammer to form smaller pieces. **Chemical weathering** also breaks down the rocks, but it may change what the rock is made of. An example is when iron is changed to rust during the process of chemical weathering.

Facilitator:

Lead group members in a discussion of each of the following situations. Label each situation as an example of physical weathering or chemical weathering.

- | | Circle One | |
|---|-------------------|----------|
| | Physical | Chemical |
| 1. Winter freezing and thawing of rocks — Water seeps into cracks in a rock, then freezes and expands. The rock develops larger cracks and breaks into smaller pieces.
Why? _____
_____ | | |
| 2. Common minerals found in rock dissolve in acid rain.
Why? _____
_____ | | |

Stages in the Formation of Soil

Facilitator:

Four stages in soil formation, over time, are shown below. What is happening in each stage? Lead your group in a discussion of each stage.

Recorder:

Take notes of the group discussion in the spaces provided below each picture.

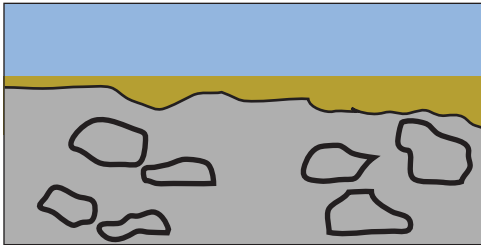

Stage 1

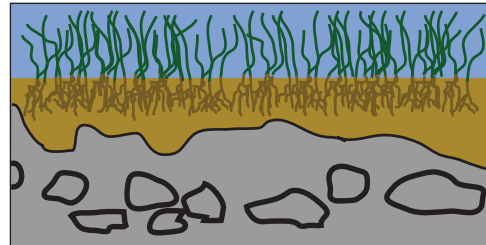

Stage 2

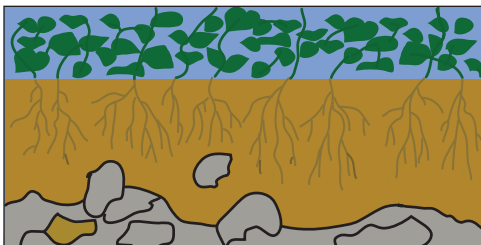

Stage 3

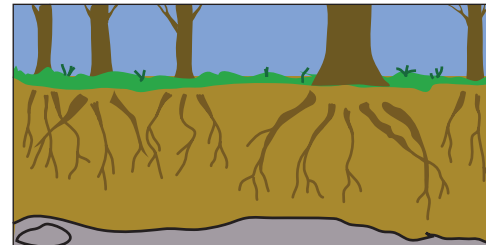

Stage 4

Presenter(s):

Lead group members in a discussion of how to teach this information to the rest of the class. Your group should prepare a presentation of Time and Weathering as factors in the formation of soil. Your presentation should take approximately 5-7 minutes. The teacher has provided transparency masters, poster paper, and other materials for you to use in your presentation. Refer to the attached grading rubric.

The Formation of Soil

Work Sheet

Group 2: Organisms

There are five factors that influence the formation of soil. They are,

1. Parent Material
2. Climate
3. Organisms
4. Topography
5. Time

Your group will examine how organisms influence soil formation.

Reader:

Read the following paragraphs on the composition of soils to your group members.

Soils are a mixture of different things: rocks, minerals, and dead decaying plants and animals. Soil can be very different from one location to another, but generally consists of organic and inorganic materials, water and air. The inorganic materials are the rocks that have been broken down into smaller pieces. The size of the pieces varies. It may appear as pebbles, gravel, or as small as particles of sand or clay. The organic material is decaying living matter. This could be plants or animals that have died and decay until they become part of the soil.

Live organisms (plants, animals, and microscopic organisms) also influence soil formation. Live animals move around in the soil and help break large pieces into smaller pieces. Microscopic organisms help the decay of dead plants and animals. Roots of growing plants can break apart dense, hard soil or rocks. Humans are organisms that also affect soil formation by the way they use soils—think about paving over a field to make a parking lot or growing corn. Live animals such as rabbits and cows deposit waste materials on the ground that changes soil.

Facilitator:

Lead group members in a discussion of each of the following.

Recorder:

Take notes of the group discussion.

1. Write a group description of the differences between inorganic and organic materials.

2. Label each of the following as inorganic or organic material.

Lump of clay _____

Quartz crystal _____

Leaf fallen from tree _____

Broken piece of glass _____

Gasoline _____

Moss _____

3. What kinds of organisms do you think you would find in soils at the beach?

Why?

How do you think they might influence the formation of the soil?

4. What kinds of organisms do you think you would find if you dig in soils in a natural area (i.e., a forest) close to your school? Why?

How do you think they might influence the formation of the soil?

Facilitator:

Lead group members in a discussion of each of the following.

Recorder:

Take notes of the group discussion.

5. List at least five ways that organisms can influence soil formation (besides the ones already mentioned). Check with your teacher to make sure you are correct.

1. _____
2. _____
3. _____
4. _____
5. _____

Presenter(s):

Lead group members in a discussion of how to teach this information to the rest of the class. Your group should prepare a presentation of Organisms as factors in the formation of soil. Your presentation should take approximately 5-7 minutes. The teacher has provided transparency masters, poster paper, and other materials for you to use in your presentation. Refer to the attached grading rubric.

The Formation of Soil

Work Sheet

Group 3: Parent Material and Topography

There are five factors that influence the formation of soil. They are,

1. Parent Material
2. Climate
3. Organisms
4. Topography
5. Time

Your group will examine how parent material and topography influence soil formation.

Reader:

Read the following paragraphs on the composition of soils to your group members.

One of the most important things that scientists have discovered is how soil forms from rock. The rock that forms soil in any location is known as the parent material of that soil. The parent material can be bedrock, organic material, an old soil surface, or a deposit of materials from water, wind, glaciers, volcanoes, or materials moving down a hillside. The character composition of the parent material plays an important role in the determination of soil properties, especially during the early stages of development.

For example, soils developed on parent material that is coarse, or with large grains of minerals, will have obvious large grains in the soil. Beach sand is an example of soil with large grains. It has formed from the breaking apart of bedrock known as sandstone which has then blown or been washed to the sea. The bedrock below the sea also contains sandstone, which can be broken apart and deposited on the shore by waves. Fine, small grain soils form from parent material and minerals that break apart easily into very small particles.

Parent materials have a direct impact on how soils support plant and animal life. Parent materials rich in certain substances such as calcium and sodium that are easily dissolved in water will produce a soil where these chemicals are readily available for plants. If the parent materials do not contain substances that dissolve easily in water, soils may be low in chemicals needed for healthy plant growth. Parent material that is made of once living things may produce a soil that is very acid.

Facilitator:

Lead group members in a discussion of each of the following.

Recorder:

Take notes of the group discussion.

1. Write a group definition of parent material.

2. Is parent material different from bedrock? If yes, how?

3. Examine the two different soil samples on your table. What kind of parent material to you think was the basis for these soils?

Soil A parent material? _____

Soil B parent material? _____

Why do you think this?

Why do you think this?

Where do you think you would find this soil in nature?

Where do you think you would find this soil in nature?

Reader:

Read the following paragraph on topography to your group members.

The location of a soil on any landscape can affect how climate processes (such as rainfall) affect it. For example, soils at the bottom of a hill will end up with more water than soils on the slopes, and soils on slopes that face the sun will be drier than soils on slopes that do not face the sun. Also, certain areas may allow water to collect, which can lead to an accumulation of minerals – some of these minerals may be healthy and some may be harmful to plants and soil organisms.

Facilitator:

Lead group members in a discussion of each of the following.

Recorder:

Take notes of the group discussion.

1. How might each of the following landscapes affect the soil?
 - a. Hill with no plants on it –
 - b. Hill with a lot of plants on it –
 - c. Hole in the ground that used to contain an old tree trunk –
 - d. Area that faces sun, but is half covered with shade trees -

Presenter(s):

Lead group members in a discussion of how to teach this information to the rest of the class. Your group should prepare a presentation of Parent Material and Topography as factors in the formation of soil. Your presentation should take approximately 5-7 minutes. The teacher has provided transparency masters, poster paper, and other materials for you to use in your presentation. Refer to attached grading rubric.

The Formation of Soil

Work Sheet

Group 4: Climate

There are five factors that influence the formation of soil. They are,

1. Parent Material
2. Climate
3. Organisms
4. Topography
5. Time

Your group will examine how climate influences soil formation.

Reader:

Read the following paragraphs on climate and soils to your group members.

Climate, particularly temperature, precipitation (rain and snow), and frost have a lot of influence on how soil will form in any area. Climate determines what type of weathering processes occur, and how these might differ in any one place. This also affects the type of plants that will grow, which in turn affects soil-forming processes. A few things to consider:

- a. A lot of precipitation will dissolve chemicals that seep through soil layers and dissolve minerals in bedrock and other soil forming parent materials.
- b. Cold winter temperature causes frost that can physically break apart rocks.

The formation of soil happens over a very long period of time. It can take 1,000 years or more. Soil is formed from the weathering of rocks and minerals. The surface rocks break down into smaller pieces through a process of weathering and is then mixed with moss and organic matter. Over time this creates a thin layer of soil. Plants help the development of the soil. How? The plants attract animals, and when the animals die, their bodies decay. Decaying matter makes the soil thick and rich. This continues until the soil is fully formed. The soil then supports many different plants.

Weathering: Weathering is the process of breaking down rocks. There are two different types of weathering: 1) Physical weathering and 2) Chemical weathering. Physical weathering breaks down the rocks into smaller pieces, but what it's made of stays the same. Chemical weathering breaks down the rocks, but this process may change what the rock is made of.

Facilitator:

Lead group members in a discussion of each of the following.

Recorder:

Take notes of the group discussion.

1. Write a group explanation of how climate affects the formation of soils.

2. What kind of climate would you expect to find in the following areas?

a. The Mojave Desert in California

How do you think the desert climate influences soil formation?

Why do you think this?

b. Fairbanks, Alaska

How do you think climate in Fairbanks influences soil formation?

Why do you think this?

c. Miami Beach, Florida

How do you think the climate in Miami Beach influences soil formation?

Why do you think this?

Presenter(s):

Lead group members in a discussion of how to teach this information to the rest of the class. Your group should prepare a presentation of Climate as a factor in the formation of soil. Your presentation should take approximately 5-7 minutes. The teacher has provided transparency masters, poster paper, and other materials for you to use in your presentation. Refer to the attached grading rubric.

GLOBE Soils Presentation

Group Work and Presentation Rubric:

Teacher name: _____

Group members: _____

Category	Excellent 4 Points	Good 3 Points	Satisfactory 2 Points	Needs Improvement 1 Point
Preparedness	Group and presenters are completely prepared and comfortable with content and their presentation.	Group and presenters seem prepared, but not comfortable with content and their presentation.	Group and presenters are somewhat prepared, and not comfortable with content and their presentation.	Group and presenters not at all prepared or comfortable with content and their presentation.
Creativity	Makes excellent use of color, graphics, effects, etc. to enhance the presentation and get the ideas across. Ideas are creative and inventive.	Makes good use of color, graphics, effects, etc. to enhance to presentation. Ideas are fairly creative and inventive.	Makes use of color, graphics, effects, etc. but occasionally these detract from the presentation content. There is little evidence of creativity.	Use of color, graphics, effects, etc. but these often distract from the presentation content. No evidence of creativity.
Time-Limit	Presentation is 5-7 minutes long.	Presentation is 4 minutes long.	Presentation is 3 minutes long.	Presentation is less than 3 minutes OR more than 8 minutes.
Stays on Topic	Stays on topic all (100%) of the time. Materials flow in logical sequence.	Stays on topic most (90-99%) of the time. Materials flow in logical sequence.	Stays on topic some (75-89%) of the time. Materials flow in a disjointed manner.	It was hard to tell what the topic was. Materials don't flow well.
Content	Demonstrates a full understanding of the topic.	Demonstrates a good understanding of the topic.	Demonstrates a good understanding of parts of the topic.	Does not seem to understand the topic very well.

Created using <http://rubistar.4teachers.org/>

Soil Horizons Student Handout

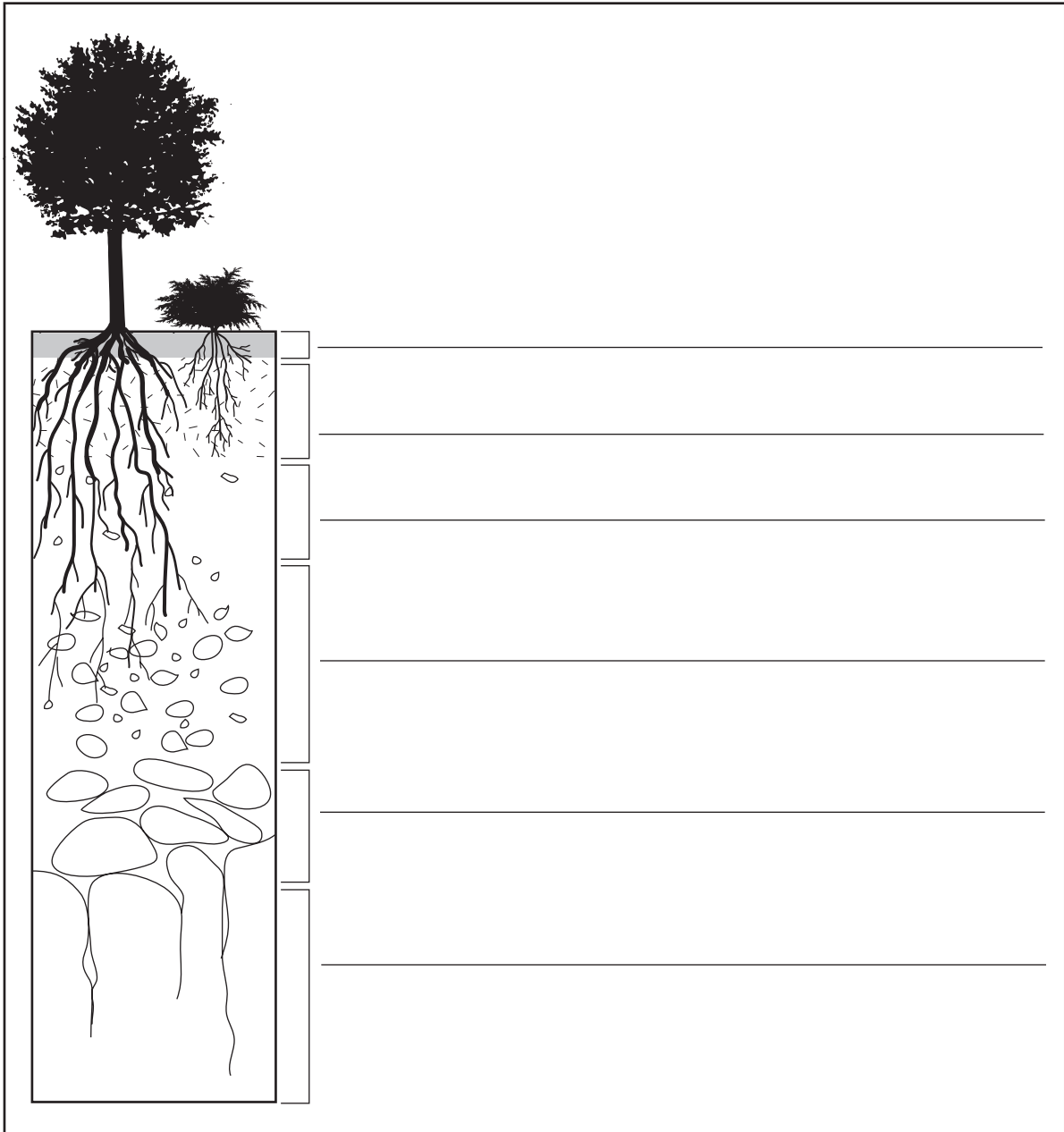

Composition of an Average Soil

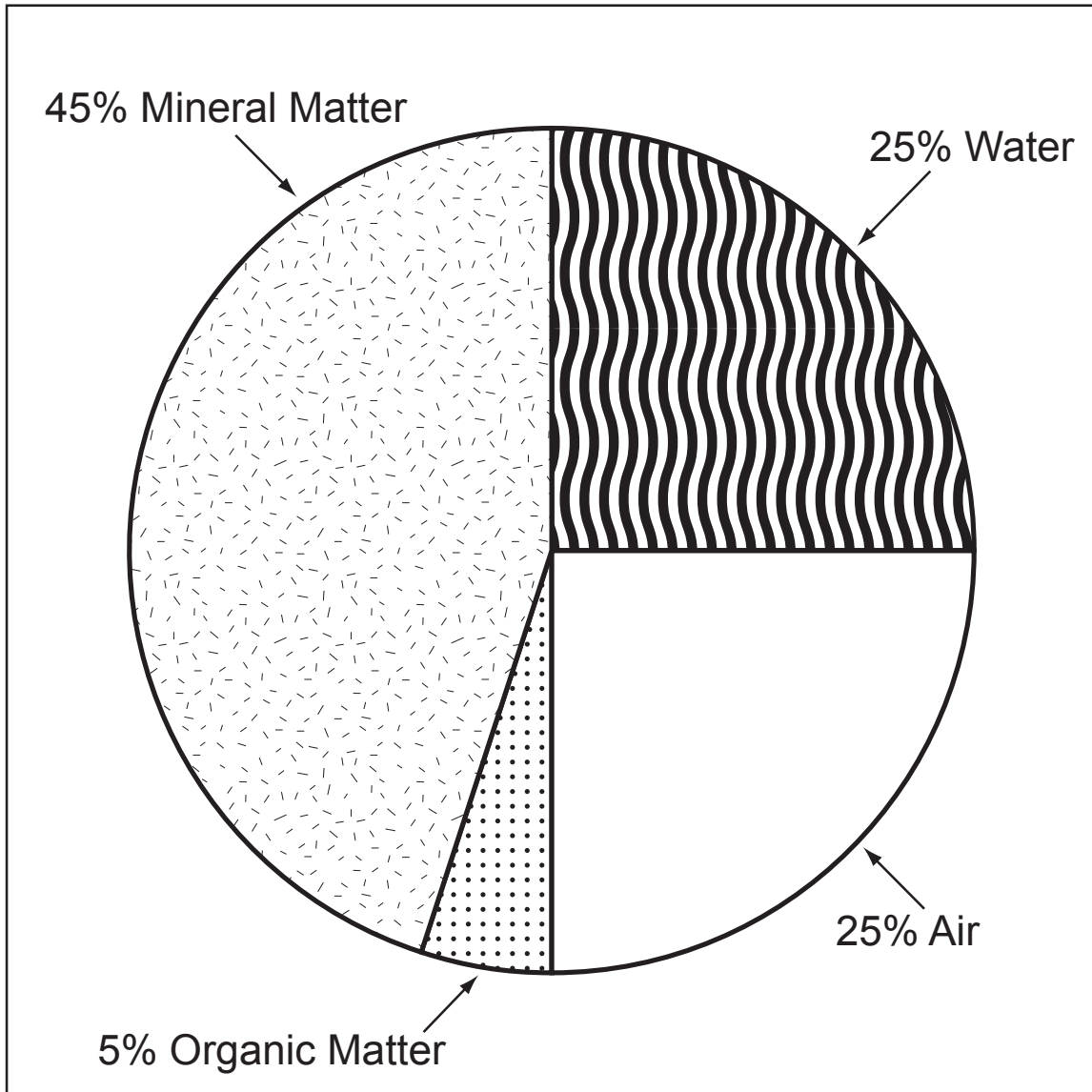

Source: National Council for Agricultural Education

Soil Profile

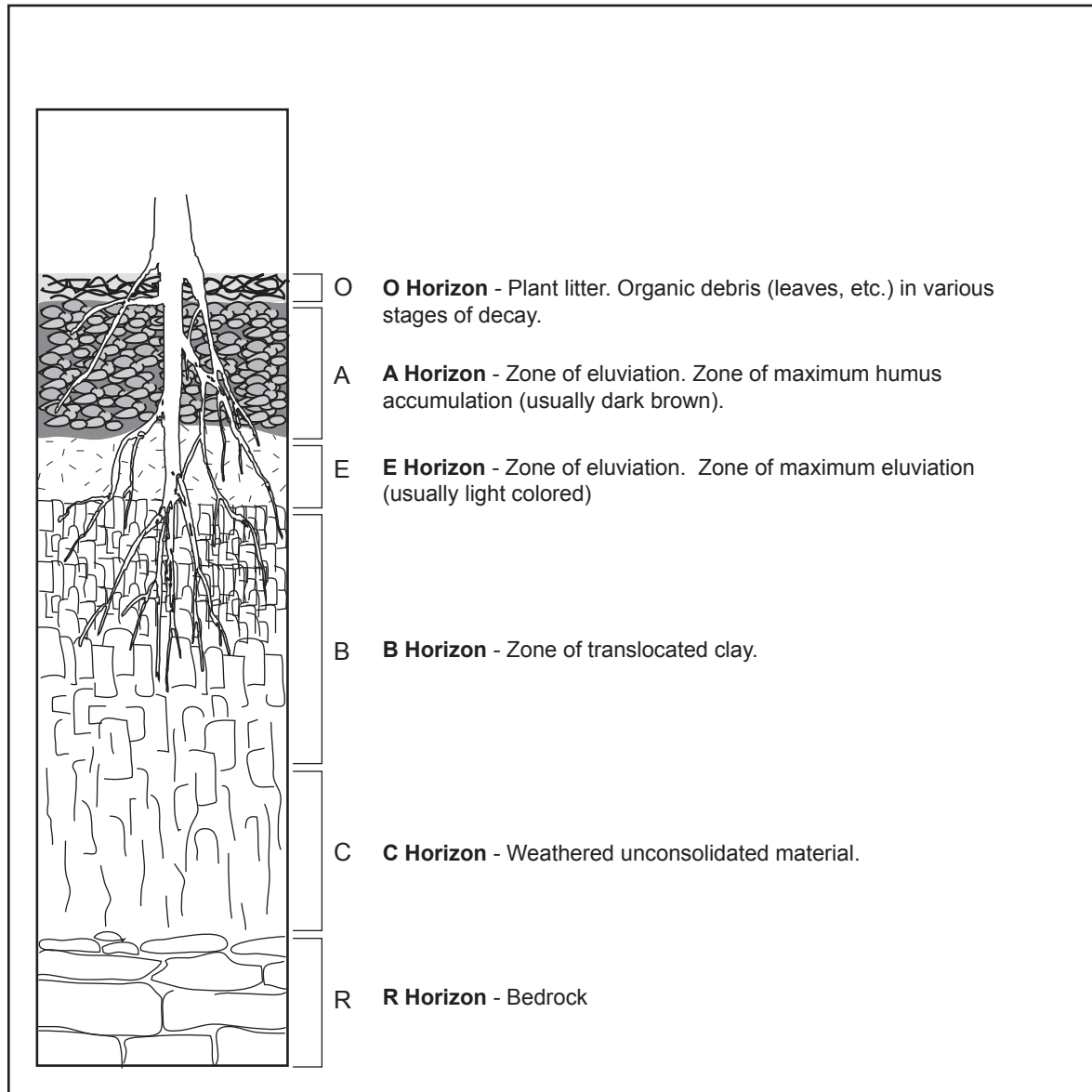

Source: National Council for Agricultural Education

Relative Soil Particle Sizes

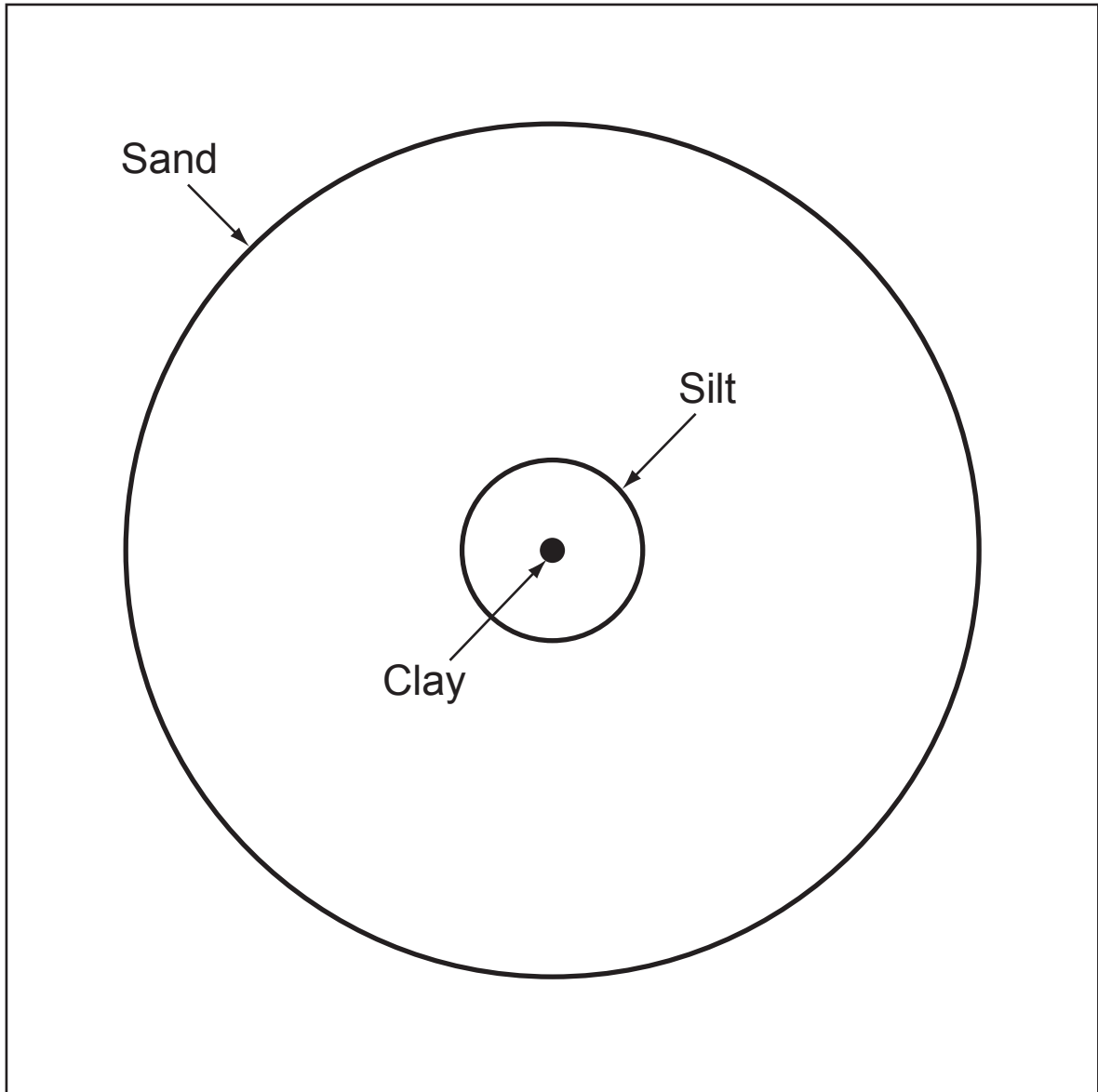

Source: National Council for Agricultural Education

Various Soil Structures



Granular

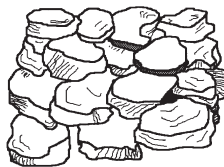

Blocky

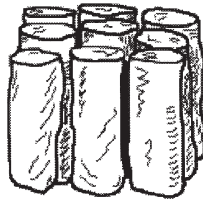

Prismatic



Columnar

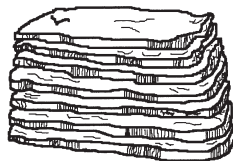

Platy

Soil Formation and Composition

Work Sheet

Name: _____

Part 1

True and False

Write "True" to the left of statements that are true and "False" to the left of statements that are false. *If a statement is false, rewrite it in the space below to make it a true statement.*

_____ 1. Parent materials have a direct impact on how soils support plant and animal life.

_____ 2. Ice and snow can break a rock apart, but rain cannot.

_____ 3. Climate does not affect how soils are formed. Desert and tropical climates influence soil formation in exactly the same way.

_____ 4. Organic matter comes from the decomposition of any plant or animal life.

_____ 5. The top layer of the soil is mostly composed of bedrock.

Part 2

Fill in the blank.

Write a word or phrase that best completes the statement.

6. The rock that forms soil in any location is known as the _____ of the soil.

7. _____ is the process of breaking down rocks.

8. Decomposed organic material is also known as _____.

9. How various size particles are arranged in the soil is known as _____.

10. _____ is the shape that the soil takes based on its various chemical and physical properties.

Part 3

Matching

Match the statements in Column A with the soil terms in Column B. Items in Column B may be used more than once.

- | | |
|---|--------------------|
| _____ 11. Usually lighter in color than the horizon above. Composed of parent material that has been weathered so much that it is much different in appearance than parent material | A. The O – Horizon |
| _____ 12. Could be the parent material of the soil. | B. The A – Horizon |
| _____ 13. First horizon made up of mineral materials. | C. The B – Horizon |
| _____ 14. Made up of organic matter, typically from twigs and leaves. | D. The C – Horizon |
| _____ 15. Typically referred to as topsoil. | E. The R – Horizon |
| _____ 16. Resembles parent material with no change in color. | |
| _____ 17. Represents layer of bedrock. | |
| _____ 18. No soil structures formed in this layer. | |
| _____ 19. Contains organic materials mixed with mineral matter. | |
| _____ 20. Commonly known as the subsoil. | |

Part 4

Short Answer

21. List the three main components of soil and the percentages of each in a typical soil.

	Component	Percentage
1		
2		
3		

22. Which of these components will increase with a rainfall? _____

Why? _____

23. Which of these components will decrease with a rainfall? _____

Why? _____

24. In your own words, describe the difference between chemical and physical weathering. _____

25. Label each of the following as either chemical or physical weathering and explain your answer:

Process	Chemical or Physical	Reasons for selection
Water carrying small pieces of rock wears away surface of larger rock		
Water separates into hydrogen and oxygen molecules and leads to formation of acid that dissolves rock		
Pressure from plant roots breaks apart rock		
d. Heat during day, cooling at night causes rock to expand and contract		



Soil Unit

Sample Soils Lesson Plan



Unit:

Soils

Topic:

Calibrating Fingers: Feel the Difference

Time:

2-3 class periods

This activity is intended to be the introduction to GLOBE Soil Characterization activities. Students often have trouble characterizing soil because they have difficulty feeling the differences in grain sizes found in natural soils. This activity helps students to learn about calibration by actually calibrating their fingers. They will also learn to read, explain, and create the Textural Triangle charts found in the *Protocol* section of the *Soils Investigation* in the GLOBE *Teacher's Guide* that identify a soil's texture.

Standards:

Science as Inquiry
Science in Personal and Social Perspectives
Earth Science
Life Science

Learning Objective(s):

Upon completion of this lesson, students will be able to,

1. recognize, describe and identify soil components by touch; and
2. construct a Textural Triangle chart.



Materials/Equipment Needed:

Notebook
Pencil/pen
Cupcake tins
Sand, silt, clay, loam
Handout—*Soil Textural Triangle*
Hand-lens
Spoons
Newspaper
Paper plates
Water bottles
GLOBE Soil Characterization video

Soil Textural Triangle

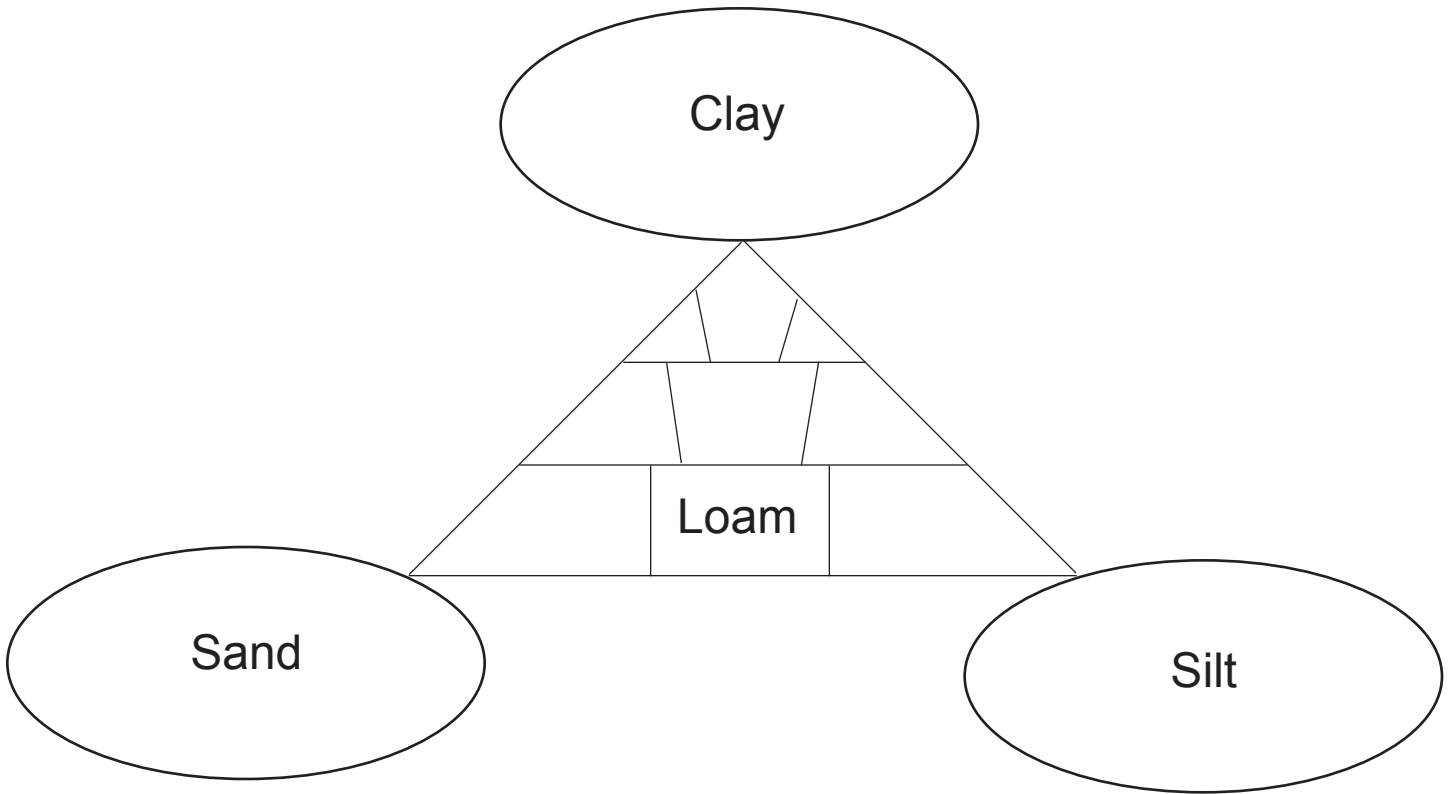



Procedures (Class Period 1):

1. Lesson Prep

Have newspapers spread out on desks. Students will be working in groups of 3-5, so prepare enough cupcake tins so that each group has one tin. Place samples of silt, sand, loam, and clay in the cups and label each (these will be handed out as lesson progresses). Have four sections identified on the board (to create lists or record descriptions) with the following headings: Silt, Sand, Loam, Clay. A side blackboard/whiteboard is good for this activity, or post-it easel pads, so the lists can remain on the board overnight or longer.

Each worktable should have spoons, water bottles, hand-lens, and paper plates. Also, have 2-3 standard soil samples (in flower pots or small cans such as tuna cans) sitting at each worktable. Each student should have his/her Journal or notebook to take notes, as needed.

2. Lesson Introduction/Elicitation

(10 minutes)

Ask students to examine the 2-3 soil samples contained in the flowerpots or cans. Ask them to describe each one as it compares to the others. Have a student volunteer record descriptions on the board. Most will concentrate on color, general texture, and physical components of the soil they can see, etc. This part of the lesson is designed to get them thinking about soils.

3. Concept Invention

(20 minutes)

- Group students in appropriate sized groups (3-5). Handout triangular soil chart with all mixtures of major components blanked out. (See handout included *Soil Textural Triangle*). Pass out cupcake tins with silt, sand, loam and clay.
- Have students put a small spoon of clay in their palms. Wet the clay and have students describe what it feels like and how it responds to getting wet. Repeat for each soil component.

- Have students mix 1 spoonful of sand and clay. Have students describe what they feel and show the students where this would fit in the Textural Triangle chart. Since there is no LOAM it would be next to clay along the sand clay continuum. See *Soil Textural Triangle* in *Soil Characterization Protocol* section of the *Soils Investigation*.)
- Add loam to the mixture of sand and clay and show where this would be in the chart.
- Mix sand and loam only and show where this would fit in the chart.
- Have students complete the silt side of the chart.

4. Concept Application/Evaluation/ Wrap-Up

(15 minutes)

Students need to take the original 2-3 samples of “real” soil from the elicitation (in flower pots or cans) and characterize the soil. If correct, students’ fingers are calibrated.

Note: If students have had no prior experience with calibration, introduce the concept at this point, explaining to students that,

- We have used our fingers as data collection instruments and to make observations in this activity;
- In order for scientific observations taken with instruments to be as accurate as possible, scientists do something called *calibrating* instruments before they collect data;
- Calibration is a technique that allows scientists to adjust their instruments so that they can be sure that measurements will be accurate. It (calibration) is a form of testing the instrument using a known solution, quantity, or item;
- Example:** Placing a pH meter in a substance with a guaranteed pH of 7.0; and
- We will calibrate instruments we use in many of our GLOBE data collection activities.



Procedures (Class Period 2)

(45 minutes)

View GLOBE Soil Characterization *Protocol* video and prepare for going into the field.

Procedures (Class Period 3)

(45 minutes)

Students conduct Soil Characterization in the field at soil study site (see GLOBE Teacher's Guide, *Protocol* section of the Soils Chapter).

5. Assignment(s)

Students re-create a Textural Triangle for their portfolios, with a complete description of what it means, explaining what it is used for and how.

6. Evaluation

Evaluation of portfolio assignment.

Provided courtesy of The Idaho GLOBE Partnership, The University of Idaho



Sample Earth as a System Unit Plan

**Unit:**

Earth as a System

Topic:

First Impressions: Describing Earth

Time:

Five 45-Minute Lessons



This unit is intended to be used as the introduction to the GLOBE program and the *Earth as a System*. Lessons provide opportunities for students to construct the major contexts of study in the GLOBE Program (*Atmosphere, Biosphere, Hydrosphere, and Soil (Pedosphere)*).

Standards:

Science as Inquiry

Science in Personal and Social Perspectives

Earth and Space Science

Physical and Life Science

**Learning Objective(s):**

Upon completion of this unit, students will be able to,

1. recognize, describe and organize major concepts, everyday phenomena and natural processes as experienced in their local settings;
2. work together in groups to synthesize and distill the concepts such that by the end of the activity they arrive at GLOBE's major inquiry frameworks (*Atmosphere, Biosphere, Hydrosphere, and Soil (Pedosphere)*); and
3. recognize and diagram processes that transfer energy and material among these areas of study.

**Materials/Equipment needed:**

Field notebook or journal

Pencil/pen

Colored markers

Butcher paper/poster board

GLOBE *Teachers Guide*

GLOBE Earth System Science Poster Activity

GLOBE Introductory Video

Computer

Internet access

Map of Earth and a globe

Procedures (Class Period 1):

1. Lesson Prep

Following the lesson introduction, students will be working collaboratively in groups of four. Each worktable should have a piece of poster board or butcher paper for students to record their group ideas. Make a chart on the board/sideboard/easel pad paper that will have four unlabeled columns.

2. Lesson Introduction

(10 minutes)

Students will close their eyes and visualize their favorite image of earth (favorite place). Students then think about what their senses tell them about that setting—what they think, hear, smell, etc. Students then create a quick sketch in their Field Notebooks or Journals and write a paragraph describing why they selected this image to describe how it makes them feel. Students develop a bulleted list of 10 descriptive words taken from their paragraph/narration of their sketch.

3. Collaborative Learning Group Activity

(35-40 minutes)

Students gather into groups of four, sharing individual sketches, narratives and word lists. The group collaboratively develops a hierarchy of concepts and natural processes to present to the class in poster format. Posters are displayed side by side in order to compare, contrast and develop a super hierarchy (recorded on a separate poster) facilitated by the instructor. The final outcome is intended to represent and include each of the major fields of inquiry in The GLOBE Program (*Atmosphere, Biosphere, Hydrosphere, and Soil (Pedosphere)*).

The instructor guides the organization of the class discussion and records on the board/projector the responses provided by the students. It is suggested that the super-organizing chart consist of 4 unlabeled columns. Once completed students are likely to label the columns water, earth, air, life. The instructor then uses the GLOBE labels of Atmosphere, Biosphere, Hydrosphere, and Soil (Pedosphere), in the appropriate areas.

Procedures (Class Period 2):

1. Lesson Prep

Have displayed in the front of the room various depictions of images of the Earth. Examples include a globe, atlas, map, the GLOBE Earth System poster, satellite images from the GLOBE *Teacher's Guide* (remote sensing images from Land Cover chapter), etc. You will want a large map of the earth and some push pins accessible for the main lesson activity.

2. Lesson Introduction

(5-7 minutes)

Ask students to spend several minutes observing the globe, posters, and other images of Earth that you have displayed in the room. Ask for a student volunteer to write student observations in a list on the board.

Note: There are no right or wrong answers; any response is acceptable. Encourage students to point out Earth's obvious physical features and to identify geographic areas with significantly different features.

Ask students to consider what might be evidence of life in any of the images they see. Could anything that happens in another part of the world affect what happens in your community?

3. Lesson Activity 1

(10 minutes)

Who do you know elsewhere in the world?

Ask students who they know who lives outside their own community, particularly if they know someone living in another part of the world. Mark those areas with a push pin. Ask students to consider what they might learn from these people about other parts of the world (*weather, rainfall, snow, soil, agriculture crops, types of plants, water bodies, acid rain, etc.*). Point out to students that data from others is very valuable as is their own personal data from their own personal observations. Also stress that they will soon become experts in their own GLOBE study sites, and will contribute their data to the world community.



Lesson Activity 2

(15 minutes)

Brainstorming. Divide students into groups of four. Each group should have a recorder, a group facilitator, and a presenter. Groups should brainstorm about the following questions:

- How is Earth able to support life? (*atmosphere, water; planetary systems of water, soil, and air working together; evolution of organisms and the planet together*)
- What challenges are faced by the Earth? (*human impact, pollution, population pressures, atmospheric changes*)
- What might the world be like 50 and 100 years into the future?

Ask 2-3 groups to volunteer to present their findings to the class (3-5 minutes each).

4. Wrap-Up

(2 minutes)

Welcome students to The GLOBE Program. Provide each student with a GLOBE sticker if available.

Procedures (Class Period 3):

Read and review all sections of the GLOBE Earth System Science Poster Activity. Follow all instructions as listed in the packet. Use the animations that support the GLOBE ESS Poster Activity Guide found on the GLOBE Website.

Procedures (Class Period 4):

1. Lesson Prep

Read and review basic content material found in *GLOBE Teacher's Guide* (The Big Picture) for each of GLOBE's major fields of study (*Atmosphere, Biosphere, Hydrosphere, and Soil (Pedosphere)*).

2. Lesson Introduction

Show the *GLOBE Introductory Video* or use the Earth as a System GLOBE training slides hold the mouse cursor over commuty and click on *Trainers*; Click on the *Training Materials* tab; click on *Earth as a System/Phenology*.

3. Lesson Activity

Introduce GLOBE measurements for studying the spheres. Have students form questions and then predict which measurements might help them find answers.

4. Wrap-Up

Demonstrate the organization of the website www.globe.gov highlighting the use of student collected date in building regional and global visualization of Earth's processes.

5. Assignments

Ask students to reflect and describe the manner in which they used their senses and reasoning to construct sketches and descriptions of favorite places. (i.e. How did you synthesize the sensory experience and build a memorable vision of your favorite place? How might we extend our sense gathering strategies through scientific/strategic data gathering?) They should write these reflections in their journals.



Procedures (Class Period 5):

Discussion/Application/Evaluation of the Lesson

1. Lesson Prep

Prepare a list on the board of example events. Cover with map, poster, or other object so it is not visible as students enter the room.

Example events include,

- A hurricane; (i.e. Hurricane would be listed in both the atmosphere and hydrosphere domains. It also affects the Biosphere and Soil)
- Floods;
- Droughts;
- Forest fires;
- Antarctic and/or Greenland ice caps melting;
- A meteorite hitting the Earth;
- Cutting down all the trees in the forest; and
- Humans polluting the water, the air, etc.

2. Lesson Introduction

(5-10 minutes)

Tell students that they are going to synthesize all that they have learned over the past few days about Earth as a System by thinking about various events that happen and how the spheres interact before, during, and after those events. Ask them to refer to the list on the board and to provide additional examples.

3. Cooperative Learning Activity

(15 minutes)

Ask students to pair with another student. Assign one event to one-half the class and one event to the other half. Individual students think for about 5-7 minutes about the event, and jot notes in their notebooks about which spheres are involved and how they interact. They pair with their partner for another 7-10 minutes to develop their group response.

4. Wrap-Up

Whole class discussion on spheres' interactions using students' responses from group activity.

5. Assignment

Each student should pick one event not covered during class discussion and do a description of spheres' interactions before, during, and after the event in his/her Journal.

6. Evaluation

- Objective test
- Evaluation of written work and student reflections

Provided courtesy of The Idaho GLOBE Partnership, The University of Idaho



Sample Biosphere (Land Cover) Unit Plan



Unit:
Pixel Mapping

Topic:
Using Geometry and Graphs for Pixel Mapping

Time:
1-2 weeks



This unit plan integrates GLOBE, science, mathematics and geography, providing students the opportunity to see the relationship between mathematics and the everyday world. The outlined pixel mapping technique works best in areas where there are few trees. These lessons also allow for collaboration between science, mathematics, technology, agricultural science, and social studies teachers.

Standards:
Science as Inquiry
Science in Personal and Social Perspectives
Earth and Space Science
Physical and Life Science
Science and Technology.



Materials/Equipment needed:

- Two measuring tapes – 50 m each,
- Compass
- GPS receiver
- Five flags
- Four stakes
- 200 m kite string
- Field notebooks
- Graphing paper
- Presentation slides
- Pencils
- Ruler
- Materials for creating densiometers and clinometers
- GLOBE *MUC Guide*
- Equipment for Grassland Protocol (if needed)



- Digital camera
- Computer with Internet access
- GLOBE *Teachers Guide*

Learning Objective(s):

Upon completion of this unit, the students will be able to,

1. locate and define the boundaries of a 30 m x 30 m study site using an understanding of geometric relations.
 - a. Concepts covered include solar noon and true north, orienteering, maps, GPS, biometry, tree height, trunk circumference, canopy cover, ground cover, and species identification.

1. Introductory Lesson (science or math classrooms):

Discuss the construction of a square using an understanding of the geometry (i.e. how can we use geometry to make a perfect square?). Explain to students that during the unit they are going to construct a square outside to define their study site.

2. Lessons/Activities 2-9—Pixel Mapping (science, math, social studies, or agriculture classrooms):

Field work—Setting up the boundaries of the study site. The attached diagrams provide the specific instructions to complete the boundaries of a Biosphere (land cover) study site. The plan outlines this activity in terms of multiple 45 minute periods resulting that this unit could be conducted by the Science teacher alone (2-week unit), or as an interdisciplinary unit carried out in the science, math, technology and social studies classrooms (1-week unit).

3. Concluding Activity (technology classroom):

Students enter study site location information on the www.globe.gov website including metadata descriptions.

4. Assignment:

Students produce a sketch map, using field notes and study site sketches, of what they think the setting looks like as if viewed from above (hot air balloon hovering 500 m above). Use of computer drawing tools is also appropriate.

5. Optional Activity:

Locate a topographic map (library, map cabinet or with the help of a local expert) of the local area. Identify a local study site location. Determine latitude, longitude and elevation of the location. Use pixel-mapping exercise at this site.

6. Evaluation:

Did the students produce a field sketch of the study site? Did they accurately describe how they produced the map? Did they MUC the site? Did they enter the information online (define a study site)?

A. Lesson 2: Where do we start?

Determining True North and Solar Noon

(science or math teachers—45 minutes)

1. Students will calculate “Solar Noon” for their location. Follow the instructions in the *Atmosphere* section of the *Teachers Guide, Introduction*. Use the local Newspaper (Sunrise/Sunset) to make calculations. Students need to save their calculations for comparison to the ancient Greek method of finding True North when they again find Solar Noon during the next class period. Explain to students the process that they will follow during the next class period (lesson 3 below).

B. Lesson 3: Determining True North and Solar Noon

(science or math teachers—45 minutes)

1. Students will find True North and solar noon using sun shadow (Gnomon). The teacher will need to set up a gnomon (stick in the ground) during the 1st class period of the day. Each period the students will come outside and mark the movement of the shadow top every 3 minutes. You can use GLOBE Flags or chalk. As the

day continues a parabola will emerge. The lowest point of the parabola is due south. The shadow at this point will point due north. Record the time as this is Solar Noon. Mark a line connecting the gnomon and the top of the shadow. This line runs True North and South.

C. Lesson 4: Align compasses to True North (science, math or social studies teachers—45 minutes).

1. Take classes outside and show the students the parabola created the day before and the mark for True North. Adjust compass for Magnetic North “declination” (offset) using the line defined by the gnomon activity.
2. Compare the time of Solar noon (calculated during lesson 2) to the time determined by the gnomon (calculated during lesson 3).

Lessons 5-9:

Use geometry to mark a perfect pixel (square). (science, math or social studies teachers—5-45 minute sessions). It is recommended that teachers refer to the *Biosphere* section of the *GLOBE Teachers Guide* for instructions on *GLOBE Biosphere Protocols* and additional *Learning Activities* as needed.

D. Lesson 5: Setting up a Pixel—45 minutes

E. Lesson 6: Finding the middle of the Pixel—45 minutes

F. Lesson 7: Site Mapping—45 minutes

G. Lesson 8: Determine Biometry at Study Site—45 minutes

H. Lesson 9: Determine dominant / co-dominant vegetation (45 minutes)

I. Lesson 10: Technology: Enter data and draw maps (45 minutes)



Lesson 5: Setting up a Pixel (45 minutes)

1. Choose a point to be the starting corner, place flag (South Flag).

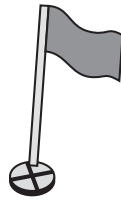

2. From this point, measure North "30 meters", check with compass, place flag (North Flag).

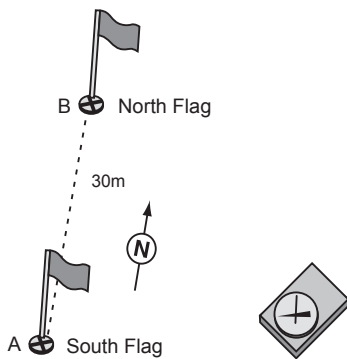

3. From the South Flag, measure 30 meters to west (compass bearing).
4. At the same time (as C) from the North Flag, measure 42.42 meters southwest to join at southwest corner (this makes a triangle with 30 meter sides and a 42.42 meter hypotenuse), place flag (Southwest Flag).

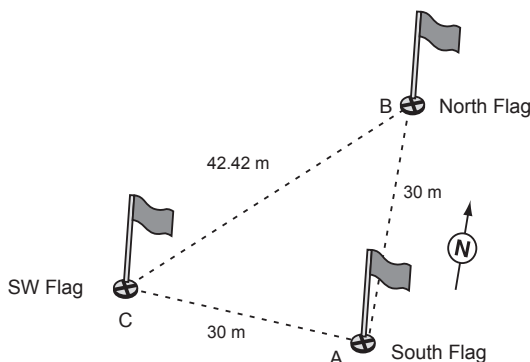

Note: Make sure tapes are pulled tight, and cross at 30 meters and 42.42 meters.

5. Repeat step "D", but this time measuring 30 meters west from North

Flag, and 42.42 meters northwest from South Flag, place flag (Northwest Flag).

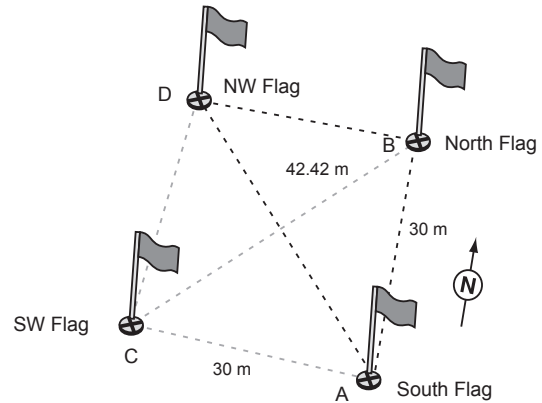

6. To check for accuracy, measure distance between Northwest and Southwest Flags, the distance should be 30 meters.

Lesson 6: Find the middle of the Pixel (45 minutes)

1. Cross tape measures along diagonals, they should meet at 21.21 meters, place flag (Pixel Center Flag).

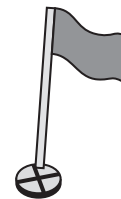

2. Use GPS unit and data work sheet. Perform GPS Protocol (see GPS Investigation in the GLOBE manual).
3. Take pictures (digital camera) from pixel center, facing North, East, South, and then West



4. Label and record picture information.



Lesson 7: Site mapping (45 minutes)

1. Find the number of “steps” it takes you to walk 30 meters.
2. Using map template (graphing paper), create “x - y” axes along square sides, using your “steps” as a scale measure.
3. With your step scale, locate objects within your pixel and graph them in your field notebook or on your map template, identify objects (tree, sidewalk, waterway, etc.).
4. **Optional Activity:** Individual student groups use blank transparencies to map different elements found within their Pixel. These transparencies can be combined to produce one site map to show the different objects.

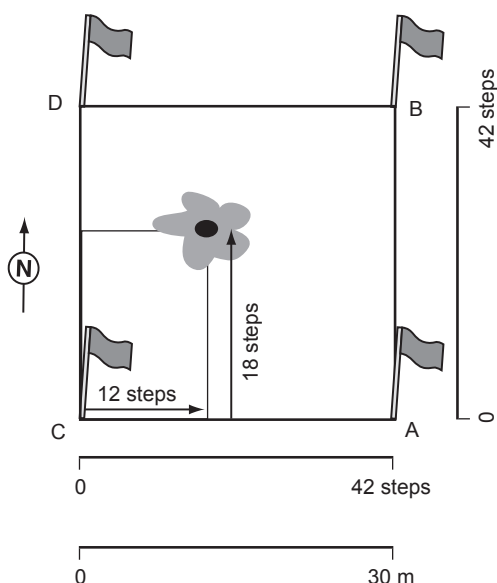

Note: The activity can be done using the “step method” or using a tape measure. Tape measure method: Use 2 tape measures, lay each along the pixel sides and pace the axes noting where objects occur, recording coordinates in meters.

Lesson 8: Determine “biometry” at Study Site (45 minutes)

1. Create Densimeter (*Biosphere Protocols*) and Clinometer (*Biosphere Protocols*) in the classroom. Take instruments to Study Site.
2. Canopy cover assessment (use

Densimeter tool).

3. Ground cover assessment (visual estimate).
4. Tree height (use Clinometer tool).
5. Tree trunk circumference (at 1.35 meters above ground).
6. Record MUC (use the *GLOBE MUC Guide*).

Lesson 9: Determine dominant/co-dominant vegetation (45 minutes)

1. Use species identification key (trees of the region).
2. For grasses, use “grassland protocol”.

Lesson 10: Enter data on the GLOBE Sample Student Map

1. Students enter study site location information on the GLOBE website (www.globe.gov) including metadata descriptions.
2. Students produce a sketch map, using field notes and study site sketches, of what they think the setting looks like as if viewed from above (hot air balloon hovering 500 m above).

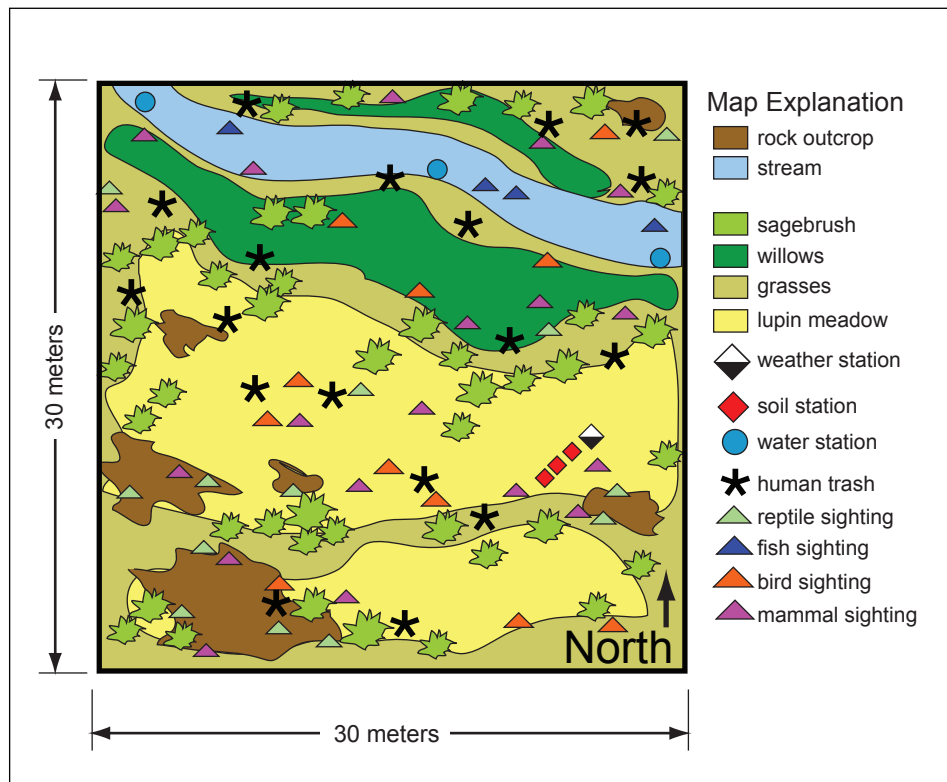

Provided courtesy of The Idaho GLOBE Partnership, The University of Idaho