



## Optical Transport Network (OTN) Tutorial

Disclaimer:

**This is a Tutorial.**

**This is NOT a Recommendation!**

**This tutorial has no standards significance. It is purely for educational purposes. In case of conflict between the material contained in the tutorial and the material of the relevant Recommendation the latter always prevails.**

**This tutorial should NOT be used as a reference; only the relevant Recommendations can be referenced.**

### Summary

This document provides a tutorial for Optical Transport Network standards and their applications. The objective is to provide the telecommunications engineers with a document that forms the basis for understanding OTN.

---

**Contact:** Timothy P. Walker  
AMCC  
USA

Tel: 1-978-247-8407  
Fax:  
Email: [twalker@amcc.com](mailto:twalker@amcc.com)

---

1	Scope.....	5
2	Abbreviations.....	5
3	What is OTN/OTH.....	7
	3.1 OTN Standards .....	7
4	Where is it standardized for .....	8
5	Why use OTN.....	8
	5.1 Forward Error Correction (FEC) .....	8
	5.1.1 Theoretical Description .....	9
	5.1.2 Coding Gain.....	11
	5.2 Tandem Connection Monitoring .....	14
	5.3 Transparent Transport of Client Signals.....	17
	5.4 Switching Scalability .....	17
6	OTN Hierarchy Overview .....	18
7	OTUk, ODUk, OPuk Frame Structure.....	20
8	OPuk Overhead and Processing.....	21
	8.1 OPuk Overhead Byte Descriptions .....	22
	8.1.1 Payload Structure Identifier (PSI) .....	22
	8.1.2 Payload Type (PT).....	22
	8.2 Mapping Signals into an OPuk.....	22
	8.2.1 Frequency Justification.....	23
	8.2.2 Mapping a CBR2G5 signal (e.g. STM-16) into OPU1 .....	25
	8.2.3 Mapping a CBR10G signal (e.g. STM-64) into OPU2 .....	26
	8.2.4 Mapping a CBR40G signal (e.g. STM-256) into OPU3 .....	26
9	ODUk Overhead and Processing .....	27
	9.1 Path Monitoring (PM) Byte Descriptions.....	29
	9.1.1 Trail Trace Identifier (TTI).....	29
	9.1.2 BIP-8.....	29
	9.1.3 Backward Defect Indication (BDI).....	29
	9.1.4 Backward Error Indication and Backward Incoming Alignment Error (BEI/BIAE).....	30
	9.1.5 Path Monitoring Status (STAT) .....	30
	9.2 Tandem Connection Monitoring (TCM) .....	30
	9.2.1 Trail Trace Identifier (TTI).....	30
	9.2.2 BIP-8.....	31
	9.2.3 Backward Defect Indication (BDI).....	31

9.2.4	Backward Error Indication and Backward Incoming Alignment Error (BEI/BIAE).....	31
9.2.5	TCM Monitoring Status (STAT).....	32
9.2.6	Tandem Connection Monitoring ACTivation/deactivation (TCM-ACT) .....	33
9.2.7	General Communication Channels (GCC1, GCC2).....	33
9.2.8	Automatic Protection Switching and Protection Communication Channel (APS/PCC).....	33
9.2.9	Fault Type and Fault Location reporting communication channel (FTFL) .....	33
10	OTUk Overhead and Processing.....	33
10.1	Scrambling.....	34
10.2	Frame Alignment Overhead .....	35
10.2.1	Frame alignment signal (FAS) .....	35
10.2.2	Multiframe alignment signal (MFAS).....	35
10.3	SM Byte Descriptions .....	36
10.3.1	Trail Trace Identifier (TTI).....	37
10.3.2	BIP-8.....	37
10.3.3	Backward Defect Indication (BDI).....	38
10.3.4	Backward Error Indication and Backward Incoming Alignment Error (BEI/BIAE).....	38
10.3.5	Incoming Alignment Error (IAE) .....	39
10.4	General Communication Channel 0 (GCC0).....	39
11	ODUk Multiplexing.....	39
11.1	Multiplexing Data Rates .....	39
11.1.1	ODU1 to ODU2 Justification Rate .....	39
11.1.2	ODU2 to ODU3 Justification Rate .....	40
11.1.3	ODU1 to ODU3 Justification Rate .....	40
11.2	4 x ODU1 to ODU2 Multiplexing.....	41
11.2.1	4 x ODU1 to ODU2 Multiplexing Structure .....	41
11.2.2	4 x ODU1 to ODU2 Justification Structure.....	43
11.2.3	OPU2 Payload Structure Identifier (PSI) .....	44
11.2.4	OPU2 Multiplex Structure Identifier (MSI) .....	44
11.2.5	Frequency Justification.....	45
11.3	ODU1/ODU2 to ODU3 Multiplexing .....	46
11.3.1	ODU1/ODU2 to ODU3 Multiplexing Structure .....	46
11.3.2	ODU1/ODU2 to ODU3 Justification Structure.....	48
11.3.3	OPU3 Payload Structure Identifier (PSI) .....	49
11.3.4	OPU3 Multiplex Structure Identifier (MSI) .....	49
11.3.5	Frequency Justification.....	50
11.4	Maintenance Signal Insertion .....	51

11.4.1	Client source ODUk-AIS .....	51
11.4.2	Client source ODUk-OCI .....	51
11.4.3	Line source ODUk-AIS .....	51
11.5	Defect detection and correlation.....	52
11.5.1	dPLM (Payload Mismatch) .....	52
11.5.2	cPLM .....	52
11.5.3	dMSIM (Multiplex Structure Identifier Mismatch supervision) .....	53
11.5.4	cMSIM.....	53
11.5.5	dLOFLOM (Loss of Frame and Multiframe) .....	53
11.5.6	cLOFLOM.....	54
11.5.7	aAIS (AIS insertion) .....	54
11.5.8	SSF (Server Signal Fail).....	54
12	ODUk Virtual Concatenation / OTN over SONET .....	55
13	Synchronisation .....	55
13.1	Introduction .....	55
13.2	Network requirements .....	55
13.3	Mapping and Multiplexing .....	57
13.4	Equipment requirements .....	57
14	OTN Maintenance Signals.....	57
14.1	OTUk maintenance signals.....	57
14.1.1	OTUk alarm indication signal (OTUk-AIS).....	57
14.2	ODUk maintenance signals .....	58
14.2.1	ODUk Alarm Indication Signal (ODUk-AIS).....	58
14.2.2	ODUk Open Connection Indication (ODUk-OCI).....	58
14.2.3	ODUk Locked (ODUk-LCK) .....	59
14.3	Client maintenance signal.....	59
14.3.1	Generic AIS for constant bit rate signals.....	59
15	OTN Defects .....	60
16	Acknowledgements .....	61
17	Bibliography .....	61
18	Open Issues .....	62
18.1	ODUk Virtual Concatenation / OTN over SONET .....	62

## 1 Scope

This document provides a tutorial for Optical Transport Network standards and their applications. The objective is to provide the telecommunications engineers with a document that forms the basis for understanding OTN.

## 2 Abbreviations

This tutorial uses the following abbreviations:

0xYY	YY is a value in hexadecimal presentation
3R	Reamplification, Reshaping and Retiming
ACT	Activation (in the TCM ACT byte)
AI	Adapted Information
AIS	Alarm Indication Signal
APS	Automatic Protection Switching
BDI	Backward Defect Indication
BEI	Backward Error Indication
BIAE	Backward Incoming Alignment Error
BIP	Bit Interleaved Parity
CBR	Constant Bit Rate
CI	Characteristic Information
CM	Connection Monitoring
CRC	Cyclic Redundancy Check
DAPI	Destination Access Point Identifier
EXP	Experimental
ExTI	Expected Trace Identifier
FAS	Frame Alignment Signal
FDI	Forward Defect Indication
FEC	Forward Error Correction
GCC	General Communication Channel
IaDI	Intra-Domain Interface
IAE	Incoming Alignment Error
IrDI	Inter-Domain Interface
JOH	Justification Overhead
LSB	Least Significant Bit
MFAS	MultiFrame Alignment Signal
MFI	Multiframe Indicator
MS	Maintenance Signal

MSB	Most Significant Bit
MSI	Multiplex Structure Identifier
NNI	Network Node Interface
OCh	Optical channel with full functionality
OCI	Open Connection Indication
ODU	Optical Channel Data Unit
ODUk	Optical Channel Data Unit-k
ODTUjk	Optical channel Data Tributary Unit j into k
ODTUG	Optical channel Data Tributary Unit Group
ODUk-Xv	X virtually concatenated ODUk's
OH	Overhead
OMS	Optical Multiplex Section
OMS-OH	Optical Multiplex Section Overhead
OMU	Optical Multiplex Unit
ONNI	Optical Network Node Interface
OOS	OTM Overhead Signal
OPS	Optical Physical Section
OPU	Optical Channel Payload Unit
OPUk	Optical Channel Payload Unit-k
OPUk-Xv	X virtually concatenated OPUk's
OSC	Optical Supervisory Channel
OTH	Optical Transport Hierarchy
OTM	Optical Transport Module
OTN	Optical Transport Network
OTS	Optical Transmission Section
OTS-OH	Optical Transmission Section Overhead
OTU	Optical Channel Transport Unit
OTUk	Optical Channel Transport Unit-k
PCC	Protection Communication Channel
PM	Path Monitoring
PMI	Payload Missing Indication
PMOH	Path Monitoring OverHead
ppm	parts per million
PRBS	Pseudo Random Binary Sequence
PSI	Payload Structure Identifier
PT	Payload Type

RES	Reserved for future international standardization
RS	Reed-Solomon
SAPI	Source Access Point Identifier
Sk	Sink
SM	Section Monitoring
SMOH	Section Monitoring OverHead
So	Source
TC	Tandem Connection
TCM	Tandem Connection Monitoring
TS	Tributary Slot
TxTI	Transmitted Trace Identifier
UNI	User-to-Network Interface
VCG	Virtual Concatenation Group
VCOH	Virtual Concatenation Overhead
vcPT	virtual concatenated Payload Type

### **3 What is OTN/OTH**

#### **3.1 OTN Standards**

There are many standards that fall under the umbrella of “OTN”. This document focuses on Layer 1 standards. Therefore, it does not describe the Physical or Optical layers. Furthermore, it doesn’t describe any layers implemented in Software. Thus this document only describes the digital layer that could be implemented in ASIC.

The Optical Transport Hierarchy OTH is a new transport technology for the Optical Transport Network OTN developed by the ITU. It is based on the network architecture defined in ITU G.872 "Architecture for the Optical Transport Network (OTN)"

G.872 defines an architecture that is composed of the Optical Channel (OCh), Optical Multiplex Section (OMS) and Optical Transmission Section (OTS). It then describes the functionality that needed to make OTN work. However, it may be interesting to note the decision made during G.872 development as noted in Section 9.1/G.872 :

“During the development of ITU-T Rec. G.709, (implementation of the Optical Channel Layer according to ITU-T Rec. G.872 requirements), it was realized that the only techniques presently available that could meet the requirements for associated OCh trace, as well as providing an accurate assessment of the quality of a digital client signal, were digital techniques....”

“For this reason ITU-T Rec. G.709 chose to implement the Optical Channel by means of a digital framed signal with digital overhead that supports the management requirements for the OCh listed in clause 6. Furthermore this allows the use of Forward Error Correction for enhanced system performance. This results in the introduction of two digital layer networks, the ODU and OTU. The intention is that all client signals would be mapped into the Optical Channel via the ODU and OTU layer networks.”

Currently there are no physical implementations of the OCh, OMS and OTS layers. As they are defined and implemented, they will be included in this tutorial.

Thus the main implementation of OTH is that described in G.709 and G.798.

#### 4 Where is it standardized for

The optical transport network architecture as specified in ITU-T G.872 defines two interface classes:

- Inter-domain interface (IrDI);
- Intra-domain interface (IaDI).

The OTN IrDI interfaces are defined with 3R processing at each end of the interface. This would be the interface between Operators. It could also be thought of as the interface between different Vendors within the same Operator (see Figure 1).

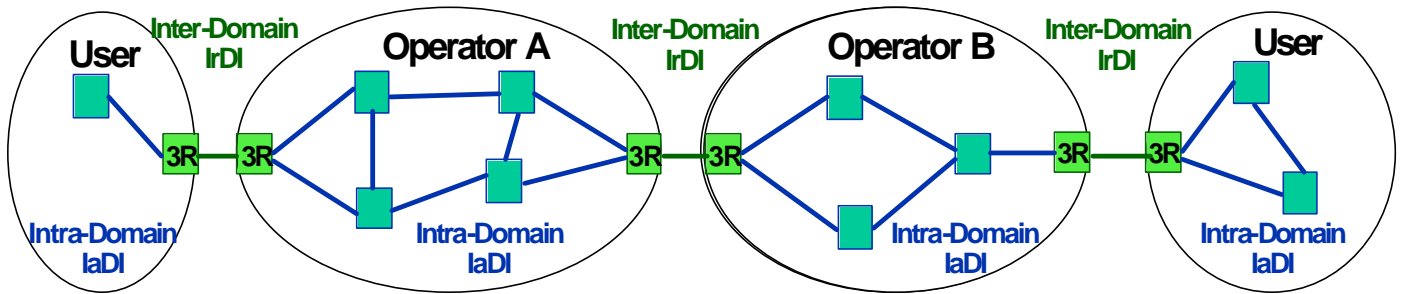

Figure 1 IaDI vs. IrDI

The IaDI is the interfaces within an Operator or a Vendor domain.

G.709 applies to information transferred across IrDI and IaDI interfaces. G.709 compliance by itself is not sufficient to guarantee mid-span meet, since it doesn't specify the electrical or optical interfaces. It is important to note that G.709 only defines logical interfaces.

#### 5 Why use OTN

OTN offers the following advantages relative to SONET/SDH:

- Stronger Forward Error Correction
- More Levels of Tandem Connection Monitoring (TCM)
- Transparent Transport of Client Signals
- Switching Scalability

OTN has the following disadvantages:

- Requires new hardware and management system

We will discuss the advantages and disadvantages in the following sections.

##### 5.1 Forward Error Correction (FEC)

Forward error correction is a major feature of the OTN.

Already SDH has a FEC defined. It uses undefined SOH bytes to transport the FEC check information and is therefore called a in-band FEC. It allows only a limited number of FEC check information, which limits the performance of the FEC.



For the OTN a Reed-Solomon 16 byte-interleaved FEC scheme is defined, which uses 4x256 bytes of check information per ODU frame. In addition enhanced (proprietary) FEC schemes are explicitly allowed and widely used.

FEC has been proven to be effective in OSNR limited systems as well as in dispersion limited systems. As for non-linear effects, reducing the output power leads to OSNR limitations, against which FEC is useful. FEC is less effective against PMD, however.

G.709 defines a stronger Forward Error Correction for OTN that can result in up to 6.2 dB improvement in Signal to Noise Ratio (SNR). Another way of looking at this, is that to transmit a signal at a certain Bit Error Rate (BER) with 6.2 dB less power than without such an FEC.

The coding gain provided by the FEC can be used to:

- Increase the maximum span length and/or the number of spans, resulting in an extended reach. (Note that this assumes that other impairments like chromatic and polarization mode dispersion are not becoming limiting factors.)
- Increase the number of DWDM channels in a DWDM system which is limited by the output power of the amplifiers by decreasing the power per channel and increasing the number of channels. (Note that changes in non-linear effects due to the reduced per channel power have to be taken into account.)
- Relax the component parameters (e.g launched power, eye mask, extinction ratio, noise figures, filter isolation) for a given link and lower the component costs.
- but the most importantly the FEC is an enabler for transparent optical networks: Transparent optical network elements like OADMs and PXCs introduce significant optical impairments (e.g. attenuation). The number of transparent optical network elements that can be crossed by an optical path before 3R regeneration is needed is therefore strongly limited. With FEC a optical path can cross more transparent optical network elements. This allows to evolve from today's point-to-point links to transparent, meshed optical networks with sufficient functionality.

Note: There is additional information on FEC in Section 11 of sup.dsn Also Appendix 1 of G.975.1 lists some additional Enhanced FEC schemes.

### **5.1.1 Theoretical Description**

G.709 FEC implements a Reed-Solomon RS(255,239) code. A Reed-Solomon code is specified as RS(n,k) with s-bit symbols where n is the total number of symbols per codeword, k is the number of information symbols, and s is the size of a symbol. A codeword consists of data and parity, also known as check symbols, added to the data. The check symbols are extra redundant bytes used to detect and correct errors in a signal so that the original data can be recovered.

For G.709:

s = Size of the symbol = 8 bits

n = Symbols per codeword = 255 bytes

k = Information symbols per codeword = 239 bytes

A typical system is shown in Figure 2:

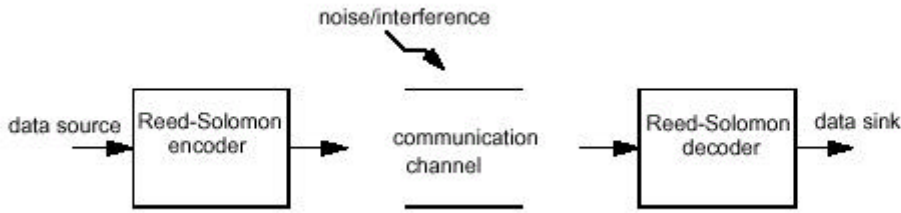

**Figure 2 FEC Block Diagram**

This means the encoder takes  $k$  information symbols of  $s$  bits, each, and adds check symbols to make an  $n$ -symbol codeword. There are  $n-k$  check symbols of  $s$  bits, each. A Reed-Solomon decoder can correct up to  $t$  symbols that contain errors in a codeword, where  $2t = n-k$ .

The following Figure 3 shows a typical Reed-Solomon codeword:

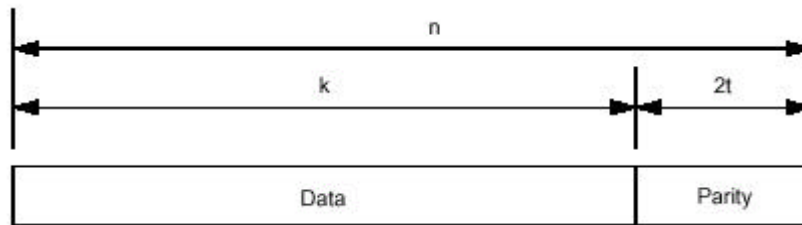

**Figure 3 Reed-Solomon Codeword**

For the standard ITU recommended RS (255,239) code:

$$2t = n - k = 255 - 239 = 16$$

$$t = 8$$

Hence, the decoder can correct any 8 symbols in a codeword

Reed-Solomon codes treat errors on a symbol basis; therefore, a symbol that contains all bits in error is as easy to detect and correct as a symbol that contains a single bit-error. That is why the Reed-Solomon code is particularly well suited to correcting burst errors (where a series of bits in the codeword are received in error by the decoder.)

Given a symbol size  $s$ , the maximum codeword length ( $n$ ) for a Reed-Solomon code is

$$n = 2^s - 1 = 255$$

Interleaving data from different codewords improves the efficiency of Reed-Solomon codes because the effect of burst errors is shared among many other codewords. By interleaving, it spreads the impact of a noise burst over multiple symbols, which come from several codewords. As long as each deinterleaved codeword has fewer errors than it can correct, the interleaved group of codewords will be corrected. It is possible that some codewords will be corrected and some not if excessive errors are encountered.

Interleaving actually integrates the error correction powers of all of the codewords included in the interleaved group, that is the depth of the interleaver. This allows a higher rate of code and channel efficiency and still protects against an occasional very long error. For example, if 64 codewords that can correct 8 errors each are interleaved, the interleaved group can correct almost any combination of symbol errors that total less than 512. It does not matter if all 512 are in one long burst, there are 512

one-symbol errors, or anywhere in between. Both ITU-T G.709 and ITU-T G.975 specify interleaving as part of the transport frame to improve error-correction efficiency.

### 5.1.2 Coding Gain

The advantage of using FEC is that the probability of an error remaining in the decoded data is lower than the probability of an error if an FEC algorithm, such as Reed-Solomon, is not used. This is coding gain in essence.

Coding Gain is difference in Input SNR for a given Output BER. The Input SNR is measured either as “Q factor” or as  $E_b/N_0$  (Section 5.1.2.2), or OSNR ().

The “Net Coding Gain” takes into effect that there was a 7% rate expansion due to the FEC. What this means is that the data rate had to increase by 7% in order to transmit both the data and the FEC.

#### 5.1.2.1 Coding Gain measured via Q Factor

The widely used technique of measuring coding gain is the Q-factor (Quality factor) measurement. This technique estimates the OSNR at the optical amplifier or receiver by measuring BER vs. voltage threshold at voltage levels where BER can be accurately determined (see Figures 4 and 5). In reality, however, Q-factor is derived from the measurement of the eye-pattern signal. It is defined as the ratio of peak-to-peak signal to total noise (conventionally electrical):

$$Q = (\mu_1 - \mu_0) / (\sigma_0 + \sigma_1)$$

Where:  $\mu_1$  and  $\mu_0$  are the mean signal levels of level 1 and level 0  
 $\sigma_1$  and  $\sigma_0$  are the respective standard deviations

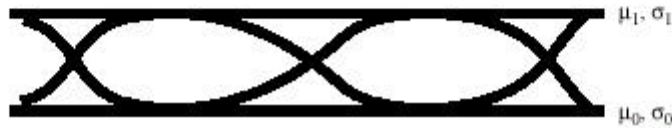
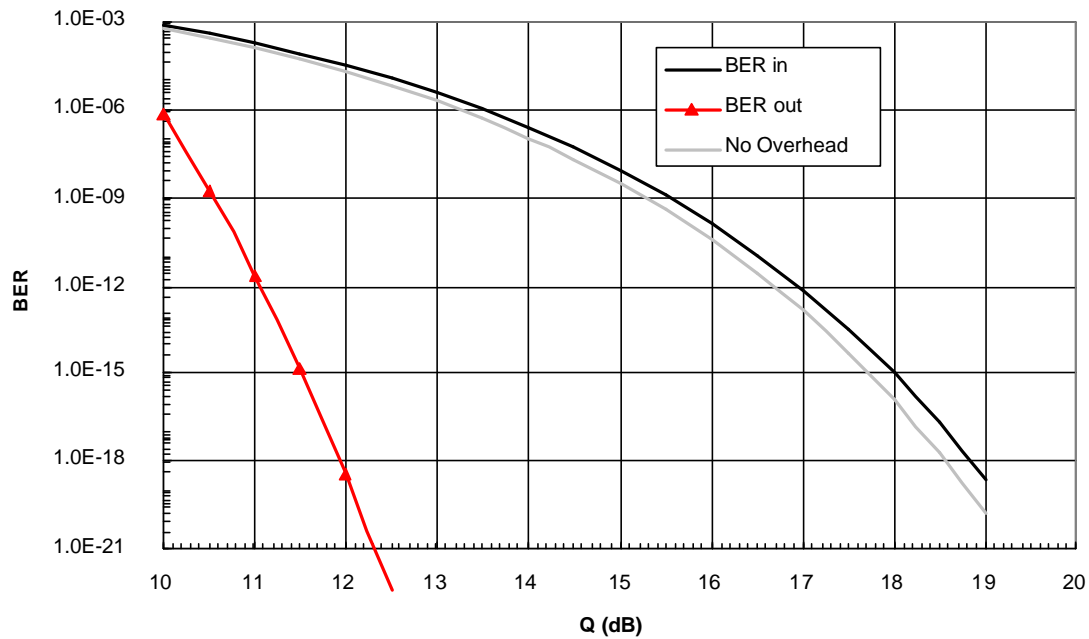

Figure 4 Eye Diagram

- $u_1$  = ON level average value
- $\sigma_1$  = ON level noise standard deviation
- $u_0$  = OFF level average value
- $\sigma_0$  = OFF level noise standard deviation

A system that requires an operating BER of  $10^{-15}$  has a Q-factor measurement of 18 dB without FEC. If RS(255, 239) FEC is employed, the Q-factor measurement decreases to 11.8 dB, yielding 6.2 dB of coding gain.

**BER vs Q for R-S 255 Code (t = 8)**

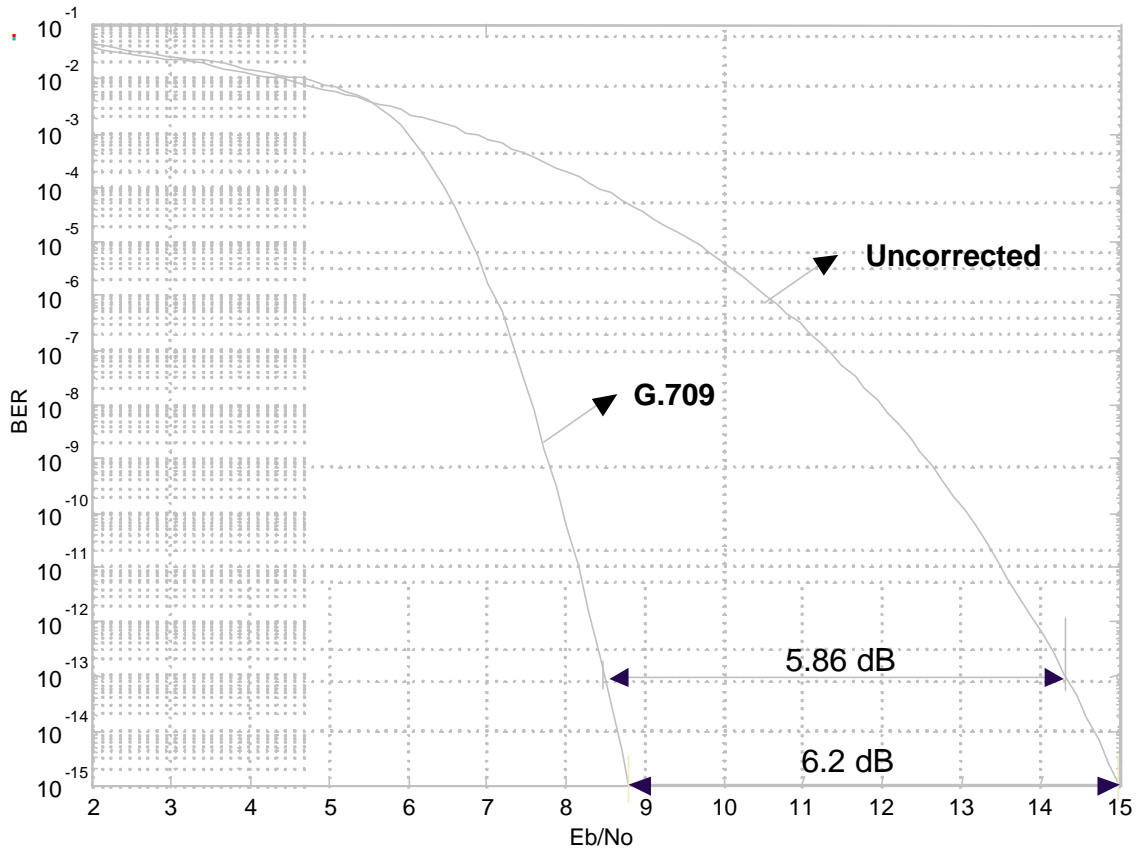

**Figure 5 BER vs. Q Factor**

The 6.2 dB gained through FEC would allow a transmission with longer span while maintaining the original BER. Thus the transmission distance is improved with relatively small increase in semiconductor content.

### 5.1.2.2 Coding Gain measured via $E_b/N_0$

Another way to measure coding gain is with a plot of BER vs.  $E_b/N_0$ .  $E_b$  is the bit energy and can be described as signal power (S) times the bit time  $T_b$ .  $N_0$  is the noise power spectral density and can be described as the noise power (N) divided by the bandwidth (W). Thus  $E_b/N_0$  is equal to SNR \* (Bandwidth/Bit Rate). For a more thorough discussion see [Sklar]



**Figure 6 BER vs  $E_b/N_0$**

What Figure 6 shows is that for a given input SNR ( $E_b/N_0$ ), what the BER out of the FEC decoder would be. Thus if one wanted to operate their system at  $10^{-13}$  BER, then they would need over 14 dB SNR without FEC or only 8.5 dB with FEC.

### 5.1.2.3 Coding Gain measured via OSNR

Figure 7 shows the FEC net coding gain (NCG) of various FEC schemes. These are theoretical and real measurements results from running systems.

Coding gain is the reduction of signal-to-noise ratio due to the use of the FEC at a reference BER

The Net Coding Gain (NCG) takes into account the fact that the bandwidth extension needed for the FEC scheme is associated with increased noise in the receiver.

For example consider a reference BER of  $10^{-15}$ . The SDH in-band FEC provides a NCG of 4 dB. The standard OTN FEC a NCG of 6.2 dB and a enhanced FEC a NCG of 9.5 dB.

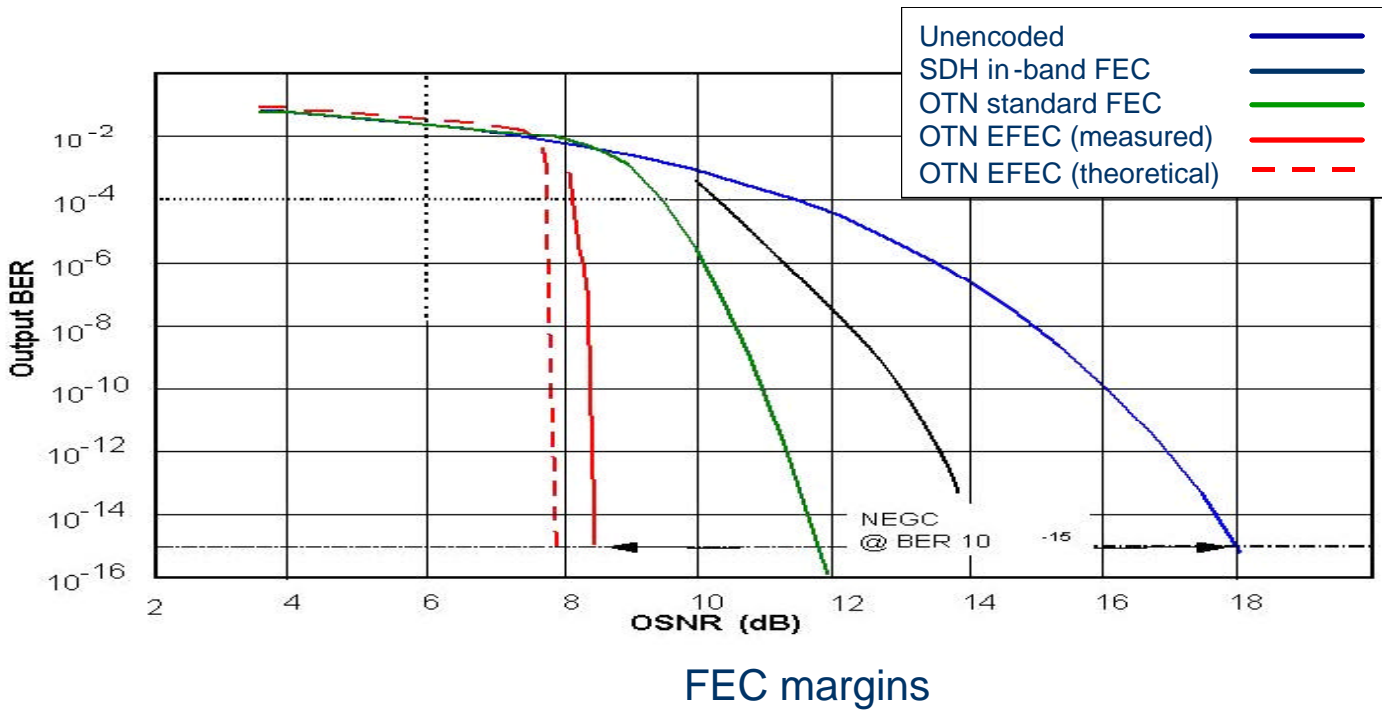
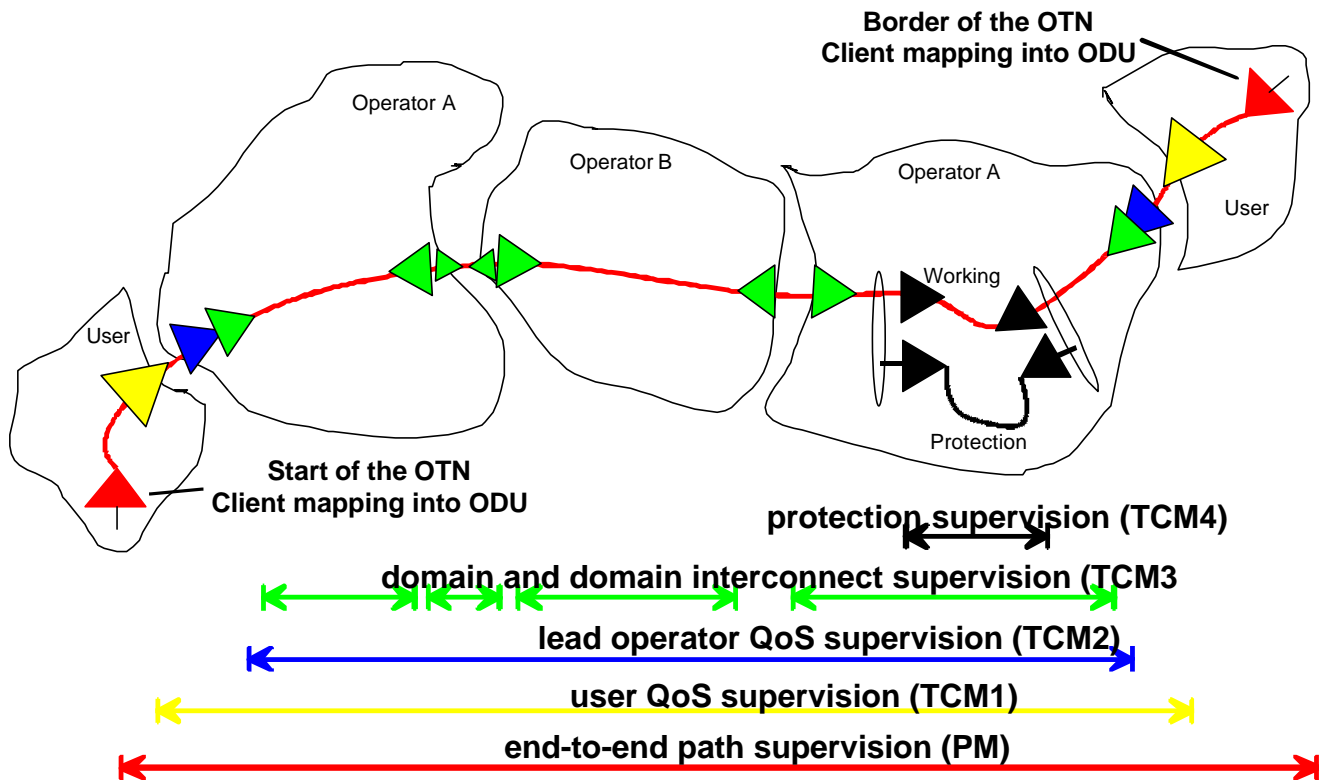

Figure 7 Coding Gain measured via OSNR

### 5.2 Tandem Connection Monitoring

SONET/SDH monitoring is divided into Section, Line and Path monitoring. A problem arises when you have “Carrier’s Carrier” situation as shown in Figure 8, where it is required to monitor a segment of the path that passes another carrier network.



**Figure 8 Tandem Connection Monitoring**

Here Operator A needs to have Operator B carry his signal. However he also needs a way of monitoring the signal as it passes through Operator B's network. This is what a "Tandem connection" is. It is a layer between Line Monitoring and Path Monitoring. SONET/SDH was modified to allow a single Tandem connection. G.709 allows six.

TCM1 is used by the User to monitor the Quality of Service (QoS) that they see. TCM2 is used by the first operator to monitor their end-to-end QoS. TCM3 is used by the various domains for Intra domain monitoring. Then TCM4 is used for protection monitoring by Operator B.

There is no standard on which TCM is used by whom. The operators have to have an agreement, so that they don't conflict.

TCM's also support monitoring of ODUk (G.709 w/0 FEC) connections for one or more of the following network applications (refer to ITU-T G.805 and ITU-T G.872):

- optical UNI to UNI tandem connection monitoring; monitoring the ODUk connection through the public transport network (from public network ingress network termination to egress network termination);
- optical NNI to NNI tandem connection monitoring; monitoring the ODUk connection through the network of a network operator (from operator network ingress network termination to egress network termination);
- sublayer monitoring for linear 1+1, 1:1 and 1:n optical channel subnetwork connection protection switching, to determine the signal fail and signal degrade conditions;
- sublayer monitoring for optical channel shared protection ring (SPRing) protection switching, to determine the signal fail and signal degrade conditions;

- Monitoring an optical channel tandem connection for the purpose of detecting a signal fail or signal degrade condition in a switched optical channel connection, to initiate automatic restoration of the connection during fault and error conditions in the network;
- Monitoring an optical channel tandem connection for, e.g., fault localization or verification of delivered quality of service.

A TCM field is assigned to a monitored connection as described in 15.8.2.2.6/G.709. The number of monitored connections along an ODUk trail may vary between 0 and 6. Monitored connections can be nested, overlapping and/or cascaded. Nesting and cascading is shown in Figure 9. Monitored connections A1-A2/B1-B2/C1-C2 and A1-A2/B3-B4 are nested, while B1-B2/B3-B4 are cascaded.

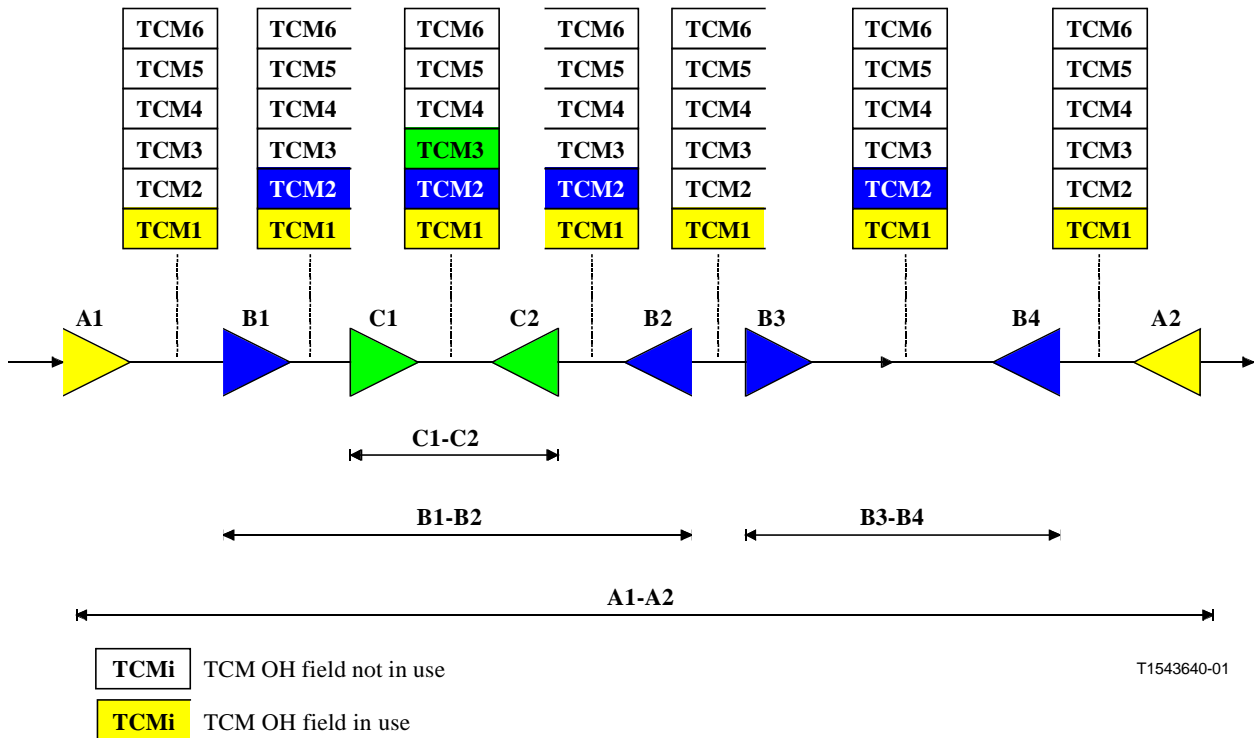

**Figure 9 ODUk monitored connections (Figure 15-16/G.709)**

Overlapping monitored connections as shown in Figure 10 (B1-B2 and C1-C2) are also supported.



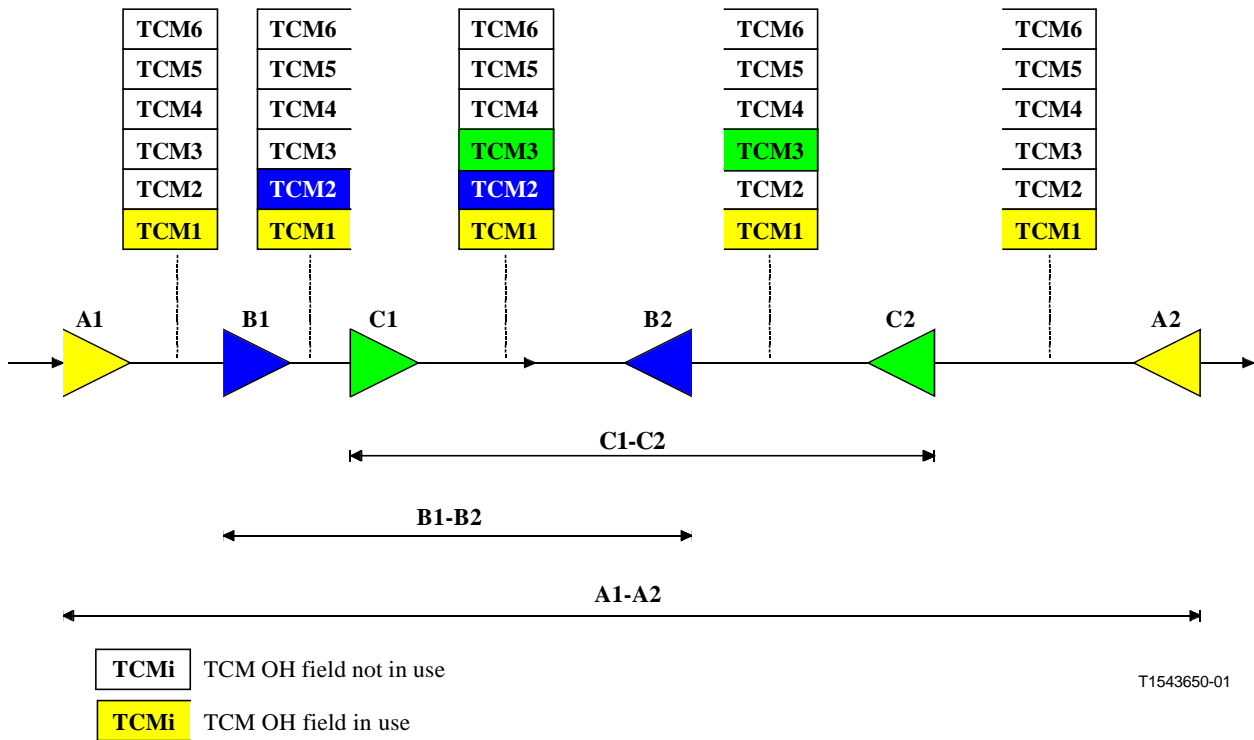

**Figure 10 Overlapping ODUk monitored connections (Figure 15-17/G.709)**

### 5.3 Transparent Transport of Client Signals

G.709 defines the OPUk which can contain the entire SONET/SDH signal. This means that one can transport four STM-16/OC-48 signals in one OTU2 and not modify any of the SONET/SDH overhead. Thus the transport of such client signals in the OTN is bit-transparent (i.e. the integrity of the whole client signal is maintained).

It is also timing transparent. The asynchronous mapping mode transfers the input timing (Asynchronous mapping client) to the far end (Asynchronous demapping client).

It is also delay transparent. For example if four STM-16/OC-48 signals are mapped into ODU1's and then multiplexed into an ODU2, their timing relationship is preserved until they are demapped back to ODU1's.

### 5.4 Switching Scalability

When SONET/SDH was developed in the mid eighties its main purpose was to provide the transport technology for voice services. Two switching levels were therefore defined. Lower order switching at 1.5/2 Mbit/s to directly support the T1/E1 voice signals and a higher order switching level at 50/150 Mbit/s for traffic engineering. Switching levels at higher bit rates were not foreseen.

Over time the line rate increased while the switching rate was fixed. The gap between line rate and switching bit rate widened. Furthermore new services at higher bit rates (IP, Ethernet services) had to be supported.

Contiguous and virtual concatenation were introduced in order to solve part of the services problem as they allow to support services above the standard SONET/SDH switching bit rates.

The gap between line or service bit rate and switching bit rate however still exists as even with concatenation switching is performed at the STS-1/VC-4 level.

For a 4x10G to 40G SONET/SDH multiplexer this means processing of 256 VC-4 in the SDH case and even worse, processing of 768 STS-1-SPEs in the SONET case. This will result not only in efforts in the equipment hardware, but also in management and operations efforts.

For efficient equipment and network design and operations, switching at higher bit rates has to be introduced.

One could now argue that photonic switching of wavelengths is the solution. But with photonic switching the switching bit rate is bound to the bit rate of the wavelength and as such would be the service. A independent selection for service bit rates and DWDM technology is not possible.

A operator offering 2.5 Gbit/s IP interconnection would need a Nx2.5G DWDM system. When adding 10 G services he has to upgrade some of its wavelengths to 10G. This would lead to inefficient network designs.

OTN provides the solution to the problem by placing no restrictions on switching bit rates. As the line rate grows new switching bit rates are added.

A operator can offer services at various bit rates (2.5G, 10G, ...) independent of the bit rate per wavelength using the multiplexing and inverse multiplexing features of the OTN.

## 6 OTN Hierarchy Overview

G.709 defines a number of layers in the OTN hierarchy (Figure 11).

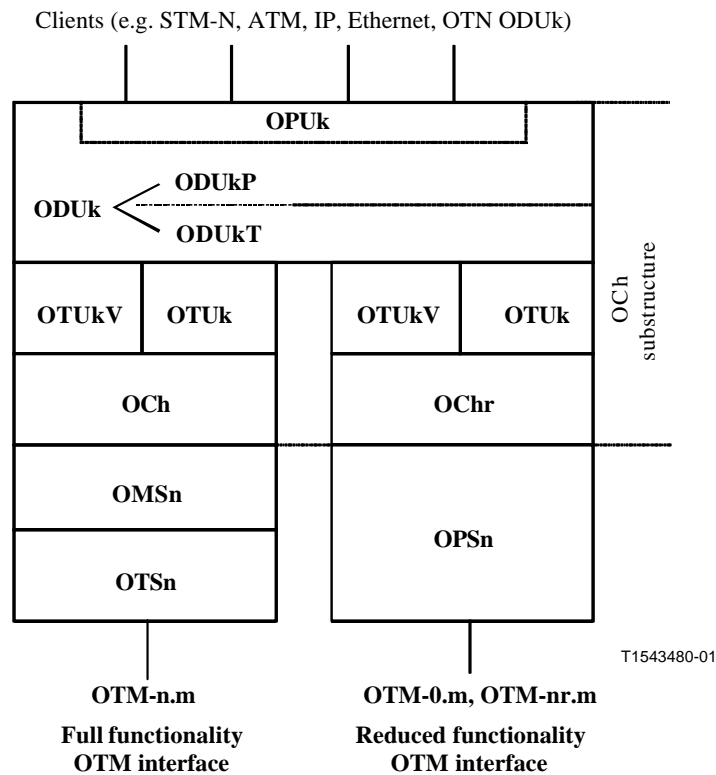

Figure 11 Full OTN Hierarchy

Figure 12 shows how they are envisioned being used in a network.

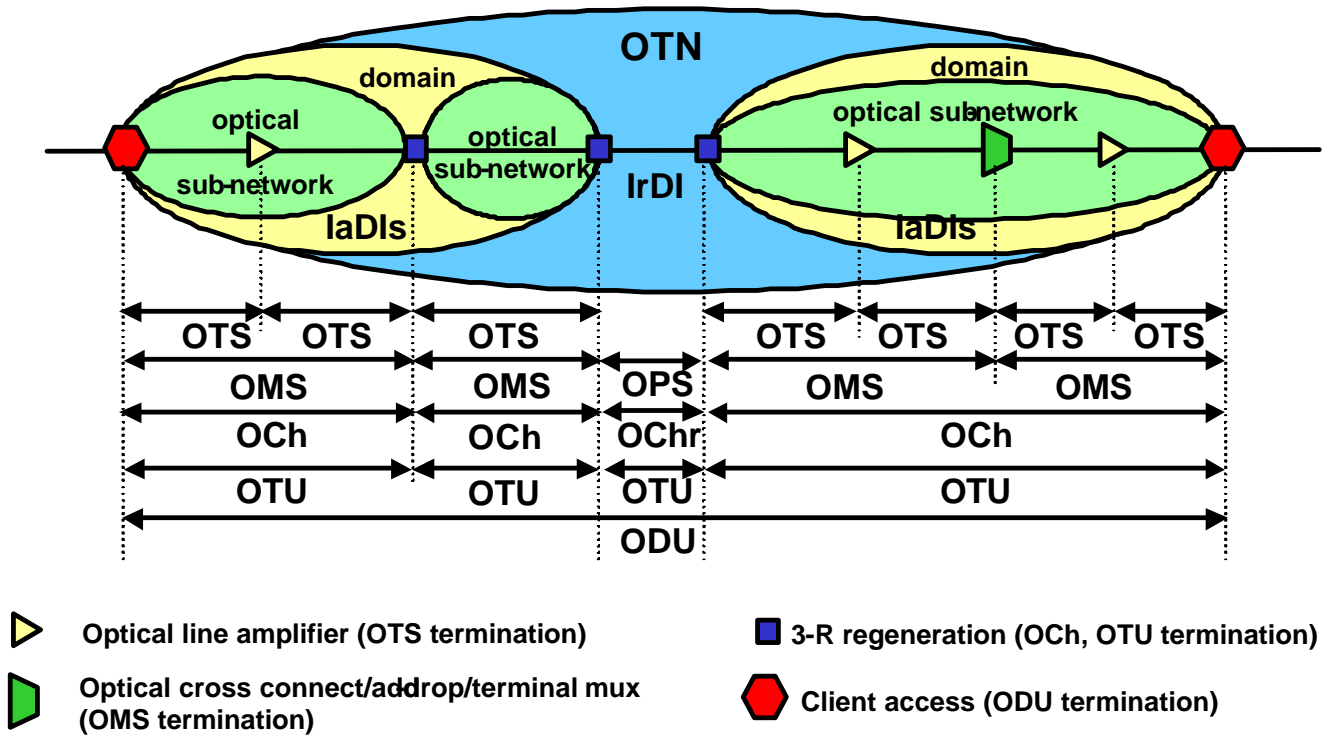

Figure 12 OTN Network Layers

However for all intents and purposes there are only four layers

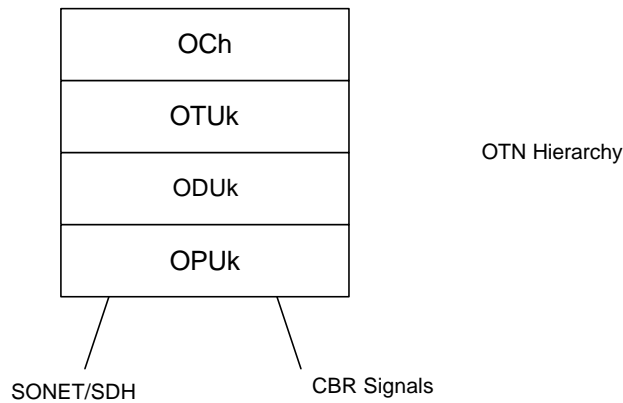

Figure 13 OTN Hierarchy

The OPUk, ODUk, and OTUk are in the electrical domain. The OCh is in the Optical domain. There are more layers in the Optical domain than just the OCh, but they are not being used now.

The OPUk encapsulates the Client signal (e.g. SONET/SDH) and does any rate justification that is needed. It is analogous to the Path layer in SONET/SDH in that it is mapped at the source, demapped at the sink, and not modified by the network.

The ODUk performs similar functions as the Line Overhead in SONET/SDH.

The OTUk contains the FEC and performs similar functions as the Section Overhead in SONET/SDH. After the FEC are added, the signal is then sent to a SERDES (Serializer/Deserializer) to be converted to the Optical Domain.

The data rates were constructed so that they could transfer SONET/SDH signal efficiently. The bit rates are shown in the following tables:

**Table 1 OTU types and capacity (Table 7-1/G.709)**

OTU type	OTU nominal bit rate	OTU bit rate tolerance
OTU1	$255/238 \times 2\,488\,320$ kbit/s	±20 ppm
OTU2	$255/237 \times 9\,953\,280$ kbit/s	
OTU3	$255/236 \times 39\,813\,120$ kbit/s	
NOTE – The nominal OTUk rates are approximately: 2 666 057.143 kbit/s (OTU1), 10 709 225.316 kbit/s (OTU2) and 43 018 413.559 kbit/s (OTU3).		

**Table 2 ODU types and capacity (Table 7-2/G.709)**

ODU type	ODU nominal bit rate	ODU bit rate tolerance
ODU1	$239/238 \times 2\,488\,320$ kbit/s	±20 ppm
ODU2	$239/237 \times 9\,953\,280$ kbit/s	
ODU3	$239/236 \times 39\,813\,120$ kbit/s	
NOTE – The nominal ODUk rates are approximately: 2 498 775.126 kbit/s (ODU1), 10 037 273.924 kbit/s (ODU2) and 40 319 218.983 kbit/s (ODU3).		

**Table 3 OPU types and capacity (Table 7-3/G.709)**

OPU type	OPU Payload nominal bit rate	OPU Payload bit rate tolerance
OPU1	2 488 320 kbit/s	±20 ppm
OPU2	$238/237 \times 9\,953\,280$ kbit/s	
OPU3	$238/236 \times 39\,813\,120$ kbit/s	
NOTE – The nominal OPUk Payload rates are approximately: 2 488 320.000 kbit/s (OPU1 Payload), 9 995 276.962 kbit/s (OPU2 Payload) and 40 150 519.322 kbit/s (OPU3 Payload).		

**Table 4 OTUk/ODUk/OPUk frame periods (Table 7-4/G.709)**

OTU/ODU/OPU type	Period (Note)
OTU1/ODU1/OPU1/OPU1-Xv	48.971 μs
OTU2/ODU2/OPU2/OPU2-Xv	12.191 μs
OTU3/ODU3/OPU3/OPU3-Xv	3.035 μs
NOTE – The period is an approximated value, rounded to 3 digits.	

## 7 OTUk, ODUk, OPUk Frame Structure

Figure 14 shows the overall Frame format for an OTUk signal. The various fields will be explained in the following subsections.

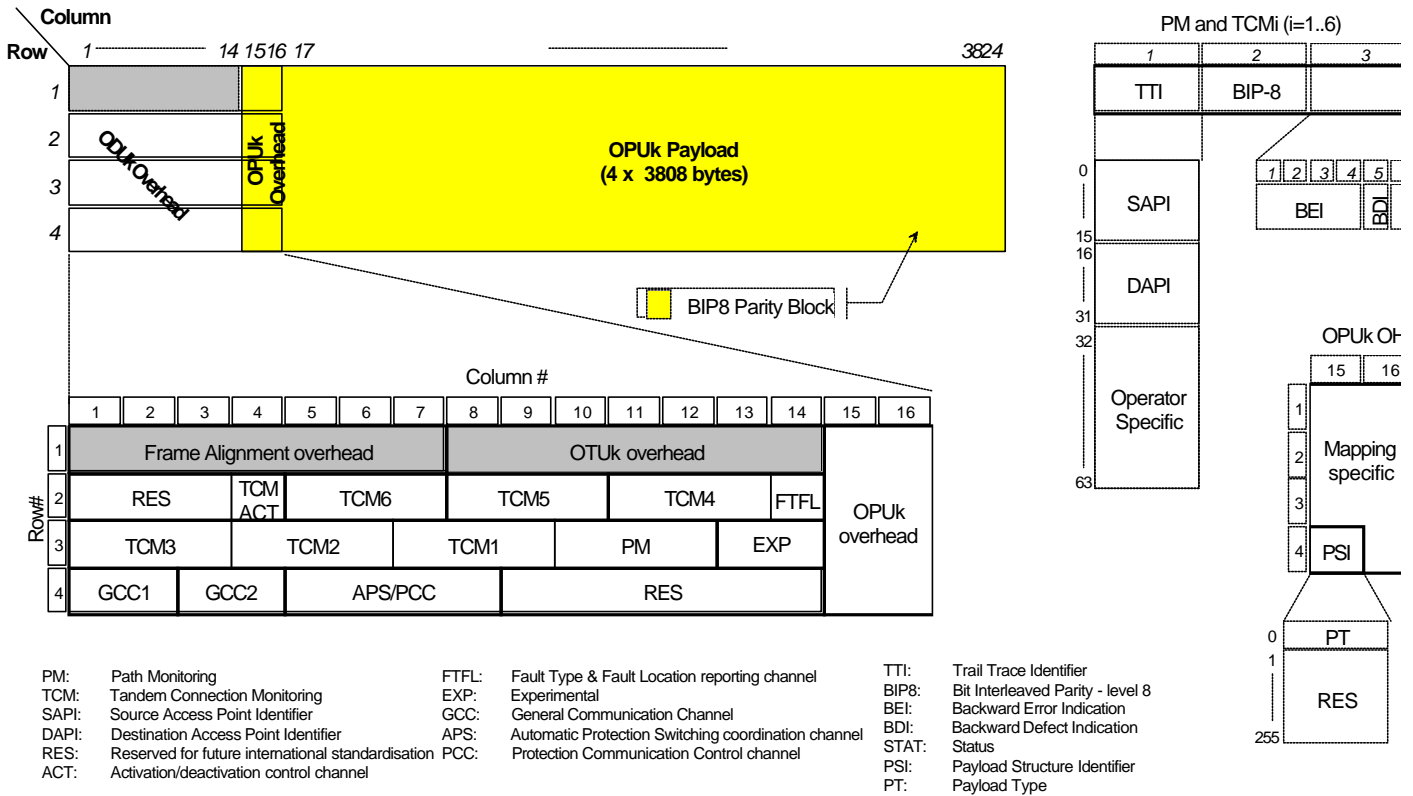
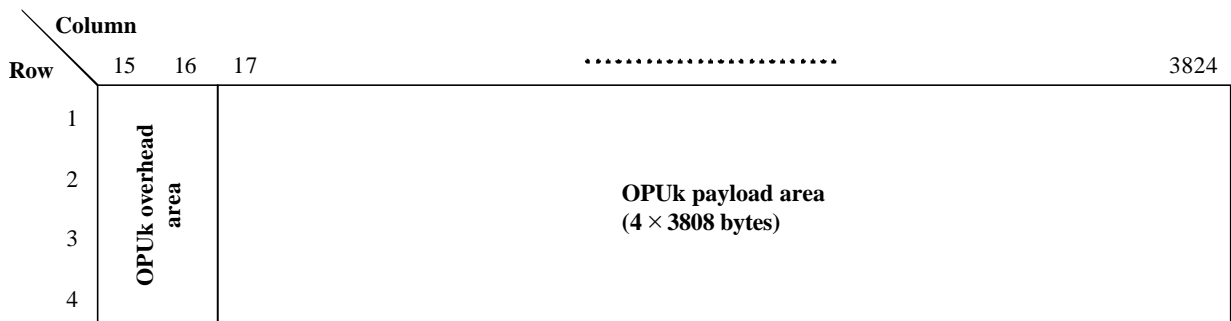

Figure 14 OTN Frame Format (Figure 15-3/G.709)

### 8 OPUk Overhead and Processing

The OPUk (k = 1,2,3) frame structure is shown in Figure 15. It is organized in an octet-based block frame structure with four rows and 3810 columns.



T1542440-00

Figure 15 OPUk frame structure (Figure 13-1/G.709)

The two main areas of the OPUk frame are:

- OPUk overhead area;
- OPUk payload area;

Columns 15 to 16 of the OPUk are dedicated to OPUk overhead area.

Columns 17 to 3824 of the OPUk are dedicated to OPUk payload area.

NOTE – OPUk column numbers are derived from the OPUk columns in the ODUk frame

OPUk OH information is added to the OPUk information payload to create an OPUk. It includes information to support the adaptation of client signals. The OPUk OH is terminated where the OPUk is assembled and disassembled.

### 8.1 OPUk Overhead Byte Descriptions

The OPUk Overhead bytes are shown in Figure 16

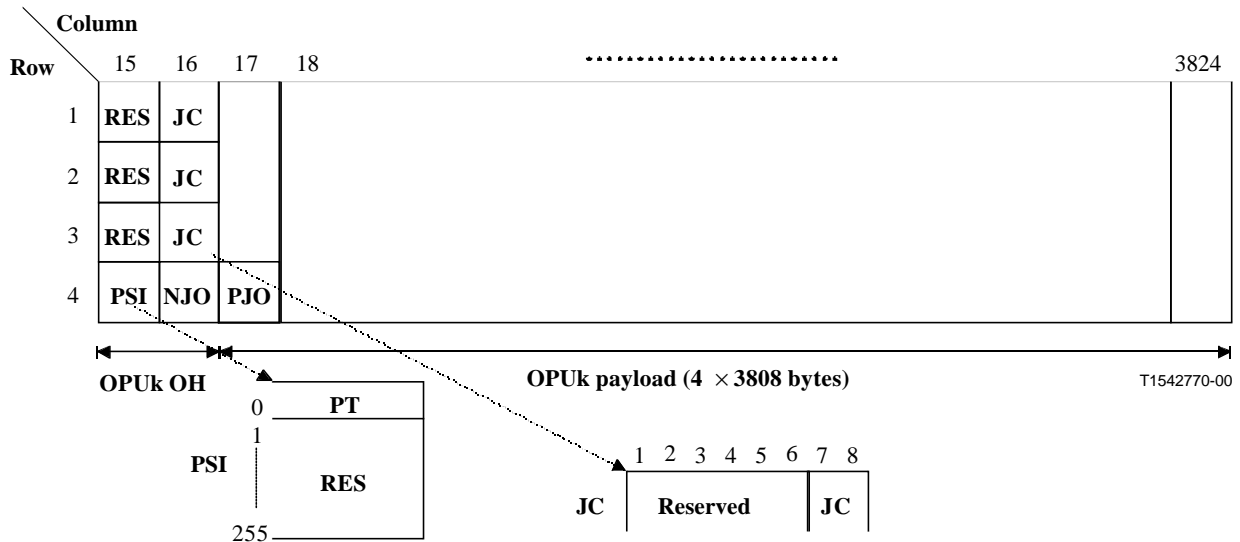

Figure 16 OPUk frame (Figure 17-1/G.709)

#### 8.1.1 Payload Structure Identifier (PSI)

The 256-byte PSI signal is aligned with the ODUk multiframe (i.e. PSI[0] is present at ODUk multiframe position 0000 0000, PSI[1] at position 0000 0001, PSI[2] at position 0000 0010, etc.).

PSI[0] contains a one-byte Payload type. PSI[1] to PSI[255] are mapping and concatenation specific.

#### 8.1.2 Payload Type (PT)

A one-byte payload type signal is defined in the PSI[0] byte of the payload structure identifier to indicate the composition of the OPUk signal. The code points are defined in Table 5.

### 8.2 Mapping Signals into an OPUk

There are a number of Payload Types defined in Table 5..

**Table 5 Payload type code points (Table 15-8/G.709)**

<b>MSB 1 2 3 4</b>	<b>LSB 5 6 7 8</b>	<b>Hex code (Note 1)</b>	<b>Interpretation</b>
0 0 0 0	0 0 0 1	01	Experimental mapping (Note 3)
0 0 0 0	0 0 1 0	02	Asynchronous CBR mapping, see 17.1
0 0 0 0	0 0 1 1	03	Bit synchronous CBR mapping, see 17.1
0 0 0 0	0 1 0 0	04	ATM mapping, see 17.2
0 0 0 0	0 1 0 1	05	GFP mapping, see 17.3
0 0 0 0	0 1 1 0	06	Virtual Concatenated signal, see 18 (NOTE 5)
0 0 0 1	0 0 0 0	10	Bit stream with octet timing mapping, see 17.5.1
0 0 0 1	0 0 0 1	11	Bit stream without octet timing mapping, see 17.5.2
0 0 1 0	0 1 1 0	20	ODU multiplex structure, see 19
0 1 0 1	0 1 0 1	55	Not available (Note 2)
0 1 1 0	0 1 1 0	66	Not available (Note 2)
1 0 0 0	x x x x	80-8F	Reserved codes for proprietary use (Note 4)
1 1 1 1	1 1 0 1	FD	NULL test signal mapping, see 17.4.1
1 1 1 1	1 1 1 0	FE	PRBS test signal mapping, see 17.4.2
1 1 1 1	1 1 1 1	FF	Not available (Note 2)

NOTE 1 – There are 226 spare codes left for future international standardization.

NOTE 2 – These values are excluded from the set of available code points. These bit patterns are present in ODU<sub>k</sub> maintenance signals.

NOTE 3 – Value "01" is only to be used for experimental activities in cases where a mapping code is not defined in this table.

NOTE 4 – These 16 code values will not be subject to standardization.

NOTE 5 – For the payload type of the virtual concatenated signal a dedicated payload type overhead (vcPT) is used, see 18.

The Virtual Concatenated signal and the ODU multiplex structure are dealt with later in this document. Mapping SONET/SDH (CBR) into OPU<sub>k</sub> either synchronously or asynchronously is the most common mapping. Synchronous mapping is a subset of asynchronous mapping, thus we will only discuss asynchronous mapping.

### 8.2.1 Frequency Justification

Asynchronous mapping of a CBR2G5, CBR10G or CBR40G signal into an OPU<sub>k</sub> (k = 1,2,3) may be performed (see Figure 17). The maximum bit-rate tolerance between OPU<sub>k</sub> and the client signal clock that can be accommodated by this mapping scheme is ±65 ppm. With a bit-rate tolerance of ±20 ppm for the OPU<sub>k</sub> clock, the client signal's bit-rate tolerance can be ±45 ppm. If the client's frequency is out of range, then there aren't enough justification bytes in the OPU<sub>k</sub> overhead to make up the difference.

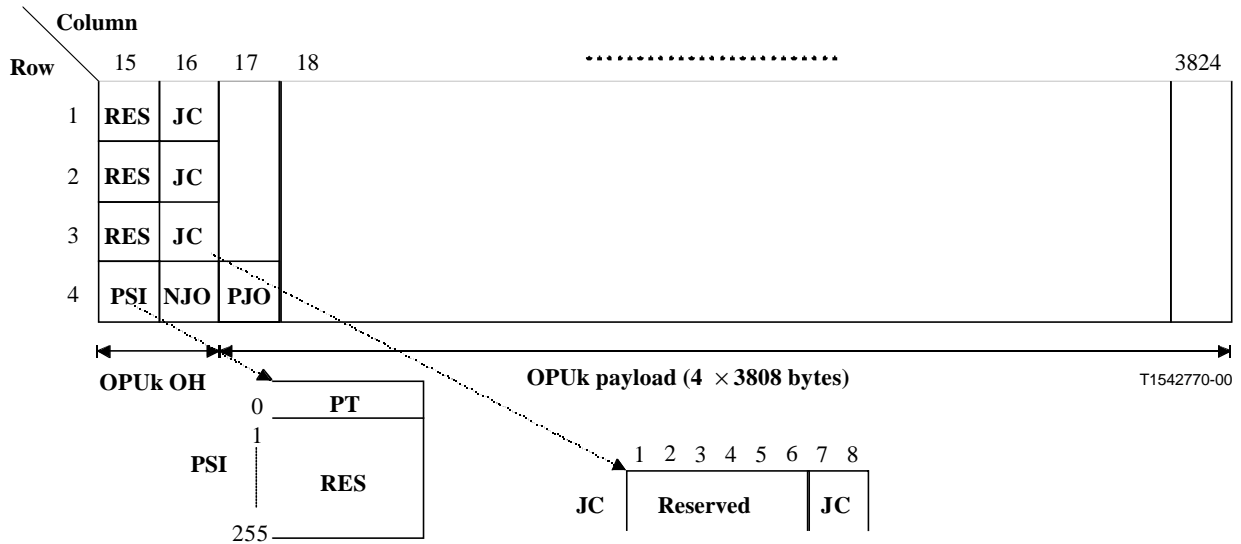

**Figure 17 OPUk frame structure for the mapping of a CBR2G5, CBR10G or CBR40G signal (Figure 17-1/G.709)**

The OPUk overhead for these mappings consists of a payload structure identifier (PSI) including the payload type (PT) and 255 bytes reserved for future international standardization (RES), three justification control (JC) bytes, one negative justification opportunity (NJO) byte, and three bytes reserved for future international standardization (RES). The JC bytes consist of two bits for justification control and six bits reserved for future international standardization.

The OPUk payload for these mappings consists of  $4 \times 3808$  bytes, including one positive justification opportunity (PJO) byte.

The asynchronous and bit synchronous mapping processes generate the JC, NJO and PJO according to Table 6 and Table 7, respectively. The demapping process interprets JC, NJO and PJO according to Table 8. Majority vote (two out of three) is used to make the justification decision in the demapping process to protect against an error in one of the three JC signals.

**Table 6 JC, NJO and PJO generation by asynchronous mapping process (Table 17-1/G.709)**

JC [78]	NJO	PJO
00	justification byte	data byte
01	data byte	data byte
10	not generated	
11	justification byte	justification byte



**Table 7 JC, NJO and PJO generation by bit synchronous mapping process (Table 17-2/G.709)**

JC [78]	NJO	PJO
00	justification byte	data byte
01	not generated	
10		
11		

**Table 8 JC, NJO and PJO interpretation (Table 17-3/G.709)**

JC [78]	NJO	PJO
00	justification byte	data byte
01	data byte	data byte
10 (Note)	justification byte	data byte
11	justification byte	justification byte
NOTE – A mapper circuit does not generate this code. Due to bit errors a demapper circuit might receive this code.		

The value contained in NJO and PJO when they are used as justification bytes is all-0s. The receiver is required to ignore the value contained in these bytes whenever they are used as justification bytes.

The OPUk signal for the asynchronous mapping is created from a locally generated clock, which is independent of the CBR2G5, CBR10G or CBR40G client signal. The CBR2G5, CBR10G, CBR40G signal is mapped into the OPUk using a positive/negative/zero (pnz) justification scheme.

The OPUk clock for the synchronous mapping is derived from the CBR2G5, CBR10G or CBR40G client signal. The CBR2G5, CBR10G or CBR40G signal is mapped into the OPUk without using the justification capability within the OPUk frame: NJO contains a justification byte, PJO contains a data byte, and the JC signal is fixed to 00.

It should be noted that unlike SONET/SDH, there is no “Start of Payload” indication or Pointer.

### 8.2.2 Mapping a CBR2G5 signal (e.g. STM-16) into OPU1

Groups of 8 successive bits (not necessarily being a byte) of the CBR2G5 signal are mapped into a Data (D) byte of the OPU1 (Figure 18). Once per OPU1 frame, it is possible to perform either a positive or a negative justification action.



## 9 ODUk Overhead and Processing

The ODUk (k = 1,2,3) frame structure is shown in Figure 21. It is organized in an octet-based block frame structure with four rows and 3824 columns.

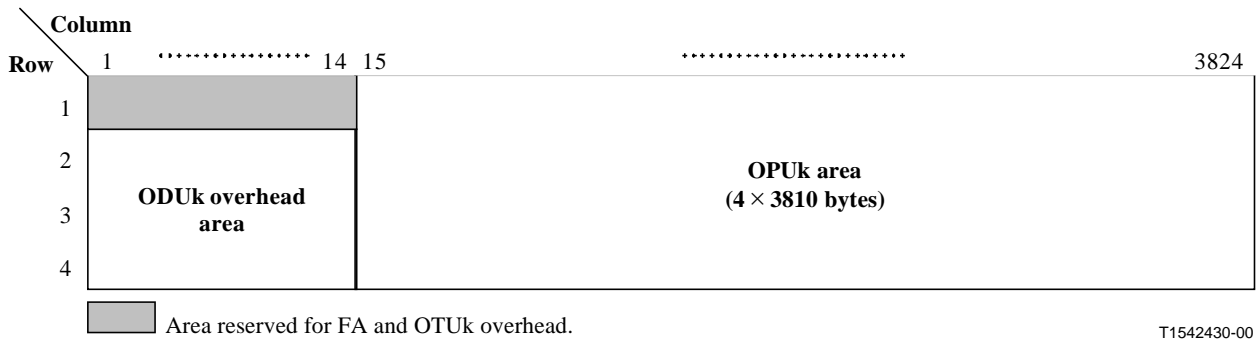

**Figure 21 ODUk frame structure (Figure 12-1/G.709)**

The three main areas of the ODUk frame are:

- OTUk area
- ODUk overhead area;
- OPUk area.

Columns 1 to 14 of rows 2-4 are dedicated to ODUk overhead area.

Columns 1 to 14 of row 1 are reserved for frame alignment and OTUk specific overhead.

Columns 15 to 3824 of the ODUk are dedicated to OPUk area.

ODUk OH information is added to the ODUk information payload to create an ODUk. It includes information for maintenance and operational functions to support optical channels. The ODUk OH consists of portions dedicated to the end-to-end ODUk path and to six levels of tandem connection monitoring. The ODUk path OH is terminated where the ODUk is assembled and disassembled. The TC OH is added and terminated at the source and sink of the corresponding tandem connections, respectively.

When people talk about the ODUk, it may or may not include the bytes in row 1. If one talks about the ODUk rate, then the bytes in row 1 are included. However if one talks about the ODUk OH then the bytes in row 1 are not included. In the functional model (G.798) the ODUk is considered to include row 1, but with all the bytes in row 1 equal to zero (Section 14/G.798 and Section 14.3.1.1/G.798).

The ODUk overhead location is shown in Figure 22, Figure 23 and Figure 24.

		Column #															
		1	2	3	4	5	6	7	8	9	10	11	12	13	14	15	16
Row #	1	Frame alignment overhead							OTUk overhead							OPUk overhead	
	2	RES			TCM ACT	TCM6			TCM5			TCM4		FTFL			
	3	TCM3			TCM2			TCM1			PM		EXP				
	4	GCC1		GCC2		APS/PCC				RES							

T1543810-01

**Figure 22 ODUk overhead (Figure 15-12/G.709)**

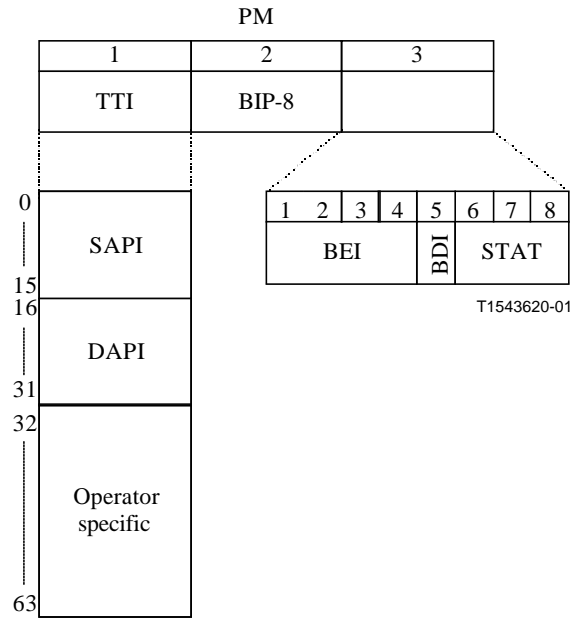

**Figure 23 ODUk path monitoring overhead (Figure 15-13/G.709)**

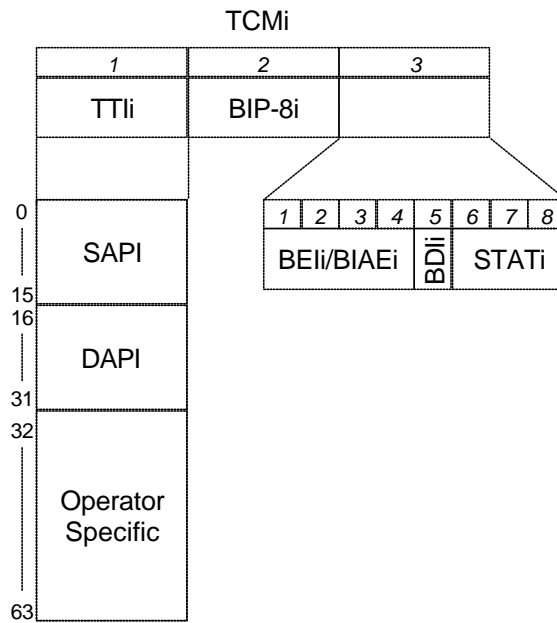

**Figure 24 ODUk tandem connection monitoring #i overhead (Figure 15-14/G.709)**

## 9.1 Path Monitoring (PM) Byte Descriptions

### 9.1.1 Trail Trace Identifier (TTI)

The TTI is a 64-Byte signal that occupies one byte of the frame and is aligned with the OTUk multiframe. It is transmitted four times per multiframe. The definition of what the fields' mean is in G.709/Section 15.2.

### 9.1.2 BIP-8

This byte provides a bit interleaved parity-8 (BIP-8) code. For definition of BIP-8 refer to BIP-X definition in ITU-T G.707/Y.1322.

The ODUk BIP-8 is computed over the bits in the OPUk (columns 15 to 3824) area of ODUk frame *i*, and inserted in the ODUk PM BIP-8 overhead location in the ODUk frame *i+2* (Figure 25).

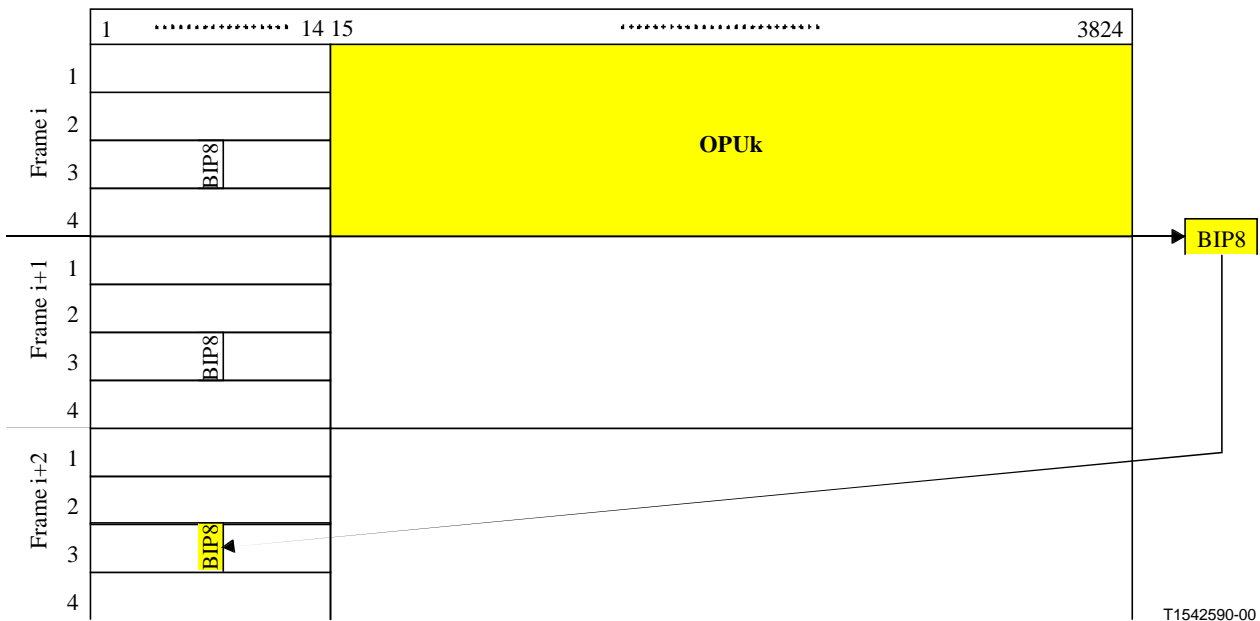

Figure 25 ODUk PM BIP-8 computation (Figure 15-15/G.709)

### 9.1.3 Backward Defect Indication (BDI)

This is defined to convey the “Signal Fail” Status detected at the Path Terminating Sink Function, to the upstream node.

This signal is created by the consequent action of aBDI (G.798/14.2.1.2). The actual defect equations are:

$$RI\_BDI = aBDI = CI\_SSF \text{ or } dAIS \text{ or } dOCI \text{ or } dLCK \text{ or } dTIM$$

dAIS, dOCI, dLCK, dTIM are all detected at the PM layer

CI\_SSF = AI\_TSF at TCM layer

$$AI\_TSF = aTSF = CI\_SSF \text{ or } (dAIS \text{ or } dLTC \text{ or } dOCI \text{ or } dLCK \text{ or } (dTIM \text{ and not } TIMActDis)) \text{ and } TCMCI\_Mode == OPERATIONAL$$

dAIS, dLTC, dOCI, dLCK, and dTIM are TCM defects

$$CI\_SSF = aSSF = dAIS \text{ or } dLOF \text{ or } dLOM \text{ (G.798/12.3.1.2)}$$

dAIS here is the SM AIS

### 9.1.4 Backward Error Indication and Backward Incoming Alignment Error (BEI/BIAE)

This signal is used to convey in the upstream direction the count of interleaved-bit blocks that have been detected in error by the corresponding ODUk path monitoring sink using the BIP-8 code. This count has nine legal values, namely 0-8 errors. The remaining seven possible values represented by these four bits can only result from some unrelated condition and are interpreted as zero errors (Table 9).

**Table 9 ODUk PM BEI interpretation (Table 15-2/G.709)**

<b>ODUk PM BEI bits 1234</b>	<b>BIP violations</b>
0000	0
0001	1
0010	2
0011	3
0100	4
0101	5
0110	6
0111	7
1000	8
1001 to 1111	0

### 9.1.5 Path Monitoring Status (STAT)

They indicate the presence of a maintenance signal (Table 10). For more explanation on the different types of maintenance signals, see Section 14 “OTN Maintenance Signals”

**Table 10 ODUk PM status interpretation (Table 15-3/G.709)**

<b>PM byte 3, bits 678</b>	<b>Status</b>
000	Reserved for future international standardization
001	Normal path signal
010	Reserved for future international standardization
011	Reserved for future international standardization
100	Reserved for future international standardization
101	Maintenance signal: ODUk-LCK
110	Maintenance signal: ODUk-OCI
111	Maintenance signal: ODUk-AIS

## 9.2 Tandem Connection Monitoring (TCM)

There are six TCM’s. They can be nested or overlapping.

### 9.2.1 Trail Trace Identifier (TTI)

The TTI is a 64-Byte signal that occupies one byte of the frame and is aligned with the OTUk multiframe. It is transmitted four times per multiframe. The definition of what the fields’ mean is in G.709/Section 15.2.

### 9.2.2 BIP-8

This byte provides a bit interleaved parity-8 (BIP-8) code. For definition of BIP-8 refer to BIP-X definition in ITU-T G.707/Y.1322.

Each ODUk BIP-8 is computed over the bits in the OPUk (columns 15 to 3824) area of ODUk frame i, and inserted in the ODUk TCM BIP-8 overhead location (associated with the tandem connection monitoring level) in ODUk frame i+2 (Figure 26).

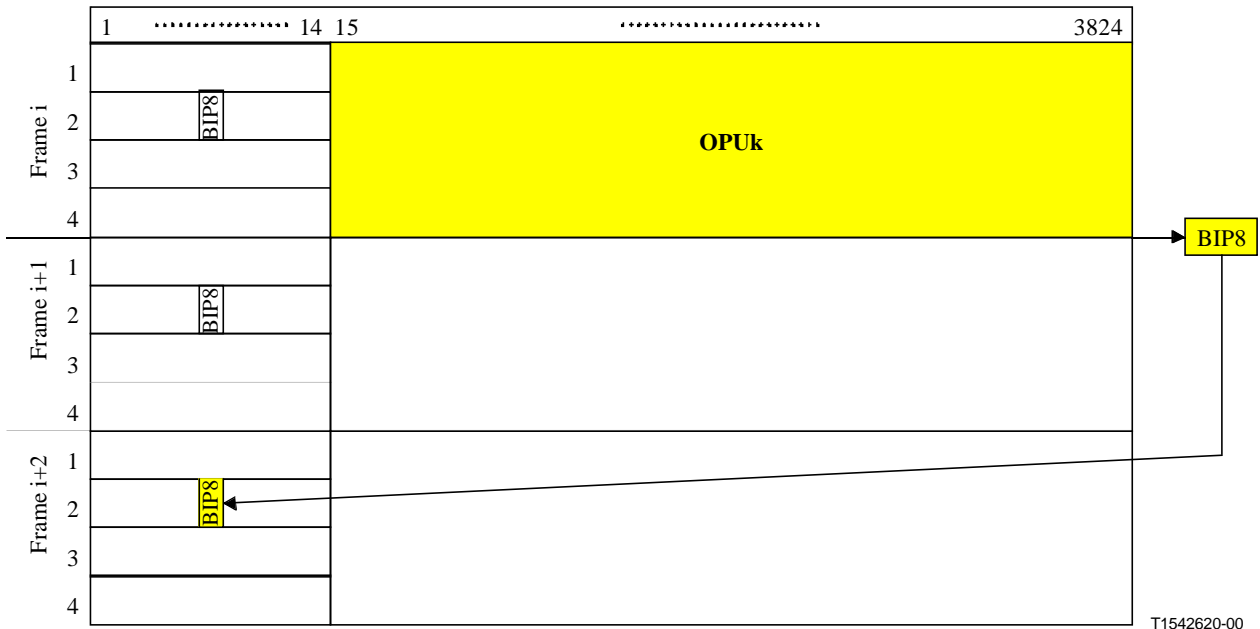

**Figure 26 ODUk TCM BIP-8 computation (Figure 15-18/G.709)**

The BIP-8 is only overwritten at the start of a Tandem Connection. Any existing TCM is not overwritten.

### 9.2.3 Backward Defect Indication (BDI)

This is defined to convey the “Signal Fail” Status detected at the Path Terminating Sink Function, to the upstream node.

This signal is created by the consequent action of aBDI at the TCM level (G.798/14.5.1.1.2). The actual defect equations are:

$$RI\_BDI = aBDI = (CI\_SSF \text{ or } dAIS \text{ or } dLTC \text{ or } dOCI \text{ or } dLCK \text{ or } (dTIM \text{ and not } TIMActDis)) \text{ and } TCMCI\_Mode \neq \text{TRANSPARENT}$$

dAIS and dTIM are TCM defects

$$CI\_SSF = aSSF = dAIS \text{ or } dLOF \text{ or } dLOM \text{ (G.798.12.3.1.2)}$$

dAIS here is the SM AIS

### 9.2.4 Backward Error Indication and Backward Incoming Alignment Error (BEI/BIAE)

This signal is used to convey in the upstream direction the count of interleaved-bit blocks that have been detected as being in error by the corresponding ODUk tandem connection monitoring sink using the BIP-8 code. It is also used to convey in the upstream direction an incoming alignment error (IAE) condition that is detected in the corresponding ODUk tandem connection monitoring sink in the IAE overhead.

During a IAE condition the code "1011" is inserted into the BEI/BIAE field and the error count is ignored. Otherwise the error count (0-8) is inserted into the BEI/BIAE field. The remaining six possible values represented by these four bits can only result from some unrelated condition and are interpreted as zero errors (Table 11) and BIAE not active.

**Table 11 ODUk TCM BEI interpretation (Table 15-4/G.709)**

<b>ODUk TCM BEI bits 1234</b>	<b>BIAE</b>	<b>BIP violations</b>
0000	false	0
0001	false	1
0010	false	2
0011	false	3
0100	false	4
0101	false	5
0110	false	6
0111	false	7
1000	false	8
1001,1010	false	0
1011	true	0
1100 to 1111	false	0

### **9.2.5 TCM Monitoring Status (STAT)**

For each tandem connection monitoring field three bits are defined as status bits (STAT). They indicate the presence of a maintenance signal, if there is an incoming alignment error at the source TCM, or if there is no source TCM active (Table 12).



**Table 12 ODUk TCM status interpretation (Table 15-5/G.709)**

<b>TCM byte 3, bits 678</b>	<b>Status</b>
000	No source TC
001	In use without IAE
010	In use with IAE
011	Reserved for future international standardization
100	Reserved for future international standardization
101	Maintenance signal: ODUk-LCK
110	Maintenance signal: ODUk-OCI
111	Maintenance signal: ODUk-AIS

**9.2.6 Tandem Connection Monitoring ACTivation/deactivation (TCM-ACT)**

Its definition is for further study.

**9.2.7 General Communication Channels (GCC1, GCC2)**

The protocol of the bytes in this channel is defined in G.7712/Y.1703.

**9.2.8 Automatic Protection Switching and Protection Communication Channel (APS/PCC)**

Up to eight levels of nested APS/PCC signals may be present in this field (Table 13). The APS/PCC bytes in a given frame are assigned to a dedicated level depending on the value of MFAS as follows:

**Table 13 Multiframe to allow separate APS/PCC for each monitoring level (Table 15-6/G.709)**

<b>MFAS bit 678</b>	<b>APS/PCC channel applies to connection monitoring level</b>	<b>Protection scheme using the APS/PCC channel (NOTE)</b>
000	ODUk Path	ODUk SNC/N
001	ODUk TCM1	ODUk SNC/S, ODUk SNC/N
010	ODUk TCM2	ODUk SNC/S, ODUk SNC/N
011	ODUk TCM3	ODUk SNC/S, ODUk SNC/N
100	ODUk TCM4	ODUk SNC/S, ODUk SNC/N
101	ODUk TCM5	ODUk SNC/S, ODUk SNC/N
110	ODUk TCM6	ODUk SNC/S, ODUk SNC/N
111	OTUk Section	ODUk SNC/I

For linear protection schemes, the bit assignments for these bytes and the bit-oriented protocol are given in Recommendation G.873.1. Bit assignment and byte oriented protocol for ring protection schemes are for further study.

**9.2.9 Fault Type and Fault Location reporting communication channel (FTFL)**

See G.709 section 15.8.2.5 for an explanation of FTFL.

**10 OTUk Overhead and Processing**

The OTUk (k = 1,2,3) frame structure is based on the ODUk frame structure and extends it with a forward error correction (FEC). 256 columns are added to the ODUk frame for the FEC and the

overhead bytes in row 1, columns 8 to 14 of the ODUk overhead are used for OTUk specific overhead, resulting in an octet-based block frame structure with four rows and 4080 columns.

The bit rates of the OTUk signals are defined in Table 1.

The OTUk forward error correction (FEC) contains the Reed-Solomon RS(255,239) FEC codes. If no FEC is used, fixed stuff bytes (all-0s pattern) are inserted.

The RS(255,239) FEC code is specified in Annex A/G.709.

OTUk OH information is part of the OTUk signal structure. It includes information for operational functions to support the transport via one or more optical channel connections. The OTUk OH is terminated where the OTUk signal is assembled and disassembled.

The overhead is shown in Figure 27:

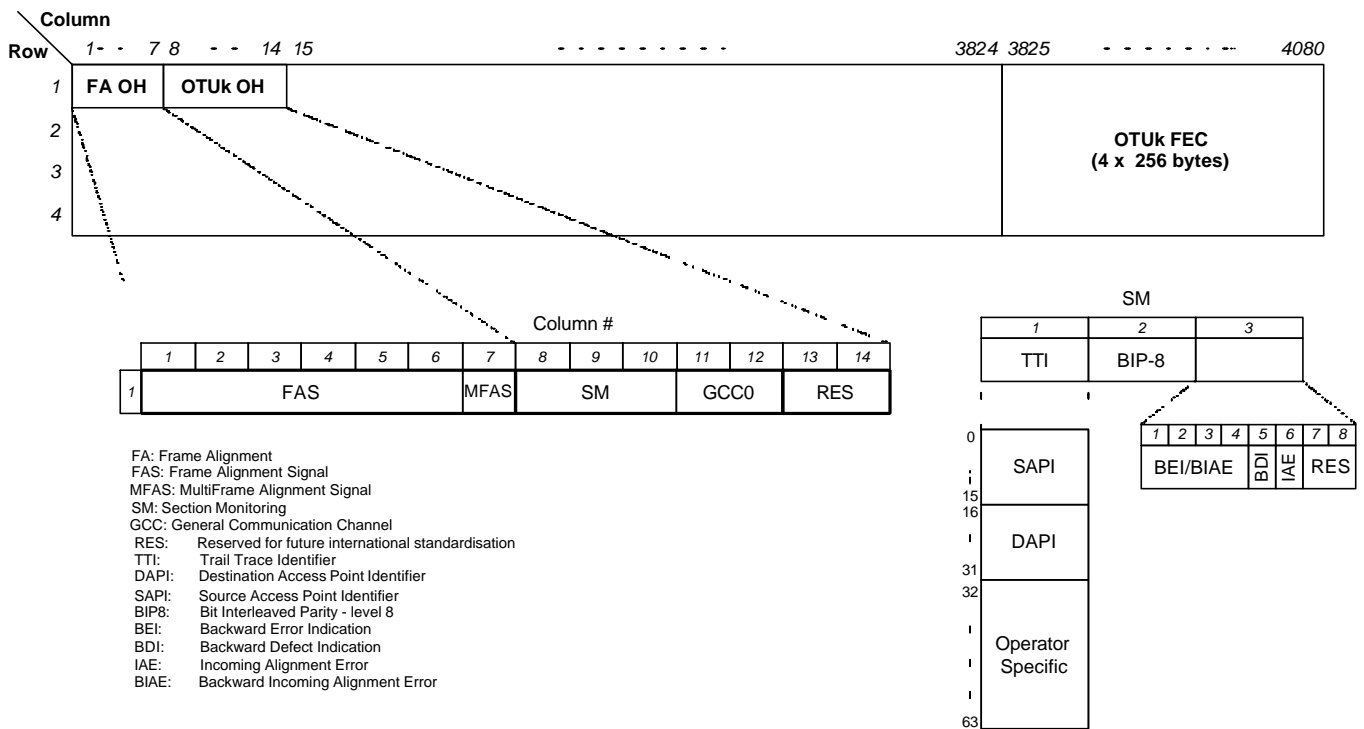

Figure 27 OTUk Overhead (Figure 15-2/G.709)

### 10.1 Scrambling

The OTUk signal needs sufficient bit timing content to allow a clock to be recovered. A suitable bit pattern, which prevents a long sequence of "1"s or "0"s, is provided by using a scrambler.

The operation of the scrambler is functionally identical to that of a frame synchronous scrambler of sequence length 65535 operating at the OTUk rate.

The generating polynomial is  $1 + x + x^3 + x^{12} + x^{16}$ . Figure 28 shows a functional diagram of the frame synchronous scrambler.

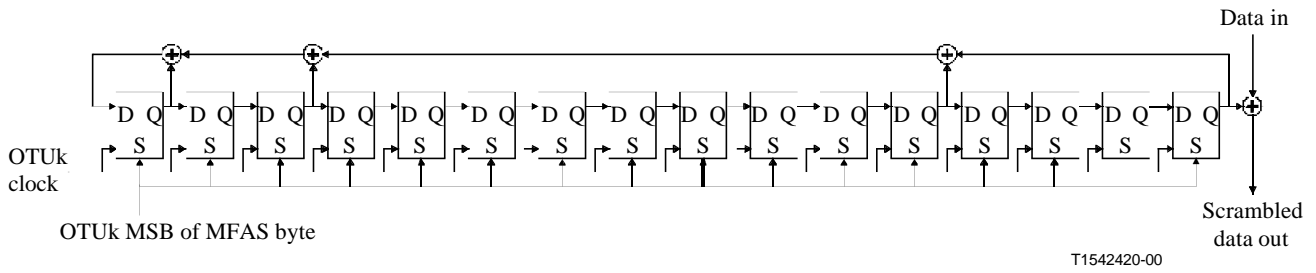

**Figure 28 Frame synchronous scrambler (Figure 11-3/G.709)**

The scrambler is reset to "FFFF" (HEX) on the most significant bit of the byte following the last framing byte in the OTUk frame, i.e. the MSB of the MFAS byte. This bit, and all subsequent bits to be scrambled, are added modulo 2 to the output from the  $x^{16}$  position of the scrambler. The scrambler runs continuously throughout the complete OTUk frame. The framing bytes (FAS) of the OTUk overhead are not scrambled.

Scrambling is performed after FEC check bytes computation and insertion into the OTUk signal.

## 10.2 Frame Alignment Overhead

### 10.2.1 Frame alignment signal (FAS)

A six byte OTUk-FAS signal (Figure 29) is defined in row 1, columns 1 to 6 of the OTUk overhead. OA1 is "1111 0110". OA2 is "0010 1000".

FAS OH Byte 1								FAS OH Byte 2								FAS OH Byte 3								FAS OH Byte 4								FAS OH Byte 5								FAS OH Byte 6							
1	2	3	4	5	6	7	8	1	2	3	4	5	6	7	8	1	2	3	4	5	6	7	8	1	2	3	4	5	6	7	8	1	2	3	4	5	6	7	8	1	2	3	4	5	6	7	8
OA1								OA1								OA1								OA2								OA2								OA2							

T1542510-00

**Figure 29 Frame alignment signal overhead structure (Figure 15-7/G.709)**

### 10.2.2 Multiframe alignment signal (MFAS)

Some of the OTUk and ODUk overhead signals span multiple OTUk/ODUk frames. A single multiframe alignment signal (MFAS) byte is defined in row 1, column 7 of the OTUk/ODUk overhead (Figure 30). The value of the MFAS byte will be incremented each OTUk/ODUk frame and provides as such a 256 frame multiframe.

MFAS OH Byte							
1	2	3	4	5	6	7	8
⋮							
0	0	0	0	0	0	0	0
0	0	0	0	0	0	0	1
0	0	0	0	0	0	1	0
0	0	0	0	0	0	1	1
0	0	0	0	0	1	0	0
⋮							
1	1	1	1	1	1	1	0
1	1	1	1	1	1	1	1
0	0	0	0	0	0	0	0
0	0	0	0	0	0	0	1
⋮							

MFAS sequence

T1542520-00

**Figure 30 Multiframe alignment signal overhead (Figure 15-8/G.709)**

Individual OTUk/ODUk overhead signals use this central multiframe to lock their 2-frame, 4-frame, 8-frame, 16-frame, 32-frame, etc. multiframe to the principal frame.

### 10.3 SM Byte Descriptions

The OTUk overhead location is shown in Figure 31 and Figure 32.

		Column #															
		1	2	3	4	5	6	7	8	9	10	11	12	13	14	15	16
Row #	1	Frame alignment overhead							SM			GCC0		RES		OPUk overhead	
	2																
	3																
	4																

T1542530-00

**Figure 31 OTUk overhead (Figure 15-9/G.709)**

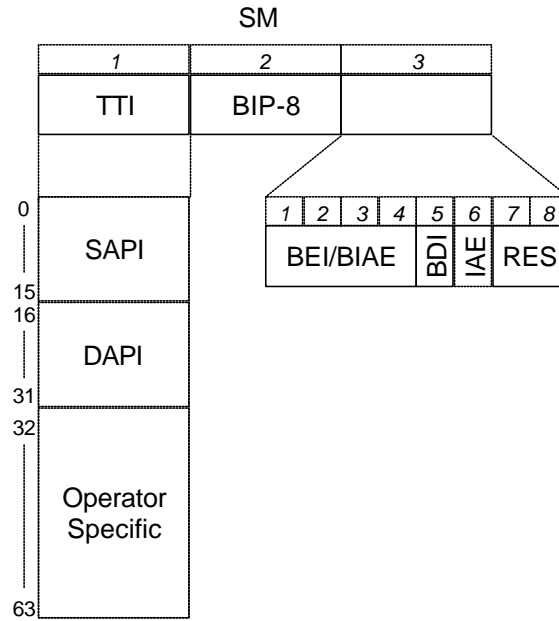

**Figure 32 OTUk section monitoring overhead (Figure 15-10/G.709)**

**10.3.1 Trail Trace Identifier (TTI)**

The TTI is a 64-Byte signal that occupies one byte of the frame and is aligned with the OTUk multiframe. It is transmitted four times per multiframe. The definition of what the fields mean is in G.709/Section 15.2.

**10.3.2 BIP-8**

This byte provides a bit interleaved parity-8 (BIP-8) code. For definition of BIP-8 refer to BIP-X definition in ITU-T G.707/Y.1322.

The OTUk BIP-8 is computed over the bits in the OPUk (columns 15 to 3824) area of OTUk frame *i*, and inserted in the OTUk BIP-8 overhead location in OTUk frame *i+2* (Figure 33).

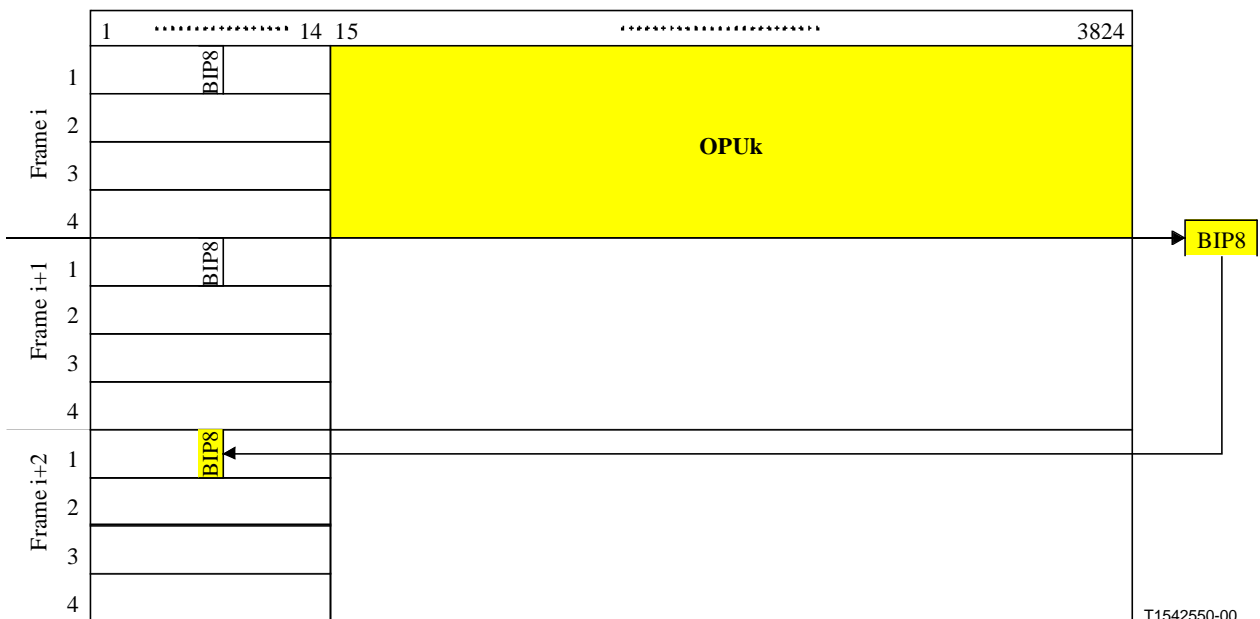

T1542550-00

**Figure 33 OTUk SM BIP-8 computation (Figure 15-11/G.709)**

Note: The OPUk includes the Justification Bytes, thus an OTN signal can not be retimed without demapping back to the client signal.

### **10.3.3 Backward Defect Indication (BDI)**

This is defined to convey the “Signal Fail” Status detected at the Section Terminating Sink Function, to the upstream node.

This signal is created by the consequent action aBDI at the SM level (G.798/13.2.1.2). The actual defect equations are:

$$RI\_BDI = aBDI = CI\_SSF \text{ or } (dTIM \text{ and not } TIMActDis)$$

$$CI\_SSF = aSSF = dAIS \text{ or } dLOF \text{ or } dLOM \text{ (G.798.12.3.1.2)}$$

$$dAIS = OTUk\text{-AIS (G.798.6.2.6.3.1)}$$

$$dTIM = G.798.6.2.2.1$$

### **10.3.4 Backward Error Indication and Backward Incoming Alignment Error (BEI/BIAE)**

This signal is used to convey in the upstream direction the count of interleaved-bit blocks that have been detected in error by the corresponding OTUk section monitoring sink using the BIP-8 code. It is also used to convey in the upstream direction an incoming alignment error (IAE) condition that is detected in the corresponding OTUk section monitoring sink in the IAE overhead.

During a IAE condition the code "1011" is inserted into the BEI/BIAE field and the error count is ignored. Otherwise the error count (0-8) is inserted into the BEI/BIAE field. The remaining six possible values represented by these four bits can only result from some unrelated condition and are interpreted as zero errors (Table 14) and BIAE not active.

**Table 14 OTUk SM BEI interpretation (Table 15-1/G.709)**

<b>OTUk SM BEI/BIAE bits 1234</b>	<b>BIAE</b>	<b>BIP violations</b>
0000	false	0
0001	false	1
0010	false	2
0011	false	3
0100	false	4
0101	false	5
0110	false	6
0111	false	7
1000	false	8
1001,1010	false	0
1011	true	0
1100 to 1111	false	0

**10.3.5 Incoming Alignment Error (IAE)**

A single-bit incoming alignment error (IAE) signal is defined to allow the ingress point to inform its peer egress point that an alignment error in the incoming signal has been detected.

IAE is set to "1" to indicate a frame alignment error, otherwise it is set to "0".

The egress point may use this information to suppress the counting of bit errors, which may occur as a result of a frame phase change of the OTUk at the ingress of the section.

G.798 shows an incoming alignment error being detected on the source side (Section 13.3.1.1/G.798). The consequent action (AI\_IAE) is then used to set the SM IAE bit (Section 13.2.1.1). Practically it is detected on the sink side and then passed to the source side. However if one is going through an ODUk switch, then it would need to be detected on the source side.

**10.4 General Communication Channel 0 (GCC0)**

The protocol of the bytes in this channel is defined in G.7712/Y.1703.

**11 ODUk Multiplexing**

Multiplexing in the OTN domain is defined in Section 19 of G.709. Four ODU1's can be multiplexed to an ODU2. Up to sixteen ODU1's or four ODU2's can be multiplexed to an ODU3. It is possible to mix ODU1's and ODU2's in an ODU3.

For ODU2 to ODU3 multiplexing, there has to be two positive stuff opportunities! For ODU1 to ODU3 multiplexing, there is a fixed stuff in column 119! Thus the stuffing for multiplexing is different from the stuffing for mapping. In order to understand why, it is necessary to examine the data rates.

**11.1 Multiplexing Data Rates**

**11.1.1 ODU1 to ODU2 Justification Rate**

For the case of multiplexing ODU1 to ODU2:

From Table 2 ODU1 rate =  $239/238 * OC48 \pm 20 \text{ ppm} = 2,498,775,126 \pm 49,976 \text{ b/s}$

We can put data in the "Fixed Stuff" bits of the OPU2 payload that is shown in Figure 19. Thus the OPU2 payload is now  $238/239 * \text{ODU2 rate}$

or:  $238/239 * 239/237 * \text{OC192} \pm 20 \text{ ppm}$

The OPU2 payload is time sliced for the four ODU1's. Thus each ODU1 has:

$238/237 * \text{OC48} \pm 20 \text{ ppm} = 2,498,819,241 \pm 49,976 \text{ b/s}$

The worst case frequency difference is then:

$(2,498,819,241 + 49,976) - (2,498,775,126 - 49,976) = 144,067 \text{ b/s}$  or  $57.65 \text{ ppm}$

Thus we have to account for a data rate mismatch of 144,067 b/s by stuffing. The stuffing is done on a multiframe basis. Each timeslot is stuffed once per four frames.

The stuffing rate is:  $(\text{stuff bits/frame})/(\text{bits/frame}) * (\text{data rate})$

$= (8/4)/(3824*4*8)*(238/237*\text{OC192}) = 163,364 \text{ b/s} = 65 \text{ PPM}$

Thus in the worst case, there are enough data bytes coming in to match the outgoing rate!

### 11.1.2 ODU2 to ODU3 Justification Rate

For the case of multiplexing ODU2 to ODU3:

From Table 2:  $\text{ODU2 rate} = 239/237 * \text{OC192} \pm 20 \text{ ppm} = 10,037,273,930 \pm 200,745 \text{ b/s}$

We can put data in the "Fixed Stuff" bits of the OPU3 payload that is shown in Figure 20. Thus the OPU3 payload is now  $238/239 * \text{ODU3 rate}$

or:  $238/239 * 239/236 * \text{OC768} \pm 20 \text{ ppm}$

The OPU3 payload is time sliced for the four ODU2's. Thus each ODU2 has:

$238/236 * \text{OC192} \pm 20 \text{ ppm} = 10,037,629,830 \pm 200,753 \text{ b/s}$

The worst case frequency difference is then:

$(10,037,629,830 + 200,753) - (10,037,273,930 - 200,745) = 757,398 \text{ b/s}$  or  $+75 \text{ ppm}$

and

$(10,037,629,830 - 200,753) - (10,037,273,930 + 200,745) = -45,598 \text{ b/s}$  or  $-4.5 \text{ ppm}$

Thus we have to account for a data rate mismatch of 757,398 b/s by stuffing. The stuffing is done on a multiframe basis. This is more than the  $\pm 65 \text{ ppm}$  that the normal scheme can accommodate. Thus, each timeslot has two positive stuff opportunities and one negative stuff opportunity per four frames.

The stuffing rate is:  $(\text{stuff bits/frame}) * (\text{bits/sec})/(\text{bits/frame})$

$= (16/4)/(3824*4*8)*(238/236*\text{OC768}) = 1,312,452 \text{ b/s} = 130 \text{ PPM}$

Therefore in the worst case, there are enough data bytes coming in to match the outgoing rate!

### 11.1.3 ODU1 to ODU3 Justification Rate

For the case of multiplexing ODU1 to ODU3:

From Table 2:  $\text{ODU1 rate} = 239/238 * \text{OC48} \pm 20 \text{ ppm} = 2,498,775,126 \pm 49,976 \text{ b/s}$

We can put data in the "Fixed Stuff" bits of the OPU3 payload that is shown in Figure 20. Thus the OPU3 payload is now  $238/239 * \text{ODU3 rate}$

or:  $238/239 * 239/236 * \text{OC768} \pm 20 \text{ ppm}$

The OPU3 payload is time sliced for the 16 ODU1's. Column 119 of the time sliced ODU3 is fixed stuff. An all-0s pattern is inserted in the fixed stuff bytes. Thus each ODU1 has:



$$237/239 * 239/236 * OC48 +- 20 \text{ ppm} = 2,498,863,728 +- 49,977 \text{ b/s}$$

The worst case frequency difference is then:

$$(2,498,863,728 + 49,977) - (2,498,775,126 - 49,976) = 188,555 \text{ b/s or } 75.46 \text{ ppm}$$

Thus we have to account for a data rate mismatch of 188,555 b/s by stuffing. The stuffing is done on a multiframe basis. Once again each timeslot has two positive stuff opportunities and one negative stuff opportunity per 16 frames.

The stuffing rate is: (stuff bits/frame) \* (bits/sec)/(bits/frame)

$$= (16/16)/(3824*4*8)*(238/236*OC768) = 328,113 \text{ b/s} = 130 \text{ PPM}$$

Therefore in the worst case, there are enough data bytes coming in to match the outgoing rate!

## **11.2 4 x ODU1 to ODU2 Multiplexing**

### **11.2.1 4 x ODU1 to ODU2 Multiplexing Structure**

The OPU2 is divided in a number of Tributary Slots (TS) and these Tributary Slots are interleaved within the OPU2 (Figure 34). The bytes of an ODU1 input are mapped into one of four OPU2 Tributary Slots. The bytes of the Justification Overhead to adapt the asynchronous ODU1 to the ODU2 clock rate are mapped into the OPU2 OH area.

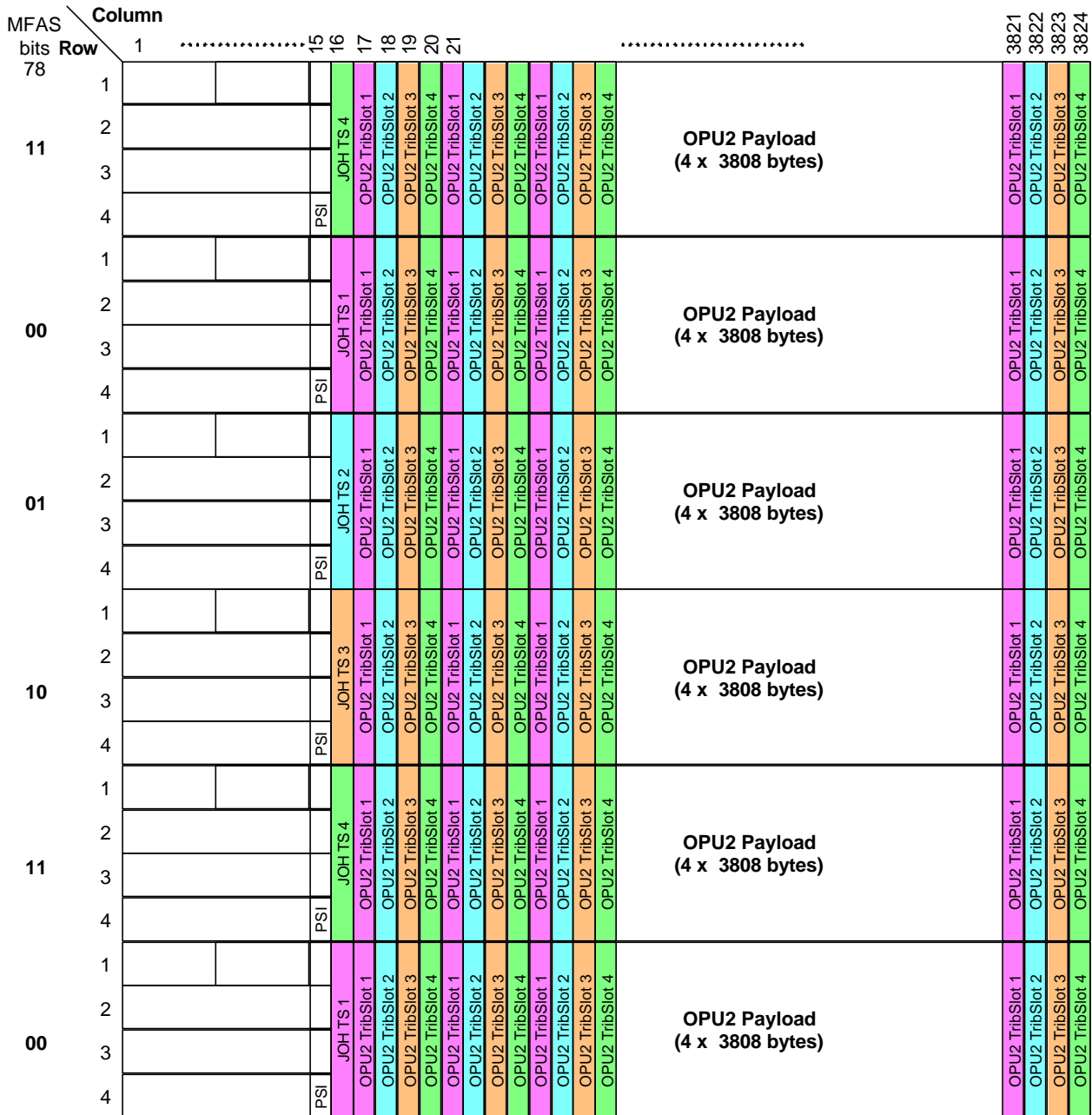
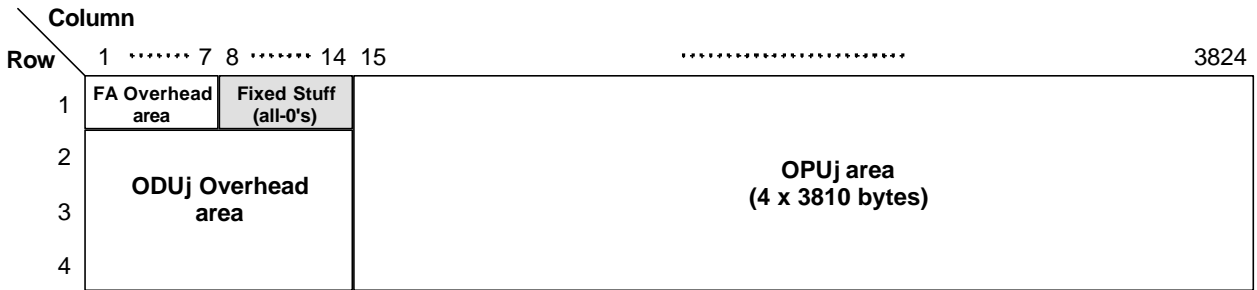

**Figure 34 OPU2 tributary slot allocation (Figure 19-1/G.709)**

An OPU2 Tributary Slot occupies 25% of the OPU2 Payload area. It is a structure with 952 columns by 4 rows. The four OPU2 TS's are byte interleaved in the OPU2 Payload area.

It is important to note that the ODU1 frame repeats every four ODU2 frames! One of the implications of this is that the FAS bytes in the ODU1 frame could cause false locking of the ODU2 frame. This is not suppose to be a problem according to contributions to the ITU.

However the FAS bytes can't be removed because there is no standard on where the ODU1 frame starts. Thus the ODU1 FAS bytes are needed to frame the recovered ODU1 signal. The OTU1 OH (SM, GCC0 and RES) is set to all 0's.



**Figure 35 Extended ODUj frame structure (Figure 19-10/G.709)**

**11.2.2 4 x ODU1 to ODU2 Justification Structure**

The Justification Overhead (JOH) consisting of Justification Control (JC) and Negative Justification Opportunity (NJO) signals of the 4 OPU2 TSs are located in the overhead area, column 16 of rows 1 to 4. The JOH is assigned to the related tributary slots on a per frame base. JOH for a tributary slot is available once every 4 frames. A 4-frame multiframe structure is used for this assignment. This multiframe structure is locked to bits 7 and 8 of the MFAS byte as shown in Table 15 and Figure 36.

**Table 15 OPU2 Justification OH tributary slots (Table 19-1/G.709)**

MFAS bits	JOH TS
78	
00	1
01	2
10	3
11	4

The PJO1 and PJO2 bytes are in the ODU1 payload. Figure 36 shows how the bytes are distributed.

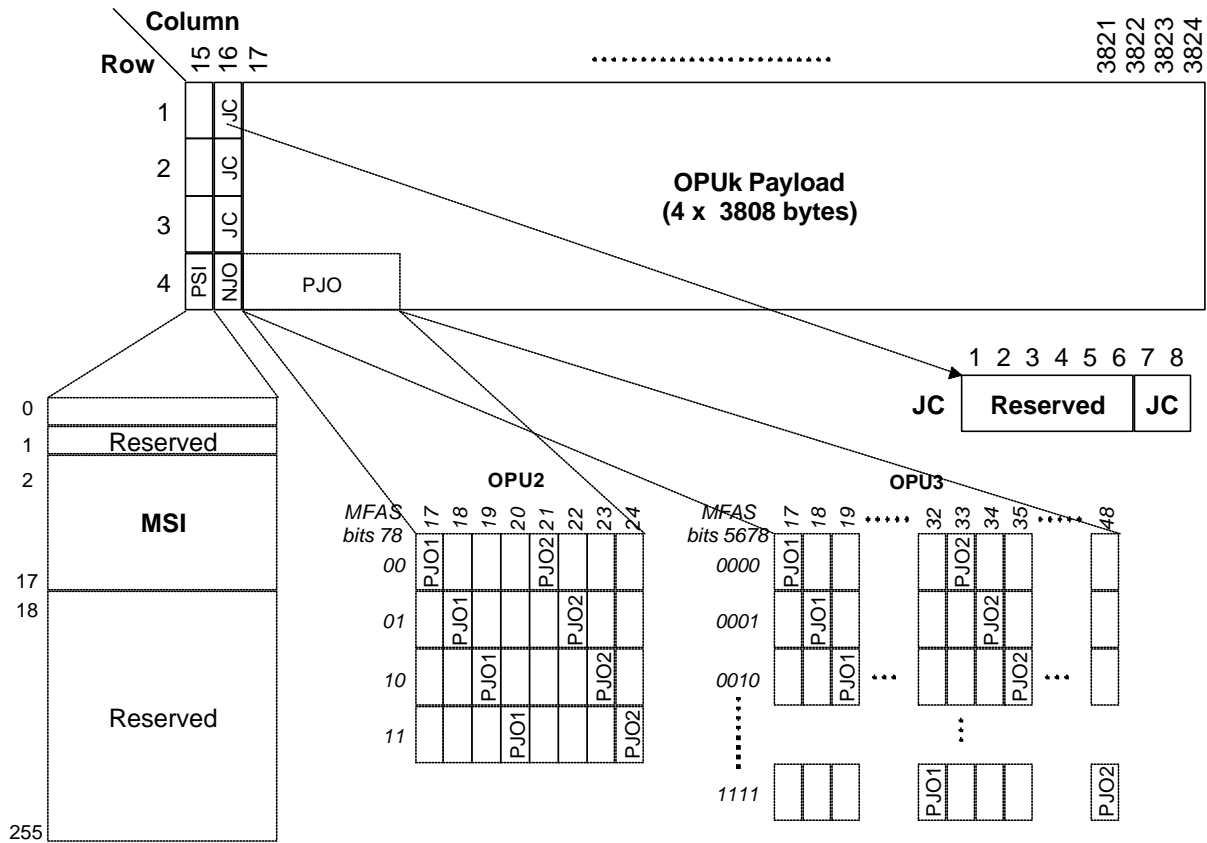

**Figure 36 OPUk Multiplex Overhead (Figure 19-6/G.709)**

The thing to note is that there are two PJO bytes and only one NJO bytes. This is because the timeslot provides more capacity than is needed.

### 11.2.3 OPU2 Payload Structure Identifier (PSI)

Byte 0 is defined as the Payload Type and is equal to 0x20.

Byte 1 is reserved

Bytes 2-17 are the “Multiplex Structure Identifier”

Bytes 18-255 are reserved

239 bytes are reserved in the OPUk PSI for future international standardization. These bytes are located in PSI[1] and PSI[18] to [PSI255] of the OPUk overhead. These bytes are set to all Zeros.

### 11.2.4 OPU2 Multiplex Structure Identifier (MSI)

The multiplex structure identifier (MSI) overhead, which encodes the ODU multiplex structure in the OPU, is located in the mapping specific area of the PSI signal (PSI[2]... PSI[17]). The MSI indicates the content of each tributary slot (TS) of an OPU2. The generic coding for each TS is shown in Figure 37. One byte is used for each TS.

- Bits 1 and 2 indicate the ODU type transported in the TS.
- Bits 3 to 8 indicate the tributary port of the ODU transported. This is of interest in case of flexible assignment of ODUs to tributary slots (e.g. ODU2 into OPU3). In case of fixed assignment the tributary port number corresponds to the tributary slot number.

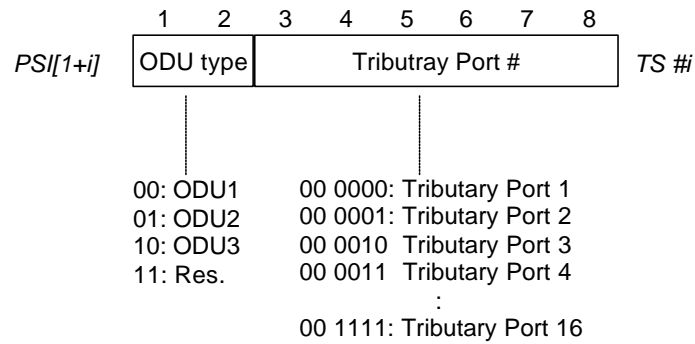

**Figure 37 Generic MSI coding (Figure 19-7/G.709)**

For the 4 OPU2 tributary slots 4 bytes of the PSI are used as shown in Figure 38.

- The ODU type is fixed ODU1.
- The tributary port # indicates the port number of the ODU1 that is being transported in this TS; the assignment of ports to tributary slots is fixed, the port number equals the tributary slot number

The remaining 12 bytes of the MSI field (*PSI[6]* to *PSI[17]*) are unused. They are set to 0 and ignored by the receiver.

	1	2	3	4	5	6	7	8	
<i>PSI[2]</i>	00		00 0000						<i>TS1</i>
<i>PSI[3]</i>	00		00 0001						<i>TS2</i>
<i>PSI[4]</i>	00		00 0010						<i>TS3</i>
<i>PSI[5]</i>	00		00 0011						<i>TS4</i>

**Figure 38 OPU2-MSI coding (Figure 19-8/G.709)**

### 11.2.5 Frequency Justification

The mapping of ODU1 signals (with up to ±20 ppm bit-rate tolerance) into the ODU2 signal is performed as an asynchronous mapping.

The OPU2 signal for the multiplexed ODU1 structure is created from a locally generated clock, which is independent of the ODU1 client signals.

The ODU1 signal is extended with Frame Alignment Overhead and an all-0's pattern in the OTU1 Overhead field;

The extended ODU1 signal is adapted to the locally generated ODU2 clock by means of an asynchronous mapping with -1/0/+1/+2 positive/negative/zero (pnz) justification scheme.

The asynchronous mapping process generates the JC, NJO, PJO1 and PJO2 according to Table 16.. The demapping process interprets JC, NJO, PJO1 and PJO2 according to Table 16.. Majority vote (two out of three) is used to make the justification decision in the demapping process to protect against an error in one of the three JC signals.

**Table 16 JC, NJO, PJO1 and PJO2 generation and interpretation (Table 19-3/G.709)**

<b>JC [7,8]</b>	<b>NJO</b>	<b>PJO1</b>	<b>PJO2</b>	<b>Interpretation</b>
00	justification byte	data byte	data byte	no justification (0)
01	data byte	data byte	data byte	negative justification (-1)
10	justification byte	justification byte	justification byte	double positive justification (+2)
11	justification byte	justification byte	data byte	positive justification (+1)

The value contained in NJO, PJO1 and PJO2 when they are used as justification bytes is all-0s. The receiver is required to ignore the value contained in these bytes whenever they are used as justification bytes.

Note: based on the calculations for ODU1 to OPU2 mapping (See Section 11.1.1), there should never be a need to do a “Double Positive Justification”.

### **11.3 ODU1/ODU2 to ODU3 Multiplexing**

#### **11.3.1 ODU1/ODU2 to ODU3 Multiplexing Structure**

The OPU3 is divided in a number of Tributary Slots (TS) and these Tributary Slots are interleaved within the OPU3 (Figure 34<sup>1</sup>). The bytes of an ODU1 or ODU2 input are mapped into one or four OPU3 Tributary Slots. The bytes of the Justification Overhead to adapt the asynchronous ODU1 or ODU2 to the ODU3 clock rate are mapped into the OPU3 OH area.

---

<sup>1</sup> NOTE TSB: In the second line has to be read Figure 39 instead of 34 ?

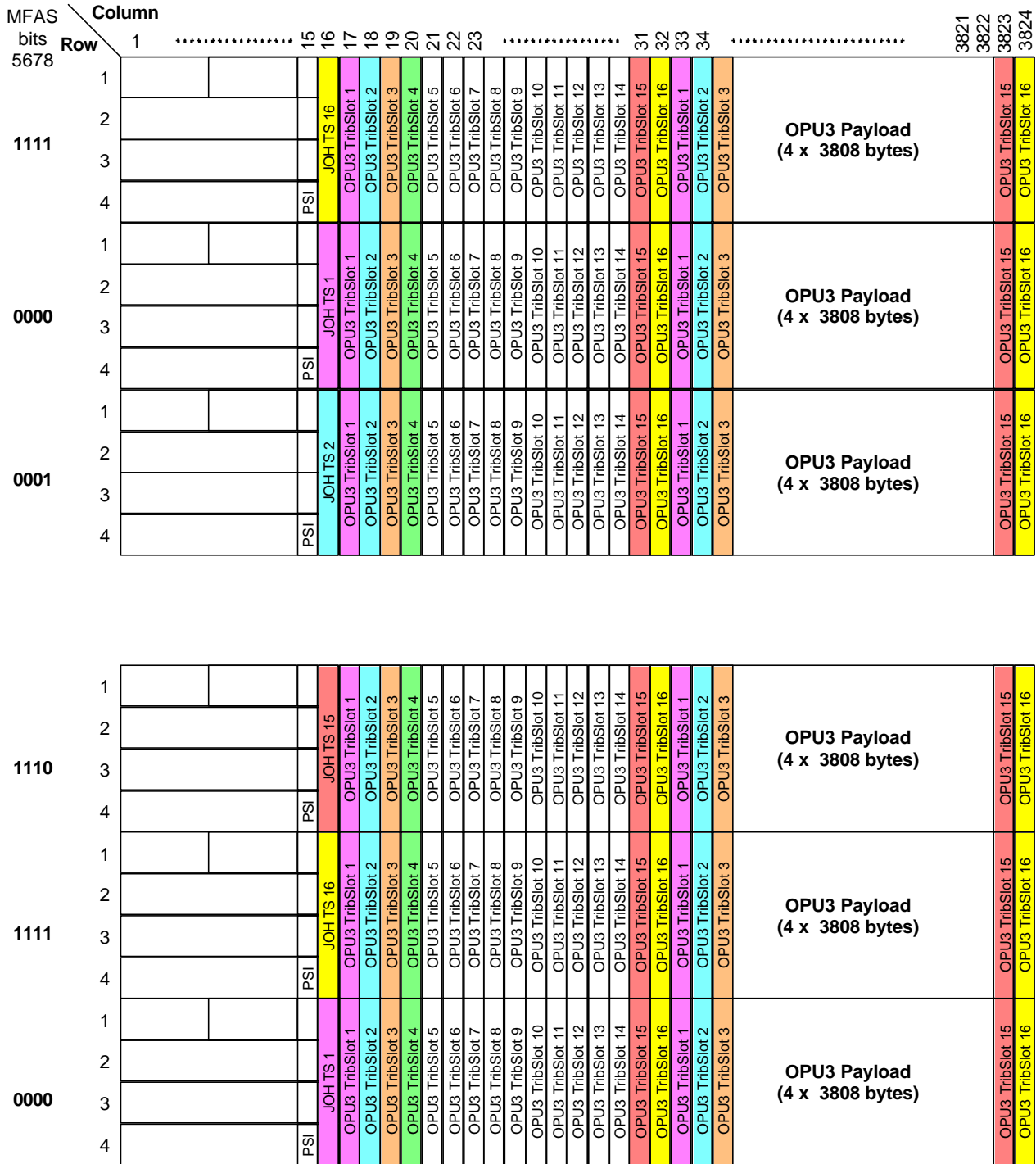
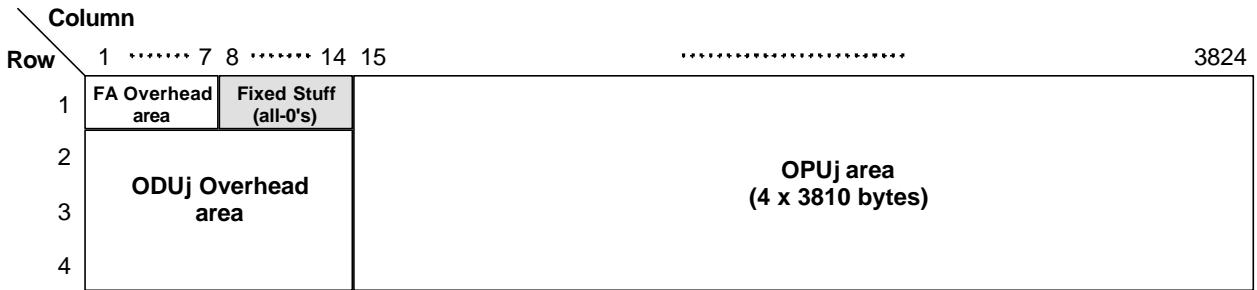

**Figure 39 OPU3 tributary slot allocation (Figure 19-2/G.709)**

An OPU3 Tributary Slot occupies 6.25% of the OPU3 Payload area. It is a structure with 238 columns by 4 rows. The sixteen OPU3 TS's are byte interleaved in the OPU3 Payload area.

It is important to note that the ODU1 frame repeats every sixteen ODU3 frames! One of the implications of this is that the FAS bytes in the ODU1 frame could cause false locking of the ODU3 frame. This is not suppose to be a problem according to contributions to the ITU.

However the FAS bytes can't be removed because there is no standard on where the ODU1 frame starts. Thus the ODU1 FAS bytes are needed to frame the recovered ODU1 signal. The OTU1 OH (SM, GCC0 and RES) is set to all 0's.



**Figure 40 Extended ODUj frame structure (Figure 19-10/G.709)**

**11.3.2 ODU1/ODU2 to ODU3 Justification Structure**

The Justification Overhead (JOH) consisting of Justification Control (JC) and Negative Justification Opportunity (NJO) signals of the 16 OPU3 TS's are located in the overhead area, column 16 of rows 1 to 4. The JOH is assigned to the related tributary slots on a per frame base. JOH for a tributary slot is available once every 16 frames. A 16-frame multiframe structure is used for this assignment. This multiframe structure is locked to bits 5-8 of the MFAS byte as shown in Table 17 and Figure 36<sup>2</sup>.

**Table 17 OPU3 Justification OH tributary slots (Table 19-2/G.709)**

MFAS bits	JOH TS	MFAS bits	JOH TS
5678		5678	
0000	1	1000	9
0001	2	1001	10
0010	3	1010	11
0011	4	1011	12
0100	5	1100	13
0101	6	1101	14
0110	7	1110	15
0111	8	1111	16

The PJO1 and PJO2 bytes are in the ODU1 payload. Figure 36 shows how the bytes are distributed.

<sup>2</sup> NOTE TSB: Figure 36 should be read Figure 41 instead?



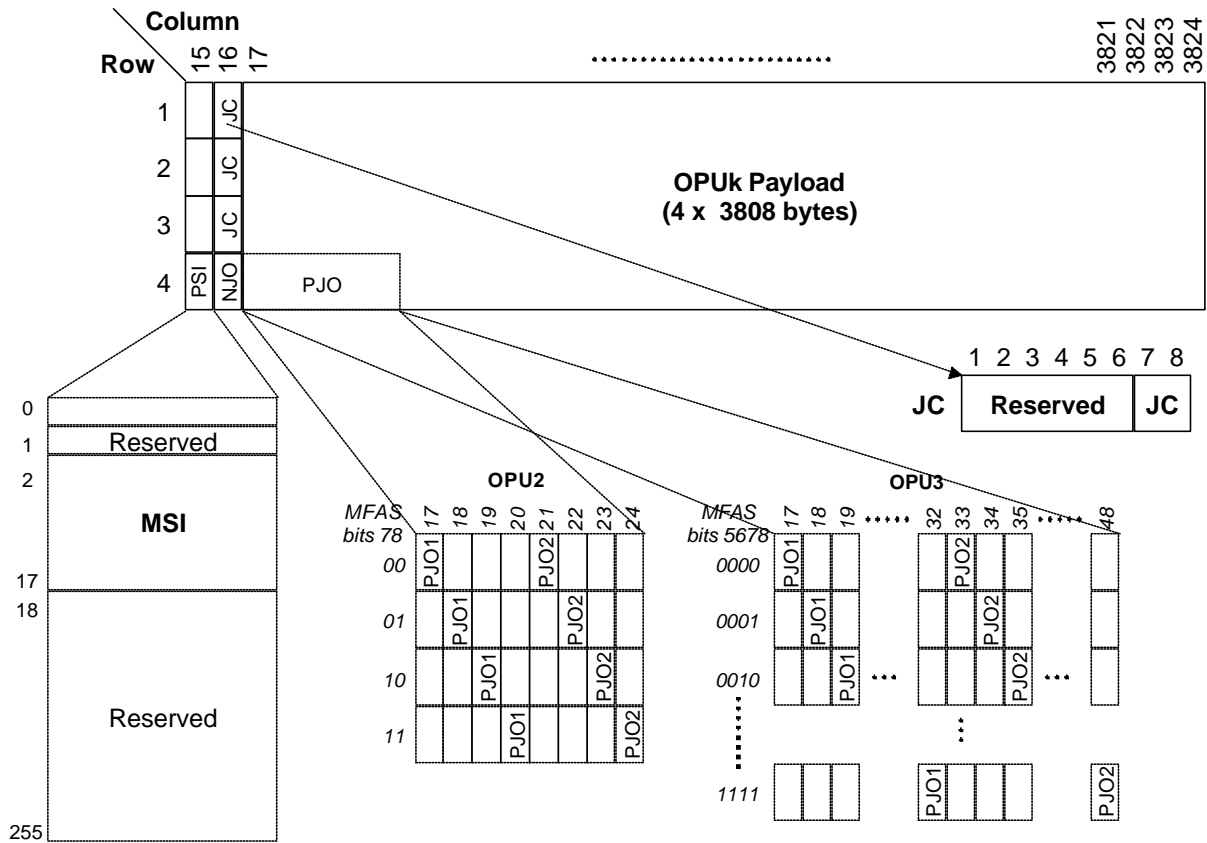

**Figure 41 OPUk Multiplex Overhead (Figure 19-6/G.709)**

The thing to note is that there are two PJO bytes and only one NJO bytes. This is because the timeslot provides more capacity than is needed.

### 11.3.3 OPU3 Payload Structure Identifier (PSI)

Byte 0 is defined as the Payload Type and is equal to 0x20.

Byte 1 is reserved

Bytes 2-17 are the “Multiplex Structure Identifier”

Bytes 18-255 are reserved

239 bytes are reserved in the OPUk PSI for future international standardization. These bytes are located in PSI[1] and PSI[18] to [PSI255] of the OPUk overhead. These bytes are set to all Zeros.

### 11.3.4 OPU3 Multiplex Structure Identifier (MSI)

The multiplex structure identifier (MSI) overhead, which encodes the ODU multiplex structure in the OPU, is located in the mapping specific area of the PSI signal (PSI[2]... PSI[17]). The MSI indicates the content of each tributary slot (TS) of an OPU3. The generic coding for each TS is shown in Figure 42. One byte is used for each TS.

- Bits 1 and 2 indicate the ODU type transported in the TS.
- Bits 3 to 8 indicate the tributary port of the ODU transported. This is of interest in case of flexible assignment of ODUs to tributary slots (e.g. ODU2 into OPU3). In case of fixed assignment the tributary port number corresponds to the tributary slot number.

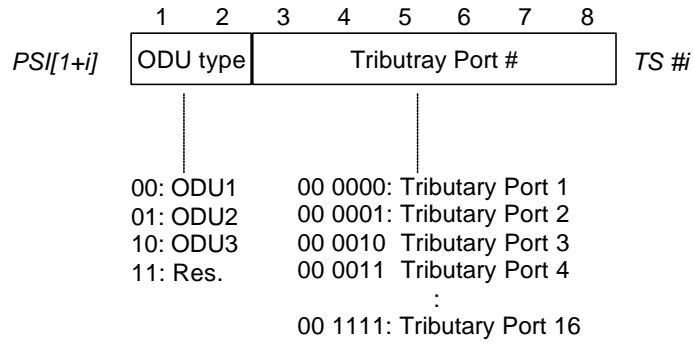

**Figure 42 Generic MSI coding (Figure 19-7/G.709)**

For the 16 OPU3 tributary slots 16 bytes of the PSI are used as shown in Figure 43.

- The ODU type can be ODU1 or ODU2.
- The tributary port # indicates the port number of the ODU1/2 that is being transported in this TS; for the case of ODU2 a flexible assignment of tributary ports to tributary slots is possible, for the case of ODU1 this assignment is fixed, the port number equals the slot number. ODU2 tributary ports are numbered 1 to 4.

	1	2	3	4	5	6	7	8	
<i>PSI[2]</i>	ODU type		Tributray Port #						<i>TS1</i>
<i>PSI[3]</i>	ODU type		Tributray Port #						<i>TS2</i>
<i>PSI[4]</i>	ODU type		Tributray Port #						<i>TS3</i>
<i>PSI[5]</i>	ODU type		Tributray Port #						<i>TS4</i>
<i>PSI[6]</i>	ODU type		Tributray Port #						<i>TS5</i>
<i>PSI[7]</i>	ODU type		Tributray Port #						<i>TS6</i>
<i>PSI[8]</i>	ODU type		Tributray Port #						<i>TS7</i>
<i>PSI[9]</i>	ODU type		Tributray Port #						<i>TS8</i>
<i>PSI[10]</i>	ODU type		Tributray Port #						<i>TS9</i>
<i>PSI[11]</i>	ODU type		Tributray Port #						<i>TS10</i>
<i>PSI[12]</i>	ODU type		Tributray Port #						<i>TS11</i>
<i>PSI[13]</i>	ODU type		Tributray Port #						<i>TS12</i>
<i>PSI[14]</i>	ODU type		Tributray Port #						<i>TS13</i>
<i>PSI[15]</i>	ODU type		Tributray Port #						<i>TS14</i>
<i>PSI[16]</i>	ODU type		Tributray Port #						<i>TS15</i>
<i>PSI[17]</i>	ODU type		Tributray Port #						<i>TS16</i>

**Figure 43 OPU3-MSI coding (Figure 19-9/G.709)**

### 11.3.5 Frequency Justification

The mapping of ODU1/ODU2 signals (with up to ±20 ppm bit-rate tolerance) into the ODU3 signal is performed as an asynchronous mapping.

The OPU3 signal for the multiplexed ODU1/ODU2 structure is created from a locally generated clock, which is independent of the ODU1/ODU2 client signals.

The ODU1/ODU2 signal is extended with Frame Alignment Overhead and an all-0's pattern in the OTU1 Overhead field;

The extended ODU1/ODU2 signal is adapted to the locally generated ODU3 clock by means of an asynchronous mapping with -1/0/+1/+2 positive/negative/zero (pnz) justification scheme.

The asynchronous mapping process generates the JC, NJO, PJO1 and PJO2 according to Table 18. The demapping process interprets JC, NJO, PJO1 and PJO2 according to Table 18. Majority vote (two out of three) is used to make the justification decision in the demapping process to protect against an error in one of the three JC signals.

**Table 18 JC, NJO, PJO1 and PJO2 generation and interpretation (Table 19-3/G.709)**

JC [7,8]	NJO	PJO1	PJO2	Interpretation
00	justification byte	data byte	data byte	no justification (0)
01	data byte	data byte	data byte	negative justification (-1)
10	justification byte	justification byte	justification byte	double positive justification (+2)
11	justification byte	justification byte	data byte	positive justification (+1)

The value contained in NJO, PJO1 and PJO2 when they are used as justification bytes is all-0s. The receiver is required to ignore the value contained in these bytes whenever they are used as justification bytes.

## 11.4 Maintenance Signal Insertion

### 11.4.1 Client source ODUk-AIS

During a signal fail condition of the incoming ODUj client signal (e.g. OTUj-LOF), this failed incoming signal will be replaced by the ODUj-AIS signal as specified in G.709/16.5.1. This ODUj-AIS is then mapped into the respective timeslot in the ODUk.

### 11.4.2 Client source ODUk-OCI

For the case the ODUj is received from the output of a fabric (ODUj connection function), the incoming signal may contain (case of open matrix connection) the ODUj-OCI signal as specified in G.709/16.5.2. This ODUj-OCI signal is then mapped into the respective timeslot in the ODUk.

Not all equipment will have a real connection function (i.e. switch fabric) implemented; instead the presence/absence of tributary interface port units represents the presence/absence of a matrix connection. If such unit is intentionally absent (i.e. not installed), the associated timeslot in the ODUk should carry an ODUj-OCI signal. If such unit is installed but temporarily removed as part of a repair action, the associated timeslot in the ODUk should carry an ODUj-AIS signal.

### 11.4.3 Line source ODUk-AIS

During signal fail condition of the incoming ODUk/OPUk signal (e.g. in the case of an ODUk-AIS, ODUk-LCK, ODUk-OCI condition) the ODUj-AIS pattern as specified in G.709/16.5.1 is generated as a replacement signal for the lost ODUj signal.

This signal is selected by the consequent action “aAIS”.

The clock, frame start and multiframes start are independent from the incoming clock.

NOTE: This means if the line clock is lost, an external reference or free run local clock is required to generate the AIS signal.

### 11.5 Defect detection and correlation

There are no defects detected in the Multiplexer. There are defects detected in the Demultiplexer. A functional model of the Demultiplexer is shown in Figure 44.

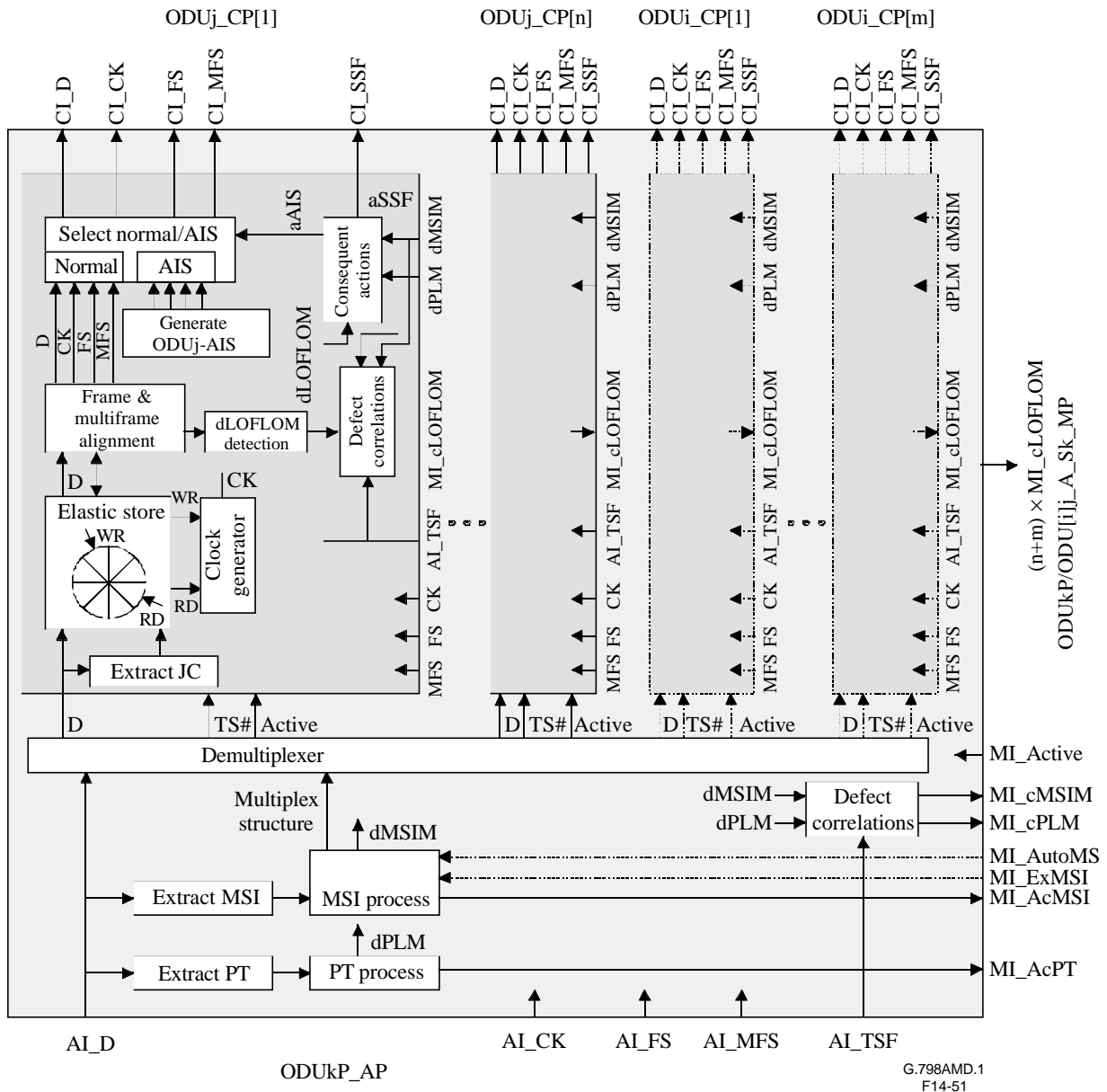

Figure 44 ODUkP/ODU[i]j\_A\_Sk processes (Figure 14-51/G.798)

#### 11.5.1 dPLM (Payload Mismatch)

dPLM is declared if the accepted payload type (AcPT) is not equal to the expected payload type(s) as defined by the specific adaptation function. dPLM is cleared if the accepted payload type is equal to the expected payload type(s) as defined by the specific adaptation function.

Note - An adaptation function may support more than one payload type.

A new payload type PT (AcPT) is accepted if a new consistent value is received in the PSI[0] byte in X consecutive multiframes. X is 3.

#### 11.5.2 cPLM

cPLM == dPLM and (not AI\_TSF)

AI\_TSF = aTSF = CI\_SSF or dAIS or dOCI or dLCK or (dTIM and not TIMActDis)  
(G.798.14.2.1.2)

(dAIS, dOCI, dLCK, dTIM are all detected at the PM layer)

CI\_SSF = AI\_TSF (at TCM layer)

AI\_TSF = aTSF = CI\_SSF or (dAIS or dLTC or dOCI or dLCK or (dTIM and not TIMActDis)) and TCMCI\_Mode == OPERATIONAL) (G.798.14.5.1.2.2)

(dAIS, dLTC, dOCI, dLCK, and dTIM are TCM defects)

CI\_SSF = aSSF = dAIS or dLOF or dLOM (G.798.12.3.1.2)

(dAIS here is the SM AIS)

### 11.5.3 dMSIM (Multiplex Structure Identifier Mismatch supervision)

dMSIM is declared if the accepted MSI (AcMSI) is not equal to the expected multiplex structure identifier (ExMSI). dMSIM is cleared if the AcMSI is equal to the ExMSI. ExMSI is configured via the management interface. A new multiplex structure identifier MSI (AcMSI) is accepted if a new consistent value is received in the MSI bytes of the PSI overhead (PSI[2...5] for ODU2, PSI[2...17] for ODU3) in X consecutive multiframes. X is 3.

### 11.5.4 cMSIM

cMSIM == dMSIM and (not dPLM) and (not AI\_TSF)

AI\_TSF = aTSF = CI\_SSF or dAIS or dOCI or dLCK or (dTIM and not TIMActDis)  
(G.798.14.2.1.2)

(dAIS, dOCI, dLCK, dTIM are all detected at the PM layer)

CI\_SSF = AI\_TSF at TCM layer

AI\_TSF = aTSF = CI\_SSF or (dAIS or dLTC or dOCI or dLCK or (dTIM and not TIMActDis)) and TCMCI\_Mode==OPERATIONAL) (G.798.14.5.1.2.2)

(dAIS, dLTC, dOCI, dLCK, and dTIM are TCM defects)

CI\_SSF = aSSF = dAIS or dLOF or dLOM (G.798.12.3.1.2)

(dAIS here is the SM AIS)

### 11.5.5 dLOFLOM (Loss of Frame and Multiframe)

If the frame alignment process is in the out-of-frame (OOF) state for 3 ms, dLOFLOM is declared. To provide for the case of intermittent OOFs, the integrating timer is reset to zero until an in-frame (IF) condition persists continuously for 3 ms. dLOFLOM is cleared when the IF state persists continuously for 3 ms.

The ODUj frame and multiframe alignment is found by searching for the framing pattern (OA1, OA2 FAS bytes) and checking the multiframe sequence (MFAS byte) contained in the ODUj frame.

In the out-of-frame state the framing pattern searched for is the full set of the OA1 and OA2 bytes. The in-frame (IF) is entered if this set is found and confirmed one frame period later and an error-free multiframe sequence is found in the MFAS bytes of the two frames.

In the in-frame state (IF) the frame alignment signal is continuously checked with the presumed frame start position and the expected multiframe sequence. The framing pattern checked for is the OA1OA2 pattern (bytes 3 and 4 of the first row of the ODUj[i] frame). The out of frame state (OOF) is entered if this subset is not found at the correct position in 5 consecutive frames or the received MFAS does not match with the expected multiframe number in 5 consecutive frames.

The frame and multiframe start are maintained during the OOF state.

There is one of these defects for each tributary.

### 11.5.6 cLOFLOM

cLOFLOM == dLOFLOM and (not dMSIM) and (not dPLM) and (not AI\_TSF) and (Active)

(“Active” is provisioned by the management interface)

AI\_TSF = aTSF = CI\_SSF or dAIS or dOCI or dLCK or (dTIM and not TIMActDis)  
(G.798.14.2.1.2)

(dAIS, dOCI, dLCK, dTIM are all detected at the PM layer)

CI\_SSF = AI\_TSF at TCM layer

AI\_TSF = aTSF = CI\_SSF or (dAIS or dLTC or dOCI or dLCK or (dTIM and not TIMActDis)) and TCMCI\_Mode == OPERATIONAL) (G.798.14.5.1.2.2)

(dAIS, dLTC, dOCI, dLCK, and dTIM are TCM defects)

CI\_SSF = aSSF = dAIS or dLOF or dLOM (G.798.12.3.1.2)

(dAIS here is the SM AIS)

### 11.5.7 aAIS (AIS insertion)

For each ODUj:

aAIS == AI\_TSF or dPLM or dMSIM or dLOFLOM or (not Active)

(“not Active” is provisioned by the management interface)

AI\_TSF = aTSF = CI\_SSF or dAIS or dOCI or dLCK or (dTIM and not TIMActDis)  
(G.798.14.2.1.2)

(dAIS, dOCI, dLCK, dTIM are all detected at the PM layer)

CI\_SSF = AI\_TSF at TCM layer

AI\_TSF = aTSF = CI\_SSF or (dAIS or dLTC or dOCI or dLCK or (dTIM and not TIMActDis)) and TCMCI\_Mode == OPERATIONAL) (G.798.14.5.1.2.2)

(dAIS, dLTC, dOCI, dLCK, and dTIM are TCM defects)

CI\_SSF = aSSF = dAIS or dLOF or dLOM (G.798.12.3.1.2)

(dAIS here is the SM AIS)

### 11.5.8 SSF (Server Signal Fail)

For each ODUj:

aSSF == AI\_TSF or dPLM or dMSIM or dLOFLOM or (not Active)

(“not Active” is provisioned by the management interface)

AI\_TSF = aTSF = CI\_SSF or dAIS or dOCI or dLCK or (dTIM and not TIMActDis)  
(G.798.14.2.1.2)

(dAIS, dOCI, dLCK, dTIM are all detected at the PM layer)

CI\_SSF = AI\_TSF at TCM layer

AI\_TSF = aTSF = CI\_SSF or (dAIS or dLTC or dOCI or dLCK or (dTIM and not TIMActDis)) and TCMCI\_Mode == OPERATIONAL) (G.798.14.5.1.2.2)

(dAIS, dLTC, dOCI, dLCK, and dTIM are TCM defects)

CI\_SSF = aSSF = dAIS or dLOF or dLOM (G.798.12.3.1.2)

(dAIS here is the SM AIS)

## 12 ODUk Virtual Concatenation / OTN over SONET

TBD

Editors Note: Who wants to write this?

## 13 Synchronisation

### 13.1 Introduction

Basic statements on timing in OTN has been done by ITU-SG13 during its February 2000 meeting. It has been decided that OTN must be transparent to the payload it transports within the ODUk and that the OTN layer does not need to transport network synchronization since network synchronization can be transported within the payload, mainly by SDH/SONET client tributaries. In order to meet these requirements the OTN frame has been designed so that the client mapping/demapping and the transfer through OTN network equipments and 3R regenerators, do not prevent SDH tributaries to meet the G.825 jitter and wander requirements. Two types of mapping have been specified for the transport of CBR payload, e.g. SDH/SONET. The first one is the asynchronous mapping, which is the most widely used, where the payload floats within the OTN frame. In this case, there is no frequency relationship between the payload and the OTN frame frequencies, thus simple free running oscillators can be used to generate the OTN frame. The second is the synchronous mapping where the timing used to generate the OTN frame is extracted from a CBR client tributary, e.g. SDH/SONET; in case of LOS of the input client, the OTN frequency that does not transport payload is generated by a free running oscillator, without need for an holdover mode.

This specification allows for very simple implementation of timing in OTN equipments compared to SDH/SONET. SDH/SONET has been specified to be a network layer able to transport network synchronization because its introduction in the network could corrupt the existing 2 Mbit/s synchronization network with the VC12 pointer adjustments.

An OTN NE do not require synchronization interfaces, complex clocks with holdover mode nor SSM processing. Another difference with SDH is that there is no geographical option for the timing aspects of OTN.

OTN transports client signals into a G.709 frame, OTUk, that is transported by an OCh on one lambda of the Optical Transport Module (OTM). Each lambda carries its G.709 frame with its own frequency, there is no common clock for the different OTUk of the OTM.

A trail through OTN is generated in an OTN NE that maps the client into an ODUk and terminated in another OTN NE that de-maps the client signal from the ODUk. Between the 2 OTN trail terminations, there might be 3R regenerators, which are equipments that perform complete regeneration of the pulse shape, clock recovery and retiming within required jitter limits (see fig27/G.872 and Annex A/G.872). The number of 3R regenerators that can be cascaded in tandem depends on the specification of this regenerator and on the jitter and wander generation and tolerance applicable to the OTUk interfaces; it is stated to be at least 50 in G.8251.

ODUk multiplexing has been standardized, its implication on timing has been taken into account in the relevant recommendations.

### 13.2 Network requirements

In an OTN, jitter and wander accumulate on transmission path according to the generation and transfer characteristics of interconnected equipments, 3R regenerators, client mappers, demappers and

multiplexers, demultiplexers. In order to avoid the effects of excessive jitter and wander, G.8251 recommendation specifies the maximum magnitude of jitter and wander, and the minimum jitter and wander tolerance at OTN network interfaces. These specifications have been established together with the definition of the clocks required by all functions defined for OTN, i.e client mapping/ demapping, ODUk multiplexing/demultiplexing and 3R regenerators.

The OTN generates and accumulates jitter and wander on its client signals due to the buffers of the mapping into ODUk and due to the ODUk multiplexing. The limits for such accumulation are given in G.825 for SDH signal clients. Jitter and wander is also accumulated on the OTN signals itself due to the ODUk multiplexing and 3R jitter generation. The network limits for this are given in G.8251, section 5.

G.8251 specifies the jitter and wander tolerance in section 6. As OTN clocks do not generate wander, no wander limit has been defined for OTN. G.8251, and its amendment 1 for ODUk multiplexing, specifies the different type of clocks that are required to perform the following functions (see Table A.1/G.8251): the accuracy of these clocks depends on the definition of the G.709 frame and on the accuracy specified for the clients.

- Asynchronous mapping of a client into an ODUk and ODUk multiplexing: this **ODCa** clock is a free- running clock with a frequency accuracy of  $\pm 20$ ppm.
- Synchronous mapping of a client into an ODUk: this **ODCb** clock is locked on the client frequency.
- 3R regeneration: this **ODCr** clock is locked on an OCh input frequency which must be within  $\pm 20$ ppm.
- Demapping a client signal from an ODUk and ODUk demultiplexing: this **ODCp** clock is locked on an OCh input frequency which must be within  $\pm 20$ ppm.

G.8251 Annex A specifies the jitter generation of these clocks and, when applicable, noise tolerance, jitter transfer and transient response.

Note: All these clock functions are used for clock recovery and clock filtering of a particular signal. They never serve as an equipment synchronization source. Therefore there is no holdover mode specified for these clocks since there is no need for an accurate clock when the input signal disappears. This is a major difference compared to SDH.

G.8251 appendix 2 provides a provisional adaptation of the SDH synchronization reference chain to include OTN islands. This is an amendment of the reference chain being defined in G.803. Considering that SDH may be transported by OTN islands, the SEC will no longer be present but replaced by OTN NEs. This leads to the definition of a reference chain where all SECs located between 2 SSUs are replaced by an OTN island. The local part of the reference chain, after the last SSU can still support 20 SECs in tandem. Each of these islands may be composed of OTN NEs performing mapping/demapping or multiplexing/demultiplexing operations. This adaptation of the reference chain raises a buffer size constraint for the OTN NEs in order to keep the overall network wander performance within specified limits. Predominantly the mapping and the demapping functions of the OTN contribute to wander accumulation due to the buffers being involved in these functions. The size limit of these buffers is specified in recommendation ITU-T G.798. This allows to insert up to 10 mapping/ multiplexing nodes per OTN island. A total of 100 mapping/demapping functions can be performed on this synchronization reference chain.



G.8251 appendix 3 presents an Hypothetic Reference Model for 3R regenerator jitter accumulation: according to this model, at any OTUk interface the jitter will remain within network limits in a chain of one mapping clock and up to 50 cascaded 3R regenerators plus a de-mapping clock. Appendix 4 reports the results of extensive simulations showing that it is possible to have 50 OTN regenerators without exceeding the network limits of OTUk interfaces, assuming the regenerators comply with the model defined in this appendix. Appendix 7, published in the amendment 1, reports CBRx and ODUj[i] payload jitter and wander accumulation analyses.

### 13.3 Mapping and Multiplexing

These topics have been already presented in previous sections of this tutorial related to G.709 frame where the justification process is specified.

Note that two different mappings of CBR client has been specified, asynchronous and bit synchronous. The asynchronous mapping uses a -1/0/+1 justification scheme and the maximum size of the buffers have been specified to be 2, 8 and 32 bytes respectively for the STM 16, 64 and 256 SDH clients. These mappings have been specified so that an asynchronous demapper may extract the CBR client signal mapped according to both techniques.

The multiplexing process is unique and based on an asynchronous multiplexing scheme.

It is important to know that the justification process has been defined so that all client signals and the G.709 (OTN signals) may have a frequency range of up to ±20 ppm .

### 13.4 Equipment requirements

Detailed specifications related to atomic functions contributing to timing and jitter are defined in G.798. An important requirement is that the demapping function must have a maximum bandwidth of 300 Hz.

## 14 OTN Maintenance Signals

### 14.1 OTUk maintenance signals

#### 14.1.1 OTUk alarm indication signal (OTUk-AIS)

The OTUk-AIS (Figure 45) is a generic-AIS signal. Since the OTUk capacity (130 560 bits) is not an integer multiple of the PN-11 sequence length (2047 bits), the PN-11 sequence may cross an OTUk frame boundary.

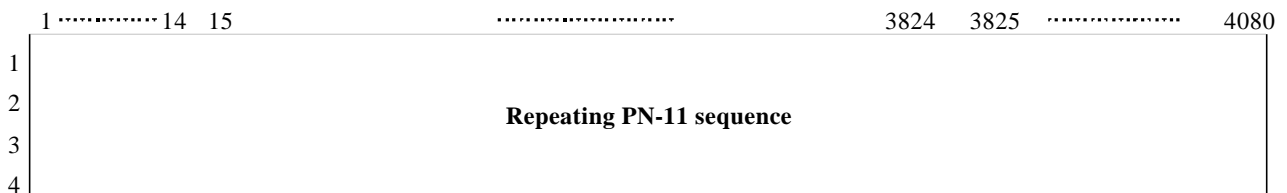

T1543670-01

Figure 45 OTUk-AIS (Figure 16-1/G.709)

The PN-11 sequence is defined by the generating polynomial  $1 + x^9 + x^{11}$  as specified in 5.2/O.150. (See Figure 46)

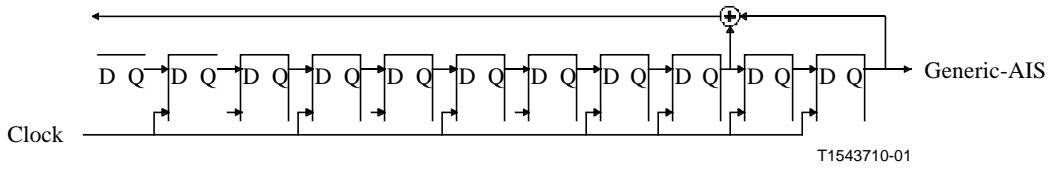

**Figure 46 Generic-AIS generating circuit (Figure 16-5/G.709)**

NOTE – OTUk-AIS is defined to support a future server layer application. OTN equipment should be capable of detecting the presence of such a signal, but it is not required to generate such a signal.

**14.2 ODUk maintenance signals**

Three ODUk maintenance signals are defined: ODUk-AIS, ODUk-OCI and ODUk-LCK.

**14.2.1 ODUk Alarm Indication Signal (ODUk-AIS)**

ODUk-AIS is specified as all "1"s in the entire ODUk signal, excluding the frame alignment overhead (FA OH), OTUk overhead (OTUk OH) and ODUk FTFL (Figure 47).

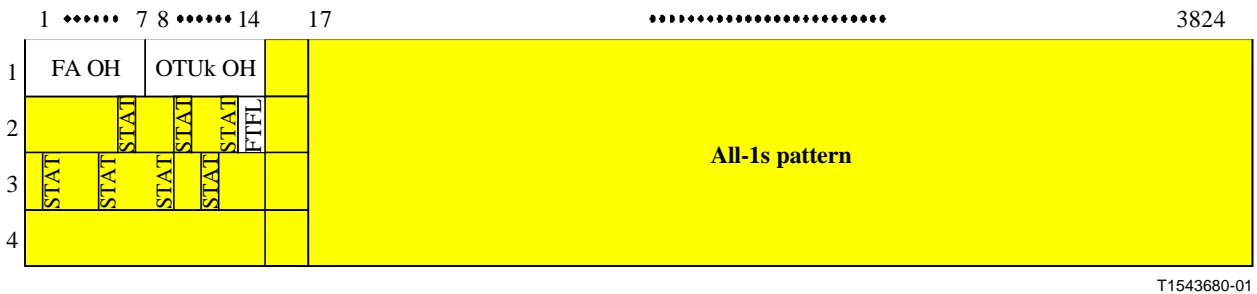

**Figure 47 ODUk-AIS (Figure 16-2/G.709)**

The presence of ODUk-AIS is detected by monitoring the ODUk STAT bits in the PM and TCMi overhead fields.

ODUk-AIS is generated if the OTUk input signal fails (Section 13.3.1.2/G.798) or it detects ODUk-OCI or ODUk-LCK on the input signal (Section 14.5.1.1.2/G.798)

**14.2.2 ODUk Open Connection Indication (ODUk-OCI)**

ODUk-OCI is specified as a repeating "0110 0110" pattern in the entire ODUk signal, excluding the frame alignment overhead (FA OH) and OTUk overhead (OTUk OH) (Figure 48).

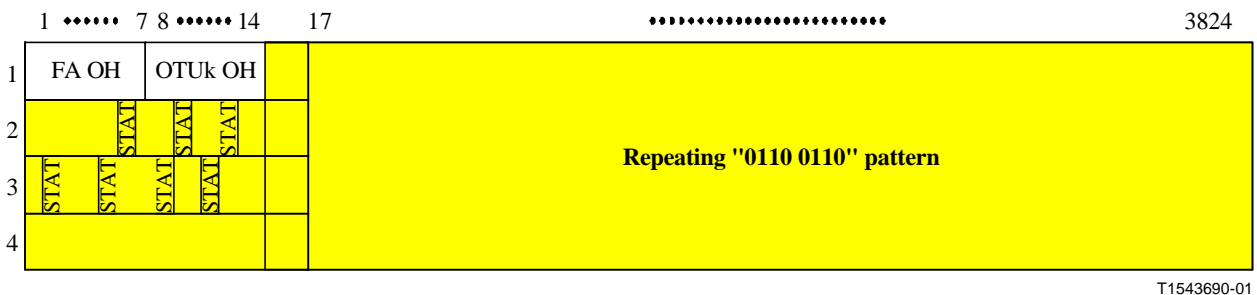

**Figure 48 ODUk-OCI (Figure 16-3/G.709)**

NOTE – The repeating "0110 0110" pattern is the default pattern; other patterns are also allowed as long as the STAT bits in the PM and TCMi overhead fields are set to "110".

The presence of ODUk-OCI is detected by monitoring the ODUk STAT bits in the PM and TCMi overhead fields.

The insertion of this is under management control. There is no defect that inserts ODUk-OCI.

### 14.2.3 ODUk Locked (ODUk-LCK)

ODUk-LCK is specified as a repeating "0101 0101" pattern in the entire ODUk signal, excluding the Frame Alignment overhead (FA OH) and OTUk overhead (OTUk OH) (Figure 49).



T1543700-01

**Figure 49 ODUk-LCK (Figure 16-4/G.709)**

NOTE – The repeating "0101 0101" pattern is the default pattern; other patterns are also allowed as long as the STAT bits in the PM and TCMi overhead fields are set to "101".

The presence of ODUk-LCK is detected by monitoring the ODUk STAT bits in the PM and TCMi overhead fields.

The insertion of this is under management control. There is no defect that inserts ODUk-LCK.

## 14.3 Client maintenance signal

### 14.3.1 Generic AIS for constant bit rate signals

The generic-AIS signal is a signal with a 2047-bit polynomial number 11 (PN-11) repeating sequence.

The PN-11 sequence is defined by the generating polynomial  $1 + x^9 + x^{11}$  as specified in 5.2/O.150. (Figure 50)

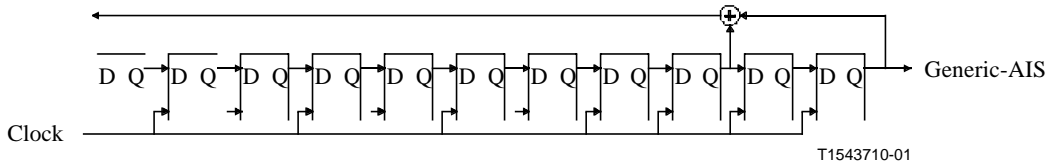

T1543710-01

**Figure 50 Generic-AIS generating circuit (Figure 16-5/G.709)**

During a signal fail condition of the incoming CBR2G5, CBR10G or CBR40G client signal (e.g. in the case of a loss of input signal), this failed incoming signal is replaced by the generic-AIS signal, and is then mapped into the OPUk.

During signal fail condition of the incoming ODUk/OPUk signal (e.g. in the case of an ODUk-AIS, ODUk-LCK, ODUk-OCI condition) the generic-AIS pattern as specified in 16.6.1 is generated as a replacement signal for the lost CBR2G5, CBR10G or CBR40G signal.

### 15 OTN Defects

G.798 defines all the defects for OTN. The document is very large and complex. The following diagrams (Figures 51 and 52) give a summary of the various defects. They are intended as a “Cheat Sheet” to use when reading G.798

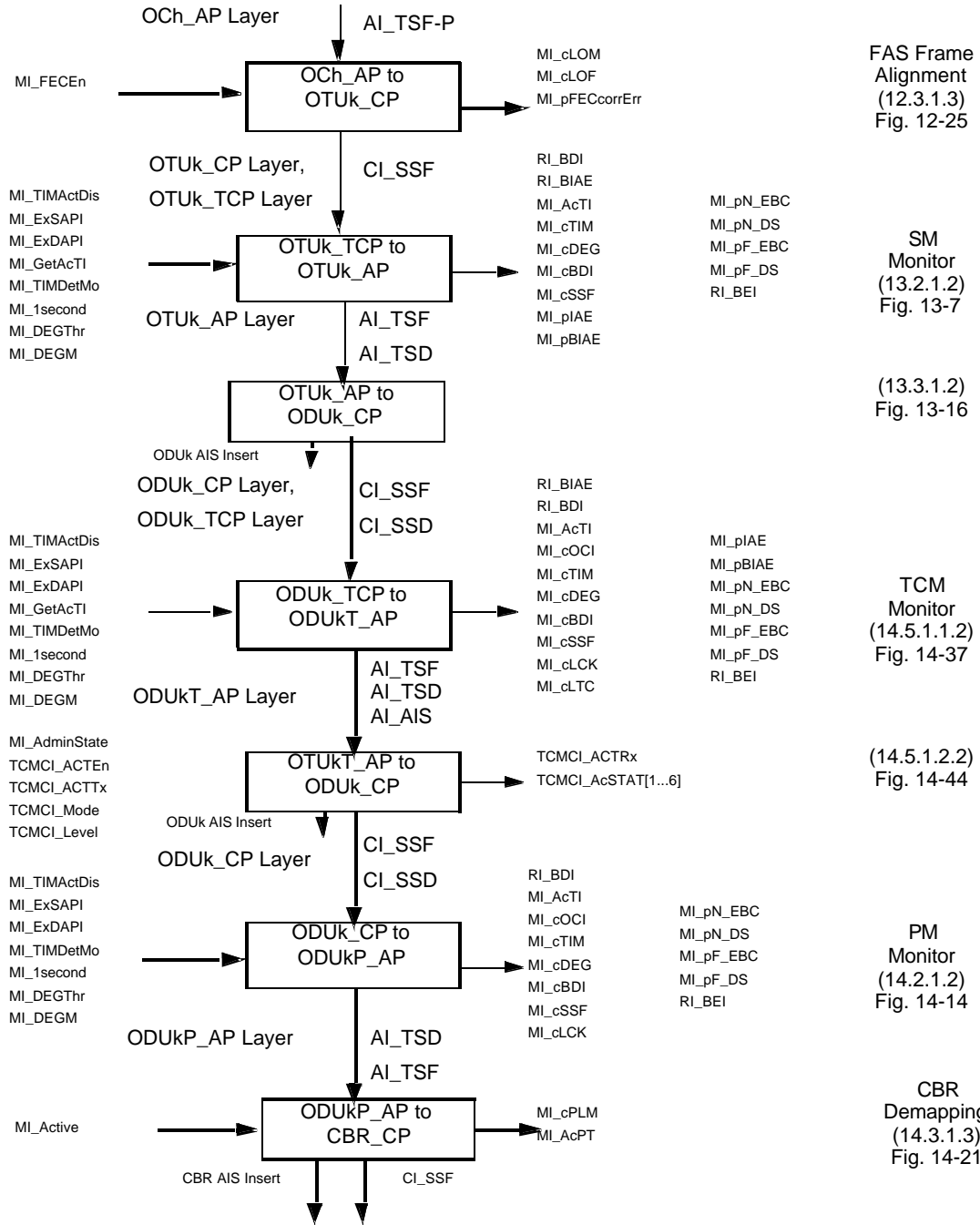
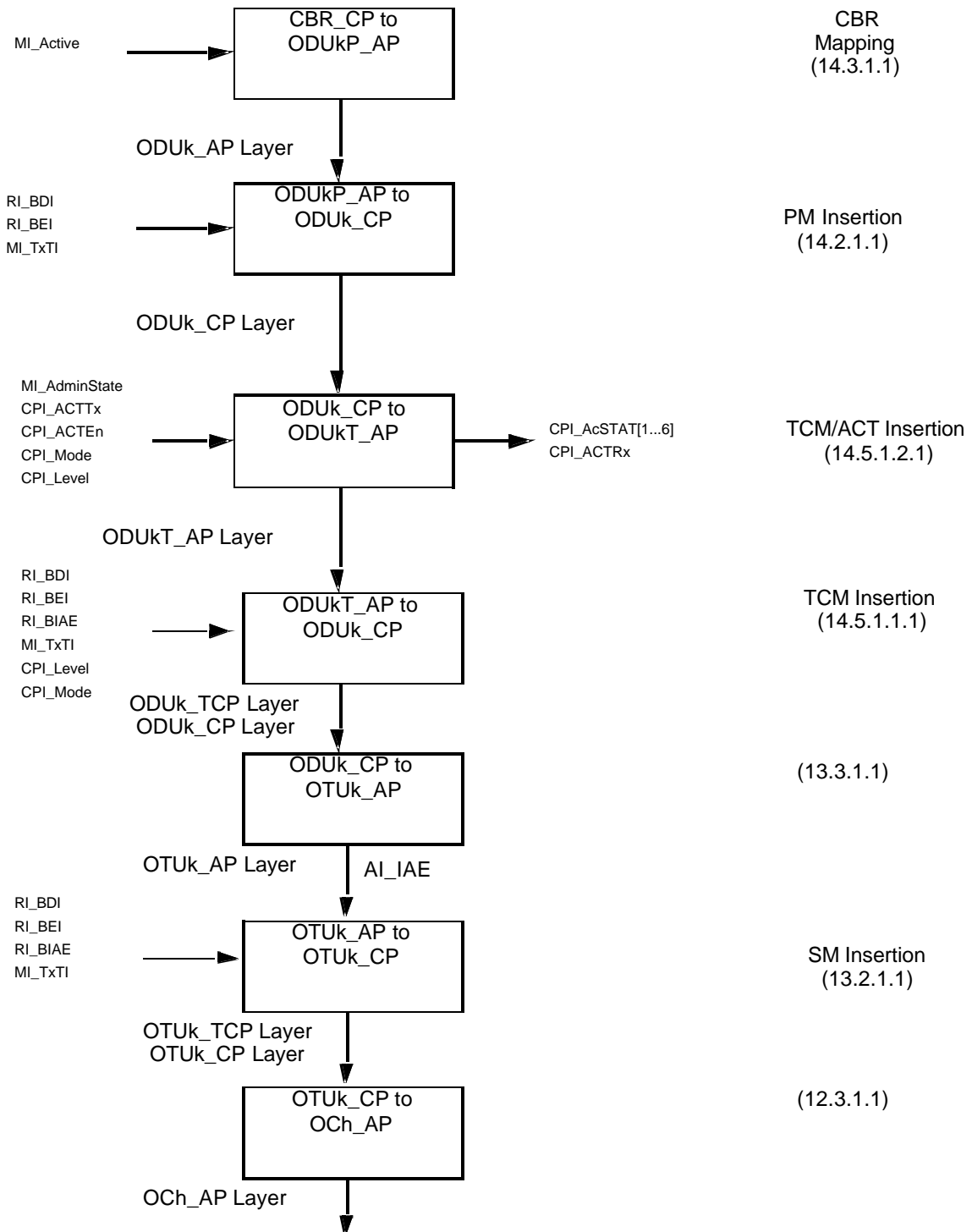

Figure 51 OTN Receive Defects



**Figure 52 OTN Transmit Defects**

## 16 Acknowledgements

I (Tim Walker) would like to thank the following people whose help and documents I used freely: Maarten Vissars, Juergen Heiles, Gilles Joncour, Ghani Abbas, Jean-Loup Ferrant, Shahrukh Merchant, Lieven Levrau.

## 17 Bibliography

<http://ties.itu.int/u/tsg15/sg15/wp3/q11/g709/g709-intro-v2.ppt>

[http://ties.itu.int/u/tsg15/sg15/wp3/q11/g709/oth\\_public\\_09\\_2002.ppt](http://ties.itu.int/u/tsg15/sg15/wp3/q11/g709/oth_public_09_2002.ppt)

[Sklar] "Digital Communications", 2<sup>nd</sup> Edition, 2001, Prentice-Hall

ITU-T G.709 (01/03), Interfaces for the Optical Transport Network (OTN)

ITU-T G.798 (5/02), Characteristics of Optical Transport Network (OTN) Hierarchy Equipment Functional Blocks

ITU-T G.872 (10/01), Architecture for the Optical Transport Network (OTN)

ITU-T G.8251 (10/01), The Control of Jitter and Wander within the Optical Transport Network

## **18 Open Issues**

### **18.1 ODUk Virtual Concatenation / OTN over SONET**

Needs description (volunteers?)

---