

HOMEOWNERS HANDBOOK
TO PREPARE FOR NATURAL DISASTERS

Designed For Homeowners In Louisiana





Introduction

Why Read This Handbook?

We all know Mother Nature can be intense and devastating. While there may be many reasons to put off hazard preparation, your family and home deserve protection that only you can provide. If you live near the coast, as many people do, you need to be aware of the threat of coastal natural hazards, such as hurricanes and flooding, as well as the additional threat of tornadoes. While it is not possible to eliminate all risk from natural hazards, there are many small and cost-effective steps you can take to reduce your risk, be prepared, and increase your resilience.

Purchasing a home is one of the major milestones in life and is typically your largest investment. While providing you and your family protection from the elements, a home also holds all your worldly possessions, whether you rent or own. The resources, recommendations, and advice in this Handbook come from leading organizations in the fields of preparedness, recovery, and construction. This information is brought together to provide you with the tools needed to help you strengthen your home and prepare for and recover from disasters.

This Handbook is designed to be an easy to use reference for both homeowners and renters, providing you and your family access to the information you need easily and in one place. This will allow you to take action and reduce the risk of experiencing loss or damage from a natural disaster, and learn what to do if you do have damage after a disaster.

**Natural hazards include
hurricanes, floods, tornadoes
and other severe weather events.**

What are Natural Hazards?

According to the Federal Emergency Management Agency (FEMA), natural hazards are “natural events that threaten lives, property, and other assets. Often, natural hazards can be predicted. They tend to occur repeatedly in the same geographical locations because they are related to weather patterns or physical characteristics of an area.” In this book, we cover floods, hurricanes, tornadoes, and other coastal hazards and what you can do to mitigate, or reduce, your risk of property damage or loss.

What is Mitigation?

Mitigation is “the effort to reduce loss of life and property by lessening the impact of disasters,” according to FEMA and that “for mitigation to be effective we need to take action now—before the next disaster—to reduce human and financial consequences later.” In this handbook, an explanation of mitigation activities you can take include: preparing for a hurricane or flooding event with adequate supplies and evacuation, protecting and strengthening your home through proper building techniques and practices, and putting yourself and family into a better financial situation before an event with good insurance.

What is Resilience?

In general, resilience is the ability to withstand and recover from an event. This can include natural hazards and disasters, personal or family situations, or other traumatic events. For the purposes of this Handbook, we will explore ways that you can better position yourself and your family to prepare for and anticipate the impacts of natural hazards and disasters so that you can persevere through the event and get on with your life as quickly as possible.

Why is Insurance Important?

A key element to being prepared is closing your insurance gap, which is the difference between what is currently insured and what is insurable. There is no more important or valuable disaster recovery tool than insurance. This includes the National Flood Insurance Program (NFIP). However, it is not just flood insurance; all types of insurance have a role to play in reducing financial risk for individuals, businesses, communities, and the nation.¹



What Will You Learn in This Handbook?

This handbook is divided into five sections. Each builds off the other so the knowledge you gain will add value to the next section of information:

Part 1 Understanding the risks of coastal natural hazards

Part 2 How to prepare yourself and your family

Part 3 How to protect and strengthen your home against natural hazards

Part 4 The disaster declaration process and funding mechanisms

Part 5 How to be more financially secure against hazards

How Can You Strengthen Your Home?

Many factors come into play regarding the strength of your home, including its location, year built, construction materials and method, and maintenance record. Regardless, there are always steps you can take to improve your home's ability to withstand weather events and natural disasters. If you live in a wind-prone area, the first step is to make sure you have a strong roof. We recommend building to the Insurance Institute for Business and Home Safety (IBHS) FORTIFIED Home construction standard when replacing your roof or building a new home (see section 3.1.2).

If you live in a flood zone, you can elevate your home or, when allowed and reasonable, incorporate floodproofing techniques. Some techniques for floodproofing can be found in Part 3.7. If you are unsure about your risk of flooding, you can also consult with a local floodplain manager or speak with a knowledgeable engineer.

Next, one of the most common steps to strengthening your home is to make sure your openings are protected from the wind by installing window protection, like impact-resistant shutters or windows. Lastly, you can prepare your property by trimming trees and reducing possible wind-borne debris. It may all seem like a daunting task, but this handbook guides you through the process to make it as simple as possible. You may have to spend money on some mitigation practices, and research has shown that every \$1 spent on mitigation saves \$6 in the long run.² This is a substantial benefit if you consider how much damage could rack up if you do not mitigate.

Five Steps You Can Take

There are five essential steps you can take to provide greater protection from coastal hazards for your family and your property. The rest of the handbook will provide information and actions for each step.

These steps are:

1. Gather emergency supplies and personal documents before a disaster (create a kit).
2. Create an evacuation plan for both a flood and a hurricane.
3. Understand the strength of your house and property, as well as your local risks, so you can take the actions that fit your circumstances.
4. Buy and maintain proper insurance for your risk and perils; take advantage of potential discounts for premiums and finance any needed repairs creatively. Review and update your insurance policies every year. **Be aware flood policies and homeowner policies are separate policies.**
5. When you have any work done to your home, seek the assistance of qualified, licensed professionals. You should consult an engineer or architect when making any structural modifications to your existing home or building a new home. It is recommended to get at least three bids for any major project.



This handbook is available free as a downloadable PDF at the Louisiana Sea Grant College Program website at www.laseagrant.org/sglegal/publications/other/homeowners-handbook/. It will be updated on an as-needed basis as new information becomes available and feedback from the public is obtained. You can also request a copy by contacting Roy Kron at Louisiana Sea Grant at rkron@lsu.edu or 225-578-6564.



Acknowledgments

A special thanks is extended to the University of Hawaii Sea Grant College Program for assisting us with the first version of this handbook and for allowing us to model the handbook after the original Homeowner's Handbook authored by Dennis Hwang and Darren Okimoto.

This is the fourth edition of the handbook, developed in partnership with Louisiana Sea Grant (LSG) and the Gulf of Mexico Alliance (GOMA) Coastal Resilience Team with support from Smart Home America.

GOMA is a partnership of federal, state and local organizations that share a vision for healthy and resilience communities. A key priority of GOMA and LSG is to increase the resilience of coastal communities to natural hazards. A major component of healthy communities is enhancing individual resilience and recognizing that adjustments to day-to-day living are necessary. This book is designed to promote individual resilience by equipping homeowners with the resources they need to strengthen their homes and protect their property.

This updated handbook would not have been possible without the support of numerous partners including: National Oceanic and Atmospheric Administration (NOAA), Mississippi-Alabama Sea Grant Consortium, LSG, Smart Home America, and the many member organizations of the GOMA Coastal Resilience Team.

This publication was supported by the NOAA Regional Coastal Resilience Grant (Award NAS16NOS4730008) awarded to the Gulf of Mexico Alliance. The views expressed herein do not necessarily reflect the views of GOMA, NOAA, LSG, or any of its subagencies. Financial support for printing of this handbook was provided by the NOAA Office for Coastal Management through the Government Printing Office.

Suggested Citation: Gulf of Mexico Alliance, Louisiana Sea Grant, and Smart Home America. Homeowners Handbook to Prepare for Natural Disasters: Designed for Homeowners in Louisiana. (2020).



Contents

- Introduction ii-v
- Table of Contents vi

- PART 1: COASTAL NATURAL HAZARD AWARENESS 1**
- 1.1 Hurricane Hazards..... 2
 - 1.1.1 Hurricane Formation..... 2
 - 1.1.2 Wind & The Saffir-Simpson Scale..... 5
 - 1.1.3 Storm Surge & Storm Tide..... 5
 - 1.1.4 Rainfall 6
- 1.2 Flood Hazards 7
 - 1.2.1 Coastal Flooding 8
 - 1.2.2 Flash Floods..... 9
 - 1.2.3 High-Tide Flooding..... 9
 - 1.2.4 Other Elements of Flooding 10
- 1.3 Tornado Hazards 11
- 1.4 Additional Hazards 13
 - 1.4.1 Severe Thunderstorms 13
 - 1.4.2 Drought/Extreme Heat 13
 - 1.4.3 Wildfire..... 14
 - 1.4.4 Earthquakes and Sinkholes 14
 - 1.4.5 Tsunamis..... 15
 - 1.4.6 Sea-Level Rise..... 15
 - 1.4.7 Erosion 16

- PART 2: PLAN, PREPARE, AND ACT 17**
- 2.1 Emergency Supplies for the Home..... 18
- 2.2 Evacuation Kit (a.k.a. “Go Bag”)..... 19
- 2.3 Evacuation Planning..... 20
 - 2.3.1 Prepare Your Family 20
 - 2.3.2 Prepare Your Property 22
 - 2.3.3 Emergency Alerts 24
- 2.4 Evacuation Procedures 27
 - 2.4.1 Evacuation for a Hurricane 27
 - 2.4.2 Evacuation for a Flood..... 28
 - 2.4.3 After the Storm..... 29



- 2.5 Emergency Information and Contacts 30
- 2.6 Electrical and Power Issues 31
 - 2.6.1 Wet Electrical Equipment..... 32
 - 2.6.2 Downed Power Lines 32
 - 2.6.3 Alternate Power Sources 33
 - 2.6.4 Generators 33
 - 2.6.5 Power Stations 34
 - 2.6.6 Portable Chargers..... 35
 - 2.6.7 Battery Chargers..... 35
 - 2.6.8 Inverters..... 35
- 2.7 Mental and Physical Health 36
- 2.8 Guidance for Using Social Media 38

- PART 3: PROTECT AND STRENGTHEN YOUR PROPERTY 39**
- 3.1 Best Standards for Building Better 40
 - 3.1.1 Understanding Building Codes 40
 - 3.1.2 FORTIFIED Home™ 41
 - 3.1.3 Design For Your Risk 42
- 3.2 Retrofitting an Existing Home 43
 - 3.2.1 Roof-to-Wall Connection..... 43
 - 3.2.2 Re-Roofing 43
 - 3.2.3 Foundation Uplift Strengthening Restraint 44
- 3.3 Strengthening the Roof System 44
 - 3.3.1 Roofing Assembly 45
 - 3.3.2 Strengthening Gables and Soffits 50
- 3.4 Shutters and Other Protective Barriers 52
 - 3.4.1 Garage and Entry Doors 56
 - 3.4.2 Opening Protection to Avoid 57
- 3.5 Continuous Load Path, Design Pressure, and Chimney Anchoring 58
 - 3.5.1 Continuous Load Path Connections..... 58
 - 3.5.2 Window and Door Design Pressure 60
 - 3.5.3 Chimneys 60
- 3.6 Foundation 61
- 3.7 Flood Prevention..... 62
 - 3.7.1 Wet Floodproofing..... 63
 - 3.7.2 Dry Floodproofing 65
 - 3.7.3 Elevating Existing Structures 67



- 3.8 Concrete Structures 69
 - 3.8.1 Safe Rooms 69
- 3.9 Trees..... 70
 - 3.9.1 Landscaping Tips 71

- PART 4: DISASTER RESPONSE AND RECOVERY..... 72**
- 4.1 Understanding the Disaster Declaration Process 73
- 4.2 Timeline of Events 74
- 4.3 Roles of the Local, State and Federal Gov't During the Disaster 75
- 4.4 Assistance During Response and Recovery..... 75
- 4.5 Post-Disaster Federal and State Funding 76
 - 4.5.1 Federal Programs 77
 - 4.5.2 State Programs 81
- 4.6 Rebuilding After a Storm 82
 - 4.6.1 What to Expect for Inspections..... 82
 - 4.6.2 Before the Building Process Begins 83

- PART 5: FINANCIAL PROTECTION 85**
- 5.1 Understanding and Obtaining Good Insurance 86
 - 5.1.1 Shopping For Your Insurance..... 87
 - 5.1.2 Determining How Much Insurance You Need 88
- 5.2 Insurance for Wind Events 89
- 5.3 Insurance for Flood Events..... 91
 - 5.3.1 National Flood Insurance Program 93
 - 5.3.2 Community Rating System 94
 - 5.3.3 Increased Cost of Compliance (ICC) Coverage 94
- 5.4 Making a Claim After Receiving a Loss 96
- 5.5 Choose a Qualified Contractor and Avoid Scams..... 99
 - 5.5.1 Tips to Choose a Qualified Contractor 99
 - 5.5.2 Avoid Being a Victim of a Fraud 100

- APPENDIX A: Glossary 102**
- APPENDIX B: Emergency Contact Information 107**
- APPENDIX C: Websites and Publications..... 109**
- APPENDIX D: Disaster Supplies Checklists..... 112**
- APPENDIX E: Emergency Supplies for the Home 117**
- ENDNOTES 119**

PART 1

COASTAL NATURAL HAZARD AWARENESS

In Louisiana, many different types of natural hazards and severe weather can occur. These include hurricanes, flooding, tornadoes, thunderstorms, sea-level rise, erosion, drought/extreme heat, wildfire, earthquakes, and even tsunamis. This handbook concentrates on the most likely and potentially devastating hazards in Louisiana with regard to loss of life and property damage: hurricanes, flooding, and tornadoes. Preparing for these more frequent events will help protect against other hazards, too. The costs and impacts from hazards are steadily increasing with time, underscoring the importance of understanding and preparing for your risks.

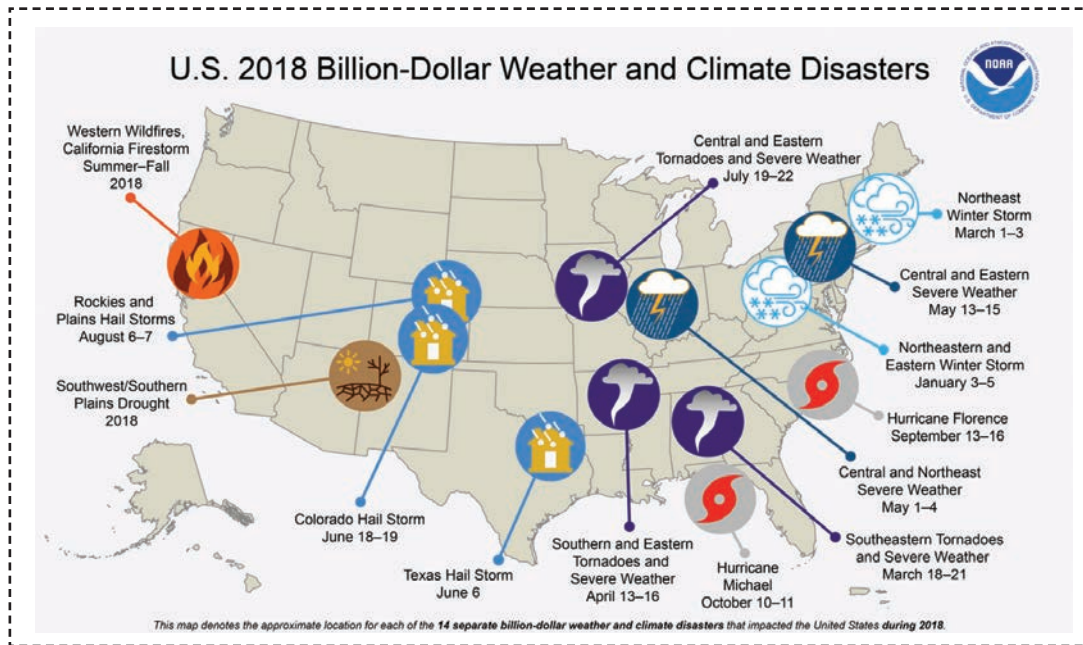

FIGURE 1-1 - SOURCE: NOAA

PART 1.1

HURRICANE HAZARDS

1.1.1 HURRICANE FORMATION

Hurricanes are massive storm systems that form over warm ocean waters and can threaten land. Potential threats from hurricanes include powerful winds, heavy rainfall, storm surges, coastal and inland flooding, rip currents, tornadoes, and erosion. The Atlantic hurricane season runs from June 1 to November 30.³ However, this does not mean hurricanes cannot occur outside of this period.

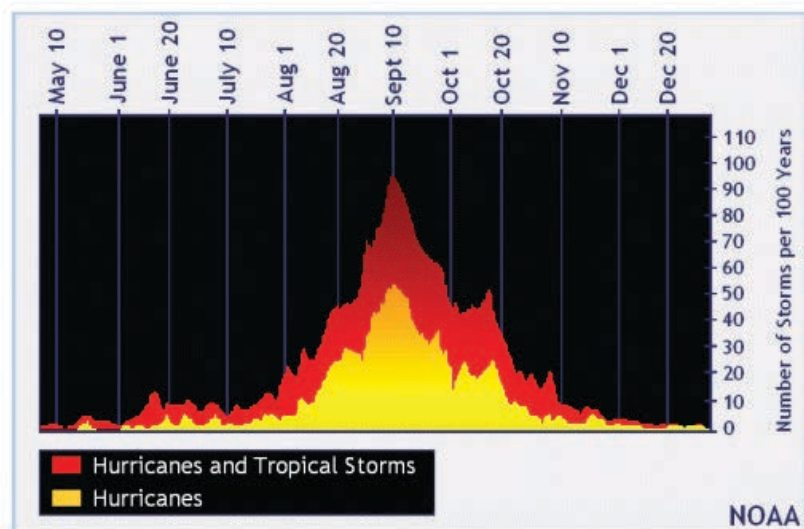

FIGURE 1-2 - SOURCE: NOAA

Hurricanes:

- Can happen along any U.S. coast or in any territory in the Atlantic or Pacific oceans.
- Can affect areas more than 50 miles inland.
- Are most common in September.

Direct hurricane hits on US mainland (1851-2017)

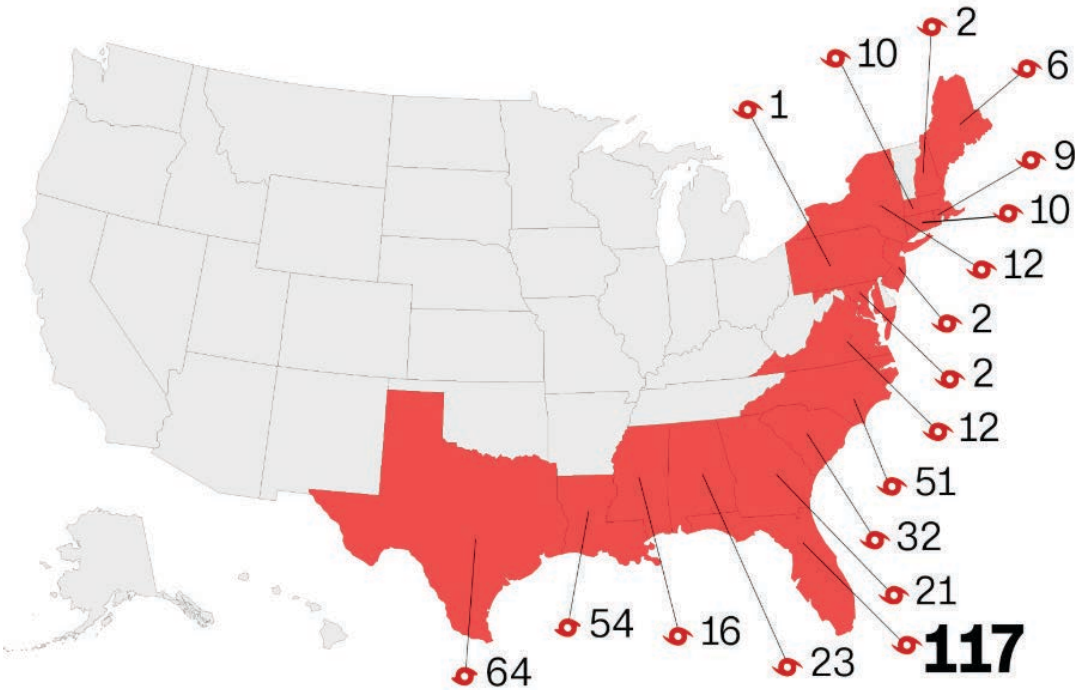

Figure 1-3- SOURCE: CNN

STORM TYPES	
Kind of Storm	Definition
Tropical Depression	An organized system of persistent clouds and thunderstorms with closed low-level circulation and sustained winds of 38 mph or less.
Tropical Storm	An organized weather system with well-defined circulation, but the sustained winds are between 39 and 73 mph.
Hurricane	An intense tropical weather system with a well-defined circulation pattern and sustained winds of 74 mph or more

Tropical storms and depressions usually occur more frequently than hurricanes in the Gulf of Mexico and usually are more common early in the season. While not full-fledged hurricanes, these severe weather events can still cause substantial damage.



FIGURE 1-4 - SOURCE: INSURANCE INSTITUTE FOR BUSINESS AND HOME SAFETY (IBHS)

During a hurricane, there is a triple threat of damage from high winds, storm surge, and rain-caused flooding. In a hurricane, the winds rapidly increase in strength from the weakest on the outer edge to the strongest near the eye. The eye is generally 20 to 40 miles wide and the eyewall contains the most intense wind.⁴ Hurricanes can also produce tornadoes, which add to their destructive power.

Hurricane Quadrants

Hurricanes are divided into four sections, or quadrants, with a distinct eye in the center. Due to the counterclockwise rotation and forward-moving track, the right front quadrant of the storm has stronger winds because of its forward velocity. Additionally, the greatest destruction, highest surge, and most tornadoes are generally found in the right front quadrant⁵ in relation to landfall. Communities near to each other, but located in opposite quadrants of where a storm makes landfall, can experience significantly different impacts.

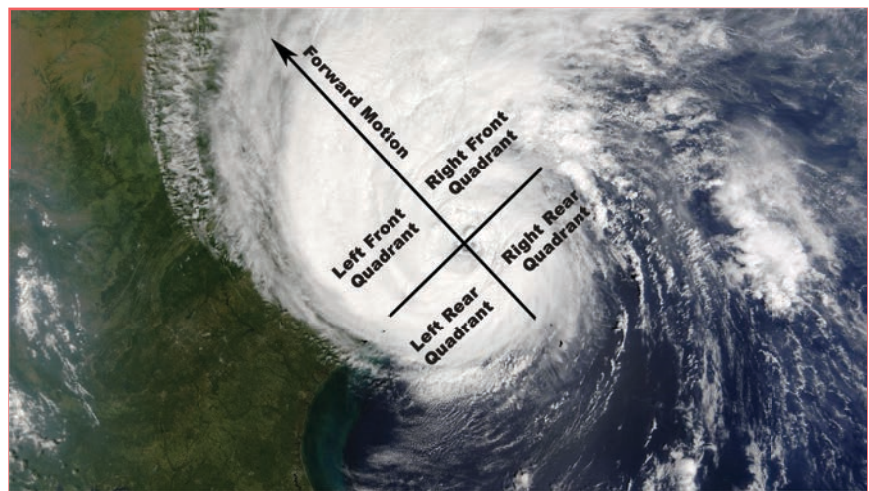

FIGURE 1-5 - SOURCE: WeatherNation

1.1.2 WIND AND THE SAFFIR-SIMPSON SCALE

Hurricane strength is categorized using the Saffir-Simpson Scale (Figure 1-6), which rates hurricanes from 1 to 5 based on the intensity of the sustained winds. It is important to note that the Saffir-Simpson Scale illustrates the peak of “sustained winds” in a hurricane. “Wind gusts,” which come and go, will reach speeds above a category. In addition, hurricane winds rapidly increase in strength going from the outer edge of the storm in toward the eyewall.

DIGITAL TIP:

Enter your address here for your wind risk:
hazards.atcouncil.org

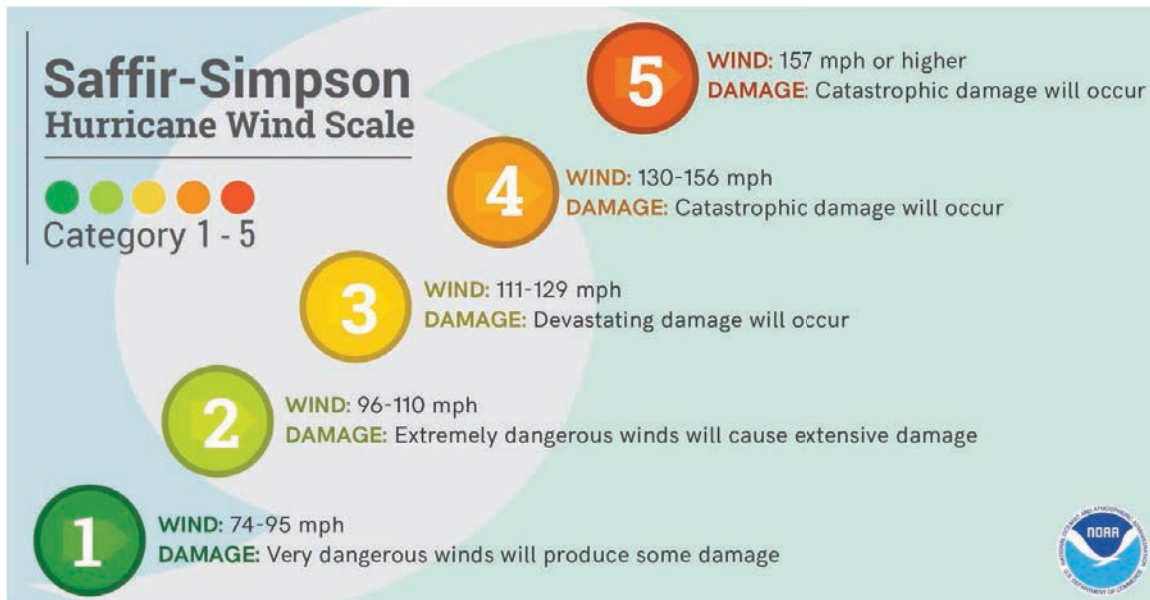
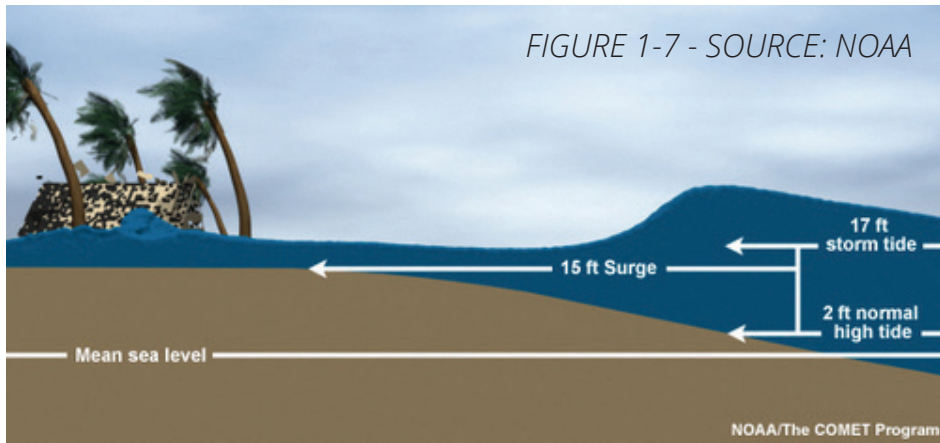

FIGURE 1-6 - SOURCE: NOAA

1.1.3 STORM SURGE AND STORM TIDE

Storm surge develops as the high winds and low pressure inside a hurricane’s eye sucks up a dome of ocean water and strong winds push that dome ashore. Storm surge is affected by the depth of near-shore waters, topography, hurricane size, speed, and angle to the coast. It can reach anywhere well over 20 feet and can span hundreds of miles of coastline.⁶ Storm surge flooding has accounted for nearly half of the deaths associated with landfalling hurricanes over the past 50 years.⁷ The higher the surge the further inland flooding can occur.



Storm tide is the combination of storm surge and a normal tide⁸ (i.e., a 15-foot storm surge combined with a 2-foot normal high tide creates a 17-foot storm tide). Wave action on top of the storm tide increases the destructive power and height to the storm surge elevation.

WEATHER TIP:
The higher the winds, the higher the high tide, which increases storm surge.

1.1.4 RAINFALL

Hurricanes and tropical storms often produce widespread, torrential rains in excess of 6 inches.⁹ Torrential rains continue inland long after the high winds of a hurricane have diminished. How much rainfall accumulates depends upon a number of factors, including the speed of the storm’s movement. The pattern of rainfall also changes throughout the course of a 24-hour day. Typically, a “core rainfall” event occurs at night and concentrates in a smaller area, whereas the outer “rainbands” expand during the day and take action over a wider area. As an example, with its slow-moving track, Hurricane Harvey kept up a constant cycle of core rainfall and active rain bands for five days. Although it had been downgraded to a tropical storm by the time it reached the Houston area, Harvey created record-breaking amounts of rain in that area. Figure 1-8 compares the characteristics of Hurricane Harvey and other recent, well-known storms.

ALLISON	KATRINA	IKE	SANDY	HARVEY
78 mph	100 mph	97 mph	95 mph	150 mph
40+ in	10+ in	18+ in	12+ in	50+ in
2.5 ft	30.0 ft	15.0 ft	12.7 ft	12.5 ft
12.0 billion	161.3 billion	35.1 billion	70.9 billion	125.0 billion

FIGURE 1-8 - SOURCE: NOAA

PART 1.2

FLOOD HAZARDS

Floods are the most common and costly natural disasters in the nation and can happen in any location at any time and are increasing in frequency and intensity. They can affect areas as small as a local neighborhood or community, to as large as an entire river basin and multiple states. In fact, 98% of U.S. counties have experienced a flood event¹⁰ and FEMA has paid out \$8.2 trillion in flood-related claims since 1968.¹¹ It is important for you to understand the flood risk to your property and community so you can take steps now to keep your family and home safe. Floodplain management is a way for communities to manage, and mitigate, flood impacts on a community, but the practice does not necessarily prevent flooding during a weather event.

Anywhere it rains, it can flood. If your property floods during small rain events, then the problem will be greater during larger events. Severe flooding can be caused by a hurricane, tropical storm, tropical depression, high tides, or other weather systems that produce heavy rain or storm surge. Additionally, as sea levels rise, tides will increasingly generate coastal flooding as it exacerbates common meteorological events, such as high tides or onshore winds.¹²

In addition to knowing about the different types of flooding, it is also important to understand your personal risk from flooding. FEMA has defined zones that are outlined on Flood Insurance Rate Maps (FIRMs). The maps show in which zone your property lies and what type of risk you face. The most common flood zones are the A or V Zones (100-year flood), or the “Special Flood Hazard Area” (SFHA), and the X Zone (500-year zone). Homeowners with a mortgage and located in the SFHA are required to purchase flood insurance. Even if you are not in an official flood zone, you may still be at risk from flooding. Talk to your

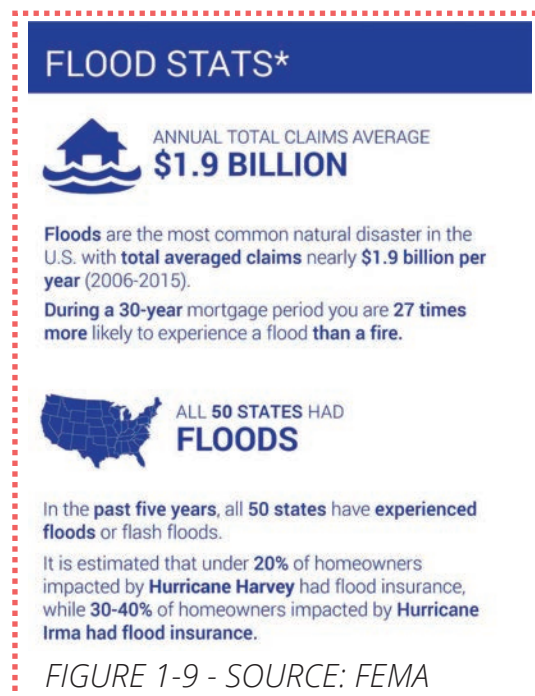

community's floodplain manager or enter your street address into the following website to determine a general estimate of the flood risk for your property: [msc.fema.gov/portal](https://www.msc.fema.gov/portal).

FEMA answers homeowners' frequently asked questions about flood hazard maps and risks on their webpage, [fema.gov/homeowners-frequently-asked-questions](https://www.fema.gov/homeowners-frequently-asked-questions).

More than 20% of flood claims come from properties outside high-risk flood zones.¹³ If you think you are vulnerable to flooding, then you can protect yourself by purchasing flood insurance, improving the local drainage, and making your house resistant to floods

by floodproofing (See Section 3.7). It is important to note that you do not need to be in an official flood zone to obtain flood insurance. **Remember, just because you have not experienced a flood in the past does not mean you will not experience one in the future.**

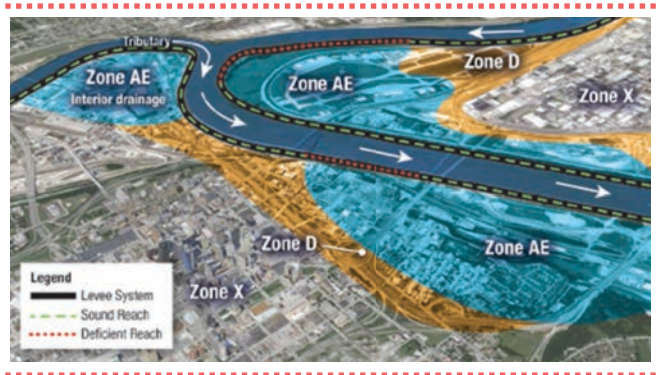

FIGURE 1-10 - SOURCE: FEMA

1.2.1 COASTAL FLOODING

Coastal flooding results from factors including storm surge, wave, and tidal action, and is usually associated with hurricanes or tropical storms. As described earlier, the low pressure inside a storm's eye creates a dome of ocean water near the center of the storm. As the storm approaches land, the storm's strong winds push the accumulated water ashore as

storm surge. An intense hurricane can have a dome of water that is many miles wide and more than 20 feet high as it hits the coast. In addition, with this temporary increase in sea level, breaking waves and floating debris have access to areas and structures that were not designed to withstand the pounding of ocean waves. During hurricanes, these battering

waves are responsible for most beach erosion and extensive damage to coastal structures, including buildings, roads, bridges, marinas, piers, boardwalks, and sea walls.¹⁴

In addition to storm-driven flooding, coastal flooding due to high tides is becoming more frequent and occurring in more places as sea levels rise.

An intermediate-low scenario has a 96% chance of happening.¹⁶ Learn more at ([masgc.org/northern-gulf-of-mexico-sentinel-site-co/two-pager](https://www.masgc.org/northern-gulf-of-mexico-sentinel-site-co/two-pager)).

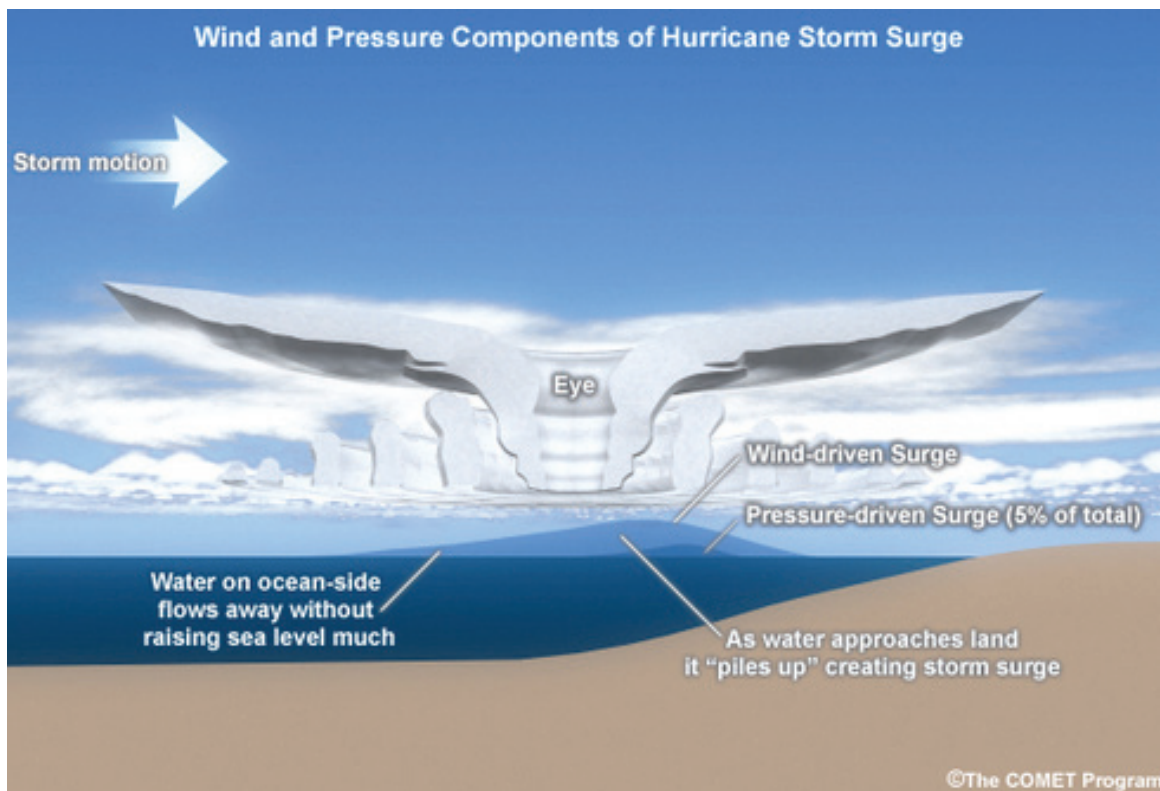

FIGURE 1-11 - SOURCE: NOAA

1.2.2 FLASH FLOODS

Flash floods generally develop within six hours of the immediate cause. Flash Flooding can be caused by heavy rain, ice or debris jams, and levee or dam failure¹⁷ and include a rapid rise in water, high-velocity water flow, and large amounts of associated debris. These characteristics can make a flash flood more dangerous, and even fatal, compared to other types of flooding. Factors that contribute to the severity of flash floods are the intensity and duration of rainfall and the steepness of the area's terrain.

1.2.3 HIGH-TIDE FLOODING

High tides are causing more flooding for communities. High tide flooding, also known as "nuisance" flooding, is coastal flooding caused by higher than usual tidal heights at high tide. Nuisance flooding can create minor impacts, which can cause public disruptions.⁶³ These floods creep into busy city centers and streets. In the past, coastal flooding mostly occurred during strong storms. Today, it

occurs more frequently during high tide cycles and calmer weather. Though high tide flooding today is rarely life-threatening, it is a serious concern in several communities. Of great concern, however, is when a storm surge event happens during a high tide, which then leads to higher and more severe flooding.

HIGH TIDE FLOODING



FIGURE 1-12 - SOURCE: Paul Krashefski, FEMA

1.2.4 OTHER ELEMENTS OF FLOODING

There are several other factors which influence flooding that communities have the ability to improve or update because they are part of infrastructure:

Impervious surfaces, which do not absorb water well, can cause excessive runoff during heavy rainfall and bring about flash flooding. Rocky terrain, asphalt, cement, certain types of soil, and land hardened by long periods of drought are examples of impervious surfaces in the natural environment and rural communities. However, with vast road systems, parking lots, and concrete buildings, cities usually contain larger percentages of impervious surface.

Stormwater systems are built to control runoff during severe rain events but may not keep pace with the rate of urban development. If these systems become overwhelmed, they can release stormwater back into the community in the form of flash flooding.

Low water crossings exist in areas where it is inefficient to build bridges or culverts, such as creek beds that remain dry for extended periods and roads that do not get a lot of traffic. Yet, during extreme rainfall, water can quickly rise above the crossing and flash floods can even wash away the crossing structure. Permanent warning signs may be placed at low water crossings and roads may be blocked off during flash flood events to protect the public.



FIGURE 1-13 - SOURCE: MISSISSIPPI-ALABAMA SEA GRANT CONSORTIUM



FIGURE 1-14 - SOURCE: MISSISSIPPI-ALABAMA SEA GRANT CONSORTIUM

Dams, levees, and floodwalls are structures built to contain water and to protect communities. They can pose a danger if they become overwhelmed during heavy rain events, especially tropical storms and hurricanes. If they are overtopped or undergo structural failure, flash flooding could occur with little to no warning.

PART 1.3

TORNADO HAZARDS

Tornadoes can cause fatalities and devastate a neighborhood in seconds. Tornadoes resemble funnel-shaped clouds that stretch from a thunderstorm to the ground. Winds in these rotating funnels of air may surpass 250 miles an hour and can clear a pathway over a mile wide and 50 miles long.¹⁸

The size of a tornado is not necessarily an indication of its intensity; large tornadoes can be weak, and small tornadoes can be incredibly powerful. The Fujita (F) Scale was developed by Dr. Tetsuya Theodore Fujita in 1971; the scale helped determine tornado wind speeds by noting damage from tornados. An Enhanced Fujita (EF) Scale (Figure 1-15) was developed by an assembly of esteemed meteorologists and wind engineers, these professionals improved the original F scale, which is the scale used today.¹⁹

Tornadoes generally occur near the trailing edge of a thunderstorm or accompany a tropical storm or hurricane as it moves onshore. Waterspouts

are tornadoes that form over water. The average tornado moves southwest to northeast, but they can move in any direction. The average forward speed of a tornado is 30 mph but may vary from stationary to 70 mph. Peak tornado season in the southern states is March through May, and they are most likely to occur between 3 p.m. and 9 p.m., but can occur at any time.²⁰

FIGURE 1-15 - SOURCE: iSTOCK

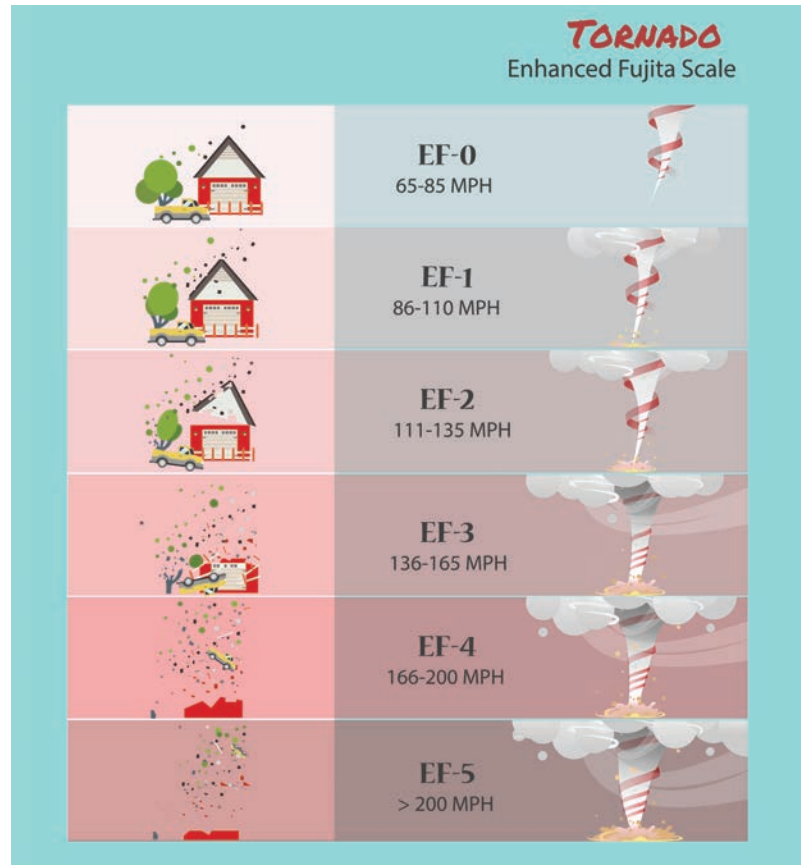

If you're under a
TORNADO WARNING
SEEK SHELTER RIGHT AWAY

INDOORS	OUTDOORS
<p>Get to a safe room, basement, or storm cellar. </p> <p>If there's no basement, get to a small, interior room on the lowest level. </p> <p>Use your arms to protect your head and neck. </p> <p>Stay away from windows, doors, and outside walls. </p>	<p>If you can safely get to a sturdy building, do so immediately. </p> <p>If there's no nearby shelter, take cover in a stationary vehicle & buckle up. </p> <p>Do not get under an overpass or bridge. You're safer in a low, flat location. </p> <p>Watch out for flying debris, which causes significant fatalities and injuries. </p>

Ready.

Before a tornado hits, the wind may die down, and the air may become very still. A cloud of debris can mark the location of a tornado even if a funnel is not visible. You may also hear a sound similar to a train coming towards you. It is not uncommon to see clear, sunlit skies behind a tornado.

FIGURE 1-16 - SOURCE: FEMA

PART 1.4

ADDITIONAL HAZARDS

1.4.1 SEVERE THUNDERSTORMS

Although thunderstorms typically impact a small area, they can be extremely dangerous due to their capability of generating tornadoes, hail, strong winds, flash floods, and damaging lightning. These storms can move through an area very quickly or linger for several hours with longer durations resulting in the possibility of excessive precipitation and increased likelihood of flash floods. The National Weather Service considers a thunderstorm to be severe if it produces hail of at least 1 inch in diameter, winds of 58 mph or stronger, or a tornado. Straight-line winds associated with severe thunderstorms can exceed 125 mph and are responsible for most thunderstorm damage.²¹ Straight-line winds, or downbursts, are much more common than tornadoes and tend to cause more damage than the typical tornado in Louisiana.

1.4.2 DROUGHT/EXTREME HEAT

Drought conditions are caused by long periods with minimal precipitation. According to the Delaware City Hazard Mitigation and Climate Adaptation Action Plan, "Human activities, high temperatures, high winds, and low humidity can exacerbate drought conditions and may also make areas more susceptible to wildfire. Periods of drought can have significant negative impacts on agriculture, water reservoir levels, surface and groundwater supplies, or any water-dependent resource or product."⁶⁵ In most of the United States, extreme heat is defined as an extended period (2-3 days) of high heat and humidity with temperatures above 90 degrees.² It can also be produced due to large increases in ozone in urban areas, where concrete and buildings reflect heat towards the atmosphere. This is called the urban heat island (UHI) effect.² Periods of extreme heat in Louisiana are also often accompanied by high humidity. Extreme heat is a significant risk to humans, especially the elderly, young children, and people with respiratory difficulties because extreme heat can cause medical difficulties.

1.4.3 WILDFIRE

Wildfires, or any naturally occurring fire in a grassland, brush, or forested area, are especially dangerous hazards during periods of drought. The most common cause of wildfires is negligent human behavior (causing accounting for 84% of all wildfires and 44% of total area burned).²⁴ Lightning strikes are the second most common cause and typically occur during summer months. Areas with large amounts of dry fuel, such as vegetation, debris, or trees, are particularly susceptible to wildfires caused by lightning strikes. Fire probability depends on local weather conditions, human activity, and the implementation of community fire prevention measures.

1.4.4 EARTHQUAKES

According to the Delaware Geological Survey, around 3 million earthquakes occur each year. Between 2000 and 2009, in the United States about 32,000 earthquakes occurred; six were considered major earthquakes and occurred in either Alaska or California. Additionally, earthquakes occur all over the US. Seven earthquakes with magnitudes greater than 6.0 have occurred in the central and eastern portions of the US since 1811.²⁵ A magnitude 5.8 earthquake occurred with an epicenter in Virginia in August of 2011 and was felt across a dozen states and several Canadian provinces, resulting in building damage between \$200 million and \$300 million.²⁶

You can check your risk at
earthquake.usgs.gov/earthquakes/byregion/.

1.4.5 TSUNAMIS

A tsunami is a series of ocean waves generated by sudden displacements in the sea floor, landslides, or volcanic activity.²⁷ The history of U.S. Atlantic Coast tsunamis is short but shows that tsunamis can happen in the region. Key events include an earthquake in 1886 and underwater landslide in 1964 that both produced small local tsunamis. Also, a tsunami produced by an earthquake-generated landslide off Newfoundland, Canada (1929) recorded as small waves along the U.S. coast but caused death and destruction near its source. Underwater landslides and meteotsunamis (large waves driven by air-pressure disturbances often associated with fast-moving weather events, such as severe thunderstorms, squalls, and other storm fronts)²⁸ are the most likely source of tsunami waves in the region. More distant tsunami threats come from the Puerto Rico trench, the Canary Islands, and the Azores-Gibraltar fault zone.

The U.S. Gulf Coast, like the U.S. Atlantic Coast, has not seen many tsunamis or much seismic activity recorded in the region. Still, evidence suggests a tsunami is possible. An earthquake off Puerto Rico (1918) produced the only tsunami on record for the Gulf Coast. However, the geography of the Gulf may reduce the impact of most distant tsunamis. Geologic evidence in the Gulf of Mexico points to underwater landslides as the region's likeliest tsunami source.²⁹

1.4.6 SEA-LEVEL RISE

Seas are rising due to melting ice caps and thermal expansion of the oceans. Rising sea levels are having direct and indirect impacts on coastal living, acting as a coastal hazard and exacerbating other coastal threats. Higher high tides will begin to regularly flood roads and other infrastructure as a direct result of sea-level rise. This will increase infrastructure maintenance costs, jeopardize people and property, and impact commerce and transportation. Indirect impacts already occurring include making storm surge more intense and far reaching, increasing rates of erosion, and reducing storm water drainage capacity, which increases rain-driven flooding. Sea-level rise is not occurring uniformly or having the same impacts across the United States; however, for the majority of the U.S. coastline, sea-level rise is expected to be above the global average. The first step to preparing your home for sea-level rise is to understand local risks to sea-level rise. You can find information on sea-level rise and other intersecting coastal hazards from the *National Climate Assessment Four*, Volume II, Chapter 8 at nca2018.globalchange.gov/chapter/8/.

1.4.7 EROSION

Beach erosion occurs when waves and currents remove sand from the beach system. Erosion causes beaches to become narrower and lower in elevation. Storm waves move this sand away from the shore, creating large sandbars. After a storm, the sand is slowly returned to the beach by normal wave patterns. States that rely on beach-related tourism can be affected by beach erosion and this has become a concern for coastal communities. Erosion can threaten coastal homes, businesses, roads, and other infrastructure. Storms can erode the shoreline and leave these communities at risk for future damage (Figure 1-18).³⁰



FIGURE 1-18 - SOURCE: MISSISSIPPI-ALABAMA SEA GRANT CONSORTIUM

PART 2

PLAN, PREPARE, AND ACT

This part of the handbook covers the topic of preparing yourself and your family for natural hazards. In particular, it is important that your household has a stock of emergency supplies, an evacuation kit, and an evacuation plan. You should discuss and practice the plan with your family once a year, or whenever there is a major lifestyle change (for example, when a member of the family goes to a new school or is working in a different location).

For a community to be resilient (i.e., able to bounce back quickly from a hazard event), it is important that all individuals and organizations prepare. Get to know your neighbors. Contrary to popular belief, the most likely immediate assistance you will get after a hazard event that turns into a disaster is not

from the local, state, or federal government. It is likely to be from your neighbors or local community members. This is because the government may be over-whelmed in responding to life-threatening emergencies or maintaining critical infrastructure. Your community will be better able to cope with a disaster when you work with your neighbors and local government agencies as a team.³¹ To get more involved join a local Community Emergency Response Team (CERT). More information can be found in this FEMA resource: [fema.gov/pdf/areyouready/areyouready_full.pdf](https://www.fema.gov/pdf/areyouready/areyouready_full.pdf).

DIGITAL TIP:
Download these phone apps now to see and utilize disaster advice:
[fema.gov/mobile-app](https://www.fema.gov/mobile-app)
[redcross.org/get-help/how-to-prepare-for-emergencies/mobile-apps](https://www.redcross.org/get-help/how-to-prepare-for-emergencies/mobile-apps)

PART 2.1

EMERGENCY SUPPLIES FOR THE HOME

Along with reading the information below, please see Appendix D (page 112) for a full list of disaster supplies.

The general rule when preparing for a hazard event is to be self-sustaining for a minimum of 72 hours.³² Depending on the severity and impact of the event, basic supplies from the government may be unavailable or inaccessible for several days thereafter. If you are sheltering in place or returning home while utilities are still disrupted, a week or two weeks' worth of supplies is advised. However, it is always advised to evacuate when told to do so.

Emergency supplies should be assembled as soon as possible; do not wait until an emergency to gather supplies. For food items, it is advised to purchase non-perishable products. A good rule of thumb is to check the expiration dates and batteries for electronics (including smoke alarms) when changing your clocks for Daylight Savings. See Appendix D for a complete emergency supply list. You can copy this document and use it as a checklist to update your kit every year!

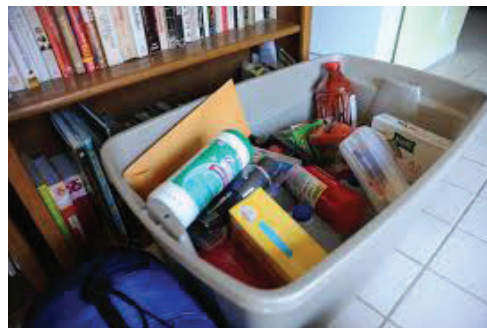

FIGURE 2-1 - SOURCE: FEMA

PART 2.2

EVACUATION KIT (A.K.A. “GO BAG”)

An evacuation kit differs from a stock of emergency supplies because this kit should be taken with you if an evacuation is necessary. Be mindful that this kit is subject to the space available in a car, public transportation, or at an evacuation shelter. The components of the evacuation kit should be stored in one place so that they are ready to go at a moment’s notice. Be sure to keep your kit prepared all year round in case of late-season storms or other emergencies. Keep this kit in a designated place and make sure all family members know where the kit is kept. It is still recommended that you pack enough supplies to last at least 72 hours. The kit should include the following at a minimum:

PRO TIP:

Write a list of kit items on the side of empty totes as a reminder of what to gather quickly when evacuating.

- Map of your evacuation route
- Cash, since ATMs may not be working
- Key personal records – driver’s license, birth certificate, proof of residence, homeowner’s insurance, and health insurance, etc.
- Cell phone and charger
- List of emergency telephone numbers, in case cellphones are not working
- One gallon of potable water per person per day
- Supply of nonperishable foods
- Change of clothes, personal hygiene items, towels
- Prescription medications and list of any medical care directives
- First aid kit
- Flashlights, portable radio, batteries
- Pillows, blankets, sleeping bags, or air mattresses
- Gas tanks for refueling a car, if applicable
- Pet supplies and documentation

If you go to a shelter, keep in mind that there will be limited space, so bring only what is recommended unless you are instructed otherwise by your emergency management agencies. There is a fine line between bringing too many supplies that overload the limited shelter space of 10 square feet per person and not bringing enough. If you have pets or special medical needs, contact the shelter before you leave to find out if it can accommodate them (not all shelters allow pets) or if there is another shelter you should go to (pet-friendly or medical needs shelter).

DIGITAL TIP:
Buy a pre-made kit online at the start of hurricane season, or search for “emergency preparedness supplies” on Amazon.

PART 2.3

EVACUATION PLANNING

2.3.1 PREPARE YOUR FAMILY

An evacuation plan should be created and reviewed with your family every year. When forming an evacuation plan, here are some things to consider:

PRO TIP:

Find your evacuation zone:
[flash.org/pdf/
2019EvacuationZones.pdf](http://flash.org/pdf/2019EvacuationZones.pdf)



FIGURE 2-2 - SOURCE: iSTOCK

- The Louisiana Department of Transportation & Development has hurricane information and evacuation routes on their website. Visit these web pages for assistance: gisweb.dotd.la.gov/evacuationroute/desktop.html
- If you may need assistance evacuating, check with your local government to see if any assisted evacuation programs or resources exist (e.g., New Orleans City-Assisted Evacuation Plan).
- Evacuation plans should consider all members of a household, especially those with special health needs. Practice evacuation procedures annually and when major changes occur, like moving.
- Make sure to know what your company's or organizational evacuation plan consists of.
- Parents should learn their child's school's evacuation plans and confirm where students will be held and for how long in the event of a disaster. Parents should not drive to school to pick up their children unless directed to do so by school officials.
- If needed, include special needs family members or those with limited mobility. If people with special health needs are with a care-provider, confirm that the care-provider has an evacuation plan. Also, you can contact your local/state government to see if a Special Needs Registry has a list of special needs shelters.

DIGITAL TIP:
While creating your evacuation plan, save the addresses as favorites in your phone's map app.

- Develop a plan for your pets. Be advised that not all shelters take pets. Service animals, which assist people with disabilities, are the only animals allowed in Red Cross shelters. Check with the American Red Cross to determine if there are any pet-friendly shelter locations nearby. You may also want to identify pet-friendly hotels along your evacuation route. Microchip pets at your veterinarian's office or local Humane Society well in advance of a storm event to aid in the quick identification and return of your pet in case you are separated during an emergency.

- Consider how family members and friends will communicate if they become separated. Create a list of telephone numbers and email addresses of everyone in the family and phone numbers of a few contacts outside of the family.
- Vehicles should be kept in good operating condition, and gas tanks should be full. Ensure all emergency kits are packed.
- Plan on going to a shelter? There are a limited number of hurricane shelters and spaces that offer protection from wind, rain and coastal waters. Because there may be a shortage of shelters, there may be a possibility you cannot get in. Therefore, plan to use a shelter only as a last resort.

PREPAREDNESS TIP:

Print paper copies of your zones and maps to include in your home evacuation kit.

2.3.2 PREPARE YOUR PROPERTY

In addition to preparing a stock of emergency supplies, an evacuation kit, and an evacuation plan, there are preparations you and your family should make to secure your property before you evacuate.

- **Wedge sliding glass doors with a brace or broom handle** to prevent them from being lifted from their tracks or being ripped loose by wind vibrations.
- **Deploy window protections well in advance of the arrival of any winds** (Section 3.4).
- **Bring in any outdoor objects** such as patio furniture, hanging plants, trash cans, large planters, and barbecue grills.
- **Adjust refrigerator temperatures to the coldest settings** to reduce the potential for food spoiling if the power is temporarily lost. If power is lost during the event, try not to open the refrigerator unless necessary. Put several containers of water in the freezer — this will help keep items frozen or cold longer. According to the U.S. Food and Drug Administration, any food above 40 degrees F for two hours or more should be discarded.

Without power, an unopened refrigerator will keep food cold for about four hours, and a full freezer will keep food cold for about 48 hours (24 hours if half full).³³

- **Package valuables**, such as jewelry, titles, deeds, insurance papers, licenses, etc., for safekeeping in waterproof containers. Do not forget to protect your family photos. Large plastic zipper seal bags make for quick and secure storage of your irreplaceable family memories.
- **All digital information should be fully backed up**, preferably offsite, such as a cloud-based service. If you leave your home, it is wise to take your hard drive with you. If you have everything already backed up on an external drive, take that with you as well. Store any hard drives that remain in your home in a high, protected location.
- **Learn how to safely turn off your utilities** in advance (check with your utility provider) and ensure you have a shutoff wrench at your breaker box.
- **Shut off electricity** at the main switch near the meter, turn off gas to prevent leaks from occurring, and turn off water to prevent flooding from broken pipes.
- **Store chemicals, fertilizers, or other toxic materials** in a safe section or secure area of the premises. Propane tanks should not be stored near sources of heat.
- **Store boats securely or move them** to designated safe areas well in advance of hurricanes. Do not attempt to tow a trailer or boat in high winds.
- **Shut all interior doors.** Research has shown that if a door or window is breached, shutting interior doors helps to compartmentalize the wind pressures and can reduce the overall forces on your home.³⁴

PREPAREDNESS TIP:

FEMA needs to see your historical home and/or rental bills (e.g., utilities, phone) to provide you with assistance to pay them.

2.3.3 EMERGENCY ALERTS

The Emergency Alert System (EAS) is the official source of natural hazard information and instructions. This information can originate from county, state, or federal agencies. The statewide network will be activated by the National Weather Service to announce weather-related watches or warnings.

If a public alarm sounds, turn on the radio. Some radios with the NOAA weather radio band turn on automatically when an emergency broadcast through the EAS is activated. The NOAA weather radio station broadcasts round-the-clock weather information. Many local radio stations voluntarily agree to participate in the EAS system (see the radio stations in Table 2-1). Apps are also available for download that will deliver weather alerts to your smartphone. Additional information may be issued on local or cable television networks and through local community websites or social media.

Radio Station Coverage

Alexandria:

- AM 970 (KSYL)
- AM 580/FM 96.9 (KZMZ)
- FM 93.1 (KQID)

Baton Rouge:

- AM 1150 (WJBO)
- FM 102.5 (WFMF)

Crowley:

- FM 102.9 (KAJN)

Lafayette:

- AM 1330 (KVOL)
- FM 99.9 (KTDY)

Lake Charles:

- AM 1470 (KLCL)
- FM 99.5 (KHLA)

New Orleans:

- AM 870 (WWL)
- FM 101.9 (WLMG)

Northeast:

- AM 540/FM 101.9 (KNOE)

Ruston:

- AM 1490 (KRUS)
- FM 107.5 (KXKZ)

Shreveport:

- AM 1130/FM 94.5 (KWKH)

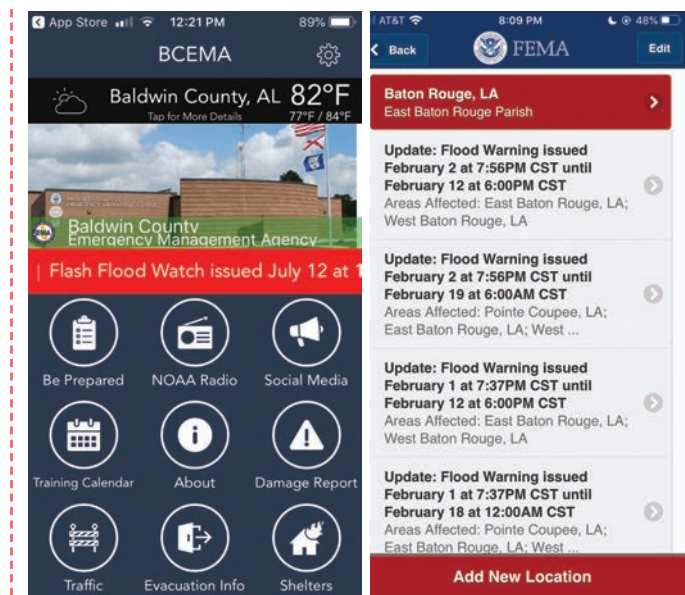

FIGURE 2-3 - SOURCE: MISSISSIPPI-ALABAMA SEA GRANT CONSORTIUM

When listening to alerts, note the difference between a hazard watch and a hazard warning. Definitions of watches, warnings, and hazards are provided on page 25 from NOAA (Table 2-2). Depending on the alert, there are different actions to take. Also, note that civil defense or emergency management agencies may issue a mandatory evacuation in the case of a hurricane warning. Familiarize yourself with these terms.³⁵

TABLE 2-2

FLOODING, TROPICAL STORM, AND HURRICANE ADVISORIES

Flood Watch	Issued when flash flooding or flooding is possible within the designated watch area. Homeowners should be prepared to move to higher ground and should listen to NOAA weather radio, local radio, or local television stations for information.
Flood Warning	Issued when flash flooding or flooding has been reported or is imminent. Take necessary precautions at once and avoid going through flooded areas as the force of the water may cause your vehicle to drift into the water. Turn around, don't drown. If advised to evacuate to higher ground, do so immediately.
Tropical Storm Watch	Issued when there is a good possibility of tropical storm conditions and associated damaging winds, surf, and flooding rains occurring anytime within 36 hours. Homeowners should prepare their homes and review plans for evacuation in case a tropical storm warning is issued.
Tropical Storm Warning	Issued when there is a high probability of tropical storm conditions (sustained winds of 39 to 73 mph) occurring anytime within 24 hours. Homeowners should complete all storm preparations and leave the threatened area if directed by local officials. A tropical storm warning may not always be preceded by a tropical storm watch.
Hurricane Watch	Issued when there is a good possibility of hurricane conditions and associated damaging winds, surf, and flooding rains occurring anytime within 36 hours. Homeowners should prepare their homes and review plans for evacuation in case a hurricane warning is issued.
Hurricane Warning	Issued when there is a high probability of hurricane conditions (sustained winds of 74 mph or greater) occurring anytime within 24 hours. Homeowners should complete all storm preparations and leave the threatened area if directed by local officials. A hurricane warning may not always be preceded by a hurricane watch.
Extreme Wind Warning	Extreme sustained winds of a major hurricane (115 mph or greater), usually associated with the eyewall, are expected to begin within an hour. Take immediate shelter in the interior portion of a well-built structure.

FIGURE 2-4 - SOURCE: IBHS

PART 2.4

EVACUATION PROCEDURES

If an evacuation has been called, follow the order issued by officials. Emergency and rescue services may not be available during the storm, and other communications may be rendered inoperable. Get out of the danger area as soon as authorities indicate it is time to do so. Leave as early as possible to avoid traffic, preferably in daylight, and have your destination planned well in advance. However, evacuate only when it is your area's time — not before!

Stay alert, stay calm, and be informed. Tuning in to local radio and television stations is important. Listen to your local radio and television stations carefully as there may be additional or modified directions based on the best available information at that time.

You can also search for open shelters on an interactive map online on the Red Cross webpage, www.redcross.org/get-help/disaster-relief-and-recovery-services/find-an-open-shelter, or text "SHELTER" and your zip code to 43362 (FEMA's dedicated number). Evacuation shelters have a maximum space of 10 square feet of bare floor per individual. Bedding, food, water, and other essentials may or may not be provided, so your evacuation kit (see Section 2.2) should contain these important items.

2.4.1 EVACUATION FOR A HURRICANE

Do not be deceived into disregarding an evacuation order for a Category 1 or 2 hurricane. Evacuations were ordered for Plaquemines and Terrebonne parish following Tropical Storm Barry due to storm surge, even though the storm only briefly reached Category 1 wind speeds. "Run from the water, hide from the wind" is a hurricane adage that has been used from Florida to Texas by emergency management teams for hurricane response. Despite the adage, you should always follow an evacuation order, especially if any of the following conditions apply:

- You live in a mobile home or temporary structure.
- You live in a high-rise building.
- You live on the coast, in a floodplain, near a river, or on a peninsula or barrier island.

- You live in a Special Flood Hazard Area (Zone A) or a high-velocity wave/storm surge zone (Zone V).
- You live in an older home with wood frame construction.
- You live in an area that has been directed to evacuate by local authorities.

Your local emergency management office or top elected official has the authority to order an evacuation. When you evacuate, locate a place that is far from flood or inundation zones and far from the projected track of the storm. Also, be sure to stay in a structure that is able to withstand strong winds and rain. To implement a large-scale, multi-jurisdictional evacuation, evacuation zones have been designated by the Louisiana Department of Transportation & Development and are based on the severity of the storm.

2.4.2 EVACUATION FOR A FLOOD

The general rule for evacuating from a flood is to stay away from floodwaters and head to higher ground. In flooded areas, you may not be able to perceive the depth of the water, the condition of the ground under the water, or debris contained in the water. This is especially true at night when vision is limited. **Never attempt to cross through flooded roadways** – roadbeds may be washed out. If caught in a home during a flood, go to the second floor or the roof, but do not go into the attic where ventilation is limited unless you have an ax or other means of escaping to the roof.

Basic Safety Tips

- **Turn Around, Don't Drown!®** - Do not drive through closed/flooded roads.
- **Avoid walking or driving through floodwater.** Just 6 inches of moving water can knock you down, and one foot of moving water can sweep your vehicle away. Water may also contain dangerous debris, chemicals, or insect swarms.
- **Do not drive on bridges that are over fast-moving floodwater.** Floodwater can scour foundation material around the footings and make the bridge unstable.
- If there is a chance of flash flooding, **immediately move to higher ground.**

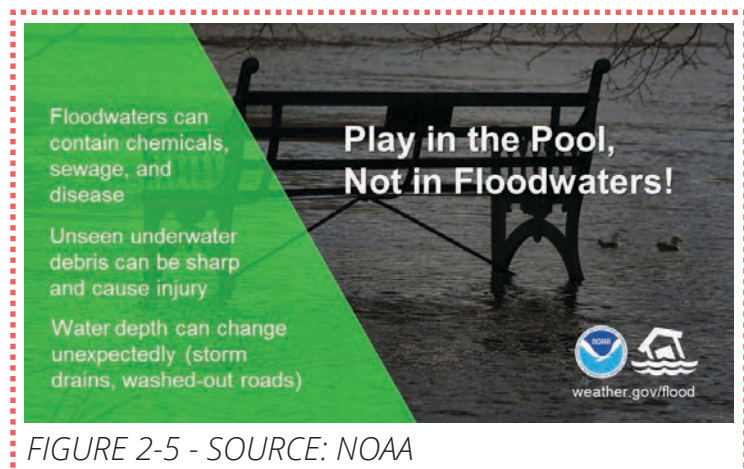

FIGURE 2-5 - SOURCE: NOAA

- If flood water rises around your car and the water is not moving, **abandon the car** and move to higher ground. However, **do not enter moving water**.
- **During heavy rainfall, avoid camping or parking along streams, rivers, and creeks.** These areas can flood quickly and with little warning. Obey all road closures and never drive across barriers; the majority of flooding deaths occur when vehicles attempt to drive through flooded roadways.³

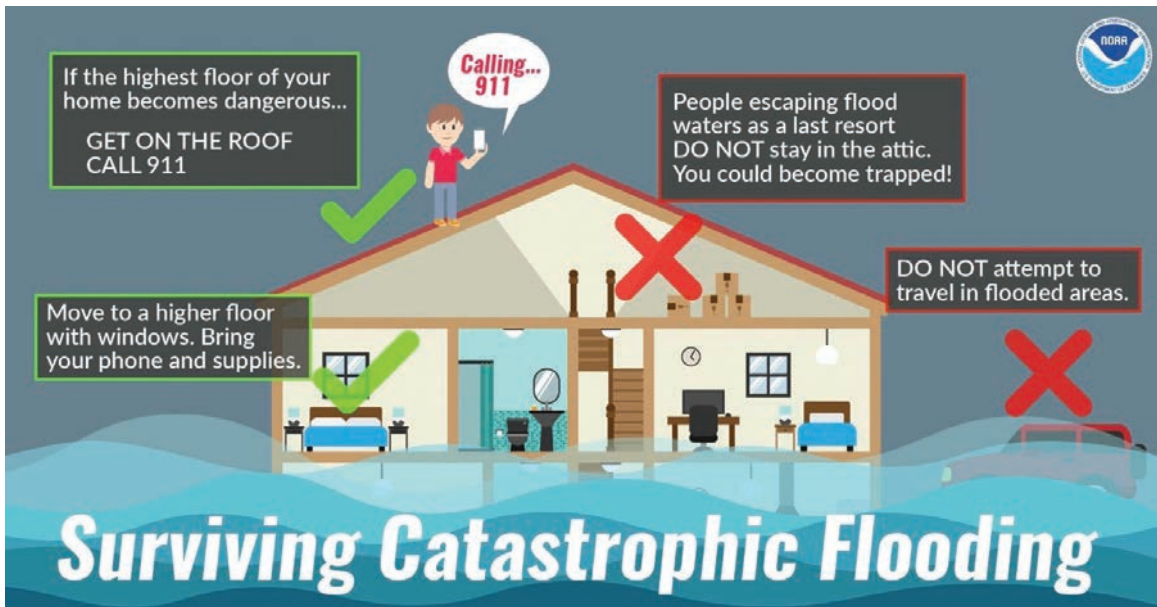

FIGURE 2-6 - SOURCE: NOAA

2.4.3 AFTER THE STORM

- Keep listening to radio, TV, or NOAA Weather Radio All Hazards.
- Wait until the area is declared safe before entering.
- Never use generators indoors or in other non-ventilated areas.
- Avoid weakened bridges and washed out roads.
- Once home, inspect the outside of your property first. If you notice or suspect structural damage, have a building inspector determine that the home is safe before you enter.
- If you notice or suspect a gas leak, a downed power line, or electrical hazard, move to a safe location first and then call 9-1-1 followed by the utility company.

- If your home is safe to enter, check gas, water, and electrical appliances for damage.
- Use a flashlight to check for damage; do not use a candle for inspecting.
- Wear proper shoes (fully enclosed) to prevent cutting feet on sharp debris.
- Do not drink or prepare food with tap water until officials say it is safe.
- Discard all food that may have been contaminated by flood waters or spoiled due to a power outage.
- See Section 4.6 for information about the inspection and rebuilding process.
- See Section 5.4 for information about making a claim.

PART 2.5

EMERGENCY INFORMATION AND CONTACTS

The NOAA Extreme Weather Information Sheet (NEWIS) for each state, including Louisiana, is updated each year with current information, phone numbers, and websites relevant to weather emergencies. To download the latest version of this sheet, go to ngdc.noaa.gov/newis/.

For general emergency information, contact your local Office of Emergency Management.



FIGURE 2-7 - SOURCE: IBHS

NOAA Extreme Weather INFORMATION SHEET

WRN Weather-Ready Nation: Saving Lives and Livelihoods

STATE INFORMATION *To download the latest updated version of this sheet: www.ngdc.noaa.gov/news*

Louisiana Office of Homeland Security and Emergency Preparedness	225-925-7500	www.gohsncp.la.gov
Get a Game Plan		www.getagameplan.org
Official State Website		www.louisiana.gov
Louisiana Department of Transportation (www.sdp.dotd.la.gov)	1-877-4LA-DOTD (452-3683)	
Louisiana Office of Tourism (www.louisianatravel.com)	1-800-677-4082	
Louisiana State Police (www.lsp.org)	225-925-6006 (*1SP from cell phone)	
Louisiana Governor's Office (https://gov.louisiana.gov)	225-342-0991 or 1-844-860-1413	
Louisiana Attorney General (www.ag.state.la.us)	225-326-6079	
Louisiana Department of Agriculture & Forestry (www.ldaf.state.la.us)	1-866-927-2476	
Louisiana Department of Environmental Quality (https://deq.louisiana.gov)	1-866-896-LDEQ (5337)	
Louisiana Department of Insurance (www.lid.la.gov)	1-800-259-5300	
Louisiana Department of Wildlife & Fisheries (www.wlf.louisiana.gov)	225-765-2800	
Louisiana Department of Natural Resources (www.dnr.louisiana.gov)	225-342-8955	
Louisiana Department of Health (http://ldh.la.gov)	225-342-9500	
Louisiana Department of Children and Family Services (www.dcs.state.la.us)	1-888-LAHELP4U (524-3578)	
Louisiana Workforce Commission (www.laworks.net)	225-342-3111	
National Weather Service Forecast Office (New Orleans/Baton Rouge) (www.weather.gov/lix)	504-522-7330	
National Weather Service Forecast Office (Lake Charles) (www.weather.gov/lch)	337-477-5285	
National Weather Service Southern Region		www.weather.gov/south
StormSmart Coasts		http://gon.stormsmart.org
US Coast Guard, 8th District		www.atlanticarea.uscg.mil/Out-Organization/District-8/
Cleco Corporation (www.cleco.com)	1-800-622-5537	
Energy (www.energylouisiana.com)	1-800-ENTERGY (368-3749)	
Power outages: 1-800-9OUTAGE (968-8243)		
Jeff Davis Electric Co-op (www.jdec.org)	Outage 1-800-256-5332	

COUNTY INFORMATION

FOR EMERGENCIES CALL 911		FOR NON-EMERGENCIES CALL 211	
ACADIA			
Emergency Management	337-783-4357	JEFFERSON DAVIS	337-821-2100
www.apjo.org/emergency-preparedness-homeland-security	337-788-8700	Sheriff	337-824-3850
Sheriff	www.apjo.org		www.jdpsa.org
BEAUREGARD			
Emergency Management	337-460-5442	LAFAYETTE	337-291-5075
http://beauregardparishsheriff.org/emergency-preparedness	337-463-3281	Sheriff	www.lafayettehosp.org/Pages/default.aspx
Sheriff	www.beauregardsheriff.org		337-232-9211
CALCASIEU			
Emergency Management	337-721-3800	ST. LANDRY	337-948-2177
www.ccpj.net/services/emergency-preparedness	337-491-3600	Emergency Management	www.stlandryparish.org/using/emergency-preparedness
Sheriff	www.ccpo.com	Sheriff	337-948-6516
CAMERON			
Emergency Management	337-775-7048	ST. MARTIN	337-394-2800
https://centralcap.louisiana.gov/centralcap/office-of-emergency-preparedness	337-775-5111	Emergency Management	www.stmartinshosp.org
Sheriff	www.cameronso.org	Sheriff	337-394-3071
EVANGELINE			
Emergency Management	337-363-3345	ST. MARY	985-385-2600
www.evangelineparishpolicejury.com/emergency-services.aspx	337-363-2161	Emergency Management	www.stmaryshosp.org
Sheriff	http://www.communitynotification.com/cap_main.php?offic=54801	Sheriff	337-828-1960
IBERIA			
Emergency Management	337-369-4427	VERMILION	337-898-4308
www.iberiaparishgovernment.com/2018-admin/911.asp	337-369-3711	Emergency Management	www.vermilionsparishpolicejury.com/2012DEP/Security.html
Sheriff	www.iberiaso.org	Sheriff	337-893-0871
			https://vpsso.net/

PART 2.6

ELECTRICAL AND POWER ISSUES

By following key safety precautions when dealing with electricity during and after disasters, you can help prevent death, injuries, and property damage. Take care when stepping into a flooded area, and be aware that submerged outlets or electrical cords may energize the water, potentially posing a lethal trap.

In case of an emergency, the power to your house should be turned off through the main breaker switch, circuit breaker panel, or fuse box. In addition, all homes should be equipped with ground fault circuit interrupters (GFCIs). GFCIs are inexpensive electrical outlets that, if installed to existing wiring, are designed to protect people from severe or fatal electric shocks. GFCIs could prevent over two-thirds of electrocutions.³⁷ Because a GFCI detects ground faults, it can also prevent some electrical fires and reduce the severity of others by interrupting the flow of electric current. GFCIs are commonly found in kitchens, bathrooms, laundry rooms, or other places where water and electricity are close together. If you do not have them, consider having them installed by a licensed electrician.

2.6.1 WET ELECTRICAL EQUIPMENT

Do not use electrical appliances that have been wet. Water can damage the motors in electrical appliances, such as furnaces, freezers, refrigerators, washing machines, and dryers. For more information, the National Electrical Manufacturers Association (NEMA) has produced a brochure, *Guidelines for Handling Water Damaged Electrical Equipment*, to provide advice on the safe handling of electrical equipment that has been exposed to water for use by suppliers, installers, inspectors, and users of electrical products. It outlines which items will require complete replacement and which can be reconditioned by a trained professional. The NEMA brochure can be downloaded free of charge at nema.org/Products/Documents/guidelines-handling-water-damaged-elect-equip.pdf.

2.6.2 DOWNED POWER LINES

Downed power lines can still carry an electric current strong enough to cause severe injury or possibly death. These tips can help you avoid injury:³

- Don't touch any downed powerlines or anything in contact with them.
- Move away from the line by shuffling away with small steps, keeping your feet together and on the ground at all times. This will lower your risk for a strong electric shock. Do not touch a person directly or indirectly in contact with a power line. You could become the next victim. Call 9-1-1.
- Do not attempt to use another object such as a broom or stick to move a downed power line or anything in contact with the line. Even nonconductive materials like wood or cloth, if slightly wet, can conduct electricity and electrocute you.
- Be careful not to put your feet near water where a downed power line is located.
- If you are in your car and it is in contact with the downed line, stay in your car. Tell others to stay away from your vehicle.
- If you must leave your car because it is on fire, jump out of the vehicle with both feet together and avoid contact with the car and the ground at the same time. This way you avoid being the path of electricity from the car to the earth.
- **Do not drive over downed lines!**



FIGURE 2-8 - SOURCE: FEMA

2.6.3 ALTERNATE POWER SOURCES



SOURCE: Energy Star

Energy efficient equipment will be especially useful during an emergency when you may be on alternative forms of power with limited supply. For example, a regular 100-watt lamp running off an emergency power station (essentially built around a car battery) may run for two hours. That same emergency station can run a fuel-efficient 23-watt compact fluorescent light for about 8-9 hours with the same light output. As another example, a refrigerator with the EPA's Energy Star label

can run on a fuel-efficient generator for 16 hours on one gallon of gas. Since most refrigerators do not need to run continuously, it may be possible to run the efficient refrigerator on one gallon of gas for one or two days.

Making your house as energy efficient as possible as you replace equipment and appliances at the end of their normal life will save you money during daily life and make life easier during a disaster. For example, if the lights, television, or refrigerator need replacing, consider products with the U.S. Environmental Protection Agency's (EPA) Energy Star label. These products may cost slightly more, but over their lifetime, the energy savings will far outweigh the small initial cost increase.

2.6.4 GENERATORS

Some households may require uninterrupted power because of the critical needs of some family members. For example, family members that are elderly, disabled, or sick may require a respirator, dialysis machine, or other medical equipment. Some medicine such as insulin, which is stored over a month, may need to be refrigerated. For many families, the most important major power requirement is to run a refrigerator or freezer. If your family cannot get by without the refrigerator, or there are other critical power needs for medical or other purposes, then you may want to consider a portable generator.



SOURCE: Deposit Photos

While portable electric generators can provide a good source of power, if improperly installed or operated, they can become deadly. Do not connect generators directly to household wiring. Power from generators can backfeed along power lines and electrocute anyone coming in contact with them, including utility workers making powerline repairs. A qualified, licensed electrician can install your generator directly to your home's breaker box and ensure that it meets local electrical codes.

Most importantly, **never run a generator indoors, in your garage, or near an open window** because of the possibility of carbon monoxide gas accumulation, which cannot be detected by smell. Good ventilation is required. Operate your generator outside away from your home.

Other generator-related tips include:

- Check to ensure you have enough fuel for your generator as part of your pre-storm preparations.
- Keep the generator dry and on firm ground.
- Make sure extension cords used with generators are rated for the load, are free of cuts or worn insulation, and have three-pronged plugs.
- Do not overload the generator. Only run essential appliances at the time you need them. Alternate the electrical supply to appliances if necessary.

In general, when running your refrigerator with a generator, keep the refrigerator and freezer at the coldest setting. Refrigerators may only need to run a few hours a day to preserve food. You should aim to maintain 40 degrees in the refrigerator compartment and 0 degrees in the freezer. Open the refrigerator door as little as possible.

2.6.5 POWER STATIONS

Power stations are found in many hardware stores and may have a radio, flashlight, air compressor, battery jump starter, AC outlet, or DC outlet built around a modified car battery. These units can come in handy during a power outage since they fulfill part of your stock of emergency supplies and provide limited emergency power.



SOURCE: PIXABAY

2.6.6 PORTABLE CHARGERS

Several models of small, portable chargers are available that can be used to charge electronic devices like smartphones, tablets, or laptop computers. It should be noted that during or after an emergency there might be other reasons, despite being charged, that these types of devices do not have a cellular or data/Wi-Fi signal that are beyond your control, such as heavy traffic or a disrupted internet connection. Solar chargers have added the benefit of the ability to recharge once depleted even if power has not yet been restored.

2.6.7 BATTERY CHARGERS

Your car battery can be an important source of DC and AC power with an inverter. To keep the car battery charged, you should consider a battery charger as part of your emergency supplies. The charger only works when there is household power or backup power through a generator, but it can recharge your car battery if it is needed. New units are small and portable and provide a quick charge to a dead battery in only a few minutes and a total charge in a few hours.

2.6.8 INVERTERS

Inverters take the 12-volt DC power from your car battery and convert it to 115-volt AC power that can run small tools and appliances. This can be very important if you need to use power tools in an emergency, and the power is out. The inverter will drain your car battery, so look for inverters that have a low battery shutdown feature to prevent total battery drain. **You should not run an inverter with the car running unless the manufacturer provides specific instructions with safety guidelines.**

PART 2.7

MENTAL AND PHYSICAL HEALTH

Resilience doesn't just apply to building methods. It also applies to your personal resilience. After a disaster, the main focus of disaster victims may not be their mental and physical health. However, dealing with what is left after a hurricane, tornado, or other events can be extremely hard on anyone emotionally, physically, and mentally. The following suggestions will help you be as prepared as you can before an event occurs so you can reduce the strain of a disaster. The less you have to worry about during recovery, the easier it will be to sustain positive mental and physical health.

Physically, you should make sure before and after a disaster that you have everything you and your family need to stay healthy. Necessary over-the-counter and prescription medicines, medical devices, and other health-related items should be part of your disaster kit. Additionally, water and food may be contaminated after a disaster, so be sure to keep yourself updated on where there is known contamination. Staying healthy will help minimize stress during and after a disaster.

Emotionally and mentally, condition your brain to respond properly to a disaster by practicing your disaster plans, knowing where your disaster kits are, what they consist of, and collecting everything you could need after a disaster. This can help you feel more secure during and after a disaster happens. This is one of the best ways to reduce pre-disaster stress and help minimize post-disaster stress.

If you are hit by a disaster, there are many common reactions that people experience. These can really take a toll on you and your family if you are not prepared. Reactions can occur immediately following an event as well as weeks and months after. Some of these reactions include:³⁹

- Disbelief and shock
- Fear and anxiety about the future
- Disorientation, difficulty making decisions or concentrating
- Apathy and emotional numbing
- Nightmares and recurring thoughts about the event
- Irritability and anger
- Sadness and depression
- Feeling powerless
- Changes in eating patterns, loss of appetite or overeating

- Crying for “no apparent reason”
- Headaches, back pains, and stomach problems
- Difficulty sleeping or falling asleep
- Increased use of alcohol and drugs

These reactions and feelings can be hurtful to your recovery process, but there are ways to successfully cope with them after a disaster. You can minimize the impact of these feelings and reactions by doing things like: ⁴⁰

- **Talking about it.** By talking with others about the event, you can relieve stress and realize that others share your feelings.
- **Spending time with friends and family.** If your family lives outside the area, stay in touch by phone. If you have any children, encourage them to share their concerns and feelings about the disaster with you.
- **Taking care of yourself.** Get plenty of rest and exercise, and eat properly. If you smoke or drink coffee, try to limit your intake, since nicotine and caffeine can also add to your stress.
- **Limiting exposure to images of the disaster.** Watching or reading news about the event over and over again will only increase your stress.
- **Finding time for activities you enjoy.** Healthy activities can help you get your mind off the disaster and keep the stress in check.
- **Taking one thing at a time.** For people under stress, an ordinary workload can sometimes seem unbearable. Pick one urgent task and work on it. Once you accomplish that task, choose the next one. “Checking off” tasks will give you a sense of accomplishment and make things feel less overwhelming.
- **Doing something positive.** Give blood, prepare “care packages” for people who have lost relatives or their homes or jobs, or volunteer in a rebuilding effort. Helping other people can give you a sense of purpose in a situation that feels ‘out of your control.’
- **Avoiding drugs and excessive drinking.** Drugs and alcohol may feel helpful in the short term but may actually cause more problems on your road to recovery.
- **Asking for help when you need it.** There are things after a disaster that are out of your control. Asking for help is not a sign of weakness.

DIGITAL TIP:

You can use Substance Abuse and Mental Health Services Administration's (SAMHSA's) Disaster Distress Hotline: 1-800-985-5990 or text TalkWithUs to 66746 if you need help coping with a disaster.

PART 2.8

GUIDANCE FOR USING SOCIAL MEDIA

To be informed before, during, and after a disaster, social media can be a valuable tool. In the recent past, Twitter and Facebook became communication tools after Hurricane Harvey and other disasters. You should follow accounts like:

- Federal Emergency Management Agency (FEMA): @fema @Readygov
- State Emergency Management Departments
- Local police, sheriff, fire, and other first responder organizations
- Local utilities
- Local and national news organizations
- NOAA National Hurricane Center: @NHC_Atlantic
- Local National Weather Service office
- Organizations involved in disasters preparedness and response: @RedCross
- Louisiana Governor's Office of Homeland Security and Emergency Preparedness: @GOHSEP

You can also make sure your family members know how to use social media to their advantage during and after a disaster. Teach them how to search for specific organizations that may be useful for information. Also, teach them how to use Facebook's Safety Check to mark themselves safe after a disaster. Make sure you are using the preferred social channels to contact emergency services. Remember, some organizations may prefer you to call them for help rather than tweet at them.

PART 3

PROTECT AND STRENGTHEN YOUR PROPERTY

Protecting your property and your family goes hand in hand. Your home provides shelter from daily weather conditions, and a stronger home means you will more likely have a home to come back to after you evacuate. Homeowners can take several steps to protect their property and reduce property damage caused by natural disasters. These standards of construction are referred to as mitigation, which is the effort to reduce the risk of loss by lessening the impact of disasters. Knowing your risks, like flooding and hurricanes, and then mitigating for them can keep natural hazards from having catastrophic impacts. Whether reroofing, elevating, building new or remodeling, following the recommendations in this chapter will greatly improve the chances your home will survive.⁴¹

The ability for your house to survive a hazard event is limited by a number of factors, some of which are listed below:

- 1) Your location
- 2) The severity of the hazard event
- 3) How well your home was built
- 4) How your home has been maintained
- 5) What steps you take to strengthen your home

PART 3.1

BEST STANDARDS FOR BUILDING BETTER

Research and data have informed the best practices to strengthen your home. Building codes are the minimum standard and homes can be built above what code requires using “beyond code” standards and building methods. Building this way allows homes to better withstand the hazards they will face and allows homeowners to recover more quickly.

3.1.1 UNDERSTANDING BUILDING CODES

When and how your home is built can make a big difference in how it will perform during severe weather. Many cities and jurisdictions adopt and enforce building codes, but some do not. You need to know what codes are now or were in place, if any, when you buy, build a new home, re-roof or update your home, and in case you need to rebuild after a disaster. Additionally, building to newer building codes can reduce claim frequency by 60% and claim severity by 42%.⁴² Find out which codes are in place in your area by contacting your local building code office or planning and zoning department.

But what is a building code? According to FEMA, “Building codes are sets of regulations governing the design, construction, alteration, and maintenance of structures. They specify the minimum requirements to adequately safeguard the health, safety, and welfare of building occupants”.⁶⁴

Rather than create and maintain their own codes, most states and local jurisdictions adopt the model building codes maintained by the International Code Council (ICC). The ICC family of International Codes include:

- **International Building Code (IBC):** Applies to almost all types of new buildings
- **International Residential Code (IRC):** Applies to a new one- and two-family dwellings and townhouses of not more than three stories in height
- **International Existing Building Code (IEBC):** Applies to the alteration, repair, addition, or change in occupancy of existing structures

If your city, jurisdiction, or municipality enforces building codes, then they typically adopt them every three to six years to provide a level of life-safety protection and to provide the local building industry a level of consistency. Building codes are intended for life safety, not property protection, or ensuring your property is there after the next big storm. While you must meet the minimum code requirements in your area, you can exceed minimum building standards when remodeling, re-roofing, or building new.



FIGURE 3-1 - SOURCE: FEMA

3.1.2 FORTIFIED HOME™

For homeowners who want a tested and fairly straightforward way to strengthen their home using “beyond code” standards, we recommend the FORTIFIED Home™ program. FORTIFIED is a nationally recognized building standard based on more than 20 years of scientific research and real-world testing by the Insurance Institute for Business and Home Safety (IBHS). The program can be used when building a new home, reroofing, or updating an existing home. FORTIFIED delivers superior performance during severe weather (such as hurricanes, strong thunderstorms, and lower-level tornadoes) and gives you the peace of mind that comes from knowing your home has been strengthened to offer additional disaster protection.

FORTIFIED gives you the option to strengthen your home and has a third-party verification requirement that assures your home is built, reroofed, or retrofitted to meet the program’s stringent requirements. A FORTIFIED Designation may also qualify a homeowner for insurance discounts in many coastal states, as well as in some inland areas.

Studies have also shown that FORTIFIED can increase home value.⁴³ You can find the discounts at smarthomeamerica.org/about-insurance/insurance-discounts-and-savings or by contacting your insurance agent.



FIGURE 3-2 - SOURCE: IBHS

3.1.3 DESIGN FOR YOUR RISK

When building or retrofitting your home, think about and build for all the risks your home is likely to face, such as flooding and high winds. Regardless of where you live, getting your roof right by building or reroofing to resist damage from high winds is affordable and usually an easy upgrade to make. High-wind design and retrofitting start at the roof and work down, ideally into the foundation using a continuous load path. Flood design and retrofitting are the opposite; they are bottom-up processes. Elevating a home above the floodwater or preventing damage from flood water using floodproofing techniques are common approaches.

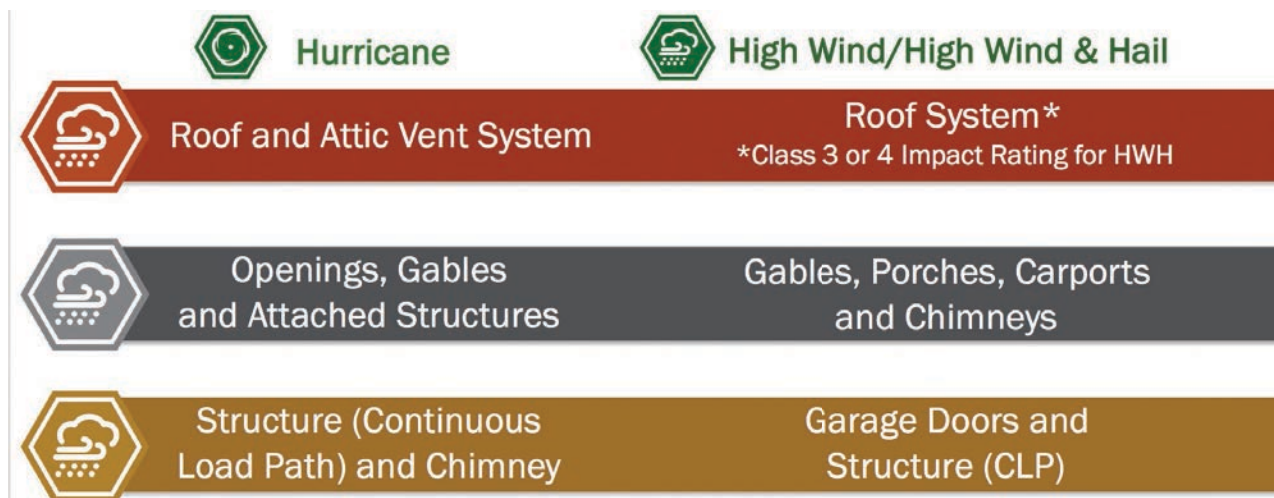

FIGURE 3-3 - SOURCE: IBHS

PART 3.2

RETROFITTING AN EXISTING HOME

Most of us live in existing homes, and when updating or retrofitting an existing home, you should consult with a licensed structural engineer or architect. They can go over the costs and benefits of installing the following common retrofit options:

- Roof-to-wall and wall-to-foundation connections
- Hurricane clips only without additional foundation connection
- Stronger connectors than those required in the current building code

3.2.1 ROOF-TO-WALL CONNECTION

Concepts regarding the roof-to-wall connection are covered in Part 3.5. A properly selected hurricane clip is required for each rafter. In addition, the rafters at gable end eaves should be strapped down. Exterior beams supported by corner columns also require strap down. For houses with post-and-beam roof construction, fasteners should be for roof rafter to roof beams, top of post to horizontal ridge beam, and post to beam connections located at the exterior wall.

You should seek a licensed structural engineer or architect to select the proper connectors and nails for your house. You can then do either all or part of this work yourself, or hire a licensed contractor.



FIGURE 3-4 - SOURCE: U.S. AIR FORCE/
JERRY SASLAV

3.2.2 REROOFING

The wind from a hurricane attacks any weaknesses in the roof. Once a weakness is exposed, adjacent areas can be more easily damaged and peeled away.

Thus, strengthening the roof is important and should be considered for new construction and when a roof is replaced after its expected life. The roofing option involves installing a continuous structural sheathing (for example, plywood where it is missing or damaged). Additional fasteners and a secondary waterproof membrane are required. You should seek a licensed roofing contractor to do this work.

As a side note, there are small things you can do to strengthen the roof even if it is relatively new. For example, if you climb in your attic and see that nails that are supposed to attach the plywood sheathing to the truss have missed the truss, then you have found what could be a structural weakness. The joint can be strengthened with a wood epoxy or the application of closed cell foam insulation. Refer to Figure 3-8 to see what spray foam looks like.

3.2.3 FOUNDATION UPLIFT STRENGTHENING RESTRAINT

Strengthening the foundation to resist uplift will generally require the removal of interior finishes. The installation of uplift connections should be planned by a licensed structural engineer only after they have inspected the home to understand the materials and methods used to construct the home and have calculated the uplift requirements.

PART 3.3

STRENGTHENING THE ROOF SYSTEM

The roof is your home's first line of defense against severe weather and is often one of the most vulnerable systems of the home. Roofs are highly exposed to wind, rain, and hail and have the risk of failing in any given weather event. Roof damage is common, even in lower-level hurricanes and other high-wind events, often leading to significant property damage inside the home when the roof covering is lost, allowing water intrusion. Strengthening the roof is one of the most important and often cost-effective ways to reduce damage from severe weather events. The best opportunities for strengthening the roof are when building new or reroofing, but there are techniques to strengthen roofs on existing homes that do not require reroofing.

3.3.1 ROOFING ASSEMBLY

Several layers of materials add to the structural strength of a roof and keep water out from the interior of the home. After the roof decking goes on, the next layer on top is called an underlayment and keeps moisture from the decking. Felt material is the most common underlayment that is paired with shingles. Synthetic roof underlayment recently began replacing traditional roofing felt.

What you see from the outside of a home is the roof covering, typically in the form of shingles, metal, or tile. It protects your home from weather, heat, rain, hail, and wind during its lifespan and must be replaced at least once within the lifetime of your mortgage. Shingle roofs can last up to 20 or more years depending on type location, sun exposure, and maintenance. Metal, slate, or tile roofs can last much longer, usually 40+ years.⁴⁴

It is important to ensure your roof covering is installed properly according to where you live based on wind speeds, building codes, and the roof covering manufacturer specifications. To be sure your roof is properly installed, only hire a licensed, trained, and insured roofer or contractor, preferably with credentials and references.

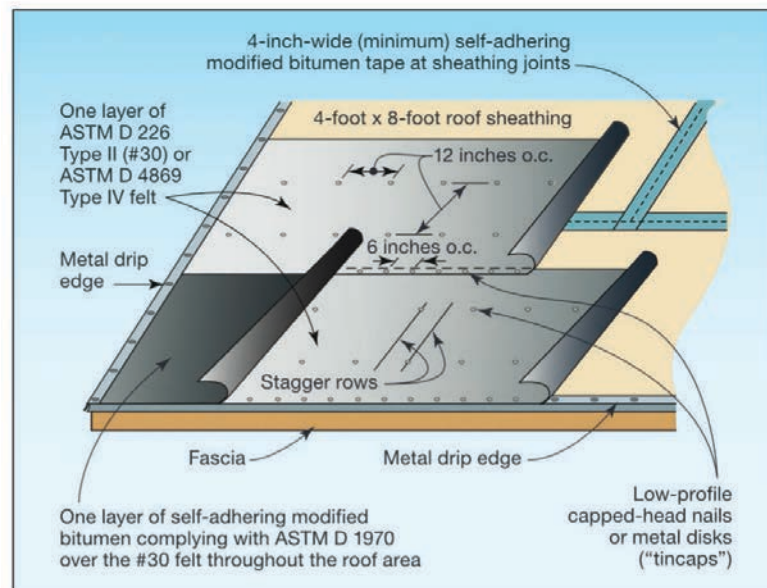

FIGURE 3-5- SOURCE: FEMA

FIGURE 3-6 - SOURCE: IBHS



Roof Deck - This is the wood paneling or boards (sheathing) that are attached to the roof structure (trusses or rafters). Once attached, the roof framing becomes stronger and rigid, so it transfers wind or weight loads to the exterior walls.

The roof deck is typically plywood, oriented strand board (OSB), or, in case of many older homes, individually sawn wooden boards (often called "one by's," 1x's). The minimum recommended roof deck thickness is 7/16", but it is common to find 1/2" roof decking. Anything thinner than 7/16" can be too weak to protect a home from damage during a severe storm or hurricane and is not allowed under the FORTIFIED program.

Sealed Roof Deck - Sealing the roof deck is not typically required by code but is one of the most important components of the FORTIFIED program. A properly sealed roof deck is one that seals seams or gaps between pieces of the roof decking, so that water cannot flow into the attic if the roof cover is lost. This is not a common practice in most areas. However, some cities and counties have started requiring this added protection. Check with your state and local building code requirements to understand the minimum requirements for underlayment.

The best time to seal a roof is when re-roofing or when building a new home. When re-roofing, it is recommended that the roof covering be removed to check overall roof condition, to make any necessary repairs, to re-nail the roof deck, and to apply the sealed roof deck properly. There are three ways to achieve a sealed roof deck when building new or re-roofing:

- 1) Install a 4-inch-wide modified bitumen or acrylic roofing flashing tape over all roof deck seams, then cover with a 30# felt or equivalent synthetic underlayment (Check out this Information on choosing the right tape: smarthomeamerica.org/resources/sealing-the-roof-deck-choosing-the-right-tape).
- 2) Install a self-adhered (peel-and-stick) membrane over entire roof deck.
- 3) Install a double layer of 30# felt.

See FORTIFIED Home guidance for proper installation of these sealed roof deck methods.



FIGURE 3-7 - SOURCE: IBHS

If you have an existing home that is not in need of a new roof and the entire underside of your roof deck is accessible from your attic, it may be possible to seal your roof deck by applying a closed cell foam (Figure 3-8) from



FIGURE 3-8 - SOURCE: IBHS

the inside along the seams and rafters or trusses. This should only be done by a professional installer that is trained in this specific application of foam.

Roof Deck Attachment

- How a roof deck is secured to the structure of a



FIGURE 3-9 - SOURCE: IBHS

home's roof, the trusses or joists, is called its attachment. Nails, screws, and staples, collectively called fasteners, are common ways to attach a roof deck to the roof's structure. Typically, roof decking is nailed with "8d smooth" nails. Stapling is the weakest attachment type, while what are

called ring shank nails, can double the strength of a roof's attachment compared to 8d smooth nails. The distance between nails is also important to maximize their holding power. The farther apart the nails are, the less effective they are. Nailing should be spaced according to the building code to resist the design wind loads and pressure on the roof.

The stronger the roof deck attachment, the better a home's chance of withstanding a major hurricane or high winds and avoiding damage during storms. Whereas, a weaker roof deck attachment is more likely to be peeled off or damaged. Building codes typically require the appropriate attachment types according to the probable risk in your area. Reroofing or building new are opportune times to increase the strength of your home's roof deck attachment and reduce your risk of damage in a cost-effective way.

Drip Edge - Drip edge or drip eave (Figure 3-10) is important flashing at the edge of the roof that helps channel water away from the roof facade, reducing the chance of rotting the roof deck and fascia. Drip edge may not be installed in many existing homes and even in some areas for new construction but is required by the FORTIFIED program.

Roof Underlayment - This is installed between your shingles and your roof deck and is an added layer of protection from severe weather. It is primarily designed to act as a moisture barrier. (Figure 3-11)

Underlayment has historically been known as “tar paper” or roofing felt, but there are other options to choose from, including what’s called synthetic underlayment and the fully adhered membrane, or “peel-and-stick,” which also



FIGURE 3-11 - SOURCE: IBHS

achieves the sealed roof deck. The FORTIFIED program requires certain criteria for each type of underlayment. For more information, see the FORTIFIED roofing checklist here: smarthomeamerica.org/resources/fortified-re-roofing-checklist.

Roof Cover - The roof cover is the final layer of the roof system, most commonly consisting of shingles, metal or tile. When selecting a roof cover, it is important to know the building code and wind speed requirements for your area and that your roof cover will withstand the highest possible winds to which your home might be susceptible.

Shingles are the most common and inexpensive type of roof cover. It is important that shingles be “high wind” rated and properly installed, usually meaning 6 nails per shingle. Ask about the shingle rating during the purchase and bidding process. Look for a rating of Class G, H, or F. Roof covers other than shingles (metal, tile, low-sloped roofs, wood shakes/shingles) should be rated and installed for the site-specific wind speed and design pressures. Information on the wind speed for your home’s location should be available at your local building department.



FIGURE 3-10 - SOURCE: ALABAMA Homeowner's Handbook

PREPAREDNESS TIP:
Be sure your roof cover is high wind rated AND properly installed.

Roof Slope - Roof slope is the incline of the roof expressed as a ratio of the vertical rise to the horizontal run. This ratio is always expressed as inches per foot. A roof that rises 4 inches for every 1 foot, or 12 inches, of run is said to have a “4 in 12” slope. If the rise is 6 inches, then the roof slope is “6 in 12.” The slope can also be expressed as a ratio. For example, a “4 in 12” slope can be expressed as the ratio of 4:12.

Common roof slope terms are flat, low slope, and steep slope. Building codes and product manufacturers dictate the type of roofing materials needed and how they are installed based in part on the slope of a roof. Common roof slopes are between 4:12 and 9:12. When a roof's slope exceeds 9:12, it is commonly called a steep sloped roof, and code or manufactures may require special installation techniques or materials. For guidance on low-sloped roofing, see the FORTIFIED Technical Bulletin here: disastersafety.org/fortified/resources/#standards.

Ridges - These are the high points of a roof, where the roofing comes to a peak. Often, roof ridges are used to add attic ventilation using ridge vents. Ridge vents can be an access point for wind-driven rain unless a high wind rated vent is used and properly installed.



FIGURE 3-12 - SOURCE: IBHS



FIGURE 3-13 - SOURCE: IBHS

Valleys - Opposite of a ridge, valleys are formed where two inward sloping roof lines meet. These areas require additional sealing to keep water from entering the home. This sealing is often done using thin metal plating under the roof covering or by adding additional fully adhered roofing membrane or underlayment, often known as “ice and water shield” or peel-and-stick. Peel-and-stick can also be used over an entire roof deck to create a fully sealed roof deck.

Roof Venting - Venting allows your home to breathe, maintain comfortable interior temperatures, but also must keep wind-driven rain and pests out of your home and attic. There are many ways to vent an attic. The proper approach, number, and size of vents are critical to ensuring your home performs well during storms. It also keeps your home comfortable while keeping heating and cooling costs as low as possible. It is important to properly install Miami Dade approved or TAS 100A rated roof and soffit venting product. Please see the glossary for a list of the different types of venting systems.

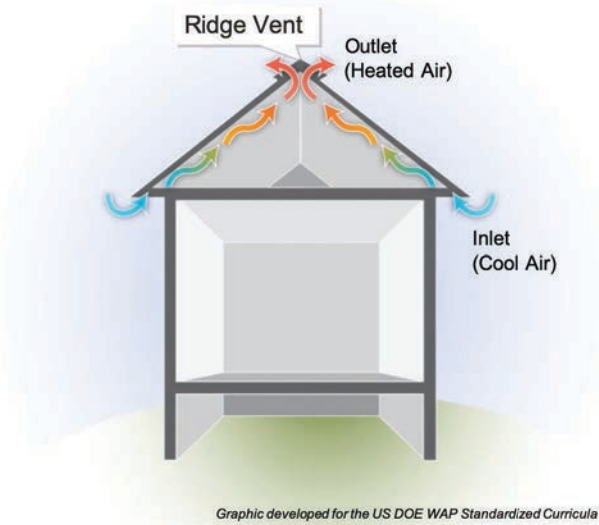

FIGURE 3-14 - SOURCE: US DEPARTMENT OF ENERGY

3.3.2 STRENGTHENING GABLES AND SOFFITS

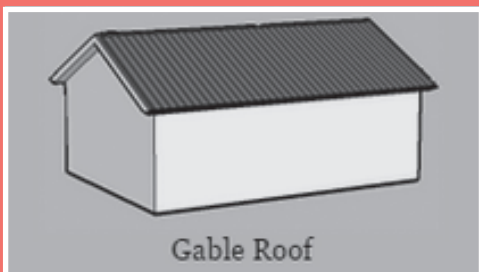

FIGURE 3-15

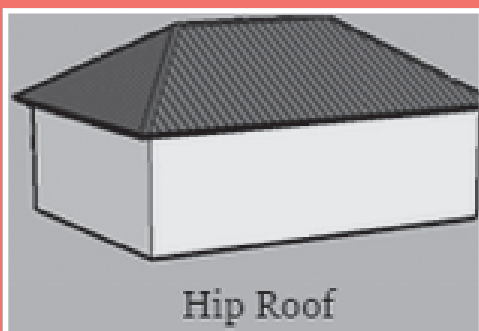

FIGURE 3-16

Roof Framing and Bracing

There are two common types of roof framing for a home. Gable-end roofs have two flat ends that are A-shaped and two sloped sides (Figure 3-15). Hip roofs have all four sides of the roof sloping up towards the center of the roof (Figure 3-16). This inward sloping design makes hip-style roofs inherently more sturdy than gable style roofs. During a hurricane, gable-end roofs are vulnerable to intense wind pressure on their flat ends. If one of these ends collapses, it can allow wind-driven rain to enter through the attic and allow wind pressure to blow off the roof decking, potentially causing catastrophic damage to a home.

Strengthening a gable-end roof is recommended and can be done by adding lateral and diagonal bracing. Figure 3-17 demonstrates gable-end bracing. For lateral bracing, a system of metal connectors and 2x4s are attached to the gable-end wall framing and braced against the next four to five adjacent trusses of the roof. Each vertical member of the gable-end wall should be braced using this method, and additional vertical braces behind the gable-end wall may be necessary to achieve appropriate bracing. Diagonal bracing runs from the top of the gable-end to the bottom of the fourth truss and from the top of the fourth truss to the bottom of the gable-end.



FIGURE 3-17 - SOURCE: FEMA

In this application of lateral bracing, the 2 x 4's are 18 inches from the ridge and connect to horizontal members that attach the opposing trusses. Not all roofs will have the horizontal members. The 2 x 4's are connected with two #14 3-inch screws (A) and overlap over two trusses (A and B). The end is connected to the gable end with an angle or L bracket (C).

Soffits and Eaves - When a roof overhangs the exterior walls of a home, it creates eaves, which are typically the ends of the roof's structure, sometimes called rafters. Eaves can be used to help vent the home's attic or protect the sides of a home from rain. A home can have no eaves, or they can range from 4 to 24 inches or more in depth. Soffits cover exposed eaves and protect the interior of a home from water intrusion and wind. Many different materials can be used for soffits. More durable soffit materials include rigid materials, such as plywood or fiber cement, but it is very common to find more flexible materials, such as vinyl or aluminum.

PRO TIP:

Look at the "Don't Goof When You Reroof" campaign to see how to improve the strength of your roof the right way.

DontGoof.org

Vinyl or aluminum soffits can be a weak link in a home's protection when they are 12" in depth or more and not reinforced or braced. Without reinforcement, these types of soffits can fail in high winds by being blown off or pushed into the attic space, allowing wind and water to get into a home. Bracing unreinforced vinyl or aluminum soffits can be done easily in many cases and by using several different approaches.



FIGURE 3-18 - SOURCE: iSTOCK

PART 3.4

SHUTTERS AND OTHER PROTECTIVE BARRIERS

Keeping out wind and water is critical to the survival of your home during severe weather. Protective barriers, such as shutters and impact-rated windows and doors should be installed well in advance of a storm. Installing impact-rated windows and doors are also permanent protection. The FORTIFIED program requires shutters or impact ratings on all



FIGURE 3-19 - SOURCE: ROLL-A-WAY/QMI

openings to meet specific testing standards in any location with wind speeds greater than 130 mph. However, many current codes allow the use of plywood. It is important to check with your local building code department for requirements specific to your area. If plywood is used, it must be properly fastened, and installation should not be attempted once the wind begins to blow. **Hanging plywood in high winds is extremely dangerous.**

Many homeowners think using window and opening protection is to simply protect the glass from breaking, but that is only partially true. Shutters and even impact windows can, and do, bend or break. Once a window breaks, the inside of your home is exposed to both wind and wind-driven rain. Wind can cause a home to pressurize and experience vast damage, such as losing part or all of the roof, walls blowing out, or other interior damage.

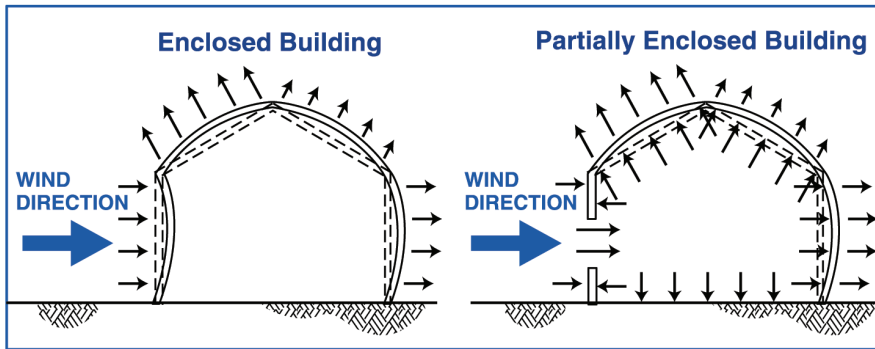

FIGURE 3-20 - SOURCE: FEMA

Finally, **DO NOT tape your windows**, it is a myth that this will prevent them from breaking when impacted by windborne debris. This method provides no protection and wastes valuable time that should be used for other storm preparation tasks.

Benefits of Protective Barriers for Openings

When installed properly, protective barriers can:

- Keep wind pressure from building up inside, which often leads to loss of the roof.
- Reduce the chance glass will break.
- Reduce the chance of wind-driven rain soaking the interior.
- Help ensure continued habitability of a home.

Protective Barrier Options

Protective barriers may be temporary or permanent. When possible, install permanent protection, such as impact-rated windows and doors or roll-down shutters. For temporary protection, permanent fasteners should be installed on the building long before storm warnings, so shutter panels can be put in place quickly when needed. A wide range of products are available to fit your budget, including some do-it-yourself options, which are about 50% less per square foot than options requiring professional installation. Aesthetics may also be important when determining the right protection. Some permanent barriers have a greater impact on a building's appearance, which should be taken into

consideration. However, there are also options that do not affect appearance, like impact-resistant glazing. Many homeowners choose a mixture of protective measures to meet their individual needs, budgets, and tastes.

Plywood Shutters

One of the most common options for window protection is regular plywood. Plywood is available at almost every hardware store and offers good protection if properly installed. Furthermore, the material cost is the least expensive of any of the other options discussed.

If budget for protective barriers is a hurdle, then it is recommended to buy and prepare plywood with the recommended thickness of at least 5/8" well in advance of hurricane season. Once you make your customized system, you can quickly install them before evacuating for a hurricane.

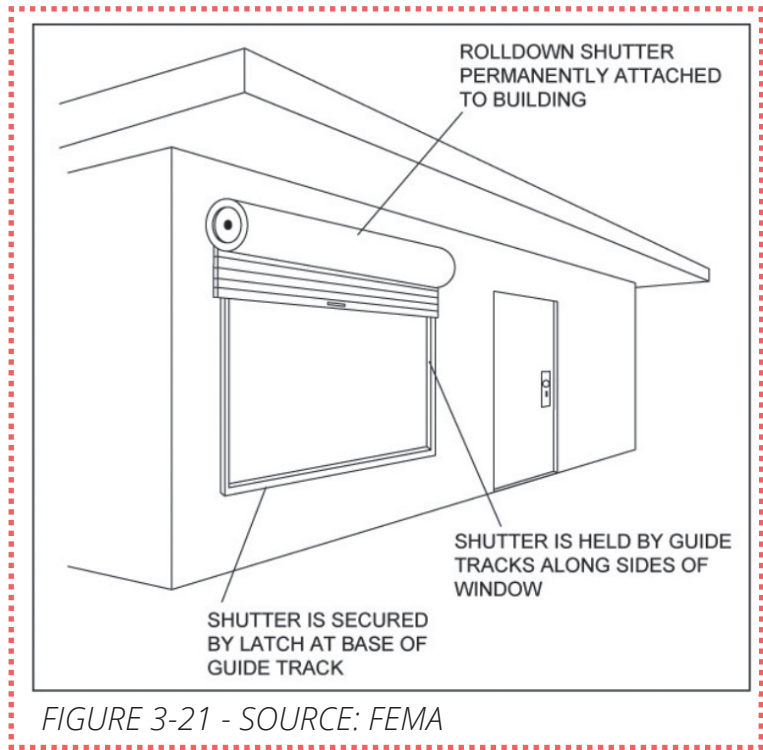

FIGURE 3-21 - SOURCE: FEMA

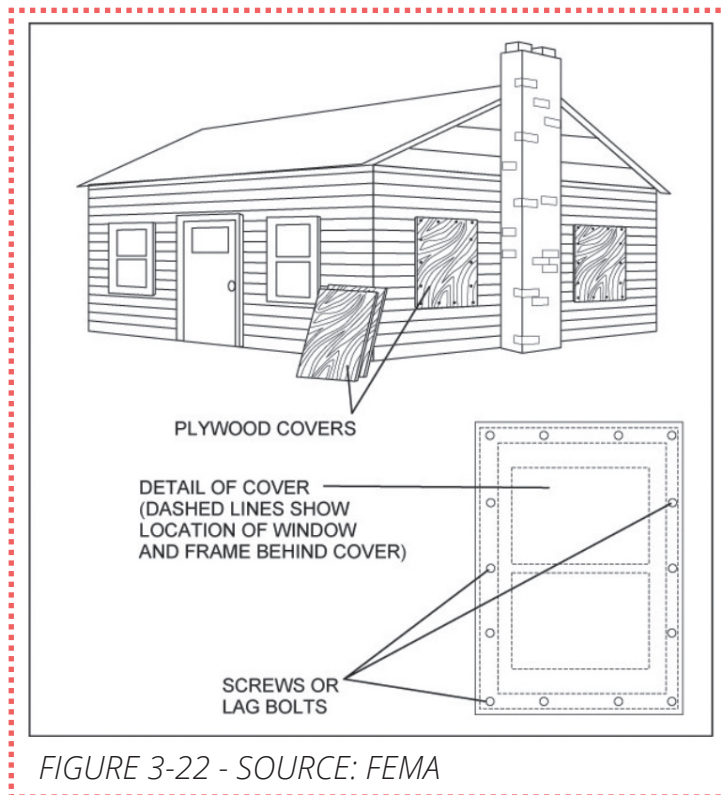

FIGURE 3-22 - SOURCE: FEMA

The disadvantages of plywood are that it can rot or warp if stored in a wet or warm area. In addition, plywood shutters are relatively heavy. You will need two people who can lift 30-40 pounds to help with the preparation and deployment of these shutters.

Please refer to this installation resource: flash.org/pdf/060111_EmergencyBoardUp.pdf.

Ratings and Labels

Choose products with the proper approval rating for impact resistance based on your local building code requirements or FORTIFIED Home™ recommendations. The label “hurricane tested” alone is not adequate. The most common impact rating for opening protection is commonly known as the “Large Missile Impact Test,” meaning that it has withstood the impact of a 9-pound 2x4 lumber board fired at the shutter at 30+ miles per hour followed by cyclic wind load testing. Look for these ratings or labels, and if you have questions contact your local building code department:

- ASTM E1886 and E1996
- AAMA 506



FIGURE 3-23 - SOURCE: IBHS

Consider These Questions When Determining the Appropriate Opening Protection:

- Am I a year-round resident?
- Am I capable of installing temporary shutters by myself?
- Do I have the tools needed to install temporary shutters (ladders, plywood, screws, etc.)?
- Do I have a single-story home?
- Will the look of permanent products, such as roll down or accordion-style shutters, negatively impact the appeal of my home? (These often have visible storage “boxes” on a home’s exterior when not in use.)

If the answer to any of these questions is no, installing permanent shutters or impact-rated windows and doors is highly recommended.

Protective Barriers Resources

Learn more using the “IBHS Opening Protection Selection Guide” at smarthomeamerica.org/resources/opening-protection-guide to compare all the types of opening protection and choose what is right for you.

The International Hurricane Protection Association (a trade association group of manufacturers, contractors, and other industry professionals) has several tips regarding the selection of projects, installing contractors, and other useful information on its website: inthpa.com. Regardless of the system you choose, installation is key. We encourage you to consult with a competent, licensed, and insured contractor specializing in supplying and installing these systems.

3.4.1 GARAGE AND ENTRY DOORS

One of the most important yet frequently overlooked openings in a home that also requires protection is its doors — both the garage door and entry doors. Most major suppliers of both types of doors offer products that meet both wind and impact resistance requirements.

The garage door is often a significant weakness during a hurricane due to its large area and the forces to which it is subject.⁴⁵ Its failure can cause extensive damage. Garage door options include replacement with a stronger door, horizontal bracing, vertical bracing, or other types of bracing kits. For many garage doors, vertical bracing is a popular and reasonably priced option.

The FORTIFIED program requires that garage doors without glazing (windows) should, at the very least, be pressure rated for the location of your home. These stronger door assemblies should come with more brackets to fasten the door to its frame. Garage doors are available with impact ratings as well. If a garage door does have windows, it is important that the door be impact rated or be protected by a tested shutter system. Often, replacement of a non-rated door with one of these newer types is cost-effective when compared to the cost of providing protection for the door.

Double-entry doors, such as French doors, should have slide bolts at the top header and bottom threshold of the inactive door, a deadbolt with at least 1-inch throw length between each door, and three hinges attaching the door to the frame. Single-entry doors should have three hinges and a bolt long enough that it goes into the 2x4 framing of the door. Non-impacted rated double-entry doors should still be covered by a tested shutter system or plywood.

As with impact-resistant windows and doors, any replacement of a door with a stronger or impact-resistant garage or entry door should be done by a qualified, licensed, and insured professional.



FIGURE 3-24 - SOURCE: IBHS

3.4.2 OPENING PROTECTION TO AVOID

Window film is an aftermarket product used to enhance glass breakage characteristics and is commonly known as security window film. Such products are often touted as “hurricane film” or similar – claims that cannot be substantiated by testing. Application of any of these window films to existing windows does not constitute adequate opening protection, does not meet the appropriate impact testing standards, and should not be considered for use as opening protection. Additionally, for example, the State of Florida has ruled that window film does not meet the standards for hurricane protection and may not be sold or marketed as such. For more information, visit the website of the International Window Film Association (IWFA): iwfa.com.

Above all, do not use tape as an opening protection measure!

PART 3.5

CONTINUOUS LOAD PATH, DESIGN PRESSURE, AND CHIMNEY

3.5.1 CONTINUOUS LOAD PATH CONNECTIONS

All homes have some connection from the roof to the foundation; otherwise, they would fall apart. The continuous connection from the roof to the foundation is often called a “load path” and is analogous to a chain — it is only as strong as the weakest link. In response to recent hurricane damages, much stronger connections are now required to protect against hurricane winds. New homes are designed with continuous load path connections; older homes may need to be retrofitted to add load path components.

Framing and creating the structure of a home can be done with many types of materials, like wood, concrete, and steel framing. New technologies and methods have also emerged and are being used, such as insulated concrete forms (ICF), Structural Insulated Panels (SIPs), and even modular homes where the walls and other structural components are built off-site, shipped, then assembled on the lot. There are even new “advanced framing” techniques to increase energy efficiency and reduce the amount of materials used while retaining the strength of a structure. Each of these has advantages and disadvantages, but when building a new home using any of

these systems, an engineer should always be involved in the design to assure that the appropriate connections and load path are specified for the specific wind speeds and wind loads based on where the home is located.

Most homes are built using wood frame construction, with the walls, floors, ceilings, and roof structure made of wood. Building codes outline how a home

should be built based on its location and the materials used. The specifics of the continuous load path connection are illustrated in Figure 3-25. The roof is tied to the wall typically

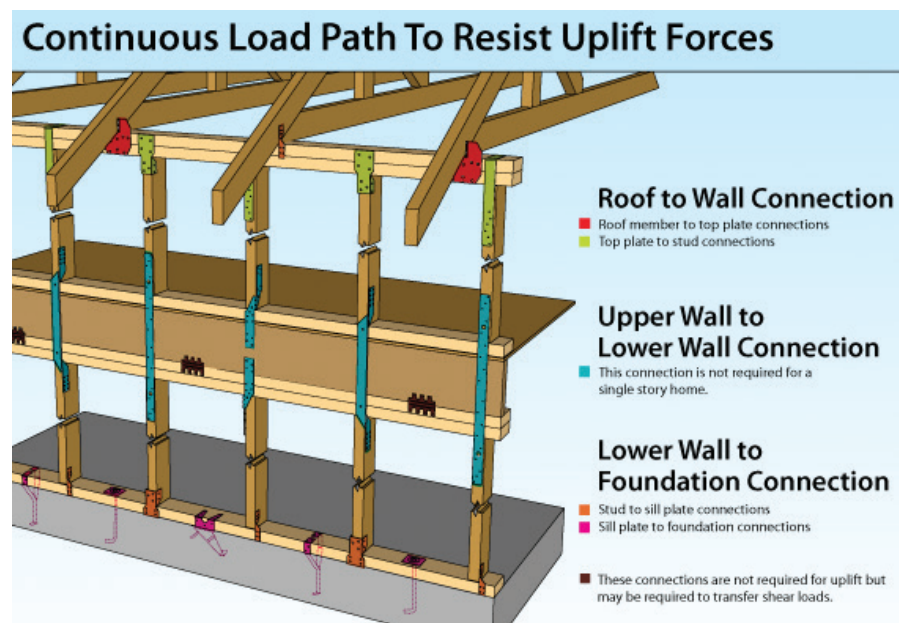

FIGURE 3-25 - SOURCE: IBHS

with hurricane clips and plate ties. The wall of a higher story is tied to a lower story with straps. The walls are tied to the foundation with plate ties and anchors. There are a wide variety of clips, ties, and anchors available for all these connections, and it is critical that an engineer specify which are appropriate for each location in order for them to work properly.

The weakest link for many homes is the roof-to-wall connection. The hurricane clip (aka hurricane tie) was created to improve this connection. There are several types of hurricane clips; which one should be used on your home depends on the design and the load of the home. A properly selected hurricane clip is required for each truss or rafter.

For older houses, it is possible to add load path connections. Each home is different, but in general, it will be easier and less expensive to put in hurricane clips than to add the foundation connections. Hurricane clips help to keep your roof from blowing off during a hurricane or high winds. Check with a licensed professional or structural engineer or architect to determine what is feasible for your home. You can then determine if you can do the retrofitting yourself or if you will need to hire a licensed contractor.

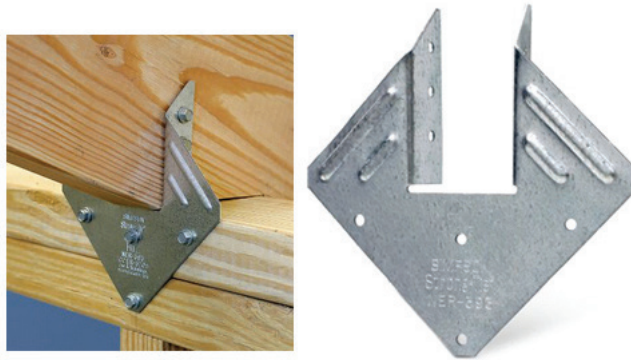

FIGURE 3-26 - SOURCE: SIMPSON STRONG-TIE

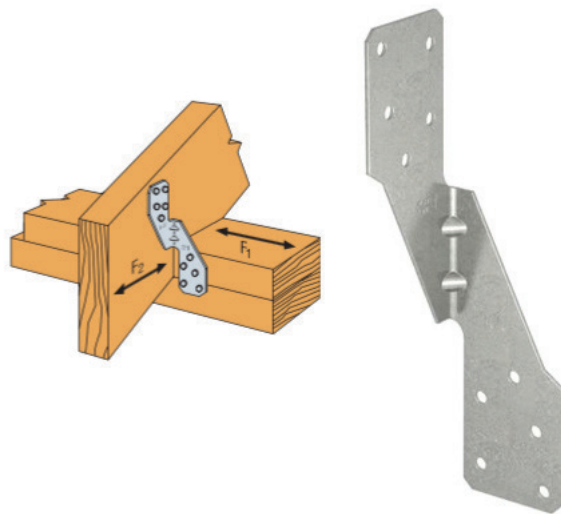

FIGURE 3-27 - SOURCE: SIMPSON STRONG-TIE

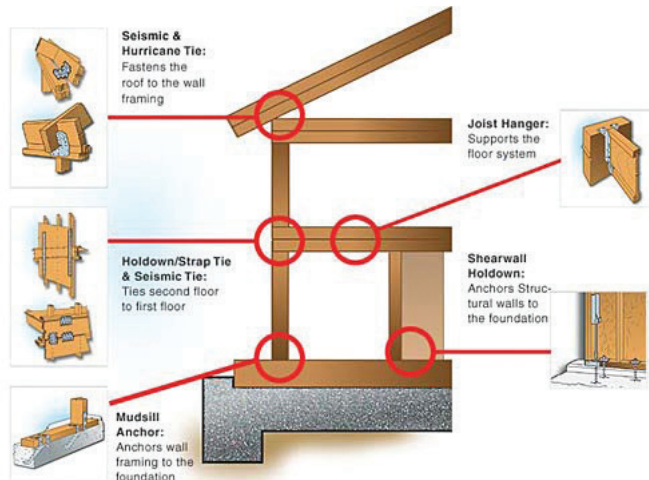

FIGURE 3-28 - SOURCE: SIMPSON STRONG-TIE

3.5.2 WINDOW AND DOOR DESIGN PRESSURE

When an engineer is designing a load path, he or she is taking into account the ways that wind and other pressures affect all parts of and materials in a home. The walls, foundation, and roof, however, are not the only parts of a home where pressure must be taken into account. Windows and doors are also designed to withstand specific amounts of pressure and are rated using a Design Pressure rating (DP rating). This rating takes into account the entire window or door assembly, not just the components like glass, sash, or frame of the window. These DP ratings are set by local building codes and keep these components from breaking or failing under normal circumstances. It is important to note that because of the way wind flows around and acts on a home's surface, windows or doors near the corners of a home experience more pressure than those closer to the center of walls.

When purchasing doors and windows, most will come with labels showing the design pressure. It is nearly impossible to tell the design pressure of openings in existing or older homes. However, if you are replacing openings or building a new home, you should purchase those with design pressure ratings for the location of your home.

Design pressure is different from impact rating. Impact rated doors and windows keep debris from penetrating the opening but does not protect the window from the wind pressure. To assure your windows and doors will keep wind and water out of your home in a severe weather event, you should consider both design pressure rating and impact rating.

3.5.3 CHIMNEYS

Chimneys that have wood framing around a chimney flue can also be particularly vulnerable to severe wind events. It is important that when an engineer is designing the load path and specifying the opening design pressure that they also specify framing and hurricane tie connections for the framing of the chimney. This is very difficult to achieve for an existing home, but can easily be done when designing and building a new home.

PART 3.6

FOUNDATION

A building's foundation is arguably its most important structural element. It must support the building above it and all the loads that are exerted on it. It must resist weathering, decay, and corrosion (with little or no maintenance) to remain viable for the entire life of the building. Because of the many factors involved in determining the loads on a foundation and the best type for your location, it is important to involve a professional or structural engineer in foundation design for new construction.

The foundation a home needs, or has, depends on several factors:

- **The load capacity.** Some foundations are meant to hold a certain amount of weight. Exceeding that load-bearing capacity can result in some very unfortunate results, like complete foundation and home failure or collapse.
- **Groundwater.** If a home's foundation is over-exposed to groundwater, it can weaken it. Foundations should be built in an area with good drainage; in some cases, this can simply mean on top of a hill. In other instances, this means using gravel, grading, or sloping the area around a home to drain water away. Other types of foundations may lift a home off the ground. However, some foundations cannot be used in areas where the ground remains too saturated.
- **Climate and risks.** Different climate zones and local risks determine the type of foundation a home will need. A home in a high-risk flood zone will have a different foundation (e.g., pier and beam) versus one that is not (e.g., concrete slab). The same goes for areas with extreme temperature ranges. Places that freeze, areas with heavy rainfall, or that may flood require different foundations and materials.

There are three common closed foundation types: slab, basement, and crawlspace. Additional options include a stem wall. These are becoming popular choices for many reasons, and we recommend homeowners consider them depending on their location and the hazards to which they are exposed. There are variations of each type of foundation type you can talk about with your contractor, engineer, or inspector.

The primary open foundation practice in coastal high-risk flood zone areas is an elevated home because it allows the home to sit above the base flood elevation (BFE).

They typically have a wood-frame foundation that is secured atop concrete columns or wooden piles (often called stilts), which are poured or driven into the ground based on the building code requirements. Generally, the deeper the columns or piles, the more secure the home will be.

In the Special Flood Hazard Area, elevated homes may have “breakaway” components beneath them (we recommend this approach regardless), such as staircases, storage areas, etc. When flooded, these breakaway elements are designed to come off the structure, leaving the main, elevated home intact. Many areas have building codes and flood ordinances that do not allow permanent fixtures or rooms on the ground level in areas where homes must be elevated. This is because the risk of flooding or storm surge is too great. If you live in a special hazard flood area, using breakaway walls may decrease your flood insurance premium costs, except in an X Zone, in which premiums may increase with any structure below the BFE. Please double-check the building standards in your area and contact your insurer.

Refer to the glossary for definitions of each type of foundation.

PART 3.7

FLOOD PREVENTION

Protecting your property from flooding can involve a variety of actions, from inspecting and maintaining the building to installing protective devices. Most of these actions, especially those that affect the structure of your building or their utility systems, should be carried out by qualified maintenance staff or professional licensed contractors. The most important information to know about your home when considering flood prevention techniques is the BFE shown on the Flood Insurance Rate Map (FIRM) for your community. Minimum elevation requirements can differ by community and is reflected through local codes and ordinances.

Based on the age of your building and the cost of the mitigation, your local floodplain manager can provide you guidance on whether your home needs to meet any minimum elevation requirements. These minimum elevation requirements are usually referenced off the BFE but can often require 1 or 2 feet above the BFE as a minimum elevation requirement (known as “freeboard”). Flood insurance premiums are also significantly

higher when a home is below the BFE and drop for every foot that a home is built above the BFE (up to 4 feet), so additional elevation above the BFE is recommended.



FIGURE 3-29

Elevating a home above the minimum elevation requirement provides the best protection from flooding.

There are some other options that may be less expensive, although, it should be noted that they can provide less protection. Floodproofing a home requires taking the necessary precautions to minimize water damage from storm surge or rising flood waters to protect critical electrical and mechanical equipment, as well as interior contents. There are two main types of flood proofing systems: wet floodproofing and dry floodproofing. Prior to considering any mitigation measures homeowners should review FEMA P-312, *Homeowner's Guide to Retrofitting*, which addresses several techniques.

3.7.1 WET FLOODPROOFING

The first method to prevent significant flood damage is to design and construct areas of the home in the floodplain to allow water to pass through. Wet floodproofing is designed with the understanding that the portion of the building below a specific elevation, or the Base Flood Elevation (BFE), will flood. Doing so will either remove critical components of the home from the potentially flooded areas or reduce the pressure of flood waters from the walls.

Successful wet floodproofing, according to FEMA, involves the following:

- Allowing floodwaters to enter and exit a home. For NFIP compliance, floodwaters must be able to exit a home without the use of mechanical pumps.
- Allowing floodwaters inside a home to rise or fall at the same rate as floodwaters outside the home
- Reduce damage caused by floodwater in areas of the home that are below the flood height
- Protect mechanical equipment and appliances inside and outside the home (by elevating or other means)
- Relocate valuable contents stored below the Design Flood Elevation to a higher location

Methods for wet floodproofing involve the following:

- **Repurpose all floors below the minimum elevation** - Floors located below the minimum elevation can be used for storage, access or parking. The walls must also be designed with flood openings or to break away under flood loads.
- **Install flood vents and/or flood openings in walls** - This will allow water to pass through perimeter walls and throughout the wet floodproofed areas.
- **Elevate Critical Systems** - It is important to elevate interior and exterior critical systems like mechanical, air handling, electrical, and plumbing above the minimum elevation to ensure their function during a flood, prevent direct contact with floodwater, and minimize damage and repair costs.
- **Provide backwater valves for water and sanitary systems.**
- **Elevate, secure, or tie down fuel tanks** - If tanks, including fuel oil or water tanks, cannot be elevated above the BFE, tanks must be secured or properly tied down.
- **Use flood resistant materials** - For example, tiled floors can be easily cleaned after a flood whereas carpet must be replaced.

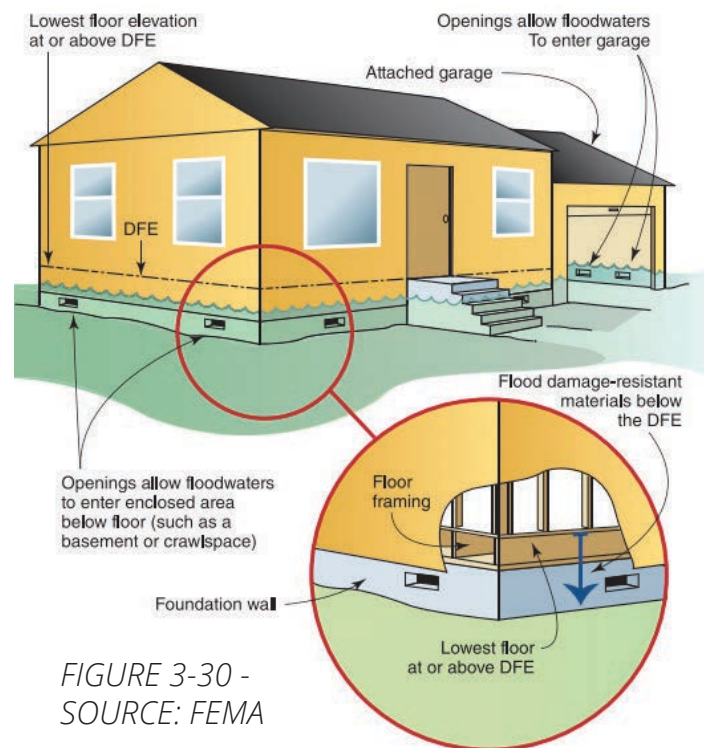

FIGURE 3-30 -
SOURCE: FEMA

Look at FEMA's *Protect Your Home From Flooding* to see low-cost ways you can help protect your home against flooding: www.fema.gov/media-library-data/1528734155205-5dba7257256260a5785db8bf7a63243e/Protect_Your_Home_From_Flooding_Brochure.pdf.

3.7.2 DRY FLOODPROOFING

Another way to protect a structure and its contents from flood damage is to seal the building so that floodwaters cannot enter, or make it watertight. This method, referred to as “dry floodproofing,” encompasses a variety of measures. This method is not allowable in many instances for residential buildings, cannot bring a building into compliance with floodplain regulations, and is not eligible for any flood insurance premium discounts.

Success with dry floodproofing is extremely difficult, and failure to do it properly can result in flooding of the building or even worse, the collapse of building walls. The design of a dry floodproofed building and inspection during construction should be done by a professional structural engineer. You may also need to consult with your local building department for allowable dry floodproofing measures. Some of the measures necessary to dry floodproof a home are:

- **Strengthening walls** so that they can withstand the pressures of floodwaters and the impacts of flood-borne debris.
- **Applying a waterproof coating** or membrane to the exterior walls of the building.
- **Constructing watertight shields** to cover doors, windows, and other openings and the ability to install them quickly.
- **Anchoring the building** as necessary so that it can resist flotation.
- **Installing backflow valves** in sanitary and storm sewer lines.
- **Raising HVAC and electrical system** components above the flood level.
- **Anchoring fuel tanks** and other storage tanks to prevent flotation.
- **Installing a sump pump** and foundation drain system that can run for extended periods when area power has been lost.

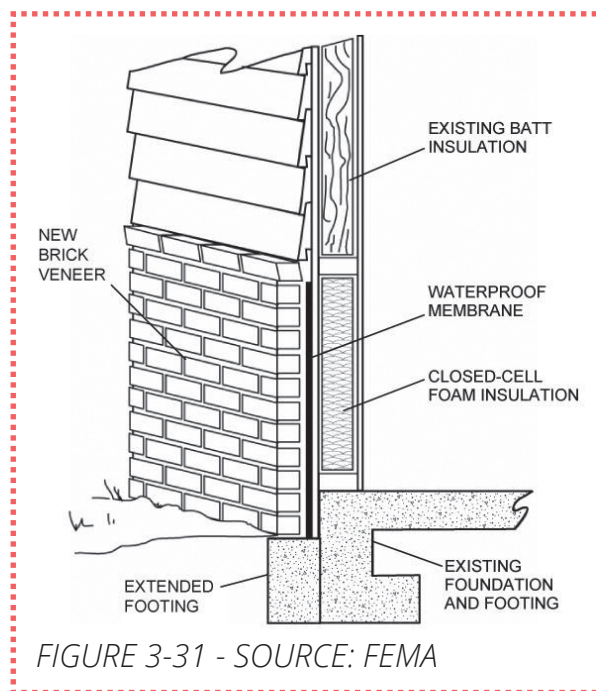

- **Building with materials** that can withstand floodwaters for at least 72 hours (examples: concrete, ceramic tile, pressure-treated lumber, steel, metal, brick, epoxy paint, foam, and closed-cell insulation).
- **Ensuring wells are properly constructed** to avoid contamination from floodwaters. Keep these points in mind when you dry floodproof:⁴⁶
- **Dry floodproofing** is appropriate primarily for slab-on-grade buildings with concrete or solid masonry walls. Concrete and masonry are easier to seal, more resistant to flood damage, and stronger than other conventional construction materials.
- **You cannot dry floodproof** a “substantially damaged” or “substantially improved” building (as defined by the National Flood Insurance Program [NFIP] regulations) or a newly constructed building. Check with your local floodplain manager or building official for more information.
- **You cannot dry floodproof** a structure built after the adoption of the local Flood Insurance Rate Map (i.e., “Post-FIRM” building).

TABLE 3-1. FLOOD RESISTANT MATERIALS

Material Type	Acceptable	Unacceptable
Structural Flooring Materials	<ul style="list-style-type: none"> • Concrete • Naturally decay-resistant lumber • Pressure-treated plywood 	<ul style="list-style-type: none"> • Engineered wood or laminate flooring • Oriented-strand board (OSB)
Finish Flooring Materials	<ul style="list-style-type: none"> • Clay tile • Ceramic or porcelain tile • Terrazzo tile • Vinyl tile or sheets 	<ul style="list-style-type: none"> • Engineered wood or laminate flooring • Carpeting • Wood flooring
Structural Wall and Ceiling Materials	<ul style="list-style-type: none"> • Brick face, concrete, or concrete block • Cement board / fiber-cement board • Pressure-treated plywood • Solid, standard structural lumber (2x4) • Non-paper-faced gypsum board 	<ul style="list-style-type: none"> • Fiberglass insulation • Paper-faced gypsum board • OSB
Finish Wall and Ceiling Materials	<ul style="list-style-type: none"> • Glass blocks • Metal cabinets or doors • Latex paint 	<ul style="list-style-type: none"> • Wood cabinets and doors • Non-latex paint • Particleboard cabinets and doors • Wallpaper

The height of your dry floodproofing should not exceed three feet. The pressures exerted by deeper water can cause walls to buckle or collapse.⁴⁷ If your dry floodproofing measures require human intervention before flood waters arrive, such as placing shields over doors and windows, you should have an operations and maintenance plan that describes all the actions that must be taken and lists the persons who are responsible.

3.7.3 ELEVATING EXISTING STRUCTURES

Elevation certificates are required for new construction and substantial improvements to existing structures within the floodplain; the forms demonstrate a structure's compliance with local floodplain ordinances. It is recommended that a structure is surveyed by a registered professional after major storm events or when purchasing a home in a Coastal V-Zone. The elevation certificate needs to be completed by a registered professional land surveyor, engineer, or architect to ensure that all elevations and requirements

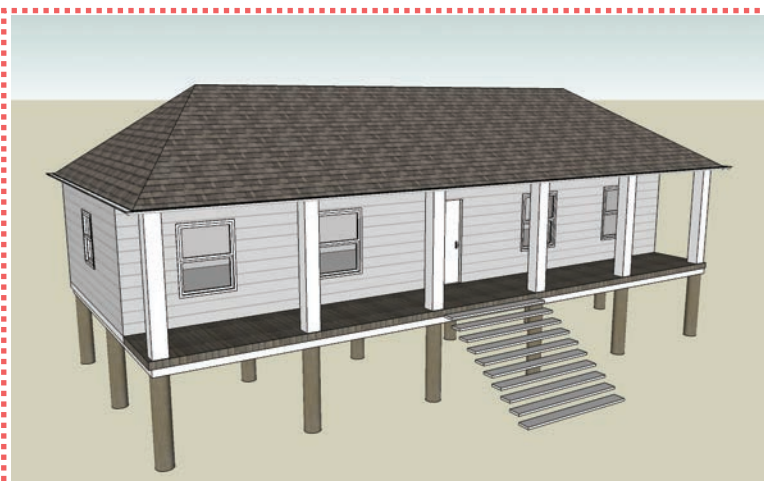

FIGURE 3-32 - SOURCE: STORMSMART COASTS

are met per the community's flood damage prevention ordinance.

The lowest floor elevation of a structure that is new or substantially improved (where repairs are 50% or more of the market value of the structure) must be at or above

the locally required minimum elevation. Any area below the minimum elevation can only be used for parking, storage, or access. In V Zones and where Coastal A Zones are applicable, additional elevation requirements apply. The area below the base flood level must be free of obstruction and any enclosure must be made of breakaway walls. In V Zones and Coastal A Zones, a breakaway wall certification letter may be required, and any structure below the minimum elevation may substantially increase flood insurance premium rates. You can find examples of A and V zones in Chapter 7 of FEMA's *Coastal Construction Manual* at [fema.gov/media-library/assets/documents/3293](https://www.fema.gov/media-library/assets/documents/3293).

FEMA's publication *Free-of-Obstruction Requirements* (Technical Bulletin 5) provides more information on building and protecting homes located in V Zones. In any floodplain, elevation is the single most important factor in reducing the risk of flooding but in areas subject to coastal storm surge, wave action high-velocity water can destroy buildings with insufficient foundations.

Major storms and flash floods can cause waters to rise higher than the BFE; therefore, it is always a good investment to build in a safety factor above the BFE.

Even if you are not in a designated flood zone, you are still at risk from flooding. You can go to the FloodSmart website and type in your street address to determine a general estimate of the flood risk for your property: [floodsmart.gov](https://www.floodsmart.gov).

For those properties located within a flood zone, elevating a building's lowest floor above predicted flood elevations by an additional height (known as "freeboard") has very little effect on the look of a home yet can lead to substantial reductions in damages caused by flooding as well as reductions in flood insurance premiums.



FIGURE 3-33 - SOURCE: STORMSMART COASTS

The home in Figure 3-33 is elevated with freeboard. The home in Figure 3-34 is elevated at the minimum requirement.

FEMA has several other tools and resources designed to help citizens build safely and cost-effectively in the Coastal V Zone, including the "Home Builder's Guide to Coastal Construction" fact sheet series (FEMA P-499), which can be found at [fema.gov/media-library/assets/documents/6131](https://www.fema.gov/media-library/assets/documents/6131), and "Recommended Residential Construction for Coastal Areas: Building on Strong and Safe Foundations" (FEMA P-550, second edition), which can be found at [fema.gov/media-library/assets/documents/3972](https://www.fema.gov/media-library/assets/documents/3972).



FIGURE 3-34 - SOURCE: STORMSMART COASTS

Look at FEMA's "Protect Your Home From Flooding" to see low-cost ways you can help protect your home against flooding: [fema.gov/media-library-data/1528734155205-5dba7257256260a5785db8bf7a63243e/Protect_Your_Home_From_Flooding_Brochure.pdf](https://www.fema.gov/media-library-data/1528734155205-5dba7257256260a5785db8bf7a63243e/Protect_Your_Home_From_Flooding_Brochure.pdf).

PART 3.8

CONCRETE STRUCTURES

Concrete structures, even for residential units, are becoming much more popular in coastal areas. Concrete homes were some of the few left standing in storm surge zones after Hurricanes Katrina (2005), Ike (2008), and Michael (2018). Along with well-built, wood-frame structures, concrete structures can withstand the high winds in Category 4 and 5 storms, as well as lower category tornadoes.⁴⁸

Concrete may be somewhat more expensive initially than a wood-frame home, but the arrival of insulated concrete forms (ICF) allows for a structurally sound, wind-resistant house with excellent insulation. In the long run, these thermal properties of ICF and other concrete technologies mean overall lower energy costs. Keep in mind, in a coastal surge zone, elevation is still an important factor.

3.8.1 SAFE ROOMS

A safe room is a room designed to withstand winds from hurricanes and tornadoes. This option should only be considered if the safe room is outside of all known flood and storm surge zones and sited in accordance with FEMA requirements.² Although costs vary nationwide, it is much less expensive to build a safe room during the original construction of a home. The safe room can also double as a master closet, bathroom, or utility room. The additional cost can be wrapped into the original home mortgage. This is a good investment that yields a sizable return in that it adds value to your home as well as protection and peace of mind for your family.

More information regarding design and construction of safe rooms can be found in ICC 500 at codes.iccsafe.org/content/ICC5002014?site_type=public, FEMA Publication 361, "Design and Construction Guidance for Community Safe Rooms," at fema.gov/media-library/assets/documents/3140 and Fema Publication 320, "Taking Shelter from the Storm," at fema.gov/fema-p-320-taking-shelter-storm-building-safe-room-your-home-or-small-business.

PART 3.9

TREES

Cutting or trimming trees that overhang your home is an additional measure you can take to protect your property during a hurricane. There is a serious danger if there are large trees or limbs that are close enough to fall on your home. Tree limbs or branches falling onto or impacting your home will cause considerable damage — few roofs are strong enough to withstand a falling 20-inch diameter tree. FEMA recommends that the distance between a tree and your house should always be greater than the height of the tree when it is fully grown. This is to prevent a tree from falling on the roof, either at its current size or in the future.

If it is not possible to remove a tree, you can at least cut off all branches that hang over the roof of the home. Generally, you should hire a licensed arborist to perform an evaluation of what should be done. The Louisiana Department of Forestry has several resources available online, including information on how to find a licensed

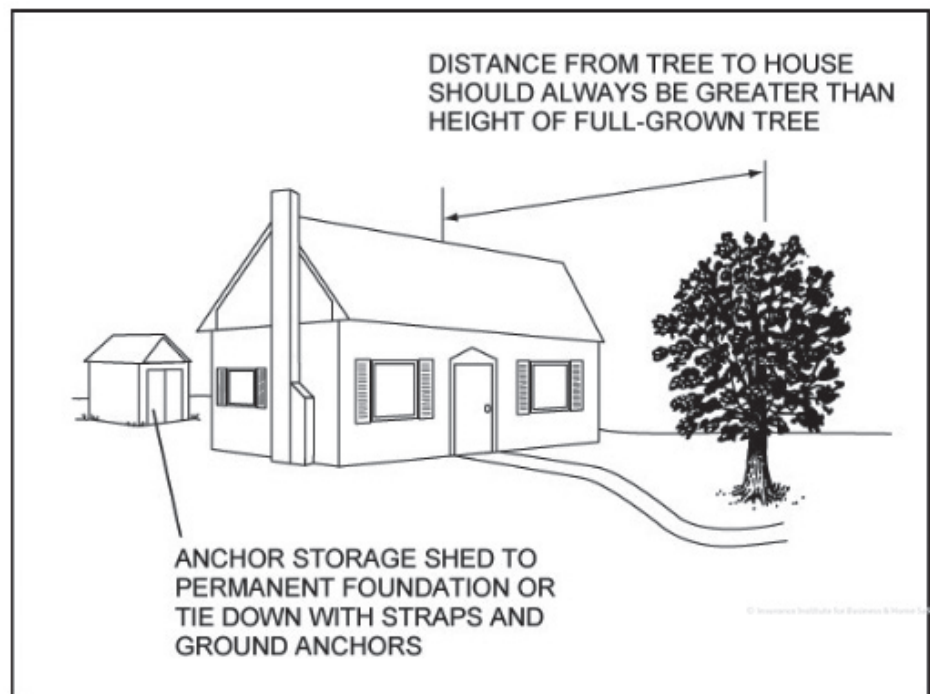

FIGURE 3-35 - SOURCE: FEMA

arborist. See their website, <http://www.ldaf.state.la.us/ldaf-programs/horticulture-programs/louisiana-horticulture-commission/>, for more information.

3.9.1 LANDSCAPING TIPS

Choosing the right landscaping can be the difference between a tree being in your living room or harmlessly falling a safe distance from your house. No matter if this is your current home or the one you're deciding to build or buy, look at the land it is built on or will be constructed on and ask yourself these questions:

- **Are these trees healthy?** Trees afflicted by disease or decay are much weaker than healthy trees. Some signs of disease are the loss of leaves (other than in fall or winter), fungus growth, brittle limbs or bark, holes, and soft or spongy wood. If you spot trees that are diseased or rotten, remove them. We know this can be expensive to do, but so is removing the same tree out of your kitchen after a storm. Consult a certified arborist⁴⁹ if you need help identifying trees to remove, that need pruning or trimming, or need to be brought back to good health.
- **Are large trees too close to the home or power lines?** Identify trees that are too close to your home or powerlines. Have the trees removed or professionally pruned to reduce the chance for problems and damage during a storm.
- **Is there a place where rainwater settles?** If there is, this can be good or bad. If that gathering place is near or under your home, then consider using swales, berms, or other techniques to divert the water. If you are in a floodplain, consult with your local floodplain manager before constructing anything to divert water.

When deciding what vegetation to use in your landscape, consider the climate you live in and how it affects your home and property. A coastal home will have different native plants and protection needs than an inland home. Research which trees are best for your area, the risks your home will face, your natural climate and environment, and which plantings will fit into the aesthetic you are aiming for in your landscaping.

Some good general rules are:

- **Choose trees and shrubs with deep growing root systems.** Healthy root systems are what keep the wind from toppling your vegetation even after the ground is rain saturated.
- **Make sure the trees you use are not susceptible to breaking under heavy wind or rain loads.**
- **Stick to a reasonable size.** Be mindful of the distance from your house, the size in area where it has to grow, and the spacing from other trees and shrubs. Think about trees with flexible trunks and limbs. Look for trees that tend to have some give in the wind. Compare trees based on their wind resistance.⁵⁰

PART 4

DISASTER RESPONSE AND RECOVERY

Responding to and recovering from a disaster is a tough task. Often, the journey is long, hard, and full of twists and turns. Besides what you are personally dealing with, there is a whole field of professionals following procedures and trying to do the right thing. Understanding the process behind disaster response and recovery can help you get out in front of it.

PART 4.1

UNDERSTANDING THE DISASTER DECLARATION PROCESS

A disaster declaration is made by the Louisiana governor's office through the regional FEMA office. State and federal officials conduct a preliminary damage assessment (PDA) to estimate the extent of the disaster and its impact on individuals and public facilities.⁵⁰ This information is included in the governor's request to show that the disaster is of such severity and magnitude that effective response is beyond the capabilities of the state and the local governments and that federal assistance is necessary.

Based on the governor's request, the president may declare that a major disaster or emergency exists, thus activating an array of federal programs to assist in the response and recovery efforts. The determination of which programs are activated is based on the needs found during damage assessment and any subsequent information that may be discovered.⁵¹

The Stafford Act (§401) requires that: "All requests for a declaration by the President that a major disaster exists shall be made by the Governor of the affected State."

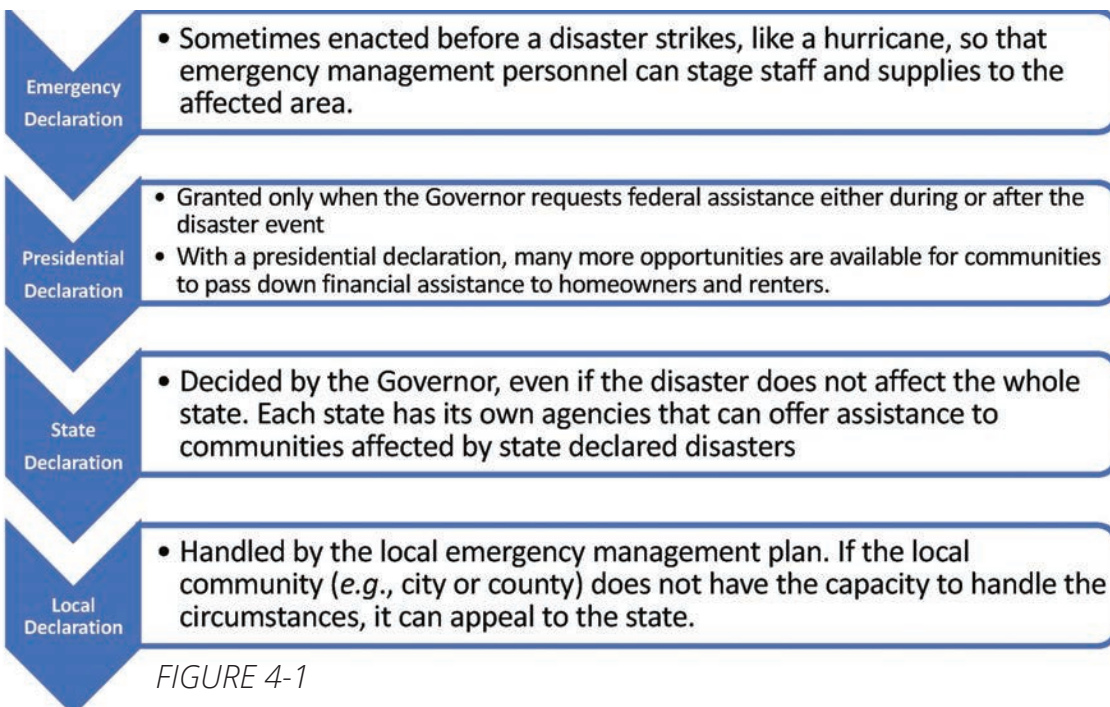

FIGURE 4-1

Eighty-two Presidentially-declared disasters have occurred in Louisiana since 1953. Floods and hurricanes are the most common disasters in Louisiana, with 27 floods and 26 hurricanes declared as disasters in the last 66 years.

PART 4.2

TIMELINE OF EVENTS

Knowing the timeline of events can help position you to achieve tasks and set expectations. Typically, disaster “response” lasts days after the event. This period is when lives are saved, supplies are given, and residents make it back to the community. Once the response to the event ends, then there is a transition to “recovery,” which can take months to years. This is when city systems (e.g., power, water) come back online, buildings get repaired or rebuilt, and people get back to daily routines (e.g., work, school, church, etc.).

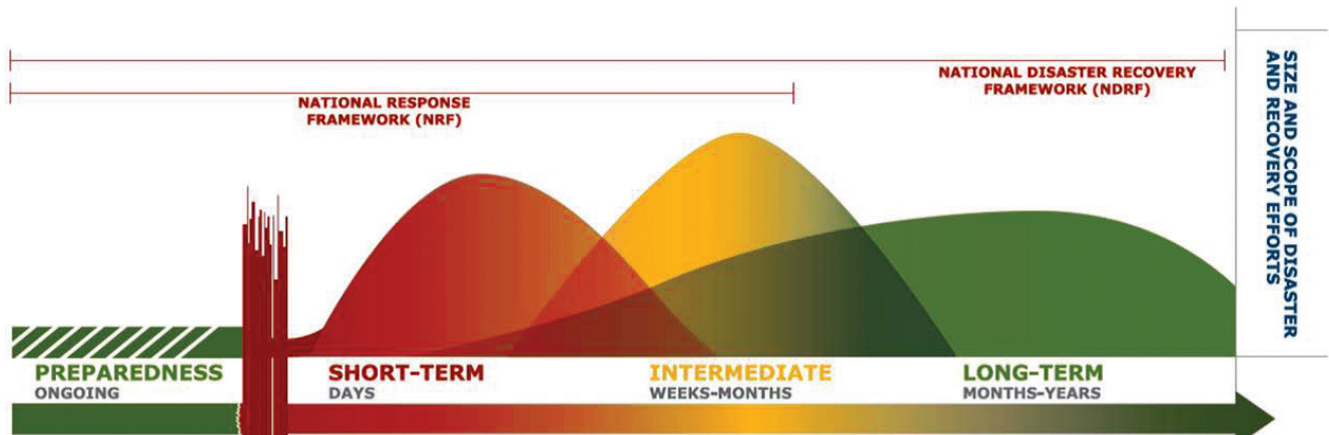

FIGURE 4-2 - SOURCE: FEMA SPENDING EXPLORER

PART 4.3

ROLES OF THE LOCAL, STATE AND FEDERAL GOVERNMENTS DURING THE DISASTER

Before a storm hits an area, emergency management personnel start their process of preparedness and activate multiple lines of defense against the storm. These include:

- Staging personnel and equipment (e.g., generator)
- Communications
- Evacuations
- Triggering Memorandums of Agreements with state agencies, other communities, and/or private sector for additional support

While the storm is affecting an area, the next stages of action take place which mainly include protecting lives and property. These include:

- Opening local shelters up
- Life-saving measures
- Search and rescue

After the storm passes, actions are taken to understand the extent of the impacts on the community and establish ways to get the community up and running again. These include:

- Damage assessments
- Public utilities back online
- Coordinating with state/federal government
- Distribute supplies and food

PART 4.4

ASSISTANCE DURING RESPONSE AND RECOVERY

Once a disaster declaration has been set for your area, federal and state funding will flow for relief efforts, including your personal situation. If eligible, you could receive money for living expenses, repairs, and rebuilding. The

amount of federal funding you receive will depend on insurance coverage and the disaster-caused damages you experienced; federal disaster assistance legally cannot duplicate benefits provided by your insurance coverage. Either way, it is a good idea to register with FEMA and begin the FEMA assistance application process while going through the insurance claims process to save time. You must register within 60 days of the disaster declaration date. Applying for post-disaster assistance from ice/water, temporary sheltering to damage assessments?

- Checklist: disasterassistance.gov/get-assistance/application-checklist
- Factsheets: disasterassistance.gov/information/fact-sheets

KEEP IN TOUCH WITH FEMA
to make sure assistance isn't delayed

*If you haven't heard from us after applying for assistance, you may need to update your contact information. If you changed your address or phone number, even temporarily, be sure to let us know. **HERE'S HOW:***

-  Visit **DISASTERASSISTANCE.GOV** to update and track your application.
-  Make changes in person at a **DISASTER RECOVERY CENTER**. Find one near you at fema.gov/DRC.
-  Give us a call at **800-621-3362** (711 or Video Relay Service available) or **800-462-7585** (TTY).

You can also check your local post office for your FEMA letter. They may be holding your mail until all delivery services are available.



FIGURE 4-3 - SOURCE: FEMA

PART 4.5

POST-DISASTER FEDERAL AND STATE FUNDING

Your first avenue for financial assistance after a disaster is to work with your insurance agent, file a claim, and find out if your damage is covered by homeowners or flood insurance. Whether you have insurance or not it is also possible to receive assistance from several state

and federal programs. Eligibility is always determined on a case-by-case basis, especially if you do receive money from an insurance claim. Programs are not only available for home repair; they can also include new construction, relocation, and rental assistance.

In Louisiana, some federal programs are administered by state-run agencies. This will be explained more in depth in the following sections. The availability of each program will depend on whether the disaster is a local declaration, state declaration, or presidential declaration.

4.5.1 FEDERAL PROGRAMS

FEMA Individual Assistance (IA) is administered directly to homeowners and renters and is not dependent on community participation in any program. It is typically the second avenue of financial assistance after an insurance policy but can also act as the first step and gateway to other federal assistance programs. It pays for a variety of services in addition to housing. The following can be provided through the Individuals and Households Program:⁵²

- **Temporary housing (a place to live for a limited period of time):** Financial assistance may be available to homeowners or renters to rent a temporary place to live. If no rental properties are available, a government housing unit may be provided but only as a last resort.
- **Lodging expenses reimbursement:** Reimbursement of hotel expenses for homeowners or renters may be available for short periods of time due to inaccessibility or utility outage if not covered by insurance or any other program.
- **Repair:** Financial assistance may be available to homeowners to repair disaster-caused damage to their primary residence that is not covered by insurance. The goal is to make the damaged home safe, sanitary, or fit to occupy only, not to return to a pre-disaster condition.
- **Replacement:** Financial assistance may be available to homeowners to replace their home destroyed in the disaster that is not covered by insurance. The goal is to help the homeowner with the cost of replacing their destroyed home.
- **Permanent or semi-permanent housing construction:** Direct assistance or money for the construction of a home. This type of help occurs

only in insular areas or other locations specified by FEMA, where no other type of housing assistance is possible.

To apply online, you'll need the following to complete your registration:

- Social Security Number (SSN) or the SSN of a minor child in the household who is a U.S. Citizen, Non-Citizen National, or Qualified Alien
- Annual Household Income
- Contact Information (phone number, mailing address, and damaged home address)
- Insurance Information (coverage, insurance company name, etc.)
- Bank Account Information (if you are eligible to receive financial assistance, the money can be deposited into your account)

Small Business Association (SBA): Home and Property Disaster Loans are available to individuals after they have already pursued insurance claims and FEMA's Individual Assistance. If you register for disaster assistance and are referred to the SBA, it is important to complete the loan application.

You aren't required to accept a loan if offered one, but FEMA uses loan eligibility to determine if you may qualify for other types of federal assistance. You do not need to be a business owner to apply for an SBA loan; you can be a homeowner, renter, or member of a common interest development (e.g., homeowner associations or condominiums).

Loans can pay for repairs, personal property, relocation assistance, and sometimes mortgage refinancing.⁵³

- Homeowners can apply for a loan of up to \$200,000 to replace or repair their primary residence. This loan cannot be used to upgrade homes or make additions unless required by local building code. If you make improvements that mitigate the risk of future damage from a similar disaster, you may be eligible for up to a 20% loan amount increase above the real estate damage, as verified by the SBA.
- In some cases, SBA can refinance all or part of a previous mortgage when the applicant does not have credit available elsewhere and has suffered substantial disaster damage not covered by insurance.
- Renters and homeowners may borrow up to \$40,000 to replace or repair personal property, such as clothing, furniture, cars, and appliances damaged or destroyed in a disaster.

For additional information, please contact the SBA disaster assistance customer service center.

Call: **1-800-659-2955 (TTY: 1-800-877-8339)**

Email: disastercustomerservice@sba.gov

FIGURE 4-4 - SOURCE: FEMA

RECOVERY TIP:
Visit this website to apply for Individual Assistance.
disasterassistance.gov/

FEMA Public Assistance (PA): Helps communities to get back up and running again by paying for debris removal and infrastructure repairs in neighborhoods. Typically, there is a 75/25 cost share on the funding spent. The federal government will pay 75% of the total costs, and the local government pays 25%.

Hazard Mitigation Grant Program (HMGP): Funded by FEMA but is administered by the Governor's Office of Homeland Security and Emergency Preparedness. Hazard Mitigation is implemented before a disaster in order to reduce the risk from hazards. However, communities can receive recovery funding if their state has or agrees to develop a state-wide Hazard Mitigation Plan. Whether projects are implemented before or after a disaster, they are intended to benefit the whole community. Projects can be structural (e.g., levees and floodwalls) or non-structural (e.g., protecting wetlands and land use

Sometimes these projects benefit individuals as well, especially when local government can buy properties located in the floodplain and assist homeowners in relocating to non-hazardous areas.



FIGURE 4-5 - SOURCE: FEMA

According to FEMA⁵⁴, “examples of mitigation projects that can be funded through the HMGP include but are not limited to:

- **Acquisition and structure demolition/relocation:** The community purchases and permanently removes, with FEMA funding, a flood-prone property from an individual person.
- **Dry floodproofing of historic residential structures:** The home is protected with barriers to prevent flood water from entering.
- **Elevation:** The home is raised so that potential flood waters may flow underneath the home.
- **Mitigation reconstruction:** The existing home is demolished, and a new (similar in size) elevated home is constructed.
- **Structural retrofitting of existing buildings:** Enhancements are made to a home to make it more resistant to floods and earthquakes.
- **Residential and community safe rooms:** A safe room is constructed inside a home or in a nearby community location close to the home to provide safety from strong winds, such as those experienced during a tornado.
- **Wildfire mitigation:** Fire-resistant materials are used on the exterior of the home, and trees or brush are cleared to remove flammable materials from around the home.
- **Wind retrofit:** Enhancements are made to strengthen the roof, walls, doors, and windows and minimize damage caused by high winds.”



FIGURE 4-6 - SOURCE: FEMA

Flood Mitigation Assistance (FMA) is administered by the Governor’s Office of Homeland Security and Emergency Preparedness but is only available to communities that participate in the National Flood Insurance Program. The supported projects are similar to HMGP projects, such as relocation, building elevation, and flood control.⁵⁵

Community Development Block Grant – Disaster Recovery (CDBG-DR) is administered by the Louisiana Office of Community Development (OCD), but the funding comes from the U.S. Department of Housing and Urban Development (HUD). The Louisiana OCD Disaster Recovery Unit must create a state-wide action plan explaining how it will use the funding, and HUD must approve the plan before the funds are released. The action plan is posted for public comment for a limited time, so Louisiana residents can advocate for different projects if they disagree with the plan. Like many other programs, CDBG-DR is only available at a community level, but it is also specifically for low-income and other socially vulnerable neighborhoods. The projects are aimed at the elimination of blight and slums and supporting fair and affordable housing, infrastructure upgrades, and economic development. Individuals could benefit from the projects in a multitude of ways, so reading and understanding the action plan is advised. For more information, you can read this fact sheet provided by HUD. hudexchange.info/resources/documents/CDBG-DR-Fact-Sheet.pdf

4.5.2 STATE PROGRAMS

The Louisiana Governor’s Office of Homeland Security and Emergency Preparedness (GOHSEP) administers the state Hazard Mitigation Grant Program (HMGP). This program provides funds to assist communities with taking action to mitigate future damage following a Presidentially declared disaster. Applications for funds are made to GOHSEP by local governments,

tribal agencies, nonprofits, and state agencies. Individuals apply through their local parish government. For more information, visit gohsep.la.gov/GRANTS-INDEX/DISASTER-RELATED-GRANTS/HMGP or contact your parish contact (full list of parish contacts is available here: gohsep.la.gov/ABOUT/PARISHPA).

PART 4.6

REBUILDING AFTER A STORM

After a disaster, it is easy for anyone to feel overwhelmed; there are countless things to deal with. Yet, when you return to your property, there are certain things that you must do in order to file an insurance claim to repair any damage to your property and your home or rebuild. Be prepared to receive visits from more than one inspector. They may represent federal, state, county, or local government agencies; the U.S. Small Business Administration; your home insurance company; or the National Flood Insurance Program. Representatives of volunteer agencies may also contact you to offer their services.

It is also important to be aware of individuals who may be posing as insurance inspectors and FEMA representatives. Inspectors from any governmental agency and FEMA representatives will show photo ID badges. If you are not shown photo identification, then do not allow the inspection. If you suspect someone is posing as an inspector, call your local law enforcement agency.

4.6.1 WHAT TO EXPECT FOR INSPECTIONS

The following list compiles advice from FEMA regarding what to have ready before an insurance agent or adjuster arrives:

- An adult 18 or older, who lived in the residence before the disaster must be present for the inspection, with photo identification
- Proof of ownership and occupancy of the damaged residence, such as property tax bill, mortgage payment bill or receipt, or utility service bill
- Insurance documents and policy numbers
- Detailed descriptions of the damage to the home and its contents
- A brief description of what caused the damage (e.g., wind, flooding, debris)
- Photographs of the damage (very important before you begin any repairs)
- List of persons living in residence at the time of disaster
- Best contact information for reaching you (consider that you may not be able to stay in your house or receive mail at your address, and your phone may not have service)

4.6.2 BEFORE THE BUILDING PROCESS BEGINS

Contact your local building official or floodplain manager to obtain a building permit BEFORE starting repairs to your home or business to avoid costly mistakes!

- **If there is damage, first contact your insurance agency to file a claim.** You may need to make temporary repairs to prevent further damages (e.g., tarping the roof).
- **Ask for a Substantial Damage Determination from your local building official or floodplain manager.** They will provide specific details regarding local ordinance requirements and will help you decide what the best course of action is for rebuilding.
- **Local floodplain management requirements for new construction will apply to substantial improvements.** The building must be brought into compliance with the National Flood Insurance Program. This may include elevating the building, relocating the building to an area outside of the high-risk flood zone, or demolishing the building and rebuilding in compliance.
- **Learn whether there are specific re-building requirements for your community.**
- **Consult local building officials for information and permits** when considering new construction or repairs on property affected by recent flooding, tornadoes/high winds, fire, winter storms, or earthquake.
- **Obtaining building permits for homes or businesses in a high-risk flood area is extremely important** since additional permits may be required, like a land use permit or zoning permit. This depends on the property location.
- **Local governments cannot change or disregard the floodplain requirements for construction or repairs for any reason, even if the cause of damage was not flooding.**
- **Repair projects are required to meet local building codes and flood-damage prevention ordinances.**

RECOVERY TIP:
Visit this website for more guidance: sbpusa.org/start-here

- **Residents must receive permits from their building department BEFORE starting construction or repair.**
- **Make sure to check with your insurance company before making any permanent repairs.** Do not make these repairs without first determining what they will cover and for what they will pay.
- **Recommendation:** Document everything! Interactions with FEMA, insurance, contractors; copies of all forms and correspondence; save receipts and track all recovery expenses for claims and reimbursement.

800-462-7585 (TTY) • Check application status
• Find a Disaster Recovery Center

FIGURE 4-7 - SOURCE: FEMA

PART 5

FINANCIAL PROTECTION

There are two ways to protect your property from natural hazards. The proactive way is to strengthen your house to address the individual hazard. If, however, there is still damage, insurance can provide resources to aid recovery. Unfortunately, many homeowners do not know what is covered through their insurance policies, let alone what perils are included for coverage. This chapter will discuss the types of insurance available to homeowners, the information to navigate, what to do after an event, and how to properly rebuild.

This section will teach you four basic rules for properly insuring your home:

- 1) Know your risks
- 2) Know your policy
- 3) Know your coverage
- 4) Know your deductible

PART 5.1

UNDERSTANDING AND OBTAINING GOOD INSURANCE

Homeowners insurance (HO) covers both damage to your property and your liability or legal responsibility for any injuries and property damage you or members of your family cause to other people. Homeowners insurance will cover damages caused by many disasters, including fire and burglary, but there are exceptions. You must buy a separate policy for damage from floods, termites, pests, and earthquakes. When a policy specifically lists or names the perils that it insures against, it is said to be using the “named perils” approach. If damage is caused by a peril not specifically named, it will not be covered. Whereas, an “all-risk” insurance policy offers you coverage and protection from all risks or perils that could damage your home or contents and personal property unless the risks are excluded specifically in the policy wording. To add, there are many carriers that provide insurance, and markets often change, which makes finding the right company and coverage a daunting task. Here are the steps to keep in mind with purchasing insurance.

- Step 1:** Know your risks and costs of assets
- Step 2:** Selecting agents and insurance companies
- Step 3:** Request quotes and complete applications
- Step 4:** Compare quotes
- Step 5:** Purchase the policy

INSURANCE TIP:

When purchasing coverage for the structure of your home, remember this simple guideline: Purchase enough coverage to rebuild your home.

A homeowners policy is a package policy because it bundles both property and liability insurance into a single policy for convenience and economy. Besides covering the principal dwelling and other structures, it also includes coverage for additional living expenses, personal property, and medical payments. There are two major sections of the HO policy. Part I is for property coverage, and Part II is for liability. Part II liability coverage is always the same for homeowners policies.

Most homeowners policies are written on Insurance Services Offices (ISO) forms and expressed as “HO” followed by a number. Each of these ISO forms covers property in a different way or covers property of different types. Some companies may have their own proprietary forms; however, they usually mirror ISO standard forms to a large extent. **A knowledgeable insurance agent is critical to helping understand what each carrier’s policy covers.**

Here are the forms currently in use:

- **HO-2** is also known as the Broad or “cheap” form but provides more coverage than HO-8.
- **HO-3**, the Special Form, is the most common; it is the middle-of-the-road form.
- **HO-4** Contents Broad Form is the tenants’ form and is a special, contents-only policy for renters.
- **HO-5** provides the best coverage and is considered the high-end form.
- **HO-6** is the Condominium Form for condominium owners.
- **HO-8**, the Modified Coverage Form, gives more limited coverage than other forms.

5.1.1 SHOPPING FOR YOUR INSURANCE

For many people, the task of getting the right insurance seems daunting, and the perceived rewards are too small to warrant such effort. However, the market for homeowners insurance changes frequently as new companies enter and existing companies decide not to insure coastal wind risk. If it has been more than a few years since you shopped for insurance, or if you have never shopped beyond your current agent or insurance company, you could be paying too much or not getting the right coverage.

When shopping around, be sure to ask these 10 questions to be sure you get the insurance coverage you deserve and can afford.

- 1) How much coverage did you quote on my house, and does this include detached structures (garage, workshop, etc.)?
- 2) How much coverage is provided for my personal property (my stuff)?
- 3) Are my contents insured for replacement cost or actual cash value (ACV)?
- 4) Is my house insured for replacement cost or actual cash value (ACV)?
- 5) Do I have sewer and water coverage?
- 6) How much is my deductible in dollars? How about my wind deductible?
- 7) Do I have (or did you quote) a separate Wind/Hail policy?
- 8) Do I have coverage for Additional Living Expenses?
- 9) How much Ordinance and Law coverage do I have?
- 10) Do I have (or did you quote) a Flood Policy? What is my flood zone?

Learn more by downloading this Insurance Shoppers Guide developed by the University of Alabama: aciir.culverhouse.ua.edu/wp-content/uploads/sites/26/2018/12/ShoppersGuide_Online_8.5x11_2018_Update.compressed.pdf.

5.1.2 DETERMINING HOW MUCH INSURANCE YOU NEED

Standard homeowners policies provide coverage for natural disasters, such as damage due to fire, lightning, hail, and explosions. Those who live in areas with flood or earthquake risks will need coverage for those disasters since standard policies don't usually include these. You want the limits on your policy to be high enough to cover the cost of completely rebuilding your home. Keep in mind that there will not be economies of scale when rebuilding as there are for builders when creating a new subdivision and that other items, such as debris removal, must be considered when selecting the proper coverage amount.

The price you paid for your home—or the current market price—may not be the cost to rebuild. You'll want to consider the cost of rebuilding to current building code. And if the limit of your insurance policy is based on your mortgage (as some banks require), that also might not cover the cost of rebuilding.

While your insurer will provide a recommended coverage limit for the structure of your home, it is a good idea to educate yourself as well. To make sure your home has the right amount of structural coverage, consider:

- Factors that impact the rebuilding costs for your home
- Specific styles and features of your home
- Whether or not your home is up to code

You will also be required to select coverage for “Other Structures,” which are structures not attached to the main dwelling, such as sheds and detached garages. Typical coverage ranges from 10 - 25% of the dwelling limits depending on the size of the structure and its contents.

Most homeowners insurance policies provide coverage for your belongings at about 50 to 70% of the insurance on your dwelling. However, that standard amount may or may not be enough. To learn if you have enough coverage:

- **Conduct a home inventory of your possessions**
- **Take stock of expensive items**
- **Make a visual record with photos/video**, have copies of receipts and an itemized list with details for high-value items, update annually/after major purchases, store safely

Additional Living Expenses (ALE) is a very important feature of a standard homeowners insurance policy. If you cannot live in your home due to a fire, severe storm, or other insured disaster, ALE pays the additional costs of temporarily living elsewhere. It covers hotel bills, restaurant meals, and other living expenses incurred while your home is being rebuilt.

Liability portion of homeowners insurance covers you against lawsuits for bodily injury or property damage that you, family members, or pets cause to other people, as well as court costs incurred and damages awarded. You should have enough liability insurance to protect your assets, which typically ranges from \$100,000 to \$500,000.⁵⁶

PART 5.2

INSURANCE FOR WIND EVENTS

In 19 states, a wind insurance policy is separate from your homeowners policy, will have a different deductible, and covers specific damages or losses. These “shared markets” are state-run programs that provide insurance to high-risk individuals and properties that do not qualify for private insurance. Since they are designed to cover such high amounts of risk, they rely on the backing of the government, which spreads the cost among all the insurers in the state.

Residual Market insurance programs are considered a last resort option for consumers. They are expensive, and they often require applicants to prove that they have been rejected by a number of private insurers before issuing coverage.

In Louisiana, Louisiana Citizens Property Insurance Corporation is the shared market for residential properties. Visit their website to learn more: lacitizens.com/.

Homeowners vs. Dwelling: The basic difference between dwelling insurance and homeowners insurance is that dwelling insurance covers property only, not liability (although some liability protection is available by endorsement).

Deductibles: There are two kinds of wind damage deductibles: hurricane deductibles, which apply to damage solely from hurricanes, and windstorm or wind/hail deductibles, which apply to any kind of wind damage. Key facts to remember about deductibles:

- **Deductibles apply to every property loss.**
- **Dollar deductibles are a specified amount that you choose** (subject to a company-specific minimum).
- **Percentage deductibles are a percentage of the amount of coverage on the house.** When applied, they are translated into a dollar amount based on the dwelling limit and applicable percentage. Small changes in percentages can translate into large dollar differences; consult your insurance agent to learn more.
- **The deductible is subtracted from the amount of loss,** not the amount of coverage.

Actual Cash Value: This is the cost to replace damaged or destroyed property with new property of like kind and quality minus the value of its physical depreciation. Essentially, the “used up” value of the property is subtracted from the loss payment. The policy does not provide payment for the entire cost to repair or replace your house.

Replacement Cost Value (RCV): The insurance policy pays to repair or replace damaged property with NO deduction for depreciation. Importantly, there are other clauses in RCV policies that can limit coverage, but this generalization largely holds true.

Ordinance and Law: This is an endorsement to the policy that will pay extra money on your claim for the increased cost of construction due to local building standards and codes.

Additional living expenses: If your house suffers major damage due to a covered peril, you may not be able to live in your house while it is being repaired. This creates additional living expenses, such as rent and utilities for an apartment. A decrease in revenue, such as lost income from renting out a section of your home, is also included in additional living expenses. Some insurance policies cover additional living expenses, and some do not.

PART 5.3

INSURANCE FOR FLOOD EVENTS

Flooding is the most common natural disaster in the U.S. Flood insurance is recommended for those who live near coastlines, rivers, stream systems, or any other body of water. On average, just 1 inch of water could cause



FIGURE 5-1- SOURCE: FEMA

\$25,000 in damages to a home. All homeowners policies specifically exclude coverage for flood. You must purchase a separate flood policy if you want to be insured for losses caused by flood damage, typically from the National Flood Insurance Program, but there are now more options from private insurance companies.

Maintaining flood insurance is mandatory if you have a mortgage and live within a Special Flood Hazard Area (SFHA). Outside

this area, insurance is not required, but many people have policies because flooding can occur. For example, **FEMA estimates that nearly 1 in 4 of all federal flood claims occur outside of high-risk areas.**⁵⁷ The rates for properties outside the SFHA are very affordable, as they qualify for the lowest rates that are offered by the National Flood Insurance Program (NFIP) and are “priceless” if a flood should occur. If you are a first-time applicant for flood insurance from the NFIP, know that there is a 30-day waiting period before a flood insurance policy goes into effect. Additionally, new policies will not be written and existing policies cannot be modified when a hurricane is predicted or approaching your area.

You can purchase flood coverage from either NFIP or from a private flood market. Private carriers who specialize in covering flood risk may offer competitive rates as well; consult your insurance agent to learn more. The NFIP form is generally much less expensive because the rates and thus premiums are subsidized by the government.⁵⁸

Key facts to know about flood insurance:

- All homeowners insurance policies exclude flood.
- Homeowners use the NFIP Dwelling Form.
- Flood coverage in the Dwelling Form is provided on a replacement cost basis on two conditions:
 - The house is insured to 80% of its replacement cost or the maximum amount of coverage available from the NFIP (\$250,000), and
 - You live in the house at least 80% of the year.
- Flood policies are subject to a maximum limit (\$250,000 on the dwelling and \$100,000 on personal property). If the replacement cost of your house exceeds \$250,000, additional limits are available from private companies.

Separate deductibles apply to the dwelling and personal property.

- Be sure to get coverage for BOTH dwelling and contents as they are sold individually.
- There are many instances where people thought they had purchased coverage for both and found out they had only coverage for their structure.

The flood policy covers direct loss only, not additional living expenses.

- Regardless of the "Flood Zone" in which your house is located, you should purchase flood coverage.
- Flood coverage has a 30-day waiting period (unless for a loan closing or a few other reasons). Because of this, you should plan coverage well in advance, not waiting for a storm.

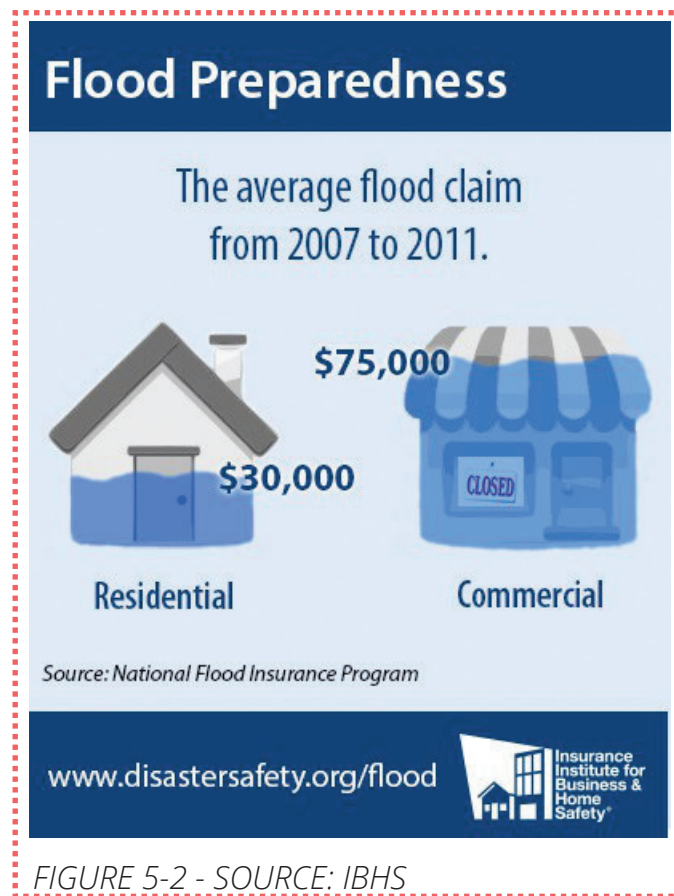

FIGURE 5-2 - SOURCE: IBHS

Five pieces of information are generally needed to get a flood quote/policy:

- An elevation certificate (not always required)
- The flood zone in which your house is located
- The year your house was built
- The year of the initial flood insurance
- Flood insurance rate map (FIRM) for your area

INSURANCE TIP:

When purchasing coverage for the structure of your home, remember this simple guideline: Purchase enough coverage to rebuild your home.

5.3.1 NATIONAL FLOOD INSURANCE PROGRAM

In 1968, the U.S. Congress enacted the National Flood Insurance Program (NFIP), primarily because flood insurance was nearly unavailable from the private insurance market. The federal government had been providing most of the funding for recovery after flooding events, but this system was not sustainable. Under the NFIP, homeowners pay premiums that contribute to their recovery should there be a flooding event. Communities must decide to join the NFIP, but the individual premiums vary according to the location of the property. Homeowners must also maintain certain requirements, such as elevating or floodproofing structures. Homeowners can learn more about flood insurance, perform an address-based risk assessment, and locate an insurance agent serving their address at [FloodSmart.gov](https://www.floodsmart.gov), a website maintained by the NFIP.



FIGURE 5-3 - SOURCE: FEMA NFIP

A preferred risk policy (PRP) is available for a property located in a low-risk area (e.g., B, C, and X zones) in a community that already participates in the NFIP. The PRP premiums are lower than those for standard policies. If your property was mapped into a low-risk flood zone you may still be eligible for a PRP.

Talk to your insurance agent. Previous and current flood zone documentation for your property must be validated for eligibility. Likewise, your property must meet certain loss history requirements, even if you are the new owner. The requirements involve the number of flood claims and the cost of the claims. You can also decide between two types of policies: building-and-contents coverage or contents-only coverage.

5.3.2 COMMUNITY RATING SYSTEM

The Community Rating System (CRS) is a program that rewards communities for floodplain management activities that exceed the minimum NFIP requirements. Individual insurance premium rates are discounted to reflect the reduced flood risk resulting from those activities. You can contact your local floodplain manager or insurance agent for more information. The three goals of the CRS program are:

- Reduce flood damage to insurable property
- Strengthen and support the insurance aspects of the NFIP
- Encourage a community's comprehensive approach to floodplain management

5.3.3 INCREASED COST OF COMPLIANCE (ICC) COVERAGE

Flood damage to homes can vary greatly for different reasons. Sometimes the damage is far greater than a homeowner can afford with a direct loss insurance claim, especially when the homeowner must upgrade the home to meet current codes and requirements. Increased Cost of Compliance (ICC) coverage may fulfill the gap between repairing your house to its pre-existing condition and complying with current codes and requirements.

For example, flooding causes \$200,000 of damage to Jane's house. After speaking with her insurance adjuster and the local building inspector, she finds out that she needs to elevate the house to meet new floodplain requirements. Jane can file for her direct loss claim and ICC coverage if she needs the additional financial assistance. The ICC coverage will provide no more than \$30,000 (for any policyholder). Also, the combined amount of the claim and the ICC coverage cannot exceed \$250,000 (the maximum limit of coverage for any residence).⁶⁰

Your community's building department must determine the extent of damage and what is necessary to bring your home up to compliance with current codes and requirements (whether you file for ICC or not). The department must then give you a written letter with those terms, which you will turn in to process your claim and ICC coverage.

There are four options to help you reduce future flood damage. You can use one of these or a combination of these measures. You should speak with your local floodplain administrator to help you decide which option is best for your property.

1. **Elevation:** Raises your home or business to or above the flood elevation level adopted by your community.
2. **Relocation:** Moves your home or business out of the risk area.
3. **Demolition:** Tears down and removes flood-damaged buildings.
4. **Floodproofing:** Available primarily for non-residential buildings. Floodproofing makes a building watertight through different adjustments or additions of features to the building that reduces the risk of flood damage.

FEMA TERMS TO LEARN BEFORE FILING INSURANCE CLAIMS

Repetitively Damaged (or Repetitive Loss - RL) means the building must have had flood damage on at least two occasions during a 10-year period, and the cost to repair the flood damage, on average, equaled or exceeded 25 percent of the market value of the building on each occasion.

Substantially Damaged (SD) means damages of any origin sustained by a structure in which the cost of restoring the structure to its before-damaged condition would equal or exceed 50 percent of the market value of the structure before the damages occurred.

Substantial Improvement (SI) means any reconstruction, rehabilitation, addition, or other improvement of a structure, the cost of which equals or exceeds 50 percent of the market value of the structure (or smaller percentage if established by the community) before the “start of construction” of the improvement. This term includes structures that have incurred “substantial damage,” regardless of the actual repair work performed.

PART 5.4

MAKING A CLAIM AFTER RECEIVING A LOSS

Being able to file a claim is why we pay for insurance. If your home or property is damaged, follow these steps to file successfully and negotiate your claim and get your damage fixed correctly.

As soon as you receive your policy, conduct a mock run-through for filing a claim, so you are familiar with the process and know what pieces of information from your deck pages will be needed. Save your claim number once you first file the claim. This will be used as a reference number for all future communication with the insurance company. Start taking notes on everything you do and correspondence you have. Include date and time. If at any time you have difficulties contacting or working with your insurance company through the claims process, then use your Louisiana Department of Insurance as a resource for help. **Also, save everything to a flash drive or a cloud drive like Google, Amazon, iCloud, or Dropbox or email it to yourself.**

More detailed steps include:

- **Follow your policy's guidelines.** Most insurance policies have a section that details how to file a claim. Follow what it says to make it easy for yourself. It should detail where to find and submit forms and the ways you can file them.
- **File your claim immediately.** Filing a claim quickly is a good idea for several reasons, including expedited handling before a rush of claims comes through that require prioritization by your carrier.
 - Your insurer will be able to help you with your claim and give you advice.
 - They will schedule an adjuster to come and visit your property.
 - You can start your claim by phone or online with many insurers.
 - You may also be eligible for additional incentives, such as Ordinance and Law to build back to the newest building code.
 - You should also ask about building back better by using certain standards, like FORTIFIED Home, or options to elevate your home to avoid the next flood.Your choices will vary based on your policy and your insurer.
- **Take pictures.** Get out your phone or camera and take pictures of the damage before you start cleaning up. You cannot take too many pictures. Get different angles, wide shots, and close-ups. Make sure to get very detailed photos where the most damage occurred.

These will help you negotiate your claim with your insurance adjuster. Be sure to include:

- The serial and model numbers of electronics and appliances.
- Down your hallways, into bedrooms, looking out of rooms, outside, inside, of the floors.
- Inside of your cabinets – your cookware, serving pieces, flatware, baking ware, small appliances, everything!
- Clothes and shoes in your dressers and closets, including labels.
- Food in your refrigerator and freezer
- **Take videos**, if possible. Conduct a walk-through of each room in the house and narrate what is in it.
 - Zoom in on each big-ticket (expensive) item's serial number, brand, etc.
- **Find or create a home inventory**. The more detailed your list, the more accurate your insurance claim payout will be when you work with your adjuster. Often, your insurance company will ask for an inventory of damaged items (usually providing a form). This practice will save you time and ensure accuracy.
 - If you have a home inventory, secure it or make it digital by taking pictures of it.
- **After documenting, begin cleanup** as soon as it's safe to do so and make temporary repairs to prevent further damage (e.g., tarping a damaged roof, boarding up damaged windows, drying out home to prevent mold growth). Insurance won't cover additional damage that you could have reasonably prevented.
 - Damaged items can be hauled outside to facilitate cleanup, but it is recommended not to have them hauled away until after your inspector has seen them (except for health hazards, such as spoiled food). Be sure to take photos of the removed items.
 - In case of flood damage, it is recommended to preserve a waterline on a wall or window and save samples/swatches of carpet, flooring, drapes, etc. to show the adjuster.
- **Save your receipts**. Save receipts from every expense from the day of the damage until your home is back to normal. If you have old receipts of purchases, take pictures of them.
 - Digital pictures do not fade, receipts do. Plan to do this with any receipts you get for future purchases too.

- **Work with your adjuster.** Have a copy of your photos, home inventory, and the damaged items ready to share. Make sure you are home during the inspection and walk them through the damage you see. Take note if they are thorough with the inspection, such as getting on the roof, taking lots of photos, and recording measurements.
- **You can negotiate your claim.** Once you receive your initial claim proposal, you can negotiate with the adjuster.
 - Use your home inventory and damage checklist as proof of what you lost and ensure the replacement costs are correct.
 - If you have Ordinance and Law coverage in your homeowners policy, make sure that was taken into account.
- **Use any contractor bids for repair work** to justify the costs needed to fix the damage.
 - These bids can also be used to negotiate your claim.
Bringing your home up to code will add additional costs to the job.
- **Use your payments wisely.**
 - Spend your money according to the claim. Otherwise, you may be ineligible to receive your recoverable depreciation.⁵⁸

DIGITAL TIP:

Save photos before and after to a cloud-based format, then you'll have records and can easily share them with adjusters and your insurance agency.

INSURANCE TIP:

How do I file my flood claim?

floodsmart.gov/flood/how-do-i-file-my-flood-claim

PART 5.5

CHOOSE A QUALIFIED CONTRACTOR AND AVOID SCAMS

Now that you understand the components of a home and how to strengthen it, this section will help you make decisions about choosing the right contractor to build or retrofit your home. This is especially important in the busy and often chaotic environment following a disaster.

Unfortunately, after a disaster, some individuals choose to take advantage of people while they are displaced. Likewise, others will prey on people after they have returned home and are assessing their damage and beginning repairs.

5.5.1 TIPS TO CHOOSE A QUALIFIED CONTRACTOR

- **Get at least three bids from qualified contractors.** Do not give a price range or let them know what you have received from your insurance claim.
 - Make sure they have (and get copies of or take pictures of):
 - A Contractor's License (General or Roof) or Home Builder's License, depending on the amount of work. Verify that their license/registration is valid by checking the Louisiana State Licensing Board for Contractors licensing registry when looking for the appropriate contractor.
 - General Liability insurance
 - Workman's Comp Insurance for their staff
 - A bond to fix any lousy work they refuse to fix, just in case
 - At least three local references you can call
 - Examples of recently completed projects
- **Get everything you want to be done in written bids on company letterhead.** Do not leave anything out and ask that they plan for additional costs, such as replacing rotted wood or other typical items they think they could find. You may not end up paying for these but having them in the contract protects you from "surprise" costs.
 - Ideally, work with local, reputable companies and contractors.
 - Once you select a contractor, get your contract in writing with everything you want and agreed to on company letterhead; do not forget those possible additional costs.

- It is okay for contractors to request a certain percentage of the costs up front if you have researched them and are under contract. 10-25% is common. Some states have limits on the amount contractors can request. Contact your local Consumer Affairs organization for information at Louisiana Department of Justice, Consumer Protection Section.
- Never pay in cash, and never pay in full upfront. The contract should include a schedule for payments in installments as work is satisfactorily completed. Issue the final payment only after all work has been completed to your satisfaction and passes any required code inspection. Upon receipt of final payment, the contractor should sign a lien waiver/release of lien indicating they have been fully paid and give up any rights to place a lien on your property in the future.
- Ensure the contractor pulls all necessary permits for your job (check with local building department on what's required) and that all are properly closed out once the job is complete.⁶¹

5.5.2 AVOID BEING A VICTIM OF A FRAUD

The demand for qualified contractors after a disaster exceeds the supply, and many reliable, honest, and licensed contractors can be booked solid for a long time. Homeowners who are eager to get their property back in shape may not take the needed precautions when hiring contractors. Fraudulent contractors know this and flock to disaster-struck communities to fool homeowners into thinking they are paying for good work.

These fraudulent contractors overcharge, provide subpar services, or use faulty materials when working on homes. A homeowner who is unfamiliar with contractor jargon and has no knowledge of building systems can easily be fooled and taken advantage of. Here are some tips to follow to protect yourself from fraudsters and identity theft:⁶²

- Ask contractors for references and proof of insurance. Check with those references regarding the contractor's dependability and quality of work.
- Get written estimates with a description of work to be done, time schedules, and payment schedules. Get estimates from more than one contractor.
Read and understand all contracts before you sign. Never sign any forms with blanks.
- Keep copies of everything you sign.
- Do not sign an AOB (Assignment of Benefits). You are essentially turning over your rights on your insurance claim.
- Never pay a contractor in full until the work is complete and acceptable.

- Check your bank and credit card statements for purchases you have not made. If you suspect you are the victim of identity theft, report it immediately to your bank, credit card company, and local law enforcement.

Follow the “SBP 7 Tips to Avoiding Contractor Fraud” on their website at sbpusa.org/public/uploads/pdfs/SBP_ContractorGuide_20181024.pdf, and use their Contractor Fraud Checklist to avoid being scammed. Learn more and download additional disaster recovery and homeowner resources at sbpusa.org/start-here.

More resources:

nicb.org/prevent-fraud-theft

iii.org/insurance-basics/disasters-preparedness/weather

nerdwallet.com/blog/insurance/home-inventory-insurance-claims/

APPENDIX A: Glossary

Actual Cash Value is the cost to replace damaged or destroyed property with new property of like kind and quality minus the value of its physical depreciation. Essentially, the “used up” value of the property is subtracted from the loss payment. The policy does not provide payment for the entire cost to repair or replace your house.

Base Flood Elevation (BFE) is the elevation shown on the Flood Insurance Rate Map (FIRM) for Zones AE, AH, A1-30, or VE that indicates the water surface elevation resulting from a flood that has a 1-percent chance of occurring in any given year.

Basement foundations are typically excavated and built into the ground. These types of foundations are waterproofed and sometimes fully completed into more living or storage space. A basement foundation is not recommended for areas that are susceptible to flooding.

Community Rating System (CRS) is a voluntary incentive program that recognizes communities for implementing floodplain management practices that exceed the National Flood Insurance Program minimum requirements. In exchange for a community’s proactive efforts to reduce flood risk, policyholders can receive reduced flood insurance premiums. For more information, visit fema.gov/national-flood-insurance-program-community-rating-system

Crawlspace foundations are when the home is built on piers or continuous walls of some sort, leaving space between the home and the ground. This allows piping or wiring to be run under the house and be accessible. It can protect the home from flooding if raised above the base flood elevation and flood openings are incorporated into walls.

Disaster An occurrence of a natural catastrophe, technological accident, or human-caused event that has resulted in severe property damage, deaths, and/or multiple injuries.

Elevation Certificates are required for new construction and substantial improvements to existing structures within Coastal V Zones and other floodplain areas; the forms demonstrate the height of the Base Flood Elevation and a structure’s compliance with local floodplain ordinances.

Emergency is any incident, whether natural, technological, or human-caused, that requires responsive action to protect life or property.

Flood is a condition of partial or complete inundation of normally dry land areas from: (1) the overflow of inland or tidal waters, (2) the unusual and rapid accumulation or runoff of surface waters from any source, or (3) mudslides.

Flood Insurance Rate Map (FIRM) is the official map of a community on which FEMA has delineated the 1% annual chance (base) floodplain or Special Flood Hazard Area,

APPENDIX A: Glossary

Base Flood Elevations (BFEs), and flood zones applicable to the community. The FIRM is used to determine flood insurance rates and requirements and where floodplain development regulations apply.

Flood Hazard Zones are lettered based on the level and type of flood risk:

- **Zone V/VE:** An area of high flood risk subject to inundation by the 1% annual-chance flood event (100-year) with additional hazards due to storm-induced velocity wave action (a 3-foot or higher breaking wave).
- **Zone A/AE:** An area of high flood risk subject to inundation by the 1% annual-chance flood event. The letters and numbers determine a base flood height and an elevation height for your house.
- **Zone AO:** An area of high flood risk subject to inundation by 1% annual-chance shallow flooding where average depths are between one and three feet.
- **Shaded Zone X:** Areas of moderate flood risk within the 0.2% annual chance floodplain (500-year); or areas of 1% annual chance flooding where average depths are less than 1 foot, where the drainage area is less than 1 square mile, or areas protected from this flood level by a levee.
- **Unshaded Zone X:** Areas of low flood risk outside the 1%- and 0.2%-annual chance floodplains.
- **Zone D:** Areas where flood hazards are undetermined but flooding is possible.

Floodplain Any land area susceptible to being inundated by water from any source.

Freeboard is the difference in height between the lowest floor of your house and the BFE. Some communities mandate either 1', 2', or 3' of freeboard in local code. This measure is put in place to help your home stay dry during a flooding event and can decrease your flood insurance premiums.

Hazard is something that is potentially dangerous or harmful, often the root cause of an unwanted outcome.

Mitigation is any effort to reduce loss of life and property by reducing the impact of disasters. For more information on mitigating flood risk, visit the Reducing Risk page.

Natural Hazard Hazard related to weather patterns and/or physical characteristics of an area. Often natural hazards occur repeatedly in the same geographical locations.

Ordinance and Law If your home does not meet the building code at the time of a loss, it could be very expensive to rebuild to the building code compared to rebuilding the house as it

APPENDIX A: Glossary

was before the loss. Insurance that covers this increase in construction expense is called “ordinance and law” coverage. Some policies provide ordinance and law coverage while others do not.

Perils In insurance parlance, the cause of a loss is called a peril. Examples of perils that can be insured include but are not limited to: wind, hail, lightning, fire, flood, theft, vandalism, and legal liability.

- If your policy does not cover the peril that damages your house, the insurance company will not pay your claim.
- “Named perils” policies (coverage forms) cover losses that are caused by one of the perils listed or “named” in the policy form.
- “Open perils” policies cover losses caused by any peril that is not specifically excluded in the policy form.

Premium The annual or monthly payment amount you make to an insurance company for coverage.

Preparedness A continuous cycle of planning, organizing, training, equipping, exercising, evaluating, and taking corrective action in an effort to ensure effective coordination during incident response.

Recovery Encompasses both short-term and long-term efforts for the rebuilding and revitalization of affected communities.

Repetitively Damaged (or Repetitive Loss - RL) means the building must have had flood damage on at least two occasions during a 10-year period, and the cost to repair the flood damage, on average, equaled or exceeded 25 percent of the market value of the building on each occasion.

Replacement Cost Value (RCV) means that the insurance policy pays to repair or replace damaged property with NO deduction for depreciation. Importantly, there are other clauses in RCV policies that can limit coverage, but this generalization largely holds true.

Resilience is the ability to prepare and plan for, absorb, respond, recover from, and more successfully adapt to adverse events.

Response is any activity that address the short-term, direct effects of an incident. Response includes immediate actions to save lives, protect property, and meet basic human needs.

APPENDIX A: Glossary

Roof Venting Types While there are many types of roof vents and ways to vent the attic, common approaches are:

- **Ridge Vents** placed at the peak of the roof. These allow hot air to escape and naturally rise through the top of a roof. They are often used in conjunction with soffit vents which allow air to be pulled from under the overhangs of your roof (soffits), circulate in the attic, and exit through the ridge. Look for a Miami Dade approval or the TAS 100A testing standard to prevent water intrusion in severe storms.
- **Soffit Vents** are visible around your home on the underside of the overhang of your roof near exterior walls. Soffits cover the eaves of your roof, the overhang of the roofing structure (or rafters). Soffit vents provide protection from wind and water while letting in air.
- **Gable Vents** are simply vents added to the gable end of a roof that allows air to pass through them. These should be high wind rated or should be protected in a hurricane to prevent water from entering the attic space during severe weather. Soffit vents should not be used on gable ends.
- **Turbine or Power Roof Vents** can have an electric motor and mechanically vent air from the attic space. These can be seen sitting on top of roofs and typically use sensors to activate them when the attic reaches a certain temperature. These vents can be blown off during high winds or hurricanes, leaving a large hole in your roof.
- **Non-venting Roofs** are included in some newer homes that are built with an enclosed attic space that does not require venting. These roofs have attics that are “conditioned” or that have access to the homes heating and air systems. The attic space may contain HVAC systems, and this approach can be very energy efficient.

Sea-Level Rise is the increase in sea level caused by a change in the volume of the world’s oceans due to temperature increase, deglaciation (uncovering of glaciated land because of melting of the glacier), and ice melt (Source: NOAA).

Slab on Grade foundations are concrete slabs poured on a level ground (i.e. grade) and sometimes strengthened with welded wire fabric or a metal grid of rebar. This technique is usually used in warm climates that do not freeze (freezing can cause cracks in the concrete and movement in the building). With this technique, there is no crawl space or basement, and piping is often encased in the slab or located below the slab.

Special Flood Hazard Area (SFHA) is the same as the 100-year floodplain. Includes building located in the A or V Zones.

APPENDIX A: Glossary

Stem Wall foundations begin by pouring a footing below grade. They then extend above grade and are typically filled in with earth or gravel. This can be used to increase the height of the homes first floor, elevating it but not leaving open space beneath the home.

Substantially Damaged (SD) means damages of any origin sustained by a structure in which the cost of restoring the structure to its before-damaged condition would equal or exceed 50 percent of the market value of the structure before the damages occurred.

Substantial Improvement (SI) means any reconstruction, rehabilitation, addition, or other improvement of a structure, the cost of which equals or exceeds 50 percent of the market value of the structure.

APPENDIX B: Emergency Contact Information

Louisiana Governor's Office of Homeland Security and Emergency Preparedness
(225) 925-7500

emergency.louisiana.gov/contacts.html

Louisiana Department of Transportation
(877) 452-3683

sp.dotd.la.gov/Pages/default.aspx

Louisiana Department of Natural Resources
Office of Costal Management
(225) 342-7591

dnr.louisiana.gov/index.cfm/page/85

Louisiana Sea Grant
3810 W Lakeshore Dr. Baton Rouge, LA
70808
(225) 578-3202

www.laseagrant.org/

American Red Cross – [Louisiana]

- **Louisiana Capital Area:** 4655 Sherwood Common Blvd. Baton Rouge, LA 70816
Telephone- (225) 291-4533
- **North Louisiana Area:** Address- 805 Brook Hollow Dr. Shreveport, LA 71105
Telephone- (318) 865-9545
- **Southeast Louisiana Area:** Address- 2640 Canal St. New Orleans, LA 70119
Telephone- (504) 620-3105

redcross.org/local/louisiana.html

Federal Emergency Management Agency
(FEMA) Region 6

FRC 800 North Loop 288

Denton, TX 76209-3698

(800)-621-FEMA or (800)-621-3362

fema.gov/region-vi-arkansas-louisiana-new-mexico-oklahoma-texas#

Emergency Preparedness Websites

Entergy Storm Center

1-800-ENTERGY

stormcenter.entergy.com/default.aspx

FEMA Incident Command System Overview
(800)-621-FEMA

fema.gov/incident-command-system-resources

FEMA Integrated Public Alert and
Warning System

(800)-621-FEMA

fema.gov/integrated-public-alert-and-warning-system

GOHSEP's Get a Game Plan

(225) 925-7500

getagameplan.org/

Louisiana Department of Agriculture and
Forestry Emergency Programs

(225) 922-1234

ldaf.state.la.us/programs/emergency-programs/

APPENDIX B: Emergency Contact Information

Louisiana Emergency Operations Plan
(225) 925-3633

gohsep.la.gov/prepare/planning-overview

Louisiana's Homeland Security and Emergency
Management State Regions
(225) 925-7500

gohsep.la.gov/about/state-regions

Louisiana State Animal Response Team
lsart.org/

Official Louisiana Survival Guide (English,
Spanish, Vietnamese)
lsp.org/lcadeg.html

LSU AgCenter Storm Recovery Guide
tinyurl.com/AgCtrSRG

NEMA Evaluating Water-Damaged Electrical
Equipment
tinyurl.com/NEMAWaterDamageEval

NOAA Extreme Weather Information Sheets
ncddc.noaa.gov/activities/weather-ready-nation/newis/

NOAA National Weather Service Safety
Brochures
weather.gov/owlie/publication_brochures

NOAA Weather Radio Frequencies for Louisiana
<https://www.weather.gov/lch/xmtr>

Specific Tips for Hurricane Preparedness
hurricanesuttersflorida.com/preparedness.html

Building and Construction Websites

Federal Alliance for Safe Homes
(877) 221-SAFE

flash.org

FEMA Building Science
(800)-621-FEMA
fema.gov/building-science

High Wind Safe Rooms
highwindsaferooms.org

Insurance Institute for Business and
Home Safety
(813) 675-1035
disastersafety.org

International Hurricane Protection Association
(844) 516-4472
inthpa.com

International Window Film Association
(276) 666-4932
iwfa.com

Louisiana Board of Architectural Examiners
(225) 925-4802
<https://lsbae.com>

Louisiana Home Builders Association
(225) 387-2714
lhba.org/

Louisiana Professional Engineering & Land
Surveying Board
(225) 925-6291
lapels.com/

APPENDIX B: Emergency Contact Information

Louisiana State Licensing Board for
Contractors
(225) 765-2301
lsbc.louisiana.gov/

Louisiana State Uniform Construction
Code Council
(225) 922-0817
succeed.dps.louisiana.gov/

LSU LaHouse
(225) 578-4161
lsuagcenter.com/en/family_home/home/la_house/

Prepare Your Home for Strong Winds and
Hurricanes
(800) 999-5099
safestronghome.com/highwind/

Simpson Strong-Tie
(800) 999-5099
strongtie.com/

Technical Preservation Services, National
Park Service
(202) 513-7270
nps.gov/tps/index.htm

Flood Insurance Websites

FEMA Flood Insurance Rate Maps (FIRMs)
(800)-621-FEMA
msc.fema.gov

Louisiana Flood Map Portal
(225) 578-4161
lsuagcenter.com/floodmaps

Official Site of the National Flood Insurance
Program
(800) 427-4661
floodsmart.gov

APPENDIX C: Websites and Publications

FEMA Publications

Are You Ready?

This FEMA publication provides a step-by-step approach to disaster preparedness by walking the reader through how to get informed about local emergency plans, how to get informed about local emergency plans, how to identify hazards that affect their local area, and how to develop and maintain an emergency communications plan and disaster supplies kit. Other topics covered

include evacuation, emergency public shelters, animals in disaster, and information specific to people with access and functional needs. [fema.gov/media-library/assets/documents/7877](https://www.fema.gov/media-library/assets/documents/7877)

After a Flood: The First Steps

Tips for staying healthy, cleaning up and repairing, and getting help after a flood. Available online at [fema.gov/media-library/assets/documents/3396](https://www.fema.gov/media-library/assets/documents/3396).

Residential Coastal Construction Manual

Investigations conducted by FEMA and other organizations after major coastal disasters have consistently shown that properly sited, well-designed, and well-constructed coastal residential buildings generally perform well. This updated Residential Coastal Construction Manual is intended to help designers and contractors identify and evaluate practices that will improve the quality of construction in coastal areas and reduce the economic losses associated with coastal disasters. [fema.gov/residential-coastal-construction](https://www.fema.gov/residential-coastal-construction)

Additional Coastal Construction Resources

- FEMA P-55 – **Coastal Construction Manual**
- FEMA P-85 – **Protecting Manufactured Homes from Floods and Other Hazards**
- FEMA P-499– **Home Builder’s Guide to Coastal Construction**
- FEMA P-550– **Recommended Residential Construction for Coastal Areas: Building on Strong and Safe Foundations**
- FEMA P-762– **Local Official’s Guide for Coastal Construction**
- FEMA P-804– **Wind Retrofit Guide for Residential Buildings**
- NFIP Technical Bulletins
- Examples of State and Local Erosion Studies and Hazard Maps

Home Builder’s Guide to Coastal Construction (FEMA P-499).

The manual contains 37 fact sheets providing technical guidance and recommendations concerning the construction of coastal residential buildings. The fact sheets present information aimed at improving the performance of buildings subject to flood and wind forces in coastal environments. [fema.gov/home-builders-guide-coastal-construction-technical-fact-sheet-series-fema-p-499](https://www.fema.gov/home-builders-guide-coastal-construction-technical-fact-sheet-series-fema-p-499)

APPENDIX C: Websites and Publications

Wind Retrofit Guide for Residential Buildings (FEMA P-804)

The guide presents mitigation measures in packages, which are required sets of retrofit measures that must be implemented for a home to provide a consistent level of protection, and identifies three successive protection packages: Basic, Intermediate, and Advanced. Implementing the mitigation packages in this guide on existing vulnerable homes within the hurricane-prone regions of the United States will result in their improved performance in high-wind events. [fema.gov/media-library-data/20130726-1753-25045-2304/508versioncombined_804.pdf](https://www.fema.gov/media-library-data/20130726-1753-25045-2304/508versioncombined_804.pdf)

American Red Cross Publications

Repairing Your Flooded Home

A booklet about how to enter your home safely; protect your home and belongings from further damage; record damage to support insurance claims and requests for assistance; check for gas or water leaks; and clean up appliances, furniture, floors, and other belongings. The booklet is available online at [redcross.org/images/MEDIA_CustomProductCatalog/m4540081_repairingFloodedHome.pdf](https://www.redcross.org/images/MEDIA_CustomProductCatalog/m4540081_repairingFloodedHome.pdf).

National Weather Service Publications

Hurricane Flooding: A Deadly Inland Danger (20052)

Brochure describing the impact of hurricane flooding and precautions to take. Available online at [weather.gov/media/owlie/InlandFlooding.pdf](https://www.weather.gov/media/owlie/InlandFlooding.pdf).

APPENDIX D: Disaster Supplies Checklists

The following list is taken from the FEMA publication “Are You Ready?” and is designed to help you determine what to include in your disaster supplies kit to meet your family’s needs.

First Aid Supplies:

- Adhesive bandages, various sizes
- 5" x 9" sterile dressing
- Conforming roller gauze bandage
- Triangular bandages
- 3" x 3" sterile gauze pads
- 4" x 4" sterile gauze pads
- Roll of 3" cohesive bandage
- Germicidal hand wipes or waterless, alcohol-based hand sanitizer
- Antiseptic wipes
- Pairs of large, medical-grade, non-latex gloves
- Tongue depressor blades
- Adhesive tape, 2" width
- Antibacterial ointment
- Cold pack
- Scissors (small, personal)
- Tweezers
- Assorted sizes of safety pins
- Cotton balls
- Thermometer
- Tube of petroleum jelly or other lubricant
- Sunscreen
- CPR breathing barrier, such as a face shield
- First aid manual

APPENDIX D: Disaster Supplies Checklists

Non-Prescription and Prescription Medicine Kit Supplies

- ▣ Aspirin and non-aspirin pain reliever
- ▣ Anti-diarrhea medication
- ▣ Antacid (for stomach upset)
- ▣ Laxative
- ▣ Vitamins
- ▣ Prescriptions
- ▣ Extra eyeglasses/contact lenses

Sanitation and Hygiene Supplies

- ▣ Washcloth and towel
- ▣ Heavy-duty plastic garbage bags and ties for personal sanitation uses
- ▣ Towelettes, soap, hand sanitizer
- ▣ Medium-sized plastic bucket with tight lid
- ▣ Toothpaste and toothbrushes
- ▣ Disinfectant and household chlorine bleach
- ▣ Shampoo, comb, brush
- ▣ Small shovel for digging a latrine
- ▣ Deodorants, sunscreen
- ▣ Toilet paper
- ▣ Razor, shaving cream
- ▣ Lip balm, insect repellent
- ▣ Contact lens solutions
- ▣ Mirror
- ▣ Feminine supplies

Equipment and Tools

- ▣ Portable, battery-powered radio or television and extra batteries
- ▣ NOAA Weather Radio, if appropriate for your area

APPENDIX D: Disaster Supplies Checklists

- Flashlight and extra batteries
- Signal flare
- Matches in a waterproof container (or waterproof matches)
- Shut-off wrench, pliers, shovel, and other tools
- Duct tape and scissors
- Plastic sheeting
- Whistle
- Small canister, ABC-type fire extinguisher
- Tube tent
- Compass
- Work gloves
- Paper, pens, pencils
- Needles and thread
- Battery-operated travel alarm clock
- Gas for a portable generator

Kitchen Items

- Manual can opener
 - Mess kits or paper cups, plates, and plastic utensils
 - All-purpose knife
 - Household liquid bleach to treat drinking water
 - Sugar, salt, pepper
 - Aluminum foil and plastic wrap
 - Resealable plastic bags
- Small cooking stove and a can of cooking fuel (if food must be cooked)

Comfort Items

- Games

APPENDIX D: Disaster Supplies Checklists

- Cards
- Books
- Toys for kids
- Foods

Food and Water Supplies

- Water
- Ready-to-eat meats, fruits, and vegetables
- Canned or boxed juices, milk, and soup
- High-energy foods, such as peanut butter, jelly, low-sodium crackers, granola bars, and trail mix
- Vitamins
- Special foods for infants or persons on special diets
- Cookies, hard candy
- Instant coffee
- Cereals
- Powdered milk

Clothes and Bedding Supplies

- Complete change of clothes
- Sturdy shoes or boots
- Rain gear
- Hat and gloves
- Extra socks
- Extra underwear
- Thermal underwear
- Sunglasses
- Blankets/sleeping bags and pillows

APPENDIX D: Disaster Supplies Checklists

Documents and Keys

(Make sure you keep these items in a watertight container)

- Personal identification
- Cash and coins
- Credit cards
- Extra set of house keys and car keys
- Copies of the following:
 - Birth certificate
 - Marriage certificate
 - Driver's license
 - Social Security cards
 - Passports
 - Wills
 - Deeds
 - Inventory of household goods
 - Insurance papers
 - Immunization records
 - Bank and credit card account numbers
 - Stocks and bonds
 - Emergency contact list and phone numbers
 - Map of the area and phone numbers of places you could go

APPENDIX E: Emergency Supplies for the Home

Food

- Non-perishable food – dry or canned goods, snacks. Also, plan for your pets.
- Manual can opener
- Paper plates, plastic utensils, cups, etc.
- Baby food, formula, bottles, if needed

Water

- Supply: 1-2 gallons per person per day for drinking, cooking, and hygiene. Remember that children, nursing mothers, the elderly and sick individuals require more water. Also, plan for your pets.
- Storage: Large, reusable containers should be well-rinsed and filled prior to the storm.

First Aid and Sanitation Items

- General first aid kit – bandages, aspirin, cold packs, etc.
- Personal hygiene items, toilet paper, feminine products, diapers, as needed
- Disinfectant, hand sanitizer
- Sunscreen, bug repellent
- Special medications and a list of prescriptions. It is advisable to have a week's supply of any daily medications on hand; if any medications need to be temperature-controlled, discuss with your healthcare provider what to do in case of power outage.
- List of physicians providing care for specific or chronic health conditions

Other Items

- Cell phone, car and/or portable charger, and a list of emergency telephone numbers (in case cell phones are not working)
- Extra cash, since ATMs may not be working
- Flashlight and extra batteries
- Portable radio or a NOAA all-hazard weather radio, with extra batteries or crank
- Matches and a lighter

APPENDIX E: Emergency Supplies for the Home

- Copies or electronic back-ups of important documents, including driver's license, social security card, proof of residence, insurance policies, deeds, birth and marriage certificates, and medical records
- Bedding and clothing (including rain gear) for each person
- Paper and pencils
- Games and books for children
- Pet supplies and documentation (vaccines, microchip number, etc.)
- Waterproof plastic sheeting or tarp, adhesive tape, and rope
- Alternate power supplies: inverters, power stations, generators (with gas tanks if needed)

END NOTES

1. Federal Emergency Management Agency. Resilience. Insurance. [fema.gov/resilience](https://www.fema.gov/resilience)
2. Multi-hazard Mitigation Council, National Institute of Building Sciences. 2017. Natural Hazard Mitigation Saves 2017 Interim Report: An Independent Study – Summary of Findings. [nibs.org/page/mitigationsaves](https://www.nibs.org/page/mitigationsaves)
3. National Hurricane Center, National Oceanic and Atmospheric Administration. Atlantic & Eastern Pacific Climatology. [nhc.noaa.gov/climo/](https://www.nhc.noaa.gov/climo/)
4. Hurricane Research Division, Atlantic Oceanographic & Meteorological Laboratory, National Oceanic and Atmospheric Administration. Hurricane Frequently Asked Questions. aoml.noaa.gov/hrd/tcfaq/A11.html
5. WeatherNation. No Quarter; Hurricane Right Front Quadrant. Oct 17, 2017. Retrieved from weathernationtv.com/news/no-quarter-hurricane-right-front-quadrant/ on Mar 7, 2018.
6. National Hurricane Center, National Oceanic and Atmospheric Administration. Storm Surge & Storm Tide. [nhc.noaa.gov/prepare/hazards.php](https://www.nhc.noaa.gov/prepare/hazards.php)
7. National Hurricane Center, National Oceanic and Atmospheric Administration. Storm Surge Watch/Warning Graphic. [nhc.noaa.gov/surge/warning/](https://www.nhc.noaa.gov/surge/warning/)
8. National Hurricane Center, National Oceanic and Atmospheric Administration. oceanservice.noaa.gov/facts/stormsurge-stormtide.html
9. National Hurricane Center, National Oceanic and Atmospheric Administration. Heavy Rainfall & Inland Flooding. [nhc.noaa.gov/prepare/hazards.php](https://www.nhc.noaa.gov/prepare/hazards.php)
10. Federal Emergency Management Agency. Data Visualization: Historical Flood Risk and Costs. [fema.gov/data-visualization-floods-data-visualization](https://www.fema.gov/data-visualization-floods-data-visualization)
11. Federal Emergency Management Agency. [nfip-services.floodsmart.gov](https://www.nfip-services.gov/floodsmart.gov)
12. National Aeronautics and Space Administration (NASA). Rising seas bring a rising nuisance: coastal flooding. sealevel.nasa.gov/news/91/rising-seas-bring-a-rising-nuisance-coastal-flooding
13. Federal Emergency Management Agency. National Flood Insurance Program. Why Buy Flood Insurance. [floodsmart.gov/why/why-buy-flood-insurance](https://www.floodsmart.gov/why/why-buy-flood-insurance)
14. James M. Wright, P.E. 2007. Floodplain Management: Principles and Current Practices. Chapter 2 Types of Floods and Floodplains. (retrieved April 24, 2018 from training.fema.gov/hiedu/docs/fmc/cover.pdf)

END NOTES

15. U.S. Global Change Research Program. Client Science Special Report. Chapter 12, Sea Level Rise.
ntrs.nasa.gov/archive/nasa/casi.ntrs.nasa.gov/20180001313.pdf
16. National Weather Service. (n.d.) Flood Related Hazards. (retrieved April 24, 2018 from weather.gov/safety/flood-hazards)
17. Department of Homeland Security (retrieved April 24, 2018 from ready.gov/tornadoes)
18. National Weather Service. (n.d.) Thunderstorm Hazards – Tornadoes. (retrieved April 24, 2018 from weather.gov/jetstream/tornado)
19. Department of Homeland Security (retrieved April 24, 2018 from ready.gov/tornadoes)
20. National Weather Service. (n.d.) Severe Weather Definitions – Severe Thunderstorm. weather.gov/bgm/severedefinitions
21. Ready.gov. Extreme Heat. ready.gov/heat
22. Climate Readiness Collaborative. Urban Heat Pollution in the Capital Region. climatereadiness.info/news-events/heat/
23. Proceedings of the National Academy of Sciences of the United States of America (PNAS) Early Edition. Human-started wildfires expand the fire niche across the United States.
pnas.org/content/pnas/early/2017/02/21/1617394114.full.pdf
24. The Delaware Geological Survey. Overview of Earthquakes in Delaware.
dgs.udel.edu/delaware-geology/overview-earthquakes-delaware
25. U. S. Geological Survey (USGS). East vs West Coast Earthquakes.
usgs.gov/news/east-vs-west-coast-earthquakes
26. National Oceanic and Atmospheric Administration.
tsunami.noaa.gov/
27. National Oceanic and Atmospheric Administration.
oceanservice.noaa.gov/facts/meteotsunami.html

END NOTES

28. National Tsunami Hazard Mitigation Program. U.S Tsunami Hazard. nws.weather.gov/nthmp/ushazard.html
29. coastal.er.usgs.gov/hurricanes/coastal-change/beach-erosion.php
30. Your community will be better able to cope with a disaster when you work with your neighbors and local government agencies as a team (LA VOAD). More information about the Louisiana VOAD is available here: lavoad.communityos.org/cms/home
31. Department of Homeland Security. (retrieved April 24, 2018 from ready.gov/build-a-kit)
32. U.S. Food and Drug Administration. Food and Water Safety During Power Outages and Floods. fda.gov/Food/ResourcesForYou/Consumers/ucm076881.htm
33. Insurance Institute for Business and Home Safety (IBHS). Shut the Doors on Wind. disastersafety.org/hurricane/
34. National Weather Service. Watch/Warning/Advisory Definitions. weather.gov/lwx/WarningsDefined#Tropical%20Storm%20Watch
35. Department of Homeland Security. (retrieved April 24, 2018 from ready.gov/floods)
36. Electrical Safety Foundation International (ESFI). Quick Reference Guide: Home Safety Technology. eta-safety.lbl.gov/sites/default/files/Quick-Reference-Guide_ESFI.pdf
37. Electrical Safety Foundation International (ESFI). Downed Power Line Safety - Downed and Dangerous. esfi.org/disaster-safety
38. Mental Health America (MHA). Coping with The Stress of Natural Disasters. Common reactions. mentalhealthamerica.net/conditions/coping-stress-natural-disasters
39. Mental Health America (MHA). Coping with The Stress of Natural Disasters. Tips for Coping. mentalhealthamerica.net/conditions/coping-stress-natural-disasters
40. Insurance Institute for Business and Home Safety (IBHS). FORTIFIED. disastersafety.org/fortified/
41. Insurance Institute for Business and Home Safety (IBHS). Hurricane Charley -

END NOTES

Executive summary.

disastersafety.org/wp-content/uploads/hurricane-charley-report.pdf

42. The University of Alabama, Culverhouse College of Commerce. Estimating the Effect of FORTIFIED Home™ Construction on Home Resale Value. smarthomeamerica.org/resources/the-effect-of-fortified-construction-on-home-resale-value
43. National Association of Certified Home Inspectors. Standard Estimated Life Expectancy Chart for Homes. smarthomeamerica.org/resources/the-effect-of-fortified-construction-on-home-resale-value.
44. Federal Emergency Management Agency (FEMA). Against the Wind. fema.gov/media-library-data/20130726-1505-20490-3483/agstwnd.pdf
45. Federal Alliance for Safe Homes (FLASH). Floods: Floodproofing – Dry. flash.org/peril_inside.php?id=59
46. Ibid.
47. Along with well-built wood-frame structures, concrete structures can withstand the high winds in Category 4 and 5 storms, as well as lower category tornadoes.
48. International Society of Arboriculture. Arborist Search. treesaregood.org/findanarborist
49. University of Florida, IFAS Extension. Selecting Coastal Plain Species for Wind Resistance. edis.ifas.ufl.edu/pdf/FR/FR17400.pdf
50. Federal Emergency Management Agency (FEMA). The Declaration Process. fema.gov/declaration-process#
51. Federal Emergency Management Agency (FEMA). Individuals and Households Program Fact Sheet. fema.gov/media-library/assets/documents/24945
52. U.S. Small Business Administration. SBA Disaster Loan Program Frequently Asked Questions. sba.gov/sites/default/files/articles/sba-disaster-loans-faq.pdf
53. Federal Emergency Management Agency (FEMA). Hazard Mitigation Grant Program. fema.gov/hazard-mitigation-grant-program
54. Federal Emergency Management Agency (FEMA). Flood Mitigation Assistance

END NOTES

Program (FMA) Eligible Uses.

epa.gov/sites/production/files/2015-10/documents/fma.pdf

55. Insurance Information Institute. Determining How Much Insurance you Need. *iii.org/article/how-much-homeowners-insurance-do-you-need*
56. National Oceanic and Atmospheric Administration (NOAA). SFHA. noaanhc.wordpress.com/tag/sfha/
57. Federal Emergency Management Agency (FEMA). Data Visualization: Historical Flood Risk and Costs. fema.gov/node/296695
58. FEMA. (n.d) Increased Cost of Compliance Coverage: Reduces Future Flood Damages brochure. fema.gov/media-library-data/1504291364571-8d8f1e5180953be3a274005f1a52d191/Increased_Cost_Compliance.pdf
59. Insurance Information Institute. Settling Insurance Claims After a Disaster. iii.org/article/settling-insurance-claims-after-a-disaster
60. National Association of Home Builders (NAHB). Don't Get Scammed: Find a Qualified Contractor. nahb.org/en/consumers/homeownership/home-maintenance-and-repair/how-to-spot-a-contractor-scam.aspx
61. SBP. Avoiding Contractor Fraud. sbpusa.org/public/uploads/general/SBP-Contractor-Fraud-Notice.pdf
62. National Oceanic and Atmospheric Administration, The 2018 State of High Tide Flooding and 2019 Outlook, (Retrieved July 24, 2019 from tidesandcurrents.noaa.gov/HighTideFlooding_AnnualOutlook.html)
63. FEMA, Building Codes Toolkit, (retrieved April 24, 2018 from fema.gov/media-library-data/20130726-1902-25045-9664/building_codes_toolkit_faq_508.pdf)
64. Delaware City Hazard Mitigation and Climate Adaptation Action Plan, 3.2.7 Extreme Heat/Drought, (retrieved July 24, 2019 from delawarecity.delaware.gov/files/2014/12/Delaware-City-Hazard-Climate-Action-Plan_no-appendices_January-20141.pdf)

HOMEOWNERS HANDBOOK

To Prepare For Natural Disasters

Designed specifically for homeowners, this is a critical resource for anyone wanting to reduce the risks to both their family and property from the threats of natural hazards. This handbook covers basic information on emergency preparedness, evacuation planning, flood and wind insurance, and steps to take to protect your property.

Are you prepared?