

---

# Comparison of Bessel and RRC filters for DCS Platforms

Robert Peters  
Stellar Solutions  
January 25, 2006

New requirement of meeting ITU -25 dB sidelobe specification calls for revision of NOAA requirements.

- Would a RRC or Bessel filter provide better performance?
- What impairment arises from a RRC Tx filter used with a Bessel Rx filter at DCS Rx station?

# Conclusions (1)

- Recommend using 2<sup>nd</sup> order RRC filter as performance is about the same as 8<sup>th</sup> order Bessel filter
- DCS Rx station can use 8<sup>th</sup> order Bessel filter with 2<sup>nd</sup> order RRC DCS Tx filter without significant degradation.

# Conclusions (2)

- **25 dB sidelobe requirement is driving factor in HPA back-off, not type of filter.**
- For more linear amplifiers, RRC filters marginally better, for less linear amplifiers, Bessel filters marginally better (both 8<sup>th</sup> order filters). But 8<sup>th</sup> Order Bessel filter needed to equal 2<sup>nd</sup> order RRC filter.
- RRC/Bessel filter differences in filter BW at -20 dBC (276 vs. 306 Hz) small compared to 100 Hz allowed frequency drift(+/- 200 Hz spacing, both 8<sup>th</sup> order filters).
- Either 8<sup>th</sup> order filter can easily support half current spacing for 300 bps links. Filter sharpness not an issue (for 8<sup>th</sup> order filter)!

# Many Interacting Variables

- Over sample rate
- Alpha of RRC filter (used NOAA recommended alpha = 1)
- Bandwidth of RRC and Bessel function
- Order of RRC and Bessel filters
- Type of Bessel filter (“analog” or digital)
- AM/AM and AM/PM of platform amplifier
- Output power back-off of amplifier

# Modeling (1)

- Uncoded 450 bps, 8 PSK links. This gives correct bandwidth coded 300 bps but  $E_b/N_0$  high by 1.8 dB.
- To determine oversample rate, filter bandwidth (BW), and filter order:
  - Used Simulink RRC Tx and Rx filters which optimize filter BW.
  - Adjusted Bessel bandwidth to approximately match RRC BW at 3 dB points
  - Modeled RRC link with no amplifier. Oversample rate increased until performance leveled out.
  - Using oversample rate and BW from above, looked at scatter plots of Rx of link using Bessel filter Tx and Rx and adjusting Bessel filter order to get good performance (found peaks in performance vs. order curve)
- Added platform amplifier, determined OPBO to exceed sidelobe specifications by 1 to 3 dB.
- Ran simulation to get BER curves for various back-offs to get implementation margin.
  - Found that OPBO drove backoff, not implementation margin

# Modeling (2)

- Repeated simulation for two additional amplifiers with greater non-linearity.
  - Found some changes in performance but no substantial change in conclusions
- Added Satellite SSPA with 18 dB NPR and 32 adjacent channels to final simulation to determine impact on C/N.
  - Found minimal impact
- Investigated impact of lower order RRC and Bessel filters
  - RRC performance remains good while Bessel filter performance deteriorated greatly.
- Modeled NPR, examined the effect of decreased carrier spacing
  - Noise constant as spacing decrease and equal to NPR
- Modeled RRC transmit, Bessel Rx filter
  - Found little difference from RRC Tx and RRC Rx in performance with 8<sup>th</sup> order Bessel filter

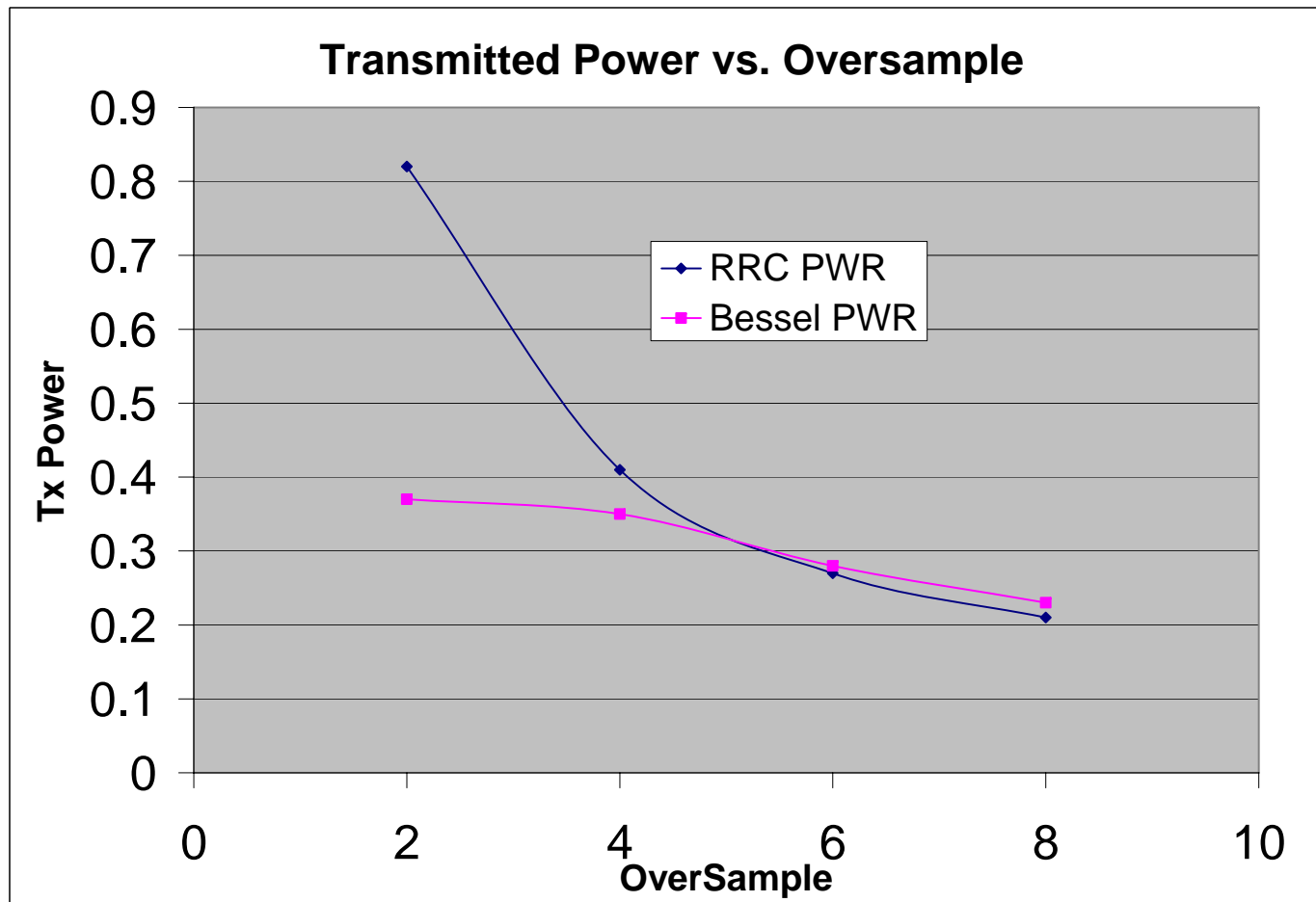

Selected sampling rate (samples/symbol) of 8 for single carrier simulations



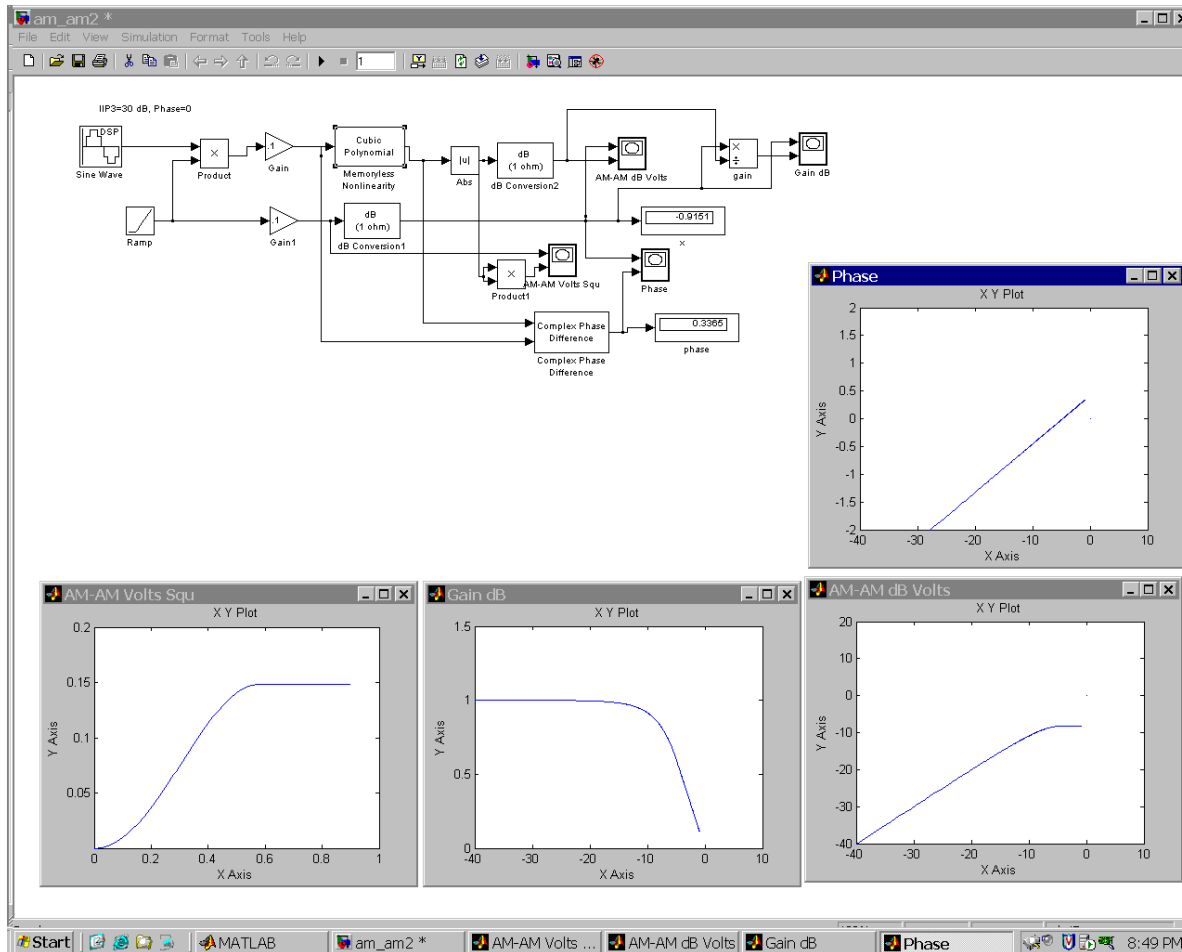

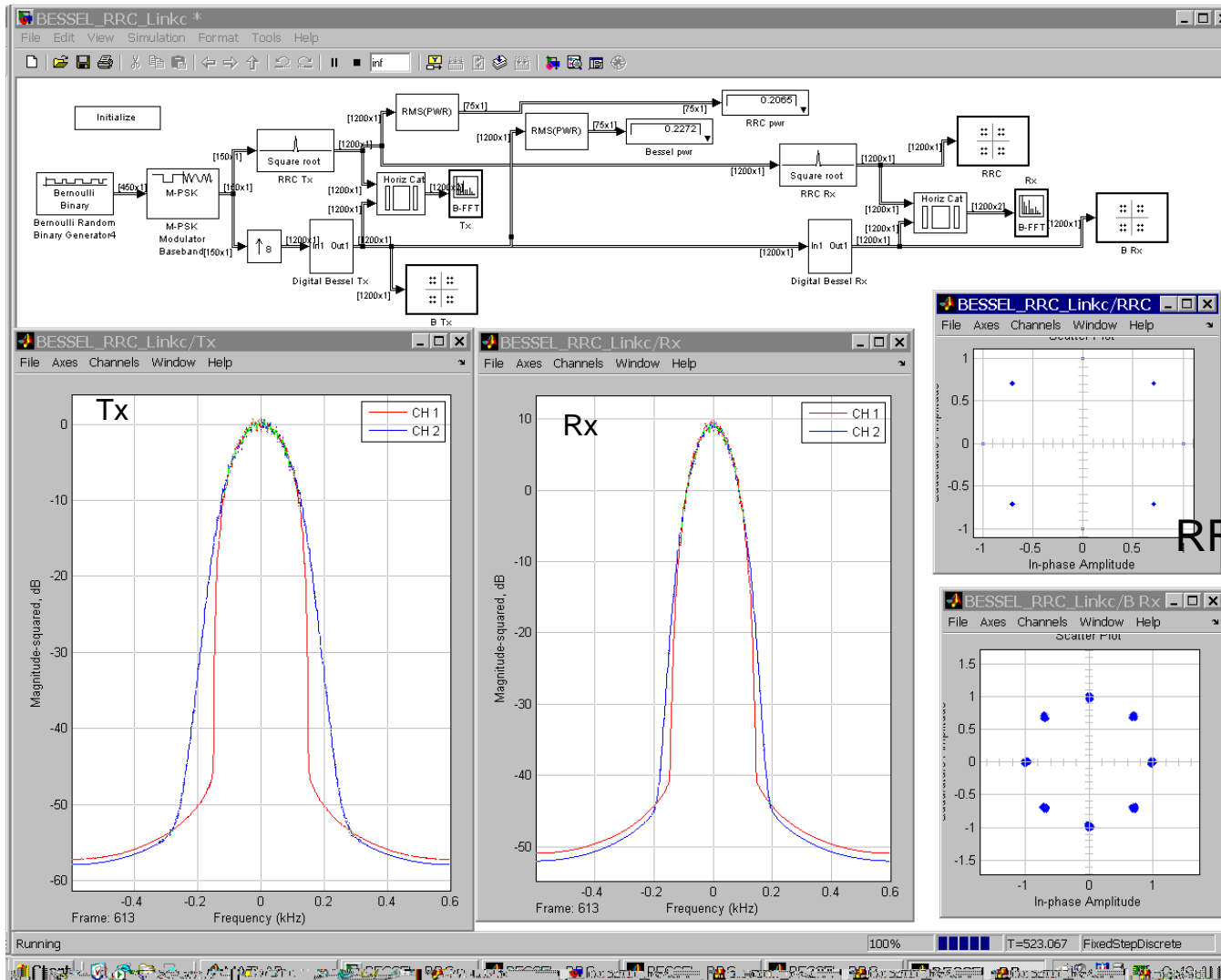

Bessel Tx  
 BW adjusted  
 so as to be  
 about equal  
 to RRC.

Note greater  
 scatter on  
 Bessel filter.

Both filters  
 are 8th order

Red=RRC

Blue=Bessel

Bessel

# Sidelobes for P<sup>3</sup>

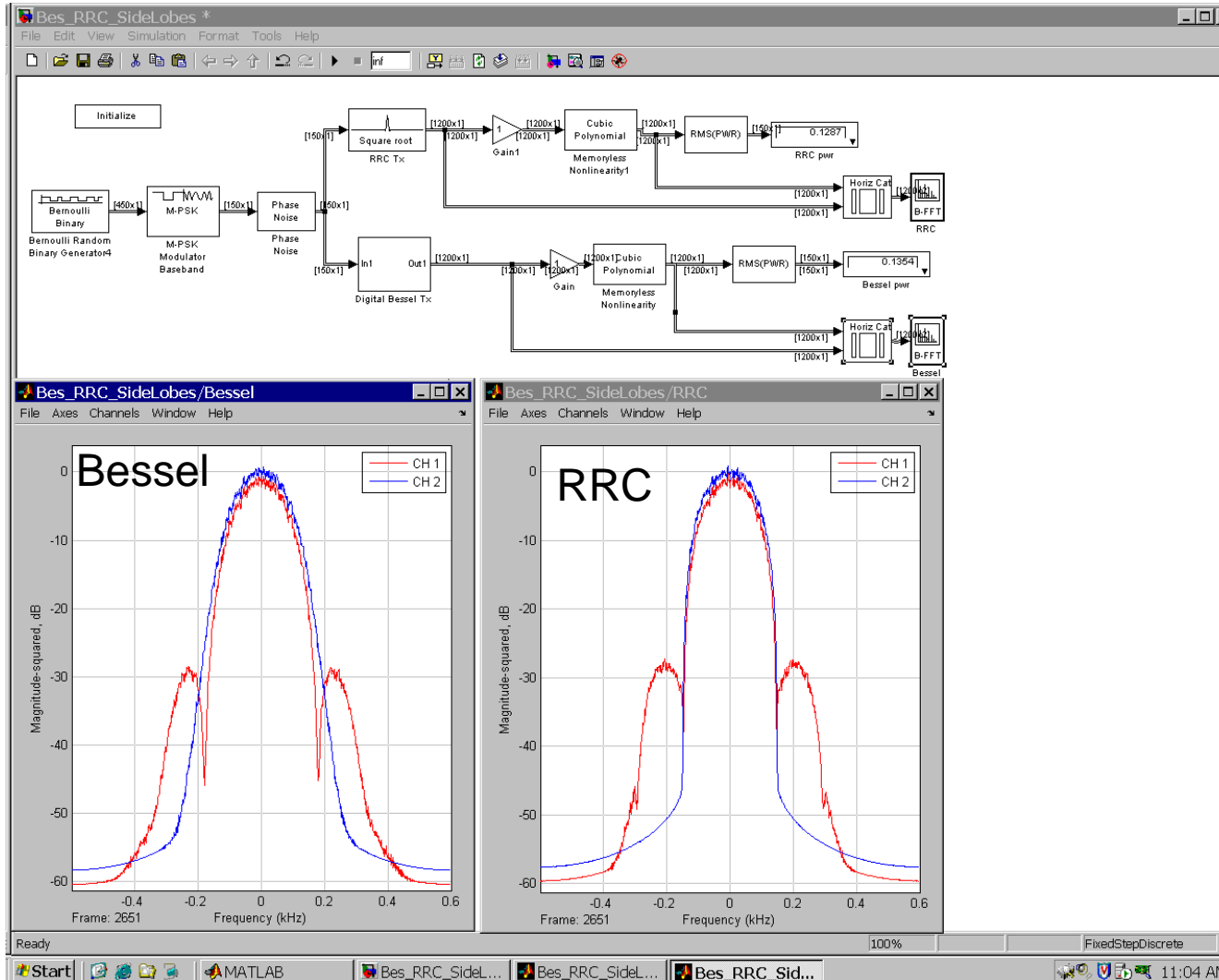

Sidelobe regrowth makes Tx bandwidths equal.

# 8<sup>th</sup> Order RRC Tx Filter

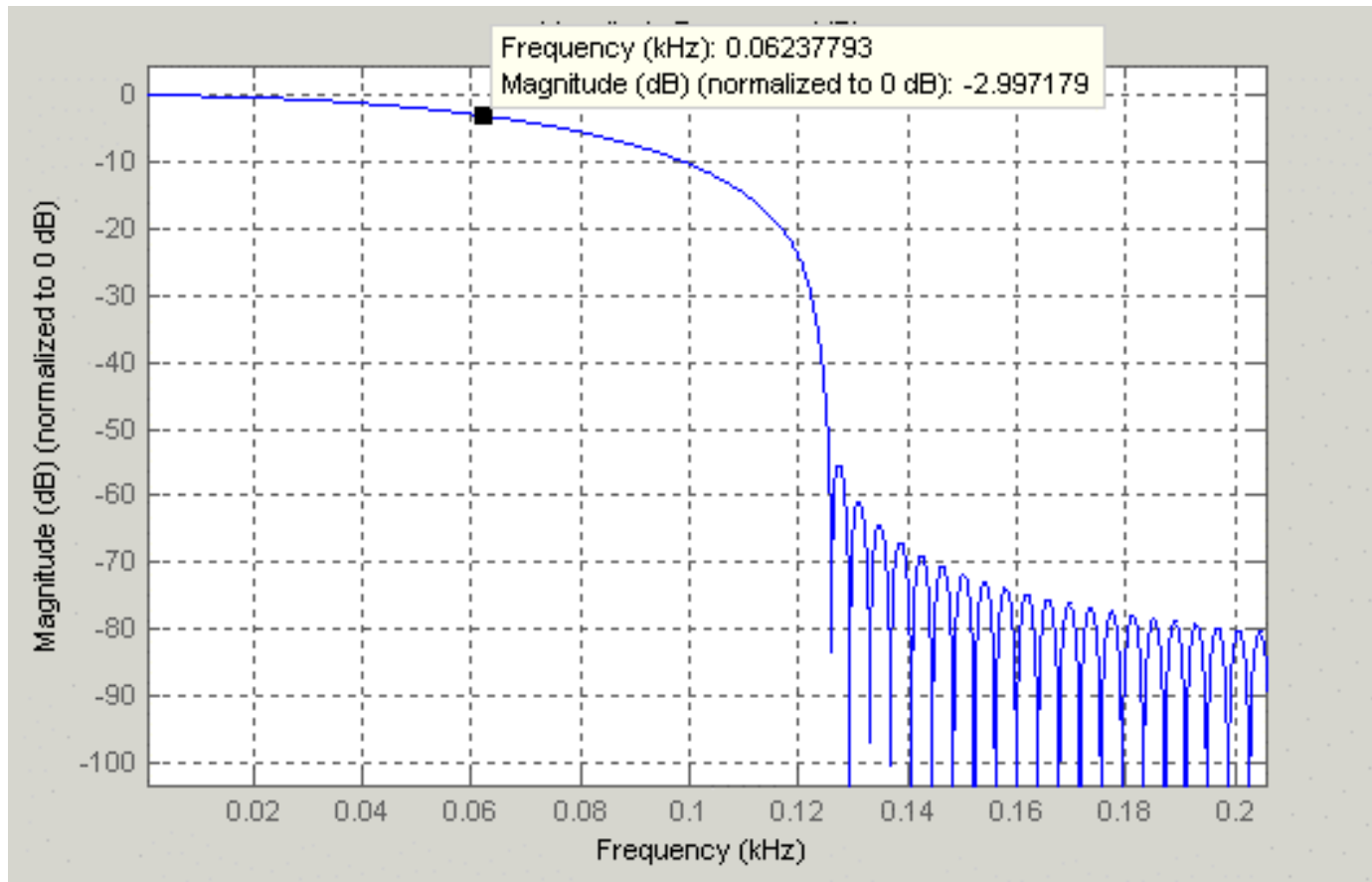

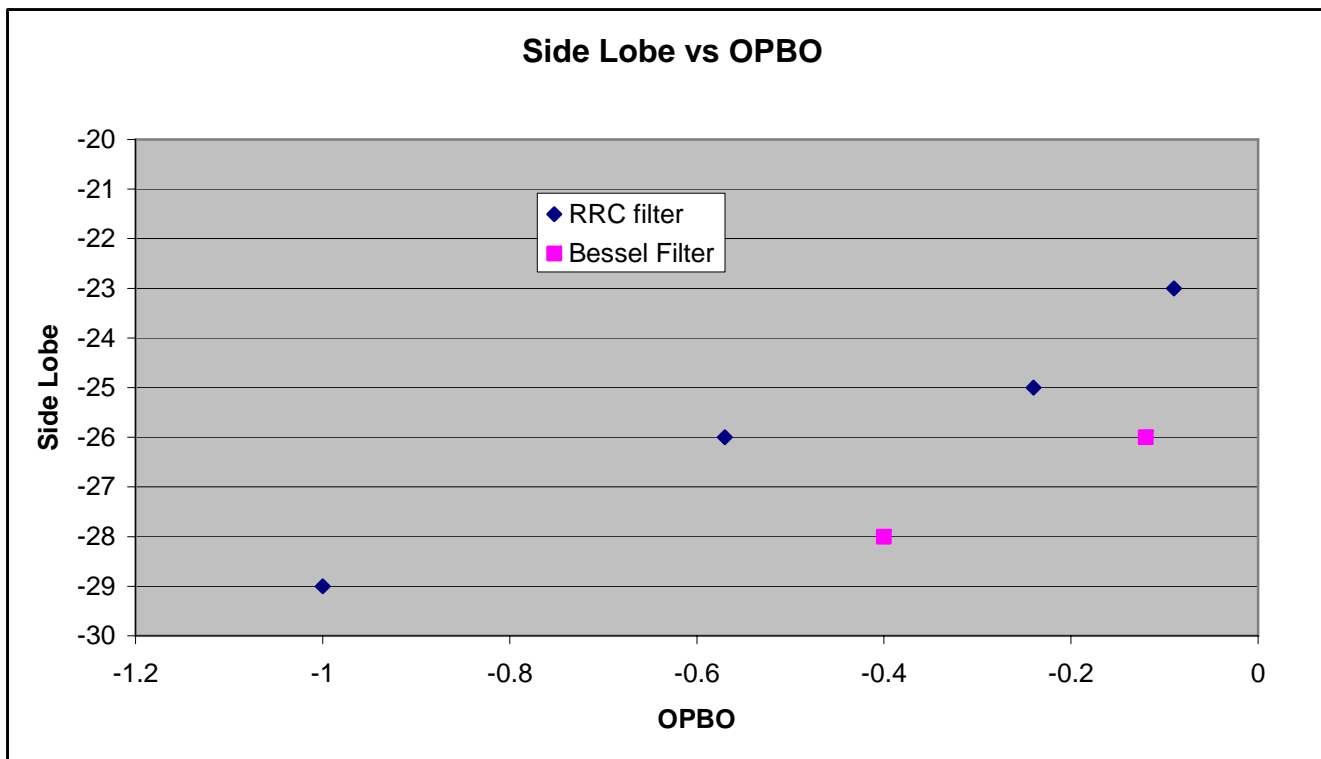

RRC filter needs greater back-off to achieve same sidelobe. For this amplifier, difference is only about  $\frac{1}{2}$  dB for sidelobes of -26 dBC.

# Added 3° Phase Noise

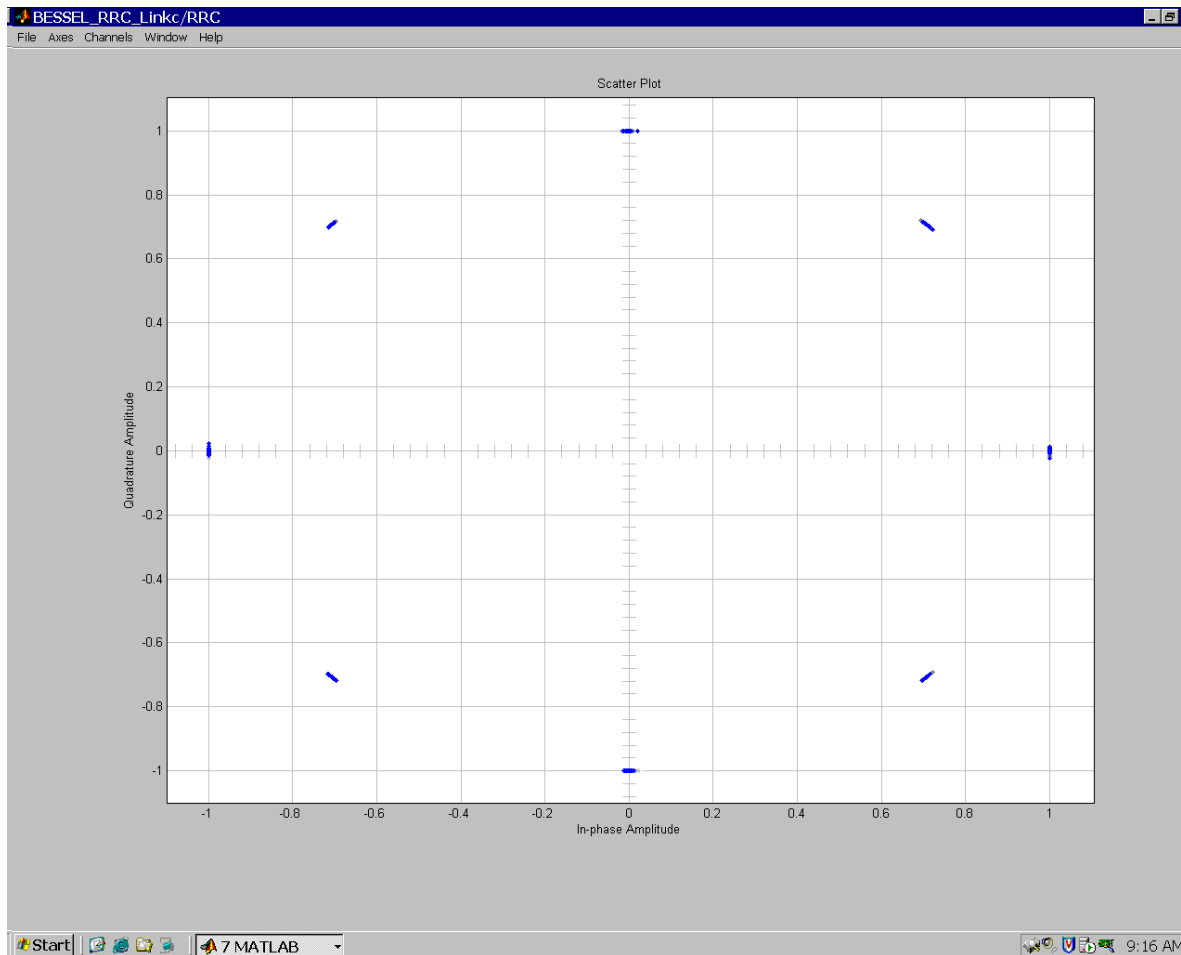

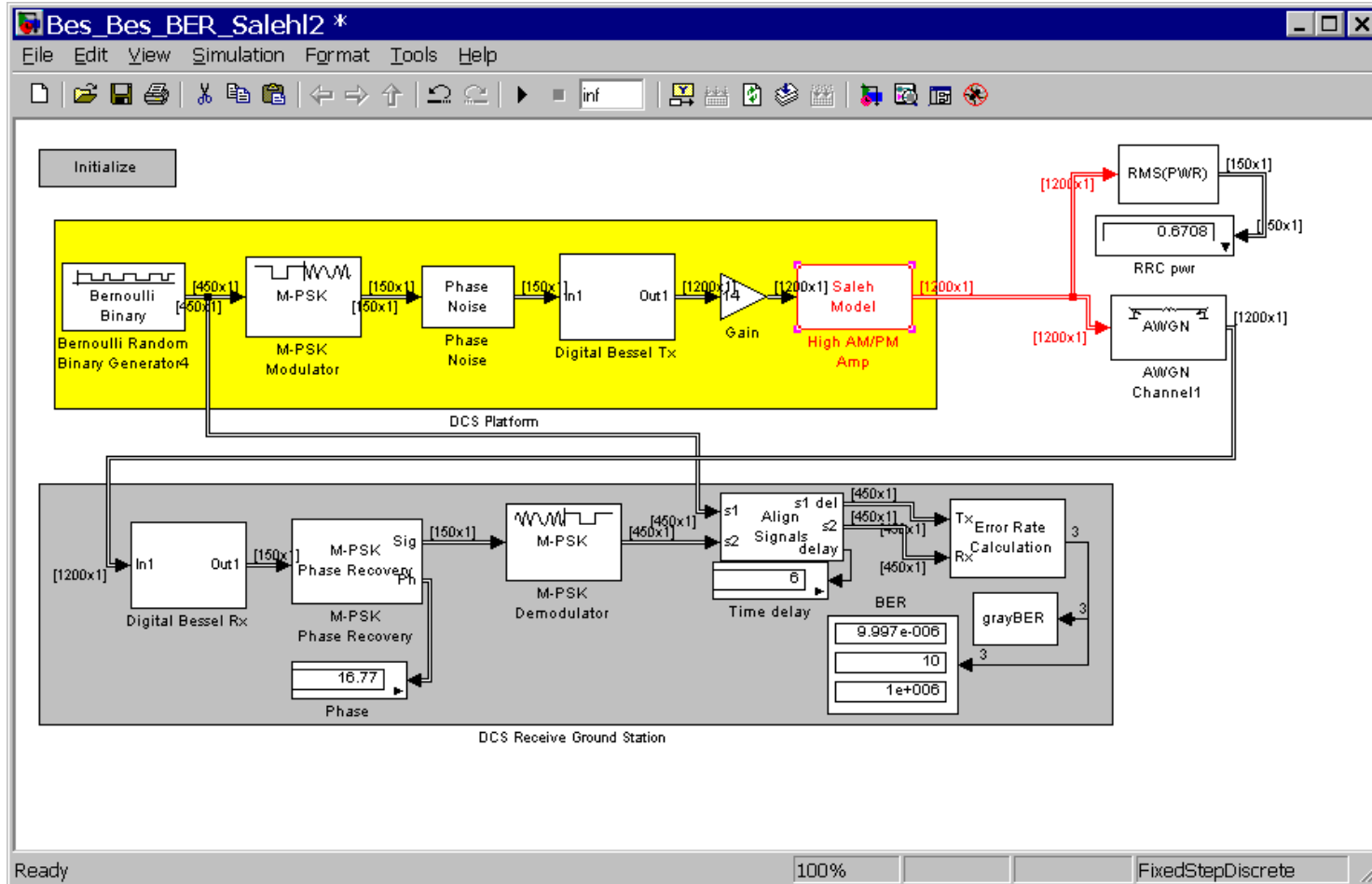

# BER Plot RRC and Bessel Filters for P3

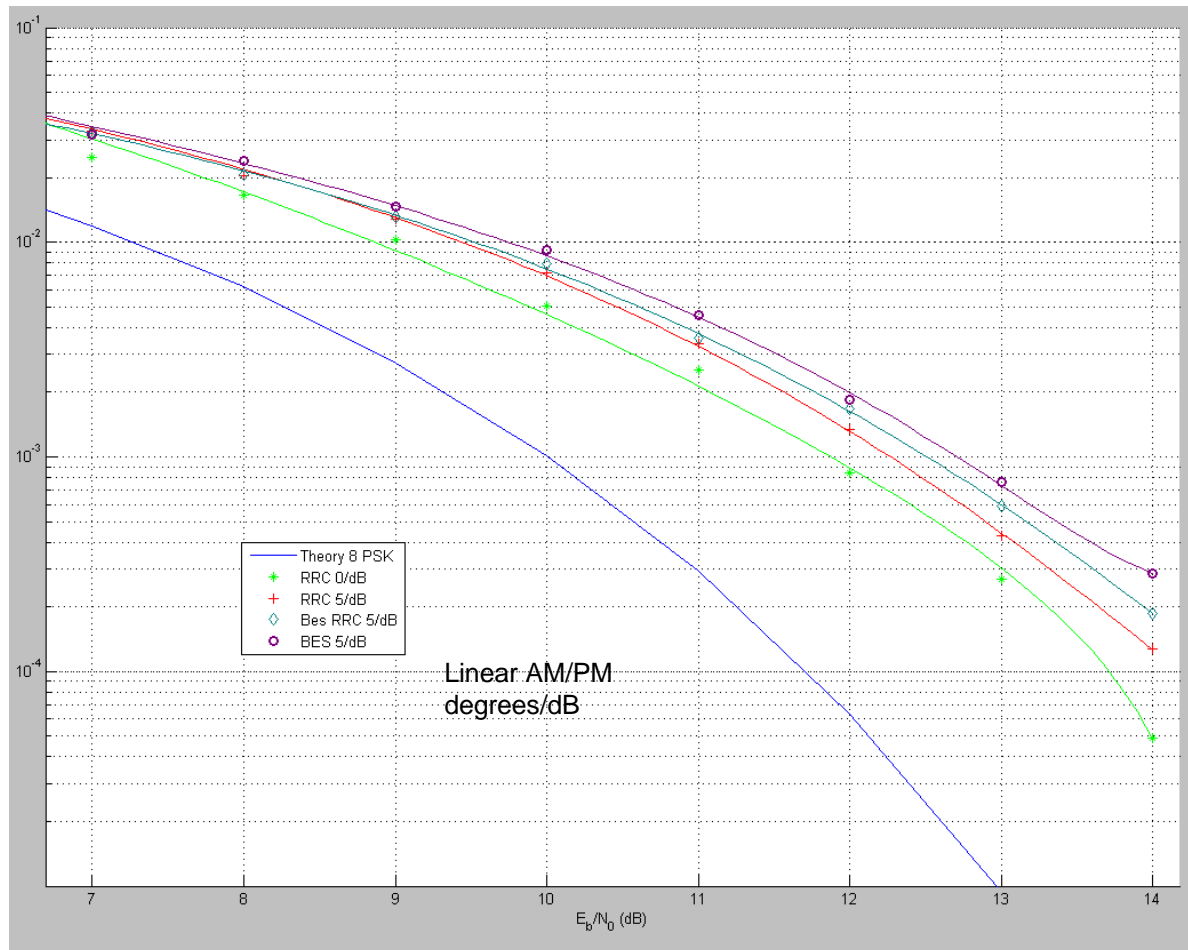

The RRC filter has about 0.7 db less implementation loss. Thus the Bessel filter loses the  $\frac{1}{2}$  dB advantage it had with lower sidelobes.

Results consistent with scatter plot shown earlier



- $P^3$  amplifier was fairly linear with linear phase change with amplitude which allowed operation very close to saturation.
- To determine effect of more realistic assumptions, two Saleth models, Saleth1 and Saleth2 developed which had greater nonlinearity than  $P^3$  model.
  - Saleth2 has similar AM/AM but higher AM/PM than Saleth1

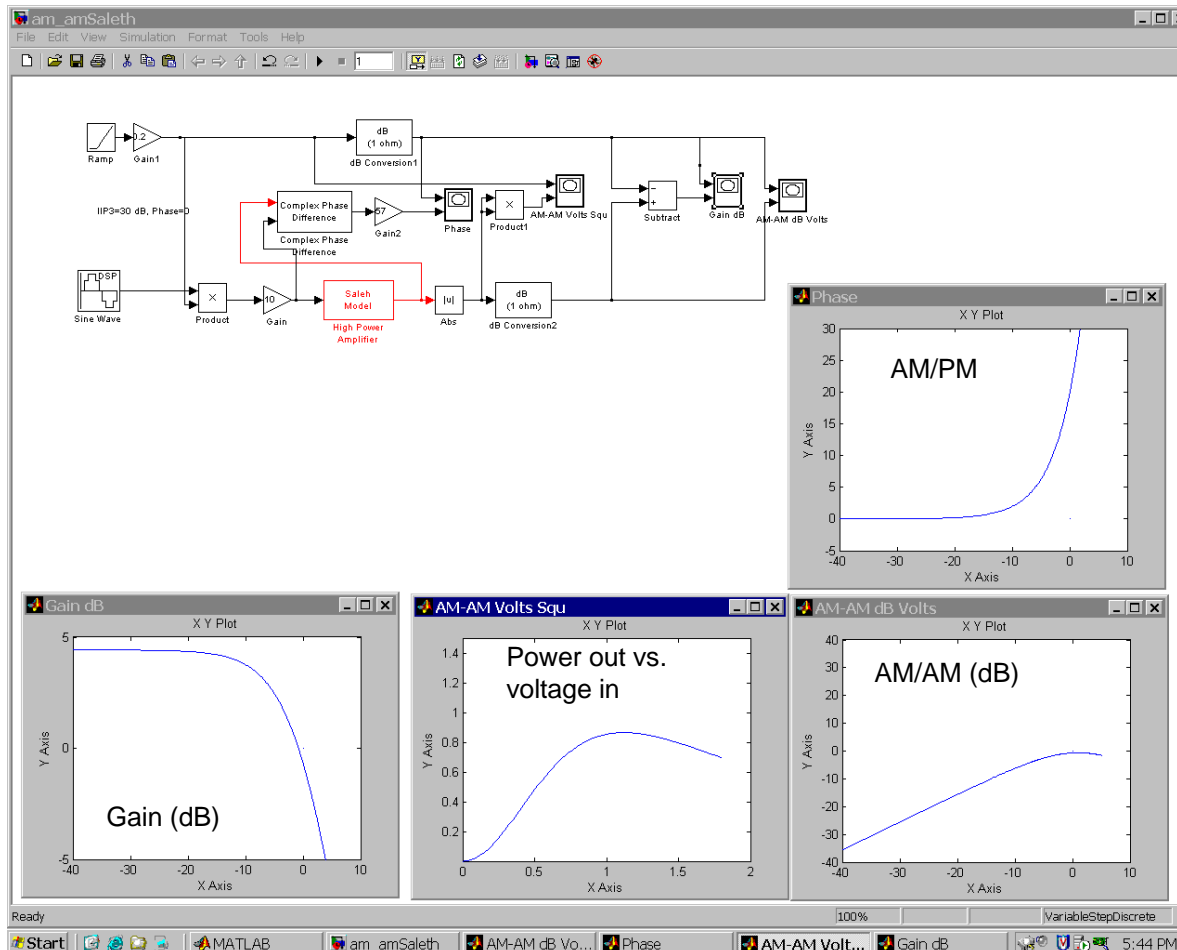

Saleth1 has higher AM/PM and AM/AM than  $P^3$ . Note AM/AM approximates a TWTA rather than an SSPA

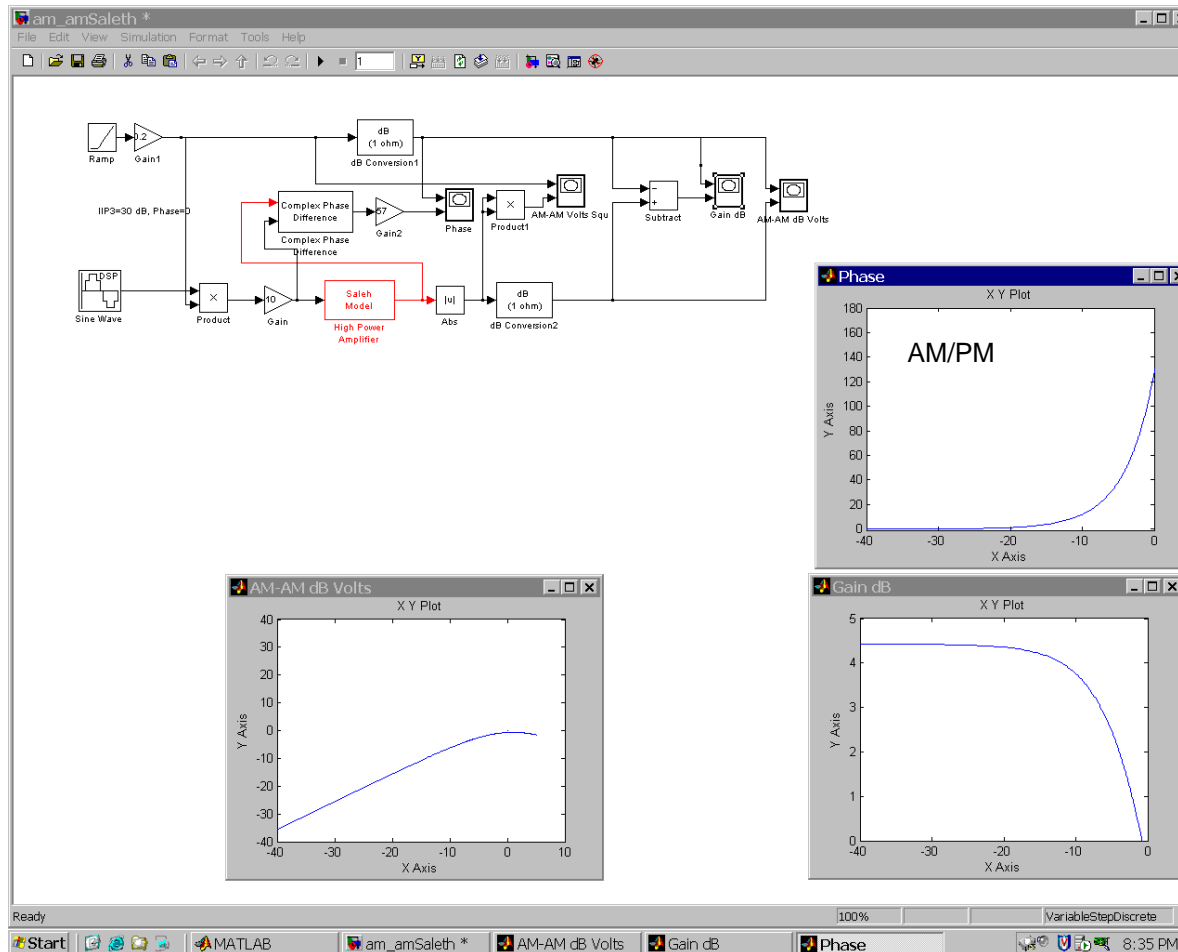

Saleth2 has same AM/AM as Saleth1, but greater AM/PM

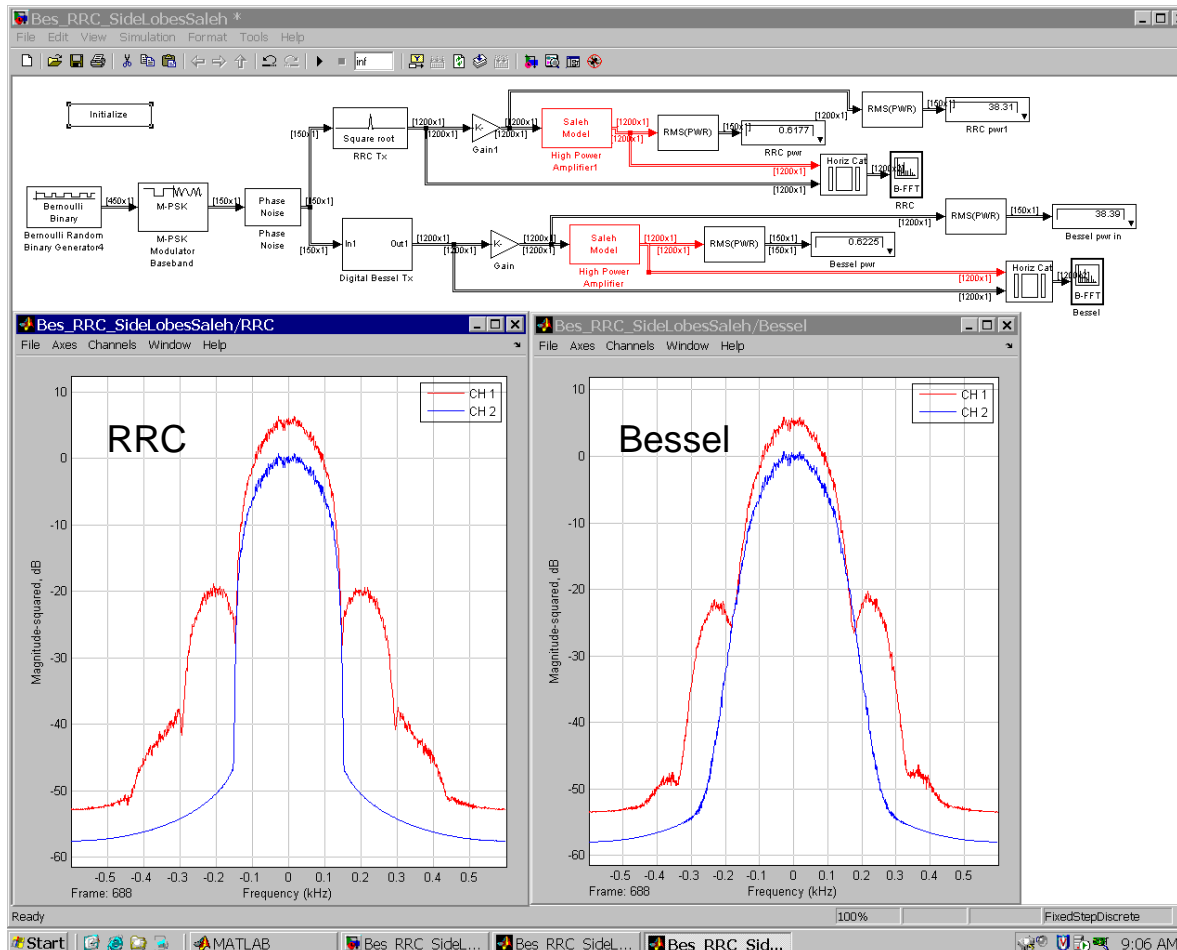

Narrower RRC filter advantage lost because sidelobe regrowth of amplifier.

Blue=before amplifier  
Red=after amplifier

# Saleth 1 (Lo phase) & Saleth 2 (Hi phase)

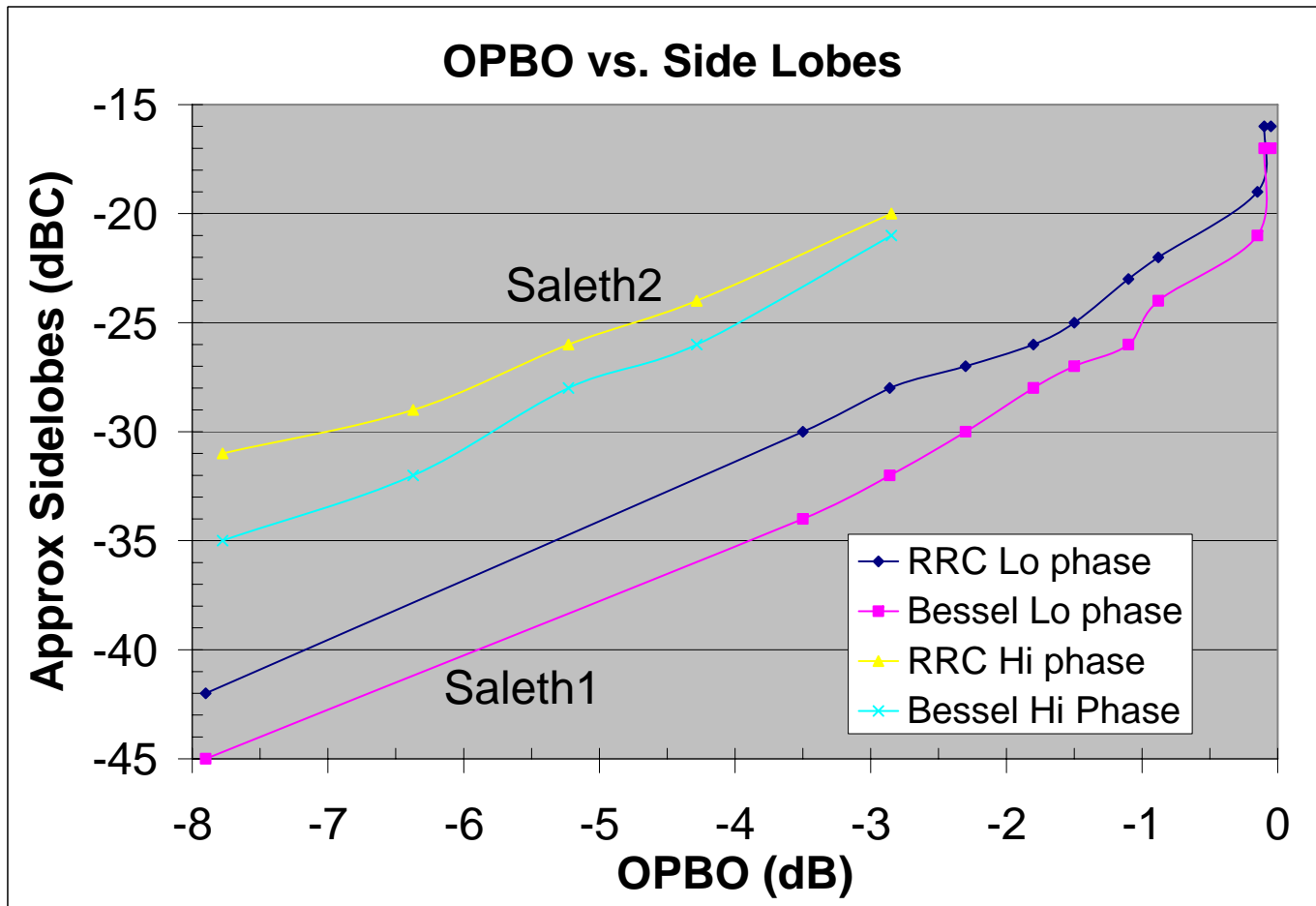

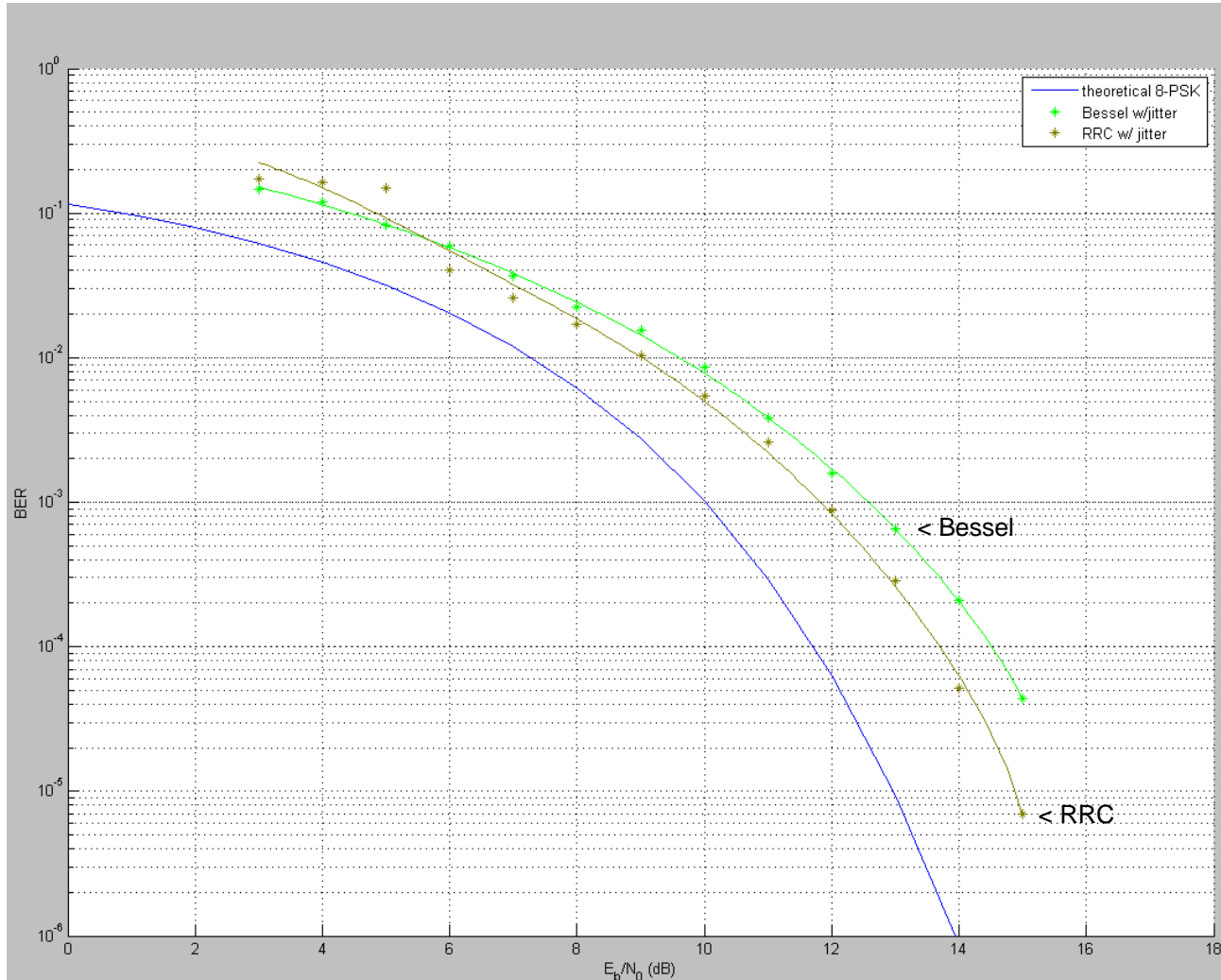

# Saleth2 (High Distortion)

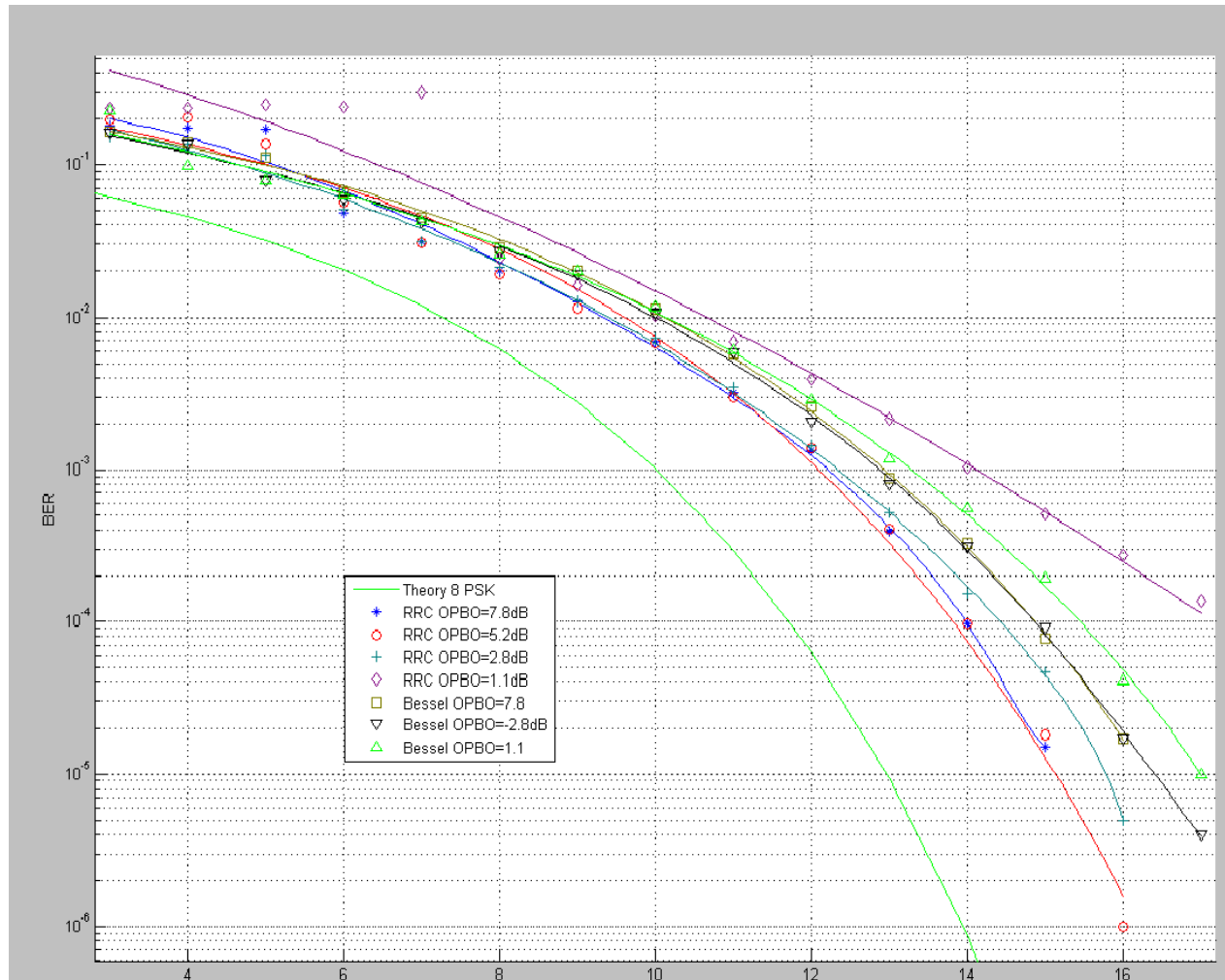

# Reduced spacing

- 300 Hz from band center, out-of-band signal is > 25 dBC.
- This would allow 5x current spacing for 300 bps link and by scaling, 2X for 1200 bps link.
- However 200 Hz bandwidth allocated to accommodate frequency drift reduces capacity increases to only 2x for 300 bps and less than 2x for 1200 bps links (for overlap at < 25 dB)



# Why RRC Performance Does Not Degrade

- Acceptable use of lower order RRC filters unexpected as filter attenuation decreases as order decreases.
- Reason: The decrease in power of modulated signals as frequency increased from carrier band edge means that high filter attenuation not necessary. Note sharpness of RRC filter roll-off does not degrade significantly as filter order is decreased so sidelobe attenuation does not change (unlike Bessel filters).

# 2<sup>nd</sup> Order Comparison

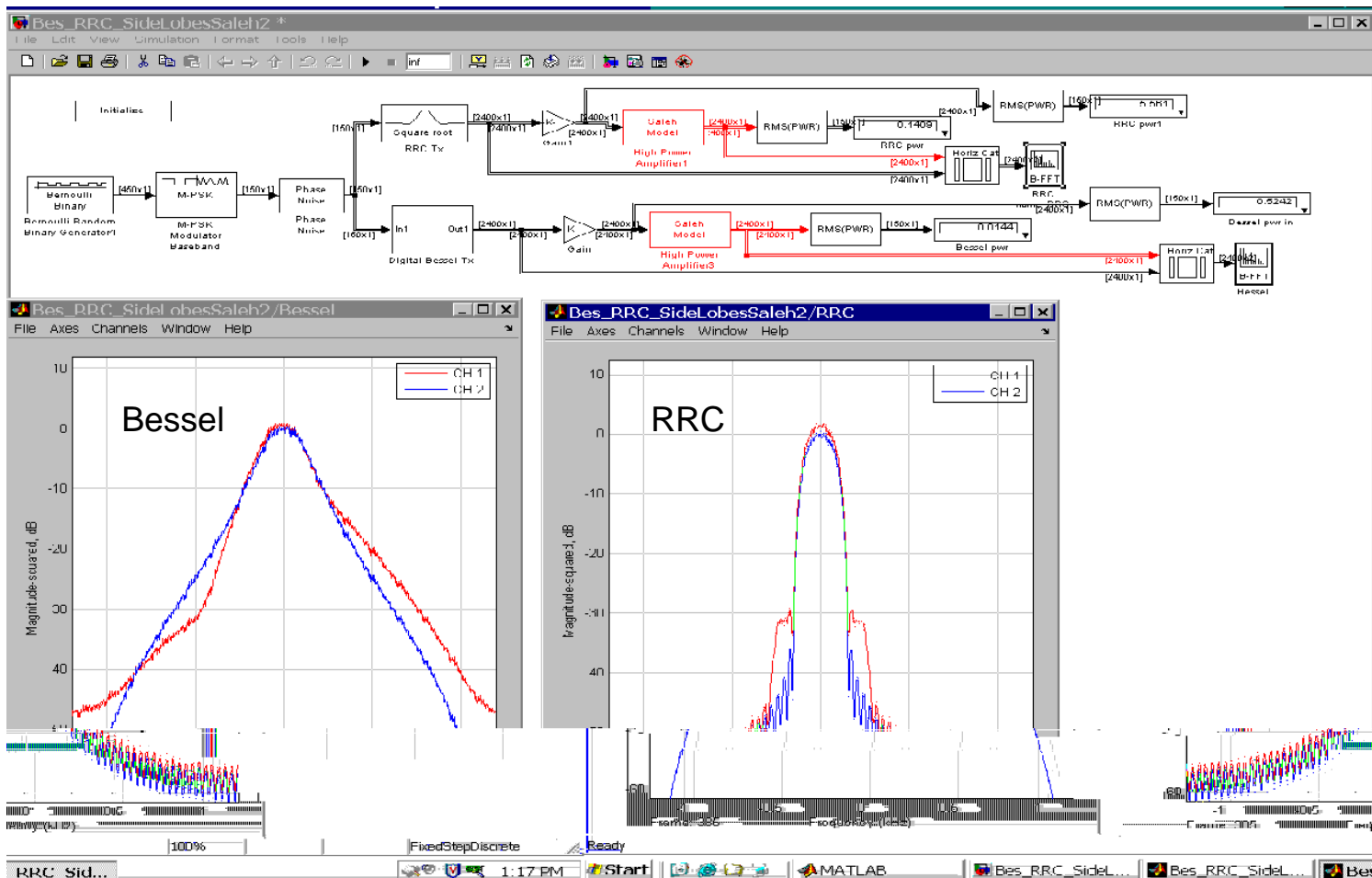

# 3<sup>rd</sup> Order Comparison

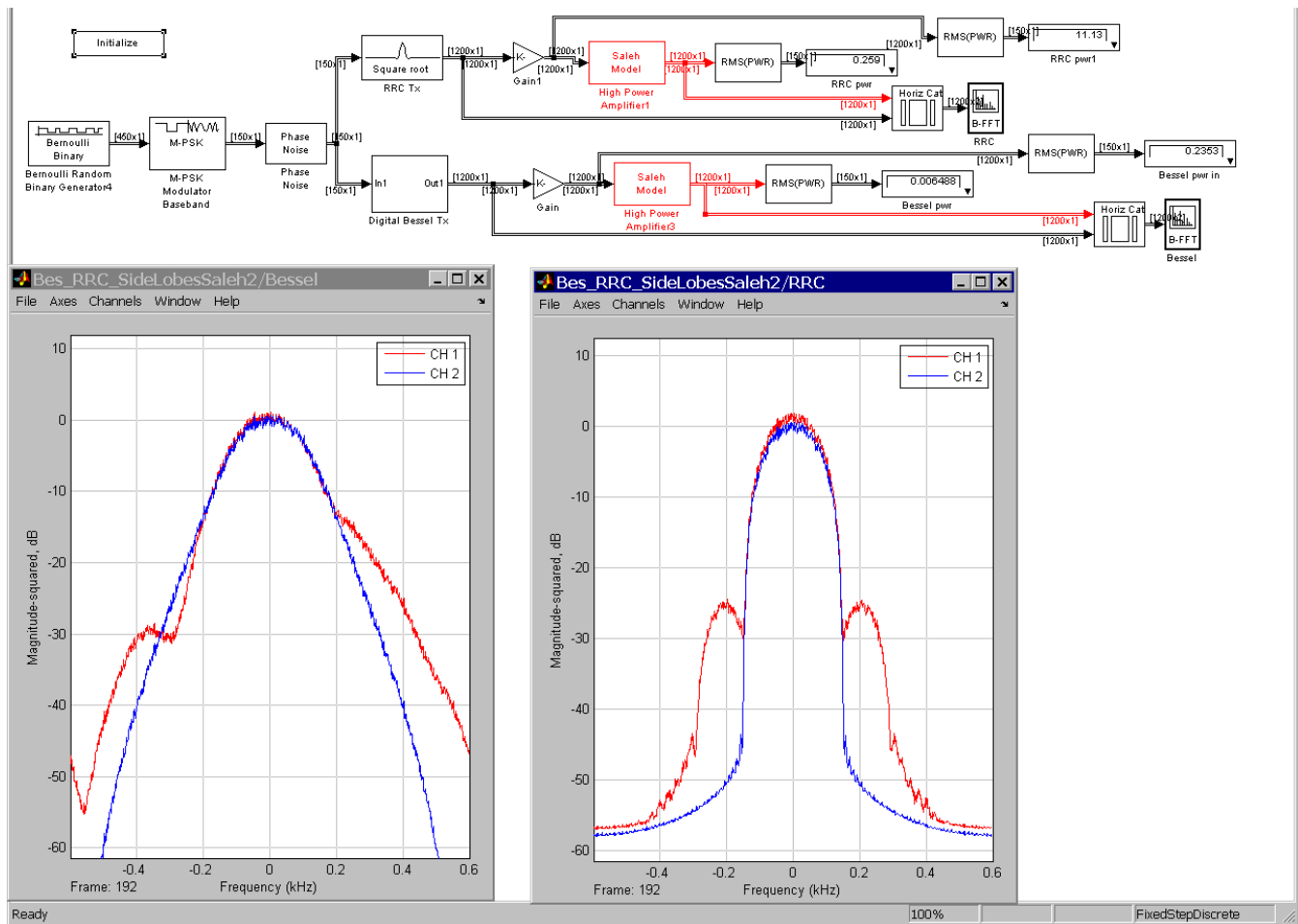

# 4th Order Comparison

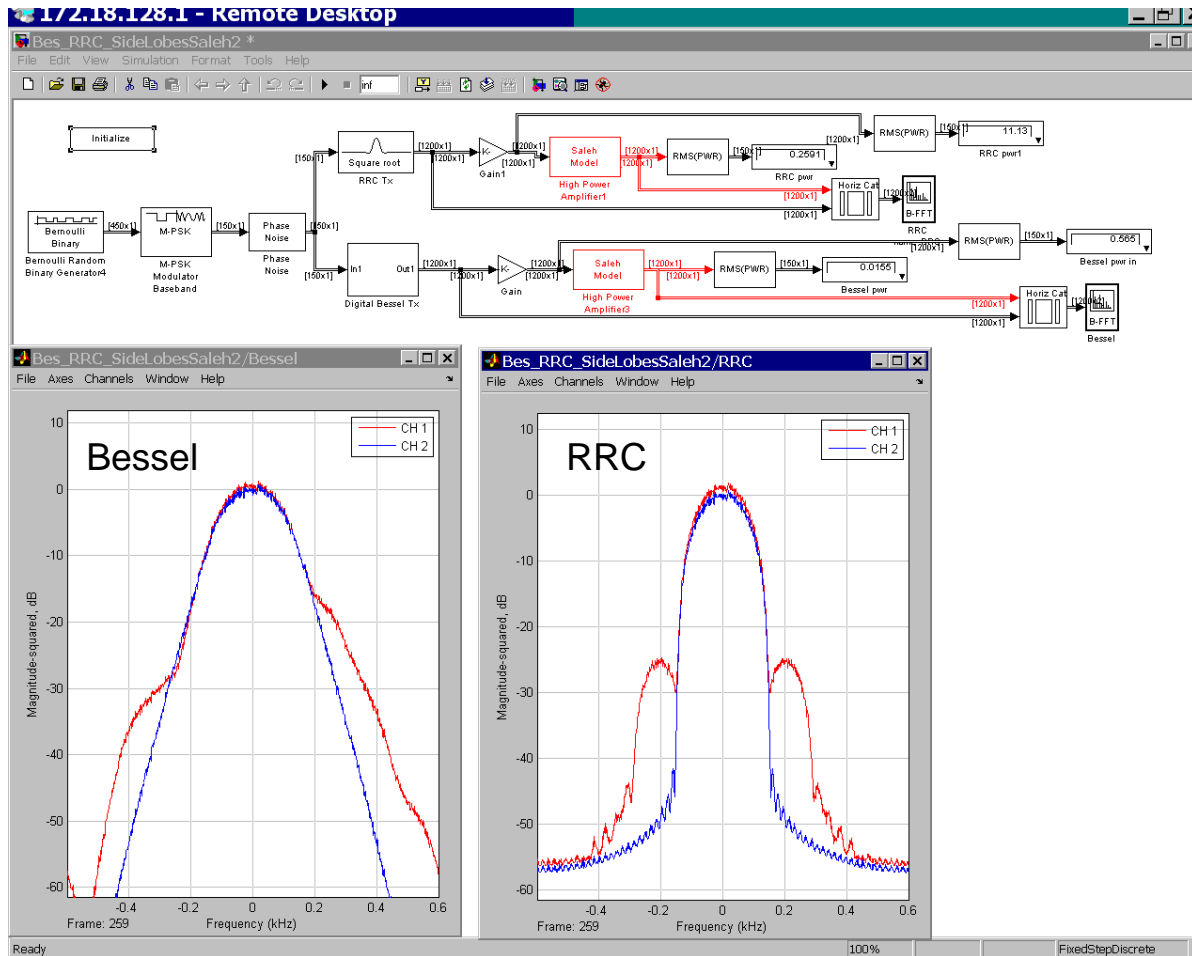

# 6th Order Comparison

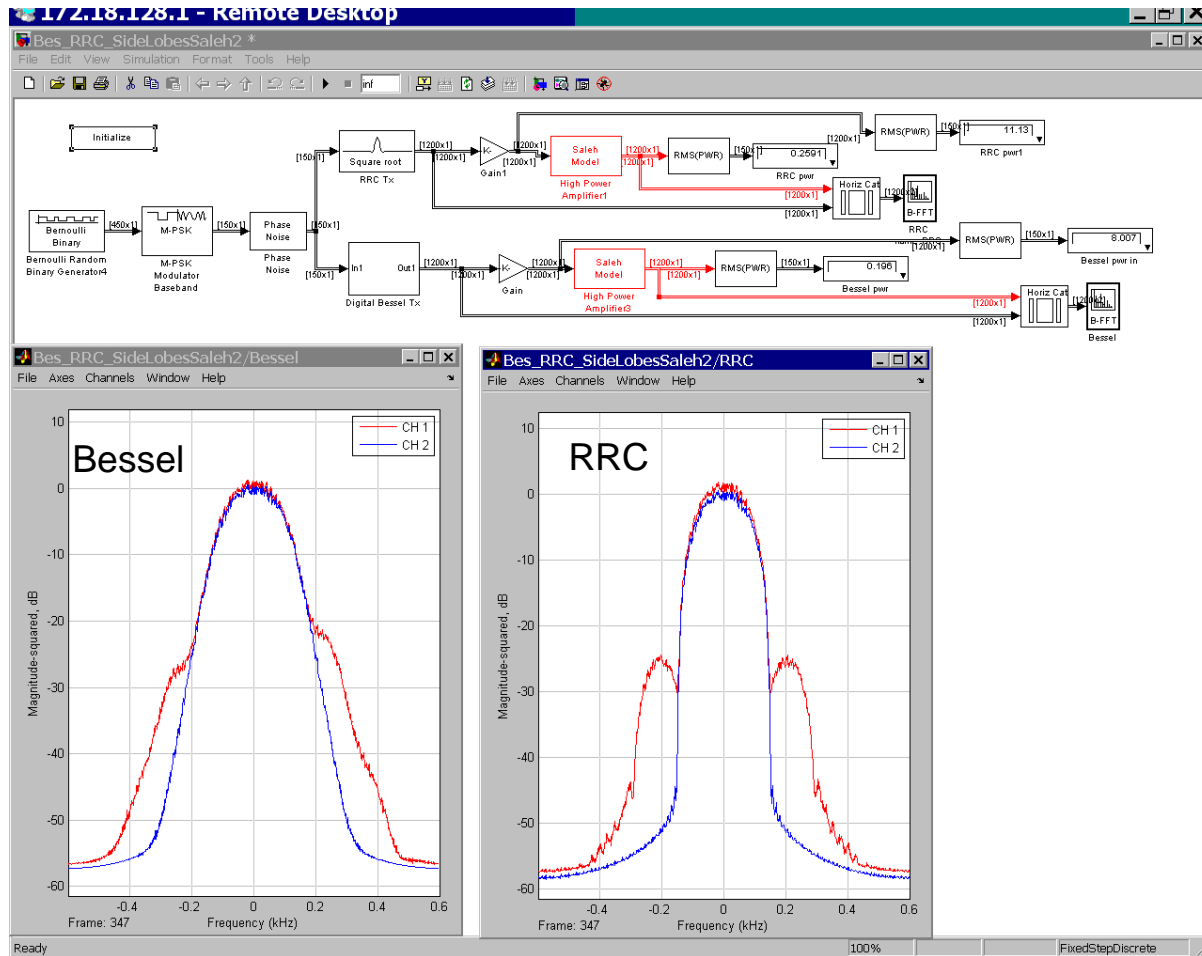

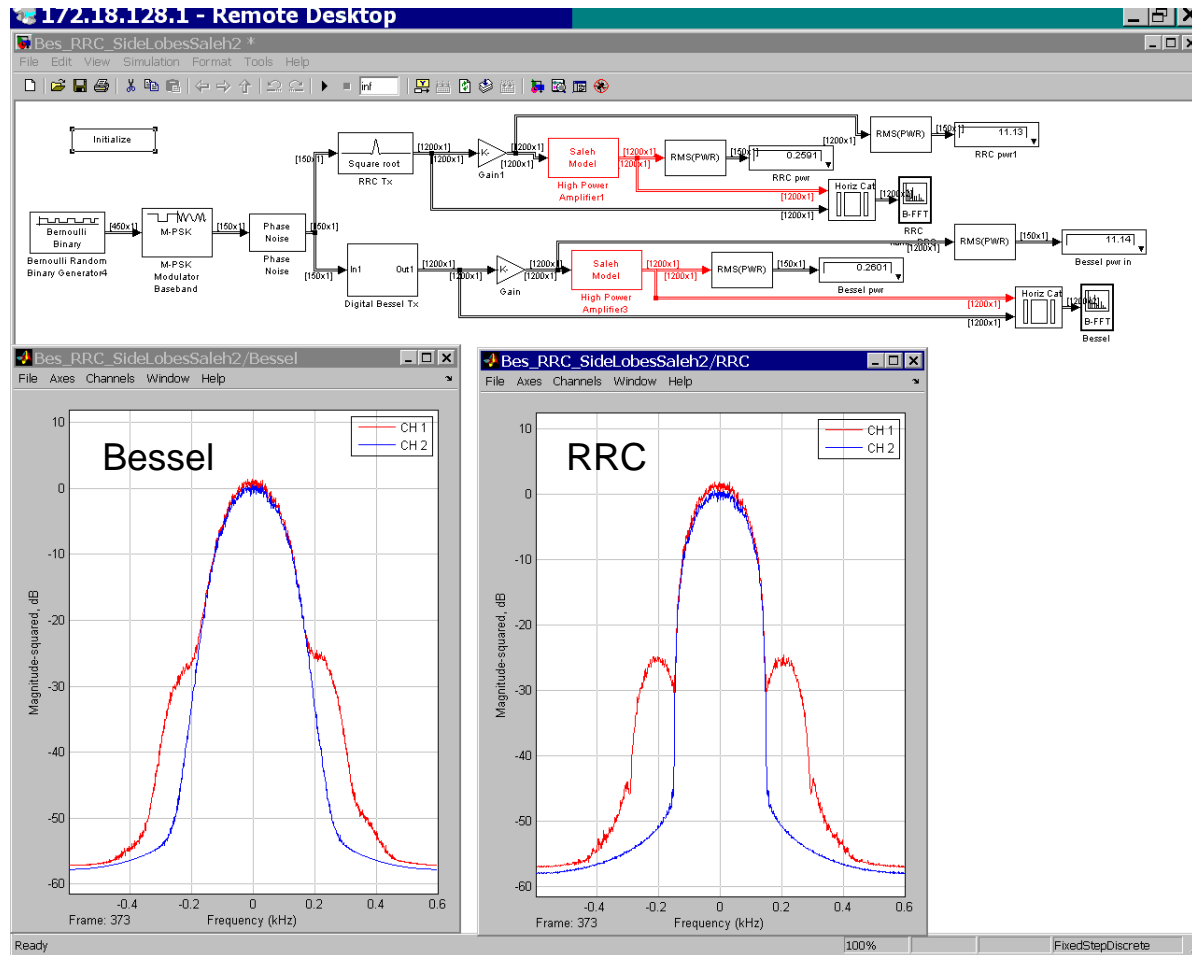

# Filter Performance vs. Filter Order

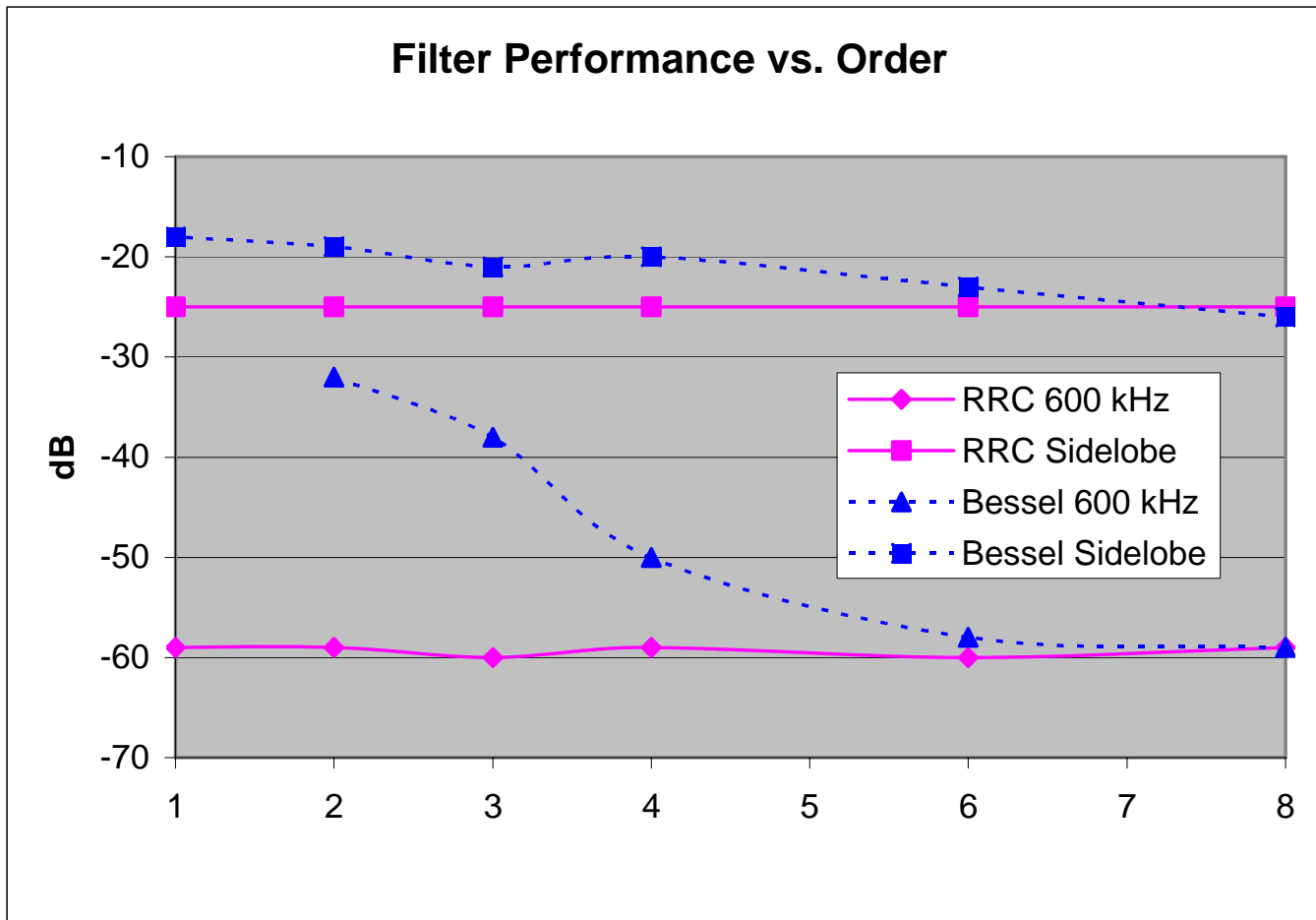

## Best reason for using RRC filters

RRC filter performance remains good as order is reduced, Bessel deteriorates below 5th or 6th order. Note 4<sup>th</sup> order Bessel cannot meet 25 dB sidelobe requirement without greatly increased backoff (and perhaps not at all).

600 Hz values shows “residual” signal (note 600 kHz should be 600 Hz).

# Bessel Filter Sidelobe Regrowth (expanded from last slide)

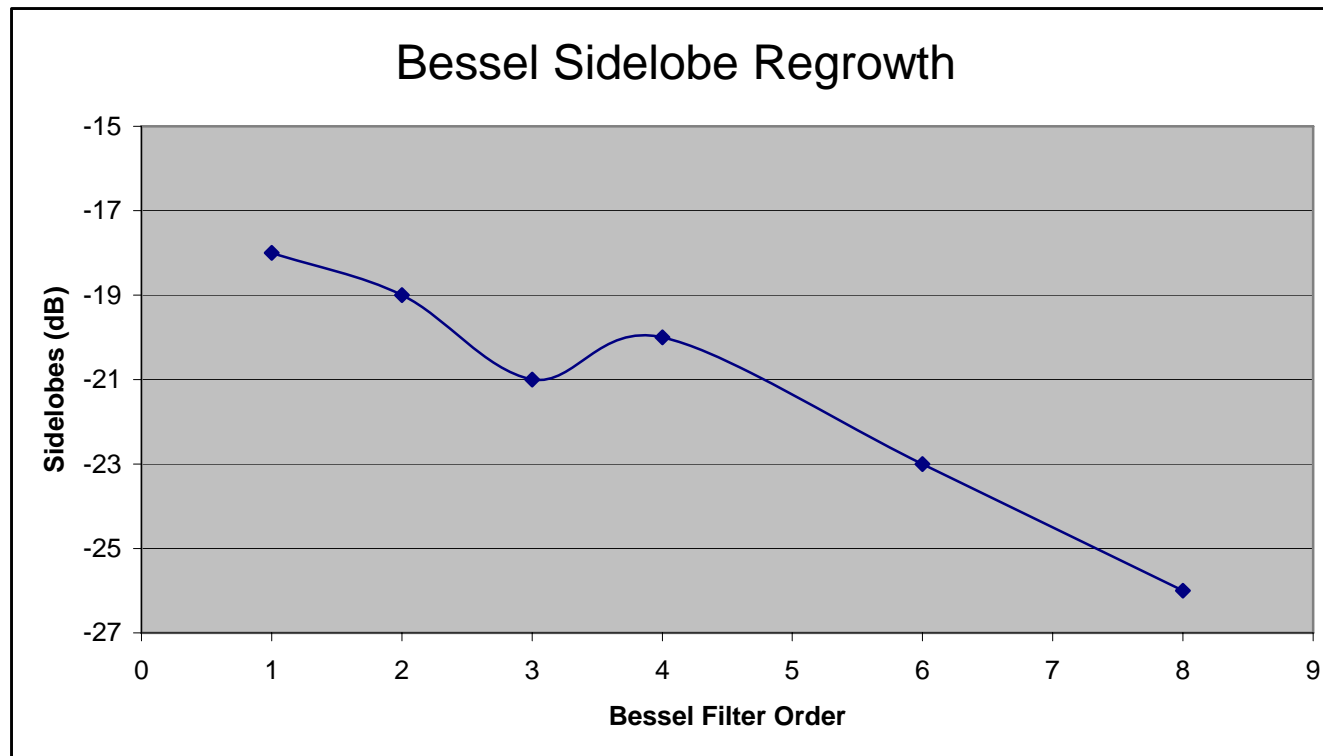

Accuracy is  
about  $\pm 1$  dB



# Insertion Loss RRC, 8<sup>th</sup> Order

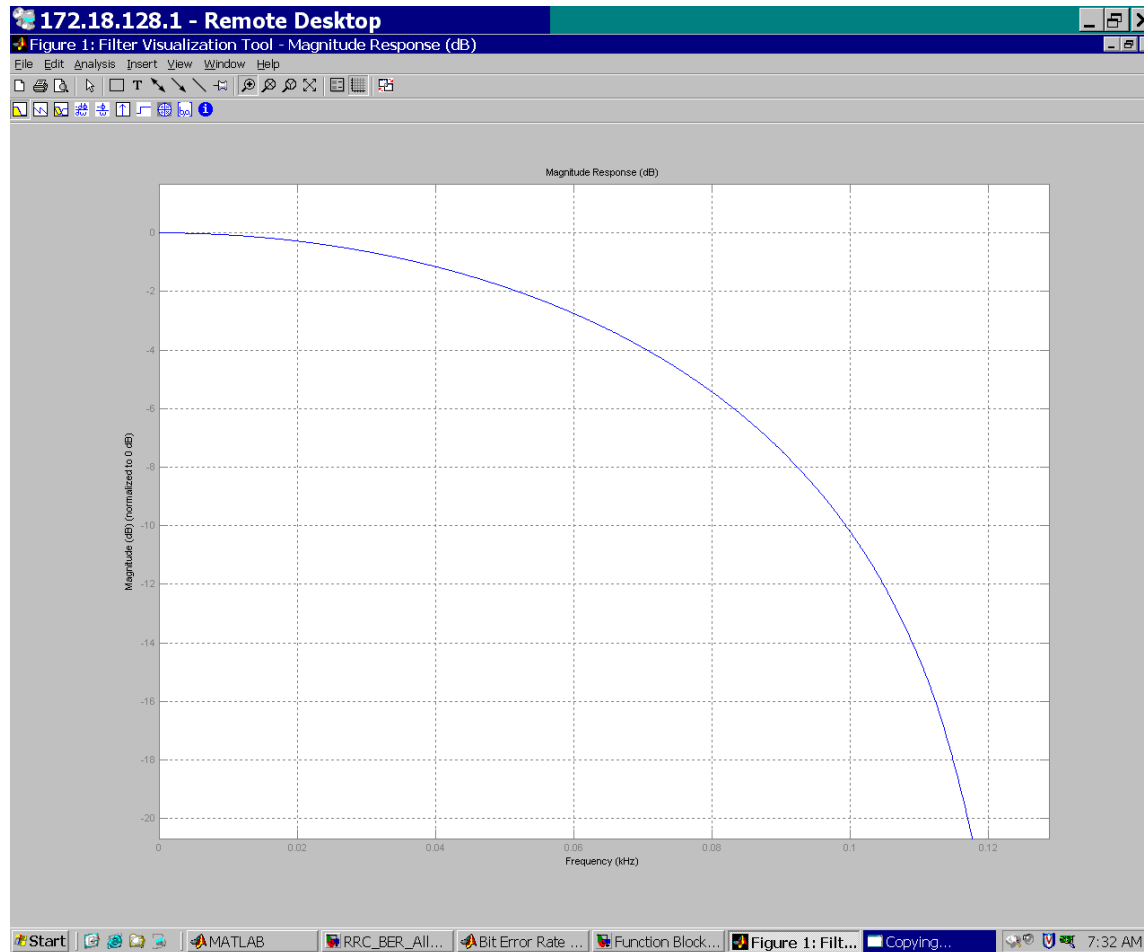

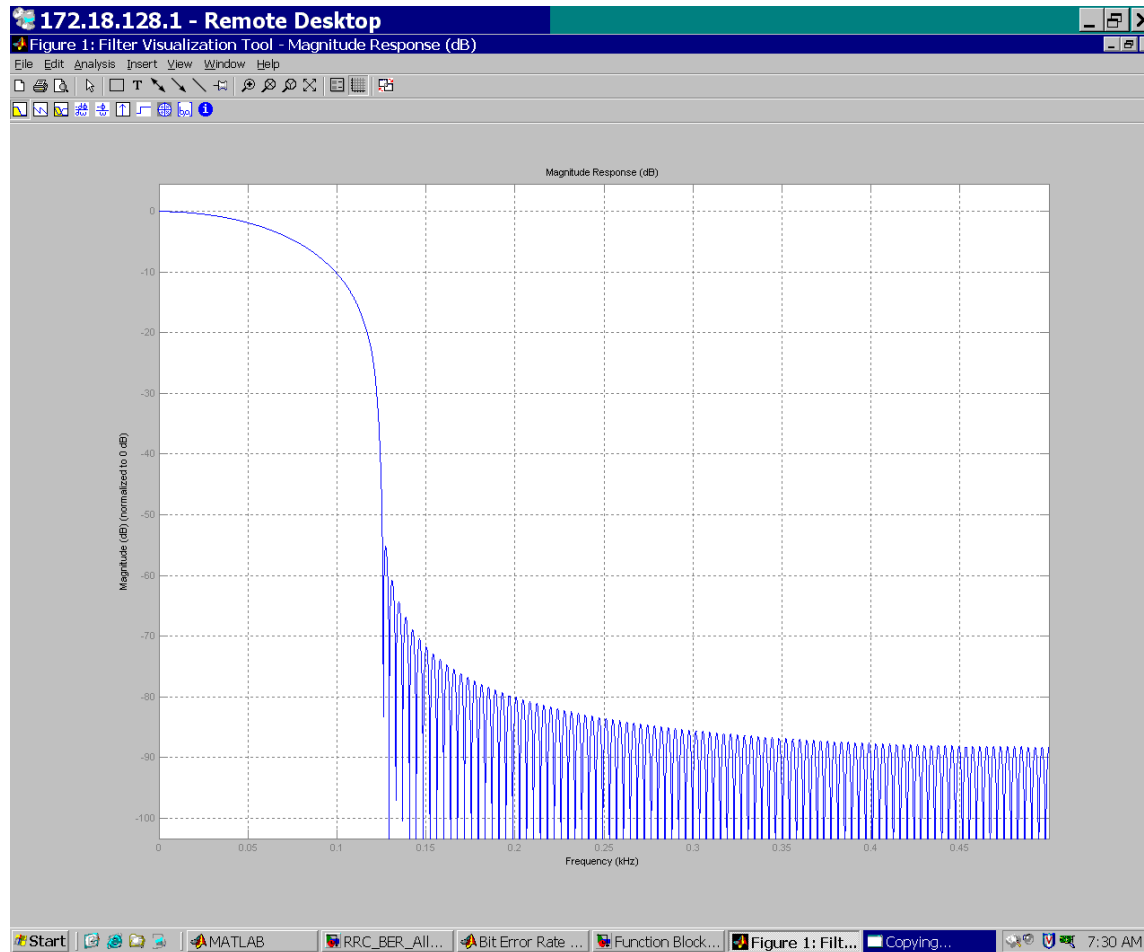

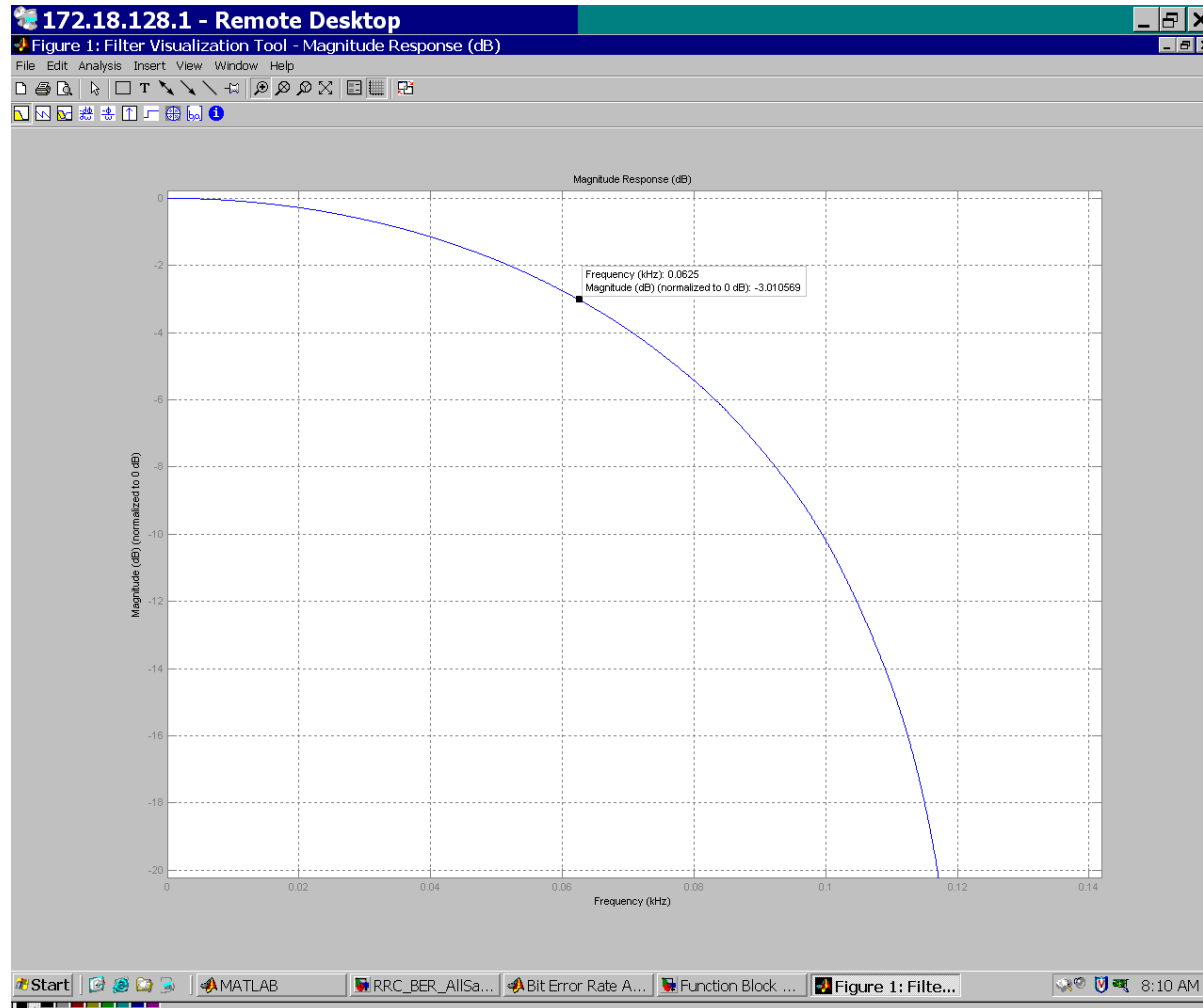

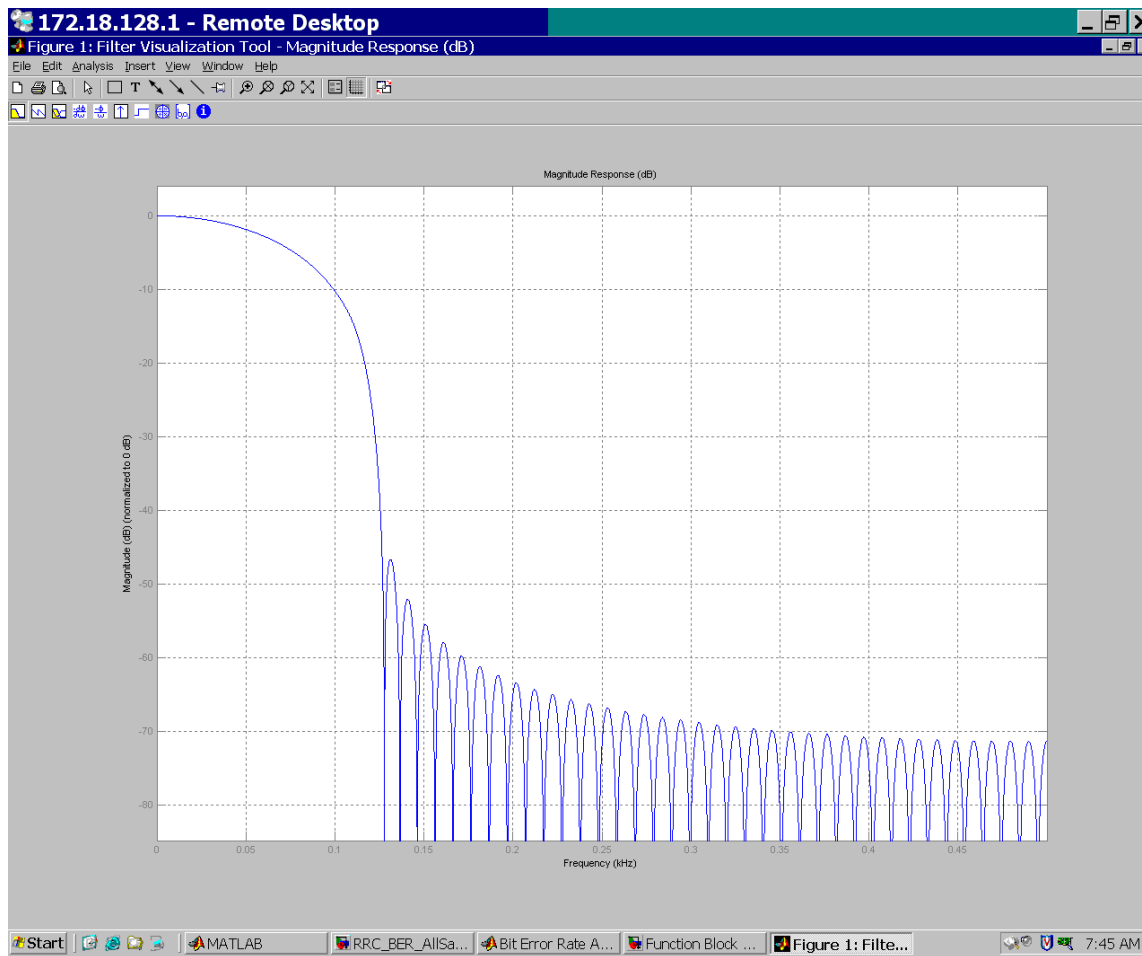

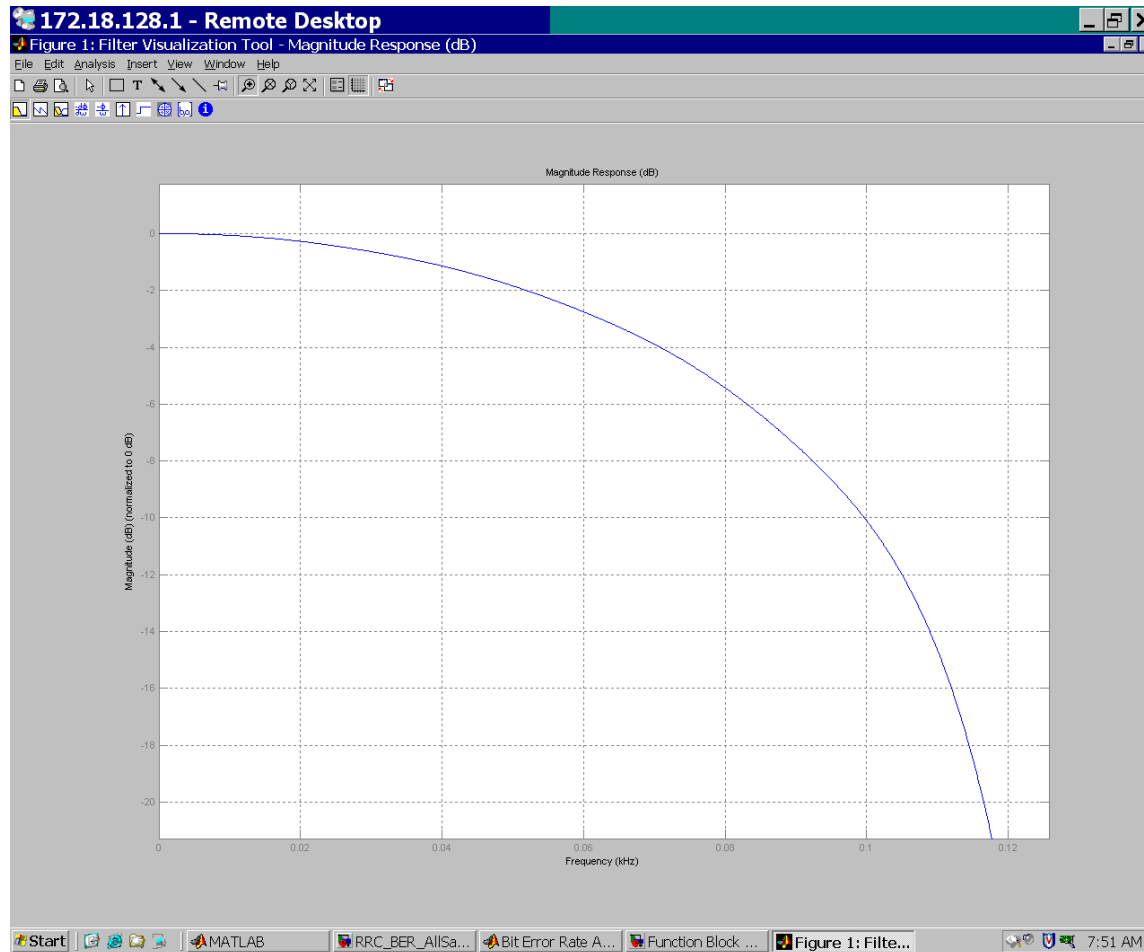

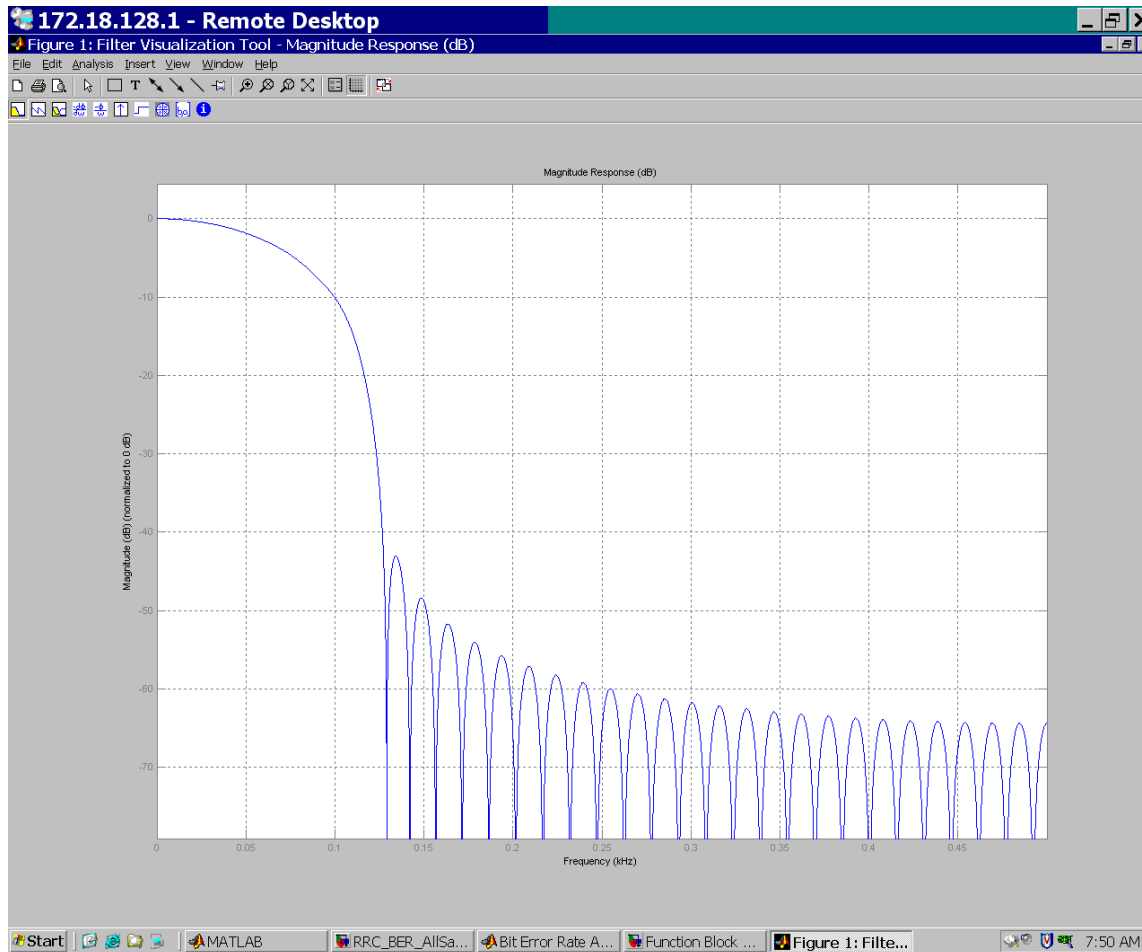

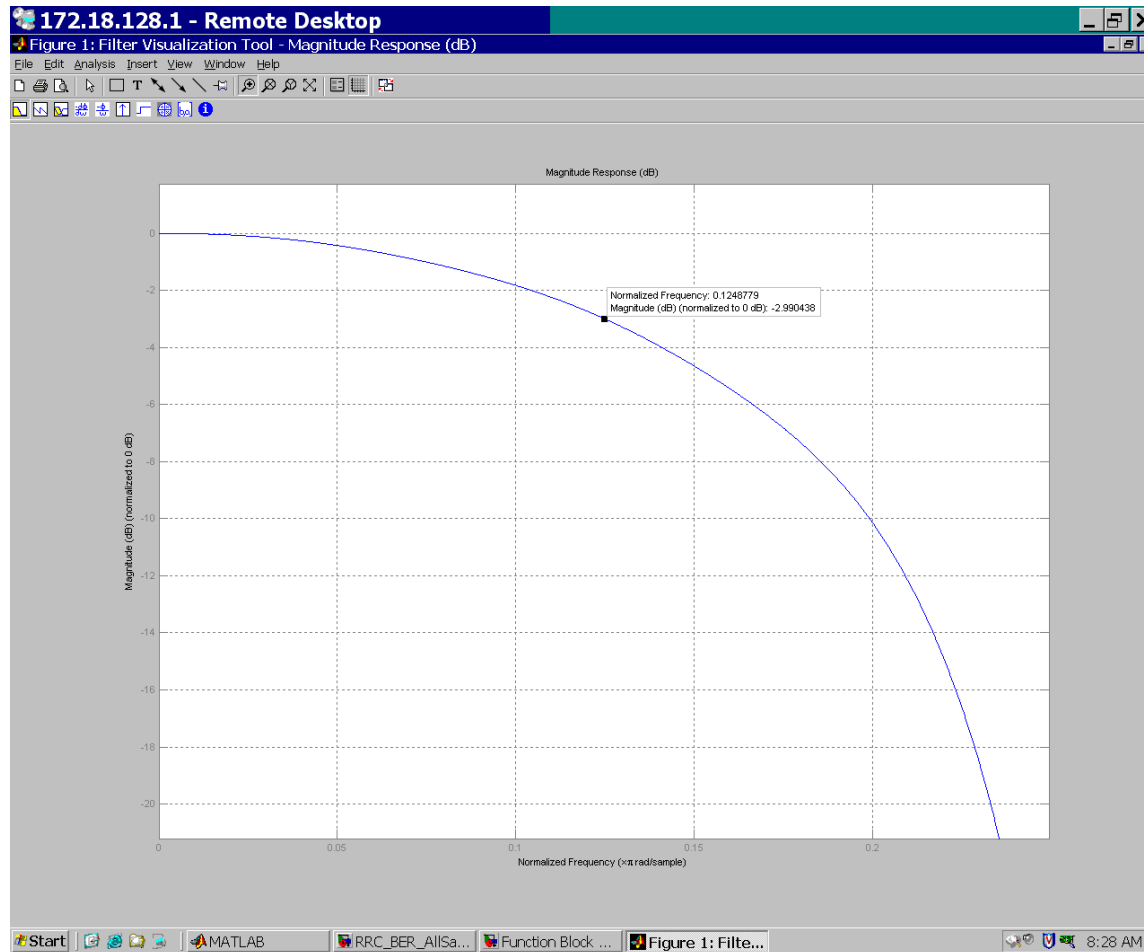

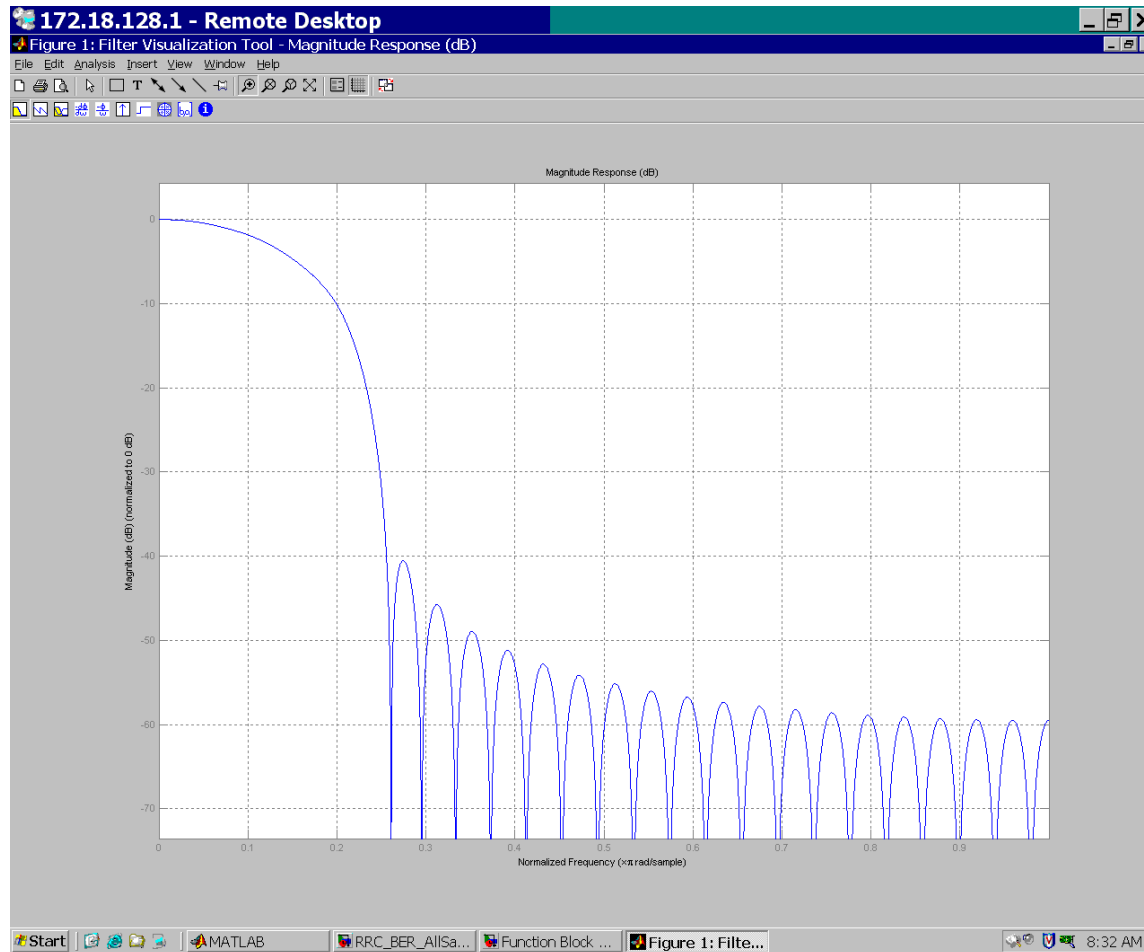



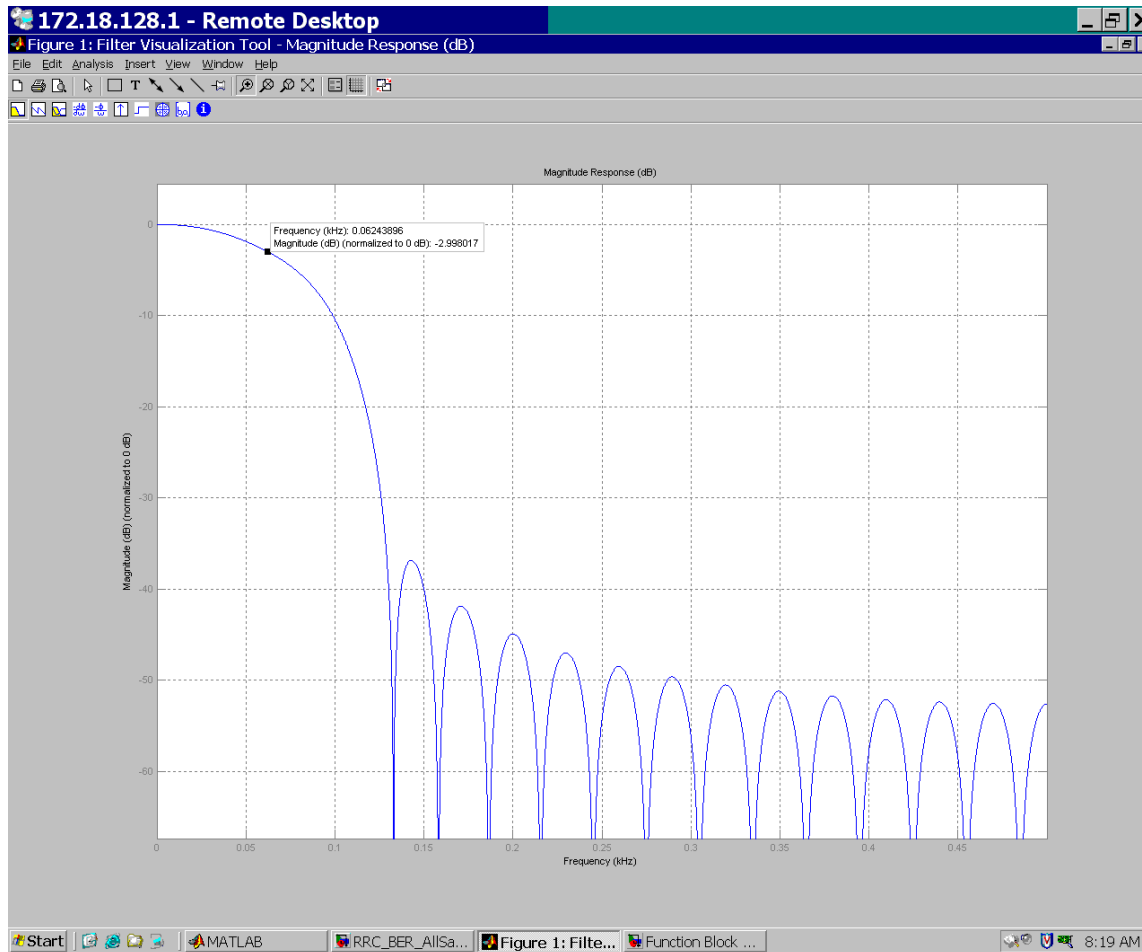

# RRC Implementation Loss for different orders

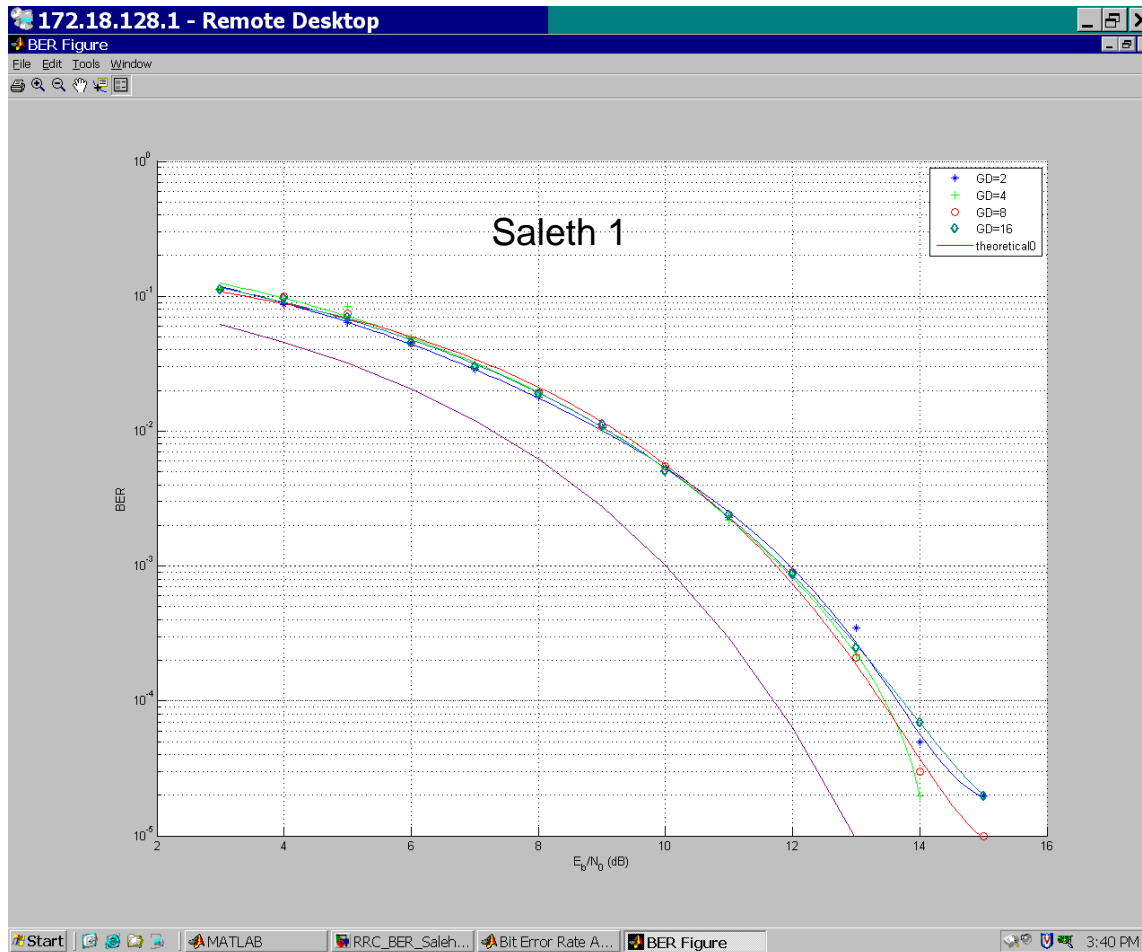

# RRC Implementation Loss for different orders

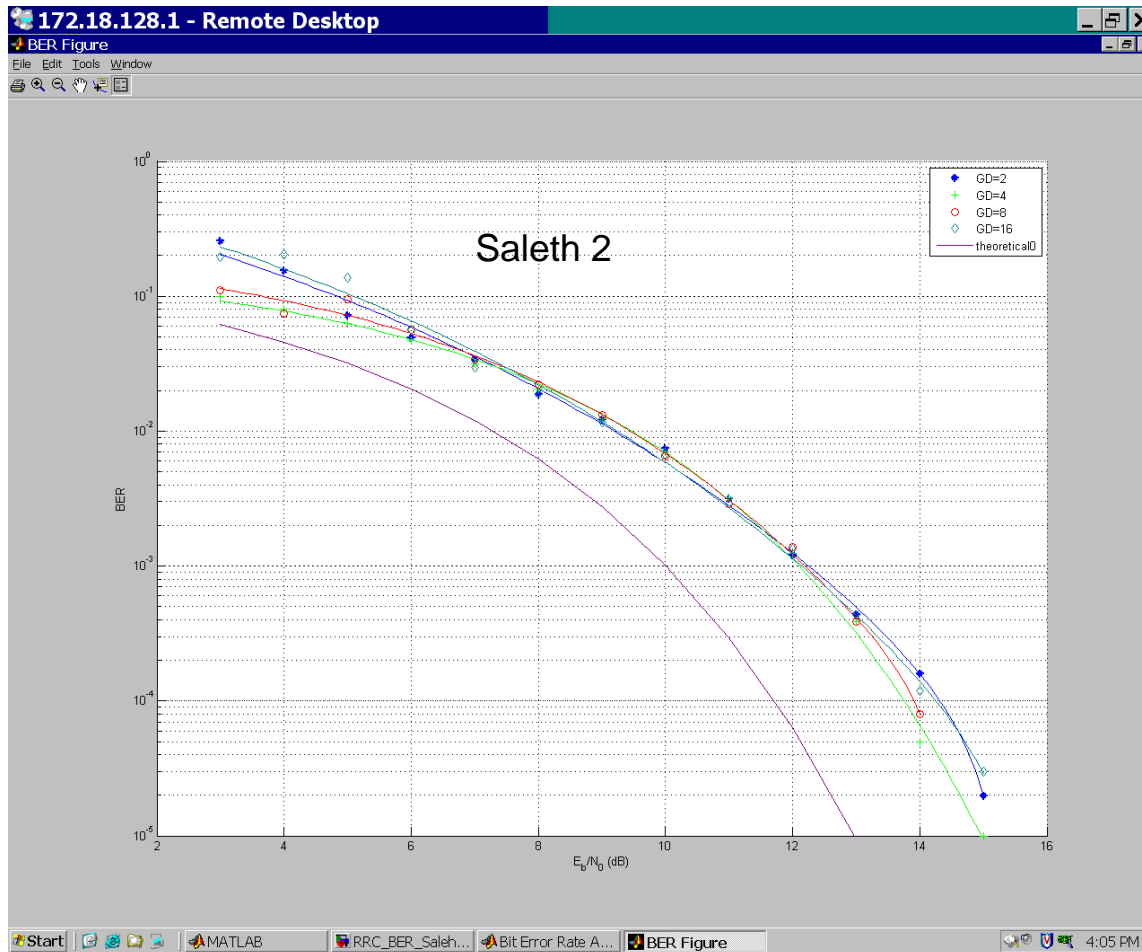

# Block Diagram NPR Simulated by 32 Channels

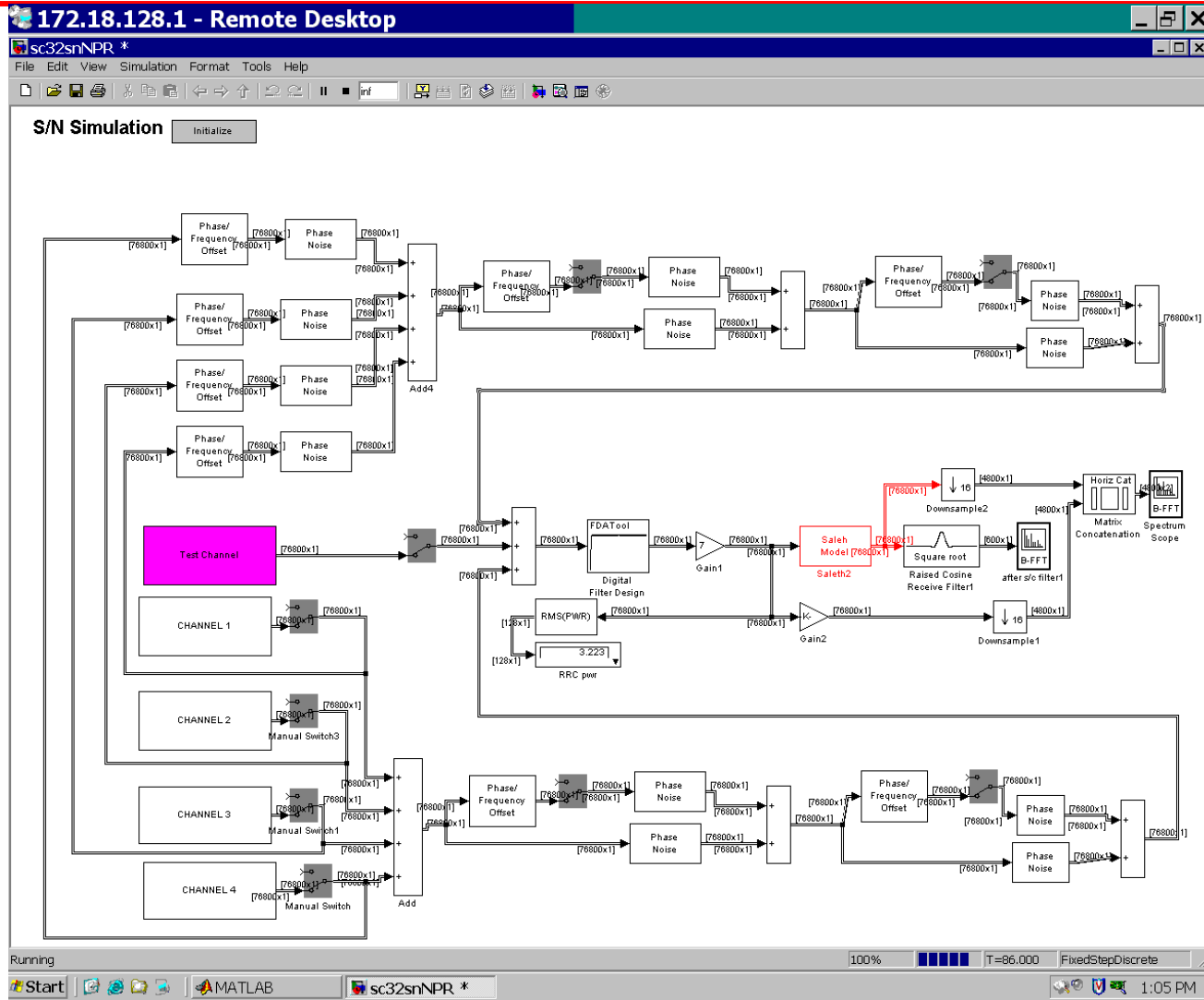



150 Symbols/sec with 160 Hz separation to approximate noise. Blue curve is before amplifier, red curve is after amplifier. Note "ripple" is actually individual carriers (not true noise).

# Noise for 160, 400 Hz Carrier Separation

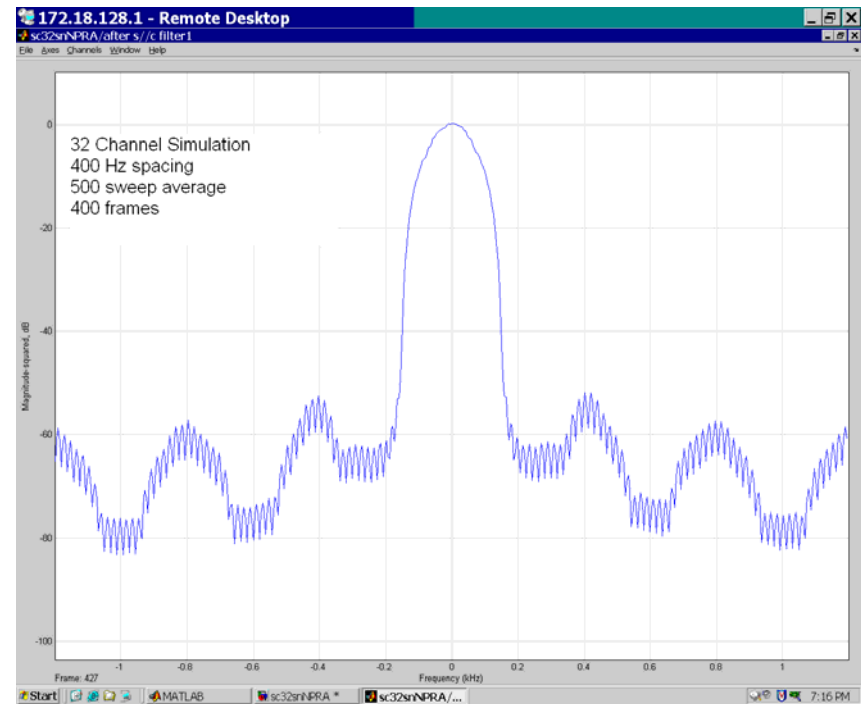
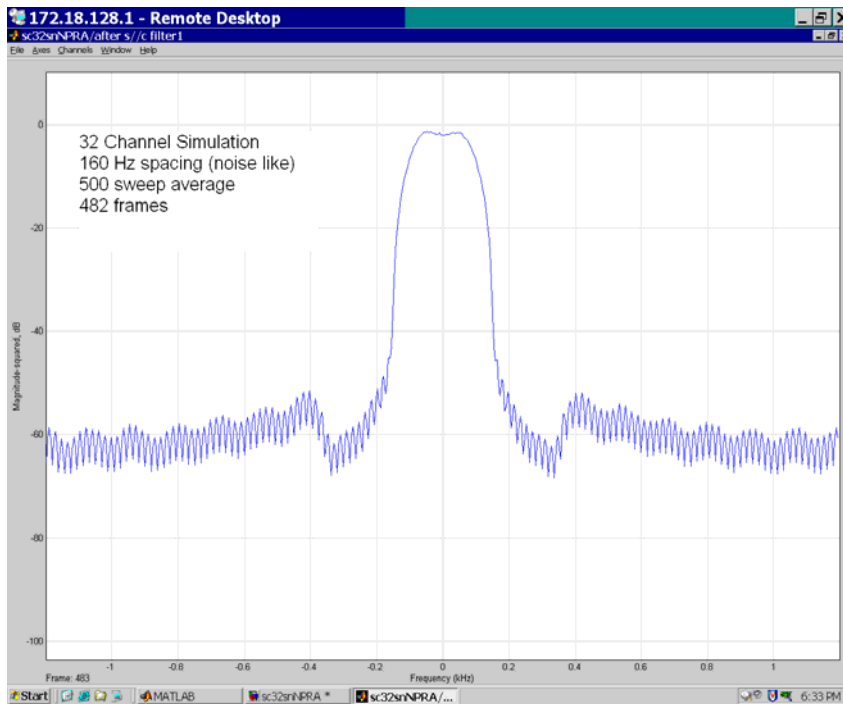

Note noise level unchanged as carrier separation increases. Only change in graphs in this and next slide is carrier separation

# Noise for 750, 1500 Hz Carrier Separation

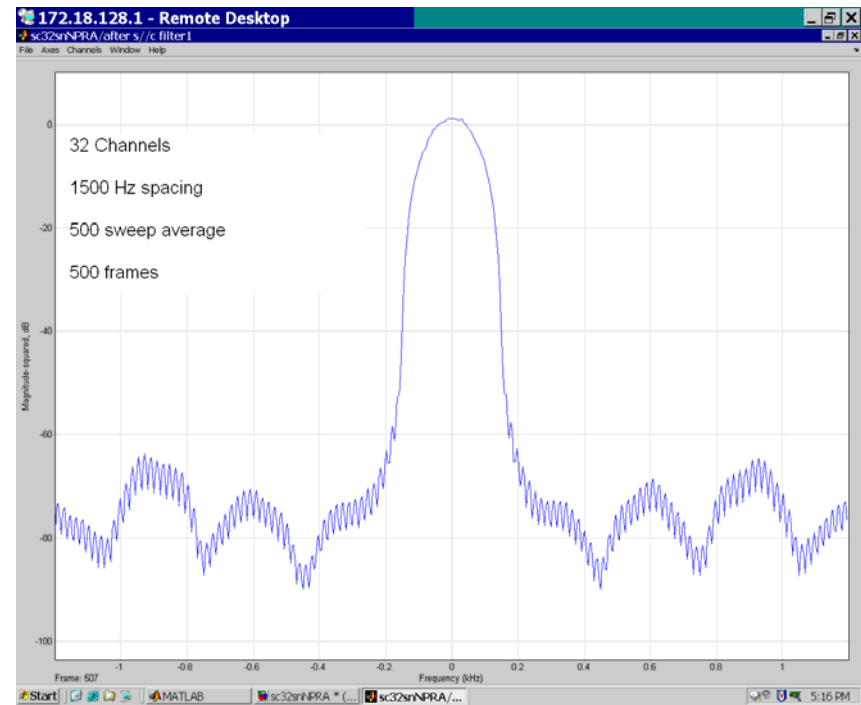
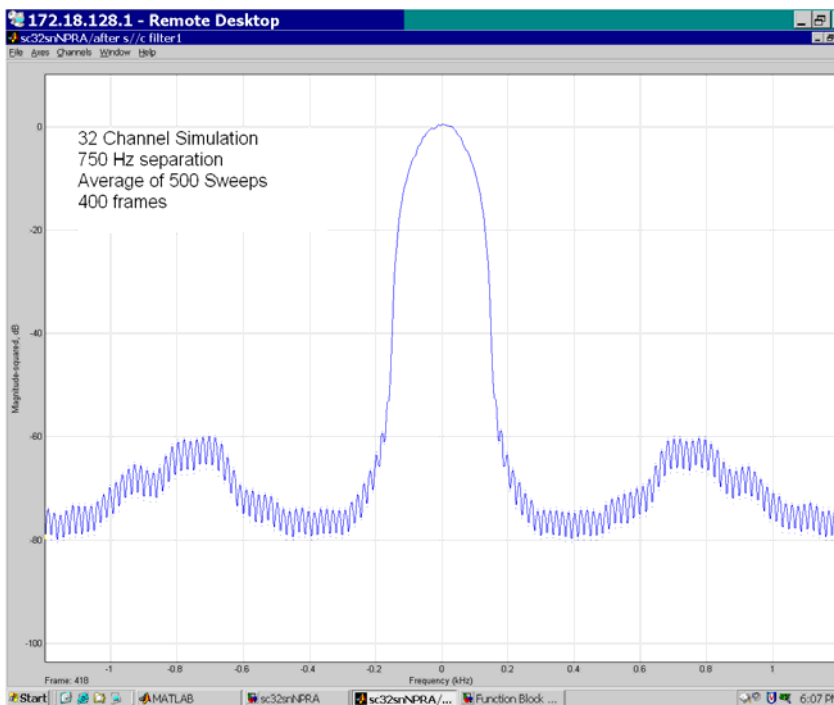

# 750 Carrier Spacing

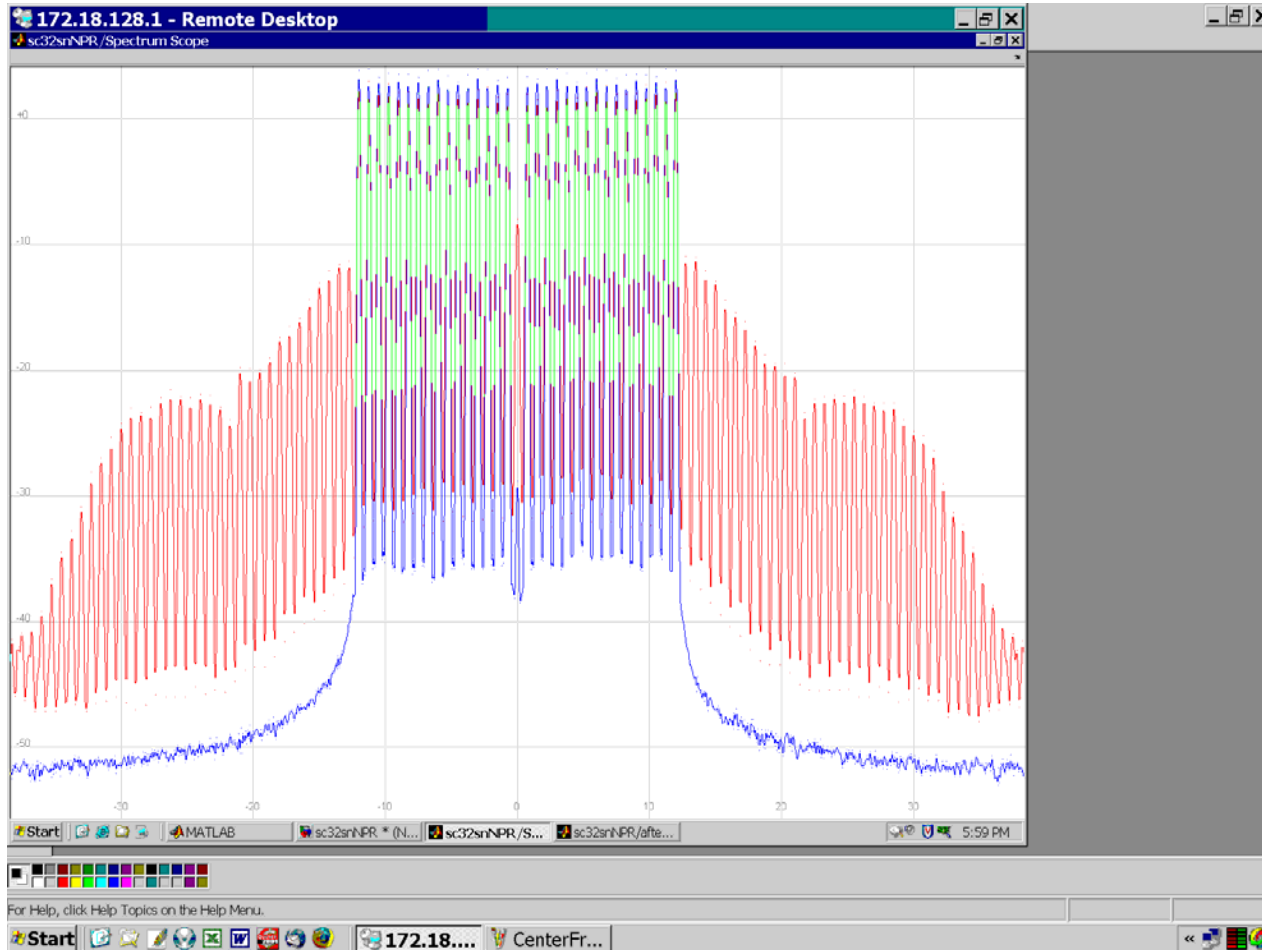



# 1500 Carrier Spacing

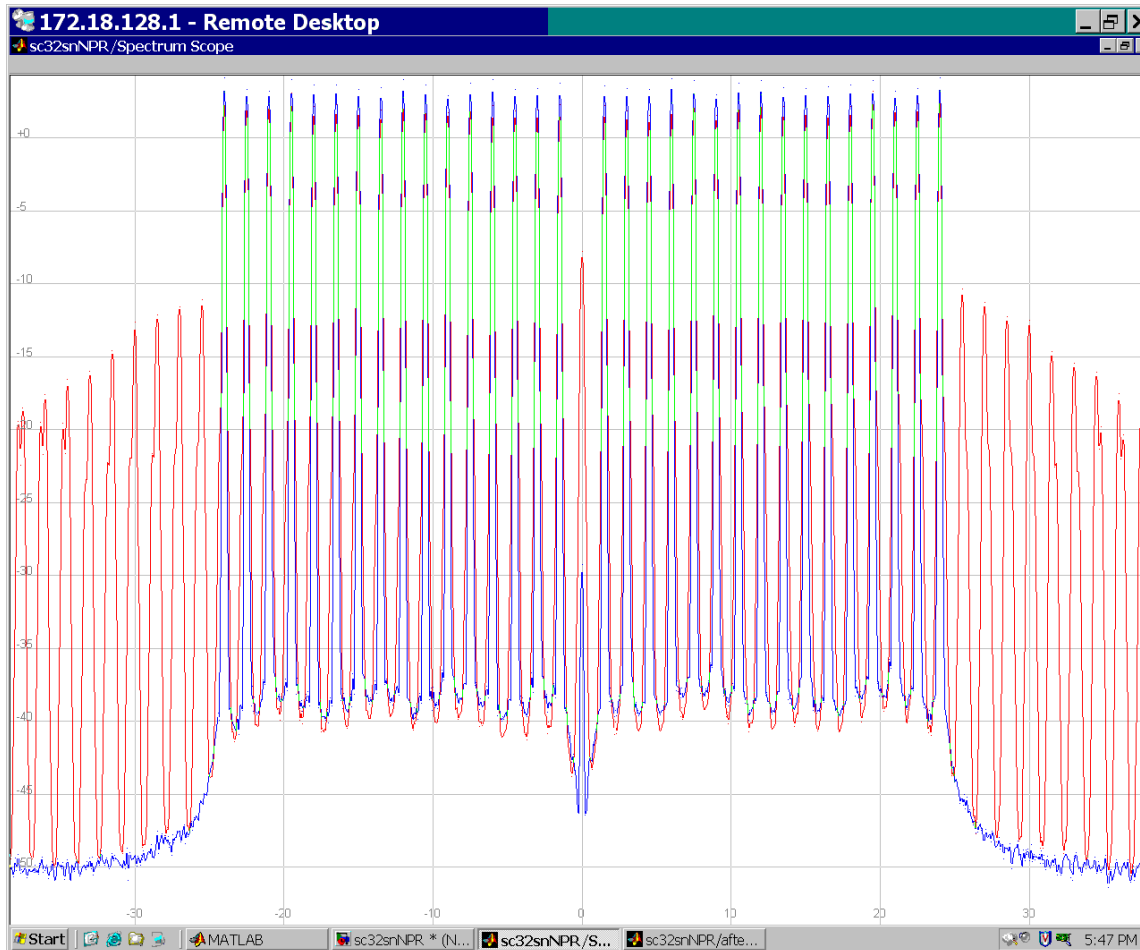

# RRC Tx - Bessel Rx & RRC Tx and Rx

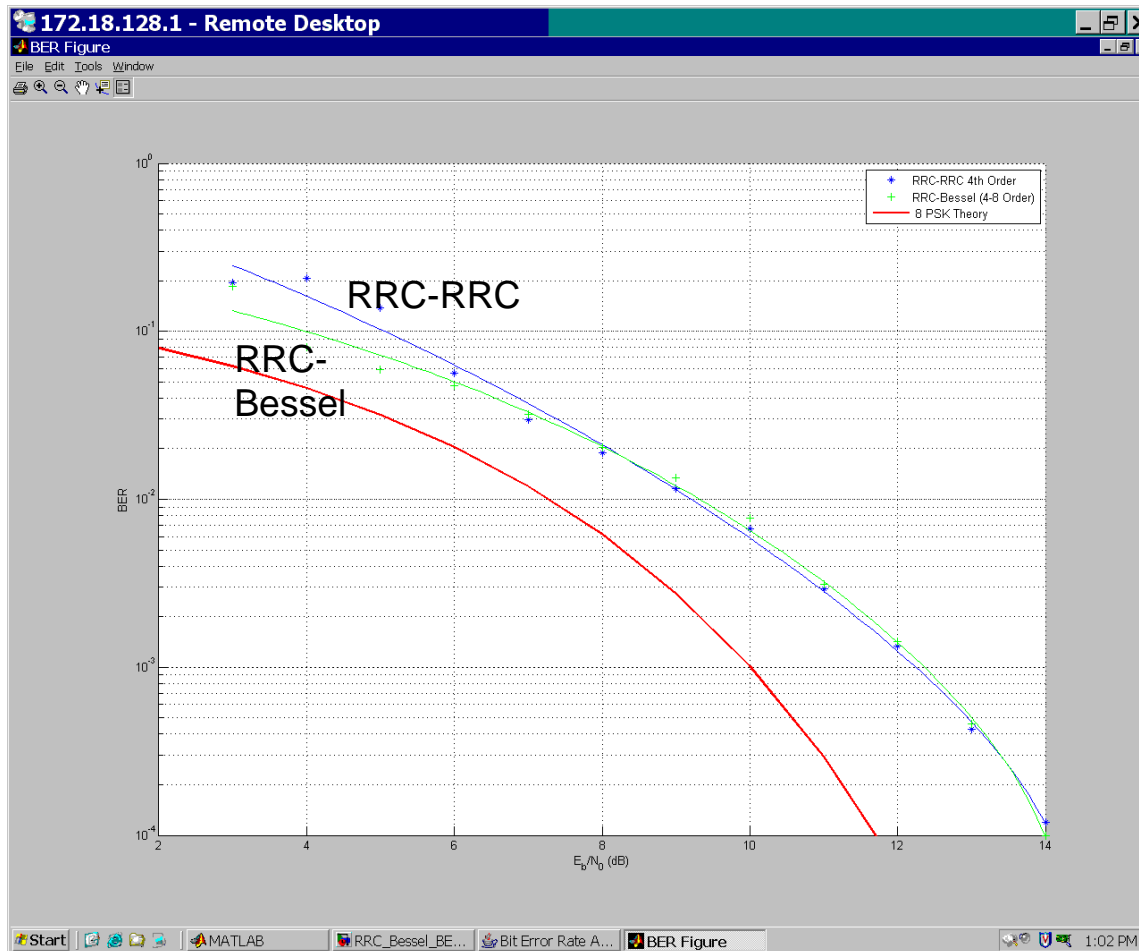

Used recommended RRC filter (65 coefficients, 2<sup>nd</sup> order) and 8<sup>th</sup> order Bessel function.

Blue=RRC-RRC

Green=RRC-Bessel

# Enlargement of RRC Tx - Bessel Rx Curve

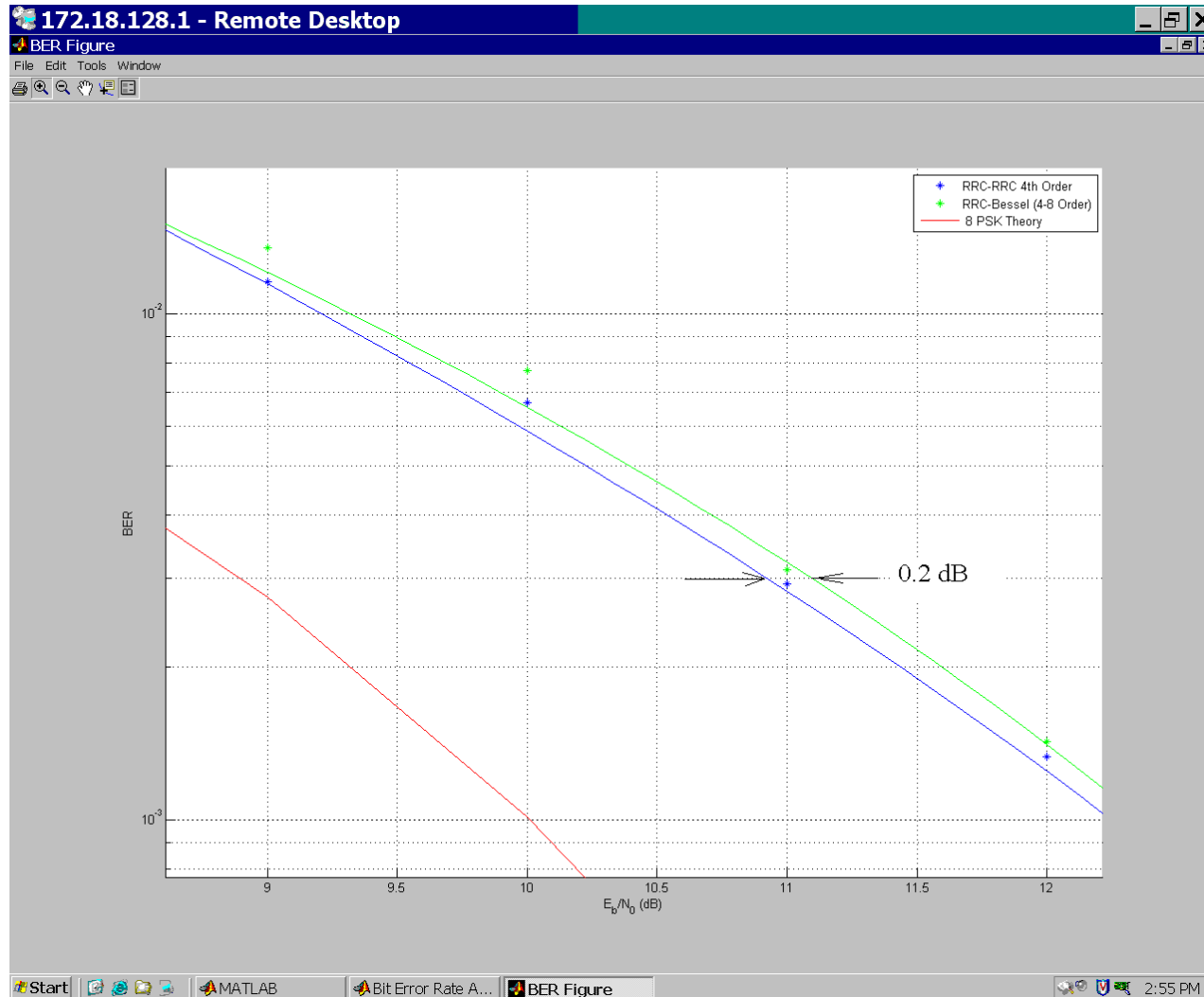

Blue=RRC-RRC

Green=RRC-Bessel

# Required Eb/No for BER=10E-3 Bessel=8, RRC=8<sup>th</sup> Order

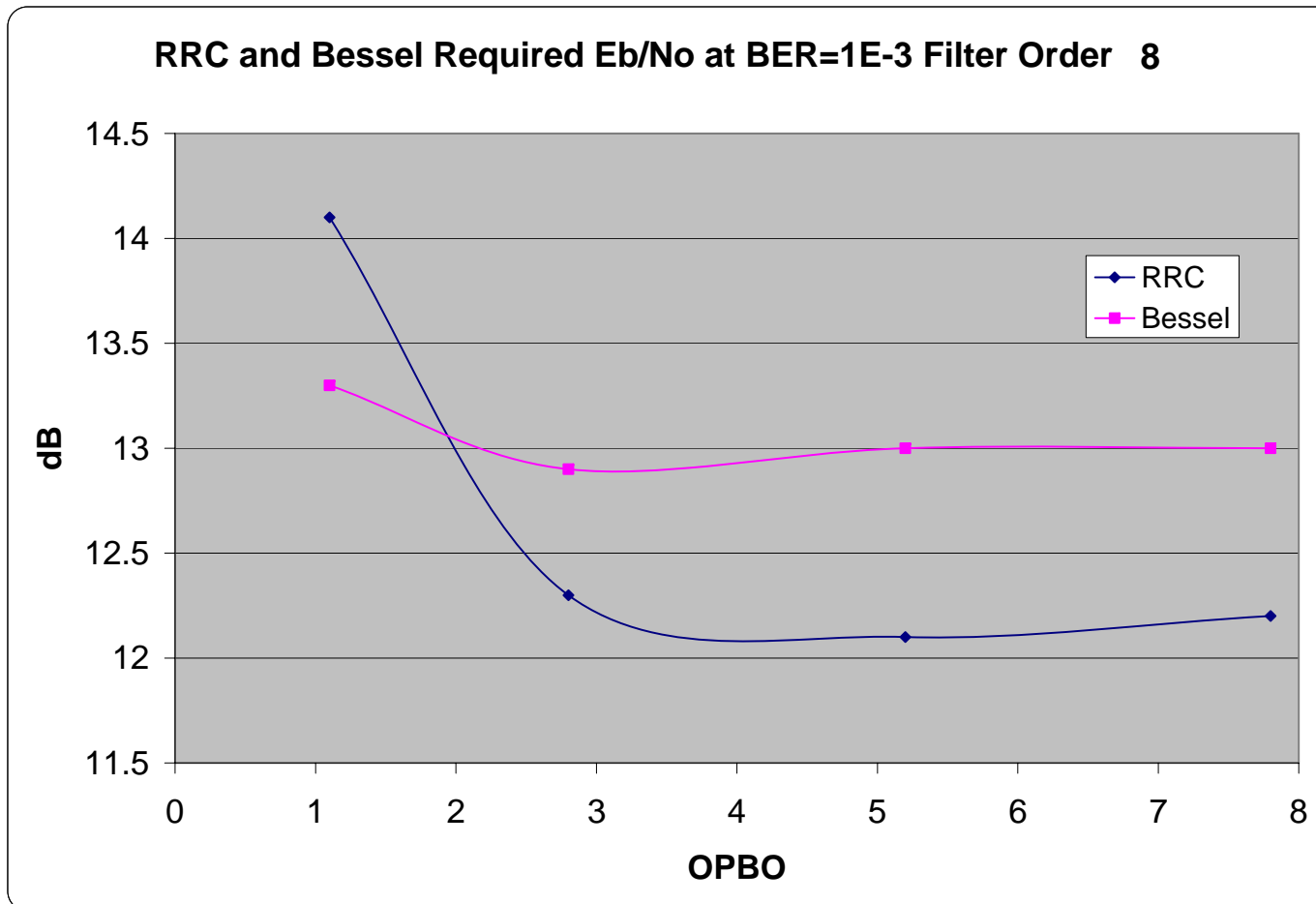

- Setting order of filters
  - Bessel function can be calculated in different ways, most common for digital involves twice as many computations as RRC. Therefore we set the order of the RRC filter to be twice that of Bessel filter. But performance varied very non-linearly on over sampling, filter order and filter bandwidth. We chose best combination. RRC filter well behaved.
- Setting BW of filters
  - Bandwidth of Bessel filter set by approximately matching  $\sim 3$  dB bandwidth of both filters was not particularly accurate
- DCS HPA used more like a TWTA than SSPA and did not have good AM/PM curves. Better amplifier not available from Simulink.
- Suitable Bessel function filter not available in Simulink, MathWorks developed one for us.



# Coeff. For 2<sup>nd</sup> Order RRC Filter



---

-0.0017653261	-0.0013304488	0.0000000000	0.0015211942
0.0023085034	0.0017561925	0.0000000000	-0.0020503052
-0.0031479591	-0.0024252182	0.0000000000	0.0029135916
0.0045470521	0.0035664973	0.0000000000	-0.0044675072
-0.0071453676	-0.0057612649	0.0000000000	0.0077166033
0.0128616617	0.0108823893	0.0000000000	-0.0165355785
-0.0300105439	-0.0282942121	0.0000000000	0.0606304545
0.1500527194	0.2546479089	0.3535533906	0.4244131816
0.4501581581	0.4244131816	0.3535533906	0.2546479089
0.1500527194	0.0606304545	0.0000000000	-0.0282942121
-0.0300105439	-0.0165355785	0.0000000000	0.0108823893
0.0128616617	0.0077166033	0.0000000000	-0.0057612649
-0.0071453676	-0.0044675072	0.0000000000	0.0035664973
0.0045470521	0.0029135916	0.0000000000	-0.0024252182
-0.0031479591	-0.0020503052	0.0000000000	0.0017561925
0.0023085034	0.0015211942	0.0000000000	-0.0013304488
-0.0017653261			



# Coeff. For 4<sup>th</sup> Order RRC Filter



-0.0004400373	-0.0003211197	0.0000000000	0.0003425449
0.0005007321	0.0003661891	0.0000000000	-0.0003923697
-0.0005749146	-0.0004214629	0.0000000000	0.0004539178
0.0006669010	0.0004902732	0.0000000000	-0.0005311805
-0.0007828838	-0.0005774329	0.0000000000	0.0006300047
0.0009320045	0.0006901027	0.0000000000	-0.0007592365
-0.0011282159	-0.0008393141	0.0000000000	0.0009327762
0.0013936785	0.0010427842	0.0000000000	-0.0011734927
-0.0017653261	-0.0013304488	0.0000000000	0.0015211942
0.0023085034	0.0017561925	0.0000000000	-0.0020503052
-0.0031479591	-0.0024252182	0.0000000000	0.0029135916
0.0045470521	0.0035664973	0.0000000000	-0.0044675072
-0.0071453676	-0.0057612649	0.0000000000	0.0077166033
0.0128616617	0.0108823893	0.0000000000	-0.0165355785
-0.0300105439	-0.0282942121	0.0000000000	0.0606304545
0.1500527194	0.2546479089	0.3535533906	0.4244131816
0.4501581581	0.4244131816	0.3535533906	0.2546479089
0.1500527194	0.0606304545	0.0000000000	-0.0282942121
-0.0300105439	-0.0165355785	0.0000000000	0.0108823893
0.0128616617	0.0077166033	0.0000000000	-0.0057612649
-0.0071453676	-0.0044675072	0.0000000000	0.0035664973
0.0045470521	0.0029135916	0.0000000000	-0.0024252182
-0.0031479591	-0.0020503052	0.0000000000	0.0017561925
0.0023085034	0.0015211942	0.0000000000	-0.0013304488
-0.0017653261	-0.0011734927	0.0000000000	0.0010427842
0.0013936785	0.0009327762	0.0000000000	-0.0008393141
-0.0011282159	-0.0007592365	0.0000000000	0.0006901027
0.0009320045	0.0006300047	0.0000000000	-0.0005774329
-0.0007828838	-0.0005311805	0.0000000000	0.0004902732
0.0006669010	0.0004539178	0.0000000000	-0.0004214629
-0.0005749146	-0.0003923697	0.0000000000	0.0003661891
0.0005007321	0.0003425449	0.0000000000	-0.0003211197
-0.0004400373			