

Polar Precision Prime OHR

October 15, 2019

Polar Research and Technology

Contents

1 Introduction 1
 2 Optical HR measurement theory 1
 3 Key user benefits of Polar Precision Prime OHR 2
 4 Optical HR measurement technology 2
 5 Scientific background 4
 6 Polar Precision Prime compared to competition 4
 7 Precision Prime validation 4
 8 Safety 5
 9 Other HR solutions by Polar 5
 10 Patents 6
 11 References 6
 12 More information 6

1 Introduction

Developed in-house at Polar Electro’s Research department, Polar Precision Prime OHR (optical heart rate) is the company’s latest solution for optical heart rate measurement. The new solution is currently used in Polar Vantage V and M devices and follows the former 2-LED and 6-LED solutions used in A360, A370, M200 and M430, M600, OH1 devices, respectively.

Polar Precision Prime incorporates unique sensor fusion technology consisting of several LED wavelengths, motion sensor and skin contact measurement. All this information is processed using the Polar Precision Prime algorithm to provide accurate heart rate even in the most demanding of conditions.

2 Optical HR measurement theory

The optical heart rate measurement system uses light to measure volumetric changes of tissue at the sensor’s location. These volumetric changes are caused by the heart pumping blood round your body. During systolic phase there is more blood

in the arteries compared to the diastolic phase. A high volume of blood causes less light to return to the optical sensor; whereas a low volume increases the amount of returning light (Fig 1.). Measuring the distance in time between high and low light intensities enables the device to measure beat-to-beat time intervals and calculate heart rate from that data (Fig 2.).

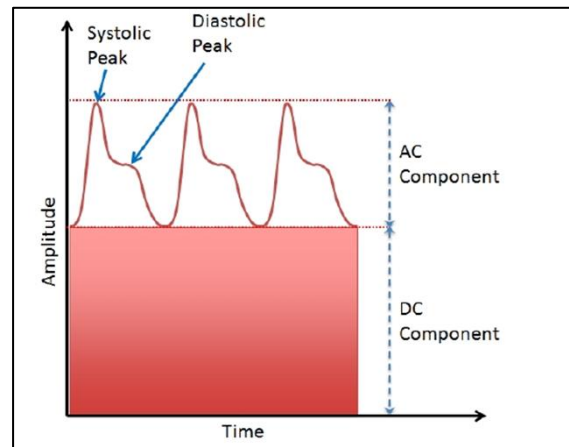
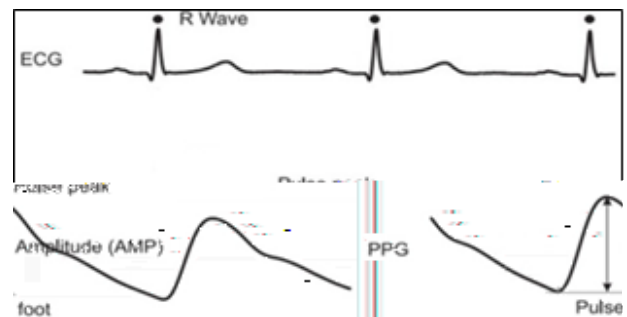

Figure 1. Measured light intensity changes with blood pressure. The AC component is typically 0.5 to 1.5% of total amplitude and is exaggerated in the picture. Note, the PPG waveform is inverted, in line with common practice.

The signal that the device measures with the optical sensor is called photoplethysmograph, and usually used in its abbreviated form, PPG.



Polar Precision Prime OHR

October 15, 2019

Polar Research and Technology

Figure 2. The PPG pulse follows synchronously ECG R-wave.

3 Key user benefits of Polar Precision Prime OHR

- This state-of the art solution to overcome motion artefacts offers the best possible optical HR performance in all sport activities.
- This solution offers reliable wear detection, which means that in 24/7 and sleep use the HR measurement is activated only when the device is properly on the wrist.

4 Optical HR measurement technology

At rest a very simple sensor consisting of one LED and one light detector is sufficient for measuring heart rate. When the person starts to move, accurate and reliable measurement becomes gradually more and more difficult (Fig 3).

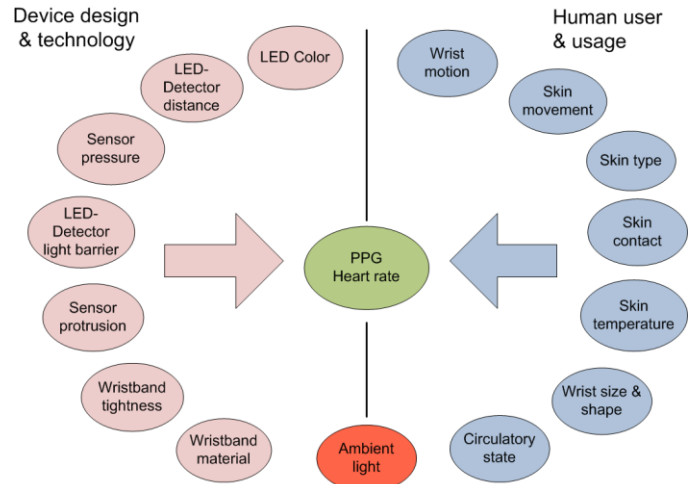

Figure 3. PPG and heart rate measurement is affected by many technical choices as well as many human use related choices.

The first invention to overcome the problems caused by the movement artefacts consisted of adding a 3D acceleration sensor in the device. Simultaneously measuring the acceleration and the optical signal enables the heart rate algorithm to differentiate volumetric changes caused by the pumping heart from the apparent volumetric changes caused by the movement of the hand. This invention is applied in Polar Electro’s 2-LED solutions.

The second invention was to add more LEDs to provide more optical light paths to the detector. Each path is measured separately providing several signal channels. When the signals are sufficiently similar the algorithm can conclude that they originate from the pumping heart and not from hand movements and it is safe to determine the heart rate. Naturally, the device also contains a 3D acceleration sensor and utilizes it in the manner explained in the previous chapter. This

Polar Precision Prime OHR

October 15, 2019

Polar Research and Technology

approach is applied in Polar Electro's 6-LED solutions.

An improvement to the second invention is to have several colors for the LEDs. Typical colors are green, red, infrared and yellow. The benefit of multiple colors is that the penetration depth of the light into the skin and tissue depends on the wavelength of the light: longer wavelengths penetrate deeper (Fig 4.). When the skin is cold it is difficult to detect blood pulsation from the optical signal as it has not penetrated deep enough. Therefore, in some cases, the red and infrared signals offer better performance.

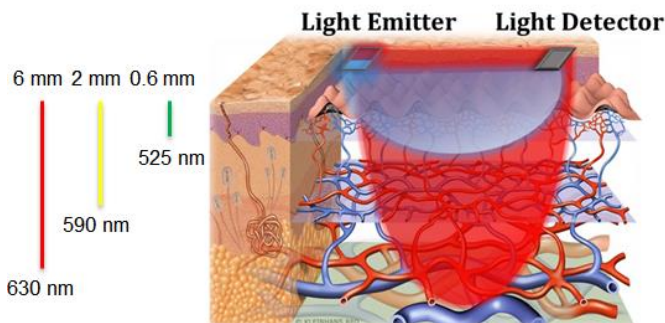

Figure 4. Penetration depth depends on the color, i.e. wavelength, of the light.

The third invention that compensates for motion artefacts is to measure the contact of the sensor in relation to the skin. This cannot be done reliably by either optical or acceleration measurement and therefore Polar has added a third sensor to the system. The third sensor measures the electrical contact from one galvanic pin to another (Fig 5.). When the back of the watch is not properly on the skin, this electrical contact is very weak or even nonexistent; whereas when the watch and skin are in good and firm contact, the electrical contact between the pins is also good. From the fluctuation of the electrical contact signal it is

possible to determine whether the sensor is moving in relation to the skin; which is always detrimental to reliable and accurate heart rate measurement.

Electrical contact measurement is also a very reliable means for detecting if the watch is on the wrist or not. This is important for 24/7 measurement where the HR measurement is meaningful only if the watch is on the person's wrist at all times.

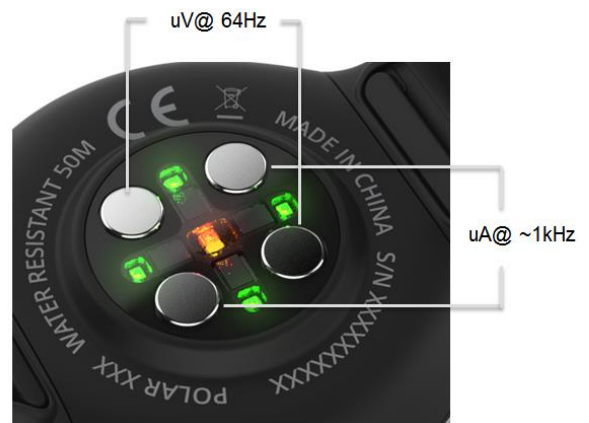

Figure 5. The technology to measure the contact between skin and the back of the wrist device.

Adding more complexity to the technical sensor solution adds more options for the algorithm to deal with noise and other disturbances and provide accurate and reliable heart rate readings in all situations (Fig 6.).

Polar Precision Prime OHR

October 15, 2019

Polar Research and Technology

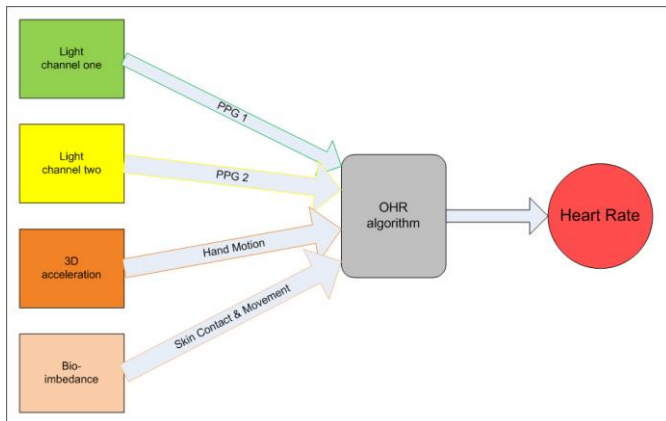

Figure 6. Simplified diagram of OHR signal sources together with the algorithm.

The Polar Precision Prime OHR is the only solution on the market to utilize three different methods for overcoming the problems caused by motion artefacts: 1) 3D acceleration sensor, 2) multiple optical channels using several wavelengths of light, and 3) electrical sensor for measuring the quality of the sensor-skin contact.

The pins of the electrical contact sensor conveniently double as charging pins (Fig 7.).

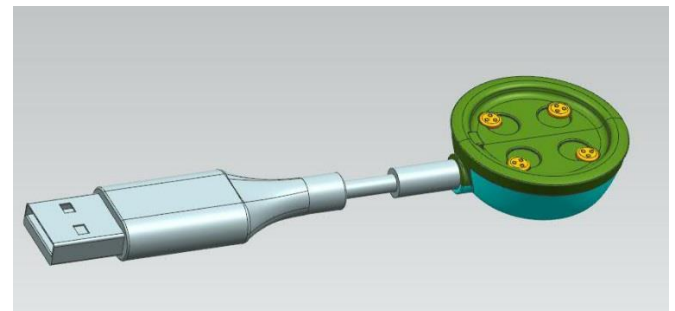

Figure 7. The charging connector.

5 Scientific background

The history of optical heart rate measurement goes hand in hand with the discovery of PPG and the development of pulse oximetry. Optical heart rate measurement without oximetry properties is just simpler as it does not need to calculate the relation in the absorption of two different wavelengths of light.

The rapid development of optical heart rate measurement for wrist devices started some 10 years ago when sufficiently small MEMS -based (microelectromechanical systems) acceleration sensors became available and could be integrated to the device to overcome some of the problems with motion artefacts.

6 Polar Precision Prime compared to its competitors

7 Precision Prime validation

Precision Prime OHR was validated by Gilgen-Amman & Schweizer from the Swiss Federal Institute of Sports Magglingen (SFISM) in 2018 (Schweitzer & Gilgen-Amman 2018). The validity was studied at rest and during exercise. The study consisted of seven different activities with ascending intensity. The selected activities were sitting and reading, household chores, free walking, free jogging, a strength training circuit, cycling on an ergometer, and a floorball course. There were 27 participants in the study. Precision Prime was compared to Polar H10 with Polar Pro strap electrocardiogram-based heart rate solution. Polar H10 was selected as a reference because it was shown to be accurate enough even for a golden standard of electrocardiogram-based HR measurement at rest and during exercise (Gilgen-Ammann et al. 2019).

Polar Precision Prime OHR

October 15, 2019

Polar Research and Technology

Polar Precision Prime correlated strongly with the Polar H10 ($r = .948$, $p < .001$). The mean absolute error (MAE) was 4.4 beats per minute (bpm) (3.7%). The lowest MAE was during rest (sitting 1.2 bpm, 1.9%), and the highest in the floorball course (12.2 bpm, 7.7 %). The lowest MAE of activities was reported from walking with an error of 1.5 bpm (1.6%). The results of all the activities are presented in table2. In conclusion, the first generation of Precision Prime OHR technology is demonstrated to be at least as accurate as previously investigated wrist-worn optical heart rate monitors. (Schweitzer & Gilgen-Ammann 2018)

Table 1: Mean HR and level of perceived exertion per activity.

	Borg ±SD	Polar H10 ±SD [bpm]	Polar PP ±SD [bpm]
All activities	11.0 ±3.5	110.8 ±34.0	108.7 ±31.3
Sitting and reading	6.1 ±0.3	63.1 ±9.8	62.1 ±9.7
Household chores	7.6 ±1.0	85.1 ±9.8	89.1 ±7.4
Walking (5.4 ±0.6 km/h)	8.6 ±0.9	86.1 ±10.3	87.6 ±10.2
Jogging (9.6 ±1.2 km/h)	11.8 ±1.0	132.8 ±15.2	132.1 ±14.0
Strength training circuit	13.5 ±1.0	117.8 ±15.4	113.1 ±13.9
Cycling ergometer (132.6 ±22.8 W)	14.2 ±1.1	135.6 ±16.6	133.7 ±18.0
Floorball course	15.4 ±1.7	155.2 ±20.5	143.0 ±23.1

Note. Adapted from (Schweitzer & Gilgen-Ammann 2018). SD = Standard deviation; bpm = beats per minute.

Table 2: Error rates of the Polar Precision Prime™ HR in comparison to the ECG-based Polar H10.

	Mean absolute error (%) [bpm]	Systematic bias (±LoA)* [bpm]	Polar PP 5% accuracy per 10s-intervals** [%]
All activities	4.4 (3.7)	-2.1 (21.4)	75.9
Sitting and reading	1.2 (1.9)	-1.0 (2.4)	83.0
Household chores	4.5 (5.9)	4.0 (12.4)	50.2
Walking (5.4 ±0.6 km/h)	1.6 (1.9)	1.5 (4.7)	85.7
Jogging (9.6 ±1.2 km/h)	2.6 (1.8)	-0.7 (11.1)	88.0
Strength training circuit	5.8 (4.6)	-4.7 (24.5)	62.0
Cycling ergometer (132.6 ±22.8 W)	2.5 (1.9)	-1.8 (15.3)	90.8
Floorball course	12.6 (7.7)	-12.2 (39.0)	71.5

Note. Adapted from (Schweitzer & Gilgen-Ammann 2018). *representing the information of a Bland and Altman plot with the systematic bias and the 95%-limits of agreement (LoA)

**Percentage, where the heart rate obtained by the Polar PP was within 5% from the criterion Polar H10.

SD = Standard deviation; bpm = beats per minute.

8 Safety

There are no safety regulations for wearable optical heart rate monitors for manufacturers that should be followed. The optical measurement is similar to Polar Electro's 6-LED solution with the addition that a second color has been added.

The electrical skin contact measurement with the contact pins uses ~10 micro ampere of current which is much lower than that currently used in

Polar Precision Prime OHR

October 15, 2019

Polar Research and Technology

body composition monitors, for example. No safety issues are expected, but a notice will be included in the user manual to inform users that the device uses a small amount of electric current to make the skin contact measurement.

9 Other HR solutions by Polar

H10 – still the best solution for serious athletes demanding accurate HR measurement in even the most extreme sport situations. Recommended especially for interval training, weight training, racket sports.

OH1 – convenient and comfortable option for those who don't like chest-straps. Located on the upper arm provides best performance.

10 Patent

Patent pending:

WO2017182677A2: ENHANCING OPTICAL CARDIAC ACTIVITY MEASUREMENT

11 References

1. J.W. Severinghaus, "Takuo Aoyagi, Discovery of Pulse Oximetry", *Anesth Analg* 2007 Dec;105(6 Suppl):S1-4.
2. J. Allen, "Photoplethysmography and its application in clinical physiological measurement", *Physiological Measurement*, vol. 28, No 3, R1, 2007.
3. A. Reisner et.al. "Utility of the Photoplethysmogram in Circulatory Photoplethysmography", *Anesthesiology* 2008; 108:950–8.
4. Y. Maeda, M. Sekine, and T. Tamura, "The Advantage of Wearable Green Reflected Photoplethysmography" *J. Med. Syst.*, vol. 35, pp. 829–834, 2011.
5. Lemay M. et.al. "Application of Optical Heart Rate Monitoring", Ch. 2.3, pp. 105–129, In. "Wearable Sensors: Fundamentals, Implementation and Applications", eds. E. Sazanov, M. R. Neuman, Elsevier 2014
6. J. Parak, I. Korhonen, "Evaluation of Wearable Consumer Heart Rate Monitors Based on Photoplethysmography", *Conf Proc IEEE Eng Med Biol Soc*, 2014; 3670–3
7. Horton J. et.al. "Comparison of Polar M600 Optical Heart Rate and ECG Heart Rate during Exercise", *Medicine and Science in Sports and Exercise*: Dec 2017, 49(12): pp 2600–2607
8. Schweizer T., Gilgen-Ammann R., "Accuracy of the optical heart rate device Polar OH1 during rest and exercise", *CISM Sport Science Abstract*, 2018.
9. Schweizer T., Gilgen-Ammann R., "Validation of Polar Precision Prime™ heart rate measurement at rest and during exercise", *CISM Sport Science Abstract*, 2018.
10. Gilgen-Ammann, R., Schweizer, T., & Wyss, T. (2019). RR interval signal quality of a heart rate monitor and an ECG Holter at rest and during exercise. *European journal of Applied physiology*, 1-8.

12 More information

White papers:

- Polar Optical Heart Rate
- Polar H10 Heart Rate Sensor System

Polar Blog:

- <https://www.polar.com/blog/optical-heart-rate-tracking-polar/>