



Easy to read

What the United Nations has been working on in 2023 and 2024

**This report is about a part of the United Nations called
the United Nations Secretariat**



**Report of the Secretary-General on the Work of the
Organization 2024.**



About this report

My name is António Guterres.



My job is Secretary-General for the United Nations.

The United Nations is called the UN for short.



The United Nations is a place for 193 countries to meet and work together.

They are working to make the world better, fairer and safer.

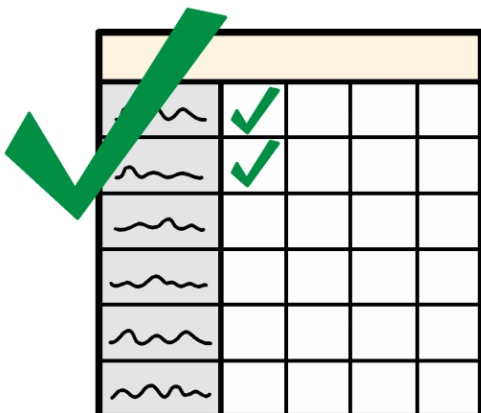

This report is about some of the main work that we have done in the last year.

When we say **we** it means the United Nations.

We did this work with many countries and organizations.

Some of our main work in the last year

Making the world better and fairer for everyone

Helping people to have better lives



There are 17 big things that countries are working on by the year 2030.

For example, countries want to make sure that everyone has enough food, clean water and money to live on.

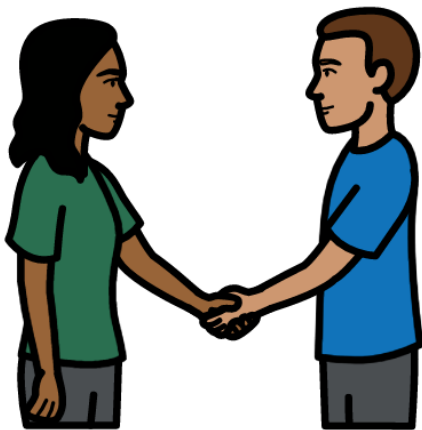

This work is not going as fast as it should.

But we supported countries to keep moving forward.



For example, we had a meeting in 2023 to help countries work faster on the 17 things by 2030.



We are helping to get more money for the work that countries promised to do.

That will also mean changing unfair rules in the world about money and tax.

That will help poorer countries to have more money to spend on things that people need.

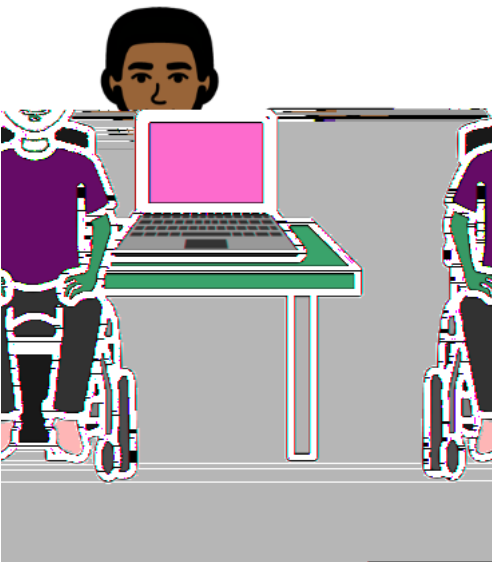

We are working to make life fairer for all groups of people in the world.

For example, we started some projects to help make sure that:

- More people in the world can use the internet.
- Everyone gets treated fairly at work and has enough money to live on.

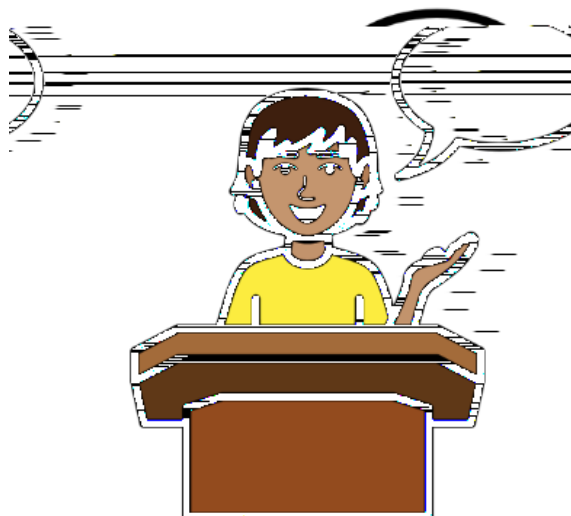

We are supporting more women and young people to help make big decisions in the world.

We set up a new team of people to help with our work with young people.

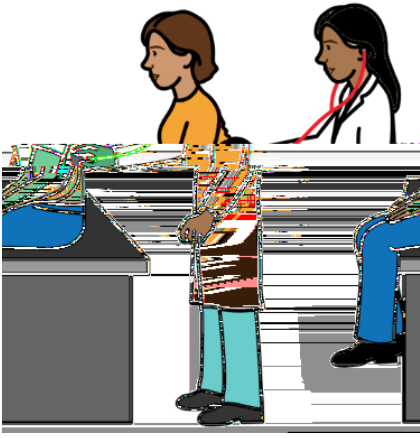

We have helped to make sure that people with disabilities get important healthcare.

That includes healthcare to do with safe sex and having children.

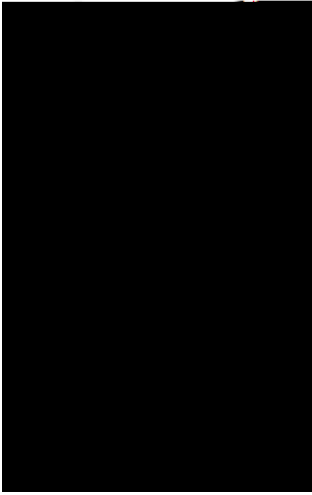

We helped countries to make plans about better healthcare and support for older people.

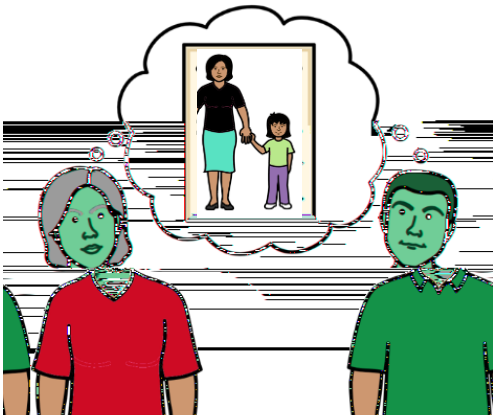

We made a new plan about making life fairer for women and girls.

The plan will help countries to work faster to give women and girls what they need.



We also helped with work to:

- Stop violence that often happens to women and girls.
- Make sure that more people who hurt women and girls go to court or prison.
- Support women in the countryside to earn money and have a better life.

Climate change

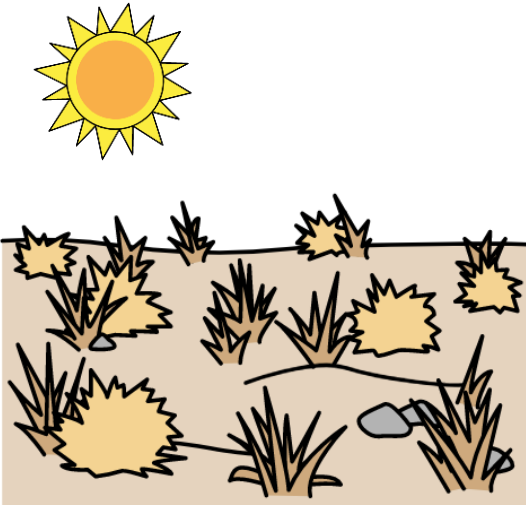

Climate change is about the earth getting warmer.

That is causing big problems for people, animals and plants.

For example, there are more big weather problems now like floods and bad storms.

We started lots of work to help keep people and our planet safe.

That includes work to:

- Stop people throwing so many things away. For example, many things could be fixed or used again.
- Change the way that we grow and make food to help stop climate change.
- Stop forests being cut down.
- Stop problems with plastic harming our planet.
- Make sure that poorer countries get more money to deal with climate change problems.



Helping the world to be peaceful and safe

We worked to keep the peace and keep people safe in many parts of the world.

For example, we have a new plan about how countries can work together for a peaceful and safe world.

We also gave some countries money and support to help with their own plans about keeping peaceful and safe.

We kept working with leaders and organizations to help stop fighting in some countries.

For example, we have been working to stop fighting getting worse between countries in some parts of the world.

We worked with governments to have fair and safe elections.

Elections are when people choose who they want to lead the country.

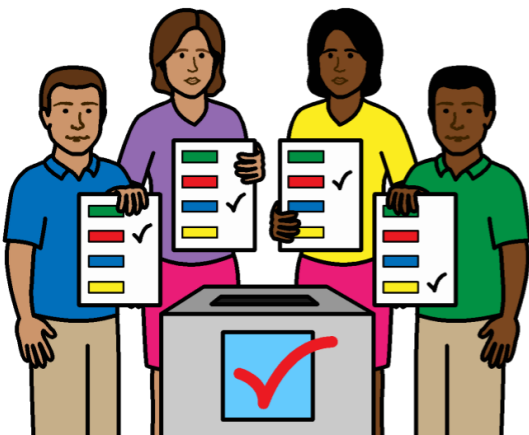
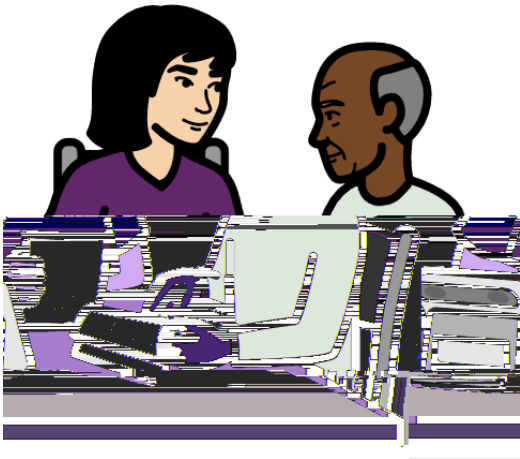



We supported more people to help make decisions about their country and how to keep people safe.

That includes women and young people.

For example, we gave some women training on how to take part in elections.



We supported the police and courts to deal with serious crimes in a better way.

That includes doing more to stop sexual violence during wars.

This is where people are forced to do sexual things they do not want to do.

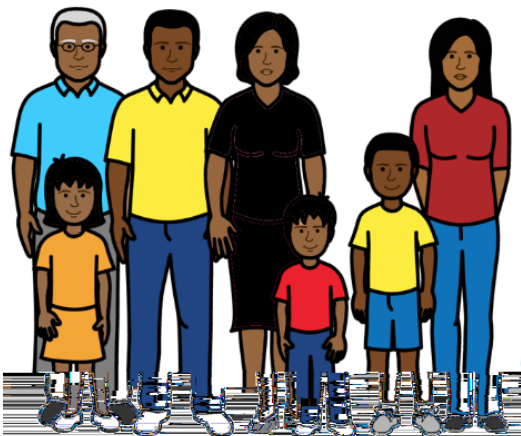

We also did more to keep children safe from violence.

That includes children who are forced to join fighting groups and take part in war.

We helped many of these children to leave fighting groups and live in the community again.



Our work in Africa

Africa is an important part of the world that we work in.



We supported countries in Africa to find new ways to:

- Get more money to make life better for everyone in Africa.

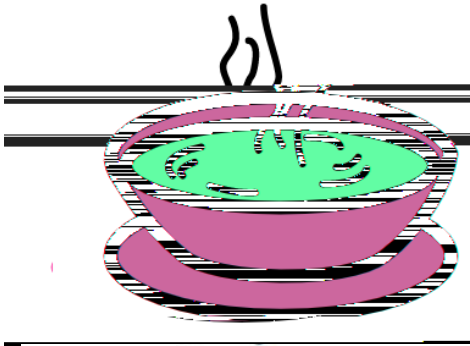

- Make sure that everyone has enough healthy food to eat.

For example, we helped to start better ways to feed children at school. The food came from local farmers.



- Create more jobs for people. That includes jobs for women and girls.

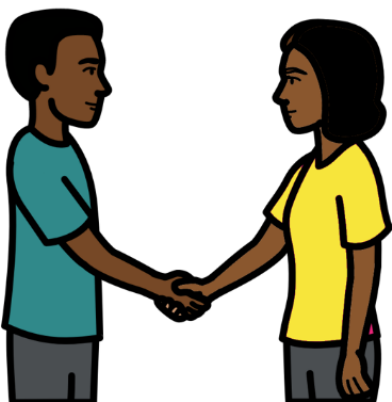

- Buy and sell things in a better way for Africa.

That includes working more with women in Africa who run a business.

Making sure that we respect people's human rights

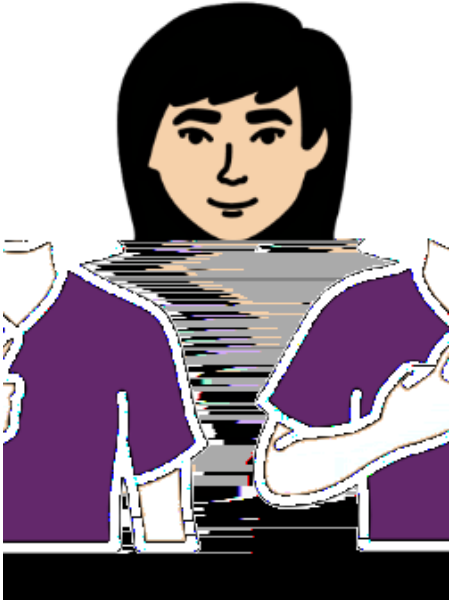

Everyone in the world has human rights.

Human rights are about how we should all be treated.

For example, everyone has the right to be safe and treated fairly.



We worked hard to help everyone to get their human rights.

For example, more countries have now promised to follow important laws in the world about human rights.



We helped countries to make human rights part of their own laws and plans.



We worked with organizations around the world to help make life better for people with disabilities.

This is part of our plan to include people with disabilities in all our work.

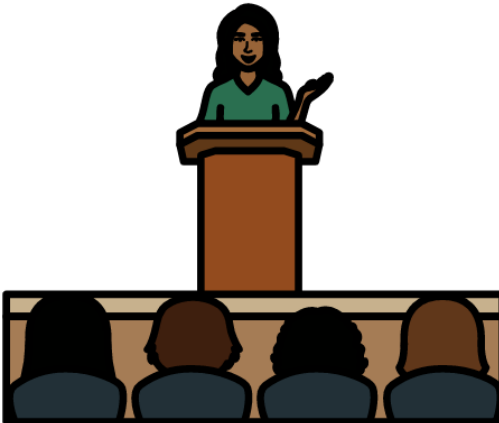

We gave more support to people and organizations that stand up for human rights.



We made a new document about how to stop information in the world that can cause harm.

For example, some people may put information on the internet that is not true.



The information may say unfair things about certain groups of people.

Many people may read the information.

Some groups of people could be hurt because of the information.

Giving people the right support when big problems happen

For example, earthquakes and bad weather problems.

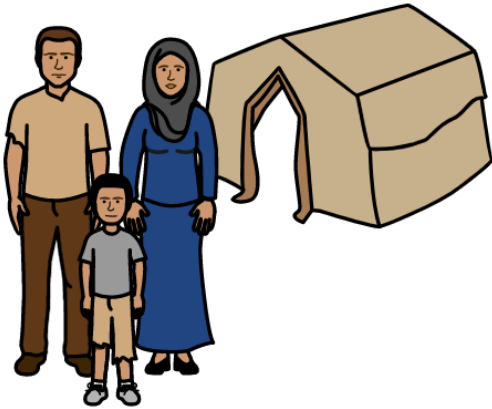

We helped many people in the world to get support quickly to save their lives.

Like support with food, clean water and healthcare.

That includes mental healthcare for some people who were very sad or worried.



We helped many countries to get ready for big problems that may happen.

For example, we helped countries to get better information to know:

- What big problems may happen.
- What can be done to stop them.
- What support people may need.

This can help people to get the right support more quickly.



Our work on weapons, drugs and crime

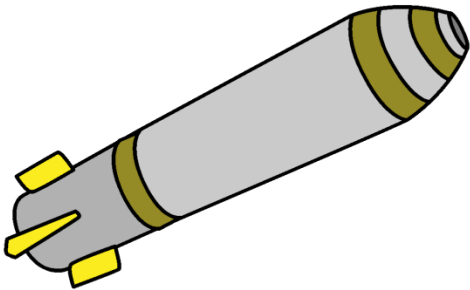

We are working with countries to have less weapons in the world.

Weapons are things that can kill people, like bombs and guns.

For example:

We are helping some countries to make a new agreement.

This is about stopping nuclear weapons and other weapons in those countries.



We set up a new team of people to help stop other dangerous weapons.

Like weapons that use chemicals to kill people.

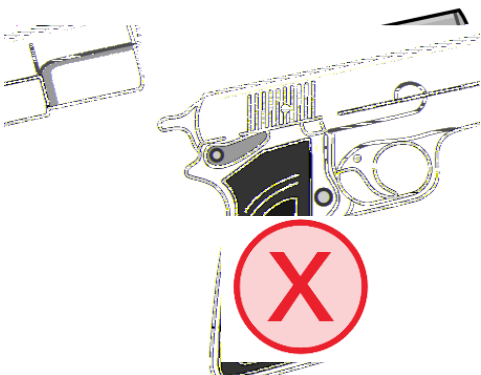

We helped with projects to make countries safer.

That includes projects to help stop guns, drugs and violence in communities.



Changing the way we work

We want to make the United Nations a better and safer place for everyone to work.

For example, we made new rules and plans about:

- Helping mothers and fathers to take time off work when they have a baby.
- Supporting our staff with their mental health.
- Stopping people being hurt or treated badly.

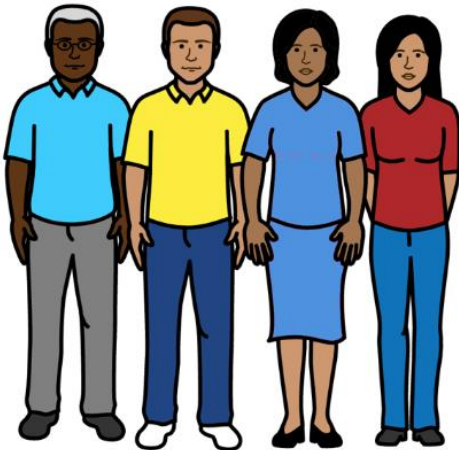

That includes stopping people being treated badly because of where they and their family are from and the colour of their skin.



We started new ways to plan our work and plan how we spend our money.

This is helping us to work in a better and quicker way.