

Department of Commerce National Oceanic & Atmospheric Administration National Weather Service

NATIONAL WEATHER SERVICE MANUAL 10-1402

DECEMBER 8, 2023

Operations and Services

Upper Air Program NWSPD 10-14

RADIOSONDE OBSERVATIONS

NOTICE: This publication is available at: <http://www.nws.noaa.gov/directives/>

OPR: W/OBS31 (T. Day)

Certified by: W/OBS3 (M. Hopkins)

Type of Issuance: Initial

SUMMARY: This new manual provides procedures for upper air launch sites operationally using the AROS or MROS system.

MEHTA.AJAY.NAT Digitally signed by
WAR.1365835825 MEHTA.AJAY.NATWAR.1365835825
Date: 2023.11.24 16:50:09 -05'00'

Ajay Mehta
Director, Office of Observations

Date

Radiosonde Observations

Table of Contents	Page
1. Purpose and Scope	2
2. Documentation of Station Upper Air Program and Facilities	3
3. Official National Weather Service (NWS) Stations.....	3
4. Unforeseen Circumstances	3
5. Office Responsibilities	3
5.1 Upper Air Station	3
5.2 Regional Headquarters	4
5.3 National Weather Service Headquarters	4
6. Appendices Overview	5
7. Reference Documentation	6
8. Acronyms & Abbreviations.....	7

Appendices

A. Observation Instrumentation.....	A-1
B. UA Platform Familiarization.....	B-1
C. Observation and Launch Preparation	C-1
D. Cloud Observation and Weather Coding	D-1
E. In-Flight Procedures	E-1
F. Data Transmission and Archiving	F-1
G. Quality Control of Data.....	G-1
H. Station Management	H-1
I. Completion of Documentation (Forms)	I-1
J. Surface Observation Systems.....	J-1
K. Station Safety	K-1
L. Special Observations	L-1

1. Purpose and Scope

Since the late 1930's the National Weather Service (NWS) has measured vertical profiles of pressure, temperature, relative humidity, wind direction and velocity through the use of balloon-borne radiosondes. This manual defines upper air operational requirements and general procedures applicable to all NWS stations.

All aspects of the radiosonde observation are covered, from preparing the radiosonde and balloon train to processing and disseminating upper air data. Also provided are procedures for completing upper air data forms and maintaining station upper air equipment.

This manual does not provide detailed system specific procedures for taking upper air observations with the Manual Radiosonde Observing Systems (MROS) or the Automated Radiosonde Observing Systems (AROS). For detailed procedures, please see the specific system's user guide.

2. Documentation of Station Upper Air Program and Facilities

Each upper air station is responsible for maintaining accurate information files pertaining to its upper air program. The procedures and responsibilities for documentation of equipment, instrumentation, and observing programs are found in Appendix H, Appendix I, and NDS 10-13.

3. Official National Weather Service (NWS) Stations

The NWS participates in the WMO's World Weather Watch Program by maintaining and operating a network of radiosonde stations in the contiguous U.S. (69 sites), Alaska Region (13), Caribbean (1), and Pacific Region (9). This network of stations comprises approximately ten percent of the global network.

4. Unforeseen Circumstances

No set of procedures can cover all possibilities that can occur in an operational setting. The observer should adhere as closely as possible to this manual to handle situations not adequately covered by specific instructions, while using their best judgment. If procedures in this manual require changes or clarification, suggest them through the site supervisor, who in turn should forward the suggestion to the Regional Office Headquarters. If it is determined the suggestion is appropriate, the Region will forward the suggestion to Weather Service Headquarters (WSH) for possible inclusion into future manual or handbook revisions.

5. Office Responsibilities

5.1 Upper Air Station

Radiosonde observations are essential for producing accurate weather forecasts and warnings. The data also serves other purposes (e.g., aviation operations). Therefore, each observer will ensure observations disseminated are of the highest quality possible. When there is reason to believe that the accuracy or validity of the upper air data are questionable or erroneous, follow the procedures outlined in the system user guides for handling such situations. If ground equipment is believed to be the source of the problem, the observer should notify the electronics technicians for corrective actions. The upper air site manager is responsible for safety and quality. They are to ensure that the equipment and balloon inflation shelter are safe for site personnel and maintained regularly to provide timely, high-quality observations to data users. They also ensure that only qualified staff release weather balloons. Qualified personnel are defined as:

- 1) Those who have passed the applicable national program courses for the sounding system and safety.
- 2) Those who have demonstrated proficiency with the local site's equipment and procedures.

5.2 Regional Headquarters

The Regional Headquarter offices are responsible for overseeing the operations at each upper air station in their Region. Specifically, they are responsible for the following activities:

- a. Provides assistance in identifying and correcting station problems and coordinating with WSH in regard to such problems.
- b. Maintains upper air station forms, containing station performance and logistical data for a minimum of three years.
- c. Prepares and disseminates quarterly reports of station performance.
- d. Develops NWS Supplements related to observing procedures and guidelines.
- e. Conducts periodic station inspections to ensure compliance with the standards and procedures of this manual.
- f. Obtain and have access to training center upper air examination records and certification results for reference.
- g. Assists WSH with field tests of new equipment, software, and observational procedures.

5.3 National Weather Service Headquarters

The NWSH's Office of Observations manages the upper air network in the development, acquisition, and management of cost-effective Upper Air observing technologies through the following activities:

OBS 31, Program Management Branch provides project and program management for life cycle support of the upper air observing system and ancillary systems. To carry out this responsibility, OBS31:

- a. Procures balloons, radiosondes and other consumables for upper air stations and maintains logistical data.
- b. Develops and maintains documentation related to operational upper air observations. This includes Policy Directives, handbooks, manuals, training materials and software installation instructions.
- c. Prepares and maintains the upper air observer exams in coordination with the NWS Training Center.

OBS 32, Services Branch provides engineering, hardware and software sustainment, and configuration management for upper air observing systems and ancillary systems. To carry out this responsibility, OBS32:

- a. Maintains, makes, and tests necessary changes to upper air software and hardware.

- b. Develops specifications for all equipment, from balloons and radiosondes to ground tracking and data processing systems.

OBS 33, Evaluation Branch is responsible for testing and integration of new hardware and software and field support of the Upper Air program. To carry out this responsibility, OBS33:

- a. Prepares reports on overall station and network performance.
- b. Ensures the operational performance of all laboratory and field equipment.

6. Appendices Overview

Appendix A - Observation Instrumentation

The purpose of this appendix is to familiarize observers with sounding components utilized by the NWS that form the flight train. This includes the radiosonde, balloon, twine, train regulators/unwinders, parachute and inflation gas used for lift.

Appendix B - UA Platform Familiarization

The purpose of this appendix is to familiarize observers with the AROS and MROS Upper Air platforms and components used to collect, process, monitor, and disseminate upper air data.

Appendix C - Observation and Launch Preparation

The purpose of this appendix is to discuss proper procedures for preparing and launching the flight train to ensure a successful flight. This includes balloon handling and inflation, preparing the flight train, radiosonde preparation, safety checks, and launch techniques. This includes utilizing a two-person technique in high winds.

Appendix D - Cloud Observation and Weather Coding

The purpose of this appendix is to provide the necessary tables and specific instructions to format and enter the cloud and weather code in the MROS software.

Appendix E - In Flight Procedures

The purpose of this appendix is to assist the observer with general post radiosonde release activities. See the specific system user guide for detailed instructions.

Appendix F - Data Transmission and Archiving

The purpose of this appendix is to provide general information about the coded messages and transmitting and archiving all required data. For system specific information, please refer to the system user guide.

Appendix G - Quality Control of Data

The purpose of this appendix is to provide general information regarding the quality control of data during and after an upper air flight. For system specific information, please refer to the system user guide.

Appendix H - Station Management

The purpose of this appendix is to provide station managers and observers information on their responsibilities for managing the upper air program and what documentation and software is required to be on site at an upper air station. This appendix also covers Upper Air Certification, the ordering of upper air consumables, accurate station data, and public requests for information regarding upper air projects.

Appendix I - Completion of Documentation (Forms)

The purpose of this appendix is to provide instructions to observers on how to properly fill out certain upper air related forms and show examples of those forms.

Appendix J - Surface Observation Systems

The purpose of this appendix is to give observers basic information about surface observation systems currently in use to obtain surface data near the launch site. In addition, this appendix provides information on what to do to obtain surface data in the event of equipment failure.

Appendix K - Station Safety

The purpose of this appendix is to cover all aspects of station safety with emphasis on correct handling of hydrogen gas.

Appendix L - Special Observations

The purpose of this appendix is to provide information for observers on what to do when special observations are requested, either internally or by external agencies.

7. Reference Documentation

Document Name	Document Number	Date	Document Reference
Rawinsonde Meteorological Handbook: Rawinsonde and Pibal Observations	FMH-3	1997	https://www.icams-portal.gov/publications/fmh/FMH3/00-entire-FMH3.pdf
Radiosonde Replacement System (RRS)	N/A	2018	https://www.weather.gov/media/upperair/Documents/RWS_Build_3.4_User_Manual_%20071818.pdf
NWS GRAW MROS User Guide	N/A	2021	https://www.ops1.nws.noaa.gov/
NWS Vaisala MROS User Guide	N/A	2021	https://www.ops1.nws.noaa.gov/
NWS Vaisala AROS User Guide	N/A	2021	https://www.ops1.nws.noaa.gov/
WMO Manual on Codes	306	2019	https://library.wmo.int/doc_num.php?explnum_id=10235

8. Acronyms and Abbreviations

AC	Alternating Current
AFSO	Analyze, Forecast, and Support Office
ASCNO	Ascension Number
AROS	Automated Radiosonde Observing Systems
ASME	American Society of Mechanical Engineers
ASOS	Automated Surface Observing System
AWIPS	Advanced Weather Interactive Processing System
AWS	Automatic Weather Station
BILS	Balloon Inflation Launch Shelter
BIT	Built-In-Test
BUFR	Binary Universal Form for the Representation of Meteorological Data
COTS	Commercial Off-The-Shelf
EEPROM	Electrically Erasable Programmable Read-Only Memory
EMRS	Engineering Management Reporting System
FAA	Federal Aviation Administration
FTP	File Transfer Protocol
GFI	Ground Fault Interrupter
GPS	Global Positioning System
GUI	Graphical User Interface
HISS	Hydrogen Inflation Safety System
IAS	International Activities Staff
IFGC	International Fuel Gas Code
IFR	Instrument Flight Rules
HOKEN	Hydrogen Generation System
LAN	Local Area Network

LED	Light Emitting Diode
METAR	Aviation Routine Weather Report
MIC	Meteorologist in Charge
MIRS	Management Information Retrieval System
MOU	Memorandum of Understanding
MSL	Mean Sea Level
MROS	Manual Radiosonde Observing Systems
NCEI	National Centers for Environmental Information
NCEP	National Centers for Environmental Prediction
NFPA	National Fire Protection Association
NLSC	National Logistics Support Center
NM	Nautical Miles
NRC	National Reconditioning Center
NWS	National Weather Service
OBS	Observation Time
OGC	Office of General Counsel
OIC	Official in Charge
PDB	Precision Digital Barometer
PTU	Pressure, Temperature, Humidity
QC	Quality Control
RADAT	Radiosonde Observation Data
RAM	Random Memory Access
RAOB	Radiosonde Observation
RH	Relative Humidity
RPU	Remote Processing Unit
RRS	Radiosonde Replacement System

RSOIS	Radiosonde Surface Observing Instrument System
SDL	System Data Logger
SDM	Senior Duty Meteorologist
SDR	Software Defined Radio
SID	Station Identification Number
SPECI	Aviation Selected Special Weather Report
SPS	Sounding Processing Subsystem
TFR	Temporary Flight Restrictions
UAIB	Upper Air Inflation Building
UHF	Ultra-High Frequency
UPS	Uninterruptible Power Supply
USB	Universal Serial Bus
UTC	Coordinated Universal Time
VFR	Visual Flight Rules
WBAN	Weather Bureau Army Navy
WFO	Weather Forecast Office
WMO	World Meteorological Organization
WS	Weather Service
WSH	Weather Service Headquarters

APPENDIX A - OBSERVATION INSTRUMENTATION

Table of Contents	Page
1. Introduction	A-2
2. The Radiosonde	A-2
2.1 Sensors	A-3
2.1.1 Pressure	A-4
2.1.2 Winds and Location	A-4
2.1.3 Temperature	A-4
2.1.4 Relative Humidity.....	A-4
2.2 Allowances for Sensors.....	A-5
2.3 Radiosonde Battery.....	A-7
2.4 Radiosonde Inspection and Preparation.....	A-7
2.5 Radiosonde Storage	A-7
3. The Balloon.....	A-7
3.1 Balloon Type.....	A-7
3.2 Balloon Performance	A-8
3.2.1 Inflation Lift Requirement	A-8
3.3 Balloon Storage.....	A-9
3.4 Balloon Warranty.....	A-10
4. Inflation Gases	A-10
4.1 Hydrogen.....	A-10
4.2 Helium.....	A-10
4.3 Inflation Gas Supply	A-10
5. The Flight Train	A-10

Figures

A-1: Upper Air Radiosonde (GRAW)	A-3
A-2: Upper Air Radiosonde (Vaisala)	A-3
A-3: Radiosonde Sensor (Vaisala).....	A-6
A-4: Radiosonde Sensor (GRAW).....	A-6
A-5: GP26 Balloon Rolled Out on Inflation Table.....	A-7
A-6: Types of Train Regulators	A-11
A-7: NWS Radiosonde Flight Train	A-11

Tables

A-1: Radiosonde Operating Conditions.....	A-5
A-2: Allowances for Sensors	A-6
A-3: Balloon Storage Environment Requirements	A-9

1. Introduction

The purpose of this appendix is to familiarize observers with sounding components utilized by the NWS that form the flight train. This includes the radiosonde, balloon, twine, train regulators/unwinders, parachute and inflation gas used for lift.

2. The Radiosonde

A Radiosonde used by the NWS is a small, expendable instrument package that measures the vertical profile of meteorological variables from the surface to more than 30 km in altitude with a minimum ascension rate of 275 meter/min. The electronics that power the radiosonde include sophisticated meteorological sensors, signal processing electronics and a radio transmitter that transmits the data at specific frequency to a ground based receiving antenna and processing module. System software further processes, encodes, presents, and disseminates the data.

The Radiosonde is suspended below a large gas filled balloon referred to as a weather balloon or sounding balloon. As the radiosonde begins to ascend at approximately 300 meters per minute, sensors on the radiosonde measure temperature, relative humidity (RH) and pressure, along with wind speed positioning data provided by a Global Positioning System (GPS) at ~ 1 second intervals or less.

Radiosondes are equipped with temperature and relative humidity sensors and leverage GPS technology for wind, pressure, geopotential height, and horizontal location. Radiosondes may include an onboard pressure sensor that does not use GPS for pressure but still rely on GPS for wind, height, and location. Radiosondes are battery powered and may include a train regulator/unwinder to support consistent radiosonde positioning and balloon tethering. Refer to the appropriate user guide for the system at the site for more information.

A Radiosonde observation can last in excess of two hours. During this time, the radiosonde can rise over 30 km and drift more than 250 km from the release point. During flight, the radiosonde can be exposed to temperatures as cold as -95 °C, RH values ranging from 0% to 100% and air pressures only a few thousandths of what is found at the earth's surface. When the balloon has expanded beyond its elastic limitations (~10 meters in diameter) and bursts, the radiosonde returns to Earth. Due to the decreased size and weight (up to 113g) of radiosondes, they pose a very low risk to life and property.

Understanding and accurately predicting changes in the atmosphere requires adequate observations of the upper atmosphere. Radiosondes provide a primary source of upper air data and will remain so into the foreseeable future.

Refer to Figure A-1 and Figure A-2 for approved NWS radiosondes. To learn more about radiosonde type and operation, refer to the appropriate user guide for the system at the site for more information.



Figure A-1: Upper Air Radiosonde (GRAW)



Figure A-2: Upper Air Radiosonde (Vaisala)

2.1 Sensors

The Radiosondes integrated sensors include temperature, relative humidity, and pressure (if applicable). When a radiosonde ascends, these sensors are linked to a battery powered radio transmitter that sends the sensor measurements to a ground receiver for processing. These sensors measure the environment as a function of changes in sensor electrical parameters such as resistance and capacitance. Refer to table A-1 for information on operating conditions.

2.1.1 Pressure

Depending on the system used at the upper air site, pressure is either derived from the radiosonde GPS height, temperature, and RH data or a pressure sensor will be located inside the radiosonde. For systems with an integrated pressure sensor, as the pressure changes, the cell expands (decreasing pressure) or contracts (increasing pressure), changing the separation between two plates contained within the instrument housing. Refer to the appropriate user manual pertaining to the system at the site.

2.1.2 Winds and Location

A GPS unit inside the radiosonde provides horizontal location data (Latitude and Longitude) as well as height data. These values are then utilized in the calculation of Wind Parameters (speed, direction, u component, v component).

2.1.3 Temperature

The resistive film type sensor utilizes resistive materials like ceramic, platinum and mirrored surfaces to reduce the effects of solar radiation and increase response times due to low mass and heat capacity and are not influenced by thermal effects of the radiosonde housing. Refer to table A-1 for information on operating conditions.

2.1.4 Relative Humidity

This thin-film capacitor is protected against moisture and icing by either a mirrored capsule or an integrated heating function that provides protection from a wet bulb effect that may occur when the radiosonde experiences excessive icing during cold and wet conditions. Refer to table A-1 for information regarding radiosonde operating conditions.

Radiosonde Operating Conditions	
Temperature	
Type: Resistive	Range: -90°C - +60°C
Resolution: 0.01°C	Accuracy: < 0.4°C
Humidity	
Type: Thin Film Capacitor	Range: 0 to 100 %RH
Resolution: 0.1 %RH	Accuracy: 4 %RH
Pressure (AROS)	
Type: Silicon Capacitor	Range: From surface pressure to 3 hPa
Resolution: 0.01 hPa	Accuracy: < 1.0 hPa
<i>*For MROS, pressure is calculated via GPS</i>	
Wind Speed	
Method: Calculated via GPS	Range: 0 to 200 m/s

Resolution: 0.01 m/s	Accuracy: < 0.1 m/s
Wind Direction	
Method: Calculated by GPS	Range: 0 to 360°
Resolution: 0.01°	Accuracy: < 1°

Table A-1: Radiosonde Operating Conditions

2.2 Allowances for Sensors

Upper Air radiosondes may differ slightly in size, weight, sensor configuration and materials depending on the system or vendor which could lead to slight measurement variations. The sensors should have no more than 5% data loss (per 5 minutes of flight time) for the duration of flight. Refer to the appropriate user manual that reflects the system at the site. See acceptable sensor allowances for NWS radiosonde sensor performance in table A-2.

Sensor Data	Allowable Measurement Error	
	Surface to 100 hPa	100 hPa to 10 hPa
Temperature (°C)	0.5°C	1.0°C
Relative Humidity (%)	5%	
Pressure (hPa)	1.8 hPa	0.6 hPa
Pressure (hPa) AROS ONLY	1.8 hPa <i>if pressure is >400 hPa and at temperature: (-95°C)-(+50°C)</i>	≤0.6 hPa <i>If pressure is 400 hPa-4.0 hPa and at temperature: (-95°C)-(+50°C)</i>
Wind Direction (Degrees)	≤5.0° at ≤15 m/s OR ≤2.5° at >15 m/s	≤5.0°

Wind Speed (m/s)	1.0 m/s	2.0 m/s

Table A-2: Allowances for Sensors

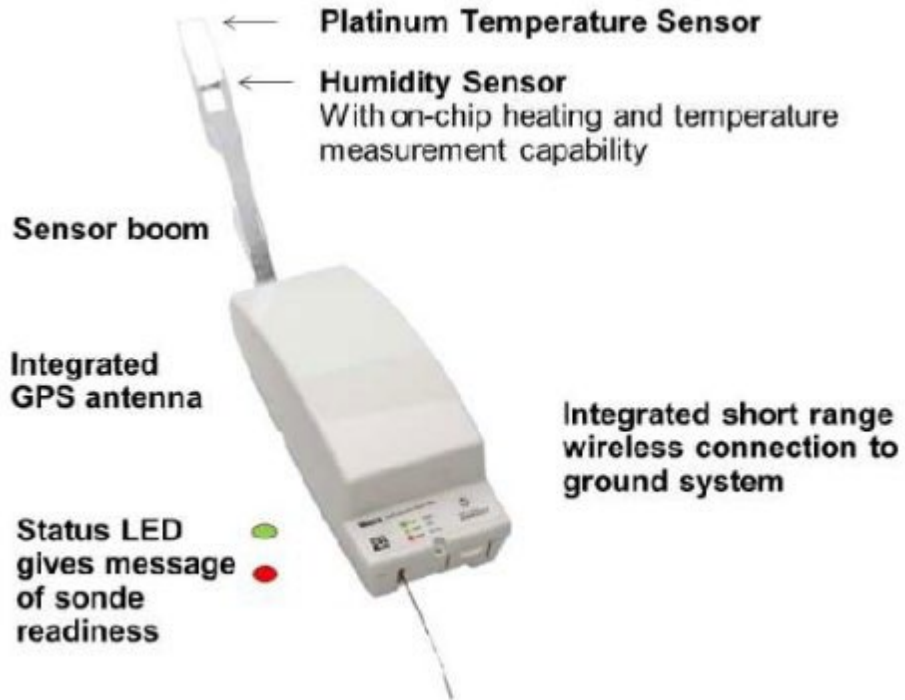

Figure A-3: Radiosonde Sensors (Vaisala)



Figure A-4: Radiosonde Sensors (GRAW)

2.3 Radiosonde Battery

Upper Air radiosondes are powered by lithium cell batteries that have up to 240 minutes of runtime. Refer to state and local regulations for disposal instructions of electronic devices containing lithium batteries.

2.4 Radiosonde Operation Inspection and Preparation

Every radiosonde should be inspected for any physical damage or defects before attempting to perform a flight. Observers are to take extra care when handling the radiosonde and avoid touching, hitting, or bending the sensor boom. Depending on the system, powering up and initializing a radiosonde and the presentation of data displayed on the upper air workstation will vary. To learn more about radiosonde type and operation, refer to the appropriate user guide for the system at the site for more information.

2.5 Radiosonde Storage

Radiosondes must be stored in their original packaging in a dry, ventilated, clean and dust-free indoor storage space, and within the following environmental limits:

- Temperature: +5°C to 40°C
- Relative Humidity: Below 85%

3. The Balloon

The NWS uses approximately 78,000 aerological sounding balloons annually to support NWS radiosonde observations required by the Office of Observations and its NWS Weather Forecast Offices. The aerological balloons must survive a wide variety of launch and flight weather conditions and provide optimal ascent rates and burst altitudes necessary for reliable and accurate radiosonde observations.

3.1 Balloon Type

The NWS uses a GP26 (600g) or GP20 (350g) balloon at nearly all 92 Upper Air sites in the network. This balloon type is designated as General Purpose (GP) followed by a two-digit numeric suffix designating the minimum bursting height in kilometers (26).

The GP26 (600g) balloon is a thin-skinned latex except at the neck where the latex is thicker (inside diameter between 3.073 cm to 4.52 cm) to accommodate an inflation nozzle, provide an ergonomic handle for person holding the balloon during a release and the means to attach the balloon with string to a flight train. When ready for release, the balloon has a diameter of about 1.5 meters with a wall thickness from 0.051 to 0.102 mm at sea level. As the balloon ascends, it reaches a diameter of up to 10 meters with a wall thickness of 0.0025 mm and a minimum bursting altitude of 26.0 km.



Figure A-5: GP26 Balloon rolled out on inflation table

3.2 Balloon Performance

Balloon performance is measured by the burst altitude and ascent rate. The optimal ascent rate is 275 to 350 meters/minute throughout the sounding. Performance is affected by the free lift, the thickness of the balloon skin, the air mass overlying the observing site, the weather conditions to which it is exposed, and the size and shape of the balloon envelope. Since most of these factors are uncontrollable, optimal performance for a given observation can best be determined by examining past balloon nozzle lift used under various surface weather conditions.

3.2.1 Inflation Lift Requirements The amount of hydrogen or helium most favorable for producing optimum performance should be ascertained before actual inflation of the balloon. Lift is defined as follows:

- Free Lift: The lift left after taking the payload into account. $\text{Free lift} = \text{Nozzle Lift} - \text{Payload weight}$.
- Nozzle Lift: The lift measured at the balloon neck (without the payload attached) – i.e. the Gross Lift less the Weight of the balloon itself. Nozzle Lift must always be more than the payload weight for obvious reasons.
- Gross Lift: The total lift provided by the Lifting Gas enclosed by the balloon (i.e. The weight of the displaced air less the weight of the lifting gas).

3.2.2 Inflation (AROS) The AROS automatically measures the volume of gas based on preconfigured settings. Refer to the AROS user guide for more information

Note: *It is important to remember that the lift capabilities of hydrogen and helium differ. Hydrogen, the lighter of the two gases, lifts 31.8 grams per cubic foot at sea level while helium lifts 28.2 grams per cubic foot at sea level.*

3.3 Balloon Storage

Care should be taken when storing aerological sounding balloons to ensure optimal performance and ensure maximum burst height. Balloons should be stored in their original sealed containers inside the office isolated from large electric motors or generators. The ozone emitted from motors and generators causes synthetic rubber to deteriorate. Ideal temperatures for storage should be in the range of 0 °C to 35 °C. Temperatures outside this range should be avoided during storage. Balloons shall not be stored in inflation shelters.

Balloons deteriorate with age and should be used in the order of their production dates to avoid excessive aging. As balloons are very delicate, no part of the balloon other than the neck should be touched with bare hands. Use soft rubber gloves, soft cotton gloves, or the plastic bag in which the balloon was wrapped when handling parts other than the neck. Refer to the table below for more detailed balloon storage requirements and exposure to various conditions.

Storage Environment Requirements	
Condition	Range
Air Temperature	0 °C to 35 °C (32 °F to 95 °F)
Air Relative Humidity	15% to 75%
Dusty	1 million particles per cubic meter, various sizes
Altitude	-50.0 m to 3.0 km, MSL (Mean Sea Level)
Radiation	Sunlight through office windows and ultraviolet light from office fluorescent lights

Table A-3 Balloon Storage Environment Requirements

3.4 Balloon Warranty

The balloon warranty period starts on the actual delivery date of the balloon to NLSC and lasts for 1 year. All aerological sounding balloons exhibiting out-of-box defects (e.g. pinholes, thin spots, patches, etc.) will be replaced if NLSC is notified of the defect within the warranty period.

4. Inflation Gases

In the NWS, there are two types of gas typically used to inflate weather balloons: hydrogen and helium gas.

4.1 Hydrogen

Although hydrogen gas is more volatile than helium (which is non-flammable), most land-based locations use hydrogen since it is only a fraction of the cost of helium. Safe practices are strictly adhered to when handling and using hydrogen. Hydrogen is either manufactured and bottled by a gas distributor or produced on site with a hydrogen generator.

4.2 Helium

Helium is safe and easy to use for inflating balloons. Unlike hydrogen, helium is an inert gas and does not pose a fire potential. However, helium costs are significantly higher than hydrogen.

5. The Flight Train

A flight train may consist of the following six components:

1. The Balloon: A GP26 (600g) / GP20 (350g) Aerological Sounding Balloon
2. A Light Stick (if required at Upper Air site): Light sticks use a non-toxic chemical to generate light. To activate a light stick, follow the activation instructions. Light sticks may only be used at MROS upper air stations that are within 5 nm of airports at night and during dim light conditions to allow aircraft pilots to see the balloon and flight train. Only a single light stick is to be used on a flight train. The AROS does not support light sticks.
3. A Parachute (if required at Upper Air site): A small parachute slows the descent of the radiosonde, minimizing the danger to people or property. Radiosondes with trajectories over bodies of water, deserts, and mountains may not require a parachute.
4. Twine: A length of twine is used to provide separation between the balloon, parachute (if used), and the radiosonde. Only NWS approved twine can be used.
5. Train Regulator/unwinder: During high surface winds, observers may be required to use a train regulator/unwinder. Train regulators/unwinders contain a spool of twine that slowly unwinds after balloon release. They enable the observer to launch a radiosonde in high winds without having to contend with many yards of slack twine. Depending on the system used at the site, a

train regulator/unwinder may be attached directly (see figure A-6). Refer to the appropriate user manual and Appendix C “Observation and Launch Preparation” for more information.



Figure A-6: Types of Unwinders / Dereelers

6. The Radiosonde: The instrument that measures meteorological variables and transmits data to a ground receiving and processing system.

Note: Do not attach any other components or payloads to the flight train, unless authorized by WSH.

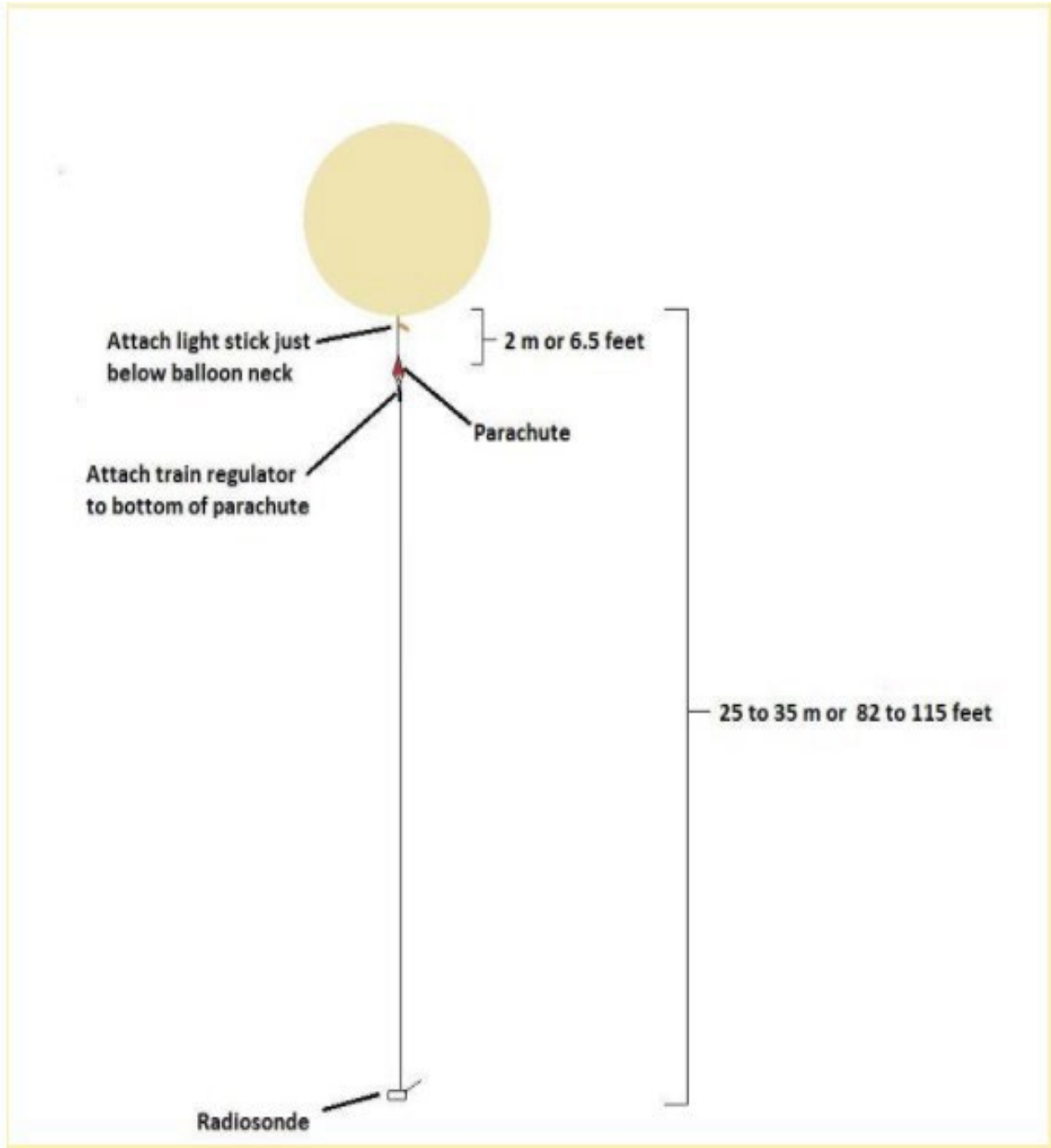

Figure A-7: NWS Radiosonde Flight Train

APPENDIX B - UA PLATFORM FAMILIARIZATION

Table of Contents	Page
1. Introduction	B-3
2. Automatic Radiosonde Observing System (AROS)	B-3
2.1 Description	B-4
2.2 AROS Component Overview	B-4
2.2.1 AROS Radiosonde.....	B-5
2.2.2 AROS Tracking.....	B-6
2.2.3 AROS Automatic Weather Station (AWS).....	B-7
2.2.4 AROS Software	B-7
2.2.5 AROS Operational Roles.....	B-9
3. Manual Radiosonde Observing System (MROS)	B-9
3.1 Description	B-9
3.2 MROS Component Overview.....	B-10
3.2.1 MROS Radiosonde	B-11
3.2.2 MROS Tracking.....	B-12
3.2.3 MROS Sound Processing Subsystems/Ground Stations.....	B-13
3.2.4 MROS Radiosonde Surface Observing Instrument System (RSOIS)	B-14
3.2.5 MROS Software.....	B-14
3.2.6 MROS Balloon Launch Sites.....	B-14

Figures

B-1: Automated Radiosonde Observing System (AROS / Autosonde / AS15).....B-3
 B-2: Autosonde AS15 Component Identification.....B-5
 B-3: AROS Structural Areas.....B-5
 B-4: Radiosonde with Unwinder (Vaisala).....B-6
 B-5: AROS: Sounding Processing Subsystem (Vaisala).....B-7
 B-6: Vaisala Automatic Weather Station (AWS).....B-7
 B-7: Color-coded Autosonde Components via Vaisala Autosonde Control SoftwareB-8
 B-8: Autosonde Software InterfacesB-9
 B-9: Vaisala MROS Components.....B-10
 B-10: GRAW MROS Components.....B-11
 B-11: MROS Radiosondes (Vaisala and GRAW)B-12
 B-12: MROS Telemetry.....B-13
 B-13: MROS: Sounding Processing Subsystem (Vaisala)B-13
 B-14: MROS: GS-E Ground Station (GRAW).....B-14
 B-15: High BayB-15
 B-16: BILS.....B-15
 B-17: Kettle Launcher.....B-16
 B-18: Inflation Table.....B-16
 B-19: Inflation Unit.....B-16

Tables

B-1: MROS Telemetry.....B-12

1. Introduction

The purpose of this appendix is to familiarize observers with the AROS and MROS upper air platforms and components used to collect, process, monitor, and disseminate upper air data. This appendix will focus on the Automatic Radiosonde Observing System (AROS) and the Manual Radiosonde Observing System (MROS).

2. Automatic Radiosonde Observing System (AROS)

Approximately 25% of the NWS Upper Air network uses a Commercial Off-The-Shelf (COTS) automatic radiosonde launcher to perform Upper Air soundings. The Vaisala Corporation is the vendor for all AROS systems. The AROS platform used operationally is the Vaisala AS15-CFG01 Autosonde (AS15) model. In addition, the terms AROS, Autosonde, and AS15 are interchangeable for the purposes of this appendix.



Figure B-1: Automated Radiosonde Observing System (AROS / Autosonde / AS15)

2.1 Description

The AROS is designed to perform soundings automatically for 24 consecutive soundings. The AROS consists of instrumentation to track and communicate with radiosondes for upper air meteorological observations, as well as electro-pneumatic equipment to automatically and/or remotely launch hydrogen or helium filled balloons to carry the radiosondes. The system also includes an Automatic Weather Station (AWS310) to provide surface observations to support radiosonde balloon launches. The AROS requires a bottled gas supply or hydrogen generation system (HOGEN) to provide lifting gas for radiosonde flights.

2.2 AROS Component Overview

The AROS consists of hardware and software components that function to prepare a radiosonde for flight, inflate and launch a weather balloon with flight train, receive and process the radiosonde telemetry into meteorological data, generate Upper Air data products, and transmit meteorological products to designated locations. The AROS components interface with each other to provide a seamless radiosonde observation, requiring minimal operator intervention. The AROS can provide up to 12 consecutive days of scheduled Synoptic soundings which can be controlled on-site or remotely via predefined network access.

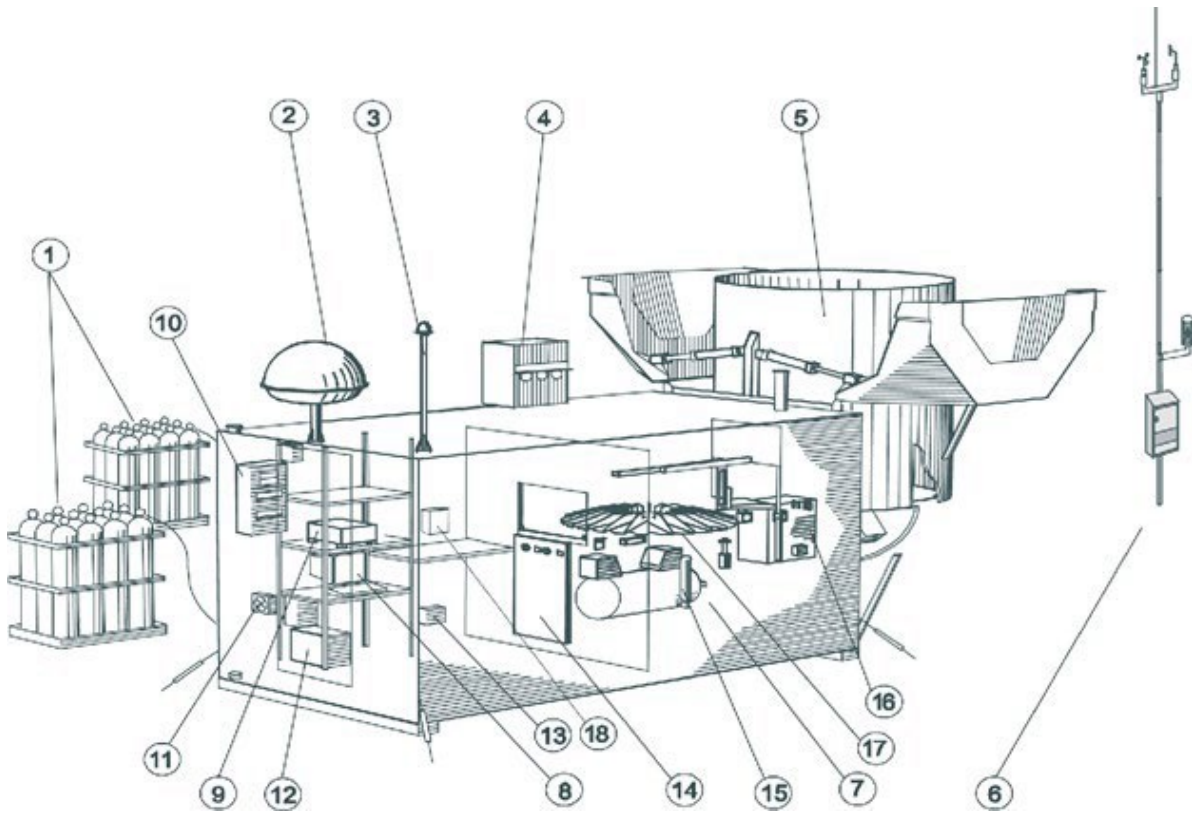

1. Gas supply: Hydrogen tanks, helium tanks, or hydrogen Generator (HOGEN)
2. Radiosonde Track Antenna (UHF Antenna)
3. Differential Global Positioning System (GPS) antenna
4. Flow meter

5. *Launch Vessel*
6. *AWS310 Automatic Weather Station*
7. *Radiosonde storage and preparation module*
8. *Personal computer with AUTOSONDE control and MW41 sounding software*
9. *SPS311 Sounding Processing Subsystem*
10. *Main electrical panel*
11. *Safety fan*
12. *Uninterruptible power supply (UPS)*
13. *HMT330 series humidity / temperature transmitter*
14. *Logic control box*
15. *Compressed air storage tank with primary and secondary air compressors*
16. *Nozzle box*
17. *Rotating table with trays containing radiosondes and uninflated balloons*
18. *Ground check device R141-AS1*

Figure B-2: Autosonde AS15 Component Identification

For nomenclature purposes, the AROS consists of sections including a prefabricated structure (Shelter) resembling a shipping container, an attached balloon launching vessel (Launch Vessel), and an Automated Weather Station (AWS). The Shelter is divided internally into two distinct areas, the Operator Room and the Robot Room. The Shelter exterior includes gas measurement components and antennae. Figure B-3 illustrates major areas of the AS15 AROS.

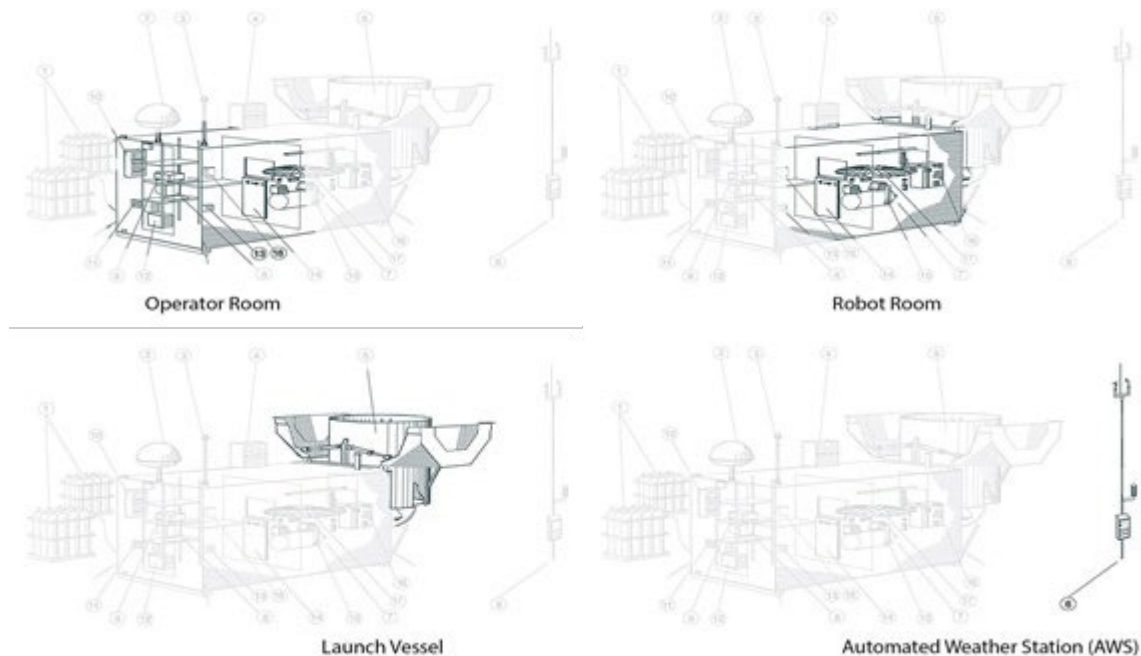
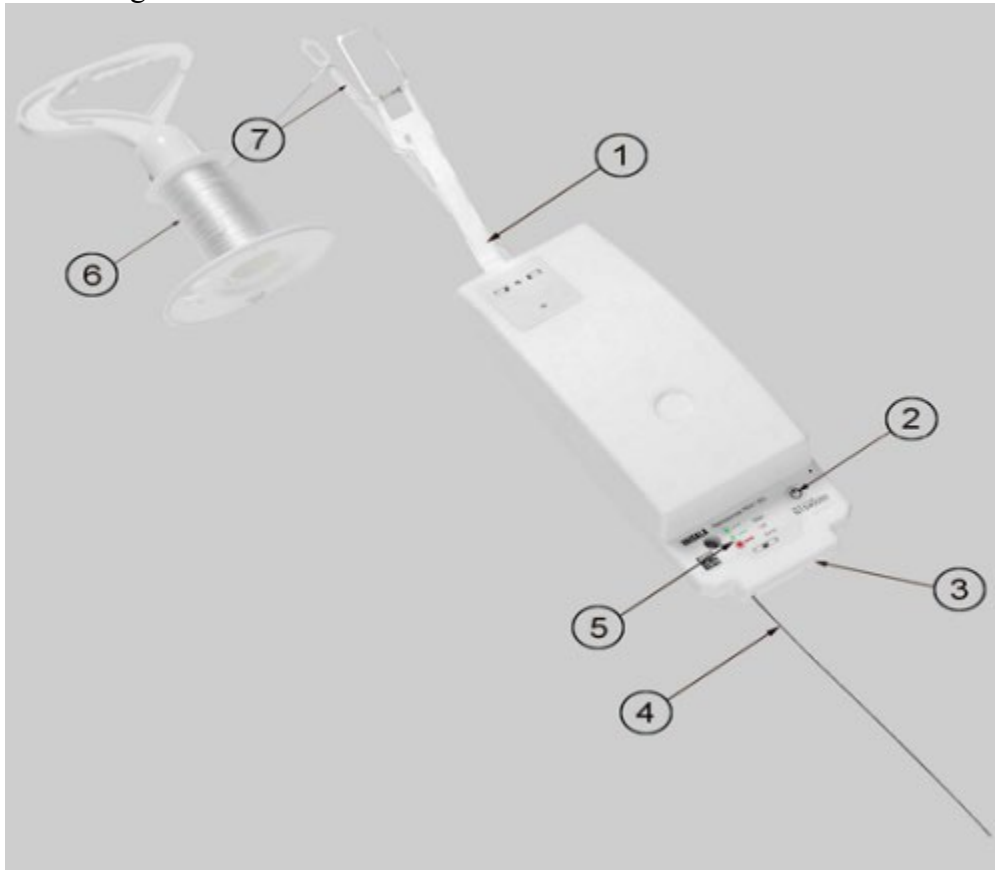

Figure B-3: AROS Structural Areas

2.2.1 AROS Radiosonde

The Vaisala RS41-SGP radiosonde operates in the 403 MHz frequency range and is the sensor package used by the AS15 Autosonde. The radiosonde uses a thin platinum resistive

temperature sensor which provides quick response times and low solar radiation error. The relative humidity sensor is a thin film capacitor with a temperature sensor included to compensate for the effects of solar radiation while a flight is in progress. The RS41-SGP also contains a shock-resistant capacitive silicon pressure sensor and leverages GPS technology for wind calculations. Additionally, The RS41-SGP includes two long life lithium batteries and an unwinder specifically designed to support consistent radiosonde sensor boom positioning and balloon tethering.



- | | |
|---|------------------------|
| 1. Sensor boom | 4. Antenna |
| 2. Power switch | 5. LED indicator light |
| 3. Additional sensor interface connector
(not utilized by NWS) | 6. Unwinder |
| | 7. Unwinder stick |

Figure B-4: RS41-SGP Radiosonde with Unwinder (Vaisala)

2.2.2 AROS Tracking

The AROS is equipped with a tracking system that includes a directional radome UHF antenna installed on the roof of the Autosonde structure. The antenna contains six monopoles with corner reflectors and a cross dipole within a small dome. It has no moving parts and is designed for telemetry signals in the 400 MHz to 406 MHz frequency band. A GPS antenna also installed on the roof is used to obtain positional calculations. The signals received by the UHF and GPS antenna are processed by the Sounding Processing Subsystem that connects to a workstation inside the radiosonde operator room.

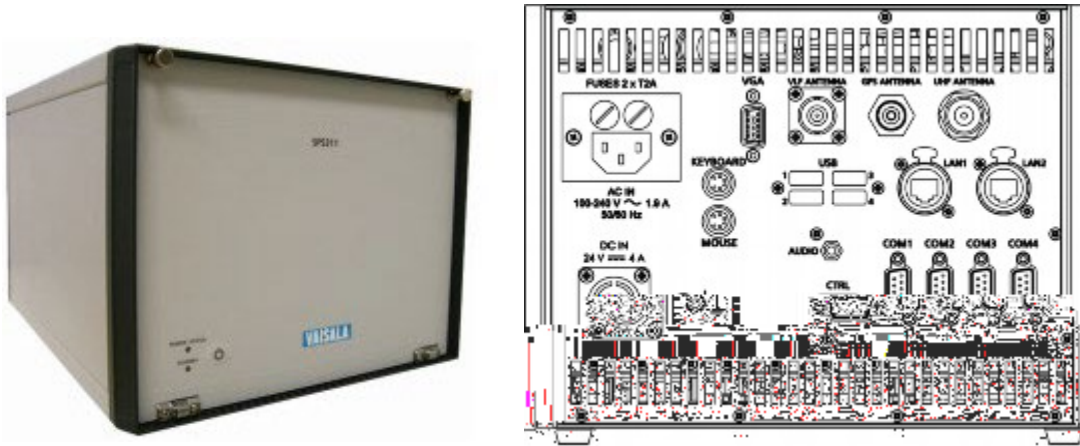

Figure B-5: AROS: Sounding Processing Subsystem (Vaisala)

2.2.3 AROS Automatic Weather Station

The NWS uses an Automatic Weather Station (AWS) to support the AROS platform. The AWS is a surface observation weather data collection system that measures, processes, and stores meteorological data. The AWS sensor array measures humidity, temperature, pressure, wind direction and speed. Observation data is collected by the central data logger which performs meteorological calculations and transmits the data to the workstation software for display and further processing by the user. For additional information on the AWS please refer to Appendix J “Surface Observation Systems”.



Figure B-6: Vaisala Automatic Weather Station (AWS)

2.2.4 AROS Software

The Autosonde interacts with three different Vaisala software interfaces: the Autosonde Control Software, the MW41 Sounding Software, and Network Manager (NM10) Software. The system consists of a workstation computer that is connected to the sounding processing subsystem that

processes pressure, humidity, temperature and wind finding data received from the radiosonde. The system includes a mouse, keyboard and a display to monitor data.

The Autosonde AS15 Control Software allows a user to monitor the status of AROS components, alerts, events, and systems; perform loading procedures; create flight schedules; grant launch permissions; and perform maintenance. The control software is the primary interface of the AROS hardware and has the capability to be controlled locally or from a remote location via a web browser.

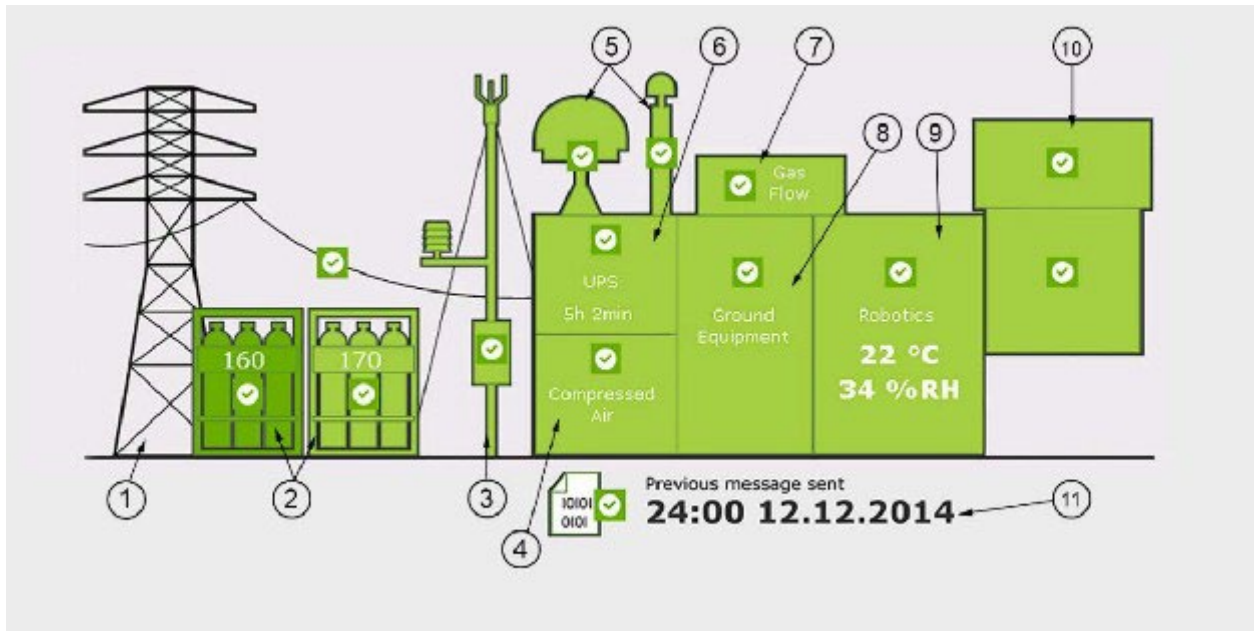

- | | |
|------------------------------------|--------------------------|
| 1. Power source for Autosonde | 7. Gas flow measurement |
| 2. Gas banks | 8. Ground equipment |
| 3. Automatic Weather Station (AWS) | 9. Robotics room |
| 4. Compressed air system | 10. Launch vessel |
| 5. UHF and GPS antennas | 11. Messages and reports |
| 6. UPS | |

Figure B-7: Color-coded Autosonde Components via Vaisala Autosonde Control Software

The MW41 Sounding Software is the interface of the Vaisala tracking system associated with the AS15 Autosonde. Similar to RRS Workstation Software (RWS), this software displays flight data graphically and in tabular format while the flight is in progress. The MW41 software has the capability to be controlled locally or from a remote location via a web browser.

The Network Manager (NM10) Software is used to manage a network of AROS systems remotely through a web server interface. The NM10 software is capable of monitoring multiple data collection sites including surface weather observation sites, airport weather observation sites, and Autosonde sites. Depending on the site location, this software interface may or may not be used.

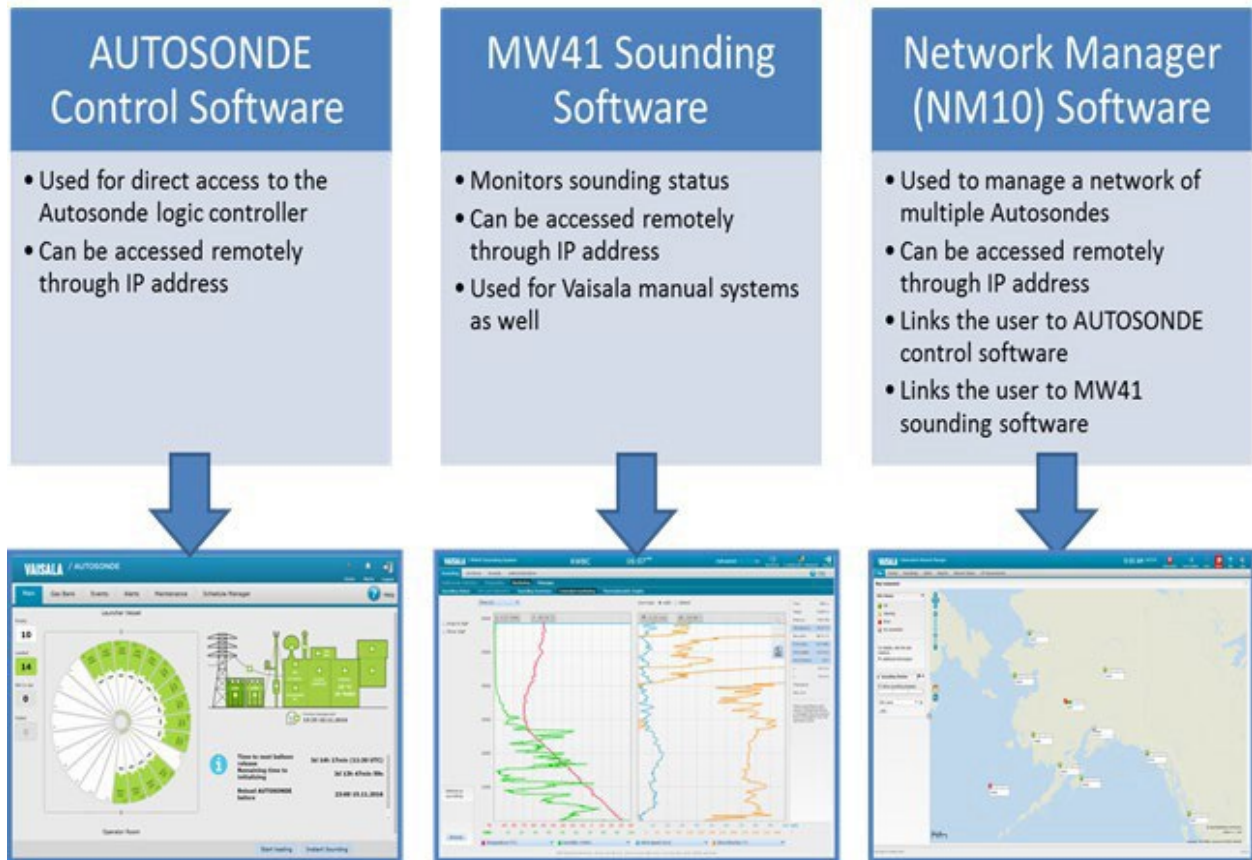

Figure B-8: Autosonde Software Interfaces

2.2.5 AROS Operational Roles

There are three operational roles associated with AROS: Site Operator, Remote Operator, and Remote Manager. Each role plays a vital part in Autosonde operations.

To learn more about the AROS platform, roles, and responsibilities, refer to the Vaisala AROS user guide.

3. Manual Radiosonde Observing System (MROS)

Approximately 75% of the NWS Upper Air network uses one of two COTS manual observing systems. The two sounding systems are Vaisala and GRAW. Both systems meet all necessary functional requirements in order to produce consistent upper air observations.

3.1 Description

The MROS is designed to perform manual launches of hydrogen or helium filled balloons that carry radiosondes for tracking and communicating upper air meteorological observations. As with the predecessor systems, the MROS utilizes the Radiosonde Surface Observing Instrument System (RSOIS) or the Automated Surface Observing System (ASOS) for surface observations. A major distinction between MROS and the predecessor RRS system is that MROS antennas contain no moving parts,

minimizing the risk of antenna-based mechanical issues.

3.2 MROS Component Overview

The MROS consists of hardware and software components that function to support the observer in preparing a radiosonde for flight, launching a weather balloon with a flight train, receiving and processing radiosonde telemetry into meteorological data, generating upper air data products, and transmitting meteorological products to designated locations.

Note: *Since MROS is supported by two vendors, depending on which version of MROS your site is using, component configuration and instrumentation will vary.*

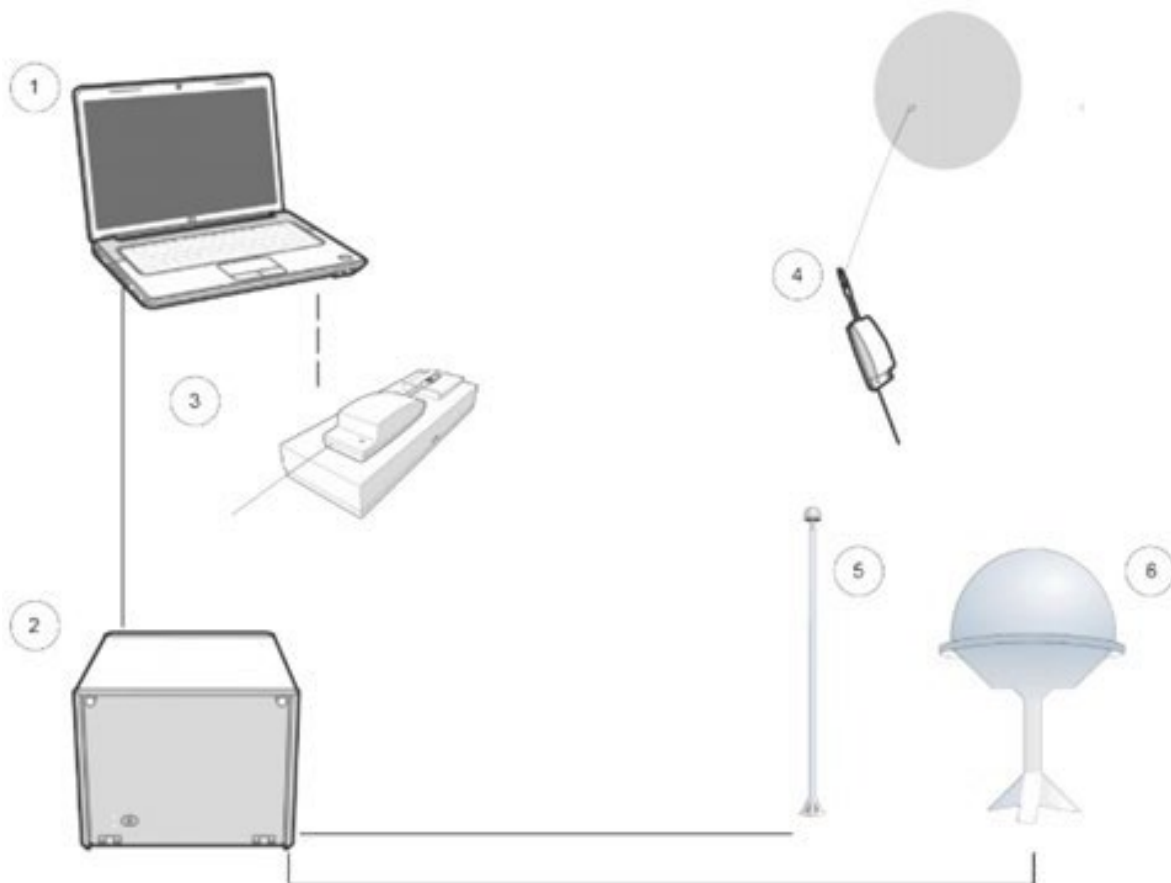

- | | |
|--|----------------|
| 1. Workstation Computer (w/display) | 4. Radiosonde |
| 2. Sounding Processing Subsystem (SPS) | 5. GPS Antenna |
| 3. Ground Check Device | 6. UHF Antenna |

Figure B-9: Vaisala MROS Components

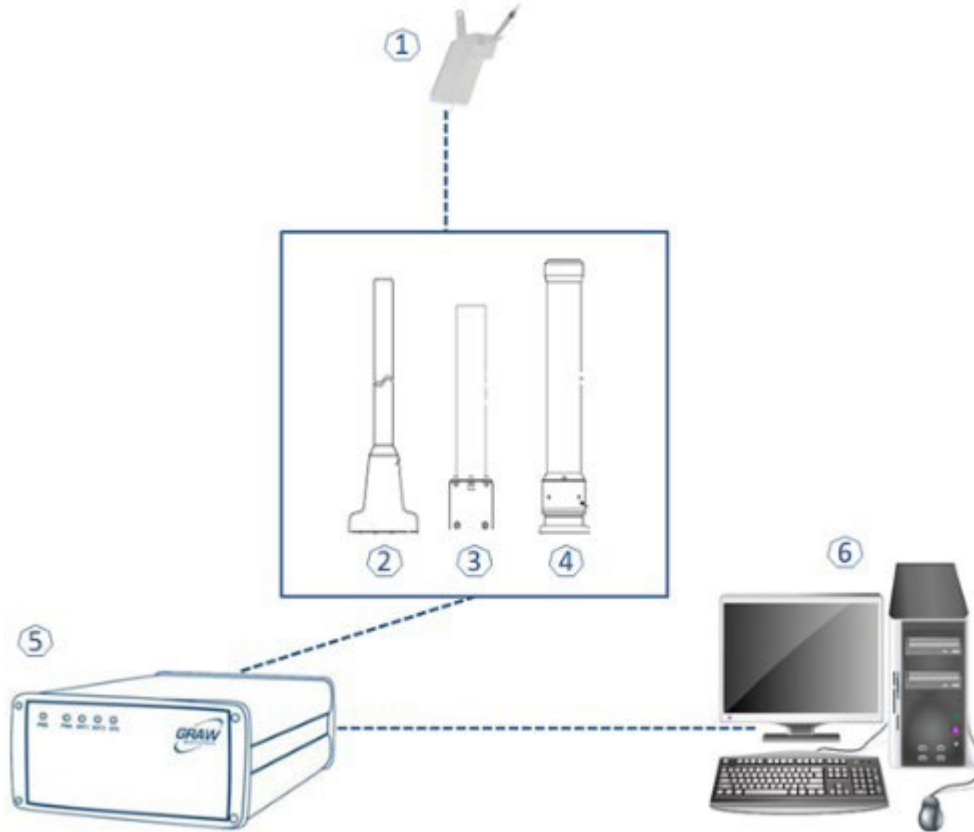

- | | |
|-----------------------------|----------------------------|
| 1. Radiosonde | 4. GPS Antenna |
| 2. Omni Directional Antenna | 5. Ground Station |
| 3. Helical Antenna | 6. Workstation (w/display) |

Figure B-10: GRAW MROS Components

3.2.1 MROS Radiosonde

Regardless of vendor (Vaisala or GRAW), the MROS radiosonde performs measurement of the atmospheric profile of temperature, humidity, wind speed and wind direction. The MROS radiosonde uses GPS technology for wind, pressure, geopotential height, and horizontal location calculations and requires a ground check process. Compared to predecessor radiosondes, MROS radiosondes are not supplied with a mailbag; however, the radiosonde will still contain “Harmless Weather Instrument” labels. For more information on operational use of MROS radiosondes, refer to the appropriate user guide for the system at the site.

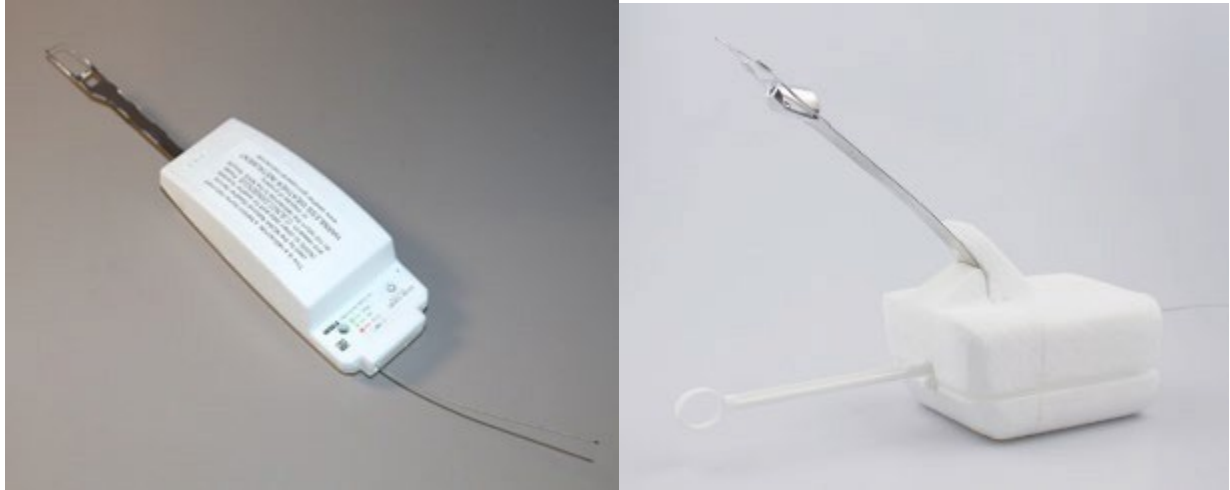

Figure B-11: MROS Radiosondes - Vaisala RS41-NG (left) and GRAW DFM-17 (right)

3.2.2 MROS Tracking

The NWS performs soundings in the 403 MHz meteorological band. The MROS platform leverages UHF and GPS antenna(e) and a Global Positioning System based tracking antenna. This receiving method provides increased accuracy and performance for wind, pressure, geopotential height and horizontal location calculations over its predecessor platforms. The MROS antenna location varies from a roof, building, or tower depending on the site.

The primary purpose of the telemetry receiving antenna is to receive the radiosonde’s transmitted frequency and the embedded data signal. The MROS tracking systems for upper air sites are composed of similar components from one of two vendors (Vaisala or GRAW). See table B-1 and figure B-12 for reference.

MROS Telemetry		
Vaisala	← Vendor →	GRAW
B31 UHF Directional Antenna	← Directional →	AT-OMNI Antenna (omnidirectional)
		AT-OVERHEAD (helical)
GA31	← GPS →	AT-GPS

Table B-1: MROS Telemetry



Figure B-12: MROS Telemetry - Vaisala (left), GRAW (right)

3.2.3 MROS Sound Processing Subsystems/Ground Stations

Sounding processing leverages Software Defined Radio (SDR) technology for receiving radiosonde signals. SDR technology is commonly used in a wide range of products including cellular base stations, military communication systems and public safety radio.

The Sounding Processing Subsystem (SPS) or Ground Station manages link performance and bandwidth efficiency. When a sounding is in progress, the SPS / Ground Station receives the radiosonde and GPS signals via SDR receiver and local antennas and the SPS decodes the data and relays it to the sounding workstation for processing and archiving.

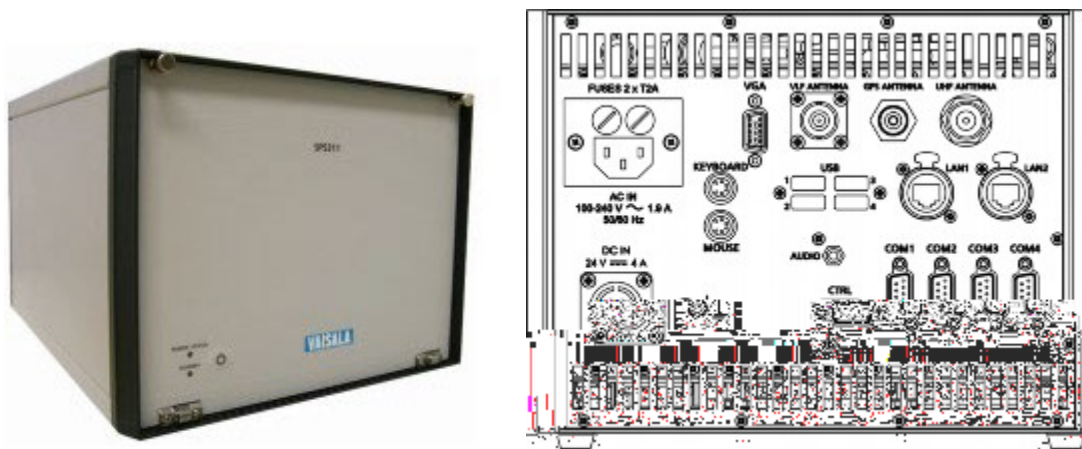

Figure B-13: MROS: Sounding Processing Subsystem (Vaisala)



Figure B-14: MROS: GS-E Ground Station (GRAW)

3.2.4 Radiosonde Surface Observing Instrument System (RSOIS)

The RSOIS captures and reports data on weather parameters at the surface to be used in analysis of the upper air data obtained during an observation. Sensors mounted on the tower in conjunction with the Precision Digital Barometer (PDB) are used to provide surface pressure, temperature, relative humidity, and wind speed and direction. For additional information on RSOIS or the PDB, refer to Appendix J “Surface Observation Systems.”

3.2.5 MROS Software

MROS sites will have 1 of 2 vendor COTS meteorological software packages that are designed by the vendor to work seamlessly with the provided hardware. The software is a radio sounding data processing, analysis, archival and relaying software that consists of a user interface running on a web browser and the sounding processor or ground station running as services on the computer. The system generates WMO weather messages as well as various graphical and tabulated evaluations specific to the NWS application such as Skew-Ts and other thermodynamic plots. The software allows for previous flight simulations and offers a user-friendly Graphical User Interface (GUI).

3.2.6 MROS Balloon Launch Sites

There are primarily three types of shelter or launch site configurations for MROS. They are the following:

1. **High Bay:** This is the most typical shelter used within the NWS. It is the largest type of shelter with adequate room for inflation due to the high ceiling.
2. **Low Bay:** This shelter is smaller in scale than a high bay with adequate room for preparing the flight train and inflation.



Figure B-15: High Bay

3. **BILS:** This Balloon Inflation Launch Shelter (BILS) has a built-in hatch on top of the structure to release the balloon and is used in locations where there is a reduced or confined balloon release area. The shelters come in various designs, but all are much smaller than the typical high-bay inflation shelter.



Figure B-16 Low Bay w/BILS

4. **Kettle Launcher:** This configuration is used in locations where there is a reduced or confined area to release the balloon. Balloon inflation is done inside a large kettle-like, canvas-lined structure. Because the inflation is done in an open environment, the Kettle Launcher is typically used at sites with dry climates and mostly warm temperatures. A canvas flap holds the balloon in place until launch.

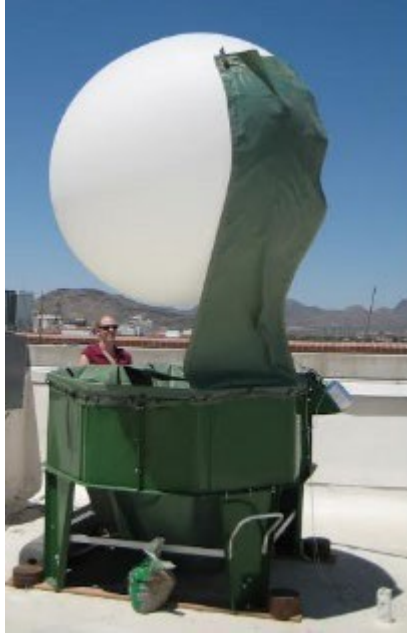

Figure B-17 Kettle Launcher

All MROS launch sites are equipped with a gas fill system including the inflation hose, nozzle, spring clamps and weight plates. Shelters also include an inflation table to lay the balloon flat prior to inflation and assemble the flight train.



Figure B-18: Inflation Table



Figure B-19: Inflation Unit

APPENDIX C - OBSERVATION AND LAUNCH PREPARATION

Table of Contents	Page
1. Introduction	C-4
2. Time of Observation	C-4
2.1 Synoptic Schedule Requirement	C-4
2.2 Non-Synoptic Observations	C-4
3. Observation Criteria.....	C-5
3.1 Successful Observation.....	C-5
3.2 Unsuccessful Observation.....	C-5
3.3 Missed Observations.....	C-6
3.4 Missing Data Events	C-6
3.5 Multiple Releases.....	C-7
3.5.1 The Second Release	C-7
3.5.2 The Third Release	C-8
3.6 Thunderstorm/Other Severe Weather Events at Release Time.....	C-8
4. Launch Preparation (MROS)	C-8
4.1 System Power Up.....	C-8
4.2 Balloon Handling and Inflation	C-9
4.2.1 Preparing the Balloon for Inflation	C-9
4.2.2 Inflation (Hydrogen and Helium)	C-9
4.2.2.1 Hydrogen Inflation Method I.....	C-10
4.2.2.2 Hydrogen Inflation Method II.....	C-11
4.2.3 Gas Amount Adjustment for Weather Conditions.....	C-12
4.2.3.1 High Surface Wind	C-12
4.2.3.2 Heavy Precipitation.....	C-12
4.2.3.3 Moderate to Severe Icing.....	C-12
4.2.4 Balloon Inspection During Inflation	C-12
4.2.5 Inflation Complete	C-13
4.3 Preparing the Balloon Flight Train	C-13
4.3.1 Balloon Tie-off.....	C-14
4.3.2 Light Stick.....	C-15
4.3.3 Parachute.....	C-15
4.3.4 Train Regulator/Unwinder	C-16
4.3.5 Radiosonde.....	C-16
4.3.6 The Assembled Flight Train	C-16
4.4 Radiosonde Preparation	C-17
4.4.1 Radiosonde Inspection.....	C-17
4.4.2 Radiosonde Baseline and Initializing.....	C-17
4.4.3 Confirm Radiosonde Frequency Band.....	C-17
4.4.4 Enter / Confirm Surface Values and Metadata	C-17

- 4.5 Final Safety Checks.....C-18
 - 4.5.1 Final Inspection of Balloon Flight TrainC-18
 - 4.5.2 Federal Aviation Administration (FAA) Tower Notification Requirements.....C-19
 - 4.5.2.1 Controlled AirportsC-19
 - 4.5.2.2 >5 NM from Controlled Airport or Non-Controlled Airport.....C-20
- 4.6 Balloon Flight Train Launch ScenariosC-20
 - 4.6.1 Fair Weather.....C-20
 - 4.6.2 Heavy Precipitation.....C-21
 - 4.6.3 One Person Launch in High Surface WindsC-21
 - 4.6.4 Two Person Technique (High Surface Winds)C-22
- 5. Countdown Activities (MROS)C-23
- 6. Launch Preparation (AROS)C-24
 - 6.1 Balloon and Radiosonde Loading.....C-24
 - 6.1.1 Start the Autosonde Control SoftwareC-24
 - 6.1.2 Preparing the Balloon and NozzleC-25
 - 6.1.3 Loading the Tray.....C-26
 - 6.1.4 Preparing the Radiosonde and UnwinderC-27
 - 6.2 MW41 Flight PreparationC-33
 - 6.2.1 The Ground Check.....C-33
 - 6.2.2 Viewing and Modifying Metadata.....C-34
 - 6.2.3 GPS and TelemetryC-34
 - 6.3 Final Checks.....C-35
 - 6.3.1 Monitor/Resolve Alerts and EventsC-35
 - 6.3.2 Notify Air Traffic ControlC-36
 - 6.4 Release OptionsC-36
 - 6.5 Managing Release FailuresC-36
 - 6.5.1 Connectivity IssuesC-36
 - 6.5.2 Balloon BurstC-36
 - 6.5.3 Stuck Balloon.....C-36
- 7. Countdown Activities (AROS).....C-37

Figures

MROS

C-1: Balloon on Inflation Table Secured w/Clamp.....C-9
 C-2: Hydrogen Line Pressure GaugeC-10
 C-3: NWS Flight Train DiagramC-14
 C-4: Balloon Neck Tie-off Post InflationC-15
 C-5: Completed Balloon Train.....C-19
 C-6: Balloon Train Prior to LaunchC-20
 C-7: One Person Release Technique.....C-21
 C-8: Two Person Release Technique.....C-23

AROS

C-9: Taking the Balloon Neck Out of the BagC-25
 C-10: Inserting Balloon Nozzle on the Balloon NeckC-25
 C-11: Inserting the Nozzle RingC-26
 C-12: Folding the Balloon Neck over the RingC-26
 C-13: Balloon Neck Correctly Folded over the RingC-26
 C-14: Do not Touch the Radiosonde SensorsC-27
 C-15: Pushing the Unwinder into Place.....C-27
 C-16: Unwinder Stick Clicks into PlaceC-28
 C-17: Radiosonde RS41-SGP and UnwinderC-28
 C-18: Placing the Radiosonde in the Holder.....C-29
 C-19: Correct Placement of the Radiosonde AntennaC-29
 C-20: Unwinder String Released from the Unwinder Coil.....C-30
 C-21: Unwinder String Running from the Flow Channel Groove.....C-30
 C-22: Unwinder Hook Attached to the Balloon NozzleC-31
 C-23: Snapping the Nozzle on the Nozzle Pipe.....C-31
 C-24: Pushing the Tray In.....C-32
 C-25: MW41 Sounding Main Window When Flight is Under PreparationC-33
 C-26: Ground Check ProgressC-34
 C-27: Viewing and Modifying Flight MetadataC-34
 C-28: GPS and Telemetry StatusC-35

Tables

C-1: Missing DataC-5
 C-2: Countdown Activities (MROS)C-23
 C-3: Countdown Activities (AROS)C37

1. Introduction

Observation and launch preparations are an integral part of ensuring a successful upper air program. Care taken during pre-observation decreases the chance of unsuccessful or missed observations due to defective components, improper procedures used or poor time management. Changing weather conditions must be considered and may affect the decision on train components used, amount of gas and the timing/type of release based on the site system or platform. As indicated in Appendix K “Station Safety,” appropriate certification and attention to safety, should be reviewed by all observers before performing a sounding.

2. Time of Observation

In the NWS and across the globe, radiosondes are launched according to UTC (Coordinated Universal Time) or Z (Zulu time). These required launch times are referred to Synoptic, Non-Synoptic and Unscheduled.

2.1 Synoptic Schedule Requirement

The standard times for scheduled Synoptic observations are 0000 UTC and 1200 UTC. Release times should be scheduled as close as conditions permit to 2300 UTC and 1100 UTC, but not earlier. On rare occasions when thunderstorms or high winds are expected to occur during the entire 90-minute release window, Synoptic observations may be released early (before 23:00 or 11:00) as directed by the office Lead Forecaster or Senior Duty Meteorologist (SDM) at NCEP and would be recorded as a special observation. *Ex: A Synoptic flight at 12:00 UTC, the launch window opens at 11:00 UTC and goes until 12:29 UTC.*

Delayed Synoptic releases are usually due to radiosonde or ground equipment problems or when a 2nd release is required. Releases may be made after the standard times of observation, but no later than 0029 UTC and 1229 UTC. Any flight after this would be considered a missed sounding. This schedule ensures the upper air observational data are available to initialize the 0000 UTC and 1200 UTC numerical weather prediction models and other products, such as upper air charts, used by forecasters.

Note: *Special soundings taken at 06:00 and 18:00 are considered Synoptic and can be released between 05:00 to 06:29 UTC and 1700 to 18:29 UTC.*

2.2 Non-Synoptic or Special Observations

Non-Synoptic or special observations are those performed outside the standard times of scheduled synoptic observations (see Section 2.1, Synoptic Schedule Requirements). Special observations may be requested by either NCEP (e.g., Storm Prediction Center), or in support of special projects authorized by WSH or Regional Headquarters. Special observations may also be requested by the WFO in support of the forecast and warning process. Each NWS upper air site will adhere to all the basic requirements for Synoptic observations.

For all non-standard observation times, the release window for the observation is from 30 minutes before to 29 minutes after the hour of assigned observation time. *Ex: release at 0231 UTC would be for the 0300 UTC observation, a launch at 0510 UTC would be for the 05 UTC observation.*

For AROS, any unscheduled observations are accomplished by performing an “Instant Sounding.” For more information on performing an Instant Sounding, refer to the AROS user guide.

3. Observation Criteria

There are several factors an observer must be aware of when considering a launch successful or unsuccessful.

3.1 Successful Observation

A successful observation will be any flight that is not terminated (automatically by the system or manually by the observer) between the surface and 400 hPa (see table C-1). The observation will be verified by the accompanying software when examining the first several minutes of data. A successful radiosonde observation is based on the following criteria that must not be exceeded:

Excessive Minutes of Missing Data	
Temperature	Pressure
4 minutes (Cumulative): No Temperature in the first 10 minutes of flight	4 minutes (Cumulative): No Pressure in the first 10 minutes of flight
6 minutes (Cumulative): No Temperature in the first 25 minutes of flight	10 minutes (Cumulative): No Pressure in the first 25 minutes of flight
12 minutes (Cumulative): No Temperature in the first 60 minutes of flight	24 minutes (Cumulative): No Pressure in the first 60 minutes of flight
16 minutes (Cumulative): No Temperature in flight	40 minutes (Cumulative): No Pressure in flight
3 minutes (Consecutive): No Temperature in flight	10 minutes (Consecutive): No Pressure in flight

Table C-1: Missing Data

3.2 Unsuccessful Observation

An unsuccessful observation is a radiosonde ascent that failed to reach 400 hPa or higher altitudes with good quality pressure, height and temperature data or had missing data exceeding limits shown in Table C-1. Special care should be taken when preparing and releasing the balloon flight train. The observer should be aware of weather conditions at release time and use proper procedures for preparing and releasing the balloon flight train to minimize the chance of the radiosonde hitting the ground and rendering the instrument unusable. Any component defects with regard to the balloon and radiosonde should be detected prior to launch when following procedures outlined in the user manual. On occasion, an observation will be deemed unsuccessful if one or more of the following occurs:

- a. Observer error, improper procedures followed, component damage
- b. GPS signal is lost
- c. Missing data exceeds the limits in Table C-1.
- d. Any amount of missing or deleted temperature and/or humidity between surface and 400 hPa

3.3 Missed Observations

A missed observation is defined as a 00Z or 12Z observation where no upper air pressure, height and temperature data of good quality are available for transmission to NCEP or NCEI. This occurs when:

- a. The ground equipment is broken and no radiosonde can be released during the required observation time.
- b. A radiosonde was released, but no or too little data was received or the data was erroneous.
- c. A second (or third) release was not authorized or those releases provided no useful data.
- d. Thunderstorms or other severe weather conditions are occurring at the site during the entire launch window.

Note: *If a small amount of good quality upper air data is available (at a minimum of 300 meters in altitude) and this was the only observation authorized, then the observation will be given an ascension number and transmitted to NCEP and NCEI. The observation will not be logged as missed. If the observation is missed, the observer will transmit coded messages notifying data users that no observation is available.*

3.4 Missing Data Events

There are several reasons that may result in missing data during an observation.

- a. Weak Signal: Weak or fading signals can result from defective radiosonde components, (i.e transmitter or battery), a radiosonde more than 250 km away, or a ground tracking antenna not correctly locking onto the radiosonde signal.
- b. Interference: Signal interference has become a problem, especially at sites located near large metropolitan areas.
- c. Sensor Failure: Radiosonde sensors may fail and provide missing or erroneous data. If the temperature sensor or GPS fails, the observation will be terminated at the last reliable data point. If the relative humidity sensor fails, the observation can be continued if the relative humidity is not considered critical for forecast operations.

- d. Excessive Missing Data: Some missing data or manually deleted temperature and pressure data are allowed, provided it does not exceed the limits listed in Table C-1. When the limits are exceeded in one stratum of missing temperature or pressure data, the observation will be terminated at the base of the stratum.
- e. Other Causes: In the event that the quality of the data becomes questionable, the ascent may be terminated.

3.5 Multiple Releases

When an unsuccessful observation has occurred, the observer must decide if there is a WFO and NCEP requirement for another release. This decision should first be made by the WFO Lead Forecaster. If the WFO does not have a meteorological need for the data, then the observer will contact the Senior Duty Meteorologist (SDM) at NCEP and inquire if another release is required.

The AROS will have a set schedule to launch flights corresponding to the Synoptic windows and in most cases, is programmed to automatically prepare a second release if the first release is unsuccessful. Any sounding performed outside of the scheduled standard Synoptic windows can only be executed by performing an “Instant Sounding.” For more information on performing an “Instant Sounding,” refer to the AROS user guide.

Note: *Under no circumstances will a station attempt more than 3 releases to obtain a successful observation.*

3.5.1 The Second Release

If a radiosonde sounding terminates or has excessive missing data before reaching 400 hPa, a second release may be required. When necessary, the second radiosonde should be released as promptly as possible in order to stay within the time limits of the scheduled observation. However, if unfavorable weather conditions, equipment problems, or other reasons may cause another unsuccessful observation, an additional release should not be made.

If a second release is not made and the record from the first one has usable data, even though it did not extend to a pressure equal to or less than 400 hPa, the record from the first release should be assigned an ascension number and transmitted to NCEP and NCEI. If neither flight has acceptable data, log the observation as unsuccessful and missed (00:00 and 12:00 UTC observations only).

When a second release is required but not made, the reasons for the omission should be stated fully in the “Remarks” section of the WS Form B-29, Radiosonde Report. If a second and succeeding release does not reach the required minimum altitude, the ascension providing the greatest amount of good quality data should be the official observation. If neither observation provides useful data and a third release is not authorized, the observation will be logged as missed (00:00 and 12:00 UTC observations only)

3.5.2 The Third Release

If observation equipment or ground equipment fails on the second release and results in another unsuccessful observation, a third release may be initiated if authorization is granted. The third release, however, marks the limit for the number of attempts to complete a scheduled Synoptic observation. No further attempts will be made if the third release fails to meet the successful observation criteria. If this release attempt fails, data from the single most complete observation with acceptable data will be disseminated. If no acceptable data is available, it will be reported as a missed observation (00:00 and 12:00 UTC observations only). Refer to section 3.3 for more information.

3.6 Thunderstorm / Other Severe Weather Events at Release Time

RELEASING A BALLOON FLIGHT TRAIN WHILE A THUNDERSTORM IS OCCURRING IS STRICTLY PROHIBITED!

If a thunderstorm is occurring at the time of the balloon release, the observer will wait until the storm passes before releasing the balloon. The following reasons to not release during a thunderstorm are:

- a. The observer may be killed or severely injured by a lightning strike when attempting to release the balloon. During a storm, the balloon flight train can become a lightning rod with the observer holding the lower end.
- b. The data collected inside or near thunderstorms are erroneous and not useful for weather forecasts. The observation does not represent the Synoptic scale environment and NCEP does not use such observations for ingestion into numerical weather prediction models.
- c. Thunderstorms typically terminate an observation early due to balloon icing or strong downdrafts.

A thunderstorm is defined as ending when at least 15 minutes have passed since the last clap of thunder has been heard. If the storm persists during the entire release time window, the Synoptic observation will be logged as a missed observation.

Caution should be taken when releasing in high surface winds (>20 knots) or heavy freezing rain, as this may cause an unsuccessful launch resulting in a missed sounding. The observer should wait to do the release until the weather improves. If the bad weather persists during the entire release time window, the observer could account for these variables, by using a dereeler/unwinder or adding more gas to the balloon. If this is unsuccessful, then the Synoptic observation will be logged as a missed observation.

4. Launch Preparation (MROS)

4.1 System Power Up

Depending on the system being used, the observer will need to have the ground equipment powered up and ready for use. This includes the workstation that runs the software for the system being used, the

Signal Processing Subsystem (SPS) or ground station. Refer to the appropriate user guide for the system at the site for more information.

4.2 Balloon Handling and Inflation

Balloon inflation should begin no more than 45 minutes prior to release. All safety procedures will be followed. The balloon is inflated, tied, and secured before other train components are fastened onto the train. It is important that the observer not touch the balloon (other than the balloon neck) with bare hands. Oils and other contaminants on the hands can damage the balloon, causing premature balloon burst. Use gloves to handle the balloon during inflation.

4.2.1 Preparing the Balloon for Inflation

Remove the balloon from the packaging and place it on the inflation table. The tabletop should be smooth, clean, and any sharp edges rounded off. The tabletop should be cleaned frequently. To reduce abrasion during inflation, the table should be large enough so the balloon can be fully extended before the inflation is started. If a table is not used, the balloon should be placed on a clean surface with all objects that have sharp points removed from the immediate vicinity of the balloon. Place the inflation nozzle in the neck of the balloon and secure it with a clamp, soft cord, or other suitable device that will not damage the balloon.



Figure C-1: Balloon on Inflation Table Secured w/Clamp

After the balloon has been prepared and inflation equipment (cylinders, hoses, clamps, safety switches) are confirmed to be in good order, begin the inflation of the balloon.

4.2.2 Inflation - Hydrogen and Helium

Depending on your location, the NWS uses hydrogen or helium lifting gas exclusively. Hydrogen gas is the lightest gas and is easily produced in large quantities. Due to hydrogen's flammability, utmost care should be taken when working with this gas. Helium is the second

lightest gas and is noncombustible but its scarce supply on earth results in costs far higher than hydrogen.

Hydrogen: When hydrogen is used, open the valve to a pressure not exceeding 15 Pounds per Square Inch (psi). Inflation should take no less than 7 minutes. If the balloon is rapidly inflated with hydrogen gas the likelihood of generation of static electricity is greatly increased and with it, the hazard of a fire or an explosion.

Helium: When helium is used, open the valve to a pressure not exceeding 20 psi. Inflation should take no less than 7 minutes. Since helium is an inert gas, there is no risk of fire or explosion.



Figure C-2: Hydrogen Line Pressure Gauge (Varies per site)

There are two methods for inflating balloons using the hydrogen safety switch. Method I allow the observer to stay outside the inflation building while the balloon is inflated. Method II allows the observer to stay inside the inflation building. Either method may be used at the discretion of the observer, but both methods require the observer to monitor the inflation process at all times.

4.2.2.1 Hydrogen Inflation Method I

To implement Inflation Method I, proceed as follows:

- a. Verify the valve on the hydrogen tank is closed.
- b. Verify the power switch on the control box is OFF.
- c. Connect the balloon neck to the inflation nozzle in accordance with established procedures.
- d. Verify the rotating latch is in the lower rest position.

- e. Align the rotating latch with the oval-shaped hole so that it is free to rise to the upper limit of travel.
- f. Open the valve on the hydrogen tank.
- g. Throw the power switch on the control box to the ON position.
- h. Set the regulator to provide the prescribed pressure: 15 psi.
- i. Depress the start switch on the control box to initiate the flow of hydrogen. The opening of the solenoid valve is indicated by a lighted indicator lamp on the control box. Continue to hold the start switch in its actuated position until the balloon has attained sufficient buoyancy to raise the rotating latch to the upper limit of travel. When this occurs, be sure that the rotating latch is aligned with the oval-shaped hole in order to retain the safety feature of the hydrogen switch. This alignment will permit the rotating latch to drop to the lower rest position if a balloon bursts during inflation. This action automatically cuts off the flow of hydrogen.
- j. Release the start button. Inflation will continue until the balloon has reached its predetermined lift. At this time, the balloon will rise and lift the switching column from the rest position. In so doing, it will cause the lower reed switch in the switch post to open. This action deactivates the solenoid switch and cuts off the flow of hydrogen.
- k. Turn off the valve on the hydrogen tank.
- l. Pull the switching column down on the switch post momentarily to the rest position. This will open the solenoid valve and relieve the pressure in the inflation hose between the hydrogen tank and the solenoid valve.
- m. Turn the power switch on the control box to the OFF position.
- n. Tie off the neck of the inflated balloon in accordance with existing instructions.

4.2.2.2 Hydrogen Inflation Method II

Using this method, gas flow is initiated by raising the rotating latch from the lower rest position to the upper rest position. With the rotating latch locked in the raised position, it is not necessary to depress the start switch at any time in the inflation cycle. Inflation will continue as in method one until the balloon has attained sufficient buoyancy to lift the switching column on the switch post.

Method II assumes the same procedures as Method I with the exception that step I and J are replaced with the following steps:

- a. Raise the rotating latch to the limits of travel and lock it into the UP position. This action will initiate the flow of hydrogen into the balloon.
- b. After the balloon has attained sufficient buoyancy to hold the rotating latch at its upper limit of travel, realign the latch with the oval-shaped hole in order to retain the safety features of the hydrogen switch.
- c. Inflation will continue until the balloon has attained sufficient buoyancy to lift the switching column from the rest position on the cover of the junction box. Doing so, will cause the lower reed switch to open. This action deactivates the solenoid switch and cuts off the flow of hydrogen.

4.2.3 Gas Amount Adjustment for Weather Conditions

When severe weather at the surface such as wind, precipitation or severe icing are present, inflation adjustments are necessary to attain appropriate nozzle lift to ensure the balloon can ascend at an acceptable rate.

4.2.3.1 High Surface Wind

Under high wind speeds (typically more than 20 knots), a train regulator/unwinder should be used and additional personnel will assist with the launch, if available. The balloon should also be inflated to attain a nozzle lift 200 to 300 grams greater than fair weather launches.

Launches in very high wind conditions (more than 30 knots) pose special problems in protecting the balloon train equipment from damage until it becomes airborne. The balloon should be inflated to attain a nozzle lift that is 300 to 500 grams greater than during fair weather launches and a train regulator/unwinder must be used. If other personnel are available, they are to assist with the launch.

4.2.3.2 Heavy Precipitation

The balloon should be inflated to attain a nozzle lift that is 200 to 300 grams greater than used during fair weather launches.

4.2.3.3 Moderate to Severe Icing

When moderate to severe icing is anticipated the observer should increase nozzle lift. A standard rule of thumb should be to increase the nozzle lift by 200 to 300 grams when moderate icing may be anticipated and 500 grams or more when severe icing is occurring.

4.2.4 Balloon Inspection During Inflation

When the balloon is about one-half inflated, close the gas valve. Listen for gas leaks coming from the balloon and examine it for small holes and defects. Serious defects include a sticky or wet balloon skin or foreign materials inside the balloon. Thin spots, discoloration or odd, non-spherical shapes of the balloon should not be regarded as a defect unless previous experience

indicates that the defects result in premature bursting at altitudes below 26 km. If the balloon is defective, reject it and begin inflating a second balloon. Otherwise, proceed with inflation.

IMPORTANT: If a hole or tear is seen in the balloon, stop inflation. For hydrogen sites, see Station Safety Appendix K section 5.2 “Hydrogen Sites”. **Do not attempt to repair the balloon. Do not release the inflated balloon.** Contact the site manager for further instructions.

As inflation proceeds, periodically check that the balloon is not in contact with the inflation shelter ceiling or another surface. If the balloon is likely to touch the ceiling before the desired lift has been reached, continue with the inflation, but secure the balloon in a manner to minimize or eliminate possible contact with the ceiling or other objects. Sites having low ceilings should use padding or netting to ensure the ceiling is smooth so damage to the balloon will not occur.

4.2.5 Inflation Complete

When inflation is complete, turn the equipment off and purge the lines of any remaining lifting gas.

4.3 Preparing the Balloon Flight Train

The flight train equipment will be assembled as shown in Figure C-3.

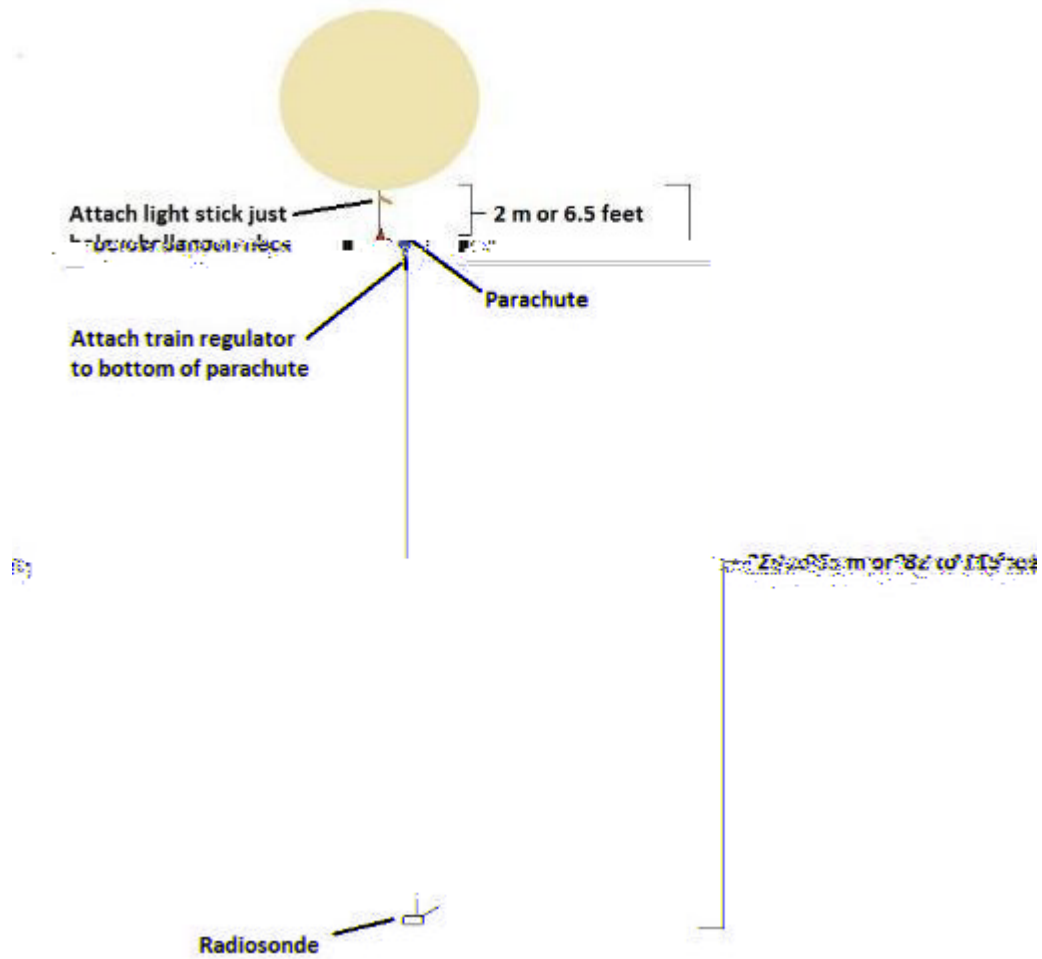

Figure C-3: NWS Flight Train Diagram

4.3.1 Balloon Tie Off

Tie the neck of the balloon with a two-meter (6.5 feet) doubled length (13 feet total) of NWS approved twine that is connected to the top of the parachute. Be sure to leave slack to allow for the balloon to be anchored down with a weight. Make one turn of the twine around the neck of the balloon near the center (close to the top of the inflation nozzle). Pull the twine as tightly as possible and tie it with a knot. Make another turn around the neck and tie again (see figure C-4 below). Remove the balloon from the nozzle, fold the neck upward and again tie the neck just above the first knot. Be sure that all twine is below the area where the neck starts to flare out to join the envelope of the balloon. Secure the balloon inside the inflation shelter by tying it to a hook or the measuring weights. The balloon should be left in the inflation shelter until preparations for the release have been completed.



Figure C-4: Balloon Neck Tie-off Post Inflation

Important: For aviation safety and environmental reasons, use only cotton twine approved by WSH. WSH approved twine is stocked at NLSC.

4.3.2 Light Stick

Light sticks use a non-toxic chemical to generate light. To activate a stick, follow the activation instructions. Light sticks are not considered standard equipment and may only be used at upper air stations that are within 5 NM of airports. They are used only at night or during dim light conditions to allow aircraft pilots to visually sight the balloon flight train. If applicable, use only one light stick attached just below the neck of the balloon. Do not attach it anywhere else on the flight train. Activate the light stick just prior to balloon release.

4.3.3 Parachute

Parachutes are not considered standard equipment and whether or not a parachute is required is determined by the station Meteorologist in Charge (MIC). A parachute is designed so that after a balloon bursts, the flight train falls at a speed no faster than 10 m/s by the time it reaches the ground. Bright colors are used to help distinguish the balloon flight train in the sky during daytime observations.

If a parachute is required, proceed with the following steps:

- a. Carefully open and inspect the parachute before attaching to the flight train. Reject any parachute that is torn, has missing strings or shows failed glue joints and report defects to

WSH.

- b. Tie a two-meter (6.5 feet) length doubled over (13 feet total) of WSH approved twine to the top of the parachute. The other end will be tied to the balloon neck.
- c. At the bottom of the parachute attach a length of single twine so that the total flight train length from the balloon neck to the radiosonde is 25 to 35 meters (82 to 115 feet).

4.3.4 Train Regulator/Unwinder

During high surface winds (typically > 20 knots), observers may be required to use a train regulator/unwinder that slowly unwinds after balloon release. The regulator/unwinder enables the observer to launch a radiosonde in high winds without having to contend with many yards of slack twine.

If a train regulator/unwinder is to be used, follow the preparation instructions. Tie the top of the regulator/unwinder to the lower end of the flight train or parachute (if used). Then, tie the free end of the regulator/unwinder twine to the radiosonde. Do not attach the regulator/unwinder to any other portion of the flight train.

4.3.5 Radiosonde

Depending on the radiosonde being used at the site, the attachment point may differ when fastening the free end of the train to the radiosonde. Refer to the appropriate user guide for the system at the site for more information

4.3.6 The Assembled Flight Train

Whenever possible, the station workload should be arranged so that release can be made within a few minutes following the testing and calibration (i.e., baseline) of the radiosonde. The balloon train should be completely assembled and ready for launch within 20 minutes from the time the radiosonde was activated. The train is usually assembled during the balloon inflation process which is performed no more than 45 minutes prior to release.

The total train length of 25 to 35 meters (82 to 115 feet) between the balloon neck and radiosonde is required. Double or triple knots should be used when tying the NWS approved twine to the flight train components. Correct assembly of the train (i.e., the balloon, parachute, radiosonde, and launching devices which may be used) is critical to the success of the observation and the accuracy of the data. Incorrect train assembly can be problematic, resulting in the following:

- a. Premature balloon burst. Excessive strain on the balloon neck or just the slightest scuff mark on the balloon skin can cause damage reducing performance of the balloon.
- b. Unrepresentative measurement of the atmosphere. Short trains less than 25 meters long will likely result in erroneous temperature and relative humidity measurements. During the day, the radiosonde temperature and RH measurements are contaminated by heat radiating from the balloon skin or parachute. Nighttime observations are also

contaminated as the balloon is often colder than the surrounding air.

- c. Malfunction of the parachute or train regulator/unwinder. Incorrect placement of these items can cause them to become entangled in the flight train twine.
- d. Higher risk of collision with ground-based obstacles at release. Not using a train regulator/unwinder or having flight trains longer than 35 meters increases this risk.
- e. An increased risk of injury to people, property damage, and entanglement in power lines and trees when the train descends to the ground. A malfunctioning parachute and/or a flight train longer than 35 meters increases this risk.

4.4 Radiosonde Preparation

Depending on the radiosonde used at the site, radiosonde preparation can differ. Refer to the appropriate user guide that coincides with the system at your site.

4.4.1 Radiosonde Inspection

Open the radiosonde packaging and inspect the radiosonde for damage. If damaged or if there are contaminants which could impact the sensor's readings, fill out the appropriate forms and select another radiosonde.

4.4.2 Radiosonde Baseline and Initializing

Confirm that the workstation is powered on and the software is on screen. When baselining or initializing a radiosonde using a USB port via a ground station (GRAW) or a separate ground check device (Vaisala), the sounding software will automatically detect the radiosonde and begin preparations that may include sensor checks, reconditioning and parameter updates.

4.4.3 Confirm Radiosonde Frequency Band

All NWS radiosondes will operate in the 400.15 – 405.99 MHz range also known as the 403MHz band. The system software enables the observer to set the frequency band.

4.4.4 Enter/Confirm Surface Values and Metadata

The surface instrumentation provides most of the required pre-flight surface observation data that is necessary for a sounding. This information can either be imported directly from the instruments, or manually entered by the observer. It is critical to ensure this information is correctly implemented within the software. It is important that care is taken to enter this information correctly. The WMO cloud group and present/past weather observations are taken separately by the observer (See Appendix D “Cloud Observation and Weather Coding”). All values should be taken and entered approximately 10 minutes prior to release and reconfirmed. Examples of surface values required are the following:

- a. Surface Pressure: Surface pressure is obtained from an NWS approved PDB corrected to read the height at where the instrument is baselined in the office. Readings will be entered to the nearest tenth of a hectopascal (hPa). When the surface pressure is less than 1000 hPa, the temperature entry from twelve hours earlier will be entered to allow the

software to estimate the 1000 hPa height or other heights for standard pressure levels less than that being observed. In addition, the digital barometer's surface pressure will automatically be registered into the flight log and, under usual circumstances; an adjustment will be made to the radiosondes pressure reading to make it the same as the digital barometer's reading. The PDB's are recertified for accuracy annually per the NWS standard for barometers. Each year, the standards laboratory automatically replaces the PDB's with programmed values (elevations and R values) put into the instrument for all sites. The PDB's have special boxes to protect the instrument during shipment.

Not applicable to AROS radiosondes as they contain a pressure cell.

- b. Temperature: Record the dry bulb temperature to the nearest tenth of a degree Celsius.
- c. Relative Humidity: Record humidity in percent to the nearest whole number.
- d. Wind Direction: The software allows winds to be entered to the nearest whole degree. For calm winds, estimate a direction or use 360 degrees.
- e. Wind speed: Wind speed is measured in meters per second (m/s). For calm winds a zero can be entered for wind speed.
- f. WMO Cloud Group: Enter the nine-digit code that contains the weather at the observation time. The clouds/weather part of the observation uses a modified WMO format in order to meet NCEI requirements for clouds and present weather. Refer to the NWS Sky Watcher Chart presented online and in Appendix D "Cloud Observation and Weather Coding."
- g. Present Weather: Record the present weather. Refer to Appendix D "Cloud Observation and Weather Coding" for more information.

Refer to the appropriate user guide that coincides with the system at your site.

4.5 Final Safety Checks

Performing final safety checks can make a difference. Avoiding mistakes or being too comfortable with the routine can matter where a NWS site may be located, care is exercised prior to launching a radiosonde.

4.5.1 Final Inspection of the Balloon Flight Train

After the balloon has been inflated and the train has been assembled, inspect the tie points along the train to ensure twine connections are fastened tight. Ensure that the balloon neck is not being overly strained. Ensure the train twine to the radiosonde is untangled and will flow freely through the hand or through the train regulator. Release procedures vary with the wind conditions at the release site. The observer should be familiar with all obstructions around the area before attempting a release. Before the balloon is removed from the inflation shelter, the observer rechecks the wind direction and speed. Visually check to confirm that the temperature

and humidity sensors are properly positioned and not damaged.

Observers are reminded that high surface winds and heavy precipitation increase the risk of balloon train entanglement in trees, high-tension power lines, and various antenna masts. To the extent possible, measures should be taken to reduce the possibility of entanglement (i.e., add extra free lift during inflation). If entanglement with a power line or antenna mast occurs, no attempt should be made to disentangle the flight train. The circumstances will be reported immediately to the appropriate owners of the power lines or tower.



Figure C-5: Completed Balloon Train

4.5.2 Federal Aviation Administration (FAA) Tower Notification Requirements

Observations taken at or near major air terminals pose a greater risk to aircraft than do those that are taken in remote areas. This is especially true during the initial, low altitude portion of the upper air observation where there is generally a greater concentration of aircraft converging during takeoff and landing operations.

4.5.2.1 Controlled Airports

Controlled airports are illustrated in aeronautical charts with blue airport symbols. The FAA airport facilities directory gives the hours of operation for the controlled airports. During hours the airport's tower is unmanned, the procedures listed in section 4.5.2.2 for non-controlled airports will be followed.

An upper air site located within 5 NM of a controlled airfield will contact the local airport tower immediately before a radiosonde observation to coordinate the balloon release. The observer will also visually check the whole sky to ensure that there are no aircraft in the area that might be affected by releasing the balloon flight train. If aircraft are present, the release will be put on hold until the aircraft are far away.

4.5.2.2 > 5 NM from Controlled Airport or Non-Controlled Airport

Upper Air sites more than 5 NM away from an airport will visually check the whole sky to ensure there are no aircraft in the area that might be affected by releasing the balloon flight train. If aircraft are present, the release will be put on hold until the aircraft are far away.

4.6 Balloon Flight Train Launch Scenarios

Each upper air office will have different obstructions and open land areas that can affect the successful launch of the balloon flight train. A successful release comes down to experience with launch area restrictions, proper planning and applying the correct launch technique. Sometimes when the weather is severe with high winds, having an assistant can be helpful.



Figure C-6: Balloon Train Prior to Launch

Note: Never launch a balloon flight train with the radiosonde lying on the ground. This will likely cause data from the instrument at release to be missing or erroneous and will increase the chance of the radiosonde striking the ground in windy conditions.

4.6.1 Fair Weather

In light winds, the balloon is held in one hand and the balloon neck in the other. The balloon flight train is carried an acceptable distance away from the inflation shelter and any obstructions. The balloon is released and when there is some tension in the twine the radiosonde is then released. If done correctly, the radiosonde will lift away with no jolting motion.

4.6.2 Heavy Precipitation

The radiosonde sensors, especially the RH sensor, can become contaminated and provide erroneous data if the radiosonde is exposed to heavy rain or snow for a prolonged period prior to release. When such weather conditions are occurring, the radiosonde will be kept inside the inflation shelter for as long as possible prior to release. Observers should be mindful of the GPS signal acquisition interruptions when taking the radiosonde inside the shelter.

4.6.3 One Person Launch in High Surface Winds

When a train regulator is used in high surface winds, the balloon is held in one hand and the train regulator/unwinder and radiosonde are held in the other. The train length should be kept as short as possible, and the train regulator/unwinder is held in such a way that neither the weight of the radiosonde nor the lift of the balloon unwinds the twine until release. At launch, the balloon is quickly taken from the shelter and released away from obstructions and almost simultaneously, the radiosonde is released. As the balloon rises, the weight of the radiosonde causes the twine to slowly unwind from the train regulator/unwinder resulting in a manageable release. If done correctly, the radiosonde will lift away with no jolting motion and the train regulator/unwinder unwinds correctly.



Figure C-7: One Person Release Technique

4.6.4 Two Person Launch in High Surface Winds

If there are high winds over 20 knots at release time or the wind direction will cause the flight train to collide with nearby obstructions, an additional person may assist with the release, if available. This two-person technique can be applied with or without a train regulator. The observer and assistant should plan the flight train release in advance for the launch to be successful. The first person will hold the radiosonde, grasp the twine further up the train with the other hand, and then extend the twine outside the inflation shelter downwind, away from obstructions, until a slight tension is exerted. The second person will then quickly remove the balloon from the shelter, take it to a preselected location, preferably close to the inflation shelter, and launch it. The person holding the radiosonde will release it when the balloon is nearly overhead and there is some tension in the flight train. If done correctly, the radiosonde will lift away with no jolting motion and the train regulator unwinds correctly (if used).

Another technique is that when the balloon is released the person holding the radiosonde runs downwind until the rising balloon takes up the slack and there is some tension in the flight train. As this happens, the radiosonde is raised with one hand and the twine brought forward in the other hand. If the movement of the hands is coordinated, the radiosonde will lift away with no noticeable jolt.

If the flight train lifts away, but the radiosonde struck the ground or an obstruction during release, the data will immediately be checked for accuracy and applicable data quality control procedures are to be followed. A second release may be required if there is poor quality or excessive missing data.



Figure C-8: Two Person Release Technique

5. Countdown Activities (MROS)

The following table can be used as a guide to aid the observer in time management during radiosonde flight preparations for MROS systems.

MROS Countdown Activities		
Time to Launch (mins)	Action	Notes
T-50 minutes	Confirm the workstation is powered on and the sounding software is running. Check weather and wind conditions expected at release time.	GRAW software: GRAWMET Vaisala software: MW41
T-45 minutes	Prepare balloon and flight train. Inspect all equipment for defects	Balloon inflation will begin no more than 45 minutes prior to release.
T-30 minutes	Inspect radiosonde and sensors for any equipment damage	

T-20 minutes	Confirm radiosonde is detected, powered on and begin baselining and conditioning.	GRAW radiosonde: DFM-17 Vaisala radiosonde: RS41-NG
T-15 minutes	Confirm radiosonde frequency	Use site specific frequency
T-10 minutes	Complete preflight information	Enter/confirm baseline and surface weather conditions: Take cloud and present weather observation.
T-5 minutes	Attach radiosonde to balloon train	
T-3 minutes	Final check of inflated balloon, flight train and radiosonde powered on and software prompting for launch	
T-1 minute	Perform visual check of the sky and contact Air Traffic Control (if required) for authorization to launch	Visual check is required
T-0 minute	Launch! Release balloon flight train.	

Table C-2: MROS Countdown Activities

6. Launch Preparation (AROS)

The AROS system used by the NWS is the Vaisala AS15. The observer or site operator is required to prepare the radiosonde flight train utilizing an automated system that includes electro-pneumatic equipment capable of launching flight trains automatically and/or remotely with minimal human intervention. Understanding launch preparation is vital to a successful release. The Autosonde Control software operates the Autosonde and the MW41 sounding software is primarily used to monitor the soundings launched from the Autosonde as well as prepare the radiosonde for flight. The AROS system is supported by operators with specific user roles (Site Operator, Remote Operator and Remote Manager). For detailed information and procedures, refer to the AROS system user guide.

6.1 Balloon and Radiosonde Loading

The AROS is designed to perform soundings automatically for 24 consecutive releases. Proper handling and loading of flight train components is essential for a successful launch.

6.1.1 Start the Autosonde Control Software

Log into the Autosonde control software using the appropriate credentials and role (Site Operator, Remote Operator, or Remote Manager)

The AS15 control software provides a visual display that prompts the operator. By selecting the “start loading button” one of the 24 unoccupied trays will rotate into position. A loading hatch opens which enables the operator to pull the available tray out which enables the operator to

begin preparing the balloon and nozzle. Perform a brief wipe down of the tray using a microfiber cloth and appropriate cleaning solution.

6.1.2 Preparing the Balloon and Nozzle

Use the balloon bag or protective gloves to avoid damaging the balloon surface. Minor grease stains can damage a balloon, causing premature balloon burst or an unsuccessful sounding. Open the balloon bag and pull out only the balloon neck.



Figure C-9: Taking the Balloon Neck Out of the Bag

If using a balloon with an integrated parachute, locate the parachute string integrated in the balloon neck and thread it through the hole on the side of the balloon nozzle. Tie the string to the nozzle with a simple double knot. The knot should be on the inside of the nozzle. Slide the balloon neck over the nozzle until about half (two inches) of the neck is past the end of the nozzle. The balloon nozzle tool may be used to assist in the process.



Figure C-10: Inserting Balloon Nozzle on the Balloon Neck

Place the nozzle ring around the neck of the balloon and slide it down until it is flush against the lip of the nozzle.

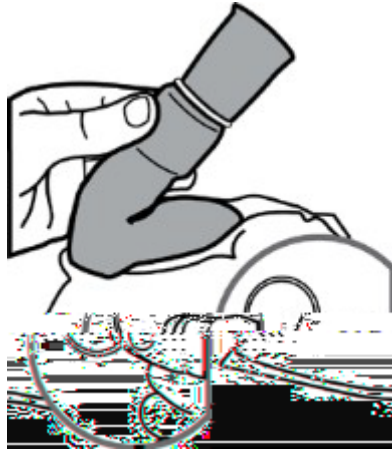

Figure C-11: Inserting the Nozzle Ring

Fold the balloon neck back over the ring. The balloon is ready to be placed in the tray.

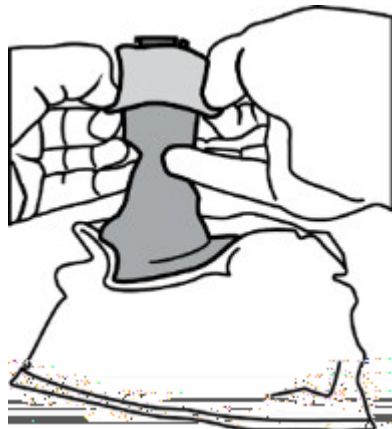

Figure C-12: Folding the Balloon Neck over the Ring



Figure C-13: Balloon Neck Correctly Folded over the Ring

6.1.3 Loading the Tray

Lay the balloon into the tray on top of the protective cloth, folding the balloon neatly so that the nozzle is on top and close to the nozzle pipe. Be sure that the balloon is not twisted.

6.1.4 Preparing the Radiosonde and Unwinder

Open the radiosonde packaging and remove the radiosonde, ensuring not to touch or hit the sensors.

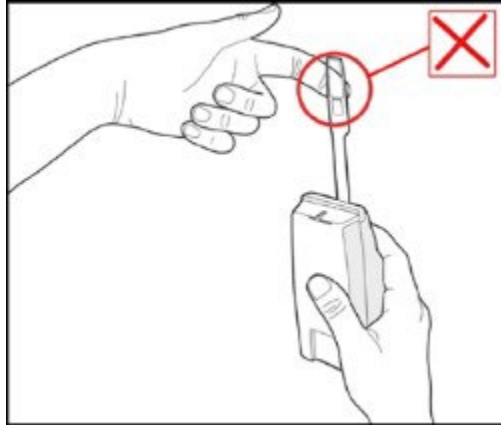

Figure C-14: Do not Touch the Radiosonde Sensors

Obtain an unwinder and detach the lifting post from its original position, unwinding a small amount (about 1 foot) of string. An unwinder is used to manage the full length of the radiosonde tether string after the balloon has been launched. By providing a short tether at the time of launch, the wind is much less likely to cause tangling.

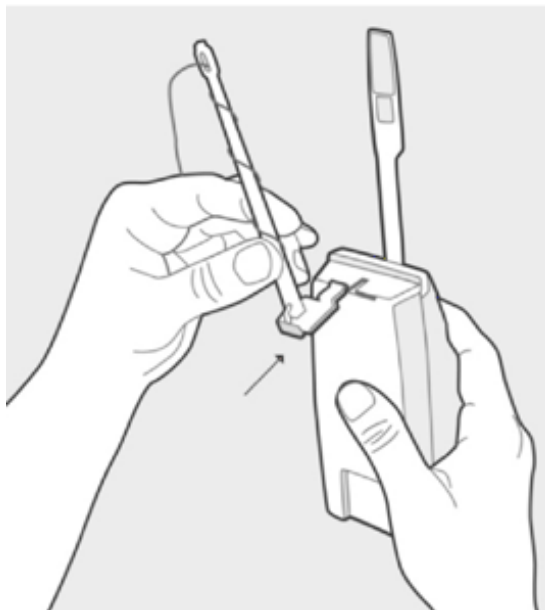

Figure C-15: Pushing the Unwinder into Place

Attach the unwinder stick to the radiosonde by sliding it into the space on the top of the radiosonde until it clicks signifying that it is locked into place. The sensor boom should now be at the appropriate 45-degree angle.

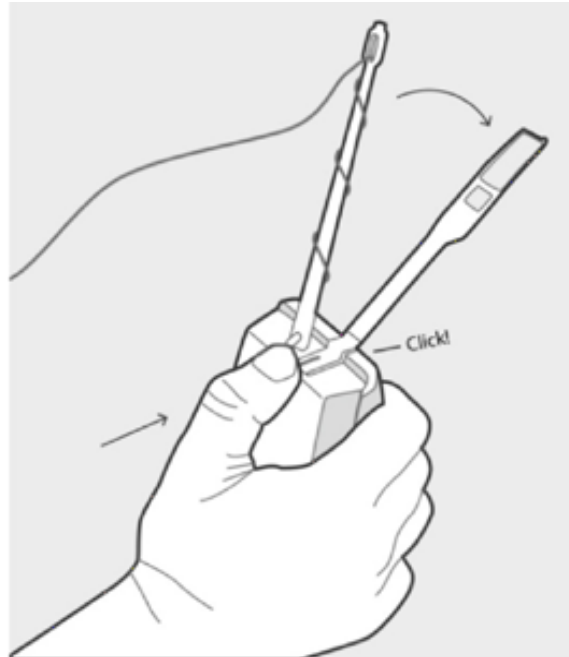

Figure C-16: Unwinder Stick Clicks into Place

Set aside the completed radiosonde/unwinder and make sure the string does not unwind too much to avoid tangles.

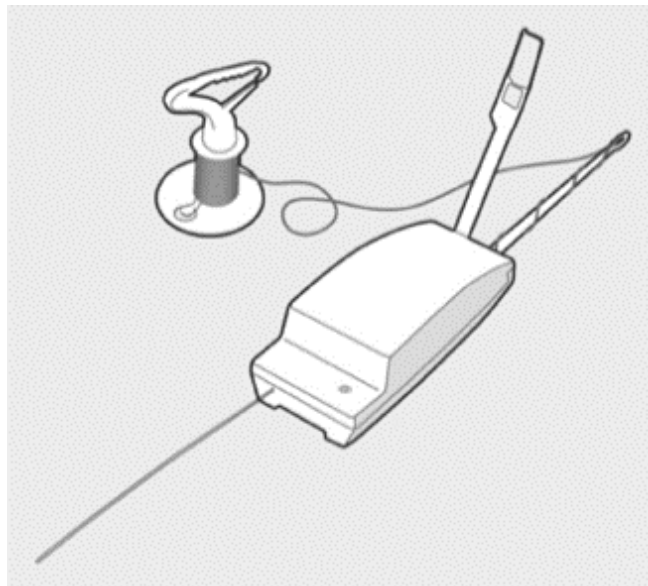

Figure C-17: Radiosonde RS41-SGP and Unwinder

Raise the radiosonde holder so that it is upright and place the radiosonde in it. The radiosonde antenna will naturally bend and rest behind the white plastic hook on the holder keeping it from getting caught in any moving parts.



Figure C-18: Placing the Radiosonde in the Holder

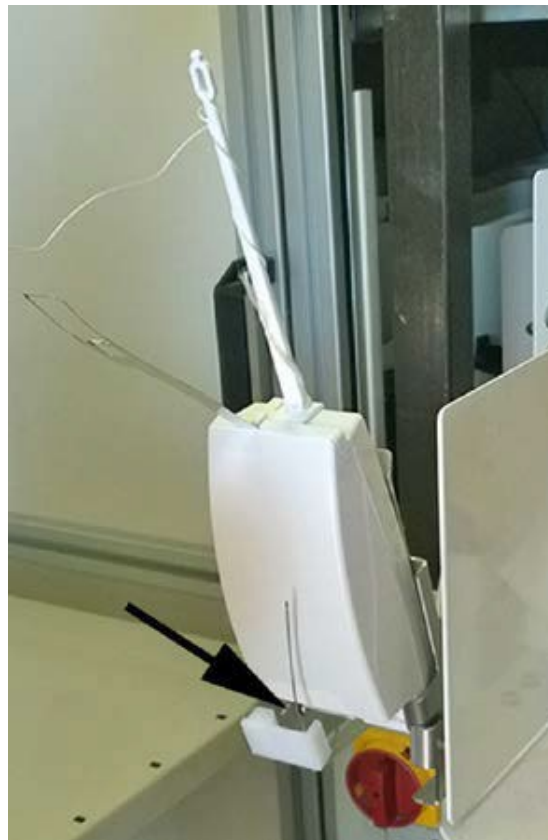

Figure C-19: Correct Placement of the Radiosonde Antenna

Release some string from the unwinder coil so that there is a free length of string between the unwinder and the radiosonde. For best results, do not open more than 1 foot of string. Make sure the string is not tangled.

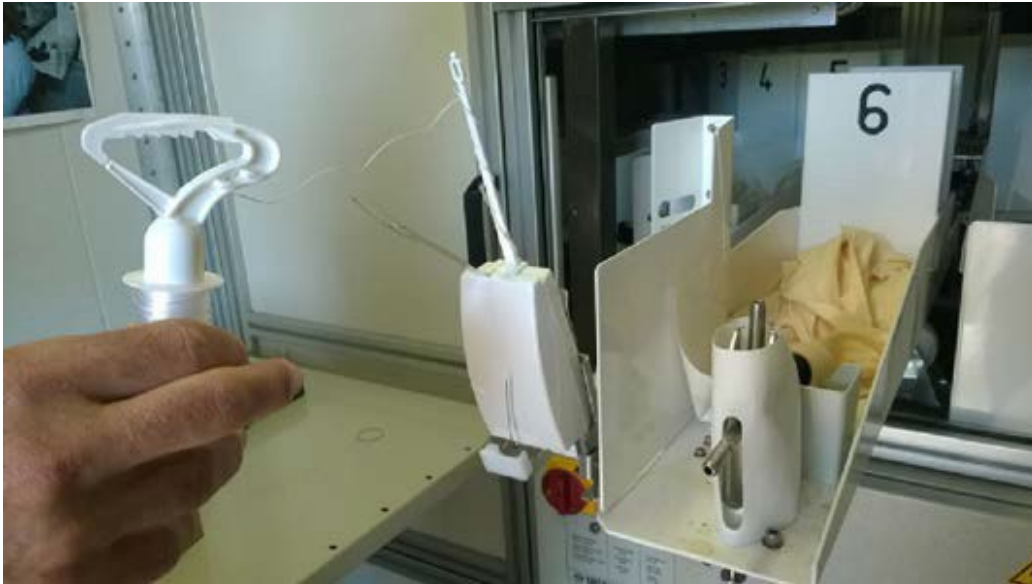

Figure C-20: Unwinder String Released from the Unwinder Coil

Gently place the radiosonde in the down position prior to running the string into the flow channel groove.

Place the unwinder coil in the string cup on the right-hand side of the tray. Make sure that the unwinder string runs through the flow channel groove in the divider and not over or around it.

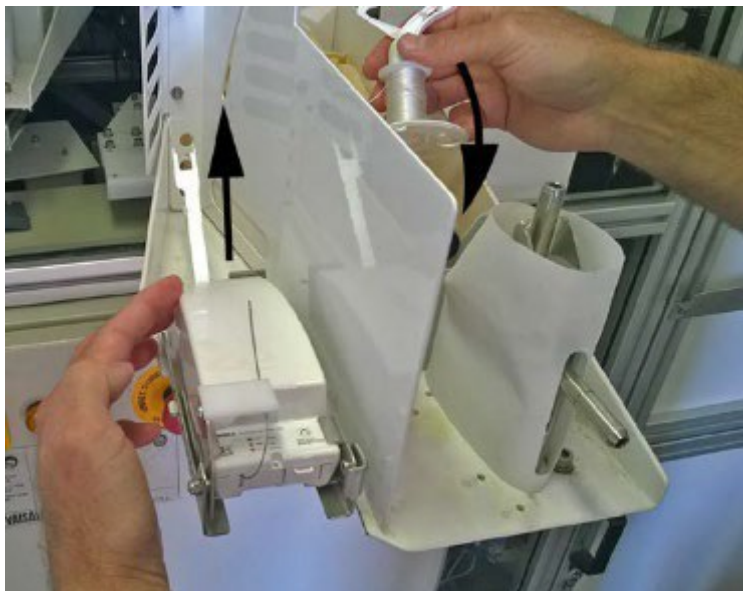

Figure C-21: Unwinder String Running from the Flow Channel Groove

Connect the unwinder hook to the balloon nozzle. Push the balloon nozzle down onto the pipe until it clicks and the two claw-like hooks latch onto it. It is required that you use your other hand to stabilize and support the tray while pressing down, to avoid bending the tray.



Figure C-22: Unwinder Hook Attached to the Balloon Nozzle



Figure C-23: Snapping the Nozzle on the Nozzle Pipe

Return to the Autosonde control software computer and fill in the Material Set information. This would include date of manufacture and serial number for the balloon as well as comments. For comments, please enter the loader's initials. Then slide the loaded tray back into the carousel

through the loading hatch. The glass loading hatch will close and the system will connect with the radiosonde to perform a brief check. The indicator light on the radiosonde will blink green while this occurs. When the check is complete, the radiosonde will turn off, the wheel will rotate, and the hatch will open again so that the next empty tray can be slid out.



Figure C-24: Pushing the Tray In

The Site Operator will repeat the loading process until all or the desired number of trays are filled. When finished loading, click the Exit loading button located in the top right-hand corner of the display, or when all trays are loaded, the system will automatically go into idle mode. The hatch will close along with the loading window on the interface. Once a green icon is displayed in the main window, the system is ready to perform a sounding.

For detailed step by step procedures, refer to the appropriate user guide that coincides with the system at your site.

6.2 MW41 Flight Preparation

Flight preparation activities are performed via the MW41 monitoring software. The Remote Manager must be logged into the software in order to have access.

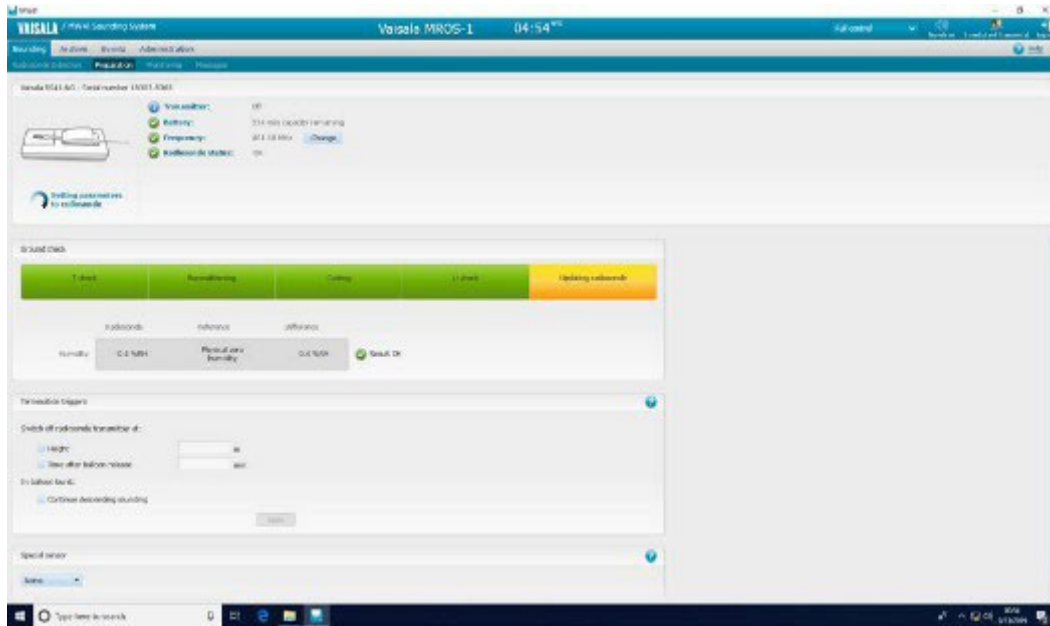

Figure C-25: MW41 Sounding Main Window When Flight is Under Preparation

6.2.1 The Ground Check

When AROS is preparing a radiosonde for flight it will perform a ground check via the MW41 Monitoring sub menu. The radiosonde box provides the user with all the pertinent data about the radiosonde itself, as in the serial number, estimated battery life, transmission frequency, and whether the radiosonde is functional. The Ground Check box has an advancing bar depending on the state of the check process. The system goes through temperature checks, reconditioning, cooling, U check (physical zero humidity), and updates the radiosondes coefficients.



Figure C-26: Ground Check Progress

6.2.2 Viewing and Modifying Metadata

The MW41 software enables Remote Operators to view, modify and confirm the surface level values and metadata.

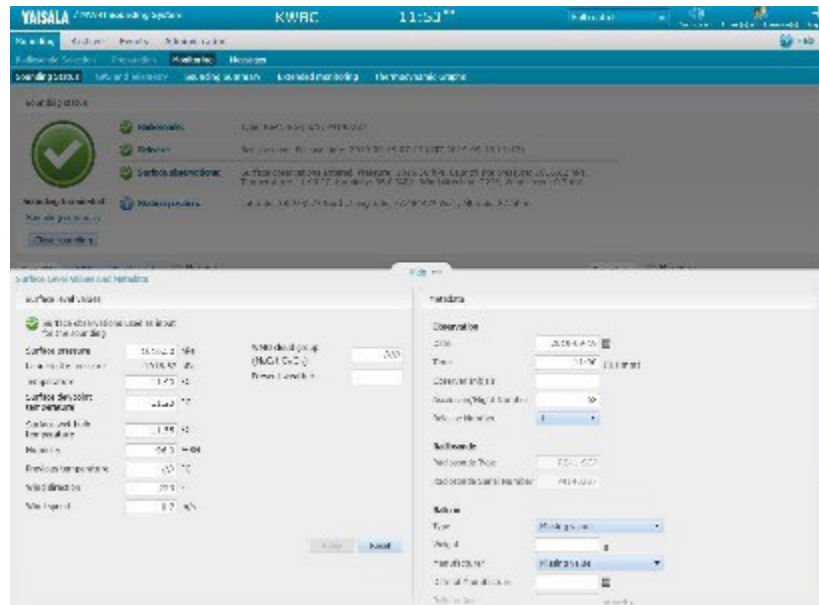

Figure C-27: Viewing and Modifying Flight Metadata

6.2.3 GPS and Telemetry

The GPS and Telemetry window provides status information regarding the receiver and the GPS divided into separate viewing areas on the display screen the; Telemetry Status and the GPS Status.

The Telemetry link status shows the antenna segment being used to track the radiosonde at any given time as well as a spectrum analyzer that displays the frequency of the radiosonde transmitting in the 403 MHz band.

The GPS status box displays information on the GPS calculation in a graphical format. The Remote Operator can confirm the GPS data is valid and in case of a problem, get more information on the source of the problem. The Operator can view the radiosonde GPS or the local GPS. The information provides the telemetry of the satellites being tracked, how many satellites are being used and the quality of the signal being received.

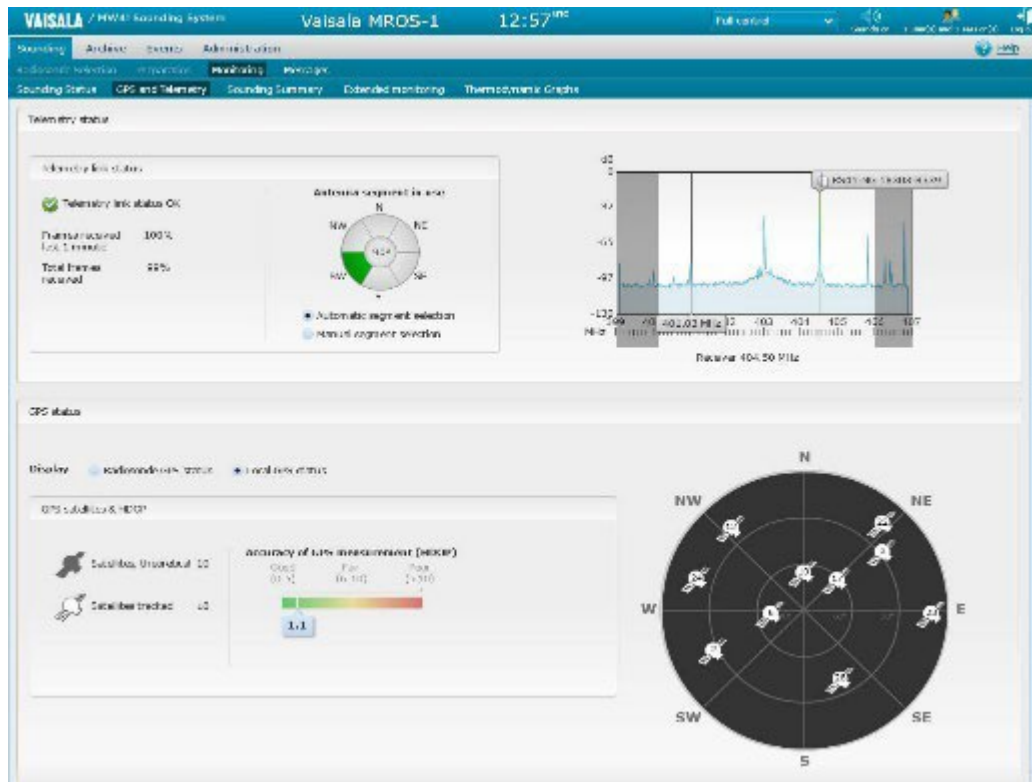

Figure C-28: GPS and Telemetry Status

6.3 Final Checks

Double check all procedures outlined in detail in the appropriate user manual to ensure that all last-minute checks are completed before moving forward with a sounding. Refer to the Autosonde interface and MW41 software to review any alerts or events that may need attention. Check the radiosonde tray status and look for the green icon in the main window indicating the system is ready to perform the next scheduled sounding.

6.3.1 Monitor / Resolve Alerts and Events

Check the alerts and events to either resolve, acknowledge or identify issues that may need to be escalated to the remote manager, help desk or other qualified personnel prior to attempting corrective actions. Refer to the appropriate user guide that coincides with the system at your site.

6.3.2 Notify Air Traffic Control

An upper air site located within 5 NM of a controlled airfield will call the local airport tower immediately before a radiosonde flight to coordinate the balloon release. If possible, a visual search of the observation area must be made.

For normal, scheduled Synoptic flights within the operational window, notify any affected air traffic control before opening the cover lids. For a special sounding outside of the operational window, the same coordination applies.

In the case of a partially inflated stuck balloon, notify the air traffic control prior to opening the cover lids, just in case a balloon is inadvertently released.

6.4 Release Options

Remote Managers can release the flight train from the Autosonde locally, using the Autosonde control software or manually, using the wired switch in the Autosonde shelter. A third way is to release it remotely by using the Vaisala Observation Network Manager NM10 software. For more information refer to the AROS user guides.

6.5 Managing Release Failures

When abnormal operations occur, they can result in failed launches.

6.5.1 Connectivity Issues

If the Autosonde control software has no connection to the MW41 software and no sounding can be performed, the Site Operator should call the Remote Manager to determine the best course of action for your region.

6.5.2 Balloon Burst

In the event the balloon bursts while it is being filled, the sounding system will notice the pressure does not decrease after the release. The program will proceed with a new sounding using a spare radiosonde.

6.5.3 Stuck Balloon

Stuck balloons are one of the most common problems. In the event that a stuck balloon is detected by the Site Operator, call the Remote Manager to determine the best course of action for your site/region. For details on how to remove the stuck balloon please see the AROS Site Operator user guide.

7. Countdown Activities (AROS)

The following table can be used as a guide to aid the observer in time management during radiosonde flight preparations for the AROS system.

AROS Countdown Activities		
Time to Launch (mins)	Action	Notes
T-60 - T-31 minutes	Assess whether additional gas is needed and initiate instant sounding (if necessary)	If instant sounding is initialized, scheduled flight will be bypassed.
T-30 minutes	Autosonde begins assessing scheduled flight	
T-30 - T-1 minutes	Autosonde prepares radiosonde and balloon	Monitor progress and alerts and events
T-0 minutes	Launch! Remote Operator calls Air Traffic Control and grants permission in MW41 for flight	It is recommended this is done between 11:01Z - 11:05Z / 23:01Z - 23:05Z

Table C-3: AROS Countdown Activities

APPENDIX D - CLOUD OBSERVATION AND WEATHER CODING

Table of Contents	Page
1. Introduction	D-2
2. Format	D-2
3. Code Tables	D-3
3.1 Amount of Low/Middle Clouds (N_n)	D-3
3.2 Coding Low Clouds (C_l)	D-4
3.3 Height of the Cloud Base Above Ground (h)	D-5
3.4 Coding Middle Clouds (C_m)	D-6
3.5 Coding High Clouds (C_h)	D-7
4. Present Weather Coding (WWWW)	D-8
4.1 Most Common Codes	D-9
4.2 Thunderstorms	D-11
4.3 Showery Precipitation	D-12
4.4 Non-Showery Precipitation	D-13
4.5 Fog or Ice Fog	D-15
4.6 Drifting or Blowing Snow, Dust Storm, Sandstorm	D-16
4.7 Precipitation, Fog, or Thunderstorm at Station During Preceding Hour	D-17
4.8 Other Weather Phenomena	D-18
5. Examples	D-20

Tables

D-1: Amount of Low/Middle Clouds	D-4
D-2: Coding Low Clouds	D-5
D-3: Cloud Height	D-6
D-4: Coding Middle Clouds	D-7
D-5: Coding High Clouds	D-8
D-6: Present Weather - Most Common Codes	D-9
D-7: Present Weather – Thunderstorms	D-12
D-8: Present Weather - Showery Precipitation	D-13
D-9: Present Weather - Non-Showery Precipitation	D-15
D-10: Present Weather - Fog or Ice Fog	D-16
D-11: Present Weather - Drifting or Blowing Snow, Dust Storm, Sandstorm	D-17
D-12: Present Weather - Precipitation, Fog, or Thunderstorm at Station During Preceding Hour	D-18
D-13: Present Weather - Other Weather Phenomena	D-20
D-14: Examples	D-21

1. Introduction

A basic understanding of clouds and weather is necessary to correctly format the cloud and surface weather code. This appendix provides the necessary tables and specific instructions to format and enter the cloud and weather code into the MROS software.

2. Format

The cloud and surface weather entry are a nine-digit, mandatory group. **All** nine digits must be entered, regardless of the presence **or** absence of clouds or significant weather conditions.

The WMO format for entry of clouds and weather has been modified by the NWS to meet NCEI requirements. All MROS stations will follow this modified format, regardless of location; i.e. stations in either WMO Region IV or WMO Region V. Observing the elements requested and reporting them according to the tables provided in this appendix fulfills the requirement for cloud and surface weather data. A description of the nine-digit format follows:

Cloud and Weather group format: $N_h C_L h C_M C_H W W W W$

- N_h = Amount (in oktas) of the sky covered by all low clouds (C_L) observed or the amount of sky covered by all the middle clouds (C_M) observed. In no case will the amounts of the low and middle clouds be combined to report N_h . Use Table D-1 to report the amount of low or middle cloud coverage.
- C_L = Type of low cloud, based on the priority given in Table D-2. A solidus (/) is reported if C_L clouds are not visible owing to fog or similar obscuring phenomena.

Note: *Clouds are divided into three families, classified as low, middle, or high. The general height ranges for these are: surface to 6500 feet for low; 6500 feet to 20000 feet for middle; and above 20000 feet for high. Remember, these ranges are not absolute, but given as a guide only. More consideration may be given to the cloud form than the height in many cases. Each cloud family is coded with a single digit, 0 through 9. The code figure 0 is used to indicate that clouds are not present for a given family.*

- h = Height of the base of the lowest cloud observed. The height reported is with respect to the surface. The height is coded as a solidus (/) if there is a total surface-based obscuration that prevents an observation of the clouds. Use Table D-3 for the cloud base height.
- C_M = Type of middle cloud, based on priority given in Table D-4. A solidus (/) is reported if C_M clouds are not visible owing to fog or similar obscuring phenomena, or because of a continuous layer of lower clouds.
- C_H = Type of high cloud, based on priority given in Table D-5. A solidus (/) is reported if C_H clouds are not visible owing to fog or similar obscuring phenomena, or because of a continuous

layer of lower clouds.

- **WWWW** = Present weather coded in two groups of **WW**. These code groups are found in section 4. The coding starts with 99 (the highest priority) and descends to 00 (the lowest priority). Table D-6 highlights some of the more commonly used present weather codes. Tables D-7 through D-14 list all of the present weather codes, in order of priority. Code figure 17 is placed out of numerical sequence to highlight its relative coding priority. Please note that the present weather codes for some weather phenomena are for events that have occurred during the past hour, not at the time of observation. When entering **WWWW**, go down the tables in section 4 and use the first and second applicable code figures. Note that two **WW** groups must always be coded, even if that means using the same code figure twice.

3. Code Tables

In the below tables, you will find the various codes for the $N_h C_L h C_M C_H$ sections of the Cloud Code. For Present Weather (**WWWW**), please see section 4.

3.1 Amount of Low/Middle Clouds (N_h)

This section is used to determine the code for N_h , based on the amount (in oktas) of the sky covered by all low clouds (C_L) observed. If there are no low clouds, the middle clouds (C_M) observed will be used to determine the amount of sky cover. **In no case will the amounts of the low and middle clouds be combined to report N_h .**

The site used when estimating the amount of low or middle clouds should be one which commands the widest possible view of the sky, and it should not be affected by fixed lighting which would interfere with observations at night. When performing observations at night, it is very important that the observer should allow sufficient time for the eyes to adjust to the darkness.

The observer should give equal emphasis to the areas overhead and those at the lower angular elevations. On occasions when the clouds are irregularly distributed, it is useful to consider the sky in separate quadrants. The sum of the estimates for each quadrant is taken as the total for the whole sky.

There are, of course, occasions when it is very difficult to estimate cloud amounts, especially at night. Previous observations of cloud development and general knowledge of cloud structure will help the observer to achieve the best possible result. Access to reports from local automated weather stations, if available, can also be of assistance.

It may be difficult to estimate amounts if some clouds are only partly visible or temporarily concealed. This is often the case when the clouds occur in superposed layers or patches. In this situation, it may be possible to estimate the amount by observing the sky over time, because previously hidden clouds may become visible.

When the sky is partially hidden, for example, by mountains, or by haze, fog or smoke, the amount of low or middle clouds should be estimated from the visible fraction. Also, when the sky is partly veiled by precipitation, this part should be considered covered by the precipitating cloud.

Gaps between clouds near the horizon may not be visible to the observer. Only gaps that are visible from the observer's position should be considered when estimating the amount of low or middle clouds. For more information regarding low or middle clouds, refer to WMO guidance.

Code Figure	Cloud Amount in Oktas (eighths)	Cloud Amount in Tenths
0	0	0
1	1 okta or less, but not zero	1/10 or less, but not zero
2	2 oktas	2/10 - 3/10
3	3 oktas	4/10
4	4 oktas	5/10
5	5 oktas	6/10
6	6 oktas	7/10 - 8/10
7	7 oktas	9/10 or more, but not 10/10
8	8 oktas	10/10
9	Sky obscured by fog and/or other meteorological phenomena	
/	Cloud cover is indiscernible for reasons other than fog or other meteorological phenomena, or observation is not made	

Table D-1: Amount of Low/Middle Clouds

Note: *If there are any breaks in the sky at all, such as an overcast with a mackerel sky (altocumulus perlucidus or stratocumulus perlucidus), N_h would be encoded as 7. If there are only a few patches of low or middle cloud in the sky, N_h cannot be encoded as 0 but is encoded as 1. A partial obscuration does not affect the coding of N_h . A total obscuration is coded as 9, not 8 (overcast sky).*

3.2 Coding Low Clouds (CL)

This section presents the specifications for type of low cloud, CL, in order of priority. Go down the table and use the first applicable code figure.

*Consideration of predominance is restricted to the clouds corresponding to CL code figures 1, 5, 6 and 7, which have the same priority. Clouds of any one of these four specifications are said to be predominant when their sky cover is greater than that of the clouds of any of the other three specifications.

**'Bad weather' denotes the conditions which generally exist during precipitation and a short time before and after.

Code Figure	Coding Criteria
(a) Cumulonimbus present, with or without other C_L clouds	
C_L = 9	If the upper parts of at least one of the cumulonimbus clouds present are clearly fibrous or striated, use C_L = 9 .
C_L = 3	If the upper part of none of the cumulonimbus clouds present is clearly fibrous or striated, use C_L = 3 .
(b) No cumulonimbus present	
C_L = 4	If stratocumulus formed by the spreading out of cumulus is present, use C_L = 4 .
C_L = 8	If the C_L code figure 4 is not applicable and if cumulus and stratocumulus clouds with bases at different levels are present, use C_L = 8 .
C_L = 2	If the C_L code figures 4 and 8 are not applicable and if cumulus clouds of moderate or strong vertical extent are present, use C_L = 2 .
C_L = 1	If the C_L code figures 4, 8, and 2 are not applicable: if the C_L clouds present are predominantly* cumulus with little vertical extent and seemingly flattened or ragged cumulus other than of bad weather**, or both, use C_L = 1 .
C_L = 5	If among the C_L clouds present, stratocumulus other than that formed by the spreading out of cumulus is predominant*, use C_L = 5 .
C_L = 6	If the C_L clouds present are predominantly* stratus in a more or less continuous sheet or layer, and/or in ragged shreds (other than ragged stratus of bad weather**), use C_L = 6 .
C_L = 7	If the C_L clouds present are predominantly* pannus (ragged shreds of stratus of bad weather** or ragged cumulus of bad weather**), or both, use C_L = 7 .
C_L = 0	No C_L Clouds -- No cumulus, cumulonimbus, stratocumulus, or stratus, use C_L = 0 .
C_L = /	C_L clouds not visible owing to fog or similar obscuring phenomena, use C_L = / .

Table D-2: Coding Low Clouds

3.3 Height of the Cloud Base Above Ground (h)

Use the following table to report the height of the base of the lowest cloud seen, regardless of cloud amount. The height reported is with respect to the surface.

*These heights are reported in 100-foot increments

**These heights are reported in 500-foot increments

Code Figure	Reportable Heights (ft)
0	0 or 100
1	200 or 300
2	400 to 600*
3	700 to 900*
4	1000 to 1900*
5	2000 to 3200*
6	3300 to 4900*
7	5000 to 6500**
8	7000 to 8000**
9	8500 or higher or no clouds
/	Unknown height or base of clouds below the station surface The lowest cloud height is coded with a solidus (/) if there is a total surface-based obscuration that prevents an observation of the clouds.

Table D-3: Cloud Height

3.4 Coding Middle Clouds (C_M)

This section presents the specifications for type of middle cloud, C_M, in order of priority. Go down the table and use the first applicable code figure.

*There are several definitions of C_M = 7 and each has a different priority; therefore, the code figure C_M = 7 appears several times in this code table.

Code Figure	Coding Criteria
(a) Altocumulus present	
C _M = 9	If the sky is chaotic, use C _M = 9.
C _M = 8	If the C _M code figure 9 is not applicable and if altocumulus with sprouting in the form

	of turrets or battlements or altocumulus having the appearance of small cumuliform tufts is present, use $C_M = 8$.
$C_M = 7^*$	If the C_M code figures 9 and 8 are not applicable and if altostratus or nimbostratus is present together with altocumulus, use $C_M = 7$.
$C_M = 6$	If the C_M code figures 9, 8, and 7 are not applicable and if altocumulus formed by the spreading out of cumulus or cumulonimbus is present, use $C_M = 6$.
$C_M = 5$	If the C_M code figures 9, 8, 7, and 6 are not applicable, and if the altocumulus present is progressively invading the sky, use $C_M = 5$.
$C_M = 4$	If the C_M code figures 9, 8, 7, 6, and 5 are not applicable, and if the altocumulus present is continually changing in appearance, use $C_M = 4$.
$C_M = 7^*$	If the C_M code figures 9, 8, 6, 5, and 4 are not applicable and if the altocumulus present occurs at two or more levels, use $C_M = 7$.
$C_M = 7,3^*$	If the C_M code figures 9, 8, 6, 5, and 4 are not applicable and if the altocumulus present occurs at one level, use $C_M = 7$ or 3 depending on whether the greater part of the altocumulus is respectively opaque or semi-transparent.
(b) No altocumulus present	
$C_M = 2$	If nimbostratus is present or if the greater part of the altostratus present is opaque, use $C_M = 2$.
$C_M = 1$	If there is no nimbostratus and if the greater part of the altostratus present is semi-transparent, use $C_M = 1$.
$C_M = 0$	If there are no C_M Clouds -- No altocumulus, altostratus, or nimbostratus, use $C_M = 0$.
$C_M = /$	If the C_M clouds are not visible owing to fog or similar obscuring phenomena, or because of a continuous layer of lower clouds, use $C_M = /$.

Table D-4: Coding Middle Clouds

3.5 Coding High Clouds (C_H)

This section presents the specifications for type of high cloud, C_H , in order of priority. Go down the table and use the first applicable code figure.

Code Figure	Coding Criteria
$C_H = 9$	If cirrocumulus is present alone or is more than the combined sky cover of any cirrus and cirrostratus present, use $C_H = 9$.

(a) Cirrostratus present	
C_H = 7	If the cirrostratus covers the whole sky, use C_H = 7 .
C_H = 8	If the cirrostratus does not cover the whole sky and is not invading the celestial dome, use C_H = 8 .
C_H = 6	If the cirrostratus is progressively invading the sky and if the continuous veil extends more than 45 degrees above the horizon but does not cover the whole sky, use C_H = 6 .
C_H = 5	If the cirrostratus is progressively invading the sky but the continuous veil does not reach 45 degrees above the horizon, use C_H = 5 .
(b) C_H = 9 not applicable and no cirrostratus present	
C_H = 4	If the cirrus clouds are invading the sky, use C_H = 4 .
C_H = 3	If the C_H code figure 4 is not applicable and if dense cirrus which originated from cumulonimbus is present in the sky, use C_H = 3 .
C_H = 2, 1	If the combined sky cover of dense cirrus, of cirrus with sprouting in the form of small turrets or battlements and of cirrus in tufts is greater than the combined sky cover of cirrus in the form of filaments, strands or hooks, use C_H = 2 . If the combined sky cover of cirrus in the form of filaments, strands or hooks is greater than the combined sky cover of dense cirrus, of cirrus with sprouting in the form of small turrets or battlements and of cirrus in tufts, use C_H = 1 .
C_H = 0	If there are no C_H Clouds -- No cirrus, cirrostratus, or cirrocumulus, use C_H = 0 .
C_H = /	If the C_H clouds are not visible owing to fog or similar obscuring phenomena, or because of a continuous layer of lower clouds, use C_H = / .

Table D-5: Coding High Clouds

4. Present Weather Coding (WWWW)

This section presents the specifications for present weather, WW, in order of priority. *Please note, code figure 17 takes priority over code figures 49 through 20 and 16 through 00.* Go down the table and use the first and second applicable code figures. The code figure with the higher priority is reported as the first WW group and the code with the lower priority is the second WW group. This convention is followed, even if the higher priority code describes weather that occurred during the preceding hour, but not at the time of observation.

Note: *The two WW groups must always be coded, even if that means using the same code figure twice.*

- WW figures 99 through 50 are used for precipitation at the station at the time of observation.
- WW figures 99 through 80 are used for showery precipitation or precipitation with ongoing or recent thunderstorms.
- WW figures 79 through 50 are used for precipitation that is not showery in nature.
- WW figures 49 through 40 are used for fog or ice fog. *NOTE: If the visibility is 5/8 mi or more, or if the fog or ice fog is shallow, use code figures 12 through 10. To be considered shallow, the fog or ice fog should not be deeper than about 6 ft.*
- WW figures 39 through 30 are used for blowing or drifting snow, dust storms, or sandstorms.
- WW figures 29 through 20 are used for precipitation, fog, ice fog, or thunderstorms at the station during the preceding hour but not at the station at the time of observation.
- WW figures 19 through 00 are used for certain hydrometeors, electrometeors, lithometeors or no precipitation at the station at the time of observation or during the preceding hour. *NOTE: Code figure 17 takes priority over code figures 49 through 20 and 16 through 00.*

Note: *By U.S. definition, a thunderstorm is occurring at the station when thunder is first heard. The storm ends when 15 minutes has passed by without hearing thunder.*

IMPORTANT: *Never release a radiosonde while a thunderstorm is occurring. See Appendix C “Observation and Launch Preparation” for more information.*

4.1 Most Common Codes

The following table lists the most common codes that observers will utilize. Please note, the higher numbers take priority when coding. For example, if there were showers of rain during the proceeding hour, but not at the time of observation, and the state of the sky as a whole is unchanged, you would use 25 and then 02. The full table starts in section 4.2.

Code Figure	Coding Criteria
00	Cloud development not observed or not observable. This is the characteristic of the past hour. Used if clouds were not observed during the past hour, whether the sky is clear or not at time of observation.
01	Clouds generally dissolving or becoming less developed. This is the characteristic of the sky during the past hour. Used if the sky is clear at the time of observation, but there were clouds during the past hour. Also used when clouds have dissolved or become less developed during the past hour.
02	State of sky on the whole unchanged. This is the characteristic of the sky during

	the past hour.
03	Clouds generally forming or developing. Used only if there are clouds at the time of the observation, no other weather exists, and the clouds have increased or become more developed during the past hour.
10	Mist. Code figure 10 refers only to water droplets and ice crystals. The visibility restriction shall be 5/8 mi or more but less than 7 mi. Use code figure 10 whether the mist is patchy or more or less continuous.
15	Precipitation within sight, reaching the ground or the surface of the sea, but distant; i.e., estimated to be more than 3 mi from the station.
16	Precipitation within sight, reaching the ground or the surface of the sea, near to, but not at the station. The precipitation must be 3 mi or less from the station, but not at the station to use code figure 16.
21	Rain (not freezing), not falling as shower(s). Used only if there was rain during the preceding hour, but not at the time of the observation.
22	Snow not falling as shower(s). Used only if there was snow during the preceding hour, but not at the time of the observation.
25	Shower(s) of rain. Used only if there were showers during the preceding hour, but not at the time of the observation.
26	Shower(s) of snow, or of rain and snow. Used only if there were showers during the preceding hour, but not at the time of the observation.
50	Drizzle, not freezing, intermittent, light at time of observation.
51	Drizzle, not freezing, continuous, light at time of observation.
60	Rain, not freezing, intermittent, light at time of observation.
61	Rain, not freezing, continuous, light at time of observation.
62	Rain, not freezing, intermittent, moderate at time of observation.
63	Rain, not freezing, continuous, moderate at time of observation.
70	Intermittent fall of snowflakes, light at time of observation.
71	Continuous fall of snowflakes, light at time of observation.
72	Intermittent fall of snowflakes, moderate at time of observation.
73	Continuous fall of snowflakes, moderate at time of observation.

80	Light rain shower(s).
81	Moderate or heavy rain shower(s).
83	Light shower(s) of rain and snow mixed. Intensity of both must be light.
84	Moderate or heavy shower(s) of rain and snow mixed. Intensity of either may be moderate or heavy.
85	Snow shower(s), light.
86	Snow shower(s), moderate or heavy.
91	Light rain at time of observation. Thunderstorm during the previous hour but not at time of observation. No other forms of precipitation.
92	Moderate or heavy rain at time of observation. Thunderstorm during the previous hour but not at time of observation. No other forms of precipitation.

Table D-6: Present Weather - Most Common Codes

4.2 Thunderstorms

The following codes will be used when thunderstorms with precipitation are either occurring at the time of observation, or occurred during the previous hour, and there is some sort of precipitation at the time of the observation. This section covers code figures 99 through 91.

- WW figures 99 through 95 are used if there is a thunderstorm ongoing, and there is some sort of precipitation at the time of observation.
- WW figures 94 through 91 are used if there was a thunderstorm during the past hour, and there is some sort of precipitation at the time of observation. In order to have this situation, the last thunder heard must have been more than 15 minutes before the observation, but less than 1 hour 15 minutes before the observation.

IMPORTANT: *Never release a radiosonde while a thunderstorm is occurring. See Appendix C “Observation and Launch Preparation” for more information.*

Code Figure	Coding Criteria
99	Thunderstorm, severe, with hail, small hail, or snow pellets at time of observation. There may or may not also be rain or snow or a mixture of rain and snow of any intensity.

98	Thunderstorm at time of observation combined with dust storm at time of Observation. There must also be some sort of precipitation at the time of observation, but it may not be seen because of poor visibility. The observer should use their best judgment.
97	Thunderstorm, severe without hail, small hail, or snow pellets but with rain and/or snow at time of observation. The rain or snow may be of any intensity.
96	Thunderstorm with hail, small hail, or snow pellets at time of observation. There may or may not be rain or snow or a mixture of rain and snow of any intensity.
95	Thunderstorm without hail, small hail, or snow pellets, but with rain and/or snow at time of observation.
94	Moderate or heavy snow or rain and snow mixed or hail, small hail, or snow pellets at time of observation. Thunderstorm during the previous hour but not at time of observation.
93	Light snow or rain and snow mixed or hail, small hail, or snow pellets at time of observation. Thunderstorm during the previous hour but not at time of observation.
92	Moderate or heavy rain at time of observation. Thunderstorm during the previous hour but not at time of observation. No other forms of precipitation.
91	Light rain at time of observation. Thunderstorm during the previous hour but not at time of observation. No other forms of precipitation.

Table D-7: Present Weather - Thunderstorms

4.3 Showery Precipitation

The following codes will be used to report showery precipitation that is not associated with a thunderstorm. Showers fall from cumuliform clouds that are, by nature, isolated. Because of this, individual showers do not last very long. Note: Code figure 89 is not reported under United States rules, and thus is not included. This section covers code figures 90 through 80.

- WW figures 86 and 85 are used if only snow showers are observed at the station at the time of observation.
- WW figures 84 and 83 are used if mixed rain showers and snow showers are observed at the station at the time of observation.
- WW figures 82 through 80 are used to report rain showers at the time of observation.

Code Figure	Coding Criteria
90	Moderate or heavy shower(s) of hail, with or without rain or rain and snow mixed, not associated with thunder.
88	Moderate or heavy shower(s) of snow pellets or small hail, with or without rain or rain and snow mixed. All of the precipitation must be moderate or heavy.
87	Light shower(s) of snow pellets or small hail, with or without rain or rain and snow mixed. All of the precipitation must be light.
86	Snow shower(s), moderate or heavy.
85	Snow shower(s), light.
84	Moderate or heavy shower(s) of rain and snow mixed. Intensity of either may be moderate or heavy.
83	Light shower(s) of rain and snow mixed. Intensity of both must be light.
82	Violent rain shower(s). Report a rain shower as violent if the rate of fall is at least 1.0" per hour or 0.10" in 6 minutes.
81	Moderate or heavy rain shower(s).
80	Light rain shower(s).

Table D-8: Present Weather - Showery Precipitation

4.4 Non-Showery Precipitation

The following codes will be used to report precipitation that is not showery in nature. This section covers code figures 79-50.

- WW figures 79 through 70 are used to report solid precipitation not in showers.
- WW figures 79-76 are used to report ice pellets, isolated star-like snow crystals, snow grains, or diamond dust.
- WW figures 75 through 70 are used to report snow that is not in the form of showers at the station at the time of the observation. The code figure selected depends on a combination of intensity and whether the snow is intermittent or continuous.
- WW figures 69 through 66 are used to report liquid precipitation that is mixed with snow or is freezing. This includes drizzle mixed with snow.
- WW figures 65 through 60 are used to report rain that is not in the form of showers at the station at the time of the observation. The code figure selected depends on a combination of intensity

and whether the rain is intermittent or continuous.

- WW figures 59 through 56 are used to report drizzle mixed with rain, or freezing drizzle.
- WW figures 55 through 50 are used to report drizzle (but not freezing drizzle or drizzle mixed with rain) at the station at the time of observation.

Code Figure	Coding Criteria
79	Ice Pellets. Use this code figure regardless of the intensity of the ice pellets and regardless of whether the ice pellets are mixed with another type of precipitation.
78	Isolated star-like snow crystals with or without fog or ice fog.
77	Snow grains with or without fog or ice fog. Use this code figure regardless of intensity.
76	Diamond dust (ice crystals) with or without fog or ice fog.
75	Continuous fall of snowflakes, heavy at time of observation.
74	Intermittent fall of snowflakes, heavy at time of observation.
73	Continuous fall of snowflakes, moderate at time of observation.
72	Intermittent fall of snowflakes, moderate at time of observation.
71	Continuous fall of snowflakes, light at time of observation.
70	Intermittent fall of snowflakes, light at time of observation.
69	Rain or drizzle and snow, moderate or heavy.
68	Rain or drizzle and snow, light.
67	Rain, freezing, moderate or heavy.
66	Rain, freezing, light.
65	Rain, not freezing, continuous, heavy at time of observation.
64	Rain, not freezing, intermittent, heavy at time of observation.
63	Rain, not freezing, continuous, moderate at time of observation.
62	Rain, not freezing, intermittent, moderate at time of observation.

61	Rain, not freezing, continuous, light at time of observation.
60	Rain, not freezing, intermittent, light at time of observation.
59	Drizzle and rain, moderate or heavy at time of observation.
58	Drizzle and rain, light at time of observation.
57	Drizzle, freezing, moderate or heavy at time of observation.
56	Drizzle, freezing, light at time of observation.
55	Drizzle, not freezing, continuous, heavy at time of observation.
54	Drizzle, not freezing, intermittent, heavy at time of observation.
53	Drizzle, not freezing, continuous, moderate at time of observation.
52	Drizzle, not freezing, intermittent, moderate at time of observation.
51	Drizzle, not freezing, continuous, light at time of observation.
50	Drizzle, not freezing, intermittent, light at time of observation.

Table D-9: Present Weather - Non-Showery Precipitation

4.5 Fog or Ice Fog

The following codes will be used to report fog or ice fog. The fog may be made of water droplets or ice crystals (ice fog). *The visibility in fog or ice fog must be less than 5/8 mi.* If the visibility is 5/8 mi or more, or if the fog or ice fog is shallow, use code figures 12 through 10. To be considered shallow, the fog or ice fog should not be deeper than about 6 ft. The code figure used will depend on whether the fog has changed during the past hour and whether the sky can be seen (blue sky, stars or higher clouds). This section covers code figures 49-40.

Code Figure	Coding Criteria
49	Fog depositing rime, sky invisible. Fog that deposits rime will be made up mostly of supercooled water droplets.
48	Fog, depositing rime, sky visible.
47	Fog or ice fog, sky invisible. Fog has begun or has become thicker during the preceding hour.
46	Fog or ice fog, sky visible. Fog has begun or has become thicker during the preceding hour.
45	Fog or ice fog, sky invisible. Fog has shown no appreciable change during the

	preceding hour.
44	Fog or ice fog, sky visible. Fog has shown no appreciable change during the preceding hour.
43	Fog or ice fog, sky invisible. Fog has become thinner during the preceding hour.
42	Fog or ice fog, sky visible. Fog has become thinner during the preceding hour.
41	Fog or ice fog in patches. Fog has begun or has become thicker during the preceding hour.
40	For or ice fog at a distance at the time of observation, but not at the station during the preceding hour, the fog or ice fog extends to a level above that of the observer.

Table D-10: Present Weather - Fog or Ice Fog

4.6 Drifting or Blowing Snow, Dust Storm, Sandstorm

The following codes will be used to report a dust storm, sandstorm, or drifting or blowing snow. This section covers code figures 39 through 30.

- WW figures 39 through 36 are used to report blowing or drifting snow. In deciding which code figure to use, the following must be considered: snow that is being moved by the wind may be generally low (below about 6 ft) or generally high (above 6 ft). If the snow is low, it is drifting snow; if high, it is blowing snow. Code figure 37 is not reported under United States rules.
- WW figures 35 through 30 are used to report a dust or sandstorm. In deciding which code figure to use, the following must be considered: if the visibility at the station at the time of observation is less than 5/16 mi, there is a severe dust storm or sandstorm; if the visibility is at least 5/16 mi but less than 5/8 mi, there is a light or moderate dust storm or sandstorm. The code figure used depends on the intensity of the dust storm or sandstorm and any change in its intensity during the preceding hour.

Code Figure	Coding Criteria
39	Heavy blowing snow, generally high (above eye level). Visibility less than 5/16 mi.
38	Light or moderate blowing snow, generally high (above eye level). Visibility 6 mi or less but not less than 5/16 mi.
36	Drifting snow, generally low (below eye level).
35	Severe dust storm or sandstorm that has begun or has increased during the

	preceding hour.
34	Severe dust storm or sandstorm that has had no appreciable change during the preceding hour.
33	Severe dust storm or sandstorm that has decreased during the preceding hour.
32	Light or moderate dust storm or sandstorm that has begun or has increased during the preceding hour.
31	Light or moderate dust storm or sandstorm that has had no appreciable change during the preceding hour.
30	Light or moderate dust storm or sandstorm that has decreased during the preceding hour.

Table D-11: Present Weather - Drifting or Blowing Snow, Dust Storm, Sandstorm

4.7 Precipitation, Fog, or Thunderstorm at Station During Preceding Hour

The following codes will be used to report precipitation, fog, ice fog, or thunderstorm at the station during the preceding hour but not at the station at the time of observation. Use code figures 29-25 if the precipitation was showery; otherwise use code figures 24-20. This section covers code figures 29 through 20.

Code Figure	Coding Criteria
29	Thunderstorm (with or without precipitation). Since by U.S. definition, a thunderstorm ends 15 minutes after the last thunder is heard, the last thunder or lightning must have happened at least 15 minutes before the time of the observation.
28	Fog or ice fog. The visibility in the fog or ice fog must have been less than 5/8 mi.
27	Shower(s) of hail, small hail, or ice pellets, or of rain and hail, small hail, or ice pellets.
26	Shower(s) of snow, or of rain and snow.
25	Shower(s) of rain.
24	Freezing drizzle or freezing rain, not falling as shower(s).
23	Rain and snow or ice pellets, not falling as shower(s).
22	Snow not falling as shower(s).
21	Rain (not freezing), not falling as shower(s).

20	Drizzle (not freezing) or snow grains, not falling as shower(s).
----	---

Table D-12: Present Weather - Precipitation, Fog, or Thunderstorm at Station During Preceding Hour

4.8 Other Weather Phenomena

The following codes will be used to report certain hydrometeors, electrometeors, lithometeors or no precipitation at the station at the time of observation or during the preceding hour. This section covers code figures 19 through 00.

- WW figure 17, **Thunderstorm, but no precipitation at time of observation.**, has priority over code figures 49-20 and 16-00. *Never release a radiosonde while a thunderstorm is occurring. See Appendix C “Observation and Launch Preparation” for more information.*
- WW figures 12 and 11 are used to report continuous or patchy shallow fog. To be considered shallow, the fog or ice fog should not be deeper than about 6 ft. Continuous refers to covering half or more of the ground or sea; patchy refers to less than one-half coverage. The apparent visibility shall be less than 5/8 mi. Code figure 10 is used to report fog that is neither shallow nor has visibility less than 5/8 mi. (Code figures 49-40 are used to report fog that is not shallow but with visibility less than 5/8 mi.)
- WW figures 09 through 04 are used to report lithometeors. These include dust storm or sandstorm within sight, well-developed dust or sand whirls at or near the station, widespread dust in the air, haze, or visibility reduced by smoke or ash.
- WW figures 03 through 00 are used to report phenomena without significance. These include developing or dissolving clouds, if the state of the sky is unchanged, or if cloud development is not observed or is not observable.

Code Figure	Coding Criteria
19	Funnel cloud(s), tornado, or waterspout at or within sight of the station during the preceding hour of the time of observation. Since the highest code figure is reported (except code figure 17), code figure 19 cannot be used if WW can be encoded as some higher number.
18	Squalls. By U.S. definition, a sudden increase of at least 15 knots in average wind speed and sustained at 20 knots or more for at least 1 minute. This must occur at or within sight of the station during the preceding hour or at the time of observation. If a squall without any precipitation is observed, either at the time of observation or during the past hour, use code figure 18. If there was any precipitation, or if there was a thunderstorm with the squall, use one of the other code figures, possibly code figure 29 or one of the code figures 99-80. Select the one that best describes what happened.
17	Thunderstorm, but no precipitation at time of observation. A thunderstorm is an

	electrical storm that may or may not be accompanied by precipitation. Since by U.S. definition, a thunderstorm does not end until 15 minutes after the last thunder is heard, code figure 17 would be used if the thunderstorm occurred within 15 minutes of the observation. <i>This code takes priority over code figures 49 through 20 and 16 through 00.</i>
16	Precipitation within sight, reaching the ground or the surface of the sea, near to, but not at the station. The precipitation must be 3 mi or less from the station, but not at the station to use code figure 16.
15	Precipitation within sight, reaching the ground or the surface of the sea, but distant; i.e., estimated to be more than 3 mi from the station.
14	Precipitation within sight, not reaching the ground or the surface of the sea. Sometimes precipitation may fall from a cloud, but into air that is dry enough to evaporate it before it can reach the ground. This is fairly common in desert areas like some parts of the southwestern United States. This phenomenon is called virga.
13	Lightning visible, no thunder heard. There are two reasons you may see lightning but not hear thunder. The first is the lightning may be far enough away that the thunder doesn't reach the station. The other is that local sounds may muffle the thunder. Use code figure 13 to report distant lightning.
12	More or less continuous shallow fog or ice fog at the station; the fog or ice fog is not deeper than about 6 ft.
11	Patchy shallow fog or ice fog at the station; the fog or ice fog is not deeper than about 6 ft.
10	Mist. Code figure 10 refers only to water droplets and ice crystals. The visibility restriction shall be 5/8 mi or more but less than 7 mi. Use code figure 10 whether the mist is patchy or more or less continuous.
09	Dust storm or sandstorm within sight at the time of observation, or at the station during the preceding hour. Visibility in dust or sand must be (or have been) 6 mi or less.
08	Well-developed dust whirl(s) (devils) or sand whirl(s) seen at or near the station during the preceding hour or at the time of observation, but no dust storm or sandstorm.
07	Dust or sand raised by wind at or near the station at the time of observation, but not well-developed dust whirl(s) (devils) or sand whirl(s), and no dust storm or sandstorm seen.
06	Widespread dust in suspension in the air, not raised by wind at or near the station at the time of observation. This code figure may be used with any visibility,

	as long as there is dust in the air.
05	Haze. Code figure 05 is not restricted to the definition for reports of haze in the basic observation, but can be used if it is simply hazy, regardless of the visibility.
04	Visibility reduced by smoke; e.g., veldt or forest fires, industrial smoke, or volcanic ash. If the smoke is coming from a great distance, it will be spread through a deep layer of the atmosphere. In this case, use code figure 04 regardless of how much the visibility is restricted. If the smoke is coming from somewhere fairly close, then it will be pretty much layered in the lower atmosphere. In this case, the visibility has to be 6 mi or less before code figure 04 is used.
03	Clouds generally forming or developing. Used only if there are clouds at the time of the observation, no other weather exists, and the clouds have increased or become more developed during the past hour.
02	State of sky on the whole unchanged based on the past hour. This is the characteristic of the sky during the past hour.
01	Clouds generally dissolving or becoming less developed. This is the characteristic of the sky during the past hour. Used if the sky is clear at the time of observation, but there were clouds during the past hour. Also used when clouds have dissolved or become less developed during the past hour.
00	Cloud development not observed or not observable. This is the characteristic of the past hour. Used if clouds were not observed during the past hour, whether the sky is clear or not at time of observation.

Table D-13: Present Weather - Other Weather Phenomena

5. Examples

This section contains several example observations for observers to utilize.

<p>Sky:</p> <p>Weather:</p> <p>Code:</p>	<p>1/8 stratus at 500 feet, 4/8 altocumulus having the appearance of small cumuliform tufts at 10000 feet. 2/8 cirrostratus that is progressively invading the sky, but the continuous veil does not reach 45 degrees above the horizon. Clouds generally forming or developing over the last hour.</p> <p>Precipitation within sight of the station, but not reaching the ground (virga).</p> <p>162851403</p>
<p>Sky:</p> <p>Weather:</p>	<p>No low or middle clouds, 7/8 cirrostratus at 25,000 covering the whole sky. State of the sky as a whole is generally unchanged.</p> <p>Forest fire smoke is coming from a great distance away and is spread through a deep layer of the atmosphere.</p>

Code:	009070404
Sky:	3/8 moderate cumulus at 2100 feet, 1/8 stratocumulus at 5000 feet, 2/8 altocumulus (one level, opaque) at 12000 feet. State of the sky generally becoming less developed during the past hour.
Weather:	Light rain shower ended 17 minutes before observation.
Code:	485702501
Sky:	Clear sky with few patches of semi-transparent altocumulus at 15000 feet. Altocumulus covered 4/8 of the sky during the past hour.
Weather:	None.
Code:	109300101
Sky:	Surface-based obscuration in fog with 300 feet vertical visibility.
Weather:	Fog with visibility 1/2 mile. Last hour had a partial obscuration (fog) and 8/8 stratus at 400 feet
Code:	9////4747
Sky:	7/8 cumulonimbus (no anvil visible) at 1800 feet, 1/8 cirrus at 35000 feet, originating from cumulonimbus.
Weather:	Moderate showers of rain and small hail. Lightning seen in the distance (on the horizon), but no thunder heard.
Code:	734038813
Sky:	8/8 stratocumulus (with breaks) at 4500 feet. State of the sky unchanged during the past hour.
Weather:	None.
Code:	756//0202
Sky:	8/8 nimbostratus at 2100 feet. State of sky unchanged during the past hour.
Weather:	Light rain and drizzle. Patchy fog reducing visibility to 3 miles was present during the past hour but not at time of observation. No other changes.
Code:	8052/5802

Table D-14: Examples

APPENDIX E - IN-FLIGHT PROCEDURES

Table of Contents	Page
1. Introduction	E-2
2. Observation Software.....	E-2
2.1 Evaluation and Testing	E-2
3. Release	E-2
3.1 System Release Detection.....	E-3
3.2 Updating Surface Data.....	E-3
4. Reviewing Sounding Data	E-3
4.1 Monitoring	E-3
4.2 Missing Data	E-4
4.3 Notifications and Alerts	E-4
5. Data Quality Control and Editing	E-5
6. Flight Termination	E-5
6.1 Automatic Flight Termination	E-5
6.2 Manual Flight Termination.....	E-5
7. Data Transmission and Archiving	E-6
8. Reporting.....	E-6
Figures	
E-1: Sounding Status (Vaisala).....	E-2
E-2: Status Bar (GRAWMET).....	E-3

1. Introduction

After a successful flight train release, system software is essential to the observer to ensure a successful observation and timely dissemination of the upper air data. All observers will be proficient in determining data accuracy. No matter the platform (AROS or MROS), this appendix will provide helpful information. For more system specific procedures and detail, refer to the appropriate user guide for the system at the site.

2. Observation Software

The NWS upper air program currently uses observation monitoring software that receives and processes radiosonde data from pre-flight to termination. The software provides quality control and encodes and transmits meteorological products via connected data pathways. The software performs system initialization and diagnostics, communicates with peripheral devices, processes meteorological data, monitors ground system performance, and disseminates data products. The observation software allows user interaction with data displays, data products, data dissemination, and the radiosonde tracking system.

2.1 Evaluation and Testing

The software has been carefully evaluated and tested to meet or exceed NWS standards and requirements. Refer to the specific user guide for information about the system used at the site.

3. Release

Once the radiosonde is baselined and surface values are populated, the software will indicate a status indicating that the radiosonde is ready for release (see figure E-2 and E-3). Refer to the appropriate user guide for the system at the site for more information.

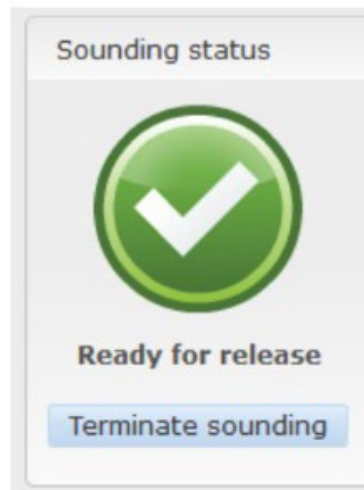

Figure E-1: Sounding Status (Vaisala MW41)



Figure E-2: Status Bar (GRAWMET)

3.1 System Release Detection

Shortly after a launch, the software will detect the release due changes in altitude and pressure. The software will then begin to present data via the system display. It is important that the observer confirms the release time by reviewing the profile data (Raw PTU, Tabular and Pressure) displays to verify the starting point of decreasing pressure and determine accurate release time. Refer to the appropriate user guide for the system at the site for more information.

3.2 Updating Surface Data

Surface values may be updated by the observer after the initial values are recorded by the software to reflect any significant changes in current weather conditions if more than 10 minutes has elapsed before the actual release. Refer to appropriate user guide for specific instructions for modifying surface values based on the system being used.

4. Reviewing Sounding Data

The observer will review the sounding data immediately after the release and throughout the flight to ensure the radiosonde, tracking system and system software are working properly. Refer to the specific system user manual being used at the site.

4.1 Monitoring

The software monitors multiple aspects of a sounding (status and position). This information is presented to the observer throughout the sounding in real time at various stages by monitoring the tabular, diagrams and plot displays. Some examples of sounding data that the MROS system provides are:

- Tabular Raw Data: measured values, as they are received from the radiosonde's sensors in a tabular format
 - Time (mm: ss)
 - Temperature (°C)
 - Humidity (%)
 - Geopotential Height (m) / Elevation
 - Azimuth
 - Range (m)
 - Ascent Rate (m/s)
 - Wind speed and direction
- Diagrams, plot displays and tabular data provide the observer a visual presentation of the sounding data
 - Raw Data / PTU (pressure, temperature, humidity) diagram and profiles

- Balloon Tracking Diagram (trajectory / flight path)
- Altitude
- Thermodynamic diagrams
 - Hodograph (wind shear conditions)
 - Skew-T (assess atmospheric instability, observe weather elements)
 - Tephigram (temperature and humidity structure)
 - Stuve (analyze predominant air layers)
- Other Display Features (refer to specific MROS system user manuals)

Depending on the MROS system, there are various tabs, tables, diagrams, and plot displays that provide additional data profiles for the observer to analyze and manipulate resulting in a comprehensive sounding experience. Refer to the appropriate user guide for the system at the site for more information.

4.2 Missing Data

Missing data can occur due to a variety of reasons, including radiosonde failure due to damage, low battery, or GPS signal loss. The observer can view notifications and alerts from the software that help to provide reasons for the missing data events. The system software also provides helpful displays to capture missing data events in tabular and graphical formats (e.g. extended monitoring and Skew-T). Refer to system specific user guide for additional information or Appendix C “Observation and Launch Preparation” on how to assess and manage missing data.

4.3 Notifications and Alerts

The system software automatically identifies meteorological, flight, and system conditions that may require the observer’s attention or acknowledgement any time during flight. Refer to system specific user manual for detailed information regarding notifications and alerts.

Notifications: Typically, notifications are informational, making the observer aware of specific events that have taken place:

- Flight reaches 400 hPa
- Flight reaches 70 hPa
- Flight terminates
- Reports created
- Other

Refer to the system specific user manual for additional notifications and any associated action required by the observer.

Alerts: Typically, alerts bring attention to issues or potential problems relating to equipment or software.

- Radiosonde failures
- Data retrieval failures
- Signal loss
- Lapse Rates

- Descending/re-ascending balloons
- Other

5. Data Quality Control and Editing

The system software provides the ability for the observer to mark erroneous flight data and review and edit sounding data during a typical observation. By editing data, the observer can exclude data and messages. Raw data is never modified or excluded. Depending on the system, it may be possible to edit live and archived data. Refer to the site-specific system for more information regarding checking and editing data.

6. Flight Termination

A sounding can be terminated manually by the observer or automatically via triggers that are preconfigured at the initial install of the system software.

6.1 Automatic Flight Termination

Typical reasons for an automatic termination by the software are:

- **Balloon Burst:** Automatically identified by an increase in pressure and a decrease in geopotential height over a specified interval.
- **Leaking or Floating Balloon:** If a balloon fails to increase in height and instead begins to float at a constant altitude or rises too slowly and in effect renders the flight unproductive.
- **Excessive Missing Data:** The software will terminate the sounding for excessive missing data after specified consecutive data, cumulative data or percentage of missing data within the first five minutes of the sounding. Excessive data can be caused by frequency interference, low GPS signal, loose connection of ground components, radiosonde failure or sensor contamination or failure. See Appendix C “Observation and Launch Preparation” or appropriate user guide for additional information.
- **Radiosonde Failure:** The system software will terminate the sounding if it appears the radiosonde has failed. Causes for this may include low or dead batteries or excessive cold temperatures.
- **Unknown Failure:** If the software abruptly closes or the workstation shuts down.

6.2 Manual Flight Termination

Typical reasons for an observer to terminate a flight via software may include:

- **Temperature Data:** Excessive erroneous data for more than three consecutive minutes
- **Faulty Data:** Sensor failure can attribute to faulty data caused by a radiosonde being ingested into a thunderstorm or convective cloud during a sounding

Note: *An observer may not change the termination time.*

7. Data Transmission and Archiving

The radiosonde observation software has visual and audible indicators when the WMO coded messages have been generated and enables the observer to confirm automatic transmission or manually transmit. Archiving is also managed by the software where an archive product is created and disseminated to NCEI post-flight. For more information on data transmission and archiving procedures, refer to Appendix F “Data Transmission and Archiving. for system specific procedures, refer to the user manual that reflects the system at the site.

8. Reporting

The observer (MROS and AROS) must complete the following forms and submit them via the MIRS website after the observation is completed. See Appendix H “Completion of Documentation (Forms)” for more information.

APPENDIX F - DATA TRANSMISSION AND ARCHIVING

Table of Contents	Page
1. Introduction	F-2
2. Checking Data.....	F-2
3. Coded Messages.....	F-2
3.1 Meteorological Codes	F-3
3.2 The RADAT Message.....	F-3
3.3 Coded Message Breakdown.....	F-5
4. Real Time Data Transmission	F-12
4.1 AWIPS Telecommunications.....	F-12
4.2 Transmission Timing	F-13
4.3 Verification of Data Receipt at NCEP	F-14
5. Archiving	F-14
5.1 Transferring Archive Files.....	F-14
5.2 Verification of Archive Receipt at NCEI.....	F-14
5.3 Archive Retention	F-14

Figures

F-1: RAOB and AWIPS Interface via LAN	F-12
F-2: RAOB and AWIPS Interface via Email.....	F-13

Tables

F-1: Automatic WMO Message Generation Levels	F-3
F-2: RADAT (Automatically Coded Groups)	F-5
F-3: Coded Freezing Data.....	F-5
F-4: Deadlines for Transmitting Upper Air Data.....	F-13

1. Introduction

During a sounding, the observer must ensure timely dissemination and transmission of the Upper Air data. This may include verifying the data, decoding upper air messages and archiving activities post observation.

2. Checking Data

High quality upper air observations are critical for NWS forecasts and warnings. The observation software provides status messages, checks and alerts to the observer throughout the sounding. The observer will monitor and check the quality of data and work to resolve any problems or inconsistencies. The observer should make every effort to identify and correct erroneous data before it is disseminated. Refer to the user manual that corresponds with the system at the site.

3. Coded Messages

The observer should understand how to properly decode upper air coded messages. The messages for the sites in the continental United States, Alaska, the Bahamas, and the Caribbean are in WMO Region IV. The sites in the Pacific Region are in WMO Region V. The coding practices will differ slightly between Regions IV and V.

The NWS utilizes the following nomenclature for WMO messages:

- Traditional Alphanumeric Code (TAC): For products such as FZL, MAN, SGL and ABV
- Binary Universal Form for the Representation of meteorological data (BUFR): A binary data format provides an increase in quantity and quality of data for meteorological products.

The system software automatically generates WMO coded messages at specific intervals during the sounding. Table F-1 depicts the automatic WMO message generation levels. Messages can also be manually generated at any time during or after the sounding. See the appropriate user guide for the system at the site for more information.

<i>Automatic WMO Message Generation Levels</i>		
AWIPS Identifier	Product	Generation Level(s)
<i>FZL</i>	<i>RADAT</i>	<i>400 hPa & Termination</i>
<i>MAN</i>	<i>TTAA</i>	<i>70 hPa & Termination</i>
<i>SGL</i>	<i>TTBB, and PPBB</i>	<i>70 hPa & Termination</i>
<i>ABV</i>	<i>TTCC, TTDD, and PPDD</i>	<i>Termination of flight</i>
<i>DD1</i>	<i>High Resolution BUFR</i>	<i>70 hPa</i>
<i>DD2</i>	<i>High Resolution Buffer</i>	<i>Termination</i>

Table F-1: Automatic WMO Message Generation Levels

IMPORTANT: *The observer must not edit in any way the coded messages unless the action is approved by WSH or SFSC. Unauthorized edits can cause data transmission and processing problems at NCEP.*

3.1 Meteorological Codes

WMO meteorological codes are defined by the World Meteorological Organization in WMO manual 306. The codes are composed of a set of values defined in tables with reference to specific position within strings of information. These defined values make up code form, and binary codes are made up of groups of letters representing meteorological or geophysical elements. Different code forms are used to represent different types of observations or products. In messages, these groups of letters are transcribed into figures indicating the value of state of elements described.

The NWS is responsible for transmitting the Freezing Level, Mandatory levels, Significant levels and levels above 100 hPa and BUFR. Refer to Section 3.3 “Coded Message Breakdown.”

3.2 The RADAT Message

The RADAT message indicates the height of the freezing level(s) in hundreds of feet based on pressure altitude, along with the highest relative humidity observer at a freezing level. This data is important to meteorologists and aviation interests. The software will automatically code the RADAT message and notify after achieving 400 hPa.

IMPORTANT: *Do NOT edit or change the data in the RADAT message. Pressure altitudes are used to generate heights and this data is not available to the observer. If the RADAT is erroneous you may code it as missing.*

The following is a breakdown of the RADAT message showing the elements the software automatically codes or can be manually coded by the observer. See table F-2 below:

Automatically Coded Groups (RADAT Message)	
CCC GGGG RADAT UU (D) (hphphp) (hphphp) (hphphp) (/n) RAICG HHMSL SNW	
CCC	3 Letter Station ID
GGGG	Observation time to the nearest hour (UTC)
RADAT	A contraction to indicate that freezing level data follows
UU	Relative humidity to the nearest percent. Use the highest RH of any of the coded crossings of the 0° isotherm. Code 00 when the RH is 100 percent. Enter “ZERO” when the entire sounding is below 0° Celsius. Code “MISG” when the surface temperature is warmer than 0° Celsius and the sounding is terminated before the 0° Celsius isotherm is reached. Coded // when RH is missing.
(D)	A letter designator identifying the 0° Celsius isotherm crossing to which the coded value of UU corresponds: L for lowest, M for middle, H for highest. When only one height value is coded, this figure is omitted.
(hphphp)	<p>A geopotential height coded in hundreds of feet above MSL at which the sounding crosses the 0° Celsius isotherm. A maximum of 3 levels are selected and displayed as follows:</p> <ul style="list-style-type: none"> A. The first crossing of the 0° Celsius isotherm after release B. The uppermost crossing of the 0° Celsius isotherm C. The intermediate cross of the 0° Celsius isotherm. When there are two or more intermediate levels, the level with the highest RH is selected. If these levels have the same RH, the lowest level is selected. D. After the levels are selected, they are encoded in ascending order of height.
(/n)	Indicator group to show the number of crossings of the 0° Celsius isotherm other than those whose heights are coded. If all crossings are coded, the /n group is omitted.
Manually Coded (RADAT Message)	
(RAICG)	<p>A contraction to indicate that icing data follows (only when icing is present)</p> <p>Note: As a general rule, RAICG should be appended if the dew point depressions at the 0° Celsius crossings are 3° or less and persist for several hundred meters.</p>

(HH)	The altitude of icing in hundreds of feet MSL as determined from the sounding. Include the indicator “MSL” following the height (e.g., RAICG 12 MSL indicating “icing above 1200 feet mean sea level”).
(SNW)	Include the contraction SNW if snow is apparently causing a slow ascension rate (e.g., RAICG 13 MSL SNW).

Table F-2: RADAT (Automatically Coded Groups)

Refer to table F-3 for examples of coded freezing level data:

Coded Freezing Data	RH %	Crossing Altitude (FT)			Coded As:
		Lowest	Middle	Upper	
Example 1	63	3500			RADAT 63L035
Example 2	89	2500	Missing	4200	RADAT 89H023///042

Table F-3 Coded Freezing Data

3.3 Coded Message Breakdown

See information below regarding coded message breakdown.

91285 TTAA 56001 91285 99011 28060 01009 00107 24856 01007
 92787 20456 33502 85514 18265 22504 70145 07413 27011 50586
 04170 33025 40758 17367 32025 30966 32764 30537 25092 40762
 30545 20241 52560 30541 15421 67158 30024 10657 79756 32024
 88999 77999 51515 10164 00011 10194 32003 23507=

IIiii TTAA YYGGId IIiii 99PPP TTTDD dffff 00hhh TTTDD dffff
 92hhh TTTDD dffff 85hhh TTTDD dffff 70hhh TTTDD dffff 50hhh
 TTTDD dffff 40hhh TTTDD dffff 30hhh TTTDD dffff 25hhh TTTDD
 dffff 20hhh TTTDD dffff 15hhh TTTDD dffff 10hhh TTTDD dffff
 88PPP 77PPP 51515 10164 000IsIs 10194 dffff dffff=

IIiii - Block number and station number

TTAA - Indicator of mandatory levels up to 100 hPa.

YYGGId-

YY - Day of the month, (When winds are given in knots 50 will be added to YY)

GG - Actual time of observation, to the nearest whole hour UTC

I_d - Indicator used to specify the pressure relative to the last standard isobaric surface for which a wind is reported. Reported to the nearest hundreds of hectopascals. (Used in TTAA and TTCC)

PPhhh - Mandatory pressure levels

PP - Starts with 99 - indicating surface 00 - 1000 hPa 92- 925 hPa 85 - 850 hPa on until 10 - 100 hPa.

hhh - Height in geopotential meters (gpm)

Sfc to 500 hPa - Reported in whole gpm (thousands not reported) 3204 gpm reported 204 500 hPa to

Term - Reported in tens of gpm 6053 gpm reported 605

TTTDD - Temperature and Dewpoint Depression Values

TTT - Dry bulb Temperature in degrees Celsius. Last digit indicates if the temperature is negative or positive. Negative temperatures will have an odd number for the 3rd digit. Positive temperatures will have an even number for the last digit.

DD – Dewpoint Depression. This number is subtracted from the dry bulb temperature. Numbers of less than 55, are degrees and tenths. (i.e.) 49 is 4.9-degree dewpoint depression. Numbers of 56 or greater are dewpoint depressions in whole degrees. To obtain the proper dewpoint depression value subtract 50 from any value 56 or greater. (i.e.) 72 would be a dewpoint depression of 22 degrees.

ddfff - Wind Direction and Speed

dd - True Wind Direction to the nearest 10 degrees. Wind directions of 500 degrees or greater indicate winds with speeds greater than 100 knots. When reading the direction in this case, one should subtract 500 from the direction and remember to add 100 to the wind speed value.

fff - Wind Speed in knots. Wind directions are actually rounded to the nearest 5 degrees. The unit digit of the wind direction is added to the hundreds digit of the wind speed. (i.e., 27520 is winds from 275 degrees at 20 knots.)

88hhh - TTTDD 88 - indicates tropopause

77hhh - ddfff 77 - indicates max wind group

51515 - Regional Code Groups Follow

10164 - Indicator that the stability index follows

10194 - Indicator that the mean low level wind groups follow

ddfff ddfff - First group mean winds sfc - 5000 feet

- Second group mean winds 5000 - 10000 feet

= (End of message symbol) It is a telecommunications character and is not part of the code.

91285 TTBB 56000 91285 00011 28060 11008 26057 22000 24856
33905 19057 44850 18265 55795 13257 66768 12260 77764 12039
88700 07413 99679 05817 11675 06259 22670 06661 33652 06061
44644 05666 55627 03462 66606 02068 77567 01163 88548 01271
99478 05769 11339 28364 22281 34763 33137 71358 44100 79756
31313 01102 82307 41414 59571=

Iiii TTBB YYGGa4 Iiii 00PPP TTTDD 11PPP TTTDD 22PPP TTTDD
33PPP TTTDD 44PPP TTTDD 55PPP TTTDD 66PPP TTTDD 77PPP TTTDD
88PPP TTTDD 99PPP TTTDD 11PPP TTTDD 22PPP TTTDD 33PPP TTTDD
44PPP TTTDD 55PPP TTTDD 66PPP TTTDD 77PPP TTTDD 88PPP TTTDD
99PPP TTTDD 11PPP TTTDD 22PPP TTTDD 33PPP TTTDD 44PPP TTTDD
31313 s_r r_ar_a s_as_a 8GGgg 41414 N_iC_LhC_MCH=

a4 - Type of measuring equipment used (used only in TTBB and TTDD)

- 0 - Pressure instrument associated with wind-measuring equipment
- 1 - Optical Theodolite
- 2 - Radiotheodolite
- 3 - Radar
- 4 - Pressure instrument associated with wind-measuring equipment but pressure element failed during ascent
- 5 - VLF-Omega
- 6 - Loran-C
- 7 - Wind profiler
- 8 - Satellite navigation
- 9 - Reserved

PPP - Pressure of Significant Levels Selected

SFC to 100 hPa - Levels selected to nearest whole hPa

Above 100 hPa - Levels selected to nearest 0.1 hPa

31313 - Data on Sea Surface Temp & Sounding System Used

s_r - Solar and infrared radiation correction.

- 0 - No correction
- 1 - Correction Made
- 4 - No Correction Made
- 5 - Correction Made

r_ar_a - Radiosonde Used

- 87 – Lockheed Martin Sippican GPS MarkIIA (USA)
- 51 - Lockheed Martin Sippican type B-2 time commutated (USA)
- 52 - Vaisala GPS RS92-NGP (Finland)

saSa -Tracking Technique/Status Used

- 00 - No windfinding
- 01 - Automatic with auxiliary optical direction finding
- 02 - Automatic with auxiliary radio direction finding
- 03 - Automatic with auxiliary ranging
- 05 - Automatic with multiple VLF-Omega frequencies
- 06 - Automatic cross chain Loran-C
- 07 - Automatic with auxiliary wind profiler
- 08 - Automatic satellite navigation

8 - Indicator

GG - Hour UTC of release

gg - Minute of release

41414 - Cloud Data NhCLhCMCH

Nh - Amount in eighths of all the CL present or, if no CL is present, the amount of all the CM present.

CL - Type of low cloud present

h - Height above surface of lowest cloud seen

CM - Type of middle cloud present

CH - Type of high cloud present

PPBB 56000 91285 90012 01009 01003 00502 90346 32002 26003
20502 90789 21005 23508 27013 91245 26512 27016 26514 9169/
31013 33026 9205/ 32523 32025 93013 31034 31538 29542 935//
30547 949// 30024 9504/ 30025 32037=

PPBB YYGGa4 Iiiii 9tnuuu dffff dffff dffff 9tnuuu dffff dffff dffff=

YYGGa4 Iiiii dffff - Previously described

9 - Indicator to show winds in units or 300 meters or 1,000 foot increments

t_n - Indicates tens digit of altitude - 0 = less than 10,000 feet 1 - 10,000 - 19,000 feet

u - Indicates the unit value of altitude of winds

91285 TTCC 56002 91285 70858 76757 05508 50059 63959 11005
30378 54160 06009 20638 51161 07512 88922 82356 33014 77999=

TTDD 5600/ 91285 11922 82356 22700 76757 33517 64359 44472
64959 55364 57560 66130 47162=

PPDD 56000 91285 9556/ 32522 33015 970// 13004 98047 08012
 09512 07012 99015 08012 08011 05005=

Breakdown for 101A_{df}A_{df} - Miscellaneous Regional Data

<u>Code Figure</u>	<u>Definition</u>
40 - 59	Reason for no report or an incomplete report
40	Report not filed
41	Incomplete report; full report to follow
42	Ground equipment failure
43	Observation delayed
44	Power failure
45	Unfavorable weather conditions
46	Unfavorable weather conditions
47	Leaking balloon
48	Ascent not authorized for this period
49	Alert
50	Ascent did not extend above 400 hPa level
51	Balloon forced down by icing conditions
53	Atmospheric interference
54	Local interference
55	Fading signal*
56	Weak signal*
57	Preventive maintenance
58	Flight equipment failure (transmitter, balloon, attachments, etc.)
59	Any reason not listed above

* Fading signals differ from weak signals in that "fading signals" are first received satisfactorily, then become increasingly weaker, and finally become too weak for reception, while "weak signals" are weak from the beginning of the ascent.

60 - 64: Miscellaneous

- 62 Radiosonde report precedes
- 64 Stability index follows: 000I_sI_s

65 - 69: Doubtful Data

- 65 Geopotential and temperature data is doubtful between following levels: 0P_nP_nP'_nP'_n
- 66 Geopotential data is doubtful between the following levels: 0P_nP_nP'_nP'_n
- 67 Temperature data is doubtful between the following levels: 0P_nP_nP'_nP'_n
- 68 Dew point depression is missing between the following levels: 0P_nP_nP'_nP'_n (not used when T_nT_n is also missing)

70 - 74 Not allocated

Breakdown for 101AdfAdf - Miscellaneous Regional Data (Continued)

- 75 - 89 Corrected Data
- 78 Corrected tropopause data section follows
- 79 Corrected maximum wind section follows
- 80 Corrected report for the entire report (first* and second* transmissions) follows
- 81 Corrected report of the entire PART A and/or PART B precedes
- 82 Corrected report of the entire PART C and/or PART D precedes
- 83 Corrected data for *mandatory levels*** follows
- 84 Corrected data for *significant levels*** follows
- 85 Minor error(s) in this report; correction follows
- 86 *Significant level(s)* not included in original report follow: //P_nP_nP_n T_nT_nT_nD_nD_n or P_nP_nP_nT_nT_n
- 87 Corrected data for *surface* follow

- 88 Corrected *additional* data groups follow: 101A_{df}A_{df}.....etc.
- 90 - 99
- 90 Extrapolated geopotential data follow: P_nP_nh_nh_nh_nh_n (d_nd_nd_nf_nf_n)
- 94 Averaged wind for the surface to 5000-foot MSL layer and the 5000 to 10000-foot MSL layer follows: ddfff ddfff (can be used in the PART A message)

Note: Numbers not shown have no assigned meaning or do not pertain to NWS upper air sites.

Unless both the stability index and the mean winds are missing, the Part A message always contains two special 101 groups as follows:

- 10164 Group that identifies stability index
- 10194 Group that identifies the man winds

A 5-character group 000IsIs follows the 10164 which contains the encoded stability index. The IsIs value that appears in the coded message for the stability index is interpreted as follows:

Stability Index Table

<u>Code Value</u>	<u>Meaning</u>
00 to 40	Stability index 0 to 40
51 to 90	Stability index is -1 to -40
91	RH < 20% at either base or 500 hPa level or calculation failed
92	RH is missing at the base level

The 10194 group for mean winds from the surface to 5000 feet MSL and from 5000 to 10000 feet MSL are encoded in two code groups using the format d_md_mf_mf_mf_m, where d_md_m is the mean direction and f_mf_mf_m is the mean wind speed. If the mean wind is missing, it is reported as // //. If winds for both layers (i.e. Sfc. - 5K and 5K to 10K feet MSL) are missing, the 10194 is not sent.

Additional 101 groups as shown in the Table can be entered after the 51515 as long as the last two digits are in ascending order with the other groups. For example, if the report has been corrected, this section would appear as follows:

51515 10164 00092 10181 10194 // // 26516=

4. Real Time Data Transmission

During the flight, upper air data is collected, processed and then disseminated by the system software as a WMO message, which NCEP is able to use to produce various analysis charts and models (e.g., 850, 500, 100, and 20 hPa, freezing level charts etc.) for data users. In addition, the system software captures and creates the 1-second data set that is packaged in a BUFR form, along with other text-based archive products that are then transmitted to National Centers for Environmental Information (NCEI) for final archival. For further information on archiving, see section 5 “Archiving.”

4.1 AWIPS Telecommunications

AWIPS decodes and stores the radiosonde BUFR collectives. AWIPS stores original radiosonde text messages in the text database. Decoded radiosonde observations are made available to CAVE D-2D which displays radiosonde data.

There are primary and secondary telecommunication paths. The primary path is via LAN. If the LAN is unavailable, the secondary path can be used. The System Software and AWIPS interfaces are depicted below in figure F-1 (LAN Transmission).

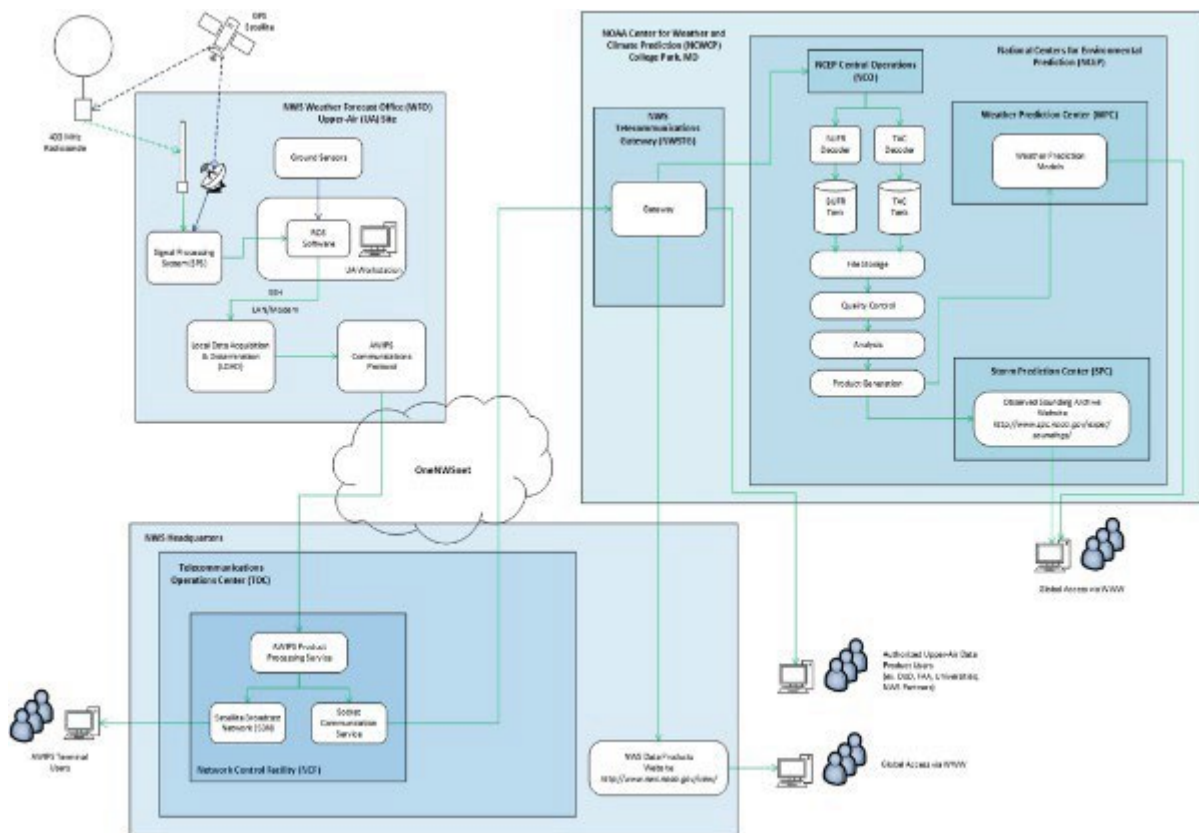

Figure F-1: RAOB and AWIPS Interface via LAN

The Secondary (manual) path is via Email in figure F-2 below:

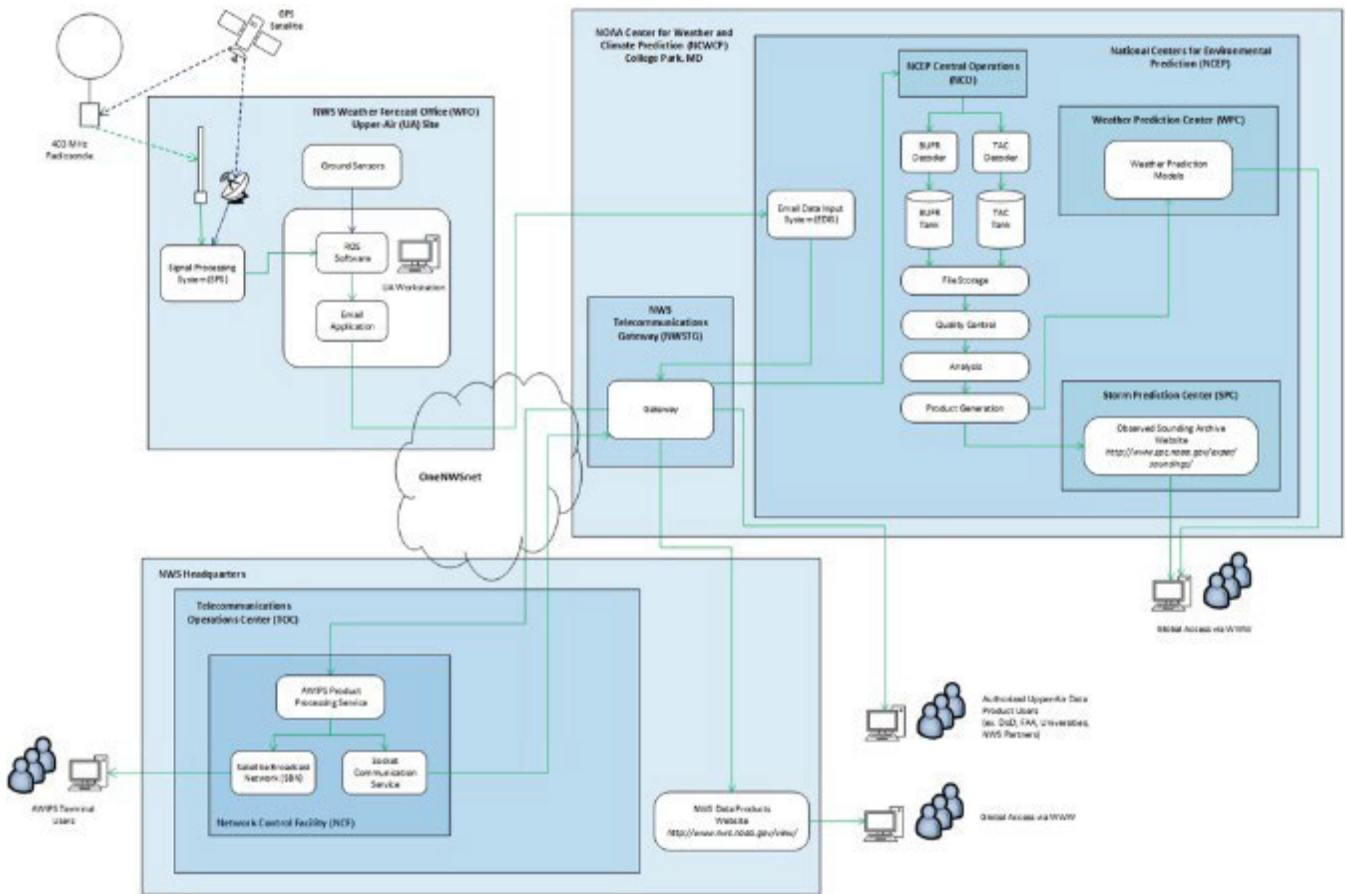

Figure F-2: RAOB and AWIPS Interface via Email

4.2 Transmission Timing

The coded messages containing data from the observation will be provided to AWIPS for dissemination to government agencies and other users in a timely manner. Once the observer has checked the quality of the data, follow guidance provided in the appropriate user manual for transmitting the coded messages. The data will be transmitted through the telecommunication system in a timely manner. Failure to transmit the observation on time will result in the data not being ingested into one or all the numerical weather prediction models. The deadlines for transmitting the coded messages are shown in Table F-4. H is the time at either 00:00 or 12:00 UTC

Part A:	H + 1 hour
Part B:	H + 1 hour
Part C:	H + 2 hours

Table F-4 Deadlines for Transmitting Upper Air Data

On a typical observation lasting 100 minutes, the Part A and B messages are ready for transmission at about H + 15 minutes and the Part C and D messages are ready at about H + 40 minutes. If the observer has other office duties to perform away from the upper air computer, the data should be checked and transmitted at the above times. If time is short owing to a delayed release or second/third release, at a minimum check and transmit Part A and Part B messages as soon as possible. Though WMO coded messages can be generated and sent anytime during or post-flight, the observer is not to exceed six hours after flight release to transmit messages.

4.3 Verification of Data Receipt at NCEP

After the coded messages are transmitted, the observer or AROS site manager will verify receipt of data by reviewing the NCEP Data Receipt “THANKS” webpage: [Quality Assessment Project \(noaa.gov\)](https://www.noaa.gov/quality-assessment-project). If all or a portion of the soundings are missed, retransmission will be done promptly.

5. Archiving

Sounding data is archived at the end of each observation by the system software. This data and meta-data are stored from the beginning of flight and can be accessed by the observer after the flight is completed or terminated. For more procedural detail on viewing the sounding summary and flight archive information, refer to the specific user guide pertaining to the sounding system at the site.

IMPORTANT: *The observer must not edit in any way the archive data unless the action is approved by WSH or SFSC. Unauthorized edits can cause data transmission and processing problems at NCEI.*

5.1 Transferring Archive Files

When a sounding is completed and the observer has reviewed the data for accuracy, the archived data files are transferred to the NCEI FTP site for future use and further dissemination.

5.2 Verification of Archive Receipt at NCEI

Upper air station staff will verify that NCEI data has received and processed all archives at least once a week. The NCEI webpages to verify receipt are found at [NCEI Integrated Global Radiosonde Archive \(IGRA\)](https://www.ncei.noaa.gov/data/upper-air/igra/) website.

For more information on transferring and verifying data to NCEI, refer to the appropriate user guide for the system at the site.

5.3 Archive Retention

All sites will retain a minimum of three months of soundings of flight data files on backup media or local/online storage approved by WSH to ensure redundancy at the site level.

APPENDIX G - QUALITY CONTROL OF DATA

Table of Contents	Page
1. Introduction	G-2
2. Upper Air Station Observer	G-2
3. National Centers for Environmental Prediction (NCEP).....	G-3
4. National Centers for Environmental Information (NCEI).....	G-3
5. Regional Headquarters.....	G-4
6. Weather Service Headquarters.....	G-4

1. Introduction

Although upper air observers are required to quality control their observation prior to dissemination, not all data errors or problems can be identified, corrected, or deleted. Effective data quality control is a multi-tiered process involving the upper air observer, National Centers for Environmental Prediction (NCEP), National Centers for Environmental Information (NCEI) and administrative offices at the regional and national level. This Appendix provides an overview of how upper air observations are quality controlled.

2. Upper Air Station Observer

The observer begins reviewing the quality of the sounding data via the system software shortly after release, throughout the sounding, prior to transmission and again prior to archiving. It is the responsibility of the observer to ensure that the basic scientific integrity of the data collected is maintained throughout the process. The observer should never assume that someone else will detect and correct the errors. See the system user guide for instructions and procedures for managing questionable and erroneous data.

There may be situations (e.g., severe weather outbreak or issuing warnings) where the workload may preclude checking the validity of the observation data prior to transmission. If such a situation occurs, and it will not be resolved before required data transmission times, allow the data to be transmitted. However, as soon as possible, check the validity of the sounding data, edit as appropriate, and resend to NCEI the sounding archive as a correction.

There may be cases when the observer is not sure about the quality of data even after edits are made and the sounding is transmitted. In such cases, the observer should contact the NCEP Senior Duty Meteorologist (SDM) and NCEI to make it known that there still may be problems with the data.

Note: *Observers must never transmit clearly erroneous soundings and expect the SDM to quality control the data. NWS soundings are used worldwide and the SDM only handles soundings used for NWS models.*

The observer and station manager should review all quality control reports received from NCEI, NCEP, Regional Headquarters, and WSH. These reports, as well as the station's WS Form B-29 information helps identify data errors and equipment problems.

Providing the highest quality upper air observations is essential for NWS forecasts and warnings. Sites will follow prescribed operating procedures using the appropriate system specific user guides and NWS approved training. Regional Office Headquarters and WSH personnel monitor observation data from the sites as do NCEP and NCEI. Disregard of data quality control procedures and policies will result in degradation of the site's performance and will be reflected in statistics compiled for evaluating the network and site performance. Refer to the system user manual to leverage alerts, notifications, plot displays and reporting features that will assist the observer in analyzing data for quality.

3. National Centers for Environmental Prediction (NCEP)

The National Centers for Environmental Prediction delivers national and global weather forecasts, warnings, and analyses to data users, including the general public. Upper air data is considered one of the most important data sets in determining the state of the atmosphere. NCEP assimilates radiosonde observations and other data into its operational models to produce weather forecasting guidance.

NCEP data quality checking includes a computerized comparison of the actual upper air data received from the upper air station with that generated from a “first guess” numerical weather prediction model. If the temperature, geopotential height, RH and/or wind data compare poorly, the upper air data are either deleted, corrected, or remain as is.

Upper air charts are also examined to help find bad data. NCEP quality control methods are not perfect and errors do pass through undetected. Thus, it is very important that the observer checks the validity of the observation data before it is disseminated.

Observers can review a summary of the NCEP upper air data quality control by reading the “Special NCEP Discussion” obtainable on the Advanced Weather Interactive Processing System (AWIPS) or other available web sources (e.g. NWS Chat or other). These messages include a log prepared by the SDM on observations they detected had data problems, were late or missing, and other information related to NCEP operations. Information on NCEP upper air data quality control is issued daily at about 02:00 and 04:00 UTC and 1400 and 1600 UTC. The first message at 02/14Z is to inform the field of the North American Mesoscale Forecast System (NAM) start and what stations were in for the NAM ingest (1315Z and 0115Z). The second message (at or about 04Z/16Z) is the status of the current cycle, including any new stations (in the NAM domain) that were available for the GFS data ingest (1546Z/0346Z).

Note: *The SDM log does not always include observation data rejected by the computerized automated Quality Control (QC) system. The SDM may overrule the automated QC recommendations to inform the field that, although the data may look erratic, the meteorology agrees that the observation is a true representation of the atmosphere. Observers need to review other NCEP reports to obtain a complete picture of their observation data quality.*

Observers should not be alarmed if, on occasion, all or a portion of their observation is flagged as having bad data. NCEP has data QC tools not available to the observer. However, NCEP’s data quality control program does not detect all errors and special care must be taken by the observer to ensure that the observations are checked for errors prior to being disseminated. If NCEP detects frequent problems with observations from a site, the station staff and Regional Headquarters will work together to determine if station equipment, software, or operational procedures are the cause and will take corrective actions.

4. National Centers for Environmental Information (NCEI)

NOAA's National Centers for Environmental Information (NCEI) is responsible for preserving, monitoring, assessing, and providing public access to the Nation's climate and historical weather data and information. NWS is required to provide the NCEI all products issued over its telecommunications and higher resolution data sets for use by researchers and other users. NCEI also provides NWS with data quality control reports. Each observation undergoes a series of checks to determine the plausibility

of all available data. If data is determined to be suspect or clearly erroneous, it is flagged as such but is not deleted from the archive.

Observers should not be overly concerned if NCEI detects errors. NCEI applies quality control techniques not available to the field sites. However, NCEI's data quality assurance program does not detect all errors and special care must be taken by the observer to ensure that the observations are checked for errors prior to being sent to NCEI. If NCEI detects frequent problems with observations from a site, the station staff and Regional Headquarters will work together to determine if station equipment, software, or operational procedures are the cause and will take corrective actions.

5. Regional Headquarters

The Regional Upper Air Program Manager, at a minimum, prepares and issues a quarterly report summarizing upper air station performance for the stations in their region. Data for this report comes from the various upper air forms (e.g., the WS Form B-29) the stations fill out each month, as well as data quality reports prepared by WSH. This report provides useful performance information (e.g., average burst altitudes) not found in the NCEP or NCEI reports. This report should be available for site review. If a site is performing poorly compared to other stations, the site and the Regional Office need to discuss the problems, identify the root cause, and determine possible solutions.

6. Weather Service Headquarters

WSH analyzes daily observations, as well as data quality reports and correspondence from NCEP, NCEI, and the Regional Offices. Stations with serious or ongoing data problems are identified. WSH coordinates its findings with Regional Offices and provides possible causes for the problems and recommended solutions.

APPENDIX H - STATION MANAGEMENT

Table of Contents	Page
1. Introduction	H-2
2. Required Documents to be On Station.....	H-2
3. Required Software to be On Station	H-2
4. Station Equipment, Safety, Inspections and Completion of Forms	H-2
5. Upper Air Observer Requirements	H-3
5.1 Recency of Experience	H-4
5.2 Cancellation of Independent Upper Air Observations Status	H-4
5.3 Staff Transferring.....	H-5
5.4 Changes in Systems or Instruments	H-5
6. Ordering Upper Air Supplies and Consumables.....	H-5
6.1 Rejected Supplies	H-5
6.2 NWS Liability for Radiosonde Incidents.....	H-6
7. Accurate Metadata Information	H-6
8. Public Requests and Access.....	H-6
9. NWS Open House and Other Public Events.....	H-6

1. Introduction

The site supervisor has the responsibility to ensure all aspects of the station's Upper Air operations are met. Station management of the Upper Air Program includes the following:

- a. Adhering to current upper air policy and procedures.
- b. Training and qualification of personnel.
- c. Assuring data quality and timely dissemination of products and information.
- d. Safety of personnel, care of equipment, and completion of station inspections.
- e. Ordering supplies and expendables.
- f. Ensuring accurate station metadata information.

2. Required Documents to be On Station

The following documents and reference manuals will be available and maintained at each upper air site:

- a. User guides for AROS or MROS platforms
- b. NWSM 10-1402, Radiosonde Observations
- c. Upper air section in the Station Duty Manual

WSH will be responsible for providing updated instructions as warranted. If the instructions are in error or require updating, notify the Regional Headquarters. If valid, Region will forward to WSH your suggested changes. These changes will be reviewed for possible inclusion in future updates.

3. Required Software to be On Station

The upper air office will have access to the vendor's latest version of software on station, at all times. Upper air offices will only have WSH authorized software installed onto the upper air workstation. Do not use unauthorized programs as they can pose a security risk and affect the overall functionality of the workstation.

4. Station Equipment, Safety, Inspections, and Completion of Forms

To ensure the safety of NWS staff working in upper air operations, all safety procedures will be stringently followed.

Each station should practice these key components for a safe and well-maintained working environment:

- a. The inflation building, Autosonde, upper air tracking equipment, compressed gas bottles, hoses, and the supply area must be well maintained. Document in EMRS any equipment problems,

deficiencies, or outages. Complete an USOS report if an equipment problem affects performing the observation.

- b. Work areas must be free of unneeded clutter and flammable materials.
- c. Observers are well trained, authorized and proficient to take upper air observations.
- d. Conduct regular maintenance and safety checks described in the operational and maintenance manuals.
- e. Conduct annual B-48 upper air station inspection and share with Regional and National Headquarters. Stations will retain a copy for three years.
- f. Notify applicable Regional Headquarters immediately of any equipment damage or safety concerns.
- g. Meet and discuss any issues to ensure site personnel have a clear understanding of issues and areas that require attention.

Regional Headquarters will complete a Station Inspection at least every two years to assess the station's overall performance. The information from this inspection should be documented and retained on-site for at least two years or until the station closes or the network is replaced by newer equipment or facilities.

5. Upper Air Observer Requirements

NWS upper air operating systems require operator intervention at some level. The expectation is that the observer knows how to perform routine and non-routine functions. This includes performing pre-release and in-flight actions to maintain a high success rate. The observer will edit and quality control data. This includes routinely checking and correcting software alerts and notifications.

The site supervisor determines whether NWS staff may be able to perform upper air observation independently after the compilation of the following minimums (depending on platform; MROS or AROS):

MROS

1. Helium sites complete the CLC compressed gas safety course as a minimum. Hydrogen sites will complete both compressed gas and hydrogen safety courses. Both types of gasses require annual recurring refresher training. Local management keeps a record of this training.
2. Complete the CLC course for the GRAW or Vaisala system (local management keeps course completion copies.)

3. Demonstrate proficiency in all activities to the satisfaction of the site supervisor. (Successfully Complete UA MROS Qualification Check-ride)

AROS

1. Complete compressed gas and hydrogen safety course (annually recurring required and local management keeps copies)
2. Complete CLC Site Operator, Remote Operator, or Remote Manager course (depending on role) (local management keeps copies)
3. Demonstrate proficiency in all activities to the satisfaction of the site supervisor

Note: An exception for editing data is for personnel utilizing the AROS platform. AROS users are not encouraged to edit and quality control the data given the high level of automation the system provides. However, in cases where obvious issues are noted, editing is necessary. Site personnel and the WSH are expected to verify the data.

5.1 Recency of Experience

An observer will take and record at least one complete upper air observation every 120 days. As a refresher, compressed gas/Hydrogen safety courses are required annually.

The site supervisor may suspend the independent upper air observations due to a failure to revalidate within 90 days of a transfer, exceeding the 120-day of maintaining experience requirement, or poor observer performance. When conditions causing the temporary suspension are corrected and verified through a successfully completed check-ride for MROS systems, the field supervisor may reinstate independent upper air observations.

5.2 Cancellation of Independent Upper Air Observations Status

The site supervisor may revoke independent upper air observations status when:

- a) More than 120 consecutive days have elapsed since the last observation.
- b) An observer is not satisfactorily performing upper air duties and responsibilities.
- c) An observer operates the equipment in an unsafe or dangerous manner.
- d) An observer has not completed annual refresher compressed gas/hydrogen training within 30 days of the annual due date.

Local management will maintain a record of canceled upper air observations status. Maintain each cancellation until no longer needed and then destroy. In the event of litigation, retain the "Cancellation" for an additional 2 years after the completion of the litigation, and then destroy.

5.3 Staff Transferring

The site supervisor has 45 days from the arrival of an existing NWS staff member from another upper air site to evaluate proficiency. Provide applicable training and determine independent upper air observations status.

5.4 Changes in Systems or Instruments

An NWS staff with a current independent upper air observation status transferring to a site that utilizes a different upper air-observing platform will successfully complete the platform requirement spelled out in section 5 above.

6. Ordering Upper Air Supplies and Consumables

Order supplies and consumables for the upper air program through NLSC only. Sites ordering consumables from sources other than the NLSC require permission from their respected regional headquarter and if needed national headquarters upper air staff.

Supplies should never drop below a 30-day inventory and never exceed 3 months. However, for remote locations (Alaska, Pacific), during extreme seasons (severe convection, hurricanes, fire weather, etc.), and approved special research projects a 4-month supply may be kept. This should allow adequate time for shipments to arrive without affecting operations. NLSC has a maximum shipping authorization on certain stock items; sites will not attempt to circumvent this by stockpiling unrealistic quantities of items. On occasion, supplies at NLSC reach very low levels. WSH will issue instructions on when to order supplies and the allowable amounts.

If inventory drops below 15 days, the office will order supplies immediately using emergency ordering procedures. Failure to adhere to this policy may result in supplies running out, resulting in missed soundings.

6.1 Rejected Supplies

WSH will determine the disposition of rejected radiosondes. Document all types of rejected radiosondes on the MIRS H-6 and if required by WSH return them to NRC within 3 days after the end of the quarter. Returning them in a timely manner is to meet the warranty period requirements. NWS will receive no compensation for the rejected radiosonde instruments when returned after the warranty period.

Enter rejected balloons on the MIRS B-29 form. The office will contact their respective regional headquarters and provide them with the manufacture date, lot number, and a picture of any damage if three or more balloons or parachutes are rejected within a month.

NWS upper air offices are not to provide upper air supplies to the public or take them for private use. Supplies include (but are not limited to) radiosondes, rejected radiosondes, balloons, parachutes, unwinders/dereelers, light sticks, and twine.

6.2 NWS Liability for Radiosonde Incidents

On rare occasions, radiosondes/flight trains may fall or fly on or into objects (tree, tower, top of a roof, vehicle), or livestock or animals may be lost or incur medical bills due to the ingestion of the balloon flight components. Contact regional headquarters to determine the disposition of a particular case. If an incident generates media attention or other inquiries, refer any requests for interviews to National Weather Service Public Affairs.

7. Accurate Metadata Information

It is essential that metadata information is accurate and up to date. Monitor Metadata periodically. If any of the entries are questionable, contact regional headquarters immediately. Do not make any modifications unless authorized by regional headquarters. If determined by Regional Headquarters to be incorrect, use the Upper Air Data Management System to submit a request to change.

Elements of upper air metadata:

1. Latitude and longitude of the baseline and balloon release points (Obtain from site surveys, blueprints, station information, and description pages.)
2. Baseline and Release points elevation to the nearest 0.1 meter
3. The height of the Precision Digital Barometer (PDB). (Release point height considered 1.2 meters above the height of the inflation-building floor. The surface pressure corrected for the difference in elevation of the baseline point and the release point).

8. Public Requests and Access

With communication electronics, including GPS receivers, getting smaller, less costly and more accessible the public has increasingly inquired about building and launching weather balloons. If an upper air station receives a request from the public asking for guidance in building a balloon payload, the site representative must refer them to the FAA. The FAA requires numerous compliance regulation standards before the public can release a balloon payload.

9. NWS Open House and Other Public Events

If the upper air office is planning public viewings of upper air launches, the site manager will follow all safety procedures. The public must stay a safe distance away from the gas supply and balloon flight train during preparation and launch. If it is released during a Non-synoptic time, the observations will be transmitted, archived, and logged in MIRs as with any other observation.

APPENDIX I - COMPLETION OF DOCUMENTATION (FORMS)

Table of Contents	Page
1. Introduction	I-2
2. Forms Required to be On Station.....	I-2
3. Completion and Submission of Forms.....	I-2
3.1 WS Form B-29 Radiosonde Report	I-2
3.2 WS Form B-48 Upper Air Program Review Guide.....	I-5
3.3 WS Form B-85 Upper Air Inventory	I-5
3.4 WS Form H-6 Report of Defective Radiosondes	I-7
3.5 WS Form H-14 Equipment Return Tag.....	I-9

Tables

I-1: WS Form B-85 Monthly Inventory Instruction	I-7
I-2: WS Form WS Form H-14 Equipment Return Tag Instruction	I-9

1. Introduction

Keeping records of upper air observation performance, equipment, and logistics is a key component of the Upper Air Program. This information is used to determine if the station is operated and maintained in accordance with established procedures and to help manage upper air supplies. Several forms are used to collect this information and this appendix provides information on their completion and submission.

Note: *It is essential that all upper air forms are completed with accurate information and submitted in a timely manner. Updates to a form submitted months ago have little value for NWS operations. All forms are to be completed accurately and submitted within 3 days after the specified period.*

2. Forms Required to be On Station

Accessibility to the following forms is required at each site either in an electronic format (soft copy), hard copy or via website:

WS Form 10-13-1	Certificate of Authority to take Weather Observations
WS Form B-29	Radiosonde Report
WS Form B-33	Station Inspection Report
WS Form B-48	Upper Air Program Review Guide
WS Form B-85	Upper Air Inventory
WS Form H-6	Report of Defective Radiosondes
WS Form H-14	Equipment Return Tag

3. Completion and Submission of Forms

Currently, there are three upper air forms that are submitted via the MIRS website. Station staff should consult their Regional Office Upper Air Program Manager for the latest URL to the website and request user accounts for new observers so they can access the following forms:

- WS Form B-29
- WS Form B-85
- WS Form H-6

WS Form H-14 is completed using Word or other approved document software and sent via email or postage mail to appropriate NWS staff as directed.

Note: *All upper air forms, paper or electronic copies, will be retained on station for at least one year or until the Office is closed. In the event of an office being transferred to a new location, the transfer-to facility will assume responsibility for record keeping.*

3.1 WS Form B-29, Radiosonde Report

WS Form B-29 is accessed via the MIRS website and should be submitted each month. Begin this form with the scheduled 0000 UTC observation on the first day of the month. Observation information should be logged into the form after each observation. The completed monthly form is then submitted at the end of the month (not to exceed three days post-EOM).

Caribbean upper air stations funded by WSH should also submit the form via MIRS website. If accessibility to the website is unavailable at any time, the site is required to prepare three copies of WS Form B-29. One of each copy should be sent to the WSH Upper Air Program Office, WSH Maintenance/Facilities Branch and one copy to stay on site for station records.

Entries on the WS Form B-29 should be made as follows:

- A. **Station Information:** The station name and the four-letter Station Identification Number (SID), the name of the person preparing the form, the form date, number of observations, and the observation ascension numbers are automatically filled in. This information should be checked for accuracy and WSH notified if errors are found.
- B. **Rejected Balloons:** Enter the balloon manufacturer, lot number or date of manufacture, and select the reason for rejection. Include in the remarks section balloon type, size, and type of defect for each balloon rejected during the period of the report.
- C. **Unsuccessful Releases:** Make entries for all radiosondes released that did not reach 400 hPa. This includes observations not assigned an ascension number. Whenever entries are made for an unsuccessful release and the cause of the early termination is known, document the problems encountered during the observation.
- D. **Second and Third Releases:** Enter the observation date, flight time, and if the release is a second or third. Include in the remarks the reason for taking the extra release.
- E. **Missed and Special Observations**
 - 1. **Missed Observations** - Enter the date, time, and reason when a scheduled observation is not taken. In the remarks section provide additional information on the missed observation and corrective actions made.

A missed observation is defined as a 00z or 12z observation where no upper air data aloft was available for transmission to NCEP and NCEI. This would occur when the ground equipment is broken and no radiosonde can be released, or, when a release occurred but no data was received or all data was considered erroneous and no second release was authorized.

If good data is obtained from a radiosonde that failed to reach 400 hPa, and no other sounding was authorized, then this sounding is given an ascension number and the data transmitted to NCEP and NCEI.

- 2. **Special Observations** - Enter the date, time of release, and the reason for taking a special. In the remarks section, note who requested the special observation, (e.g., Storm Prediction Center, National Hurricane Center, Lead Forecaster).

Note: *Enter only special observations that have been assigned an ascension number and sent to NCEI for archival. Also, enter all specials taken in the Flight Summary Information Section. Refer to*

Appendix C “Observation and Launch Preparations.”

F. **Station Operation and Equipment Remarks:** All other pertinent remarks not included in other sections of the form should be included in this block. Mandatory remarks include:

1. Effective date and time of changes in the Upper Air Program. This includes instructional changes, change in the type of radiosondes used or the number of routine observations per day, installation of new upper air equipment, and equipment modifications.
2. Ground equipment problems encountered and corrective actions taken. When a system or a component of a system has been inoperative during the period covered by the report, enter the name of the system or component and appropriate dates out of service and back in service.
3. Corrections to entries on preceding WS Form B-29’s. A brief, but complete explanation should be included.
4. Continuation of remarks from the remarks section in the Observation Summary section of the form.

G. **Flight Summary Information:** Make entries in the Flight Summary for each observation that is assigned an ascension number. Observations taken for test purposes or comparatives would be logged in the Special Releases and a note made in the “Remarks” column. Make entries as follows:

1. Ascension Number (ASCNO): List each observation that has been assigned an ascension number.
2. Date (UTC): Select the month and day of the observation.
3. Observation (OBS) Time (UTC): Enter the observation time to the nearest whole hour, UTC; (e.g., “12” would be entered for the 1200 UTC observation).
4. Radiosonde Serial Number: Enter the complete radiosonde serial number. This includes letter designations that are a part of the radiosonde serial number.
5. Sonde Type: Select the radiosonde type (GPS = Global Positioning System).
6. Manufacturer: Select the appropriate balloon manufacturer.
7. Lot Number or Date of Manufacture: Enter the balloon lot number. If not available, enter the date of balloon manufacture printed on the balloon bag or shipping box.
8. Nozzle Lift: Enter the value to the nearest 100 grams or cubic foot. foot (For AROS, input fill volume).

9. Balloon Ascent Rate: Enter the ascent rate of the balloon from the surface to the 400 hPa level and from the 400 hPa level to observation termination. Enter the values to the nearest meter.
10. Radiosonde Observation (RAOB) Termination: Select the reason for termination.
11. Height: Enter the termination height of the observation to the nearest meter.
12. Remarks: Enter remarks concerning anything unusual about the observation. If additional space is needed, the remarks should be continued in the Station Operation and Equipment Remarks section.
13. Observer: Enter the initials of the observer who took the observation.

3.2 WS Form B-48, Upper Air Program Review Guide

This checklist is an excellent tool to evaluate a site's upper air program. The WS Form B-48 serves a dual purpose. It allows the site to do a self-inspection of their upper air operations and correct deficiencies. The inspection checklist is also used by national and regional personnel when visiting an upper air site to ensure the site is following established procedures and guidelines. The form has been designed to promote uniformity in the site inspection procedures to ensure each site knows what is expected and what areas should and will be checked routinely. After completion, a copy should be emailed to WSH.

A. Completion of WS Form B-48:

1. Each site should use the checklist to perform a self-inspection once every 12 months. Deficiencies should be corrected immediately.
2. Regional personnel should visit each upper air site at least once every 2 years and use the form in conjunction with the WS Form B-33 to assess the station's overall performance.

3.3 WS Form B-85, Upper Air Inventory

WS Form B-85 is accessed via the MIRS website and should be completed promptly at the end of each month. The completed monthly form is verified for accuracy and submitted at the end of the month (not to exceed three days post-EOM).

Caribbean upper air stations funded by WSH should submit the form via MIRS website. If the website is unavailable at any time, the site is required to prepare three copies of WS Form B-85. One of each copy should be sent to the WSH Upper Air Program Office, WSH Maintenance/Facilities Branch and one copy to stay on site for station records.

Entries on the WS Form B-85 will be completed as follows:

- A. Station Information: The station name and the four-letter station identification (SID), the name of

the person preparing the form, and the date are automatically filled in. This information should be checked for accuracy and WSH notified if errors are found.

- B. Monthly Inventory - Part I: Columns identified as “Radiosondes and Balloons” are divided into sub-columns. This is for the sites having more than one type of radiosonde or balloon type on station. In such instances, separate inventories for each type of radiosonde or balloon are required.

Make the following entries:

Line #	Field	Instruction
1	Beginning Balance	Enter total number of radiosondes and balloons at the start of the month.
2	Quantity Received During Month	Enter the number of radiosondes and balloons received during the month.
3	Total Available During Month	The total of line 1 and line 2.
4	Released During Month	Total number of radiosondes and balloons released in the month. This includes the number used for additional releases and comparisons.
5	Quantity of Serviceable Items Shipped	Indicate the number of serviceable radiosondes or balloons shipped during the month. Indicate in “Remarks” the site to which they were shipped.
6	Number of Items Rejected	Number of radiosondes and balloons rejected for whatever reason.
7	Total Used	Total number of radiosondes and balloons used during the month (Sum of line 4, line 5, and line 6).
8	Ending Balance	Number of serviceable radiosondes and balloons on hand at the end of the month. This is the difference from line 3 and line 7. Do not include rejected items.
9	Ending Balance (Actual Count/Serviceable Items)	Number of serviceable radiosondes and balloons on hand at the end of the month by actual count. Do not leave this entry blank.
10	Defective Items on Hand	The number of defective radiosondes and balloons on hand at the end of the month. Enter “0” if there are no defectives.

11	Quantity of Defective Items Shipped	Total number of defective radiosondes and balloons shipped during the month to the National Reconditioning Center (NRC). Contact WSH for instructions on where to ship defective balloons.
12	Surplus Hygristors on Hand	Enter "0".
13	Surplus Batteries on Hand	Enter "0".
14	First Shipment Number	Enter the shipment number taken from the outside of the radiosonde or balloon box for the first shipment.
15	Second Shipment Number	Enter the shipment number taken from the outside of the radiosonde or balloon box for the second shipment.

Table I-1: WS Form B-85 Monthly Inventory Instruction

C. Supplemental Inventory and Remarks - Part II - Take an end of the month inventory of all upper air expendables and fill in the appropriate form entries. This includes the count of individual cylinders of lifting gas, lighting units, train regulators/dereelers, parachutes, and rolls of twine. Do not enter the quantity of boxes or cases in stock.

D. Flight Summary:

Number of 2nd Releases: Enter the total number of second balloon releases during the month.

- a. Number of 3rd Releases: Enter the total number of third releases during the month.
- b. Number of Special Releases: Enter the number of special releases for whatever reason.
- c. Number of Unsuccessful Releases and Observations: Enter the total number of releases that did not reach 400 hPa. Note: This number must be equal to or greater than the total number of 2nd and 3rd releases.
- d. Remarks: include information about supplies. This includes items missing from a shipment, excessive number of batteries rejected, damage to shipments, and the balloon and radiosonde type listed as "other." Use this space as a continuation sheet for Part I whenever necessary. In addition, sites using the AROS should use this section to track quantities of balloon nozzles.

3.4 WS Form H-6, Report of Defective Radiosondes

WS Form H-6 is accessed via the MIRS website and should be filled in and submitted as radiosondes require rejection. At a minimum, the form is completed and submitted within three days after the end of each quarter. When shipping a box of rejected Radiosondes to NRC, a hard copy of the H-6 form should be enclosed within each box of the shipment.

Caribbean upper air stations funded by WSH should also submit WS Form H-6 using approved procedures. Prepare three copies of the form. One copy should be sent to the WSH Upper Air Program Office, and one copy should be sent to the WSH Maintenance Logistics and Facilities Branch. The final copy should be kept on station until the station is closed or when networks are replaced by newer equipment or facilities.

Note: *Before shipping out rejected radiosondes, consult with Site Manager for additional guidance regarding this process.*

Entries on WS Form H-6 will be completed as follows:

- A. Station Information: The station name and the four-letter station identification (SID), the name of the person preparing the form, and the form period are automatically filled in. This information should be checked for accuracy and WSH notified if errors are found.
- B. Radiosonde Serial Number: Enter the complete radiosonde serial number for each instrument rejected. This includes letter designations that are a part of the radiosonde serial number.
- C. Date on Sonde: Select the date the radiosonde was manufactured. This is typically stamped on the outside of the radiosonde. If there is no stamped date, check the shipping information sheet for the date. For AROS, the date can be decoded from the serial number.
- D. Date Rejected: Select the date the radiosonde was rejected.
- E. Reason for Rejection: Select the reason for rejecting the radiosonde.
- F. Specific Information on why the radiosonde was rejected. Provide a description of the defect, if known. If unknown, describe the performance which resulted in the rejection.
 - a. Upon opening the radiosonde package, if the radiosonde is damaged (e.g., crushed, missing wire, broken sensor), the entire device should be rejected and a warranty return to the NRC is required.
 - b. The radiosonde is missing parts (e.g., missing sensor, other) reject the instrument.
 - c. A radiosonde being returned that is not defective but being sent back for reconditioning should be identified as such (i.e., instrument returned to office by the public).
- G. 1st OBS Inits and 2nd OBS Inits: Enter the initials of the two persons who determined the radiosonde was defective. If possible, all rejected radiosondes should be rechecked by someone other than the person who rejected the radiosonde initially.

Note: *Ship defective radiosondes by parcel post to NRC. Ship defective radiosondes every 90 days, at a minimum, to ensure the one-year warranty does not lapse.*

3.5 WS Form H-14 Equipment Return Form

WS Form H-14, Equipment Return Form, should be used to return defective balloons to the National Reconditioning Center. Each balloon found to be defective should be returned to NRC prior to its 1-year warranty expiration.

Stations will mail the original to the National Reconditioning Center in Kansas City and keep a copy of the WS Form H-14 on station until the station is closed or when the networks are replaced by newer equipment or facilities. Transfer to the new facility that assumes responsibility.

Send to:

National Reconditioning Center
 14200 Merritt Road
 Attn: NRC Logistics (Staging)
 Grandview, MO 64030

Entries on the WS Form H-14 are as follows:

Note: Refer to section *To Be Completed by Field Technician*****

Field	Instruction
Failed Item Serial Number	Enter the item serial number
For AWIPS hard drive, Server Number	Enter AWIPS server number (if applicable)
Failed Station Call Letters	Enter the station’s four-letter SID
Name	Enter Station Name
24 Hour Contact Telephone Number	Enter 24-hour contact number
Description of Malfunction	Enter detailed description of the equipment or instrument malfunction
Reason for Return <ul style="list-style-type: none"> ● Defective ● Defective Upon Installation ● Return Not Used/Excess Stock ● Returned for Calibration ● Instructed by NWS Headquarters ● Instructed by Regional Headquarters ● Incorrect Item Received ● Damaged in Transit ● Within Warranty Return ● Other (Specify Below) 	Enter a checkmark next to any boxes that apply. If “other,” specify in area provided

Table I-2: WS Form WS Form H-14 Equipment Return Instruction

APPENDIX J - SURFACE OBSERVATION SYSTEMS

Table of Contents

	Page
1. Introduction	J-3
2. Surface Observation Systems	J-3
2.1 RSOIS (Radiosonde Surface Observing Instrument System)	J-3
2.1.1. Sensors	J-4
2.1.1.1 Vaisala/Handar Wind Sensor	J-4
2.1.1.2 R.M. Young Wind Sensor	J-5
2.1.1.3 Temperature/Humidity Sensor	J-5
2.1.2 RSOIS Base Station	J-5
2.1.3 Remote Processing Unit (RPU)	J-6
2.1.3.1 Cabling and Power	J-7
2.1.3.2 Lightning Protection	J-7
2.1.4 Antenna	J-8
2.1.5 RSOIS Siting	J-8
2.1.5.1 RSOIS Tower Siting	J-8
2.1.5.2 RSOIS Sensor Siting	J-9
2.1.6 RSOIS Maintenance	J-10
2.2 Automatic Weather Station (AWS)	J-10
2.2.1 Cabling and Power	J-11
2.2.2 Lightning Protection	J-11
2.2.3 Sensors	J-11
2.2.3.1 Vaisala HUMICAP Humidity and Temperature Probe	J-11
2.2.3.2 Internal Pressure Sensor	J-11
2.2.3.3 Vaisala WINDCAP Ultrasonic Wind Sensor	J-12
2.2.4 Weather Station Enclosure	J-11
2.2.5 AWS Siting	J-12
2.2.5.1 AWS Mast Siting	J-12
2.2.5.2 AWS Sensor Siting	J-12
2.2.6 AWS Maintenance	J-12
2.3 Automated Surface Observing System (ASOS)	J-13
2.4 Surface Observation Equipment Failure	J-13

Figures

J-1: RSOISJ-3
J-2: Precision Digital Barometer (PDB)J-4
J-3: Vaisala Handar Wind SensorJ-4
J-4: R.M. Young Wind MonitorJ-5
J-5: Temperature/Humidity Sensor.....J-5
J-6: RSOIS Base StationJ-6
J-7: Remote Processing Unit (RPU)J-7
J-8: RPU Cabling - AC and FiberJ-7
J-9: Yagi AntennaJ-8
J-10: Automatic Weather Station (AWS)J-11
J-11: AWS Enclosure BoxJ-12
J-12: ASOS Sensor Rail.....J-13

1. Introduction

A complete surface weather observation is an essential part of the upper air observation and is included in the disseminated data products. This appendix describes the different Surface Observation Systems and should provide the user useful knowledge on how components operate within each respective system.

2. Surface Observation Systems

The NWS uses different Surface Observation Systems at numerous sites across the United States, Pacific Region, and upper air stations located in the Caribbean. An observer may find one or more types of Surface Observation Systems on site depending on the support requirements for that station and platforms being used. NWS Surface Observation Systems are comprised of the following systems:

- RSOIS (Radiosonde Surface Observing Instrument System)
- RSOIS PDB (Precision Digital Barometer)
- ASOS (Automated Surface Observing System)
- AWS (Automatic Weather Station)

2.1 Radiosonde Surface Observing Instrument System (RSOIS)

The RSOIS gathers and reports data on weather parameters at the surface to be used in the analysis of the upper air data obtained during an observation. In routine operations, the sensors mounted on a tower at the launch site provide data to a processor in a metal enclosure. Also mounted on the tower is the Remote Processing Unit (RPU). The processor in turn feeds data to a Radio Frequency (RF) modem or fiber optic modem housed in the same enclosure. The data are transmitted to a unit called the Base Station where the weather observer can monitor the information. The Base Station is a radio processor and LCD display housed in a single breadbox-sized unit.



Figure J-1: RSOIS (mast height may vary)

2.1.1 Sensors

The RSOIS uses multiple sensors that provide measurements for temperature, relative humidity, and wind near the location where a radiosonde is released. Pressure readings are gathered from the Precision Digital Barometer (PDB) located inside the office at the baseline location. For detailed information regarding sensor specifications and accuracy ranges, refer to the latest RSOIS Installation, Operation and Maintenance Manual.



Figure J-2: Precision Digital Barometer (PDB)

2.1.1.1 Vaisala/Handar Wind Sensor

The wind sensor provides wind speed and direction. The wind sensor does not depend on mechanical movements as do the traditional rotating-cup anemometers and wind vane direction indicators. Measurements of both averaged wind speed and direction are reported based on the transit times for ultrasound between the spikes of the wind sensor that are fixed in position. The wind sensor is a Vaisala/Handar 425AHW Ultrasonic Wind Sensor and is considered a 'smart' sensor. It contains a microprocessor that computes the averages and provides 5-second average wind speed, 5-second average wind direction, heater circuit quality, and other data. The heater is thermostatically controlled and prevents freezing rain or snow buildup. It is positioned 10 meters above ground level.



Figure J-3: Vaisala Handar Wind Sensor

2.1.1.2 R.M. Young Wind Sensor

The R.M. Young Wind Monitor provides wind speed and direction data and is used as a backup to the ultrasonic sensor. The WM is not heated; therefore, it is susceptible to icing and is only used at low-risk sites.



Figure J-4: R.M. Young Wind Monitor

2.1.1.3 Temperature/Humidity Sensor

The contained sensors are housed within a Gill Aspirated Radiation Shield which reduces radiation errors to less than 0.1°C. The sensors are located approximately 2 meters above the ground.

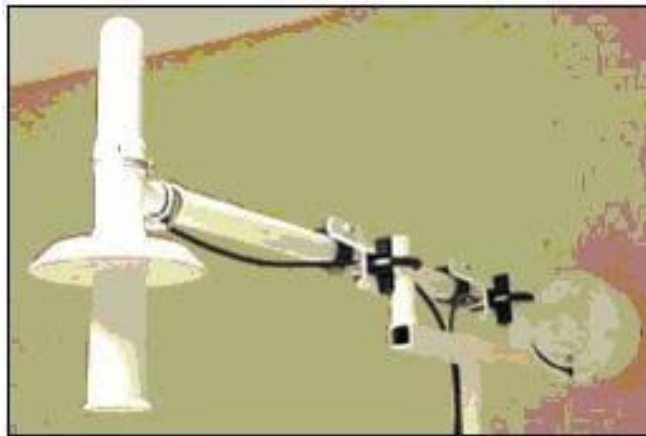

Figure J-5: Temperature/Humidity Sensor

2.1.2 RSOIS Base Station

Readings are displayed on the RSOIS Base station on a Liquid Crystal Display (LCD). If the base station is receiving data, the data light illuminates every 5 to 7 seconds.

Wind Speed and Direction Readings:

- SP: Current 2-minute average wind speed
- GU: Gust speed; max wind speed in the past 10 minutes
- PK: Peak 5 second wind speed in the past 2 minutes

- WD: Current 2-minute average wind direction
- WC: 0 for steady winds and set to 1 if the current wind speed is > 6 knots, and the total wind direction range in the current 2-minute average is 60 degrees or more.

Temperature, Dewpoint and Relative Humidity Readings:

- AT: Current 5-minute average temperature in °C
- DP: Current 5-minute average dew point temperature in °C
- RH: Current 5-minute average relative humidity by %

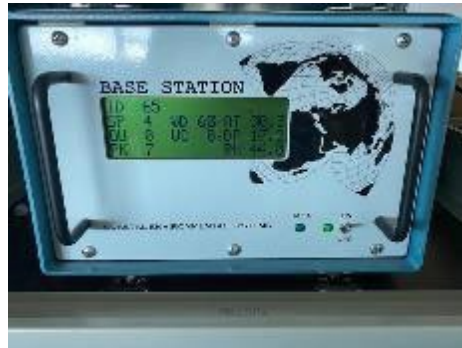

Figure J-6: RSOIS Base Station

2.1.3 Remote Processor Unit (RPU)

The Remote Processor Unit consists of the following components:

- a. System Data Logger (SDL) - The Zeno-3200 SDL is a simultaneous multi-tasker that controls the sensors, logs, performs averaging, formatting, communications and other calculations.
- b. Power supply
- c. 12-volt backup battery - The backup power is provided by a 12 VDC, 38 amp-hour YUASA battery that independently powers the RSOIS for approximately 30 hours operation depending on temperature.
- d. Spread spectrum radio
- e. Fiber optic modem
- f. Sensor ports
- g. Watchdog Timers - Built into the SDL to verify RAM and operating memory in the event of an electrical surge or lightning strike.
- h. System Software Fault Detection - This software examines the sensors and detects common faults to ensure the sensors are operating within range. If the sensor readings should fail any of the tests, an alarm message is logged and transmitted with the next data transmission.

A 32-bit Built-In-Test (BIT) field is used to convey warning information. Other SDL self-tests include:

- Analog input zero-offset reading
- EEPROM (Electrically Erasable Programmable Read-only Memory) Read/Write status
- Logging-memory status
- System power
- Internal temperature
- Real-time clock - uses a 10-year lithium battery that is independent of the system backup battery. The clock is calibrated to give an accuracy of 5 seconds per month.



Figure J-7: Remote Processing Unit (RPU)

2.1.3.1 Cabling and Power

In routine operations, the remote processing unit (RPU) is powered by alternating current (AC) entering through the base of the enclosure. This particular picture shows fiber optic cable that is used for communication with the base station. The RPU can support either radio communication or use of a fiber optic cable driver, but not both simultaneously.

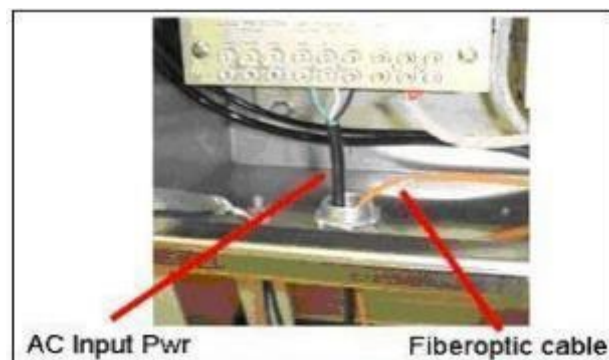

Figure J-8: RPU Cabling - AC and Fiber

2.1.3.2 Lightning Protection

The RSOIS includes a tower mounted lightning rod that is connected to an earth grounding system. Lightning protection and diversion of the RPU is in addition to protection provided by the tower-mounted lightning rod. In the event of a strike, induced currents are diverted to earth ground via the metallic electronics enclosure. Resistor-capacitor decoupling networks acting in concert with resistor-diode networks are built into each line entering sensitive semiconductor devices.

2.1.4 Antenna

The tower-mounted antenna at the RPU is a Yagi meant for the 2400-2483.5 MHz frequency band. It has a length of 7 1/4 inches. With a 60° horizontal beam width, it can be aligned visually. The radio and antenna system provide up to 3 miles line-of-sight communications.



Figure J-9: Yagi Antenna

2.1.5 RSOIS Siting

Siting requirements are necessary to ensure accurate measurements and sustained tower stability. All siting criteria below must be met unless a waiver for specific criteria has been granted by the Office of Climate, Weather, & Water Services. If RSOIS is to be moved, contact WSH for consultation and approval.

2.1.5.1 RSOIS Tower Siting

The RSOIS tower shall meet the following requirements:

- a. The tower shall be plumb and at least 6.00 to 10.00 meters tall.
- b. The structural integrity at the apex of the tower is able to withstand a 113.5 kilograms vertical load and wind speeds to 75.00 knots sustained and 110.00 knots gust.
- c. RSOIS requires 115 VAC single phase, 15 ampere circuit power. The tower should have a power distribution panel with GFI breaker. A disconnect box outlet should be available at or near the base of the tower.

- d. The RSOIS stainless steel cabinet shall be securely mounted to the tower near the mounting attachment for the humidity sensor arm. Power, signal, and fiber optic cables shall enter the bottom of the stainless-steel cabinet.
- e. Other systems may be mounted on the tower provided there is space to accommodate RSOIS and other systems mountings will not contaminate temperature, RH, and wind measurements.
- f. The tower shall have appropriate manufacturer warning signs attached.
- g. The tower shall have lightning protection. RSOIS components on the tower are to be protected in a 60-degree cone below the tip of the lightning rod (or tower apex). The Ultra Sonic Wind Sensor shall be mounted, at the required height, within this cone without obstruction from other equipment on the tower.
- h. The tower must be properly grounded in accordance with the instructions in Engineering Handbook 11, Volume 2, Section 3.6, Draft Modification Note 1. Existing earth grounding should be 25 ohms or less or within local electrical code.

2.1.5.2 RSOIS Sensor Siting

The RSOIS sensors shall meet the following requirements:

- a. Located within 200 meters of the balloon launch area. The surface must be in its natural state and grass kept to a height of no more than 20 cm. The area should not be walked on except along paths (not made from asphalt or concrete).
- b. The RSOIS tower shall not constitute a hazard to the radiosonde release. The location should be off to the side of the launch area and not in line with launches in prevailing winds.
- c. Wind sensors must be mounted on a tower between 6.00 and 10.00 meters above the ground. The downwind distance between the wind sensor and any obstruction must be at least 6 times the height of the obstruction. The siting of the wind sensor upwind of an obstruction can be twice the height of the structure. Wind equipment should be located outside this zone of influence.
- d. The temperature/RH sensors must be securely mounted on the tower between 1.25 and 2.00 m above the grass covered ground. Stations with significant snow depth accumulations shall mount the temperature and RH sensor 1.25 to 2.00 m above the worst average snow depth. An acceptable site shall be over level ground, freely exposed to sunshine and wind, and not shielded by or close to obstructions such as trees and buildings.
- e. It is preferred for the wind sensor, temperature sensor, and RH sensor to be mounted on the same tower. However, if wind sensor siting is difficult, separation from the temperature and RH sensors can be accommodated. The wind sensor can

be placed within 60 cable meters of the tower mounted data electronics enclosure.

- f. If the radiosonde is launched from the roof of a building and ground-based siting of RSOIS is not feasible, the surface sensors may be installed on the roof provided special arrangements are made to minimize roof top heating effects.

Note: *The RSOIS equipment is not to be used as an official backup to other observing systems. This observation system is strictly to be used with upper air observations.*

2.1.6 RSOIS Maintenance

Routine and preventative maintenance is required. This system is an official National Weather Service (NWS) observing system. For detailed information regarding RSOIS, refer to the Technical Manual Organization Level Maintenance Manual Rev B.

Reference Documents: Engineering Handbook 9/Equipment Manuals: Section 1.2 Radiosonde Surface Observing Instrumentation System/Manual Index: Technical Manual Organization Level Maintenance Manual for more information.

NCEP issues a monthly report on super-adiabatic lapse rate layers detected by their data QC system. The report can be referenced here: <https://sites.google.com/a/noaa.gov/nws-radiosonde-observations/ncep-radiosonde-super-adiabats>

Site staff should review this report monthly and if strong supers off the surface are observed, corrective actions shall be taken. The surface weather equipment may be out of calibration or sited poorly.

2.2. Automatic Weather Station (AWS)

The NWS utilizes an Automatic Weather Station exclusively to support the AROS platform. The Vaisala AWS is normally installed within 200 meters from the Autosonde structure. The weather station has a 10-meter high tiltable mast and guy wires to support the mast and sensors. It is designed to withstand high wind conditions up to 112 mph. The AWS is a data collection system that measures, processes, and stores meteorological data and transmits that data to the workstation software for further processing and presentation for the observer.



Figure J-10: Automatic Weather Station (AWS)

2.2.1 Cabling and Power

The AWS is powered by AC entering through the base of the enclosure terminated to the mains circuit breaker.

2.2.2 Lightning Protection

The AWS mast has an earth grounding system independent from the Autosonde that in the event of a strike, induced currents are diverted down to the system grounding point in the enclosure connected to earth ground.

2.2.3 Sensors

The AWS sensor array includes humidity, temperature, pressure, wind direction and speed.

2.2.3.1. Vaisala HUMICAP Humidity and Temperature Probe HMP155

The Vaisala HUMICAP probe measures relative humidity and air temperature, which is used to calculate dew point. A radiation shield is installed to provide proper ventilation while protecting the sensor from solar radiation and precipitation.

2.2.3.2 Internal Pressure Sensor (Baro-1)

The AWS incorporates a measurement module for determining barometric pressure. The module uses a capacitive sensor and performs barometric pressure calculations for Height Corrected Pressure (HCP), Pressure at a certain level (QFE), Pressure reduced to mean sea level (QNH), and internal temperature compensation which results in accurate pressure readings. This module also performs self -diagnostics to ensure working performance.

2.2.3.3 Vaisala WINDCAP Ultrasonic Wind Sensor WMT700

The ultrasonic wind sensor measures wind speed and direction.

2.2.4 Weather Station Enclosure

The AWS310 contains an enclosure which houses the AWS battery, mains power switch, battery regulator, Data Logger (QML), and static pressure head connection.

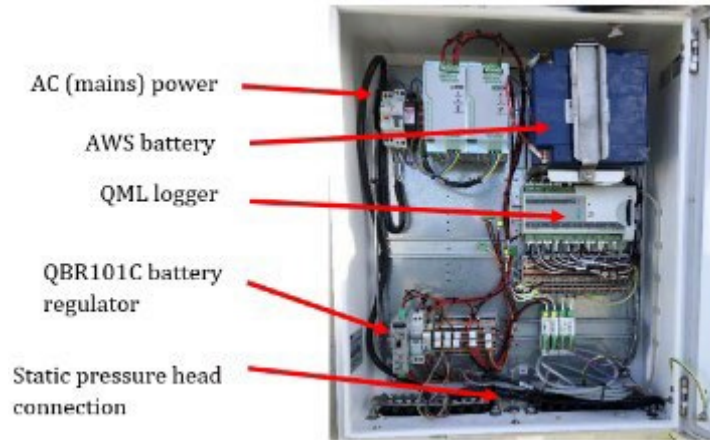

Figure J-11: AWS Enclosure Box

2.2.5 AWS Siting

Siting requirements are necessary to ensure accurate measurements and sustained mast stability. All siting criteria below must be met unless a waiver for specific criteria has been granted by the Office of Climate, Weather, & Water Services. If the AWS is to be moved, contact WSH for consultation and approval.

2.2.5.1 AWS Mast Siting

The AWS mast should be positioned at least 200 feet from the Autosonde Structure. Sufficient clearance for the mast to be lowered and erected should be provided. Any vegetation surrounding the station must be kept short and away from equipment.

2.2.5.2 AWS Sensor Siting

Access should be provided to the sensors in the lowered mass position and leave room for the weather station enclosure when lowered. Sensors are installed on the mast or on the sensor support arm. Install sensors close to the mast to reduce risk of low signal quality as well as operating and heating voltage loss. To protect humidity and air temperature sensors from direct sunlight, use a radiation shield. For more information on sensor placement options refer to vendor documentation.

2.2.6 AWS Maintenance

The AWS mast is tiltable and enables one maintenance person to lower the mast and maintain the sensors and other equipment installed on the mast. Any vegetation surrounding the station must be kept short and away from the equipment. Snow should not touch or cover the enclosure or connectors. Sensors should be maintained and inspected per vendor recommendations.

NCEP issues a monthly report on super-adiabatic lapse rate layers detected by their data QC system. The report can be referenced here: <https://sites.google.com/a/noaa.gov/nws-radiosonde-observations/ncep-radiosonde-super-adiabats>

Site staff should review this report monthly and if strong supers off the surface are observed, corrective actions shall be taken. The surface weather equipment may be out of calibration or sited poorly.

2.3 Automated Surface Observing System (ASOS)

The primary function of ASOS is to provide up to the minute observations and generate the basic Aviation Routine Weather Report (METAR) and Aviation Selected Special Weather Report (SPECI). This information is essential for safe and efficient aviation operations and is used by the public to plan day-to-day activities. ASOS also provides valuable information for the hydrometeorological, climatological, and meteorological research communities. Though ASOS is not considered an Upper Air System that supports AROS or MROS, depending on the location, it can be used if it is within 200 meters of the release point and should be considered a last resort if other surface observation systems (RSOIS, AWS) are unavailable.



Figure J-12: ASOS Sensor Rail

2.4 Surface Observation Equipment Failure

In the event the PDB, RSOIS or ASOS equipment used for taking the surface weather observation has failed, alternative equipment may be used as a temporary backup to capture the following surface data:

- a. Station Pressure: If available, the use of a secondary PDB set to the same height is recommended. If a secondary PDB is not available, a sounding cannot be taken, and the flight will be logged as missed.

- b. Temperature and Dewpoint: Use a WSH approved psychrometer with measurements taken over natural terrain (no concrete or asphalt surfaces) and within 200 meters of the release point.
- c. Wind: Wind speed and direction entries can be estimated. Use nearby surface weather observations as a guide.
- d. Cloud Height: This measurement can be estimated. Use nearby surface weather observations as a guide.

APPENDIX K - STATION SAFETY

Table of Contents	Page
1. Introduction	K-3
2. Upper Air Site Inspections.....	K-3
3. Upper Air Safety Issues Inside the Office	K-3
4. Compressed Gas Safety	K-3
4.1 Storage of Compressed Gas Cylinders	K-3
4.2 Caps.....	K-4
4.3 Securing Gas Cylinders.....	K-4
4.3.1 Chains, Racks and Cabinets.....	K-4
4.3.2 Nesting	K-5
4.4 Corrosion/Damage	K-5
4.5 Combustible Material.....	K-6
4.6 Hydrogen Pressure Vessels (tanks other than cylinders).....	K-6
4.6.1 Combustible Material.....	K-6
4.6.2 Pressure Relief Device.....	K-6
4.7 Piping/Tubing Materials for Helium/Hydrogen.....	K-6
4.7.1 Helium.....	K-7
4.7.2 Hydrogen.....	K-7
4.8 Gas Supply Manifold	K-7
4.9 Hydrogen Emergency Shutoff Provisions	K-7
4.9.1 Manual Gas Shutoff.....	K-8
4.9.2 Automatic Gas Shutoff	K-8
4.10 Hydrogen Inflation Safety System (HISS)	K-8
4.10.1 Hiss Safety Features.....	K-9
4.11 Excess Flow Control.....	K-11
4.12 Hazard Identification and Warnings.....	K-11
4.12.1 Marking of Compressed Gas Piping/Tubing	K-11
4.12.2 Compressed Gas Warning Signage.....	K-12
5. The Upper Air Inflation Building	K-13
5.1 Generic Safety Issues for All Inflation Sites.....	K-13
5.1.1 Outside the Inflation Building	K-13
5.1.2 Inside the Inflation Building	K-14
5.2 Hydrogen Sites.....	K-16
5.3 Electrical Safety.....	K-17
5.3.1 Hydrogen Generators.....	K-20
5.3.2 HISS Ventilation.....	K-21
5.3.3 Combustibles/Waste at UAIB.....	K-21

6. The Autosonde K-21
 6.1 Site Operator K-22
 6.2 Outside the Autosonde K-23
 6.3 Inside the Autosonde..... K-23
 6.4 AROS Hazard Zones..... K-24

7. Safety Issues Prior to Release K-25

8. Safety Training Requirements K-26

Figures

K-1: Properly Secured Cylinders (non-seismic area) K-4
 K-2: AROS Gas Storage Cabinets K-5
 K-3: Nested Cylinders NOT ALLOWED..... K-5
 K-4: Typical Fill Valve with approved hose to nozzle, 1/4 turn isolation valve, fill pressure gauge, stainless steel grounded table, and classified fill controller/solenoid K-7
 K-5: AROS Manifold and Individual Cylinder Valves K-8
 K-6: Typical Inflation Building K-10
 K-7: Typical Inflation Building - with HISS K-10
 K-8: Acceptable Markings for Helium/Hydrogen Tubing..... K-11
 K-9: Acceptable Markings for Helium/Hydrogen Tubing..... K-12
 K-10: Helium Sign..... K-12
 K-11: Hydrogen Sign..... K-12
 K-12: NFPA 704 Placard for Hydrogen K-13
 K-13: Foot Plate at Top of Stairs K-14
 K-14: Authorized Personnel Only Sign K-14
 K-15: Typical Brass Non-Sparking Wrench..... K-16
 K-16: Ceramic Scissors..... K-16
 K-17: Hydrogen Safety Poster K-19
 K-18: Hydrogen Generator (HOGEN)..... K-20
 K-19: Lock Out / Tag Out Materials..... K-22
 K-20: Hazard Zone Classification Areas of the Autosonde..... K-25

1. Introduction

Safety is a vital part of the upper air program. Each site shall have the required safety equipment and documentation on station. The site supervisor is responsible to ensure that proper safety procedures and practices are being followed. This emphasis on maintaining a safe work environment is especially important at sites using hydrogen for inflation.

2. Upper Air Site Inspections

The WS Form B-48, the Upper Air Station Inspection Checklist is an excellent starting place for the site supervisor to ensure safety guidelines are being met. Annual Upper Air site inspections are essential to make sure the upper air facility and equipment are operating in an efficient and safe manner for office employees and that high-quality upper air soundings are being disseminated.

Appropriate Upper Air site personnel must complete and submit to their Regional Headquarters Office Form B-48, with updated photos at least once per year. If Regional Headquarters Office personnel are conducting the inspection, they must complete the Form B-48, as well as a Form B-33, Station Inspection Report. The observers must do a visual inspection of the inflation building and inflation room prior to and during the inflation process.

After the Regional Headquarters Office has reviewed the B-48 form submitted by the site managers, and any needed corrections are completed, a copy of it shall be sent to the WSH Upper Air Program Manager. If the Regional Headquarters Office completed the inspection, a copy of the B-33 form shall be included. If there are urgent repairs or safety issues that cannot be resolved by the site manager or Regional Office staff, the WSH Upper Air program manager shall be contacted as soon as possible with request for assistance. Site managers shall not allow personnel to perform work at Upper Air site if there is recognized serious threat to employees' safety and health, until the safety issue is resolved.

3. Upper Air Safety Issues Inside the Office

These tasks inside the office need to be performed to ensure the upper air program's safety: A posting of the location of wires, antennas, and other obstructions throughout a 360-degree circle within a 1/4 mile of the launch site. This chart shall be prominently posted by the upper air workstation inside the office. The station manager shall advise all the staff of the inherent dangers of trying to disentangle a balloon train from wires of any kind that carry an electrical current.

4. Compressed Gas Safety

The following requirements apply to all sites using helium or hydrogen as a lifting gas.

4.1 Storage of Compressed Gas Cylinders

Compressed gas cylinders shall be stored in an upright position with the valve end up.

4.2 Caps

Compressed gas cylinder valves shall be protected from physical damage by means of protective caps, collars or similar devices when not in use.

4.3 Securing Gas Cylinders

Compressed gas cylinders shall be secured within a rack framework with wall-mounted supports, cabinet or similar assembly designed for such use to prevent dislodgement.

Note: *Only gas suppliers shall move the compressed gas cylinders.*

4.3.1 Chains, Racks and Cabinets

Depending on the site configuration and platforms used, steel or stainless-steel chains, metal racks and storage cabinets shall be used to secure compressed gas cylinders.

- a. Chains shall be secured at approximately $\frac{2}{3}$ of the cylinder's height (See Figure K-1) and, in seismically active areas, at two points ($\frac{2}{3}$ and $\frac{1}{3}$ of the cylinder's height).

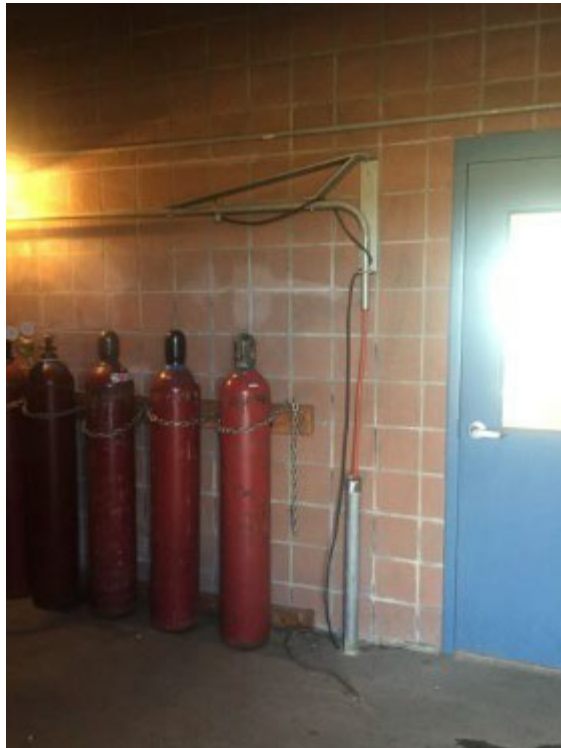

Figure K-1: Properly Secured Cylinders (non-seismic area)

- b. The working load rating of the chain and all connectors shall be 300 lbs. minimum. Straight link steel or stainless-steel 1/4-inch chain is acceptable.
- c. Metal racks may be utilized in lieu of chains and can allow cylinders to be stored and secured more than one cylinder deep against a wall. Metal racks shall be

bonded/grounded when used.

- d. Gas storage cabinets are used to safely store cylinders for AROS sites that do not utilize a Hydrogen Generator (HOGEN)



Figure K-2: AROS Gas Storage Cabinets

4.3.2 Nesting

Cylinders shall not be nested (See Figure K-2). Fire codes prohibit cylinder nesting at all NWS facilities.

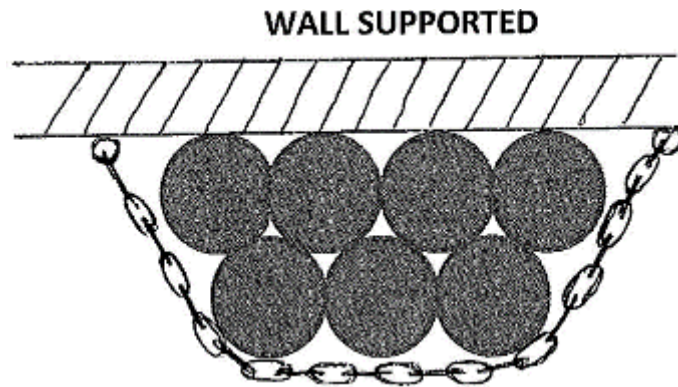

Figure K-3 - Nested Cylinders **NOT ALLOWED**

4.4 Corrosion/Damage

Any corroded, defective or damaged cylinders shall be returned to the supplier for inspection and/or removal.

4.4.1 If the safety cap cannot be removed by hand, the cylinder shall be marked as defective and removed from service.

4.4.2 If the cylinder valve cannot be operated by hand, the cylinder shall be marked as defective and removed from service.

4.4.3 Leaking cylinders shall be marked as defective and removed from service.

Note: *Contact gas supplier as soon as possible and request removal of defective leaking cylinders.*

4.5 Combustible Material

Combustible vegetation (if outdoors) and combustible storage shall be at least 10 feet from flammable gas cylinders.

4.6 Hydrogen Pressure Vessels (tanks other than cylinders)

The following requirements apply to storage of compressed gas in tanks or similar pressure vessels.

4.6.1 Combustible Material

Combustible vegetation (if outdoors) and combustible storage shall be at least 10 feet from flammable gas pressure vessels.

4.6.1.1 If hydrogen storage exceeds 5,000 cu ft total, then the separation distance to exposures shall be in accordance with NFPA 2, Hydrogen Technologies Code).

4.6.2 Pressure Relief Device

4.6.2.1 All pressure vessels shall be equipped with a pressure relief device designed to vent the vessel contents in the event of an overpressure.

4.6.2.2 Pressure relief shall occur at or below the rated pressure of the vessel (Maximum Allowable Working Pressure).

4.6.2.3 The pressure relief device shall be sized by the pressure vessel manufacturer or a qualified designer.

4.6.2.4 The pressure relief device outlet shall be routed to an approved vent stack (in accordance with NFPA 2, Hydrogen Technologies Code) with an approved vent stack cap that does not discharge hydrogen in a downward direction.

4.6.2.5 The pressure relief device shall be inspected or replaced in accordance with manufacturer's instructions.

4.6.3 Inspections

Hydrogen pressure vessels shall be inspected and re qualified by an inspector certified in accordance with the National Boiler Inspection Code or similar at intervals not to exceed 10 Years.

4.7 Piping/Tubing Materials for Helium/Hydrogen

Only approved dual stage hydrogen regulators, piping / tubing, and equipment shall be used. Engineering Handbook 1 lists authorized equipment stocked at

NLSC:<https://www.ops1.nws.noaa.gov/Secure/ehbs/EHB1files/ehb1jsec.pdf>

4.7.1 Helium

Helium gas piping / tubing shall be designed and installed with any material intended for this use.

4.7.2 Hydrogen

New installations of flammable gas piping / tubing shall be designed and installed in 300 series stainless steel tubing from the storage container to the point of use per the International Fuel Gas Code (IFGC) and the American Society of Mechanical Engineers (ASME) B31 Series Standards. Flexible tubing / hose is not permitted in new installations with the exception of a short 3-foot-long connector piece between the buoyancy fill valve and weather balloon nozzle for each site using hydrogen.

4.8 Gas Supply Manifold

A manifold at the gas supply is permitted for helium systems. Hydrogen supply systems shall not be manifolded unless the site uses a Hydrogen Inflation Safety System (HISS) or Autosonde system which utilizes excess flow control.

4.9 Hydrogen Emergency Shutoff Provisions

Hydrogen gas systems shall be provided with emergency shutoff valves at each point of use and at each source.

- a. Shutoff at Source. A manual or automatic emergency shutoff valve shall be installed on supply piping at the cylinder or pressure vessel source. Automatic valves shall be fail safe. Cylinder valves may be used as the required emergency shutoff valve where the source of supply is limited to a single connected cylinder.
- b. Shutoff at Point of Use. An emergency shutoff valve shall be installed on the supply piping at the fill valve on the inflation table (See Figure K-4)



Figure K- 4 - Typical Fill Valve with approved hose to nozzle, 1/4 turn isolation valve, fill pressure gauge, stainless steel grounded table, and classified fill controller/solenoid

- c. For AROS sites, emergency valves for each gas bank shall be installed above the regulator box.

4.9.1 Manual Gas Shutoff

Quarter-turn valves shall be utilized for manual gas shutoff valves. These valves are quick acting and are of the indicating type so that operators can quickly recognize valve position.

- a. The manual valves at the hydrogen supply cylinder and at the fill table shall be normally closed and only opened when performing a balloon fill.
- b. For sites using hydrogen cylinders with a single cylinder connected, the cylinder valve, which is not a quarter-turn valve is acceptable.
- c. For AROS sites using gas storage cabinets, the manifold valve, individual cylinder valves, and emergency valves are to be manually turned off when replacing gas cradles.

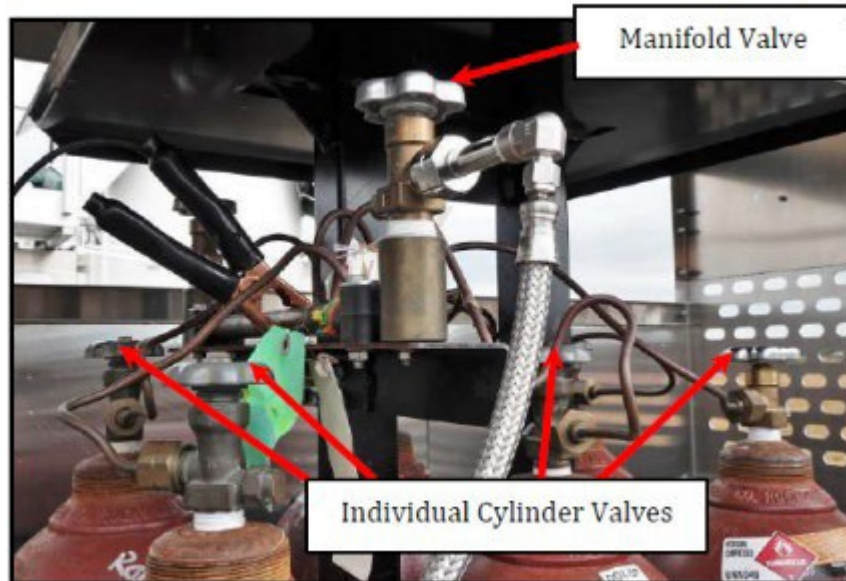

Figure K-5: AROS Manifold and Individual Cylinder Valves

4.9.2 Automatic Gas Shutoff

Automatic gas shutoff is provided by use of a Hydrogen Inflation Safety System (HISS) and by the Autosonde systems for sites utilizing these systems.

4.10 Hydrogen Inflation Safety System (HISS)

Some NWS sites have installed a safety system that addresses fire code issues associated with the use of hydrogen. This has primarily been driven by converting a site from helium to hydrogen as the primary inflation gas. Because fire codes prohibit filling of balloons with hydrogen and limit indoor storage quantity, these sites have addressed these prohibitions by installing a Hydrogen Inflation Safety System which justifies the use of hydrogen in NWS balloons and incorporates additional automatic safety

features as well as relocation hydrogen storage to outdoors. Figure K-6 and K-7 show a typical UAIB layout without and with a HISS installed.

4.10.1 HISS Safety Features

The HISS incorporates numerous safety provisions including:

- a. Excess flow with automatic shutoff. Automatically shuts off flow of hydrogen through a normally closed solenoid valve located outside. The safety function is to automatically shut off the flow of hydrogen gas if the mass of hydrogen flowed is excessive. A mass flow meter precisely measures the quantity of hydrogen flowed per fill event (a batch process) and automatically terminates gas flow with a normally closed solenoid valve at ~150% of the expected fill volume for a given balloon.
- b. Ventilation interlock. Hydrogen cannot flow unless the active exhaust ventilation system is continuously operating.
- c. Excess fill time. The system shall terminate the flow of hydrogen if the fill time exceeds 30 minutes. Most uninterrupted fills shall complete in about 10-12 minutes.
- d. Excess flow rate – Flow rates that can result in excess nozzle pressure shall automatically terminate the flow of hydrogen.
- e. Automatic and emergency shutoff provisions shall be provided. This limits the volume of hydrogen that could be released if all other safety features failed.
- f. The HISS requires manual reset for each fill event.
- g. Pressure gauge at fill table
- h. Hydrogen storage and regulator located outdoors

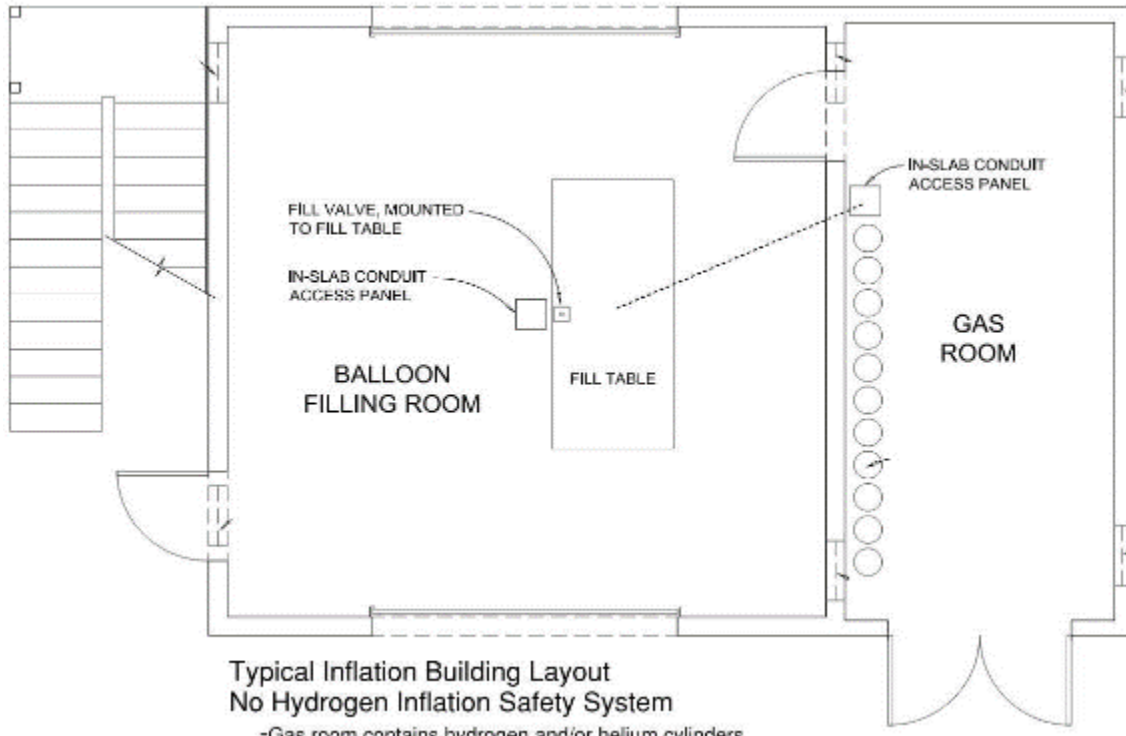

Figure K-6: Typical Inflation Building

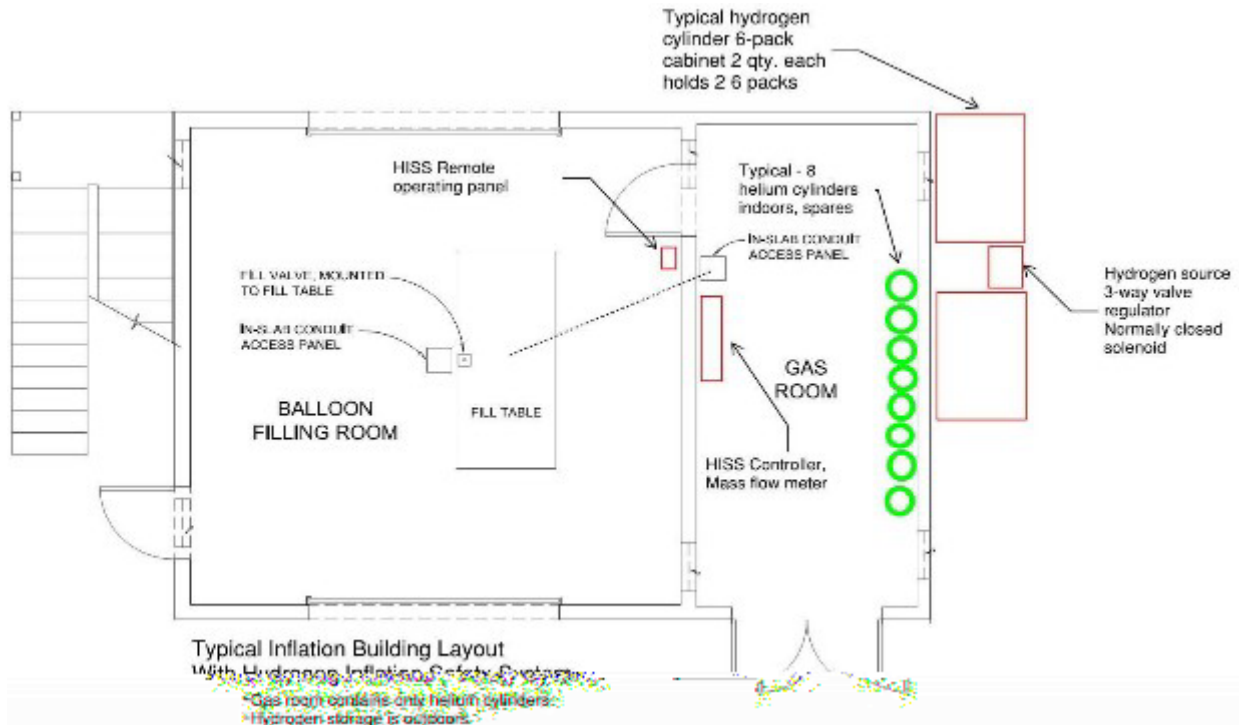

Figure K-7: Inflation Building Typical – with HISS

4.11 Excess Flow Control

There are no requirements for excess flow control with helium gas inflation systems. The hydrogen regulator must be set at 15 psi or less. For sites with a HISS or an Autosonde, excess flow control is provided by the system.

4.12 Hazard Identification and Warnings

4.12.1 Marking of Compressed Gas Piping/Tubing

Piping/tubing systems shall be marked in accordance with ASME A13.1 and the following:

- a. Markings used for piping/tubing systems (See Figures K-6 and Figure K-7) shall consist of the content's name and include a direction-of-flow arrow.

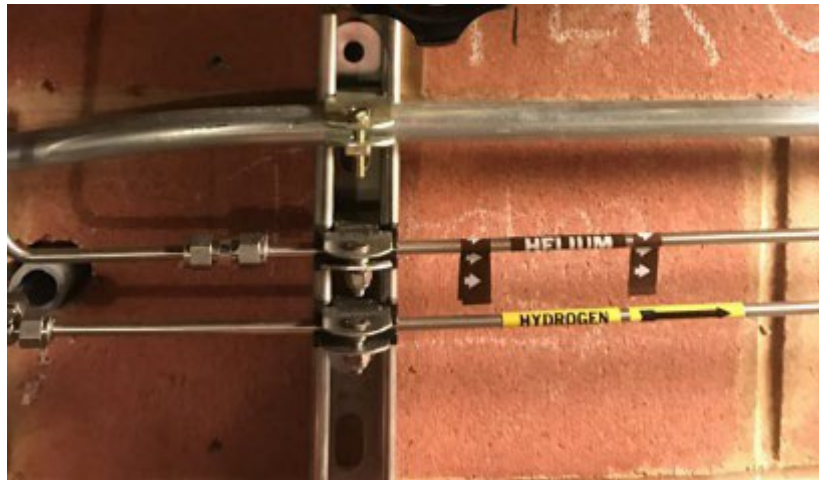

Figure K-8: Acceptable Markings for Helium and Hydrogen Tubing

- b. Markings shall be provided at each valve; at wall, floor or ceiling penetrations; at each change of direction; and at not less than every 20 feet or fraction thereof throughout the piping / tubing run.
- c. Piping / tubing that is designed or intended to carry more than one gas at various times (i.e., primary use hydrogen with helium use as backup) shall have appropriate signs or markings posted at the manifold, along the piping / tubing and at each point of use to provide clear identification and warning.



Figure K-9: Acceptable Markings for Helium/Hydrogen Tubing

4.12.2 Compressed Gas Warning Signage

Rooms or outdoor storage areas containing compressed gases shall be conspicuously labeled: COMPRESSED GAS. This requirement applies to helium as well as hydrogen and a sample sign is shown in Figure K-8. Areas with hydrogen also need a hydrogen sign as shown in Figure K-9 below.



Figure K-10: Helium Sign



Figure K-11: Hydrogen Sign

All hydrogen sites shall have NFPA 704 placards with numbering as shown below in Figure K-10 at entrances to locations where hydrogen is stored.



Figure K-12: NFPA 704 Placard for Hydrogen

5. The Upper Air Inflation Building

The upper air inflation building is where most of the items dealing with safety are based. Responsibility for safety lies with all on-site personnel. The site supervisor shall stay alert to issues that need attention and act promptly to ensure problems are resolved. (Note: Section 2 of this Appendix includes discussion of safety inspections).

5.1 Generic Safety Issues for All Inflation Sites

There are generic aspects with the inspection of the inflation building that are common to both hydrogen and helium sites. There are also items that pertain strictly to hydrogen sites.

5.1.1 Outside the Inflation Building

The following items shall be routinely checked outside the inflation building:

- a. The area surrounding the inflation building shall be clear of obstacles, including snow and ice, and be level to allow the operator an environment that is safe to launch the balloon.
- b. The areas around the overhead doors and side doors shall be free of ice and snow. Salt or ice melting particles shall be available in case of icy conditions.
- c. The building, when not in use, shall have all doors locked to ensure unauthorized persons do not have access to the area.
- d. The foot and hand railings shall be secure and sturdy. A foot rail or kick plate shall be installed at the top of the stairs leading up to the radome to eliminate the potential of personnel possibly slipping off or falling from the stairs during icy or slippery conditions (See Figure K-13).



Figure K-13: Foot Plate at Top of Stairs

- e. All outside lights shall work and the area shall be well lit.
- f. A communication system is required and shall be turned on prior to an individual going out to the inflation building. This is to ensure an open line of communication is kept with the office. This requirement is especially needed for launches during inclement weather and to ensure that if an operator is injured there is a means of calling for help.
- g. Overhead doors and louvers shall be in good operational condition.
- h. Entrance to the stairwell leading to the top of the roof or radome shall be either secured or have an “Authorized Personnel Only” sign chained across the stairs (See Figure K-14).



Figure K-14: Authorized Personnel Only Sign

5.1.2 Inside the Inflation Building

The following items are required inside the inflation building at all sites:

- a. The floor shall be kept clean and free of debris.
- b. Fire extinguishers with a minimum 2A:10B:C rating (typically achieved by a 5 lb. agent weight dry chemical stored pressure type) shall be placed inside the inflation building and inside the radome (no more than 2 are required for a typical UAIB) and inspected annually by a certified, licensed fire extinguisher service company and visually inspected for adequate pressure and access and initialed off monthly by station personnel.

- c. The inflation table shall be clean and free of dirt.
- d. Expendable items stored in the inflation building shall be stored within electrically grounded metal cabinets.
- e. The interior of the building shall be well lit.
- f. The gas cylinders shall be properly marked (contents) and secured individually to ensure they cannot topple over (See Figure K-2).
- g. To achieve code compliance, no more than fifteen (15) hydrogen cylinders shall be stored/used indoors. The limit applies depending on cylinder type / capacity and applies to all hydrogen cylinders regardless of fill status (e.g., empty, full or partially full). The limit is based on the latest NFPA-2 code.
- h. Hydrogen cylinders in excess of the fifteen (15) allowed indoors, shall be located outdoors.
- i. Caps shall be on all cylinders full and empty not connected to the supply line.
- j. Cylinders shall be pre-positioned by gas supply vendors to minimize NWS personnel from moving cylinders themselves. Compressed gas cylinders shall not be rolled or stored on their sides, dragged or slid.
- k. Cylinders shall not be manifolded unless a HISS or Autosonde (both of which feature automatic excess flow control) has been installed. Hydrogen supply shall be from only one cylinder.
- l. First-aid kits shall be available at the inflation building or in the Weather Forecast Office building
- m. Telephones, flashlights, pagers, and other electronics shall not be used unless intrinsically safe. See NWSM 50-115 (Chapter 9, Section 9.3.6)

Note: *Emergency communications, (e.g., telephone, cell phone, two-way radio) including frequency of contact with the weather forecast office, shall be established for personnel who must perform work in the Upper Air Building alone.*

- n. One spare UL approved, NWS standard regulator for each gas used shall be available.
- o. The fill rate follows NWS instructions and does not exceed 15 psig for hydrogen.

Note: *For HISS sites the regulator is pre-set to achieve the safe fill rate. Do not adjust the regulator.*

- p. The “Hydrogen Safety Poster” (See Figure K-17) shall be displayed in the cylinder storage area for all sites using hydrogen except those using a HISS or an Autosonde which have unique signage requirements.
- q. All gas tubing, hose and fittings shall be annually leak tested using a gas leak detection fluid such a “Snoop” or equivalent at a pressure of 30 ± 5 psig.

5.2 Hydrogen Sites

The following additional rules apply to sites using flammable gas such as hydrogen:

The connection to a hydrogen cylinder is a standard CGA-350 fitting with left handed threads (reverse of most threaded fittings). The wrench size needed is 1-1/8 inch. Only UL- listed spark proof tools are to be used. WSH approved tools shall be used on the gas tank regulator and any other components or equipment near the gas tanks and hoses. See Figure K-15 showing a typical non-sparking brass wrench. Ceramic scissors (see Figure K-16) or other approved scissors shall be used to cut the twine during preparation of the radiosonde flight train



Figure K-15: Typical Brass Non-Sparking Wrench

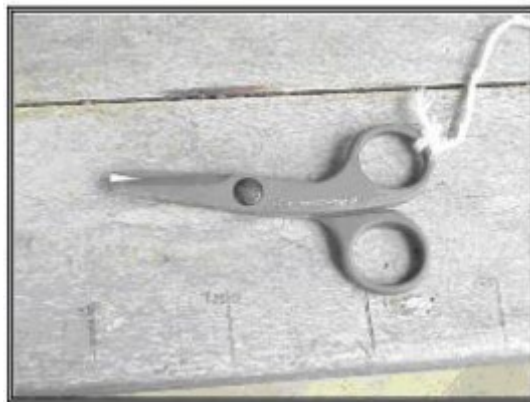

Figure K-16: Ceramic Scissors

Smoking or lighting of flammable materials shall not be allowed within 25 feet of buildings where hydrogen gas is stored or generated.

In the event of a hydrogen fed fire and non-hydrogen fire, the following procedures shall be followed:

- a. Immediately exit the Upper Air Inflation Building
- b. Turn off Hydrogen Safety System outside
- c. Call 911 for local fire emergency response and notify the Station Manager
- d. Do not extinguish the fire with an extinguisher.

In the event of rupture or leak of a hydrogen filled balloon, the following procedures shall be followed:

- a. Immediately exit the Upper Air Inflation Building
- b. Turn off NWS Hydrogen Safety System outside
- c. Notify the Station Manager
- d. Allow 15 minutes for building to ventilate naturally before re-entering

5.3 Electrical Safety

- a. All electrical switches, lights, heaters and wiring must meet National Electrical Code (NEC) requirements related to classified (hazardous, explosion proof) locations in the Inflation Room.
- b. The correct classification for a typical UAIB using hydrogen is: Class I, Division 2, Group B for hydrogen.
- c. For sites with a HISS, the classified area is limited to within a 5-ft. radius (e.g., sphere) of the balloon buoyancy fill valve. Other areas in the Fill Room do not require classified electrical equipment (based upon safety systems installed).
- d. Bonding and Grounding. Exposed noncurrent-carrying metal parts, including metal gas piping systems, that are part of flammable gas supply systems located in a hazardous (electrically classified) location shall be bonded to a grounded conductor in accordance with the provisions of the NWSM 30-4106, "Lightning Protection, Grounding, Bonding, Shielding and Surge Protection Requirements." Static-producing equipment located in flammable gas storage or use areas shall be grounded.
- e. The Fill Room table shall be constructed of metal conductive material to facilitate bonding and grounding for hydrogen fill sites. A metal table is superior to wood or nylon webbing for hydrogen inflations to allow bonding and grounding of the table and reduce the potential for a static discharge and possible ignition. The table shall have smooth finishes and no sharp surfaces or edges to prevent puncturing the balloon.

Compliance Note: *UAIBs that are currently operating with non-metal fill tables shall achieve compliance by 2026 or annually extend compliance with a written justification approved by NWS Upper Air PMO.*

- f. All overhead door runners shall be electrically grounded for hydrogen fill sites. Grounding can be accomplished by using a grounding wire and connecting it to a nearby grounding rod.
- g. The hydrogen fill system including the inflation hose, nozzle, and inflation table shall be grounded with the frame of the building and have a resistance of less than 5 ohms per NWSM 30-4106 at a 5-year frequency.
- h. An anti-static mat shall be placed at the head end of the inflation table where the operator stands during the process of attaching the balloon to the nozzle and tying of the balloon after inflation.
- i. The Hydrogen Safety poster shall be prominently displayed in the inflation room and cylinder storage area. (See Figure K-17).

HYDROGEN SAFETY POSTER

HYDROGEN FACTS

- ✓ Colorless
- ✓ Odorless
- ✓ Rapidly diffuses in air
- ✓ Flame is nearly invisible (pale blue)
- ✓ Rapidly rises in air (~45 mph)

HYDROGEN FIRES

In the event of a hydrogen fire:

1. Exit the building.
2. Turn off NWS Hydrogen Safety System outside.
3. Call 911 then Notify MIC.
4. Do not extinguish the fire with an extinguisher.

HYDROGEN BALLOON RUPTURE

In the event of:

In the event of rupture or leak of a hydrogen filled balloon:

1. Exit the building.
2. Turn off NWS Hydrogen Safety System outside.
3. Notify MIC.
4. Allow 15 minutes for building to ventilate naturally.

HYDROGEN FIRE

NON-HYDROGEN FIRE

1. Exit the Building
2. Turn off NWS Hydrogen Safety System outside.
3. Call 911 then Notify MIC.

HYDROGEN CYLINDER SAFETY

HYDROGEN CYLINDER SAFETY

Do not use with the regulator connected, being filled. Use proper restraints such as metal chain. Do not be turned by hand, leaks, damage, etc.).

1. Safety caps shall be installed unless cylinder is "in use".
2. Cylinder valve shall be closed unless a balloon is being filled.
3. All cylinders shall be secured with non-combustible restraints.
4. Mark defective cylinders (safety cap or valve cannot be turned by hand, leaks, damage, etc.).
5. No combustible storage within 10 ft. of cylinders.

Figure K-17: Hydrogen Safety Poster

For sites where a HISS has been installed a set of updated posters providing both local operation instructions and hydrogen safety notifications shall be posted.

5.3.1 Hydrogen Generators

Hydrogen can be generated on site through the use of an electrolyzer (which makes hydrogen gas from water using electricity). The following requirements apply to sites with hydrogen generators.

- a. Untrained personnel shall not be allowed to perform service of maintenance on hydrogen generators.
- b. Hydrogen generators shall be installed as specified by the manufacturer's installation instructions.
- c. Hydrogen generator manufacturers require room ventilation to provide a steady flow of outside air whenever the unit is in operation.
- d. Hydrogen generators which are designed for operation in a non-classified (non-hazardous) electrical area are acceptable. For example, some hydrogen generators utilize internal powered ventilation and an internal hydrogen gas detector which shuts the unit down upon detection of gas at 30% of the Lower Flammability Limit (LFL), or 1.2% concentration in air. These engineered features combine to allow use of the hydrogen generator in a room that is electrically unclassified.
- e. Hydrogen generators that use a gas vent shall be routed to an approved vent stack (in accordance with NFPA 2, Hydrogen Technologies Code) with an approved vent stack cap that does not discharge hydrogen in a downward direction.



Figure K-18: Hydrogen Generator (HOGEN)

5.3.2 HISS Ventilation

Active exhaust ventilation shall be installed in the fill room in locations where a HISS system is installed. The justification for each site requires mechanical exhaust ventilation as a hazard mitigation. The ventilation system is interlocked with the HISS.

Ventilation requirements generally include:

- a. Exhaust shall be within 12 inches of the ceiling since hydrogen is lighter than air.
- b. Interlocks. Exhaust ventilation must be on to initiate gas flow and interlocked to the HISS so there can be no flow of gas if the ventilation system is not operating. The interlock is electrical
- c. Timer. Systems shall operate continuously during balloon filling operations and the exhaust ventilation must run for at least 60 minutes once activated.
- d. Mechanical ventilation shall be at a rate of not less than 1 cubic foot per minute per square foot of floor area or as required by the site-specific analysis
- e. The location of both the exhaust and inlet air openings shall be designed to provide air movement across all portions of the floor or room to prevent the accumulation of vapors.
- f. Exhaust air shall not be recirculated.

5.3.3. Combustibles/Waste at UAIB

- a. Combustibles within the Fill Room. Only a minimal amount of combustible materials shall be allowed inside the inflation building. Combustible materials shall be placed within a metal storage cabinet when not in use. Combustible items shall be limited to only those supplies needed for the operation and stock quantities shall be maintained as low as reasonable. A roll of string or twine used for balloon launching can be stored on or near the fill table. Trash cans shall be kept outside the inflation building or shall be metal and have a lid securely in place.

6. The Autosonde

The Vaisala AS15 Autosonde is exclusive to the AROS platform and due to unique site characteristics AROS may have specific safety issues and requirements identified by the responsible entities such as the Meteorologist in Charge (MIC) at the WFO or the Official in Charge (OIC) at a WSO. The Autosonde is intended to be operated in an environment that is not accessible to the general public. Responsibility for safety lies with all on-site personnel. The site supervisor shall stay alert to issues that need attention and act promptly to ensure problems are resolved. Potential hazards at AROS sites include hydrogen gas, falling ice and snow especially when launch vessel covers are opened, and automatic start mechanism related hazards.

6.1 Site Operator

Among other UA support responsibilities, the site operator routinely visits the Autosonde to perform visual inspections, take care of any necessary cleaning and supports maintenance by reporting issues found at the Autosonde. When it comes to safety, the Site Operator plays a vital role. The Site Operator must:

- a. Communicate with the Remote Operator or any other relevant party when they perform any maintenance work.
- b. Report any issues or safety concerns.
- c. Ensure the correct amount of people are at the Autosonde for any basic maintenance activity.
- d. Not enter the Robot Room, Launch Vessel, or climb onto the roof unless instructed and guided by the Remote Operator (or other qualified personnel).
- e. Press the emergency stop button and remove the key before any work on the Autosonde is started.
- f. Notify Air Traffic Control prior to the removal of a stuck balloon (if the Autosonde is within 5 NM of an airport).
- g. Not attempt to fix or repair anything without proper authorization/permission.
- h. Keep away from live circuits. Site Operators are not removing instrument covers as dangerous voltages may exist.
- i. Contact the Remote Operator if any Lock Out / Tag Out signs and /or locks (See figure K-19) are present on electrical panels inside the Autosonde.



Figure K-19: Lock Out / Tag Out Materials

6.2 Outside the Autosonde

The following items shall be routinely checked outside the Autosonde shelter:

- a. The area surrounding the Autosonde (including fencing) and compressed gas supply area shall be clear of obstacles, including snow and ice, and allow the operator an environment that is safe.
- b. The gas supply from the cylinder banks to the Autosonde shall be inspected for bends, holes or breaks.
- c. The Autosonde heat pump / air handler and roof area, including telemetry equipment and launch vessel shall be free of ice and snow.
- d. The Autosonde, when not in use, shall have the door locked to ensure unauthorized persons do not have access to the shelter.
- e. The compressed gas cylinder banks shall be properly marked (contents) and secured in the container bank.
- f. All outside lights shall work and the area be well lit.
- g. A method of voice communication is required for site operators in the event of inclement weather and to ensure that if an operator is injured, there is a means of calling for help.
- h. The shelter door and louvers shall be in good operational condition.
- i. Access to the ladder leading to the rooftop shall be either secured or have an “Authorized Personnel Only” sign displayed across the ladder.

6.3 Inside the Autosonde

The following items are required inside the inflation building at all AROS sites:

- a. The floor shall be kept clean and free of debris.
- b. A fire extinguisher with a minimum 2A: 10B:C rating (typically achieved by a 5 lb. agent weight dry chemical stored pressure type) shall be placed inside the Autosonde shelter and inspected annually by a certified, licensed fire extinguisher service company and visually inspected for adequate pressure and access and initialed off monthly by station personnel.
- c. The workstation space shall be clean and free of dirt or clutter.
- d. Consumable items in the Autosonde shall be stored in the provided storage cabinet.
- e. The interior of the shelter shall be well lit.

6.4 AROS Hazard Zones

In normal operation, The AROS Site Operator must not enter the hazardous areas in and around the launch vessel. However, the site Operator may be instructed to enter the Launch Tube and / or Robot room with instruction from a qualified individual if necessary. Vaisala classifies the areas of the AROS into four distinct hazard zones. A hazard zone is an area where an explosive gas atmosphere is present or can be expected to be present to such an extent that special precautions for the construction, installation and use of electrical apparatus are required. The AROS hazard zones are described and summarized below:

Non-Hazard Area: An area where an explosive gas atmosphere is not expected to be present in such quantities that would require special precautions for the construction, installation, maintenance and use of electrical apparatus.

Zone 0: An area where an explosive gas atmosphere is present continuously or is present for long periods. Zone 0 consists of balloon loading operations when a balloon is filled with hydrogen in the launch chamber for about 10 minutes prior to release.

Zone 1: An area where an explosive gas atmosphere is likely to develop in normal operation. Zone 1 consists of the space inside the balloon launch chamber and above the filling nozzle during filling operations. In Zone 1 there are no electrical devices or components allowed.

Zone 2: An area in which an explosive gas atmosphere is not likely to develop in normal operation. If it does develop, it will exist only for a short period of time. Zone 2 includes the zone under the filling nozzle in the launch chamber, a 1.5m wide open area outside the launch vessel, a 3m wide area around the gas measurement system on the roof of the shelter, and a 1m wide area around the main magnetic valve. In Zone 2, all actuators are pneumatically controlled, and all mechanical devices are electrically grounded.

The graphic below (Figure K-20) maps the hazard zone classification areas of the Autosonde.

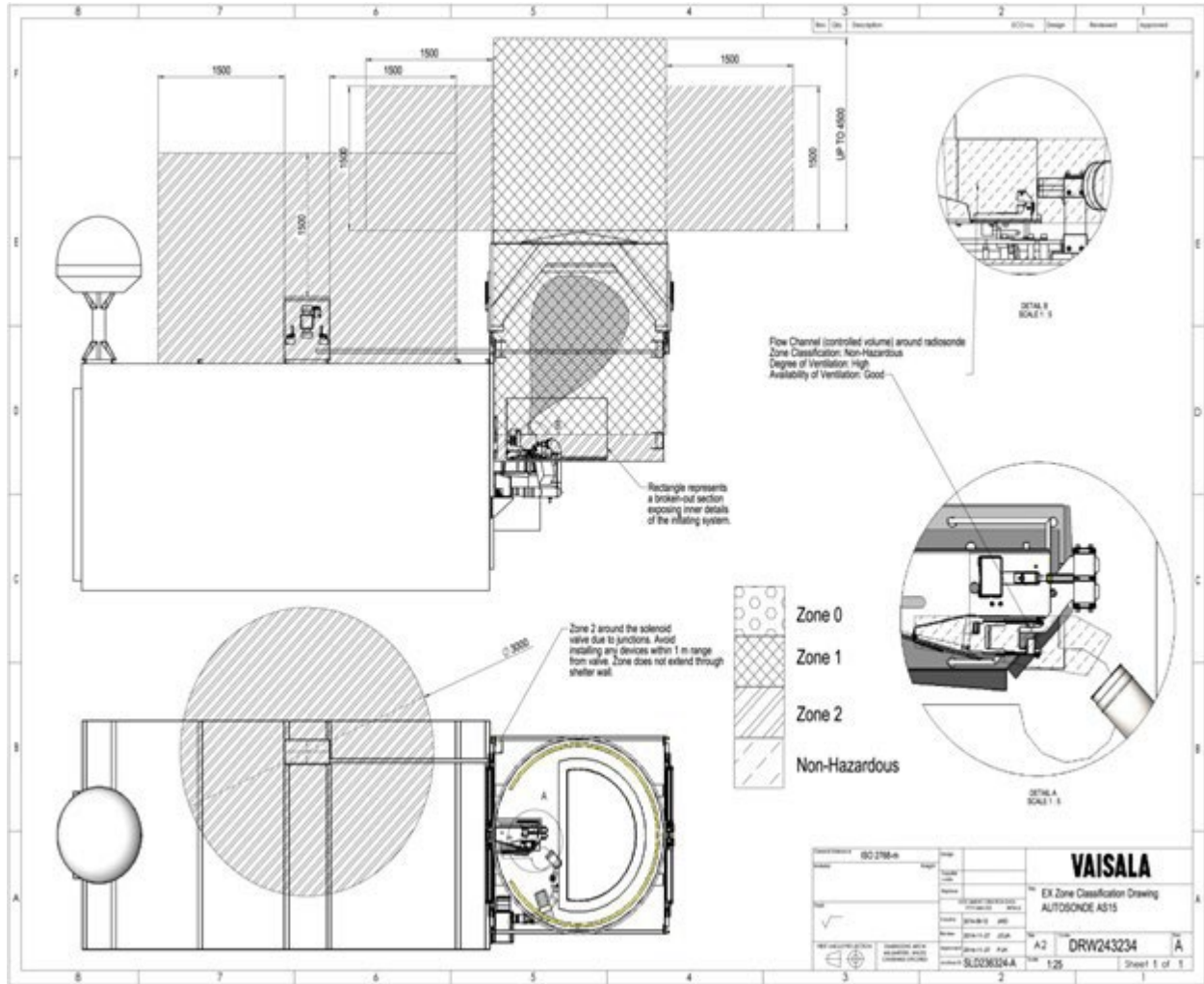

Figure K-20: Hazard Zone Classification Areas of the Autosonde

7. Safety Issues Prior to Release

The following shall be followed prior to launching a balloon:

- a. Sites located within 5 NM of an active runway for a controlled airport shall contact the aircraft controlling authority and notify Air Traffic Control that a balloon will be released unless the air traffic control authority has waived the requirement.

Note: *The requirement for filing a Notice to Airmen (Notam) is no longer necessary. The radiosondes used by the NWS do not meet the size and weight requirements that demand a Notam be filed. This does not, however, eliminate the coordination call if a site is located within 5 Nautical Miles (nm) of an active runway at a controlled airfield.*

Part 101 and/or any NOAA WX Balloon operations are authorized everywhere. NOAA and other groups are to follow their normal coordination process and procedures for releasing these balloons.

(U.S., Canadian and Mexican registry) Part 135 operations are authorized everywhere IFR and VFR, including the TFR's, as long as the operation within the TFR's is strictly conducive to that required for landings and departures.

8. Safety Training Requirements

NWS Hydrogen Safety Awareness Training available at Commerce Learning Center shall be completed by all certified Upper Air observers and personnel involved in maintenance/repairs of Upper Air buildings and equipment.

Initial hydrogen generator training is offered by the manufacturer at the time of the generator installation. Previously certified employees provide training to new hires on hydrogen generator operations and safety procedures.

Autosonde classroom training is provided by the manufacturer during system installation.

APPENDIX L - SPECIAL OBSERVATIONS

Table of Contents	Page
1. Introduction	L-2
2. Types of Projects.....	L-2
3. Clearance and Policy Resources	L-2
4. Administrative Responsibilities	L-2
4.1 Weather Service Headquarters.....	L-2
4.2 Regional Headquarters.....	L-3
4.3 Local Office	L-4
5. Special Project Costs.....	L-4
5.1 Overtime Authorization	L-4
5.2 Consumables	L-4
6. Disposition of Data and Archive Files.....	L-4
7. Information Reported.....	L-4
8. Special Projects and Activities Timeline	L-5
9. Request for Space	L-6
Tables	
L-1: Upper Air Special Project and Activities Timeline	L-5

1. Introduction

Special observations may be requested by private enterprise and government agencies, on occasion. This requires a formal fee-for-service memorandum of agreement in which the sponsor pays in advance and the National Weather Service (NWS) reimburses the sponsor for non-executed services. In most cases, legal authorization for special observations derives from the special studies provision of the Commerce and Trade code, also known as 15 U.S.C. 1525. This appendix outlines the administrative process for the clearance, coordination, and execution of special projects.

2. Types of Projects

The primary requesters are NOAA, NASA, state, and local government agencies who conduct research studies. Other requesters include university and private corporations who conduct research and develop technology.

Any time the sponsor is an international agency or organization, the sponsor shall inform the NWS International Activities Staff (IAS) who will determine whether clearance is required by the Department of State. If the sponsor's organization has a pre-existing multi-year Memorandum of Understanding/Reimbursable Agreement (MOU/RA) still in force, then IAS may request OGC exempt the sponsor from having to submit a new MOU/RA.

3. Clearance Policy and Resources

Whenever a proposal is made for supplemental Upper Air observations by an organization external to NWS, this will imply a fee-for-service special project. Both parties to the agreement can access necessary information to prepare a Memorandum of Understanding (MOU) and the Reimbursable Agreement (RA) by following NWSI 70-211 and through the NOAA Core Financial System (CFS) website:

<https://www.corporateservices.noaa.gov/finance/reimburse.html>

The data produced by the special observations will be made available by the National Centers for Environmental Information (NCEI). The data files produced by the special project will be available in BUFR format. It is up to the sponsor to coordinate with NCEI to obtain data or decoder files if necessary.

4. Administrative Responsibilities

4.1 Weather Service Headquarters

Each prospective sponsor states in writing to the Director, Analyze, Forecast and Support Office (AFS), the sponsor's request for special observations. The AFS representative reviews the request with the Office of Observations Director and may recommend NWS support. The AFS representative then

coordinates and prepares the request in the form of a Memorandum of Understanding (MOU) and Reimbursable Agreement (RA). The documents will be submitted for the review and clearance of the Office of General Counsel (OGC) at the Department of Commerce. The responsibilities of Weather Service Headquarters (WSH) are to:

- a. Calculate total projected cost and coordinate with Region.
- b. Provide a memorandum of understanding (MOU) and RA templates to the Sponsor and Weather Forecast Office (WFO).
- c. Coordinate MOU and RA with parties and CFO2 submits signed agreement to OGC for clearance.
- d. Coordinate with National Centers for Environmental Information (NCEI) to ensure Sponsor has access to high density upper air data via File Transfer Protocol (FTP).
- e. Coordinate with CFO2 and NOAA divisions to reimburse the Sponsor and Regions, as needed. Follow guidance in Chapter 10, of the NOAA Finance Handbook at the following link: <https://www.corporateservices.noaa.gov/finance/Finance%20Handbook.html>
- f. If necessary, provide instructions to each regional office and site on completing a Special Project Status and Activities Report.

For more information and templates, please refer to Chapter 10, of the NOAA Finance Handbook

4.2 Regional Headquarters

Upon receiving a letter of request, the Region will inform the AFS representative of the request. If the project is limited to several sites in the one Region and a small number of supplementary observations are requested, then WSH will still be notified and coordinated. The Regional Upper Air Manager coordinates with field offices and prepares the Region-to-WASH Coordination form to document whether overtime labor is authorized for the local office.

The Regional Upper Air Manager will:

- a. Coordinate with the Field Office managers for their review of the MOU and determine if the office can schedule overtime (if applicable).
- b. Upon completion of Region-to-WASH coordination, the Region should send the WSH/Region Coordination Form, signed and dated, to the AFS representative.
- c. Forward a copy of the RA to the Regional Budget Officer (e.g., W/ER5).
- d. If required, email Special Projects and Activities Report to the AFS representative.

- e. Ensure the Regional Budget Office prepares an amended RA to account for the actual field labor and material expenses (remember to exclude the cost of radiosondes).

4.3 Local Office

The local office examines staff schedules to assess the office's ability to accommodate the overtime work. The local office will handle all special observations as routine operational observations concerning the naming, logging, transmitting, and archiving of upper air observations and reporting radiosonde performance. If required, the Special Projects and Activities Report should be completed.

5. Special Project Costs

The total project cost can be calculated from two figures, the per-observation-cost (at overtime rate) and the administrative fee.

5.1 Overtime Authorization

Unless precluded by local station management, overtime is typically authorized to conduct special observations.

5.2 Consumables

In nearly all cases, the site's common stock of radiosondes is used. On occasion, there might be a request to use special radiosondes, batteries, and associated equipment.

6. Disposition of Data and Archive Files

The NWS makes the data collected from the observation available in the standard coded message format as soon as the message is generated. The observation data is treated as another routine observation. The file is saved for archive and ultimately sent to NCEI.

7. Information Reported

The WSH upper air Program Manager may request each office taking special observations submit a Special project Status and Activities Report as necessary. The information required in the report may include:

- a. Title and nature of the project.
- b. Total number of special observations taken.
- c. Total number of radiosondes used.
- d. Release dates and times, with space provided for remarks on each observation.

- e. Amount of overtime used per observation. This helps ensure the Region is reimbursed for proper labor charges. (Maximum 3 hours overtime per observation is allowed).

8. Special Projects and Activities Timeline

Timeframe	Activities
9 Months	Sponsor composes letter of request to Director, Analyze, Forecast, and Support Office (AFSO) National Weather Service Headquarters Director, Analyze, Forecast and Support Office 1325 East-West Highway Silver Spring, Maryland 20910
8 Months	AFSO Director coordinates with OBS Director and responds with approval/disapproval after internal NWS review of resources is completed. If the sponsor is an international organization, then consultation with International Activities Staff (IAS) is required prior to AFSSO decision.
7 Months	Preliminary drafts of the MOU and RA are coordinated between parties.
6 Months	Regional Manager works with WSH to obtain final costs for each observation and any associated administration costs and provides this information to the sponsor.
4 Months	NWS and sponsor ratify the MOU and RA with signatures on hard copy.
3 Months	The Office of General Council (OGC) clears the MOU.
2 Months	Sponsor internally coordinates and arranges the advance payment to NWS.
1 Month	CFO2 takes delivery of the sponsor's payment to NWS.
0 Month	Special Upper Air Observations start
+1 Month	AFS representative calculates actual cost and informs sponsor.
+2 Month	Region receives the amended RA to execute labor and expendables budget.
+3 Month	NOAA/NWS sends reimbursement payment to Sponsor, if necessary.
End of FY	In the case of a multi-year MOU, the AFS representative contacts the sponsor to learn if there are any amendments to MOU and RA.

Table L-1: Upper Air Special Projects and Activities Timeline

9. Request for Space

When a space at a WFO is requested from within NOAA agencies, that does not affect the working process, require NWS personnel to perform any launches, or involve reimbursement of any kind, then a simple request from the Head of the project to the Regional Director should suffice.