

NESDIS Satellite Programs



Matthew Seybold,
GOES-R Data Operations Manager



Chris Sisko,
JPSS Data Operations Manager

NWS Partners Meeting
November 1, 2016 – Silver Spring Civic Center



NOAA Satellite Conference
July 17-21, 2017
New York City, New York



Overview of GOES-R

Matthew Seybold

GOES-R Data Operations Manager (DOM)
and Team Lead for Product
Readiness & Operations (PRO)

NWS Partners Meeting
November 1, 2016



GOES Constellation

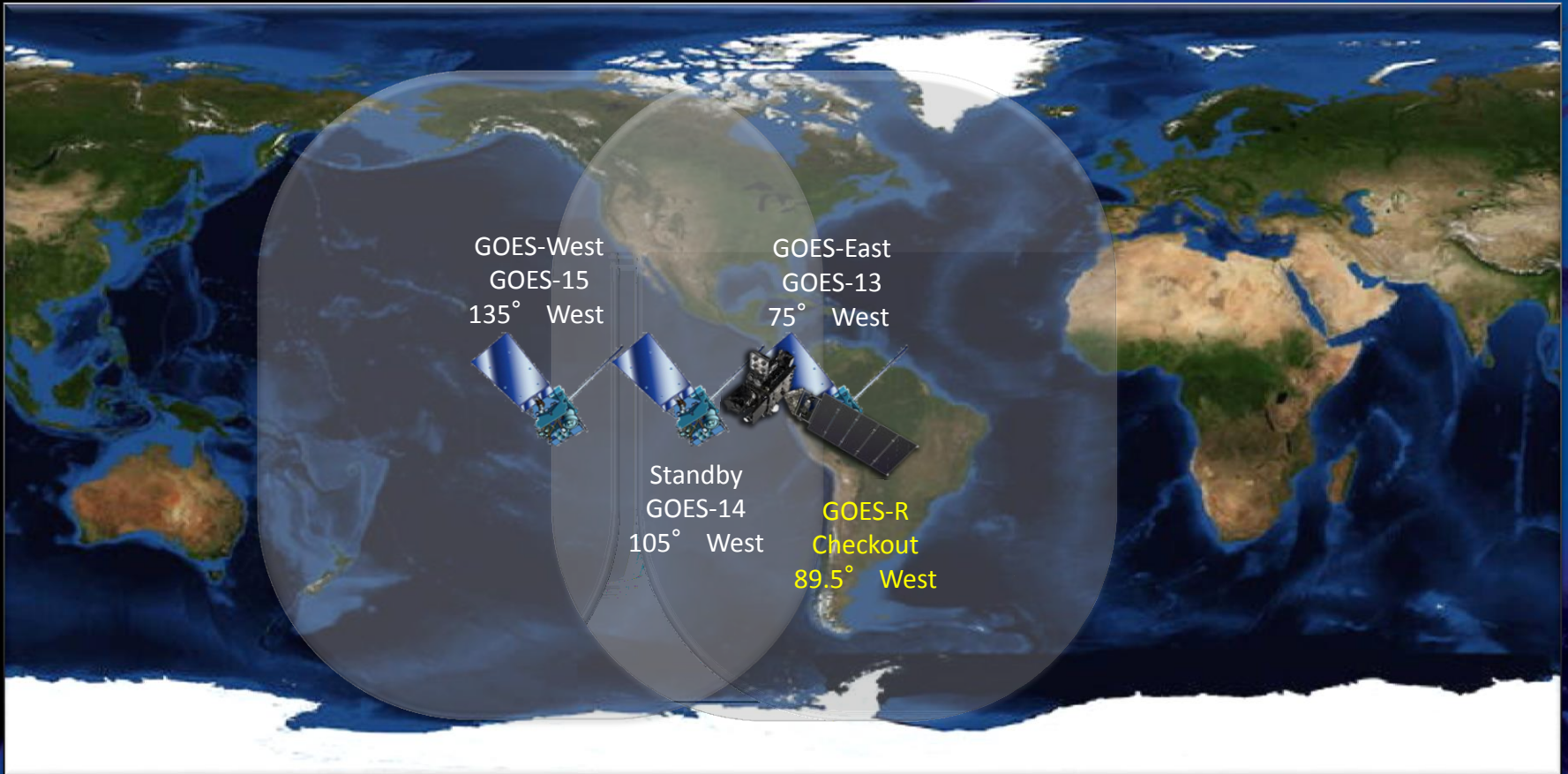

- Primary source of data for short term forecasting, especially of severe weather such as tropical storms
- Continuity of Operations since 1974



GOES Constellation



GOES-West
GOES-15
135° West

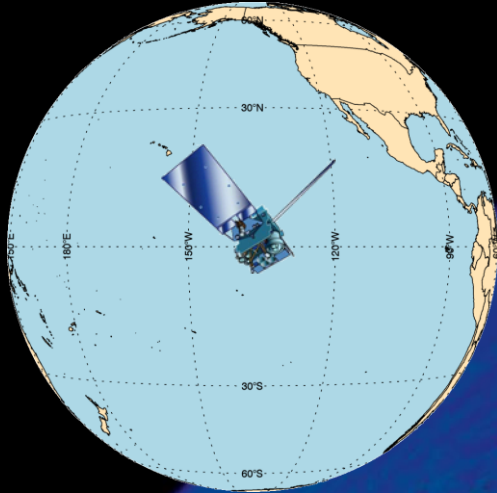

Standby
GOES-14
105° West

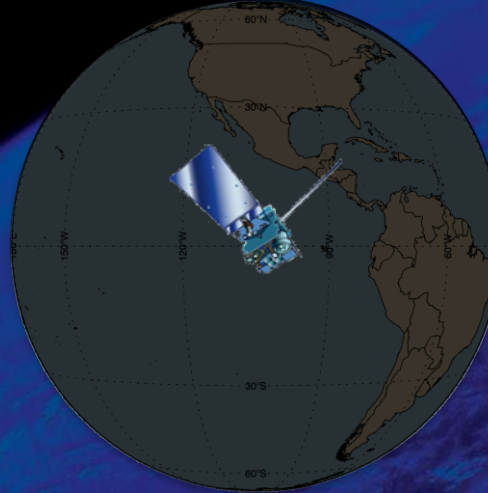

GOES-East
GOES-13
75° West

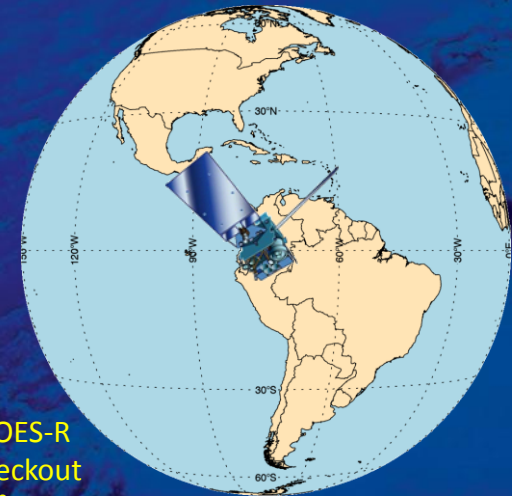

GOES-R
Checkout
89.5° West

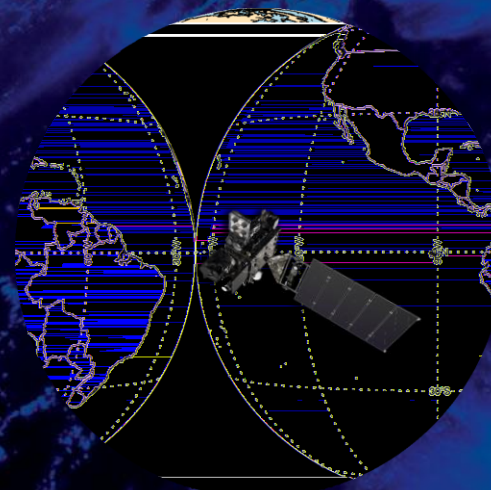

- Primary source of data for short term forecasting, especially of severe weather such as tropical storms
- Continuity of Operations since 1974



GOES-R Series



- GOES R, S, T, U
- GOES-R launch November 16, 2016 at 4:42 pm
 - Launching from: Cape Canaveral Air Force Station, Florida
 - Vehicle: United Launch Alliance Atlas V (AV-541)
 - Pad: Launch Complex 41
 - First public images ~Feb. 2017
 - First imagery released for public use ~Mar. 2017
 - Assume position at East/West ~Dec. 2017
- GOES-S launch Feb. 2018
- GOES-T launch 2019
- GOES-U launch 2024





GOES-R Capabilities



The GOES-R series will provide significant improvements in the detection and observations of meteorological phenomena that directly impact public safety, protection of property, and our Nation's economic health and prosperity.

ABI

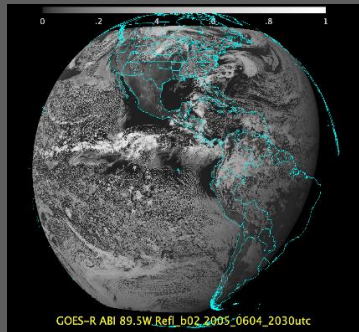

*Visible & IR
Imagery*

GLM

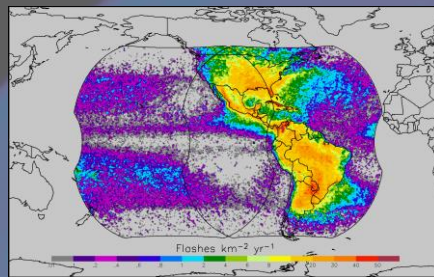

*Lightning
Mapping*

SEISS and MAG

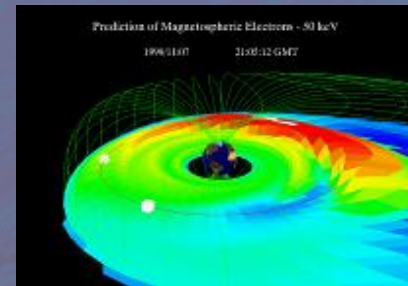

*Space Weather
Monitoring*

EXIS and SUVI



*Solar
Imaging*



Assembled GOES-R Spacecraft





Trip to Florida





Fairing Encapsulation & Branding





Advanced Baseline Imager (ABI)



- Primary instrument in GOES-R series
- 16 channel imager

GOES-R THE FUTURE OF FORECASTING

3X MORE CHANNELS



Improves every product from current GOES Imager and will offer new products for severe weather forecasting, fire and smoke monitoring, volcanic ash advisories, and more.

4X BETTER RESOLUTION



The GOES-R series of satellites will offer images with greater clarity and 4x better resolution than earlier GOES satellites.

5X FASTER SCANS



Faster scans every 30 seconds of severe weather events and can scan the entire full disk of the Earth 5x faster than before.



GOES-13/14/15 Spectral Bands

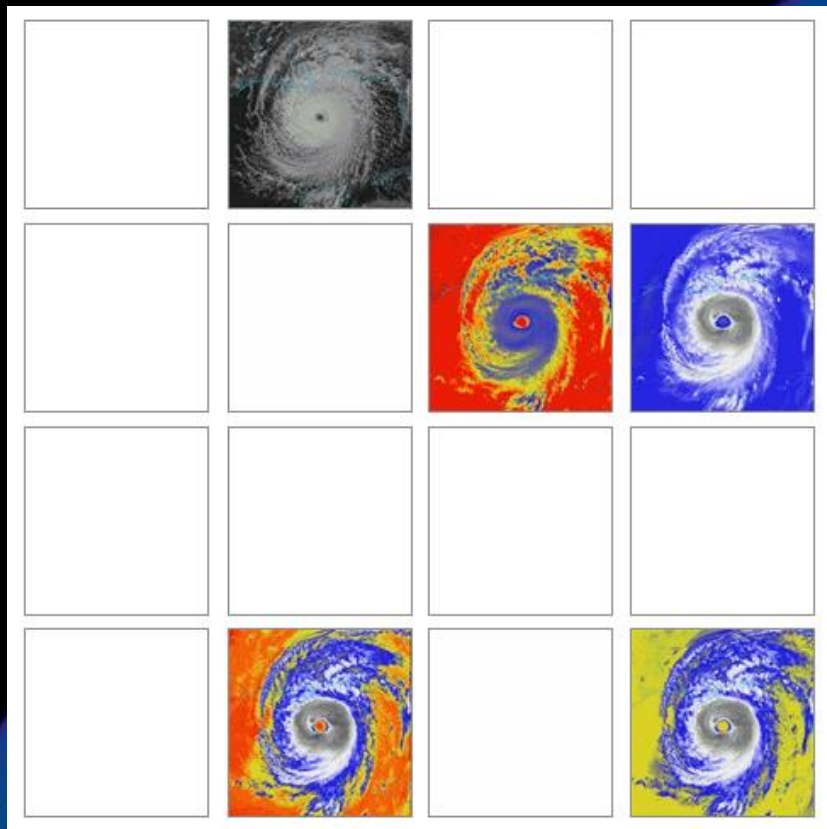

GOES-R Spectral Bands

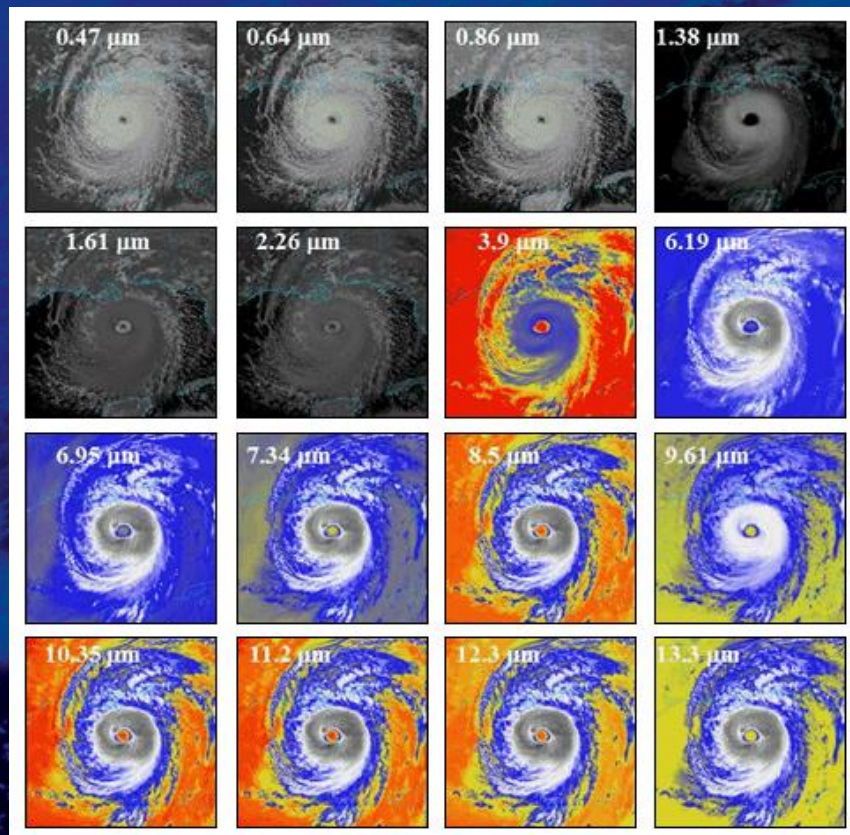



Four Times More Spatial Resolution

Spatially:	GOES-R	Current
0.64 um VIS:	0.5 km	1 km
other VIS/NIR:	1 km	n/a
IR:	2 km	4 km

GOES

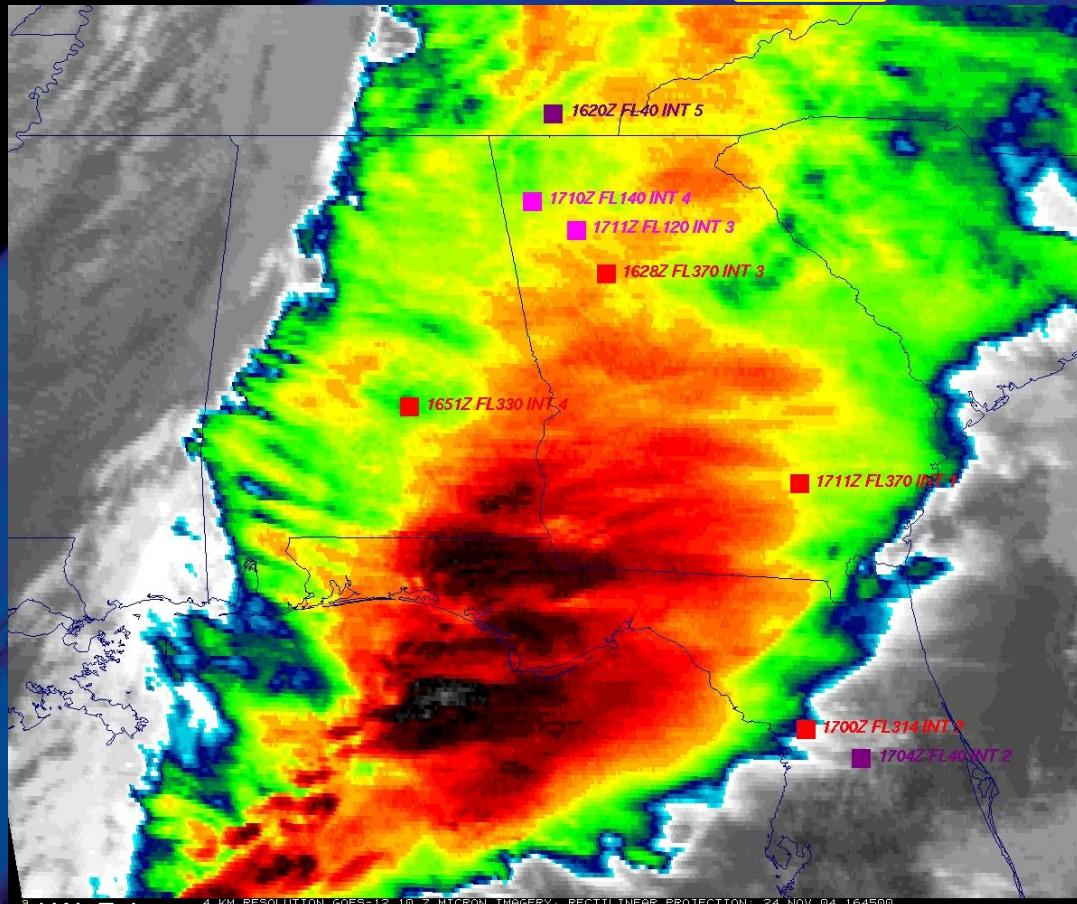

4 KM RESOLUTION GOES-12 10.7 MICRON IMAGERY, RECTILINEAR PROJECTION: 24 NOV 04 164500



Four Times More Spatial Resolution



Spatially:	GOES-R	Current
0.64 um VIS:	0.5 km	1 km
other VIS/NIR:	1 km	n/a
IR:	2 km	4 km

“ABI” from MODIS

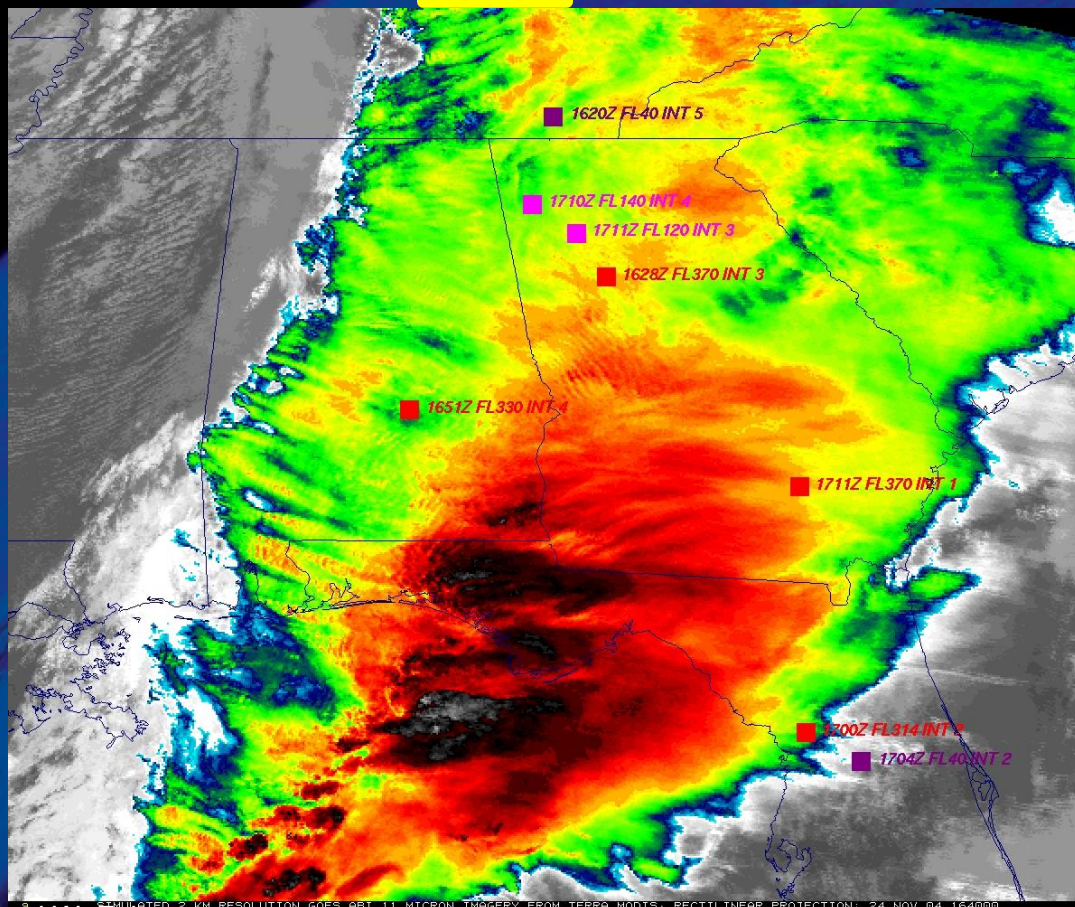



Five Times Faster Coverage



Current GOES
5 minute Capability

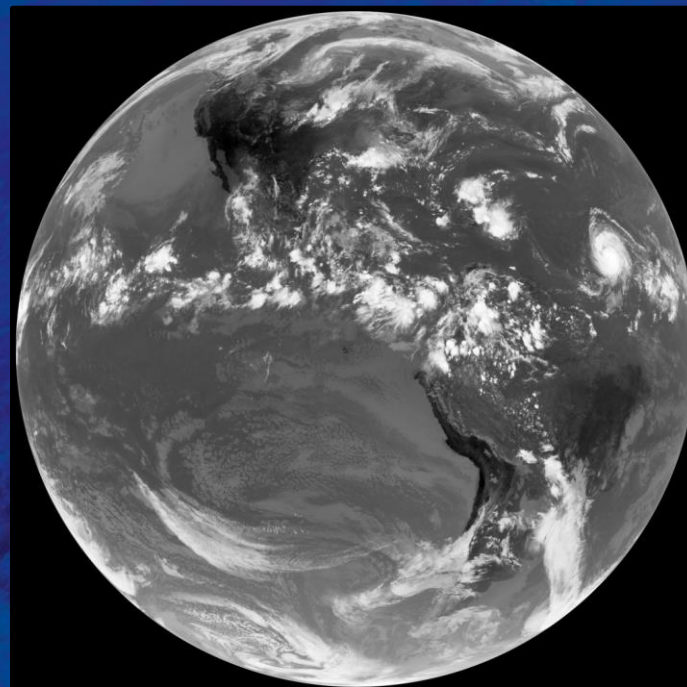

GOES-R
5 minute Capability



ABI: Temporal



Numerous ~1-minute “super rapid scan” periods of evaluation (from GOES-14) have shown great benefit to analyzing and diagnosing high-impact weather events.

- *Convective Initiation*
- *Convection Evolution*
- *Fire Elements*
- *Fog/Stratus Evolution*
- *Volcanic Ash Dispersion*
- *Many others...*

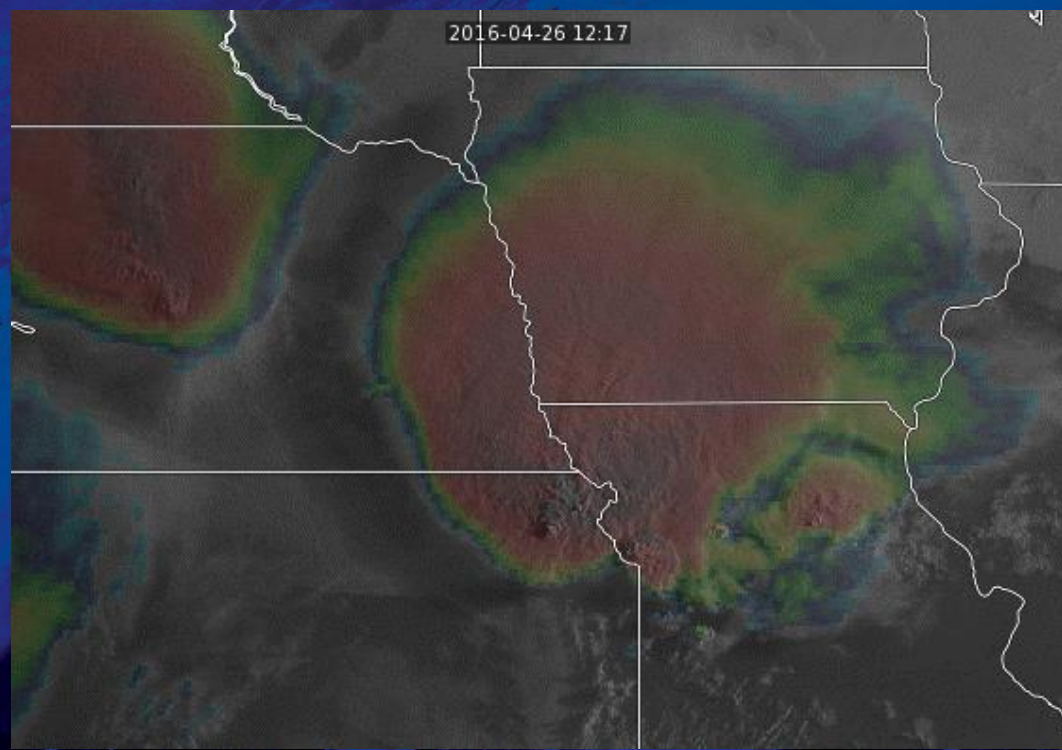



Flexibility of the ABI



Two Primary Modes of Operation:

- **Mode 3: Flex Mode**
 - Default Mode (per NWS request)
 - Full Disk (FD) domain every 15 mins
 - Contiguous US (CONUS) domain every 5 mins
 - 2 Mesoscale domains every 1 minute
 - or
 - 1 Mesoscale domain every 30 seconds
- **Mode 4: Continuous Full Disk (FD) Mode**
 - Full Disk domain every 5 mins
- The NCEP/Senior Duty Meteorologist (SDM) will receive requests for mode and mesoscale location changes from NWS, NCEP, NESDIS requesting entities

Flex Mode Scanning

Approximate Pixel Area (Nominally 1km at Nadir) from -75.0 West

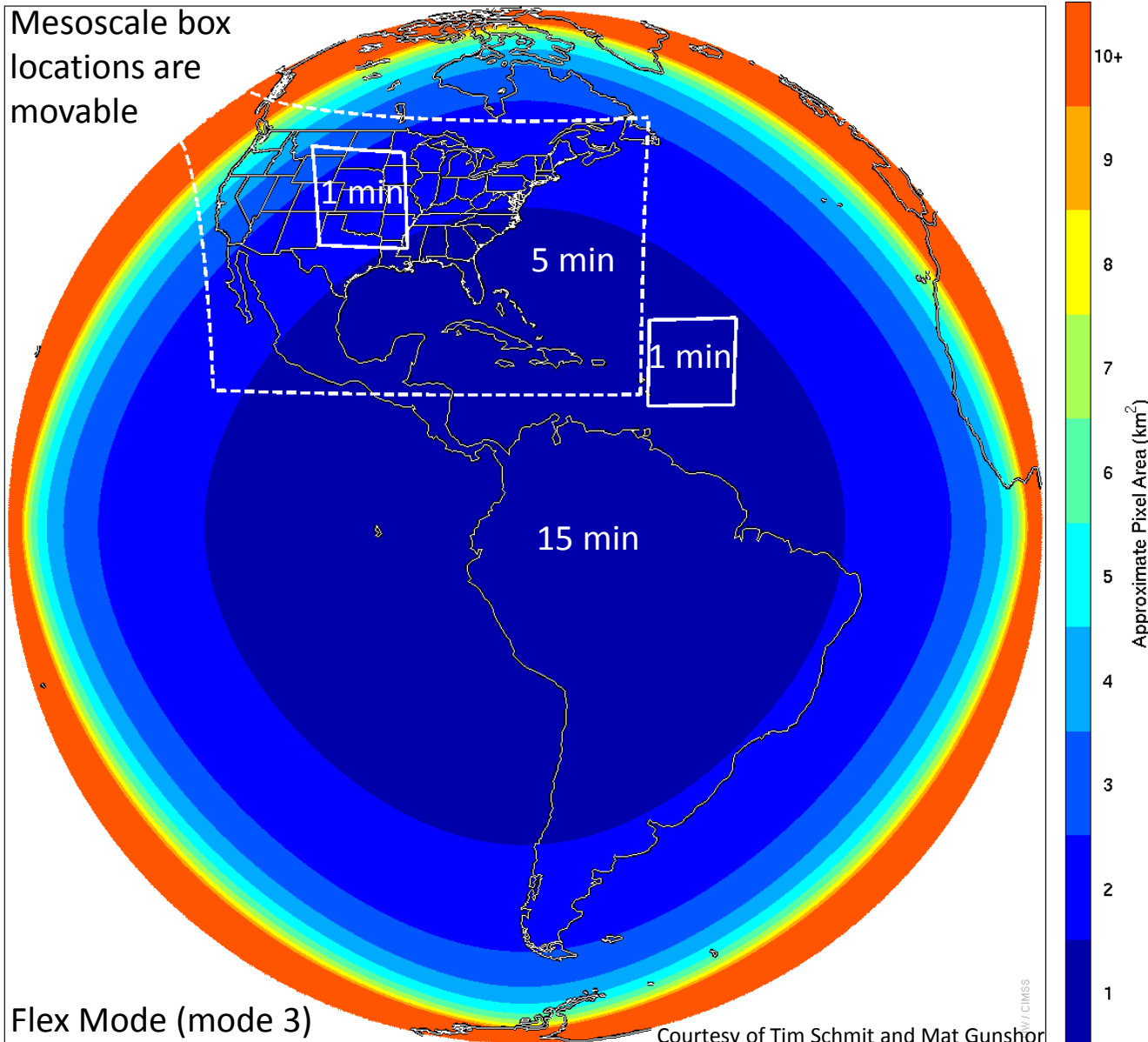



With 2 ABIs (GOES E & W)



= 4 Mesoscale Domain Sectors (MDS)

Approximate Pixel Area (Nominally 1km at Nadir) from -137.0 West

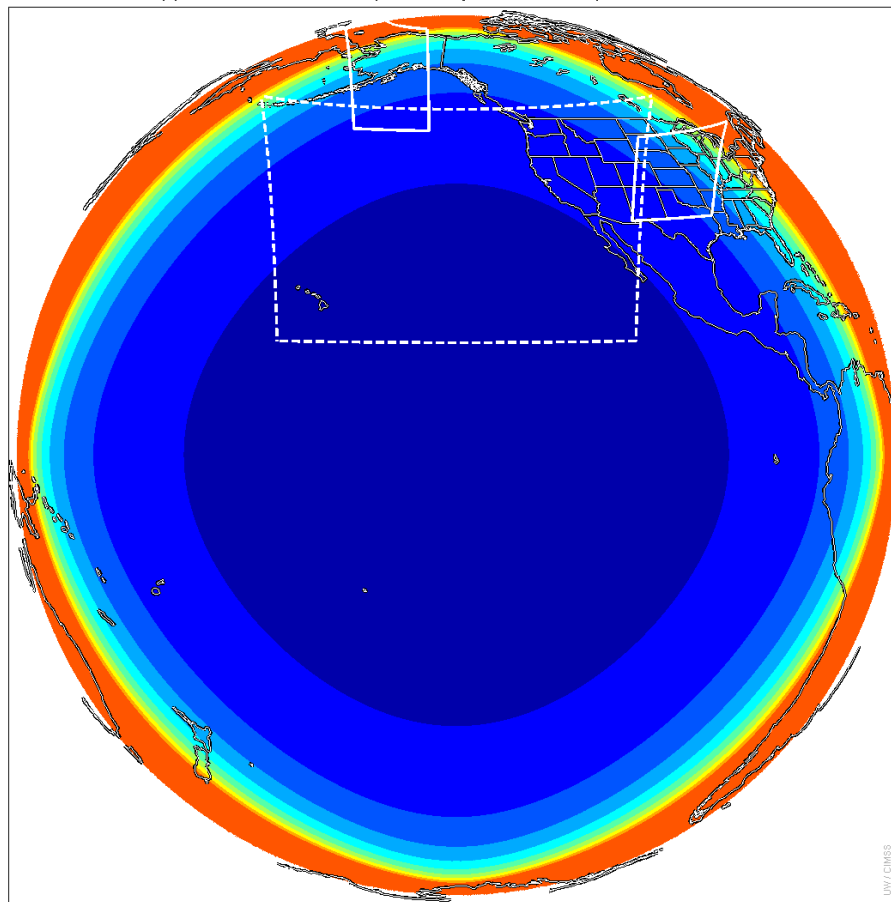

Approximate Pixel Area (Nominally 1km at Nadir) from -75.0 West

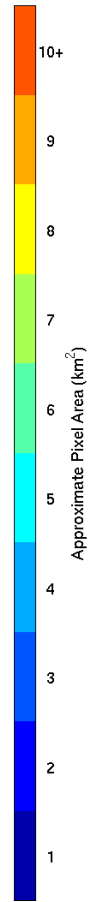
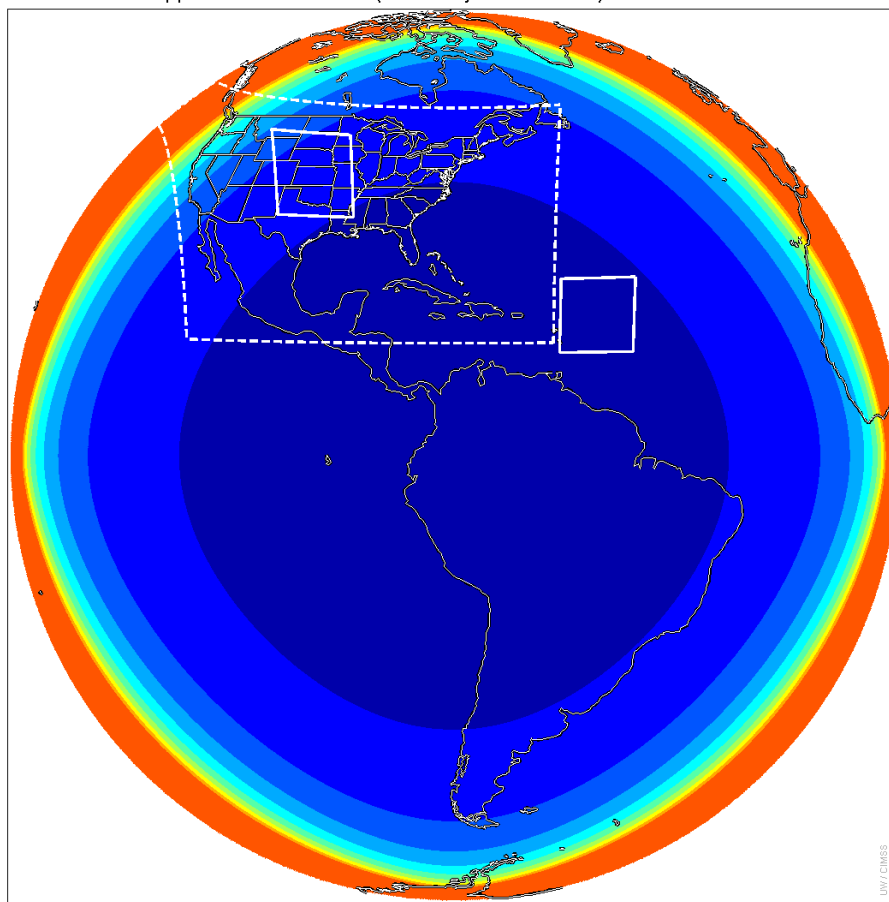



Flex Mode Mesoscale Domain Default Positions



- Commercial airline route corridors shown for both GOES-E and GOES-W
- These will be default Mesoscale Domain Sector (MDS) locations if there are no other requests

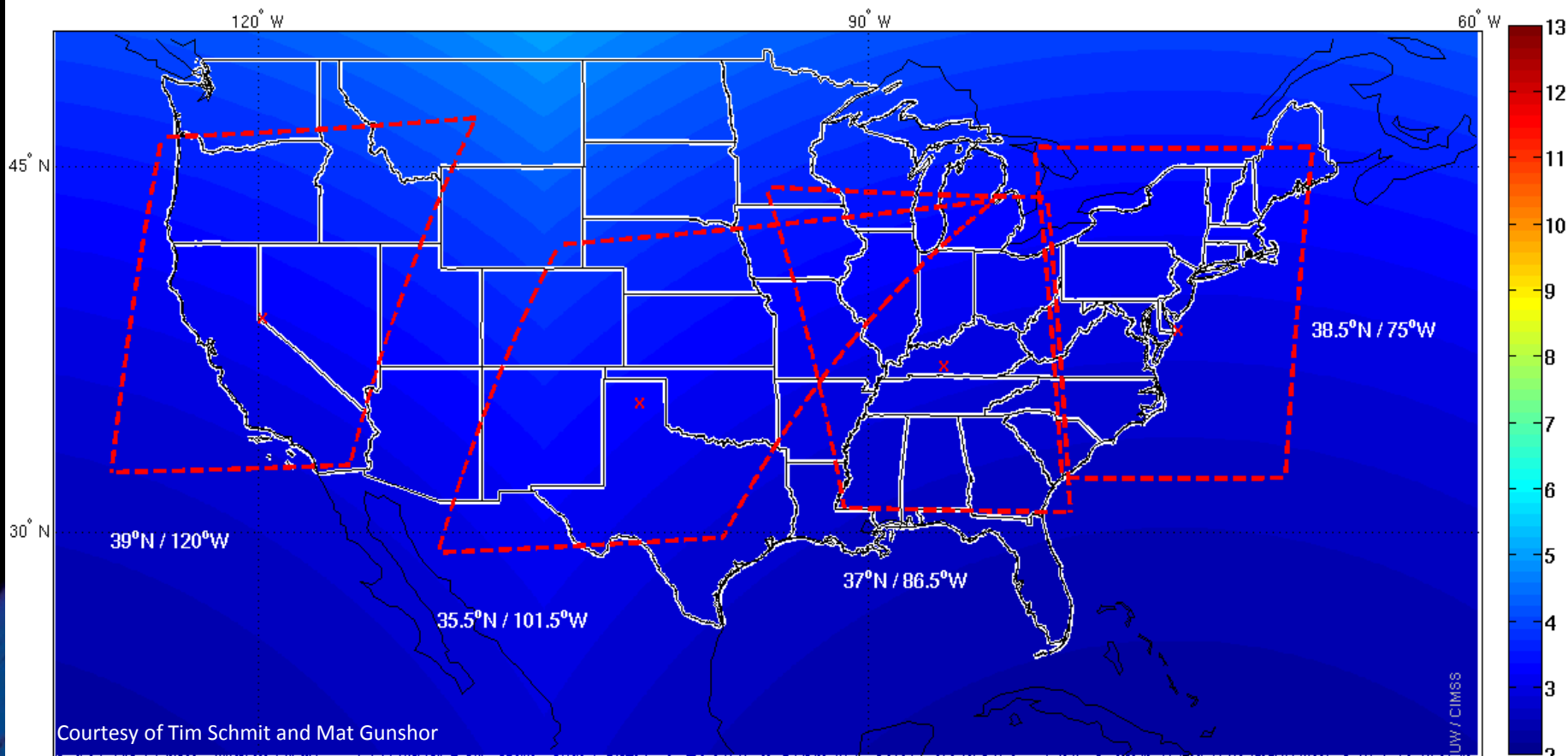

GOES-R Era West (137W) & East (75W) Pixel Size with potential default Mesoscale scan location examples

GOES-R Data Distribution

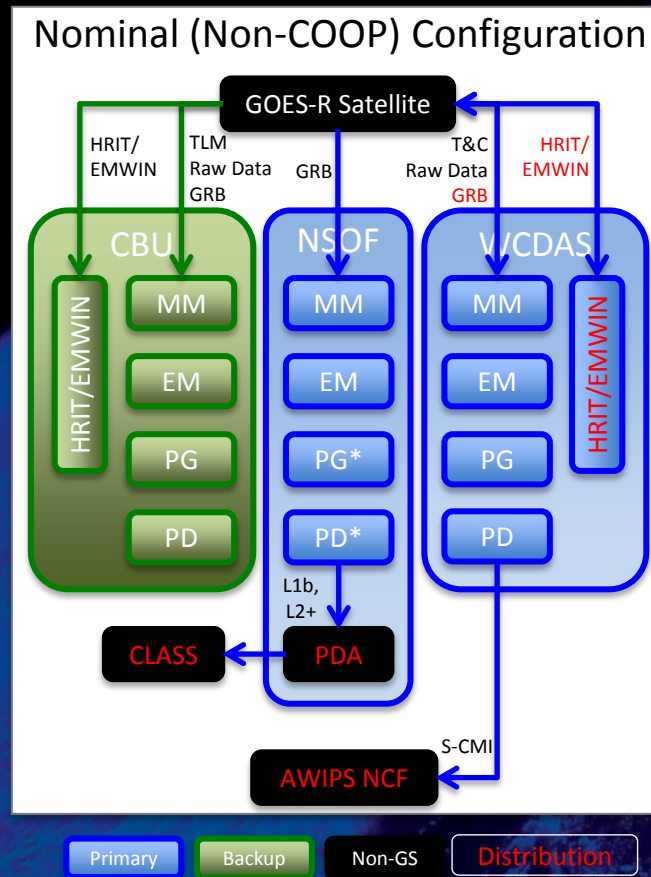

- PG Only GRB (L1b) & Sectorized CMI generation
- PD Only GRB delivery to satellite, Sectorized CMI delivery to AWIPS, L0 to LZSS (WCDAS only); delivery only by OE
- PG* L1b reconstruction, L2+ generation
- PD* L1b, L2+ delivery to PDA; delivery only by OE

GRB & AWIPS delivery remains in tact for COOP scenarios



GOES-R Data Access



Acronym	System Name	Description
GRB	GOES Rebroadcast	One channel of the space data relay service of GOES-R for Level 1b data products (ABI L1b, Space Weather L1b, and GLM L2). These data are available to all users with GRB receivers in view of a GOES-R series satellite at the East or West operational longitudes.
AWIPS	Advanced Weather Interactive Processing System	Interactive computer system that integrates meteorological and hydrological data, enabling forecasters to prepare forecasts and issue warnings. GOES-R will provide selected products through AWIPS. Sectorized Cloud and Moisture Imagery will be delivered via NOAAPORT/SBN (Satellite Broadcast Network).
HRIT/ EMWIN	High Rate Information Transmission/ Emergency Managers Weather Information Network	EMWIN is a direct service that provides users with weather forecasts, warnings, graphics and other information directly from the NWS in near real-time. The HRIT service is a new high data rate (400 Kpbs) version of today's LRIT (Low Rate Information Transmission), broadcasting GOES-R satellite imagery and selected products to remotely-located user terminals.
PDA	Product Distribution and Access	The Environmental Satellite Processing and Distribution System (ESPDS) is responsible for receiving and storing real-time environmental satellite data and products and making them available to authorized users (ABI L1b and L2+, Space Weather L1b, and GLM L2). PDA will provide real-time distribution and access services for GOES-R users.
CLASS	Comprehensive Large Array-data Stewardship System	Web-based data archive and distribution system for NOAA's environmental data. CLASS will provide retrospective data access and distribution services of GOES-R data to all users.

L0 Data

```
01010100110  
11110001010  
10101000111  
1001011010...
```

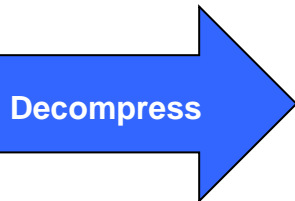

L1a Data

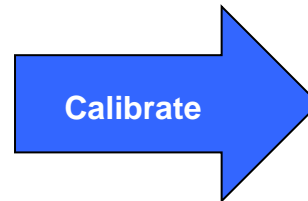

L1 α Data

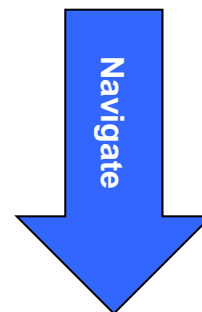

Sectorized CMI (AWIPS)

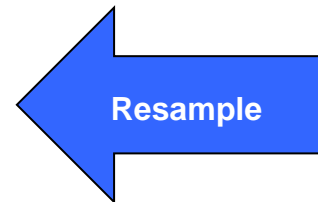
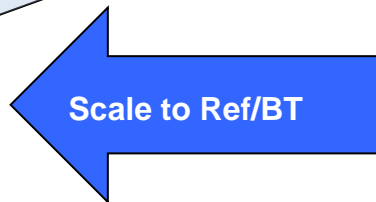
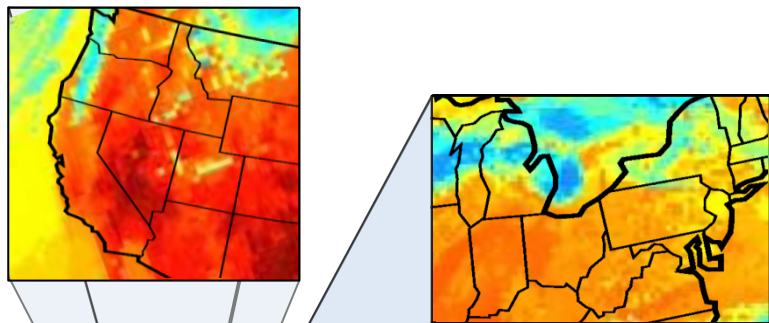

CMI

L1b Image

L1 β Data



Baseline Products



ADVANCED BASELINE IMAGER (ABI)

- Aerosol Detection (Including Smoke and Dust)
- Aerosol Optical Depth (AOD)
- Clear Sky Masks
- Cloud and Moisture Imagery
- Cloud Optical Depth
- Cloud Particle Size Distribution
- Cloud Top Height
- Cloud Top Phase
- Cloud Top Pressure
- Cloud Top Temperature
- Derived Motion Winds
- Derived Stability Indices
- Downward Shortwave Radiation: Surface
- Fire/Hot Spot Characterization
- Hurricane Intensity Estimation
- Land Surface Temperature (Skin)
- Legacy Vertical Moisture Profile
- Legacy Vertical Temperature Profile
- Radiances
- Rainfall Rate / QPE
- Reflected Shortwave Radiation: TOA
- Sea Surface Temperature (Skin)
- Snow Cover
- Total Precipitable Water
- Volcanic Ash: Detection and Height

GEOSTATIONARY LIGHTNING MAPPER (GLM)

- Lightning Detection: Events, Groups & Flashes

SPACE ENVIRONMENT IN-SITU SUITE (SEISS)

- Energetic Heavy Ions
- Magnetospheric Electrons & Protons: Low Energy
- Magnetospheric Electrons & Protons: Med & High Energy
- Solar & Galactic Protons

MAGNETOMETER (MAG)

- Geomagnetic Field

EXTREME ULTRAVIOLET AND X-RAY IRRADIANCE SUITE (EXIS)

- Solar Flux: EUV
- Solar Flux: X-ray Irradiance

SOLAR ULTRAVIOLET IMAGER (SUVI)

- Solar EUV Imagery

Level 1b 6 L1b Algorithms (1 per instrument)
9 L1b Products (none from GLM
which only has L2 products)

Level 2+ 16 L2+ Algorithms
25 L2+ Products



Simulated Data in NOAAAPORT



- The NOAA STAR Cooperative Institute CIMSS creates 16 bands of real-time modeled data using WRF and GFS models, called AAWDS (ABI AWG/UW-Madison Data Set)
- RaFTR-CIMSS-SIM software formats the data and interpolates to the GOES-R real-time cadence for sampling Earth then the data are injected to the GOES-R GS data fabric

NWS AWIPS 4-Panel Display

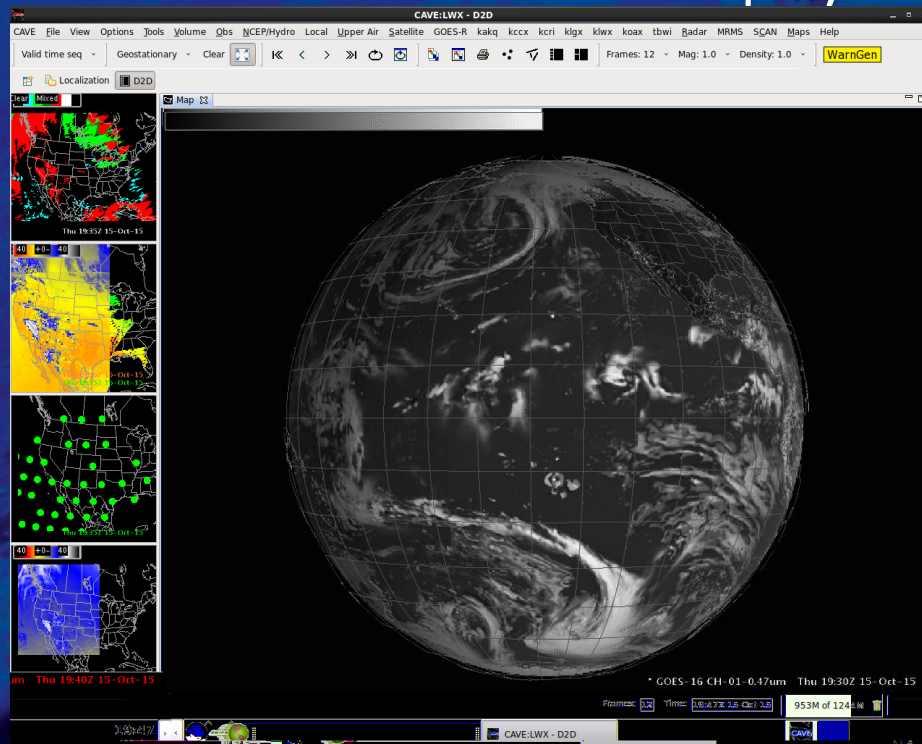

NWS AWIPS 4-Panel Display
L2+ CMI during GRE-DO1 (AAWDS & RaFTR-CIMSS-SIM)



Simulated Data in NOAAPORT



- Finally, PD sends the simulated NetCDF files over the SBN and to AWIPS-II terminals at WFOs
- Forecasters then look at these simulated “GOES-R products” and can see the spatial/spectral/temporal benefits and make side-by-side comparisons against other tools

NWS AWIPS 4-Panel Display

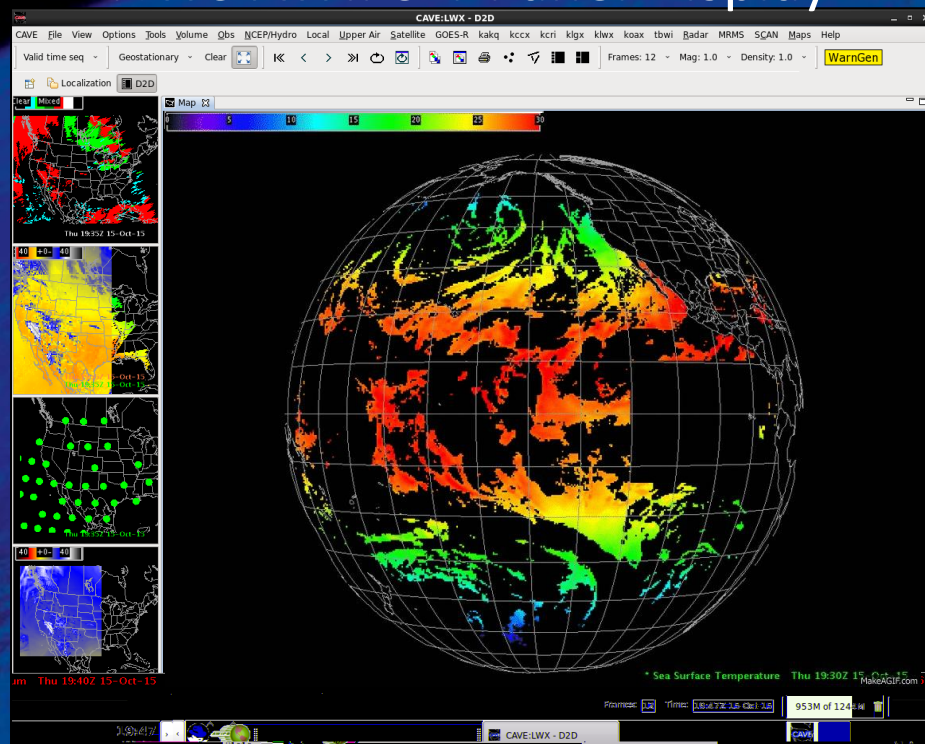

NWS AWIPS 4-Panel Display
L2+ Products SST, Cloud Top Phase, Cloud Mask
during GRE-DO1 (AAWDS & RaFTR-CIMSS-SIM)



Simulated Data in NOAAPORT



- NOAAPORT TIN (Technical Implementation Notices) on the testing of simulated GOES-R Imagery across SBN: http://www.nws.noaa.gov/os/notification/tin15-24goes-r_imagery.htm
- Test Products are broadcast across the GOES-R West & East SBN Channels //PIDS 107 and 108, respectively//.
- Purpose
 - Test data flow across the SBN
 - Acquaint users with cadence and spatial/spectral/temporal capabilities of GOES-R data
 - **NOT intended to be used for science studies, meteorological analysis, forecast purposes, or redistribution**
- WMO Headers are listed in the TIN
- Timing
 - Near-Continuous flow through at least February, 2016
- Further TINs will be issues to publicize information about these tests including formats and headers
- In addition, static samples of simulated GOES-R imagery will be posted on the NOAAPORT users page: http://www.nws.noaa.gov/noaaport/html/GOES_R.shtml
- User's Guide: http://www.nws.noaa.gov/noaaport/document/GOES-R_NOAAPort_SBN_040416.pdf



Science Product Validation Schedule

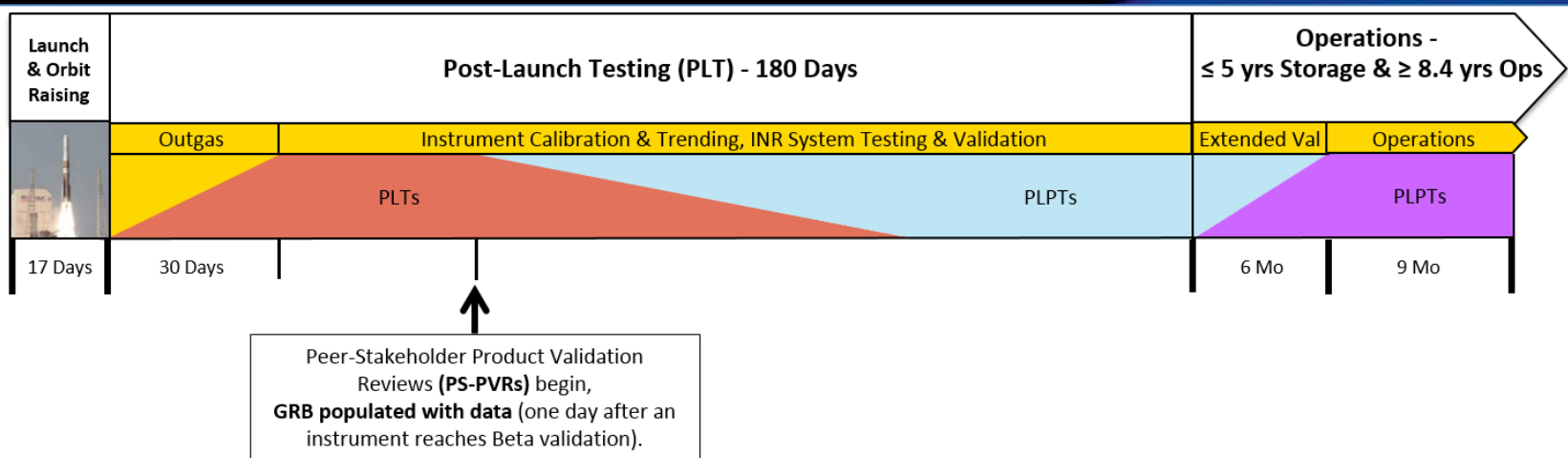

- Product Validation Review (PS-PVR) will be held which appraises the status of product quality with respect to Program definitions
- Declares products have achieved a product maturity level
- Once each instrument reaches Beta Maturity, data from that instrument will populate the GRB (GOES Re-Broadcast) stream and thus all downstream users including PDA



Science Product Validation Schedule

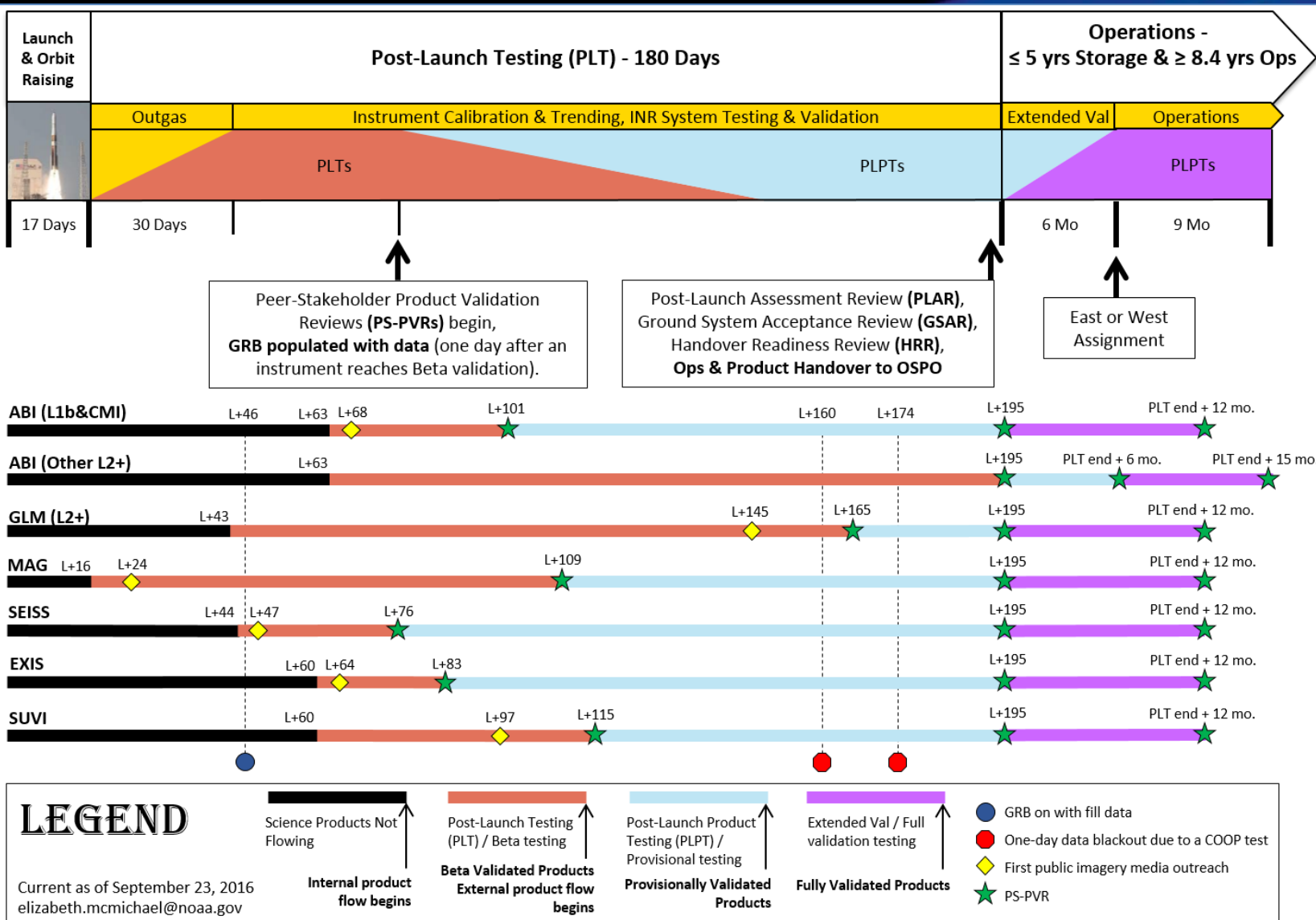



Science Product Validation Schedule

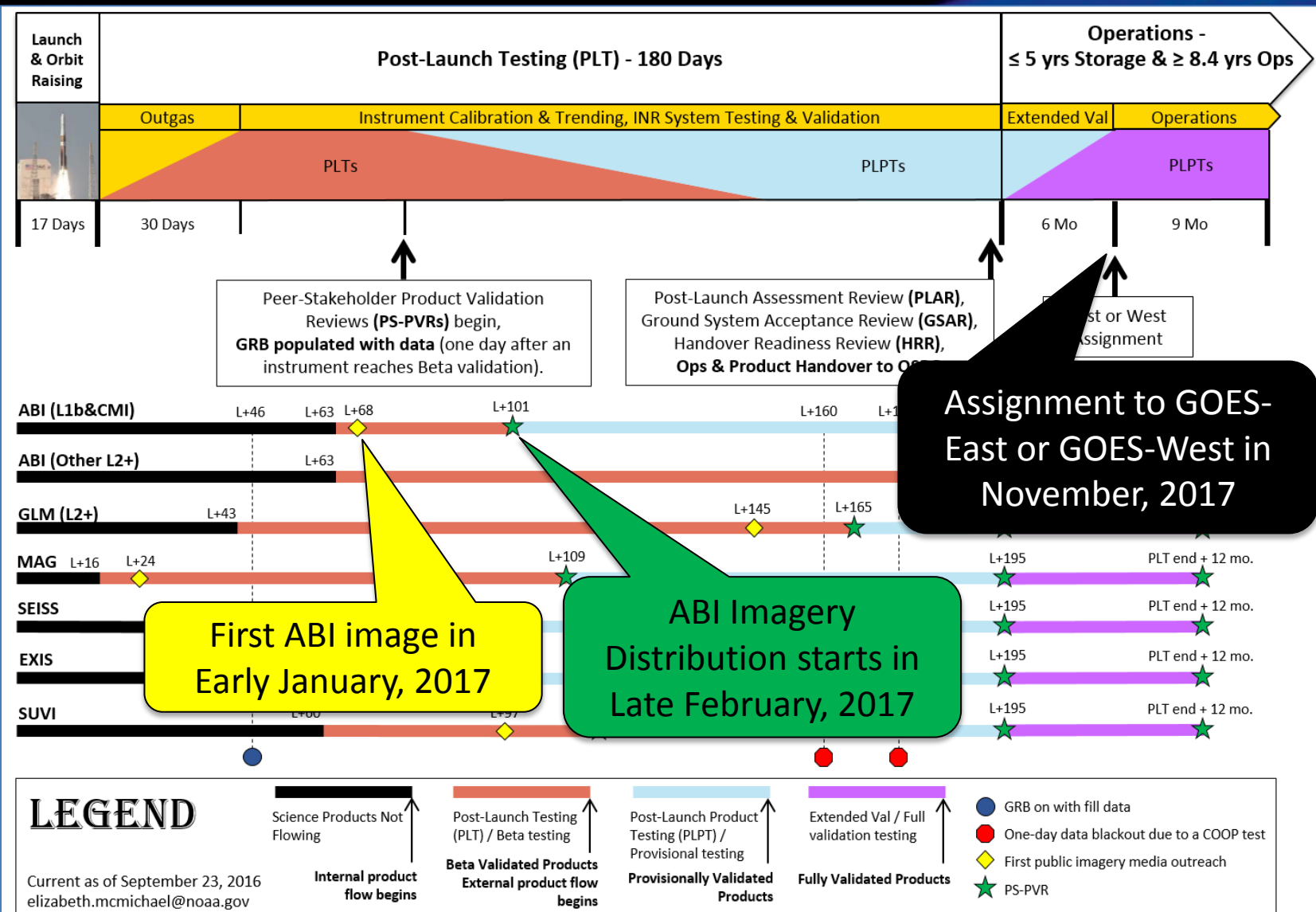

Status of GRB Simulator Loan Project

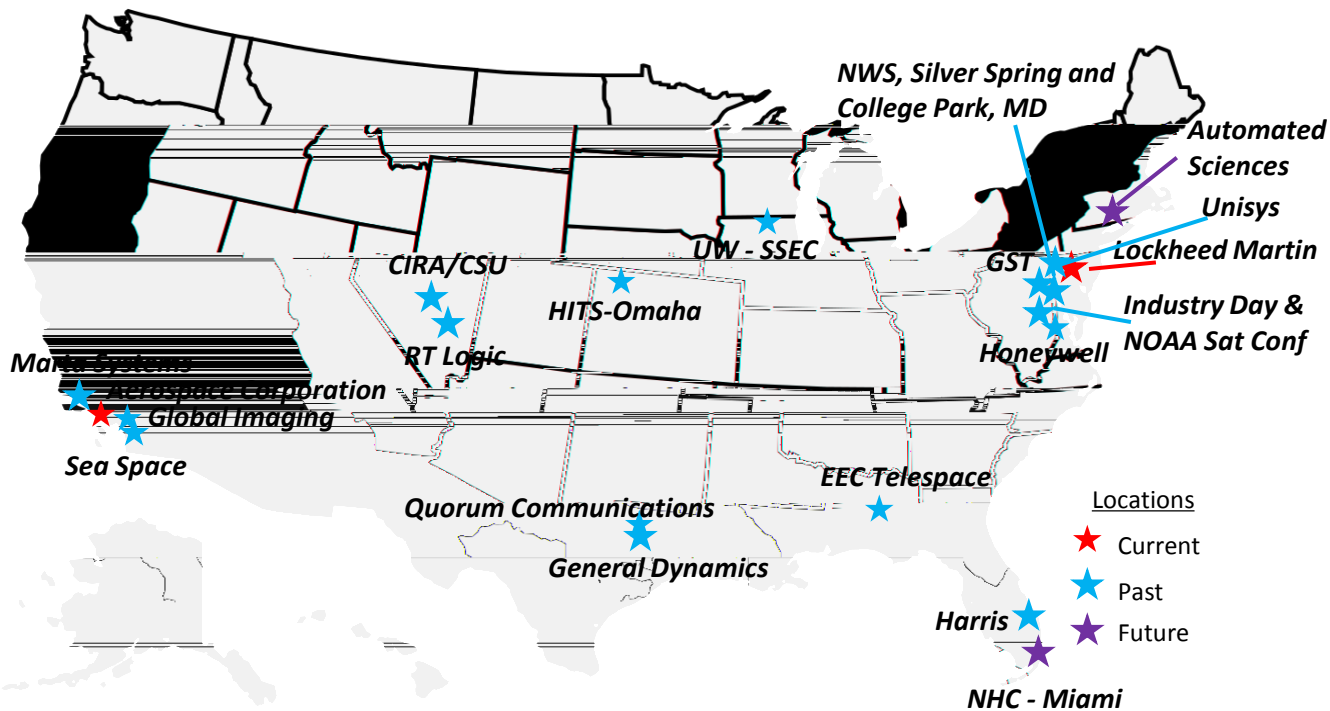

- Loans, training, and outreach are all at high levels of activity
- Simulators are Healthy
- Strong support to NWS
- 15 borrowers, some were return customers
- 8 are manufacturers
- 5 vendors now offer GRB solutions
- 3 more vendors currently working on GRB solutions
- Supporting NWS Site Acceptance Tests
- The “GRB User & Vendor WG” is proving to be a beneficial outreach forum
- Loans continue and user outreach increasing

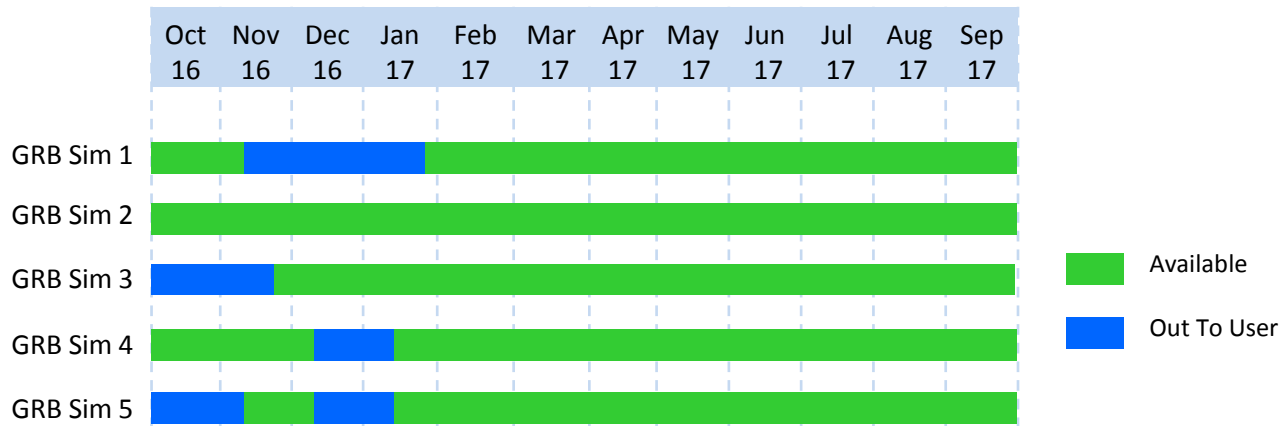



GRB Client-Side L2+ Product Processing Software Solution



- Space Science & Engineering Center (SSEC at U Wisconsin) is developing a software package for processing GRB data with funding from GOES-R, called “CSPP-GEO” (Community Satellite Processing Package - GEO)
- GRB V0.3 prototype released October 2015
 - Creates ABI Level 1 and GLM Level 2 datasets
 - Writes output to NetCDF4 files
 - Test dataset provided
- Software and documentation available from website: <http://cimss.ssec.wisc.edu/csppgeo/>
 - Includes ICD describing planned upstream data interface
- Planning new releases ~every 3 months, eventually support all GOES-R instruments
- Directed developers to modify software client to include only baseline products and exclude future capabilities
 - Actively discussing the modifications with the development team





GOES-R Notifications



- Environmental Satellite Processing Center (ESPC) is the source for GOES-R Notifications via Email
 - Subscription Requests: ESPCOperations@noaa.gov
 - Telephone Inquiries: 301-817-3880
- Between Launch and Operations Handover (Launch + 6 months), notifications will only occur for distribution turn-on milestones (and RSO-matched MDSs after external distribution starts)
- After Operations Handover, nominal O&M Notifications commence



www.goes-r.gov



- Home
- Mission
- User Info
- Outreach
- Multimedia
- Resources
- Organization

GEOSTATIONARY OPERATIONAL ENVIRONMENTAL SATELLITE-R SERIES

A collaborative program of NOAA and NASA

COUNTDOWN TO GOES-R LAUNCH

55 days 03 hrs 55 mins
01 secs

Launch is currently scheduled for November 4, 2016 at 21:40 GMT (5:40 pm EDT)

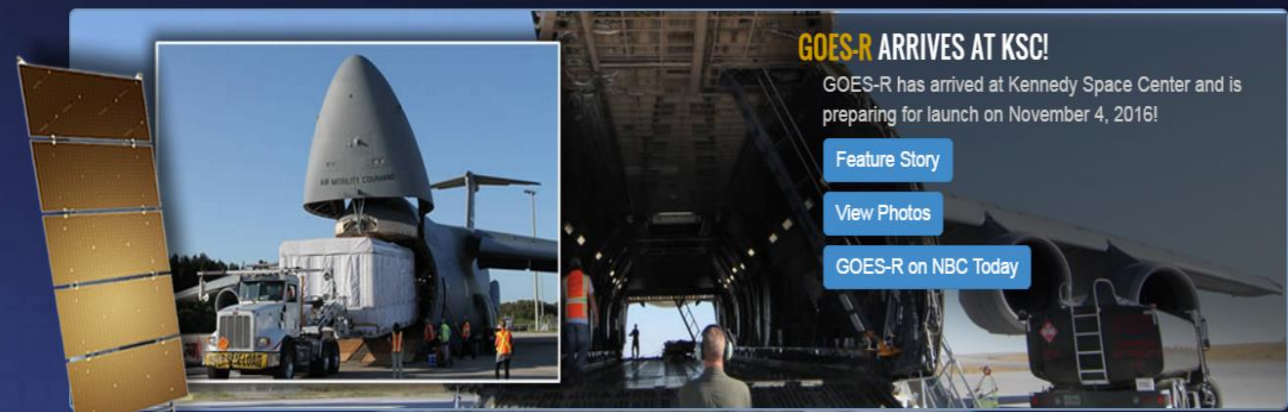

GOES-R ARRIVES AT KSC!

GOES-R has arrived at Kennedy Space Center and is preparing for launch on November 4, 2016!

- Feature Story
- View Photos
- GOES-R on NBC Today



HIGHLIGHTS :

-
-
-
-
-
-





<http://www.goes-r.gov/spacesegment/abi.html>
<http://www.goes-r.gov/users/training.html>



ABI MODES OF OPERATION

- **Full Disk:** Hemispheric Coverage of 83° local zenith angle, temporal resolution of 5-15 minutes, and spatial resolution of 0.5 to 2km.
- **Mesoscale:** Provides coverage over a 1000x1000km box with a temporal resolution of 30 seconds, and spatial resolution of 0.5 to 2km.
- **Continental US:** The CONUS scan is performed every 5 minutes coverage of the 5000km (E/W) and 3000km (N/S) rectangle over the CONUS. The spatial resolution is 0.5 to 2km.
- **Flex Mode:** The flex mode of scanning will provide a FD scan over CONUS every 5 minutes, and a Mesoscale every 30 seconds.
- **Continuous Full Disk:** Continuous full disk mode will provide coverage of the full disk every 5 minutes.



GOES-R TRAINING

OVERVIEW



The GOES-R Series Program is committed to providing extensive training for the operational and educational communities that will address both end users' and developers' needs, bridging the gap between research and operations. Training will focus on the quantitative and qualitative use of GOES-R data and products, methods for interpreting GOES-R data, new features, capabilities and algorithms, and a better understanding of atmospheric sciences and mesoscale meteorology in preparation for the future GOES-R series satellites.

GOES-R training is developed and provided by a number of partners across the weather enterprise through the [GOES-R Proving Ground](#), e-learning training modules, seminars, weather event simulations, and special case studies.

The GOES-R Series Program has also implemented the position of "satellite liaison" to prepare forecasters for the data that will be available with GOES-R and to ease the transition to operations. Satellite liaisons are stationed at most of the National Centers and the NWS Training Center. Satellite liaisons are tasked with running the various GOES-R demonstrations within these testbed locations. They are essentially research-to-operations liaisons, improving upon training from the product developers to present to testbed participants, and providing participant feedback to the developers for further improvement.

Also, in an effort to promote more frequent communication with the user community about GOES-R science and demonstration activities, the GOES-R Program provides semi-monthly [virtual science seminars](#). The seminars allow scientists to highlight their recent work to the rest of the community.

TRAINING RESOURCES

For more information click on the [GOES-R Training Plan](#). For general information on the GOES-R series mission, access the [GOES-R 101 training module](#) or the [GOES-R: Benefits of Next-Generation Environmental Monitoring module](#).

Check out our [Fact Sheets](#) section for quick guides on GOES-R instruments, ground system and products.

TRAINING RESOURCES BY INSTITUTE

Click on logo to access training resources.



NWS Training Division



In collaboration with:



TRAINING RESOURCES BY TOPIC

- [General Satellite Meteorology](#)
- [Aerosols/Air Quality/Atmospheric Composition](#)
- [Aviation](#)



GOES R

GEOSTATIONARY OPERATIONAL ENVIRONMENTAL SATELLITE R-SERIES

For more information visit www.goes-r.gov

CONNECT WITH US!



www.facebook.com/GOESRsatellite

www.youtube.com/user/NOAASatellites

twitter.com/NOAASatellites

www.flickr.com/photos/noasatellites

The next generation
of geostationary
environmental satellites



BACKUP SLIDES



Geostationary Lightning Mapper (GLM)



- ~ 10 km across field of view with 8 km CONUS, 14 km at edge of field of view
- Detects extent of total lightning activity
- Day/night coverage with 70-90% flash detection (better at night)
- Near-uniform detection efficiency spatially across the domain
- Continuous coverage (2 ms frame rate)
- <20 sec latency

East/West GLM FOV

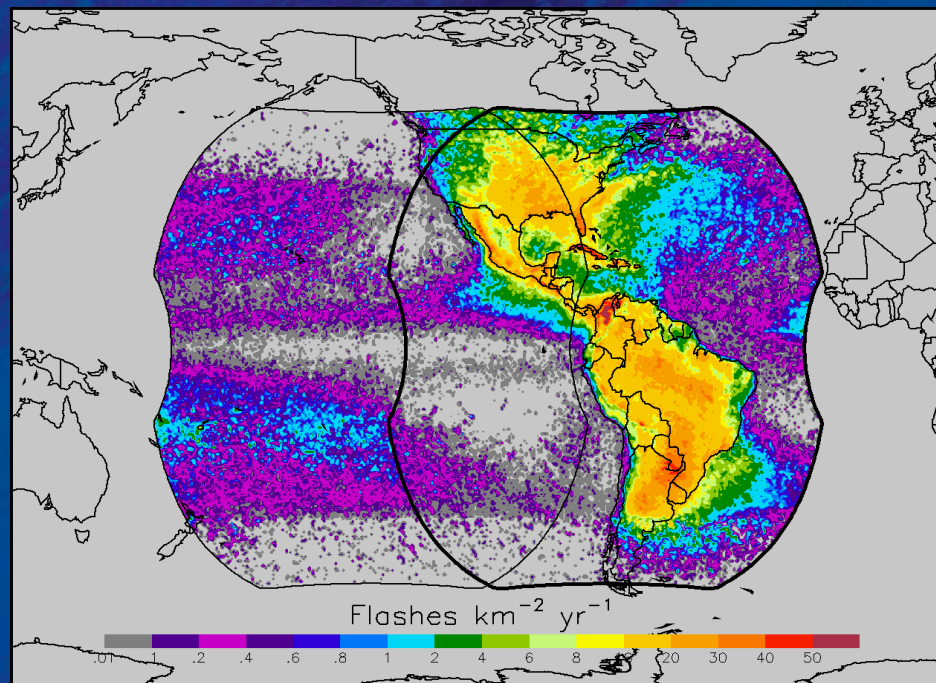



Geostationary Lightning Mapper (GLM)



- Mission Benefits
 - Cover data sparse regions
 - Diagnosing convective storm structure and evolution
 - Improved warning decision-making when combined with radar and satellite imagery
 - Aviation and marine convective weather hazards
 - Tropical cyclone intensity change
 - Decadal changes of extreme weather – thunderstorms/ lightning intensity and distribution

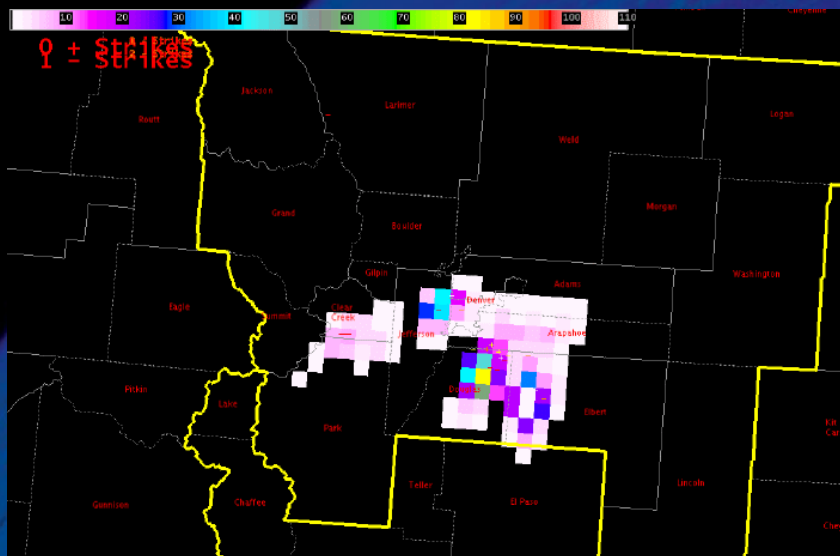

PGLM Total Lightning – Denver
NLDN CG overlaid

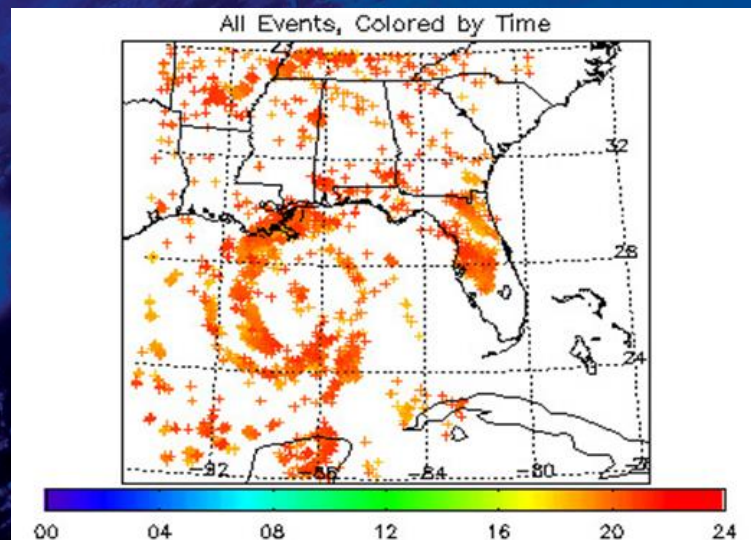

Hurricane Katrina



NOAA

OFFICE OF SATELLITE
AND PRODUCT OPERATIONS

NATIONAL ENVIRONMENTAL SATELLITE, DATA, AND INFORMATION SERVICE

National Weather Service NWS Fall Partners Meeting NESDIS Polar Satellites Status

Chris Sisko

NESDIS/OSPO

Telephone: 301-817-4783

Email: Chris.A.Sisko@noaa.gov



NOAA

OFFICE OF SATELLITE
AND PRODUCT OPERATIONS

NATIONAL ENVIRONMENTAL SATELLITE, DATA, AND INFORMATION SERVICE

Presentation Outline

- Current S-NPP Status
- Enterprise Distribution: ESPC 2.0/PDA
- Future Operations: JPSS-1
- Background Slides



S-NPP Status as of October, 2016

Spacecraft	S-NPP
Launch Date	Oct 28, 2011
Mission Category	LTAN 1330 (PM) +/- 10 mins

Payload Instruments	Status
ATMS	G
CERES	G
CrIS	G
OMPS – Nadir	G
OMPS – Limb	G
VIIRS	G

Spacecraft Subsystem	Status
TLM, Command & Control	G
ADCS	G
EPS	G
Thermal Control	G
Communications	G
CDP	G
SCC	G
GPS	G
1553	G
1394	G







- Operational (or capable of)
- Operational with limitations (or in standby)
- Operational with degraded performance
- Not functional
- Functional but turned off
- No status reported

ATMS microwave sounder

- instrument is exhibiting high current excursions in the scan drive motor; this is indicative of possible obstruction within the bearing – mitigation step of a once a day scan drive motor reversal to redistribute the lubricant within the bearing.
- Engineers/Operators have instituted higher level of monitoring; instrument would be placed in safe mode if the event the SDM exceeds 500mA over 1 min
- Twice Per Orbit Scan Reversals implemented Aug 18 following ATMS FSW upload on August 9.

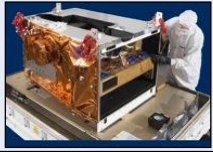
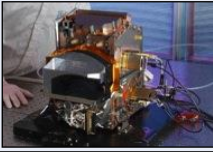

S-NPP/JPSS-1 Instruments

JPSS Instrument		Measurement
	ATMS - Advanced Technology Microwave Sounder	ATMS and CrIS together provide profiles of atmospheric temperature, moisture, and pressure
	CrIS - Cross-track Infrared Sounder	
	VIIRS – Visible Infrared Imaging Radiometer Suite	Provides daily high-resolution imagery and radiometry across the visible to long wave infrared spectrum
	OMPS - Ozone Mapping and Profiler Suite	Spectrometer with UV bands for ozone total column measurements
	CERES - Clouds and the Earth's Radiant Energy System	Scanning radiometer which supports studies of Earth Radiation Budget



NOAA

OFFICE OF SATELLITE
AND PRODUCT OPERATIONS

NATIONAL ENVIRONMENTAL SATELLITE, DATA, AND INFORMATION SERVICE

Key Points: Suomi-NPP and JPSS-1

- Main mission objective is to provide KPPs (Key Performance Parameters):
 - Sounder data (ATMS/CrIS) for NWP data assimilation purposes
 - Imagery for high latitudes (VIIRS) for nowcasting purposes where geostationary satellite coverage is not present - Alaska
- Data volume outputs from these satellites are large (1.5 - 4 TB/day).
- Activities to extend critical life expectancy of key instruments (ATMS microwave sounder) have been implemented.
- Collision avoidance with space debris remains a challenge that is mitigated with risk mitigation maneuvers performed by the satellite.
- A significant ground system update is expected to take place in 2017.



Data Access to SNPP and New Mission Data

- Access to data today is via a mission specific system called NDE.
 - Utilize FTP-S for secure data transfer
- Access to data will change to an enterprise distribution system called PDA in Jan/Feb 2017
 - Utilize FTP-S and SFTP for secure data transfer
 - Will distribute multi-mission data (GOES-R and JPSS series spacecraft)
 - Provides standing data subscriptions and ad-hoc data request capabilities
 - Enables product tailoring (sectorization, band/channel selection, etc.) – for products in netCDF-4/CF convention

NDE – NPP Data Exploitation system (product generation and distribution)

PDA – Product Distribution and Access (enterprise distribution system)

ESPC – Environmental Satellite Processing Center



Product Distribution and Access (PDA) Overview

- ESPC has a new enterprise data processing and distribution system for near real-time users.
- New local area network enclave integrated within ESPC system boundary:
 - Implements greater security controls commensurate with a HIGH security system as defined by NIST FIPS 199
 - Provides far greater network capacity/performance (internal and external)
 - Includes a scalable architecture
- NDE 2.0 segment (product generation)
 - Designed as a enterprise PG system
 - NDE 1.0 has been operating since 2013 at above 99.9%
- PDA segment (product distribution)
 - Utilizes secure data transfer protocols
 - Provides multi-mission distribution for both GOES-R and JPSS missions



Product Distribution and Access (PDA) Details

PDA Ingress Capacity	14.25 TB/day
GOES-R Data Production	GOES-R will generate ~1.75 TB/day (compressed)
JPSS-1 Data Production	JPSS-1 will generate ~1.5 TB/day (compressed) or ~4 TB/day (uncompressed)
PDA Egress Capacity	35.92 TB/day
Peak Throughput	23.5 Gbps (initial)
Network to Edge	Scalable to 120 Gbps
NWAVE	10 Mbps (primary & back-up)

TB – Terabyte (1 TB = 10^{12}) bytes

Gbps – Gigabit per second (1 Gigabit = 10^9 bits per second)



Future ESPC Data Operations

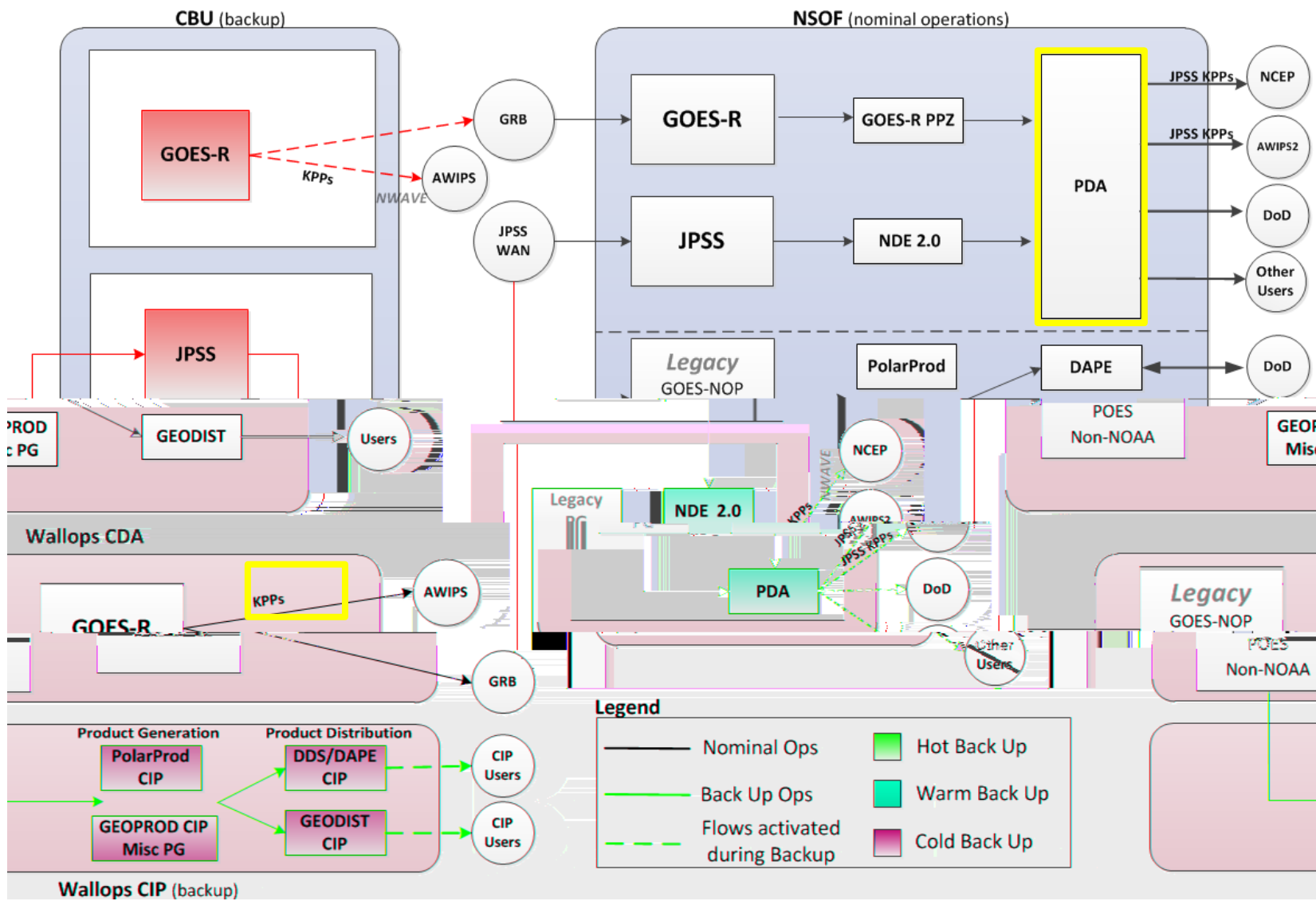



Future ESPC Data Operations Nominal Operations (NSOF)

NSOF (nominal operations)

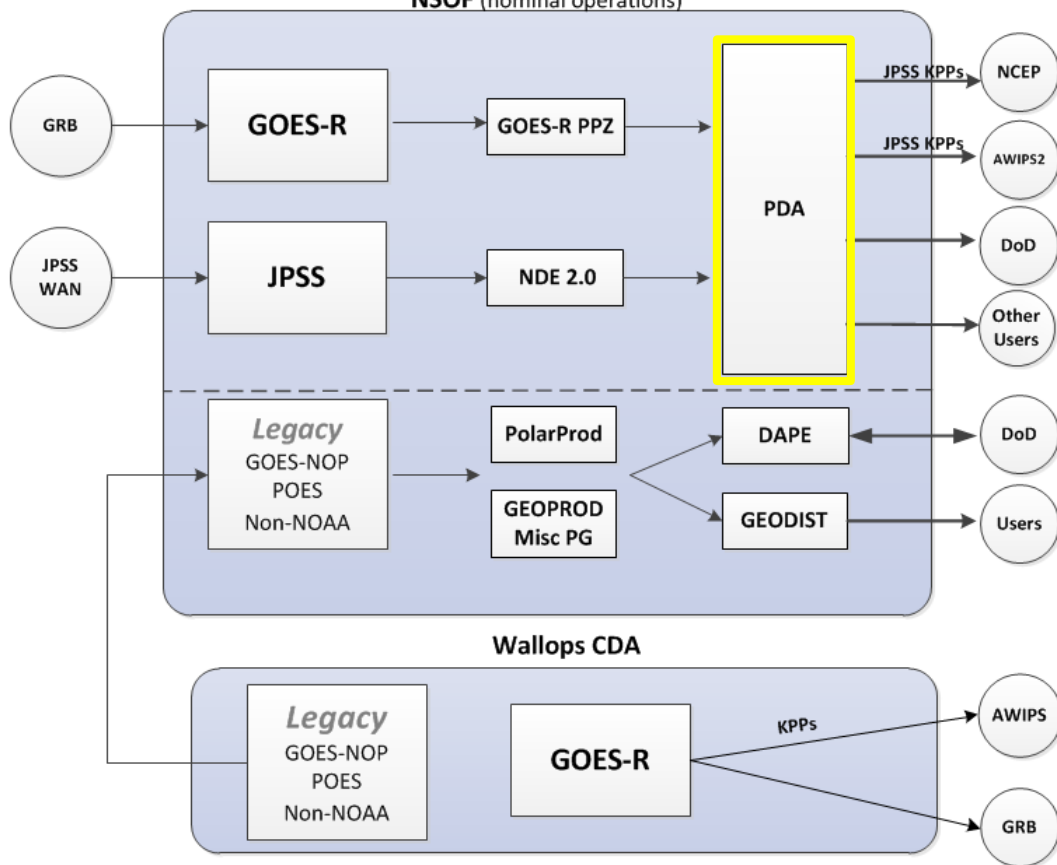

Legend

	Nominal Ops		Hot Back Up
	Back Up Ops		Warm Back Up
	Flows activated during Backup		Cold Back Up



Future ESPC Data Operations Backup/COOP Operations (CBU/APC)

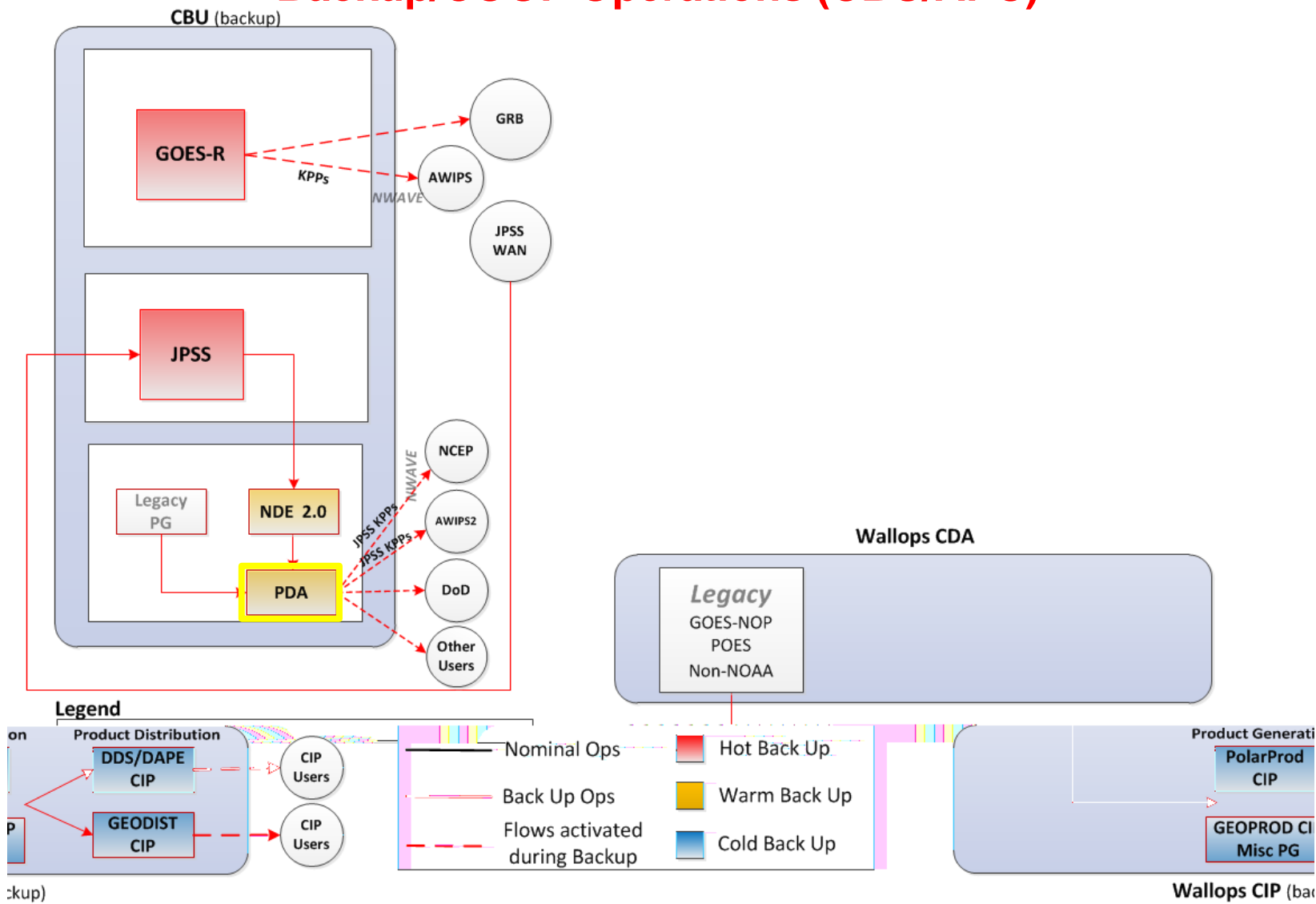



ESPC PDA Operations – User Prioritization





- PDA supports near real-time users – prioritized according to most critical mission need first.
- PDA operators can perform load shedding of the lowest priority users – this is a system management feature that guarantees resources for the highest priority users if so needed.
- The new ESPC network infrastructure is a high performance, horizontally scalable network; however, distribution time is governed by the slowest link speed between source and destination.
- The Prioritization approach, table below, allows ESPC to manage user return to service expectations during significant anomalies/outages.

Operational Prioritization Approach	
1	Life & Property / National Interest Missions
2	Int'l Agreement Missions / NRT NOAA-NASA Environmental Missions/ Launch Support-Cal Val
3	External Mission Support (i.e. AR) / Data Preservation/Archive
4	Operations Test Support
5	Mission (Development) Test Support / Long term Approved RT Request
6	Prototype dataflow / temporary dataflows or tests – research to operations

PDA User Data Volume Allocation

Data Volume (per day)	FTP-S	SFTP	Bandwidth Projection* (aggregated 24 hrs)	PoP Req'd	Concurrent Sessions	Comments
50 GB/day	O	O	~5 Mbps	No	3	This is the default data volume for users who are unable to determine their available bandwidth
100 GB/day	O	O	~10 Mbps	No	3	Option for users with larger data needs who have sufficient network/system resources
150 GB/day			~15 Mbps			
250 GB/day	D	A	~25 Mbps	A	3	Special authorization required from data access management group
500 GB/day			~50 Mbps		3	
1.0 TB/day			~95 Mbps		A	
1.5 TB/day	D	N	~140 Mbps	Yes	A	Special authorization required from data access management group, accompanied with a technical assessment
2.0 TB/day			~190 Mbps			
3.0 TB/day			~280 Mbps			

O – Optional
 D – Default
 A – Authorization required
 N – Not Authorized
 PoP – Point of presence/dedicated route

	Default allocation based on less stringent requirements		Premium allocation based on critical need by user
	Basic Premium allocation based on user capabilities		Special allocation for select vital users with a major mission justification

*note – absolute bandwidth minimum, does not factor in meeting user’s latency needs based on slowest link within the network path.



Data Distribution Latency as a Function of Time and Bandwidth

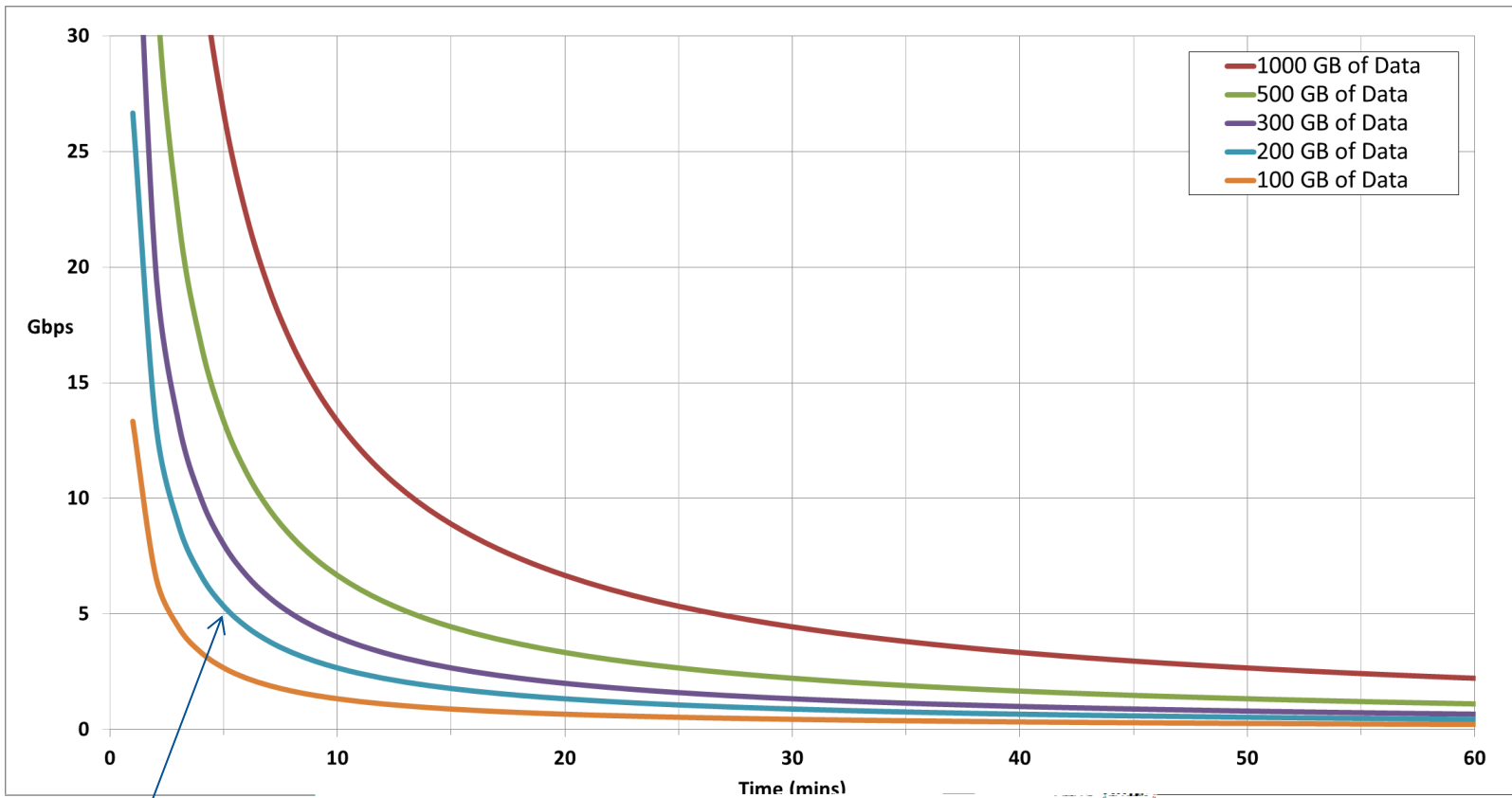

Example: Distribution of 200 GB of data from end to end in 5 minutes would require approximately 5 Gbps of dedicated bandwidth throughput.



JPSS-1 Information

- Launch expected no earlier than Sept 2017.
- A larger ground system provides the following:
 - Half orbit dumps in both polar regions (Svalbard and McMurdo)
 - A full backup instantiation in Fairmont, WV for continuity of operations
 - Redundancy at the primary site (NSOF – Suitland, MD)
 - The ability to use TDRSS (Tracking and Data Relay Satellite System) for additional critical telemetry/command control and capability for receiving stored mission data
- Products/data will be made available in phases based on the calibration/validation schedule: Emphasis is focus on KPP products first.



JPSS-1 Cal/Val Plan

The Cal/Val activities for JPSS-1 are expected to be much more accelerated than those for S-NPP, and JPSS-1 data products will be provided to decision makers/users with a much-improved latency.

Team	Product	JPSS-1 Algorithm Cal/Val Timeline (Launch/Activation + Months)																																				
		1	2	3	4	5	6	7	8	9	10	11	12	13	14	15	16	17	18	19	20	21	22	23	24	25	26	27	28	29	30	31	32	33				
Clouds	VIIRS Cloud Mask																																					
	Cloud Property Algorithms																																					
Aerosol	Aerosol Optical Thickness and Particle Size Parameter																																					
	Suspended Matter																																					
Cryosphere	Ice Surface Temperature																																					
	Sea Ice Concentration and Ice Thickness																																					
	Binary Snow Cover																																					
	Fraction Snow Cover																																					
Land	Active Fire																																					
	Land Surface Temperature																																					
	Land Surface Albedo																																					
	Surface Type																																					
	GST (Global Gridded Surface Type)																																					
	Land Surface Reflectance																																					
	Vegetation Index																																					
OCC	Ocean Color																																					
SST	Sea Surface Temperature																																					
Sounding	Sounding (NUCAPS: AVMP,AVTP)																																					
OMPS EDR	OMPS Ozone EDR: NP & TC																																					





JPSS-1 Cal/Val Plan

Three-Month Handover

Team	Product	JPSS-1 Cal/Val Timeline (Launch + Months)												Timeline	
		1	2	3	4	5	6	7	8	9	10	11	12		
SDR	ATMS SDR	▲	▲					▲							B:L+20D; P:L+36D; V:L+6M
	CrIS SDR			▲	▲						▲				B:L+68D; P:L+90D; V:L+9M
	VIIRS SDR		▲	▲			▲								B:L+60D; P:L+90D; V:L+6M
	OMPS SDR			▲	▲						▲				B:L+68D; P:L+90D; V:L+9M
Imagery	VIIRS Imagery			▲	▲					▲				B:L+70D; P:L+90D; V:L+9M	
		Beta			Provisional						Validated				



JPSS-1 LEO&A

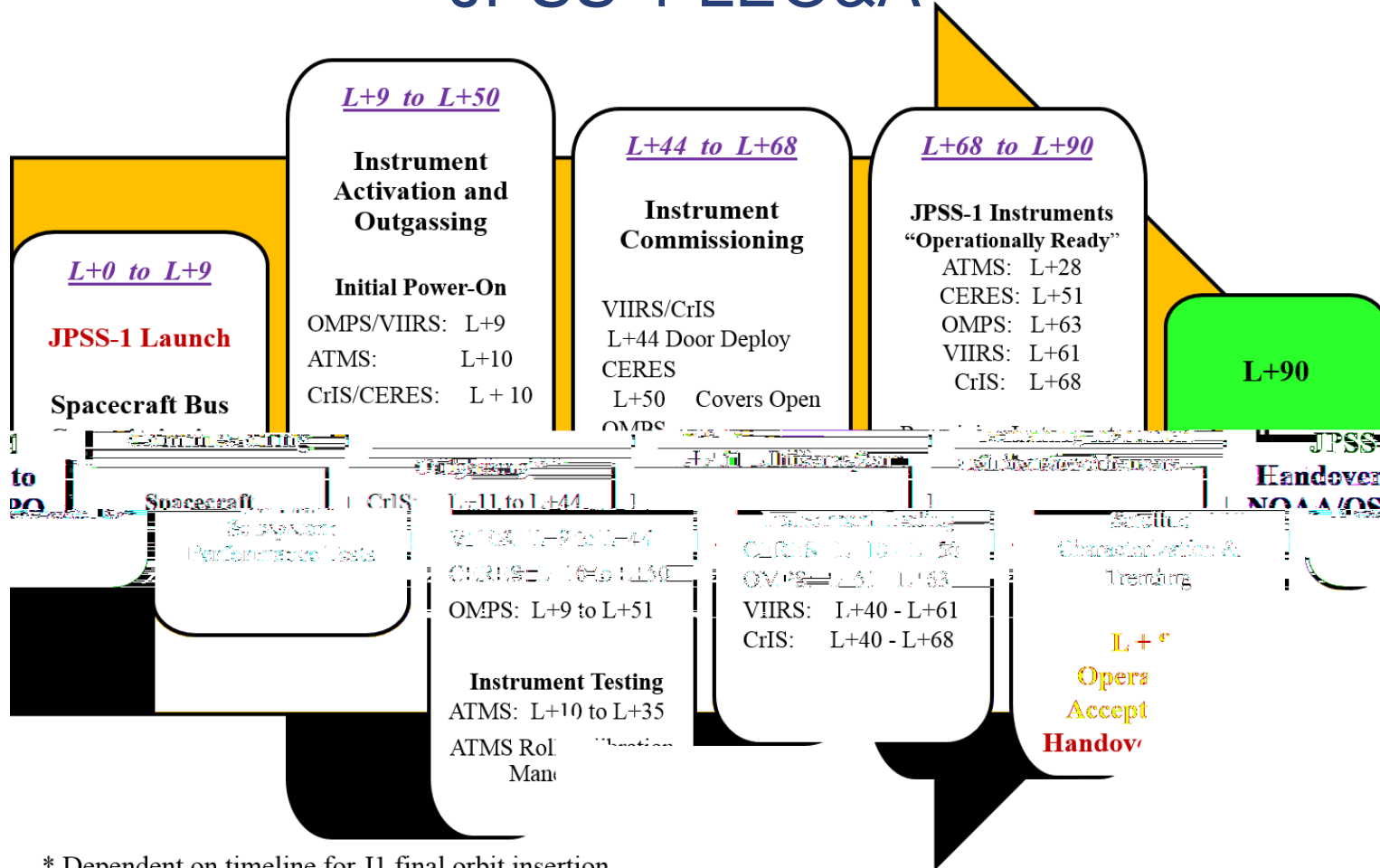

* Dependent on timeline for J1 final orbit insertion

Phase 1	Phase II A	Phase II B	Phase III
---------	------------	------------	-----------



NOAA

OFFICE OF SATELLITE
AND PRODUCT OPERATIONS

NATIONAL ENVIRONMENTAL SATELLITE, DATA, AND INFORMATION SERVICE

Summary

- S-NPP satellite status is nominal; the ATMS instrument is being closely monitored and procedures are in place to maximize the instrument life.
- PDA is the new enterprise distribution system for near real-time users.
- JPSS-1 (NOAA-20) will provide data continuity once it is launched and commissioned (no earlier than March 2017).



NOAA

OFFICE OF SATELLITE AND PRODUCT OPERATIONS

NATIONAL ENVIRONMENTAL SATELLITE, DATA, AND INFORMATION SERVICE

Many Thanks!



Q+A